

# Electronics<sup>®</sup>

Why foreign exhibitors come to IEEE: page 82

Computer helps design IC's: page 94

Designing radiation-resistant circuitry: page 122

March 4, 1968

\$1.00

A McGraw-Hill Publication

Below: Batch-fabricated diode displays, page 104

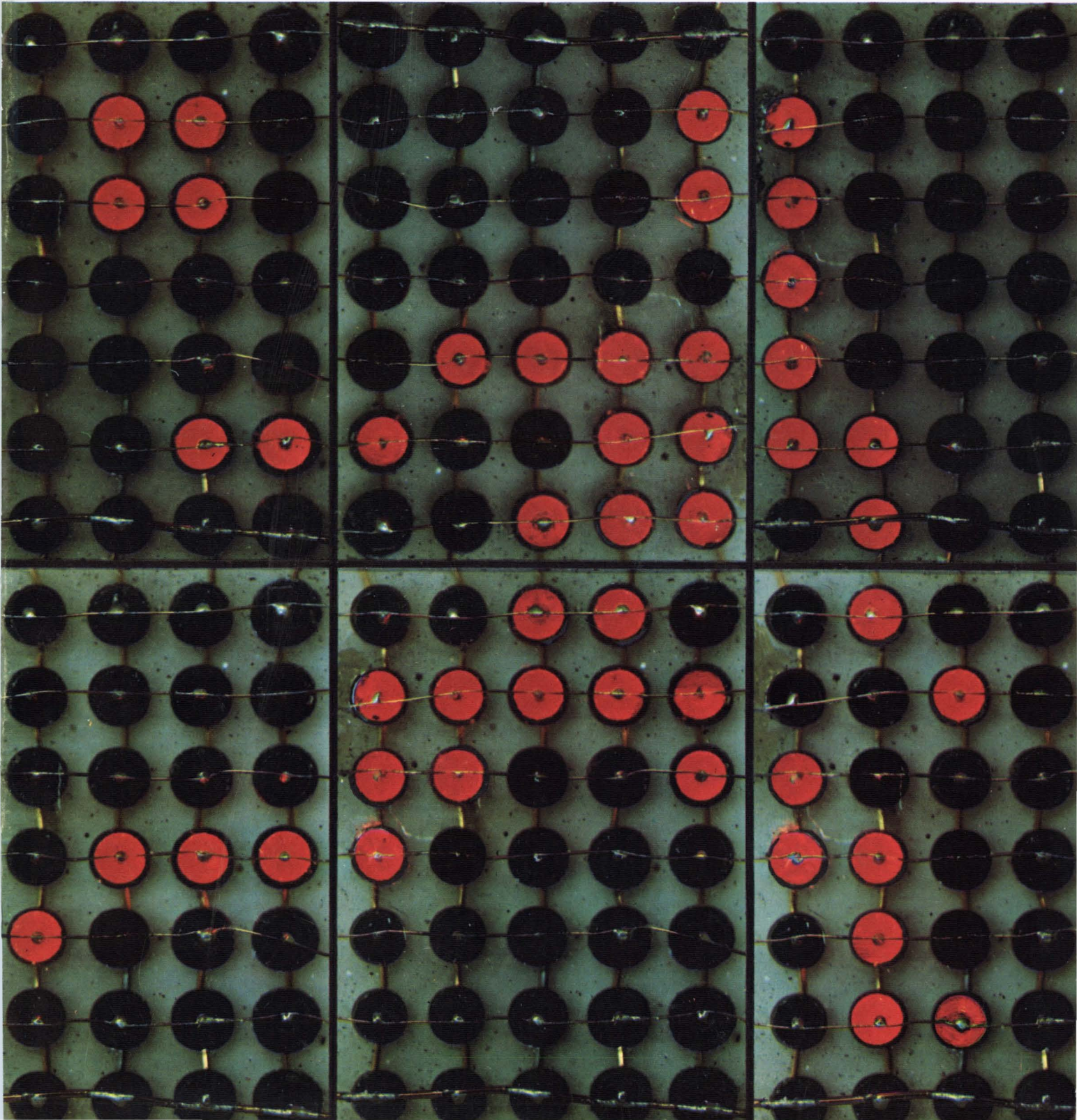



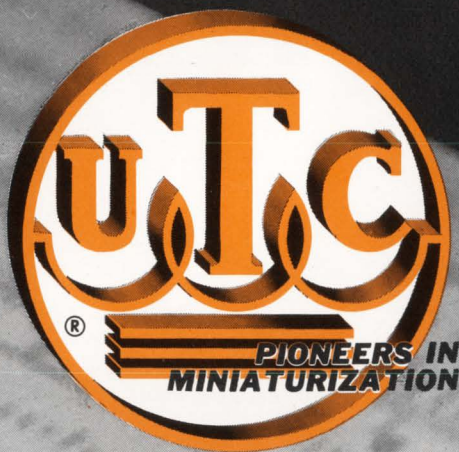

## NEW BIT-250™ LINE

### SMALLEST METAL-ENCASED TRANSFORMERS AVAILABLE!

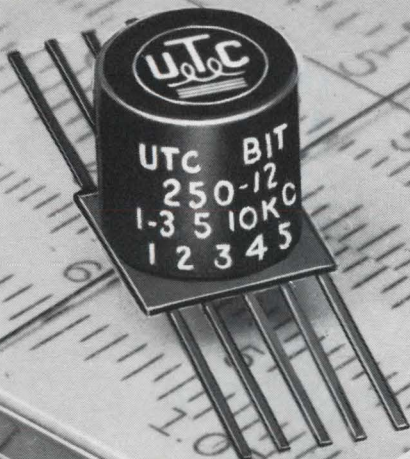

BIT-250's achieve outstanding reliability, in a profile compatible with Flat Packs and IC's, while maintaining response and power levels found only in larger units. MIL-T-27B, Grade 4, completely ruggedized. Seventeen items immediately available from stock, plus specials to your requirements. Patent applied for.

Write for descriptive brochure depicting ranges and capabilities. See it displayed at IEEE Show.

**UNITED® TRANSFORMER CO. TRW®**

DIVISION OF TRW INC. • 150 VARICK STREET, NEW YORK, N. Y. 10013

In CANADA: A. C. SIMMONDS & SONS LTD., Agincourt, Ontario

Circle 900 on reader service card



A single Hewlett-Packard 8690A Sweep Oscillator is now equivalent to several: Its flexibility and performance have been extended to multi-band sweeping. When an HP 8706A Control Unit is installed in the 8690A main frame, it selects any of three RF plug-in modules installed in an 8707A RF Unit Holder. A sweeper/control unit can drive up to three holders.

Push a button on the control unit to select the band you want. Push a second button, and in one second you're sweeping a new range. Using simple contact closures, band selection can be made remotely. And by using broadband coax switches, the outputs from the RF units can

be multiplexed through a single output connector.

The compact new sweeper-holder combination is the first time-saving, economical way to do multi-band sweeping without having to stack several sweepers or continually change RF units.

Multi-band operation is a logical extension of the convenience that comes with the 8690A Sweep Oscillator. Functional panel layout, push-button selection of sweep functions and operating modes, high-resolu-

tion scale—all result in straightforward, error-free operation.

Price: 8690A Sweep Oscillator, \$1600; 8707A RF Unit Holder, \$1050; 8706A Control Unit, \$375. There's an RF plug-in covering 0.1 to 110 MHz for \$950; microwave plug-in units covering 1 to 40 GHz in octave and waveguide bands start at \$1575. Pin diode leveling/modulation is available for the 1 to 12.4 GHz microwave units.

For more information on how to get extra convenience and flexibility in multi-band sweep operations, call your local HP field engineer or write Hewlett-Packard, Palo Alto, California 94304; Europe: 54 Route des Acacias, Geneva.

HEWLETT **hp** PACKARD  
SWEEP OSCILLATORS

04725

**If you bought a bench full of sweepers,  
you couldn't  
cover more  
bands than  
this one does.**





# bits in/volts out

10,000 TIMES FASTER THAN YOU CAN SAY HEWLETT-PACKARD

+50 V

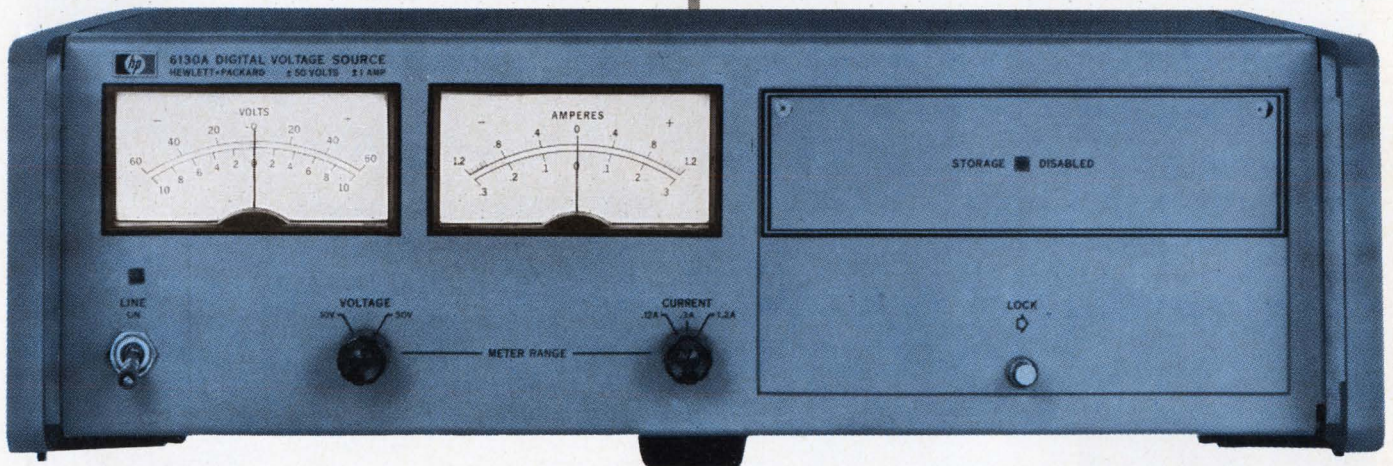
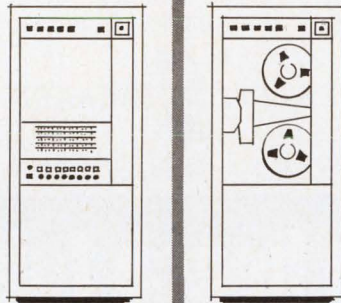

Digitally Program From +50 to -50 VDC. Up to 1 Amp in 100  $\mu$ Seconds!

Designed primarily for fast programming by digital computer, Hewlett-Packard's new 6130A Digital Voltage Source will deliver +50 to -50 VDC at hefty currents up to 1 amp—in less than 100  $\mu$ seconds. This means the user can program any voltage level in a  $\pm 50$  VDC range at 10,000 voltage steps a second. This digitally programmable supply consists of an accurate digital-to-analog converter followed by a fast power amplifier. Accuracy and resolution is 10 mV.\*

Complete interface, including input/output cards and the software, is available for use with the Hewlett-Packard 2116A instrumentation computer. \*1 mV on the 10 V range

Packard 2116A instrumentation computer. The Digital Voltage Source works with 8-4-2-1 BCD or binary number inputs. Plug-in board design allows fast and low-cost modifications to suit the coding and logic levels of any computer. At \$1500, the 6130A is the fastest and least expensive of its kind available.

For more information, call your local HP field engineer or write Hewlett-Packard Company, 100 Locust Avenue, Berkeley Heights, New Jersey 07922. Europe: 54 Route des Acacias, Geneva.

-50 V

HEWLETT  PACKARD

POWER SUPPLIES

21804



## News Features

### Probing the News

- 157 From help wanted to jobs wanted  
165 Pacing ultrahigh-speed computers  
171 Automating the whole shooting match

### Electronics Review

- 39 **Integrated electronics:** Uncoiling r-f amplifiers; Drawing on computers  
40 **Advanced technology:** A little millimeter radar  
41 **Consumer electronics:** Moog music; Toward tubeless tv  
44 **Military electronics:** Drafting computers; Khaki kitchen  
48 **Industrial electronics:** Accentuating the negative  
48 **Instrumentation:** Spotting faults; A tv film special  
52 **Communications:** Channel sharing  
54 **For the record**

### Electronics Abroad

- 315 **Japan:** Sayonara to flybacks; Playback platter; Roundhouse swing  
316 **West Germany:** Pushing polychrome; Tunnel talk  
317 **Great Britain:** Bulldog spirit; Tripling the guard  
318 **Hong Kong:** Tailoring antennas  
320 **France:** Way in  
320 **Around the world**

### New Products

- 187 **IEEE product preview**  
187 Make, buy, and now sell IC's  
188 Next-generation phase shifter  
189 Reliability registers high  
190 Tabs ease bonding  
192 Dvm has sensitivity and range  
192 Voltage regulation at the site  
194 Other key products at show  
214 **Components review**  
214 IC's divide price of multiplier  
216 British enter U.S. connector market  
220 Zener can take 1,000 watts  
224 **Instruments review**  
224 Digital voltmeter logs in decibels  
230 Counter extended to 100 megahertz  
233 **Production equipment review**  
233 No fresh air for degreaser solvent  
236 **Subassemblies review**  
236 Zapping components for better IC's  
238 Data recorders pack it tight  
247 **Consumer products review**  
247 Tv tuner tuned to ease of repair  
248 Varactor diodes search f-m band  
252 Transceiver puts an FET up front  
256 **Microwave review**  
256 Buzzing drones at C band  
258 Smaller mixer stays discrete  
260 Cleaning up f-m broadcasts  
265 **Semiconductor review**  
265 MOS used as capacitor

Title R registered U.S. Patent Office; © copyright 1968 by McGraw-Hill Inc. All rights reserved, including the right to reproduce the contents of this publication, in whole or in part.

## Technical Articles

- IEEE 82 **Foreign exhibitors restrain enthusiasm**  
Overseas firms view the IEEE show as a place to discuss technical problems rather than a marketplace

- Circuit design** 87 **Designer's casebook**  
▪ Adding a transformer halves uhf frequencies  
▪ Low-cost Schmitt trigger made with digital IC  
▪ Bridge rectifier clips dangerous voltages  
▪ Stretching video pulse keeps indicator on

- Design theory** 94 **Computer-aided design: part 14**  
**Start with a practical IC model**  
A program based on component geometry, junction characteristics, and material properties assures a working IC on the first design try  
Robert Mammano, Arinc Research Corp.

- Advanced technology** 104 **Lighting up in a group**  
Batch-processed light-emitting diodes look promising for alphanumeric displays  
Lawrence A. Murray, Sandor Caplan, and Richard Klein, RCA Electronic Components Division

- Industrial electronics** 112 **Integrated circuits in action: part 10**  
**Linearizing sensor signals digitally**  
Adding bits to, or subtracting them from, a transducer's digital output gives simpler, less expensive conditioning circuitry  
Jacek H. Kollataj and Teuvo Harkonen, Nokia Inc.

- Military electronics** 122 **Skipping the hard part of radiation hardening**  
Straightforward equations help predict a component's behavior under radiation  
Joseph T. Finnell and Fred W. Karpowich, Avco Corp.

- Consumer electronics** 130 **Boosting color tv's i-f performance**  
Integrated circuits improve i-f amplifier gain and automatic gain control  
Brent Welling, Motorola Semiconductor Division

## Departments

- |    |                        |     |                        |
|----|------------------------|-----|------------------------|
| 4  | Readers Comment        | 40  | Index of Activity      |
| 8  | People                 | 61  | Washington Newsletter  |
| 14 | Meetings               | 274 | New Books              |
| 16 | Meeting Preview        | 280 | Technical Abstracts    |
| 23 | Commentary             | 292 | New Literature         |
| 25 | Electronics Newsletter | 307 | Newsletter from Abroad |



# Electronics

Editor-in-Chief: Donald Christiansen

## Associate managing editors

Technical: Stephen E. Scrupski  
News: Robert Henkel  
Copy: Sally Powell

## Senior associate editors

Joseph Mittleman, Harry R. Karp

## Department editors

**Avionics & Space:** Alfred Rosenblatt  
**Computers:** Wallace B. Riley  
**Communications:** William Buccu  
**Consumer electronics:** John D. Drummond  
**Design theory:** Joseph Mittleman  
**Industrial electronics:** Harry R. Karp  
**Instrumentation:** Carl Moskowitz  
**Military electronics:** Richard Gundlach  
**Solid state:** Mark B. Leeds

## Section editors

**Electronics abroad:** Arthur Erikson  
**Electronics review:** Stanley Zarowin  
**New Products:** H. Thomas Maguire,  
William P. O'Brien  
**Probing the news:** Eric Aiken

## Assistant editors

Stephen Wm. Fields, Peter Schuyten,  
James Kirby, Owen Doyle

## Regional bureaus

### Domestic

**Boston:** James Brinton, manager; Robin Carlson  
**Los Angeles:** Lawrence Curran, manager; Burton Bell  
**New York:** Howard Wolff, manager  
**San Francisco:** Walter Barney, manager; Peter Vogel  
**Washington:** Robert Skole, manager; William D. Hickman, Paul Dickson

### Foreign

**Bonn:** John Gosch  
**London:** Michael Payne  
**Tokyo:** Charles Cohen

## Copy editors

James Chang, Frederick Corey, James Darby

## Graphic design

**Art director:** Saul Sussman  
**Assistant art directors:** Ann Mella, Valerie Betz  
**Production editor:** Arthur C. Miller

**Editorial secretaries:** Claire Benell, Lynn Emery, Kay Fontana, Patricia Gardner, Lorraine Longo, Barbara Razulis, Frances Vacca

## McGraw-Hill News Service

**Director:** Arthur L. Moore; **Atlanta:** Fran Ridgway; **Chicago:** Bruce Cross;  
**Cleveland:** Arthur Zimmerman; **Dallas:** Marvin Reid;  
**Detroit:** James Wargo; **Houston:** Robert E. Lee; **Los Angeles:** Michael Murphy  
**Pittsburgh:** Louis Gomolak  
**San Francisco:** William F. Arnold  
**Seattle:** Ray Bloomberg; **Washington:** Charles Gardner, Daniel B. Moskowitz,  
Herbert W. Cheshire, Seth Payne, Warren Burkett, William Small

## McGraw-Hill World News Service

**Bonn:** Robert Dorang; **Brussels:** George Williamson; **Hong Kong:** Wes Perry;  
**London:** John Shinn; **Mexico City:** Gerald Parkinson; **Milan:** Ronald Taggiasco, Jack Star;  
**Moscow:** Howard Rausch; **Paris:** Robert E. Farrell, Peter Kilborn;  
**Rio de Janeiro:** Leslie Warren; **Tokyo:** Marvin Petal

**Reprints:** Susan Nugent

**Circulation:** Milton Drake

## Publisher: Gordon Jones

**Electronics: March 4, 1968, Vol. 41, No. 5**

Published every other Monday by McGraw-Hill, Inc. Founder: James H. McGraw 1860-1948.

Printed at 99 North Broadway, Albany, N.Y. 12207; second class postage paid at Albany, N.Y.

Executive, editorial, circulation and advertising addresses: McGraw-Hill Building, 330 W. 42nd Street  
New York, N. Y. 10036. Telephone (212) 971-3333. Teletype TWX N.Y. 710-581-4235. Cable address:  
MCGRAWHILL N.Y.

Subscriptions solicited only from those professionally engaged in electronics technology. Subscription rates:  
qualified subscribers in the United States and possessions and Canada, \$8.00 one year, \$12.00 two years,  
\$16.00 three years; all other countries \$25.00 one year. Non-qualified subscribers in the U.S. and  
possessions and Canada, \$25.00 one year; all other countries \$50.00. Air freight service to Japan \$50.00  
one year. Single copies: United States and possessions and Canada, \$1.00; all other countries, \$1.75.

Officers of McGraw-Hill Publications: Joseph H. Allen, President; Bayard E. Sawyer, Executive Vice-President;  
J. Elton Tuohig, Senior Vice-President-Operations; Vice Presidents: John R. Callahan, Editorial;  
John M. Holden, Marketing; Paul F. Cowie, Circulation; Angelo R. Venezian, Production; Jerome D. Luntz,  
Planning & Development; Robert M. Wilhelm, Controller.

Officers of the Corporation: John L. McGraw, Chairman of the Board; Shelton Fisher, President;  
L. Keith Goodrich, Executive Vice President; Daniel F. Crowley, Senior Vice President & Treasurer;  
Donald C. McGraw, Jr., Robert E. Slaughter, Senior Vice Presidents; John J. Cooke, Vice President & Secretary

Title registered in U.S. Patent Office: © Copyright 1968 by McGraw-Hill, Inc. All rights reserved. The contents  
of this publication may not be reproduced either in whole or in part without the consent of copyright owner.

**Subscribers:** The publisher, upon written request to our New York office from any subscriber,  
agrees to refund that part of the subscription price applying to copies not yet mailed.  
Please send change of address notices or complaints to Fulfillment Manager; subscription  
orders to Circulation Manager, Electronics at address below. Change of address notices  
should provide old as well as new address, including postal zip code number. If possible,  
attach address label from recent issue. Allow one month for change to become effective.

**Postmaster:** Please send form 3579 to Fulfillment Manager, Electronics,  
P.O. Box 430, Hightstown, New Jersey 08520

## Readers Comment

### Denial

To the Editor:

Concerning the news story on General Precision Equipment Corp. [Feb. 19, p. 26], the statement that the corporation may lay off 2,000 of the 7,000 employees at its Kearfott Group is completely erroneous.

It is particularly disturbing that a responsible magazine such as Electronics made no reference at all to the true facts which had been given its reporters by the undersigned while giving space to speculation from anonymous sources.

The facts are that as part of the company's continuous efforts to improve operations and results, Kearfott Group laid off a total of about 300 employees. The layoffs were not GPE company-wide. This reduction in work force at Kearfott is complete. The action did not reflect any other factors and the report that it did is completely without foundation.

Norman Wicks

Vice president  
General Precision Equipment  
Tarrytown, N.Y.

### Wobbling

To the Editor:

I was amused to read the report on the improvement of television picture quality without adding bandwidth [Jan. 22, p. 37].

The technique, known as spot wobbling, is as old as television and was used by tv stations in their kinescope recordings prior to the introduction of the video tape recorder, to eliminate the line structure of the tv image.

The same idea was used extensively in Europe, in deluxe big-screen television sets for the same purpose. If my memory serves me well, about 12 or 13 years ago a U.S. manufacturer introduced a crt incorporating a pair of vertical deflection plates for the same purpose. The frequency used was of the order of 20 Mhz. So the idea is not new, and the researchers could have spared their time and efforts.

Whether spot wobble could be obtained by adding a "switchable



# across the spectrum...all your filter needs

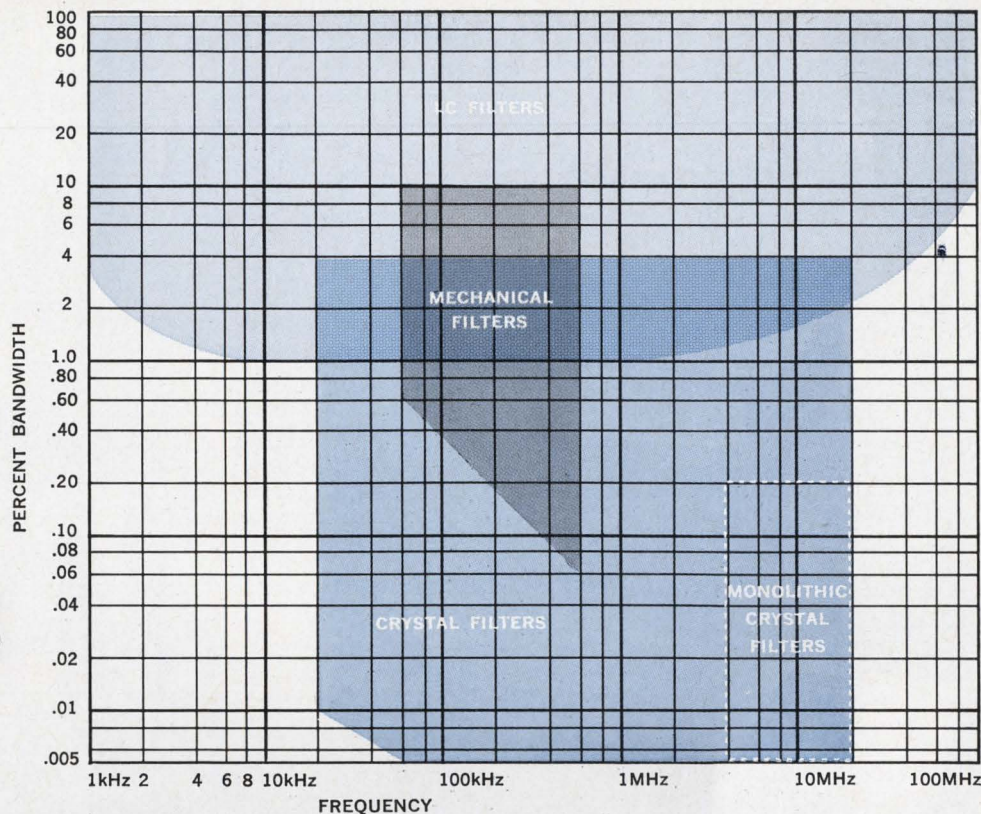

Only Collins offers mechanical, crystal and LC filters covering the practical spectrum from 1 kHz to 100 MHz. At Collins, you get the filter best suited to your need — you're not limited to the best available from a single product line. The diagram defines areas served by Collins' computer-design program. This program means accelerated deliveries at product line prices. Hundreds of design combinations are available immediately. Take advantage of Collins' quality, reliability, and large-volume, on-schedule production capabilities. For Collins' newly published Components Portfolio, describing a complete line of filters and magnetic products, write to Collins Radio Company, Newport Beach, California 92663. Telephone: (714) 833-0600.

## Crystal Filters

With its rapidly-expanding crystal filter capability, Collins now offers all filter types and techniques in the frequency range of 20 kHz through 20 MHz, including narrow, intermediate or wide-band — selector, sideband or notch. Collins' technical and production competence ensures on-schedule delivery and competitive prices with Collins quality and reliability. **NEW: COLLINS MONOLITHIC CRYSTAL FILTERS.** New solid-state functional elements providing outstanding performance in a subminiature package.

## Mechanical Filters

Collins offers — from stock — hundreds of mechanical filter designs in frequencies from 60 to 600 kHz, and with 60-db to 6-db shape factors as low as 1.2 to 1. Collins mechanical filters are smaller in size and less expensive than other filters in their frequency range. They tolerate extreme temperature changes and long, continuous service without aging, breakdown or drift. **NEW: COLLINS MINI-FILTERS.** Low-cost mechanical filters in ultrasmall packages with a total volume of less than 1/10 cubic inch.

## LC Filters — Magnetics

Collins offers an extensive line of LC wave filters covering the subaudio to 100-MHz frequency range including low-pass, high-pass, band-pass, band-rejection and other phase or amplitude responsive networks. Other products in the magnetics field are toroids, magnetic amplifiers, and saturable reactors. **NEW: COLLINS PCT INDUCTORS.** Printed circuit toroids transfer-molded of hi-temp epoxy resin with leads spaced to match 0.1 inch circuit board grids. Collins is one of the world's largest suppliers of LC filters and precision inductors.

COMMUNICATION / COMPUTATION / CONTROL

See the new mini-filters, monolithic filters and printed circuit toroids at New York IEEE, Booths 3C11-3C13.

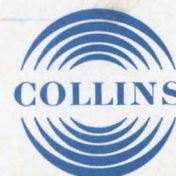



# Little plug-ins make the big difference in 50 MHz counters



When you look only at the main frame, it's hard to find important differences between 50 MHz counters. But when you compare plug-ins, you'll find great differences and decisive advantages. Only Systron-Donner plug-ins can give you:

## 1. Final-answer frequency readings to 40 GHz.

A single plug-in, our Model 1292 semi-automatic transfer oscillator, boosts the counter's frequency-measuring range to 15 GHz. Measures FM and pulsed RF above 50 MHz. And the complete dc to 15 GHz system (counter with plug-in) costs only \$3250. Our new Model 1298 semi-automatic T.O. now gives you final-answer readings up to 40 GHz—a new record.

Contact Systron-Donner Corporation, 888 Galindo Street, Concord, California. Phone (415) 682-6161.

## 2. Automatic frequency readings to 18 GHz.

Three Acto<sup>®</sup> plug-ins now produce fully-automatic microwave frequency readings: 50 MHz to 3 GHz (P, L & S band), 3 to 12.4 GHz (S & X band), and 12.4 to 18 GHz (K<sub>u</sub> band).



Find more unique measuring capability in this catalog

## 3. Time readings with 10-nano-second resolution.

Our latest time interval plug-in gives you time readings with 10-nanosecond resolution—greater precision than ever before possible with a standard counter.

All this unique measuring capability can be yours today—or tomorrow—when you buy your basic counter from Systron-Donner. Sixteen different plug-ins have been especially designed to give your Systron-Donner counter more measuring power at less cost than any other system.

SYSTRON  DONNER

Circle 6 on reader service card



delay line to the vertical oscillator and switch it in and out of successive frames" or by "disconnecting the ground of the vertical oscillator and applying a small bias, varied from frame to frame" is debatable. However, I fail to see, and I guess every television engineer would agree with me, how a "switchable delay line added to the horizontal oscillator" could do it.

The third listed method [using electrostatic and magnetic deflection] is customary and not original.

The conclusion that, and I quote once more, "The scheme improves resolution without needing more bandwidth" is, in my belief, totally unfounded. As everybody knows, the maximum vertical resolution is a system constant and is usually expressed as 0.7 times the active number of scanning lines.

This resolution depends on the focusing of the raster lines both at the transmitting and the receiving end and the accuracy of interlace. It has obviously no relation to the transmitted or received bandwidth. This was demonstrated by Kell some 30 years ago.

Spot wobble does not improve resolution, it merely reduces the visibility of the line structure of the television picture.

Michael Robin  
Montreal

▪ The "wobulator" principle is not what was described in our story.

Spot wobbling most certainly will reduce the sharpness of raster lines. Normally, this is accomplished by the use of an oscillator in the monitor only, running at about 20 megahertz. Because only the monitor is involved, information is actually displaced from its true position, and while a pleasing soft-focus picture is obtained, reso-

lution is actually degraded over that obtainable with a conventional scan. The use of identical spot wobbling at both the camera and monitor would, of course, improve resolution, but the transmission of the required 20-megahertz sync signal plus video information over a 4.5-megahertz bandwidth television channel imposes certain practical problems.

Because spot wobbling is not involved, the methods described are perfectly valid. As to the Kell constant for vertical resolution, this can be derived mathematically and verified with physical instrumentation, but fails to take into account the temporal integration characteristics of the visual system of the observer.

### Swedish hospitals

To the Editor:

The article concerning one of our medical computer systems in Sweden [Dec. 11, 1967, p. 259] is not correct in several respects.

The system is a large-scale totally integrated medical computer system, valued at approximately \$2.5 million, five times the price you quoted and will be the first of its kind in the world. It will go into the 1,500-bed Danderyd hospital, one of the most modern hospitals of the world and large by anyone's standard.

The first application will go online in July 1968 and in early 1972 it will expand to include the 1,750-bed Huddinge hospital and shortly afterwards all of Stockholm's fifteen hospitals totaling over 13,000 beds and 2 million outpatients.

W.R. McCreight

Univac  
Sweden

# COME... ...HEAR The Latest in Power Supply Technology



## KEPCO, INC.

will again present its popular lecture/film series at the New York Coliseum (second floor) during the IEEE Show. The theatre entrance is adjacent to Kepco's display, Booth No. 2F51-2F53. Come hear qualified engineers and scientists discuss the new operational analog for power regulators, offset ratings and applications data. We'll also have new product seminars, demonstrations, and films.

Find out about:

- Precision Power Regulators
- Fast Programming
- Digital Techniques
- Quick Recovery Current Regulators
- Computer Power Supplies
- Redundant Overvoltage Protectors

All at the **KEPCO  
POWER SUPPLY THEATRE**

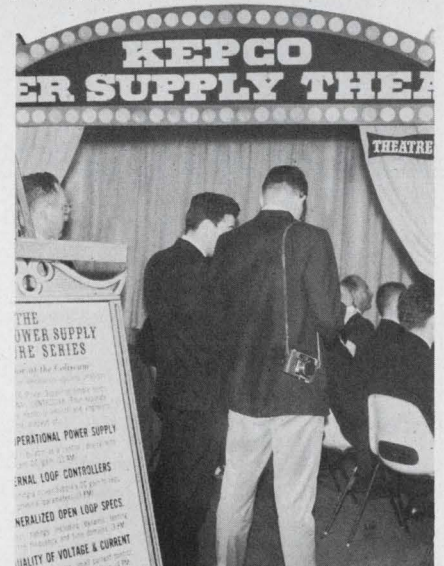

BOOTH 2F51



131-38 SANFORD AVENUE • FLUSHING, N.Y. 11352

### SUBSCRIPTION SERVICE

Please include an Electronics Magazine address label to insure prompt service whenever you write us about your subscription.

Mail to: Fulfillment Manager  
Electronics  
P.O. Box 430  
Hightstown, N.J. 08520

To subscribe mail this form with your payment and check  new subscription  renew my present subscription

Subscription rates: qualified subscribers in the U.S.: 1 year \$8; two years, \$12; three years, \$16. Non-qualified: 1 year \$25. Subscription rates for foreign countries available on request.

### CHANGE OF ADDRESS

ATTACH  
LABEL  
HERE

If you are moving, please let us know five weeks before changing your address. Place magazine address label here, print your new address below.

name

address

city

state

zip code



# Get a complete Electronic Package from Chassis-Trak of Indianapolis

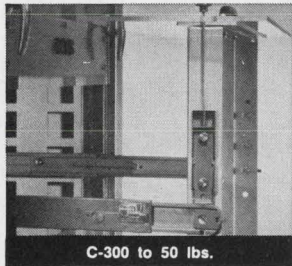

C-300 to 50 lbs.

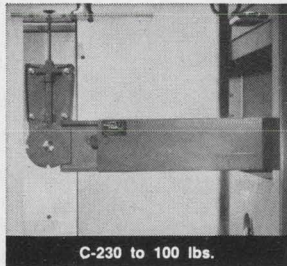

C-230 to 100 lbs.

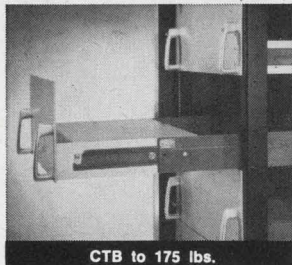

CTB to 175 lbs.

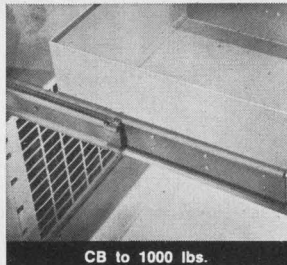

CB to 1000 lbs.

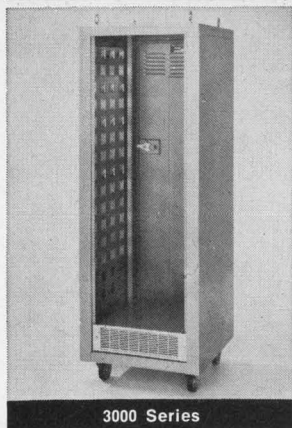

3000 Series

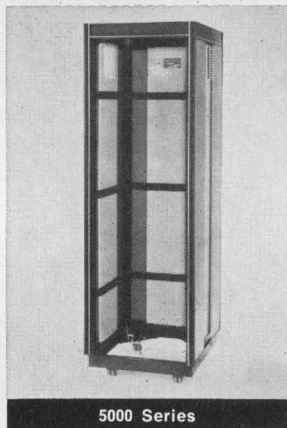

5000 Series



5050 Series

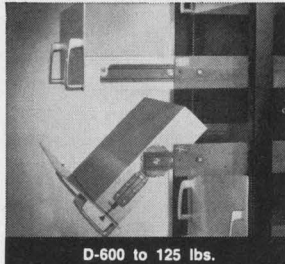

D-600 to 125 lbs.



VENT-RAK Modular Chassis

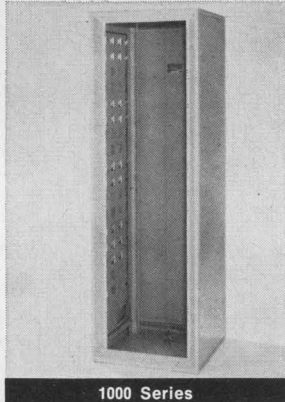

1000 Series

**"See you at  
IEEE  
Booth 1F02"**



Whatever your electronic packaging needs, military or commercial, light-weight or heavy-duty, Chassis-Trak offers a complete line of slides in capacities from 50 lbs. to 1,000 lbs., hardware, and cabinets in a wide range of styles, sizes and materials. The *Chassis-Trak* of Indianapolis name on your electronic package is your assurance of quality and economical *versatility*.

To learn more about *total electronic packaging* write Chassis-Trak, Inc.

525 South Webster Avenue, Indianapolis, Indiana 46219

## People

"We're just going to turn this guy loose and watch," says a Teradyne Inc. spokesman, talking about Tage Peter Sylvan, a new senior project engineer. What the Boston firm will be watching is Sylvan's work on improved digital integrated circuit test techniques.

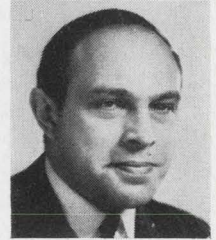

T.G. Sylvan

"Future testers will be computer controlled, like other units in Teradyne's line," Sylvan says, "but it will be capable of testing circuits with 100 gates or so—medium-scale integration." He has decided against the inclusion of dynamic tests, but feels "direct-current tests of sufficient accuracy and flexibility, applied intelligently do almost all that need be done."

Sylvan is also an in-house consultant. "I've had lots of experience testing odd-ball devices, and some of the test gear I had to build myself. So I can fit in pretty well with what's going on here." With his background, Sylvan would fit in practically anywhere.

Sylvan, 39, graduated summa cum laude from Bowdoin College with a B. A. in Physics. In 1952, he joined the General Electric Co. where he worked until early this year. During his 15 years at GE, Sylvan generated 65 patent dockets, won 15 patents, and published about 60 technical papers. At the same time, he laid the groundwork for development of the unijunction transistor, the silicon controlled switch, and other semiconductors.

The ujr, which now sells at the rate of more than \$6 million worth a year, was almost abandoned by GE, which had found no ujr market. "They had looked for buyers for a device that no one knew anything about," says Sylvan, "and when they found none—as you'd expect—they decided to shelve it."

But on his own, Sylvan started a circuit development and characterization program and eventually handed GE a lucrative ujr product line. While working on ujr, he co-authored five editions of the GE transistor manual, the GE tunnel





## Guide to Machlett Electron Tubes

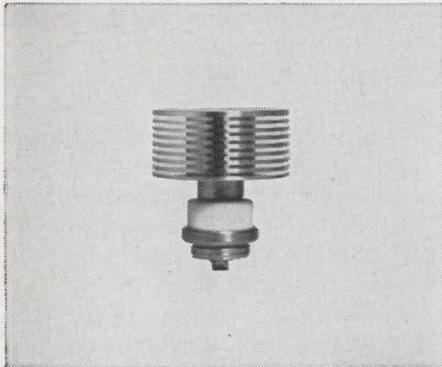

### Planar Triodes.

Grid pulsed to 1 kw at 6 Gc. To 35 kw in pulse modulator service. For communications, radar beacons and navigation.

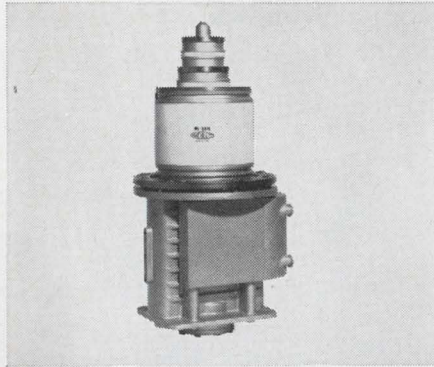

### Magnetic Beam Triodes.

Pulsed ratings to 6 Mw with only 2.5 kw drive. CW ratings to 200 kW with only 0.7 kW drive.

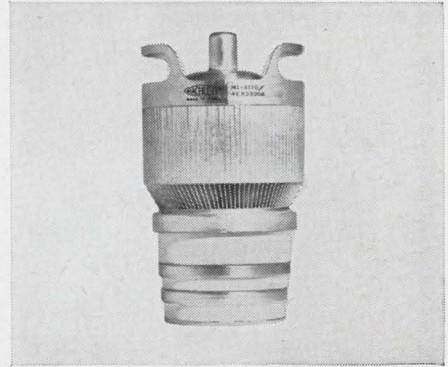

### Heavy Duty Tetrodes.

Forced air cooled, water cooled and vapor cooled for broadcasting and communications.

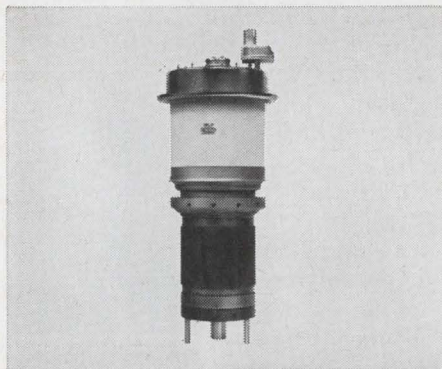

### Pulse Modulators.

Shield grid triodes (oxide cathode) to 4.5 Mw, 80 kv peak. High voltage triodes (thoriated tungsten cathode) to 20 Mw with plate voltages to 200 kv peak.

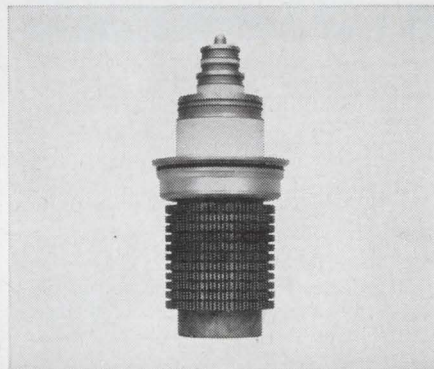

### Heavy Duty Triodes.

Includes vapor cooled triodes, to 440 kW CW.



### Vacuum Capacitors, Variable.

RMS amperes to 75A; voltage to 15 kv peak. Capacities from 5-750 pF to 50-2,300 pF.

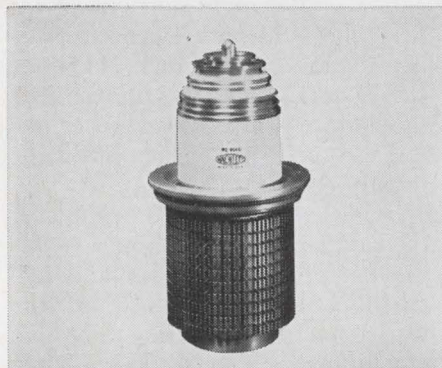

### High Power Tetrodes.

Vapor cooled tetrodes to 350 kw CW for communications.

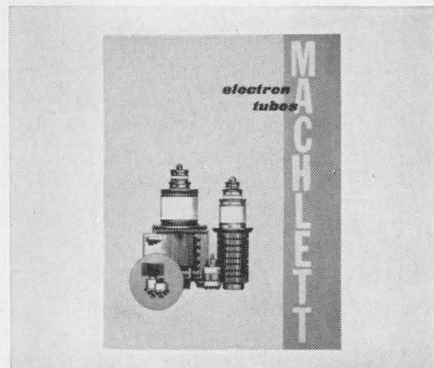

### Send for latest condensed catalog

covering the entire line of Machlett electron tubes. Write: The Machlett Laboratories, Inc., 1063 Hope Street, Stamford, Conn. 06907

RAYTHEON

THE MACHLETT LABORATORIES, INC.

A SUBSIDIARY OF RAYTHEON COMPANY



# Trigate® Pulse Transformers...

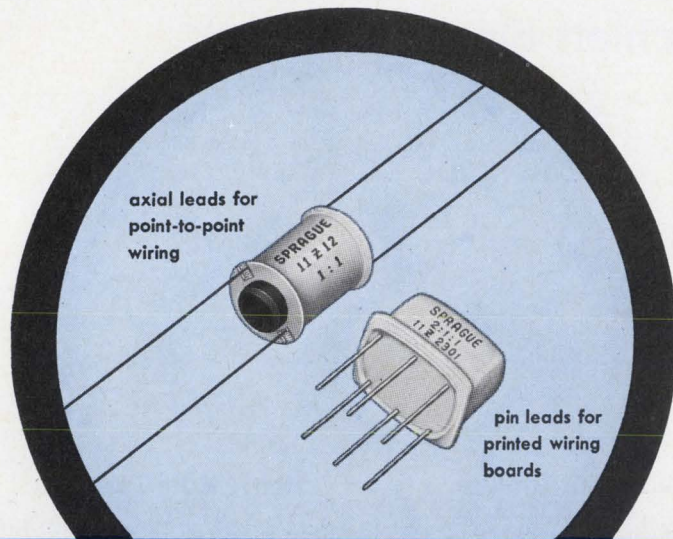

**the industry's lowest-cost SCR triggers!**

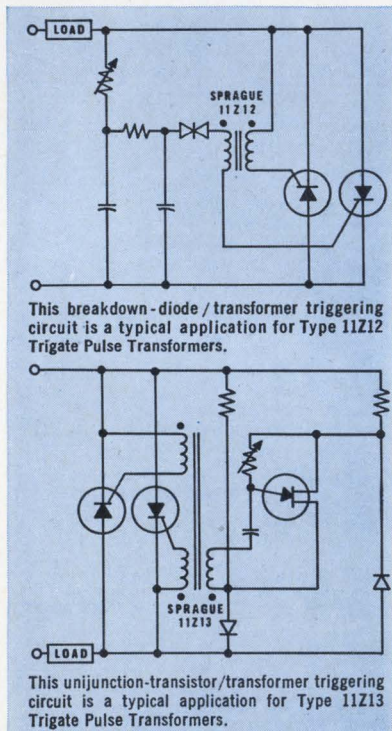

## Dependable enough for industrial equipment, yet priced for high-volume commercial applications

Here's good news for designers of appliances; lighting controls; air-conditioning and heating controls; industrial controls. You can actually cut costs while upgrading your present method of SCR triggering!

Type 11Z Trigate\* Pulse Transformers offer these unique features:

1. Balanced pulse characteristics and energy transfer from primary to secondary and tertiary windings.
2. Minimum saturation effect to allow operation where increased pulse widths are required.
3. Fast pulse rise time and increased current capability to prevent SCR  $di/dt$  failure.
4. Increased energy transfer efficiency.

Temperature operating range,  $-10^{\circ}\text{C}$  to  $+105^{\circ}\text{C}$ . 2- and 3-winding designs for half- and full-wave applications. Turns ratios, 1:1, 1:1:1, 2:1, 2:1:1, 5:1. Available for use with line voltages up to 240 VAC or 550 VAC. Inductances to 1 mH at 550V, 5 mH at 240V.

For complete information, write for Engineering Bulletin 40,003A to the Technical Literature Service, Sprague Electric Co., 35 Marshall St., North Adams, Mass. 01247

\*trademark

### SPRAGUE COMPONENTS

PULSE TRANSFORMERS  
CAPACITORS  
TRANSISTORS  
RESISTORS  
THIN-FILM MICROCIRCUITS  
INTEGRATED CIRCUITS

INTERFERENCE FILTERS  
PACKAGED COMPONENT ASSEMBLIES  
FUNCTIONAL DIGITAL CIRCUITS  
MAGNETIC COMPONENTS  
CERAMIC-BASE PRINTED NETWORKS  
PULSE-FORMING NETWORKS



\*Sprague® and ® are registered trademarks of the Sprague Electric Co.

455C-6102R3

## People

diode manual, two editions of the GE SCR manual, and a hundred-odd-page UJT application note—which, with his technical articles, was largely responsible for creating the demand for UJT's.

Sylvan also developed methods for measuring the stored charge in high-speed diodes, designed and built much of GE's process control, test, and classification equipment for tunnel diodes, back diodes, and planar silicon diodes.

Why leave? The years at GE were productive but Sylvan felt confined. "Teradyne will give me more time for product development and take less for organization duties," he says.

"I don't foresee the FCC trying to duplicate the Bell Laboratories," says the commission's new chief engineer, William H. Watkins. "But I do want to see more efforts in such areas as long-range planning on the use of the frequency spectrum. We are very much interested in investigating expansion into the 10- to 100-gigahertz range."



William H. Watkins

Watkins is careful in discussing future plans for his office: he's a career civil servant and one of the few who hold both electrical engineering and law degrees. He joined the Federal Communications Commission in 1946 as an engineer and for the past two years has been deputy chief engineer.

**Evolution.** On the question of the land mobile congestion, he notes that the problem "has been studied to the point of nausea." But he warns against expecting anything revolutionary from his office. "Only rarely is one able to accomplish anything in the frequency management area other than in an evolutionary way."

Watkins avoids offering proposals on how the FCC might spend its first real research money—\$600,000, which is in the current budget, and \$1 million in the 1969 budget.



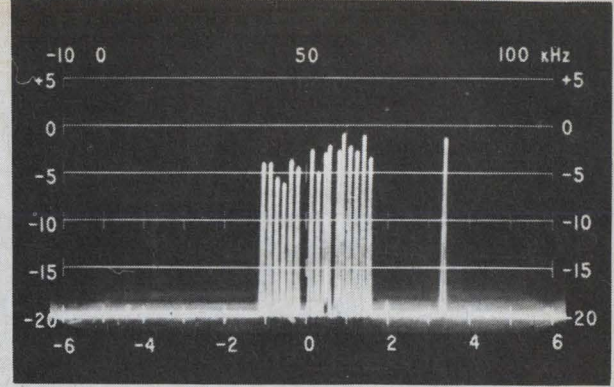
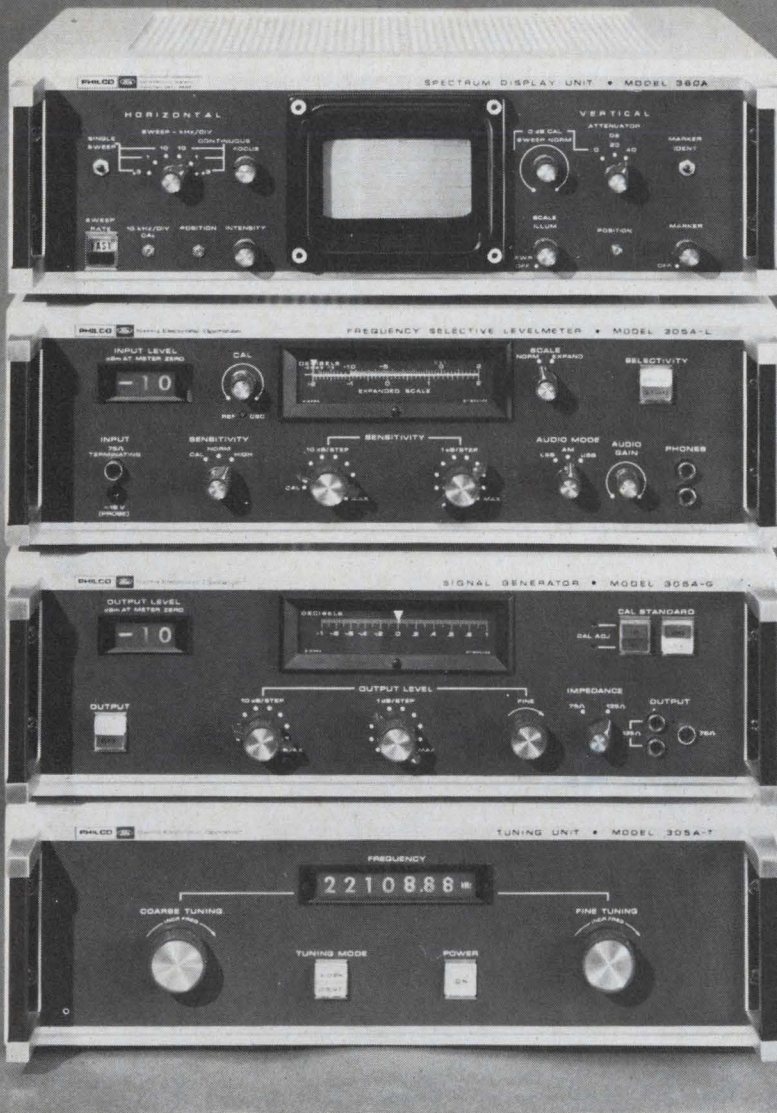

Three 4-kHz channels of L3 carrier multiplex system. Center channel has teletype subcarriers. Model 360A is in 12-kHz sweep width mode, sweeping from 6.780 to 6.792 MHz.

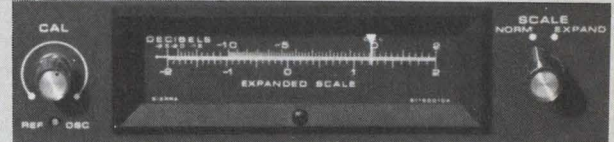

Switch-selected meter modes, normal or expanded scale, provide level measurement resolution of 0.05 dB. Signal generator level increments as fine as 0.01 dB can be readily resolved.

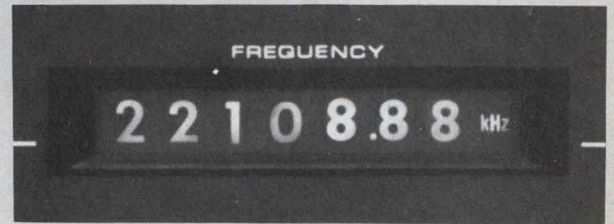

Frequency resolution to nearest 10 Hz in phase-locked tuning mode is displayed on flat-plane, high-brightness readouts. Alternative continuous tuning mode presents frequency resolved to nearest 100 kHz.

## A Communications System Test Set (VLF to HF)...

engineered for humans (A to VB\*)

From Sierra comes the most thoroughly human-engineered instrument for HF-radio and telephone-carrier applications in today's knob- and meter-ridden world: The Model 305/360 Communications System Test Set.

Model 305/360 gives you ultra-bright, unambiguous electronic digital readouts of frequency. Built-in counter automatically totals outputs of both the coarse and fine tuning oscillators, reads out tuned frequency with 10-Hz resolution. Attenuator levels appear in three-digit displays, with unique logic and switching circuits combining the levels of the 10-dB and 1-dB per step attenuators. Rear-projection meters with luminous pointers permit parallax-free viewing from any angle with easy resolution of fine-level increments.

Performance features include phase-locked tuning circuits, a single continuous tuning range covering voice frequencies through 32 MHz, and selective bandwidths of 250 and 3100 Hz. You can resolve signals separated by as little as 35-Hz.

Model 305/360 does everything humanly possible to keep foibles from fouling your readings. For the brochure, write Sierra, 3885 Bohannon Drive, Menlo Park, California 94025.



PHILCO-FORD CORPORATION  
Sierra Electronic Operation  
Menlo Park, California • 94025

Circle 11 on reader service card

\*Average to Very Bright



# NOW...TWO GENERATIONS OF

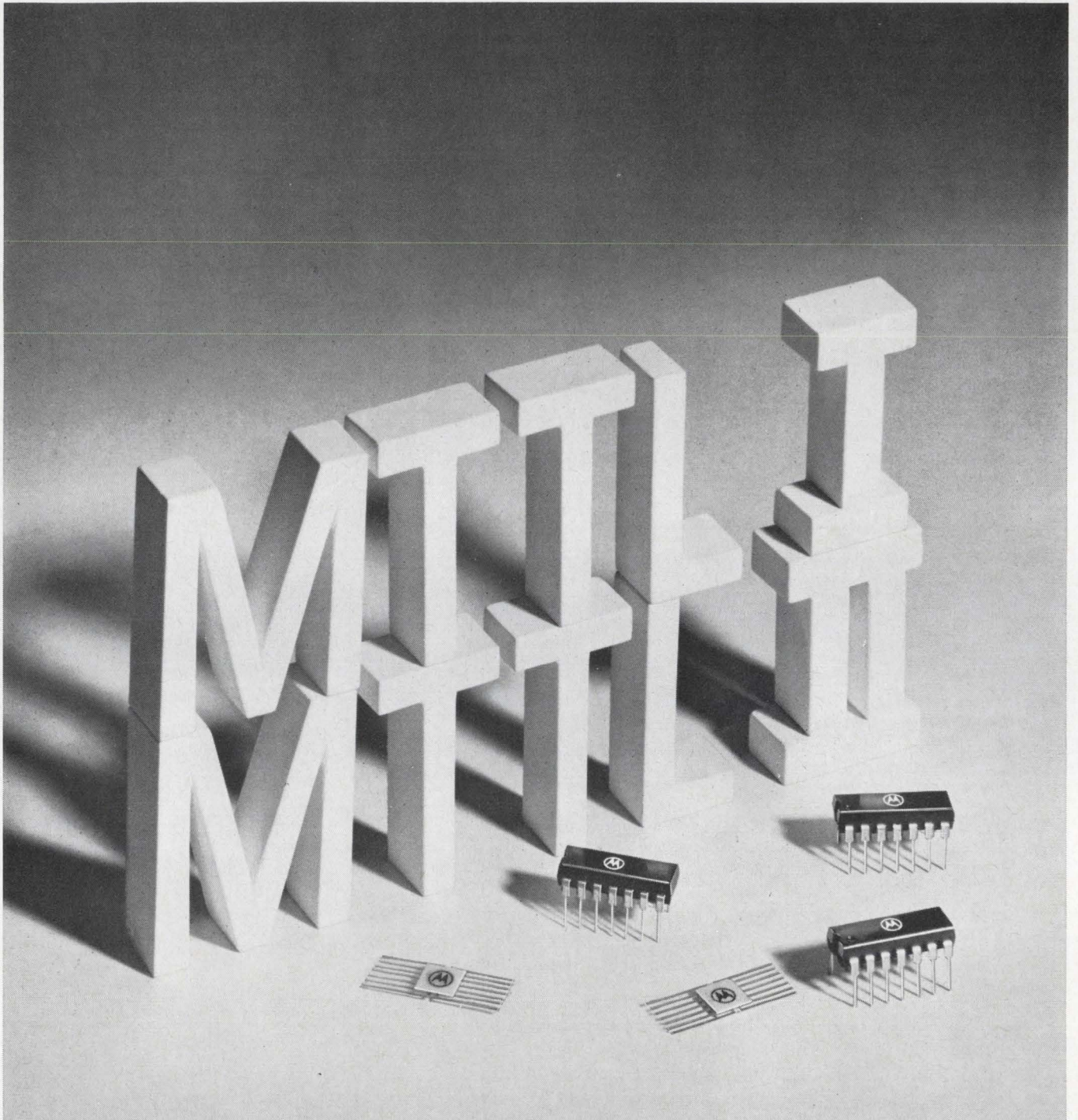

**MTTL<sup>†</sup> I & II OFFER A WIDE CHOICE OF T<sup>2</sup>L FUNCTIONS  
IN BOTH FLAT-PACKS & LOW-COST PLASTIC!**

†MTTL is a trademark of Motorola Inc.

*-where the priceless ingredient is care!*





# MOTOROLA T<sup>2</sup>L INTEGRATED CIRCUITS!

OPTIMUM SELECTION & DESIGN FLEXIBILITY AT LOW COST!

CIRCUIT DESCRIPTION*	-55° to +125°C						0 to +75°C					
	SUHL Type No.	Motorola Type No. F.O. = 15	Motorola Price 100-Up	SUHL Type No.	Motorola Type No. F.O. = 7	Motorola Price 100-Up	SUHL Type No.	Motorola Type No. F.O. = 12	Motorola Price 100-Up (F) 1000-Up (P)	SUHL Type No.	Motorola Type No. F.O. = 6	Motorola Price 100-Up (F) 1000-Up (P)
Dual 4-Input NAND Gate	SG-40-02	MC500F	\$5.45	SG-41-02	MC550F	\$4.35	SG-42-02 SG-42-03	MC400F MC400P	\$3.15 1.75	SG-43-02 SG-43-03	MC450F MC450P	\$2.50 1.40
Expandable 4-Wide 2-2-2-3-Input AND-OR-INVERT Gate	SG-50-02	MC501F	6.00	SG-51-02	MC551F	4.80	SG-52-02 SG-52-03	MC401F MC401P	3.50 1.95	SG-53-02 SG-53-03	MC451F MC451P	2.75 1.55
Single 8-Input NAND Gate	SG-60-02	MC502F	5.45	SG-61-02	MC552F	4.35	SG-62-02 SG-62-03	MC402F MC402P	3.15 1.75	SG-63-02 SG-63-03	MC452F MC452P	2.50 1.40
2-Wide 3-Input AND-OR-INVERT Gate with Gated Complement	SG-90-02	MC503F	5.45	SG-91-02	MC553F	4.35	SG-92-02 SG-92-03	MC403F MC403P	3.15 1.75	SG-93-02 SG-93-03	MC453F MC453P	2.50 1.40
Expandable 3-Wide 3-Input AND-OR-INVERT Gate	SG-100-02	MC504F	6.00	SG-101-02	MC554F	4.80	SG-102-02 SG-102-03	MC404F MC404P	3.50 1.95	SG-103-02 SG-103-03	MC454F MC454P	2.75 1.55
Expandable 2-Wide 4-Input AND-OR-INVERT Gate	SG-110-02	MC505F	6.00	SG-111-02	MC555F	4.80	SG-112-02 SG-112-03	MC405F MC405P	3.50 1.95	SG-113-02 SG-113-03	MC455F MC455P	2.75 1.55
Expandable 8-Input NAND Gate	SG-120-02	MC506F	6.00	SG-121-02	MC556F	4.80	SG-122-02 SG-122-03	MC406F MC406P	3.50 1.95	SG-123-02 SG-123-03	MC456F MC456P	2.75 1.55
Quad 2-Input NAND Gate	SG-140-02	MC508F	5.45	SG-141-02	MC558F	4.35	SG-142-02 SG-142-03	MC408F MC408P	3.15 1.75	SG-143-02 SG-143-03	MC458F MC458P	2.50 1.40
4-Wide 3-2-2-3-Input Expander for AND-OR-INVERT Gates	SG-150-02	MC509F	4.90	SG-151-02	MC559F	3.90	SG-152-02 SG-152-03	MC409F MC409P	2.85 1.20	SG-153-02 SG-153-03	MC459F MC459P	2.25 1.20
Dual 4-Input Expander for AND-OR-INVERT Gates	SG-170-02	MC510F	4.90	SG-171-02	MC560F	3.90	SG-172-02 SG-172-03	MC410F MC410P	2.85 1.20	SG-173-02 SG-173-03	MC460F MC460P	2.25 1.20
Dual 4-Input Expander for NAND Gates	SG-180-02	MC511F	4.90	SG-181-02	MC561F	3.90	SG-182-02 SG-182-03	MC411F MC411P	2.85 1.20	SG-183-02 SG-183-03	MC461F MC461P	2.25 1.20
Triple 3-Input NAND Gate	SG-190-02	MC512F	5.45	SG-191-02	MC562F	4.35	SG-192-02 SG-192-03	MC412F MC412P	3.15 1.75	SG-193-02 SG-193-03	MC462F MC462P	2.50 1.40
R-S Flip-Flop	SF-10-02	MC513F	6.00	SF-11-02	MC563F	4.80	SF-12-02 SF-12-03	MC413F MC413P	3.50 1.95	SF-13-02 SF-13-03	MC463F MC463P	2.75 1.55
AND J-K Flip-Flop	SF-50-02	MC515F	7.65	SF-51-02	MC565F	6.10	SF-52-02 SF-52-03	MC415F MC415P	4.40 2.80	SF-53-02 SF-53-03	MC465F MC465P	3.50 2.25
OR J-K Flip-Flop	SF-60-02	MC516F	7.65	SF-61-02	MC566F	6.10	SF-62-02 SF-62-03	MC416F MC416P	4.40 2.80	SF-63-02 SF-63-03	MC466F MC466P	3.50 2.25
Expandable 2-Wide 4-Input AND-OR-INVERT Gate	SG-210-02	MC2100F	7.20	SG-211-02	MC2150F	5.75	SG-212-02 SG-212-03	MC2000F MC2000P	4.20 2.35	SG-213-02 SG-213-03	MC2050F MC2050P	3.30 1.85
Quad 2-Input NAND Gate	SG-220-02	MC2101F	6.55	SG-221-02	MC2151F	5.20	SG-222-02 SG-222-03	MC2001F MC2001P	3.80 2.10	SG-223-02 SG-223-03	MC2051F MC2051P	3.00 1.70
4-Wide 3-2-2-3-Input Expander for AND-OR-INVERT Gates	SG-230-02	MC2102F	4.90	SG-231-02	MC2152F	3.90	SG-232-02 SG-232-03	MC2002F MC2002P	2.85 1.20	SG-233-02 SG-233-03	MC2052F MC2052P	2.25 1.20
Dual 4-Input NAND Gate	SG-240-02	MC2103F	6.55	SG-241-02	MC2153F	5.20	SG-242-02 SG-242-03	MC2003F MC2003P	3.80 2.10	SG-243-02 SG-243-03	MC2053F MC2053P	3.00 1.70
Expandable 4-Wide 2-2-2-3-Input AND-OR-INVERT Gate	SG-250-02	MC2104F	7.20	SG-251-02	MC2154F	5.75	SG-252-02 SG-252-03	MC2004F MC2004P	4.20 2.35	SG-253-02 SG-253-03	MC2054F MC2054P	3.30 1.85
Single 8-Input NAND Gate	SG-260-02	MC2105F	6.55	SG-261-02	MC2155F	5.20	SG-262-02 SG-262-03	MC2005F MC2005P	3.80 2.10	SG-263-02 SG-263-03	MC2055F MC2055P	3.00 1.70
Dual 4-Input Expander for AND-OR-INVERT Gates	SG-270-02	MC2106F	4.90	SG-271-02	MC2156F	3.90	SG-272-02 SG-272-03	MC2006F MC2006P	2.85 1.20	SG-273-02 SG-273-03	MC2056F MC2056P	2.25 1.20
AND J-K Flip-Flop	SF-250-02	MC2109F	9.20	SF-251-02	MC2159F	7.30	SF-252-02 SF-252-03	MC2009F MC2009P	5.30 3.35	SF-253-02 SF-253-03	MC2059F MC2059P	4.20 2.70
OR J-K Flip-Flop	SF-260-02	MC2110F	9.20	SF-261-02	MC2160F	7.30	SF-262-02 SF-262-03	MC2010F MC2010P	5.30 3.35	SF-263-02 SF-263-03	MC2060F MC2060P	4.20 2.70

\*Interchange with SUHL\*\* I & II types.

\*\*Trademark of Sylvania, Inc. "F" suffix denotes flat-pack. "P" suffix denotes dual in-line plastic package. Sylvania suffix -03 numbers denote dual in-line ceramic packages.

**S**election . . . Availability . . . Economy! Three good reasons why you should evaluate M TTL I (MC400/500 series) and M TTL II (MC2000/2100 series) . . . Motorola's answer to the T<sup>2</sup>L "availability" problem.

Whether you want the low-cost approach offered by the 14-pin dual in-line plastic package — or have more stringent temperature requirements calling for the 14-pin ceramic flat-pack (—55 to +125°C) — Motorola now offers the T<sup>2</sup>L circuit for every designer. In fact, you can choose from 24 different logic functions, offered in some 150 different types. More importantly, 15 more complex-function circuits, including a 50 MHz Flip-Flop, will be introduced in this line during the next few months.

Now, the computer/industrial system designer can combine the top performance of this highly-popular line with system costs that are competitive with practically any form of I/C logic. For example, the price of the MC2009P J-K AND Flip-Flop is just \$3.35, and the MC2001P Quad 2-Input Gate is \$2.10 (both 1,000-up). Production quantities are available for all types.

†M TTL is a trademark of Motorola Inc.

**MOTOROLA** Semiconductor Products Inc.

#### Check These Other Design Advantages:

- Choice of fan-out — up to 15
- High-noise immunity — 1.0 volt (typ)
- High-capacitance drive — 600 pF (max)
- Low-power dissipation — averages 15 mW per gate (M TTL I) and 22 mW per gate (M TTL II)

Evaluation units are now available from your local distributor's warehouse stock. For production quantity pricing and schedules, contact your Motorola field representative. Write for details . . . P.O. Box 955, Phoenix, Arizona 85001.



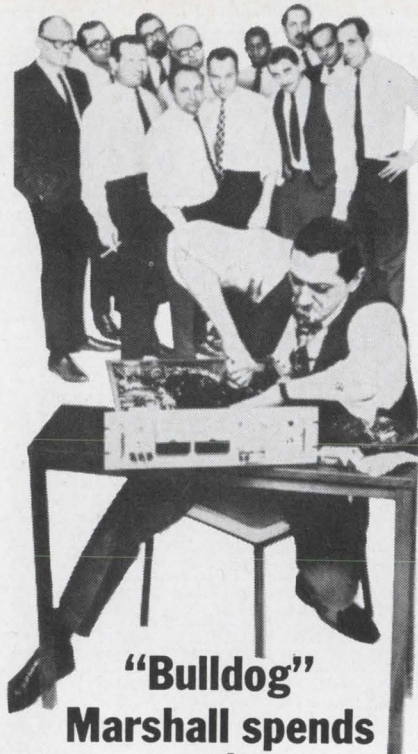

**"Bulldog"  
Marshall spends  
another  
disappointing day  
with Super-Mercury.**

Marshall? He's the crankiest of the Twelve Cranks on Pleasant Avenue. One of the extra-picky grumps at Trygon Power Supplies who feels good all over only when he can pick something off our production line and shriek, "Hey! This is no % # & @ # good!"

So far, he's had problems with our Super-Mercury series. Because there haven't been any problems.

The Super-Mercury is a brand new competitively priced series, the new generation of the industry-accepted, field-proven Trygon Mercury Series: fully programmable wide-range power supplies, power and value packed, offering precision Constant Voltage/Constant Current operation. Precision performance (with up to 2000 watts output), in ranges up to 160 volts and up to 100 amps. .005% regulation and 0.015% stability are standard (.005% stability optional) as is MIL Spec, RFI-free performance. Total ripple and noise less than 1mv rms and 10MV P-P (to 10MHz). Master-slave tracking, auto-load share paralleling and remote sensing and programming are also standard with Trygon's patented tracking overvoltage protection available.

Marshall and his friends check the dozens of Super-Mercury features that make this series a Super-buy for you. Now it's your turn to check on them. Order a Super-Mercury as a starter.

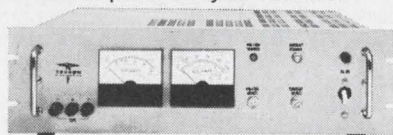

**Trygon Power Supplies**  
111 Pleasant Avenue, Roosevelt, L.I., N.Y. 11575  
Trygon GmbH 8 Munchen 60, Haidelweg 20, Germany

## Meetings

**Western Regional Technical Session,** Electrochemical Society; Hilton Inn, San Francisco, **March 7.**

**Conference of the American Society for Nondestructive Testing;** Biltmore Hotel, Los Angeles, **March 11-13.**

**Physics Exhibition,** Institute of Physics and the Physical Society; London, **March 11-14.**

**International Convention and Exhibition,** IEEE; Coliseum and N.Y. Hilton Hotel, N.Y., **March 18-21.**

**International Convention,** Aerospace and Electronics Systems of IEEE; Warwick Hotel, New York, **March 19.**

**Modulation Transfer Function,** Society of Photo-Optical Instrumentation Engineers; Boston, **March 21-22.**

**Symposium on Microwave Power,** International Microwave Power Institute; Statler Hilton Hotel, Boston, **March 21-23.**

**Flight Test Simulation and Support Conference,** American Institute of Aeronautics and Astronautics; Los Angeles, **March 25-27.**

**International Aerospace Instrumentation Symposium,** College of Aeronautics and Instrument Society of America; Cranfield, England. **March 25-28.**

**Quality Control Conference,** American Society for Quality Control; University of Rochester, N.Y., **March 26.**

**Railroad Conference,** IEEE and American Society of Mechanical Engineers; Conrad Hilton Hotel, Chicago, **March 27-28.**

**Electrical Engineers Exhibition,** American Society of Electrical Engineers; London, **March 27-April 3.**

**International Conference on Color Television,** Electronic Industries Association of France; Paris, **April 1-5.**

**International Components Show,** Federation Nationale des Industries Electronique; Paris, **April 1-6.**

**Business Aircraft Meeting and Engineering Display,** Society of Automotive Engineers; Broadview Hotel, Wichita, Kan., **April 3-5.**

**International Magnetics Conference,** IEEE; Sheraton Park Hotel, Washington, **April 3-5.\***

**Meeting and Technical Conference of the Numerical Control Society;** Marriott Motor Hotel, Philadelphia, **April 3-5.**

**Symposium on Engineering Aspects of Magnetohydrodynamics,** American Institute of Aeronautics and Astronautics, University of Tennessee, Tullahoma, **April 3-5.**

## Short Courses

**Systems logic design,** University of Wisconsin's College of Engineering, Madison, Wis., **March 11-15; \$150.**

**Microwave calibration workshop,** U.S. Department of Commerce, National Bureau of Standards, Washington, **May 6-10; \$300.**

**Modern automatic control,** Purdue University's Schools of Engineering and Laboratory for Applied Industrial Control, Lafayette, Ind., **May 27-June 7; \$300.**

## Call for papers

**Standards Laboratory Conference,** National Conference of Standards Laboratories; Boulder Laboratories of the National Bureau of Standards, Boulder, Colo., Aug. 26-29. **March 15** is deadline for submission of abstracts to J.L. Hayes, Metrology Engineering Center, naval plant representative, 1675 W. 5th Ave., P.O. Box 2507, Pomona, Calif. 91766

**Fall Joint Computer Conference,** American Federation of Information Processing Society, IEEE; San Francisco Hilton Hotel, San Francisco, Dec. 9-11. **May 12** is deadline for submission of papers to Robert Glaser, technical program committee chairman, 1968 Fall Joint Computer Conference, P.O. Box 2309, Stanford, Calif. 94305

**Symposium on Reliability,** IEEE, American Society for Quality Control; Palmer House, Chicago, Jan. 21-23, 1969. **May 1** is deadline for submission of abstracts to J.E. Condon, program chairman, NASA, Code KR, Washington, D.C. 20546

\* Meeting preview on page 16.



# The connector thing

A periodical periodical designed quite frankly to further the sale of Microdot Inc. connectors and cables. Published entirely in the interest of profit.



## Give me your tired, your froze, your thirsty masses...

and we will rescue you brothers, from the tremors, shakies, vapors, chills, and foot sore wearies of the IEEE marathon.

## Let Microdot rescue you from New York.



There'll be a beacon in the New York sky overlooking the Avenue of the Americas. (Sixt Evenuh t' New Yawkuhs.)

That's where our Rescue Mission is. In the modestly opulent east penthouse suite of the New York/Hilton just five blocks over (and a block-and-a-half up) from the Coliseum where you-know-who will be shuffling in and out of all those booths.

Throughout IEEE days, we will be looking down from this exquisite hospitality suite daily from 4 in the afternoon on. We hope you'll be there at least once.

You may stop in for a stirrup cup with us, or stay for the whole saddle. If pressed, we will regale you with per-

formance anecdotes on the you-know-whats that we make.

Your Rescue Mission button retained and worn at all times, is your ALL TIME PASS any time during IEEE. In real life the badge is neat tin, attractively painted in plain color and will go with most wardrobes, except puce glen plaid suits.

Your Rescue Mission button is your constant passport. So to obtain yours, write now, right now.

See you, starting the eighteenth of March at 53rd or 54th and Avenue of the Americas (depending on which direction you're cabbing or walking) which is another way of saying top o' the New York/Hilton.

Incidentally, it's only fair to warn you that as you're relaxing about our lush little paradise, that you can and indeed must expect to be pitched. Which is really all to your benefit because we have a lot of keen connectors to talk about. And, so you won't have to just take our word for it, we'll just happen to have inspectable proofs of what we're talking about.

High density packing is available in our connectors. It's done with Twist/Con,\* a principle of getting rid of the

standard contact spring member and replacing it with our unique breathing helical spring. This makes for very high density.

There's a variety of push-pull, thread or bayonet hermetic seal connectors to Mil-Specs.

**Lepra/Con\*** mini-minis (5/32" o.d. and 3/8" to 7/16" long) all crimp, no solder connectors in seven configurations with screw-on or slide-on designations.

Standard coaxial connectors, slide-on, screw-on, hermetically sealed, with bend-relief caps and enough combinations to give you hundreds of variations.

**Golden Crimp,\*** a solderless miniature coax cable with a fast, four step, double crimp assembly that's completely moisture and humidity proof.

And **Microcrimp,\*** the tiny crimp type coax connector in line-cable, bulkhead or snap-lock mounting. An easy crimping method eliminates soldering, burning or miscrimping.

**The MARC 53.\*** A multi-unlimited-application type high density, cylindrical, multi-pin connector with front insertable contacts. It's the only one in that category to meet the USAF spec MIL-C-38300A. No insertion or removal tools needed.

What could be better than that? Maybe MARC 53 RMD. Same as the MARC 53, but with rear insertable and removable pins and sockets.

All these great things add up to better deals for you. Old homilies like greater reliability, longer life, more raises, bigger promotions and a blow for freedom.

Please buy.

Now that you've read this, fill in the request for your Rescue Mission button, so that you can join us and luxuriate where Heads of State have romped.

\*Registered trademarks of Microdot Inc.

### REQUEST FOR RESCUE

NAME \_\_\_\_\_

ADDRESS \_\_\_\_\_

CITY \_\_\_\_\_

STATE \_\_\_\_\_

ZIP \_\_\_\_\_

Incidentally, you could unload a  
 sales rep. or  literature on   
MARC 53  Lepra/Con  Standard  
Connectors  Pin and socket con-  
nectors  whatever.



**MICRODOT INC.**

220 Pasadena Ave.  
South Pasadena, Calif. 91030



# 1970

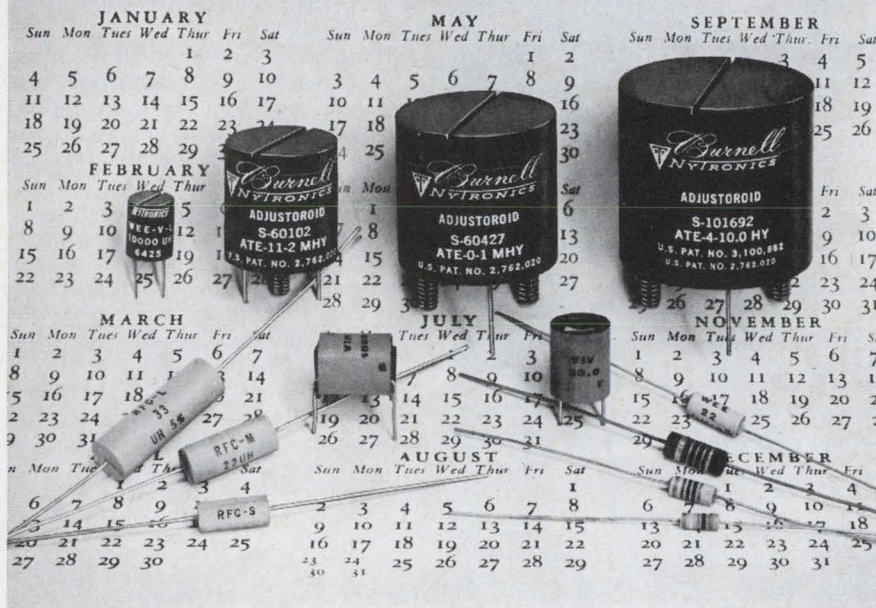

## Nytronics Inductors are ahead of their time!

Nytronics continuous research and development have produced standardized quality inductors with the superb precision and stability to meet the demanding requirements of tomorrow's circuitry. Yours today — delivered off the shelf from a large inventory. Pioneering is a Nytronics specialty!

**WEE-DUCTOR** — Magnetically shielded with inductance range 0.1 to 180,000uH, designed to MIL-C-15305, Grade 1, Class B. Encapsulated Envelope: 0.157" diameter x .450" length.

**SUPER WEE-DUCTOR/90537 TYPE** — Manufactured in accordance with MS90537, Molded Magnetically shielded with inductance range 0.1 to 100,000uH  $\pm 10\%$  tolerance. Molded Envelope: 0.163" diameter x 0.410" length.

**WEE WEE-DUCTOR** — Magnetically shielded with inductance range 0.1 to 10,000uH. Designed to MIL-C-15305. Encapsulated Envelope: 0.125" diameter x 0.335" length.

**DECI-DUCTOR** — Subminiature with inductance range 0.1 to 1000uH. Designed to MIL-C-15305, Grade 1, Class B. Molded Envelope: 0.100" diameter x 0.250" length.

**S-M-L INDUCTORS** — Non-shielded with inductance range 0.1 to 10,000uH. Designed to MIL-C-15305, Grade 1, Class B. Molded Envelope: "S" Type — 0.188" diameter x 0.44" length, "M" Type — 0.25" diameter x 0.60" length, "L" Type — 0.31" diameter x 0.90" length.

**VARIABLE INDUCTOR** — Unshielded with adjustable range 0.1 to 4700uH. Designed to meet MIL-C-15305, Grade 1, Class B. Encapsulated Envelope: 0.400" diameter x 0.500" length. Vertical or Horizontal mounting.

**WEE V-L** — Magnetically shielded adjustable range 0.1 to 100,000uH. Designed to MIL-C-15305, Grade 1, Class B. Epoxy Molded 0.300" diameter x 0.400" length.

**ADJUSTOROID** — Adjustable toroid available in nominal values from 0.01Hy to 12Hy. This unit provides stepless adjustment in a completely hermetically sealed package.

Nytronics off-the-shelf inventory also includes a wide range of capacitors, delay lines, and resistors. Write today for complete engineering data.



## NYTRONICS®

...for Precision Electronic Components

550 Springfield Ave., Berkeley Heights, N.J. 07922 (201) 464-9300 TWX: 710-984-7977

## Meeting preview

### Magnetic attraction

This year's InterMag meeting, like those in previous years, is no place for the engineer seeking a broad overview of magnetics technology. By its very nature, the International Conference on Magnetics, scheduled for April 3 to 5 in Washington, caters to highly specialized engineers. Separate sessions will cover cryoelectronics, signal and power control, magneto-optics, microwave devices, memory technology, and thin films.

Among the more exotic papers will be one delivered by two Russian engineers, M.A. Boyarchenkov and V.P. Zinkevich, from Moscow's Institute of Automation and Telemechanics. They will describe the use of toroidal cores in an analog memory.

In another paper, C.W. Steele and J.C. Mallinson, researchers at the Ampex Corp., will describe how a computer can determine the limiting factors in magnetic tape-bit density.

**Compensate.** In a related paper, G. V. Jacoby, a design engineer at RCA's Camden, N.J., research facility, will describe how controlling amplitude and phase characteristics can compensate for signal distortions caused by recording heads.

At the session on memory technology, Gordon E. Moore, director of research and development at Fairchild Semiconductor, will deliver a paper on semiconductor read-write memories for computers. In his paper, he will point up the speed and bit-capacity capabilities of this type of memory, which he believes will be competitive on a cost-per-bit basis with other types by the early 1970's.

Other papers in this session will discuss ferrite core, planar film, plated wire, and batch-fabricated magnetic-film arrays. William M. Overn, of the Sperry Rand Corp.'s Univac division, will deliver a paper on today's planar-film technology, which he will then compare with ferrite core technology. The paper's aim will be to determine the future of planar technology.

For more information contact A.D. Krall, U.S. Naval Ordnance Laboratory, Silver Spring, Md. 20910.



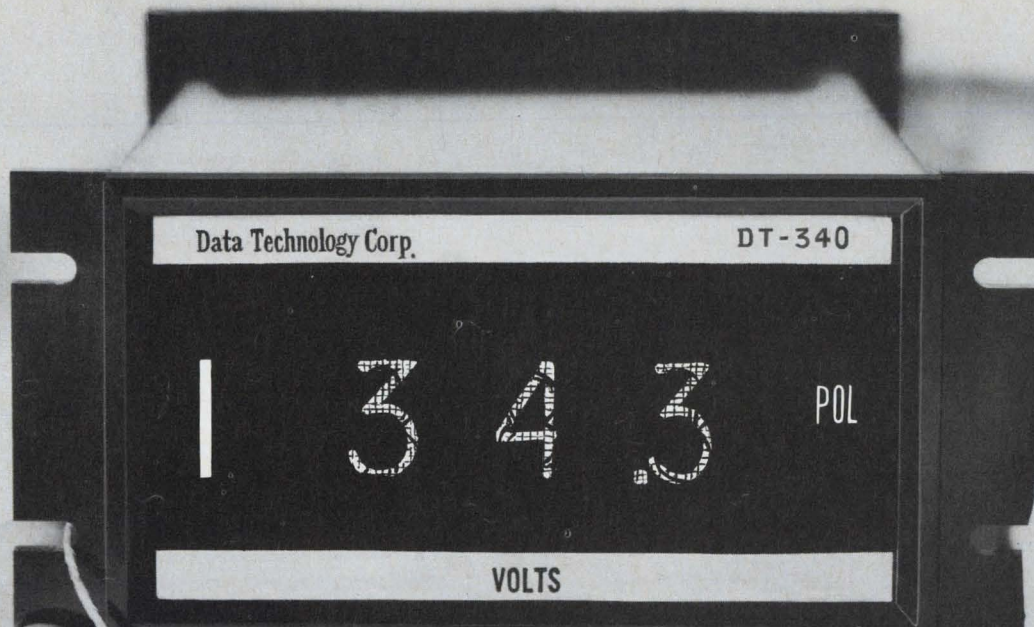

## Have you seen the season's newest panel show?

You should. Because Data Technology's new digital panel meter puts an end to the problems of meter movements. No more parallax, needle hang-ups or needle width interpolations. □ The Data Technology model DT-340 panel meter indicates either voltage or current with three digit readout, and 100% overranging, and will indicate wrong polarity. BCD outputs and external trigger provisions are standard features. To simplify calibration, both the zero and full-scale adjustments are on the front panel. □ The DT-340 will read voltages from 100 microvolts to 1000 volts in any one of five decade ranges. □ The DT-340 is small (2.4" high x 5.2" wide x 7.5" deep) and light (less than 20 oz.) and will replace practically every panel meter in existence. Its non-blinking, high intensity display makes easy reading, even in the dark. □ Contact your local Data Technology representative for a demonstration, or write for complete information.



**Data Technology Corporation** 2370 Charleston Road, Mountain View, California 94040. Phone (415) 321-0551, TWX (415) 969-9150.

**"VISIT US AT THE IEEE SHOW, BOOTHS #3A51, 3A52."**



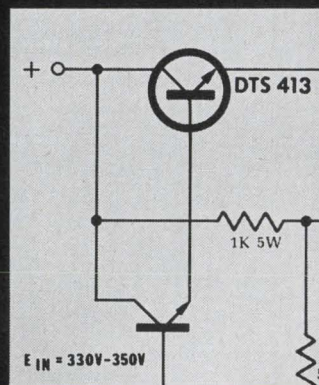

# The Kokomoans'



with it. And comes to you in Delco applications engineers stationed in nearby offices throughout the country. Engineers who've worked with people in everything from TV to space technology. Engineers who'll work with you to help take your pro-

Power semiconductors. And that knowledge can help you solve your most intricate problems in power.

Our applications experience began the moment the power industry was born. Grew

gram from concept into production. Help you simplify circuits, lower costs or take care of most anything that might be short-circuiting your operation.

Prompt delivery's no problem because the Delco Radio organization is keyed 100% to mass production: mass production of components to meet customer production schedules. And mass production of our own end products—car radios and automatic temperature control systems. StereoTape systems. Portable military communications equipment.

When a company is geared like this, you know you'll get your parts on time.

You'll find that Delco devices come with conservative specs. Plus the uniform high quality and reliability gained through our precision high-volume production. So you can design with confidence.

**SEMICONDUCTOR DISTRIBUTORS: EAST**—BALTIMORE, MD. 21201, Radio Electric Service Co., 5 North Howard Street, (301)-539-3835 BINGHAMTON, N.Y. 13902, Federal Electronics, Inc., P. O. Box 1208, (607)-748-8211 CLIFTON, N.J. 07015, Eastern Radio Corporation, 312 Clifton Avenue, (201)-471-6600 NEWTON, MASS. 02195, The Greene Shaw Co., Inc., 341-347 Watertown St., (617)-969-8900 NEW YORK, NEW YORK 10036, Harvey Radio Co., Inc., 2 West 45th St., (212)-582-2590 PHILADELPHIA, PENN. 19123, Almo Industrial Electronics, Inc., 412 North 6th Street, (215)-922-5918 PITTSBURGH, PENN. 15206, Radio Parts Company, Inc., 6401 Penn Ave., (412)-361-4600 WOODBURY, L. I., N.Y. 11797, Harvey Radio Company, Inc., 60 Crossways Park West, (516)-921-8700 **SOUTH**—BIRMINGHAM, ALA. 35233, Forbes Distributing Company, Inc., 1416 Fourth Ave., South, (205)-251-4104 MIAMI, FLORIDA 33142, Mountain Electronics, Division of Mountain National Co., 3730 Northwest 36th St., (305)-634-4556 RICHMOND, VA. 23220, Meridian Electronics, Inc., 1001 West Broad Street, (703)-353-6648 WEST PALM BEACH, FLA. 33402, Mountain Electronics, Division of Mountain National Co., 1000 N. Dixie Highway, (305)-833-5701 **MIDWEST**—CINCINNATI, OHIO 45237, United Radio, Inc., 7713 Reinhold Drive, (513)-761-4030 CLEVELAND, OHIO 44125, The W. M. Pattison Supply Co., Industrial Electronics Division, 4550 Willow Parkway, (216)-441-3000 INDIANAPOLIS, IND. 46225, Graham Electronics Supply, Inc., 122 South Senate Avenue, (317)-634-8486 KALAMAZOO, MICH. 49005, Electronic Supply Corp., P. O. Box 831, (616)-381-4626 KANSAS CITY, MO. 64111, Walters Radio Supply, Inc., 3635 Main



# knowledge is power.

You'll find that detailed Delco data sheets and applications notes are written especially for engineers in a standard, easy-to-analyze form.

And you'll find that often we can recommend suitable devices at a lower cost than those originally applicable. Once you get what you need, you get follow-up service to make sure each device works where it's supposed to.

For more information on what's in Delco power semiconductors for you, contact your local Delco distributor or Delco sales office. See why the Kokomoans' power is knowledge.

#### FIELD SALES OFFICES

Union, New Jersey\* 07083  
Box 1018 Chestnut Station  
(201) 687-3770  
Chicago, Illinois\* 60656  
5151 N. Harlem Avenue  
(312) 775-5411

Syracuse, New York 13203  
1054 James Street  
(315) 472-2668  
Santa Monica, Calif.\* 90401  
726 Santa Monica Blvd.  
(213) 870-8807

Detroit, Michigan 48202  
57 Harper Avenue  
(313) 873-6560  
Kokomo, Ind. 46901  
700 E. Firmin  
(317) 459-2175 Home Office

\*Office includes field lab and resident engineer for application assistance.



MARK OF EXCELLENCE

**DELCO RADIO**  
DIVISION OF GENERAL MOTORS  
**KOKOMO, INDIANA**

Street, (816)-531-7015 MINNEAPOLIS, MINNESOTA 55401, Stark Electronics Supply Co., 112 3rd Ave., North, (612)-332-1325 SKOKIE, ILL. 60076, Merquip Electronics, Inc 7701 N. Austin Ave., (312)-282-5400 ST. LOUIS, MO. 63144, Electronic Components for Industry Co., 2605 South Hanley Road, (314)-647-5505 WEST—ALBUQUERQUE N. M. 87103, Sterling Electronics, Inc., 1712 Lomas Blvd., N. E., (505)-247-2486 DALLAS, TEXAS 75201, Adleta Electronics Company, 1907 McKinney Ave., (214)-742-8257 DENVER, COLO. 80219, L. B. Walker Radio Company, 300 Bryant Street, (303)-935-2406 HOUSTON, TEXAS 77001, Harrison Equipment Co., Inc., 1422 San Jacinto Street, (713) 224-9131 LOS ANGELES, CAL. 90015, Radio Products Sales, Inc., 1501 South Hill Street, (213)-748-1271 LOS ANGELES, CAL. 90022, Kierulff Electronics, Inc., 2585 Commerce Way, (213)-685-5511 OKLAHOMA CITY, OKLAHOMA 73102, Radio, Inc., 903 North Hudson, (405)-235-1551 PALO ALTO, CAL. 94303, Kierulff Electronics, Inc., 3969 East Bayshore Road, (415)-968-6292 PHOENIX, ARIZ. 85005, Sterling Electronics, Inc., 1930 North 22nd Ave., (602)-258-4531 SAN DIEGO, CAL. 92101, Milo of California, Inc., 2060 India Street, Box 2710, (714)-232-8951 SEATTLE, WASH. 98108, Kierulff Electronics, Inc., 5940 6th Ave., South, (206)-763-1550 TACOMA, WASH. 98402, C & G Electronics Company, 2502 Jefferson Ave., (206)-272-3181 TULSA, OKLAHOMA 74119, Radio, Inc., 1000 South Main Street, (918)-587-9124 CANADA—SCARBOROUGH, ONTARIO, Lake Engineering Co., Ltd., 123 Manville Rd., (416)-751-5980





# COMPONENT CAPSULES

## General Electric VTM's develop over 500 watts to give you a better ECM device

No other electronically tuned device on the market today can match GE Voltage Tunable Magnetrans for power output (over 500W) and conversion efficiency (to over 70%).

Magnetic shielding virtually ends degaussing effects in GE VTM's. Tube/equipment inter-

## Highest volumetric efficiency at half the size—with GE wet slug capacitors

GE 69F900 wet slugs meet high-density application needs with highest volumetric efficiency of any capacitor. We halved the military (CL64) wet slug size, and essentially kept its electrical and performance traits.

The 69F900 has excellent capacitance retention at low temps . . . can be

## Alnico 5-7 magnetic material—a great improvement over Alnico 5

GE Alnico 5-7 improves or equals performance of conventional Alnico-5—with reduced magnet length, smaller cross-section.

Alnico 5-7 has great advantage where space and weight must be minimal, and high demagnetization resistance is required.

## Specify Volt-Pac® variable transformers for maximum life, minimum maintenance

Construction is the key to Volt-Pac's optimum performance. Here's why.

A spring-loaded, grain-oriented carbon brush means even contact, reduced wear. Self-lubricating nylon bearing lessens voltage selector friction.

Here are more features—Polyesterimide in-

## Bonded heater version of popular 7077/7486 tube now available

The new GE16411 may solve your most perplexing oscillator problem.

This small planar triode provides low levels of oscillator side-band noise. A bonded heater addition makes the GE16411 useful under high shock, vibration conditions.

GE16411 recently made possible significant im-

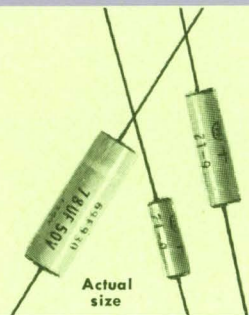

Actual size

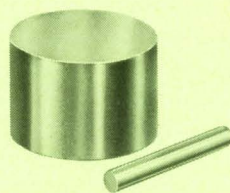

Manual uncased unit, exposed terminals

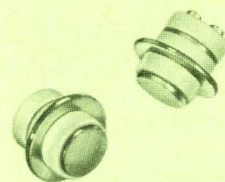

Actual size

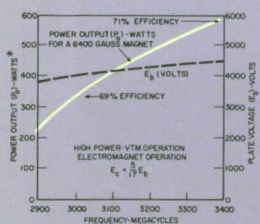

face problems are minimal—each VTM can have an integral isolator designed for your system.

Airborne application features are: linear electronic tuning, rapid modulation, minimal power variation over the band, temperature compensation, and light, compact packaging.

GE VTM's are offered in low-, intermediate-, and high-power configurations for other microwave applications. Circle **Number 198** for more details.

\* Recent developmental model

stored to  $-65^{\circ}\text{C}$ . Operating range is  $-55^{\circ}\text{C}$  to  $+85^{\circ}\text{C}$ . It's tough too— withstands vibration to 2000Hz; 15G acceleration!

GE's new capacitor is fully insulated; has low, stable leakage current. Ratings are available from 6 to 60 volts; capacitance ranges from 0.5 to 450  $\mu\text{f}$ .

RATING	CASE SIZE	VOLUME
50V, 30 $\mu\text{f}$	solid (CS12)	.341X.750 100%
	wet slug (CL64)	.281X.681 58%
	69F900	.145X.600 15%
15V, 80 $\mu\text{f}$	solid (CS12)	.341X.750 100%
	wet slug (CL64)	.281X.681 58%
	69F900	.145X.600 15%
6V, 180 $\mu\text{f}$	solid (CS12)	.279X.650 100%
	wet slug (CL64)	.281X.641 100%
	69F900	.145X.600 25%

Circle **Number 232** for more data.

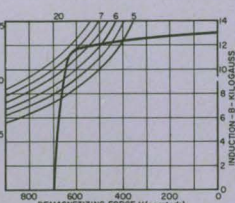

Demagnetization vs energy output, Alnico 5-7

Typical applications for Alnico 5-7 are high-density meter movements; electron tube devices; compact loud speakers; motors and generators.

Let our engineers work with you to design a Cast Alnico 5-7 magnet for your application. Circle **Number 233** for technical and ordering information.

sulation of coil windings gives extra reliability. Aluminum radiator and base evenly dissipate heat, extend life. Gold-plated track reduces possible heat build-up at brush contact, minimizes burn-out risks.

A-c voltage range of these autotransformers is zero to 100%, or 117% of fixed-input voltage without waveform distortion.

Manual or motor-operated Volt-Pacs can be ordered with or without enclosures, and with exposed or covered terminals. For more Volt-Pac facts, Circle **Number 234**.

provement in short-term, long-term stability characteristics in a spectrum-analyzer design.

It also provides direct retrofit fast warm-up capability for the 7077/7486 family—about 3 seconds to 90% of steady-state plate current.

The new triode is another example of how GE product improvements can aid you in designing reliable, top performing equipment. Circle **Number 235** for more information.



# A TECHNICAL DIGEST FOR INNOVATORS OF ELECTRONIC EQUIPMENT

## High performance d-c motors for computer and peripheral jobs

New Hyper-Servo\* d-c motors meet needs of single-capstan tape transports, disc packs, high-speed printers, card sorters and similar equipment.

Hyper-Servo motors offer **instant response**—to one millisecond!; up to 50 times more **frequency response** (band width)

\*Trademark of General Electric Co.

## Don't miss this one—smallest 50 mW, 2-amp relay on the market

It just takes 50 milliwatts to operate this extra small, 2-pole, 2-amp relay.

Size-wise, this newest GE 150-grid relay is only 0.32" high, 0.31" wide, 0.61" long. And, it meets or exceeds MIL SPEC environmental, electrical requirements.

Micro-electronic circuit

## Check these Darlington amplifiers for high gain

GE D16P monolithic Darlington amplifiers (D16P1, 2, 2N5305-8) with current gains as high as 70,000 are available in 2 housings. They offer dissipation capability of 400 mW or (with heatsink package) 900 mW.

D16P's high gain is ideal for preamplifier input stages requiring input

## Nickel-cadmium batteries are rechargeable—last hundreds of times longer

Get lasting battery power and versatility suitable for many commercial and consumer applications. Types include sealed, pressure-relieved, and vented cells. Custom designs to your specifications are also available.

Nominal ratings range from 0.1 amp-hours to 4.0 amp-hours in sealed

## New catalog has full information on GE panel instruments

What's your special requirement for panel instruments? Taut band suspension, special scales or colors, one percent accuracy?

Check General Electric—we're now offering the biggest selection of sizes, ratings, and models ever!

The new GE catalog, GEC-1076, gives you



Model 5BLG32HA1  
(3.4" dia, 4.28" long)

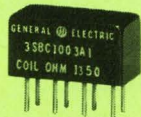

Actual size

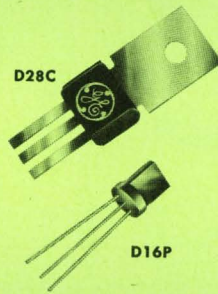

D28C

D16P



than standard d-c industrial motors.

Fast, repeatable acceleration is easy with: **low** rotor inertia, armature circuit inductance, resistance; **high** torque-to-inertia ratio, constant torque-per-ampere relationship, voltage constant. Circle **Number 236**.

### Model 5BLG32HA1

Rated Armature Voltage	12 volts
Current	8 amps
Rated Torque	32 oz-in.
Rated Speed	2700 rpm
Rated Output	64 watts
Shunt Field	PM shunt
Arm. Circuit Inductance	82 $\mu$ H
Resistance	.43 ohms
V Constant	.0291 V Sec./Rad
Torque Constant	4.0 oz-in./amp
Arm. Inertia	.0028 oz-in. Sec <sup>2</sup>
50 Milliseconds Pulse Torque	320 oz-in.
Pulse Current	80 amps
Time Constant	
Inertial	9.0 ms
Inductive	.19 ms
Torque/Inertia @ Rated V	40,000 Rad./Sec <sup>2</sup>
Continuous RMS Current Rating	8 amps

applications are ideal for this relay because of its low operate power and compatible size.

Like all GE 150-grid relays, this 50 mW version is available with options. You can choose coil ratings for a wide range of system voltages, plus popular mounting forms and header types.

Want more facts? Circle **Number 237**.

impedances of several megohms.

GE's D28C monolithic power Darlington also offers very high gain (60,000 typical at 200 mA) with higher power and current ratings. Dissipation is 1.2W in free air and 4.0W at 70C case. Continuous IC is 500 mA.

The high gain affords virtually unlimited applications including: power transistor drivers, touch switches, oscillators, amplifiers and buffers, plus audio output stages for TV, radio, and other audio equipment. Circle **Number 238**.

cells and up to 160 amp-hours in vented types at the one-hour rate.

GE nickel-cadmium cells feature unique construction providing a very high discharge rate capability. To find out more, Circle **Number 239**.

prices, technical and ordering information on the full line of General Electric panel meters, meter relays, controlling pyrometers and other related components. It also describes a sales and service army that backs up all your **SPECIAL** requirements. To order your free copy, Circle **Number 240**.

FOR THE NEW IDEAS IN ELECTRONICS, look to General Electric—your best single source for electronic components

ELECTRONIC COMPONENT SALES OPERATION

GENERAL  ELECTRIC



# PROGRESS REPORT

*We invite you to join our growing list of customers who are specifying the quality levels of the ceramic substrates needed for the particular application.*

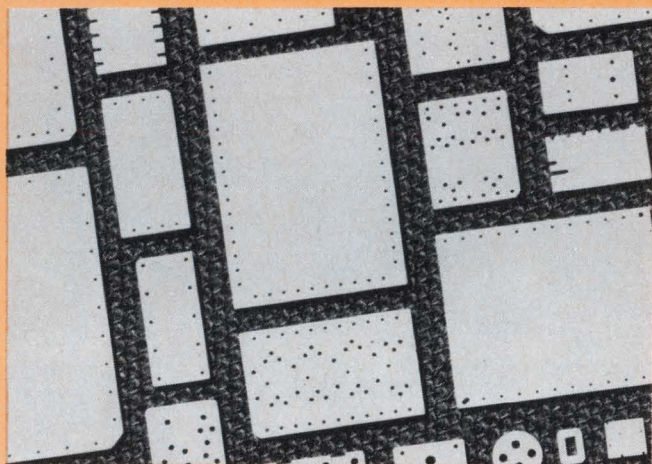

Parts illustrated approximately 3/4 size.

You can eliminate both the risk of ordering parts which may not be useable, and the cost of writing your own specs, by sending for your copy of American Lava's AISiBase Substrate specifications today.

American Lava has been the leading supplier of ceramic substrates since pioneering them in the early 1950's. Certain standards have emerged from large volume production over this span of years.

It is now apparent that the industry can benefit from

the establishment of Class A, Class AA and Class AAA AISiBase Substrates and Snap-Strates. Specifications and AQL's for the three grade levels are based on MIL Standard 105, latest revision, Level II. Multiple normal sampling will apply.

AISiBase Substrate Specification Sheets give details of quantity, delivery, size range, tolerances on dimensions, holes, camber, visual defects, and other pertinent data. These sheets can save you money by helping you specify the lowest class level which can meet your specific needs.

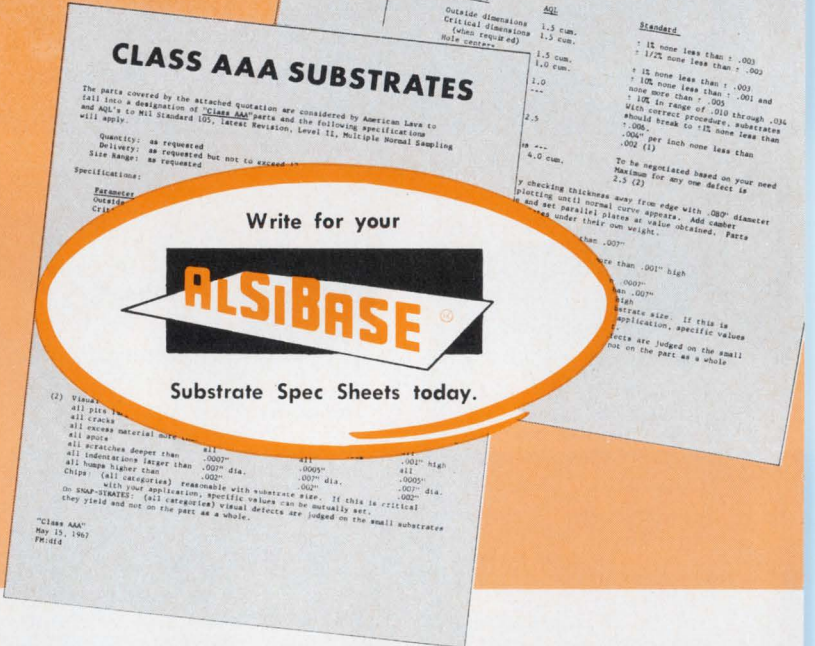
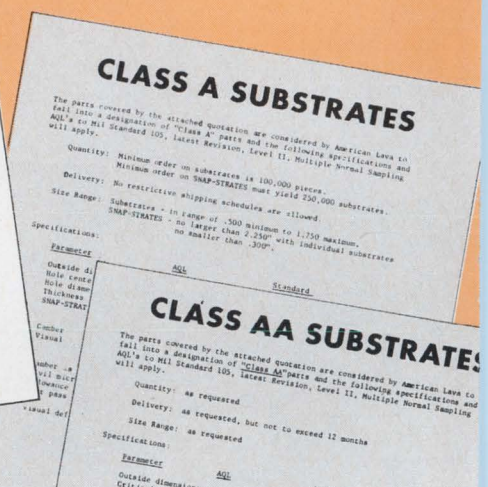

**American Lava Corporation** **3M COMPANY**  
 A SUBSIDIARY OF  
 PHONE 803/682-3215, LAURENS, S. C. 29360  
 or 615/265-3411, CHATTANOOGA, TENN. 37405



CODE IDENT. NO. 70371

For service, contact American Lava representatives in Offices of Minnesota Mining and Manufacturing Company in these cities (see your local telephone directory): Boston: Needham Heights, Massachusetts • Chicago: Glen Ellyn, Illinois • Cleveland, Ohio • Dallas, Texas • Laurens, S. C. • Los Angeles, Calif. • Metropolitan New York: Ridgefield, N. J. • Up-State New York and Canada: Baldwinsville, N. Y. • Orange, Conn. • Philadelphia, Penna. • Roanoke, Virginia • St. Louis: Lee's Summit, Missouri • So. San Francisco, Cal. • Troy, Mich. • 3M International: c/o American Lava Corp., Chattanooga, Tenn. 37405, U.S.A., 615/265-3411



---

**Commentary**

---

## One-way street to a dead end

The electronics industry has always taken big risks to move innovations out of R&D and into the payoff stage. Eventual profit—in commercial or Government business—is the spur. Traditionally, the Pentagon has not objected to reasonable profit for its contractors, but the Government—concerned about “war profiteering”—has devised a one-sided policy of controls. Most irritating is the firm, fixed-price contract in which the contractor and the Government agree to a set price at the outset. The businessman goes out on a limb by signing such a contract. If his cost estimates are accurate he will make money; if they aren't, the Government will not guarantee him a profit.

Most contractors are willing to take their chances under this arrangement. What angers them are the post-award audits calculated to protect the Government against error in procurement. It's a one-way street they say. If an audit turns up a case of higher-than-normal profit, new controls are added to stem the “leak.” The result, contractors complain, is an unwieldy patchwork-system of controls that encourages disputes and misinterpretations. The audit, they contend, could have been made before the contract was awarded.

Robert M. Ward, president of the Western Electronic Manufacturers Association, said recently, “Whether the Government needs a microwave radar tube for missile detection or a laser for research in cancer treatment, it should have the most reliable, effective product available. Yet, quality producers are becoming so beleaguered by the conditions imposed on selling to the Government that their shareholders are questioning not only the profitability of accepting Government contracts, but the wisdom of even selling standard commercial items.”

Nonetheless, a number of firms, badly burned by Government defense contracts, are still obliged to enter into them under the Defense Production Act.

At the same time that the Department of Defense has held down profits, industry's capital investment for defense business has rocketed. Profits have dropped from greater than 10% of total capital investment in 1958 to less than 7% in 1966. Companies may be willing to sell the Government products that they are making in the normal course of commercial business, but are understandably reluctant to embark upon hazardous R&D projects. In particular, firm, fixed-price contracts aren't worth the high risks involved.

As profits on defense business decline, contractors not involved with the Government enjoy profits well above 10% of total capital investment.

Those firms that have forsaken the defense market to concentrate their sales to the Government's civilian agencies—for projects such as water and air pollution control, transportation, and urban renewal—find that Pentagon-

style procurement policies continue to plague them.

A study conducted by the Logistics Management Institute for the Department of Defense pinpoints several changes urged by defense contractors. Significantly, the study suggests backing off on controls for high-risk projects.

Many contractors have another complaint—they feel that the Pentagon contract supervisors ignore the importance of the profit motive. Their tendency, the contractors note, is to make profit-cutting one of their primary functions. Furthermore, contractors say that DOD negotiators are unduly influenced by recommendations of the Defense Audit Agency.

Being accused of profiteering at the expense of the public may wound a contractor, but being subjected to straitjacket controls in a high-risk environment could be fatal. Without the profit motive, the attitude toward risk-taking could degenerate to that of many European companies whose governments stifle competition and innovation.

## Show and tell

Shows like the IEEE provide an atmosphere in which the attendee can relax and be more objective about his job. Suddenly, problems that seemed unsurmountable don't seem so bad.

Today, few marketing executives consider the show as a place to write orders. This is not to say that some companies don't do a land-office business; a few semiconductor makers have installed tie-lines from booth to plant just to handle the load.

But more and more firms are considering the show as an educational experience. Oddly enough, the Europeans and Japanese have taken the lead [see story on page 82]. In 1962, for example, Sony unveiled its first video tape recorder at what was then the IRE show. Using comments gathered at the show, it developed the first commercial model and began delivering units a year later.

This year Sony hopes to do the same thing with a new magnetic scale that may help it crack the numerical control market in a wide variety of applications. Again, Sony will use showgoers' reactions to the prototypes as a guide to the development of its entire product line—a series of scales featuring linear and rotary models plus a digital counter for readout.

One German marketing executive views the show as a big gathering of specialists who come to discuss their problems. “We are there to see how those problems can best be solved and get a good feel of what's required in the future,” he says.

A British firm whose first crack at the IEEE show was last year, is back again to learn more about the U.S. market. The firm says that inquiries from the show were better than those at recent European shows.

All told, about 70 exhibitors from foreign countries will participate. Japan leads with 21 exhibitors; Canada will have 16; and West Germany and Denmark 11 each.



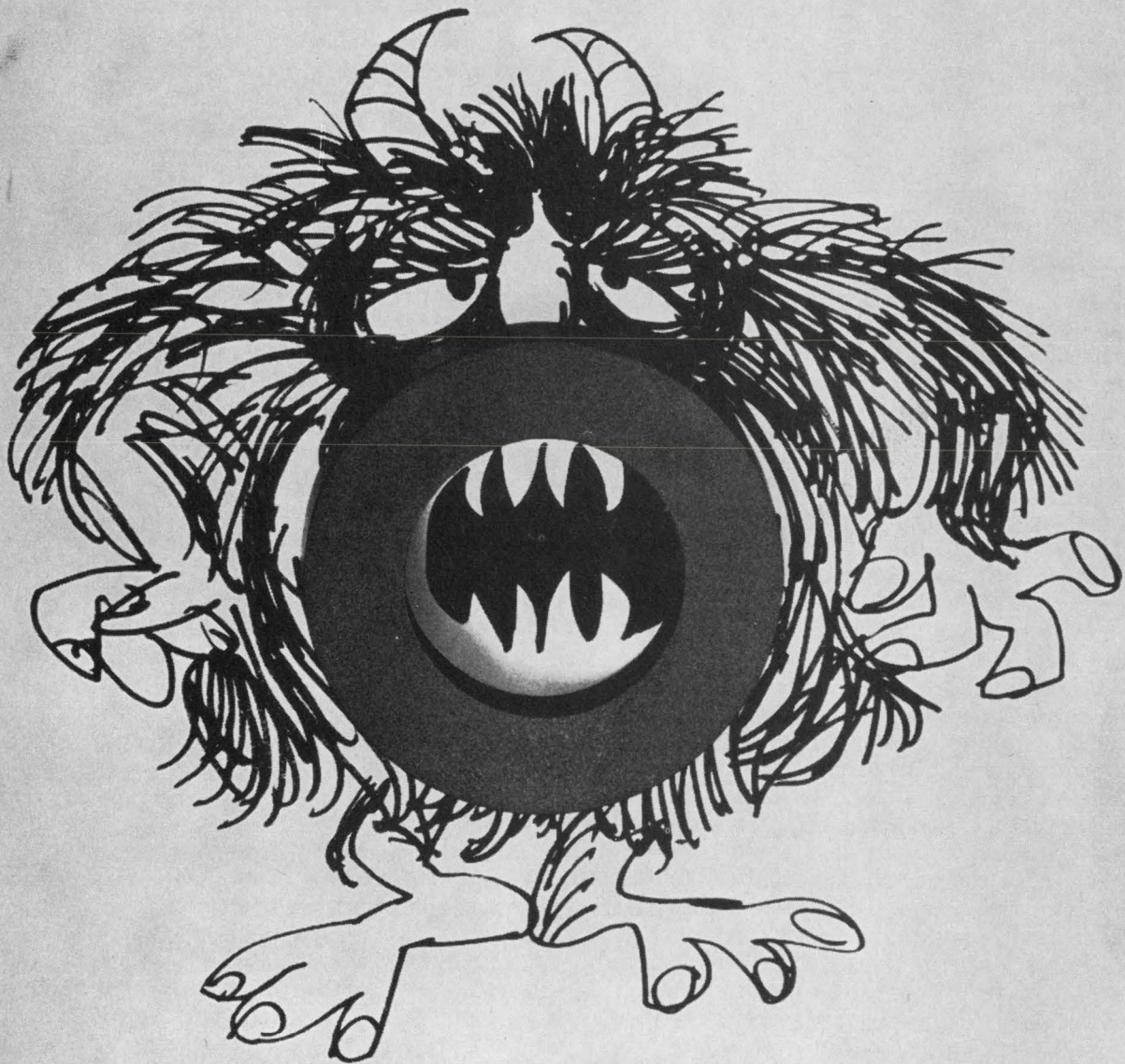

## Toroid selection for pulse transformers used to be a nightmare.

But our ferrites have changed all that.

They're Pulse-Rated. A first for the industry.

The only toroids with specified characteristics for pulse transformer applications. Not just the usual irrelevant magnetic properties. Each part is designated as a pulse component, and listed by its pulse inductance, pulse magnetizing current and ET

product, according to ASTM methods.

We also guarantee all parameters. Every pulse transformer toroid we make is 100% tested. Performance reliability is assured from samples to production quantities. We make use of automatic high speed testers to guarantee these parameters.

It marks the end of trial and error spec'ing.

Especially for computer applications. The 230 mil diameter core is just the first in our series of PR toroids.

For literature or samples of our new PR toroids, write Indiana General Corporation, Electronics Division/Ferrites, Keasbey, N. J. Pleasant dreams.

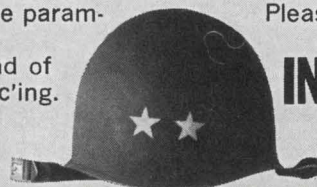

**INDIANA GENERAL**

Making Magnetics Work



---

# Electronics Newsletter

---

March 4, 1968

## TRW-RCA rivalry boosts transistors' power capabilities

Power ratings and operating frequencies of radio-frequency transistors are getting a lift from heightened competition between the backers of interdigitated and overlay approaches. TRW Semiconductor is now ahead in the combined ratings battle, with its interdigitated power transistors, but the RCA Electronic Components division is about ready to challenge that lead with an overlay design.

TRW aims to unveil a 5-watt, 2-gigahertz interdigitated transistor at the IEEE Show, and hopes to have units handling 15 watts at 1 Ghz and 1 watt at 3 Ghz available by late spring. RCA is shooting for the introduction by midyear of devices handling 100 watts at 76 Mhz, 8 watts at 2 Ghz, and more than a watt at 3 Ghz.

In terms of power-frequency product, interdigitated transistors such as a TRW device handling 50 watts at 500 Mhz lead the race, but state-of-the-art overlays hold the separate records for highest power and highest frequency [Electronics, Feb. 19, p. 98]. And a TRW spokesman concedes that the firm had to derate the gain figure for its 50-watt transistor by 20% when production runs showed the device to be "not quite as hot" as originally thought.

## Siliconix has MOS, bipolar chipmates

What appears to be the industry's first commercial monolithic integrated circuits combining bipolar and metal oxide semiconductor transistor elements have been developed by Siliconix. In producing these linear chips, the company has gained the lead over a number of large IC makers in the race to market the long-awaited field effect-bipolar combination [Electronics, Nov. 13, 1967, p. 25, and Dec. 25, 1967, p. 25]. The monolithics, a gating-type analog driver switch and an integrator, contain npn and pnp bipolars, p-channel MOS FET's, zener diodes, and resistor elements.

Siliconix plans to market the devices this spring, as direct plug-in replacements for the hybrid IC versions it introduced last year. Aside from the electrical advantages offered by the active-element combination, the prime benefit of the monolithic form will be lower cost.

## Whiskers shave memory cycle time

A new family of computer systems that the National Cash Register Co. will announce this week contains high-speed memories built around metal "whiskers"—improved versions of the company's thin-film rod memories—and magnetic disk storage units that are part of the computer. Logic in the new line, called the 615 series, is provided by monolithic integrated circuits.

## Navy calls Phoenix antimissile missile

The Navy claims the Phoenix antiaircraft missile also has an antimissile capability. If this capability can be proved, the Phoenix could be used to counter the Soviet's Styx missile, a medium-range weapon that may be deployed worldwide, and a Soviet bomber-carried stand-off missile that may be introduced.

Egypt used a Styx to sink an Israeli destroyer late last year, and U.S. reports say North Vietnam has some of the missiles. If the stand-off missile works like the U.S. short-range attack missile (SRAM), a Soviet



---

# Electronics Newsletter

---

bomber would be able to release a nuclear payload while out of range of anti-aircraft batteries.

Hughes Aircraft is building the Phoenix for the Navy's controversial F-111B. Now that it appears that the F-111B will be dropped, the Phoenix is expected to go on a less costly fighter [Electronics, Feb. 5, p. 60].

## Airbus rivals split on avionics buying

The two giant plane manufacturers flying the Great Airbus Race—McDonnell Douglas with its DC-10 and Lockheed with its L-1011—have taken different routes to avionics procurement. Lockheed, apparently undismayed by Douglas' \$400 million sale of 25 DC-10's to American Airlines, is going ahead with plans to give one firm the job of integrating and installing the L-1011 avionics gear. Requests for bids on this tall order are now being prepared. Douglas is following conventional procedure and doing its own avionics buying.

## CATV firms riled by microwave ban

The FCC's latest CATV ruling is heating up the long feud between the agency and its critics in both the cable television industry and Congress. The decision, which prohibits the industry from setting up any new microwave relay facilities in the 4- and 6-gigahertz bands, is considered by many a further move to protect the broadcasters. The CATV industry and the three FCC commissioners who dissented say the order will restrain technological development and make the use of microwave frequencies more expensive for cable tv firms.

Besides assigning new frequencies—10.7 to 11.7 Ghz—to the community antenna relay service, which transports cable-system tv signals, the FCC has directed CATV firms to hold off on any new microwave relays until the commission has ruled on the industry's bid to establish a network to relay original programs.

## It's still all relative, even on fourth try

Scientists at the MIT's Lincoln Laboratory have established a fourth proof of Einstein's general theory of relativity—the first proof that was not suggested by Einstein himself. Using a 400-kilowatt, 7.84-gigahertz radar installed at the Haystack astronomy facility near Tyngsboro, Mass., a group of eight scientists carefully tracked the planet Mercury as its orbit took it behind the sun. They were looking for an increase of about  $\frac{1}{2}$  millisecond in the radar pulses' round-trip time as the beam brushed past the limb of the sun.

They found it. In experiments conducted in spring and late summer of 1967, the sun's gravitational field not only reduced the propagation speed of the radar pulses, but bent the beam slightly, thus increasing path length and travel time.

## Dozen bids expected on new postal order

A dozen electronics companies are expected to bid on a new type of the Post Office's facer-canceler machine that automatically turns letters to the address side and cancels the stamp. The cancelers would replace Pitney-Bowes units that are partly hand-fed; Post Office officials are understood to be unhappy with the \$24,000 price tag on these machines. They hope a new development effort will yield a lower-priced, fully automatic machine suited to a postal "production line" that will include optical Zip Code and address readers and sorters.



# THIS FREE NEW OPERATIONAL AMPLIFIER HANDBOOK WILL HELP YOU SOLVE APPLICATION PROBLEMS THREE WAYS:

- 1 **REFERENCE SECTION** — Written by op-amp experts. Includes up-to-date theoretical and practical data on the proper selection and application of operational amplifiers. Invaluable aid to the engineer designing with op-amps.
- 2 **SELECTION GUIDELINES** — Selection of the proper amplifier for every application is made easy. A new series of handy graphs show at a glance the interactions of various key parameters and how they affect circuit performance.
- 3 **PRODUCT CATALOG** — Complete specifications (including prices) on hundreds of operational amplifiers and accessories. Many new products appear for the first time in print. An op-amp for virtually every application can be found here.



## AMONG THE NEW PRODUCTS IN THIS CATALOG

<b>FAST CHOPPER STABILIZED AMPLIFIERS</b>	0.2 $\mu$ V/ $^{\circ}$ C and 0.5pA/ $^{\circ}$ C, .01% settling in 1 $\mu$ s, \$165
<b>LOW DRIFT CHOPPERLESS DIFFERENTIALS</b>	1.5 $\mu$ V/ $^{\circ}$ C, \$65; 3 $\mu$ V/ $^{\circ}$ C, \$45; 1 $\mu$ V p-p noise
<b>ECONOMY FOUR-QUADRANT MULTIPLIER</b>	400 kHz, 0.25% linearity, \$165
<b>ACTIVE LOW-PASS FILTERS</b>	1 to 1000 Hz, 80db/decade attenuation, 20 $\mu$ V/ $^{\circ}$ C, \$75
<b>LOW COST OP-AMP POWER SUPPLIES</b>	miniature pc mounting, $\pm$ 15Vdc @ 40mA, \$39 (10 lot)

### INSTANT

MAIL THIS POSTAGE PAID CARD DIRECTLY TO ANALOG DEVICES AND YOUR HANDBOOK WILL BE ON ITS WAY TO YOU WITHIN 3 DAYS.

### ACTION

## BUSINESS REPLY MAIL

No postage stamp necessary if mailed in the United States

POSTAGE WILL BE PAID BY



**ANALOG DEVICES INC.**  
221 FIFTH STREET,  
CAMBRIDGE, MASS. 02142

AIR MAIL  
Permit No. 39342  
Cambridge, Mass.

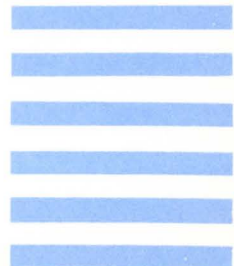



# DON'T BUY FET OP-AMPS UNTIL YOU'VE SEEN THESE

Best performance per dollar you can buy!

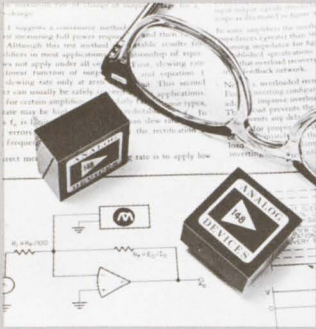

Analog Devices now announces a complete new family of FET operational amplifiers.

These amplifiers are the result of extensive research and the application of today's most sophisticated components and design techniques. They offer by far the most performance at the lowest cost of any FET op-amps presently on the market.

All models are in stock and evaluation samples are available.

## LOWEST COST

\$25 unit price

Low cost FET types from \$25 are best values where CMRR, voltage drift and speed are not critical. Low price tag brings good FET performance to many new applications where high cost of previously available FET op-amps has been the major limitation.

## BEST SPECS

$2\mu\text{V}/^\circ\text{C}$ ,  $3 \times 10^5$  CMRR

High gain, fast response, lowest voltage drift and best CMRR are outstanding features of models 143 and 147. Chopper stabilized types can often be replaced by these models where low drift and differential inputs are required.

## FAST SETTLING

0.01% accuracy  $< 1\mu\text{s}$

Fast settling time of models 148 and 149 make them ideal op-amps for A/D and D/A converters, sample-and-hold circuits, and other applications where speed is the most important parameter. 0.01% settling time of  $1\mu\text{s}$  is the fastest available anywhere.

MODEL
OPEN LOOP GAIN
RATED OUTPUT ( $\pm 10\text{V}$ )
FREQUENCY RESPONSE
Unity gain, small signal
Full power response, min.
Slewing rate, min.
Overload recovery
Settling time to 0.01%
INPUT IMPEDANCE
CMRR
TYPE
VOLTAGE DRIFT ( $\mu\text{V}/^\circ\text{C max.}$ )
$I_{\text{bias}}$ @ $25^\circ\text{C}$ (pA max.)
PRICE (1-9)

	141	142
OPEN LOOP GAIN	$8 \times 10^4$	$8 \times 10^4$
RATED OUTPUT ( $\pm 10\text{V}$ )	2mA	20mA
FREQUENCY RESPONSE		
Unity gain, small signal	3MHz	5MHz
Full power response, min.	50kHz	150kHz
Slewing rate, min.	$3\text{V}/\mu\text{s}$	$10\text{V}/\mu\text{s}$
Overload recovery	1.4ms	1.5ms
Settling time to 0.01%	—	—
INPUT IMPEDANCE	$10^{11}\Omega$	$10^{11}\Omega$
CMRR	1000	2000
TYPE	A B C	A B C
VOLTAGE DRIFT ( $\mu\text{V}/^\circ\text{C max.}$ )	75 40 25	50 25 15
$I_{\text{bias}}$ @ $25^\circ\text{C}$ (pA max.)	50 30 30	50 30 30
PRICE (1-9)	\$25 \$30 \$35	\$30 \$40 \$55

	143	147
OPEN LOOP GAIN	$10^5$	$10^6$
RATED OUTPUT ( $\pm 10\text{V}$ )	20mA	10mA
FREQUENCY RESPONSE		
Unity gain, small signal	5MHz	10MHz
Full power response, min.	100kHz	150kHz
Slewing rate, min.	$7\text{V}/\mu\text{s}$	$10\text{V}/\mu\text{s}$
Overload recovery	1.5ms	400 $\mu\text{s}$
Settling time to 0.01%	—	—
INPUT IMPEDANCE	$10^{11}\Omega$	$10^{12}\Omega$
CMRR	40,000	300,000
TYPE	A B C	A B C
VOLTAGE DRIFT ( $\mu\text{V}/^\circ\text{C max.}$ )	30 15 7	15 5 2
$I_{\text{bias}}$ @ $25^\circ\text{C}$ (pA max.)	30 15 15	30 15 15
PRICE (1-9)	\$55 \$65 \$90	\$95 \$115 \$135

	148	149
OPEN LOOP GAIN	$3 \times 10^4$	$10^5$
RATED OUTPUT ( $\pm 10\text{V}$ )	20mA	15mA
FREQUENCY RESPONSE		
Unity gain, small signal	10MHz	15MHz
Full power response, min.	500kHz	1.5MHz
Slewing rate, min.	$50\text{V}/\mu\text{s}$	$100\text{V}/\mu\text{s}$
Overload recovery	15 $\mu\text{s}$	0.5 $\mu\text{s}$
Settling time to 0.01%	1 $\mu\text{s}$	1.5 $\mu\text{s}$
INPUT IMPEDANCE	$10^{11}\Omega$	$10^{11}\Omega$
CMRR	2000	15,000
TYPE	A B C	A B C
VOLTAGE DRIFT ( $\mu\text{V}/^\circ\text{C max.}$ )	50 25 15	30 15 7
$I_{\text{bias}}$ @ $25^\circ\text{C}$ (pA max.)	50 30 30	30 15 15
PRICE (1-9)	\$42 \$47 \$62	\$75 \$85 \$105

## INSTANT ACTION REQUEST

### Please send:

- 36 page operational amplifier catalog
- DATA SHEET
- EVALUATION SAMPLE
- FET Model (s) \_\_\_\_\_
- New Chopper Series
- Low Drift Differentials
- Four Quadrant Multiplier/Divider
- Active Low Pass Filters
- Op Amp Power Supply

### My interest is for:

- Immediate application
- Anticipated application
- Information only

- I am now using \_\_\_\_\_ Quantity per year
- Operational Amplifiers  1-50
- I expect to be using \_\_\_\_\_
- Operational Amplifiers  50-250
- Over 250

My principal source of supply is \_\_\_\_\_

- Please add my name to AD mail list

Name \_\_\_\_\_ Title \_\_\_\_\_

Company \_\_\_\_\_

Dept./Mail Station \_\_\_\_\_ Phone \_\_\_\_\_

Address \_\_\_\_\_

City \_\_\_\_\_ State \_\_\_\_\_ Zip \_\_\_\_\_

FILL IN THIS AIR MAIL POSTAGE PAID INSTANT ACTION CARD FOR YOUR FREE NEW HANDBOOK, ADDITIONAL LITERATURE, OR EVALUATION SAMPLES.



221 Fifth Street,  
Cambridge, Mass. 02142  
617/492-6000



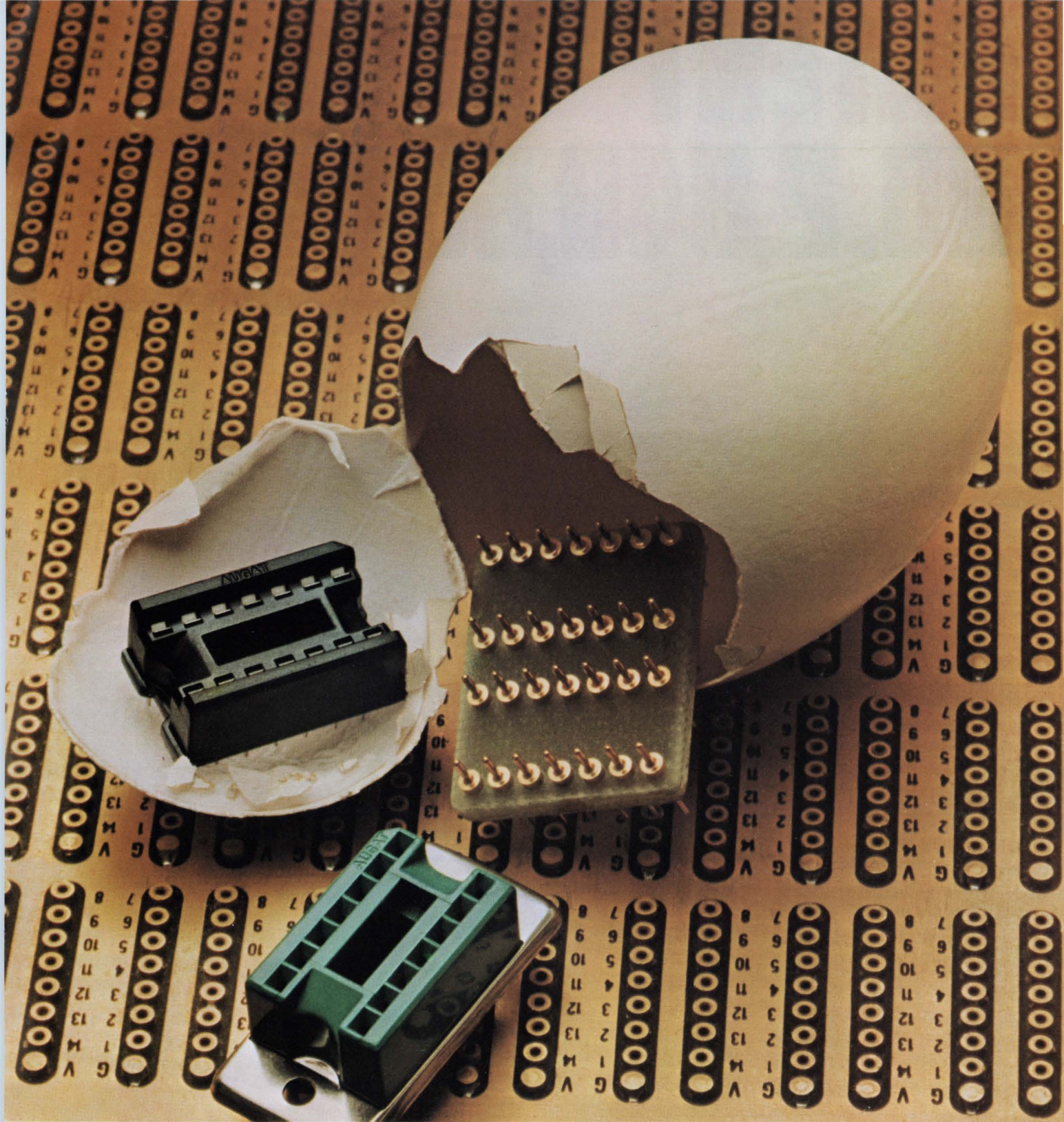

# Get fresh thinking

Try Augat Creative Ideas On Your IC Packaging Problem

Actually we're old timers when it comes to handling IC's . . . been in the business since the beginning . . . all of three years. We work closely with the IC producers in developing our line. That's why we have sockets tooled and available when the producers announce new packages. We keep our sockets and panels simple . . . produce them efficiently. Maybe that's why our

prices are right. Augat has over 40 stocking distributors backed by technical representatives strategically located throughout the country. Why not find out which one is in your area. Our experience can save you a few headaches and a lot of money. Tel. 617/222-2202 or write for our complete IC folder. Augat Inc., 30 Perry Ave., Attleboro, Mass. 02703.

**AUGAT**.INC.

← Circle 28 on reader service card

IEEE Booth Nos. 4H12-4H14.

Circle 29 on reader service card



# **PATENT NO. 2,840,657**

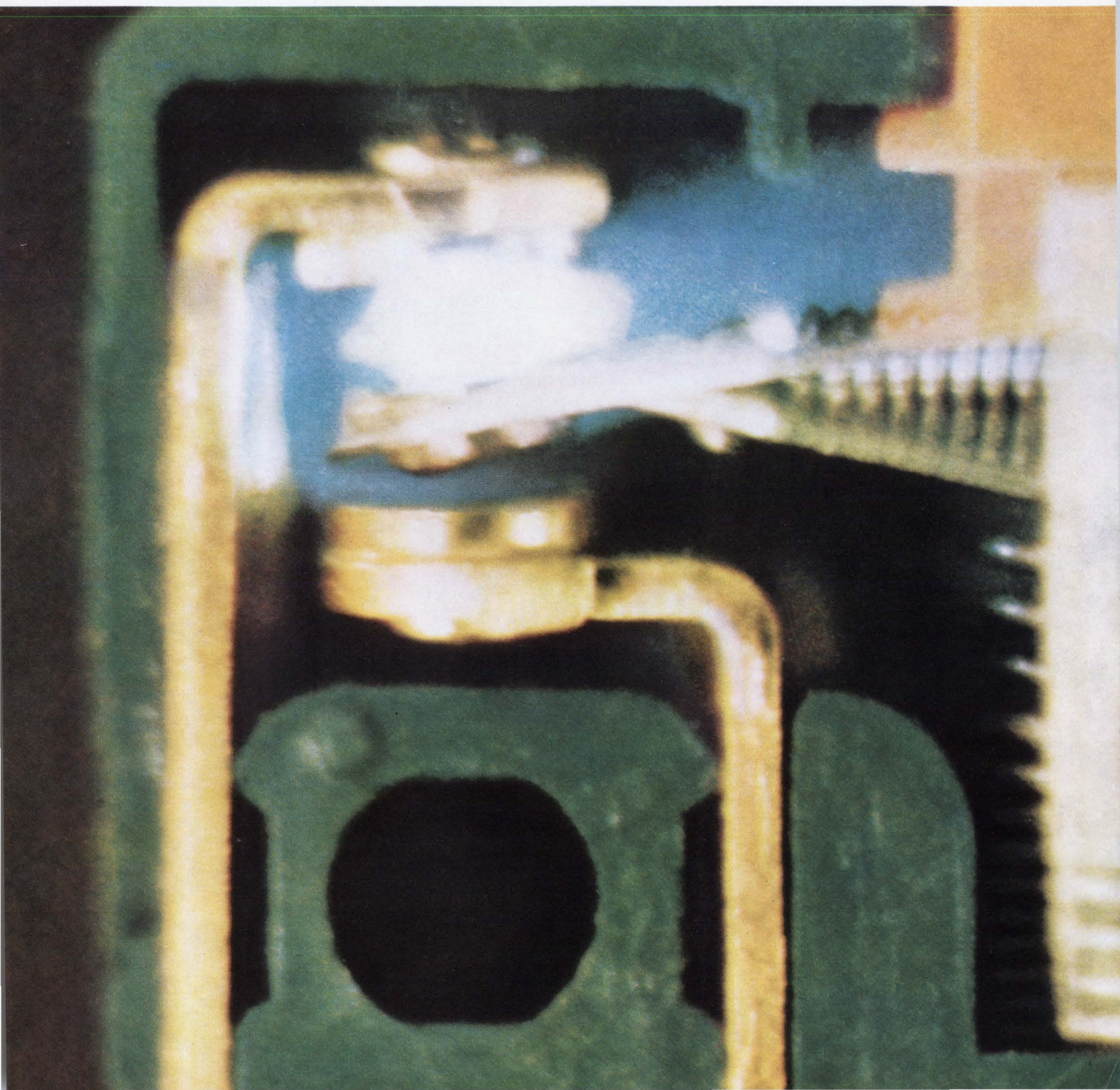



"Impossible!" people said. "Companies that are bigger than Licon and older than Licon can't do it—why, it's just like trying to put ten pounds of features in a five pound container!"

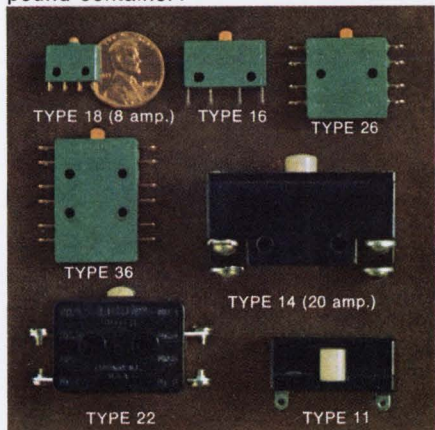

We took a lot of kidding. Then, after a lot of hard work, we took our design to the U. S. Patent Office. They don't kid around: If it's completely different, totally unique, you get what you came for. That's what happened: Patent No. 2,840,657.

We also took the photograph below (TYPE 16 nearly 400 times actual size) to show the impossible in action. Then we started supplying just about every engineer around with the switch that size-for-size has twice the advantages of the "standard" single break switches.

A Licon Butterfly® Double Break Switch gives you twice as many contact gaps, twice as many contact surfaces, two transfer blades instead of one. *Double everything* (and, generally speaking, that includes *double the electrical rating*) in the same size package. (If necessary, you can even control two isolated electrical cir-

# LICON

cuits with a single switch.)

Even when subjected to extremes of vibration and shock, this exclusive Licon design gives substantially longer life: *twenty million* mechanical cycles without alteration of original switch characteristics!

The complete double break switch story—and the wide range of sizes available—would fill a book. So we wrote one. You can get a free copy by return mail just by writing on your company letterhead to: LICON, Division Illinois Tool Works, Inc., 6615 West Irving Park Road, Chicago, Illinois 60634.



Circle 31 on reader service card

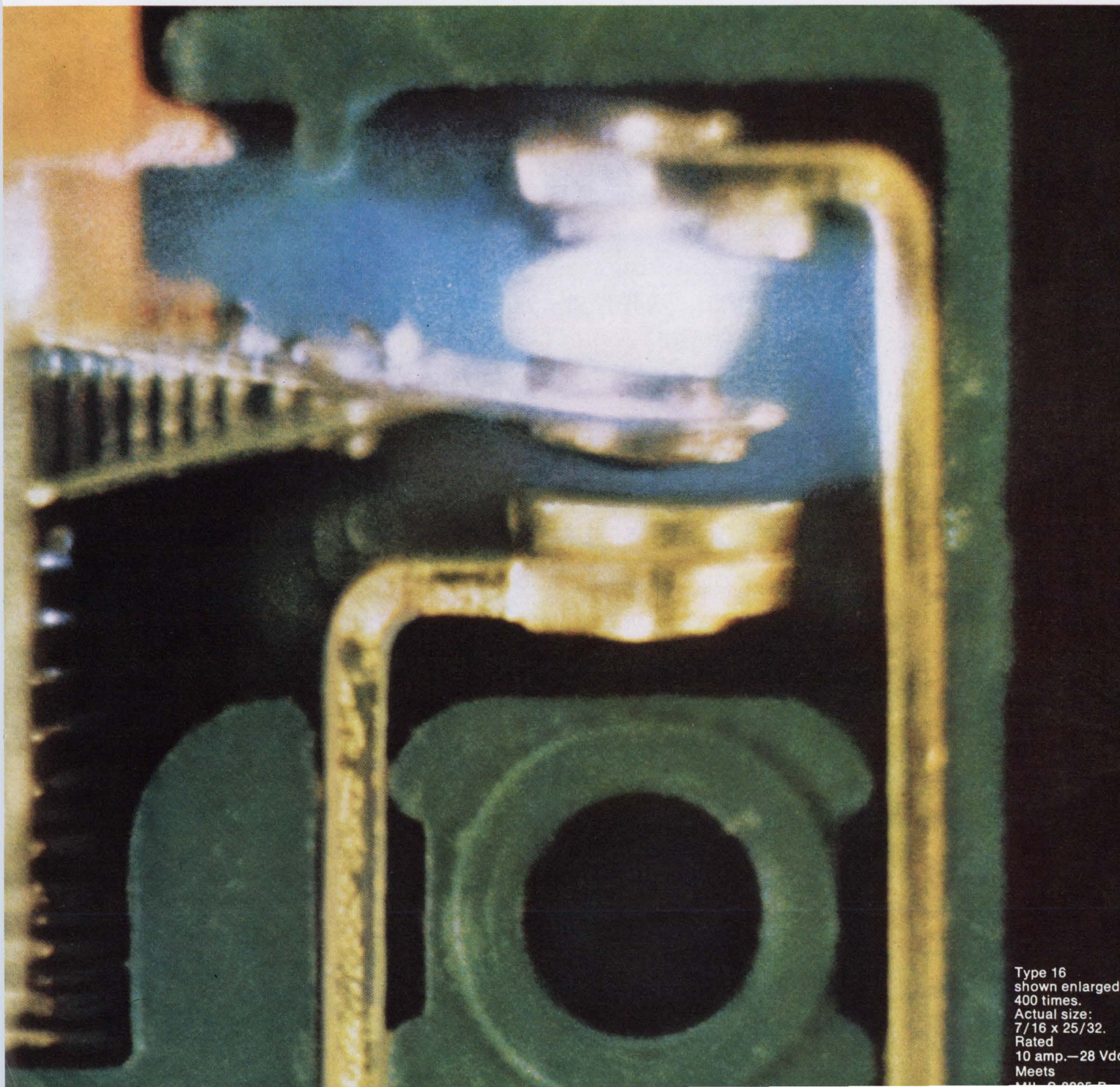

Type 16  
shown enlarged  
400 times.  
Actual size:  
7/16 x 25/32.  
Rated  
10 amp.—28 Vdc  
Meets  
MIL-C-8895 B



# We figured that if we couldn't change the Universal Amplifier Concept we would just go fly a kite.

In 1752 Ben Franklin slipped a key over a kite string and risked electrocution to prove that lightning was in fact electricity. The science of electricity has come a long way since then. Fingers and kite strings are out. And even universal amplifiers are obsolete.

This is because Amelco has developed the world's largest family of integrated circuit operational amplifiers. Now you can have greater design flexibility with optimum performance in each application. Our newest, the 809, is ideally suited for industrial applications. It is the lowest cost, high performance Op Amp available with single component compensation. And it's overvoltage and shortcircuit proof as well.

Others include the 808 ultra-low current drift and 2809 FET front end. We've got a whole string of them.

The development of this family concept is another example of our leadership and total capability in linear microcircuits. So when we say we build more types of Op Amps than anybody, you know we're not feeding you a line.

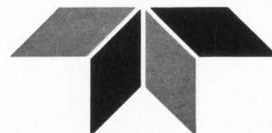

For quality in quantity  
**AMELCO SEMICONDUCTOR**

---

A TELEDYNE COMPANY

---



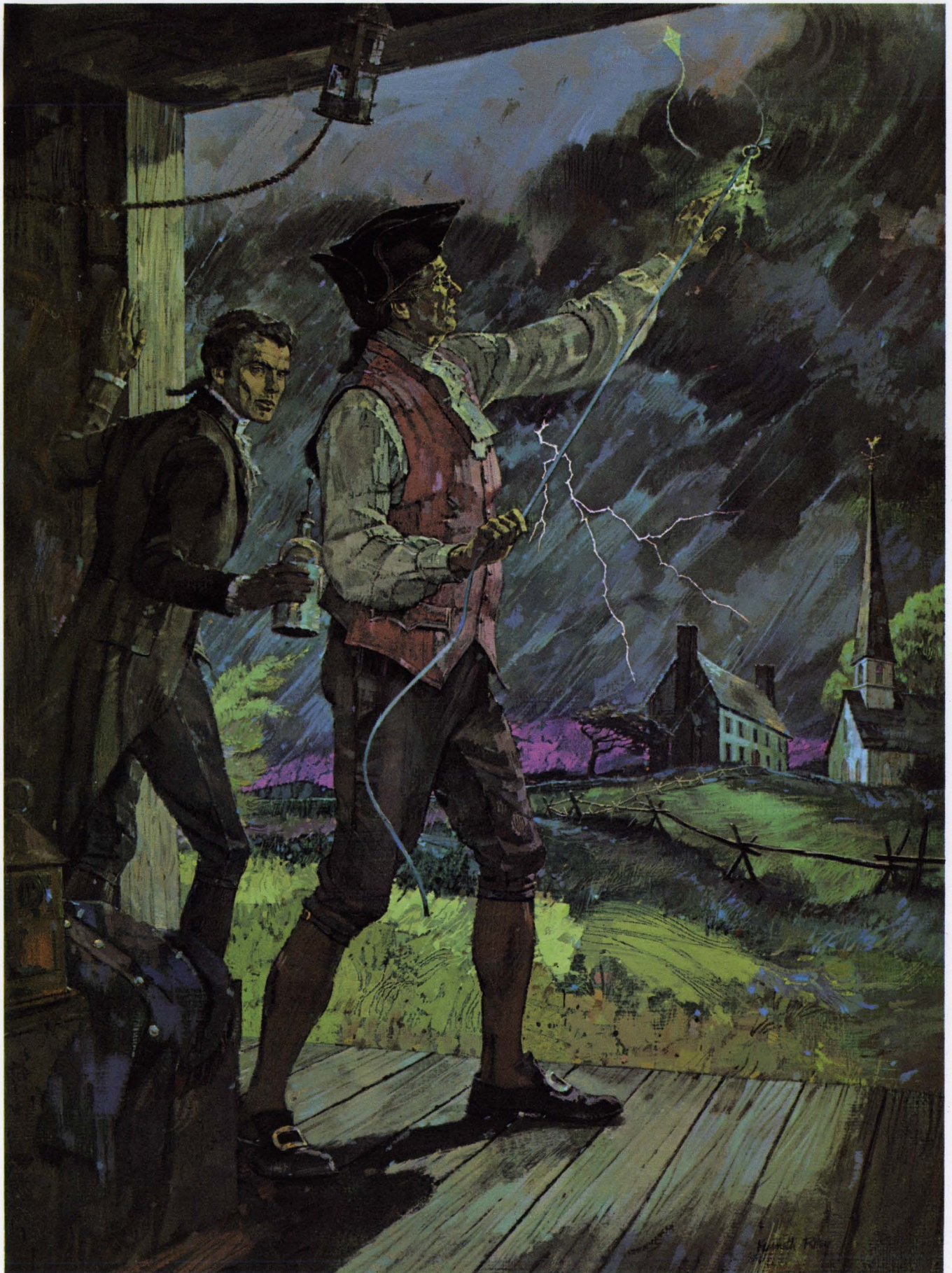

This painting by Kenneth Riley is one of the collection "Innovators and Leaders in the Science of Electricity," commissioned by Amelco Semiconductor. The paintings in this collection illustrate the dramatic achievements and discoveries of some of the forefathers of electronics . . . Magnes, Volta, Franklin, Henry, Edison, Shockley. Limited reproductions of these handsome paintings will soon be made available at \$25 apiece. They will serve as a reminder of the tradition handed down by these famous men, and as a reminder that among the leaders and innovators in the world of electronics today one name is of particular current significance. That name—Amelco.



# FETS FOR DIFF AMPS

A matched FET pair and a constant current diode...

... combined with 2 resistors will produce a high-performance differential amplifier.

The 2N5196 - 99 series of matched FETs in one package offers tracking from  $5\mu\text{V}/^\circ\text{C}$  max ... offset as low as 5mV ... input current below 15 pA. With four tracking and drift specs, one should fit your cost/performance goals.

Standard current-limiter diodes have nominal operating currents between  $220\mu\text{A}$  and 4.7 mA. There are many other uses for CL diodes besides replacing the load resistor in the diff amp circuit ... try one wherever you need a constant current source.

Want data sheets and circuits?

Contact us.

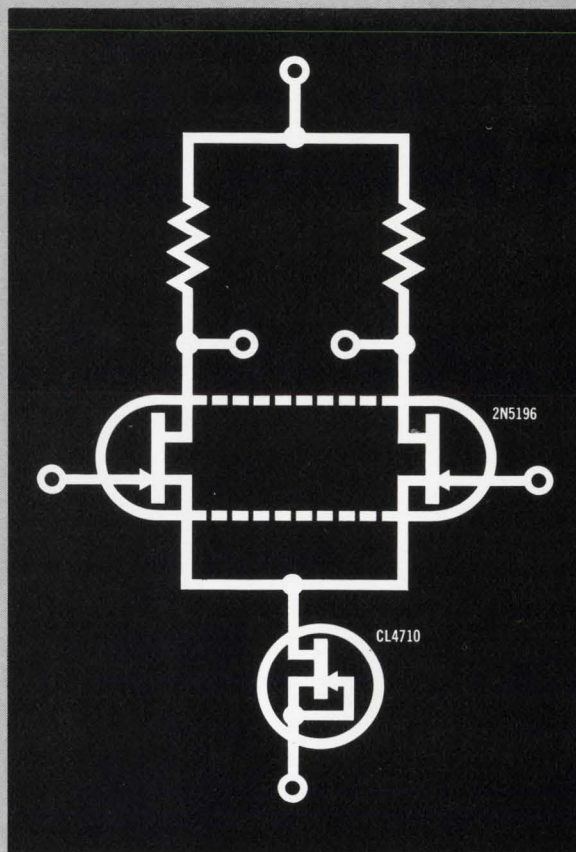

## DESIGNER KITS

DK-5 Complete range of nine CL diodes plus application data at ... [\$29.95.]

DK-7 Four matched FETs— one each of the 2N5196 - 99 series and two CL diodes at ... [\$84.50.]

Both in stock at any of our franchised distributors.

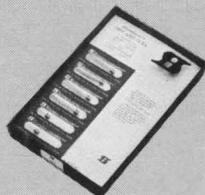

## NEW LOW COST FET TESTER

The SI200 Semiconductor Tester features plug-ins for expandable test capability, simplicity of operation, and low cost.

Price: SI200 Tester ... \$960.

Price: SI201 (DC &  $g_{fs}$ ) Plug in Module ... \$1335.

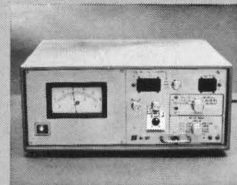

**Siliconix incorporated**

1140 W. Evelyn Ave. • Sunnyvale, CA 94086  
Phone (408) 245-1000 • TWX: 910-339-9216





## WHAT'S NEW FROM GR AT IEEE-68

**Now make impedance-comparison measurements automatically** — The new 1681 impedance comparator system is direct-reading in impedance magnitude and phase angle. Readout is digital in-line with decimal point and measurement units indicated automatically. Balancing time is  $\frac{1}{2}$  second. The 1681 is ideal for comparative-type measurements such as component matching, balancing of transformer windings, cable testing, tracking measurements of adjustable components, and reliability studies. The bridge can be easily used by unskilled personnel or can be installed as the heart of a fully automated impedance-measuring system, complete with scanners, limit comparators, computer, or many other available accessories. Magnitude differences as great as 100% and phase-angle differences up to 1 radian can be measured over a 2- to 20-megohm  $|Z|$  range. Comparisons can be made to an accuracy of 0.005%.

**The "V" in this DVM stands for versatility** — Two plug-ins and one adaptor make the 1820 DVM one of the most versatile general-purpose laboratory voltmeters available today. With the 1820 you can measure ac volts from  $10 \mu\text{V}$  to 200 V up to 1.5 GHz; dc volts from  $5 \mu\text{V}$  to 1000 V; resistance up to 50 M $\Omega$ ; dc current with picoampere resolution and ac current down into the nanoampere region. With an adaptor the 1820 becomes a fully balanced differential voltmeter, with better than 100-dB common-mode rejection. Proper polarity, units, and decimal-point location are automatically indicated. Linear or log readout can be selected. Input impedance of better than 10 M $\Omega$  for dc measurements up to 220 volts virtually eliminates errors due to loading. Basic dc accuracy is  $\pm 0.1\%$  of reading.

**New Recipromatic counter throws away the range controls** — Our new 1159 Recipromatic counter combines the resolution and speed of a period measurement with the convenience of a direct frequency readout. All you need do is plug in the unknown signal. The 1159 measures the period and automatically computes the reciprocal and displays the frequency. A full high-resolution six-digit reading is always given, regardless of the frequency being measured, as proper period multiples and clock frequency are also automatically selected by the counter's built-in computer. Full programmability rounds out the automatic virtues of the 1159. Measuring range is from 0.6 Hz to 20 MHz directly, up to 500 MHz with accessory scaler without loss in accuracy.

**A digital divider for period and delay synthesis** — The 1399 is a new high-resolution programmable digital delay generator that is also a frequency divider. With the unit's internal 10-MHz clock time delays are available from  $0.3 \mu\text{s}$  to 10 s in increments of  $0.1 \mu\text{s}$ . When the internal clock signal is replaced by an external signal between 100 Hz and 12 MHz, the instrument behaves as a frequency divider, providing frequency ratios of from 3:1 to 99,999,999:1. The divider can be used to provide a normalizing frequency for frequency-ratio counters to make them direct-reading in any desired unit or parameter, as an event totalizer and gate to make a counter read elapsed time, as a timing source for the generation of precision pulses, and as a means of measuring time interval by substitution techniques.

**Two new aids for precision time comparisons** — The 1124 Receiver is a time-signal receiver for Loran-C, WWV, and CHU transmissions. It consists of a storage oscilloscope with rf and time-base plug-ins for quick, visual time comparisons between frequency standards and transmitted time signals.

The 1125 Parallel-Storage Unit will accept on command up to 11 digits of time-of-day information in 2 microseconds, store and display the information, and transfer it to such slow-speed devices as card and tape punches or printers.

### WHAT ELSE IS NEW?

How about a totally new look in instrument design and function? What about a pair of random-noise generators that produce a *true* symmetrical Gaussian amplitude distribution? Would you like a new precision uhf bridge that fills the gap between lumped-parameter bridges and slotted lines? How about a lazy man's SWR meter? Or, maybe you'd like to see a 4-Hz to 60-kHz tunable filter that will perform as a low-pass, high-pass, or band-reject filter at the turn of a switch?

These are just a portion of the 60 products to be shown by GR at the IEEE show. Of the 60, more than half of them are brand new.

See them all at Booth 2E26-2E36.

**GENERAL RADIO**

Circle 35 on reader service card

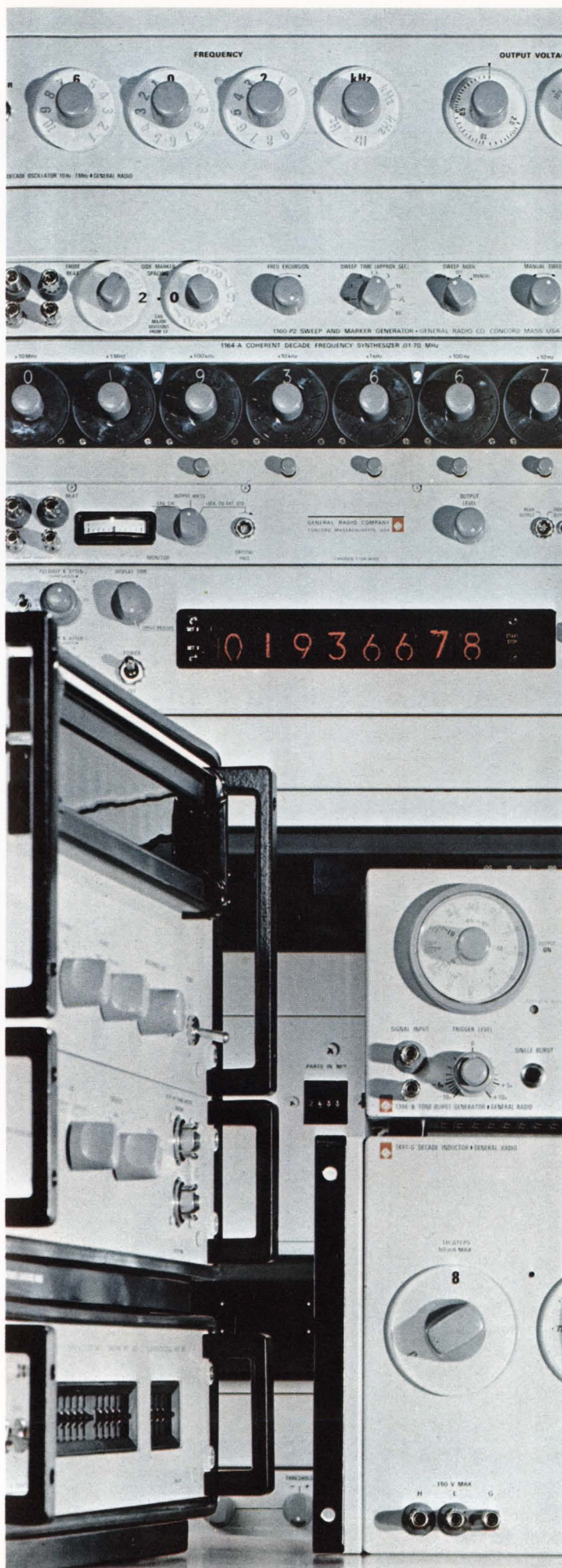



# EMI FILTER *BREAKTHROUGH*



## ERIE *115 volt ac* LINE FILTERS

**SMALLER and LIGHTER THAN ANY OTHER  
LINE FILTER AVAILABLE!**

- **DESIGNED FOR OPERATION IN . . .**  
400 Hz lines @ 85°C  
60 Hz lines @ 125°C
- **INSERTION LOSS GUARANTEED FROM . . .**  
-55°C to +125°C @ rated current
- **TYPICAL INSERTION LOSS . . .**  
30 db @ 150 kHz  
80 db @ 1 MHz and up



These hermetically sealed ERIE EMI Power Line Filters represent a substantial reduction in size and weight without sacrifice in performance through the use of a sophisticated state of the art dielectric. Most measure less than 1 inch long and weigh less than 10 grams, making these tiny Filters perfect for power supply applications where reliability, size, and weight are design considerations.

The broad line of ERIE EMI Filters economically provides optimum performance for virtually any environment. For detailed specs see your local ERIE applications engineer or write for Catalog 9000.

ERIE  
TECHNOLOGICAL  
PRODUCTS, INC.



Erie, Pennsylvania



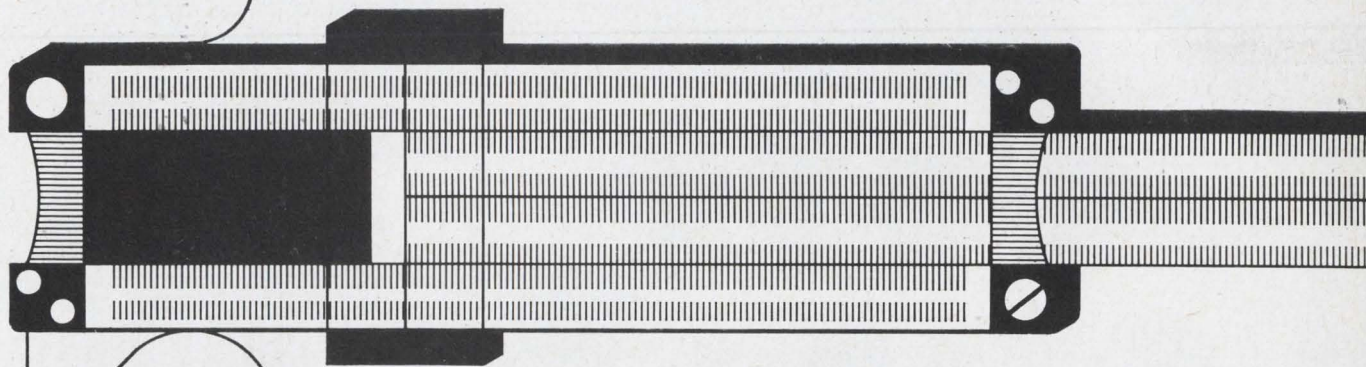

**The precision compounds deliver.**

## **Durez® phenolic, diallyl phthalate, and alkyd molding compounds**

Whether your specs call for moldability that can give you walls as thin as .050 inch, or superior heat and chemical resistance on the job, the precision molding compounds from Durez deliver.

Durez' broad line of phenolic, diallyl phthalate, and alkyd molding compounds offer the balance you want from among these key design requirements: good electrical and thermal properties, impact strength, durability, relatively low cost; heat, corrosion, and chemical resistance; flame retardance, dimensional stability, and retention of electrical properties after

long periods at high humidity.

The precision compounds are now playing a major role in electrical component design. Ask our sales engineers and technical service men to check your specific application or materials selection problem.

Specify the precision compounds from Durez.

For complete information on the complete line of precision compounds write Durez Division, Hooker Chemical Corporation, 9003 Walck Road, North Tonawanda, New York 14120.

 **hooker**  
DUREZ DIVISION





## Tuned Amplifier/Oscillator is Six Instruments in One

- LOW-NOISE AMPLIFIER
- LOW-DISTORTION OSCILLATOR
- WAVE ANALYZER
- DISTORTION ANALYZER/NOTCH FILTER
- SENSITIVE AC VOLTMETER
- ALLPASS DELAY PHASE SHIFTER

The PAR<sup>TM</sup> Model 110 Tuned Amplifier/Oscillator is a frequency selective amplifier operating over the range of 1 Hz to 110 KHz with Q variable from 1 to 100 (with no gain change). This versatile unit can function as several general-purpose instruments including:

**Wave analyzer** with bandwidth adjustable from 1% to 100%.

**Flat or selective AC voltmeter** with sensitivity ranging from 10 microvolts to 5 volts rms full scale.

**Distortion analyzer** to measure distortion levels as low as 0.1% (as low as 0.001% when used with a second Model 110).

**Low-noise amplifier** (typical noise figure of 1 dB) with voltage gain ranging from 1 to 10<sup>4</sup>.

**Stable general-purpose low-distortion oscillator** providing up to 5 volts rms into 600 ohms, capable of being synchronized by an external signal.

**AC-DC converter** with ground-based output.

Four 600 ohm outputs, each capable of delivering 5 volts rms into a 5K ohm load, are provided simultaneously: a second order (resonance) bandpass; a second order band-reject (notch) with set frequency rejection in excess of 100 dB; a second order allpass characterized by an amplitude response which is flat with frequency and a phase lag which increases monotonically with frequency; and a flat output. A front panel AC voltmeter permits measurement of any of the four outputs.

Price of the Model 110 is \$1195. Export price is approximately 5% higher, except Canada. For more information, write for PAR Bulletin T-140 to Princeton Applied Research Corporation, Box 565, Princeton, New Jersey 08540 or call (609) 924-6835.



PRINCETON APPLIED RESEARCH CORPORATION



## Integrated electronics

### Uncoiling r-f amplifiers

As much as radio and television designers would like to apply integrated circuits for tuned r-f amplification, two factors, other than costs, have barred their use:

- The ic's exhibit only modest selectivity because stable high Q-factors are tough to obtain with the RC active filter elements on the ic's, which lack inductors.

- And the use of external coils to sharpen selectivity is disliked by most monolithic linear ic makers, who prefer to use resistors and capacitors when possible.

Researchers at the microelectronics laboratories of the University of California at Berkeley, however, have come upon a way to provide highly selective circuits without using the outside coils. Their developmental r-f amplifiers have Q's of 50 to 150, center frequencies in

the 10-megahertz range, and temperature stabilities of about 5% between  $-10^{\circ}$  and  $+110^{\circ}\text{C}$ .

Instead of requiring external inductors, the ic's are shaped with both positive and negative feedback loops and high-quality resistor-capacitor networks. The combination provides tight stability, requires fewer active devices than conventional means, and minimizes the external component count.

**Film finesse.** The selective amplifier, developed by a team headed by Graham A. Rigby, contains both monolithic and thin-film ic parts. The compatible portion on which the precision, high-value, nichrome resistor elements are situated, frees the monolithic from having to provide bulky resistors and capacitors. Three external capacitors complete the entire circuit.

Rigby expects the new ic to form the basic building block for premium-performance selective circuits in radio and television systems, particularly the f-m portions

and voltage-tunable front-ends.

He disclosed that a number of major ic makers, including Motorola Inc., the Sprague Electric Co., and RCA, have shown interest in the circuit technique.

Although satisfied with the ic as a space-saving way of obtaining high variable Q's that are temperature stable, Rigby explains that further changes are needed before the chip is ready for volume production. Foremost of these is reducing costs so that the ic can compete with discrete selective amplifiers.

Other requirements include a more thorough investigation of the noise behavior of the circuit, and optimizing its voltage-control feature.

### Drawing on computers

Texas Instruments, a Johnny-come-lately when it comes to MOS ic's, is using computers to catch up with the field. At the IEEE show in New

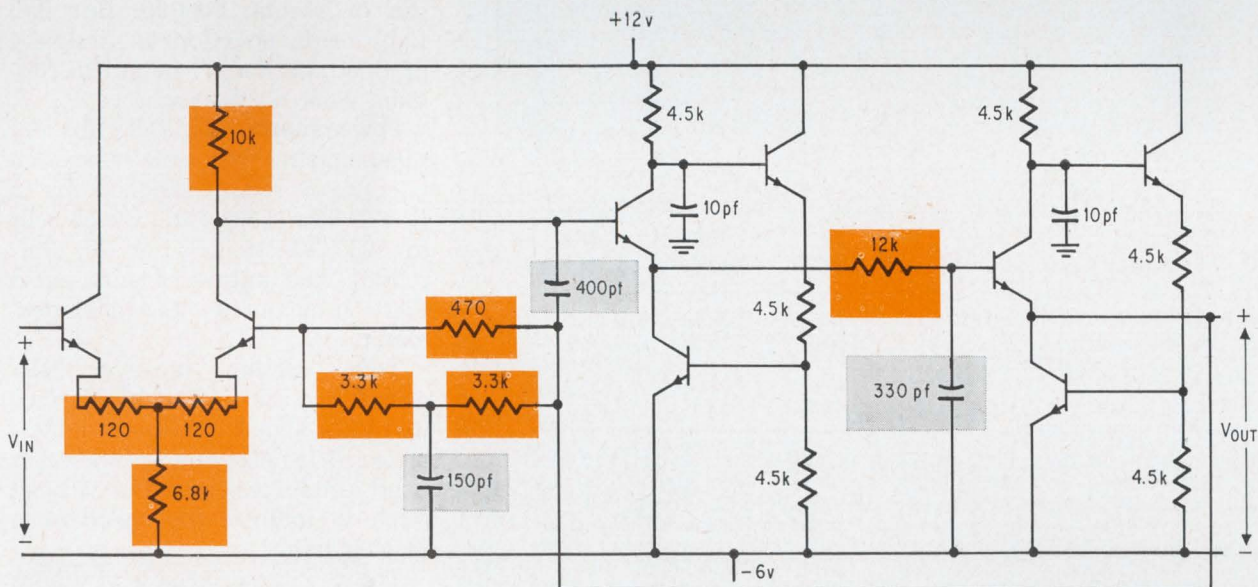

**On the chip.** R-f selective amplifier without an inductor is formed by compatible IC's and three external capacitors (shown in gray). All transistors, small resistors, and 10 pf capacitors are on a monolithic chip. Large resistors in differential stage and bridged-tee network and the 12 K coupling resistor are on thin-film nichrome IC portion (shown in color).



York later this month, the company will introduce the first off-the-shelf metal oxide semiconductor integrated circuits for which computers were used to crank out the artwork for the masks.

The new TI circuits, numbering between six and 10, duplicate others already on the market or are similar.

When the company decided to make its bid for the high-volume MOS IC market, it followed the pack by generating the masks with conventional manual techniques. But TI quickly ran into trouble.

**Error prone.** Because of the complexity of generating an MOS mask—sometimes as many as 10,000 cuts may be necessary and as many as 600 individual elements may have to be defined—errors can easily crop up with manual meth-

ods. The company found the error rate was running as high as 30%. And some of these errors weren't determined until the devices had been made and diagnostic tests run at final inspection.

Since turning to computer-aided design, TI has sharply reduced the error rate. In fact there were no errors in 10 sets of recent artwork, says Charles Phipps, MOS product line manager at TI and a key figure behind the company's earlier success in bipolar IC's.

In MOS IC development, the MOS cell is used for both active and passive circuit elements. This, along with its symmetry and simplicity of structure (one diffusion), makes the MOS IC a good choice for CAD, says Phipps.

The company is now developing computer programs for MOS IC tests

and analysis, which should be ready by the end of 1969. With the over-all computer program, says Phipps, TI will be able to produce complex MOS designs within six weeks after the logic function has been defined. This would be a far cry from the lead time of three to four months which were required when manual methods were used, Phipps points out.

### Advanced technology

#### A little millimeter radar

What started out in Bell Telephone Labs as a project to demonstrate that a limited space charge accumulation (LSA) diode [Electronics, Nov. 13, 1967, p. 131] can oscillate, mix, and amplify signals simultaneously has resulted in a portable, simple, and relatively inexpensive radar that may prove of interest to both the military and the blind.

The developers, John Copeland, who was first to predict the LSA mode in 1966, and Robert Spiwak, have built a five-pound, battery-operated radar no bigger than a shoe box. With the application of microelectronics and more attention to design, Copeland says, the size can be shrunk fivefold. But Bell Labs made no effort to design a product and doesn't intend to continue work on the radar.

**Power source.** The Bell Labs' design compares with a matchbox-size microwave radar designed by a British firm, Telta Ltd., which sells for \$250 [Electronics, Feb. 20, 1967, p. 296]. That unit uses a Gunn-effect diode oscillator as its signal generator.

Telta's design, however, isn't geared for use by the blind since its return signal is measured by a meter; Bell Labs' unit, on the other hand, produces a sound of varying pitch to indicate the speed of a moving target.

The U.S. radar consists of a horn antenna, transistor amplifier, power supply, speaker, the diode, and its circuitry. It beams a 4-milliwatt, 70-gigahertz (4 millimeter) signal at

### Electronics Index of Activity

March 4, 1968

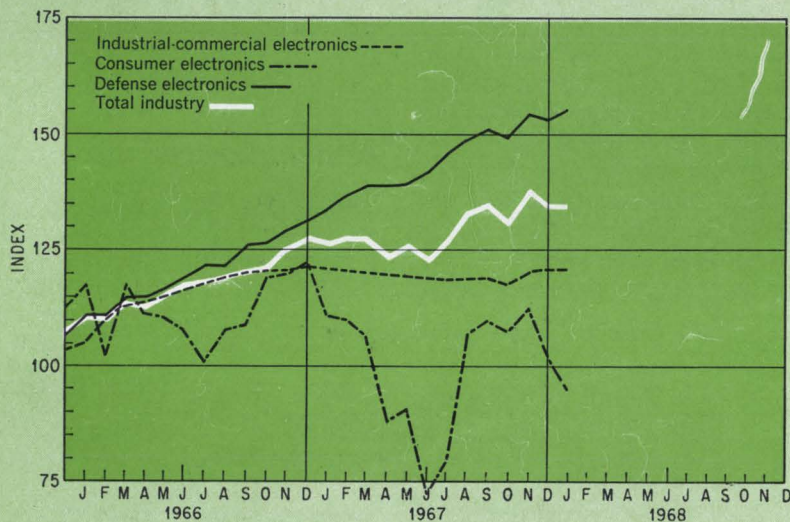

Segment of Industry	Jan. 1968	Dec. 1967*	Jan. 1967
Consumer electronics	95.7	102.9	111.1
Defense electronics	155.2	152.9	134.0
Industrial-commercial electronics	121.2	121.2	122.0
Total Industry	135.2	135.1	126.3

Electronics production chugged along in January at about the December pace, inching up but 0.1 index point to a level 8.9 points above the year-earlier figure. A 2.3-point rise in defense production offset a 7.2-point drop in the consumer electronics segment. This decline follows a 10-point drop in December and reflects consumer worries about inflation, taxes, and the Vietnam war. Industrial-commercial output held steady in January, down 0.8 point from a year ago.

Indexes chart pace of production volume for total industry and each segment. The base period, equal to 100, is the average of 1965 monthly output for each of the three parts of the industry. Index numbers are expressed as a percentage of the base period. Data is seasonally adjusted.  
\* Revised.



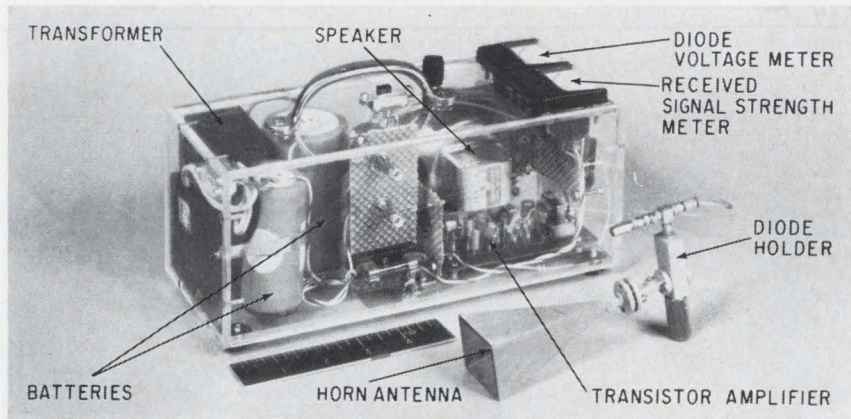
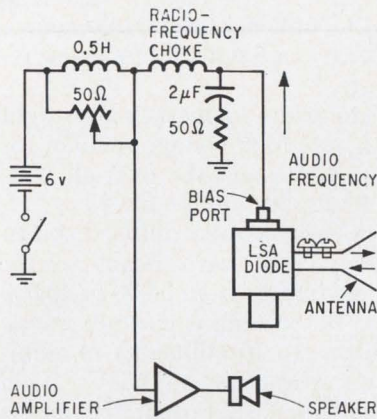

**Electronic eyes.** Doppler radar designed at Bell Labs demonstrates the use of a limited space charge accumulation diode to simultaneously oscillate, mix, and amplify a signal. The developers say the portable unit could be used by the military and as an aid to the blind.

objects up to about 300 feet away and detects movement at velocities ranging from about half a foot a second to 40 miles an hour.

As the transmitted signal reflects off the moving target, it shifts frequency because of the doppler effect, then mixes with the original signal in the LSA diode. For every half wavelength of distance moved, the reflected signal shifts 1 hertz in frequency. At the millimeter wavelengths that are transmitted, the difference frequency is therefore in the audible range, heard through the loudspeaker. At X band (5,000 to 10,900 megahertz), the frequency shift would be much smaller than at 70 Ghz for an object traveling at the same velocity and could be below the range of hearing.

Requiring only 4 volts power and operating on a few hundred milli-amperes current, the radar uses a 25 decibel-gain horn antenna to transmit a beam with a width of about 8 degrees. Because the LSA diode acts both as detector and oscillator, there's no need for such components as circulators and isolators, which complicate circuitry and, especially at millimeter frequencies, increase costs.

Except for the millimeter circuitry, all parts are relatively inexpensive, off-the-shelf items.

**Simple circuits.** Bell is interested in exploring the LSA diode's potential in millimeter superhetrodyne detectors. Up to now millimeter superhetrodyne receivers have required separate local oscillators and mixers. Because the LSA diode per-

forms both functions, it promises simpler circuits and thus potentially higher reliability.

Copeland predicts that LSA transmitter and receiver performance should improve in the near future to the point where continuous outputs will reach one watt up to 200 Ghz.

## Consumer electronics

### Moog music

It's doubtful whether the Beatles will be replaced by the Moog, an electronic music synthesizer, but before long they may be using one. In fact, such pop music groups as the Monkees and the Supremes are joining several university music laboratories and some composers of electronic music in jumping on the Moog bandwagon.

The synthesizer can be used by performers and composers alike to produce almost any sound or combination of sounds, from a cello's E flat to that of a sick cat.

Music synthesizers aren't new, but older systems have to be pre-programmed and rely heavily on tape editing and splicing. The Moog, ranging in price from about \$2,800 to \$6,200 can either be programmed by punched paper tape or manually controlled through a keyboard or linear controller to produce voltage changes.

**Do-re-mi.** As its inventor, Robert

A. Moog, explains it: "You start with modules that produce raw noise, such as oscillators and noise generators, and connect them to produce raw sound material. Generators turn out sine, triangular, sawtooth, and square waveforms, and the voltage-controlled oscillators are driven by these waves.

"The relationship between the control voltage and the frequency is exponential," he goes on. "A 1-volt increase raises the pitch one octave. The raw sound material is then put through the modifiers and fed to a tape recorder. The tape can then be edited or spliced to produce the final composition."

**Last laugh.** The 33-year-old inventor developed his first synthesizer in 1964. "Everyone thought there was no market for this sort of thing, that it was ridiculous," says Moog. "But last year our sales soared to \$150,000."

The synthesizer is available in three models. The smallest and least complex consists of two voltage-controlled oscillators, two voltage-controlled amplifiers, a white-noise source, a voltage-controlled filter, a reverberation unit, a fixed filter bank, a power supply, an envelope generator, and a keyboard and linear controller. Other modules, such as envelope followers, multichannel mixers, and filters, can be added to form more advanced instruments; specially designed systems are also available.

**Seventy-six trombones?** To use the synthesizer as a concert instrument, the keyboard can be preset



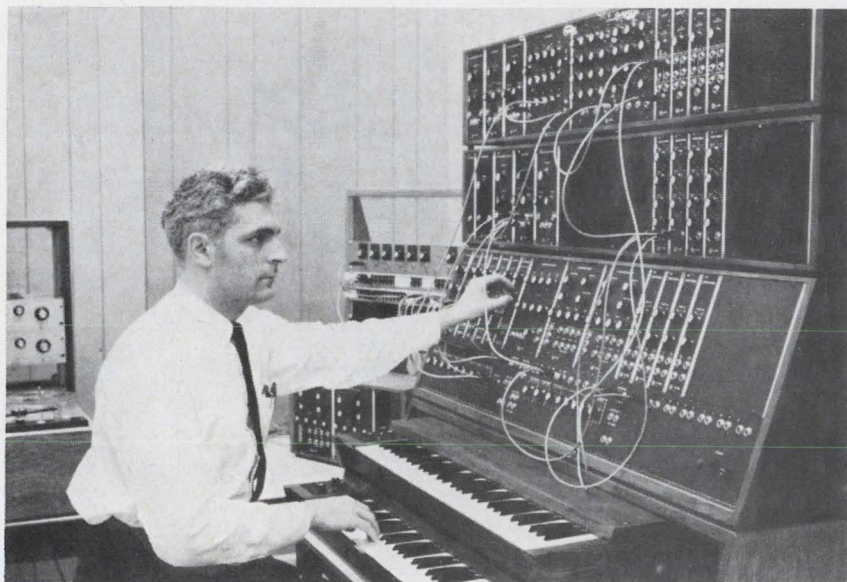

**Music man.** Inventor Robert Moog is setting the tone for a new kind of music with his sound synthesizer.

to vary the voltage difference between the keys, thus varying the scale. In performance, as in composition, the synthesizer will produce sounds varying from those of a single instrument to the sounds of an entire ensemble.

Moog, who became interested in electronic instruments in high school, put himself through graduate school by manufacturing and selling Theremins, one of the first electronic music-makers. His meeting in 1964 with Herbert Deutsch, a composer at Hofstra University, Long Island, N.Y., gave Moog the composers' point of view, which he translated into electronic equipment. "The idea of voltage-controlled instruments came out of the blue," Moog says. "Herb told me what he wanted, and voltage control seemed to be the answer."

The R.A. Moog Co., Trumansburg, N.Y., is currently working on a small-performance synthesizer that can be used by both instrumental and vocal groups, or even by a musician-composer at home, and will be priced at around \$1,500.

### Toward tubeless tv

Television companies around the country are experimenting with a high-voltage rectifier that may eliminate the problem of X radia-

tion in color receivers. The new component may also cause some set makers to go completely solid state in large-screen black-and-white and color models for 1970.

The rectifiers are designed into voltage-multiplier circuits developed by Varo Inc. of Garland, Texas. The firm has been sending sample devices to tv manufacturers. At least three producers are understood to be planning to use Varo's device and make all solid state color sets in 1970.

**Shunt.** The rectifier tube is the only one—other than the picture tube—remaining in some black-and-white sets. The new device is designed to replace this tube and also the shunt regulator tube, which has

been identified as the major source of X-ray emissions from color receivers.

Varo plans to market a straight solid state high-voltage rectifier for about \$1.50, and the over-all voltage-multiplier circuit for \$5.

The fast-recovery diffused silicon rectifiers will have peak reverse voltage ratings from 5,000 to 40,000 volts. Rated output currents range from one to 10 milliamps in ambient temperatures to 65°C. Each assembly includes capacitors and is used as pulse voltage doublers and voltage triplers.

Varo's multiplier device will enable set makers to replace not only the high-voltage rectifier tube but also the focus diode and high-voltage shunt regulator tube in color receivers, according to Jan Collmer, product manager for the firm's Special Products division.

Collmer says set makers may save between \$4 and \$7 per color set with Varo's voltage multiplier, because two tubes plus the focus diode can be eliminated; and a high-voltage cage can be shrunk. Also, he says, various processing steps, such as filament winding and making sockets for tubes can be reduced.

Last year Philips' Gloeilampenfabrieken of the Netherlands introduced a solid state high-voltage rectifier in the United States; but because of high price and other problems the product was abandoned.

The potential market in the U.S. for these assemblies is estimated at

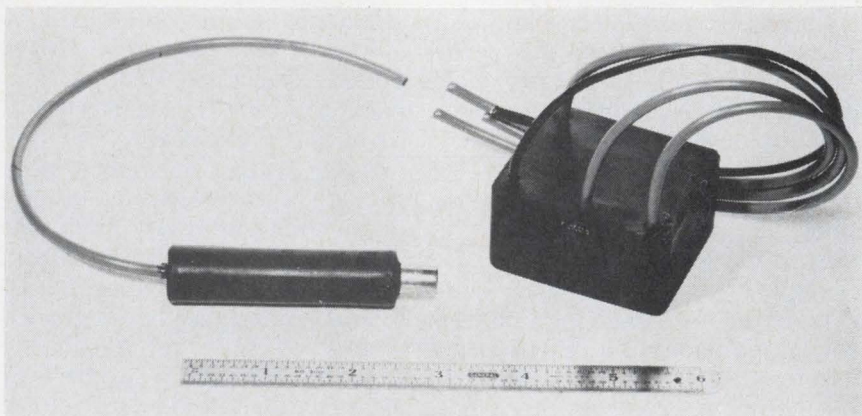

**Replacing tubes.** Varo's new solid state high-voltage rectifier (on the left) and voltage multiplier (right) may be designed into many 1970 model tv sets.



**WHO PINNED A MEDAL ON THIS**

TRW-608

**TINY TRW CAPACITOR?**



**...nearly everybody!**

For your next design where there's too little room for components and *no room for compromise*...turn to "tiny but tough" TRW Type 608 Mylar\* capacitors.

Excellent electrical characteristics and exceptionally small size make the Type 608 ultra-miniature a good capacitor for exacting military and instrument applications. Add the remarkable record of space-proven reliability and TRW Type 608 becomes a great capacitor!

Look at these outstanding features!

- 50% smaller than MIL-C-27287
- 4½ lb lead pull capability
- Mylar-foil, tape-wrapped construction
- Exceeds characteristics of many larger units
- MIL-C-27287 performance
- 50V and 100V, .001 to 2.0 mfd
- Temp. range -55 to +85°C; to 125°C with derating
- Tolerance to ±1% available

Product information is available from TRW Capacitor Division, TRW INC., Box 1000, Ogallala, Nebraska. Phone (308) 284-3611. TWX: 910-620-0321. \*DuPont's trademark for polyester film.

**TRW**®





## Why companies standardize on WANG electronic calculators

**VERSATILITY** Just one basic calculator design, the WANG 300 Series, can solve the needs of many company operations. On compact keyboard displays, all basic arithmetic functions (+, -, ×, ÷) can be performed instantly, silently, accurately by simply touching a key. Optional keys produce  $x^2$ ,  $\sqrt{x}$ ,  $\text{Log}_e x$ ,  $e^x$ . 80 Step tab cards and plug-in card readers can make any model fully programmable.

**EXPANDABILITY** As needs increase, add-on compatibility makes it possible to expand into a powerful computing system that will branch, loop, do sub-routines, make decisions and manipulate arrays.

**CONVENIENCE** Wang calculators are as simple to learn and operate as a ten-key adding machine but infinitely faster and more powerful.

**ECONOMY** Wang multiple keyboard systems cost far less per station than any comparable electronic calculators. In use, they can eliminate 67 to 93 per cent of calculation time. (One leading company reports a saving of \$73,000 four months after installing Wang Electronic Calculators.)

Why not investigate? Write or call:



Dept. 3-H, 836 North St., Tewksbury, Mass. 01876  
Tel.: (617) 851-7311

**In Major Cities, Tel.:**

(201) 241-0250 (313) 278-4744 (514) 482-0737
(203) 666-9433 (314) 727-0256 (518) 463-8877
(205) 245-6057 (317) 631-0909 (601) 234-7631
(206) 622-2466 (319) 365-2966 (612) 881-5324
(212) 682-5921 (402) 341-6463 (617) 851-7311
(213) 278-3232 (404) 457-6441 (702) 322-4692
(214) 361-4351 (405) 842-7882 (702) 735-5802
(215) 642-4321 (412) 366-1906 (713) 668-0275
(216) 333-6611 (415) 454-4140 (714) 234-5651
(301) 588-3711 (416) 364-0327 (716) 381-5440
(301) 821-8212 (504) 729-6858 (717) 397-3212
(303) 364-7361 (505) 255-9042 (816) 421-0890
(305) 841-3691 (512) 454-4324 (817) 834-1433
(312) 456-1542 (513) 531-2729 (919) 288-1695

about \$35 million a year.

Varo's tv devices have grown out of similar units made for manufacturers of oscilloscopes and allied equipment. These have been running \$15 to \$20 each, however, far too high for producers of television receivers.

Collmer won't say exactly how his firm has lowered the costs. "We believe we have considerable lead time and we want to hold it," he points out.

Basically, Varo's method involves stacking high-voltage gold diffused silicon junctions. Currently, solid state high-voltage rectifiers are made of selenium stacks.

### Military electronics

#### Drafting computers

The Army is dressing some commercial computers in military khaki in a program to evaluate their performance on the battlefield. But because defense dollars are being diverted to the Vietnam war, the Army may not get enough computers to make a complete evaluation of the equipment.

The program, called tactical operations systems (tos), began in 1965 when the Army overhauled its command control information systems—1970 concept. The master plan for introducing data processing systems was then renamed ADSAF, for automatic data systems.

**To the field.** Tos will bring data processing to commanders of field armies, corps, and divisions. It will give them information on friendly forces, enemy units, and fire support at their disposal—cannon and missile artillery, tactical air forces and naval gunfire. The other parts of ADSAF are the tactical fire direction system (Tacfire) and the combat service support system, which will computerize logistics, personnel, and administrative functions [See related story on page 171]. ADSAF is administered by the Automatic Data Field Systems Command, Fort Belvoir, Va.

The Seventh Army in Europe ac-

cepted the first commercial computer in January. It will be used to work out detailed requirements for the militarized computers and related software. The Seventh Army effort is limited to outlining tos needs for that command. The Combat Developments Command, also headquartered at Fort Belvoir, is defining an Army-wide system so that bids can be requested in 1970.

"The Army has had trouble defining what it wants in tos," says Lt. Col. Albert Crawford, former chief of Tacfire engineering and management. A fund stretchout now would give the Army a "less valid definition of the requirements" than it would like to have, adds Col. John Ely, head of the tos directorate at the command post. But he adds quickly that he doesn't believe a stretchout would delay the system's planned introduction in 1974.

**Nuts and bolts.** About \$20 million was earmarked for tos in 1965, but that figure "has ceased to have any significance," Ely says. The first increment—\$4 million—provided the system that went to Europe in January. It consists of one 3300 central processor, four remote data stations, each served by a 1700 computer, plus 18 input-output devices made up of a cathode-ray tube display and electric typewriter.

The Control Data contract contains two options to purchase two more 3300 central processors, plus additional remote data stations and input/output devices for Seventh Army evaluation. One of the option periods begins this month, Ely explains, and the second option period will begin in about November. He doubts, however, that either option will be exercised anytime soon, but points out that the option periods are somewhat open-ended so the delay should not affect the project.

Ely adds, however, that multiple central processors are envisioned "and if we don't get more than one, the results of the evaluation will be degraded by that deficiency." The commercial computers being used in the Seventh Army effort are strictly to give field com-



# 4 ways to view displays with the Tektronix Type 564

## split-screen storage oscilloscope

The Tektronix Type 564 is virtually two instruments in one. It offers all the advantages of a storage oscilloscope plus those of a conventional oscilloscope.

### Split-Screen Displays

An unique split-screen display area enables you to simultaneously use either half of the screen for storage and the other half for conventional displays, or use the entire area for stored or conventional displays.

Independent control of both halves of the screen permits you to take full advantage of the storage facilities. For example, you can use half the screen to store a reference waveform, the other half to display waveforms for comparison. You can erase or retain either half of the display area as you choose.

### Bistable Storage Advantages

With bistable storage oscilloscopes, such as the Type 564 and Type 549, the contrast ratio and brightness of stored displays are constant and independent of the viewing time, writing and sweep speeds, or signal repetition rates. This also simplifies waveform photography. Once initial camera settings are made for photographs of one stored display, no further adjustments are needed for photographs of subsequent stored displays.

Storage time is up to one hour, and erase time is less than 250 milliseconds. An illuminated 8 cm by 10 cm graticule facilitates measurements and aids in taking photographs with well-defined graticule lines. Adding to the operating ease is a trace position locator that indicates, in a nonstore area, the vertical position of the next trace or traces.

Tektronix bistable storage cathode ray tubes are not inherently susceptible to burn-damage and require only the ordinary precautions taken in operating conventional oscilloscopes.

### Plug-In Unit Adaptability

The Type 564 accepts Tektronix 2 and 3-series plug-in units for both vertical and horizontal deflection. Display capabilities of these units include single and multi-trace with normal and delayed sweep; single and multiple X-Y; low-level differential; dual-trace sampling; spectrum analysis, and many other general and special purpose measurements.

- Type 564, without plug-in units . . . . . \$ 925
- Rack-Mount RM564 . . . . . \$1025  
Similar electrical characteristics to Type 564. 7" high.
- Type 3A6 Dual-Trace Amplifier Unit . . . . . \$ 525  
DC to 10 MHz from 10 mV/div to 10 V/div. 5 display modes. Internal signal delay line.
- Type 3B4 Time Base Unit . . . . . \$ 425  
Sweep speeds from 0.2  $\mu$ s/div to 5 s/div. Single sweep. Up to X50 direct-reading magnifier extends fastest sweep to 50 ns/div.

U.S. Sales Prices FOB Beaverton, Oregon

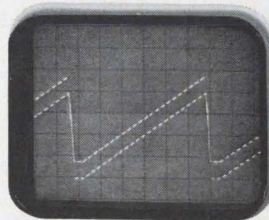

Entire screen can be used for a stored display.

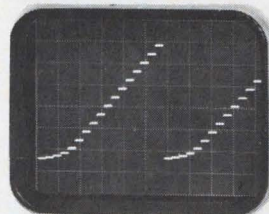

Entire screen can be used for a nonstored display.

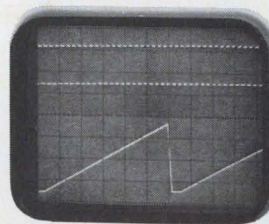

Each half of split-screen can be used independently for stored displays.

Either half of the split-screen can be used for a stored display, the other half for a nonstored display. (Shown below).

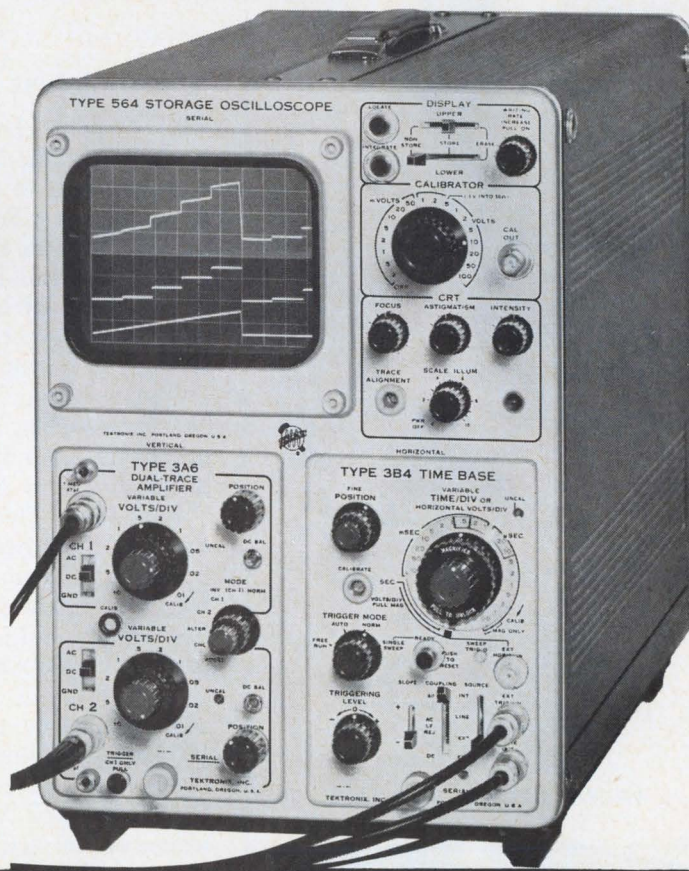

**Tektronix, Inc.**



For a demonstration, contact your nearby Tektronix field engineer or write: Tektronix, Inc., P. O. Box 500, Beaverton, Oregon 97005.



# now there are 3 time & tool-saving double duty sets

New PS88 all-screwdriver set rounds out Xcelite's popular, compact convertible tool set line. Handy midgets do double duty when slipped into remarkable hollow "piggyback" torque amplifier handle which provides the grip, reach and power of standard drivers. Each set in a slim, trim, see-thru plastic pocket case, also usable as bench stand.

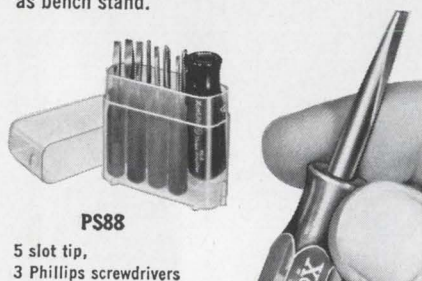

**PS88**

5 slot tip,  
3 Phillips screwdrivers

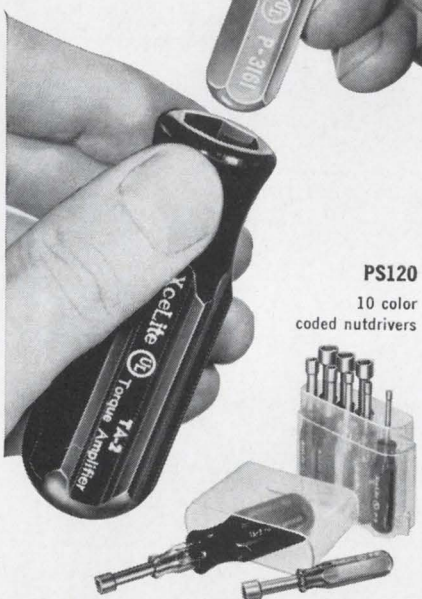

**PS120**

10 color  
coded nutdrivers



**PS7**

2 slot tip,  
2 Phillips screwdrivers,  
2 nutdrivers

WRITE FOR CATALOG SHEET N563



XCELITE, INC., 130 Bank St., Orchard Park, N. Y. 14127  
In Canada contact Charles W. Pointon, Ltd.

## Electronics Review

manders experience with tactical data processing, he says. When the ros requirements are finally worked out, a new procurement will be drafted to obtain completely militarized computers.

One thing seems certain in the clouded ros picture. The Pentagon's demand for commonality will play a large part in determining its hardware. And that means the Data Systems division of Litton Industries Inc. will have the post position for a production contract. The division is prime contractor for Tacfire, and a secondary objective of that procurement was to provide "a family of fully militarized, general-purpose digital equipment, plus general-purpose software, which can be made to satisfy other tactical army requirements for ADP support." This is what Crawford told an audience at last month's Winter Convention on Aerospace and Electronic systems in Los Angeles.

### Khaki kitchen

The Army's "chow call" now appeals to a soldier's ear, but the call to breakfast of tomorrow could tickle his nose. Soon, a frontline GI may awaken in his foxhole to the aroma of bread being baked in a nearby field kitchen.

Hardly a secret weapon, the field kitchen, in a program called Speed (for subsistence preparation by electronic energy diffusion) will use microwaves for both cooking and baking.

**Fast food.** The Army is testing two models of Speed: a microwave bakery that's capable of serving a brigade of 5,000 men with fresh bread daily and a kitchen that can spew out approximately 200 meals an hour.

The Atherton division of Litton Industries, Minneapolis, built the ovens for Speed's prime contractor, the AiResearch Manufacturing division of the Garrett Corp., Phoenix, Ariz. Each oven uses four 1.5 kilowatt magnetrons operating at 2,450 megahertz.

Why microwaves?

"First, it's up to six or seven

times faster than thermal cooking," says Richard J. Campbell, chief of the Army's Natick, Mass., laboratories' food service equipment division. Microwave cooking is also cool—no thermal insulation is needed, making for a smaller, lighter oven; electronic cooking is clean and there is far less danger of fire than with gas or gasoline-fired equipment. Microwave cooking also allows dishes to be prepared in throw-away paper or plastic trays or dishes.

**Too many cooks.** Speed will require half as many cooks as current methods. It will get fresher meals to the front lines—a big morale factor. And it will probably cost less to run than conventional field kitchens—it's all electric, and powered by a turbine generator that operates on relatively cheap jet fuel.

Speed kitchens and bakeries can also move with the troops—the first company kitchens to do so since the Civil War, according to Campbell. They are built in pod form and can be carried on trucks, towed on their own wheels, or flown by helicopter. The whole Speed system weighs about 2.5 tons.

Like a modern fighter plane, a speed pod is modular for quick repair. It takes only three to five minutes to replace a magnetron and power supply module; only 10 to 15 minutes to pull out a whole oven; and only 15 to 20 minutes to remove and replace the turbine generator.

**What about KP?** Speed would use prepackaged foods, have disposable eating utensils, and incinerate its garbage. As a further blow to KP duty, any remaining dishwashing might eventually be done in an ultrasonic sink—using the same technique now used to clean delicate electronic gear.

When tests are complete, the Speed field kitchen will begin a tour of Army posts, but "it's already been seen by more brass than anything we've ever built," says Campbell. "And now the Navy and Marine Corps are interested. Atomic subs with nuclear power supplies are naturals for microwave cooking."

A Speed kitchen is now feeding



## Power that's simply super

Useful outputs up to 500 kW, at frequencies up to 50 MHz... that's the story of RCA's A2872A and A2873A, developmental beam power tubes. Designed for use in a variety of applications that includes communications, particle accelerators, radar and control, these high-gain units feature one simplified, all-internal liquid cooling system.

Outgrowths of continuing research by RCA in electronic and mechanical design, A2872A and A2873A employ the well-known superior electron optics of RCA-6806 and -2041. These designs result in excellent linearity, a rugged stability, low RF drive voltages, and exceptionally high RF power output.

Only 12" x 18", the tubes are designed with a centrally located plate surrounded by a circular array employing unitized electron optics. This coaxial structure permits close spacing, accurate alignment, and efficient cooling. The electronic circuit design provides low RF feedback and effective screen-to-cathode RF bypassing.

Find out more about these RCA super power tubes for economical operation, high emission, and long life. See your RCA Representative about details. For technical data, write: Commercial Engineering, Section C19Q1, RCA Electronic Components and Devices, Harrison, New Jersey 07029.

RF Power Amplifier Class C Telegraphy or Class C Telephony			
Tentative Maximum Ratings up to 50 MHz	A2872A	A2873A	
DC Plate Voltage	25	25	kV
DC Grid—No. 2 Voltage	1500	1500	V
DC Grid—No. 1 Voltage	-400	-400	V
DC Plate Current	25	50	A
Plate Dissipation	125	250	kW
Grid—No. 2 Dissipation	1900	3800	W
Grid—No. 1 Dissipation	1000	2000	W

Super Power Tube, A2873A



# RCA



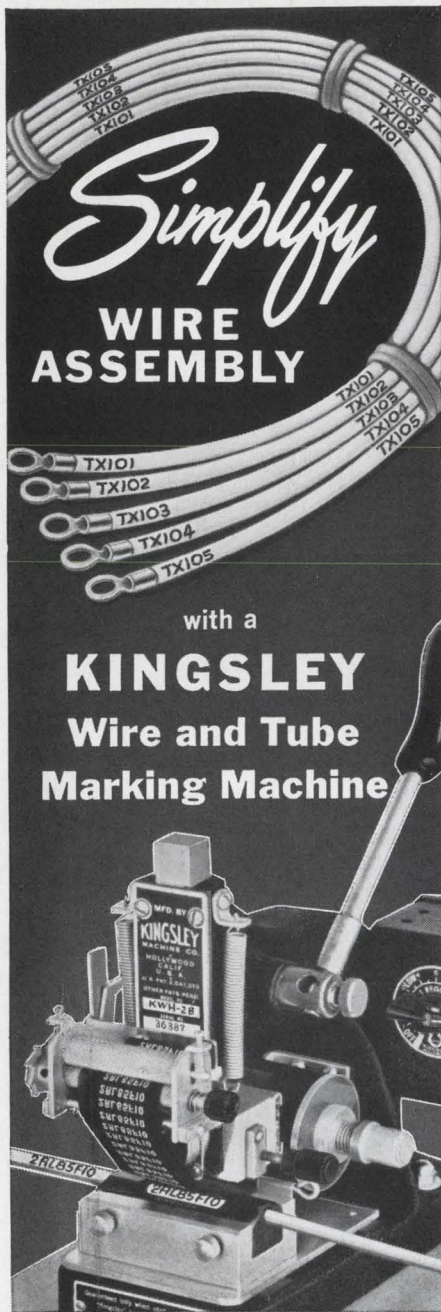

Now you can mark each wire or piece of plastic tubing with its own circuit number... quickly...economically, right in your own plant.

You reduce wire inventories because you need only one color of wire for as many circuits as necessary.

Simplify your assembly methods and speed production with the same machine that has proven so successful in the aircraft and missile field. Write for details.

**KINGSLEY MACHINES**

850 Cahuenga • Hollywood 38, Calif.

"SEE US AT BOOTH 1J25—IEEE SHOW MARCH 18-21."

## Electronics Review

trainees at Fort Devens, Mass., where they eat almost as well as the Navy, with such things as French toast for breakfast.

### Industrial electronics

#### Accentuating the negative

Out of the frying pan into the dryer. Not only are microwaves cooking food, but they're drying motion picture film.

A continuous processing machine that uses microwaves to dry 35-millimeter movie film has been developed by Chicago's Reeve Electronics Inc. Priced at about \$10,000 each, five machines have already been sold and six more are in the works. Reeve is planning a similar machine that would process 16-mm film.

**Speed up.** Unlike conventional forced-air techniques, which take as long as 20 minutes to dry 200 feet of 35-mm film, Reeve's microwave unit needs only a scant minute to dry the same amount of film.

A 2.5-kilowatt magnetron dries the film uniformly from the inside out, much like the way microwaves cook food. Because heated air isn't used, the microwave method is dust free.

Alvin Davis, vice president of sales for Reeve's Microwave division, says the company expects to market a microwave curing system soon for resin-impregnated glass fiber.

### Instrumentation

#### Spotting faults

The idea hit Philip Eisenberg as he used an automatic money changer at an airport. If this machine can be taught to recognize the features of a dollar bill, he thought, why can't a system be built that will visually inspect integrated circuits? The human eye takes a lot of time

and its judgment is fallible.

Researchers at the North American Rockwell Corp.'s science center and its Autonetics division believe they've demonstrated the feasibility of visual inspection of IC's by computer.

Their work on the system so far is "very preliminary," says Robert Osteryoung, head of the science center's physical chemistry group. But Eisenberg says some IC producers, the Air Force, and NASA, are already interested.

**Takes time.** Eisenberg, supervisor of special projects in the Autonetics physical sciences department, is an authority on IC failure mechanisms [Electronics, May 1, 1967, p. 33]. He says semiconductor manufacturers who supply the high-reliability devices Autonetics uses in such programs as the Minuteman 2 guidance computer and the F-111 avionics system have estimated that visual inspection of one device can take an hour and is only 85% effective. Autonetics officials think they can come close to 100% with a computer.

The experimental system uses a Digital Equipment Corp. PDP-8.

The biggest task the developers anticipate is writing the program that will enable the computer to spot defects and to discriminate between acceptable and unacceptable ones. The programs now used is described by Howard Cohen, a chemist working with Eisenberg, as very rough. Osteryoung adds, however, that it has shown them "that it is feasible to get information into the computer in such a way that decisions can be made" about device acceptability.

The North American Rockwell team describes the system this way: the front end is an optical device—as sophisticated as optics used in mask-making—that looks at and magnifies the circuit being inspected. The image is relayed to a transducer, which might be any of a number of devices: a vidicon tube, an image dissector, a flying spot scanner, a movable photodiode, or a photosensitive array.

The controls in the system will depend on the kind of transducer used. A sampling oscilloscope was used in the science center arrange-





# DCL <sup>SM</sup> WARRANTY

With your purchase of Sprague Series 8000 DCL integrated circuits you are guaranteed...

*Worst case DC noise margins*

*Worst case DC loading*

*Worst case AC loading*

*Min/Max propagation delay limits*

*Power consumption per gate limits*

*Absolute maximum ratings*

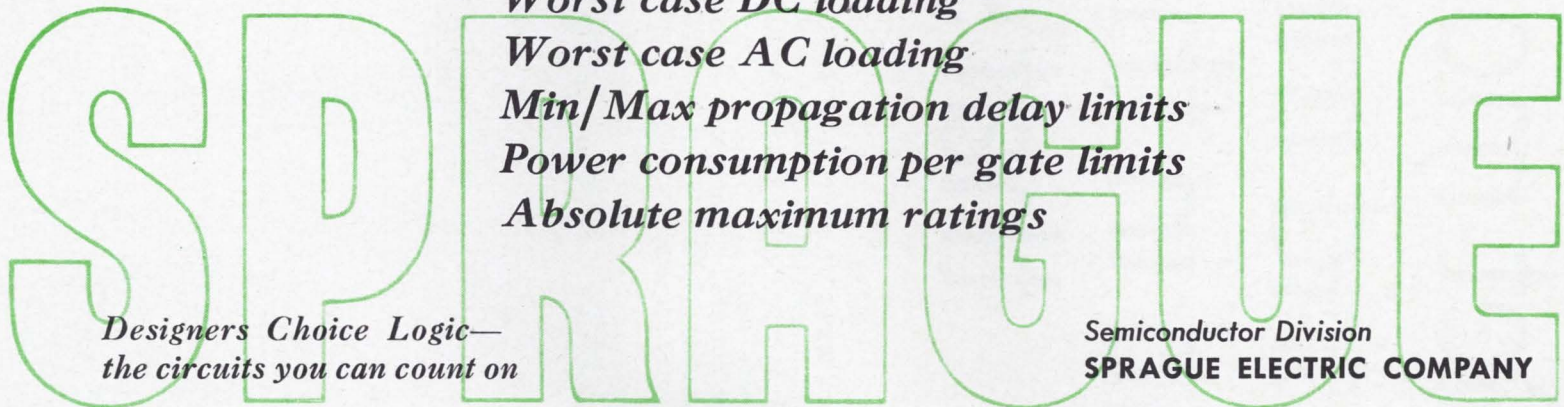

*Designers Choice Logic—  
the circuits you can count on*

Semiconductor Division  
**SPRAGUE ELECTRIC COMPANY**

\*Trademark of Signetics Corp.



# Get more from a hybrid microcircuit... and in the package that's right.

Sometimes the best solution to a circuitry problem isn't just an IC alone, or PC assemblies, or cordwood construction. It's a hybrid circuit from Electronic Components in a package tailored to your needs.

EC is the only supplier that's fully qualified in all modern production techniques and materials. That means we have no axe to grind. You get what you really believe is right for

you—not a sales talk for a substitute.

What's more, EC's new pilot production line can now help you prove out new designs more completely than ever.

Why not give us a shot at your toughest problem? Get full details from Hybrid Microcircuit Marketing Manager, (215) 355-5000, TWX 510-677-1717. Or write direct.

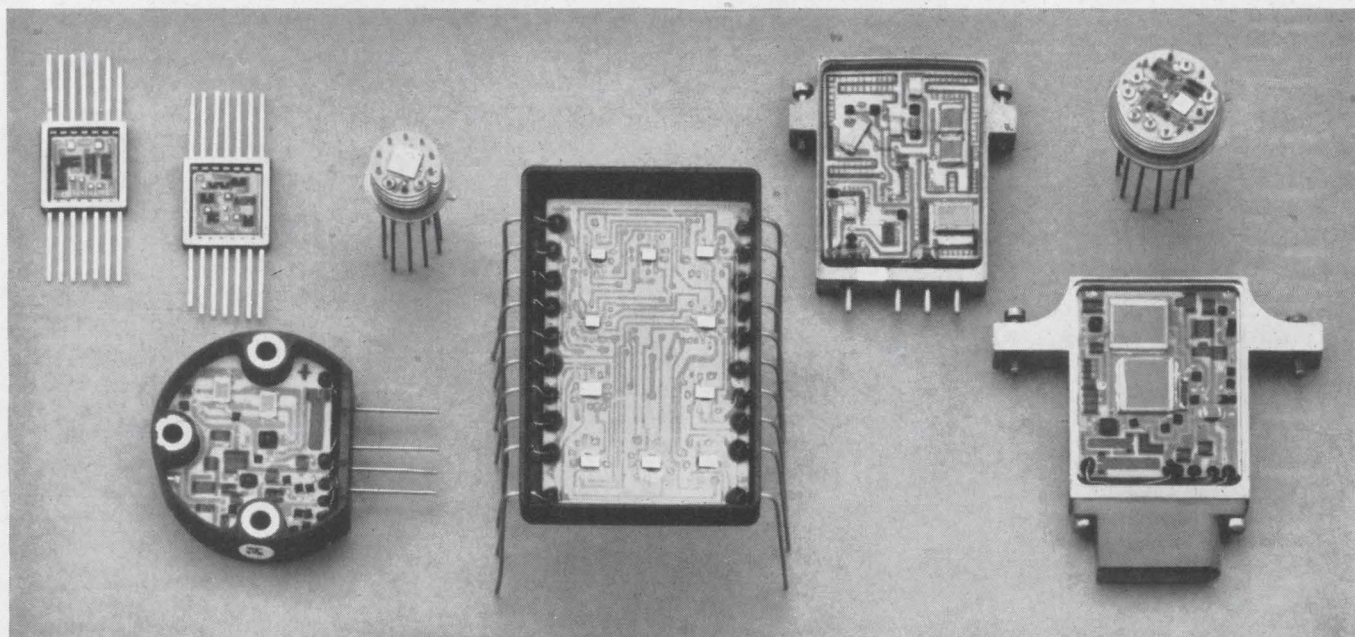

**Electronic Components** DIVISION OF **United Aircraft**

TREVOSE, PENNSYLVANIA 19047

See us at IEEE Booths 4F26—4G33.



ment. Eisenberg says if the transducer is a vidicon tube, and there are 1,000 points to be inspected on a 40-by-60-mil die, "the control is the device that increments the sampling position of the electron beam. If the transducer is a pin diode, the control positions it on x and y coordinates, and as soon as you get the data from one sampling point into the computer, the control electronically positions the diode over the next sampling point."

**A tv film special**

Movies may not be better than ever, but their quality, as far as clarity of image is concerned, is undeniably better than anything projected on a tv screen. Television producers until now have had to employ kinescopic techniques to make inexpensive motion pictures for tv, accepting the inferior resolution as a fact of life.

But the 3M Co.'s Mincom division has built a system that uses an electron beam to record directly on film, a system the firm claims is superior to the kinescope.

**One yea vote.** The new recorder appears to meet the needs of the tv industry. Its price—\$55,000, exclusive of sound equipment—isn't prohibitive, and the resolution achieved is far better than anything obtained with video tape recorders

or kinescopes. The company says the first customer for the recorder, the U.S. Information Agency, is enthusiastic about the unit, dubbed the EBR-100.

The 3M recorder can receive a signal from a tv tuner, a television camera, or a vtr, and transfer it by electron-gun bombardment to special motion picture film. The film is coated with electron-sensitive silver halides and can thus be developed by conventional processing [Electronics, May 30, 1966, p. 88].

The primary advantage of the EBR-100, according to its inventor, Richard F. Dubbe, is that it does the same tasks as kinescope recorders without needing the conventional system's phosphor screen, glass faceplate, and optical system to interface between the electron beam carrying the television signal and the photographic film storing it. And, with an intensity-modulated electron beam, he says, the quality of the original signal is nearly duplicated. High resolution—1,000 lines—results from the small spot size—0.0003 inch—of the new unit's electron beam.

**Double trouble.** Dubbe notes that the electron-beam approach raises a couple of unique problems: photographic film must be introduced into a high-vacuum system for recording, and the beam builds up an electrostatic charge on the film that tends to deflect it.

These problems have been over-

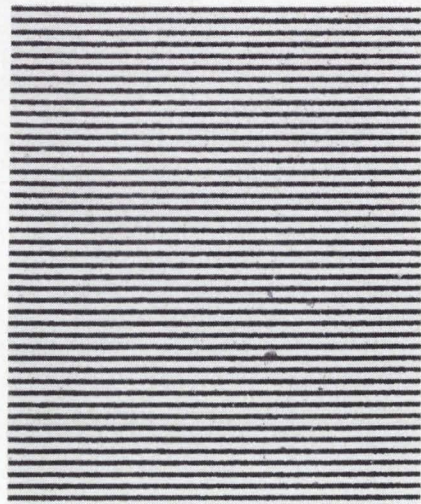

**Now you see it.** Electron-beam recorder, developed by the 3M Co., produced the high-quality image on left. Kinescope generated fuzzy picture on right.

**Size 9 DC Motor  
State-of-the-Art  
is off the shelf at  
AEI**



The size 9 DC Permanent Magnet Motor, .875 in. dia x 1.375 in. length, is available open with Terminals or closed with Leads or Terminals.

Frame is Aluminum, finish Alodine per MIL-C-5541, with Armature supported in Ball Bearings.

Mounting either by Servo Clamps or Face Mounting by screws. Performance speeds are available from 5000 RPM to 20,000 RPM, at a continuous running torque of .21 in. oz. with an operating voltage of 6–50 VDC.

The Size 9 will meet all of the requirements of MIL-M-8609. Available accessories include Planetary Gearheads, RF Filter and Speed Governor.

Complete literature is available by writing Electro-Mechanical Group, American Electronics, Inc., 1600 East Valencia Drive, Fullerton, Calif. 92634, (714) 871-3020, TWX 910-592-1256

**Electro-Mechanical Group AEI  
AMERICAN ELECTRONICS INC.**

- Please rush checked item(s)  
 DC Motor Design Manual  
 DC Motor Technical Catalog

NAME \_\_\_\_\_

TITLE \_\_\_\_\_

COMPANY \_\_\_\_\_

ADDRESS \_\_\_\_\_

CITY \_\_\_\_\_ STATE \_\_\_\_\_ ZIP \_\_\_\_\_



## FREE SAMPLE ECCOSPHERES®

GLASS MICROBALLOONS®

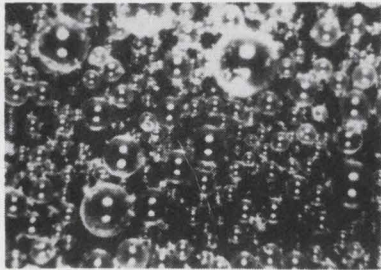

Micron sized hollow particles look like fine sand. Under the microscope they appear as in photo. The ideal filler for low weight and high strength. Excellent electrically and mechanically.

CIRCLE 306 ON READER SERVICE CARD

## ECCOAMP

ELECTRICALLY CONDUCTIVE  
ADHESIVES & COATINGS

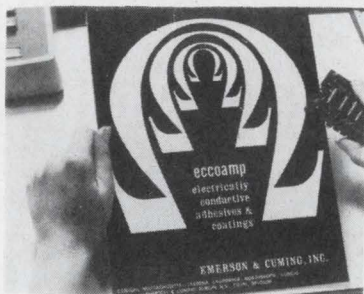

New four page folder describes materials from 0.0001 to 100 ohm-cm. Adhesive pastes to replace hot solder, thin liquids, silver lacquer in aerosol spray, glossy coatings, etc. A complete line.

CIRCLE 307 ON READER SERVICE CARD

## PLASTICS/CERAMIC for ELECTRONICS CONDENSED CATALOG



New folder describes product lines—casting resins, adhesives, foams, sheet stock, coatings, silicones, microwave absorbers, anechoic chambers, shielding materials, etc. Post card included for obtaining more details.

CIRCLE 308 ON READER SERVICE CARD

## Emerson & Cuming, Inc.



CANTON, MASS.  
GARDENA, CALIF.  
NORTHBROOK, ILL.  
Sales Offices  
in Principal Cities

EMERSON & CUMING EUROPE N.V., Oevel, Belgium

## Electronics Review

come, Dubbe says, by reducing the vacuum pressure in the area containing the film magazine and transport to about 15 millimeters. This cuts the strain on the vacuum seal between the film magazine and the electron gun and permits the use of a simple border around the aperture through which the electron beam passes to achieve a vacuum of about  $10^{-3}$  mm at the recording aperture.

The unit can be switched from a 525-line, 60-field-per-second tv format to one of 625 lines and 50 fields per second, making it compatible with nearly all recording modes.

**Roll 'em.** Its 16-mm fine-grain positive stock film is contained in preloaded cassettes that hold 1,200 feet in a coaxial configuration. When running, the film is pulled down by a stable claw during a blanking cycle of the electron gun, eliminating the need for a mechanical shutter mechanism. The drive motor of the camera is locked to the vertical synchronizing pulse of the incoming video signal to provide a constant and flutter-free film movement through the camera.

Dubbe further notes that the 3M system enhances picture join-up by wobbling the electron beam vertically at about 30 megahertz to blend adjacent recorded raster lines and eliminate spacing.

## Communications

### Channel sharing

For years, the land mobile industry has hungrily eyed unused television channels. Now, much to the alarm of tv broadcasters, Congress is finally examining the question. Furthermore, recent tests in the Washington, D.C., area have shown that unused vhf television channels can be used.

The land mobile industry failed utterly to get the Federal Communications Commission to take steps that might lead to allocating them tv channels. The big-money tv industry, which has plenty of pull with the fcc, wouldn't hear of it. Land mobile interests decided to

go the other route: via Congress.

With the backing of U.S. police chiefs, who plead for more frequency space, the land mobile people finally persuaded John D. Dingell (D., Mich.), to hold "panel discussion" on "whether fcc's allocation of frequencies meets today's communications needs." Dingell heads the subcommittee on activities of regulatory agencies relating to small business.

**More pressure.** As expected, interests clashed sharply during the two-day hearings. While the full impact of the hearings is not yet clear, they will undoubtedly put new pressures on the Congress-conscious fcc to take steps. The fcc came under fire from most witnesses—except those representing tv broadcasters.

Seymour N. Siegel, director of New York City's municipal broadcasting system, in listing the many frequency problems there, described the fcc's attitude as "laissez faire." Kenneth Norton, outspoken physicist in the Commerce Department's Institute of Telecommunications Services, said bluntly the fcc should have done something in this area 20 years ago.

Two concepts to alleviate congestion were stressed: revising the block allocation system, and allocating some uhf spectrum to land mobile. These are not new. But land mobile interests privately said it was significant that a Congressional subcommittee was at least listening.

**Wasteland.** Siegel said New York police and fire departments got some spectrum by persuading the fcc to allocate frequencies designated for the U.S. Forestry Service. William L. Detweiler, president of the Radio Specialists Co. of Denver, pointed out that space allocations to maritime services is "wasted" in Denver and other inland cities.

Although broadcasters support revising the block allocations system, they adamantly oppose suggestions that unused uhf channels be earmarked for land mobile. A new lobby, the Association of Maximum Service Telecasters, has been established to battle any attempts at taking tv spectrum.

**Channel sharing.** While most of the debate raged over uhf, tests in



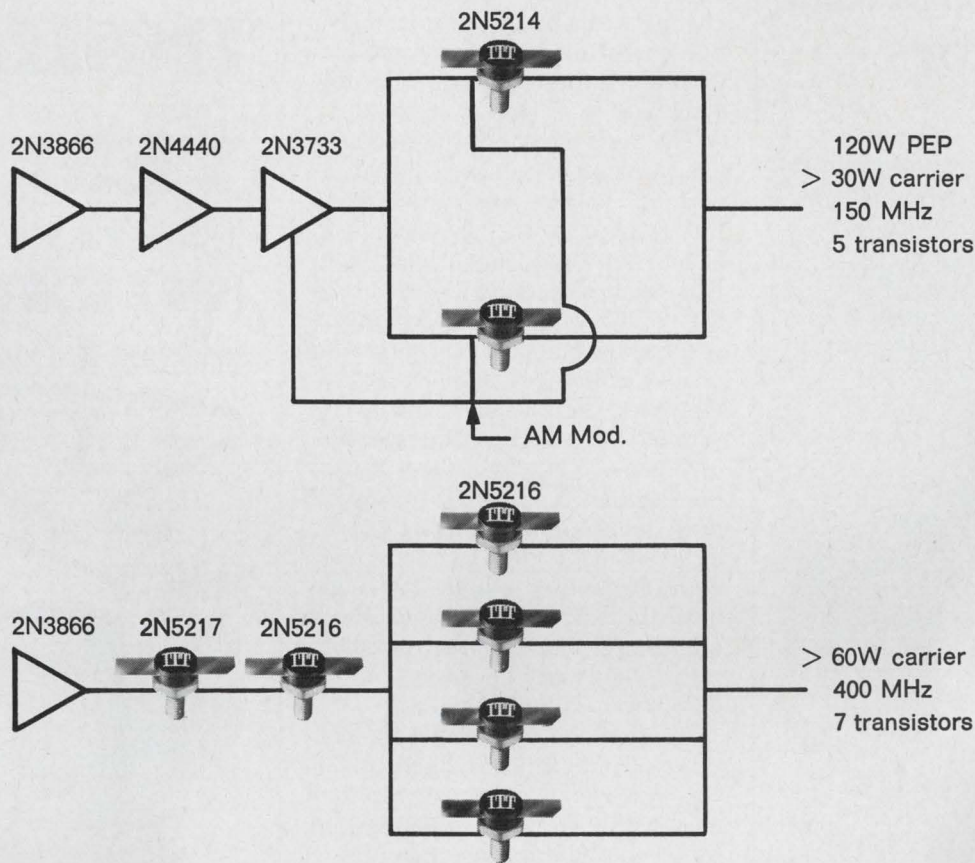

## Only ITT delivers so much broadband RF power with so few transistors

### Another reason to buy from "The Predictables"

Is your goal circuit simplification through higher power? Would you like to increase reliability and cut cost by reducing the total number of components in your equipment? Then ITT's strip line RF power transistors are for you.

Two application examples are

shown above, but the possibilities are almost endless. Here's why:

Strip line packaging gives you lower inductance, higher power output, broader bandwidth and greatly improved stability. The high  $BV_{CEO}$  ratings of the 2N5214 and 2N5216 give you better up modulation capabilities and reduce the danger of damage from transients. Resistor stabilization provides increased safe operating area and built-in bias stability

for class A and AB amplifiers.

Want more information? Write for a free copy of "VHF/UHF Transistor Power Amplifier Design". Want immediate delivery of strip line transistors? Contact any ITT distributor or your ITT factory representative. ITT Semiconductors is a Division of International Telephone and Telegraph Corporation, 3301 Electronics Way, West Palm Beach, Florida.

semiconductors **ITT**

FACTORIES IN FLORIDA • CALIFORNIA • MASSACHUSETTS • ENGLAND • FRANCE • GERMANY • PORTUGAL • AUSTRALIA



# Need custom sub-miniature oscillators fast?

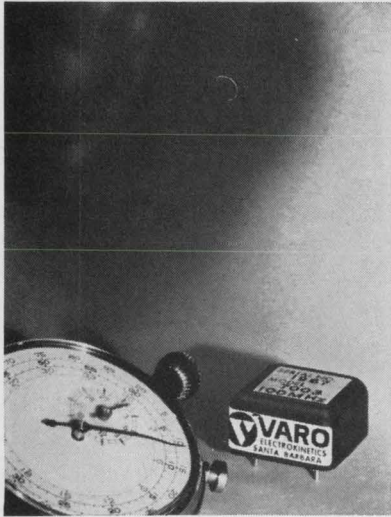

For logic clock applications?

## Call Varo.

Model 7003 crystal oscillator is just  $\frac{7}{8}$ " x  $\frac{7}{8}$ " x  $\frac{3}{8}$ ". Weighs only  $\frac{1}{2}$  ounce. Extremely accurate for its size. Stability vs. time at any constant temperature is one part in 10 million per 24 hours. Frequency range: 3 MHz to 100 MHz. Stability  $\pm .005\%$  from  $-55^{\circ}\text{C}$  to  $+125^{\circ}\text{C}$ .

## Varo answers fast.

Because our business is oscillators. Not oscillators and ovens and crystals, etc., but oscillators. Period. Tell us what you need. We'll tell you how and when. Like we've done for McDonnell-Douglas, Martin, Honeywell, R.C.A., Aerojet-General and others. Try us for speed.



**TIME & FREQUENCY PRODUCTS**  
402 GUTIERREZ ST. SANTA BARBARA, CALIF.  
TELEPHONE (805) 963-2055 TWX 805 4497200

## Electronics Review

Washington run jointly by the FCC and industry, show that unused vhf channels can be used for land mobile except for one unexpected major problem: interference with cable systems.

The tests involved transmissions over Channel 6—unused in Washington. The aim was to determine interference with Channel 5 in Washington and Channel 6 in Richmond and Philadelphia. Because of the controversial subject, engineers are cautious about offering initial results until all data is analyzed. However, they do say that there is "limited interference" to reception of Channel 5 only when the 25-watt base station is "close" to receivers; they will not say precisely how close. When it came to interference with Channel 6, there was none until the base station was in Fredericksburg, Va., 51 miles from Richmond; and in Lancaster, Pa., 58 miles from Philadelphia.

Interference with cable systems was not initially considered. But it was discovered there was interference with Channel 6, which is used by schools and apartment houses to distribute Channel 20 and 26 uhf signals. Full-scale tests on this problem will begin in about a week.

Although land mobile interests are cooperating in these tests, they are not enthusiastic, pointing out that the big problem is of interference from a mobile unit. Tests on this might be scheduled later, but nothing is definite.

### For the record

**Photo finish.** RCA will begin selling a new version of its Videocomp electronic typesetter. The machine, dubbed Videocomp 70/830, generates characters at a rate of up to 6,000 per second, 10 times faster than the 1966 version.

**Overruled.** Solitron Devices Inc. has moved one step closer in its determined effort to take over Amphecol Corp. A Federal District Court judge has denied an Amphecol request for a temporary injunction.

# DID YOU SAY INSIDE?

## YES!

Delevan will put

# MICRO*i*

## Inductors & Transformers

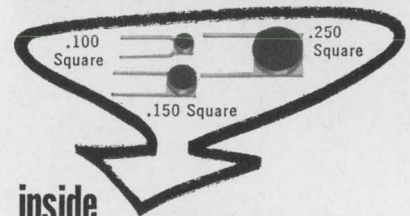

inside  
IC's

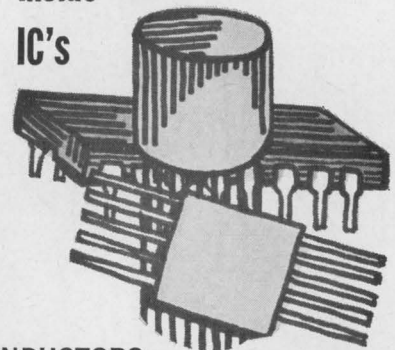

### INDUCTORS

- Size .100, .150, .250 SQ x .065 HIGH
- L Range .015 uh to 1000 uh
- Shielded, Encapsulated, Excellent T.C.
- Meet MIL-C-15305C Grade & Class 5

### TUNABLE INDUCTORS

- Size .150, .250 SQ x .125 HIGH
- L Range .10 uh to 1,300 uh
- Tuning Range 1.7 to 1
- Excellent Resolution, Non-Retractable Tuning

### RF TRANSFORMERS (FIXED AND TUNABLE)

- Size .100, .150, .250 SQ x .125 HIGH MAX.
- Frequency Operation — 500 KHz to 50 MHz
- IF & Wideband Designs Available
- 30 MHz & 60 MHz IF Designs in stock

### HI-Q COILS

- Size .250 SQ x .125 HIGH
- L Range .12 uh to 1000 uh
- Q values in area of 100
- Direct replacement for toroids
- L tolerances as low as  $\pm 1\%$

**Delevan Electronics Corporation / Division**  AMERICAN PRECISION INDUSTRIES INC.  
270 QUAKER RD. / EAST AURORA, N. Y. 14052  
TELEPHONE 716/652-3600 TELEEX 091-299

OTHER DIVISIONS OF AMERICAN PRECISION INDUSTRIES INC.:  
BASCO INC. • ELECTRO-MECHANICAL PRODUCTS DIVISION



**The world's smallest 10 watt zener  
has a 350 watt surge capacity...**

**600% more than an ordinary one,  
35% more than a 50 watt.**

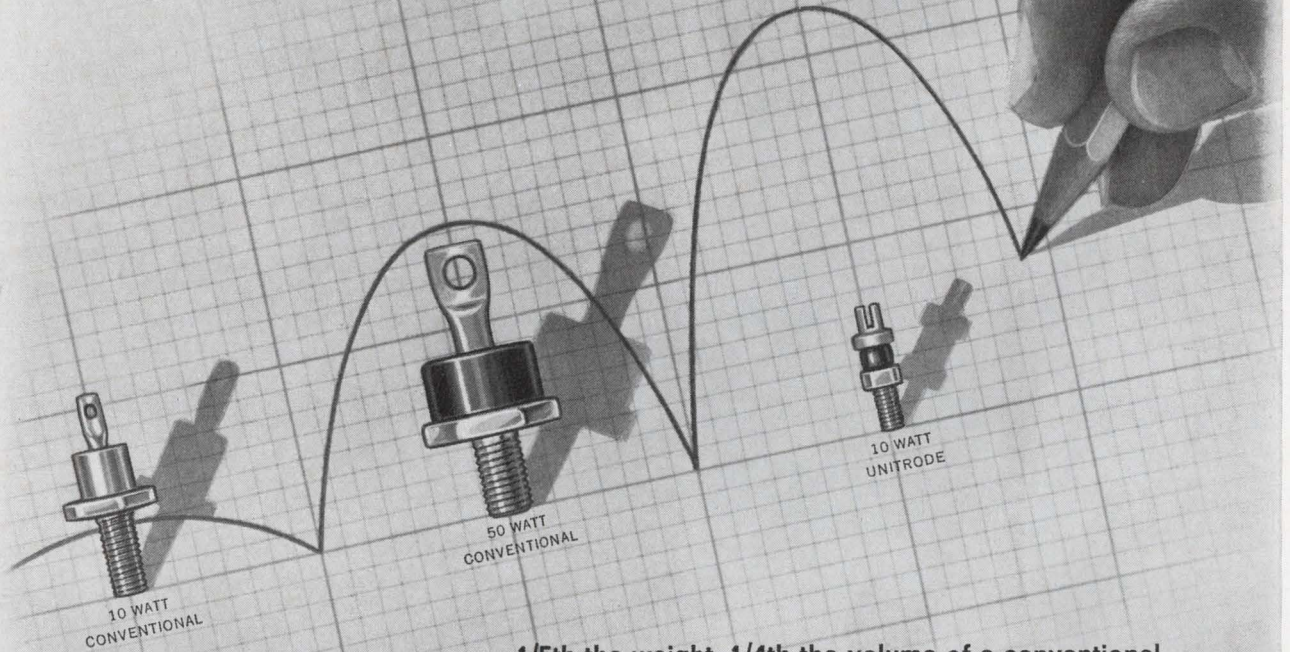

- 1/5th the weight, 1/4th the volume of a conventional 10 watt (smaller than an ordinary 400 milliwatt).
- 1/10th the weight, 1/20th the volume of a conventional 50 watt
- 10 watt continuous rating — stud mounting
- 6 watt leaded version for mounting on circuit boards, has same high surge capacity
- 6.8 to 100 volt range
- Low leakage current
- Electrical characteristics remain stable throughout life, exceeding the environmental requirements of MIL-S-19500

580 Pleasant St., Watertown, Mass. 02172, (617) 926-0404

**UNITRODE** 



**THE UNIQUE UNITRODE CONSTRUCTION**

With the silicon die metallurgically bonded between terminal pins of the same thermal coefficient, the hard glass sleeve is fused to the entire outer silicon surface. Result — a voidless, monolithic structure.



ACTUAL SIZE



Don't forget to see us at the IEEE Show.

Get yourself a complete set of specs that give you all kinds of detailed information. Circle the reply card number.



A new way to  
dependable,  
compact,  
low-cost, digital  
**COUNT AND  
CONTROL**

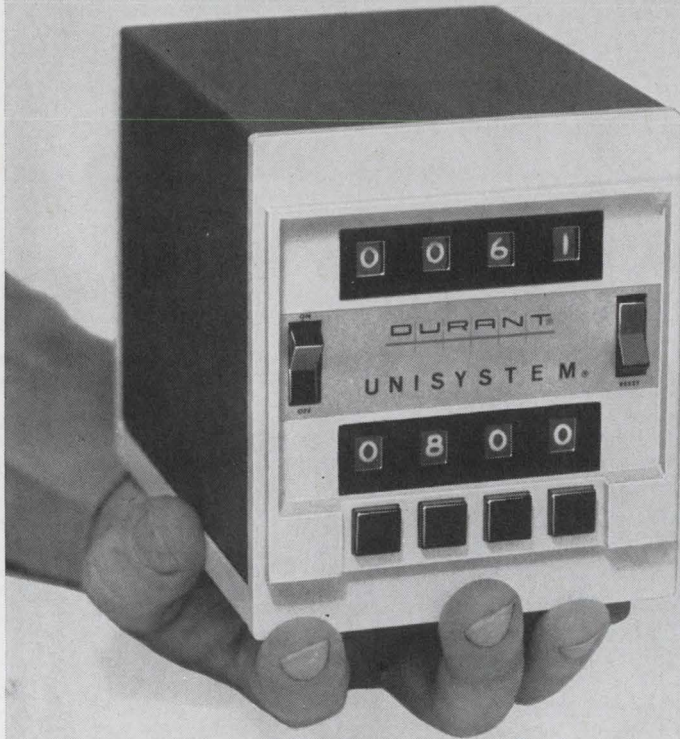

**DURANT 49600 UNISYSTEM**

The answer to a need for fast, accurate count or control in most industries — machine tool, textile, wire, boxboard, electrical, paper, lumber, printing, food, chemical, and other industries. Controls fluid metering, batching, testing, cutting, packaging; counts cartons, coil turns, lineal lengths, and units per bundle. Exceptionally dependable; count always retained in case of power failure.

Compact size permits space-saving desk mount or panel mounting. Choose 2, 3 or 4-digit predetermining and count levels. Also available in Splash and Dustproof models. Speed ranges from 0 to 30 cps (1800 cpm). Large, easy-to-read visual display

Easy push-button setting of predetermined number — preset value always retained, always visible. Instant electric reset from panel front, remote reset, or automatic cycle repeat. Setup and connecting is easy, too . . . rear panel terminals allow 49600 to be readily applied to a variety of operating functions.

See it demonstrated at your desk! Write for specifications.

**DURANT**  
MANUFACTURING COMPANY

622 North Cass Street

**MILWAUKEE, WISCONSIN**

In Europe: Durant (Europa) N.V. Barneveld, Netherlands

Visit Booth Nos. 3A-37 & 38 at IEEE Show for Demonstration

**Electronics Review**

tion to prevent Solitron from making an exchange offer to Amphenol stockholders.

**Braided characters.** The low-cost cathode-ray tube display units to be manufactured by Computer Displays Inc. [Electronics, Feb. 19, p. 50], will use the braid-memory character generators manufactured by Memory Technology Inc. [Electronics, Jan. 8, p. 52], as did their prototype at the Massachusetts Institute of Technology.

Not only that, but the new firm is moving in next door to MIT's quarters in an old watch factory, in Waltham, Mass.

**Lock, stock and . . .** Control Data Corp. has announced it has come to a preliminary agreement to acquire Electronic Associates Inc., a New Jersey manufacturer of analog and digital computers and peripheral equipment.

**For sale.** When Tenneco Inc., a Houston oil company, took over the Kern County Land Co. it also acquired the Watkins-Johnson Co., a Palo Alto, Calif., electronics firm specializing in microwave devices. Now Tenneco is trying to unload Watkins-Johnson to the highest bidder, explaining that electronics is foreign to its principal line of business.

**Well done.** RCA has entered the microwave cooking field with an electron tube that can bake a cake in under four minutes. The new tube, weighing 8.5 pounds, will be sold to microwave oven manufacturers.

**All aboard.** The Illinois Central Railroad has awarded a \$2 million contract to Lenkurt Electric Co., a General Telephone & Electronics subsidiary, for an 800-mile microwave radio communications system. The new system will have a 600-channel capacity.

**Patented.** Pieter D. Davidse and Leon I. Maissel, IBM researchers, have received a patent for their development of an r-f sputtering system that deposits insulator film on integrated circuits.

6455



# NO CONTEST if you're looking for 1 to 2 watts of continuous audio power

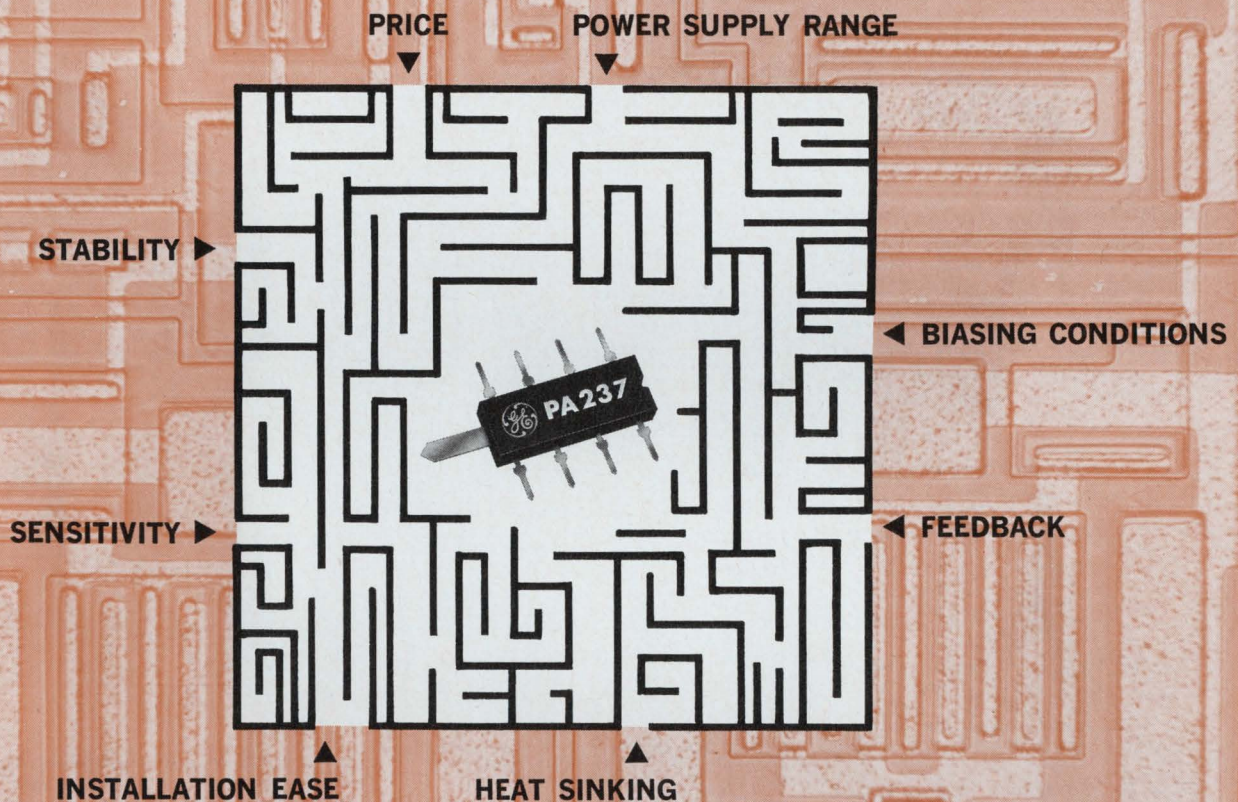

**See for yourself why General Electric's silicon monolithic IC's  
can't be beat.**

No matter what your application, the PA234 or PA237 probably fits . . . and you save on design expense. See if you can draw a path from the feature most important to you, to the PA237 amplifier in the center of the puzzle. If you *can* get to the center, the PA237 is right for you. If you want to prove it to yourself, tell us your expected application and we'll send you a free PA237 to put to the test. Simply tear out this page and send it with your name, address, title, company, and PA237 application to Product Manager, Monolithic Audio Amplifiers, General Electric Company, Northern Concourse Office Bldg., North Syracuse, N.Y.

For more facts, turn the page. ▶

SEMICONDUCTOR PRODUCTS DEPARTMENT

**GENERAL**  **ELECTRIC**



# Save design expense. Take advantage of the PA237's application versatility.



Because General Electric's PA237 operates over a supply voltage range of 9 to 27 volts, you can probably use this one circuit for most of your applications and save money. It is capable of delivering up to two watts of power to resistive or inductive loads. (Pictured actual size.)

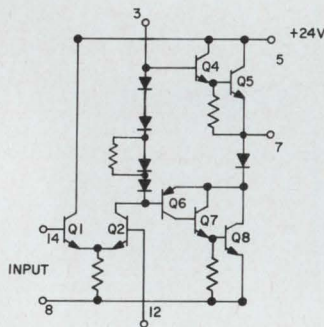

The PA237, shown in this circuit diagram, converts 8 mV of input signal to 2W of continuous, low distortion output power.

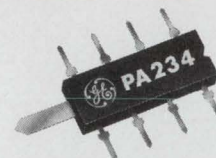

General Electric's PA234 gives you the lowest total cost for a 1-watt amplifier function through a combination of low device cost and minimum number of outboard components. (Shown actual size.)

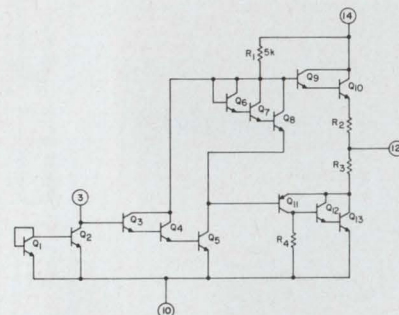

PA234 audio amplifier delivers 1 watt of continuous power to a 22-ohm load from a 22-volt supply.

## Now you can use a single IC for most of your audio applications by simply varying its bias.

General Electric PA237 silicon monolithic audio amplifier is designed to have its biasing network external to the chip. Thus appropriate biasing for any power supply from 9- to 27-volts is readily achieved.

External biasing permits operation with Class A, Class A-B, or Class B output modes. The input may be biased for voltage or current sources as well as differential signals.

In addition to the PA237's wide range of supply voltage and bias alternatives, feedback may be applied to the amplifier to allow adjustment of stability, input and output

impedance and amplifier sensitivity. Simple AC and DC feedback networks are employed to provide excellent stability with frequency and temperature.

General Electric's 1- and 2-watt low-distortion amplifiers are packaged in an 8-lead dual-in-line plastic package with a tab for transferring heat to a printed circuit board. This means easy insertion into the P.C. board and easy heat sinking too. **General Electric's PA234** is the ultimate in low cost 1-watt monolithic audio IC's. Its low cost plus the least number of outboard components of any audio amplifier on

the market makes the PA234 the most economical alternative for achieving one watt of audio power.

Both General Electric's PA234 and PA237 offer you outstanding performance and top reliability in a wide range of circuit applications. These varied uses include phonographs, dictating equipment, tape player/recorders, and TV, AM, and FM receivers. Plus: the PA237 can drive inductive loads or provide voltage regulation for 1% typical over a 9- to 27-volt range. For more information on how GE can save you design expense and cash outlay **circle number 515**.



## Here are some other outstanding GE semiconductors on which you can depend.

### Industry's most predictable UJT saves time and money.

Stand-off ratio spread  $\pm 3\%$ !!  
Oscillator frequency shift .6% max.!  
( $-15^{\circ}\text{C}$  to  $+65^{\circ}\text{C}$ )

GE's D5K1 and D5K2 planar complementary unijunction transistors offer greater stability and uniformity than any UJT previously available. They have characteristics of standard unijunction transistors except that, being complementary, their currents and voltages are of opposite polarity. For most applications, polarity is unimportant.

The D5K1 and D5K2 combine planar and integrated circuit techniques resulting in a much tighter intrinsic-standoff ratio distribution and lower saturation voltage. This gives them both a new high level of performance predictability versus temperature.

Timing stability of 0.5% is achievable without the necessity of expensive temperature testing on individual devices to determine the compensating resistor. For more details **circle number 516**.



### 1200-volt, 400-amp PRESS PAK silicon rectifier costs less.

If you want a high power silicon rectifier diode with the same proved, all-diffused construction of the A90 series, General Electric offers the A390 PRESS PAK. The package innovation delivers far more continuous current than comparable stud-mounted devices, and it's smaller, too.

The new PRESS PAK package, using pressure contacts, allows double-side cooling to significantly reduce thermal resistance and, therefore, increase current ratings about 60%. Result: You get more average amps per dollar.

Light weight, hermetically-sealed PRESS PAK also features reversibility of mounting, thus eliminating the need for special reverse polarity units. And it complements many SCR's already in the PRESS PAK package. For more details, **circle number 517**.



### Now you can custom tailor UJT characteristics to meet your specific needs.

With General Electric's D13T1 and D13T2 programmable unijunction transistors (PUT) you can now program unijunction characteristics such as  $\eta$ ,  $R_{BB}$ ,  $I_P$ , and  $I_V$  to your specific needs by adding two external resistors.



Generally, the D13T gives programmability without increasing circuit complexity. In fact, it often reduces circuit cost. And the PUT offers tight parameter specifications, high sensitivity, low unit cost, low leakage current, low peak point current, low forward voltage, and fast, high-energy trigger pulse too.

D13T2 is specifically characterized for long interval timers and other applications requiring low leakage and low peak point current. The D13T1 has been characterized for general use where low peak point current is not essential. **Circle number 518**.

## Semiconductor Applications Seminar

Two informative sessions during the IEEE International Convention. Everyone welcome—no tickets needed. For those attending, free samples of many new devices.

Tuesday, March 19  
Barbizon Theatre  
Barbizon-Plaza Hotel  
106 Central Park South  
New York City

Integrated Circuits 9:00-12:00 noon  
Semiconductor Control and Power  
Conversion 1:30-4:30 p.m.

For more information on these and other General Electric semiconductor products, call or write your GE sales engineer or distributor, or write General Electric Company, Section 220-63, 1 River Road, Schenectady, N. Y. 12305. In Canada: Canadian General Electric, 189 Dufferin St., Toronto, Ont. Export: Electronic Component Sales, IGE Export Division, 159 Madison Ave., New York, N. Y. 10016.

SEMICONDUCTOR PRODUCTS DEPARTMENT

**GENERAL**  **ELECTRIC**



The Electronic Countermeasures System, a valuable penetration and survival tool for B-52's, posed a tough isolator problem which was successfully solved by Sperry.

What was so tough about the isolator spec? Among other things were power handling capability (400W CW, 4kW peak); isolation VSWR limited to 1.18:1; insertion loss (only 1 db permitted), and RFI shielding to prevent interference with other aircraft systems. All parameters had to be met at altitudes up to 60,000 feet and over the temperature range of  $-55^{\circ}\text{C}$  to  $+55^{\circ}\text{C}$  without cooling.

Sperry met the challenge with Model No. D-44S9, a specially engineered isolator that helps assure the reliability of B-52 ECM.

Is there a particularly difficult isolator problem Sperry can solve for you? There's a broad line of standard items, plus plenty of engineering talent if you need it. For full details, contact your Cain & Co. man or write Sperry Microwave Electronics Division, Sperry Rand Corporation, Box 4648, Clearwater, Florida 33518.

## SPERRY

MICROWAVE ELECTRONICS DIVISION  
CLEARWATER, FLORIDA

**When B-52's count on ECM, they count on isolators from Sperry . . . the first name in microwaves.**

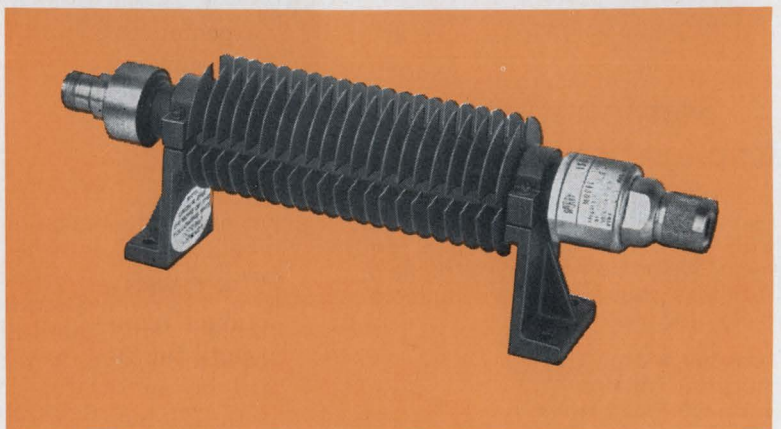



---

# Washington Newsletter

---

March 4, 1968

## Military seeks improved version of Tacsatcom

Military researchers are pushing hard for a fast start on a second-generation tactical communications satellite (Tacsatcom) even before the test model of the first version is launched. **A request for proposals on a new and improved Tacsatcom will go out to industry in midsummer, about the same time that the launching of the initial satellite is scheduled.**

Officials explain that their rush for the new system stems from the relative unsophistication of the first craft, which had to use whatever technology was readily available. **Another reason is that the military wasn't ambitious enough when it set performance and design goals for the first craft, which is now being built by Hughes Aircraft.**

While the Hughes satellite design has been frozen for months, the military has been getting a large amount of test data from the LES-5 satellite, which has successfully tested several new tactical techniques.

## Government urged to monitor regional frequency crowding

**Thorough studies of local radio-frequency congestion will be strongly urged in a report to be issued next month by a joint committee of the IEEE and the Electronic Industries Association.** The panel will recommend that Federally sponsored teams of 10 to 20 engineers be assigned to congested areas to monitor the way frequency bands are being used.

The FCC now has engineers in the field monitoring the spectrum, but primarily to detect illegal or unauthorized transmissions. One result of the report could be an augmentation of these FCC teams; another **might be the speedier revision of the block allocation system** [see story on p. 52].

The committee's recommendations have been presented so far only to the Office of Telecommunications Management. Top officials of the FCC will be briefed on the report within a few days.

## Air Force speeds satellite studies

**The Air Force surprised bidders for the 621B navigation satellite program by scheduling award of the project's two study contracts by May 1, instead of next summer or later as expected.** One bidder noted that this amending of a request for proposals is quite unusual and said it shows the Air Force is "raring to go on this one." Between six and eight companies are expected to bid as prime contractors for the system, which will provide secure and highly accurate navigational fixes for aircraft flying at supersonic speeds. **Proposals are due today for the parallel studies, which will be funded at \$500,000 each.**

## NASA astronomy plans take shape

The space agency's plans for one of its major applications areas—astronomy—are becoming clear. **A new program, the National Astronomical Space Observatory (NASO) has been identified, but it won't appear in budget requests for several years since the observatory isn't slated to fly until the 1978-80 period.**

NASO will be an orbiting observatory designed for long life and equipped with 120-inch telescopes that can be operated automatically or by astronauts. The program would be the culmination of existing efforts in this area, including the new Astronomical Space Telescope Research Assembly (Astra). **Astra, planned for launch in 1974, is scheduled to get into the system definition stage in fiscal 1969.** It will have



---

# Washington Newsletter

---

the long life of the Orbiting Astronomical Observatory, along with the capability of being serviced by astronauts who will replace film and instruments. Astra will provide better resolution and directional accuracy than OAO, which is being readied for launch later this year.

## Lack of FAA funds stalls two programs

A lack of funds in the FAA is starving two important projects. One is the aeronautical services satellite, already held back several times because of technical problems and confusion over policies [Electronics, Nov. 27, 1967, p. 59]. Comsat has pushed for a 1970 launching date, but this doesn't appear possible now. The satellite, designed to relay vhf communications between transoceanic airliners and ground stations, would require outlays by both the airlines and the FAA, whose share would amount to several million dollars annually over five years.

The other project in trouble is the FAA plan to develop for the 1970's an air-ground communications system in which aircraft would use a single frequency and channel switching would be performed by ground stations [Electronics, Jan. 22, p. 51]. The program is now being stretched out to keep it alive, but agency insiders say it may die before it gets into the second development phase.

## Air command post bids seen this year

The Pentagon is moving ahead on an airborne emergency command post for its projected post-1975 worldwide military command system [Electronics, Oct. 16, 1967, p. 69] and expects to be ready to request industry proposals by late this year. R&D costs will exceed \$100 million.

Current plans are to replace the airborne command posts now being flown aboard Boeing 707 craft with an improved system installed on either Lockheed C-5A's or Boeing 747's. These planes could keep the emergency system aloft for longer periods, and their greater size would permit an increase in capabilities, particularly in data processing. Chances are that more of the airborne posts will be needed after 1975 than the handful now being flown.

## Protection bills face opposition

The fate of the so-called electronics protection bills submitted by Massachusetts Republicans Sen. Edward W. Brooke and Rep. Sylvio O. Conte is still in doubt. "All anyone's saying is that there's going to be a lot of compromises," says a Capitol Hill source. Committee hearings are probably at least a month away.

As proposed, the bills would limit imports of consumer electronics goods to the level prevailing in 1966; components imports would be pegged at the 1964-66 average. Country-by-country quotas would also be established. The issue is thorny because while the Administration wants to staunch the dollar drain, it opposes protectionist legislation.

## Panel on standards gets down to work

The new interagency committee on standards, formed to centralize work formerly carried on by many Federal organizations, is expected to set up three task forces this week. They would study the economic effects of standards and the relation between the Federal Government and industrial standards-setting groups.

The committee, made up of representatives from 18 Federal agencies, may also begin planning a metric system study that Congress might get around to funding this session.



**All the Volts: 6kV  
All the Watts: 1.5kW  
All the Time!**



Dollar for dollar—  
spec for spec—6000 Vdc  
/1500 W/  $\pm 0.075\%$  Regulation—  
dependability when and where  
it counts!

## ***New Sorensen DCR-HV:***

- Voltage/Current Regulation with Automatic Crossover
- $\pm 0.075\%$  Voltage Regulation for Maximum Line and Load Changes Combined
- All Solid State Design Featuring Reversible Polarity

Model Number	Output Voltage Range	Output Current Range @ Ambient			Sizes (inches)			Price
		@ 30°C	@ 55°C	@ 71°C	h	w	d	
DCR600-2.5A	6-600 Vdc	0-2.87A	0-2.50A	0-1.65A	10½	19	18	\$ 875.
DCR1500-1.0A	15-1500	0-1.15	0-1.00	0-0.66	12¼	19	18	995.
DCR3000-0.5A	30-3000	0-0.58	0-0.50	0-0.33	12¼	19	18	1250.
DCR6000-0.25A	60-6000	0-0.29	0-0.25	0-0.17	12¼	19	18	1495.

Contact your local  
Sorensen representative  
or: Raytheon Company,  
Sorensen Operation,  
Richards Ave., Norwalk,  
Conn. 06856.  
TWX 710-68-2940.



for more data on this versatile instrument... **Call Sorensen: 203-838-6571**



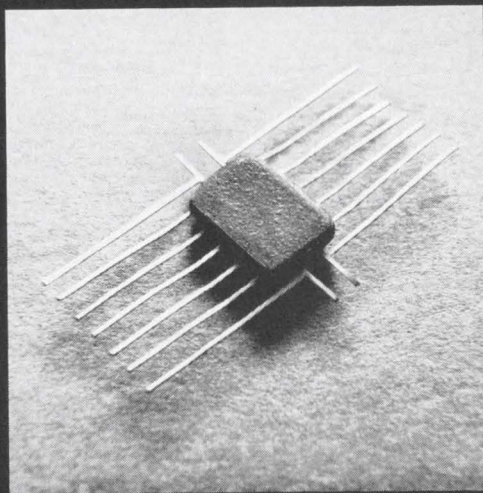



This is the first IC TTL.

We made it back in '63.

Since then we've improved it 361 times. And developed 380 different types. SUHL<sup>™</sup>, J-Ks, arrays.

We're still improving it. And every improvement is immediately incorporated into our entire line.

That's what it takes for us to stay ahead.

Which helps you stay ahead.

**SYLVANIA**  
A SUBSIDIARY OF  
GENERAL TELEPHONE & ELECTRONICS

Sylvania Electronic Components, Semiconductor Division, Woburn, Massachusetts 01801



# 4 breakt new NI



**size** .530" dia. x 1.5" for IC compatibility - largest numeral height provides best readability.



**anode strobing** new design permits all like-numerals to be driven in parallel for time sharing operation with improved brightness.



**pin spacer** simplifies both PC board layout and tube insertion.



**price** in quantities of 1,000 - only **\$395** each.



# throughs: XIE<sup>®</sup> tube

This new tube, type B-5750, has been engineered to achieve all these outstanding breakthroughs in a single design. The new slim-line tube not only has two internal decimal points but also has an "in-line" lead arrangement which is compatible with dual in-line IC's. In addition, the numeral aspect ratio has been designed to provide the optimum in readability and viewing distance.

The movable pin spacer-standoff, which is used to align the tube pins for ease of PC layout and insertion, is part of the tube assembly.

The anode-strobing/time-sharing operation permits substantial reduction in driver costs for many multi-digit display applications. For more information on these and other features contact your nearest Burroughs representative or sales engineer, or write:  
*Burroughs Corporation, Electronic Components Division, P.O. Box 1226, Department N8, Plainfield, New Jersey 07061 TEL: (201) 757-5000.*



ACTUAL SIZE

**Burroughs** 

Circle 67 on reader service card

"SEE B-5750 AT IEEE BOOTH 2 D 39"



# Today...the switch is to TECH LABS

For high quality, precision switches designed for long service life, industry turns to Tech Labs. All Tech Lab switches are manufactured for rugged service and exacting performance. They meet all applicable Military Specifications and are available in a wide range of sizes and types to fit your most demanding designs.

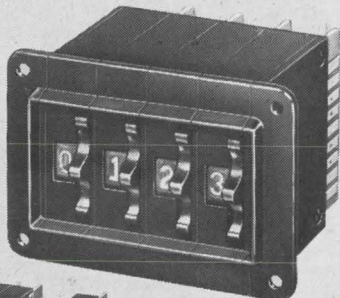

## THUMBWHEEL SWITCHES

A compact, molded, printed-circuit wafer switch for limited space and in line readout. Modular type for either front or back of panel mounting: Modules  $\frac{1}{2}$ " between center lines, height 2". Single or double pole, 10 position, binary or complementary codes, standard. Other codes available on request. Available with adjustable stops.

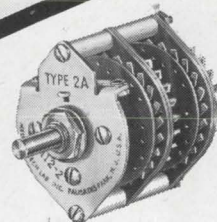
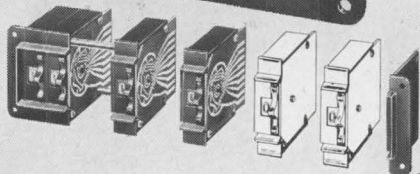

**Type 2A:** An instrument control switch of the highest quality possible with a reasonable price. This switch is a must for all applications where the rating and requirements are high. Rating 5 amp carrying. Size  $1\frac{3}{4}$ " by  $2\frac{1}{4}$ ". Available in all combinations with up to 26 decks and 2 to 26 positions. Has adjustable stop. Solenoid operated if required.

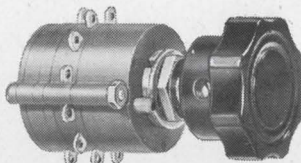

**Type 3A:** A molded miniature switch used in military and commercial applications where space is a premium and a superior switch is required. Can be furnished with up to 8 decks, 12 positions per deck single pole, or 6 positions double pole, adjustable stop. Rating is 5 amps carrying and it can be solenoid operated and hermetically sealed. Only  $1\frac{1}{4}$ " diameter.

## TAP SWITCHES

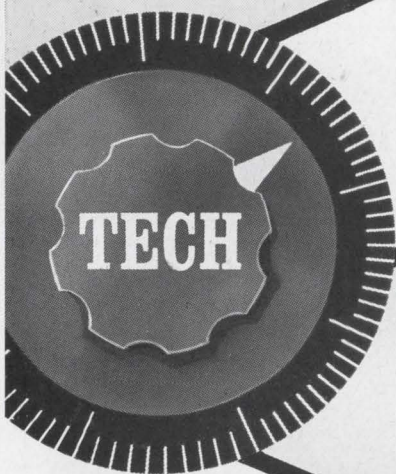

## ATTENUATORS

We also manufacture a complete line of attenuators, both audio and RF. These include potentiometers, ladders, T-pads, H-pads, etc., in many varieties of sizes. Our attenuators are approved by the most particular users in this country.

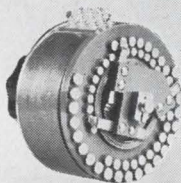

## STEPPING SWITCHES

All our switches can be fitted with a stepping mechanism and can be furnished HERMETICALLY SEALED, EXPLOSION PROOF, if desired. We have built stepping switches with 500 positions per deck.

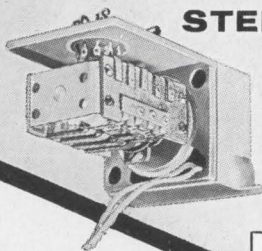

## HEAVY DUTY CONTROL SWITCHES

We manufacture a line of heavy duty control switches in various sizes, which are extremely flexible in the combinations available. These switches are particularly useful where a large number of poles are required.

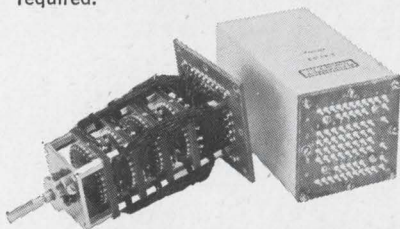

## SPECIAL SWITCHES

When standard switches will not meet the requirement, we design and manufacture special switches to order. Send us your specs.



FREE!

Send today for our 24 page Switch Catalog

Telephone: 201-944-2221 • TWX: 201-947-4730

**TECH LABORATORIES, INC., Palisades Park, N. J.**

SEE US AT BOOTH NO. 3H11 --- IEEE SHOW.



# NEW

## Printer Designs For The O.E.M.

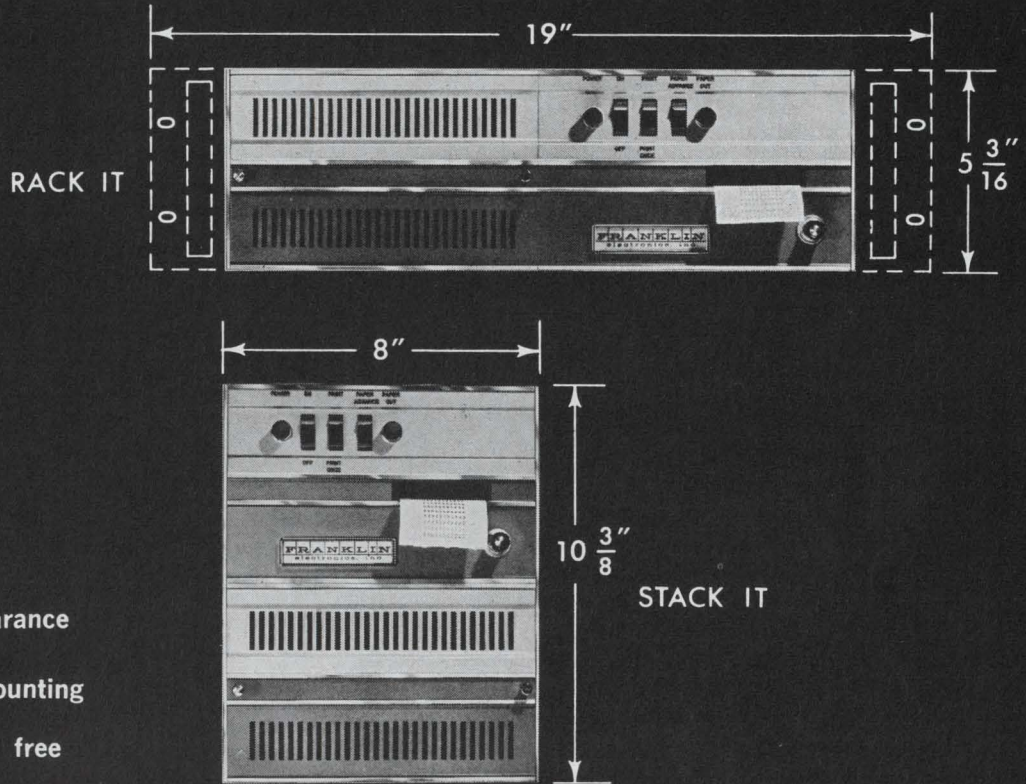

- low cost
- small size
- smart appearance
- universal mounting
- maintenance free

SEE THEM AT IEEC

## Series 800 DIGITAL PRINTERS

**Low cost . . .** Model 812D is typical: 8 columns, 12 lines per second, complete with electronics, power supply, etc. As illustrated, less than \$1500.

**Small size . . .** Depth behind panel is only 17" (less connector depth of 2 5/8"). Other dimensions as shown in illustration.

**Smart appearance . . .** Two-tone grey. Extruded aluminum front panel—with satin finish aluminum trim. Dresses up the appearance of any equipment.

**Universal mounting . . .** Four rubber feet for table mounting. Matching mounting ears for attractive 19" rack

mounting. Options permit half-rack mounting, stacked table mounting, or remote mounting. (One chassis contains the print head; the other contains the solid-state electronics and power supply.)

**Maintenance free . . .** For perfect performance, occasionally clean the reusable air filter, brush out any accumulated dust or dirt, apply two or three drops of oil to the drive-motor bearings each year. That's all.

There are a lot of other features too. They're all described in Engineering Data Sheet 3008. Also ask for a copy of free 36-page Printer Engineering Guide.

### OTHER FRANKLIN PRINTERS

BASIC MODEL NO.	MAXIMUM NO. OF COLUMNS	PRINT RATE IN LINES PER SEC.	PRINTABLE CHARACTERS	
			NUMERIC	ALPHA-NUMERIC
120A	1	20		✓
812D-4	4	12	✓	
812D-6	6	12	✓	
812D-8	8	12	✓	
812D-10	10	12	✓	
1200	12	20	✓	
1200	12	30	✓	
1200	12	40	✓	
1600	16	20	✓	
1600	16	30	✓	
1600	16	40	✓	
2200	22	20	✓	
2200	22	30	✓	
2200	22	40	✓	
2200	22	20		✓
3200	32	20	✓	
3200	32	30	✓	
3200	32	40	✓	
3200	32	20		✓

**FRANKLIN**  
electronics, inc  
BRIDGEPORT • PENNSYLVANIA

A SUBSIDIARY OF MOHAWK DATA SCIENCES CORPORATION

**MD**



# 60A, 1400V Controlled Avalanche Thyristors..

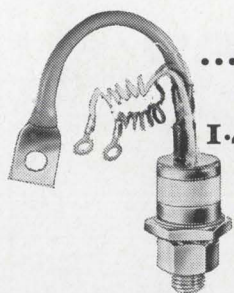

...part of a range covering  
1.0 to 62.5A, 100V to  
1.4kV in 4 different series

Standard types, high temperature types, avalanche types and inverter grades—all readily available from Mullard at competitive prices.

Here are the details—

<b>Avalanche Types</b> Rated: 85°C Stud	Average Current Ratings	Up to 60A
	Min. Avalanche Voltage	Up to 1400V
<b>High Temperature Types</b> Rated: 110°C Stud	Average Current Ratings	Up to 11.5A
	Max. Crest Reverse Working Voltage	Up to 400V
	Turn off time (up to 10A)	10 μs
<b>Inverter Types</b> Rated: 85°C Stud	Max. Crest Reverse Working Voltage	Up to 500V
	(up to 62.5A)	15 μs
	Average Current Ratings	Up to 62.5A
<b>Standard Types</b> Rated: 85°C Stud	Max. Crest Reverse Working Voltage	Up to 1000V

Every designer should have a copy of the Mullard Quick Reference Guide containing information on thyristors, rectifiers, stacks and modules.

Also ask to be put on the mailing list of the Mullard Bulletin—a regular publication which gives details of new components and applications . . . the result of extensive research and development programs in the Mullard laboratories in England. Mullard employ 1,000 qualified scientists and engineers and have six major plants, with over 3 million square feet of floor space.

Write today for information on Mullard thyristors, and for the name of your local Distributor.

Mullard Limited, Mullard House, Torrington Place, London WC1, England.

U.S.A. enquiries to Mullard Inc., 100 Finn Court, Farmingdale, Long Island, New York. 11735 U.S.A.  
Telephone: (516) 694-8989 Telex: 961455

# Mullard LIMITED

MOL41



Oak's design engineers are impatient . . . nothing is ever quite good enough. They figure improved products today mean better circuits tomorrow. Take these: ♦ Oak-manufactured Rotary Solenoids and Selectors for multiple switching functions in limited space under severe operating and environmental conditions. ♦ Molded Pushbuttons designed specifically for computers, communications and other panel equipment. ♦ Rotary Switches with molded diallyl phthalate stators and rotors, Unidex™ indexing. ♦ Lever Switch with molded diallyl phthalate type "A" stator for miniaturization, versatility in a small area. Plus these—Rocker Thumbwheel, Pushbuttons, Lever and Slide Switches. Oak offers widest selectivity in quality switches for industrial, commercial or military requirements. In fact, Oak has more switches that meet MIL-S-3786 than all other manufacturers combined—over 24 switch products. The next switch manufacturer has six. In addition, Oak offers sub-assembly service to save you production time and costs. These are only highlights of a small part of the complete Oak line of components. Send today for Catalog 24.

**DESIGNED FOR TOMORROW'S  
CIRCUITS!**



Ph: 815-459-5000 TWX: 910-634-3353

**OAK**

CABLE ADDRESS: OAKMANCO

MANUFACTURING CO.

A DIVISION OF OAK ELECTRO/NETICS CORP  
CRYSTAL LAKE, ILLINOIS 60014



# THINKING RELAYS?

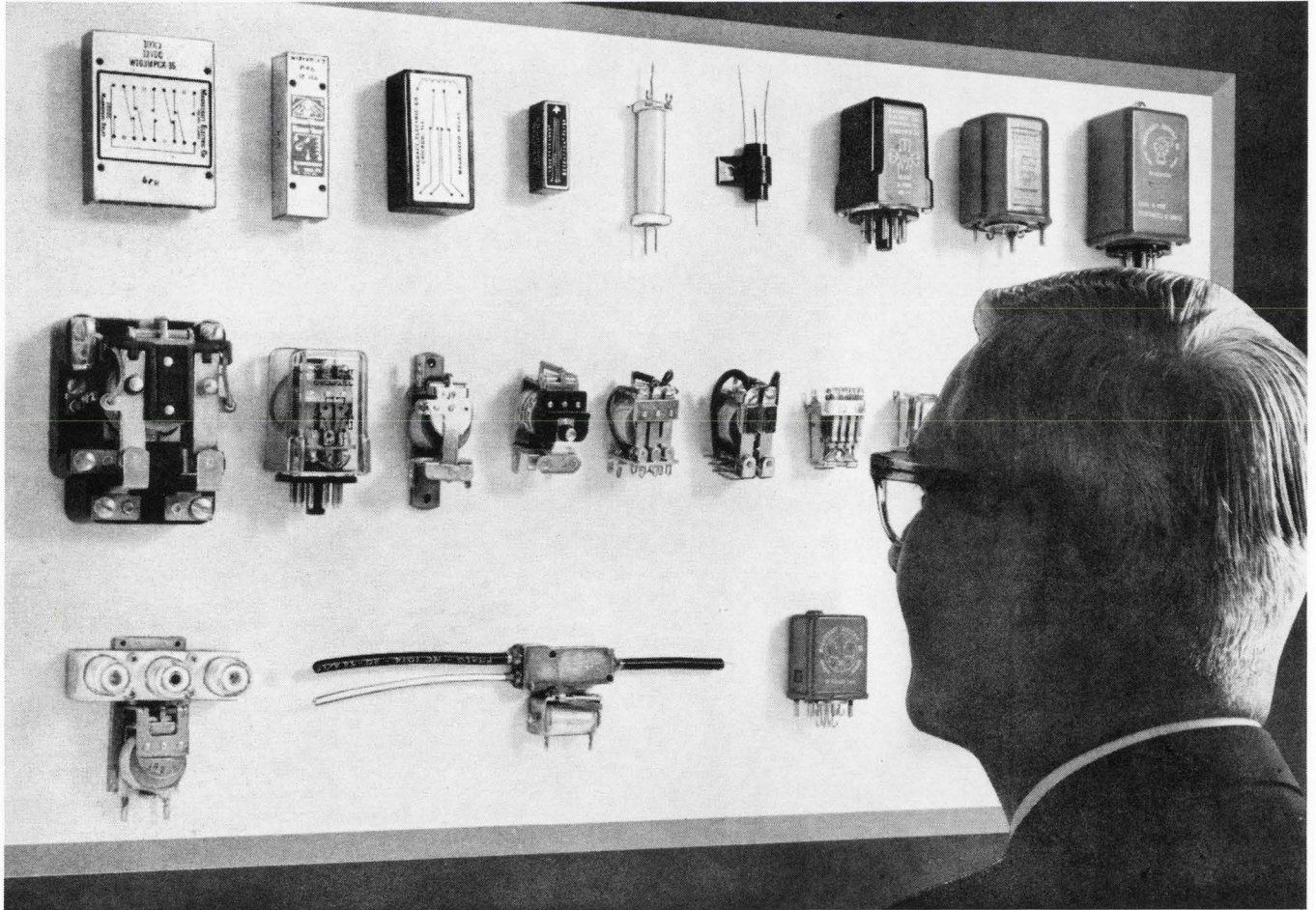

# THINK MAGNECRAFT!

(that's all we think about, exclusively)

We specialize in relays. Not only dry reed and mercury-wetted relays, but a full line of quality, long lasting relays. There are Magnecraft general purpose, telephone type, time delay and power relays, as well as coaxial relays for UHF switching.

All Magnecraft relays are built to provide reliable performance in any application. And to insure this reliability, our demanding quality control system puts every part and assembly through repeated inspections before any shipment leaves our plant.

Everyone at Magnecraft concentrates on relays to provide you with quality products, quickly delivered and at competitive cost. That's because all we think about is relays! Just ask our wives!

See us in Booth No. 3J06 at the IEEE Show

**Magnecraft**<sup>®</sup> ELECTRIC COMPANY

5575 NORTH LYNCH AVENUE • CHICAGO, ILLINOIS 60630 • 312 • 282-5500



**FREE! Product File** — Yours for the asking. Contains full details on all our stock relays.



From any angle the Crossflo<sup>®</sup> is new

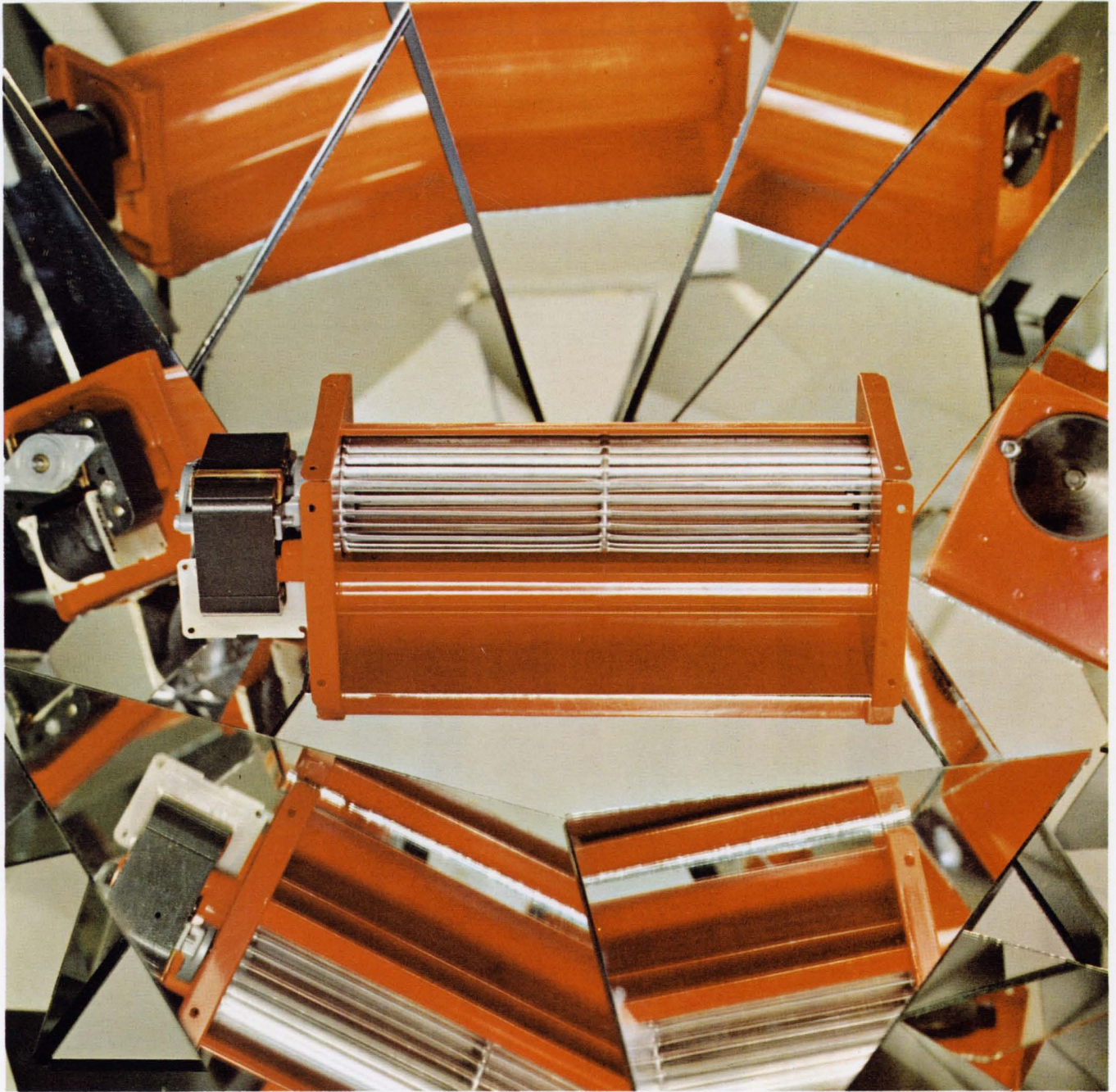

Remember how the fluorescent tube changed things in lighting? Crossflo brings the same freedom for design to air moving.

In size it is a wide slim wheel and scroll, actually unlimited in width. This important configuration not only makes the Crossflo look different than the usual blower, but also removes a dimension from the air stream. Standard centrifugals have a three dimensional air flow which is basically uneven in delivery. A two dimensional air stream is the unique advantage of Crossflo. At any station along the length of the wheel, the flow profile plot is the same. The velocity of air at this point is established by the diameter and speed of the wheel. The total volume of air delivered is then simply a function of the unit width.

Since the air stream is always perpendicular to the shaft from inlet to outlet, there is no end clearance demand except that necessary for mounting.

Translated into product designs this wide ribbon of air, capa-

ble of working against pressure, can flatten evaporator coils on auto air conditioners, wrap a refrigerator display case in a cold blanket, permit the thinnest of wall heaters, and send a cooling flow of air through a compact electronic unit. Torrington engineers are constantly designing a great variety of Crossflo sizes for specific applications, they have also created a completely standard product which is delivered "off the shelf". Standard sizes are 2" x 7" and 2" x 9". For your own evaluation we suggest you order a "standard" sample, test it out, and then define your needs to our application engineers who can advise you as to your specific requirements. From any angle the Crossflo is new, exhibiting features that we believe you will like to work with.

**TORRINGTON**

**TORRINGTON MANUFACTURING COMPANY**

**United States:**Torrington, Connecticut/Van Nuys, California/Rochester, Indiana **Canada:**Oakville, Ontario **England:**Swindon, Wilts. **Belgium:**Nivelles **Australia:**Sydney



# Even if the impact strength after heat aging of **NORYL<sup>®</sup>-3** doesn't astonish you

THERMOPLASTIC RESIN

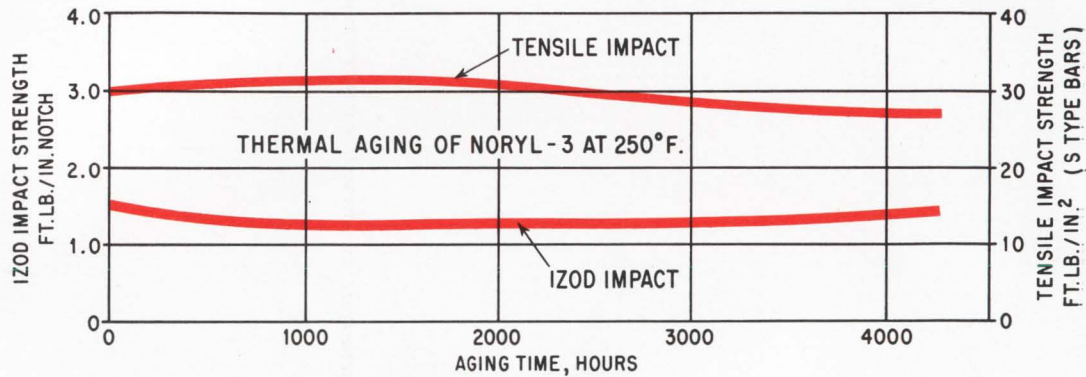

## or the tensile strength either

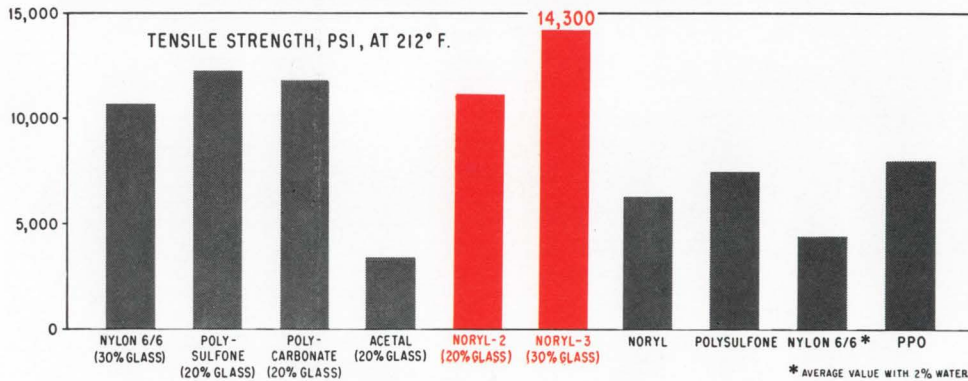

## the price will.

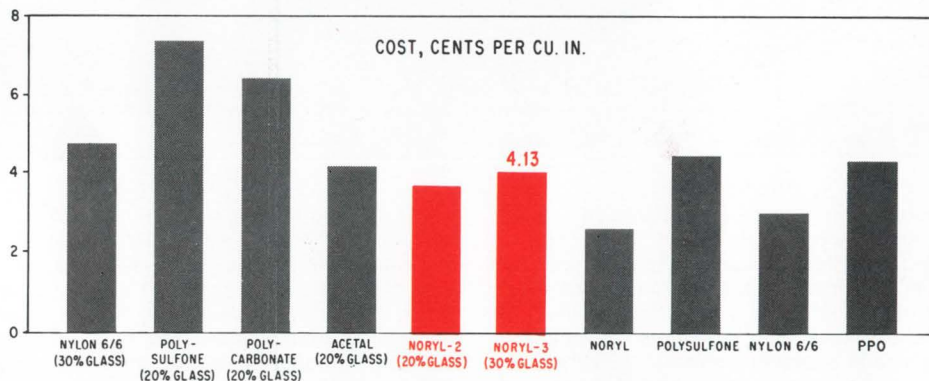

The right combination of high performance properties at the right price has made Noryl catch on faster than any other engineering thermoplastic for electrical components, housings, pump components, autoclavable food processing and serving equipment and hot water reservoirs. For complete data, see your GE Chemical Sales Representative or write us at our brand new multi-million dollar plant, Polymer Products Operation, General Electric Company, Long Lane, Selkirk, N.Y. 12158. In Europe, N.V. Polychemie AKU-GE, 76 Velperweg, Arnhem, The Netherlands.

Leader in Engineering Plastics

PPO<sup>®</sup> • LEXAN<sup>®</sup> • NORYL<sup>®</sup> • PHENOLICS

**GENERAL  ELECTRIC**



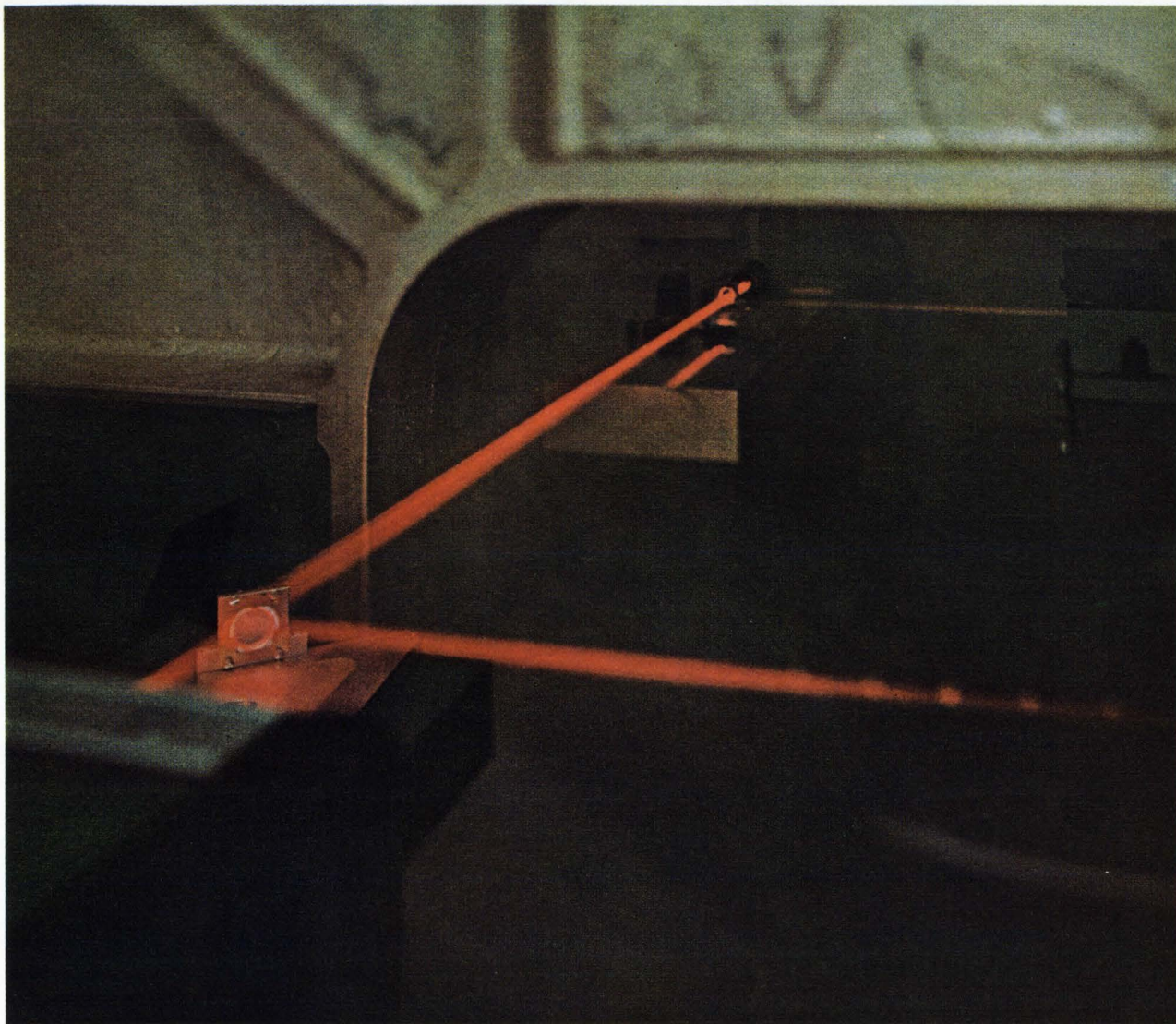

## Only ITT has laser-controlled IC mask making.

### **Another reason to buy from "The Predictables."**

Mask variations used to mean performance variations in Series 930 DTL. Now ITT initiative has eliminated the problem. An exclusive laser-controlled, fully automated mask making machine assures absolute repeatability of masks and of circuit performance.

ITT's machine, representing an order of magnitude improvement over older processes, holds mask registration tolerances to  $\pm 122$  silicon atoms (based on the crystal lattice constant). It is tape programmed, with memory storage capacity of 10,000 separate semiconductor devices, and it can complete a matched set of up to nine masks in as little as 10 minutes.

If you think all Series 930 DTL

circuits of the same type should act the same, the solution is simple: buy them from "The Predictables." ITT predictability also extends to diodes, rectifiers, and silicon planar transistors. Ask for a quote on any or all. They are on-the-shelf at your ITT distributor. ITT Semiconductors is a division of International Telephone and Telegraph Corporation, 3301 Electronics Way, West Palm Beach, Florida.

semiconductors **ITT**

FACTORIES IN FLORIDA • CALIFORNIA • MASSACHUSETTS • ENGLAND • FRANCE • GERMANY • PORTUGAL • AUSTRALIA



**IF YOU MAKE  
SOMETHING  
FOR WHICH  
GCC CAN'T SUPPLY  
WIRE AND CABLE,**



**YOU'RE MAKING  
SOMETHING  
THAT DOESN'T NEED  
WIRE OR CABLE.**

Do you need magnet wire, coaxial cable, Teflon\* resin-coated wire or fabric? How about cord sets, harnesses or connectors? Or maybe lead wire, hookup wire, audio wire or electronic wire?

What type? What rating? No matter. General Cable has it. Because GCC is in the OEM business and in it big! How big? Come to booth 4J29 and 4J31 at the IEEE Show and see for yourself!

**GCC**  
GENERAL CABLE CORPORATION

\*Teflon is DuPont's registered trademark for its fluorocarbon resins.

730 Third Avenue, New York, N.Y. 10017



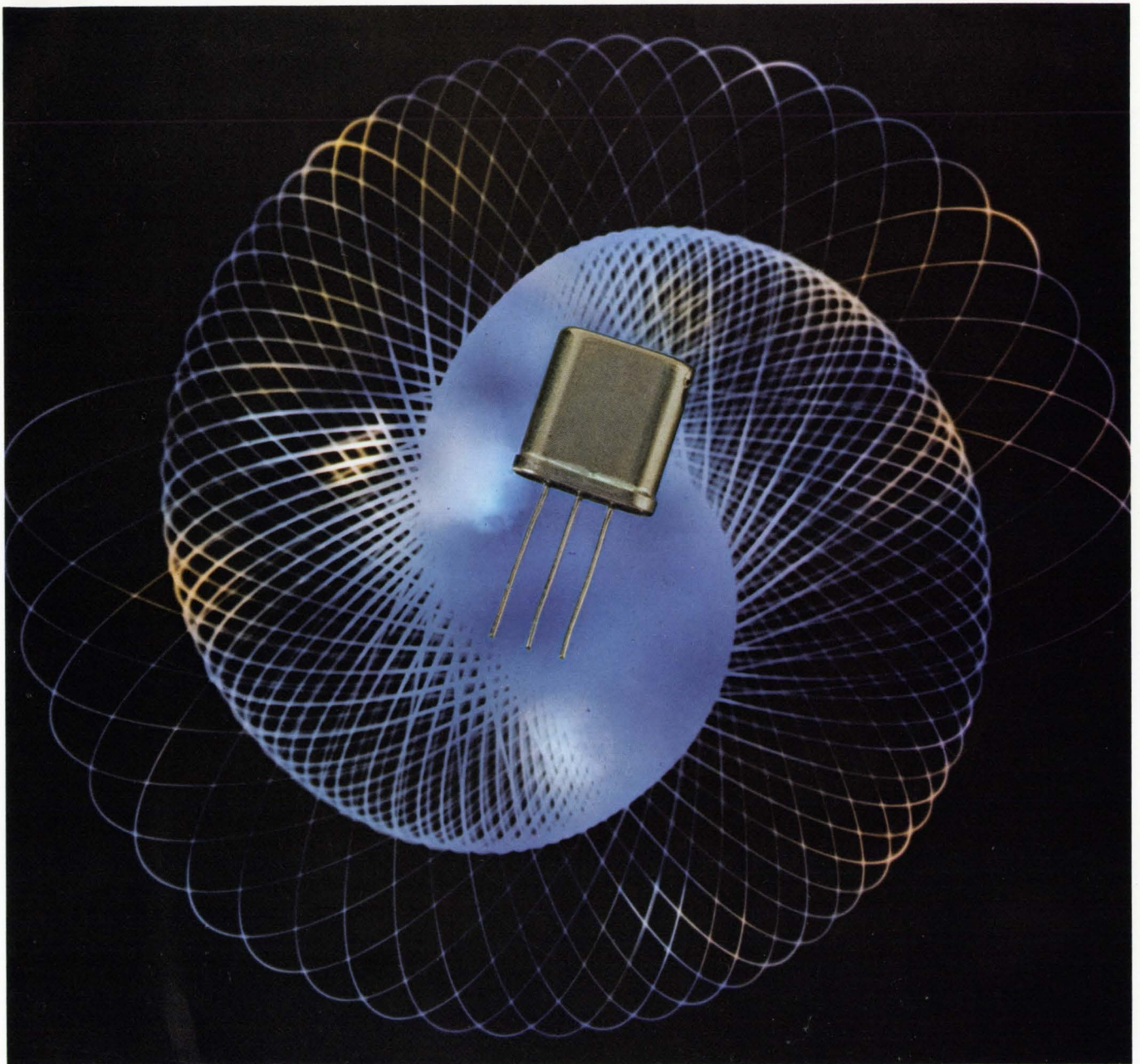

## DISCRIMINATE YOUR FREQUENCY ...WITH M<sup>c</sup>COY PRECISION

Now!—new advances in design and manufacture of VHF crystal filters means even more latitude in your choice of M<sup>c</sup>Coy filters for frequency discrimination. New filters range 35-216MHz...35-93MHz (bandwidths 5-100KHz), 93-150KHz (7-40KHz) and 150-220MHz (10-24 KHz).

These in addition to the previous M<sup>c</sup>Coy range covering 5KHz to 125MHz...the most complete line of filters in the world. You can depend on M<sup>c</sup>Coy because we make our own crystals with the optimum combination of inductance, capacitance, Q and frequency stability

...the best assurance of quality crystal filters.

Whatever your requirements...sophisticated electronics; miniature size and weight for performance; environmental stress of vibration, shock or temperature ...we've probably already met a similar problem.

M<sup>c</sup>Coy has the fastest delivery in the industry because our engineering, manufacturing and testing are completely coordinated. For any application...large or small, complicated or simple...let us hear from you. Write for full details with selectivity graph.



### M<sup>c</sup>COY ELECTRONICS COMPANY

A Subsidiary of OAK ELECTRO/NETICS CORP

Mt. Holly Springs, Pennsylvania 17065

Tel. 717-486-3411

TWX: 510-650-3548



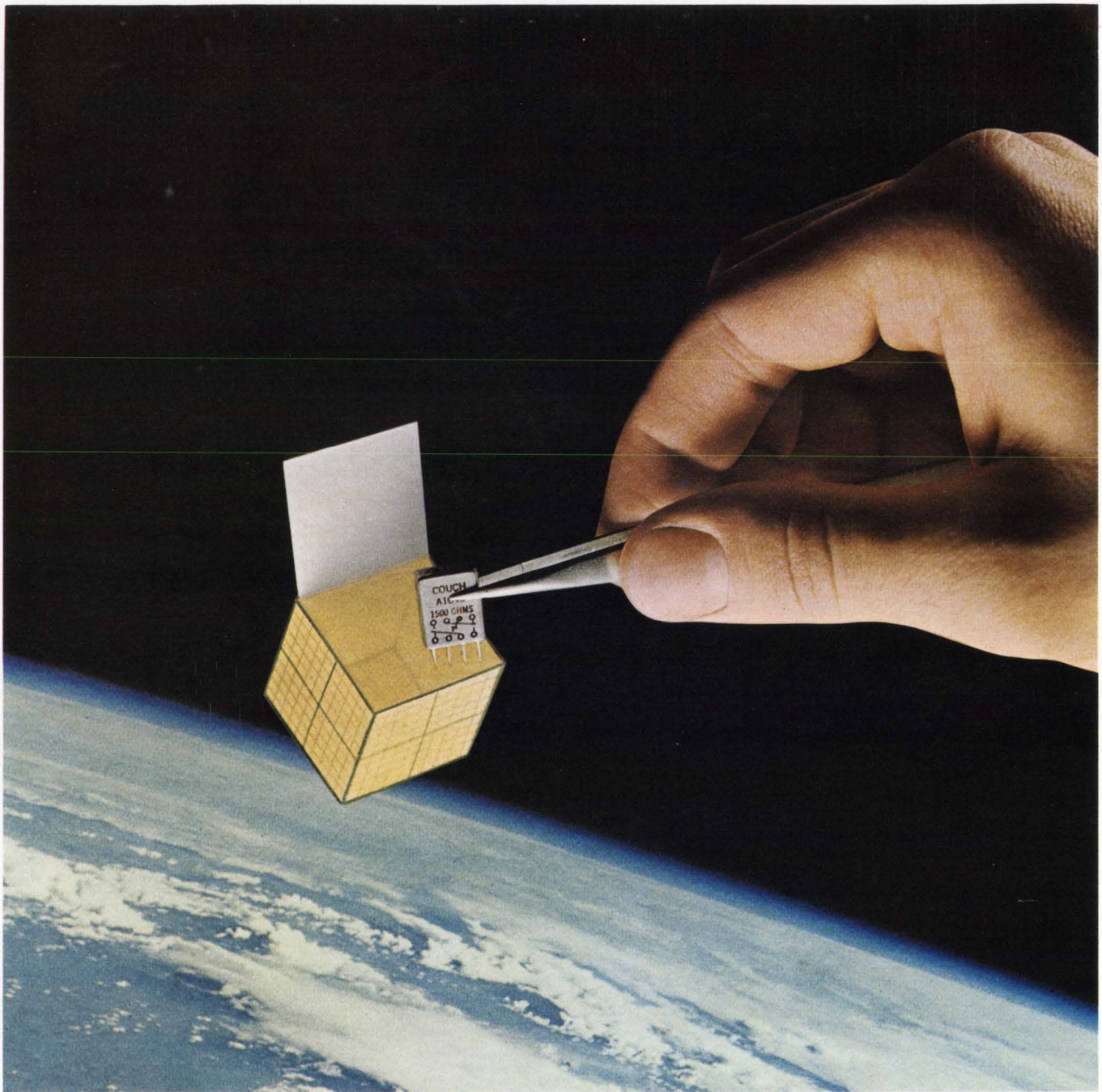

NASA

## Couch 2X relays in new 1/7 size meet MIL-R-5757D/19 in 1/25th of a cubic inch

The new Couch 2X 1/7 size rotary relay helps solve switching problems where space and weight are critical factors. Predecessors of the Couch third generation relays delivered unfailing performance in the missile, aircraft and space fields — and they still do. Today the new Couch 2X offers the same high degree of reliability in microminiature. Use them with complete confidence for signal switching with other circuit board components. Each relay delivered is fully tested. Additional screening tests are available at your option. Couch 2X relays are made in a variety of coil resistances, three terminal styles and in a wide choice of mounting styles. Other products available include: 10 amp rotary relays, ultra-sensitive crystal can relays and full-size rotary switches.



	2X (DPDT) 2-pole	1X (SPDT) 1-pole
Size	0.2" x 0.4" x 0.5"	same
Weight	0.1 oz. max.	same
Contacts	Low Level to 0.5 amp @ 30 VDC	same
Sensitivity	100 mw	70 mw
Coil Resistance	60 to 4000 ohms	125 to 4000 ohms
Temperature	-65°C to 125°C	same
Vibration	20 G to 2000 Hz	same
Shock	75 G, 11 Ms	same

Write for Data Sheets No. 9 and 10.

RUGGED ROTARY RELAYS  Dynamically and Statically Balanced

**Couch**  
1894

**COUCH ORDNANCE, INC.**

3 Arlington Street  
North Quincy, Mass. 02171  
(617) 298-4147

A subsidiary of S. H. COUCH COMPANY, INC.



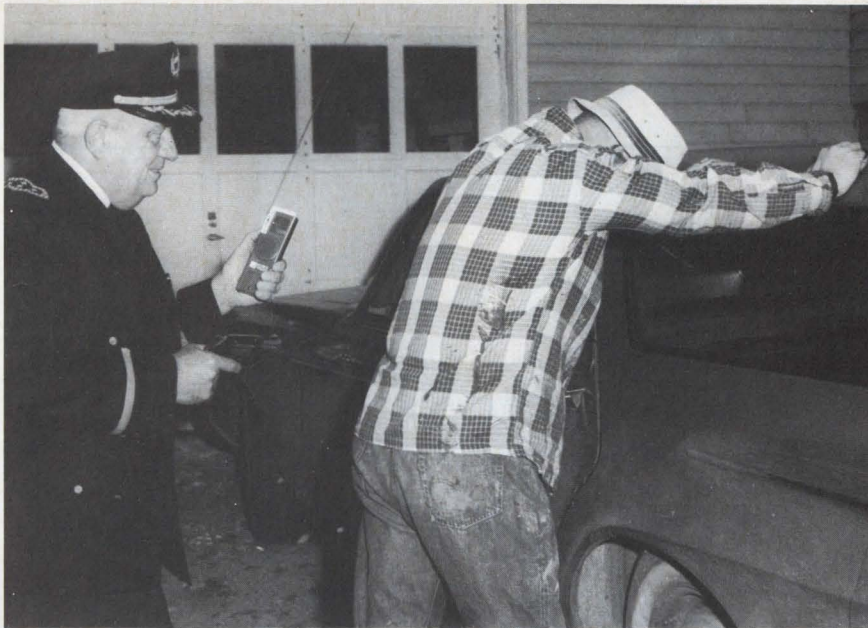

**Application:** Shirt pocket size 1-watt FM transceiver.

**Problem:** How to fit a precision two channel, 1-watt FM transceiver into a 7" x 2 3/8" x 7/8" package weighing 18 ounces and still not sacrifice performance or reliability.

**Solution:** Ultra high density packaging utilizing Minitan subminiature solid tantalum capacitors.

The pocket sized transceivers carried by policemen, the beacon-transceivers in aircrew survival packs, and the tape recorders in our latest space shots have at least one thing in common — Minitan subminiature solid tantalum capacitors. Wherever large value capacitors are needed for by-passing, coupling, or filtering, there is really no substitute for electrolytics. And among electrolytics, none offers greater capacitance to volume ratios or greater reliability than Minitan subminiatures.

Minitans are up to 75% smaller than equivalent CS13 styles and up to 90% smaller than "miniature" aluminum electrolytics. They are even smaller than monolithic chip ceramics and miniature Mylars beginning at about .05 mfd. Minitans don't sacrifice performance and reliability for size, however. This is why they are designed into a growing number of portable and miniature communications equipments.

Minitans operate reliably to 125°C, handle 130% voltage surges, withstand Method 106 moisture testing, and have excellent TC's. Standard tolerances are  $\pm 20\%$ ,  $\pm 10\%$ , and  $\pm 5\%$ . DC leakage is typically less than .01uA per mfd-volt. Impedance is typically below 10 ohms between 1MHz and 10MHz.

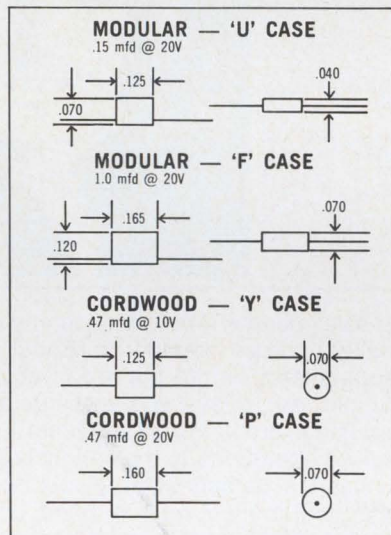

Will equipment give thousands of hours of trouble-free life even after being stored for months or years? We can't guarantee the equipment, but we can the capacitors which never require re-forming, never leak or dry out, and have normal life expectancies measured in the tens of thousands of operational hours.

## how to save space in subminiature communications gear...

What about voltage derating for even greater reliability and longer life. Don't try this with capacitors whose dielectric uniforms with less than rated applied voltage. But with Minitan solid tantalums, voltage derating not only substantially reduces leakage values but materially increases reliability and life as well.

Minitans are available in 11 case sizes, working voltages to 35 volts, and capacitance values from .001 to 220 mfd. A full line of non-polar styles is offered for severe reverse DC bias applications.

Both axial and radial leads are available in both tubular and rectangular case styles. For maximum IC compatibility, gold plated ribbon leads are a standard option.

Components, Inc. offers more subminiature case styles and ratings than anyone else. **Our products are designed in, not added on.** So we welcome requests for samples, performance and reliability data, and applications aid. Almost every catalog part can be shipped in prototype quantities within 24 hours.

... with  
**Minitan<sup>®</sup>**  
solid tantalum  
capacitors

VISIT US AT BOOTHS 4D-15-4D-17, IEEE SHOW

**COMPONENTS, INC.**  
MAINE DIVISION

SMITH STREET / BIDDEFORD, MAINE 04005  
TEL. 207-284-5956 / TWX-710-229-1559



**WE  
AT  
COOK  
ELECTRIC  
ARE  
OUT  
TO  
CHANGE  
YOUR  
OUTLOOK...**

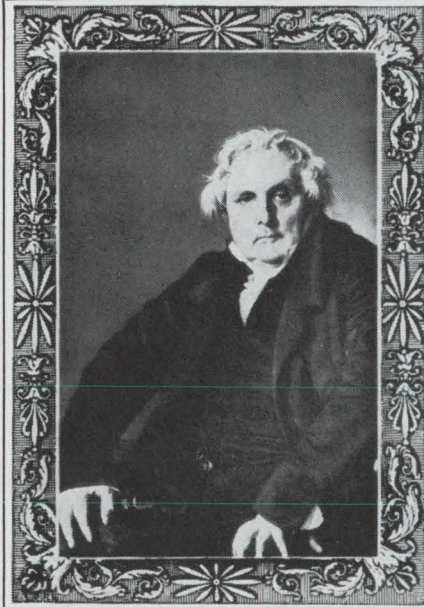

About sales and sales people. About service and delivery deadlines. About quality you can depend on. About new products to meet new requirements before the need becomes an emergency. For example, our relays and pressure switches have been solving industrial problems for 20 years...ranging from small manufacturing operations to the national space program.

Whether you need a component replacement today, or a specially-designed unit to meet a future need, count on us. We specialize in having solutions on hand before problems arise.

And if you're tired of promises unkept and delivery dates unmet, we invite you to investigate the production and service facilities of Cook Electric. You'll find it's good business. With us, performance comes before promise.



**COOK  
ELECTRIC**

AUTOMATIC CONTROLS DIVISION

200 E. DANIELS ROAD • PALATINE, ILLINOIS 60067 • 312-359-2100



# Technical Articles

---

**Overseas firms come to IEEE to swap ideas and keep in touch**  
page 82

Foreign exhibitors at the IEEE show agree with many domestic exhibitors on at least one thing: most engineers don't come to the convention to place orders. Yet the show turns out to be a gathering place of specialists who want to talk about techniques and problems, and the foreign firms are here to learn as well as sell. Some European exhibitors find they get more and better inquiries about their products at the IEEE show than they do at home. The Japanese will be testing reactions to some promising new developments, including luminescent diodes and a magnetic scale for numerical control.

**CAD: Practical approach to IC's**  
page 94

Some of the programs proposed for the computer-aided design of integrated circuits provide models that bear little resemblance to real IC's. But a new computer program that takes into account only such salient device parameters as impurity concentrations and diffusion profiles and relates them to the desired electrical characteristics, can make CAD a far more practical tool.

**Batch fabrication of light-emitting diodes**  
page 104

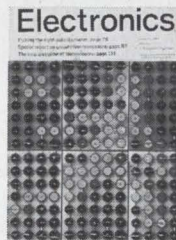

Batch fabrication of light-emitting diodes may signal a new generation of alphanumeric displays. Such arrays might constitute the entire instrument panel of an automobile or be used to display tv channel numbers or the temperatures of range ovens. Researchers have already produced experimental five-by-seven arrays from single wafers of gallium arsenide phosphide. On the

cover, six of these arrays are appropriately lighted to depict a running figure.

**Linearizing transducer signals digitally**  
page 112

A new digital method improves the accuracy and cuts the cost of transducer-signal conditioning. Developed in Finland, the method replaces the time-honored analog technique. In one application—an industrial logger—four different types of thermocouples and one resistance-temperature detector are linearized on a single p-c card at a cost per function of about \$20.

**Predicting components' response to radiation**  
page 122

Testing circuit components individually to see if they can stand up to radiation is costly and time-consuming. With some fairly simple equations, the designer can predict components' radiation behavior on the basis of parameters measured under ordinary conditions—an easier way to select both semiconductors and passive elements for radiation-hardened circuits.

**IC's improve color sets' video i-f amplifier**  
page 130

The burden on the i-f amplifier of a color tv receiver is great. It must provide most of the set's gain and handle a good share of the automatic gain control without distorting or clipping the incoming signal. Integrated circuits have a future in the video stage; they provide input-output isolation, simplify alignment and give better age than discrete components can.

---

**Coming  
March 18**

- Thin-film transistors revisited
- Infrared as a measuring tool



# Foreign exhibitors restrain enthusiasm

Most look for contacts, not sales, and some wouldn't mind skipping the whole thing—but the Japanese go all out

**If you're going** to look for new products from foreign companies at the IEEE show you'd better brush up on your Japanese. Most European exhibitors will be at the Coliseum just to fly their company flags. Their attitude toward the March 18-21 show is summed up by a West German marketing executive:

"While we consider the IEEE the No. 1 show—Wescon is a close second—we look at it as a place to make contacts, not as a place to sell. So there's no real reason to trot out our newest devices; we'd rather display the familiar ones that we're best known for." Another European executive says:

"We'd just as soon skip the whole thing. But our closest competitors are there, so we have to be."

The Germans are mounting an all-out assault on American electronics shows, but they have no illusions about the IEEE show as a marketplace. Peter Hoellein, sales director of Rohde & Schwarz, Munich, says his company has been a New York exhibitor for many years and sees no reason to quit. But, he adds, "We're not exhibiting to make big sales. Rather, we want to take the opportunity to show American engineers what we can do." His advice to firms seeking big orders: stay away. "Our intentions," Hoellein adds, "are different. By making contacts with engineers and impressing them with our abilities, we hope to help them meet specific requirements. It's these contacts that lead to inquiries about our products, and finally to orders." He regards the show as an excellent place to pinpoint needs. "It's really a big gathering of specialists who come to discuss and present their problems. We're there to see how those problems best can be solved and get a good feeling of what's required in the future."

He also likes the atmosphere at the Coliseum. "Engineers are relaxed there," he says, "free from tensions and removed from the troubles and anxieties that plague them at their jobs. An exhibitor-visitor relationship exists at the show that's quite different from that experienced when you go see an engineer in the narrow confines of his office at the plant."

The British agree the Coliseum is no order-writing office. Bernard J. Haynes, group managing director of KGM Electronics Ltd., feels the IEEE exhibit's

main claim to support is that it gives him a feel of the American market. A small independent group of companies with about 200 employees, KGM is mostly making illuminated digital or alphabetical readout devices for instrument makers. Says Haynes:

"Our first shot at the IEEE was last year, and we're coming back. Our previous exporting experience had taught us that it's vital to know the market you want to sell in. We knew that marketing in the U.S. was far different from marketing in Europe, and we also knew that IEEE was a meeting place for U.S. marketing men far more than European shows are meeting places for European marketing men."

Inquiries last year, Haynes estimates, were 50% more numerous and more serious than those encountered at recent European shows. He attributes this to the fact that the IEEE show is a meeting place for agents, and he was looking for agents. "If an American is interested in your product," he says, "he usually comes straight on to the stand and asks about it. On the other hand, a Briton may be interested, but he'll prowl around at a distance trying to make his own judgment without actually talking to you." Haynes believes one other plus for the IEEE convention is that it attracts fewer casual inquirers than European shows. "The IEEE is a good introductory education in American selling methods."

A bit different is the experience of the English Electric Valve Co., part of the English Electric Co. group and one of Europe's largest makers of special electronics tubes. English Electric Valve, coming to New York for the eighth year, receives fewer inquiries at the Coliseum than at European shows. But, explains sales manager Robert Coulson, this is due to the nature of the products. "With conventional components, such as tubes, U.S. buyers naturally tend to think of U.S. suppliers first, and there are plenty of those." Also, English Electric Valve has been concentrating on European and Commonwealth markets for many years and is much better known there than in America. "In the U.S.," Coulson adds, "an inquirer has probably made his assessment of American products before he approaches us; in Europe, we'll most likely be considered first."

G.&E. Bradley, a British firm specializing in sub-systems for microwave system builders, is coming



to the show for the first time. Ken Sharpe, manager of the Microwave Products division, explains: "It's unprofitable to custom-make subsystems, so we've developed one that can be mass produced. Now, we have to show it where the action is—the U.S."

Many foreign companies won't tell in advance what they're showing. Others apparently make up their minds at the last minute. Still others leave the decision to their New York office and write off the IEEE meeting as an important showplace. Within those limits, here's a rundown on foreign firms.

#### France: comme ci, comme ca

Most French companies represented are allowing their New York offices to decide what will be put on the stands.

Compagnie Française Thomson Houston-Hotchkiss Brandt shrugs off its display as "just a few tubes": power-grid tubes, uhf triodes and tetrodes, high-gain triodes, light-sensing tubes, pickup tubes, light image intensifying tubes, and special purpose tubes. Compagnie Générale de Electricité talks vaguely about "some lasers," and Adret Electronique admits only that it will show up.

#### Britain: hope springs eternal

Electronics executives in Britain have adopted a generally thumbs-up attitude about the IEEE exhibit.

KGM will be showing its acrylic resin edge-lighted readout indicator. The units have 10 layers of acrylic, each engraved with a different digit, and 10 tiny incandescent bulbs, one against the edge of each sheet. The unit attaches to a solid state pulse decoder made by KGM, but it also can be operated manually. The company claims its patents make it difficult for anyone else to equal its indicators in using this principle. One patent in particular permits use of a bent acrylic sheet with the row of bulbs

mounted along the back of the unit. Everyone else has to use flat sheets, adding to the indicator's width, says KGM.

English Electric Valve has found the products that sell in the U.S., and which it therefore features in its IEEE display, fall into two categories:

- Basically standard tubes that the company makes in high enough volume to be competitive. The best example is a mechanically tuned pulse magnetron intended for linear accelerators. Another example is a long-anode magnetron also aimed at linear accelerators.

- Special products that have no U.S. equivalent. The best example is a high-gain transmission, secondary-emission image intensifier that can be used for direct viewing or photographing events at very low light levels.

G.&E. Bradley, the microwave subsystems specialist, found that custom construction was not only unprofitable but also a waste of microwave engineers, who are scarce in England. So the company developed subsystems that could be volume-produced—solid state microwave sources built up of modules to give a variety of outputs. It has taken space at the show to promote wide sales. Says Sharpe: "The only way a British maker of microwave subsystems can hope to compete in America is to make modules specifically designed for volume production. We're planning to turn out 2,000 klystron replacement modules per year." Bradley's biggest triumph so far came a little more than a year ago when its U.S. agent, Edwin Industries of Silver Spring, Md., sold a big order to Lockheed Electronics for a solid state x-band source.

#### West Germany: no blitz like show blitz

The German electronics industry has plans to come on like a Panzer division at American shows during 1968. At the IEEE show, 27 companies will have space in the 3,000-square-foot central German exhibit—notably AEG-Telefunken, the nation's second largest electronics firm. Some firm's have additional stands of their own.

Rohde & Schwarz says the most important item it's showing is an ultra-high-frequency signal generator, a new version of the firm's so-called SLRD model. The instrument won't be shown in Germany until June.

Designed for a 275-to-2,750 megahertz range, it's intended primarily for testing duplexers, input stages of radar receivers, and other radar components. A special circuit (n&s refuses to reveal details) allows pulse modulation with a simple pulse generator. Small rise and fall times, even at a relatively low frequency of 300 Mhz, allow pulse scanning with microsecond pulses. A few volts suffice for 100% modulation. The new SLRD has a power output

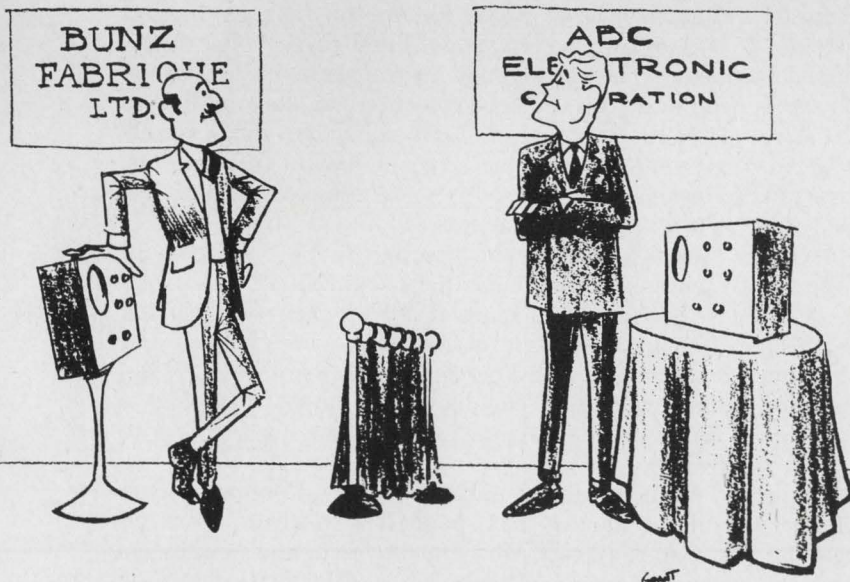

"We'd just as soon skip the whole thing—but our closest competitors are there so we have to fly the company flag too."



of at least 75 watts and its short-term stability is  $5 \times 10^{-5}$ .

The device contains a varactor diode arrangement which, along with a synchronizing unit, can give synchronization to a quartz frequency standard at any frequency. The short-term stability is then improved by several factors of 10.

The signal generator also furnishes power at small levels for testing semiconductor circuits. To eliminate spurious radiation, which cannot be tolerated in such circuits, the SLRD features a shielded oscillator in addition to an improved cut-off attenuator.

Another exhibit *r&s* hopes will grab attention is a frequency and time standard called the Type CAQA. It contains a shock-mounted 5-Mhz crystal in the harmonic mode with high precision and small drift in continuous operation: the company guarantees precision of  $10^{-10}$  and drifts of  $\Delta f/f \leq 5 \times 10^{-10}$  per day and a short-term stability of  $\Delta f/f \leq 4 \times 10^{-11}$  for measurement times of 1 second. The instrument is fitted with silicon planar transistors.

The CAQA delivers sinusoidal voltages of 50/60 hertz, 1 khz, 100 khz, 1 Mhz, and 5 Mhz as well as square-wave pulses between 1 Hz and 10 khz in decade steps. The signal-to-noise ratio is better than 85 decibels. A goniometer phase shifter that provides a digital readout adjusts the phase of frequencies from 1 Hz to 10 khz, and the seconds and minutes counter and clock movement to values desired. The phase shifter is calibrated in units of 10 microseconds.

Also on the *r&s* stands will be a super high-frequency range signal generator, the Type SMCI, intended for measurements in the 4.8-to-12.6-ghz range. It uses a reflex klystron with a tunable coaxial cavity resonator as an oscillator. R-f energy is brought out by a piston attenuator.

Rounding out the exhibit will be a 100-Mhz counter, called Type FET 2, designed to measure frequencies, revolutions per time unit, timing mark intervals, and clock pulses in computers.

AEG-Telefunken will display a tiny transmitter that is designed to be swallowed. Called the Heidelberg capsule, the transmitter is about 18 millimeters long and 8 millimeters in diameter. After it's swallowed, the capsule transmits continuous pH (acidity) readings from the patient's stomach or intestinal tract. The signals are picked up by an antenna system strapped around the patient's waist, and indicated and recorded by a receiving system. The capsule does away with tubes inserted through the mouth.

In the capsule are a 1.9 Mhz transmitter and an electrochemical cell which consists of a zinc and a silver chloride electrode with a salt solution serving as an electrolyte. The solution is put into the cell just before the capsule is swallowed.

The pH measuring system consists of an outer antimony ring electrode in addition to the silver chloride electrode. The pH-dependent potential difference between these electrodes is fed as a frequency-determining measuring voltage to the transistor, an AF 128 type. The measuring voltage varies

around 400 millivolts, depending on the pH value in the acidity range from pH 1 to pH 7.

Sales executives at Siemens America admit they can't even guess how much of their \$12 to \$15 million annual sales can be traced to contacts made at the IEEE convention. But the company feels its fairly high Coliseum tab is worth it.

Stan F. Martens, who is arranging Siemens' exhibit, says he wanted to take six booths but could get only five. Last year, Siemens had four—two for components and two for instruments.

Siemens, though, wound up with as much space as it wanted this year. As West Germany's largest electrical-electronic producer, the company was one of the first signed on for the Government-run pavilion. On the national stand, Siemens will beat the

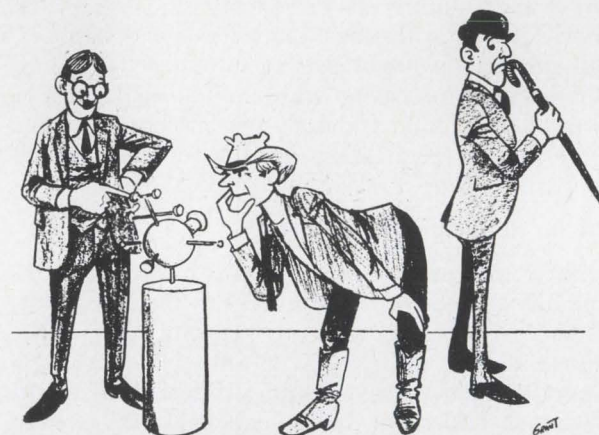

"An American walks right up and asks. But a Briton prowls around trying to make his own judgment."

drums for its UBL laser and for its line of oscillographs.

As usual, Siemens gives separate booths to components and equipment.

There'll be nothing that's spanking new. But there'll be a showcase for one of Siemens' biggest U.S. money makers—a gas-filled surge voltage protector. The device sops up transients by first glowing and then arcing. Protection can start as low as 90 volts or as high as 1,400 volts. The smaller units are button types; the larger mount in fuse holders. Siemens also will show semiconductors and an extensive line of capacitors.

In instruments, the accent will be on check-out devices for communications equipment. The trend is toward digital readout and Siemens has carried the movement to level metering, where powers and voltages are measured in logarithmic terms. A digital level meter can handle a range of 30 Hz to 120 khz and a digital level oscillator ranges up to 2 Mhz.

Siemens had planned to show a 75-ohm controllable attenuator that spanned a spectrum from direct-current to 2 Mhz. But the company's engineers couldn't get the attenuator ready for market in time for the IEEE display and the unveiling has been put off until the Wescon show.



## Canada: the neighbor brings her family

Canada isn't counted among the big five electronics-manufacturing nations, but you'd have a hard time explaining that to a layman visiting the Coliseum. Repeating last year's one-for-all plan, 15 manufacturers and the government have teamed up to take over the Coliseum's mezzanine floor.

The 1968 exhibitors include eight of the 14 who participated last year. With the added seven, they represent a cross-section of the industry: components, equipment, and services.

Displays will range from the highly sophisticated, such as Litton Systems (Canada) with its LN-15 inertial navigator, to the basic, such as Amphenol Canada's ferrite filter connector or the resistor line of the Constanta Co. In between will be the solid state circuitry applied to medical electronics by Hargrave Applied Research Corp., the custom display equipment and injection luminescence research of Bowmar Canada, and the antenna tuning and phasing systems made by Geleco Electronics.

## Japan: another opening, another show

Japan will put on the biggest new product show. For the energetic Japanese, the IEEE show is a captive audience of engineers in a good mood. No Japanese businessman worth his salt is going to ignore that kind of audience—even though most of it might be more interested in the New York nightclub circuit than any other kind.

The Matsushita Electric Industrial Co. will show a new indium antimonide Hall generator that uses several thin chips of InSb instead of the relatively thick single crystal. This, says Matsushita, yields four to 10 times the sensitivity—which is inversely proportional to thickness—and promises to be less expensive than conventional thin-crystal devices.

The company's fabrication method is to deposit a 1-to-2-micron thick InSb film on an alumina substrate. Not only does this offer low noise level and stability but it also has output voltage with the high value of 60 millivolts per kilogauss and the low power input of only 5 milliwatts. By using higher control currents, the sensitivity can be increased to several hundred millivolts per kilogauss; maximum control current is limited to about 30 amperes.

Normally, Hall devices are made with a thickness in the range of 10 to 20 microns by chemical etching. Somewhat thinner single-crystal devices can be manufactured, but the yield is poor and they're expensive.

Matsushita says it found a way to vacuum deposit a compound of indium and antimony, a technique that had stymied researchers. The firm uses separate sources for the metals and evaporates them with a tungsten heater. Specially developed ionization gages, which do not leave shadows in the deposited film, monitor the evaporation rates. This data makes it possible to control film composition and thickness.

Another new Matsushita device, to be debuted in its IEEE display but not yet commercially available, is a pressure-sensitive diode. Developed at the



"The IEEE is an education in U.S. selling methods."

company's Electric Machine and Apparatus Laboratory, the diode is headed for diverse applications ranging from a replacement for contacts under keys in electronic desk calculators to a sensing element in scales for weighing loaded trucks.

One of the major characteristics that distinguishes it from other semiconductor devices is its copper dopant, normally considered undesirable in semiconductors and avoided like a plague because of the deep impurity levels given.

The firm claims sensitivity to pressure change is 100 times greater than that of previous devices, with response extending to ultrasonic frequencies. Its resistance change is normally greater than three orders of magnitude. The diode's starting material is p-type silicon; copper is diffused into one side where the deep impurity level causes inversion to n-type. A silver film is evaporated onto the surface with high copper impurity concentration to form a Schottky junction, and a gold contact is alloyed onto the other side.

The device is packaged in a can similar to the normal TO-5. A sapphire stylus used to apply pressure to the diode rides in a guide and protrudes from the top of the can.

Also developed by the lab, and also using copper as an impurity, is another semiconductor making its debut—a switch useful for triggering thyristors, much the same as a diac [Electronics, Feb. 19, p. 171], or as a pulse generator in electronic equipment. The device has a symmetrical current-controlled negative resistance with a very sharp high-speed response curve.

N-type silicon is doped with copper, giving deep impurities and inversion to p-type. Gold alloy contacts are attached to the two faces of the silicon chip, which gives the device superficial resemblance to a germanium alloy transistor. Lead wires are attached to the two gold regions. The device's mechanism probably makes use of an avalanche effect.

The trigger switch can be built with threshold voltages in the 10-to-70 range. Turnover current is normally less than 200 microamperes. For a diode



with a threshold voltage of 27, the dip is to about 10 volts during switching.

Matsushita is also sending an industrial color television camera that it bills as one of the world's smallest: 13½ inches long, 7 inches wide, 9¾" high, and weighing 39½ pounds without lenses. The size—and accompanying cost reduction—is due to a simplified optical system, the details of which are the company's secret, and small vidicons.

### Tipping the scale

If the Sony Corp. has its way, American engineers will be using its magnetic recording equipment for more than just listening to Bach, Beethoven, and Baez. Sony hopes that by 1969 its new magnetic scale for numerical control—with applications including automatic fabrication of integrated circuits—will become as necessary as a slide rule.

There are a whole line of scales featuring linear and rotary models plus a digital counter for readout. All will be dipping a tentative toe into the marketing waters at the Coliseum. Sony will use the reaction to guide development of the product line, which should start to make its weight felt around Jan. 1.

This procedure, the company points out, was tried before. The prototype of its video tape recorder was introduced at the 1962 IRE show, and Sony used feedback gathered there to develop the first commercial model with deliveries starting the following year [Electronics, Nov. 14, 1966, p. 157]. Sony is not aiming to sell a limited number of scale systems at extremely high prices. The magnetic scale line is expected to range from position transducers competitive with moderately priced optical transducers, such as the Tru-Rota, made by Trump-Ross Industrial Controls Inc. for a basic price of \$192.50 [Electronics, Jan. 22, p. 168], to complete numerical control or readout systems up to \$5,000.

Sony's marketing wedge is the replacement of expensive and delicate optical scales with the more rugged magnetic version. Another advantage is that some optical devices give an analog readout, but all the magnetic scales have a digital readout. The development of the magnetic portion of the equipment was based on Sony's wide experience with audio, instrumentation, and vtr's, and with magnetic recording tape. Logic and readouts are based on the hybrid ic's and other components developed for Sony's desk calculators.

The basic component that serves as the company's membership card in this new field, though, is essentially new. It's a multigap flux responsive magnetic head invented by Saburo Uemura and patented in the United States a year ago. Uemura's group started work on the head in 1960, and units have been used in-house with numerical control equipment developed by Sony for production of its hybrid ic's.

The flux head differs from a standard magnetic recording head in having two sets of windings: an exciting winding and an output winding. Thus it can be used in measurements where the output must be independent of speed, and where there must be

output even at zero speed. On the other hand, ordinary tape recorders, including audio, instrumentation, and video, give an output proportional to the rate of change of magnetic flux at the playback head—fine for fixed-speed applications but bad for measurement.

In basic operation, a sine wave current of 5 to 10 khz, or higher in some applications, is applied to the exciting winding to saturate the core. If the head is used to reproduce a magnetic medium that records a square wave signal, the recorded magnetic flux either adds to or subtracts from flux caused by the exciting current. Output voltage at the head is at twice the carrier frequency, with output voltage and sign dependent on the magnitude and direction of the recorded information under the head gap.

Information from the heads is electrically detected to obtain pulses each time the head assembly traverses one wavelength of information, or a fraction of the wavelength, recorded on scale. By using heads spaced so their output is in phase quadrature, it's also possible to get directional information by logic similar to that used with optical scales. The basic linear scale has a recorded wavelength of 200 microns, although 100-micron versions also can be made. The head is made of alternating laminations and nonmagnetic spacers, each 50 microns thick, to give two gaps per recorded scale wavelength. By using a counter with precise interpolation, output with a resolution of 5 microns is obtained. This makes the scale accurate enough for use with numerical control machine tools.

For linear measurements, the scale consists of a strip of beryllium copper 20 millimeters wide by 0.15 mm thick. A nickel-cobalt film about 20 microns thick is plated to the strip to serve as the magnetic recording medium. The basic recorded wavelength is 200 microns. Two side-by-side heads, slightly askew to obtain the required 90° phase separation, reproduce information on the center 10 mm of the scale.

The target prices, says Sony, range from \$500 for a readout with simple interpolation to \$1,000 for one with precise interpolation.

Hayakawa Electric Co. completes the lineup of the Japanese stands at the IEEE.

Most of Hayakawa's display will consist of established products. But two luminescent diodes, the GLE-502 and the GLE-102—similar to those shown last year—are back with a few additional features: increases in radiated output by greater than an order of magnitude and lower prices. Also, the diameter of the smaller unit, the 102, for mounting on 0.1-inch centers, has been reduced. The first units had diameters almost equal to the center-to-center spacing, and therefore were hard to mount.

Reports for this article came from John Gosch in Bonn, Michael Payne in London, Charles Cohen in Tokyo, and Peter Kilborn in Paris. It was written in New York by Howard Wolff.







saturation of  $Q_1$ . It is this positive feedback that speeds up the turn-on of  $Q_1$  and  $Q_2$  sufficiently to enable the circuit to operate reliably over the uhf range.

Transistor  $Q_1$  remains on during the entire negative half-cycle of the input waveform and the output voltage remains at ground. As the input begins to go positive again,  $Q_1$  begins to conduct less and the cycle repeats. Since  $Q_2$  is more strongly back biased,  $Q_2$  turns on first when the input goes negative again. With  $Q_2$  on, the output voltage drops

about two volts, terminating the output pulse. In this manner, a complete cycle of the input waveform generates a single output pulse and thereby divides the frequency of the input signal in half.

The frequency divider can be made to operate at lower frequencies by increasing the values of capacitors  $C_1$ ,  $C_2$ , and  $C_3$ . With  $C_1$  and  $C_2$  at 1,000 picofarads and  $C_3$  at 660 pf, the circuit halved the frequencies of input signals in the 10- to 300-Mhz range.

## Low-cost Schmitt trigger made with digital IC

By P.A. Francis and K.R. Whittington

Tube Investments Research Laboratories, London

An inexpensive digital integrated circuit can be operated as a Schmitt-trigger level detector. The microcircuit in the detector is Texas Instruments' SN7360 quadruple NAND gate. Two of these gates are cross-coupled to form a binary switch generating output pulses in response to signals exceed-

ing a preset threshold value.

The detector's input threshold is adjustable over a wide range; input amplitudes as low as 0.7 volt will trigger off to an output pulse. The detector's turn-off level can be adjusted independently so that the circuit's hysteresis—the difference between turn-on and turn-off levels—can be altered as desired, regardless of the height of the input threshold. The minimum hysteresis attained in this circuit was 50 millivolts.

Input signals are applied to the junction of potentiometers  $P_1$  and  $P_2$ , which attenuate the inputs and pass them to the quadruple NAND gate. The attenuated signals are waveforms A and B. Signal B has been inverted by NAND 1 and is applied to NAND 3 to turn on the output pulse at time  $T_2$ . Signal A is applied directly to NAND 2 to turn off the output pulse at time  $T_4$ . Signals A and B trigger the NAND gates to which they are applied when their amplitudes rise above or fall through the threshold level of V volts. The threshold level for the SN7360 was found to be 0.7 volt. A signal that rises above the V-volt triggering level of the NAND gates constitutes a 1 in the truth table; a signal which falls below the V-volt level is a 0.

To begin the cycle, the circuit is in the condition described in line 1 of the truth table, that is, A is 0 and B is 1. When an input signal is applied, the voltage at A rises from ground level and passes through the trigger level V at time  $T_1$ , placing a 1 on input 1 of NAND 2. No change occurs in the output condition of Q or  $\bar{Q}$ , but the switch is now set to the state indicated in line 2 of the truth table and is rendered receptive to changes on the other input line, input 2 of NAND 3.

Meanwhile, the voltage at B is falling from  $+V_{cc}$  toward 0 volts. As soon as voltage B reaches level V, the 1 at input 2 of NAND 3 becomes a 0 and the switch changes state—to line 3 of the truth table—placing a 1 on output  $\bar{Q}$  to produce the leading edge of the output pulse.

But the B voltage starts to rise again toward  $+V_{cc}$  and passes through the V-volt trigger level at time  $T_3$ , placing a 1 on input 2 of NAND 3 and

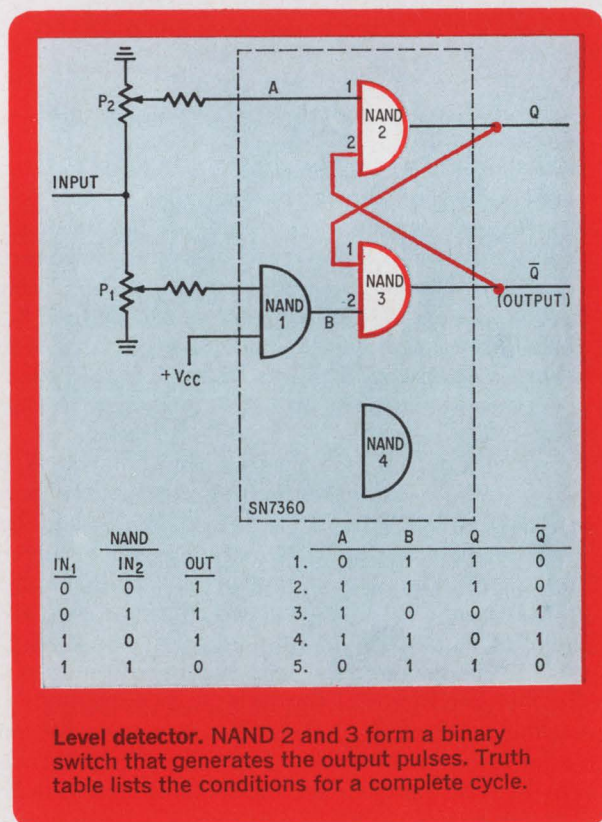



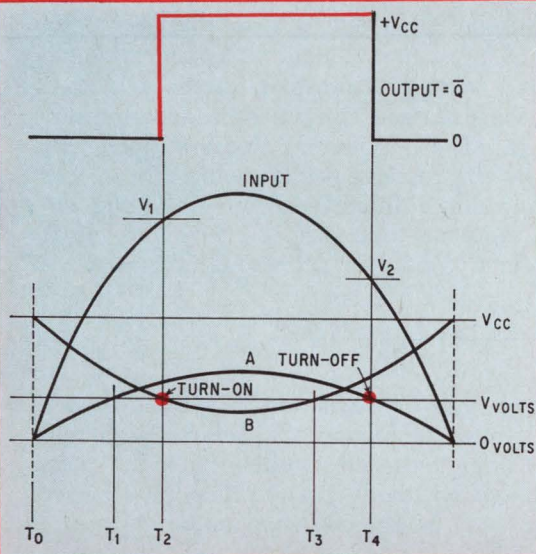

Waveform diagram. Signal B turns on the output  $\bar{Q}$  at time  $T_2$  to initiate the output pulse while signal A turns  $\bar{Q}$  off at time  $T_4$  to terminate the output pulse.

returning the switch to the condition shown in line 4 of the truth table: outputs  $Q$  and  $\bar{Q}$  remain unaffected.

The A voltage, meanwhile, has been falling toward 0 volts. At time  $T_4$ , the amplitude of signal A falls below the V-volt trigger level, placing a 0 on input 1 of NAND 2; this returns the binary switch to its initial state, terminating the output pulse.

The input threshold may be varied by adjusting potentiometer  $P_1$ . The turn-off voltage level may be altered separately by potentiometer  $P_2$ . The NAND gate in the SN7360 triggered almost uniformly at 0.7 volt. Potentiometers  $P_1$  and  $P_2$  are also used to compensate for differences in electrical characteristics among differential microcircuits. A similar circuit that would be independent of device characteristics can be built, at greater expense, by forming the binary switch with two operational amplifiers. The two amplifiers would be cross-connected in a manner analogous to the wiring of NAND 2 and NAND 3.

The scope tracings show the output pulse superimposed on the input pulse when  $P_2$  is set for minimum hysteresis (top) and for maximum hysteresis (bottom). The difference between on and off trigger levels in the latter case is indicated.

## Bridge rectifier clips dangerous voltages

By Lyman E. Greenlee

Mobile Electronics Inc. Anderson, Indiana

**High line voltage surges**, that occur in the late evening hours override the regulation transformers in a-c line filters. This raises the supply voltage in line-powered equipment such as refrigerators and

freezers, and as a consequence endangers equipment operation. Otherwise harmless transients in the line riding on the boosted d-c level destroy transistors or trigger-sensing circuits in monitoring apparatus.

A bridge-rectifier and its resistance-capacitance load, connected to the a-c line filter, keeps the voltage in the filter at 117 v. False triggering of intensive-care apparatus in hospitals and process-control equipment in industry are prevented.

The a-c voltage on the secondary of  $T_1$  sees the low impedance of capacitor  $C_4$ , on the other side of the bridge rectifier. While charging the capaci-

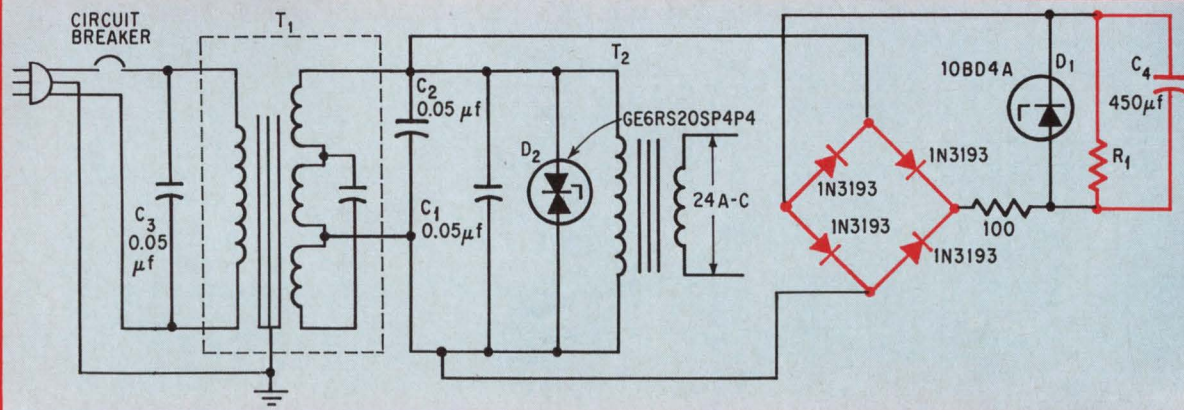

Voltage reduction. Rectifier and its RC load bleed the a-c filter and keep the primary voltage on transformer,  $T_2$  at 117 volts. Thus, equipment that operates off  $T_2$  is protected.



tor, the a-c voltage in the filter is clipped down to the maximum voltage that  $C_4$  can maintain. The constant discharging of the capacitor by  $R_1$  keeps the voltage low, and zener diode,  $D_1$ , keeps the voltage on  $C_4$  clamped at 110 v.

Capacitors  $C_1$  and  $C_2$ , in the primary and secondary of  $T_1$ , level off the infinitesimally narrow spikes that occur. Damped r-f oscillations, generated when transistors and diodes are shut off, are removed by  $C_3$ .

Positive and negative surges are trapped by the Thyrector diode,  $D_2$ , a silicon diode that acts as an insulator up to its rated voltage and as a conductor above rated voltage. Persistent surges fed back from the transistorized equipment cannot be handled by  $D_2$ . These potential line transients are removed by the rectifier bridge before  $T_1$ .

Because voltage drops occur in grounding circuits and cause malfunctions, the secondary of  $T_1$  and the primary of  $T_2$  are not grounded.

## Stretching video pulse keeps indicator on

By Willie A. Magee\*

Electro Optical Systems Inc. Pasadena, Calif.

**Indicator lamps** on ground-support test equipment can be used to signal the presence of pulses at points throughout a radar receiver. Each pulse—the result of a properly operating subsystem—is vividly displayed on a test panel to the attending tester. Unfortunately, narrow video pulses, such as those found in automatic-gain-control and countermeasure circuits, must be expanded to keep the indicator lamps on long enough to alert the tester. A field effect transistor, gated into conduction while the narrow pulse is slowly discharged from a capacitor holds the indicator on for 180-milliseconds.

This lamp-indicating system is as effective in trouble-shooting pulse circuits as more expensive systems that use oscilloscopes. It can also be incorporated into a portable test set for testing color tv and f-m multiplex circuits.

\* Formerly with Aerojet-General Corp., Azusa, Calif.

When the pulse is generated, it biases diode  $D_1$  and  $D_2$  into conduction. Capacitor  $C_1$  charges to the  $-15$  volt pulse amplitude. When the pulse returns to ground, diode  $D_2$  becomes back biased and capacitor  $C_1$  is isolated from the input.

Since the voltage on  $C_1$  is greater than the breakdown voltage of zener diode,  $D_3$ , the capacitor discharges. As it flows through  $R_1$ ,  $R_2$ , and  $R_3$ , the discharge current develops a negative voltage across  $R_3$ . This voltage neutralizes the positive 5 volts developed by voltage divider  $R_3$  and  $R_4$  and places the anode of  $D_4$  and the gate of  $Q_1$  at ground.

Loss of the positive voltage at the gate brings the field effect transistor out of pinchoff and into a low-resistance conduction region. The indicator bulb comes on and remains on until the voltage on  $C_1$  falls below the zener voltage of  $D_3$ .

When the anode voltage of  $D_3$  returns to ground, the field effect transistor is biased off by the positive 5 volts of the voltage divider. Turnoff of  $Q_1$  and, consequently, the indicator is instantaneous because zener diode  $D_5$  behaves as a high resistance when its anode voltage hits  $-10.5$  volts.

The high negative voltage that first appears on the anode of  $D_3$  is prevented from drawing currents and therefore destroying the FET by the back biasing action of  $D_4$ .

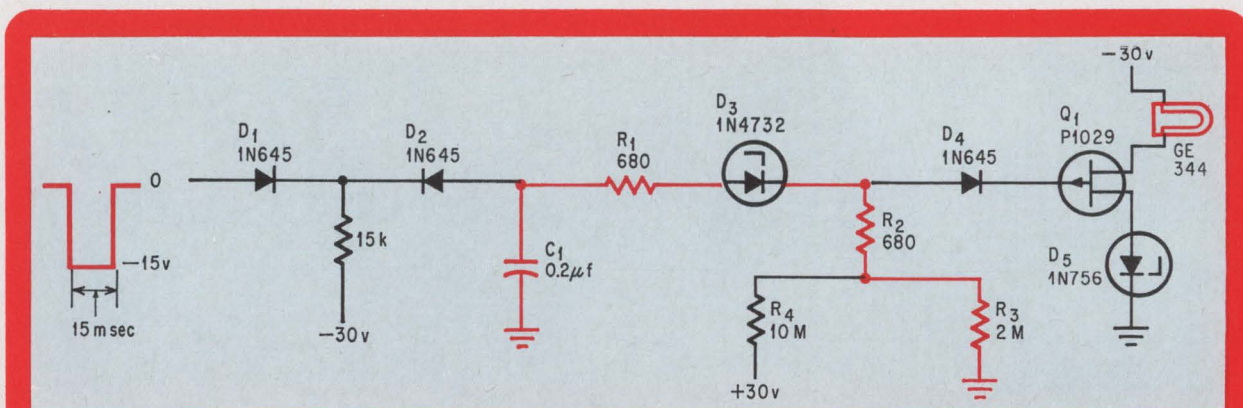

**Visual assurance.** Indicator bulb alerts test engineer that equipment is operating properly. Narrow pulse is coupled to capacitor  $C_1$ , then allowed to discharge slowly through the long time constant of  $C_1$  ( $R_1 + R_2 + R_3$ ).



# Do you have a "special" photocell problem?

## Clairex probably has a "standard" answer with the industry's widest line.

### If not, we can design a photoconductive cell to meet your needs.

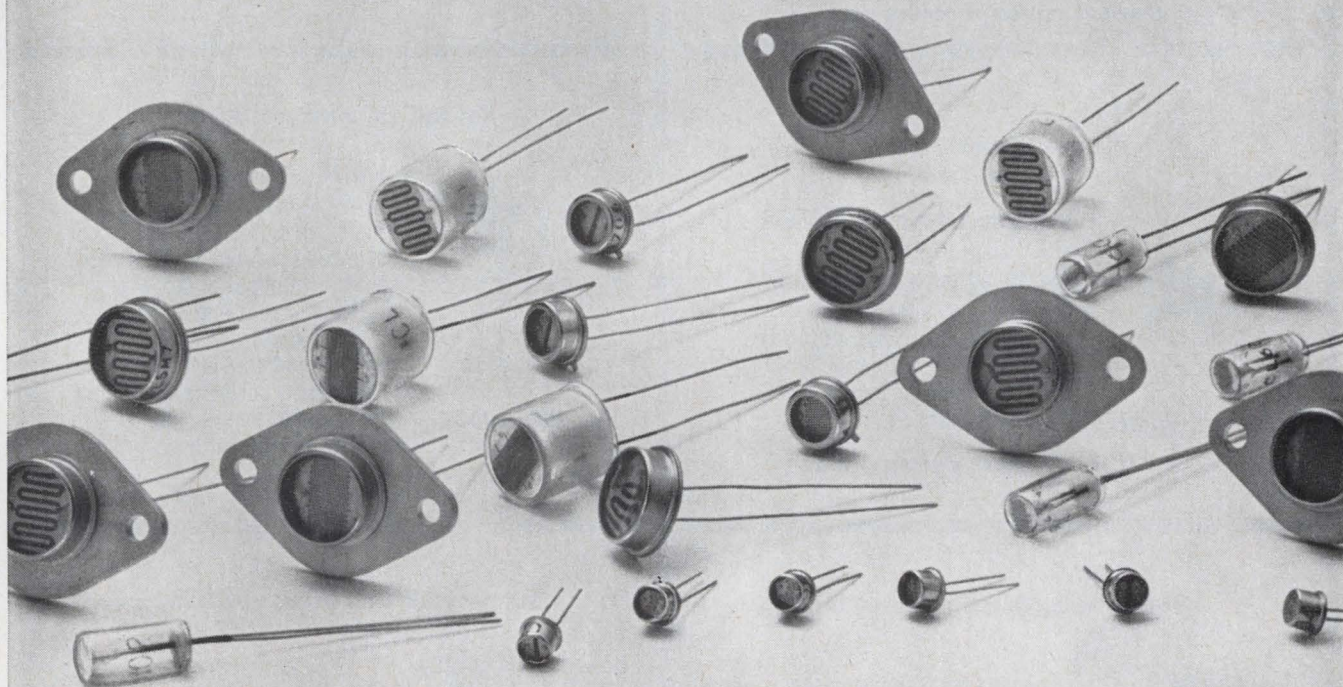

Helping industry solve problems involving light control has been Clairex's only business since 1953. To provide creative engineering to the country's leading companies, we have developed the industry's widest line of photoconductive cells . . . over 80 standard types of CdS and CdSe units.

Standard Clairex cells provide combinations of features that you need to meet most needs . . . high speed, low temperature coefficients, low memory, high linearity, uniform color temperature response, small size, high stability. They come in 6 hermetically sealed packages from TO-18 to TO-3.

If a special photocell is required, Clairex can

design one to meet your requirements. And don't hesitate to call on us for help in setting up your specifications. We are frequently able to save time and money for customers who consult us before establishing detailed cell designs.

If you'd like more information, remember, we wrote the book. Send for your copy of the Clairex Photoconductive Cell Design Manual.



CLAIRES ELECTRONICS, INC. ■ 1239 BROADWAY, NEW YORK, N.Y. 10001



# RCA "overlay" Transistors ... for Total RF Power

## New Plastic Design for SSB Communications



**TA2758**  
(Molded Silicone Plastic)

Circle 26 on reader service card

75 Watts PEP Output (Min.)  
@ 30 MHz,  
IMD—30 dB (Max)  
Intended for 2- to 30-MHz SSB  
power amplifiers operating from  
a 28-volt supply, this high gain  
transistor is encased in RCA's  
new plastic package with  
isolated pin-pad electrodes. It  
uses an internally mounted  
diode for temperature  
compensation.

## High Power Performance at 400 MHz



**2N5016 (TO-60)**  
**TA7036 (TO-60)**

Circle 39 on reader service card

Both types are in the popular,  
time-tested TO-60 package. The  
RCA 2N5016 is designed for  
Class-B and -C rf amplifiers and  
offers 15 watts (min.) at 400  
MHz. The TA7036 is a higher  
power version and provides 20  
watts (min.) at the same  
frequency.

## Microwave Coaxial Package



**TA7003**  
(Coaxial Lead Package)

Circle 40 on reader service card

1 Watt Output with 5 dB Gain  
@ 2 GHz  
2 Watts Output with 10 dB Gain  
@ 1 GHz  
Low-inductance package for UHF  
and microwave oscillator,  
frequency-multiplier, and  
rf-amplifier service.

## High Gain UHF driver or oscillator



**2N5108 (TO-39)**

Circle 41 on reader service card

1 Watt Output (Min.)  
@ 1 GHz, 5 dB Gain  
High gain device for Class B or C  
operation in final, driver, and  
pre-driver amplifier stages in  
UHF equipment and as a  
fundamental frequency  
oscillator at 1.68 GHz.  
Specifically designed for L-Band  
pulse radar, mobile, and  
telemetry applications.

## High-Reliability types available off the shelf

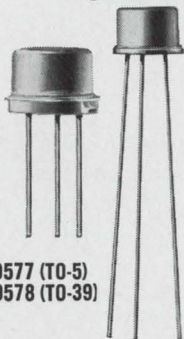

**40577 (TO-5)**  
**40578 (TO-39)**

40577 is electrically similar to  
RCA 2N3118; 40578 has as its  
parent type RCA-2N3866. Both  
devices add to RCA's expanding  
high-reliability line which  
includes 40305, 40306, 40307  
(parent types 2N3553, 2N3375  
and 2N3632).

Circle 61 on reader service card

## JAN types with off-the-shelf availability

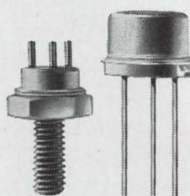

**JAN-2N3553 (TO-39)**  
**JAN-2N3375 (TO-60)**

Circle 62 on reader service card

Tested to MIL-S-19500/341,  
these RCA "overlay" types  
conform to JAN specifications  
and are available right now in  
quantity.



# Circuit Coverage

## For Military and Industrial Applications



2N5070 (TO-60)  
2N5071 (TO-60)

2N5070  
25 Watts PEP Output with  
13 dB Gain (Min.) @ 30 MHz and 28 V  
2N5071  
24 Watts Output with 9 dB Gain (Min.)  
@ 76 MHz and 24 V  
The RCA 2N5070 is designed  
specifically for 2- to 30-MHz single-  
sideband military and ham  
transmitters. The 2N5071 is intended  
as a high-power, Class B and C rf  
amplifier for FM communications in  
wideband and narrowband circuits.

Circle 165 on reader service card

## Load Mismatch Protection for Aircraft Transmitters

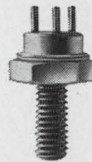

2N5102 (TO-60)

15 Watts Output (Min.) @ 136 MHz  
RCA-2N5102 is intended  
as a high power device for  
Class C, AM amplifier service  
(for aircraft VHF) in the 108- to  
150-MHz range. Each unit is  
individually tested at worst-case  
conditions (full modulation and  
no current limiting) for complete  
load mismatch protection.

Circle 166 on reader service card

## Class A Linear Amplifier for VHF—UHF

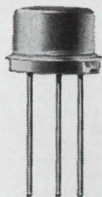

2N5109 (TO-39)

$f_T = 1200$  MHz (Min.)  
@  $I_C = 50$  mA,  $V_{CE} = 15$  V  
New generation "overlay"  
transistor featuring low  
distortion, low noise for  
wideband applications in CATV,  
MATV, Class A, or linear  
amplifiers with large dynamic  
range.

Circle 187 on reader service card

## Famous 2N3866 Performance in TO-60 case

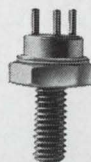

2N5090 (TO-60)

1.2 Watts Output (Min.)  
@ 400 MHz, 7.8 dB Gain  
1.6 Watts Output (Typ.)  
@ 175 MHz, 12 dB Gain  
Intended for Class A, B, or C  
amplifier, frequency-multiplier,  
or oscillator circuits, 2N5090  
may be used in output, driver, or  
pre-driver stages in VHF and  
UHF equipment.

Circle 188 on reader service card

## 27-MHz Output Transistors for Citizens-Band Transmitters

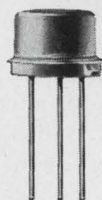

40581 (TO-39)  
40582 (TO-39  
with Flange)

These two new devices are  
designed specifically for output  
stages of 5-watt CB equipment.  
The 40581 has an output of 3.5  
watts at 27 MHz with  $P_T =$   
5 watts; the 40582 has an output  
of 3.5 watts with  $P_T = 10$  watts  
and is equipped with a factory-  
attached mounting flange for  
improved heat-sinking.

Circle 189 on reader service card

For more information on these and other RCA  
"overlay" transistors, see your RCA Repre-  
sentative or your RCA Distributor. For tech-  
nical data on specific types, write: Commercial  
Engineering, Sec. PN3-1, RCA Electronic Com-  
ponents and Devices, Harrison, N.J. 07029.

Circle 190 on reader service card



# Computer-aided design: part 14

## Start with a practical IC model

With component geometry, junction characteristics, and material resistivity included in a program, a computer can calculate their impact on circuit performance and an engineer can design an IC on the first try

By Robert Mammano

Arinc Research Corp., Santa Ana, Calif.

**Without the aid of a computer**, designing a complex integrated circuit would be well nigh impossible. But too often in turning to a computer, designers take into account only the circuit's electrical parameters and ignore component geometry, junction characteristics, material resistivity, and their impact on circuit performance. Rarely, as a result, is the full potential of the computer-aided design realized.

Designing a circuit is difficult enough. But designing a monolithic IC is far more complex because the components, built on a common substrate, have parasitic interactions that significantly affect performance. If computer-aided design is to be used to full advantage, the computer program should go beyond the electrical characteristics to include these interactions. One such program is the Arinc Research Corp.'s Snap, simulated network analysis program.

An early version of this program, now written in Fortran 4 for machine independence, is fully described in *Electronics*, July 10, 1967, p. 89. It analyzes any linear discrete or IC circuit and permits both d-c and steady-state a-c investigation, including several options: nominal solutions, parameter-sensitivity analysis, special solutions, frequency re-

sponse plotting, and Monte Carlo statistical analysis to determine circuit performance spread for circuits in production.

To effectively use the circuit's geometry, material resistivity, and junction characteristics, the designer must first understand IC construction.

### Forming the IC

Most conventional IC's start with a p-type substrate. For low collector resistance, n+ buried layers are diffused into the substrate. An n-type epitaxial material is then grown over the entire wafer, and individual components are isolated by a deep p+ diffusion. The transistor base regions and all the resistor elements are formed by a p-type diffusion. To form the transistor emitters and to decrease the contact resistance a high-concentration n-type material is diffused into both the base and the collector contacts.

A passivating and insulating layer of silicon dioxide is then grown over the entire circuit and openings are cut where electrical contact to the semiconductor elements are required. Next, a metalization layer is evaporated on top of the silicon dioxide and etched to form the interconnection pattern for the components.

These manufacturing processes and materials can be defined in terms of impurity concentrations, diffusion profiles, junction depths, resistivity and thickness of the epitaxial layer, buried layer, base-sheet resistances, and base width; all of which combine to determine the electrical characteristics of the circuit components.

The importance of these factors can be summarized in one word—interaction. An IC's collector-series resistance, for example, is affected by the

### The author

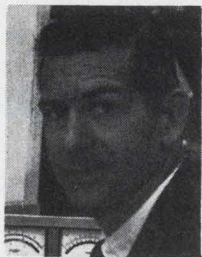

Robert Mammano has been active in computer-aided design for four years at Arinc Research Corp., and is one of the contributors to the company's integrated-circuit training program.



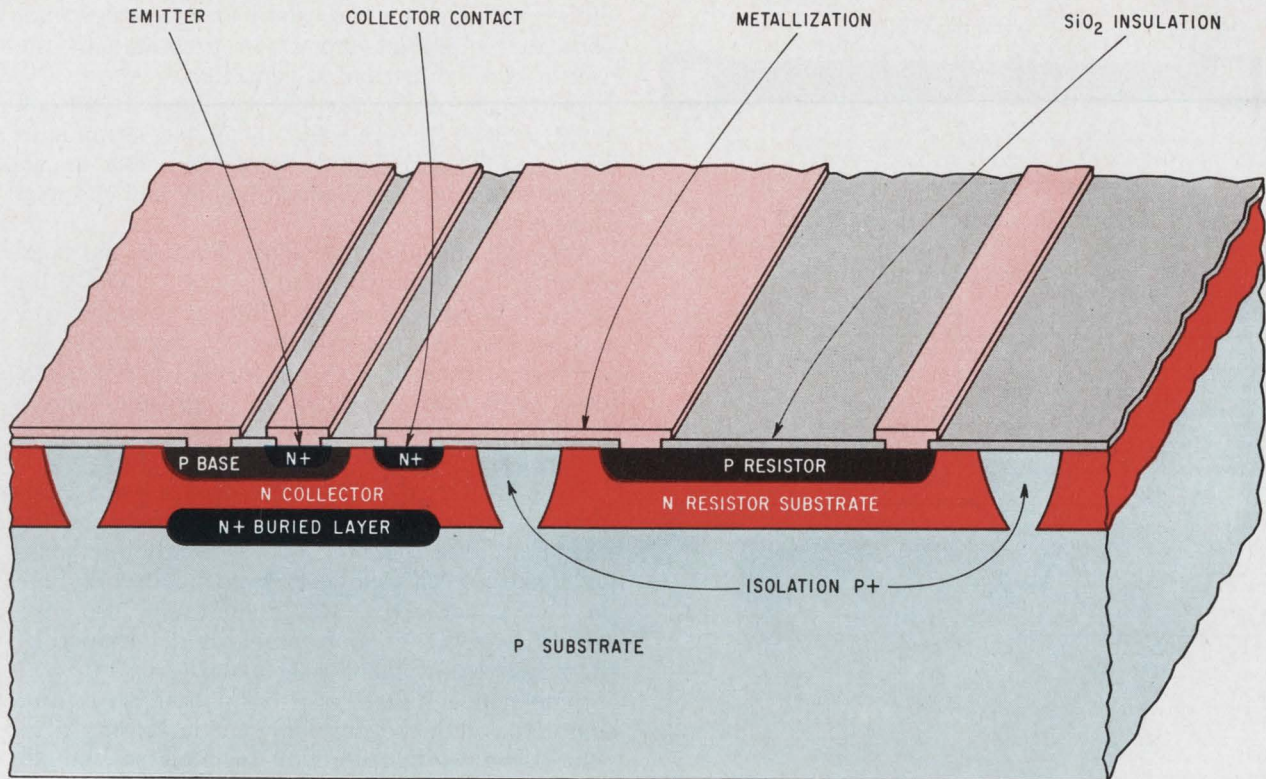

**IC cross-section.** Surfaces between p and n regions cause distributed parasitic capacitances that must be included in the computer model. Buried layer and top-surface geometry also affect final design.

collector's resistivity, thickness, and geometry, and the properties of the buried layer if there is one. The resistivity also affects the capacitance of both the collector-substrate and the collector-base junctions—the higher the resistivity, the lower the capacitance—and establishes the voltage capabilities of these junctions.

The epitaxial layer's thickness also determines the area required for the lateral diffusion that occurs during p+ isolation diffusion. And just as resistivity affects capacitance and resistance, base width—a vertical dimension between the emitter and collector—affects current gain and the frequency response of the integrated circuit.

### Layout considerations

In determining the top-surface geometry of the individual components, the designer is confronted with the problem of optimizing component sizes as a tradeoff between performance and ease of manufacture. Since much of a circuit's performance depends on the components' geometry, the designer must consider:

- The effective emitter perimeter that yields the optimum current-handling characteristics;
- The total emitter area that contributes to frequency response;
- The base area that determines base-collector junction capacity and base-spreading resistance;
- The collector area that determines collector-substrate junction capacity and collector-series resistance;
- The length-to-width ratio of each resistor that,

together with sheet-resistance value, is used to design individual resistors.

### Modeling IC components

Before a circuit's over-all performance can be predicted, its individual components must first be accurately described. This description represents the electrical characteristics in terms of the design parameters, which should include such factors as geometry and resistivity. For example, the a-c equivalent circuit for a diffused resistor has an associated distributed capacity to the n-region, a secondary capacity to the substrate, and a pnp transistor. Usually, the n region is biased to the most positive potential in the circuit, which cuts

### Gain sensitivity

Parameter	% input change	% output change at 100 Mhz	
		High gain	Low gain
$h_{re}$	90	4.9	7.9
$f_t$	40	13.0	9.9
$C_{b'e'}$	20	-11.2	-12.2
$R_c$	40	-6.8	0.2
$C_s$	20	-5.2	0
$R_s$	40	-1.5	4.0
$R_t$	6	1.6	3.0
$R_b$	6	-0.9	-1.5
$R_o$	6	-1.0	-0.4
$C_b$	20	0.9	6.2
$C_o$	20	0.5	7.2



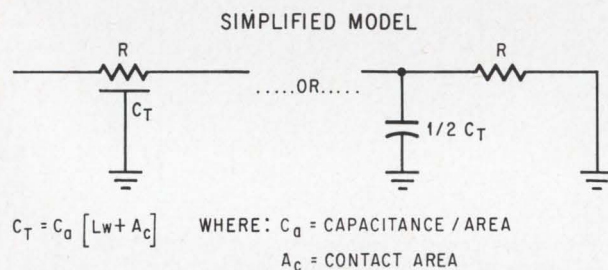
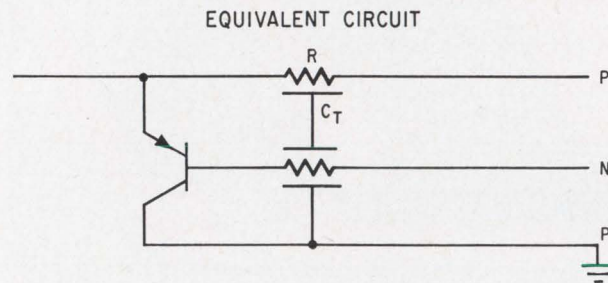
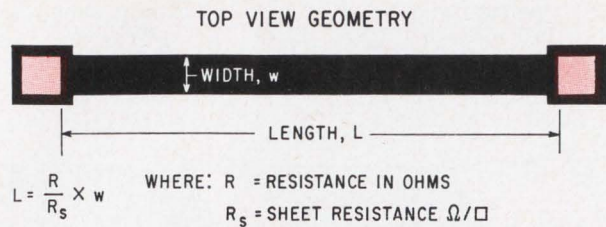

**Resistor calculations.** Equivalent circuit is drawn from the top-surface geometry of an IC and indicates distributed resistance and capacitance  $R$  and  $C_T$ , respectively. If one end of the resistor is connected to an a-c ground, the distributed capacitor can be represented by a lumped element whose value is equal to one half  $C_T$  and connected to the ungrounded end.

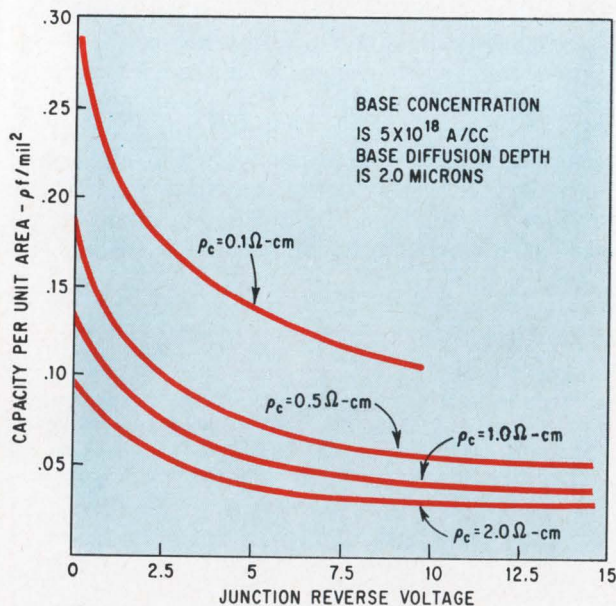

**Collector resistivity.** Both the junction voltage and collector resistivity affect the junction capacity of a diffused resistor in an IC. In determining the value of the diffused resistor, the engineer must evaluate between increasing the resistor line width to achieve better accuracy and decreasing it to reduce the parasitic capacity. Increasing the junction voltage decreases the capacity per unit area.

off the pnp transistor and establishes an a-c ground. Thus, the equivalent circuit is represented by the resistor and its distributed capacity.

The circuit can be further simplified if one end of the resistor is connected to an a-c ground. In this case, the distributed capacitance can be replaced with a lumped element having half the total capacitance.

Although adequate for most biasing and load resistors, this approximation cannot be made for feedback resistors that don't have a common connection. Because the distributed capacitance behaves as a transmission line, the RC component's phase shift can be significantly greater than a lumped capacitor's  $90^\circ$ . This can cause problems in feedback applications.

The parasitic capacity of a diffused resistor stems from the reverse-biased p-n junction between the resistor and the n region, which acts as the isolating substrate. This capacity is a function of both the d-c voltage across the junction and the characteristics of the junction, primarily determined by the resistivity of the n-type material.

In defining a diffused resistor the designer is often confronted with the problem that increasing a resistor's line width improves accuracy in the d-c value, but this also increases the parasitic capacity. To minimize the parasitic capacity, he may turn to an n region having a high resistivity, but this would increase the series resistance in the transistor's collectors. An adequate model for the integrated circuit helps provide optimum compromises between these and other factors.

### Modeling transistors

A transistor model can be selected from the many developed for discrete transistors and then modified to include the added monolithic components. In an equivalent circuit, these additions are basically an increased collector-series resistance, caused by the top contact for the collector region, and the collector-substrate junction capacity, caused by the reverse-biased p-n junction that isolates the transistor from adjacent components.

One of the best models for small-signal analog circuit application is the hybrid- $\pi$  circuit, which can be used over a broad range of frequencies. The effects of process and geometry on this model's parameters are easily seen. For example, the base-spreading resistance,  $R_{bb}'$ , is equal to the base-sheet resistance multiplied by the length-to-width ratio between the base and emitter contacts. The collector-base capacity,  $C_{b'c}'$ , which stems from the same junction that forms the parasitic capacity of the diffused resistors, is determined with the aid of the base-area and the junction capacity-per-unit-area curves.

The collector-series resistance,  $R_c$ , is determined by the collector resistivity and the volume geometry between the collector contact and the emitter edge closest to the base contact. The transistor's low-frequency current gain and the high-frequency gain bandwidth product are determined by the effective base width between the emitter and collector junc-



# Designing an IC

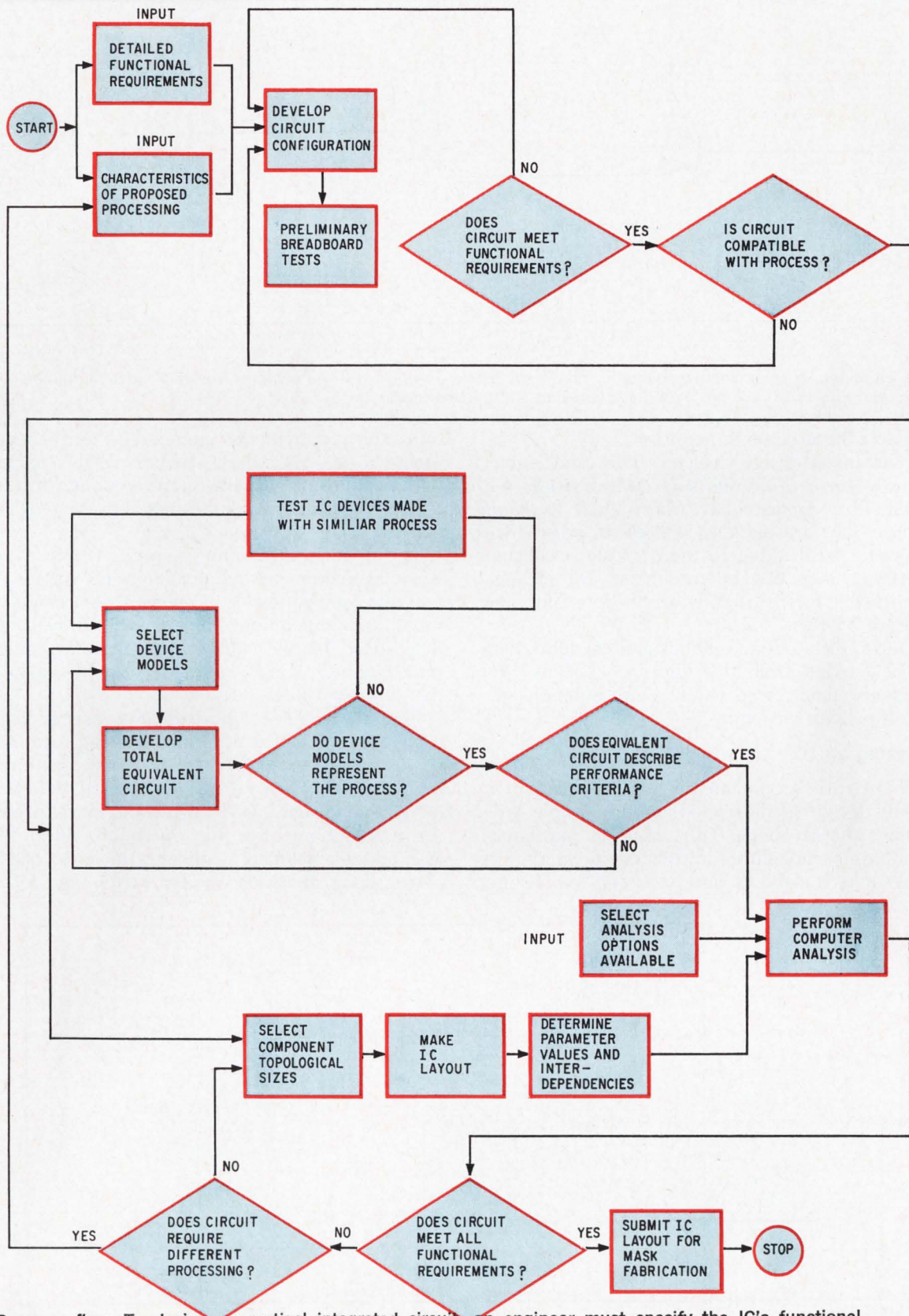

**Program flow.** To design a practical integrated circuit, an engineer must specify the IC's functional requirements and characteristics of proposed processing as input. The computer then follows the design decisions indicated, which are those specified by the program. Final design depends on how accurately the model represents the IC equivalent circuit in terms of geometry and electrical properties.



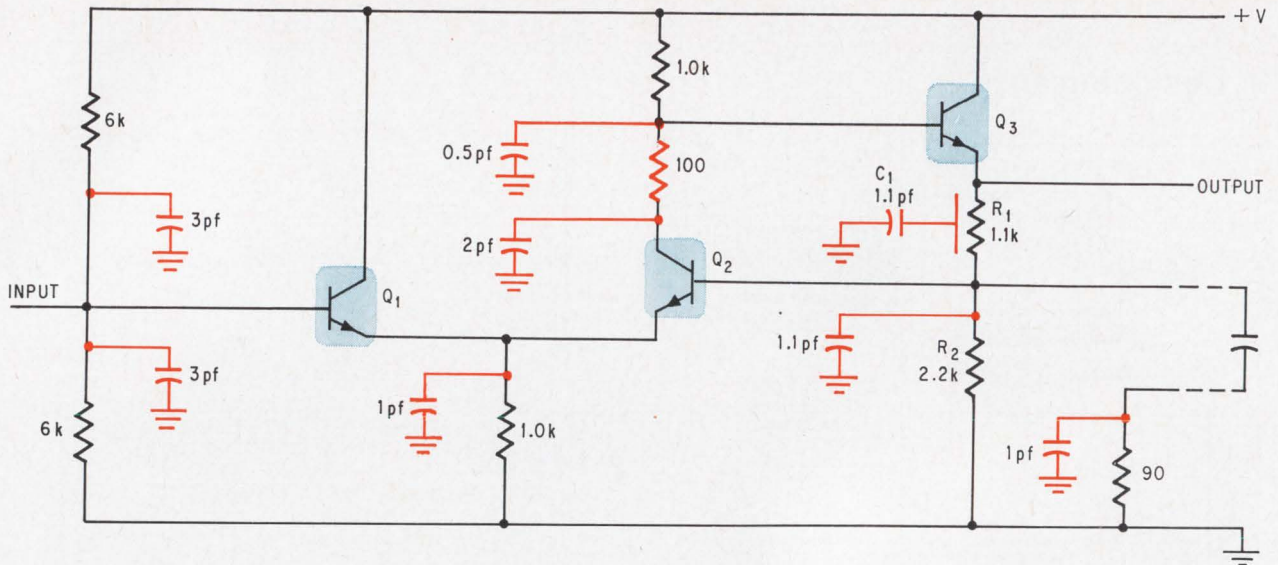

**Video amplifier.** A preliminary schematic, shown in black, is drawn by the designer for this video amplifier. Capacitors, shown in red, are added to represent the parasitic conditions.

tions and the area of the emitter.

In making a design decision here, the engineer must recognize trade offs such as transistors with very small geometries have the highest frequency response, they are the most difficult to process with high yields; and although the transistor's collector-series resistance can be minimized by adding a buried layer, this is a costly addition to the manufacturing process.

Models for integrated diodes and capacitors may also be derived from this approach because they are usually made from one or more junctions of a basic transistor structure.

### Designing an IC

The way these parameters can be used in an over-all design is illustrated by the simple video amplifier shown above. This circuit is particularly amenable to monolithic construction since it requires only transistors and resistors, yet its per-

formance requirements included a frequency response to 100 megahertz. Obtaining this response with component geometries large enough to insure a high yield in their processing represented a significant design problem.

The circuit, a three-stage amplifier with feedback, has a common-base stage that supplies voltage gain and two common-emitter stages that provide high input and low output impedance. Over-all gain, determined by the ratio of emitter and collector impedances  $R_1$  and  $R_2$ , may be altered by changing the effective value of  $R_2$ .

First the engineer approximates resistor values, transistor characteristics, and biasing conditions necessary for the circuit to meet its performance requirements. Then he hypothesizes a preliminary monolithic design based upon some initial processing assumptions. For the video amplifier, these assumptions included a collector thickness of 1 mil having a resistivity of 0.5-ohm centimeter with no

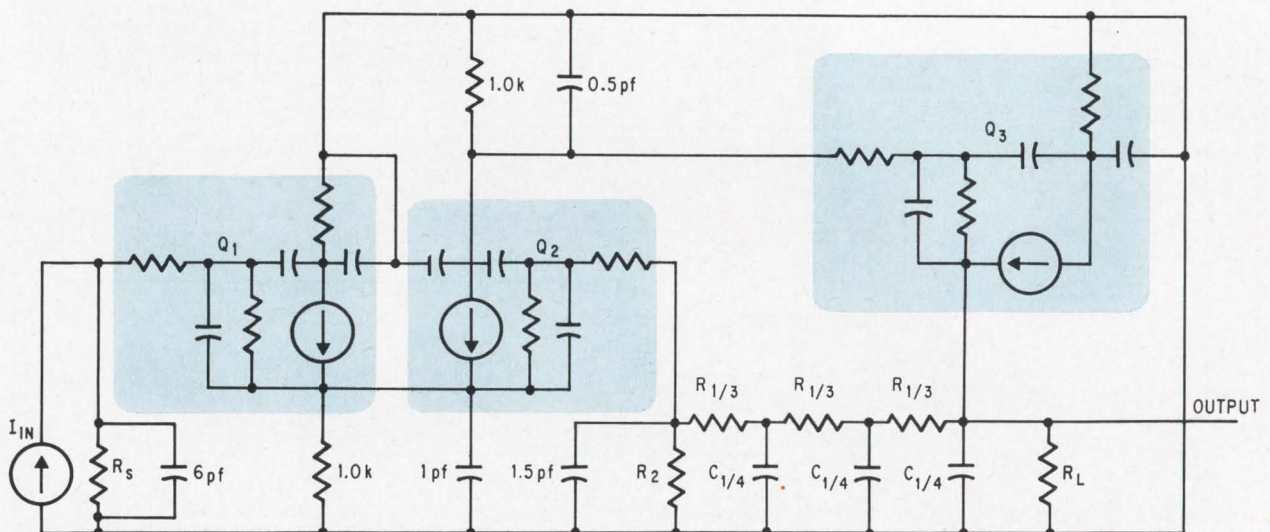

**Final model.** After the preliminary design is drawn for the video amplifier, transistors  $Q_1$ ,  $Q_2$ , and  $Q_3$  are replaced by their hybrid-pi equivalents and the capacitors and resistors by lumped elements.



buried layers, a base-sheet resistance of 200 ohms per square, and a resistor line width of 1 mil.

Approximate values for parasitic capacities and collector-series resistances are then calculated and included to yield the equivalent circuit at the bottom of the opposite page, which now shows the parasitic elements in lumped form for all components except  $R_1$ , a feedback resistor. Each transistor is replaced by a hybrid- $\pi$  model.

Since  $R_1$  is a feedback resistor with neither end at an a-c ground, its distributed capacity is simulated by several lumped parameters as a linear approximation to a nonlinear function. Although this approximation complicates the analysis by adding several additional nodes to the circuit, a high-speed digital computer makes complexity relatively unimportant. However, this complexity underscores the need for a computer analysis program.

To be effective, the computer program should handle all of the individual component parameters through special subroutines that are written to relate the electrical parameters to design data. In one such program, Arinc's Snap, the parasitic capacity of each resistor needn't be entered into the computer directly. Instead, the capacity is calculated on the basis of the resistor's value, the sheet resistance, the line-width considerations, and the capacity-per-unit area.

Thus, a change in the collector resistivity, for example, that affects the value of capacity-per-unit area would apply to all of the parasitic capacities in the entire circuit as in actual monolithics.

With Snap, the computer calculates both the magnitude and the phase of the equivalent circuit's node voltages. Additional subroutines can be applied to relate these node voltages to the impedance characteristics, the over-all gain, and the phase shift. Moreover, such subroutines can enable the computer to calculate gain in absolute units or decibels.

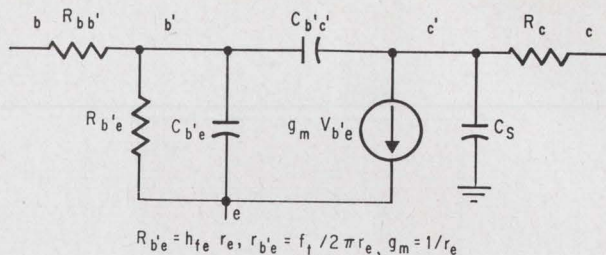

**Transistor model.** Hybrid- $\pi$  transistor model enables accurate circuit analysis over wide frequency range.

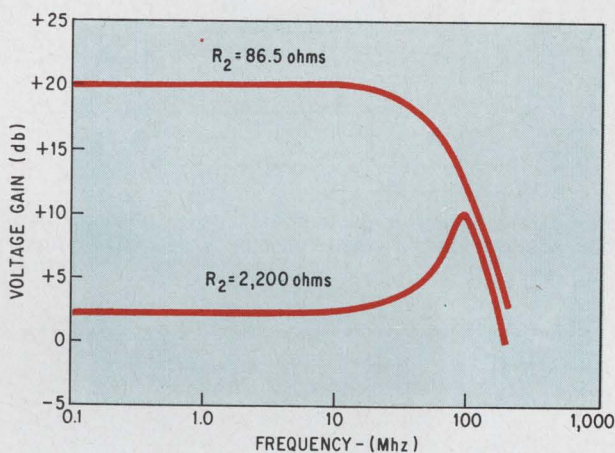

**Frequency response.** Two gain settings,  $R_2$  equal to 86.5, and 2,200 ohms, are plotted against frequency. Response for 86.5 ohms is flat for the plot and falls off as expected at the higher frequency end. Response for 2,200 ohms is also flat for most of the plot but has an undesired peak at 100 megahertz.

### Making it work

In analyzing this video-amplifier, the designer must determine whether, with the parasitic elements, the circuit is still stable and the bandwidth requirements are attainable. The answers can be obtained by plotting amplifier gain as a function of frequency.

First, frequency response is calculated by the computer for two gain settings—high and low. The high gain curve is based on the assumption that the 90-ohm parallel resistor lowers the effective resistance of the 2,200-ohm  $R_2$  to 86.5 ohms, while the low gain curve is plotted with  $R_2$  alone. The high gain curve is about 8 db down at 100 megahertz, which is short of the design goal. In the low-gain curve, a peak occurs near 100 Mhz, indicating positive feedback.

Since both characteristics are undesirable, additional analysis is necessary to determine which circuit parameters are the cause.

A parameter-sensitivity test is applied. This calls for the computer calculating circuit performance—in this case, gain—as each component is sequentially varied by a predetermined tolerance. The computer thus performs a numerical partial derivative

Understanding IC properties	
Circuit parameter	Major contributing factors
Resistor value	Length-to-width ratio Base-sheet resistance
Resistor-parasitic capacity	Area (length times width) Collector resistivity
Transistor current gain	Base width
Frequency response	Base width Emitter junction area
Optimum operating current	Effective emitter perimeter
Maximum operating voltage	Collector resistivity
Base-spreading resistance	Base-sheet resistance Base geometry
Collector-base capacity	Base area Collector resistivity
Collector-series resistance	Buried layer or collector resistivity, thickness, and geometry.
Collector-substrate capacity	Collector resistivity Effective collector area



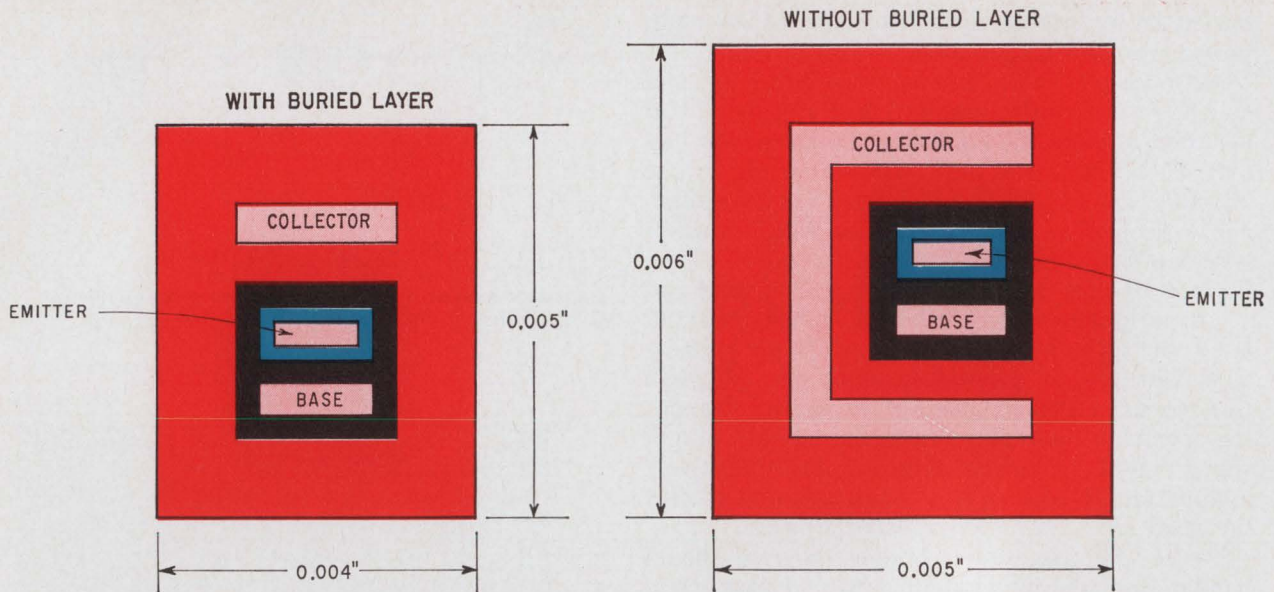

**Comparing transistor geometries.** In the transistor at the left, the buried layer causes low resistance, consequently only a small collector is needed. At right, a large collector is required to reduce resistance.

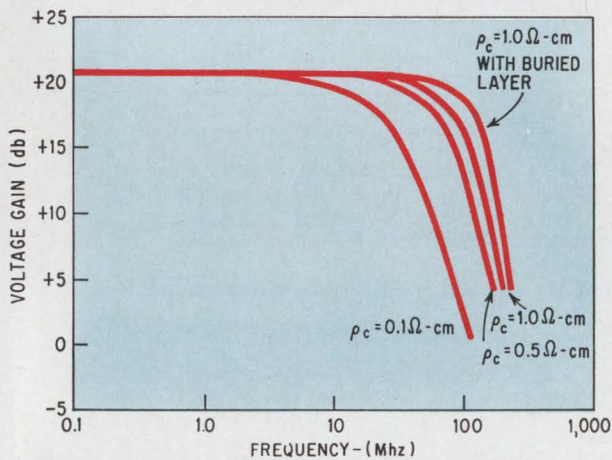

**Gain plot.** Adding a buried layer to an IC improves the frequency response of the amplifier. Without a buried layer curves fall off too soon.

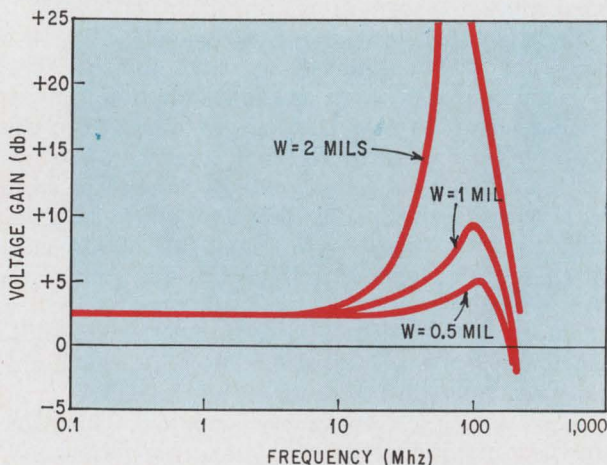

**Line-width effect.** Increasing the line width of an IC resistor causes the gain plot to blow up. Minimum line width is more desirable.

of circuit performance as a function of each component.

If tolerances are properly described, both individual component and total processing effects on circuit performance can be evaluated. Resistors, for example, are assigned individual and collective tolerances based on geometry and sheet resistance. To take account, the variation between resistors in a given circuit, the value of the individual tolerance is  $\pm 3\%$ . For the collective tolerance, the value of  $\pm 20\%$  is used to describe processing variations that affect all the resistors in the circuit.

If the sensitivity test is performed at 100 Mhz, the designer can easily pinpoint the parameters causing the drop in response at high gain and regeneration at low gain.

In the high gain configuration, there parameters are the gain-bandwidth product, collector-base capacity, the collector resistance, and collector-substrate capacity, of the transistors while in the low gain configuration, the parasitic capacity of  $R_1$  and  $R_2$  becomes significant.

Although the frequency response and collector-base capacity of the transistors have the greatest effect, the effect is similar in both gain configurations. What is needed is some modification to the circuit that will increase the response under high gain conditions and decrease it at 100 Mhz in the low gain configuration.

Two candidates for improving the high-gain response are collector series resistance and substrate capacity, which must be made as small as possible. The circuit's response was initially calculated on the basis of a structure without a buried layer, but with a collector contact on three sides of the base region to minimize resistance and a 0.5 ohm-centimeter collector resistivity. When the collector resistivity is decreased, the collector series resistance also is decreased. But this increases the value of



## Forming a histogram

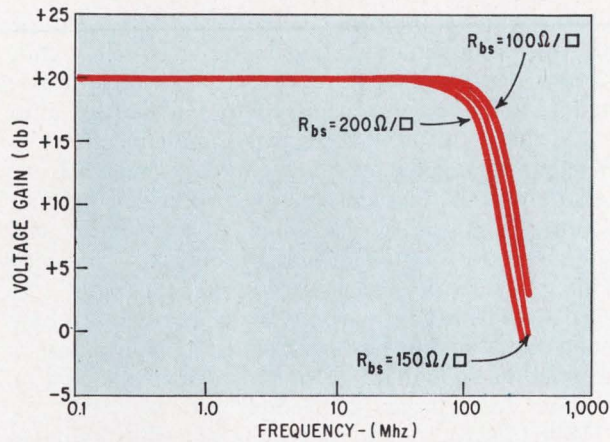

**Sheet resistance.** By keeping the base-sheet resistance low, the gain response is kept flat over the desired frequency range. Higher resistance values shorten the flat portion of the curve. Typical parameter variations of a diffused resistor, upper right, are useful for predicting an over-all circuit tolerance from a Monte Carlo analysis. In such an analysis, the computer evaluates circuit performance many times by randomly selecting parameter values. For discrete components, the analysis is somewhat inaccurate because it is difficult to get an accurate distribution. With integrated circuits, the distribution is considered Gaussian. Based on these calculations, a histogram, at the lower right, is plotted. The plot shows that a controlled process yields the best results.

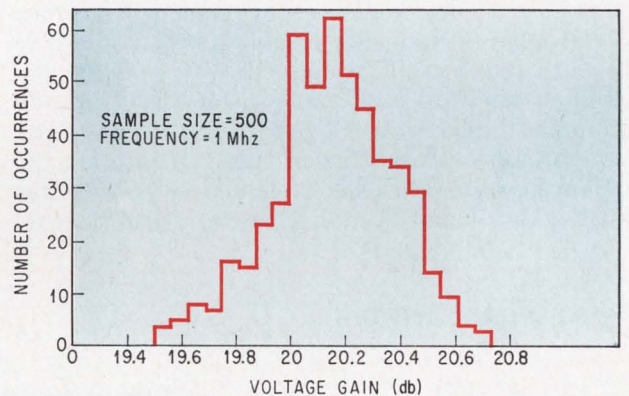
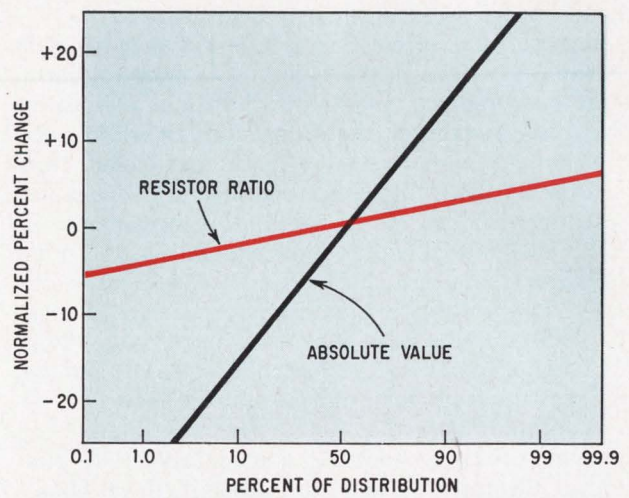

parasitic capacity per unit for both the collector-base and collector-substrate junctions of the transistors, and for all the resistor parasitics as well.

However, if a buried layer is added to lower resistance, a high-resistivity collector material can be used to reduce the capacity per unit.

Buried layers provide a low-impedance path around the high resistivity material, thus enabling a designer to build the circuit with single-contact geometry that minimizes the area of the collector-substrate junction. Whether there is enough increase in performance to justify the added process-

ing costs of a buried layer can be determined by the computer if it is programed with the performance data. For the video amplifier, a gain improvement of about 6 db at 100 Mhz was sufficient to justify the need for the additional step.

Since the sensitivity test pointed up the importance of the parasitic capacity of  $R_1$  and  $R_2$  the same type of analysis was conducted for the low-gain configuration to determine optimum line-widths for the resistors. Tradeoff between ease of manufacturing wide line widths and stability of circuit performance was determined from the fre-

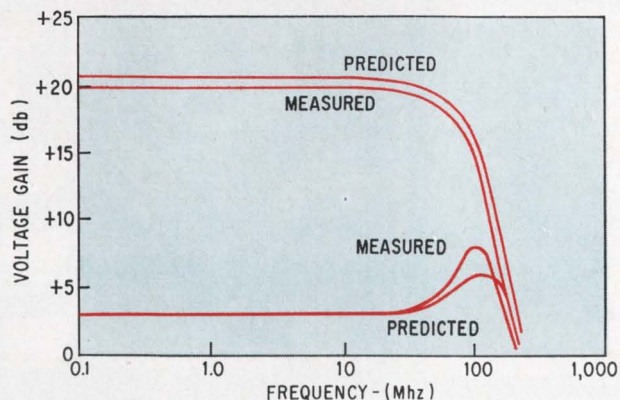

**Verification.** Discrepancies between curves are due to differences in the transistor models.

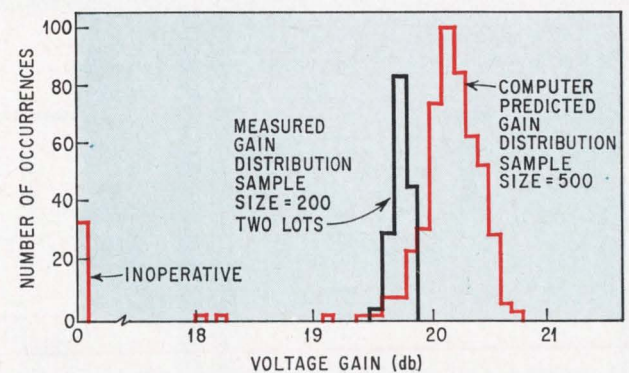

**Yield prediction.** Plots indicate the gain tolerance of two manufacturing runs. Although close in agreement, small discrepancies exist.



quency-response curves. This data established the need for 0.5-mil wide resistors for  $R_1$  and  $R_2$ .

An additional item that is often of some benefit is the optimum value of sheet resistance for forming the resistors. Since this diffusion also forms the base region of the transistors, it affects the transistor parameters as well. In particular, transistors can be built with a significantly higher frequency response if the value sheet resistance is reduced below 200 ohms per square. On the other hand, as the value sheet resistance decreases, the length of each individual resistor has to increase to maintain the same total resistance value. This, of course, increases the parasitic capacity and decreases the frequency response of the resistors.

Computer data that determined the relative importance of these opposing considerations are plotted at the top of page 101. Although these curves show that the lowered sheet resistance will improve the amplifier's frequency response, this was largely because the use of the buried layer and the decreased linewidths for the resistors have already minimized the negative factors. Since 200 ohms per square appeared satisfactory towards meeting the initial performance objectives, and since this was a standard manufacturing process, it was selected

as the sheet resistance for this design.

### Calculating manufacturing yield

An additional performance criteria established for the video amplifier was that the low-frequency gain have a maximum variation of  $\pm 0.5$  db, or approximately  $\pm 5\%$ . Because the resistors' absolute value could vary by  $\pm 20\%$ , there was some concern as to whether this gain accuracy could be maintained.

To predict a tolerance for over-all circuit gain as a function of the tolerances of all the component parameters, a Monte Carlo analysis was performed. This is a statistical analysis wherein a computer is used to repetitively make a large number of computations of circuit performance. Each computation is based on individual parameter values selected at random from preassigned distributions.

With discrete component circuits, this analysis tends to be somewhat inaccurate due to the difficulty in determining the accurate distribution for each component. In most cases, component manufacturers control this distribution by a selection process. Integrated-circuit components, however, cannot be selected, and therefore the distribution of each component is Gaussian.

By using component distribution data, the prob-

## Preparing the artwork

Step 1

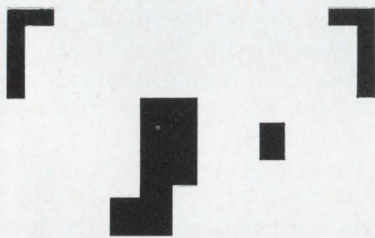

Step 2

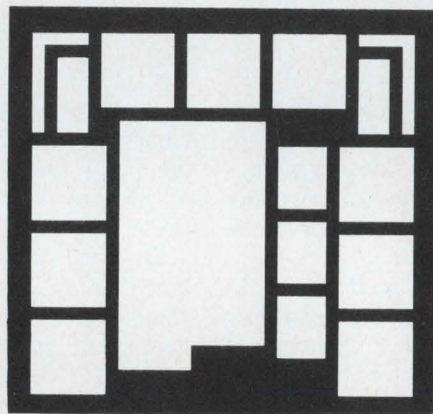

Step 3

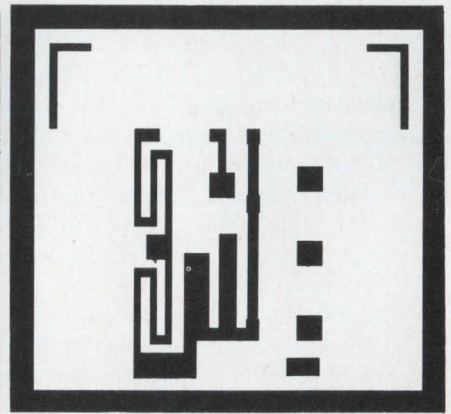

Step 4

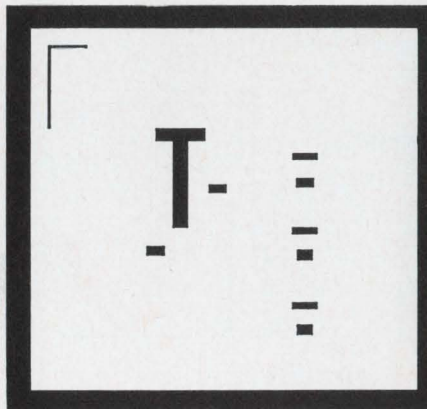

Step 5

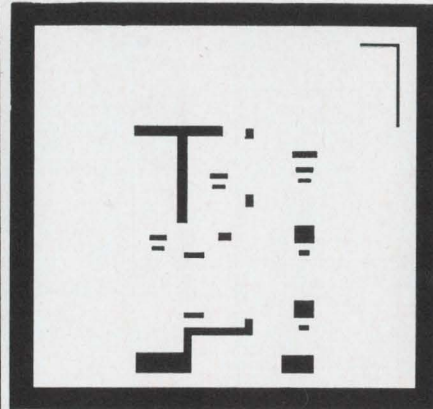

Step 6

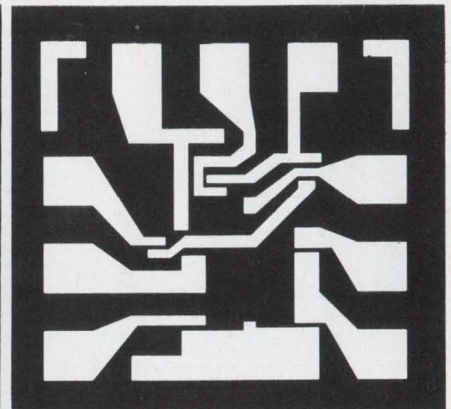

**Mask generation.** Details for laying out the artwork that will result in the IC fabrication masks are shown in these six steps. Each step represents a separate stage in the manufacturing process.



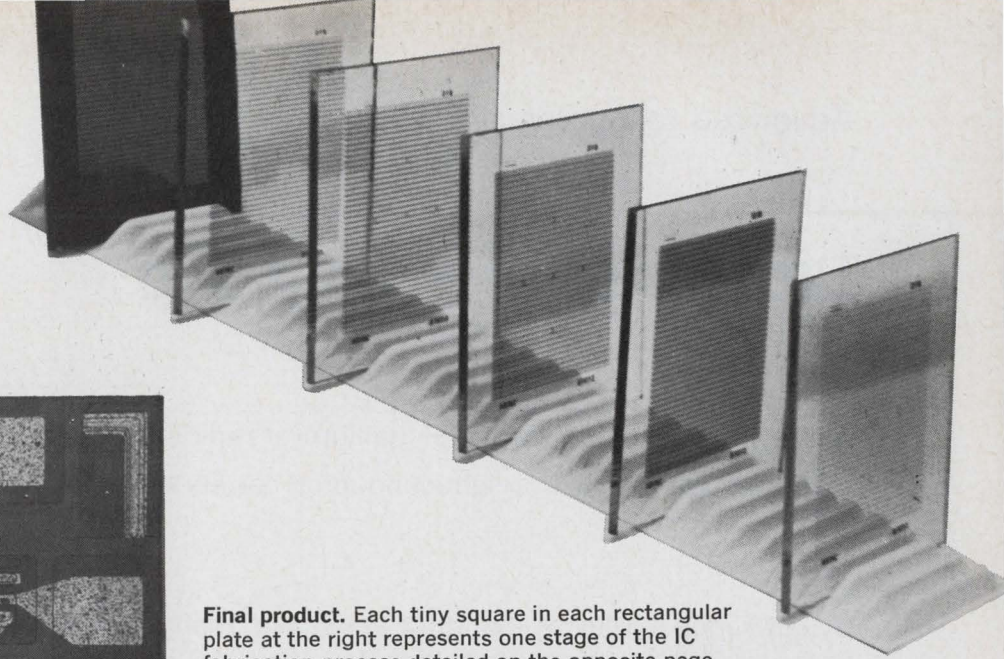
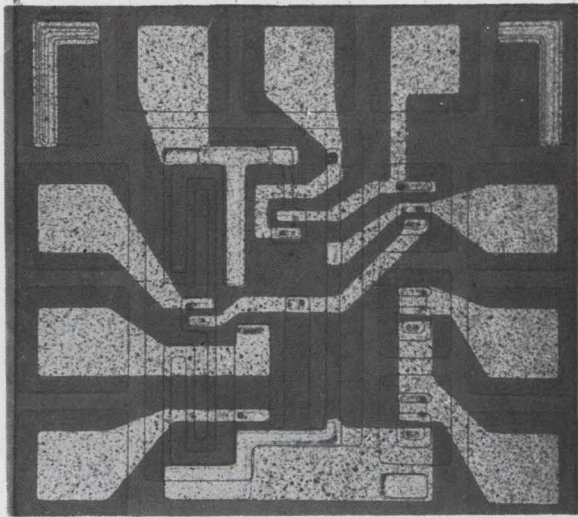

**Final product.** Each tiny square in each rectangular plate at the right represents one stage of the IC fabrication process detailed on the opposite page. Finished integrated circuit is shown at the left.

able distribution of gain as a function of over-all manufacturing tolerances can be computed and plotted as a histogram. This plot for the video amplifier indicated a manufacturing yield of better than 90%.

### Verifying the analysis

The design data generated with Snap established the optimum manufacturing process and geometry for each component, and provided a design that satisfied all the performance objectives. From this, a circuit layout was developed that led to the fabrication of the production masks. This artwork detailed each step in the manufacturing process.

The completed video-amplifier circuit contained some additional components, including resistors, which when externally connected would provide the amplifier with fixed gains of 3, 10, 20, or 28 db; and a pair of diodes, which vary the amplifier gain from 3 to 25 db as they are biased into conduction. The geometry of the individual resistors differed considerably. Where capacity was important, small line widths were used. Larger line widths were used elsewhere to provide a greater probability of more accurate tolerances.

Where the base of the transistor was connected to a resistor, the two were diffused together to eliminate one contact area and reduce over-all size.

Production devices from the first two manufacturing lots were sampled to measure the actual performance of a typical device. These measurements compared favorably with those predicted by the computer. Differences were attributed to the approximations included in the transistor model used

for the computer analysis. However, the discrepancies were considerably less than those usually found when comparing theory with actual practice.

Gain tolerance was also evaluated in the sampled devices. Although the sample size was relatively small—only 200—the agreement with the predicted distribution illustrates the accuracy of computer-analysis techniques. The nominal gain was off by about 0.7 db, but the predicted tight gain distribution was achieved. Discounting the defective units that were caused by factors not considered in the tolerance analysis, the yield was 95%.

### Cost of analysis

The advantages of using high speed digital computers, in conjunction with general-purpose computer programs, to analyze and design monolithic IC's are obvious. Not only can most phases of circuit performance be evaluated and modified, but process controls can be compared with critical parameters and potential problems identified early in the program.

Although this additional analysis may boost overall design costs, the increase is significantly less than the cost of redoing a set of production masks.

### Bibliography

- A. Phillips, "Transistor Engineering," McGraw-Hill, Inc., 1962, p. 65.
- R. Mammano, K. Pope, and E. Schneider, "Computer-assisted circuit analysis," EDN, November 1965, p. 132.
- Arinc Research Corp., "Integral Electronic Course Notebook," May 1967.
- J. Pilcicki and R. Hughes, "Making a video amplifier to measure," Electronics, July 10, 1967, p. 85.
- Motorola Semiconductor, "Integrated Circuits," McGraw-Hill, Inc., 1967, p. 131.



# Lighting up in a group

Batch processing of arrays of gallium arsenide phosphide diodes may presage the use of semiconductor panels as alphanumeric displays

By Lawrence A. Murray, Sandor Caplan, and Richard Klein

RCA Electronic Components Division, Somerville, N.J.

**Batch fabrication** of light-emitting diodes may point the way to a new generation of alphanumeric displays. Besides needing less space and power than today's vacuum-tube, electroluminescent, or projected displays, batch-processed semiconductor panels would cost much less than the similar arrays of separately packaged diodes that have so far been produced experimentally.

Researchers at RCA have made experimental five-by-seven diode arrays in batches, and the technique appears applicable to large-scale commercial production. Fabricated from single wafers of gallium arsenide phosphide, the injection electroluminescent diodes emit dots of red light when turned on by solid state driver circuitry, and these dots can form any letter or number.

Work is now under way to integrate the driver circuits on semiconductor chips through a metal oxide semiconductor approach.

## Expansion program

Wafers processed thus far have generally been 300 mils square, but sizes up to  $\frac{3}{4}$  inch square are possible with the technology and the epitaxial deposition equipment now being used. Combining such an array with mos control circuitry could produce a complete, digitally addressable alphanumeric display measuring about  $\frac{3}{4}$  by  $\frac{1}{4}$  inches.

Within a year, the fabrication equipment will be enlarged to handle wafers up to 2 inches square. Within the same period, a 50-by-50 array of diodes will be processed on a 1-inch-square wafer. A 4-by-5-inch array is expected by 1970.

The work with gallium arsenide phosphide is sponsored by the Research and Technology division, Air Force Avionics Laboratory, in Ohio, and was initially directed at determining the feasibility of using arrays of solid state light sources as alphanumeric displays in aircraft cockpits. The feasibility

of the approach has now been demonstrated by the development of the five-by-seven array.

Now Russell Runnels, contract monitor at the Avionics Laboratory, has his long-range sights set on a flat display panel of tiny light sources measuring roughly  $3\frac{3}{4}$  by 5 inches. Such a display might be hooked to a computer aboard a plane to present information to the pilot on, say, hydraulic pressure, fuel supply, or temperature. Fuel, pressure, and temperature levels could be sampled by a multiplexer driven by the computer; the values would be displayed either on command or when a malfunction or dangerous condition was detected.

The dot matrix would be, in effect, a solid state kinescope. With suitable control and driving circuitry, it could assume any function now performed by a kinescope tube, from radar displays to alphanumeric message displays.

Two types of batch-fabricated alphanumeric arrays are now being tested:

- The five-by-seven dot-source array on the next page measures 200 by 300 mils and consists of 20-mil-diameter diodes on 40-mil centers. Dot sources have been made anywhere from 10 to 200 mils in diameter.

- The array of 13 straight-line diodes shown on page 108 arranged to form different alphanumerics when various segments are energized. These lines of light have been made anywhere from 80 to 225 mils long and 18 mils thick. The over-all array measures 200 by 250 mils.

## Divided they fall

Arrays of light-emitting diodes have usually been put together from separate devices. Even if they're made from the same gallium arsenide phosphide slice, the diodes are sawed apart early in the fabrication process and are then put into individual packages, tested, and interconnected into an array.

This technique would be practical for arrays of



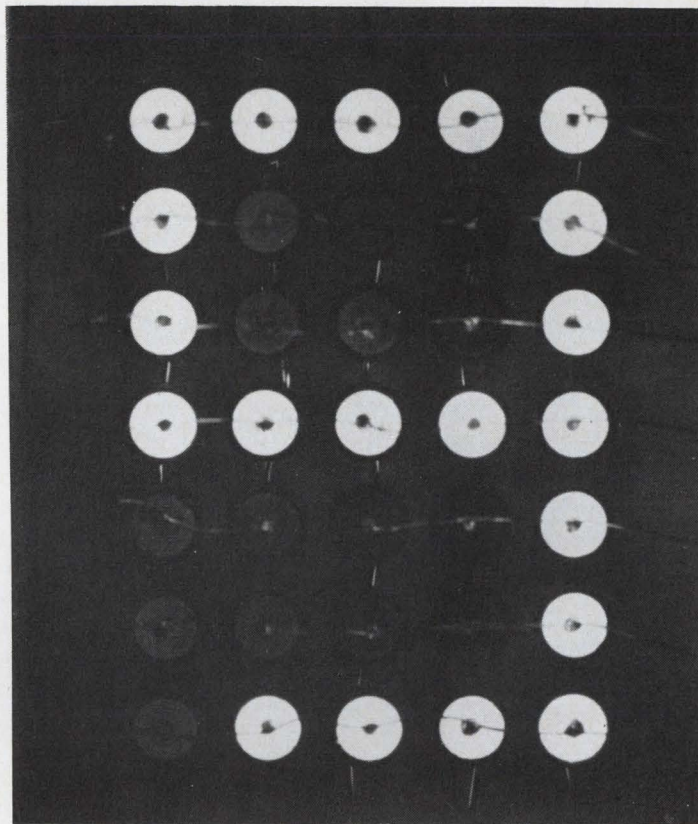
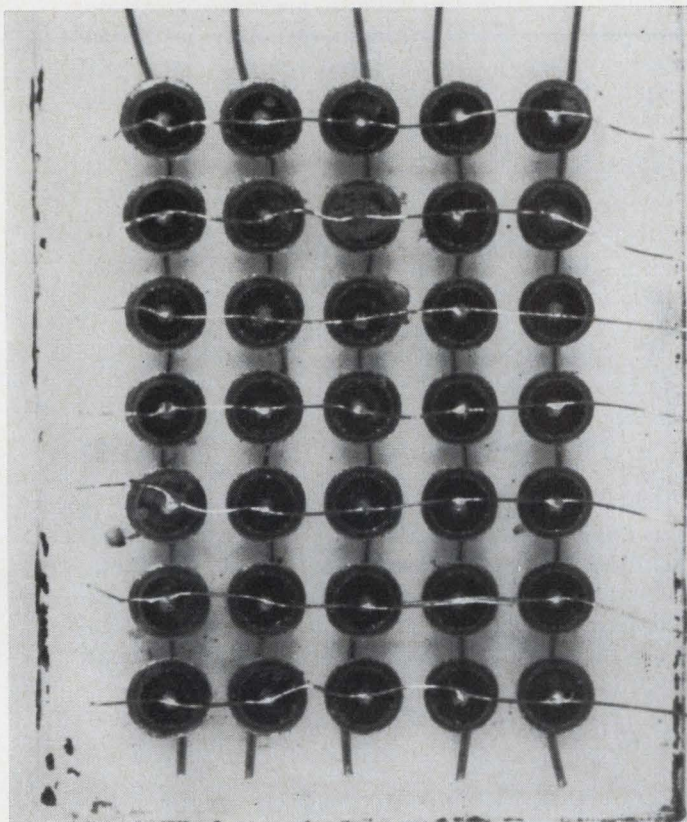

**Dot array.** Five-by-seven array of injection electroluminescent diodes was batch fabricated in single wafer of gallium arsenide phosphide. The diodes are individually addressable through x-y contact lines, which were soldered in place in earlier versions, but are now vacuum evaporated.

only a few dozen diodes at most; the cost of separating, packaging, and interconnecting the devices becomes prohibitive with larger amounts. Also, the individual packages and the connections between them prevent any close packing of the diodes.

At present, there are three injection electroluminescent materials that provide efficient optical emissions when a p-n junction is forward biased and are relatively easy to produce in large quantities: gallium arsenide phosphide, Ga(As,P); gallium aluminum arsenide, (Ga,Al)As; and gallium phosphide doped with zinc and oxygen, GaP(Zn:O). The work at RCA has dealt primarily with Ga(As,P) because, as the oldest of the three, its processing is the best known.<sup>1</sup>

Each of these materials emits in a band that includes the red region of the spectrum, but their light-emission wavelengths and bandwidths differ. Gallium arsenide phosphide emits from green through infrared—5,600 to 9,000 angstroms, depending on the amount of phosphorus. The higher the phosphorus content, the shorter the wavelength, page 110. With a 45% phosphorus content, an emission peak occurs in the red at about 6,400Å, top, page 109.

External efficiency—the ratio of visible light energy out of the surface to electrical energy into the semiconductor—ranges from 0.1 to 0.01%. In-

ternal quantum efficiency—the relation of light photons generated to the injected electrons—is far higher.

The critical angle at which light from inside the material strikes the surface and is totally internally reflected is also important. The smaller the angle, the smaller the amount of generated light passing through the surface.

The index of refraction for Ga(As,P) is typically 3.5. If the diode interfaces with the atmosphere, the critical angle measured from the normal to the surface is 16.65°. Assuming isotropic radiation emitted at the p-n junction, only 2.87% of the light will emerge from the top of the diode. But if the diode were covered by a substance with a larger index of refraction, such as an epoxy lens with a refraction index of 1.6, the critical angle would increase to 27.29°. The efficiency of emission would thus be improved by a factor of three—that is, 9.3% of the emitted light would get through the surface of the semiconductor diode.

#### In the eye of the beholder

With Ga(As,P), the region around 6,400 Å appears brightest to an observer. Although the quantum efficiency of the material has already passed its maximum at this point, the response of the viewer's eye is still increasing logarithmically with decreas-



ing wavelength.

Gallium aluminum arsenide emits at wavelengths that vary with its composition in a manner much like Ga(As,P), and it's hoped that this material may have a greater optimum brightness.<sup>2</sup>

Gallium phosphide's output starts in the red and goes out to the infrared. The material has a peak intensity at 7,000 Å—about the limit for the human eye—but because it has a spectrum spanning about 2,000 Å, an appreciable portion of its emission falls in a region the eye can easily see.<sup>3</sup>

External efficiencies reported for both GaP and (Ga,Al)As have reached 2%, considerably higher than that of Ga(As,P). However, because these diodes emit light at wavelengths to which the eye is relatively insensitive, they don't appear much brighter than the Ga(As,P) devices. In addition, the brightness of GaP(Zn:O) isn't linear with current, and the material therefore isn't feasible for an array of many diodes because of the way the display is scanned—high current pulses at low duty cycles. But the present materials processing technique is such that should either the (Ga,Al)As or GaP prove better than gallium arsenide phosphide, they could be easily substituted for it. The choice of the best material for alphanumeric displays has yet to be

made from among these materials.

To produce the dot array, mesas are ultrasonically cut into a layer of gallium arsenide phosphide epitaxially grown on gallium arsenide substrate. The process defines the boundaries of the individual light-emitting diodes in the array. Ultrasonic cutting is used instead of etching to avoid undercutting or side-cutting the mesas.

### Cutting out

A die into which the desired diode pattern has already been machined is placed very close to the wafer, and the ultrasonic agitation of the abrasive slurry cuts a corresponding pattern of mesas in the semiconducting material in about a minute.

Machining the die limits the spacing between diodes to a minimum of about 20 mils. For greater density, the arrays can be cut mechanically with a saw; arrays have been cut on five-mil centers this way.

Once the diodes have been cut, a clear glass sheet is pressed onto the mesa structure at temperatures above the flow point of the glass. The substrate is lapped away, leaving the diodes isolated from each other and held together by the glass matrix. The glass is etched away over small

### Shining examples

Any semiconductor under forward bias emits light, but most at such low efficiency that the emissions cannot be easily detected. The light results from hole-electron recombinations between

the valence and conduction bands (transition I in the figure), between low-lying energy levels (transition II), between the conduction band and acceptor level (III), or between deep

levels (IV and V).

The wavelength of the emitted radiation depends on the energy gap of the material ( $E_c - E_v$ ) or the energy levels of the dopants ( $E_a - E_a$ ). Peak wavelengths for efficiently emitting diodes vary from 9,000 angstroms down to 6,200 Å. For visible radiation, the material must have an energy gap above 1.8 electron volts (radiation from 7,000 Å to 6,200 Å for transitions I, II and III). When the energy gap isn't significantly greater than 1.8 electron volts transitions IV and V occur and light is emitted in the far infrared.

Transition I is likeliest in lightly doped gallium arsenide, II in silicon carbide, III in gallium arsenide phosphide, IV in copper-doped zinc sulfide electroluminescent cells, and V in zinc- and oxygen-doped gallium phosphide.

The cadmium sulfide and zinc sulfide families, as well as many ternary compounds, aren't suitable here; they can be made in either p types or n types, not both.

For the transitions to be efficient and useful, further restrictions must be considered. The need for a small absorption coefficient holds true for the red line in gallium phosphide, but not for the green line. The coefficient is somewhat higher for the lines emitted by gallium arsenide and gallium arsenide phosphide.

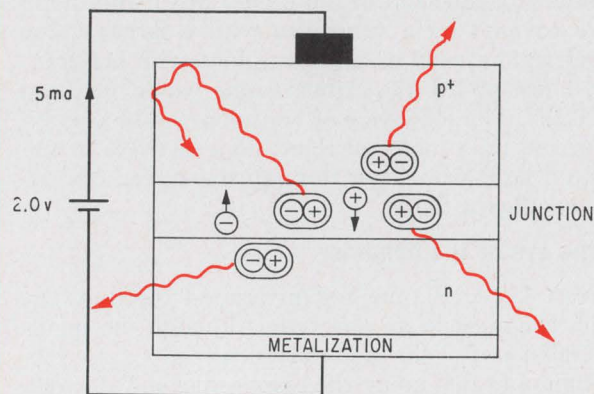
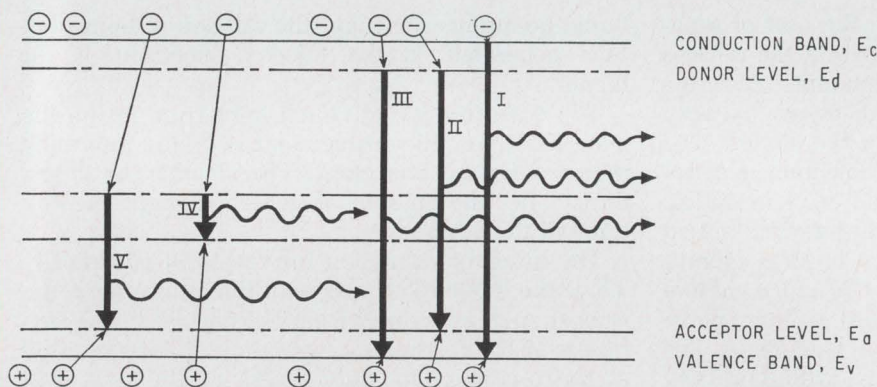

**Transitions.** Holes are injected into the n region and electrons into the p region where they recombine with the majority carriers. The recombination energy is released as randomly directed light.



## Served under glass

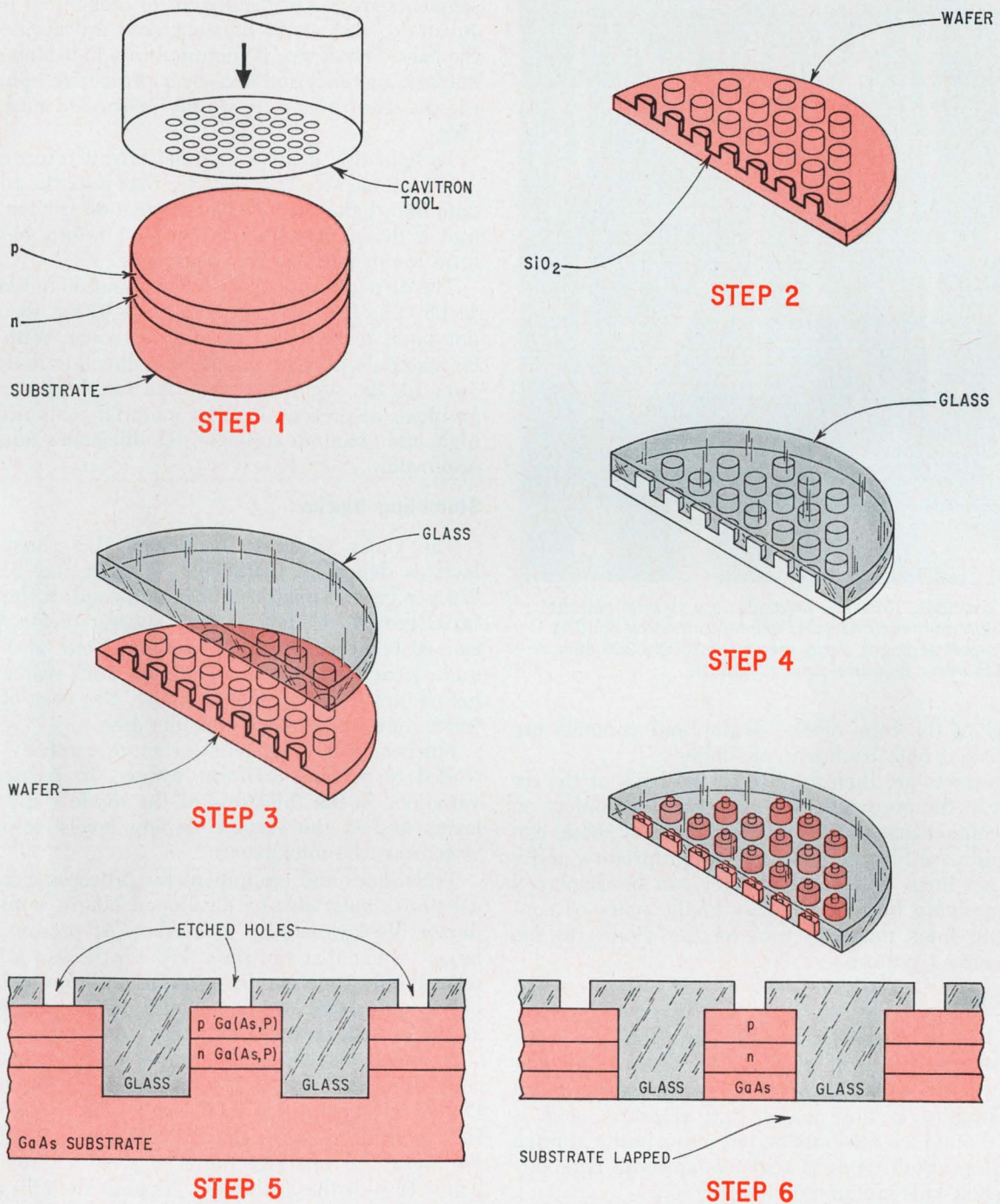

**Processing the array.** In step 1, a gallium arsenide substrate with epitaxially deposited layers of p- and n-type gallium arsenide phosphide is ultrasonically cut with a Cavitron tool into a pattern of mesas. A thin layer of silicon dioxide is deposited (step 2) to serve as a passivation coating over the array, shown in crosssection. A layer of glass, selected to match the thermal properties of the semiconducting material, is then pressed into the array under high temperature and pressure (step 3). The array is now a solid structure of glass and semiconductor (step 4). Holes are etched through the glass into the top of the array so that contacts can be made to the p layers of the diodes (step 5), and the excess substrate is lapped away from the bottom of the array (step 6). The diodes, now isolated and held securely by the glass alone, are ready for metal interconnections to be evaporated in the x direction at the top of the wafer and the y direction at the bottom.



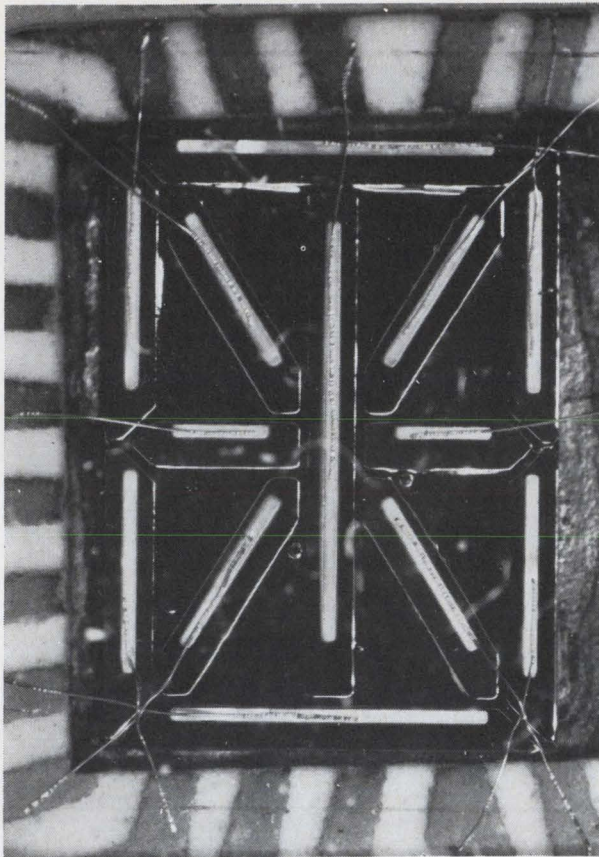

**Thin red lines.** Thirteen line diodes are so arranged that any alphanumeric character can be formed by lighting the correct segment. Array measures 200 by 250 mils and fits into a half-inch-square flatpack.

areas in the tops of the diodes and contacts are deposited onto each row of diodes.

Contacts are then applied to the back of the diodes in the perpendicular direction to complete an x-y contact matrix. The result is that any diode can be addressed by energizing the appropriate x and y contact lines, and any character can be displayed by applying biasing voltages to the pairs of contacting lines that will turn on the diodes in the character's pattern.

### No blink

When the array is scanned more than 30 times per second, the light from the display appears constant. The scan is generated by the synchronous clocking of x- and y-axis shift registers, and is based on video information fed into x and y storage registers. Both types of registers are built from off-the-shelf mos integrated circuits.

Because of the high current requirements of the diodes—an average of 20 milliamperes each—x- and y-axis drivers are also needed. It's hoped, though, that material efficiency can be increased to the point where a few milliamps suffice and the diodes can be driven directly by the 1.5- or 2-volt levels of the logic. The result would be an addressing-driving circuitry smaller than the display itself, circuitry that could easily fit on the back of the panel or around its edge in three or four half-inch-

square commercially available flatpacks.

Similar circuitry could be applied to larger arrays and to the display of characters that change or move with time.

The 13-bar segmented display is made in much the same way as the dot matrix. The individual segments are ultrasonically cut or etched out of the substrate, and metal line contacts are applied to the bars. The device is mounted in a half-inch-wide flatpack and enclosed in a clear protective epoxy or plastic. The process is simply controlled and reliable.

To light this display, parallel six-bit information is fed into an mos tree decoder that puts the binary data into digital form. The information is then sent into a diode matrix that encodes it into base-13 form for driving display segments.

The displays built so far need about 50 milliamps at 1.8 volts for each segment, and 10 ma for each dot diode, to stand out in a lighted room. With better materials, current should be reduced to less than 5 ma for the segments and 1 ma for the dots. The problems at present are that material costs are too high, and quantum and external efficiencies must be improved.

### Stumbling blocks

The GaAs substrate on which the phosphide layer is deposited epitaxially is expensive—\$10 to \$15 per gram. So is the phosphine used in the epitaxial growth reactor. A simple wafer of Ga(As,P) can cost several hundred dollars. Four alphanumeric panels could be made on one such wafer, but before this is done commercially, the cost of the wafer must come down considerably.

Further, processing must be more carefully controlled to produce uniform wafers. In particular, variations in the thickness of the diode's epitaxial layers and in the surface doping levels across a wafer must be minimized.

Techniques and equipment for processing larger substrates must also be developed before semiconductor displays can go to market. At present, the largest wafer that can pass through the RCA equipment is only 1 inch in diameter. In addition, volume has to be boosted; only one wafer can be processed at a time with present methods.

A switch to GaP (Zn:O) might ease processing constraints and could speed manufacturing time. Doping levels and thickness don't have to be carefully controlled with gallium phosphide because the light the material emits has an energy far below that of the absorption region. All light produced within the crystal gets to the surface.

The possibility of using silicon as the initial substrate material instead of gallium arsenide is being studied. So is the use of germanium. Besides costing less than the GaAs, these semiconductors can be made in considerable larger diameters. Single silicon crystals 12 inches in diameter have been produced, for example.

The first prototypes built by RCA required more than 100 ma of current per segment for visible out-



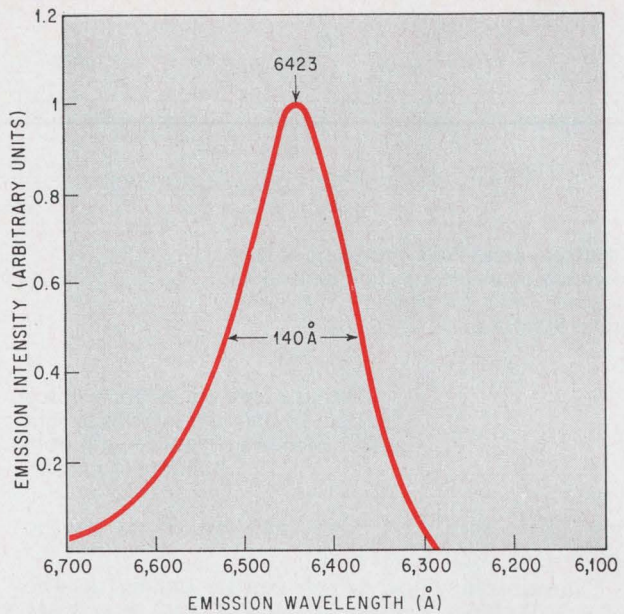
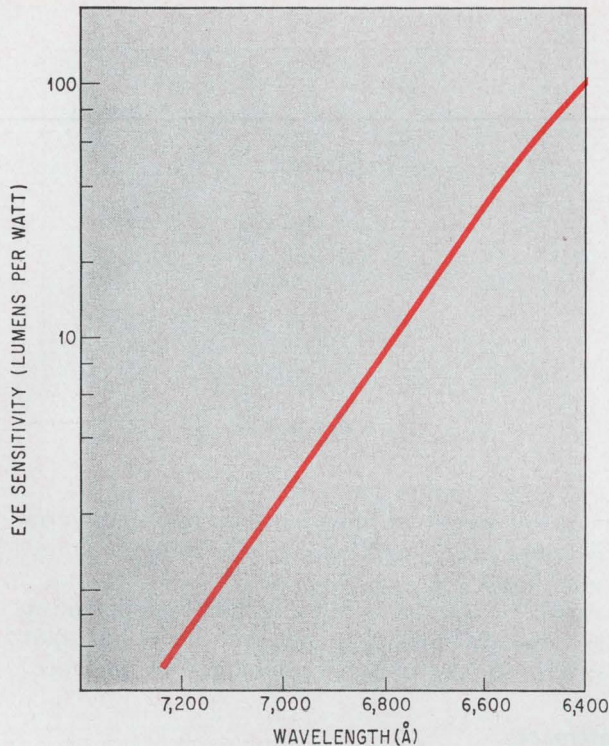

**Easy on the eye.** With a content 45% phosphorus, Ga(As,P) has an emission intensity, above, that peaks in the red at 6,423 angstroms. Eye sensitivity is also relatively high at this wavelength, left.

put. But material produced more recently has had quantum efficiencies 10 to 50 times better, and the current needed to drive each segment should soon be within the capability of mos circuitry. Although gallium arsenide phosphide emits bright red light at fairly low currents it's still a relatively inefficient material—0.1% or less now. There's plenty of room

for improvement in efficiency here.

Quantum efficiency isn't really that serious a problem, though, when doping is done properly. Most of the energy is lost to competing energy transitions, absorbed in the lattice structure of the crystal, or blocked out by critical angle reflections.

The use of dopants with larger energy separa-

### Graded growth

The light-emitting p-n junction in these diodes is contained in carefully graded gallium arsenide phosphide layers grown on gallium arsenide in a vapor epitaxial chamber. Variation of the layers' composition serves to minimize the crystal dislocations formed when one material is grown on another with a different lattice constant.

In the process, gases containing arsenic, phosphorus, zinc, and selenium are introduced into the chamber under precise control.

The first layer is grown with a composition running from pure GaAs to a one that's 55% gallium arsenide and 45% gallium phosphide. After this layer takes on the correct phosphorus composition, the level of n-type doping with the selenium is adjusted to optimize the emission efficiency of the crystal. Thus, the second layer is deposited.

After the n doping gas is abruptly turned off, the p-type

dopant—zinc in the form of zinc chloride—is introduced to form the p-n junction. This layer is kept as narrow as possible to hold down its absorption of the light generated at the junction. After the junction is formed, the flow of phosphorus gas is increased and the arsenic flow is decreased so as to form a "window"—a region of

low light absorption. The phosphorus content of this region is also graded.

Finally, the p-type gas flow is increased to form a layer conductive enough to cause the current injected at the contact to spread to the edges of the diode junction. This ensures that light will be emitted uniformly.

**Delicate balance.** The p- and n-type layers must be carefully graded in phosphorus content as the gallium arsenide phosphide is grown epitaxially on the gallium arsenide substrate.

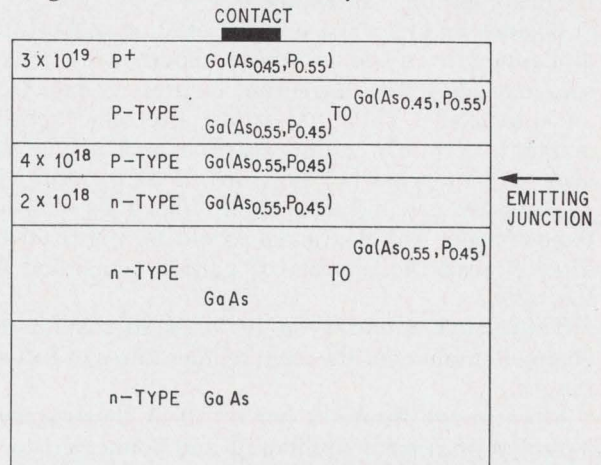



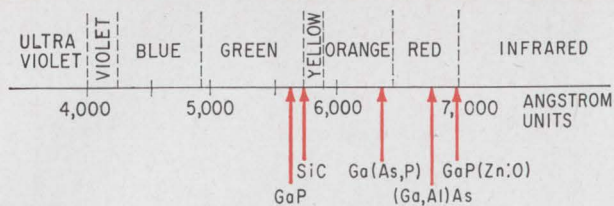

**Spectrum.** Peak light emissions of commercially available injection electroluminescent materials range from yellow-green to infrared.

**Getting a glow on.** As phosphorus content of Ga(As,P) increases, light output decreases in wavelength from infrared to green.

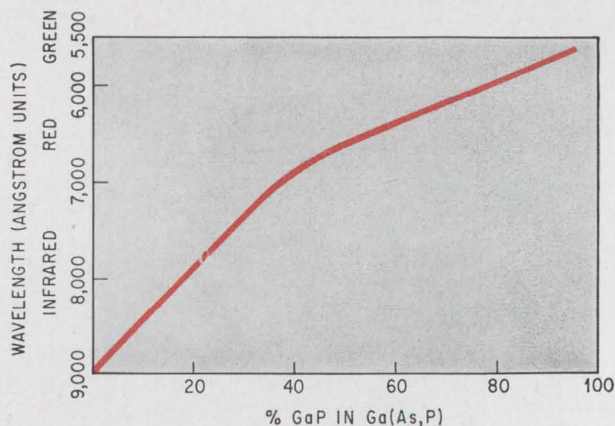

tions from the band edges can cut down on the amount of light absorbed.

External efficiency, which can be defined as the internal efficiency times the probability that light will be emitted through the surface, could be boosted by forming the diode into a domed shape similar to that of a modified Weierstrass sphere, coating it with a plastic or glass with a high index of refraction, and plating its back face with a highly reflective coating.

### Brighter future

To extend the range of applications for light-emitting-diode arrays, more colors will have to be produced. At present, green light has been obtained from gallium phosphide at an external efficiency of 0.01%,<sup>4</sup> and yellow from silicon carbide at a far lower efficiency. Increasing these efficiencies is the next step.

Also, materials that emit light at shorter wavelengths will have to be developed. They may be mixed compound systems, n-p heterojunctions of the zinc sulfide or cadmium sulfide families, or even epitaxially grown diamond.<sup>5</sup>

The driving circuits have generally been breadboarded functional blocks in the form of silicon integrated circuits. But completely integrated control circuitry is now being designed and built, with no major hurdles anticipated.

Besides finding a place in the existing market for alphanumeric readouts, these diode arrays may someday constitute the entire instrument panel of an automobile. Their use in an electronic speedometer is certainly entirely feasible, and they might also read OK when oil pressure or temperature is within tolerance and HI or LO if either falls into the danger zone. The gas gauge could be digitized to directly read the number of gallons remaining in the tank.

The arrays might even be used to display tv channel numbers or the oven temperatures of future ranges.

More in the future, a bar of 10 of these arrays mounted on a car's dashboard and connected to a small radio receiver could display information from directional transmitters located along highways.

The driver would be provided with information on traffic and road conditions, speed limits, and upcoming exits.

Another market possibility is the development of new products entirely dependent on solid state displays—an electronic, wristwatch, for instance.

### References

1. C.J. Neuse, J. Tietjen, J. Gannon, and H. Gossenberger, "Extended Abstracts of Transactions of the Metallurgical Society of the American Institute of Metallurgical Engineers," New York, August 1967.
2. F.A. Trumbore, M. Kowalchik, and H.G. White, *Journal of Applied Physics*, vol. 38, pp. 1987, 1967.
3. H. Rupprecht, J.M. Woodall, and G.D. Pettit, *Applied Physics Letters*, vol. 11, p. 81, 1967.
4. P.J. Dean, M. Gershenson, and G. Kaminsky, *Journal of Applied Physics*, vol. 38, pp. 5,332-5,342, 1967.
5. W.G. Eversole, "Synthesis of Diamond," U.S. Patents 3,030,187 and 3,030,188.

### The authors



For almost 10 years, Lawrence A. Murray has been developing techniques for growing III-V semiconducting and lasing materials and measuring their parameters at RCA's Electronic Components division. He heads up the division's device physics group.

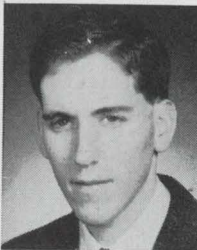

Sandor Caplan, an associate engineer in the device physics group has worked in many areas of solid state physics since joining RCA in 1963. He's now studying the electro-optical properties of light-emitting semiconducting devices.

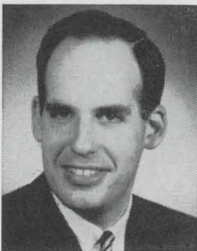

Richard Klein, another associate engineer in the device physics group, is studying the electroluminescent and photoluminescent spectra of III-V semiconductors. He holds a master's degree in electrical engineering from Cal Tech.



"Some people say we're the most conservative company in the integrated circuit business. I prefer the word responsible, because it implies as much concern for our customers' problems as it does for our own. And besides—it's a proven way to make profit."

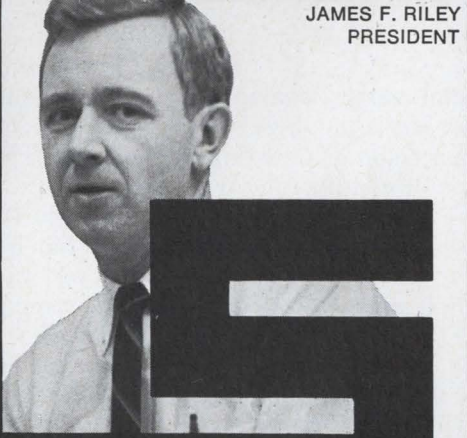

JAMES F. RILEY  
PRESIDENT

**SIGNETICS INTEGRATED CIRCUITS**  
SIGNETICS CORPORATION  
THE RESPONSE/ABILITY COMPANY



# Integrated circuits in action: part 10

## Linearizing sensor signals digitally

This technique of conditioning signals is simpler and less expensive than analog methods now used in multiple-input data-acquisition systems

By Jacek H. Kollataj and Teuvo Harkonen

Nokia Inc., Helsinki, Finland

**Digital versus analog** may well become a one-sided battle in the industrial arena. The latest blow to the traditional analog method is a digital technique of conditioning transducer signals. Not only does this technique handle nonlinearities at a lower cost than analog techniques, but it provides higher accuracy and better noise rejection. Moreover, it makes the job of digital conversion fairly easy for data-acquisition systems.

By adding or subtracting the proper number of bits depending on the measured variable's value, signals from transducers can be characterized so their values are directly proportional to the measured variable—a linearizing effect. These values can be scaled to engineering units.

In analog linearizing and scaling, a function-

generator module, whose transfer characteristic is the inverse of the transducer characteristic, is inserted in the signal line. A square-root transducer characteristic, for example, requires a squaring-function generator. Analog modules for such straightforward, standard functions as square root, square, and logarithm, with an accuracy of about 0.15%, cost about \$400. Analog linearizers for thermocouples and resistance-temperature detectors are far more complex. Because they follow a third-order law, they tend to be even costlier. However, some of the cost is attributable to the necessary temperature compensation and tight tolerances.

In multiple-input systems like data loggers and control computer systems, both the number and variety of sensors affect the input system's capacitance. In essence, the greater the number of nonlinear analog modules that are switched, the higher the capacitance and the lower the noise-suppression capability.

Many digital data-acquisition systems rely on analog function generation for conditioning the input signals. However, in some systems built around stored-logic digital computers, conditioning is done with specific programmed subroutines—not hardware—that linearize and scale each input whenever a measurement is taken. The digital method developed at Finland's Nokia Inc. competes with both analog hardware and stored digital programs. It operates by wired digital logic and can be adapted to installations without a computer.

Nokia's method of digital conditioning uses integrated-circuit logic. In one application, for a data logger, four different types of thermocouples and one resistance-temperature detector have been linearized—on a single printed-circuit card at a component cost of about \$100. With an average

### The authors



Jacek H. Kollataj holds a master's degree from Politechnika Slaska in Gliwice, Poland. He joined Nokia Inc. in 1966, where he specializes in data-logging systems.



Teuvo Harkonen leads Nokia's data-logging and alarm systems group. A graduate of Helsinki's Teknillinen Opisto, he has been with the company since 1964.



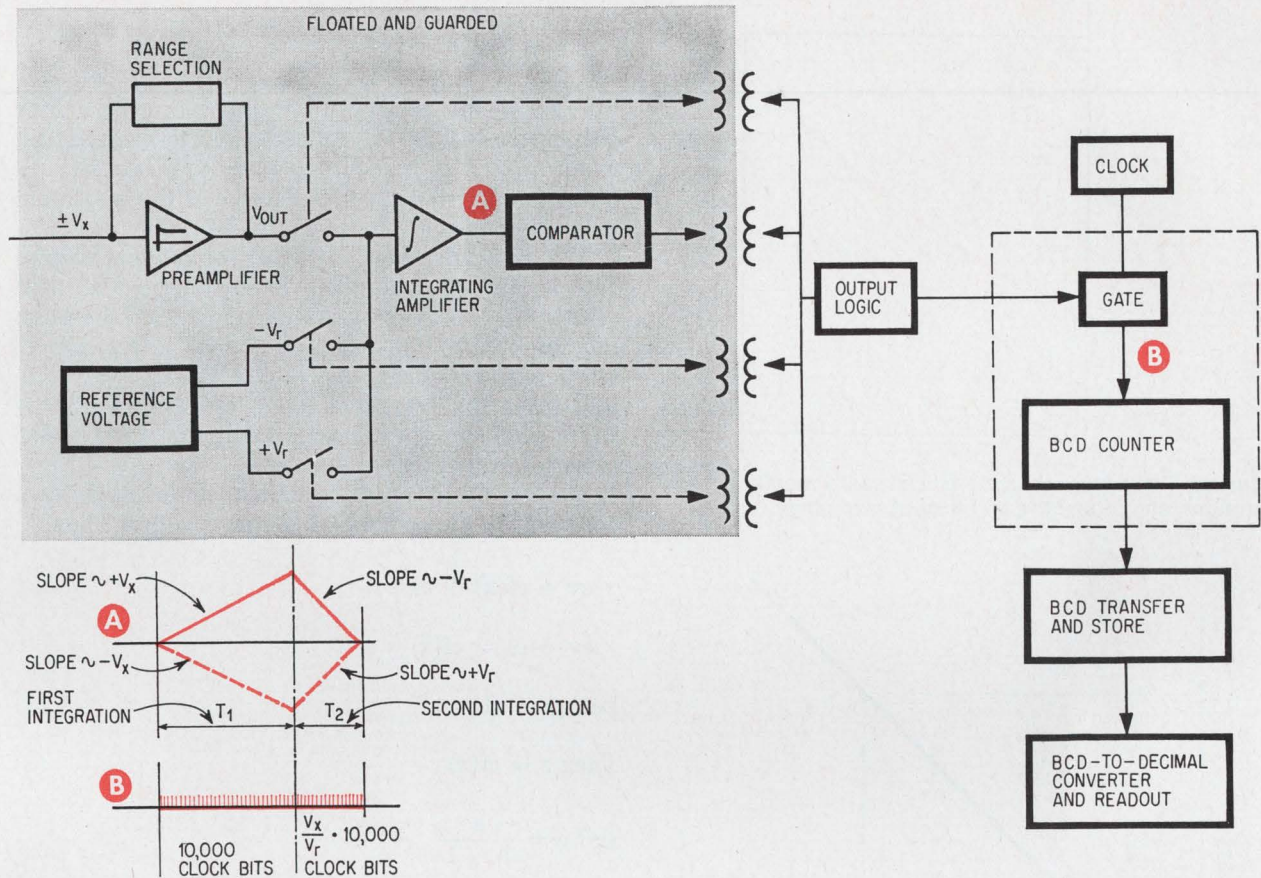

**Keeping count.** Digital voltmeter displays measured value after clock bits have been modified by control logic (see below) inserted at point B—between the gate and the dvm's binary-coded-decimal counter. Display then reads out such data as temperature and pressure in engineering units.

cost of \$20 per function, this approach offers strong competition to common methods of analog linearization.

Nokia's method works with any digital voltmeter that uses a voltage-to-time or voltage-to-frequency conversion technique. Such dvm's are ideally suited to acquire, convert, and read out signals from industrial measurements. They are fast, accurate, sensitive, and they suppress noise. The integrating dvm is one type.

During the dvm's first integration period, the measured voltage,  $v_x$  is integrated and the output logic turns on the gate to let clock-frequency pulses into the binary-coded-decimal (BCD) counter. During the second integration period, the reference voltage,  $v_r$ , of the opposite slope keeps the gate open until the integrated voltage reaches zero. The number of pulses remaining in the BCD counter is then proportional to  $v_x/v_r$ . Since the reference voltage is fixed, the number of pulses in the counter at the end of the second integration period, represents the input voltage.

### Working on the bits

The number of bits fed into the counter from the gated clock during the second integration period is multiplied or divided, depending on the

amount and direction of correction for the non-linearity. Clock bits are either added or stopped by a predetermined linearizing program. For each type of sensor characteristic, the program must be determined, designed, and implemented via a logic-function card. A control-logic circuit decides when and how many bits have to be added or stopped.

Consider an analog signal that is both non-linear and exhibits a non-zero value (offset) at the low end of the range. The characteristic is then

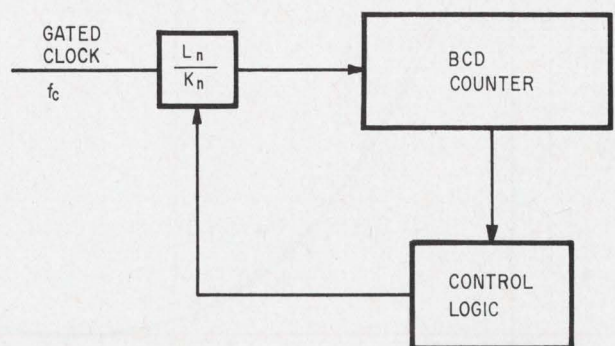

**Control logic.** Signals from BCD counter trigger the add-or-stop circuit,  $L_n/K_n$ , to perform required correction for linearization.



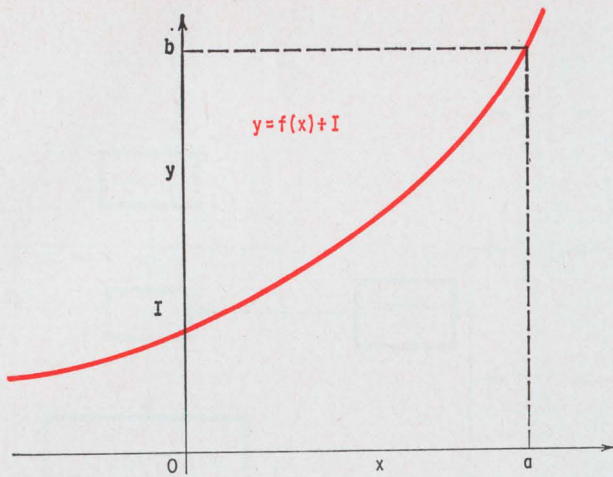

**Curved.** Transducer characteristics usually aren't straight, and often have an offset at zero range.

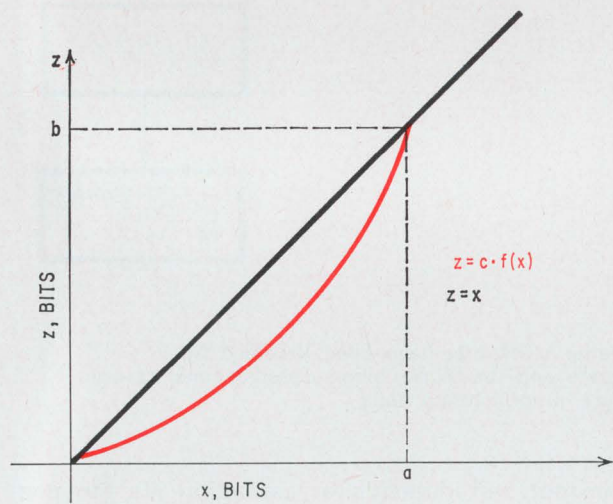

**Straightened.** Transducer output is more meaningful when it is linearized.

described by

$$y = f(x) + I$$

where  $x$  is the measured variable,  $y$  is the sensor output, and  $I$  is the offset or intercept. Thus, when  $x = 0$ ,  $f(x) = 0$ , and  $y = I$ . When  $x = a$ ,  $y = b$ , and  $f(a) = b - I$ . Here  $a$  is the maximum value of range.

The signal is then scaled to equivalent digital bits so that the number displayed on the dvm equals the measured variable expressed in engineering units. For example, when a resistance-temperature detector senses  $247.6^{\circ}\text{C}$ , the dvm will store the correct amount of bits to display 247.6—neglecting a tolerable error due to straight-line-approximation.

The nonlinear characteristic is multiplied by a constant,  $c$ , to accomplish digital scaling. Thus

$$cy = cf(x) + cI$$

$$cy - cI = cf(x)$$

$$\text{Let } cy - cI = z \tag{1}$$

$$\text{Then } z = cf(x) \tag{2}$$

$$\text{and } c = \frac{a}{b - I} \tag{3}$$

The coefficient  $a$  is then scaled to equivalent bits. Thus, for a temperature range of  $1,500^{\circ}\text{C}$ , constant  $a$  could be stipulated as 15,000 stored bits, giving a resolution of  $0.1^{\circ}$ . The factor  $cI$  is the offset in bits.

To linearize the transducer characteristic, a correction function,  $e(x)$ , equal to the difference between the nonlinear function,  $z = cf(x)$ , and its

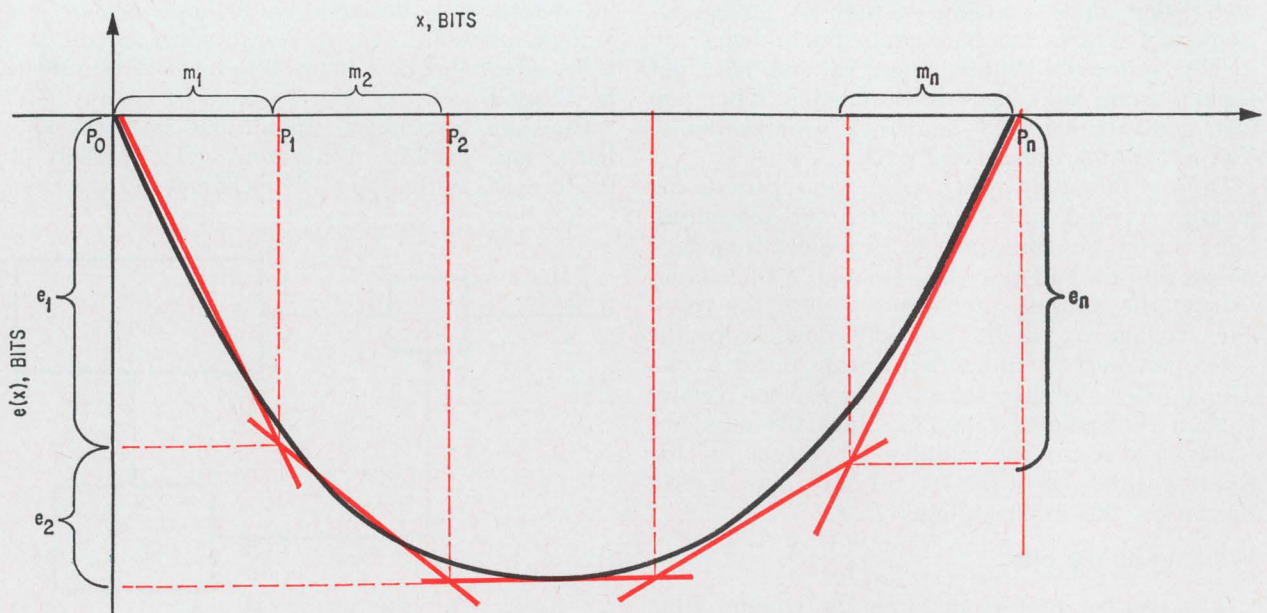

**Plot and correct.** Difference between nonlinear characteristic and its linearized equivalent equals the amount of correction,  $e(x)$ . Straight lines approximate the correction curve, and are used in circuit design.



scaled linear representation,  $z = x$ , must be developed. Thus

$$e(x) = cf(x) - x \quad (4)$$

### Step-by-step calculations

If an engineer wants to design a nonlinear correction program, he should take a step-by-step approach in his calculations. He should

- Determine the transducer characteristic  $y = f(x) + I$  by calculation or from a table.

- Determine point a, the maximum range of the transducer, and corresponding point b; find offset I; subtract I from  $f(x) + I$ , leaving  $f(x)$  to be linearized.

- Calculate constant c from  $c = \frac{a}{b - I}$  where

a is expressed as the number of its for full range; calculate digital offset cI, expressed in bits.

- Multiply  $f(x)$  by c to obtain  $z = cf(x)$ ; both x and z at this point are expressed in bits.

- Determine the correction function,  $e(x) = cf(x) - x$ .

- Plot correction function  $e(x)$  versus x and employ the straight-line approximation technique, using an appropriate number of line segments. The number depends on several factors, primarily the required accuracy and minimum redundancy of logic circuits.

- Determine the sign of  $de/dx$  in each segment.

- Add bits if correction slope is negative. The expression  $L_n/K_n$  means that, in section n,  $L_n$  bits are added for every  $K_n$  bits produced by the clock. The design equation is:

$$\frac{L_n}{K_n} = \frac{e_n}{m_n - e_n} \quad (5)$$

In frequency terms, the required correction is

$$f_n = f_c \left( 1 + \frac{L_n}{K_n} \right) \quad (6)$$

where  $f_n$  is the frequency of bits to the BCD counter and  $f_c$  is the clock frequency.

- Stop bits if correction slope is positive. Here,  $L_n/K_n$  is interpreted to mean that  $L_n$  bits are stopped, or inhibited, from the  $K_n$  bits from the clock. The appropriate design equation for positive error correction is:

$$\frac{L_n}{K_n} = \frac{e_n}{m_n + e_n} \quad (7)$$

In frequency terms, the required correction is

$$f_n = f_c \left( 1 - \frac{L_n}{K_n} \right) \quad (8)$$

- Tabulate the results. Data in color in table at upper right is used in logic circuit design.

n	$m_n$	$e_n$	$P_n$	$L_n$	$K_n$	ADD/ STOP
1	$m_1$	$e_1$	$P_1$	$L_1$	$K_1$	----
2	$m_2$	$e_2$	$P_2$	$L_2$	$K_2$	----
⋮	⋮	⋮	⋮	⋮	⋮	⋮

**Tabulation.** End result of calculations shows  $L_n/K_n$  ratios, bits to be added or stopped.

### Linearizing criteria

Of two practical logic circuits for digital linearization, one—type A—uses fractional multiplication of the dvm's clock frequency and the other—type B—uses whole number multiplication. The magnitude of the slope of the correction curve determines which logic circuit to apply. Type A works well for such "weak" nonlinear sensors as thermocouples and resistance-temperature detectors. Type B is for "strong" nonlinearities, including square-root compensation of flow measurement.

Type A can add a maximum of one bit for every clock bit, or can stop a maximum of one bit from every two bits from the clock. Thus, the number of bits,  $f_n$ , stored by the dvm during its second integration ranges from  $2f_0$  to  $f_0/2$ , where  $f_0$  is the number of bits from the clock during the second integration period. Specifically, the add-or-stop type A circuit proves useful when the  $L_n/K_n$  values calculated for negative correction slope are one or less, and values calculated for positive slope are

### Resistance temperature detector characteristic

Temp. $t, ^\circ\text{F}$	$x = 10t$ BITS	$R_t/R_{70}$ $\Omega/\Omega$	$f(x) = (R_t/R_{70})$ -0.857	$c \cdot f(x)$	$e(x) =$ $c \cdot f(x) - x$
0	0	0.857	0	0	0
50	500	0.959	0.102	566	66
100	1,000	1.061	0.204	1,132	132
150	1,500	1.161	0.304	1,686	186
200	2,000	1.261	0.404	2,241	241
250	2,500	1.360	0.503	2,790	290
300	3,000	1.458	0.601	3,334	334
400	4,000	1.651	0.794	4,404	404
500	5,000	1.842	0.985	5,464	464
600	6,000	2.029	1.172	6,501	501
700	7,000	2.212	1.355	7,516	516
800	8,000	2.392	1.535	8,515	515
900	9,000	2.569	1.712	9,497	497
1,000	10,000	2.743	1.886	10,462	462
1,100	11,000	2.913	2.056	11,405	405
1,200	12,000	3.080	2.223	12,332	332
1,300	13,000	3.244	2.387	13,241	241
1,400	14,000	3.404	2.547	14,129	129
1,500	15,000	3.561	2.704	15,000	0







point b is 3.561. The minimum range is 0°F, therefore I is 0.857.

Using equation 3, the scaling factor can now be determined.

$$c = \frac{a}{b - I} = \frac{15,000}{3.561 - 0.857} = 5,547.3$$

With the scaling factor known, the digital zero offset cI can be calculated as  $5,547.3 \times 0.857 = 4,754$  bits.

Both the scaled and the correction functions are shown in the table on page 115. The function is then plotted and approximated with straight-line segments, showing a slope that is positive below 6,000 bits and negative above 9,000 bits, page 116. No correction is needed between these two values.

Equations 5 and 7 yield the results listed in the table at upper right, which puts the maximum value of  $L_n/K_n$  at  $1/8$ . That is, in the range between 12,000 and 15,000 bits (1,200°F to 1,500°F) one extra bit is added for every eight from the clock.

On the basis of the linearization criteria, type A is the circuit to be used.

Add or stop the bits

n	$m_n$	$e_n$	$p_n$	$L_n$	$K_n$	Add or Stop
1	1,000	132	1,000	2	17	Stop
2	2,000	210	3,000	2	21	Stop
3	3,000	167	6,000	1	19	Stop
4	3,000	0	9,000	—	—	All
5	3,000	167	12,000	1	17	Add
6	3,000	333	15,000	1	8	Add

### Building the linearizer

The type A circuit for the platinum resistance thermometer uses NAND logic. This circuit includes five stores and a five-gate frequency divider, counter B, which are reset at the start of the dvm's first integration period and are inhibited. The circuit also includes an add gate and a stop gate, which are inhibited when linearization isn't required.

When the number of clock bits stored in the BCD counter is less than 1,000, the  $L_n/K_n$  correction is 2/17—two bits are stopped for every 17 allowed

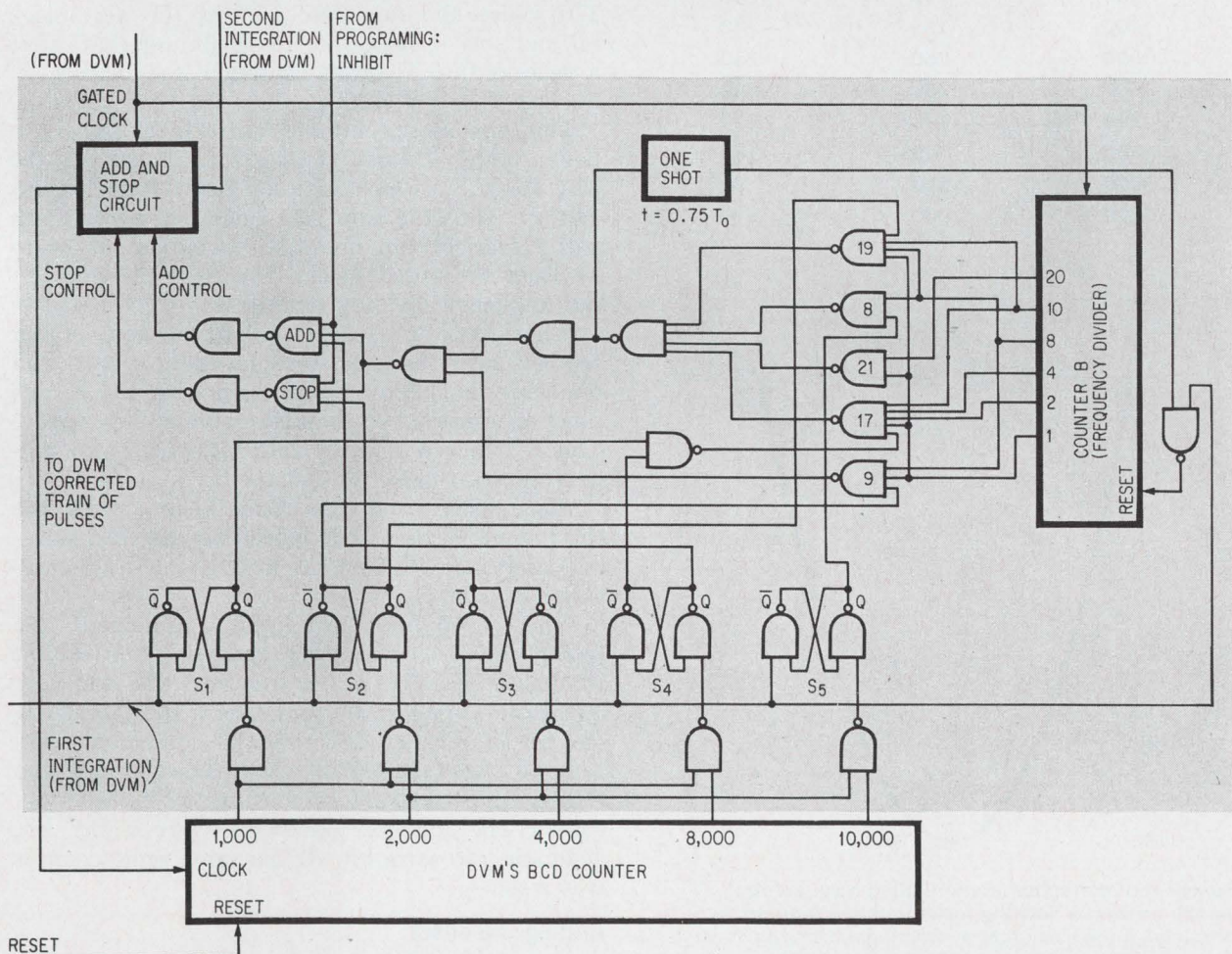

**Linearizer for temperatures.** As the count goes up in the BCD counter, stores set accordingly and change the frequency-dividing ratio in counter B to add or stop the correct number of pulses in each part of the range.



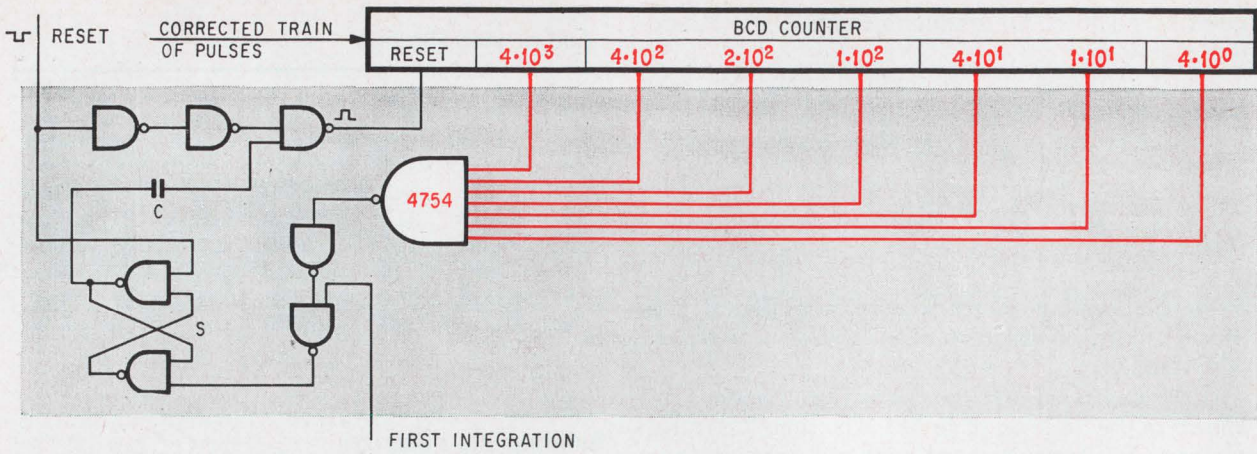

**Offset for zero.** When the transducer characteristic has a non-zero value at the low end of the measurement range, the proper number of bits—in this case 4,754—are counted, then discarded prior to linearization.

### Square-root bits correction

x	z(x)	e(x)
0	0	0
100	10	-90
200	40	-160
300	90	-210
400	160	-240
500	250	-250
600	360	-240
700	490	-210
800	640	-160
900	810	-90
1,000	1,000	0

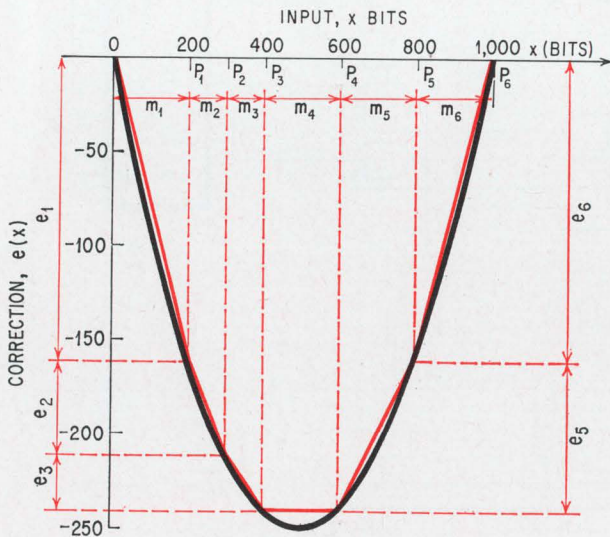

**Square-root correction.** Conditioning a square-root signal, as from a flowrate measurement, requires multiplying the clock bits by fractional ratios as determined from the slopes of the straight-line segments. Circuit for doing this is shown on page 119, and discussion follows in detail on page 120.

into the digital voltmeter's counter.

At the start of the second integration period, the five stores inhibit frequency-dividing gates 19, 8 and 21, but not gates 9 and 17. The first eight pulses from the gated clock go to both the frequency-divider gates and the BCD counter. On the ninth pulse the stop gate opens, preventing the next clock bit from going to the counter. On the 17th pulse, the stop gate inhibits the next clock bit and sets the one-shot multivibrator that, after a delay of  $0.75 T_0$ , resets counter B for another sequence.  $T_0$  is the clock period.

This operation continues until 1,000 bits have been stored. Counts greater than 1,000 set the first store,  $S_1$ , which inhibits gate 17 and opens gate 21. Thus the stop gate opens on every ninth and 21st clock bit, inhibiting two bits for every 21 from the gated clock. The 21st pulse resets the frequency dividing circuit.

When the count reaches 3,000, the BCD counter sets the next store,  $S_2$ , thus blocking gate 9 and removing the inhibit signal from gate 19. At this point only one out of 19 pulses have to be stopped. This is achieved with the 19th bit, which also triggers the reset pulse for counter B.

When 6,000 clock bits have been stored, the third store,  $S_3$ , sets, thus inhibiting the stop gate—and every clock bit passes through to the binary-coded-decimal counter.

When 9,000 bits have been accumulated, the fourth store,  $S_4$ , sets, thus removing the inhibit from gate 17 and from the add gate. The add gate opens on every 17th bit and after a delay of  $T_0/2$ , one bit is generated. Counter B resets on every 17th bit. After 12,000 bits have been stored, the fifth store,  $S_5$  sets—thus removing the inhibit from gate 8. The add gate opens on every eighth bit, generating an extra bit. At the same time, counter B is reset.

### Adding the offset

The circuit, above, that produces negative offset is straightforward. The BCD counter and store are



reset before measurement starts by a signal from the dvm's logic. During the first integration period, the counter operates as a frequency divider and determines the integration time, when signals between a seven-input gate and the store are inhibited. This gate is called the 4754 because it matches the value in bits of the digital zero offset.

At the start of second integration period, the BCD counter starts from zero. When 4,754 bits have been stored in the counter, gate 4754 opens, thus setting the store, whose output resets the counter. All the arriving bits are then totaled. This number corresponds to measured temperature, with each bit equal to  $0.1^{\circ}\text{F}$ .

This method of generating zero offset applies only when the offset is negative and the measurements have positive values.

When a positive zero offset constant is required, two counters have to be used. One could be the BCD counter in the dvm, and the other a supplementary unit. During the first integration period, the dvm's BCD unit could count to the value of the zero offset constant and stop. The supplementary counter would take over and act as a frequency divider determining the integration period. During the second integration period, the BCD counter would pick up the count from the value of the previously stored constant and continue.

### Linearizing by multiplying

n	$m_n$	$e_n$	$p_n$	$L_n$	$K_n$	$f_n$ calc	$f_n$ actual
1	200	160	200	4	1	$f_o \cdot \frac{10}{2}$	$f_c/2$
2	100	50	300	1	1	$f_o \cdot \frac{10}{5}$	$f_c/5$
3	100	30	400	3	7	$f_o \cdot \frac{10}{7}$	$f_c/7$
4	200	0	500	—	—	$f_o \cdot \frac{10}{10}$	$f_c/10$
5	200	80	800	2	7	$f_o \cdot \frac{10}{14}$	$f_c/14$
6	200	160	1,000	4	9	$f_o \cdot \frac{10}{18}$	$f_c/18$

When the function to be linearized has both positive and negative ranges, and the corresponding readings have to be displayed, an up-down BCD counter becomes necessary. For a resistance-temperature detector, which requires a negative zero offset constant, the dvm's BCD counter operates only during the first integration period. With the start of second integration, the up-down counter, which is preset to the value of the offset constant, starts counting down into the negative range. After

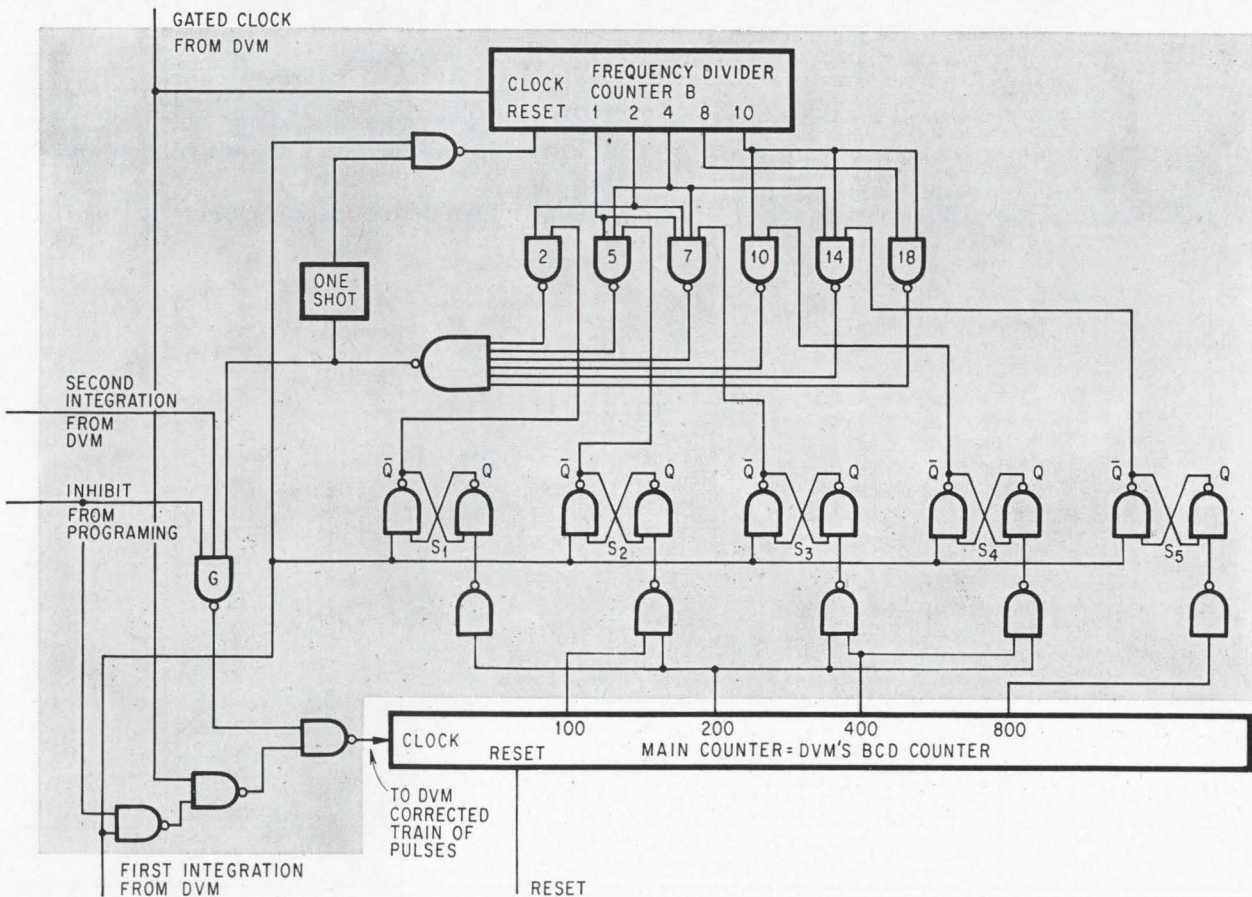

**Strong nonlinearities.** When transducer characteristic's slope changes rapidly with measured value, the correction for linearizing calls for dividing clock bits by a frequency that may be different in each segment of the range. This square-root linearizer changes its amount of frequency division from values of  $1/2$  down to  $1/18$ .



the count reaches zero, the counter starts counting up into the positive range.

### Square-root function

Flow rates of fluids are usually measured with an orifice plate. The flow rate is proportional to the square root of the differential pressure across the

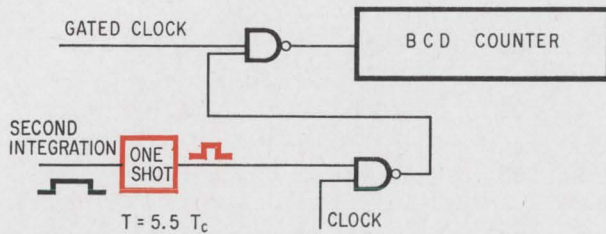

$$T_c = \frac{1}{f_c}; \quad f_c = \text{CLOCK FREQUENCY}$$

**Shifting.** Adding a few bits, five in this case, averages error over the entire range.

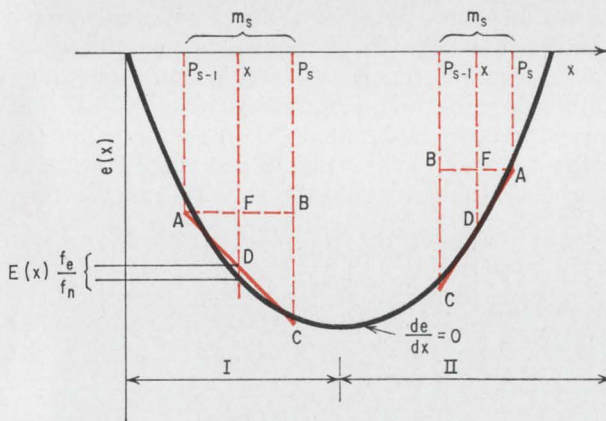

**Like triangles.** Geometry applied to correction curve aids development of error equations on page 121.

orifice. Therefore, to obtain flow-rate readings in engineering units, the nonlinear relationship must be scaled and linearized.

Consider a differential pressure across the orifice corresponding to a range of 0 to 1,000 cubic feet per hour. On the dvm, the full range is displayed at 1,000. Required accuracy is  $\pm 0.5\%$  of full scale in the range of 200 to 1,000. Readings below 200 will be disregarded.

The relationship between flow rate and differential pressure is

$$F = k\sqrt{(p_1 - p_2)}$$

where  $F$  is the flow rate,  $(p_1 - p_2)$  the differential pressure across the orifice, and  $k$  a scaling constant. Pressure is converted to current for transmission to a data logger and its associated dvm. Thus, the function to be linearized is  $I = kF^2$ , which can be expressed as  $y = x^2$ . The maximum value of  $x$  (point a) is 1,000. Therefore, corresponding point b is

$$b = a^2 = 1,000^2 = 1,000,000$$

$$c = \frac{1,000}{1,000,000}$$

$$\text{and } z(x) = \frac{1}{1,000} x^2$$

$$e(x) = \text{ex} \left( \frac{x}{1,000} - 1 \right)$$

The correction results were tabulated, page 118, and plotted, using a straight-line approximation. This resulted in a negative slope below 400, zero between 400 and 600, and a positive slope above 600.

Values from the correction curve were used in

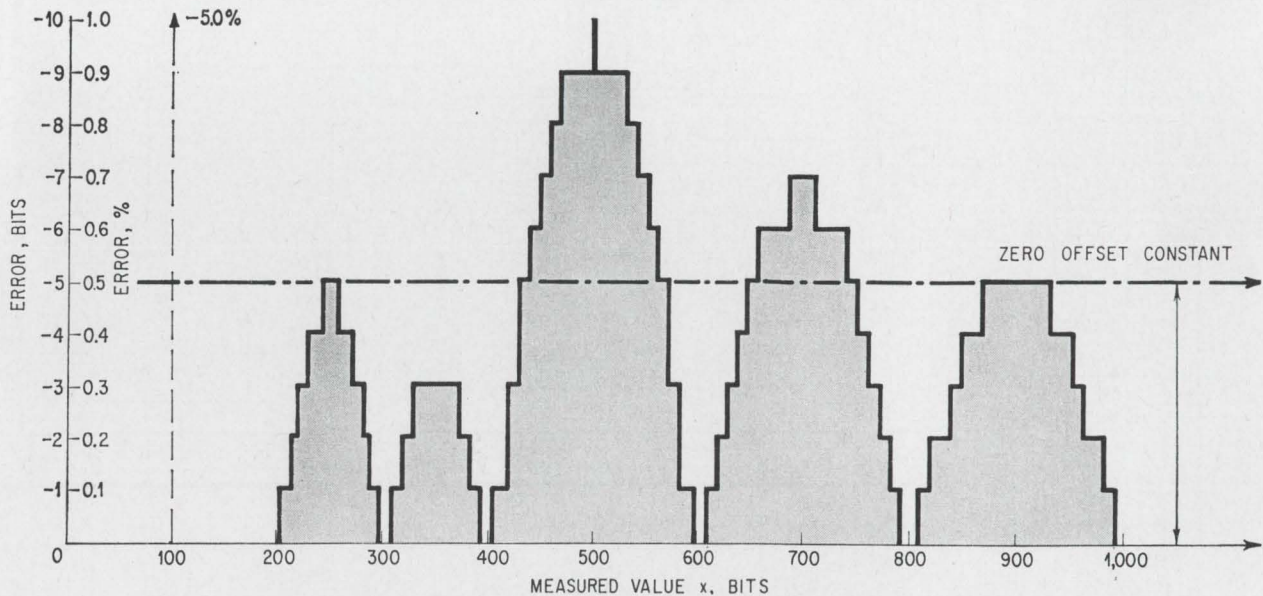

**Error histogram.** To see how well the linearization circuit actually works, error is plotted throughout the range. This histogram is for the square-root linearizer. The error is always negative, and its maximum value is  $-1\%$ . The error is larger below 200, but is disregarded. Because the error exceeds the prescribed  $\pm 0.5\%$ , an extra five bits is added to the BCD counter using the shifting circuit to translate the reading  $+0.5\%$ .



equations 5, 6, 7, and 8 to yield a clock-frequency multiplication needed to correct each section of the range. Where the correction slope was negative, the  $L_n/K_n$  values equaled or exceeded unity. Thus, a type B circuit was used for linearization of the squaring function.

With a table that includes all design data, the engineer can determine the range of multiplications. In the table, page 119, the second column from the right involves multiplication by whole numbers and fractions. In an actual circuit, the clock frequency is increased tenfold over the calculated frequency,  $f_0$ . That is,  $f_c = 10 f_0$ . This means only frequency division is required over the entire range. The actual frequency in any linearized section is shown in the right column of the table.

In the square-root circuit, page 119, the first integration signal resets and inhibits the five stores and frequency dividing counter B. A low inhibit signal permits normal operation of the dvm, thus bypassing the linearizing circuit. When the inhibit signal is high, the linearizing function is generated. During the first integration period, all bits from the gated clock are passed on to the BCD counter. The second integration signal, higher than the first, removes the inhibit signal from gate G, which reroutes clock bits through the linearizing circuit before they go on to the BCD counter.

When the number of bits stored in the BCD counter is less than 200, counter B operates as divide-by-two counter. After 200 clock bits have been stored in the BCD counter, the first store,  $S_1$ , sets—thus blocking gate 2—and counter B becomes a divide-by-five counter. When 300 clock bits have been stored,  $S_2$  sets—thus blocking gate 5—and counter B becomes a divide-by-seven counter. The circuit continues in a similar manner. When 800 clock bits have been stored,  $S_5$  sets—thus blocking gate 14—and counter B becomes a divide-by-18 counter.

The linearization error, negative throughout the range, has a maximum value of  $-1\%$ . But the specified accuracy is  $\pm 0.5\%$ . A simple circuit is added that adds five bits, which shift the linearized function  $0.5\%$ , bringing the entire range within tolerance. The end of the second integration signal triggers the one-shot multivibrator for 5.5 clock periods. The gates open long enough to pass on the extra five clock bits to the binary-coded-decimal counter.

### Determining error

Linearization error can be defined as either

- The difference between the number of clock bits stored in the BCD counter for a given input and the input's true value in bits; or

- The difference between the value of correction function  $e(x)$  and the value on the straight-line approximation at a given  $x$  that is multiplied by frequency ratio  $f_n/f_0$ .

The equation for calculating linearization error,  $E(x)$ , depends on whether the correction-curve slope is positive or negative. These equations are

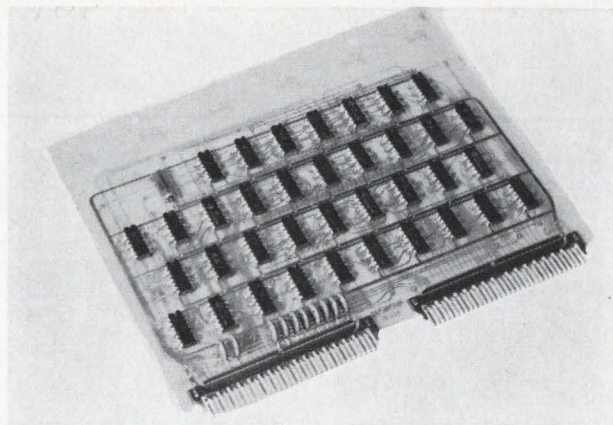

**Five on one.** Printed-circuit card contains functions for linearizing five transducers. Some portions of the circuits are shared, reducing cost per function.

derived from geometrical considerations.

For a negative slope, the equation is

$$E(x) = \left\{ e(x) - \left[ \sum_{t=1}^{t=s-1} e_t + (x - p_{s-1}) \frac{e_s}{m_s} \right] \right\} \frac{f_s}{f_0}$$

For a positive slope, the equation is

$$E(x) = \left\{ e(x) - \left[ \sum_{t=s}^{t=n} e_t + (p_s - x) \frac{e_s}{m_s} \right] \right\} \frac{f_s}{f_0}$$

where  $n$  is the total number of segments,  $s$  is the segment of interest,  $f_s$  is frequency of bits in the BCD counter, and  $f_0$  is the clock frequency.

The results of the computations can be plotted in an error histogram.

### Counting the cost

Digital linearizing circuits for five functions—four different types of thermocouples and one resistance-temperature detector—fit on one p-c card, above. Nokia used Texas Instruments' Series 74 transistor-transistor logic. Each function, with its zero-offset-constant circuit, requires nine quadruple two-input NAND gates, two triple three-input NAND gates, a dual four-input NAND gate, two eight-input NAND gates, a master-slave J-K flip-flop, and two decade counters.

In quantities, this complement costs about \$35 per function. But when five functions are built on a single card, the price per function drops because the add or stop circuit, the frequency divider, and some stores—which account for 50% of the cost—are common to all linearizing functions.

Conceivably, a digital linearizing circuit could be built on an integrated-circuit chip. Technologically, this is possible. But whether there is a demand for such an IC remains to be seen.



# Skipping the hard part of radiation hardening

Instead of testing each component individually, the designer can crank laboratory-measured device parameters into fairly simple equations to predict the responses of his circuit elements to radiation

By Joseph T. Finnell Jr. and Fred W. Karpowich

Missile Systems Division, Avco Corp., Wilmington, Mass.

**The hard way** to assess how circuit components will stand up to radiation is to test each one in a simulated environment. The easy way is to measure certain component parameters in the laboratory without radiation, and then crank the values obtained into some fairly simple equations. The equations express the relationships between these parameters and radiation-induced effects, and enable the engineer to predict a component's behavior under radiation.

Because of their relative sensitivity, semiconductors have been the chief subjects of research in this field, but there are equations available that can indicate the transient and permanent effects of radiation on passive elements.

All these equations have been derived by meas-

uring some component parameter, such as storage time, before and after exposure to radiation, and then analyzing the results to find a correlating factor.

Transistors are particularly sensitive to the ionizing effects of gamma radiation and the displacement effects of neutron bombardment. Gamma rays produce extra hole-electron pairs that flow as photocurrents because of the charge-segregating action of the electric fields across the p-n junctions. And when neutrons collide with atoms in the crystal structure, the atoms can be stripped from their usual lattice position. The effects of gamma rays change the transistor's gain and increase radiation storage time; the effects of neutron bombardment reduce the gain and increase saturation resistance.

The amount of primary photocurrent,  $i_{pp}$ , and the magnitude of the radiation storage time,  $t_{SR}$ , resulting from a transistor's exposure to radiation are complicated functions of device geometry, diffusion constant, and generation rate of hole-electron pairs. An equation containing these parameters would be of little use to the engineer; he needs terms representing parameters he can easily measure in the laboratory.

## Coming to terms

An equation that relates the  $i_{pp}$  of a silicon planar or mesa npn transistor to storage time,  $t_s$ , and the gamma-ray dose rate  $\dot{\gamma}$ , is simply:

$$i_{pp} \cong \dot{\gamma}(1.2 \times 10^{-8})t_s$$

Because of differences in the diffusion constants of npn and pnp devices, the value of  $i_{pp}$  is doubled for a pnp transistor.

## The authors



Joseph T. Finnell Jr., a 17-year veteran of the military electronics field, heads the section at the Avco Corp. that determines the nuclear vulnerability of missile systems.



Now studying transient-radiation effects, Fred W. Karpowich designed hardened circuits at Hughes Aircraft and Philco-Ford before joining Avco as a senior staff engineer.



Circuit designers can thus predict primary photocurrents by measuring a transistor's storage time. It should be noted, though, that a radiation pulse of less than 20 nanoseconds will produce an  $i_{pp}$  smaller than that forecast by this equation because primary photocurrent doesn't usually reach equilibrium in that short a time.

Radiation storage time—the length of time a transistor remains saturated after the radiation pulse has disappeared—can be predicted on the basis of complicated equations relating such factors as impurity levels and diffusion constants—information not usually given in manufacturers' specification sheets. But here again, there's an easy way. For gamma dose rates greater than  $10^8$  rads per second (lesser rates generally aren't a problem) and storage times greater than 100 nsec (covering most transistors), the radiation storage time can be related to the easily measured  $t_s$ .

$$t_{SR} \cong 0.138t_s \log_{10}\dot{\gamma}$$

If, for example, an engineer wanted to determine the  $t_{SR}$  of a 2N2222 that was to be subjected to a gamma dose rate of  $10^{11}$  rads/sec, he could measure the device's storage time in the test circuit on page 125. Finding  $t_s$  to be 3 microseconds, he would use this value in the equation and come up with a radiation storage time of approximately 4  $\mu$ sec. Under actual radiation conditions, the  $t_{SR}$  was measured at 3.8  $\mu$ sec.

Transistor degradation from neutron bombardment usually shows up as a decrease in small-signal current gain,  $\beta$ . A transistor's final gain,  $\beta_f$ , after radiation exposure depends on the initial current gain,  $\beta_i$ ; the alpha cutoff frequency  $f_{\alpha\omega}$ ; the magnitude of the neutron fluence,  $\phi$ ; and the lifetime-damage constant, K, a function of the base material. A typical value of K for silicon monolithic and discrete transistors is approximately  $3 \times 10^6$  nvt-sec.

Gain degradation as a function of neutron fluence can be calculated to an accuracy of 50% by:<sup>1</sup>

$$\frac{\beta_f}{\beta_i} \cong \frac{1}{1 + \frac{0.2\phi\beta_i}{Kf_{\alpha\omega}}}$$

Nomographs for the solution of this equation, plus exact values of K for several materials, have been published previously [Electronics, Jan. 11, 1965, p. 70].

In general, the prime characteristics that suit transistors to radiation-hardened circuitry are a high alpha cutoff frequency and current gain, low power and collector-to-emitter saturated voltage, and a small geometry.

### Turning it on

With silicon controlled rectifiers, gate current gain and leakage current determine when the device latches on—that is, when the anode current is limited only by the external load resistance. Any increase in the gate or leakage current, whether caused by light, heat, or gamma radiation, boosts the switching current gain; if the dose rate is large enough, the SCR will eventually turn on.

Neutron irradiation increases anode-cathode voltage, holding current, and saturation resistance, and shortens the lifetimes of minority carriers, thus reducing the switching gain. Providing the SCR isn't severely damaged, it can be turned on by additional gate drive.

More than 180 SCR's—20 types from 9 manufacturers were tested in the circuit on page 125 using a 5- $\mu$ sec, 10-milliampere pulse of gate current. Switching times ranged from 10 nsec to more than 1  $\mu$ sec. Correlating this data with the radiation-induced ionization current observed under actual exposure yields an equation relating the SCR's equilibrium photocurrent,  $I_{AGO}$ , in milliamps, to the switching time,  $t_{ON}$ , in microseconds.

$$\Delta I_{AGO} \cong 8t_{ON}$$

With another equation developed in a similar manner, an engineer can predict an SCR's transient

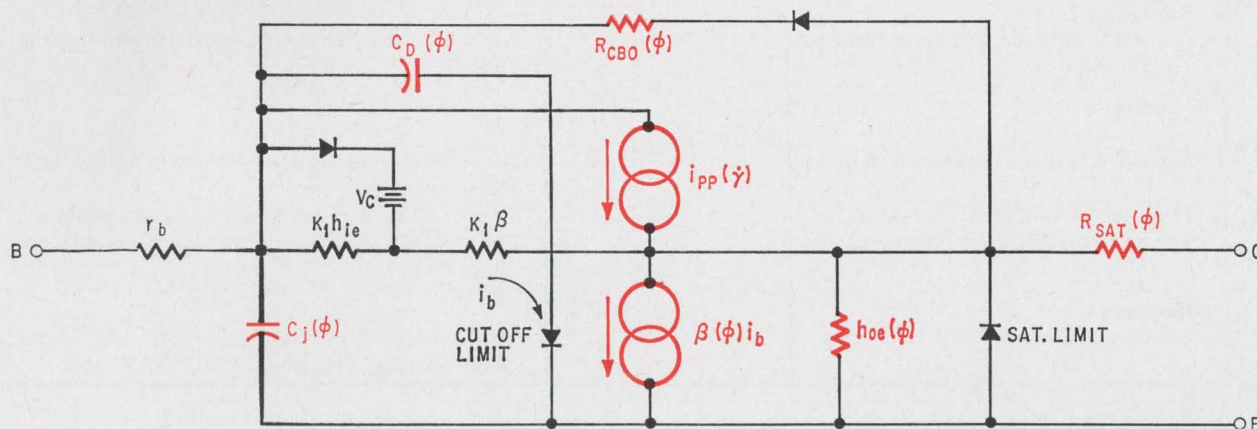

**Model transistor.** Common-emitter equivalent circuit of an npn transistor is accurate enough for circuit analysis. The parameters shown in color are functions of radiation.



radiation switching threshold,  $\dot{\gamma}_{Tx}$ , for various radiation pulse widths. This equation, valid when the circuit's power supply voltage is less than half the SCR's breakover voltage and when the equivalent parallel resistance of the gate impedance,  $Z_G$ , and the source impedance,  $Z_S$ , is greater than 500 ohms, is

$$\dot{\gamma}_{Tx} \cong \frac{i_{GTx}(10^6)}{t_{ON}} \left[ 1 + \frac{V_{GCT1} - V_{GG}}{i_{GT1}Z_G} + \frac{V_{GCT1}}{i_{GT1}Z_S} \right]$$

where  $\dot{\gamma}_{Tx}$  = predicted gamma-dose rate switching threshold for a pulse width of  $x$   $\mu$ sec in rads/sec.

$i_{GT1}$  = switching current for a pulse width of 1  $\mu$ sec in milliamps.

$i_{GTx}$  = switching current for a pulse width of  $x$   $\mu$ sec in milliamps.

$V_{GCT1}$  = switching voltage for a pulse width of 1  $\mu$ sec in volts.

$V_{GG}$  = gate bias voltage in volts.

$Z_G$  and  $Z_S$  are in kilohms.

Either of these SCR equations allows the engineer

to predict behavior within a factor of three with 87% confidence, or within a factor of two with 68% confidence. As the equations suggest, the SCR's most likely to withstand radiation have fast switching times and large switching currents. Once again, small device geometry is an advantage, and experimentation has shown epitaxial passivated construction to be preferable to other types.

### It figures

The principal effects of radiation on a diode are a change in body resistance,  $r_b$ , due to neutron fluence, and the generation of primary photocurrents. The prediction equation for primary photocurrent<sup>2</sup> is the rather intimidating:

$$i_{pp} \cong qgA \left\{ \left[ (W + L) \operatorname{erf} \left( \frac{t}{\tau} \right)^{1/2} \right] u(t) - \left[ (W + L) \operatorname{erf} \left( \frac{t - t_p}{\tau} \right)^{1/2} \right] u(t - t_p) \right\}$$

## Radiation effects on components

Component	Function dependence on radiation	Specific examples
<b>Silicon transistors</b>		
Photo-current ( $i_{pp}$ )	$\propto \dot{\gamma}$	2.4 ma at $10^8$ Rads/sec for a 2N2222
Radiation storage time ( $t_{SR}$ )	$\propto \log_{10} \dot{\gamma}$	3.5 $\mu$ sec at $10^{11}$ Rads/sec for a 2N2222
Forward current gain ( $\beta$ )	$\propto \frac{1}{\phi}$	Decreases 18% at $10^{12}$ nvt and 57% at $10^{14}$ nvt for a 2N3736
Collector saturation resistance ( $R_{SAT}$ )	$\propto \frac{1}{\phi}$	Increases approximately 38% at $10^{12}$ nvt and 63% at $10^{14}$ nvt for a 2N708
<b>Diodes</b>		
Photo-current ( $i_{pp}$ )	$\propto \dot{\gamma}$	4.3 ma at $10^8$ Rads/sec for a 1N662
Saturation resistance ( $r_b$ )	$\propto \phi$	Forward voltage drop increases approximately 125% at $10^{13}$ nvt for a 1N550
<b>Silicon controlled rectifiers</b>		
Holding current ( $I_H$ )		For a 2N1774: $I_H$ increases 28% at $10^{12}$ nvt; $V_{AC}$ increases 21% at $5 \times 10^{12}$ nvt; $I_G$ increases 95% at $5 \times 10^{12}$ nvt
Voltage drop ( $V_{AC}$ )	$\propto \phi$	
Gate current drive ( $I_G$ )		
Transient induced gate current ( $\Delta I_{AGO}$ )	$\propto \dot{\gamma}$	3.4 ma at $8 \times 10^7$ Rads/sec for a 2N1595
Transient induced switching threshold ( $\dot{\gamma}_{Tx}$ )	$\propto \dot{\gamma}$	$8.6 \times 10^7$ Rads/sec at 1 $\mu$ sec pulse width for a 2N887
<b>Resistors</b>		
Transient leakage resistance ( $R_S$ )	$\propto \frac{1}{\dot{\gamma}}$	$2 \times 10^3$ kilohms at $10^{10}$ Rads/sec for carbon composition
Compton replacement current ( $I_R$ )	$\propto \dot{\gamma}$	5 ma at $10^{10}$ Rads/sec for carbon composition
Permanent resistance changes ( $\Delta R$ )	$\propto \phi$	2% reduction at $10^{14}$ n/cm <sup>2</sup> (fast) for carbon composition
<b>Capacitors</b>		
Leakage resistance ( $R_S$ )	$\propto \dot{\gamma}^\delta$	Approximately 1.4 kilohms for a 0.01 $\mu$ f tantalum oxide capacitor irradiated at $10^{10}$ Rads/sec.

$\dot{\gamma}$  = gamma-dose rate  
 $\phi$  = neutron fluence  
 $\delta$  = empirical radiation exponent



It's not really all that difficult. The first group of terms expresses the buildup of  $i_{pp}$  when the pulse is applied, and the second group describes what happens at time  $t_p$  after the pulse. The junction area,  $A$ , depletion width,  $W$ , and diffusion length,  $L$ , are physical parameters. The diode minority carrier lifetime is represented by  $\tau$ ; the charge of an electron by  $q$ , and the generation rate of hole-electron pairs per cubic centimeter per second by  $g$ . The expression  $\text{erf}$  is an error function and can be found in mathematical tables.

Finally, the equation assumes that  $L$  is much longer on one side of the junction than on the other, that the contact on the longer diffusion length side is at least one diffusion length away from the edge of the nearest depletion layer, and that the diode geometry is such that a one-dimensional analysis can be used.

Having defined terms, the problem is to assign values to them.

The junction area can be expressed in terms of the depletion region width,  $W_1$ , and the junction capacitance,  $C_1$ , for a reverse bias of 1 volt, while the dielectric constant of silicon,  $\epsilon$ , and the permittivity of free space,  $\epsilon_0$ , can be found in the literature. The equation relating these diode parameters is

$$A \cong \frac{C_1 W_1}{\epsilon \epsilon_0}$$

With the curves shown on page 126, the engineer can quickly evaluate  $W_1$  by measuring the avalanche voltage,  $V_A$ , and exponent  $b$ . This exponent can be found from the relationship  $C \cong C_1 V_B^b$ . The most common values of  $b$  in diodes are  $-0.5$  for the abrupt-junction type and  $-0.33$  for the linearly graded junction. With the value of  $W_1$  determined, the depletion width of any junction voltage,  $V_B$ ,—except in highly forward-biased diodes—is approximately

$$W \cong W_1 V_B^{-b}$$

Diffusion length in lightly doped diodes depends on the diffusion constant, storage time, and the forward and reverse diode currents,  $I_f$  and  $I_r$ . The relation of all these parameters is given by:

$$L \cong \frac{\sqrt{Dt_s}}{\text{erf}^{-1} \left( \frac{I_f}{I_f + I_r} \right)}$$

Generation rate can be calculated from the absorbed gamma-ray dose rate, expressed in rads/sec; the mass density,  $\rho$ , in grams/cm<sup>3</sup>; and the average amount of energy,  $\bar{e}$ ,—in electron volts—required to form the hole-electron pairs. With these values,  $g$  can be determined by:

$$g \cong \frac{\dot{\gamma}(100)\rho}{1.6(10^{-12})\bar{e}}$$

If, for example, the values of  $\bar{e}$  and  $\rho$  for silicon are plugged into the equation directly above the

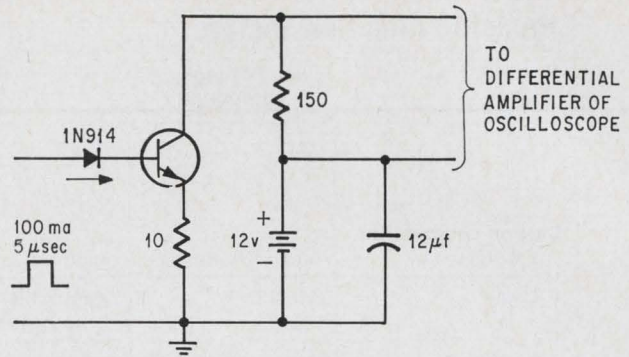

**Storage time.** Leading edge of the pulse drives the transistor into saturation, and the time needed for the transistor to recover is then measured on the oscilloscope.

generation rate for silicon would be:

$$g_{Si} \cong 4 \times 10^{13} \dot{\gamma}_{Si}$$

If the engineer is just interested in selecting the most radiation-resistant diodes, instead of determining the actual magnitude of induced photocurrent, he should choose devices featuring fast recovery, low power, and small junction volume.

### Coating counts

Although much research has been done on the radiation behavior of specific resistor types, little effort has gone into correlating this data. One reason: the data spans such a wide range of values for a given measurement that radiation effects on resistors sometimes appear unpredictable. However, it is known that ionization of the resistance material and its surroundings causes leakage paths that change over-all resistance, electron scattering due to collisions between a photon and an electron creates transient electric currents, and neutron bombardment causes permanent or long-term resistance changes.

Though these effects may seem minor when compared with the ones that occur when active devices are irradiated, a method for selecting ra-

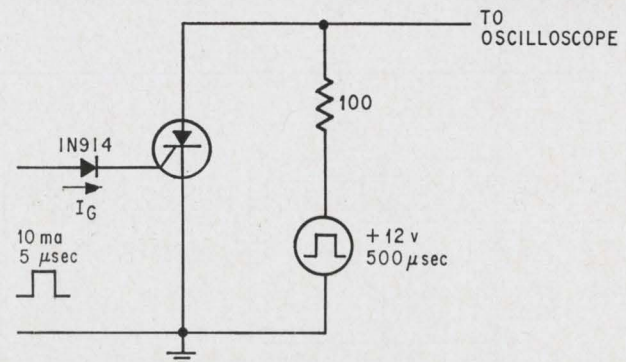

**Switching time.** SCR turns on when a pulse is simultaneously applied to gate and anode. After the anode pulse disappears, the SCR turns off until the next gate and anode pulses. This cycling ensures that the switching time displayed on the oscilloscope is suitable for photographing.



## Resistor radiation factors

Resistor type	Potting compound	Radiation		Empirical factors	
		Type	Intensity (megarads/sec)	B <sub>1</sub> (ohms-Rads/sec) (10 <sup>13</sup> )	B <sub>2</sub> (amps/Rads/sec) (10 <sup>-12</sup> )
Carbon composition 1 watt	Air (630 mm Hg)	gamma	1	2.1	0.78
1 watt	Silastic	gamma & neutrons	10	>4.3	0.5
1/8 watt	Dow-Corning 200	gamma	1.5	>1.7	3
(ceramic encased)	Paraffin	gamma	1.5	>170	0.045
	Paraffin	electrons	800	>330	0.023
Metal film 1/8 watt	Paraffin	gamma	1.5	>40	0.044

diation-hardened resistors is helpful.

A resistor is affected by gamma rays and neutrons. The gamma rays create current generators within the atomic structure of the resistor material, and those current generators reduce shunt resistance. Neutron fluence can cause permanent changes in both the series and shunt resistance.

Two simple equations that provide the designer with a first-order approximation of the shunt leakage resistance and the Compton replacement current are:<sup>3</sup>

$$R_s \cong \frac{B_1}{\dot{\gamma}}$$

$$i_R \cong B_2 \dot{\gamma}$$

The designer need only know the approximate amount of gamma radiation his circuit must withstand and the type of resistor he intends using. With the resistor radiation factors in the table shown above, he can find the value of the shunt-leakage and current-generation constants, B<sub>1</sub> and B<sub>2</sub>, that correspond to the resistor potting material he is using and the type of radiation he has to contend with.

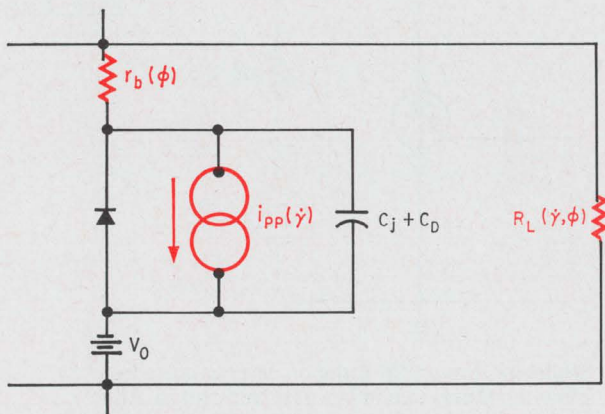

**Diode parameters.** The forward characteristics of diodes that are shown here in color are those caused by radiation.

## Checking for leaks

Leakage resistance severely limits a capacitor's ability to function in a radiation environment. If it decreases during irradiation, the circuit time constant will also decrease, possibly rendering a timing circuit useless.

The total leakage resistance, R<sub>T</sub>, of a capacitor can be expressed as the parallel equivalent of the leakage resistance before and after exposure, R<sub>0</sub> and R<sub>s</sub>, and is a function of the permittivity of free space, ε<sub>0</sub>, the dielectric constant, ε, and the conductivity before and after irradiation, σ<sub>0</sub> and σ. This total leakage resistance is approximately

$$\frac{1}{R_T} = \frac{1}{R_s} + \frac{1}{R_0} = \frac{(\sigma - \sigma_0)C}{\epsilon \epsilon_0} + \frac{\sigma_0 C}{\epsilon \epsilon_0}$$

It might appear from this that all an engineer has to do is choose the capacitors with the highest dielectric constant. Not so. Some material with a high dielectric constant may be very susceptible to radiation and exhibit excessive leakage. Also, ionizing radiation causes induced conductivities that alter the leakage resistance.

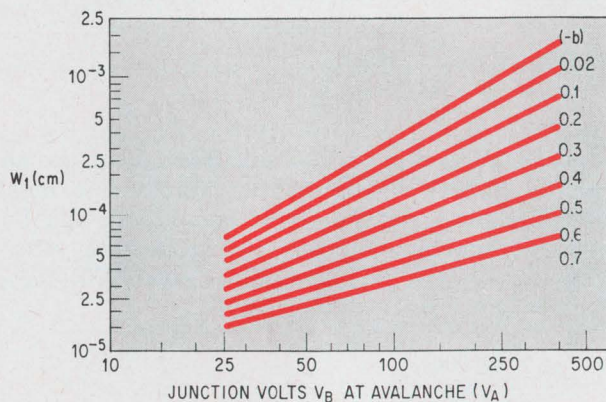

**Intersection.** After measuring the two diode parameters,  $V_A$  and  $b$ , one can use this graph to find the depletion width,  $W_1$ .



## Capacitor radiation factors

Dielectric material	Dielectric constant	Empirical factors					
		Radiation exponent	Dielectric conductivities			Time constants	
			$\delta$	$K_p$ ( $10^{-5}$ )	$K_{d1}$	$K_{d2}$ ( $10^{-6}$ )	$\tau_{d1}$ ( $10^{-4}$ )
Ceramic (barium titanate)	Varies	1	0.09	0.06	5	0.24	1.1
Mica	6.8	0.83	2	—	3		1.3
Mylar	3	0.86	6	2	9	4	1
Paper (dry)	11	0.7	100	0.07	1	2	0.5
Paper (oil impregnated)	10.8	1	5	0.4	1	4	1
Tantalum oxide	20	1	0.9	0.09	0.9	7	1.5

$$\frac{1}{R_s C} \cong \left[ K_p + \sum_{i=1}^2 K_{di} \tau_{di} \right] \dot{\gamma}^\delta$$

The amounts of shunt leakage that can be expected with different types of capacitors are expressed in three equations. The first two give a complete time history of the radiation-induced time constant,  $R_s C$ , while the third is a simplified form useful in selecting capacitors on a relative basis.

For a capacitor irradiated with a square pulse of amplitude,  $\gamma$ , over a time,  $T$ , the radiation storage time when the pulse is applied is approximately

$$\frac{1}{R_s C} \cong \left\{ K_p + \sum_{i=1}^2 K_{di} \tau_{di} \left[ 1 - e\left(\frac{t}{\tau_{di}}\right) \right] \right\} \dot{\gamma}^\delta$$

After the pulse is removed, the equation becomes

$$\frac{1}{R_s C} \cong \sum_{i=1}^2 K_{di} \tau_{di} \left[ e\left(\frac{T}{\tau_{di}}\right) - 1 \right] e\left(\frac{t}{\tau_{di}}\right) \dot{\gamma}^\delta$$

The simplified form of these equations assumes a constant exposure rate several times longer than the long-term time constant. The radiation-induced time constant is then given by:

$$\frac{1}{R_s C} \cong \left[ K_p + \sum_{i=1}^2 K_{di} \tau_{di} \right] \dot{\gamma}^\delta$$

where  $K_p$  is conductivity constant during the radiation pulse,  $K_{d1}$  and  $K_{d2}$  are constants of the dielectric and independent of the applied pulse,  $\tau_{d1}$  is the long-term time constant,  $\tau_{d2}$  is the short-term time constant, and  $\delta$  is the empirical radiation exponent.

These equations can be used with the table of capacitor radiation factors shown above to compare the shunt leakage effects of various dielectric ma-

terials. If, for instance, a choice had to be made between mica or ceramic 0.01-microfarad capacitors that were to be exposed to a gamma-ray dose rate of  $10^{10}$  rads/sec, a designer would use the table to determine the constants for mica and ceramic, and would plug these values and the magnitude of the gamma dose rate into the simplified equation. He would then find that  $R_s$  is approximately 1.3 kilohms for the ceramic dielectric and 21 kilohms for the mica dielectric.

## Bibliography

- M. Frank and Frank Lavin, "Effect of Operating Conditions and Transistor Parameters on Gain Degradation," IEEE Transactions on Nuclear Science, October 1965, p. 126.
- E.A. Carr, "Simplified Techniques for Predicting TREE Responses," IEEE Transactions on Nuclear Science, October 1965, p. 30.
- D.S. Gagi, "Calculation of Electrical and Radiation Storage Time in Transistors," IEEE Transactions on Nuclear Science, October 1965, p. 112.
- F.W. Karpowich, "Silicon Controlled Rectifiers—Hardening Design," IEEE Conference on Nuclear and Space Radiation Effects, University of Michigan, Ann Arbor, 1965.
- D.C. Jones, editor, TREE Handbook [Transient Radiation Effects on Electronics], DASA 1420, Battelle Memorial Institute, Columbus, Ohio, July 1966.
- J.T. Finnell, D. Bertetti, F.W. Karpowich, "Equivalent circuits estimate damage from nuclear radiation," Electronics, Oct. 30, 1967, p. 73.
- W.W. Chang and J.P. Raymond, "Prediction of Integrated Flip-flop Circuit Radiation Vulnerability," paper presented at 1967 IEEE Annual Conference on Nuclear and Space Radiation Effects.

## References

1. H.L. Olesen, "Designing against space radiation: Part 2," Electronics, January 11, 1965, p. 70.
2. E.A. Carr and K.R. Walker, "Simplified Engineering Techniques for Predicting Diode TREE Responses," IEEE Transactions on Nuclear Science, December 1966, p. 105.
3. Radiation Effects Information Center, "Nuclear Radiation Effects on Resistive Elements," REIC Memorandum 31, July 15, 1966.



# Aye, Aye, Sir!

## LSI Arrays Win Top Billing In Naval Air Systems Plans

By JACK ROBERTSON

WASHINGTON. — The Naval Air Systems Command is asking all Navy aircraft builders to include LSI arrays in future projects if possible.

It marks the first commitment by a major service to large-scale integration. Some in industry liken it to the Defense Department directive 5 years ago ordering IC use wherever possible.

The Navy Avionics Department for

avionics official said. The LSI end-user is

steps with IC-cordwood modules may be necessary.

The Navy looks particularly for LSI-multiplexers to allow a radically new approach to in-terior avionics. Instead of a fan-tastic maze of wiring throughout the plane, the Navy hopes to use a single coax line, connecting all avionic subsystems by multi-plexing onto the single carrier.

"The advantages are obvious, weight and size are reduced, costs are cut, and reliability higher since a mass of interconnections is avoided.

space, give greater reliability and more flexibility.

The Navy also hopes to take advantage of LSI arrays to do sophisticated jobs not possible today. For instance, self-check controls and fault-finding circuits could be added right at the multiplexer.

**LSI Package a Goal.**  
At first, the multi-plexer will be well to

ELECTRONIC NEWS, MONDAY, DECEMBER 25, 1967

IEEE Booth 4F04-4F10

## General Instrument's Exclusive MTOS Makes These LSI Multiplexers Available Today!

### MEM 5015—Random Access Multiplexer

- 16 Channels of Current or Voltage Mode Multiplexing
- Address Holding Flip-Flops
- "4 in, 16 out" Decoding Matrix
- 16 Single-Throw, Double-Throw Switches
- Extremely High Off-to-On Resistance Ratio
- Low Cross Talk
- Zero Offset
- High Logic Noise Immunity

### MEM 5116—16 Channel Random/Sequential Access Multiplexer

- Random/Sequential Modes of Addressing
- 16 Channels of Voltage Mode Multiplexing
- "4 in, 16 out" Decoding Matrix
- 16 Single-Throw Switches
- Extremely High Off-to-On Resistance Ratio
- Low Cross Talk
- Zero Offset
- High Logic Noise Immunity

LSI MULTIPLEXERS		POWER CON-SUMPTION	SUPPLY VOLTAGE (VOLTS)	CLOCK RATE	DESCRIPTION
TYPE	FUNCTION				
MEM 5015	16 CHANNEL RANDOM ACCESS MULTIPLEXER	80 mW	-27V±1V	100 kHz	Sixteen Channel Multiplexer with address storage and decoding.
MEM 5116	16 CHANNEL RANDOM/SEQUENTIAL ACCESS MULTIPLEXER	100 mW	-27V±1V	500 kHz	Sixteen Channel Multiplexer with parallel access counter and decoding.

Call your authorized General Instrument Distributor for off-the-shelf delivery. Write for complete data. For information relating to MTOS in Europe, write: General Instrument Europe, Via Turati 28, Milano, Italy.



GENERAL INSTRUMENT CORPORATION • 600 WEST JOHN STREET, HICKSVILLE, L. I., NEW YORK



# This little relay can make you a living legend.

The new RF3 vacuum relay is 2¼ inches long...that's small for something which can take peak voltages up to 12,000 volts with no strain.

It carries 25 amps rms at 2.5 MHz quite easily. It interrupts 20,000 watts of power like nothing (7 Kv or 3a max). That means it can be used in any operation involving power or rf currents...in either communications or industrial applications.

The RF3 is only one ounce heavier than our RF1 vacuum relay, which at ¾ ounce controls more power for more applications than any other relay in the world. This makes the RF3 an extremely economical item for handling almost 20 times more power with only a limited increase in space requirement.

Details: 7.5 peak kv at 16 MHz operating voltage; 17 amps rms at 16 MHz continuous current; contact resistance of less than .012 ohms; life of 10<sup>6</sup>; less than 10 milliseconds operate time; and SPDT latching contact arrangement...soon to be supplemented by non-latching Form C configuration.

All of this should give you a lot of ideas as to how the RF3 vacuum relay can make you a legend in your own time.

For more detailed information write to ITT Jennings, a Division of International Telephone and Telegraph Corporation, 970 McLaughlin Avenue, San Jose, California 95108.

JENNINGS **ITT**



# Boosting color tv's i-f performance

Although integrated circuits do a better job than discrete components in a tv set's video i-f amplifier, there's still one hangup—IC's are costlier

By Brent Welling

Motorola Semiconductor Products Inc., Phoenix, Ariz.

**When it comes** to color-television receivers, integrated circuits are, for the most part, on the outside looking in. The only way IC's can replace discrete circuitry in these sets is either by doing as good a job but at a lower cost, or doing the job so much better that the cost disadvantage becomes relatively unimportant.

One area in which IC's hold out great promise is the video intermediate-frequency amplifier, which provides most of the over-all gain, handles a large share of automatic gain control, and rejects adjacent-channel signals while passing a wide range of in-band frequencies. By substituting two or three IC amplifiers for the discrete transistor circuitry, the i-f amplifier's design can be accomplished and performance improved even when there is a variation in the signal strength.

Moreover, the IC's can improve isolation between input and output, simplify the stage-by-stage alignment by reducing the internal feedback admittance, and assure constant input impedance for better age.

In designing an i-f amplifier, the engineer must select an IC that has a constant input impedance over the entire age range, low internal-feedback admittance, high power gain, good noise figure, and high voltage gain-bandwidth product and good linearity characteristics to avoid intermodulation problems.

## The author



Brent Welling has been with the applications department at Motorola Semiconductor Products since 1966. Besides doing research and development, he is responsible for evaluating new devices. He holds a master's degree in electrical engineering from Arizona State University.

## Setting the stage

The i-f amplifier must provide enough gain to deliver to the video detector load a composite signal—video, audio, and synchronization—of between 1 and 3 volts peak-to-peak. If the receiver's minimum sensitivity is set at 5 microvolts, root-mean-square, an industry standard for channel 2, a voltage gain of 105 decibels is required from the tuner input to the video detector output to get a 3-v p-p signal.

Since most tuners can provide a gain of at least 35 db, the i-f amplifier has to produce the balance. This can be achieved by cascading three IC amplifiers. Several manufacturers are now working on a single circuit package to provide all the gain required for the i-f stage.

A selectivity curve for the video i-f amplifier of a color set, although comparable to that of a monochrome set, must satisfy more stringent requirements. With the picture carrier transmitted at 45.75 megahertz and the sound carrier transmitted at 4.5 Mhz above this picture carrier, the audio frequency is received at 41.25 Mhz because of the receiver's heterodyning action. Similarly, the chrominance information, transmitted at 3.58 Mhz above the picture carrier, is located at 42.17 Mhz in the i-f band-pass.

Because of vestigial-sideband transmission, in which only the upper sideband and a portion of the lower sideband are used, both the picture and chrominance carriers must appear 6 db below the maximum flat response. This assures maximum power within the frequency spectrum and a fairly linear phase response near the carrier frequency.

To achieve accurate color reproduction, phase distortion must be minimized. Because the receiver must handle very rapid changes in signal amplitude and phase, signal delays throughout the i-f amplifier must be kept uniform and constant. And since a 1-Mhz bandwidth is required to handle the chrominance-signal deviation produced by phase and amplitude modulation, it is mandatory



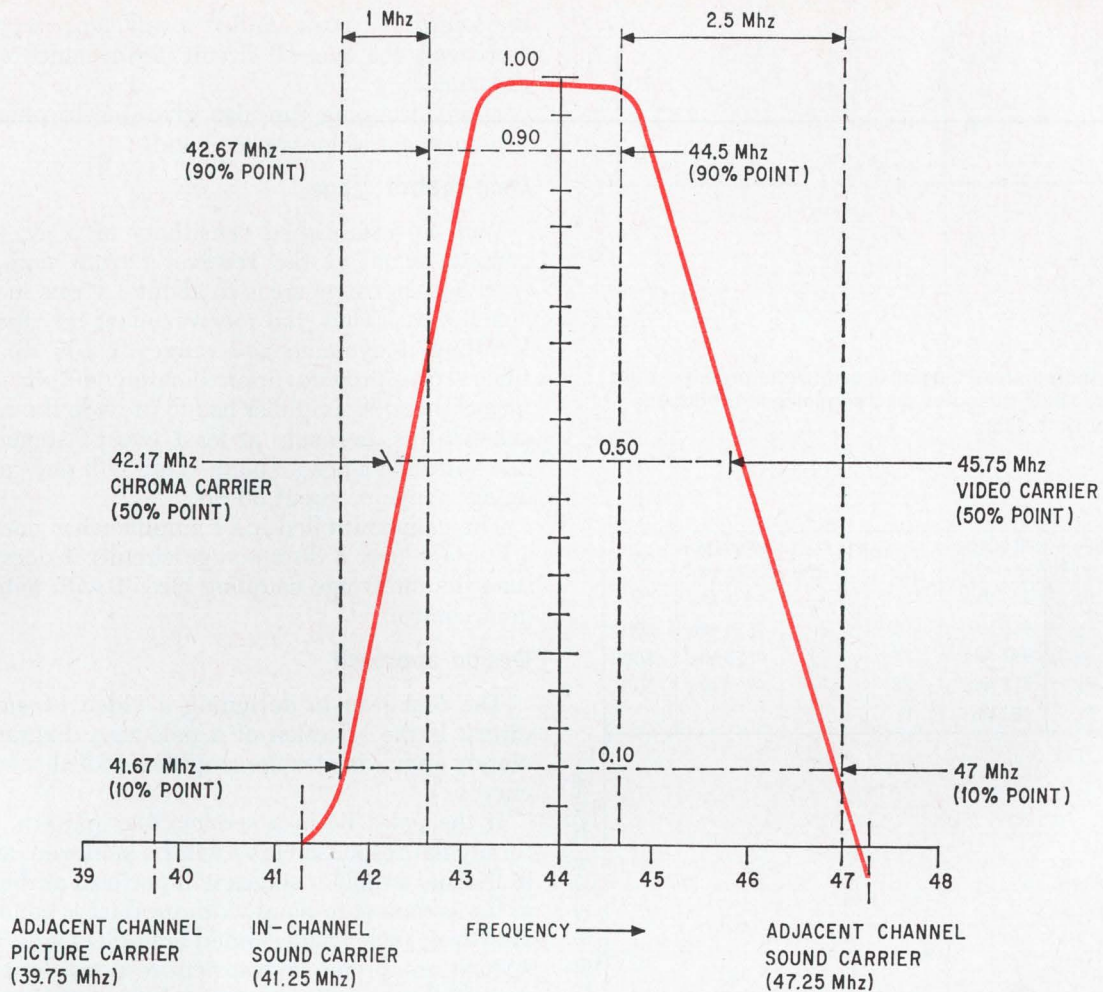

**Ideal selectivity curve.** Overall i-f requirements for a color tv receiver show in-channel sound with adjacent channel sound and picture carriers.

to have a linear frequency rolloff between 42.67 and 41.67 Mhz. The phase response must be as near to flat delay as possible.

In addition, the ic amplifier must not only be designed to provide the required in-channel amplification but also to reject adjacent channel carriers. For example, the picture carrier for channel 3 is at 61.25 Mhz. To achieve the required 45.75 Mhz i-f, the receiver's local oscillator must operate at 107 Mhz for channel 3. And although the sound carrier for channel 2—59.75 Mhz—is separated from the channel 3 oscillator frequency by 47.25 Mhz, it is located only 1.5 Mhz below this channel's picture carrier. This can cause problems.

To avoid a 1.5-Mhz beat that would lie in the video bandpass, the 47.25-Mhz oscillator signal must be attenuated at least 40 db below the in-channel picture carrier. Similarly, the picture carrier for channel 4 (67.25 Mhz) is located 39.75 Mhz away from channel 3's oscillator frequency, 1.5 Mhz below the in-channel sound (41.25 Mhz) and 2.42 Mhz below the in-channel color carrier. Thus, the upper-channel picture carrier, which is at 39.75 Mhz in the i-f bandpass, must be attenuated by at least 40 db below the 42.17 Mhz in-channel color carrier.

This is because of the inherent nonlinearity of diode detector circuits which causes the 41.25-Mhz in-channel sound frequency to heterodyne with the 42.17-Mhz color carrier and produce a 920-kilohertz beat, unless the sound frequency is attenuated in the i-f 40 to 50 db below the color carrier just prior to the video-takeoff point.

Both the exact attenuation and the trap location is a tradeoff between optimum performance and design cost. If the sound carrier is attenuated too heavily, an extra amplifier stage may be needed in

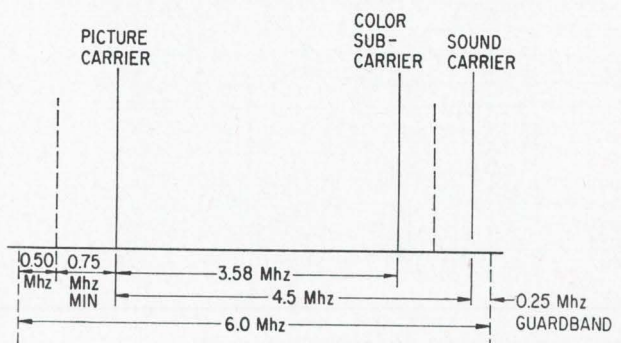

**Practical selectivity curve.** Characteristics of vestigial-sideband system show the 3.58 Mhz color subcarrier.



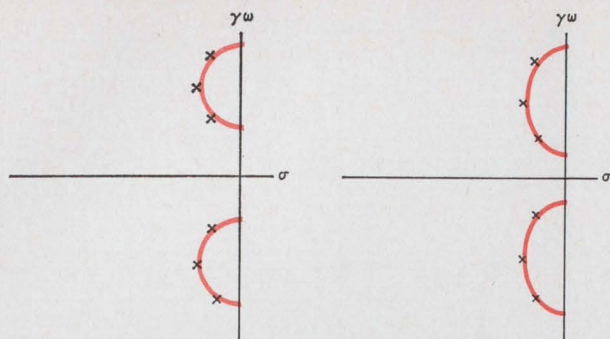

**Pole-zero diagram.** Poles on a semicircle produce a flat response while the poles on a semiellipse produce constant time delay.

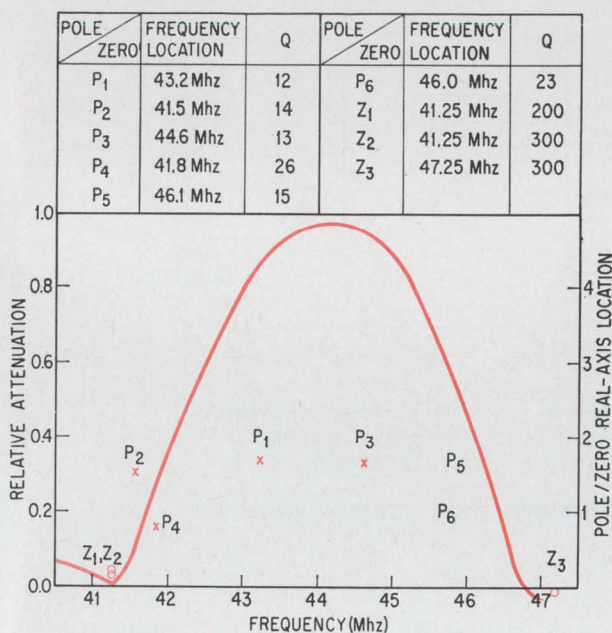

**Pole-zero locations.** The calculated amplitude response curve is based on the pole-zero locations for the particular design.

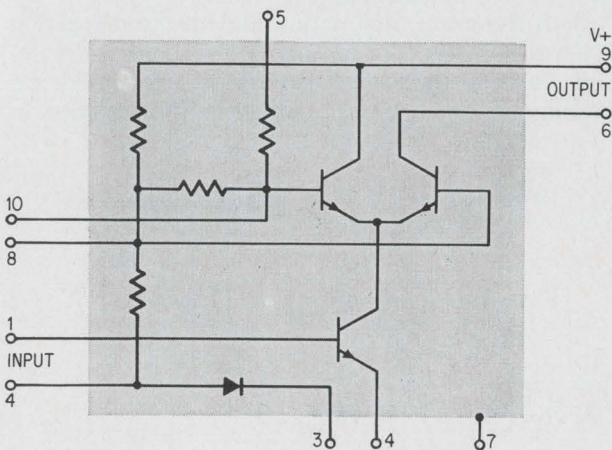

**Motorola's IC video i-f amplifier.** Basically a common-emitter, common-base cascode design, with low reverse transfer admittance.

the sound i-f circuit. And if insufficient trapping is employed, the over-all circuit performance may be degraded.

Heavy trapping can also give rise to phase distortion in the color-carrier band.

### Gain-control range

With an established sensitivity of 5  $\mu\text{V}$ , the incoming signal at the receiver's front end varies from 5  $\mu\text{V}$  in fringe areas to about 1 v rms in strong signal areas. Thus, the receiver must be capable of handling a dynamic agc range of 105 db. Most tuners can provide approximately 40 db, which means the ic i-f amplifier has to provide the rest. To achieve this, normally at least two i-f stages must be controlled since a single stage will only provide an agc range of about 30 db.

The gain-controlled ic i-f amplifier has one major advantage over a discrete agc circuit: it doesn't detune the interstage coupling circuit with automatic gain control.

### Design approach

The first step in designing a video i-f amplifier circuit is the selection of a pole-zero diagram that closely approximates the amplifier's ideal selectivity curve.

If the poles lie in a semicircular pattern, a uniformly flat response curve will be achieved, and the individual amplifier stages will perform at their best so far as their gain-bandwidth product is concerned. However, such stagger-tuned amplifiers with flat response are prone to transient-response overshoot and exhibit poor linear phase characteristics.

If, on the other hand, the poles lie in an elliptical pattern, the amplifier's bandpass characteristics will exhibit the desired linear phase-shift characteristics but the bandpass will not be flat, and the gain-bandwidth product will be degraded. Most video i-f designs are a compromise between the semicircular and elliptical patterns.

Pole-zero locations for an ic i-f amplifier with calculated amplitude response are shown at left. Poles P<sub>1</sub>, P<sub>3</sub>, P<sub>4</sub>, and P<sub>6</sub> are located on an elliptical pattern centered at 43.9 Mhz. The pole pattern is almost vertically symmetrical, except for pole P<sub>4</sub>, which was moved toward the horizontal axis (higher Q) to help relieve the "sidebiting" effect that the double-zero position has on the bandpass at 41.25 Mhz. Poles P<sub>2</sub> and P<sub>5</sub> are located in similar positions to help the bandpass recover from the effects of the zeroes.

One design for an ic video i-f strip uses Motorola's MC1550 r-f/i-f amplifier shown at left, a common-emitter, common-base cascode circuit. The reverse transfer admittance for this circuit is two orders of magnitude below the reverse transfer admittance of a single common-emitter transistor. The amplifier thus can be considered unilateral for all practical purposes. As such, stage-by-stage alignment is fairly easy.

This feature is particularly important in the third i-f stage, which handles signals that are fairly



## A dollars and sense issue

It's doubtful that television-set makers will shift to integrated circuits unless cost savings can be materialized. A change is seldom made for marginal improvements alone. Thus, discrete components are expected to be the mainstay of tv sets—be it color or black and white—for at least a couple of years.

Several semiconductor makers are offering off-the-shelf ic's for use as radio-frequency and intermediate-frequency amplifiers, limiters, frequency-modulated detectors, and audio drivers in f-m stereo receivers. To a lesser degree, these ic's are also used as oscillators and mixers in a variety of communications equipment.

The ic's, offered to tv-set pro-

ducers, are monolithic, wideband, general-purpose circuits that can be used in video i-f amplifiers. These include Fairchild's  $\mu$ A703, RCA's CA3032 and CA3028, Philco-Ford's PA7600, and Signetics' SE510 and NE510A, as well as the ic described by Brent Welling, Motorola's MC1550.

**Not alone.** None of the available devices provide enough gain by itself to replace all stages of a typical i-f strip. Most have an average gain of 25 decibels; thus, three ic's would be required to satisfy the gain requirements of a typical tv receiver, which is about 70 db.

One of the difficulties in producing a high-gain chip is the instability that sets in whenever the gain

exceeds 50 db. A proposed solution is to encapsulate two or more chips in a single dual in-line package. Motorola, however, will soon be producing a wideband high-gain amplifier that can be used with a single discrete transistor to provide all the power gain and age range for the video i-f.

Although some tv-set makers have long started replacing discrete with ic's in the sound i-f of their top-line sets, others are still taking a wait-and-see attitude. Some, responding to the declining prices of transistors, are reluctant to even consider ic's. And, they point out, tv servicemen find ic circuits harder to troubleshoot than transistor circuits.

large, requiring that feedback be kept to a minimum. In discrete designs a high-quality transistor in the third i-f stage will have a reverse capacitance of 0.5 picofarad. The MC1550 has a reverse capacitance of less than 0.003 pf at 45 Mhz.

The agc characteristic of this ic is such that with a signal applied between pins 1 and 4, and the output signal taken across a load between pins 9 and 6, the signal through the load can be varied by adjusting the d-c voltage applied to pin 5. In this manner, the signal current is merely switched between the top transistors. With the current through the input transistor constant, the input admittance also remains constant, and the tuned input stage is not detuned by the agc voltage.

The next step is to consider the trap circuits that will be required to reject unwanted signals. In the basic i-f amplifier shown below, the collector of the mixer serves as the first pole of the i-f amplifier. The signal from the mixer is usually carried to the first i-f stage through a 50-ohm coaxial cable. The first stage of the three-stage circuit provides a gain of

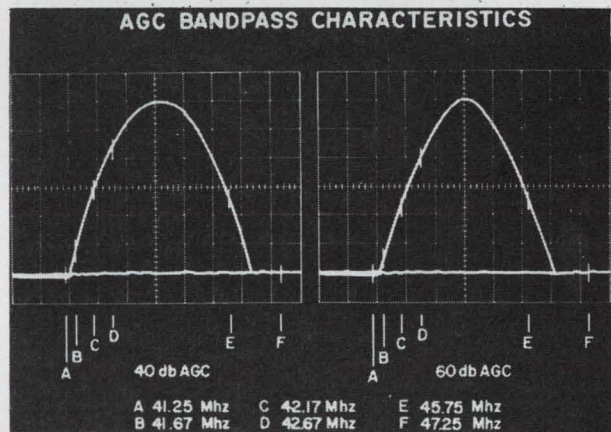

**Intermediate-frequency bandpass.** Actual photographs of the amplifier response curves show constant bandpass as the amplifier is gain-controlled through its range to 60 decibels. Maximum shift of the chrominance carrier frequency (42.17 Mhz) from its position as 6 db down from bandpass center is 6%.

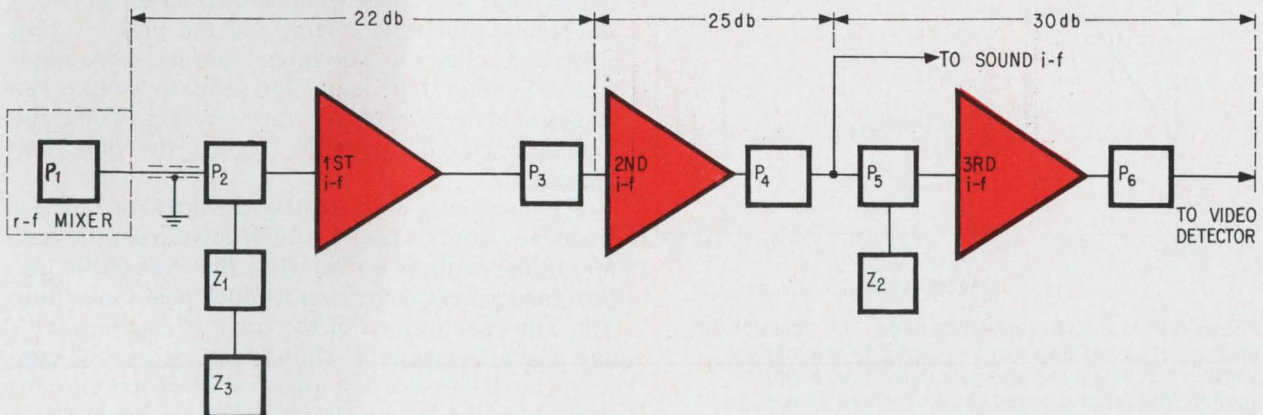

**Video i-f amplifier block diagram.** Basic amplifier shows pole-zero locations from mixer to video detector.



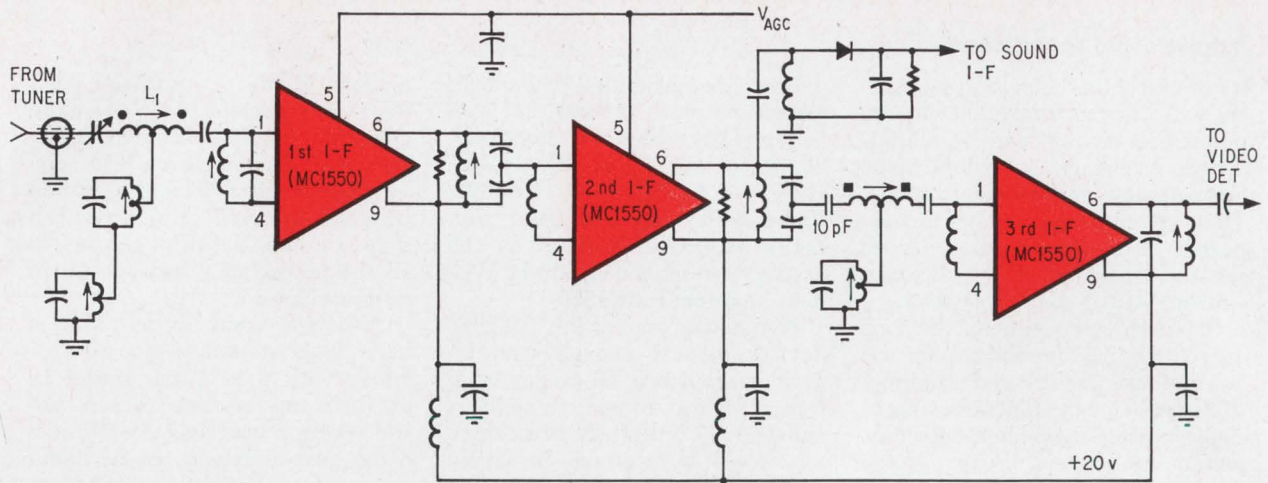

**Final amplifier design.** In a typical circuit, sound takeoff point can be located as shown. Although split capacitor interstage matching is employed in the design, transformer coupling can also be used.

### Chrominance phase shift

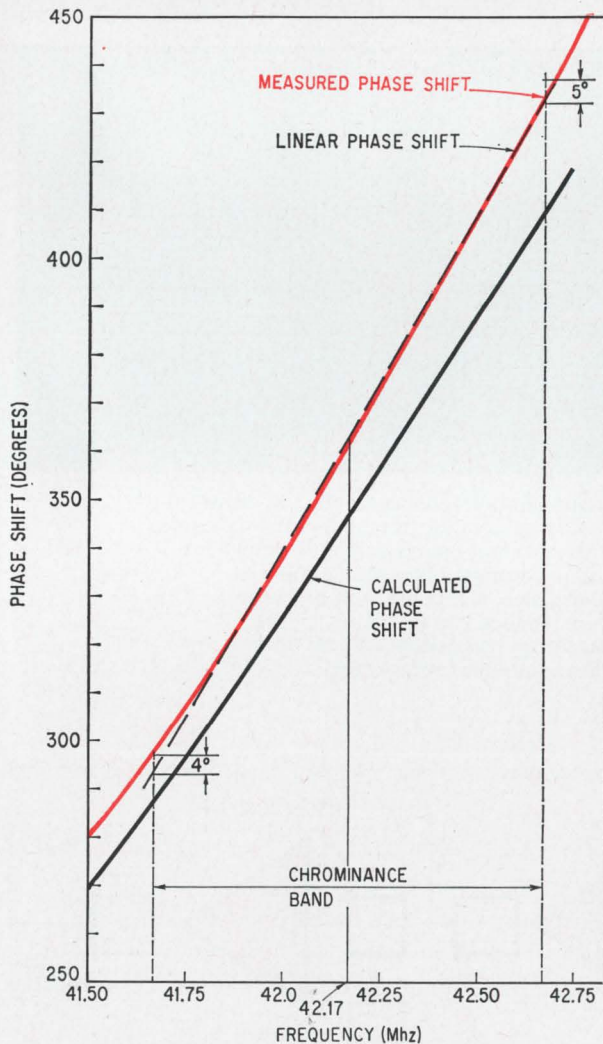

**Phase shift in the chrominance band.** The effect of the in-channel sound trap can be readily determined by plotting the measured and calculated phase shifts against frequency. Curves show excellent phase characteristics with maximum shift of the chrominance carrier frequency.

22 db, the second stage 25 db, and the third stage 30 db. If the detector efficiency is 50% (-6 db), adequate gain should still be achieved.

In the complete circuit shown above, a bifilar-T trap ( $L_1$ ,  $L_3$ ,  $L_4$ ) at the input of the first i-f amplifier provides about 50-db rejection of the adjacent channel's sound, which is at 47.25 Mhz, and 26-db rejection of the in-channel sound at 41.25 Mhz. The trap eliminates the possibility of the 920-khz beat without suppressing the sound beyond recovery, and minimizes phase shift, resulting in a high-Q zero pole and a moderate-Q pole. This circuit arrangement also produces a good phase-shift characteristic in the color band. Thus, with the sound-takeoff point immediately following the second i-f stage, the in-channel sound can be further trapped out of the circuit by placing the second bifilar-T trap between the second and third i-f stages.

Tests have shown that the adjacent picture carrier at 39.75 Mhz was sufficiently attenuated and didn't require further suppression. Although split-capacitor-interstage matching was used here, transformer coupling can be used with equal success.

### Limited interaction

The amplifier can be aligned without any discernible interaction between the tuned input and output stages, and with only limited interaction between the second i-f output circuit and the bifilar-T trap stage that follows it. The interaction has been minimized by the 10-pf capacitor used to couple the stages, and by the bifilar trap winding. Thus, the interstage can be properly aligned the first time around.

The maximum shift of the chrominance-carrier frequency from its position 50% down from the center of the bandpass is 6%, while the shift of the picture carrier frequency from its 50% position is only 5%. The effectiveness of the traps is constant with age, and only negligible shift is detected in the center of the bandpass. The phase shift in the chrominance band can also be measured to see what effect the in-channel sound trap had on the phase linearity.



# LOW PROFILE

## hot-molded trimmer for close circuit board stacking

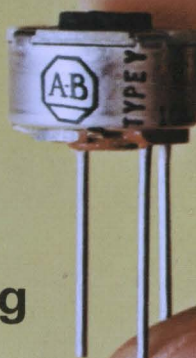

Basic Type Y unit  
shown actual size

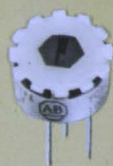

With wheel for  
side adjustment



With attachment for  
horizontal mounting and  
wheel for side adjustment



With attachment for  
horizontal mounting

**New Type Y** single turn trimmer is especially designed for use on printed circuit boards. It has pin-type terminals for use on boards with a 1/10" pattern. And the new low profile easily fits within the commonly used 3/8" space between stacked printed circuit boards.

For greater operating convenience, the Type Y can be supplied with an optional thumb wheel for side adjustment, or an optional base for horizontal mounting, or both. The Type Y enclosure is splash-proof as well as dust-tight, and the metal case is isolated to prevent accidental grounding.

While featuring a new low profile, this new Type Y trimmer retains the popular Allen-Bradley solid resistance element, which is produced by A-B's exclusive hot-molding technique. With virtually infinite resolution, adjustment is smooth at all times. Being essentially noninductive, the Type Y can be used at frequencies where wirewound units are inadequate. The Type Y is rated 1/4 watt at 70°C and is available in resistance values from 100 ohms to 5.0 megohms. Standard and special tapers are available.

Let us send you complete specifications on this newest addition to the Allen-Bradley line of quality electronic components. Please write: Allen-Bradley Co., 222 W. Greenfield Ave., Milwaukee, Wis. 53204. In Canada: Allen-Bradley Canada Ltd. Export Office: 630 Third Ave., New York, N. Y., U.S.A. 10017.

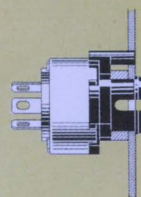

New Type Y with handy  
snap-in panel mount,  
supplied with spacers for use  
on panels up to 1/8" in thickness



**ALLEN-BRADLEY**  
QUALITY ELECTRONIC COMPONENTS



“we have used many millions of Allen-Bradley hot molded resistors. The uniformity of quality from one shipment to the next is truly astounding. There can be no question about the reliability of these resistors.”

Wang Laboratories

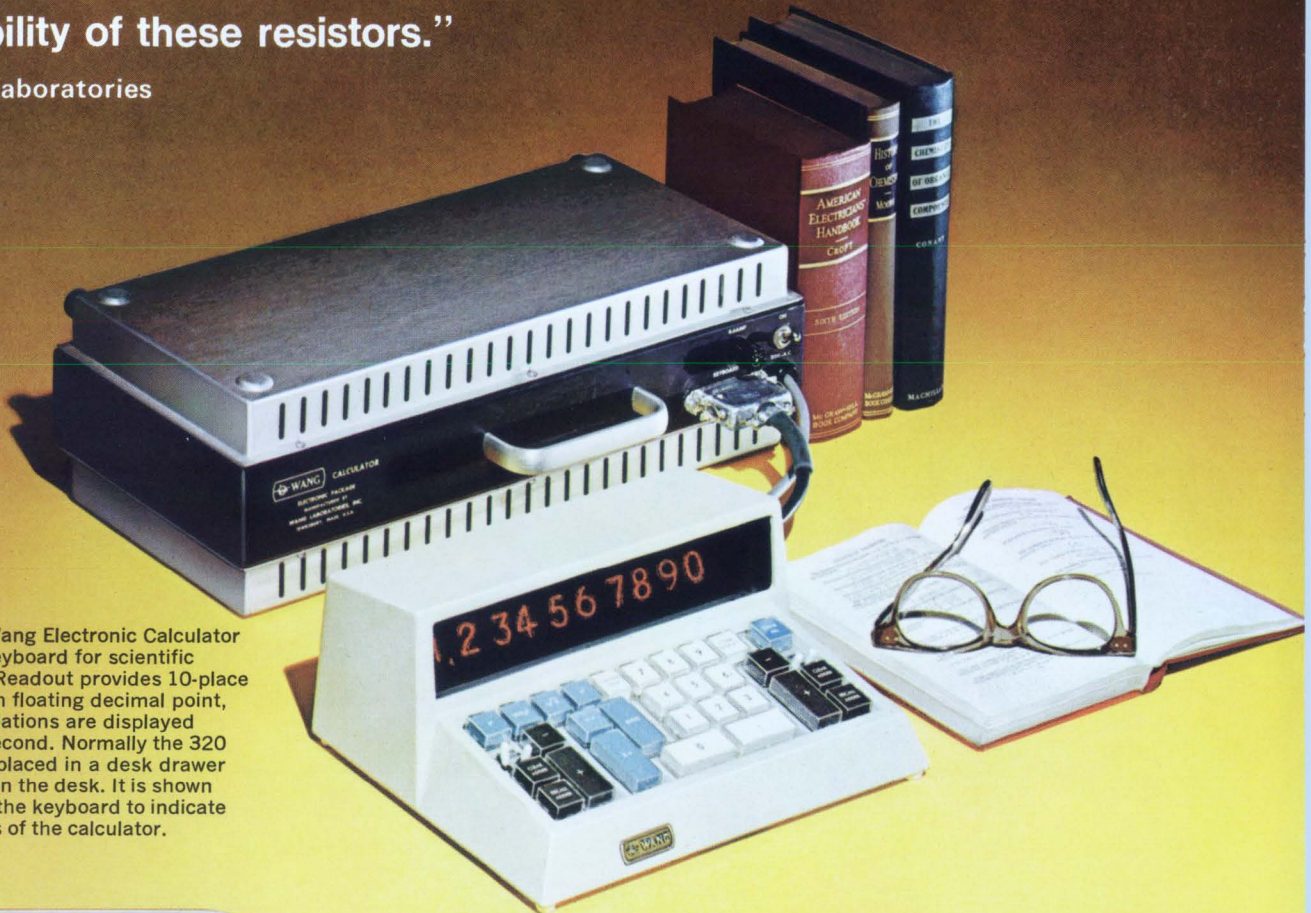

Model 320 Wang Electronic Calculator with 320K keyboard for scientific application. Readout provides 10-place accuracy with floating decimal point, and all calculations are displayed in one millisecond. Normally the 320 calculator is placed in a desk drawer rather than on the desk. It is shown here next to the keyboard to indicate compactness of the calculator.

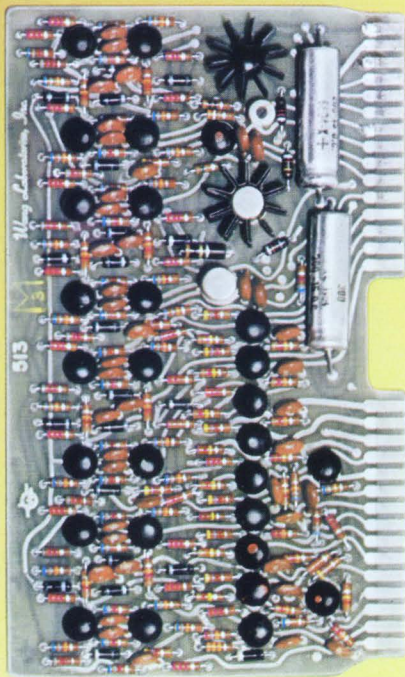

One of the printed circuit cards from the Model 320 calculator. All resistors on this card are Allen-Bradley Type CB 1/4 watt hot molded resistors.

To insure the extremely accurate and high speed operation of the 300 Series Wang Electronic Calculators, all components are selected with utmost care. Thus, it was only natural that Allen-Bradley hot molded resistors were chosen for this most exacting application.

Composition resistors, not produced by the technique of hot molding used by Allen-Bradley—using completely automatic machines—cannot equal the quality and uniformity of production for which the hot molded Allen-Bradley resistors have a worldwide reputation. The precise control during manufacture results in such uniformity of one A-B resistor to the next—million after million—that long term resistor performance can be accurately predicted. There is no record of any Allen-Bradley hot molded resistor having failed catastrophically.

Let the experience of the engineers at Wang Laboratories become your

own experience. Allen-Bradley fixed and variable hot molded resistors will do exactly as well for you as they have done for all other users. For complete specifications, please write for Technical Bulletin 5000: Allen-Bradley Co., 222 W. Greenfield Ave., Milwaukee, Wis. 53204. In Canada: Allen-Bradley Canada Limited. Export Office: 630 Third Ave., New York, N. Y., U.S.A. 10017.

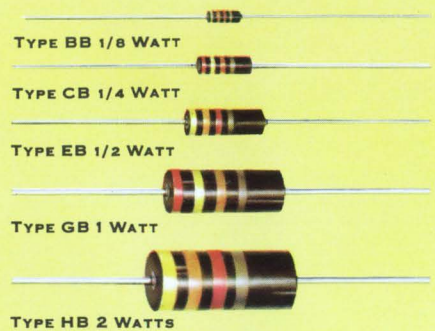

**HOT MOLDED FIXED RESISTORS** are available in all standard resistance values and tolerances, plus values above and below standard limits. Shown actual size.



**ALLEN-BRADLEY**  
QUALITY ELECTRONIC COMPONENTS







## NEW FROM COWECO

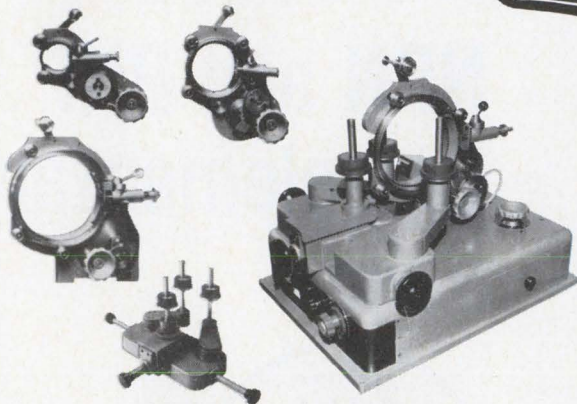

### MODEL **RS** TOROID WINDER

- 6 interchangeable heads for all core sizes
- shuttles available for extremely small cores
- provision for segment or continuous winding



**COIL WINDING EQUIPMENT CO.**

OYSTER BAY, N.Y. 11771 — (516) WA 2-5660  
COWECO OYSTERBAYNEWYORK

## NEW FROM COWECO

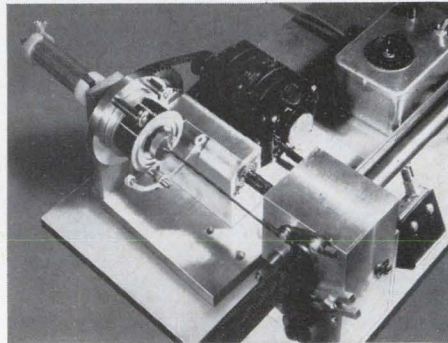

### MODEL **PTS**

#### POTENTIOMETER WINDER

- core is wound and formed continuously
- extremely accurate wire placement
- easy change-over; high production
- windings may be treated in machine or separately



**COIL WINDING EQUIPMENT CO.**

OYSTER BAY, N.Y. 11771 — (516) WA 2-5660  
COWECO OYSTERBAYNEWYORK

VISIT OUR BOOTHS 1J02-1J04 AT THE IEEE

## NEW FROM COWECO

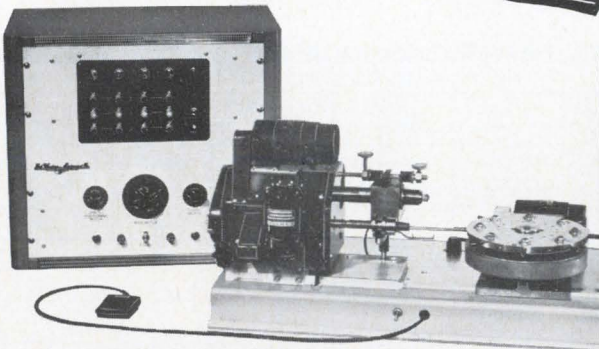

### MODEL **KLK** TURRET TRANSFER TYPE WINDER

- camless, gearless convenience
- high production at low cost
- precise electronic count control
- single or multiple layers at will



**COIL WINDING EQUIPMENT CO.**

OYSTER BAY, N.Y. 11771 — (516) WA 2-5660  
COWECO OYSTERBAYNEWYORK

## NEW FROM COWECO

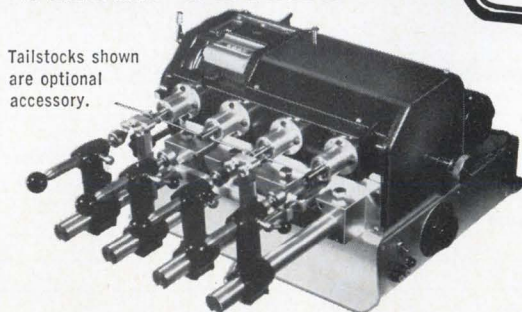

Tailstocks shown  
are optional  
accessory.

### MODEL **KL-4**

#### FOUR SPINDLE HIGH SPEED BOBBIN WINDER

- 4 times the production; minimum investment
- compact, self contained; one operator may supervise several units
- camless, gearless; easy to set up
- spindle speeds to 10,000 RPM; high torque slower speed version available



**COIL WINDING EQUIPMENT CO.**

OYSTER BAY, N.Y. 11771 — (516) WA 2-5660  
COWECO OYSTERBAYNEWYORK



# One for the road.



## 417—the lightweight recorder for heavy duty field use

Hit the road with the rugged, portable Lockheed 417. Take it where the data is—around the plant, around the lab, around the campus or around the world.

Weight: only 28 lbs. with battery—50 lbs. under any comparable recorder. Measures 14"x15"x6" (fits under a plane seat).

Runs on 110/220v AC/DC or internal battery. Power consumption as low as 10w.

Accuracy matches large rack machines. Has phaselock servo for precise speed control. Records on 7 channels, IRIG compatible.

Tagged as low as \$7,000.



Exclusive low-mass differential capstan drive gives precision recording even in rough field conditions. Simplified, maintenance-free mechanism works under vibration and in any position.

Frequency response: 100 kc direct, 10 kc FM.

Send for our catalog containing full details on the 417—one of a family of precision data recorders for land, ocean, air and space application. Write: Boyd McKnight, Dept. #E-30, Lockheed Electronics Company, Edison, New Jersey.

Have questions on data recording?  
Call (201) 757-1600.

## LOCKHEED

Lockheed Electronics Company. A Division of Lockheed Aircraft Corporation





**OLYMPUS CORPORATION  
OF AMERICA**

PRECISION INSTRUMENT DIV. DEPT. E  
1190 Brooks Ave., Rochester, N.Y. 14624

Send information on Olympus stereo microscopes,  
including  JM,  XL-4,  SZ-III,  X-TR  
and  microscope cameras,  X,  VT-II,  
 VA-II,  MTX. My applications include:

\_\_\_\_\_

Name \_\_\_\_\_

Title \_\_\_\_\_

Address \_\_\_\_\_

City \_\_\_\_\_

State \_\_\_\_\_ Zip \_\_\_\_\_

# The Olympus stereo microscope line.

## It puts things in perspective.

We now offer a stereo microscope for almost every purpose. Which may give you a new perspective on us, if you've known Olympus only for our metallurgical microscopes, our metallographs, or our medical and research instruments.

A closer look will reveal some surprising features: working distances to 18", dark-field illumination, and the only trinocular optical system (for simultaneous viewing and photography) in the stereo field. And you can see their quality even before you look through precision optics.

Olympus stereos fit your budget as easily as they fit your applications. Tell us what those applications are. We'll give you the full perspective on the Olympus microscope that suits them.

A. Model JM dark-field zoom.

B. Model XL-4 long (8 1/2") working distance (shown on VS-V universal arm stand).

C. Model SZ-III extra-long (5.7:1) zoom range (shown on VS-IV universal arm stand).

D. Model X-TR Trinocular for viewing and photography (shown with PM-7 camera).

E. Model X with convenient turret magnification selector (shown on transilluminating stand).

F. Models VT-II, VA-II priced for use throughout your plant. (VT-11 shown with LSG epi-illuminator).

G. Model MTX (not shown) with 18" working distance. Camera accessories available.



Circle 140 on reader service card

B





## Meet the conformist

At GAF, nobody looks down on conformity. After analysis of industrial x-ray problem areas, GAF research came up with SCREEN-PAK™—a convenient, disposable lead screen “package”—that goes out of its way to be a conformist.

*SCREEN-PAK conforms easily to curves.* While thicker than other disposable screen packages, it bends easily around a small part.

*SCREEN-PAK conforms to the need for contrast.* Consistently better visualization of structural defects, thanks to superior absorption of scatter radiation by the pure lead foil (.003” thick).

*SCREEN-PAK conforms to exposure requirements.* Reduced exposure time over the broadest range of radiation energies (120 KV to 1.25 MeV)—

but with intensification comparable to that with conventional lead screens and superior to that with thinner disposables.

Introduced as Industrial “B” Film, new GAF SCREEN-PAK is also available in Industrial “A” and “H-D” on special request.

A call to your x-ray film distributor or GAF Technical Representative will bring full information on SCREEN-PAK and other GAF products for industrial radiography. Or, write: Industrial X-ray Marketing Department.

02568

another  
fine product  
from



General Aniline & Film Corporation  
140 West 51 Street, New York, New York 10020



# How many PAF resistors per hour do you need?

**Y**ES, the state of the art has advanced to the point where this is your major decision. You needn't wonder whether you can design, build or buy the equipment you need to achieve your tolerances or your production requirements. Just call S.S. White and say how many PAF resistors per hour you need.

S.S. White offers you a whole series of resistor-trimming systems. They're based on the proven Airbrasive® concept, controlled by precision electronics. The systems trim and monitor simultaneously.

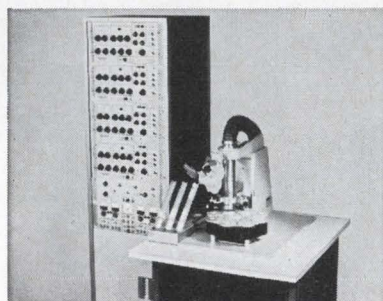

## Big daddy: the 4,000-per-hour AT 704

On our production models, the AT 701 and the AT 704, accuracy is guaranteed within 0.5%, and experience shows that accuracy within 0.1% can often be achieved in practice.

Our large production model, the AT 704 can trim as many as 4,000 resistors per hour at a cost of about 1/2¢ per trim including materials, labor, and amortization of equipment. Our standard production model, the AT 701, has a capacity of up to 600 trims per hour, and though its initial investment is lower, the cost per trim is about the same as for the AT 704. Both machines are in current production and can be delivered within a few weeks.

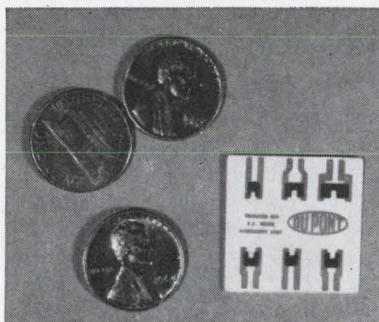

## The non-problem: six accurate trims for 3¢

There are numerous machines of both models presently in operation here and abroad. Installation requires nothing more than a level spot on your floor and a 110V a.c. outlet. We'll send an engineer along, however, to show you how to program the machine you choose. Once programmed either machine can be operated by ordinary unskilled workers.

An exciting new development is the S.S. White model LAT-100, a low-cost, resistor trimming system with accuracy within 1%. The LAT-100 is ideal for low-volume and prototype work, and experimental layouts. Like the production models, the LAT-100 is equipped with a complete exhaust

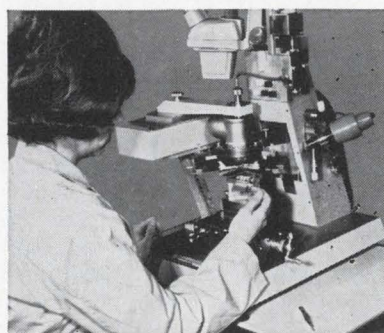

## Our most popular model—Linda operates the AT 701

system to maintain clean-room conditions. The LAT-100 is now in production, but we suggest you place your order early if you need fast delivery.

S.S. White has been active in microelectronics since the Year 1. Our proprietary Airbrasive cutting concept has been proven in the electronics industry long before it became the basis for these Resistor Trimming Systems. Shockless, heatless removal of resistance material means high yield, great accuracy and speed of production, with no altering of the substrate.

Inquire, S.S. White Industrial, Dept. R, 201 East 42nd Street, New York, N.Y. 10017. Telephone 212-661-3320.

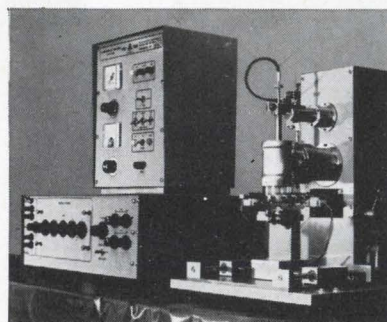

## The latest: Model LAT-100 to be unveiled at the IEEE show in March

SEE US  
AT BOOTH 1C 32  
IEEE SHOW



**S.S. WHITE**  
A DIVISION OF PENNSALT CHEMICALS CORPORATION



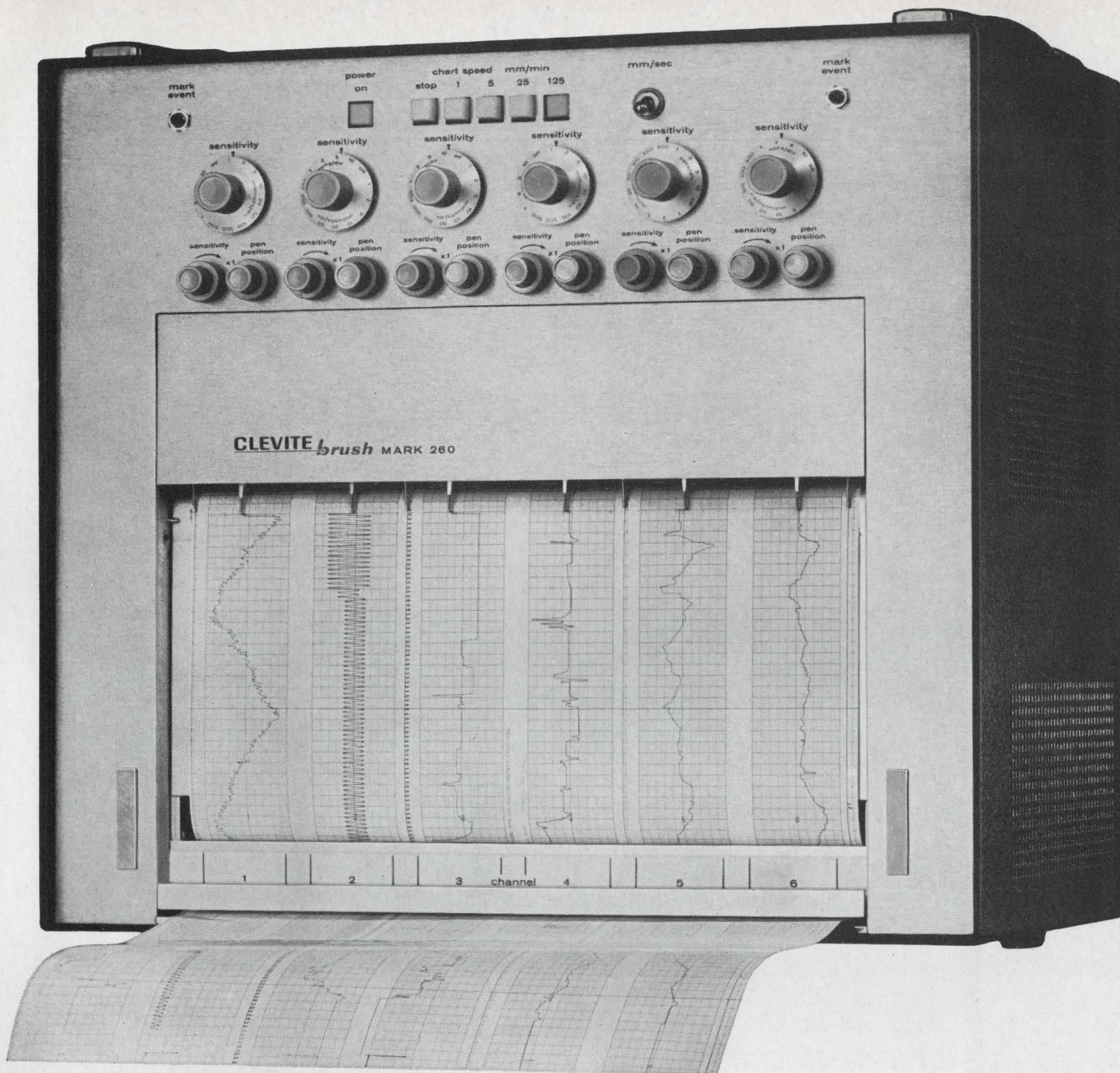

## A no-compromise recorder at \$4500. (That's half the big-system price)

... and we mean *no* compromise. The new Brush Mark 260 meets the standards of the famous Brush Mark 200—and that's more than anyone else can do. ■ Just listen: Six analog channels, four event channels (that's more than you get with recorders twice its size, and twice as expensive) ... the Brush pressurized-ink writing system (the most readable recordings ever made—dry on contact) ... 99½% accuracy (enforced by a frictionless no-nonsense servo system) ... frequency response out to 150 Hz at usable amplitudes ... rugged, reliable solid state electronics. (Bounce it around a bit. We don't mind, and the Mark

260 doesn't either) ... measurement range from 1 millivolt to 500 volts (enough for almost anything you're likely to handle). And you can plug it in, put it in writing—anywhere! ■ At \$4500 the new Mark 260 is the recorder value of the year. A full-color brochure is yours for the asking. Write: Clevite Corporation, Brush Instruments Division, 37th and Perkins, Cleveland, Ohio 44114.

**CLEVITE BRUSH**

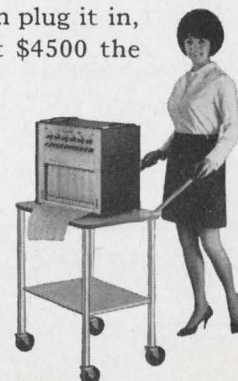

Circle 143 on reader service card



# Air variables from JFD solve your high Q high frequency problems

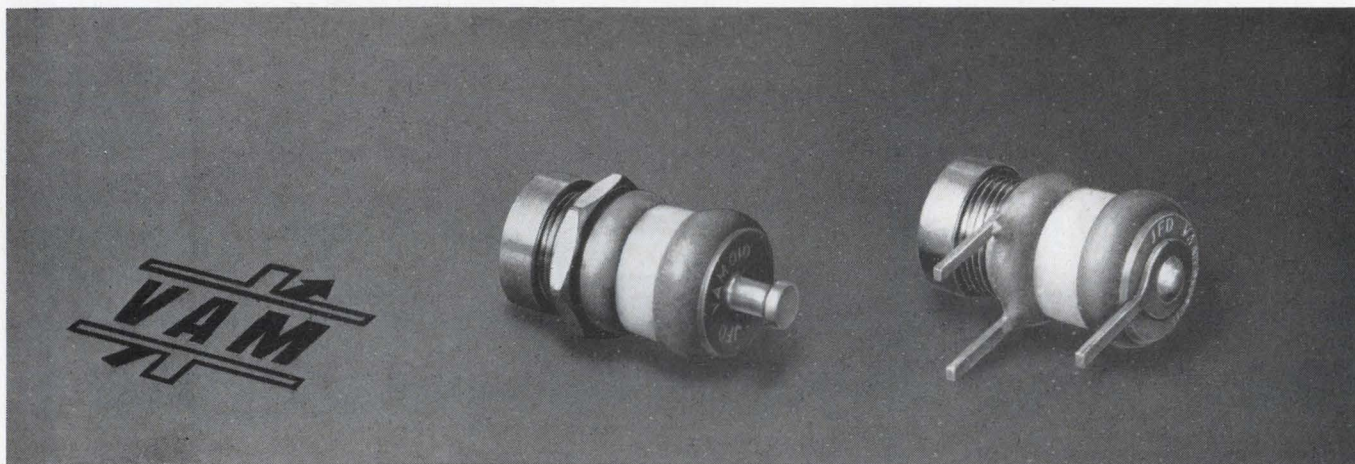

Capacitors shown enlarged 120%

The JFD air variable miniature capacitor series—VAM—is specifically designed for high frequency applications that demand extreme stability, small size and high Q (greater than 2,000 measured at 10 pf and 100 MHz) VAM's have rugged construction, measure approx. ½" in length and are completely interchangeable with competitive devices.

## ELECTRICAL DATA — ALL VAM MODELS

Cap. Range at 1 MHz ... 0.8 to 10.0 pf  
 Q at 10 pf & 100 MHz ... >2,000  
 Insulation Res. at 25°C ... 10<sup>4</sup> megs.  
 at 100 VDC  
 Temp. Coeff. of Cap. (-55°C to  
 +125°C) ... 0 ±20 PPM/°C  
 WVDC ... 250 VDC  
 Test Voltage ... 500 VDC

## ACTUAL SIZES

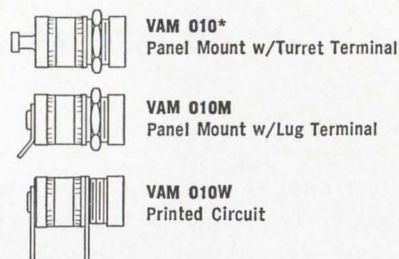

\*VAM 010 also available as VAM 010H with 4-40 threaded stud replacing turret terminal.

Write for catalog VAM-66-A

*"TODAY'S COMPONENTS BUILT FOR TOMORROW'S CHALLENGES"*

**JFD** JFD ELECTRONICS CO. / COMPONENTS DIVISION • 15th Avenue at 62nd Street • Brooklyn, New York 11219 / Phone 212-331-1000  
 Sales Offices — Arcadia, California / Chicago, Illinois / Baltimore, Maryland / Saxonville, Massachusetts / Brooklyn, New York  
 New Hartford, New York / Cincinnati, Ohio / Philadelphia, Pennsylvania / Pittsburgh, Pennsylvania / Paris, France / Azor, Israel

"SEE US AT IEEE BOOTH 4E26." "Also, March 27th-April 3rd, London Electronics Engineering Exhibition / April 1st-6th, Paris Components Show / April 27th-May 5th, Hannover Fair, Hannover, Germany."





## We have more than 200 models within easy reach. And we're adding more.

That's the way this business goes. You start with a CRT that's almost a scientific curiosity—thirty years later you wind up with an inventory. All because someone is constantly thinking of something else a CRT can do.

Obviously, we were lucky enough to have men who knew what they were doing. Our product line proves that. Round face, rectangular, fibre-optics or stand-

ard—short necks or long, one gun to twelve gun, transparent multicolor phosphors and distortionless rear windows. Name it. We've got it. Order it. It's yours.

You'd think we'd stop and just keep someone watching the store. But that's not the way this business goes.

Somewhere out there, right now, somebody is thinking of something new for a CRT to do.

That's how we add to our line.

If you're looking for any kind of quality CRT, our kind of inventory gives you the best place to start.

One thing is sure. We've got enough to say yes, rather than maybe. Try us. Write or call. And send for our free literature. It's free.

Electronic Tube Division,   
General Atronics, Philadelphia,  
Pennsylvania 19118



**GENERAL ATRONICS**



**The new AO  
StereoStar/ZOOM  
Microscope  
gives you high  
resolution,  
new convenience,  
superior optics  
and wide  
magnification  
range.**

Here are a few of the outstanding advantages that make the new AO<sup>®</sup> StereoStar/ZOOM Microscope the finest instrument of this type available today:

- Widest total magnification range: 3.5–210X
- High resolution to meet the most exacting needs
- The most convenient zoom control available
- Choice of five interchangeable, rotatable zoom power bodies
- Crisp, sharp images at all magnifications
- Extra large field of view and high eyepoint eyepieces
- Wide choice of stands for every purpose
- Long working distance
- Even illumination over the entire field
- Coolest operating illuminator.

See for yourself. Contact your AO Sales Representative for a demonstration, or write for our 24-page, full-color brochure on the newest in stereo microscopes—the AO StereoStar/ZOOM.

<sup>®</sup>TM Reg., American Optical Co.



**AO INSTRUMENT  
COMPANY**

**BUFFALO, NEW YORK 14215**

*Formerly Instrument Division of  
AMERICAN OPTICAL COMPANY*

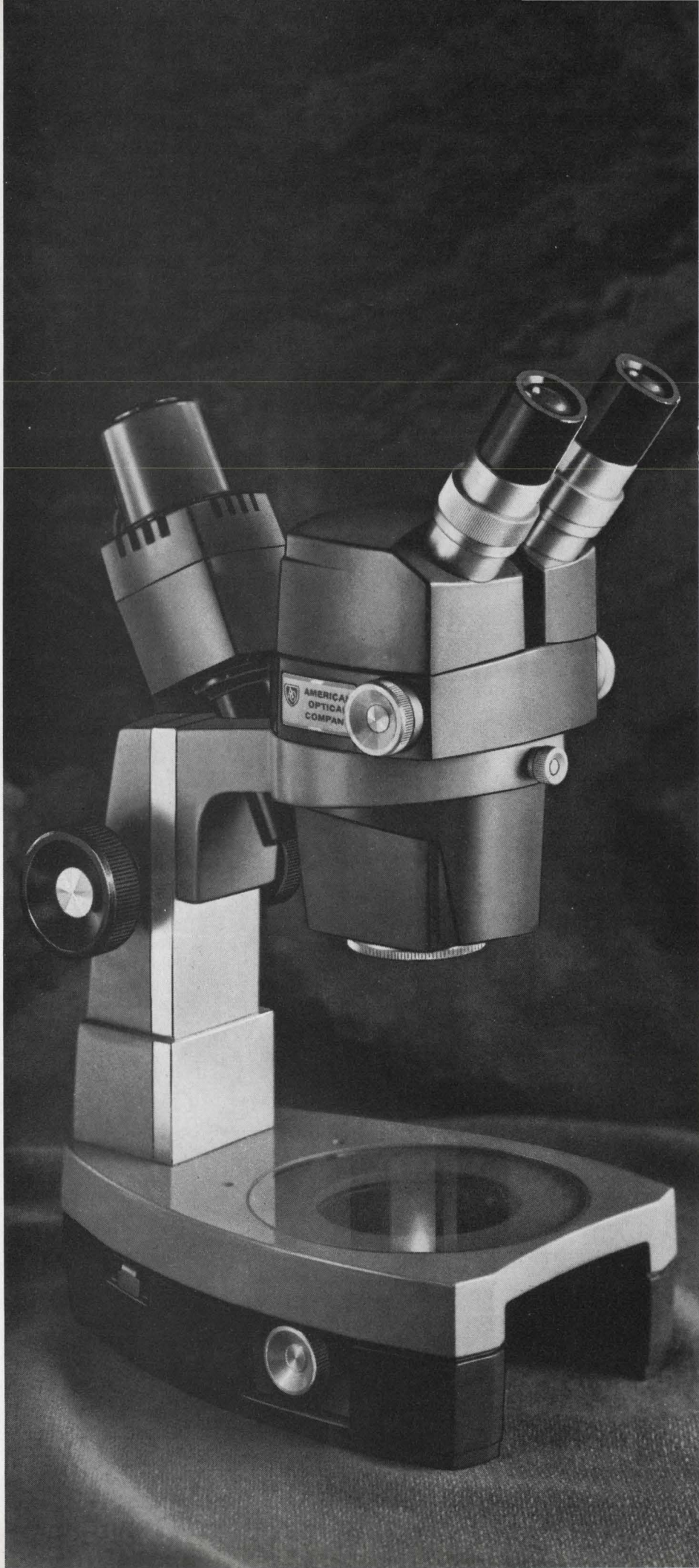



Minnesota is a fertile land for Electronics!

## New business climate nurtures growth of money trees

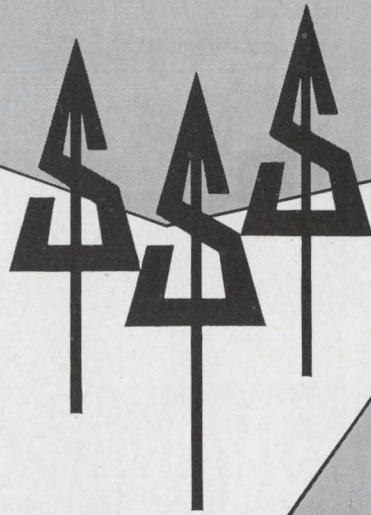

Take a new look at Minnesota. Our rich land is the perfect foundation in which your company can take roots. Hundreds of small, medium and large electronics firms are already prospering here. Minnesota's sunny people and tropical business climate make your growth potential as vast as our great outdoors. Minnesota means business!

The updating of our business laws is just one indicator of our people's positive, progressive attitudes toward making money. For example:

**Revenue Bonding Bill:** Hundreds of smaller Minnesota communities, eager and able for industry, receive the encouragement of the government in selling tax-free municipal bonds for plants and offices at very low interest rates. Minnesota means business!

**Reorganization of the Department of Economic Development:** Minnesota gives state assistance to businesses. We've added specialists in every region of the state to help you prosper. And our Governor has a 21-member advisory board comprised of leading executives to help maintain our growth atmosphere. Minnesota means business!

**Tax Reform and Relief Act:** The people of Minnesota, speaking through their state legislature, have voted to reform and lower the tax burden on business. This allows Minnesota manufacturers to compete favorably, both on a national and international basis. Minnesota means business!

**Metro Council:** Proof of the progressive attitudes of Minnesotans, our Metro Council serves a seven-county area helping all citizens and businesses maintain a healthy, productive community. Minnesota means business!

**Copper-Nickel Bill and the Taconite Amendment:** New laws encouraging the development and growth of mining establish tax limits. Minnesota means business!

Large corporate plants . . . small corporate headquarters . . . *all* businesses can sow the seeds of profit throughout Minnesota. We're a large and active financial market with an eager eye on tomorrow and a growth capital to match. Plant a plant in our rich land . . . and reap your harvest from our money trees!

For specific information, we'd like you to visit us personally. Or have your banker, broker, or agent contact us for confidential information applicable to your interests.

# minnesota!

## 10,000 LAKES

*"We don't just talk  
about progress.  
We make it happen."*

Dept. of Economic Development  
57 West Seventh Street  
St. Paul, Minnesota 55102



**NOW** our new policy allows  
you to

**rent an  
automatic  
RFI/EMI  
specification  
measuring  
system**



**for \$186\* PER DAY**

**...including a trained operator!**

you'll find this automatic system  
300 times faster than conventional  
manual methods in data collection,  
reduction and presentation! means  
lower EMI and TEMPEST testing costs.  
consult us now or at the bid stage...  
your competitors do!

\*Based on one month rental of the 120A System.

670 Lotstrand Lane  
Rockville, Maryland 20850  
Tel. (301) 424-2900



WHITE  
ELECTROMAGNETICS  
INCORPORATED

See us at the IEEE Show

148 Circle 148 on reader service card

Electronics | March 4, 1968





***This is  
a  
racket buster...***

## ***for High Voltage Instrument Manufacturers***

Recent developments in the electronics industry indicate a crash effort is required to measure and control many possible sources of electronics 'racket', in the form of potentially injurious radiated energy. Designed for immediate application in instruments for measurement of 'noise' radiations from television receivers and other kinescope equipment, these new units provide greater voltage stability and overall measurement accuracy than similar types long used as range multipliers. Resistance change with applied voltage is minimized by special element size, permitting application as a High Voltage Extended Range multiplier with standard instrument circuits. The slender configuration is 'specially suited to insertion in a probe body. Terminals and accessories are available for in-cabinet mounting.

FOR TV, RADAR & OTHER H-V METERS

RPC TYPE HP-6, 6" x 5/16"

RESISTANCES 100 Megohms to 3 Gigaohms  
( $1 \times 10^8$  to  $3 \times 10^9$ )

STANDARD RESISTANCE TOLERANCE  $\pm 3\%$ , 0 to  
30,000 Volts

RESISTANCE TOLERANCES  $\pm 2\%$ ,  $\pm 1\%$ , can be  
supplied for specific voltage levels or ranges.

Voltage Coefficient of Resistance, 1 PPM/volt maximum

Special Applications assistance available.

Other styles and ratings available.

See us at Booth 4H24  
1968 IEEE Exhibition  
March 18-21

  
***Resistance Products Co.***

914 SOUTH 13th STREET • HARRISBURG, PA. 17104 • (717) 236-5081

Circle 149 on reader service card



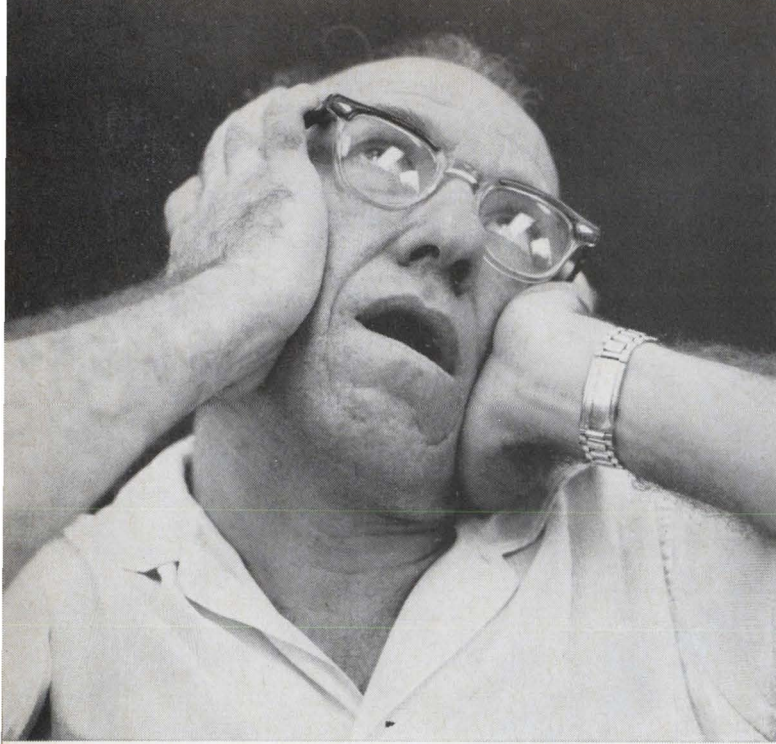

"I was in terrible trouble. The additional circuitry changed my power supply requirements."

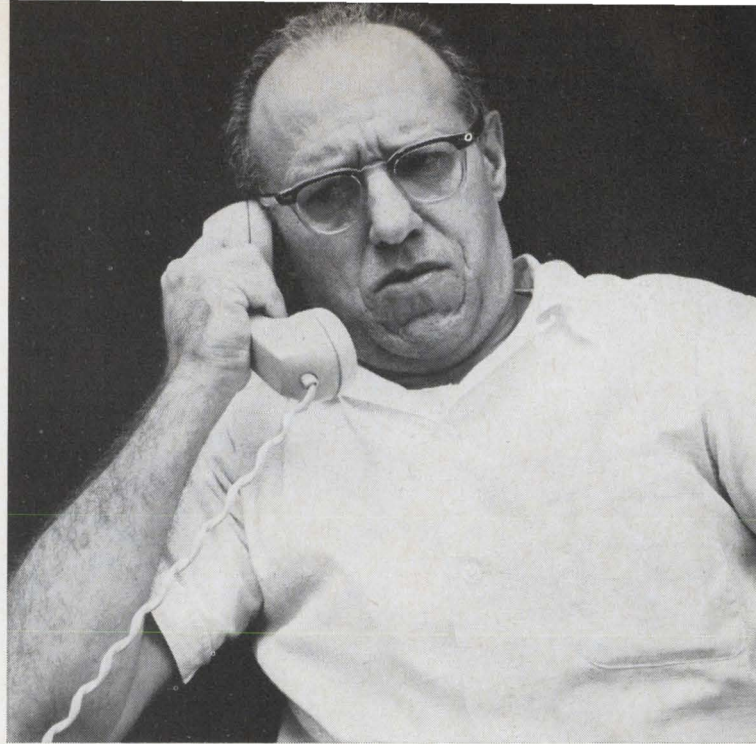

"More trouble . . . my usual source of supply said, 'Six weeks to get power supplies with the new ratings.'"

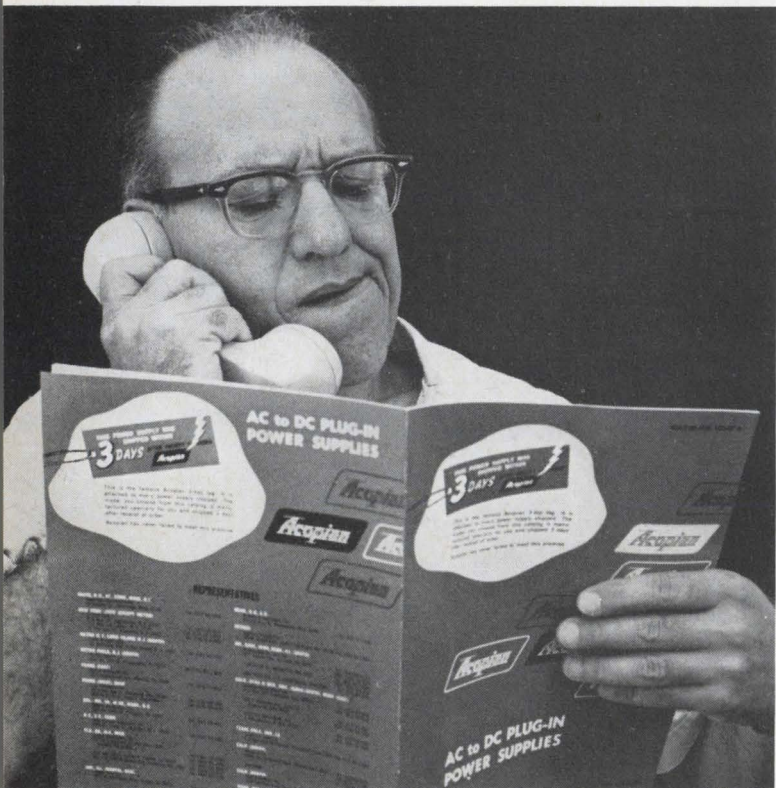

"I had heard about Acopian's incredible 3-day shipment guarantee on their 62,000 different types of AC to DC plug-in power supplies, and decided to give them a try."

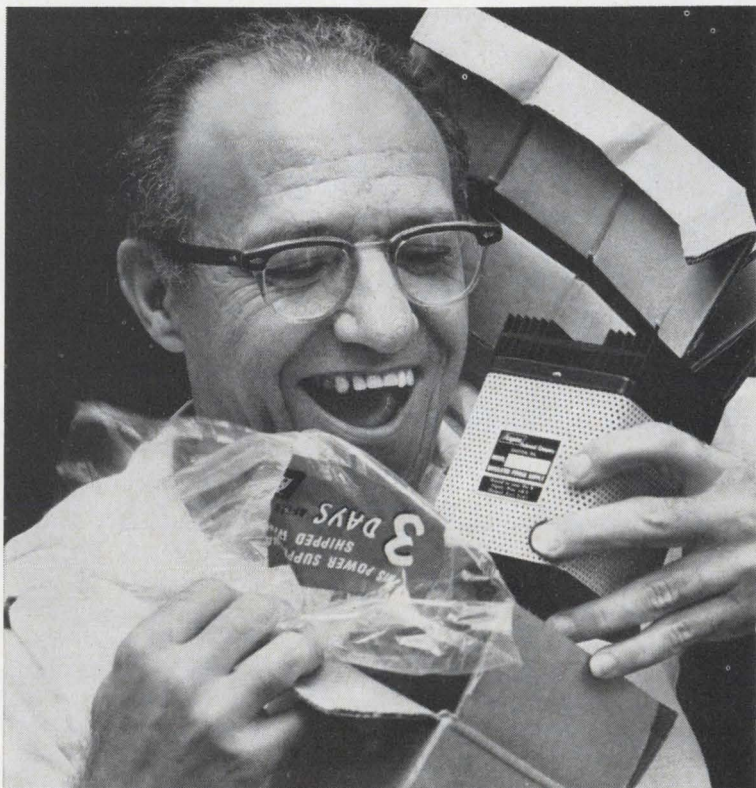

"Imagine my glee . . . when a few days later . . ."

Next time you're in trouble with power supply delivery, contact Acopian. If you do not have a copy of our latest catalog, by all means, request one. It lists 62,000 different AC to DC plug-in power supplies, any of which will be shipped to you in just three days! For particulars, contact your local Acopian rep., call us at (215) 258-5441, or write to Acopian Corp., Easton, Penna. 18042. 

Circle 150 on reader service card



When you need data  
about something too distant to reach  
or too numerous to count,



call Kodak

**Call (716) 325-2000, Ext. 3257.** This number is your pipeline to a large staff of scientists and engineers who specialize in *photographic* ways to collect, interpret, store, and retrieve information.

Systems of their design, or in which they participated, have furnished information about the moon and solar

system. They've provided detailed studies of debris on the ocean floor. They've even followed the complex tracks of subatomic particles.

There's a strong probability that photographic solutions to your problem are already available. There is just as strong a likelihood that the equipment, materials, and technology

can be taken right from the Kodak shelf. A conversation with us may save you time and money. Call.

Or, if you wish, write:

Instrumentation Sales,  
Eastman Kodak Company,  
Rochester, N. Y.  
14650.

The Kodak logo is positioned at the bottom right of the advertisement. It features the word "Kodak" in its signature serif font, set against a dark, triangular background that resembles a corner of a page being folded over. The logo is partially obscured by the edge of this fold.

**Kodak**



# The latest instruments from Aerometrics

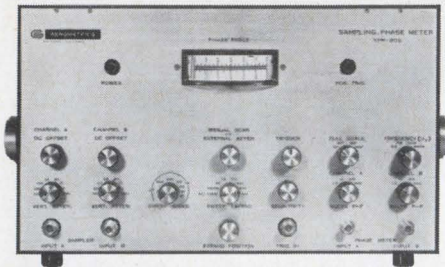

**New Sampling Phase Meter.** This SPM-800 is unique. It covers the broadest frequency range of any phase meter available today. It offers such plus features as:

- Precise phase measurement from 10 Hz to 400 MHz.
- Phase measurement of asymmetrical wave forms.
- Accuracies to  $\pm 0.2\%$ .
- Alternate use as a high frequency general purpose sampler.



**New Auto-Ranging Multimeter.** The MM-110 offers the broadest current ranges available with auto-ranging. Ranges cover 5 na to 150 ma, voltages from 5 mv to 1500 v and resistance from 5 ohms to 15 megohms.



**New Pulse Generator.** Model PG-300 is fully programmable for all functions, including variable rise/fall and base line offset. The rise and fall are linearly variable from 5 nsec to 1 msec, base line offset variable from 0 to  $\pm 10$  volts. Simultaneous positive and negative pulses.

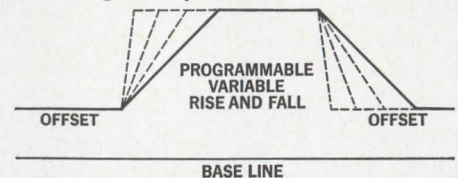

See the full range of Aerometrics instrumentation at IEEE Booths 3A34 and 3A35.



P.O. Box 216 F, San Ramon, Calif. 94583

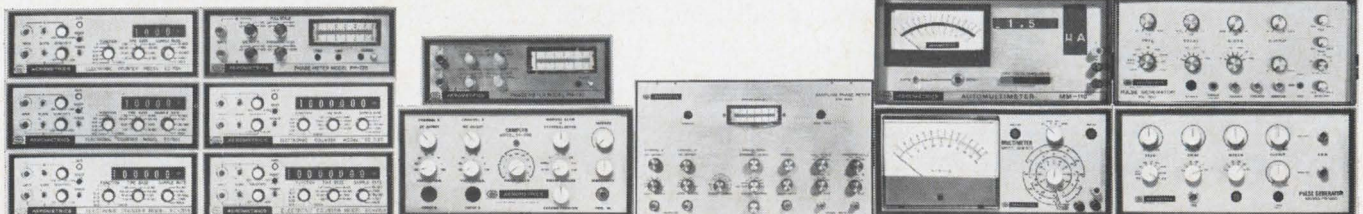



No need! Nearly twenty years of flight time on aircraft from the B-29 to the C-5A have proven the dependability of wiring insulated with TEFLON fluorocarbon resins. Lab tests are O.K.; we've got hundreds on record, but nothing tops the proof of use . . . and TEFLON has the proof

of millions of flying hours in scores of aircraft.

Ask for our brochure explaining in detail why there are no test flights for TEFLON. It may help you eliminate one unnecessary variable from *your* next test flight. Write Du Pont Company, Room 5617C, Wilmington, Delaware 19898.

\*Reg. U.S. Pat. Off. for Du Pont fluorocarbon resins and films.

**There are no test flights for Teflon\***



Better things for better living  
...through chemistry

TEFLON... the proven performer



# DEECO dispatches TI's family of TTL ICs on the double

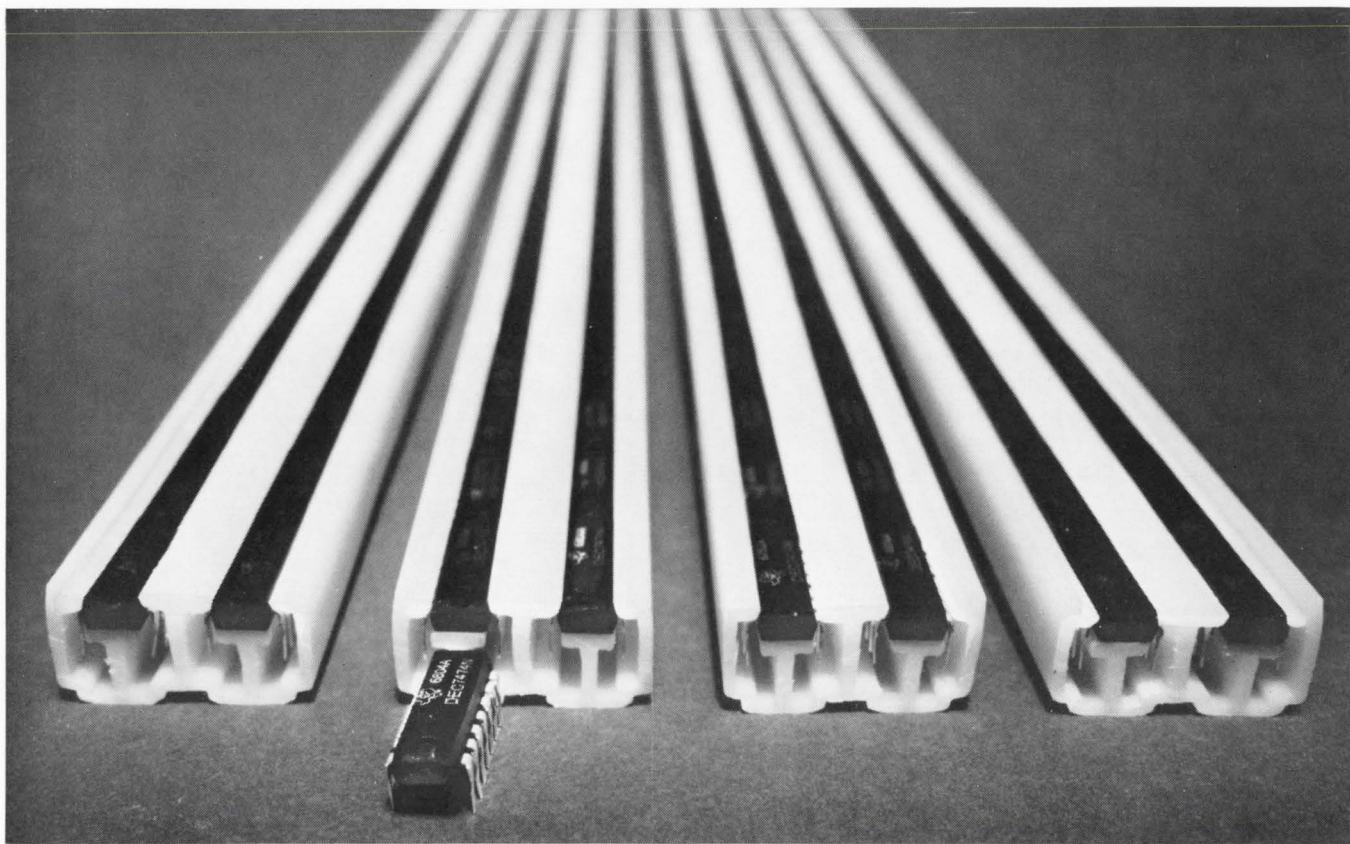

Holding a double row of ICs, this new TI shipping carrier proves a real convenience on your assembly line. Simplifies handling whether assembly is by machine or by hand. Nips seconds off assembly time. TI's Series 54/74 TTL standard and high-speed ICs are available in this handy carrier—and from us!

Our pipeline to Texas Instruments keeps our stocks up to snuff on this

most versatile and complete line of TTL ICs going. You get your best combination of speed, power dissipation, performance and cost-per-function.

We deliver what you want, in the quantity you want on the double. Same with the entire TI line of economy semiconductors.

Check it out for yourself. Circle number 299 on reader service card for a

free copy of this new brochure describing *all* TI economy plastic semiconductors: digital and linear ICs, SILECT™ transistors, FETs, SCRs, unijunctions and silicon rectifiers. Do it today—and depend on delivery *on the double*.

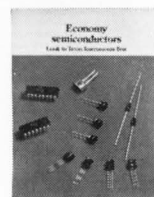

**DEECO**  **Inc.**

DISTRIBUTORS — SERVING INDUSTRIALS EXCLUSIVELY

618 FIRST STREET N. W. • CEDAR RAPIDS, IOWA • PHONE 319 365-7751

**AUTHORIZED**  
**DISTRIBUTOR** 



# SCIENCE/SCOPE

The seventh Surveyor, sent to explore the unknown rock-strewn ridges of the moon's south polar region, landed only 1½ miles from its bullseye near the crater Tycho. Its TV camera shortly revealed the boulders it had barely missed. Later, laser beams aimed at the moon from stations in California and Arizona were recorded by Surveyor 7 and transmitted back to earth. One of the lasers was built by Hughes Research Laboratories.

So complete had four earlier Surveyors tested and photographed all proposed landing areas for the first manned moon mission that Surveyor 7 could be freed for this important scientific mission. NASA scientists hoped to learn more about the character of the moon, which could lend clues to its origin and that of the universe, by landing near the fallout from this large new crater.

Surveyor 7's only glitch -- its temporary inability to lower the tiny box containing its alpha backscattering instrument all the way to the surface -- was turned into a brilliant demonstration of the commandable-spacecraft concept by a 40-man team of JPL and Hughes scientists. After an all-night session of delicate maneuvering, they successfully used the surface scoop to free the box and guide it to the soil.

The West German Ministry of Defense has awarded Hughes a contract for two prototype computer-controlled flight-line testers for their F-104G Starfighter's inertial navigation system. The tester, using pre-programmed test sequences, enables relatively unskilled operators to make fast, accurate tests. It uses a Hughes H3118M computer, and can be adapted for testing other avionics.

Hughes has openings for engineers in these fields: circuit and logic design, telecommunications systems design, display systems, space/airborne command system design, computer memory systems. Requirements: accredited degree, U.S. citizenship, and at least two years related experience. Please write: Mr. J.C. Cox, Hughes Aircraft Co., Culver City, Calif. An equal opportunity employer.

It's the TV camera in Walleye's nose that gives this U.S. Navy and U.S. Air Force air-to-surface weapon its phenomenal accuracy. After launch, its electro-optical guidance system keeps it on course as it glides to its target. Walleye is now being manufactured at the Hughes Tucson, Arizona, plant under a second-source contract.

First working laser, developed in 1960 at Hughes Research Laboratories, was the ruby laser. Last November, Hughes was awarded a U.S. patent covering all ruby laser systems until 1984. Although many patents have been granted on other lasers since 1960, the ruby laser is one of the most important for practical applications.





# CTS <sup>2-watt</sup> <sup>3/4" dia.</sup> Cermet Pots

in Wirewound or Carbon Price Range

less than **98¢** each  
(in production quantities)

Only CTS, high volume automated producers of cermet controls, offers a line of 3/4" dia., 2-watt cermet potentiometers at prices you would expect to pay for industrial wirewound or carbon pots.

Series 550 combines long life, low noise, high overload capability, high stability and wide resistance range in compact construction that exceeds MIL-R-23285 (a tighter cermet version of MIL-R-94). Single, dual and concentric constructions.

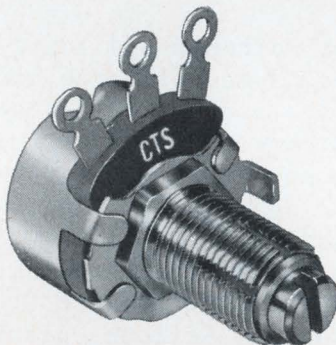

### Series 550

2-watt 3/4" dia.

**Cermet Variable Resistor**

Compare these specifications (linear taper)		
	Standard Characteristics	Optional Characteristics (no more than 10c extra per item)
<b>Temperature Coefficient</b>		
Resistance ohms 40Ω to 1.35KΩ 1.36KΩ to 2.9KΩ 3KΩ to 1.35 meg. 1.36 meg. to 5 meg.	TC PPM -50 to +200 -100 to +300 -100 to +250 ± 250	TC PPM -0 to +100 -0 to +250 ± 100 ± 150
<b>ENR</b>	± 2%	± 1%
<b>Rotational Life</b>	50,000 cycles ± 5% Δ R	100,000 cycles ± 10% Δ R
<b>Resistance Range</b>	50 ohms through 1 megohm	25 to 49 ohms or 1 megohm to 5 megohms
<b>Independent Linearity</b>	± 5%	± 3%

For help in your application, call on CTS, the world's largest producer of variable resistors.

Most models available through CTS distributors.



Founded 1896

**CTS OF BERNE, INC.**  
BERNE, INDIANA

Subsidiary of CTS Corporation, Elkhart, Indiana



# Probing the News

## Manpower

### From help wanted to jobs wanted

Industry's belt-tightening softens short-run demand for experienced EE's despite prospective long-range shortages; more recruiters interview grads

By Eric Aiken

Probing the News editor

**Industry's demand** for electronics engineers still outstrips supply, but the gap is narrowing, at least temporarily. Cutbacks in civilian aerospace projects and basic research programs, as well as uncertainties in the consumer and commercial areas, are softening the manpower market.

Good men, as always, are hard to find. And the welcome mat is out for engineers with experience in circuit design, electro-optics, metal oxide semiconductor technology, thin-film methods, antenna design, acoustics, digital techniques, and electronic countermeasures.

Recruiters are changing their tactics, but as much in response to spiraling costs as to the slackened demand. Most are now willing to give offbeat methods a try and check the talent in their own backyards before going far afield for specialized skills. Increasingly, firms are arranging intracompany transfers for engineers caught in divisional layoffs.

**Fringe benefits.** Graduate electrical engineers are still elusive prey. And with salaries continuing to rise, such considerations as professional challenge and locale are bulking larger in their decisions to accept or reject offers.

One important reason for this sellers' leverage in what is becoming, for the moment at least, a buyers' market is the fact that a long-term deficit in qualified technical manpower is now shaping up. According to data compiled by the Engineering Manpower Commission of the Engineers Joint Coun-



**New ballgame.** Observers expect a shift this year to a buyers' rather than a sellers' market for experienced electrical engineers.

cil, industry's demands for engineers of all kinds averages 69,000 annually. However, the nation's colleges are graduating only 41,000.

#### I. Situation report

However, corporate recruiters, campus placement counselors, and personnel agencies across the country confirm that demand is slowing. In Southern California, where EE's were once as sought after as seven-foot basketball players, significant changes are occurring.

"Last year, we had openings for 30 or 40 EE's, but now we're down to about half that number," says Frank McCarter, employment manager for the Guidance and Control

Systems division of Litton Industries Inc. "Business has dropped off, so now we have a larger staff to do the same amount of work."

Robert Martin, employment director at the Hughes Aircraft Co., says "We're still looking for engineers, but the picture isn't what it was a year ago." The phasing out of the Surveyor program and the Navy's apparent intention to jettison its controversial F-111B aircraft for which Hughes was to supply the avionics and missile systems complicates the company's hiring situation.

Along with a number of his industry fellows, Martin expects to fill what openings exist with home-grown talent. "It's cheaper and



## ... firms have been very resourceful in holding down turnover costs ...

more effective to recruit locally," he says.

**Delayed action.** Up the coast in the San Francisco Bay area, John M. Harris, the head of Harris Associates, a technical employment agency, foresees problems. "At the moment, there are fewer unemployed EE's than there were last year," he says. "However, I anticipate an increase in unemployment in electronics within the next six months. We have already seen a slump in demand."

Back East, Thomas W. Harrington, director of placement at the Massachusetts Institute of Technology, says: "It's hard to tell exactly what's happening, but I suspect we're getting into a buyers' market because of cutbacks in research and development funding. The demand for quality is still high, but quantity needs are down."

Robert Condon, personnel manager at Microwave Associates Inc., agrees: "The situation is quieter on both coasts. We will continue to need good people—but to a lesser degree than we have in the past." He believes there are more engineers in the market, noting that "I'm getting more walk-ins."

At Sylvania Electronic Systems,

a division of Sylvania Electric Products Inc., Richard S. Osterberg, manager of industrial relations, feels that the stockpiling of EE's is on the way out. Very simply, he says, "It costs too much." With cost-plus-fixed-fee contract awards, "there's no way you can hide engineers until you need them."

A source at a Midwestern instrument house echoes Osterberg's sentiments: "As a result of Vietnam-induced uncertainties, the big aerospace and electronics firms aren't mounting any national body-snatching campaigns this year."

### II. Settling for less

Some firms are compromising hitherto rigid hiring policies when filling jobs requiring little creativity. At the Raytheon Co., for example, a spokesman says, "As our needs increase, we're forced to dip farther down in the barrel. But a lot of jobs don't really require top men. In some cases, it's better not to hire them since the work would be below their capacity."

John Evans, personnel director at the Bendix Corp. in Detroit, is thinking along the same lines. "Maybe the time has come to look at just how the engineer is being

used," he says. "We'll be checking on just what's involved in hiring two-year people with associate degrees."

**Shuffles.** Besides freeing better trained engineers for more creative assignments, in-house shifting of technical personnel can hold down the costs associated with turnover. And in this area, a number of electronics and aerospace firms have exhibited resourcefulness.

At the Westinghouse Electric Corp., for example, C.T. Hamilton, recruiting administrator, says, "We avoid simultaneous hiring and firing by using an in-house manpower registry system. Opportunities for professional engineering employees who may be involved in shifts as a result of program completions are published regularly." Recently, a number of EE's moved from the company's Cheswick, Pa., facility to the nearby Youngwood Semiconductor division.

Texas Instruments runs a job opportunity program in which all openings at domestic installations are advertised in the company newspaper. Employees can bid on any job for which they consider themselves qualified. If they're accepted, TI underwrites the necessary transfer expenses. Since last June, when the program was launched, well over 2,000 employees have made switches. An estimated 25% of this number were engineers.

The Convair division of the General Dynamics Corp. has a similar policy in regard to employees stationed around Cape Kennedy. As activities along the Eastern Test Range are throttled back, the "seasoned hands" are being snapped up by other corporate divisions, according to Ken Newton, Convair's Cape Kennedy manager.

**Odd man out.** With the rollout of the giant C-5A transport set for next month, the demand for engineers at the Lockheed-Georgia Co., a division of the Lockheed Aircraft Corp., has long since passed its peak. In recent months, 1,500 contract engineers and 200 staffers have been let go. However, for the latter group, Lockheed has invoked its "employment in reverse" program—an effort to place surplus engineers at other Lockheed divisions or with one of 60 companies expressing an interest in hiring



**Enough's enough.** Due to uncertainties stemming from the Vietnam War, firms are less apt to stockpile engineers in anticipation of contracts.



them. Rick Green, employment manager at Lockheed-Georgia, says the company is also checking the feasibility of lending out potentially surplus engineers pending decisions on civilian programs that may develop from the C-5A.

On the West Coast, Robert Bird-sall, personnel manager at the Lockheed Missiles and Space Co., Sunnyvale, Calif., says his firm is working on a plan to lease engineers within the aerospace industry. "We feel companies in the field should help each other during

Calif., "is spending more money." His plaint is echoed by personnel managers across the country. Philip Oliver, industrial relations manager for the Western Development Laboratories of the Philco-Ford Corp., estimates that it costs between \$1,200 and \$1,500 to recruit an engineer—exclusive of any moving expenses that may be involved.

In Houston, where the Manned Space Flight Center is located, H. S. McDonald, who oversees Philco-Ford's employment activities in the area, notes that his com-

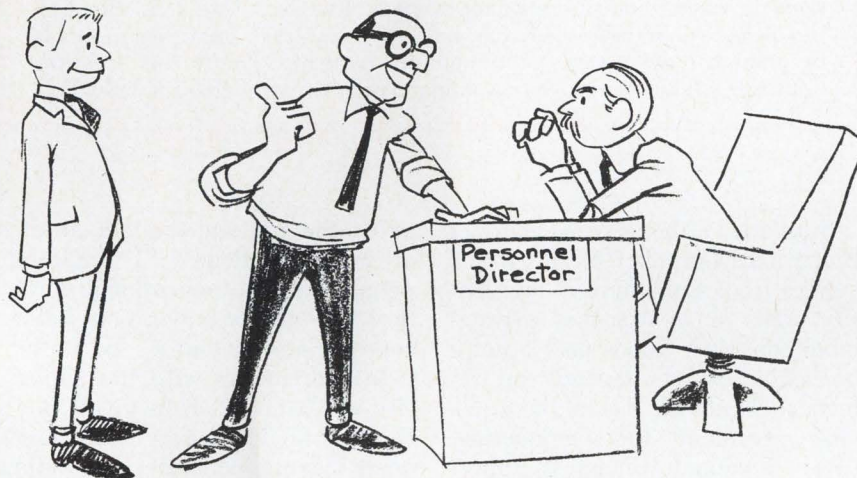

**Over the transom.** With recruiting costs rising fast, many companies find that referrals are their best source of new engineering talent.

peaks and plateaus," he says. "The situation on proprietary information would be no worse than it is already with job-hoppers."

While firms looking for EE's with experience and specific skills still lean on such time-honored recruiting methods as newspaper and trade journal advertising, flying visits to industrial areas, and career centers at conventions, a large number are willing to try new approaches. The Hoffman Electronics Corp., El Monte, Calif., for example, has been using radio spot ads with good effect. Robert L. Landee, the company's general manager, recorded a message outlining opportunities and providing a number to call collect. Response to the commercial, broadcast over the CBS outlet in Los Angeles, has been good, say company officials.

Spiraling costs are at the root of recruiters' willingness to experiment. "What I'm doing differently this year" says John R. Doolittle, director of employee relations at the Ampex Corp., Redwood City,

pany had trouble getting the sort of engineers it needed from local universities until recent years. Last year, largely to cut down on the expense of using "headhunters," Philco-Ford's Houston operations joined forces with four other area employers—the Lockheed Electronics Co., the National Aeronautics and Space Administration, the Link group of General Precision Systems, Inc., and the Federal Electric division of the International Telephone & Telegraph Corp.—in a joint recruiting venture. The idea was to set up a mutually advantageous exchange of qualified applicants. But while NASA and Philco-Ford expressed satisfaction with the results of the consortium, the other three did not, and the idea came a cropper.

**Friendly persuasion.** Many firms are finding that relief from the difficulties of recruiting comes in over the transom. "Referrals are unexpectedly the most productive method of hiring engineers," says a source at Raytheon.

**Precise dimensional accuracy, one step, ceramic-to-glass-to-metal thermo-bonding and Mil-spec quality standards, provide optimum performance and maximum design freedom in microcircuit packaging.**

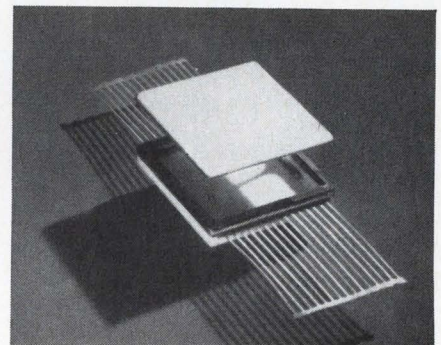

**TYPICAL CONFIGURATIONS**

Available in closed and "see-through" types.

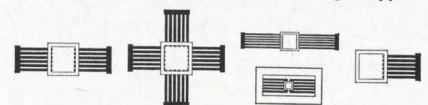

**WRITE FOR "MICROCIRCUIT PACKAGES"**



This brochure tells the Tung-Sol Flat Pack story in eight fully detailed pages.

TUNG-SOL DIVISION, Wagner Electric Corporation, One Summer Avenue, Newark, N.J. 07104.

**TUNG-SOL "FLAT PACKS"**  
MICROCIRCUIT PACKAGES





# COMPACT POWER PACKS

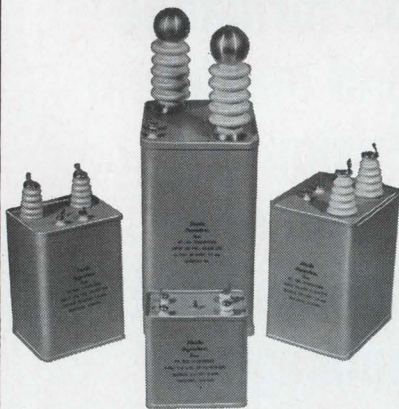

## The new Compact "M" Series Power Packs offer you:

- Rated output voltages from 1000 to 75,000 DC
- Rated output currents of 1.5, 5, and 10 milliamperes
- Input voltages of 118, 220, 230, and 240 volts AC
- Variable output from 0 to rated voltage
- Input frequency range 50 to 500 CPS
- Output ripple 1% RMS at rated voltage
- Hermetically sealed construction

Why pay more, and settle for less... PC's new compact power packs give more quality, more versatility, more dependability, plus smaller size, and best of all, most sizes are available in stock to meet your immediate needs.

Write for complete information and new catalog today!



**Plastic Capacitors, INC.**

2620 N. Clybourn • Chicago 14, Ill.  
DI 8-3735

## Young EE's feel a draft

After several months of waiting for other shoes to drop here and in Vietnam, young electrical engineers in school and industry found out just where they stand with regard to Selective Service two weeks ago when the National Security Council abolished most deferments for graduate study and suspended occupational exemptions.

If the outraged cries of educators are to be believed, the move will hurt graduate schools' enrollment. The presumption is many young men are willing to take their chances in industry now that working toward advanced degrees provides no shelter from military service. Electronics and aerospace firms, in particular, are finding that while their recruiters are making fewer offers to seniors, they are getting more acceptances than in previous years.

But prospective grads seeking shelter with firms doing defense work are apparently due for a disappointment. While local boards will continue to have wide discretionary powers, Lt. Gen. Lewis B. Hershey, the Selective Service chief, has made it clear that exemptions should be granted only in cases of community hardship. Under this stricture, draft-age engineers working on military projects are liable for induction.

Similarly, the Wells-Gardner Electronics Corp. in Chicago, which suffers from something of an identity crisis since it makes private-label consumer goods and is not a household word, depends on referrals. Chadwick Pierce, the firm's vice president for engineering, says: "Personal contact is important to us. We attend society meetings as well as keeping in touch through our employees. Quite often, when a man is dissatisfied with his situation, he'll come and talk to us."

**Rifle shots.** Along with a number of smaller outfits, the Jerrold Electronics Corp., a General Instruments Corp. subsidiary that makes cable-antenna television gear and operates systems, emphasize its selectivity. "Unlike the bigger firms, we don't sweep up EE's" says Marvin J. Krantz, director of the Philadelphia firm's industrial relations. "We try to match the man to the job."

### III. To have and to hold

Many firms are going to great lengths to keep their EE's on the payroll. The Autonetics division of the North American Rockwell Corp., for one, has been successful in using education as an inducement to stay. Eugene F. Brunetti, the Anaheim, Calif., unit's administrator of professional employment, attributes the company's modest attrition rate to the availability of in-house courses in engineering and the sciences, as well

as to the underwriting of studies at nearby colleges. "I think our people take the educational opportunities into consideration before contemplating a move," he says.

In cooperation with the University of Colorado, Honeywell Inc.'s Denver facility offers staff engineers videotaped courses providing graduate credits. Classes are taped at the university and screened two days later at the plant during working hours. At the moment, 32 Honeywell engineers are enrolled. "This program has been a tremendous incentive for our engineers here," says Will Volkmer, director of training.

A similar in-plant educational tv program has been set up in the Dallas area. Southern Methodist University beams graduate courses into TI, LTV Inc., General Dynamics, and the Collins Radio Co. for the edification of engineers.

Engineers are being pampered in other ways. At the Denver division of the Martin-Marietta Corp., for instance, they're no longer herded into bullpens. Robert Greer, who heads recruitment and employment activities, says, "We're going to a modular concept with each engineer assigned to a cubicle of his own."

### IV. Scholarly approach

For all the retrenching in industry, the campuses are still a hotbed of recruiting activity. But this year there are fewer offers and more acceptances.



From Cambridge, Mass., to Berkeley, Calif., college placement directors report company representatives are swarming to their campuses, though with fewer offers in their briefcases. The situation at Cleveland's Case Western Reserve University is typical: almost 600 firms will be checking in this spring, according to Dale Barbee, director of student placement, 100 more than came last year. Among others, the University of Washington, Northwestern University, MIT, the Illinois Institute of Technology, Georgia Tech, and the University of California at Los Angeles report comparable increases.

**Customized.** One big reason for wooing grads is future needs. "If we don't train engineers ourselves, we won't get what we need," says Robert McNamara, a recruiting manager for the Laboratory for Electronics Inc. in Boston. Another reason is that local institutions are doing a better job of tailoring their output to the needs of the area. In Houston, for example, Philco-Ford says it's able to satisfy its needs largely by tapping talent at nearby campuses; five years ago, the company was forced to mount a nationwide campaign.

John E. Jones, placement center director at the University of Southern California puts it this way: "We're trying to serve Los Angeles and Southern California com-

panies first, then others."

Despite their obvious regional bias, pragmatic recruiters still cast nationwide nets. Litton's McCarter concedes that "there are a certain number of Eastern companies with men we're interested in. We go back about once every two months." Another reason for keeping the hunt nationwide is the attitude of engineers themselves. "Employees tend to identify with their field and profession rather than a particular company," says a source at the Blue Bell, Pa., facility of the Sperry Rand Corp.'s Univac division. "Few are inclined to stick around for pensions."

Autonetics' Brunetti agrees. "Though the industry has stabilized during the past six months, engineers will pick up and go where the action is, providing such other factors as pay and location are equal," he says.

There are, however, limits to geographic mobility. Sylvania's Osterberg points out that EE's with school-age children will put up with a lot to stay in a particular area. "But younger men without burdensome family responsibilities are generally willing to move."

**Hardship post.** Apparently, certain locations are more attractive than others to engineers, and recruiters are ruefully sensitive about the presumed shortcomings of their bailiwicks. The Control Data

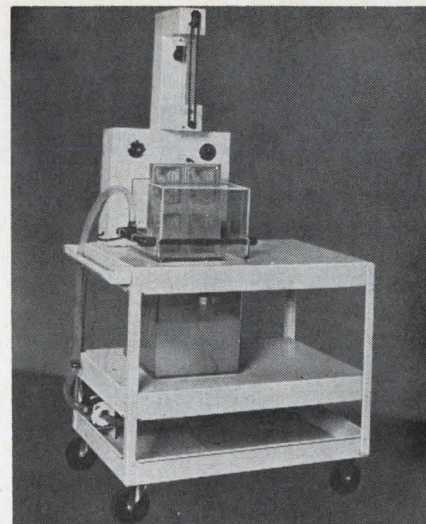

## "fine line" etcher

for prototypes—limited runs

Model No. 201 (illus.), etches two 11" x 14" one-sided boards or one 11" x 14" two-sided board: **\$795** Pat. applied for

**ETCH YOUR OWN  
P C BOARDS  
AUTOMATICALLY**  
(in less than 5 minutes)

from this →  
to 11" x 14"

Shown Actual Size

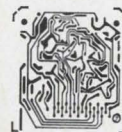

- No cooling or venting required!
- Etches as fine as .001"!
- Cuts costs in half—saves time!
- Complete photo processing instructions!
- Work is illuminated while etching!
- No patterning . . . minimum undercutting!

### NOW IN USE BY:

AMP, Inc.  
Ampex Corp.  
Atomic Energy Com.  
Bendix  
Charles Bruning  
Esso Research  
General Dynamics  
General Electric  
IBM  
ITT  
Lear Siegler  
Magnavox  
Micro Switch  
NASA  
Owens-Illinois

Sprague Electric  
Union Carbide  
U.S. Air Force  
Western Electric  
Whirlpool  
M.I.T.  
Oklahoma State U.  
Purdue Univ.  
Washington Univ.  
Univ. of Calif.  
Univ. of Chicago  
Univ. of Colorado  
Univ. of Georgia  
Univ. of Hawaii  
Univ. of Penn.

## CYCLO-TRONICS, INC.

3858 N. CICERO — CHICAGO, ILL. 60641  
TELEPHONE: (312)-282-6141

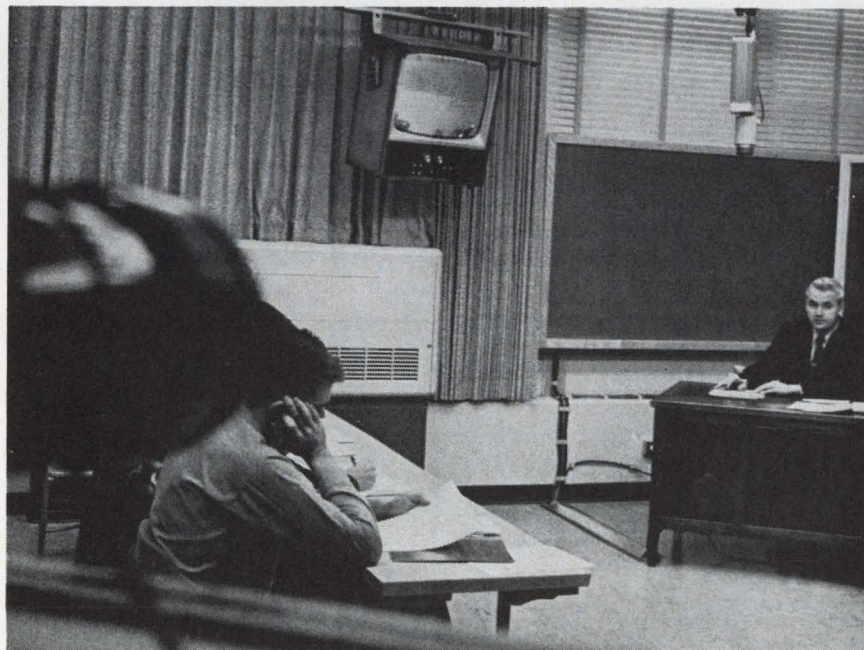

**School days.** Graduate electrical engineering course being videotaped at Colorado State will be played back two days later for Honeywell Inc. employees in Denver, Southern Methodist has a similar setup in Dallas.



# WE TURNED ON THE IC INDUSTRY

## No Wonder We're No. 1 in 1 MHz Capacitance Bridges



We can't say what the IC boys would have done without us. The fact is, we came along with a fine 1 MHz capacitance measuring tool that filled the bill precisely when it was needed. The measurement capability of our three-terminal bridges, under almost any conceivable conditions, still turns on the IC people . . . and the diode and transistor people . . . and the capacitor people . . . and lots of other people.

It's not surprising when you look into it: bridge, oscillator, and detector all in one handy box . . . low millivolt test levels and dual dc bias . . . a needle-sharp detector that gives balance direction even at extreme off-range settings . . . and, for good measure, a new differential detector for capacitance sorting. (By the way, our bridges have civilized panel meters rather than clumsy headphones).

We don't stop there either. We even make a 1 MHz Capacitance Limit Bridge with programmable tolerance settings that flashes out a "high," "go," or "low" indication in 50 ms and, with the flip of a switch, doubles as a regular manual bridge as well.

What's more, you can have all this over a capacitance range from 0.00005 pF to 1000 pF (or 0.1  $\mu$ F with our range extender).

If you've gotten this far, you must be interested. So, send for the specs\* and see for yourself why we are No. 1 with the IC boys . . . and almost everybody else who measures capacitance at 1 MHz.

\*We'll throw in specs on our other Capacitance Bridges and Meters, too.

**BOONTON  
ELECTRONICS**  
CORPORATION

ROUTE 287  
PARSIPPANY, N.J. 07054  
Telephone: 201-887-5110  
TWX: 710-986-8241

IEEE: BOOTHS 2E 46-50

Corp.'s Minneapolis man, for example, says many prospects view the company's location as the ice-box of the U.S. Similarly, a Philco-Ford source cites Houston's reputation as the Calcutta of the Southwest. And a spokesman at the Corning Glass Works in upstate New York says, "We lose a lot of talented young EE's simply because they don't want to live and work in East Nowheresville."

Not all engineers have readily transferable skills, however. "The man who works at Cape Kennedy is a different breed of cat," says Harold Roberts of the Florida State Employment Service. "He's oriented toward troubleshooting and checking out hardware rather than design." Roberts feels such men, accustomed as they are to the fat salaries paid for front-line space work, will have a difficult time adjusting to another kind of setup. Even if manufacturing concerns were willing to take them on and retrain them, Roberts says, these engineers would be loath to move.

**Drawing wages.** Salaries are still on the rise throughout the industry, and variations in pay scales from region to region are generally smaller than in years past. Beginners right out of school with only a bachelor's degree can count on earning \$750 or so a month. Those with master's degrees get about \$100 more. Depending on their specialty, Ph.D.'s \$10,000 and up a year.

Jack Yelverton, a partner in the San Francisco employment firm of Wilkinson, Sedgwick & Yelverton, feels that the competition for engineering grads is now only about half what it was a year ago, a situation that will tend to deflate starting salaries. "For some years, the bottom end of the maturity curve has been catching up with the top," he explains. In other words, the salary paid a man five years out of college has been almost overtaken by that paid a new grad. And something has to give.

Contributions to this report were made by Walter Barney, William Arnold, and Peter Vogel in San Francisco; Lawrence Curran in Los Angeles; James Brinton in Boston; Howard Wolff in New York; Lisa Lazorko in Philadelphia; Robert Coram in Atlanta; James Rubenstein in Chicago; Tom Jacobs in Cleveland; Marvin Reid in Dallas; Robert Lee in Houston; Vincent Courtenay in Detroit; Barbara Koval in Pittsburgh; Ray Bloomberg in Seattle; Sue Butler at Cape Kennedy; Frank Pitman in Denver; and Paul Dickson in Washington.





SEEKING SOLUTIONS  
**TO FUSEHOLDER  
 PROBLEMS?...**  
*YOU'LL GET THE  
 RIGHT ANSWERS FROM*  
**BUSS**

Panel mounted, in-the-line, lamp indicating, signal activating, visual indicating fuseholders—with solder terminals, quick-connect terminals or special terminals—for fuses from  $\frac{1}{4}$  x  $\frac{5}{8}$  inches and larger.

Fuseholders of various types to meet Commercial and Military specifications.

For full information on the many small dimension fuse mountings and companion fuses available from BUSS... write for BUSS Bulletin SFB.

**BUSSMANN MFG. DIVISION, McGraw-Edison Co., St. Louis, Mo. 63107**

**SEE US AT THE  
 IEEE SHOW  
 BOOTH 3B-24**

**BUSS:** Makers of the complete line of fuses, blocks and holders of unquestioned high quality.

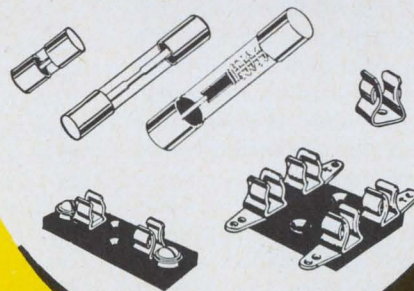

Supplied the Economical Way—  
 thru Distributors

**BUSS QUALITY**



Report from

**BELL  
LABORATORIES**

# Movies via computer

**Abstract or complex concepts are difficult to communicate. Often they are best grasped visually—particularly through animated films. But making such movies has been tedious and expensive. At Bell Laboratories, therefore, we are experimenting with movies by photographing computer-controlled cathode-ray tubes. Not only is this more efficient than traditional methods, for many kinds of movies, but the computer can sometimes reveal motions and shapes which are otherwise concealed in masses of data. Here are examples of our work.**

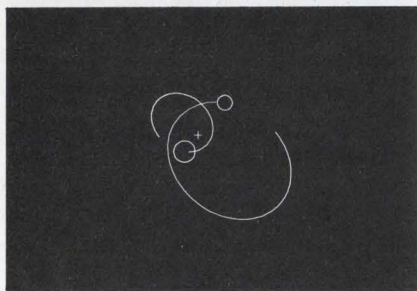
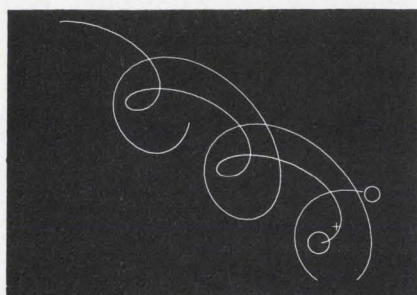

"Force, Mass, and Motion," an educational film by F. W. Sinden, shows how gravity-like forces and inertia affect bodies with various initial velocities. This interplay is hard to visualize, but is clear on the screen. It produces the curves in the upper picture, one frame from the movie. This film, costly with conventional animation, is inexpensive here because the computer makes pictures by solving equations.

In one sense, the computer movie is a "perfect laboratory"; it demonstrates exactly how our mathematical models would behave and helps us to look for imperfections in our experimental apparatus when we do go ahead in the laboratory.

The lower picture is another frame from the movie. Here the program was slightly altered to view the system from a reference frame moving with the center of mass. The apparently complex curves traced by the bodies in the upper picture turn out in the lower one to be ellipses moving together linearly.

K. C. Knowlton's BEFLIX (Bell flicks) is a computer program whose input is a description of the desired movie in the language of the filmmaker: CAMERA, DISSOLVE, ZOOM. Its output is a magnetic tape containing an encoding of pictures. These are subsequently displayed on a cathode-ray tube where they are photographed.

The BEFLIX picture is a rectangular array of dots; the intensity of each can vary through eight levels. The filmmaker can tell BEFLIX that lines or arcs should be drawn, areas "painted" various shades of gray, displayed shapes moved in various directions, and the like. There is an assortment of letter sizes and faces for titling.

The frames below were produced in the BEFLIX language. The first is from a movie describing BEFLIX itself. The second is from a movie about a new programming language produced at Bell Laboratories. In this film, animated "bugs" demonstrate how information is moved around in the computer.

In this new method of animation, both film motion and display on the tube can be controlled automatically by information on a magnetic tape.

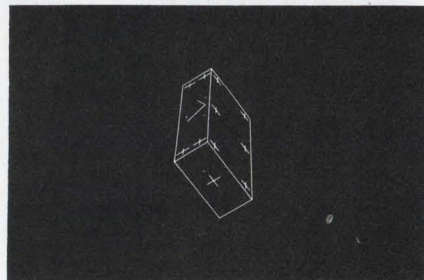
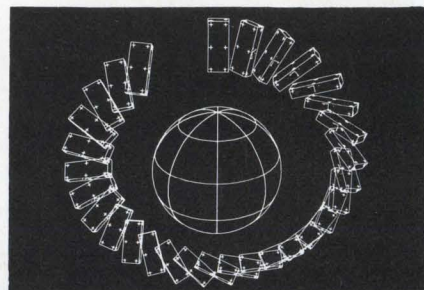
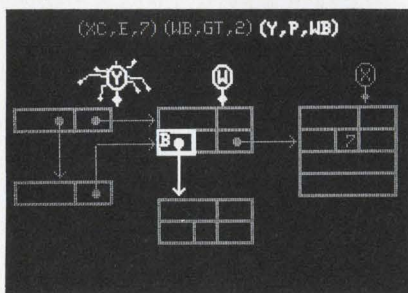
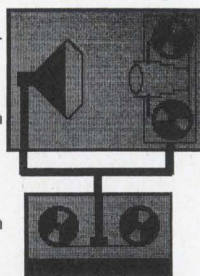

A movie by E. E. Zajac demonstrates the effects of gravity in keeping a communications satellite facing the Earth. Satellite motion is described by complicated differential equations. They can be solved on a computer, but the resulting list of numbers is almost incomprehensible. In the movie, however, the dynamics of satellite motion—stability, orientation, and time—are instantly visible.

The pictures show two parts of the movie. At top, the stylized satellite-Earth system is seen from a position fixed relative to Earth (thirty selected frames are superimposed). The lower picture shows the satellite from a position orbiting with it. This is an advantage of computer movie-making: the second viewpoint required only relatively minor program changes.

The film was "reshot" several times to show the effects of various stabilizing parameters.



**Bell Telephone Laboratories**  
Research and Development Unit of the Bell System



# Pacing ultrahigh-speed computers

Work continues on devices and machines operating in the microwave range in the quest for even faster, high performance data processing equipment

By Wallace B. Riley

Computer editor

**Scientists trying** to make faster, high-performance computers have long since found the speed of light an ultimate limit. But around the world a lot of them are still pushing ahead with ultrahigh-speed data-processing work. Much of it isn't even with hardware in mind, but just out of interest in speed for its own sake, hope of inventive fallout, eagerness to solve a particular problem, or simple scientific curiosity.

Some research teams are designing devices and equipment to operate at hitherto unprecedented speeds. Others are seeking to develop computer organizations that capitalize on effects significant only at frequencies approaching those of light.

## I. New leaf

John A. Copeland, a scientist with the Bell Telephone Laboratories, a subsidiary of the American Telephone & Telegraph Co., heads a project using techniques in the gigahertz, or microwave, frequency range. Copeland hopes to develop Gunn-effect and related devices rather than find specific digital applications. Already, he has come up with switching circuits having 10-nanosecond propagation delay times, and is now at work on devices in the 0.5-to-1-nsec range.

While Copeland is not interested in applications, AT&T's manufacturing arm, the Western Electric Co., is. The firm is developing a pulse-code-modulation system with a transmission rate of 250 megabits per second, and wants to expand the rate into the 1-to-3-gigabit range, using an assembly like Copeland's.

One big advantage in using a Gunn-effect source for microwaves,

Copeland says, is that the device can be turned on and off quickly enough to produce a 1-cycle pulse. Thus, the source can generate single fast pulses rather than wave trains that rise and fall relatively slowly. It is impossible to get a 1-cycle pulse with other microwave assemblies.

Experimental work on high-speed devices is also being done at the International Business Machines Corp.'s laboratories in Yorktown Heights, N.Y. A research group, headed by Arnold Reisman, has produced comparatively conventional semiconductor circuits with switching times of less than 250 picoseconds, using germanium rather than silicon.

**Sardine syndrome.** Devices made from germanium—the leading semiconductor material of the 1950's—can operate at higher speed than silicon assemblies. However, commercial planar techniques are practicable only with silicon, which has superior temperature stability characteristics. Though capable of higher speeds, germanium was left in the backwash. At ultrahigh speeds, however, the time required

to propagate signals among active devices becomes critical. Elements must be crammed close together to take advantage of the full speed potential.

Closely packed circuits generate large quantities of heat per unit area, says Reisman. As a result, different devices on the same chip or on adjacent chips, being pulsed at different rates, may have significantly different temperatures. Although silicon is stable up to 150° or even 200° C, two such elements operating at different temperatures behave like two different materials. This is because silicon's band gap—the difference in energy between electrons in the conduction band and those in the valence band—shrinks as temperature rises. Reisman says that since silicon-based devices must be externally cooled to keep them at uniform temperatures, it's just as easy to cool them all the way down to room temperature.

**Tradeoffs.** But at room temperature, 25° C, silicon has no particular advantage over germanium. As a result, the latter material is attractive to researchers. Techniques have even been devised to make planar devices with germanium, Reisman says. Germanium operates well at any temperature below 40° C. Furthermore, it can be used at cryogenic levels where the reliability of metal interconnections between chips improves by a factor as high as one million [Electronics, Feb. 5, p. 47].

Another consideration, Reisman says, is the transmission-line properties of conductors on chips. Elements can't be connected by a wire because a wire acts like an antenna, radiating rather than conducting energy. Tiny strip lines



**Foreign matter.** Daniel Maeder is working on a 500-megahertz memory unit at the University of Geneva.



## ... high-speed work is not exclusively the province of American scientists ...

must be used. However, because of the electrical characteristics of semiconductors, including germanium, extended transmission lines are hard to build. But it's comparatively simple to link two or more chips. It is thus preferable to have  $x$  circuits per chip on 100 chips than  $100x$  circuits on one big wafer. At high speeds, large-scale integration is better defined in terms of density than of chip size or number of devices per chip.

**Split seconds.** Measuring the switching time of a high-speed circuit is at least as difficult a job as developing an assembly. A. S. Farber, a colleague of Reisman's, has, however, devised a technique. He adds precise nanosecond delays to picosecond devices and measures the differential output to determine the basic switching time. Determining the difference between say, 10,500 and 10,750 picoseconds (10.50 and 10.75 nanoseconds) is easier than directly measuring 250 picoseconds—the time required for light to travel 3 inches.

### II. Swiss movement

High-speed work is not exclusive with U.S. scientists. In Europe, for example, Daniel Maeder, a professor with the electronics group at the University of Geneva's Institute of Experimental Nuclear Physics, has connected a 500-megahertz memory to an IBM 1800 computer. This machine's standard memory operates at only 1/1,000 that rate.

Maeder's memory is simple, being a coiled piece of coaxial cable with circuitry to load information into one end for withdrawal at the other. The cable is 30 meters long and 100 millimeters in diameter; it takes about 100 nsec for a pulse to get from one end to the other. At the 500-Mhz rate, therefore, approximately 50 signals that are 2 nsec wide can be put in at one end before they begin to show up at the other end. These signals can be generated by any high-speed source for analysis by the computer. Or, they can be recirculated in the cable for as long as necessary, then taken out a few at a time for analysis at conventional speeds.

Maeder's approach is essentially a souped-up version of the acoustic delay line first used 20 years ago and now widely used in electronic desk calculators. Acoustic devices operate in the millisecond range—at a speed some three to six orders of magnitude slower than the coaxial cable.

**Trio.** Maeder hopes to beef up his devices to perform high-speed computations as well as straightforward storage. For example, to multiply two floating-point numbers, he could use three coaxial cables—one for the multiplier, one for the multiplicand, and one for the product. Under control of the multiplier, the bits of the multiplicand would be shifted out of the cable one at a time as they recirculated, adding to the gradually growing product circulating in the third cable. The completed result could then be removed from the third cable in groups of eight bits and stored in the IBM 1800's conventional memory.

An attempt to apply microwave frequencies to data processing was made in the late 1950's by several commercial outfits under a contract from the Navy's Bureau of Ships. They used the code name of Project Lightning. Ways to switch microwave carrier frequencies, and hence to build logic circuits and digital systems from microwave

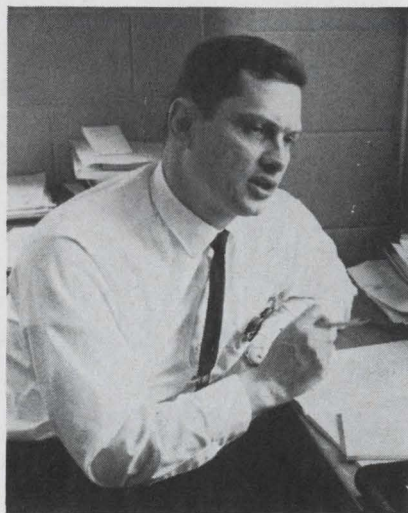

**Researcher.** Thomas A. Kriz, a doctoral candidate at Marquette, hopes to build a computer capitalizing on microwaves.

components, were checked. However, the use of carrier frequencies proved to be inconveniently complex, so the project was dropped. One major difficulty was in providing a one-way element—such as a transistor or vacuum tube—for microwave switching. Another problem was the physical size of the required waveguide networks. The subsequent development of strip transmission lines has largely overcome the plumbing objection.

**Model.** Investigators at Syracuse University have just completed a year-long investigation under a contract from the Army Electronics Command, Fort Monmouth, N.J., in which they worked out the properties of phase-shift strip-line devices and other microwave components. The proposed assemblies could be used in data processing systems. However, the contract was only for the study of mathematical models; no hardware was built. Funds are not available for continuing the work.

Two of the Syracuse men, Hugh Hair and Carl Gerst, have since formed their own company, Anaren Microwave, which is making components. While they are not concerned directly with data processing applications, their products could be used in computers. Says Hair, "Our phase discriminator could, for example, be applied to such things as automatic Smith chart plotting (a method of solving transmission-line and waveguide problems), single-pulse frequency measurement, or instant direction finding."

**Skeptic.** Hair feels that anyone who tries to apply microwave technology to conventionally organized computers is making a serious mistake. "This would require an unattainable clock skew accuracy," he says. [Clock skew is the departure from perfect synchronism of clock pulses.] "Nevertheless, microwaves have an inherent capacity to perform correlation functions like calculating Fourier transforms with a passive matrix or processing radar or communications signals in other ways," says Hair.

### III. A new approach

Thomas A. Kriz, a graduate student at Marquette University, Mil-



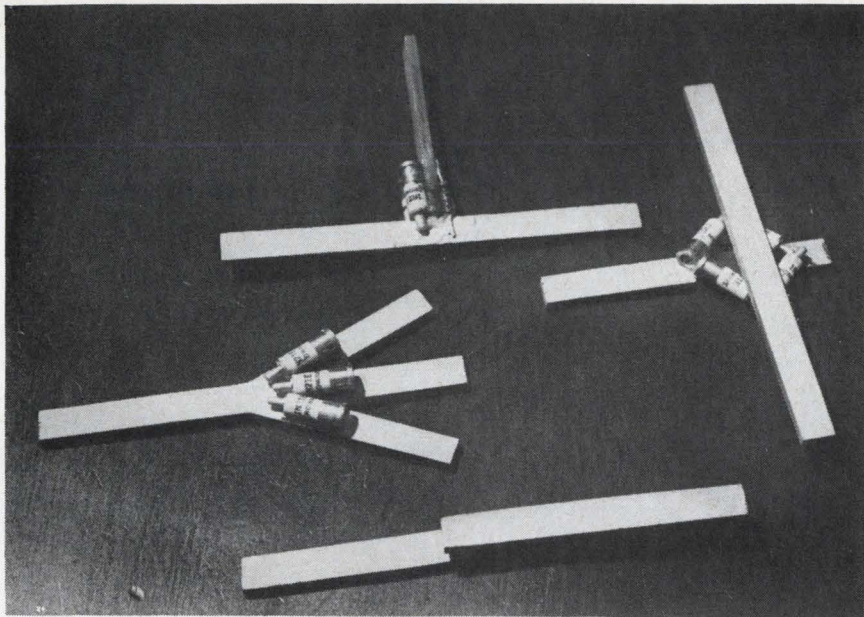

**Assortment.** Logic blocks for demonstration microwave computer are made of Fiberglass that's coated with conductive paint and point-contact diodes.

waukee, is undaunted. As part of his work toward a doctorate, Kriz has designed and hopes shortly to build a small demonstration machine called Marquic I. It will retain essentially the classic general-purpose outlines, but capitalize on the unique properties of microwaves to process data at hitherto unreachable speeds.

Kriz' technique calls for a conventional ferrite-core memory and conventional input-output devices to be connected to multiplexing networks. These assemblies route the data to and from a relatively simple logic network of interconnected transmission lines and diodes. One form of organization under consideration uses only two NOR blocks. These are time-shared by all logic functions at gigahertz speed to process data transferred in and out of a "slow" memory operating in the microsecond range.

#### IV. Route step

With this organization, one or more memory cycles would produce data to fill up the primary input buffer, the contents of which are then multiplexed into the ultra-simple logic network, through the output multiplexer, and thence into the output buffer. From there the data can be cycled back either to the input buffer or to the memory. Most conventional computational steps require many logic cycles be-

fore results are returned to the memory.

**Converging.** Kriz' simple input multiplexer consists of: input signal lines for each bit to be multiplexed; control lines to select the various inputs; and ferrite cores linking the respective control lines to the proper signal lines. Each input line is biased to one of two binary values by a flip-flop in an input buffer. A pulse on a control line, linked to one or more input lines, gets to the output line through a diode switch if the input line is biased properly.

The output multiplexer is similar, but steers pulses from one or two inputs either to one of many flip-flops in an output buffer or back to the input multiplexer through a delay line. From the output buffer the data can be transferred back to the input unit for another pass or passed on to the computer's main memory.

For the ratio of machine cycles to memory cycles envisioned by Kriz, a single-stage multiplexer/buffer combination of, perhaps, 100 by 100 would be necessary. Assemblies of this size don't work very satisfactorily because of the number and degree of parasitics involved. For example, an output line with 100 diode switches connected to it would suffer from a heavy capacitive load, creating a mismatch that would cause unwanted pulse reflections in the mul-

**BRAMCO**  
TONE ACCESSORY BAND STOP FILTER  
Size: 9" x 4-1/2" x 1-1/4"

**BRAMCO**  
DUAL HIPASS-LOWPASS FILTER  
Size: 5/8" x 2-1/4" x 3-3/4"

**BRAMCO**  
TONE TELEGRAPH BANDPASS RECEIVE FILTER  
Size: 4-15/16" x 2-9/16" x 2-9/16"

RF20, CONTACTLESS RESONANT REED FILTER

**Bramco**  
**Custom Designed**  
**LC and**  
**Electromechanical**  
**Filters**  
**Operate from**  
**0 to 200 kHz**

At Bramco we specialize in custom engineering LC and electromechanical filters. We offer experience and speed. And our computer synthesis program makes sure you get optimum design and performance.

Write for helpful literature and data sheets...or outline your special requirements.

IEEE Booth #4B 17-21



**BRAMCO CONTROLS DIVISION,**  
**LEDEX INC.**

542 South Street, Piqua, Ohio 45356  
Phone (513) 773-8271



# BEST

FOR  
PROTECTIVE  
CUSTODY

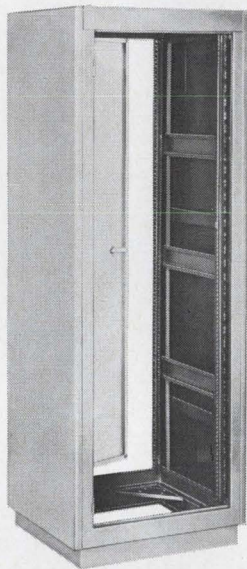

## SERIES SIXTY CABINET RACKS

● The most attractive and practical cabinet rack yet designed for housing a single piece of equipment or a large instrumentation system. All-welded, monolithic frame is capable of supporting the heaviest loads without structural fatigue or distortion.

Ordering Bud Series 60 Cabinet Racks eliminates the frustrating and time consuming procedure of selecting components to complete an enclosure. No assembly costs are incurred.

Bud Series 60 Cabinet Racks are available in 17 sizes. They are delivered ready for immediate use from your Bud Distributor. Ask him to tell you about Series 60. Write us for literature.



**BUD RADIO, INC.**  
Willoughby, Ohio 44094

your product  
*Belongs* in a BUD cabinet

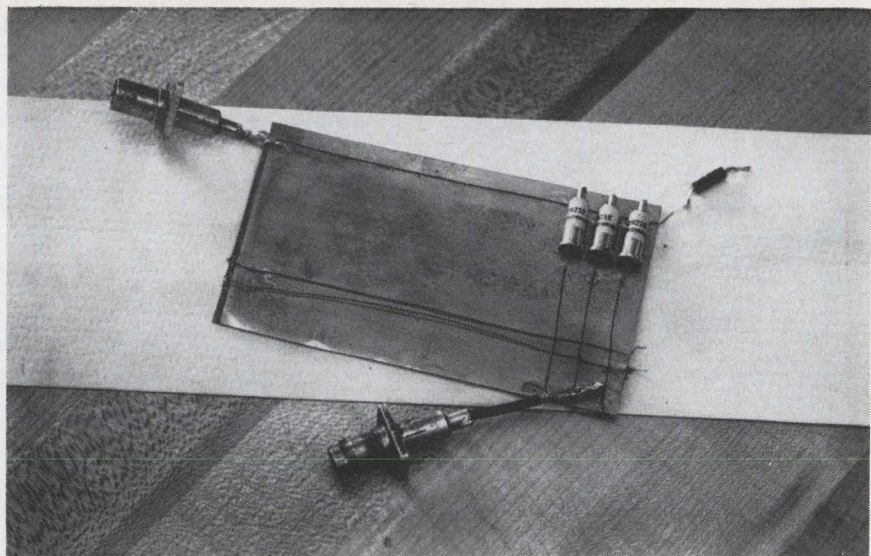

**Silver platter.** Experimental multiplexer for microwave computer has input signal and control lines with ferrite core links plus switching diodes.

tiplexer. Kriz plans to insert a smaller input buffer between the main one and a multiplexer closer to 10 by 10 in size, to do part of the multiplexing between the two buffers.

Other approaches to multiplexing have been considered; for example, the appropriate control pulse could be gated directly onto the output line through a diode bridge controlled by the input quantity. Such a multiplexer, however, would be considerably more expensive because of the number of diodes required.

**Microprogram.** The positioning of the cores in the input and output multiplexers and the order in which the control lines are pulsed constitute a microprogram that controls the operation of the entire computer. Kriz' microprogram design is considerably more complex in design than those used in conventional third-generation computers. However, the concept is fundamentally the same.

With this approach, an extreme degree of serial computation is necessary. Most computers, particularly the faster ones, process several bits at once along parallel paths that have common control circuits. Some low-cost computers have only one bit path. These machines generally operate at relatively low speeds. But Kriz is using microwave technology to design an ultraserial computer. His circuits are so fast that, although they process only one bit at a time,

they pass it through the data path many times to accomplish what an ordinary serial computer can do in one pass. Moreover, these circuits can keep up with what would ordinarily be a rather fast memory. Kriz mentions as many as 500 machine cycles for each memory cycle; this compares with a ratio of four or five to one in some third-generation computers and 15 or 20 to one in some of the old vacuum-tube machines whose memories had cores the size of Cheerios.

**Stop and go.** The secret of Kriz' organization is ultrafast logic. His basic logic block is simply a pair of transmission lines linked by a diode network. A signal on one of the transmission lines biases the diode network to either short-circuit or open-circuit the other transmission line. Then, a pulse of microwave energy traveling along the second line is transmitted, reflected, or simply obliterated when it encounters the biased diode.

### V. Two way

Kriz defines two forms of microwave logic: pulse reflection logic (PRL) and pulse transmission logic (PTL). With PRL, a pulse injected at the output of a transmission-line logic block travels backward along the line until it encounters a diode biased one way or the other by signals from the block's input. Depending on whether the output line is short-circuited or open-circuited, the pulse is reflected with or without inversion. Inversion indicates



whether the input conditions are or are not realized.

With PTL, a bridge connection between two transmission lines can be short-circuited or open-circuited by a signal on one of the lines. A short-circuited bridge permits the passage of a signal on the other line. A combination of bridges in series or parallel allows its logic functions to be implemented much the same as with relays. For example, an AND block passes a signal on the horizontal transmission line only if both diode bridges are biased forward. The horizontal line may contain another diode bridge that controls a third transmission line.

**Sole support.** With both PRL and PTL, signal sources are independent; for the former, there are separate generators at the input of each linked transmission line. Each pulse dies in its block's termination. The generators need not be physically separate devices; the energy can come from a single powerful source with appropriate distribution and delay networks, or from several synchronized sources. The generators are, however, separate as far as the logic functions in each block are concerned.

Kriz' separation of energy source and logic function produces a significant design advantage: the logic blocks themselves contain no active devices other than the diodes. Because the pulses are not propagated from block to block, they need not be amplified. As a result, the logic blocks can be essentially passive devices like relay contacts.

Kriz has fabricated a few sample logic blocks to test his theories on logic function generation. Essentially they are strips of Fiberglass cut to size and painted with conductive paint to make a piece of stripline. Point-contact microwave diodes are glued on in the proper places and pieces of stripline put together.

**Drawback.** The diodes present the major frequency limitation in Kriz' design. Strip transmission lines have bandwidths up to 10 gigahertz or more; run-of-the-mill diodes usually have recovery times of several hundred picoseconds, imposing a lower ceiling. Diodes with 25 psec recovery are available, but are expensive.

## BUD enclosure says something important about the DINADE by MICROLAB/FXR

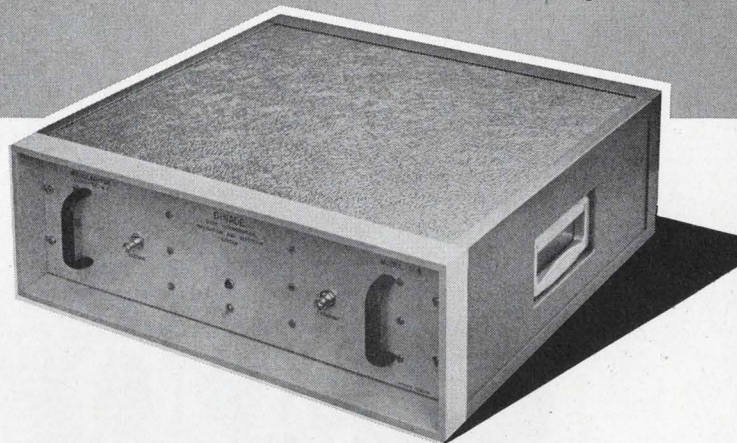

# CLASSIC CABINETS

After this important producer of electronic systems developed this sophisticated instrument, Bud Classic Cabinet was selected as the most distinguished enclosure to best portray the character of the device.

Classic Cabinets provide extra sales appeal by presenting an image designed to enhance the value of the contents. They offer an unusual opportunity for builders of electronic equipment to house their products to the best advantage. Available from stock in a selection of 15 sizes and two attractive vinyl textured finishes.

These cabinets are but one of thousands of our standard enclosures available for immediate delivery. Bud service also includes modifying standard products to meet your specific requirements and creating entirely new housings from your prints. Let your Authorized Bud Distributor outline what we have to offer. Our catalog is available upon request.



**BUD RADIO, INC.**  
Willoughby, Ohio 44094

your product *Belongs* in a BUD cabinet.





# .000500" GOLD

This is not a typographical error. Burndy's new printed circuit receptacle springs are clad to this thickness at point of contact.

Burndy has found a way to boost the reliability of ultraminiature connectors (.050" contact spacing) without unduly increasing the price.

Specially developed for a major computer manufacturer, the unusually thick gold coating is concentrated

on the springs at point of contact. Applied by Burndy's special "cladding" method, it makes possible a pore-free diffusion-proof surface, unequalled for corrosion resistance. Formed of gold flashed beryllium copper wire, the clad spring provides a connection with unusually stable contact resistance.

Burndy also makes a full line of PSE printed circuit connectors with springs gold plated to .000030 minimum for less critical applications. Samples of both are available for comparison tests.

Just write:

 **BURNDY**  
NORWALK, CONNECTICUT

INTERNATIONAL SALES HEADQUARTERS AND MANUFACTURING FACILITIES:  
CANADA: Scarboro, Ontario / ENGLAND: St. Helens, Lancs. / BELGIUM: Mechelen / MEXICO: Naucalpan de Juarez / BRAZIL: Sao Paulo / JAPAN: Tokyo / Sales Offices in Other Major Cities

170 Circle 170 on reader service card

Electronics | March 4, 1968



# Automating the whole shooting match

Tacfire will replace Fadat, a system limited to ballistic calculations, by 1971 and improve Army field artillery's fire control and selection

By Lawrence Curran

Los Angeles bureau manager

**First-round accuracy**—the ability to put shell No. 1 close enough to a target to be effective—was a hit-and-miss proposition for Army artillerymen until electronic data processing equipment became available. At present, the service is making do with Fadat (for Field Artillery Digital Automatic Computer)—a machine limited to ballistics. However, by 1971 the Army will have equipment called Tacfire (for Tactical Fire Direction System) that will automate fire direction and selection by integrating all necessary data. This includes meteorological, trajectory, survey, and logistical information.

The prime contractor for Tacfire is Litton Industries Inc.'s Data Systems division in Van Nuys, Calif. To win the procurement plumb, worth an estimated \$122 million, the company had to beat out the International Business Machines Corp. and the Burroughs Corp. [Electronics, Nov. 13, 1967, p. 26].

**Triple play.** Litton's Tacfire contract has another objective besides providing for a fully automated field artillery force. A secondary aim is to produce a family of militarized, general-purpose digital equipment—plus software—which can be easily adapted to satisfy other tactical requirements for automatic data processing. For example, many of the Tacfire modules might be used in the still-to-be-defined Tactical Operations System (tos), scheduled for field introduction in 1974. The system, being worked on by the Control Data Corp., will provide field army, corps, and division commanders with current information and intelligence to assist them in making tactical operational decisions.

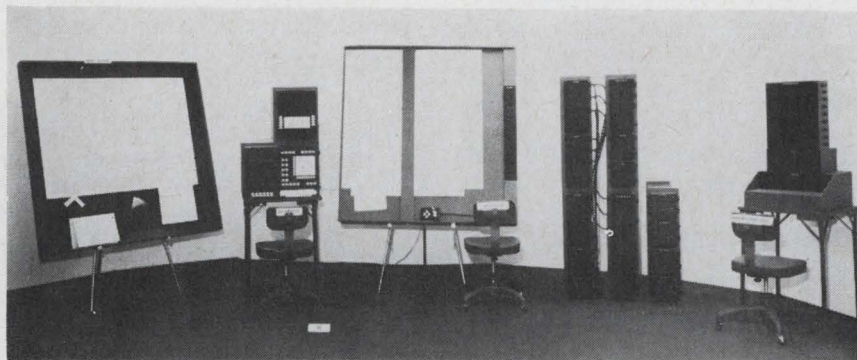

**Togetherness.** Electronic equipment for a Tacfire battalion fire-direction center includes (from left to right): an artillery control console with a medium-speed printer; data processing system; and a communications station.

Along with Tacfire, tos is part of the three-pronged approach to data processing that is administered by the U.S. Army Automatic Data Field Systems Command at Fort Belvoir, Va., in a program designated ADSAF (for Automatic Data Systems within the Army in the Field). The third facet—the combat service support system CS3—will eventually computerize control of a range of logistics, personnel, and related administrative data ranging from stock control to casualty reports.

Stanford Research Institute participated with Litton as a software consultant during the Tacfire contract-definition phase, but programming for the production contract will be handled by Informatics Inc. and the Planning Research Corp.

Litton's engineers are hoping to put Tacfire in the field by 1971. Until then, the Army will use Fadat. While this machine had a checkered development and production career, its field performances—including combat stints in Vietnam—have been praised by both the Army and industry. Fadat solves cannon and rocket trajectory

problems and—from meteorological and muzzle velocity inputs—tells what fuzes should be used.

George Romano, Litton's program manager on the Tacfire project is enthusiastic about Fadat, having seen it at the Army's Artillery and Guided Missile School in Fort Sill, Okla. Using Fadat, a howitzer crew put the first round right on target. "Fadat's a fine computer; its development is analogous to the progress involved in going from manual reckoning to a desk-top calculator," says Romano. "But Tacfire will be like going to a third-generation computer."

**School days.** Romano attributes Litton's success to responsiveness: "A couple of us attended the Senior Officers Artillery School last summer. And we learned a lot."

## I. Tacfire's tasks

Tacfire will automate in real time 24 separate functions of battalion and division fire-direction centers. Each function will have an individual computer program. Among these functions are: tactical and technical fire control (calculation of three-dimensional ballistics



# A-to-D Converters

... up to 12 bits  
... loaded with options



4½" x 2¾" x ¼"

- High-frequency FET input amplifier.
- Bipolar or unipolar input signals of varying ranges.
- Parallel and serial outputs of binary or BCD codes.
- TTL logic for high speed and fanout drive capability.
- Resolution up to one part in 4096 (12 bits)
- Extended temperature capability.

Get any of these options easily in the Pastoriza Model ADC-12<sub>1C</sub> analog-to-digital converter — without the usual delays and extra cost that "specials" always involve.

The 12-bit Model ADC-12<sub>1C</sub> is a single-card, general purpose, integrated circuit A-to-D converter that accepts input voltages on command and converts them to a 12-digit binary code in 25 microseconds. The single card contains an input amplifier, precision reference supply, logic, weighing network, switching, comparison, and internal clock. Only external DC power is needed.

The Model ADC-12<sub>1C</sub> 12-bit converter is just one of Pastoriza's many competitively priced A-to-D and D-to-A converters. All are available with a variety of different input options, resolutions, and output codes.

Write or call for more information  
on ADC TTL Series.

**PASTORIZA**  
ELECTRONICS, INC.

385 Elliot St., Newton, Mass. 02164 • 617-332-2131

## Fadac feedback

During the late 1950's, planners at the Army's Frankford Arsenal in Philadelphia used a computer to solve trajectory equations for the Redstone tactical missile. Next, they considered cannon and rocket applications. The Autonetics division of what was then North American Aviation Inc. was asked to develop a processor, and Fadac (Field Artillery Digital Automatic Computer) was born.

Autonetics received a \$2 million research and development contract in June, 1958; two years later a \$700,000 award was made for production engineering. Autonetics supplied its last production engineering versions of Fadac in December 1961. Following delivery, the Army solicited bids from industry on a production contract.

**Honorable discharge.** Stanley Greenberg, Fadac action officer at Frankford, denies reports that Autonetics lost out on the production contract because of cost overruns and technical problems. Autonetics had a "good technical data package, and if there was an overrun, it was minimal," he says. "The production contract simply went to the lowest responsible bidder." The winner was the Teledyne Systems Corp., a division of Teledyne Inc.

Teledyne, under a contract "in the vicinity of \$5 million," turned out 148 Fadac systems, the last in 1965. In March 1963 the Army named the Magnavox Co. as a second source. Greenberg insists there was no trouble with Teledyne's performance, the service simply wanted another supplier. Magnavox is still producing Fadac.

The first Fadac system went operational in Europe during 1965. The system has since been sent to Vietnam, and according to Greenberg, reports indicate Fadac is doing "fantastically well." He says, "There's no doubt that the number of first-round hits has been increased greatly with Fadac. In less than a month, the computer can save enough money on ammunition to pay for itself."

solutions and the formatting of fire commands); ammunition and fire unit status (the location, strength, ability, mission, and ordnance inventory of groups within a command); and target intelligence (information from forward observers and lower echelons).

Litton has contracted to supply hardware and spare parts for 16 divisions along with technical manuals. It will also provide field support personnel until the Army is ready to take over. The award, made jointly last December by the Army Electronics Command and the Automatic Data Field Systems Command, runs through September 1973. Litton's gross could rise another \$75 million if the service exercises an option to provide Tacfire for higher corps and field commands.

**Short rounds.** Unlike Fadac, which was built with discrete components, the Tacfire system makes extensive use of integrated circuits. Romano says that there will be about 6,000 ic's built into each computer.

At the heart of the system is Litton's L-3050M (M for mobile), general-purpose digital computer,

an offshoot of the L-304F machine the company built for the Navy's E2A aircraft. Plans call for a computer to be located at each of the six fire-direction centers in a division.

Spiro Greenwood, who headed Burroughs' Tacfire team, says his company proposed an upgraded version of its D84 military computer. The machine would have had more advanced circuitry and higher power than similar models being used in the Army's Pershing and Sergeant missile programs. The other bridesmaid, IBM, had pinned its hopes on 4 pi, a system already being used in many military applications.

**Memory to spare.** Romano says a single L-3050M computer can handle the processing load at battalion level, using only about half of its 32,000-word memory. A standby unit will back up the L-3050M used at division headquarters. Both processors could be run simultaneously. Or, the standby could replace a failed machine at the battalion center. Specified mean time between failures for the computer is 1,000 hours.

Lt. Col. Albert Crawford, former



chief of Tacfire engineering and management at the Automatic Data Field Systems Command, says the Army originally wanted the mass-memory to be nonmechanical. However, it had to settle for a magnetic drum when contract definition showed a solid-state memory was not yet technically feasible. However, Romano says that both plated-wire and deposited core techniques are being evaluated, and chances are that production versions of Tacfire will use one of these.

The memory is broken into four 8,000-word ferrite core memory modules having 33-bit words (32 bits plus a parity bit). Typical memory cycle time, says Romano is 2.3 microseconds; 4.6 microseconds is required for an add operation. "The Army can get along with 2 microseconds very well," he says. "But the memory could operate as fast as 500 nanoseconds."

## II. About the circuit

Transistor-transistor logic from Sylvania's SUHL 2 (Sylvania Universal High-Level Logic) line is used in the computer. Romano says it was chosen because of its high speed—5- to 6-nanosecond propagation times—and its availability from several sources.

A 10 million-bit magnetic drum random-access memory will be provided for the divisional artillery center's computer by RCA's West Coast division. In all, Romano es-



**In the round.** The tactical display backstops the digital plotter maps, used in the fire-direction centers, giving detailed data on small areas.

timates, about 50% of the Tacfire hardware will be made by subcontractors. In dollars, subs will have about one-third of the action.

Other peripheral equipment includes a tape memory loading unit, four data terminals, and a go, no-go hand-held module test set with which operators will be able to spot faults in the computer's circuitry. The test set, together with a proprietary Litton power-plane switching technique, will result in almost instant troubleshooting. Plug-in, throwaway modules, most costing under \$50, will be used. Mean time to repair is pegged at 10 minutes.

**Shopping list.** Litton plans to purchase the tape-memory loaders, "perhaps units like those made by Kinellogic Corp. and Raymond Engineering Labs Inc.," Romano says. Each center will have several tape-memory loaders with different computer programs, Romano believes. The four data terminals will also be bought outside from a source to be decided upon. These units will work half-duplex—at 600 and 1,200 bits per second—over artillery communication nets.

The remainder of the Tacfire hardware falls into two categories—equipment for the centers and for remote units. For the centers there are two kinds of tactical situation displays. One, a digital plotter map that can be either manually or computer driven plots lines, boundaries, or target site symbols on a surface four feet square. Arvin Systems Inc. will supply the unit. The second display unit has a round cathode-ray tube 16 inches in diameter, on which more detailed information about a smaller area can be shown. It can be driven by the computer to display map lines and 250 site symbols. The digital plotter map is used at both the division artillery headquarters and battalion fire-direction centers; the crt equipment only at division.

Here again, the Army had to settle for less than it wanted because its requirement was two or three years ahead of technology. Col. Crawford says Tacfire planners sought a single, all solid-state large-screen tactical display instead of the two electromechanical devices they're getting.

An artillery control console and a medium-speed printer complete the hardware for centers. The con-

# NEW Concept in Digital-Analog Converters

The use of Model DIC 2760 Digital-to-Current Converter with any operational amplifier provides the designer with a variety of high performance digital-to-analog converters with premium specifications.



3/4" x 3/4" x 1 1/2"

**MODEL DIC 2760** converts TTL logic levels to weighted currents in less than 50 nanoseconds. This module contains reference supply, resistor network, and up to 12 high-speed precision switches.

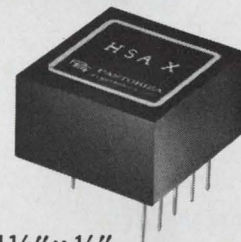

1 1/8" x 1 1/8" x 1/2"

**MODEL HSA X** Digital Operational Amplifier with FET input provides current-to-voltage conversion for voltage outputs of up to  $\pm 10$  volts at  $\pm 10$  mas.

The combination of HSA X and DIC 2760 results in a very high performance digital-to-analog converter with:

- Input levels of up to 12 bits resolution at TTL logic levels.
- Total conversions in 1 microsec.
- Complete DAC, in two modules, requiring less than 2 sq. in. of P.C. card.

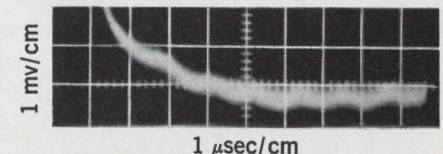

Response of D/A converter output to a full-scale change of 10 volts.

Write for detailed specifications and application data.

**PASTORIZA**  
ELECTRONICS, INC.

385 Elliot St., Newton Upper Falls, Mass. 02164

(617) 332-2131



Buy this  
**7nA**  
 (full scale)  
**Null Detector**  
 for  
 only \$350...



...and get a "FREE"

- Calibrated nanoammeter with four zero center ranges
- DC preamplifier
- Deviation meter ( $\pm 30\%$  sensitivity)

RFL's Model 485 Null Detector, available now from stock, is a *four-in-one*, solid state instrument featuring integrated circuit design coupled with a magnetic modulator (chopper free) which virtually replaces all light beam galvanometers.

The unit features four calibrated ranges, from  $\pm 10$  nanoamperes full-scale to  $\pm 10,000$  nanoamperes full-scale. Low input resistance stays constant when changing ranges, making the Model 485 excellent for Kelvin and Wheatstone bridges, lab potentiometers, URS, DRRS; measuring op-amp feedback currents and measuring dry-switch resistance.

The 485 accepts overloads as high as  $1 \times 10^7$  and is battery-powered (AC supply optional). Easy-to-read  $4\frac{1}{2}$ " taut band suspension meter.



For technical data or free evaluation loan—write or call Bill Jauch.

**RFL Industries, Inc.**  
 FORMERLY RADIO FREQUENCY LABORATORIES, INC.

Instrumentation Div. • Boonton, N. J. 07005  
 Tel: 201-334-3100 / TWX: 710-987-8352 / CABLE: RADAIRCO, N. J.  
 SEE US AT IEEE, BOOTH #2D05-2D09



Out front. Forward observers use the fixed format message entry device to compose and store fire requests to battalion centers over radio links.

trol console has two crt's—one for incoming and one for outgoing messages—to display alphanumeric data. Its keyboard is a standard ASCII (for American Standard Code for Information Interchange) unit with editor controls. The nonimpact printer, a 600-character-per-second device, uses a crt with a fiberoptic bundle to print photographically on paper. Litton's Datalog division is negotiating to purchase the units from outside sources.

### III. Up front

Forward observers carry the most important pieces of remote equipment—the fixed format message entry devices. There is also

a variable format message entry device for two-way communication between such remote units as survey parties or missile fire-direction centers and the principal fire-direction center. It uses the same display editor and keyboard as the artillery control console and the same data link terminal printers that are used at division or battalion centers. Finally, there is a display unit for the headquarters of individual batteries. It is essentially a receiver that displays and makes hard copies of fire orders or other messages. The unit looks like the variable format message entry device, minus the display editor and keyboards needed for message transmission.

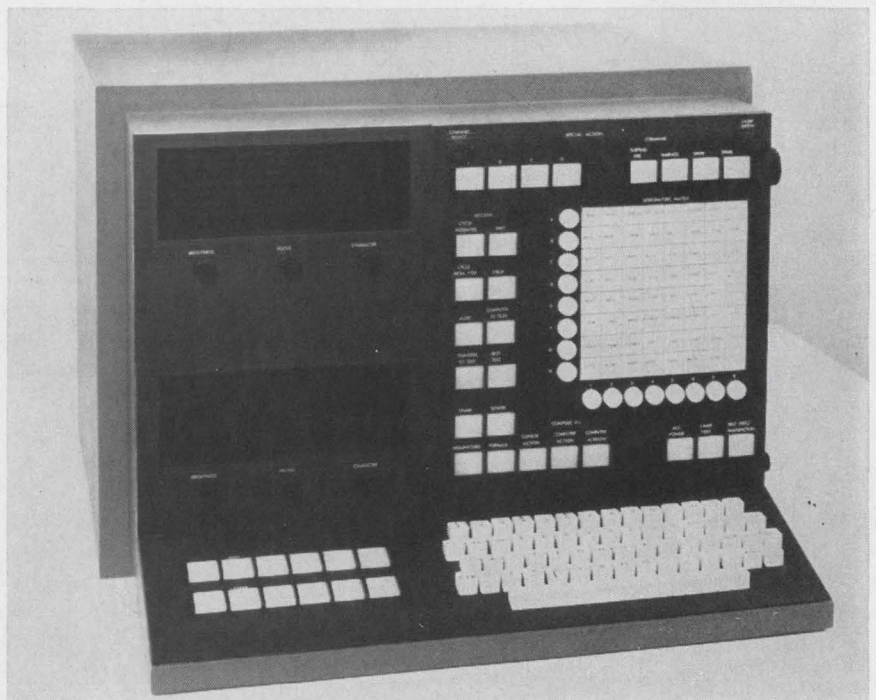

Closeup. Artillery control console in battalion centers has crt's for both incoming and outgoing messages; conventional keyboard is used.



## Off-the-job training

To strengthen its bid for the Tacfire contract, Litton sent its program director to an Army school. Last summer, midway through the contract definition phase, when Burroughs, IBM, and Litton were struggling for the development and production award, Litton officials proposed that George Romano be allowed to attend the Army's Artillery and Guided Missile School at Fort Sill, Okla. He wanted to get a better understanding of the problems Tacfire was being designed to solve. The Army liked the idea, and Litton believes his tour helped win the award.

Romano sat in on a two-week refresher course for senior artillery officers. Instruction covered staff management, communications and electronics, the M-18 gun direction computer (Fadac), and nuclear munitions. Classmates included majors and lieutenant colonels on their way to Vietnam to be battalion commanders.

His fellow students wanted to learn as much as possible about the use of artillery in Southeast Asia. "It's a whole new art there," Romano says. "Usually, a howitzer battalion has a straight-ahead field of fire and a well-defined division between enemy and friendly troop deployments." Not in Vietnam.

"The areas that had the most impact were artillery fire planning and target intelligence, particularly the integration of target intelligence into fire plans," he says. "There's a set of specific computer programs for each of these functions in Tacfire. Eight more people from Litton's Data Systems division are taking a detailed course at the school to help us make certain that the computer programs for these functions are well defined."

**Passing the word.** The forward observer uses the message entry device to compose and store fire requests and other messages for transmission to the fire-direction center by hard-wire or manpack radio links. Romano says Litton is shooting for a maximum weight of five pounds for the device. It will use two large-scale integrated chips as a shift register. It has 25 switches with which the observer sets up his message in ASCII format for entry into the shift register. Romano says the two chips will have about 100 cells each. Just two seconds after the observer enters the message, he receives an audible tone confirming that it has been received.

At the moment, there is no requirement now for anything more than eyeball observations in the Tacfire system. But Litton officials are talking with ITT Gilfillan, a division of the International Telephone & Telegraph Corp. that makes a mortar-locating radar, and Romano is "quite sure there will eventually be a direct digital tie between the new countermortar radars and the Tacfire system."

Typically, a fire request from a forward observer contains digital data giving his identity, location, and an authentication code, which is changed every few hours for

security. The fire request may also contain such information as the target's relative position and altitude as well as its type and size. The observer's message may also include a recommendation on ordnance that should be used and whether the burst should be air or impact.

When received at the fire-direction center, the message is routed from the data terminal to the computer, which triggers three separate actions: the fire request and computer-suggested fire orders are displayed on the artillery control console; target location is plotted on the digital; and the fire request is printed out. The fire request can be altered in the center. If it is, the artillery control console operator enters any changes and re-computed fire orders are displayed. When the officer in charge is satisfied, he orders the console operator to press the transmit button. Then, the computer routes appropriate fire orders to each battery through separate data terminals over separate links. The orders are then posted on the remote battery display units for action.

**Timetable.** Litton is required to deliver the first Tacfire system in December 1969. All hardware must fit into an S-280 helihut or an A-577 armored personnel carrier.

## The Material of Unlimited Uses...

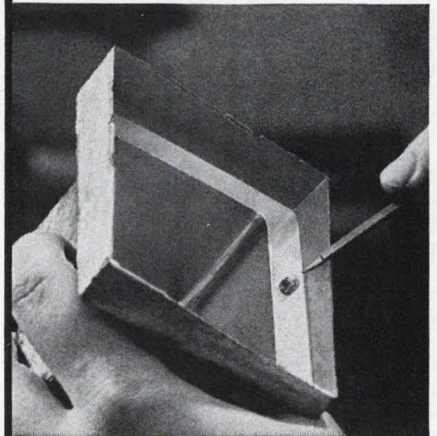

## INSTANT DIP-A-MOLD

In seconds, you can make perfect molds, like this one, for potting any encapsulation, and make them economically, with low-melting CERRO® Alloys. Just dip the master in molten alloy. A thin coating of alloy clings to the pattern. Withdraw the pattern, and you have a perfect high fidelity mold. When the encapsulating plastic cures, simply remove the CERRO Alloy. Use it over and over again, almost without limit.

This particular alloy—CERROTRU®—does not shrink, slips easily from the pattern without parting or contaminating compounds or coatings. Because of its low melting point, it is safe and easy to handle.

You can reproduce such unusual details as positioning lugs for transformer cases, as shown above, without the use of cores, inserts or secondary operations.

Instant molding is just one of the many uses for CERRO Alloys. To find out more, contact Cerro Copper & Brass Co., Cerro Alloy Dept., Stamford, Conn. 06907... R. S. Darnell (203) 327-0550.

# CERRO®



what's better than an op amp?

Bell & Howell's new...

# 007 and 008

## OPtimal OPerational AMPlifiers

value engineered for OPTIMAL balance between performance, size and cost.

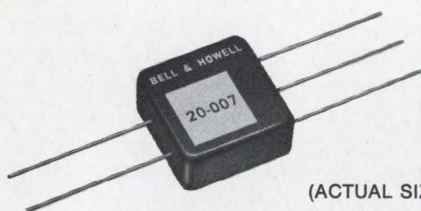

(ACTUAL SIZE)  
TYPE 20-007 general purpose Optimal op amp

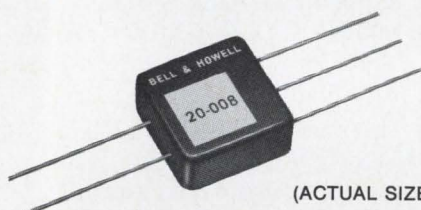

(ACTUAL SIZE)  
TYPE 20-008 FET input Optimal op amp

With this matchless pair you can satisfy the requirements of most op amp applications, and real meaning has now been given to the term "universal op amp." Note these major features:

- choice of bipolar or FET input
- hybrid microcircuit construction
- frequency compensated
- input and output fully protected
- offset trimmed (where else can you find this?)
- small, compact size (0.6" x 0.6" x 0.25")

Compare the typical characteristics of Bell & Howell Optimal Op Amps with ordinary op amps and see what value engineering does for you:

CONTROL PRODUCTS DIVISION



Opt for 007 and 008 by writing or telephoning for complete technical information. Ask for a Bell & Howell sales engineer to call on you to discuss your particular application. Control Products Division, Consolidated Electro-dynamics Corp., a Bell & Howell Company, 706 Bostwick Avenue, Bridgeport, Connecticut 06605. Telephone: (203) 368-6751. Ask for Mr. Isdale.

	20-007	20-008
Voltage offset	200 $\mu$ V	200 $\mu$ V
Input bias current	150 na	25 pa
Common mode rejection	100 db	100 db
Gain band width (at 10 kHz)	20,000,000	10,000,000
Output current	5 ma	5 ma
Price (in quantities of 100, any mix)	\$16.50	\$26



# How do most companies move a fast-thinking, precision-built, time-saving computer?



They choose a calmly efficient, utterly trustworthy, nerve-saving van line. Allied Van Lines carefully moves more computers than any other van line.

Call the utterly trustworthy Allied Agent in your town.

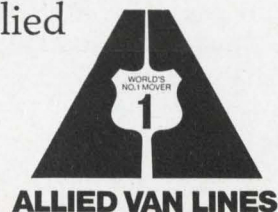





## Try this \$580 EAI Digital Measuring System for two weeks—FREE!

Now—you can get the EAI 6200 DVM on a two week memo billing to prove the performance claims for yourself. We bet you'll keep it, but if we lose there's no obligation. Just tell us your reasons!

What are the claims? First it's a great dc DVM, with features like automatic polarity, 100 microvolt resolution, pushbutton ranging, 1000 volt overload protection and  $\pm 0.1\%$  accuracy ( $\pm 1$  digit); and a few more you'll find for yourself.

What makes it a DIGITAL MEASURING SYSTEM? Low cost modules that create an ac DVM and a counter. Not just any counter, but a 10 MHz crystal controlled counter and time interval meter that can totalize and measure period—all for only \$210. For ac measurements, there's a 20 Hz—100 KHz converter good to 300 volts with a 1 megohm input impedance and packaged in a

compact plug-in module for only \$250.

For you systems-minded people, a rack-mounted version called the 6240, with a BCD output option, costs a little less—\$550 as a DVM.

Interested? Call us—collect—at 201-229-4400 extension 6200 with a consignment purchase order and we'll ship you one for a two week trial (if you're in the US, that is... we do have to limit the offer to continental US only). Or ask for more specs...they'll be return mailed to you.

See the EAI 6200 Digital Measuring System at Booths 2D32-2D36 at the IEEE March 18-21.

**EAI**® *Electronic Associates, Inc., West Long Branch, New Jersey*





"Orphan" jobs are the ones not short enough for hand operation — not long enough for high production tooling. Some people call them "losers."

With the new Di-Acro N/C Turret Punch Press you can apply the economies of numerical control to these awkward jobs as well as any other short or long run production. These features help assure your profits.

- Punches up to 3/8" diameter holes in 10 gauge mild steel or up to 1 1/2" holes in 1/4" mild steel plate.
- Tools change automatically — 20-tool capacity minimizes setup work.
- Workpiece moves automatically and smoothly on ball screws and anti-backlash ball nuts.

- Travels 36" on X axis (can be extended by reclamping) and 24" on Y axis.
- Hits 60 times per minute on 1" centers (minimum) with  $\pm .005$ " precision.

The advanced electronic design of this machine features integrated circuits that increase reliability six times or more by eliminating thousands of conventional components and connections. Logo modules are warranted for five years. No cooling of the control is required. Operation is highly resistant to electrical noise interference. A convenient protected location is provided for the tape reader and manual data switches.

For full information, write to us.



THIS 15-TON N/C TURRET PUNCH PRESS  
AUTOMATES THE HIGH COST OUT OF YOUR  
"ORPHAN" JOBS!

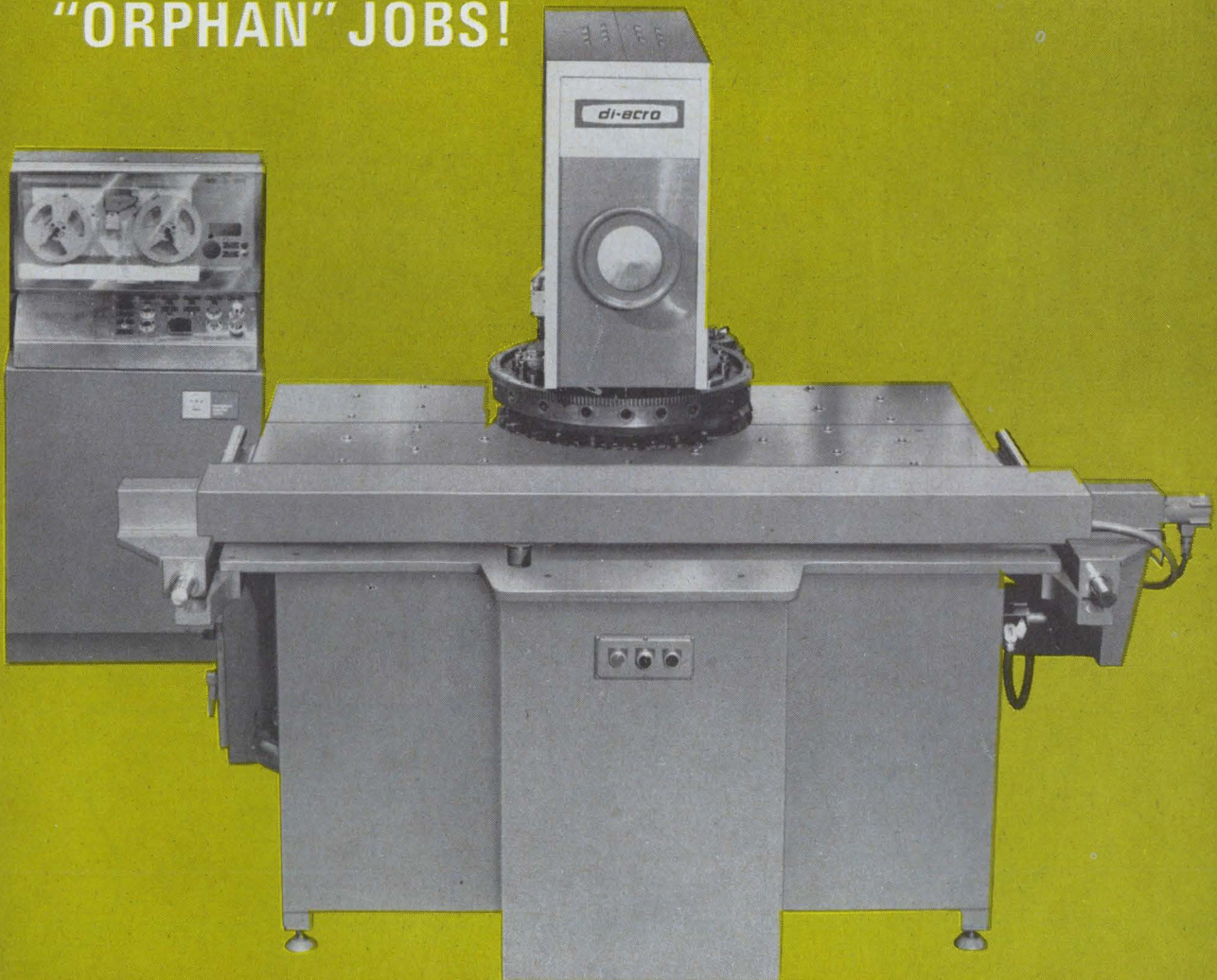



# We want our Scotchpar<sup>®</sup> film reviewed by every critic in the country.

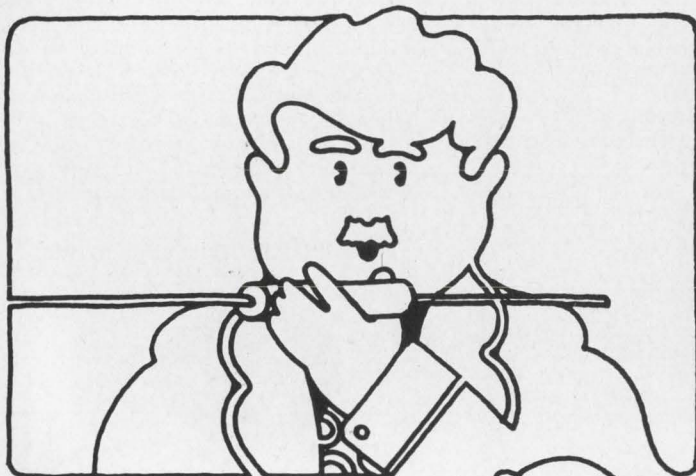

Many important "critics"—manufacturers of capacitors, transformers, motors, wire and cable—have already given 3M's SCOTCHPAR polyester film their highest praise: They bought it for insulation.

They bought a lot of it for capacitors, because 3M is in the capacitor business with thin films.

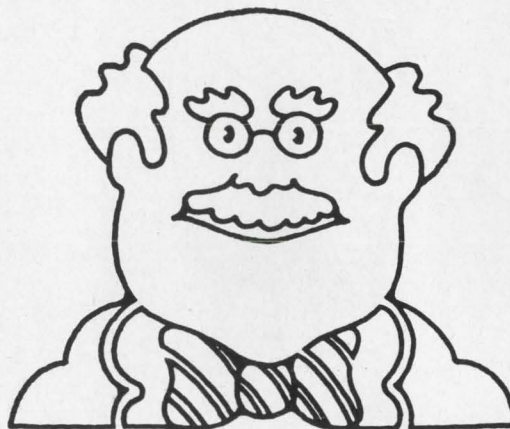

Or if they wanted heat sealable SCOTCHPAR, they bought SCOTCHPAK.<sup>®</sup>

We hope you'll give our film the same critical acclaim, because we've put a lot into our polyester film to help it win over some of the followers of the "big name" film.

SCOTCHPAR combines excellent electrical strength and steel-like tensile strength with resistance to moisture and solvents. It's thin, tough, flexible and durable. And it comes in a variety of thicknesses and types.

With that much going for it, SCOTCHPAR may be the film of the year.

3M Company, Film & Allied Products Division, 3M Center, St. Paul, Minnesota 55101.

**Scotchpar**<sup>®</sup>  
BRAND

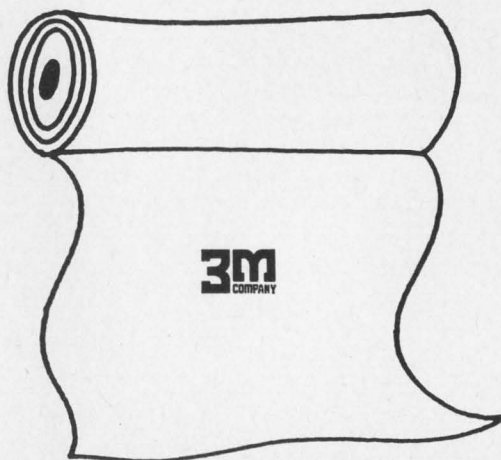



# “There’s another giant in Jolly Green’s Valley.” (ho ho ho)

Already people are saying that we’re much bigger in the relay and timer business than we claim to be. They’re saying there’s another giant up in the Jolly Green’s Minnesota Valley.

That’s a bunch of nonsense!

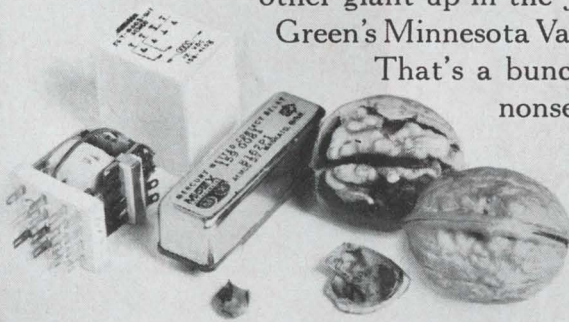

Sure we’ve cracked some tough nuts for people like 3M Company and Collins Radio and IBM, but that’s because we dove into their problems head first and didn’t come up until we had an answer. We kinda feel that our customers like that attitude when they come in with a timer or relay problem . . . instead of the Ho Ho Ho they get from some of the giants.

There’s usually not much Ho Ho-ing around here until later. Because you can bet that the first time a customer contacts us, it’s not with a fat, easy order. He’s usually been busting his knuckles for weeks with a tough, dirty little problem. He’s finally up against it, and he wants an answer fast.

Sure it’s tough!

But, we don’t expect people to come around passing out relay or timer orders like popcorn. In fact, when you’re a little guy, you expect ’em to come around with problems that will back you up against the wall a few times. But we don’t mind . . . we always remember what Pop used to tell us about the village rough-neck: “If you just lick ’em once, he’ll be your friend for life.”

Wanna fight?

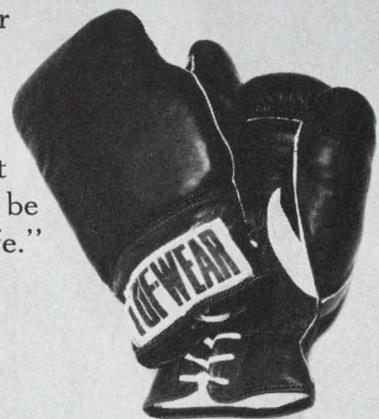

**MIDTEX**  
INCORPORATED



**AEMCO DIVISION**  
10 STATE STREET  
MANKATO, MINNESOTA 56001

PROGRAMMERS/TIME DELAY RELAYS/MINIATURE COAXIAL RELAYS/INDUSTRIAL RELAYS/MERCURY-WETTED CONTACT RELAYS



# mark sensing with no trouble-gap

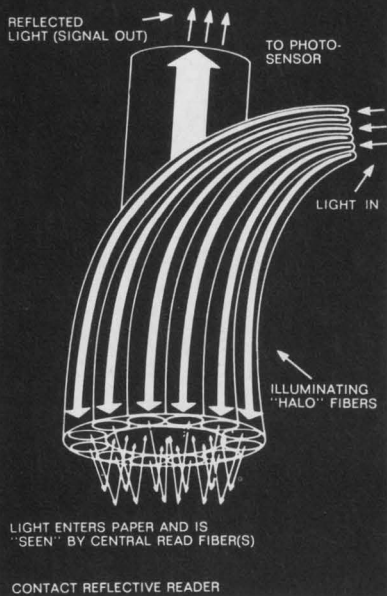

**THE NEW BENDIX FIBER OPTIC CONTACT REFLECTIVE READER!** Now you can achieve a new consistently reliable, extraordinarily high level of efficiency in your data processing mark-sensing, punch tape reading and magnetic tape monitoring. Efficiency in signal-to-noise ratio of 100:1. The answer: the unique, new fiber optic read head developed by Mosaic — it rides in contact with the paper!

The Mosaic fiber optic reflective reader components are based on a new discovery by Mosaic: that with certain fiber sizes and bundle configurations, very high signal-to-noise ratios can be achieved with the sensor head in contact with the paper. A special *fused flexible fiber bundle* was designed and fabricated to utilize the phenomenon: a central core of read fibers .008" in diameter, surrounded by a halo of thirteen .003" illuminating fibers. The result is the elimination of the trouble-gap in mark-sensing: the critical gap ordinary fiber optic readers need to angle light onto the work so it can reflect back into the pick-up fibers.

Gone with the gap is the troublesome collecting point for dirt carried by the paper: contaminants that cause rapid degeneration of signal-to-noise ratios and resultant sensor errors. Gone, too, are the clear epoxy or transparent plastic gap-fillers utilized with ordinary read heads — compromisers at best which do nothing to increase efficiency. Dramatic efficiency. Consistent, superior performance with signal-to-noise ratios of 100:1. Reliability never possible before. This is what you achieve with the new fiber optic contact reflective reader from Mosaic — the largest single source of fiber optic technology in the world. Contact Mosaic Fabrications Division, The Bendix Corporation, Galileo Park, Sturbridge, Massachusetts 01518. Telephone: 617/347-9191.

Write for complete descriptive literature, today!

**Bendix Electronics**



## How to flatten spikes precisely and for pennies

One look at this circuit and you recognize the answer to voltage transients.

But forget about paired diodes.

A single Carborundum® varistor gives you precise suppression for pennies. "VDR" marks the spot.

Our nonpolarized varistors flatten spikes from either direction, defy installation error. They're rugged enough to handle severe overloads, and they will do it with better reliability than diodes.

Aside from their low purchase price, Carborundum varistors can save you transistor dollars, too. Their precision damping performance means you can settle for lower breakdown ratings in transistors.

Send us your problems with transient suppression and voltage control and we'll send you precise technical and cost data.

Write to Mr. Harry Emes,  
The Carborundum Company,  
Refractories & Electronics Division,  
Niagara Falls, N. Y. 14302.

Precisely yours . . .

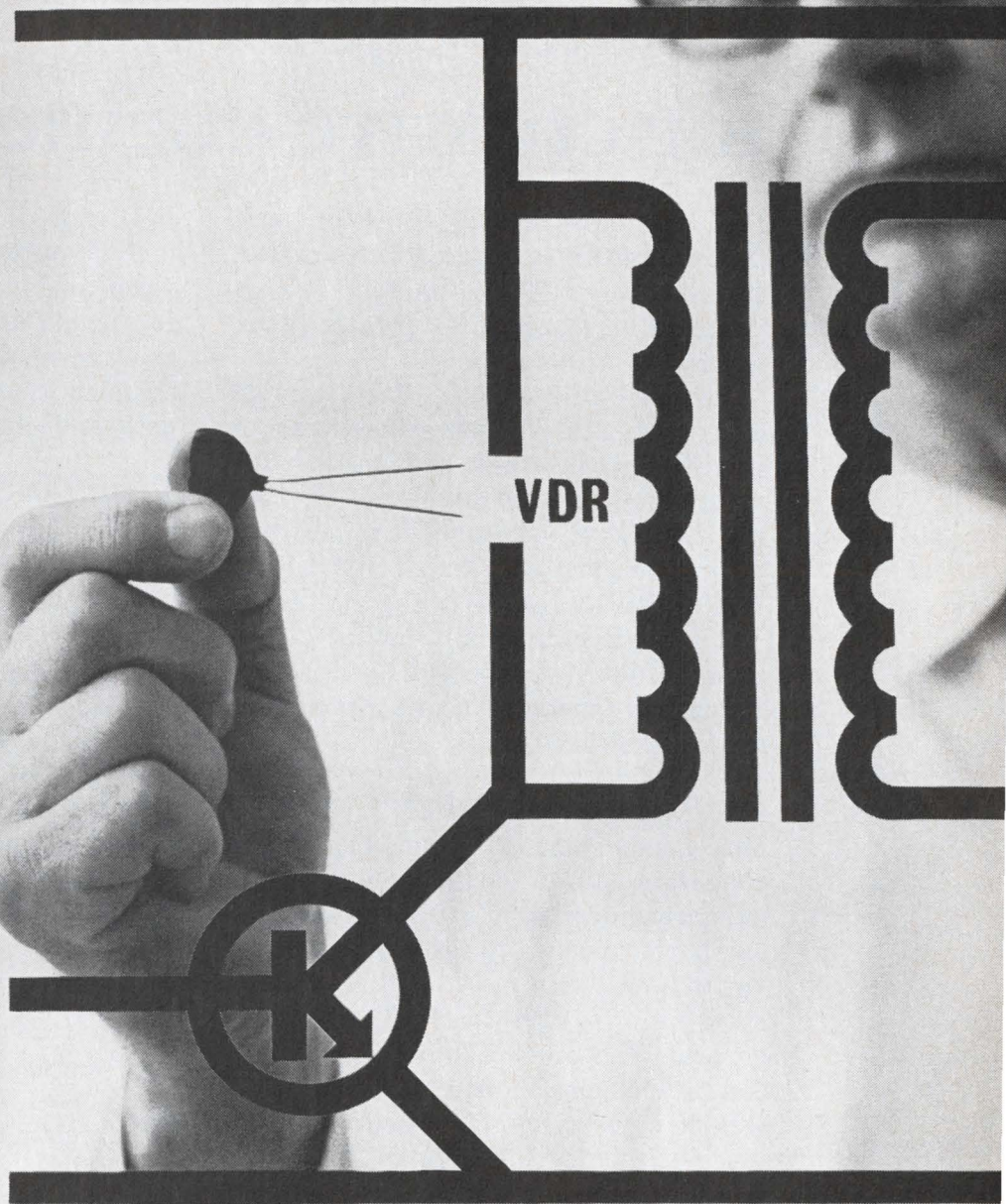

**CARBORUNDUM**



See Carborundum varistors in action at the IEEE Show, Booth 3H05-3H07.



# Creative jobs for creative engineers

IBM has immediate openings for qualified engineers in Endicott, New York. Here are a few reasons we feel the environment here generates creative engineering.

We just outline the objectives; you decide how to achieve them. Sometimes you get insights into new areas that don't seem directly related to what you're working on. You get the chance to follow them up and see where they lead. Initiative and curiosity don't get lost in the shuffle.

You work individually, or in a small team of four or five people. Good work is recognized quickly. And we promote on merit-not seniority.

## Immediate openings

IBM needs some creative *engineering* done right now, in the following areas:

**Design engineering**—These jobs offer an excellent opportunity for creative, innovative work with electron beams, solid-state circuitry and electronic systems in general. The problem is to develop new test technologies and circuit packages.

**Quality engineering**—We need people to establish quality control programs for the manufacture of printed circuit assemblies and sub-assemblies. This is quality *assurance*, not typical quality control.

**Test engineering**—This involves liaison and support assignments with engineers from many other areas of specialization. For engineers capable of handling complicated electronic system testing, this job offers an overview of the entire EDP field.

**Systems engineering**—If you're interested

in a future in this area, IBM may be able to offer you one. We need people to plan, develop, code and install computer programs for manufacturing control application, experiment design, product testing, instrument monitoring, numerical control data, and simulation.

## What Endicott offers you

These positions are at IBM Endicott in upstate New York. Endicott/Binghamton (population 200,000) is surrounded by beautiful farmland and small woods. The area is noted for its recreational facilities, schools, and cultural activities.

There are educational facilities for advanced study. You can get your M.S. or M.A. in Engineering, Physics, Math or Chemistry through IBM's tuition-refund program. A liberal benefits plan is also paid for by the company.

## Interdisciplinary environment

For simplification, we've listed these jobs in categories. But people don't fit into categories, and neither does their work. At IBM, we try to do as little categorization as possible; the more overlap and inter-involvement there is among our engineers, the better we like it. If that idea interests you, send a brief outline of your educational background and experience to: Mr. J. D. Hinkley, Personnel Department, Dept. BC1017, IBM Corporation, 1701 North Street, Endicott, New York 13760.

# IBM®

An Equal Opportunity Employer



# EECO's 970 synchronizes down range timing.....

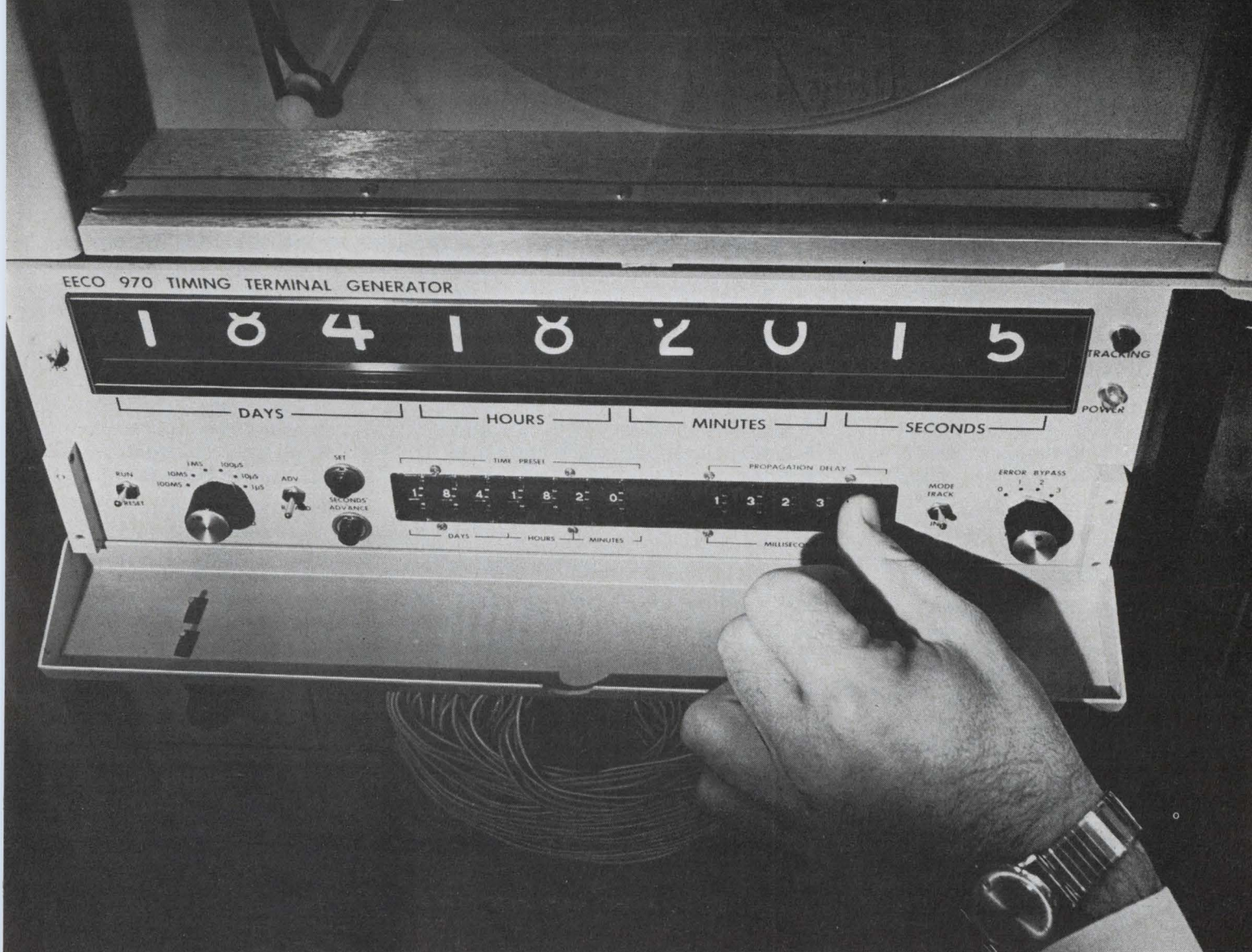

## and provides multiple code outputs

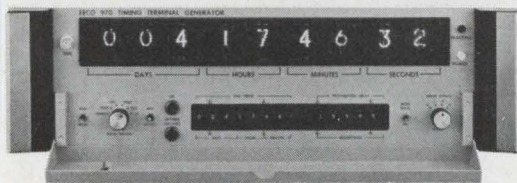

The new EECO Model 970 Timing Terminal Generator synchronizes down-range timing with a central time code generator for later correlation and processing of remotely recorded data. The 970 accepts incoming 1 kHz carrier time codes in IRIG B, NASA 36-bit, or AMR D5 formats, and simultaneously generates up to five different output time codes. Unique propagation delay provisions, from 0 to 199.99 msec., permit output synchronization to within 5  $\mu$ sec; an error by-pass option allows reception of up to 3 erroneous time frames without affecting output. If the incoming signal is interrupted, codes are generated internally; when re-established, the unit automatically resynchronizes. Send for the data sheet covering the advanced Model 970.



### **INSTRUMENTS DIVISION**

ELECTRONIC ENGINEERING COMPANY OF CALIFORNIA

1601 EAST CHESTNUT AVENUE • SANTA ANA, CALIFORNIA 92701 • (714) 547-5501

"SEE THE COMPLETE EECO PRODUCT LINE AT THE IEEE SHOW, BOOTH #4J12-4J18"



# APG SERIES MAGNETIC PROTECTORS



SERIES APG, low cost electromagnetic circuit protectors, are designed for industrial applications and ground support military equipment. The compact size, together with a wide range of current ratings and delays, make it an invaluable component where positive protection is a requisite.

## FEATURES

- Low cost
- Compact size
- 1, 2 or 3 poles
- Single toggle
- Choice of delays
- 50V DC; 120/240V 60 and 400 Hz
- Ratings from 50 ma to 30 amperes
- Quick connect or screw terminals
- $-40^{\circ}\text{C}$  to  $+95^{\circ}\text{C}$  operating range
- Special contacts quench arc rapidly
- Positive latching
- High rupture current
- Trip free
- Magnetic operation
- Low series R or Z

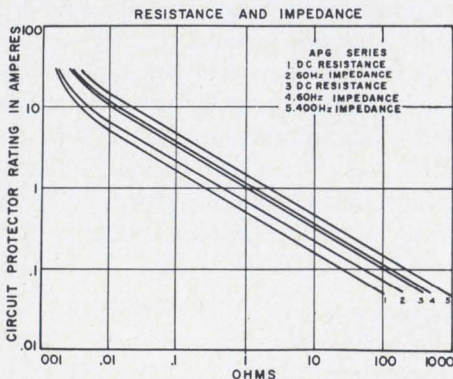
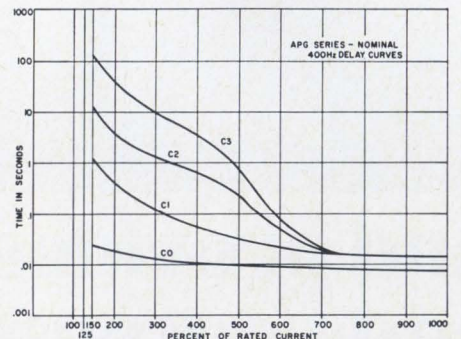
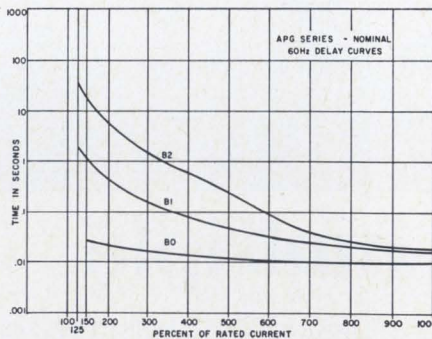
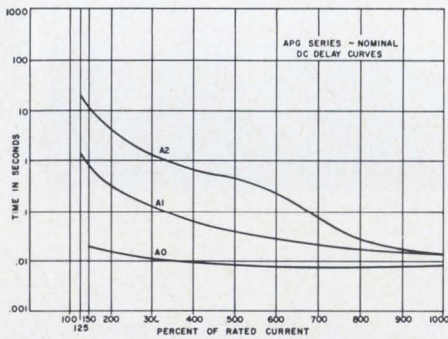
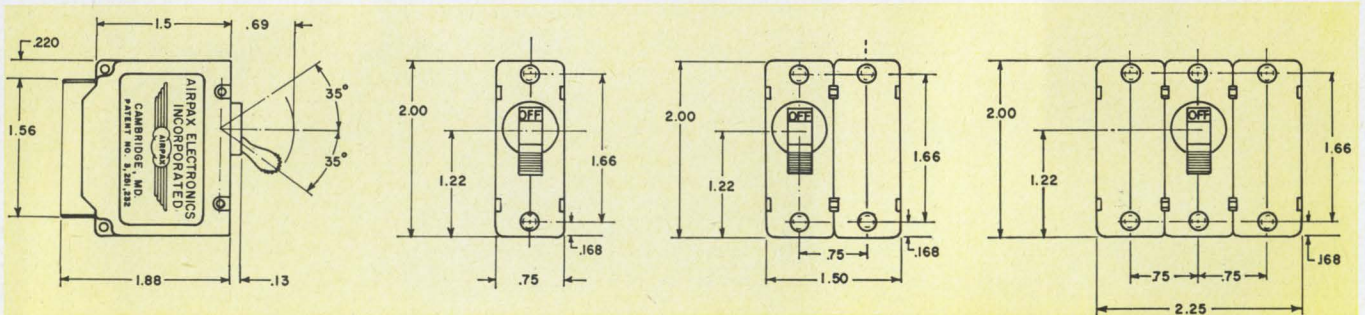

**AIRPAX ELECTRONICS**

CAMBRIDGE DIVISION, CAMBRIDGE, MARYLAND

Phone (301) 228-4600

TWX 710 865-9655

TELEX 8-7715



# Two headliners in the show

Sharing top billing with integrated circuits at the 1968 IEEE International Convention and Exhibition will be digital readouts.

During the four-day show, March 18 to March 21 in New York City, visitors will find that IC's are being used routinely to improve performance and cost, and that something new has been added. While many equipment companies are reassessing the IC make-or-buy issue, some have

already decided to make-and-sell.

Digital readouts will be everywhere at the show, replacing the old panel meters. They are expected to get a hearty welcome, now that they're cost competitive, because they minimize human error and permit direct input of data to computers.

In the previews that follow are some of the most interesting new products that will be introduced.

## New semiconductors

### Make, buy, and now sell IC's

A stake in integrated-circuit technology is now considered so crucial that many equipment manufacturers have answered the make-or-buy question by both making and buying IC's for their gear.

The Hewlett-Packard Co. goes them one better. The instrument manufacturer will continue to buy IC's, but will also sell some units it developed for its own equipment [Electronics, April 4, 1966, p. 23].

The first IC's it's offering are hybrid units for preamplifier and power-amplifier functions in the radio-frequency and microwave spectrums. The microwave modules have electrical characteristics that make them suitable for communications systems, receivers, signal generators, and intermediate-frequency networks.

The IC's, made by H-P's Microwave division, have been under development for nearly two years. A short time ago, the company realized that the devices could do more than just fill in-house needs. It saw a market among equipment makers

outside the instrumentation field for such components as wideband, high-gain, flat-response amplifiers.

**Educated guess.** As a supplier of electronic components and

equipment, H-P has an established marketing operation. And as a big purchaser of standard IC's, it's in a position to judge the market potential of its own devices. Says Paul Ely, H-P's manager of microwave integrated-circuit products, "We knew we had the capability to produce — in quantity — high-performance circuits with broad applications."

The hybrid modular preampli-

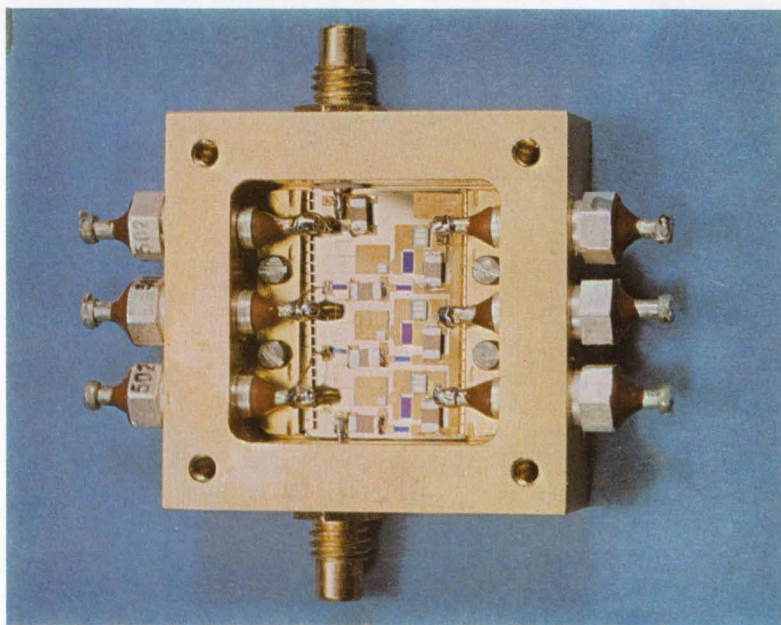

**Power block.** Hybrid microwave IC amplifier is designed for 25-db gain over the band from 10 Mhz to 1.3 Ghz.



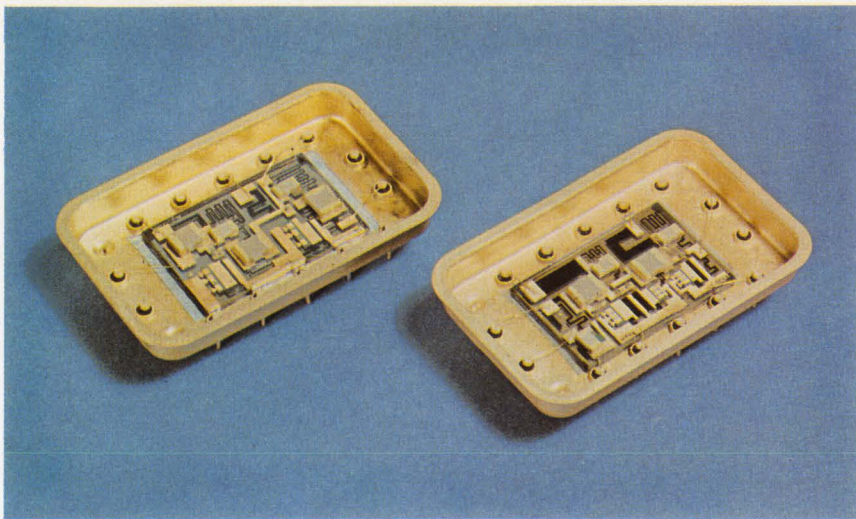

**Dishing it out.** Preamplifier module, left, and power amplifier provide high gain with low distortion.

fiers and power amplifiers are broadband, flat, high-gain circuits. Some of the first to be marketed are:

- A 0.1-to-2-gigahertz power amplifier with 40-decibel gain, 40 milliwatts of output, and a flatness of  $\pm 3$  db.

- A 0.1-to-1.3-Ghz power amplifier with 25-db gain, 10-mw undistorted output, and flatness of  $\pm 2$  db.

- A 10-khz-to-300-Mhz power amplifier with 20-db gain, 100-mw undistorted output, and flatness of  $\pm 0.5$  db.

- A 100-khz-to-110-Mhz power amplifier with 20-db gain, 10-mw undistorted output, and flatness of  $\pm 1.5$  db.

- A 100-khz-to-110-Mhz preamplifier with 30-db gain, flatness of  $\pm 1.5$  db, and a harmonic content down 40 db at  $-10$  dbm.

- A 10-khz-to-300-Mhz preamplifier with 20-db gain, flatness of  $\pm 0.5$  db, harmonic content down 40 db at  $-10$  dbm, and a noise figure of 5 db.

All but the first—which combines lumped and distributed components—are made by hybrid thin-film, lumped-element techniques.

The first three devices, Ely says, could not be made economically with standard components because of isolation and parasitic problems, low yield, and a diversity of elements. "With the hybrid approach, we tailor the module's makeup to overcome each of the discrete limitations—something you can't do with monolithics at the present time," he declares. A typical ic

in this series contains eight to 10 different metallic and dielectric films that can be combined only in hybrid form.

H-P will market the ic's off the shelf at unit prices ranging from \$250 to \$1,500. The company expects to discount as much as two-thirds of the price for quantity orders.

The modules are encased in sealed, 12-lead metal cans that feature matched feed-through ele-

ments to permit higher-frequency operation. Two versions, one for printed-circuit boards and the other with r-f coaxial connectors, will be offered.

The hybrid approach is being followed by most makers of microwave ic's, largely because present production volume doesn't justify a switch to monolithics. The hybrids have the usual ic advantages over discretely—lower cost, higher reliability, smaller size—and, when developed by a user, may offer other benefits as well.

For example, a user-supplier is bound to apply its own knowledge of job requirements when tailoring a circuit to a specific function. Thus, H-P can combine such materials as germanium, silicon, gallium arsenide, and yig, with high dielectrics and single-crystal sapphire substrates, or use thin-film resistors and capacitors with gold conductors and the appropriate active-element chips.

The firm indicates that it doesn't plan to confine its ic marketing efforts to the microwave area, but declines to pinpoint future moves as a supplier.

Hewlett-Packard Co., Microwave Division, Palo Alto, Calif. [309]

## New microwave

# Shifting into the future

**High-powered** phased-array-radar systems of the next few years will probably use diode phase shifters to steer their beams. Although there's talk of using microwave integrated-circuit phase shifters and ferrite devices, industry seems to favor the discrete diode. Ic's can't handle enough microwave power, and ferrite devices waste too much

power in heat loss.

A new diode phase shifter from Microwave Associates Inc. hints at beam-steering designs of the next generation of high-powered arrays. The shifter operates in the C band, at 5.2 to 5.8 gigahertz, and changes the phase of microwave pulses traveling through it by switching lengths of transmission line into

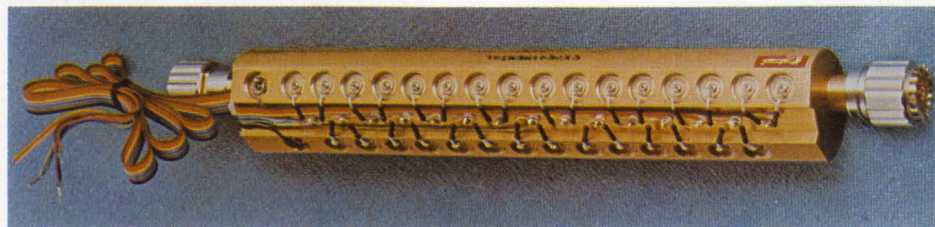

**C-band shifter.** By using 15 pairs of p-i-n diodes as switches, the device can introduce phase shifts in 22.5° steps up to 337.5°.



and out of its circuit.

Each of the shifter's 15 pairs of p-i-n diode switches shifts a wave forward  $22.5^\circ$  so a maximum positive shift at  $337.5^\circ$  is possible.

The company developed the phase shifters for use by the Naval Ship Systems Command, and is competing to supply other shifters for the General Electric Co.'s perimeter acquisition radar—part of the Sentinel antimissile system. The company has also made shifters for Raytheon's missile site radar.

**Demanding job.** Phase shifters must perform well in several areas: power dissipation, unit-to-unit phase shift repeatability, insertion loss, switching time, and weight requirements.

Microwave Associates' new device can handle 200 watts of microwave power continuously and 15 kilowatts peak. Phase shift is repeatable to  $\pm 3^\circ$ . Insertion loss is a maximum of two decibels, and the average value for the shifter is 1.3 decibels.

The device operates for an average driving power as low as 3 watts. Maximum can reach 6 watts. The phase shifting is done in under one microsecond.

**Weight problem.** Size and weight are larger than the company would like, but Microwave feels it can reduce the diameter from 1.8 inches, the length from 14 inches, and the weight from 42 ounces.

For efficient operation at high frequencies, which means fast switching times, the capacitance of each diode should be low, and the cutoff frequency should be high. The special diodes used in the shifter have a capacitance of 1.3 picofarads and a cutoff frequency of 330 gigahertz.

To prevent the excessive buildup of heat in the diodes, whether from switching currents or microwave heating, the thermal resistance has been reduced to  $15^\circ\text{C}$  per watt. And some are as low as  $10^\circ\text{C}$  per watt.

Even if all other specifications are under control, the r-f breakdown voltage must be high enough to prevent the damage to the diode by high energy bursts. The phase shifter's diodes have a 400-volt root mean square breakdown level.

Microwave Associates Inc., Northwest Industrial Park, Burlington, Mass. 01803 [310]

## New semiconductors

# Reliability registers high

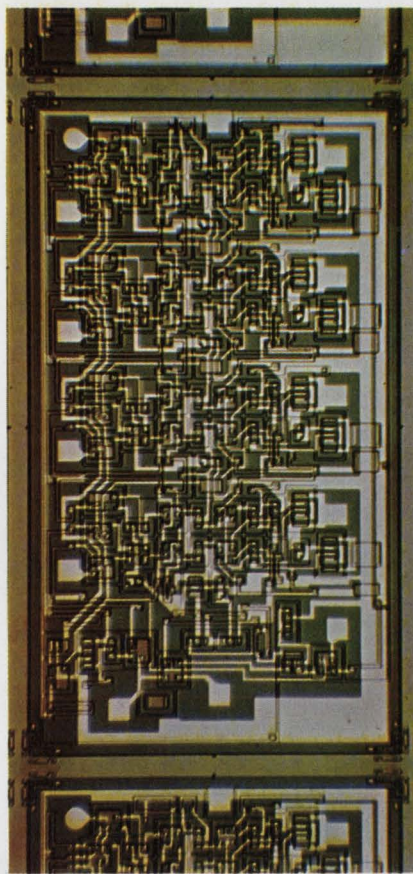

Inside. The SN5495/7495 has four gates, four flip-flops, six inverter drivers.

**As integrated circuits become** more complex, the design engineer's job becomes easier. Walter Weyler, transistor-transistor logic product manager at Texas Instruments Incorporated, feels  $\text{Tl}$  is freeing the designer from the task of determining basic logic circuits by supplying more complex devices.

The latest in the company's 54/74 devices are three shift registers. Because they perform more complicated functions than their predecessors, they let the design engineer use fewer integrated-circuit packages in his circuits, and fewer packages mean fewer leads. System reliability thus goes up.

Applications for the registers are as shift-left/shift-right registers, storage registers, shift counters, Johnson counters, and shift-register generator counters.

The first will appear in military

ground based air control systems, airborne computers, electronic countermeasure receivers, and industrial radiation counters.

**The three.** The SN5494/7494 is a four-bit, parallel-entry/serial-entry shift register. It has four set-reset master/slave flip-flops, four AND-OR-INVERT gates, and four inverter-drivers inside a 16-pin package.

This register will perform serial-in/serial-out or parallel-in/serial-out operations.

The propagation delay time from clock to output is 25 nanoseconds and the typical power dissipation is 175 milliwatts.

The maker says the SN5494/7494 can be used as a parallel-to-serial converter in systems where the accumulation rate is faster than the desired transmission rate or where the number of transmission lines must be reduced.

The second new register is the SN5496/7496. It has five set-reset master/slave flip-flops inside a 16-pin package, and it can be used for parallel-to-serial-to-parallel conversion of binary data.

The SN5496/7496 can also be used as a shift-register generator counter, programmed to count to any cycle length from 2 to 31. Propagation delay time is 25 nanoseconds, and typical power dissipation is 240 milliwatts.

Two or more of the SN5496/7496's can also be interconnected to act as a divide-by-n counter where n is the number of binary elements in the counter.

The company says the most versatile of the new devices is the SN5495/7495 shift-left/shift-right register. It has four set-reset master-slave flip-flops, four AND-OR-INVERT gates, and six inverter-drivers in a 14-pin package.

Besides right-shift and left-shift operations, the SN5495/7495 can also be used as an n-bit storage register with gate control.

Its propagation delay time is 25 nanoseconds, typical power dissipation 250 milliwatts.

The three registers are available



for evaluation from TI field offices. Prices in quantities over 100 are \$10.34 for SN5494/7494, and \$11.55 for the SN5495/7495 and the SN-5496/7496.

TI says some of the new functions available are military and commercial versions of four-bit serial-in/serial-out shift registers with parallel load capability from two

independent sources, four-bit shift-right/shift-left parallel-in/parallel-out shift registers, and a five-bit serial-input, parallel/serial-output shift register with parallel-load capability. Other functions will be added this year.

Texas Instruments Incorporated, 13500 North Central Expressway Dallas, Texas, 75222 [311]

extending over the edges. Raytheon has managed to control the etching process so well, the flip-tab 709 chip takes up only 53 mils square. The gold beams, 3 mils wide and half a mil thick, extend 6 mils over the edge.

Instead of being scribed and mechanically broken apart, the devices must be chemically milled, leaving the beams hanging in space.

With conventional etchants and silicon, the chip would be etched sideways destroying the components as fast as it was etched through. The active devices would have to be placed far enough from the edge to avoid destruction. An anisotropic etching process—a way of cutting the silicon crystal so the etchant works 20 to 30 times faster along one axis than along any other—solves the problem.

**Silicon change.** The basic change made at Raytheon, according to Richard Greene, materials product manager, was to shift from the generally used 1-1-1 silicon to 1-0-0 oriented silicon. The 1-1-1 silicon has the best crystal stability and is easiest to pull, although 1-0-0 silicon is being investigated for metal-oxide-semiconductor

## New semiconductors

# Tabs ease bonding

**Flip-chip** integrated-circuit dice can cut production costs but present the problems of aligning the aluminum bumps with the bonding pads and making the bond without burning the bumps off the chip. Beam-lead dice, which offer the same single-shot bonding advantages as the flip-chip, are rugged and easy to align but they cost more.

The Semiconductor Operation of the Raytheon Co. has been work-

ing for two years to combine the bonding ease of beam-lead dice with the low cost of flip-chip dice. The result is what Raytheon calls a flip-tab device.

**Over the edge.** The flip-tab differs from the beam lead developed at the Bell Telephone Laboratories. Bell uses gold leads to hold together the active devices, etching away whole chunks of the silicon chip itself. But Raytheon makes a conventional chip with gold beams

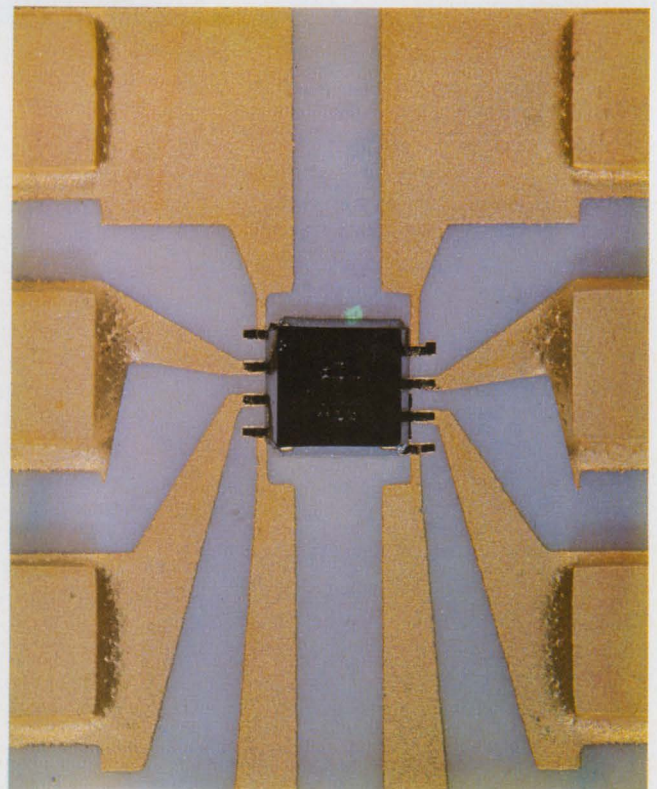
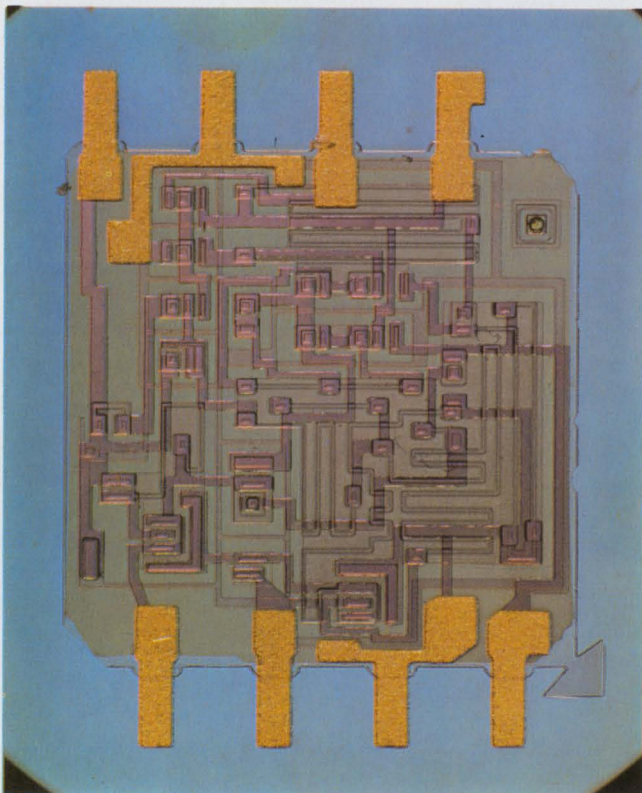

**Golden.** Integrated circuit chip, left, is made with gold tabs extending over the silicon. Then, in one process, the chip is placed in a package, right, and the beam-type leads are bonded to the pads, which are also gold.



manufacture because it has more favorable oxidation properties.

The silicon crystal is placed so the etchant eats into it at an angle of 54°. The process is therefore self-terminating; it ends when the two sides of the silicon meet, or when the etchant reaches the gold tab. The chip angle is always 54°.

Raytheon uses an alkaline etchant, rather than the conventional acid. The switch to 1-0-0 silicon meant the company had to relearn its diffusion recipes; but this was so easy it now plans to use 1-0-0 silicon for all devices.

**Here's how.** Putting gold tabs on the chips is an eight-step process:

- Contact windows are etched in the silicon-dioxide layer that covers the chip and the devices that have been diffused into it.

- Platinum is deposited through the window, forming the platinum-silicide contacts.

- The contacts are connected, the interconnect pattern being 500 Angstroms of molybdenum, 1,000 Angstroms of gold, and 500 Angstroms of molybdenum.

- A silicon-dioxide glassivation layer is deposited.

- Holes are etched in the moly-gold-moly layer.

- Gold tabs are formed.

- The slice is turned over, and a silicon-dioxide mask is deposited.

- The silicon under the tabs is etched away, separating the chips and leaving the leads free. The etching process takes from a half hour to two hours.

The bonds, between the gold tabs and the gold pads on the substrate, are very strong. The gold-on-gold metal system avoids the purple plague problem, common with aluminum. And since gold is malleable, the bonds resist thermal shocks, as well as mechanical shocks up to 100 G's.

Raytheon will not have complete reliability data on the flip-tab at IEEE, and Greene does not expect prototype production before late May or early June. But he does expect the process to have an immediate impact on designers. "In effect," says the semiconductor materials specialist, "it makes packages, which cost money and take up space, obsolete."

Raytheon Co., Semiconductor Operation, 350 Ellis St., Mountain View, Calif. [312]



**KROHN-HITE**

Visit Krohn-Hite  
at IEEE Booth  
2H30-2H32

0.001 Hz to 100 kHz

**1966**  
**\$850**

Model 4000



0.01 Hz to 1 MHz

**1967**  
**\$550**

Model 4100

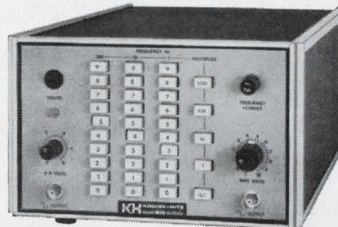

10 Hz to 10 MHz

**1968**  
**\$350**

**Model 4200:** The newest addition to the family of K-H Quality Oscillators.

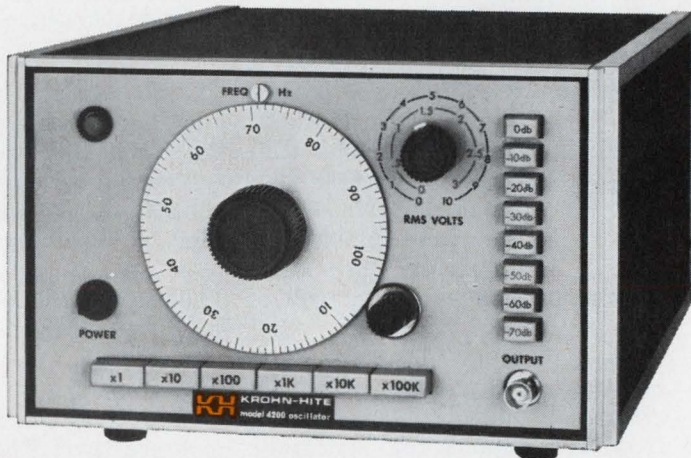

The 10 Hz to 10 MHz Model 4200, the newest (and lowest cost) member of the new family of Krohn-Hite all solid-state oscillators, performs as well as or better than competitive units costing as much as \$250 more! This proves that Krohn-Hite quality instruments do not necessarily have a high price tag.

Here's a general purpose oscillator that spans 10 Hz to 10 MHz with a frequency response so flat that a panel meter isn't necessary. Add to that — the half-watt output is available all the way to 10 MHz! That's not all — the amplitude stability is better than 0.1%/20 hours, the distortion is less than 0.1%, and the frequency response is within 0.025 db.

Pushbuttons provide 10-db attenuation steps for rapid, easily resettable control of output level. A vernier is provided for levels within the 10-db steps.

Write for Model 4200 data.



580 Massachusetts Ave., Cambridge, Mass. 02139, U.S.A.  
Phone: (617) 491-3211 TWX: 710-320-6583

Oscillators / Filters / AC Power Sources / DC Power Supplies / Amplifiers



## Sensitive and far-ranging



**High or low.** New dvm can measure quantities as small as a picoampere or a millivolt, and resistances as high as 50 megohms—with decibel readout.

A rookie with impressive credentials is breaking into the digital voltmeter league. The model 1820, the General Radio Co.'s first dvm, measures resistances up to 50 megohms, and current and voltage from d-c to 1.5 gigahertz. Sensitivity can be as good as 1 microvolt or 1 picoamp, and, in some applications, input impedance of millions of megohms is possible.

One instrument with both this frequency response and sensitivity would have been almost impossibly expensive to build, so General Radio used two plug-ins and a counter module. The p-1 plug-in reaches ultrahigh frequencies, while p-2 is for sensitivity at frequencies up to 2 megahertz.

No adapters are needed and accuracy is 0.1% minimum in all six automatically selected ranges. Impedance, one of the most common sources of measurement error, is a very high 100,000 megohms minimum and 1,000,000 megohms typical with the p-1 plug-in; with the p-2 it is 1,000 megohms minimum on all but one range.

General Radio added direct reading in decibels—heretofore available only with analog measurement devices. This should be especially valuable in uhf measurements with the p-1 plug-in, and for amplifier response measurements at other, lower frequencies.

**Impedance no impediment.** The 1820 reaches its exceptionally high input impedance by applying up to

80 db negative feedback around its input amplifier. But even before this preamp, there is a 270-hertz photochopper with an impedance of 500 megohms in the p-1 plug-in and 50 megohms in the p-2. Typical input impedance on the p-1, when both the photochopper and negative feedback components are considered, is about 5 million megohms—making General Radio's 100,000 megohm specification very conservative. The company has also done away with input attenuations, reducing measurement errors due to circuit loading effects almost to zero.

Low input impedance makes some dvm's incapable of resistance measurements on resistors of 10 megohms or more. Other dvm's fail because their current sources won't operate well across such impedances.

General Radio gets around the latter problem by using a floating voltage source in series with a resistance, which in turn is in series with the feedback loops around the input amplifiers. With a floating source, no current can flow through the amplifier, thus the current is directed through the resistor under test. This approach puts about 1 volt per megohm across the unknown resistor. The neon bulb circuit can be opened up to 200 megohms. The normal maximum is 50 megohms.

**RMS too.** The p-2 plug-in includes a precision half-wave rectifier for a-c to d-c conversion, calibrated in root mean square volts for sine waves. A passive resistor-capacitor filter removes residual a-c components while keeping settling time low. For very low frequency measurements, the user can switch in extra filtering to further reduce residual a-c.

The 1820 has a five-digit numerical readout, an automatic decimal point, a variable sampling rate, short measurement time, and a binary coded decimal readout for coupling to digital computers.

The General Radio Co., West Concord, Mass. 07181 [313]

### New semiconductors

## Regulation at the site

**The problems of busing,** isolating, and shielding regulated d-c power in a computer are sometimes more complex than designing the power supply itself. To eliminate these problems, Westinghouse Semiconductor division has introduced a monolithic integrated circuit voltage regulator for a printed-circuit board or a subsystem.

Designated the WC109T, the unit provides up to 150 milliamps of regulated output current within

the range of 4 to 15 volts. Total regulation is within 1% regardless of line, load or temperature variations. Overload protection is built in and the desired limit is set by a single external resistor.

**In the bank.** Advantages of local supply regulation are: sub-functions are made independent of fluctuations in the main power supply; interference and interaction of the systems' parts are eliminated by the high degree of board-to-



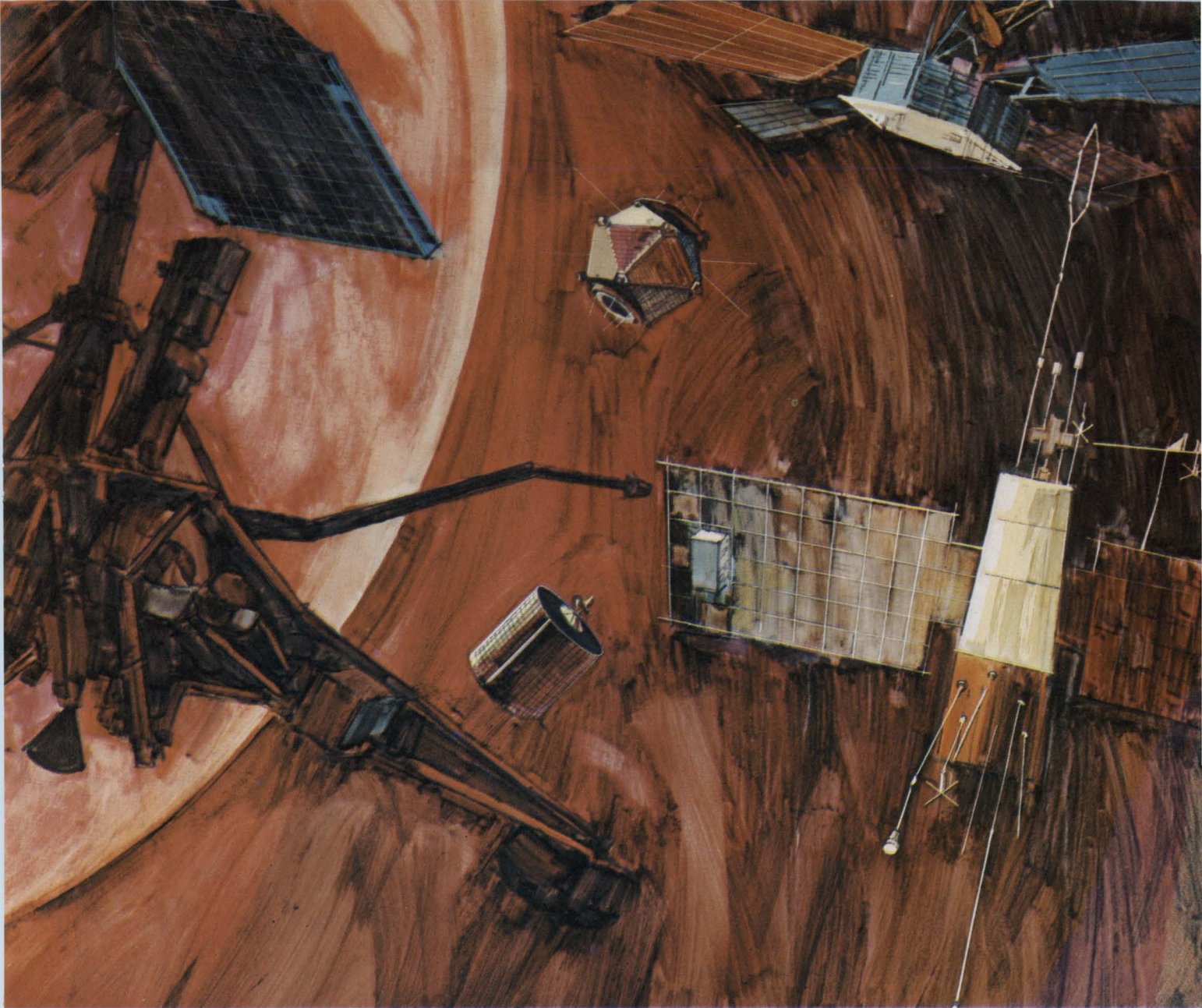

## CINCH AEROSPACE CONNECTORS GO BEYOND MIL SPECIFICATIONS

Since 1963 Cinch has been a major source for these ultimate performance rack and panel connectors. America's major space and defense spacecraft use these Cinch connectors in space and on the moon...TRW's Intelsat III, OGO, Pioneer and VELA spacecraft and JPL's Mariner satellites.

Their production involves complex quality control procedures beginning with raw material selection through every stage of fabrication and "clean room" assembly. Plating QC alone involves 119 lab measurements for 4 different characteristics, on the pre-assembled contacts. The completed connector must have a maximum residual magnetism of less than 20 gamma at the magnetometer probe and be free of visible contamination under 25x microscopic examination.

Do your connector requirements involve unusual design or production problems? Cinch can help you. For more information on Cinch aerospace connectors and the Cinch capabilities available to you, write Cinch Manufacturing Company, 1501 Morse Avenue, Elk Grove Village, Illinois 60007.

C-6810

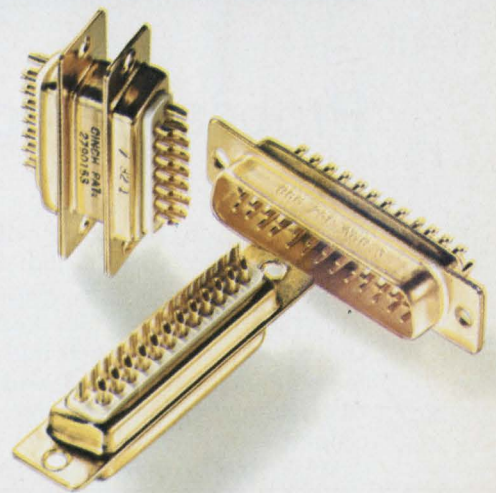

**CINCH**

DIVISION OF UNITED-CARR

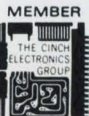

MEMBER  
THE CINCH ELECTRONICS GROUP  
CONSISTING OF CINCH MANUFACTURING COMPANY, CINCH-GRAPHIK, CINCH-MONADNOCK, CINCH-NULINE, UCINITE (ELECTRONICS) AND PLAXIAL CABLE DEPT.

Circle 193 on reader service card



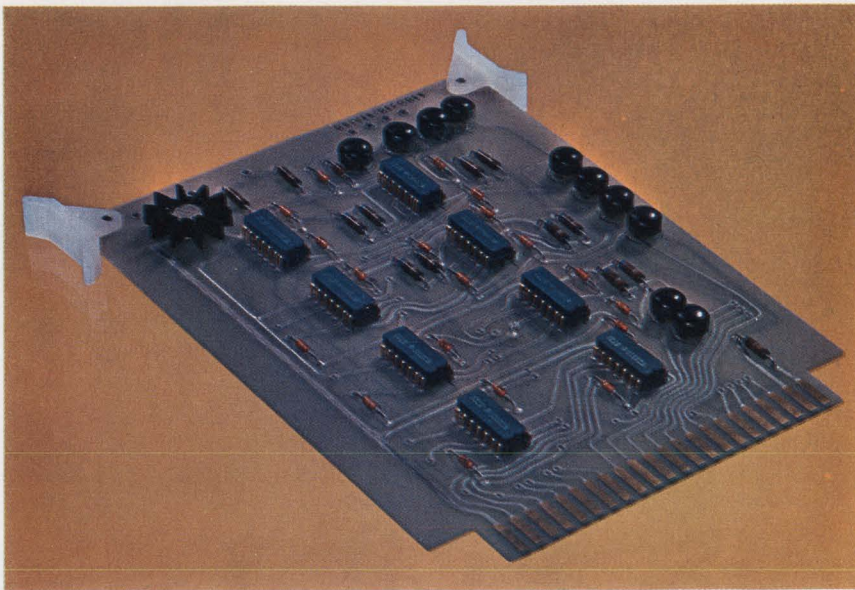

**Corner guard.** Monolithic voltage regulator, upper left, supplies power to module containing 22 gates.

board decoupling; smoothing or ripple filters can be discarded because of the unit's 60-decibel ripple reduction; and trouble-shooting is made easier by the on-card system.

The difference between a voltage reference and a sample of the regulated output is detected and amplified by a comparison amplifier. A series control element senses the magnitude and polarity of this difference and regulates the load voltage accordingly.

The voltage reference of the WC109T is derived from a 6-volt

avalanche breakdown diode and a voltage divider network. Its positive temperature coefficient is offset by another diode, giving a net change of zero volts per degree C at the base of the differential amplifier's input transistor. The reference voltage is 3.6 volts, low enough to allow for 4-volt output operation.

**Robber on job.** A composite lateral pnp transistor and associated biasing and regulator circuitry act as a current source for the comparison amplifier and the series control element. Current limiting is pro-

vided by a transistor and an external trip resistor. They cause the regulator to go into constant current operation by robbing the series control element of base drive. Additional protection against overload is provided by a silicon controlled rectifier. Compensation against instability is accomplished by connecting a 300 picofarad capacitor between pins 6 and 11. For applications requiring current outputs up to 7 amps, the WC109T can drive an external power transistor, such as a 2N3055. The regulator is priced at \$13.50 in 50-99 quantity and is available from stock.

Westinghouse isn't the first company to develop a voltage regulator intended to mount directly to a p-c board. Last year [Electronics, July 10, 1967, p. 144] the Helipot division of Beckman Instruments Inc. introduced a line of hybrid ic voltage regulators. Beckman's first units were for fixed-voltage operation, but because of an increasing demand for "on-card" regulators, the line was expanded to include variable output units. Certain advantages are seen for both the hybrid and the monolithic type, depending on the application. The Westinghouse monolithic regulator is smaller and is easier to attach to a heat sink. Beckman's hybrid unit has a higher output current and provides better regulation.

Westinghouse Electric Corp., Box 7377, Elkridge, Md. 21227 [314]

## New production equipment

# Probes run hot and cold

**It's all out** in the open with a new temperature test aid built by EG&G Inc., Boston. Formally called Thermo Tip and nicknamed Coldfinger, the device brings the temperature to the integrated circuit instead of the other way around.

With other systems, the environmental chambers range from about a cubic foot to walk-in size. In them, temperature is varied to measure electronic component performance. This sort of test is com-

mon to almost all military-specified and to many commercial components.

But most environmental chambers can't regulate temperature accurately. Nor can some chambers span the full  $-55^{\circ}$  to  $+180^{\circ}\text{C}$  range needed for military tests. Finally, because at least part of the chamber itself must be heated or cooled—along with the component—temperature cycling times are lengthy.

But Thermo Tip is small, reaches

the desired temperature quickly, brings the heat or cold—depending on the probe—to the work area and applies it directly to the component. There's no need to use hard-to-regulate liquids, gases or complex and sometimes dangerous refrigeration systems usually needed for lower temperature testing. Everything is electronic.

**Productive chat.** The idea for EG&G's new thermal probes originated at the 1967 IEEE show in a conversation between Leo G. McPherson of the Aerospace division of the Westinghouse Electric Corp. and EG&G product specialist Thomas Gerendas.

McPherson needed a small, easy-to-use aid for environmental testing and Gerendas was a proponent of small, hand-held thermoelectric de-



**Environment Proof  
is what we call it.**



## Tough New Arrival

The Stackpole Series 100 miniature rotary switch is here! New, compact  $1\frac{1}{8}$ " diameter body size. Totally enclosed to protect against exposure, contact contamination and production damage. Explosion-proof. Ideally suited for today's rugged demands and space applications.

Reliability and long life are assured by Stackpole's unique mode of switching—field proven

in the larger Series 600 switch. Internal intermixing of electrical functions and interconnection of decks and terminals provide unprecedented switching versatility. Inherently economical — Stackpole enclosed rotaries are competitively priced with open deck, clip type switches. This new versatility and economy encourage complete freedom of design and afford the use of enclosed rotary switches for all applications.

Sample switches, made to your exact specifications, are shipped in 2 to 3 days and production quantities in 2 to 3 weeks. For prompt quotations and samples, send your wiring diagrams or specifications to: Stackpole Components Company, P. O. Box 14466, Raleigh, North Carolina 27610. Telephone: 919-828-6201. TWX: 510-928-0520.

Now in two sizes

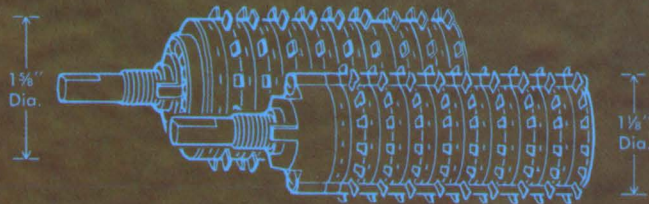

**STACKPOLE**  
COMPONENTS COMPANY



More compact...more versatile  
*...and truly handsome!*

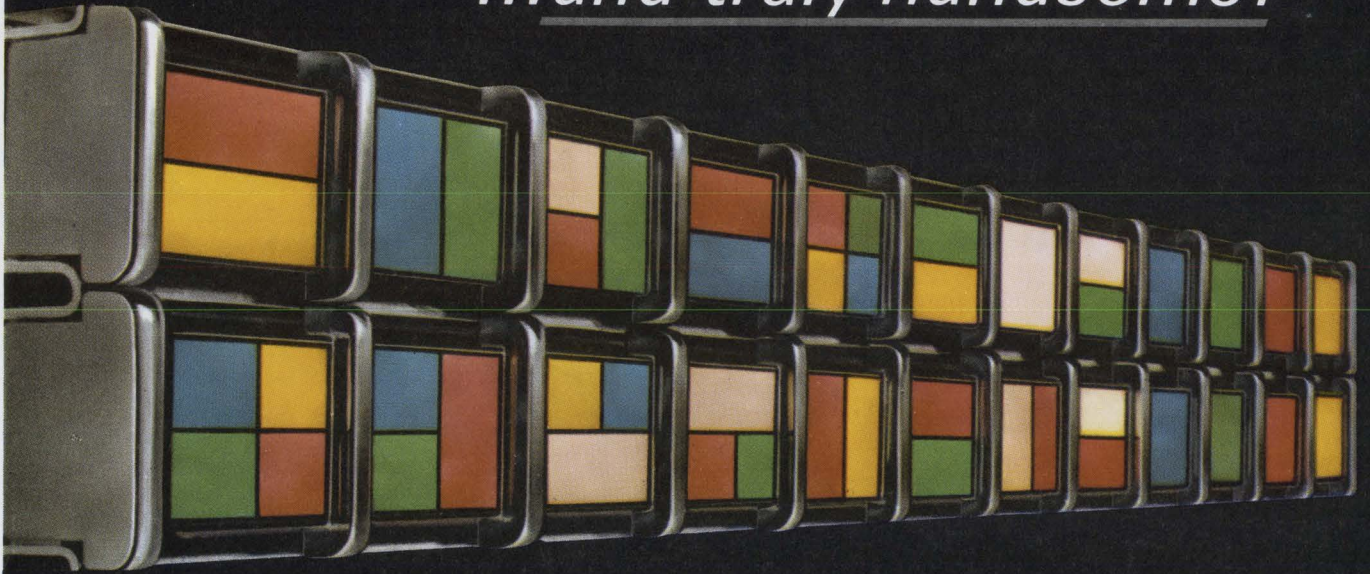

## Switchlights by **CLARE-PENDAR**

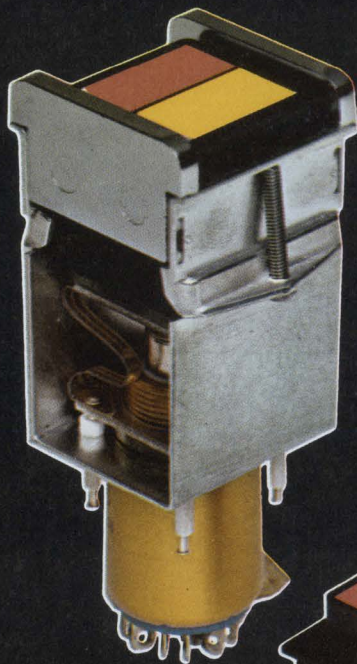

Switchlight  
Hardmount  
Assembly

Indicator  
Snap-in  
Module

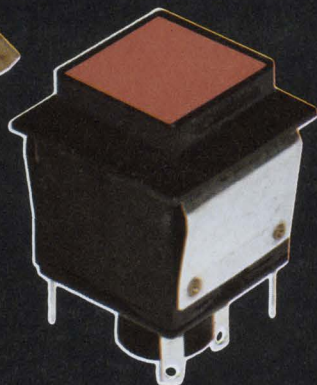

■ Clare-Pendar achievements put you in full control. Over 90 basic switches . . . 30 styles of "optimized light" lenses . . . single, dual and 4-lamp operation, give you hundreds of "mix & match" design answers. There's no compromise—ever—in switch performance or in compact display.

New 4-lamp switchlights in  $\frac{3}{4}$ " to  $\frac{7}{8}$ " sizes—single units to compact assemblies—minimize multi-light space needs. Include electrical or mechanical interlocking . . . mechanical control . . . matching indicators as needed.

In single and dual-lamp design, you can meet your most exacting function, appearance, and human engineering considerations—optimize your installation for efficiency and appearance.



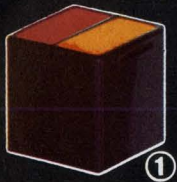

## NO-TOOL RELAMPING

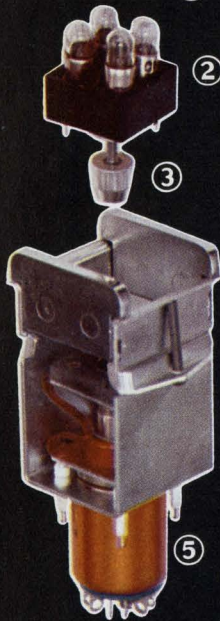

- 1) release lamp contact base
- 2) with a few twists of the center lens insert (3) replace T1, T1¼ or T1½ lamps as installed.
- 4) Luster finish barriers (4) minimize switching errors . . . single and multi-station assemblies accept standard C-P switch (5) or indicator types.

**BEHIND THE PANEL,** you step far ahead in meeting cost, reliability, and system production requirements:

- Base your design on the *right* switch—momentary, alternate, snap-feel and solenoid . . . the *right* circuit—SPST to 6PST, DPDT to 4PDT and more . . . the *right* contacts—snap action, dual wiping, double break and transfer.
- Meet the most demanding service needs . . . from single switch to custom assemblies . . . with front or sub-panel mounting . . . with interlocking and mechanical controls . . . with coordinated accessories . . . with Clare-Pendar's experienced Application Engineering services.

For complete line data, circle Reader Service Number, or write:



a subsidiary of  
C. P. Clare & Co.

a GENERAL INSTRUMENT company



vices, but was still hunting a useful application. When McPherson criticized environmental chambers, Gerendas figured he had found a market. The result was Coldfinger, and McPherson got serial No. 1 last week.

Three subassemblies make up the system: A controller and heat exchanger chassis, one probe for +30° to +180° C tests, and another for -60° to +80° C.

Two meter-type temperature readouts, two push-buttons, two potentiometers and an on-off switch comprise the control panel. To set a temperature on either the hot or cold probes, a technician pushes a button below the appropriate meter and turns the potentiometer until the needle rises or falls to the desired reading. When the button is released, the needle returns to its former position to trace the change in temperature of the probe tip.

**Exact and more.** Temperature control is to within  $\pm 0.5^\circ$  C, more than exact enough for mil spec testing. For even more exacting measurements, control to one hundredth of a degree can be obtained.

The probes are 2 by 2 by 7 inches and connected by 6-foot cords to the control and heat exchanger

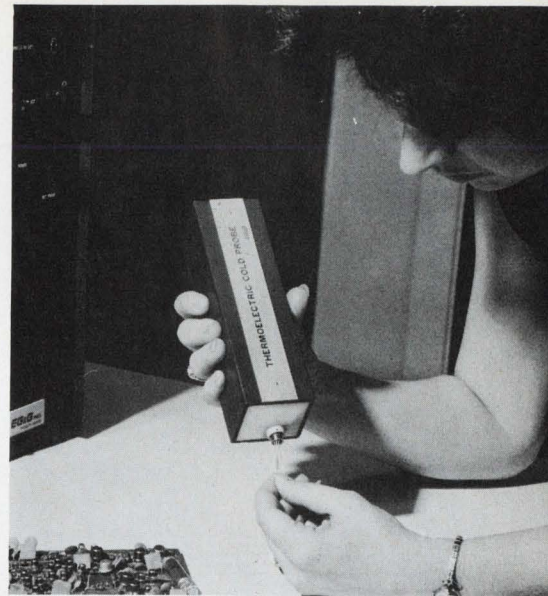

**Freezer.** Temperature of component is brought down by solid state probe.

chassis. In the low-temperature probe is a two-stage thermoelectric cooler made of p- and n-type bismuth-telluride alloys. In the high-temperature probe, a copper plate is heated by simple resistance elements.

Both probes have nylon insulation covering the tip.

EG&G Inc., 170 Brookline Ave., Boston, Mass. 02215 [331]

## New microwave

# Coupling cuts the time

**A microwave design** engineer has to be a good matchmaker. If the impedance of a load in his circuit is not the same as the impedance of the transmission line, power is wasted. Voltage waves reflect from the load, and combine with incoming signals to form a standing wave in the mismatched line.

Designers at Weinschel Engineering are introducing a system to measure voltage standing wave ratios which, they say, is the most accurate, available off-the-shelf.

The accuracy of vswr measurements depends, in part, on the amplitude of the residual vswr which is introduced by the measuring device. Residual vswr is caused by reflection of input voltage by the

slotted-line connectors and probe, and by mechanical imperfections, like an off-center inner conductor.

**Three parts.** The Weinschel system has three components—a carriage assembly, a probe-detector assembly, and the Model 1021 slotted section. The section's residual vswr is low and easily measured.

According to Gunther Sorger, Weinschel's research director, the residual vswr of the 1021 is less than 1.01 between 2 and 10 gigahertz, and less than 1.02 between 10 and 18 gigahertz, if GPC-7 connectors are used. If type-N connectors are used, the residual vswr will be under 1.03 between 2 and 12.4 Ghz, and under 1.04 between 10.4 and 18 Ghz.



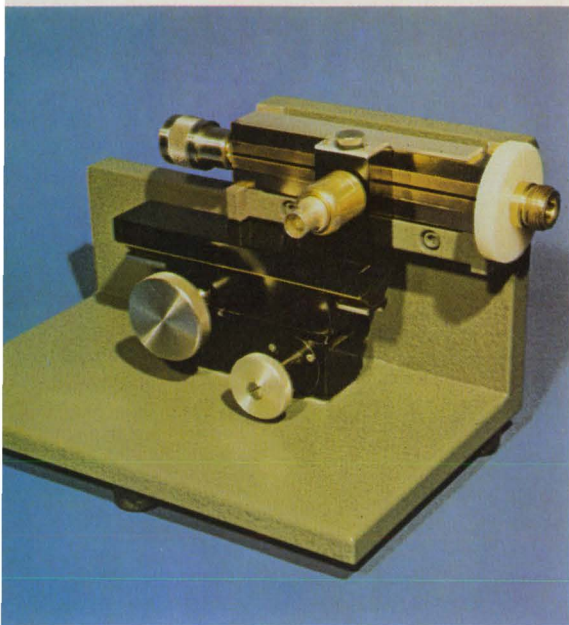

One problem in making slotted lines is supporting the inner conductor without causing reflection. In the 1021, the inner conductor is fastened with an insulator bead at the input port. At the output, three nylon strings, each 1/1,000-inch thick, are used to support the conductor. Sorger says this technique introduces no additional reflection up to 18 Ghz.

**Coupled.** Normally, an engineer measures residual vswr by attaching a movable load to the slotted line, and taking measurements at different load and probe positions. "The measurements and calcula-

tions take all day," says Sorger.

In Weinschel's system, the probe is mechanically coupled to the load, so the phase shift between the two is constant. If reflection from the load is small, the probe measures the voltage caused by the 1021 only. "It makes measurements simple and fast—two minutes at most," says Sorger.

Using the sliding load, an engineer can measure residual vswr in the slotted section with an accuracy of  $\pm 0.002$ , and the coupled load is useful when measurements are made on two-port devices, such as cable segments, filters, and transistors.

**Looking for trouble.** Measurement of vswr is precise because the Model 1021 causes very little reflection.

Weinschel Engineering Co., Box 577, Gaithersburg, Md. 20760 [332]

## New instruments

# Seeing things wrong

**Visual inspection** of printed-circuit boards or electronic assemblies is, quite literally, a pain in the neck. The inspector must continually switch his gaze from the components to a master drawing for comparison, a slow, unreliable, expensive, and fatiguing procedure.

But a new British instrument puts the inspector in front of a binocular-type eyepiece through which he sees alternately flashed images of the production unit and an approved sample. Called the Comparascope, it was developed by Vision Engineering Ltd. and is being marketed here by Bausch & Lomb Inc.

The U.S. distributor claims the instrument can cut inspection time by at least a factor of seven compared with existing methods. Errors are also reduced because the operator doesn't have to retain an image in his mind when looking from one component to another.

**Custom jobs.** The Comparascope is priced at about \$4,400. Although there is no comparable commercial instrument, some firms have built similar systems for in-house use. A few customized types have been sold, but these one-of-a-kind set-

ups have cost up to \$50,000, depending on their level of sophistication.

In the Comparascope, the master sample and the unit to be inspected are placed side by side on the

viewing table. Areas 5 inches square are illuminated by two fan-cooled, 200-watt quartz-iodine lamps equipped with reflectors, condensing optics, projection grids, and lens systems. This arrangement prevents shadows, internal light scatter, or any parallax error between the fields.

**His master's choice.** The operator sees an image of the master, then one of the unit being inspected. Defects stand out clearly. For example, the image of a missing com-

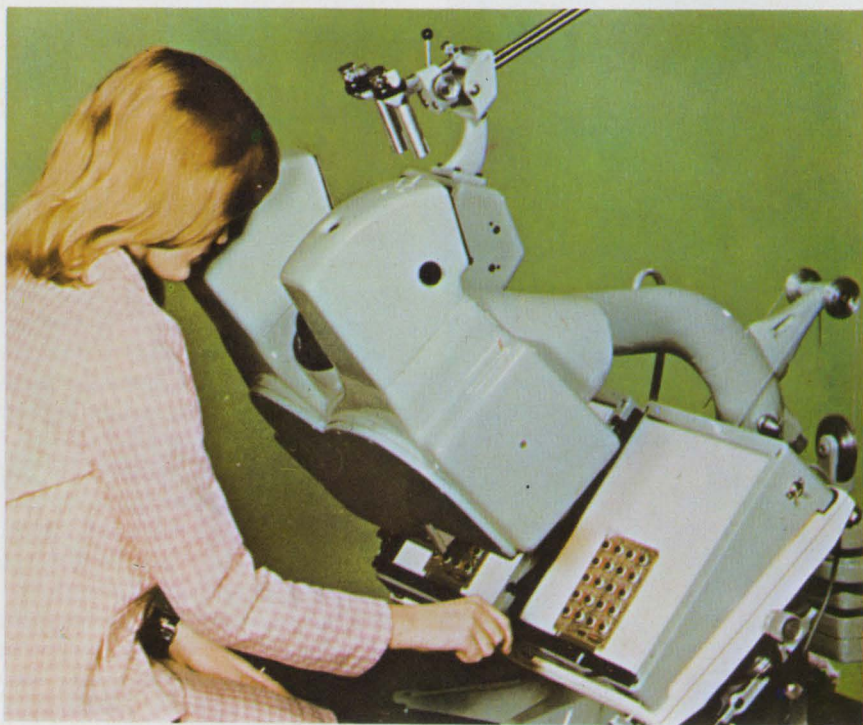

**Quick change.** The operator sees alternate views of a master and a production piece. Defects are easily spotted.



ponent appears and disappears, or color codes change.

The transition from one image to another isn't abrupt, and no glaring, white light shows through the eye-piece. This almost completely eliminates eye fatigue, according to Bausch & Lomb.

The scanning speed can be varied to accommodate different

operators, and, in some cases, speed can be adjusted according to the complexity of the work piece. For example, if a prolonged view of either the master or job piece is required, the scanning can be done manually.

Bausch & Lomb Inc., Rochester, N.Y. [333]

## New instruments

# A plug-in's plug-in

**Plug-in subassemblies** for oscilloscopes were developed originally to take advantage of common circuitry and give the buyer flexibility; he does not have to buy a new scope to perform different functions. At IEEE, Tektronix Inc., will show a new plug-in unit that contains its own smaller plug-ins. The device is intended to work with the company's 560 series scopes.

A year ago at IEEE, Tektronix displayed two sampling units, the 3S1 and 3S3. Sampling heads were built into these plug-ins. The new 3S2 can use two types of sampling heads: the S-1, with a rise time of 350 picoseconds, and the S-2, with a rise time of 50 ps.

The tradeoff, explains project manager Al Zimmerman, is in signal-to-noise ratio. The noise figure on the S-1 is under 2 millivolts; on the S-2 it is 6 mv. On the faster unit, Zimmerman notes, fewer electrons are collected during the shorter gate period, and therefore the signal-to-noise ratio is smaller.

**It's remote.** The new device permits the heads to be set up remotely. Signal degradation is normally greatest in the coaxial cable between the source and the sampling head itself. If the heads are set up at the source, these cable losses can be reduced.

Zimmerman says separate packaging of the heads alleviated the problem of shielding against crosstalk between the two channels.

The sampling head circuitry determines the characteristics of the entire plug-in, Zimmerman says. It includes a sampling gate (a gallium-arsenide diode), a strobe generator,

and a preamplifier. What remains for the mother plug-in would be the same for a fast or a slow sampling head—amplifier circuitry, memory, dual-trace switch circuitry, and a power supply.

A sampling sweep unit (an independent plug-in called the 3T2) determines the time to take a sample,

and generates a trigger pulse, routed to the sampling head in the 3S2. This pulse triggers the strobe generator, which causes the diode gate to conduct, thus taking in a brief sample of the input. These signals are amplified in the head and passed on to the circuitry in the 3S2.

The trigger for the sampling sweep unit is a portion of the input signal itself, taken in through a rear connector in the head and routed to the 3T2.

This internal triggering lets the user see the pulse he is triggering on without an external delay line. There is a b-trace delay switch that can be continuously adjusted to  $\pm 5$  nanoseconds to permit the second trace to be moved with respect to the first, a factor that eliminates the effect of differing cable lengths.

Price of the 3S2 is \$800, with its plug-ins, the S-1 and S-2, respectively priced at \$250 and \$300. The 3T2 costs \$990.

Tektronix Inc., Box 500, Beaverton, Ore. 97005 [334]

## New industrial electronics

# Chopping out line noise

**When designer** Marius Janson tackled the development of Honeywell's new temperature controller for industrial furnaces, the Versatronik 7161R/S, he began by choosing 600 hertz for the circuit's internal frequency, thus assuring 120-to-140-decibel rejection of 60-hz line noise.

Instead of a mechanical chopper that couldn't operate at this high frequency for long, he decided to use a metal-oxide semiconductor field effect transistor chopper that's smaller, costs less, and should give the device longer life.

**Isolation.** Another innovation is the use of junction FET's, which provide isolation between circuits and have good temperature stability. High-gain integrated-circuit operational amplifiers vary the feedback around the main amplifier to yield a wide range of gain and integration modes for closed-

loop control.

The R (manual reset) model of the controller is said to have a proportional band of 6°C to 200°C,



**Pick a temperature.** Selection is made with dial, and pointer shows deviation.



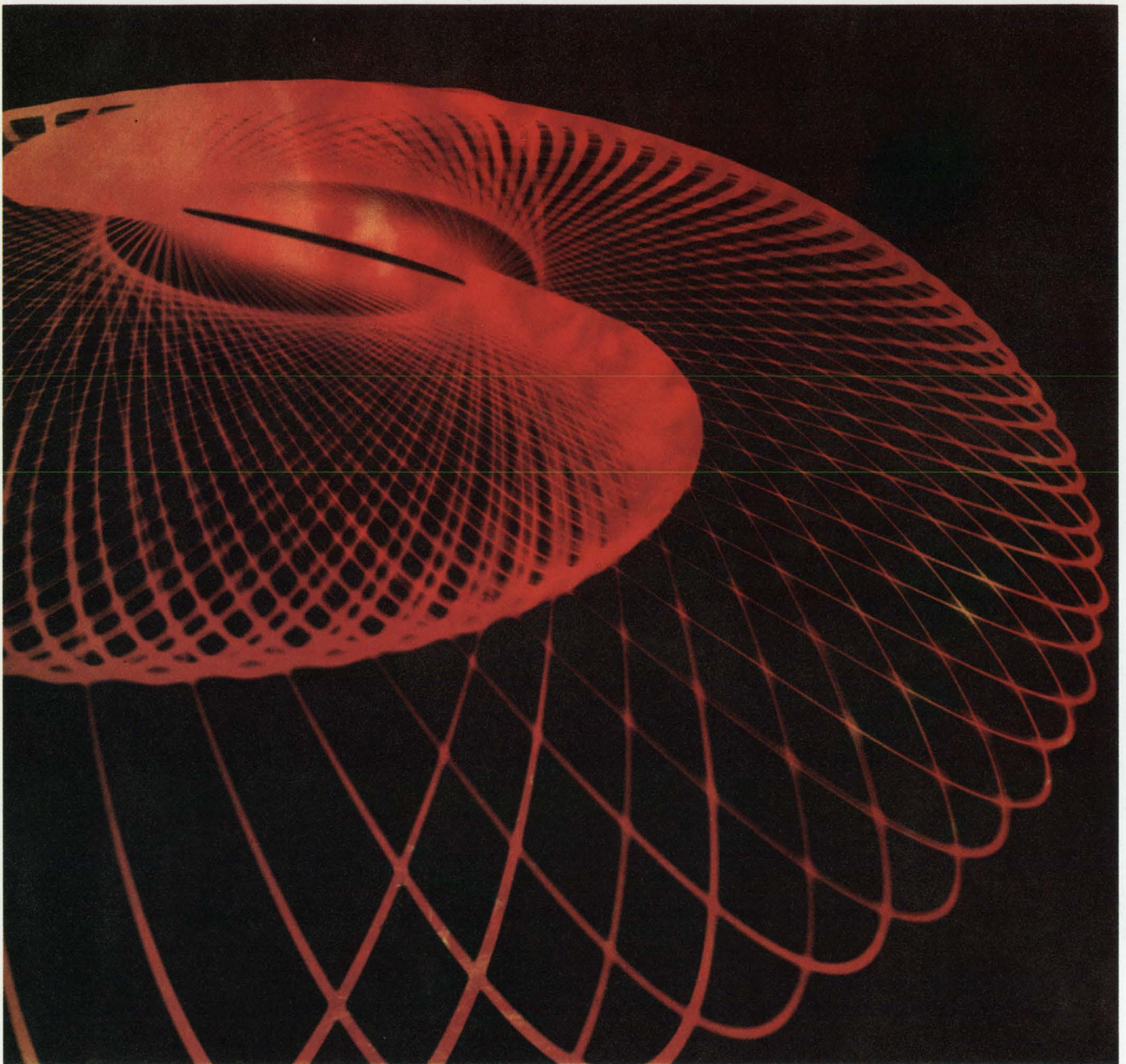

# O/E/N...

## EVOLUTION IN THE WIDENING WORLD OF ELECTRONICS

Planned, aggressive expansion—through research, development and acquisition—has made O/E/N a major supplier to the electronics industry. Our specialists assure manufacturers a myriad of choices for any environment from aerospace to oceanography. The one common denominator is engineering and manufacturing excellence. O/E/N components are preferred wherever circuitry must perform precisely and dependably.

That's why electronic manufacturers turn to us for an ever-widening variety of products—all with a common hallmark: excellence. O/E/N subsidiaries and divisions have traditionally pioneered many advances in technology and will continue to do so. Let us help you make things better by putting this long experience at your disposal. For complete information send for booklet describing the O/E/N companies and products.

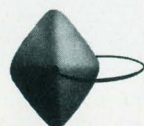

O/E/N

OAK ELECTRO/NETICS CORP  
CORPORATE OFFICE  
CRYSTAL LAKE, ILLINOIS 60014



while the S (automatic reset) type has a band of 6°C to 500°C.

The reset mode eliminates droop caused by load changes. In the manual controller, the mode ranges from full on to full off. In the automatic controller, the reset action is adjustable between 0.2 and 10 repeats per minute.

When set at a proportional band of 30°C, for example, the controller's output will be 4 milliamperes without any deviation from setpoint, and 20 milliamps at 30°C deviation. By a simple lead change, the output becomes 0.5 to 5 milliamperes.

**Set to stay.** The odometer-type setpoint control gives a 1°C resolution, but once set, the controller maintains the desired temperature to within 0.25°C. A meter inde-

pendent of the control circuit shows the deviation from set point, with a full excursion from zero-center representing about 5°C.

Control temperatures range, in steps, up to about 1,650°C with types E, J, K, R, and S thermocouples.

The sensitivity of the solid-state temperature controller makes it suitable, Honeywell says, for laboratory furnaces, industrial processing lines, diffusion and source furnaces, bonding machines, alloying furnaces, annealing ovens, and pneumatic or hydraulic valves.

The list price is about \$350 for manual reset models and about \$400 for the automatic units.

Honeywell Apparatus Controls Division,  
2727 South Fourth Avenue, Minneapolis, Minn. 55408. [335]

## New Instruments

# Computer aide designed

**Computers help engineers** by doing tedious chores. Now, engineers at North Atlantic Industries Inc. are returning the favor.

North Atlantic does a lot of work with surveillance and navigational equipment. While testing such systems, the firm's engineers noted that a lot of computer time was spent sending commands to the digital-to-resolver and synchro converters that position antennas.

To cut down on this waste of the computer's time, they developed the Series 660 Digital Angle Generator, a device that can be programmed to deliver a variety of position commands to converters in the same digital form as the computer's output.

**Up the staircase.** The 660 is basically a staircase generator, with each step of the staircase output corresponding to a certain angular displacement. The device can command displacements as small as 19.8 seconds and as large as 180°. Slew rate is controlled by a clock circuit that can fix it at anywhere between 0.01° and 1,000° per second.

A computer would have to issue 64,800 separate digital commands to rotate an antenna through 360° in discrete steps of 19.8 seconds. It would need either a large memory or an iterative program. But now it can give just one order and leave the driving to the programmed 660.

**Sweeping choices.** The 660 has other features. The operator can set an initial angle with a row of binary switches on the front panel. There's also a switch that directs the device to count up or down—in other words, to rotate the antenna in a clockwise or counterclockwise direction.

Some models have another row of switches for the setting of a step angle through which the antenna will be continuously swept. With all models, a row of lights above the switches displays the angular displacement in binary code. And there's also a single-step mode.

**Keeping in touch.** Though a single command is all that's needed to start a simple rotate program, the computer can still control any of the 660's functions. The com-

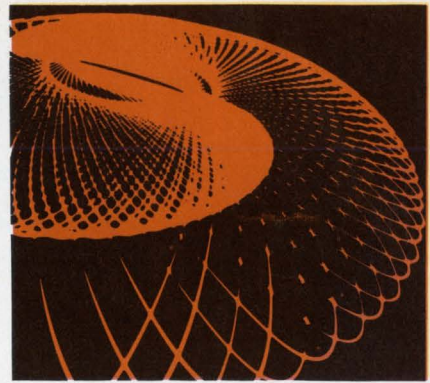

THIS IS  
**O/E/N...**

SEVENTEEN DIVISIONS AND SUBSIDIARIES OPERATING TWENTY-FIVE MANUFACTURING PLANTS IN THE U.S. AND THE FREE WORLD.

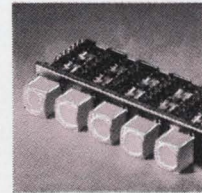

### OAK DIVISION

Switches (rotary, push-button, rocker thumb-wheel, slide, lever, snap); Tuners (TV-UHF, VHF); Solenoids.



### MARCO-OAK

Lighted and unlighted Pushbuttons; matching Indicator Lights.

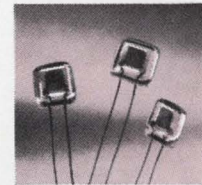

**MCCOY ELECTRONICS CO.**  
Highest quality Quartz Crystals, Filters and Oscillators.

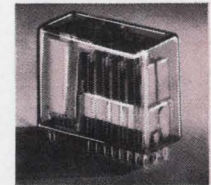

### HART-ADVANCE

Relays... general purpose, miniature, time delay, volt-sensitive.

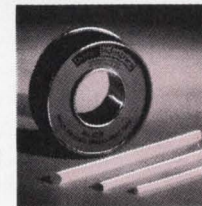

**DODGE INDUSTRIES, INC.**  
Teflon\* Products—sheets, coated yarns, glass-reinforced tapes, spray coatings, copper and aluminum clads for electronic/electrical use. \*TM of DuPont

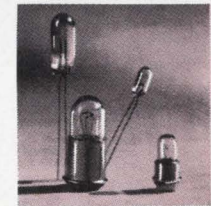

### LOS ANGELES MINIATURE PRODUCTS, INC.

Miniature and sub-miniature incandescent lamps for high density light sources in electronic/electrical use.

**O/E/N**  
OAK ELECTRO/NETICS CORP.  
CORPORATE OFFICE  
CRYSTAL LAKE, ILLINOIS 60014



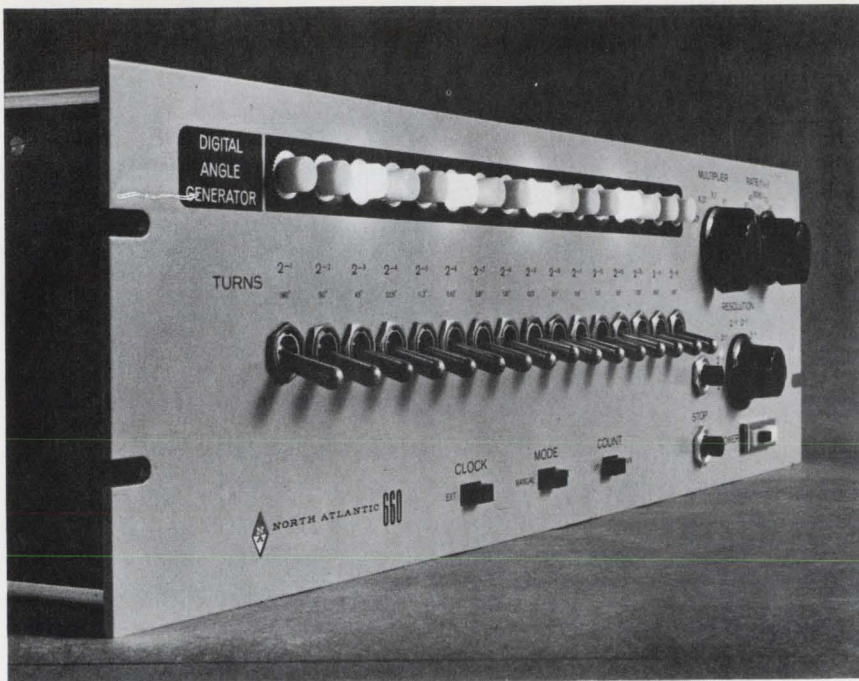

**Computer's pal.** Angle generator frees computer from the repetitious job of sending digital positioning commands to synchro or resolver converters.

puter can, for example, introduce angular acceleration by changing the clock rate.

Changing the slew rate would also be useful in radar applications where the antenna is to sweep slowly through some angle, swing

back to the first position quickly, and begin the slow scan again.

The 660 was designed for compatibility with North Atlantic's line of synchro and resolver converters, but the company says the unit can be used with most converters on

the market.

With the 660, an engineer can use a sophisticated computer more efficiently, or can get by with a less sophisticated machine. He can also use the 660 by itself for a simple rotational control.

Although the device was designed for testing and controlling antennas, North Atlantic says it has many other applications and cites numerically controlled machine tools as one.

The 660 measures 5¼ by 19 by 12 inches and can be mounted in a rack with other test equipment. Prices start at \$2,700 and delivery time is less than five weeks.

#### Specifications

Data rates	0.01°/sec to 1,000°/sec continuously variable, 5 decade ranges
Output	one speed, 16 bits with display
Start angle	16 binary switches set initial angle
Stop angle	16 binary switches set stop angle
Enter pushbutton	registers and displays start angle
Count pushbutton	initiates count sequence
Power	115v or 230v ± 10%, 40hz to 420hz
Connectors	clock input, clock output, data bits

North Atlantic Industries Inc., Terminal Drive, Plainview, N.Y. 11803 [336]

## New subassemblies

# Digits for everyone

**Meters are simple** analog devices and often highly accurate. But the men who read them can make errors, especially when the needle hangs between gradations or when an elbow jars the workbench. Almost any engineer would rather have a numerical readout than a meter.

A new digital voltmeter subassembly offers a reasonably inexpensive way of supplying the numerical display. Although designed for equipment makers, the Series 800 dvm from Microdyne Instruments Inc. is small enough for many retrofit applications.

The 800 is an outgrowth of four integrated-circuit testers unveiled last year. The most expensive models use similar digital readouts.

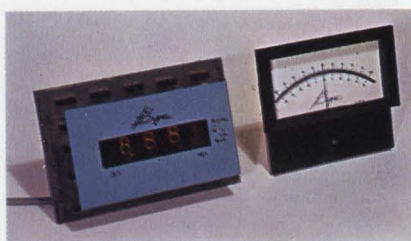

**Drop-in.** Digital panel meter directly replaces needle movement

The new unit can give a reading of anything for which a transducer exists—from acceleration to pH.

Absolute accuracy of the 800 is 0.1%, and resolution is one part in 1,500. Input impedance isn't high, but is adequate for most measurements at 1 megohm (100 kilohms on the device's 0.1-volt scale). Common-mode rejection is 80-db.

**Three ranges.** The display consists of two neon bulbs and three Burroughs 5441 Nixie tubes with built-in decimal points. One bulb lights for "greater than full-scale" indications; the other indicates negative voltages. Although range switching isn't automatic, Microdyne rates the 800 for three ranges: ±0.1, 1, and 100 volts.

Besides Nixies, Microdyne engineers have built in a binary-coded decimal pickoff (1-2-4-8) for printers or computer interfaces.

**In and on.** Mechanical installation consists of cutting a rectangular hole in a panel and attaching Nixies and circuit boards from the back and the antireflective polarized bezel from the front. Calibration is quick, too. It takes only a screwdriver zero adjustment and a push-button plus screwdriver adjustment to make the displayed voltage match that of a built-in zener diode standard.

Microdyne Instruments Inc., 225 Crescent St., Waltham, Mass. 02154 [337]





Why is this **MSD** tech rep smiling?

*Wouldn't you, if your efforts were backed up by the industry's leading engineering and design assistance and testing procedures that were available to help solve your customer's problems?*

*...and your company's products (Netic and Co-Netic magnetic shielding foils, sheet stock, fabricated shielding and tape preserver containers) were the finest in the field?*

*...and, if you provided all this at the right price with guaranteed on-time delivery... wouldn't you be smiling, too?*

West Coast:  
Tech Rep Distributor Co.  
10606 W. Pico Blvd.  
Los Angeles, Calif. 90064  
213, 836-6806  
213, 871-0055

Write for Catalog No. 68



## **MAGNETIC SHIELD DIVISION**

PERFECTION MICA COMPANY

1322 North Elston Avenue • Chicago, Illinois 60622

Phone: 312, EV 4-2122 TWX 910 221-0105



# Now You Have a Choice

**\$1293**

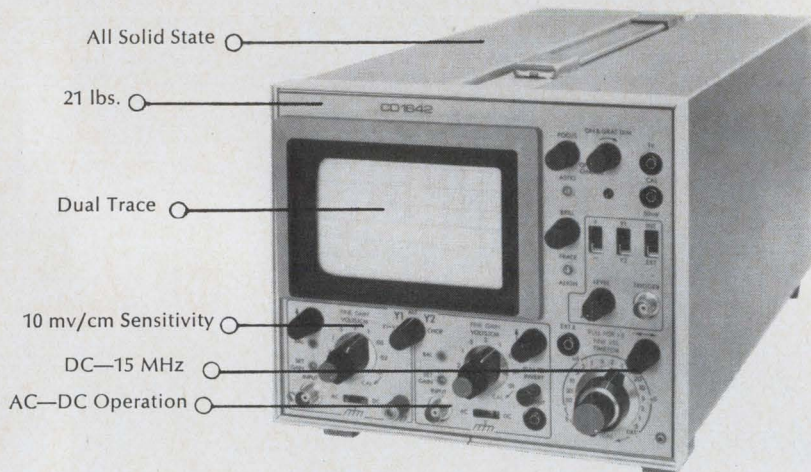

No longer is there just one ultimate performance, AC/battery powered scope available. Now you have a choice—Data Instruments CD 1642. Of course, we don't think that "choice" is exactly the right word. Because, as a basic oscilloscope, the CD 1642 offers so much more. 20% greater display area, for instance, and full centimeter divisions. Sensitivity, also, is better by 20% and the sweep is faster by the same amount. Moreover, the CRT has far superior focus and contrast so a better display is possible. The rise time is somewhat faster and the instrument will trigger well in excess of its rated 15MHz. And finally both AC and internal as well as external battery operation are included in the basic instrument.

On the other hand, there is the Status Symbol Factor. The CD 1642 has not yet achieved this. That other great scope has, and perhaps there is significant psychological value attached to it. The question is—is it worth paying 40% more to own a status symbol? We don't know. We can only point to the specs.

VERTICAL AMPLIFIER (2 channels Y1, Y2)					
BANDWIDTH	SENSITIVITY/CM	RISE TIME	ACCURACY	IMPEDANCE	AUX. AMP. Y2
DC-15MHz (DC) 2Hz-15MHz (AC)	10mv to 5v 9 ranges	20ns.	± 5%	1MΩ + 40pf	× 10 Gain 40Hz-5MHz
TIME BASE		CRT		POWER	PHYSICAL
SWEEP/CM	TRIGGER	HOR. AMP.	DUAL TRACE	AC & DC	WT. & DIM.
0.5μs-200ms 18 ranges	Int., Ext., +, - Normal and Automatic	Exp. X5 1v/CM DC-500KHz	6 x 10CM 4kv	AC 44-440Hz 117-220v DC Bat. 12-30v 25w	7¼" x 8¾" x 19" 21 lbs.

Why take our word for it? Compare Data Instruments CD 1642 with that other scope and make your choice. True, we can't offer you a Status Symbol, but we can improve your image.

**Data Instruments Division • 7300 Crescent Blvd. • Pennsauken, N. J. 08110**

## New instruments

### Panel-size meter prints out data

Servo controlled indicator  
cuts cost of information  
readout and storage

Measuring electrical parameters and printing out the results has traditionally been expensive. Digital voltmeter and printing system combinations cost well over \$1,000. But this price barrier has been broken with Abbey Electronics Corp.'s Digiprinter.

Abbey's digital recording voltmeter sells for \$475. The instrument is a self-contained unit that provides a continuous digital readout and a printout on command on adding machine tape. The standard model has a range of 100 millivolts for a full-scale count of 1,000. Overranging is 10%. Accuracy is within ±0.1% full scale, ±one count, and resolution is 0.5%.

The Digiprinter is aimed at applications where speed isn't essential—production testing and quality control, for instance. Slewing speed is about eight seconds and printing speed is two seconds. Permanent records can be made of voltage, current, or any parameter that can be converted into a d-c signal, such as speed, torque, strain, pressure, temperature, and tension.

The basic element of the Digiprinter is Abbey's Digimeter, a nulling-type, servo driven digital voltmeter.

**Difference input.** A two-phase servo motor is driven by a high-gain, a-c preamplifier. The preamp

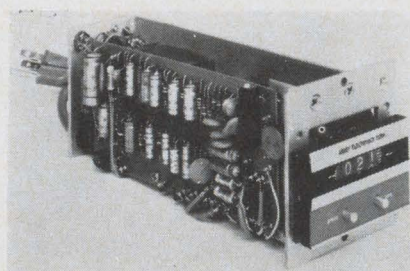

**Inky.** Printing wheel connected to readout provides permanent record.



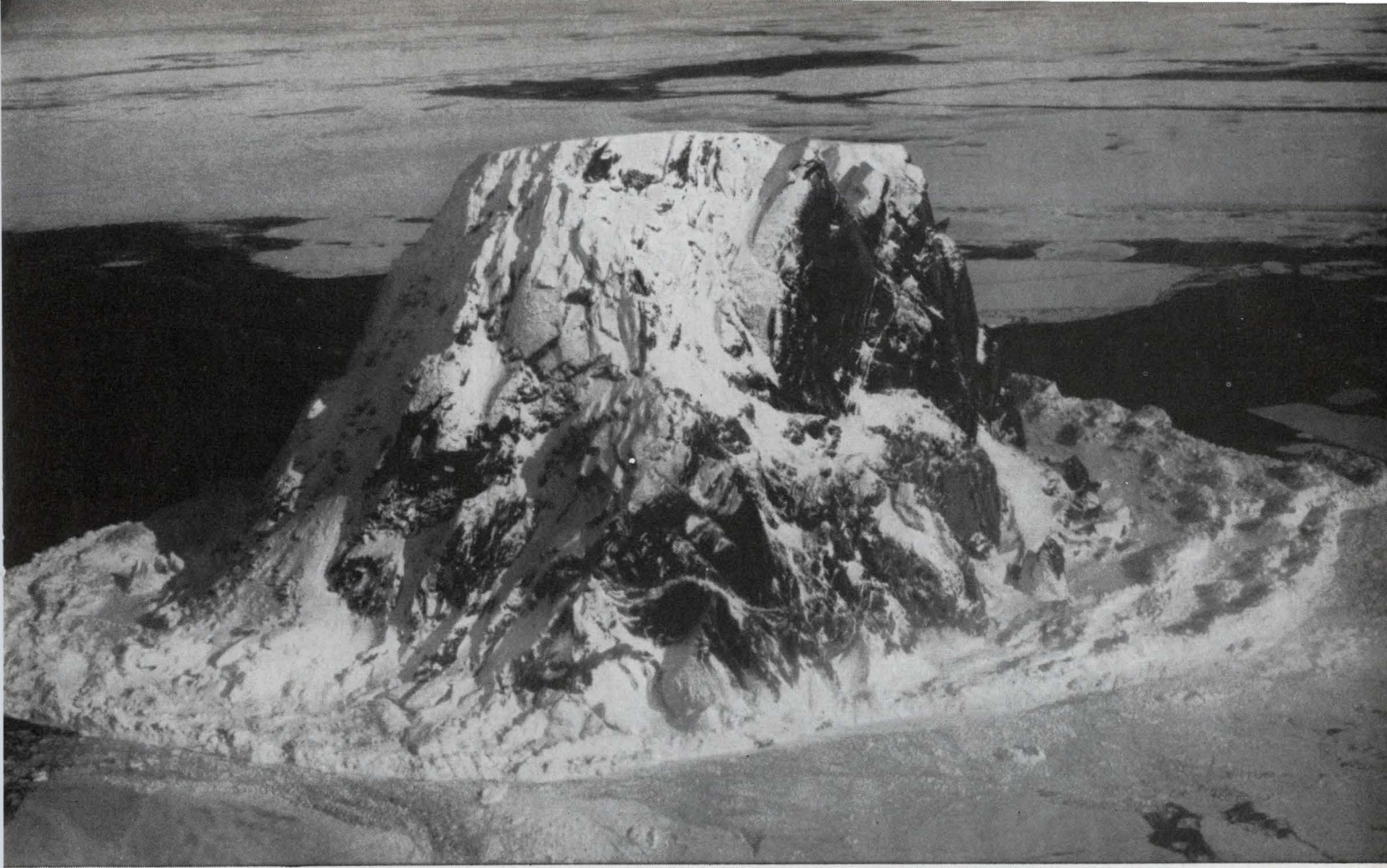

# Nuclear power works here. Have you a tougher job for it?

Our portable nuclear generator has been powering an oceanographic station on lonely Fairway Rock in the Bering Strait 24 hours a day for 19 months.

**It can keep this up for five years, non-stop.**

**Without refueling. Without maintenance.**

**Power output is guaranteed.**

Martin Marietta portable nuclear generators are not laboratory curiosities. Not by a long shot.

They're rugged, dependable, available. Right now.

They're designed to meet low power requirements in remote locations where it's too expensive—or downright impossible—to use a conventional power source.

Models offered produce 3, 25, or 50 watts non-stop for five years without refueling. The 50-watt generator will produce more than 2-million watt

hours on a single isotopic fuel charge. Performance is guaranteed.

The generators have no moving parts, so they won't wear out. They need absolutely no maintenance.

And power can be stored on a cyclical basis, so that system output can be stepped up to several kilowatts.

The generators are unaffected by heat, cold, dust, gasses, etc. You can put them on a mountain peak, in the middle of a jungle, or hundreds of fathoms under the sea.

They're now taking on such tough jobs as powering a navigation beacon 15,000 feet below the Atlantic, a floating weather platform in the Gulf of Mexico, navigation lights and fog horn on an offshore oil platform, and an ocean buoy which will transmit oceanographic or weather information to passing satellites, ships and planes.

We are now producing several generators designed to solve remote

power problems for the oil industry, in exploration, production and pipeline transportation.

An undersea wellhead control system, *without hydraulic or electrical connections to the surface*, already has been developed. The nuclear generator sits on the wellhead, right on the ocean floor where the power supply is vital. It receives acoustical commands from the surface. We also have developed a blowout preventer (BOP) control system.

If you have a remote power problem in the oil industry, or in monitoring and control systems, lighting, marking, communications or navigation, a portable nuclear generator might solve it right now.

For further information, write John Morrison, Box 1100-L, Nuclear Division, Martin Marietta Corporation, Baltimore, Maryland 21203.

**MARTIN MARIETTA**



# NOW...THERE'S A 50-60 CYCLE UNIT

## TUNG-SOL 28 GP SERIES POWER SUPPLIES



**up to 400 AMPS. D.C. in  
new weight-saving package**

A tremendous break-through was achieved in space and weight reduction of air-borne power supplies when the Tung-Sol Y-series configuration was first developed. Now, this unique design has been adapted to the requirements of ground-based equipment, to provide the same advantages for applications in the 100 amp. to 400 amp. range.

The Tung-Sol 28 GP series consists of four standard units that supply 100, 200, 300 or 400 amps. at 28 volts D.C. They are production items available on an off-the-shelf basis. All units embody high-performance characteristics. They have high environmental adaptability and are especially suited to seaborne installations. Important, also, is the fact that they can be mounted in any attitude. For equipment that is to be transported by air, the weight factor is an exceptional advantage.

<b>28 GP 100</b> Output: 100 Amps. Size: 8½" L x 4" W x 5¼" H Weight: 7.5 lbs.	<b>28 GP 300</b> Output: 300 Amps. Size: 10½" L x 6" W x 7½" H Weight: 19 lbs.
<b>28 GP 200</b> Output: 200 Amps. Size: 10½" L x 5" W x 6¼" H Weight: 13 lbs.	<b>28 GP 400</b> Output: 400 Amps. Size: 13" L x 6" W x 7½" H Weight: 26 lbs.

For full technical information write for Bulletin.  
**TUNG-SOL DIVISION**  
**Wagner Electric Corporation**  
 630 West Mt. Pleasant Ave., Livingston, N.J. 07039

**SEE IT AT THE  
IEEE SHOW  
BOOTH 3E15-3E17**

input is the difference between the input voltage and the voltage at the wiper of a follow-up potentiometer. A chopper alternates between the two signals. The motor is driven until the input signal and the potentiometer wiper voltage equal each other. A zener reference circuit provides the potentiometer, or nulling voltage.

As the motor turns, it drives a digital counter display and a digital printing wheel. The print command can be made from a button on the front panel or remotely by a relay contact closure.

The Digiprinter is modified easily for other than the standard, 100-mv range. A built-in potentiometer enables the instrument to accommodate 10 to 200 millivolts. Adding a voltage divider makes it possible to measure up to 1,000 volts.

Abbey Electronics Corp., 15 Burke Lane, Syosset, N.Y. 11791 [379]

New industrial electronics

## Digital meter has its limits

Set by switches or diodes,  
high and low points extend  
panel meter applications

When an executive considers accepting a new position, the enticement often comes from stock options, not salary. In API Instruments Co.'s digital panel meter, one of the enticements is plenty of options, too. Result is a three-digit panel meter that, with added thumbwheel switches, doubles as a high and low set point digital meter relay.

"Our basic digital panel meter contains certain electronics and design innovations. But we're counting on price, \$320 list with liberal discounts, and API's reputation and application experience in the meter and relay field for our share of the market," says chief engineer Jack Crowdes.

One of API's earliest products was the d'Arsonval meter-relay.



Simply connect your oscilloscope and sweep oscillator or signal generator to a new Polarad Model 2400 Spectrum Analyzer Converter, (cost: \$2990) and suddenly you have a spectrum measurement system which will out-perform other analyzers costing \$10,000 or more.

For example, it will provide a calibrated display with a **70 db** dynamic range on a large screen or storage oscilloscope, or any other inexpensive 'scope available.

Frequency range is 0.01 — 12.4 GHz into the first mixer; up to 90 GHz with external mixing.

Sensitivity is **-105 dbm (10 KHz: bandwidth)** with fundamental mixing, and, since you supply the i.o., you can retain the sensitivity of fundamental mixing anywhere in the frequency range.

Frequency sweeps (spectrum widths) can be varied from 10 KHz to 4 GHz, limited only by your oscillator's sweep-range. Image separation is 520 MHz.

You are afforded the best features of a front end swept, narrow band i.f. analyzer, with a swept i.f. for narrow spectrum widths.

For more information, or a demonstration — any i.o. or 'scope will do — call your local Polarad field engineering office or write Polarad Electronic Instruments, 34-02 Queens Boulevard, Long Island City, N. Y. 11101. Telephone: (212) EX 2-4500.



Circle 207 on reader service card

## now for only \$2990 you can get \$10,000 spectrum analyzer performance





# MAGNETIPS

from Mr. MAGNETICIAN



## MAGNETIC MATERIALS AND INSTRUMENTATION

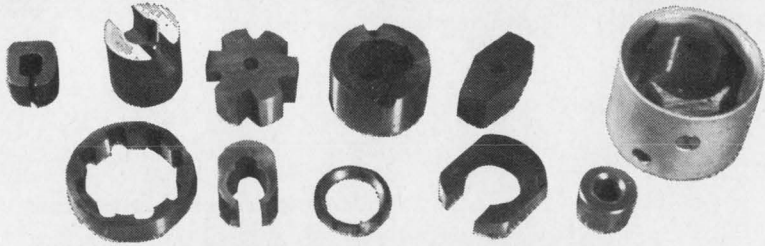

### PERMANENT MAGNETS

Custom-engineered to size, shape and specific magnetic properties for sophisticated applications from a complete range of permanent magnet alloys. Production availability of new high energy product Columax 9 and ultra-high coercive force Alnico 8-C. Write for Bulletin M304 C "Metallic Alloy Permanent Magnets, and Bulletin M303 "Permanent Magnet Design."

## MAGNETIZATION

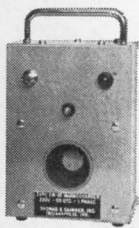

Model EM-10

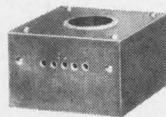

Model EM-20

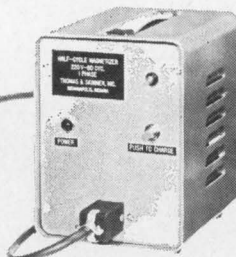

Special fixturing

T & S Magnechargers from lightweight, portable units to larger bench models will magnetize all permanent magnets. Charging fixtures may be designed and built by user to suit needs, or built to specifications by Thomas & Skinner. Write for Bulletin A-930, "Magnetic Instrumentation."

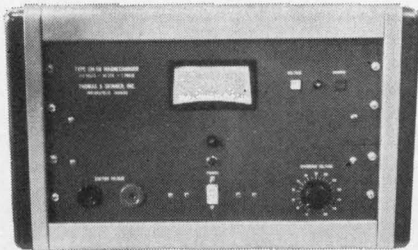

Model EM-50

Universal power supply with large charging capacity permits customer to make own coils with only 6 or 8 turns of wire.

- OTHER T & S MAGNETIC INSTRUMENTATION
- DEMAGNETIZERS • FLUXMETER • GAUSSMETER
  - BALANCED MAGNETIC BRIDGE
  - RECORDING PERMEAMETER

Member



### NEW PRODUCTS ON DISPLAY AT IEEE 68

Be sure to visit Mr. Magnetician at Booth 3J17 at the New York Coliseum during IEEE 1968 Exhibition. March 18, 19, 20, 21.



*Thomas & Skinner, Inc.*

Box 111, 1120 East 23rd Street, Indianapolis, Indiana 46205  
Phone: 317-923-2501

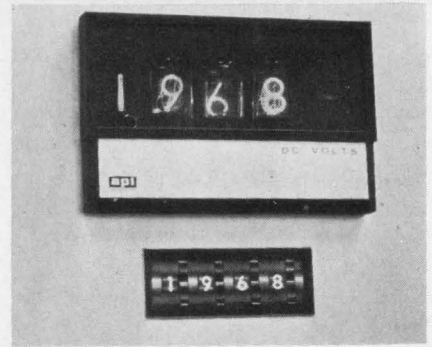

Setter. Thumbswitch below readout sets alarm limits of panel meter.

When the meter's pointer deflected enough to touch adjustable high or low contacts, an alarm or control signal resulted. Functionally, the company's new digital panel meter will perform the same way, but with better accuracy and resolution.

The basic digital panel meter is a single range instrument with fixed decimal point. Standard current ranges are 0 to 2, 0 to 20, and 0 to 200 microamperes; and 0 to 2, 0 to 20, and 0 to 200 milliamperes. Voltage ranges are 0 to 200 millivolts and 0 to 2, 0 to 20, 0 to 200, and 0 to 1,000 volts.

**Flashing alarm.** The three-place display reads from 000 to 999. When the input exceeds this value a 1 lights up at the left, thus extending the range to 1999. During all of this 100% overrange condition, the meter stays as accurate as is claimed for the three-digit range. Voltage-model accuracy is  $\pm 0.1\%$  of reading,  $\pm 1$  digit; current models are 0.25% of full scale. Should the input exceed the overrange value of 1999, then the 1 starts flashing. Reverse polarity is indicated by the 1 flashing and the other digits at 000.

The digital panel meter uses a dual-slope integration principle. It has a reading rate of 10 per second, but only 10 milliseconds of the 100 millisecond reading period is needed for conversion. Thus, there is no flicker. Because of a 500-kilo-hertz clock frequency, even the largest input change is converted in one period, so that the observer isn't bothered by the display of intermediate values.

API's digital panel meters have two alternatives to setting high and low limit alarm points. Where the alarm points are permanent, the customers can set the values by



# NEW

## HIGH GAIN PLANAR TRIODES

# 20 dB

FOR U. H. F.  
TELEVISION  
TRANSLATORS  
470 - 960 Mcs

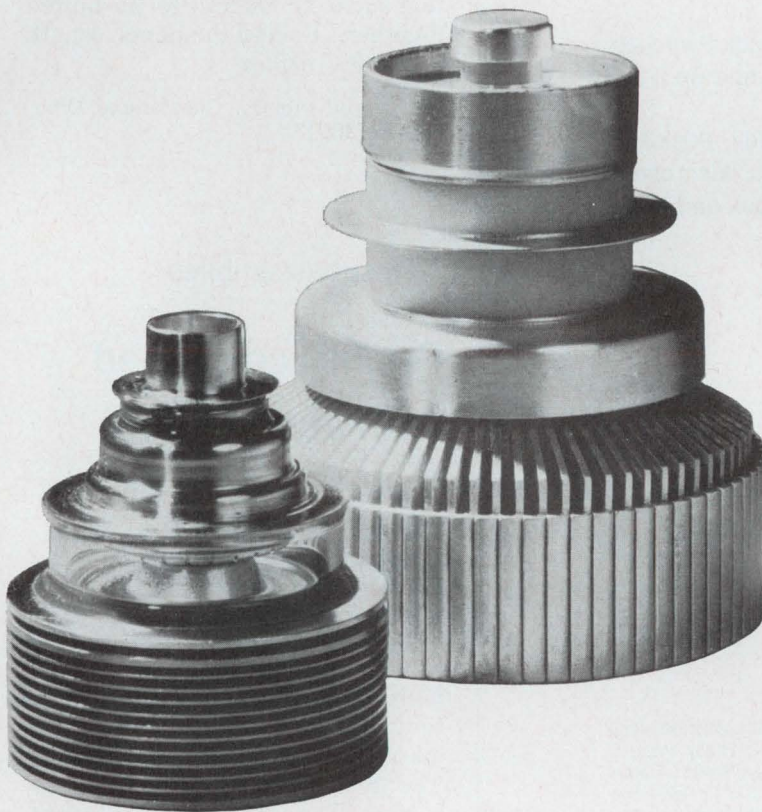

*...a trusted name*

- \* THE MOST ADVANCED TECHNOLOGY
- \* THE LOWEST OPERATION COST

### LONG LIFE - HIGH RELIABILITY

RATINGS		TH. 302	TH. 328
HEATER VOLTAGE	V	5	5
HEATER CURRENT	A	1,9	5
ANODE VOLTAGE	kV	1,6	2
ANODE CURRENT	mA	130	250
OUTPUT POWER	W	25*	100*
INTERMODULATION LEVEL (3 Tones Test)	dB	> 52	> 52

\* The indicated output power corresponds to critical linear class A operation in U.H.F. Television translator handling both sound and vision signals and complying with C.C.I.R. - F.C.C. - O.I.R.T. specifications.

These tubes are designed for use in power amplifiers associated with solid-state drivers.

High gain U.H.F. Planar Triodes TH 302 and TH 328 are also recommended for use in Communication and Television Transmitters.

*We are ready to solve your problem. Please contact for specific information*

## THOMSON HOUSTON - HOTCHKISS BRANDT

ELECTRON TUBE DIVISION - 8, RUE CHASSELOUP-LAUBAT - PARIS XV<sup>e</sup> - FRANCE - TEL. : 566.70.04

THOMSON ELECTRIC Co INC. 50 ROCKEFELLER PLAZA · ROOM 916 NEW-YORK, 10020 N.Y. U.S.A. · Phone : 212 245 3900



## You can selectively transfer 216 circuits with these two Ledex switches and only 10 wires

As you can see from the diagram, our Selector Switches can do a lot of work in a small space. And they'll do many different jobs, some smaller, some larger. That's why they are known by many different names.

To some engineers a Ledex Switch is a programmer or a batch accumulator. To others it's a light dimmer or binary-to-decimal converter. To you it might be a sequencer, a thermo-couple scanner, a memory pulse decoder, a destruct switch or an intervalometer.

We have 36 stock models, 28 and 100 VDC, to give you a quick start on your prototype. Or, if you've got a special problem, our engineers will come up with a custom model.

Our 36-page catalog tells all about Ledex Switches. For your copy just drop us a note. Or, call and we'll talk about your special application.

Write for catalogs on Rotary Solenoids, Push-Pull Solenoids, Stepping Motors and Rectifiers. Also check our "Package Control Service" for black box and timed switching solutions.

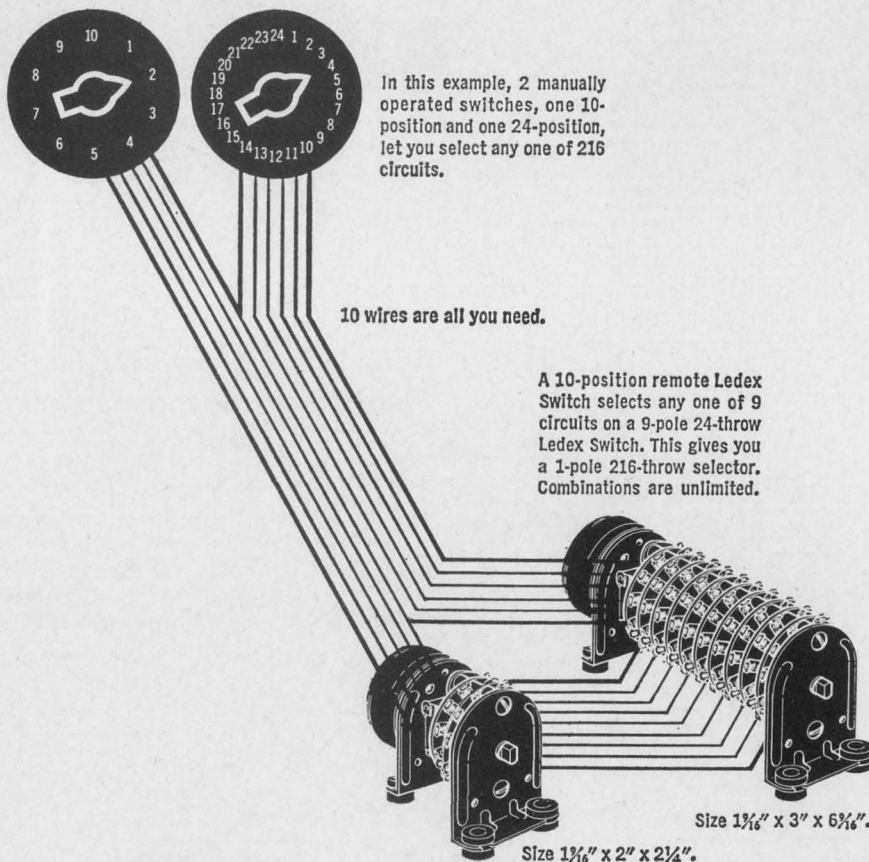

LEDEX DIVISION, LEDEX INC.  
123 Webster Street, Dayton, Ohio 45402 • phone (513) 224-9891  
Custom Circuitry & Controls

IEEE Booth #4B 17-21

adding a few diodes according to instructions supplied by API. A more expensive, but more versatile, way of adjusting alarm setpoints is by three-digit thumbswitches, one set for high or low alarm and two for high-low alarm applications. The thumbswitches plug into the front of the panel meter. Asked about remotely set (as from a computer) high-low limits, Crowdes says, "We don't have this option yet, but it's feasible."

To be offered soon is a range-switching digital panel meter. It will have three ranges, with moving decimal point display.

Maximum panel area is 3 inches high by 4 1/2 inches wide, permitting adjacent meters to be butted together. Behind-the-panel length is about 7 inches.

API Instruments Co., Chesterland, Ohio 44026 [380]

New subassemblies

## Quality combined with automation

Computer control in a portable system yields very precise testers

Until recently, there was little need to blend ultrahigh precision with automated measuring techniques. The two characteristics were desirable, but somewhat incompatible. To meet current quality-assurance requirements, though, manufacturers of resistors, zeners, gyroscopes, and accelerometers now require a significant number of test points and a stable precision of one part per million.

Meeting this demand was difficult. The voltage divider—the basic component for highly accurate d-c measuring systems—hasn't been available in a programmable, one-part-per-million version.

**Combination.** But Julie Research Laboratories Inc. has developed the divider needed to extend 1-ppm d-c measurements to high-speed automatic testing. And with Julie's



# NRC™ products . . .

BRAND

## YOUR BEST MOVE IN VACUUM COMPONENTS AND SYSTEMS

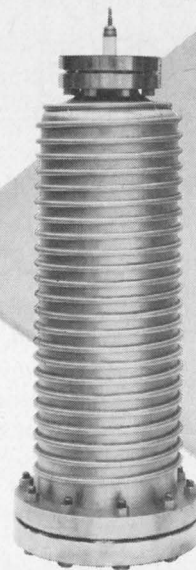
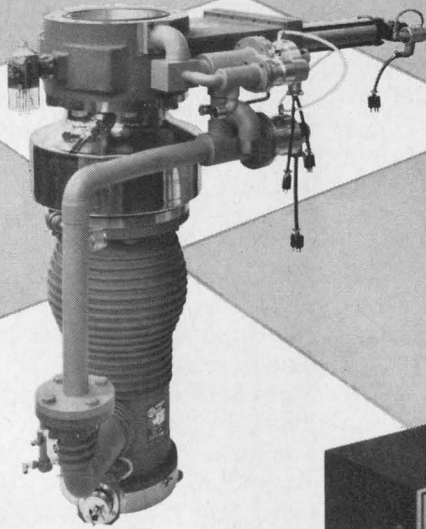
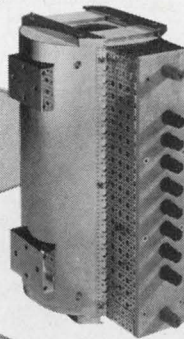
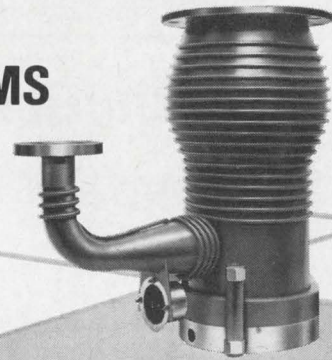
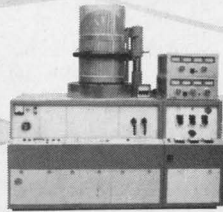

**NORTON VACUUM EQUIPMENT DIVISION**  
FORMERLY NRC EQUIPMENT CORP.  
160 CHARLEMONT ST. NEWTON, MASS. 02161

Check for product information

- |  |   |
|--|---|
| <input type="checkbox"/> Thin Film Coaters   | <input type="checkbox"/> Diffusion Pumps  |
| <input type="checkbox"/> Pumping Systems     | <input type="checkbox"/> Tubular Furnaces |
| <input type="checkbox"/> Leak Detectors      | <input type="checkbox"/> Ion Pumps        |
| <input type="checkbox"/> Gauges and Controls | <input type="checkbox"/> Vacuum Furnaces  |

NAME \_\_\_\_\_

COMPANY \_\_\_\_\_

ADDRESS \_\_\_\_\_

CITY \_\_\_\_\_ STATE \_\_\_\_\_ ZIP \_\_\_\_\_

**NORTON VACUUM EQUIPMENT DIVISION**  
FORMERLY NRC EQUIPMENT CORP.  
160 CHARLEMONT ST. NEWTON, MASS. 02161



# Resistor Adjustment Problems?

## Automatic Solution...

### BR-670



Now you can lease Bunker-Ramo's unique precision **Film Resistor Adjuster, Model BR-670.**

For a low monthly charge plus a penny-a-pulse, you can use our proprietary thin-film processes. The equipment and processes have been thoroughly tested in daily production of custom microcircuits. We adjust thin-film resistors to .01% and match the temperature coefficient of resistance to track within  $\pm 5\text{ppm}/^\circ\text{C}$ . Our substrates are also available, providing a complete microelectronics package with no investment in capital equipment.

Call our Microelectronics Operation for a demonstration; we are sure that one demonstration will convince you that the highest in precision can only be attained with the BR-670 Resistor Adjuster. Available for immediate installation. Please call Joe Crist, Marketing Manager, Microelectronics Operation at (213) 346-6000. Or write:



**THE BUNKER-RAMO CORPORATION**  
DEFENSE SYSTEMS DIVISION  
8433 FALLBROOK AVENUE • CANOGA PARK, CALIFORNIA 91304

See you at the IEEE Show—Booth 4E 39-41

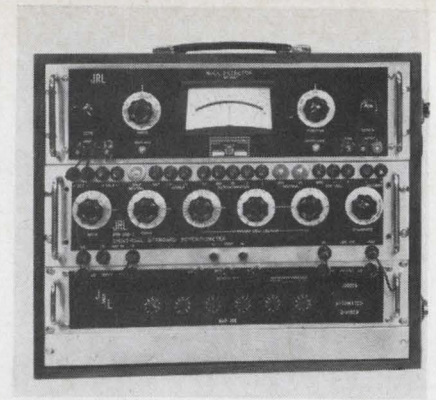

**Automated.** Measurement system is accurate to one part per million.

RVD-106, tape and computer programming capabilities can be added to bridges, potentiometers, and voltage and current sources.

Loebe Julie, president of Julie Research, notes that "programmable systems make for faster and more efficient production of high-precision components by keeping closer checks on tolerances and presenting data immediately."

The RVD-106 is designed for keyboard, punched-tape, magnetic-tape, and direct computer control inputs. Outputs can be fed to visual displays, paper-tape or typewriter printers, tape punches, and computer magnetic memories.

Important characteristics include a resolution of 0.001% (six decades), an input impedance of 100,000 ohms, and a stability of 0.5 ppm per year. The maximum input voltage is 700 and the temperature coefficient is 0.25 ppm per degree Centigrade.

**Six places.** The divider's six decades are made with a hermetically sealed, secondary-standard resistor. Each decade is set up with 10-line information that controls internal, electromechanical switches; 24 volts on any of the 10 lines sets the switch position. The resulting six-place ratio is accurate within one count, and the contact resistance is stable to within  $\pm 0.005$  ohms. Thermal electromotive force is on the order of 0.1 to 0.2 micro-volt.

The basic RVD-106 divider costs \$1,790. Options include a decimal converter that permits operation with standard 1248 or 1224 digital codes.

Julie Research Laboratories Inc., 211 West 61st St., New York 10023 [430]



*These are specialized **TRACOR** instruments designed for your specific needs.*

*See them at IEEE booths 2J-30, 32 & 34.*

**FREQUENCY STANDARDS**



**RUBIDIUM FREQUENCY STANDARD**  
 $1 \times 10^{-10}$  freq  
 $2 \times 10^{-11}$  stnd dev/yr  
 use Reader Service #315.



**CRYSTAL STANDARDS**  
 $5 \times 10^{-11}$ /24 hours  
 5 to 0.1 MHz  
 use Reader Service #316.



**LOW COST HOUSE STANDARD**  
 $1 \times 10^9$ /24 hours  
 use Reader Service #317.

**ULTRASTABLE CLOCKS AND DIVIDERS**

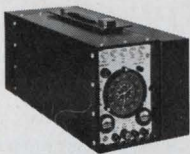

**PORTABLE RUBIDIUM ATOMIC CLOCKS**  
 $5 \times 10^{-12}$ /100 sec avg—37 pounds!  
 use Reader Service #318.



**CRYSTAL CLOCKS**  
 $2 \times 10^{-6}$  secs  
 per day  
 use Reader Service #319.

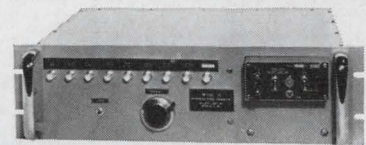

**REFERENCE SIGNAL GENERATORS**  
 200 Hz-6.25 kHz  
 use Reader Service #320.

**VLF RECEIVERS—FREQUENCY/PHASE COMPARATORS**

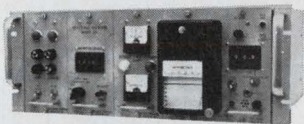

**VLF TRACKING RECEIVER/COMPARATORS**  
 Continuous tuning 3.00 to 99.5 kHz  
 use Reader Service #321.

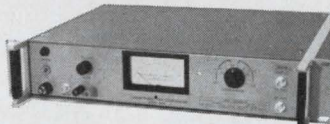

**LINEAR PHASE/TIME COMPARATOR**  
 1 nanosecond time resolution  
 0.01 cycle phase resolution  
 use Reader Service #322.



**FREQUENCY DIFFERENCE METER**  
 difference to  $1 \times 10^{11}$ , error multiplied by  $10^4$ .  
 use Reader Service #323.

**NOISE ANALYSIS**



**CONTINUOUSLY-VARIABLE PASSIVE FILTERS** 15 Hz-672 kHz  
 use Reader Service #324.

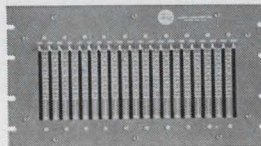

**EQUALIZERS/SPECTRUM GENERATORS**  
 Up to 40  $\frac{1}{3}$ -octave increments  
 use Reader Service #325.



**VLF/OMEGA NAVIGATIONAL SYSTEMS**  
 For broad-area navigation

use Reader Service #326.

**NORTHERN SCIENTIFIC, INC.**

**ASTRO-SCIENCE CORP.**

**WESTRONICS INC.**

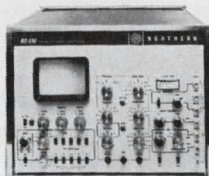

**DIGITAL MEMORY OSCILLOSCOPES and Pulse Height Analyzers**

use Reader Service #327.

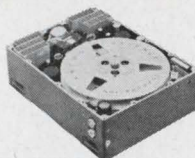

**ASTRO-SCIENCE MULTI-CHANNEL AIRBORNE INSTRUMENTATION TAPE RECORDER/REPRODUCERS**  
 use Reader Service #328.

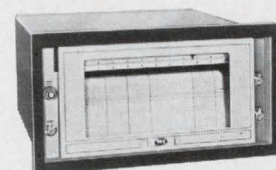

**MULTIPOINT AND CONTINUOUS PEN CHART RECORDERS**

use Reader Service #329.

For a short-form catalog of TRACOR instruments, please use Reader Service #330.

**Industrial Instruments Division**







Cermet pot 3301 is a 1 5/16-in. diameter unit offering a 1,000-ohm to 1-megohm resistance range,  $\pm 5\%$  standard resistance tolerance,  $\pm 0.5\%$  standard independent linearity, and 0.75-w power rating at  $+65^\circ\text{C}$ . Ambient operating range is  $-25^\circ$  to  $+105^\circ\text{C}$ . The unit has molded-plastic housing. Beckman Instruments Inc., 2500 Harbor Blvd., Fullerton, Calif. 92634. [341]

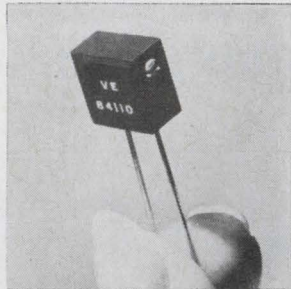

The Varoid h-f adjustable toroid is for widely-varied tuned circuit, filter, and network applications. It is available in different sizes, the smallest measuring 0.375 x 0.375 x 0.2 in., in a series offering inductance values from 0.1  $\mu\text{h}$  to 1 mh. Larger units have values up to 10 mh. Vanguard Electronics, 930 W. Hyde Park Blvd., Inglewood, Calif. 90302. [342]

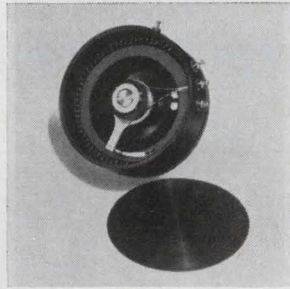

Conductive plastic pot 32C-1 offers a linearity of  $\pm 0.035\%$  in the electrical function angle range from  $340^\circ$  to  $356^\circ$ . The continuous rotation, 2-in.-diameter unit features infinite resolution and resistances from 500 to 50,000 ohms,  $\pm 10\%$ . Prices start at \$125 per unit in production quantities. Gamewell Division, E.W. Bliss Co., 1238 Chestnut St., Newton, Mass. 02164. [343]

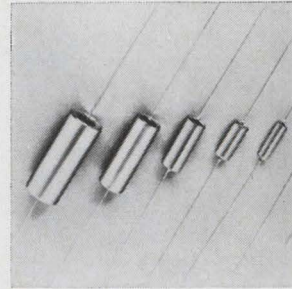

Polycarbonate-foil capacitors series 401 have an operational temperature range from  $+85^\circ$  to  $+125^\circ\text{C}$ . Capacitance change is less than 2% over that range, and dissipation factor vs temperature curve is relatively flat. Units are hermetically sealed in a tinned nonmagnetic tubular case with glass-to-metal end seals. Gulton Industries Inc., 340 W. Huron St., Chicago 60610. [344]

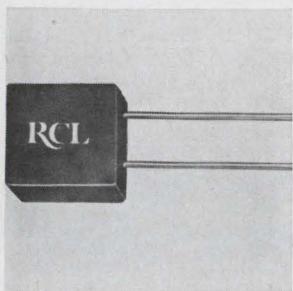

Encapsulated rectangular resistors R-451 feature a max. resistance of 200 kilohms and are rated at 0.20 w. Tolerances range from 0.01% to 1%. Operating temperatures are from  $-55^\circ$  to  $+125^\circ\text{C}$ , derated to zero w at  $150^\circ\text{C}$ . Standard temperature coefficient is  $\pm 10$  ppm. Dimensions are 0.295 x 0.300 in. RCL Electronics Inc., 700 S. 21st St., Irvington, N.J. 07111. [345]

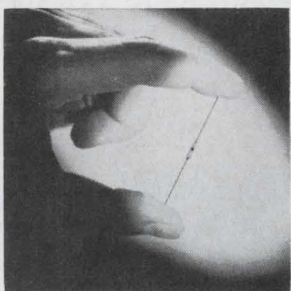

Miniature, bead-type thermistors are hermetically sealed in shock-resistant glass. They are useful for temperature sensing, compensation and control, and are suited for p-c applications. Units are available with nominal resistances from 100 ohms to 10 megohms, and tolerances from  $\pm 1\%$  to  $\pm 30\%$ . Fenwal Electronics Inc., 63 Fountain St., Framingham, Mass. 01701. [346]

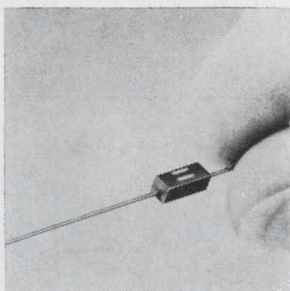

Metal film resistor Fix-Trim V5 may be user adjusted before or after installation, up to 5 times its basic value, with accuracies to  $\pm 0.02\%$ . Molded size is 0.085 x 0.090 x 0.200 in. Rating is 1/20 w at  $125^\circ\text{C}$ . Twelve base resistance ranges cover 350 standard 1% values from 1 to 4,600 ohms. Angstrom Precision Inc., 7811 Lemona Ave., Van Nuys, Calif. [347]

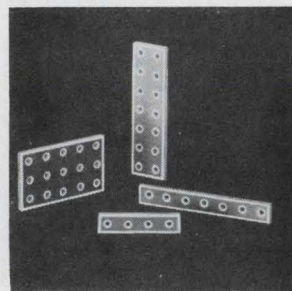

Multisection ceramic capacitors provide multiple bypass and filter functions without the space requirements of feed-through units. They come in 13 patterns from 1 to 21 channels with values from 100 pf to 0.35  $\mu\text{f}$ . Tolerances are  $\pm 20\%$ . Sizes run from 0.150 x 0.150 in. to 1.050 x 0.450 in. U.S. Capacitor Corp., 2151 N. Lincoln St., Burbank, Calif. 91504. [348]

### New components

## IC's divide price of multiplier by two

Pulse-width/pulse-height technique in analog unit combats drift; radar system and medical uses seen

Intronics Inc. has halved the price of an analog multiplier introduced two years ago. The machine, as originally designed, required no adjustments, was easily installed in a system, and cost about \$500. By going to integrated circuits, though, Intronics engineers have built a

new version, the M301, costing \$245.

Arthur Pfaelzer, Intronics vice president, says the device is the only multiplier that uses the pulse-width and pulse-height technique. Other all-electronic techniques, he says, require continuous adjust-

ment, or subject the multiplier to drift, nonlinearity, or low output levels. And because devices built with these other techniques usually need external circuits, they are more costly than the M301. Electro-mechanical systems can't match the response time of electronic systems.

**No time lag.** The M301 instantaneously multiplies two signals by using them to control the area under a square pulse. Inside the unit's encapsulated package is a free-running, 25-kilohertz pulse generator. One input controls pulse width, and the other controls pulse amplitude. The modulated pulses are fed to a low-pass filter, and the



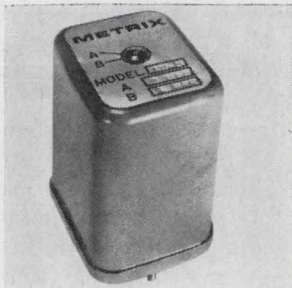

Low-pass filters series AF limit the spectrum of analog signals to prevent the generation of unwanted "aliasing" frequencies when signals are sampled by a multiplexer. They are flat to d-c and use toroidal inductors for low distortion and low pickup. Units are offered mounted on p-c cards or in sealed metal cans. Metrix Instrument Co., Box 36501, Houston, 77036. [349]

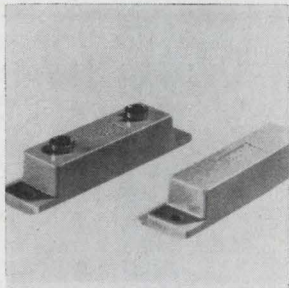

Proximity switch RS-24PR features the inherent simplicity of the basic dry reed switch for long life (18 million operations at 48 v) and reliability. An encased Alnico-5 permanent magnet provides the force to actuate the switch within distances of 1 in. apart. Current rating is 0.5 amp (break) and 1 amp (carry). Alco Electronic Products Inc., Lawrence, Mass. 01843. [350]

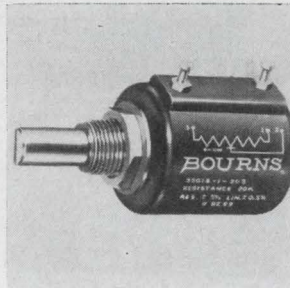

Resistance range of model 3501 Infinitron conductive plastic element pot is now 1,000 ohms to 1 megohm. Standard linearity is 0.5%. Output smoothness is 0.05% standard. The unit has a rotational life of 4 million cycles and exceeds the moisture resistance requirements of MIL-R-39023. Trimpot Division, Bourns Inc., 1200 Columbia Ave., Riverside, Calif. 92507. [351]

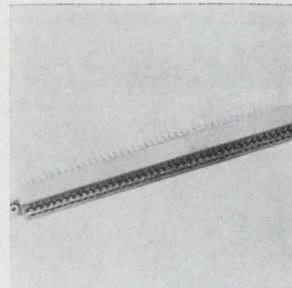

Card edge receptacle 6023 has 86 dual-readout or 43 single-readout wire-wrap contacts spaced on 0.156-in. centers. It accommodates a 1/16-in. p-c card. Contacts are of the double-cantilever, bifurcated nose type with a 0.750 in. long by 0.045 in. square wire-wrap tail. Contact ratings are 0.006 ohm max. resistance and 5 amps max. current. Elco Corp., Willow Grove, Pa. 19090. [352]

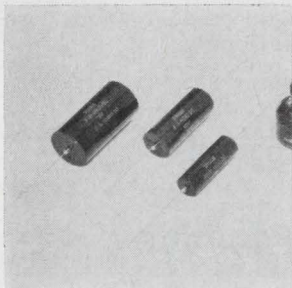

High-voltage capacitors 185P come in capacitance tolerances of  $\pm 10\%$  and  $\pm 20\%$ . Voltage ratings are from 3,000 through 10,000 v d-c. Maximum operating temperature is 85° C. Units utilize a dual dielectric of paper and polyester film impregnated with mineral oil. The casing is resistant to heat and humidity. Sprague Electric Co., 35 Marshall St., North Adams, Mass. 02147. [353]

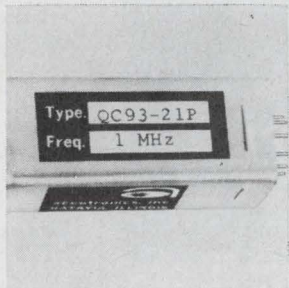

Crystal oscillator QG is for driving IC logic. Output voltages are 0  $\pm 0.5$  v to greater than 2 v and less than 5 v peak, square wave with rise and fall times of less than 60 nsec. Standard frequencies are 1, 2, 5, 10, and 20 Mhz with a frequency stability of  $\pm 0.01\%$  from +15° to +45° C. Prices are \$37.50 from 1 to 100 pieces. Accutronics Inc., 628 North St., Geneva, Ill. 60134. [354]

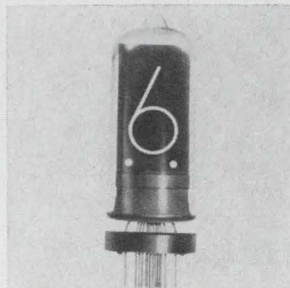

Nixie tube B-5750 can display the numerals 0-9 and has 2 decimal points. High-current capability allows time-sharing operation. A movable pin-straightener-standoff, used to align the tube pins for easy IC connection, also acts as an insulator and allows solder gas to escape. Price is \$3.95 in 1,000-unit quantities. Burroughs Corp., Box 1226, Plainfield, N.J. 07061. [355]

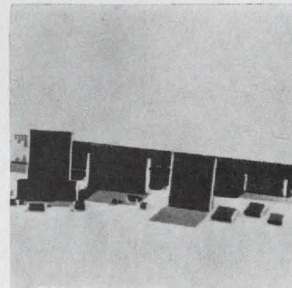

Miniature ceramic chip capacitors type K1200, for 25 vdcw, offer a range of 5 pf to 3  $\mu$ f with a standard tolerance of  $\pm 20\%$ . They come in 18 sizes of small rectangular, square and rectangular configurations. Dimensions range from 0.050 x 0.035 x 0.040 in. to 0.585 x 0.298 x 0.070 in. Monolithic Dielectrics Inc., P.O. Box 647, Burbank, Calif. 91503. [356]

filter's output is amplified. The amplified signal is directly proportional to the product of the M301's two inputs.

The inputs can be either positive or negative, and the output will have the correct sign. Each input can be any shape and have any frequency under 1 kilohertz.

The accuracy of the technique drops off as the input frequencies approach the frequency of the pulse generator, but Intronic's says the M301's accuracy is 0.5% from d-c to 1 KHz.

**A few pins.** The M301 is easily installed. The pin connections are for the two multiplication inputs,

an input for other applications, the output, and the power supply.

The device does more than multiply. When the same signal is attached to both inputs, the output is the square of the applied signal. And without any external circuitry, the unit will divide and take square roots.

By using three M301's, a systems engineer can electronically determine the sides, angles, sines, and cosines of a right triangle. With switching circuits, the unit can be used on a shared-time basis.

**Heartbeats and radar.** Pfaelzer points to modulation and demodulation, autocorrelation and cross-

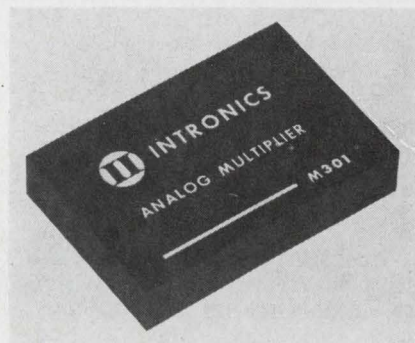

**X times Y.** The M301 multiplies, divides, squares, and takes square root of signals of different shapes and frequencies.





## Why pay more for the "same" transformer? To find out, send for the informative booklet shown here.

Both of these transformers look alike...but they're not!

The \$25 transformer on the left is typical of the units which have established Raytheon's reputation for transformer quality in vital military systems.

The \$50 unit is a high reliability transformer. It costs more because it was designed to meet defined MTBF goals and manufactured in a separate, environmentally-controlled facility. This transformer also underwent rigorous screening and qualification testing to make certain it met the specified high reliability standards.

Raytheon is an experienced manufacturer of high reliability magnetic components, having participated in numerous NASA and DOD programs such as Apollo, Sert II, and MOL.

Get your free copy of the Raytheon transformer brochure shown above. It describes our high reliability facilities and programs. And it shows why Raytheon's high reliability transformers are well worth the difference in price. Send the reader service card or write directly to: *Raytheon Company, Magnetics Operation, 180 Willow Street, Waltham, Mass. 02154.*



correlation, power measurement, and real-time analog control and computation as typical applications.

The ability of the M301 to solve for values of right triangles may make it valuable in radar systems.

Some uses even surprise Pfaelzer. "Doctors have started calling me up and asking about the multiplier." The physicians want to use the device for vector cardiography, a clinical technique that describes heart action more precisely than standard electrocardiography.

### Specifications (multiplication)

Linearity	0.2%
Inputs	± 10v d-c or a-c, single-ended or differential
Output	±10v d-c or a-c
Null output	0.0 ±10mv d-c
Power	±15v d-c
Input impedance	10 kohms min
Output impedance	1 ohm max
Availability	2 to 3 weeks
Resolution	no hysteresis

Intronics, 57 Chapel St., Newton, Mass. 02158 [357]

### New components

## British invade a common market

Plessey takes on rough competition in offering three connectors in U.S.

It is one of the largest electronics firms in England, and sells in most of the world, but the Plessey Co. is little known in the U.S.

Wallace Chandler, technical manager in the firm's components group, is trying to change that. He is leading the company's invasion of the U.S. connector market, a field where many American firms are already slugging it out.

"We make about 40 different connectors in England," says Chandler. "We've picked the ones we feel will give us a definite competitive edge in the states."

**Looking for converts.** Plessey will have to make believers out of design engineers because, with one exception, its connectors cannot be mated with American units.

In June, Plessey will introduce



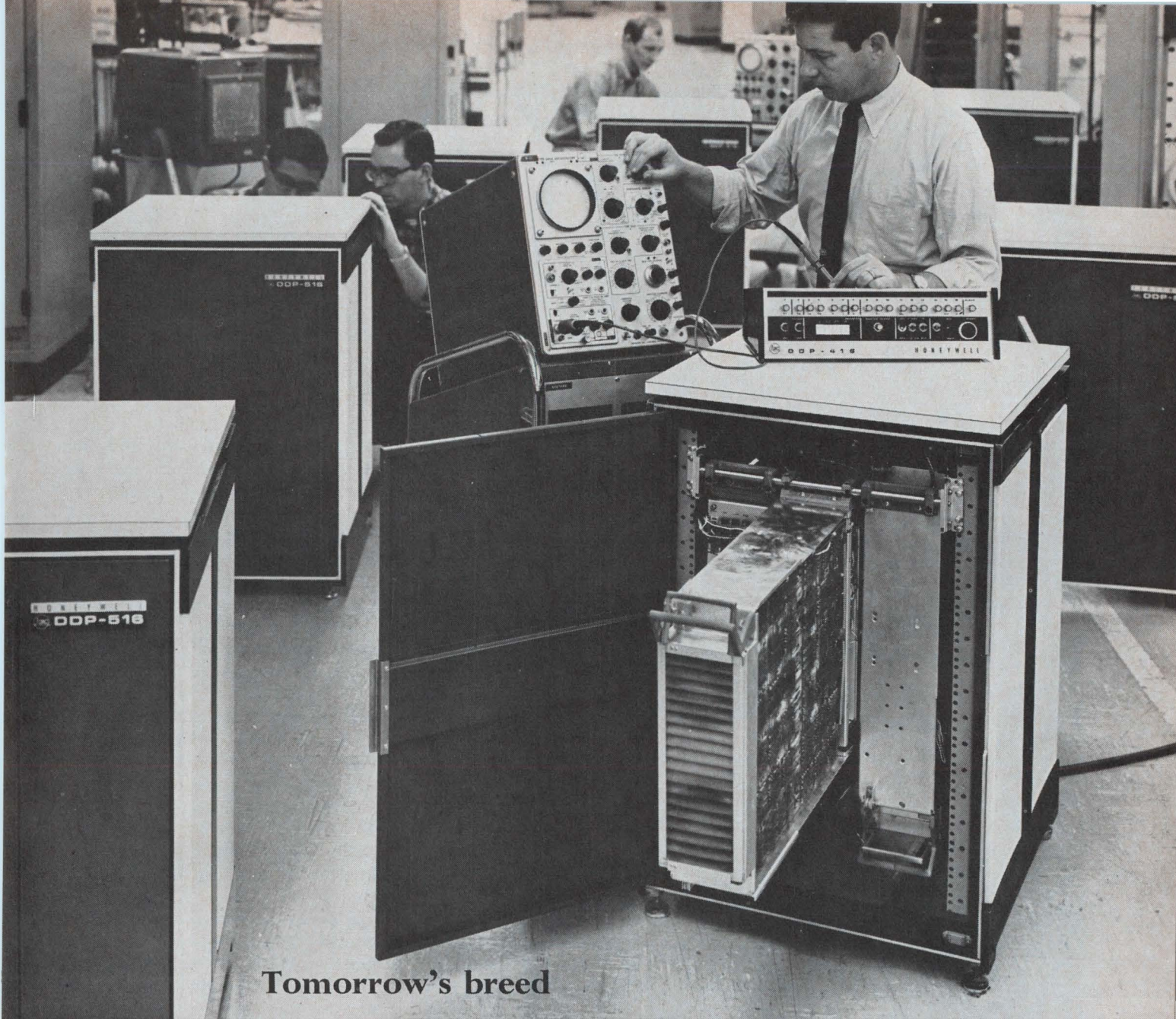

Tomorrow's breed

**of I/C computer...  
...and they're being  
delivered today!**

$\mu$ -COMP DDP-516 is the most advanced I/C 16-bit compact now available. Hardware includes 4096-word memory (expandable to 32K), 960 nsec cycle time, 72 instructions, and optional high-speed multiply and divide — just a few of the basic hardware specs.

Software? 250 field-proven programs are available, including ASA FORTRAN IV compiler, assembler with DESECTORIZING loader that lets you ignore memory restrictions, and OLERT (on-line executive for real time).

If you don't require this full capability, you can get the DDP-416 (at considerable savings, too). For more details on a "tomorrow machine" today, write Honeywell, Computer Control Division, Old Connecticut Path, Framingham, Massachusetts 01701.

# Honeywell

 **COMPUTER CONTROL  
DIVISION**

Circle 217 on reader service card



# 5x10<sup>-10</sup>

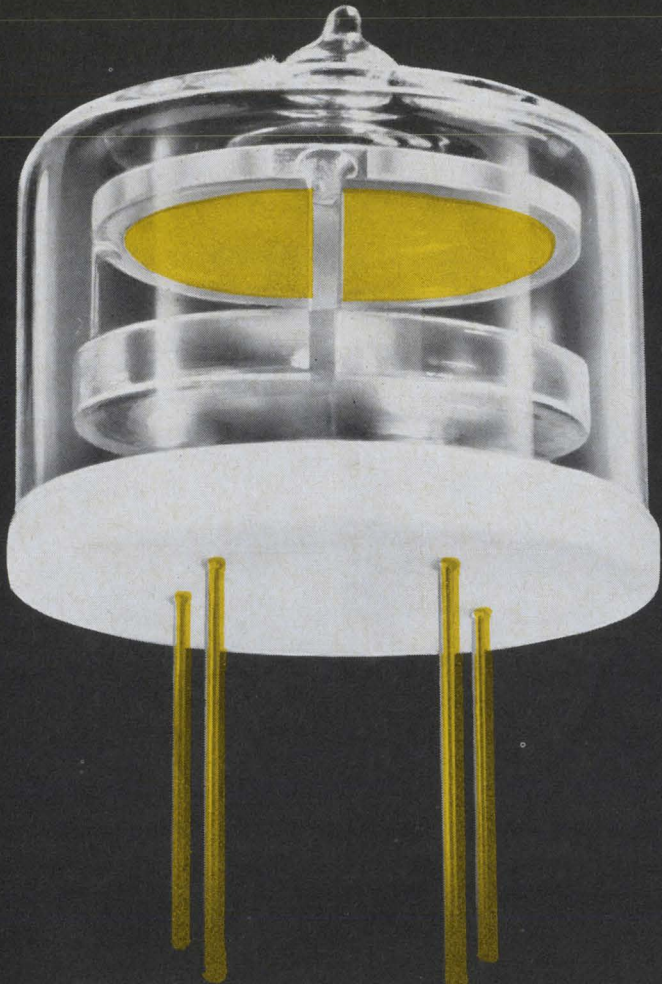

This new Bliley 5 MHz crystal unit has an aging rate less than  $5 \times 10^{-10}$  per day after 3 days. Superior aging, with exceptionally fast recovery and retrace following turn-off, is achieved with special techniques and a new mounting development that permits bake-out at higher temperature. Type BG61AH-5S represents an outstanding step forward in crystal technology that can be applied as an ultra-precise time base in frequency standards, synthesizers and systems clocks. Request Bulletin 547 for complete specifications.

**Bliley** if you buy quality

**BLILEY ELECTRIC COMPANY**

2545 West Grandview Blvd. • Erie, Pennsylvania 16512

1968 IEEE Exhibition Booth No. 3C15

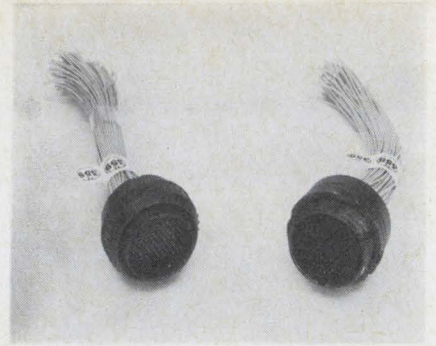

**Mark 4.** High-density connector has a shrinkable Teflon sleeve around each contact for insulation and support.

three models it says cost less than American connectors and have design features that make them easier, safer, or more economical.

**On your mark.** The Mark 4 high-density connector is used in wiring harnesses, like those found in aircraft, and large scientific and industrial equipment. There is no metal inside its shell, except for the contacts that are easily removed and replaced with a special tool. The connector takes any wire from 22 to 30 AWG, and leads are soldered or crimped to the contact.

The contacts are held between two moldings inside the Mark 4, and each contact has a shrinkable Teflon sleeve, which gives the lead mechanical support and insulating protection.

Plessey designers have made it almost impossible to mismatch pairs of Mark 4's. By putting male and female contacts in every connector, they assure proper alignment. Each connector comes with a plastic insert that slides over some of the contacts, and can be placed in one of five positions. Unless the inserts of two connectors are in complementary alignment, they can't be mated.

**Fewer parts.** Chandler estimates a saving of 10% if the Mark 4 is used. He says Plessey's low prices are possible because each connector has half the parts used in standard units. Gary Leven, Plessey's component sales manager in America, says a matched pair of 104-pin Mark 4's cost \$54.

The Mark 4 comes in four shell types—aluminum fine thread, brass coarse thread, aluminum bayonet, and aluminum push-pull—and is available with 17, 44, or 104 pins.

It has been approved for NATO



# No bubble, no trouble.

When you immerse your components in hot 3M Brand Inert Fluorochemical Liquids, bubbles of escaping air quickly detect gross leaks.

No bubble, no trouble.

That's one of the known test bath applications for 3M Inert Liquids. Thermal shock tests, transistor matching, temperature testing of integrated circuits at  $-55^{\circ}\text{C}$  and  $+150^{\circ}\text{C}$ , are just a few other examples.

Our Inert Liquids quickly drain and leave no residue. So when the test is finished, additional cleaning steps are unnecessary. You save time and get greater accuracy.

Test 3M Inert Liquids... and save a lot of trouble.

3M Company, 3M Center  
St. Paul, Minn. 55101

Dept. KAX-3-68

Send me all the details about 3M Brand Inert Liquids.

Name \_\_\_\_\_

Company \_\_\_\_\_ Title \_\_\_\_\_

Address \_\_\_\_\_

City \_\_\_\_\_ State \_\_\_\_\_ Zip \_\_\_\_\_

**Chemical Division**

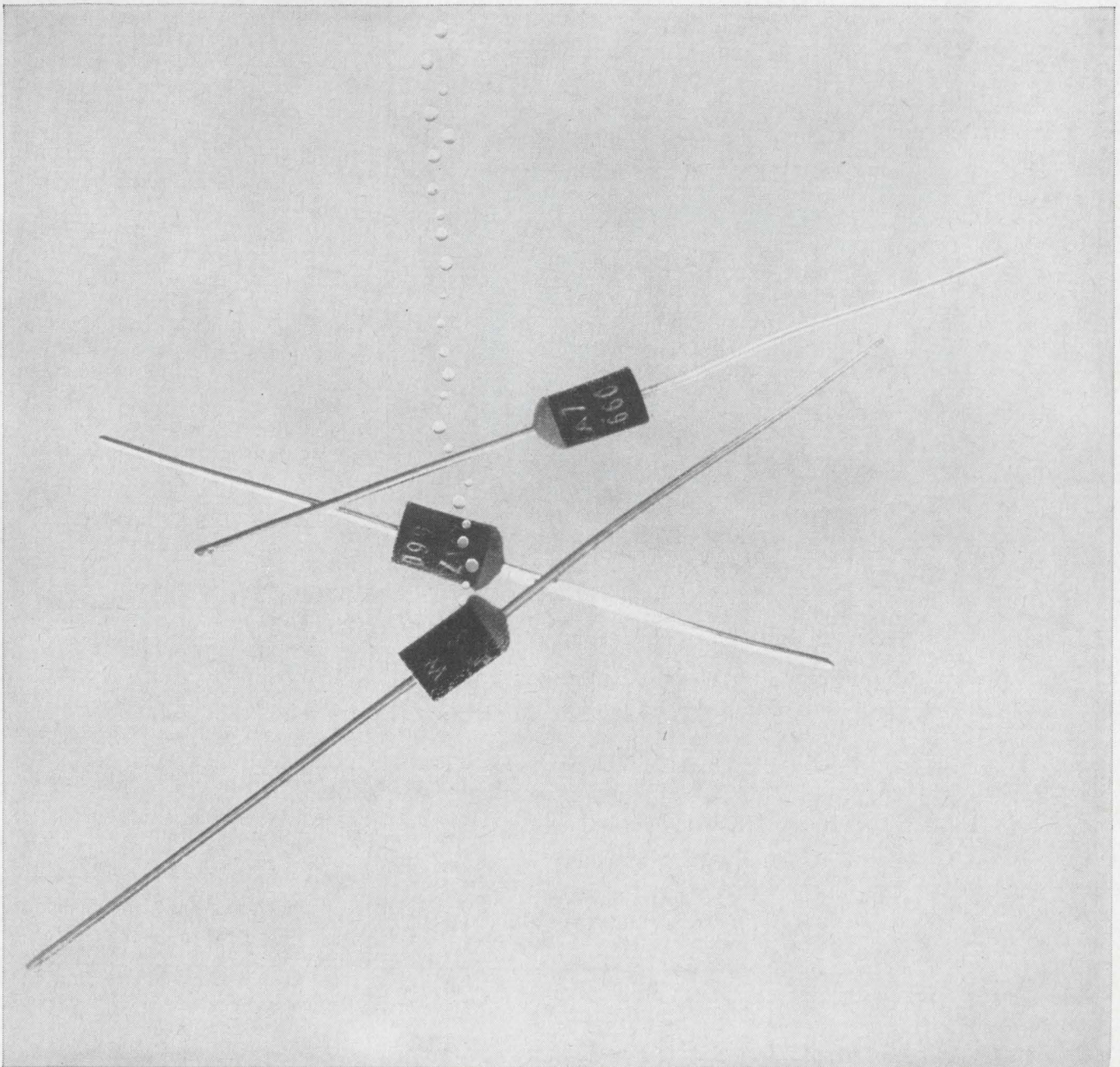



# calibration's a breeze

with Weston's NEW, high-precision  
Model 166 Instrument Calibrator for



## VOM's/Panel Meters/Portable Instruments

Here is a new breed of calibrator . . . an instrument designed for the greatest possible simplicity and speed of operation. Not only does it check and calibrate a broad variety of test and production instruments — it does so by means of pleasantly straightforward, uncomplicated procedures which save valuable time and reduce chance of error.

The Model 166 provides all the advantages of other late model calibrators . . . plus exclusive features all its own, like these:

- Automatic mode for quick, convenient GO-NO-GO testing
- Automatic fractional scale division for fast cardinal point calibration
- Automatic computation of % full-scale error
- Four-terminal voltage sensing
- Can be used as either voltage or current standard

### CALIBRATION RANGES

#### Voltages: AC & DC

1 mV to 1111.110 V, 1 mV res.

1  $\mu$ V to 1111.110 mV, 1  $\mu$ V res.

#### Currents: AC & DC

1  $\mu$ A to 11.11110 A.

DC Accuracy: 0.2% to 1A, 0.5% to 11A.

AC Accuracy: 0.25% to 1A, 0.5% to 11A.

#### Resistance

1 Ohm to 11.11110 Megohms — 1-Ohm steps

Accuracy: 0.1% to 1 Meg., 0.25% to 11 Meg.

**Weston Instruments, Inc.**  
**Weston-Lexington Division**

17 Hartwell Avenue, Lexington, Mass. 02173

**WESTON®**

prime source for precision . . . since 1888

a Schlumberger company

See us at IEE, Booth 2C49

... made in England,  
stocked here ...

use and can meet military specifications, Chandler says. Plessey will sell a special version of the Mark 4, called the JT, which will mate with connectors built to MIL C 85999 specifications.

**Little one.** Plessey's entry in the miniature connector field is the Mark 14. Contacts are replaceable, and leads can be crimped or soldered. The Mark 14 can have 3, 7, 14, 19, or 37 pins. The diameter of the 37-pin model is 0.79 inches and 0.4 in. for the three-pin model. Any wire from 24 to 28 AWG can be used. The company says the Mark 14 weighs 25% less than other connectors of similar size.

For use in toasters, typewriters, and other commercial equipment, Plessey will offer the 442, a rectangular connector, made of hard, flexible plastic. Contacts are removed by bending the connector. Where more than one is needed, 442's can be stacked.

Plessey says the price is about a penny a contact, and estimates savings of 50% for U.S. users.

Initially, Plessey will build the connectors in England and stock them in America. Delivery time will be four to six weeks.

Plessey Inc., 170 Finn Court, Farmingdale, N.Y. 11735 [358]

New components

## Zener can take 1,000 watts

Diode, developed for mobile radio equipment, maintains 36 volts at high power levels

**Mention voltage regulation** to an engineer, and he'll smile and say, "zener diode." If you add high power applications, he'll just groan. But, now he can keep smiling—a zener with power-handling muscle has been developed.

Zeners do an excellent job of



# Now- Count to 150 MHz for \$640!

See it at IEEE  
Booth 2H07 - 2H09.

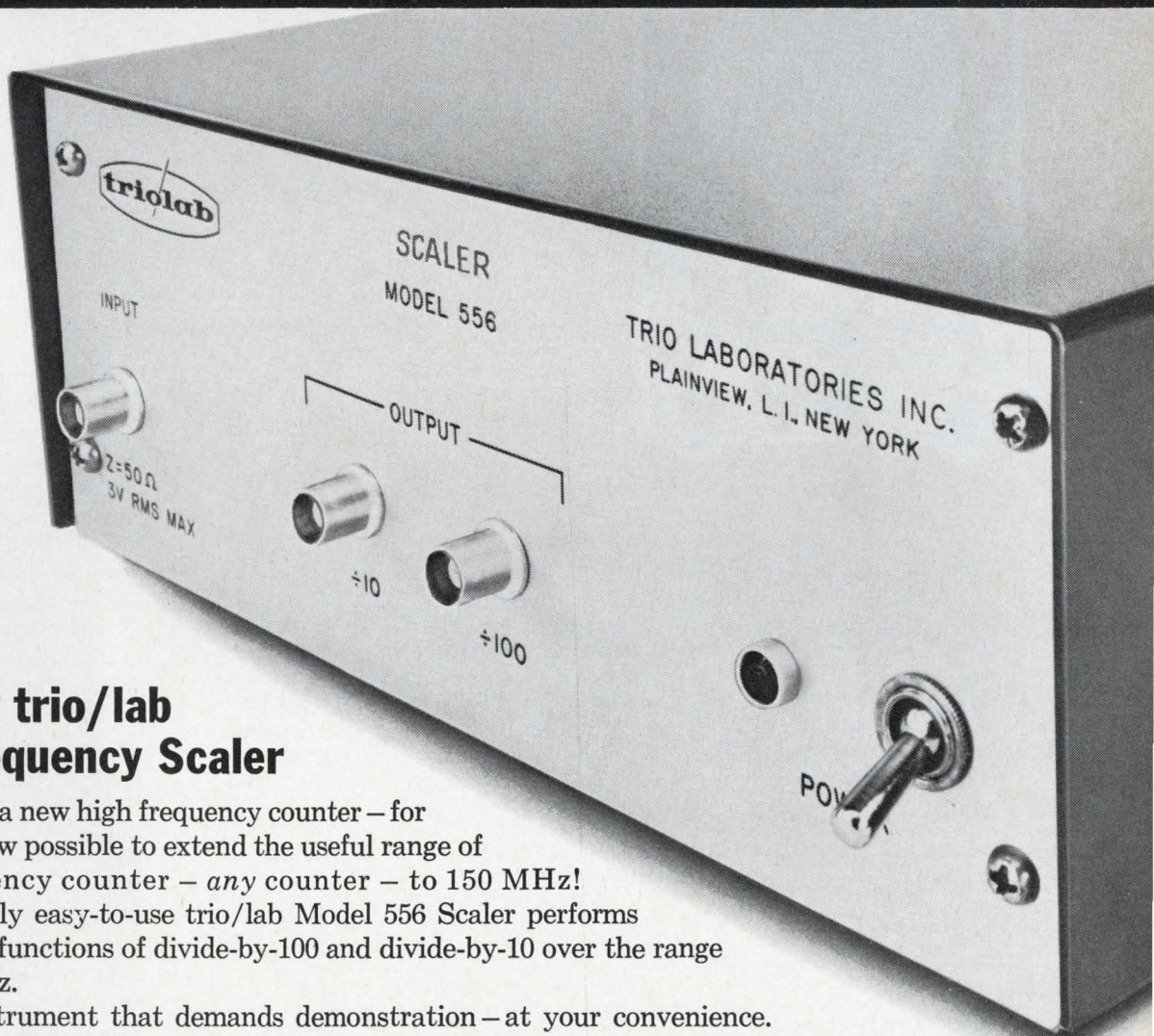

## With the new trio/lab Universal Frequency Scaler

Forget the cost of a new high frequency counter - for a modest \$640 it is now possible to extend the useful range of your old low frequency counter - *any* counter - to 150 MHz! The unique, extremely easy-to-use trio/lab Model 556 Scaler performs simultaneous scaling functions of divide-by-100 and divide-by-10 over the range of 1 MHz to 150 MHz.

A remarkable instrument that demands demonstration - at your convenience.

• Truly universal - Scales *any* counter • No controls - Power switch only • High sensitivity - 50 MV at 150 MHz • Large output swing - 1 V drives any counter • Self-powered - All solid-state.

Trio Laboratories, Inc. • 80 DuPont St., Plainview, L. I., N.Y. 11803  
Tel.: 516-681-0400 • TWX: 510-221-1861

**trio/lab**<sup>®</sup>

Original Concepts in Instrumentation

Circle 221 on reader service card



# Is Your Budget Too Tight For Your Bandwidth?

**\$284**

○ Low Cost

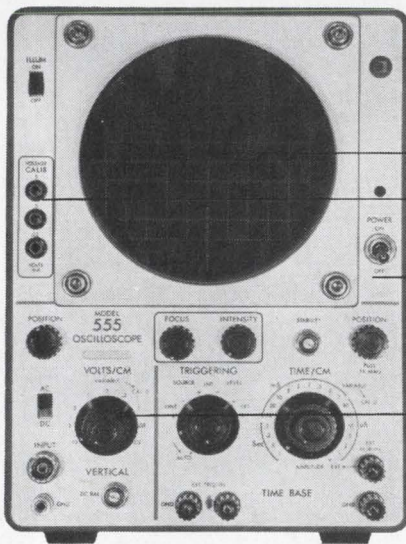

○ 8 cm x 10 cm Viewing Area

○ Voltage Calibrator

○ Solid State Reliability

○ 7 MHz Bandwidth

Try this one for size—Data Instruments Model 555. For any application, Production Line, Field or Laboratory, this scope is a perfect fit. Look at what it offers: (1) Performance. A 7 MHz bandwidth, and an extremely linear time base with variable controls over 19 calibrated ranges and a variety of triggering modes. (2) Display. A 5 inch Braun type tube with an edge lit, removable graticule provide highly precise and legible traces on an 8 x 10 centimeter viewing area. (3) Reliability. All attenuators are solid state and fully compensated. Backing up this solid state reliability is a full year's warranty and complete field and factory service.

Examine the specifications.

VERTICAL AMPLIFIER					
BANDWIDTH	SENSITIVITY/CM	ATTENUATOR	RISE TIME	ACCURACY	IMPEDANCE
DC-7 MHz	20mv	9 position	.05 $\mu$ s	$\pm$ 5%	1M $\Omega$ + 33pf
TIME BASE			CRT	PHYSICAL	
SWEEP/CM	TRIGGER	HORIZONTAL AMP.	DIA.	DIM. & WT.	
1 $\mu$ s-1 sec. (19 ranges)	20Hz-7MHz (20mv)	Exp. X5 2Hz-200KHz	5" (1600V)	8" x 10.5" x 16" 22 lbs.	

Look at the scope in action. Drop us a note and we'll arrange a demonstration in your plant. You'll find the 555 fits your bandwidth requirements comfortably. At \$284 its very comfortable indeed.

**Data Instruments Division • 7300 Crescent Blvd. • Pennsauken, N.J. 08110**

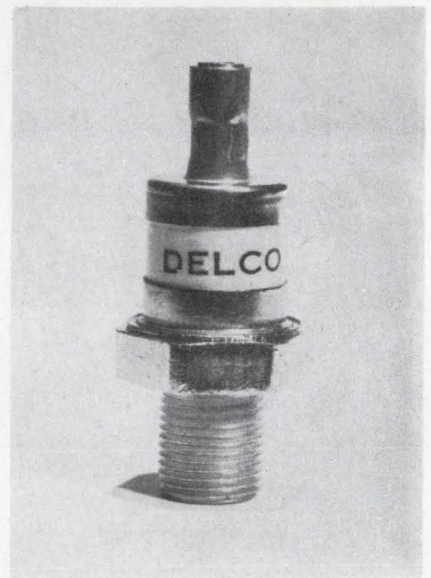

**On guard.** The DRZ-250, a diffused-junction, silicon device, handles 250 watts of continuous power.

maintaining a fixed voltage level, but can dissipate only a few watts. And even the best have trouble when the input power tops 100 watts. So in high power work, engineers who want to use zeners are forced to tie groups of them together. That often means unacceptable size.

Now, engineers at the Delco Radio Division of General Motors have developed the DRZ-250, a zener rated at 250 watts of continuous power, and 1,000 watts of peak power for 50 milliseconds. The DRZ-250 has a breakdown voltage of 36 volts and can handle 120 amperes.

**Army power.** Delco saw a need in the military market. Communications gear, mounted on trucks, tanks, and other vehicles run off power supplies prone to high energy spikes. More and more, communications equipment is being made with solid state devices. But these devices must be protected from power surges, a common cause of solid state circuit failure.

Motorola's Semiconductor Division developed an array of 18 36-volt, 50-watt zeners for the Army Electronics Command. The protective array worked, but the brass wanted something smaller. So Delco tried its hand and produced the DRZ-250, which is now available in sample quantities.

Delco Radio Division, General Motors Corp., Kokomo, Ind. 46901 [359]



## Philbrick/Nexus has got it... a \$15 FET op amp

That's the price of QFT-5's in quantities of 100. Philbrick/Nexus has a lot more to offer in FET operational amplifiers — the broadest and best line in the industry. No matter what your requirements, Philbrick/Nexus has the FET for you. If you need a FET with the lowest offset voltage in the industry, Philbrick/Nexus has got it. Looking for the lowest noise and lowest input current anybody can offer? Philbrick/Nexus has got it. No matter what you need Philbrick/Nexus offers you more in FET operational amplifiers — including the lowest priced FET. Check below for some of the outstanding specifications you'll get from Philbrick/Nexus. Call your Philbrick/Nexus sales representative for complete specifications, prices and applications assistance. Or write, Philbrick/Nexus Research, Allied Drive at Route 128, Dedham, Massachusetts 02026.

### UNEQUALLED SPECIFICATIONS OF PHILBRICK/NEXUS FETs:

Lowest offset voltage . . . Model QFT-2B . . . 5  $\mu\text{V}/^\circ\text{C}$  Max.  
Lowest noise . . . . . Model PP25C . . . . 2  $\mu\text{V}$  wideband noise  
Lowest input current . . . Model PP25C . . . . 10 pA Max.  
Highest CMRR . . . . . Model 1003 . . . . . 1,000,000:1 CMRR  
Lowest price . . . . . Model QFT-5 . . . . \$15 in quantities of 100

VISIT PHILBRICK/NEXUS AT IEEE IN BOOTHS 2A-34 AND 2A-36



**PHILBRICK/NEXUS RESEARCH**

A TELEDYNE COMPANY

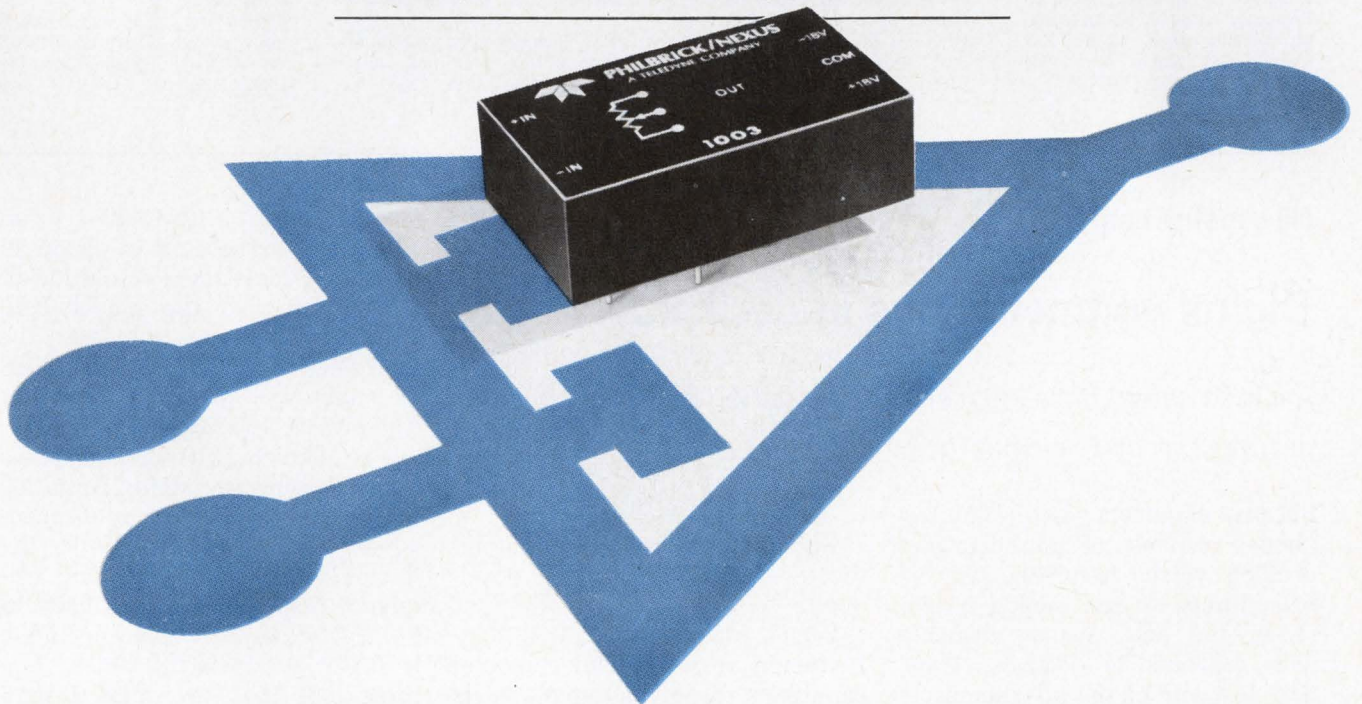



## New Instruments Review

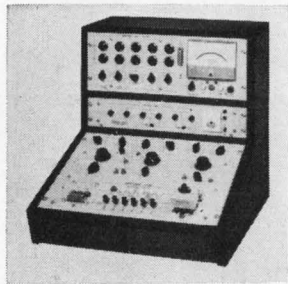

Transistor/diode tester model 1 makes 19 measurements and automatically sequences through 5 tests, indicating results by meter readings, indicator lights, and contact closures. It tests any of 6 configurations for breakdown voltage or reverse current with voltage compliance to 1,000 v d-c and measuring resolution to 100 pa. Test Equipment Corp., 2925 Merrell Rd., Dallas 75220. [361]

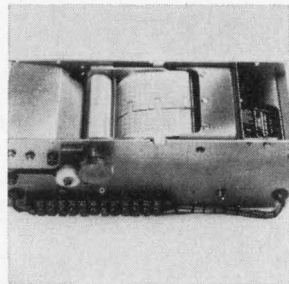

Strip chart recorder EM6702 combines a chart drive assembly, transistorized amplifiers and closed loop servo driven pen motor into a module suitable for industrial and medical systems makers wishing to display analog recording capability as part of an equipment package. It fills a panel opening 4 x 10 x 4 in. Computer Instruments Corp., 92 Madison Ave., Hempstead, N.Y. [362]

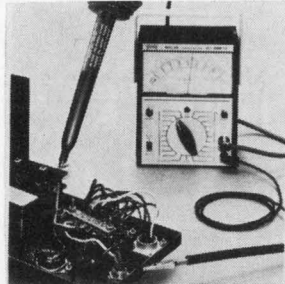

Portable, 40,000-v d-c, h-v test probe model 72-265 is designed to operate with the 11-megohm input impedance, battery-operated transistorized volt-ohmmeter model 600 for aligning and trouble shooting color tv receivers. Suggested net price is \$25.20 complete with heavy-duty ground lead; availability, from stock. Triplett Electrical Instrument Co., Bluffton, Ohio 45817. [363]

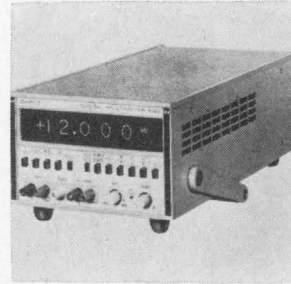

Half-rack, automatic, digital multimeter 440 needs no zero or other calibration controls to hold a d-c accuracy of 0.01%  $\pm 1$  digit for 90 days. Automatic ranging with 20% over-range, instantaneous pushbutton switching for mode and range changing a/e standard. Common mode rejection is 140 db at 60 hz. Darcy Industries Inc., Cloverfield Blvd., Santa Monica, Calif. [364]

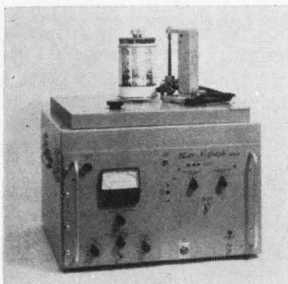

Audio spectrum analyzer model 6051A provides contour type analyses and features a start-stop tape adaption. It takes information from a record, tape recorder, or microphone and makes clear accurate voice prints plotting amplitude vs frequency vs time. Frequency range is 85 to 8,000 hz; dynamic range, 42 db. Kay Electric Co., Maple Ave., Pine Brook, N.J. 07058 [365]

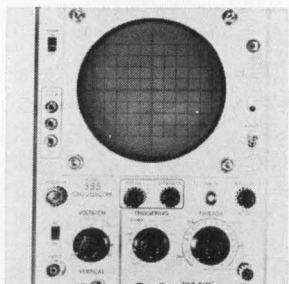

General purpose scope 555 is for lab and field use. The crt is a 5-in. flat-faced Braun tube divided into a viewing area of 8 x 10 cm by a removable edge-lit graticule. All amplifiers are multistage d-c coupled, and solid state with full compensation for optimum response. Price is \$284. Data Instruments Division, 7300 Crescent Blvd., Pennsauken, N.J. 08110. [366]

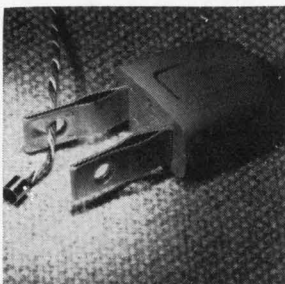

Wafer-thin and flush diaphragm pressure transducers are offered in a 1/8-in.-diameter series. They have a high frequency response and measure both static and dynamic pressures, providing full-scale outputs up to 20 mv/v. Several models come in pressure ranges from  $\pm 5$  psid up to 5,000 psia. Sensotec Div., Scientific Advances Inc., 1400 Holly Ave., Columbus, Ohio 43212. [367]

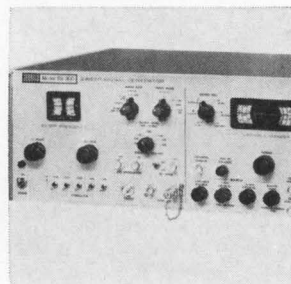

Solid state sweep generator system SS300 incorporates in one unit a sweep generator covering khz to 300 Mhz, a marker generator and a detector system. It features start-stop frequency tuning, automatic leveling without frequency shift, low radiation toggle switch attenuators, and 50-400 hz power input. Jerrold Electronics Corp., 401 Walnut St., Philadelphia, Pa. 19105. [368]

### New instruments

## Digital voltmeter logs in decibels

A-c instrument does logarithmic calculation itself, permits direct db output to computer or printer

**Because engineers** plotting the frequency response of amplifiers plot decibels versus frequency, they've been forced to use analog instruments—the only meters available with readouts in decibels. Thus, they lost one of the advantages of digital instruments—direct output

to a computer or a printer.

But a digital voltmeter that indicates in decibels has been developed.

Pacific Measurements Inc. is introducing an a-c digital voltmeter capable of displaying input signals directly in decibels above one milli-

watt (dbm), in a db relative to an arbitrary reference, or in db on an expanded scale for a resolution of 0.01 db. Called the model 1010 Log/Lin a-c digital voltmeter, the instrument is the second in a line. The first was a power meter for microwave applications.

The model 1010 also displays linearly voltages ranging from 300 microvolts to 15 volts root-mean-square. In the decibel mode, the dynamic range is 70 db, and frequency response is from 5 hertz to 5 megahertz. The basic accuracy is 0.1% at low frequencies. The three-digit plus overrange instrument sells for \$1,750.



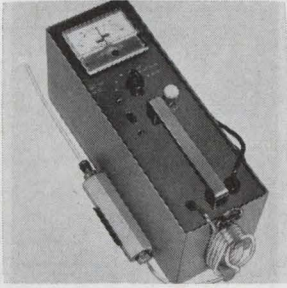

Gas leak detector 21-200 comes with a self-contained rechargeable battery pack and charging unit. Weighing 8 lbs, and smaller than a cigar box, the unit will detect light or heavy gases, inert or combustible, in hot or cold systems or storage tanks. It uses a thermal conductivity cell and solid state amplifier. Gow-Mac Instrument Co., 100 Kings Rd., Madison, N.J. 07940. [369]

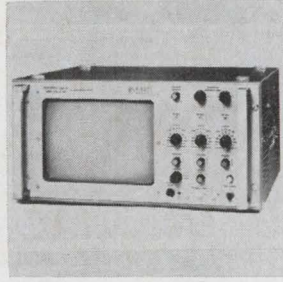

Multichannel oscilloscope DU-11 permits the X-Y display and resolution of frequency response curves and can be used in conjunction with almost any frequency sweep generator. The crt has a usable area of about 6 x 8 in. Deflection linearity in the Y axis is 3%, and X axis 5%. Price of the DU-11 is \$1,495. Texscan Corp., 4610 N. Franklin Rd., Indianapolis 46226. [370]

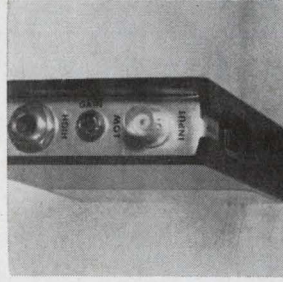

Instrumentation amplifier model MN-100 is a compact 0-to 100-db unit with a continuous voltage gain adjustment from 0 to 100,000. Maximum output voltage is 1 v rms into a 10-kilohm load; harmonic distortion, under 0.5%; recovery time, 100 msec from 10 v peak-to-peak. Price is \$139; delivery, 1 week. Roveti Instruments Inc., 1643 Forest Drive, Annapolis, Md. 21403. [371]

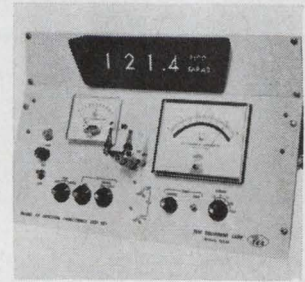

Junction capacitance test set model 77 can make a 1-Mhz measurement on npn and pnp transistors, diodes and small capacitors. A 5-in. taut band meter is standard as a readout on the basic instrument. Accuracy is  $\pm 1\%$  or  $\pm 0.1$  pf whichever is greater. The unit measures 12 x 8 x 19 in. and weighs 42 lbs. Price is \$830. Test Equipment Corp., 2925 Merrell Rd., Dallas. [372]

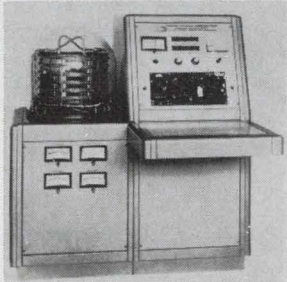

Guarded hot plate instrument GP-1800 is designed for the absolute determination of the thermal conductivity of plastics, ceramics, glasses, rubber, intermetallics and insulating materials. It conforms to ASTM C177-63 spec and provides accuracy of  $\pm 2\%$  from 75° to 800° F and  $\pm 5\%$  over 800° to 1,800° F. Thermo-Physics Corp., 17 Webster Ave., Cambridge, Mass. 02141. [373]

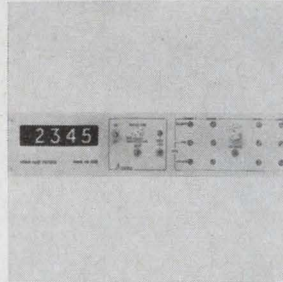

Strain gauge digitizer DR-100R is for instrumentation problems where a single instrument is desirable to excite strain gauges, and to display results in engineering units for such variables as pressure, force, weight, stress, strain and torque. The power supply voltage is switch-selectable to 10 or 15 v. Anadex Instruments Inc., 7833 Haskell Ave., Van Nuys, Calif. 91406. [374]



Grid dip meter 90651-A has a transistor d-c amplifier to increase sensitivity. It provides full scale meter reading at all frequencies from 1.7 to 300 Mhz. It has a taut band meter to eliminate possibility of the meter becoming "sticky". Five added coils are available for extending the range to 165 khz. James Millen Mfg., Co., 150 Exchange St., Malden, Mass. [375]

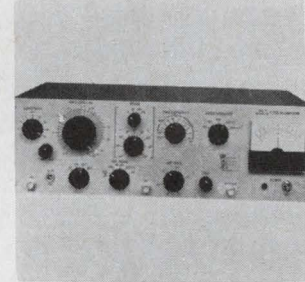

Lock-in amplifier 122 is continuously tunable from 5 hz to 50 khz in 4 ranges. It operates as a narrowband detector with an equivalent noise bandwidth of less than 0.008 hz. Center frequency is locked to the input signal, eliminating drift problems otherwise encountered when narrow-banding to eliminate noise. Princeton Applied Research Corp., Princeton, N.J. 08540. [376]

**Scope monitoring.** An analog output is provided to drive an oscilloscope or x-y plotter. In the linear operating mode, output is equivalent to a full-scale reading on the digital display. The linear mode output can be used for observing modulation envelopes on an oscilloscope. In the logarithmic mode, the output is 1 volt for each 10-db change in the input signal. A binary-coded decimal output is also available for feeding directly to a computer or data-acquisition system.

The instrument's output impedance is 2,000 ohms; the input impedance is approximately the same

as that on most oscilloscopes, permitting the device to be used with standard scope-input probes.

The average detection technique generates a d-c voltage precisely proportional to the a-c input signal. A mixer, driven by a large signal source, produces an output proportional to the input signal, but at a frequency equal to the difference between the input frequency and the drive-signal frequency. In this case, the drive signal is derived from the input signal and is in phase with it. But its amplitude is large and independent of the input amplitude. Since its frequency and phase are the same as the input



**Reader's choice.** Digital a-c voltmeter's readout can be in volts or decibels.

signal, the difference frequency is zero, and the output amplitude is equal to  $1/\pi$  times the peak input-signal amplitude.

**High balance.** To employ a lin-



# HOW

## To Solve YOUR Semiconductor Encapsulation Problems

**HYSOL** has more answers than anyone in the business.

**HYSOL's HYFLO® epoxy molding powders** have solved the problems of transfer molding encapsulation of a wide range of semiconductors, from simple to the most sophisticated.

**New HYSOL liquid epoxy systems**, compatible with almost every type of semiconductor, open new doors for casting or potting for short or long runs and extremely delicate items.

We have devoted thousands of laboratory man hours finding answers to the kind of encapsulation problems you may be facing right now. Our laboratories are ready to tackle new problems, as technology progresses, just as we have done in the past for scores of leading electronic component manufacturers.

**For application engineering help**, write, wire or phone **HYSOL** today. For technical data on standard semiconductor encapsulation products, ask for our semiconductor literature.

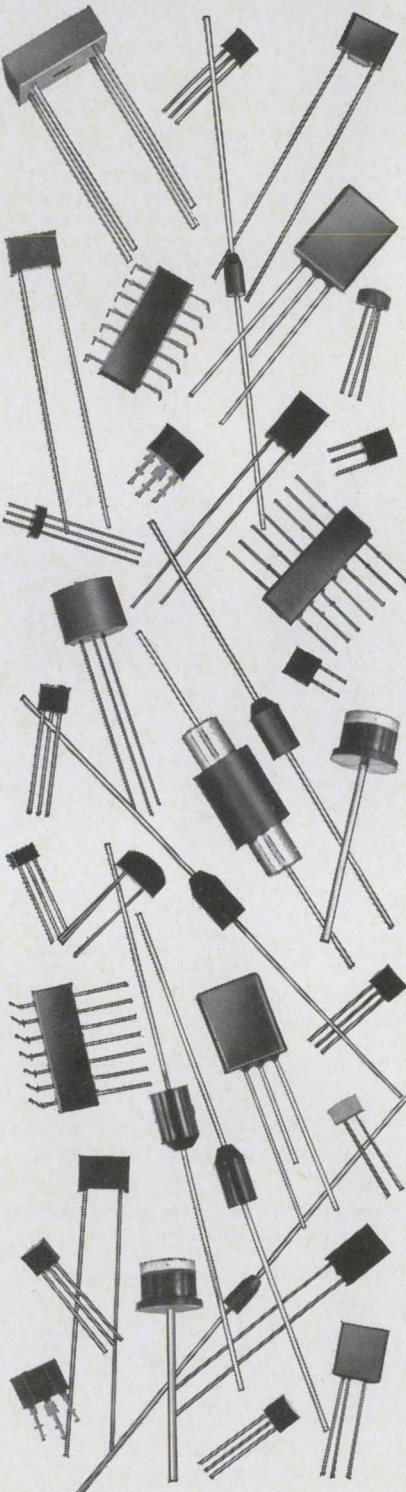

**HYSOL** HYSOL DIVISION  
THE DEXTER CORPORATION  
CLEAN, NEW YORK 14760 • 716/372-6300

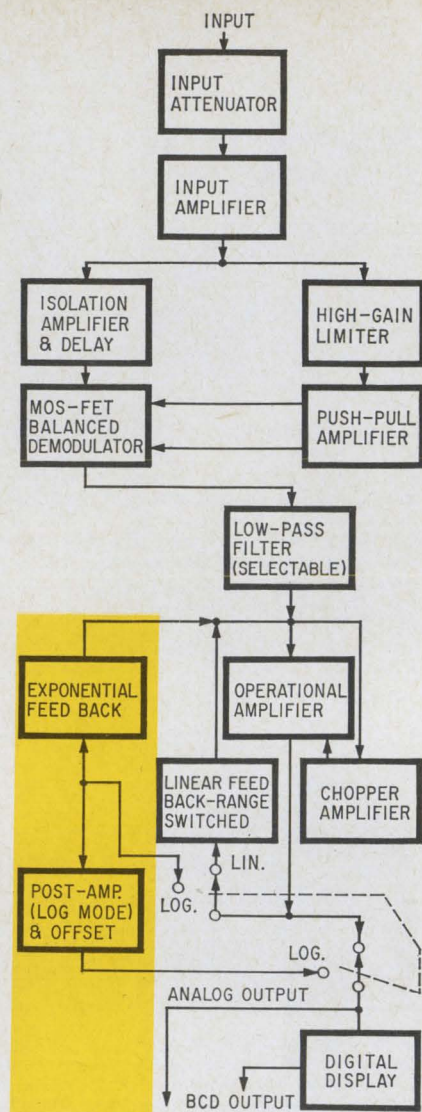

**Switching logs.** Decibel display is created by inserting exponential feedback circuit.

ear mixing detector for a zero difference frequency application, the detector itself must generate no d-c voltage. Metal-oxide semiconductor field effect transistors are used to obtain a mixer with exceedingly high balance and, consequently, no d-c output in the absence of an input signal.

The input signal is first supplied to a constant-impedance input attenuator to measure signals that would otherwise saturate the detector—more than 1-volt rms. An amplifier increases the magnitude of the signal to compensate for the peak-to-average detection loss in the mixer. The signal then is split into two paths—one directly to the detector via delay line; the other to a high-gain amplifier.

The high-gain amplifier provides



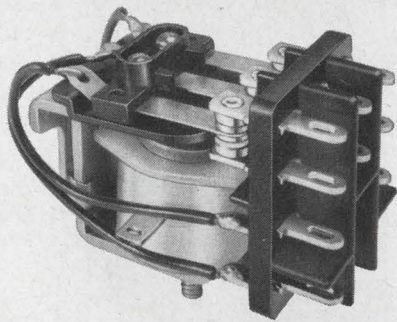

# In "THE GREAT RELAY RACE"

**GET YOUR FREE RELAY!...YOU'RE A WINNER EVERYTIME!**

Run your own relay race (evaluation test) in your own plant, under your own conditions, using your choice of our general purpose and medium power relays.

**YOU BE THE OFFICIAL JUDGE!** Verify the results shown in the chart on the right. You will find that Eagle Relays run longer and better; that there is no premium in cost and that they are always readily available.

GET YOUR FREE RELAY TODAY by writing for your OFFICIAL JUDGE'S ENTRY BLANK to: Relay Race, Eagle Signal Division, 736 Federal Street, Davenport, Iowa, 52808, or by circling reader service number below.

CONTACTS	COMPETITIVE BRANDS						EAGLE RELAYS
	"A"	"B"	"C"	"D"	"E"	"F"	
Arrangement Rating	3 PDT 5 Amp.	3 PDT 5 Amp.	3 PDT 5 Amp.	3 PDT 5 Amp.	3 PDT 5 Amp.	3 PDT 5 Amp.	3 PDT 5 Amp.
LIFE Mechanical	15,061,261 Operations	14,077,866 Operations	28,808,000 Operations	21,625,333 Operations	16,923,133 Operations	29,433,600 Operations	34,492,950 Operations
ELECTRICAL 5 Amp. Resistive	295,466 Operations	490,433 Operations	129,600 Operations	235,700 Operations	778,200 Operations	921,400 Operations	948,675 Operations
1.6 Amp Inductive	488,666 Operations	1,071,666 Operations	496,000 Operations	284,333 Operations	3,529,466 Operations	1,842,000 Operations	3,102,200 Operations

This comparison chart shows that Eagle Relays have a 100% greater life than the average of our six competitors at 5 amps, resistive and an almost 140% greater electrical life than the average of the six competitors at 1.6 amps inductive.



A DIVISION OF THE E. W. BLISS COMPANY

IN CANADA: EAGLE SIGNAL DIVISION, E. W. BLISS COMPANY OF CANADA LTD., GEORGETOWN, ONTARIO  
 "VISIT WITH US IN BOOTHS 4D26-4D28 AT THE IEEE SHOW"

Circle 227 on reader service card



# Does a gamma dose rate of $10^{11}$ Rads per second or electron energy of 600 joules in 20 nanoseconds interest you?

If it does, talk to Physics International.  
Our smallest Pulserad 310 simulator produces that.

Today, engineers, physicists and life scientists in all disciplines are critically interested in the effects of massive radiation on organic substances and inorganic materials as well as systems of all kinds.

Physics International's Pulserad high energy pulsed radiation simulators, consistently produce the highest dose rates ever attained . . . leading the state-of-the-art. They provide the ideal laboratory capabilities in all disciplines for the evaluation of radiation effects.

The five models of Pulserads produce 2MeV to 10MeV pulses of 20-40 nanosecond duration. Gamma, X-ray, electrons or neutrons can be produced as desired. The modular design of Pulserad simulators creates a high degree of reliability. Units currently in use have produced well over 1,500 pulses . . . without replacement of the tube.

A number of options are available for the purchase and installation of a Pulserad in your facility. Model 310 Pulserads may be traded-in on larger models when desired. Three different Pulserads are operating in our San Leandro headquarters and time can be rented on them for testing. Write or telephone the Marketing Manager today for detailed literature and full information.

## 2 MeV Pulserad 310 Performance

### ELECTRON OUTPUT

Peak current (amps) 20,000  
Pulse length (nanoseconds) 20  
Energy (joules/pulse) 600  
Energy density (cal/cm<sup>2</sup>) 100

### X-RAY OUTPUT

Pulse length (nanoseconds) 20  
Dose per pulse (Rads)  
At external anode 7,000  
At 12" from anode 40

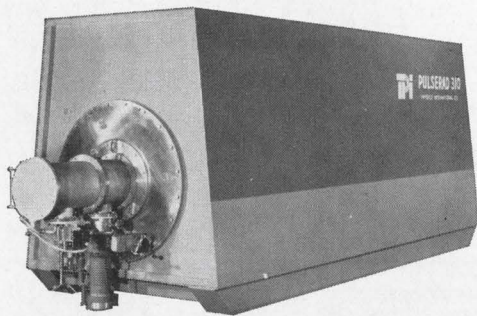

## PHYSICS INTERNATIONAL COMPANY

2700 Merced Street • San Leandro, California 94577  
Phone 415/357-4610 • TWX: 910/366-7033

. . . log or linear display  
determined by feedback . . .

Carefully controlled clipping characteristics. The amplifier gain is sufficient to cause it to limit on almost all signal levels. The limiting action of the amplifier is feedback regulated so the output waveform is symmetrical and approximately in phase with the input waveform. The output of this amplifier feeds a Schmitt trigger, which generates square waves of exceedingly short rise time. An output amplifier develops the necessary differential (push-pull) signal required by the mixer (demodulator). This signal is then applied to the gates of the FET's.

**Slower for lower.** The mixer consists of two MOS FET's connected in series shunt. The detected signal feeds an output filter, which removes the input-frequency component but preserves the d-c. This filter may be adjusted to provide fast response when it is only required to reject relatively high frequencies, and a somewhat slower response when rejecting lower frequencies.

An operational amplifier with selectable linear or exponential feedback develops a high-level signal to drive the digital display and output connector. The operational amplifier is stabilized by a 1-khz chopper amplifier. The chopping frequency permits the chopper amplifier to eliminate most of the 1/f noise in the operational amplifier. Feedback is either from a resistive divider—for linear operation—or for logarithmic operation, from the collector of a grounded-base transistor whose collector current is exponentially proportional to the emitter-base voltage.

A regulated oven keeps the logging transistor at a constant temperature, assuring accurate, repeatable characteristics. An adjustable offset permits db scale expansion for displaying a 0.01 db change. In addition, a d-c coupled oscilloscope can be used to monitor the output at any signal level. The digital display can read the magnitude of the offset, permitting precise calibration of oscilloscope displays.

Pacific Measurements Inc., 940 Industrial Ave., Palo Alto, Calif. 94303 [377]



PILL COUNTING/HEATING/METAL WORKING/HEAT TREATING/POSITIONING/ELECTRIC MOTOR CONTROL/COIL WINDING/WAREHOUSING/CONVEYOR CONTROL/PROCESS MATERIALS HANDLING/PACKAGING/INVENTORY CONTROL/PLASTIC MOLDING/PHARMACEUTICALS

# LOOKING FOR LOW-COST AUTOMATION?

PILL COUNTING/HEATING/METAL WORKING/HEAT TREATING/POSITIONING/ELECTRIC MOTOR CONTROL/COIL WINDING/WAREHOUSING/CONVEYOR CONTROL/PROCESS MATERIALS HANDLING/PACKAGING/INVENTORY CONTROL/PLASTIC MOLDING/PHARMACEUTICALS

**EAGLE makes it possible...**

## with 56 basic types of Time/Count Controls.

PILL COUNTING/HEATING/METAL WORKING/HEAT TREATING/POSITIONING/ELECTRIC MOTOR CONTROL/COIL WINDING/WAREHOUSING/CONVEYOR CONTROL/PROCESS MATERIALS HANDLING/PACKAGING/INVENTORY CONTROL/PLASTIC MOLDING/PHARMACEUTICALS

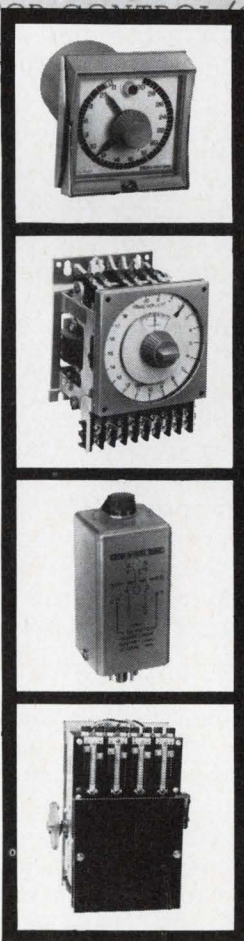

HERE ARE 4 TYPICAL INTERVAL TIMERS . . .

**Plug-In Timing.** The CYCL-FLEX® type, available as timers for intervals to 100 hours; as counters to 100 counts. Plug-in feature minimizes downtime.

**High-Accuracy Timing.** The MICRO-FLEX®, 20-turn dial provides setability and accuracy to 1/10 of 1% of full dial range. Standard time ranges: .05 seconds to 120 hours. Counters to 1,000 counts.

**Time Delay Relays.** Both "ON" and "OFF" delay solid state plug-in as well as motor driven. Time ranges from 0.2 seconds to 55 minutes.

**Sequence Timing.** Multiple-circuit-type, close and open circuits in a timed sequence for machine and process control. Both dial and cam types available.

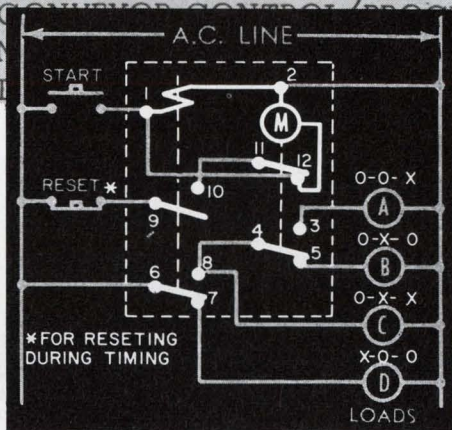

Here's a typical interval timing control circuit  
3 symbols in sequence denote load switch condition in:

Reset	Timing	Timed Out
O	O	X

X Circuit closed or "ON" • O Circuit open or "OFF"

**2 Helpful Catalogs—FREE!** Send for FREE catalog illustrating all 56 types and our "How-To-Do-It" booklet on timer and counter applications. Use reader service number below, or write:

Eagle Signal Division,  
E. W. Bliss Company,  
736 Federal St.,  
Davenport, Iowa 52808.



In Canada: Eagle Signal Division,  
E. W. Bliss Company  
of Canada, Ltd.,  
Georgetown, Ontario



A DIVISION OF THE E. W. BLISS COMPANY

"Visit us in Booths 4D26-4D28 at the IEEE Show"



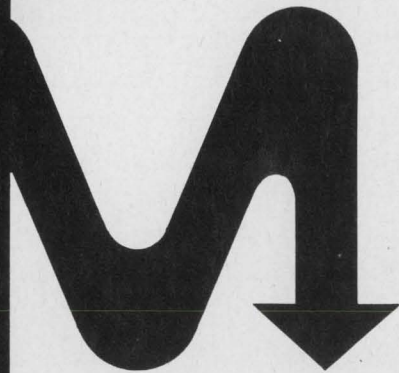

## CYCLIC A/D CONVERTER

For more than a decade, engineers have attempted to design a workable CYCLIC A/D converter. Bunker-Ramo has engineered and manufactured the first practical Cyclic A/D converter, the B-R 850.

- **CYCLIC!** Within the B-R 850, the signal is synthesized rather than successively approximated. Input data conversion is continuous, eliminating requirement for sample and hold. Output can be sampled continuously or on command.
- **FAST!** Worst-case conversion time: 1  $\mu$ sec. for 8-bit word. 1-bit changes as short as 60-nsec. When following a multiplexer, conversion time will add less than 1  $\mu$ sec.
- **ECONOMICAL!** \$1,348 (single unit price); POWER: max 7½ watts; SIZE: 3¾" x 4¾" x 7½"; WEIGHT: less than 2-lbs.

SPECIAL PROBLEMS? NEED HIGHER SPEED—GREATER RESOLUTION—  
LOWER POWER—SMALLER SIZE? TRY US FOR THE SOLUTIONS!

For more information on the BR-850 and on our upcoming line of components, (i.e.: 12-bit, 300 KHz; 8-bit, 3 MHz converter; 16-channel multiplexer and others) please contact Mr. W. G. Garner. Phone (213) 346-6000 or write:

"SEE YOU AT THE IEEE SHOW—Booth 4E39-41"



**THE BUNKER-RAMO CORPORATION**  
DEFENSE SYSTEMS DIVISION  
8433 FALLBROOK AVENUE • CANOGA PARK CALIFORNIA 91304

New instruments

## Counter extended to 100 megahertz

Plug-in uses 1-Mhz crystal and multiplies its output, yielding 10-nsec resolution

A West Coast instrument company, realizing one of its products might become obsolete, decided to do something about it. The company's engineers designed a plug-in unit to update the basic instrument.

Last year, Beckman Instruments Inc. introduced the model 6148 counter with a range of 100 megahertz. But because its gating resolution was only 0.1 microsecond, the instrument could make time interval or period measurements only to 10 Mhz. This year Beckman is introducing a plug-in unit, the 625 timer, that improves resolution to 10 nanoseconds and extends time domain measurements to a maximum of 100 Mhz.

The 6148 obtains its 10-Mhz clock rate by multiplying the output of a 1-Mhz crystal. The 625 plug-in is an almost empty box containing only control circuitry and multipliers to get the 10 Mhz up to 100 Mhz—yielding the 10 nsec resolution.

Though the circuitry may be simple, "Getting from 10 Mhz to 100 Mhz isn't easy," says Beckman engineering manager Jerry Reinen. Getting the required amplitude and signal-to-noise ratio is a function of the purity of the signal. Reinen says, "It's hard not to pick up stray capacity and other parasitics in the process."

The plug-in, Beckman says, makes the 6148 useful in shock wave analysis, time delay reflectometry, or any application requiring high resolution phase, velocity, or elapsed-time measurement. With the 10-nsec resolution in time domain, the instrument can also check frequency sources by error expansion.

Beckman Instruments, Inc., Electronic Instruments Division, 2400 Wright Ave., Richmond, Calif. 94804 [378]



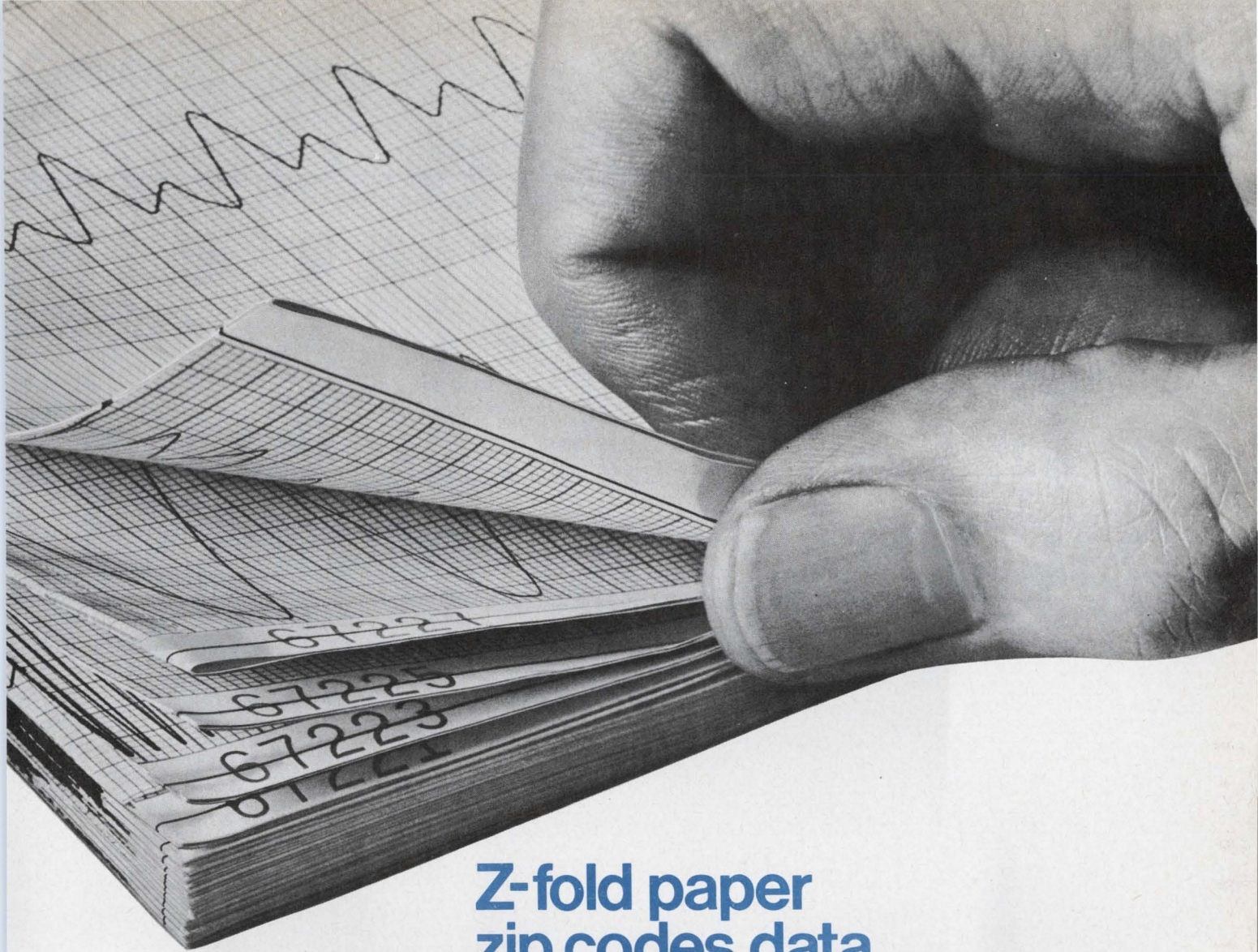

## Z-fold paper zip codes data for quick retrieval

Data recorded on Z-fold paper by the Hewlett-Packard 7800 Series Rectilinear Recorder is instantly retrievable. Each page is numbered to simplify reference to recorded data. Z-fold chart packs store easily in their original cartons.

Contactless pen tip sensing and a *modulated pressure ink system* produce traces of equal density from all signals and throughout the recorder's variable speed ranges of .025 to 200 mm. per second. *You get black ink reproducibility compatible to diazo or any similar process.*

Designed with modular, solid-state electronics, the 7800 Systems provide high-resolution, permanent, rectilinear recording of up to eight variables from dc to 160 Hz.

Eight 8800 Series Preamplifiers provide signal conditioning to the driver-amplifiers which drive the recording pens. The recording system is available with eight different or eight identical preamplifiers of your choice. Frequency re-

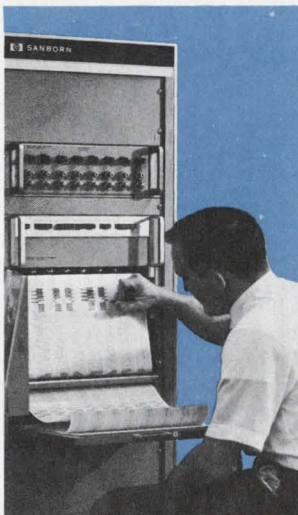

sponse of the recorder is 160 Hz for 10 div p-p deflection and 58 Hertz maximum for full scale deflection. Maximum ac or dc non-linearity is 0.5% full scale. Additional features include: choice of chart paper in Z-fold packs or rolls; 14 electrically-controlled chart speeds; built-in paper take-up; ink supply warning light; disposable plug-in ink supply cartridge that may be replaced while the recorder is in operation and complete modular construction for easy maintenance.

For complete information on the 7800 system, optional and related equipment, contact your local HP Field Office or write Hewlett-Packard, Waltham Div., 175 Wyman St., Waltham, Mass. 02154.

HEWLETT  PACKARD  
RECORDING SYSTEMS



# Laundromat for E.E.'s.

(Barnstead's Micro-Cleaners and transistor washers lower rejects with rinses of hot, high-purity water.)

Barnstead's microelectronic cleaning systems make micro-circuits and other highly critical electronic parts come clean with cascades of hot, distilled water. And they do it at minimum cost.

The water not only measures 15 to 18 megohms/cm but is also free from the particles, organic, gaseous and biological impurities that often cause circuit failure. Because it is far purer than water that is only demineralized, it makes the ideal rinsing medium. Continuous repurification and recirculation makes several gallons do the work of



thousands, saving on water and heat.

Whether you want a cabinetized, dust-free station, like the one shown here, or a hoodless built-in for your own clean room . . . we can engineer it to your needs. Chemical baths, ultrasonic cleaners or solvent rinses may be incorporated too, if you wish.

We also make a complete line of stills and demineralizers for the electronics industry. For full information on any of these products write Barnstead Still and Sterilizer Co., 225 Rivermoor Street, Boston, Massachusetts 02132.

**Barnstead**

Ritter Pfaudler Corporation



## New Production Equipment Review

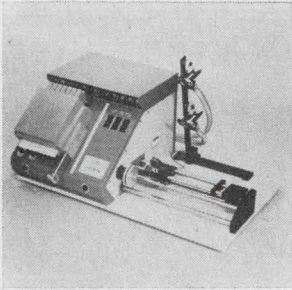

Coil winder ACW-10A is programmed by inserting an IBM card, and winds automatically at speeds up to 8,000 turns per minute to precise tolerances. Features include an electronic counter that provides turns count accuracy within  $\frac{1}{4}$  turn at all speeds, and a traverse counter that controls winding length and turns per layer. Eubanks Engineering Co., Monrovia, Calif. [421]

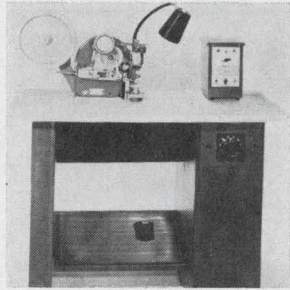

A contact welding machine can be tooled for dial, strip and in-line uses. It uses bimetal electrical contact tape for bonding contacts to electrical and electronic components. The unit can produce up to 5,000 weldments/hr. Tape is automatically cut to predetermined length and resistance welded to the piecepart. Wikstrom Machines Inc., 30 Main St., Bklyn., N.Y. [422]

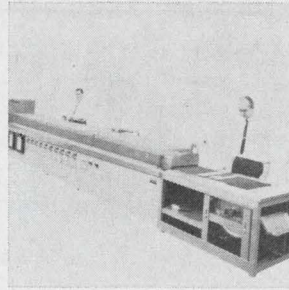

A volume-production thick film firing furnace is 70 ft long and has a 16-in.-wide belt, free cooling and water cooled sections, and 40 ft of heated length consisting of 10 individually controlled zones. At a belt speed of 12 in./minute and using a 1 x 1 in. square substrate, it delivers approximately 12,000 circuits/hr. BTU Engineering Corp., Bear Hill, Waltham, Mass. 02154. [423]

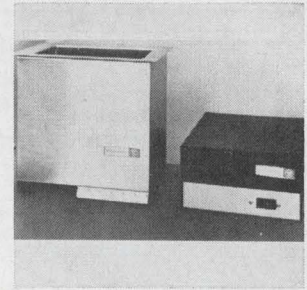

Mini-Magnapak ultrasonic cleaner gives high reliability and performance for cleaning small pieces such as silicon wafers, components and p-c boards. It occupies less than 1 cu ft and includes a  $1\frac{1}{2}$  gallon stainless steel cleaning tank with magnetostrictive transducers, and a 20-khz Magnatrac generator with 200-w output. Westinghouse Electric Corp., Box 868, Pittsburgh, Pa. 15230 [424]

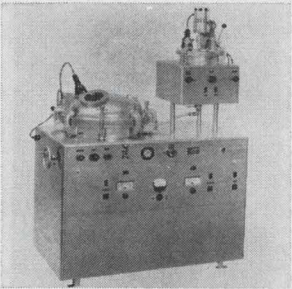

High-vacuum epoxy encapsulation system model ESL provides control over all process variables. It will heat, mix, and deaerate resins . . . heat, dry, and deaerate work pieces . . . and fill molds under high vacuum. Many sizes of work pieces can be accommodated, each indexed so that it is centered under the filling head. Red Point Corp., 105 W. Spazier Ave., Burbank, Calif. [425]

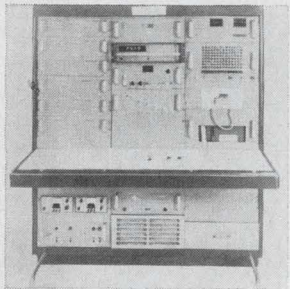

Automatic relay test station model 3000 provides go, no-go comparisons to high and low limits for each measurement and includes a 4-digit readout for the value of each parameter. A loop of punched paper or Mylar tape is used to program the limits, test conditions and connections for each test. Optimized Devices Inc., 220 Marble Ave., Pleasantville, N.Y. 10570. [426]

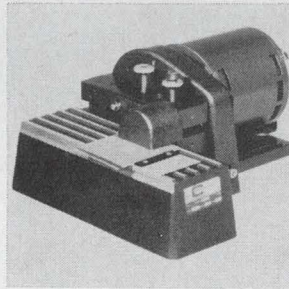

Machine model 44, designed to end-strip flat cables made of flat or round conductors, employs a counter-force stripping principle that obsoletes the use of cable clamping devices. Insulation is stripped off in a matter of seconds, and the conductors are electrically clean and ready for termination. The machine is 12 x 7 x 15 in. Carpenter Mfg. Co., Manlius, N.Y. 13104. [427]

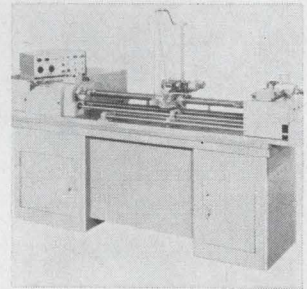

Precision pot winder 637-AL simultaneously winds 2 round mandrels per cycle to an accuracy of 0.0005 in. in 0.5 in. Maximum traverse for a single continuous winding is 24 or 48 in. Wire sizes wound are 0.010 to 0.0004 in. Winding range is 44 to 3,040 turns/in.; winding speeds, up to 4,000 rpm. Price is \$11,500. Geo. Stevens Mfg. Co., N. Key-stone Ave., Chicago 60646. [428]

### New production equipment

## No fresh air for degreaser's solvent

Tank-in-a-tank construction of industrial cleaner cuts evaporation losses and allows spraying of longer pieces

A few sentences in a technical bulletin from the Du Pont Co. resulted in a new product for Cyclo-Tronics Inc. The paper suggested that if the vapor generating tank in degreasing machines were offset, boiling solvent wouldn't be lost through evaporation.

Most machines have one large tank divided by a baffle about half the tank's height. Solvent is boiled on one side, and the workpieces are dipped and sprayed on the other.

The vapor from the boiling tank rises to the level of a cooling coil,

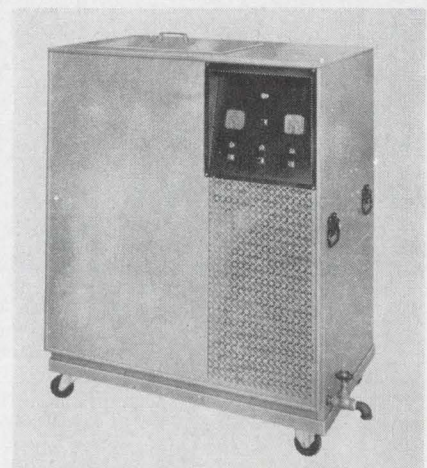

To the cleaner. Spray from six jet ports dissolves grease on workpieces.



# New FROM AD-YU

## ELECTRONICS INC.

249-259 TERHUNE AVENUE, PASSAIC, N. J.  
Phone (201) 472-5622 • CABLE: ADYU PASSAIC

### DIGITAL PHASE METER TYPE 524A3

±0.03 Degree Accuracy, 20 CPS to 500 KC



Type 524A3 with indicator. Computer alone (bottom panel) can produce analog output to drive recorder and d.c. digital voltmeter. Price \$999.

#### FEATURES:

Phase reading directly in degrees in 5 digits (or 4 digits).

No amplitude adjustment from 0.3v to 50v.

No frequency adjustment up to 500 kc.

Analog output available for recorder or program mable system.

#### USES:

Plot phase vs. frequency curve of unknown network.

Plot envelope delay curve with RF sweep oscillator.

A standard phase meter with 5-digit readout.

### WIDEBAND PHASE STANDARD TYPE 209

0.015° Accuracy 50 CPS to 10 KC

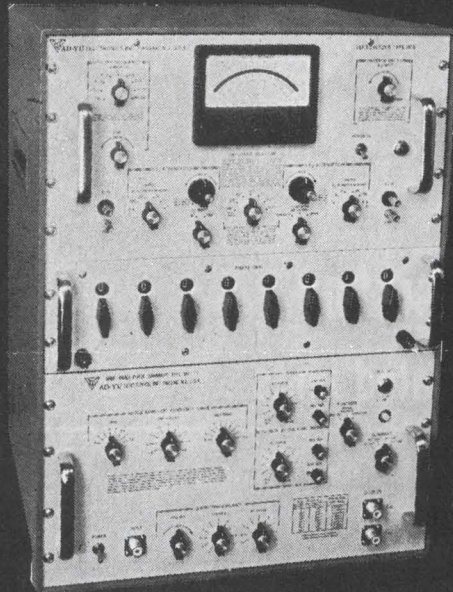

Directly traceable to  
National Bureau of Standards.

#### FEATURES:

Accuracy 0.015° resolution 10 micro-degrees (10<sup>-5</sup>).

Self-calibration, self-checking by means of fundamental bridge balancing without the use of an external standard.

Phase shift can be set from 0° to 360° with 7-digit resolution.

No error due to loading of both output signals.

#### SPECIFICATIONS:

##### FREQUENCY RANGE:

Continuous coverage from 50 cps to 10 kc.

##### PHASE RANGE:

Can be set for any phase angle from 0° to 360° with 7-digit resolution.

##### ACCURACY:

±0.015° for 50 cps to 1 kc; gradually increases to ±0.07° at 10 kc.

##### RESOLUTION:

0.00001 degree (10 micro-degrees).

where it is condensed and trapped in a reserve tank. This liquid is then used in a spray gun.

**Ring around the tub.** Cyclo-Tronics engineers have removed the baffle and built the boiling tank around the cleaning area, separating the two concentric tanks with a perforated wall. The coiling coils are 26 inches up from the bottom of the tank.

The Cyclo-Tronic degreaser is designed to use Du Pont's Freon solvents. Because their boiling point is much lower than that of most contaminants, the distilled solvents are very pure.

The reserve tank's liquid is used to feed six jets positioned to spray the cleaning tank from its bottom up to a height of 24 inches. Thus, a piece 48 inches long can be cleaned.

**Windbreaker.** The cleaning tank is always open to the air because the operator is continuously putting in and taking out workpieces. To hold vaporous solvents, designers rely on condensation at the coils. They also extend the wall of the tank beyond the cooling coils to keep out air currents. This extra height is 17.5 inches in the Cyclo-Tronic degreaser.

But this degreaser further reduces solvent loss by covering the boiling tank, an innovation that Goldware says, cuts solvent loss in half.

**One cooker.** The solvent is heated by four 400-watt strip heaters that shut off automatically if refrigeration fails. When not using the machine, the operator can leave on just one heating element. This reduces warmup time by keeping the solvent in the boiling tank just below its boiling temperature. One heater will also vaporize enough solvent to refill the reserve tank overnight.

The degreaser has a total solvent capacity of 18.7 gallons—3.8 gallons for the reserve tank, 7 for the cleaning tank, and 7.9 for the boiling tank. The system can operate with a minimum solvent volume of 12 gallons and will shut itself off if the volume falls below this.

The cleaning tank is 12 by 18 by 37.5 inches and the whole system measures 36 by 24 by 42 inches. The price is \$1,595.

Cyclo-Tronics Inc., 3858 N. Cicero Ave., Chicago 60641 [429]

Measure phase between two antennas.

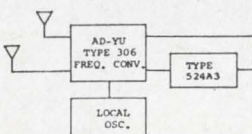

Measure signals from transducers, accelerometers, magnetic pickups, impedance heads, etc.

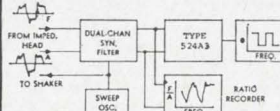

Measure phase shift of unknown network with accuracy better than 0.02°

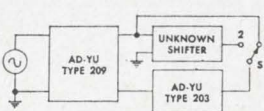

"See our Booths 2J43-2J45 at the IEEE Show."



# GOOD

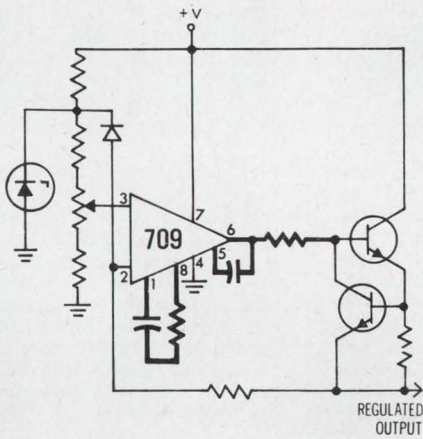

This good regulator circuit . . .

# BETTER

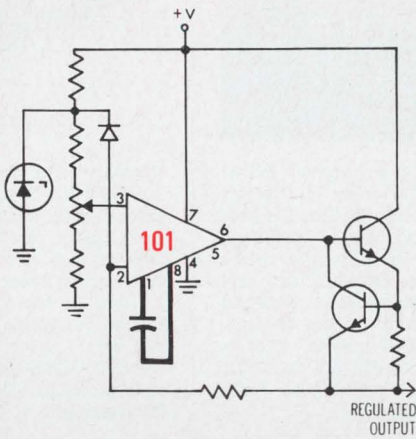

can just be improved . . .

# BEST

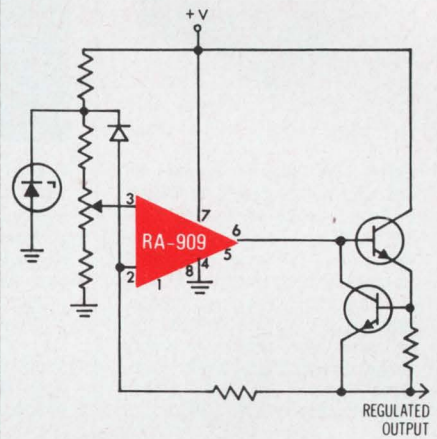

or it can be optimized!

## ***Now optimize all 709 circuits by using the NEW compensationless RA-909.***

*It's a pin-for-pin replacement offering a faster slew rate,  
lower power dissipation, better transient response, greater D. C. gain stability,  
and a noise level so low that we'll even publish it (see below)!*

The regulator circuit above is only one example of how you can optimize your present designs by using the RA-909. Design it into any circuit where you would use a 709 or use it as a replacement in equipment already in use. It's in an eight pin TO-5 and a TO-86 flatpack configuration. Both have blank leads where the 709 and 101 require compensation. This permits you to use the RA-909 even though compensation networks are already on the circuit board. And you'll find that the cost is competitive.

The new RA-909 is dielectrically isolated and incorporates vertical PNP and NPN transistors in the same monolithic structure. These processes eliminate the need for external compensation and insure a slew rate of 5 volts per microsecond; power dissipation of 52 milliwatts; transient response of 40 nanoseconds (10 to 90% points) with a 200 millivolt output into a 2K  $\Omega$ , 100 pF load in the worst-case unity gain configuration; and a maximum equivalent input noise of 5 microvolts rms. For complete information contact our nearest sales office.

Visit us at IEEE '68 Booth 4H19-4H21



**RADIATION**  
INCORPORATED

SUBSIDIARY OF HARRIS-INTERTYPE CORPORATION  
MICROELECTRONICS DIVISION

Sales Offices: 600 Old Country Road, Garden City, N.Y. 11530, (516) 747-3730 — 2600 Virginia Avenue, N.W., Washington, D.C. 20037, (202) 337-4914 — 6151 W. Century Boulevard, Los Angeles, Calif. 90245, (213) 670-5432 — P.O. Box 37, Melbourne, Florida 32901, (305) 727-5430 — International Sales: Marketing Department, P.O. Box 37, Melbourne, Florida 32901, (305) 727-5412



## New Subassemblies Review

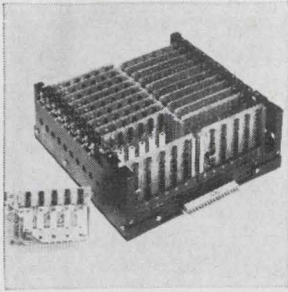

Series 056 Datedreed provides all the control advantages of matrix switching, while eliminating limitations of open contacts and critical, close tolerance mechanical linkages. Contact rating is 12 v-a, 0.5 amp max.; breakdown voltage, 400 v d-c; characteristic impedance, 50 ohms; frequency range, greater than 10 Mhz. A. D. Data Systems Inc., 830 Linden Ave., Rochester, N.Y. [381]

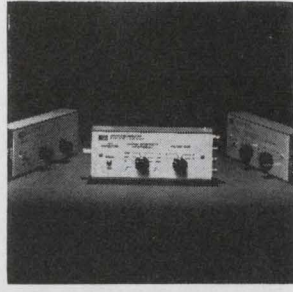

Charge-sensitive preamp 5554A works with a variety of detectors—including scintillation, gas proportional, and geiger types, and particularly semiconductor detectors, such as lithium drifted germanium diodes—without requiring soldered circuit changes. It measures 3 x 3 $\frac{3}{8}$  x 8 in. Price is \$300. Hewlett-Packard Co., 1501 Page Mill Rd., Palo Alto, Calif. 94304. [382]

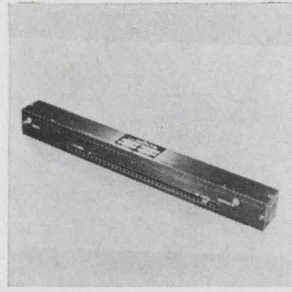

Magnetostrictive delay line model LD-50S offers 5 to 50  $\mu$ sec adjustable delay range under sine wave carrier conditions. It features up to 6 outputs with minimum spacing between outputs of 2.5  $\mu$ sec. It has a sensitivity of 2.5 mv rms across a 1,000-ohm load with 1 v rms input at 450 khz and is linear up to 10 v rms of input voltage. Seaelectro Corp., Mamaroneck, N.Y. 10543. [383]

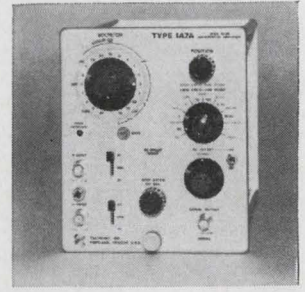

Plug-in amplifier type 1A7A is designed for stability and ease of control in the low-level measurement area. Basic deflection factor is 10  $\mu$ v/cm, d-c coupled, with a bandwidth of d-c to 1 Mhz. Trace drift is 10  $\mu$ v/hr, d-c coupled, with constant line voltage and temperature. Displayed noise is 16  $\mu$ v or less. Price is \$440. Tektronix Inc., Box 500, Beaverton, Ore. 97005. [384]

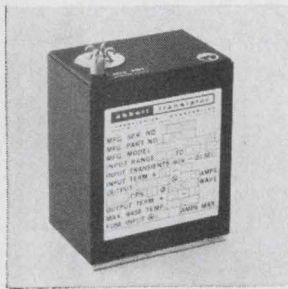

Static inverter S05D converts 28 v d-c to 400-hz sine wave voltages of either 115 or 26 v a-c. With continuous full-load operation at 212°F, it supplies an output of 5 v-a. Modular design provides a package of 1 $\frac{7}{8}$  x 2 $\frac{3}{4}$  x 3 $\frac{1}{4}$  in. that weighs less than 1.6 lbs. Price is as low as \$292 each. Abbott Transistor Laboratories Inc., 5200 W. Jefferson Blvd., Los Angeles 90016. [385]

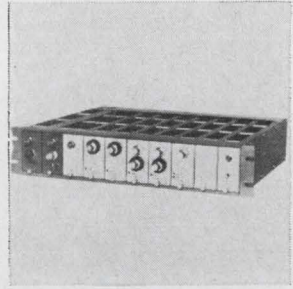

Plug-in d-c amplifiers and isolated power supplies provide a flexible signal conditioning system in a 3 $\frac{1}{2}$  x 19-in. package. Amplifiers are available with frequency response from d-c to 100 khz and gains of less than unity up to 2,500. Each provides 100-ma output at 0.5-ohm impedance. Instrumentation Amplifiers & Supplies Inc., 29 Newtown Rd., Plainview, N.Y. 11803. [386]

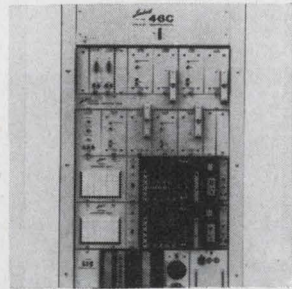

Coaxial transmission system 46C handles up to 600 multiplexed voice-frequency channels on 2 coaxial tubes. It is suited for interconnection of microwave radio and multiplex facilities, for expansion of high-density communications routes, and for terminal-to-terminal medium haul communications of 100 miles or more. Lenkurt Electric Co., 1105 County Rd., San Carlos, Calif. 94070. [387]

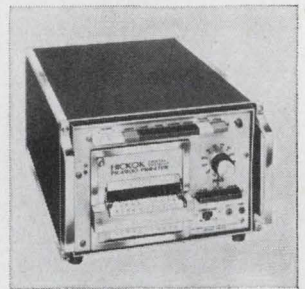

IC digital printer PR4900 may be used with any device that provides 10-line decimal or BCD coded data. Voltage, frequency, resistance, capacitance, or event counts can be recorded. The print command can be remote, local, or at calibrated time intervals switched in 36 steps from 10 sec to 120 minutes. Hickok Electrical Instrument Co., 10514 Dupont Ave., Cleveland, Ohio 44108. [388]

### New subassemblies

## Zapping components for better IC's

Trimming and hole drilling are only the first applications for compact solid state laser system

A Q-spoiled yttrium-aluminum-garnet (YAG) laser, equally capable of trimming excess metal off integrated circuit components or locating missing objects under water has been developed by the Korad division of the Union Carbide Corp. For underwater searching applica-

tions the laser is used with a second-harmonic crystal in a gated viewing system.

In such a system the viewing device is synchronous with the laser's pulse rate. For example, the Korad laser has a pulse width of 80-100 nanoseconds. It takes about 200

nanoseconds for the beam to hit an object 100 feet away and return to illuminate the television, image-conversion tube or other light sensitive device.

The laser can be operated in a continuous-wave or pulsed mode and changed from one to the other by a simple mechanical switch. It can trim resistors or remove metal from IC substrates. Operated in c-w, it can weld. It can also repeatedly drill holes as small as 2.5 microns in diameter in all metals and most other materials. James Boyden, director of Korad's Product Engineering and Development division, says this is the smallest hole—with an



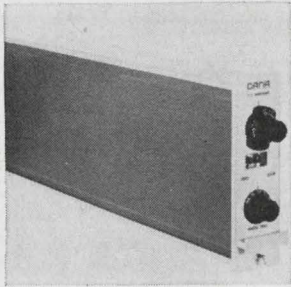

D-c data amplifier 2850 is designed for research instrumentation and data acquisition. Full scale output is  $\pm 10$  v and  $\pm 100$  ma. A front-panel control allows output to be set at any one of 5 bandwidths: 10 hz, 100 hz, 1 khz, 10 khz, and wideband. A 3-pole Bessel filter establishes desired cutoff frequency. Dana Laboratories Inc., 2401 Campus Dr., Irvine, Calif. 92664. [389]

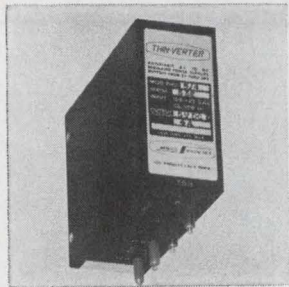

Modular power supply PHU-I is a 40-w unit suited for systems sensitive to r-f and uhf ranges, such as IC's and differential amplifiers. Units are available for any output from 3 v to 5,000 v d-c and for currents up to 8 amps. Dimensions are  $1\frac{1}{8} \times 3\frac{5}{8} \times 5$  in. Weight is 30 oz. Delivery is from 2 to 8 weeks. Arnold Magnetics Corp., 6050 W. Jefferson Blvd., Los Angeles 90016. [390]

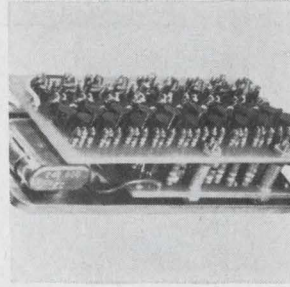

IC compatible, compact crystal oscillator modules provide either square- or sine-wave outputs. Frequency range with square-wave output is 0.05 hz to 10 Mhz, or with sine-wave, 50 hz to 10 Mhz. The modules operate from supply voltages as low as 3 v d-c. Units come in 7 packages for either pcb or chassis mounting. Fork Standards Inc., 211 Main St., West Chicago 60185. [391]

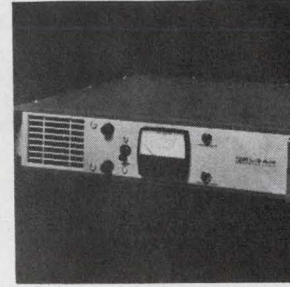

A-c line conditioner 7006 is a solid state unit with a response time of less than 50  $\mu$ sec. It delivers 500 v-a of 60 hz power with less than 0.25% distortion and up to 10% distortion on the output. It measures  $3\frac{1}{2}$  in. high and weighs 35 lbs. The unit has detachable rack adapters for portable bench-type operation. Elgar Corp., 8046 Engineer Rd., San Diego, Calif. 92111. [392]

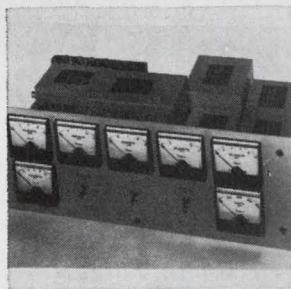

Model A6550 is a typical application of packaging of the HRM power supply modules to meet needs for well regulated, h-v multiple d-c outputs. It uses 6 modules operating from 115 v, 57 to 420 hz, to supply simultaneous outputs from 350 to 20,000 v, regulated to less than 0.03% with ripple less than 0.03% rms. Del Electronics Corp., E. Sanford Blvd., Mt. Vernon, N.Y. [393]

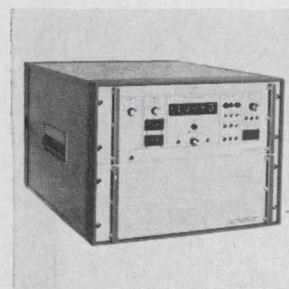

A portable digital data logger can measure and record any combination of physical parameters that are convertible by transducers to voltage, current, or resistance. Some examples are temperatures, pressures, velocities, accelerations, weights and displacements. Price ranges from \$7,500 to \$15,000. Control Equipment Corp., 19 Kearney Rd., Needham Heights, Mass. 02194. [394]

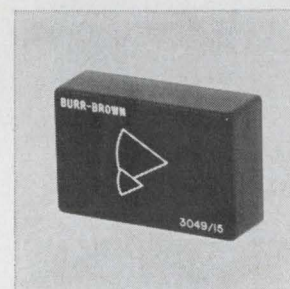

Chopper-stabilized amplifier 3049/15 occupies less than 1.3 cu in. and has a maximum weight of 2 oz. Rated output is  $\pm 10$  v at  $\pm 10$  ma with maximum input voltage drift of  $\pm 1 \mu$ v/ $^{\circ}$ C and maximum input current drift of  $\pm 2$  pa/ $^{\circ}$ C. Bandwidth is 10 Mhz and max. frequency for rated output is 500 khz. Burr-Brown Research Corp., Int'l Airport Industrial Park, Tucson, Ariz. [395]

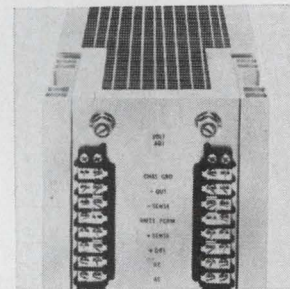

Convection-cooled, dual-output d-c power supply packages come in 2 series, SCDC and SCDE. In either, a choice of 90 power modules is available. Each package consists of 2 such modules. Modules range from 2.5 v, 0.75 amp to 60 v, 1.2 amps. The supplies are regulated to  $\pm 0.05\%$  or 2 mv, whichever is greater. Consolidated Avionics, 800 Shames Dr., Westbury, N.Y. 11590. [396]

aspect ratio of 250:1—ever drilled by a laser.

Boyden says the YAG laser yields an almost diffraction-limited beam with a peak power output of more than 5,000 watts at 1.06 microns while similar solid-state lasers attain only a 2,000-watt level. Normal repetition rate is between 800 and 1,200 pulses per second. The average power for the pulse mode is 0.5 watts, while for the continuous-wave mode it is between 3 and 5 watts.

Another advantage, Boyden says, is long-term reliability and reduced operating costs. Because of intense power densities in the pulsed mode,

the laser is particularly effective in operating on isolated components of an IC for high-reliability quality control. When the laser beam is directed at any part of the circuit, the material is simply evaporated—with little heating of adjacent material. This lets the laser operate more accurately than similar systems because of its repeatability and cleanliness.

The National Aeronautics and Space Administration is considering using the Korad Q-switched laser for destructive testing of IC's. Korad officials say the YAG system is more rugged than a laser using glass. And the YAG can be con-

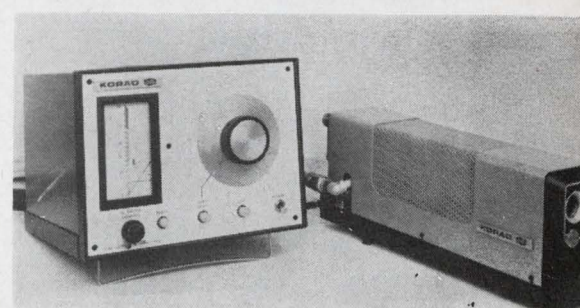

Trimmer. First application for laser is in component modification.

trolled by a digital computer for automatic testing.

Boyden says the Korad laser can be used in nonlinear optic studies as well as in a continuously oper-



# Water-Cooled Power Capacitors with Ceramic Dielectric

Capacity: 200 to 5000 pF  
 Rated Voltage: up to 20 kV  
 Reactive Power: up to 2000 kVAR



Convection-cooled Power Capacitors shaped as tubes, pots or plates

Capacity: 3 to 6000 pF  
 Rated Voltage: up to 15 kV  
 Reactive Power: up to 80 kVAR

Kindly direct your enquiries to:

**ROSENTHAL-ISOLATOREN-GBH**

Plant III  
 8672 SELB  
 West-Germ.

or to our USA agency: United Mineral & Chemical Corp., 129 Hudson Street, New York, N. Y. 10013, USA

## ... Navy wants green laser ...

ated range finder in a time-flight mass spectrometer. Because of its modulation capabilities as a c-w laser, it could be used as part of a communications network using electro-optical techniques. Boyden says the Navy is studying the use of the YAG laser if an average power of several watts can be produced in the green spectrum.

The price is \$12,000 to \$15,000—depending on the cooling system. Power input of the lamps is 2,000 watts and additional power is required for the coolant.

Since the YAG laser operates in the near-visible spectrum at 1.06 microns, special filters in the eyepieces protect the user from the dangerous rays.

The laser could be valuable in medical research, according to Boyden, to conduct reaction studies of individual biological cells. He says it has industrial applications in analysis and production of calibrated leaks in mass spectrometers or vacuum systems. It can also perform fine metal etching and hole drilling for wire dies made out of tungsten carbide or boron carbide compounds.

Korad division of Union Carbide Corp., 2520 Colorado Blvd., Santa Monica, Calif. 90406 [397]

## New subassemblies

### Data recorders pack it tight

New data processing technique records more with less error

**Reliable recording** and reproduction of digital data has been limited to packing densities of less than 3,000 bits per inch per track—even on high-resolution instrumentation tape.

Now, the Leach Corp. has a technique that raises that figure to more than 10,000 bits per inch per track



# The follower leader.

The great thing about our new LM102 voltage follower is that it's the first monolithic amplifier that has combined low input current with high speed. A slew rate of  $10V/\mu s$  means fast operation. Yet, the maximum input current is an incredible 10 nA.

The circuit is designed so that leakage isn't a problem. Input currents better than 10 nA at  $125^\circ C$  can be guaranteed. Considering high temperatures, it even gives better performance than FET amplifiers.

The LM102 has an offset voltage less than 5 mV, a guaranteed accuracy of 0.1%, needs no external compensation and is short circuit protected. Plus, it's a plug-in replacement for both the LM101 and the 709 in voltage follower applications.

Although it's really not a complete operational amplifier, it's a dream in low drift sample and hold circuits. And it's a wonder as a buffer amplifier for high speed analog commutators, in active filters or as an impedance buffer in analog computation circuits.

The LM102 will cost you \$30.00 each for 100 or more pieces. For \$12.00 we'll give you an LM202, which works from  $-25^\circ C$  to  $+85^\circ C$ . If you're really pinched, the LM302 does it on a  $0^\circ C$  to  $70^\circ C$  temperature range for \$5.50. And you can get them all today.

National Semiconductor Corporation, 2975 San Ysidro Way, Santa Clara, California, (408) 245-4320.

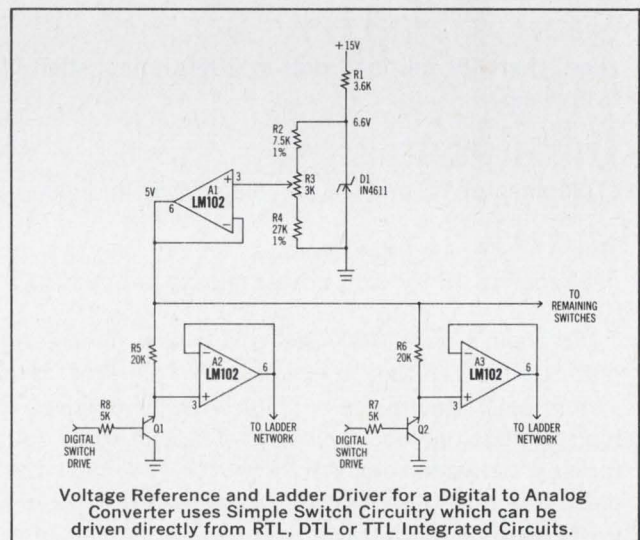

Voltage Reference and Ladder Driver for a Digital to Analog Converter uses Simple Switch Circuitry which can be driven directly from RTL, DTL or TTL Integrated Circuits.

## National Semiconductor



# the perfect high voltage resistor?



## you be the judge!

### HIGH OHMIC VALUES

(10 K ohms to 500 Megohms)

### HIGH STABILITY

(Less than 1% full-load drift in 2000 hours; shelf life drift less than 0.1%/year)

### HIGH PRECISION

(Tolerance of 1% and 2% all values; 0.5% in limited values)

### HIGH VOLTAGE

(Voltages to 15 Kv with power ratings to 5 watts @ 70°C)

Victoreen's new MOX Series is a new generation of metal oxide glaze resistors. If they're not actually "perfect," at least they're ideal — for meter multipliers . . . high-voltage dividers and bleeders . . . high-voltage probes . . . electrostatic paint spray equipment . . . pulse forming networks, etc. Why fight it? You can't beat a metal oxide glaze resistor — now that you can get **Victoreen MOX resistors with values to 500 Megohms.**

A-1110

**VICTOREEN INSTRUMENT DIVISION**  
10101 WOODLAND AVENUE • CLEVELAND, OHIO 44104  
IN EUROPE: GROVE HOUSE, LONDON RD., ISLEWORTH, MIDDLESEX, ENGLAND



See us at IEEE Booth 3B8—3B10

... portable recorder  
holds 2.4 billion bits ...

with an error rate of less than one bit in  $10^7$ . That is an accuracy two orders of magnitude better than present recording techniques can achieve, according to Leach's tape products manager, Eugene Murray.

The technique has been dubbed high density digital recording (HDDR)—and is used in three new tape recorders due at the IEEE show. A patent is pending. The three recorders are a portable unit, a satellite instrument and a cartridge-loaded digital device.

The portable recorder is an instrumentation-quality digital tape unit with a storage capacity of 2.4 billion bits—comparable to the capacity of ground station equipment, using 14-inch reels, Murray explains. This is achieved by packing 6,000 bits per inch per track on 2,400 feet of 1-inch, 14-track tape.

**The measurements.** The unit is compact and lightweight (8.6 by 9.5 by 20 inches; 54 pounds) and uses 8-inch reels. Murray says this model, MTR-3500, will be tailored to suit the user's requirements, but adds it's a fully-developed recorder and available for delivery.

Murray says HDDR was developed in response to the then-existing situation in which the relatively low packing density achievable frequently placed an impossible burden on the design engineer to whom size, weight and power were critical. He adds that it is a relatively simple one-track record system operating at 100 ips and  $10^6$  bits per second.

Leach engineer Kermit Norris says each track recorded longitudinally along the tape possesses a maximum theoretical packing density in bits per inch that cannot be exceeded for error-free operation regardless of the modulation scheme.

Thus, he continues, it can be determined that maximum density expressed in cycles per linear inch is a function of only two parameters and can be graphically described by plotting the noise power and the signal plus noise power in decibels versus the bandwidth in cycles per linear inch. The area bounded by these two curves represents the theoretical maximum packing den-



# The one-up op amp.

Since we announced the LM-101 op amp, our improvement on the 709, we've had great response: fan letters, purchase orders, and a new idea.

So now we have two 101's. The original LM-101 and the LH-101 which goes it one better by putting all required frequency compensation inside the package.

Operation guaranteed for supply voltages from  $\pm 5V$  to  $\pm 20V$ .

Low current drain—even with the output saturated. No latch-up when common-mode range is exceeded. Continuous short-circuit protection.

Input transistors protected from excessive input voltage.

Available now from our stocking distributors.

Prices (100 pcs.): LH-101, \$48.00. LH-201 (commercial unit), \$11.40. Write for details: National Semiconductor Corporation, 2975 San Ysidro Way, Santa Clara, California 95051, (408) 245-4320.

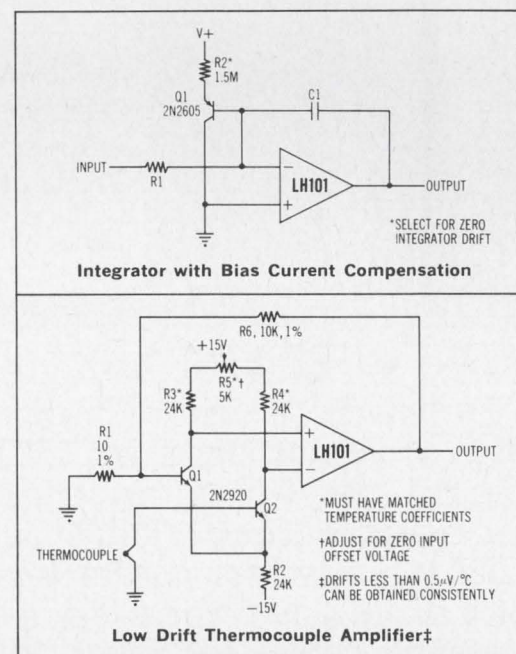

## National Semiconductor



NEW  
SERIES 20  
**DIGICATOR<sup>®</sup>**  
with the  
**1/4" PROFILE**



**TOTAL COST  
PER  
CHARACTER** **\$7.95**  
(IN QUANTITY)

**INCLUDES:**

- ★ LAMPS
- ★ POLARIZED FILTER
- ★ BEZEL
- ★ MOUNTING STUDS

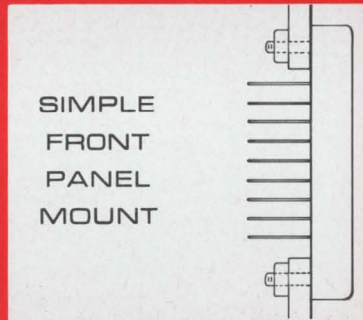

**FEATURES:**

- ★ Brilliant 1-inch high characters
- ★ Readable at 50 feet—in bright daylight ambient
- ★ Low Current
- ★ Low Voltage
- ★ 1,000,000 hours lamp life
- ★ No costly rectangular front panel cutouts

**DISCON CORPORATION**

4250 NORTHWEST 10th AVE. • FT. LAUDERDALE, FLORIDA 33309  
PHONE: (AREA CODE 305) 565-5511

... three sections  
make up system ...

sity. The resulting density, Norris continues, is approximately 250,000 bits per linear inch per track. Using 1 inch tape, 50 or more tracks can be placed side by side to store approximately  $10^7$  bits per square inch of oxide.

**Cut by half.** If the track width is reduced by half, Norris says, the noise power per track drops  $\frac{1}{2}$ , the signal power drops to  $\frac{1}{4}$ , and the number of tracks per inch of tape may be doubled. Net result is an increase in total density of almost 2:1.

The HDDR recording system consists of an encoder, a record channel, and a decoder, Norris says. The data source is considered to be binary digital data. In addition, the data is assumed to be continuous and entering at a constant rate. The encoder selects a particular wave form from its set for each message element or group of elements received.

The signal set size is exponentially related to the number of message elements per group. The record channel supplies noise to the system, Norris says, and in so doing restricts the available bandwidth. The decoder receives the recorded signal plus channel noise and decides which of the original signal elements was most likely recorded. From this decision, the corresponding message element or element group is reconstructed and sent to the message sink.

In Leach's satellite recorder, the MTR-2500, a total data storage capacity of 864 million bits (10,000 bits per inch per track on 1800 feet

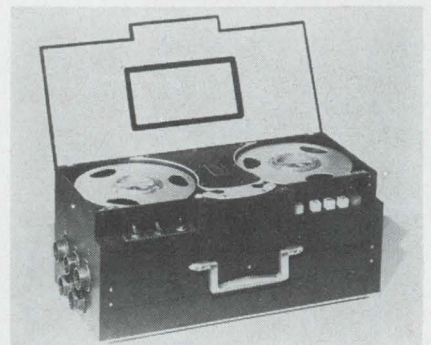

**Earthbound.** Portable 8-inch reel recorder has data capacity of 14-inch ground station equipment.



# GOOD THINGS COME IN SMALL PACKAGES

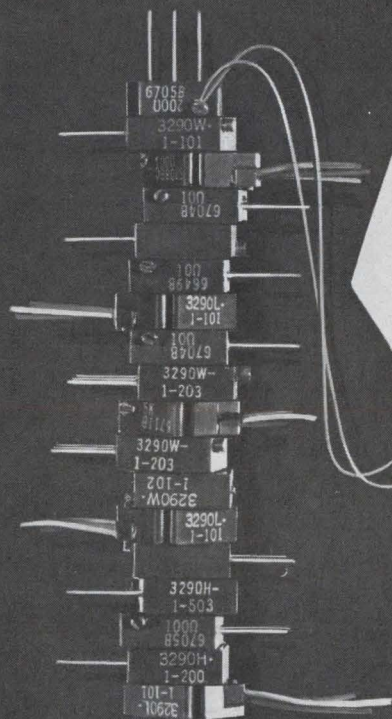

**TRIMPOT®  
MODEL 3290  
THE THIN LINE**

**THINNER  
3/8" SQUARE  
POTENTIOMETER  
NOW AVAILABLE**

It's an old saying . . . but truer today than ever before with the Model 3290 TRIMPOT® Potentiometer. This outstanding high-quality unit measures only  $\frac{3}{8}$ " x  $\frac{3}{8}$ " x less than  $\frac{5}{32}$ " thick, yet offers specifications available in larger units—all at the competitive price of \$4.52\*

Available with leads and three printed circuit-pin mounting styles, the Model 3290 meets or exceeds requirements of MIL-R-27208 . . . is rated at 1 watt at 70°C, and has a temperature range of -65°C to +175°C. The all-plastic case is sealed against liquids and potting compounds and a resistance range of 10Ω to 50K gives you plenty of selection for your projects.

When your designs and programs call for the very best in potentiometer quality and small size, at competitive prices . . . test and then specify the Model 3290! Write today for complete technical data or contact your nearest Bourns office, representative or stocking distributor!

\*1000 piece price.

Circle 243 on reader service card

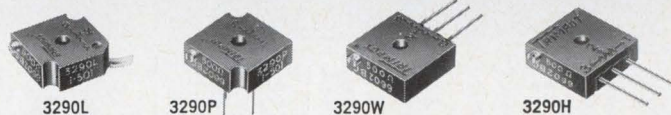

#### SPECIFICATIONS

Size	$\frac{3}{8}$ " x $\frac{3}{8}$ " x .150"
Standard Resistance Range	10Ω to 50KΩ
Resistance Tolerance	±5% Standard
Resolution	1.01% to 0.10%
Power Rating	1 watt at 70°C
Operating Temperature Range	-65°C to +175°C
Temperature Coefficient	50 PPM/°C max.
Moisture Resistance (MIL-R-27208)	100 megohms min. insulation resistance
Mechanical Adjustment	25 turns



BOURNS, INC., TRIMPOT DIVISION • 1200 COLUMBIA AVE., RIVERSIDE, CALIF.  
TELEPHONE (714) 684-1700 • TWX: 910 332-1252 • CABLE: BOURNSINC.

TRIMPOT® and Precision Potentiometers - Miniature Relays - Electronic Modules - Microcomponents



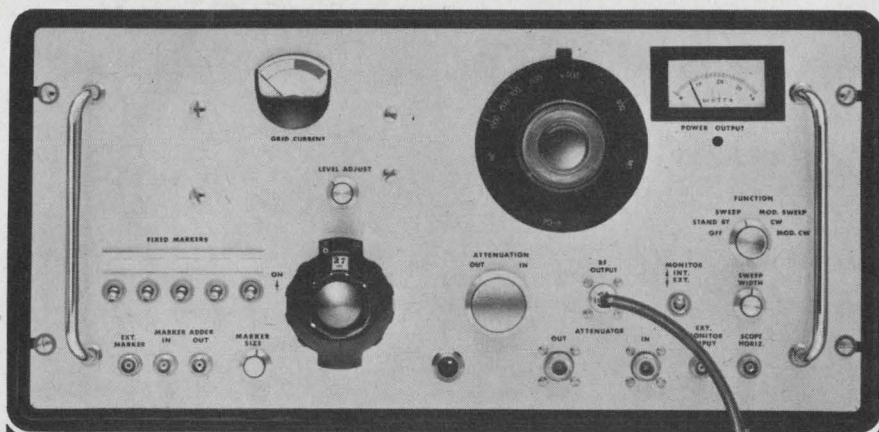

You don't need a sweep generator to run a high intensity lamp, but the 8-watt output of Telonic's new PD series sweep generators will allow you to test varactor multipliers, align high-power transmitter and amplifier chains, establish multi-test station swept signal distribution systems, and test high-loss and non-linear devices—among other things.

Four new instruments in this series cover frequencies to 1000 MHz, operate in swept and modulated RF, CW and modulated CW models, have continuously variable sweep width, automatic level control and birdy-by-pass marking system. All models are equipped with watt meter to read output directly.

Specifications

MODEL NO.	PD-2B	PD-3B	PD-7B	PD-8B
Center Frequency (MHz)	20-100	100-250	200-375	375-1000
Sweep Width	0.2-15%	0.2-15%	0.2-10%	0.2-15%
Peak Power Output				
Swept	8 watts minimum into 50 Ω			
CW	4 watts minimum into 50 Ω			
Flatness	± 0.5 dB w. internal leveling*			

\*External leveling may be used with addition of optional accessory, Model 8500.

Catalog 70A contains complete specifications on the PD-(B) series and all other Telonic Sweep Generators plus an entire section on **applications**—Write today for your copy. Telonic Instruments, 60 N. First Avenue, Beech Grove, Indiana 46107. Tel: 317-787-3231, TWX—810-341-3202.

*Telonic* INSTRUMENTS A Division of  
Telonic Industries, Inc.

The new Telonic PD  
Sweep Generators  
have an output  
of 8 WATTS  
minimum



... cartridge unit  
has seven channels ...

of ¼ inch, 4 track tape) is achieved—along with an error rate of less than one bit in 10<sup>7</sup>. The unit is 7.6 by 7.1 by 5.3 in., weight is 15 pounds, and power consumption is 15 watts.

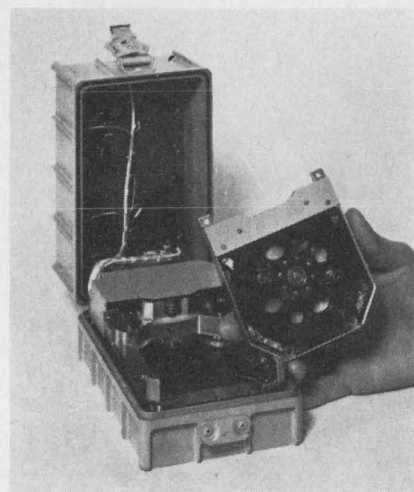

**Airborne.** Small cartridge recorder stores 130 million bits of data.

**In the air.** It is also useful as a flight-test instrument recorder, and the Air Force already has similar Leach systems. Geologists also use the unit to record data on rock strata from dynamite blasts and then feed the information into a computer for analysis.

Leach's third new recorder—the cartridge-loaded MTR-8500—weighs 5 pounds, and can store 130 million bits of digital data. This is at least 7 times greater than conventional units, Leach engineers say.

The cartridge-loaded unit can record up to 7 channels at a packing density of 6,000 bits per inch per channel, and each cartridge holds 260 feet of ¼ inch magnetic tape to provide a total record time of nearly 30 minutes at 1 7/8 ips. The unit can record and reproduce at speeds up to 30 ips.

Murray says the MTR-8500 can operate in environmental conditions ranging from 0-130° F, 100% humidity and altitudes of 150,000 feet. Power consumption is 20 watts and the unit will operate on 28 volt aircraft systems.

Leach Corp. Controls Div. 717 No. Coney Ave. Axusa, Calif. [398]

See TELONIC at IEEE, Booths SH 12 - SH 20



About a year ago we re-engineered our line of strip chart recorders. We reorganized our production and QC facilities, and we built these instruments with Varian pride and quality throughout. And something happened.

Delivery times dwindled to 3 weeks A. R. O. Our in-warranty service claims plummeted. These all-new recorders were staying on

the job, delivering accurate data every day, any day, all day.

To show how great we think they are, we make this offer with every one we sell. If you aren't completely satisfied with a Varian strip chart recorder within 30 days from shipment, send it back! We'll return your money, no questions asked.

Series G-1000, single channel 5-inch recorder prices start under \$750.

Series G-2000 (shown here), single or dual channel 10-inch recorder prices start under \$950.

Series G-4000 single or dual channel 10-inch recorder, with interchangeable



**varian**  
recorder division

input modules, prices start under \$1,000.

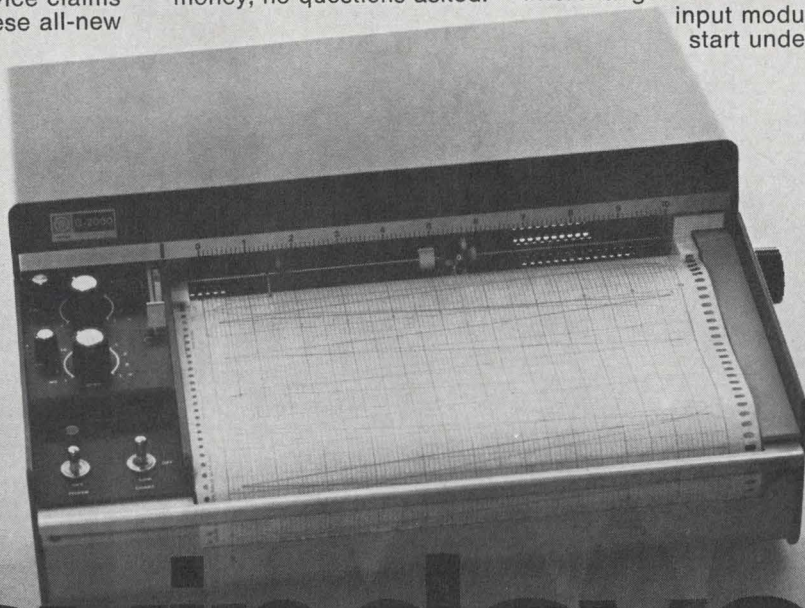

# day in day out data

from varian's new strip chart recorders

Send for a Varian recorder catalog.  
Write Sales Manager,  
Varian Recorder Division,  
611 Hansen Way,  
Palo Alto, California 94303.  
International offices in:  
Zug, Switzerland  
Sydney, Australia



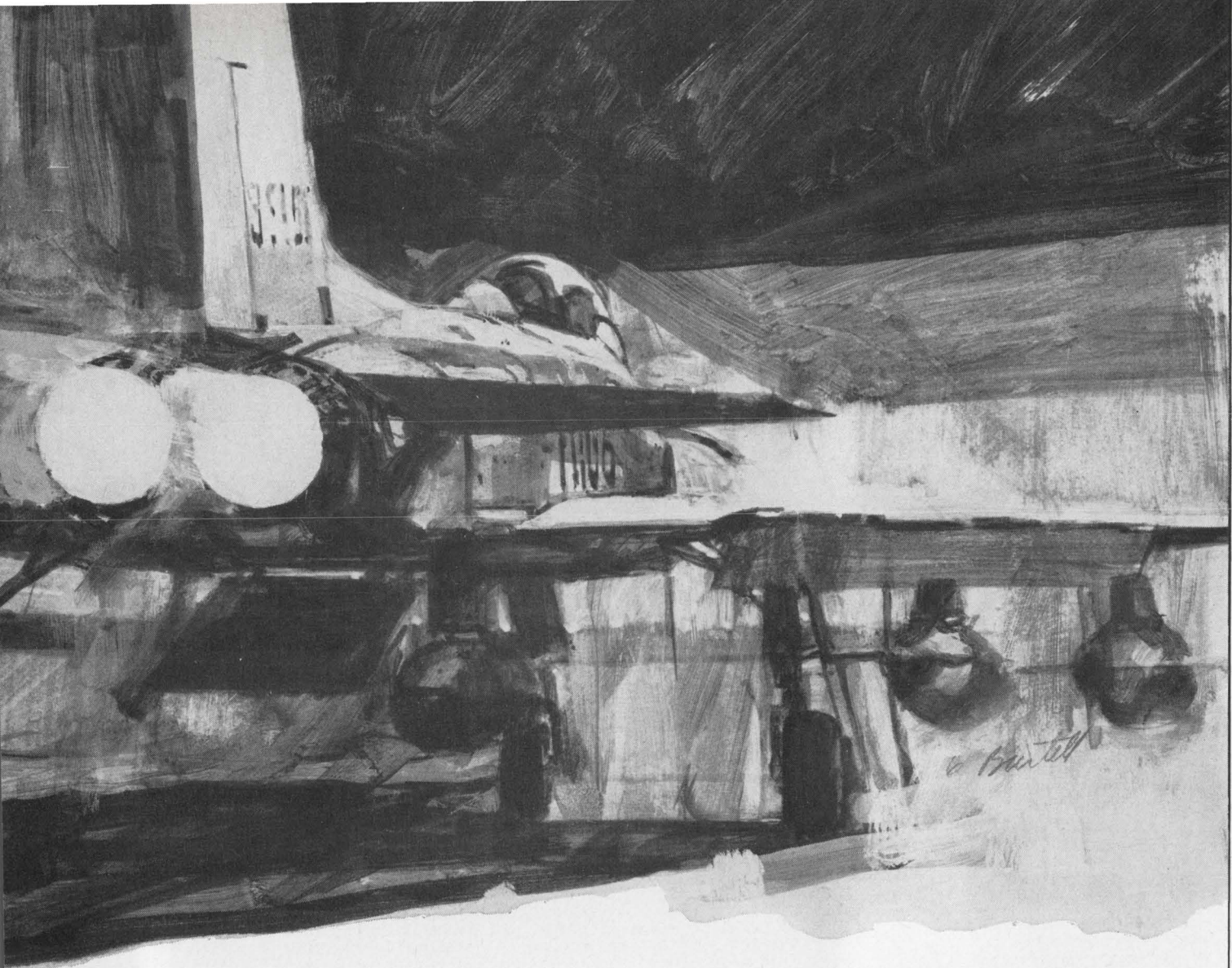

## When the heat's on... take the pressure off with Cannon® firewall plugs

Designed to increase maintainability and dispatch-reliability, ITT Cannon's new high performance FRF — firewall — connectors meet tomorrow's high temperature and fluid resistance requirements... in jet aircraft, missiles, and propeller aircraft.

These lightweight connectors exceed the requirements of MIL-C-5015, Class K, and feature front release, rear insertion, crimp snap-in MIL-C-39029 type contacts. They also operate

continuously in temperatures from  $-55^{\circ}\text{F}$  to  $+400^{\circ}\text{F}$

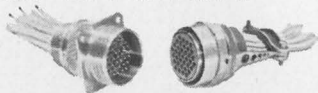

and up to  $2000^{\circ}\text{F}$  for short term. Besides saving weight by 25%, and assembly and servicing time by 200%, ITT Cannon's FRF plugs offer superior environmental sealing and feature high temperature elastomers which are compatible with aircraft fluids. Other features? One-piece steel shell and barrel hardware... optional self-locking coupling nut... rugged metal clip retention

system... intermateability with MIL-C-5015 connectors.

When the heat's on (for any connector application) let ITT Cannon take the pressure off. For our FRF catalog, write ITT Cannon Electric, 3208 Humboldt Street, Los Angeles, California 90031.

A division of International Telephone and Telegraph Corporation.



# CANNON ITT



## New Consumer Electronics Review

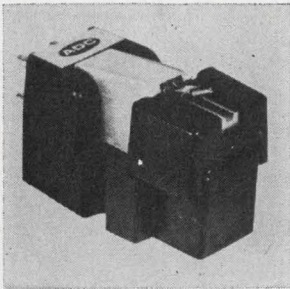

Magnetic cartridge ADC 10/E-Mark II is designed for high fidelity equipment. Frequency response is 10 to 20,000 hz  $\pm 2$  db. Channel separation is 30 db, 50 to 15,000 hz. Elliptical stylus contact radius is 0.0003 in.; lateral radius, 0.0007 in. Vertical tracking angle is 15°. Tracking force range is  $\frac{1}{2}$  to  $1\frac{1}{2}$  grams. Singer Products Co., 95 Broad St., New York 10004. [399]



Knight stereo headphones KN-885 are provided with separate tone and volume controls in each earpiece. The adjustable stainless steel headband is cushioned and earseals are of soft polyvinyl chloride. The headset uses moving-coil dynamic transducers to give a frequency range of 15 to 20,000 hz. Impedance is 8 ohms. Allied Radio Corp., 100 N. Western Ave., Chicago 60680. [400]

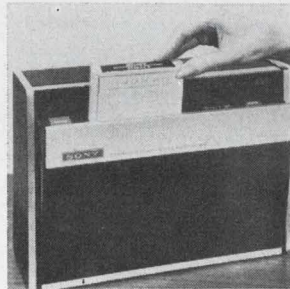

The Sony TC-8 provides an economical means of recording and duplicating 8-track stereo cartridge tapes. It can record from a number of sound sources, such as a home tape recorder, phonograph or f-m multiplex. To record, just tilt the cartridge panel slightly forward, insert cartridge and press "record" button. Superscope Inc., 8150 Vineland Ave., Sun Valley, Calif. 91352. [431]

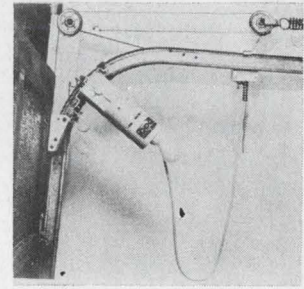

An automatic garage door operator comes with a manual giving instructions and photos of each step for do-it-yourself homeowners. A palm-sized battery-powered radio transmitter for dashboard mounting opens and closes the garage door without the driver leaving the car. Price is \$99.95, without installation. GDO Co., 248 Broad Ave., Palisades Park, N.J. [432]

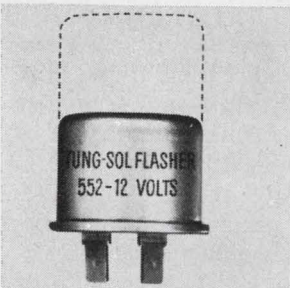

Tung-Sol heavy-duty signal flasher 552, offered to the automotive replacement market, can replace No. 536 flasher. Comparison of sizes is shown. The new unit uses one-third fewer parts. Its variable load characteristics permit flashing of up to five 32-candlepower turn signal lamps, or 8 hazard warning lamps. Wagner Electric Corp., 6400 Plymouth Ave., St. Louis, Mo. 63133. [433]

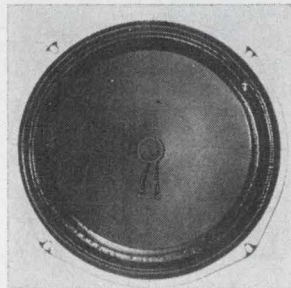

High efficiency, 12-in. pincushion mount loudspeaker is for use as a woofer in a 2-way system. It is less than 2½ in. thick. Power rating is 12-15 w (average), 25-30 w music power. Frequency response is 40 hz to 5 khz. Units with 1-in. voice coil and 4.8 oz barium ferrite magnet cost \$2.75 each in lots of 1,000. CTS of Paducah Inc., 1565 N. 8th St., Paducah, Ky. 42001. [434]

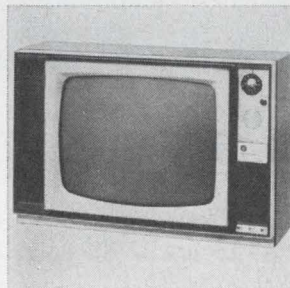

Automatic fine tuning is featured in the Host hotel-motel color tv line. All the guest does is to turn on the set and select the desired channel. If channels are changed, the set continues to fine-tune itself. Instant color fidelity automatically cancels magnetism when the set is turned on. Westinghouse Electric Corp., Route 27 & Vineyard Rd., Edison, N.J. 08817. [435]

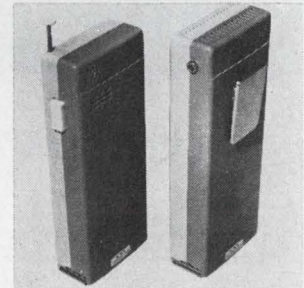

Two piece, 2-way radio, the Pocketfone, operates in the uhf band from 450 to 470 Mhz. Complete with batteries, the all-transistor transmitter and receiver each weigh less than 10 oz. Both are about 6¼ x 2¼ x 1¼ in. The transmitter has an r-f output of 150 mw; the receiver, an a-f output of 60 mw. Pye Communications Inc., U.S. H'way 46, Mtn. Lakes, N.J. 07046. [420]

### New consumer electronics

## Tv tuner tuned to ease of repair

Thick-film integrated-circuit module replaceable without need for realignment of vhf device

A television tuner that won't scare a repairman is now on the market. Usually service technicians are reluctant to attempt tuner repairs because inductors can't be disturbed without time-consuming front-end alignment, and parts are usually inaccessible. Then, too,

tampering with frequency-determining components usually means a realignment job.

The new tuner makes servicing easier. It is an all-solid state unit with a modular thick-film integrated circuit containing all of the transistor elements in addition to

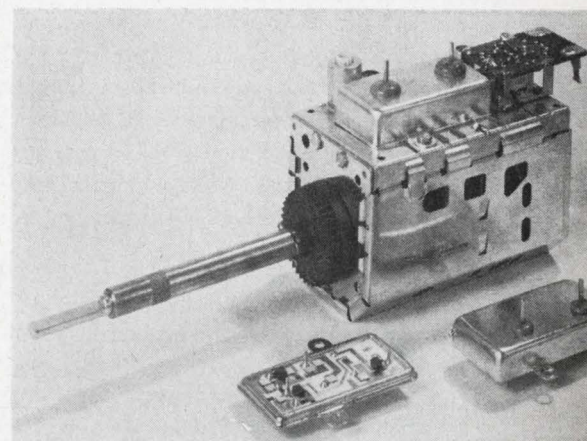

Replacement. Thick-film module, front, contains electronic elements of tuner



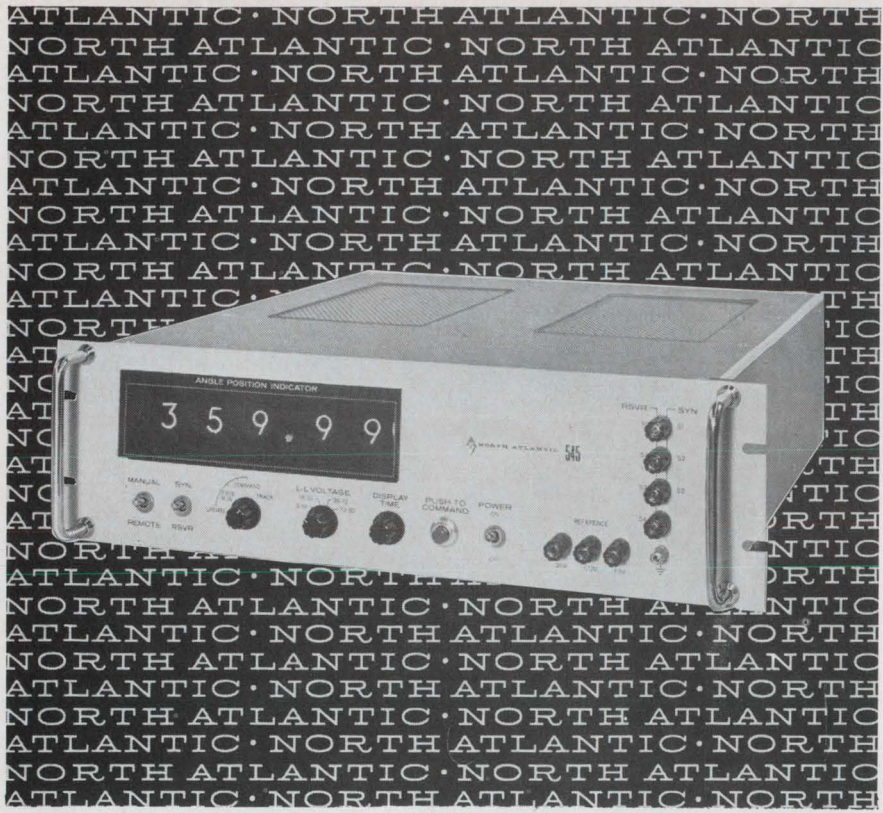

# resolver/synchro to digital conversion

~~20,000~~ <sup>20,000</sup> **.01° accuracy**  
~~2000~~ <sup>20,000</sup> **/sec. tracking**

North Atlantic now brings you a new generation of solid-state analog-to-digital converters for resolver and synchro data. They offer major advances in high-speed precision tracking as required in modern antenna readout, ground support, simulation, and measurement systems.

For example, the Model 545 provides conversion of both resolver and synchro data at rates to ~~2000~~ <sup>20,000</sup>°/second, and accommodates 11.8v to 90v 400Hz line-line signals. For multiplexed applications, acquisition time is less than 50ms. Digital output data is visually displayed and simultaneously available on rear connectors. All modes are programmable as well as manually controlled. Optional features include .001° resolution with 10 arc second accuracy, data frequencies from 60Hz to 4.8KHz, data freeze command for digital readout at a critical instant, and programmed mode where difference angle computation is required.

Your North Atlantic representative (see EEM) has complete specifications and application information. He'll be glad to show you how these converters can answer critical interface problems in your system.



**NORTH ATLANTIC industries, inc.**  
TERMINAL DRIVE, PLAINVIEW, NEW YORK 11803 • 516-681-8600

SEE IT AT IEEE - - BOOTHS 2B12 AND 2B14.

... IC module  
contains 28 units ...

resistors and capacitors. The manufacturer, the Oak Electro/Netics Corp., says a replacement ic module can be inserted into a previously aligned tuner without needing realignment. The vhf tuner will be priced at about \$9, and Oak estimates that the module will cost the serviceman about \$3.

**Fabrication.** The ic module contains 10 film resistors, 8 chip capacitors, 7 integrated capacitors, and 3 transistors in addition to connecting pins. The resistors and interconnecting conductors are formed on a ceramic substrate, and the transistor chips are bonded to special conductor areas. Capacitor chips are formed by solder-flow technique. After fabrication, the module is hermetically sealed against atmospheric contamination. Gold-plated steel pins at the base of the module provide interconnection with the tuner circuitry. Production samples were produced in Oak's Crystal Lake, Ill., facilities, but volume production will be at the company's Hong Kong factory.

Oak Manufacturing Co., Division of Oak Electro/Netics Corp., Crystal Lake, Ill. 60014 [445]

New consumer electronics

## Varactor diodes search f-m band

Electronic tuning method  
in radio set includes  
anti-drift circuit

The radio with electronic tuning has added the f-m dimension. Two years ago, the Matsushita Electric Industrial Co. of Japan introduced the first broadcast-band a-m radio with electronic tuning [Electronics, July 11, 1966, p. 179]. The company now offers an a-m/f-m combination designated the model RE-6125.

As in the a-m sets, the standard tuning capacitor has been replaced



# Will the capacitor you take for granted take out your entire system?

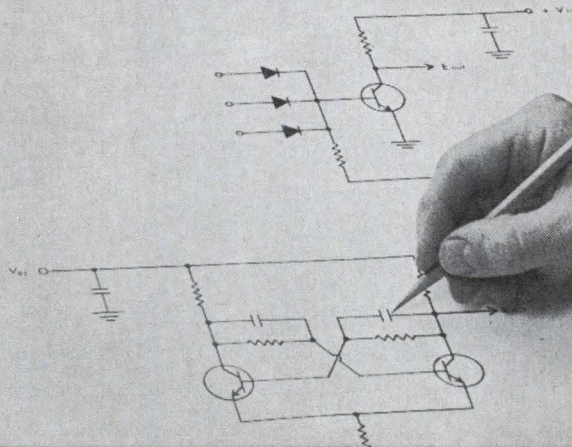

## Specify CORNING® Capacitors for confidence.

Considering the finality of capacitor failure, anything less than the reliability of glass is false economy.

Protect all the critical design work you put into your active circuits. Back them up with the documented reliability of glass dielectric capacitance in the vital roles of coupling, bypass, filtering. Corning offers this confidence in a full range of types, sizes, values and costs.



CORNING® CYFR Capacitors, from .5 to 10,000  $\mu\text{f}$ , substantially exceed the requirements of Mil-C-11272, including environmental performance and Quality/Reliability Assurance, and are backed by a heritage that includes use in Surveyor, Minuteman, Gemini, among others.



CORNING® CYFM Capacitors offer low cost, high reliability, from .5 to 10,000  $\mu\text{f}$ . Give you CYFR-type environment-proof performance at substantial savings.

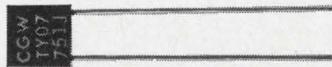

CORNING® TYO Capacitors from 1 to 2700  $\mu\text{f}$ , radial leads, precision case for snug, upright mounting. Dense circuitry without doubts. Meet or exceed all performance requirements of Mil-C-11272.



CORNING® Glass-K Capacitors cram from 1000 to 100,000  $\mu\text{f}$  in a quarter-inch case size with a new dielectric material for guaranteed reliability.

In all types, standard items are shipped in two weeks or less. Tell us what you want in capacitance; we'll tell you which CORNING® Capacitor will give you the confidence you need.

For complete specs, write to:  
Corning Glass Works,  
Electronic Products Division,  
3913 Electronics Drive, Raleigh, N.C.

**CORNING**  
ELECTRONICS



Only the best  
panel meters have  
dual slope integration



actual size

## API's new digital panel meter

has it—which means the meter maintains its  $\pm 0.1\%$  accuracy (DC voltage) over long periods of time. Erroneous signal transients are eliminated also.

There are other digital panel meters, but this one has an exceptional combination of attributes. It doesn't flicker annoyingly. It counts fast and it reads fast, so that you are always seeing an up-to-the-split-second signal.

API's digital meter not only looks pretty, but its required panel space is only 3 inches high and  $4\frac{1}{2}$  inches wide. It has no "iceberg" configuration behind the panel. Standard ranges begin at 0 to 20 microamperes DC and 0 to 200 millivolts DC.

List price: \$320.00

See it at Booth No. 2G-34 and 36, IEEE Show.

Bulletin 61 has full details

**api**  
INSTRUMENTS CO.

CHESTERLAND, OHIO 44026 • (CLEVELAND - 216) 729-1611 • TWX: 810-427-9230  
In Canada: Oshawa, Ontario • (416) 576-1541

... stations are selected  
by pressing tuning bar ...

by varactor diodes to provide continuous tuning across the frequency band of interest. When the tuning bar is touched, a search operation begins and the radio automatically locks onto a station. Each time the tuning bar is touched, the radio tunes to a station at the next higher frequency until the entire spectrum has been scanned. Then it recycles and swings back to the first station at the low end of the dial. Stations can't be bypassed, nor can they be tuned in at random. Once a station has been passed, it can only be tuned in again when the set recycles.

**Lock-on feature.** A simplified schematic diagram of the sweep circuit is shown below. When a station is tuned in on either a-m or f-m, a portion of the i-f signal is detected and applied to Q1, turning it on. The output at the collector turns off Q2, capacitor C1's charge is stabilized, and the diodes tune in the station. To prevent drift, Matsushita has introduced a new circuit it calls an automatic sensitivity recovery switch, and a two-stage d-c amplifier. The switch compensates for variations in signal strength by applying a correction voltage to the amplifier. This voltage, in turn, varies the charge on C1 as necessary.

The switch is a transistor that

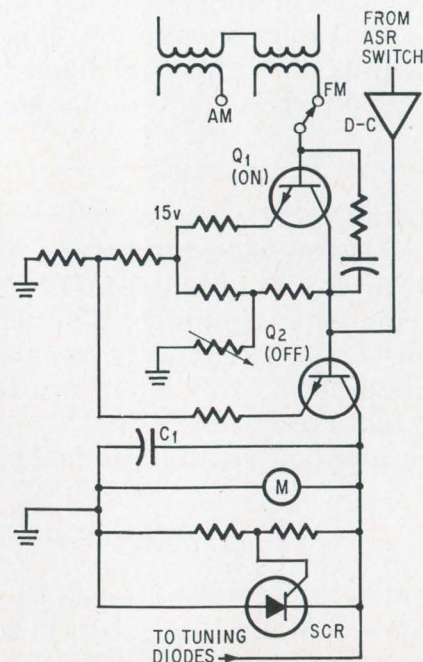





SIEMENS

# FILTER COMPONENTS

## FERRITE "SIFERRIT®" POT CORES

**PRECISION-ENGINEERED:** Each assembly has unique built-in advantages consisting of easy adjustment to a precise inductance, high stability with time and temperature, high Q, low distortion as well as self-shielding that allows compact component density without regeneration or cross-talk problems. Their uniform electrical characteristics month after month allow them to meet the most critical requirements for filters used in multiplex and other filter applications.

**WIDE RANGE OF MATERIALS:** Ten different types of material provide optimum properties for frequencies ranging from audio up to 40 mc/s for oscillator and filter coils—up to 400 mc/s for transformers.

**WIDE RANGE OF SIZES:** Diameters range from 0.22" to over 2.75" including all International I.E.C. Standard Sizes.

**MOUNTING ASSEMBLIES AND BOBBINS:** All cups are available with a variety of printed circuit, rivet or bayonet style mounting assemblies complete with a variety of bobbin configurations.

**TEMPERATURE COEFFICIENTS:** Closely controlled to match the values for compensating capacitors such as polystyrene.

**HIGH Q AND INDUCTANCE VALUE:** An international size 26 x 16mm cup assembly with an inductance of 315 mh per thousand turns at 100 kc has a Q value in excess of 1000 at 100 kc/s.

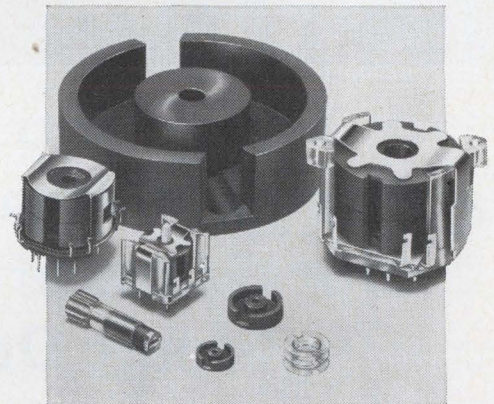

## POLYSTYRENE "STYROFLEX®" CAPACITORS

**UNIQUE PROPERTIES:** The method of manufacturing developed by Siemens has resulted in LOW COST polystyrene "Styroflex" capacitors offering:

**RELIABILITY:** Each unit is tested at 3.3 times its rated voltage to prevent voltage breakdown. Positive welded contacts between foil and leads assures operation in the microvolt range.

**STABILITY:** The special Siemens manufacturing process has assured maximum stability of capacitance over long periods of time, temperature and voltage conditions.

**LOW SELF-INDUCTANCE:** Values as low as extended foil construction.

**LOW DISSIPATION FACTOR:** Lower than mica capacitors making them especially suitable for LC filter circuits.

**HIGH RESISTANCE TO HUMIDITY:** Polystyrene has the lowest water absorption coefficient of all capacitor dielectric materials.

**HIGHEST INSULATION RESISTANCE:** Higher than for any other kind of dielectric material.

Should you require any additional engineering information concerning the above mentioned products as well as other Siemens components such as METALIZED PAPER, PLASTIC LACQUER, METALIZED MYLAR and ELECTROLYTIC CAPACITORS, a variety of MAGNET WIRE, SEMI-CONDUCTORS, DIODES, RECTIFIERS, ELECTRONIC and MICROWAVE TUBES, please contact:

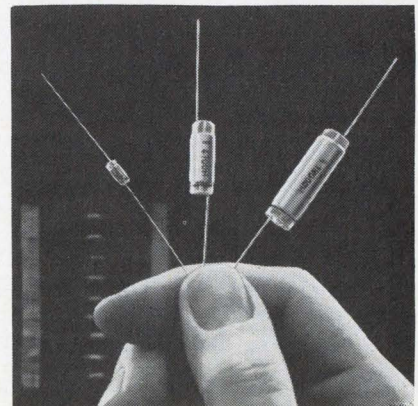

VISIT BOOTH 4-J-20-22  
I.E.E.E. SHOW

SIEMENS AMERICA INCORPORATED

Components Division • 230 Ferris Avenue, White Plains, N.Y. 10603



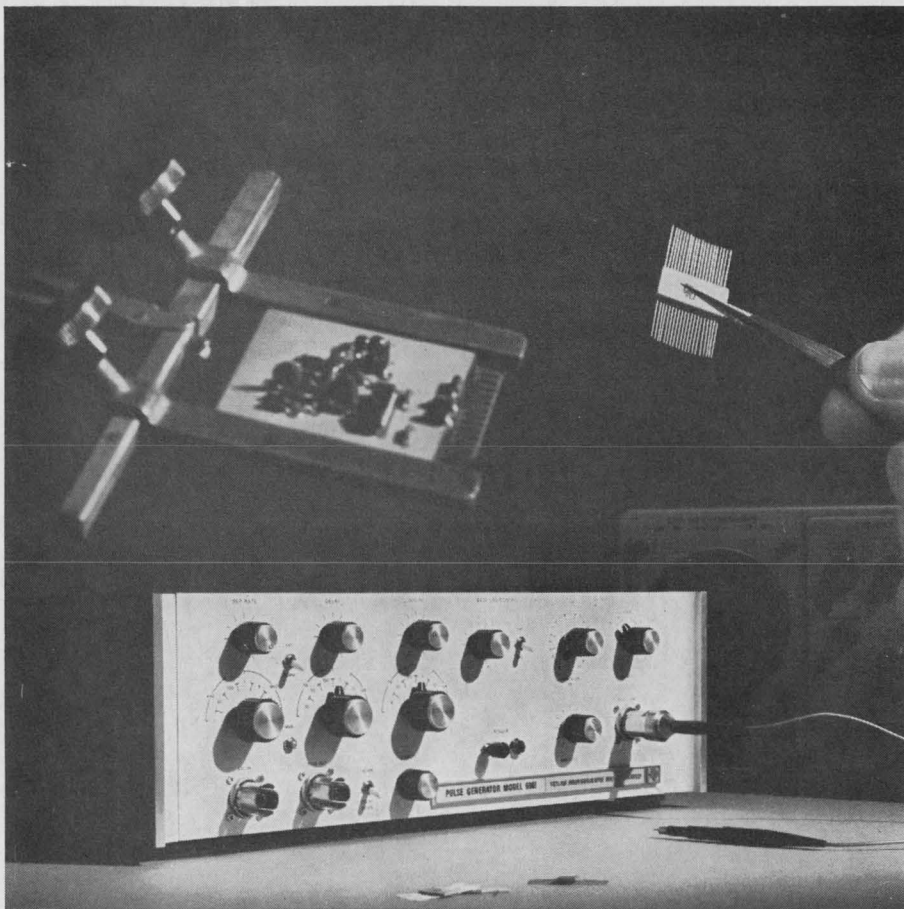

## Why You Need a Special Pulse Generator for State of the Art Circuit Design

With high speeds and critical design parameters, you need the best test instruments to be sure your designs will be optimum. The TI Model 6901 Pulse Generator gives outputs from 1 KHz to 0.1 GHz; independent amplitude and baseline controls; jitter less than 0.1% of period + 50 psec; and count-down synchronization output.

The 6901 makes your designing simpler, too. Because the pulse amplitude of the generator can be changed without affecting DC offset, you can use the offset instead of an external bias supply for your circuit.

For additional information, contact your TI Field Office, or the Industrial Products Division, Texas Instruments Incorporated, P. O. Box 66027, Houston, Texas 77006.

**TEXAS INSTRUMENTS**  
INCORPORATED

827 A

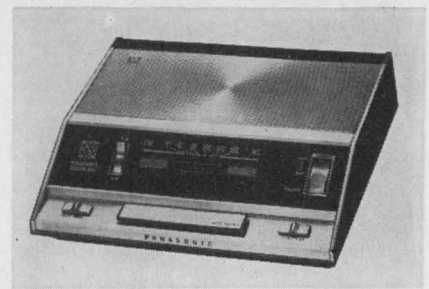

**Easy touch.** Sweep tuning for both a-m and f-m is now available.

is normally off when the radio is not tuned to a carrier, but which turns on to short out a gain reduction resistor when the station signal is lowered. A silicon controlled rectifier fires to discharge the capacitor at 10 volts—the value required to tune in the dial's upper region. The voltage reduction upon discharge of the capacitor tunes the varactor diodes to frequencies at the low end of the dial. The tuning indicator, M, indicates the relative charge on the capacitor. Each time the power is turned off, the capacitor discharges to restart the cycle.

The RE-6125, which sells for \$69.95, operates on 110 volts, 60 hertz, and is almost insensitive to line voltage variations. It is housed in a profile black cabinet with silver trim, and has a 3½-inch dynamic speaker. It has separate dial calibrations for a-m and f-m, but only the active band lights up.

Matsushita Electric Corp. of America,  
200 Park Ave., New York, N. Y. 10017  
[338]

New consumer electronics

## Transceiver puts an FET up front

Single-sideband unit  
covers 80-10 meters,  
puts out 180 watts

**By leaving more** of the assembly work to the buyer, cutting fancy features, and using a lightweight cabinet, the Heath Co. brings to the kit market an 80-10 meter, single-sideband transceiver for \$240



Now,  
the next time  
you need  
just a spool-full  
or so of  
Brand Rex  
you can just  
run around the  
corner to your  
nearest  
Birnbach  
Brand Rex\*  
distributor

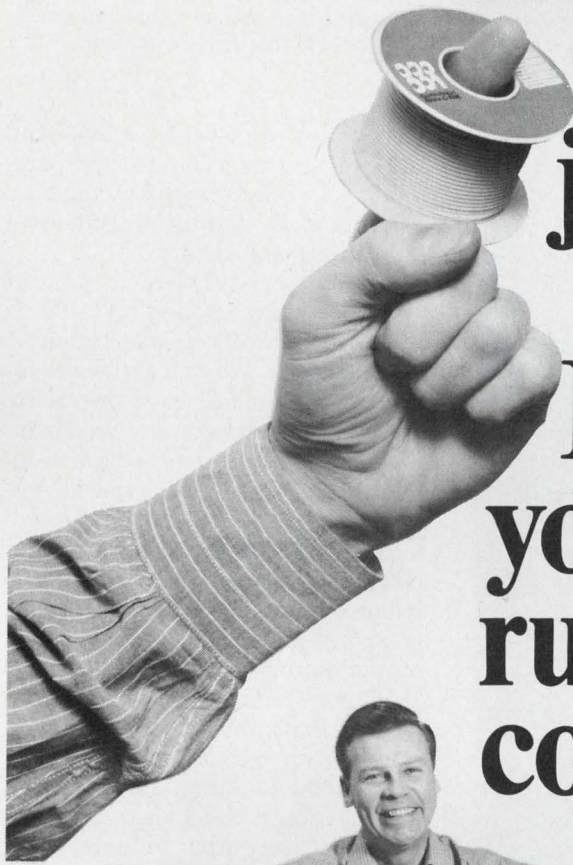

\*Brand Rex wire marketed by Birnbach

**(he's got a warehouse full.)**

If you hadn't heard of a B/BR distributor before, that's because there wasn't one before. Now there is. Nearby. And it means you can buy the full range of Brand-Rex electronic products, in a full range of quantities. If you don't know just where to find your local B/BR man, drop us a line. We'll corner him for you.

Birnbach Brand-Rex, 435 Hudson Street, New York, 10014 Phone: 212-255-6600





# NEW...

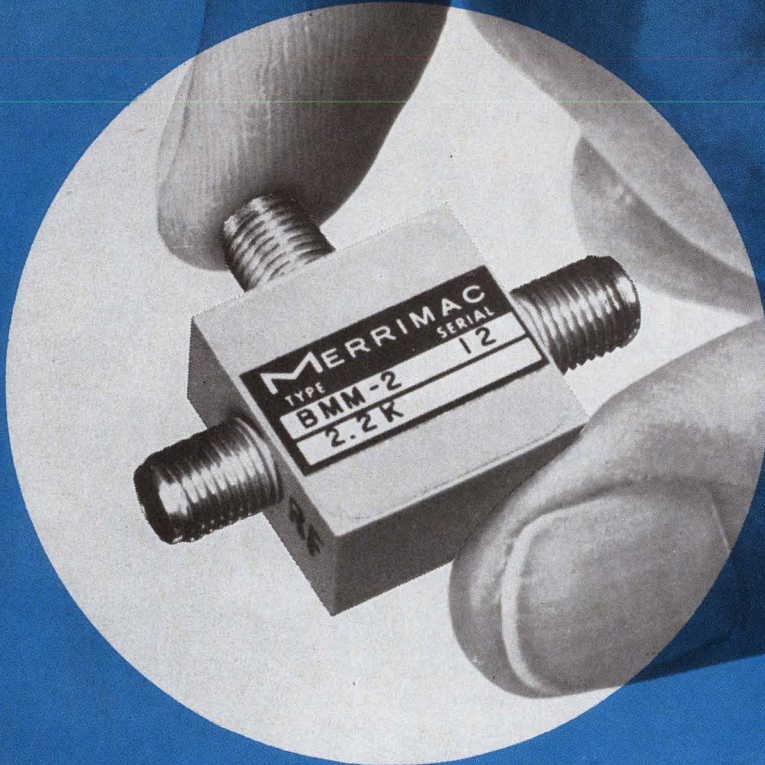

## miniature microwave mixers

The new BMM-2 Series of miniature balanced mixers measure less than  $\frac{1}{4}$  cubic inch and weigh only 12 grams. Their small size was made possible by use of Merrimac's novel ultraminiature hybrid coupler. Various mixers in this series can be supplied from 1 GHz to 5 GHz. The BMM-2-2.2K, for example, covers the 2.1 GHz to 2.3 GHz range. Its noise figure is 6.5 db. These mixers were designed for such applications as telemetry, radar, communications and navigation systems.



**MERRIMAC RESEARCH AND DEVELOPMENT, INC.**  
41 FAIRFIELD PLACE, WEST CALDWELL, N. J. 07006 • 201-228-3890



**Complete.** Transceiver kit includes FET variable frequency oscillator.

—its lowest price yet for a five-band ssb transceiver. The variable frequency oscillator, which must be assembled by the user, includes a field effect transistor.

Like the SB-101, which sells for \$370, the new model HW-100 is rated at 180 watts input peak effective power on ssb and 170 watts input on continuous-wave operation.

In the transmit mode, which includes voice-operated or push-to-talk, the audio input signal is coupled to a speech amplifier through a limiting resistor. The amplifier output is applied to a ring-type balanced modulator through a level control that establishes the amount of modulation. Two Colpitts crystal oscillators comprise the carrier oscillator that provides the r-f signal required for transmit operation.

**Matched for filter.** Both the upper and lower sidebands, and c-w signals at the output modulator are applied to an isolation amplifier that buffers the modulator and provides proper impedance matching for a crystal filter that precedes the first i-f amplifier. The filter passes either the sum or difference frequencies, for upper or lower sideband operation, to the first i-f amplifier. The output from a Hartley variable-frequency oscillator is mixed with the i-f signal in the first transmitter mixer, and the sum of these two signals is selected and passed onto a second mixer through a bandpass filter.

**Add and subtract.** In the receive mode, the input signal is coupled to two mixer stages. The sum and difference frequencies from the first mixer are coupled to a bandpass filter that selects the difference frequency and applies it to the second mixer. The second mixer output passes through a crystal filter to select the i-f, which is applied to a detector.

Heath Co., Benton Harbor, Michigan  
[339]



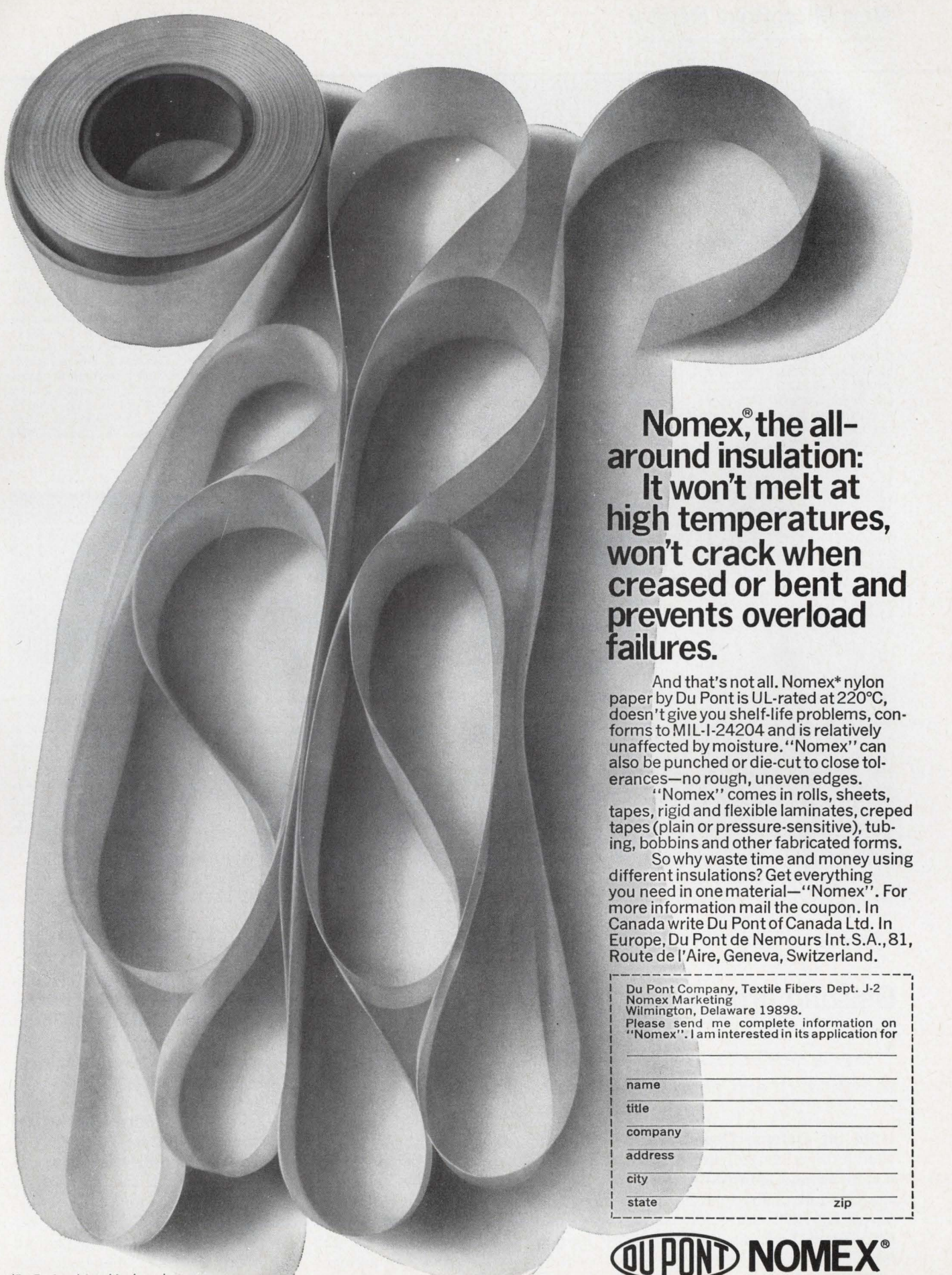

**Nomex<sup>®</sup>, the all-around insulation:  
It won't melt at high temperatures,  
won't crack when creased or bent and  
prevents overload failures.**

And that's not all. Nomex\* nylon paper by Du Pont is UL-rated at 220°C, doesn't give you shelf-life problems, conforms to MIL-I-24204 and is relatively unaffected by moisture. "Nomex" can also be punched or die-cut to close tolerances—no rough, uneven edges.

"Nomex" comes in rolls, sheets, tapes, rigid and flexible laminates, creped tapes (plain or pressure-sensitive), tubing, bobbins and other fabricated forms.

So why waste time and money using different insulations? Get everything you need in one material—"Nomex". For more information mail the coupon. In Canada write Du Pont of Canada Ltd. In Europe, Du Pont de Nemours Int. S.A., 81, Route de l'Aire, Geneva, Switzerland.

Du Pont Company, Textile Fibers Dept. J-2  
Nomex Marketing  
Wilmington, Delaware 19898.

Please send me complete information on  
"Nomex". I am interested in its application for

\_\_\_\_\_

name \_\_\_\_\_

title \_\_\_\_\_

company \_\_\_\_\_

address \_\_\_\_\_

city \_\_\_\_\_

state \_\_\_\_\_ zip \_\_\_\_\_

\*Du Pont registered trademark.





## New Microwave Review

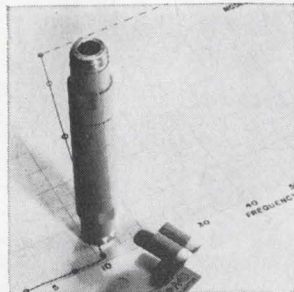

Coaxial low pass filters series FLD are of rugged tubular construction. Typical cut-off frequency is 10 Mhz. Passband insertion loss is 0.2 db typical, 0.5 db max. Selectivity is 40 db at 14 Mhz, 60 db at 17.5 Mhz, 80 db at 25 Mhz, and 100 db from 30 Mhz to 11 Ghz. Size is 0.75 in. in diameter, 2.75 in. long. American Electronic Laboratories Inc., Lansdale, Pa. 19446. [401]

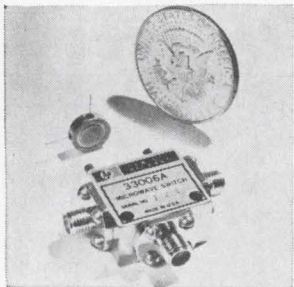

Spdt transmission-line switches control signals from 400 Mhz to 18 Ghz. They use p-i-n diodes functionally integrated into a 50-ohm module. Type 33006A has 3-mm miniature connectors for co-ax application, and is complete with bias parts and d-c returns. The 33007A has leads for mounting directly in 1/8-in. symmetrical stripline. Hewlett-Packard Co., Berkeley Hts., N.J. 07922. [405]



Planar spiral antenna DMR35-1 is for airborne ECM receiving systems. Frequency range is 2.6 to 5.2 Ghz. Squint angle is kept at less than 5° and 3-db beamwidth at less than  $\pm 8^\circ$  over the entire 2:1 band, regardless of polarization or antenna orientation. Gain track is within  $\pm 0.5$  db. Units weigh 8 oz. Dorne and Margolin Inc., Veterans Memorial Hwy., Bohemia, N.Y. 11716. [402]

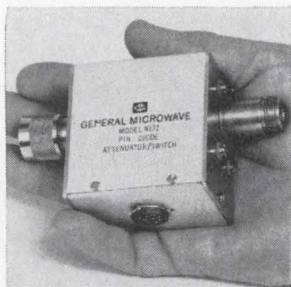

P-i-n diode attenuator/switch N172 is a 2-port device for operation as a current controlled, precision coaxial variable attenuator, high-speed, high-isolation switch or amplitude modulator. In the matched mode, used as an attenuator, its dynamic range is up to 40 db over most of the 50-Mhz to 8-Ghz range. General Microwave Corp., 155 Marine St., Farmingdale, N.Y. 11735. [406]

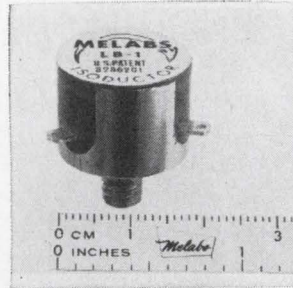

Realization of nonreciprocal, passive isolators and circulators in vhf circuits is possible with the miniature LB-1 Isoductor. The component provides high isolation with low insertion loss at any center frequency in the 200 to 400-Mhz range. The unit measures 3/4 in. in diameter and 5/8 in. high. Melabs, 3300 Hillview Ave., Stanford Industrial Park, Palo Alto, Calif. [403]

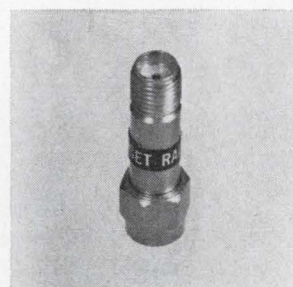

Coaxial switch model M404 is for service in 3-mm subminiature cable systems. It covers 0.5 to 12 Ghz instantaneously with over 50 db isolation at 9 Ghz, 0.5 to 2 db insertion loss, 1 w c-w and 100 w peak power. Switching speed is 10 nsec maximum. Temperature range is  $-65^\circ$  to  $+150^\circ\text{C}$ . Price is \$195. Somerset Radiation Laboratory Inc., 200 N. 14th St., Arlington, Va. [407]



R-f directional wattmeters series 4110 Thruline are 50-ohm instruments for servicing communications equipment in the 2-175 Mhz range. They can be switched from forward to reflected power on the blow-protected front panel. Units weigh 1 lb, measure 2 x 3 x 4 1/2 in. Price is \$93; delivery, 90 days. Bird Electronic Corp., 30303 Aurora Rd., Cleveland, Ohio 44139. [404]

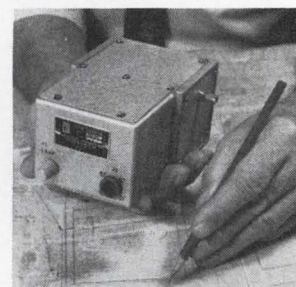

Miniature step attenuators series 96, 97, and 98 provide remotely-programmable attenuation control in 1-db steps up to 149 db over a frequency range of d-c to 18 Ghz. They have incremental insertion loss accuracies of less than  $\pm 0.3$  db of the 1-db steps and less than  $\pm 1.5$  db at 90 db with vswr under 1.5 up to 18 Ghz. Weinschel Engineering Co., Gaitherburg, Md. 20760. [408]

### New microwave

## Buzzing drones at C band

Tracking-telemetry system is designed to tighter rfi and noise specs for 1970's

Until the Defense Department issued a directive assigning all drone command and control functions to the C band (3,900 to 6,200 megahertz) by 1970, the 4,400-to-4,800-Mhz band had been a no man's land, says Ray Elliott, senior engineer at Motorola's Government

Electronics division.

Even then, the Pentagon directive, which also shifted telemetry functions out of the ultrahigh-frequency band, was ignored by almost everybody because of the cost involved in shifting equipment to C band. The move requires de-

velopment of almost all new hardware.

**Systems approach.** But about a year ago, the Motorola division set out to develop a complete C-band drone-control system consisting of a command receiver, digital encoder, telemetry encoder, and C-band transmitter for the airborne package, and another C-band receiver and transmitter, a computer, xyz plotting board, controller, and telemetry encoder for the ground station. The system, developed with Motorola funds, operates between 4,400 and 4,800 Mhz and performs tracking, telemetry, and command functions.



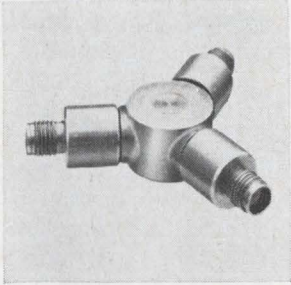

Resistive power dividers DA-2FF are for use in the d-c to 18 GHz range. Units are available with all major connector types. With MFM connectors, vswr is 1.50 for 0 to 12.4 GHz, and 1.90 for 12.4 to 18 GHz. Diameter is 2 in.; height, less than 1/2 in.; weight, 1.2 oz. Prices start at \$60, depending on connector required. Microlab/FXR, 10 Microlab Rd., Livingston, N.J. 07039. [409]

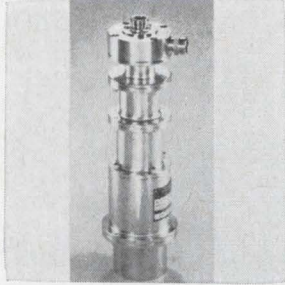

The Omegaline 25-kw dummy load for 3 1/8-in. transmission lines weighs 11 lbs. Frequency range is 60 hz to 1.8 GHz. Maximum vswr is 1.10 to 1 GHz, 1.15 to 1.5 GHz, and 1.2 to 1.8 GHz. Internal pressure drop is less than 10 lbs psi at water-flow rate of 6 gpm. Length is 15 in.; finish, nickel plate. Altronic Research Corp., 13710 Aspinwall Ave., Cleveland, Ohio 44110. [410]



R-f coaxial switcher TC-2 permits simultaneous viewing of 2 separate traces on an oscilloscope, with or without a zero base line. Mercury-wetted switch contacts on the solid state unit insure high reliability. Features include excellent return loss characteristics (vswr), and low insertion loss. Jerrold Electronics Corp., 401 Walnut St., Philadelphia, Pa. 19105. [411]

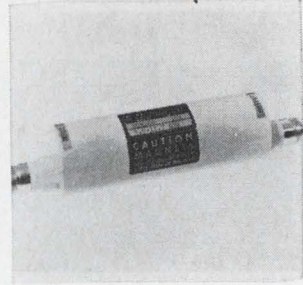

Coaxial isolator model SCX10P covers 1 1/2 octaves. It is suited for critical laboratory, system and countermeasure applications. Frequency range is 3.8 to 11.7 GHz; isolation, 10 db minimum; vswr, 1.30 max.; temperature range, -50° to +50° C; dimensions, 6 5/8 x 1 1/2 in.; weight, 24 oz (nominal). E&M Laboratories, 7419 Greenbush Ave., North Hollywood, Calif. 91600. [412]

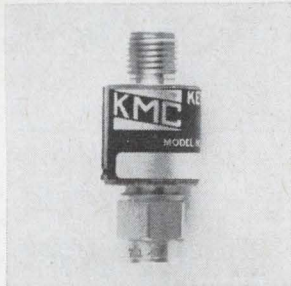

Miniature fixed attenuators KMC-8524 are suited for applications where a known attenuation is required or where padding or isolation is needed in a 50-ohm line. Values of attenuation are 3, 6, 10, 20 and 30 db. Frequency is d-c to 6 GHz. Maximum vswr is 1.3. Length is 1.3 in. and maximum diameter is 0.375 in. Kevlin Manufacturing Co., 24 Conn St., Woburn, Mass. 01801. [413]

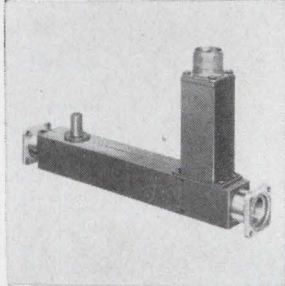

Gas discharge noise source TN52/T44L1D is for critical applications in the L band at frequencies from 1 to 2 GHz. Designed for direct coupling in a 7/8-in. coaxial circuit, the noise source may be operated by a 100-μsec pulse width or by c-w. Excess noise ratio is 18.5 ± 0.5 db. Vswr (fired) is 1.7 max. Signalite Inc., 1933 Heck Ave., Neptune, N.J. 07753. [414]

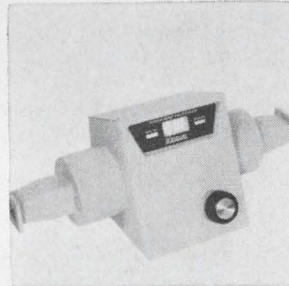

Rotary vane attenuators, designed to accommodate the WR-75, WR-159 and WR-229 waveguide systems, have a range of 0 to 60 db and a maximum vswr of 1.15 over the full waveguide frequency range. Accuracy from 0 to 50 db is ±2% of db reading or ±0.1 db, whichever is greater. Insertion loss is 1 db maximum and typical loss is 0.5 db. Waveline Inc., West Caldwell, N.J. 07006. [415]

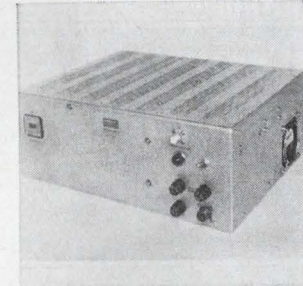

Voltage tunable solid state sources HFS-SW generate signals with a long-term stability of 0.005%/°C. Power output is from 7 1/2 w in L band to 350 mw in Ku band. Output frequency is tunable over a range as great as ±100 Mhz from center frequency. Tuning sensitivity is 1 Mhz to 16 Mhz per v. Applied Research Inc., 76 S. Bayles Ave., Port Washington, N.Y. 11050. [416]

The command receiver and digital encoder in the airborne package are new developments. Elliott calls the MCR-701 airborne command receiver the most critical portion of the system. "If you can't receive," he comments, "you can forget the rest of the system." Motorola will sell the receiver or any other item of the airborne package singly.

**Easy plug-in.** The MCR-701 airborne receiver will plug into existing very-high-frequency systems, easing the strain of conversion to C-band that will take place in the next few years. It occupies 16 cubic inches, weighs 1 1/4 pounds, and is

designed to meet Military Standard 826A, which imposes much more stringent electromagnetic interference specifications than previous specs. Linear integrated circuits in TO-5 cans are used for such functions as the complete intermediate frequency strip, and in limiter, discriminator and video circuits.

The front end incorporates a Motorola-developed balanced mixer. "We get a noise figure at its frequency better than those obtained as low as vhf," says Elliott. "It's an extremely small (2 by 1 by 1/4 inch) stripline printed circuit mixer, but it uses pretty straightforward passive techniques."

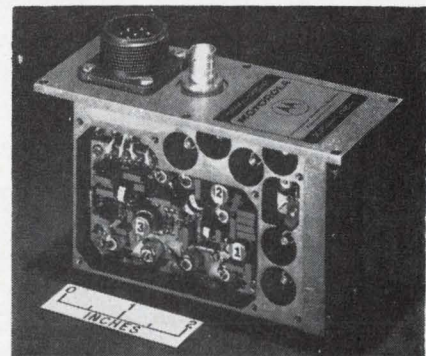

Compact. Extensive use of IC's reduces receiver noise figure.



# INSTANT GRAPHIC COMMUNICATIONS AND DATA DISPLAY FOR THE AEROSPACE COMMUNITY

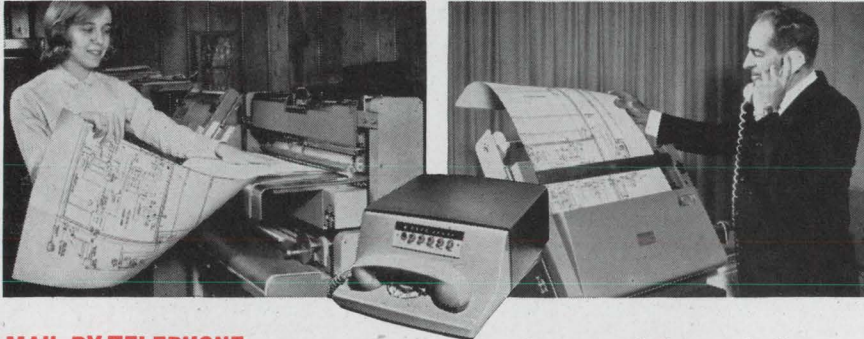

**MAIL BY TELEPHONE** Now . . . for geographically-separated plants and offices . . . **Instant**, 2-way exchange of all graphic material . . . engineering drawings, parts lists, photos, documentation. **Faster turnover** of projects requiring interplant coordination . . . no mail delays . . . no travel time. **Tighter control**, fewer misunderstandings, better decisions through complete visual data exchange *when the need for coordination occurs*. **SEND IT ALL** . . . send notes, telegrams, letters, photos, large drawings . . . on the Alden ALPURFAX Scanner. Send microfilm data with the Alden 16mm or 35mm Scanner Head. **RECEIVE IT ALL** . . . on the Alden 18 ALPURFAX Recorder . . . anywhere, anytime, attended or unattended. All you need is a standard telephone terminal, an AT & T Dataphone dataset, and an Alden 18 ALPURFAX System.

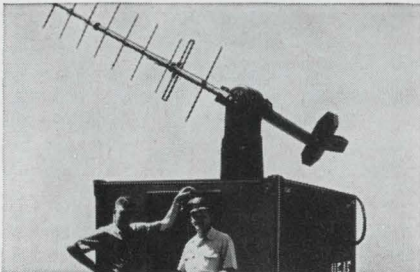

## APT (Satellite Picture) RECEIVING SYSTEMS

Receive clear, detailed facsimile cloud cover pictures direct from ESSA, Nimbus, ATS Satellites. Pictures, enlarged to 10" x 10", are ready for instant use as received.

Also, on the same Alden recorder, receive landline or radio facsimile weather charts and data.

Alden equipment, from basic recorder to complete shelter systems, is available to meet any requirement . . . any budget.

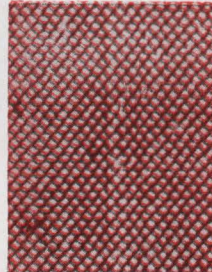

## FACSIMILE RECORDING COMPONENTS

Alden component recorders are ideal for producing hard copy output from scanning systems using sonar, infrared or optical scanners. They can provide continuous hard copy from CRT displays, facsimile scanners, TV, and computer outputs.

You get clear, economical, permanent records with high information content.

Typical application: (shown above) Recording data from the nondestructive testing of wing panels by ultrasonic scanning.

Alden Facsimile Recorders and Scanners are widely used as system building blocks by major system producers and airframe manufacturers who produce their own special systems.

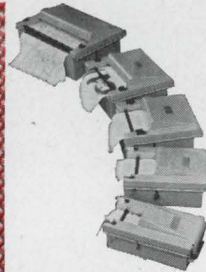

Send me complete information and catalogue on:

MAIL BY TELEPHONE  
 APT and Facsimile Weather Data Communications  
 Component Facsimile Recorders and Scanners

Why not see for yourself? Visit us in our country estate environment. Attend a special seminar on MAIL BY TELEPHONE, Weather Data Communications, and/or Instrumentation Recorders and Systems. See APT, Radar information, Cellometer data . . . also how Alden's unique facsimile scanning and recording techniques have saved time and dollars in other fields: Information Retrieval, Oceanography, Graphic Display of any time base signal.

Indicate your preferred dates for an Alden Seminar held Wednesdays.

Name  Title   
 Company  Division   
 Address  Telephone

## ALDEN

ELECTRONIC & IMPULSE  
RECORDING EQUIPMENT  
CO., INC. ALDEN RESEARCH  
CENTER, WESTBORO, MASS.  
TELEPHONE: (617) 366-4467  
Dept. E-3

SEE US AT IEEE BOOTH 1F15.

. . . message updated  
107 times a second . . .

**Silence is golden.** Twelve decibels is the usual noise figure associated with drone applications, says Elliott, and will be the typical level achieved by the MCR-701. But the receiver could get down as low as 8 db if the customer wants to pay for it. According to Elliott, it will cost about 50% more to get 8 db than 12 because more expensive mixer diodes, varactor multiplier diodes, and radio-frequency transistors are required.

The system will accommodate subsonic or supersonic drones, and has a command bit rate of 9,600 per second. "This means that we can update a complete command message 107 times a second," Elliott notes. Telemetry data rate is also 9,600 bps in 27 channels; the receiver can handle up to 64 commands.

## Specifications (MCR-701 receiver)

Operating frequency	4,400 Mhz to 4,800 Mhz
Noise figure	12 db
Oscillator	crystal with multiplier
Oscillator stability	±0.003%
Electromagnetic interference	military standard 826A
Operating temperature	-54° C to +85° C
Vibration	20 g's to 2000 hz
Shock	100 g's
Altitude	unlimited

Motorola Inc., 8201 East McDowell Rd., Scottsdale, Ariz. 85252 [417]

New microwave

## Smaller mixer stays discrete

Gigahertz device does the same job as older model 10 times as big

**The coming of** integrated circuits made dramatic reduction of equipment size an everyday thing. But engineers at RHG Electronics Laboratories Inc. have shrunk a product to 1/10th the size of an older model—and they did it with discrete components.

The MMP/6 microwave mixer-preamplifier, which RHG will intro-



# Can you make practical contributions to the computer sciences?

Our Data Systems Division is continuing its expansion into areas which will present the greatest challenge for the foreseeable future—advanced aerospace weapon delivery, navigation digital and analog computers, advanced analog/digital control and telemetry. Openings exist in a wide variety of disciplines in Laboratories which are responsible for advanced technology, preliminary design and applications, and digital and analog circuitry. All of these require accredited degrees and a demonstrable capacity to do creative design or analysis. Although experience is required for most of the positions, several are open to recent graduates. Opportunities are immediately available for:

## **Preliminary Design Engineers:**

Helpful experience would include: Digital, Analog and Hybrid Systems Applications Engineering; Logical Design; Memory Design (solid state, ferrite or drum); Electro-mechanical Design Engineering; Physical Product Design; Thermal Analysis or Packaging Trade-off Studies.

## **Automatic Test Program Analysts:**

Systems Test, In-flight Self Test, Time-sharing or Maintenance Depot experience would be directly applicable to our openings. A basic understanding of the mathematics involved with circuitry and computers, or weapon systems analysis would be of particular value.

**Microcircuitry:** Development of hybrid-integrated devices, both digital and linear. Experience with processes and applicable techniques is required.

**Circuit Design Engineers:** Duties would involve the design of logic and computing circuits, many forms of input/output devices, high-reliability low-power circuits for spacecraft VHF and UHF telemetry.

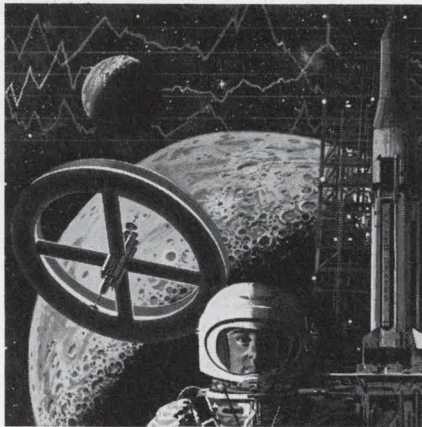

## **Systems Integration Engineers:**

Experience is required in such areas as system integration, system checkout, test equipment, design, test specification and procedure writing.

There are also several openings for Mechanical Engineers and Physicists who have acquired specialized professional experience which is directly applicable to the design or analysis of aerospace digital systems.

## **Computer Program Design:**

Requires experience in the design of real-time command and control programs, or of software programs for execution on an IBM 7094 or GE 635 computer. Responsibilities include: specification, design, implementation, checkout and support of computer programs for a wide variety of applications including: Airborne Navigation & Fire Control, Digital Simulation of Airborne Computer and its environment, Automatic In-Flight & Depot System Testing, Assemblers and Compilers and Automation of Electronic Equipment Design.

For immediate consideration, please airmail your resume to:

Mr. Robert A. Martin  
Head of Employment  
Hughes Aerospace Divisions  
Dept. 37

11940 W. Jefferson Blvd.  
Culver City, Calif. 90230

U.S. citizenship is required  
An equal opportunity employer - M & F





# Ballantine Solid State True RMS Voltmeter

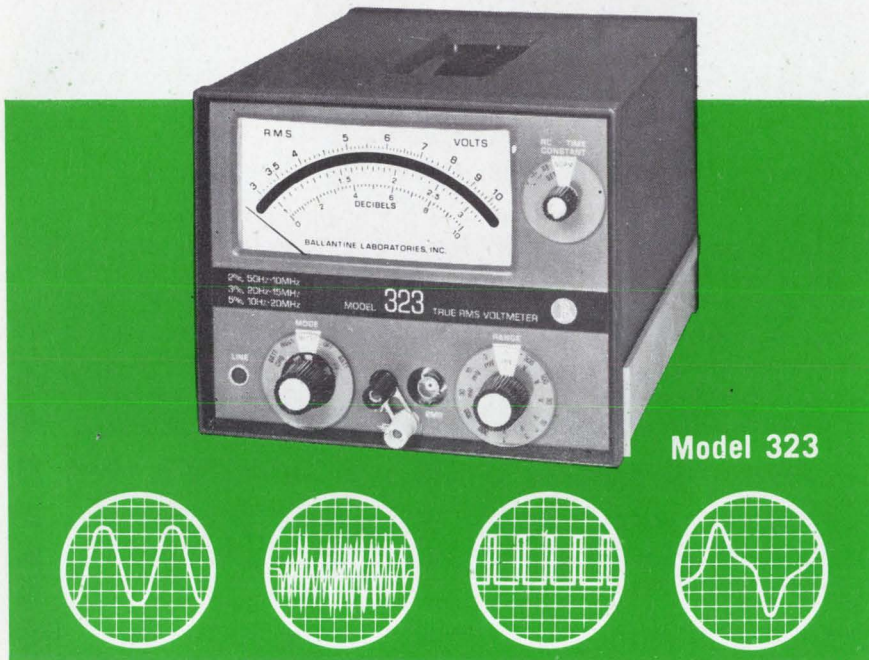

## Measures from 10 Hz to 20 MHz regardless of Waveform

Ballantine's new Model 323 is a rugged, all-solid-state voltmeter for True RMS measurements for 10 Hz to 20 MHz . . . and for a wide variety of waveforms. Use it as a completely portable instrument isolated from line effects (due to built-in rechargeable batteries), or plug it into the power line. (Model 323-01 is for use on power line, only.)

### FEATURES:

- ★ Measures True RMS of sine waves, square waves, noise voltages and a range of pulses
- ★ Frequency range of 10 Hz to 20 MHz
- ★ Voltage range of 300  $\mu$ V to 330 V. (As null detector to 70  $\mu$ V)
- ★ Unmatched accuracy: 2% of indication, 50 Hz to 10 MHz; 3% of indication, 20 Hz to 15 MHz; 5% of indication, 10 Hz to 20 MHz. Ballantine's accuracy of 2% means 2% of the actual indication, whether at the top or bottom of a scale
- ★ Operates from built-in rechargeable batteries or line power
- ★ Ideal for recorder applications — DC output of 0.1 to 1.0 V for each range simultaneous with meter reading
- ★ Crest factor: 5 at full scale to 15 at down scale
- ★ Separate isolated signal and case grounds
- ★ Optional 80 dB Attenuator Probe, Model 1301, for operation up to 10,000 V

Prices: Model 323, \$560 (Battery & Line)  
Model 323-01, \$505 (Line only)

Write for complete technical data today



**BALLANTINE LABORATORIES INC.**  
Boonton, New Jersey

CHECK WITH BALLANTINE FIRST FOR DC AND AC ELECTRONIC VOLTMETERS/AMMETERS/OHMMEASUREMENTS, REGARDLESS OF YOUR REQUIREMENTS. WE HAVE A LARGE LINE, WITH ADDITIONS EACH YEAR. ALSO AC/DC LINEAR CONVERTERS, AC/DC CALIBRATORS, WIDE BAND AMPLIFIERS, DIRECT-READING CAPACITANCE METERS, AND A LINE OF LABORATORY VOLTAGE STANDARDS FOR 0 TO 1,000 MHz.

duce at the IEEE show, weighs less than 2.5 ounces, takes up 2 cubic inches, and has all the capabilities of RHG's older, larger unit. Sidney Wolin, applications engineering manager at RHG, says that for its specifications, the MMP/6 is the smallest mixer available.

The new device comes in four models, which cover 1 to 8 gigahertz. Intermediate frequencies of 30, 60, and 70 megahertz are standard. Other i-f's can be specified. Minimum gain is 20 decibels.

**Small talk.** RHG says the MMP/6 will increase the miniaturization of communications equipment. It will probably be first used in aircraft systems, but the company expects man-pack systems to be a big market.

RHG reduced the mixer's size by using fewer components. Wolin says advances in component technology made this possible. "We found that the transistors coming out of the factories now could do a lot more than the transistors we got a few years ago."

Wolin says the next step will be the use of IC's. "IC's aren't ready for us now. And when they are, they won't buy us any size once you add the coils, sockets, and additional circuits. But eventually they will enable us to improve reliability and cost."

Prices on the MMP/6 start at \$595. Delivery time is four to six weeks.

RHG Electronics Laboratory Inc., 94 Milbar Blvd., Farmingdale, N.Y. 11735 [418]

New microwave

## Cleaning up f-m broadcasts

Amplifier system corrects frequency deviations in phone line bearing signals

Frequency characteristics of the phone lines used to carry f-m broadcasts from remote studio to transmitter are automatically stabilized



At ECI in St. Petersburg, Florida...  
Communication Systems Opportunities

## For a special breed of engineer

If you're one of that special breed of communication engineers who finds a challenge in projects beginning with applied research and advanced development and continuing through prototype and product design, you may well be the kind of person we're looking for.

Check this partial list of systems engineering activities at ECI. If you'd like to help push the state-of-the-art in any of these or other areas in communications, send us your resume. You'll design systems and equipment for satellite communications, multiplexing, electronic switching, command and control and advanced radio communications for some of the nation's major defense and space programs.

### Communication Systems Engineering Activities:

- Propagation Analysis
- Advanced Antennas
- Coding Theory
- Detection Techniques
- Communication System Design
- Communication System Integration
- Reliability Techniques

### CHALLENGE, GROWTH . . . and LOCATION TOO!

At ECI your job will be challenging. At ECI you'll find real opportunity for growth instead of just another confining groove — two-thirds of all advanced development is done in regular engineering development areas. And, at ECI you'll like where you're living just as much as you'll like your job. We'll match subtropical, sunny St. Petersburg against any location in the U. S. for stimulating, comfortable living.

SEND YOUR RESUME TODAY — in confidence — to K. E. Nipper, Supervisor of Professional Placement, Electronic Communications, Inc., P. O. Box 12248, St. Petersburg, Florida 33733.  
(An equal opportunity employer, M & F.)



ELECTRONIC COMMUNICATIONS, INC.  
ST. PETERSBURG DIVISION

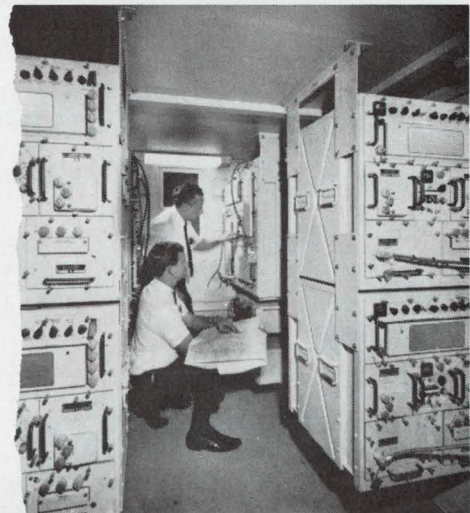



SERIES  
260  
AND  
265

1/8"  
SHANK

# SOLID CARBIDE CIRCUIT BOARD DRILLS

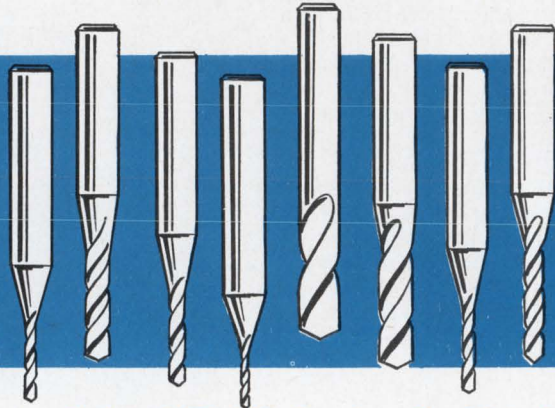

Choice of 58 drill sizes from No. 80 to 1/8"  
ALL WITH COMMON 1/8" DIAMETER SHANKS

for  
precision  
drilling  
with  
every drill  
size!

You can now maintain location and hole size tolerances to extremely close limits . . . at drill feeds up to 15 feet per minute! The unequalled rigidity of solid carbide plus the added support of 1/8" shanks gives maximum deflection-free performance in drilling all diameter circuit board holes. All drills precision ground with unique four facet drill point configuration. Common 1/8" shank design eliminates need for collet and bushing inventory for each drill size. Your Metal Removal distributor provides vital sales and engineering liaison . . . call him or write for Catalog D67.



## THE METAL REMOVAL COMPANY

1859 West Columbia Avenue • Chicago, Illinois 60626  
Plants Located in CHICAGO/LOS ANGELES/SAN JUAN

MASTER TOOL AND WHEEL MAKERS FOR THE WORLD  
END MILLS / DRILLS / REAMERS / BURS / SPECIAL TOOLING

Circle 262 on reader service card

## Our little black book has over 100,000 phone numbers.

You never had a black book like it. Over 1,500 pages. And those phone numbers! More than 100,000 telling you who to call/where to go, for the over 4,000 different product categories listed and advertised in the yellow pages of the Electronics Buyers' Guide.

It's the industry's one-stop shopping center that lets you find the products and services you need quickly. You can depend on EBG.

### Electronics Buyers' Guide

A McGraw-Hill Market Directed Publication,  
330 West 42nd Street, New York, N.Y. 10036

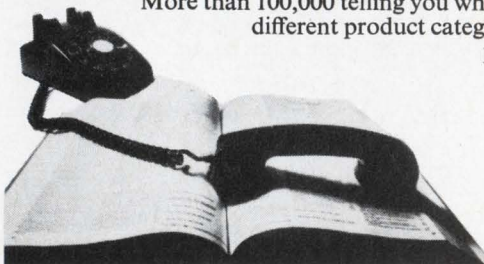

... detects changes  
in phone line ...

by a new system developed by Alpine Geophysical Associates Inc.

Designated the 505 AR, the system continuously checks line characteristics by transmitting a pre-determined wave form at certain intervals in the regular program material. It detects any changes caused by external conditions by comparing the wave form of the program signals with this check wave form at the receiving location.

The program and check waves are converted in part to indicate their energy levels. Any difference in energy is then applied to a series of correction amplifiers that equalize the line characteristics. The energy difference indicates the de-

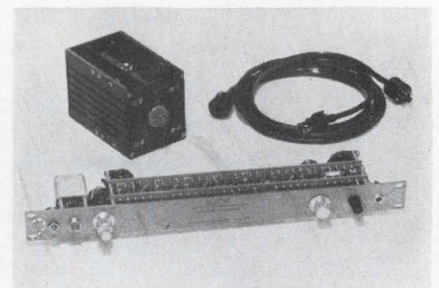

**Equalizer.** Correction amplifier with power supply and connecting cables is used at remote f-m sites.

gree of correction needed, while differences in wave form shape establish a corrective direction.

Energy levels are indicated on a digital voltmeter and the difference between them is retained and automatically presented to the equalization amplifier system at preset intervals.

The transmitted wave forms are similar to those used in television's conventional K-factor testing procedures. The major difference is that there the pulse section represents the upper frequency limit desired from the system, and the plateau of the bar section represents the lower limit.

At the end of a series of wave form transmissions, a single negative-going pulse is transmitted to reset the digital voltmeter circuits.

Alpine Geophysical Associates Inc., Oak St., Norwood, N.J. [419]



# The newest "Vee Jem" capacitor has a 3-point lead over every other chip!

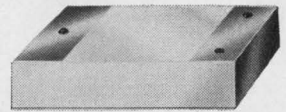

Cutaway of "VEE JEM" Capacitor on Thin Film Circuit

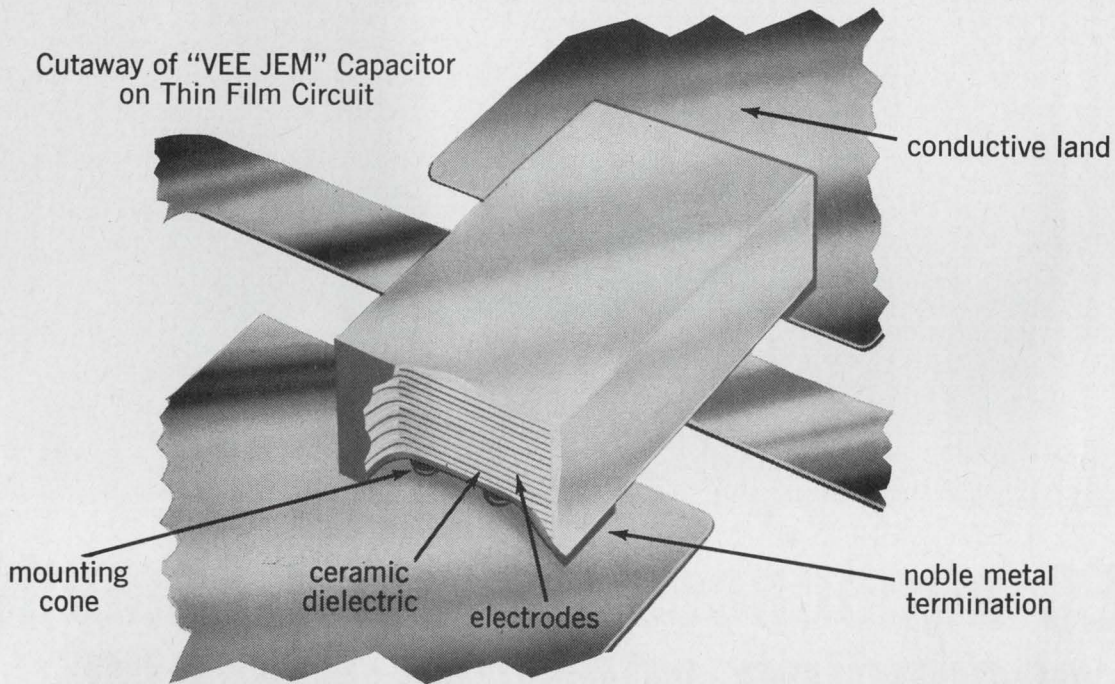

If your game is designing hybrid microcircuits, the newest "VEE JEM" Capacitor will immediately give you a three-point lead over every other chip you've used.

The three-point lead: a miniature (noble metal) termination featuring three mounting cones. The cones, barely visible to the naked eye, make component attachment a problem of the past.

The cones provide a superior bonding and mounting stability, and permit a concentration of pressure — vastly improving component attachment with ultrasonic and thermal-compression bonding methods.

This configuration also provides a solder flow path to the termination when bonded by reflow soldering techniques.

Extremely high solderability is assured because the termination's noble metal is free of surface oxides and frit (which inhibit soldering).

So make the design game easier — specify the new "VEE JEM" Chip. (Its new termination could be the 3-point lead you need to stay ahead in the microcircuit field.)

Write for Data Sheet C21

### "Vee Jem" Chip Line-up

- Dimensions: .085" long x .055" wide x .040" thick (max.)
- Capacitance Values: 100 to 10,000 pf
- Voltage Ratings: 50 & 25 vdc
- Temperature Range: -55°C to +125°C
- Tolerances: ±10% & ±20%
- Temperature Characteristic: ±15% or better

## VITRAMON

VITRAMON, INCORPORATED  
BOX 544  
BRIDGEPORT, CONN. 06601

In Greater Europe Contact:  
VITRAMON EUROPE  
Wooburn Green, Bucks, England



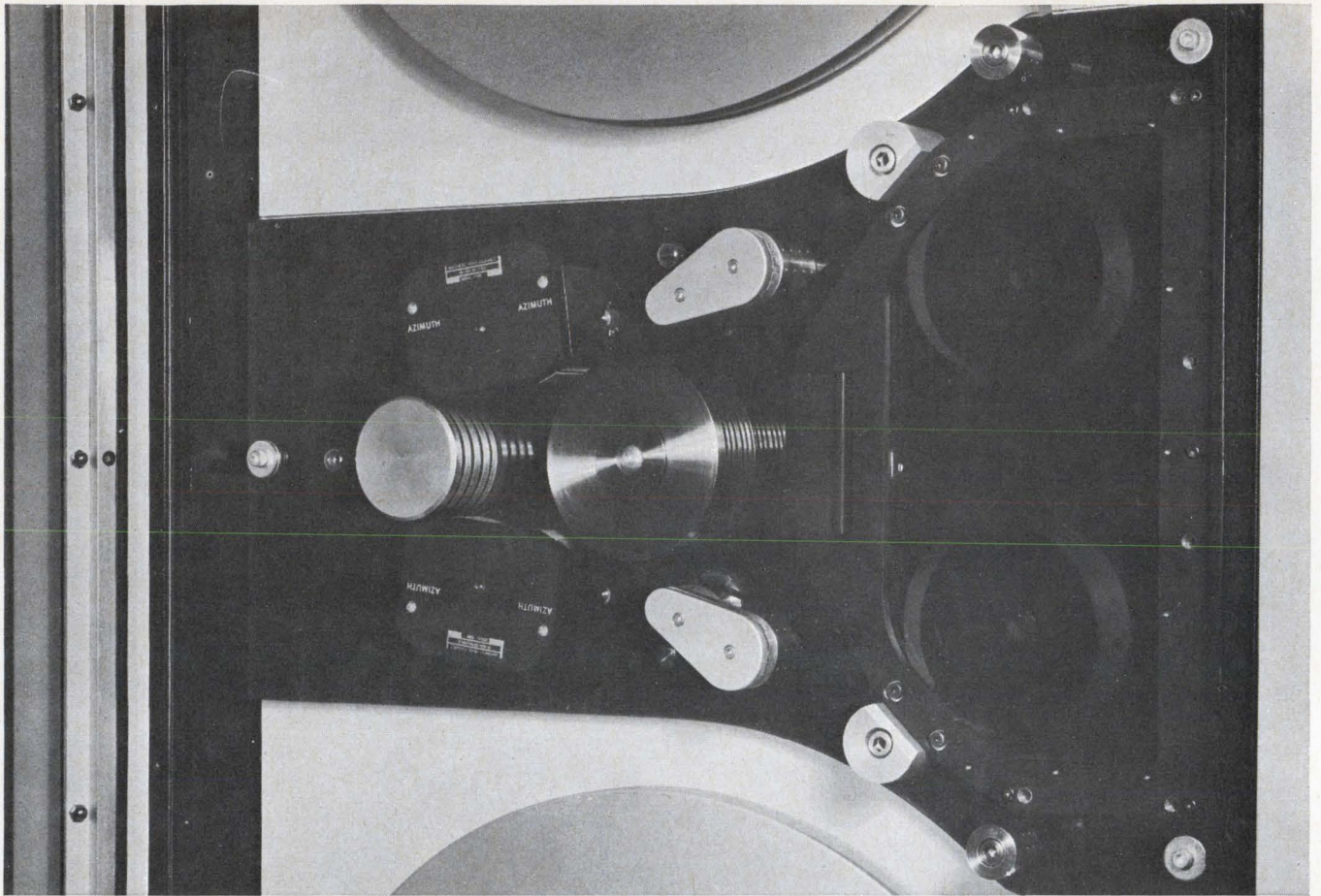

DUAL INERTIA DRIVE, INERTIA DISENGAGED

# CEC announces the most important recording advance in years... a time base error of $\pm 400$ nanoseconds maximum



The recorder is CEC's new 2.0 MHz VR 5000. Because of its improvements in time base error, the ultimate in real-time restoration of data is now possible. Tapes made on conventional data acquisition recorders under severe environmental conditions can be successfully reduced with correct time base restored.

To some, however, there is another achievement of the VR 5000 which may be even more significant. It has a flutter correction capability *five times more effective* than that of our nearest competitor.

Reason: the VR 5000 is the only recorder that offers Dual Inertia\* drive, translating the ideal system concept into a working reality—*high mass recording and low mass reproduce.*

CEC also offers a complete line of other analog recorders for mobile, laboratory and aerospace use at considerable savings.

### Comparative performance report on VR 5000 now available.

For your copy, call your nearest CEC Field Office. Or write Consolidated Electrodynamics, Pasadena, California 91109. A subsidiary of Bell & Howell. Ask for Bulletin VR 5000-X9. \*Patent Pending

### CEC/DATATAPE PRODUCTS





# New Semiconductors Review

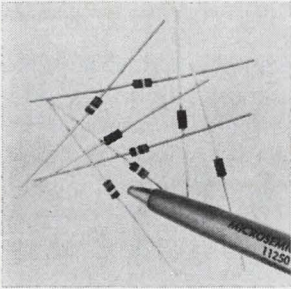

Tiny multiplier rectifiers are suited for electro-optical imaging and IR search and tracking systems. Voltage ranges of 1,000 to 6,000 v, leakage less than 0.020  $\mu$ a and capacitances of less than 1 pf are standard. Rugged mechanical sizes of 0.075 x 0.150 in. with 0.020 in. diameter leads are available. Micro Semiconductor Corp., 11250 Playa Court, Culver City, Calif. 90230. [436]

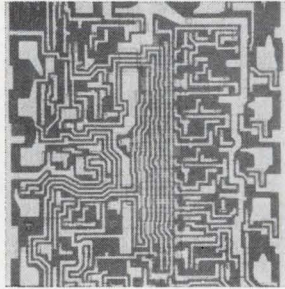

High-complexity (28 gates), medium-scale IC, the 9307 decoder, accepts 4 inputs in standard 8421 BCD code, provides active high outputs for a 7-segment numerical display, and has additional capabilities for blanking, lamp testing, and intensity modulation. Maximum package size is 0.200 x 0.375 x 0.785 in. Fairchild Semiconductor, 313 Fairchild Dr., Mtn. View, Calif. 94041. [437]

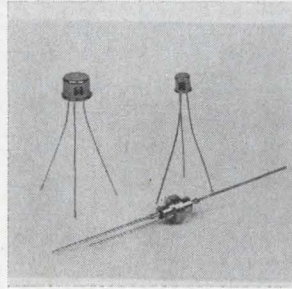

Small signal, pnp silicon alloy amplifier and chopper transistors come in T0-5, T0-18 and co-ax packages. Breakdown range of the amplifiers is 40 to 200 v; beta ranges, 10 to 100. Alloy choppers, also offered in matched pairs, have symmetrical breakdowns up to 160 v, saturation resistance 10 ohms. Solitron Devices Inc., 1177 Blue Heron Blvd., Riviera Beach, Fla. [438]

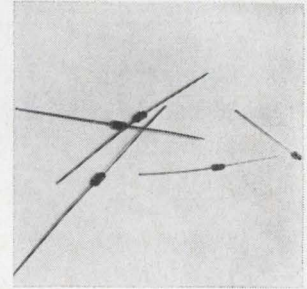

Schottky-barrier diodes 4882 and 4883 span vhf to L-band. They utilize a bilithic process that encapsulates the metal-silicon junction in a hermetic glass seal. This allows a large-area, low loss top contact to the junction for improved reliability. Typical max. frequency is 890 Mhz; max. noise figure, 6.5 db. Microwave Associates Inc., Burlington, Mass. 01803. [439]

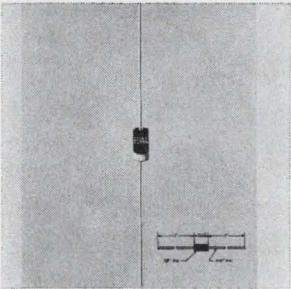

Silicon rectifiers series B feature currents to 2 amps at 25° C ambient. Units meet humidity requirements of MIL Standard 202A, Method 106. Voltages to 1,200 piv, currents from 200 ma to 2 amps, and high performance bulk avalanche types are offered. Weight is 0.4 gram, body length, 1/4 in.; diameter, 0.115 in. Edal Industries Inc., 4 Short Beach Rd., East Haven, Conn. [440]

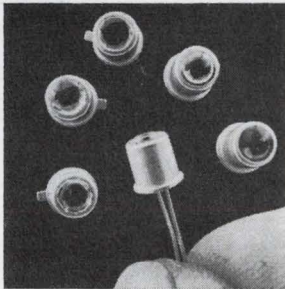

Gallium arsenide infrared emitter SSL-4's peak light wavelength, about 9,000 angstroms, makes it useful as an action-triggering device. It is mounted on a standard transistor base and capped by a top-hat capsule and lens. It is for use in card readers and other photoelectric applications. Sample quantities cost \$9.50. General Electric Co., Nela Park, Cleveland 44112. [441]

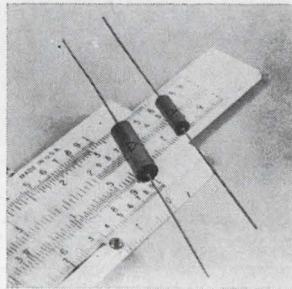

Positive temperature coefficient thermal resistor designated Sensitron is available in a resistance range of 10 ohms to 10 kilohms at tolerances of 5 to 10%. Units come in 1/8 or 1/4 w packages with tinned dumet leads. Operating temperature range is -65° to +150° C. Devices meet or exceed MIL-T-23648A specs. Delta Semiconductors, 225 Paularino Ave., Costa Mesa, Calif. [442]

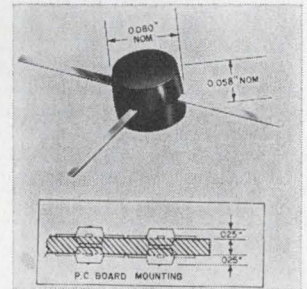

A low-level, high-speed switch MMT2369 and an r-f amplifier MMT918 have been added to the Micro-T transistor line. They are housed in a package about one-tenth the size of a 10-18 can. The MMT918 is priced at \$1.65, and the MMT2369 at 97 cents each, in 1,000 quantities and up. Motorola Semiconductor Products Inc., P.O. Box 13408, Phoenix, Ariz. 85002. [443]

## New semiconductors

### MOS used as capacitor in diode package

Impulse circuit operating in shunt mode matches input to microwave device, eliminating parasitics problem

**Fast pulses**—0.1 nanosecond—produced by step-recovery diodes are rich in usable harmonics, so these diodes are often designed into frequency multipliers and comb generators. It is very difficult, however, to match the input circuit to a step-recovery diode, and package para-

sitics are a severe constraint in going to frequencies above S band. HP Associates, the Hewlett-Packard Co. division where the diode was developed, has attacked both problems by integrating the diode into a hybrid circuit that produces useful spectral lines to 12.4 Gigahertz,

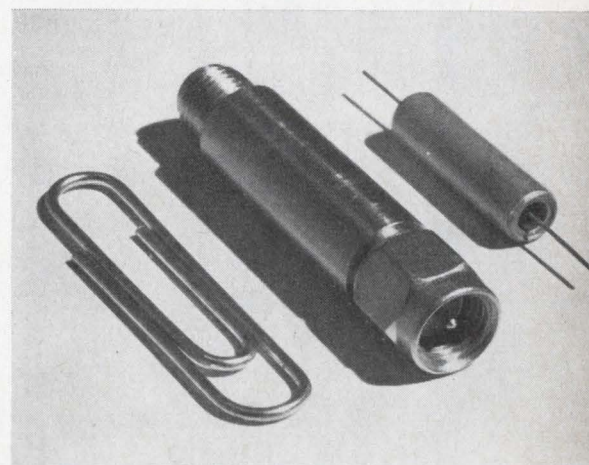

**In the round.** Two types of packages are available: wire leads and coaxial connectors.



# Low Cost FET Testing

**New**  
**Test Equipment**  
**Corporation**  
**Model 57**  
**Field Effect**  
**Transistor**  
**test system**  
**gives you the**  
***most inexpensive***  
***all digital***  
**approach to the**  
**testing concept.**



Here's a FET test system that gives you the advantages of all digital testing, the versatility of easily interfacing in and out and at a lower cost than you'd expect!

The Test Equipment Corporation Model 57 FET test system measures eight static and two transconductance parameters at an average speed of 100 milliseconds per test. It sequences through six tests (12 test capability optional) on FETs in either manual or automatic testing.

A wide range of electrical capabilities and the versatility of fast, easy program changing make the Model 57 ideal for quality assurance applications. It is equally well suited for incoming inspection, engineering evaluation and production testing.

Write today for full technical and pricing information.

### And, check these Plus features!

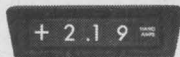

High visibility projected three digit read-out of test results gives you all test information at a glance.



Easy-to-set thumb wheel switches make possible fast, accurate settings, virtually eliminate operator set-up errors.

## Test Equipment

CORPORATION  
 P.O. BOX 20215, DALLAS, TEXAS 75220 • 214/357-6271

Circle 113 on reader service card

... clean package  
 with pure inductance ...

well beyond X band.

Two capacitors and two inductors are packaged with the diode to form a complete shunt-mode impulse circuit that is constructed as a hermetically sealed section of a coaxial line. The capacitors are tiny metal oxide semiconductor devices. "Getting rid of the packages gets rid of all uncertainties," says HPA marketing director Paul Lufkin. "There is no doubt that the inductance is a pure inductance, with no stray capacity; it's a very sanitary system."

**Problem curve.** The difficulties of realizing circuit elements increase

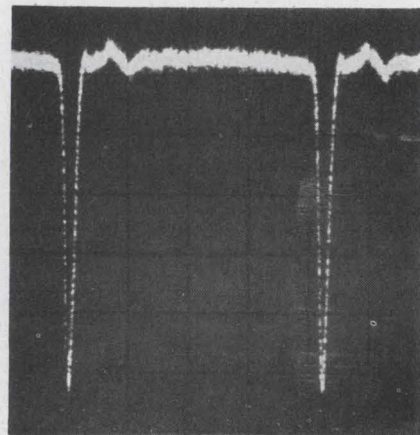

**Spiked.** Diode output may be used as high-repetition-rate clock pulses for high-speed computer systems.

as the output frequency increases. Steve Hamilton, an engineer in the HPA applications group, spent a year studying the theory of the shunt mode of operation before beginning design work. The final configuration, he found, permitted manufacture of a circuit that can be operated as a times-100 multiplier—an achievement impossible with discrete devices because of the tolerances of the units.

The hybrid package has a Kovar center section with a glass/Kovar bead on each end. The leads, which also serve as the drive inductor, are silver. Hamilton first tried gold, which is easier to work with because it is inert; but the hermetically sealed package made silver equally attractive, and silver behaves better at the higher currents

## PARKER

"The Modern Movement"

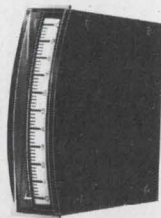

E-35

THE 3-1/2" METER WITH THE 3-1/8" SCALE LENGTH.

- **DEPENDABLE** — Long life and long term stability due to Alnico VIII magnets. Inherently rugged PARKER movement with High Shock, high overload etched circuit coil.
- **SPECIFICATIONS** — Meets ALL ASA requirements.
- **PRICE** — Competitive pricing, with quantity purchase discounts, yields lowest possible customer costs.
- **DELIVERY** — From Stock.

STOCKED IN DEPTH BY LEADING DISTRIBUTORS

For information ask your local electronics distributor or write:



**PARKER** Instrument Corp.  
 200 Harvard Ave. • Stamford, Conn. 06904 • (203) 325-4361



# VSMF is a product supermarket

*John Manning, Missiles Systems Division, Raytheon Company, Bedford, Mass., has installed 4 VSMF Files: Defense Design, Documentation, Mil Specs and Mil Standards.*



## look into it!

Design engineers have been telling us for years that VSMF is much like a product supermarket. That's because Visual Search Microfilm Files contain more than 1,000,000 products from over 15,000 manufacturers—all arranged with design engineers in mind.

Of course, VSMF isn't exactly a supermarket. At Information Handling Services, we've collected 1¼ million pages of product data, indexed them, microfilmed them, put them in compact consoles, and combined them with the most modern microfilm retrieval equipment. VSMF has all the advantages of a product supermarket... complete, easy-to-use and up-to-date.

We know that when you design a product you want to use the best components and materials. And, to do this, you need to compare all that is available. VSMF can help you in this comparison because VSMF supplies the data on *all* products. You supply the judgment.

Manufacturers who place their data in VSMF know this and invite comparison. The constantly changing "state of the art" is reflected in the pages of VSMF.

More than 125,000 engineers in 500 great corporations now shop in the VSMF supermarket. If you have VSMF in your company, look into it. If you don't, you might look into that, too. Write for "Looking into VSMF."



**Information**

HANDLING SERVICES, INC.

Dept. E-34

Denver Technological Center  
Englewood, Colo. 80110

Circle 267 on reader service card



**NOW FROM AUSTRON**



Model 20  
Power Converter

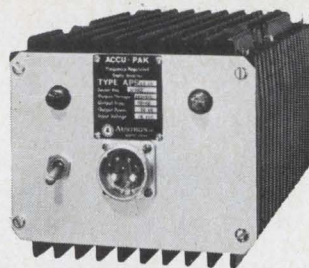

APS Series  
Power Inverter

## Power Modules

**Model 20:** Used as a frequency controlled power converter where square wave output is desired, the Model 20 converts unregulated 55-70 Hz or 340-460 Hz a-c input to an output at 60 or 400 Hz (or any required frequency) with a frequency tolerance as close as  $\pm 5 \times 10^{-7}$ . **APS Series:** These rugged inverters produce precision 50 Hz, 60 Hz, or 400 Hz, 115 V a-c, 30 to 200 VA outputs. Models for 12 V d-c or 24 V d-c inputs are available. Other configurations available on special order. Write today for data sheets.

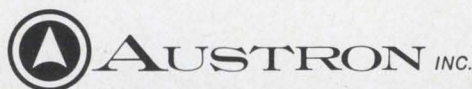

10214 NORTH INTERREGIONAL HIGHWAY, AUSTIN, TEXAS 78753 TELEPHONE (512) 454-2581

Circle 115 on reader service card

... all modules generate  
to beyond 12.4 Ghz ...

that result from the low drive inductances required by the circuit. Gold, Hamilton says, had a tendency to fuse.

For multiplier applications, the new diode comes as a clean module because a user will want to apply his own d-c return bias. The coaxial barrel is added for comb generators. Both are available for input frequencies of 100 Megahertz, 250 Mhz, 500 Mhz or 1 Ghz. These packages, to be introduced at the IEEE show, are available off the shelf; HPA will take orders for other frequencies with a 90-day delivery.

All modules generate components to beyond 12.4 Ghz. With half a watt input power, the 500 Mhz and 1 Ghz modules, which have fewer spectral lines, obtain 1 milliwatt of power between 4 and 8 Ghz, and better than 0.1 milliwatt above 8 Ghz.

**Widening use.** This relatively high power output, Hamilton says, opens up some new applications. The 1-Ghz module delivers -10 dbm at 12.4 Ghz, which makes it possible to consider it as a local oscillator without further filtering. Filters essentially deliver all the power of the comb to one line. If power were raised to zero dbm, the circuit might be used with a pad and a yig filter as a first local oscillator in a digital receiver.

The 100-Mhz unit could be used with a 100-Mhz crystal to get a stable 10-Ghz oscillator.

Production of the diode packages, designated models 3302A through 3305A, is tricky, Hamilton says. The assemblers must use a reflectometer setup to match components. Matching the coil is especially difficult, because the package must be open when the spacing is adjusted—but closing the package changes the match. Production workers themselves have overcome the problem so well that the circuit can be tuned in three minutes, Hamilton reports.

Price of the modules is \$125, in units of one to 9, compared to about \$70 for a conventional diode alone. Without the d-c return and the coax section, the circuits sell for \$100.

Hewlett Packard Associates, 1501 Page Mill Rd., Palo Alto, Calif. [444]

**EXHIBITS**  
NEW YORK COLISEUM

**TECHNICAL SESSIONS**  
NEW YORK HILTON

Monday through Thursday

PROGRESS IN AN EXPLODING TECHNOLOGY

- 48 GENERAL SESSIONS at the New York Hilton. Hours: 10:00-12:30; 2:00-4:30.
- FOUR FLOORS OF EXHIBITS at the N. Y. Coliseum including over 750 firms. Hours: 10 a.m.-8 p.m. 4 Days.
- GALA ANNUAL BANQUET—Wednesday 7:15 p.m. N. Y. Hilton Grand Ballroom—\$16.00.
- FREE SHUTTLE BUSES between the Hilton and the Coliseum—every few minutes.

- REGISTRATION—Good all days—General Sessions and exhibits. In and out privileges.—IEEE Members \$3.00. Non-members \$6.00. Ladies \$1.00. High School Students \$3.00 if accompanied by an adult—One student per adult; Thursday only—limit of 3 students per adult.
- REG-IDENT CARD speeds request for exhibitors' literature. Ask for one when registering.
- ESCALATORS/EXPRESS ELEVATORS to the Fourth Floor.



**IEEE Exhibition MARCH 18-21, 1968**



# business trips rule out evening classes?

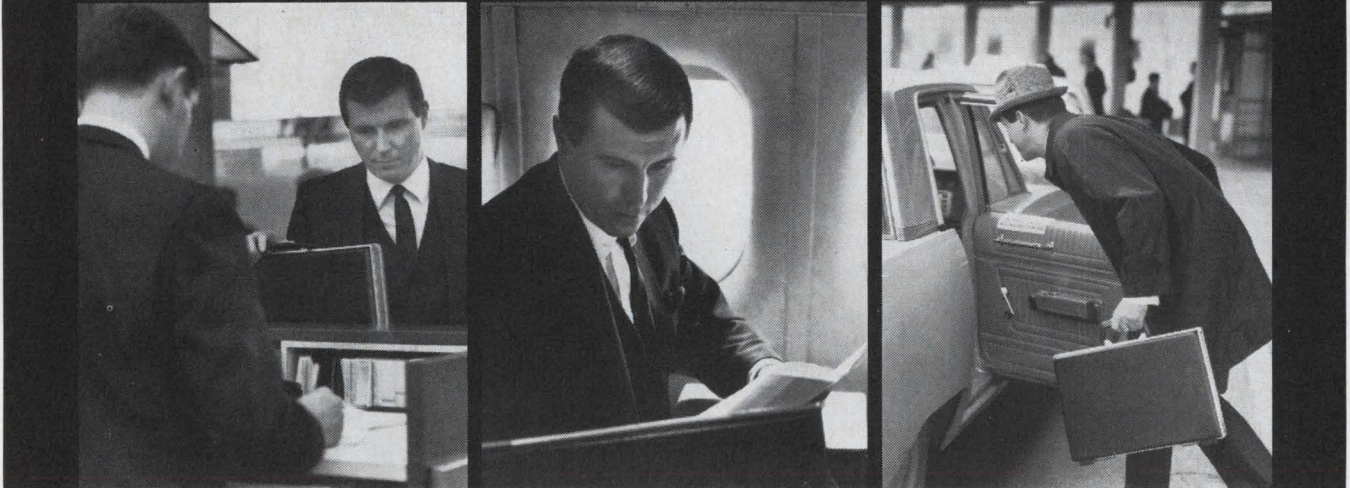

## here's a practical way to update your knowl- edge of electronics

Are irregular hours, travel and family obligations keeping you from attending classes—even though you worry about becoming technically obsolescent? Check into the Special Programs in Electronics for Engineers developed by CREI, the Home Study Division of the McGraw-Hill Book Company.

These are not simply courses, but comprehensive programs in advanced electronics offering major electives in such fields as:

Communications Engineering, Aeronautical and Navigational, Television Engineering, Automatic Control Engineering, Missile and Spacecraft Guidance, Radar and Sonar Engineering, Nuclear Instrumentation and Control, Computers.

Industry-recognized CREI Programs make it possible for you to catch up on new developments in electronics through study in your own home, at your own pace,

your own schedule. Free book gives complete information and details of technical material covered. For your copy, mail coupon below or write: CREI, Home Study Division, McGraw-Hill Book Company, Dept. 1810-G, 3224 Sixteenth St., N.W., Washington, D.C. 20010.

Founded 1927



Accredited Member of the National Home Study Council



**CREI, Home Study Division, McGraw-Hill Book Company**  
Dept. 1810-G, 3224 Sixteenth St., N.W.  
Washington, D.C. 20010

Send me free brochure describing CREI Programs in Electronics for Engineers.

NAME \_\_\_\_\_ AGE \_\_\_\_\_

ADDRESS \_\_\_\_\_

CITY \_\_\_\_\_ STATE \_\_\_\_\_ ZIP CODE \_\_\_\_\_

COMPANY \_\_\_\_\_

TITLE \_\_\_\_\_



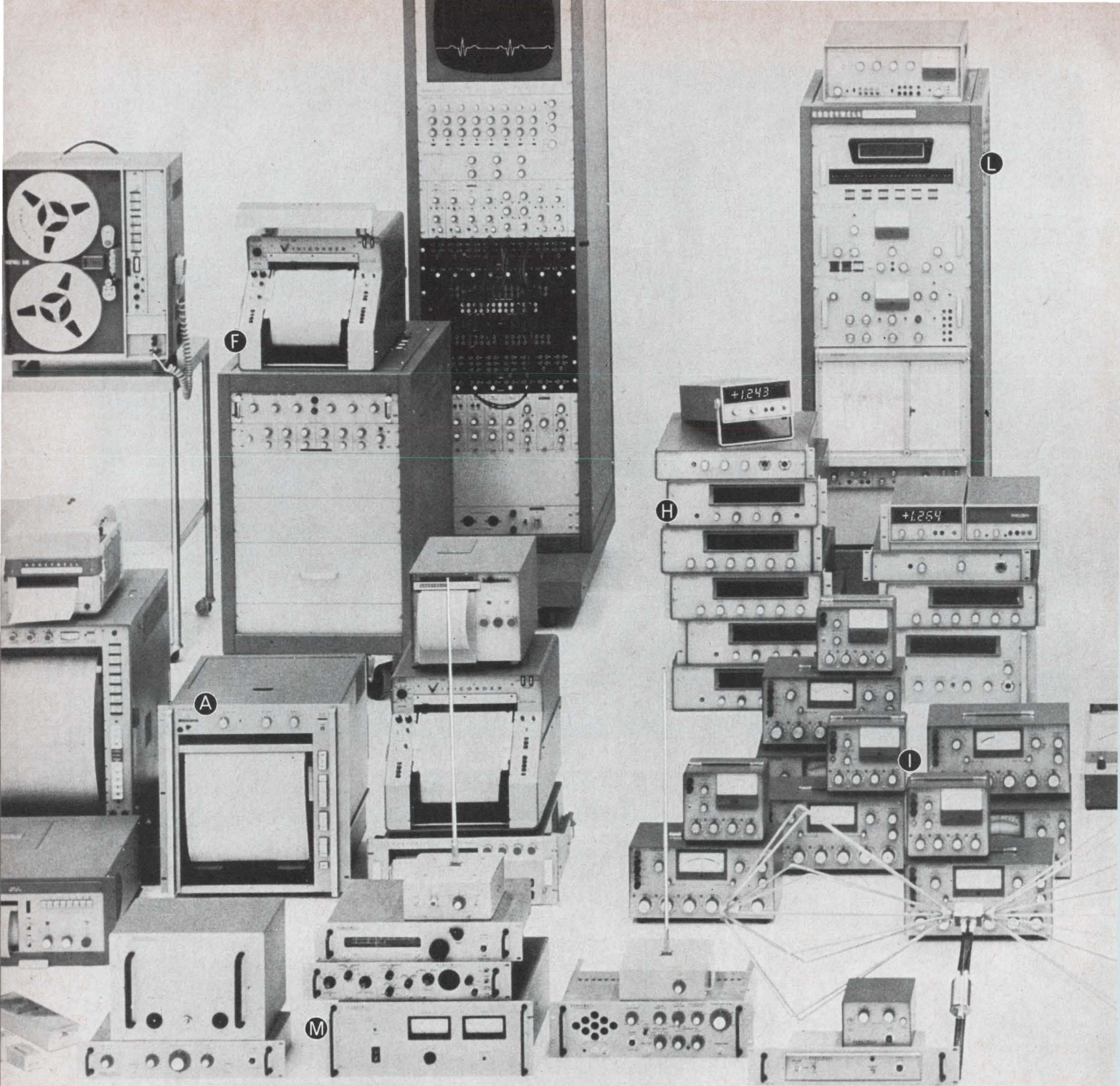

Here's just part of the full Honeywell line, which includes: **A** 117 Visicorder direct-recording oscillographs in 6", 8", and 12" models; **B** 2 Model 1806 fiber-optics CRT Visicorder oscillographs; **C** 26 magnetic tape systems, including the 7600 Series in 10½" and 15" reel versions; **D** 84 amplifiers and other signal-condi-

We build **847**  
 instruments to be sure we  
 have the exact **1** you need.



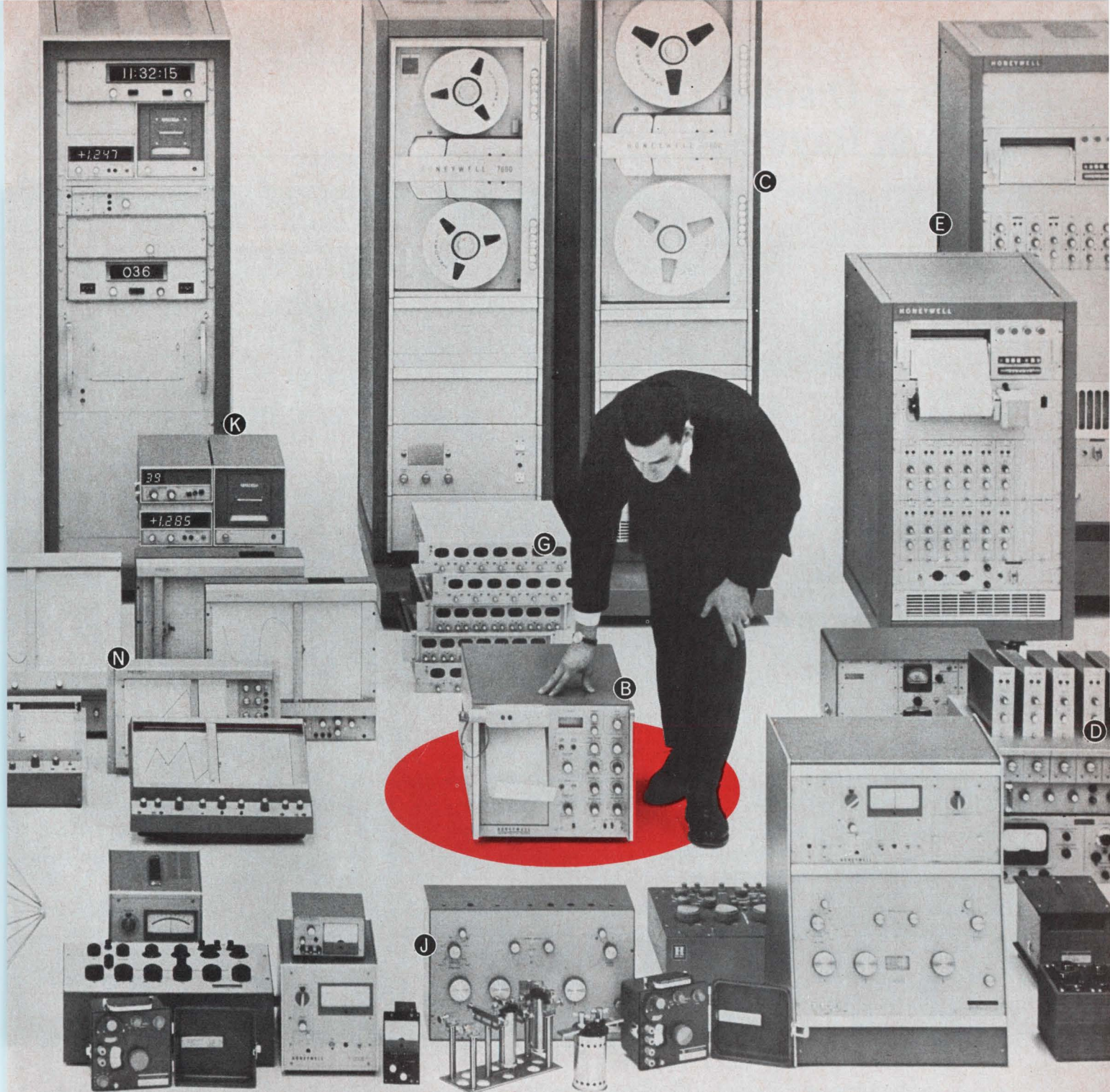

tioning units; E 78 analog recording systems; F 46 electronic medical systems; G 14 oscilloscopes; H 37 digital multimeters; I 29 differential voltmeters; J 179 precision laboratory standards and test instruments; K 128 data loggers; L 9 analysis systems; M 61 EMI products; N 37 X-Y graphic recorders.

Your Honeywell sales engineer can zero in on the *precise* solution to your instrumentation problems. Quickly and efficiently. You won't have to settle for "almost" what you need because the Honeywell sales engineer isn't handicapped by a limited line. He can choose from 847 basic instruments whose combinations and permutations approach the infinite.

The solution might be a Visicorder recording oscillograph. Or one of our modular magnetic tape systems. Or an X-Y recorder, a digital multimeter, or a portable potentiometer. But whether it's a single instrument or a complete data system, you can be sure the solution will be the right one, carefully thought out with your future requirements considered as well as your current needs.

Local service and nationwide metrology facilities back up your Honeywell instrument or system. And, we can even provide factory training courses for *your* operating personnel. For the full story on how Honeywell can help you, call your local sales engineer or write: Honeywell, Test Instruments Division, Denver, Colorado 80217.

**Honeywell**

Honeywell engineers  
sell solutions Circle 271 on reader service card

See us at the IEEE Show—New York Coliseum, March 18-21. Booths 2G39 to 2G49.





## Data Display Devices from Raytheon

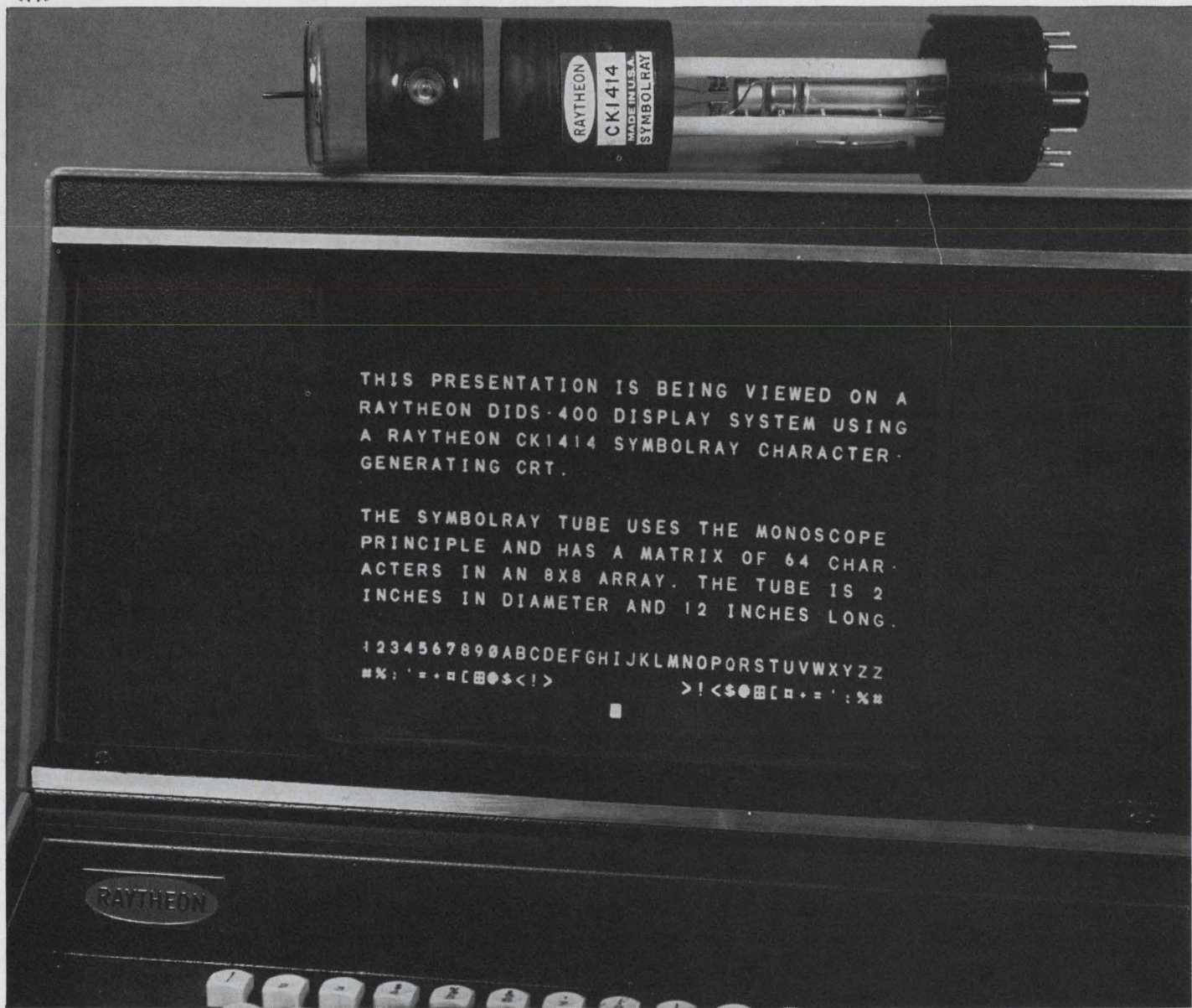

The presentation you see above was generated by a Symbolray\* Cathode Ray Tube identical to the one lying on the console. A new type of monoscope, the Symbolray can generate alphanumeric characters from electrical signals for cathode-ray display or for hard copy print-out. The presentation here is shown on a Raytheon tube (CK1415) used in a Raytheon DIDS-400 display system.

**An economical method of generating characters.** Priced at less than \$100 in quantities of 1,000, the Symbolray provides a more economical method of generating

electronic displays than using large numbers of circuit cards.

The output of the Symbolray operating as a monoscope is obtained by electrically deflecting the electron beam to desired characters on the target and scanning them sequentially with small raster. The display cathode ray tube on which this output is viewed is scanned in synchronism. When the Symbolray method is used in conjunction with buffer-memory techniques, full messages can be displayed—as shown above. The Symbolray tube uses electrostatic deflection and

focus, and is available in designs with 64 and 96 character matrices.

**Raytheon's wide range of Data-ray\* CRTs** cover the screen sizes from 7 to 24". Electrostatic, magnetic and combination deflection types are available for writing alphanumeric characters while raster scanning. Raytheon also offers combination deflection or "diddle plate" types and all standard phosphors. Or, Raytheon can meet your special CRT design requirements.

For more information—or a demonstration—call or write your Raytheon regional sales office.



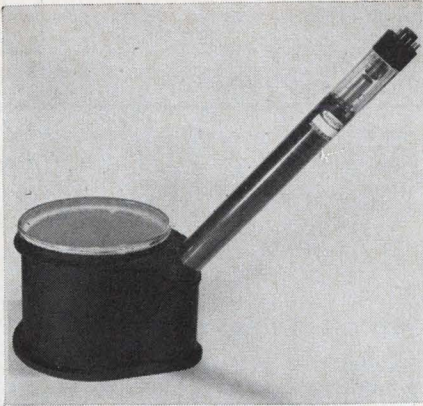

**Cathode-Ray Projection Tube.** A new family of Projectoray\* CRTs provide high quality projection of television or other displays. As compared with more conventional projection tubes, the Projectoray provides substantial improvement in life and brightness without sacrifice in picture quality.

These devices are available in designs which utilize refractive optics or Schmidt optics, with one special design using a Schmidt spherically-curved mirror built within the cathode-ray tube.

The high light output and long life—more than 500 operation hours—are due to novel design. The phosphor screens are deposited on thermally conductive materials capable of being cooled readily by air flow or liquid cooling techniques to inhibit screen burning. The final display will provide 15 foot-lamberts on a 3-foot by 4-foot lenticular screen, permitting operation of the projection system in a lighted room.

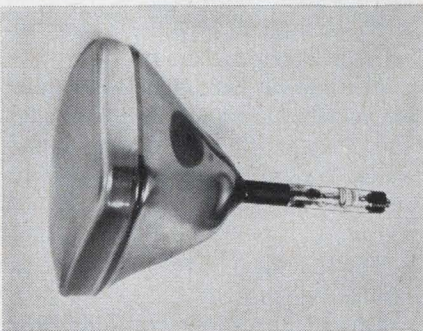

**Dataray\* Cathode Ray Tubes.** Raytheon makes a wide range of industrial CRTs—including special types—in screen sizes from 7" to 24". Electrostatic, magnetic, and combination deflection types are available for writing alphanumeric characters while raster scanning. All standard phosphors are available and specific design requirements can be met. Combination deflection or "diddle plate" types include CK1395P (24" rectangular tube), CK1400P (21" rectangular), and CK1406P (17" rectangular).

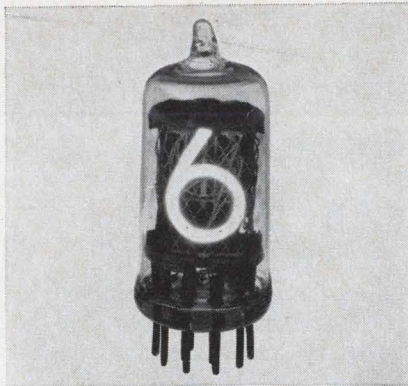

**Datavue\* Side-view Tubes.** Type 8754 with numerals close to the front, permits wide-angle viewing. These side-view, in-line visual readout tubes display single numerals 0 through 9, preselected symbols, + and - signs, and decimal points. Their 5/8" high characters are easily read from a distance of 30 feet. Less than \$5 each in 500 lots, they can be supplied with lacquer coating to eliminate the need for expensive filters. Datavue types are interchangeable with NL840, 841, 842, 843, and 848 tubes.

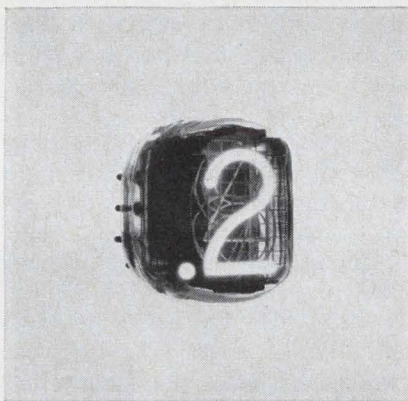

**Datavue\* End-View Tubes.** Raytheon makes round (CK8421) and rectangular (CK8422) Datavue indicator tubes on automated equipment capable of high production rates and top quality. The CK8422 rectangular tube is also available with decimal point, ± symbols, and in other special versions. Both round and rectangular types fit existing sockets and conform to EIA ratings. These ultra-long-life tubes are designed for 200,000 hours or more of dynamic operation.

VISIT RAYTHEON  
IEEE SHOW  
BOOTHS  
3F01-3F07  
3F02-3F08

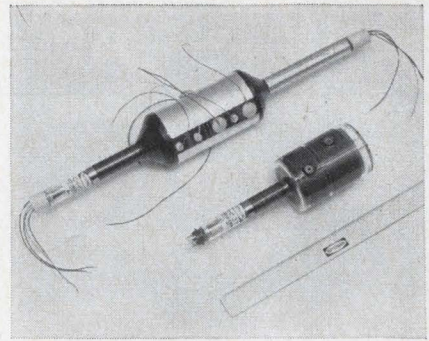

**Recording Storage Tubes.** The two new designs shown utilize miniaturized guns and necks to provide high deflection and focus sensitivity, resulting in savings in coil and power supply weight and size. They provide Kiloline resolution, long storage and fast erase capability. The single-gun version is Type CK1537 and the dual-gun version is Type CK1535.

Raytheon's complete line of electrical-output storage tubes feature high resolution and non-destructive reading. Information can be written and stored by sequential techniques or by random-access writing. Complete, gradual or selective erasure is possible.

Raytheon storage tubes are readily available for applications in radar scan conversion, slow-down video, signal processing, signal enhancement, time delay, and stop motion.



**Send Reader Service Card** for literature on the:

Symbolray CRT	491
Projectoray CRTs	492
Datavue Indicator Tubes	493
Recording Storage Tubes	494
Dataray CRTs	495

Or call your Raytheon regional sales office. Or write to *Raytheon Company, Components Division, Quincy, Mass. 02169.*

\*Trademark of Raytheon Company



**Industrial Components Operation—A single source for Circuit Modules/Control Knobs/Display Devices/Filters/Hybrid Thick-Film Circuits/Industrial Tubes/Optoelectronic Devices/Panel Hardware**



# MULTI-CAP<sup>®</sup>

## CERAMIC CAPACITORS

### SAVE SPACE AND MONEY

# ALSIMAG<sup>®</sup>



## 8 STOCK SIZES

Experience shows that these 8 sizes from .085 x .055 to .380 x .157 cover most requirements for high capacitance-to-volume ratio units. Readily solderable silver terminations are standard. Other metals are available. Stocked in both Low Loss High Stability NPO and in K-1300 Temperature Stable materials. Other materials available with K to 8000 and TC from P120 to N5600 ppm/°C. American Lava offers the widest range of materials in the industry.

### CUSTOM DESIGNS

Prototypes for your evaluation can be made in a wide range of ceramic materials, sizes and capabilities. Outline your needs and let us suggest solutions.

Bulletin 682 gives charts, graphs, data on standard and special sizes. Sent on request.

American Lava Corporation **3M**  
A SUBSIDIARY OF COMPANY

Chattanooga, Tennessee 37405  
Sixty-Sixth Year of Ceramic Leadership

## New Books

### Data, data everywhere

Snurdley Is a Bad Guy  
Douglas L. Richardson  
Vantage Press Inc.  
185 pp., \$3.75

"Snurdley Is a Bad Guy" adds to the problem it's supposed to help solve. Its author, Douglas L. Richardson complains of the flood of data engulfing our society, but offers only a soggy sponge as a dam.

He blames the "information explosion" on a group of characters he creates—the Snurdleys. These he describes as engineers, scientists, data processors, company librarians, aerospace executives, and other technologists who generate records like misers hoard money. In addition, he complains many persons waste time rediscovering things that have long been discovered. The result is a ballooning catalog of facts most of which can't be found by those seeking them.

Richardson quotes Vice President Humphrey, then chairman of a subcommittee of the Senate Science Advisory Committee:

"The annals of science include many cases of lost data—significant papers which did not come to the attention of investigators for years or decades after publication. The result of such cases in the past has been unnecessary duplication of effort, the waste of investigators' time and funds, and delays in the progress of research. Even abstracts have become so thick that there are in some fields needs for abstracts of the abstracts."

But as Richardson points out, the problem is how to keep tabs on the data and make it readily available.

Unfortunately, he is long-winded and he often side-tracks his readers by this obsession with his Snurdley character. He has tried to personalize the problem but all he has done is make the reader work harder.

His wet sop of a remedy is to cite the computer as a possible unsnarler of red tape—but who hasn't? Richardson proposes little else that is novel.

The problem of buried informa-

tion remains. Richardson's book has only added its smidgen of unnecessary information.

J.B. Steuer  
Electronics Consultant

### Processed data

Annual Review of Information Science and Technology, Volume 2  
Edited By Carlos A. Caudra  
Interscience Publishers,  
John Wiley & Sons,  
484 pp., \$15.

Carlos Caudra has again contributed handsomely to information science. This second annual review contains the work of 14 professionals. They survey the latest in the gathering, storing, and retrieving of information and in systems analysis.

New microfilm and computer hardware, including image storage and retrieval, image transmission, and digital storage are evaluated.

But this is not a book for specialists only. Anybody who can use a digital computer or microfilm for the storage and retrieval of information will appreciate it. Mr. Caudra offers articles addressed to those in linguistics, medicine, chemistry, and publishing, as well as electronics and data-processing.

The book is particularly outstanding in articles on information needs and uses, and on the design and evaluation of information systems and services. Recent hardware and products are described. National issues that concern the science are also discussed.

Finally, the bibliographies are a thorough guide to additional, detailed information sources for each subject covered.

Stephen Strell  
Computer Consultant

### On the circuit

Electronic Circuit Analysis  
Vol. 2, Active Networks  
Phillip Cutler  
McGraw-Hill Book Co.,  
628 pp., \$10

Cutler has done a good job in presenting a picture of modern circuit-analysis techniques, that is useful to beginners and professionals



Say "good bye" to hand loading of charts

(also to high prices)

# 3 new X-Y recorders

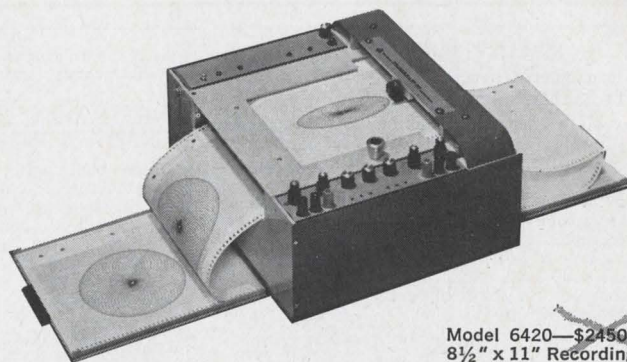

~~Model 6420—\$2450~~  
8 1/2" x 11" Recording  
Surface

**NOW \$1950.**

All the advantages of conventional X-Y's yet based on a radically new but proven recording principle

**Chart Paper** Z-fold. Perforated for ease in tearing out to notebook size. Automatic chart advance eliminates the need to manually load and unload each chart.

**Recording Mechanism** Two independent servo drives for X and Y. Automatic index or reversal of chart on command—local or remote.

**Slewing Speed** 15 in/sec., of course.

**English/Metric Scale** Front panel control quickly selects either scale.

**Input Impedance** 1 megohm all ranges—fixed or variable.

**Accuracy**  $\pm .2\%$  of full scale.

**Repeatability**  $\pm .1\%$  of full scale.

**Standardization** Dual regulated temperature compensated zener reference.

**Pen Control** Local or remote.

**Voltage Ranges** 18 calibrated ranges for each axis, continuously variable in between.

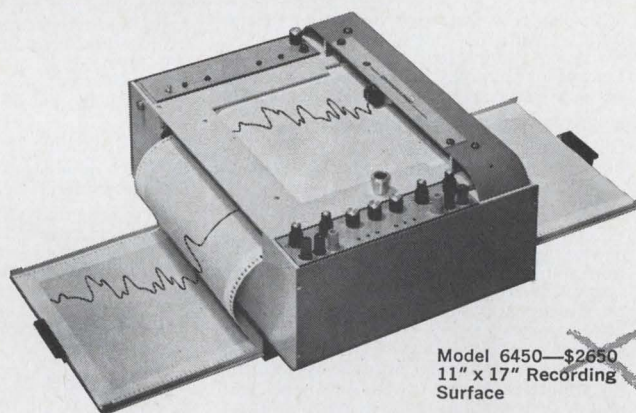

~~Model 6450—\$2650~~  
11" x 17" Recording  
Surface

**NOW \$1950.**

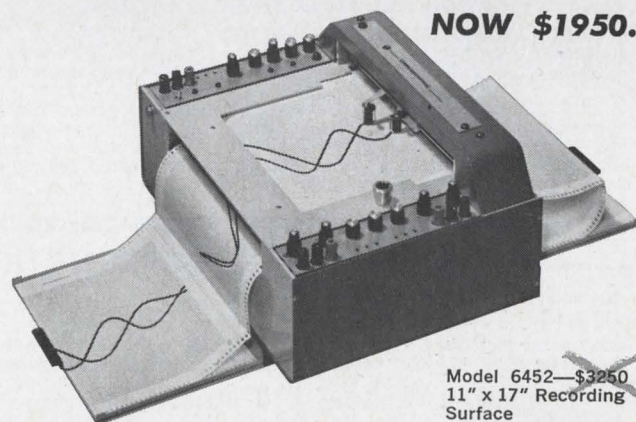

~~Model 6452—\$3250~~  
11" x 17" Recording  
Surface  
X-Y-Y' (2 pen)

**NOW \$2720.**

**houston  
instrument**

DIVISION OF BAUSCH & LOMB

4950 TERMINAL AVENUE, BELLAIRE, TEXAS 77401

(713) 667 7403 CABLE HOINCO



# Technical books of timely importance from McGraw-Hill

**1 SOLID-STATE ELECTRONICS: A Basic Course for Engineers and Technicians.**  
By ROBERT G. HIBBERD. New.

Here is another valuable addition to the popular Texas Instruments Electronics Series. Especially designed for anyone interested in solid-state electronics, but with little or no electronics background—from non-electronic engineers and technicians to non-technical management personnel. The volume gives you a broad, basic understanding of solid-state electronics from the fundamentals of semi-conductors through integrated circuits. **192 pp., \$8.95**

**2 LASER TECHNOLOGY AND APPLICATIONS.**  
Edited by SAMUEL L. MARSHALL. New.

Here is an authoritative, up-to-date guide to the design and construction of lasers—prepared by a distinguished group of contributors, many of them pioneers in the laser field. Covering all current technology, this book offers a practical, engineering approach that emphasizes the “how” as well as the “why” of lasers. The subject matter is divided into specialized areas, each treated by an outstanding expert in his particular field. **330 pp., \$14.00**

**3 HANDBOOK OF PHYSICS, 2nd Edition.**  
By E. U. CONDON and HUGH ODISHAW. New.

This monumental handbook covering all branches of classical and modern physics, has been completely updated to reflect recent advances. It provides authoritative information on all aspects of the subject—with particular emphasis on basic concepts and mathematical methods. Features new material on nuclear physics, relativity theory, plasma physics, superconductivity, magnetic resonance, etc. **1500 pp., \$32.50**

**4 DISPLAY SYSTEMS ENGINEERING.**  
Edited by H. R. LUXENBERG and RUDOLPH L. KUEHN. New.

Here, for the first time under one cover, are all the essential aspects—derived from different classical disciplines—of one of the newest and most exciting developments in information science—the modern display system. Here, too, are concepts unique to machine/man visual information transfer, introduced at a systems level. The treatment features a large number of illustrations and diagrams, a mathematical level suitable for the generalist as well as the specialist, and unique presentations in the fields of photometry, colorimetry and optics. **444 pp., \$16.50**

**5 DESIGN AND APPLICATION OF TRANSISTOR SWITCHING CIRCUITS.**  
By LOUIS A. DELHOLM. New.

This book offers you a straightforward approach to the design of transistor switching circuits, and no extensive prior knowledge of transistor operation is required. The book covers recent advances, and it is the

only one available that discusses such a variety of transistor switching circuits in detail. **220 pp., \$14.50**

**6 MATHEMATICAL QUICKIES.**  
By CHARLES W. TRIGG.

These challenging problems will engross the mathematics enthusiast of any age or level of sophistication. The problems vary widely, each illustrating a different mathematical principle for its solution. Each invites the reader to devise a solution more elegant than that provided in the quick, complete set of solutions in the book. **232 pp., \$7.95**

**7 ELECTRICAL CHARACTERISTICS OF TRANSISTORS.**

By R. L. PRITCHARD.

This book was written to fill the gap between books on semi-conductor physics on the one hand, and those on transistor circuit applications on the other. It covers the fundamental properties of the transistor, and includes direct-current characteristics . . . low- and high-frequency alternating-current characteristics . . . of gain, distortion and noise . . . and temperature variations. **715 pp., \$19.50**

**8 THERMOELECTRIC AND THERMOMAGNETIC EFFECTS AND APPLICATIONS.**

By T. C. HARMAN and J. M. HONIG.

This is a thorough explanation of the fundamentals of thermoelectric and thermomagnetic effects in metals, semimetals, and semiconductors subjected to electric, magnetic, and temperature fields. The phenomenological descriptions are presented within the framework of irreversible dynamics, while the atomistic parameters are evaluated with the aid of transport theory. **384 pp., \$17.50**

**9 SPACE-CHARGE FLOW.**

By PETER T. KIRSTEIN, GORDON S. KINO and WILLIAM WATERS. New.

Here is a complete, systematic account of the theory and mathematical techniques to use in analyzing space-charge flow problems. It shows you how these techniques can be applied to the design and analysis of electron and ion guns and focusing systems, and includes examples of exact solutions to the flow equations. **650 pp., \$22.50**

**10 TECHNIQUES OF SYSTEM ENGINEERING.**

By STANLEY M. SHINNERS. New.

This is the most complete and up-to-date work available on system engineering today. Covering more topics than any other book of its kind, it is analytical in approach and emphasizes system theory and practical applications in a clear and unified manner. State-of-the-art techniques are illustrated with current and planned applications in the commercial and military fields. **498 pp., \$14.00**

At your bookstore or direct from publisher for  
**10 DAYS FREE EXAMINATION**

McGraw-Hill Book Co., Dept. 23-L-34  
330 West 42nd Street, New York, N. Y. 10036

Send me the book(s) circled below for 10 days on approval. In 10 days I will remit for book(s) I keep, plus a few cents for delivery costs, and return others postpaid. Include local sales tax if applicable.

1 28650-0    2 40566-2    3 12404-0    4 39143-3    5 16253-7  
6 65192-7    7 50870-5    8 26589-2    9 34867-2    10 56875-8

Name (print) \_\_\_\_\_

Address \_\_\_\_\_

City \_\_\_\_\_

State \_\_\_\_\_

Zip Code \_\_\_\_\_

For prices and terms outside U.S. write McGraw-Hill Int'l NYC

23-L-34

## New Books

alike. By using controlled source models, but confining analysis to steady-state impedance methods, the author covers the gain and bandwidth properties of linear vacuum-tube and transistor circuits, plus feedback theory, including signal flowgraph analysis and stability investigations with Nyquist plots. He also discusses oscillators and nonlinear circuitry, including diode networks in power supplies and control rectifiers.

The text is clear and complete. Many problems are worked out in algebraic detail with particular attention given to units of measurement.

This book is a big step forward in advanced circuit training. One irritation, though, is the mixed usage of plus and minus signs and “voltage rise” arrows to represent voltages; arrows now usually refer only to current.

R.C. Levine

Electronics Consultant

## Turn on, tune in

An Introduction to Masers and Lasers  
T.P. Melia  
Chapman & Hall, Ltd (U.K.)  
Barnes & Noble (U.S.A. distributors)  
162 pp., \$5.50

The invention of the maser and laser got a lot of attention and publicity but masers and lasers have not been commercial successes. This despite substantial interest of scientists and an abundance of R&D work. As Melia points out, the obstacle has been economics, not basic technology.

Perhaps the technology needs a fresh start. Few engineers really know what masers and lasers are, how they work, how they may be harnessed, or what makes them cost so much. Much of the promulgation about the devices has been esoteric.

Melia's Introduction bridges the gap. Aside from giving fundamentals and a comprehensive study, the text is addressed to college seniors, recent graduates and general engineers.

The author explains how electromagnetic radiation can stimulate a substance in a particular energy



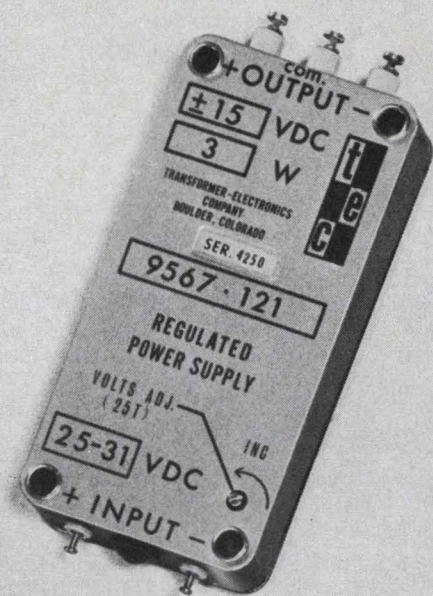
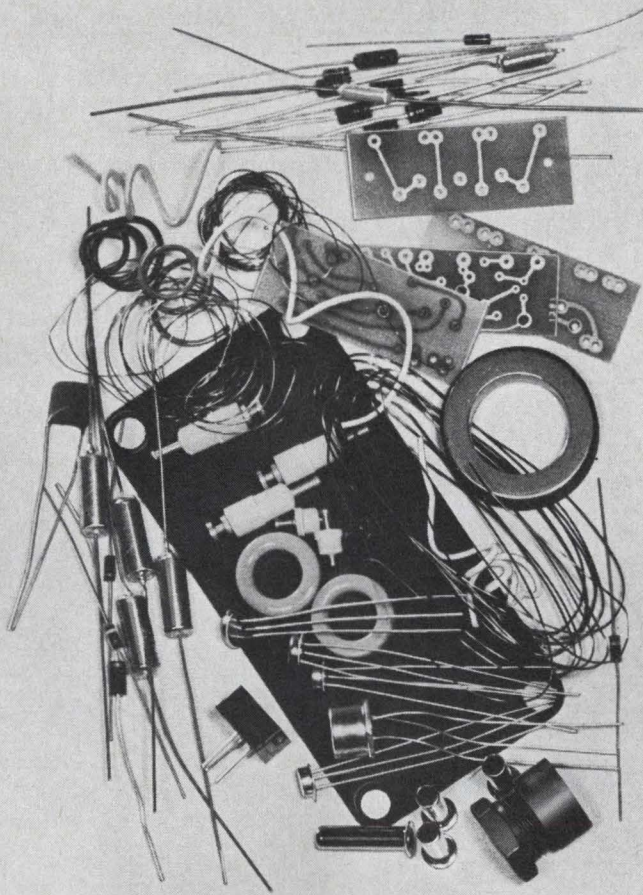

# Make or Buy?

If you're asking yourself this question about DC to DC power supplies . . . check with Transformer Electronics Company *before* you decide.

There are many more components to figure into the cost of making your own power supplies than just the ones in the picture. At least 90% of the cost of making your own power supplies comes from intangible components. Design and engineering, testing, compiling reliability data, and setting up and maintaining purchasing, inventory and quality control systems . . . all add up to time and money!

Transformer Electronics Company has already solved all these problems—as well as the technical ones—

*for you.* That's why Transformer Electronics Company can offer you consistently reliable power supplies. They're immediately available. They are priced substantially lower than it would cost to make your own.

Transformer Electronics Company understands that your power supply requirements may be unique, too. That's probably why you've considered making your own. Transformer Electronics Company is confident that its years of experience in producing dependable power supplies for customers with a variety of needs can be helpful in solving your particular power supply problem.

Make or buy? Call or write Transformer Electronics Company first!



TRANSFORMER ELECTRONICS COMPANY • BOULDER INDUSTRIAL PARK • BOULDER, COLORADO 80302 • (303) 442-3837



## YOUR SINGLE SOURCE FOR OSCILLATORS

- Tuning fork
- Crystal
- RC-IC
- Many case styles
- Standard/custom

Want to talk applications? Phone us . . . or mail this coupon and we'll call you!

**FORK STANDARDS, INC.**  
221 Main Street • West Chicago, Illinois 60185  
Phone (312) 231-3511

NAME \_\_\_\_\_  
COMPANY \_\_\_\_\_  
ADDRESS \_\_\_\_\_  
PHONE NO. \_\_\_\_\_  
APPLICATION \_\_\_\_\_

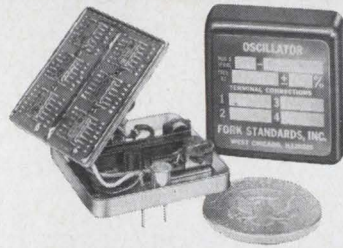

MODEL FO: Tuning fork; .1 Hz to 15 kHz; to .01 accuracy; 1½" sq. x ¾"—½" H.  
MODEL U: Crystal; 50 Hz to 10 MHz; to .001% accuracy; 1½" sq. x ½"—¾" H.  
SUPPLY: 3-12 VDC.

Circle 117 on reader service card

How'd you like to  
drill carbon plates  
6 times faster?  
Pinpoint accuracy—  
even for unskilled  
operators with the  
new multi-spindle

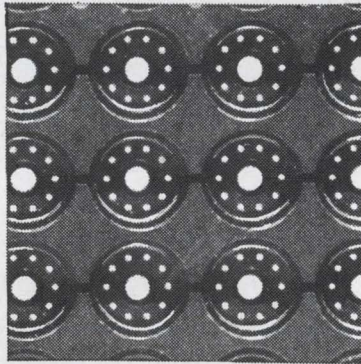

# Engravograph<sup>®</sup>

Speed transistor mounting! Now anyone can drill six carbon plates in one operation from one template with registration and depth of hole controlled to a plus-or-minus .001" tolerance.

Drill up to 1600 holes per minute. Save time, labor . . . and especially costs.

For details write: Dept. 175.

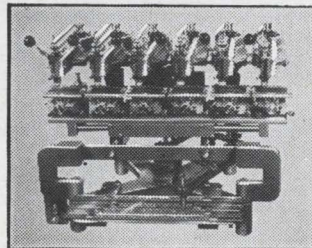

*new hermes engraving machine corp.*   
20 Cooper Sq., N.Y., N.Y. 10003 • Chicago, Atlanta, Los Angeles, Dallas, Montreal, Toronto, Mexico City

"SEE US AT BOOTH 1H11 AT THE COLISEUM SHOW"

## New Books

state into emitting radiation and how it can amplify the incident beam. He details atomic and molecular energy states and gives criteria for selecting a state. The next passage, electromagnetic radiation theory, helps the reader understand maser (microwave or molecular amplification by stimulated emission of radiation) and laser (light amplification by stimulated emission of radiation) action.

Melia examines major device types, including separation, inversion, and three-layer masers, and optical resonating lasers and laser systems. He also discusses solid state, gas, Raman, semiconductor, chemical, and chelate lasers, and looks at applications in such fields as industry, communications, computers, the military, medicine, meteorology, harmonic generation, spectroscopy, photography, and astronomy.

The author touches on health hazards associated with lasers, and safety measures. In his conclusion, Melia puts the most important questions—"Can the laser or maser perform a given task more economically than other equipment? Can it perform tasks no previous technique could, and, if so, does the result justify the cost?"

The reader gets an excellent, practical grounding. An appendix lists available commercial systems.

### Recently published

**Transform Circuit Analysis for Engineering and Technology**, William D. Stanley, Prentice-Hall Inc., 314 pp., \$11.50

For engineers and technicians, this guide to the current transform methods is presented in a clearly illustrated step-by-step sequence. Covers fundamentals of transient theory and systems analysis with a minimum of advanced mathematics.

**Modern Electromagnetic Fields**, P. Silvester, Prentice-Hall Inc., 332 pp., \$12

Detailed description of the major physical concepts of electromagnetic field theory furnishes a thorough engineering background for specialized studies in microwave devices, electric machines, and other areas of electromagnetic engineering.

**Correlation Techniques**, F.H. Lange, D. Van Nostrand Co., 464 pp., \$13.50

Comprehensive survey of theoretical foundations and practical applications of correlation analysis. Emphasizes engineering methods not mathematics. Directed towards engineers in data processing, communications, instrumentation, acoustics, optics, control systems, and radio astronomy.



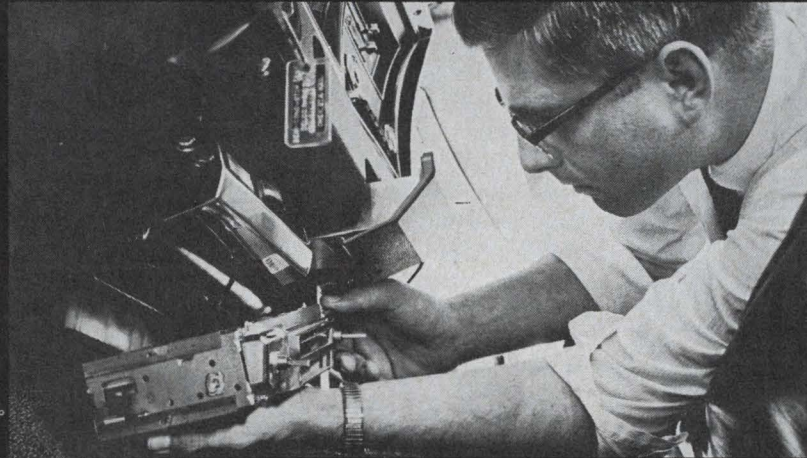
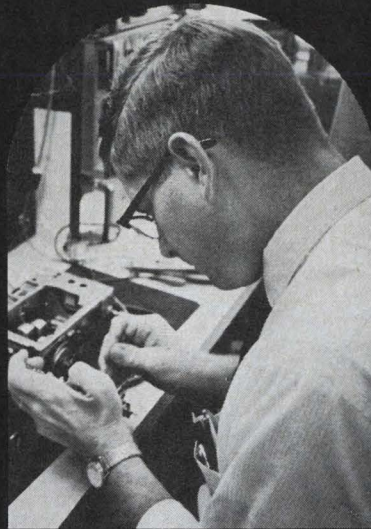
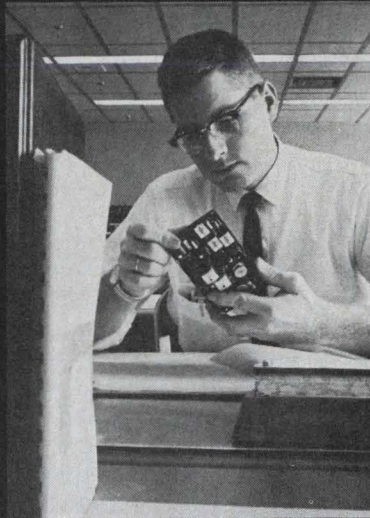

## Mondays never look the same to Bob Byse

When you're breaking ground on a new idea at Delco, you don't see a lot of your own desk. For Bob Byse, design engineering means work with two dozen solid professionals . . . people whose specialties range from microelectronics to model making to production. Wherever the project leads, Bob Byse is on his way. And every skill is at his disposal. Right through full production. And beyond. If there's trouble shooting under dealer warranty three years from now, Bob Byse is still the man we'll call for. That's why no two Mondays ever look alike to Bob Byse and his colleagues at Delco.

The question is . . . can you say the same? Take a good hard look at how your responsibility shapes up, compared with Bob's. In fact, why not discuss it with us. By letter or telephone. Collect. Area Code 317/459-2808.

Contact: Mr. C. D. Longshore, Supervisor, Salaried Employment,  
Dept. 304, Delco Radio Division of General Motors, Kokomo, Indiana.

**DELCO  
RADIO**



AN EQUAL OPPORTUNITY EMPLOYER  
DIVISION OF GENERAL MOTORS  
KOKOMO, INDIANA



# MATSUO

Highly Reliable Capacitors

## POLYESTER FILM CAPACITORS.

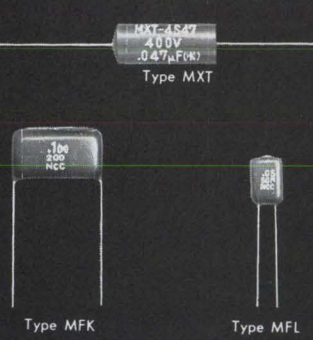

**Type MXT**  
In plastic tube.  
Capacitance Range: .001 MFD to .22 MFD.  
Voltages: 100v, 200v, 400v, 600v DC.

**Type MFK**  
Dipped flat shape, non-inductive construction.  
Capacitance Range: .01 MFD to .47 MFD.  
Voltages: 100v, 200v, 400v, 600v DC.

**Type MFL**  
Dipped flat shape.  
Capacitance Range: .001 MFD to .22 MFD.  
Voltages: 50v, 100v, 200v DC.

## METALLIZED POLYESTER FILM CAPACITORS.



**Type FNX-H**  
Mylar wrapped semiroll with epoxy end seal.  
Capacitance Range: 1 MFD to 10 MFD  
Voltages: 100v, 200v, 400v, 600v DC.

## SOLID TANTALUM CAPACITORS.

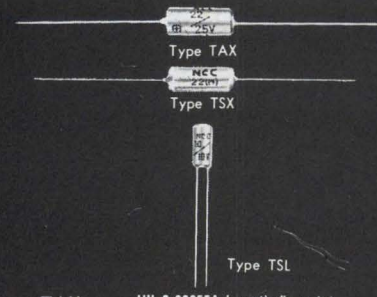

**Type TAX**  
MIL-C-26655A hermetically sealed.

**Type TSX · TSL**  
Sealed with epoxy resin.  
Capacitance Range: .22 MFD to 330 MFD.  
Voltages: 3v, 6v, 10v, 15v, 20v, 25v, 35v, 50v DC.

for full details, contact :

**MATSUO  
ELECTRIC CO., LTD.**

3-chome, Sennari-cho, Toyonaka-shi, Osaka, Japan  
Cable Address "NCC MATSUO" OSAKA

## Technical Abstracts

### Margin for error

Improving measurement accuracy for higher systems reliability  
William A. Wildhack  
National Bureau of Standards  
Washington

Equipment-reliability equations are themselves only as reliable as the values cranked into them. And these values are derived from more or less uncertain measurements.

"Measurement or calibration error" is a phrase sometimes offered as a probable cause of electronic mishap. Names are rarely made public but there are rumors: the range safety officer who destroyed a test missile when it was the calibration of his tracking instruments that was at fault, not the missile; or the second generation computer that failed because tolerances of measurement uncertainty were widened too much.

So, a reliability engineer has to be concerned with the entire measurements system.

That system meshes people, organizations, activities, and knowledge. Some informal sectors can be defined.

The logic sector comprises physics, mathematics, statistics, and international agreements on units and standards. The hardware sector includes instrument manufacturers, calibration laboratories, and users of measuring equipment. Voluntary scientific, technical, and industrial organizations make up the society sector.

The legal sector includes regulatory agencies, and the state and local groups who enforce measurement tolerances. In the United States, the legal sector is not as dominant as in other countries. The National Bureau of Standards is empowered by Congress to maintain and improve standards, but has no enforcement powers. Its role is mainly one of technical support and cooperations.

But the success of the national and international measurement system depends on the competence and integrity of the people.

There is an economics factor in the measurement system, too. In this country alone, the replacement value of all measuring instruments

and equipment is estimated at \$50 billion. The hardware is growing at the rate of \$5 billion a year.

The core of the logic sector is the International System of Units comprised of six fundamental quantities: the meter, the kilogram, the second (actually defined by its inverse, frequency), the ampere, the degree Kelvin, and the candela. Comparison between "national" standards in technologically advanced countries reveals uncertainties from one to the other. The kilogram has an uncertainty of 1 part in  $10^8$ ; the meter, 1 part in  $10^7$ ; the second, 5 parts in  $10^{12}$ ; the ampere, 5 parts in  $10^6$ ; and temperature,  $0.0001^\circ\text{K}$ .

These uncertainties are not small to reliability engineers who seek system components with a reliability expressed by five or six nines; that is, an R of 0.99999 or 0.999999. Furthermore, this high accuracy exists only in national laboratories. When these standards go through three to five echelons of calibrations the inherent performance of successive standards becomes progressively lower and environmental disturbances progressively greater.

Presented at the Symposium on Reliability, Boston, Jan. 16-18

### Search for savings

Air Force approach to life-cycle costing  
George S. Peratino  
Headquarters, USAF  
Washington

In a report on the Armed Services Procurement Act of 1947, a Senate committee used the phrase "lower ultimate cost" in contrast to lower immediate cost. It requested the Defense Department to consider lower ultimate cost in awarding contracts. But only with a memorandum of July 10, 1965 has the Pentagon acted. Studies begun under the prodding of that memo have come up with the concept of life-cycle costing—or the real price of owning a piece of hardware.

The department and each military service set up groups to investigate the concept. Ten task groups of the Air Force looked into such factors as reliability and



# NEW from NEY

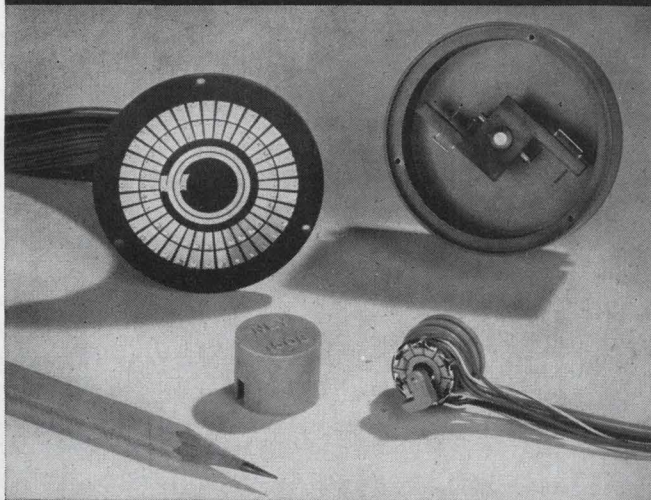

## STANDARD OFF-THE-SHELF ROTARY SWITCH ASSEMBLIES

The two rotary switch assemblies shown above are standard off-the-shelf items. The larger (#1510), a 36-position, 2-pole switch, is capable of 10 million revolutions with a noise level of only 1 millivolt. Rotating at 300 rpm, this assembly is capable of switching 0.5 amperes at 30 volts DC, non-inductive.

The smaller switch (#1508) is a 12-position, single-pole switch and is designed for the low-price commercial application. The performance of a #1510 switch can be obtained with the #1508 with some modification and at extra cost. Modifications can be made in either switch to suit particular requirements; or each, with slight changes, modified into slip ring assemblies.

Both of these switch assemblies offer the long proven, ideal combination of Neyoro® G Neyetch commutator rings (solid precious metal alloy bonded to a rigid insulator) and Paliney® 7 brushes. The Neyoro G Neyetch commutator means added product reliability and greatly reduces costly maintenance. It also eliminates such common plating defects as porosity, flaking, peeling, pits and inclusions. If your requirements include low level switches, standard or special, large or small, Ney's capabilities can help you. Detailed information available on request.

48-PAGE ELECTRICAL CONTACT CATALOG ON REQUEST

THE J.M. NEY COMPANY **NEY**  
Maplewood Ave., Bloomfield, Conn.

# MODERNIZE the Easy Way With HIGH POWER ADD-ON AMPLIFIERS

- 40 to 18,000 Mhz • 100 Watts to 2.5 KW
- CW or PULSE OPERATION

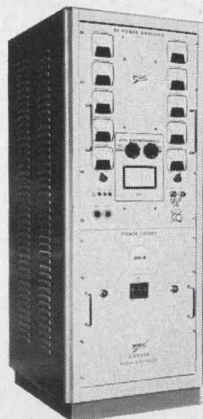

An exclusive MCL advancement in self-contained, rack-mounted amplifier systems which affords quick and economical conversion of older installations to modern and efficient high power operation. Contributes to work area efficiency by eliminating clutter of multi-unit, multi-cable lashups otherwise required for comparable power and frequency ranges. Complete with power supply, cooling source, sequential circuitry, protective interlock and fusing. Built to standard 19" rack mounting dimensions for use as complete subsystem to your specifications.

## CW TETRODE AMPLIFIER SYSTEMS

Model	Freq. Range MHz	Power Output	Gain db.	Bandwidth at 3 db.
10038	200-260	125 watts	13	5 MHz
10039	220-400	125 watts	13	5 MHz
10270-11043	40-200	1.0 KW	13	1 MHz
10270-11044	200-400	1.0 KW	13	5 MHz
10270-11045	400-800	1.0 KW	13	6 MHz
10270-11046	800-1000	1.0 KW	12	4 MHz
11017	400-450	2.5 KW	13	6 MHz

## KLYSTRON AMPLIFIER SYSTEMS

High Gain, High Efficiency  
Or Broad Band Tuning Modes

Model	Tube Type	Freq. MHz	Power Output	Max. Gain Tuned Gain db.	BW MHz	Max. B.W. Tuned Gain db.	BW MHz
10282	4K3SJ	1700-2400	1.0 KW	47-45	4-6	—	—
10283	4K3SL	1700-2400	1.0 KW	41-38	9-12	38.3	13-14
10284	4K3SK	2400-2700	1.0 KW	43-42	10-15	—	—
10285	4K3SN	2850-3050	1.0 KW	45	7	—	—
10276	VA888	4400-5000	1.0 KW	51	6-8	41	13-19
10233	VA834B	4400-5000	1.0 KW	51	5.5-7.5	41	11-17
10277	VA834D	5500-5850	1.0 KW	51	5.5-7.5	41	11-17
10278	VA861	5900-6400	1.0 KW	58	7-8	48	11
10286	VA866	7100-8500	1.0 KW	59	12	50	20
10287	VA930	15000-18000	0.5 KW	50	12	40	20

Additional standard models available at other power levels and frequencies.

Write for complete MCL Catalog describing triode and tetrode cavities, accessories, test equipment, subsystems and custom capabilities.

See MCL "MICROWAVE MARKETPLACE" Spread,  
1968 Electronics Buyers' Guide

## MICROWAVE CAVITY LABORATORIES, Inc.

10 North Beach Avenue  
La Grange, Illinois 60525  
Phone: (312) 354-4350  
Western Union Telex 25-3608





# VACTEC

## PHOTOCELLS

Would you believe 48,000 per hour?

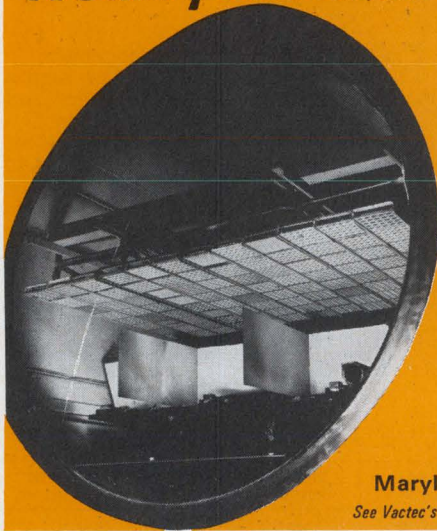

That's the capacity of this 4-ft. dia. high vacuum system. (And Vactec has two of them!) Just one example of the modern equipment in Vactec's new plant.

Facilities like this, plus engineering know-how and production skill have made Vactec one of America's largest photocell specialists. An ideal supplier if your applications demand prompt delivery of large quantities of photocells at competitive prices.

Standard Cd, CdSe, and Se types. Custom engineering to meet special needs. Catalogs and facilities brochure available on request.

VACTEC, INC.



2423 Northline Ind. Blvd.  
Maryland Hts., Mo. 63042 AC 314, 432-4200

See Vactec's listing in EBG under "Semi-Conductors" and in EEM Sec. 3700.

Circle 119 on reader service card

"See us at the IEEE Show, Booths # 1C09-1C11"

FASTENERS FROM



DIE CAST ZINC ALLOY



Wing Nuts



Cap Nuts



Thumb Nuts



Thumb & Wing Screws



Screws



Hex Nuts



Washers



Screw Insulators

Big help for your tiny assemblies!

MINIATURE molded NYLON SCREWS

Now as small as #00

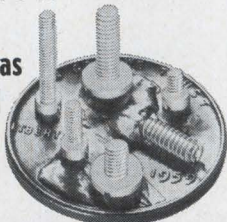

GRC Small & miniature screws simplify designs—at lower cost.

- Sizes #00, #0, #1, #2, #3 and #4.
- Many head types, lengths. Set screws, too.
- Flash-free, precise and uniform.
- Corrosion-resistant, vibration proof, electrical insulating with high strength to weight.

Ask for sample kit prices . . . data about other GRC Plastic Fasteners—screws, nuts, washers, etc.



GRIES REPRODUCER CO.

Division of Coats & Clark Inc.  
151 Beechwood Avenue  
New Rochelle, N.Y. 10802  
(914) 633-8600

World's Foremost Producers of Small Die Castings and Plastic Moldings

Ultra-small Lamps!  
Long life and reliability.

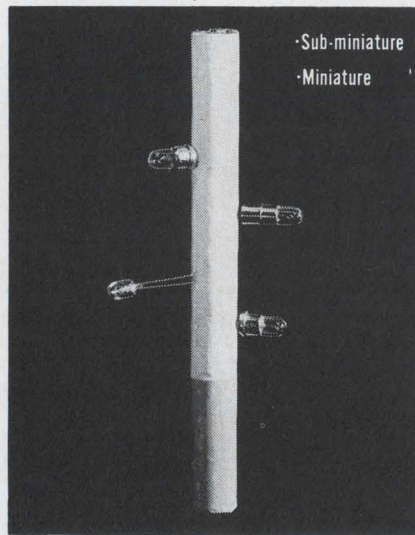

OKAYA ELECTRIC INDUSTRIES CO., LTD.

Yasuda Bldg., 8-3, 1-chome, Shibuya  
Shibuya-ku, Tokyo, Japan

Circle 282 on reader service card

## Technical Abstracts

maintainability prediction, maintenance cost, verification and demonstration of reasonableness of analytical methods and procedures, supply management, training, operating cost, service life, equipment selection, and contractual provisions.

Conclusions have been reached, even though the final report has not been issued. One task force defined the life cycle cost as the sum of the acquisition costs, initial logistic costs, and recurring logistic costs. Another group calculated that the one-time cost of introducing new items and spare parts into inventory was \$171 for a new part and \$223 for a new assembly. Training cost, it was found, would not be a meaningful factor in purchasing decisions except for high-cost major assemblies and total systems.

Decision tables were developed to aid in selecting candidates for life cycle costing. Under consideration are reparable assemblies and systems, items already in inventory, purchases whose anticipated cost exceed \$100,000, items that have a lead time before contracting of over six months, parts and assemblies having anticipated inventory life of over five years, and purchases that can be estimated to have a cost differential exceeding \$10,000 between alternative contractors.

Presented at Symposium on Reliability, Boston, Jan. 16-18.

### Stress stretcher

New concepts in the optimal control of thermal power plants  
Dietrich Ernst  
Siemens A.G.  
Erlangen, Germany

Steam temperatures and pressures, and their rates of change, cause mechanical stress on the walls of turbines that drive generators. Only gradients within certain safe limits can be tolerated. A new wall-stress computer monitors and adjusts maximum allowable steam changes.

Two differential-temperature thermocouples measure gradients in the walls. The thermocouple signals enter an electronic analog





## It's never too early to start saving their hearts

Help your children form good health habits now to reduce risk of heart attack later:

- Encourage normal weight; obesity in youth may persist throughout life;
- Build body health through regular physical activity;
- Serve them foods low in saturated fats;
- Teach them that cigarette smoking is hazardous to health;
- Make medical check-ups a family routine.

Set a good example. Follow the rules yourself and guard *your* heart, too.

**GIVE...**  
so more will live  
**HEART FUND**

*Contributed by the Publisher*



**When Only Excellent is Adequate TURN to Grayhill**

## WHAT'S NEW ABOUT THIS SWITCH?

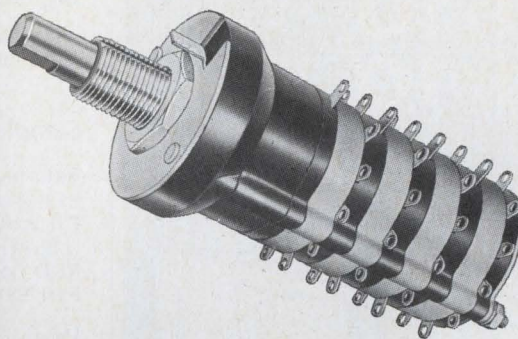

### It's NOT Because It

- 1) is explosion proof.
- 2) has up to 12 positions/deck.
- 3) could have up to 6 poles/deck.
- 4) comes in shorting or non-shorting versions.
- 5) is available in sealed, military or standard versions.

*NO...* These are Standard Grayhill Rotary Switch features.

### IT'S NEW BECAUSE

one or more positions may be ISOLATED from normal shaft turning techniques. It has its own built-in shaft turning SAFETY feature.

For details on this  
and other Switches  
Ask for Catalog G-304-A



523 Hillgrove Avenue  
LaGrange, Illinois 60525  
Area Code 312, Phone 354-1040

The Difference Between Excellent and Adequate



**-TR- 84M,  
Takeda's Sensitive  
Vibrating Reed  
Electrometer  
Is Capable  
Of Detecting**

**20  $\mu$ V  
1  $\times 10^{-17}$ A  
1  $\times 10^{-15}$ C**

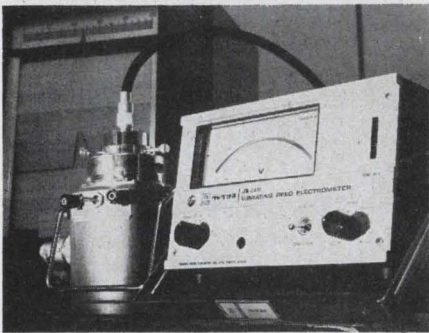

The **-TR-84M**, either directly or with abundantly available accessories, has an exceptionally wide range of application, as follows:

- Mass Spectrometry
- Measuring radiation, extra-high insulation resistance, specific resistivity, Hall electromotive force, photoconductive material resistivity and electrostatic charge
- Basic research in physics, chemistry, biology and medical science.

**SPECIFICATIONS:**

□ **MEASURING RANGE:**

Potential— $\pm 1\text{mV} \sim 30\text{V f.s.}$ , 10 ranges  
Current— $\pm 1 \times 10^{-15}\text{A} \sim 3 \times 10^{-5}\text{A f.s.}$

□ **INPUT IMPEDANCE:**

Potential ranges—more than  $1 \times 10^{15} \Omega$   
Current ranges—Variable with turret selection switch  $1 \times 10^{12}$ ,  $1 \times 10^{10}$ ,  $1 \times 10^8$  and  $1 \times 10^6 \Omega$

□ **STABILITY:**

Short period noise— $1 \times 10^{-15}\text{C}$   
Zero drift—less than  $300 \mu\text{V}$  per day

Visit us IEEE Show—Booth No.3A53

**Takeda Riken  
Industry Co., Ltd.**

285, Asahi-cho, Nerima-ku, Tokyo, Japan  
Cables: TRITRONICS TOKYO Phones: 930-4111

**Technical Abstracts**

computer where thermal compressive and tensile stresses are calculated first. Then, comparative stresses are determined and matched against permissible material strength. Finally, the computer yields stress margins within which speed and load can be safely raised and lowered. The computer is used for both startup and loading control.

Presented at ASME Winter Meeting, Pittsburgh, Nov. 12-17.

**Sampling procedures**

Rationale and use of military sampling handbooks  
Cyrus A. Martin  
U.S. Army Mobility Equipment R&D Center  
Fort Belvoir, Va.

Production lots of electronic items are accepted or rejected on the basis of samples. The mathematical relationships between sample size and over-all lot are described in seven Government handbooks, each of which approaches these relationships from a different angle. These publications are:

Mil Std 105-D: Sampling procedures and tables for inspection by attributes.

H-108: Sampling procedures and tables for life and reliability testing.

Mil Std 690A: Failure rate sampling and procedures.

Mil Std 781-B: Reliability tests; exponential distributions.

TR-7: Procedures for applying Mil Std 105-D plans to life and reliability testing.

Mil Std 1235: Single and multi-level continuous sampling procedures.

Mil Std 414: Sampling procedures and tables for inspection by variables.

The Mil Std 105 handbook—the best-known publication—contains plans that permit the inspector to accept a lot when the sample has less than a prescribed number of defective items, or reject it when the sample has more than a predetermined number of defects.

An attributes-time-to-failure test procedure is commonly desired, and this requires data on an item's failure rate. For such tests, TR-7 indi-

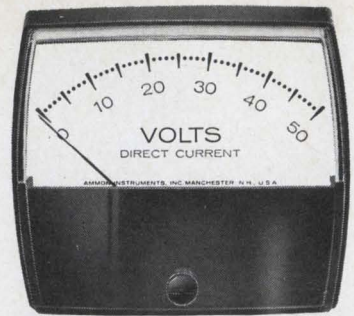

2 1/2 in. AP-2

**Snap-in Dial  
2% full scale accuracy,  
self-shielded panel meters**

New! Panel meters with plastic bezels give you tailor-made meters at no increase in price. Covers snap off . . . interchangeable dials snap in. High torque mechanism offers 1% linearity, 2% accuracy and sensitivity to 20 ua. Magnetic system is unaffected by external field influences, mounts on any material without interaction. Size: 2 1/2". Choice of colors and finishes. ASA/MIL 3 or 4-stud mount.

**AMMON**

AMMON INSTRUMENTS, INC.  
345 Kelley St., Manchester, N.H. 03105

Circle 114 on reader service card

**DIFFERENTIAL TRANSFORMERS**  
For measurement and remote control use

Capable of obtaining output voltages exactly proportional to any kind of mechanical variation.

Measuring value: 1/100,000~100mm  
More than 500 types are available.

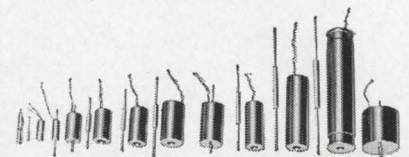

Features:

- \*Outstanding interchangeability
- \*Quite free from outer magnetic field
- \*Insensitive to ordinary shock, water and heat

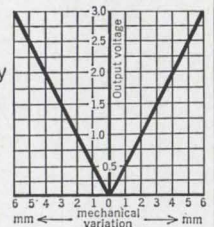

Manufacturers of Differential Transformers

**NIPPON COIL CO., LTD.**  
Amakawa Bldg. 1, 1-chome, Hommachi, Higashi-ku, Osaka, Japan.

Circle 510 on reader service card



for **\$195\***, get the highest accuracy (.05%) per dollar from this newest, smallest 5 range

**DIGI▲EC®** dvm



Test drive the newest **DIGI▲EC®** compact

Want to take a test drive? Circle the reply card number below or zoom in at IEEE, Booth 2J31, 33.

**ACCURACY** of .05% plus 1 digit is unparalleled by any instrument in its price field. High stability circuits provide the "confidence factor" so often lacking in DVM's.

**VERSATILITY** of measurement. This new compact cruises the broad spectrum of 5 decades from 100 MV to 1 KV DS full scale with a bonus of 50% overrange.

**RELIABILITY** is proven by over 20,000 instruments that have travelled in the field providing MTBF in excess of 24 months. Simplicity of design and dramatic reduction of components is made possible by the utilization of the latest semi-conductor art. This instrument is warranted for one year (or 24,000 miles).

**READABILITY** is enhanced by combining the non-ambiguous presentation of digital readout with the resolute qualities of analog display. Typically, instrument is readable to 20  $\mu$ V on 100 MV range.

**DIGI▲EC®** by **UNITED SYSTEMS CORPORATION**

Stocking representatives throughout the world

\*for quantity 10 to 49 for 1 to 9—\$225

918 Woodley Road, Dayton, Ohio 45403

Circle 120 on reader service card

**E-Z-HOOK®**  
Box 105 Covington  
Ky. 41012

Phone 606-261-1495

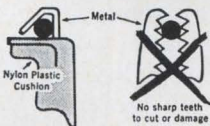

**The Gentle Connector**

Reduces rejects, repairs & salvage... protects Quality

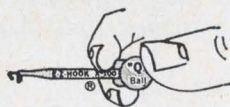

E-Z-Mini-Hook X-100

**Easy To Use**

Hold between the thumb and two fingers, (like a hypo-dermic needle). Press on "Q" Ball with Thumb until hook is exposed. Release pressure, to close.

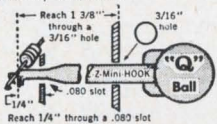

**Hard-To-Get-To Places**

Makes connections in places never before possible.

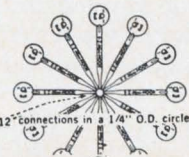

Not A Short In The Dozen

# E-Z-HOOK®

TEST AND PRODUCTION CONNECTORS  
• CLIPS • ADAPTERS • TEST LEADS • PROBES

Designed for Your Pleasure and Profit

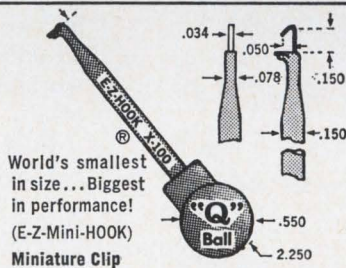

World's smallest in size... Biggest in performance!  
(E-Z-Mini-HOOK)  
Miniature Clip

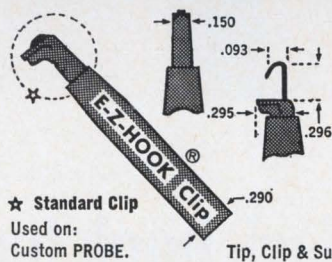

★ Standard Clip  
Used on:  
Custom PROBE. Tip, Clip & Sub.

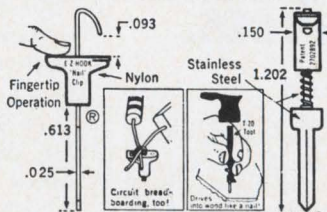

No holes to drill, or washers & nuts to place  
**Harness Cable Board Clip**

**Harness Cable Board Clips**

Use E-Z-HOOK "Nail" Clips to improve quality, to reduce rejects and scrap, to increase production and profits. Write for the Reprint which tells how one Company estimated saving over \$20,000, annually by switching to them.

Catalogue In V.S.M.F. -- ascam Satisfaction Guaranteed eem -- Radio Master

Order E-Z-HOOKS from your Parts Distributor or direct from Factory

SAVE TIME®  
**E-Z-HOOKs**  
SAVE TROUBLE

Pat. No. 2702892



Won't Short... Can't Pull Off  
Automatic short protection... spring keeps Nylon insulator over any unused clip metal... Provides constant protection against accidental shorts.



**Easy To Use.**

To connect: Place Nylon end on Test Point... Press on test point until hook extends over it... Slide hook over test point and release!



Chassis Edge Through Holes Component Leads

**Connects Anywhere**

A new freedom of action in connecting



**Durably Constructed**

Made of finest materials in an efficient hook design that provides good reliable performance.

Circle 285 on reader service card



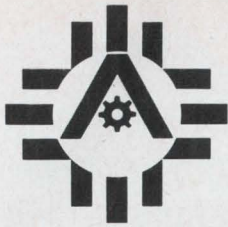

We're not the nation's best-kept secret any more!  
Albuquerque . . . Sunshine. No crowds. No smog.  
You can golf and ski on the same winter day.  
Two universities, outstanding recreation outdoors.  
Symphony, opera, much more, in unique New Mexico.  
**Contact: Albuquerque Industrial Development Service**  
400 B Elm N.E., Albuquerque, New Mexico 87103



Circle 286 on reader service card

## Technical Abstracts

cates which Mil Std 105-D sampling procedure to use.

H-108 contains a large number of reliability-test plans, and minimum-cost formulas that can be useful when inspection costs are known. Mil Std 781, also on reliability, gives more instructions to the user, including test levels, burn-in steps, and procedures for preventive maintenance during test.

Variables procedures, or plans, are more economical in sample size than attributes plans, and on this basis Mil Std 414 may appear to be more useful than Mil Std 105-D. But variables plans in Mil Std 414 may be more complicated to administer.

Continuous sampling plans, Mil Std 1235, permits the inspector to make a decision on the portion of the lot already tested.

Presented at Symposium on Reliability, Boston, Jan. 16-18.

### Millimeter avalanches

A microwave oscillator using series-connected Impatt diodes  
F.M. Magalhaes and W.O. Schlosseur  
Bell Telephone Laboratories, Inc.  
Murray Hill, N.J.

For the first time, Impatt (for impact avalanche and transit time) diodes have been connected in series to provide power output that is the sum of the individual diode outputs. Although power is theoretically the same in both series or parallel connections, the series structure has the advantage of working at a higher impedance level.

In an experimental setup, three packaged 4.5-gigahertz diodes with a total output of 750 millivolts were placed in a coaxial cavity and biased in series. The cavity was tuned with a triple-slug tuner. The power output was measured, and, when observed on a spectrum analyzer, had no parasitic responses.

To check the effect of the spacing, two diodes were connected in series and spaced up to-eighth wavelength. Half-wavelength separations were also checked to make sure the diodes did not operate in opposition to each other.

Power output closely followed the sum of the outputs of the two

## Our little black book has over 100,000 phone numbers.

You never had a black book like it. Over 1,500 pages. And those phone numbers! More than 100,000 telling you who to call/where to go, for the over 4,000 different product categories listed and advertised in the yellow pages of the Electronics Buyers' Guide.

It's the industry's one-stop shopping center that lets you find the products and services you need quickly. You can depend on EBG.

### Electronics Buyers' Guide

A McGraw-Hill Market Directed Publication,  
330 West 42nd Street, New York, N.Y. 10036

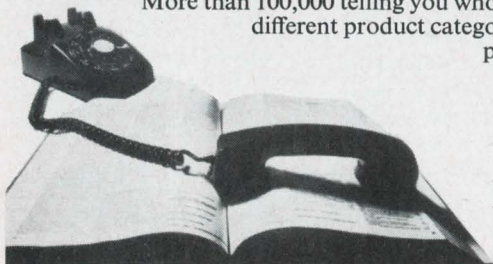





**These Japanese Exhibits make your trip to the I.E.E.E. worthwhile!**

Electronic Products & Components:	
Fujitsu Ltd.	4L02-4L03
Hayakawa Electric	4F20
Komatsu Electronic Metals Co., Inc.	4D18
Kyoto Ceramic Co. Ltd.	4J10
Matsushita Electric Corp. of America	4C12-4C18
Mitsubishi Electric	4C29
Murata Mfg. Co. Ltd.	3B33
NGK Spark Plug	4J11
Nikon, Inc.	2J24-2J28
Nippon Electric Co. Ltd.	3A30
Nitsuko Ltd.	4E19
Shibaden Corp. of America	3A44-3A45
Sony Corp. of America	3A56-3A58
Susumu Industrial Co., Ltd.	4J23
Takeda Riken	3A53
Toshiba America, Inc.	3A05-3A06
TSK Int'l. Div. of Tokyo	
Seimitsu Kogyo Co., Ltd.	1A20
Yaskawa Electric Mfg. Co., Ltd.	4D07
Yokogawa Electric Works Inc.	2F44
Trade Press:	
Dempa Publications	1D39

\* Serving America's leading companies with data on prime suppliers of Japanese electronic products and components, for the last decade.

**ELECTRONIC INDUSTRIES ASSOCIATION OF JAPAN**

Write for your free copy of the new 36 page guide, *Electronics in Japan '67-'68* and the comprehensive *Index of Manufacturers*.

Electronics Division  
Japan Light Machinery Information Center  
437 5th Ave., New York, N.Y. 10016 • (212) MU 6-0731

**the last time you used a 'scope, did you really need more performance than these Heathkit® models provide?**



**Heathkit IO-17**  
... new 5 MHz  
3" 'scope ... only  
**\$79.95**

**IO-17 SPECIFICATIONS — VERTICAL CHANNEL:** Input impedance: 1 megohm shunted by 25 pf; x 50 attenuator position 1 megohm shunted by 15 pf. Sensitivity: 30mV P-P/div. (uncalibrated). Frequency response: 5Hz to 5MHz ±3 db. **HORIZONTAL CHANNEL:** Input impedance: 10 megohm shunted by 15 pf. Sensitivity: 300 mV P-P/div. Frequency response: 2Hz to 300 kHz ±3 db. **HORIZONTAL SWEEP GENERATOR:** Sweep generator: Recurrent type. Frequency: 20Hz to 200 kHz in four overlapping ranges. Retrace: Blanked by a pulse from blanking amplifier. Synchronization: Automatic type. **GENERAL:** Tube complement: (1) 3RP1 cathode ray tube, medium persistence, green trace; (3) 12AU7; (1) 12AX7; (1) 6GH8; (1) 6BH6; (1) 6BQ7. Power requirements: 105-125 volts 50/60 Hz or 210-250 volts 50/60 Hz. Power consumption: 60 watts. Overall dimensions: 9½" H x 5½" W x 14½" L. (Dimensions include handle, knobs, etc.). Net weight: 12 lbs.



**Heathkit IO-14**  
... DC to 8 MHz  
5" 'scope ...  
triggered sweep  
... 0.25 usec  
delay line input ...  
assembled  
**\$399.00**  
kit  
**\$259.00**

**IO-14 SPECIFICATIONS — (VERTICAL) Sensitivity:** 0.05 V/cm AC or DC. Frequency Response: DC to 5 MHz — 1 dB or less; DC to 8 MHz — 3 dB or less. Rise time: 40 nsec (0.04 microseconds) or less. Input impedance: 1 megohm shunted by 15 pf. Signal delay: 0.25 microsecond. Attenuator: 9-position, compensated, calibrated in 1, 2, 5 sequence from 0.05 V/cm to 20 V/cm. Accuracy: ±3% on each step with continuously variable control (uncalibrated) between each step. Maximum input voltage: 600 volts peak-to-peak; 120 volts provides full 6 cm pattern in least sensitive position. **(HORIZONTAL) Time base:** Triggered with 18 calibrated rates in 1, 2, 5 sequences from 0.5 sec/cm to 1 microsecond/cm with ±3% accuracy or continuously variable control position (uncalibrated). Sweep magnifier: X5, so that fastest sweep rate becomes 0.2 microsecond/cm with magnifier on. (Overall time-base accuracy ±5% when magnifier is on.) **Triggering capability:** Internal, external, or line signals may be switch selected. Switch selection of + or — slope. Variable control on slope level. Either AC or DC coupling. "Auto" position. **Triggering requirements:** Internal; 0.5 cm to 6 cm display. External; 0.5 volts to 120 volts peak-to-peak. **Triggering frequency response:** DC to 2.5 MHz approx. **Horizontal input:** 1.0 v/cm sensitivity (uncalibrated) continuous gain control. **Bandwidth:** DC to 200 kHz ±3 db. Power requirements: 285 watts. 115 or 230 VAC 50-60 Hz. Cabinet dimensions: 15" H x 10½" W x 22" D includes clearance for handle and knobs. Net weight: 40 lbs.



**FREE 1968 CATALOG**

Describes these and over 300 kits for stereo/hi-fi, color TV, amateur radio, shortwave, test, CB, marine, educational, home and hobby. Save up to 50% by doing the easy assembly yourself. Mail coupon or write Heath Company, Benton Harbor, Michigan 49022.

**HEATH COMPANY, Dept. 520-28**  
Benton Harbor, Michigan 49022

Enclosed is \$ \_\_\_\_\_, plus shipping

Please send model (s) \_\_\_\_\_

Please send FREE Heathkit Catalog.

Please send Credit Application.

Name \_\_\_\_\_ (Please Print)

Address \_\_\_\_\_

City \_\_\_\_\_ State \_\_\_\_\_ Zip \_\_\_\_\_

Prices & specifications subject to change without notice. TE-178



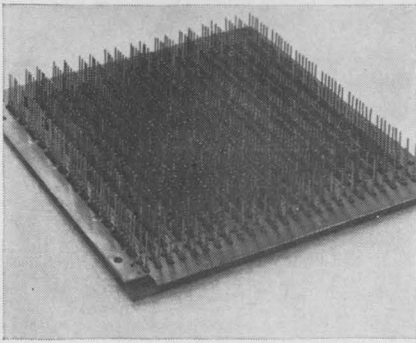

## You're more productive with back-plane wiring

These new panels let you get the most out of wire-wrapping techniques. By combining specially drawn Wire-Wrap\* terminals (for machine or hand-gun interconnection) with CAMBION®'s exclusive cage jack (for IC pluggability) you can have both packaging density and high production.

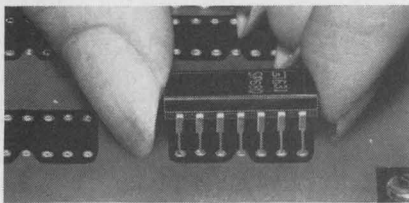

The concept of these panels allows you to order a size to meet your space or function requirements whether you're mounting 50 or 500 dual in-line IC's. If you are redesigning with integrated circuits, let CAMBION help you make the most of your design effort. For complete specifications on this reliable interconnection technique, contact: Cambridge Thermionic Corporation, Digital Products Division 447 Concord Avenue, Cambridge, Massachusetts 02138. Phone: (617) 491-5400.

®REG. U.S. PAT. OFF.  
\*T. M. Gardner-Denver

**CAMBION**  
CAMBRIDGE THERMIONIC CORPORATION

Standardize on CAMBION . . .  
21,541 guaranteed electronic components

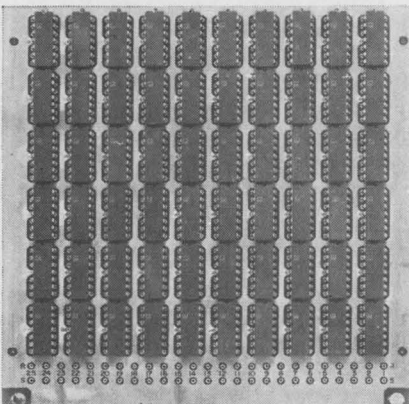

## Technical Abstracts

diodes operating separately for all bias values and spacings used. Similar tests were carried out with the three-diode arrangement. Again, power output was nearly independent of the spacing of the diodes. Further, the radio-frequency current through the diodes could be doubled without changing the output power by more than 10%.

The experiments also showed that because the spacings between diodes were relatively large, it's easy to extract heat during operation.

Presented at the International Solid State Circuits Conference, Philadelphia, Feb. 14-16.

### Factor of 1,000

LSI and the large computer systems designer  
M.O. Paley  
IBM Corp.  
Menlo Park, Calif.

By the mid-1970's, computers will be executing instructions 10 times faster than today's large systems, which are themselves 100 times faster than the IBM 7090. This anticipation of a 1,000-fold increase in speed is based on trends over the past 10 years.

However, the same trends project an input/output rate of only about 50 times that of the 7090, which means that balancing the computational rate of future computers against their input/output rate will be a problem of considerable difficulty.

[The IBM 7090 is a large, pure binary computer first delivered in 1960. According to one estimate, only a few dozen have been installed; the similar, but more powerful, IBM 7094 has reached a couple of hundred installations.]

The key to improved performance and reliability is large-scale integration as applied to both logic elements and to memory. In turn, LSI requires the computer designer to be more aware of subtle physical and electrical properties of materials, and to develop new tools and techniques.

How can we reasonably expect to reach higher performance levels? The answer lies in three factors that affect system performance: the

# Sony replaced IFTs in this FM/AM stereo tuner with the

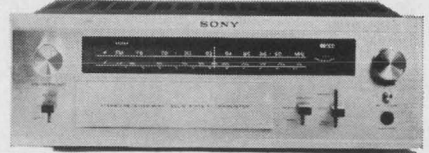

## new Murata ceramic filters



SF-10.7MA



WF-10.7MA



WF-4.5MA

Sony have introduced the new stereo receiver Model STR-6060 that shows revolutionary selectivity (FM—50dB, 83MC, AM—25dB, 1000KC). It uses Murata's ceramic filters instead of conventional IFTs.

The ceramic filters not only reduced the parts cost of the radios but the assembly cost as well. The radio in production needs no I-F alignment because the filters are supplied already fixed-tuned to their I-F frequency.

Improve your next stereo tuner with the Murata ceramic filters for FM and AM.

Request today for the latest technical bulletin for complete specifications and selectivity curve.

*muRata*

**Murata Mfg., Co., Ltd.**  
Nagaoka, Kyoto, Japan  
Cable: MURATAKYOTO  
Telex: 5422-317KYO

**Murata Corp. of America**  
160 Broadway, New York,  
N.Y. 10038  
Phone: (212) 686-2510  
Telex: MURATA421690

See us at IEEE Booth 3B33.



CHECK **TENSION** QUICKLY

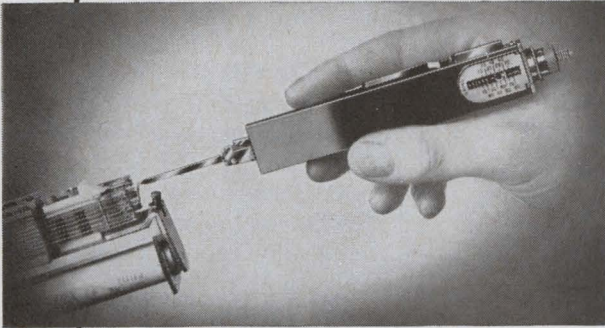

with the  
**GENALEX TENSION GAUGE**

For checking the tension of springs or similar resistive forces.

- Most precise
- Easiest to read

Available in six tension ranges from 4 to 2500 grams for free illustrated leaflet, write to



P.O. BOX 46, 151 MYSTIC AVE., MEDFORD, MASS. 02153  
U.S. Agents for the General Electric Company, Ltd. of England

Circle 123 on reader service card

*mechanical  
refrigeration  
to -85° F  
for only  
\$745*



**Only Associated Gives You Full Range  
Military Testing At This Low Price!**

Associated's Model SW-5101 Temperature Chamber offers a new concept in mechanical refrigeration that enables you to perform 90% of all military low-high temperature tests at equipment cost-savings of up to \$200.

**SPECIAL FEATURES OF THE SW-5101:**

- full 1 cubic foot test area
- temperature range from -85 to +350° F.
- all solid state controller with  $\pm 3/4$ ° F stability
- delivery from stock
- adjustable high-temperature fail-safe with signal lamp
- indicating thermometer in door
- combination hinged and removable door
- bench-top design, can be modified for stacking
- stainless steel feed-through port, 3/4" diameter

Check the SW-5101 specifications against your testing requirements. You'll find they add up to outstanding performance at a down-to-earth price — without sacrifice of quality or reliability.

*The new Associated catalog of environmental chambers is yours for the asking. Write for your free copy today.*

**ASSOCIATED  
TESTING  
LABORATORIES  
INC.**



200 Route 46, Wayne, N.J. 07470 • (201) 256-2800



**FASTENER KNOW-HOW**

Here's complete design and application data on precision GROOV-PINS . . . the solid cylindrical fastener pins with longitudinal grooves. Now! Combine economy, versatility, reliability with positive locking action. Get your copy of this helpful 12-page catalog by writing: Groov-Pin Corporation, 1121 Hendricks Causeway, Ridgefield, N.J. 07657, WH-5-6780.

FASTENER DIVISION

**GROOV-PIN CORP.**

"Visit us in Booth 385 at the DESIGN ENGINEERING SHOW"

Circle 124 on reader service card

Circle 289 on reader service card

289



# SMALL BARGAIN!

**BARNES LOW-PROFILE  
DIP SOCKETS...  
SMALL SIZE!  
SMALL PRICE!**

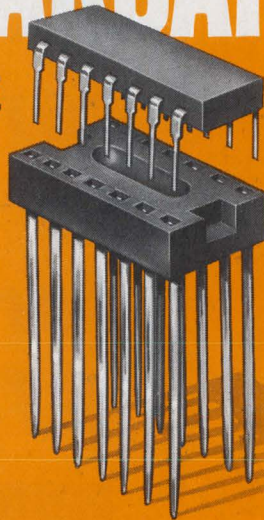
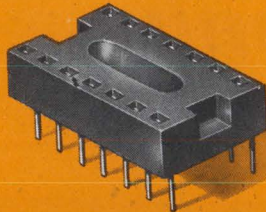

Wish you could squeeze more dual-in-lines onto a P.C. board—for production mounting or breadboarding? Try the low-cost, low-profile Barnes Series 041 DIP sockets. Designed for easy device insertion, yet excellent lead retention, the sockets are only a little larger than the device itself . . . and fit on the same centers. The low body height (only .135") gives you greater packing density between boards. Write or call for more data, and ask for a free sample.



Lansdowne, Pa. 19050 • 215/MA2-1525

**barnes** / THE FIRST WORD IN CARRIERS, CONTACTORS AND SOCKETS FOR I.C.'S

Circle 125 on reader service card

## MICO

**NEW MODEL 885  
SEVEN RATIO  
WIDE-RANGE ENGRAVER**

NO. 885

FOR LONG AND  
MULTI-LINE WORK

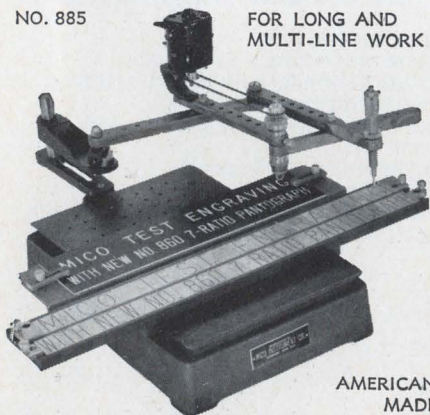

AMERICAN  
MADE

- A time-saver for large plate work
- Engraves 3" x 19" area in one set-up.
- Seven pantograph ratios—from 1:5:1 to 6:1.
- Choice of 3-ball-bearing spindle assemblies for 1/8", 3/16" or taper-shank cutters.
- HSS, COBALT and Solid Carbide Cutters.
- Single and multi-line copy carriers for holding, blanks 3/4" to 3 1/2" high.
- Accommodates Mico standard accessories.

Send for bulletins and prices

**MICO INSTRUMENT CO.**

77 Trowbridge St. Cambridge, Mass. 02138

290 Circle 290 on reader service card

## ECONOMICAL Thin Film!

If you want to be a leader, keep up with developments in SUSUMU's unique and original line of thin film products.

World's newest!



● Plate-ohm:  
evaporated metal  
film resistor

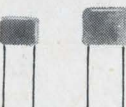

● Pla-con:  
organic thin film  
capacitor produced  
by plasma reaction



● Pla-module

Visit us at IEEE booth 4J23

Specialists in thin film technology

**SUSUMU INDUSTRIAL CO., LTD.**

**Export Department:**  
Minami Bldg., 1-12 Ebisuminami,  
Shibuya-ku, Tokyo, Japan  
TEL. Tokyo (03) 712-5990  
TELEX NO. 246-6270

Circle 126 on reader service card

## Technical Abstracts

logic circuit switching speed, the number of circuits, and the system architecture that efficiently relates the number and speed of circuits to the system's memory and input/output facilities.

Switching time will probably be cut to 1 nanosecond by the mid-1970's—20 times the 7090 speed and about four times today's fastest. This time is the sum of three major effects: device switching time, delay caused by loading, and delay caused by the package. The first two are easily controlled in LSI; but the third introduces challenging problems, because today's conventional packaging techniques would exceed the 1-nanosecond time even if device switching time and loading delay were zero. The required package delay demands up to 200 circuits squeezed into a square inch—which in turn creates severe heat-removing and noise-decoupling problems.

For these reasons, it is difficult to foresee a complete processor of thousands of circuits on a single LSI wafer.

The number of circuits depends partly on the machine's word length and instruction set, and partly on such performance-enhancing contrivances as algorithms for particular instructions, internal traffic management, and overlapping of independent functions. These contrivances often require additional buffer registers that would not be economical or sufficiently reliable unless implemented with LSI. The registers store data temporarily that otherwise would require accession to memory more times, thus slowing the machine. Memory accessions are less detrimental as the memory cycle time decreases; LSI techniques again indicate the possibility of cycle times less than 50 nanoseconds—a factor of 10 to 20 times today's "fast" memories.

[Maxwell O. Paley is director of advanced computing systems at IBM's Menlo Park laboratories. While the System 360 was being developed, he was the manager of the engineering laboratory at IBM's Poughkeepsie, N.Y. plant.]

Presented at the International Solid State Circuits Conference, Philadelphia, Feb. 14-16.

Electronics | March 4, 1968



## NATVAR'S New Silicone Rubber Fiberglass Sleeving

- Unmatched durability under stress at high temperatures
- Excellent abrasion resistance

Natvar's new improved silicone rubber fiberglass sleeving is engineered to take extreme punishment. The sample shown here was given maximum stress...total push back. Then we oven-aged it for 1000 hours at 250°C. Results—no cracking, splitting or loss of dielectric strength and still going strong.

Notice what happened to five other major brands given the same test. They all cracked after oven-aging for periods of 16 to 336 hours.

Put Natvar silicone rubber fiberglass sleeving to test yourself. Send for specifications and FREE SAMPLE.

ORDINARY SILICONE RUBBER FIBERGLASS SLEEVING



**NATVAR CORPORATION**  
P. O. BOX 67 • RAHWAY, N. J. 07065

Circle 127 on reader service card

## The \$12.00 C.P. pot.

Helipot's new Model 3351 conductive plastic potentiometer

is your twelve-dollar solution to applications requiring high precision and long, trouble-free life at minimum cost.

Here are just a few of the specs:

- Resistance range: 1K to 75K ohms
- Linearity:  $\pm 0.5\%$
- Power rating: 0.75 watts at 70°C
- Bushing mounted

If you like the specs and the price, get in touch with any

Helipot Sales Rep. He'll give you the complete non-wire-wound pot story—about both cermet and conductive plastic models.

**Beckman®**

INSTRUMENTS, INC.  
HELIPOT DIVISION  
FULLERTON, CALIFORNIA • 92634

INTERNATIONAL SUBSIDIARIES: GENEVA; MUNICH; GLENROTHES, SCOTLAND; TOKYO; PARIS; CAPE TOWN; LONDON; MEXICO CITY

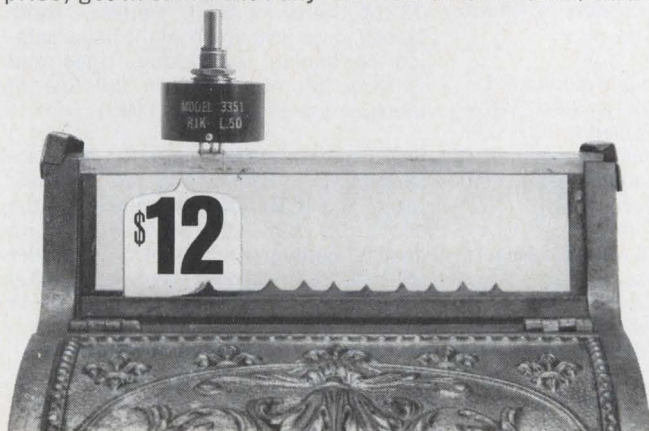

Circle 128 on reader service card

## NEW. Low Frequency Ceramic Band Pass Filter.

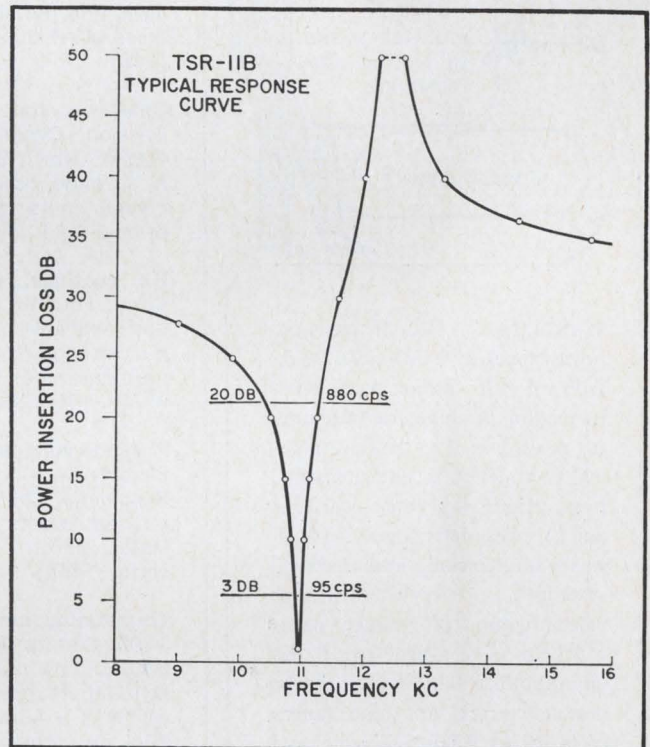
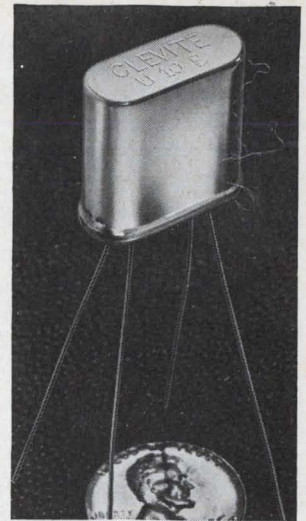

## Big performance in a quarter ounce package.

Looking for something better in a low frequency filter? Look no more. Clevite's new generation of fixed-tuned ceramic band pass filters combine narrow bandwidths and high performance with surprisingly small size and low weight.

Check the specs and see for yourself:

**Center Frequency** — from 9kc to 50kc

**Bandwidth (% fo)** — @ 3db-1%; @ 20db-13%

**Stability** — Within 0.2% for 5 years  
Within 0.2% from -40°C to +85°C

**Dimensions**—HC-6/U case  $\frac{3}{4}$ " x  $\frac{3}{4}$ " x .34" (hermetically sealed)

**Shock** — 20g any axis 20-2000 cps per mil std. 202B.

As we said, look no more for a high performance, low frequency filter. This new one from Clevite is the perfect choice. Write for free Technical Bulletin 94023. Clevite Corporation, Piezoelectric Division, 232 Forbes Road, Bedford, Ohio 44014.

**CLEVITE**

Circle 291 on reader service card

291



## Catch 1 $\mu$ s voltage peaks.

Why?

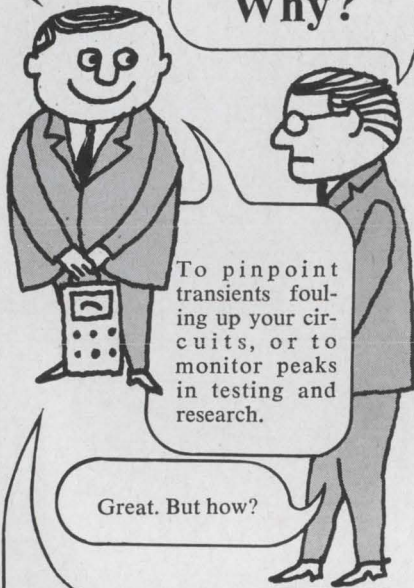

To pinpoint transients fouling up your circuits, or to monitor peaks in testing and research.

Great. But how?

With PEAK LOK. It measures positive, negative or bipolar peaks with 1% full scale accuracy, holds its reading in an analog state until it's reset. Use it to measure physical parameters in environmental tests, record surges in power lines and supplies, detect overload transients in electronic and electrical systems . . . everywhere precise determination of voltage peaks can help solve a problem. It has an output for data logging, can be remotely reset, has nine ranges from 0.1 to 1000v full scale, and can go up to 30 kv with a high voltage probe. When you're not catching transients, use PEAK LOK as a sensitive DC voltmeter, to measure that hard to get to voltage with a quick touch of the probe.



**For complete specifications** write to PEAK LOK Sales, Dept. 249, Analog-Digital Systems Division, Control Data Corporation, 4455 Eastgate Mall, La Jolla, California 92037. Or phone 714/453-2500.

**CONTROL DATA**

CORPORATION

4455 Eastgate Mall, La Jolla, Calif.

## New Literature

**Reflectometers.** Alford Mfg. Co., 120 Cross St., Winchester, Mass. 01890. Bulletin 701 describes a new line of Hybrid reflectometers that offer continuous overlapping frequency coverage from 200 Mhz to 12.4 Ghz. Circle **446** on reader service card.

**P-c connectors.** Amphenol Industrial Division, Amphenol Corp., 1830 S. 54th Ave., Chicago 60650. An eight-page brochure details a standard line of precious-metal-tip p-c connectors. [447]

**Coaxial antenna connectors.** Connector Corp., 6025 N. Keystone Ave., Chicago 60646. Two-page technical publication 46A contains illustration, technical data, and dimensional drawings of five types of r-f coaxial antenna connectors. [448]

**Quartz crystal units.** Reeves-Hoffman Division, Dynamics Corp. of America, 400 W. North St., Carlisle, Pa. 17013. A six-page brochure describes quartz crystal units available in solder-seal or cold-weld holders. [449]

**P-c coatings.** Hysol Division, Dexter Corp., Franklin St., Olean, N.Y. 14760, has available data bulletins on four p-c coatings (three epoxy type and one urethane type) that meet requirements of MIL-I-46058B. [450]

**Phase-to-voltage converter.** Solid State Electronics Corp., 15321 Rayen St., Sepulveda, Calif. 91343. A single-sheet bulletin covers the model 791 solid state silicon, phase-to-voltage converter. [451]

**Terminating unit.** Lenkurt Electric Co., 1105 County Rd., San Carlos, Calif. 94070, has published a flysheet describing its four-wire terminating unit, which is a high-quality hybrid connection for converting a four-wire communications circuit to two-wire circuit. [452]

**Thin-film microcircuits.** Halex Inc., 139 Maryland St., El Segundo, Calif. Custom microcircuits that combine Nichrome thin-film passive resistor networks with silicon IC's and other semiconductor dice are described in a new brochure. [453]

**Crystal oscillators.** Arvin Frequency Devices, 2505 N. Salisbury, West Lafayette, Ind. 47906. Bulletin TC/VCXO 200 describes and illustrates a line of temperature-compensated, voltage-controlled crystal oscillators. [454]

**Vernier controls.** CTS Corp., Elkhart, Ind. 46514, has issued data sheet 1150, which illustrates and describes two carbon and one wirewound vernier variable resistors. [455]

**Radio-relay equipment.** Cardion Communications, a unit of General Signal

Corp., Long Island Expressway, N.Y. 11797, offers a four-page brochure on solid state, FCC type-accepted radio equipment for the 952- to 960-Mhz band. [456]

**Dumet wire.** Sylvania Electric Products Inc., 12 Second Ave., Warren, Pa. 16365. A technical brochure describing the types and properties of Dumet (glass sealing) wire, is available by writing on letterhead stationery.

**N-element crystal.** Reeves-Hoffman Division of DCA, 400 W. North St., Carlisle, Pa. 17013. The N-element crystal, a double-rotation plate vibrating on its width-length fundamental mode, is discussed in a single-page specification sheet. [457]

**Solid state detector.** Nuclear Diodes Inc., P.O. Box 135, Prairie View, Ill. 60069. A 10-page catalog lists an expanded line of silicon surface barrier radiation detectors. [458]

**Low-temperature detector.** Leeds & Northrup Co., Sumneytown Pike, North Wales, Pa. 19454. A four-page data sheet describes and illustrates the 8845 low-temperature Rayotube detector for noncontact, continuous measurement over the range of 100° to 700° F. [459]

**Ceramic flatpacks.** Tung-Sol Division, Wagner Electric Corp., Newark, N.J. 07104. An eight-page booklet covers a line of high-performance ceramic flatpacks for IC packaging. [460]

**Oscillographs.** Test Instruments Division, Honeywell Inc., P.O. Box 5227, Denver, Colo. 80217, has published brochure D-2228 describing the model 1912 Visicorder and other direct-write oscillographs. [461]

**Ultrasonic cleaning equipment.** Redford Corp., 968 Albany-Shaker Rd., Latham, N.Y. 12110. A series of five product data sheets describe ultrasonic cleaners, generators, system components, vapor degreasers, and ultrasonic soldering systems and machines. [462]

**Power supplies.** Valor Instruments Inc., 13214 Crenshaw Blvd., Gardena, Calif. 90249, has issued an eight-page catalog containing description, price and delivery information on a full line of modular power supplies. [463]

**Serializer-controller.** Analog Digital Data Systems Inc., 830 Linden Ave., Rochester, N.Y. 14625, offers a bulletin on the series 016-020 serializer-controller, a flexible coupler and system controller for use as an interface between digital outputs and recording media in data loggers. [464]

**Line voltage regulator.** Polyphase Instrument Co., East 4th St., Bridgeport, Pa. 19405. Bulletin PC200 describes



# SPECIAL COSMICAR<sup>®</sup> LENSES

COSMICAR lenses have improved in quality as CCTV cameras have improved.

There is no problem whether your cameras are with built-in an EE mechanism or a viewfinder mechanism.

COSMICAR will make whatever new lenses you need for your CCTV cameras to satisfy your every CCTV purpose.



# FOR YOUR SPECIAL CCTV CAMERAS

For example, COSMICAR lenses can be adopted to automatic or rear control system by one hand.

Superb lenses of proven ability from 12.5mm to 1,00mm and Zoom lenses are on sale.

For further details, write to:



## COSMICAR OPTICAL CO., LTD.

(Former name: ICHIZUKA OPTICAL CO., LTD.)

568, Shimoochiai, 2-chome, Shinjuku-ku, Tokyo Cable Address: "MOVIEKINO TOKYO"

Circle 129 on reader service card

## TDK CORE

The high-performance ferrite cores that made possible many breakthroughs in Japan's electronics technology

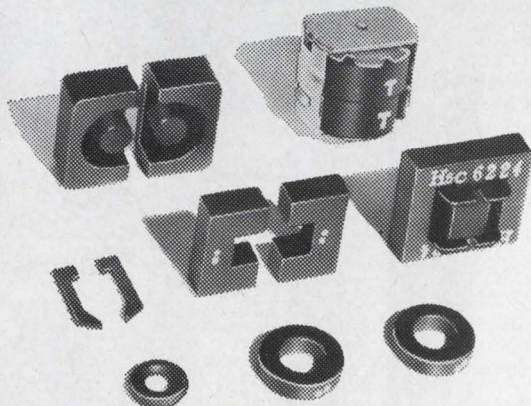

Write to MH&W for full technical data and information applications



Representative in U.S.A & Canada for Ferrite Core for Communications

**MH&W INTERNATIONAL CORPORATION**

280 Midland Avenue, Saddle Brook, N.J. 07662  
Phone: Area Code 201-791-6277  
N.Y. Phone: Area Code 212-244-0695



**TDK** ELECTRONICS CO., LTD.  
2-14-6 Uchikauda, Chiyoda-ku, Tokyo Japan.

Circle 130 on reader service card

## Faster, easier set-ups with

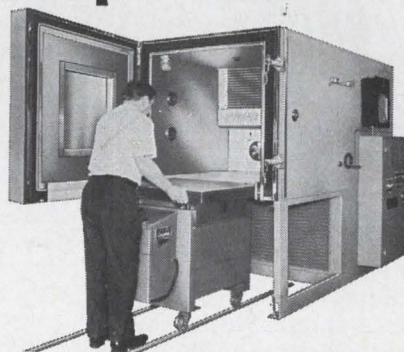

## advanced "AGREE" chambers

Tenney's "AGREE" Chambers have always offered the utmost in performance to meet and exceed all test levels of MIL-Std-781A. Now you also get the utmost in operator convenience. Tenney's exclusive "Redi-Seal" (patent applied for) provides a soft cushion of foam to seal between the chamber and L.A.B. or comparable vibration testing machines. No more cumbersome diaphragms...no removable chamber sections...just roll the table in place. Save set-up time. Fully automatic operation of chamber, vibrator, and test item. Make it easy for yourself. For complete information on the latest in "AGREE" testing, write or call



**Tenney**  
ENGINEERING, INC.

1090 Springfield Rd., Union, N. J. 07083 • (201) 686-7870  
Western Div.: 15721 Texaco St., Paramount, Calif. 90723

487

Circle 293 on reader service card

293



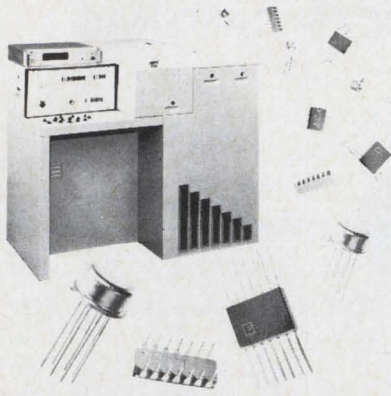

Would you believe 1 million devices per second?

Well, would you believe 100,000 per minute?

No? How about an easy 3,600 parts per hour, twenty-four hours a day, day after day? DELTA's ASTEC is a unique concept in handling electronic components at extreme temperatures. The ASTEC system will even sort your parts automatically on the basis of your measurement. Would you believe that? You should, it's true.

Send for our latest catalog.



Delta Design, Inc.  
8000 Fletcher Parkway  
La Mesa, California 92042  
Telephone (714) 465-4141

## New Literature

Volt-Check, a 400-hz solid state, line voltage regulator. [465]

**Materials catalog.** Icore Electro-Plastics, 1050 Kifer Rd., Sunnyvale, Calif. 94086. A 24-page catalog discusses a line of materials including spiral-cut plastic wrap, heat-shrinkable tubing, zipper tubing, vinyl, fiberglass and Teflon tubing, lacing tape and cable clamps. [466]

**Silicon p-i-n diodes.** Micro State Electronics, 152 Floral Ave., Murray Hill, N.J. 07974. Features and specifications for a line of silicon p-i-n diodes are contained in bulletin D-109. [467]

**Cable shield.** Metex Corp., 970 New Durham Rd., Edison, N.J. 08817, has available a four-page catalog sheet on Zip-Ex cable shield, an all-metal shielding jacket of knitted mesh that can be zipped around any shape before or after installation of a cable harness. [468]

**Automated audio instruction.** Cognitronics Corp., 333 Bedford Rd., Mount Kisco, N.Y. 10549. A data sheet describes an automated method of furnishing clear audio instructions to production assemblers from digitally encoded data with vocabularies ranging from 10 spoken digits to 189 words. [469]

**Synchro converters.** Natel Engineering Co., 7129 Gerald Ave., Van Nuys, Calif. 91406. Revised specification sheet 101 covers a complete family of synchro converters including synchro-to-sine/cosine converters, synchro-to-linear d-c converters, synchro-to-digital converters, and angle position indicators. [470]

**Air-core solenoids.** Magnion Division, Ventrion Instruments Corp., 144 Middlesex Turnpike, Burlington, Mass. 01803. A four-page brochure describes Plasmaflux large volume, air-core solenoids designed for producing steady-state high magnetic fields. [471]

**Converters.** Kearfott Group, General Precision Systems Inc., 1150 McBride Ave., Little Falls, N.J. 07424, offers a 28-page brochure entitled "Analog-to-Digital and Digital-to-Analog Converters." [472]

**Precision potentiometers.** New England Instrument Co., Kendall Lane, Natick, Mass. 01760, has a six-page brochure summarizing its capabilities in custom-designed conductive plastic and wire-wound potentiometers and elements. [473]

**Switch applications.** MicroSwitch, a division of Honeywell Inc., 11 W. Spring St., Freeport, Ill. 61032. Over a dozen switch applications to help solve industrial problems are described in is-

Specifically  
Engineered  
for RF  
Components!



A-27 Superfine  
**Q-max**  
EXTREMELY LOW-LOSS  
RF LACQUER

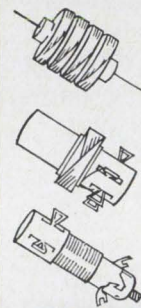

Q-MAX impregnating and coating composition penetrates deeply, seals out moisture, provides a surface finish. Q-MAX imparts rigidity and promotes stability of the electrical constants of high frequency circuits. Effect on the "Q" of RF windings is negligible.

Write for catalog today.

**Q-max Corporation**  
MARLBORO, NEW JERSEY 07746

Telephone: 462-3636 (Area Code 201)

Circle 131 on reader service card

FOR  
**Phono Drives**



Think

**Walsco**



Solve phono drive problems in minutes... with quality parts from Walsco Electronics!

Choose from hundreds of round and flat rubber belts, fabric belts, idler wheels, pressure rollers, turret drives, drive wheels and pulleys, in sizes and shapes to meet every need. Remember too, all are available from stock for immediate shipment to save you tooling costs, valuable production time.

Write today on your Company letterhead for the big FREE Walsco Phono Drive Wall Chart

FR-250-W, cross referenced for every need.



**GC Electronics**

400 South Wyman Street  
Rockford, Ill. 61101

A Division of  
GC - Hydrometals, Inc.  
Shipping warehouses in:  
Hicksville, L.I., N.Y.  
Los Angeles, California



Circle 132 on reader service card



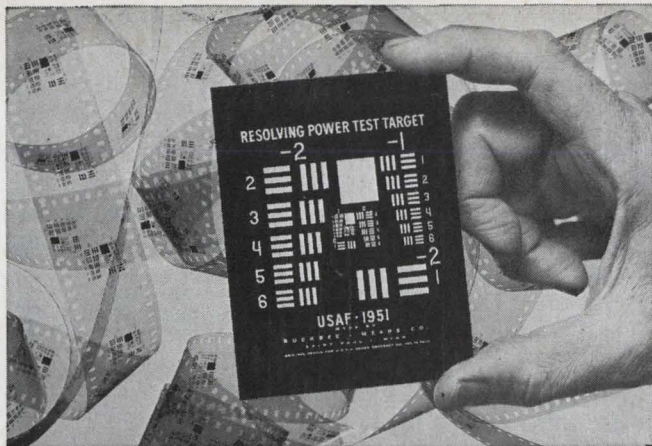

## RESOLVING POWER TEST TARGETS

Resolving Power Test Targets have been designed and produced for U.S.A.F. under contract, for American Standards Association Resolution Chart and National Bureau of Standards Microcopy Resolution Test Chart . . . High and low resolution targets are available — low targets in high, medium and low contrast. Special Resolution Chart Targets are made on 35 mm film in 20 foot rolls. Specialized targets to custom specification. Send us your requirements in sketch or blue print — we will rush quote.

**BUCKBEE/MEARS  
COMPANY**  
245 E. 6th ST./SAINT PAUL, MINN.



Circle 133 on reader service card



**NTK**  
for better metalized  
electro-ceramics.

Exhibited at IEEE booth 4J11

NTK electro-ceramics are mass-produced under rigid quality-control. They include

- Rectifier Containers
- Transistor Headers & Packages
- I.C. Substrates & Packages
- Envelope for Vacuum Circuit Breakers

For further information, call or write to:  
**NGK SPARK PLUGS (U.S.A.), INC.**  
4010 Sawtelle Blvd., Los Angeles, California  
90066 Phone: 213-397-8184

**NGK SPARK PLUG CO., LTD.**  
NTK Special Ceramics Division  
Mizuho-ku, Nagoya, Japan  
Cable: PLUGNGK NAGOYA

Circle 81 on reader service card

# alpha

number one source for economical  
reliable soldering materials...  
a complete range of  
compatible fluxes, soldering  
chemicals and solders

- **PRECLEANERS**

Removal of oil, grease and other organic soils. Tarnish (oxide, etc.) removal for solderability.

- **PROTECTIVE COATINGS**

Protection of surface solderability. Prevention of contamination.

- **SOLDER RESISTS**

Permanent resist for selective soldering. Temporary, easily removable soldering mask.

- **FLUXES**

Fluxes for every method of application — dip, wave, spray, brush, foam, etc.

- **FLUX THINNERS**

Control of flux density. Maintenance of flux properties.

- **SOLDERS**

Manufactured to specification — produced from virgin metals and available in both Vaculoy® and standard types.

- **POST-SOLDERING CLEANER**

Post-soldering cleaning and residue removal for rosins and ionizables.

- **SOLDER BLANKET**

Dross control of solder bath surface. Reduce surface tension of molten solder.

- **RESOLDERING OR TOUCH-UP**

Core solder manufactured to the material specifications required by the process.

For further information on the complete range of Alpha solders, fluxes and soldering chemicals call or write for Bulletins A-103A and A-104.

**alpha**

**ALPHA METALS, INC.**

56 WATER ST., JERSEY CITY, N. J. 07304 201-434-6778  
Los Angeles, Calif. • Alphaloy Corp. (Div.), Chicago, Ill.  
Alpha Metals, Inc. (U.K.) Ltd., Hounslow, Middlesex, Eng.

9339

"Look for us at the IEEE—Booth 1F08-1F10"

Circle 295 on reader service card

295



## Compact electronics package?

# COOL IT...

...with a small size, long life, high output AiResearch fan.

Garrett-AiResearch special purpose fans are individually designed and custom built to deliver more flow and greater pressure rise with a minimum envelope size.

Take a typical AiResearch small size fan: computer-optimized for required performance under all operating environments; our own motor, engineered and manufactured for a perfect match to its fan; and up to 40 percent more airflow than any other ventilating fan of similar input, size, and weight.

Next time you need a ventilating fan for a very special airborne or ground electronics enclosure specify AiResearch. Available for high temperature and cryogenic applications, with flow rates and power requirements as specified. AiResearch Manufacturing Division, Torrance Facility, 2525 190th Street, Torrance, California 90509.

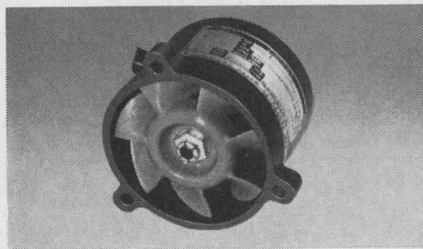
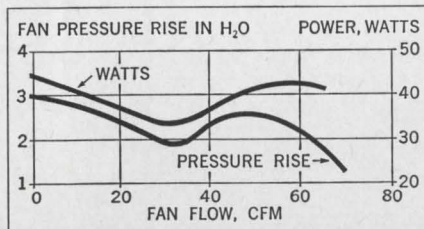

## AIRESEARCH SPECIAL PURPOSE FANS



## New Literature

sue No. 30 of "Uses Unlimited," an eight-page booklet. [474]

**Positive followers.** GPS Instrument Co., 188 Needham St., Newton, Mass. 02164, offers a brochure describing the FO-200 series of FET-input positive followers. [475]

**Reed relays.** HiG Inc., Spring St. & Route 75, Windsor Locks, Conn. 06096. Bulletin 160 describes the 3500 and 3600 series of miniature glass reed relays. [476]

**Switching tachometers.** Airpax Electronics Inc., P.O. Box 8488, Fort Lauderdale, Fla. 33310. A 10-page technical manual describes a line of solid state electronic switching tachometers that monitor the rpm of rotating devices and provide switching functions at preset speeds. [477]

**Microwave equipment.** Farinon Electric, 935 Washington St., San Carlos, Calif. 94070. A 12-page brochure describes microwave equipment for transmitting up to 300 high-quality voice channels. [478]

**Multipole relays.** Cutler-Hammer Inc., P.O. Box 463, Milwaukee, Wis. 53201. Illustrated brochure LA-105 describes 300- and 600-v multipole convertible circuit relays. [479]

**Event recorders.** Simpson Electric Co., 5200 W. Kinzie St., Chicago, Ill. 60644. Folder L-1002 covers miniature 10-channel event recorders. [480]

**Magnetic reed switches.** Gordos Corp., 250 Glenwood Ave., Bloomfield, N.J. 07003. Detailed specifications for a full line of magnetic reed switches are given in a six-page catalog. [481]

**Slotted line.** Alford Mfg. Co., 120 Cross St., Winchester, Mass. 01890. Bulletin 703 describes a 3.5-mm coaxial slotted line. [482]

**Power transistor.** Bendix Corp., Semiconductor Division, South St., Holmdel, N.J. 07733. An eight-page data sheet provides descriptive information on the B-148000 and B-155000 series high-frequency power transistors. [483]

**Waveguide test equipment.** Waveline Inc., P.O. Box 718, West Caldwell, N.J. 07006, has published a four-page short form catalog of waveguide test instruments for the satellite communication frequencies. [484]

**Silicone rubber molding.** Master Dynamics Corp., 922 California Ave., Sunnysvale, Calif. 94086, offers a brochure describing its silicone rubber molding capabilities, and detailing a full line of colored standard silicone rubber lamp filters. [485]

# PROFIT

from iron core research  
by  
**PERMACOR®**  
Iron Core Engineers

Countless years in the research, development and production of quality iron cores for various applications enable us to more efficiently serve your needs in the following ways:

- In the development of specialized iron cores for unique product applications.
- In providing qualified research personnel familiar with your product and production problems including circuitry and coil winding.
- In supplying iron cores, based on experience, that perform better, lower product and production costs.

Whether your problems involve military, commercial, miniaturization, micromodular, or special applications, let us show you why PERMACOR "Engineered Economy" has made us the largest iron core manufacturer.

We invite your inquiry at any time  
... no obligation, of course!

**PERMACOR®**  
A Division of Radio Cores, Inc.  
9540 Tulley Ave., Oak Lawn, Ill.  
Phone: 312/GA 2-3353

Circle 82 on reader service card

Cartoon by Whitney Darrow, Jr.



## Be a buddy!

One gift works many wonders  
**THE UNITED WAY**



## announcing the NL-5750 from NATIONAL®

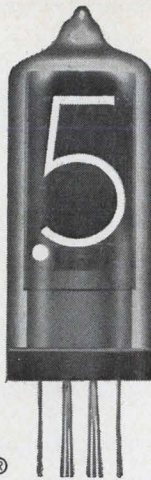

Our lowest priced readout tube, \$3.95 in 1000 quantity.

- ultra long life ■ compact .530" diameter.
- .5" numeral height ■ two decimal points standard
- flexible leads with standoff spacer for ease of pc board insertion.

# NATIONAL

REQUEST  
BULLETIN

ELECTRONICS, INC.  
a varian subsidiary

PHONE: (312) 232-4300 • GENEVA, ILLINOIS 60134

Circle 83 on reader service card

## DIODE CURVE TRACER MODEL

# 587A

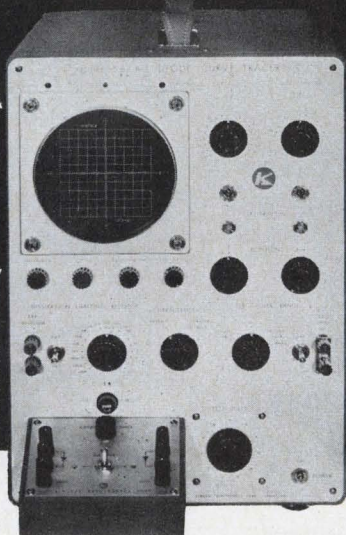

INTERNAL TEST  
VOLTAGE SUPPLY  
(RECTIFIED SINE WAVE)

**RANGE 1: FULL WAVE**  
0~20V PEAK 10A MAX  
**RANGE 2: FULL WAVE**  
0~200V PEAK 1A MAX  
**RANGE 3: HALF WAVE**  
2000V PEAK 0.1A MAX

Over-current Cutoff Relay: Sensitivity is proportional to sensitivity of current axis (vertical axis) amplifier. To be operated (mA/div) × (12~13 div).  
Dissipation Limiting Resistors 19 ranges: 0/1/2/5/10...200~500KΩ  
Voltage Axis (Horizontal Axis) 11 ranges: 0.1/0.2...100/200V/div Accuracy: ±3%  
Current Axis (Vertical Axis) 19 ranges: 0.001/0.002~200/500 & 1,000mA/div.  
CRT: SUPIF Dimensions and Net Weight: 315W × 445H × 578Dmm, 30Kg approx.



# kikusui

KIKUSUI ELECTRONICS CORP.  
3-1175, SHINMARUKO-HIGASHI, KAWASAKI-CITY,  
KANAGAWA-PREF., JAPAN  
CABLE ADDRESS: "KIKUSUIDE" KAWASAKI

## PROVEN RELIABILITY— SOLID-STATE POWER INVERTERS, over 260,000 logged operational hours— voltage-regulated, frequency-controlled, for missile, telemeter, ground support, 135°C all-silicon units available now—

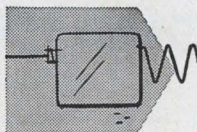
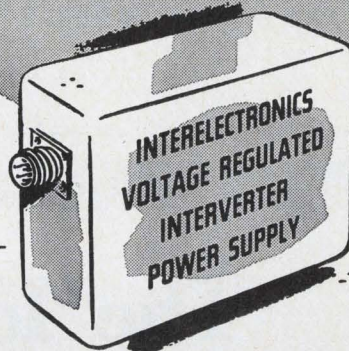

Interelectronics all-silicon thyatron-like gating elements and cubic-grain toroidal magnetic components convert DC to any desired number of AC or DC outputs from 1 to 10,000 watts.

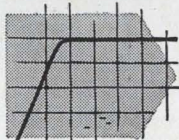

Ultra-reliable in operation (over 260,000 logged hours), no moving parts, unharmed by shorting output or reversing input polarity. High conversion efficiency (to 92%, including voltage regulation by Interelectronics patented reflex high-efficiency magnetic amplifier circuitry.)

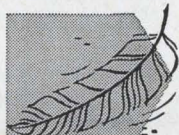

Light weight (to 6 watts/oz.), compact (to 8 watts/cu. in.), low ripple (to 0.01 mv. p-p), excellent voltage regulation (to 0.1%), precise frequency control (to 0.2% with Interelectronics extreme environment magnetostrictive standards or to 0.0001% with fork or piezoelectric standards.)

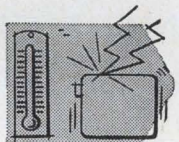

Complies with MIL specs. for shock (100G 11 msec.), acceleration (100G 15 min.), vibration (100G 5 to 5,000 cps.), temperature (to 150 degrees C), RF noise (I-26600).

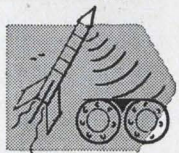

AC single and polyphase units supply sine waveform output (to 2% harmonics), will deliver up to ten times rated line current into a short circuit or actuate MIL type magnetic circuit breakers or fuses, will start gyros and motors with starting current surges up to ten times normal operating line current.

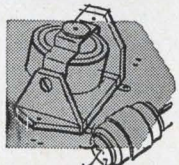

Now in use in major missiles, powering telemeter transmitters, radar beacons, electronic equipment. Single and polyphase units now power airborne and marine missile gyros, synchros, servos, magnetic amplifiers.

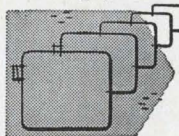

Interelectronics—first and most experienced in the solid-state power supply field produces its own all-silicon solid-state gating elements, all high flux density magnetic components, high temperature ultra-reliable film capacitors and components, has complete facilities and know-how—has designed and delivered more working KVA than any other firm!

For complete engineering data, write Inter-electronics today, or call 914 Elmwood 8-8000.

## INTERELECTRONICS CORP.

700 U. S. Route 303 Congers, New York 10920





# EMPLOYMENT OPPORTUNITIES

**THE MARKET-PLACE  
FOR ALL YOUR  
EMPLOYMENT NEEDS**

**Closing Date Information:** April 1st Issue Closes March 11th  
**New Ads or Inquiries:** Send to Classified Advertising Division,  
**Electronics:** Post Office Box 12, New York, N. Y. 10036

SEE INDEX LISTING ADDITIONAL EMPLOYMENT ADS

## The Total Growth Company

Hallicrafters is entering an exciting new era of growth. Our recent affiliation with Northrop Corporation has opened new areas of engineering challenge. At our new ultra-modern Engineering & Administrative Center, located in northwest suburban Chicago, we are engaged in R&D activities which will lead to the development of a new generation of highly sophisticated techniques and equipment.

Here you'll become an integral part of a small, dynamic task group and enjoy an environment conducive to professional growth and achievement while working with pride and a continuing dedication to product excellence.

If you're a professional who thrives on this concept of personal growth and creativity, you're invited to share these goals. Together, we can grow as far as professionals like yourself can take us.

### ELECTRONIC ENGINEERING

#### SYSTEMS EXPERIENCE

- Radar Systems
- ECM Systems
- Vulnerability Evaluation
- Tracking Loop Analysis

#### MICROWAVE SYSTEMS

- Semiconductor Circuit Design
- Microwave Circuits
- Solid State Power Design

#### CIRCUIT EXPERIENCE

- Electronic Countermeasures
- Solid State Power Supplies, Regulators & Modulators
- Microwave Applications Design
- Video Signal Processing Design

#### MECHANICAL ENGINEER

Apply your knowledge & experience in the design & innovation of equipment packaging.

We invite you to "come grow with us." Please submit your resume in confidence to: Roy C. Anderson, Professional Placement.

*the hallicrafters co.*

A Subsidiary of Northrop Corporation

Engineering & Administrative Center  
600 Hicks Road, Rolling Meadows, Illinois 60008

An Equal Opportunity Employer



### AVIATION ELECTRONIC ENGINEERS

We are a rapidly expanding, Midwestern manufacturer of electronic equipment for the General Aviation Industry. Our rapid growth has created openings at all levels within our engineering department. Our "small company" environment provides unique opportunity for the individual who seeks to demonstrate his leadership capabilities as well as his creative engineering talent.

If you have experience in aviation electronics design, and are willing to meet the challenge of new product development, from design concept through production, send your resume and salary requirements to:

P-4791, Electronics  
645 N. Michigan Ave., Chicago, Ill. 60611

CIRCLE 967 ON READER SERVICE CARD

#### EMPLOYMENT SERVICES

Across The Spectrum In the Electronics Industry—Engrg—Mgmt—Sales, Gardner Assoc.  
MU 7-6616 545 5th Ave., N.Y., N.Y. 10017.

### FOR INFORMATION

about  
classified advertising  
contact the McGraw-Hill  
office nearest you

- ATLANTA, 30309**  
1375 Peachtree St., N.E. 404-875-0523
- BOSTON, 02116**  
607 Royleston St. 617-262-1160
- CHICAGO, 60611**  
645 No. Michigan Avenue 312-664-5800
- CLEVELAND, 44113**  
55 Public Square 216-781-7000
- DALLAS, 75201**  
1800 Republic Nat'l, Bank Tower 214-747-9721
- DENVER, 80202**  
1700 Broadway, Tower Bldg. 303-255-5483
- DETROIT, 48226**  
856 Penobscot Building 313-962-1793
- HOUSTON, 77002**  
2270 Humble Bldg. 713-224-8381
- LOS ANGELES, 90017**  
1125 West Sixth Street 213-482-5450
- NEW YORK, 10036**  
500 Fifth Avenue 212-971-3594
- PHILADELPHIA, 19103**  
Six Penn Center Plaza 215-568-6161
- PITTSBURGH, 15222**  
4 Gateway Center 412-391-1314
- ST. LOUIS, 63105**  
7751 Carondelet Avenue 314-725-7285
- SAN FRANCISCO, 94111**  
255 California Street 415-362-4600

CIRCLE 966 ON READER SERVICE CARD



BILL PEARSON, BCE, Univ. of Virginia '61, checked the calculations on internal bulkheads, stiffeners and plating and aided in the re-design of the motor cowling for the TRIESTE II, the Navy's 20,000 ft. bathyscaphe.

FOR INTERVIEW DURING  
THE IEEE CONVENTION,  
CALL GEORGE DANYLA  
AT THE AMERICANA HOTEL

# Young engineers are key engineers at the San Francisco Bay Naval Shipyard.

If you're ready for more responsibility than your present employer is willing to give you, join the young engineers who are handling the big jobs at the San Francisco Bay Naval Shipyard.

Critical assignments in the development of deep submergence vehicles and in the conversion of conventional and nuclear surface craft and submarines have created immediate openings for men qualified by education and experience in the areas of:

• **Instrumentation** • **Optical Systems** •

**Piping Systems** • **Structural Engineering** • **Materials Development, Test & Evaluation** • **Power Systems (Conventional and Nuclear)** • **Hydrodynamics & Ship Design** • **Mechanical Equipment Engineering** • **Configuration Control** • **Systems Analysis** • **Radar & Sonar Systems** • **Communications Systems**

SALARIES TO \$13,500 A YEAR

Higher-level positions usually filled by promotion from within.

Positions available at both San Fran-

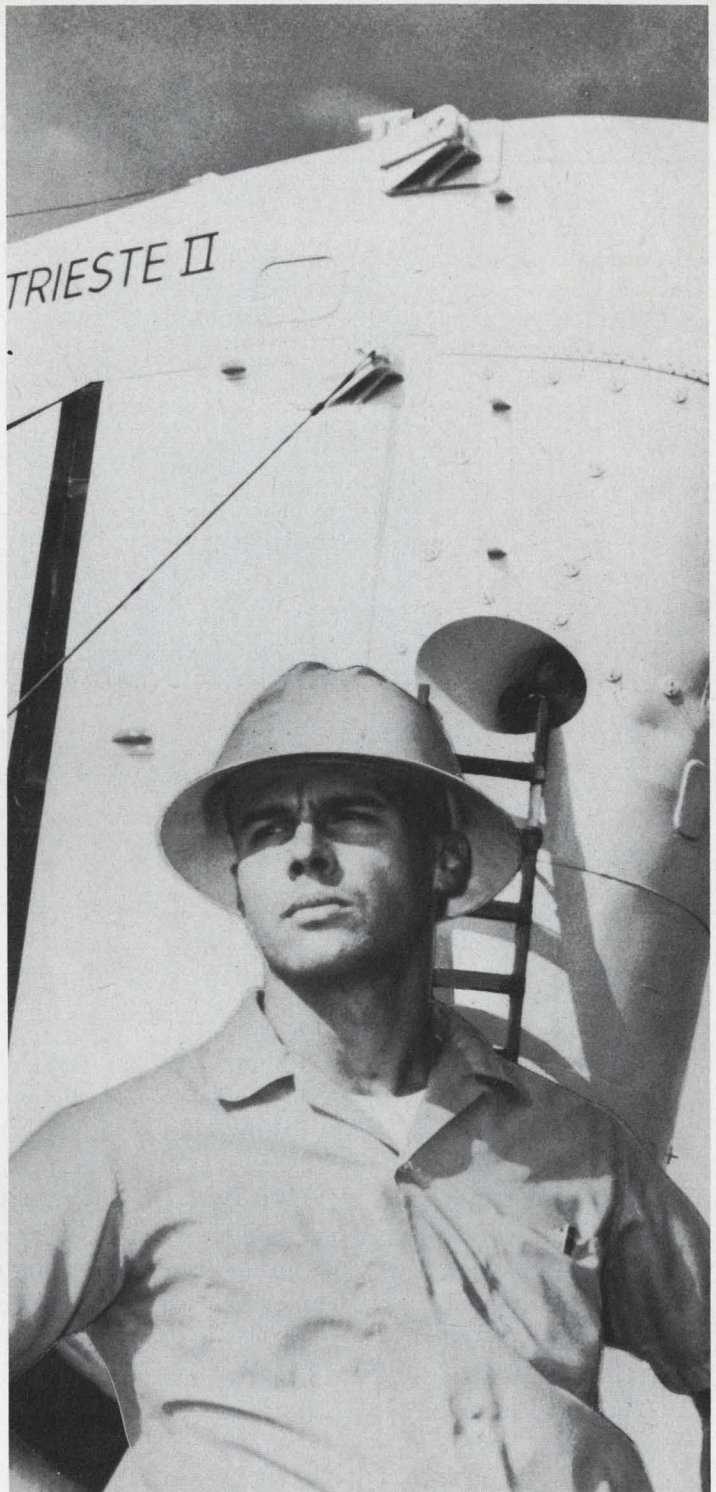

cisco and Vallejo facilities of the San Francisco Bay Naval Shipyard. Full Civil Service benefits plus tuition payment plan for advanced degrees. Relocation expenses paid.

---

Send resume or SF-57 to:  
**Employment Manager, Code 174-5M**  
**San Francisco Bay Naval Shipyard**  
**Vallejo, California 94592**

---

*An Equal Opportunity Employer*  
*U. S. Citizenship Required*

CIRCLE 970 ON READER SERVICE CARD



# Professionalism at Grumman

*is the Team Concept  
in Electronics*

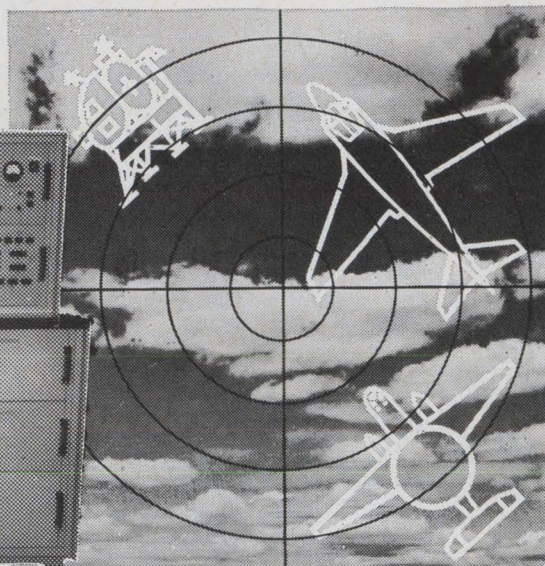
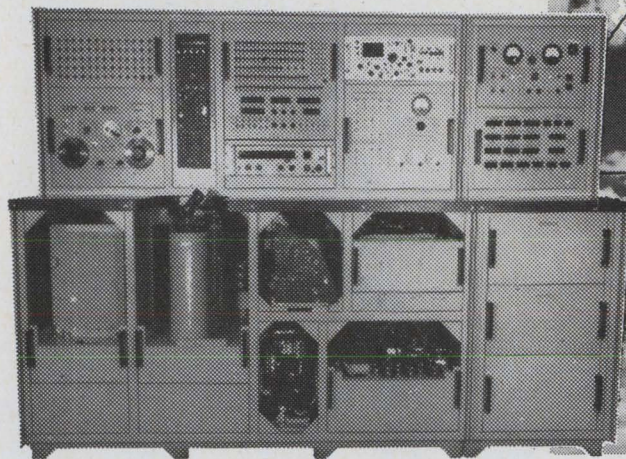

Basic to the systems approach to the problems of related electronics equipment (airborne and support) is the concept of airborne and support electronics engineers as *partners*.

At Grumman we believe that . . .

- a weapon does not become an operational part of a weapons system without an effective support system
- a weapon or spacecraft is only as good as the sum of its inherent design reliability, and the reliability of the support system
- the airborne equipment and the support equipment engineer can best contribute to an effective weapons or spacecraft system by working in conjunction with each other from the conception of the system through development and acceptance test.

Because we believe this, Grumman has established a partnership between airborne electronics and support electronics. Together, the airborne equipment engineer and the support equipment engineer:

- determine what is best for the system
- use the same ground rules, based on realistic tactical requirements
- develop their separate equipments in partnership and jointly test them for compatibility.

The result is a system with proper balance . . . a truly integrated system.

Electronic systems engineering represents a unique and significant branch of Grumman engineering due to the many airborne and space vehicles requiring extensive state-of-the-art electronics. Working closely with all engineering disciplines—from concept thru design, development and acceptance test—our rapidly expanding electronic systems requirements offer an unusual opportunity for engineers to grow with us in a vital field. Your direct action is invited by the following immediately available opportunities.

**EMC Systems Engineers**—BS in Engineering to perform systems analysis, state-of-the-art reviews & develop advanced EMC techniques. Will be responsible for generating design data, control plans, test plans, directing tests, analyzing results, generating fixes and preparing reports for conformance to MIL-E-6051C & 6181D. Should have specific experience & be familiar with all aspects of EMC. Familiarity with computer math modeling is desirable.

**ECM Engineers**—BS in Engineering with a minimum of 3 years experience in RF systems performance testing, troubleshooting & evaluation. ECM experience should be extensive, encompassing antenna, receiver, encoder computer, display integration, and malfunction evaluation.

**Communications Engineers**—BS in Engineering or equivalent and a minimum of 3 years experience in design, development, and test of airborne, spaceborne & navigation equipment systems. Knowledge of communication & RF navigation requirements techniques, methods, and uses as well as knowledge of fabrication techniques, limitations & requirements, are essential.

**Antenna/Radome Engineers**—B.S. in Engineering & a minimum of 2 years job related experience in the design & development of aircraft antennas, radomes & microwave components. Experience should include design of antennas in all frequency bands.

**Electronic Test Engineers**—BS in Electronics or Physics with a minimum of 3 years experience in systems testing. Applicants demonstrating the equivalency will be considered. Experience in one or more of the following areas is mandatory: Search & Track Radars, Digital Computers, Communications, Inertial Guidance & Electrical Power Systems.

**Auxiliary Systems Engineers**—BSEE with experience in the design or test of logic & switching circuitry for spacecraft pyrotechnic initiators & detonator devices.

BSEE with experience in fuel management, fire detection & extinguishing, environmental control, central air data computers; warning caution systems.

**Armament Controls Engineers**—BSEE with a minimum of 3 years experience in the design or test of aircraft electronic solid-state armament controls, for monitoring, pre-conditioning, release & jettison of various weapons.

**Aerospace Electrical Power Systems Engineers**—B.S. in E.E. or Physics with a minimum of 2 years experience in design, development, or integration of aircraft or spacecraft electrical, power systems. Positions available in aircraft programs, manned & unmanned spacecraft programs; aircraft & spacecraft advanced systems.



**Stabilization & Control Engineers**—B.S. in E.E. or Physics, with 3 to 5 years experience in aircraft or missile electronic system testing (specifically digital programmer electronics). Primarily assignments will involve integrating & testing of the LM mission programmer including the establishment of requirements for integration test procedures, conducting tests; evaluation of test results & the writing of final test summaries & reports.

**Aerospace Navigations Systems Engineers**—BSEE with a major in control theory and 3-8 years experience with small analog computers, inertial sensors and solid-state circuit design. Knowledge of aircraft navigation systems, required; capable of designing small analog computer and investigating total navigation system problems.

**Field Engineers**—Expanding Field Engineering force requires individuals who can supply evidence of a professional technical background in intergrated weapon systems or experience in one or more of the following areas: radar, digital computers, inertial navigation systems; automatic ground support equipment. Degree is desirable, but not required. Successful Field Engrg. background considered to be the most appropriate qualification. Field benefits are liberal.

**Digital Systems Engineers**—BSEE with experience in military digital and data processing equipment. Must be capable of performing a comprehensive analysis of digital equipment to establish support concepts and define support requirements.

**Logic & Switching Engineers**—BSEE with experience in digital logic; timing and control, arithmetic elements and time sharing systems. Must be capable of developing a detailed logic design from system specification. Should be able to perform detailed system analysis to minimize hardware, eliminate hazards & timing problems & to specify testing requirements.

**RF Engineers**—BSEE (or equivalent) with experience in radar, communications or electronic countermeasure systems to determine support equipment requirements and/or design & development of electronic support equipment to checkout & fault isolate aircraft or space vehicle RF systems.

**Servo Engineers**—Graduate Engineers with experience in one or more of the following: Circuit analysis, servo design, inertial navigation, displays, and flight instruments.

**Support Systems Engineers**—BS or MS in ME, AE or EE with experience in support system analysis; support element integration, AGE interface; logistics and planning.

**Training Devices Engineers**—B.S. & experience with weapon system & maintenance trainers or equivalent, capable of programming & utilizing digital computers to solve real-time simulation problems. Will be responsible for development of training criteria, systems analysis, design, subcontractor monitoring, operation & test of training devices and systems.

**Electronics Instructors**—Will be responsible for instruction of military &/or civilian personnel in aircraft electronic systems (eg. maintenance, trouble shooting, etc.), & for preparing written training material & graphic aids to supplement verbal instruction. A minimum of 4 years electronic experience & 2 years of college or equivalent required.

**Aircraft Electro-Mechanical Designers**—Designers with experience in aircraft electrical/electronic circuit design, installation, liaison, packaging to military specifications.

**Electronic Packaging Engineers**—B.S. in E.E., M.E. or Physics, with a minimum of 4 years experience in all phases of military airborne electronic packaging per MIL specs.

**Reliability Engineers**—experienced in at least one of the following areas: design reviews, predictions & tradeoff studies; circuit analysis; system/mission effectiveness studies; reliability testing techniques & procedures; electrical component part evaluation; corrective action; reliability & maintainability data systems. B.S. is desired.

**Maintainability Engineers**—will establish maintainability goals, plan & direct maintainability programs, perform tradeoff studies & participate in planning & implementation of maintainability testing & demonstration. Experience in supportability, repairability or operations analysis will be put to good use. Degree is desired, but applicable experience is acceptable.

**Electronic Parts Engineer**—B.S.E.E. or equivalent with a minimum of 2 years experience. Duties entail electronic parts selection, application & specification review.

**Computer System Engineers**—Engineers & Mathematicians with 1-5 years experience in the analysis, design and development of digital computer systems.

**Electronics Systems Test Engineers**—BS in Engineering or Physics (or equivalent) with a minimum of 3 years test experience in one or more of the following areas: radar, inertial attitude control, computers, communications, electrical power.

**Software Systems Programmers**—Minimum 4 years experience in large-scale operating system, including I/O supervisory routines, and real-time task management. Must be capable of mastering systems internals with a minimum of instruction, knowledge of computer hardware and a BS in physics, mathematics, engineering (or equivalent) are required. Tasks will include design and maintenance of a real-time multi-programming data reduction system.

**Test Data Analysts/Programmers**—Team leaders to design and implement programming systems for the reduction and analysis of aircraft and spacecraft telemetry and instrumentation data. BS (or equivalent) required with minimum 3 years experience in programming large-scale scientific computer systems. Fundamental knowledge of test vehicle instrumentation valuable.

**Applications Programmers**—To assist in development of state-of-the-art applications programs for the reduction of aircraft and spacecraft test data. BS required, 1-3 years programming experience. Current operations include: evaluation of aircraft weapons systems, radar and electronics, structures and total performance, spacecraft checkout, thermal vacuum testing and total mission performance.

**Airborne Computer Systems Programmers**—To develop and implement software for real-time Airborne/Spacecraft Computer Systems. Experience in real-time multi-programming and ground-based support simulations is desirable.

**Management Systems Programmers**—Will write programs to implement advanced Management Information Systems for Engineering, Material and Manufacturing control. Should be familiar with concepts of medium-to-large-scale general purpose systems employing time-sharing, teleprocessing and multi-processing. Knowledge of IBM S/360 and COBOL desirable.

**Test Data Reduction Specialists**—BS and minimum of 2 years' experience with telemetry ground station operation, digital computer processing of test data, data acquisition systems, data processing planning, and data reduction.

**Analog/Digital Operations Systems Engineers**—BS or equivalent with a minimum of 1 year experience operating analog/digital data processing equipment including wideband tape recorders, FM discriminators, PCM demodulation systems, and analog display equipment. Computer software experience desirable.

**Vibration Analysis Systems Engineers**—BS or equivalent and a minimum of 2 years' experience in operation of vibration analysis data reduction equipment including power spectral density, transfer function, correlation, and other typical vibration data output.

**Systems Integration Engrs. (Flight Development)**—BSEE or equiv. with 3-5 years exp. in systems integration. Will work in areas of airborne weapon systems development, evaluation & demonstration of following systems: Radar, IR, ECM, LLLTV, A to D Converters, detection processors, computer data processing, data links, communications, navigation systems, missile systems & ASW systems.

**Instrumentation Design Engineers**—BSEE with a minimum of 3 years experience in digital logic & system design. Experience with telemetry & analog multiplex tape systems, highly desirable. Will be responsible for complete check-out of airborne instrumentation from component procurement to systems checkout.

**Instrumentation Measurement Engineers**—BS in EE or Physics with 4 years experience in Instrumentation measurement problems. A good theoretical and practical knowledge of transducers, their specifications and application to measurement of temperature, pressure flow, acceleration, rate, force, is required.

BS in ME, EE or Physics with a minimum of 2 years experience, to work with telemetry, digital systems & tape recorders as applied to Flight Test Development Programs.

**Instrumentation Application Engineers**—BSEE with a minimum of 2 years experience in electronics circuit application with knowledge of digital techniques. Will operate analog & digital data acquisition systems.

BS in ME, EE or Physics with a minimum of 2 years experience, to work with telemetry, digital systems & tape recorders as applied to Flight Test Development Programs.

**GRUMMAN INTERVIEWING IN N. Y. C. DURING IEEE**  
Mon. thru Thurs., March 18th thru 21st. Arrange an interview by calling  
Mr. Carl Sica, at (212) JU 6-7000, between 9 AM and 7 PM.

Arrange a Bethpage interview  
by sending comprehensive resume  
to: Mr. George E. Kwak, Manager,  
Engineering Employment, Dept. GR-76



**GRUMMAN**

**AIRCRAFT ENGINEERING CORPORATION**  
Bethpage • Long Island • New York, 11714

WHERE MAN IS THE HEART OF THE SYSTEM

An Equal Opportunity Employer (M/F)



Just because you work  
with hardware like this...

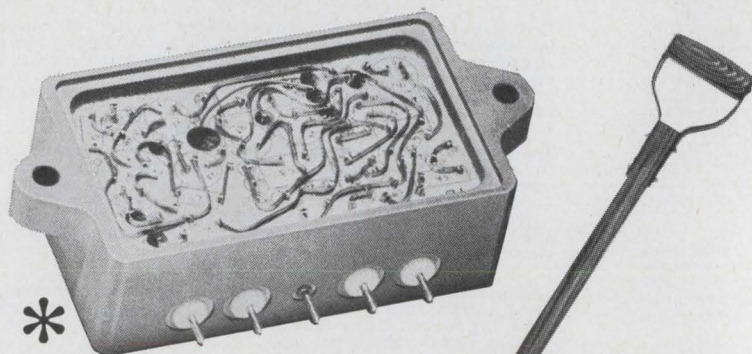

\*

doesn't mean you have to  
work with hardware like this!

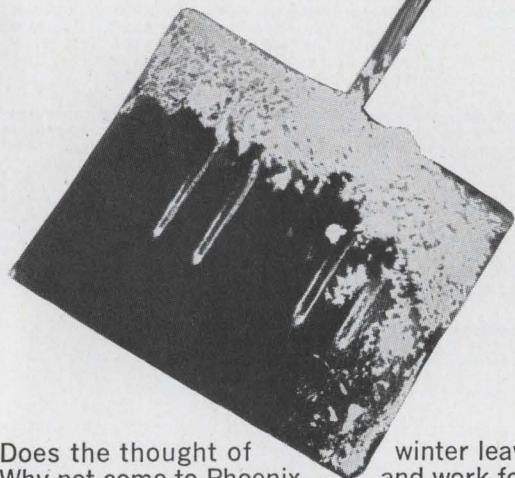

Does the thought of winter leave you cold? It does us. Why not come to Phoenix and work for Motorola's Aerospace Center? The work is important, the assignments are rewarding, the freedom is refreshing, the state-of-the-art is challenged, and, lest you forget, the weather's great. If you can qualify, send us a resume. You'll never feel snowbound again.

\*Motorola VCO shown actual size

#### Specific Opportunities:

Space Communications ■ Radar Systems ■ Tracking & Telemetry ■ Fuzing ■ Digital Data Transmission ■ Guidance & Navigation ■ ECM & Elint ■ Checkout Systems ■ Coherent Transponders ■ Radar Transponders ■ Integrated Electronics ■ Antennas & Propagation ■ Reliability & Components ■ Advanced RF & Microwave Techniques

in PHOENIX  MOTOROLA

Government Electronics Division • Aerospace Center

Write: Paul Ahler, Recruitment Mgr., Dept. 65 Box 1417, Scottsdale, Arizona

MOTOROLA ALSO OFFERS OPPORTUNITIES AT CHICAGO, ILLINOIS — AN EQUAL OPPORTUNITY EMPLOYER

*"Put Yourself in the  
Other Fellow's Place"*

**TO EMPLOYERS**

**TO EMPLOYEES**

Letters written offering Employment or applying for same are written with the hope of satisfying a current need. An answer, regardless of whether it is favorable or not, is usually expected.

**MR. EMPLOYER**, won't you remove the mystery about the status of an employee's application by acknowledging all applicants and not just the promising candidates.

**MR. EMPLOYEE** you, too, can help by acknowledging applications and job offers. This would encourage more companies to answer position wanted ads in this section.

We make this suggestion in a spirit of helpful cooperation between employers and employees.

This section will be the more useful to all as a result of this consideration.

Classified Advertising Division

**McGRAW-HILL, INC.**

330 West 42nd St.,

New York, N. Y., 10036



# Want to make a name for yourself?

Don't be just a "what's-his-name". A cog.

There's a difference between being part of a machine... and being part of a team.

At Aerojet-General's Electronics Division you'll have a chance to make your name — as an individual member of a team.

And as a contributor to our space satellite program you'll be doing some of the most important work in the country. Your colleagues will be top engineers and scientists. They'll stimulate you. And challenge you to do your best work.

More important, you'll get recognition.

We need engineers and scientists — such as electronic circuit design and project engineers, optical engineers, infrared specialists — for work on some of the nation's most advanced programs. In such fields as sophisticated space surveillance, satellite payloads, infrared and star sensing devices, data processing. And many more.

If you're good, we'll help you make a name for yourself. Just tell us what it is.

Send your resume to Director of Personnel, Aerojet-General Corporation, Box 303F, Azusa, California 91702.

We are an equal opportunity employer.



CIRCLE 972 ON READER SERVICE CARD



# Today's brand new ocean opens your brand of engineering career opportunity.

Newport News, world's largest and most advanced shipbuilding company—involved with all today's revolutionary marine developments—has immediate career openings in all these engineering fields:

Mechanical Engineers	Civil Engineers
Electrical Engineers	Metallurgical Engineers
Marine Engineers	Data Programmers
Industrial Engineers	Systems Analysts
Naval Architects	Chemists
Nuclear Engineers	Laboratory Analysts

With an order backlog now over \$500,000,000, we're bidding for creative engineers who like challenges and personal responsibility. Write our employment manager, John J. Gaughan. You'll get fast action.



**Newport News**  
SHIPBUILDING AND DRY DOCK COMPANY, NEWPORT NEWS, VIRGINIA  
An Equal Opportunity Employer

CIRCLE 978 ON READER SERVICE CARD

## Immediately Required ELECTRONIC AND MECHANICAL ENGINEERS

who want to make significant contributions in the fields of:

- Advanced broadband airborne communications and navigation antennas
- Electronically steered phased arrays
- ECM and Tactical System Components

Our Chief Engineer, Ed Sornberger, will be pleased to fill you in on prerequisites, opportunities, benefits and compensation. Why not call him collect today at

(516) 585-4000

# dorne and margolin, inc.

AN EQUAL OPPORTUNITY EMPLOYER

*Over 20 Years of Leadership in Antenna Technology*

HEADQUARTERS: 2950 VETERANS MEMORIAL HWY., BOHEMIA, N.Y. 11716  
TEL. 516 585-4000 • TWX 510 228-6502

AEROSPACE DIV.: 9730 COZYCROFT AVE., CHATSWORTH, CALIF. 91311  
TEL. 213 341-4010 • TWX 213 341-4646



CIRCLE 979 ON READER SERVICE CARD

## In electronics it's Electronics magazine to sell used equipment!

Your advertisement will produce Results in Electronics. Engineers turn to Electronics magazine for the latest technical developments — and for the latest buying information. You can reach them inexpensively in Electronics Searchlight Section.

For information:  
Searchlight Section  
Classified Advertising Division  
Post Office Box 12  
New York 10036

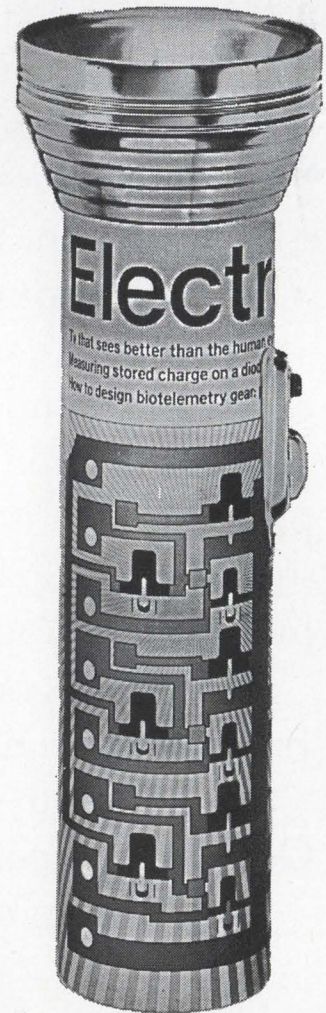



# PHILADELPHIA NAVAL SHIPYARD

your growth with the  
Now let's discuss  
still growing...  
years old and  
are 160  
we

# ENGINEERS

Call, write or visit  
Industrial Relations Office  
Dept. 173AD  
Phone: (215) 755-3672  
PHILADELPHIA NAVAL SHIPYARD  
Philadelphia, Pa. 19112

An Equal Opportunity Employer

CIRCLE 973 ON READER SERVICE CARD

## AUTOTRACK ANTENNA MOUNT

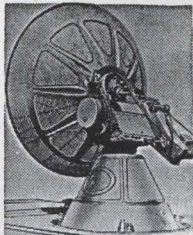

360 degree azimuth, 210 degree elevation sweep with better than 1 mil. accuracy. Missile velocity acceleration and slewing rates. Amplidyne and servo control. Will handle up to 20 ft. dish. Supplied complete with control chassis. In stock—immediate delivery. Used world over by NASA, USAF, MP-61-B. Type SCR-584. Nike Ajax mounts also in stock.

## PULSE MODULATORS

**MIT MODEL 9 PULSER 1 MW—HARD TUBE**  
Output 25kv 40 amp. Duty cycle .002. pulse lengths .25 to 2 microsec. Also .5 to 5 microsec. and .1 to .5 microsec. Uses 6C21. Input 115v 60 cycle AC. Mfg. GE. Complete with driver and high voltage power supply. Ref: MIT Rad. Lab. Series, Vol. 5, p. 152.

**2 MEGAWATT PULSER**  
Output 30 kv at 70 amp. Duty cycle .001. Rep rates. 1 microsec 600 pps. 1 or 2 msc 300 pps. Uses 5948 hydrogen thyratron. Input 120/208 VAC 60 cycle. Mfr. GE. Complete with high voltage power supply.

**250 KW HARD TUBE PULSER**  
Output 16 kv 16 amp. Duty cycle .002. Pulses can be coded. Uses 5D21, 715C or 4PR60A. Input 115 v 60 cy. AC \$1200 ea.

**18 MEGAWATT PULSER**  
Output 150KV at 120 amps. Rep rate: 50-500 PPS. Pulse length: 5 msec. 15KV 120 amp. into pulse transformer. Rise time 1.5 msec. Filament supply 5V 80 amp. incl. 17.5KV 1.5 amp DC power supply. Input: 220V 60 cy AC.

**INDICATOR CONSOLES**  
AN/SPA-4A, PPI 10" to 300 mi.  
AN/UPA-25, PPI 10" to 250 mi.  
VI-1 RFI 12" to 200 mi, 60K ft.

## IBM 704 IBM 650

These computers in stock for immediate delivery

**SCR 584 AUTOTRACK RADARS**  
Our 584s in like new condition, ready to go, and in stock for immediate delivery. Ideal for telemetry research and development, missile tracking, satellite tracking. Fully Desc. MIT Rad. Lab. Series, Vol. 1, pps. 207-210, 228, 284-286. Comp. Inst. Bk available \$25.00 each.

## SONAR SYSTEMS IN STOCK

AN/FQS-1A, AN/UQS-1B, QHBa scanning sonars. Rochelle salt hydrophones 6 ft. \$150 ea.

## MICROWAVE SYSTEMS

**L BAND RF PKG.**  
20 KW peak 990 to 1040 MC. Pulse width .7 to 1.2 micro sec. Rep. rate 180 to 420 pps. Input 115 vac incl. Receiver \$1200

**200-225 mc RADAR SYSTEM**  
1 Megawatt output. 200 nautical mile range for long range detection of medium and high altitude jet aircraft as well as general search. AN/TPS-28.

**SURVEILLANCE DRONE RADAR SYSTEM**  
X-Band tracking system with plotting boards. Type AN/MPQ-29. Drone also in stock.

**5 MEGAWATT C-BAND**  
Klystron RF package delivering nominal 5 megawatt pulse RF. Complete with pulser and power supply.

**500 KW L BAND RADAR**  
500 kw 1220-1359 msc. 160 nautical mile search range P.P.I. and A scopes. MTTI. thyratron mod 5326 magnetron. Complete system.

**100 KW X BAND RADAR**  
Complete 100 kw output airborne system with AMTI. 5C22 thyr. mod. 4J52 magnetron. PPI, 360 deg as sweep, 60 deg. elev. sweep, gyro stabilizer, hi-gain revr. Complete with all plugs and cables.

**AN/GPG-1 SKY-SWEEP TRACKER**  
3 cm. automatic tracking radar system. Complete package with indicator system. Full target acquisition and automatic tracking. Input 115 volts 60 cycle New. In stock for immediate delivery. Entire System 6' long, 3' wide, 10" high. Ideal for Infrared Tracker, Drone Tracker, Missile Tracker, R. & D.

**500KW S BAND RADAR**  
250 miles search 115V 60 cy AC. Mfg. G.E.

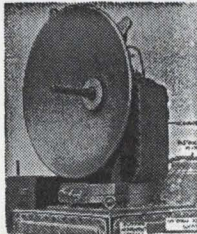

RADAR SYSTEMS GROUND AND AIRBORNE. AUTOMATIC TRACKING ANTENNA SYSTEMS. NIKE AJAX NIKE HERCULES M-33 MSC-1A. MPS-19. MPS-9. SCR 584. TPS-1D. TPS-28. FAA-ASR-2. AIRBORNE SYSTEMS. APN-84. APN-102. APS-20. APS-27. APS-45. DPN-19. DIGITAL COMPUTERS. IBM 650. IBM 704.

LARGEST INVENTORY OF RADAR AND MICROWAVE EQUIPMENT IN THE WORLD.  
**RADIO RESEARCH INSTRUMENT CO.**  
45 WEST 45TH ST. N. Y. 10036 212-JU 6-4691

CIRCLE 974 ON READER SERVICE CARD

CLASSIFIED ADVERTISING

## SEARCHLIGHT SECTION

BUSINESS OPPORTUNITIES  
USED OR SURPLUS EQUIPMENT

## GET IT from GOODHEART!

EVERYTHING UNCONDITIONALLY GUARANTEED!

SILIC. RECTIF. 8000 PIV 400 MA. Large user's termin. invent., not rejects! Slater SZA08-2. Max: reverse, 2 uA; fwd drop, 8.2 v. Cost \$8 ea. Bakel. encapsul. 3x1/2x1" ht ea. PAIR postpaid.....\$5.50

GRTD. LOWEST-PRICED COUNTER to 220 or 510 mc! Like-new appearance; recent-date Certif. of Calif. traceable to Nat. Bur. of Standards. With 5 books. ± 1 count ± .0001%. Hewl-Pack #524B with #525A & #525B or C. ....WRITE FOR LOW REDUCED PRICES!

BOONTON #225A AM/FM Sig. Gen. 10-500 mc. ASK! HEWL-PACK #608A AM Sig. Gen. 10-500 mc. ASK!

MARCONI FM DEVIATION METER TF-934, regularly \$890. Reads dev. w/ranges 5, 25, 75 kc. Has audio monitor. Made for MIL, 2 1/2-100 mc, easily reaches 1000 mc on harmonics; we include all instructions. Checked out, ready to use.....\$249.50

Brand New VHF revrs look like BC-453 Command but are 9-tube 108-135 mc. 2 uv sens; 2 rfs. 3 IP's; noise lntr; avc W/schem., instruct., spline knob, & graph to set freq. by counting turns. A.R.C. Type 13B, 28v htr wiring; 7# shpg wt.....\$22.50 R32 is same but w/squelch; 14v htr wiring.....\$27.50

R-23/ARC-5 Command revr 190-550 kc.....14.95  
A.R.C. 12 #22 Command revr 540-1600 kc.....17.95  
IM-14 Freq. meter, .01% 125 kc-20 mc.....57.50  
TS-323/UR Freq. meter 20-480 mc, .001%.....169.50  
BC-221's OK.....\$67.50 TS-175 OK.....127.50

CLOSING OUT Radio Receivers 38-4000 mc at CRAZY LOW PRICES! Ask for APR-4/4Y/CV-253 sheet.

ALL-BAND SSB RCVR BARGAIN: Hallcrafters R-45/ARR-7., 550 kc to 43 mc continuous. Voice, CW, MCW, all med, grtd, w/book: 2-RF, 2-IF's S-meter; noise lntr: 3 xtl, 3 non-xtl selectivity choices. Less pwr spl'y.....149.50  
60 cy pwr spl'y: \$30. SSB product detector.....\$20

SP-600-JX Revr .54-54 mc, Exc. Cond., w/book 325.00

Super. EMT 6220Y 3 ph 20 kva Line V Regulator 450.00  
Sorens. 10000S 10 kva Line V Regulator.....695.00  
And others from 250 VA up. Ask for Regulator List.

Automichron Cesium-Beam Freq. Standard...ASK!  
Regulated Power Supplies, Meter Calibrators...ASK!  
All kinds of AUDIO Test Equipment.....ASK!  
Standard Signal Generators CW/AM/FM/Sweep...ASK!  
Bridges, Potentiometers, other Lab Standards...ASK!  
Electronic & Rotary Frequency Converters...ASK!  
Noise & Field Strength Meters.....ASK!

TIME PAY PLAN: Any purchase totaling \$160.00 or more, down payment.....10%

Above is a small sampling of our terrific inventory. WE ALSO BUY! We want Tektronix scopes, Hewlett-Packard equip., Aeronaut, radio-shop equip., etc. ... AND Military Communications of all kinds.

DO NOT ASK FOR CATALOG! ASK FOR SPECIFIC ITEMS OR KINDS OF ITEMS YOU NEED!  
**R. E. GOODHEART CO. INC.**

Box 1220-E, Beverly Hills, Calif. 90213  
Phones: Area 213, office 272-5707, messages 275-5342

CIRCLE 975 ON READER SERVICE CARD

**Minifluid DISPENSER**  
AIR OPERATED  
for miniature potting and encapsulating

Available in 3 sizes  
6cc - 12cc - 30cc

**\$34.00 UP**

**PHILIP FISHMAN COMPANY**  
7 CAMERON ST., WELLESLEY, MASSACHUSETTS 02181

CIRCLE 976 ON READER SERVICE CARD

## ELECTRON TUBES

KLYSTRONS • ATR & TR • MAGNETRONS  
SUBMINIATURES • C.R.T. • T.W.T. • 5000-  
6000 SERIES  
• SEND FOR NEW CATALOG A2 •  
A & A ELECTRONICS CORP.  
1063 PERRY ANNEX  
WHITTIER, CALIF.  
696-7544

CIRCLE 977 ON READER SERVICE CARD

## SURPLUS EQUIPMENT

All Types of Hard to Get Equipment Such as:  
H. P. TEKTRONIX; G. R. Also Government  
Equipment—such as: UFM-42a, PRM-21, UPM-  
6E, UPM-12a, G. P. M. 25. Write for Free Catalog

## SELECTIONS

1206 S. Napa St. Philadelphia, 46, Pa.  
Telephone HO 8-4645 or HO 8-7891

CIRCLE 978 ON READER SERVICE CARD

Don't forget the

## BOX NUMBER

When answering the classified advertisements in this magazine don't forget to put the box number on your envelope. It's our only means of identifying the advertisement you are answering.



# Tips on cooling off hot transistors

See how circuit designers use IERC heat dissipators to protect semiconductors...improve circuit performance and life.

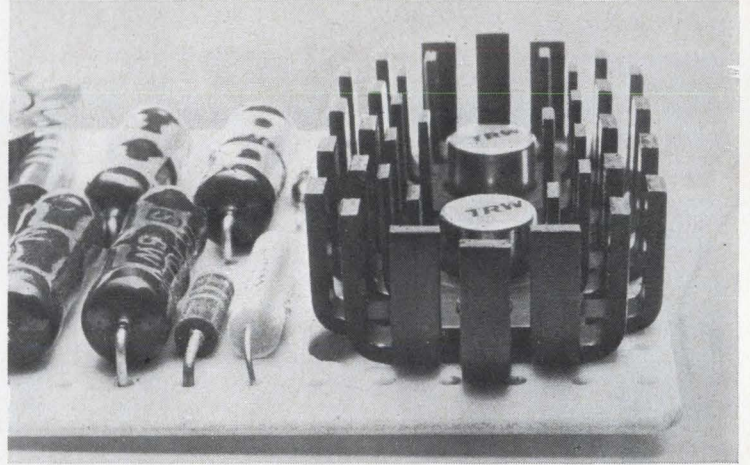
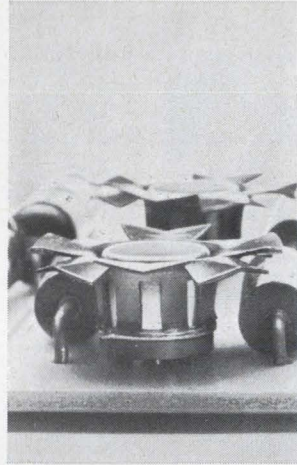
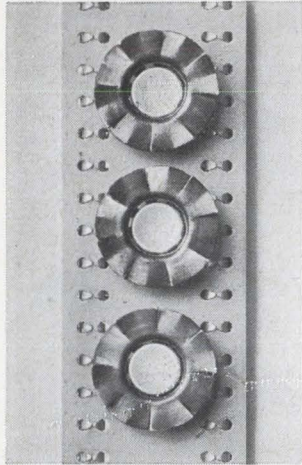

**Fan-top dissipators for TO-5 and TO-18 cases drop temperatures dramatically; cost just pennies.** T-shape adds almost nothing to board height; allows components to snuggle close to transistors. Spring fingers provide fast, press-on installation.

**To cool off low-to-medium power transistors in TO-5 and TO-18 cases, use IERC's efficient LP's.** Patented, staggered-finger design maximizes radiation and convection efficiency, radiates heat directly to ambient. Available in single or dual mounting for thermal mating of matched transistors.

**IERC Thermo-Link Retainers provide efficient thermal links** between transistors and chassis or heat sinks. (Also, excellent dissipation when used on p-c boards.) Integral BeO washers reduce capacitance up to 2/3. Fast, no-snap installation; transistors are firmly held.

**New! Dissipators and retainers for plastic and epoxy transistors.** 3 new series for RO-97A, RO-97 and X-20's. Permit a jump of 10% to 33% in operating power.

**Free 8-page short form catalog** discusses IERC's complete line of dissipators, retainers and tube shields. Gives specifications, prices, how to order. Send for your copy today.

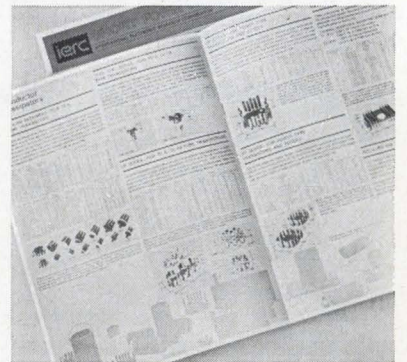
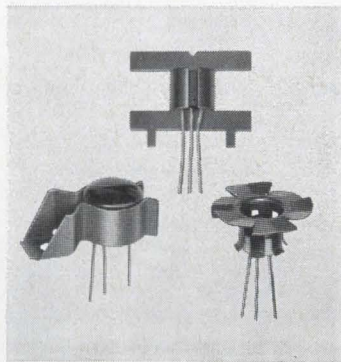
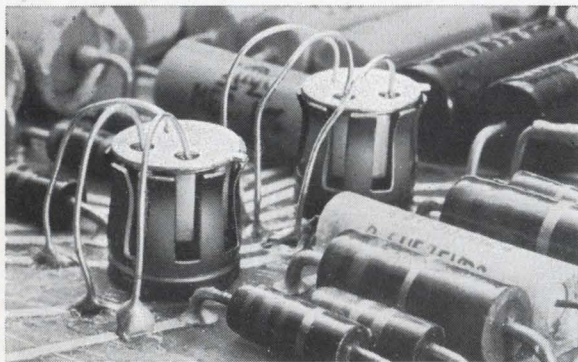

**Special insulating coating** — Insulube 448, a special non-hygroscopic finish developed by IERC, combines excellent dielectric properties, 50 K megs insulation resistance, and high heat emissivity. Also protects against salt spray, fungus, etc.

**Tough heat dissipating problem?** IERC engineers welcome your letter-head inquiry for specific information or assistance in selecting heat dissipators.

**ierc**  
SEMICONDUCTOR  
HEAT DISSIPATORS



---

# Newsletter from Abroad

---

March 4, 1968

## Peruvian dish upsets Hughes

Hughes Aircraft is now out of the running for the contract to build a Peruvian ground station to work with Intelsat 3 satellites.

In a first round of bidding late last year, Hughes topped the list with a bid of \$4.3 million and seemed sure of getting the contract after the Peruvian government issued a tentative award. Later, though, the government canceled the award. The official reason: Hughes had effectively withdrawn its bid because of "financing problems." The cancellation edict indicated the company would pay Peru \$60,000 for pulling out.

Hughes admits it was the apparent low bidder, but insists there was no penalty payment. Hughes' original competitors for the Peruvian job are convinced Hughes shaved its bid too closely and then later balked when the government insisted on tacking on extras at no additional cost.

## French rocket rattles Germans

West German space officials are growing impatient waiting for France to come up with a working Coralie rocket, the second stage of the Europa-1 booster slated to launch the Franco-German Symphonie communications satellite in 1971.

A mid-1968 test flight with all stages live has been scheduled for the three-stage Europa-1 by its developer, the seven-nation European Launcher Development Organization. But in two earlier test flights with only the first and second stages live, the Coralie fizzled and there's little chance that an improved version will be ready much before the end of the year.

The Germans now want the French to put together a dummy second stage so that the German-built third stage can be flight-tested for the first time this summer. This, say the Germans, would keep the Europa-1 development program—Coralie excepted—on schedule.

There's no indication yet whether the French will go along with this proposal. But there are signs the French space agency will step up its efforts with Coralie. The agency last month pulled the project out of the armed forces missile development facility and turned it over to the government-controlled missile-making company, Societe d'Etudes et de Realisations d'Engins Balistiques.

## Intelsat 4 will have foreign accent

The International Telecommunications Satellite Consortium apparently intends to give European and Japanese electronics companies a bigger share in future programs.

Bids for the 5,000-to-10,000-circuit Intelsat 4 are due early next month, and though the half-dozen contenders for the prime contract will be U.S. firms, each will be teamed up with foreign subcontractors. Comsat, the project manager for the 61-nation organization, predicts that a third or more of the proposed work on the giant satellite will be done outside the U.S. Overseas firms, it notes, got only "modest" subcontracts for the Intelsat 3 craft to be launched this fall.

## British price war looms in computers

Pressures are building in Britain toward a price war among suppliers of small computer systems in the class of the IBM 360 Model 20.

The skirmishing started early this year, when the International Business Machines Corp. was forced by the sterling devaluation to raise its



# Newsletter from Abroad

prices about 10%, thereby making the market for small machines more attractive to competitors. International Computers & Tabulators jumped in with its 1901A machine, priced at \$110,000 for processor plus line printer, card reader, and direct-access disk memory.

Honeywell Inc.'s British subsidiary followed in late February with its Model 110, one of Honeywell's 200 series machines. It sells for \$117,000 but rents for \$2,325 a month, \$175 less than ICT gets for its 1901A.

A third new small machine will go on the British market this week when the National Cash Register Co. introduces the 100 Model of its 615 series [see story p. 25]. Price hasn't been set yet, but market watchers figure NCR at the very least will have to match Honeywell's \$2,325 monthly rate to make any headway.

## Belgians yet to set offset for new jets

Belgian electronics producers still don't know how much fallout they'll get from their country's decision to buy 88 Mirage 5 fighters from France's Dassault.

To land the \$150 million contract, Dassault agreed to farm out \$105 million in contracts to Belgian companies. But the Brussels government still has to split up the orders. Under one proposed formula, the offset would include \$26.25 million of electronics gear; under another, the electronics allotment would run to \$18.76 million.

Either way, the Belgian electronics industry will get from the Mirage 5 deal what it has wanted for a long time—a chance to gain a foothold in European avionics [Electronics, Jan. 22, p. 191]. Industry insiders believe the electronics hardware for the 88 fighters will amount to something between \$15 and \$18 million, so Belgian companies stand to get orders for the avionics of other planes built by Dassault.

## GE again boosting stake in Bull-GE

General Electric, which started out with a 50% holding in the joint company it formed four years ago with Machines Bull and then boosted its holding to 66% last year, will pour more capital into the venture.

The money will go toward offsetting Bull-GE's operating losses, which are expected to continue until 1969 at least. Last year's loss was \$17.5 million, some \$5.7 million narrower than 1966's.

Company officials won't say how much more will be invested, but insist it will be under last year's \$30 million, raised entirely by GE. This gave GE a controlling interest temporarily; the American company's French partner has the right to buy back its half of last year's additional funding. This year's increase in Bull-GE's capital, though, would almost certainly come solely from GE.

## European airbus needs U.S. orders

Backers of the European airbus project are now convinced that prospects for the planned 300-passenger jet hinge on orders from U.S. short-haul carriers.

The French, British, and West German governments have agreed to help finance development of the plane as soon as airlines take out options to buy 75 production versions. The government-run airlines of the three countries, though, don't want that many [Electronics, Oct. 16, p. 226].

Deutsche Airbus GmbH, a company set up by five German aircraft firms to handle the project, claims that small U.S. carriers are showing interest in the plane. The firm pegs its U.S. potential at 40 to 50 planes.



Dana has just entered  
 the modest price DVM market  
 with the best modest price DVM  
 in the market.

Get yours without waiting.  
 Fill out this order blank  
 and take it to booth 2J05 at  
 the IEEE show.

\$1,150 is the price of our new model 4400 series DC digital multi-meter. If you need AC too, add \$200. (Actually, \$195.) Either way, you can't get a better DVM for the sum. It has a DC accuracy of 0.01%, and rejects noise by 60 dB. With voltage ranges of 1 to 1000, it displays four digits with a fifth digit 20% over range. The unit comes in the usual rack-size, but if you're cramped for space, you can buy the same thing in a model that's only half as wide and twice as high. And at no extra charge. Dana Laboratories Inc., 2401 Campus Drive, Irvine, Calif. 92664 (714) 833-1234.

METROPOLITAN PRINTING CO., 424 W. 6TH ST., TUSTIN, CALIF. 92680—(714) 844-7470 OR (213) 269-1123



**SALES ORDER**

**Dana Laboratories Incorporated**  
 2401 Campus Drive at Von Karman Ave., Irvine, Calif. 92664  
 Phone: (714) 833-1234 ~ TWX: 910-595-1136

SHIP TO



BILL TO

DATE SHIPPED	SHIPPED VIA
AMOUNT	WAYBILL NO.
NO. OF PIECES	BOXES

CUSTOMER ORDER NO.

DATE OF ORDER

SHIP VIA

ITEM	DESCRIPTION	PART NUMBER	QTY. ORD.	QTY. SHIP.	EST. SHIP. DATE	SALES CODE	QTY. B.O.	QTY. SHIP.	UNIT PRICE
	 model 4470		<input checked="" type="checkbox"/>						
	 model 4430								

SALES ORDER — ORIGINAL



# The data sheet is dead...

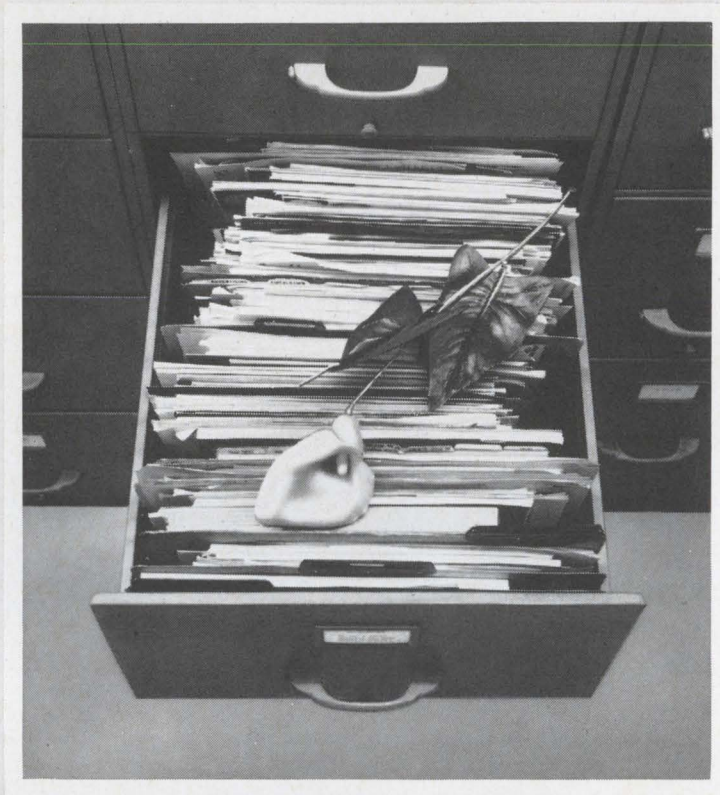

The file drawer is the final resting place for a lot of data. More gets lost in transit, or under coffee. Then there's the problem of updating. Simply containing today's explosion of information strains one's resources... retrieval approaches impossibility. But now the problems of data retrieval have been solved, in a desk's worth of space, by the Sweet's/McGraw-Hill organization...



# Long live the data sheet!

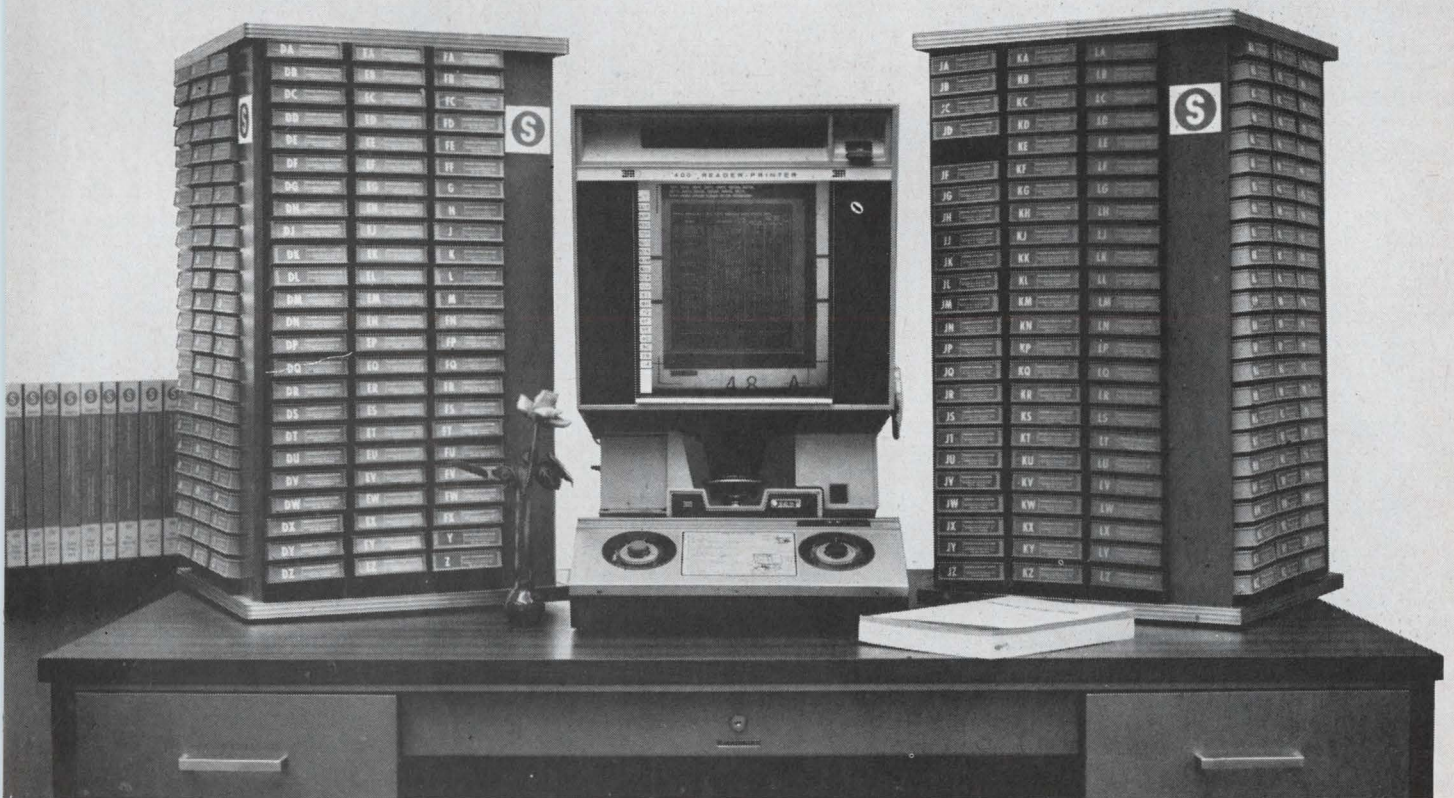

One million pages of live data: The complete data of 5500 important product vendors, all MIL specs, plus MIL standards, QPLs, the D.A.T.A. File, and other specialized information packages. All this is in Sweet's Microfilm Service, and you can find any page of it in less than two minutes. The data, the high speed reader/printer, comprehensive indexing and regular updating cost less than a file clerk.



Circle 87 on reader service card

**SWEET'S INDUSTRIAL INFORMATION SYSTEM/MICROFILM**

For more information call G. O. Stevens collect (212) 971-3586  
or write 330 West 42nd Street, N.Y.C. 10036  
a McGraw-Hill Information System



**Where is there an  
energy-conversion material  
with a high Curie point?  
And a high mechanical  $Q_m$ ?  
And low resonant resistance?  
And a high coupling coefficient?**





P.C.M. shapes up into improved transducers, filters, sensors, high voltage generator, many other components.

## Right here.

Ever run into problems when it comes to converting mechanical energy into electrical energy? And vice versa? You'll probably solve a lot of them with Panasonic's new P.C.M. ("Piezo-ceram"\*).

Reason: P.C.M. succeeds—where other conversion materials usually won't.

That's why it's converting many kinds of electronics engineers into P.C.M. users.

Take Curie temperature, for instance. Depending on the formulation, P.C.M. works fine up to 230° C., or even 490° C. Can stand applications with a wider environment.

The mechanical quality factor  $Q_m$  is over 1,000. And the resonant resistance is surprisingly low. Gives you bigger design freedom. What's more, the piezoelectric coupling coefficient is over 30%.

Result: Extra sensitivity. So you can design smaller components. And save space.

It takes a company like Panasonic to create a material like P.C.M. We've got more than 2,500 scientists and engineers. Make over 4,500 products. Market them in more than 120 countries.

Matter of fact, we're one of the biggest integrated producers of electronic components... and we make over *one billion* of them every year.

See P.C.M.—and other Panasonic breakthroughs including an industrial color camera, radar oven magnetron, video sheet recorder, precision magnetic head, traveling wave display tube, and ceramic solar battery—at the IEEE show. Chances are, we can help you convert some of your biggest headaches. Into big successes.

\*79 patent applications. 30 patents granted internationally.

# PANASONIC<sup>®</sup>

Matsushita Electric Industrial Co., Ltd., Osaka, Japan.  
Matsushita Electric Corporation of America,  
200 Park Ave., New York, NY 10017.

SEE P.C.M. AT PANASONIC BOOTH #4C12-4C18, IEEE SHOW, NEW YORK COLISEUM, MARCH 18-21



# PROGRESS IN FREQUENCY CONTROL FROM REEVES-HOFFMAN



## NEW **MINILITH** FILTER

In Reeves-Hoffman's new miniature, monolithic filter, a single crystal wafer replaces many discrete components, such as inductors, capacitors and numerous crystals, providing a high degree of selectivity with less insertion loss than conventional filters. Only two connections to be made (input and output). Only one temperature coefficient to be concerned with. And the wafer can be ruggedly supported to provide optimum resistance to shock and vibration. All contribute to Minilith's greater reliability. Available in cold-weld or solderseal crystal-holder configurations.

### TYPICAL SPECIFICATIONS

Center Frequency . . . . . 10.7 MHz  
 3 dB Bandwidth . . . . . 13 kHz Min.  
 60 dB Bandwidth . . . . . 30 kHz Max.  
 Ripple . . . . . 1 dB Max.  
 Insertion Loss . . . . . 3 dB  
 Terminating Impedance . . . . . 2K Ohms

**VISIT IEEE BOOTH 3B43**

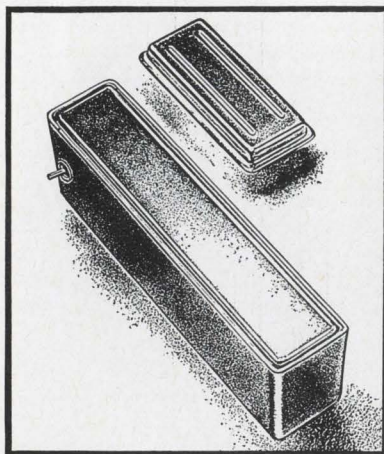

Reeves-Hoffman's new "Minilith" Filter compared to a conventional six-crystal, multi-unit filter of same frequency.

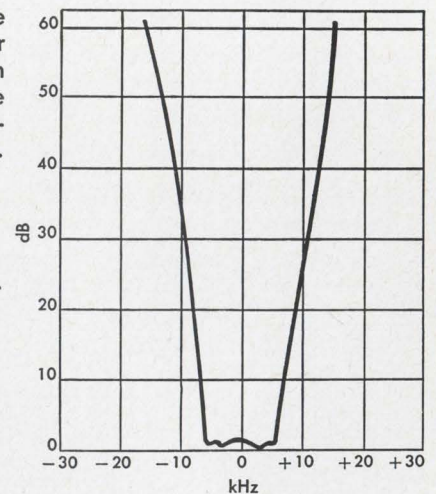

TYPICAL RESPONSE IN 10 MHz RANGE



DIVISION OF **DCA**  
 400 W. NORTH ST., CARLISLE, PA. 17013  
 TELEPHONE • AREA CODE 717 • 243-5929





# Electronics Abroad

Volume 41

Number 5

## Japan

### Sayonara to flybacks

Time is running out for the conventional flyback transformer, a jack-of-many trades in today's television sets but a costly and bulky component with a heavy ferrite core and many turns of fine copper wire. The likely successor: a piezoelectric bar developed by the Matsushita Electric Industrial Co.

Matsushita hints that a commercial product is near, and the first sets with the piezoelectrics could be on the market before the year is out. Although piezoelectric prototypes are planned for transistorized 12-inch receivers, the company says versions could be designed for sets of any size.

**Right mixture.** Actually, the idea of substituting a slab of piezoelectric ceramic for the flyback transformer isn't new. But previous attempts to turn the trick failed because the low-cost ceramics saturated before they could be polarized sufficiently to yield high piezoelectric outputs. Matsushita's ceramic is a mix of lead titanate, lead zirconate, and a third compound composed of lead, magnesium, columbium, and oxygen.

Three electrodes are attached onto the bar, which measures about 0.5 by 0.2 by 6 inches. Half the bar, with an electrode on each side, works as a driver. Flyback pulses applied to these electrodes cause the bar to oscillate violently in the long direction, and a high voltage appears at the output electrode at the other end of the bar. For 200-volt flyback pulses, the output voltage is about 6,000 volts.

**Stacks up.** In the prototypes, the slab is packaged in a receiving-tube envelope 1½-inches in diameter along with two stacks of selenium rectifiers. The stacks are connected in a voltage-doubler arrangement so that the output of the package

is the 12,000 volts needed for the picture tube of a 12-inch set.

Because the piezoelectric device handles only the high-voltage step-up function of the transformer, the package has to be paired with a small choke in a tv receiver. The choke provides the d-c feed to the horizontal output transistor, a feed normally picked off the primary of a flyback transformer. Taps on the choke would take care of the other signals generally picked off the primary.

### Playback platter

There should be a market somewhere for a video recorder that can play back instantly at normal speed for 12 seconds or in slow motion for 12 minutes. And if such a market exists, the Matsushita Electric Industrial Co. hopes to discover it at the annual IEEE convention later this month in New York.

Matsushita will exhibit the prototype of a video recorder that works with sheets of magnetic material rather than tape. The sheets, about 10 inches in diameter, store 12 seconds of tv pictures recorded at normal speeds. The playback time can be stretched out as much as 60 times for anyone who wants a lengthy look at a motion, be it a golf swing or the flexing of a machine part. The input to the sheet recorder can come from a tv camera, a receiver, or a tape recorder.

**Round and round.** For the recordings, the sheets are stretched out over a metal disk and held there by a ring in much the same way as material is held by embroidery hoops. An overhead arm similar to a groove-cutting mechanism carries the recording and playback

head as the disk whirls at 60 revolutions per second.

There are two major differences between a record-cutter head and the vtr head, however. The latter barely touches the sheet and its radial movement isn't continuous. Instead of a spiral, then, the tv signals are recorded on concentric tracks, and there can be up to 360 tracks on one sheet.

**Play the field.** The standard tv format for both the U.S. and Japan has 60 fields of 262.5 lines each per second, interlaced to get 30 frames per second. The blanking time between fields is 1.3 milliseconds—not enough to allow the head to move from concentric circle to concentric circle between fields.

Matsushita gets around this limitation by recording every other field. Playing back alternate fields, though, would give a flickering image and a dim one. Instead, the recorder plays back each field

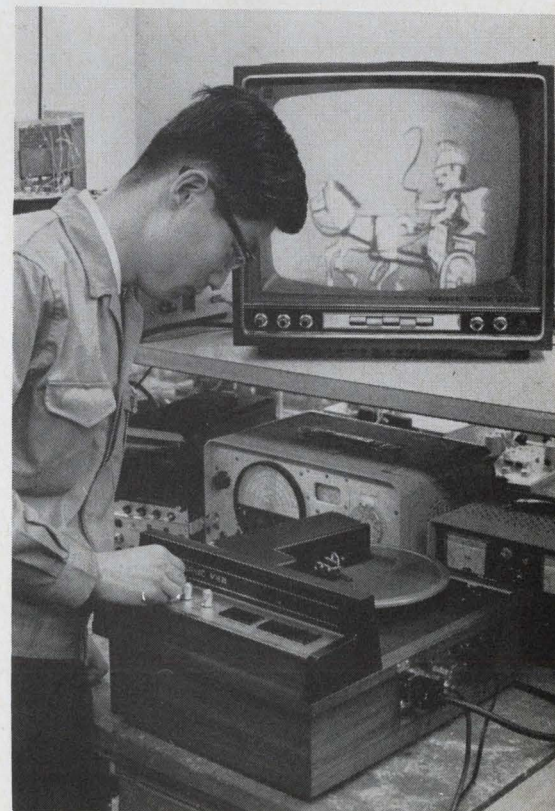

**Video plateau.** Television signals stored on record-like sheet of magnetic material can be played back instantly—fast or slow.



twice. This brings the brightness back up and cuts out the flicker. However, it also cuts the vertical resolution in half.

The company won't explain in detail how the equipment "splices" together the replayed fields. For slow motion, each field is played back several times, and for stills the same field is repeated over and over.

### Roundhouse swing

The Japanese National Railways has been the world's frontrunner on the tracks ever since it put its 110-mile-an-hour New Tokaido run into operation 2½ years ago.

Now JNR is set to become a leader in the roundhouse, too. The railroad expects to have a computer-controlled line of seven lathes turning out repair parts for electric locomotives at its suburban Tokyo overhaul shop next month. So far, using a computer to oversee a group of production machine tools has been done only by a few machine-tool makers in the U.S.

**Lineup.** With its line of lathes, JNR will produce mostly large bushings and shafts. The parts are needed in a hurry, but stocking them in quantity is out of the question; exact size in many cases depends on the wear of old—but not replaced—parts the replacements must match. What's more, the railroad's maintenance men can't order large kingpin parts ahead of time since what needs replacing often can't be spotted until a locomotive has been taken apart.

With seven lathes under control of a single computer, JNR figures it can cut fabrication time for bushings and shafts by as much as 30%. And there'll be side benefits. Along with the numerical control instructions for the lathes, the computer stores a work schedule for the shop. Thus the lathes turn out most-used standard parts for inventory—but only when there's no call for specials to speed the overhaul of a locomotive in for work. JNR expects one day to recoup in savings the capital outlay for the system, worth something like \$300,000.

The railroad's labor bill for the machining operation, for example, will be only one-fifth that of an operator-controlled installation.

**Mastermind.** The system works under control of a Facom 270-20 computer, which has an internal core memory of 16,000 words. An additional magnetic-drum memory, with 131,000 word capacity, stores the over-all working program, the numerical-control processing instructions, and the data gathered by the system to monitor itself.

Fujitsu Ltd. supplied the computer and also the four numerical-control units for the lathes. Two of the NC units are production versions of the Fanuc 260 [Electronics, Oct. 31, 1966, p. 151], which can control—one at a time—tool movements either parallel to the long axis of the workpiece or perpendicular to it. The other two NC units are Fanuc 280 types that control movements on two axes simultaneously.

---

### West Germany

---

#### Pushing polychrome

By and large, German television-receiver makers haven't done too badly with color-set sales so far. Color broadcasts began late last summer and by the end of the year an estimated 100,000 sets had been sold.

But few in the industry believe the initial spurt signals the start of a long-lasting boom. Retailers lately have been grumbling about the sluggishness that set in—despite a downtrend in set prices—after the holidays. Many feel the hoped-for steady rise in color sales can't come until next fall, when the country's two networks double their current color programing of eight hours weekly between them.

**Spreading the word.** One major set manufacturer, though, thinks it'll take a lot more to get sales soaring. What's needed says Wolfgang Junge, sales manager for the Kuba-Imperial group, is an aggressive campaign to popularize the

medium. And Kuba-Imperial, a subsidiary of the General Electric Co., has started plumping for polychrome in a nationwide drive it calls "Farbe ins Haus"—color into homes.

Compared to Europe's staid marketing practices, Kuba's campaign is revolutionary. The company is giving anyone who asks for it a month's home trial for \$7. Once they've had a taste of color, Kuba figures, viewers will hold onto the receivers.

**Success story.** Kuba won't say how many sets it's sold through this promotion scheme. But officials claim a high percentage of the ones put out on trial have been bought. These are 25-inch and 22-inch models priced at just under \$500.

Kuba does say that about 200 people a day send in their \$7 asking for color-set trials. The plan will run through March, a month longer than first scheduled. When the trial got under way, the Winter Olympics sparked buyer interest. With heavy color programing slated for the annual pre-Lenten Carnival, Kuba expects little letdown this month.

Even when a tryer doesn't become a buyer, Kuba isn't particularly put out. Says Junge, "The campaign also gives us an idea of who is interested in color and what's required on future models." When he gets the set, the customer also gets a questionnaire covering his color preferences.

#### Tunnel talk

Subways are no place to try to communicate. Besides the noise and crowding that squelch riders' efforts at conversation, there are hazards for high-frequency radio signals, too. The steel supports in the tunnels interfere with the signals, and, together with reflections set up by curves, limit straight-line range to about 1,000 feet.

There's no relief in sight for hoarse-voiced passengers, but AEG-Telefunken has found a way to adapt two-way radio links to the subway environment. In building a radiotelephone network for the sub-





**Inside or out.** Quarter-wave antenna loop on Munich subway car works equally well in a tunnel or above ground.

way system now under construction in Munich, the firm is installing slotted cable that acts as both a radiating element and an r-f transmission line in the tunnel.

**Olympian task.** The equipment, which links transceivers on the trains to transmitters and receivers at control stations, has already been put to work in a mile-long underground stretch of tracks in Munich's Freimann area. The subway system, fully equipped with radio-telephone communications, is scheduled for completion in time for the 1972 Olympic Games in Munich. Besides keeping in touch with trains in case of emergencies or breakdowns, the control center will be able to communicate with buses and streetcars in the city.

Telefunken's transmission and radiating cable—a 60-ohm coaxial line 1 inch in diameter—has a slit running along the underside of its outer conductor to allow some r-f energy to leak into the space below it. The company found that a slot width about one-quarter the outer conductor's circumference represents the best compromise between attenuation and the radiated power required.

The cable has an attenuation of about 30 decibels per kilometer, a

rate that moisture and dirt increases by only 2 db per kilometer—not enough to seriously affect transmission.

**All hung up.** To keep the distance between the cable and the train-mounted antennas as small as possible, the cable is installed about 4 inches below the roof of the tunnel; at stations, it's run along the platforms, out of sight, for aesthetic reasons.

The system employs five channels—four for subways and one for streetcars and buses. Carrier frequencies range from 149 to 153 megahertz, and channel separation is about 20 kilohertz.

Each transmitter in the network puts out 6 watts of power and will cover an area 2 kilometers on either side of it. The control-station receivers have a sensitivity of 0.5 microvolts for a signal-to-noise ratio of around 20 db. Receivers and transmitters are far enough apart to be decoupled by the cable's attenuation.

Telefunken notes that the cost of the system is surprisingly low. Control-station gear and three subway transceivers will cost together only about \$20,000. The figure includes installation of the cable, which itself is priced at about 50 cents a foot.

## Great Britain

### Bulldog spirit

Nothing, apparently, can stay the General Post Office from switching to pulse code modulation for Britain's telephone network.

To be sure, the GPO's ambitious plans for digital telephony and electronic exchanges have hit many snags, most of them involving money. The large TXE-1 exchange, for example, cost more than \$3 million to develop—about 10 times the cost of a comparable crossbar exchange. And seven years after its inception, this project is still "experimental."

But the GPO continues undeterred. Its Dollis Hill research unit in North London has built a pcm tandem ex-

change through which digital signals pass without being converted to conventional analog form. Experimental pcm tandem exchanges have been built before [Electronics, Oct. 3, 1966, p. 119], but this British unit will soon become the first digital exchange to operate in a public telephone network.

**The right slot.** A major problem in pcm switching is to transfer pulses from incoming to outgoing time slots while keeping the two slots in phase as long as a phone call lasts. If a time slot for the called outgoing line were always available, the only task would be the relatively simple one of switching the incoming line onto the outgoing. Unhappily, this is the case only about 40% of the time, so the exchange needs selection in time as well as the selection in space that links the called to the calling line.

In the Dollis Hill exchange, a conventional time-division multiplex register searches for a free time slot among the outgoing lines to the called exchange. When it finds one, it holds it until a route can be found through the switching array from the incoming line to the outgoing one.

**At the right time.** Combinations of three arrays of transistor-transistor-logic circuits and three groups of cord circuits establish several routes through the exchange. Under the scheme, any crosspoint of the incoming array can be switched—at a rate of 1.6 megahertz—onto any crosspoint of the outgoing array through a buffer. When the search turns up a free slot in a correct outgoing line, the logic circuits try to make an instantaneous switch between crosspoints in the incoming and outgoing arrays.

If this can't be done, the logic circuits look for a connection through cord circuits with fixed delays of one, two, or three time slots. If the connection can't be made this way, the incoming line is switched onto the outgoing one through a cord circuit whose delay can be varied up to 23 time slots.

The Post Office estimates that with a 2,500-line exchange, only about 5% of the calls during a peak period will require delays of more



than a few time slots. The fixed delays of one, two, and three slots are provided by diode-capacitor elements in the experimental exchange, but later versions may use ultrasonic delay lines.

**Out of step.** Synchronization is still a problem. Future pcm exchanges will have to be equipped with extensive buffer storage to cope with the different propagation delays in the lines linking them. The Post Office has found that even its single all-pcm exchange needs some buffer storage to compensate for differences in propagation time caused by temperature variations in outgoing and incoming lines.

### Tripling the guard

As chemical-processing plants around the world get bigger and more expensive, their operators are forced to run them closer and closer to critical limits to make money. As a result, the demands on automatic shutdown systems are becoming tougher than ever. The systems must act fast once a critical limit is passed, but they mustn't shut the plant down—a costly proposition—on a spurious signal.

The usual way of handling this problem is to build considerable redundancy into a fail-safe system of relays. But the English Electric Co. has a ferrite device that can do the job of the relay, and will use it in a shutdown system at an ethylene oxide plant now under construction in Yorkshire. Engineers of the plant's owner, Imperial Chemical Industries Ltd., teamed with English Electric's automation men to design the system, which checks on 55 parameters.

**Holed up.** English Electric's device is a small ferrite disk that operates as a two-input AND gate with a nondestructive readout.

Each disk measures about a half-inch in diameter and has a small aperture at the center surrounded by three larger apertures. There are three windings on the disk—one for interrogation, one for reset, and one that develops an output if the flux conditions established by the other two windings are right.

In the 1C1 installation, the discs

are interconnected in groups of three with similar but somewhat simpler devices that act as buffers and amplifiers. Each triplet of disks and buffers forms a logic module for one of the 55 parameters.

**Majority rules.** The modules are designed to operate in a fail-safe fashion, putting out pulses as long as the parameters under surveillance stay within limits. As a first line of defense against spurious shutdowns, though, each module gets inputs from three independent sensors keeping track of the associated parameter, and it will keep on generating output pulses as long as two of the three inputs are within limits.

But 1C1 and English Electric have taken still more precautions. The interrogation pulses are passed from module to module so that a failure in one prevents the development of pulses in any succeeding module. What's more, the whole string of 55 modules is triplicated so that output pulses will keep coming if two out of the three strings are working. If two or all three strings stop pulsing, a shutdown signal from a pulse-to-d-c converter is fed to the crucial controls in the plant.

English Electric puts the response time of individual modules at less than 1 millisecond. Thus there's a delay of about 50 msec at the most before a shutdown signal is generated after the sensors sig-

nal a hazardous condition. This isn't an appreciable lag since the shutdown valves themselves take about a second to close.

## Hong Kong

### Tailoring antennas

A new look in television antennas may soon come to the hills of Hong Kong now that Shiu-chang Loh has developed a "backfire" layout to handle ultrahigh frequencies. Uhf color broadcasting began in the Crown Colony late last year.

Loh, who heads the physics department at the United College of the Chinese University, claims his new antennas can easily quadruple the power gain of ordinary endfire aerials. Along with higher gain, Loh adds, a narrower beamwidth gives the viewer a clearer picture.

An endfire antenna becomes a backfire unit when a large surface-wave plane reflector is added to the open end. A surface wave launched at the feed point travels along the antenna until it strikes the plane reflector; it then bounces back to the feed and radiates into free space in a direction opposite to that of the normal endfire system.

According to Loh, recent experiments show that the gain of the

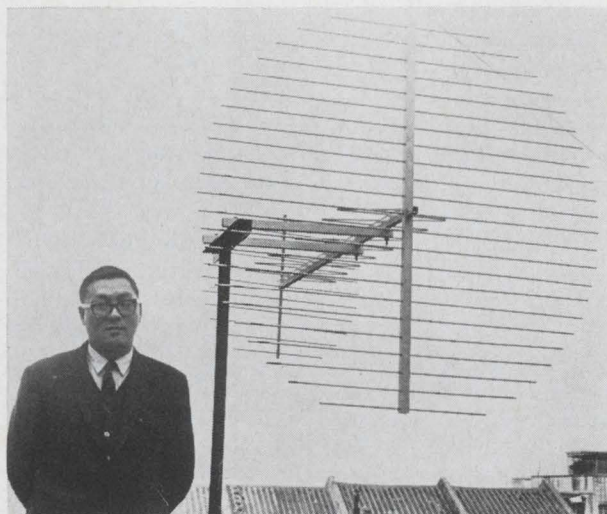

**Reflective.** Shiu-chang Loh added a plane reflector to an endfire antenna to get a backfire array that improves gain by 3 decibels.



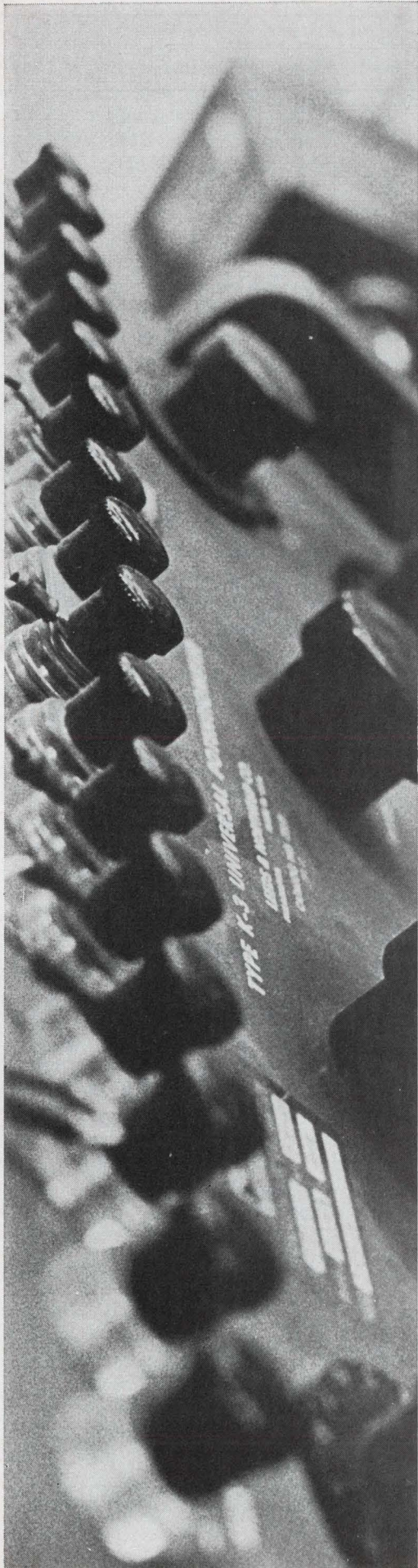

# Most complete line of reference zeners — with stability to 0.5 mv/year . . .

## Semcor TCRE's!

Semcor pioneered the first silicon diffused junction TCRE in 1957. And kept right on going and growing. Today, many call its line of precision zener reference elements "the finest, most reliable and complete in the industry." Look it over and you'll agree. Voltage from 6.2 V to 200 V. Temperature coefficient from .01 % / °C to .0002 % / °C. Temperature range as wide as -55°C to +185°C. And long-term stability as low as .5 mv/year. Whether your need is for a standard or custom unit, don't speculate. Get everything you seek in a reference element — plus prompt delivery — by specifying Semcor. A division of Components, Inc. — industry's leader in fair pricing, prompt delivery and superior reliability of electronic components. For full information, see your nearest dealer or write: 3540 W. Osborn Road, Phoenix, Arizona 85019. Phone 602-272-7671.

LONG TERM STABILITY TEST

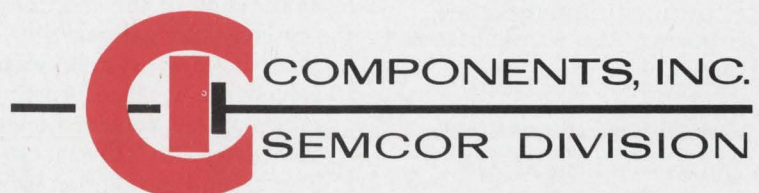
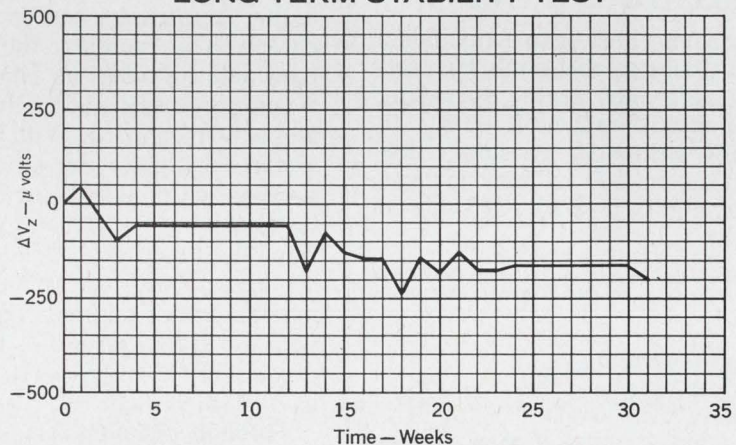

VISIT US AT IEEE BOOTHS 4D15 & 4D17



# free! new

## 1968 NEWARK INDUSTRIAL ELECTRONICS CATALOG

- Industry's Most Complete Buying Guide
- Over 70,000 items—500 Standard Brand lines
- 700 Pages
- Over \$7,000,000 Industrial Electronics Inventory— your assurance that NEWARK has it now.

### NEW P&B CH SERIES SOLID STATE TIME DELAY RELAYS

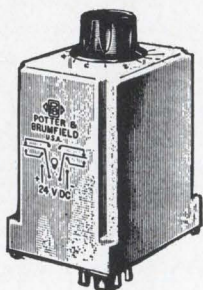

Cost saving answer to many industrial timing applications. Dial setting reference scale; operating temperature range of  $-10^{\circ}\text{C}$  to  $-55^{\circ}\text{C}$  with  $\pm 10\%$  accuracy. Reset time in 100 milliseconds and repeatability is  $\pm 2\%$ . 24 types in stock.

*Immediate delivery from stock—factory OEM prices  
—fast efficient service from 10 Newark warehouses.*

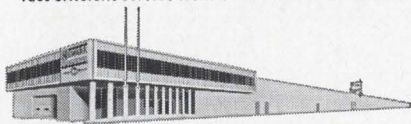

#### New Main Office & Warehouse

**NEWARK** 500 North Pulaski  
Chicago, Illinois 60624

#### ELECTRONICS CORPORATION

#### AUTHORIZED P & B WAREHOUSES IN

- |                                       |  |   |
|---------------------------------------|--|---|
| ● Chicago, Illinois<br>(312) 638-4411 | ● Detroit, Michigan<br>(313) 548-0250      | ● |
| ● Cincinnati, Ohio<br>(513) 421-5282  | ● Los Angeles Area<br>(213) OR 8-0441      | ● |
| ● Denver, Colorado<br>(303) 757-3351  | ● Grand Rapids, Michigan<br>(616) 452-1411 | ● |
| Other Newark Warehouses in:           |  |   |
| ● New York City<br>(212) 255-4600     | ● New Orleans, Louisiana<br>(504) 834-9470 | ● |
| ● Dallas, Texas<br>(214) BR 2-3571    | ● Houston, Texas<br>Opening Soon           | ● |

## Electronics Abroad

backfire system increases with frequency, again just the opposite of the effect in endfire systems, which have a relatively narrow frequency range.

Though experiments indicate that the backfire antenna outperforms endfire systems—in Hong Kong, anyway—Loh is at a loss to explain why. To narrow the gap between theory and practice, Loh and his associates have been working for more than a year on an analysis of the backfire antenna and will publish the results next month.

### France

#### Way in

What with the Omega and Loran systems developed in the U.S. and the British-bred Decca system, the market for long-range hyperbolic navigation gear is pretty much an Anglo-Saxon preserve. But there's a Gallic challenger for short-range, precision systems—the Compagnie des Compteurs.

Where the Anglo-Saxons stick with very-low and low frequencies to get distance, CDC has opted for higher frequencies and greater accuracy. This summer, the French navy will install at its home bases a CDC port-entry system that operates at 80 megahertz. With the gear, a ship's navigator can pinpoint his position within 33 feet or better at distances up to 50 nautical miles from the port he's headed for. An accuracy of 300 feet at 300 miles—possible under optimum conditions with the Decca system—is the most precise for the high-seas hyperbolic navigation systems.

**Through channels.** CDC calls its system RAGEP, for radioguidage d'entrée de port. And André Cecchini, chief of the CDC division that produces navigational aids, stresses that the new system wasn't conceived to replace existing long-range aids. Cecchini hopes to sell the system to other NATO navies. The ground installation for a port is priced at \$80,000 and the shipboard receiver, fitted with a plotter, at \$12,000.

Like long-range systems, RAGEP establishes a hyperbolic grid with master-slave transmitter pairs. Prime use for the system will be to guide warships through channels cleared by minesweepers, which will also plot their courses by RAGEP.

The narrow channels established by the gear measure only 130 yards wide. To ensure that a warship doesn't head up an unswept narrow channel, the system employs four frequencies to get three frequency-difference combinations that prevent ambiguity.

One combination shows the navigator which broad channel (3,250 yards wide) he's in. A second combination shows the intermediate channel (650 yards wide), and the third the narrow channel. In each case, the fix is made by comparing the phase difference in the frequencies received from the master and slave transmitters.

To distinguish among the three frequency-difference combinations, the receiver has three sensitivities. The fine channel's is 25 times greater than that for the broad channel and five times that of the intermediate channel.

### Around the world

**The Netherlands.** Philips Gloeilampenfabrieken now has a contract to set up a nationwide network to check air pollution in Holland. The system, on which the government will spend \$57 million over the next three years, will be made up of several hundred checking stations linked to a central computer at the Bilthoven headquarters of the National Institute of Public Health.

**Great Britain.** The Ministry of Technology has tapped the Marconi Co., one of the firms in the English Electric group, to build the three ground stations for Britain's "Skynet" military communications satellite network. Under the \$2.5 million contract, Marconi will build an all-new facility with a 42-foot antenna dish in southern England and modify two existing overseas stations to work with the Skynet satellites.



**West Germany.** Saba GmbH, a family-owned company that is one of West Germany's leading consumer-electronics producers, has found the partner it has been looking for in recent months [Electronics, Feb. 5, p. 211]. Under a deal worked out with Saba's owners, the General Telephone & Electronics Corp. will take a holding in the German company and will also bolster its design and development effort. The amount of GTE's holding in Saba has not been disclosed.

**Hungary.** An ambitious program to improve the country's communications network will begin this year. Among other advances, the work will bring direct dialing by long-distance operators for calls to other countries, a microwave link between Budapest and Vienna, and the preparations for the beginning of color-tv broadcasts by December 31, 1969.

**Kenya.** The first commercial communications satellite ground station in Africa most likely will be built atop Mount Margaret. East African External Telecommunications Co., a joint venture by Kenya, Tanzania, and Uganda, has called for bids on the station. The antenna dish will probably be 90 feet in diameter and the facility will probably cost about \$4.25 million.

**Switzerland.** The quartz-controlled, integrated-circuit wrist-watch developed at the Swiss Horological Electronics Center was a hands-down winner at the 102nd International Chronometric Competition, 45 days of tests that ended in mid-February at the Neuchâtel Observatory.

Prototypes of the Swiss IC watch took the 10 top places in the competition, followed by a Japanese IC watch entered by Suwa Seikoshi [Electronics, Feb. 5, p. 209]. In the tests, the best Swiss watch strayed no more than one-tenth of a second daily, while the best Japanese entry gained or lost about twice that.

**Finland.** AEG-Telefunken's PAL (phase-alteration-line) color television system has been adopted by Finland, bringing all Scandinavia into the PAL fold. Test broadcasts in color have already started but regular programs for Finnish viewers are three or four years off.

## multi-range recorder

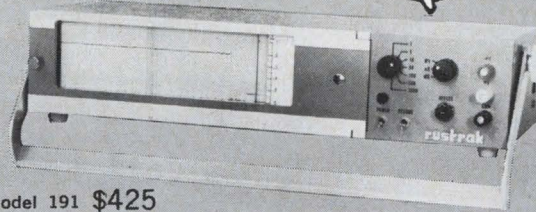
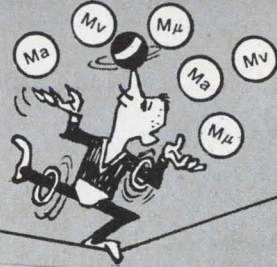

Model 191 \$425

The Rustrak multi-purpose recorder Model 191 features selection of 21 DC ranges plus an event recorder channel. Select from one to 1000 millivolts, microamperes or milliamperes with 2 panel switches. A panel-mounted control permits  $\pm 1X$  full scale offset adjustment independent of attenuator or function switch. The event marker has an approximate 10 millisecond response time and will follow a 20 Hz on-off signal. Carrying handle also serves as a tilt-viewing support. Rack mount hardware available. Write for bulletin No. 36706.

**rusttrak**  
"THE BIG LITTLE LINE"

IEEE Show  
Booth 2K21-23

Rustrak Instrument Division — Gulton Industries Inc.  
Municipal Airport, Manchester, N. H. 03103 • (603) 623-3596

IEEE Show Booth 2K21-23

Circle 95 on reader service card

### FIXED COMPOSITION RESISTORS

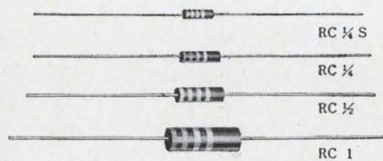

### SEMI-FIXED RESISTORS



### NOISE SUPPRESSORS FOR CAR RADIOS

TYPE K(II)

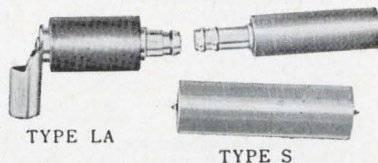

TYPE LA

TYPE S



**TAIYO DENKI CO., LTD.**

1-12, 3-Chome, Sunamichi  
Sakai c., Osaka, Japan  
TEL: SAKAI (3) 6841

## NORTON Magnetic Tape Heads



### SERIES 4500

Crosstalk—50 DB  
+75°C Temperature Operation

Send now for complete technical literature.

**NORTON**

ASSOCIATES, INC.

10 Di Tomas Court, Copiague, N.Y. 11726  
Phone: 516 598-1600



# Electronics advertisers

March 4, 1968

■ Acopian Corp. Mort Barish Associates	150	Cambridge Thermionic Corp. Chirurg & Cairns, Inc.	288	■ Eagle Signal Div. of E.W. Bliss Co. Feeley & Wheeler, Inc.	227, 229
Ad-Yu Electronics, Inc. P & G Adv. Agcy.	234	Capital Radio Engineering Institute Henry J. Kaufman & Associates	269	Eastman Kodak Co., PCIM Market Development Rumrill Hoyt, Inc.	151
Aerojet General Corp. D'Arcy Adv. Co.	152	Carborandum Co., The Rumrill Hoyt, Inc.	183	Electronic Assoc., Inc. Ross Roy of New York, Inc.	178
Airpax Electronics, Inc. Welch, Mirabile & Co., Inc.	186	Cerro Copper & Brass Co. Feeley & Wheeler, Inc.	175	Electronic Communications, Inc. Neals & Hickok, Inc.	261
■ Alden Electronics Larcom Randall Adv., Inc.	258	■ Chassis-Trak, Inc. Quinlan Keene Peck & McShay, Inc.	8	Electronic Engineering Co. of California Jansen Associates	185
Allen-Bradley Co. Fensholt Adv. Agcy.	135, 136	■ Cinch Manufacturing Co. Stral Advertising Co.	193	Electronic Industries Association of Japan Pace Advertising Agency	287
Allied Van Lines, Inc. Young & Rubicam, Inc.	177	■ Clairex Corp. Michel-Cather, Inc.	91	Emerson & Cuming, Inc. Edwin F. Hall	52
Alpha Metals, Inc. Black-Russell-Morris	295	Clare & Co., C.P. Reincke, Meyer & Finn Adv., Inc.	196, 197	Erie Technological Products Co., Inc. Altman-Hall Associates	36
■ Amelco Semiconductor Div. of Teledyne, Inc. Dailey & Associates	32, 33	■ Clevite Corp., Piezoelectric Div. Carr Liggett Adv., Inc.	291	■ E-Z Hook Test Products	285
American Electronics, Inc. Alden Adv. of California, Inc.	51	■ Coil Winding Equipment Co. J.J. Coppo Co., Inc.	138		
American Lava Corp., Sub. of Minnesota Mining & Mfg. Co. Designers, Inc.	22, 274	■ Collins Radio Co. John G. Burnett Advertising	5		
■ Ammon Instruments, Inc. Culver Adv. Inc.	284	Components, Inc. Creative Advertising Agency	79		
■ Analog Devices, Inc. Kenen Associates	27, 28	Consolidated Electrodynamics Corp., Sub. of Bell & Howell Hixson & Jorgensen, Inc.	264		
AO Instrument Co. Fuller & Smith & Ross, Inc.	146	Control Data Corp., Analog Digital Systems Div. Barnes-Champ Advertising	292	■ Fork Standards, Inc. Jody Advertising, Inc.	278
■ A.P.I. Instruments George Z. Griswold Advertising	250	Control Products Div. Consolidated Electrodynamics Corp., a Bell & Howell Co. Watson-Manning, Inc.	176	■ Franklin Electronics, Inc., Sub. of Mohawk Data Sciences Corp. Kimberly-James Advertising	69
Associated Testing Laboratories, Inc. Murray Heyert Associates	289	■ Cook Electric Co. Automatic Controls Div. Grant/Jacoby, Inc.	80		
■ Augat, Inc. Horton, Church & Goff, Inc.	29	Corning Glass Works Electronics Products Div. Rumrill Hoyt Co., Inc.	249		
Austron, Inc. Don L. Baxter, Div. of Albert Frank-Guenther-Law, Inc.	268	■ Cosmocar Optical Co., Ltd. Matsushita, Inc.	293	Garrett Corp., Airesearch Mfg. Div. J. Walter Thompson Co.	296
		■ Couch Ordnance, Inc., Couch Co. Div. Culver Advertising, Inc.	78	G-C Electronics Co., Industrial Div. Sander Rodkin Adv. Agcy., Ltd.	294
		■ CTS Corp. Burton Browne Advertising	156	General Aniline & Film Corp. L.W. Frolich & Co/Intercon International, Inc.	141
		Cyclo-Tronics, Inc. Bernard J. Hahn & Associates	161	General Atronics Corp. Garceau Hallahan & McCullough, Inc.	145
Ballantine Laboratories Lang-Lawrence Adv., Inc.	260			General Cable Corp. Hicks & Greist, Inc.	76
■ Barnes Corp. Industrial Public Relations, Inc.	290			■ General Electric Co., Electronic Component Sales Operation Robert S. Cragin, Inc.	20, 21
■ Barnstead Sub. of Ritter Pfaudler Corp. Creamer, Trowbridge, Case & Basford, Inc.	232	■ Dale Electronics, Inc., Sub of Lionel Corp. Swanson, Sinkey, Ellis, Inc.	3rd Cover	General Electric Co., Polymer Products Operation Div. Ross Roy of New York, Inc.	74
■ Beckman Instruments, Inc., Heliport Div. Hixson & Jorgensen, Inc.	291	Dana Instruments Jay Chiat & Assoc., Inc.	309	General Electric Co., Semiconductor Products Div. Robert S. Cragin, Inc.	57, 58, 59
Bell Telephone Laboratories N.W. Ayer & Son, Inc.	164	Data Instruments Division Technical Marketing	204, 222	General Instrument Corp., Semiconductor Products Div. Norman Allen Associates	128
■ Birnbach Co. Kornazagrapphic	253	■ Data Technology Bonfield Assoc., Inc.	17	General Radio Co. Horton, Church & Goff, Inc.	35
■ Bliley Electric Co. Barber & Drullard, Inc.	218	Delco Radio Div. of General Motors Corp. Campbell-Ewald Co.	18, 19	■ Grayhill, Inc. Merchandising Adv., Inc.	283
Boonton Electronics Corp. The Creative Group	162	Delco Radio Div. of General Motors Corp. Macbill/Ross, Inc.	279	Gries Reproducer Co. Harrold Marshall Advertising	282
Bourns, Inc., Trimpot Div. Lester Company, The	243	Delevan Electronics Corp. Stahka, Faller & Klenk, Inc.	54	Groov-Pin Corp. Feeley & Wheeler, Inc.	289
Brush Instruments Div. of Clevite Corp. Carr Liggett Adv., Inc.	143	Delta Design, Inc. Pacific Publications	294		
Buckbee-Mears Co. Midland Assoc., Inc.	295	Di-Acro-Corp., Div. of Houdaille Industries, Inc. Charles E. Brown Adv. Agcy.	179		
Bud Radio, Inc. Allied Adv. Agcy., Inc.	168, 169	Discon Corp.	242		
Bunker-Ramo Co. Diener & Dorskind, Inc.	212, 230	■ DuPont de Nemours Co., Industrial Fibers Nomex Batten, Barton, Durstine & Osborn, Inc.	255	■ Heath Co., Sub. of Schlumberger, Ltd. Advance Advertising Service	287
■ Burndy Corp. Don Kemper Co., Inc.	170	■ DuPont de Nemours Co., Teflon Div. Batten, Barton, Durstine & Osborn, Inc.	153	■ Hewlett Packard, Harrison Div. Healy Advertising Agency	2
■ Burroughs Corp., Electronics Components Div. Conti Adv. Agcy., Inc.	66, 67	Durant Manufacturing Co. Franklin Mautner Advertising	56		
■ Bussmann Mfg. Div. of McGraw Edison Co. Henderson Adv. Co.	163				



■ Hewlett Packard, Microwave Div. Lennen & Newell, Inc.	1	McCoy Electronics Co., Div. of Oak Electro/Netics Corp. Buchen Adv., Inc.	77	Okaya Electric Industry Co., Ltd. Diamond Agcy Co., Ltd.	282
Hewlett Packard, Waltham Div. Culver Advertising, Inc.	231	McGraw-Hill Encyclopedia and Subscription Book Division David Altman Advertising	276	Olympus Corporation Kameny Assoc., Inc.	140
Honeywell, Computer Control Div. Franklin P. Folts, Inc.	217	■ Machlett Laboratories, Div. of Raytheon Co. Fuller & Smith & Ross, Inc.	9	■ Parker Instrument Corp. HPM Advertising	266
■ Honeywell, Test Instruments Div. Campbell Mithun, Inc.	270, 271	Magnecraft Electric Co. Mills, Fife & MacDonald, Inc.	72	Pastoriza Electronics Co. L.K. Frank Co., Inc.	172, 173
Hooker Chemical Corporation, Durez Div. Rumrill-Hoyt, Inc.	37	■ Magnetic Shield Div., Perfection Mica Co. Burton Browne Advertising	203	■ Philbrick/Nexus Research Culver Adv., Inc.	223
Houston Instrument, Div. of Bausch & Lomb Ray Cooley & Assoc., Inc.	275	Martin Marietta Corp. Redmond Marcus & Shure, Inc.	205	Philco Ford Corporation Sierra Electronics Operation Hal Lawrence, Inc.	11
Hughes Aircraft Co. Foote, Cone & Belding	155, 259	■ Matsuo Electric Co., Ltd. Daiyusha, Inc. Adv.	280	Physics International Conley Baker & Steward	228
Hysol Corp. Barber & Drullard, Inc.	226	Matsushita Electric Corporation of America, Panasonic Div. Dentsu Corporation of America	312, 313	■ Plastic Capacitors Inc. Sander Rodkin Adv. Agcy., Ltd.	160
■ IBM Corp. Ogilvy & Mather, Inc. Adv.	184	Merrimac Research & Development, Inc. Walker & Gessell, Inc.	254	■ Polarad Electronic Instruments Mort Barish Assoc., Inc.	207
IEEE (Institute of Electrical & Electronic Engineers) Alpaugh Advertising	268	Metal Removal Co., The Advertising Producers Associates	262	Princeton Applied Research Corp. Mort Barish Assoc., Inc.	38
■ Imtra Corp. S. Gunnar Myrbeck & Co., Inc.	289	Mico Instrument Co.	290	Q Max Corporation George Homer Martin Assoc.	294
■ Indiana General Corp., Ferrites Div. Griswold & Eshleman	24	Microdot, Inc. Gumpertz, Bentley & Dolan Advertising	15	Radiation, Inc. W.M. Zemp & Assoc., Inc.	235
Industrial Foundation of Albuquerque Geha-Paskind & Assoc., Inc.	286	■ Microwave Cavity Laboratories, Inc. Art Brown Writing Service	281	Radio Cores, Inc. Sander Rodkin Adv. Agcy., Ltd.	296
Information Handling Service Martz & Associates	267	Midtex/Aemco Chuck Ruhr Assoc. Adv.	181	Radio Corporation of America Al Paul Lefton Co.	4th Cover, 47, 92, 93
■ Interelectronics, Inc. Samuel H. Meyer Advertising	297	Minnesota, State of, Department of Economic Development The Erle Savage Co.	147	■ Raytheon Co., Components Div. Fuller & Smith & Ross, Inc.	272, 273
International Electronic Research Corp. Van Der Boom, McCarron, Inc., Adv.	306	■ Minnesota Mining & Mfg. Co., Chemical Div. Young & Rubicam, Inc.	219	Raytheon Co., Microwave & Power Tube Div. Fuller & Smith & Ross, Inc.	216
ITT Cannon Electric West, Weir & Bartel, Inc.	246	■ Minnesota Mining & Mfg. Co., Scotchpar Div. Young & Rubicam, Inc.	180	■ Reeves Hoffman, Div. of Dynamics Corporation of America Adams Assoc., Inc.	314
■ ITT Jennings Mfg. Co. West, Weir & Bartel, Inc.	129	Mosaic Fabrications, Inc., Sub. of Bendix Corp. Van Christo Assoc., Inc.	182	■ Resistance Products Co. Eldridge, Inc.	149
ITT Semiconductors Div. Neals & Hickok, Inc.	53, 75	Motorola Semiconductor Products, Inc. Lane & Bird Adv., Inc.	12, 13	RFL Industries, Inc., Instrumentation Div. Josephson, Cuffari & Co.	174
■ JFD Electronics Co., Components Div. Delphi Adv., Inc.	144	Mullard, Ltd. Roles & Parker, Ltd.	70	Rosenthal-Isolatore GMBH Werbeagentur Kurt Linnebach	238
■ Kepco, Inc. Weiss Advertising	7	■ Murata Mfg. Co., Ltd. Dentsu Advertising, Ltd.	288	Rustrak Instruments Division— Gulton Industries, Inc. Cohen-Kelley Promotion	321
Kikusui Electronics Corp. Kyodo Adv. Co., Ltd.	297	■ National Electronics, Inc. Connor-Sager Associates	297	Semcor Division Components, Inc. Marketing & Corporate Communications, Inc.	319
Kingsley Machine Co., Aero Space Div. L.J. Globus, Inc.	48	National Semiconductor Corp. Jay Chiat & Associates	239, 241	■ Siemens America, Inc. Clinton E. Frank, Inc.	251
Krohn-Hite Corp. L.K. Frank Co., Inc.	191	Natvar Corp. Sanger-Funnell, Inc.	291	Signetics Corp., Sub. Corning Glass Works Cunningham & Walsh, Inc.	111
■ Ledex, Inc. Yeck & Yeck, Inc.	210	■ Newark Electronics Corp. Stral Adv. Co.	320	■ Siliconix, Inc. Graphics West	34
■ Ledex, Inc., Bramco Controls Div. Yeck & Yeck, Inc.	167	New Hermes Engraving Machine Corp. Lester Harrison Adv., Inc.	278	Solitron Devices, Inc., Transistor Div. Haselmire Pearson Adv., Inc.	137
Licon Division, Illinois Tool Works, Inc. Hurvis, Binzer & Churchill, Inc.	30, 31	■ Ney & Co., J.M. Peck-Adams, Inc.	281	■ Sorensen Operation, Raytheon Co. James Advertising, Inc.	63
Lockheed Electronics Co. McCann-Erickson, Inc.	139	■ NGK Spark Plug Co., Ltd. New Asia Trading News Agcy., Ltd.	295	Sperry Rand Corporation, Sperry Microwave Electronics Division Neals & Hickok, Inc.	60
		Nippon Coil Co., Ltd. Dai-Ichi International, Inc.	284	Sprague Electric Co., The The Harry P. Bridge Co.	10, 49
		■ North Atlantic Industries, Inc. Murray Heyert Associates	248	■ Stackpole Carbon Co., Electronic Components Div. Meek & Thomas, Inc.	195
		■ Norton Associates, Inc. J.J. Coppo Co.	321		
		Norton Co., Vacuum Equipment Div. S. Gunnar Myrbeck & Co., Inc.	211		
		Nytronics, Inc. The Stukalin Adv. Agcy.	16		
		■ Oak Manufacturing Co., Div. of Oak Electro/Netics Corp. Bucken Advertising, Inc.	71, 200, 201		





■ **Susumu Industry Co., Ltd.** 290  
Dentsu Advertising

**Sweet's Industrial Information System** 310, 311  
J.J. Lane, Inc.

**Sylvania Electric Products, Inc. Electronic Components Group** 64, 65  
Doyle, Dane, Bernbach, Inc.

**Systron-Donner Corp.** 6  
Bonfield Associates, Inc.

**Taiyo Denki Co., Ltd.** 321  
Sanko Sha Adv. Co., Ltd.

**Takeda Riken Industry Co., Ltd.** 284  
Shinwa Adv. Co., Ltd.

■ **TDK Electronics Co., Ltd.** 293  
Fuji Agency

■ **Tech Laboratories, Inc.** 68  
Lewis Adv. Agency

■ **Tektronix, Inc.** 45  
Hugh Dwight Adv., Inc.

**Telonic Instruments** 244  
Jansen Associates, Inc.

**Tenney Engineering, Inc.** 293  
Keyes, Martin & Co.

**Test Equipment Corp.** 266  
Dean & Bain Adv., Inc.

**Texas Instruments Incorporated Components Group** 154  
Don L. Baxter, Div. of  
Albert Frank-Guenther Law, Inc.

■ **Texas Instruments Incorporated Industrial Products Group** 252  
Robinson-Gerrard

**Thomas & Skinner, Inc.** 208  
Dan Frye Adv., Inc.

**Thomson Electric Co., Inc.** 209

**Torrington Mfg. Co., Air Impeller Div.** 73  
Wilson, Haight & Welch, Inc.

■ **Tracor, Inc.** 213  
Weekley & Valenti, Inc.

■ **Transformer Electronics Co.** 277  
Dacey, Wolff & Weir

**Trio Laboratories, Inc.** 221  
Zam & Kirshner, Inc.

**TRW Electronics, Capacitors Div.** 43  
Fuller & Smith & Ross, Inc.

■ **Trygon Electronics, Inc.** 14  
Kameny Associates, Inc.

■ **Tung-Sol Division, Wagner Electric Corp.** 159, 206  
Feeley & Wheeler, Inc.

**United Aircraft—Electronics Components** 50  
Cunningham & Walsh, Inc. Adv.

■ **United Systems Corp.** 285  
Advertising & Merchandising, Inc.

■ **United Transformer Co., Div. of TRW, Inc.** 2nd Cover  
Philip Stogel Co.

■ **Unitrode Corp.** 55  
Silton Brothers, Inc..

■ **Vactec, Inc.** 282  
Coleman & Associates Advertising

**Varian Associates, Recorder Div.** 245  
Botsford, Constantine & McCarty, Inc.

**Varo, Inc.** 54  
Tracy-Locke Co., Inc.

**Victoreen Instrument Co.** 240  
Palm & Peterson, Inc.

**Vitramon, Inc.** 263  
Ted Sommers, Inc.

■ **Wang Laboratories** 44  
Impact Advertising, Inc.

**Weston Instruments, Inc., Lexington Div.** 220  
Larcom Randall Adv., Inc.

**White Electromagnetics** 148  
E.G. White Adv., Inc.

**White Co., S.S., Abrasive Div.** 142  
W.L. Towne Co., Inc.

**Xcelite, Inc.** 46  
Harold Warner Adv., Inc.

**Classified Advertising**

F.J. Eberle, Manager

**EMPLOYMENT OPPORTUNITIES**

178, 259, 261, 279, 298-305

**Aerojet General Corp.** 303

**Dorne & Margolin, Inc.** 304

**Grumman Aircraft Corp.** 300, 301

**Hallicrafters Co.** 298

**Motorola** 302

**Newport News Shipbuilding & Dry Dock** 304

**U.S. Navy Philadelphia Naval Shipyard** 305

**U.S. Navy San Francisco Bay Naval Shipyard** 299

**EQUIPMENT**

(Used or Surplus New)  
For Sale 305

**A & A Electronics Corp.** 305

**Philip Fishman Co.** 305

**R.E. Goodheart Co., Inc.** 305

**Radio Research Instrument Co.** 305

**Selectronics** 305

■ For more information on complete product line see advertisement in the latest Electronic Buyer's Guide

**Electronics Buyers' Guide**

**George F. Werner, General Manager** [212] 971-2310

**Ray Smyth, Eastern Regional Manager** [212] 971-6538

**Regina Hera, Directory Manager** [212] 971-2544

**Thomas M. Egan, Production Manager** [212] 971-3140

**Circulation and Research**

**Milton Drake, Manager** [212] 971-3485

**Isaac Siegel, Assistant Circulation Manager** [212] 971-6057

**David Strassler, Assistant Research Manager** [212] 971-6058

**Chloe D. Glover, Research Associate** [212] 971-6057

**Advertising Sales Staff**

**Frank E. LeBeau** [212] 971-6464  
Advertising Sales Manager

**Wallis Clarke** [212] 971-2187  
Assistant to sales manager

**Donald J. Austermann** [212] 971-3139  
Promotion Manager

**Warren H. Gardner** [215] LO 8-6161  
Eastern Advertising Sales Manager

**Atlanta, Ga. 30309:** Michael H. Miller, 1375 Peachtree St., N.E. [404] 892-2868

**Boston, Mass. 02116:** William S. Hodgkinson McGraw-Hill Building, Copley Square [617] CO 2-1160

**Cleveland, Ohio 44113:** William J. Boyle, 55 Public Square, [216] SU 1-7000

**New York, N.Y. 10036**  
500 Fifth Avenue  
Donald R. Furth [212] 971-3615  
James R. Pierce [212] 971-3616  
John A. Garland [212] 971-3617

**Philadelphia, Pa. 19103:**  
Jeffrey M. Preston  
Warren H. Gardner, 6 Penn Center Plaza, [215] LO 8-6161

**Pittsburgh, Pa. 15222:** Warren H. Gardner, 4 Gateway Center, [412] 391-1314

**Rochester, N.Y. 14534:** William J. Boyle, 9 Greylock Ridge, Pittsford, N.Y. [716] 586-5040

**J. Bradley Mackimm** [312] MO 4-5800  
Midwest Advertising Sales Manager

**Chicago, Ill. 60611:** Robert M. Denmead, J. Bradley MacKimm, Ralph Hanning, 645 North Michigan Avenue, [312] MO 4-5800

**Dallas, Texas 75201:** Richard P. Poole, 1800 Republic National Bank Tower, [214] RI 9-7271

**Houston, Texas 77002:** Kenneth George, 2270 Humble Bldg., [713] CA 4-8381

**Detroit, Michigan 48226:** Ralph Hanning 856 Penobscot Building [313] 962-1793

**Minneapolis, Minn. 55402:** J. Bradley MacKimm, 1104 Northstar Center [612] 332-7425

**St. Louis, Mo. 63105:** Robert M. Denmead The Clayton Tower, 7751 Carondelet Ave. [314] PA 5-7285

**James T. Hauptli** [415] DO 2-4600  
Western Advertising Sales Manager

**Denver, Colo. 80202:** Joseph C. Page, David M. Watson, Tower Bldg., 1700 Broadway [303] 255-5484

**Los Angeles, Calif. 90017:** Ian C. Hill, John G. Zisch, 1125 W. 6th St., [213] HU 2-5450

**Portland, Ore. 97204:** James T. Hauptli, 218 Mohawk Building, 222 S.W. Morrison Street, Phone [503] 223-5118

**San Francisco, Calif. 94111:** James T. Hauptli, 255 California Street, [415] DO 2-4600

**Pierre Braude Tel: 225 85 88**

**European Director**  
88-90 Avenue Des Champs-Elysees, Paris 8

**Milan:** Robert Saidel  
1 via Baracchini Phone: 86-90-656

**Frankfurt/Main:** Hans Haller  
Elsa-Brandstroem Str. 2  
Phone: 72 01 81

**Geneva:** 1, rue du Temple Phone: 31 95 60

**Tokyo:** Nobuyuki Sato, 1, Kotohiracho Shiba, Minato-Ku [502] 0656

**Osaka:** Ryoji Kobayashi 163, Umegae-cho Kita-ku [362] 8771

**United Kingdom and Scandinavia**  
**Brian Bowes Tel. Hyde Park 1451**  
34 Dover Street,  
London W1

**Business Department**

**Wallace C. Carmichael, Manager** [212] 971-3191

**Stephen R. Weiss, Production Manager** [212] 971-2044

**Thomas M. Egan, Assistant Production Manager** [212] 971-3140

**Dorothy Carmesin, Contracts and Billings** [212] 971-2908

**Frances Vallone, Reader Service Manager** [212] 971-2865



OM-3 Power Supply (Darcy Industries, Behlman Division)  
... one of 414 different models using Dale HLT Resistors.



**"We standardized on  
Dale Industrial Wirewounds"**

## Darcy Industries, Behlman Division, meets 414 power supply requirements with one Dale HL style

"In our OM power supplies, we use Dale HLT resistors to assure balance between power transistors and to help provide long-term stability in the series regulator circuit. With 414 models in this DC silicon module design, we needed to standardize on a single resistor type. Dale responded quickly to our design needs for a specific tapped resistor and has met our quality and delivery requirements—a total combination difficult to find in a single vendor."

*Darcy Industries, Behlman Division  
Santa Monica, California*

### DALE INDUSTRIAL WIREWOUNDS

**Tubular** Silicone coated lug (HL), tapped (HLT), adjustable (HLA) and lug with lead (HLW) styles. Meet MIL-R-26 and MIL-R-19365C. 5-225 watts, .1 ohm to 1.3 megohms. Tolerance  $\pm 5\%$ ,  $\pm 10\%$ . Non-inductive styles available.

**Flat** Silicone coated standard (HL) and miniature (HLM) styles. Meet MIL-R-26. 10-95 watts, .1 ohm to 150K ohms. Tolerance  $\pm 5\%$ ,  $\pm 10\%$ . Miniature size has patented mounting for limited space, high vibration areas.

**Axial Lead** (CW) Silicone coated. 1.25-13 watts, .1 ohm to 273K ohms. Tolerance  $\pm 5\%$ ,  $\pm 10\%$ . For applications requiring near precision performance at low cost.



**For faster response to your industrial resistor needs, call Dale ... 402-564-3131**

For Resistor Catalog A, Circle 181



**for optimum value in industrial resistors**

DALE ELECTRONICS, INC., 1300 28th Ave., Columbus, Nebraska 68601

Printed in U.S.A.



# How to eliminate a transformer, two SCR's and a triggering device...

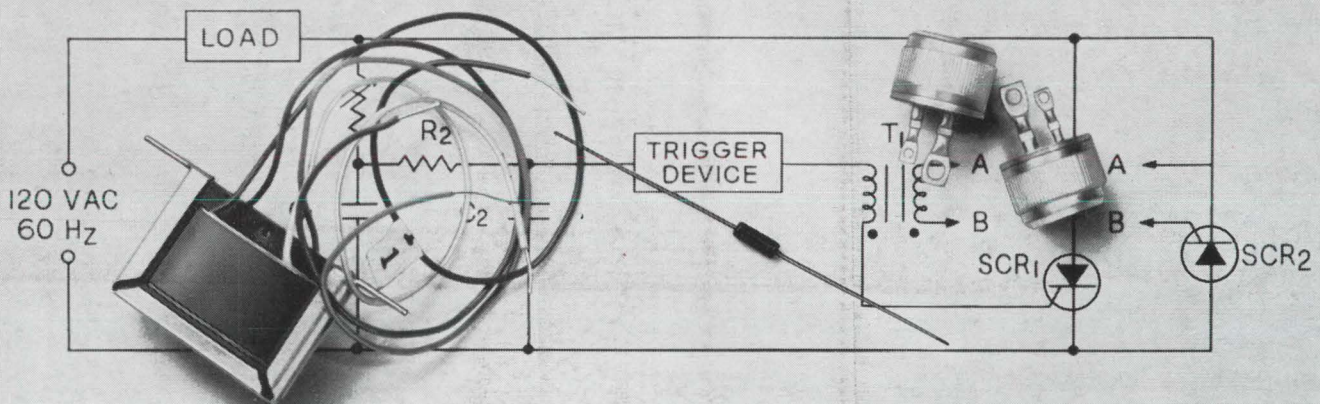

## use one of RCA's new 6A Triacs with integral trigger!

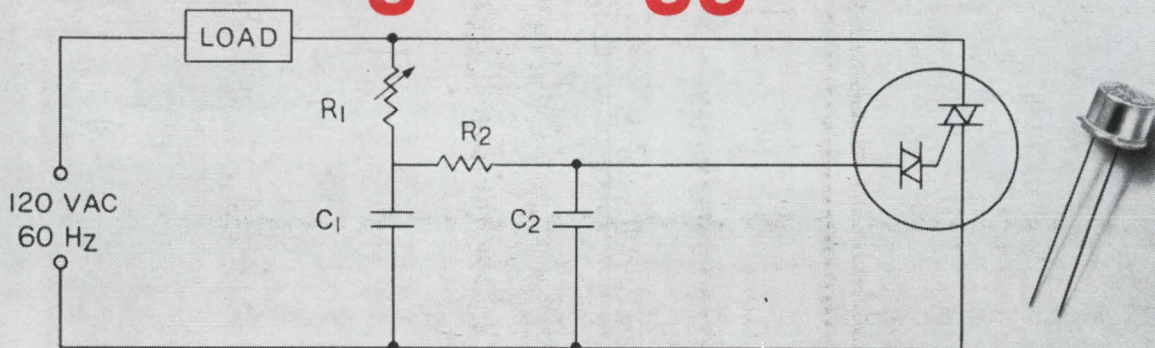

Why design in RCA's new 6A Triacs? Here are just a few of the more important reasons:

Because the triggering device and the firing characteristics of the 40431 and 40432 Triacs are integrated inside the compact TO-5 case by RCA before they sell you the device... you don't have to worry about designing in additional triggering components.

Because a Triac, by its very nature and construction, can replace two SCR's and a pulse transformer in ac circuits... you achieve significant savings in engineering and manufacturing costs, and you improve packing density.

And because RCA's 40431 and 40432 have excellent gate symmetry and surge current protection up to 100 amps... you get top circuit performance and reliability.

The 40431 controls 720 watts at 120 volts, 60 Hz. It costs only \$1.80\*. The 40432 controls 1440 watts at 240 volts, 60 Hz. It costs only \$2.28\*. So for modern, efficient phase control of ac loads in applications such as light dimming, universal and induction motor control, and heater control, specify RCA's new Triac with built-in trigger. Your RCA Field Representative can give you complete information, including price and delivery. Or for additional technical data, write RCA Commercial Engineering, Sec. RN3-1, Harrison, N. J. 07029. See your RCA Distributor for his price and delivery.

*\*Prices in quantities of 1,000 and up.*

# RCA

Circle 902 on reader service card