

High-voltage IC's widen design horizons 90

Negative feedback in active filters 96

Nitride lowers MOS thresholds 117

\$1.00 A McGraw-Hill Publication

March 31, 1969

Electronics®

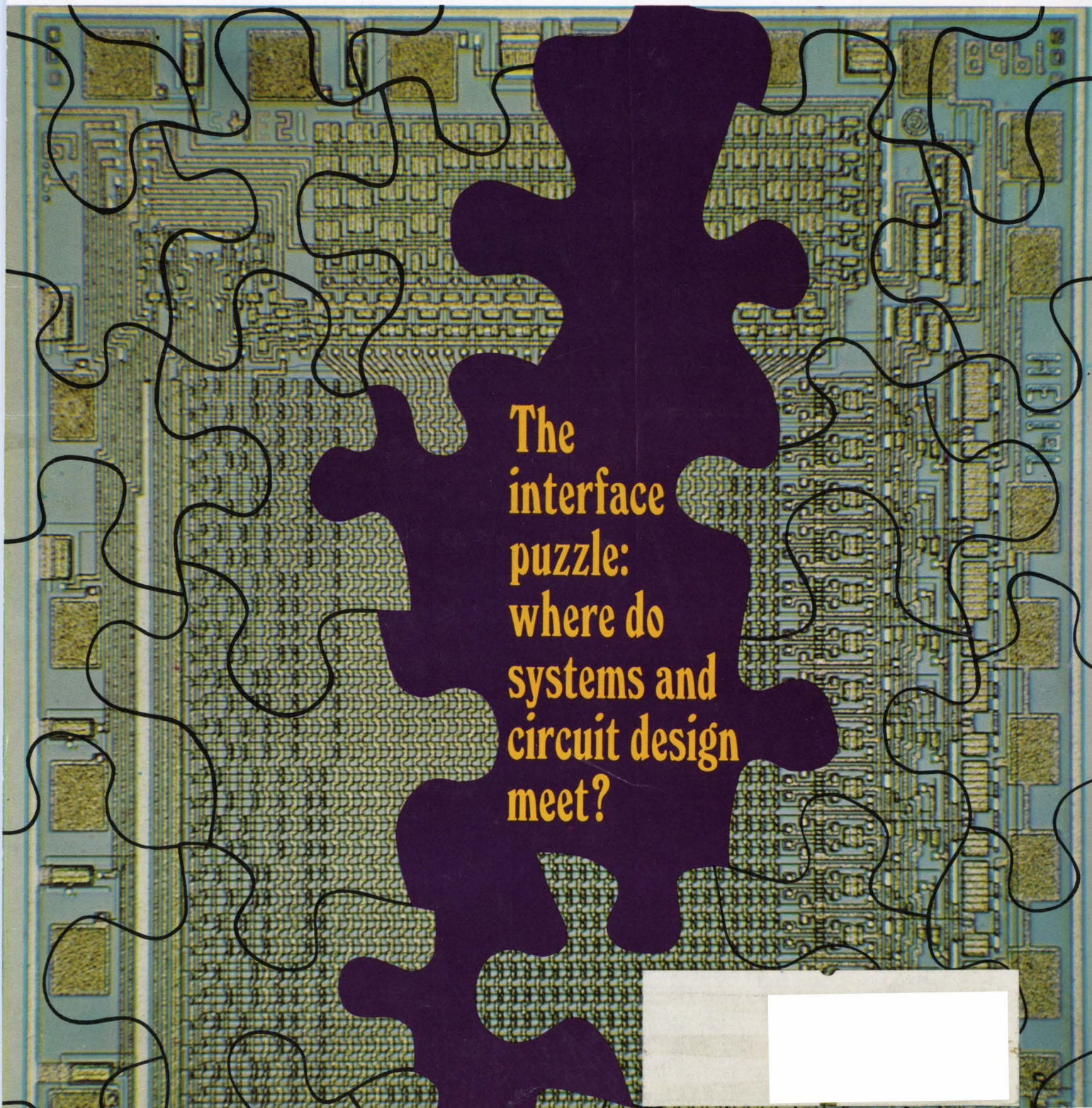

The
interface
puzzle:
where do
systems and
circuit design
meet?

They're on our shelf



The "special" audio transformers you need
are "standard" at UTC.

When you're ready to specify transformers and inductors, before you turn to costly specials, check UTC. Chances are there's a *standard* unit that fits your special electrical and mechanical requirements exactly.

UTC has over 500 audio types in stock, ready for immediate delivery. And UTC engineers are constantly adding to the line. Microwatts to kilowatts. Less than $\frac{1}{4}$ Hz to greater than 1 MHz. MIL-T-27 or industrial. Metal-encased or open frame. Input, output, mixing, matching, modulating, phase shifting, hybrid,

baluns, ring modulator. All in continuous production for sample or high-volume requirements.

If the specific unit you need isn't on our shelf, we'll tailor a standard unit to your special requirements—saving the time and costs of starting from scratch. Check your local distributor for immediate off-the-shelf delivery. For catalog, write: United Transformer Company, Division of TRW INC., 150 Varick Street, New York, N.Y. 10013.

TRW
UNITED TRANSFORMER COMPANY

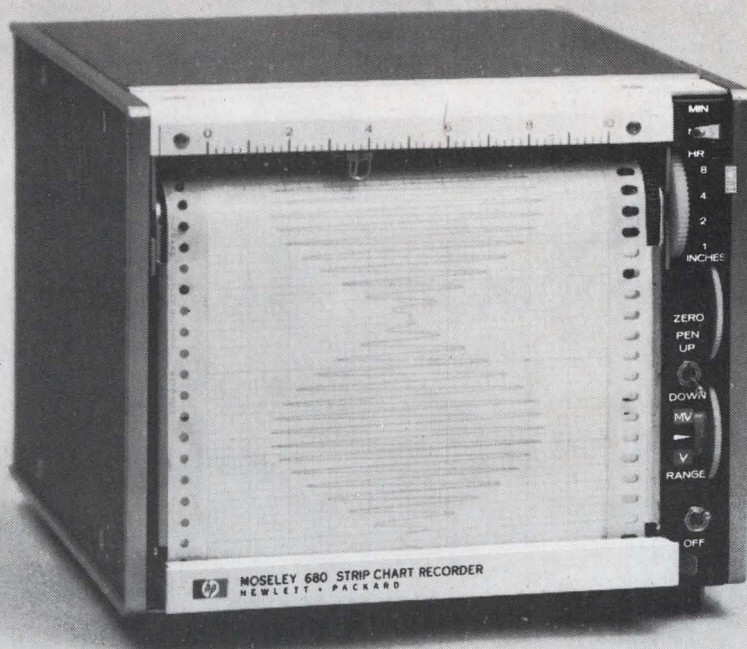

Leave it Alone

Let's face it. There are places where even the *best* strip-chart recorder could be improved. Like in the desert, on mountains or undersea. Anywhere there's dust, moisture or high humidity. Jobs that demand wear-free, corrosion-free reliability.

That's why Hewlett-Packard developed a unique photoslidewire (Option 17) for the HP 680 Strip-Chart Recorder. Users around the world tell us it has one outstanding feature: you can leave it alone. The photoslidewire combines a proven

null balance technique with optical coupling to eliminate mechanical contacts. A narrow light source on the stylus and HP-made photoconductor strips replace the mechanical slidewire contacts which balance the positioning servos. Photoslidewire (Option 17) cuts down preventive maintenance time and need for trained personnel. Price: Model 680 plus Option 17, \$850. And for long-term unattended operation, where a standard pen system is not practical, add HP's exclusive electric writing (Option 15) for

crisp, clean, permanent recording, \$75. Call your local HP field engineer for details on this extra measure of reliability. Or write Hewlett-Packard, Palo Alto, California 94304; Europe: 1217 Meyrin-Geneva, Switzerland.

HEWLETT  PACKARD
GRAPHIC RECORDERS

When you need clean low-level signals with improved settability, the 204D's built-in step attenuator is a step-saver. It eliminates the aggravating process of hanging an attenuator between the signal source and your system. And, it eliminates the extra problems that extra interconnections create. As a result, you get the clean signals you need for accurate measurements — quicker and easier.

The 204D has the same low distortion, high stability, and wide frequency range of 5 Hz to 1.2 MHz that makes the HP 204C an industry standard. Both models can be operated with line power, mercury battery, or a rechargeable battery pack.

Not all our changes are big ones, but each is intended to help you make better measurements in less time with less effort. Whether you chose a 204C or 204D depends, of course, on your requirements. If you don't need a built-in calibrated

step attenuator, then get the 204C and save the \$75 difference in price.

Whichever you chose, order today by calling your nearest HP order desk. For data sheets, write to Hewlett-Packard, Palo Alto, California 94304. Europe: 1217 Meyrin-Geneva, Switzerland. Price: HP 204C, \$250; HP 204D, \$325.

099/12

HEWLETT  PACKARD
SIGNAL SOURCES

Eliminate the unnecessary... With the 80 dB step-attenuator in the new HP 204D Oscillator

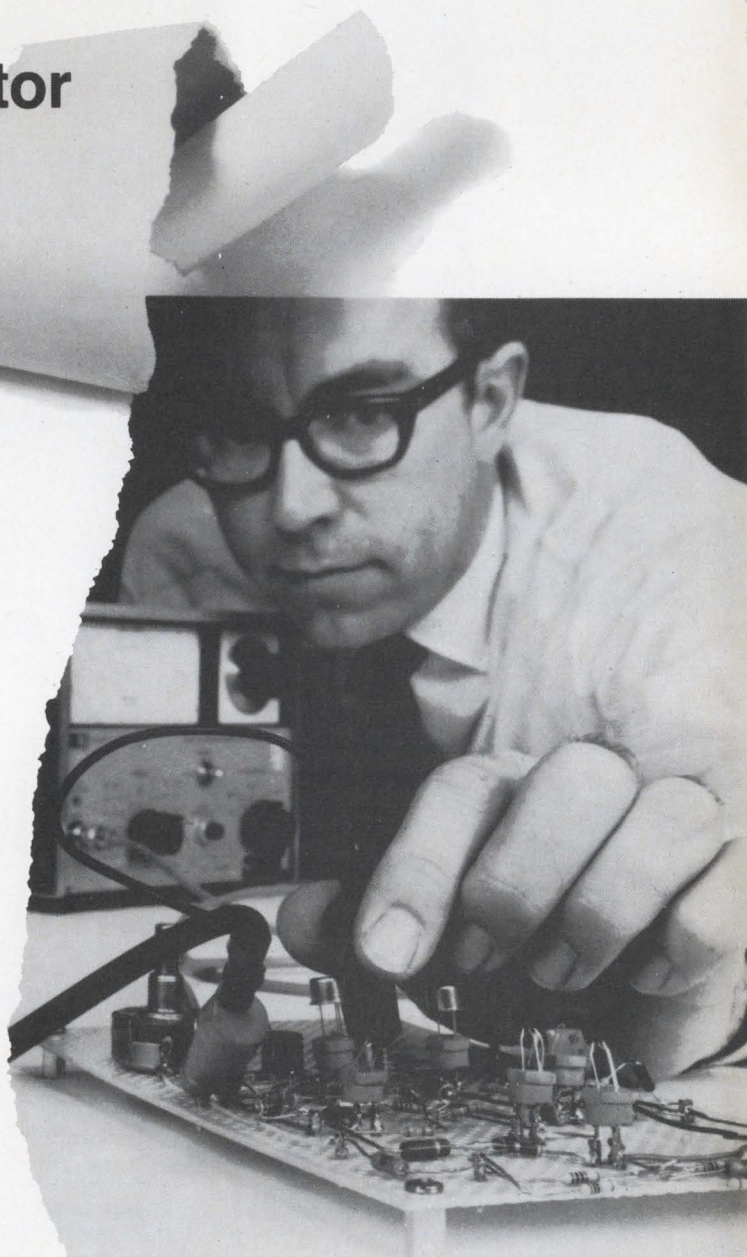
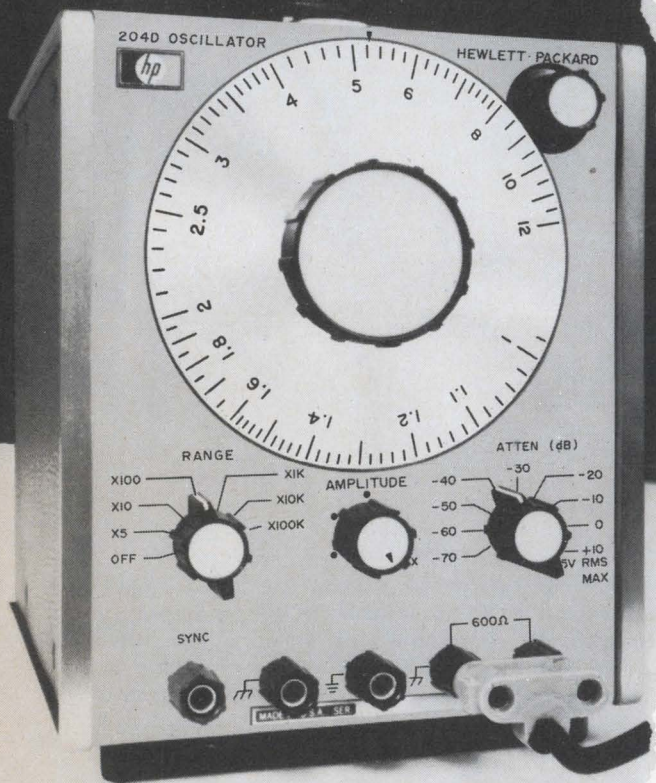

News Features

Probing the News

- 117 **Solid state:** Nitride passivation links TTL, MOS
- 123 **Manpower:** IUE tries to stem outflow of jobs
- 129 **Companies:** Bigtime profits in a rural setting for Grass Valley Group

U.S. Reports

- 43 **Radar:** Analog techniques replace phase shifters in phased array
- 44 **Solid state:** "Hot plate" controls temperature inside TO-5 or TO-8 can
- 44 **Optoelectronics:** Hologram system for fast fingerprint identification
- 45 **Computers:** Data processor for airborne command post being tested
- 46 **Avionics:** Doppler radar techniques spot wind vortex patterns; TI studies state of the future art
- 50 **Space electronics:** Forerunner of way-out space computer
- 55 **Government:** NASA turns practical
- 56 **For the record**

Electronics International

- 179 **Great Britain:** Royal Radar Establishment develops low-cost instrument to plot semiconductor impurity profiles; point-contact diodes detect submillimeter laser beams; atom-powered battery points way to longer-lived pacemakers
- 181 **Japan:** Video tapes copied in a jiffy; double epitaxial isolation gets transistors closer together on chip
- 182 **Czechoslovakia:** Magnetic field varies turn-on time of "Timistor"
- 182 **West Germany:** Bavarian observatory to run four-year radar rain check

New Products

- 133 **In the spotlight**
- 133 Flat display has inherent memory
- 139 **Components review**
- 139 Magnetic modules are flatpack-slim
- 142 Plug-in switch for p-c boards
- 147 **Instruments review**
- 147 Sweep oscillator has broad range
- 151 **Data handling review**
- 151 Core memory with 5-wire design
- 154 Computer directs in-out traffic
- 159 **Semiconductor review**
- 159 Annular-structure power transistor
- 163 **Production equipment review**
- 163 Flexible tester for digital IC's
- 164 Low-price unit sorts transistors

Title R registered U.S. Patent Office; © copyright 1969 by McGraw-Hill Inc. All rights reserved, including the right to reproduce the contents of this publication in whole or in part.

Technical Articles

- Integrated electronics** 78 **LSI and systems: the changing interface** (cover)
Increasingly complex integrated circuitry is disturbing traditional supplier-customer relationships. Systems houses are insisting on a bigger role in IC design; semiconductor makers are watching developments with a wary eye
George F. Watson, associate editor
- Circuit design** 86 **Designer's casebook**
- Improved Miller sweep uses an active load
 - Transistor "zener" has zero dynamic impedance
 - Pulse generator triggered by a step function
 - D-a converter improves accuracy of thermal unit
 - Full-duty single shot recovers fast
- Solid state** 90 **IC's break through the voltage barrier**
Dielectric isolation and a field plate permit fabrication of IC's with breakdown voltages better than 300 volts and pricetags comparable to those on costs with commercial p-n junction units
Hans Camenzind, Bohumil Polata, and Joseph Kocsis, Signetics Corp.
- Design theory** 96 **Active filters part 8: Positive results from negative feedback**
The availability of integrated circuits with many active devices on a single chip make it practical and economical to design stable negative-feedback filters
Gunnar Hurtig, Kinetic Technology Inc.
- Components** 104 **Log diodes can be counted on**
Diodes with specified logarithmic voltage-current curves can now be turned out in quantity for use in simple circuits to perform computing functions
Robert W. Hull and Karabet Simonyan, Computer Diode Corp.

Departments

- | | | | |
|----|--------------------------|-----|--------------------------|
| 4 | Readers Comment | 67 | Washington Newsletter |
| 8 | Who's Who in this issue | 166 | New Books |
| 14 | Who's Who in electronics | 168 | Technical Abstracts |
| 24 | Meetings | 170 | New Literature |
| 33 | Editorial Comment | 177 | International Newsletter |
| 35 | Electronics Newsletter | | |

Electronics

Editor-in-Chief: Donald Christiansen

Senior staff editors

Technical: Stephen E. Scrupski
News: Robert Henkel
International: Arthur Erikson

Managing editor: Harry R. Karp
Art director: Gerald Ferguson

Senior associate editor: Joseph Mittleman
Assistant managing editors: Stanley Zarowin, Eric Aiken, H. Thomas Maguire
Senior copy editor: James Chang; Senior staff writer: Howard Wolff

Department editors

Advanced technology: William Bucci, Richard Gundlach
Communications: John Drummond, Raphael Kestenbaum
Computers: Wallace B. Riley, George Weiss
Design theory: Joseph Mittleman
Instrumentation: Owen Doyle, Walter Barney
Military/Aerospace: Alfred Rosenblatt; William F. Arnold (Military); Paul Dickson (Aerospace)
New products: William P. O'Brien
Solid state: George Watson, Stephen Wm. Fields

Domestic bureaus

Boston: James Brinton, manager; Gail Farrell
Chicago: Frederick Corey, manager
Los Angeles: Lawrence Curran, manager
San Francisco: Walter Barney, manager; Peter Vogel
Washington: Robert Skole, manager; Paul Dickson, William F. Arnold

Foreign bureaus

Bonn: John Gosch
London: Michael Payne
Tokyo: Charles Cohen

Copy editors: Larry Miller, Edward Flinn
Staff writer: Peter Schuyten

Assistant art director: Kenneth L. Dix
Production editors: Susan Hurlburt, Arthur C. Miller

Editorial research: Anne Mustain

Editorial secretaries: Lorraine Longo, Claire Goodlin, Barbara Razulis, Vickie Green, Bernice Pawalk

McGraw-Hill News Service

Director: Arthur L. Moore; Atlanta: Fran Ridgway; Chicago: Robert E. Lee
Cleveland: Arthur Zimmerman; Dallas: Marvin Reid
Detroit: James Wargo; Houston: Barbara LaRoux
Los Angeles: Michael Murphy; Pittsburgh: Louis Gomolak
San Francisco: Margaret Drossel
Seattle: Ray Bloomberg; Washington: Charles Gardner, Daniel B. Moskowitz, Herbert W. Cheshire, Seth Payne, Warren Burkett, William Small, William D. Hickman

McGraw-Hill World News Service

Bonn: Robert Dorang; Brussels: James Smith; Hong Kong: Wes Perry;
London: John Shinn; Mexico City: Gerald Parkinson; Milan: Ronald Taggiasco, Jack Star;
Moscow: Jack Winkler; Paris: Robert E. Farrell, Stewart Toy
Rio de Janeiro: Leslie Warren; Tokyo: Marvin Petal
Reprints: Susan Nugent
Circulation: Isaaca Siegel

Publisher: Gordon Jones

Assistant to the publisher: Wallace C. Carmichael

Electronics: March 31, 1969, Vol. 42, No. 7

Published every other Monday by McGraw-Hill, Inc. Founder: James H. McGraw 1860-1948.
Publication office 99 North Broadway, Albany, N. Y. 12202; second class postage paid at Albany, N. Y.

Executive, editorial, circulation and advertising addresses: McGraw-Hill Building, 330 W. 42nd Street
New York, N. Y. 10036. Telephone (212) 971-3333. Teletype TWX N.Y. 710-581-4235. Cable address:
MCGRAWHILL N.Y.

Subscriptions solicited only from those professionally engaged in electronics technology. Subscription rates:
qualified subscribers in the United States and possessions and Canada, \$8.00 one year, \$12.00 two years,
\$16.00 three years; all other countries \$25.00 one year. Non-qualified subscribers in the U.S. and
possessions and Canada, \$25.00 one year; all other countries \$50.00. Air freight service to Japan \$50.00
one year. Single copies: United States and possessions and Canada, \$1.00; all other countries, \$1.75.

Officers of McGraw-Hill Publications: Joseph H. Allen, President; J. Elton Tuohig, Executive Vice President;
David J. McGrath, Senior Vice President-Operations; Vice Presidents: John R. Callahan, Editorial; Paul F. Cowie,
Circulation; John R. Emery, Administration; John M. Holden, Marketing; David G. Jensen, Manufacturing;
Jerome D. Luntz, Planning & Development; Robert M. Wilhelmy, Controller.

Officers of the Corporation: Shelton Fisher, President and Chief Executive Officer; John L. McGraw, Chairman;
Robert E. Slaughter, Executive Vice President; Daniel F. Crowley, Donald C. McGraw, Jr., Bayard E. Sawyer, Senior
Vice Presidents; John J. Cooke, Vice President & Secretary; Gordon W. McKinley, Vice President & Treasurer.

Title ® registered in U.S. Patent Office; © Copyright 1969 by McGraw-Hill, Inc. All rights reserved. The contents
of this publication may not be reproduced either in whole or in part without the consent of copyright owner.

Subscribers: The publisher, upon written request to our New York office from any subscriber,
agrees to refund that part of the subscription price applying to copies not yet mailed.
Please send change of address notices or complaints to Fulfillment Manager; subscription
orders to Circulation Manager, Electronics at address below. Change of address notices
should provide old as well as new address, including postal zip code number. If possible,
attach address label from recent issue. Allow one month for change to become effective.

Postmaster: Please send form 3579 to Fulfillment Manager, Electronics,
P.O. Box 430, Hightstown, New Jersey 08520

Readers Comment

Big Brother

To the Editor:

There are at least three items in the Feb. 17 issue of *Electronics* which emphasize the totalitarian trend of our culture. Hardly anyone is concerned nowadays by the fact that Government is regulating and controlling more and more aspects of our nation's private and business activities.

On page 39, the editorial "Heading off IBM" informs us that "the Justice Department wants IBM to change its way of doing business." Why does it want this change? Because IBM "has been so faultless in the way it has planned, manufactured, and marketed computers and computer services that if it merely continues its successful practices, its competitors may be unfairly treated." This statement clearly shows that the intention of the Government is to restrain or punish excellence, because to let those with superior ability, superior energy, or superior effort keep the earned consequences of their superior performance would mean that competitors with inferior performance would be "unfairly treated."

On page 58, the article "Pushing buttons" informs us that the Federal Communications Commission intends to force television-receiver manufacturers to include detent uhf tuners so that "all receivers will have 'comparable ease of tuning' on both vhf and uhf channels." After failing to persuade the industry to do this voluntarily, the FCC proposes a rule and follows up with the comment: "Maybe we won't have to make a ruling. Perhaps the threat will do it."

Such a "persuasion" or ruling will unquestionably result in higher receiver costs. In principle, this requirement does not differ from one that would require all sets to have remote controls for ease of tuning or to display color images and produce stereophonic sound for ease of viewing and listening. The only difference is that the consequences to the purchaser would be a little less obscure in the latter cases.

Finally, on page 71 we are con-

Wet-sintered-anode Tantalex[®] Capacitors

Buy the best. And save money doing it.

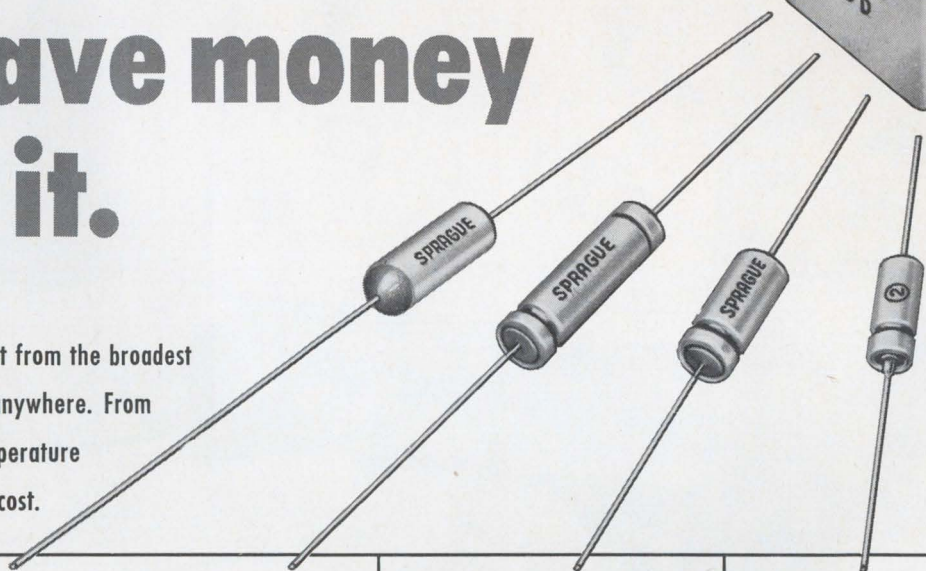
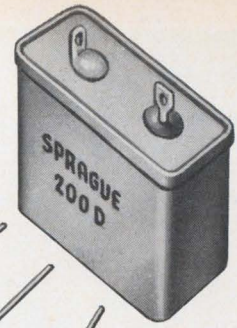

Here's how: Select from the broadest line of tantalum capacitors anywhere. From Sprague. The lower your temperature requirement, the lower your cost.

For operation to + 85 C		For operation to + 125 C	
<p>Type 145D</p> <p>Volumetric efficiency up to 210,000 μF-volts per cubic inch. For use in miniature commercial/industrial printed wiring boards, packaged circuit modules, and wherever else cost and space are prime considerations. Elastomer end seal capped with plastic resin insures against electrolyte leakage and lead breakage. Available in voltage ratings from 6 to 75 VDC.</p>	<p>Type 109D</p> <p>A superior design that meets all the basic military requirements for capacitors within this temperature limit. There is no compromise in quality. Voltage ratings from 6 to 150 VDC.</p> <p>For extra large values of capacitance, use Type 200D or 202D package assemblies, which consist of several 109D - type capacitor elements in a hermetically-sealed case.</p>	<p>Type 130D</p> <p>Exceptional electrical stability due to chemical inertness of tantalum oxide film to specific electrolytes used, low diffusion of TFE-fluorocarbon elastomer seal, and special aging for 125C operation. Voltage ratings from 4 to 100 VDC.</p> <p>Dual temperature ratings of Type 200D and 202D package assemblies give you extra high capacitance values for +125 C operation.</p>	<p>Type 137D</p> <p>Proven glass-to-metal hermetic seal qualifies these outstanding capacitors for use in satellites, missiles, and other critical aerospace applications. They have greater volume efficiency than has been previously available for wet-sintered-anode capacitors in this temperature range. Type 137D capacitors exhibit extremely low leakage currents. Available in voltage ratings from 2 to 150 VDC.</p>

CIRCLE 515 ON READERS SERVICE CARD

CIRCLE 516 ON READERS SERVICE CARD

CIRCLE 517 ON READERS SERVICE CARD

CIRCLE 518 ON READERS SERVICE CARD

Select the capacitor type that meets your temperature requirements. That's how to save money. Specify Sprague Tantalex[®] Capacitors. That's how to get the best.

For complete information on Type 145D Capacitors, write for Engineering Bulletin 3750 (Type 109D, Bulletins 3700F and 3700.2; Type 130D, Bulletins 3701B and 3701.2; Type 137D, Bulletin 3703A; Type 200D and 202D, Bulletin 3705B) to the Technical Literature Service, Sprague Electric Company, 35 Marshall St., North Adams, Mass. 01247.



*Sprague' and '®' are registered trademarks of the Sprague Electric Co.

THE BROAD-LINE PRODUCER OF ELECTRONIC PARTS

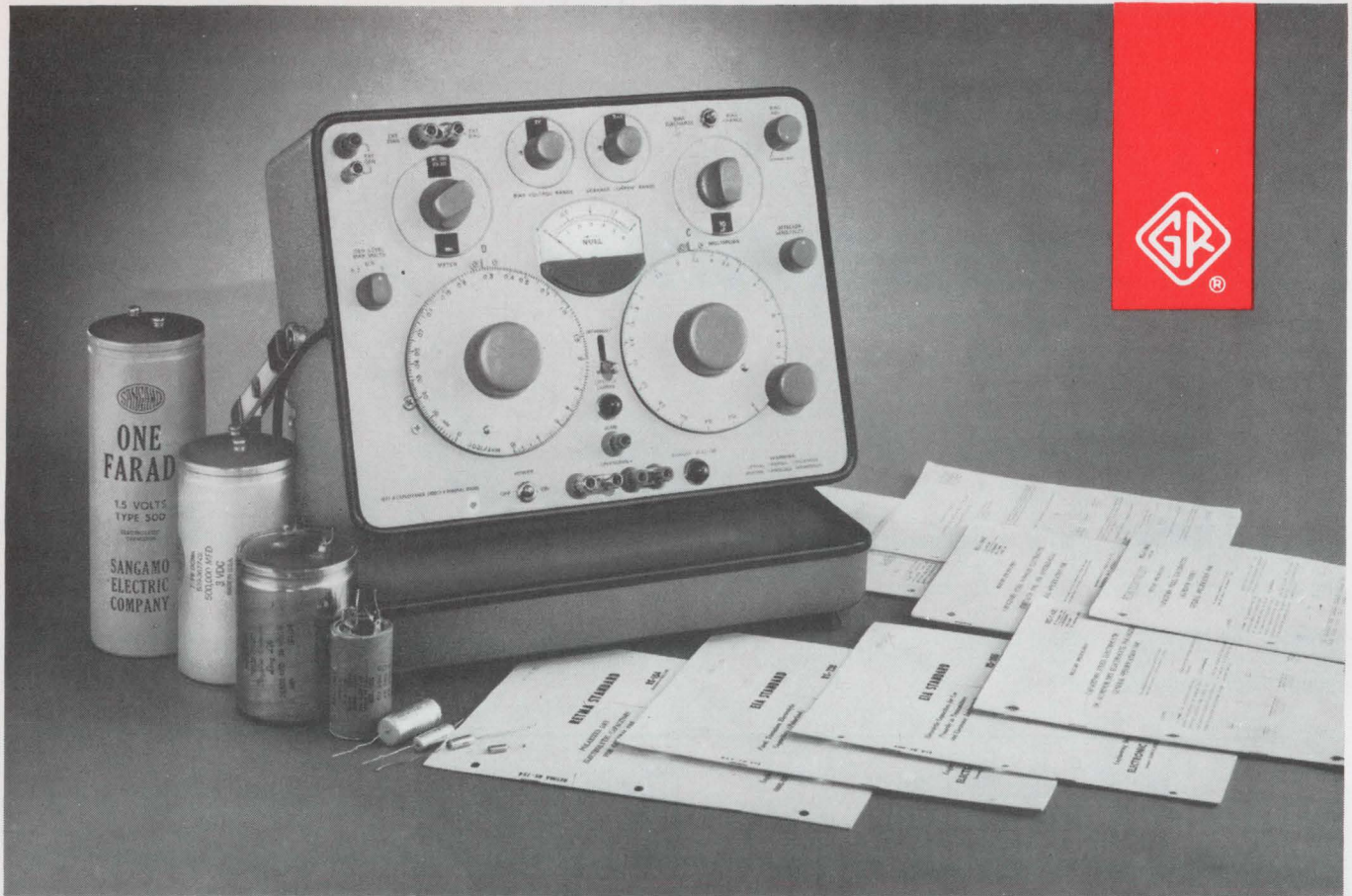

A "system" for testing tantalum and aluminum electrolytics

The Type 1617 Capacitance Bridge is really a system in one package designed specifically to test electrolytic capacitors at 120 Hz per MIL or EIA specifications. However, this 1% bridge can measure any capacitor, including those as large as 1.1 F. Besides having an exceptionally wide C range, the 1617 has many other features that make it an excellent general-purpose bridge for component testing at quality-control and incoming-inspection stations.

WIDE RANGE. C range of 10^{12} , from 1 pF to 1.1 F, with an accuracy of $\pm 1\% \pm 1$ pF and 2% from 0.11 F to 1.1 F. D range from 0 to 10 with an accuracy of approximately $\pm 2\% \pm 0.001$.

CONVENIENCE. The 1617 is completely self-contained; just plug it into a power line and start measuring. It includes a 120-Hz generator, a tuned detector, and an adjustable dc polarizing voltage, all enclosed in a handy, portable, flip-tilt carrying case.

MIL and EIA SPECIFICATIONS. It meets or exceeds the requirements of: MIL-C-39003 (Solid Tantalum), MIL-C-3965C (Tantalum Foil and Sintered Slug), MIL-C-39018 (Aluminum Oxide), (EIA) RS 154B (Dry Aluminum), MIL-C-62C (Polarized Aluminum), (EIA) RS 205 (Electrolytic), MIL-C-26655B (Solid Tantalum), (EIA) RS 228 (Tantalum).

OTHER FEATURES. The 1617 bridge:

- has a metered, dc polarizing voltage that is adjustable

from 0 to 600 volts; external bias up to 800 volts may be applied.

- provides for 2-, 3-, 4-, or 5-terminal connections to minimize the effects of residual impedances.
- detects leakage current down to $0.5 \mu\text{A}$.
- can operate at frequencies up to 1000 Hz with an external generator.
- has important safety features, such as warning lights and discharge circuitry, which protect both the operator and the instrument.
- has Orthonull® balance finder to permit rapid bridge balances and eliminate sliding nulls during high-D capacitance measurements.
- has a generator that is phase-reversible to reduce the effects of hum pickup; amplitude is selectable and limited to 0.2 V, 0.5 V, or 2 V.

The 1617 bridge can also measure the capacitance and loss of cables, transformers, insulating materials, and electric motors.

Price: \$1250 in the U.S.A. For complete information, write General Radio, W. Concord, Massachusetts 01781; telephone (617) 369-4400. In Europe: Postfach 124, CH 8034 Zurich 34, Switzerland.

GENERAL RADIO

Electronics | March 31, 1969

Readers Comment

fronted with "Compulsory f-m will get big push." This item tells us that f-m broadcasters "are about to launch a strong drive for a law requiring that all receivers be able to pick up both a-m and f-m. A bill to that effect was introduced last month by Sen. Frank Moss (D., Utah), a member of the communications subcommittee of the Senate Commerce Committee."

In a free country, the citizen, and not the Government, decides what and from whom he does or does not wish to purchase, and he expresses his desires with his dollars.

Ernst F. Germann

Austin
Texas

Scattering light

To the Editor:

In the article on solid state displays in the British IC's series [Feb. 3, p. 100], a description is given of Bragg-angle diffraction by the propagating planes of altered refractive index associated with the sound energy in a moving domain.

It is surprising that 50% to 75% of the light was found to be deflected to the detector. The diffraction pattern of the equivalent transmission grating, as shown in the diagram on page 102, should be symmetrical, with about equal energy in the right and left diffracted beams. In addition, neglecting the energy in the higher-order beams, the zero-order, or undeflected, beam usually has greater intensity than any other diffracted beam.

If 50% or more of the light input is in one deflected beam, the phenomenon is possibly one of total reflection by the domain interface or a refractive effect with bending from some gradient or wedge geometry in the domain.

Leo Mackta

Belle Harbor
N.Y.

■ Gordon Robertson and C.P. Sandbank of Britain's Standard Telecommunication Laboratories, authors of the article in question, reply:

"The essential difference between a diffraction grating and Bragg-type diffraction is that the former is planar while the latter is many wavelengths in depth. Thus, the zero-order beam can be scattered many times. By introducing the light at the Bragg angle in an ideal system of this type, all the energy would emerge in only one of the first-order beams. Destructive interference occurs in all other directions. The intensity of the scattered light beam is a function of the change in refractive index caused by the acoustic wave—hence, of the intensity of the acoustic wave and of the thickness of the sample. In this case, use of a 1-millimeter-wide crystal is quite sufficient to give substantial scattering.

Readers' letters should be addressed:

To the Editor
Electronics
330 West 42nd Street
New York, N.Y. 10036

Applications Power*



PUTTING CURRENT-LIMITER DIODES TO WORK

Problem: How to improve the performance of this bipolar series voltage regulator and reduce circuit complexity?

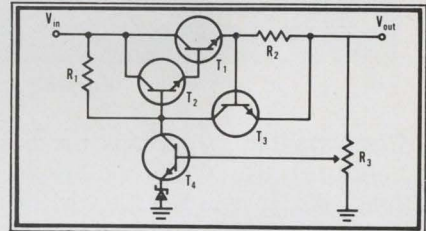

Solution: Replace the darlington pair with a FET and a CL diode.

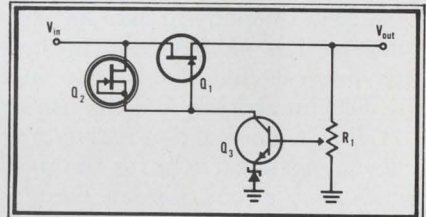

Increases in V_{OUT} are inverted and amplified by Q_3 . The increased V_{GS} on Q_1 reduces the supply current, decreasing output voltage. Current-limiter Q_2 (1) acts as a load for Q_3 and (2) when the output is short circuited it limits the forward bias current of Q_1 , limiting short circuit output current to the I_{DSS} of Q_1 . The use of the FET increases circuit power gain, reducing ripple, and increasing regulation.

For immediate applications assistance call the number below; ask for extension 19.

Siliconix
incorporated

1140 W. Evelyn Ave. • Sunnyvale, CA 94086
Phone (408) 245-1000 • TWX: 910-339-9216

*Applications Power: A broad product line and an in-depth applications team waiting to serve you.

SUBSCRIPTION SERVICE

Please include an Electronics Magazine address label to insure prompt service whenever you write us about your subscription.

Mail to: Fulfillment Manager
Electronics
P.O. Box 430
Hightstown, N.J. 08520

To subscribe mail this form with your payment and check new subscription renew my present subscription

Subscription rates: qualified subscribers in the U.S.: 1 year \$8; two years, \$12; three years, \$16. Non-qualified: 1 year \$25. Subscription rates for foreign countries available on request.

CHANGE OF ADDRESS

ATTACH LABEL HERE

If you are moving, please let us know five weeks before changing your address. Place magazine address label here, print your new address below.

name

address

city

state

zip code



Kocsis

Camenzind

Polata

Cosmopolitan is perhaps the best word for the Signetics trio who wrote the article on high-voltage IC's (page 90). Joseph Kocsis, who manages the company's microwave and high-frequency research group, was born in Hungary and educated in Britain. Before joining Signetics last year, he spent three years each at the Bell Telephone Laboratories and ITT Semiconductor. He has always been intrigued by novel devices, an interest that led him to investigate surface-controlled breakdown and the use of field plates for IC's.

Hans Camenzind, a native of Switzerland, has been designing linear IC's for the past six years. He is the author of a book, *Circuit Design for Integrated Electronics*, and is on the faculty of Santa Clara University where he teaches a graduate course on IC design. His

main interests center on the development of designs that open up new areas for IC's. Camenzind, who joined Signetics a year ago, was previously with the P.R. Mallory Co. He holds a master's degree from Northeastern University.

Bohumil (Bob) Polata, a Czechoslovakian by birth, joined Signetics early in 1966. His background includes stints with Beckman Instruments and Fairchild Semiconductor's research and development lab in Palo Alto. While at Fairchild, Polata worked on linear IC's using thin-film resistors and on MOS capacitors for space telemetry applications. He also developed a 10-bit a-d and d-a converter system that uses medium-scale integration circuits and tantalum resistor arrays as building blocks.

Active filters have long been a professional preoccupation of Gunnar Hurtig. One of the founders of Kinetic Technology Inc. and now its vice president for operations, he designed the monolithic unit discussed in the article beginning on page 96. Before helping KTI set up shop, Hurtig was a group manager at Western Microwave Labs and president of the Ninic Corp., which was bought by Fairchild Semiconductor. Hurtig stayed on with Fairchild, where he was in charge of the firm's active-filter facility. He received his bachelor's and master's degrees from Cornell.



Hurtig

Semiconductors are a common ground for Karabet Simonyan and Robert Hull, authors of the article of log diodes beginning on page 104. Simonyan, born in Turkey, has a bachelor's degree in applied physics from Hofstra University. He is now vice president of engineering at the Computer Diode Corp.

Hull, who holds a doctorate from MIT was one of the founders of the General Instrument Corp. He later formed a consulting firm that did work for Computer Diode, and has recently started a new company that manufactures semiconductor materials.

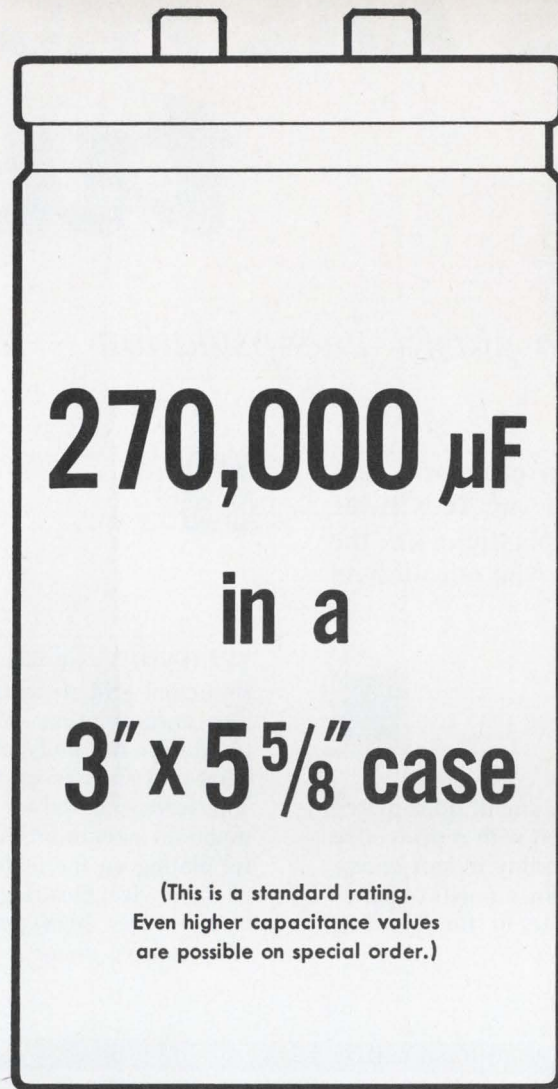

270,000 μ F

in a

3" x 5⁵/₈" case

(This is a standard rating.
Even higher capacitance values
are possible on special order.)

POWERLYTIC[®] CAPACITORS ARE PACKED WITH CAPACITANCE!

Improved Capacitance Capability

Type 36D aluminum electrolytic capacitors now have as much as 60% more capacitance in a given case size than previously available.

Higher Operating Temperature

Improved Powerlytic capacitors may now be operated at 85 C.

High Ripple Current Capability

Ideal capacitors for use in "brute-force" filtering and pulse discharge applications. Single capacitors are capable of handling up to 20 or more amps rms at 25 C, 120 Hz.



Superior Seal and Safety Vent

Beaded aluminum can is crimped onto a rubber gasket recessed in a rigid molded cover, providing an expected operating life in excess of ten years. Pressure-type safety vent employs silicone rubber for reliable, predictable release of excess pressure.

Choice of Insulating Tubes, Terminal Styles

In addition to the standard bare case, Type 36D capacitors are available with a clear plastic tube or with a Kraftboard tube. Tapped terminals in two different heights, as well as solder lug terminals are available.

**For complete technical data, write for Engineering Bulletin
3431B to Technical Literature Service, Sprague Electric Co.,
35 Marshall Street, North Adams, Mass. 01247**

SPRAGUE COMPONENTS

CAPACITORS
TRANSISTORS

RESISTORS

INTEGRATED CIRCUITS

THIN-FILM MICROCIRCUITS

48C-8130R1

PULSE TRANSFORMERS

INTERFERENCE FILTERS

PULSE-FORMING NETWORKS

TOROIDAL INDUCTORS

ELECTRIC WAVE FILTERS

CERAMIC-BASE PRINTED NETWORKS

PACKAGED COMPONENT ASSEMBLIES

BOBBIN and TAPE WOUND MAGNETIC CORES

SILICON RECTIFIER GATE CONTROLS

FUNCTIONAL DIGITAL CIRCUITS

SPRAGUE[®]

THE MARK OF RELIABILITY

Sprague' and '®' are registered trademarks of the Sprague Electric Co.

OUR IC'S ARE PACKAGED *twice*

A unique approach to plastic encapsulation

We don't compromise between price and reliability. That's why we package our IC's twice to combine the economy of plastic with the reliability of hermetic sealing. And our method is unique.

1

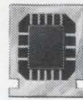

FIRSTLY, we mount the chip on a small, gold-plated grid. After the chip has been provided with a protective lacquer coating we package the assembly in soft epoxy resin. The resin protects the chip against moisture penetration, and prevents thermal fatigue of the bonding wires.

2

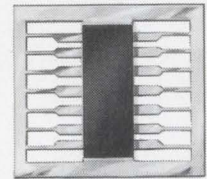

SECONDLY, we weld this sub-assembly into the final tin-plated grid structure and package it in the dual-in-line encapsulation. We chose a special ultra-strong plastic for the body of the device, to withstand severe bend-pull stresses on the external leads.

The leads themselves have been specially designed to maintain maximum adhesion to the plastic body. The tin plating on the leads continues right inside the body of the device, ensuring excellent corrosion resistance; it also ensures high-quality soldered connections even after storage under tropical conditions.

THIS "TWO-IN-ONE" IC PACKAGE GIVES SUPERIOR RELIABILITY!

We prove our IC reliability the hard way - with a tough series of tests. Apart from stringent quality control during each step of manufacture, batches from each production run are taken and tested for reliability under virtually every kind of stress - electrical, thermal, mechanical and climatic.

We test resistance to THERMAL FATIGUE by dissipating power in RTR-circuit *) resistors and transistors, so as to cycle crystal temperatures from very low to very high thousands of times.

We test a circuit's overall ENDURANCE under conditions of intermittent dissipation in the same way, but this time increasing junction temperature over a two-and-a-half-hour period, then allowing the circuit to cool down.

This test gives a good indication of BOND STRENGTH, BULK LEAKAGE, and any degradation of electrical performance under severe thermal stress.

We also check the endurance of RTR-circuits by reverse-biasing the transistor time after time at high ambient temperatures. This is a searching test of lacquer or plastic influence on the CRYSTAL STATE, since it shows the effects of SURFACE CHARGES and SURFACE TRAP DENSITY.

We check production circuits for the same qualities, but with the input diodes reverse-biased and the output transistor dissipating power, again at a constant high ambient temperature. The reverse-bias test for RTR-circuits, and its counterpart for production circuits, are also carried out under tropical conditions of temperature and humidity.

We test the ability of our circuits to withstand HIGH and LOW TEMPERATURE STORAGE. This is very important, because weaknesses in solder structure, lacquer deterioration, and 'plague' effects can all show up under adverse storage conditions.

We follow this up by storing circuits for weeks at a time under true TROPICAL conditions.

We really try out a digital circuit's SWITCHING capabilities by switching its input at 50% duty cycle under maximum fan-out and temperature conditions.

We carry out full sequential TEMPERATURE TREATMENT tests to MIL-spec requirements.

Our mechanical checks include SOLDERABILITY, the effect of PULLING or TWISTING the LEADS, resistance to SHOCK, ACCELERATION, and VIBRATION.

Finally, STEP STRESS TESTS are carried out to determine the extent of the temperature stress over a number of cycles needed to induce failure. This is a rapid method of detecting potential failure modes which may occur under normal conditions.

*) test device with separate transistor and resistors

PHILIPS EUROPE'S STRONGEST GROUP IN SOLID STATE DEVICES

... AND ALL THESE CIRCUITS COME IN THE "TWO-IN-ONE" PACKAGE



DTL INTEGRATED CIRCUITS

FC FAMILY medium speed
(Compatible with the 200 series)

STANDARD CIRCUIT RANGE:

DESIGNATION	TYPE NUMBER
single NAND gate	FCH101* FCH111
dual NAND gate	FCH121* FCH131
triple NAND gate	FCH141* FCH161 FCH151* FCH171
quadruple NAND gate	FCH181* FCH191
sextuple NAND gate	FCH201* FCH211
dual line driver NAND gate	FCH221 FCH231
single 5-bit comparator	FCH281
single 10-bit parity checker	FCH291
gated 4-bit decoder	FCH301
input expander	FCY101
single JK flip-flop	FCJ101
single JK master-slave flip-flop	FCJ111 FCJ201
dual JK master-slave flip-flop	FCJ121 FCJ131 FCJ191 FCJ211
quadruple latch flip-flop	FCJ221
monostable multivibrator	FCK101
level detector	FCL101
single decoder NIT driver	FCL111

*Without collector resistors

TTL INTEGRATED CIRCUITS

FJ FAMILY high speed
(Compatible with the SN74N series)

STANDARD CIRCUIT RANGE:

DESIGNATION	TYPE NUMBER
single NAND gate	FJH101
dual NAND gate	FJH111
triple NAND gate	FJH121
quadruple NAND gate	FJH131
dual buffer NAND gate	FJH141
dual AND-OR-NOT gate	FJH151
single expandable AND-OR-NOT gate	FJH171
single AND-OR-NOT gate	FJH181
quadruple NOR gate	FJH221
quadruple two input NAND gate	FJH231
single JK flip-flop	FJJ101
single JK master-slave flip-flop	FJJ111
dual JK master-slave flip-flop	FJJ121
dual latch flip-flop	FJJ131
single decade counter	FJJ141
quadruple latch flip-flop	FJJ181
dual JK master-slave flip-flop	FJJ191
dual gate expander	FJY101

TTL INTEGRATED CIRCUITS

FH FAMILY ultra-high speed
(compatible with the SUHL II series)

STANDARD CIRCUIT RANGE:

DESIGNATION	TYPE NUMBER
single NAND gate	FHH101A FHH101B
dual NAND gate	FHH121A FHH121B
quadruple NAND gate	FHH141A FHH141B
single expandable AND-OR-NOT gate	FHH161A FHH161B
	FHH181A FHH181B
JK flip-flop (AND inputs)	FHJ101A FHJ101B
JK flip-flop (OR inputs)	FHJ121A FHJ121B
AND-OR-NOT expander	FHY101 FHY121

LINEAR CIRCUITS

TAA470 RGB matrix pre-amplifier with thermal matching to drive cathode or grid of a colour picture tube.

TAA630 Synchronous detector for colour receivers driving either colour difference output transistors or RGB matrix TAA470.

TAA700 Higher order linear circuit which combines seven signal processing functions in a TV set.

TAD100 AM radio circuit containing oscillator, mixer, IF amplifier, detector, AF pre-amplifier, and driver stage.

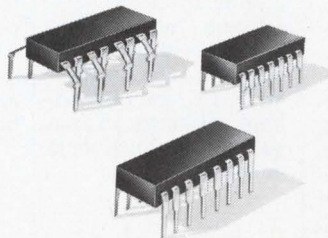

Our unique 'twice packaged' dual-in-line encapsulation comes in either a 14-lead or a 16-lead version.

The linear circuits which are used in applications where easy mounting is more important than space-saving are supplied in a quadruple-in-line encapsulation.

PHILIPS ELECTRONIC COMPONENTS AND MATERIALS DIVISION EINDHOVEN, THE NETHERLANDS

distributed and sold in the U.S. by: **AMPEREX ELECTRONIC CORPORATION** Providence Pike, SLATERSVILLE, Rhode Island
230 Duffy Avenue, HICKSVILLE, New York 11802 • 801 E. Charleston Avenue, PALO ALTO, California 94303 • 360 E. North Avenue, NORTHLAKE, Illinois 60164

Circle 11 on reader service card

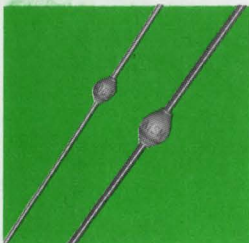
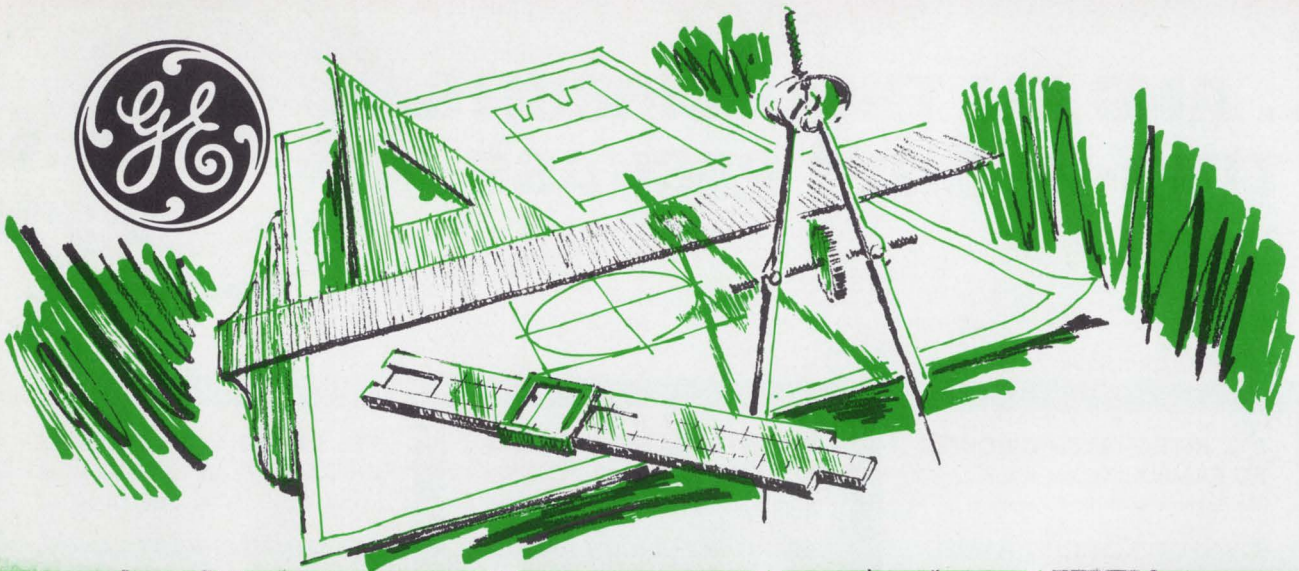

GE's 3 amp hermetic A15 replaces costlier A14

GE offers a higher rated companion to its field-proved, 1 amp A14 rectifier at a significantly lower cost than stud or other lead mounted units (depending upon configuration). The A15 is rated 3 amps at 70 C and the 200 to 800 volt models are transient voltage protected up to 1000 watts for 20 μ S in reverse direction.

A15's dual heat sink design means low thermal impedance and easy adaptation to PC board mounting . . . reduced installation cost.

Both the A15 and A14 are hermetically sealed in an all-diffused, glass passivated junction structure. No internal cavity means more resistance to environmental stresses . . . thus increased reliability.

High-power A15 is now available through GE distributors in quantities up to 9999 for applications including time delay circuits, battery chargers, TV damper diodes, communication equipment and small portable appliances. Circle number 505.

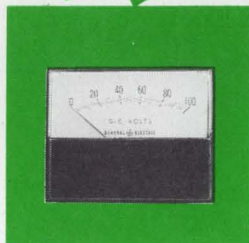

Select your instruments from industry's most complete line

● **Panel meters.** Measure a-c, d-c volts and amps. 1½ to 4½-inch sizes in THE BIG LOOK® style. 2½ to 4½-inch sizes in HORIZON LINE® style.

● **Meter relays and pyrometers.** Indicate, monitor and control temperature or other variables directly or with transducers. BIG LOOK and HORIZON LINE style. 2½ to 4½-inch sizes. "Piggy-back" control module.

● **Edgewise meters.** Measure a-c and d-c volts and amps. Miniature type 185, 2¼ inch or large type 180, 6-inch. Both can be multi-stacked vertically or horizontally. Standard accuracy of 2%, 1% optional.

● **Switchboard instruments.** Measure volts, amps, speed, vars, power factor, frequency, phase angle, other variables. 4½ and 8½-inch sizes. Standard one percent accuracy. For full line information, circle 506.



Reduce redesign cycles with reliable GE microwave circuit modules

GE microwave circuit modules (MCM) help reduce design cycles, provide retrofit and lead to improved system performance by optimum integration of active devices. And lower system cost results from circuit simplicity, easy application and longer life.

These rugged GE devices are built to deliver reliable performance in adverse environments of shock, vibration, high altitude and extreme temperatures. MCM's may be designed for use as oscillators, amplifiers, integrated isolators and circulators.

General Electric microwave modules encompass all planar triode and diode uses—from DC to X-band, from milliwatts to kilowatts. For details, circle number 507.



GE wet slug capacitors . . . highest efficiency in half the size

GE 69F900 wet slugs meet high-density application needs with highest volumetric efficiency of any capacitor. We halved the military (CL64) wet slug size, and essentially kept its electrical and performance traits.

The 69F900 has excellent capacitance retention at low temps . . . can be stored to -65 C. Operating range is -55 C to +85 C. It's tough too—withstands vibration to 2000Hz; 15G acceleration!

GE's capacitor is fully insulated; has low, stable leakage current. Ratings are available from 6 to 60 volts; capacitance ranges from 0.5 to 450 μ f. For more information, circle magazine reader card number 508.

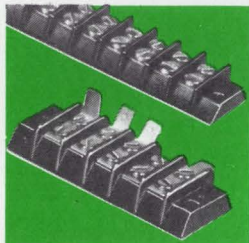

New 36 point one-piece Terminal Boards

General Electric has stretched its reliable line of one-piece terminal boards to 36 contact points. And they are available in eight configurations of solder, screw and quick-connect points.

The new expanded line of CR151, Type D1 or D7, is rated 15 amperes with breakdown voltage of 3600. Of course, other designs are still available in ratings up to 30 amperes and breakdown voltage to 7500.

No insulation is required between board and panel because the molded plastic base already provides the protection. Marking strips or stamped markings can be provided on top and/or bottom.

The expanded D1 and D7 boards add just another dimension to what is already the broadest terminal board line on the market. For more information, circle reader card number 509.

10 more

electronic components tailored for designers

General Electric components are engineered for reliability and cost effectiveness. No other single manufacturer offers such a wide selection of quality electronic components as General Electric. Specify GE in your designs.

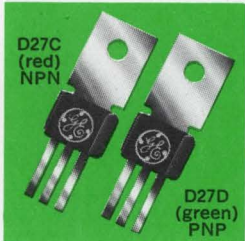

Complementary power transistors—up to 20W in audio applications

Complementary D27C/D27D silicone-encapsulated, planar, epitaxial power transistors have low collector saturation voltages and offer a dissipation of 8W total power with tab at 70 C. Their 0.5" leads can be formed to fit TO-66 and TO-5 configurations.

Key Characteristics

Collector current
3 amps (continuous)
5 amps (peak)
Collector saturation voltage
D27C: 0.5V typ., 3.0A
D27D: -1.0V typ., -3.0A
Collector-to-emitter voltage
30 and 40 volts
Total power dissipation (with tab)
1.7W (free air at 50 C)
2.1W (free air at 25 C)
8.0W (tab at 70 C)
Forward current transfer ratio
120 max., 200 mA
Gain band width product
D27C: 50MHz typ.
D27D: 40MHz

Their small size and power handling capability offer a great variety of applications including drivers, voltage regulators, power switching, audio output for automobile or phono stereo, TV, radio. And they are color coded for identification. Circle number 510.



Designing a radar? New GE 4-cell tetrode improves bandwidth 300%

Up go electronic bandwidths with GE's unique ZP-1081 "multi-cell" tetrode, a compact, air-cooled transmitting tube that incorporates four high-performance tetrode units in a single vacuum envelope. This innovation leads to very high transconductance and significantly low output capacitance, to provide high gain-bandwidth in amplifier circuits.

Electronic bandwidth of about 120 MHz has been demonstrated under RF power amplifier operation at 475 MHz. Related typical performances includes 70 KW of useful peak power output with a peak drive power of 15KW.

Output efficiency is close to 40%, and low operating voltages are used under RF grid-pulsed amplifier service. Bandwidth achieved is on the order of 200-300% of that available from previous tetrodes and associated circuitry operating at comparable power and frequency. For more information, circle number 511.



GE's Economy Pack... proved thermistors at budget prices

Growing uses of printed circuit boards in new applications have demanded hermetically sealed temperature compensation units at lower cost. And in response to this need, GE has put its proven 1H-Series (negative temperature Coefficient) Thermistors in a new Economy Package.

As low as 16¢ each in OEM quantities, these high-quality units are available in 5%, 10%, 20% and 30% tolerances with Zero-Power Resistance Values from 18K to 56K ohms at 25 C.

1.125 inch gold-plated Dumet leads may be welded or soldered... ideal for PCB designs.

Proved quality at lower cost makes GE thermistors the answer to your PCB needs. For more facts on the GE Economy Package, circle number 512.

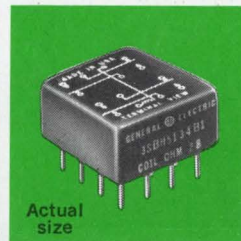

Smallest 4-pole relay available anywhere... GE's 150 grid

The General Electric 150 grid sealed relay is now a better buy than ever. It's the smallest available. And three years of application experience rank it with the most reliable GE sealed relays ever designed.

Low in price, it is even less than GE's standard 4-pole relay which is 4 times larger.

It meets Mil Spec 5757E, rated 2 amps, 250 MW sensitivity, and has all welded construction. Ask for the best 4-pole sealed relay buy on the market—GE's Type 3-SBH 150 grid.

Circle number 513 for more information.



Instant response for driving computer peripherals

When your equipment calls for instant response—inertial time constants low as 1 millisecond—look to GE's new Hyper-Servo* motor. It can accelerate faster than any previous GE design.

The Hyper-Servo motor makes possible new performance capacity in motor-driven peripheral data processing equipment. It is available in 3.4-, 4.6-, 4.8- and 4.9-inch diameters. And look at these performances: torque-to-inertia ratios in excess of 350,000 rad/sec² and; cont torque ratings from 32 oz-in at 2700 rpm to 326 oz-in at 2800 rpm.

These and other high performance characteristics make the Hyper-Servo motor adaptable to nearly every computer peripheral drive application. Circle magazine inquiry card number 514.

* Trademark of the General Electric Company.

Look to General Electric—your best source for more in electronic components.

ELECTRONIC COMPONENTS SALES OPERATION

GENERAL  ELECTRIC

METALIZED POLYESTER CAPACITORS

ACTUAL SIZE

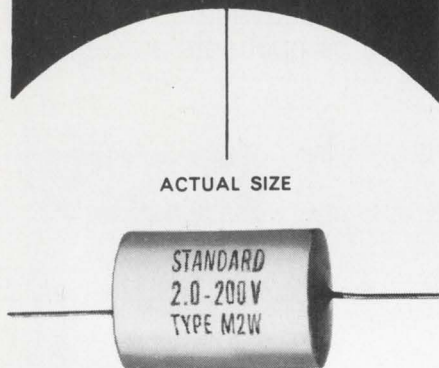

M2W
SERIES

ANY SIZE, VALUE,
VOLTAGE AND
TOLERANCE

to your exact
specifications...
at stock prices

Unique, self-healing units that remain in circuit during voltage surges with little or no loss of electrical properties. Use the M2W's where size and weight are limiting factors and long life and dependability are required. The units utilize metalized Mylar* Dielectric with film wrap and custom formulated epoxy resin end fill. Available in round and flat styles.

*Du Pont Trademark for Polyester Film

Samples available on
your letterhead request

Standard

CONDENSER CORPORATION

Dept. EL-3, 1065 W. Addison St.,
Chicago, Ill. 60613 • 312-327-5440

Who's Who in electronics



Graham

"The shift to the Houston area is not a short-term answer to a problem," says George Graham, 36, manager of transistor transistor logic for Texas Instruments, who will manage the new plant there. This spring, TI will shift the bulk of its integrated-circuit activities to a 181,000-square-foot plant in the Houston suburb of Stafford, moving nearly 1,000 professional personnel to run the facility [*Electronics*, March 17, p. 36].

The company did such a good job of selling TTL to designers that demand far outstripped supply last year. But Graham says that the capacity situation was already well in hand when the move was decided on. "We made our significant investment, in equipment and people, last year," he notes. "I think I'll be able to supply anything our customers need—certainly by the end of the second quarter. I expect to be on top of the situation long before the transfer is complete; the move is really to make sure that we stay that way."

Future. As plant manager, Graham will be host to TI's so-called TCC (for Technology Customer Center) projects under Charles Phipps. This operation includes the high-technology areas in which TI expects its growth to come: MOS IC's, large-scale integration, and memories. (Phipps will continue to report to Glenn E. Penisten, TI vice

president in charge of business development. Graham reports to C. Morris Chang, vice president in charge of IC's.) The inclusion of TCC operations in the shift to Stafford underlines Graham's observation that "TI has realized for some time that it needed another business base for the Components group." The corporation purchased 200 acres in Stafford three years ago; the semiconductor personnel will occupy a building that now houses the Industrial Products division, which makes TI's IC test equipment.

Industrial Products is moving into a new 15,000-square-foot plant next door, and TI will soon begin construction of a third building as large as the existing structure.

Big H. Why Houston? The site seemed a natural to the Texans who will move there. It's only 250 miles from the Dallas headquarters, with frequent plane service; the labor market isn't quite so tight as in Dallas (the housewife market is hardly tapped, Graham says), and there is a good scientific and educational community, with the NASA Manned Spacecraft Center and Rice University. "You go into this with some apprehension, but so far the response has been good," Graham says.

Not too many executives rise to the top through the engineering ranks, but Victor H. Pomper did. In 1950, fresh out of MIT Graduate School, he joined audio manufacturer H.H. Scott Inc. of Maynard, Mass., as a sales engineer; in December Pomper became president.

With no formal business training, he was forced to learn management on the job and admits making mistakes. "There have been frustrations and failures, but all one can do is assemble facts and deal with them objectively," says Pomper.

Right feeling. Pomper must deal with both engineering and management—when and where to apply new technology, carefully weighing a new technique's worth in the marketplace against its cost. But in the end, Pomper says, one often

How a little Rexolite® helps Amphenol plug leaks in microwave lines.

Amphenol RF Division knew they had a tiger by the tail when they set out to come up with a new 7 mm precision connector. And they say their choice of Rexolite 1422 dielectric material had a lot to do with their success.

The challenge — Microwave test equipment and air lines had advanced to the point, particularly in low-signal-strength applications, where equipment manufacturers were calling for a new, stable connecting link that would have almost no loss at all! Current coaxial connectors, producing VSWR's of about 1.35 at 10 GHz wouldn't do.

The solution — Working within parameters established in an IEEE subcommittee, Amphenol developed the precision coaxial connector shown here. It operates to 18 GHz with a maximum VSWR of 1.039.

WHY REXOLITE —

1. The **dielectric constant** of this Brand-Rex material, chosen for the insulation, proved "just right for a coaxial design of 7 millimeters inside diameter" according to Amphenol engineers.
2. Rexolite's **consistency** of properties, piece-to-piece and batch-to-batch was found better than that of other materials considered.
3. And it provided better **stability**, particularly where temperature variations were involved.
4. Finally, Amphenol found Rexolite 1422 **machines beautifully**. The disk is cut from rod stock to within .0002" tolerance on thickness, I.D. and O.D. And sharp shoulders (.002" max. radius) are held.

Can you use a real, problem-solver dielectric like this? Write for the facts on REXOLITE clad, rod and sheet stock.

American Enka Corp., Brand Rex Division,
Willimantic, Conn. 06226, Phone: 203 423-7771.

BRAND-REX

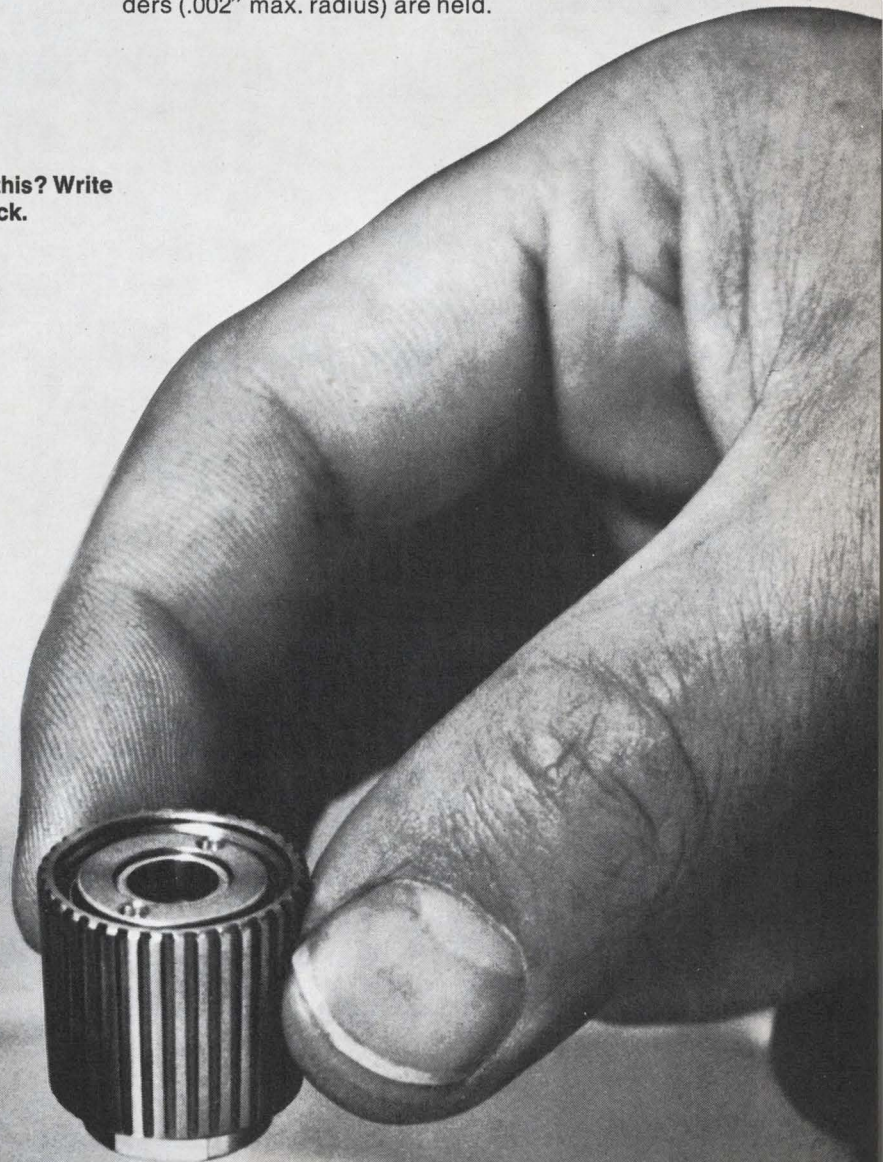

When your 50 V filter fails better get a



USCC
100 V RFI
filter

and be safe!

Better System Protection

100 V at 85°C
50 V at 125°C

Increased Reliability

operating life eight times as great

Greater Transient Protection

up to 200 V

No Increase in Size

same case as the 50 V filter

In a packaging breakthrough, USCC has designed a 100 V RFI/EMI filter into a size previously available only for filters up to 50 V. This makes it the smallest 100 V RFI filter around.

The hermetically sealed, non-polar units are for operation in the 10 kHz to 10 GHz frequency range. Using feedthrough construction in bulkhead mounted configurations, the 2100 Series demonstrates superior RFI/EMI shielding. They also meet the applicable requirements of MIL-F-15733.

A unique internal construction, incorporating mechanical assembly techniques as well as soldered connections, provides improved reliability.

For complete technical information, write or call: U.S. Capacitor Corporation, 2151 N. Lincoln Street, Burbank, California 91504. Telephone: (213) 843-4222. TWX: 910-498-2222.

USCC

Who's Who in electronics



Pomper

has to make "risky entrepreneurial decisions on the basis of intuition or guts. You must stick your neck out."

Scott claims to have developed the first hi-fi amplifier, the first wideband f-m tuner, and to have used silicon transistors, field effect transistor's and IC's before most competitors thought them feasible. Now Scott is working with Motorola to develop thick-film circuits; also forthcoming is a new speaker.

Many of Scott's firsts occurred during Pomper's 19 years with the company. Meanwhile, the payroll grew from 12 to 700. Ironically, if Scott had been that large in 1950, Pomper might not have joined. While a co-op student, he had worked at Philco, and this decided him against larger companies.

Hobby. An MIT professor who knew Hermon Scott recommended the young firm to Pomper, whose first reaction was: "It's a hobby, not a company." But he soon decided that Scott held opportunities even though he had never worked with audio equipment.

Pomper recalls: "I worked 70 hours a week at first and had no social life. People thought I was crazy."

But now both Pomper and the corporation are ready for a slower pace. "In the last 15 years we have doubled our business every three years," he says. "Now we'll grow a little more slowly; we want to consolidate before diversifying."



ERIE

When you need a new way to see in the dark...

Photographed in Vietnam by Howard Sochurek

bring ERIE in early.

The jungle night falls fast for a pilot downed behind "Charlie's" lines. But, rescue choppers no longer wait for morning light to find him. The answer? New portable night vision devices that actually intensify available light...even starlight...thousands of times. From the start, those working on this project have relied on the Research Engineers and component capability of ERIE TECHNOLOGICAL. Our new sub-miniature high voltage supply is at the heart of the system. Proof, once again, that whatever your area of electronics, it pays to bring ERIE in early.

ERIE TECHNOLOGICAL PRODUCTS, INC.

644 West 12th Street, Erie, Pennsylvania 16512
Area Code 814-456-8592

Triplett turned to Durez[®] 11540 to protect both their meters and their customers



Triplett Electrical Instrument Company needed a case for its new portable volt-ohm-milliammeter that could stand up under the rugged bumps of portable use and protect the user against shock.

They found the right combination of physical and electrical properties in Durez 11540 phenolic molding compound.

Its dielectric strength meets the toughest specs, including Mil-M-14F, Type CFG.

Durez 11540 is just one of dozens of Durez compounds that offer you the right choice for electrical applications in almost any environment. If you're trying to solve a problem, let us give you more facts to work with. Write Durez Division, Hooker Chemical Corp., 504 Walck Road, North Tonawanda, N. Y. 14120.

MOLDED PROPERTIES (specimens compression molded at 340°F.)

Durez 11540 Black Phenolic Material			Durez 11540 Black Phenolic Material		
	Value	ASTM Method		Value	ASTM Method
Specific gravity	1.36-1.38	D 792	Flexural strength, psi	10,500 min.	D 790
Molding shrinkage, in./in.:			Tensile strength, psi	7,000 min.	D 638
Compression	0.006-0.008	D 955	Compressive strength, psi	30,000 min.	D 695
Transfer	0.009-0.011	D 955	Defl. temp., °F., 264 psi	330 min.	D 648
Water absorption, %	0.6	max. D 570	Modulus in tension, psi	1.2x10 ⁶ avg.	D 638
Impact, Izod, ft. lb./in.	0.35	min. D 256	Hardness, Rockwell, E scale	85 avg.	D 785

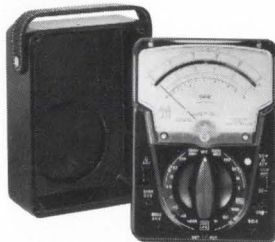

hooker
durez DIVISION



Flutter measurements
have one
basic problem...

They're usually wrong.

And wrong measurements are of no value to anyone. Most oscilloscope presentations of flutter give you an inaccurate picture for several reasons: they make you *subjectively* evaluate a composite waveform, and even experts have trouble with this; their economical scope construction often can't compete with lab-quality display devices; they lack uniformity in repetitive flutter readings, or several units of the same model give different readings; and they can't track or measure noise-like waveforms accurately.

That's a lot of places to go wrong.

MICOM gives you highly accurate flutter and wow measurements without forcing you to make "eyeball" readings, yet are simple to operate. The MICOM line of meters accurately measure long-term speed errors or drift, and will quickly locate resonant flutter peaks within the flutter bandwidth. Outputs for scope displays are available. MICOM flutter meters can save you both time and money in evaluating your analog recorder—with the confidence that your equipment will meet published specifications.

So if wrong measurements aren't doing you any good... correct them by selecting the MICOM flutter meter that best suits your needs.

MODEL 8100/8100-W FLUTTER METER—for professional accuracy and flexibility in measuring to NAB and DIN standards. Used in recording stations, production line testing, and lab work in tape recorder manufacturing.

MODEL 8150 FLUTTER METER—for professional accuracy and best economy in radio/TV broadcast stations, service applications, and production line testing. Available in NAB and DIN configurations.

MODEL 8200/8200-W WIDEBAND FLUTTER METER—for highly critical audio or transport design applications where scrape flutter or automatic peak-to-peak measurement to 1, 2, or 3 sigma limits is important.

MODEL 8300/8300-W IRIG FLUTTER METER—meets all IRIG Standard requirements and eliminates subjective "eyeball" analysis and associated errors in the IRIG measurement. Accepted as the industry standard by the major instrumentation magnetic tape recorder manufacturers.

MODEL 9100/9100A FM MODULATOR—for exceptionally low-phase noise, linear modulation over a wide deviation. Also used for calibration of flutter meters.

For more details, contact MICOM, Inc., at 855 Commercial Street, Palo Alto, Calif. 94303. Telephone (415) 328-2961.

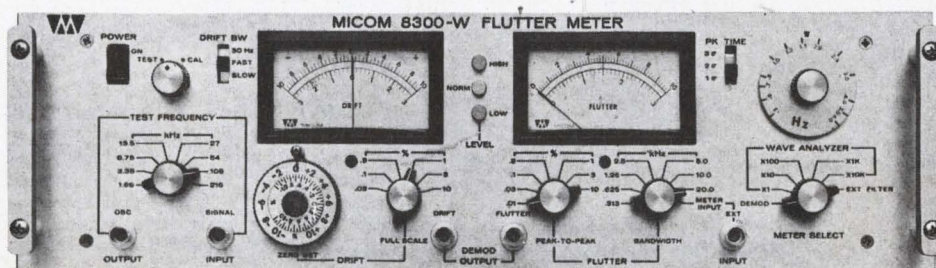

Custom(er) Cable Constructions by Chester

Proof of Chester's ability to produce plastic coated multi-conductor cable construction to customer requirements is reflected in part by the production samples shown on these pages. Though only representative of the thousands of "specials" made for our many customers they graphically prove Chester's ability to translate a wide range of special multi-conductor needs into dependable and practical cable constructions.

When standard cable constructions will not suffice, Chester's vast resources, technical skills and manufacturing facilities are placed at your disposal to manufacture conductors, insulations and jackets to meet your most exacting requirements.

Whatever your multi-conductor cable needs, check first with Chester. We know you'll be more than pleased with the expeditious and thorough handling of your request.

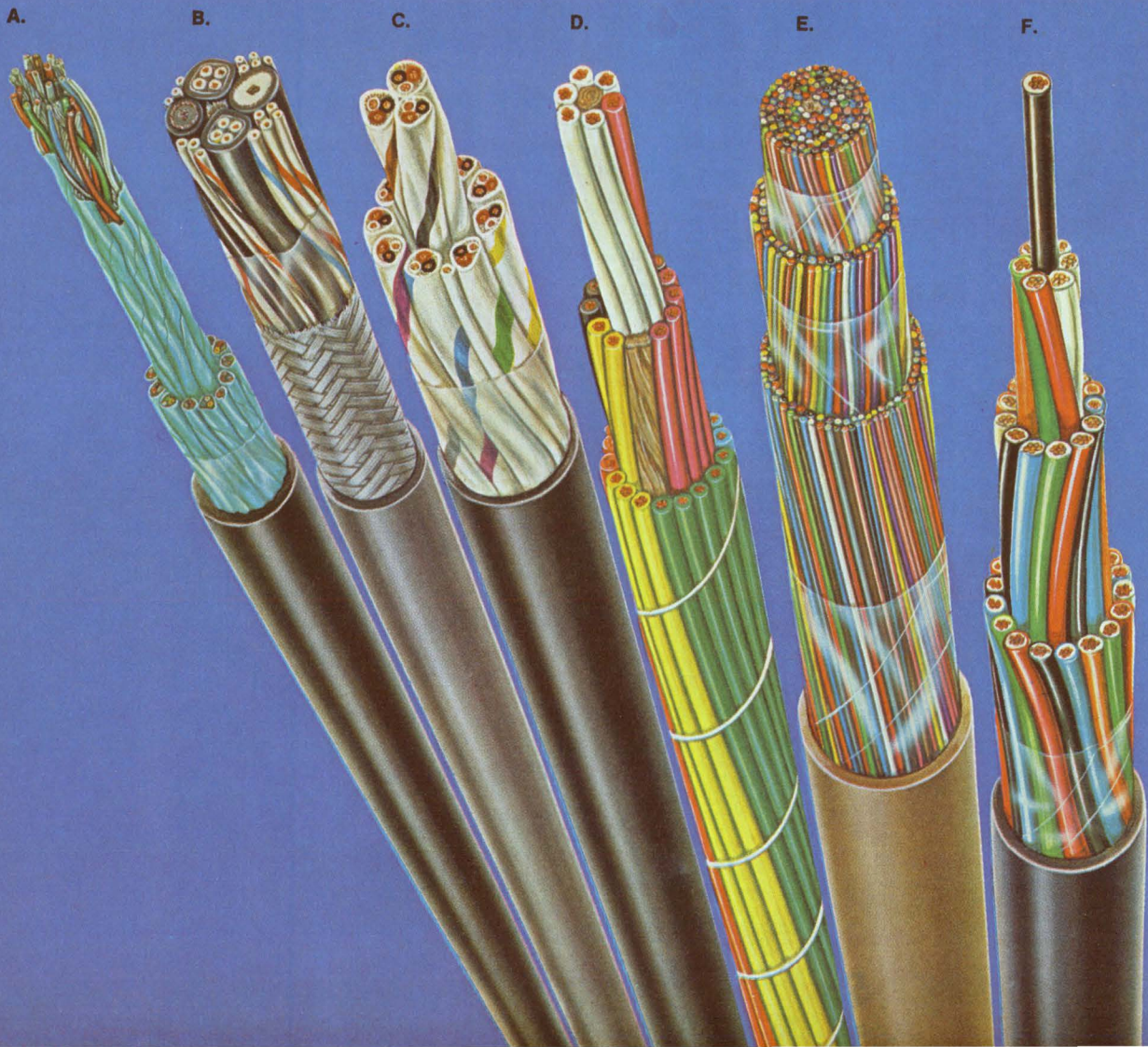

- A. RECORDING STUDIO:** Audio sound cable: 25 shielded pairs, stranded copper conductors, low loss insulation, twisted with uninsulated drain wire, isolated aluminum tape shields, cabled, PVC jacket.
- B. TV CAMERA MFR.:** Camera control cable for Audio and Video signals: a composite of PVC and polyethylene insulated conductors, cabled, overall braid shield, PVC jacket.
- C. AIRCRAFT SIMULATOR MFR.:** Control cable: 12 shielded jacketed, stranded copper conductors, PVC insulated, individual shield jackets color coded, cabled, overall PVC jacket.
- D. ELEVATOR MFR.:** Control cable: 35 conductors, stranded copper, PVC insulated, conductors coded by colors and printed numbers, cabled with open binder; individual conductors U/L listed.
- E. INTERCOM EQUIPMENT MFR.:** 250 conductor inter-office communication and signaling cable: solid bare copper, PVC insulation, paired, cabled, PVC jacket; U/L listed.
- F. ELECTRIC UTILITY CO.:** Station control cable for general use: 37 conductors, stranded, polyethylene and PVC insulated, color coded, cabled, overall tough PVC jacket; per NEMA/IPCEA Specifications.
- G. LARGE CITY:** Communication cable: 50 pairs, polyethylene insulated, cabled, continuous layer of copper shielding tape, PVC jacket; per spec. IMSA-19-2, 600 volts.
- H. LEADING SHIPBUILDER:** shipboard cable: stranded conductors, nylon-jacketed PVC insulation, pairs shielded and jacketed, cabled, PVC jacket, and aluminum braid armor overall; per spec. MIL-C-915.
- I. U. S. GOVERNMENT:** Coaxial cable: type RG-218/U, solid copper conductor, polyethylene insulated, copper braid shield, PVC jacket; per spec. MIL-C-17/79.
- J. BROADCASTING COMPANY:** Remote control broadcasting cable: stranded conductors, polyethylene insulation, pairs & triples shielded and jacketed, cabled, PVC jacket overall.
- K. COMPUTER MFR.:** Computer control cable: 55 conductors, stranded copper conductors, PVC insulated, formed into 7 groups of 7 conductors, cabled, PVC jacket; U/L listed.
- L. MACHINERY MFR.:** Bus drop cable: 3 PVC insulated stranded conductors, with split uninsulated grounding conductor, cabled, overall PVC jacket; U/L listed; per NEC.



CHESTER CABLE CO.

DIVISION TENNESSEE CORPORATION

CHESTER, NEW YORK • 10918

PHONE: (914) 469-2141 TWX (914) 469-9801

A SUBSIDIARY OF CITIES SERVICE COMPANY

HP 3450A Multi-Function Meter:

The basic HP 3450A digital multi-function meter measures dc voltage and **true four-terminal** dc ratio. From there you make up your own unit with options to fit your needs now—then add other field-installable capabilities later to make your unit a complete "dodecameter" with five digit plus overrange digit readout for dc, ac and ohms measurements. Full autoranging capability for all functions is standard.

Add the AC Option and you can make **true RMS** ac measurements from 45 Hz to 1 MHz—and true four-terminal ac ratio. Add the OHMS Option for six four-wire ohms ranges including a 100 Ω range and ohms ratio. Put in the LIMIT TEST Option and you have HI GO LO and digital readout with two preselected limits for dc, ac and ohms — and ratio limit tests for ac, dc and ohms. That gives you a total of twelve measurement functions. But, that's not all! Add the DIGITAL OUTPUT Option for nine columns of digital output to a printer. With the addition of the REMOTE CONTROL Option, you have added full programmability for systems use. The only option that must be factory-installed is the REAR INPUT Option for isolated front and rear input capability! All this capability is contained in a rack-mountable cabinet only 3½ inches high. All-solid-state construction—including more than 220 integrated circuits—gives you increased reliability and lower maintenance. Turn the instrument on, and in seconds it's ready to operate.

Call your nearest HP Sales and Service Office to learn how you can save time and reduce bench clutter with the one multi-function meter with twelve measurement capabilities. For

full specifications, write to Hewlett-Packard, Palo Alto, California 94304. Europe: 1217 Meyrin-Geneva, Switzerland.

DC VOLTAGE and DC RATIO

DC voltage and dc ratio capabilities are contained in the basic unit.

The 3450A uses a dual-slope integration technique and is fully guarded for excellent noise immunity at 15 readings per second on

all five dc voltage ranges (100 mV to 1000 V). Input resistance is $>10^{10} \Omega$ on the lower three ranges and $10^7 \Omega$ on upper ranges to minimize the effects of resistive loading of your sources. The four-terminal ratio on the 3450A gives you complete isolation between X and Y inputs so you can measure the ratio of two independent dc voltages. Four ranges (1:1 to 1000:1) of true four-terminal dc ratio are provided. Price of basic 3450A, \$3150.

AC VOLTAGE and AC RATIO (Option 001)

The 3450A with ac option is the only true RMS digital voltmeter with five-digit resolution for ac measurements



from 45 Hz to 1 MHz. This greatly increases the capability previously available in a digital meter. You get true RMS responding measurements on four ranges (1 V to 1000 V). And the 3450A has a $\pm 0.05\%$ midband accuracy!

Adding the ac converter (Option 001) to your basic 3450A provides ac voltage and true four-terminal ac ratio. Price Option 001, \$1250.

THE INCREDIBLE DODECAMETER

Start with the basic meter... Order what you *need* now...
Add what you *want* later!

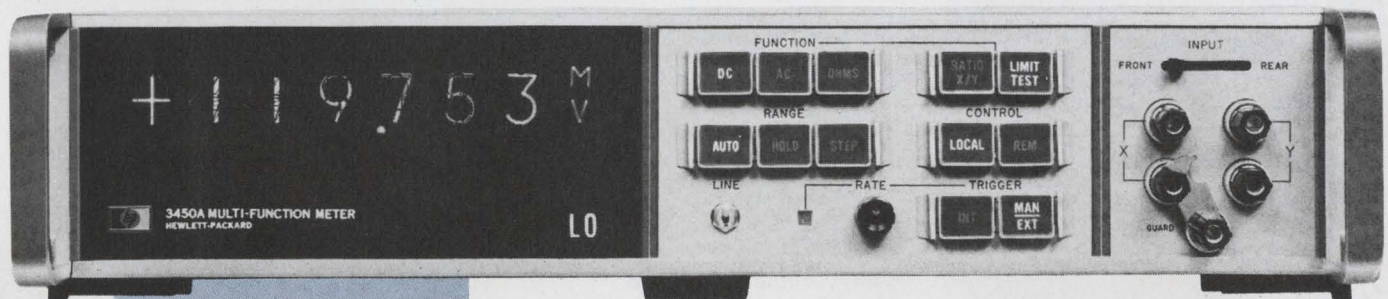

dc ratio limit test

dc limit test

ohms ratio limit test

ac limit test

OHMS and OHMS RATIO (Option 002)

Six ranges (100 Ω to 10000 k Ω) of four-wire ohms measurements at 15 readings/sec are available when you add the ohms converter to the 3450A basic unit. A maximum of 1 mA signal current reduces self-heating in the resistor under test. The ohms converter also adds four ranges of ohms ratio. Price Option 002, \$400.

LIMIT TEST (Option 003), DIGITAL OUTPUT (Option 004)

Install the limit test converter in your 3450A. Then you can use contact-

closures-to-ground to preset two four-digit limits (with an additional digit for 20% overranging) and polarity for dc and dc ratio limit tests. When your 3450A has ac and ohms capability, plus the limit test option, you have ac limit and ac ratio limit tests, ohms limit and ohms ratio limit tests. HI, GO, LO front panel lights clearly indicate results of a test.

With the digital output (Option 004), you get 9 columns of information including HI, GO, LO limit test decisions in 1-2-4-8 "1" state positive BCD form. Buffered BCD output stores previous reading until printer can record it and allows DVM to immediately make another reading. Price Option 003, \$350; Option 004, \$175.

REMOTE CONTROL (Option 005)

For systems applications, remote control option installed in the 3450A allows full programmability. All programmable front panel controls can be locked out in remote operation. Price Option 005, \$225.

REAR INPUT TERMINALS (Option 006)

Addition of this option provides a set of rear input terminals and a FRONT / REAR INPUT selector switch on the front panel. Price Option 006, \$50.

098/9

HEWLETT  PACKARD
DIGITAL VOLTMETERS

Circle 23 on reader service card

VECO THERMISTORS FOR MIL. APPLICATIONS



...the strength and sensitivity of an ant

Ever see an ant move masses larger than itself? Or the speed it responds with at the slightest sound?

Strength and sensitivity exactly like our line of thermistor disks and rods for military or industrial use. Each is manufactured to meet, or even exceed, the requirements of MIL-T-23648.

Rugged insulated design...high reliability...and precise accuracy... makes them especially suitable

for applications of temperature measurement and control, such as transistor circuitry, within a range of -55°C to $+125^{\circ}\text{C}$.

Whether your application is military or industrial, there is a VECO thermistor engineered for your requirements.

VECO
**VICTORY
 ENGINEERING
 CORPORATION**
 VICTORY ROAD, SPRINGFIELD,
 NEW JERSEY 07081
 (201) 379-5900 • TWX 710-983-4430

Meetings

Discrete components fight for survival

More than ever, participants at the Electronic Components Conference are concerned with building a future for the discrete-components industry. The competition from integrated circuits gets heavier every year. [For more on the shifting scene, see p. 78.]

A review of today's status will be given by Bruce R. Carlson, president of the Sprague Electric Co., at the conference banquet. The title of his talk is "Mayday for the Components Industry—Problems of an Industry in Transition." Carlson is expected to discuss the role that the components industry will play in future electronic systems.

The conference, scheduled for April 30 to May 2 in Washington, will also cover the heavy use of hybrid circuits across the entire applications range from military and space systems to consumer products. The importance of hybrids will be underlined in a special evening panel session entitled "Role of Hybrids in the Microelec-

tronic Domain," in which such aspects as interface problems, packaging, and reliability will be discussed by Alfred Levy and Fred Herzfeld of RCA, Harold Larsen of Halex Inc., William C. Littell Jr., of Fairchild Semiconductor, Mick Strief of Beckman Instruments, and George S. Szekely of Aerojet-General.

Microwave. Another evening panel discussion will cover new microwave components, including Gunn and avalanche diodes, microwave integrated circuits, and ferrites. Among the participants will be Harold Sobol of RCA, M. Gilden of Microwave Associates, D.H. Temme of MIT's Lincoln Laboratory, and B.T. Vincent of TI.

The 10 day sessions will cover topics from trimming potentiometers to high-frequency hybrid filters—and almost everything in between.

For further information contact Roger D. Allan, Electronic Industries Association, 2001 Eye St. NW, Washington, D.C. 20006.

Calendar

Quality Control Conference, University of Rochester; Rochester, N.Y., April 1.

Numerical Control Society; Stouffer's Motor Inn and Convention Center, Cincinnati, April 1-3.

Mathematical Aspects of Electrical Network Analysis, American Mathematical Society; Providence, R.I., April 2-3.

International Symposium on Computer Processing in Communications, Polytechnic Institute of Brooklyn; Waldorf-Astoria Hotel, New York, April 8-10.

High Frequency and Microwave Power, Radio Standards Engineering Division of the NBS Institute for Basic Standards; Boulder, Colo., April 14-16.

Structures, Structural Dynamics, and Materials Conference, American Society of Mechanical Engineers and the American Institute of Aeronautics; Fontainebleau Motor Hotel, New Orleans, April 14-16.

Computer Aided Design Conference, IEEE; University of Southampton, England, April 15-18.

Joint Railroad Conference, IEEE; Queen Elizabeth Hotel, Montreal, April 15-16.

International Magnetics Conference (Intermag), IEEE; RAI Building, Amsterdam, Holland, April 15-18.

International Geoscience Electronics Meeting, IEEE; Twin Bridges Marriott Hotel, Washington, April 16-18.

Man in his Environment, Technical Meeting and Equipment Exposition, Institute of Environmental Sciences; Anaheim Convention Center, Anaheim, Calif., April 20-24.

Conference for Protective Relay Engineers, Texas A&M University College of Engineering; College Station, Texas, April 21-23.

Conference on Switching Techniques

(Continued on p. 26)



less
than
\$1.00*

for new high performance
A-B solid hot-molded
variable resistor...

A-B Type W
variable resistor
shown about 5 times
actual size

The **QUALITY** is Allen-Bradley—the price is **COMPETITIVE!** This new Type W variable resistor is a commercial version of the Type G control.

This Type W variable resistor features a solid, hot-molded resistance track for long operating life. Life tests show less than 10% resistance change after 50,000 complete cycles. Noise level is low initially and actually becomes less after normal use. Furthermore, the resolution is essentially infinite, and the low inductance permits operation at high frequencies where wirewound controls are useless.

The Type W control, while only $\frac{1}{2}$ inch in diameter, is immersion-proof. The shaft is sealed with an "O" ring, making it watertight at that point.

Rated $\frac{1}{2}$ watt at 70°C, the Type W can be operated at 120°C ambient with zero load. Nominal resistance values are from 100 ohms to 5.0 megohms.

For complete specifications on tolerances, tapers, and options, please write Henry G. Rosenkranz and request Publication 5212. Allen-Bradley Co., 1201 S. Second St., Milwaukee, Wis. 53204. Export Office: 1293 Broad St., Bloomfield, N.J. U.S.A. 07003. In Canada: Allen-Bradley Canada Ltd.

EC69-1



ALLEN-BRADLEY
QUALITY ELECTRONIC COMPONENTS

Improved brightness solid-state lights are attention-getting panel indicators.

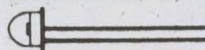

MV10B
Actual Size

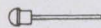

MV10A
Actual Size

Solid-state lights from Monsanto are brighter than ever. 1,000 foot-lamberts is typical. They're RELIABLE—1,000,000 hours life*; FAST—1 ns switching time; and SMALL—.10 inch diameter for the MV10A3. SPECTRAL EMISSION is an attention-demanding 6,700 Å red.

Low current requirements, down to 5 ma for 50 ft/L output, make them compatible with low cost integrated

circuits. The long life and solid state ruggedness of these emitters eliminates the need for redundant indicators and in-field servicing, even in the most critical applications.

For more information on our MV10A and MV10B red indicators and other Gallium Arsenide Semiconductors, write or call Monsanto Electronic Special Products, 10131 Bubb Rd., Cupertino, Ca. 95014, (408) 257-2140.

* $T_A = 25^\circ\text{C}$, $I_F = 50$ ma. Result of step-stress testing with end of life projections.

Monsanto

Meetings

(Continued from p. 24)

for Telecommunications Networks, IEEE; London, April 21-25.

Conference and Exhibit, Temperature Measurements Society; Hawthorne, Calif., April 21-22.

Spring Meeting, United States National Committee, International Scientific Radio Union, IEEE; Shoreham Hotel, Washington, April 21-25.

Symposium on Circuit Theory, Department of Electrical Engineering and Electronics Research Center; University of Texas at Austin, April 21-22.

RTCM Assembly Meeting, Radio Technical Commission for Marine Services; Hollenden House, Cleveland, April 21-23.

National Telemetry Conference, IEEE; Hilton Hotel, Washington, April 22-24.

International ISA Pulp & Paper Instrumentation Symposium, Instrument Society of America; Vancouver, Canada, April 22-26.

Relay Conference, National Association of Relay Manufacturers and Oklahoma State University's School of Electrical Engineering; Oklahoma State's Student Union Building, Stillwater, April 22-23.

Southwestern Conference & Exhibition, IEEE; Convention & Exhibition Center, San Antonio, April 23-25.

Photo-optical Techniques in Simulators, Society of Photo-optical Instrumentation Engineers; South Fallsburg, N.Y., April 28-29.

Symposium on Information Processing, Purdue University's School of Electrical Engineering; Memorial Center, Lafayette, Ind., April 28-30

Optical electronics, IEEE; Kirtland Air Force Base, Albuquerque, N.M., April 28.

Surface Science, Evaporation and Effusion, American Vacuum Society; Los Alamos Scientific Laboratory, New Mexico, April 28-30.

Audio Engineering Society Convention and Exhibition; Hollywood Roosevelt Hotel, Los Angeles, April 28-May 1.

Electronic Components Conference, Electronic Industries Association; Shoreham Hotel, Washington, D.C., April 30-May 2.

Electronic Components Conference,

(Continued on p. 28)

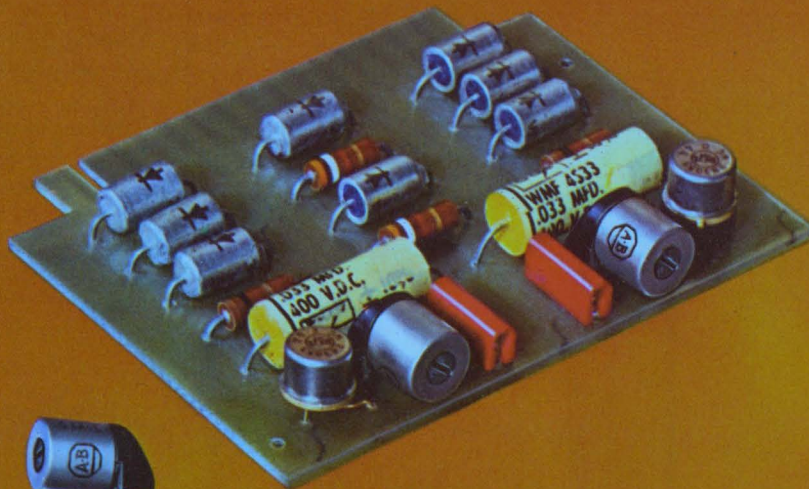

All components shown actual size

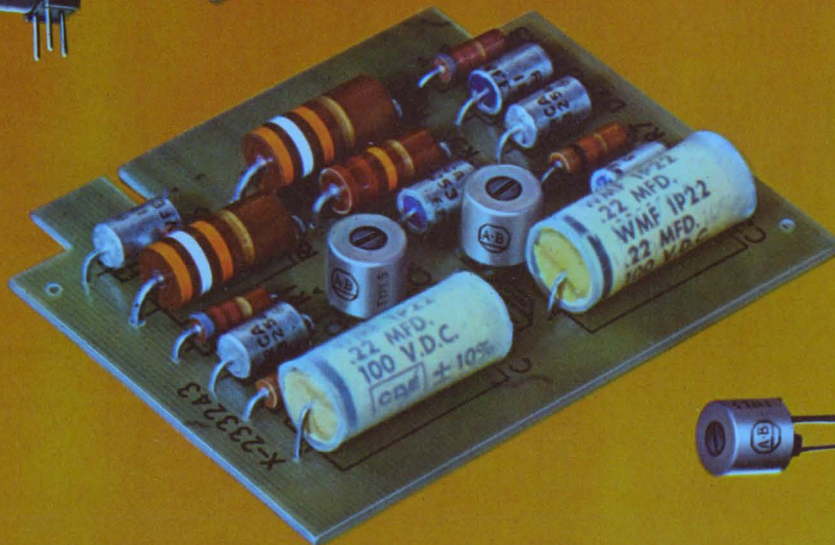

Only the new Allen-Bradley Type S cermet trimming resistors have all these features

Type S shown twice actual size



for side adjustment

for top adjustment

The Allen-Bradley Type S is a one turn cermet trimmer in which you will find incorporated a wider range of features than in any other trimmer now on the market. Here are a few of the more important features.

- **COMPACT**—body is $\frac{3}{8}$ " dia.
- **BUILT FOR EITHER TOP OR SIDE ADJUSTMENT**
- **50 OHMS THRU 1 MEGOHM**
- **THE SEALED UNIT** is immersion-proof
- **TEMPERATURE COEFFICIENT** less than 250 ppm/°C over all resistance values and complete temperature range
- **UNIQUE ROTOR DESIGN** provides exceptional stability of setting under shock and vibration
- **SMOOTH CONTROL**, approaches infinite resolution
- **PIN TYPE TERMINALS** for use on printed circuit boards with a 1/10" pattern

- **VIRTUALLY NO BACKLASH**
- **WIDE TEMPERATURE RANGE** from -65°C to +150°C
- **RATED $\frac{1}{2}$ watt @ 85°C**
- **EXCEPTIONAL STABILITY** under high temperature or high humidity
- **MEETS OR EXCEEDS ALL APPLICABLE MIL SPECS**
- **COMPETITIVELY PRICED!**

You'll find the new Type S trimmer equal to the traditional Allen-Bradley quality. You really ought to know more about the Type S. Won't you write for detailed specifications? Allen-Bradley Co., 1201 S. Second Street, Milwaukee, Wis. 53204. Export Office: 1293 Broad Street, Bloomfield, New Jersey, U.S.A. 07003. In Canada: Allen-Bradley Canada Limited.



Convert your present scope into a curve tracer: \$595.00*

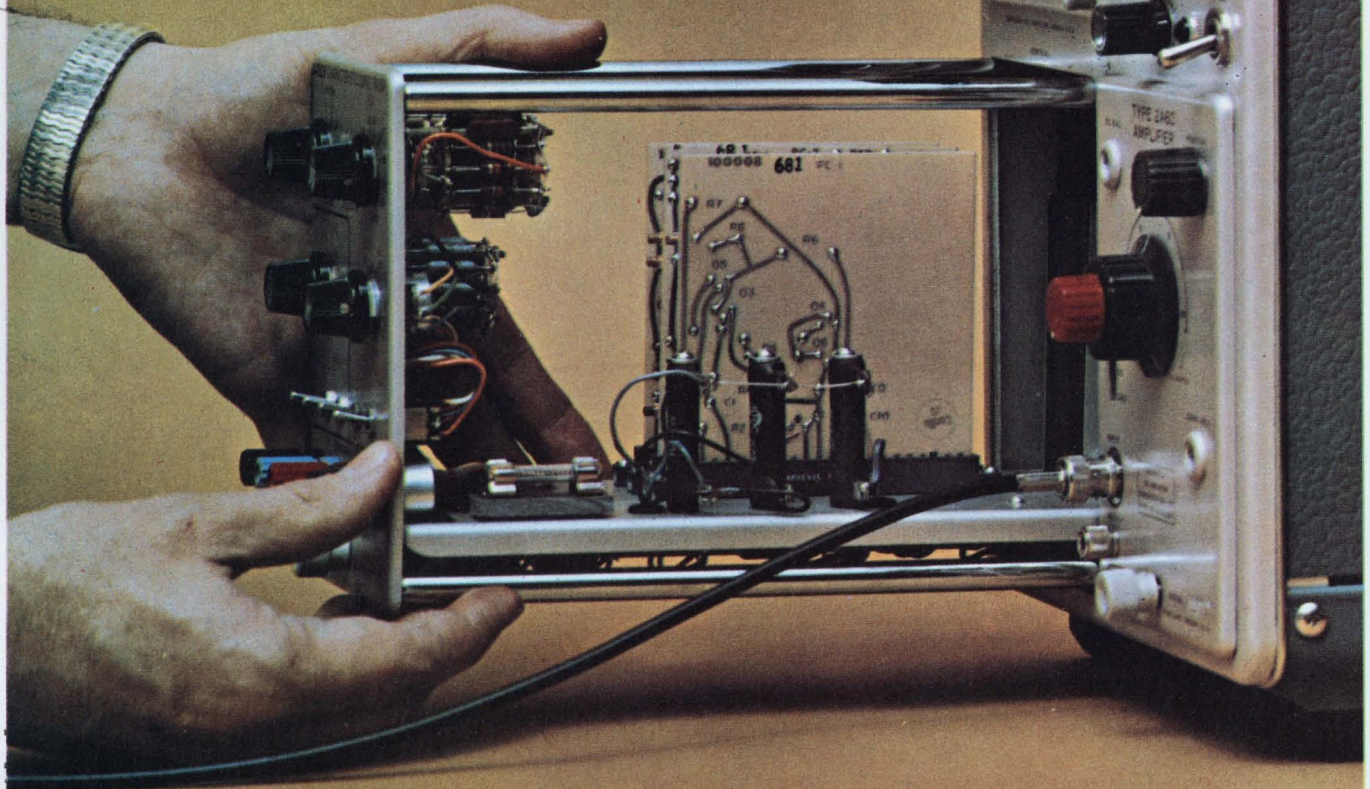

The first plug-in unit that transforms an existing scope into a curve tracer—at 1/2 to 1/3 the cost!

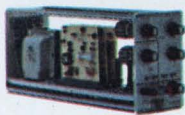

U-Tech plug-in
Model 681: \$595.00*
For use with Tektronix 560 series Oscilloscopes.

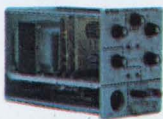

U-Tech plug-in
Model 682: \$615.00*
For use with Tektronix 530, 540, 550, 580 series Oscilloscopes.



U-Tech Console
Model 683: \$625.00*
For use with any X-Y Oscilloscope.

*Prices apply to purchases and shipments within U.S.A. fob Salt Lake City, Utah.

Now you can expand your present Oscilloscope to include curve tracer capabilities. U-Tech plug-in and console units enable any X-Y Oscilloscope to display the dynamic characteristics of both NPN and PNP transistors, N Channel and P Channel junctions, FETs, MOS-FETs, bipolars, unijunctions, diodes, tunnel diodes and SCRs.

So, if it wasn't in the budget before, now it can be, and even if you were planning for a curve tracer, you can now buy two, possibly three, of these units for the price of any other characteristic curve tracer.

Ask your distributor about these U-Tech curve tracer units or order direct.

U-TECH

A Division of Industrial Physics and Electronics Company

4190 South State Street, Salt Lake City, Utah 84107

Yes, send me curve tracer model _____

Enclosed is: Check P.O. Bill me Send literature

Name _____ Title _____

Company Name _____

Company Address _____

City _____ State _____ Zip _____

**Reliability is six things we do
that nobody else does.**

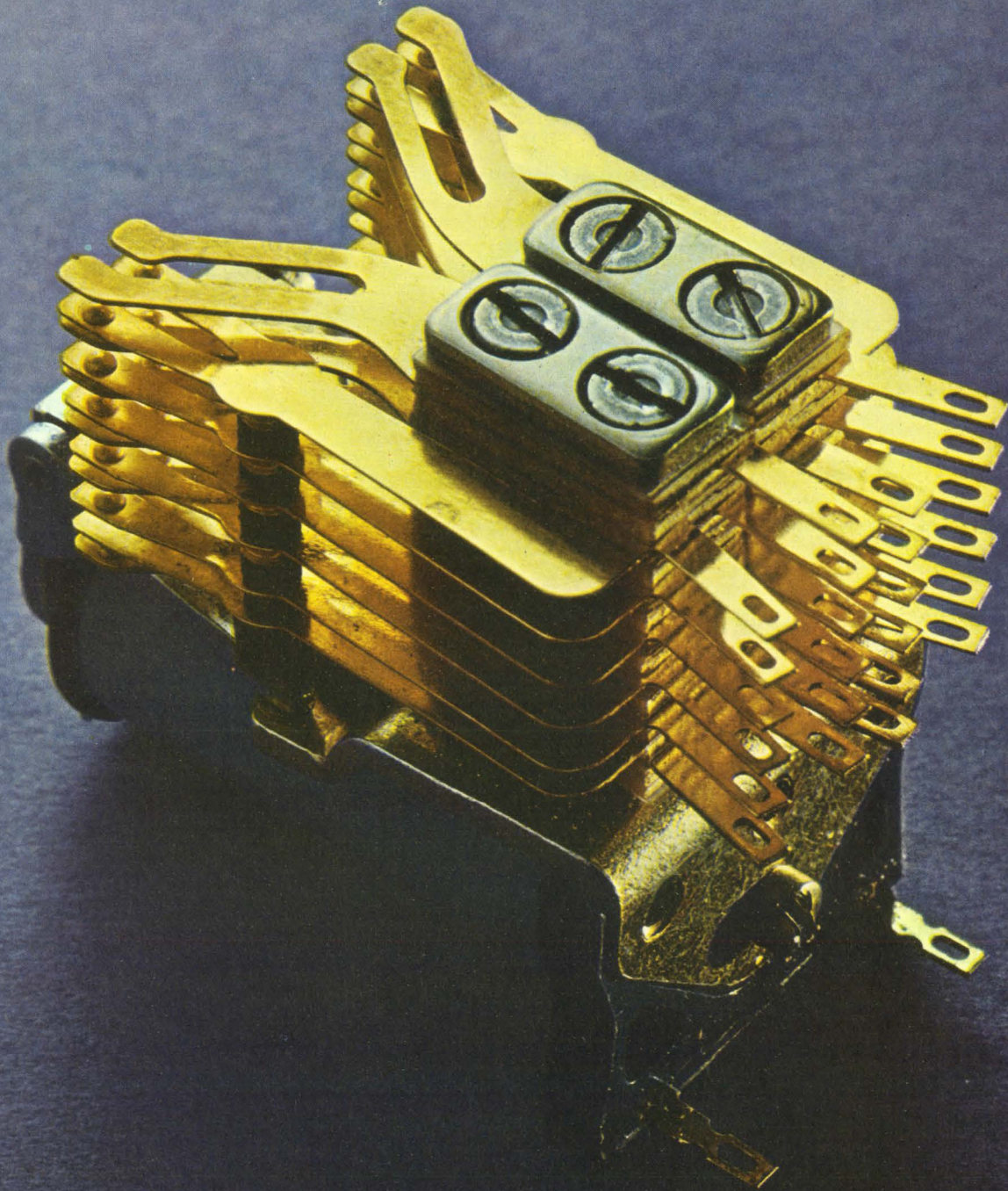

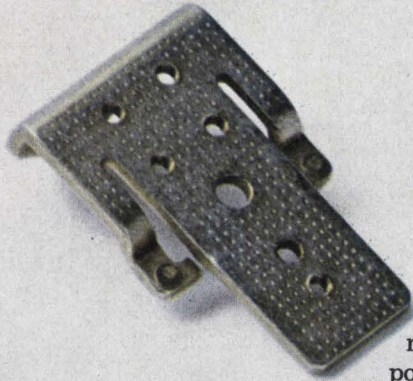

We're fanatics.

We build our relays stronger than we have to. That way, they last lots longer than they ever have to. Our Class E relay (shown on the opposite page) is a good example of our way of thinking.

The industry's strongest heelpiece.

We make the strongest heelpiece in the industry. A gigantic machine bangs them out extra fat and extra flat.

Extra fat to carry a maximum of flux. To handle big loads. Extra flat so that once an AE relay is adjusted, it stays adjusted.

Since our backstop is part of the heelpiece, it's just as thick and flat. But, tough as it is, the slightest wear here would throw the entire contact assembly out of whack. So, to be safe, we weld two tiny, non-magnetic pads where the armature arms meet the backstop. You might say we created the no-stop backstop.

Three parts that'll wear like crazy.

When you build a relay like a small tank, you have to think of everything. We try. Right down to the tiniest part. For example, we make our armature arms and bearing yoke extra thick.



Thicker than years of testing and use say they have to be. Then, to make sure they don't cause wear problems, we insert a hardened shim between the hinge pin and the frame. The pin rides on the shim, instead of wearing into the heelpiece. (You can forget the bearing, it's permanently lubricated.)

Buffers with lots of muscle.

We make our buffers of a special tough phenolic material that lasts. And lasts. And lasts. All without wear or distortion. Another reason why our relays stay in whack.

To make sure our buffers stay in place, we weld the buffer cups to the armature arms. We weld, instead of using rivets, because our lab found that rivets have a habit of falling out.

For the very same reason, we weld buffer cups to the contact springs. And also use the same special tough phenolic buffers.

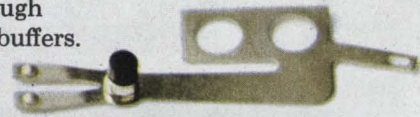

No, we didn't forget the contact springs.

We have some strong feelings as to what makes a contact spring reliable. Our sentiment is that two contacts are better than one. So, we bifurcate all the springs, not just the make and break. This slotting and the addition of another contact to each spring means you get a completed circuit every time.

We make each set of contact points self-cleaning. The bad stuff doesn't have a chance to build up.

Now, what's different about our bobbin?

Our bobbin is one piece—molded of glass-filled nylon. This provides the maximum in insulation resistance.

Because our bobbin is nylon, we don't have to impregnate with varnish. Moisture and humidity have no effect on the stubborn nylon material. No effect means no malfunctions for you to worry about.



What all this means to you.

What this all adds up to is reliability. The kind of toughness no one else can give you. It means an AE relay works when it's supposed to, longer than it has to.

Isn't this the kind of reliability you really need? Automatic Electric Company, Northlake, Ill. 60164.

AUTOMATIC ELECTRIC

SUBSIDIARY OF GENERAL TELEPHONE & ELECTRONICS



FOR CONNECTOR CONFIDENCE

CINCH ROYAL D MARK III SUBMINIATURES

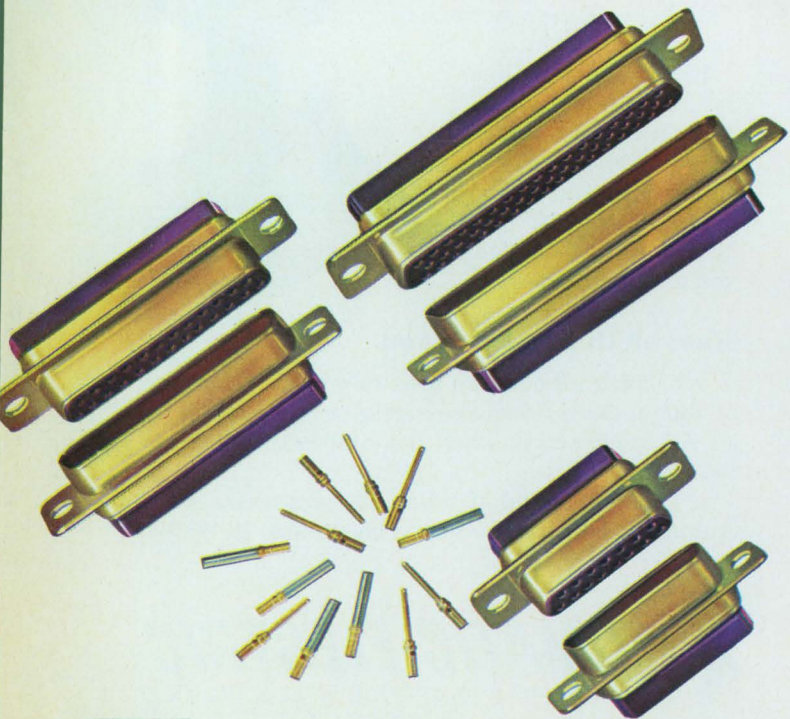

There is an added feeling of confidence that comes with knowing that your D-subminiature connectors will be delivered on time and meet all your specifications at competitive prices.

Cinch Royal D MARK III* rack and panel connectors are confidently used in a wide range of military and industrial applications. They are precision, high density connectors with 0.109" contact centers, meet MIL-C-24308 specifications, and are available in 9, 15, 25, 37 and 50 contact configurations.

The Royal D MARK III incorporates a rear release crimp-on, snap-in contact assembly. A diallyl phthalate insulator provides a hard, closed entry socket for positive contact alignment and high bend resistance. A simple plastic tool permits quick contact removal and replacement without damage to the contact or insulator.

Be confident! Let Cinch supply your Royal D MARK III on fast, dependable delivery schedules. Call your local Cinch Electronics Group Sales Office or write to Cinch Manufacturing Company, 1501 Morse Avenue, Elk Grove Village, Illinois 60007.

IMMEDIATE DELIVERY from stock—can be made through Cinch Electronic distributors.

C-6912

*Manufactured under license agreement with ITT Cannon Electric, Inc.



CINCH MANUFACTURING, CINCH-GRAFIK, CINCH-MONADNOCK, CINCH-NULINE AND PLAXIAL DIVISIONS OF UNITED-CARR INC., A SUBSIDIARY OF TRW INC.

Editorial comment

When it pays to do it yourself

Trying to decide whether a complex integrated circuit is a device or a system is a futile exercise. The arguments on either side generate lots of heat but little light. The answer, of course, is that it's both. And as such, it attracts a proprietary interest at both semiconductor-device makers and large system houses.

Though most systems houses profess no ambitions to compete with device suppliers, more and more of them are setting up their own facilities to make IC's. These are the reasons most frequently given:

- In-house facilities are a source of technical innovation. The designer can immerse himself in the problems of IC design and fabrication. He can develop sophisticated designs impossible with off-the-shelf devices, thereby gaining a competitive advantage for his company.

- Home-based facilities narrow the communications gap between IC designer and manufacturer that usually crops up when outside suppliers are involved.

- By studying IC technology firsthand, systems makers can exert a greater influence on the design and fabrication of devices at a supplier's factory. In fact, such knowledge makes the system designer a more perceptive buyer of IC's.

- An in-house facility can handle those production runs that are too limited for a large semiconductor firm. At Lockheed, for example, an official notes: "A large IC order for satellites is rare. In one case, each of five birds had black boxes containing 20 identical circuits, for a total of 100 circuits." No semiconductor house would touch such an order unless the circuits came close to matching an existing device or at least a device similar to one in research and development.

- An in-house capability permits a systems maker to control its own device delivery times and quality.

- Since the proliferation of IC's tends to chip away at system assembly requirements, some systems manufacturers feel it's necessary to make some of their IC's in-house to retain their share of value added.

In sum, the systems house may maintain its own facility either to help design the IC's best suited to its own applications, or to actually produce a portion of the circuitry it uses.

Those systems makers that follow the second course should heed the advice of Texas Instruments' Jack Kilby and concentrate on IC's that aren't generally available outside or are peculiar to the equipment they build. ■

Toward better communication

Computer-aided design plays an important part in the development of complex integrated circuits. It comes into play at many stages of the design cycle, from definition of functions to final testing of the circuits. But as Rudolph Thun of Raytheon's Missiles Systems division observes (page 85), the CAD chain must be broken at some point. Here, the systems house steps out of the picture and the device manufacturer takes over.

To ease the division of labor, Thun suggests that semiconductor makers and systems houses adopt a common form of documentation covering software schemes, programs,

and formats. And William Dunn of Sylvania's Semiconductor division notes that the semiconductor manufacturer can help by making its wiring rules, specifications, guard bands, and other standards available to customers.

Another approach is being tried by Fairchild Semiconductor, which makes its own CAD programs available to selected systems houses.

The goal of common software is commendable but may prove unattainable. A worthwhile first step, though, would be to unscramble the semantic confusion (by basing IC definitions on MIL/STD 1313, for example). ■

from the leader in assembly equipment

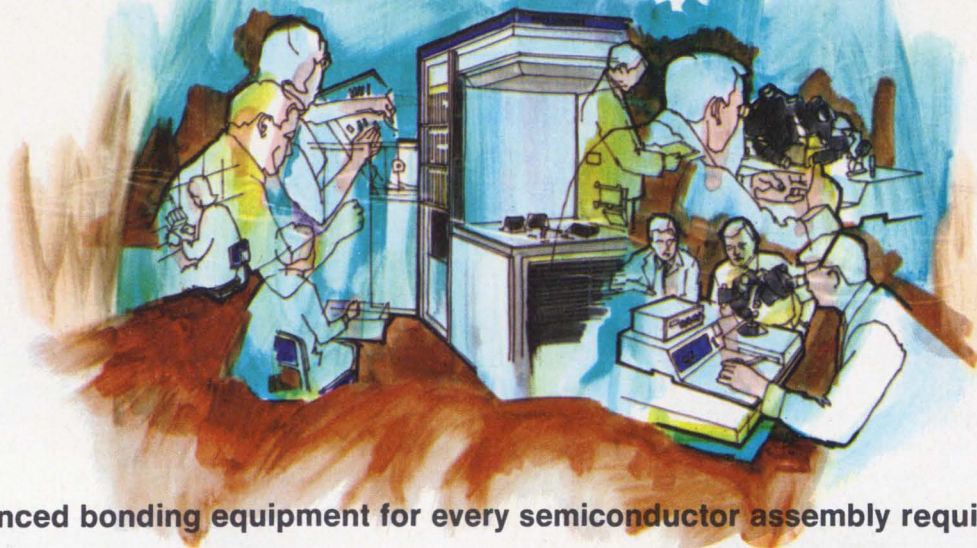

Advanced bonding equipment for every semiconductor assembly requirement.



MODEL 1350 ULTRASONIC WIRE BONDER

- Handles hybrids and LSI IC's up to 3" across
- Stitch bonds continuously at multiple levels
- Bonds wire with automatic feed and cut-off



MODEL 2000 FLIP CHIP BONDER

- Totally automatic bond cycle
- Adaptable to automatic die attach
- Two step leveling force

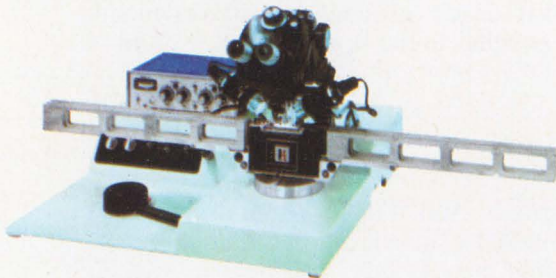

MODEL 1370 RACK FEED ULTRASONIC BONDER

- Hi-speed transistor bonding
- Production bonding of 14 lead IC's
- Bonds up to .020" wire for power device production



MODEL 2100 UNIVERSAL ASSEMBLY MACHINE

- Automatically bonds beam lead devices
- Thermocompression flip chip and die bonding
- Reflow solders flip chips or die with heated substage

Other **Hugle Industries'** products: Horizontal Epitaxial Reactors • Vertical Barrel Reactors
• Epitaxial and Diffusion Doping Systems • IR Microscopes • PCD Process Controllers

First in service to semiconductor manufacturers



HUGLE Industries

750 North Pastoria Avenue Sunnyvale, California 94086 (408) 738-1700

Electronics Newsletter

March 31, 1969

Burroughs readies plasma display panel

Burroughs is about to introduce its own plasma display panel, hard on the heels of the Owens-Illinois Digivue [see "Flat display has inherent memory," p. 133]. Both displays are based on work done at the University of Illinois by D.L. Bitzer and H.G. Slottow [*Electronics*, July 22, 1968, p. 39].

Burroughs, unlike Owens-Illinois, has retained the three-layer sandwich design of the Bitzer-Slottow model. Plasma displays—under development at a dozen or so labs around the world—have suffered from a common problem: high voltage punching through the insulation. Owens-Illinois and Burroughs have apparently found solutions, although both designs require more than 100 volts to operate.

Two firms ready new processors for digital signals

Two companies will introduce digital signal processors at the Spring Joint Computer Conference May 14. Both systems perform fast Fourier transforms, convolutions, averaging, and auto- and crosscorrelation. Applications should range from seismic data processing to speech studies and biomedical research.

Raytheon's Computer division will announce its peripheral processor called ATP (for array transform processor). ATP works with the firm's small 16-bit computers (models 703 and 706); software shunts lengthy, repetitive operations of fast Fourier or other techniques into ATP's hard-wired processor to speed filtering or correlation. Fast Fourier is said to be 80 times faster with the ATP than on a Raytheon 703 computer alone. First deliveries are forecast for autumn.

By contrast, Computer Signal Processors' CSS-3 is a stand-alone system with a 4,096-word memory, a built-in 16-bit general-purpose processor, plus teletypewriter input and crt output. According to the company's president, Edmund U. Cohler—designer of Sylvania's ACP-1—the CSS-3 is about a tenth as fast as hard-wired processors, but more flexible because it has a large library of software to suit it to other tasks and to allow further processing of data after such things as filtering and correlation. Deliveries will start in May.

TI's MERA arrays ready for market . . .

Now that MERA solid state phased array is pretty much under control, Texas Instruments will begin a major program to market the MERA modules and the hybrid integrated circuits from which the modules are built. TI has spent millions of dollars on the MERA (Molecular Electronics for Radar Applications) program; costs were shared by the Air Force. Next month TI will test a quarter-array of 151 radiation elements. The full 604-element array will be ready for test by mid-May, the company says.

Meanwhile, TI has been selling some of the circuits and modules on an evaluation basis. Now it is ready to go all out to sell microwave IC's and recoup the expenses of the painful development period. Difficulties in transferring devices from development to production delayed MERA considerably, but now TI figures it is ahead of the field since it now has a total capability from discrete devices through thin-film fabrication and hybrid IC design.

The MERA circuits include a 500-megahertz intermediate-frequency

Electronics Newsletter

amplifier, an X-band mixer, a local oscillator multiplier, an S-band small-signal preamplifier, an S-band power amplifier, a transmit and receive switch, and a times-4 multiplier.

TI is also selling microwave sources, both transistor-multiplier and bulk-effect types (the latter for frequencies at X-band and above), and it is making a line of Gunn diodes.

... Honeywell places first module order

Honeywell's Aerospace division is among the first to buy the MERA microwave modules. According to John King, the division's manager of contracts, Honeywell has ordered 25 of the thin-film strip line devices for the PRC-95 identification-friend-or-foe Tacan transponder. This is a cigarette-pack-size transponder that downed fliers use to signal for help. Honeywell, according to King, expects to receive the first bread-board models in four months, two prototypes in about six months, and the 25 pilot production versions in about 10 months.

NASA, Air Force weigh joint projects

The heads of the Air Force and NASA have indicated that a major shift in space policy may be in the offing. NASA Administrator Thomas O. Paine has suggested that a joint NASA-Air Force development program might be pursued for such programs as space shuttlecraft and a shuttle launch complex. And Secretary of the Air Force Robert Seamans Jr. made a similar proposal at the same Air Force Association meeting.

If NASA and the military do team up on such projects, it would be the space agency's first major leap into military work.

Real-time monitor for DC-10 airbus

What may be the first real-time data acquisition system to monitor new commercial aircraft during certification tests will begin to be installed this summer or fall at the Douglas Aircraft division of McDonnell Douglas and will be used to check out the DC-10 airbus.

Scientific Data Systems is supplying a Sigma 7 and three Sigma 2 computers for the ground-based flight test data-processing facility at Long Beach, Calif., under a \$3.3-million contract. The system is believed to include a pulse-code-modulated telemetry link for aircraft-to-ground data transfer, plus graphic terminals to be provided by Sanders Associates.

NASA aims grants at 'software gap'

NASA's Electronics Research Center will soon announce more than \$400,000 in research grants aimed at narrowing the "software gap." According to David Van Meter, head of the center's computer research laboratory, hardware production is much faster and better organized than software development. As a result, new machines often stay idle while software problems are solved or use—inefficiently—software designed for earlier computers.

Proposed research areas include unified processor-software design, highly adaptable general-purpose computer languages, computer-assisted software design, and software subdivision to permit both serial and parallel operation in multiprocessors. The program is open-ended, says Van Meter, and the research grants are expected to run for five years or more.

The grants will go to scientists at the Universities of California, Maryland, and Texas; Stanford University, MIT, Case-Western Reserve University, and the Rand Corp.

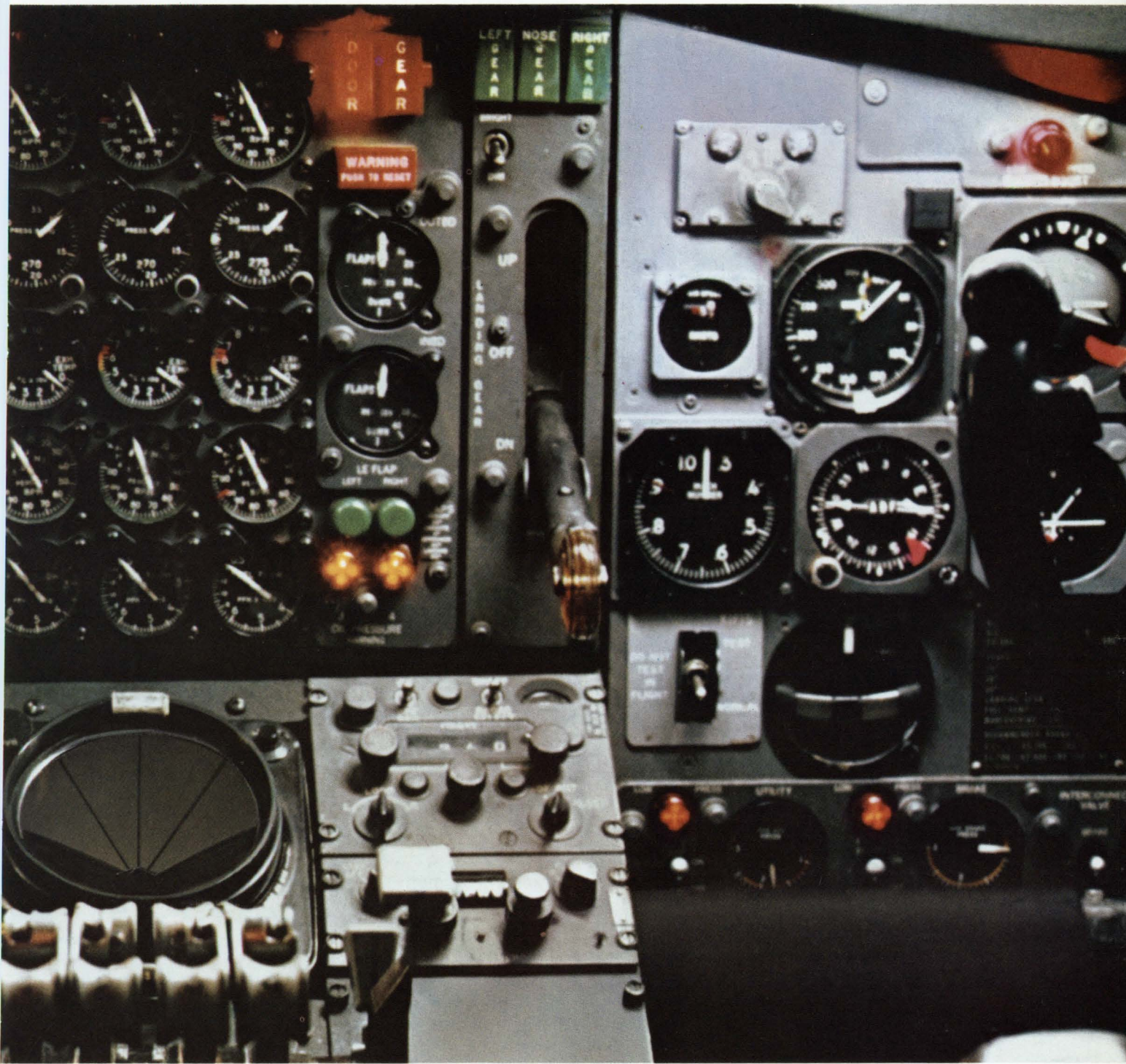

want to
take off
in electronics?

ask us

Components manufactured by O/E/N companies are vital in keeping today's jets flying. On the control panel you'll find pushbuttons, indicator lights, thumbwheel and rotary switches. In communications systems...crystal filters and oscillators, and potentiometers. And elsewhere, from the cockpit to the tail...relays, solenoids and electronic insulation.

Each component is engineered to provide instant, accurate response, as well as compact, clean and readable visual information. We're in ground control equipment, up in the jets, and even beyond...in aerospace. We're a single source of supply for a variety of components used by almost every industry today.

Matter of fact, we're not sure where we'll be next. Our R/D people are a restless lot, never satisfied, always trying to make something better. This constant updating of technology has been O/E/N's driving force.

Here are a few highlights and we'd be pleased to tell you even more about them. Write for individual product literature and/or booklet describing O/E/N, its companies and products.

Reader Service Card No. 310

simpler, better control panels result from Multidex[®] switches

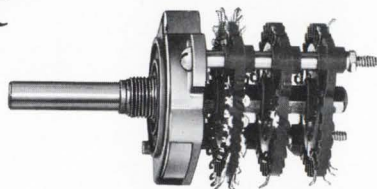

Multidex switches were engineered to meet the increasing demands for flexible and fast designs faced by today's electronic engineers.

This versatile switch line offers an almost unlimited number of variations of the most popular options and features and eliminates much tedious design work for the engineer. In fact, it is his best choice to replace seven older sizes and types of switches. What's more, Multidex switches are smaller and yet provide more contacts (even 32 and 36 positions).

Detent mechanism offering a crisp, uniform action is available in a wide number of throws. Diallyl phthalate insulation is used and Oak-pioneered double-wiping contacts are a further guarantee of dependable operation. If rotary switch design is your job, you'll want full details on the versatile, new Multidex line of rotaries.

OAK MANUFACTURING CO.

Crystal Lake, Illinois 60014

Reader Service Card No. 311

O.K., now...by the numbers!



Zero to nine (optional decimal point) daylight visible and from wide angles...that's LAMP's new filament readout Numeralamp. This 4-volt AC/DC lamp offers 200,000 hours average life. Numerals (0.4" x 0.7") formed by seven tungsten filaments operating at 1800°K., emit 4,000 foot-lambert brightness. Filaments are the type used in Military Standard lamps of high reliability and duration.

Lamps, (2.1" high x 0.83" dia.) sealed in a standard 9-pin vacuum tube base, mount on 1" centers.

LOS ANGELES MINIATURE PRODUCTS

17000 South Western Avenue
Gardena, California 90247

Reader Service Card No. 312

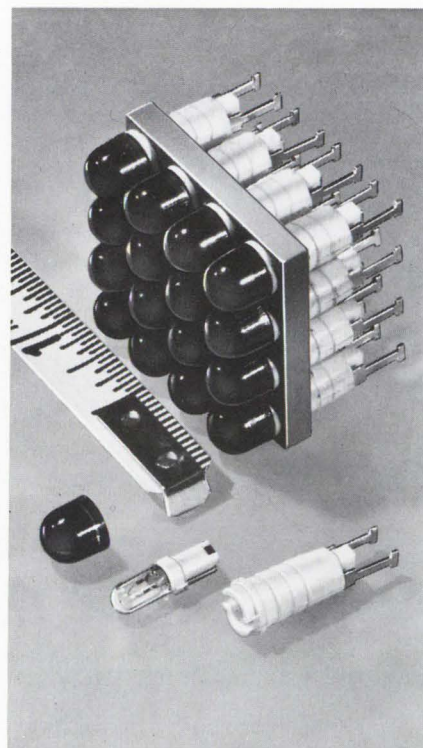

dot-lite lamps aim high

They're a natural for computers, but the extremely small size and high brightness of these bantam-weight indicator lights makes them a logical choice for sophisticated airborne displays as well.

Sixteen of these tiny T-1 units can be mounted in a single square inch of panel space and the lamp base snaps right into the panel mounting holes (without any hardware) on 0.218 centers.

In addition, the T-1 lamp can be replaced in just seconds, from the front of the panel, without tools.

There's no guesswork in replacing lamps either, as far as proper voltage rating is concerned. Lamp ratings range from 1.5 V to 28 V and each base is color-coded for instant identification. Snap-on lens caps are available in a wide choice of colors and shapes.

MARCO-OAK

P. O. Box 4011
207 S. Helena Street
Anaheim, California 92803

Reader Service Card No. 313

midget tick-tock for computers

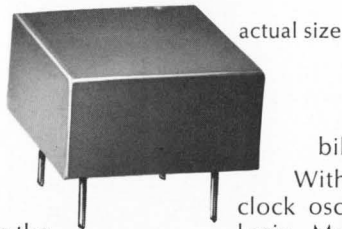

Compact, inexpensive, versatile—sums up the reasons for designing M^CCoy's new MC109A1 clock oscillator into computers and peripheral equipment. It's only 1" square by 1/2" high, yet offers output over the entire 30 kHz to 50 MHz range. It holds ± 150 ppm maximum from -55° to $+105^{\circ}$ C. over the 30-650 kHz

range, ± 50 ppm from -55° to $+125^{\circ}$ C. over the 180 kHz to 50 MHz range. Over smaller temperature ranges, even better stabilities are possible.

With an input voltage of only 5 vdc ($\pm 5\%$), this clock oscillator is compatible with DTL, RTL or TTL logic. Meets all requirements of MIL-E-5400, class 2 (commercial versions also available). While the basic styles give general capabilities, all electrical specifications are variable and can be altered for specific requirements. Delivery time is 2-6 weeks, depending on frequency desired.

M^CCOY ELECTRONICS COMPANY
Mt. Holly Springs, Pennsylvania 17065

Reader Service Card No. 314

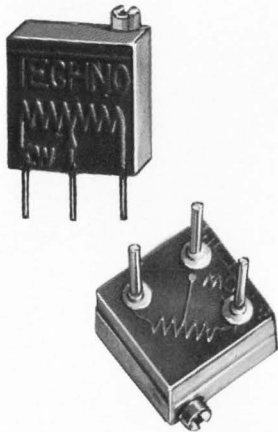

trim your controls with a wee pot

Only 1/4" square, these efficient little wirewound trimming potentiometers still allow a 25 turn screw adjustment... trim over a 10 to 25 k ohm range. They're rated for 3/8 watts @ 85° C., with excellent resolution at all resistances. High temperature diallyl phthalate case—with molded "O" ring moisture resistant seal—eliminates insulation problems.

The units are available with positive clutch stops or optional continuous rotation. Load life of 1,000 hours meets or exceeds MIL-R-27208, Style RT27, requirements. Printed circuit pins meet MIL-STD-1276, Type N2, requirements.

TECHNO COMPONENTS CORP.
7803 Lemona Avenue
Van Nuys, California 91405
Reader Service Card No. 315

insulation problems... call for Fluorglas[®] products



They'll do any job that calls for insulation with high dielectric strength, low dissipation factor...that won't burn, carbonize or support combustion.

Fluorglas products are compatible with all materials, resistant to chemicals and fungus, thermally-stable, moisture-resistant and strong.

They're made in lacing tapes for wire-bundling, yarns for wire wrap and harnesses, adhesive tapes for cable wrap and laminates for microwave uses. You couldn't want much more... write today for Catalog DE-03.

DODGE INDUSTRIES, INC.
Hoosick Falls, New York 12090
Reader Service Card No. 316

turn on... with a tom thumb relay

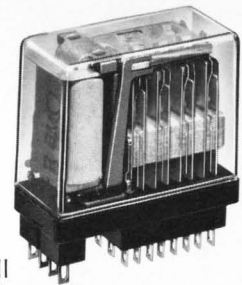

When space, weight and cost are important, "Versapac" 67 relays fill the bill. These miniature relays do a tremendously big job for their compact, less-than-a-cubic-inch size.

They're the only industrial relays available offering 2 to 8 Form C's, single and bifurcated 3 or 5 amp contacts. They're versatile and adaptable with solder lugs or printed circuit sockets, and a mechanical life tested at over 100-million operations.

Unusually precise adjustments are made possible by the use of Armco steel for the one-piece frame and core. These relays are protected by a clear plastic cover and operate at ambients from -55° to $+71^{\circ}$ C.

HART-ADVANCE RELAY DIVISION
Crystal Lake, Illinois 60014
Reader Service Card No. 317



O/E/N IS WORLDWIDE

Electronic components for the free world are supplied by the worldwide operations of fifteen O/E/N subsidiaries and divisions, which operate 24 plants—16 in the U.S. and 8 off shore.

This import-export balance assures domestic customers the same O/E/N quality for their overseas operations, whether from local inventories, U.S. exports or manufactured by O/E/N plants in England, Europe, South Africa and Asia.

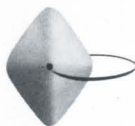

O/E/N

OAK ELECTRO/NETICS CORP
CORPORATE OFFICE
CRYSTAL LAKE, ILLINOIS 60014

DIRTY LINEN

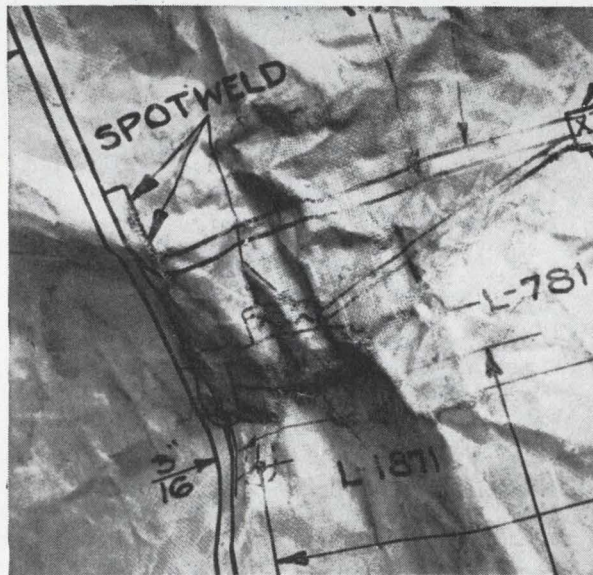

Keep that original safe. Make a second original on KODAGRAPH Wash-Off Film.

This old battered drawing on cloth was once a thing of beauty—the culmination of weeks of design and many hours on the drafting board. Yet pretty soon, with handling, staining, smudging, and flaking, it can look like this.

That's why it really pays to have your blueprinter make a second original on KODAGRAPH Wash-Off Film, ESTAR Base. Preserve the cloth master and drop the second original into your active file. It won't crack or yellow. Stains and fingerprints will wipe right off. You'll

still be getting great white prints years from now.

Revisions are easy. You get rid of unwanted photographic lines on KODAGRAPH Wash-Off Film, ESTAR Base, with a drop of water and a touch or two of your eraser. Its matte drafting surface permits twice the erasures, yet accepts and holds pen-and-ink corrections smoothly.

More details? Just contact your local Kodak Technical Sales Representative for a no-obligation, certified survey of your present operation... and a look at all the smart KODAGRAPH Products available now. Or write us: Eastman Kodak Company, Business Systems Markets Division, Rochester, New York 14650.

Kodak

DRAWING REPRODUCTION SYSTEMS BY KODAK

NEW TECHNIQUE IMPROVES LOW-LEVEL SIGNAL MEASUREMENTS

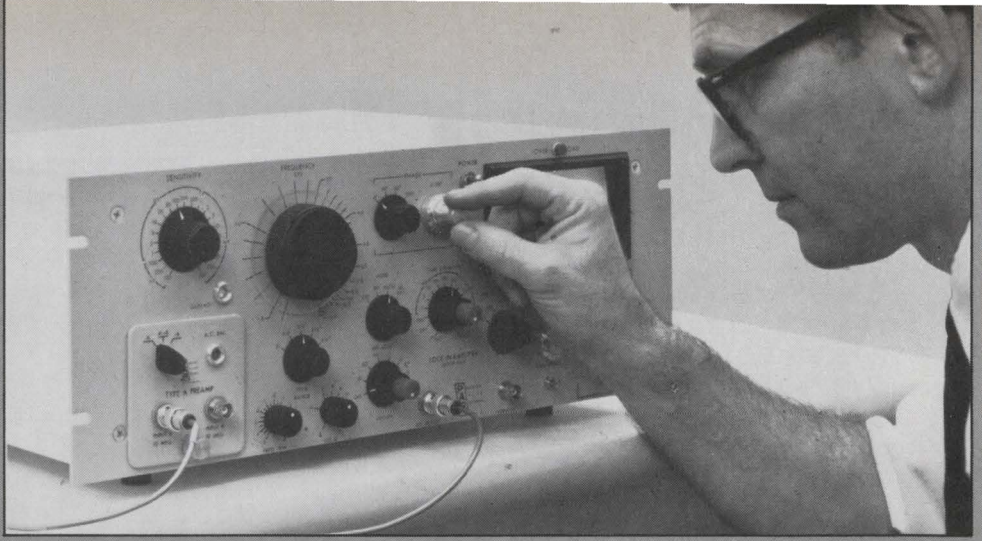

Where extremely low-level signals must be measured in the presence of obscuring noise, the use of a PARTM Lock-In Amplifier can often transform a complex and sometimes futile investigation into a routine test procedure. For example, Lock-In Amplifiers can be used to:

MEASURE AMPLIFIER CROSSTALK TO ONE NANOVOLT

Where amplifiers are in close proximity in low level data processing systems, the minimum detectable signal is frequently limited by the crosstalk or mutual interference generated. By using a Lock-In Amplifier to measure crosstalk: (1) The source of feed-through can often be identified since very low-level crosstalk can be measured over a wide frequency range. (2) Further extraneous signal coupling errors are eliminated because no instrumentation other than the Lock-In Amplifier is necessary. (3) Crosstalk levels as small as one nanovolt can be detected. (4) The phase of the crosstalk can be identified.

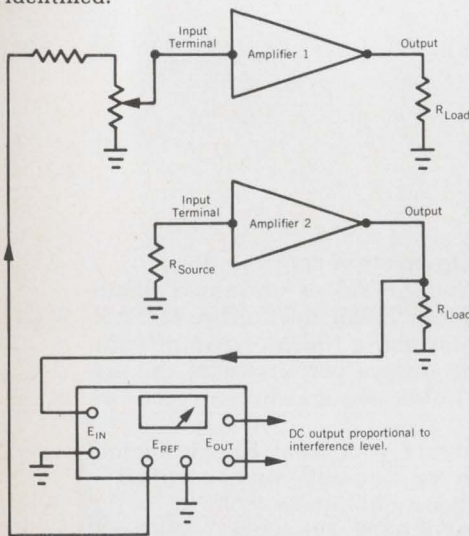

LOCK-IN AMPLIFIER
USED FOR AMPLIFIER CROSSTALK MEASUREMENT

IMPROVE BRIDGE SENSITIVITY TO ONE NANOVOLT (FS)

A Lock-In Amplifier improves bridge sensitivity without over-driving the bridge circuit. Excite the bridge with the Lock-In Amplifier's internal oscillator and connect the external null detector termination to the signal input to get: (1) Measurements over frequencies of 1.5 Hz to 150 kHz. (2) Optimum noise figures using available preamplifiers with input impedances of several ohms to 100 megohms. (3) One nanovolt full-scale sensitivity for improved null accuracy and extremely low power dissipation in critical circuits. (4) A dc signal proportional to the off-null condition for use in modifying bridge parameters or as a recorder input. (5) Detection of in-phase (resistive) and quadrature (reactive) bridge components which can be nulled independently (and simultaneously, if desired).

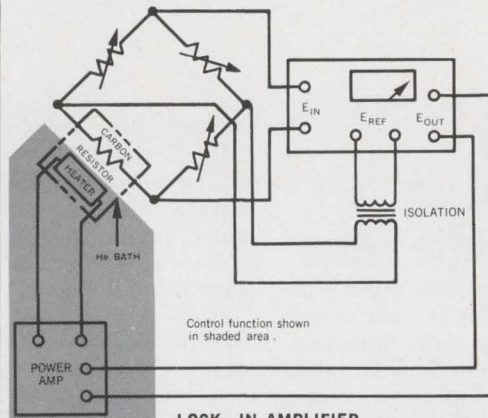

LOCK-IN AMPLIFIER
USED AS BRIDGE OSCILLATOR/NUL DETECTOR

MONITOR OP AMP SUMMING JUNCTION VOLTAGES TO 10 NANOVOLTS

The open-loop gain of op amps can be measured by monitoring the summing point voltage while operating the amplifier in its normal closed-loop configuration. The advantages of using a Lock-in Amplifier to make these measurements are: (1) Its self-contained oscillator serves as a signal source for the op amp over a wide frequency range. (2) Distortion and offset at the summing junction are minimized by the Lock-In Amplifier's high input impedance and low noise. (3) Summing junction voltages as low as 10 nanovolts can be measured and recorded to permit measurement of extremely high open-loop gains. (4) Phase shift can be measured.

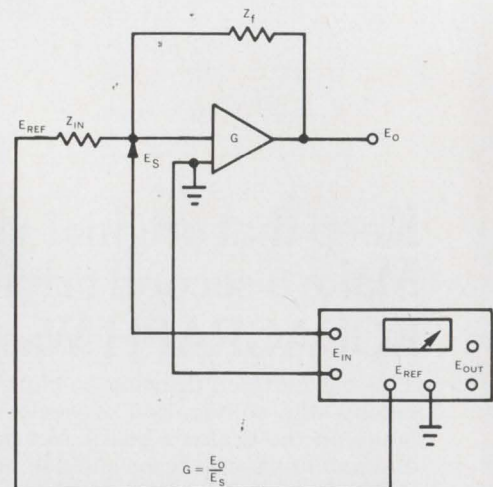

OP AMP OPEN-LOOP GAIN MEASUREMENTS
WITH LOCK-IN AMPLIFIER.

If you have a problem unearthing low-level signals buried in noise, why not call on a PAR applications specialist. He may be able to show you a better way to dig. Call him at (609) 924-6835, or write Princeton Applied Research Corporation, P.O. Box 565, Princeton, New Jersey 08540.

PAR

PRINCETON APPLIED RESEARCH CORPORATION

Phased array's analog method keeps antenna beam shaped up

Ryan technique needs no beam-steering computer, has step recovery diode capable of both frequency multiplication and phase shifting

Most phased-array radars being developed today use ferrite or p-i-n diodes to perform digital phase shifting because simple analog phase shifters haven't been available. One-bit systems shift the phase 180°, two-bit systems shift in 90° increments, three-bit systems in 45° steps, and four-bit units in steps of 22.5°. Thus, if a phase shift of only 20° is desired in a three-bit system, the 45° step limitation can lead to significant phase errors resulting in unwanted sidelobes and pointing problems.

For radars using very large antennas—500 or more elements and gains greater than 33 to 35 decibels—these errors average out to become almost unnoticeable. John Aasted, program manager for phased-array development in electronic and space systems at the Ryan Aeronautical Co., maintains this error averaging is the reason digital phase shifting is so popular in large phased arrays. These systems often use beam-steering computers to help shape the beam. But for smaller systems, in which a beam-steering computer would be an expensive extra, phase errors can become intolerable.

To solve the problem, Ryan has developed a phased array which changes phase by an analog method that combines phase shifting with signal generation in a frequency multiplier, completely eliminating the usual phase shifters [*Electronics*, Sept. 2, 1968, p. 102].

Delivery. Ryan has just delivered a prototype of a combined acquisition and tracking radar incorporating this novel design to NASA's Manned Spacecraft Center. The prototype could be used to assist in

rendezvous with a disabled spacecraft, to identify and track space debris, or to track meteorites. The array has 16 elements, each putting out 0.25 watt at C band. Each module is 1 by 1 by 3 inches deep, and contains a "bow tie" antenna, a transmitter, a receiver, and a circulator to isolate transmission and reception on the antenna.

But the part of the unit that Ryan officials believe is unique is a step recovery diode capable of both frequency multiplication and phase shifting. Aasted says its adoption resulted from a search for a way to electronically steer the beam of antennas such as the one the firm provides for its landing radar on

the lunar module for project Apollo, which is a fixed-beam unit but not all solid state. Ryan wanted an all solid state system for its next generation of radars. Aasted believes the array just sent to the Manned Spacecraft Center is the first all solid state phased array to be delivered to a Government agency.

As with ferrite or p-i-n diode phase shifters, the Ryan system begins with a master oscillator, splitting the signal to each module in the array. But there the similarity ceases. The signal is generated at about 200 megahertz, boosted in frequency by the step-recovery diode which is used as a 10-times frequency multiplier, "and then we

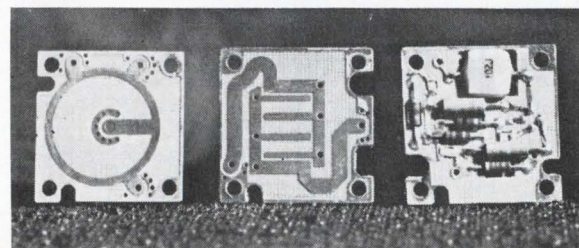
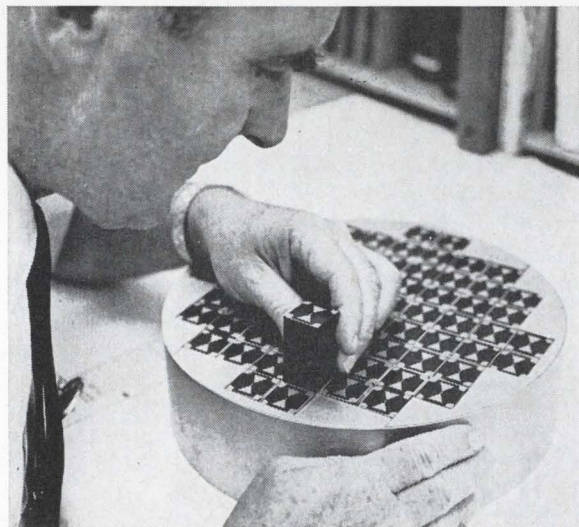

Steering.

Phased-array radar developed by Ryan uses analog techniques, eliminating the phase shifters, which often add errors to the beam steering. Prototype of acquisition and tracking radar has been delivered to NASA. Array contains 16 elements, each emitting 0.25 watt at C band. The module measures 1 by 1 by 3 inches. Shown is earlier 68-element array built for Army.

U.S. Reports

vary the bias of the diode so that the output is not only multiplied but phase shifted," Aasted explains. One step-recovery diode is used in each module. Ordinarily, in a system using ferrite phase shifters, the shifters would be inserted after the multiplier.

Aasted has no firm cost comparisons for the Ryan method compared with more conventional phase shifting, but he says the Ryan method achieves high gain at a lower cost than a system using transistors to boost the signal, and he maintains efficiency is better. "The cost of transistors at 2,000 Mhz is several thousand dollars, but the step-recovery diode at 200 Mhz is a fraction of that. Besides, we don't need the beam-steering computer."

Solid state

Canned heat

Outside temperature changes can wreak havoc with the performance of electronic circuits, and as a result, sensitive military test and communications equipment must take those changes in stride.

Designers generally try one of

two things: let the user sense the temperature and then compensate for the performance change; or build the key circuits into an "oven" to keep them at a constant temperature. But the user method is cumbersome and subject to human error, and the oven takes up weight, space, and power in restricted military environments.

However, Bendix Corp. engineers think they have a better way. They have put the sensitive integrated circuits on a "hot plate" inside a TO-8 or TO-5 can. Besides being a simple and small circuit, the "hot plate" could keep an operational amplifier, for example, within $\pm 0.5^\circ\text{C}$ of the desired temperature over most of the military range of -55°C to $+125^\circ\text{C}$, according to Norman Green, director of the new device development section at the Bendix Communications division in Towson, Md. Prototype r-f voltmeter diode probes using this principle are now being delivered to the Navy for the versatile avionics shop test (VAST) system.

Hot seat. Essentially it's a hybrid bridge temperature-feedback circuit, for which Bendix is applying for patents. The design consists of a proprietary configuration of three transistors, one thermistor, and two diodes acting as a thermostat and

heater for a gold substrate, the "hot plate." These in turn are mounted on a glass substrate suspended from the header of the TO-8 can by the leads.

In the bridge, the collector of one of the transistors and the thermistor are mounted on the gold substrate. The collector, by dissipating power through the substrate, becomes the heater. The thermistor provides the feedback to the circuit by keeping its resistance constant, which in turn controls the power the collector dissipates. The four arms of the bridge are composed of the thermistor and the three resistors while the other two transistors sense imbalance in the bridge.

The 100-by-130-mil gold substrate is like a table, which is supported by four 20-square-mil glass legs, about 27 mils above the 20-by-130-by-360-mil glass substrate. The glass legs and substrate act as insulators. Those components that need to be temperature controlled are mounted on the gold table; those that need not be can be mounted on the header.

Flipped out. In the present design the feedback circuit takes up half the area of the hot plate. Bendix has already developed designs where the hot plate can be flipped so that the feedback circuit is underneath and the top of the table is clear for larger audio oscillators or op amps. But Green hints that his group "is working on new geometries which won't even look like this," and won't be as costly.

There are other single-purpose temperature-controlled microcircuits being built. Fairchild Semiconductor, for example, makes a temperature-controlled preamplifier which sets its own temperature. "The Fairchild circuit has its own oven," Green comments. "Ours controls anything that can fit on it."

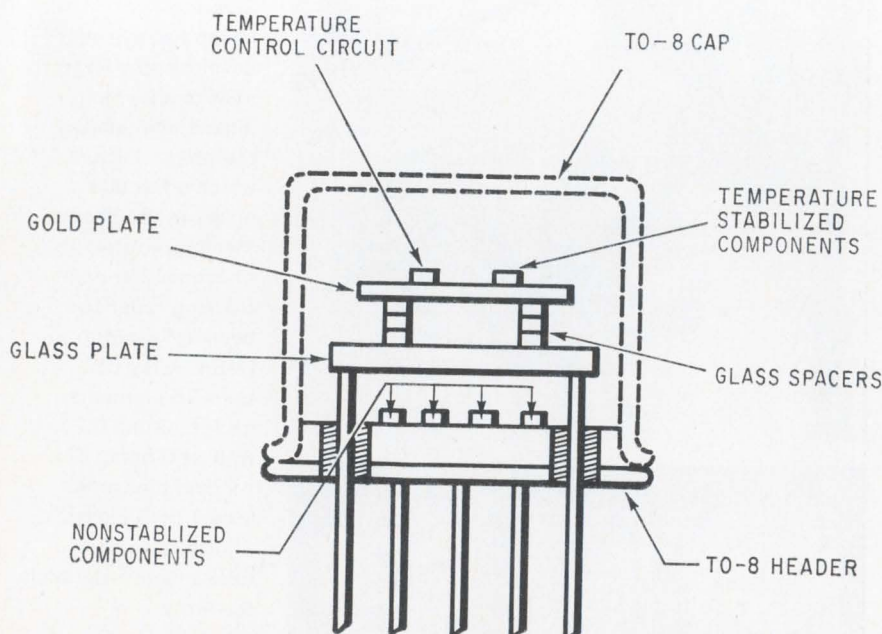

Hot plate. Bendix's answer to the problem of temperature changes features small heating circuit inside a TO-5 or TO-8 can with component itself.

Optoelectronics

Holograms for cops

Despite the obvious advantages of automatic fingerprint matching and identification systems, most of them have been greeted with blank stares

by police agencies. The lawmen have found the systems—some of which have been knocking around labs for a long time—incompatible with present setups and hard to operate.

But the Conduccion Corp. of Ann Arbor, Mich., thinks it might be able to turn the stares into smiles with its Confess (for Conduccion fingerprint electro-optical search system). The company says Confess, currently a lab model, could go through the New York City Police Department's file of about 1.5 million prints in less than two minutes. It now takes 100 employees about 15 minutes to identify a suspect's print.

"It's the only automatic system we've seen so far that looks like it's going to work," said a New York police official. In early April, the department will witness tests by Conduccion. "If the tests are successful," says the official, "we'll recommend the system to the Federal Government to try to get a research grant."

Bright spot. The technique, which has aroused the interest of a number of police agencies around the country, is based on the matching of a hologram with a photographic film containing a library of fingerprints. A print taken at a police station is forwarded to the fingerprint bureau, which makes a transparency of it. A hologram is then made of the transparency and inserted into a holder on an optical bench. On the bench, laser light passes through two lenses that expand and collimate the beam. The film, driven by a servo motor, is run until a bright spot appears on a television screen. This occurs when some print on the film matches the hologram. The film can be rewound by hand to zero in on the correct print.

The technique works because the film print and hologram are complex conjugates of each other. This permits pure laser light to strike the camera aperture, causing the bright spot. The system is analogous to the transferring of maximum power when two networks are complex conjugates of one another. In both cases, the output intensity is maximum.

The phenomenon in optics rests on the Wiener-Kinchin law of cross-correlation. That law deals with

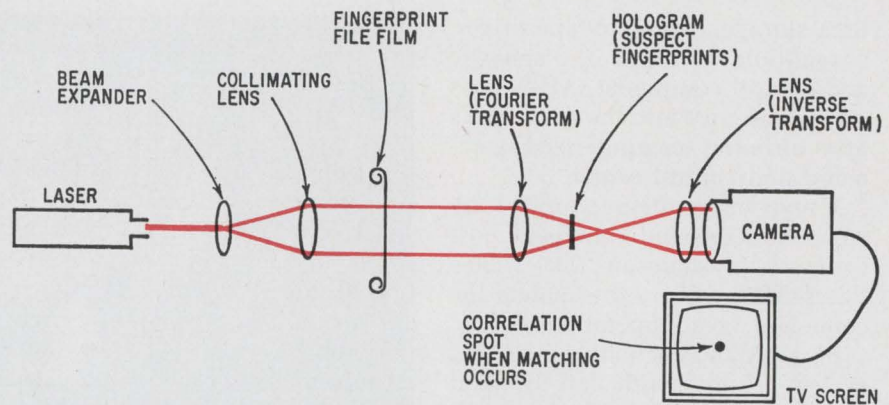

Fingerprint matching. Optical correlator bench in Conduccion's Confess system. When file print matches sample, reference beam is seen as spot on crt.

the Fourier transform of one function correlating with, or multiplying, the complex conjugate of a second function. In Confess, the second function is the holographic pattern, which is actually a record of the complex conjugate of the suspect's print. It is constructed away from the bench by a filter generator.

The first function is the print pattern. The beam passes through the film, picking up its information, and gets Fourier transformed through a lens. It then goes through the hologram and an inverse transform lens onto the camera lens. When a match occurs, the two patterns multiply as autocorrelations; the beam, carrying no film or holographic information, produces the bright spot.

Headache. Conduccion plans to market Confess this year at \$750,000. This includes the bench, a transparency generator, and the filter generator, but not the camera and display unit.

The system can't now holograph latent prints on door knobs, weapons, or the like, but Conduccion is working on this.

The headache that remains, according to law enforcers, is putting central files onto film. "It would be a helluva job converting the 18 million fingerprints of our criminal file into film" says an FBI official. "Then, too, we'd have to make holograms of each of the 30,000 prints that come into the bureau for identification each day."

The FBI says it isn't interested in Confess now. It is pinning its hopes on another type of optical

system—compatible with its inked file—being developed under FBI contract by Cornell Aeronautical Laboratory and Autonetics. The work, due to be completed this summer, is based on flying-spot scanning techniques that can discern certain whorl and loop structures on fingerprint cards and match them with those on file.

Computers

Wild blue data

The Strategic Air Command uses flying command posts designed to ensure control after nuclear attack; these EC-135's are called Paccs, for Post Attack Command and Control Systems. To follow Paccs are the Advanced Airborne Command Post (AACCP) and the Airborne Warning and Control System (Awacs)—systems that will make heavy use of on-board electronic data processing gear, which SAC doesn't have yet.

But last week, the Air Force Electronic Systems division of Bedford, Mass., began flight tests of a Paccs aircraft equipped with a data processing system supplied by RCA's Aerospace division, Burlington, Mass.

ADA and VIC. Called ADA for Airborne Data Automation, the system is built around RCA's VIC variable instruction computer [*Electronics*, March 17, p. 36]. Together with five cathode-ray tube display and keyboard consoles, a 100-mega-bit twin-drum mass memory, core

U.S. Reports

data storage, magnetic tape drives, a real-time clock, and diagnostic and control equipment, ADA turns a Paccs aircraft into the Air Force's first airborne computerized command and control center.

Using information supplied by SAC's underground command post computer system—an IBM 7090—Paccs-ADA will try to simulate the command post's operation aloft.

Paccs-ADA is actually an austere system, built with off-the-shelf hardware, some of which wasn't designed to fly. Thus the Air Force is probing the potential of airborne data processing without paying for specially developed gear. The cost of the two-year Paccs-ADA procurement is therefore estimated at a relatively low \$5 million.

Answers. Paccs-ADA is a one-time procurement designed for a specific mission, according to Lt. Col. Robert F. Macko, the project officer. "Paccs-ADA is to determine how effectively a man can use electronic data processing in the air; can he make decisions on the basis of stored data; is the data readily available in a form he can use; is there enough data and can it be properly organized? These are the sort of questions we need answered about the man-machine interface. While we are sure that Paccs-ADA will outperform a nonautomated system, the insight gained in these flights will demonstrate just how much of an improvement computers buy us," says Macko.

Some of the information will help the Air Force reinforce arguments for AACP and Awacs. And, according to Macko, who is also AACP project officer, "ADA's procurement already has taught us enough about airborne EDP for good estimates of advanced hardware needs."

Mass memory is one example. Later systems are almost sure to take a different tack from Paccs-ADA for a couple of reasons. Paccs-ADA's memory drums spin like gyroscopes and try to process as the aircraft maneuvers. Resulting forces strain bearing structures, distort the drums, and thus could cause loss of data during readout because of head drift.

Weight. The drums are also the heaviest single Paccs-ADA compo-

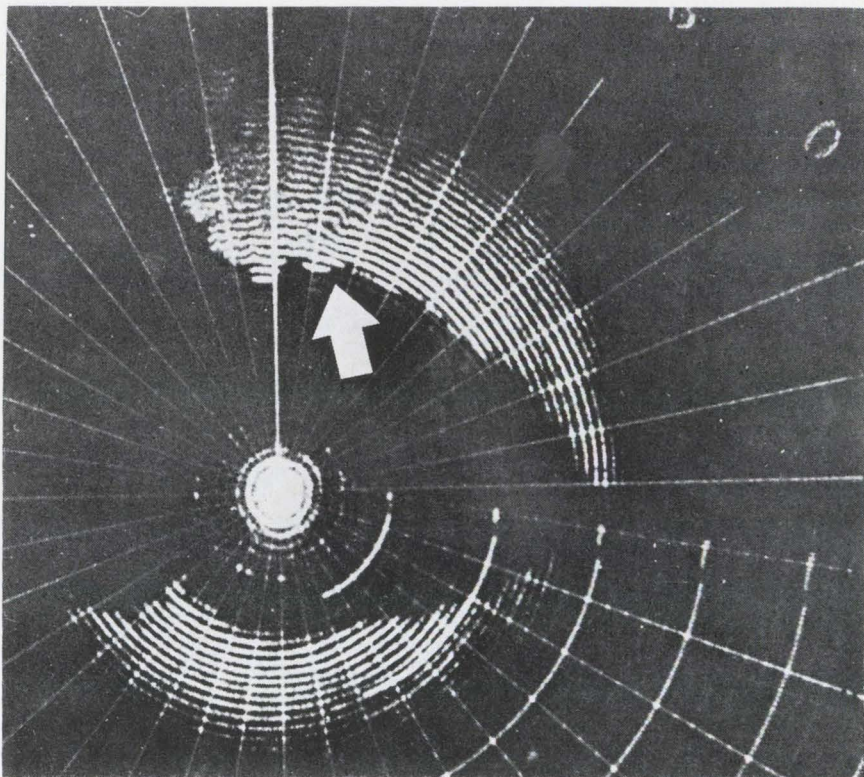

Turbulence on display. Doppler radar techniques are used to detect wind vortex patterns. Wavy lines in display distinguish the turbulent air from constant wind flow.

nent, weighing 1,490 pounds out of a 4,290-pound total, and Macko says that lighter, smaller systems will probably be a must in future memory systems. Thus it seems that AACP or Awacs might use plated wire, woven wire, etched Permalloy, or thin-film memories. Each of these was investigated by RCA. Some were dropped to keep Paccs-ADA's cost down; others weren't readily available.

Temperature extremes and high humidity have also troubled Paccs-ADA hardware. "After a heat or cold soak, for example, it has taken far longer than desirable to get some parts operating at spec," according to Maj. Albert J. Pikul, the Electronic Systems division's Paccs-ADA flight test director. AACP or Awacs equipment will face tough environmental specs.

The tribulations of hardware procurement for Paccs-ADA may have helped the system meet one of its major goals by supplying data for future advanced system procurements. But some secondary areas can be explored only during the 13 months of test flights.

Avionics

Shear look

Ground-based doppler radar techniques have been used experimentally to spot shifting storm winds, so hazardous to aircraft, by detecting precipitation or cloud formations. But although these techniques can measure wind speeds, they can't adequately chart dangerous wind vortex patterns—much less plot them in real time on a radar scope.

At the Air Force's Cambridge Research Laboratories, however, researchers are experimenting with an approach that promises to accurately distinguish between turbulence and constant wind flow as well as display the turbulence patterns. Called Plan Shear Indicator (PSI), the new display mode "forgets about wind velocity measurement and concentrates on how the wind is changing in a small space," says Ralph J. Donaldson Jr., a research physicist at the lab. "If the wind speeds are changing in one direction, then they'll change all

Semtech introduces...the "METOXILITE*" Rectifier.

Metoxilite is fused to the metallurgically bonded junction-tungsten pin assembly forming a "tough" sub-miniature package. A "state-of-the-art" rectifier that can be used anywhere — you'll see them used in stringent military and space environments, industrial and commercial applications. The Metoxilite rectifier is the result of over three years of applied research and extensive testing. Available in two current ratings — 6 amps / MIL-STD-750A (3 amps @ 55°C / no heat sink) and 3 amps / MIL-STD-750A (1 amp @ 55°C / no heat sink) — the Metoxilite rectifiers feature PIV up to 1000 volts and extremely low reverse leakage with Medium (t_{rr} 2 μ sec) or Fast (t_{rr} 150 nsec) Recovery characteristics.

Exceeds all MIL and space requirements
Electrically approaches theoretical
Available in production quantities
Immediate delivery

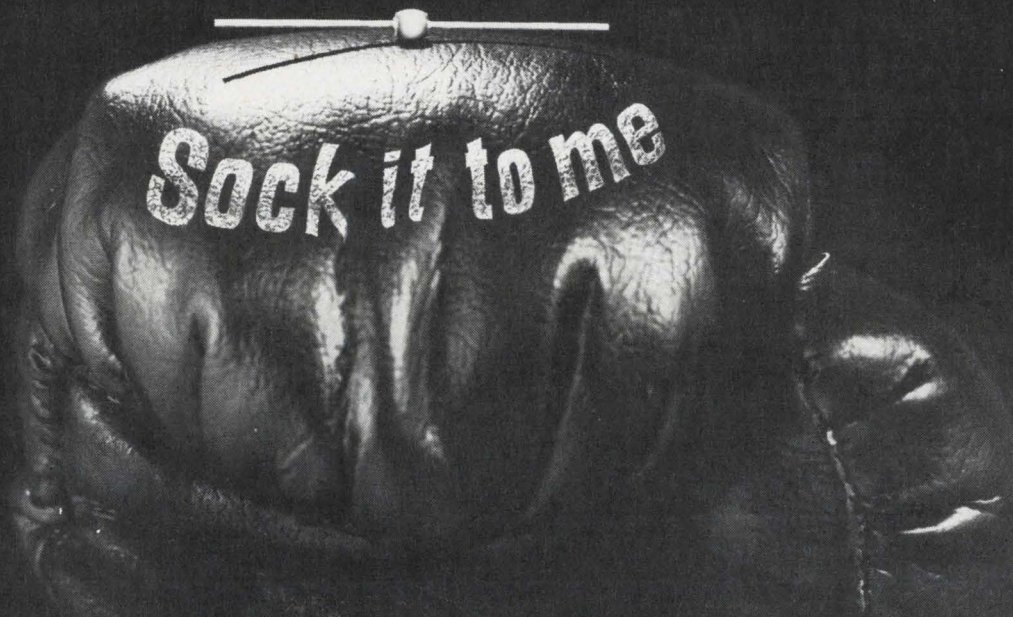

*"METOXILITE" — fused metal oxides.

San Francisco—941 E. Charleston, Suite 10, Palo Alto, California 94303 / (415) 328-8025
Chicago—140 N. La Grange Road, La Grange, Illinois 60525 / (312) 352-3227 / TWX: 910-683-1896
Dallas—402 Irving Bank Tower, Irving, Texas 75060 (214) 253-7644
New York—116-55 Queens Blvd., Forest Hills, New York 11375 / (212) 263-3115 / TWX: 710-582-2959
European Sales—Bourns A. G. Alpenstrasse 1, Zug, Switzerland / (042) 4 82 72/73

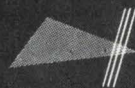

SEMTECH
CORPORATION

652 Mitchell Road, Newbury Park, California 91320
(805) 498-2111, (213) 628-5392 / TWX: 910-336-1264

U.S. Reports

the patterns in every direction." PSI indicates disturbed wind patterns along the beam.

The PSI display for a scanning doppler radar uses an ordinary scope in which a coherent memory filter handles intensity modulation. The coherent memory filter performs a frequency analysis at all ranges of the doppler signal returned by precipitation or clouds. When displayed on the scope, the output of the filter allows the operator to distinguish easily between turbulence and constant wind flow. By converting radial measurement to displacement measurement at regular intervals, PSI displays wind pattern in concentric arcs.

Arc types. Thus, radial turbulence, or shear, is indicated by gaps or bunching of the arcs; tangential shear is indicated by wrinkles in the arcs. Turbulence on a scale smaller than measurable wind shear broadens the doppler spectrum and is shown by an increase in the thicknesses of the concentric arcs.

Conventional-pulsed doppler radar uses a range gate at the selected range interval, a boxcar circuit to search the return signal, and a bank of parallel bandpass filters to perform the frequency analysis.

The coherent memory filter provides real time analysis at all ranges. It consists of a summing network; a delay line and associated amplifiers; a single-sideband mixer, the output of which is the sum of the input frequency and the scanning frequency; a frequency generator, the period of which matches the radar pulse width; and an envelope detector, which converts the filter's infrared region to video output. The filter essentially equates a frequency shift with a linear time-varying phase shift.

PSI achieves the real-time capability at the cost of mediocre resolution of ranges and wind speeds. But tests so far with various kinds of storms near the Sudbury, Mass., site show that PSI can make a distinction between turbulence that endangers aircraft and that which doesn't. Effectively, this would give airfields and pilots up to an hour's warning of dangerous approaching

storms.

Physicist Donaldson and his research colleague, Graham M. Armstrong, an electrical engineer, plan further storm monitoring. They would like to replace the coherent memory filter with a fast Fourier transform processor, but acknowledge that it would run the cost up to \$200,000—a high sum at a time when research budgets are tight.

Flights of fancy

"Running an airplane is like running a corporation," suggests Bernard H. List, director of systems and information at Texas Instruments' research and engineering laboratory. List is quite serious. "Forget the mechanics of flying the plane," he says. "Just take all your inputs—radar, performance indications, and so forth—and imagine that you could let a computer monitor them. If anything went wrong, a light would inform the pilot, and he would be given an indication of the possible corrective actions he could take. Mark Shepherd [president of TI] would love to have a screen on his desk that would light up when the company

was in trouble and tell him what his alternatives were."

List is directing parallel studies for Wright-Patterson Air Force Base and the Naval Air Systems Command concerning the nature of avionics systems in the late 1970's and the early 1980's. But avionics itself, in the sense of hardware, hardly enters into the studies at this stage. As far as List is concerned, he's studying "information management systems," and that is the title of the two studies being made by the Dallas company.

Data deluge. List observes that because the complexity of air missions and aircraft is increasing at the same time the size of air crews is decreasing, fliers nowadays must deal with a superabundance of information. Work at Wright-Patterson has led to a concept of avionics in which the goal is to simplify the information presented to the pilot so that he can handle it more efficiently. List notes that the kind of solid state arrays being built for TI's MERA (molecular electronics for radar applications) program can be put anywhere on the plane. Also, the availability of large-scale integrated circuits should lead to airborne computers of great sophisti-

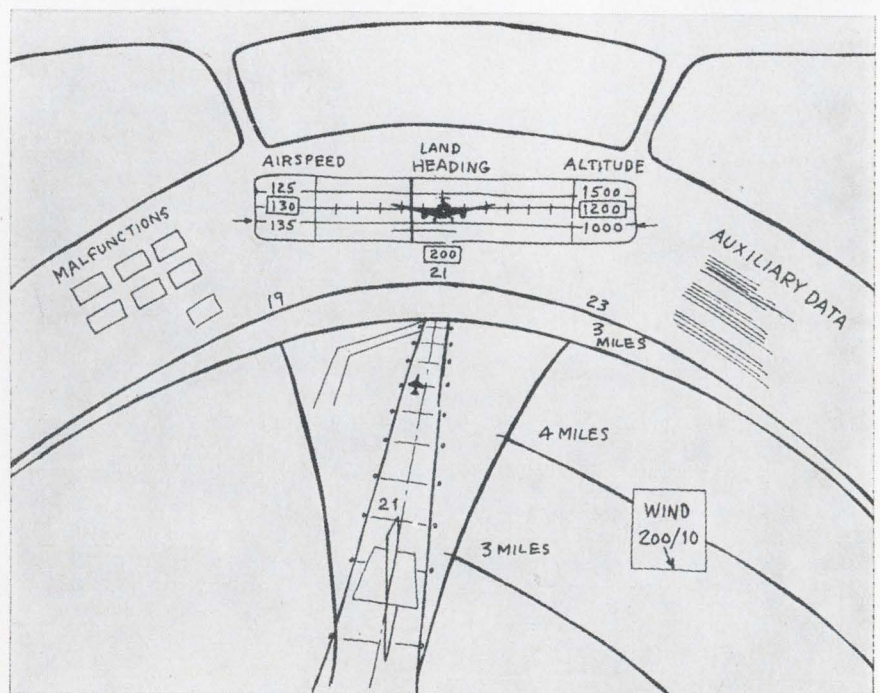

Brainstorm. Here's one possible future cockpit display. The plane is landing, as seen on still-to-be-invented flat-screen crt at center.

Battery Powered!



15-MHz, Dual-Trace Portable Oscilloscope

Your waveform measurements no longer need be compromised by adverse field conditions or the absence of a convenient power connection. The Tektronix Type 422 Portable Oscilloscope brings the precision of the laboratory "on site" to meet your measurement requirements.

This compact, rugged oscilloscope combines small size and light weight with 15-MHz, dual-trace performance! Two models are available. One is powered from AC; the other from AC, DC, or internal rechargeable batteries. The AC version weighs less than 22 pounds including accessories and operates from 115 or 230 VAC $\pm 10\%$, 45 to 440 Hz, 40 watts. The AC/DC version (MOD 125B) with

built-in battery recharger weighs 30 pounds including accessories and batteries and operates from an internal 24-volt rechargeable battery pack; from 115 or 230 VAC $\pm 20\%$, 45 to 440 Hz, 27 watts; or from 11.5 to 35 VDC, 23 watts.

For a demonstration of the Type 422 in your application call your Tektronix Field Engineer or write, Tektronix, Inc., P.O. Box 500, Beaverton, Oregon 97005.

Type 422 Oscilloscope, AC powered	\$1450
Type 422 MOD 125B Oscilloscope, AC/DC powered (without battery pack)	\$1800
Battery Pack for Type 422 MOD 125B (order 016-0066-02)	\$ 125

U.S. Sales Prices FOB Beaverton, Oregon



Tektronix, Inc.
committed to progress in waveform measurement

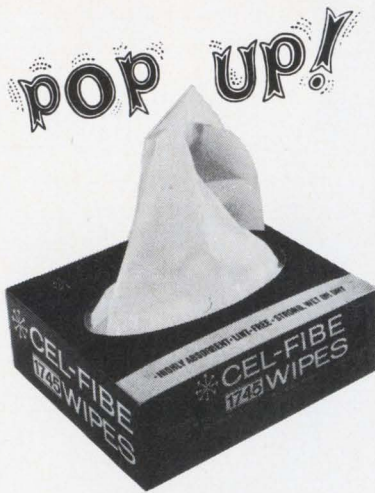

• **New Feature for Faster Wiping...**

• **The Versatile Wipe with the "Automatic" Feed**

• **Soft, Highly absorbent, Lint-free, Strong—wet or dry**

Another Top Choice from Today's Widest Selection of Industrial Wipes

For light to medium duty wiping, Cel-Fibe's number 1745 "Pop-Up" wipe is unexcelled... economical too. The specifically designed surface is ideal for cleaning laboratory equipment, glassware, T.V. picture tubes, electronic parts, delicate instruments, circuit components and a host of other items. This is but one type in a complete line of industrial wipes offered by Cel-Fibe.

Free Samples: to see, feel, try. Send for them today!

CEL-FIBE



Milltown, New Jersey 08850
201-524-7191
*Trademark ©1968 Cel-Fibe

U. S. Reports

cation.

"There are really two classes of problems for the system," List says. "First is the plane still flying? This is a fault-detection and-isolation problem, and we can take advantage of redundancy at every level in dealing with it. Take altitude; let's say you have a radar altimeter that conks out. There'll be terrain-following radar on board, too, and if you used this to read distance and phase angle, you could get a perhaps degraded, but still useful, altitude reading. A lot of black boxes have this capability, but the trick is to connect them to the central processor to provide backup modes. You get more reliable avionics at no extra cost.

Wing and a prayer? "The second class of problem involves loss of information or the incorrect interpretation of information. What happens if the computer itself fails?" List suggests that with the development of semiconductor memories, it might be possible to build modular parallel processing computers that would degrade gradually. "When you get down to the last module, that one gets you home," he says.

The display shown on p. 48 is one product of the TI studies. With this kind of system, the pilot could punch up a cockpit display for any given situation—attacking, landing, cruising. He would then be given a visual display of his attitude and bearing, plus the minimum digital information necessary to make the proper responses.

The flat-screen display at the lower part of the drawing is, of course, only an idea. Besides, List notes, airborne computers aren't yet sophisticated enough to handle the necessary calculations. The TI study deals with conceptual system design only. List warns that "you can go off half-cocked in the concept stage"—meaning that the temptation to come up with blue-sky solutions is strong—but he adds that out of this brainstorming may come some hardware—perhaps the computer for the nation's Airborne Warning and Defense System, which is slated to fly before 1975.

The intention of both the Air Force and Navy studies is to pro-

duce enough information so that system design can begin in two years, List says. That warning system for TI's president may have to await more sophisticated business sensors, however.

Space electronics

Quick Exam

"Even the best components can offer only so much computer speed and reliability," says Gary Y. Wang of NASA's Electronics Research Center. "Soon it becomes necessary to approach dependability and speed on a systems level."

This is what Wang, the center's aerospace computer branch chief, is doing in the Exam project. Exam, for experimental aerospace multi-processor, is now being developed at the Cambridge, Mass., center as a forerunner of the computers needed for the complex, long space missions of the mid- and late 1970's.

Exam-type computers could use as many as four data processors and four memories interconnected by a crossbar switching system like that in a small telephone exchange. Through the switching system, any one of the processors could access any of the memories, making it possible to continue operation despite failure of other processors. With all processors operating, an Exam computer would provide several channels through which data could be handled simultaneously, thus increasing the machine's capacity for work, or throughput.

Wang says Exam will be modular. More or fewer processors or memory modules could be added, depending on the reliability and throughput needed to perform a mission. "During launch or other critical phases of a mission, we could set all the processors to the same task and compare their outputs in a sort of a vote, with the spacecraft obeying the majority," Wang says. "After launch we could set each working in parallel to boost throughput."

Failure. Multiprocessors have been built before, but their com-

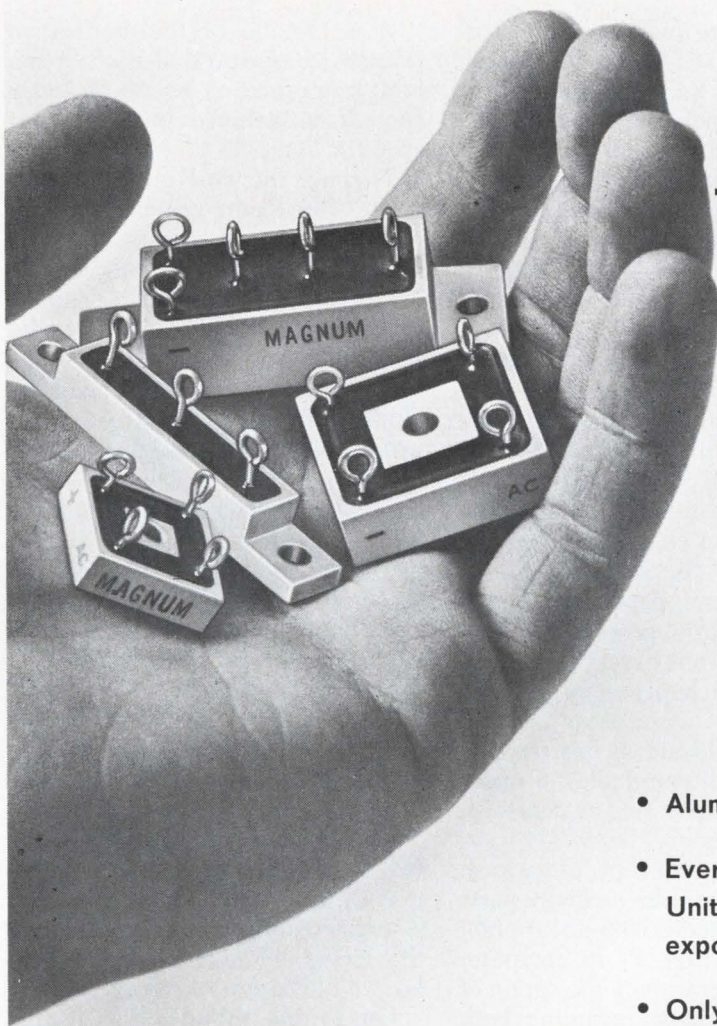

The "inside-out" bridge --
the first 25 amp
rectifier assemblies
designed for reliability
from the inside out...
and priced competitively

- Aluminum package optimizes heat dissipation.
- Every chip individually fused in glass in a complete Unitrode monolithic package, so . . . silicon is not exposed to possible contamination by plastic filler.
- Only controlled avalanche rectifiers used.
- Terminal pins directly connected to silicon make direct thermal path — not only to case, but to lead wires — thus lower junction temperatures.

#678 Series Three Phase 25 Amp Bridges
#679 Series Single Phase 25 Amp Bridges
#680 Series Single Phase 10 Amp Bridges
#681 Series 15 Amp Doublers and
Center Tap Rectifiers

PIV'S to 600V.
4 different packages
6 circuit configurations
All available in regular,
fast, or ultra-fast recovery

THE MAGNUM RECTIFIER ASSEMBLY by

UNITRODE

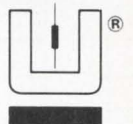

580 Pleasant Street, Watertown, Massachusetts 02172 • (617) 926-0404

IN ITS HEART, YOU KNOW IT'S RIGHT . . .

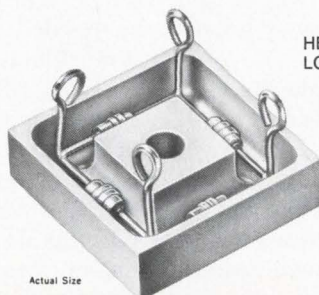

HERE'S WHAT IT
LOOKS LIKE INSIDE

Even before it's potted, the Magnum has all the toughness, reliability, and electrical characteristics of the unique Unitrode fused-in-glass diode as the heart of its construction.

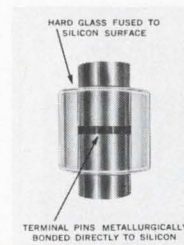

HERE'S WHAT IT
LOOKS LIKE INSIDE
THE INSIDE

With the silicon die metallurgically bonded between terminal pins of the same thermal coefficient, the hard glass sleeve is fused to the entire outer silicon surface. Result — a voidless, monolithic structure.

For fast action, call Dave Greene COLLECT at (617) 926-0404.

ROTARY ATTENUATORS MINIATURE



MA-51
0-60 db
10db Steps
\$ 125.
1 5/16"
Diameter
2 3/8"
Long

ATTENUATION VS. FREQUENCY

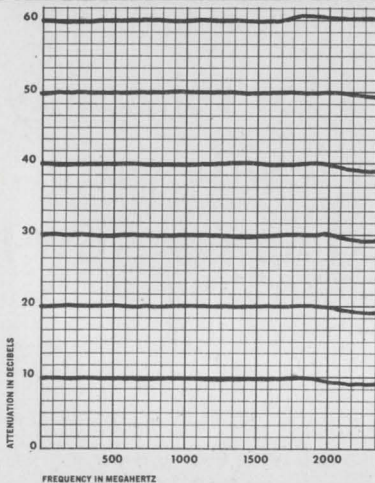

MA-50
0-10 db
1db Steps
\$ 125.
1 5/16"
Diameter
1 3/4"
Long

ATTENUATION VS. FREQUENCY

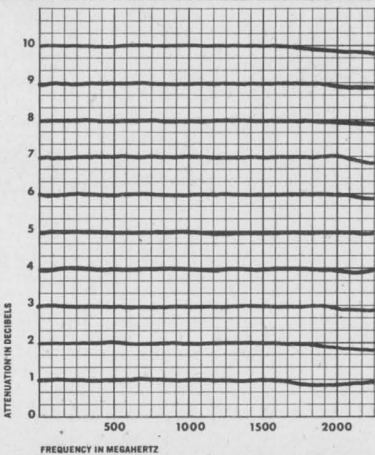

**TEXSCAN
CORPORATION**

2446 N. Shadeland Avenue
Indianapolis, Indiana 46219
Telephone (317) 357-8781
TWX: 810 - 341 - 3184

U.S. Reports

plex hardware made them expensive. Most have also needed powerful executive software routines to make them operate. They have also been vulnerable to failure of their executive processor, which assigns tasks and priorities among the others. A failure of this single executive section was equivalent to failure of the whole complex system.

Exam is being designed to avoid these problems. Wang feels that the cost should be reasonable, because much of the system is to be made of metal oxide semiconductor large-scale integrated circuits, which he says should be very inexpensive by the mid-1970's.

To overcome dependence on a single executive processor, Exam would parcel out executive authority among each processor in turn. Finally, an associative control memory would aid in this division of responsibility and allow a major reduction in operating system software and memory, he says.

The Exam concept already is about two years old, and with parts deliveries scheduled in about eight months, the first Exam computer should be operating in the spring of 1970, Wang says. Including both in-house and contract efforts, Exam should cost NASA no more than \$250,000 to \$300,000 through fiscal 1970, Wang adds.

By today's standards, this is a small price, but some of it is buying some pretty fancy hardware. RCA's Electronic Components division, Somerville, N. J., is supplying Exam with a complementary MOS 16-by-16 bit LSI scratchpad as well as a four-bit arithmetic unit capable of addition, subtraction, multiplication, and division, and left-right shift.

Seems fast. Honeywell is working on a p-channel MOS LSI associative memory circuit. It will be 256 by 64 bits, and delivery is scheduled for early 1970.

Wang notes that while the MOS circuits have a relatively low 4-megahertz clock rate, Exam will seem faster because of its parallel processing capability. Thus, a four-processor Exam computer would seem like a 16-Mhz single processor.

It is the job of the associative memory to ensure that each of the four processors is used efficiently enough to achieve this apparent speed.

To make the work go faster, programs for Exam are broken into parts. Some of these may be worked on independently, while others must await completion of earlier sections before they can be started. If this breakdown is done elegantly, each processor will be either working or taking on its next task via the associative memory.

As a processor finishes its job, it checks to see whether any of the others has executive control of Exam. If none has, it can access the associative memory, tell it what's been done (updating the record of work done toward completion of a program), and accept the next task. If another processor has executive control, the first processor gets in a queue and awaits control, normally for a matter of microseconds.

Though rare, it is possible for two processors to demand executive control at the same time, but so-called conflict resolution logic in the switching allows only one to access the control memory.

Up to the minute. All of this could be handled in software, but the result would be a slower computer with a massive, expensive memory. In Exam, the associative memory records the status of all parts of a program as well as ranking the remaining jobs in their priorities. The associative memory is updated each time a new processor assumes executive control. Its data is always up to the minute, and changes in job or processor priority and interrupts are taken in stride.

As a processor accesses the control memory it searches its whole content in a single memory cycle rather than word by word as might be needed with a random-access store. The associative memory fires back the title and location in core memory of the next task in as little as 300 nanoseconds, and uses far less software than is needed to search a random-access memory.

Wang also plans to use the associative memory to control input-output access, for memory paging



MOS CLOCK SAVERS

Extra effort in the design of MOS clock-drive networks can pay large dividends in power savings and lower component costs. Compared with straightforward designs, component counts and power dissipation often can be cut in half or more by reorganizing the MOS subsystem to reduce operating frequency and duty cycle, by redistributing the clock power with buffers, or by combining these approaches.

The larger the drive network, the more opportunities the designer has to economize if he appreciates the power-frequency-load tradeoffs of MOS devices. For openers, consider the 20,000-bit serial memory in Figure 1. It could be built with 100

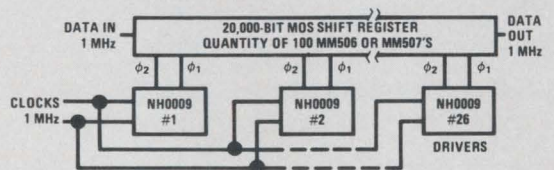

FIGURE 1. Straightforward Drive Network Can Be Costly

MM506 dual 100-bit dynamic shift registers and 26 NH0009 two-phase clock drivers at 70°C. Each MM506 presents a capacitive load of about 80 pF and takes a voltage swing of 16V. At 1 MHz, an NH0009 can drive four MM506's. (If single-phase clocks were preferred, NH0007 or NH0012 drivers could be used.)

A designer could cut the cost and power of the Figure 1 design by reducing operating frequency and data rates. The energy needed to charge and discharge load capacitance is, in any driver,

$$P_{\text{transient}} = CV^2f$$

where C is the load, V the voltage change, and f

the repetition rate. If the frequency is halved, for instance, each driver can handle twice the number of MOS devices. At a frequency of 200 kHz, our drivers can handle 80 complex MOS devices in well-designed systems. The savings can be greater than 1:1 because reductions in duty cycle and internal power consumption of the drivers and registers can be made at lower frequencies. Total power dissipation is the sum of load and internal power consumption.

Suppose, though, that a reduced data rate is not acceptable. If the shift registers are rearranged and the data multiplexed as in Figure 2, the operating frequency of the registers can be cut to 250 kHz and each NH0009 can drive many additional MM506's. A suitable clock format can be provided by only two drivers, 24 drivers being replaced by a few bipolar binaries and seven gates, for a considerable savings in power and component costs. The registers will also dissipate much less power. As an alternative, we could keep the drivers (26) and raise the data rate to 4 MHz.

It would be difficult to find a more economical drive network for a large system than Figure 3. Here, a single NH0009 drives remote pnp-npn switches that buffer and distribute the clock signals. If each buffer is made with 2N4142 and 2N4140 transistors, each could do the work of two NH0009's. Transient power would remain the same as in Figure 1, since the load is not changed, but each transistor would dissipate only one-fourth the average DC power of an NH0009. Such a network can synchronously operate a very large MOS memory assembly, whether it is a serial system like Figure 1 or a multiplexed configuration like Figure 2.

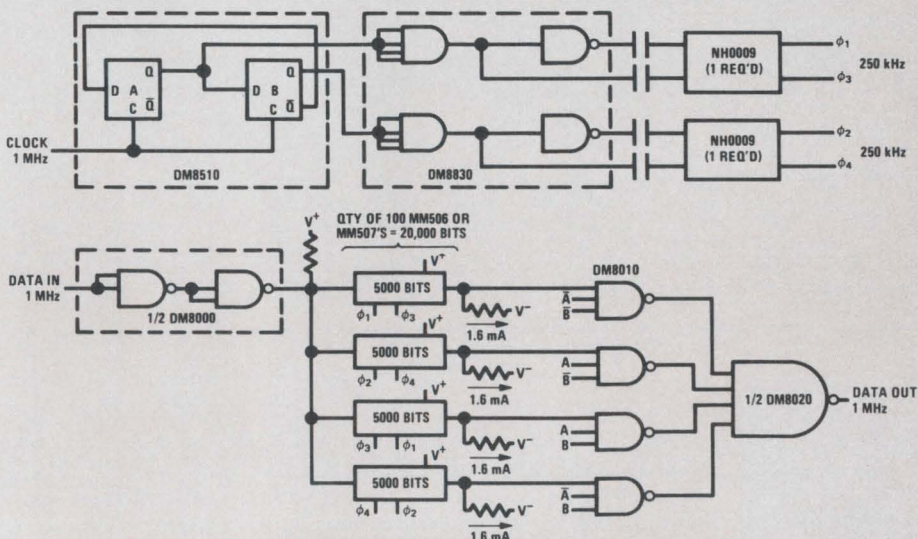

FIGURE 2. Parallel Organization Eliminates 17 Drivers

MOS BRIEF 5 MOS CLOCK SAVERS Write: National Semiconductor Corp., 2975 San Ysidro Way, Santa Clara, California 95051

MOS BRIEF 5 MOS clock savers

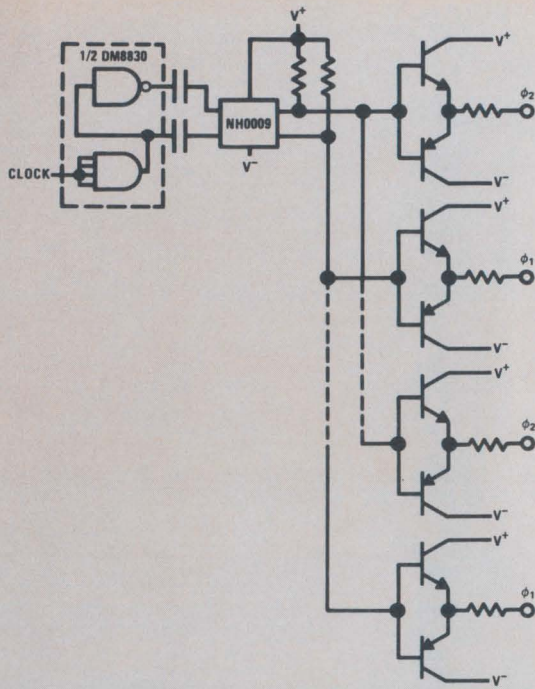

FIGURE 3. Remote Buffers Redistribute Clock Signals

The NH0009 simplifies these examples because it adapts to any practical variation in C, V and f. Discrete-component drivers such as Figure 4 can also do a good job, but clutter up a diagram (as well as PC boards). Figure 5 is a neater subassembly because a voltage translator interfaces the TTL control lines and the buffers. Either of these circuits can drive several MOS devices.

Whatever technique the designer prefers, he must take certain precautions. Since the drivers source and sink large currents into their capacitive loads,

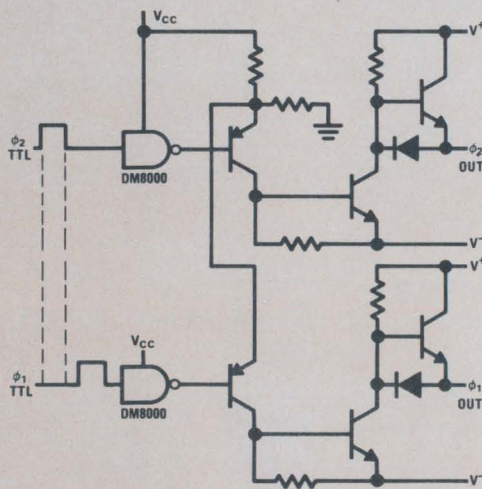

FIGURE 4. Typical Discrete-Component MOS Driver

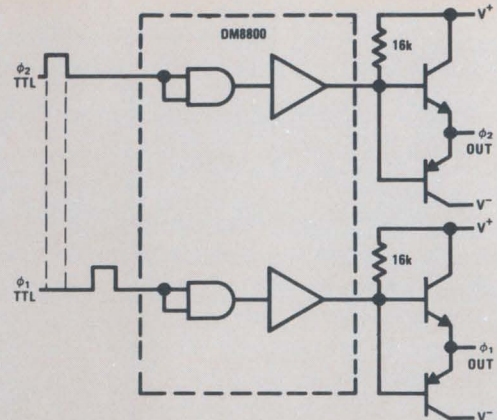

FIGURE 5. Voltage Translator Simplifies Driver Design

they require adequate power-supply decoupling. In large systems, clock-line layouts should be adjusted to avoid excessive clock swinging, of course. Clock lines may have to be terminated to prevent oscillations and noise generation. During positive logic transitions, no clock line should swing more than 0.5V more positive than the most positive bias on the MOS device driven. To avoid malfunctions due to excessive overshoot, the transitions may have to be clamped with a germanium diode, or other low-impedance terminations such as the remote buffer driver shown in Figure 3.

Problems like those are overcome nicely in Figure 3. The long lines between the NH0009 and the buffers carry relatively small currents. The collector-base junctions in the transistors act as clamps and terminations, while the emitter resistors control clock transition time and minimize overshoot. A pullup resistor was added to the NH0009 to maintain the required DC margin and to keep impedance low during the logic "0" state of the buffers.

Overall system costs can be further reduced by techniques—such as a one-resistor TTL/MOS signal interface—that are described in other National Semiconductor literature. Finally, to keep this discussion of savings in perspective, it should be remembered that merely using MOS shift registers, read-only memories, character generators and other large-scale MOS circuits in a digital system will usually make the cost considerably less than an all-bipolar design. No other process is as stingy with valuable silicon "real estate". The register in these examples, the MM506, contains 1240 elements in a 92-by-78-mil chip. And it consumes less than a milliwatt per storage cell.

Data sheets and additional application information on the MOS devices are available upon request.

National Semiconductor Corporation

2975 San Ysidro Way, Santa Clara, California 95051

(408) 245-4320/TWX (910) 339-9240



3-69 PRINTED IN U.S.A.

U.S. Reports

and protection, and as a directory, giving the main memory location of any desired data.

The associative memory scheme may also allow internal diagnosis and repair. Even if massive failures were to take place, the Exam computer would try to complete its mission not only by restructuring its pattern of interconnections but also by restructuring the way its programs are divided and the priorities for each division. This self-healing capability will be studied under a contract to be awarded this spring.

Government

Year of the application

NASA's Office of Advanced Research and Technology is planning to spend \$35 million on electronics research in fiscal 1970. And the job of convincing the House subcommittee on advanced research and technology that every cent of the total is needed went to Francis J. Sullivan, NASA's director of electronics and control. Sullivan appeared before that group earlier this month and made it clear that NASA's electronics research program is taking a turn for the practical.

As Sullivan came to each program, he noted how it would fit into current needs in space and astronautics. The battle plan calls for an extensive push in aviation electronics with the concentration put on research that will lead to an alleviation of air traffic control problems and the improvement of safety. Among the programs which will be pushed in this area are aircraft satellite radio links (L-band), further work in pilot-warning indicators, phased array antennas for aircraft, electronic clocks for sophisticated collision-avoidance schemes, beacon landing systems, inertially aided instrument landing system, and new techniques in man/machine communications between aircraft and computer. Particular attention is being paid to V/STOL aircraft technology with a major emphasis on inertial and combined inertial-radar systems to permit



IT'S TIME to kill the Jabberwocky. Namely, all that jabber about which is the best laboratory recorder for the money.

So instead of more adjectives about who's best, here are the facts... about the VR-3700.

Time base error is unsurpassed at every speed. (Less than ± 1 μ s at 120, 60 and 30 IPS.)

Flutter is a mere .15% peak-to-peak cumulative at 120 IPS.

Magnetic head life is guaranteed to exceed 1000 hours. (More important, in the three

years since these heads were introduced, not one has had to be replaced.)

Minimum maintenance feature permits fuller use of instrumentation engineer's time.

Frequency range extends to 2.0 MHz with direct electronics; 500 KHz with FM.

So much for the Jabberwocky.

How much for the VR-3700? A little less than the runner-up.

For further information, call our nearest office. Or write Bell & Howell, Pasadena, Calif. 91109. Ask for Bulletin Kit 3305-X1.



CEC / DATA INSTRUMENTS DIVISION



BELL & HOWELL

U.S. Reports

"blind" V/STOL landings.

Component research. Specific aircraft instrumentation work which will be in NASA's plan for fiscal 1970 include precision inertial sensors, new techniques in cockpit cathode-ray tube displays, a V/STOL airspeed indicator and a fluidic yaw control system.

For the record

Whither ABM? The Pentagon is keeping the technical details of its newly slimmed down \$6 billion-to-\$7 billion Safeguard ABM system a secret, but some clues were dropped by Defense Secretary Laird in his testimony before the Senate Armed Services Committee. He said an "improved, longer-range" Spartan missile is under development, that the new system is designed to intercept "at least the first salvo" of submarine-launched missiles, and that the perimeter acquisition radars are being increased (to seven with 11 faces) to cover all approaches including the seaward.

Quick frisk. When the Federal Aviation Administration held a press briefing on what was being done to develop electronic means to thwart would-be hijackers, it proudly displayed three black boxes. But the FAA refused to say what was in them (it turned out they were magnetometers to detect metal objects), who was making them, or how they will be improved (only one worked perfectly during a test demonstration).

Time for a change. The Electronic Industries Association is going to reorganize. Under the proposed changes, members of the EIA's present seven divisions would be allowed to join mutual interest groups the association would form. Initially, four new groups have been proposed: consumer products, Government-industry, passive components, and active components. In addition, each group would have its own autonomous board of directors. The reorganization plan is expected to be approved by the membership at the association's annual convention in Chicago June 23 to 26.

10Hz @ 10MHz
40Hz @ 70MHz

Sweep Synthesizer
100KHz-70MHz

5ppm/min,
20ppm/hr.

\$4065 includes 100MHz wide-sweep

0.5Hz,
overall

Sweep Plug-in
20Hz-200KHz

3Hz/min,
15Hz/15 min.

\$505 includes 20KHz wide-sweep*

1.0Hz,
overall

Sweep Plug-in
100Hz-2.0MHz

30Hz/min,
120Hz/15 min.

\$400 includes 2.0MHz wide-sweep*

100Hz,
overall

Sweep Plug-in
10KHz-115MHz

500Hz/min,
3KHz/hr.

\$630 includes 100MHz wide-sweep*

10Hz @ 5MHz,
75Hz @ 100MHz

Sweep Plug-in
2MHz-220MHz

200Hz/min,
@ 12MHz.

\$475 (tentative specs)*

Log-Amp

20KHz-220MHz, 80 db
Hi-Z input, **\$845**

*plug-in rack \$525, markers extra

KAY ELECTRIC COMPANY

MAPLE AVENUE, PINE BROOK, N. J. PHONE (201) 227-2000

IT'S A WINNER!

VERSAWATT

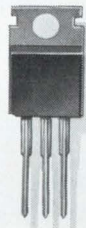

Now, the contest is over! And a winning package for RCA transistors and thyristors has a new winning name: **VERSAWATT!** You gave us thousands of names. We picked **VERSAWATT**... because it most aptly describes the quality and versatility of our molded silicone package.

VERSAWATT is RCA's plastic unit on a solid-copper base which displays brute power dissipation capability—up to 50 watts in the transistor line; power handling capability up to 10 kW in thyristors. It is rugged. It has "volumetric" efficiency. It has compactness—a space-saving advantage over larger, equivalent types—that makes **VERSAWATT** an ideal package for PC board applications where hermetic types previously were employed.

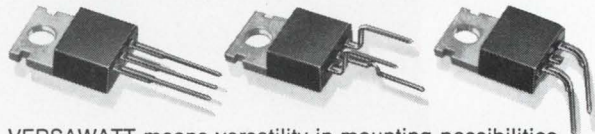

VERSAWATT means versatility in mounting possibilities. RCA offers three basic configurations (you can devise your own option to fit your needs). These configurations are for PC boards and direct plug-in for TO-66 sockets.

VERSAWATT is a plastic package offering different chips for outstanding electrical performance—in transistors, from milliamperes to several amperes. In thyristors, 120- and 240-volt line operation **VERSAWATT** 8-ampere triacs have low thermal resistance—better than many hermetic types. They offer a high 100 A peak surge current capability.

VERSAWATT has proven reliability, backed by data from more than three years of field testing in commercial and industrial applications. An added plus: **VERSAWATT** transistor units employ Hometaxial-base construction, the industry's best answer yet for freedom from second breakdown.

Check the charts for units packaged as **VERSAWATT** transistors and thyristors. There are more to come. Right now, see your local RCA Representative or your RCA Distributor for more information. For technical data on specific types, write: RCA Electronic Components, Commercial Engineering, **Sec. IN3-7**, Harrison, N.J. 07029.

The winning entry, submitted by Mr. Donald P. Clark, of Attleboro, Mass., has won for him a 10-day round-trip vacation for two to Hawaii.



RCA **VERSAWATT** Transistor Family

TYPE	V _{CE} (sus)**	h _{FE}
2N5293+	75 V	30-120 @ I _C = 0.5 A, V _{CE} = 4 V
2N5294+		
2N5295+	50 V	30-120 @ I _C = 1 A, V _{CE} = 4 V
2N5296+		
2N5297+	70 V	20-80 @ I _C = 1.5 A, V _{CE} = 4 V
2N5298+		
2N5490*	50 V	20-100 @ I _C = 2.0 A, V _{CE} = 4 V
2N5491*		
2N5492*	65 V	20-100 @ I _C = 2.5 A, V _{CE} = 4 V
2N5493*		
2N5494*	50 V	20-100 @ I _C = 3 A, V _{CE} = 4 V
2N5495*		
2N5496*	80 V	20-100 @ I _C = 3.5 A, V _{CE} = 4 V
2N5497*		

+θ_{J-C} = 3.5°C/W max. *θ_{J-C} = 2.5°C/W max. **R_{BE} = 100 ohms

RCA **VERSAWATT** Triac Family

	V _{DROM}	I _{GT}	
		I ₁ , + III - modes	I ₁ , - III + modes
40668	200 V	25 mA max.	60 mA max.
40669	400 V	25 mA max.	60 mA max.

θ_{J-C} = 2.2°C/W max.

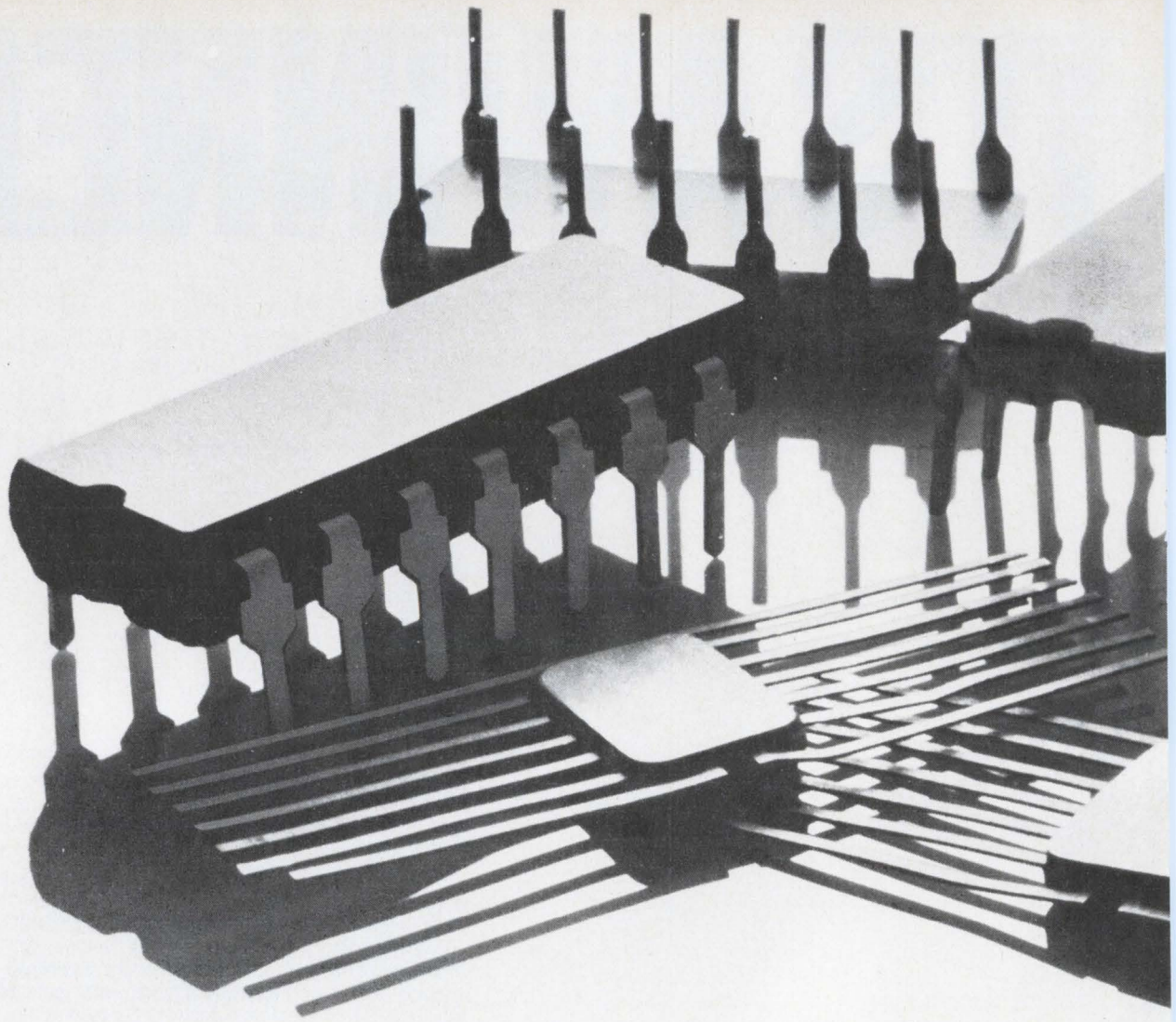

Sylvania presents

The only way our competitors could match Sylvania SUHL integrated circuits was to copy them.

They're good imitations but we think our circuits are still better.

For instance, we use aluminum bonding wires where others use gold. This eliminates the chance of "purple plague" and gives better reliability, too.

The lower mass of aluminum wire also improves shock and vibration characteristics.

We are the only maker that performs 100% DC tests at temperature extremes. Of course, we make 100% AC tests, too.

We use a metal-to-metal seal for better hermeticity. We've been told that we have the best package on the market, based on tests by large-

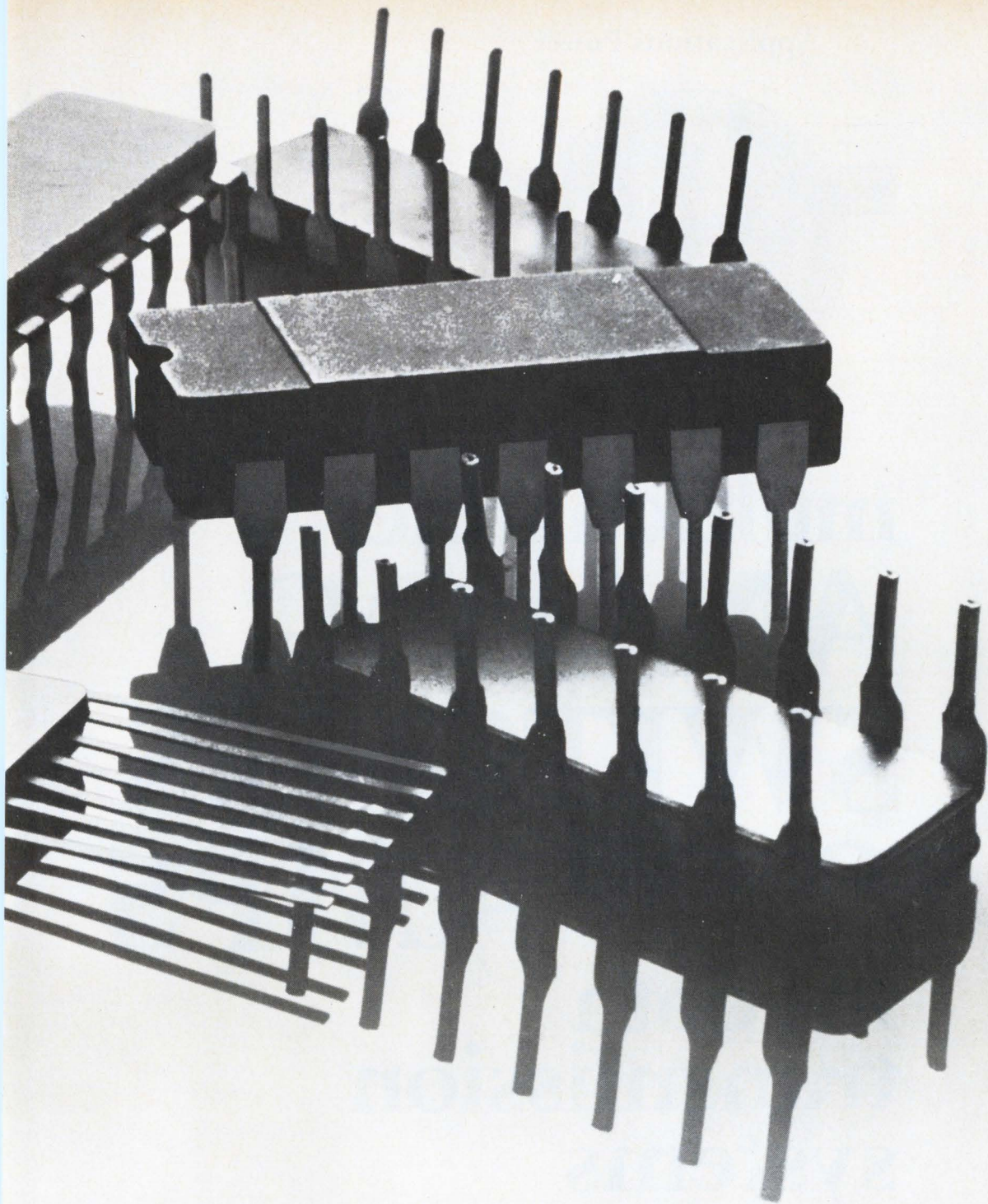

eight good imitations.

scale users.

Our entire SUHL circuit line is available in both flat packs and dual-inline packages.

And we have the broadest SUHL circuit line in the marketplace. And that includes MSI.

All Sylvania MSI are completely compatible with SUHL circuits. Which means, if you are thinking of going the MSI route, Sylvania MSI is

the only way to go.

So why settle for good imitations when you can get the real thing?

Sylvania Electronic Components,
Semiconductor Division, Woburn, Mass. 01801.

SYLVANIA
GENERAL TELEPHONE & ELECTRONICS

Circle 59 on reader service card



multichannel
**ANALOG
SWITCHES
& OP AMPS**
for data
transmission
systems

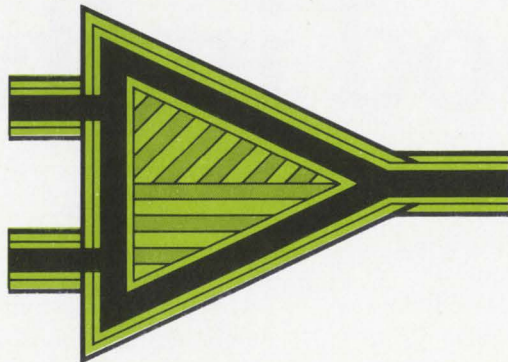

* Applications Power: A wide variety of driver/FET switch combinations and an in-depth applications team waiting to serve you!

Siliconix offers over 32 integrated driver/switch combinations particularly suited to data transmission systems. Choose from a wide variety of junction or MOS FET switches, depending on your system requirements. These, combined with a Siliconix OP AMP, can be applied to a great variety of data transmission requirements.

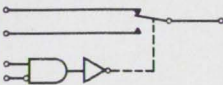
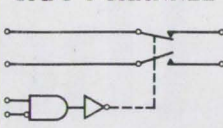
Functional Description	Type	Max. $r_{DS(ON)}$ (ohms)	Switch Type
 SPDT 1-CHANNEL	DG136	600	PMOS
	SI3002	600	NMOS PMOS
 SPDT 1-CHANNEL	DG113	600	PMOS
	143	80	N
	144	30	N
	146	10	N

A number of switches with the ON resistance ranges best suited to your application are available from Siliconix. These driver-switches accept standard DTL, RTL, and TTL logic control inputs.

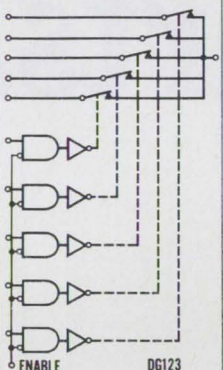
Functional Description	Channels	Type	Max. $r_{DS(ON)}$ (ohms)	Switch Type
 DG123	2	DG102	100	N
		103	100	N
		104	100	N
		110	600	PMOS
		111	600	PMOS
		112	600	PMOS
		133	30	N
		134	80	N
		141	10	N
		147	600	PMOS
	148	40	PMOS	
	4	DG116	600	PMOS
		118	600	PMOS
5	DG123	600	PMOS	
	125	600	PMOS	

System requirements will dictate which of the above combinations are best for your multiplexer combination.

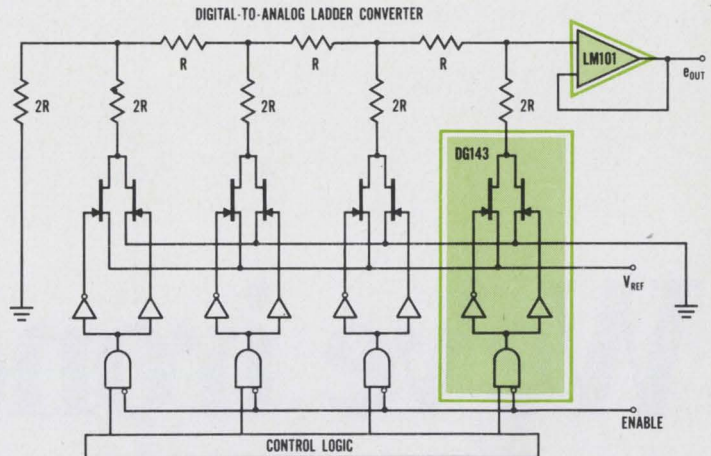

We recommend Junction FETs for this popular digital to analog converter, but if you prefer MOS FETs, we have them, too.

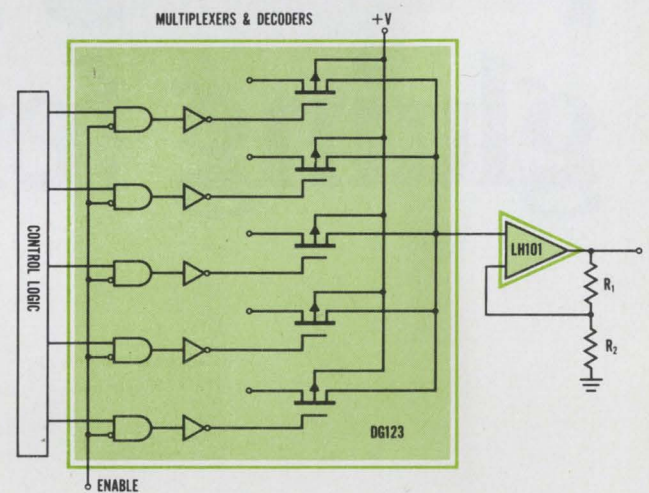

Only one TO-86 package is required to accomplish the above switching functions. Packages include switch drivers that accept standard DTL, RTL, or TTL logic signals.

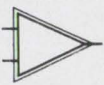
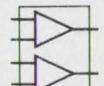
SILICONIX OP AMPS	Max. input offset voltage -55 to +125°C	Max. input current	Min. open loop gain	Output voltage swing	Slew rate	
 LM 101 LH 101 (Internally compensated)	6 mV	200 nA	50K	±12V	.25V/μsec.	<ul style="list-style-type: none"> • Operation from ±5 to ±20V power supplies • Low current drain • Continuous short circuit protection • Same pin configuration as 709 amplifier
 L 120	200 mV	50 pA	100	±12V	20V/μsec.	<ul style="list-style-type: none"> • Low input leakage • High slew rate • Unity gain stable • Ideal for sample and hold, integrating and fast voltage comparisons

Working on data transmission? Write today for complete information on all Siliconix FET switch combinations and OP AMPS.

For instant applications assistance, call the number below. Ask for Extension 19.

 **Siliconix incorporated**
 1140 West Evelyn Ave. • Sunnyvale, Calif. 94086
 Telephone (408) 245-1000 • TWX 910-339-9216

**We've ironed out the
pressing problem of
gluing ferrite parts.**

INDIANA GENERAL *We make it easy for the design engineer.*



Know what happens to magnetic characteristics, costs and delivery schedules when small ferrites are epoxied together to make a large one? It's enough to make you come unglued: So Indiana General's *pressing* them. The results are single piece large parts with dimensions that will open your eyes —and a lot of new design opportunities.

We've already made tubes up to 7" o.d. x 12" long, and 15" tubes with a wall thickness of only 0.250". Solid plates, 6" x 6" x 2". Pot cores up to 7" o.d. And these aren't even our maximum capabilities. Nor our only configurations. For instance, we're working right now on 6½" o.d. flared yokes, and in the future, 10" o.d. x 20" tubes.

Whether your applications involve very low frequency or high frequency/high power, material selection is critical. And Indiana General not only makes single piece large parts; we make them with the "right" ferrites. Our 0-5 is the industry's best material for VLF, due to its high permeability and low power loss characteristics needed for "brute force" demands of denser-than-air media. And we introduced Q-1, Q-2 and Q-3 ferrite materials to the market for HF/HP; they're still the leader.

So instead of looking high and low for high power, low frequency ferrites, look to Indiana General. Where we stick with the solution of magnetics problems to keep them from becoming sticky ones for you. Our coupon brings you further technical information on our large ferrite parts.

Mr. K. S. Talbot, Manager of Sales
Indiana General Corporation
Electronics Division/Ferrites
Keasbey, New Jersey

Let's take a closer look at how single piece large ferrites can make it easier for me.

NAME _____ TITLE _____
COMPANY _____
ADDRESS _____
CITY _____ STATE _____ ZIP _____

RCA Solid-State Data for Designers

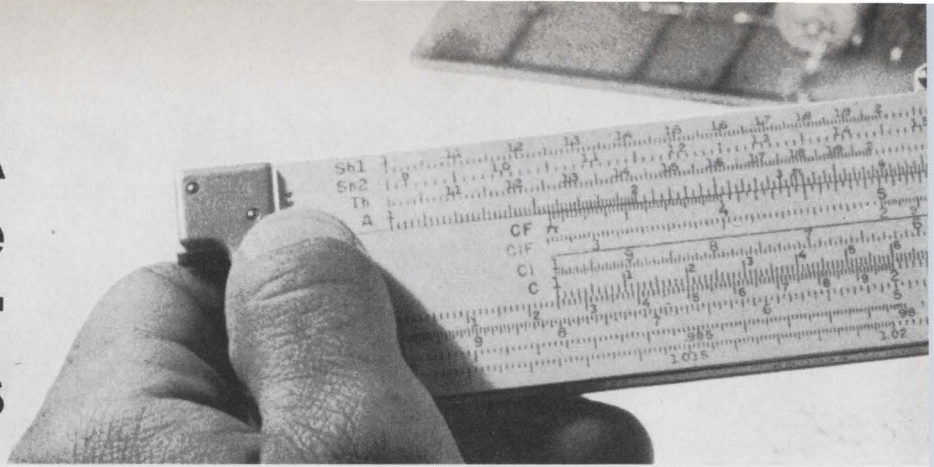

You Don't Have to See the Light... Just Look at the Data for the 40598A IR Emitter

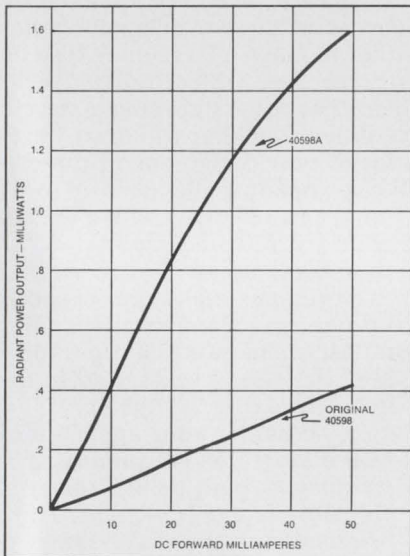

- 3X More Power Than Original 40598
- Same Drive Current—50 mA
- Same Small Package
- Same Low Price

Typical Irradiance on Photodetector

Distance from Photodetector to IR Emitter	Punched Card (mW/cm ²)	Punched Paper Tape (mW/cm ²)
0.150"	15	14
0.200"	10.5	10

Immediate availability in quantity. That's the story of our exceptional IR emitter and the entire RCA line of solid-state GaAs lasers. Each of these invisible light devices offers important electro-optic opportunities in secure communications, intrusion alarms, traffic control, instrumentation, ranging, and field illumination.

For further information, circle Reader Service No. 250.

Match Your RF Power vs. Frequency Requirements

RCA RF power transistors provide equipment designers with the proven advantages of the RCA "overlay" construction in a full line of ever-

expanding commercial and developmental devices. These devices cover frequencies up to 2 GHz and power outputs up to 80 watts PEP.

For your copy of RCA's new, completely-revised RF Power Transistor brochure featuring "overlay" transistors for HF, VHF, UHF and Microwave applications, circle Reader Service No. 251.

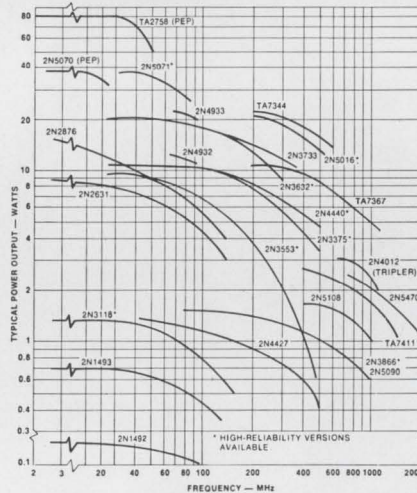

Send for Comprehensive Catalog to Keep Tabs on 98 RCA Thyristors

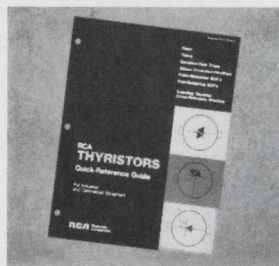

To help keep your controls under control, send for this new RCA quick reference guide to SCR's, triacs and diacs. It's RCA Publication SCR-500B...complete and up-to-date information in handy form for designer use.

You'll find maximum ratings, electrical characteristics and quick reference charts for all 98 RCA Thyristors. There's also a cross-reference directory for more than 175 popular industry types. Look for

application information, too, along with a glossary of terms and symbols from latest JEDEC standards.

Circle Reader Service No. 252 for your copy of the new RCA Thyristors Quick Reference Guide. For specific product information or Application Notes listed in SCR-500B, see your local RCA Representative or your RCA Distributor.

- **READY with superior performance, inherent reliability**
- **READY with off-the-shelf delivery**

Power Gain*	
G _{pe} = 12.5 dB min. @ 450 MHz Gain-Bandwidth product f _T = 1000 MHz min.	
N.F. = 4.5 dB max. @ 450 MHz	N.F. = 3.4 dB max. @ 450 MHz
Ultra-High Reliability 40294	40296
High Reliability 40518	
Military and Aerospace JAN2N2857 40294†	40518† 40517†
Commercial 2N2857	
2N3839	

*Neutralized common-emitter circuit
†Meet performance requirements of MIL-S-19500/343

READY for your critical applications, RCA's well-known, low-noise, communication-type 2N2857 family of silicon n-p-n epitaxial planar transistors will give unmatched performance and dependability in your:

- aerospace and other high-reliability circuit designs
- military communication, navigation and instrumentation equipments
- commercial and industrial instrumentation, control and communication gear

For further information on this family, circle Reader Service No. 253.

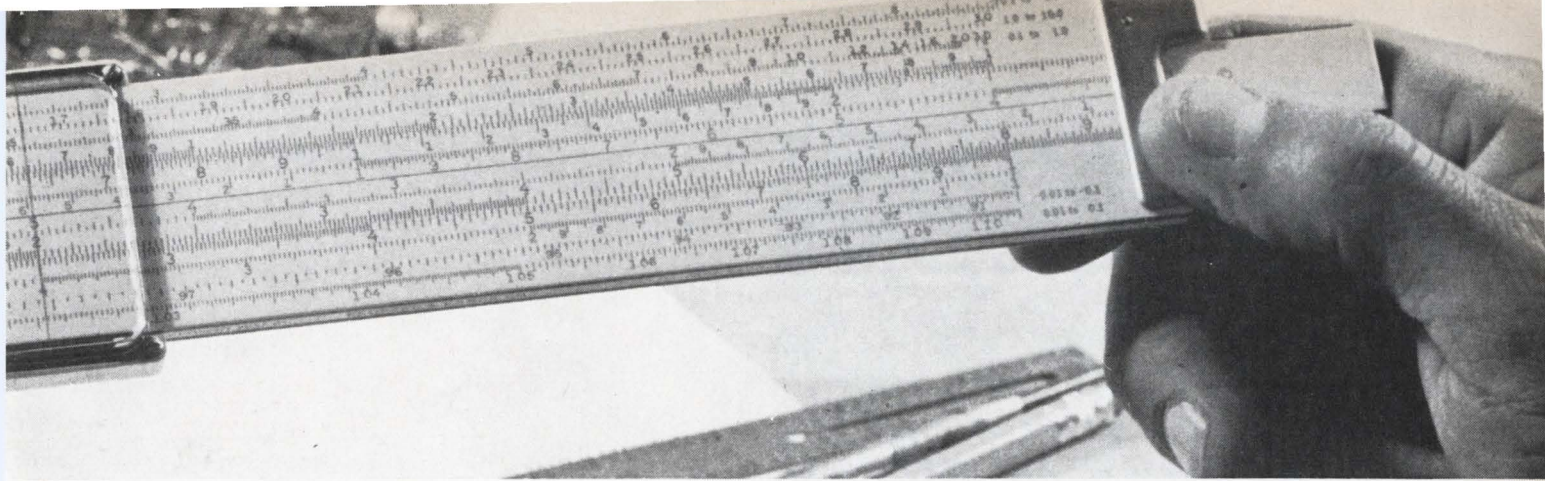

What Can You Do With a 300 W/100 A Silicon Power Transistor in a Modified TO-3 Case?

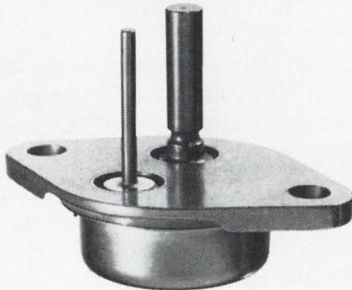

For complete design flexibility, RCA's new 2N5578 family of six high power, high current Hometaxial-base silicon n-p-n transistors is your best lead to military, industrial and commercial equipment applications. Best *three* leads, really! Choose from a new, heavy pin design...soldering lugs... flexible lead with solderless connectors.

All three take you to the same place—circuit cost savings in such uses as inverters, regulators, motor controls and other linear and switching applications. Check the chart for a quick rundown on these six devices. And for further information, check Reader Service No. 254.

Characteristic	Test Conditions			2N5575 2N5576 2N5577		2N5578 2N5579 2N5580		Units
	V _{CE} V	V _{BE} V	I _C A	Min.	Max.	Min.	Max.	
h _{FE}	4		40	—	—	10	40	
V _{CEO} (sus)	4		60	—	40	—	—	V
I _{S/b} ^a	25		0.2	12	—	12	—	A
E _{S/b} ^b		-1.5	7	0.8	—	0.8	—	J
θ _{J-C}				0.5	—	0.5	—	°C/W

^a With base forward biased

^b With base reverse biased and R_{BE} = 10 Ω, L = 33mH

Design Delight—Dual Darlington Diff Amp Arrays

RCA-CA3050 and CA3051 offer designers a significant opportunity to work with the inherent device match of monolithic construction PLUS

building-block flexibility. On a single chip, in a dual-in-line package, each type offers:

- Independently accessible inputs and outputs
- Diode temperature compensation of constant-current-transistor bias
- High input impedance—460 KΩ typical
- Low input offset current—70 nA max.
- Low input offset voltage—5 mV max.

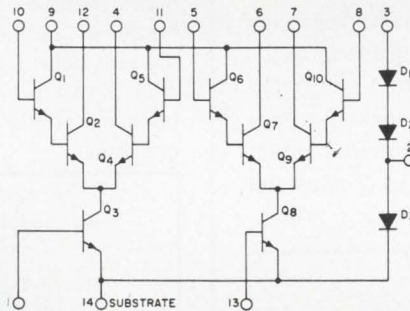

Get the feel of real design freedom with CA3050 or CA3051 for matched dual amplifiers, dual sense amplifiers, dual Schmitt triggers, doubly-balanced detectors and modulators—and anywhere you want matched device performance.

Prices: CA3050 in dual-in-line ceramic, \$2.25 (1000 units); CA3051 in dual-in-line plastic, \$1.65 (1000 units).

Circle Reader Service No. 255 for full technical data.

Using 830 and 930 DTL? RCA CD2300 Series Adds 4 Dual Flip-Flops in 3 Package Styles

Directly interchangeable with 830 and 930 series units, there are now 57 types in RCA's CD2300 Series DTL line. New 24-page technical bulletin, File No. 374, now contains information on all types including:

CD2315—dual JK flip-flop; with separate JK, clock, and set inputs, 6 KΩ pullup. For ripple counter applications.

CD2316—same as CD2315 except for 2 KΩ pullup.

CD2317—dual JK flip-flop; with common clock and clear inputs, with separate JK and reset inputs, 6 KΩ pullup. For shift-register and clocked counter applications.

CD2318—same as CD2317 except for 2 KΩ pullup.

Type numbers above indicate -55°C to +125°C ceramic flat pack. Add

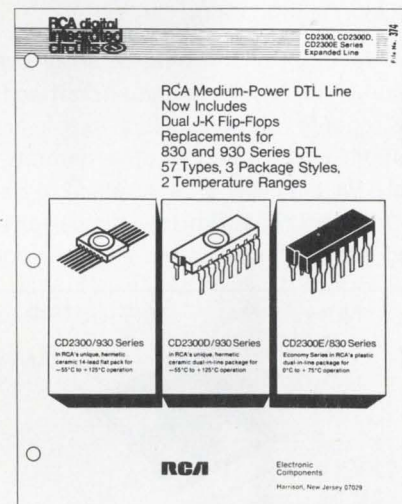

"D" suffix for 14-lead ceramic dual-in-line package; add "E" suffix for 14-lead dual-in-line plastic package for 0°C to +75°C operation.

For information on 57 RCA-CD2300 Series integrated circuits—plus High-Reliability Bulletin #373, covering 38 ceramic packaged types, processed and tested in accordance with MIL-STD-883—circle Reader Service No. 256.

For price and availability information on all solid-state devices, see your local RCA Representative or your RCA Distributor. For specific technical data, write RCA Electronic Components, Commercial Engineering, Sec. No. QN3-5, Harrison, N.J. 07029.



MICROWAVE IC PROGRESS REPORT #7: COMMUNICATION MODULES

Sperry's PACT (Progress in Advanced Component Technology) Program is developing a fully-integrated transmitter/receiver/duplexer module for an airborne communications array at X-band. The program has contractual support from the Air Force Avionics Laboratory, USAF, Dayton, Ohio.

The function of the phased array system is to establish communications between aircraft and synchronous satellite repeater stations, which in turn are linked to a ground station network and to other aircraft. This makes it possible for the crew of an airplane to be in constant contact with anybody, worldwide. Handy for all sorts of missions and indispensable in the event of conflict.

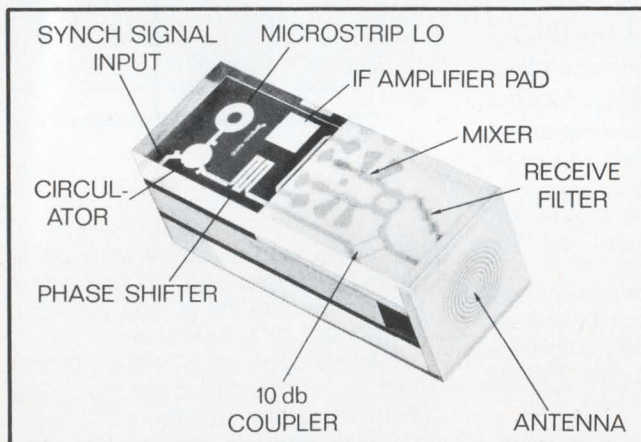

RECEIVER CIRCUIT FOR COMMUNICATIONS MODULE

Within the confines of each phased array element, which is less than an inch square and three inches long, is a complete transmitter/receiver/duplexer. Essentially composed of a signal source, a receiver, a mixer and an antenna, the module utilizes Sperry's advanced thinking throughout.

The rf circuitry is photo etched on metallized ceramic substrates 0.055 inches thick. Conductors are vacuum deposited gold on top of chromium. Follow-up plating produces half-mil thick strips. Transmission efficiency can be gauged by measuring rf energy loss, which, in this case, is no more than 0.15 db per inch.

Transmitter signals are generated by a Sperry Avalanche Transit Time Oscillator (ATTO), discussed in Progress Report #1. Energized by a DC voltage, the ATTO yields a 1-watt CW, X-band signal at an efficiency of 5%.

Sperry's gallium-arsenide Schottky-barrier diodes do the active conversion work in the receiver and the "rat-race" hybrid handles the signal with a single sideband noise figure of better than 6.5 db over a 12% bandwidth. (Sperry hybrid work was discussed in Progress Report #5.) Signal processing and control circuitry design has been materially aided by a Sperry-developed computer program.

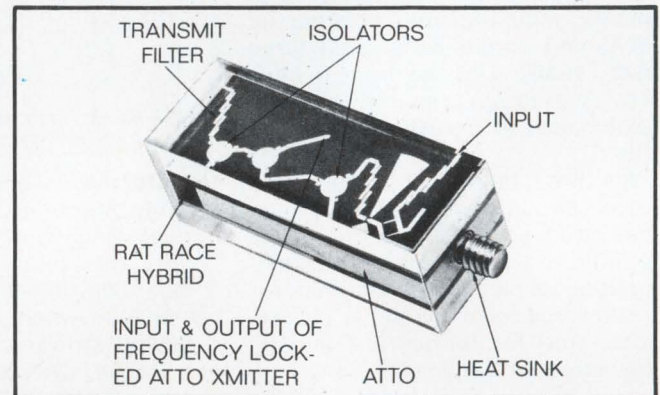

TRANSMITTER CIRCUIT FOR COMMUNICATIONS MODULE

What we have accomplished for the Air Force, we can accomplish for your microwave system, regardless of frequency or operational mode. At Sperry, PACT is more than a clever acronym. Our business is **microwaves**, and our goal is to provide customers with ways of accomplishing microwave functions.

May we hear from you about your system requirement?

*For faster microwave progress,
make a PACT with people
who know microwaves.*

SPERRY

MICROWAVE ELECTRONICS DIVISION
CLEARWATER, FLORIDA

Washington Newsletter

March 31, 1969

Move is on to force U. S. to reshuffle Intelsat delegation

Between now and next November, when delegates to the Intelsat consortium get together again, the White House is going to be pressed to realign the U.S. delegation. Observers both in and out of the Government feel that this country's showing at Intelsat's first session left much to be desired. The U.S. delegates didn't have a definite position on many of the points raised at the meeting, and in some cases didn't agree with one another on the positions that were taken. This divided front reflected a rift between the State Department's representatives and those from Comsat. Explains one observer, "The State Department looks at Intelsat as an arm of U.S. foreign policy and Comsat looks at it as part of its business."

Factions in the Federal Communications Commission, the Office of Telecommunications Management, and Comsat are already pushing for a recomposition of the delegation.

Navy command plane may get a completely automatic radar ...

The Navy wants to automate the overland operations of the APS-111 radar slated for its E2-C flying command post. In its present form, the computer-based system can automatically track targets over water; over land areas, however, its operator has to manually track targets with a strobe pencil. The Naval Air Test Center is now working on the problems involved in adding an automatic overland capability, and study contracts have been let to GE and Hazeltine. The first E2-C planes are scheduled to come off the production line in the fall of 1972.

... and will get passive detectors

The electronics shopping list for the E2-C continues to grow. The Naval Air Systems Command is adding a passive detection system that will zero in on enemy radar and communications signals. The Defense Department has approved this highly classified subsystem, which was not in the original plans for the Grumman-built plane.

Because the Navy doesn't want any subsystem to hold up delivery of the E2-C, Grumman has had to reject some state-of-the-art proposals for the system due to the long development times involved. For the design engineering phase, the company has narrowed the field of potential producers to about four. The first production prototype is due this fall.

The Navy is also considering the system for its S-3A (VSX) antisubmarine aircraft.

ATS-G will have L-band transponder

NASA has definitely decided to put an L-band transponder on Applications Technology Satellite-G. This means there'll be L-band units on three consecutive ATS satellites, starting with ATS-E [*Electronics*, Nov. 25, 1968, p. 65]. The repeaters planned for each of the three birds will be increasingly powerful. As now foreseen by NASA, the repeater on ATS-E will not be powerful enough for voice tests with practical antennas but will be suitable for data transmission tests.

NASA sees L-band as the hope for efficient aeronautical services satellites, and is moving quickly to prove it's right. The space agency is pursuing two concepts for aircraft L-band antennas—directive slot-array units and hemispherical turnstiles—and two satellite-to-aircraft techniques: multipath and direct.

Washington Newsletter

Five jump gun on ERTS bids

Even though no formal request for proposals has been issued, five firms have given NASA informal proposals for the development of an Earth Resources Technology Satellite. They are General Electric, RCA, TRW Systems, Lockheed, and Hughes Aircraft. The unsolicited proposals are an indication of the eagerness of firms to get a crack at the first two satellites, ERTS-A and -B [*Electronics*, March 17, p. 58].

The formal proposal has been written, but it will probably be at least a month before NASA issues it; a number of Government units, including the departments of Agriculture and the Interior, must first review the proposal.

Marks to head Comsat in May

Leonard Marks, a well-known figure in communications circles, will soon take over as chairman and chief executive officer of the Communications Satellite Corp., according to Washington informants. Marks, who last week resigned as chief of the U.S. Intelsat delegation, will be replacing James McCormick, who is stepping down voluntarily. The target date for the changeover is said to be sometime in May.

Before heading this country's delegation to the first Intelsat meeting, where he also chaired the 80-nation conference, Marks was director of the U.S. Information Agency in the Johnson Administration. He was also a member of the President's task force on telecommunications policy.

How Marks' appointment would affect future Comsat policies is not known, but he is said to be vigorously opposed to releasing the telecommunications task force report which recommends, among other things, that Comsat put up a pilot domestic satellite system.

Uhf satellite relays due for a promotion

A major push for deployment of uhf satellite relays for military communications will be made at the June meeting of the Armed Forces Communications and Electronics Association.

Speakers at the Washington meeting will stress that the LES-5 and LES-6 satellite relay test programs have established the technical feasibility of using the 225-to-400-megahertz band, and will claim that "highly reliable" intercontinental communications are thus possible with simple and inexpensive antennas and terminals. Present satellite communications systems use the 4-to-6-gigahertz band. Army, Navy, and Air Force speakers will join those from Electronic Communications Inc., which has been running tests with LES-5 and LES-6 uhf satellite relays.

Addenda

Rep. Joseph E. Karth, (D., Minn.), chairman of the House subcommittee on space science and applications, wants NASA to put more money into supporting graduate students at universities. In budget hearings Karth expressed anger at NASA's cutback in such funding: from about \$25 million annually in 1965 and 1966 to less than \$1 million in the past two years and \$1.3 million for fiscal 1970. The congressman was especially upset by the cuts because his committee hadn't been informed about them. The committee might end up putting more money into the program than NASA asked for the coming year. . . . The FAA's sharpest critic is not satisfied with the agency's proposal to require crash-locator beacons on "air taxis" and small commercial aircraft. Rep. Richard Ottinger (D., N.Y.), wants the devices on all aircraft—especially commercial airliners [*Electronics*, March 18, 1968, p. 70]. Ottinger, who has submitted a bill to this effect calls the FAA plan "too little and too late."

High-speed programmable dc power supplies \$178⁰⁰

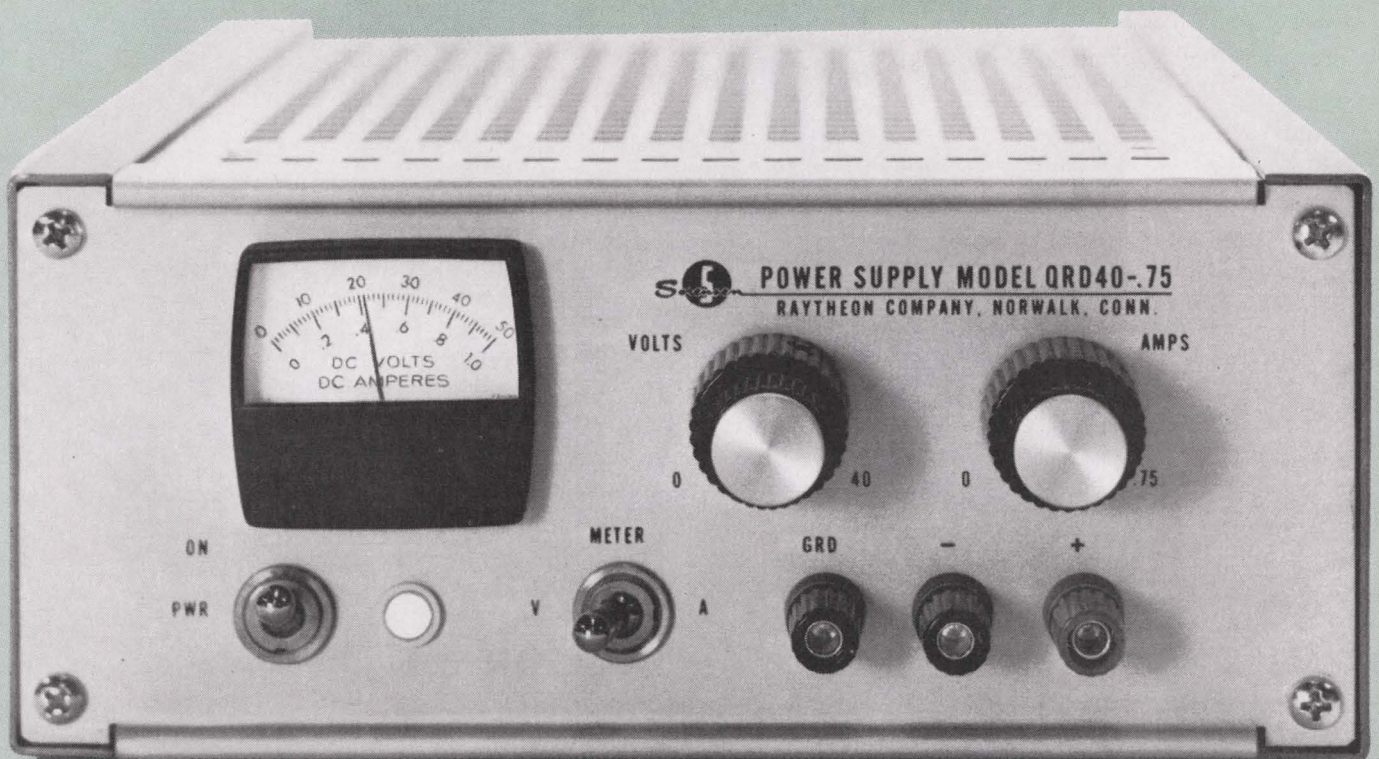

The QRD Series of precision power supplies is composed of seven off-the-shelf models covering the range of 0-60Vdc at current levels up to 4 amperes.

In the high speed programming mode the QRD's performance is unmatched — less than 10 microseconds for a step change of $E_{max.}$ to 0! The capability of being programmed by resistance, voltage or current signals to frequencies of 100kHz makes the QRD Series unequalled in digital, microcircuit testing and servo system applications.

Other features include: ■ $\pm 0.005\%$ voltage regulation ■ $200\mu V$ r.m.s (3mV p-p) ripple ■ automatic crossover between

constant voltage and constant current operation.

Send *your* high-speed programming power supply specifications to Sorensen, today, for the optimum solution of your modular, bench or rack mounted power supply problem.

For more information contact your local Sorensen representative or; Raytheon Company, Sorensen Operation, Richards Avenue, Norwalk, Connecticut 06856.

Tel: 203-838-6571;
TWX: 710-468-2940;
TELEX: 96-5953.

RAYTHEON



Circle 200 on Inquiry Card

Monolithic logic today.
Monolithic systems tomorrow.
We've got ideas to deliver.

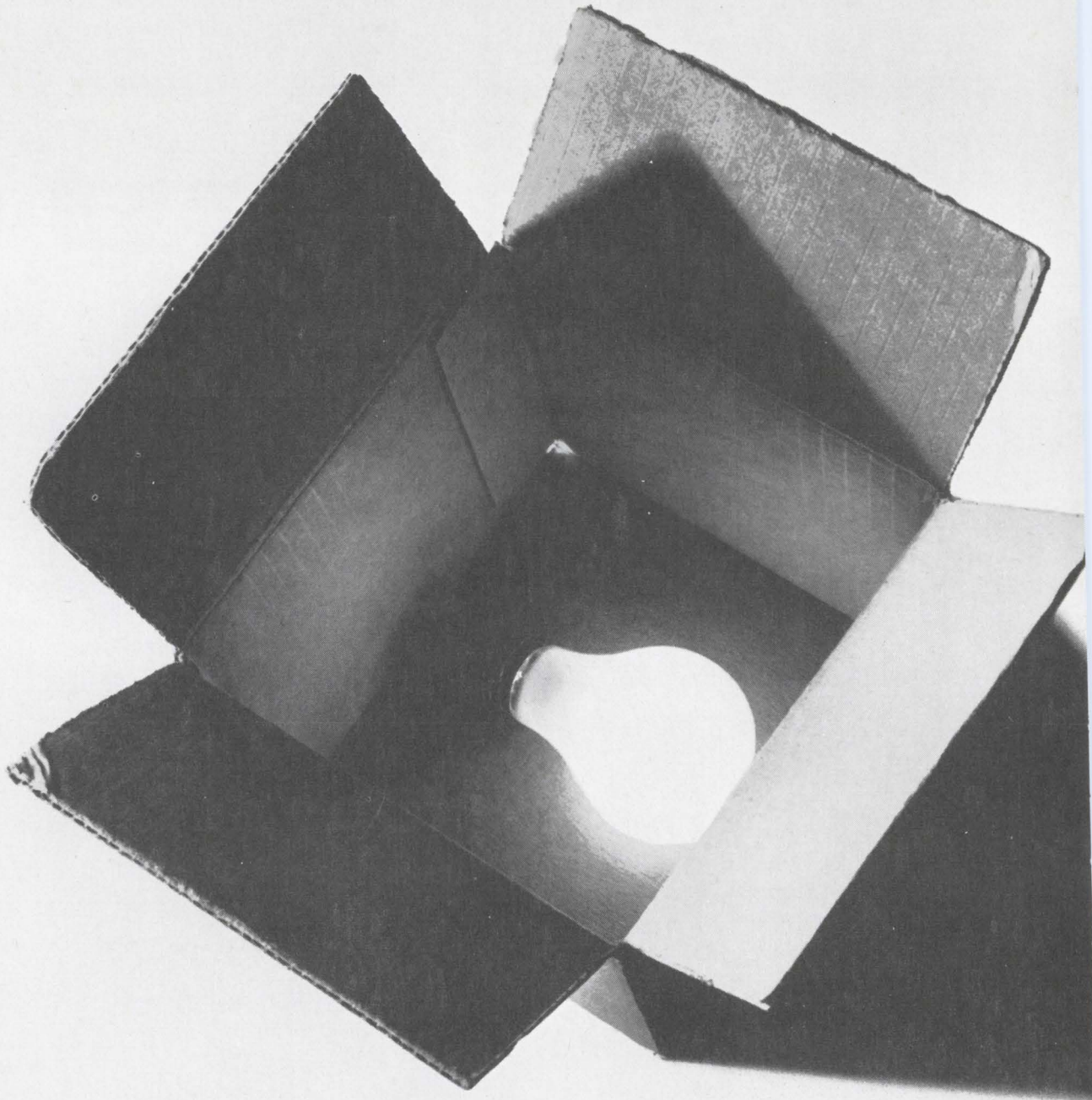

Many wafers ago Raytheon drafted a blueprint for success in the semiconductor industry. It's drawn around some very sharp idea men to nudge the state-of-the-art ever forward. Plus a production line that can turn ideas into products and pour them out en masse and on time. Here's a roll call of results, delivered and on the way.

Products for now

DTL: Over 95 circuits in Series 200, 930 and 1000.

TTL: More than 100 circuits in our industry's-fastest Ray III, and our SUHL-equivalent Ray I and II.

MSI: We're booming in TTL types, with 18 production circuits based on Ray I and II, 54/74 and 64/84 logic. And more coming fast.

Linears: Industry's broadest line of popular types. 17 circuits, including standard and 'A' versions of 100, 4100, 700 and 4700 Series.

Transistors: More than 400 standard and high-rel mil types. Switches, drivers, choppers. And amplifiers—general purpose, low level, high frequency, differential, dual and Darlington.

Diodes: 1800 types of switching and general purpose diodes, ranging from IN91 to IN4308, at speeds down to 1.0 nanoseconds.

And ideas for tomorrow

But the best is yet to come. Here's what's cooking for delivery within one year.

Beam lead, of course. Plus 2-layer metal interconnects. 64-bit random access memories.

256-bit read-only memories. Multi-chip memory arrays. Very high speed logic.

High speed NPN and PNP single and quad core drivers. Monolithic diode arrays.

RF transistors.

And we've got even brighter things docketed for a little more distant delivery.

Advanced packages—up to 78 leads, using beam lead and multi-layer substrates.

Bipolar and MOS LSI. Computer-controlled LSI design. Radiation hardened circuitry.

Low power ECL MSI.

Just promises? Not so. We're working on everything on that list, logging day-by-day progress toward production. So keep your eye on us. Because we intend to be getting the ideas—and delivering them—for a long time to come.

Browse through one of our detailed, just-completed catalogs. Yours for the asking. Raytheon Semiconductor, Mountain View, California, (415) 968-9211.



CONTROL DATA

C O M P U T E R S Y S T E M

6634



We made a tiny contribution to their esprit de core.

Or rather, our microminiature connectors did.

And it's a sophisticated memory core, too—the Extended Core Storage (ECS) System, for the huge #6000 Series computers of Control Data Corporation.

One of the largest and most powerful computers built, the #6600 has a transfer rate up to 10 million words per second to and from central memory. And the ECS will handle up to four of these computers at once.

We supply 11 different special microminiature connectors for the ECS. This includes various sizes and configurations of our basic 50-MIL STRIP connectors, supplied on a harness for interconnection between all the memory planes. Over 1,000 connector assemblies per system.

These connectors feature the 2 things most required by a computer: high density and exceptional reliability.

Both are achieved by the unique, MICROPIN® twisted pin* contact. This flexible twist pin allows .050" centers; gives 7 spiral lines of contact; will mate under the most severe misalignment; and maintains contact during intense vibration and shock.

This type of advanced design interest you? We can cover just about any need you may have in rectangular,

circular, edgeboard or strip with our microminiature connector corps: MICRO-D; MICRO-K; 50-MIL STRIP; CENTI-K; and CENTI-LOC.

For further information, write ITT Cannon, 3208 Humboldt Street, Los Angeles, California 90031. A division of International Telephone and Telegraph Corporation.



* Licensed by New Twist

CANNON ITT

Powerful Computing Genie: \$4900

READY, WILLING AND ABLE.

Ready—to relieve you of waiting to get on the big computer. Constantly available. At your fingertips whenever you need it. Ready to abolish tedium from scientific and engineering computation. Ready to slash through long routines and come up with answers in milliseconds.
The new Hewlett-Packard 9100A personal computer.

Willing—to perform log and trig functions, even hyperbolics and coordinate transformations, at the touch of a key. Willing to work with extremely large and small numbers simultaneously. Willing to take your programming commands in mathematical language. No computer language or programming specialist required. Willing to communicate with you on *your* terms.
The new Hewlett-Packard 9100A computing marvel.

Able—to take on the most complex problems: roots of a fifth-degree polynomial . . . solutions to three simultaneous equations . . . Bessel functions . . . Fourier analysis . . . elliptic integrals . . . real and complex polynomial evaluation . . . coordinate geometry . . . regression analysis . . . numerical integration . . . vector analysis . . . and many, many more!
Able to be your fast, responsive mathematical servant.
The new Hewlett-Packard 9100A electronic genie.

This major computing capability is compressed into one 40 pound package. Its only moving parts are the keys, the switches and one decimal wheel. No noise.

The 9100A computing genie is being delivered *NOW*, with an extensive—and growing—program library that puts you in control.

Examine the keyboard, question every key and switch. Then decide to command the computing genie. A telephone call or purchase order directed to any HP Sales and Service Office (in principal cities throughout the world) will start the executive process. If you are still skeptical, or of faint heart ask for a demonstration. It will affirm, assure (and only slightly delay) your entry into the solid-state of personal computing power. Be a Master.
Hewlett-Packard, Box 301,
Loveland, Colorado, 80537;
Europe: 1217 Meyrin-Geneva,
Switzerland.

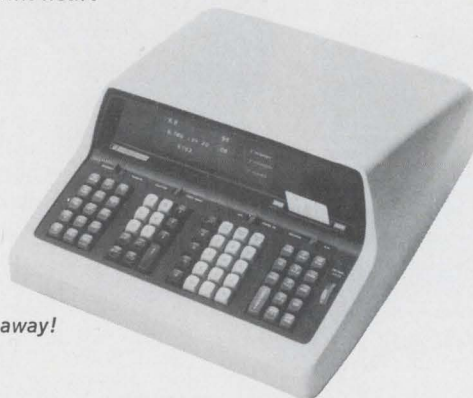

9100A puts answers just a touch away!

HEWLETT  PACKARD

754.8387	z temporary
5.338 845 815 05	y accumulate
33.50	x keyboard

Dynamic range 10^{-98} to 10^{99} , nearly 200 decades. Observation of math operations on 3 displayed registers. Up to 16 more registers for data storage.

TO
POLAR

Complex and vector arithmetic simplified with coordinate transformation keys, rectangular-to-polar and vice-versa, in milliseconds.

tan x

Trig functions covering all quadrants and any size angle in degrees or radians.



Up to 196 program steps, each a simple key stroke. "IF" keys permit looping and branching flexibility found only on large computers.



Edit programs easily. Single-step through programs to check and de-bug. Address an individual step and make corrections without re-entering the entire program.

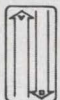

Program from the keyboard. Record and store programs on credit-card-size magnetic cards for repeated use.

Designed for expansion. Printer, plotter, electrical data input/output will become available.

*the only
IC Decimal Counters
available!*

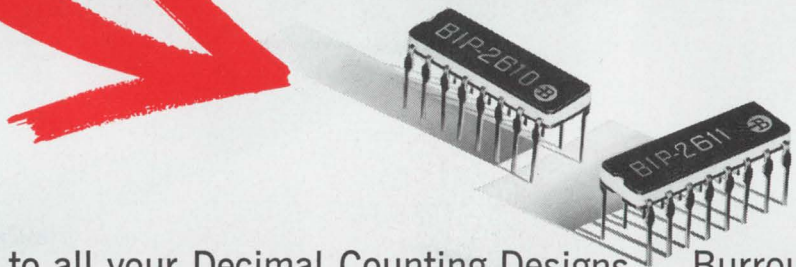

An Economical Approach to all your Decimal Counting Designs. Burroughs' new dual-in-line packaged decimal counters were designed to satisfy an industry need for a low-priced, highly-reliable, IC decimal counter that would replace the two packages now required to provide a decimal count. This Burroughs innovation fulfills these requirements through the use of 10-stage SCS ring-counter logic and provides the extra advantages of high noise immunity, (up to 6V peak); preset inputs; re-settable to any number; plus the inherent advantages of Bi-polar MSI. Designed for applications with 12 volt logic, this new hermetically-sealed counter is available in two configurations: **the BIP-2610, designed with output voltage sufficient to directly drive a NIXIE® tube, and the BIP-2611, a lower-cost unit designed with output voltage sufficient for all applications not requiring a NIXIE tube readout.** Call or write Burroughs Corporation, Electronic Components Division, Box 1226, Dept. C1, Plainfield, N.J. 07061. Tel: (201) 757-5000.

Burroughs



Technical Articles

**LSI and systems:
the changing interface**
page 78



As the discrete-device maker becomes a producer of complex integrated circuitry and, in effect, a subsystem supplier, his relationship with the customer—the systems manufacturer—is undergoing a fundamental shift. Unless LSI logic can be standardized—and there's still a possibility it can—systems houses will insist on playing an increasingly active role in the design and manufacture of IC's. Even at this early stage of the game, such companies are developing in-house facilities at least capable of making prototype circuits. For the cover, art director Jerry Ferguson took a shot of a 2,048-bit MOS read-only memory built by General Instrument and overlaid a jigsaw puzzle to suggest the current flux.

**IC's break through the
voltage barrier**
page 90

Dielectric isolation, which permits the use of high-resistivity substrates, and a field plate that neutralizes positive surface charges make it possible to fabricate integrated circuits with breakdown voltages of better than 300 volts. With this technique, yield is enhanced and components can be more densely packed than is possible in comparable p-n junction circuits. So far as costs, therefore, dielectrically isolated circuits compare favorably with commercial p-n junction units having lower breakdown voltages.

**Positive results
from negative feedback
in active filters**
page 96

Active filters to which positive feedback is applied require fewer components than those using negative feedback. Unfortunately, however, such circuits tend to oscillate. But now integrated circuits with many active devices on a single chip are commercially available, making it both practical and economical to design stable negative-feedback filters.

**Log diodes
can be counted on**
page 104

Semiconductor technology has reached the point where diodes with specified logarithmic voltage-current curves can be turned out in quantity. Purchasers can thus use these units in simple circuits to perform computing functions without going through the laborious process of testing and matching them.

**Squeezing size and cost
in microwave IC amps**

Coming

Uhf and microwave power amplifiers can be built with lumped passive elements designed as if they were to operate at lower frequencies where distributed reactances are no problem. The development promises cheaper and smaller circuitry.

LSI | The and | changing systems | interface

Large-scale integration is turning IC's into subsystems
and blurring the separate identities of IC firms and systems houses

By George F. Watson

Associate editor

Go inside many a plant these days and you'll be hard pressed to decide whether you're at a systems house or a semiconductor device manufacturer. There are diffusion furnaces and mask-making equipment at the systems company and systems engineers working with block diagrams at IC firms. Causing this blurring is the ever increasing complexity of the large-scale integrated circuit, as LSI moves farther into the subsystem level.

It's not clear how things will finally shake out, but there's no doubt that the relationship between the IC user and supplier is undergoing a fundamental realignment. Most of the activity is in the big systems house currently, but it's only a matter of time before this changing interface affects every company building equipment.

In some cases, the suppliers are turning over a greater portion of the design task; in others, they are retaining the IC design function but making it easier—by means of computer-aided design—for the systems designer to interface with them. But the most significant response is the trend of systems houses setting up their own IC fabrication facilities.

Who should design and fabricate IC's, after all? They are semiconductor devices, and the traditional semiconductor houses tend to feel proprietary toward them. But they are subsystems too, and the systems houses are reluctant to relinquish their traditional prerogative.

The position of the interface depends on the particular combination of user and maker of IC's.

In some instances, the design may be done entirely by the IC vendor; the systems house merely furnishes performance specifications. Or the customer may do the entire design, furnishing the supplier with a composite diagram or masks of the IC. Or the systems house may even go so far as to use its own IC production line to make circuits.

The systems houses are now assuming more and more of the responsibility for designing IC's. Whether this trend will persist depends on how successful the IC makers are in developing standard, off-the-shelf LSI circuits and persuading their customers to use them.

So far, only memories and similar repetitive circuits appear to be amenable to standardized LSI. Michael Callahan, director of IC research and engineering at Motorola's Semiconductor Products division, for example, believes that there will be some, but not many, standards in LSI. The general logic control function won't become standardized, he says. "The bulk of computer arithmetic units, for example, will be custom, but memories will become pretty common and fairly standardized, as will shift registers," he asserts. "These have very high component counts and are really LSI devices, but they're used by many customers."

But with the advent of read-only memories—which can be used to perform control logic functions—this could change. ROM's may profoundly influence the design interface, shifting it toward the IC maker again. Robert N. Noyce, president of the Intel Corp., says he is fascinated by the

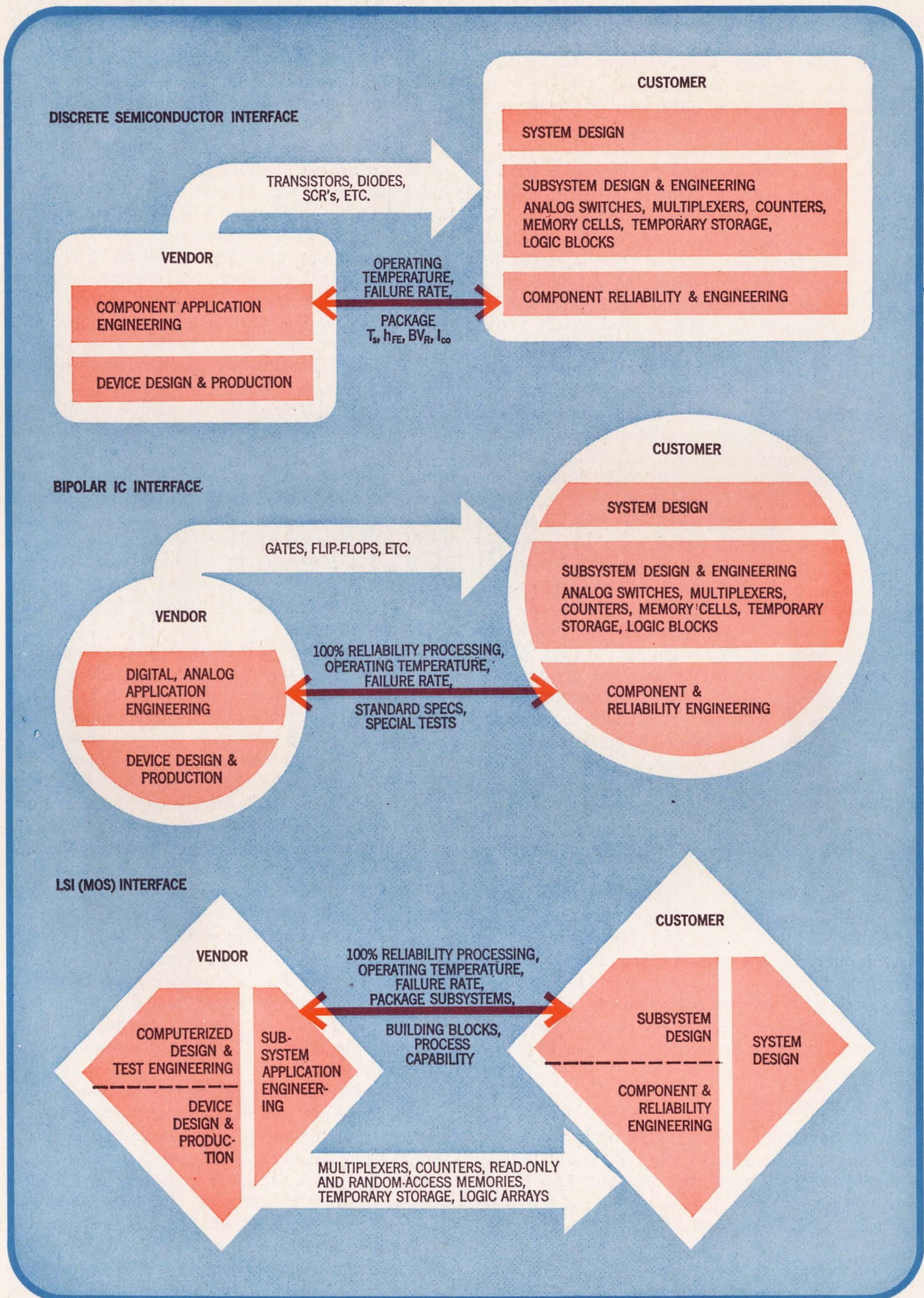

Change. As semiconductor devices have become more complex, the vendor's responsibility has come to resemble what was formerly the customer's. However, the customer has a much greater influence on the device design—at least in MOS LSI.

ROM approach, although he is not yet sure that it is practical. "Memories are easy to interface," Noyce says. "But what about the rest of the system, the control logic?" In the absence of standard modules, control logic requires expensive custom design. "But there is another route, which is to treat control logic as a huge read-only memory, in which you do microprogramming, and then standardize on the rest of the machine".

The goal is to replace random logic with orderly arrays of iterative stages, with each stage leading to a ROM that provides the instruction for the next stage. "Designing the ROM is the same as designing the computer," Noyce says. "You get the wiring pattern of the computer and duplicate it as the ROM. This overcomes my major objection to LSI—that design costs will kill you."

Whatever the role of standardized LSI in the future, LSI is designed and manufactured on a highly customized basis right now. The experience of Richard A. Stokes, manager of planning at Burroughs' Electronic Systems organization, is representative. Burroughs required LSI circuits (more than 100 gates makes a circuit LSI by Stokes' definition) for the Illiac 4 computer.

Stokes' group selected word-axis instead of bit-axis partitioning for the LSI circuits. Even though bit-axis partitioning results in fewer interconnections, Stokes feels that the word-axis approach is preferable because it's cheaper; fewer circuit designs are needed. "We were able to develop a more general family of LSI chips," he says. "Having the semiconductor manufacturer execute the partitioning by making all the necessary interconnections on a given substrate is really a major investment in time and money. In each case, minimizing the number of different kind of chips minimizes the engineering investment." The same applies, of course, to testing.

Pointing out that "we were not sure there was a viable LSI technology available" at that time, Stokes reports, "We started at ground zero and we did an initial logic design—in terms of registers, adders, multipliers, things like that." This logic design was a rough blocking out, since the logic family had not yet been selected. "Then we looked at families" and selected a vendor whose approach to LSI seemed most feasible. The vendor "sent in a group of very capable people who pretty much lived with us as we set about partitioning," Stokes says.

Staying uninvolved

So far so good: "About 80% of it went very fast because the partitions were obvious." But the Burroughs-vendor team spent "about 90% of our partitioning time on that last 20%. The control part of it was the one that we had the problem with."

Nevertheless, the group arrived at an initial partitioning, although it was "completely untried and untested as to what one might do on a piece of silicon," Stokes says. The vendor took the designs,

"made a few false starts," spent six months in laying out the masks, and then further developed the chips. "As we found we couldn't do certain things, there was iteration at partitioning, there was iteration at the chip layout," Stokes reports, "and then iterations from the final performance of the chip—from the partitioning back to the logic."

Often the vendor prefers to stay uninvolved in the circuit design as much as possible. The General Instrument Corp. is one such semiconductor manufacturer. GI has about 140 people working on MOS circuit design. According to Art Sidorsky, product marketing manager, "Most of these people were systems engineers and circuit designers who had to learn about devices when they came to GI." They work with the customer to implement his requirement, and their starting point can be a logic diagram, black-box specifications, or anything in between.

But rather than tie up the company's own design personnel, GI likes to have the customer do most of the design, from black-box specs, to logic diagram, to schematic, to operating schematic (containing a generalized layout of the components), to a composite diagram. GI then uses the composite to make the masks for the IC. GI engineers can teach a customer the ground rules for the design—in a few days, according to Sidorsky—so both the customer and the supplier are speaking the same language.

For circuits of its own design, GI uses computer-aided techniques that generate a punched paper tape, which is then used to drive an automatic mask-making machine. (The program that's used to generate the mask-making tape simultaneously generates a tape to program GI's automatic testing equipment.) "The ideal case," says Sidorsky, "would be to have the customer use the same program, so that when he wants a new circuit, he produces a tape that we use to make the masks and test the final product. This will not only speed up the design process but also save the customer money because he's not tying up our design people with details of the circuit design."

GI now has offices in New York, Salt Lake City, Los Angeles, and Scotland where a customer can have his composite diagrams turned into tapes or masks. The people at these locations can also assist the customer with the chip layout and the composite diagram.

The philosophy at Hughes Aircraft Co.'s Newport Beach, Calif., division is essentially the same as that at GI; engineers give the impression that they're delighted to have the systems house do the bulk of the work. (Hughes is gathering considerable momentum in complex MOS arrays, so the division's viewpoint is that of an IC vendor, not that of a systems house.) Says Jack Hirshon, division manager, "Our philosophy is that the systems people know systems performance characteristics and are in a better position to partition their designs into subsystems that a vendor will make. We

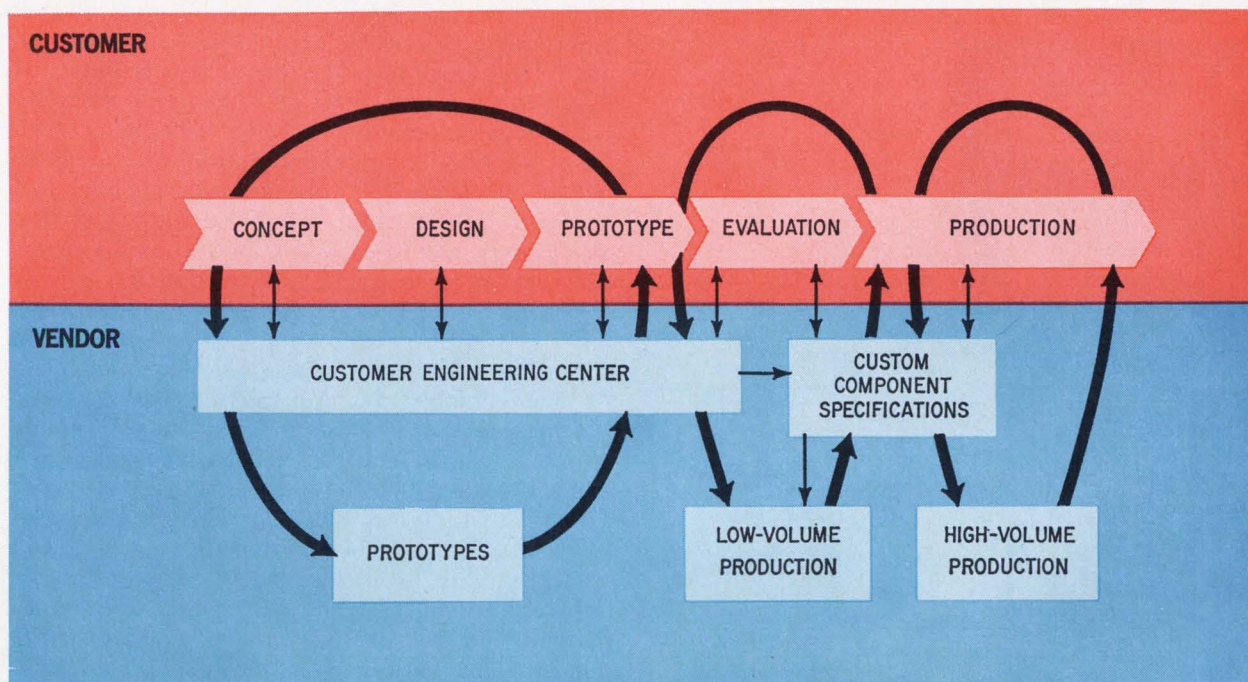

Looped. Texas Instruments uses the three-loop concept in its relations with systems houses. The light-colored arrows represent the typical design cycle through which a system passes in the systems builder's house, from initial concept through production and delivery to the end-user. The dark-colored areas represent activities at TI. The slender arrows show communication between the systems builder and the IC manufacturer. The broad arrows—the loops—indicate the flow of software and hardware between the segments of the customer's and the vendor's activities.

furnish design rules that include line widths, component spacing, and crossover considerations." Hughes also provides a library of building blocks that can be interconnected to form read-only or random-access memories, certain kinds of shift registers, and some random logic.

Texas Instruments' policy of participation with the customer is perhaps more representative of the industry. According to Jack Kilby, manager of the customer requirements center at TI's components group, "Our present mood is to encourage the systems house to participate fully with us. We want them to work closely with us in the actual circuit design. We think this work takes a closer customer-device maker relationship than one of just mailing specifications back and forth. We think this will continue to be our position."

Kilby has reservations, though. The systems house will be content to let the circuit maker devise designs "to the extent that we can save him money while providing him with performance gains." The big thing, he says, is economics; he says the IC maker can now show customers money savings in the beginning on complex custom circuits and extend the lure of even lower costs as orders increase "because we can have more automation." Says Kilby, "That is the key factor."

Rudolph Thun, manager of the microelectronics department at Raytheon's Missile Systems division and technical director of the Components division,

describes what he considers an ideal working relationship: "Systems designers should model circuits as best they can to see if they will work." They should then supply the IC maker with a schematic, the models, and full transistor characteristics. Finally, the customer should provide "a set of black-box specs and be prepared to yield a little on design, and perhaps some on performance-cost relations as well."

Hedging bets

Whatever the interface favored by the semiconductor manufacturers, there is no question about the direction in which the systems houses are moving: they are setting up their own microelectronics fabrication facilities. In most cases, the systems houses disavow any intention of competing with the established suppliers. Nevertheless, it's clear that, by learning IC technology first-hand, they intend to exercise greater influence on design and fabrication.

The reasons for establishing in-house capability are varied and complex. Perhaps the most common motivation is simply a desire to get the job done. Lockheed's Missiles and Space division can serve as a good example. Several years ago, when hybrid IC's were considered advanced technology by the component manufacturers, the division needed 300 such circuits built to the company's own specification. Lockheed awarded the contract to one of

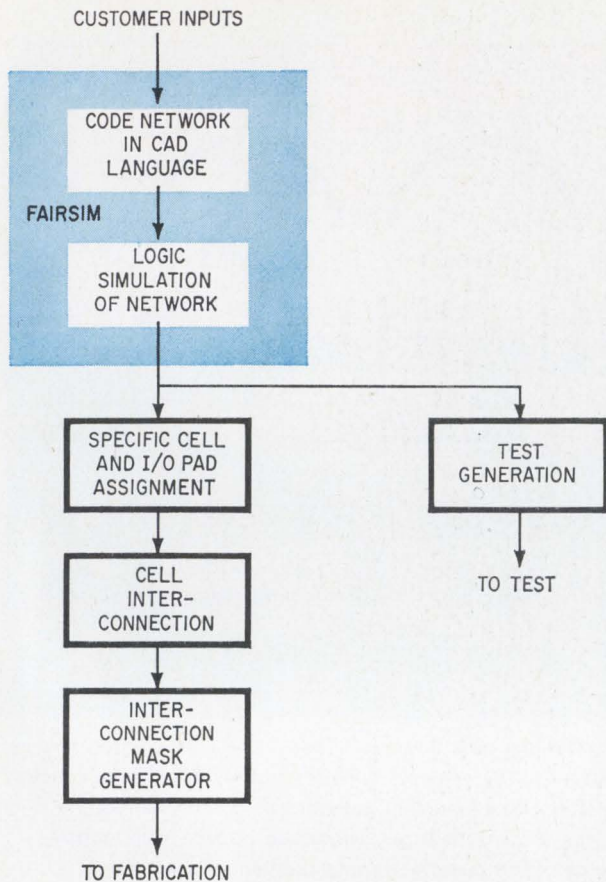

Fair similitude. Fairchild's Fairsim program for computer-aided design of LSI and MSI circuits may eventually be linked directly to systems houses.

the large semiconductor firms for less than \$50,000—\$158 per circuit.

A year later, the semiconductor house was staggering eight months behind schedule. At an emergency conference, an executive vice-president of the semiconductor supplier told Lockheed: "I have no product to sell." Despite \$400,000 spent to develop the hybrid quad output driver, the company had to concede that it couldn't build the circuit.

Finally, after three of the big semiconductor firms had tried to make the circuit, a fourth succeeded.

It was about then that Lockheed started to think about getting into microelectronics design and fabrication itself. The company finally took the plunge and it's now firmly committed to prototype and pilot-line production of hybrid and monolithic IC's.

And other companies, such as Martin-Marietta, Autonetics, Boeing, TRW—apparently every major systems house—have found it expedient to encompass a significant part of fabrication within their own organizations.

As with Lockheed's star-crossed circuit, the IC supplier may be unable to do the job technically. Or he may not want to handle a small-quantity order. Engineers at the Lockheed division are par-

ticularly nettled at this reluctance of major manufacturers to make limited production runs of custom devices. Lockheed's programs, officials say, are mostly small-quantity; except for Polaris and Poseidon programs, most of Lockheed's work requires only one-of-a-type IC's for each space vehicle or satellite. A large order is rare for satellites; indeed, officials recall only one program that had a "large" order; each of five satellites had two block boxes, and in each box there were 10 identical circuits, for a grand total of 100 IC's. "Now you go to Fairchild or Texas Instruments and ask them to run off 100 circuits for you and they're not really interested," says a Lockheed engineer. "The only thing that will induce them to make this run for you is if the device happens to resemble something they've got going in Research and Development and they think they can get a little subsidy for their R&D work." Therefore the systems house often has no choice; it must do its own development.

Another problem influencing systems houses to develop their own microelectronic capability is the difficulty of two-way communication. The semiconductor houses sometimes just don't understand the user's need, or vice versa. "When you try to be cute with a maker," observes William F. List, manager of molecular systems at Westinghouse's Aerospace division, "and not tell him what the circuit is intended for, you can wind up in trouble. For example, the maker naturally tries to make the circuit cheaper and more efficient and may change the design a little while still meeting specs. He may meet specs, but the device won't plug into the system because it throws the parasitic components off."

Burroughs has found that it works the other way, too; by adhering blindly to specifications, the vendor may impede the development of an IC. In interfacing with a vendor during the development of LSI circuits for the Illiac 4 computer, Stokes was "surprised at the way semiconductor people take certain logic designs as absolute gospel. In many cases, the interconnections you make are very much arbitrary—only one of several ways of doing it." To stick with only one way of designing the interconnections may be contrary to the best interests of the LSI partitioning. In the Illiac 4, of course, circuit speed is critical, and one of the design rules suggested to the IC vendor was that the least significant bits in a word be processed first to minimize delay. But a combinatorial logic unit works backwards: it starts shifting the more significant position first. "You can delay the least significant positions a couple of gates later," Stokes says. When the vendor's engineers got to this kind of circuit, "they agonized over that partitioning because of the delay" that resulted when the least-significant digit priority was observed, "without the knowledge that we could just as easily look at the most significant bits first," Stokes adds. "When that came to the fore, the whole problem was solved."

And the separation of more than 1,000 miles between user and vendor didn't help communication. "I can't overemphasize the need for absolute intimacy," Stokes says.

The systems companies like the short lead time that an in-house microelectronic facility affords. Lockheed, for instance, can get its new circuits fabricated "virtually overnight," according to a spokesman.

"There are a lot of other intangibles" that an in-house facility provides, says Dale Hartman, who is setting up such a facility for Martin-Marietta in Orlando. "For instance, technical image. If you're competing for a big proposal, and have a review team coming in, if you don't have a basic capability in microcircuits today, I feel that your technical image suffers."

Probably, however, the fundamental reason that the big firms are rolling their own is simply that they want to preserve their traditional role and protect against incursions of IC suppliers into the heart of the systems design activity. If this process were carried to its logical conclusion, the microelectronic supplier would assume the task of systems design and the systems house would become merely an assembler.

To prevent this, many companies believe that the design engineer must become personally involved in the new technology; he must go into the lab and make the circuit, because he'll understand only by doing the job himself. "The designer can't really conceive in this business without having a personal feel for it. That's why we've invested in our microelectronics facility at Lockheed," says Julius Y. Kaplan, director of engineering at the Military Systems division of Lockheed Electronics.

One of the by-products of in-house electronics, many systems manufacturers feel, is that it aids in buying components intelligently. The buyer who understands what he's buying can strike a better bargain. "Let's face it," Kaplan says, "price is not a manufacturer's cost plus a reasonable fixed fee. Rather, it's what the market will bear. Helping a systems house to gauge his supplier's costs should more than pay for a microelectronics facility, even if this were the only benefit."

(Semiconductor manufacturers, incidentally, scoff at the notion that a line for fabrication of prototype IC's will give even a remote indication of production costs.)

Trust and prudence

Finally, there's the competitive advantage that design control provides. To stay in the running—to maintain their identity—in the competition for systems contracts, most manufacturers are convinced that they must originate some of the IC's they use. Westinghouse's List cites shift registers with correlation, which his company developed and will soon use in systems. Westinghouse, he says, has a three-year lead on the company that waits until such circuits are available as a catalog item. "The key is that it's very important for a

successful systems maker to focus on what to put into the product to make it sell. You don't have to make 99% of the IC's that go into your systems to keep up. You can buy a certain number off the shelf, but you can't buy all of them because the competition could buy the same," List says.

One of the reasons often given in the past to justify in-house microelectronics—protection of proprietary circuits or processes—appears to have little real significance. A Hewlett-Packard spokesman sums up the feeling of most systems houses: "In general we get along well with the IC manufacturers; we tell them a great deal about what we mean to do with their circuits, but not everything. There have been no cases where we feel an IC sales engineer has spilled our secrets." By and large, the systems houses don't see much benefit resulting from extreme attempts to preserve proprietary rights when they work with vendors; at best, they can only buy time. The prevailing attitude seems to be trust, with a dash of prudence, in dealings with vendors.

Vendors, on their part, are determined to merit their customers' trust. First, IC suppliers recognize that they have a position to protect; they can lose that position if they don't respect confidential information. And John A. Ekiss, manager of the circuit development department at Philco-Ford's Microelectronics division, points out that while the customer may indicate that information is proprietary, the semiconductor vendor often doesn't know why. The information might relate to a new system organization, for example, which the vendor would have no way of evaluating. "The semiconductor vendor does not want to capitalize on the fact that information is proprietary," Ekiss says. "What would he do with it?"

Thun, the Raytheon manager, concurs: "As far as systems information is concerned, component manufacturers are very ethical. I've never seen a leak."

TRW's position, however, is somewhat different. The company's policy is to share innovations if they are modifications of standard circuits. "But if a circuit gives you a competitive edge in a system, only a fool would let the design get out of the house," says Ben Duwaldt, manager of TRW's microelectronic center. "If you have a hot idea, you'll do everything possible to protect it, maybe even setting up a special in-house shop to develop it." (This shop would be in addition to the existing in-house semiconductor facility.) TRW hasn't been burned by semiconductor suppliers on proprietary designs because it hasn't let them get outside the house for production. "It's pretty rare that we have to go outside the TRW family for production quantities, so it's not difficult to protect a design" points out James Bowie, head of the microelectronic center's technology section.

The center designs, but doesn't make, its own masks. Bowie requires a guarantee from the mask maker that he'll keep the design confidential and return all masters. "But trust enters into it, too,"

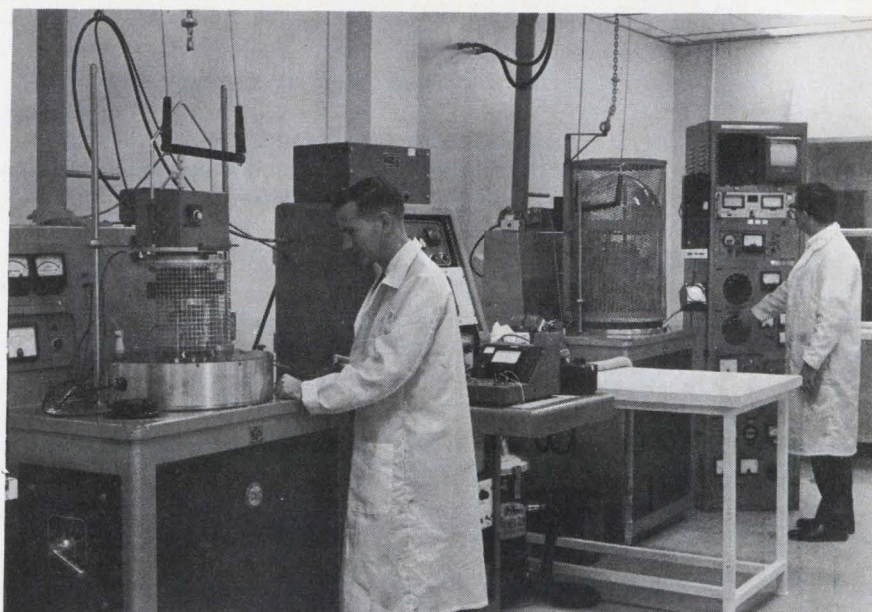
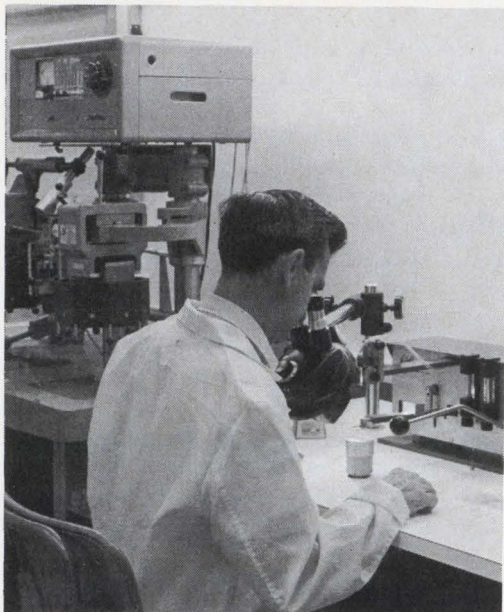

Investment. Equipment for IC fabrication—such as the thermal compression pulse bonder (left) and thin-film deposition chambers (right) at Martin-Marietta—does not come cheap. One estimate puts the cost of a monolithic IC fabrication line at \$1 million, of a thick-film line at \$100,000, and a thin-film line somewhere in between—all for very limited prototype fabrication.

Bowie declares. On a highly proprietary design, the wafer would most likely be processed by the center.

Brash excursion?

Even when the IC vendor's parent company also maintains a systems division, proprietary considerations don't seem to be a serious problem. Kaplan of Lockheed Electronics puts it this way: "Whenever you deal with a components company that also has a systems division bidding for your own business, things can be sticky. We assume a certain amount of business ethics prevailing but we aren't foolish about it. Sure, fellows from the same company will talk to each other. But if we have more to gain than to lose, we go ahead and tell the components company what we're up to."

What do the traditional IC suppliers think of the emerging independence of their systems-oriented customers? Opinions range from complete acceptance (and willingness to work with the customer on his own terms) to strong disapproval of what's considered a brash excursion into the black art of IC technology. The middle ground, shared by the majority of IC producers, is approval of a small IC fabrication line—just enough to build prototype circuits, at the most. This, the IC houses say, would help the systems-house engineers gain a better understanding of IC design and technology, and would lead to more effective cooperation between vendor and user. The interface would still be a set of performance specifications for the IC, given by the customer to the vendor. The vendor would decide how the circuit should be designed and made.

William Dunn, who is in charge of custom LSI at Sylvania's Semiconductor division, sums up the middle-of-the-road policy: "The systems house will generally supply black-box specs, and we can tell from them if the design is practical." He continues, "A systems house can never duplicate the economic leverage of a true semiconductor vendor—thus, to my way of thinking, a systems house's capability should be limited to modeling, feasibility study, and so on."

Dunn cautions that "this doesn't mean that the systems house is going to be able to send his masks to a semiconductor producer and get back LSI, though. His approach might not interface at all with the production technology used at the IC maker's plant."

A sense of direction is needed, too, according to TI's Kilby. In-house capability is useful, Kilby says, when the systems house is big enough and when it needs components that aren't available outside.

Unfortunately, not many houses are using their capability in this way, Kilby adds. "Most are limited in size. Since they don't have enough money to keep up, they usually end up specializing in things available to them from outside. So, they don't perform an especially useful function." Often, systems houses will work on digital IC's; this, says Kilby, is a needless and wasteful duplication of activity in the semiconductor houses, which are far better equipped and more experienced. "We can produce these (digital circuits) cheaper than any systems house can. Unless they are prepared to put in enough dough to match our scale of operations, they will find that they are on a head-on collision

course with our operations."

Raytheon's Thun is enthusiastic in his support of in-house capability: "Any firm doing about \$150 million or more a year has no business being without some in-house development capability. Firms grossing \$600 million a year and up should have manufacturing capabilities for captive needs." A big advantage, Thun feels, is that both vendor and customer feel that they cannot put anything over on the other. "This can make both sides run scared and that's good—makes 'em work and keeps 'em honest."

Another advantage is that in-house facilities are a source of technical innovation. "Many original ideas will come from systems houses," Thun says, "and eventually these should find their way into semiconductor lines." Engineers from the systems houses voice the same idea; they see the IC manufacturers as having a vested interest in existing technology.

On the other hand, Motorola's Callahan is still not convinced that the systems house should set up its own IC facility in the first place. The biggest problem is talent, Callahan says. "It's difficult for them to amass enough talent to take the next step forward" into production.

However, Callahan believes that an in-house facility may be justified for second sourcing, "to handle the small-volume jobs the large semiconductor manufacturers don't care to." He adds, "It's difficult for Motorola, TI, and Fairchild to second-source each other on complex functions, so the in-house capability at the systems house is justified as a second-source shop. The volume isn't great enough for the big manufacturers to second-source each other on these devices."

Costly proposition

However they feel about the advisability of a limited in-house capability, the IC manufacturers are predictably emphatic in discouraging systems houses from competing with them. "Unless it's a huge firm, it's a mistake to get into the business," warns Robert Sanborn, marketing manager for microelectronics at Hughes, because "there are so many suppliers available, the dollar investment is immense, and the technology is running too rapidly for such a company to set up its own facility." [For Sanborn's impression of the evolution of the interface, see p. 79.] Ekiss of Philco-Ford points to the highly competitive market for IC's. This should deter systems house from selling IC's outside, he says.

What about those giant corporations with both systems and IC manufacturing divisions? The advantages of such a combination may be more apparent than real. The IC division usually has to compete with outside suppliers for the systems division's business, and, by the same token, the systems division does not always have an inalienable right to the IC division's facilities and personnel. Only about 10% of Philco-Ford Microelectronics' business is in-house. "You need the conditioning of the

external market," a Philco spokesman says. "That's the market that's going to keep you snappy, that's going to ensure that you're successful, that you obviously know how to do the business. Then you can be of benefit to the company. But if you don't have to stand the gaff of the open market, then maybe apathy can slip in."

Holding hands with a CAD

Even those companies that have major semiconductor divisions are still setting up in-house prototype capability for their systems divisions. Even though Raytheon, for example, has that large semiconductor operation in Sunnyvale, Calif., the company has established prototype monolithic IC capability at its Missile Systems division in Bedford, Mass.

General Electric, too, is augmenting its commercial semiconductor department with an Integrated Circuit Center (IC-squared to GE engineers). This custom facility will service the GE systems divisions with sophisticated IC's.

Hand-in-glove with the design interface are computer-aided design techniques. "There is literally no alternative to CAD, which under the proper circumstances can save five months' design time," says Dunn of Sylvania. Aside from speed, CAD means greater confidence in artwork and test procedures. But cooperative use of CAD by supplier and user is still very much in the formative stage.

CAD is pervasive in systems design—to describe functions, to partition them into circuits, to design the circuits, make masks for them, process them, and test them. But at some point, this chain has to be broken when the IC maker takes over. "What's needed to make this division of labor a smooth one, says Thun, "is a common form of documentation for use both by systems and semiconductor houses—and nobody has one."

Dunn agrees that there is a serious problem in transferring data from one company to another. "Differences in software and documentation just don't allow information to make the jump unscathed," he says. Dunn believes that vendors can help by describing in full their custom capabilities, wiring rules, spec guard bands, and so forth. "Then say also, 'This is our software interface; if you can adapt to it it will speed things up greatly.' This is another of these things which must be ironed out early in the user-vendor relationship."

Some companies have already made a start at cooperative CAD. Fairchild, for example, is making its Fairsim CAD program available on a limited basis. A proposed LSI design is coded into Fairsim language along with a test sequence. After simulation, the data becomes the basis for computer-aided cell placement, interconnection, and acceptance test programs.

More such schemes can be expected in the future, in view of the overwhelming importance of CAD in the design interface. As Kilby of TI points out, "CAD cannot be over-emphasized. It is the key. It makes all of this possible." ■

Designer's casebook

Improved Miller sweep uses an active load

By Dipak K. Basu and Biswajit Nag

Jadavpur University, Calcutta

When a large load resistor is used in a Miller sweep circuit to obtain a high gain, the sweep's flyback time is increased and a high collector supply voltage is needed to ensure a good current gain from the amplifier's transistor. If the resistor is replaced by an active load in the form of a common-base

transistor, the transistor will act as a current source, providing several megohms of dynamic impedance at a few milliamps of collector current. This reduces the flyback time and improves linearity.

A positive gating pulse turns Q_1 on, delivering a slightly negative voltage to Q_2 's emitter and Q_3 's base. Q_3 cuts off and C quickly charges from the current source, Q_4 , through the diode D_2 and the switching transistor Q_1 . Q_5 remains cut off because of the forward drop across D_2 , but Q_5 's emitter also contributes a small amount of charging current.

At the negative transition of the pulse, Q_1 turns off and its rising collector voltage is transmitted through Q_2 to Q_3 's base, turning it on. C now starts to discharge through R , Q_5 , and Q_3 , starting the Miller rundown at Q_3 's collector.

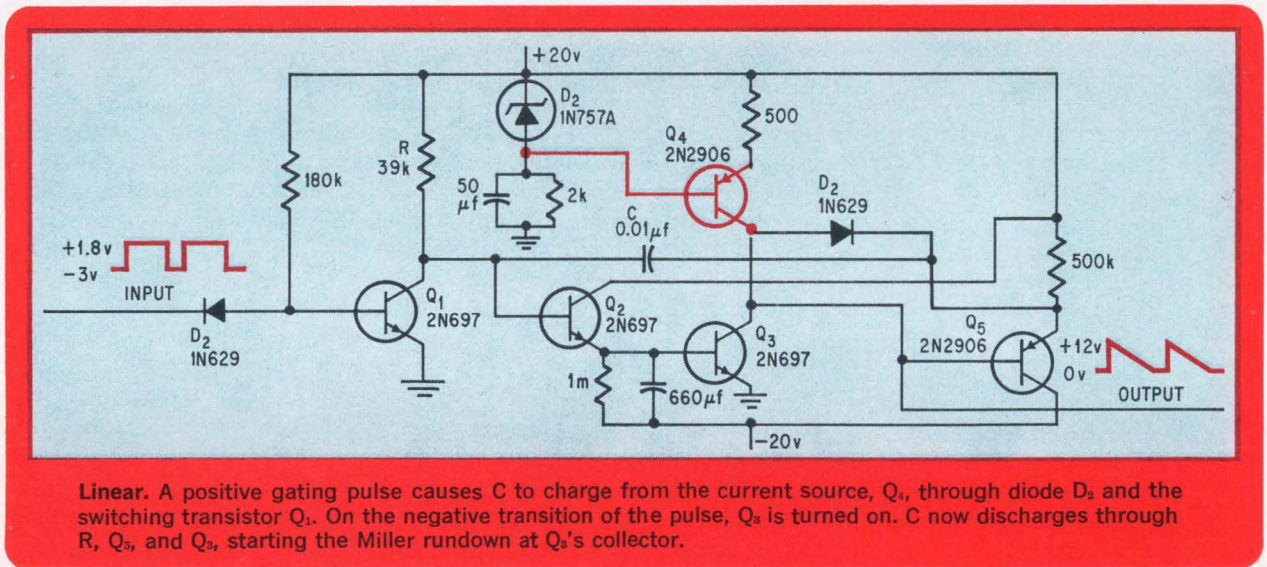

Transistor "zener" has zero dynamic impedance

By Heinz Stadler

Georz Electro GmbH, Vienna

The best way to regulate voltages below the zener minimum of 2 volts is to use two transistors and a resistor. The advantage of this "zener" over the cascading of two or more silicon diodes is its zero dynamic impedance from 20 to 150 milliamperes.

If the applied voltage is greater than 1.4 volts, both transistors begin to conduct. When the resistor, R , is infinite, the circuit's characteristic is

that of the first curve. The other extreme occurs when the resistor is zero (curve 2). Between these extremes exists a region where the dynamic impedance of the device can be made equal to zero (curve 3). If the base-emitter impedance, r_{be} , is lin-

ear and equal for both transistors, the resistor can be calculated:

$$R = 2r_{be} (1 - h_{FE}/1 + h_{FE})$$

The temperature response is -5 millivolts per degree Centigrade.

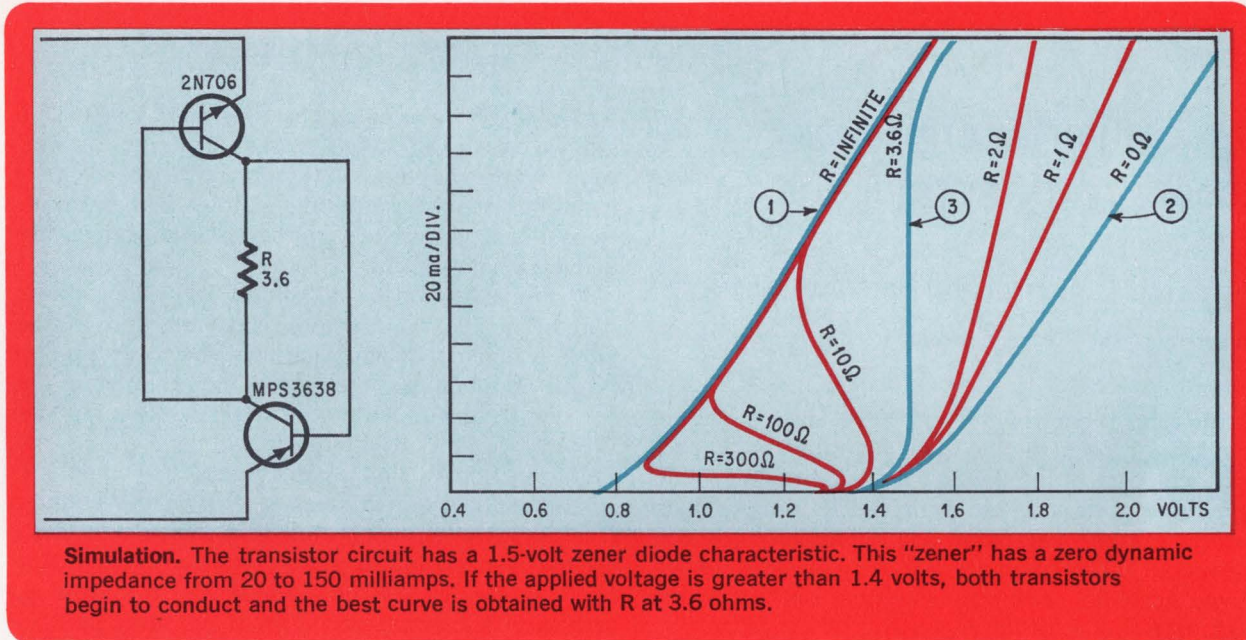

Pulse generator triggered by a step function

By Robert J. Hoss

Collins Radio Co., Dallas

Adding a single transistor to the feedback loop of a monostable multivibrator enables it to be triggered by a step function and generates a pulse of variable width. The circuit was used to produce trigger pulses for a digital system from the step function of a shaft encoder.

A negative going transition at the input to the circuit is differentiated and amplified by transistor Q_2 , which then switches Q_3 off. Q_3 is ordinarily held off for a period determined by the constant, R_5C_2 . But the negative-going voltage at the output is fed back to Q_1 's base so that Q_1 is switched on as the output reaches its crest. The pulse's trailing edge is shunted to ground, switching Q_2 off. The charging current through C_2 reverses, switching Q_3 on and creating a fast falling edge on the output, which is taken off of Q_3 's collector.

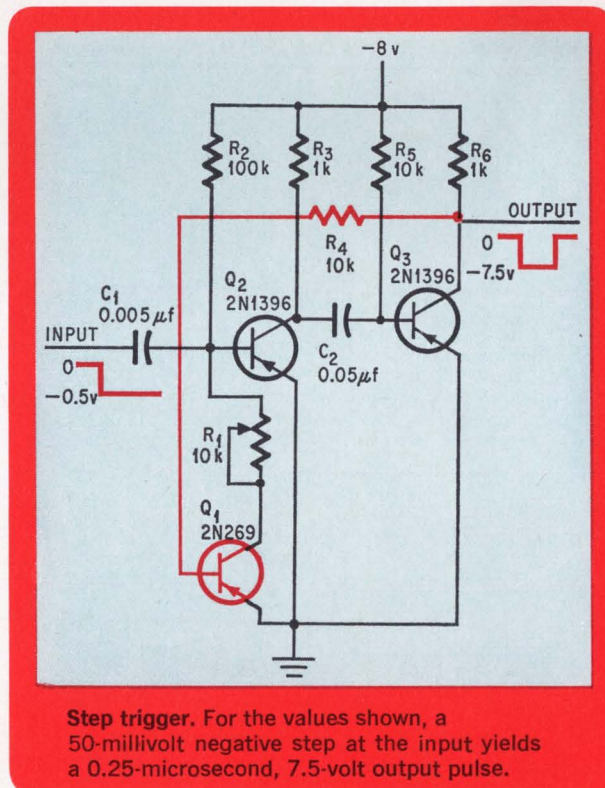

If R_1 is set at zero, Q_1 causes the output pulse to fall as soon as it crests, its width depends only on the delays in the transistors. R_2 determines the output pulse width.

By adjusting R_2 , the amount of current which remains to keep Q_2 on after Q_1 has switched, can

be regulated and consequently the width of the output pulse can be adjusted.

The input signal must be limited to a 0.5-volt level to prevent the circuit from breaking into damped oscillation.

The circuit values yield a 0.25-microsecond pulse.

D-a converter improves accuracy of thermal unit

By Marcel Nougaret and Bertrand Lisee

University of Sherbrooke, Canada

Temperature control systems that use a digital computer present a few special problems. If proportional control is required, as in programmed temperature profiles, on-off control does not give accurate results. One can use a digital-to-analog converter followed by a memory device and a power amplifier to supply electrical heating to the load, but this is quite expensive.

One way to overcome these problems is to use a d-a converter in which pulses discharge a preset counter and charge an integrator until the counter is empty. At each sampling period, as many half-sinusoids as there were numbers in the register are delivered to the load.

At the beginning of the sampling period, T , the content of the accumulator is transferred to the flip-flop register through gating logic. The flip-flop is set and enables the pulses coming from the Schmitt trigger to enter the register. The register is wired as a down-counter, and as long as the counter is not 0 a signal gates thyristors—which are silicon controlled rectifiers—on. When the counter reaches 0, the flip-flop resets and the system waits for the next sampling period. It takes only a few microseconds to set the counter and the flip-flop, and the SCR's always fire at the 0 crossover point.

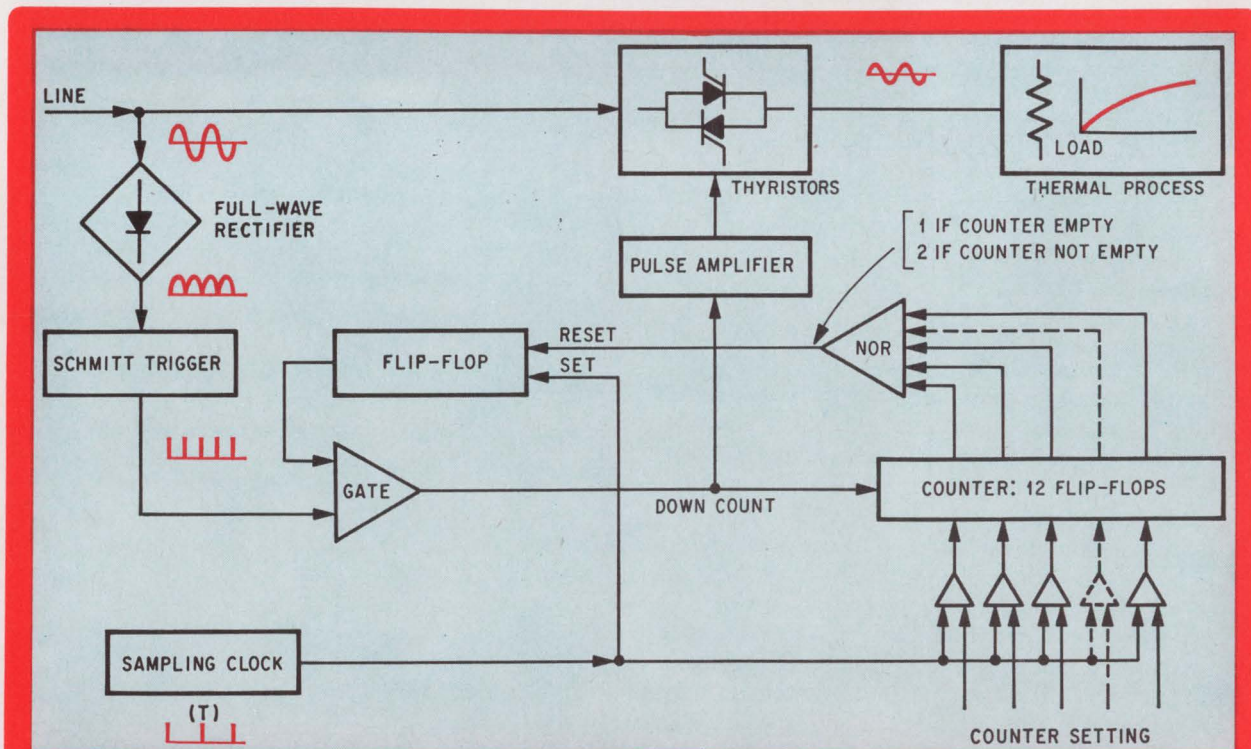

Legerdemain. A thermal process can be proportionally controlled even if one has only digital equipment available. The trick is to use a digital-to-analog converter whose pulses discharge a preset counter. This method is less costly than using a d-a converter with a memory device.

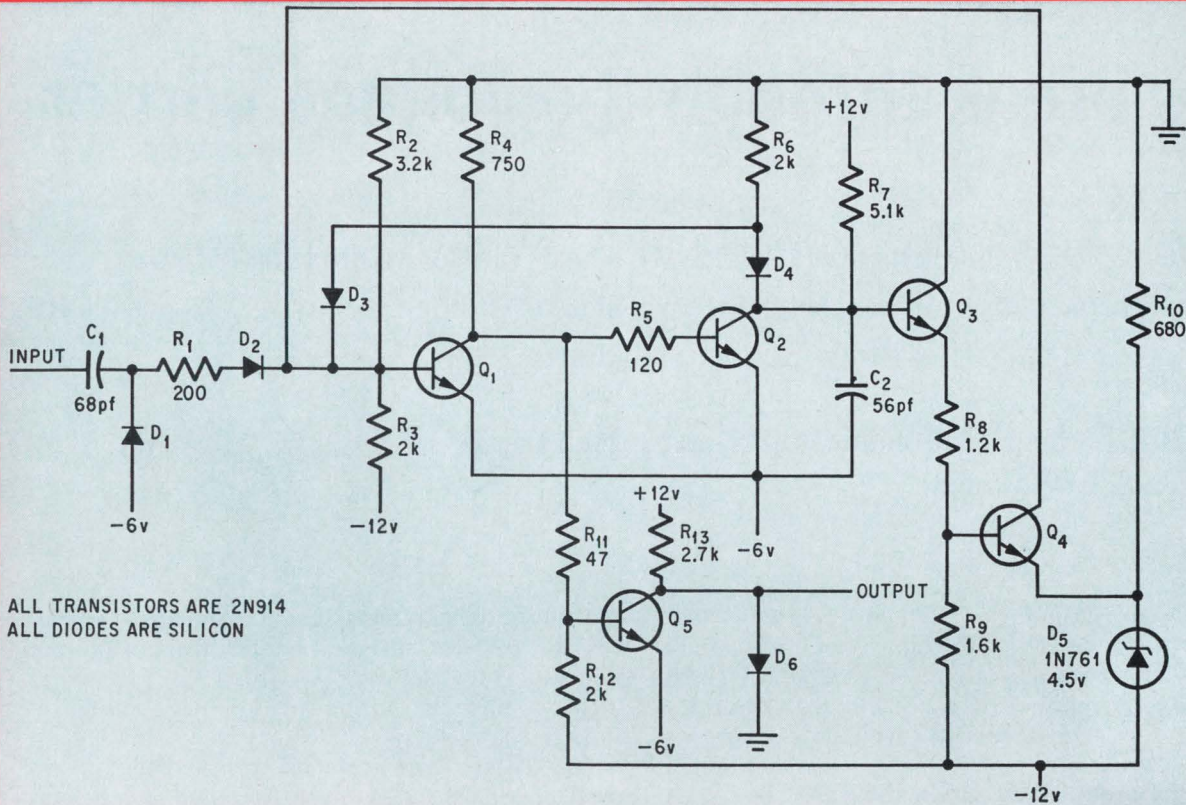

ALL TRANSISTORS ARE 2N914
ALL DIODES ARE SILICON

Quick discharge. The single shot achieves its extremely fast response through the use of a timing capacitor which discharges directly through the low impedance of a transistor, instead of through the customary resistor. The output pulse width is about 100 nanoseconds.

Full duty single shot recovers fast

By James H. Williams

International Business Machines Corp., Kingston, N.Y.

Many fast-recovery single-shot multivibrators permit false triggering, responding to an input pulse before the completion of the preceding output pulse. This single shot has a duty cycle of more than 95% and has little chance of triggering falsely. It has a faster recovery than most such circuits, and an output which is virtually independent of its input rise time, duration and amplitude.

To achieve its extremely fast response, the single shot uses a timing capacitor which discharges directly through the low impedance of a transistor, instead of through the customary resistor. The output pulse width is approximately 100 nanoseconds, large enough to make the duration of the output pulse independent of transistor variations.

In the quiescent state, Q_1 and Q_4 are off while Q_2 and Q_5 are on (Q_3 is an emitter follower, neither on nor off). A negative-going transition at the input turns Q_1 on, which turns Q_2 off. D_3 and D_4 provide isolation between C_2 and Q_1 . Q_1 is held on by R_6 and D_3 .

C_2 , which was held at a low voltage by Q_2 , now begins to charge through R_7 . Q_3 , R_8 , R_9 , and Q_4 compare the voltage on C_2 to a reference voltage generated by R_{10} and D_5 .

After C_2 has built up a charge, its voltage is positive enough to turn Q_4 on, which then turns Q_1 off and completes the cycle. There is a rapid recovery because Q_2 turns on as Q_1 turns off, and very rapidly discharges C_2 .

The output is translated into the required -6-volt level by R_{11} , R_{12} , and Q_5 . R_{13} and D_6 help provide a rapid positive transition at the output. Since the time required to discharge C_2 is of the same magnitude as the fall time of the output, the circuit is ready to accept another input as soon as the output has fallen.

Once the timed interval has started, the circuit is insensitive to variations at the input, except for a very small period of time (10 nanoseconds).

IC's break through the voltage barrier

Operating levels of 300 volts are possible with a field plate for neutralizing surface charge and a directional etchant for dielectric isolation.

By Hans R. Camenzind, Bohumil Polata, and Joseph Kocsis

Signetics Corp., Sunnyvale, Calif.

Constrained by the lack of integrated circuits that operate much beyond 50 volts, circuit designers often reluctantly go to discretés. One new type of IC, however, could not only cost less than discretés but also offer high breakdown voltages—up to 300 volts. Such devices can be made routinely; single laboratory circuits have attained 1,000 volts.

Up to now, most IC's have been low-voltage types because it's almost impossible to grow high-resistivity n epitaxial collectors on p substrates and because surface breakdown couldn't be controlled. But two recent developments make the routine fabrication technically and economically feasible.

The first—a "field plate" that's merely an exten-

sion of the planar metal circuit contacts—neutralizes the positive surface charges responsible for premature breakdown.

The second—dielectric isolation with an anisotropic etchant—allows collectors to be formed on high-resistivity grown silicon rather than on epitaxial material. And it makes it possible for components in high-voltage circuits to be packed far more densely than they can be with p-n junction isolation techniques. This will be discussed in more detail in a future article.

Positive charges gather at the surface of IC's for two reasons. For one thing, sodium and other impurities in either the passivating oxide layer or in

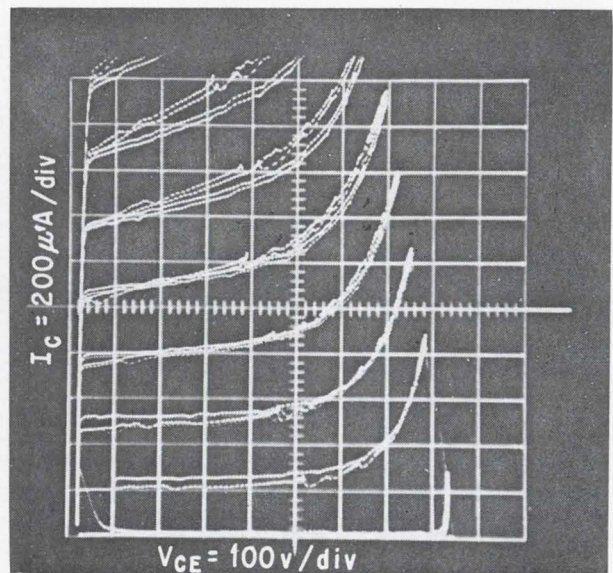
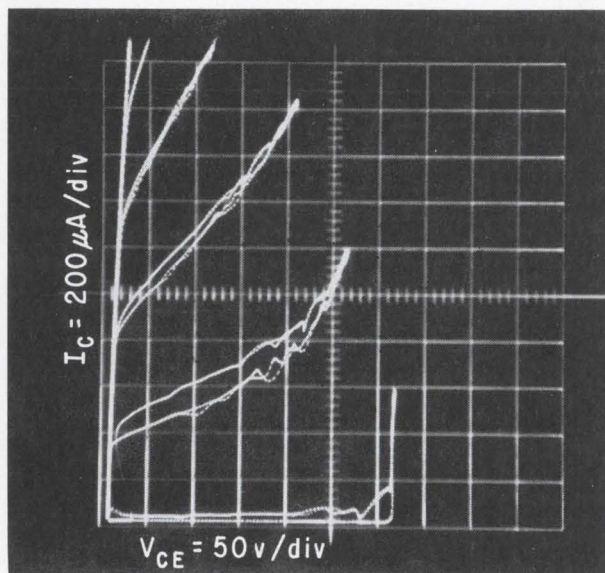

IC traces. Collector-emitter voltages of npn transistors fabricated in high-voltage IC's are plotted against collector current. Left, with base current equal to 5 microamps per step, breakdown voltage, $BV_{e_{co}}$, is 300 volts. Right, with I_B equal to 20 microamps per step, $BV_{e_{co}}$ is 800 volts.

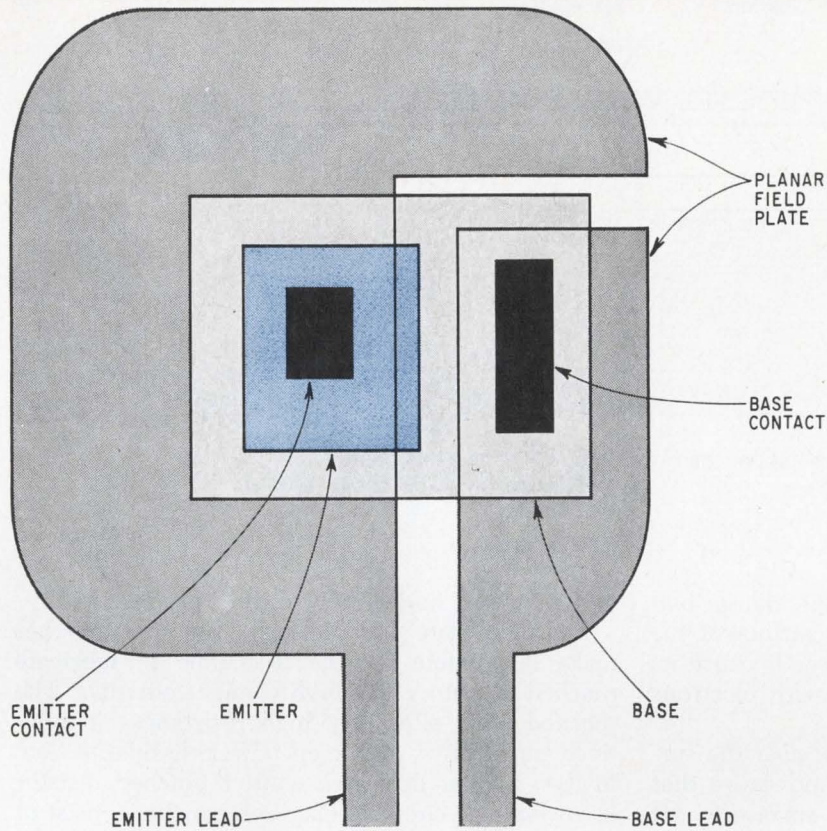

Plates and grooves. Keys to high-voltage IC's are field plate shown in top view and side view and dielectric isolation. Field plate spreads out depletion layer, preventing surface breakdown, and dielectric isolation allows collectors to be fabricated on a high-resistivity substrate.

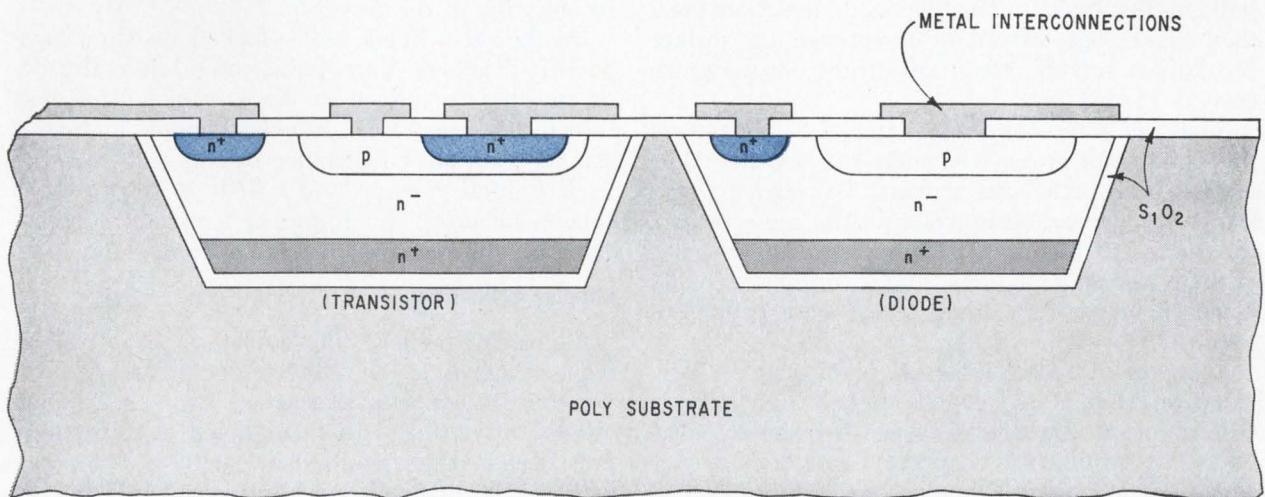
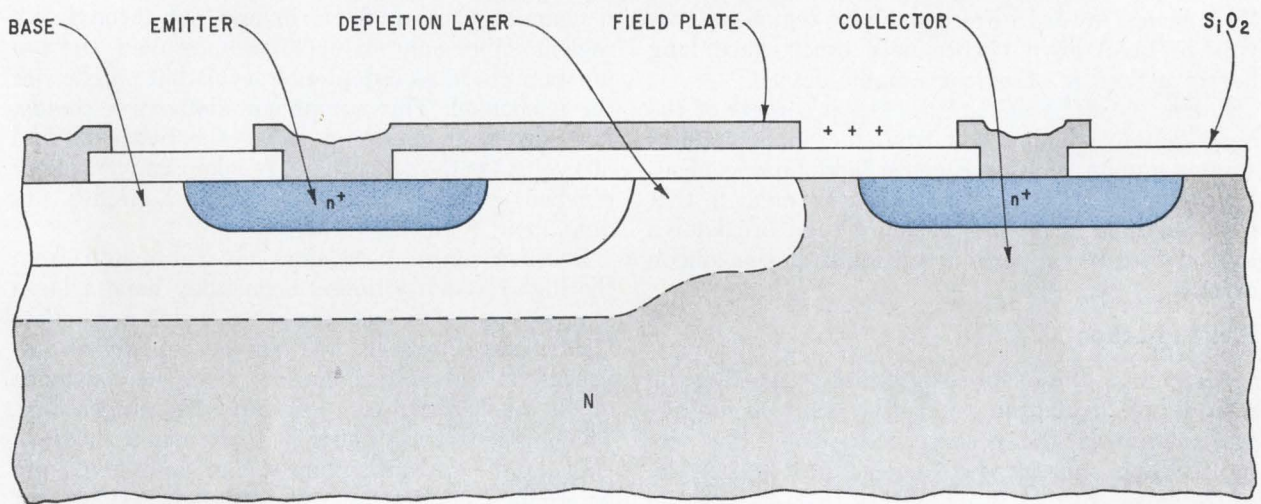

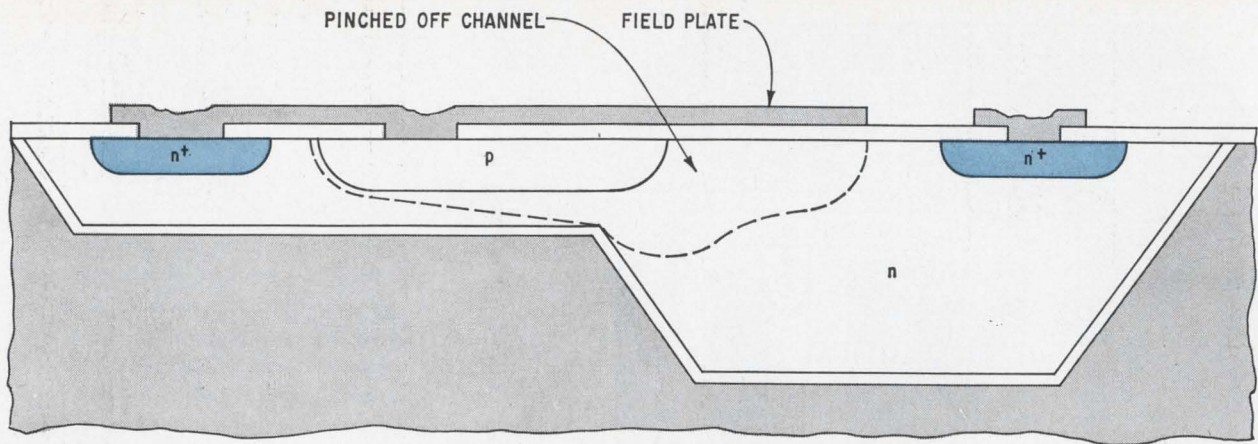

In a pinch. Dielectric isolation makes possible pinched resistors such as this that deliver a constant low current and take up little space.

the metal interconnections disturb the charge balance. For another, the silicon at the surface of the single crystal has a net positive charge because its valence bonds end abruptly there, with electrons missing.

These charges add to the potential near the surface with an applied reverse bias and cause that part of the depletion layer near the surface to act like a low-resistivity area. As a result, the depletion layer bends inward toward the base region, so that voltage breakdown occurs near the surface long before it does in other parts of the device.

Other "weak" areas are the sharp corners of the base region, which result from the shallow diffusions common in IC's. Electric field lines concentrating at these corners in a manner similar to that in the corona effect can cause voltage breakdown long before it happens in the bulk of the silicon crystal.

Fielding action

Metallizing the oxide surface and connecting the resulting field plate to a negative point on the circuit neutralizes the positive charge near the surface. This is equivalent to increasing the resistivity of the layer, so that it actually exceeds that in the bulk of the crystal. The widened depletion layer then bends out instead of in, preventing surface breakdown and effectively smoothing out the sharp corners of the base.

Since all interconnections must be planar and the plate can't cross over emitter and base leads, it must be an extension of them. To prevent shorting of the device, designers split the plate in two, leaving a 10-micron gap between. The effect is virtually the same as that from a continuous plate, however, because the edges of the fields from both overlap.

Economical dielectric isolation was achieved by using an etchant developed by Bell Laboratories that attacks one crystal plane much faster than the other. The resulting V-shaped isolation area wastes very little silicon and can be precisely controlled

vertically and horizontally during production.

The field plate and dielectric isolation together make it possible for the first time to fabricate pinched resistors in high-voltage circuits. The pinched units offer very high resistances in relatively small areas and keep power dissipation low in IC's. Similar to a base-emitter pinched resistor in low-voltage circuits, these components consist of a p-type region that forms a junction with a narrow n channel. Current flows in and out through n⁺ regions. With only about 20 volts applied, the p-n junction produces a depletion layer that pinches off the n channel. This component delivers a steady, low current at operating voltages between 20 and 300 volts. On the other hand, breakdown voltages of pinched resistors in junction-isolated circuits are only about 6 volts.

Because pinched resistors are fabricated from the high-resistivity bulk silicon, they have a large temperature coefficient—about 0.5 to 1% per degree Centigrade. However, this can be actually an advantage in high-voltage circuits, since the resistance of the pinched resistors goes up with temperature. This increase doesn't change performance, because gain and d-c operating point in high-voltage IC's are determined not by the value of each resistor but by the ratio of the resistors.

On the other hand, bulk pinched resistors have one disadvantage: they require an additional processing step to diffuse in the p region. For that reason they're not used in every type of high-voltage IC. The sheet resistance of the bulk material itself is high enough—about 5 to 10 kilohms per square—for many circuit applications and thus conventional diffused resistors are adequate.

Unique difficulties

Alternative methods don't do the job as well in high-voltage IC's. Thin-film resistors are too expensive because they add processing steps. (They are necessary in radiation hardened circuits, however, because diffused resistors exhibit high leakage when exposed to radiation.) And p type diffused re-

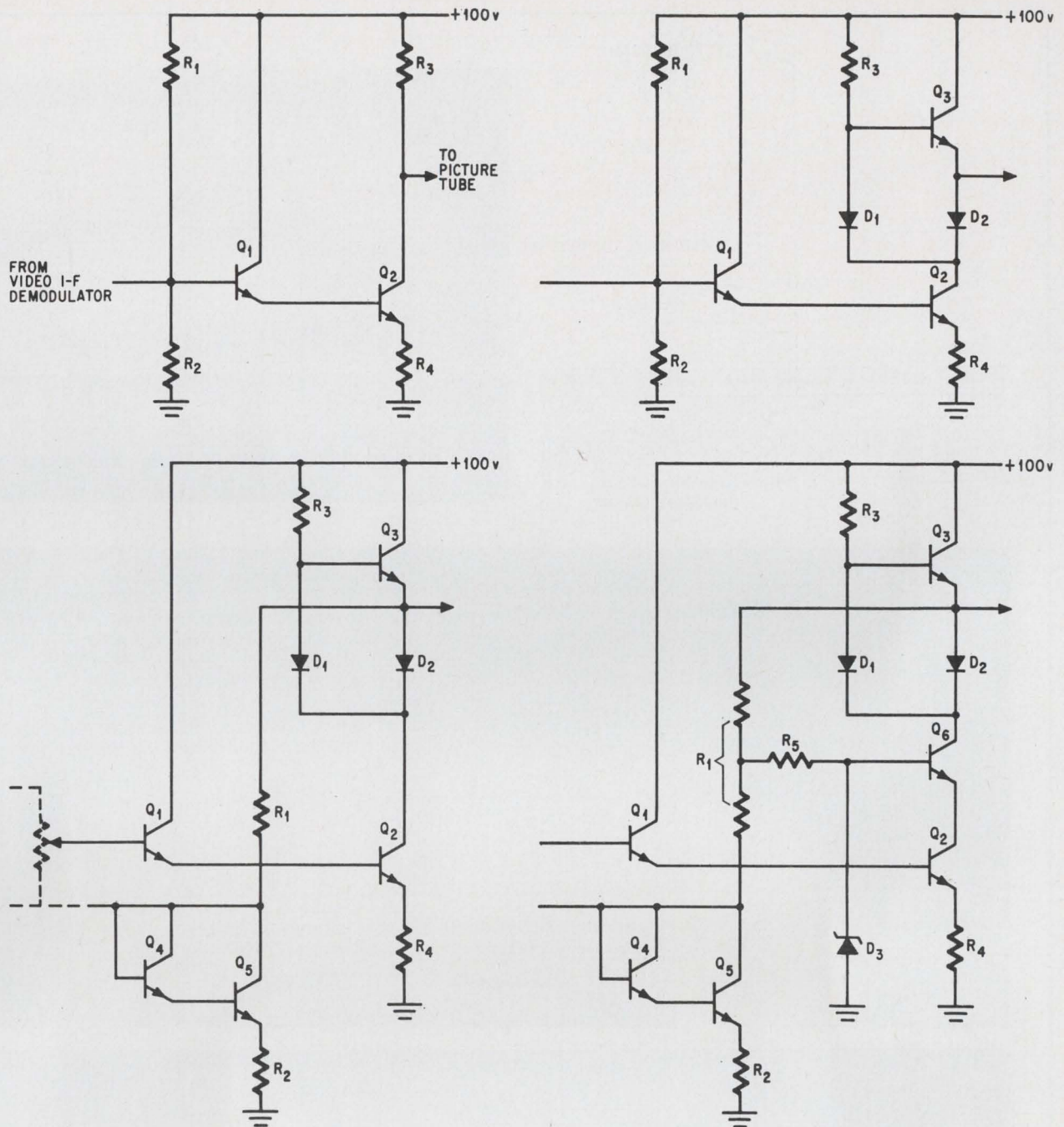

TV amp. Left to right, stages in development of high-voltage integrated video i-f amplifier are traced from discrete version, early IC version, intermediate version with poor frequency response, and final version, which includes additional active components.

sistors are out for all high-voltage applications because their sheet resistivity is only about 135 ohms per square.

High-voltage IC design doesn't differ much from low-voltage design but does have some unique problems. For example, using high-resistivity silicon hurts transistor performance, requiring the addition of active devices to lower requirements for individual components. Also, more active devices are required than in low-voltage IC's to reduce power dissipation. High-voltage IC's must dissipate

less than a watt unless they're large, and the big ones are expensive. Finally, circuits can't be designed around precision resistors because the bulk silicon's resistivity isn't uniform.

These factors were taken into account in the design of a high-voltage integrated video amplifier for a black-and-white television set. The amplifier, which drives either the cathode or grid of the picture tube, must provide a peak-to-peak voltage swing of up to 70 volts, a voltage gain of about 50, and a frequency response to at least 3.5 megahertz.

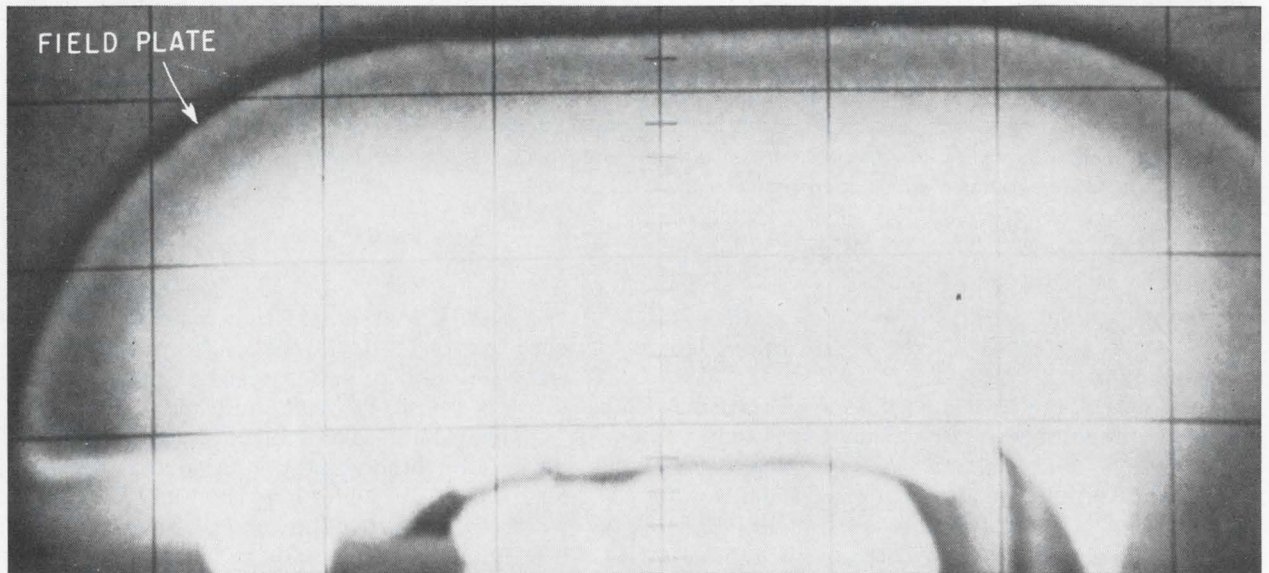
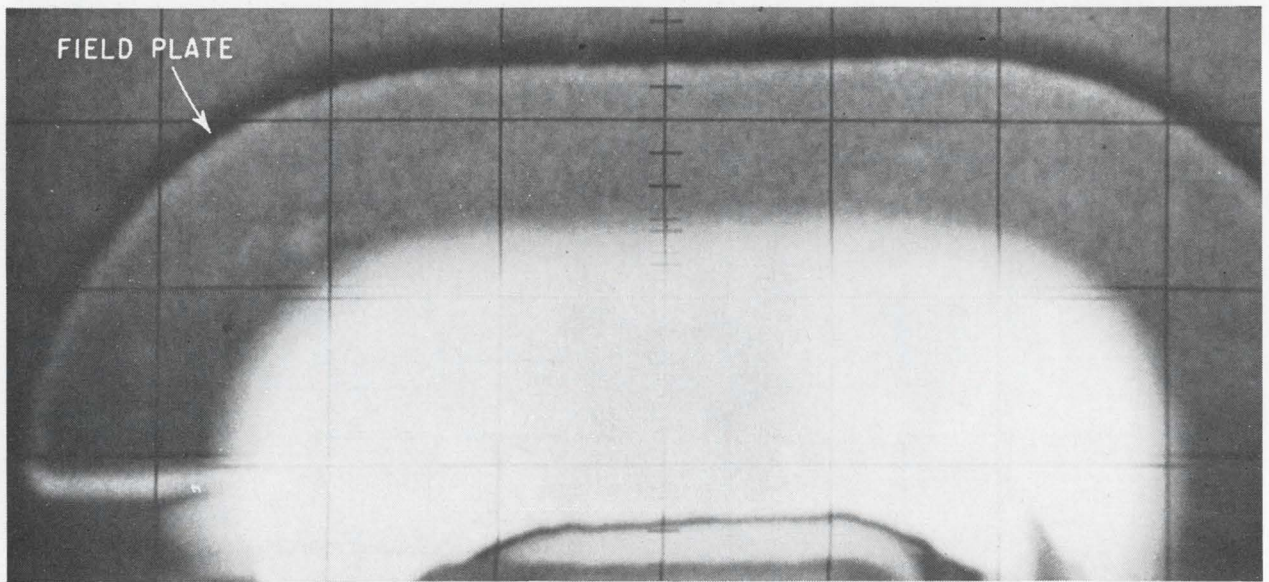
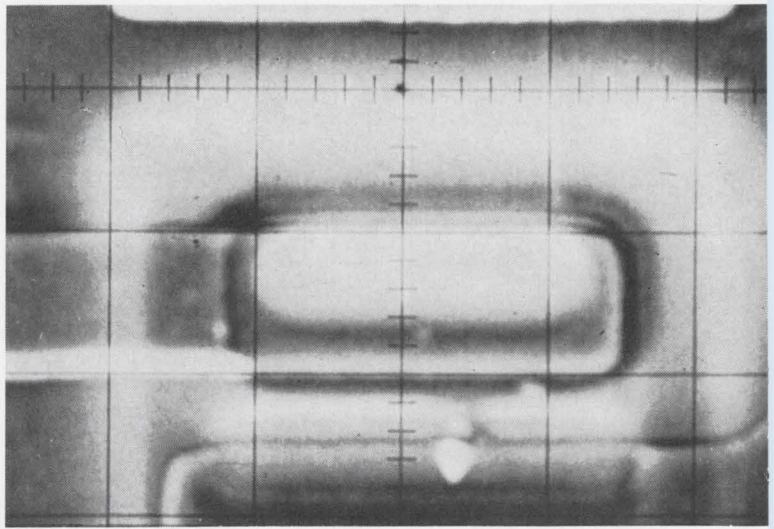
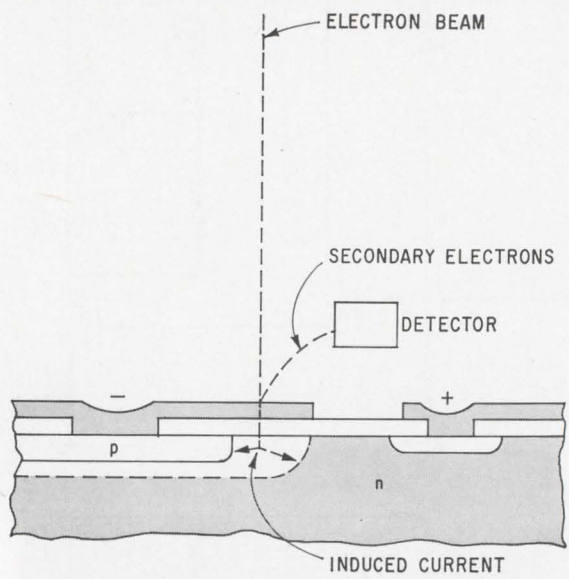

Seeing is believing

A scanning electron-beam microscope can make visible the potentials near the surface of an IC making it possible to see how the shape of the depletion layer changes with variations in bias voltages and with the addition of a field plate.

As the beam is directed at the surface of the IC, secondary electrons bounce off and can be collected, amplified, and used to modulate the intensity of an oscilloscope. Metal, silicon, and silicon dioxide reflect electrons differently, so that an image of the IC's surface appears if the scope is scanned in synchronism with the electron beam. Deflecting the cathode-ray tube of the scope over a wider distance than the microscope beam gives a large magnification.

Pairing off. Some of the electrons from the beam aren't reflected but instead penetrate the IC and the field plate. In the silicon they create electron-hole pairs. If these pairs are within the depletion region, the electron is swept toward the positive voltage and the hole toward the negative one, causing a current to flow across the junction. This is the current that can be amplified. Hole-electron pairs created outside the depletion layer don't cause current flow because they recombine in a few microseconds.

Superimposing the reflected electrons and induced current causes a bright region to appear on the scope and shows how the depletion layer spreads out underneath the field plate as the bias voltage is increased. As this technique shows, when the IC doesn't have a field plate its depletion layer is much narrower and devices break down at a much lower voltage.

Bright spot. Combination of secondary electrons reflected from IC surface and induced current can be amplified and shown on scope to display transistor depletion layer. Top, without field plate, depletion layer (luminescent area) bends in near surface under application of 80 volts. With field plate, layer spreads out under 100 volts, middle and 300 volts. Thus, device doesn't break down prematurely at surface of IC.

It's instructive to follow the evolution of this circuit from the discrete stage. The picture tube represents a circuit load of about 10 picofarads and—along with the load resistor—forms a low-pass RC network that limits frequency response. The output resistor must have a low value, even when peaking coils are added, to provide the required frequency response. Thus, since the amplifier is class A, current through the output stage must be large and power dissipation about 1.5 to 2.5 watts—[see diagrams on page 93.]

More for less

Adding an output transistor and converting to class B operation lowers power dissipation and increases cost very little. In this circuit—designed in the early phases of the high-voltage IC work—a third transistor carries positive load current. As the negative part of the wave flows through the second transistor, a diode becomes forward-biased and the base-emitter voltage of Q_3 drops to zero. As a result, the two output transistors are never on together. On the other hand, the trouble with this circuit is that the two biasing resistors must have very large values to maximize input impedance and minimize power dissipation.

One solution to this problem was to design a circuit in which two transistors and a resistor provide a bias potential for the source. This combination, Q_4 , Q_5 , and R_2 is identical to that of Q_1 , Q_2 , and R_4 , so that whatever current flows through the feedback resistor, R_1 also flows in the collector of Q_2 —as long as there's no signal at the input. If R_1 and R_3 are made equal, the voltage drops across them must then be the same and the quiescent output voltage, therefore, stays at half the supply voltage. Because resistor ratios are predictable and insensitive to temperature changes in IC's, both the gain and quiescent d-c voltage are precise and stable.

However, this circuit has a frequency response of only about 1 Mhz because of the feedback capacitance (Miller capacitance) from the collector to the base of Q_2 . In high-voltage circuits such as this one the feedback is essentially the collector-base capacitance multiplied by the voltage gain.

In the final version of the video amplifier circuit, the designers added a cascade stage to the output. This type doesn't contribute to gain but shields Q_2 from the large output voltage swing, thus eliminating the Miller capacitance. This circuit, fabricated on a 40-by-45-mil chip, has an operating voltage up to 250 volts, a gain of 50, a frequency response extending to 7 Mhz and a dissipation of 300 milliwatts.

Signetics has been selling a high-voltage IC driver for Nixie tubes. Other applications being considered by the company are comparators to drive high-voltage displays and sense an error signal, operational amplifiers with a ± 100 -volt swing for hybrid computers, audio amplifiers and voltage regulators for direct-line voltage operation, and line-voltage fault detectors. ■

Active filters: part 8

Positive results from negative feedback

By applying IC assembly techniques, engineers can now build highly stable filters with many active elements at a cost lower than they'd pay for discrete circuits employing positive feedback

By Gunnar Hurtig

Kinetic Technology Inc., Los Gatos, Calif.

Cost-consciousness largely explains the preference designers have shown for positive feedback in active filters. Although the positive-feedback circuits have a tendency to oscillate, they simply require fewer active elements than do more stable filters built with negative feedback.

This cost edge has been erased by integrated-circuit developments, however. The designer can now offset the need for more components by building a negative-feedback active filter in hybrid IC form. In doing so, he achieves the low Q sensitivity of this kind of circuit while paying out less than he would for a discrete device employing positive feedback.

The application of integrated-circuit techniques will also serve to make active filters more competitive. A typical passive filter now sells for about \$5 per pole pair, against approximately \$25 per pole pair for active filters made with conventional p-c or cordwood techniques. But the use of hybrid IC assembly methods can shave this 5:1 cost differential to about 2:1 in most cases.

Although sensitivity is of prime importance in active-filter technology, it wasn't until recently that general statements could be made regarding the behavior of active networks with active- or passive-element variations. It's now known that Q sensitivity to element variations in positive-feedback circuits is a function of Q. It can also be stated that negative-feedback structures exhibit smaller Q sensitivities—usually less than unity.

Another general statement can be added to this list: the use of monolithic active elements and hybrid IC techniques can result in high-performance active filters capable of operating from dc to several megahertz. Such a filter has been built.

Two points must be kept in mind in selecting the circuit for an active filter. First, the network should generate the same complex poles and zeros produced by its passive counterparts. Hence, the designer wants a circuit that's as widely applicable as an LC network but is also capable of producing any stable second-order transfer function. Second, the cost of the filter should approximate that of a passive filter of equivalent performance.

The basic design chosen by KTI for its network is shown on next page, top. The denominator function, $D(s)$, generated by the system is of second order:

$$D(s) = s^2 + K_2\omega_1s + K_1\omega_1\omega_2$$

Depending on where the output is taken, the overall transfer function takes one of three forms—low pass, high pass, and bandpass. Pole-zero diagrams for each of these simple second-order types are on the next page, along with an RLC circuit for achieving the values shown.

Those transfer functions that have zeros at other than zero or infinity are called complex second-order functions. In most active-filter networks capable of generating complex zeros, a change in a parameter's value causes an interaction between the zeros and poles. This isn't the case with the basic system described here, however.

Any complex zero can be generated by summing the three outputs of the system in a simple differential amplifier. For example, any $j\omega$ -axis zero can be obtained by simply combining the high-pass and low-pass outputs. The location of the $j\omega$ -axis zero is the solution in s where the numerator, $N(s)$, equals 0.

A root-locus plot helps the designer evaluate

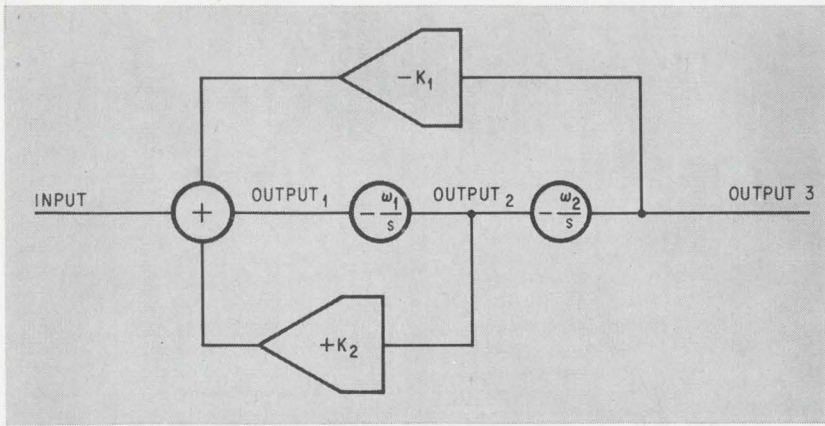

Feedback functions. The output of terminal 3 is fed back to the input in this case. Each of the three terminals produces a second-order transfer function, but only the feedbacks from 1 and 3 are negative. Output 1 produces a high-pass function, output 2 a bandpass function, and output 3 a low-pass function. Responses for each function and possible passive networks for producing them are also shown.

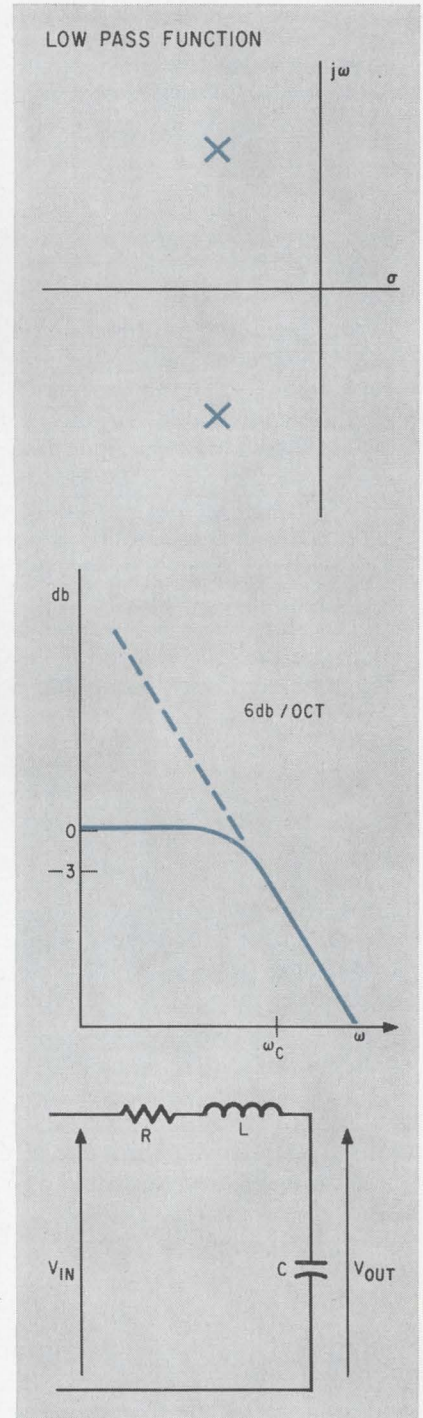
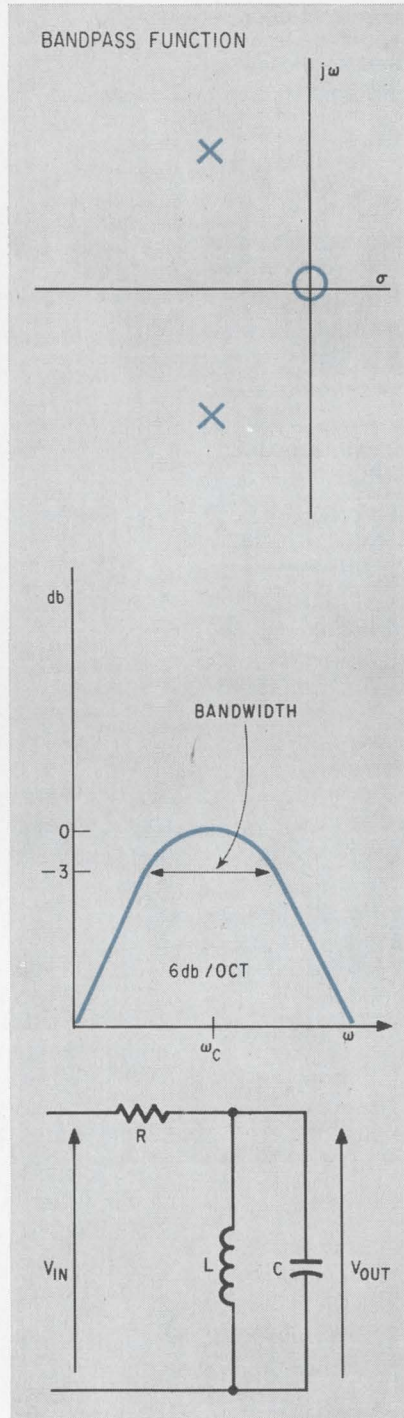
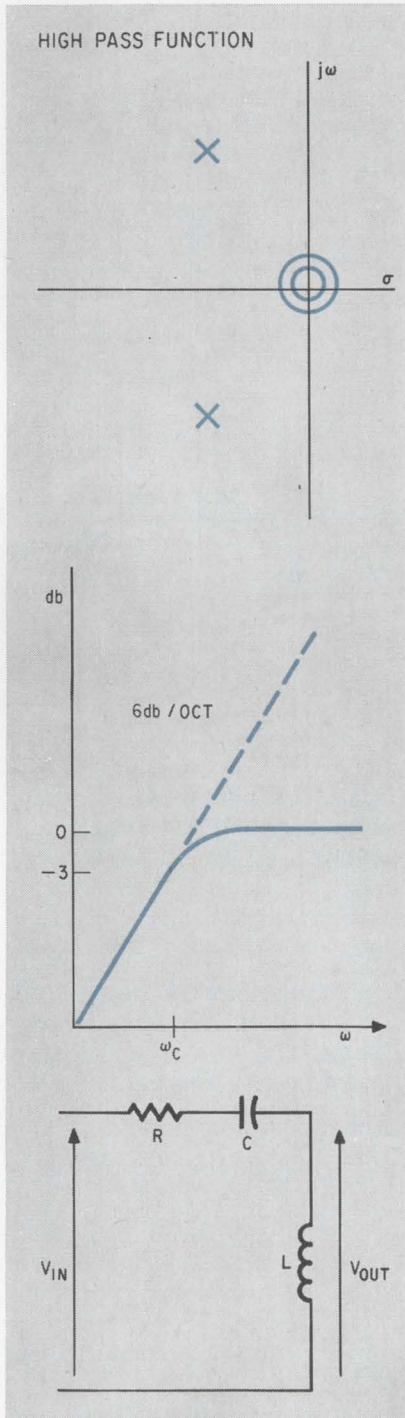

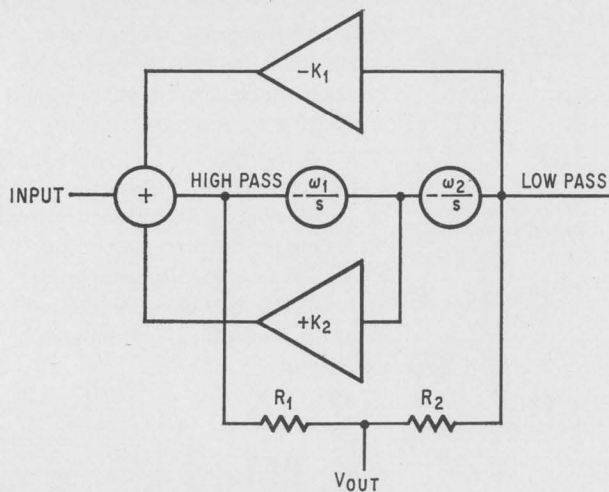

Producing naught. By combining the high-pass and low-pass outputs of the basic negative-feedback system, an engineer can get any zero on the $j\omega$ axis.

the system's sensitivity. Consider a simple flow graph of the system and the locus plot of the pole as a function of $1/K_2$. The designer determines from the root-locus analysis that if there are no poles on the negative-real axis due to stray capacitance or amplifier rolloff, the system is unconditionally stable for any value of K_1 , K_2 , ω_1 , or ω_2 . There's no oscillation because the root locus of this simple system doesn't cross the $j\omega$ axis into the right-half plane. This behavior is expected in such a system—essentially a multiloop with negative feedback. Gytrators also fall into this class.

On the other hand, the possibility of oscillation in positive-feedback systems is indicated in the plot of a positive-gain amplifier on the next page. The transfer function in this flow diagram takes the form

$$T(s) = \frac{K_2\omega_1}{s + \omega_1} \frac{1}{1 - \frac{K_1K_2s\omega_1}{(s + \omega_1)(s + \omega_2)}}$$

From the resulting root-locus diagram, plotted as a function of K_1K_2 , the designer notes that for a sufficiently large value of K_1K_2 the poles of this system can move into the right-half plane.

For the positive-feedback system, the sensitivity of Q in relation to an element change is

$$[(\partial Q/Q)/(\partial E_i/E_i) \geq Q]$$

The Q sensitivity of the negative-feedback system with an element change is

$$[(\partial Q/Q)/(\partial E_i/E_i) \leq 1],$$

where

$$(\partial Q/Q)/(\partial E_i/E_i)$$

denotes the percentage change of Q with an equal percentage variation of an element, E_i . The conclusion is that multiloop, negative-feedback sys-

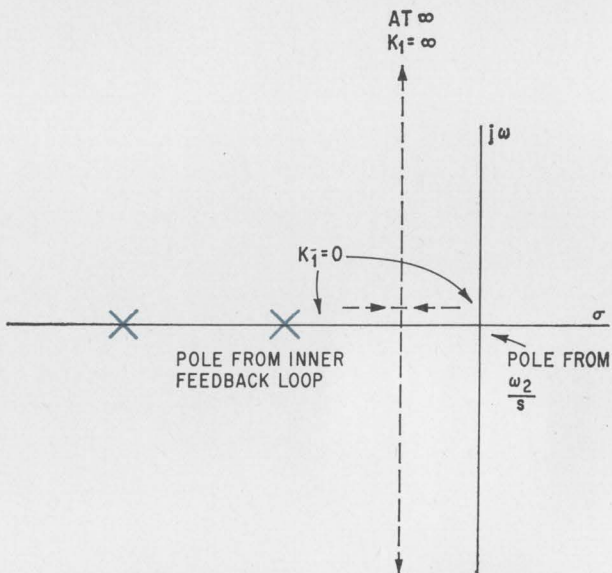
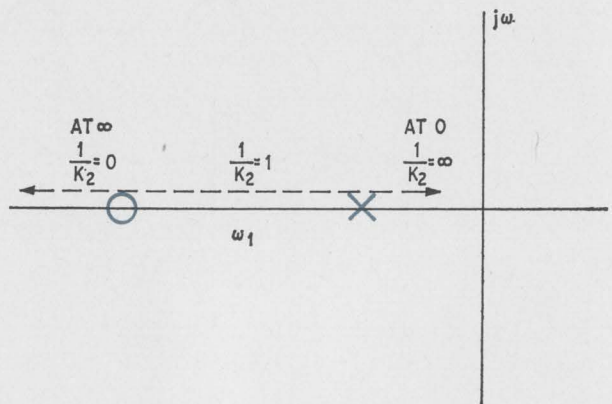
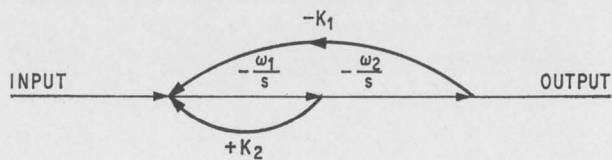

Signal-flow graphs. In this representation of a negative-feedback system, root-locus plot for the inner loop is at bottom with a plot for the outer loop above it.

tems generate any stable form of second-order transfer function, aren't bothered by interaction among tuning elements, and have a sensitivity at least as good as that of passive networks.

Separating the elements

With these factors in mind, KTI built its hybrid active filter. To facilitate testing, the circuit is assembled on two ceramic substrates, each measuring 0.75 by 0.4 by 0.025 inch. The first contains all the resistors and capacitors necessary for setting Q and the center frequency. The resistors are hybrid thick-film devices with an absolute temperature coefficient of less than 200 ppm/ $^{\circ}\text{C}$ and a capability for ratio tracking below 50 ppm/ $^{\circ}\text{C}$.

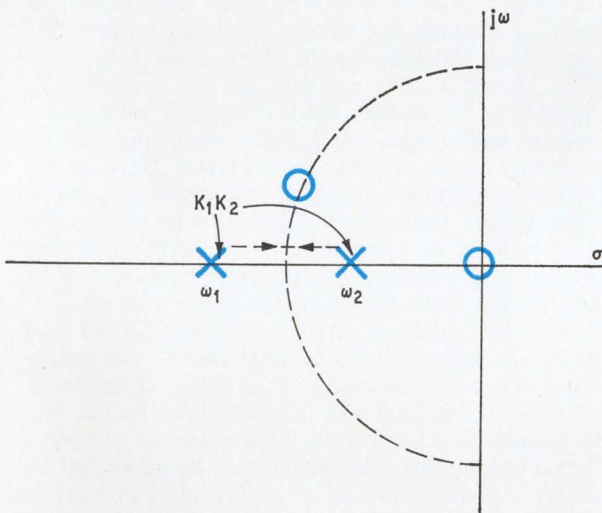
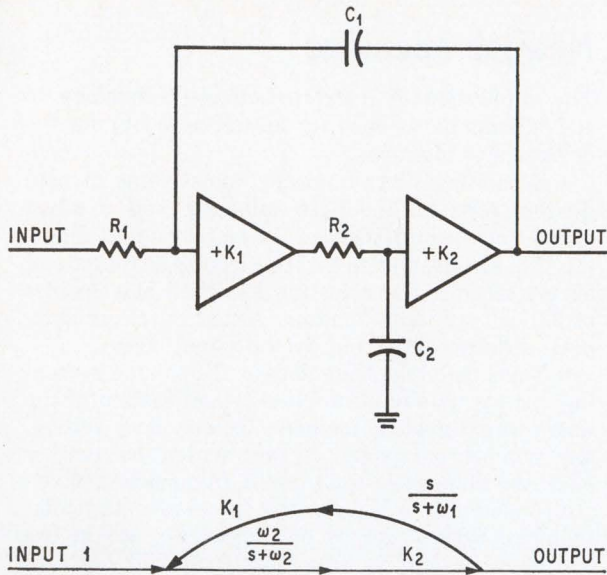

The plot develops. Signal-flow graph for this typical positive-feedback amplifier is used to plot the root locus. The larger $K_1 K_2$ is, the greater is the chance of oscillation.

The capacitors are ceramic and have absolute temperature coefficients of less than 25 ppm/°C.

The second substrate contains the active elements to which the external tuning elements are connected. Since the performance of the filter is essentially independent of the active elements, the choice of these elements is determined by the particular application.

Three versions of the filter are currently in production. Two contain linear bipolar monolithic integrated circuits and are made with conventional chip-and-wire-bonding hybrid techniques. The third model uses a linear IC containing three completely compensated differential amplifiers. The substrate holding the passive tuning elements is

...continued on page 102

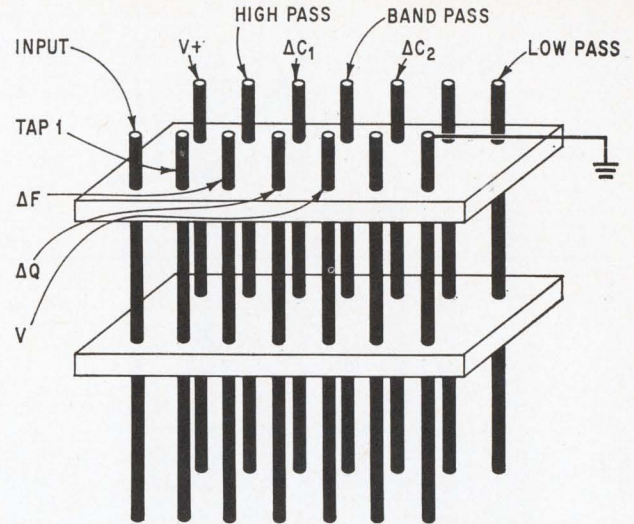

Two levels. In this active filter, the passive tuning elements are on the upper ceramic substrate and the active elements are combined with their compensations on the lower substrate.

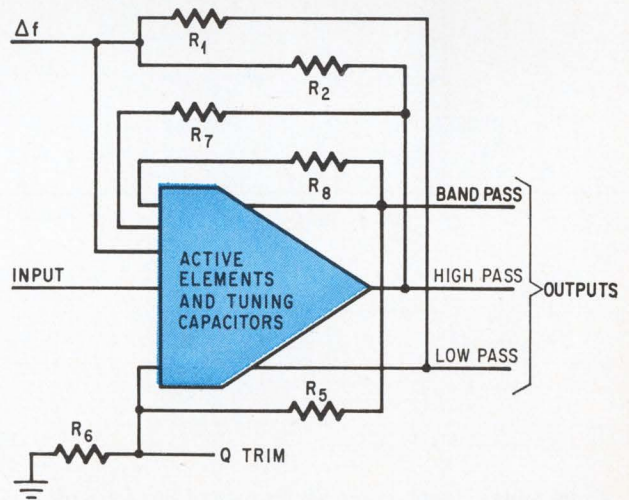
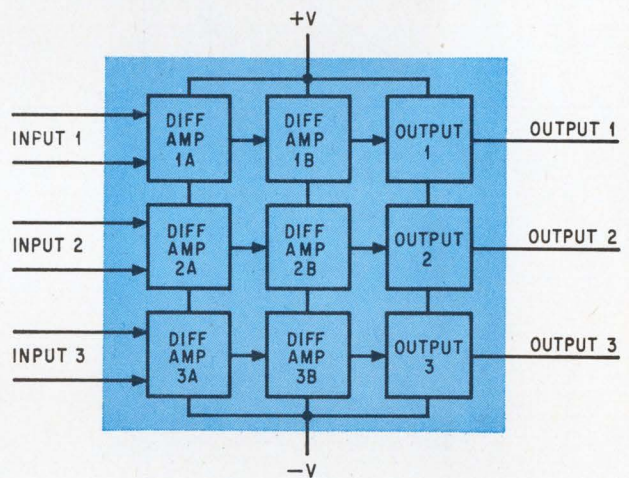

Hookup. In one version of KTI's negative-feedback filters, the MOS chip at top is connected to resistors that determine frequency and provide the output response.

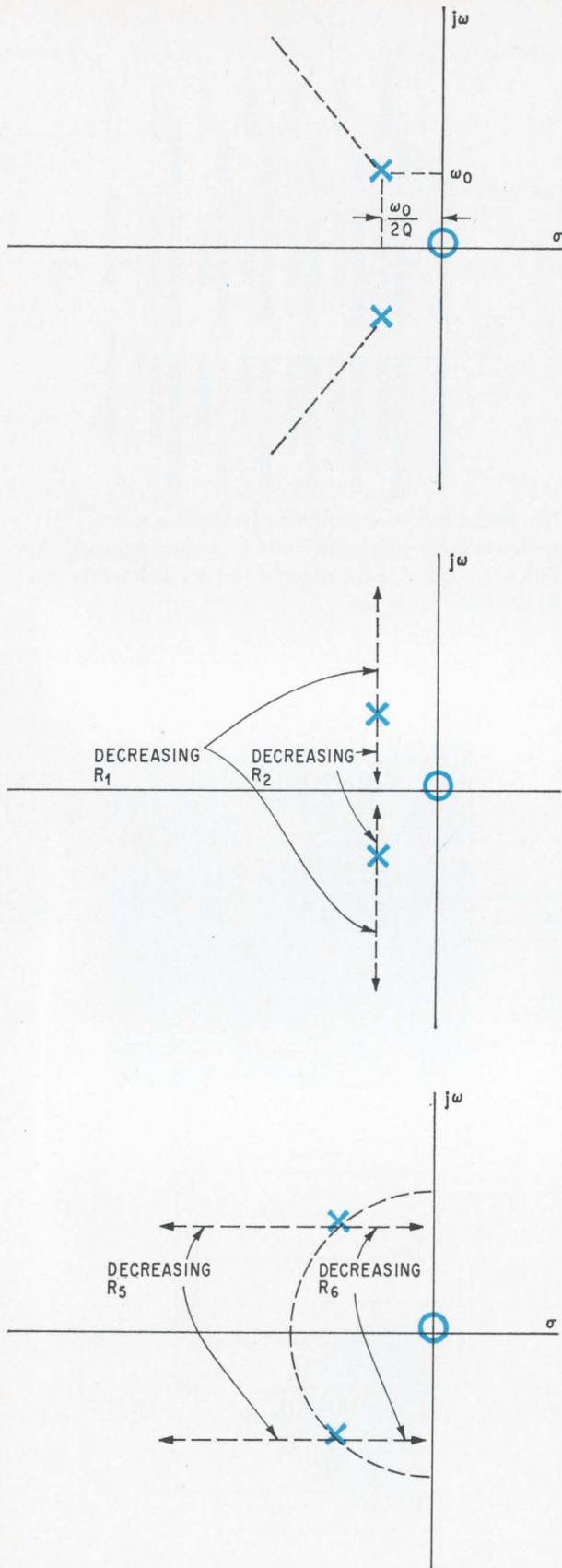

Three routes. Graph at top shows path of the poles of $D(s)$ as a function of decreasing R_7 and R_8 for a bandpass output. At center is the path as a function of R_1 and R_2 , and at bottom is the path as a function of R_5 and R_6 .

New job openings

The application of integrated-circuit technology to active filters has opened up several new jobs for the devices. For instance:

- Separating silver from clad-metal coins. A clad quarter rings at about 16 kilohertz and a silver quarter at about 10.6 khz. By employing ic filters, the U.S. Mint is able to sort these coins at the rate of 50 per second. The coins are launched at velocities of 20 feet per second and are sorted by electromagnetic deflection triggered by the sound cues.

- Touchtone telephone dialing. Telephone switching systems usually incorporate a modification of the single-wire signaling method. In a typical system, any number or symbol is represented by two or more simultaneously transmitted frequencies, which are combined in a logic matrix to operate particular switches. Several groups of frequencies are in use at present, extending from less than 250 hertz to 2,000 hz. singlepole filters usually suffice.

- Coded squelch circuits. Conventional squelch circuits are supposed to mute electromagnetic noise in communications receivers when the transmitter isn't on channel. But today's bands are so crowded that these squelch circuits often prove ineffective. The answer to this problem lies in multiple-tone squelching, a system that's triggered only when several audio tones are present simultaneously for a certain length of time. Very sharp ic filters in the receiving equipment can select the audio frequencies that trigger the system. These filters are readily adaptable to any frequency in the audio spectrum and they're tunable; if the receiver is moved or new equipment is added, codes can be changed.

- Single sideband. Almost all commercial and military communications installations use ssb signals for voice communications. This mode of transmission is less sensitive than others to interference, and it requires less bandwidth for a given set of modulation frequencies. The signals can be generated by either a phasing method or a filter, but phasing is more expensive and requires frequent adjustment.

Until the advent of the active filter, crystal-lattice and mechanical filters were the only components with the bandpass characteristics necessary for ssb filtering. However, they were also costly, cumbersome, fragile, and nontunable.

But now a single ic active filter can be tuned to the desired sideband while maintaining the bandpass characteristic required for the range of modulating frequencies in use. Its adjustable bandpass and center-frequency capabilities make the active filter applicable to voice or continuous-wave communications.

Another application of the active filter in equipment is speech processing. The task is usually handled by a speech amplifier with carefully designed interstage coupling and degeneration, a method involving circuit components and extra amplification stages. However, an elementary speech amplifier can be used if it's followed by an active filter adjusted to the bandpass and center frequency appropriate for the speech being filtered. This arrangement increases the efficiency of the ssb equipment, cuts its cost, and reduces the number of components needed.

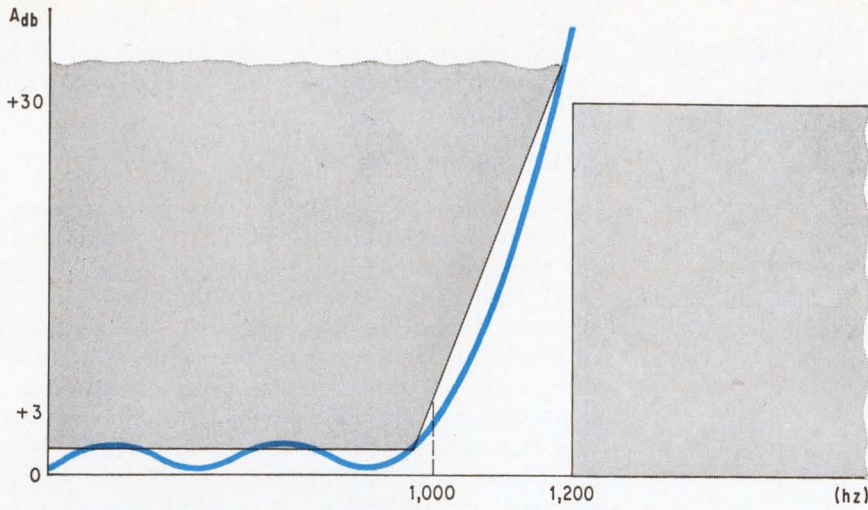

Specifications. This typical low-pass response curve calls for a flat response within 1 db between d-c and 1,000 hz.

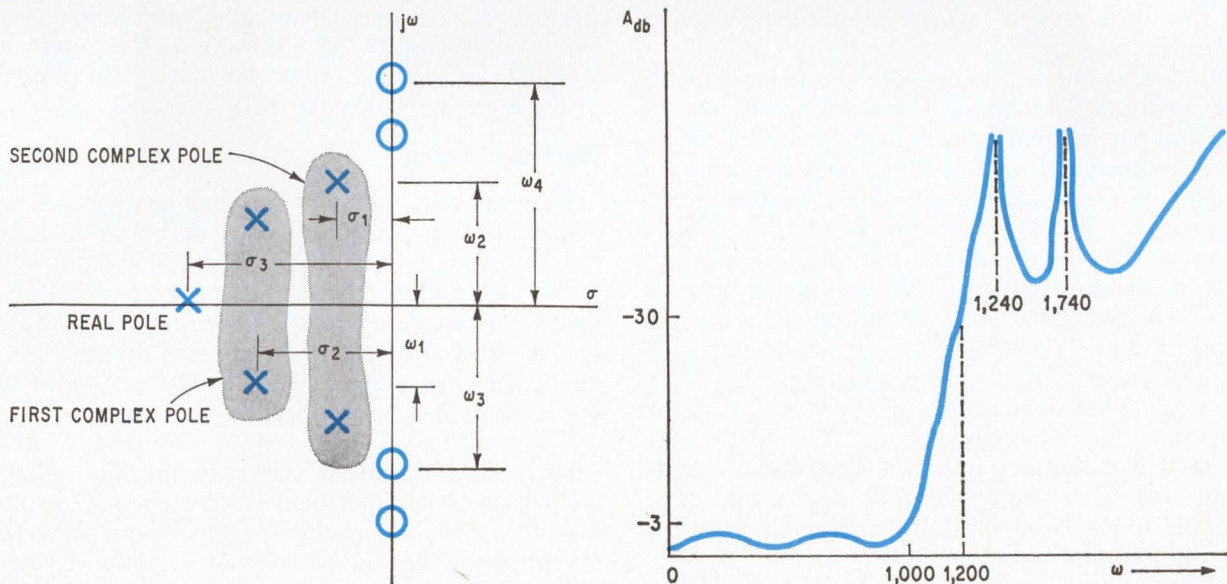
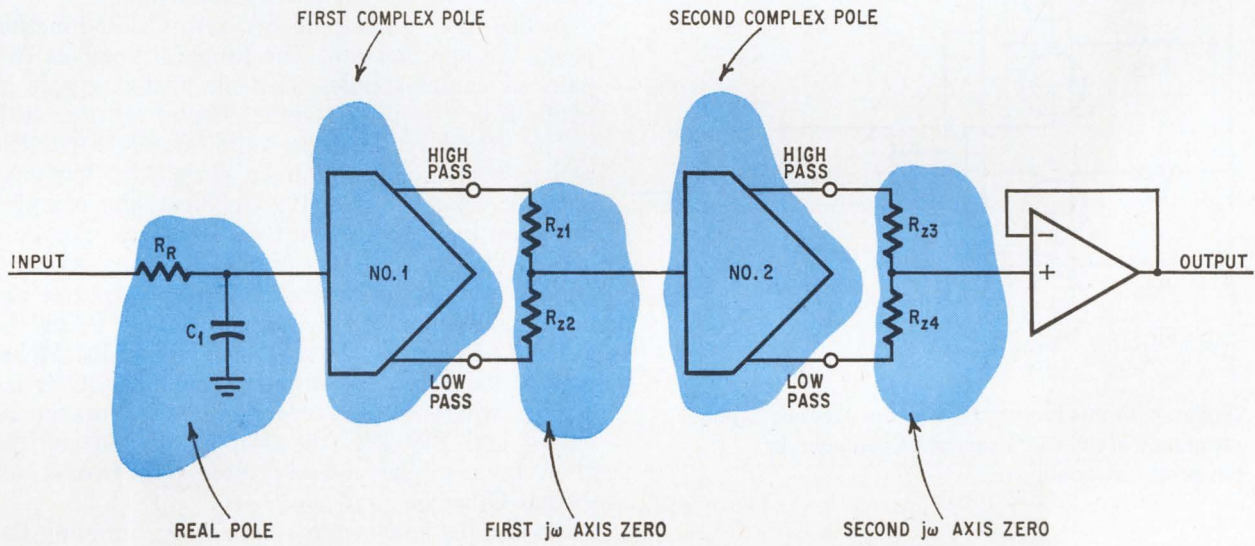

Causer filter. The fifth order arrangement at top produces the low-pass response specified. At lower left is the filter's pole-zero location, and at lower right is its over-all response curve.

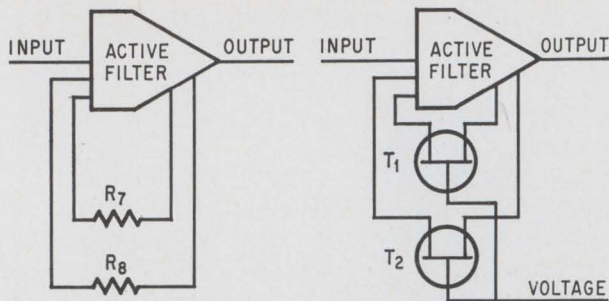

Analog. The filter can be electrically tuned if resistors R_7 and R_8 are replaced by MOS FET devices.

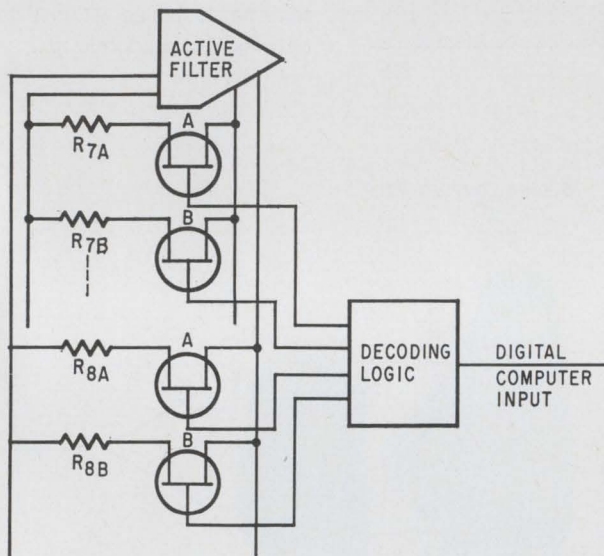

Digital. With this tuning scheme, the dynamic channel resistance of the FET's cannot be degraded by temperature variations.

identical in all three cases. The technique followed in the third version reduces the filter's power requirements.

In the hookup of the network shown on page 99, the elements determining frequency are R_7 , R_8 , R_1 , R_2 , and two internal capacitors not shown. The filter can be tuned over a wide range of frequencies and values of Q by paralleling other resistors across R_7 and R_8 . If the poles were moved on a radial passing through the origin, the Q of the network would remain constant as the frequency changes.

The approximate locus of the poles of the network as R_1 or R_2 is varied is shown on page 100. Decreases in R_1 boost the center frequency of the network, while decreases in R_2 lower it. In contrast to tuning achieved by varying R_7 and R_8 , this process is essentially a constant bandwidth mode. And since Q is simply the ratio of the center frequency to the bandwidth, it increases or decreases as the frequency rises or falls.

The Q of the network can also be adjusted by decreasing either R_5 or R_6 . The locus of the poles in this case is also shown on page 100. The

bandwidth, and thus the Q , of the network can be varied without changes in center frequency. As R_5 is decreased, Q is decreased; as R_6 is decreased, Q is increased.

Setting up the poles

In building KTI's FS-20 filter, designers were presented with an amplitude specification calling for a flat response within 1 db between d-c and 1,000 hz and an attenuation of at least 30 db at 1,200 hz and beyond. Most active-filter networks aren't capable of generating complex or $j\omega$ -axis zeros, so that the designers are restricted to an all-pole transfer function—Butterworth or Chebychev types. Such a function that satisfies the design criteria would be a seven-pole Butterworth filter with 1 db of ripple in the passband. However, by availing himself of a technique that permits the synthesis of complex zeros, the designer often finds that he's able to reduce the number of poles required.

In this case, a five-pole two-zero Causer function meets the specification. The function involves two pairs of complex poles and one real-axis pole in addition to two $j\omega$ -axis zeros, shown on page 101.

The actual synthesis is quite simple. First, the real pole is established by a simple RC low-pass network where $\sigma_3 = 1/R_{p1} C_1$. Next, the complex poles are tuned with two FS-20 sections. For pole one, $Q_1 = \frac{1}{2}\sigma_2$, $\omega_1 = \omega_1$, so that the center frequency is measured at the bandpass output of the filter and is adjusted by varying either R_7 or R_8 .

The Q is then set by adjusting R_5 or R_6 . Measured at the bandpass output of the filter, Q is f_c/BW_{3db} , where f_c is the frequency of maximum output and BW_{3db} is the 3-db bandwidth of the filter. In a similar manner, pole pair two is set so that $Q_2 = \frac{1}{2}\sigma_2$ and $\omega_{c2} = \omega_2$.

Finally, the $j\omega$ -axis zeros are set by summing the high-pass and low-pass outputs in the proper ratio. By setting R_{z1} to equal 10 kilohms and adjusting R_{z2} so that a rejection occurs at ω_3 —and following a similar procedure to get a zero at ω_4 —the design is complete. The final response curve is plotted at the lower right of page 101.

Electrical tuning

Either analog or digital schemes can be used to vary R_7 and R_8 simultaneously, and thus to tune the filter over a range of frequencies without disturbing Q . In the analog scheme upper left, R_7 and R_8 are replaced by junction devices or MOS field effect transistors. By changing the d-c gate voltage on these devices, the channel resistance of the unit can be changed over a wide range.

It's desirable in many applications to switch among several different center frequencies. Since temperature can affect the dynamic channel resistance of a FET, a digital tuning technique may be preferred. In the digital scheme the FET devices are switched either full on or full off; when devices A are full on, resistors R_{7A} and R_{8A} are inserted in the circuit. ■

Truth is stronger than fiction.



The truth about our A/D converters is stronger than the fiction you hear about others.

The truth about ours is that word lengths vary from 4 bits to 9 bits; word conversion rates vary from 1 MHz to 25 MHz; and aperture time is as low as 0.2 nanosecond!

Prices range from only \$4,200 to \$9,660 and include internal sample-and-hold, power supplies, and self-test features.



Not only that . . .
We also have D/A converters
that match our A/D's in speed
and accuracy. Honest!

COMPUTER EL LABS

for tomorrow's technology today

(919) 292-6427 • 1109 SOUTH CHAPMAN ST.
GREENSBORO, N. C. 27403

Log diodes can be counted on

It has become easier to use these devices as computing elements; latest production methods assure uniform characteristics within batches, and thus eliminate the need for exhaustive testing by the purchaser

By Robert W. Hull and Karabet Simonyan

Computer Diode Corp., Fair Lawn, N.J.

Silicon technology has reached the point where logarithmic diodes with wide dynamic ranges can be consistently produced in fairly uniform batches. And this producibility increases the usefulness of these devices as computing elements. Log diodes have output voltages that are exponentially proportional to input current—a characteristic they employ to perform such arithmetic functions as multiplying, dividing, and raising to powers. The circuitry involved in these functions can be easily implemented.

Though all silicon diodes exhibit an exponential relation between forward voltage drop and current, they're useless as computing elements unless their exponents stay constant over a wide range. However, with recent improvements in the technology, log diodes can now be designed and fabricated to assure this constancy both within themselves and in relation to other diodes in their batch.

This characteristic applies to both alloyed diodes having long carrier lifetimes and operating at low current densities, and diffused diodes with short carrier lifetimes and higher-current-density operations. But with a forward-voltage slope of 60 millivolts per decade over six to eight decades of current, the alloyed diode has a wider dynamic range than the diffused diode, with a slope of 120 mv per decade over four to six decades.

Exponents reflect many factors. The current transport across a p-n junction can be considered the sum of the currents stemming from carrier diffusion across the junction, carrier recombination in the junction region, surface recombination, channeling, and tunneling. It must also be kept in mind that the over-all current is reduced by ohmic losses in the electrode contacts and in the bulk semiconductor outside the active region. Each of the individual currents can be described by theoretical formulas, but exact computation is impossible. Many of the

parameters can't be readily measured in the active regions; they can only be estimated.

As shown below, the logarithmic region increases as recombinations are suppressed as much as possible. This is done by using silicon free of deep trapping impurities and by forming the junction without generating dislocations that could serve as recombination centers. The series resistance of the contact electrodes should also be minimized. The curves shown are for an alloyed diode made with aluminum and n-type silicon doped to approximately 10^{16} donors per cubic centimeter, and with a junction area of 5×10^{-4} cm² and a base width of 5×10^{-3} cm.

As indicated opposite, a quality diode's characteristics should follow the equation $V_o = A \log I$ —that is, the result should be a straight line on a

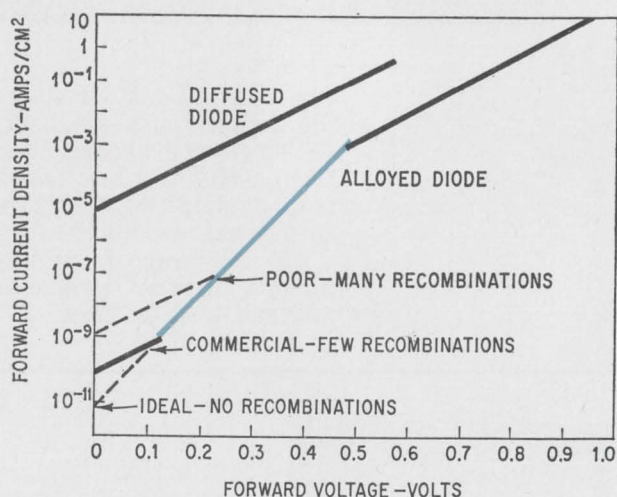

Log region. The widest logarithmic range is obtained by suppressing the recombination centers.

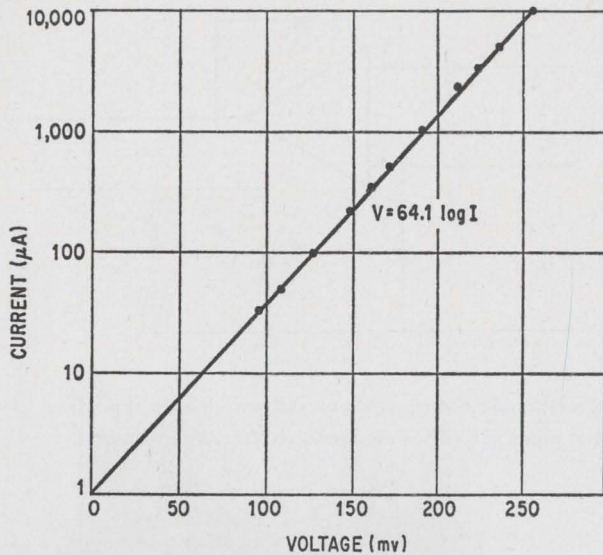

Straight up. An ideal log diode's characteristics should follow a straight line on a semilog plot.

similog plot of I versus V_o . In this graph, the measured points deviate by less than 0.1%.

Log diodes are manufactured and classified according to the equation for forward conduction

$$V_o = A \log I + BI + C$$

where one constant, A , is a linear function of the absolute temperature, B is a series resistance, and the other constant, C , is a function of the built-in, temperature-dependent, barrier or offset voltage. In a properly designed log diode, B is negligible over the useful operating range and only A and C have to be considered in designing circuitry.

The improved production techniques permit the designer to choose a diode by type number rather than having to undertake the burdensome task of selecting and matching by exhaustive testing. Rather sophisticated equipment—and knowledge—are needed if one wants to test to millivolt accuracy over the required current and temperature ranges.

Least-square averaging of measured data and extraction of the equation for any specific diode can be done graphically, but the job is a very tedious one if a large number of diodes are to be checked. However, a recently developed computer program enables the vendor to quickly check and categorize many diodes and match them as sets.

As shown above right, a log function is generated by one diode, while a similar diode, operated at unity current, subtracts the constant C , eliminating offset voltage. Therefore, unity current represents the voltmeter zero on the log scale.

But since the constant A can't be removed in this manner, the output depends on temperature to the extent of a deviation of 0.3%/°C from 25°C. This temperature dependence can be minimized either by separate compensation networks or by maintaining the diodes at a constant temperature.

In the circuit above right, n diodes are connected

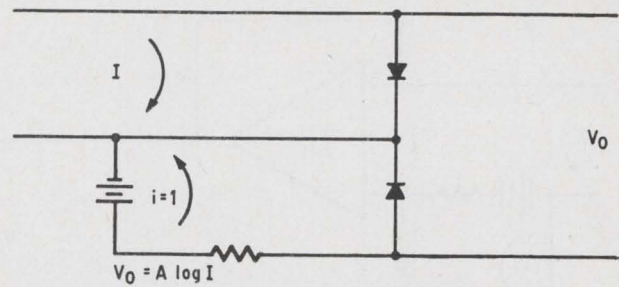

Function. The log of the input is generated by one diode, while the other subtracts the constant C .

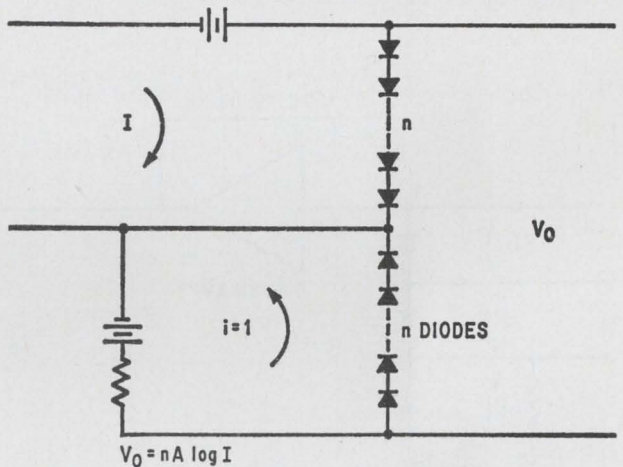

Chain reaction. With n diodes connected in series, the exponent of the output is increased by n .

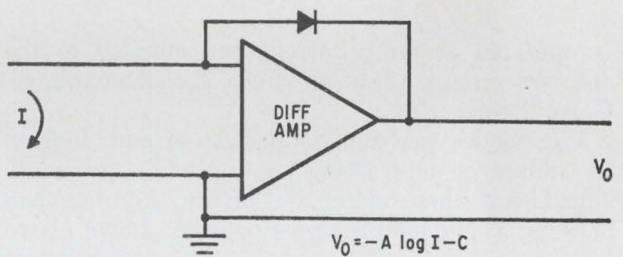

Booster. Differential amplifier provides another way to increase the output voltage.

in series to provide n times each diode's output voltage. This circuit is particularly useful in radiation detectors because of its high signal-to-noise ratio. There's a noise improvement for very small signals since the voltages add linearly while the noise adds by the square root. By feeding such circuits into an electrometer-type voltmeter, it's possible to measure input currents from 10^{-10} amps or less to 10^{-3} amps on a single logarithmic scale.

In another typical log function generator, shown above, a differential amplifier drives the output voltmeter. With only a single diode, neither the A nor C constants are removed. But if a second diode

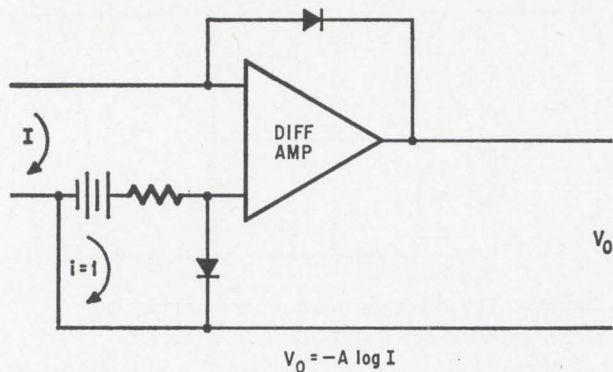

No offset. By adding another diode to the differential amplifier circuit, the constant C is eliminated.

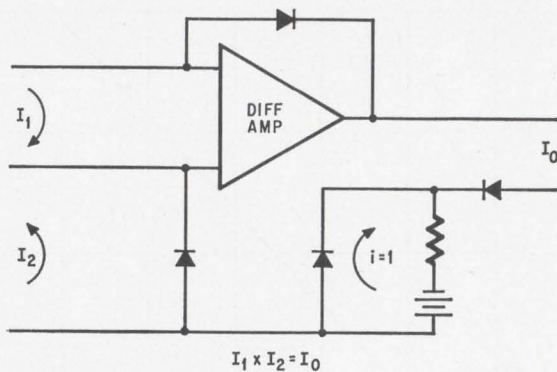

Commonality. With a differential amplifier in the adder, the input and offset diodes have the same terminal.

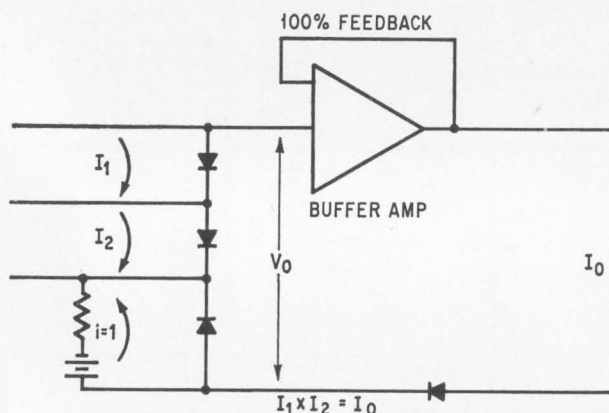

Adder. A complete adding circuit employs an operational amplifier and an antilog diode.

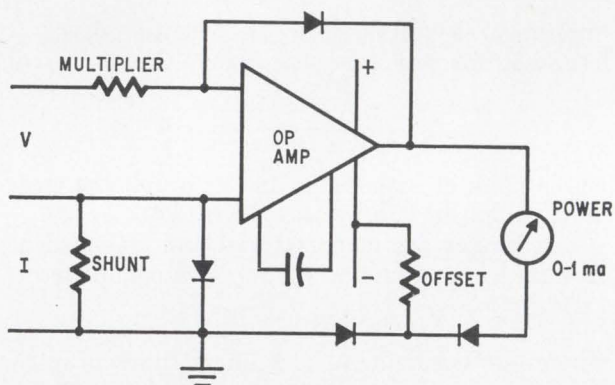

Instrumental. Besides doing arithmetic, the log diodes can be used in such things as a wattmeter.

is operated at unity current and coupled to the amplifier circuit, as shown above, the offset voltage, C, can be canceled.

Log diodes perform multiplication and division by adding or subtracting logarithms of individual signals and then taking the antilog. Addition can be done by the simple series network shown above—an analog circuit that's not temperature dependent if all diodes are kept at the same temperature, and has no offset voltage. Because the buffer amplifier—an op amp with 100% feedback—has unity gain, the antilog diode (output) operates at the same current as the log diodes (input). All four diodes are identical, and it's mandatory that the same number of diodes face in each direction around the arithmetic loop if A and C are to be canceled.

With a differential-input operational amplifier as a buffer, the diodes can be used in the feedback paths so that the input currents and the unity offset current have a common terminal as shown above.

The input currents may, of course, be changed to input voltages by the use of series resistors. And parallel diodes of opposite polarity can be used for a-c inputs and outputs. Basic multiplication, division, raising to powers and root extraction can be combined in one circuit.

The circuit shown above functions as a wattmeter; voltage times current equals power. In this arrangement, temperature need not be constant but it must be precisely the same for all four diodes. The close mounting of the diodes in one epoxy module must therefore be considered. The precision with which the characteristics of the diodes track one another determines the precision of the computation. Accuracies of 0.1% to 1.0% are possible with currently available diodes.

A and C can be properly canceled only when the diodes are closely matched to the same characteristic curve. The op amp generates an error no larger than the inverse of its open-loop gain, and is, in this respect, superior to a single transistor; the transistor's base-emitter temperature coefficient and offset voltage make the cancellation of the constants extremely difficult.

Attempts have been made in the past to compensate for this problem by using diode-connected transistors. But such circuits were successful only where the devices were carefully selected. Emitter currents in diode-connected transistors fall under the same equation that applies to diodes, and the use of these transistors demands the same attention to the cancellation of constants. ■

Test your logic.

a) Suppose you designed the DCL MSI 8260, world's fastest adder, and its logic diagram looked like this:

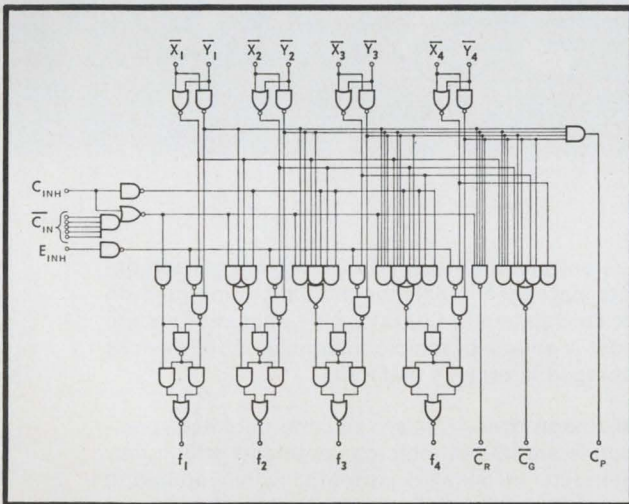

b) And it gave a speed and package count, which beat any other IC family, like this:

No. of Bits	Package Count			Addition Time per Bit (ns)	Total Addition Time Input to Output (ns)
	8260	8261	Quad 2-Input NAND Gates		
16	4	1	—	3.3	52
24	6	3	—	3.3	52
32	8	3	—	2.0	64
48	12	6	1	1.3	64
64	16	7	1	1.2	76

c) Next, suppose you came up with eleven new MSI elements—all perfect fits with the 8260, our other MSI elements, and the entire DCL family—like this:

8230	8-Input Digital Multiplexer
8232	8-Input Digital Multiplexer
8241	Quad Exclusive-OR
8242	4-Bit Comparator
8266	2-Input, 4-Bit Multiplexer
8267	2-Input, 4-Bit Multiplexer with Bare Collector
8268	Full Adder
8275	Quadruple Latch
8276	8-Bit Shift Register with Clock Inhibit
8284	4-Bit Binary Up/Down Counter
8285	BCD Up/Down Counter

d) Now then: wouldn't you logically buy a full-page ad to tell the world in Electronics? And wouldn't you sign it like this:

Signetics DCL

Signetics Corporation/811 E. Arques Ave., Sunnyvale, Calif. 94086/A subsidiary of Corning Glass Works

Logical afterthought: For written proof that Signetics is right in the middle of MSI, send for our DCL handbook. It's 120 pages—and free!

When your IC bugs out, chances are the heat's on!

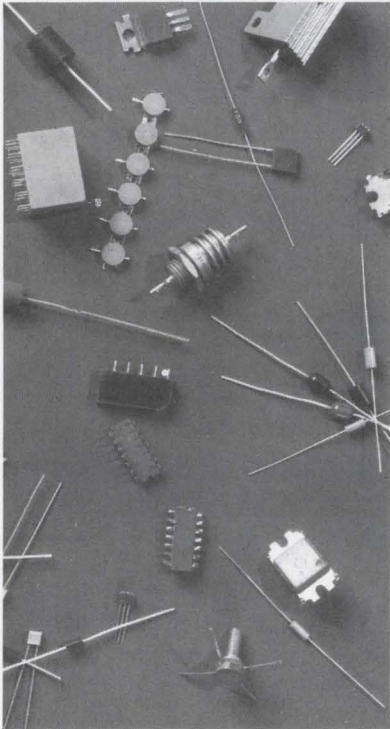

Devices packaged in Dow Corning® silicone molding compound are physically and electrically stable—even after long term exposure to both high heat and humidity. Derating, a practice common with organic packaging, is not necessary. In fact, you can design for high device and component density by using silicone molding compound. One manufacturer of glass package power diodes reduced the part to 1/30th of its former volume. Sizes from 1/5th to 1/3rd smaller can be obtained by using silicone molding compound in place of other plastics.

Little moisture absorption. Silicone molding compounds when exposed for 1000 hours to 93% RH at 70 C showed an average weight increase of 0.32% with the greatest increase being 0.5% and the least being 0.17%. Five organic plastics had average weight increases ranging from 1.0 to 2.1%—an average of nearly five times greater than silicone molding compounds under the same test conditions.

No cracking. Unlike other thermal setting plastics, Dow Corning silicone molding compounds are virtually unaffected by thermal shock. For example, a power resistor molded in Dow Corning® 307 compound was cycled repeatedly from -65 to 350 C without damaging the packaging material or the component.

Will not burn. Silicone molding compounds are

inherently nonburning. Thus, components and devices packaged in silicone molding compound do not constitute a fire hazard. No flame snuffers are used—a source of ionic contamination for devices packaged in organic materials.

Corrosion free. These silicone molding compounds are free of ionic contaminants which may contribute to metallic corrosion when operating in high humidity and influenced by voltage bias.

Competitive price. Costing only a fraction of a cent per device, Dow Corning silicone molding compounds enjoy a substantial price advantage over metal cans . . . glass packages.

Manufacturing economies. Transfer molding enables manufacturers to package devices and components with a minimum of manual labor and supervision. Good mold release and minimum flash assure high production rates . . . reduced deflashing costs. These manufacturing advantages make silicone molding compounds totally competitive with organic plastics.

So why be bugged by device failures because of a cheap plastic package? Specify Dow Corning® brand silicone molding compound, and get the best package protection in your electronic equipment . . . lets you keep your cool. For technical data, write: Dept. A-8472, Dow Corning Corporation, Midland, Michigan 48640.

DOW CORNING 

Anyone can think small.



Frankly, we had something bigger in mind.



We built our second generation DPM* to fit into seven square inches of panel. That's less than any other digital panel meter requires. But we didn't stop there. The Model 1290 mounts completely from the front of the panel. The entire chassis pulls out from the front for servicing or replacement. Even the Nixie** tubes are pluggable! Think of the convenience in continuous systems opera-

tion. Despite the smaller package, Model 1290 has all the features our original DPM is so widely acclaimed for—3-digit plus 100% overrange display, 0.1% \pm 1 digit accuracy, circularly polarized window filter, dual slope integration, full-buffered storage display and BCD output. Many of these standard Weston features are still "optional at extra cost" on competitive units. Our new compact

is styled for tomorrow, available today, and priced below \$200 in quantity. Anything else in the industry is just small talk. WESTON INSTRUMENTS DIVISION, Weston Instruments, Inc., Newark, New Jersey 07114.

a Schlumberger company

WESTON®

*U.S. Pat. #3,061,939 and patents pending.
**Registered trademark, Burroughs Corp.

Introducing pulling.



As opposed to pushing and swearing a lot.

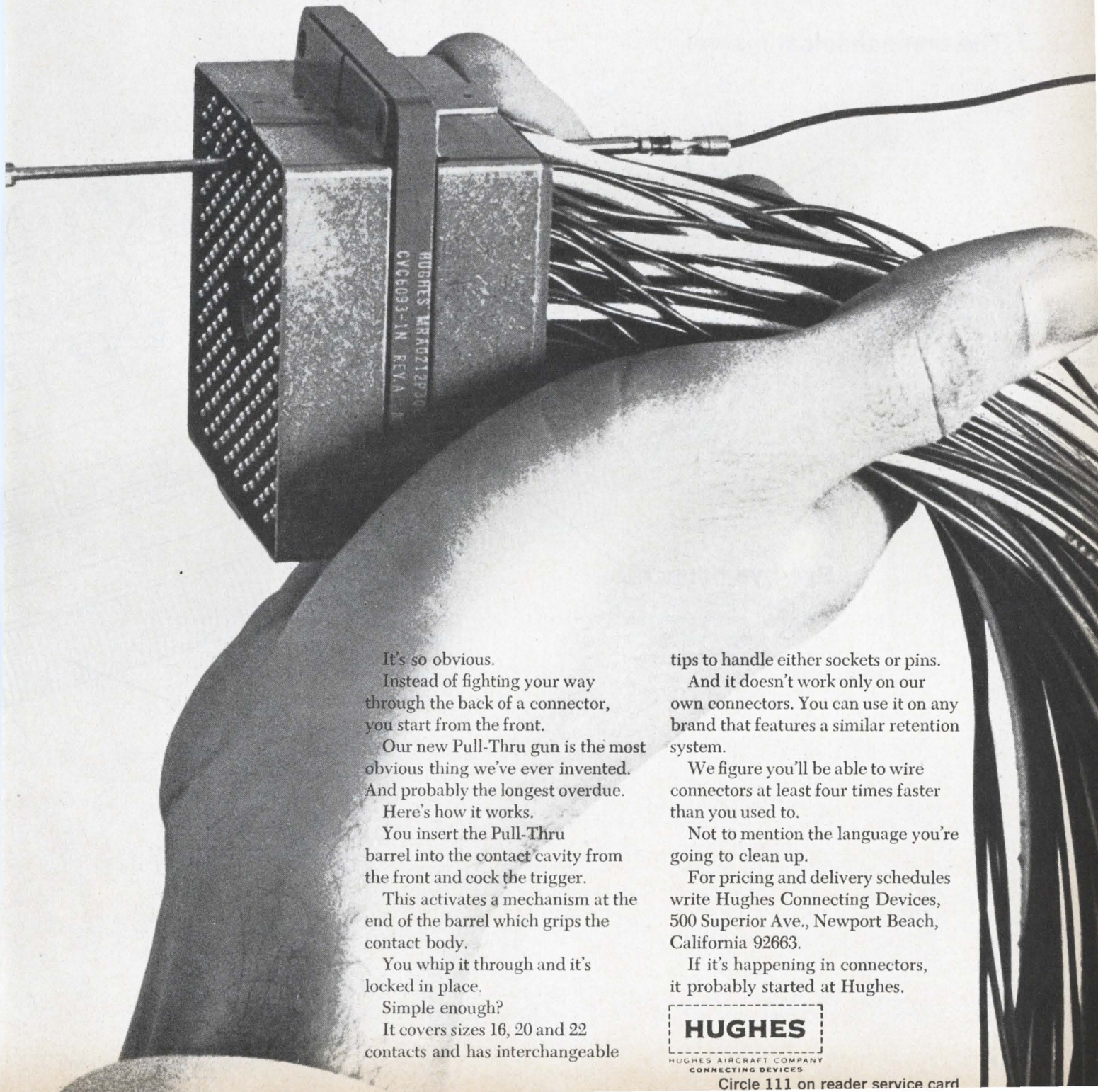

It's so obvious.

Instead of fighting your way through the back of a connector, you start from the front.

Our new Pull-Thru gun is the most obvious thing we've ever invented. And probably the longest overdue.

Here's how it works.

You insert the Pull-Thru barrel into the contact cavity from the front and cock the trigger.

This activates a mechanism at the end of the barrel which grips the contact body.

You whip it through and it's locked in place.

Simple enough?

It covers sizes 16, 20 and 22 contacts and has interchangeable

tips to handle either sockets or pins.

And it doesn't work only on our own connectors. You can use it on any brand that features a similar retention system.

We figure you'll be able to wire connectors at least four times faster than you used to.

Not to mention the language you're going to clean up.

For pricing and delivery schedules write Hughes Connecting Devices, 500 Superior Ave., Newport Beach, California 92663.

If it's happening in connectors, it probably started at Hughes.

HUGHES

HUGHES AIRCRAFT COMPANY
CONNECTING DEVICES

Circle 111 on reader service card

We've re-invented the name is the same.

The unmechanical marvel.

We've uncomplicated the keyboard by getting rid of the mechanical linkages, the electromechanical parts, the moving contacts. And came up with a virtually trouble-free, all solid state design.

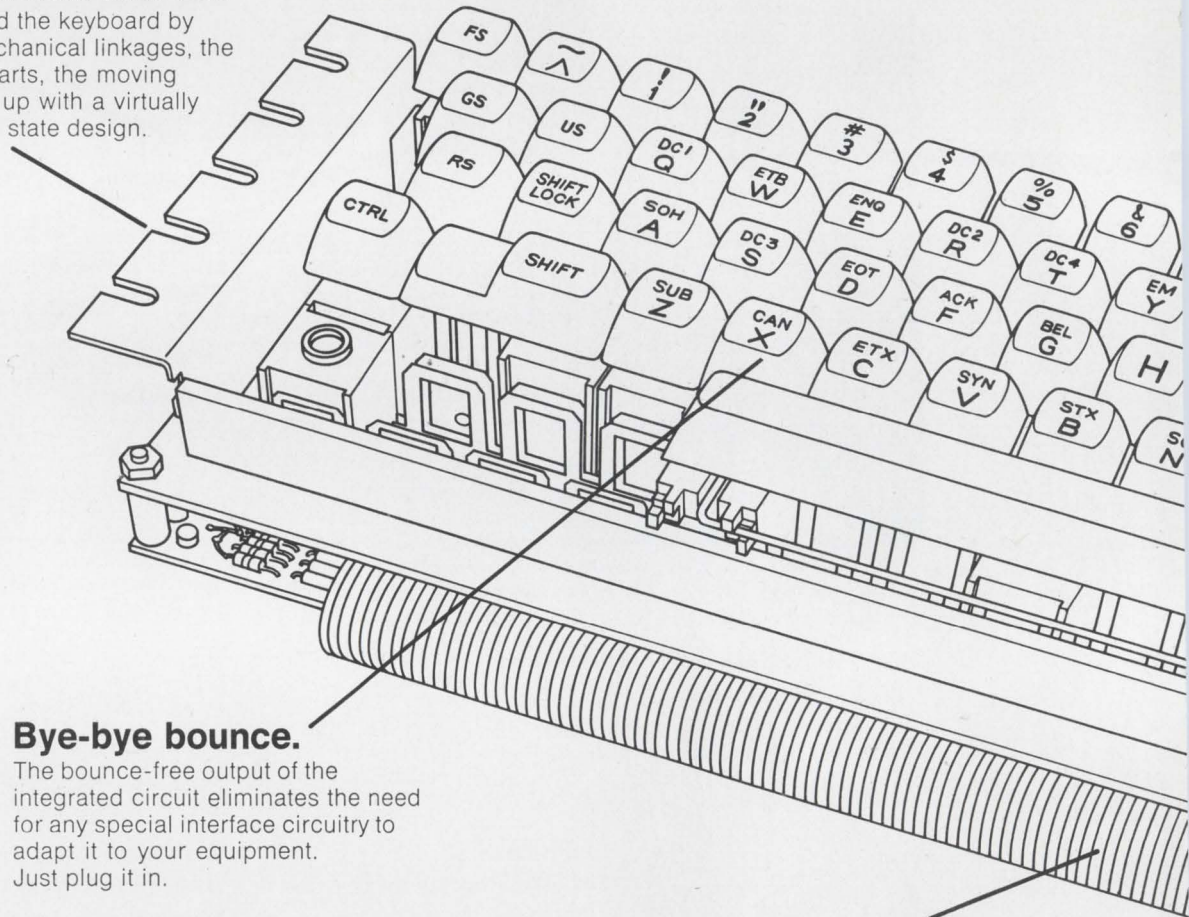

Bye-bye bounce.

The bounce-free output of the integrated circuit eliminates the need for any special interface circuitry to adapt it to your equipment. Just plug it in.

Pick a code.

We supply any 8-bit code (or less); hexadecimal; Baudot, BCD; USASCII mono-mode, dual-mode and tri-function; plus EBCDIC and custom codes.

keyboard. Only the

Solid state all the way.

The re-inventing started with the world's first application of an integrated circuit as a keyboard switching element. Actuated by a magnet on the key plunger, the integrated circuit delivers a digital output which is fed into the encoding matrix of the keyboard.

The \$100 understanding.

We agreed with you that a one hundred dollar volume price for an all solid state, assembled and encoded keyboard was ideal. And realistic. If we could get rid of the hundreds of moving parts and the big black box of buffer circuitry.

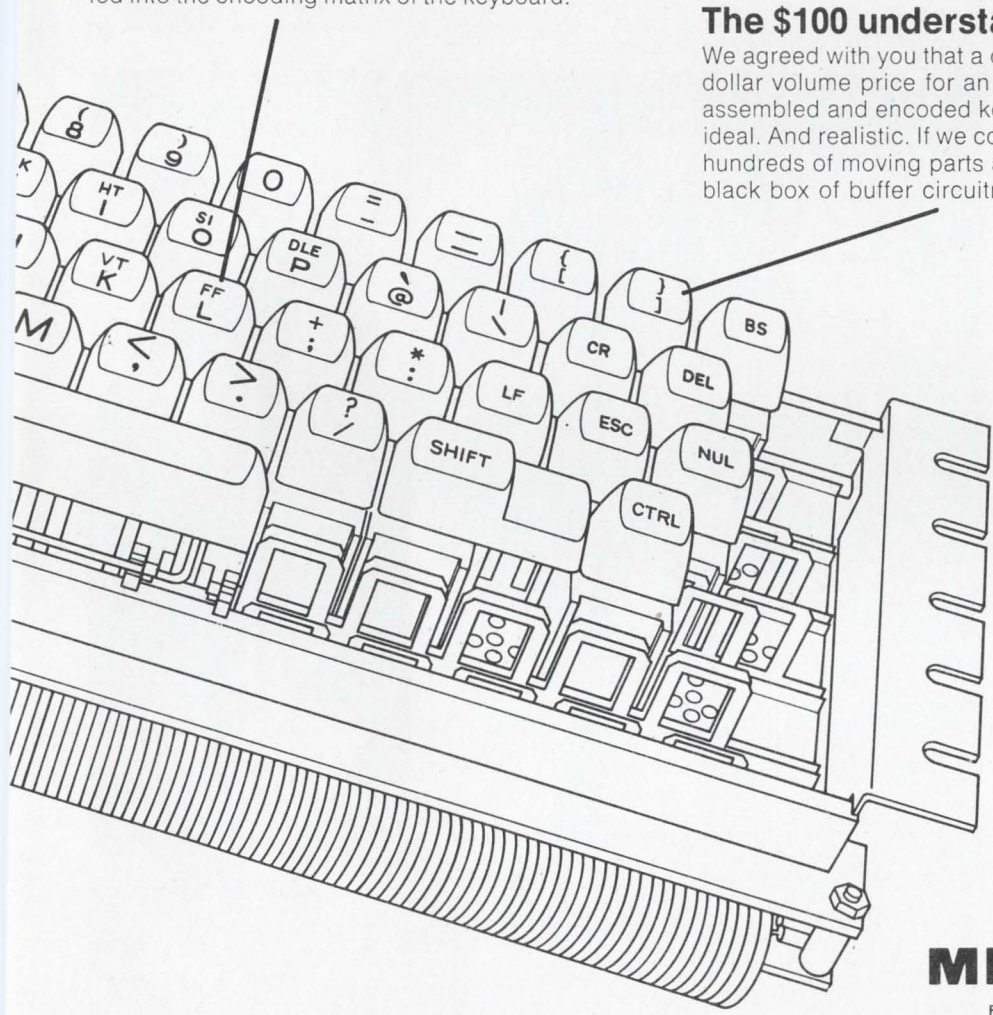

A good start.

Our handy "Condensed Keyboard Guide" briefly discusses keyboards and options to give you an idea of the broad offering that we already have available. MICRO SWITCH application engineers are ready to work with you in developing the most economical keyboard designs to meet your precise format and encoding needs.

MICRO SWITCH

FREEPORT, ILLINOIS 61032

A DIVISION OF HONEYWELL

IBM Circuit Design and Packaging Topics

- Elevator control manufacturers reduce system size and cost with IBM relays
- IBM subjects reed switches to rigid tests before shipping

□ Elevators: controller size and reliability critical

IBM wire contact relays help elevator control system manufacturers solve the major problem of reducing increasingly complex control systems without sacrificing reliability.

With many presently used large switching devices, for example, a typical controller unit for a 6-car installation fills a 10' x 10' room, floor to ceiling.

Larger and more complicated installations increase size even further, leading inevitably to controllers of unacceptable proportions. The answer is a smaller control system—which means smaller components. It is this trend that leads the elevator industry to growing recognition of the advantages offered by IBM relays.

□ Elevators: relays allow dramatic reductions in size

One elevator manufacturer, Dover Corporation/Elevator Division, Memphis, Tennessee, chose IBM wire-contact relays after conducting extensive tests to determine which components offer the best combination of high reliability, small size, and low cost. Products were evaluated under worst-case conditions. Life tests showed that IBM wire-contact relays exceeded Dover's most stringent reliability requirements.

IBM wire-contact relays are smaller than most. The dense and compact packaging made possible by use of 4-, 6-, and 12-pole IBM relays slashes Dover's elevator controller size by over 75%. It also results in substantial manufacturing cost reductions plus savings in shipping and installation.

□ Elevators: relays cut manufacturing costs

F. S. Payne Co., Cambridge, Massachusetts elevator manufacturer stresses that any new controller should use relay logic for serviceability and overall economy. IBM wire-contact relays were thoroughly tested in the lab, in Payne's

test tower, and in field installations. They proved 100% reliable.

IBM relays cost less per contact than presently-used relays and their multipole configuration reduces the number of relays needed. Because the entire control system is smaller, it can be made in less time, with fewer parts, by fewer people.

Elevator passenger safety is the overriding design consideration which depends, in large part, on controller reliability. IBM relays greatly surpass reliability criteria for elevators while offering dramatic space savings in control unit size.

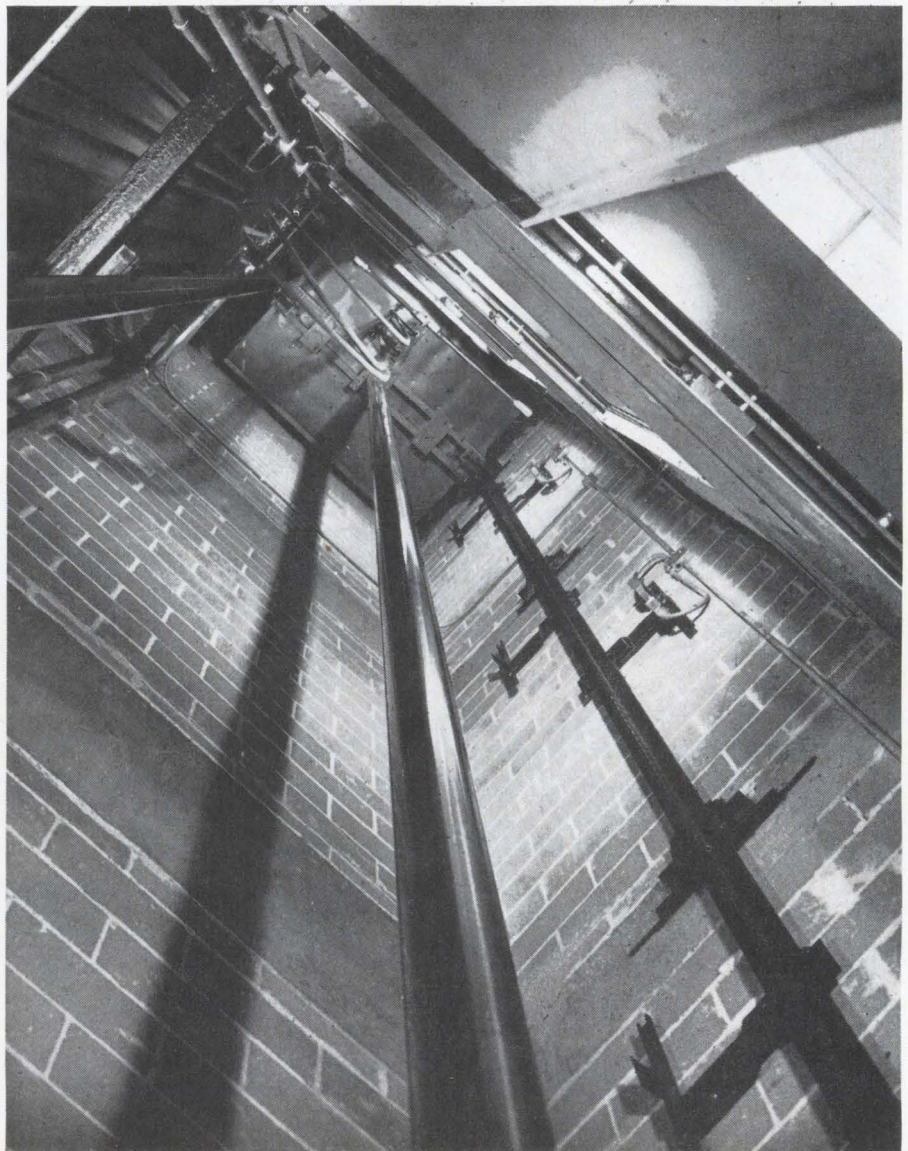

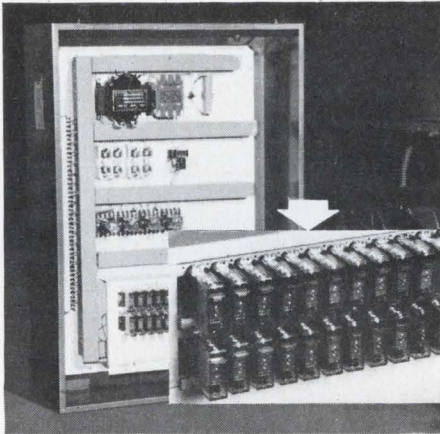

IBM relays can slash more than 75% off the size of elevator controller units without sacrificing reliability.

Elevators: relays permit design flexibility

Another elevator manufacturer, United States Elevator Corp., Spring Valley, California, finds IBM wire-contact relays important for design flexibility.

Their controller is programmed to sense changing needs for elevator cars as traffic patterns vary, as opposed to timing cars to arrive during pre-determined peak traffic hours. This requires simultaneous switching of many circuits. When U.S. Elevator investigated various switching components, they found the IBM 12-PDT relay to be ideal since it offered up to twelve separate switching circuits within one small component.

Additional design flexibility is provided by plug-in insertion and taper-pin wiring of relay receptacles which allows for future controller expansion.

Long life and ease of maintenance are two important design considerations for all elevator controllers. The IBM

relay, with mechanical life of 200 million-plus operations, and pluggable construction, fulfills both needs.

These are only three of many manufacturers benefiting from IBM wire-contact relays in their control systems. To find out how these relays can help you, contact IBM now.

High-speed reed switches undergo rigid testing

For applications requiring higher speed switching, IBM offers a line of reed relays built around the rhodium-over-gold IBM miniature dry reed switch.

These switches are designed for applications where fast, ultra-reliable operations are essential. They also serve ideally as an interface between solid state and relay logic.

To insure consistently superior performance with these switches, IBM uses advanced manufacturing equipment and rigid inspection techniques in every production phase.

For example, shipment populations of IBM reeds are sampled as a final process control measure to guarantee

product uniformity. Switches are tested under four operating conditions for life vs. resistive load and one condition for life vs. inductive load (100 mA inductive load with diode suppression).

Full documentation on quality assurance and failure parameters concerning these reeds are available on request.

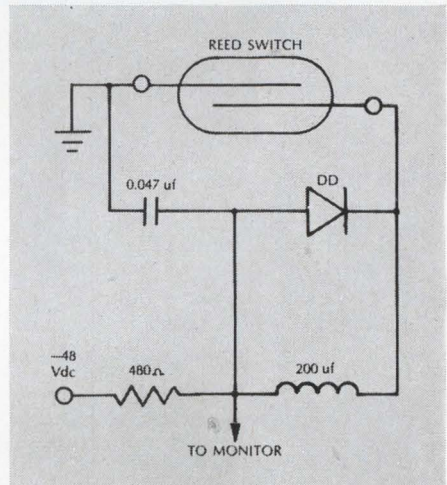

The diagram above shows just one of the circuits (48 VDC suppressed) used to test IBM miniature dry reed switches prior to shipment.

**IBM Industrial Products Marketing Dept. E331
1271 Avenue of the Americas
New York, New York 10020**



Please send information on:

- IBM wire contact relays**
- IBM reed relays and switches**

name _____

position _____

company _____

address _____

city _____ state _____ zip _____

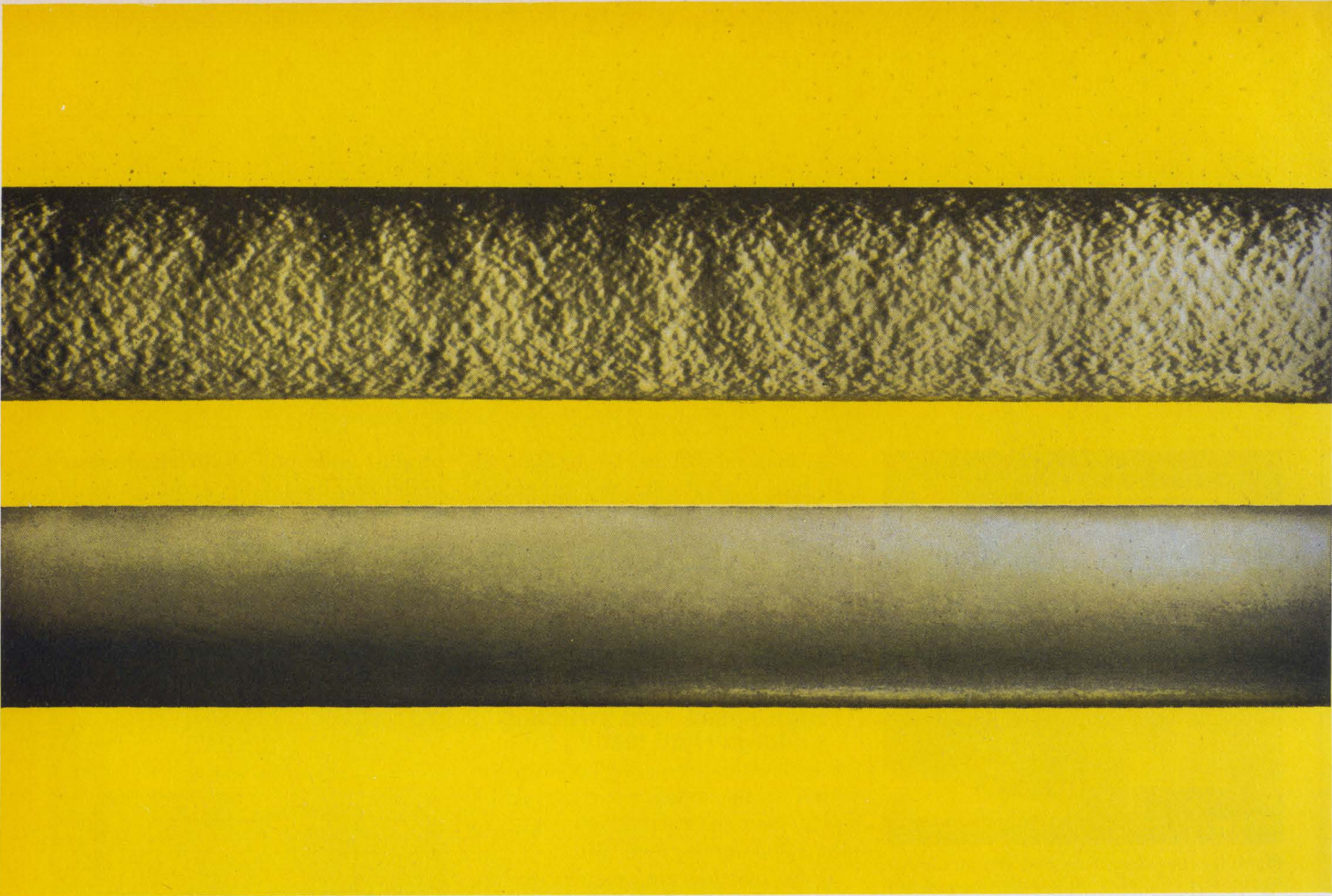

Which is the slippery wire?

The seemingly simple problem of pulling telephone wires through conduit has important economic implications. In large buildings, for example, we would like to add more wires in existing conduits as the need for communications services grows. But friction between the wires eventually prevents more from being drawn through. Then, a new conduit must be installed, even though the previous one is not really full. What is needed is slippery wire.

Recently, Bell Laboratories and Western Electric greatly increased the useful capacity of conduits by developing a new low-friction polyvinyl insulation for the Bell System's general-purpose wire. Since the new wire slides

more easily, it needs less tensile strength, and so it can be smaller. This further increases the number of wires a conduit can hold. Twenty-three wires now fit into a conduit that previously held only four.

We did several things to make the new wire more slippery. We made its jacket harder—by reducing the amount of plasticizer (vinyl softener). We added paraffin wax for permanent lubrication.

And we made the jacket rougher—not smoother. (The low-friction wire, enlarged about eight times, is the top one in the picture.) Smooth surfaces lead to more intimate contact and, therefore, more friction.

As a result of this work at Bell Lab-

oratories, Western Electric altered its manufacturing process: previously, the hot vinyl jackets were cooled by water under high pressure as they emerged from an extruder. This created a smooth finish. Now, Western Electric avoids applying pressure during the cooling process and thus obtains a micro-rough, low-friction surface.

This kind of interaction between Bell Laboratories and Western Electric is a major factor in making improvements quickly available to operating telephone companies.

From the Research and Development Unit of the Bell System.



Bell Labs

Nitride passivation links TTL, MOS

Several firms, notably TI and GI, believe they've hit on a process to make low-level metal oxide semiconductor devices

By Walter Barney

Associate editor

"In the real world," concedes Lee Seely of the General Instrument Corp., "there is TTL." Seely, general manager of the Microelectronics division of GI's Semiconductor group, has no real quarrel with the prevalence of transistor-transistor logic, but as a leading developer of metal oxide semiconductor technology, he would like to find some way to coexist with it. Historically, MOS has operated at higher voltages than bipolar circuits, meaning that level shifters and extra power supplies were necessary if the two were to work together. The incompatibility has undoubtedly delayed the development of MOS. In the past year, some companies—notably the National Semiconductor Corp. and American Micro-systems Inc.—have offered MOS circuits that worked at or near TTL voltage levels. And this month, both GI and Texas Instruments announced a new MOS process that they say overcomes some of the difficulties of making low-level MOS. Motorola and ITT Semiconductor are among the other contenders in nitride passivation.

The process turns out to be an old friend—silicon nitride passivation [*Electronics*, March 17, p. 35]. The bipolar world has taken to nitrides like a cat to catnip; Si_3N_4 has been hailed as the compound that makes possible the "hermetic chip." TI and GI do value the protective properties of nitride, since they think it will make plastic-packaged MOS feasible, but they cherish it too for its high dielectric constant (twice that of silicon oxide), which lowers the threshold voltage for metal oxide semiconductor devices.

Geometric geography

An MOS transistor consists of two regions—source and drain—of a particular type dopant diffused into a substrate of the opposite type. (Normally they are p regions in an n substrate.) Current flows from source region to drain region when a voltage is applied to a contact over the area between them, temporarily creating mobile positive charges in the n substrate. The voltage required to invert this area, the gate, is directly proportional

to the surface state charge (Q_{ss}) on the silicon and the thickness of the oxide over the gate, and inversely proportional to the dielectric constant of the insulator between the semiconductor material and the gate metal.

One can lower threshold voltage, then, by reducing surface state charge or oxide thickness, or by increasing the dielectric constant. Shaving the oxide, which may be only about 750 angstrom units thick to begin with, does not appeal to anyone. "The oxide is already as thin as it should be," says L.J. Sevin, who directs MOS activity at TI. Oxide defects can be murderous on yields. It is possible to reduce the surface state charge, however, by using silicon of a different crystal orientation, and this is what most companies have done.

National Semiconductor pioneered the switch from 111 silicon, which has a densely populated surface, to 100 silicon. The 111 plane has a lot of uncommitted bonds, which look like a charge on the silicon surface. Silicon cut on the 100 plane has fewer such bonds, and a significantly lower Q_{ss} . Devices made with 100 silicon have threshold voltages as low as 1.6 volts—compared with the 4 volts of passivated 111 SiO_2 devices—and consequently operate easily with a 5-volt TTL power supply. (The rule of thumb is that supply voltages should be about three times threshold voltages.)

GI is familiar with the 100 silicon route. "That sounds nice, and that's where we got led down the garden path," Seely says ruefully. A year ago, GI announced a device with a 1.6-volt threshold, but the

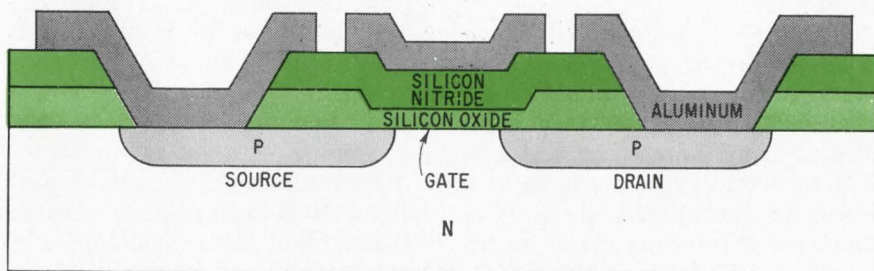

Two deep. The key to GI's low-level metal oxide semiconductor circuits is the low threshold voltage obtained with a layer of silicon nitride for passivation that's on top of a thin coating of silicon oxide. TI, Motorola, and ITT are also working in this area.

... two West Coast companies are trying to make memories with silicon nitride ...

firm was never able to deliver. The problem was unwanted field inversion. When contact metal on top of an integrated circuit passes over a diffused p region, the structure is topologically similar to the gate. This "phantom transistor" never turns on because the field oxide is so thick (typically 15,000 Å) that the threshold voltage is too high to be reached. But when 100 silicon is used, and Q_{ss} sharply reduced, the field threshold can drop dangerously, to 15 or 16 volts.

Secret solution. MOS systems need a second power supply for the devices that are used as a load resistor. The -12-volt supply available in many systems fills this role nicely, but the total voltage swing of 17 volts is frequently enough to invert the source or drain. GI's life testing showed that field thresholds of 20 to 24 volts tended to drift down, in time, to the danger level, and the company finally had to withdraw its low-level device.

Companies using the 100 silicon/oxide process are well aware of the field inversion problem. National Semiconductor claims to have solved it, but considers its solution top secret. Outside sources say that National uses an extra n^+ barrier diffusion for isolation, as do Fairchild Semiconductor and the Motorola Semiconductor Products division. It is also possible to increase the field oxide thickness, but this method makes it difficult to use small device geometries.

The difficulties associated with 100 silicon led both GI and TI to look to the third factor in the threshold voltage equation—the dielectric constant—to obtain low-level operation with 111 crystal. Silicon nitride's dielectric constant is about twice that of silicon dioxide; when nitride is used as the insulator, the gate can be chemically thick—but electrically thin compared with SiO_2 . What's more, the high dielectric constant improves the gain factor of the MOS transistor by 50%. This gain factor, K' , is the amount of current output relative to the voltage on the device; it is directly proportional to dielectric constant and inversely

proportional to insulator thickness. "When you want to drive TTL, you have to drain current," Seely says, "and this current varies with the gain factor."

So, according to TI and GI, nitrides offer the same low-level operation afforded by oxides and 100 silicon, plus better reliability, higher gain, and adaptability to plastic packages and face-down bonding. (GI is working feverishly on beam-leaded devices for multi-chip packages. TI's Sevin says, "If you ever make unpackaged devices, beam lead with Si_3N_4 is the way to do it.") Why, then, is not silicon nitride all-pervasive?

A tricky process

Partly, it seems, because the nitride process is new and tricky. Both GI and TI reportedly had difficulty in getting a handle on it. Nitride-passivated devices tend to leak current. Silicon nitride does not interface well with silicon; the uncommitted bonds result in surface states that look like uncontrollable charges. Threshold voltages on devices made with a simple nitride insulator shift dramatically in one direction when the devices are biased negatively, and in the other when they are biased positively. (At least two West Coast companies are trying to exploit this effect to make memories using silicon nitride.) To prevent this shift, it is necessary to put a layer of oxide on top of the silicon, and a layer of nitride on top of the oxide. The process provides a bonus in that defects in one layer are unlikely to match with defects in the other. But it is not simple to learn.

"Nitride is a deposited film—much harder to control than thermally grown oxide," notes Charles L. Hutchins of TI's technical staff. The deposition process is complex; if one merely exposes silicon in a nitrogen atmosphere, there is a danger that trace oxygen in the atmosphere will form silicon dioxide, and that the nitride and oxide will be deposited in an amorphous mix whose chemical and electrical properties are unpredictable. Any

trace contaminants, in fact, in the gases used to form the nitride can diffuse into the oxide, causing electrical characteristics to change under temperature stress. "The problem that we feel we have solved, on a limited basis at least, is the one of growing a compatible oxide layer," Hutchins says.

Other firms. Seely, who enjoys a friendly rivalry with Sevin, professes to be pleased by his competition's success. "If TI goes with nitrides, it will set a trend," he says. "I was disturbed when I heard that they were having trouble with the process; if they had abandoned it, they would have left us out in left field." Not that all has been smooth sailing at GI; Seely found that because nitride is almost impervious to chemicals, the device tolerances were much more critical. "It's a nice characteristic when you get done," he adds, "but it makes the process difficult to learn. You have to control the composition of the nitride very carefully." Seely and Hutchins agree that once the process is mastered, it is no more difficult than any other. GI, in fact, will sell its low-level devices at the same price as its regular line. Both companies say that circuit design was as big a headache as processing.

ITT's Semiconductor division has also introduced a nitride-passivated circuit, a dual 16-bit static shift register, although it has not advertised its process. And there are some indications that Motorola will follow suit. At present, Motorola uses 100 silicon and oxide passivation, and, because it is getting good results, is not ready to switch. "The advantages of nitride aren't so overwhelming as to make us change now," says Wally Raisanen, operations manager for IC memory and MOS products at Motorola. "There are some things about nitride that we haven't fully explored and we want to know all the ramifications of the process and be certain it's controllable before we use it."

Raisanen cites a number of peripheral advantages of nitrides, such as protection from pinholing and from device breakdown caused by transients that rupture gate oxide (nitride starts to leak current, dissipating the charge before it can harm the gate). But so far, Motor-

We frame up some of the biggest people in the industry.

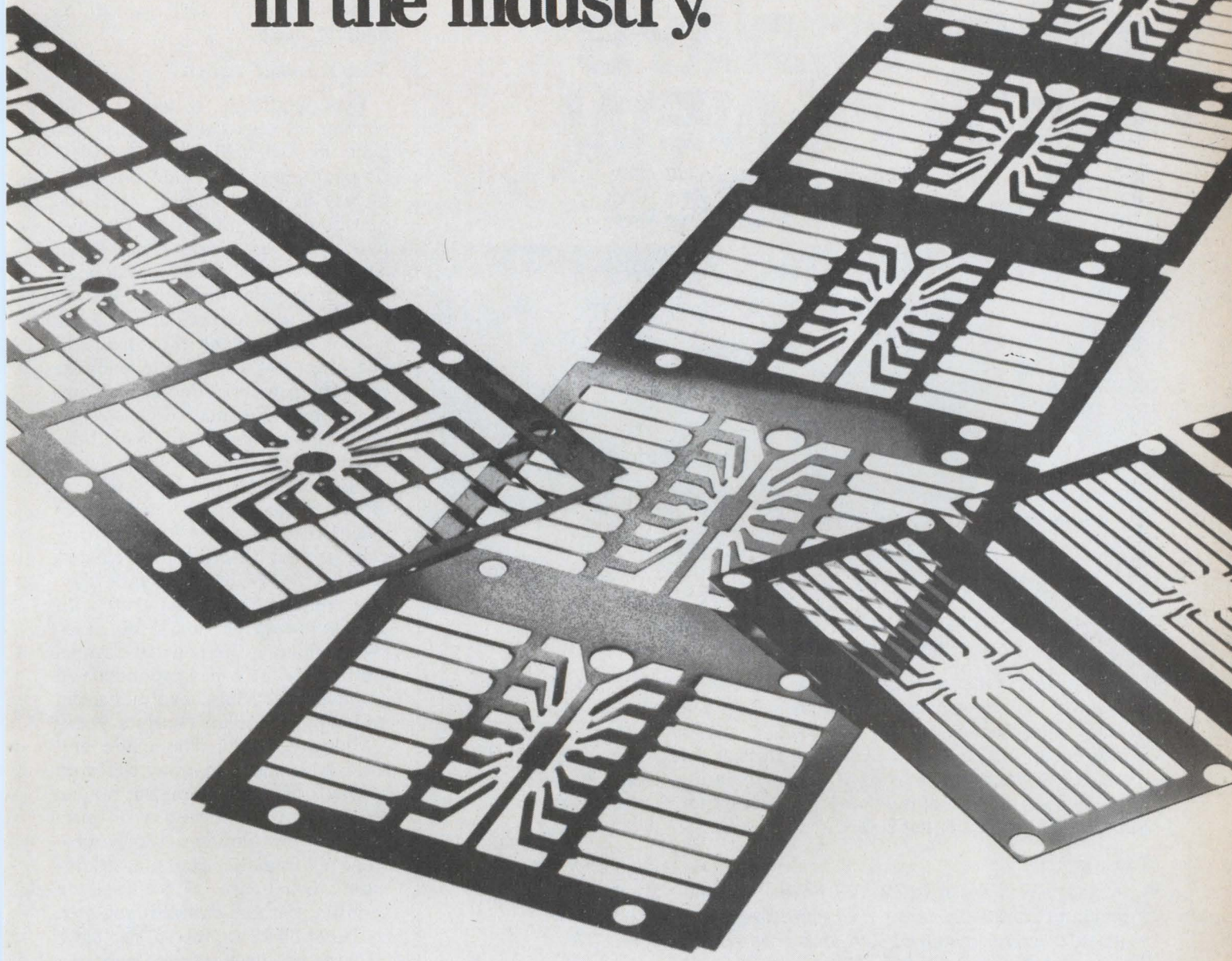

Our lead frames are used by most of the major semiconductor manufacturers.

And there are good reasons why.

They've learned that they can depend on Sylvania. For a quality product. For fast service in large production quantities. (We turned out more than 100-million frames last year).

We make lead frames for all types of semiconductor packages—flat packs,

dual-inline packages and plastic encapsulated types.

We make them out of nickel, steel, Rodar,[®] and other glass-sealing alloys.

We make them fast and we make them accurate.

And we're the only supplier that can give you a choice of photo-chemical machined parts or die-stamped parts. Whichever suits your needs the best.

That's why some of the biggest people in the industry like being framed up by us. Wouldn't you?

Sylvania Metals & Chemicals, Parts Division, Warren, Pa. 16365.

SYLVANIA
A SUBSIDIARY OF
GENERAL TELEPHONE & ELECTRONICS

SPERRY GaAs LASER DIODES AND ARRAYS NOW AT NEW LOW PRICES



Increased demand and greater production capacity now permit reductions of up to 60%.

Here is a laser that's the solution to many of today's IR source problems in intrusion, communications, navigation and station keeping, fusing, optical radar, tracking and guidance, braking and docking, and anti-collision. And the Electro-Optics Group of the Sperry Gyroscope Division has made it available for immediate delivery in a full range of diodes and arrays (with compatible modulators), all now available at new low prices. For example, our 10 watt array is now \$20 per unit in quantities of 100.

These units:

- provide peak power up to 2 watts/mil (equivalent to 4Mw/cm²)
- emit into 0.1 steradian angle (f/3 lens collects all radiation)
- radiate at approximately 9160 Å, with a half-power width ± 50 Å
- operate at room temperature
- are small, compact and simple to operate
- are available off the shelf

The line of lasers ranges from a 10 watt peak power diode through an 800 watt array. The triangular-package diodes are available in 10, 14, 18 and 30 watt peak power outputs.

Three arrays are available, providing 200, 400 and 800 watts peak. The 200 watt array has a diameter smaller than a dime and is less than 1/2" high. These uncooled units emit invisible infrared (9160 Å) radiation into a 20° cone angle.

For additional information write to the *Electro-Optics Group, Sperry Gyroscope Division, Great Neck, New York 11020*. (Telephone: 516-574-2292)

SPERRY
GYROSCOPE DIVISION
GREAT NECK, NEW YORK 11020

 **SPERRY RAND**

ola, which has had considerable experience with nitrides because of its work with Bell Labs on the Sentinel program, and which introduced nitride passivation on discrete MOS devices last year [*Electronics*, May 27, 1968, p. 46], is holding back.

They'd rather switch

Even National, which is quite content with its oxide process, expects to switch to nitride for plastic packaging. "If oxide were satisfactory as a passivating layer, the question about nitride would never have come up," says Ken Moyle, National's MOS product manager.

GI is already running evaluation tests on plastic packaging at its Naples, Italy, plant, though it will not bring out the plastic package until the low-level line is well under way. Further downstream, Seely is looking at beam-leaded devices, and he says that GI is developing a method to put beams on other manufacturers' wafers—no mean trick. The first low-level device, a dual 16-bit static register, will be introduced in mid-May. The company will follow up with a 200-bit register, a 512-bit read-only memory, and a 16-channel multiplexer. TI's first products will be custom. (GI has been delivering military devices for nearly a year.)

Unlucky figure. The oxide and the nitride partisans may differ on methods of passivation, but no one challenges the desirability of operating at low voltages. Seely provides a dramatic example, admittedly worst-case: "We sell a serial-in, parallel-out shift register, the MEM 30-12 SP, for \$6," he says. "There are 12 lines out and one line in—meaning that the user has to have 13 level shifters, at about a dollar a terminal. That's more than twice as much for buffers as he spends for the device. We still sell these parts, but we'd like to save those extra dollars."

Since the devices operate at lower voltages, they can operate with lower power dissipation; halving the supply voltage reduces power consumption fourfold. The devices can also operate faster, if they need drive only low-level TTL circuits. The low-voltage operation seems to have arrived; what's still to be decided is the best method of obtaining it.

Any chips off the new IC?

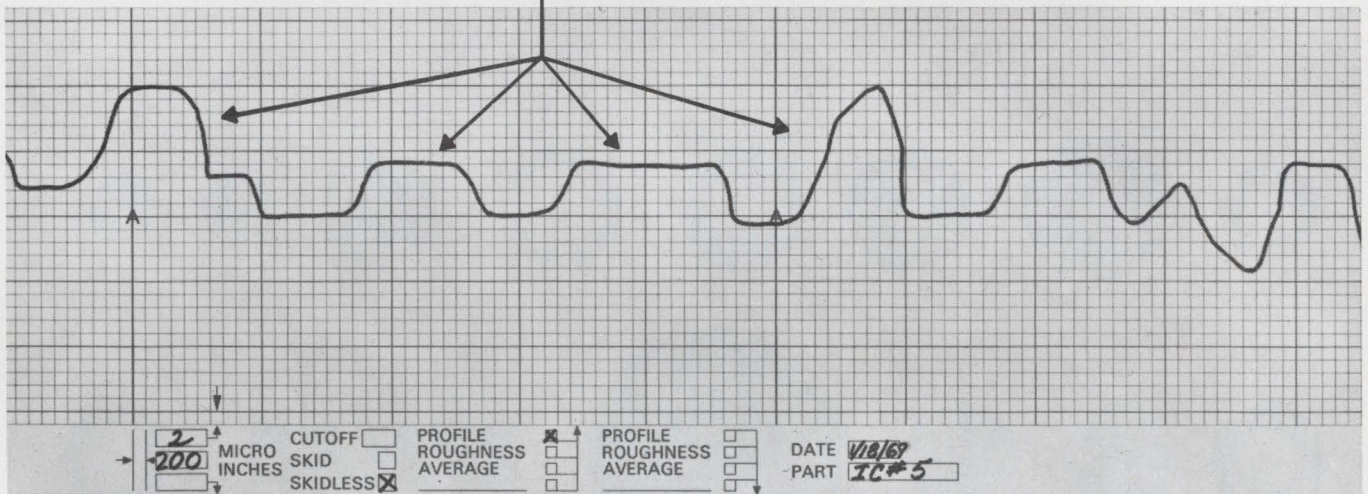
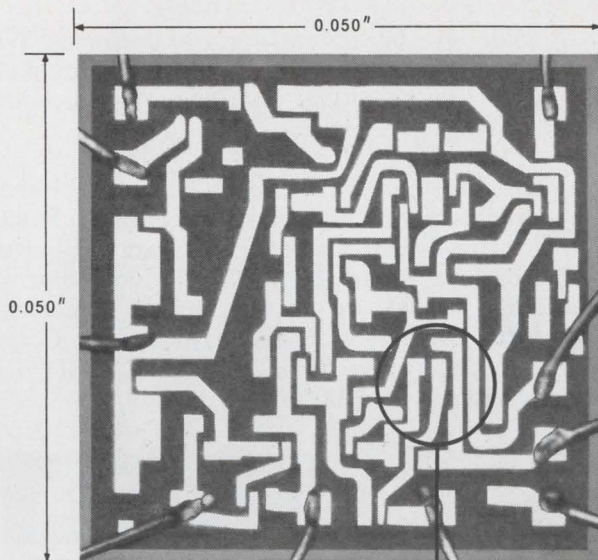

Non-destructive Clevite Surfalyzer tells you for sure. Shows deposit thickness, steps and true surface profile of a 0.500" diameter IC on a chart 3 feet long! And we haven't scratched the surface!

Never will either.

The stylus of the Surfalyzer adds the required light touch to surface measurement—glides across delicate circuit deposits at just 0.05 grams. Picks up the slightest imperfection . . . provides an undistorted view of the IC surface.

Note the extra-wide rectilinear channel. And the engineered chart paper that allows actual dimensional measurement of deposit on substrate. And the razor-sharp smudge-

proof trace. It's all part of our plan to provide IC manufacturers and suppliers with the most accurate, easy-to-read, easy-to-use surface recording system.

Have we done it? You be the judge. Write for complete details and the name of your nearest distributor. There's one close by waiting to demonstrate this extraordinary test equipment. Clevite Corporation, Gaging & Control Division, 4601 N. Arden Drive, El Monte, Cal. 91731. Phone: 213-442-7755.

Clevite Surfalyzer 150 Surface Measurement System

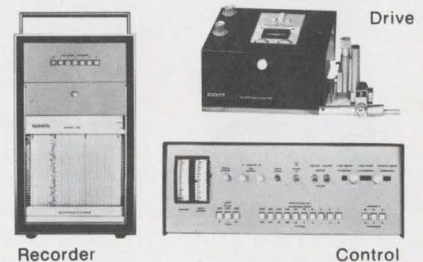

CLEVITE

THAT TOUGH GLASS SEAL PROBLEM... FUSITE SOLVED IT FOR YOU YESTERDAY

We've been specializing in difficult sealing applications for over 25 years, so probably the solution to your particular problem is already in our files.

Reliability? Fusite is the *only* sealer that formulates, smelts, and preforms technical glasses. This means a greater in-depth capability to solve your problem, design the part, build the dies, smelt the glass, make and assemble it to your specs. At less cost than you could do it yourself. Want proof? Send us your latest design for hermetic terminals, glass preforms, or glass-ceramic substrates or lids. Challenge our experience with low temperature

solder glasses as coatings and preforms. We'll send you a similar part for inspection. Plus a cost estimate for prototype quantities—or production in millions.

For solutions to all your sealing glass problems, call Fusite in Cincinnati. Or, if your interests are overseas, call one of these plants: Fusite N.V., Konigweg 16, Almelo, Holland; Fusite-Japan, Gotemba, Japan; Terminal Products, Hormigueros, Puerto Rico; or, Fusite GmbH, Dieselstrasse 5, Karlsruhe, West Germany. Fusite Corporation, 6000 Fernview Ave., Cincinnati, Ohio 45212... phone (513) 731-2020.

FUSITE

GLASS-TO-METAL HERMETIC TERMINALS
GLASS / GLASS-CERAMIC PREFORMS & SUBSTRATES

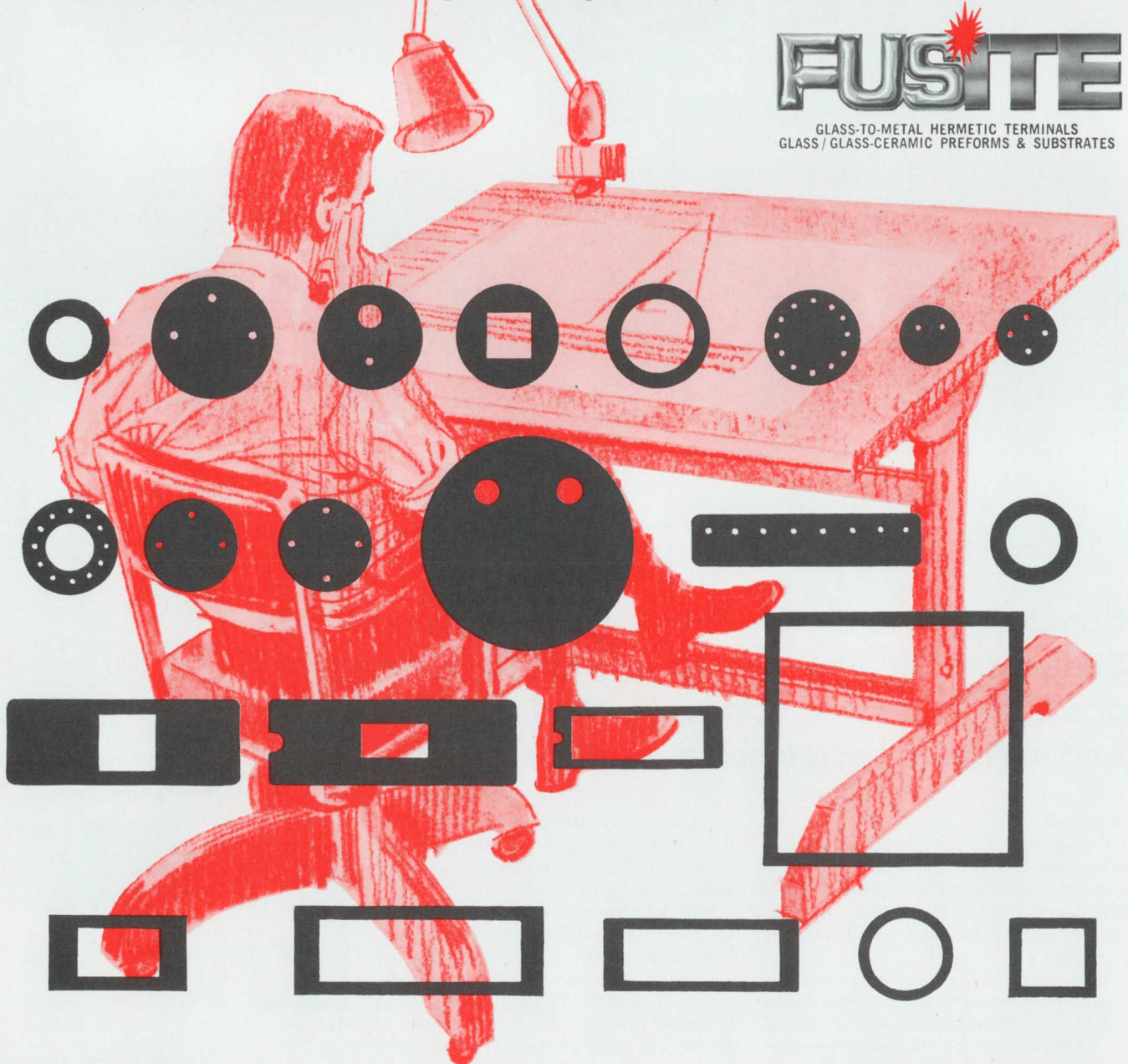

IUE tries to stem outflow of jobs

With one eye on big contract talks next fall, union is fighting relocations overseas, pushing for labeling of imports, and recruiting white-collar types

By Paul A. Dickson

Associate editor

The leaders of the International Union of Electrical, Radio, and Machine Workers (AFL-CIO) have more on their minds right now than the new three-year contracts they'll negotiate with Westinghouse and General Electric next fall. Not that these negotiations aren't a prime topic of conversation around the IUE's headquarters these days. In a year when not many large industrial contracts are up for renewal, the GE and Westinghouse deals loom as two of the most important in the nation. "Not only will they set the pace for the electronics and electrical industries," says a union spokesman, "but they'll be reflected in contracts in other industries." However, while the IUE girds for this traditional battle, it is also trying to come to grips with two recently emerging trends—the exodus of electronics jobs to other nations and the increasing willingness of engineers and other salaried workers to unionize.

Currently, the IUE has 340,000 members represented by about 600 locals at more than 1,200 companies. Membership in 1968 was about the same. But the union would like to keep growing—or at least to hold its ground. To do so, it must either stem the movement of blue-collar jobs to operations overseas or capitalize on the new inclination of white-collar workers to organize. The union would like to do both.

Kearny coup. Sanford V. Lenz, the head of the IUE's professional, technical, and salaried conference board, is an engineer who coordinates the union's recruiting in the white-collar area. Lenz can boast that the IUE has more than 15,000 white-



Entente cordiale. IUE president Paul Jennings and Shinryo Kiyoto, who heads Japan's metalworkers union, are pursuing common goals.

collar workers on its rolls, most of them professional engineers. Last December, Lenz' group scored a major victory when more than 700 salaried workers at Western Electric's Kearny, N.J., plant voted to join the IUE. Most of these members are engineers, the rest being engineering assistants. It was the largest single catch of engineers to

date by the IUE, and it came in the union's first attempt to enroll engineers at an industry giant.

Says Lenz, "I'm convinced that the action at Kearny was not a fluke but the emergence of a very real and important trend." He points out that the IUE is now involved in serious discussions with a large number of engineers at other

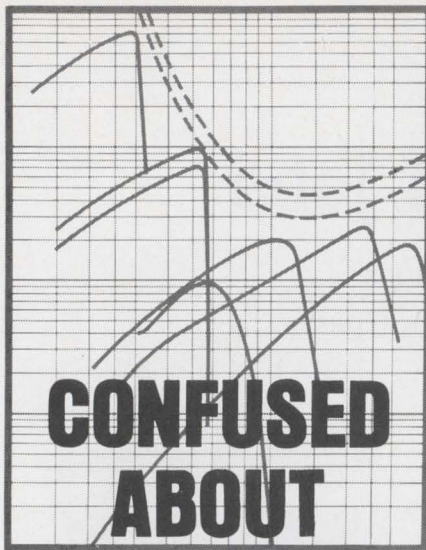

CONFUSED ABOUT INFRARED DETECTOR SPECS?

**Get the answers from
the experts at Barnes!**

Head in a spin with noise-value figures? Time constants? Detectivity? Flake sizes?

Do you need a simple thermal detector? Cooled or uncooled photodetector? A sophisticated mosaic array?

Why not ask the experts?

Our credentials speak for themselves. For the past 15 years our infrared specialists have been helping customers select the best detector for their requirements. We've built complex detectors to meet the most demanding specs for advanced military, space, and research programs. And we've made them simple for off-the-shelf delivery to industry.

For personal service, competitive prices and fast delivery, just call or write: Product Sales Manager . . .



**BARNES
ENGINEERING
COMPANY**

30 Commerce Rd/Stamford, Conn. 06902
Phone (203) 348-5831 / TWX 710-474-3367

Western Electric facilities, with engineers at other companies, and with some small unaffiliated unions of engineers. Western Electric engineers at the Merrimac Valley plant will soon vote on IUE membership, and Lenz predicts that other large blocs of engineers will affiliate themselves with the union before the year is out.

According to Lenz, the trend reflects an increasing feeling of alienation among men with middle-level jobs. "These people see the production worker affecting decisions through his union, see the higher-echelon managers making company decisions, and see themselves excluded from the decision-making process," he explains. "As conglomerates continue to grow and companies become more and more diverse, this feeling of alienation becomes more acute. If we had to thank someone for helping us attract engineering and technical professionals, it would have to be the conglomerates."

Lenz and other IUE officials expect the white-collar segment of the union to show the highest percentage growth in the coming years.

Missing jobs

But while the union's white-collar membership is increasing, its blue-collar rolls are being steadily eroded by the relocation of production facilities overseas. Union locals have been regularly reporting the elimination of U.S. jobs as firms look to Asia and Latin America for labor and products.

The U.S. Department of Labor has recently released statistics that support the IUE's contention. The Government's figures show a decline of 50,000 jobs in the manufacture of radio and tv receiving sets and electronics components between 1966 and 1968. According to the report, U.S. employment in radio and tv production dropped from an average of 135,000 workers in 1966 to 110,000 in 1968, and from 287,000 to 262,000 in components production over the same period.

The IUE maintains that the situation is getting worse as more and more firms announce their intention to move manufacturing operations to the Far East or Mexico. Not only is the union concerned

about further erosion in the consumer-products and components areas, but it sees a similar trend developing in the calculator and computer fields.

According to Abe Morganstern, IUE research director: "We've got a major problem with no easy answers. Electronics is a growth industry and we're not participating in the growth. Simply, we don't like layoffs and we're looking for ways to stop them without adopting a stance of protectionism."

Label lobby

The union's efforts to plug the leak with Federal legislation got results last month when Sen. Clifford P. Case (D., N.J.) proposed a "Truth in Import Labeling Act" for consumer electronics products. The bill, which was introduced at the request of the union, would require companies importing foreign-made appliances and equipment under their own trade names to clearly designate the origin of the products.

The bill calls for permanent and conspicuous labels made of metal, unless the Federal Trade Commission decides this to be inappropriate; the letters indicating the nation of origin would be at least half the height and width of the product's brand name, but no less than a quarter-inch high. The bill, which has been referred to the Senate Commerce Committee and is expected to come to the floor for a vote later this year, is described by Case as "a necessary and logical extension of the Truth in Labeling Act."

Ganging up. Besides lobbying for passage of the import labeling bill, the IUE is trying more direct means of keeping jobs in this country. For one, the union is working closely with unions in the countries where the electronics work is going.

IUE president Paul Jennings heads the International Metalworkers Federation's committee on multinational companies. In April, the committee will sponsor a meeting in Bogota, Colombia, of unions represented at GE facilities throughout the world, and similar meetings are planned for unions dealing with other large electrical and electronics firms. The aim of the Bogota conference is to press GE to equalize its wages and bene-

fits on a worldwide basis and thus eliminate the conditions that cause it and other companies to globe-hop. Says a union official, "This type of action may be one of our best weapons."

Hands across the sea

In this same direction, the IUE itself is strengthening its ties with unions in other countries. For example, Denki Roren—the Japanese electrical workers union—and the IUE have agreed to reciprocal visits, exchange of information, and the like. In fact, several top IUE officials have just returned from a fact-finding mission to Asia. And Denki Roren will, in turn, send a delegation to the U.S. later this year. According to the IUE, Japanese unions are faced with a problem similar to its own: namely, work is being shifted from Japan to such low-wage areas as Taiwan, Hong Kong, Korea, and Singapore. While in Asia, the IUE officials visited Korea and Taiwan to get firsthand information on wages, unions, and the general labor situation.

The IUE also plans to make "run-away" jobs an issue at the bargaining table—demanding assurances from companies that they won't replace existing product lines with imports. And though it has had little luck so far, the union will continue to press for relief from the U.S. Tariff Commission under the adjustment assistance provisions of the Trade Expansion Act of 1962, which calls for the retraining and compensation of men who have lost their jobs because of imports. Morganstern says all applications so far have come back marked "rejected."

Field reports. But as the union wrestles with the problem in a general way, the situation is deteriorating in a very specific way. When the labeling bill was introduced, the union called some of its local presidents to Washington to discuss developments in their areas. The discussion was often grim.

- Local 491 president Ted Petty, representing salaried workers at the Westinghouse plant in Edison, N.J., said that membership in his unit had dropped from 225 to 84 in the past 18 months due to a shift of tv-set production to Asia.

- Local 401 president Ted

The smaller we go... the bigger we grow!

Day after day, Delevan engineers are cramming more values into smaller, micro-sized coils. We're able to do this because you demanded it. That's why Delevan continues to grow.

Many have depended on Delevan ingenuity and quality. You can too! Call us.

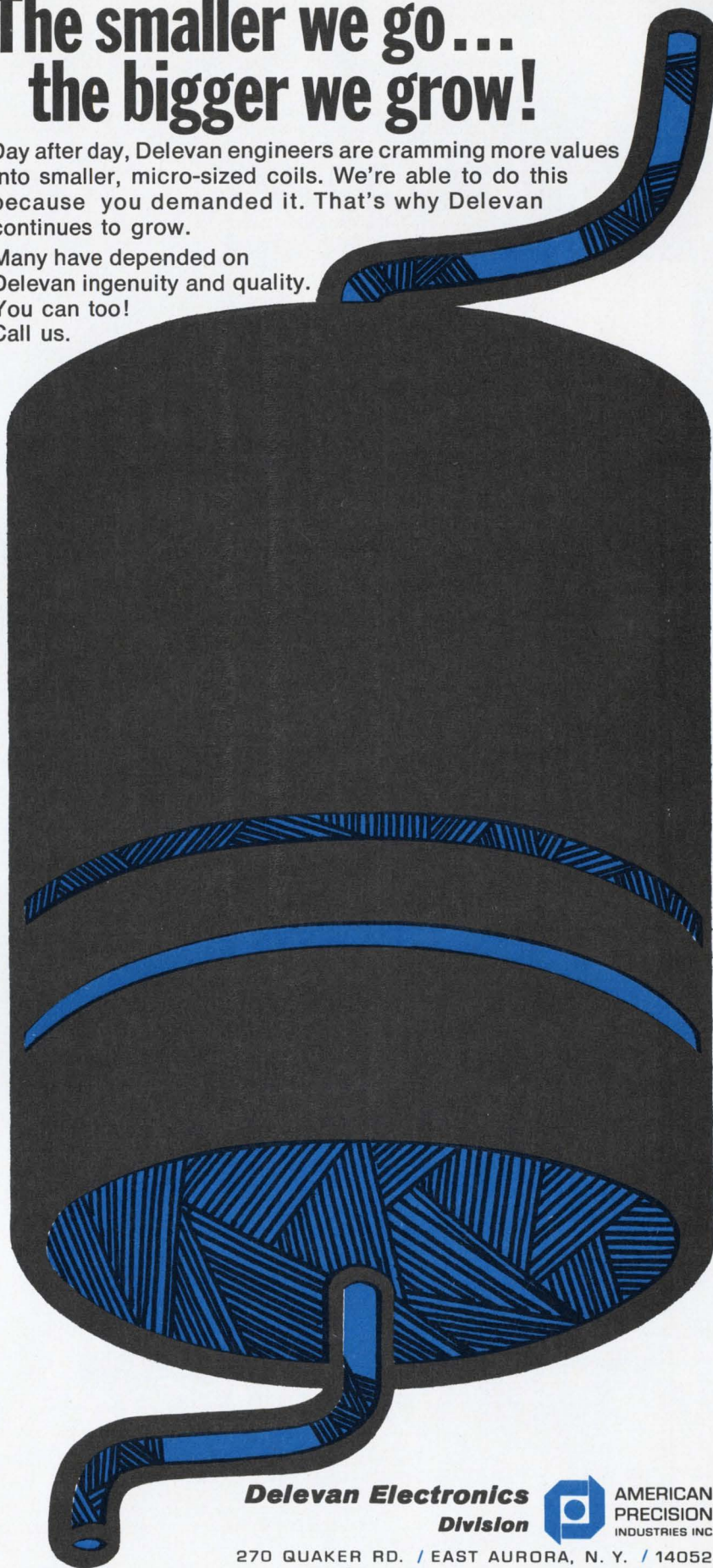

Delevan Electronics
Division



AMERICAN
PRECISION
INDUSTRIES INC.

270 QUAKER RD. / EAST AURORA, N. Y. / 14052
TELEPHONE 716/652-3600 TELEEX 091-2993

OTHER DIVISIONS OF AMERICAN PRECISION INDUSTRIES INC.: BASCO • DUSTEX • ELECTRO-MECHANICAL PRODUCTS • MOELLER INSTRUMENT CO. • OXFORD CORP. • TRUCK EQUIPMENT CO.

SPECIFY **NEW** PANEL BOARD INSTRUMENTS by **HICKOK**

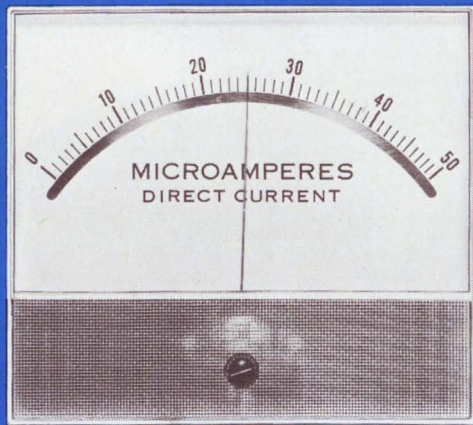

Three
Standard
Sizes

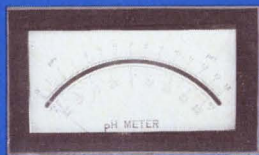
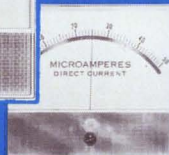
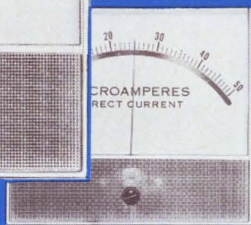

Rear Panel
Flush Mounted

A NEW LINE OF INSTRUMENTS PRECISION QUALITY AT COMPETITIVE PRICES

Colorado Hickok Corp., Division of Hickok Electrical Instrument Co., Cleveland, announces a NEW LINE of Panel Board Instruments at highly competitive prices. Hickok Instruments can read anything in electronics—ruggedized instrumentation with pioneer-proven reliability. Fast deliveries can also be made from Hickok's factory mod department. Hickok's NEW LINE features clear acrylic plastic front cases for front or rear-of-panel mounting, available in 3½ — 4½ — 5½ inch width cases, in D-C D'Arsonval and A-C Repulsion Vane and Dynamometer Movements, CALL OR WRITE FOR ADDITIONAL INFORMATION.

- Accuracies 1.5% full-scale
- A-C Iron Vane Repulsion
- Current Range 10 milliamps — 30 amps*
- Voltage Range 5-300 volts*
- D-C Self-Shielded Core Magnet
- Pivot-Jewel or Tautband Suspension
- Current Range 10 microamps — 30 amps*
- Voltage Range 15 millivolts — 300 volts*

*Higher A-C current and voltage ranges may be supplied for use with transformers or multipliers; and with D-C shunts and multipliers.

Colorado **HICKOK**

CORPORATION

A Division of The Hickok Electrical Instrument Co. — Cleveland.
2897 North Avenue Grand Junction, Colorado 81501
Telephone — Area Code 303 / 243-2124

Aurillo, representing production workers at the same Westinghouse plant, reported a drop from 2,300 members in 1966 to 400 today as a result of imports.

Local 101 president Joseph Burns of Philco-Ford in Philadelphia blamed foreign imports and runaway jobs for a drop in the work force there from 9,000 to 2,100 over the past decade.

Basic training

Along with trying to protect its membership rolls, the union is moving itself into new areas. It has, for instance, embarked on an on-the-job training program in conjunction with the Labor Department and the firms at which the IUE is represented. In the first program set up with the Labor Department, 1,300 individuals were trained; under a second contract, another 1,200 are being trained. These programs have been aimed at members of minority groups, older people, the handicapped, and those with police records.

The IUE is proud of the work it's done in this area. It cites the case of one plant that employed no Negro production workers until the IUE program got going; at last count, there were 59 black workers at the plant, each making at least \$2.75 an hour.

The union is also undertaking educational programs for members. Last year's IUE convention approved the establishment of high school equivalency programs, English literacy classes for Spanish-speaking members, courses in union activities vis-à-vis changing technologies, and a college degree program.

New lineups. But for all these new plans and programs, the IUE's big job is still at the bargaining table. And the negotiations later on this year will find the companies formally cooperating for the first time with the IUE's chief rival, the United Electrical Workers. In addition, the IUE will be involved in "coordinated bargaining" in alliance with 10 other unions. Current contract goals include a full cost-of-living escalator, a "substantial" wage rise, a "substantial" increase in pension benefits, broader insurance and hospitalization coverage, and a series of job-security provisions.



**New and unique.
No loose parts.
Just open hood and
insert sub-min coax or #30
through #14 contacts.
Snap shut and tighten cable clamp.**



**Sometimes it
takes a big mouth
to get things done.**

This hood-block assembly comes ready for use without need to assemble nuts, screws, washers, etc. This saves you time and eliminates assembly headaches.

Hood opens wide for easy access to rear of block for insertion or removal of contacts. Slide latches on both sides provide for easy opening. Hood snaps shut with a positive lock. Reduces RFI. Finger-turnable jacks with no-fumble knobs assure faster plugging and unplugging. Available in 7 sizes. Write for bulletin giving all details on this and the Trim Trio family of contacts.

 **BURNDY**
NORWALK, CONNECTICUT

INTERNATIONAL SALES HEADQUARTERS AND MANUFACTURING FACILITIES:
CANADA: Ontario / ENGLAND: St. Helens, Lancs.
BELGIUM: Mechelen / MEXICO: Naucalpan de Juarez / BRAZIL: Sao Paulo
JAPAN: Tokyo / Sales Offices in Other Major Cities

Circle 127 on reader service card

Beneath this calm exterior lurks... Supertetrode!

Eimac's sensational new water cooled 50 and 100 kW tetrodes are the world's finest for high power applications. They're ideal for transmitters in HF, FM and broadcast bands, for over-the-horizon radar, distributed amplifiers, high energy physics and high power voltage regulation.

Both tetrodes feature transconductance double anything even we've been able to offer. They have greatly reduced cathode lead inductance and a unique re-entrant anode, permitting a shorter stem and lower input capacitance. Feedback capacitance also is much lower, simplifying tube neutralization and eliminating

any need for a neutralization circuit. In both tubes the screen base is designed to serve as an electrostatic shield.

These tubes have 4 to 5 dB higher gain than comparable tetrodes, yet are very compact. The 4CW50,000E (50 kW model) weighs only 35 pounds. It has 310 pF input capacitance, 52 pF C_{out} and 0.6 pF feedback capacitance. The 4CW100,000E weighs 50 pounds, has 349 pF C_{in} , 60 pF C_{out} and 0.8 pF C_f . For data and application assistance contact your nearest Varian/Eimac distributor or ask Information Operator for Varian Electron Tube and Device Group.



Bigtime profits in a rural setting

Tv-equipment maker takes to the woods, finds peace and quiet no bar to an earnings record that city slickers would envy

By Peter Vogel

Assistant editor



Anachronistic. Donald G.C. Hare, founder of GVG, and his executives find sylvan scene no drag on progress or profits.

Grass Valley, a small town in Nevada County, Calif., was nearly bypassed by the 20th Century. A relic of Gold Rush days, it is—as its name suggests—pleasant, quiet, rustic. Aging gas stations and supermarkets are its only external concession to modernity. Many residents won't drink from the public water supply, and some homes on the outskirts have no electricity. Yet sleepy Grass Valley is the home of an electronics company that has not only managed to stay in the forefront of television broadcast technology, but has compiled a phenomenal earnings record in the process.

The company, Grass Valley Group Inc., is the personal creation of physicist Donald G. C. Hare. He founded it 10 years ago, nursed it through some lean years as a one-product operation, and watched its

revenue blossom from \$200,000 to \$2.2 million and its earnings from \$27,858 to \$482,845 over the past five years. Sales and profits began to soar a year after Hare moved GVG into the business of making solid state line and terminal equipment. The firm now has 85 employees (including 10 engineers, 6 technicians, and 18 sales and administrative personnel) and markets about 100 products that amplify, edit, process, and distribute video and timing signals for tv studio and transmission systems.

"The chances are excellent," Hare says, "that just about any television program in the country moves at some point through GVG equipment." About two-thirds of all of the nation's tv stations use GVG products, Hare adds, along with some 80 colleges and univer-

sities operating closed-circuit systems. The American Broadcasting Co., the General Electric Co., and the Ampex Corp. are heavy GVG customers.

Pastoral but productive

One small irony here is that GVG's employees have a hard time picking up the programs they make possible; reception in Grass Valley is pretty much limited to a couple of Sacramento channels. But Hare apparently chose shrewdly when he founded his company in the Sierra foothills. He has had no trouble establishing good labor relations with the local community, or in recruiting engineers who are fed up with metropolitan life. Grass Valley may be a one-industry town, but the company itself is unobtrusive; its elegant buildings are nearly in-



Hare and hounds. GVG's founder-president is a confirmed dog lover, and his dachshunds are given the run of the place, including the lab.

visible against the pine forest in the valley. The entrance is marked only by a small sign, behind which some of Hare's dachshunds may be seen sporting on the firm's putting greens. The dogs are just as likely to be curled up on Hare's workbench. Next to the office building is a man-made lake on which ducks and swans swim about.

The low-pressure atmosphere seems to work. It would be hard to find another company in the hotly competitive electronics industry that can match GVG's return on sales. Because it's a closely held company that hasn't paid a dividend since 1962, and because some outsiders are skeptical of Hare's ability to attract topflight management in the future, the company has been pretty much ignored by the financial community.

But GVG's backlog last month was at an alltime high of \$690,000, of which \$540,000 was in switching and special-effects equipment. Backlog a year earlier totaled only \$110,000, and none of the orders was for such systems.

Hare started GVG in 1959 after leaving the Sangamo Electric Co. (Charles H. Lanphier, chairman of Sangamo, sits on the GVG board today.) For a year, Hare rode high on a \$500,000 contract under which CVG made the five-channel sound equipment for Cinerama's 70 theaters. "Then," Hare says, "we starved for four years, waiting for another windfall." In 1963, the company actually had a loss of \$21,000.

It was then that Hare decided to forget about sound systems and move into television. "Everyone advised me that it was too late to get into the tv-equipment business," he recalls. But Hare had one advantage over the competition: he could jump into the market with a line of completely solid state equipment, whereas his competition was still heavily committed to vacuum tubes. And GVG has under way a move toward even greater use of integrated circuits.

Even complete use of IC's won't solve the company's one basic problem: the commercial television equipment market is just about saturated, Hare concedes. So where, if the market is saturated, do you go with a fine organization and a history of excellent products and profits? Like many other presidents of successful corporations, Hare is considering diversification by acquisition.

Education moving

Hare ticks off figures about the increasing number of students and the decreasing number of teachers in the U.S., and then he considers the educational needs of the rest of the world. The big outlet of the future for a company like GVG, says Hare, is the educational television market—after the disputes about the merit, format, and content of instructional tv programs in schools are resolved.

"We have an educator on the payroll," says Hare, "and we're

studying what the needs of instructional tv will be, both from the point of view of equipment and from the point of view of program content." The most successful company in the nascent educational tv market, he suggests, will be the company that offers a complete package—hardware and prerecorded educational videotapes. It's this area into which GVG may move.

The market for instructional tv equipment will be vast compared to the amount sold to the more than 1,200 commercial television stations. Now that color cameras and video recorders have gotten pricetags below \$15,000, the run will start, Hare says. Further impetus will be added to the movement, Hare says, when the Government stops spending a "disproportionate" amount of the national income on defense preparations. In the long run, the real money will be in providing not just the line and terminal equipment, but in the production of tapes.

A major stumbling block to the expanded use of educational videotapes will be getting a consensus on how such tape should be prepared for school children. Many educators believe that the individual traditional approach to education is sacrosanct and will be impossible once the student is mated with a computer. To best overcome the objections of educators to videotape instruction the industry should introduce a method by which the student can ask questions and receive answers on the subject under consideration, Hare says.

Hare's experience with the Grass Valley community answers one of the questions frequently posed by the electronics industry. It is possible to establish a successful firm in an area not already inundated by skilled electronics personnel. Hare has recruited all his assembly personnel from the community and has trained them himself. Since electrical engineers deluge him with requests for employment anytime he advertises an opening, he can select among many applicants. Building costs and maintenance costs are low. Grass Valley offered a tranquil, rural setting yet didn't deny a continuing profit from the needs of metropolitan centers. Hare's company is a true participant in McLuhan's global village. ■

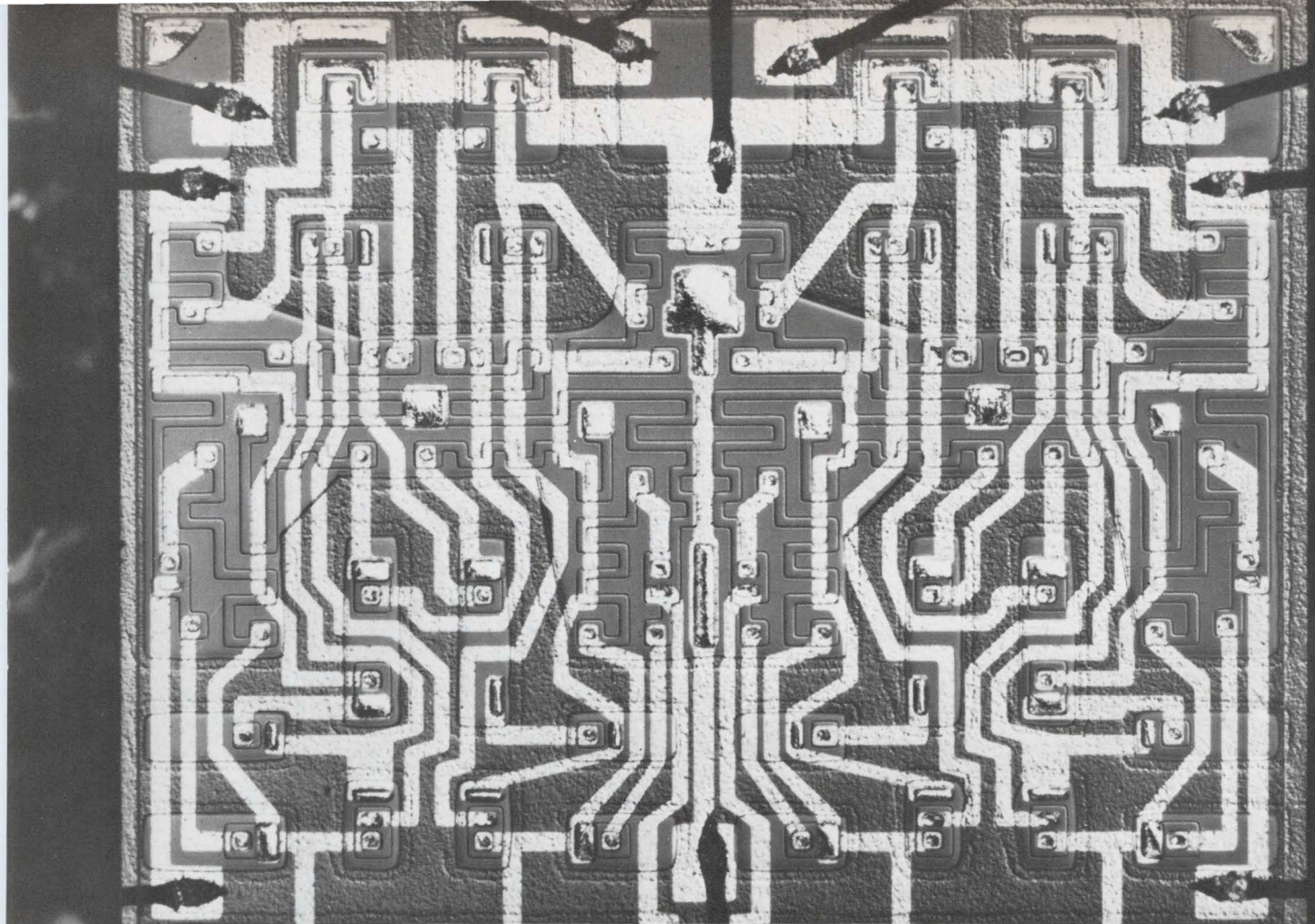

Digital logic circuit (95x enlargement). Taken with Metallograph Ultraphot IIM, Epiplan 4 POL, reflected-light Nomarski interference contrast. Courtesy of Radiation Incorporated.

Reflected light... unequaled optical quality, unlimited versatility

Whatever your requirements in reflected-light microscopy, Zeiss can meet them.

Interchangeability of optics offers unlimited possibilities, including optical systems for polarizing microscopy, phase contrast and Nomarski interference contrast. The unequalled Epiplan flat-field objectives for brightfield and darkfield at magnifications ranging from 40 to 1,000x are available as dry systems. So are oil immersion objectives, to bring magnifications to the limit of light microscopic resolution.

The *Ultraphot II*—the most versatile research instrument for magnifications starting at 5.5x has a built-in 4 x 5" automatic camera and variable bellows.

The *Universal M* is ideal for laboratory and research work, with or without automatic attachment camera for 35mm, 3¼ x 4¼", or 4 x 5".

Microscope UM is the workhorse for routine quality-control and production work where rapid inspection is desirable.

And, of course, there are the smaller routine instruments for reflected-light work, not quite as versatile, but the optics—unmatched, the mechanics—satin-smooth.

We'll be glad to send detailed information on any of these reflected-light microscope systems. Write or phone Carl Zeiss, Inc., 444 Fifth Ave., New York, N.Y. 10018. (212) 736-6070. Complete service facilities.

ZEISS

THE GREAT NAME IN OPTICS



Circle 131 on reader service card

AIRPAX

MILLIVOLT TO CURRENT CONVERTERS

Used as thermocouple amplifiers, temperature transmitters and EMF converters, these high accuracy DC amplifiers convert input signals as low as 0 to 2 MV into output currents of 1 to 5, 4 to 20 or 10 to 50 MA DC. Other output ranges from zero up to 50 MA or 30 V DC can be provided.

FEATURES

- Two inputs: #1, high impedance #2, totally isolated
- Solid state design
- Linearity is 0.05%
- Intrinsic stability, $0.5 \mu\text{V}$ per $^{\circ}\text{C}$
- Response time, 50 ms (min.)
- Power source, 115V 50-400 Hz; 24 or 48 V DC
- Up or downscale output with TC break or burnout protection
- Any input/output range obtainable without range cards
- Built-in offset adjustment available
- Cold Junction compensation
- Output can be either current or voltage source
- Case permits high density stacking with easy cover removal for installation wiring.

APPLICATIONS

SIGNAL CONDITIONER
MILLIVOLT CONVERTER
TRANSDUCER AMPLIFIER
EXPANDED-SCALE AMPLIFIER
TEMPERATURE TRANSMITTER

STRAIN GAGE AMPLIFIER
CONTROLLER AMPLIFIER
BRIDGE NULL SENSOR
CURRENT REPEATER
RECORDER DRIVER

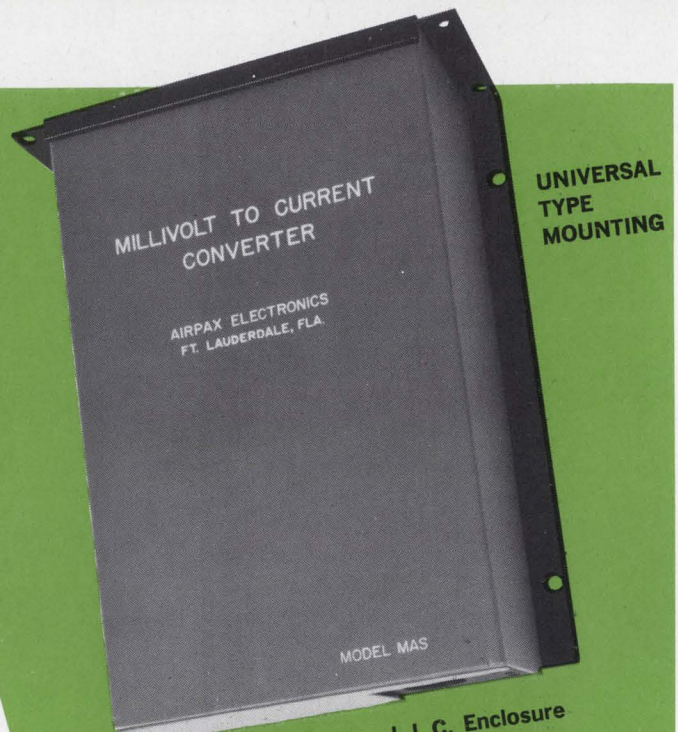

Explosion-Proof
Enclosure

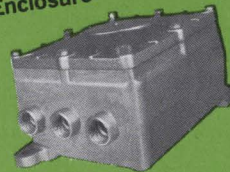

J. I. C. Enclosure

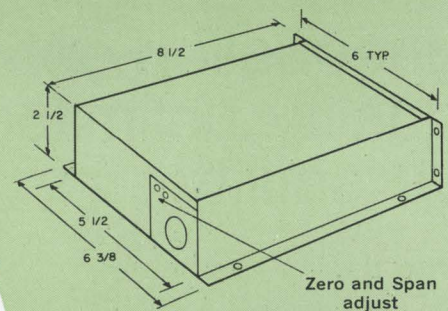

DIMENSIONAL DRAWING OF
UNIVERSAL TYPE MOUNTING

AIRPAX ELECTRONICS

SEMINOLE DIVISION
P. O. Box 8488
FORT LAUDERDALE
FLORIDA 33310
PHONE: 305-587-1100
TWX: 510-955-9866
TELEX: 051-4448

Flat display has inherent memory

Plasma readout panel using two glass layers does not require refreshing and is driven directly from digital circuitry without need for a d-a conversion

The trip from lab to marketplace is proving a speedy one for plasma display panels. Only two years ago, D.L. Bitzer and H.G. Slottow of the University of Illinois described a prototype at the Fall Joint Computer Conference. But by last summer, a slew of electronics firms were vying to develop the first commercial panel of this type [*Electronics*, July 22, 1968, p. 39].

Owens-Illinois Inc. seems to be out in front right now. It's introducing what it calls the Digivue panel, a 6-by-6-inch transparent assembly only a half-inch thick and carrying a 4-inch-square array of about 18,000 tiny spots. The race is going right down to the wire, though. The Burroughs Corp. is close to announcing a plasma display panel of its own.

In the Owens-Illinois array, the spots can be lit up one at a time—or a whole line at a time—to display a wide variety of patterns. Once turned on, the spots continue to glow without refreshment until turned off by an erasing signal. The display is completely digital; it needs none of the digital-to-analog conversion required by conventional cathode-ray-tube displays.

Paned look

The new display consists of two quarter-inch-thick glass plates separated by a gas-filled gap about 10 mils wide. The gap is maintained by thin glass spacers. On the inner faces of the plates are two sets—horizontal and vertical—of transparent electrodes covered by a thin glass insulating layer. Each set is a series of parallel lines 30 mils apart and reaching all the way across the plate; the intersections of these lines establish the spots that form the displayed patterns.

When the display is operating, a sustaining voltage alternating at 50

kilohertz and 175 volts peak is applied between the two sets of conductors. To turn on a particular spot, a write pulse is applied to the corresponding pair of conductors just as the sustaining voltage crosses the zero level from negative to positive. The write pulse amplitude is about 200 volts—high enough to initiate a discharge in the gas that creates a bright glow, similar to that in a neon tube. This glow lasts only about a microsecond; it builds up charges in the insulating layers that oppose the writing and sustaining voltages and therefore quench the discharge.

However, the charges remain in the insulation long enough to add to the sustaining voltage during the next half-cycle and thus initiate a new discharge, this time in the absence of a writing pulse. The flickering pulse thus continues at

a 100-kilohertz rate until an erasing signal is applied, with the same timing as a writing pulse but with opposite polarity. This flickering is bright enough to make the display easily visible in ordinary room lighting even though its duty cycle is only 10%.

Three-decker. The Owens-Illinois design differs substantially from that of Bitzer and Slottow. They used a three-layer glass sandwich with holes in the middle layer through which the discharge occurred; the accumulated charges that kept the display going resided in the glass walls around each hole. The registration difficulties of this design are overcome in the two-layer arrangement, because the holes needn't be directly opposite the intersections of the two sets of conductors.

Writing and erasing voltages are

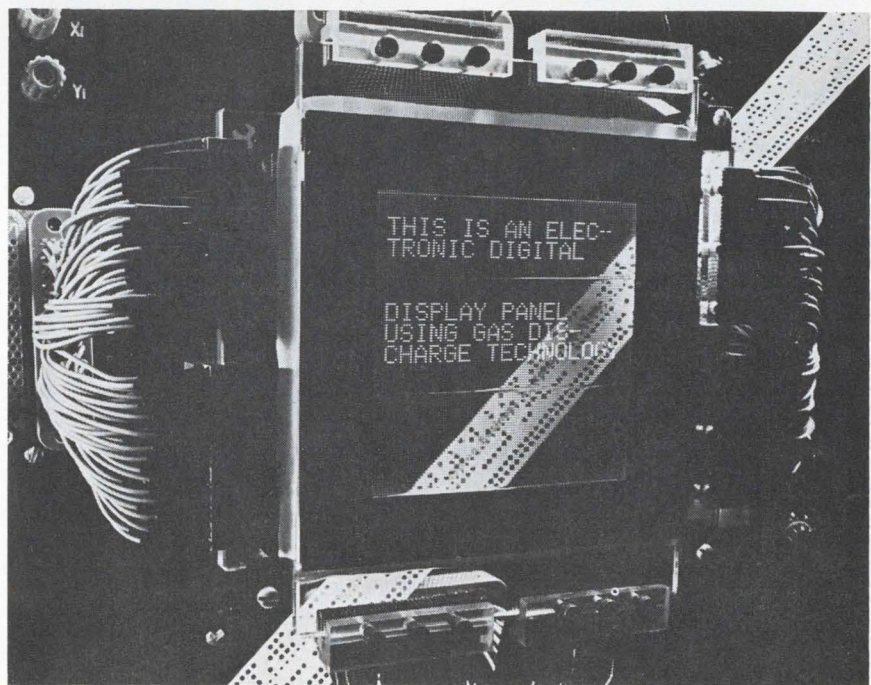

Dot by dot. A computer translates data from paper tape into coordinate information to build up flat-display pattern from arrays of dots.

High Voltage Rectifiers

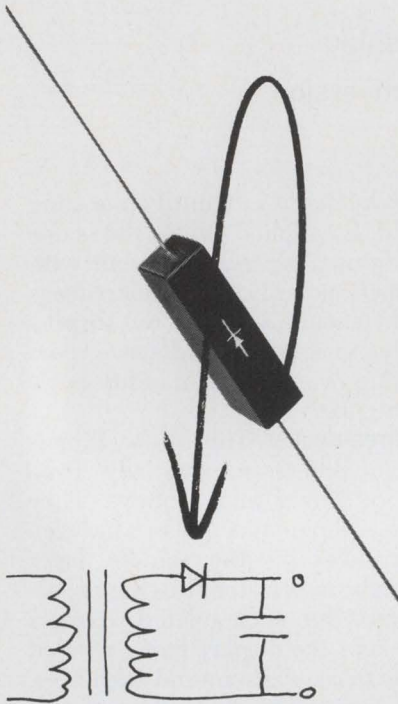

New! From Varo.

Silicon Rectifiers At Selenium Prices!

At last, economical high voltage silicon rectifiers. Ideal for use in all high voltage, low current applications.

- 5,000-40,000 Volts
- 5, 10, 25 milliamp ratings
- Standard and Fast Recovery
- In 1/4" square package.

These are the high voltage rectifiers that make completely solid state television circuits possible. Equally well suited for use in other cathode ray tube applications, electrostatic power supplies and voltage multipliers.

Only \$1.32

10,000V, 5mA rating. Quantity of 1,000. Complete details, applications, and price list available.



SEMICONDUCTOR DIVISION
2203 WALNUT STREET, GARLAND, TEXAS 75040
(214) 272-3561

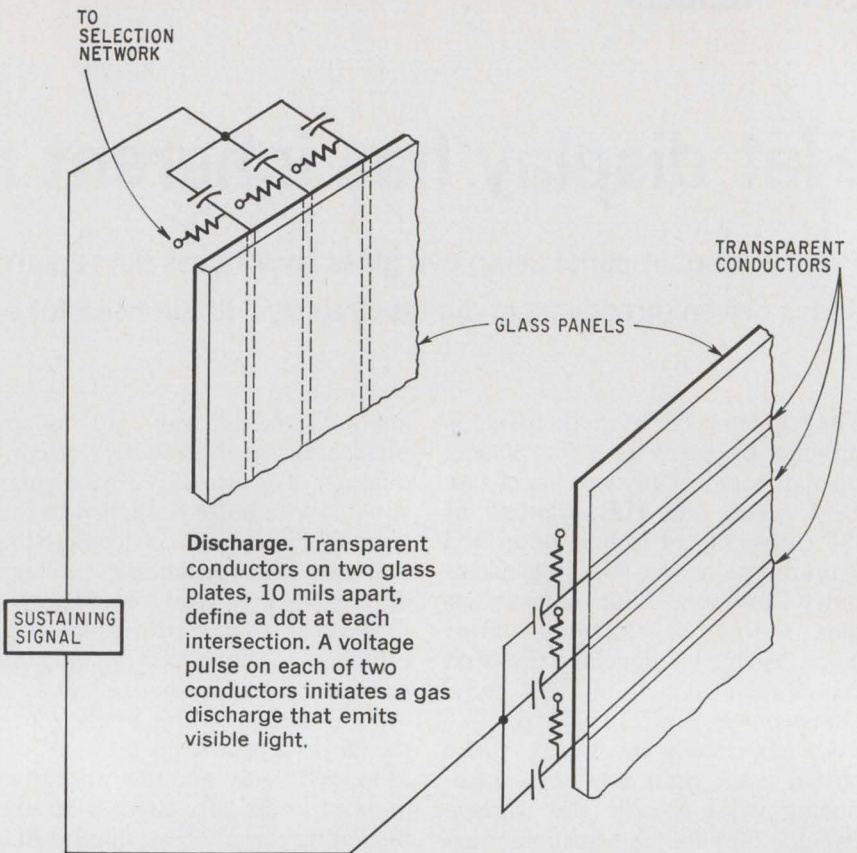

usually applied to only one conductor in each set at a time, to turn a single spot on or off. They can also be applied to a single conductor in one set and several or all conductors in the other set to change the state of many spots in a single row or column at once.

Since a new writing pulse can occur in every cycle of the sustaining voltage, the entire display can be written in a little over 2.5 milliseconds—a new pulse every 20 microseconds on each of the 130-odd conductors in a set, with appropriate conductors in the other set selected. Erasing is just as fast, but sometimes it's easier just to shut off the sustaining voltage for a large fraction of a second, long enough to let the accumulated charges dissipate.

Owens-Illinois won't identify the gas used between the plates, other than to say it's different than what Bitzer and Slottow used. That's saying very little, however, because Bitzer and Slottow tried several different kinds.

Crowded track

The others in the race haven't given up by any means. IBM is said to be pursuing the technique

avidly, although the company is still far from having a commercial product.

The Control Data Corp. says it considers the project still in the research and development stage, with a marketable product two to three years away. However, it's accepting orders from several customers for experimental models, expecting, for example, to deliver one to the National Aeronautics and Space Administration by the end of next month.

Robert H. Willson, who as a graduate student worked with Bitzer and Slottow at Illinois, is directing a plasma display project at the Westinghouse Electric Co. in Baltimore. His group has just completed a study for the Rome Air Development Center, concluding that plasma displays are feasible for wall-size panels. The Westinghouse researchers overcame a number of little problems, such as a tendency for large cells to be unstable and to have localized discharges that didn't fill up the whole cell. They've built small units with cells as large as 0.1 inch across and are working up from there.

Larger module. Willson expects the center to ask soon for bids on

Isolate with light...

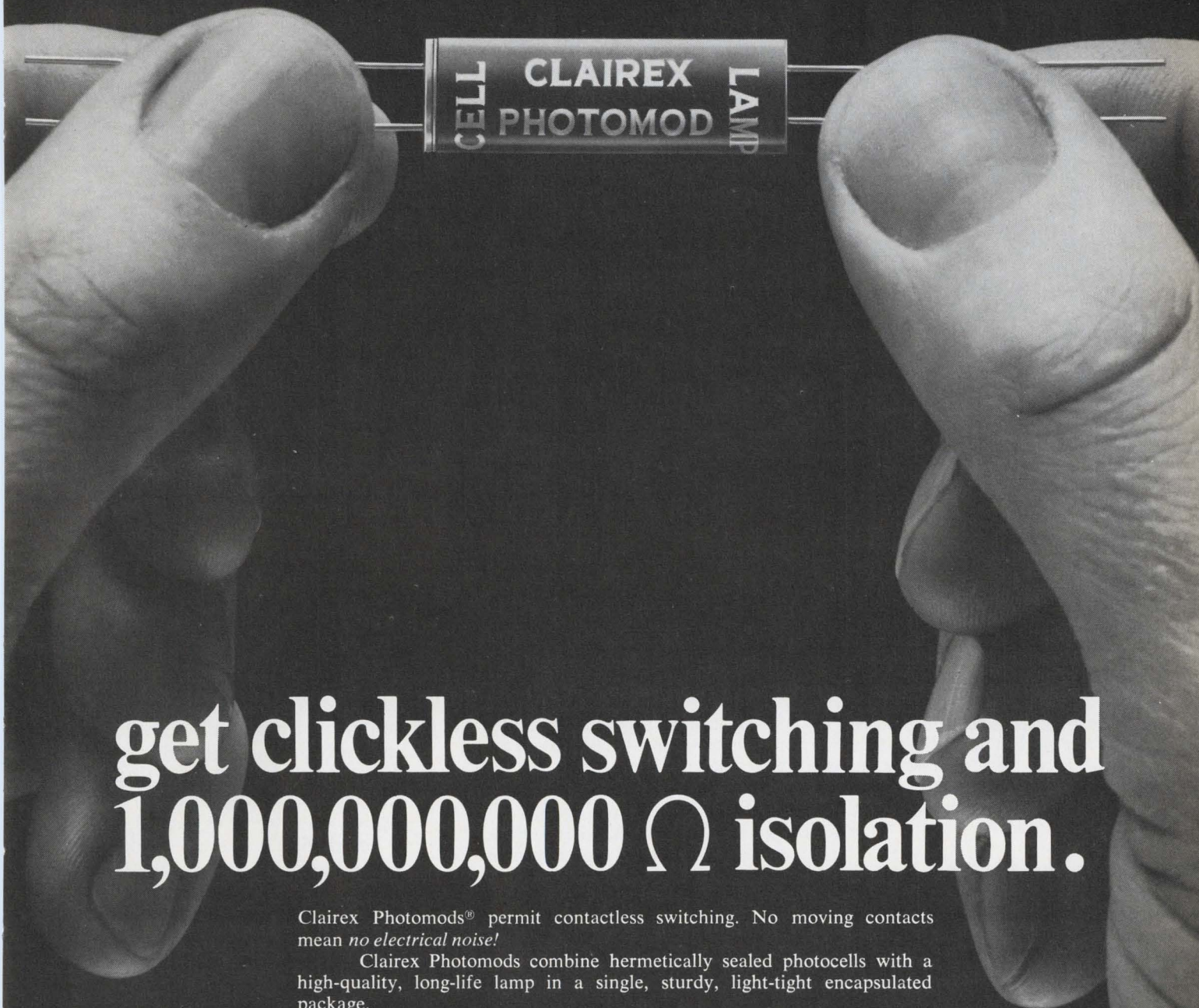

get clickless switching and 1,000,000,000 Ω isolation.

Clairex Photomods[®] permit contactless switching. No moving contacts mean *no electrical noise!*

Clairex Photomods combine hermetically sealed photocells with a high-quality, long-life lamp in a single, sturdy, light-tight encapsulated package.

The higher the voltage or current applied to the lamp, the brighter the lamp. The brighter the lamp, the lower the resistance of the cell. Thus, resistance of the cell is varied without physical contact, and no noise is generated in the signal circuit.

Let us show you how the "light touch in automation and control" can provide you with noiseless switching and control. Call (212) 684-5512 or write Clairex, 1239 Broadway, New York, N. Y. 10001.

CLAIREX ELECTRONICS, INC.[®]

The PG-11 Costs \$375

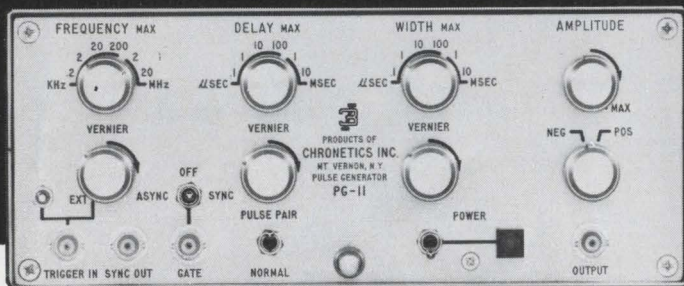

Don't tell it. It thinks it costs a lot more.

We designed the PG-11 to be the best all-around low cost pulser available for general purpose test, development and production use. It is. It can do just about anything it does extremely well and with complete reliability.

For example, it provides ± 15 volt pulses, single or double, pulse bursts when suitably gated, or one-shot pulses via a front panel pushbutton. Rep rate is continuously variable from 10 Hz to 20 MHz and amplitude, width and delay are continuously variable, too: width 25 ns to 10 ms; delay 20 ns to 10 ms; amplitude 0 to ± 15 volts at any rep rate including 20 MHz. Rise time is typically 3 ns although we spec it at

5 ns; fall time is 5 ns or better and both of them are this good at full amplitude or any other amplitude.

So, even if it's small (4" h x 8-1/2" wd x 9-1/2" d) and even if you can get two of them in 3-1/2" of rack height with our rack adapter, the PG-11 acts like it ought to cost a lot more than \$375. But don't tell it and it will never know.

Write or 'phone your nearest Chronetics representative (eem) for full data and/or a very prompt demonstration.

Chronetics, Inc., 500 Nuber Avenue, Mt. Vernon, N. Y. (914) 699-4400. In Europe: 39 Rue Rothschild, Geneva, Switzerland (022) 31 81 80.

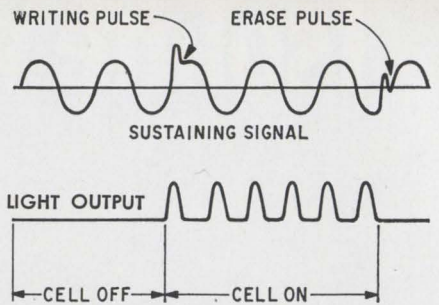

Timely. Writing pulse, plus sustaining voltage, begins discharge. Pulse of opposite polarity erases it.

a prototype module several times as large using these big cells. Westinghouse, with its foot already in the door, stands a good chance of winning a contract for such a module. One problem that Willson foresees with such modules is how to interconnect them by dozens or hundreds so that a whole wall could be filled up with a display.

In its feasibility study, Westinghouse found that the display is capacitive, which throws some light on the difficulties others are having with the technology. Although a single cell showed only 0.1 picofarad, with thousands or even millions of cells in parallel, the capacitance would produce a reactive kick that would play hob with the switching circuits. Westinghouse solved this problem. But another company may have jumped with both feet into displays as large as conventional crt units—15, 20, or 25 inches across—while everybody else is still working with 4-by-4 units. In such a display, large voltage spikes would float around and punch through almost any ordinary insulation. Rumor has it that this is happening at IBM. It's a problem that would seriously delay any development project.

Zenith Radio was interested last summer in investigating the plasma idea as a possible approach to flat-screen television. There are obvious difficulties here, since the individual spots in the basic display are either on or off, without the gray scale that television technology requires.

A Zenith spokesman said the company still hasn't solved these or other problems but hasn't lost interest.

Owens-Illinois Inc., Toledo, Ohio 43601 [338]

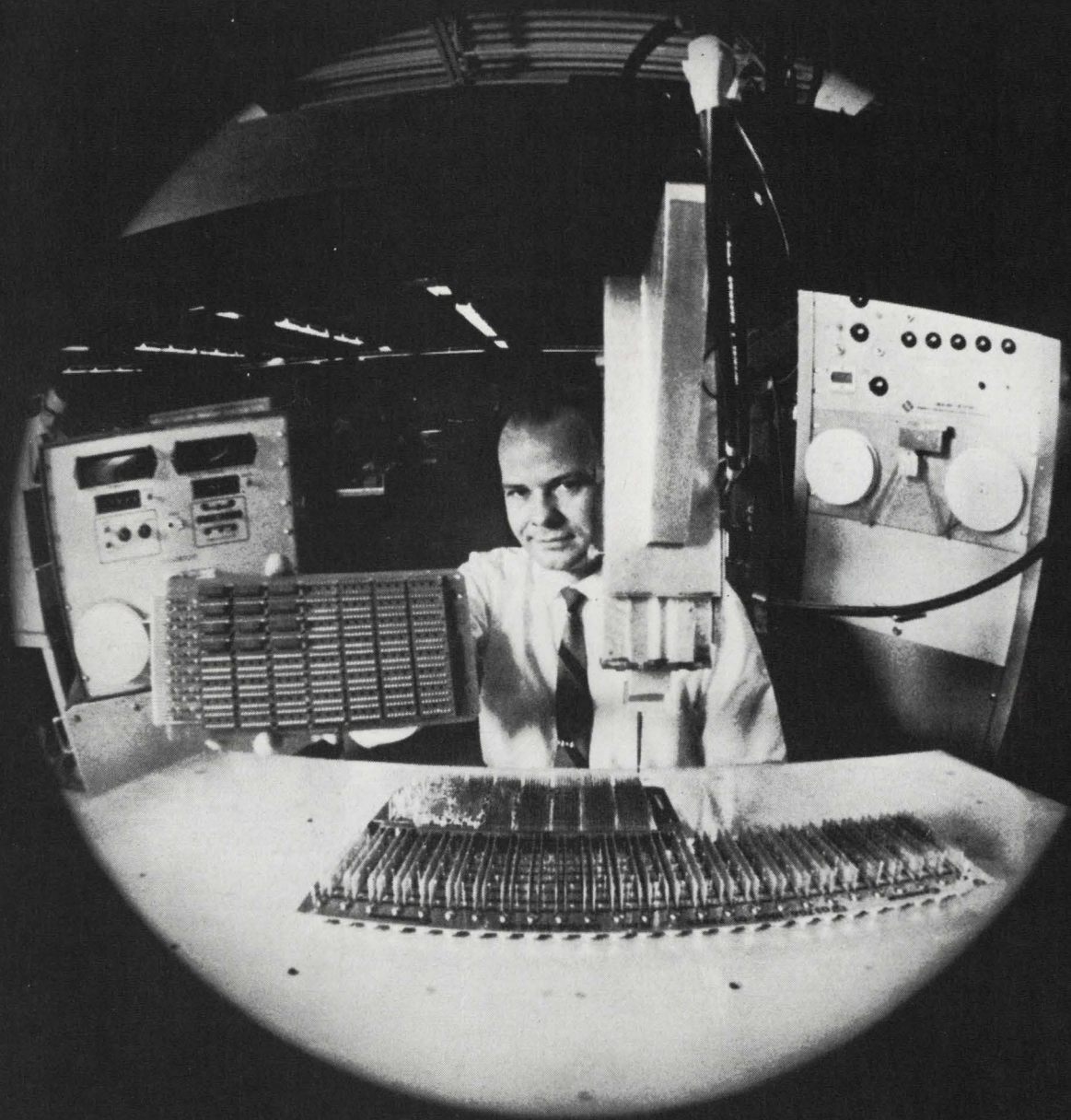

Do you or don't you?

Whether you're a budget-minded do-it-yourselfer or a guy who needs to save time, CAMBION's high density Wire-Wrap* system components let you have it your way. Quality 14, 16, 24 or 36-pin Wire-Wrap sockets, cards, card files, power planes . . . you save time and money when you build your systems with the new CAMBION line.

Whether you're building a sub-system or a full logic complex, with CAMBION Wire-Wrap components, you'll have a modular technique that provides maximum flexibility of design, high density packaging and noise immunity.

Is our automated production facility working for you? If not, let's get together!

If you want to start your design further along, we will wire-wrap our cards and package sub-systems for you.

To get the big picture of what CAMBION can do for **you**, ask for our latest literature on CAMBION Wire-Wrap products and facilities. We'll include your Logic Manual as well. They're both fact-packed to save you time and money. Free, too. Cambridge Thermionic Corporation, 457 Concord Avenue, Cambridge, Massachusetts 02138. Phone: (617) 491-5400. In Los Angeles, 8703 La Tijera Boulevard 90045. Phone: (213) 776-0472.

Standardize on

CAMBION[®]
the guaranteed electronic components

*Registered Trademark of Gardner-Denver Co.

Circle 137 on reader service card

Agg!

Where do you get yours?

Try Williams! For over 50 years Williams has been giving faster delivery and better quality, not only with silver and silver alloys, but other precious metals and their alloys. The most modern production techniques, the latest refining methods and the best equipped research laboratories make Williams your one best source for precious

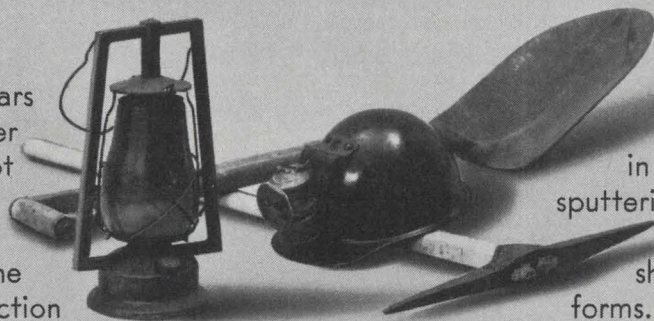

metals and their alloys. Available in ultra-high purity sputtering discs, preforms, foil, ribbon, tape, wire, sheet and other forms. Write

for our 1969 catalog and for information on our "Instant Engineering" kit.

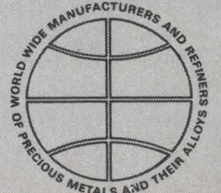

Slim magnetic modules keep company with IC's

Flatpack modulators and demodulators permit p-c board stacking for applications in missile, satellite, and avionics circuits

Geometrically, magnetic components haven't been compatible with integrated-circuit packages. The trouble is that magnetic circuit elements depend on certain spatial relationships for their properties, and as a result, they tend to be bulky by semiconductor standards. When an equipment designer wants to stack circuit boards with rather close spacing—say 0.1 or 0.2

inch between the boards—there's no problem with the IC's. In flatpacks, they can easily fit between the boards. But magnetic modules are a different story, since up to now they've had to be packaged in cubes 0.75 or 1 inch on a side.

However, General Magnetics Inc. has changed all this by developing flatpack magnetic modules. The company is offering modulators

and demodulators in a package that's only 0.1 inch thick, and can therefore be used on the same close-spaced circuit boards as IC's. Length and width range from 0.75 to 1 inch, depending on the module type. General Magnetics did it by "selecting a whole stream of new materials together with a different design approach and different geometry," according to Morris Tek-

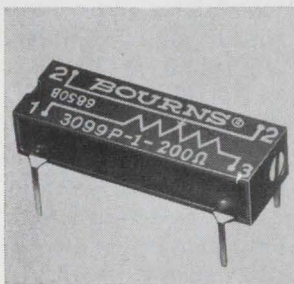

Dual in-line cermet potentiometer model 3099 measures 0.20 x 0.25 x 0.75 in. It has a standard resistance range of 10 ohms to 1 megohm, an operating temperature range of -55° to $+125^{\circ}$ C, and a power rating of 0.75 w at 25° C. Resistance tolerance is $\pm 10\%$. It is sealed to meet or exceed immersion requirements of MIL-R-22097. Bourns Inc., 1200 Columbia Ave., Riverside, Calif. [341]

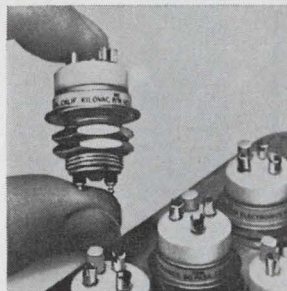

Ceramic vacuum relay model HC-1/S30 can hot-switch up to 2.5 kv d-c or 30 amps. It has a maximum operating time of 6 msec, standard coil resistance of 335 ohms. The relay will withstand vibration of 10 g's from 5 to 2,000 hz and shock to 50 g's at 11 msec. It measures 0.9 x 1.25 in. and weighs less than 1 oz. High Vacuum Electronics Inc., 538 Mission St., S. Pasadena, Calif. [342]



High Q miniature variable inductors AC7754 are offered in nominal inductances ranging from 0.1 μ h to 4,700 μ h. Designed for p-c application, the units measure 13/32 x 1/2 in. Two mounting terminals are spaced 9/32 in. on center for vertical mount. Tuning access is from either end. Approximate price is \$1.50 in quantities. Automatic Coil Co., 76 E. 2nd St., Mineola, N.Y. [343]

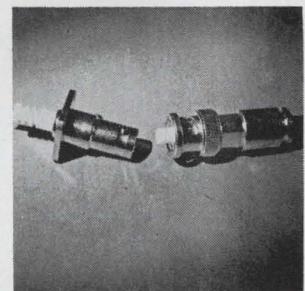

Miniature, h-v coaxial connectors have a center contact deeply recessed in Teflon with a dielectric withstanding rating of 7,500 v rms at 60 hz. A bayonet coupling device permits quick and efficient connect/disconnect operation while protection from high voltage during handling is provided by the polarized center contacts. Star-Tronics Inc., Moulton St., Georgetown, Mass. [344]

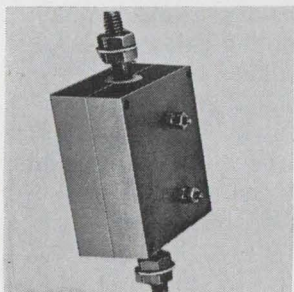

Power resistor SPR-390 has a range of from 0.001 ohm to 0.005 ohm with a temperature coefficient of ± 50 ppm/ $^{\circ}$ C from $+25^{\circ}$ to $+125^{\circ}$ C. Standard tolerance is 1%. Inductance properties are as low as 10 nh. The unit can dissipate 50 w when mounted on a 7 x 5 x 2 x 0.040 in. thick aluminum chassis. Size is 3.50 x 2.00 x 1.405 in. Dale Electronics Inc., Columbus, Neb. [345]

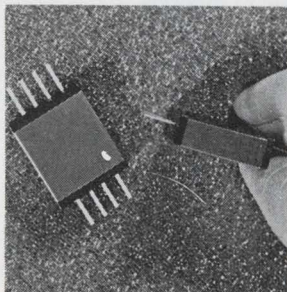

Packet relay series 14 incorporates contact assembly, bobbin, housing, and magnetic-shield/protective-cover into a single integrated sealed assembly. Units are offered with 3.6-, 6-, and 12-v coils of 300mw sensitivity and dpdt contacts. Operate time is 1 msec. Contact rating is 4 w with 200-milliohm resistance. Compac Engineering Inc., 845 Commercial St., San Jose, Calif. [346]

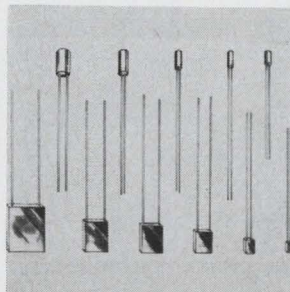

Solid tantalum capacitors in the Micron series are for applications requiring maximum packaging density. Capacitance-voltage range is 0.001-220 μ f, 2-100 v d-c. Operating temperature range is -55° to $+85^{\circ}$ C at rated voltage and to 125° C with derating. Typical uses include by-pass, coupling, filtering and timing circuits. Union Carbide Corp., P.O. Box 5928, Greenville, S.C. [347]

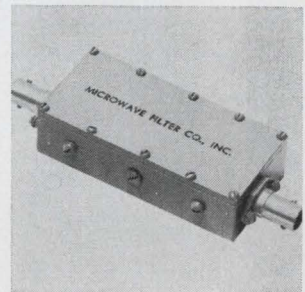

Interdigital bandpass filters series 2600 are modified for in-line connectors and shorter length. Customer-specified bandwidth is 1 to 10% in the 500-1,500 Mhz range. Center conductors are of plated Invar steel to minimize tuning drift with temperature. Price is \$178 to \$232, depending on number of poles specified. Microwave Filter Co., W. Manlius St., E. Syracuse, N.Y. [348]

RMC

DISCAPS

the complete Ceramic Disc line

Over the years Radio Materials Company has maintained its leadership in the production of ceramic disc capacitors. A complete line offering outstanding quality has been the key to continuing growth.

STANDARD

Type C, B, BA, JF, JL and JE

SUBMINIATURE

Type SM, BT, TA and Magnacaps

GREENCAPS

Type CG, JG, and BG

SPECIAL

U.L. Listed Discaps, T.C. High Voltage, High K High Voltage and Dual Section By-Pass

SOLDER-IN T.C. DISCAPS

For application in equipment where lead inductance effects must be reduced to an absolute minimum.

If your application requires special physical or electrical characteristics, contact RMC's Engineering Department.

U.L. LISTED T.C. DISCAPS

Should be specified when the use is an integral part of an antenna coupling network where compliance with Underwriters' Laboratories specifications are required.

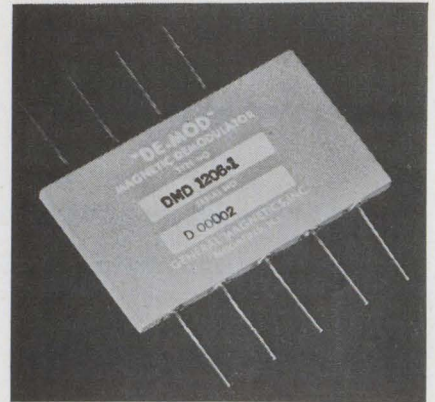

Flattened. Magnetic modulators and demodulators are as thin as IC's.

osky, company president.

Tekosky sees applications in missile, satellite, and aircraft where the new modules can be incorporated into control and guidance circuits, fire control and bombing computers, and other analog circuits.

A typical modulator, type IMM 1211-1, provides an amplitude-modulated a-c signal at 10 kilohertz in response to a d-c input. The differential gain is 1 volt rms a-c output per volt of d-c input. This response is linear within 0.25%. Input range is 0 to ± 5 volts d-c, and output range is 0 to 5 volts rms. Input impedance for both the d-c signal and the a-c carrier is 10 kilohms.

The unit is operable over a temperature range of -55°C to 125°C . The zero-point variation over this range is no more than 25 millivolts.

Other versions are available with output frequencies from 400 hertz to 1 megahertz, and output voltages up to 10 volts rms. Current-sensitive versions are also available, with differential gains of 4 mv/microampere and 16.5 mv/ μa .

The flatpack demodulators, which incorporate switching transistors in addition to the magnetic elements, have similar characteristics.

In sample quantities, prices range from \$175 to \$220 for a modulator and \$125 to \$150 for a demodulator.

The company is developing other flatpack modules for d-c to a-c multiplication, raising to a power, taking a root, multiplication of an a-c by a d-c variable, and division of these quantities.

General Magnetics Inc., 135 Bloomfield Ave., Bloomfield, N.J. 07003 [349]

DISCAP
CERAMIC
CAPACITORS

RMC

RADIO MATERIALS COMPANY

A DIVISION OF P. R. MALLORY & CO., INC.
GENERAL OFFICE: 4242 W. Bryn Mawr Ave., Chicago 46, Ill.
Two RMC Plants Devoted Exclusively to Ceramic Capacitors
FACTORIES AT CHICAGO, ILL. AND ATTICA, IND.

2½D cycle time at 3D cost!

Data Products' new 3-wire, 3D memory

...the

STORE/33™

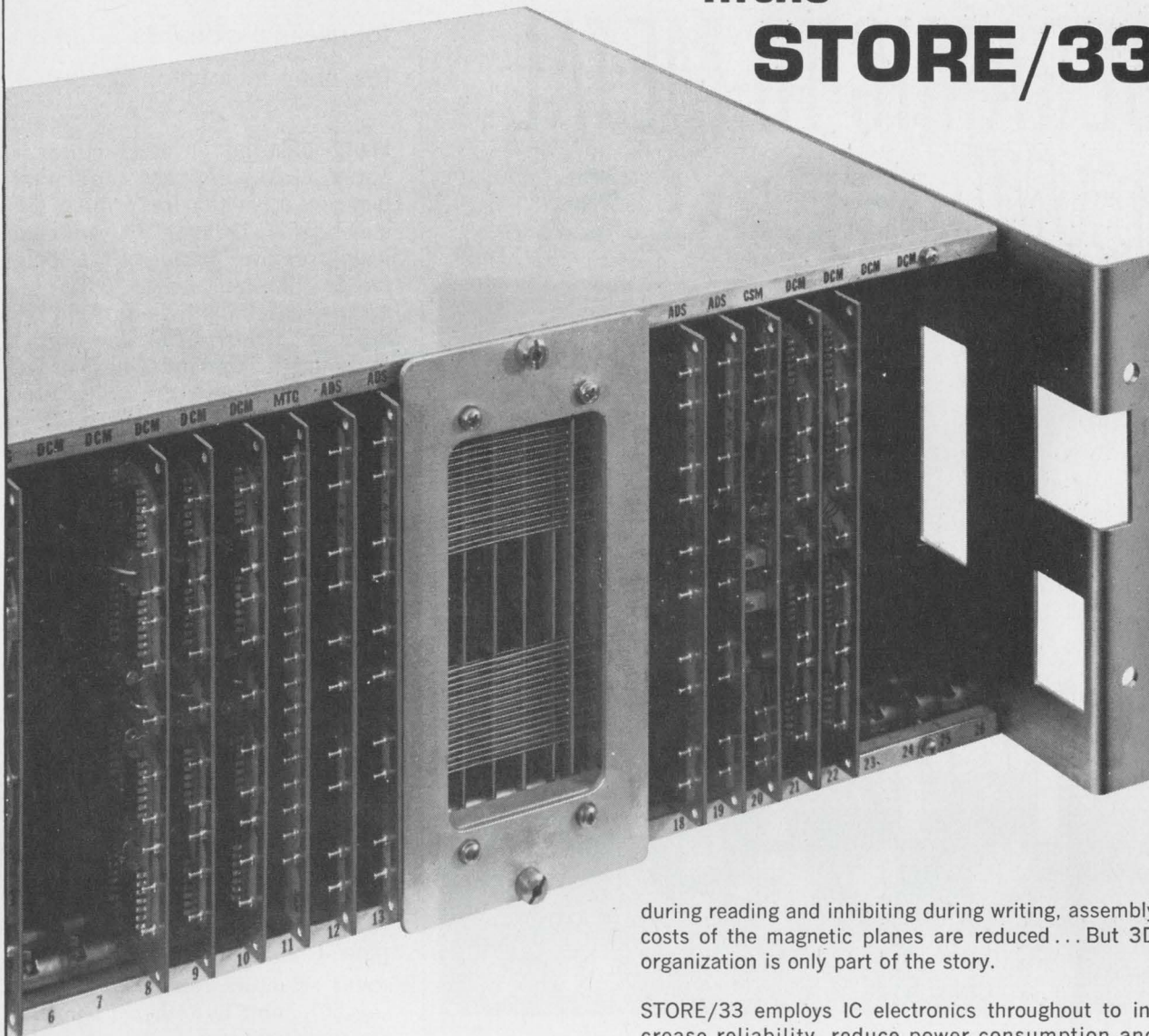

STORE/33 is in full production at Core Memories, Inc.* . . . now you can have 2½D speed at coincident-current prices! For example, the 4K x 16 version of STORE/33 uses 18 mil cores to give a full-cycle time of 650 nsec. The price? Under \$4500** in production quantities.

What makes this price breakthrough possible without a tradeoff in speed? The key, of course, is 3-wire 3D organization in which the fourth winding normally associated with coincident-current organization is eliminated. By utilizing the same winding for both sensing

during reading and inhibiting during writing, assembly costs of the magnetic planes are reduced . . . But 3D organization is only part of the story.

STORE/33 employs IC electronics throughout to increase reliability, reduce power consumption and achieve more compact packaging. The basic memory uses only four types of plug-in cards. The memory stack also plugs in. This standardization of circuit card types and modular construction reduces your inventory costs and simplifies maintenance. Word capacities to 16K, interface flexibility, plus a wide range of options . . . for the full story, write Data Products Corporation, 6219 De Soto Ave., Woodland Hills, Calif. 91364.

*Core Memories, Inc. is a subsidiary of Data Products Corp.
**Price does not include optional power supply.

Data Products manufactures LINE/PRINTERS™, DISCFILES®, Core Memories, Off-Line Printer Systems, Card Readers & Punches.

P data products

"the peripheralists"

For Extreme Processing Temperatures to 1400°F

E-I SUPER STRENGTH CERAMIC-TO-METAL NEW! SEALS

Vacuum-tight, hermetically-sealed components offer exceptional resistance to shock, vibration and corrosion, and conform to all ASTM F-18-64 requirements.

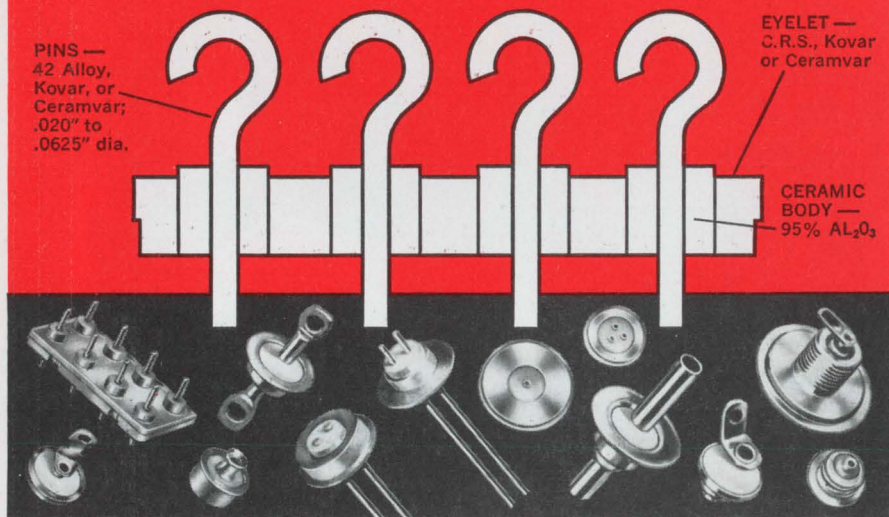

- Superior dielectric properties
- Maximum rigidity and durability
- Withstand extreme thermal stresses
- Miniaturization and design standardization

These E-I components are specifically designed to provide maximum reliability under severe environmental conditions. For example, they withstand repeated heat cycling up to 1400°F, and thermal shock comparable to electron tube processing.

E-I alumina insulated, ceramic-to-metal seals can be economically produced from hundreds of stock designs; where special configurations are required, E-I sales engineers will make recommendations from your blueprints or sketches.



Electrical Industries

A Division of Phillips Electronics and Pharmaceutical Industries Corp.
Murray Hill, N. J. 07974 — Tel.: (201) 464-3200

New components

Plug-in switch is rugged

Multideck rotary device
for use in p-c boards
has snap-lock rotor

Hand-soldering or hand-wiring is not required with a new plug-in rotary wafer switch for printed circuit boards. To avoid the mechanical pressure problems encountered with rotary switches, the new unit is also built rugged, says the Standard Grigsby Co. The firm, a division of Standard Kollsman Industries Inc., says the ruggedness of its multideck rotary switch, called the SKPC, is due to its snap-lock rotor construction and its molded, glass alkyd wafer. The molded wafer has a one-piece metal stator contact path from the p-c termination to the switching point. Each wafer in the deck has eight rigid p-c terminals and, if needed by the customer, six auxiliary solder lugs. The molded glass alkyd serves as an insulator and acts as a natural barrier to prevent excess solder from flowing onto the various contact areas.

The key feature of the switch is its simplicity of design, says John A. Udisches, sales manager. From two to six contact selector arms are available within a maximum of a 180° rotating contact. This inner stator structure can be divided at any 30° point by either a shorting division having a single cut in the metal or a nonshorting division having a pair of cuts. To ensure positive detenting at each position, a starwheel and ball are used to achieve the 30° indexing. Both the stator contacts and p-c terminals are silver-plated brass. The detent spring's torque, says Udisches, can be easily varied to accommodate multiple wafer assemblies and specific requirements.

Tension helps. The stator insulator—the glass alkyd—also serves as the container for the snap-lock rotor, which is made up of the thermoset rotor itself and a thermoplastic retainer. Driven by a double-

NOW...

Hamilton precision metals has added facilities...and is in the Photoformed® Parts business...

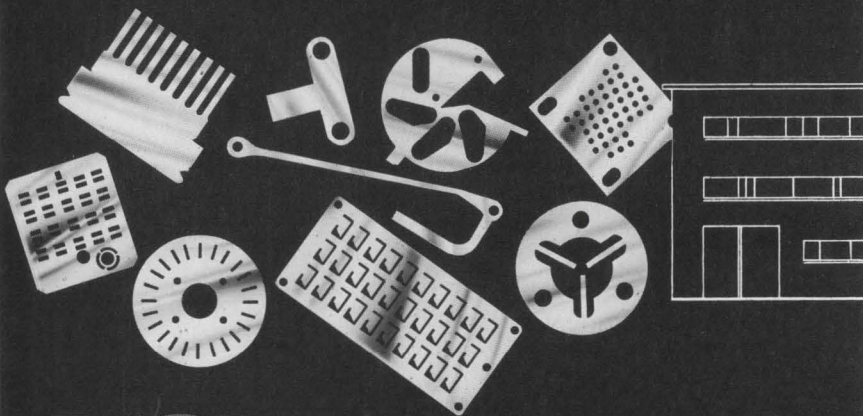

BIG!

Hamilton has added a new plant—just to produce precision, Photoformed® parts!

This new facility is equipped with the most modern photo-etching machinery on the market. The new equipment will produce precision parts in large quantities to the highest standard of dimensional accuracy.

Now, you can get from the Precision Metals Division, finished parts to the same degree of precision as world wide metal users have come to expect in Hamilton's strip and foil.

Hamilton offers the advantages of a completely integrated facility controlling every step from melt to finished strip or foil—and now to finished parts. This means that you get the same adherence to metallurgical standards and dimensional accuracy that has become the hallmark of Hamilton.

For the complete story on the capabilities of Precision Metals Division and what it can do for you, write for your copy of the Precision Metals catalog. It's yours for the asking—write today!

PRECISION METALS DIVISION
HAMILTON
WATCH COMPANY • LANCASTER, PA. 17604

flatted actuating shaft, the rotor holds the contacts in place and the retainer snap-locks them in. Thus, the rotor-stator relationship is established. According to the company, this tension minimizes end-play and backlash.

At 25,000 hertz and a contact resistance of 0.020 ohm, the SKPC's resistive load ratings are 3.5 amps at six volts d-c, 0.750 amp at 28

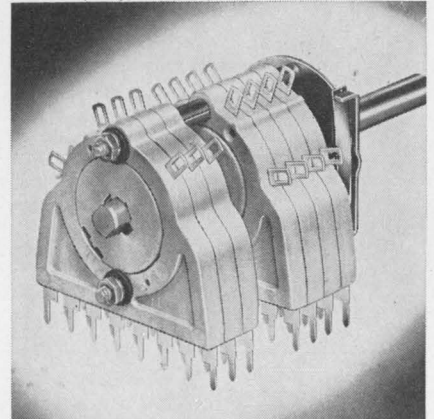

Expandable. Each wafer in the deck has 8 rigid terminals to plug into a printed-circuit board.

volts d-c, and 0.9 amp at 125 volts a-c. Maximum carrying current for a 20°C thermal rise is six amps; dielectric strength is given as 1,750 volts a-c to ground or between adjacent stator contacts.

Rated index life of the switch is 50,000 hertz minimum, and its temperature range is from -55°C to +85°C.

Standard Grigsby is also offering as optional assemblies single and dual a-c switches that can be mounted at the rear of the wafers, and either concentric shafts that can be used to drive separate detent mechanisms, or an inner shaft to drive a rear-mounted potentiometer.

Udisches says the device is being designed into new lines of hi-fi stereo sets and related equipment at Zenith, Magnavox and RCA as a function switch.

Price of the switch ranges from 40 cents to \$3 each, depending on customer specifications and quantity of the order. Delivery time of production quantities is six to eight weeks.

Standard Grigsby Co., 920 Rathbone Ave., Aurora, Ill. 60507 [350]

**BIG PRINT-OUT
CAPACITIES
COME IN SMALL
MDS PACKAGES**

22 or 32 print columns with speeds up to 40 lps... that's the story of the MDS Series 2200 and 3200 Digital Strip Printers.

These high-speed, parallel-entry printers offer a selection of several print drums, giving a variety of character choices. Both models provide numeric and alphanumeric printout.

The 3200 is supplied in a compact, easy-to-mount, two-chassis package with the printer in one chassis and the electronics in a matching chassis, for either local or remote operation.

Paper-loading on either model is easy because the printer mechanism slides forward on full-suspension, ball-bearing glide rails. Since the print drum is cantilever-mounted, paper can be easily slipped into position without being threaded. Either paper roll or fanfold stock is used in the 2200; only fanfold in the 3200.

The printer mechanism is built around a monolithic main body casting resulting in high mechanical stability and low maintenance. 120-day warranty. "Down-time" is the exception rather than the rule.

Ask for: Specifications and more information available in MDS folder-file on Series 2200/3200.

FOR MORE — MEET YOUR MAN FROM MDS



SERIES 2200
DIGITAL STRIP PRINTER

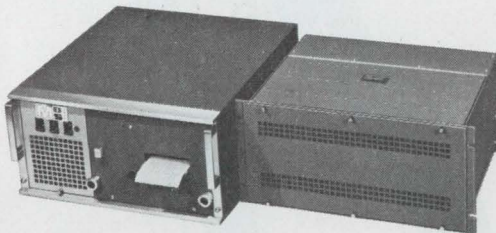

Series 3200
has dual chassis for local or
remote printer operation.

MOHAWK MDS
DATA SCIENCES CORPORATION

OEM MARKETING
122 EAST RIDGEWOOD AVENUE • PARAMUS, N.J. 07652
Telephone 201/265-7333

Every MDS office is an OEM Marketing office

DIGITAL STRIP PRINTERS • BUFFERED TAPE UNITS
HIGH-SPEED AND LOW-SPEED LINE PRINTERS
CARD PUNCHES AND READERS
PAPER TAPE PUNCHES AND READERS

REGIONAL MANAGER OFFICES

Atlanta, Ga. Tel. 404/261-8036
Waltham, Mass. Tel. 617/891-4430
Des Plaines, Ill. Tel. 312/298-4141
Los Angeles, Calif. Tel. 213/685-5165

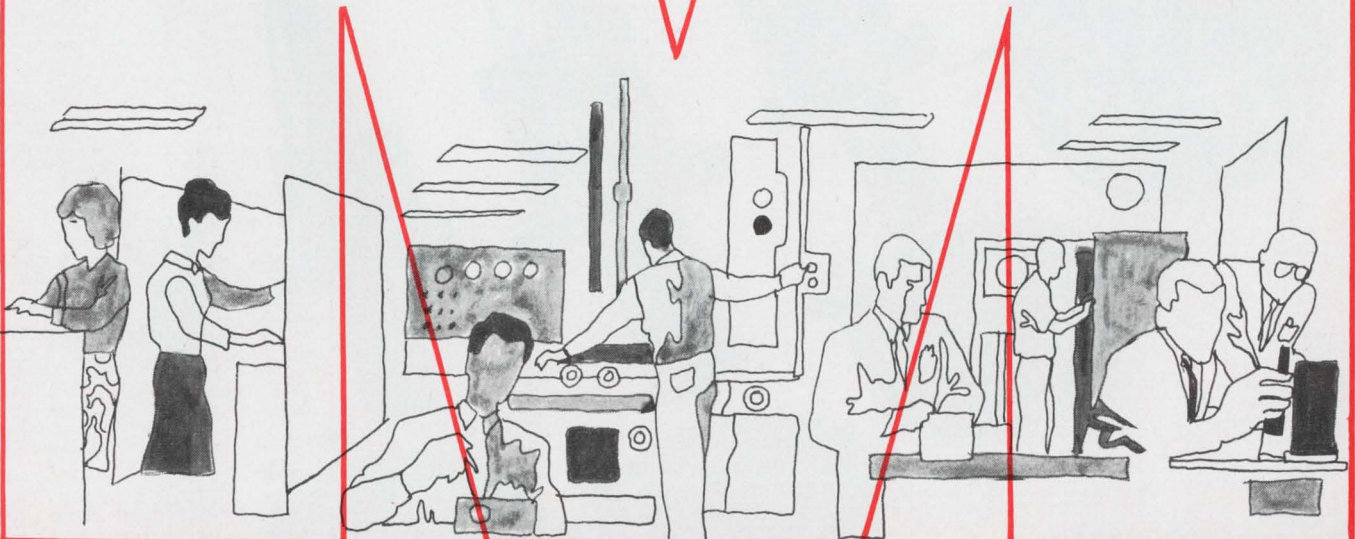

Now... the highest concurrent- rated inverter SCR

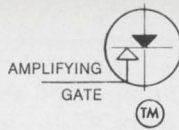

C398 inverter SCR utilizes amplifying gate design for high speed and high voltage.

The new C398 is now the highest rated SCR in GE's complete line of inverter thyristors. This new 1200 volt design boasts soft-firing gate, high di/dt and fast turn-off time. These features are the result of over one and a half years of General Electric experience in amplifying gate technology. This structure also permits superior ratings for other Press Pak (C358) and stud-mounted (C158) units.

C398's Press Pak package means simpler installation and increased application flexibility, plus double-side cooling permits a higher current capability. To mount the hermetically-sealed Press Pak, simply insert it into GE's new universal spring clamp assembly. To change polarity, just turn the unit over.

With this latest addition, GE's full line of inverter thyristors includes virtually every rating necessary for total design flexibility . . . including Press Paks (C354/355, C385, C358, C510, C398) and stud mounts (C141, C154/155, C185, C158).

Also designed for inverter use is the A96 and its Press Pak counterpart, A396. This pair of fast-recovery diodes is specifically designed to complement GE's high-speed SCR's in inverter and chopper applications.

For more information on these and other General Electric semiconductor products, call or write your GE sales engineer or distributor, or write General Electric Company, Section 220-71A, 1 River Road, Schenectady, N. Y. 12305. In Canada: Canadian General Electric, 189 Dufferin St., Toronto, Ont. Export: Electronic Component Sales, IGE Export Division, 159 Madison Avenue, New York, New York 10016.

GENERAL  ELECTRIC

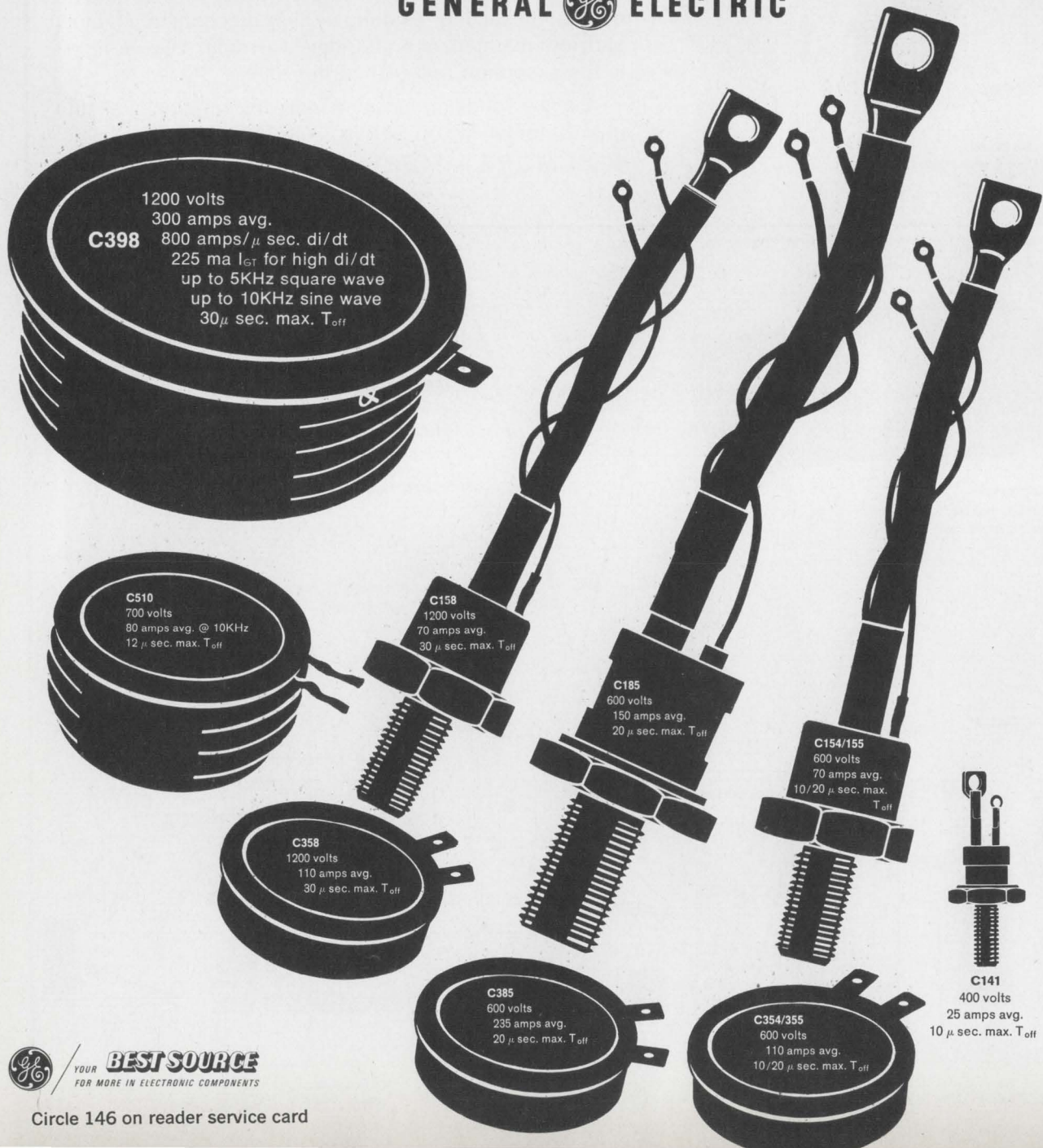

 **BEST SOURCE**
YOUR FOR MORE IN ELECTRONIC COMPONENTS

Circle 146 on reader service card

Single-sweep oscillator has multioctave range

Completely solid state generator covers 1.0 to 12.4 Ghz in either continuous-wave or sweep mode without plug-ins

"Two heads are better than one" says the adage, but the Narda Microwave Corp. disagrees. The company has a completely solid state sweep oscillator that eliminates the need for several plug-in heads, each covering an octave. The model 9500, which sweeps from 1.0 to 12.4 gigahertz in one tuning head, should be welcomed by all those who would like to test broadband de-

VICES over multioctave bands without worrying about coverage between bands, or losing time to stop and change heads every time they go from one band to the next.

"We designed this sweeper to obsolete the term 'octave,'" says J.P. Schindler, Narda's vice president of marketing, "and we think it does just that. Our sweeper is completely solid state, uses inte-

grated circuits in the logic circuitry, and a linear yig-tuned oscillator and filter combination developed for us by Watkins-Johnson."

The broadband sweeper can be programed and contains no backward-wave oscillators or other limited-life components; it can cover the complete 1- to 12.4-Ghz frequency band in one continuous sweep, or any percentage of that

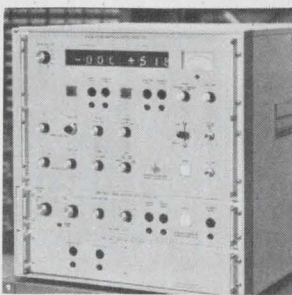

Pulse vector immittance meter series 1170 measures the driving point impedance or admittance of either a pulsed or c-w sine wave driven network. The meter supplies three simultaneous outputs: visual 3-decade decimal readout with polarity, 14-bit BCD data including sign, and analog d-c voltages. Scientific-Atlanta Inc., P.O. Box 13654, Atlanta, Ga. 30324. [3611]

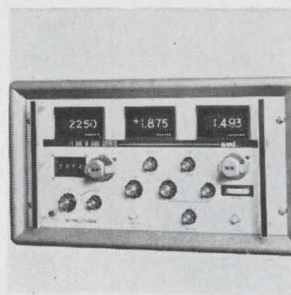

L- and S-band, f-m and p-m signal generator 3000 is for aerospace telemetry. It provides an output signal in the 1,435-1,540 Mhz and 2,150-2,310 Mhz bands. The carrier can be deviated up to ± 5 Mhz. It uses digital panel meters and displays to indicate carrier frequency, peak deviation and modulation frequency. Advanced Measurement Instruments Inc., Somerville, Mass. [362]



Digital thermoelectric power meter D6685 is designed to provide an accurate readout of average power of c-w, pulse, a-m or f-m signals. It offers power ranges corresponding to 0.03 μ w to 100 mw and -45 dbm to +25 dbm. Accuracy is provided by a solid state d-c amplifier that includes 100 db of feedback. PRD Electronics Inc., 1200 Prospect Ave., Westbury, N.Y. 11590. [363]



Memory voltmeter 5203, featuring a digital readout of d-c to 50 nsec pulses and amplitudes to $\pm 1,000$ v in 4 ranges, providing 100% over-ranges and BCD output, comes in a half-rack dual shielded cabinet. It will measure and hold the peak amplitude of one-shot or transient pulses, as well as repetitive pulses. Micro Instrument Co., 12901 Crenshaw Blvd., Hawthorne, Calif. [364]

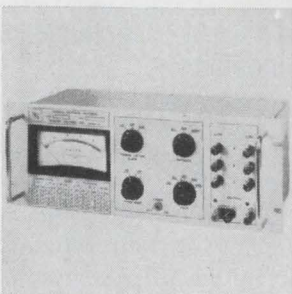

Wideband electronic wattmeter 1382A is for accurate measurement of the power consumed by small instrumentation motors, control circuits and the like. Features include full scale ranges as low as 1.25 w and as high as 160 w, 1% accuracy maintained at power factors near zero, and a frequency range of 60 hz to 1.2 khz. Scientific Columbus Inc., 1035 W. 3rd Ave., Columbus, Ohio. [365]

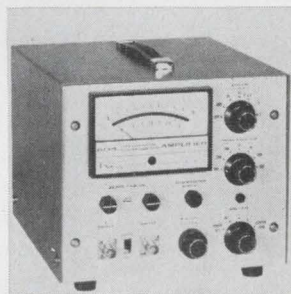

Differential electrometer amplifier model 604 features 10^{14} ohms input resistance and 75 khz bandwidth. Selectable gains are from 10 to 10^4 . Stability is 4 mv/week. The instrument also features less than 20 μ v noise and 90 db common mode rejection. It is useful as an amplifier, a millivoltmeter or a picoammeter. Keithley Instruments Inc., 28775 Aurora Road, Cleveland. [366]

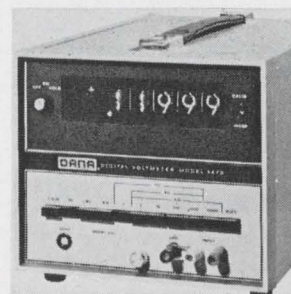

Full accuracy of $\pm 0.01\%$ of reading $\pm 0.01\%$ full scale is held against virtually any noise found in normal operating environments by the model 4470/230 digital multimeter. Input impedance resistance is 10,000 megohms. Packaged in a 8½ in. wide unit, the instrument sells for less than \$1,800. Delivery is 30-60 days. Dana Laboratories Inc., 2401 Campus Dr., Irvine, Calif. 92664. [367]

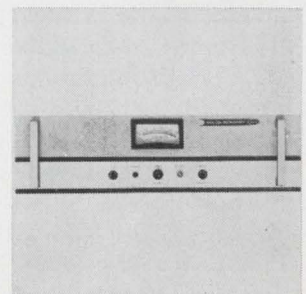

Variable frequency power conditioner V-2000 operates on the principle of the Varax variable inductor circuit that will accept any frequency from 45 to 75 hz and maintain a fixed voltage output that is both regulated to within 0.5% as well as filtered to 20 db. Prices start at \$300. Availability is off-the-shelf. Wanlass Instruments, 1540 E. Edinger Ave., Santa Ana, Calif. [368]

If cycle time
is the name of
your computer game,
read the good news:

Toko Woven Plated-Wire Memory System HS-500 is now available.

Toko's woven plated-wire memory planes and stacks are already well known for their low-cost, high-performance characteristics. Now to be marketed for the first time is Toko's complete memory system, with a capacity of 4096 words by 16 bits expandable to 8192 words and 20 bits. **Cycle time is a remarkable 500 ns.** Other characteristics are 2D organization, destructive read-out operation, and TTL logic level interface. Cost of the system is remarkably low, and fast delivery can be guaranteed.

Another outstanding feature that extends this memory system's range of applications is its wide operating temperature range without any current compensation: 0°C to 50°C. Power dissipation is a low 100W. Physical dimensions of the system (basic or expanded) are: 498cm (19-1/2") H x 480cm (19") W x 340mm (13-1/4") D.

Besides this standard woven plated-wire memory system, Toko can undertake the manufacture of custom-made systems according to your specifications. Complete technical details from our New York office.



TOKO, INC.

Head Office: 1-17, 2-chome, Higashi-Yukigaya, Ohta-ku, Tokyo, Japan

TOKO N.Y., INC.

350 Fifth Avenue, New York, New York 10001

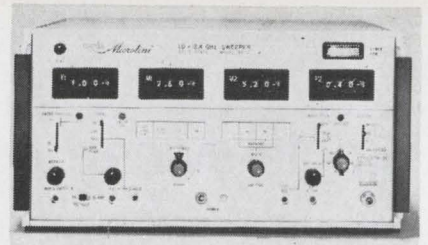

Sweeping. Oscillator covers wide band without requiring additional heads.

band. The output power can be leveled to 1 milliwatt ± 0.5 db across the entire band; the harmonically-related spurious signals are at least 20 db below the fundamental frequency, and other spurious signals are 30 db below the fundamental.

Both the frequency and the amplitude of the oscillator can be programed directly from an analog voltage source. To be programed, the frequency input requires a d-c level in volts that is just equal to the desired center frequency in Ghz. With this Ghz/volt sensitivity, one could program the entire frequency range from a simple low-voltage power supply without the need for any additional interface equipment. The amplitude of the r-f output signal is programed over a 30 db dynamic range by a 0-to-2 volt d-c control signal.

The front-panel frequency control and readout consists of four digital frequency programing wheels that allow the operator to set the oscillator to within 200 kilohertz of the desired frequency. This lets the user directly dial a continuous-wave frequency that is accurate to $\pm 0.02\%$ at 1 Ghz, and to $\pm 0.0015\%$ at the high end of the band, without the need of any interpolation of a slide-rule dial.

In the sweep mode, any combination of sweeps with or without markers can be selected by four independently controlled pushbuttons. In the c-w mode these pushbuttons allow up to four separate frequencies to be selected. Also, one of the pushbutton frequency controls has a fine control which allows the user to accurately set the frequency.

The dual-mode oscillator sells for \$9,800, and the delivery time is three months.

Narda Microwave Corp., Engineers Hill, Plainview, N.Y. [369]

Using spot ties for
wire harnessing?

HERE IS THE
**GUDEBROD
SYSTEM "S"**

—SPEEDS THE WORK—SAVES MONEY, TOO!

GUDE-TIES CUT LENGTHS—Specifically produced for spot knotting these handy cut lengths of Gudebrod Flat Braided Lacing Tape are dispenser packaged for one hand, speedy withdrawal. Available in 6", 8", 10", 12", 15", 18", 20" and 22" lengths (other lengths on order). Meet or exceed MIL-T Specs, no-slip knots hold firmly without cutting insulation.

GUDE-SNIPS—These palm-of-the-hand snips cut cleanly, easily. For right or left hand use, spring action, DuPont Teflon bearing. Allow operator to have free use of fingers without constant reaching for knife or shears. Save motion, save time.

GUDEBROD SWIVEL-TILT HARNESS BOARD MOUNT—Balanced, two dimensional action brings every section of the harness within easy reach. No stretching, no straining. Knots are tied in an easy, natural position. Cuts fatigue—speeds work.

Here you have the Gudebrod System "S" for spot tie lacing, based on the high quality, high speed Gudebrod Lacing Tape—if you're interested in saving money while speeding the harness work, get in touch with us. (For continuous tying, ask about System "C".)



Available also in other types
of Gudebrod Lacing Tapes

GUDEBROD
Electronics Division

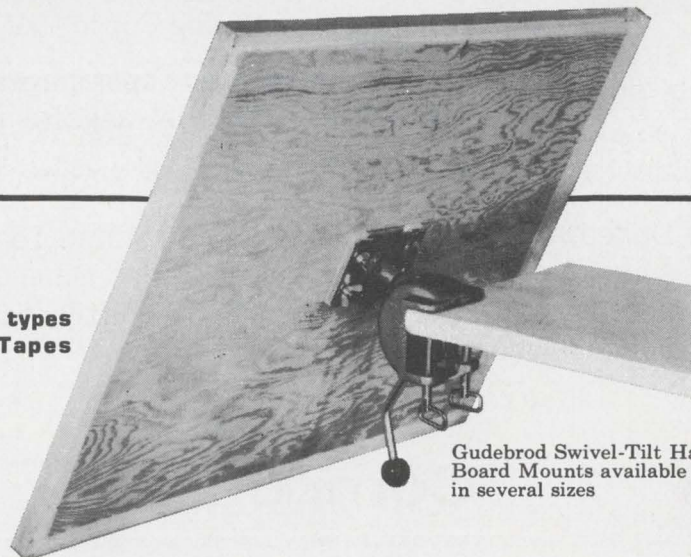

Gudebrod Swivel-Tilt Harness
Board Mounts available
in several sizes

GUDEBROD BROS. SILK CO., INC. Founded 1870, 12 South 12th Street, Philadelphia, Pa. 19107

New from United Aircraft

control logic

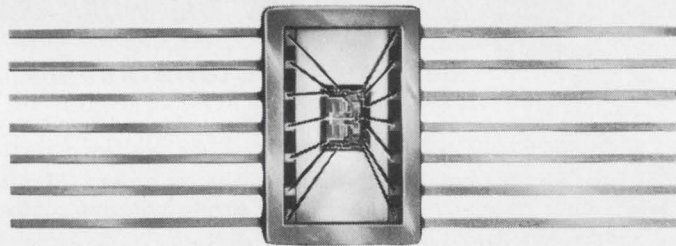

A family of 28 volt integrated circuits including dual and quad gates, expandable gates and gate expanders, set-reset flip flops, 5 volt to 28 volt converters and 28 volt to 5 volt converters, featuring:

- **Large supply variation tolerance** – 16 to 40 volts
- **High A.C. noise immunity** – rejects 2 u sec pulses of up to 90 V
- **High D.C. noise immunity** – 8.5 volt input threshold
- **High current sinking ability** – 100 mA steady state, 1 ampere transient
- **High output signal swing** – up to 90 V
- **Full military temperature operating range** – -55°C to $+125^{\circ}\text{C}$
Also available in industrial range from 0°C to $+85^{\circ}\text{C}$
- **Packaged** in $\frac{1}{4} \times \frac{3}{8}$ flatpack

United Aircraft control logic, operates from 16 to 40 volt sources and is ideally suited for directly driving indicators and actuators. Control logic replaces relays and discrete device circuitry and provides significant reduction in size and weight. For more information, contact:

Electronic Components DIVISION OF **United Aircraft**

TREVOSE, PENNSYLVANIA Tel. 215-355-5000 TWX: 510-667-1717
IN THE WEST: 128 E. KATELLA AVE., ORANGE, CALIF., (714) 639-4030

5-wire organization cuts core memory price

Two X and two Y lines plus a sense/inhibit line which is common permit simple, unidirectional circuits for applications where speed is not critical

High speed isn't a big concern with users of buffer memories. As long as the cycle time is less than 10 microseconds, they'll consider the unit if it offers economy. Richard Bravo, product manager for core products at the Computer Products division of the Ampex Corp., says this is precisely the category the division's 3DM-3000 core memory is intended to fit.

He says the unit's introduction, which will come formally at the Spring Joint Computer Conference in Boston May 14-16, will complete the Ampex core memory line, which had lacked a buffer or display-refreshing memory. He also expects the unit to be used in data terminals that require a small memory.

"The big market will be in applications where speed matching is a

consideration," Bravo notes. "This is the situation in which you have a big burst of data coming in and sitting for 5 minutes before another burst comes in. Then the data is put out at a slower rate that tapes or a disk can handle." With a 3-nanosecond cycle time, the Ampex memory is slower than some comparable core memories for buffer applications, but it will sell for



Cartridge-loaded system called Cartri-File provides PDP-8 computers with 4 digital tape transports. The system can be used to sort, match, collate and merge data. The tapes also provide program loading, off-line storage for memory dumps, and buffering for uninterrupted data accumulation. Price is \$5,700. Tri-Data, 800 Maude Ave., Mountain View, Calif. 94040. [401]

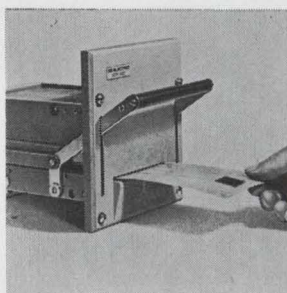

Sealectrocard 12x51 tab reader is suitable for use with microfilm IBM cards as shown. In this instance, the IBM card is used for microfilm reading as well as for word bit storage by means of punched slots. The instrument will read the card electrically, while a separate microfilm reader provides visual readout of data from the film strip. Sealectro Corp., Mamaroneck, N.Y. [402]

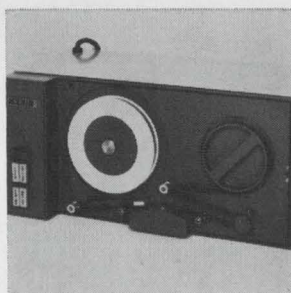

Digital magnetic tape transport model 7820 is for small digital computer and data communication terminal applications. It is an IBM compatible, 9 track, 12.5 ips, 800 bpi write/read tape transport, to provide data transfer rates of 10 khz. It occupies 7 in. of rack height. Price is approximately \$2,750. Peripheral Equipment Corp., 9551 Irondale Ave., Chatsworth, Calif. 91311. [403]



On-line digital correlator DC-100 is suited for filter functions with any data gathering or pulse recognition equipment, such as receiving systems or recorders used in radar, sonar, and other echosounding applications. Data storage is 3,072 8-bit words per channel, 12.28 sec at 4 msec rate. Price ranges from \$20,000 to \$22,000. Mandrel Industries Inc., Box 36306, Houston. [404]

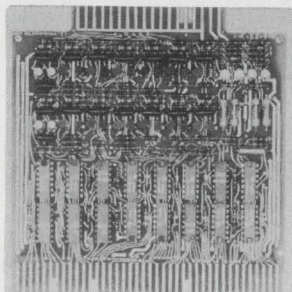

Analog I/O system ties into SPC-12 and -8 computers. It accepts up to 512 input channels of data from analytical instruments and sensors. After the computer has processed the data, it is outputted through up to 256 channels for driving displays, recorders, etc. System operates at 3.3 μ sec per bit conversion rate. General Automation Inc., W. Ketella Ave., Orange, Calif. [405]

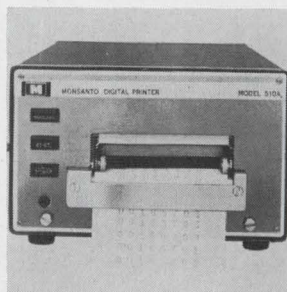

Digital printer 510A will accept either 1-2-4-8 or 1-2-2-4 BCD code, positive or negative true, as determined by internal connections. The half-rack unit prints up to 8 columns at speeds up to 4 lines/sec. Print cycle is initiated by a positive 0.9 to 10 v pulse having a minimum width of 1 μ sec. Price is \$995. Monsanto Co., 620 Passaic Ave., West Caldwell, N.J. [406]

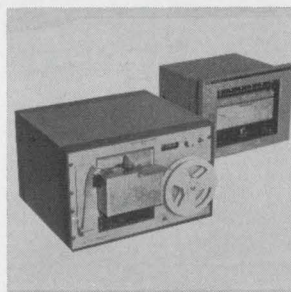

Logger model 141 connects directly to multipoint recorders, digitizes and records the data for computer entry. It makes a 4-digit record of each data point on punched paper tape in 8-level ASCII or IBM code. Logging is synchronized to the recorder, permitting automatic, unattended operation. Price is \$3,950. Control Equipment Corp., 32 Kearney Rd., Needham Heights, Mass. [407]

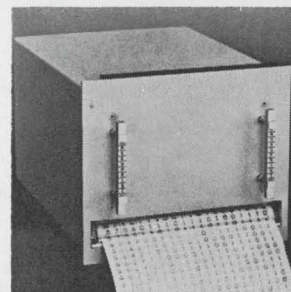

Digital events recorder model CH-183 is a panel mounted printer containing up to 17 columns of information against 24 hour time recorded by 10-minute intervals. Each column prints down time and operating time of any machine or process monitored. Down time is indicated by 0's, operate time by vertical lines. Practical Automation Inc., Shelton, Conn. 06484. [408]

Chart-Pak[®] short cuts get printed circuit masters off the board fast!

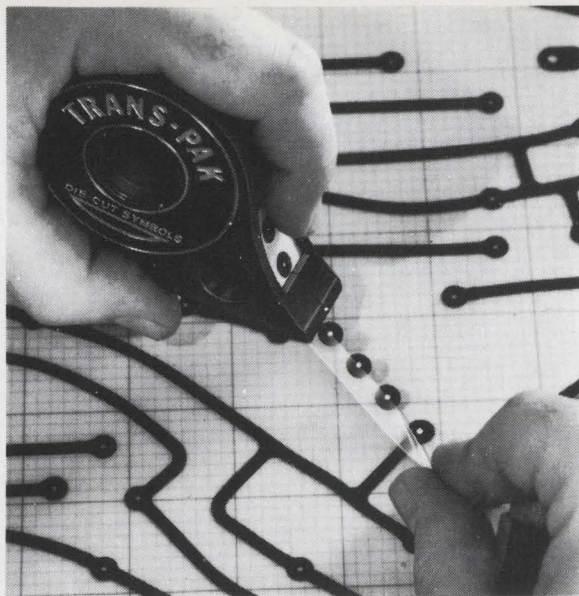

- Trans-Pak die-cut symbols and Chart-Pak pressure sensitive tapes cut time, cut cost.
 - Trans-Pak's unique patented "position, press and peel" method permits fast application of distortion-free symbols.
 - Chart-Pak crepe paper tapes precision-slit guaranteed to $\pm .002$ " accuracy.
 - Finished masters reproduce with maximum sharpness . . . require minimum opaquing.
 - Chart-Pak's Precision Grids guarantee master accuracy.
- Using is believing . . . write for free catalog showing complete line of printed circuit materials.

Look In The Yellow Pages under Charts/Business, Drafting Supplies, Tapes or Art Supplies for your dealer's name.



CHARTPAK ROTEX

A Division of Avery Products Corp.
Santa Ana, Calif. & Leeds, Mass.
Look in The Yellow Pages under Drafting Supplies,
Art Tapes, Charts/Business for your dealer's name.

Circle 189 on reader service card



Minimem. Core storage unit is suited for jobs in displays and terminals.

about 10% less than its competitors because of a novel organization.

A single module, consisting of two printed-circuit cards, will store data ranging from 128 words by four bits to 1,024 words by 12 bits; eight modules can be put together to give 8,192 words by 12 bits. One card holds the cores and the other carries the sense amplifiers, drivers, and timing circuitry. Most of the digital circuitry is transistor-transistor logic.

Simple flip-flops. The unit is essentially a three-dimensional, three-wire system in concept, but Ampex uses two extra wires. There are two independent lines in the X direction, two independent lines in the Y direction, and a common sense/inhibit line. The system doesn't reverse current after reading to write; instead, it uses separate X read and X write lines, and separate Y read and Y write lines. The fifth line, parallel to the two Y wires, acts as a sense line during reading and an inhibit line during writing.

Bravo says he knows of no other memories using this arrangement. Other units may have independent wires in both directions, he says, but they are six-wire systems because the sense/inhibit line can't be shared. It's the five-wire configuration that cuts costs. A memory that reverses the read current to write needs both read and write diodes and a tapped delay line for close timing accuracy. Because timing requirements can be relaxed in the nonreversing design, simple flip-flops can be used in place of the costlier delay line.

The module storing 128 words

This is neither an offer to sell, nor a solicitation of an offer to buy, any of the securities herein mentioned. The offering is made only by the Prospectus.

MARCH 12, 1969

260,000 SHARES

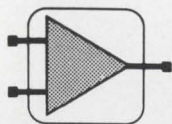

ANALOG DEVICES, INC.

COMMON STOCK

PRICE \$16 PER SHARE

Copies of the Prospectus may be obtained from the undersigned and other dealers only in States where they may legally offer these securities in compliance with the securities laws thereof.

HAYDEN, STONE
INCORPORATED

When run-of-the-mill won't do...

Transitron THYRISTORS solve your problems.

in opto- electronics

Our new RTPC Photo-SCR's for example – most advanced in the industry – operational over full MIL temperature range.

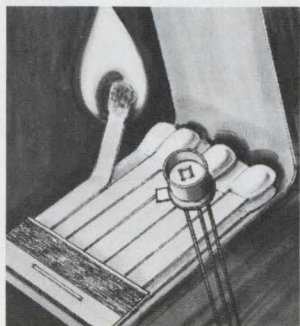

Design Engineers . . . looking for better circuit performance? Need a thyristor with special characteristics? Tell us your problem. Write details, or call collect (617) 245-4500 – ask for Thyristor Marketing.

in power conversion

Transitron fast turn-off TO-66, TO-64, TO-48 and press-fit thyristors are very big in inverter/converter applications

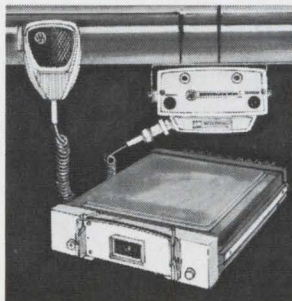

in hi-current pulse generation

Radar modulators and other pulse circuits perform better with our ultra-fast turn-on/turn-off thyristors

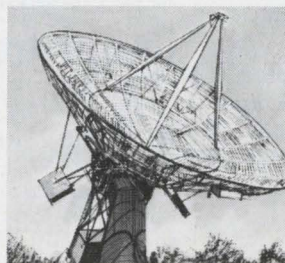

in AC power control

Our expanding TRIAC family runs the gamut, to 35A/600V in 6 package configurations including isolated case

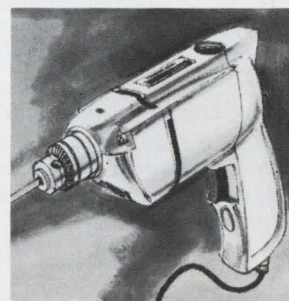

Send for **FREE**
Application Data
and **NEW**
Thyristor Selection
Guide

Transitron
electronic corporation
168 Albion Street Wakefield, Massachusetts 01880



Fast action on custom-design EMC Filters from Captor!

If your EMC problem is unique, Captor is the supplier with the fastest action on custom-design EMC filters and filter assemblies. Our application engineers will go to work immediately to evolve a prototype that fulfills your mechanical and electrical requirements and conforms to applicable MIL specifications. Captor has the manufacturing capability to produce in volume economically — cylindrical or rectangular electromagnetic interference filters for all commercial or military compliances. Also Captor offers many cataloged EMC filters ready for immediate delivery. Contact Captor today on your EMC problem!

Captor Corporation manufactures miniature filters . . . communications and security filters... custom-design filters, and other electronic components.

CAPTOR CORPORATION
APPLICATION ENGINEERING DEPT.
5040 Dixie Highway, Tipp City, Ohio 45371

by four bits is priced at \$330 and the 1,024-word module at \$950. The eight-module version will sell for approximately \$6,840. These prices include a power supply, which is optional, but Bravo says the memory can derive its power from the 12-volt supply available in most systems using buffer memories.

Low-cost drivers. "You typically need two drive voltages—one for read and one for write—plus an additional voltage for the sense/inhibit line," he says. "Most systems require 25 to 30 volts, but most of our competitors can't derive all three voltages from that supply." The memory organization and use of low-drive cores reduce the voltage requirements of the Ampex drive. The cores are 30 mils in diameter.

The 3DM-3000 can derive all three voltages it requires from the 12-volt supply. Its slightly lower speed—requiring 500 millivolts full-drive against 800 mv for some faster units of comparable size—means lower-cost drivers can be used.

Two kinds of card cages are available as options: a unit 7.25 inches high to accommodate up to eight modules mounted vertically and one 5.25 inches high for the same number of horizontally mounted modules. The 3DM-3000 operates from 0°C to +55°C and has a storage temperature of -40°C to +85°C.

Ampex Computer Products Division,
9937 W. Jefferson Blvd., Culver City,
Calif. 90230 [409]

Data handling

Computer directs in-out traffic

Machine takes on most of a processing system's communication problems

The first computer specifically designed to manage other computers—that's the way Lee Johnson, president of Comcet Inc., describes the company's Comcet 60 which proc-

DIRECT RECTILINEAR RECORDING



NORMALIZED SWEPT MEASUREMENTS

\$1,985

The Model 1815 Data Normalizer eliminates the need to repeatedly run reference lines, giving direct rectilinear display of measurements in dB vs. frequency, using standard chart paper calibrated in dB/inch. The basic Model 1815 mainframe performs these functions without the use of plug-ins when used with the Model 1810 Stabilized RF Ratio Meter, thus doing the job of a computer at a fraction of the cost.

Available plug-ins are the Model 1815-1 Log Converter to adapt the Model 1815 to any existing audio system and the Model 1815-2 Multi-Band Controller, which provides RF source control and programming for up to 4 bands in one continuous sweep and display. Additional plug-ins are being developed on a continuing basis.

For complete specifications and prices, contact your local Weinschel representative, or write:

Designers and
Manufacturers of Precision
Microwave Equipment
WEINSCHTEL ENGINEERING
Gaithersburg, Md. 20760
Tel: (301) 948-3434
TWX: 710-828-9705

evening classes won't fit your schedule?

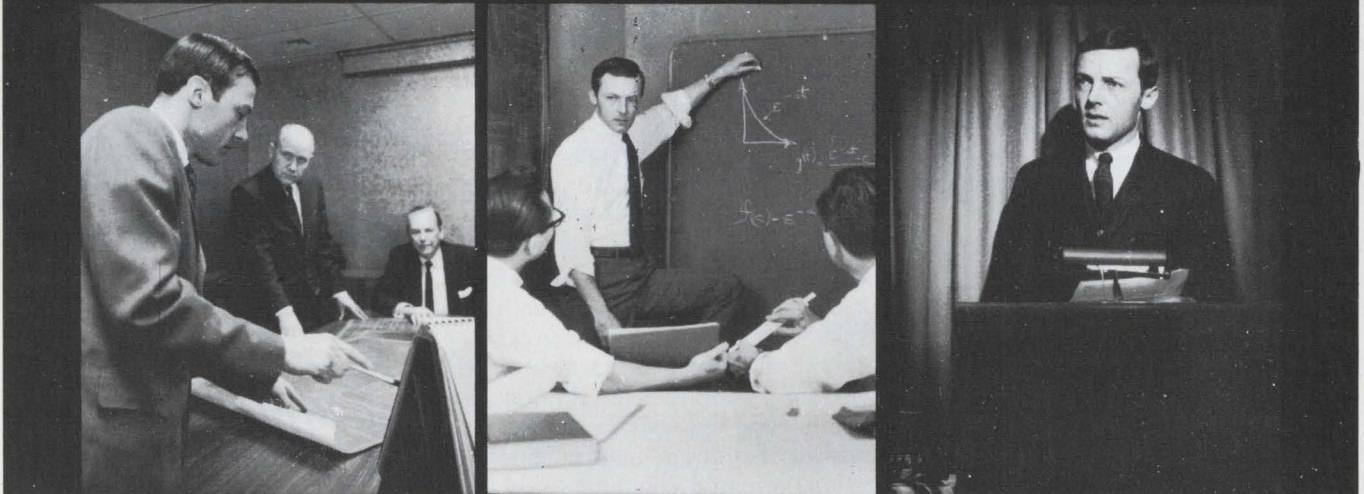

here's a practical way to keep up with new developments

Are irregular hours, travel and family obligations keeping you from attending classes—even though you worry about becoming technically obsolescent? Check into the Special Programs in Electronics for Engineers developed by CREI, the Home Study Division of the McGraw-Hill Book Company.

These are not simply courses, but comprehensive programs in advanced electronics offering major electives in such fields as :

Communications Engineering, Aeronautical and Navigational, Television Engineering, Automatic Control Engineering, Missile and Spacecraft Guidance, Radar and Sonar Engineering, Nuclear Instrumentation and Control, Computers.

Industry-recognized CREI Programs make it possible for you to catch up on new developments in electronics through study in your own home, at your own pace,

your own schedule. Free book gives complete information and details of technical material covered. For your copy, mail coupon below or write : CREI, Home Study Division, McGraw-Hill Book Company, Dept. 1858H, 3224 Sixteenth St., N.W., Washington, D.C. 20010.

Founded 1927



Accredited Member of the National Home Study Council



CREI, Home Study Division, McGraw-Hill Book Company
Dept 1858H, 3224 Sixteenth St., N.W.
Washington, D.C. 20010

Send me free brochure describing CREI Programs in Electronics for Engineers.

NAME _____ AGE _____

ADDRESS _____

CITY _____ STATE _____ ZIP CODE _____

COMPANY _____

TITLE _____



**Rochester, N.Y.
has more
skilled hands**



**the
kind of hands
that have
helped build
KODAK • XEROX
SYBRON • ITEK
GENERAL DYNAMICS
STROMBERG CARLSON
BAUSCH & LOMB**

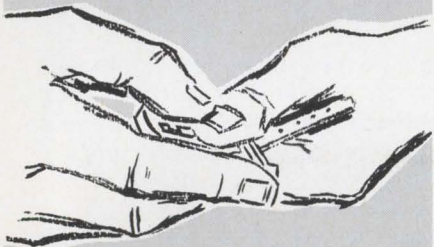

**chances are they
won't leave
Rochester... but
some of them might
be able to help you
if you moved here**

WRITE OR PHONE
ROBERT J. HALL
Director of Area Development

R AND **E**
**ROCHESTER GAS
AND ELECTRIC**

Dept. 28, 89 East Avenue
Rochester, N. Y. 14604



esses data transmitted over communication lines to and from a computer. The machine reduces the communication load on the computer from 50% or 75% of its capacity to something like 5%.

"We're the first to address the communications problem from the systems point of view," says Leo O'Keefe, a marketing executive of Comcet, which was formed by a group of former employees of Univac. "Many firms are selling hardware or software for communications applications, but none tie their products directly into the customer's computer. So the customer has to do a tremendous amount of engineering to connect the equipment and get it going."

The Comcet 60 [*Electronics*, March 17, p. 62] takes over the tasks that usually have to be done in the system's central processor by software. The new machine will do some of these communications tasks with its own software, and others with special hardware. It will, for example, maintain queues of interrupt requests in hardware; by way of contrast, most communications-oriented computers rely on software for this important job.

A key feature of the 60 is its system activity monitor. The SAM repeatedly samples the 128 communication lines and 16 points within the Comcet processor to determine their status, accumulates the activity totals in its own local memory, and dumps the total in the Comcet 60's main memory once every five seconds. Further processing of these totals can be carried out by the 60's software for various statistical results, as determined by the programmer. Any 32 of these activity levels can be manually selected and displayed as a percentage of maximum activity in the form of a bar chart on a cathode-ray tube screen.

Various experimental monitors have been built from time to time for measuring the activity of a communications-oriented or time-sharing computer, and a few small units are commercially available for certain limited applications, but the Comcet 60's SAM is the first commercially available monitor of such wide capability.

Comcet, Inc. 2 Research Court, Rte. 70-S and Shady Grove, Rockville, Md. [410]



Model 67 SCR / TRIAC Test System



**New
low-cost system
gives you full
parameter testing
automatically**

The new Test Equipment Corporation Model 67 is the first commercially available high speed automatic SCR/TRIAC test system. It offers full parameter testing with extreme accuracy, yet is priced economically for incoming inspection, production and quality assurance applications. You may specify a choice of up to eight parameter tests.

Wide test capabilities of the Model 67 include a 0-2000 v blocking voltage, 300 amp forward current and linear dv/dt to a maximum rate of 1000 v/ μ sec.

Easy-to-read visual display (inset) gives the operator all test data, or tests may be performed GO/NO-GO. Simple digital thumbwheel switches provide fast, accurate programming of test conditions.

The Model 67 may be customized to particular user requirements to include tape programming, punched out data, etc.

Write today for technical and pricing information.

Test Equipment

CORPORATION
P.O. BOX 20215, DALLAS, TEXAS 75220 • 214/357-6271

97 Projects. No Waiting.



The name of our company is MITRE.
We're in the business of designing, developing,
verifying large computer-based systems
for the Government. Under both civil
and defense contracts.

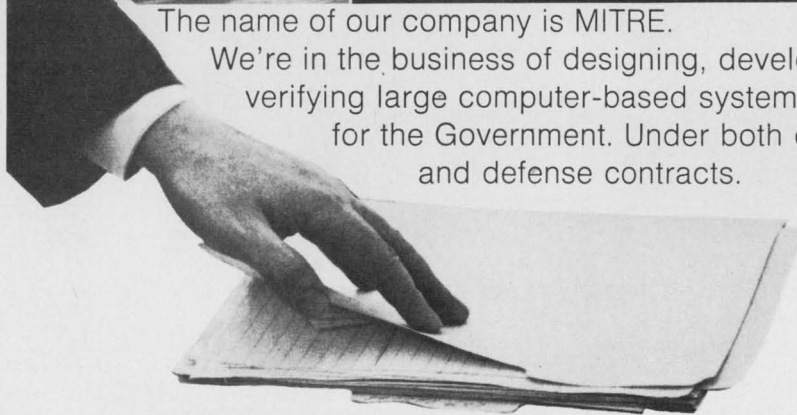

Right now we're in communications, military command
and control, air traffic control, transportation,
medical information, education, urban planning.

We have openings for systems engineers,
electronic engineers, systems analysts, mathematicians.

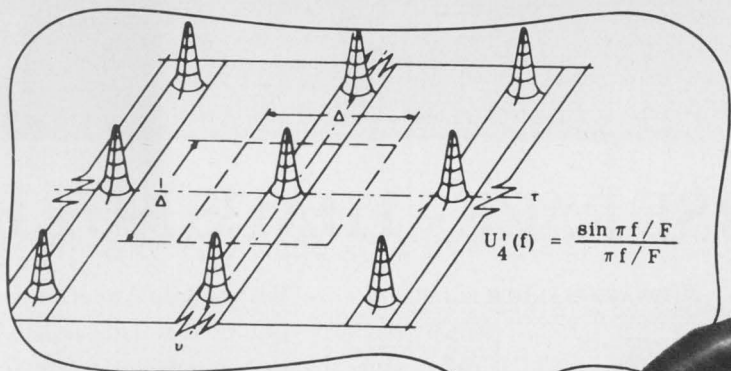

For more information write to

THE
MITRE
CORPORATION
An Equal Opportunity Employer

in Bedford.
Or Washington.

MITRE HAS
IMMEDIATE OPENINGS
IN BEDFORD, MASS.
WASHINGTON, D.C.

■ National Range Support
Systems Development

MITRE needs scientists and engineers in Washington to assist the Air Force Systems Command in its development of the future systems requirements and instrumentation plans for Test Resources Planning. Systems-oriented planning and research activities include studies of range functional subsystems categories: radar, telemetry, optics, communications, and data processing.

■ Transportation Systems

MITRE's Washington Operations provides technical planning and system support to the Office of High Speed Ground Transportation, the Urban Mass Transportation Administration and the Federal Aviation Administration. Technical assistance is provided for transportation technology as well as the analysis of economic benefits and demands for transportation.

■ Communications Engineers

MITRE's responsibility in Bedford includes technical direction on such current communications systems as 490L Overseas Autovon, TACSATCOM, and Integrated Communication Navigation and Identification (CNI). There are also openings for communications engineers on 407L, Tactical Air Control System, and related tactical communications projects. Interest and background are desired in systems analysis; design, installation and checkout of communications networks; modulation and signal processing techniques; switching systems; voice and data transmission and satellite communications and associated airborne and ground terminal hardware.

■ National Military
Command System

Scientists and engineers are needed in our Washington Operations for systems analysis and feasibility studies, communications system analysis, systems design, integration and design verification of the NMCS. This "capping system" contains all the facilities, equipment, doctrine, procedures, and communications needed by national command authorities to give them strategic direction of the armed forces. MITRE's main concern is with the technical design and integration aspects of the NMCS and the communications between NMCS and various other command systems, including the World-Wide Military Command and Control System — a group of systems operated by the unified and specified commands.

**We're only
Second
in ECL II...**



BUT IN THIS HORSE RACE – THAT’S NOT BAD !

Although we have a winning line of ECL's—Motorola's still a few circuits ahead. But we're announcing that we can match their 14 most popular MECL II units right now—with more to come!* So if you've been afraid to take advantage of the high-speed characteristics of these unique new ECL devices because you don't like sole-sourcing—relax. Go ECL II with confidence. Now you've got Stewart-Warner to back up Motorola...or vice versa.

STEWART-WARNER ECL II

CIRCUIT FUNCTION	MILITARY -55°C. to 125°C.	INDUSTRIAL 0°C. to 75°C.
Dual 4-input Complementary Gate	SW1204	SW1004
Dual 4-input Complementary Gate	SW1205	SW1005
Dual 4-input Complementary Gate	SW1206	SW1006
Quad 2-input NOR Gate	SW1210	SW1010
Quad 2-input NOR Gate	SW1211	SW1011
Quad 2-input NOR Gate	SW1212	SW1012
85-MHz AC-Coupled J-K Flip-Flop	SW1213	SW1013
Dual R-S Flip-Flop (Positive Clock)	SW1214	SW1014
Dual R-S Flip-Flop (Negative Clock)	SW1215	SW1015
Dual R-S Flip-Flop (Single Rail, Positive Clock)	SW1216	SW1016
Translator—ECL to Saturated Logic	SW1218	SW1018
Dual 2-input Expandable Gate	SW1224	SW1024
Dual 4-5 input Expander	SW1225	SW1025
Dual R-S Flip-Flop (Single Rail, Negative Clock)	SW1233	SW1033

For more information, send for our new ECL II data sheets. And, for off-the-shelf product delivery, call your local Stewart-Warner Microcircuits Distributor.

** We also offer 11 ECL's in the 300 and 350 series.*

STEWART-WARNER SYMBOL OF **SW** EXCELLENCE
COMPANIES

STEWART-WARNER MICROCIRCUITS, INC.
730 EAST EVELYN AVENUE, SUNNYVALE, CALIFORNIA 94086
PHONE 408/245-9200 TWX 910-339-9210

Ring-type barrier cuts power transistor leakage

Annular-structure devices, first in new line, dissipate 25 watts; deep-diffusion technology is principal key to development

Mesa transistors usually have narrow-base regions, making them useful primarily for switching functions but not as true power devices. The narrow base doesn't provide enough area to handle high power. But if the base can be made wide, and the active regions can be isolated effectively to reduce both channeling and surface-induced leakage, true power performance

with low leakage results.

Engineers at Motorola's Semiconductor Products division believe they've whipped the leakage and base geometry limitations of mesa devices by using an annular, or ring-shaped, structure they pioneered for small-signal silicon transistors. The fruits of their efforts are the first annular power transistors in the industry—the 2N3740A

and the 2N3741A—versions of two popular homogeneous-base pnp silicon devices, the 2N3740 and 2N3741. The annular versions are directly interchangeable with their mesa counterparts. Furthermore, they offer a 1,000-to-one improvement in leakage over the mesa devices, says Leo Lehner, operations manager for silicon power devices. Diffusing the ring, which isolates

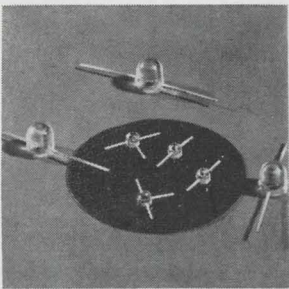

Molded-plastic phototransistors are designated MRD450 (in a two-leaded Mini-T package with an integral lens for highest sensitivity and definition), MRD100 and MRD150 (in subminiature Micro-T packages for high-density mounting use). Price of the MRD450 is \$1.50 in lots of 100; the MRD-100, \$1; and the MRD150, 80 cents. Motorola Semiconductor Products Inc., Phoenix. [436]

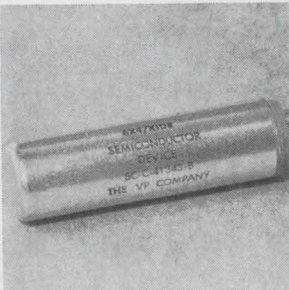

Full-wave rectifier module 6 X 4/ X 1DR is a solid state replacement for electron tubes. It can be plugged into standard miniature tube sockets or adapted to p-c boards. The encapsulated device employs a matched pair of MIL type silicon diodes in a metallic envelope that protects against extreme temperatures and vibration. The VP Co., 330 S. Fair Oaks Ave., Pasadena, Calif. [440]

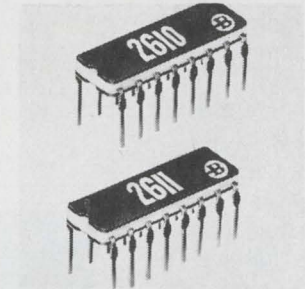

Monolithic integrated circuit decade counter type BIP-2610 is a dual in-line package designed to drive Nixie tubes directly. It is expected to find wide application in the industrial instrument and electronic controls market. With the 300 khz unit, one package now does what two packages did previously. Burroughs Corp., P.O. Box 1226, Plainfield, N.J. 07061. [437]

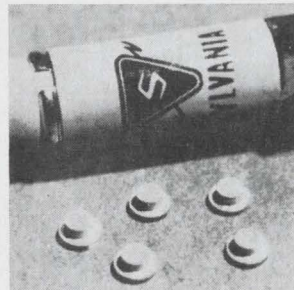

Planar germanium back diodes designed for use as video detectors come in a MicroPill (048) package for stripline applications. They consist of the D5610 (S-band), D5611 (C-band), and the D5621 (X-band). Values of tangential signal sensitivity range from -56 dbm at L-band to -50 dbm at X-band. Price (1-9) is \$25 each. Sylvania Electric Products Inc., Woburn, Mass. [441]

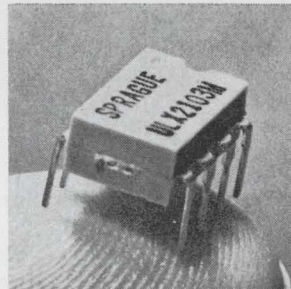

Integrated-circuit broadband amplifier ULNX-2103M having a 60 Mhz bandwidth with a 30 db typical voltage gain over the temperature range of 0° to +85°C comes in an 8-lead plastic dual in-line package. The IC provides a current gain of 10. The amplifier is suited for current amplification since input impedance is about 10 ohms. Sprague Electric Co., North Adams, Mass. [438]



MegaPack scr is being used in a-c and d-c motor speed controls, solid state contactors and electro-mechanical power supplies. When mounted in a 3-phase full wave bridge, it can control up to 1 Mw at 900 v d-c, without the cost or complexity of paralleling. It is available in ratings of 650, 850 and 950 amps rms. Power Semiconductors Inc., 90 Munson St., Devon, Conn. 06460. [442]

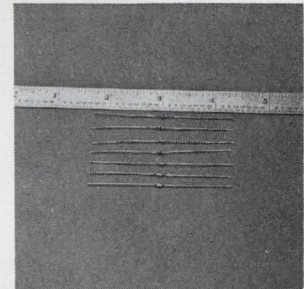

Monolithic arc suppressor diodes for relay application are nonpolarized, performing the function of two back-to-back zeners. Standard electrical characteristics are available for 28 and 110 v relay suppression. Mechanical size is 0.065 x 0.100 in. with 0.020 in. leads. The 100 piece prices start at \$1.68 each. MicroSemiconductor Corp., 11250 Playa Court, Culver City, Calif. [439]

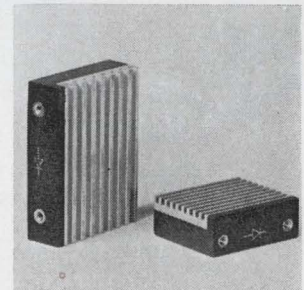

High voltage, medium power rectifier modules J531 and J532 dissipate 10 w and 20 w respectively in free air. Size of the 10-w module is 1 5/8 x 2 x 3/4 in.; the 20-w module, 2 1/8 x 3 x 3/4 in. Major uses are in general industry, particularly in heavy equipment and transmitting equipment, and in many r-f generating systems. Solitron Devices Inc., 256 Oak Tree Road, Tappan, N.Y. [443]

New... from Todd ...precision laboratory power supply.

- constant voltage
- constant current
- .01% regulation



QAD Series — 1/4 Rack — Dual Range

QAD15-2.5	0 to 15 Vdc at 0 to 1.25A or 0 to 7 Vdc at 0 to 2.5A
QAD50-1	0 to 50 Vdc at 0 to .5A or 0 to 20 Vdc at 0 to 1A



FEATURING

All silicon construction with IC Amplifiers
Fast programming — 10 V/ms
Remote sensing/programming
5 year warranty — parts and labor

Contact your local Todd
representative or:



TODD PRODUCTS CORP.

28 Laurel Street, Hicksville, N.Y. 11801
(516) 822-0784

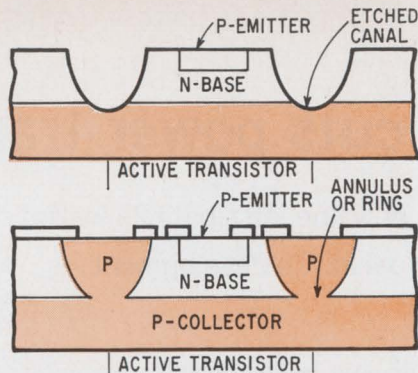

Encircled. Ring-shaped barrier, bottom, is compared to mesa transistor.

the transistor's active region, presents no great problem in small-signal devices because the technique is essentially a surface treatment on these double-diffused devices, and only penetrates the active region to a depth of about 0.2 mil. But here's the rub: the ring must be diffused to a depth of three to four mils around the transistor—deep enough to contact the collector side of the collector-base junction in a homogeneous-base device. "That's simple enough to say but difficult to do," Lehner explains.

The two new devices lead off a series of annular products made possible by deep-diffusion technology. Motorola officials believe the 2N3740A and 2N3741A will simplify the design of such circuits as direct-current-coupled amplifiers using pnp devices, and find use as drivers, switches, and replacements for germanium power transistors.

The leakage story is best told by contrasting the leakage current I_{CBO} at 80 volts of a mesa device (100 microamperes) with that of the annular versions (0.1 microamp)—1,000 times less for the annular transistor. The annular units also feature low saturation voltage (0.6 volt at one amp collector current), a good second-breakdown safe area, 25-watt dissipation, gains of 30 to 100 at 250 milliamp collector current. Voltage ratings are 60 volts for the 2N3740A and 80 volts for the 2N3741A.

"If you don't have annular construction," Lehner says, "you can't make multiple-power designs; but because we have it, the technique will lead to monolithic power Darlington pairs.

Motorola Semiconductor Products Inc.,
Box 955, Phoenix, Ariz. 85001 [444]

P/C Reed Relays

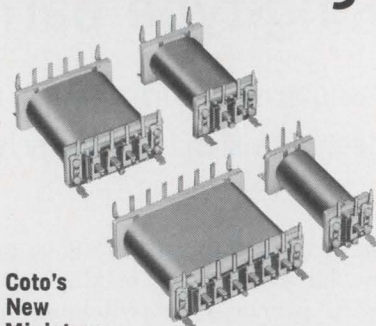

Coto's New Miniature Series 1000

- Especially designed for P/C board applications
- Pin spacing 1" x .150" centers
- Stock voltages 6, 12, 24, 32 and 48 volts
- Form C contacts, 4 poles, ratings 3 watts
- Form A mercury-wetted, 6 poles, ratings 28 watts
- Electrostatic and/or magnetic shields

Special voltages and resistances available, with multiple windings for flip-flop, memory and crosspoint selection applications.



COTO-COIL COMPANY, INC.
54 Pavilion Avenue, Providence, R. I. 02905
Tel: (401) 941-3355

Circle 192 on reader service card

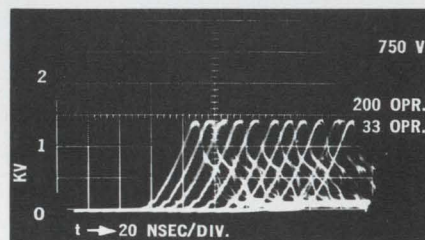

PRECISION SPARK GAPS*

Oscillogram of one of Joslyn's spark gap models—the 2001-28 made specifically for RCA—shows exact repeatability. All Joslyn spark gaps feature:

- Ultra-fast response (nanoseconds)
- Long life
- Wide dynamic range
- Stable operation
- Insensitive to light
- No isotope prompting
- Close tolerances
- Hermetically sealed
- Negligible voltage creep
- Lightning — EMP capability available

Ideal for protection of magnetron modulators, microwave stations, dc power systems, output of dc power supplies, all types of signal and data transmission lines, p.c. protectors, control circuits. Available from stock or custom designed.

Write today for new brochure JES-142. Joslyn Electronic Systems, Santa Barbara Research Park, P.O. Box 817, Goleta, California. Tel. (805) 968-3551.



JOSLYN
ELECTRONIC SYSTEMS

* Patented and Patent Pending

350

Pick a Taylorclad® copper-clad laminate ...and relax.

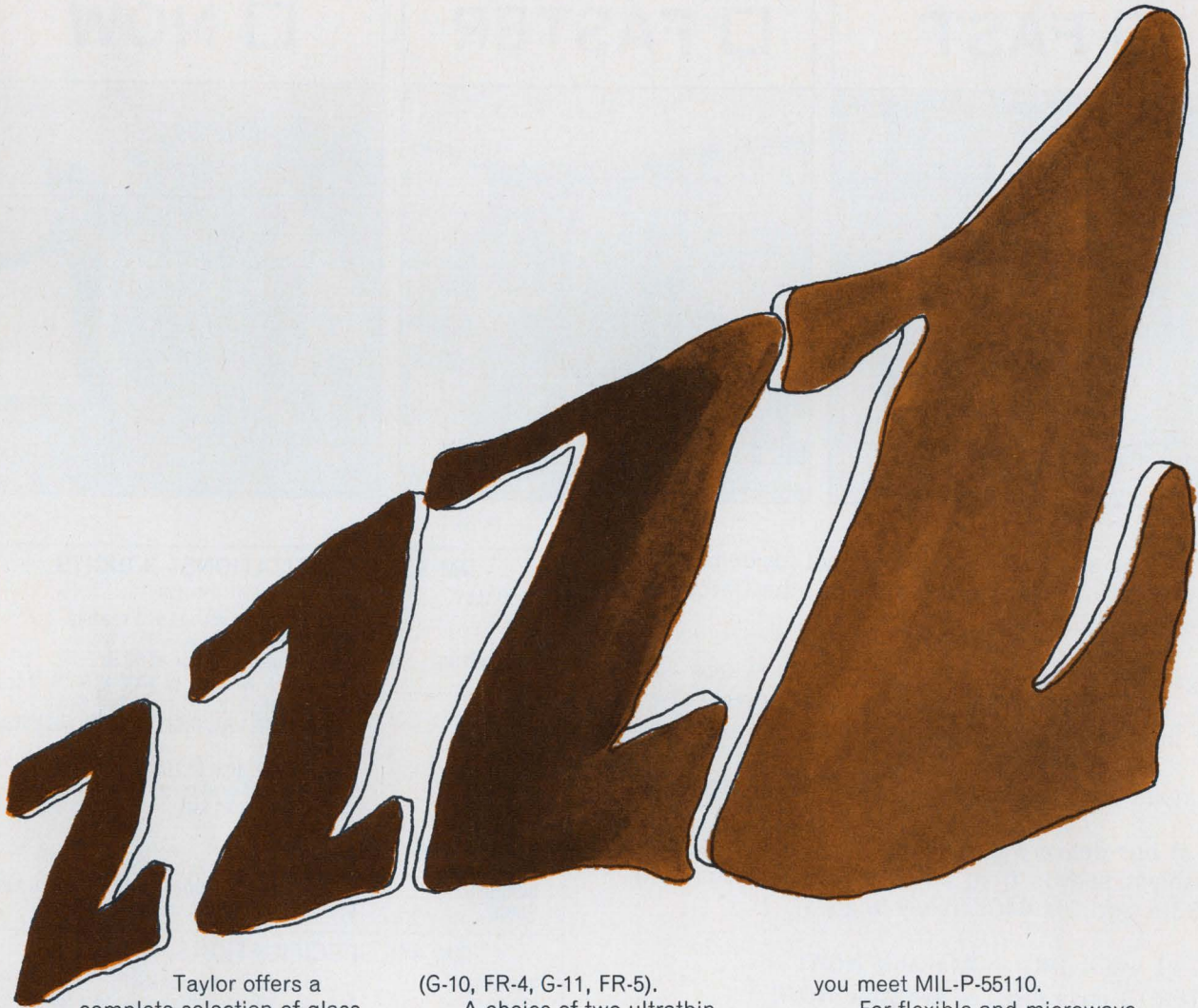

Taylor offers a complete selection of glass epoxy grades (rigid board and ultrathin) to meet Military, NEMA, and IPC specs.

Four glass epoxy rigid board grades to choose from—GEC 500 E (G-10), GEC 111 E (G-11); flame retardant grades: Fireban 600 E (G-10, FR-4), Fireban 1011 E

(G-10, FR-4, G-11, FR-5).

A choice of two ultrathin grades—GEC 550 (G-10) and Fireban 650 (FR-4).

Forms include sheets or whatever size panels you require. Prepregs are also available.

What else does Taylor offer you? Uniformly reliable products that mean processability to help

you meet MIL-P-55110.

For flexible and microwave applications, Taylor also offers a wide selection of flexible materials, including Kapton*, and Teflon*-glass copper-clads.

Ask about the choice of 7 different colors and other details on these quality Taylorclad products.

*TM Du Pont

Taylor corporation

A subsidiary of Alco Standard Corporation

Valley Forge, Pa. 19481 • 215-666-0300

La Verne, Calif. 91750 • 714-593-1341

In Canada: Small Fibre Stampings, Ltd.

Scarborough, Ont. 416-751-6655

Manufacturer of Taylorlon® Laminated Plastics,

Taylorite® Vulcanized Fibre, Taylorlon® Prepregs,

Taylor Fabricated Parts

DARCY DVM DELIVERY COMES IN 3 CONVENIENT SPEEDS

FAST



FASTER



NOW



Not too long ago you had to be patient for delivery of the two hottest DVMs in the industry, the Darcy DM 440 and DM 330.

Things have changed — You won't have to wait any more. Darcy DVM production has been **DRAMATICALLY** increased.

Just mark your order — **FAST, FASTER, or NOW!**

One of our delivery girls demonstrates above the 3 convenient speeds from our stockroom of standard DM 330s and DM 440s, **ready to go.**

FAST (1 week ARO) — **Available NOW!**
FASTER (3 days ARO) — **Available NOW!**
NOW (same day) — **Available NOW!**

Capsule specs at right tell you why customers were willing to be patient.

Give us a call. We'll turn our switch to the speed most convenient to you. Or, write to us for the whole story.

DARCY — DVMs JUST FOR GOOD MEASURE

DM 330 SPECIFICATIONS—3 DIGITS

ACCURACY1% of reading + 1 digit.
SPEED	10 readings per second or 1 reading per second-selectable.
INTEGRATING	Infinite Noise rejection at 60 Hz.
RANGE	DC Volts- 1 mv/digit to 1000 V DC Full Scale. K Ω - 1 Ω /digit to 10 meg. Full Scale. DC CURRENT- 1 NA/DIGIT TO 10MA. FULL SCALE. AC volts- 1 mv/digit to 1000 V Full Scale. 1% of reading \pm 1 digit. 50 Hz - 10 KHz.
CURRENT RESOLUTION	1 na/digit
OVERRANGE	Reads to 150% of Full Scale.
GUARDED	100 DB COMMON MODE REJECTION, DC TO 1 KHz.
PRICE	\$389 with AC, \$349 without AC.

DM 440 SPECIFICATIONS—4 DIGITS

ACCURACY	\pm 0.01% of reading \pm 1 digit.
STABILITY	Accuracy will remain as specified for not less than 90 days from calibration over temperature range of 15°C to 35°C.
COMMON MODE REJECTION	Infinite at DC, 140 dB at all frequencies up to 1 KHz with up to 1 K Ω source imbalance in either input lead. Common Mode Voltage up to 1000 VAC.
RANGE	To 1000 volts DC.
SYSTEM ORIENTED OPTIONS	DCmV (1 μ V resolution), K Ω (Kelvin), AC, DC, Ratio, and over 15 other options.
PRICE	\$995, basic DC unit.

DARCY INDUSTRIES

1723 CLOVERFIELD BLVD. • SANTA MONICA, CALIF. 90404 • Phone (213) EX 3-9611 • TWX (910) 343-6963

Flexible tester for digital IC's

With modular construction and multiple test stations, the system can be easily expanded to handle unusual or very complex devices

Special-purpose testers have to leave town when a new kind of semiconductor product blows in. They can't be adapted to handle it. Volume users and manufacturers of these products have tried using small general-purpose computers to control customized test equipment, but this approach becomes impractical when there's a great variety of items to be tested.

Well, the Industrial Products division of Texas Instruments, which has been building test systems for semiconductors for about 10 years, says it has solved the problem with its model 561 Digital Logic Tester. The secret to its solution is modular construction. The user, says TI, can start with a basic system that meets most test requirements, but then can easily expand it to handle

unusual or especially complex devices and circuits.

The basic system consists of a data control unit, a functional-test unit, a test station with a test terminal, an operator terminal, and a station console. The control unit links all portions of the 561 to such peripherals as readouts and printers. Control and test programs are entered by a paper-tape reader,

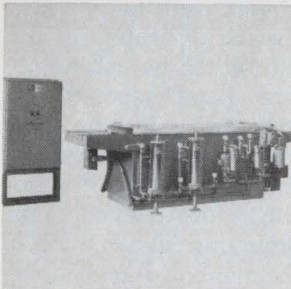

Conveyorized circuit board stripper model CBS automatically removes silk screen and photo sensitive resists after etching. Special powered nylon brushes convey p-c boards through the machine at any speed from 2 to 14 ft a minute. At the same time, both sides of the boards are flooded with solvents. Baron-Blakeslee Inc., 1620 S. Laramie Ave., Chicago 60650. [421]

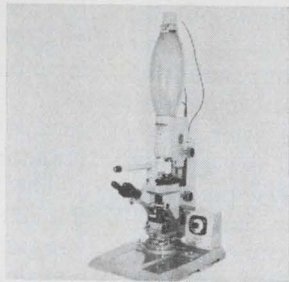
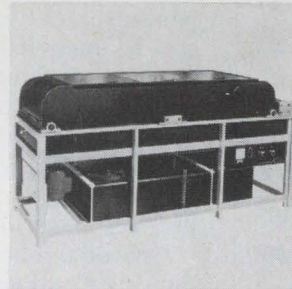
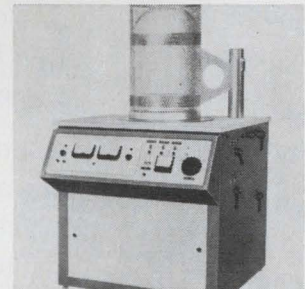

Photo-optical integrated circuit printer called Unimask 101 completely eliminates mask destruction problems associated with contact printing. It is comprised of 3 basic sections: a powerful (200,000X) radiation source, the optical image printing unit, and the multiple-eye alignment scope. Cost of basic system is \$20,000. Radarc Inc., 526 N. Garfield, Monterey Park, Calif. [422]



Spray etching machine model 440 is for etching and rinsing circuit boards. The 7-ft system features a 24-in. wide variable speed conveyor, which can accommodate large high-density boards or panels. Included are adjustable, two-sided spray manifolds, high pressure pumps and nozzles for increased operating speed. General Products Laboratory, 111 Lock St., Nashua, N.H. [423]



High-vacuum evaporator designated Econovap E-414 is a 1 x 10⁻⁷ Torr thin-film unit for relatively low-volume production requirements. Standard unit features a heavy-duty Pyrex bell jar, 14 in. in diameter by 24 in. high. It is supplied complete with an integral control panel. Weight is about 850 lbs crated. T-M Vacuum Products, 100 Rowland St., Riverton, N.J. 08077. [424]

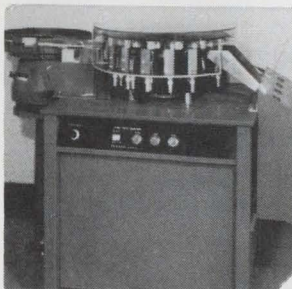

Sorter type 1612, operating with suitable test equipment, automatically tests and sorts 3,600 leadless capacitors per hour. Capacitors placed in vibratory bowl are fed, probed, tested and classified into 8 bins. Special charge and probe stations have insulation resistance greater than 10¹² at 500 v d-c. Daymarc Corp., 40 Bear Hill Road, Waltham, Mass. 02154. [425]

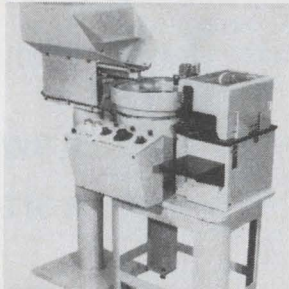

High-speed component printer model U-1185 utilizes rotary, offset printing techniques with variable speeds up to 16,000 per hour. It can print components such as plastic or metal transistors and integrated circuits in or out of the carrier. It is designed for in-line mounting to print vertically down, vertically up or horizontally. Markem Corp., 150 Congress St., Keene, N.H. [426]

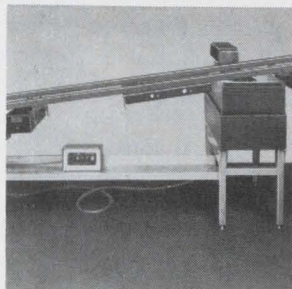

Bench-mounted automatic soldering system series TDB handles p-c boards up to 14 in. wide in the solder wave that is 3/4 in. deep. Features include close control on the oil/solder intermix meter; large solder base capacity (450 lbs); 13 speed settings on the inclined conveyor from 12 in. per minute to 75 in. per minute. Hollis Engineering Inc., Nashua, N.H. 03060. [427]



Electrical connections to IC's can be tested for reliability with the Microbond Tester, which determines the gram-range rupture force required to break these bonded interconnects. The unit is furnished with an angular dynamometer and substrate positioning stage. Six gauges are available from 0.5-5 to 15-150 grams. Engineered Technical Products, Box 1465, Plainfield, N.J. [428]

Total Capability

IN CARBON VARIABLE CONTROLS

Singles, concentric duals, tandem duals . . . with or without switches . . . All available at Mallory. Practically everything you require in standard or special construction.

Long wear, noise free elements used in all carbon controls for satisfactory trouble free operation.

Switches attached to controls available in 1, 3, 5 and 6 ampere ratings . . . Special switches for high in-rush current applications such as color TV and tungsten lamp loads made to your specifications.

Mallory Controls Company, a division of P. R. Mallory & Co. Inc., Box 327, Frankfort, Indiana 46041.

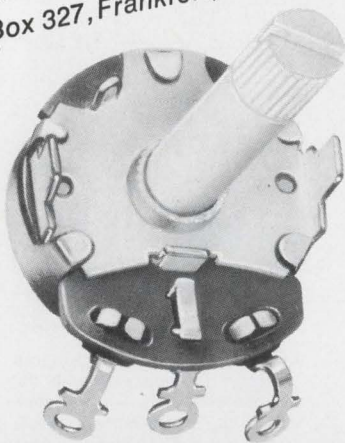

MALLORY

and a teletypewriter provides error messages and data variables. The control unit can be expanded by the addition of a magnetic disk memory for bulk program storage and a magnetic tape unit for loading programs and transferring test results from the 561 to other data processing equipment.

Four channels. According to R.K. Kressler, product manager at the Industrial Products division, a unique feature of the system's functional input-output interface is the availability of four differential-mode channels, a feature that allows a single control unit to supervise up to four test stations.

Functional tests are provided by an input-output signal assembler along with voltage-level converters and output comparators. There are also circuits for power monitoring, and power supplies for the test stations. Each station supply can furnish power for a maximum of 90 leads, and two of these supplies can be included in one test unit. Air flow, air temperature, and floating ground voltages are monitored by the test unit's master power controller. If any of these variables goes outside a specified range, the tester is automatically shut down.

One of the key factors affecting the speed and versatility of the 561 is the test terminal—one of the three parts of the test station. Circuitry at the terminal controls test conditions and the outputs from the device under test. Four printed-circuit cards in the terminal hold the necessary interface logic for programming and operation. This setup can take plug-in additions of up to 60 p-c cards, each containing the circuitry for three leads.

For straightforward testing of device functions, programming information stored in the controller is transferred as a 16-bit word into the signal assembler. Here the information is assembled into patterns of up to 180 bits, enabling the simultaneous testing of up to the maximum 180 leads. As one pattern is applied to the device, the next is being assembled.

Double-duty. Parametric d-c tests are patterned through function generators, a multiplexed analog-to-digital converter (in a separate cabinet), and a lead-switching matrix in the test station. According to Kressler, the 561 integrates func-

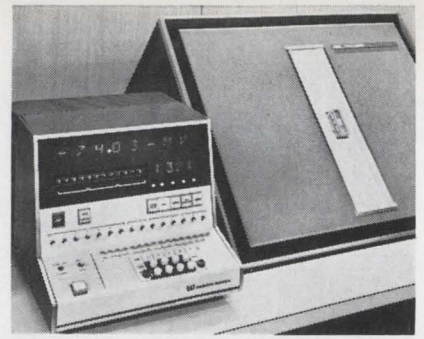

Rotatable. Test terminal, right, is at angle suitable for sit-down operation.

tional and d-c parametric test capabilities to provide worst-case conditions prior to the parametric tests. A parallel feature is that the system can perform parametric measurements—either d-c or dynamic—with a functional setup.

The test-station console contains a monitoring remote power controller and provides a mounting for the test terminal. And the operator has switches and indicators at his terminal with which he can select magnetic tape, paper tape, or the teletypewriter for recording test data, or can reject the data entirely.

The system uses a symbolic language similar in format to common computer programs. The controller translates the symbols into system-language test tapes.

Delivery time for the system is five or six months and prices start at \$100,000, depending on the number of leads and the type of testing specified.

Industrial Products Division, Texas Instruments, 12201 Southwest Freeway, Stafford, Texas [429]

Production equipment

Low-price tester sorts transistors

Instrument identifies
leads, measures beta
and breakdown voltage

If you buy transistors by the barrel and need to have them sorted by semi-skilled inspectors, a fast, versatile, and inexpensive tester made by Miracle-Hill Electronics may

help with the problem.

The Model 800, which will sell for \$495, identifies base, emitter, and collector leads; indicates whether the transistor under test is made of silicon or germanium, and whether it is an npn or pnp unit. The tester also gives a meter reading of beta. "Push two more buttons and you get breakdown voltage and leakage current," says the designer, Robert Youden.

No matter how the transistor is plugged in, the leads are scanned by circuitry until the instrument finds a combination of leads which will cause the device to function.

Voltage drop between the base and emitter terminals provides the basis for differentiating between silicon and germanium—about 0.7 volt for silicon, 0.3 volt for germanium; discrimination between npn and pnp depends on a determination of polarity derived from the current flow.

Autoranger. The leakage current is measured by again using the base-emitter drop to provide automatic change of range, or autoranging. For this reading, silicon requires a different scale than germanium.

The key components of the instrument are 16 inexpensive integrated circuits. Youden used the Signetics Utilogic II series.

Youden says the Model 800 may be used in hardware and electronics stores where amateur electronics technicians can test their transistors. More immediately, he expects that the instrument will be used for incoming inspection and quality control.

Delivery time is 30 days.

Miracle-Hill Electronics, 320-B Martin Ave., Santa Clara, Calif. 95050 [430]



If you need a relay to meet these specifications:

MS 27245 MS 27247 MIL-R5757/23

Specify this:

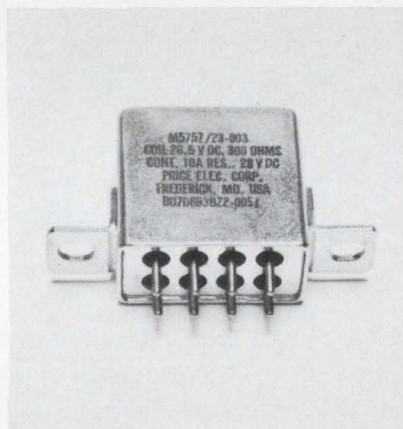

Conelco Style 7 Relay DPDT 10 amp military

You can't get a better 10 amp relay for your money than the Conelco Style 7. It was developed specifically for the aerospace industry.

So it's durable and dependable. For 3-phase AC requirements, an arc chamber is used to assure trouble free operation to 100,000 times, minimum. And all welded construction makes it absolutely reliable for the most stringent avionic applications. Independent tests have proven that the Style 7 Relay stands up against the effects of altitude, vibration and temperature extremes.

We've got a Style 7 Relay designed specifically for your needs. Send for our exclusive Select and Specify Chart.

FEATURES:

All welded construction for positive contamination control.
20% smaller than similar relays.
Arc chamber: -10 amp AC rating 115 volts single and three phase with case grounded.

CHARACTERISTICS:

DPDT 10AMP 28VDC/115VAC res.
Coil: 565 MW typical: 26.5VDC 300 ohms
Ambient temp: -65 to +125 C
Vibr: 20G up to 2000 Hz
Shock: 50G 11msec
Mil-Spec: MS 27245 MS 27247 MIL-R 5757/23

PRICE ELECTRIC CORPORATION
CONELCO
SWITCHING DEVICES
HI-SPEC ELECTRONICS CORP.

Price Electric Corporation, Frederick, Maryland 21701, 301/663-5141,
TWX: 710/862-0901, subsidiary of Consolidated Electronics Industries Corp.

Total Capability

IN SWITCHES

Rotary, lever and push button. Mallory has them all . . . and more. Dozens of different switches for hundreds of applications.

For prototype or production, Mallory can readily supply standard switches or custom-made units tailored to your specifications.

Terminal contacts are high quality, special alloy brass . . . silver plated. Low contact resistance is maintained by built-in self cleaning action between rotor and stator contacts.

Many switch sections are available in both phenolic and ceramic insulation.

Mallory Controls Company, a division of P. R. Mallory & Co. Inc., Box 327, Frankfort, Indiana 46041.

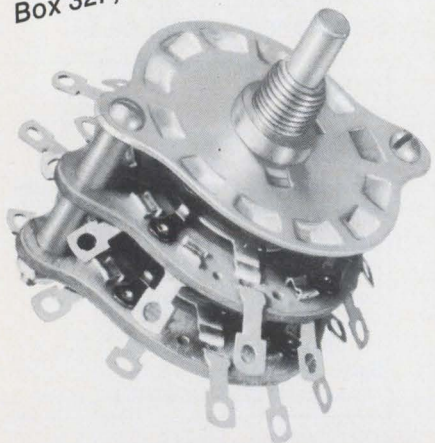

MALLORY

New Books

Line drive

Transmission Lines for Digital and Communication Networks
Richard E. Matick
McGraw-Hill Book Co., 360 pp., \$14.50

With a fairly academic, rigorous approach, the author, a member of the technical staff of the director of research at IBM in Yorktown Heights, N.Y., presents a good exposition of transmission-line theory as applied to pulse systems.

The book would be useful for a first course in transmission lines, for an engineer entering the pulse communications field, or even for an engineer who had the classical transmission-line course but now needs a brushup on pulse transmission. Throughout the book, the author attempts to supplement the mathematics with physical reasoning.

Of particular interest to digital designers will be the 57-page chapter discussing pulses on transmission lines. The chapter starts from the basic step-function response,

is supplemented with a four-page table listing the output waveforms for various output terminations, and moves on to reflection from discontinuities in the line. The author then covers nonideal inputs with finite rise times and other adjustments to the ideal case. The payoff is in the section on pulse distortion on transmission lines, in which Matick explains how skin effect becomes the major contributor to distortion. The dielectric leakage conductance is usually small, and the dielectric constant is usually constant over the frequency spectrum of the pulse. The author then develops a set of normalized curves showing the responses to pulses with various rise times.

Other chapters discuss superconducting transmission lines, both in terms of power transmission and strip lines; coupled transmission lines, and practical transmission-line parameters. This last chapter covers coaxial, strip, and helical lines.

Recently published

Electronics Reference Databook, Norman H. Crowhurst, Tab Books, 232 pp., \$7.95 hardbound, \$4.95 paperbound

In 10 chapters this book explains how to make most of the common engineering calculations. Separate chapters deal with such topics as the j operator, filter design, semi-conductors and tubes, and feedback. Included also are 45 tables.

Principles of High-Resolution Radar, August W. Rihaczek, McGraw-Hill Book Co., 498 pp., \$19.50

After explaining how radar measurements are made on single targets, the book goes through the theory of resolution. Among the topics covered are target resolution and its relation to measurement ambiguities, the fundamental limits on resolution performance, and waveform design.

Introduction to Optimal Control, Ian McCausland, John Wiley & Sons Inc., 258 pp., \$12.00

Intended as a primer on optimal control theory, this text reviews basic optimizing techniques, then discusses Weiner filtering and the Kalman filter theory. Later chapters introduce the calculus of variations, the maximum principle, and dynamic programming. Parseval's theorem and some relationships involving autocorrelation functions and spectral densities are included in the appendixes.

Principles of Quantum Electronics, William S.C. Chang, Addison-Wesley Publishing Co., 540 pp., \$17.50

Strictly for graduate courses, the book first reviews quantum mechanics, then discusses the principles of quantum electrons, particularly as they relate to lasers.

Holography—State of the Art Review . . . 1969, Thomas Kallard, Optosonic Press, 182 pp., \$12.00

This volume does the work of a very good librarian. Included in the text are a listing of books, articles, and Government R&D reports. Important patents are reprinted along with a list of manufacturers.

An Introduction to Statistical Communication Theory, John B. Thomas, John Wiley & Sons Inc., 670 pp., \$15.95

This book, for graduate students, begins with a review of probability theory and then discusses random processes and spectral analysis. Following sections deal with such topics as linear and nonlinear systems with random inputs, modulation theory, and information theory. Nine appendixes explain mathematical concepts, such as the Dirac delta function and the calculus of variations.

X-ray Diffraction, B. E. Warren, Addison-Wesley Publishing Company Inc., 381 pp., \$15.00

After a rigorous development of diffraction theory, the book discusses the application of this theory to problems in solid state physics and physical metallurgy. Some of the topics covered are temperature vibration effects, order-disorder, crystal imperfections, the structure of amorphous materials, and the diffraction of X-rays in perfect crystals.

Electrical Principles of Electronics, Angelo C. Gillie, McGraw-Hill Publishing Co., 732 pp., \$11.50

This is the second edition of a 1961 book written for technician-school students. It's divided into three sections: d-c circuits, sinusoidal circuits and nonsinusoidal circuits. Among the topics covered are motors and generators, test instruments, and filters.

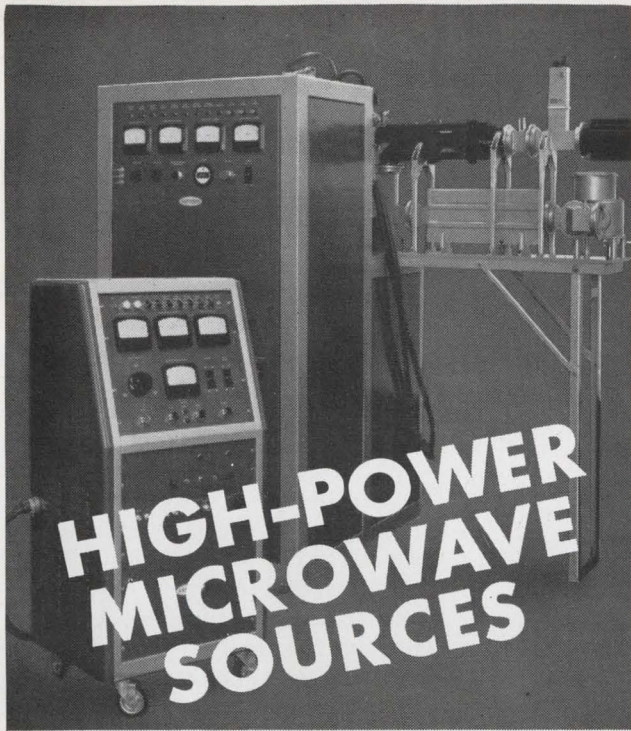

Now you can purchase highly reliable, completely mated RF sources—Raytheon-designed and -built—for precision-testing of high-power microwave components. You can also generate power efficiently for laboratory applications in UHF through Ku-Band.

These pre-engineered sources incorporate Raytheon transformers, magnetrons, and ferrite devices. They are unusually precise and versatile. For example: The Ku-Band source features high spectral purity, variable pulse (0.225, 0.7, 1.4, 2.2 μ sec), and band widths (3.4, 1.8, 0.9, 0.7 MHz) while operating on a 0.001 duty cycle at 135 Kw peak power.

Raytheon Closed Flow Calorimetric Systems for use with RF sources include closed flow heat exchanger, calorimetric waterload, and thermopile-meter combination. Standard units cover UHF through Ku-Band.

For a complete line brochure, write or call: Raytheon Company, Accelerator and Equipment Operation, 190 Willow Street, Waltham, Massachusetts 02154. Tel: 617-899-8400.

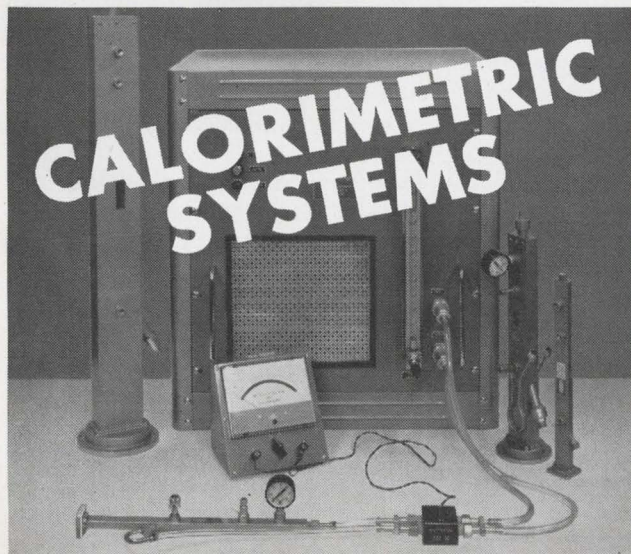

Circle 194 on reader service card

RHG OFFERS A COMPLETE tv relay link in two low cost sub-units

Solid state "Minilink[®]" FM transmitters and FM receivers are available in L, S, C, & X Band. Build them into your military system and obtain high fidelity color or monochrome TV transmission.

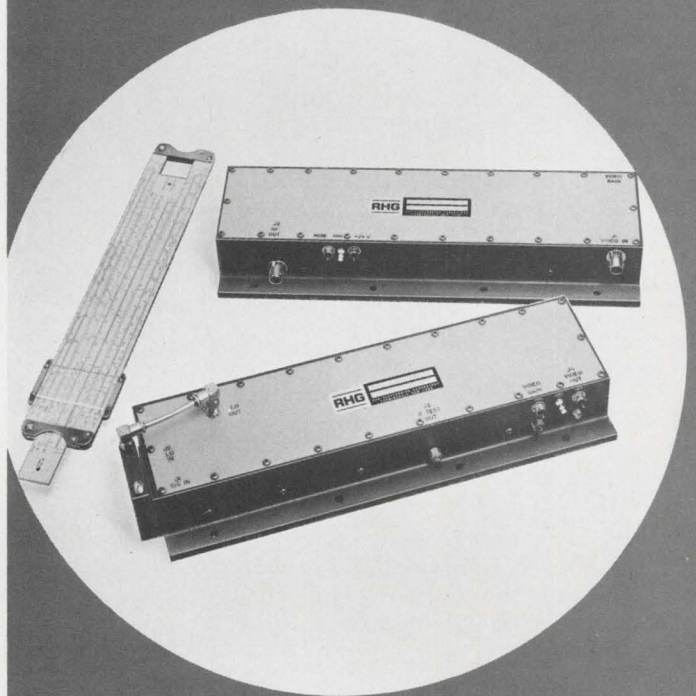

- MEETS OR EXCEEDS EIA AND CCIR STANDARDS
- 90 CUBIC INCHES PER SUB UNIT
- UP TO 4 WATTS OUTPUT

RHG "Minilinks" are solid state transmitter-receiver combinations. They offer the utmost in reliability, instant warmup, and low power drain. Designed for military applications they utilize rugged construction and RFI protection. Complete details and specifications are in RHG catalog 69B or see EEM Section 3400.

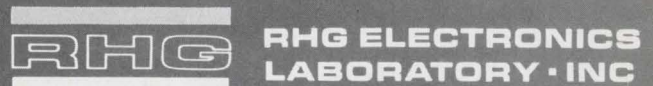

94 MILBAR BOULEVARD ■ FARMINGDALE
LONG ISLAND ■ NEW YORK 11735 ■ (516) 694-3100
Microwave Receivers, Transmitters and Components

Circle 167 on reader service card

Total Capability

IN WIRE-WOUND RESISTORS

Vitreous enamel, fixed and adjustable. Whatever you need in wire-wound resistors, Mallory can deliver. 1 ohm to 100K ohms. 3 watts to 200 watts. Cylindrical and flat, with standard or special terminals.

Excellent resistance to thermal and mechanical shock, humidity and electrolysis. High wattage dissipation. Long life and outstanding durability. Top reliability in extreme environments. Permanently welded connections.

Whatever your needs in wire-wound resistors, Mallory can fill them.

Mallory Controls Company, a division of P. R. Mallory & Co. Inc., Box 327, Frankfort, Indiana 46041.

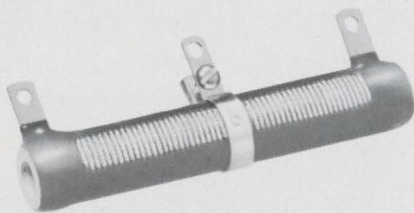

MALLORY

Technical Abstracts

A model job

Computer analysis and simulation of MOS circuits
Albert Feller
RCA, Camden, N.J.

Transient and d-c analysis of p, n, and complementary metal oxide semiconductor circuits, once tedious and time consuming, has been greatly simplified by two new computer programs. Called CASMOS-1 and -2 (for computer analysis and simulation of MOS circuits), these programs apply, respectively, to linear passive devices and to nonlinear elements.

The inputs, on punched cards, are divided into two classifications—the circuit's topology and the parameter values for the built-in models of the active and passive devices. These values are the mask geometries, the threshold voltages with a zero source-to-substrate voltage, hole and electron surface mobility, oxide thickness, donor and acceptor densities, resistivity, and several additional constants.

Both programs consist of a main routine and 10 subroutines. One subroutine generates and evaluates a set of n first-order differential equations at time zero, describing the n-dependent voltage nodes as functions of time. Dynamic inputs can be supplied by two other subroutines, giving the user a Fortran option to define analytically one or several input driving functions.

The differential equations developed are then numerically integrated for succeeding intervals of time to produce new values for the dependent voltages. Integration is assisted by four subroutines based on a Runge-Kutta starting procedure and a predictor-corrector technique. The subroutines are controlled by predefined error criteria and change the integration interval automatically. At the user's option, a d-c solution can be printed out and used automatically as the initial conditions for the transient analysis. One of the subroutines inverts the matrix.

The mathematical models are defined through several equations—for the drain characteristics in the saturated and unsaturated regions,

the threshold voltage as a function of source-to-substrate potential, the surface mobility with gate-to-source potential, and the nonlinear junction capacitance.

Parameters needed for the equations are found as follows:

- Threshold voltage—measured by connecting the devices as diodes and extrapolating the voltage where the drain current is zero.

- Surface mobility and diffusion depth—determined by first measuring the drain characteristics on the same chip of several saturated devices having different geometries and then using the drain equation for the saturated region to derive the values simultaneously. The gate-to-source voltage should be as low as possible.

- Doping level—determined by measuring the threshold voltage, but with the source biased with respect to the body or substrate. A large value of surface mobility will minimize any errors that result from assuming a value of, say, 0.75 volt for the surface potential.

Presented at the 1969 IEEE International Solid State Circuits Conference, Philadelphia, Feb. 19-21.

Matchmaker

A five-octave microwave thin-film amplifier
P.H.Y. Wang, Hewlett-Packard Co.
Palo Alto, Calif.

Microwave amplifiers have been built using a modular approach that lets the computer set up the proper module combinations needed to attain the desired over-all characteristics. When a sufficient number of two-stage amplifier blocks have been built and tested, the computer scans through the measured data accumulated and chooses a set containing three two-stage blocks and a power amplifier section that should optimize the amplifier's performance.

The final amplifier consists of several selected sections: three identical two-stage blocks that form a 36-decibel preamplifier, and a three-stage 12-db power amplifier that uses four transistors. Two of the four transistors are connected in parallel to deliver a

power level +16 decibels above 1 milliwatt into a 50-ohm resistive load.

The microwave amplifier is housed in a 3- by 0.75- by 0.4-inch package. It has a gain of 48 db within 3 db from 50 megahertz to 2.1 gigahertz. The input and output voltage standing wave ratio is less than 2:1, and the harmonics are at least 30 db below the fundamental at an output level of +16 dbm.

All of the passive elements are made from films that are deposited on a single-crystal sapphire substrate. Because the thin-film construction techniques insure that the passive elements are uniform and reproducible within tight tolerances, it is possible to use any parasitics that do occur as part of the final design. The resistors, for example, are made of tantalum pentoxide and silicon dioxide dielectric. Microstrip transmission lines are used as high impedance lines and matching elements; these and the inductor patterns are gold plated. The transistors, which are made by Hewlett-Packard, are discrete npn silicon planar passive chips with a typical gain-bandwidth product, f_t , of 4 Ghz.

Because transistor parameters vary in value, the techniques used for the synthesis, calculation, and fabrication of the final circuits must be very accurate. If they aren't, the error accumulated over the many stages of amplification precludes any accurate computer matching. Also, the characterization of the circuitry and the devices is extremely important and is determined using scattering-parameter data.

The transistor chips are characterized in the common-emitter configuration as linear two-ports from 0.1 to 2 Ghz by varying both magnitude and phase of the feedback element in series with the emitter, and by mapping the resulting family of s-parameter curves on a Smith chart. From this a single-stage amplifier is synthesized using all the plotted s-parameter data for several frequencies. This particular technique gives a fairly good physical rather than a purely mathematical insight into the behavior of a single stage.

Presented at the 1969 IEEE International Solid State Circuits Conference, Philadelphia, Feb. 19-21.

WHILE YOU'RE MAKING UP YOUR MIND TO MOVE TO SOUTH CAROLINA, SOUTH CAROLINA HAS ALREADY TRAINED YOUR LABOR FORCE.

Free. In state-sponsored technical schools. The same schools that graduated over 42,146 highly skilled workers last year for South Carolina industry.

Do you have special jobs? You'll get specially trained workers. Ready to go on opening day.

But the savings begin even before you open your plant, starting with the finest plant sites available. You'll get acres for the price of square yards almost

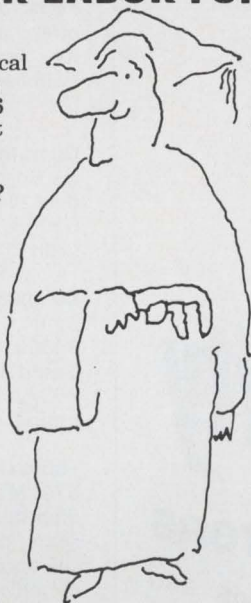

anywhere else. And construction costs will be surprisingly small. You'll have quick, economical transportation by road, rail and air. Taxes are in your favor. And plenty of electricity and natural gas is available at rates well below the national average.

Over 682 industries have made up their minds to move to South Carolina in the last 10 years. We'll help you make up yours. Mail the coupon today.

Ask Mr. R. H. Kennedy,
Vice President, Area Development
South Carolina Electric & Gas Co.
Box 764
Columbia, South Carolina 29203
He's got the facts.

Name _____
Address _____
City _____ State _____ Zip _____

SOUTH CAROLINA ELECTRIC & GAS COMPANY
We try to make life easier.

Total Capability

IN FILM RESISTORS

Precision, semiprecision and power types. Whatever you need in film resistors, Mallory can give you. $\frac{1}{8}$ watt thru 7 watt. Tolerances: Precision $\pm 1\%$ to 1% ; Semiprecision $\pm 2\%$ to 5% ; Power $\pm 5\%$ to 10% .

Precision helixing assures tight resistance tolerances and uniform heat dissipation. Molded or conformal coating with epoxy or silicon protects resistors from moisture and environmental contaminants. Special "No Flame" coating available for power types.

Whatever your needs, Mallory can fill them.

Mallory Controls Company, a division of P. R. Mallory & Co. Inc., Box 327, Frankfort, Indiana 46041.



MALLORY

New Literature

Microwave components. Raytheon Co., Micro State Electronics Operation, 152 Floral Ave., Murray Hill, N.J. 07974, offers a four-page pamphlet describing its line of microwave integrated switches and limiters. Circle 446 on reader service card.

Operational amplifiers. Melcor Electronics Corp., 1750 New Highway, Farmingdale, N.Y. 11735. A 16-page catalog C1008 covers a complete line of d-c solid state operational amplifiers. [447]

Computer systems. Varian Data Systems, 611 Hansen Way, Palo Alto, Calif. 94303, has released a 20-page illustrated booklet on the Spectro System 100/200 family of laboratory data processing systems. [448]

Tubeaxial fans. IMC Magnetics Corp., 570 Main St., Westbury, N.Y. 11591. Illustrated four-page catalog ET10 presents detailed electrical and mechanical specifications, performance curves, dimensions, and wiring data for a full line of slim-profile tubeaxial fans. [449]

Semiconductor catalog. Siemens America Inc., 350 Fifth Ave., New York 10001, offers a comprehensive 32-page buyers' guide to the company's line of semiconductors. [450]

Chopper relays. Solid State Electronics Corp., 15321 Rayen St., Sepulveda, Calif. 91343. Models 33 and 33P field-effect chopper relays are illustrated and described in a two-page bulletin. [451]

Cable fault locating. Delcon Division, Hewlett-Packard Co., 333 Logue Ave., Mountain View, Calif. 94040. Three new brochures describe the applications and operation of cable fault locating instruments for power and communications. [452]

EMI miniature filters. Genisco Technology Corp., 18435 Susana Road, Compton, Calif. 90221. Lightweight EMI miniature filters, offering a wider range of current ratings and circuit configurations than previously attainable, are described in a new catalog. [453]

Small computers. Data General Corp., 275 Cox St., Hudson, Mass. 01749. A 16-page brochure features a discussion of new small computers and describes the hardware, input, output, facilities, instruction set, and software for the NOVA. [454]

Vibration test systems. Wyle Laboratories, 128 Maryland St., El Segundo, Calif. 90245, has available a six-page brochure on Hydrashaker high-force vibration test systems. [455]

Trigger program generator. Datapulse Division, Systron-Donner Corp., 10150

W. Jefferson Blvd., Culver City, Calif. 90230. Technical bulletin 206 describes a six-channel trigger program generator that offers bit repeats or bit pair repeats, 16 bits per channel, and clock rates to 2 Mhz. [456]

Oscilloscope calibrator. Edwin Industries Corp., 11933 Tech Road, Silver Spring, Md. 20904. A four-page brochure illustrates and describes the Bradley model 156 oscilloscope calibrator that permits time, voltage and risetime calibration, with automatic readout of percentage error. [457]

Engineering plastics. General Electric Co., Selkirk, N.Y., 12158, has published an eight-page bulletin describing Lexan polycarbonate resin. Noryl thermoplastic resins, Phenolic molding compounds, and Genal injection moldable thermoset compounds. [458]

Relay catalog. Magnecraft Electric Co., 5575 N. Lynch Ave., Chicago 60630. A list of 481 different relays is featured in stock catalog No. 270. [459]

Digital readout system. Infotronics Corp., 7800 Westglen Ave., Houston 77042, offers an eight-page brochure on its CRS-160 digital readout system for suited mass spectrometry applications. [460]

Portable oscillograph. Esterline Angus, Division of Esterline Corp., P.O. Box 24000, Indianapolis 46224. A portable 40-mm oscillograph priced at \$725 and weighing 14 pounds is described in a two-color catalog sheet. [461]

Waveguide tubing. Washburn Division of A.T. Wall Co., 14725 Arminta St., Van Nuys, Calif. 91402, has issued a technical bulletin on its complete selection of laminated tubing for waveguides. [462]

Standard relays. Essex International Inc., Controls Division, 131 Godfrey St., Logansport, Ind. 46947, has published the SC-4RBM controls catalog describing over 450 different standard relays. [463]

DTL interchangeability guide. ITT Semiconductors, 3301 Electronics Way, West Palm Beach, Fla., 33407. A DTL interchangeability guide (one page two sides, with short flap) cross-references the company's hermetically sealed DTL part numbers with the part numbers of five other major manufacturers. [464]

Peak envelope power measurement. Bird Electronic Corp., 30303 Aurora Road, Cleveland 44139. A discussion of pitfalls in the accurate measurement of peak envelope power of video, pulse, a-m, and other envelope modifying modulations is the subject of a three-page application note. [465]

Degrease with ease... Spray gunk away with MS-180

MS-180 is a Freon® TF degreasing system conveniently packaged in aerosol cans. Use it in maintenance and on the line to spray grease and dirt away quickly from assemblies, components, connections. It's non-flammable and non-conductive (safe to apply while equipment is operating if you want to save even more time). MS-180 Degreaser is available in 16-oz. cans for plant use and in 6-oz. cans for field maintenance kits. Try MS-180 free. Write on company letterhead for a sample. We'll be big about it and send you the 16-oz. size.

® DuPont reg. TM



**miller-stephenson
chemical co., inc.**

Route 7, Danbury, Conn.



Circle 171 on reader service card



Every year, **ELECTRONICS** attracts requests for over 125,000 editorial reprints.

They're like interest payments on our million-dollars-a-year editorial principle.

That's how much we spend annually to produce timely, authentic, and useful articles like those listed on the reader service card as reprints currently available.

Investment and interest make both **ELECTRONICS** and its readers more meaningful to its advertisers.



EMPLOYMENT OPPORTUNITIES

**THE MARKET-PLACE
FOR ALL YOUR
EMPLOYMENT NEEDS**

**Closing Date Information: April 28th Issue Closes April 7th
New Ads or Inquiries: Send to Classified Advertising Department
Electronics: Post Office Box 12, New York, N. Y. 10036**

PRODUCT SUPPORT ELECTRONIC SYSTEMS ENGINEERS (Servo and Digital)

Major firm located in the Eastern Mid-Atlantic States region requires Digital and Servo Systems Engineers for long-term assignments on a large, versatile, computerized digital test station. Successful applicants should be experienced as follows:

Digital Systems Analysts & Designers

B.S. in E.E. or Physics with experience in digital techniques pertaining to one or more of the following:

- Analysis of digital equipment to define support equipment requirements including test design and software-hardware trade-offs
- Digital systems design including software-hardware interrelationships
- Logic & switching design
- Digital timing & control design
- Core memories
- Automatic test equipment
- Magnetic tape units

Digital Systems Development Engineers

B.S. in E.E. or equivalent with digital systems experience in one or more of the following:

- Inertial systems integration
- Systems debugging
- Systems sell-off
- Inertial support of systems application

Servo Engineers

B.S. in E.E. or Physics with experience in one or more of the following:

- Circuit analysis
- Servo design
- Inertial navigation display
- Flight instruments

Salaries to \$16,000

Commensurate with background & experience

(Junior positions also available to individuals with Associate degree or equivalent for Digital Test Engineering. Duties include laboratory evaluation and development of breadboards, revision of documents and reports)

To arrange an immediate interview, send comprehensive resume, in strict confidence, to:

**P-7775, Electronics, Classified Adv. Dept., P. O. Box 12,
New York, N. Y. 10036**

An Equal Opportunity Employer (M/F)

ADDRESS BOX NO. REPLIES TO: Box No.
Classified Adv. Dept. of this publication.

Send to office nearest you.

NEW YORK, N. Y. 10036: P. O. Box 12

CHICAGO, Ill. 60611: 645 N. Michigan Ave.

SAN FRANCISCO, Cal. 94111: 255 California St.

EMPLOYMENT SERVICES

Electronic Engineers, \$9-\$25,000. Nationwide positions available through 85 affiliate offices. Application, production, design, project & RD in circuitry, optics, instrumentation, digital circuitry, measurement systems, industrial controls, communications, solid state devices, & computers. Fees company paid. Send resume with present and desired salary with location flexibility to Leonard Personnel, 310 Empire Building, Pittsburgh, Pa. 15222.

Florida/Nationwide EE's ME's IE's needed Electronics fields. Aerospace, Industrial Manufacturing. \$9—18,000. Tech. Div., Brodeur Personnel Service Inc., 3947 Blvd. Center Dr., Jacksonville, Fla. 32207.

BUSINESS OPPORTUNITY

Capital Contacts—Before you try Public or Private Placements to Underwriters, Investment Banking Houses, write for free helpful information to Confidential Consultant, 817 51st St., Brooklyn, N.Y.

*"Put Yourself in the
Other Fellow's Place"*

TO EMPLOYERS TO EMPLOYEES

Letters written offering Employment or applying for same are written with the hope of satisfying a current need. An answer, regardless of whether it is favorable or not, is usually expected.

MR. EMPLOYER, won't you remove the mystery about the status of an employee's application by acknowledging all applicants and not just the promising candidates.

MR. EMPLOYEE you, too, can help by acknowledging applications and job offers. This would encourage more companies to answer position wanted ads in this section.

We make this suggestion in a spirit of helpful cooperation between employers and employees.

This section will be the more useful to all as a result of this consideration.

Classified Advertising Dept.

McGRAW-HILL, INC.

330 West 42nd St., New York, N. Y., 10036

CIRCLE 966 ON READER SERVICE CARD

7283940563498217890456372712345092718
8394056349821789045637271234509271890
1890991728394056349821789045637271234

PLEASE USE BOX NUMBER

*when answering classified advertisements in Electronics.
It is the only way we can identify the advertisement you're answering.*

9917283940563498217890456372712345092
2839405634982178904563727123450927189
0456372712345092718909917283940563498

Looking for a better job?

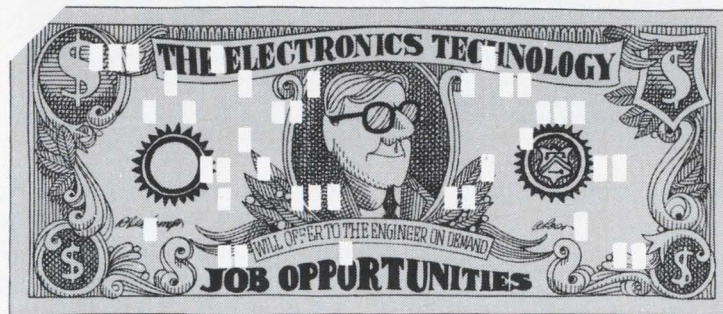

Ask Electronics' computer all about it

Electronics magazine feels an obligation to help its readers find positions in the electronics technology which will make the greatest contribution to their profession and to society — jobs in which electronics men themselves will be happiest.

Electronics has joined with a nation-wide talent search company—National Manpower Register, Inc.—to form the computerized Electronics Manpower Register.

Your qualifications and job requirements will be pro-

grammed into a GE 265 computer, direct-linked to the Manpower Register's offices in New York. The computer, once your resume form (bottom of page and following page) is received, will continuously compare all your data with the specific manpower needs of electronics companies. When a match is made, you will be contacted directly or through an affiliated agency. The company and you will be brought together on a confidential basis.

Continued on next page

<p>Resumes acceptable only from applicants residing within the United States</p>	<h3>Electronics Manpower Register</h3> <p>It is important that your information be complete and that you type or print legibly</p>	<p>Resumes acceptable only from applicants residing within the United States</p>
<p>IDENTITY</p>		
Name _____		Date _____
Home address _____		Parent company _____
City _____	State _____	Zip _____
Location (City/State) _____		Home phone _____
<p>Do you subscribe to Electronics <input type="checkbox"/> or see a library or pass-along copy <input type="checkbox"/></p>		
<p>GEOGRAPHICAL PREFERENCE (Check appropriate boxes and complete all blanks)</p>		
<p>I will NOT relocate <input type="checkbox"/> I will consider opportunities in: <input type="checkbox"/> North East <input type="checkbox"/> Mid Atlantic <input type="checkbox"/> South <input type="checkbox"/> Midwest <input type="checkbox"/> Southwest <input type="checkbox"/> Calif. <input type="checkbox"/> Northwest</p>		
<p>Prefer: <input type="checkbox"/> Metro. area <input type="checkbox"/> Medium town <input type="checkbox"/> Rural area Other: _____</p>		
<p>EDUCATION</p>		
Degree _____	Major field _____	Year _____
College or University _____		
<p>FOR OFFICE USE ONLY</p>		
<p>EMPLOYMENT INFORMATION</p>		<p>REGISTRATION NUMBER</p>
<p>Position desired _____</p>		
<p>Present <input type="checkbox"/> or most recent <input type="checkbox"/> position From _____ To _____ Title _____</p>		
<p>Duties and accomplishments _____</p>		
<p>_____</p>		
<p>_____</p>		
<p>_____</p>		
<p>_____</p>		
<p>HAVE YOU REGISTERED WITH THIS SYSTEM PREVIOUSLY? Yes <input type="checkbox"/> No <input type="checkbox"/></p>		
<p>CONTINUED ON OTHER SIDE</p>		

In electronics it's Electronics magazine to sell used equipment!

Your advertisement will produce Results in Electronics. Engineers turn to Electronics magazine for the latest technical developments — and for the latest buying information. You can reach them inexpensively in Electronics Searchlight Section.

For information:
Searchlight Section
Classified Advertising Dept.
Post Office Box 12
New York 10036



Exceptional Opportunities for Engineers in Libya

Communications Engineer

B.S. Degree in Electrical Engineering with Electronic or Communications major. Candidate will be the Company Consultant in all phases of our communication network and account custodian for the expense budgets. He will be the Contract Administrator for both leased and purchased services in the field of communications and will assist Maintenance and Operations Division in the selection of equipment and communication requirements.

Electrical or Electronic Engineer

B.S. Degree in Electrical or Electronic Engineering. Six to eight years electronics and/or communications experience required to plan, design and coordinate the design of electrical generation and distribution systems and communications and data transmission systems. Troposcatter and/or microwave experience would be helpful. Previous oil company experience not necessary.

Good starting salaries, liberal company benefits and savings plan, family housing and annual home vacation. Include present salary in your resume. All inquiries will be held in strict confidence.

STANDARD OIL COMPANY

(New Jersey)

P.O. BOX 518-L, RADIO CITY STATION, NEW YORK, N.Y. 10019

An equal opportunity employer

CIRCLE 967 ON READER SERVICE CARD

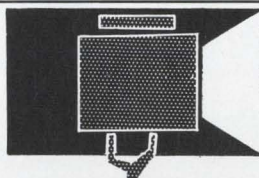

SEARCHLIGHT SECTION

- CLASSIFIED ADVERTISING • BUSINESS OPPORTUNITIES
- USED OR SURPLUS EQUIPMENT

RATES

EMPLOYMENT OPPORTUNITIES—\$79.00 per inch, subject to agency commission.

SEARCHLIGHT SECTION—\$39.75 per inch for equipment (Used or Resale), business opportunity, etc. advertising appearing on other than a contract basis. Contract rates on request.

UNDISPLAYED (Not available for Equipment Advertising)—\$3.60 per line, minimum 3 lines. To figure advance payment count 5 average words to a line and 1 line for a publication box number.

Position Wanted — undisplayed rate is one-half of above rate, payable in advance.

Send New Ads or Inquiries to:

Classified Adv. Dept.

ELECTRONICS

P.O. Box 12, New York, N. Y. 10036

RADAR SYSTEMS GROUND AND AIRBORNE. AUTOMATIC TRACKING ANTENNA SYSTEMS. NIKE AJAX. NIKE HERCULES. M-33. MSQ-1A. MPS-19. MPS-9. SCR 584. TPS-1D. TPS-28. FAA-ASR-2. AIRBORNE SYSTEMS. APN-84. APN-102. APS-20. APS-27. APS-45. DPN-19. DIGITAL COMPUTERS. IBM 650. IBM 704.



LARGEST INVENTORY OF RADAR AND MICROWAVE EQUIPMENT IN THE WORLD.

RADIO RESEARCH INSTRUMENT CO.

45 WEST 45TH ST. N. Y. 10036 212-JU 6-4691

CIRCLE 968 ON READER SERVICE CARD

SURPLUS IBM EQUIPMENT

FREE catalog of powers supplies, light & switch panels, semiconductors, test equipment, IC's, optics, etc.

GADGETEERS SURPLUS ELECTRONICS, Inc.
5300 Vine St. Cincinnati, Ohio 45217

CIRCLE 969 ON READER SERVICE CARD

free catalog

**POTTING APPLICATORS
MANUAL AND DISPOSABLE**

6cc 12cc 30cc

FOR POTTING, ENCAPSULATING, AND SEALING OF MINIATURE COMPONENTS

PHILIP FISHMAN COMPANY
7 CAMERON ST., WELLESLEY 81, MASSACHUSETTS

Remember . . .

MAIL MOVES THE COUNTRY

but . . .

ZIP CODE MOVES THE MAIL

If you thought all Daystrom pots were squares



...look again!

Rectilinear components are still a necessary requirement in many circuit applications. That's why Weston has rounded out its high-performance potentiometer line with two new rectilinear models. RT-12 styles 534 and 535 are designed for both general-purpose and military applications. They feature the same $\pm 5\%$ tolerance, 10 ohm to 50K range, and slip clutch stop protection that are standard with Daystrom Squaretrim® units, plus 24-turn adjustability and

humidity proofing. Also new this year . . . models 553 half-inch and 543 three-eighth-inch Squaretrim potentiometers in military and commercial versions. Save board space as well as money with our field proven 501 Series multi-turn and 504 Series single-turn $\frac{1}{16}$ " Squaretrims offering values to 20K in a 0.02 cubic inch case. All Squaretrim Diallyl-Phthalate cased pots give you Weston's patented "wire in the groove" construction and your choice of flexible leads,

pin and screw configurations. Whether your trimmer needs are military, industrial or commercial, you'll find the answer in this complete new low-cost line. Write today for data sheets and evaluation samples. DAYSTROM potentiometers are another product of WESTON COMPONENTS DIV., Archbald, Pennsylvania 18403, Weston Instruments, Inc., a Schlumberger company

WESTON®

International Newsletter

March 31, 1969

Germanium diodes in X-band made by Matsushita

Prototype germanium microwave oscillator diodes, and X-band oscillators using them, have been developed by Matsushita Electronics. The company claims they're the first such devices that are made in production quantities.

Matsushita says the germanium devices run at least 10 decibels quieter than silicon impatt diodes, have less negative resistance and thus more gain, and require less than half as much supply voltage.

The company hasn't released details of the device's mechanism, so it's not certain whether breakdown is caused by tunneling or by the avalanche effect.

Mullard to sell matrix display by mid-1970

Mullard Ltd. expects to have a competitive glow-discharge matrix display in production by mid-1970. Samples of the displays, which have a five-by-seven array of dots, will probably be available by the end of this year.

In production quantities, the price for a display unit will run about \$2 in Britain. A diode decoder to pair with the display itself will run \$3 or \$4 for numerals-only applications and from \$15 to \$20 for alphanumeric applications.

For desk calculators and similar equipment needing eight or more tubes driven sequentially by a numerals-only decoder, the flat displays will cost a little less than the tubes now used, Mullard believes. At the same time, there'll be a gain in brightness. Dot brightness in the prototypes Mullard now makes is 600 foot-lamberts for a current of 150 microamps at 120 volts.

Mullard builds the array around a flat lead frame containing 35 cathode pads. This assembly slips into a glass molding so that each cathode forms the base of a cavity. The tube is completed by adding an anode grid, then sealed with a glass faceplate. Sputtered cathode material, Mullard says, is trapped within the cavities and does not blacken the faceplate. Life tests so far exceed 15,000 hours without deterioration, say engineers on the project.

European airbus means a lift for avionics

A lift to avionics producers that could run as high as \$50 million is in the offing from the A-300B European airbus. France and Germany, eager to get work started on the 250-passenger plane, now say they'll go ahead with the project no matter what the potential third partner—Great Britain—decides to do.

European avionics makers will get preference, but U.S. firms may wind up with a big chunk of the business. The reason: unlike the Anglo-French Concorde supersonic transport, the airbus is strictly for business and not for prestige. The project will have a fixed development budget of about \$500 million financed by the two governments, and the builders will be free to pick the best avionics offers even if they come from non-European companies. For the Concorde, the guideline was "buy European"—even at a premium.

Unless Britain joins in, France's Sud-Aviation and Germany's Deutsche Airbus will build the plane. Deutsche Airbus groups five German aerospace firms interested in the project. The sales target is 350 planes over 10 years, with the first planes in service by late 1973.

International Newsletter

Toshiba twt has 300-watt output

A 300-watt traveling-wave tube for the 28 to 30 gigahertz range has been turned out by Toshiba's Central Research Laboratory. Previous amplifier tubes in that frequency range put out only several watts, says Toshiba.

The company was able to surmount a major obstacle for high output: as frequency increases, twt size decreases—and so does output power. By improving component fabrication, and by putting the tubes together with greater precision, Toshiba managed to have almost 100% of the electron beam pass through the slow wave circuit. It is loss in the slow wave circuit that limits output.

The tube is designed primarily for transmission of wideband multiplex pulse-code-modulation signals from ground stations to satellites.

Ferranti to try computer market in East Europe

A new twist may open up a market for Ferranti Ltd. Argus process-control computers in East Europe. The U.K. firm has lined up the Czech Institute for Industrial Management and Organization (INORGA) as its exclusive sales agent for Czechoslovakia.

Under the deal, Ferranti will supply hardware and standard software. INORGA, though, will design systems, supply special software, install systems, and maintain them. Other British computer makers operating in Eastern Europe tend to do the whole job themselves and keep teams of British engineers assigned to East European countries.

At the outset, INORGA has the right to sell in other East-bloc countries besides Czechoslovakia. But if the Czech scheme works, Ferranti probably will look for native partners in other countries. So far, Ferranti, acting as its own agent, has sold only three Argus installations in the bloc, all to Russia. Ferranti expects the Argus systems that INORGA sells will be worth between \$150,000 and \$250,000 each.

Messerschmitt wins apogee engine job for Symphonie

Messerschmitt-Boelkow GmbH, West Germany's leading aerospace firm, has cut itself in for more contracts on Symphonie, the Franco-German communications satellite, scheduled for launch in 1972. The company, which beat out French, Italian, and other German firms in the competition for Symphonie's apogee engine, will develop and supply all of Symphonie's propulsion and orbit-correction systems.

Messerschmitt-Boelkow's apogee engine is a liquid-fuel type that has a longer firing time (18 minutes) than the solid-fuel engines proposed by the other concerns. Since the engine also requires less fuel, Symphonie's payload can be increased by about 55 pounds—to 220 pounds—allowing more electronic equipment and related gear to be installed. The liquid-fuel engine also will cut the total project cost by several million dollars (to \$50 million) because it can be reused after each test firing.

Murata to make IC's for Oak tv tuners

Japan's Murata Manufacturing Co., which already has a joint venture with Oak Electro/Netics making vacuum tube tuners, will furnish Oak with thick-film hybrid integrated circuits for vhf television tuners. Each tuner will use four transistors and three diodes, one of which is a variable capacitance type for automatic frequency control.

The joint venture, which is owned 51% by Murata and has about 200 employees, will switch to the manufacture of IC tuners next year and is expected to turn out about 150,000 a month. Also, a new plant, eventually employing 500, will be built in Kanazawa because the original facility 150 miles away, near Tokyo, can't expand its labor force.

Low-cost British instrument plots impurity profiles of semiconductors

Special-purpose machine eliminates need for tedious series of voltage-capacitance measurements; it will be sold starting this summer for about \$1,700 in the home market

Specialists in semiconductors who visited the mid-March Physics Exhibition in London found what many of them had long been waiting for—the prototype of a reasonably priced instrument that plots the impurity profiles of semiconductors.

The instrument, developed by Peter Baxandall of Britain's Royal Radar Establishment, gives an on-the-spot plot of impurity concentration versus depth for semiconductors having from 10^{13} to 10^{17} impurity atoms per cubic centimeter. The profiles are crucial to semiconductor producers, particularly when they're making gallium arsenide wafers destined to become Gunn oscillators. A reading on the impurity concentration at different depths through the wafer tells if its doping is uniform enough to make it usable.

J.A.C. Electronics Ltd. will market the impurity-profile plotter. The company expects to sell the instrument in its home market for around \$1,700. This price compares with as much as \$50,000 for conventional units.

Tedium. The usual way of taking the profile is to evaporate metal dots onto the wafer surface and thus turn it temporarily into a batch of Schottky-barrier diodes. After that comes an exhaustive series of voltage-capacitance measurements taken with a capacitance bridge. The data then goes to a computer, which plots the profile.

The technique is possible because the capacitance of a semiconductor diode depends essentially on the depth of its depletion layer. The capacitance is also a function of the impurity concentra-

tion in the depletion layer. As the layer is driven deeper into the semiconductor by increasing the d-c bias on the diode, the change of capacitance stays linear if the impurity concentration is uniform.

Actually, the Royal Radar Establishment was not the first to find a way to get around tedious capacitance-bridge-and-computer methods to ferret out impurity profiles. At the International Electron Device Meeting in Washington last October, John A. Copeland of Bell Telephone Laboratories told about the "Profilometer" he had invented.

Bell Labs and the Western Electric Co., the Bell System's manufacturing arm, have since put a dozen Profilometers in trial operation. No one so far plans to market the instrument, but Copeland figures the hardware to build one would cost about \$3,000.

Ready for market. Meanwhile, J.A.C. Electronics expects to have its first batch of a dozen profile plotters ready in about three months. The instrument is essentially a small special-purpose analog computer that manipulates the capacitance-change input from the wafer

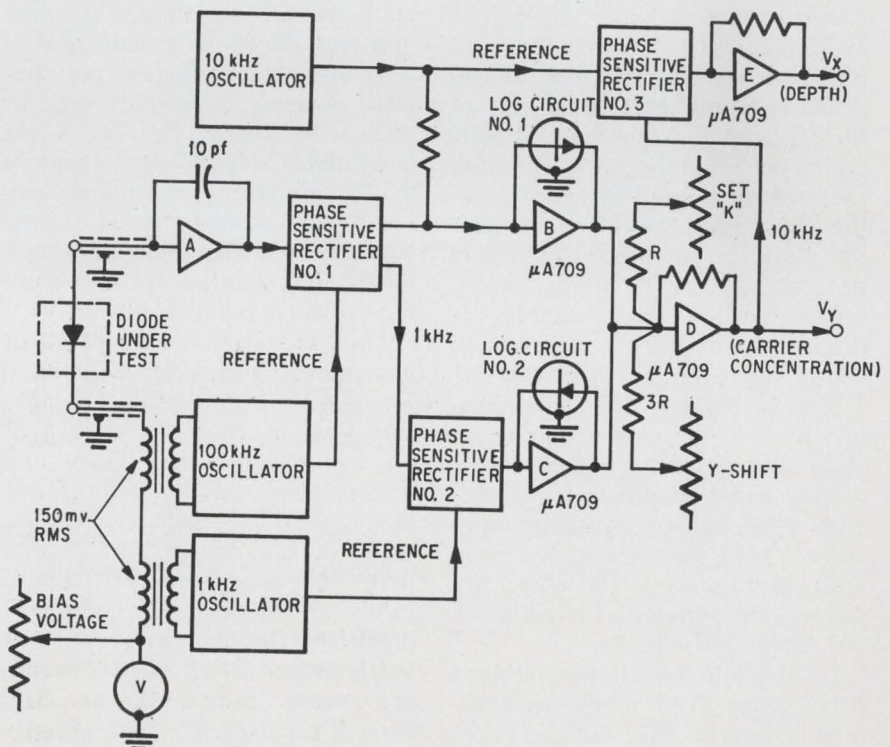

In on the plot. Phase-sensitive rectifiers and logarithmic amplifiers measure changes in semiconductor diode capacitance that reflect the carrier concentrations at different depths in a wafer.

diode that is undergoing the test.

D-c bias is set manually and applied in series with 100-kilohertz and 1-khz signal voltages at 150 millivolts rms. The 100-khz signal produces an a-c current flow through the diode; this current is amplified and fed to the first phase-sensitive rectifier. The rectifier's output current, proportional to the diode capacitance, becomes an input to a logarithmic amplifier.

The 1-khz voltage applied to the diode modulates slightly the 100-khz component, so there's a second output from the first phase-sensitive rectifier, a 1-khz component whose amplitude is a measure of the capacitance change for the change in a-c voltage across the diode. This small a-c voltage goes to the second phase-sensitive rectifier. The rectifier's output current, proportional to the change in capacitance, goes to the second log amplifier. The outputs of the two log amplifiers are summed to get a d-c signal to drive the Y axis of the plotter, which shows the log of the carrier concentration.

Special amp. To get the other output, a voltage proportional to the depth at which the carrier concentration is being checked, a 10-khz current is fed to the log amplifier driven by the first phase-sensitive amplifier. The output of the log amplifier thus has a 10-khz component that is carried through the summing amplifier and on to the third phase-sensitive rectifier. Its output is a current inversely proportional to the diode capacitance, and is thus suitable for driving the plotter's X axis, which shows depth of measurement.

The 1-, 10-, and 100-khz oscillators used in the plotter operate as class D current switchers. The diode-current amplifier is special, with a field effect transistor input stage and a gate choke for good noise performance. The other amplifiers are standard Fairchild μ A 709 integrated circuits.

In absolute terms, the plotter's performance isn't much—an accuracy of only $\pm 50\%$. But the variation in carrier concentration with depth—the key to the semiconductor's uniformity—is measured to within $\pm 3\%$.

Mixing it up

In a laboratory laser setup, a supercooled semiconductor is a workable way to get a detector with fast response. However, in the cruel but insufficiently cold everyday world, helium-cooling equipment becomes a nuisance, so there's a search on for good room-temperature laser detectors.

The most likely candidate at the moment is the point-contact semiconductor diode, according to Colin Payne and Brian Prewer of EMI Electronics Ltd. Last week, at a conference on lasers and optoelectronics held at Southampton University, they told why.

Payne and Prewer have been working on detectors and mixers for submillimeter wavelengths. They've been using a cyanide gas laser that develops an output of from 1 to 5 milliwatts at a wavelength of 0.3337 mm. And they think their detectors will be suitable for much shorter wavelengths.

Softie. At first glance, n-type gallium arsenide would seem the best semiconductor material for a submillimeter diode detector. But GaAs, despite its superior electrical properties, ran third to germanium and silicon. The main reason: a point-contact diode's performance depends on contact area as well as on carrier mobility. GaAs is relatively soft and can't stand up to the pressures around a very small point-contact area. The larger contact area required for GaAs, then, more than offsets its advantage of higher mobility.

The best combination the EMI men have found so far is germanium with a tungsten whisker. With this kind of diode in an experimental detector setup, Payne and Prewer detected—at power levels down to 10^{-6} watt—cyanide-gas laser signals chopped at 2 kilohertz. In a mixer setup with a local oscillator frequency of about 890 gigahertz, the performance was vastly better: 10^{-12} watt. The improvement comes, Payne and Prewer say, from the high i-f, only 1 Mhz below the signal frequency. The i-f cuts down inverse frequency noise and gives the germanium-tungsten diode a noise

equivalent power (threshold for useful signals) of 2.4×10^{-12} watt in a mixer that has a local oscillator input of 3 mw.

Runner-up. After germanium and tungsten, the next best combination was silicon and tungsten. Here the noise equivalent power was 3.8×10^{-6} watt in straight detection and 3.8×10^{-11} watt in mixing. Actually, the silicon diode's contact area was smaller than that of the germanium diode, but not enough to offset the lower mobility of the p-type silicon.

With GaAs, the noise equivalent power turned out to be 3.8×10^{-5} watt in straight detection and 1.2×10^{-10} watt in mixing. All kinds of whisker materials—phosphor bronze, platinum, platinum-iridium, and gold-copper—were tried to improve the diodes, but none could skirt the basic difficulty: the softness of GaAs. Another drawback of GaAs is its need of forward biasing, which adds to the noise.

Payne and Prewer believe they'll eventually get noise equivalent power of 10^{-8} watt in straight detection and 10^{-15} watt in mixing with germanium diodes.

Long lived

Battery life can be a matter of life and death for a cardiac patient who's wearing a pacemaker. Occasionally, the pacemaker itself stops working; but more often the mercury cells that power it fail. That means surgery for the patient, or else.

Medical electronics people on both sides of the Atlantic have been working on long-lived pacemaker batteries for some time. The goal is a power pack that will last a decade or longer instead of the two years or so that's usual for mercury batteries.

Nearest to that goal seems to be the United Kingdom Atomic Energy Authority. This month, the agency let out that it has had a nuclear-battery powered experimental pacemaker in operation since last June. What's more, UKAEA says it expects to be ready for clinical trials in 15 to 18 months. The U.S. Atomic Energy Commission's timetable for

pacemaker batteries calls for implants in animals by the end of 1969 and first clinical tests in 1975.

The British battery has an output of 540 microwatts and comprises a plutonium 238 heat source and a bismuth telluride thermocouple in a stainless steel can about 1 centimeter in diameter and 5 cm long. Paired with the battery is a three-stage dc-dc converter that boosts the 1.5-volt battery potential to the 4.5 volts needed for the pacemaker circuits.

As for the pacemaker itself, UKAEA won't say much except that it generates 4.5 volt pulses with a duration of about 1 millisecond at a rate of 72 per minute. Some outsiders are convinced the agency has developed a new kind of pacemaker circuit but intends to keep mum about it until it's patented.

Japan

All wound up

A new twist—literally—on an old idea may one day make most of us consumers of prerecorded video tapes.

The twist is a bifilar winding around a tape reel, and the old idea is to duplicate video tapes by "con-

tact printing." Do both, reports a Matsushita Electric Industrial Co. research team headed by Hiroshi Sugaya, and you can copy a 2,400-foot reel of tape in just 2 minutes. With conventional copying, it takes an hour to duplicate the same tape.

Matsushita's method is elegantly simple. Both the master tape and the duplicate-to-be are wound together on a takeup reel after passing under a pressure roll that squeezes out any air trapped between the tapes. When the reel is full, a 50- or 60-hertz transfer field is applied for a few seconds. The leakage flux from the master tape then acts as a signal field and the transfer field as a bias field, so there's magnetic recording on the slave tape. After the transfer, the tapes are rewound on their respective reels.

Limitations. Simple as it is, the method eliminates the major drawbacks of conventional copying, where master and slave tapes pass together in running contact through a transfer field. With the full windup before transfer, there's no slippage, as there can be with running contact. And there's no chance of trapped air keeping the tapes slightly apart, which makes for fuzzy contact printing. As a result, Matsushita's method can handle wavelengths down to about 2 mi-

croons, compared to a 10-micron lower limit for conventional copying.

There are some limitations—none serious—to the Matsushita technique. If there's an audio track on the master tape it must be wiped off before the video contact printing and put on both slave and master during the rewind. This is because the longer wavelengths of the audio signals tend to print through more than one layer.

And the master, of course, has to be recorded on tape that has a coercive force about 2½ times higher than the slave tape's. What's more, the master tape has to be a mirror image of the recording to be printed. So a special recorder is necessary, one with a reversed tape run around the recording drum.

Close quarters

The way to pack scads of bipolar transistors onto an integrated-circuit chip is to cut down the elbow room each transistor needs around it to isolate it from its chipmates. And one way to shave isolation areas is to build a "collector wall" around each element [*Electronics*, Oct. 28, 1968, p. 204].

An even better way, say Kiyoshi



Fast whirl. Matsushita video tape copying equipment can duplicate a 2,400-foot reel of master tape in just two minutes. Bifilar winding of master and slave tapes on the same reel is what makes machine a speedster.

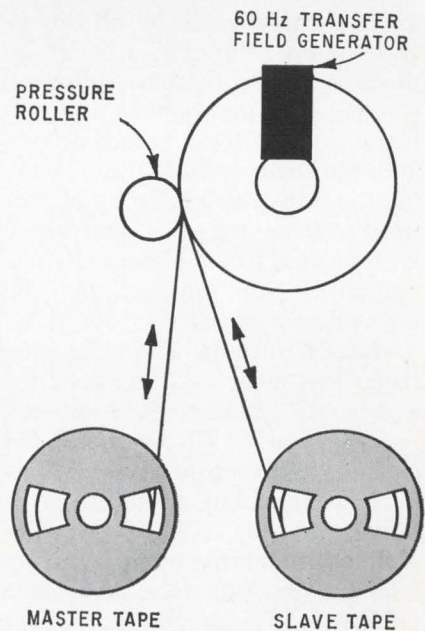

Demizu and Katsuhiko Yukawa of the Mitsubishi Electric Corp., is to adopt double epitaxial isolation. The technique not only makes for smaller isolation diffusion regions, they add, but it saves some steps in the production cycle. More development work is needed, but Demizu and Yukawa are sure the technique has exceptional promise.

Extra growth. Double epitaxial isolation starts with diffusion of an n+ layer into a p substrate in those regions that will hold the finished transistors. So far, nothing new. But next, a p-type epitaxial layer 2 to 3 microns thick is grown on the same areas, followed by an n-type epitaxial layer about 2 microns thick. Both layers are grown in one continuous process; the switch from p to n is achieved by changing gases at the appropriate time.

During the heating cycles of the epitaxial processing, there is an auto-diffusion from the n+ buried layer into the p epitaxial layer. As a result, the p epitaxial layer above the buried layer becomes a high-resistivity n-type material and the collector of the finished transistor. The p diffused base extends completely through the n epitaxial layer, and the actual base-collector junction is in the inverted epitaxial layer.

Those regions of the p epitaxial layer not over the diffused n+ areas are unaffected by all this p-type material throughout the entire process. During the base diffusion, p type isolation regions are diffused through the n epitaxial layer and into the p epitaxial layer, making the transistor's collector an isolated n island in a p sea. The device is completed by simultaneously diffusing the n+ emitters and the n+ collector contacts.

Isolated success. The technique, then, does away with the need for a separate isolation diffusion and isolation mask. What's more, the isolation diffusion need be only as deep as the base; in the conventional process, it must go completely through the epitaxial layers and into the substrate. And since impurity diffusion proceeds about the same distance laterally as vertically, the shallower isolation dif-

fusion yields narrower isolation regions. Thus, each transistor takes up less space.

There's still another advantage. With other isolation techniques, the thickness of the epitaxial layer must be precisely controlled. But this factor is much less important during the double epitaxial process because effective thickness can be adjusted by subsequent heat treatment.

Czechoslovakia

Good timing

Many's the time pulse-circuit designers have wished for an easy way to control the switch-on delay in a power semiconductor. And now a research team at the Czech Institute for High-Current Technology thinks it's found the answer: a thyristor-like device that operates in a magnet's air gap.

The Czechs call their development a "timistor," and at a meeting last week in Munich on semiconductor device research they said its switch-on time could be varied from a few microseconds to several milliseconds. In addition to power pulse circuits, the timistor should be useful for d-c motor control and for some logic circuits, says the institute's Jan Bydzovsky.

Four layers. Basically, the timistor is a 300-micron, four-layer silicon structure with three contacts. Under the anode contact there's a 10-micron p+ emitter layer. A shorter but thicker 15-micron n+ layer underlies the gate contact. Then there's an n "wide" base about 230 microns thick, a p "nar-

row" base, a second p+ emitter, and the cathode contact.

The silicon slab is soldered to a copper heat sink and encapsulated in plastic. After that, the device is about 1.5 by 7 by 0.5 millimeters, small enough to slip into the air gap of a small magnet.

Deflection. Excitation of the element is through the wide base, and the basic turn-on time depends on the current fed to the gate. A typical range of basic delays is 5 to 100 μ sec. In a magnetic field, the carrier flow between the emitter and the gate changes. The basic delay is stretched out if the field shunts more carriers toward the gate. A magnetic field in the opposite direction sends more carriers into the wide base, and the basic delay is shortened. The effect of the magnetic field is enhanced if the control voltage has a sawtooth waveform.

Typical timistors developed at the institute have cutoff voltages between 100 and 500 volts and carry maximum currents of about 300 milliamps. Control voltages run between 5 and 15 volts and control currents between 2 and 15 milliamps.

West Germany

Taking a rain check

German weathermen will be taking to the hills when it rains. A team has been assigned to work in Bavaria over the next four years to perfect techniques for measuring rainfall.

From a weather-forecasting observatory perched on the 3,000-foot Hohenpeissberg, these meteorologists will take radar readings of rainfall over an area about 60 miles in diameter. The results will be modified by data on raindrop size and later compared to information gathered by conventional rain gages and electronic integrators.

The radar the team is using is a Plessey 43X model operating in the 3-centimeter band and delivering 0.5- and 2.0-microsecond pulses with a maximum power of 75 kilowatts.

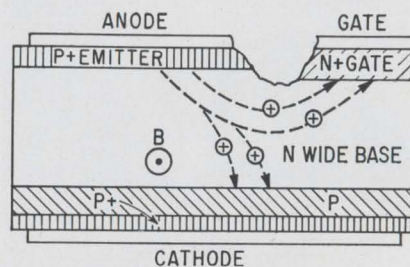

Variable. Magnetic field oriented as shown deflects carriers into wide base to cut down turn-on time.

NEW! POWERTEC GR* POWER SUPPLIES

PRICED FROM

\$29⁰⁰



* Guaranteed Reliability

PRICE & QUALITY OPTIMIZED

New low cost family of units for applications with IC's, other digital logic, OP amps and low voltage analog circuits.

Only MIL and computer grade components are used in this versatile family. Calculated reliability per MIL-HDBK-217A exceeds 150,000 hours.

Output voltages are available from 3.6 to 36VDC with $\pm 0.1\%$ regulation in a variety of types including fully adjustable units.

Input: 115VAC 47-440 Hz

Typical Outputs: 0 to 36V at .25A
5.0V at 2.5A
 $\pm 15.0V$ at .5A

The Powertec GR Series is currently available from stock. Detailed specifications and prices are available upon request.

CUSTOM POWER SYSTEMS

Powertec's experts are capable of solving your most difficult power conversion requirements.

POWERTEC DIVISION

9168 DeSoto Ave., Chatsworth, Calif. 91311
Phone (213) 882-0004



AIRTRONICS
INCORPORATED



Transitron Electronic Corp. 153
Larcom Randall Adv., Inc.
TRW Semiconductor, Inc. 185
Fuller & Smith & Ross, Inc.

United Aircraft Electronic Components 150
Cunningham & Walsh, Inc. Adv.
■ United Transformer Co., 2nd Cover
Div. of TRW, Inc.
Fuller & Smith & Ross, Inc.
■ Unitrode Corp. 51
Siltton Brothers, Inc.
U.S. Capacitor Corp. 16
J.R. Bloome Co.
U-Tech, A Division of Industrial
Physics and Electronics Co. 27
Ross Clay Advertising

Varian Assoc., Eimac Div. 128
Botsford, Constantine & McCarty, Inc.
■ Varo, Inc. 134
Tracy-Locke Co., Inc.
■ Victory Engineering Corp. 24
A.D. Adams Adv., Inc.

□ Watkins-Johnson Co. 29E
William C. Estler Public Relations
■ Weinschel Engineering Co. 154
E.G. White Adv., Inc.
Weston Instruments, Inc.,
Archbald Div. 176
Arndt, Preston, Chapin, Lamb & Keen, Inc.
■ Weston Instruments, Inc., Newark Div. 109
Arndt, Preston, Chapin, Lamb & Keen, Inc.
■ Williams Precious Metals, Div. of
Williams Gold Refining Co., Inc. 138
Stahlka, Faller & Klen, Inc.

Classified & Employment Advertising

F.J. Eberle, Manager
212-971-2557

EMPLOYMENT OPPORTUNITIES 172-175

Standard Oil of N.J. 175

EQUIPMENT

(Used or Surplus New)
For Sale

Fishman, Philip 175
Gadgets Surplus Electronics Inc. 175
Radio Research Instrument Co. 175

■ For more information on complete product
line see advertisement in the latest Elec-
tronics Buyer's Guide
□ Advertisers in Electronics International

Electronics Buyers' Guide

George F. Werner, General Manager
[212] 971-2310
Robert M. Denmead,
Midwest Regional Manager
[312] MO 4-5800
William A. Capuzzi,
New York, New England District Manager
[212] 971-3793
Regina Hera, Directory Manager
[212] 971-2544
Thomas M. Egan, Production Manager
[212] 971-3140

Circulation Department

Isaaca Siegel, Manager [212] 971-6057

Research Department

David Strassler, Manager [212] 971-6058

Advertising Sales Staff

Frank E. LeBeau [212] 971-6464
Advertising Sales Manager

Wallis Clarke [212] 971-2187
Assistant to sales manager

Donald J. Austermann [212] 971-3139
Promotion Manager

Warren H. Gardner [215] LO 8-6161
Eastern Advertising Sales Manager

Atlanta, Ga. 30309: Michael H. Miller, 1375
Peachtree St., N.E.
[404] 892-2868

Boston, Mass. 02116: William S. Hodgkinson
McGraw-Hill Building, Copley Square
[617] CO 2-1160

Cleveland, Ohio 44113: William J. Boyle, 55
Public Square. [216] SU 1-7000

New York, N.Y. 10036
500 Fifth Avenue
James R. Pierce [212] 971-3615
John A. Garland [212] 971-3617
Michael J. Stoller [212] 971-3616

Philadelphia, Pa. 19103:

Jeffrey M. Preston
Warren H. Gardner,
6 Penn Center Plaza,
[215] LO 8-6161

Pittsburgh, Pa. 15222: Warren H. Gardner,
4 Gateway Center, [412] 391-1314

Rochester, N.Y. 14534: William J. Boyle,
9 Greylock Ridge, Pittsford, N.Y.
[716] 586-5040

Donald R. Furth (312) MO 4-5800
Midwest Advertising Sales Manager

Chicago, Ill. 60611: Kenneth E. Nicklas
Ralph Hanning, 645 North Michigan Avenue,
[312] MO 4-5800

Dallas, Texas 75201: Richard P. Poole, 1800
Republic National Bank Tower,
[214] RI 7-9721

Houston, Texas 77002: Robert Wallin,
2270 Humble Bldg. [713] CA 4-8381

Detroit, Michigan 48226: Ralph Hanning,
856 Penobscot Building
[313] 962-1793

Minneapolis, Minn. 55402: 1104 Northstar
Center [612] 332-7425

St. Louis, Mo. 63105: Kenneth E. Nicklas,
The Clayton Tower, 7751 Carondelet Ave.
[314] PA 5-7285

James T. Hauptli [415] DO 2-4600
Western Advertising Sales Manager

Denver, Colo. 80202: Joseph C. Page, David
M. Watson, Tower Bldg., 1700 Broadway
[303] 255-5484

Los Angeles, Calif. 90017: Ian C. Hill,
John G. Zisch, 1125 W. 6th St.,
[213] HU 2-5450

Portland, Ore. 97204: James T. Hauptli,
Thomas McElhinny, 218 Mohawk Building,
222 S.W. Morrison Street,
Phone [503] 223-5118

San Francisco, Calif. 94111: James T. Hauptli,
Thomas McElhinny, 255 California Street,
[415] DO 2-4600

Pierre Braude Tel: 225 85 88: Paris

European Director

Paris: Denis Jacob
88-90 Avenue Des Champs-Elysees, Paris 8

United Kingdom and Scandinavia

London: Oliver Ball, Tel: Hyde Park 1451

34 Dover Street, London W1

Milan: Robert Saldel
1 via Baracchini Phone 86-90-656

Brussels: F.I.H. Huntjens

27 Rue Ducale Tel: 136503

Frankfurt/Main: Hans Haller

Elsa-Brandstroem Str. 2

Phone 72 01 81

Geneva: Denis Jacob

1, rue du Temple Phone: 31 95 60

Tokyo: Takeji Kinoshita, McGraw-Hill
Publications Overseas Corporation,
Kasumigaseki Building 2-5, 3-chome,
Kasumigaseki, Chiyoda-Ku, Tokyo, Japan
[581] 9811

Osaka: Akihiko Kamesaka, McGraw-Hill
Publications Overseas Corporation, Kondo
Bldg., 163, Umegee-cho Kita-ku [362] 8771

Business Department

Stephen R. Weiss, Production Manager

[212] 971-2044

Thomas M. Egan,
Assistant Production Manager [212] 971-3140

Dorothy Carmesin, Contracts and Billings

[212] 971-2908

Frances Vallone, Reader Service Manager

[212] 971-2865

TRW Microwave Transistors 10 Watt-1 GHz 20 Watt-1 GHz



6dB gain...50% efficiency...ultraceramic stripline

Two new microwave transistors have joined the TRW Gigahertz Family. Both the 10-watt 2N5595 and the 20-watt 2N5596 are in hermetically sealed ultraceramic stripline packages, offer excellent broadband capability, and operate from a 28 volt source. In class "C" common emitter operation, the 10

watt unit offers 6dB gain, and the 20 watt unit 5dB gain, with greater than 50% efficiency at 1 GHz.

Delivery is immediate...in production quantities. Order from the factory or any TRW distributor.

For complete information and applications assistance contact TRW Semiconductors, 14520 Aviation

Bld., Lawndale, California 90260.
Phone: (213) 679-4561. TWX: 910-325-6206. TRW Semiconductors Inc. is a subsidiary of TRW INC.

TRW®

Now, absolute measurement of low intensity light signals

with the EG&G Spectroradiometer System

EG&G's new series of high sensitivity detector heads allow use of the Model 580/585 Spectroradiometer System for absolute measurements of low intensity, pulsed or CW, light signals. These new detector heads, which incorporate photomultiplier tubes, complement the existing line of vacuum tube detector heads by providing approximately five decades of additional system sensitivity.

The Model 585-66 Detector Head encompasses a spectral range from 200-750 mu (ultraviolet-visible) and senses irradiant powers as low as 9×10^{-13} watts/cm²-mu and irradiant energies as low as 9×10^{-13} joules/cm²-mu at 450 mu.

The Model 585-63 Detector Head is now contained in a thermoelectrically cooled chamber (using EG&G thermoelectric modules) to minimize thermionic dark current and the resultant noise.

A separate controller unit assures constant chamber temperature. With a spectral range from 700-1200 mu (near infrared), the 585-63 detects irradiant powers as low as 5×10^{-12} watts/cm²-mu and irradiant energies as low as 5×10^{-12} joules/cm²-mu at 800 mu.

The new detector heads are provided with a regulated power supply and an internal calibration feature to ensure a stable sensitivity. Utilizing standards traceable to NBS, a complete 580/585 Spectroradiometer System is calibrated to its sensitivity versus wavelength thereby permitting absolute irradiant measurements of both continuous and pulsed (as fast as 1 ns) light sources.

Energy and average power measurements are obtained directly from the multi-decade meter of the Indicator Unit or from an external recorder. Provision is also made for output to an oscilloscope for pulsed sources.

Applications with the new high sensitivity detector head include measurements of phosphors, chemical reaction, electroluminescence, emissivity and reflectivity of surfaces, biochemical analysis, and other low level signals.

If you'd like more information on the EG&G Spectroradiometer System, or for that matter on any of our products, such as thyratrons, krytrons, spark gaps, flash tubes, thermoelectric modules, transformers, chokes, trigger modules, photodiodes, picoammeters, flash and strobe equipment, or light instrumentation, write: EG&G, Inc., 166 Brookline Ave., Boston, Massachusetts 02215. Tel: 617-267-9700. TWX: 617-262-9317. On west coast, telephone 213-464-2800.



NEW ACCESSORIES AVAILABLE INCLUDE A TELESCOPE AND FIBRE OPTIC PROBE

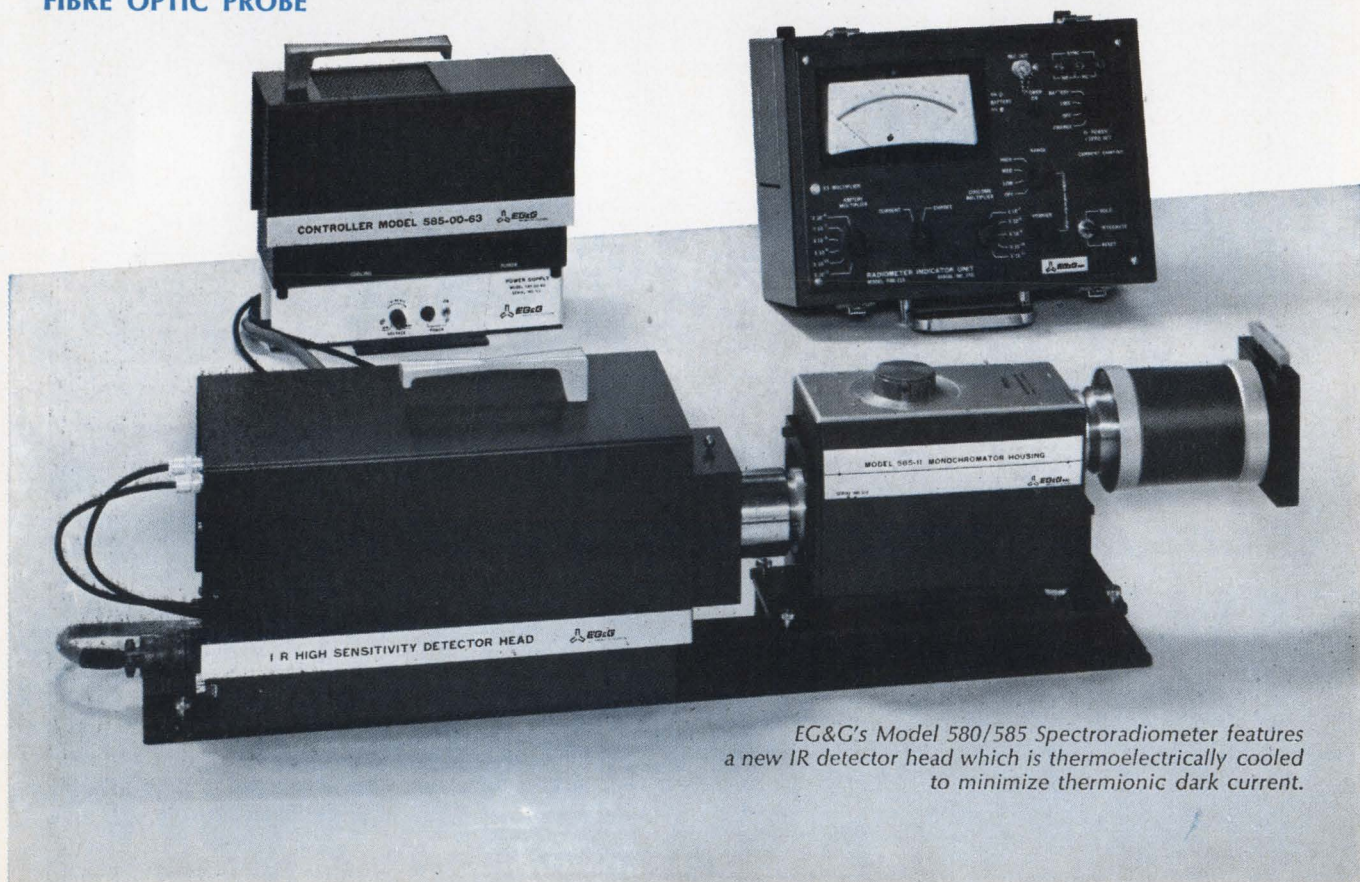

EG&G's Model 580/585 Spectroradiometer features a new IR detector head which is thermoelectrically cooled to minimize thermionic dark current.

Dale wirewounds can improve your memory.



The computer: General Electric's versatile GE/PAC[®] 4020 Process Control Computer... shown at left.

Resistor assignment: Establish line current values in the GE/PAC[®] 4020 core memory system.

The part used: Dale's Type NS...silicone coated, non-inductively wound.

Reason: Low inductance (less than 1 μ h) and unvarying stability (less than .5%/ 2000 hours).

Dale wirewounds give you unequalled design freedom in tailoring resistance, power, size and stability to your exact needs. Industrial.... precision.... established reliability.... standard or special....there's always a Dale resistor that can do the job better. Call 402-564-3131 for fast action, or circle 181 for Catalog A.

DALE

for optimum value in wirewound resistors

DALE ELECTRONICS, INC. 1300 28th Avenue, Columbus, Nebraska 68601

In Canada: Dale Electronics Canada, Ltd.

Printed in U.S.A.

Gard Testing is available to meet Established Reliability requirements at significant time/cost savings over typical 100 hr. burn in. Write for Test Report #19590.

These RCA Triacs will turn you on

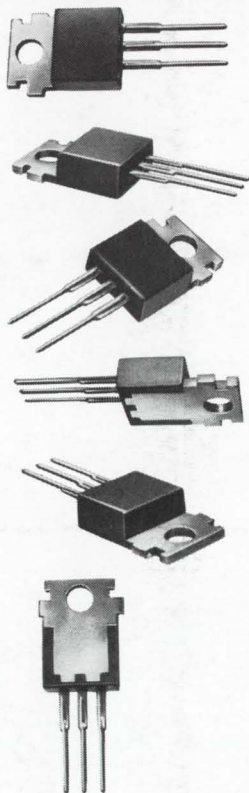

Choose New RCA 8 Amp Triacs for On-Off or Variable Phase Control of Power Into Resistive or Inductive Loads

Now's the time to think in terms of more than electro-mechanical controls and turn on with Triacs! Not just any triac—but the new RCA-40668 and RCA-40669.

Both feature the unique RCA hermetic chip in the popular, easy-to-mount RCA "plastic TO-66" package... and at prices that are just as popular.

Use the RCA-40668 for 120 V per 1-kW capability, the RCA-40669 for 240 V per 2 kW. With either, look what you get:

- Commutating dv/dt capability of 10 V per μs (typ.) permits operation into inductive loads.
- Critical rate of rise of off-state

voltage—300 V per μs (typ.) for 40668 and 250 V per μs (typ.) for 40669—minimizes false triggering caused by line transients.

- 100 A single-cycle in-rush current capability handles start-up surge loads readily.
- 8 A (RMS) capability at a case temperature of 80°C.
- 4 modes of gate control allow design flexibility and simplicity with either positive or negative DC logic.

For relay replacement, relay protection, motor speed controls and the like—in switching or phase control applications—for use in such devices as comfort control

systems, vending machines, appliances—turn to and turn on with RCA Triacs.

The RCA-40668 for 120 V per 1-kW operation is just 98¢ (1,000 units) and the RCA-40669 for 240 V per 2-kW capability is \$1.10 (1,000 units). See your local RCA Representative or your RCA Distributor for details. For technical data, write RCA Electronic Components, Commercial Engineering Section RN 3-4 Harrison, N. J. 07029.

RCA