

How MOS devices fail 106

Measuring rejection ratios more accurately 116

Computer aids ground-station design 120

June 23, 1969

Electronics®



**World's pcm
systems hit
language
barrier**

They're on our shelf



The "special" audio transformers you need
are "standard" at UTC.

When you're ready to specify transformers and inductors, before you turn to costly *specials*, check UTC. Chances are there's a *standard* unit that fits your special electrical and mechanical requirements exactly.

UTC has over 500 audio types in stock, ready for immediate delivery. And UTC engineers are constantly adding to the line. Microwatts to kilowatts. Less than $\frac{1}{4}$ Hz to greater than 1 MHz. MIL-T-27 or industrial. Metal-encased or open frame. Input, output, mixing, matching, modulating, phase shifting, hybrid,

baluns, ring modulator. All in continuous production for sample or high-volume requirements.

If the specific unit you need isn't on our shelf, we'll tailor a standard unit to your special requirements—saving the time and costs of starting from scratch. Check your local distributor for immediate off-the-shelf delivery. For catalog, write: United Transformer Company, Division of TRW INC., 150 Varick Street, New York, N.Y. 10013.

TRW
UNITED TRANSFORMER COMPANY

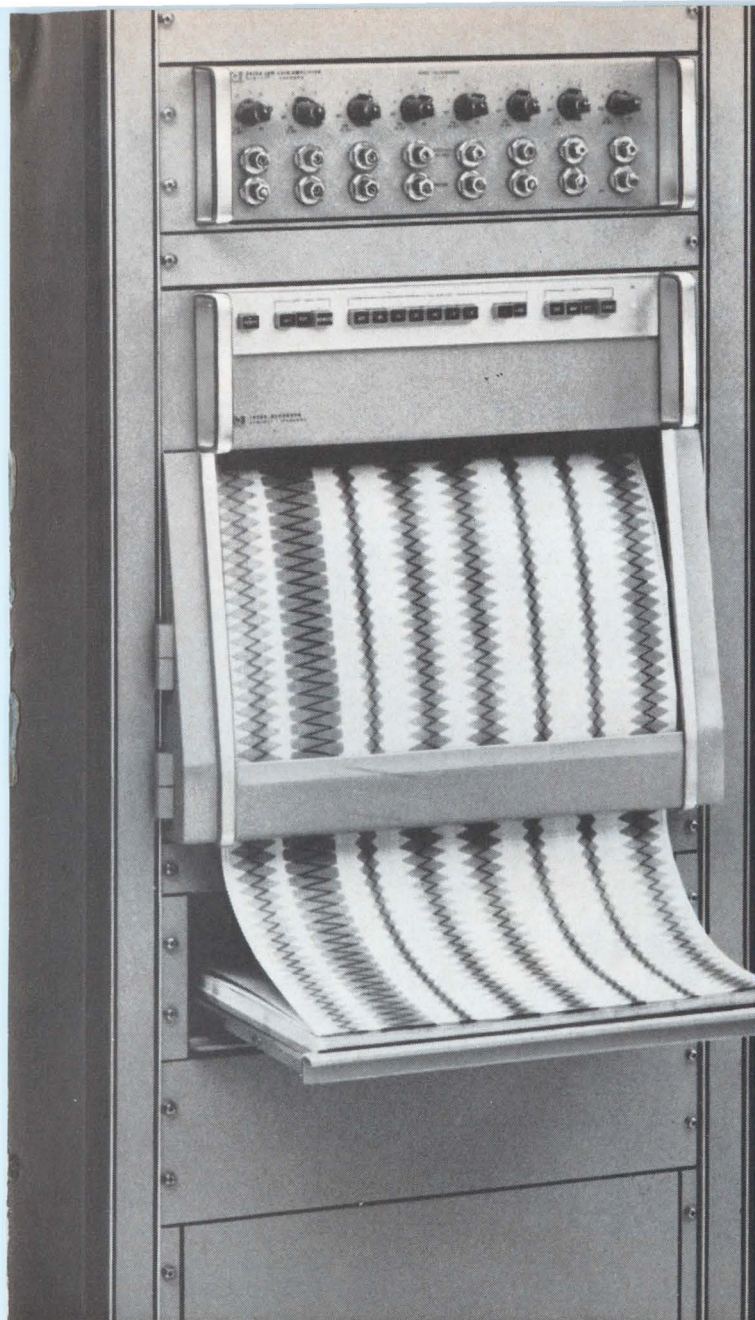

this... *

and this... **

and this, too... ***



Choice of precision signal conditioning in multi-channel units or single channel plug-ins.

Fourteen electrically controlled chart speeds

Internal 1 Sec. and 1 Min. timers and marker

Front access to secondary calibration adjustments.

Remote control for paper drive, chart speeds, and marker



Modular construction of electronic and mechanical sub-assemblies for easy on-line servicing in the rack

Individual galvanometer on each channel

Rugged, laminated pen with tungsten carbide tip

Core magnet galvanometers assure no inter-channel interaction

Low-paper interlock shuts off chart drive

Contactless capacitive pickup near pen tip for accurate feedback

Modulated low-pressure ink system assures constant trace width

Disposable ink cartridge can be changed with recorder running



Roll or Z-fold chart paper without expensive options . . . you can change from one to the other quickly and easily

True rectilinear recording
Thin-line, high quality trace



Plus . . . instant data retrieval on Z-fold paper. For help with your recording problems call your HP field engineer or write for full information on HP 7800 series recording systems. Hewlett-Packard, Waltham, Mass. 02154; Europe: 1217 Meyrin-Geneva, Switzerland.

What more could you ask for?

HEWLETT  PACKARD
RECORDING SYSTEMS

Customize this HP Function Generator to fit your Measurements

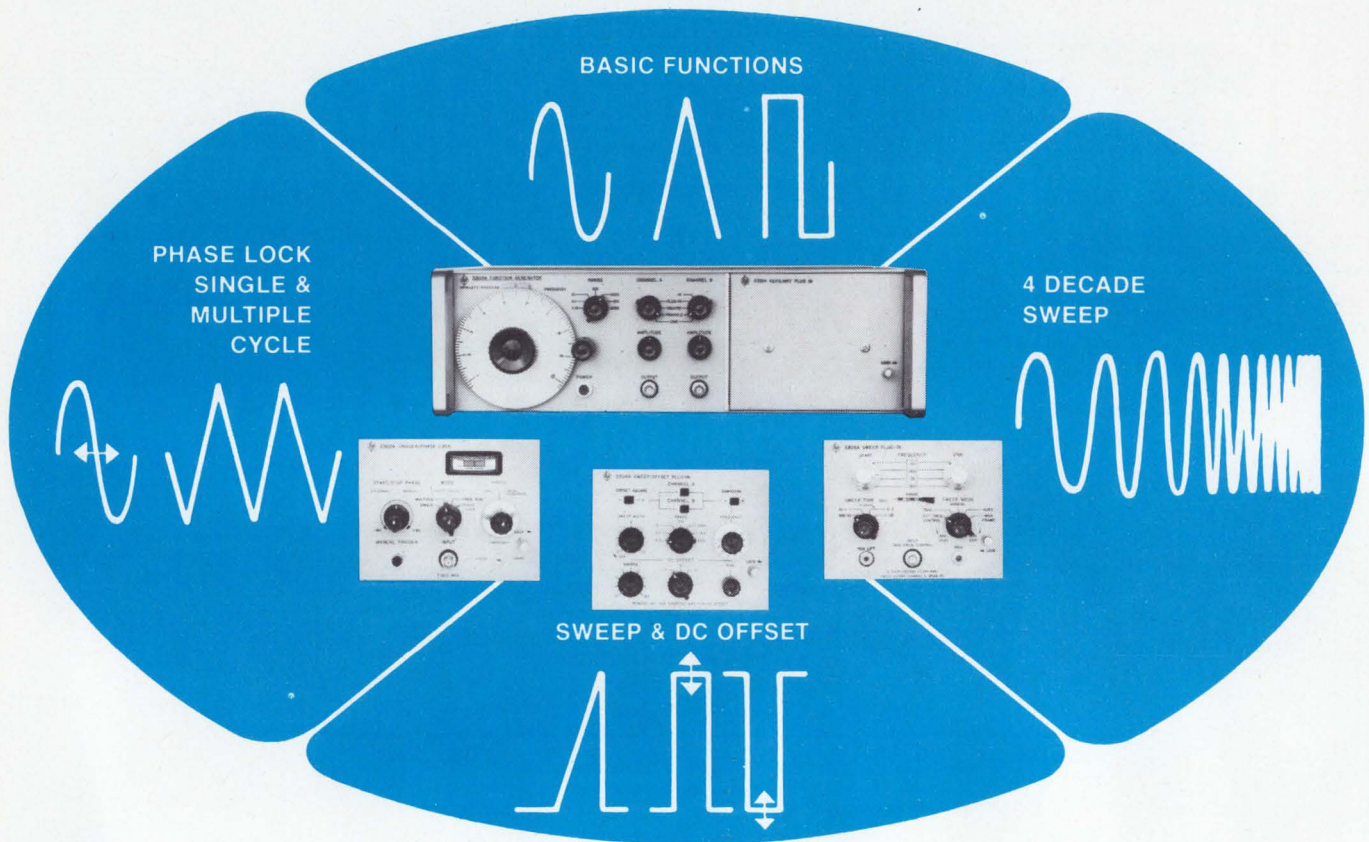

Start with the basic ability of the HP 3300A Function Generator—add the capability of its plug-ins—and you get a function generator that fits your specific needs. It's equally at home performing ordinary day-to-day lab tests or providing a sweeping signal that can be used to measure the impedance of an ape's brain. No matter what the task, you get the reliability and accuracy you need to get the job done.

The HP 3300A Function Generator gives two simultaneous outputs (sine, square or triangle) across a frequency range of 0.01 Hz to 100 kHz. Mix or match your output signals with individually selectable function and amplitude controls. Price, \$650; HP 3301A Auxiliary plug-in, \$30.

The HP 3302A Trigger / Phase-Lock plug-in lets you phase-lock any two functions to an external periodic signal. Phase can be controlled over a 360° range. Control single or mul-

iple bursts with an external signal or the front panel manual trigger. Price, \$225.

The HP 3304A Sweep/Offset plug-in provides a linear sweep adjustable in frequency and width within any decade over the entire frequency range. Variable dc offset of ± 16 Vdc is provided for each function including the internally generated sawtooth—makes hard-to-get driving functions readily available. Price, \$265.

The HP 3305A Sweep plug-in lets you sweep up to four decades without switching ranges. It sweeps logarithmically in any of three overlapping ranges for narrow or wide band testing between adjustable start/stop limits. Use the manual sweep for close inspection of any portion of the trace or for accurate frequency identification.

The 3305A's continuously adjustable sweep time of 0.01 to 100 seconds is slow enough for accurate

response testing of high-Q devices and fast enough for good visual displays of wide band response. For ease of automated testing, either the frequency or the sweep trigger can be externally controlled. Price, \$975.

Get the function generator that best fits your measurements. Consult your catalog and order by calling your nearest HP order desk. For data sheets, write to Hewlett-Packard, Palo Alto, California 94304. Europe: 1217 Meyrin-Geneva, Switzerland.

099/15

HEWLETT  PACKARD
S I G N A L S O U R C E S

News Features

Probing the News

- 141 **Computers:** Viatron—vibrant and probably viable
149 **Space electronics:** National space station puts electronics to the test

U.S. Reports

- 45 **Manufacturing:** Device to check wafers for pinhole leaks
46 **Advanced technology:** Hush-hush laser system for military photo transmission goes civilian
46 **Avionics:** Hologram in the cockpit
47 **Avionics:** Cains contract could mean big follow-up business
48 **Manufacturing:** Keeping smog out of IC's
48 **Government:** U.S. changes Comsat's Intelsat role
50 **Government:** Cancellation of manned orbiting lab program wrapped in politics
52 **Consumer electronics:** RCA and Zenith color tubes bear striking resemblance
52 **Communications:** Navy's Sanguine project runs into trouble
54 **Contracts:** Viking hardware
57 **Space electronics:** Measuring the moon's distance from the earth
57 **Instrumentation:** Navy study of mean time between failures

Electronics International

- 215 **Western Europe:** Long-lived nuclear battery for pacemaker
215 **Japan:** New approach to wiperless pot; direct drive turntable makes a comeback; protecting MOS gates with integrated diodes
217 **Belgium:** Now it's aluminum beam leads to ease bonding problems
217 **Australia:** Flying doctors finally convert network to single sideband
218 **Great Britain:** Semiautomatic hybrid bonder for small quantities

New Products

- 165 **In the spotlight**
165 Rms measuring time is cut to 300 msec
169 **Components review**
169 Coupler provides high isolation
173 Dissipator/clip keeps IC's cool
175 **Instruments review**
175 Gamma monitor covers 9 decades
178 Fluidics tests shown on scope
183 **Subassemblies review**
183 Power modules operate at 100° C
186 Transmitters for control signals
189 **Microwave review**
189 Gunn oscillators sweep X band
193 **Semiconductor review**
193 128-bit MOS read-write memory

Technical Articles

- Communications** 94 **PCM: A global scramble for systems compatibility** (cover)
Nation-to-nation differences in such characteristics as line rates and coding could decrease the effectiveness of interconnected systems; but the imminence of pcm satellites is impelling all parties to try and thrash out differences
William Bucci, Associate editor
- Circuit design** 103 **Designer's casebook**
▪ Pair of source followers keep a voltmeter steady
▪ Minimizing common-mode errors in a variable-gain amplifier
▪ SCR shift register can take a lot of noise
- Integrated electronics** 106 **How reliable are MOS IC's? As good as bipolars, says NASA**
Although failure mechanisms differ for MOS because oxide is a functional part of the device, tests indicate failure rates running at 0.016% per 1,000 hours
Leon C. Hamiter Jr., National Aeronautics and Space Administration
- Instrumentation** 116 **Common-mode rejection ratio: what the spec sheet doesn't say**
Some critical assumptions, which aren't always true, lurk behind the test circuits recommended by amplifier makers
Frederick Gans, IC Metrics Inc.
- Systems engineering** 120 **Computer simulation plays key role in design of satellite earth stations**
Systems approach offers solution to complex politico-technical interface problems in ground terminals of global communications network
Lee B. Zahalka, GT&E International Systems Corp.

Departments

- | | | | |
|----|--------------------------|-----|--------------------------|
| 4 | Readers Comment | 69 | Washington Newsletter |
| 8 | Who's Who in electronics | 197 | New Books |
| 22 | Meetings | 201 | Technical Abstracts |
| 31 | Editorial Comment | 206 | New Literature |
| 33 | Electronics Newsletter | 213 | International Newsletter |

Electronics

Editor-in-Chief: Donald Christiansen

Senior staff editors

Technical: Stephen E. Scrupski
News: Robert Henkel
International: Arthur Erikson

Managing editor: Harry R. Karp
Art director: Gerald Ferguson

Senior associate editor: Joseph Mittleman
Assistant managing editors: Eric Aiken, H. Thomas Maguire, Howard Wolff
Senior copy editor: Frederick Corey Senior staff writer: John Johnsrud

Department editors

Advanced technology: William Bucci, Richard Gundlach
Communications: John Drummond, Raphael Kestenbaum
Computers: Wallace B. Riley, George Weiss
Design theory: Joseph Mittleman
Instrumentation: Owen Doyle, Walter Barney
Military/Aerospace: Alfred Rosenblatt; Paul Dickson (Aerospace)
New products: William P. O'Brien
Solid state: George Watson, Stephen Wm. Fields

Domestic bureaus

Boston: James Brinton, manager; Gail Farrell
Los Angeles: Lawrence Curran, manager; Ralph Selph
San Francisco: Walter Barney, manager
Washington: Ray Connolly, manager; Paul Dickson, Lois Vermillion

Foreign bureaus

Bonn: John Gosch
London: Michael Payne
Tokyo: Charles Cohen

Copy editor: Edward Flinn
Staff writer: Peter Schuyten

Assistant art director: Charles Ciatto
Production editors: Susan Hurlburt, Arthur C. Miller

Editorial research: Virginia Mundt

Editorial secretaries: Lorraine Longo, Claire Goodlin, Barbara Razulis, Vickie Green, Bernice Pawlak, Patricia Bispham

McGraw-Hill News Service

Director: Arthur L. Moore; Atlanta: Fran Ridgway; Chicago: Robert E. Lee
Cleveland: Arthur Zimmerman; Dallas: Marvin Reid
Detroit: James Wargo; Houston: Barbara LaRoux
Los Angeles: Michael Murphy; Pittsburgh: Louis Gomolak
San Francisco: Margaret Drossel
Seattle: Ray Bloomberg; Washington: Charles Gardner, Daniel B. Moskowitz, Herbert W. Cheshire, Seth Payne, Warren Burkett, William Small, William D. Hickman

McGraw-Hill World News Service

Bonn: Robert Dorang; Brussels: James Smith; Hong Kong: Kate Mattock
London: John Shinn; Mexico City: Gerald Parkinson; Milan: Ronald Taggiasco; Jack Star;
Moscow: Jack Winkler; Paris: Robert E. Farrell, Stewart Toy
Rio de Janeiro: Leslie Warren; Tokyo: Marvin Petal

Reprints: Gail Niles
Circulation: Isaaca Siegel

Publisher: Gordon Jones

Assistant to the publisher: Wallace C. Carmichael

Electronics: June 23, 1969, Vol. 42, No. 13

Published every other Monday by McGraw-Hill, Inc. Founder: James H. McGraw 1860-1948.
Publication office 99 North Broadway, Albany, N. Y. 12202; second class postage paid at Albany, N. Y.

Executive, editorial, circulation and advertising addresses: McGraw-Hill Building, 330 W. 42nd Street, New York, N. Y. 10036. Telephone (212) 971-3333. Teletype TWX, N.Y. 710-581-4235. Cable address: MCGRAWHILL N.Y.

Subscriptions solicited only from those professionally engaged in electronics technology. Subscription rates: qualified subscribers in the United States and possessions and Canada, \$8.00 one year, \$12.00 two years, \$16.00 three years; all other countries \$25.00 one year. Non-qualified subscribers in the U.S. and possessions and Canada, \$25.00 one year; all other countries \$50.00. Air freight service to Japan \$50.00 one year. Single copies: United States and possessions and Canada, \$1.00; all other countries, \$1.75.

Officers of McGraw-Hill Publications Company: Joseph Allen, President; John R. Emery, J. Elton Tuohig, Senior Vice Presidents; Gordon L. Jones, Jr., Group Vice President; Vice Presidents: John R. Callahan, Editorial; Paul F. Cowie, Circulation; John M. Holden, Marketing; David G. Jensen, Manufacturing; Jerome D. Luntz, Planning & Development; Robert F. Marshall, Administration; Robert M. Wilhelmy, Finance.

Officers of the Corporation: Shelton Fisher, President and Chief Executive Officer; John L. McGraw, Chairman; Robert E. Slaughter, Executive Vice President; Daniel F. Crowley, Donald C. McGraw, Jr., Bayard E. Sawyer, Senior Vice Presidents; John J. Cooke, Vice President & Secretary; Gordon W. McKinley, Vice President & Treasurer.

Title © registered in U.S. Patent Office; © Copyright 1969 by McGraw-Hill, Inc. All rights reserved. The contents of this publication may not be reproduced either in whole or in part without the consent of copyright owner.

Subscribers: The publisher, upon written request to our New York office from any subscriber, agrees to refund that part of the subscription price applying to copies not yet mailed. Please send change of address notices or complaints to Fulfillment Manager; subscription orders to Circulation Manager, Electronics at address below. Change of address notices should provide old as well as new address, including postal zip code number. If possible, attach address label from recent issue. Allow one month for change to become effective.

Postmaster: Please send form 3579 to Fulfillment Manager, Electronics, P.O. Box 430, Hightstown, New Jersey 08520

Readers Comment

Hooray for pay tv

To the Editor:

I read with considerable interest your article concerning Zenith Phonevision [May 26, p. 123]. While the article as a whole was substantially correct, I feel obligated to take issue with one point.

On page 124 you state: "Eavesdropping . . . is prevented by varying the video coding. . . ." And further, on page 128: "Finally, Zenith's decoders were proved effective, with no known instances of encoded signals being unscrambled by privately built equipment." It is my belief that there were four groups of electrical engineers near Hartford who were trying to build their own decoder. Two companies represented were Hamilton Standard, and Pratt and Whitney Aircraft. Two of the four groups succeeded in decoding the audio, with varying degrees of audio quality.

In January, I successfully operated a "privately-built" decoder for both audio and video. While results were not perfect—due to some video smear and an incorrect component—it was viewable.

I decided to build a decoder as a senior project. However, I was told by the head of the electrical engineering department that it was not acceptable since "There was nothing to it, since all that was necessary to do was to hook a bunch of parts together."

In any event, my hat is off to the people who developed the Phonevision system. A lot of thought and hard work went into the system, and I wish them well with it—as I feel that it is about the last hope for relief from the garbage that is put out on commercial television. Perhaps some competition will improve network programming.

I noted that in your article you were careful to divulge no exact technical data. I feel much the same way, since it would hardly be fair to tell all while the system is in commercial use. There is some effort involved in building your own unit, however. My decoder, while largely composed of integrated circuits, would, if built discretely, involve somewhat in excess

All the advantages of tantalum...at low cost!

Type 196D Dipped Solid-Electrolyte Tantalex[®] Capacitors

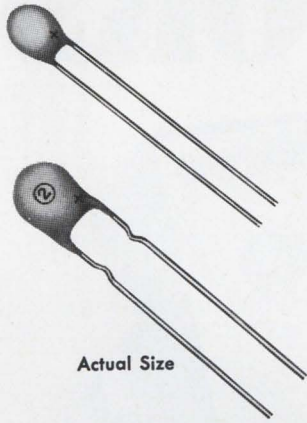

Actual Size

INFORMATION RETRIEVAL NO. 510

Here's a capacitor design that admirably fills the need for low-cost yet dependable solid tantalum capacitors suitable for printed wiring boards. Straight leads as well as crimped leads are readily available to meet your manufacturing needs.

Covering a broad range of capacitance values from .1 μ F to 330 μ F, with voltage ratings from 4 to 50 VDC, Type 196D Capacitors are protected by a tough insulating coating which is highly resistant to moisture and mechanical damage.

45C-9124

Tiny in size...Giants in volume efficiency!

Type 160D, 161D Solid-Electrolyte Tantalex[®] Capacitors for hearing aids and ultra-miniature circuits

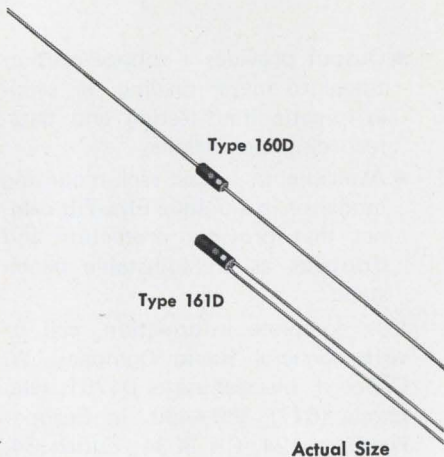

Type 160D

Type 161D

Actual Size

INFORMATION RETRIEVAL NO. 511

Tiny Type 160D/161D Tantalex Capacitors are sealed within a polyester film tube with tightly-bonded epoxy fill, so the assembly is both electrically insulated and highly resistant to moisture. They are available with axial leads as well as in single-ended construction.

Offering extremely high capacitance per unit volume (for example: 0.25 μ F @ 20 VDC in a case only .065" D. x .125" L.), Tantalex Hearing-aid Capacitors let you select from a broad range of ratings in five different case sizes.

45C-9125

For complete technical data on Type 196D Capacitors, request Engineering Bulletin 3545A. For the full story on Type 160D/161D Capacitors, write for Engineering Bulletin 3515D. Address Technical Literature Service, Sprague Electric Co., 35 Marshall St., North Adams, Mass. 01247.



Sprague' and '®' are registered trademarks of the Sprague Electric Co.

THE BROAD-LINE PRODUCER OF ELECTRONIC PARTS

THE INVESTIGATORS



1863



1864

FOR TRACKING DOWN INSULATION LEAKS

The 1863 for production and inspection testing of insulation

This versatile new "leak detective" is a high-performance megohmmeter priced at only \$385*. Five test voltages (50, 100, 200, 250, and 500 V) cover the range specified by most MIL and EIA Standards for testing the insulation resistance of mica-, glass-, paper-, ceramic-, and plastic-dielectric capacitors. The 1863 is equally suitable for insulation-resistance investigations on cables and electrical machinery; its 50-k Ω to 20-T Ω total resistance range covers most insulation specifications.

The 1864 for R and D applications

Another hundred dollars give you an even more versatile investigator, the Type 1864 Megohmmeter. It has an additional resistance range and 200 test voltages from 10 to 1000 V (1-volt steps from 10 to 109; 10-volt steps from 110 to 1000 V). The 1864

is an excellent instrument for low-voltage leakage (resistance or current) investigations of diodes, transistors, and aluminum and tantalum electrolytics. Its resistance range is from 50 k Ω to 200 T Ω . Price: \$485*.

Both have these features:

- They are direct reading.
- Basic accuracy is $\pm 3\%$ at low end of range.
- Correct meter multiplier is automatically indicated for each range.
- Super-stable meter circuitry eliminates need for meter calibration (CHECK) adjustments.
- No warmup drift.
- Safe, 5-mA, current-limited test voltage sources.
- Warning light indicates whenever potential exists across instrument terminals.
- Strap-connected guard and ground terminals permit either grounded or ungrounded measurements.
- Output provides a voltage proportional to meter reading for semi-automatic limit-testing and data-recording applications.
- Available in either rack-mounting model or in a unique Flip-Tilt cabinet that provides protection and doubles as an adjustable bench stand.

For complete information, call or write General Radio Company, W. Concord, Massachusetts 01781; telephone (617) 369-4400. In Europe: Postfach 124, CH 8034, Zurich 34, Switzerland.

*Prices apply only in the U. S. A.

GENERAL RADIO 

Readers Comment

of 218 transistors. Of course, this is not the most efficient design by any means, but it gives some feel for the circuitry involved. Needless to say, it's not a weekend project.

Henry J. Laguillon
Southampton, Mass.

Always helpful

To the Editor:

I would like to call your attention to the article "Rotating disks and drums set peripheral memories spinning" by Michael French [May 26, p. 96]. In it, I am quoted [p. 97]; while the quote is accurate, the company division referred to is wrong. We are the Magne-Head rather than the Magnefile division of the General Instrument Corp. Magnefile is a competitor of ours.

Richard J. Martin

Director of Marketing
Magne-Head division
General Instrument Corp.
Hawthorne, Calif.

Two sorts of ZIP

To the Editor:

Thank you for the notice given to the Post Office's Symposium on Pattern Recognition [May 12, p. 34]. We wish to take exception, however, to certain connotations inherent in this article.

Many readers would assume that the Philco-Ford reader, discussed at the symposium, was for machine imprinted ZIP Codes and not for uncontrolled handwritten ZIP Codes. Philco-Ford's numeric script reader is a research project and is entirely different from the 10 alphanumeric operational optical character readers now in the field.

The performance figures quoted, 45% to 47%, are correct for the numeric script reader. Our OCR's, however, maintain an average acceptance rate on the order of 75%.

Edward M. Reilley

Director
Research and development
Post Office Dept.
Washington, D.C.

HF Efficiency Experts

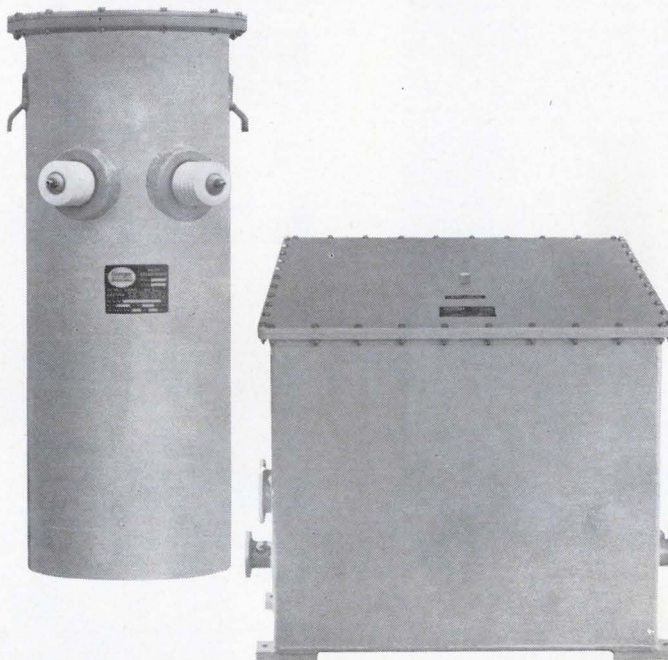

Granger multicouplers let one antenna serve two or even four HF transmitters simultaneously without interference or interaction. Each transmitter functions as if it were the only one in the circuit.

Efficient... save on antennas and ground space.

Granger balun transformers provide the most efficient way to transfer power from transmitter to antenna. *Efficient*... use economical 600 ohm lines on the long runs from transmitter to antenna and still get the 50 ohm coax connections where you need them.

Let G/A baluns and multicouplers help make you an efficiency expert in designing new HF systems... or improving older installations. Write for complete data.



GRANGER
ANTENNA AND TRANSMISSION
DIVISION

1601 California Avenue, Palo Alto, California 94304
Granger Corner, 1 Brooklands Road, Weybridge, Surrey, England
1-3 Dale Street, Brookvale, NSW, Australia



Zahalka

Well-traveled is the word for Lee B. Zahalka, who wrote the article on computer simulation's important role in ground station design that starts on page 126. A Johns Hopkins graduate, he has accumulated over 20 years experience in military, commercial, and aerospace systems work which has taken him as far afield as India, Spain, Italy, Australia, Thailand, Mexico, and a host of other countries.

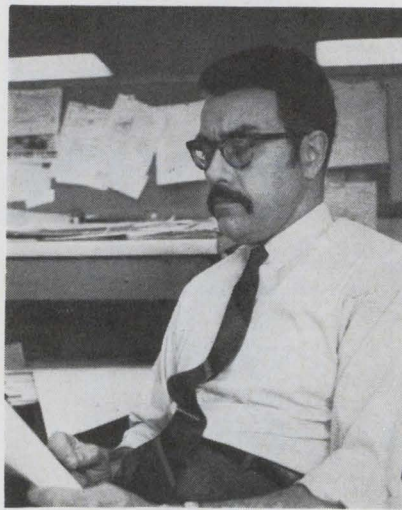

Bucci

Advanced technology is associate editor Bill Bucci's beat; the latest result of his coverage, a cover story on pulse-code modulation's growing pains, begins on page 94. A 1954 graduate of Columbia University, Bill has worked at Stevens Institute of Technology and the Bell Telephone Laboratories as a technical press relations specialist; he was an assistant editor at the Bell Labs Record, where he wrote about laser pcm, high-capacity coaxial pcm, and related subjects before joining *Electronics*.



Gans

Vice presidencies are a typical dream for many engineering students. Frederick Gans, author of the piece on common-mode rejection ratios (page 116), has made it, but is still hitting the books in pursuit of a master's degree in electrical engineering at the Polytechnic Institute of Brooklyn. Currently vice president for product development at the IC Metrics Corp., Gans earned his B.S. at Columbia University in 1966. Before joining IC Metrics last summer, Gans worked at Grumman's Microelectronics Laboratory where he helped to write a proposal for standardizing linear IC definitions used as a basis for MIL STD 883.

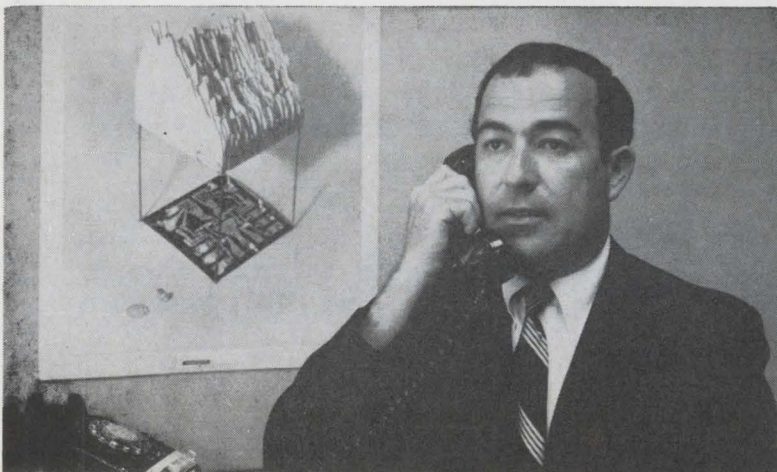

Hamiter

Reliability has been the professional preoccupation of Leon C. Hamiter Jr. during his National Aeronautics and Space Administration career. Currently chief of the parts and microelectronics branch at the Marshall Spaceflight Center's quality and reliability assurance lab, he wrote the article on metal oxide semiconductor reliability (page 106). Jay Farley, manager of reliability and quality assurance at American Micro-systems, and Don Drum, manager of reliability and quality assurance at General Instruments' Microelectronics division, contributed to both the NASA project and the article.

Sharpen your circuit ingenuity

Work with RCA's Linear IC
"Building Block" Sampler

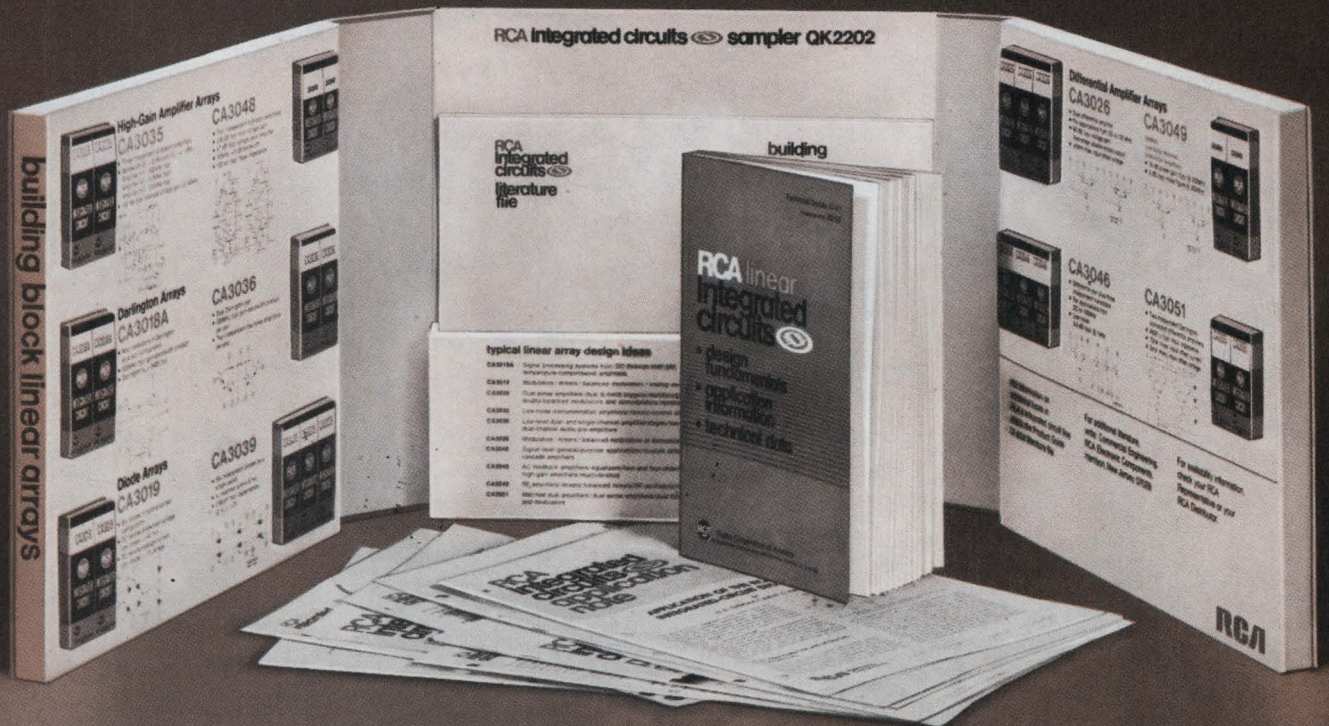

There's no better way to meet today's new circuit design challenges than with RCA's "building block" linear IC's. Evaluate them now for RF, IF, AF and DC amplifiers; sense amplifiers; multi-function circuits; Schmitt triggers; balanced multi-channel circuits and many others. Work with the RCA QK2202 Linear Array Sampler—a box full of linear integrated circuit "building blocks."

There are 10 types (23 devices in all) of virtually unlimited flexibility. You get high-gain amplifiers; differential amplifiers; Darlington and multi-transistor arrays, and diode arrays. You get wide design capabilities—from DC to 500 MHz. Of course, you get thorough documentation—technical and applications data—Linear IC Manual—mounting and connection techniques information—and a copy of ST-3895,

"Design Ideas for RCA Linear Arrays." In short, you get all you need to build your skills with RCA's dependable linear array "building blocks." Your RCA Distributor has RCA QK2202 Linear Array Sampler kits at \$37.95 (optional distributor resale price). Get yours—and get started—now. RCA Electronic Components, Harrison, N.J. 07029

Now...from
 G-R
 Industries
 ...a totally
 new breed
 of
 system
 control
 computer

gri-909

DIRECT FUNCTION PROCESSOR

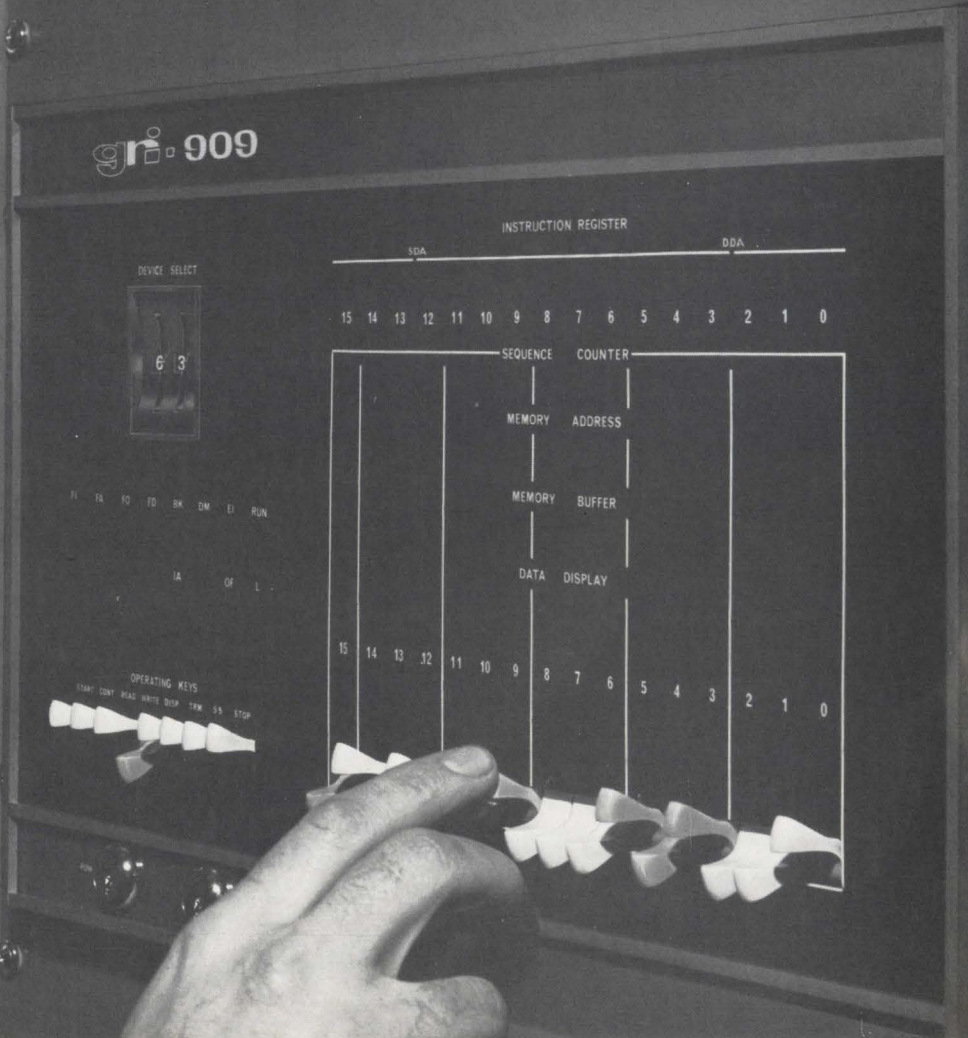
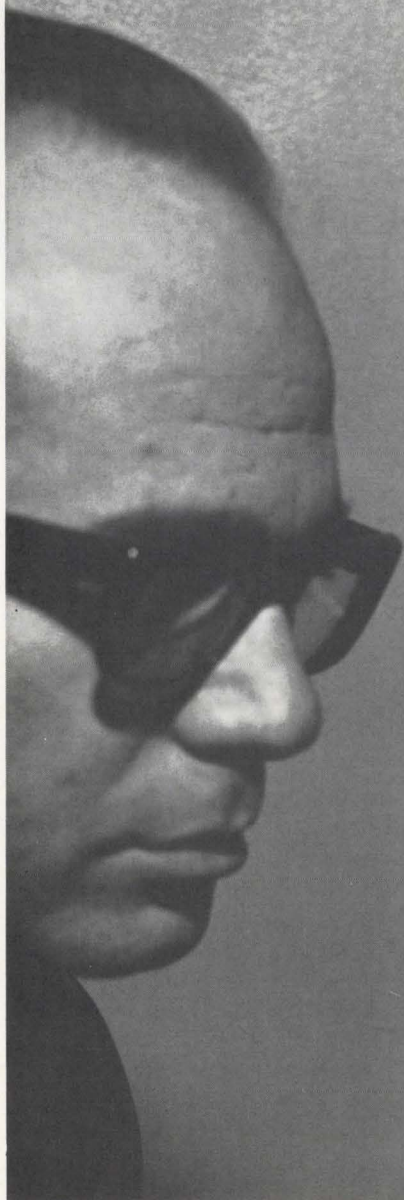

You have never seen a computer like this before

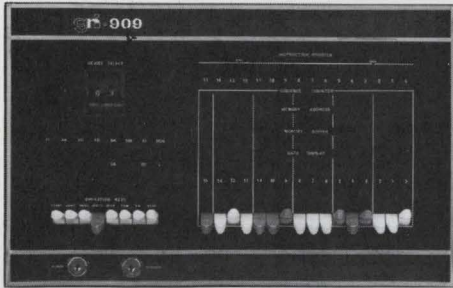

The GRI 909 is the first truly innovative approach to computer architecture since the general-purpose computer was first applied as a control device. It goes beyond traditional design to provide a new level of power and flexibility. A true system controller, it provides the only logical answer to many of the basic problems that face system designers . . . problems like these:

PROBLEM #1

The Real World Interface

In spite of claims to the contrary, the typical small computer is designed primarily as a calculating device, not as a controller. The system designer, after describing his system functionally, must either transcribe his design into the non-functional language of the computer with all its expressed and implied constraints, or turn over the programming responsibility to a specialist whose background usually is not related to the system application. Result: substantial expense, long delays and occasionally, built-in software limitations.

No problem with

The GRI 909, designed as a system controller, is organized functionally. ALL data registers, whether associated with the processor, firmware options or input/output devices, are equally accessible to the system designer. ALL data registers may be incremented, shifted or algebraically tested: the traditional arithmetic operator, with its associated registers, is optional. The GRI 909 programming language is tailored to the functional organization of the processor itself. Input/output devices are operated with

the same basic language code. The system designer can both design a system and implement its application in this functional language.

PROBLEM #2

The Data Flow Maze

Conventional computer architecture is designed around an instruction repertoire, with maximum computing power as the major criterion. The input/output instructions are a secondary consideration and instruction power is limited. The flow of data in and out is impeded by the "implied" operations of the instructions. Free communication between internal computer elements and external devices is not possible.

No problem with

Here the problem is solved by extending the I/O bus system into the heart of the central processing unit itself. Data is free to flow directly between devices external to the computer and the arithmetic unit, memory, or any of the internal registers without stopping along the way in special accumulators. This free direct flow cuts down on time consumed in moving data about, and reduces or eliminates the need for temporary storage. A unique advantage is GRI 909's ability to perform certain simple operations — increment, complement, shift left or right — on the fly.

PROBLEM #3

The Black Box Hang-Up

Once a computer is selected the system designer is locked into a pre-established set of capabilities. The CPU is essentially a black box, and there is little that can be done to alter its basic structure. If the system requirements change to include say a "hardware multiply", or "hardware square root", or "hardware byte swap", or "hardware anything", the only alternative is to go to a bigger, more expensive computer possibly requiring a complete new interface design with all new software.

No problem with

The GRI 909 has provision for the addition of firmware options. And by

firmware we mean, not merely the substitution of read-only memory for software, but a broad range of hard-wired plug-in functions which can replace a variety of software routines. This gives the system designer complete freedom to adapt the computer to changing system needs, and to evaluate trade-offs between speed and economy in individual cases.

Basic characteristics

The GRI 909 cannot be fully evaluated in conventional computer terms. But for those who like to play the numbers game, the following characteristics are listed:

- Full Cycle Time: 1.76 μ sec for a 16-bit word
- Memory Reference Instruction: 32K directly addressable — not page oriented.
- Memory Addressing Modes:
 - A. Direct Mode: Single Address Instruction, 32 bits (16 bit op. code, 16 bits address)
 - B. Immediate Mode: 32 bits (16 bits op. code, 16 bits data)
 - C. Deferred Address Mode: One level of indirect addressing with 32K of auto-indexable locations
- Every device in the system, both inside and outside the computer, is directly addressable by programmed instructions.
- Direct memory access channel is available on the same data and control lines as the programmed input/output channel (I/O rate: 1.76 μ s/word). No DMA multiplexer is required for multiple DMA devices.
- Priority interrupt system has full capability to be used as a single channel interrupt or as a full hardware interrupt at the option of the system designer.

The GRI 909 with 4K 16-bit words of memory and ASR33 Teletype sells for under \$10,000. Basic units start at \$3600.

August deliveries will include: basic assemblers which can be assembled in the GRI 909 or the IBM 360, programming aids, math routines and utility routines.

Let us tell you more — Because GRI 909 is a completely new breed of computer, it is impossible, here, to cover its many unique features and their implications for the system designer. If you build control or instrumentation systems let us tell you what GRI 909 can do for you. For a copy of our new brochure write to:

G-R INDUSTRIES, INC.



76 Rowe Street,
Newton, Mass. 02166
(617) 969-7346

**We put
a lot of
stock in**

883.

		1-24	25-99	100-999
LM 101-883	general purpose op amps	\$28.50	\$23.00	\$19.00
LM 101A-883	high performance op amps	51.00	41.00	34.00
LM 102-883	voltage follower op amps	28.50	23.00	19.00
LM 104-883	negative voltage regulators	36.00	29.00	24.00
LM 105-883	positive voltage regulators	28.50	23.00	19.00
LM 106-883	voltage comparators/buffers	33.00	26.60	22.00
LM 107-883	high performance compensated op amps	56.00	45.00	37.00
LM 709-883	general purpose op amps	10.35	8.65	7.40

PARTS NOW. Off the shelf. All Mil-Std-883 Linear ICs, straight from National's special 883 production and testing lines.
GET THE WHOLE STORY. Send for National's 883 Linear Software Package. A big, thick compilation of Mil-Std-883 literature. Includes detailed brochure on National's 883 program, specific specs on linear parts, full data sheets and price lists, plus complete 883 software—all the specs already written.

National/883

National Semiconductor Corporation
 2975 San Ysidro Way
 Santa Clara, California 95051

Please rush the big, thick, complete "883 Software Package" to

Name _____
 Company _____
 Address _____
 City _____ Zip _____

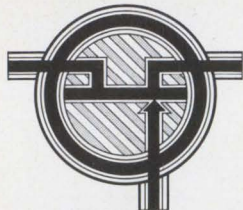

FETS IN TUNABLE FILTERS

Problem: To design a low cost, light-weight voltage tunable filter.

Solution: Use FETs as Voltage-Controlled Resistors (VCRs). Here is one approach:

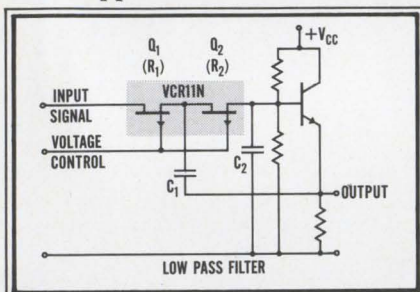

With this circuit you can have a tuning range up to 20:1 with a roll-off of 12 dB/octave. Weight is in the ounce-plus region and size is about 1½ cubic inches. Here are the design conditions and equations:

$$R_{in} > 10X_{c2}$$

$$R_o < 0.1X_{c1}$$

$$R = R_1 + R_2$$

$$M^2 = C_1/C_2$$

$$r_{ds} = \text{FET drain-source resistance,}$$

$$= \frac{r'_{ds}}{1 - V_{GS}/V_P}$$

$$r'_{ds} = r_{ds} \text{ with } V_{GS} = 0.$$

$$\omega_n = \text{Corner frequency,}$$

$$= \frac{1 - V_{GS}/V_P}{r'_{ds} MC_2}$$

* If you need a voltage tunable filter, and cost, size, weight and low power consumption are important considerations, give us a call for fast applications assistance. That's applications power: Products and service! Ask for Extension 19.

Siliconix
Incorporated

1140 W. Evelyn Ave. • Sunnyvale, CA 94086
Phone (408) 245-1000 • TWX: 910-339-9216

Who's Who in electronics



Lowell

His business card reads, "A. C. Lowell, Chairman of the Board, L-Squared Industries." The initials of his newly formed company—LSI—suggest that Art Lowell won't be out of the semiconductor business for long. Lowell, 50, resigned as Autonetics' director of microelectronics applications and advanced products three months ago to join Joseph Leaming, president of both L-Squared Industries and Electronics Development Corp. The latter firm specializes in equipment, such as frequency-modulated up-down converters, for the fast-growing community antenna television (CATV) industry.

Electronics Development expertise is the wedge that Lowell expects L-Squared will use to move into the world of the "wired community" overseas. He hopes to have a commitment shortly for a demonstration model of a wired community in an area in which there are three to four times more tv sets, already served by cable, than there are telephones; an area whose name Lowell, understandably, won't divulge.

For both the demonstration and anticipated follow-on systems for communities outside the U.S., a separate entity will be created, jointly held by L-Squared and an as-yet-undisclosed partner. The joint firm, Lowell says, would provide an advanced wideband (500 megahertz) microwave system, data

terminals, and a multiplexing arrangement.

Fun and profit. "In the overseas areas we're interested in," Lowell says, "we can provide auxiliary communications with wideband transmissions and multiplexing with a subcarrier on the video." He foresees a community having some 25,000 consumer CATV outlets plus about 2,000 businesses with data terminals.

For the data terminals, Lowell says, L-Squared will need complex large-scale integration, metal oxide semiconductor memories: random-access memories with 500 to 1,000 bits of storage and read-only memories with up to 5,000 bits. He had hoped to get them from Autonetics, but he says that because of Autonetics' backlog of more than \$110 million in orders, the semiconductor maker won't be able to meet his requirements—which, he claims, will reach a peak in 18 months.

Thus Lowell plans to build, in a separate joint venture with still another undisclosed partner, a 35,000-sq.-ft. plant to make the memories. The irrepressible Lowell hopes to have the first devices off the lines by February.

Recognizing his own unbounded optimism, which he labels "the Lowell factor," he admits that "everything has to break right for the Lowell factor to work right." This means getting the semiconductor facility on stream, locking up the commitment for the overseas wired-community demonstrations, and forming a foreign corporation—a majority of which would be held in the U.S.—to operate an overseas manufacturing facility for L-Squared Industries.

Pragmatists in Congress have long claimed that NASA gives costly space programs like Apollo and unmanned planetary probes the nod over practical programs in the area of space applications. Now NASA is responding to that criticism by elevating Leonard Jaffe, formerly director of space applications programs, to a new post: deputy asso-

Ideal Constant Current

**Like Having 2,500,000,000 Ohms in Series With
2,500,000 Volts**

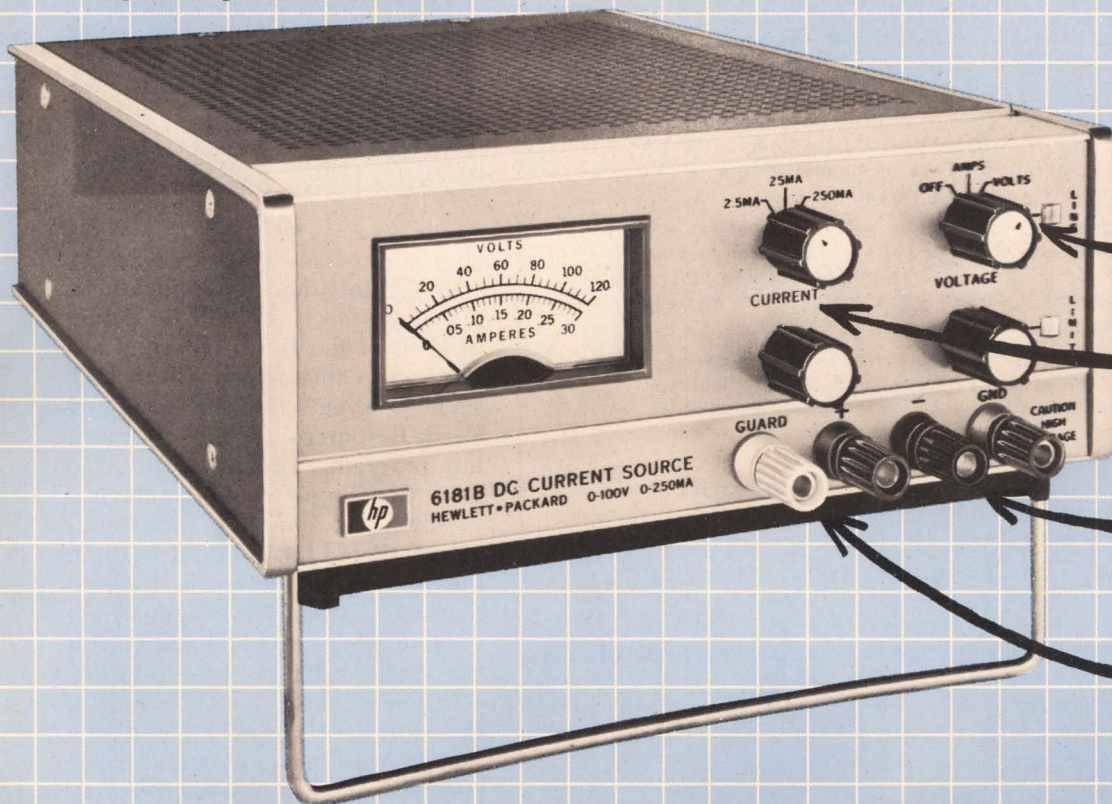

Independent Voltage Limit — preset your voltage, light warns when complying voltage limit is reached.

Excellent Resolution — 0.02% of range setting, three decades of ranges.

Precise Regulation — 25 ppm down to 1 microampere output.

Patented Guard Circuit — prevents leakage paths and voltage monitoring from degrading output.

Unlike many so-called "constant current" sources, the new CCB Series has the necessary high impedance, non-capacitive output. There is essentially no stored energy to dump, delaying response to programming or load changes. Patented Guard Circuit allows the output voltage to be monitored, externally, without degradation. Further, the new CCB Series permits you to preset current and voltage before connecting your load.

Two models are now available: the 6177B at 0-500 mA, 0-50V; the 6181B at 0-250 mA, 0-100V. Either can be remote programmed (resistance or voltage) with an accuracy of 1% or better.

Other operating features are: Transient recovery time of less than 200 μ sec for output recovery to within 1% following a full load change; programmed speed of less than 500 μ sec. from zero to 99% of programmed current output; resolution of 0.02% of the range switch setting; rms ripple less than 80 ppm of range.

Both Constant Current Sources are 3½" high half-rack size, weighing 10 lbs., and are priced at \$425.00. For additional specifications, contact your local HP sales office or write: Hewlett-Packard, New Jersey Division, 100 Locust Avenue, Berkeley Heights, New Jersey 07922 . . . In Europe, 1217 Meyrin-Geneva.

HEWLETT  PACKARD
POWER SUPPLIES

*Additional Constant Current/Voltage Models
For Higher Current . . . less sophistication*

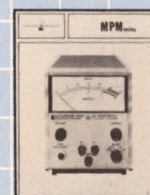

3 MODELS
0 - 3A
Up to 50V
Circle 516



9 MODELS
0 - 3A
Up to 320V
Circle 517

Circle No. for details 515

HADRON

Hadron's *LPM* Series represents a unique solution to the laser applications problem — its modular construction and easily exchangeable work fixtures make it equally useful for various industrial applications as well as for general laboratory applications. The versatile, reliable *LPM* is a fully integrated system, where the laser head, optics, and power supply are all contained in one small (24" x 18" x 12"), lightweight (125 pounds) unit. The interlocking of work fixtures minimizes radiation hazards in industrial applications. Closed-circuit television provides for viewing and setting up where required. Q-switched operation provides for synchronization.

Engineered to meet precision production tool standards, special emphasis has been placed on:
Reliability • Low Operating Cost • Compactness • Simple Operation • Ease of Maintenance • Adaptability • Safety • Versatility

Available in Q-switched as well as normal mode configurations, the *LPM* system is a proven tool not only for precision microfabrication but also for the balancing of small gyros, motor rotors, as well as watch balance wheels.

In the research laboratory, Hadron's *LPM* Series fulfills the exacting requirements of the scientist in such areas as fluorescence analyses, radiation studies, material evaluations, as well as general laboratory applications.

A rugged easily removable laser head provides for long maintenance-free operating life. Flashlamp replacement does not necessitate optics realignment.

The water-cooled *LPM* laser provides an energy up to 5 joules, a pulse width of 800 microseconds, and a repetition rate up to 1 pulse per second.



Basic *LPM* System with
Universal Welding and Drilling
Fixture and Closed-Circuit
Television Setup

THE NEW CONCEPT IN LASERS

For complete specifications, price, and delivery information, call or write:

HADRON

300 Shames Drive
Westbury, New York 11590
(516) 334-4402

Who's Who in electronics



Jaffe

ciate administrator for applications.

In addition, Jaffe will be acting director of the Earth Observations Programs Office which will include such programs as the emerging Earth Resources Technology Satellite program, Tiros, Nimbus, the new synchronous meteorological satellite, and sounding rocket programs. Slated for the directorate in the new organization is Richard Marsten, currently manager of advanced programs technology for the RCA Astro-Physics division. Marsten will head the Communications Program Office and be charged with navigation and traffic control satellites, geodetic satellites, the Applications Technology Satellite program, and activities in support of Comsat.

On your mark. Says Jaffe of the new position: "The higher level of organization is recognition on the part of NASA of the increasing importance of space applications." Jaffe sees the 1970's as the time when the big push will finally be made in such areas as data-relay satellites, and broadcast and navigation satellites. The pacing item, according to Jaffe, is the beginning of the Earth Resources Technology Satellite program. On a more mundane level, Jaffe says that the new organization will also mean a larger staff in the Space Applications Office and more money for research in the area of potential space applications programs.

Jaffe, an EE, has been with NASA since its inception, and was with its predecessor.

Convert your present scope into a curve tracer: \$595.00*

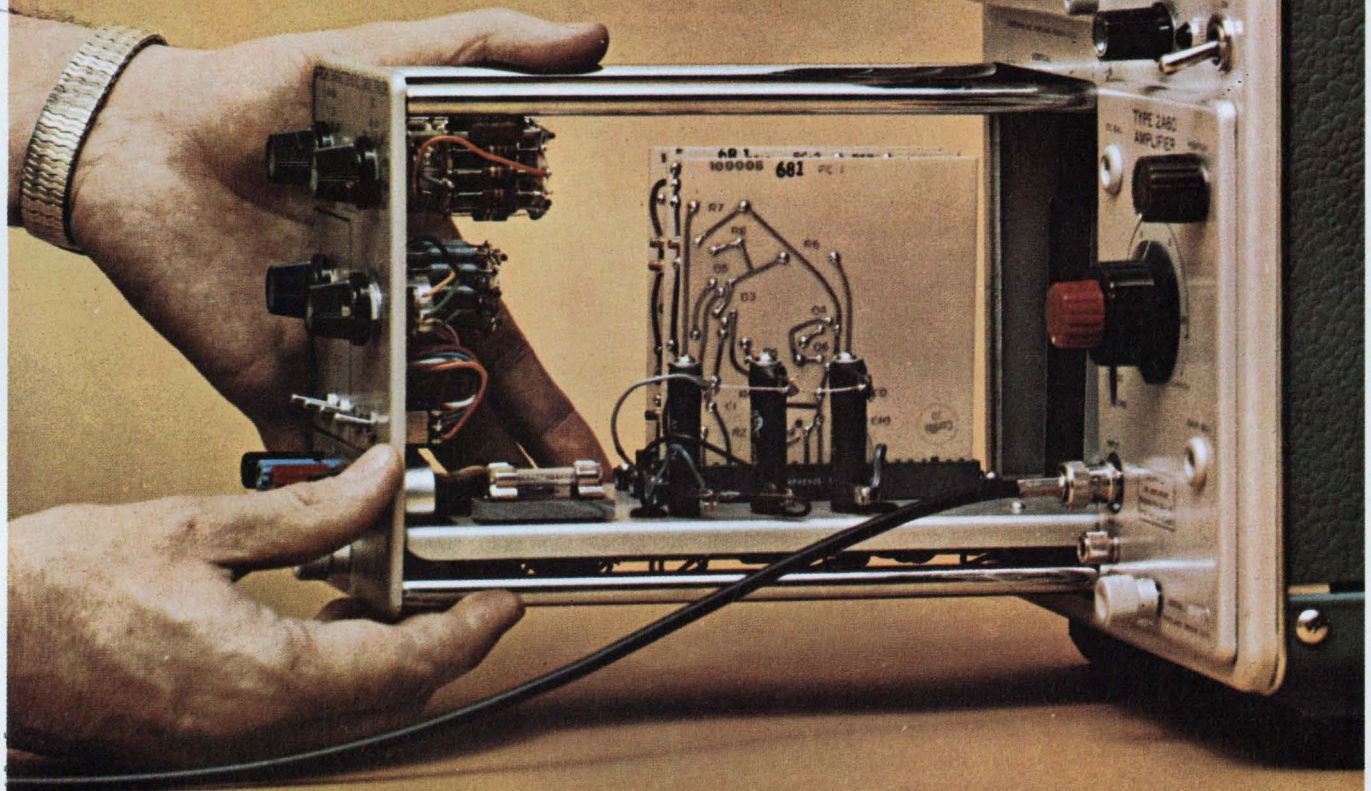

The first plug-in unit that transforms an existing scope into a curve tracer—at 1/2 to 1/3 the cost!

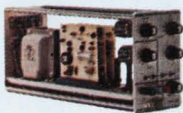

U-Tech plug-in
Model 681: \$595.00*
For use with Tektronix 560 series Oscilloscopes.

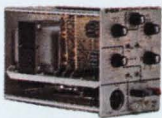

U-Tech plug-in
Model 682: \$615.00*
For use with Tektronix 530, 540, 550, 580 series Oscilloscopes.



U-Tech Console
Model 683: \$625.00*
For use with any X-Y Oscilloscope.

*Prices apply to purchases and shipments within U.S.A. fob Salt Lake City, Utah.

Now you can expand your present Oscilloscope to include curve tracer capabilities. U-Tech plug-in and console units enable any X-Y Oscilloscope to display the dynamic characteristics of both NPN and PNP transistors, N Channel and P Channel junctions, FETs, MOS-FETs, bipolars, unijunctions, diodes, tunnel diodes and SCRs.

So, if it wasn't in the budget before, now it can be, and even if you were planning for a curve tracer, you can now buy two, possibly three, of these units for the price of any other characteristic curve tracer.

Ask your distributor about these U-Tech curve tracer units or order direct.

U-TECH A Division of Industrial Physics and Electronics Company
4190 South State Street, Salt Lake City, Utah 84107

Yes, send me curve tracer model _____
Enclosed is: Check P.O. Bill me Send literature

Name _____ Title _____

Company Name _____

Company Address _____

City _____ State _____ Zip _____





Several hundred thousand unfair advantages.

There you are, busting your back trying to beat another company to market with a new, improved electronic Thing.

Everything looks good — up to the point where sub-assembly X has to be connected to board B. And you've never seen a connection like that before.

What do you do now? Take an R&D break? Give a connector-maker a panic call, and half your budget, to develop a special?

Sweat not. We're sitting over here with several hundred thousand different connectors. Most of them were specials, once. Many of them are patented. And all of them are ready. Now.

Card edge connectors. Two-piece PC connectors. Board-to-board connectors. Miniatures. Sub-miniatures. Dual-in-Line receptacles. Back panel metal plates. Rack and panel connectors. Mil spec cylindrical connectors. Tube and transistor sockets. Even new Mojo™ modular card edge connectors which you sort of invent as you go along. All available with the respected Varicon™ metal-to-metal connection that fully meets Mil-E-5400.

Because they're ready, you get a jump on your competitor while he re-invents one. Because they're standard, you put your Thing together for less money than he can. It may be unfair. But it's fun. And profitable.

But what if we *don't* have a standard for you? Still no problem. Because, with hundreds of thousands of different connectors already behind us, your special will just be a not-quite-standard. So we'll be able to save a lot of time and R&D, too.

We have several pounds of catalog, containing more information about connectors than you probably care to have. So don't just send back a reader information card. Call, write, wire, or TWX us, and tell us either your specific problem or your general field of interest. We'll send you the pertinent few ounces.

Elco Corporation, Willow Grove, Pa. 19090. (215) 659-7000 TWX 510-665-5573.



ELCO Connectors

**Everyone talks
correed reliability,**

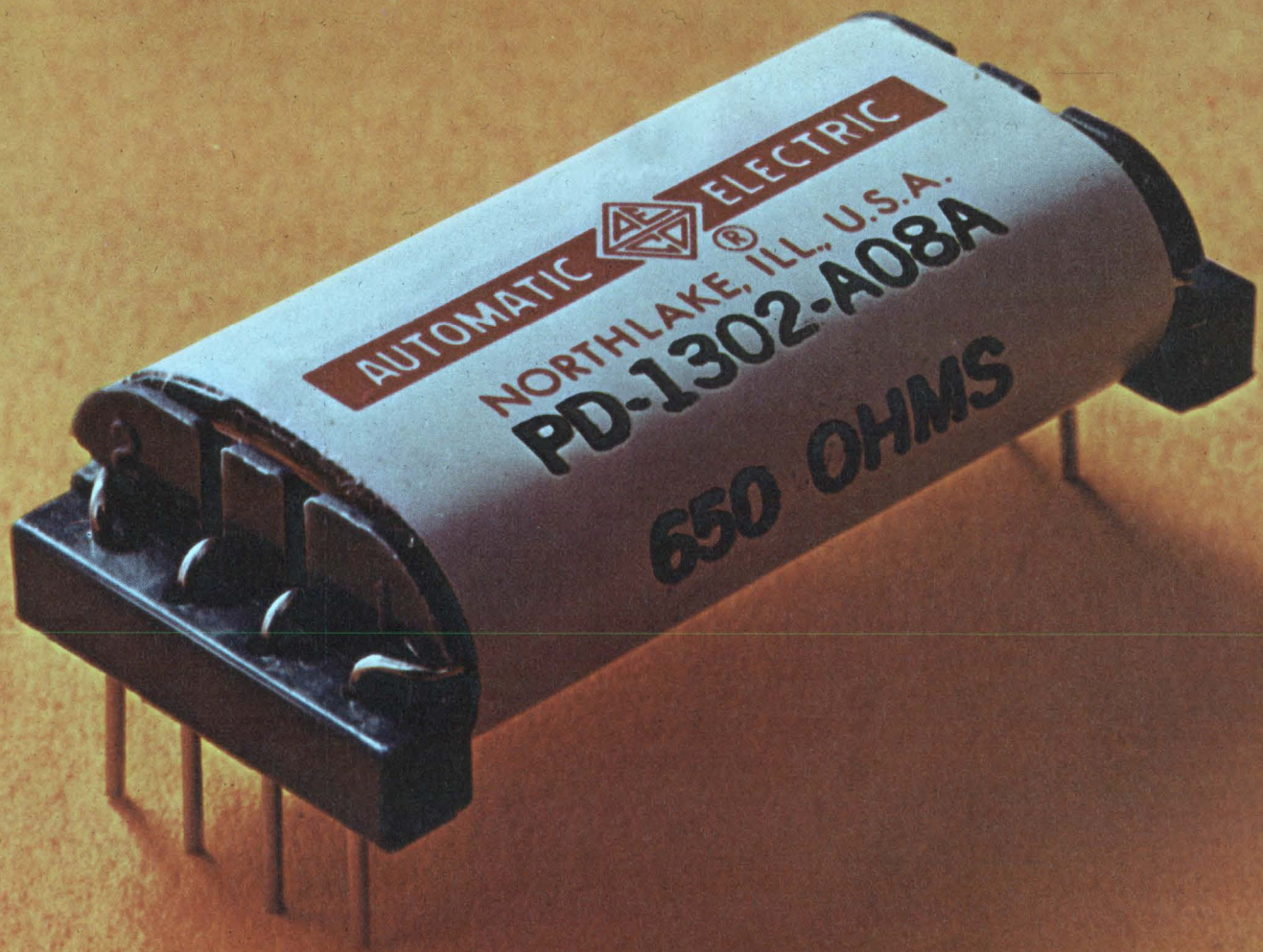

here's the way it looks.



Switches under glass.

The heart of every AE correed is a reed switch consisting of two overlapping blades. For protection, we seal them inside a glass capsule. But only after we pull out all the dirty air and pump in a special, pure atmosphere. That way there's no chance of contact contamination or oxidation. Ever.

Notice our terminals are one piece. A special machine delicately forms them to precision tolerances. It's a lot of work, but one-piece terminals have distinct advantages over the two- and three-piece kind.

For one thing, there's no extra joint so you're always assured of a positive contact. Also, one piece terminals are more reliable when the correed is used to switch low-level analog signals. That's because thermal EMF is reduced to practically zero.

A different kind of bobbin.

Since we go through so much trouble with our correed capsules, we designed a special bobbin to protect them.

It's molded of glass-filled nylon. (You know how plastic chips and cracks.) Moisture and humidity have no effect on this stubborn material. No effect means no malfunctions for you to worry about. No current leakage, either.

Running the full length of the bobbin are a series of slots. They pamper the capsules and keep them from getting damaged or jarred.

And to help you remember which terminal is which, we mold the terminal numbers into the end of the bobbin. You can read them at a glance.

Little things mean a lot.

Reliability means that we pay attention to the little things. Like the tiny pressure rods we use in every miniature correed. They're placed at

each end of the bobbin, across the one-piece terminals. What they do is prevent stresses from being transmitted from the terminals to the reed blades. This keeps the contact gap right on the button. All the time.

The contacts are normally open. To provide them normally closed, we employ another little device—a tiny magnet. It's permanently tucked into a slot next to the reedcapsule. The magnetic action keeps the contacts normally closed.

Coiled by computer.

Once all the parts are secure in the bobbin, we cover them with protective insulation. Around this, we wind the coil. You can be sure the coil winding is correct. It was all figured out for us by computer.

Our next step is to protect the coil. We do that with more protective insulation.

A coat of iron.

On top of the insulation goes a layer of annealed iron. It acts as a magnetic shield and minimizes interaction between coils. Also, it improves the sensitivity of the entire unit. A coat of iron is standard on all AE correeds.

Finally comes super wrap.

To wrap it all up, we use some very special stuff. A layer of

mylar laminated material.

It's so tough we guarantee it to withstand all cleaning solvents known to man.

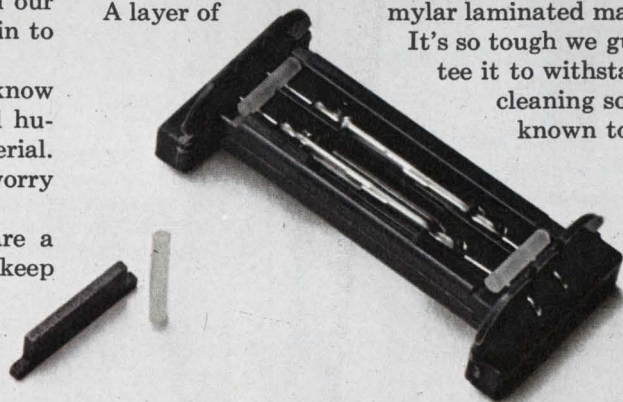
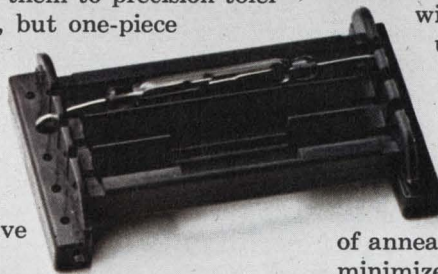

It's attention to detail that helps us keep our miniature relays miniature. Now we're just waiting to show you how perfectly it measures up to your specifications. Automatic Electric Company, Northlake, Illinois 60164.

AUTOMATIC ELECTRIC

SUBSIDIARY OF GENERAL TELEPHONE & ELECTRONICS

Circle 21 on reader service card

TODD cost cutting system power supplies!

More watts/in³/°C/\$

\$69⁰⁰
M
-SERIES



FEATURES:

- Full rating with no external heat sink required
- 71 Degree C Operating Temperature
- .5 MV RMS Ripple
- .01% Regulation
- Short Circuit & Overload Protection
- 5 year warranty
- Designed to Meet MIL Environment Specifications
- OverVoltage Protection option

Available:

- "M" Series to 1.1 amps \$69
- "A" Series to 3.7 amps \$99
- "B" Series to 5.0 amps \$115
- "C" Series to 7.5 amps \$135

For complete information, contact your local Todd representative or write to:

ATC

TODD PRODUCTS CORP.

28 Laurel Street
Hicksville, N.Y. 11801

Meetings

Diverse exposure at radiation conference

Their titles alone indicate that one of the more intriguing aspects of the annual conference on Nuclear and Space Radiation Effects—July 8-10 at University Park, Pa.—should be the roundtable discussions. Two are planned: "System prediction—fact or fancy?" and "Device hardening—its need and practicality." The former will delve into the problems involved in developing a general computer program that can be used to predict the radiation effects for just about any system, and thus avoid having to generate a new model for each new system. The latter will explore the provocative question: Should the program engineer develop new devices that are radiation hardened and then try to get manufacturers to build them; or, should he try to adapt the system to accommodate the use of existing hardware and devices?

To provide some diversity, the banquet talk will be on the subject of biological oscillations. In it, Edmond Dewan of the Air Force's Cambridge Research Laboratories will cover the natural rhythms of human and animal bodies and discuss the interesting possibility of

using human brain waves as electrical inputs to control a computer.

The conference boasts, in addition to roundtables, seven technical sessions on a wide range of topics. Several papers will treat the displacement effects in semiconductor materials and devices. They'll examine the effect of fast neutrons on transistors and concentrate on how to overcome some of the difficulties when using junction field effect transistors. Another fairly comprehensive session will focus on the problems of charge buildup in insulating layers, and on surface effects. And several papers will cover new surface preparations that minimize these effects in transistor, integrated circuit, and metal oxide semiconductors.

Other sessions will deal with the radiation effects in circuits and systems, energy disposition and dosimetry, and transient ionization effects. Also, a special symposium will include two topics: The potential of field ion microscopy in the investigation of radiation effects, and the breakdown of organic materials under irradiation.

For information contact D.K. Wilson, Bell Telephone Laboratories, Whippany, N.J. 07981

Calendar

Parallel Processor Systems, Technologies and Applications, Department of Defense, Naval Research; Navy Postgraduate School, Monterey, Calif.; **June 25-27.**

Conference on Applications of Continuous System Simulation Languages, Association for Computing Machinery, IEEE; Sheraton-Palace Hotel, San Francisco; **June 30-July 1.**

Aviation and Space Conference, American Society of Mechanical Engineers; Statler Hilton Hotel, New York; **June 30-July 2.**

Computer Science and Technology Conference, University of Manchester Institute of Science and Technology; London, England; **June 30-July 3.**

Conference on Environmental Effects on Antenna Performance, Institute for

Telecommunication Sciences, Cooperative Institute for Research in Environmental Sciences, Air Force Cambridge Research Laboratories; University of Colorado, Boulder, Colo.; **July 7-18.**

Conference on Measurement Education, IEE; University of Warwick, Warwickshire, England; **July 8-10.**

Conference on Nuclear and Space Radiation Effects, IEEE; Pennsylvania State University, University Park, Pa.; **July 8-11.**

International Conference on Medical and Biological Engineering, International Federation for Medical and Biological Engineering, Joint Committee on Engineering in Medicine and Biology, IEEE, Instrument Society

(Continued on p. 24)

A logic approach for systems having special little wrinkles

If your logic-system design matches up end-to-end with someone's standard products, fine. But if there's a peculiar little wrinkle in there — one that defies pre-packaged answers — we're your people. We supply standard products, and help smooth out wrinkles, too.

For products, we offer PHILCOLOGIC Micromodules in today's most advanced logic module design. Unique three-dimensional format accepts all existing IC's, discretes, and hybrid combinations. Size is only a fraction of PC-card modules.

Compatible logic lets you freely intermix both digital and analog functions on a common chassis.

For speedier troubleshooting, they offer front access to all input/output terminals as test points. For quicker replacement, color-coded labels identify logic type and family at a glance. For higher reliability, a rugged mechanical design proved in service at NASA Manned Space Center.

And down-to-earth prices.

For wrinkle smoothing, we offer brainpower. It comes in when your system requirement departs the beaten path. Our customer-aid engineers get paid for keeping up with the rapidly changing world of logic, which comes in handy when you need a trail blazed across uncharted design territory. The PHILCOLOGIC Support (PS) design service is available to all our logic module customers.

Product and support system Data File 155 rounds out the story. For your copy, write Product Sales Manager, WDL Division, Philco-Ford Corporation, Mail Station C-41, 3939 Fabian Way, Palo Alto, California 94303. Or call (415) 326-4350, extension 5981.

PHILCO



PHILCO-FORD CORPORATION
WDL Division • 3939 Fabian Way
Palo Alto, California • 94303

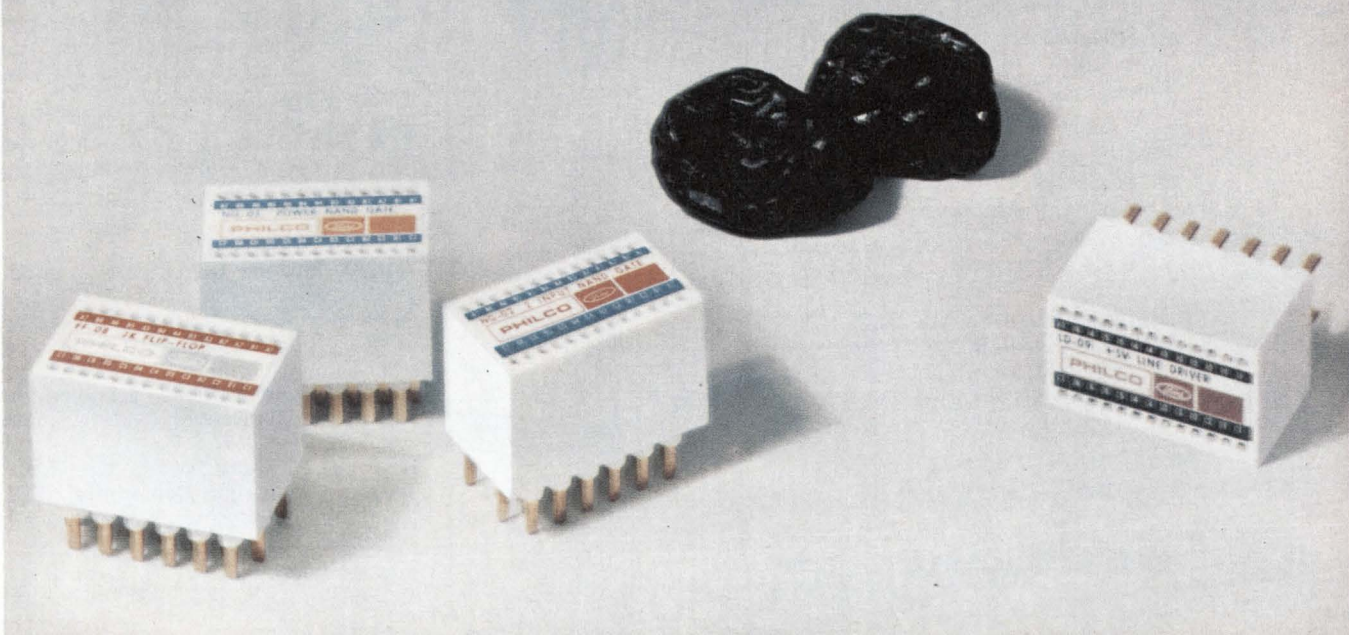

Knock it off its pedestal

and win a job
at Bell & Howell!

For two years we've
tried to top the VR 5000.
So has the competition.

But the VR 5000 was
so far ahead of its
time — in concept, per-
formance, reliability —
that even our best
heads (human and mag-
netic) have been
unable to surpass it.

And no other
instrumentation
recorder has
been able to
equal it.

Admittedly,
several others have
come fairly close. But
being close doesn't put
you on a pedestal.

If you'd care to accept
the challenge, or would
just like the facts
about the world's finest
instrumentation
recorder — call our
nearest office. Or write
Bell & Howell,
Pasadena, California
91109. Ask for Bulletin
Kit 3302-X1.

CEC/DATA INSTRUMENTS DIVISION

 **BELL & HOWELL**



Meetings

(Continued from p. 22)

of America, American Society of
Mechanical Engineers, American
Institute of Chemical Engineers;
Palmer House, Chicago; **July 20-25.**

**Annual Conference on Engineering in
Medicine and Biology**, International
Federation for Medical and Biological
Engineering, Joint Committee on
Engineering in Medicine and Biology,
IEEE, Instrument Society of America,
American Society of Mechanical
Engineers, American Institute of
Chemical Engineers; Palmer House,
Chicago; **July 20-25.**

Conference on Instrumentation Science,
Instrument Society of America; Hobart
and William Smith College, Geneva,
N.Y.; **July 28-Aug. 1.**

**Seminar on Case Studies in System
Control**, IEEE; University of Colorado,
Boulder; **Aug. 4.**

Joint Automatic Control Conference,
IEEE; University of Colorado, Boulder,
Colo.; **Aug. 5-7.**

**Third Annual Contemporary Filter
Design Seminar**, University of Missouri,
Columbia, Mo.; **Aug. 5-8.**

**International Photoconductivity Confer-
ence**; Stanford University, Palo Alto,
Calif.; **Aug. 12-15.**

**Western Electronic Show & Convention
(Wescon)**, IEEE; Cow Palace & San Fran-
cisco Hilton Hotel, San Francisco; **Aug.
19-21.**

**Symposium on Programing Languages
Definition**, Association for Computing
Machinery; San Francisco; **Aug. 24-25.**

**Defects in Electronic Materials for De-
vices**, Metallurgical Society of the Amer-
ican Institute of Mining, Metallurgical,
and Petroleum Engineers; Statler-Hilton
Hotel, Boston; **Aug. 24-27.**

**ACM National Conference and Exposi-
tion**, Association for Computing Ma-
chinery; San Francisco Civic Center;
Aug. 26-28.

**Cornell Biennial Conference on Engi-
neering Applications of Electronic Phe-
nomena**, IEEE; Cornell University,
Ithaca, N. Y.; **Aug. 26-28.**

**Education and Training Technology In-
ternational Convention**, IEE; London,
England; **Sept. 2-6.**

Electrical Insulation Conference, IEEE;
Sheraton-Boston Hotel & War Memorial
Auditorium, Boston; **Sept. 7-11.**

European Microwave Conference, IEE;

(Continued on p. 26)



less
than
\$1.00*

for new high performance
A-B solid hot-molded
variable resistor...

A-B Type W
variable resistor
shown about 5 times
actual size

The QUALITY is Allen-Bradley—the price is COMPETITIVE! This new Type W variable resistor is a commercial version of the Type G control.

This Type W variable resistor features a solid, hot-molded resistance track for long operating life. Life tests show less than 10% resistance change after 50,000 complete cycles. Noise level is low initially and actually becomes less after normal use. Furthermore, the resolution is essentially infinite, and the low inductance permits operation at high frequencies where wirewound controls are useless.

The Type W control, while only $\frac{1}{2}$ inch in diameter, is immersion-proof. The shaft is sealed with an "O" ring, making it watertight at that point.

Rated $\frac{1}{2}$ watt at 70°C, the Type W can be operated at 120°C ambient with zero load. Nominal resistance values are from 100 ohms to 5.0 megohms.

For complete specifications on tolerances, tapers, and options, please write Henry G. Rosenkranz and request Publication 5212. Allen-Bradley Co., 1201 S. Second St., Milwaukee, Wis. 53204. Export Office: 1293 Broad St., Bloomfield, N.J. U.S.A. 07003. In Canada: Allen-Bradley Canada Ltd.

EC69-1



ALLEN-BRADLEY
QUALITY ELECTRONIC COMPONENTS

©Allen-Bradley Company 1969

*Standard unit with plain bushing and hardware, 20% tolerance in 1,000 piece quantities. Price subject to change without notice.

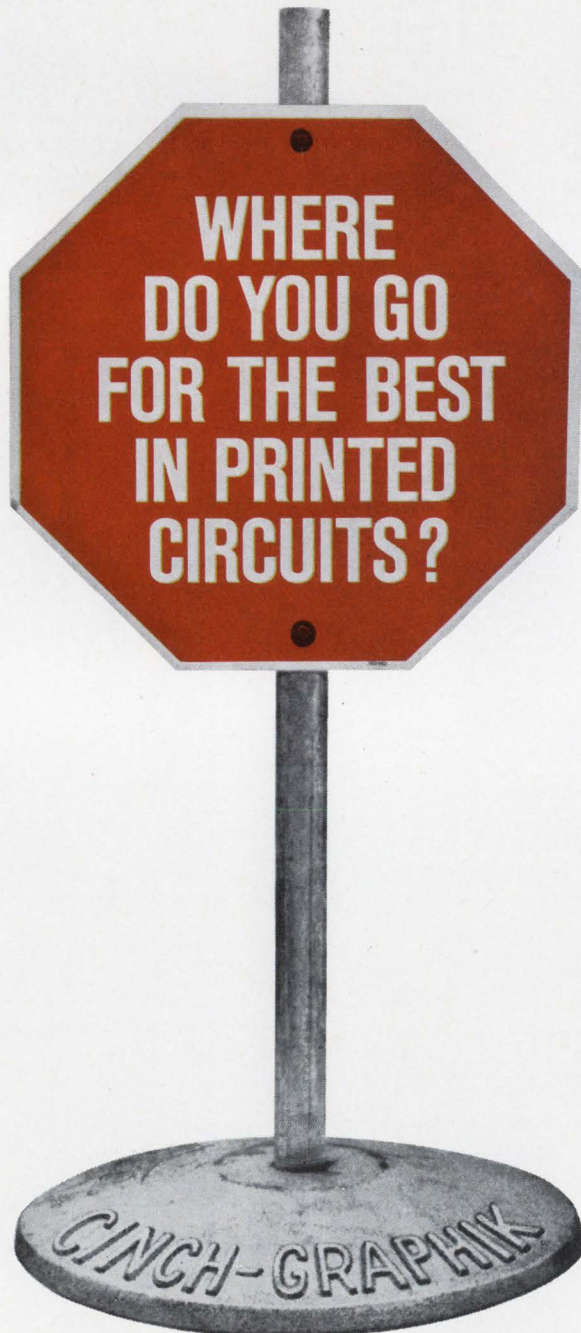

Meetings

(Continued from p. 24)

International Symposium on Man-Machine Systems, IEE; St. John's College, Cambridge, England; **Sept. 8-12.**

Convention of the Society of Logistics Engineers; Cape Kennedy Hilton Hotel, Cape Canaveral, Fla.; **Sept. 9-10.**

Petroleum & Chemical Industry Tech. Conference, IEEE; Statler Hilton Hotel, Los Angeles; **Sept. 14-17.**

International Telemetry Conference, International Foundation for Telemetering, Sheraton Park Hotel, Washington, D.C.; **Sept. 15-17.**

Conference on Trunk Telecommunications by Guided Waves, IEE; London, England; **Sept. 15-17.**

Solid State Devices Conference, IEE; University of Exeter, Exeter, Devon, England; **Sept. 16-19.**

Short courses

Probability and Random Processes for Engineers and Scientists; University of Michigan, Ann Arbor; **July 7-18.** \$400 fee.

Fundamentals of Remote Sensing; University of Michigan, Ann Arbor; **July 14-25.** \$350 fee.

Principles of Imaging Radars; University of Michigan, Ann Arbor; **July 21-Aug. 1.** \$350 fee.

Call for papers

Conference on Magnetism and Magnetic Materials, IEEE, American Institute of Physics; Benjamin Franklin Hotel, Philadelphia, Pa., Nov. 18-21. **Aug. 18** is deadline for submission of abstracts to Dr. H.C. Wolfe, American Institute of Physics, 335 E. 45 Street, New York 10017.

Fall USNC/URSI Meeting, IEEE; University of Texas at Austin, Dec. 8-10. **Sept. 22** is deadline for submission of abstracts to Dr. Alfred H. LaGrone, Engineering Science Building 535, The University of Texas at Austin 78712.

International IEEE/G-AP Symposium, IEEE; University of Texas at Austin, Dec. 9-11. **Sept. 22** is deadline for submission of abstracts to Dr. Alfred H. LaGrone, Engineering Science Building 535, The University of Texas at Austin 78712.

"ALLEN BRADLEY HOT-MOLDED RESISTORS ENHANCE THE QUALITY STANDARD OF OUR DATA-RECORDERS."

Mohawk Data Sciences Corporation

MDS The time reduction achieved by the MDS Data-Recorder method of computer input preparation demands continuously reliable operation. And this in turn demands the highest standards of performance from each and every component.

Allen-Bradley fixed composition resistors were a natural selection. Made by an automatic hot-molding technique—developed and used exclusively by Allen-Bradley—A-B resistors afford the ultimate in uniformity. From resistor to resistor—year in and year out—physical and electrical properties are unvarying. Predictable. Always of the highest order.

Performance records are equally excellent. For example, Allen-Bradley hot-molded resistors meet the requirements of the new MIL-R-39008A Established Reliability Specification at the *highest* level—the S level. And this is true for *all* three ratings—the 1 watt, ½ watt, and ¼ watt—and over the *complete* resistance range from 2.7 ohms to 22 megohms.

For complete specifications on this quality line of hot-molded resistors, please write to Henry G. Rosenkranz, and request a copy of Technical Bulletin 5000. Allen-Bradley Co., 1201 S. Second St., Milwaukee, Wis. 53204. Export Office: 1293 Broad St., Bloomfield, N.J., U.S.A. 07003. In Canada: Allen-Bradley Canada Ltd.

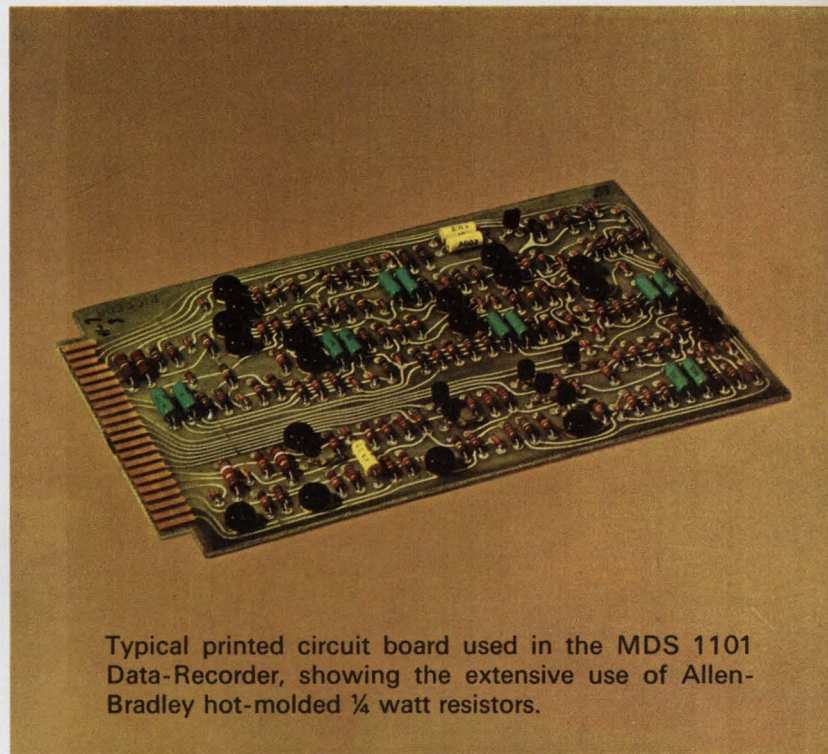

Typical printed circuit board used in the MDS 1101 Data-Recorder, showing the extensive use of Allen-Bradley hot-molded ¼ watt resistors.

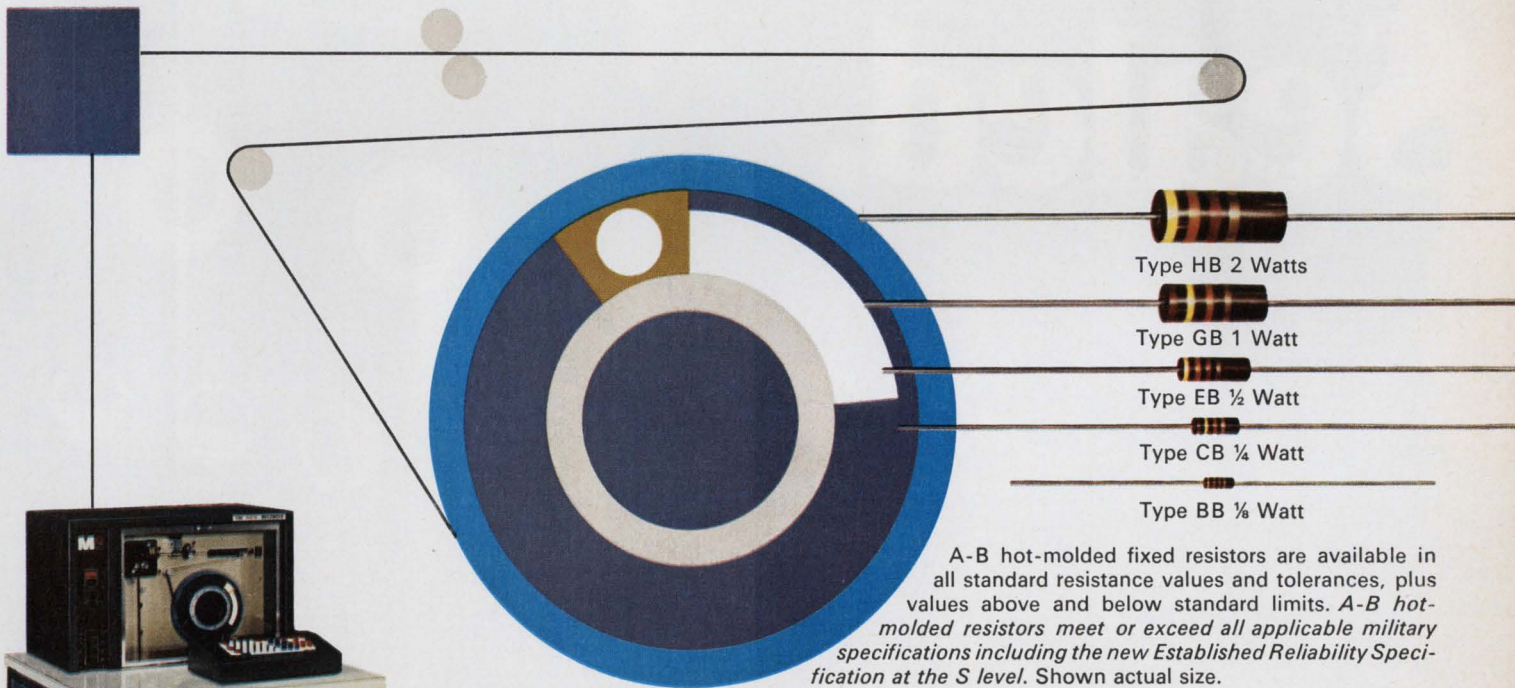

A-B hot-molded fixed resistors are available in all standard resistance values and tolerances, plus values above and below standard limits. A-B hot-molded resistors meet or exceed all applicable military specifications including the new Established Reliability Specification at the S level. Shown actual size.



Mohawk 1101 Data-Recorder permits transcribing of data from source documents direct to ½" computer magnetic tape.

©Allen-Bradley Company 1968



ALLEN-BRADLEY
QUALITY ELECTRONIC COMPONENTS

Circle 27 on reader service card

EC 6821

Sealed.

Sealed.

Sealed.

Sealed.

Our ARINC-type connectors are environmentally sealed. And intermateable with existing types, too. The whole family—every configuration in every type. Standard. High density. And coaxial.

Is sealing important? Yes! Because it assures the protection of the electronic equipment in aircraft from dust, moisture, fluids and other harmful conditions. An additional reliability factor is the crimp, snap-in, contacts with dual-spring socket design for electrical integrity under conditions of shock and vibration. Contacts are removable for easy maintenance.

When it comes to communications and navigation equipment, reliability and maintainability are vitally important. Just write for information on our ARINC-type connector improvements and we'll tell you all about them. **Industrial Division, AMP Incorporated, Harrisburg, Pa. 17105.**

TOOLING: An AMP-TAPETRONIC[★] Stripper/Crimper in your plant strips and terminates wire in a single machine. Tape-mounted pin and socket contacts can be terminated at rates of 1200 to 1500 per hour.

★Trademark of AMP INCORPORATED

Sealed.

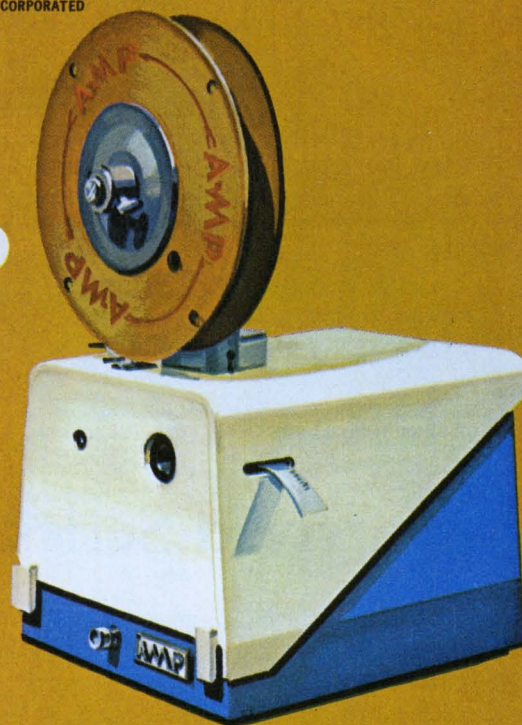

AMP
INCORPORATED

European companies or affiliates refer to International Section

Circle 29 on reader service card

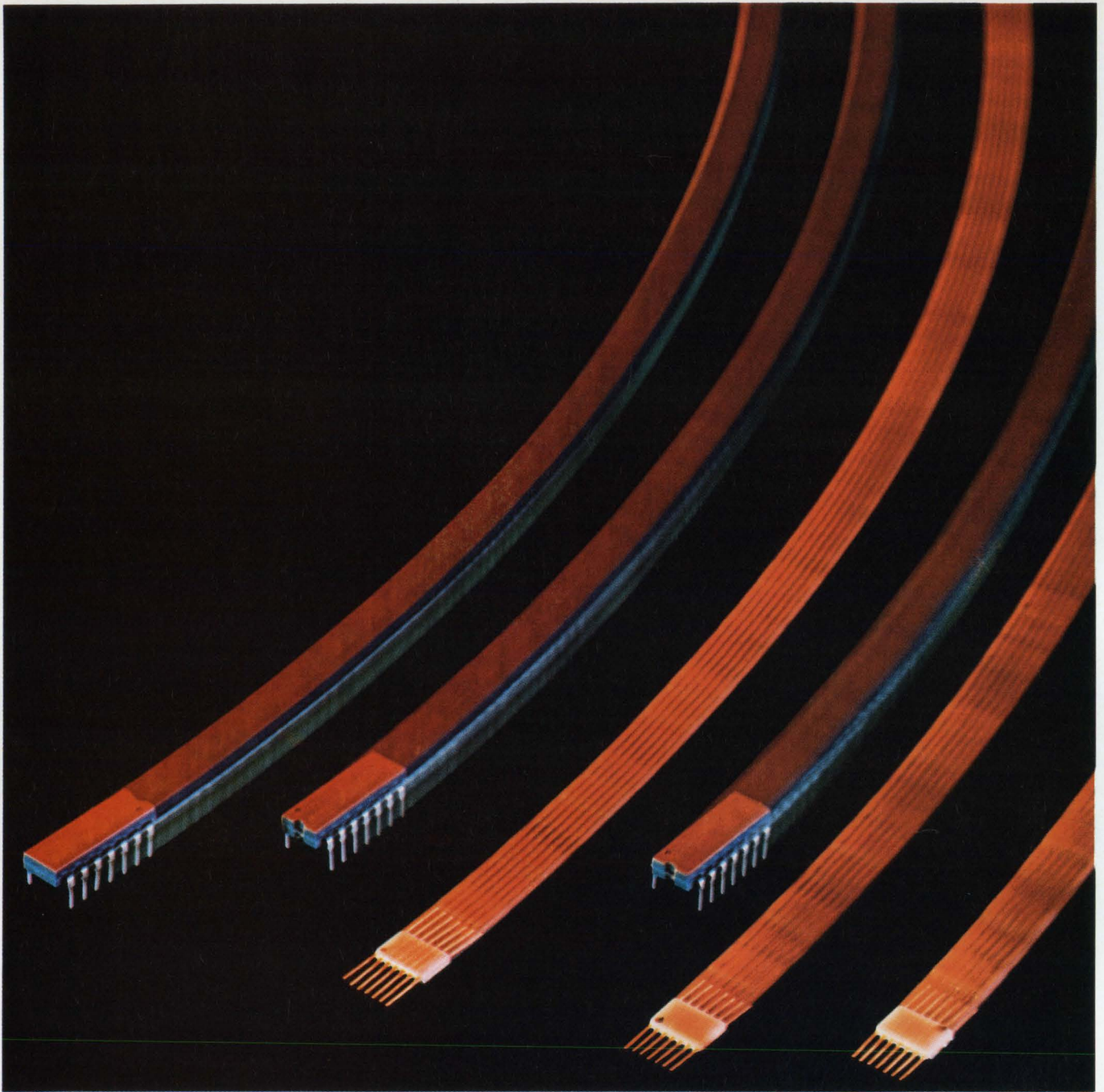

Sprague Digital ICs. Illustration: Series 54H/74H in flatpack and DIP

Just arrived. Series 54H/74H. The fast ones.

Just about the fastest saturated logic circuits around. Series 54H/74H from Sprague. The whole family. Flip-flops and all.

Use them in arithmetic and processing sections, where speed really counts. Mix and match them with Sprague's standard Series 54/74.

Get off to a fast start with Sprague Series 54H/74H.

Call Sprague Info-Central (617) 853-5000 extension 5474.

Or call your Sprague industrial distributor. He has them on the shelf.
For complete specifications, circle the reader service number below.

455-9127

TYPICAL CHARACTERISTICS	GATES	FLIP-FLOPS
Propagation Delay	6 nsec	17 nsec
Power Dissipation	22 mW	80 mW
Noise Immunity	1 V	1 V
Temperature Range	-55 to +125° C	
Series 54H	0 to +70° C	
Series 74H	DIP or Flatpack	
Packages		



Editorial comment

The case for an open market

To help close the technology gap that exists between themselves and their U.S. counterparts, European companies are opting for mergers. The gap is underscored by this statistic: 90% of installed computers in Europe, including Britain, were designed and developed in the U.S. or by subsidiaries of U.S. companies. Thus, to a great extent, mergers make sense. But there's also a trend in Europe toward government protection of domestic companies. And should this trend continue, it could prove harmful to Europe's electronics industry.

Companies like Britain's Marconi and Elliott Automation, to name but two, have merged so that they could pare costs through volume production and establish a broader financial base. (Moreover, such mergers have led to layoffs of layers of managers and technologists. Thus, in almost a single swoop, merged companies have improved their financial positions by further reducing overhead and have eased Britain's shortage of engineers too.) Britain has also enacted legislation that favors domestic companies, and the government itself "buys British." Nevertheless, there remains a dark cloud over the horizon: Britain's domestic market may be too small to support even the merged companies.

A far more plausible solution to the plight of European industry would be its cultivation of the international market. Progressive companies are already moving in this direction. In the U.K., Plessey has its eye on the overseas market for IC's. Derek Roberts, general manager of Plessey's IC operations, predicts that the company will manufacture some of its IC's in the U.S., perhaps through an arrangement with a U.S. company. Roberts says, "We've got to attack the American market or regard ourselves as second string and shut up shop." And German engineers are only half joking when they talk of an electronics product having a "Volkswagen effect." Valvo may have this idea in mind as it pushes ahead with plans to develop specialized linear IC's for color tv. The IC's, the company believes, will be marketable in the U.S. either directly or as part of television sets built by companies like Grundig. French companies too, are eyeing the world markets, starting off on a selective basis and eventually hoping to move in on a grand scale. FNIE (France's equivalent of the EIA) is studying the export market for telecommunications and medical electronics gear. And the same is being done by CEFAR, which is primarily concerned with the exports of measurement, control, and instrumentation products by its member companies. Technical managers at West Germany's AEG-Telefunken foresee "international interest groups" comprising device and equipment manufacturers in specific fields (automotive electronics, for example). In this ap-

proach, informal alliances, not mergers, would prevail. This would circumvent the legal complications usually associated with mergers that cross national boundaries.

Such mergers are fraught with problems. Aside from the language barriers, laws and tariffs differ among the nations that make up the European community. Notwithstanding, some experts believe mergers are a condition of survival.

André Charguéraud, president of Diebold Europe S.A., insists that mergers should be given priority since they'll bring "sound competition within a free-enterprise world and also pave the way toward a true European economic community." Charguéraud notes that European governments have committed more than \$500 million to the computer industry alone. In Britain, the government supports cooperation between ICT and English Electric; in Germany, the government backs cooperation between Siemens and AEG-Telefunken; in Holland, the government is assisting Philips' entry into the computer field; and in France, the government is helping sponsor the entry of CSF and CSTH into the field. But, says Charguéraud, really aggressive competition must await mergers of the successful computer companies on a Europe-wide basis. Such mergers, he believes, would benefit even the U.S. computer manufacturers through open international competition—competition that would not be unduly biased by artificial protection of smaller computer companies.

It's difficult to fault governments for helping businesses getting started, but these businesses should be able to sustain themselves without continuing protection. In their zeal to close the gap, European central governments may become overly protective and erect trade restraints that hurt those very companies they intend to help. A classic disadvantage of protective tariffs and embargoes is that they beget counter-tariffs and embargoes. The Japanese, for example, got off to a flying start in electronics under the umbrella of government protectionism. But they now find this protectionism backfiring. This policy has spurred angry resentment in the U.S., probably Japanese industry's No. 1 customer. It is likely that Japan will voluntarily restrict some of its exports to this country. Far more desirable, however, would be the liberalization of Japan's policies concerning imports and capital investments. Restrictions that favor an industry are usually easier to enact than to rescind. Whole economies can rise or fall as a consequence, and the political pressures to continue protective barriers can be overwhelming.

A free-trade policy for the electronics industry is imperative; it would speed electronics toward its destiny as an all-pervasive international business. ■

New complementary NPN/PNP power transistors from GE

Color-molded to end assembly mix-up

Now available in volume from General Electric . . . two new 1-amp and 3-amp pairs of low-cost complementary power transistors. These NPN/PNP pairs feature low saturation voltage, excellent gain linearity and fast switching . . . all in a sensible package, at a sensible price. GE's flat silicone-encapsulated power tab package is rugged enough to withstand hard use, and *with the new narrow leads (25 mils), can easily be formed to either TO-66 or TO-5 configurations.* To help eliminate NPN/PNP confusion during your assembly, each type is molded in distinctive color. No need for separate storage and production facilities for each type.

GE's new complementary power transistors are ideal for any class B audio application—everything from auto radios, tape players to televisions and stereo phonographs—from 3 to 20 watts output. These new NPN/PNP pairs are also well suited for use as drivers for higher power transistors, regulators, inverters, motor controls, lamp controls, solid-state relays, core drivers and many other applications. The 2.1W P_T free air rating allows simple printed circuit board assembly with no additional heat sinking. With added heat sinking, as much as 12W power

dissipation can be achieved. Performance at these levels is everything you'd expect from General Electric, leader in power semiconductors.

TYPE NUMBER	D40D (NPN)	D41D (PNP)	D42C (NPN)	D43C (PNP)
new	D28D	D31B	D27C	D27D
previous				
I_C (continuous)	1A		3A	
(peak)	1.5A		5A	
V_{CE} (sat.) Max.	0.5V @ 0.5A		0.5V @ 1A	
V_{CEO} (sus.)	30V, 45V and 60V		30V, 45V and 60V	
Total Power Dissipation				
Free air @ 25 C	1.25W		2.1W	
Tab @ 25 C	6.0W		12.0W	
h_{FE} (min.)	50 @ 0.1A/2V 10 @ 1A/2V		40 @ 0.2A/1V 20 @ 1A/1V*	
f_T (typ.)	60MHz		45MHz	

*Types available with $h_{FE} \geq 20$ min. @ 2A/1V

For more information on these and other General Electric semiconductor products, call or write your GE sales engineer or distributor, or write General Electric Company, Section 220-72, 1 River Road, Schenectady, N.Y. 12305. In Canada: Canadian General Electric, 189 Dufferin Street, Toronto, Ont. Export: Electronic Component Sales, IGE Export Division, 159 Madison Avenue, New York, N.Y. 10016.

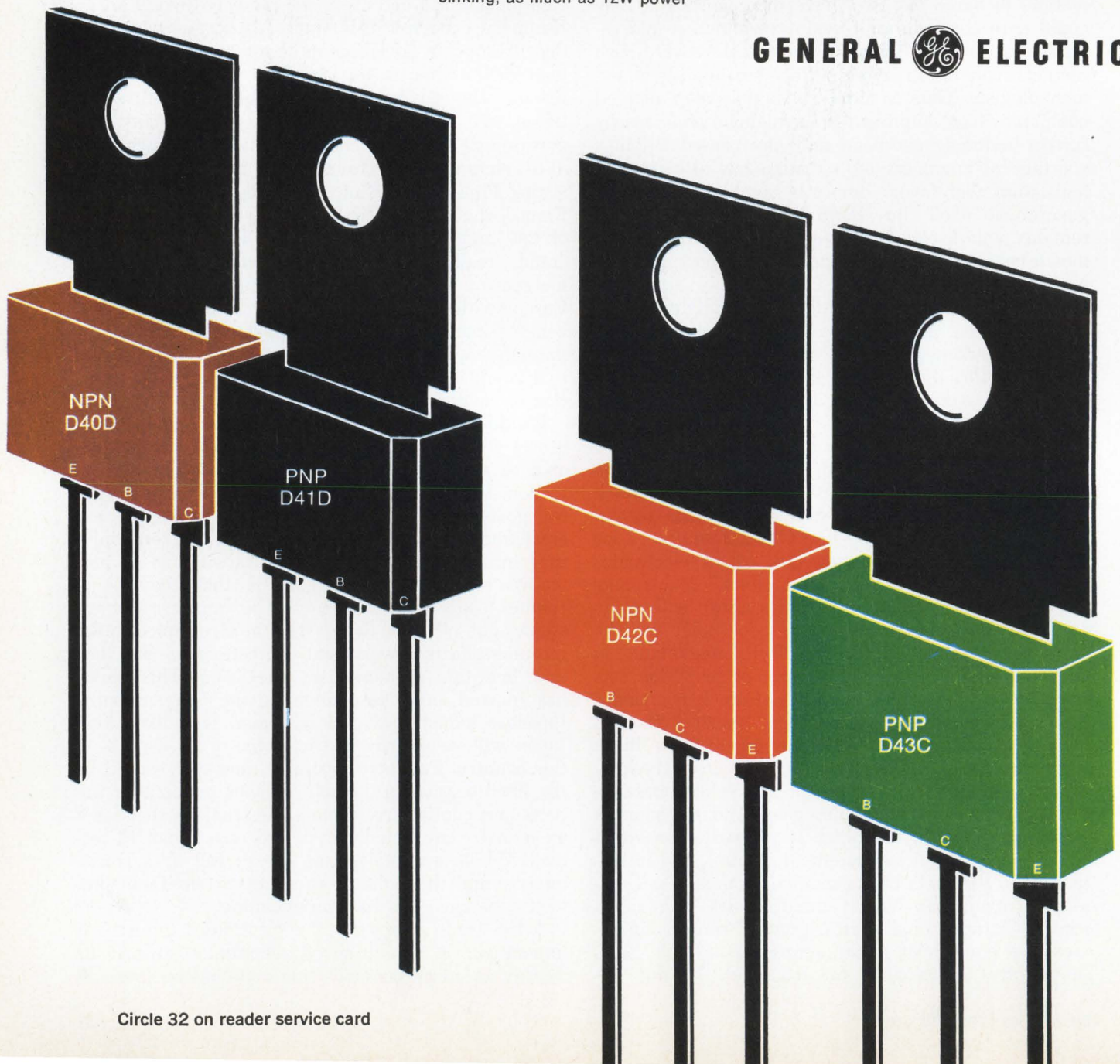

GENERAL  ELECTRIC

Electronics Newsletter

June 23, 1969

Radiation Inc. eyes commercial market

Radiation Inc., which specializes in integrated circuits for the military market, now plans to move into the commercial and industrial IC market. The Melbourne, Fla., company has broken ground for a plant that will increase manufacturing space by one and a half times. **Radiation will continue to use its dielectric isolation process to make all its IC's—the process separates circuit elements on a chip with a thin insulating layer of silicon dioxide—rather than the p-n junction isolation usually used.** Dielectric isolation provides resistance to nuclear radiation (in fact, the firm claims to have 50% of the radiation-hardened IC market), **but the company has long maintained that the process offers advantages in nonmilitary applications too—higher frequency and lower leakage, for instance.**

Now, with backing from Harris Intertype, the company has the resources to expand into these other markets. Rather than second source other IC manufacturers, Radiation will develop a proprietary product line.

Fairchild to unveil 10 linears in August

The long-awaited 715 operational amplifier linear integrated circuit from Fairchild Semiconductor [*Electronics*, May 12, p. 34] won't be alone when it's introduced at application seminars across the country in August: **nine other linear IC's will be unveiled at the same time.**

Linear IC marketing manager Mike Markkula says no other firm has ever before introduced as many as 10 linears at once, but he's touting technology rather than quantity. **There will be at least seven op amps, some of them duals; one uses dielectric isolation for radiation resistance.** There will also be an a-c power-control system incorporating a complete zero-crossing system in one package to cope with radio-frequency interference, a dual sense amplifier, and a color demodulator for television sets.

One of the devices, the 735 op amp, dissipates less than 100 microwatts vs. 50 milliwatts for Fairchild's own 741, which Markkula says is the industry standard today.

SDS minicomputers are actually built by second firm . . .

The two small computers introduced by Scientific Data Systems in March as the company's first entries in the minicomputer market are actually being made for SDS by Computer Automation Inc., a 2-year-old Newport Beach, Calif., outfit formed by two ex-employees of Varian. While this isn't the first time such a procedure is being followed—some of the Westinghouse Electric Co.'s process-control computers used in the experimental transit expressway several years ago were made by Univac—it's not an everyday practice.

The new SDS computers, 16-bit parallel-bus machines, were designed jointly by SDS and CAI engineers, but the bulk of the software was conceived by CAI. SDS calls the machines CE-16 and CF-16 and considers them peripheral equipment. **The reason for having them made elsewhere, says SDS, is based on "optimum allocation of resources"—including development dollars and available manpower.**

CAI, meanwhile, makes and markets its own line of four small computers, two eight-bit and two 16-bit machines.

Electronics Newsletter

**... which foresees
market sag as buyers
resist unreliability**

While the president of Computer Automation Inc. expects the minicomputer market to proliferate for a while—both in products and new firms to make them—he warns that the future could hold a downcurve.

Behind David Methvin's prediction is the fact that the market now is "very big, money is available, and the market is very forgiving." Methvin says that buyers expect their equipment to be heavily debugged, but the downcurve will come when they become more sophisticated and less tolerant of poor reliability. Methvin's advice to a company poised to jump into the mushrooming small-computer arena: "Start with a simple design, don't push the state of the art anywhere, use less power at less speed than you may be able to get, and give yourself enough room in the cabinet to dissipate heat well. And you can't spend too much money on quality control, particularly in aging integrated circuits."

**Pentagon pushing
to break up package**

The Defense Department already has leaped on criticism of overruns in the C-5A program as a reason to scrap the McNamara total-package procurement concept, first applied in the construction of that giant transport. Now, the Pentagon brass has come up with a second.

Total package estimates include lifetime spare parts and maintenance, yet Air Force experience with maintenance estimates and actual costs are proving so far—particularly with electronic systems—that massive overruns are inevitable. So the DOD wants to drop maintenance estimates from system cost projections on the ground that such estimates can't be reasonably determined in advance when new hardware is involved.

At the same time, the military, concerned with high electronics failure rates, is pushing for tougher contract regulations. Of the reliability problem, Gen. Jack G. Merrill of the Air Force Logistics Command says, "There has been enough improvement in the state of the art in electronics in recent years to give us much greater life in electronic systems, radios, and other gear than we are now getting. We are being plagued with high failure rates of even 25 hours between failures. We ought to be getting 2,500 hours between failures."

**RCA to expand
semiconductor plant**

RCA will spend \$17 million within the next year to expand its semiconductor operation at Mountain Top, Pa., in the heart of the Keystone State's coal-mining country, to manufacture thick-film integrated circuits.

Among the devices to be built at the plant are the recently introduced developmental 100-watt hybrid power amplifier now being built in sample quantities at Somerville, N.J. The amplifiers, slated for high-quality audio use, are scheduled to cost \$80 apiece.

**Wadsworth leaving
FCC for Intelsat post**

First to step down from the FCC under the new Administration may be James J. Wadsworth, who will resign as a commissioner to become a roving ambassador for the U.S. delegation to Intelsat. Wadsworth's departure date coincides with the expiration date of Rosel Hyde's term. Hyde, FCC chairman is expected to stay on for at least a few months to give President Nixon more time to select a successor.

Since both Wadsworth and Hyde are Republicans, President Nixon won't be able to change the FCC's political makeup until June 1970, when Democrat Kenneth Cox' term expires. It's most unlikely for the President to name Democrats to the politically sensitive commission.

HYBRID MICROELECTRONICS

New video amplifiers pack power into small package.

Versatile amplifier has 700 mW output in a one-inch-square package.

You'll find a lot of applications for our versatile new MS-100 and MS-100A wideband video operational amplifiers. With varying associated circuitry you can use them as buffer amplifiers, video detectors, phase detectors, line drivers or as straight general purpose video amplifiers.

The high power capability of 700 mW (DC or squarewave) and small size (1.0" x 1.0" x 0.2") offer a unique combination. Designed primarily for video applications, these plug-in units are capable of driving 10 Volts peak-to-peak into a 50-ohm transmission line.

Both amplifiers offer a 0 to 20 MHz bandwidth, high impedance differential inputs and DC coupling with low offset and temperature drift. Both positive and negative outputs are available. The MS-100A offers a faster slewing rate—180 volts/ μ s as compared to 100 volts/ μ s for the MS-100 model.

Both types offer output short circuit protection and an operating temperature range of -55°C to $+80^{\circ}\text{C}$.

These wideband amplifiers are only part of our growing list of off-the-shelf hybrid microelectronic devices. And we're able to provide complete support for design of custom modules as well.

Our long experience in film and packaging technology allows us the flexibility to develop many variations on our basic designs as well as develop completely new designs to your specifications. Why not discuss your design problems with our engineers?

Typical wideband amplifier specifications

	MS-100	MS-100A	Units
Open loop gain	50	50	dB
Slewing rate	100	180	volts/ μ s
Max. output voltage	± 12	± 12	volts
Power out (max.)	700	700	mW
Open loop output impedance	33	33	ohms
Input impedance (differential)	9.0	4.0	K ohms

CIRCLE NUMBER 300

This issue in capsule

Integrated Circuits

MSI simplifies binary-to-decimal conversion.

Television

Square corners are "in" for '69 set design.

Circuit Modules

'Dual in-line pac' cuts module cost.

EL Displays

Two-input power supply drives EL devices.

Diodes

How planar diode arrays save you time and money.

CRT Modules

New 12-inch monitor fits popular niche.

Manager's Corner

What it takes to stay ahead.

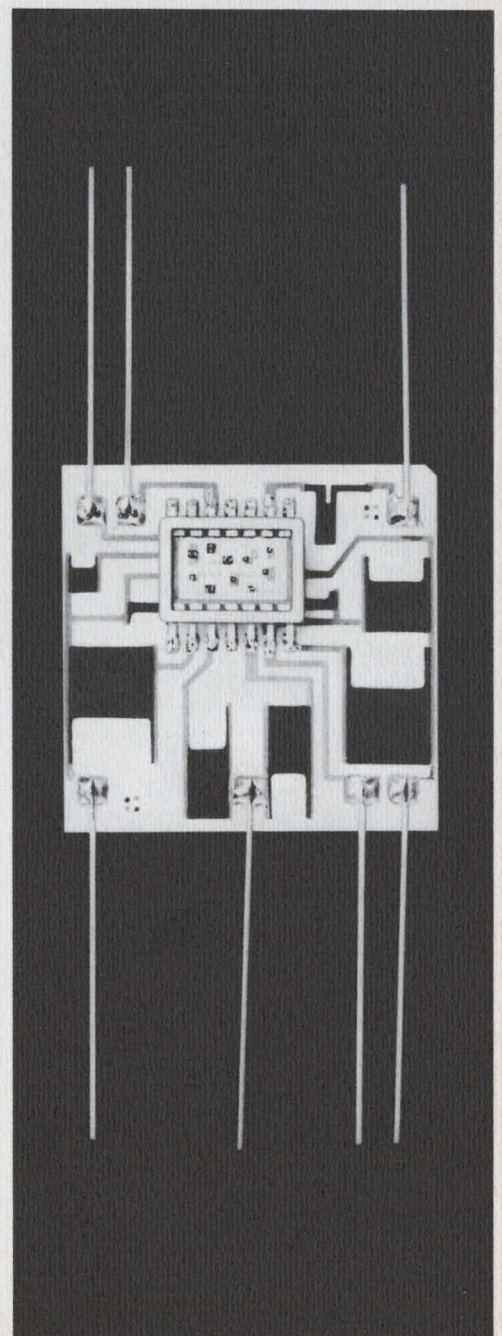

Wideband amplifier with 700 mW output is housed in one-inch-square package.

INTEGRATED CIRCUITS

MSI simplifies binary-to-decimal conversion.

Use of functional arrays cuts package count from 11 1/3 to 4 1/6.

Here's a simple way to decode 4-bit binary code into 16-line hexadecimal. It uses four SM-223 demultiplexer arrays and 1/6th of an SG-383 hex inverter. An SM-163 4-bit binary counter is used here to illustrate driving of the system. The circuit arrangement is shown in Fig. 1.

The outputs of the demultiplexers are the "true" states of the decimal number. That is, when a particular number is decoded, its corresponding output is at logic "1". All other outputs are at logic "0".

Propagation delay to any output is about 22 ns. This speed easily allows decoding at a 20 MHz rate. Thus, the system is compatible with the high-speed SM-163 4-bit binary counter or with discrete flip-flop counters.

An inverter is included between the 2³ output of the SM-163 and F₁ of the first SM-223 demultiplexer to generate the 2³.

If a hex inverter such as the SG-383 is used, maximum package count will be 4-1/6. Using conventional gates, the

most efficient design requires 11 1/3 packages when the false states of the four input bits are not available. In the conventional design, 8 dual 4-input gates and 3 1/2 hex inverters would be required.

It's our SM-223 demultiplexer array that makes the package savings possible. Using internal gates which are designed for high speed rather than drive capability, the SM-223 can produce outputs in less than 12 ns.

The logic arrangement of the SM-223 is shown in Fig. 2. The demultiplexer array consists of two decoding sections. In one section, the data input may be steered to any one of four identical outputs under control of two selection variables. In the other section, another data input may be routed to either of two identical outputs depending on the state of one selection line. The output inverter/drivers provide the "true" state of the input data allowing direct entry into subsequent stages without extra gate inversion.

The logic diagram of the SM-163 4-bit binary counter is shown in Fig. 3. The circuit consists of four J-K flip-flops interconnected as a binary (1248 code) up counter. The flip-flops are synchronously clocked through two input AND gates. These eliminate the need for restrictive clock waveshape requirements.

A logic "0" on the RESET input causes all four outputs to go to logic "0". A logic "0" on any SET line causes the corresponding output to go to a logic "1".

Both the SM-163 and SM-223 are available in 14-lead flat packs or in Sylvania's ceramic 14-lead dual in-line plug-in package.

CIRCLE NUMBER 301

Fig. 1. Circuit arrangement of binary-to-decimal (4 to 16) decoder.

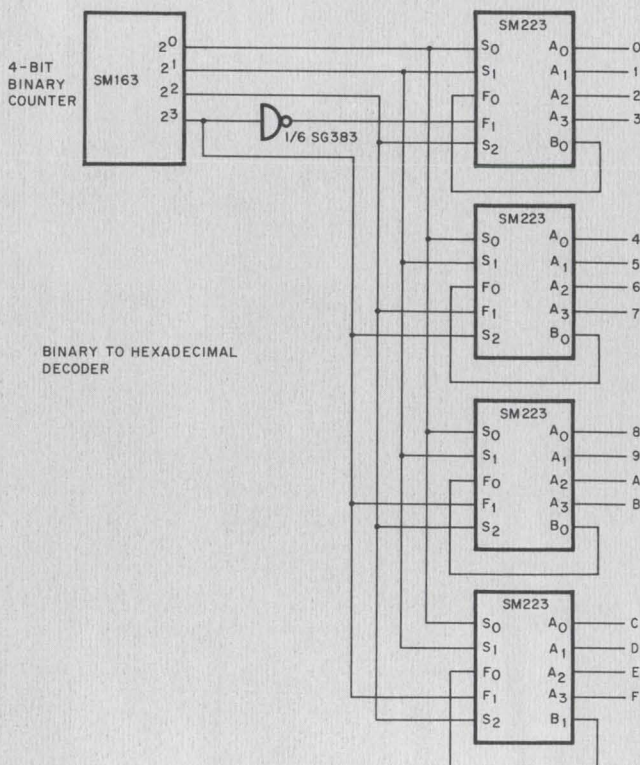

Fig. 2. Logic diagram of SM-223 demultiplexer.

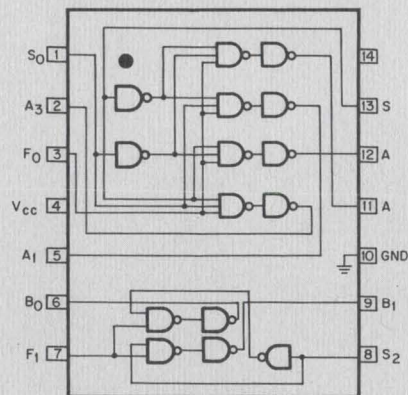
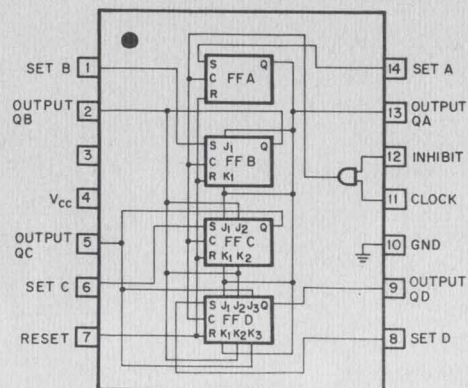

Fig. 3. Logic layout of SM-163 4-bit binary counter.



TELEVISION

Square corners are 'in' for '69 B&W set designs.

Ever see a 15-inch B&W tube with 100-square-inch viewing area? You can see it now in our modern bold-look tube.

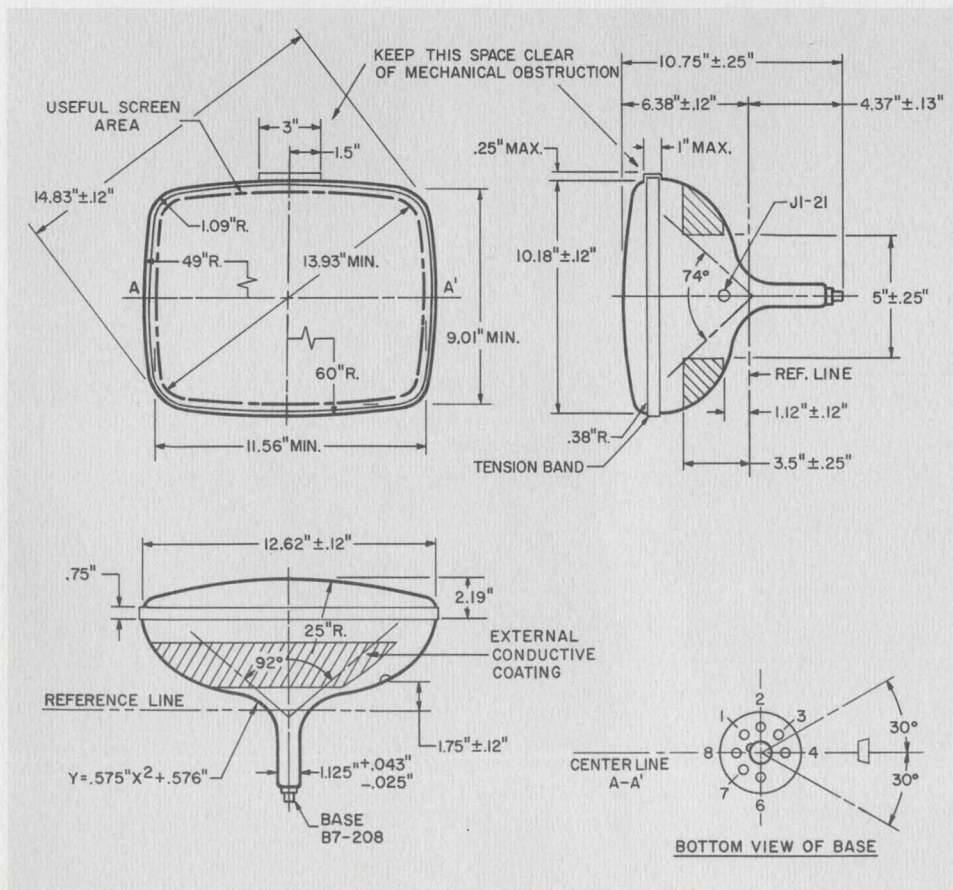
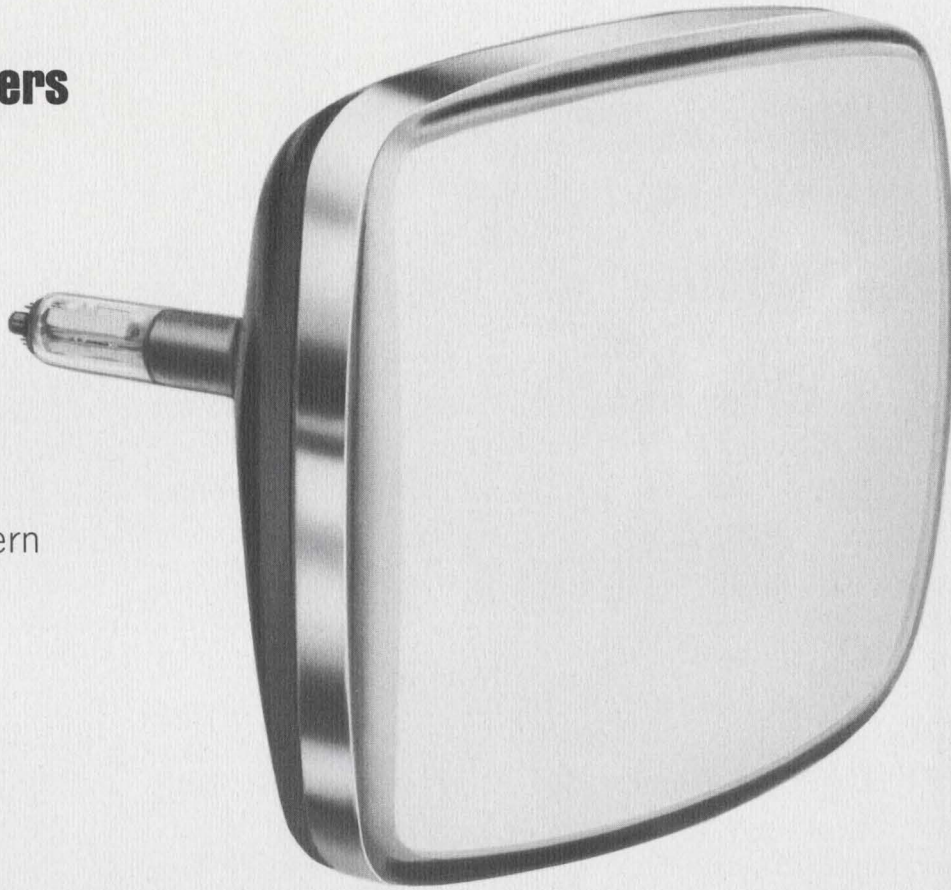

You can get that new look in your new TV set designs and you can get more usable viewing area by designing around Sylvania's new 15ADP4. Both the bold look of this tube and its larger viewing area come from the squared-off-corner construction that says "modern design."

And these are not the only features of our new 110° 15-inch tube. Its compact design and short overall length shrink cabinet size. The 15ADP4 also incorporates the 1 1/8" diameter neck that reduces your drive circuit requirements. T-band implosion protection comes as a standard feature.

Of course, our new tube incorporates all the same advances in tube design, materials and production techniques that have made Sylvania monochrome tubes the standard of the industry.

The Sylvania tube line, in fact, is one of the broadest in the industry. And our production flexibility allows custom design modifications to be made at minimum cost. Whether your need is off-the-shelf or custom design, Sylvania has the people who know how to handle the job.

CIRCUIT MODULES

'Dual In-Line Pac' cuts module cost.

New line of multilayer modules achieves high speed and low noise using dual in-line ICs.

We've got a whole new series of digital logic modules that combine low cost with the dual in-line integrated circuit package which has speed and noise properties similar to modules using flat packs.

The "Dual In-Line Pac" family is available in a wide variety of universally arranged gates and flip-flops. Included in the line of 48 modules are general gates, select gates, memories, registers, clocks, counters, decoders, drivers, and other functional types. All are capable of utilizing the 33 MHz speed of the ICs.

The circuit boards, each with positions for up to 12 IC packages, are of four-layer laminated construction. The boards utilize "buried" power and ground planes and two signal boards for lowest possible noise. Noise level is minimized by a module inductance of less than 1 nanohenry. The power/ground plane provides a built-in decoupling capacitance of 1000 pF.

Electrical interconnection from ground and power planes to the IC pins is made directly via plated-through holes. All circuit connections are terminated in a single 40-pin NAFI connector. The modules can be nested on 0.350" centers.

All modules undergo a 100% final electrical performance test to a specified test procedure. In addition, the circuit boards receive a 100% continuity test at 28 Volts and a 100% high pot test at 500 Volts before assembly.

A typical member of the "Dual In-Line Pac" family is the module type G20 shown in the photograph and logic diagram. The G20 module is a 12, 2-input gate inverting standard drive module. It is provided in eight different electrical configurations to give a variety of temperature and drive characteristics.

As with all the modules in the line, the G20 uses Sylvania's tried and proven SUHL logic circuits. The large number of device types available in this line gives us a wide flexibility in module design and permits many variations.

Our circuit board design is also compatible with other types of ICs and discrete components as well. We'll be glad to design custom modules to your exact specifications. Let us look at your designs. We'll show you how it can be realized in module form at lowest cost.

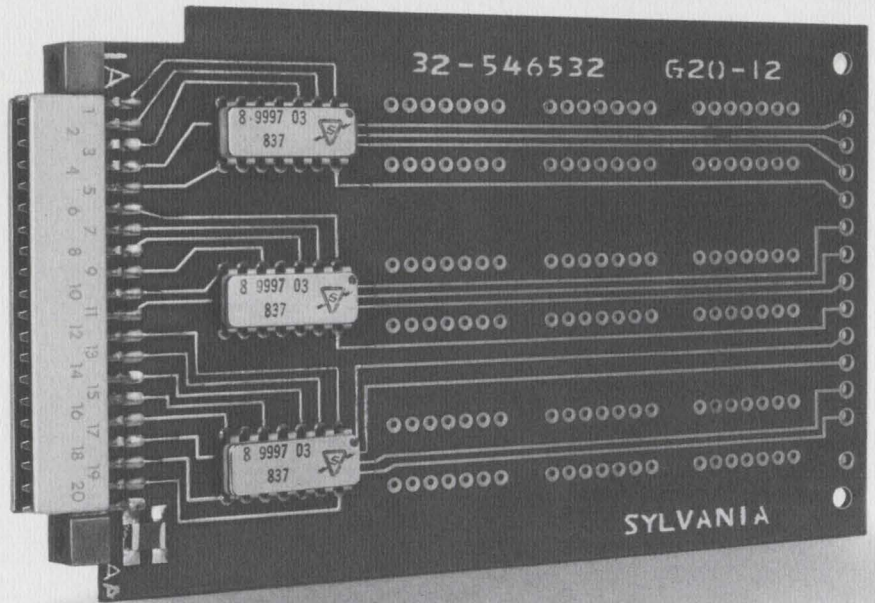

Dual in-line modules provide a fast logic at lowest cost.

Logic diagram of G20 inverting standard drive module with twelve 2-input gates.

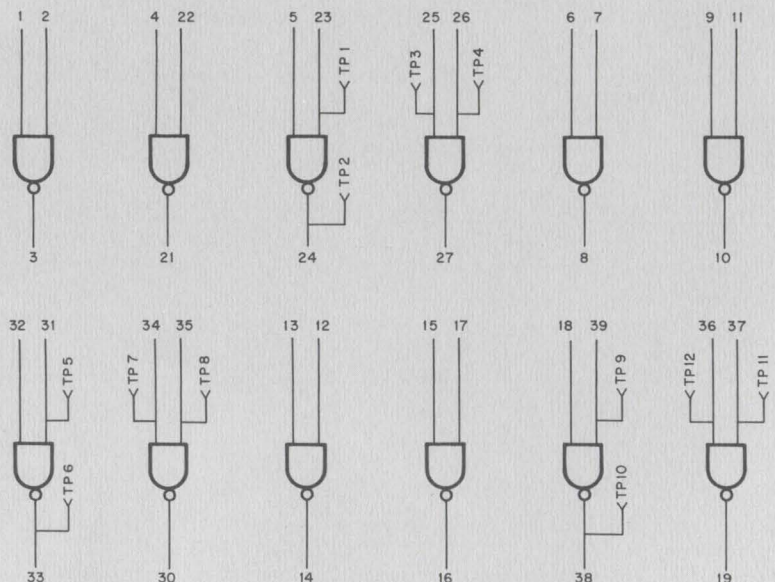

NOTE:
TP REFERS TO TEST POINT. OTHER NUMBERS ARE PIN NUMBERS.

EL DISPLAYS

Two-input power supply drives EL devices.

Compact solid-state package provides 250 V, 400 Hz power from AC line or battery.

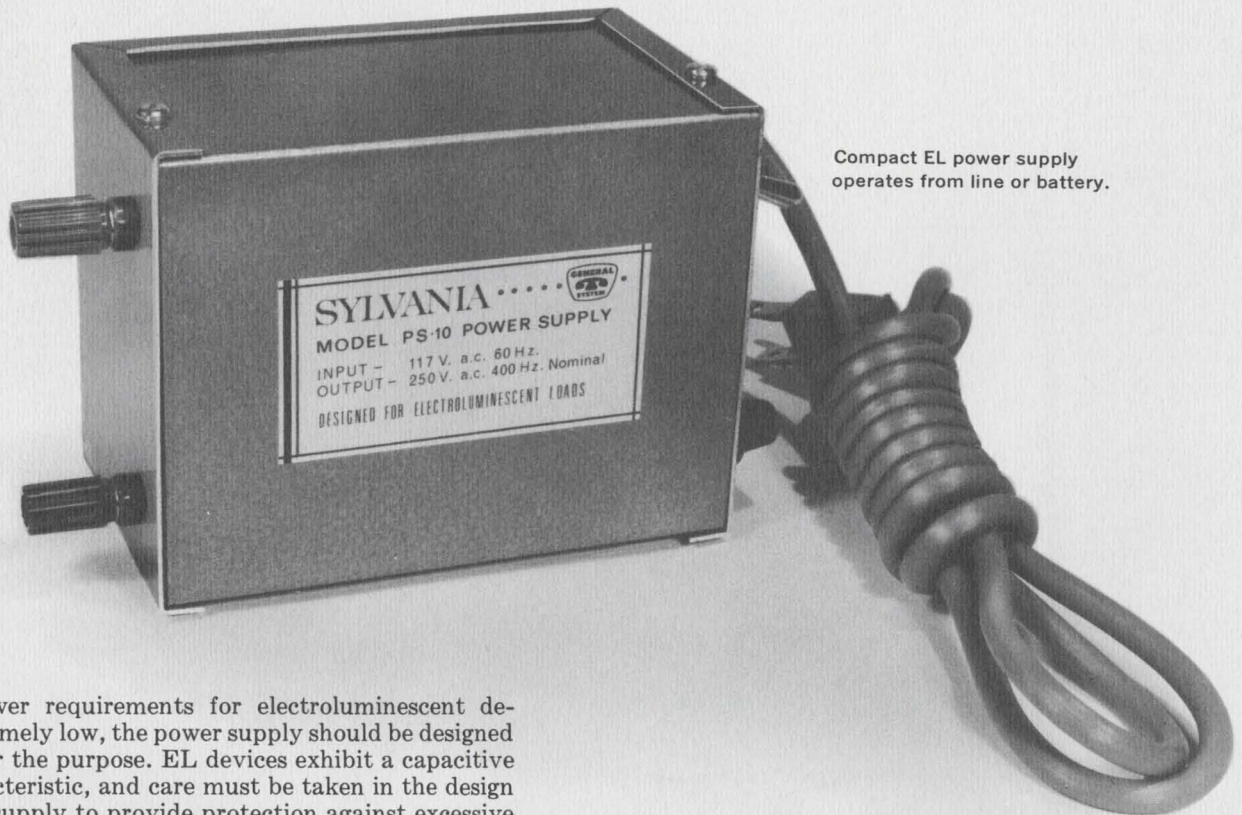

Compact EL power supply operates from line or battery.

Although power requirements for electroluminescent devices are extremely low, the power supply should be designed specifically for the purpose. EL devices exhibit a capacitive loading characteristic, and care must be taken in the design of the power supply to provide protection against excessive current transients.

A special transformer design in our new PS-10 EL power supply provides this needed protection. The PS-10 is the first of a series of special power supplies designed specifically to handle electroluminescent loads. It can operate from either a 117 V AC, 60 Hz, line or from a 12 V battery. Nominal output voltage is 250 V AC at a frequency of 400 Hz. Maximum EL load current is 25 mA peak-to-peak.

The PS-10 can drive up to 10 square inches of electroluminescent panel at a 20% power factor with less than 10% decrease in output voltage or frequency. This is equivalent to driving 29 one-inch numeric characters fully illuminated or 8 two-inch characters fully illuminated.

The compact solid-state power supply is mounted in a 2 1/8" x 3" x 5 1/4" metal cabinet. The AC input is supplied by an integral line cord. For battery operation, a phone-jack type connector is used. When the battery jack is plugged in, the AC rectification circuit is disconnected. This arrangement provides a fast and flexible means of changing power sources as needed.

CIRCLE NUMBER 304

Circuit of EL power supply.

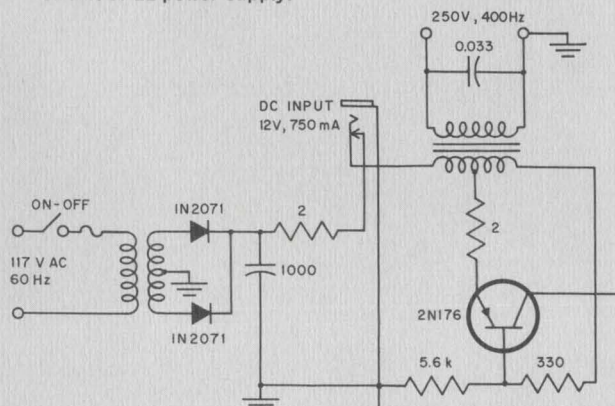

Specifications of EL power supply

AC input voltage	117V AC 60 Hz.
AC output voltage (nominal)	700V P/P
AC output frequency (nominal)	400 Hz.
Maximum EL load current	25 mA P/P
Dimensions	2 1/8" x 3" x 5 1/4"
Mounting position	Any

DIODES

How planar diode arrays save you time and money.

Arrays of 2 to 16 diodes can cut core-driver assembly time, give ultrafast switching capability.

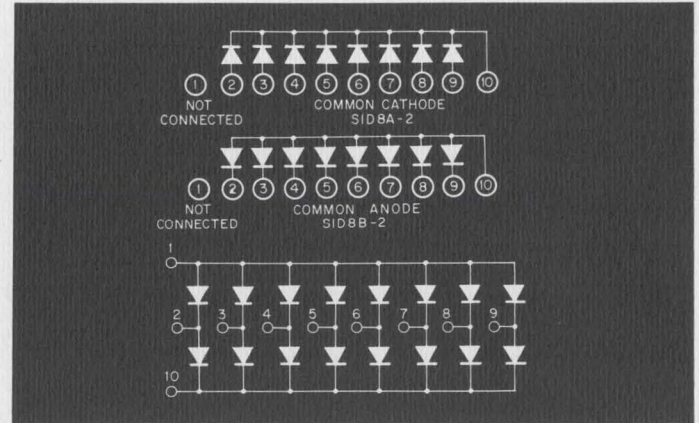

Configuration of 8- and 16-diode arrays.

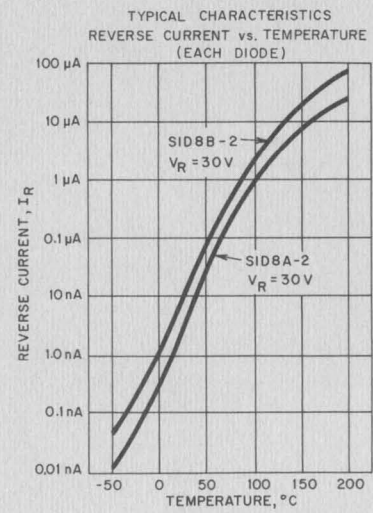
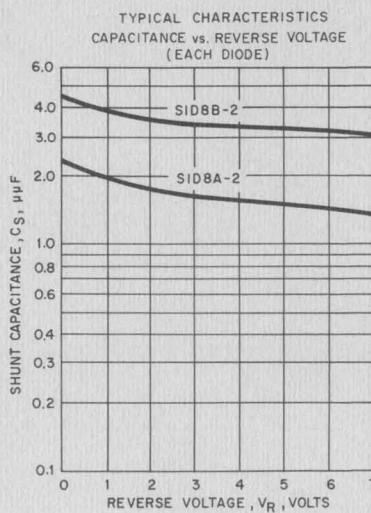
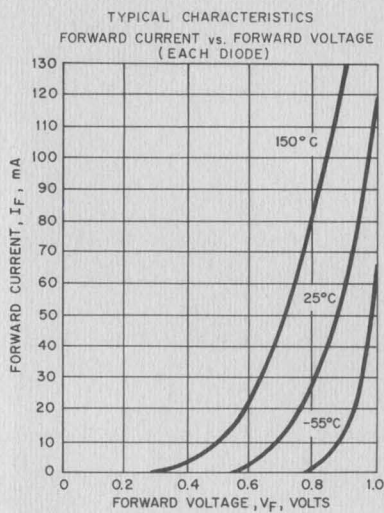

You'll find outstanding benefits in both performance and production by using our core-driver diode arrays.

In performance, you get high forward conductance, fast recovery, low capacitance, and tight tolerances. In production, you reduce your labor costs, shorten assembly time and cut external wiring in the manufacture of computer memory-core driver systems.

Take, for example, our popular 8- and 16-diode arrays. Both types of array are available in common cathode and common anode configurations. These units have a forward current rating of 300 mA and a power rating of 300 mW per diode.

As for speed, reverse recovery time is a maximum of 60 ns, even under extreme switching conditions of a forward

current of 300 mA and an I_r of 30 mA. Typical values for recovery time of I_r and I_F switching from 300 mA to 30 mA is 35 ns.

The manufacturing process used to produce these arrays results in diodes which have closely matched electrical characteristics over a wide temperature range.

The 8-diode arrays are available in 10-lead flat packs or dual in-line plug-in packages. The 16-diode array is also available in a flat pack configuration or in a 14-lead plug-in package. All of these arrays are designed to meet MIL-S-19500 standards.

Other core-driver diode arrays are available from Sylvania in units from 2 to 16 diodes connected as common cathode or common anode.

CIRCLE NUMBER 305

Maximum ratings at 25°C (each junction):

Reverse voltage, V_R	40 volts
Forward current, I_F	300 mA
Peak forward current, I_{FP}	1.0 amp (0.0 μ sec, 25% D.C.)
Average power dissipation, P_D	300 mW (500 mW total package)
Junction temperature, T_J	-65°C to +150°C
Storage temperature, T_{stg}	-65°C to +300°C

Note 1. Pulse test $\leq 300 \mu$ sec, $\leq 2\%$ duty cycle.

Electrical characteristics at 25°C (each junction):

	Conditions	Min	Max	Unit
Forward voltage drop, V_F (Note 1)	$I_F = 300$ mA	—	1.25	V
Forward voltage drop, V_F (Note 1)	$I_F = 500$ mA	—	1.40	V
Forward voltage drop, V_F (Note 1)	$I_F = 800$ mA	—	2.00	V
Reverse current, I_R	$V_R = 30$ V	—	0.1	μA
Peak inverse voltage, PIV	$I_R = 10 \mu$ A	40	—	V
Capacitance, C	$O_V = 1$ MHz	—	6.0	pF
Reverse recovery, t_{rr}	$I_F = 300$ mA	—	50	nsec
	$I_R = 30$ mA			
	$i_r = 3$ mA			
	$R_L = 100$ ohms			

CRT MODULES

New 12-inch monitor fills popular niche.

Universal display package meets a wide variety of needs from closed circuit TV to computer readouts.

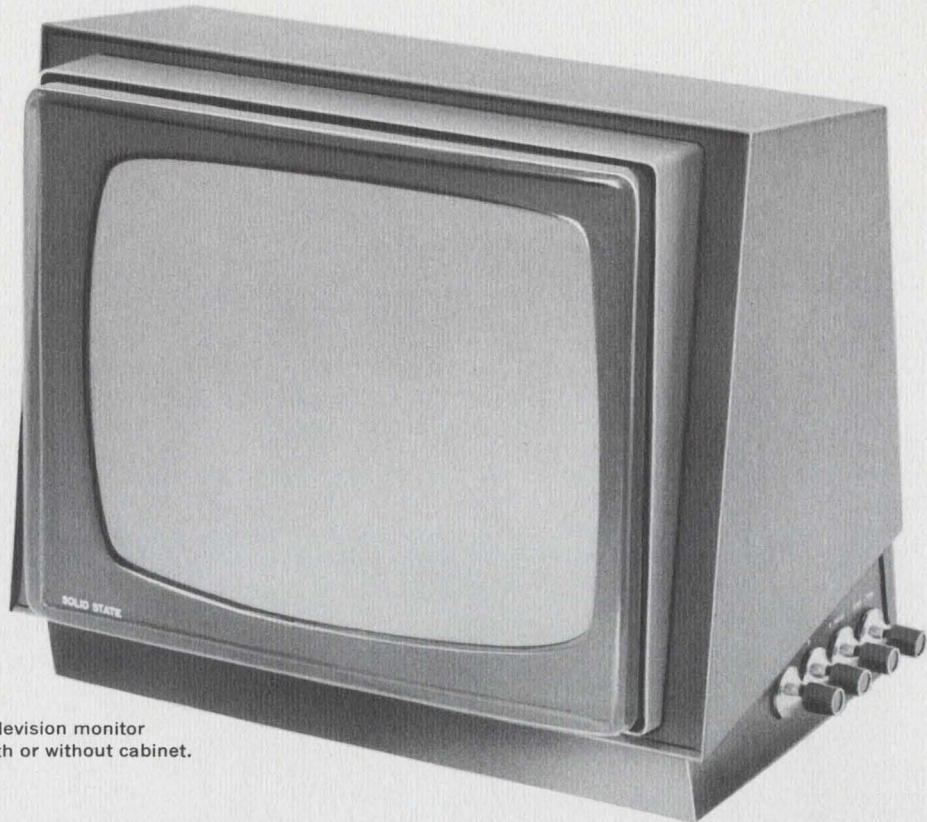

The 12-inch television monitor is available with or without cabinet.

Here's a 12-inch (diagonal) television monitor that gives you the most popular size display in a compact solid-state package. It can be used for computer terminals, airline status boards, stock-quotation displays, closed circuit TV, desk-type computers or anywhere else that a reliable high-quality display is required. And because we make it as a standard module, it means you get more performance for your money.

The module consists of circuit board, power supplies, and cathode-ray tube all packaged as a compact unit suitable for rack, console or cabinet mounting. Power supply for the module can be specified as either 117 V AC, or 22 V DC.

The display provides a standard 525 line raster and has bandwidth that is ± 1 dB from 15 kHz to 8 MHz. The composite video input signal can be from 0.5 to 1.5 Volts,

peak-to-peak.

The standard module comes with a 12CSP4 cathode-ray tube with a gray filter faceplate and bonded-frame implosion protection. If that tube doesn't meet your requirements we can easily substitute one that will.

Because we make a wide variety of cathode-ray tubes and have first-hand knowledge of drive circuit requirements, you'll find it relatively easy to get a display module that fits your needs to a tee. We can also provide custom module designs for any size CRT and to meet a wide range of circuit requirements.

The 12-inch monitor is available with or without cabinet. With cabinet, it takes up a small amount of desk space. Dimensions are 13½" wide x 11½" deep x 12" high.

CIRCLE NUMBER 306

SEE OUR SPECIFICATIONS IN
VSMF
MICROFILM CATALOG FILE

Use Sylvania's "Hot Line" inquiry service, especially if you require full particulars on any item in a hurry. It's easy and it's free. Circle the reader service number(s) you're most interested in; then fill in your name, title, company and address. We'll do the rest and see you get further information by return mail.

BUSINESS REPLY MAIL
No Postage Stamp Necessary if Mailed in the United States

FIRST CLASS
Permit No. 2833
Buffalo, N. Y.

POSTAGE WILL BE PAID BY

Sylvania Electric Products Inc.
Sylvania Electronic Components
1100 Main Street
Buffalo, New York 14209

Dept. D5 5

MANAGER'S CORNER

What it takes to stay ahead.

To remain a leader in a fast-moving field like electronics, a company must continually develop new products. To be a real innovator, such a company must develop new products even before the customer realizes that the need for the products exists.

We like to think of Sylvania as being the innovator in the industrial and military cathode-ray tube field. First of all, we have the organizational depth that makes such innovation possible. Our engineering staff has been closely associated with the development of CRTs for the home entertainment market. Here is where most of the innovations in CRTs have been made. New phosphor developments as well as improved processing techniques and materials are among our many developments in this field.

Our Industrial and Military Cathode-Ray Tube facility in Seneca Falls, N.Y. is able to translate these developments for use by our customers.

Secondly, we can draw upon the talents of the Sylvania manufacturing and marketing facilities to produce the special tubes we design and to tell us what the customer's needs are going to be.

As a result of these advantages the Sylvania I & M CRT Department has been able to lead the field in developing new products for the industrial and military user.

What are some of the new products which Sylvania has offered to the Industrial and Military marketplace?

Several years ago, as more and more display systems—such as ultrasonic testers—became portable, the need for a cathode-ray tube with a much reduced heater-cathode power was required. To fill that need, Sylvania designed the 1.5

Volt 140 mA heater. Today, it is the basis for many portable oscilloscopes.

In the display field, there has been a need for color without the problems and disadvantages of a shadow mask tube. Today, Sylvania can offer a multi-color display in almost any tube size with a resolution far superior to the standard TV type with a shadow mask.

There have been indications that the next generation of high density display tubes will require a new type of tube capable of higher brightness and higher resolution. Sylvania has just recently announced such a tube. It has seven beams with a common focus system and deflection yoke. In one horizontal sweep, it will generate one row of characters. The conventional tube requires seven horizontal sweeps to do the same job.

We have recognized in our display customers, a need to supply the tube and its immediate circuitry. To fill that need, a department has been formed which can supply, on custom specifications, an integrated display module which will include the tube, its mechanical mounting, its immediate power supply and deflection circuitry.

These are but a few of the new product needs which Sylvania has undertaken to fill in the marketplace.

The Industrial and Military Tube Department maintains its own development and production facilities, and we work closely with the Division's New Products Group to formulate new solutions. In addition, we can call upon the television-tube production facilities for large-volume production. With a total package capability like this, the I & M CRT Department is in an excellent environment to maintain its position as an innovator in CRT developments.

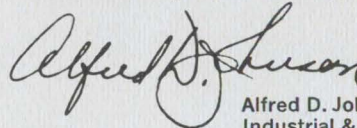

Alfred D. Johnson, Manager
Industrial & Military Cathode-Ray Tubes

This information in Sylvania Ideas is furnished
without assuming any obligations.

SYLVANIA

GENERAL TELEPHONE & ELECTRONICS

NEW CAPABILITIES IN: ELECTRONIC TUBES • SEMICONDUCTORS • MICROWAVE DEVICES • SPECIAL COMPONENTS • DISPLAY DEVICES

D5

NAME _____

PLEASE PRINT

TITLE _____

COMPANY _____

ADDRESS _____

CITY _____ STATE _____ ZIP _____

Circle Numbers Corresponding to Product Item

300	301	302	303	304
305	306			

Please have a Sales Engineer call



HOT LINE INQUIRY SERVICE

Need information in a hurry? Clip the card and mail it. Be sure to fill in all information requested. We'll rush you full particulars on any item indicated.

You can also get information using the publication's card elsewhere in this issue. Use of the card shown here will simplify handling and save time.

ORIGINAL PAINTINGS ...time, after time, after time, after...

with Fansteel's SIL-PAINT™ and other conductive coatings. Custom formulations give you assurance of batch-to-batch repeatability ...maximum conductivity...optimum solderability...superior adhesion...more parts coverage.

Choose either fire-on, air-dry or bake-on conductive coatings...gold, palladium, platinum or silver... for monolithic capacitors, hybrid circuits, end coatings and lead attachments, r.f. shielding, decorative or any application requiring conductivity. Easy to use... screen, dip, spray or brush.

Test our quick response. Specify Fansteel Sil-Paint and other conductive coatings. Be assured that you get only *your* formula... time, after time, after time. Electronic Materials Laboratory, 18201 South Santa Fe Ave., Compton, Calif. 90221. Phone (213) 638-7771.



NEW TECHNIQUE IMPROVES LOW-LEVEL SIGNAL MEASUREMENTS

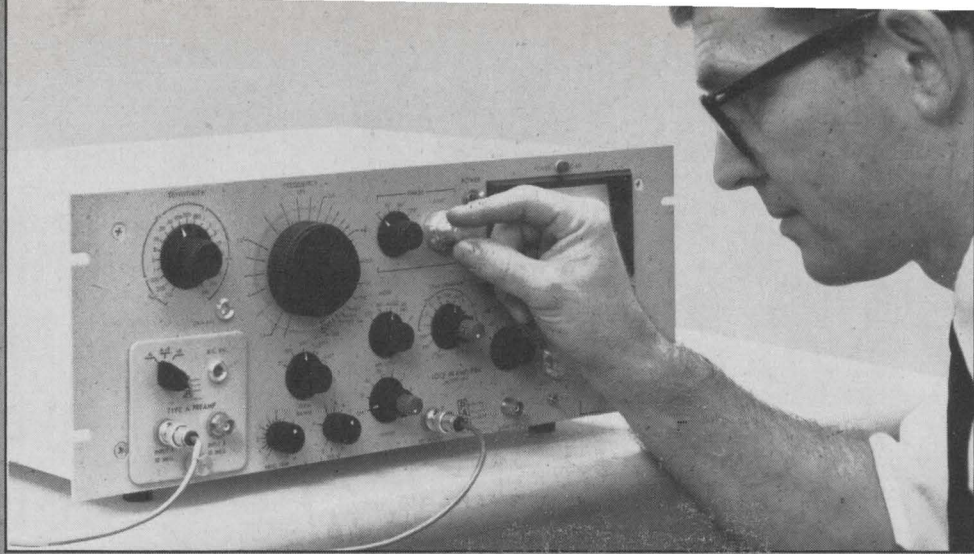

Where extremely low-level signals must be measured in the presence of obscuring noise, the use of a PAR™ Lock-In Amplifier can often transform a complex and sometimes futile investigation into a routine test procedure. For example, Lock-In Amplifiers can be used to:

MEASURE AMPLIFIER CROSSTALK TO ONE NANOVOLT

Where amplifiers are in close proximity in low level data processing systems, the minimum detectable signal is frequently limited by the crosstalk or mutual interference generated. By using a Lock-In Amplifier to measure crosstalk: (1) The source of feed-through can often be identified since very low-level crosstalk can be measured over a wide frequency range. (2) Further extraneous signal coupling errors are eliminated because no instrumentation other than the Lock-In Amplifier is necessary. (3) Crosstalk levels as small as one nanovolt can be detected. (4) The phase of the crosstalk can be identified.

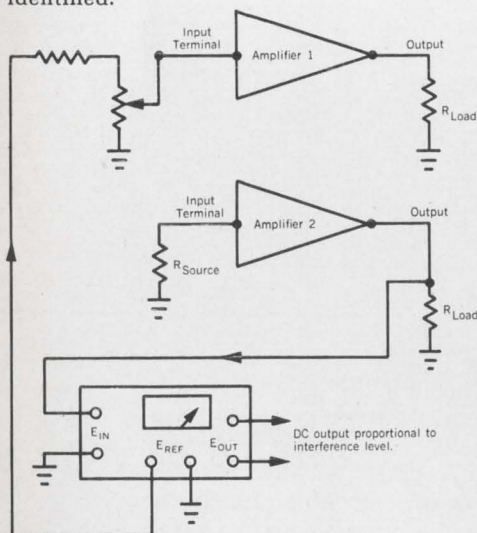

LOCK-IN AMPLIFIER
USED FOR AMPLIFIER CROSSTALK MEASUREMENT

IMPROVE BRIDGE SENSITIVITY TO ONE NANOVOLT (FS)

A Lock-In Amplifier improves bridge sensitivity without over-driving the bridge circuit. Excite the bridge with the Lock-In Amplifier's internal oscillator and connect the external null detector termination to the signal input to get: (1) Measurements over frequencies of 1.5 Hz to 150 kHz. (2) Optimum noise figures using available preamplifiers with input impedances of several ohms to 100 megohms. (3) One nanovolt full-scale sensitivity for improved null accuracy and extremely low power dissipation in critical circuits. (4) A dc signal proportional to the off-null condition for use in modifying bridge parameters or as a recorder input. (5) Detection of in-phase (resistive) and quadrature (reactive) bridge components which can be nulled independently (and simultaneously, if desired).

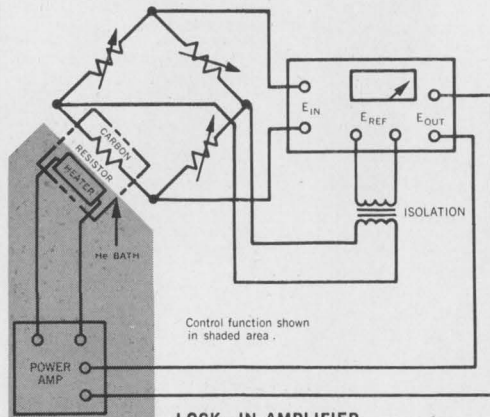

LOCK-IN AMPLIFIER
USED AS BRIDGE OSCILLATOR/NUL DETECTOR

MONITOR OP AMP SUMMING JUNCTION VOLTAGES TO 10 NANOVOLTS

The open-loop gain of op amps can be measured by monitoring the summing point voltage while operating the amplifier in its normal closed-loop configuration. The advantages of using a Lock-In Amplifier to make these measurements are: (1) Its self-contained oscillator serves as a signal source for the op amp over a wide frequency range. (2) Distortion and offset at the summing junction are minimized by the Lock-In Amplifier's high input impedance and low noise. (3) Summing junction voltages as low as 10 nanovolts can be measured and recorded to permit measurement of extremely high open-loop gains. (4) Phase shift can be measured.

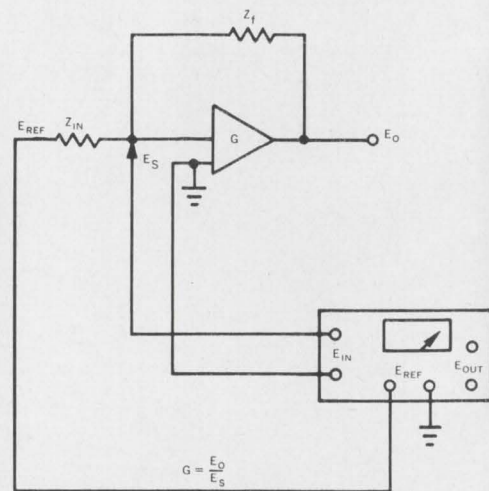

OP AMP OPEN-LOOP GAIN MEASUREMENTS
WITH LOCK-IN AMPLIFIER.

If you have a problem unearthing low-level signals buried in noise, why not call on a PAR applications specialist. He may be able to show you a better way to dig. Call him at (609) 924-6835 or write Princeton Applied Research Corporation, P.O. Box 565, Princeton, New Jersey 08540.

PAR

PRINCETON APPLIED RESEARCH CORPORATION

Pinholes: Finding pesky flaws in oxide

Dielectric-layer defect detector made by Autonetics researchers shows promise as sampling tool for quality control in wafer production

For years, Philip Eisenberg has been talking about failure mechanisms in integrated circuits at various reliability symposiums. He maintains that defects in the dielectric—usually pinholes in silicon dioxide—are the major cause of rejections in both bipolar and metal oxide semiconductor IC's. A group scientist for special projects in the Research and Engineering division at the Autonetics division of North American Rockwell, Eisenberg recently did more than talk about oxide pinholes. He, along with Kenneth Brion, a member of the technical staff in the R&E division, put together a dielectric-layer defect detector that uses established principles to locate and mark pinholes.

Eisenberg has mountains of data on the reasons for IC failures as a result of his work on spotting and analyzing flaws in devices purchased for the Minuteman program. The work showed Eisenberg that the chief cause of pinholes is the differing thermal coefficients of expansion of the bulk silicon and the silicon dioxide. The oxide is usually grown at about 1,200°C, and silicon contracts more quickly than the oxide when the wafer cools. Resulting stresses cause cracks—which appear as pinholes—in the oxide, degrading it as a dielectric because metallization put down on top of a pinhole causes shorting through to active areas.

Gas test. One method to detect pinholes used sporadically by some IC manufacturers, according to Eisenberg, exposes the oxidized wafer to gaseous hydrogen chloride at about 1,200°C. If pinholes exist, the HCl will etch through them to the silicon. But Eisenberg

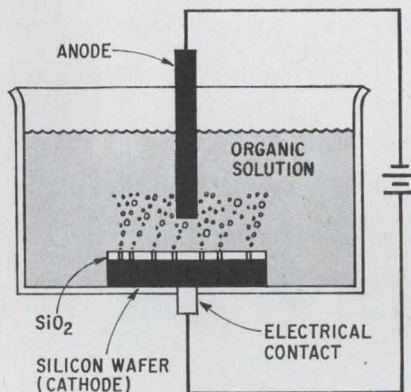

Leaky. The Autonetics detector spots pinholes in wafer's oxide layer by using electrophoretic test cell.

cites two flaws in the method: because it's used at elevated temperatures, many pinholes that occur during cooling are not detected; and the dielectric layer must be removed to find out where the HCl has attacked the silicon.

The Eisenberg-Brion detector accepts wafers up to three inches in diameter after they've cooled. After a portion of the oxide is removed from one side, the wafer is placed with the intact oxide side up in a proprietary organic solution in an electrophoretic test cell. Electrical contact is provided between the bottom of the wafer and the cup-like cell. The operator triggers a switch that positions the wafer under a binocular microscope. Then a copper anode is lowered into the solution above the wafer. Current is applied to the circuit including the anode and the silicon as cathode.

If current flows from the anode through the solution, through the oxide pinhole, and finally through the silicon, a stream of hydrogen bubbles appears at the pinhole.

The operator scans the wafer through the microscope, looking for bubble sites, after triggering a three-way switch (inspect mode, decorate mode, off) to the inspect mode. He may use a mechanical counter to determine if the pinhole incidence per square centimeter is acceptable. The test cell is mounted on an x-y stage, which the operator moves manually.

If a permanent record is desired for later failure analysis through photography or other means, the operator switches to "decorate." This increases the electrical potential, accelerating the electrolytic action, causing the anode to be attacked, and forming charged particles that are transported through the solution. This is electrophoresis. The particles deposit around the defect as they follow the current path, distinctively marking the pinhole.

Spot check. Eisenberg recommends that the pinhole detector be used as a sampling tool is quality control, not for 100% wafer inspection. He says: "If you run 50 wafers through the furnace in the first oxidation, and the sampling shows the defect density to be way off, you can strip the oxide and save the wafers." Not only can the detector be a valuable research tool to help the user better understand why oxide pinholes occur, Eisenberg believes, but it will help the user refine the oxide-growing technique most suited to his process.

The detector, which can also pinpoint flaws in such dielectrics as silicon nitride, was first shown by Navan Inc., North American Rockwell's sales subsidiary, at the IEEE show last March; intent-to-buy forms were signed by 24 firms.

U.S. Reports

They were quoted an estimated price of \$2,000 and received the option of buying 20 additional machines at Navan's eventual published price, less 15%.

Advanced technology

Smile—you're digitized

When the Air Force permitted CBS Labs to talk about its high-resolution laser-scanning system (part of Compass Link) used to transmit reconnaissance photos from Vietnam to the Pentagon in minutes [*Electronics*, April 14, p. 56], CBS officials were optimistic about the possibility of broader applications. A step in that direction has been taken with the modification of the laser scanner so that it can convert high-resolution photos for handling by a computer.

Called LIPS—laser image processing scanner—the system digitizes the image, then feeds the signal through a buffer to an IBM 360/40 computer. The computer processes the picture to emphasize fine details or improve the contrast. The reconstructed image is then read out of the computer onto photographic film. Thus, LIPS enables the photo interpreter to manipulate his picture to bring out any desired detail with a high degree of resolution.

Routine work. In operation, the interpreter tells the computer what areas he wants emphasized. For example, he could call for a routine that would bring out high-frequency detail. If the finished picture were unsatisfactory he could go to a routine that not only would emphasize high-frequency detail, but also would suppress or clean up large areas of black.

LIPS uses a sequential scan to attain a resolution of 100 lines per millimeter. It can digitize, or record from digital data, a 1.8-centimeter-square area in 15 minutes; that's at least twice as fast as conventional scanners such as those used on the Ranger moon probes.

CBS says the advantages of LIPS—high resolution and geometric



Overview. The top photo, actually a negative, shows Haiphong harbor in North Vietnam; Russian ships are clearly visible. Principle used to send picture to Pentagon in minutes is being adapted to civil use, below.



fidelity, high-speed read-write rates, and operation in standard room lighting—can be used by map makers, meteorologists, or news organizations.

Avionics

Head-up hologram

With practical applications for holograms still in the few-and-far-between stage, the Office of Naval Research and IBM believe they have a holographic application that is both practical and unique: in a head-up, all-weather landing system.

The system—now at the laboratory model stage—employs a hologram of an aircraft carrier. The hologram is picked up by an infrared vidicon and projected on a crt cockpit display.

Feel free. The achievement is one of application in which a two-dimensional representation with the so-called six degrees of freedom encountered in a carrier landing, and full ranging capability, is produced without employing a computer. The demonstration model simulates an approach window two miles wide and a half-mile high and offers a 3.5-degree glide slope. The six degrees (glide-slope deviation, localized deviation, depression angle, bearing angle, roll, and slant angle) are achieved mechanically, electronically, and optically. For example, roll is achieved as the vidicon itself is rolled; glide-slope deviation is simulated by manipulating the hologram. In the model, the generated image allows a view which includes magnification of the holographic image of the carrier up to 16-to-1 and permits views including one below the deck of the carrier.

Currently, the project is in evaluation, but IBM has submitted a new proposal to continue the work. According to Lt. Comdr. Francis L. Cundari at the ONR: "The probability of continuing the program into the next phase is high."

The electronic systems center of IBM's Federal Systems division has proposed building an advanced

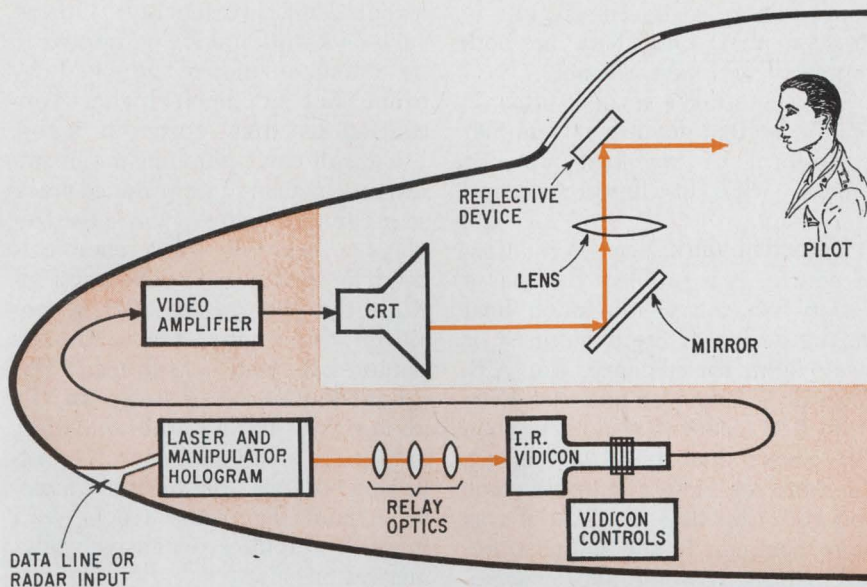

Shape up. Head-up holographic display, developed by IBM and the Office of Naval Research, would enable pilot to "see" carrier's deck despite zero visibility. System is in laboratory model stage.

system in which simulated approaches would be flown and a computer would analyze performance characteristics. Proposed technical refinements include better holographic resolution; reduction of the package size by substituting a solid state, gallium arsenide laser for the bulky helium-neon continuous-wave laser in the original. Dave Hanna of the IBM team says, "By reducing the package size we would be ready for actual flight testing in the next stage."

In case. Pilot acceptance could be a problem, however, just as it is with any significant technological change. But, Cundari says, "Even if it never gets into the cockpit, we have a very valuable tool for simulation training."

Developing a simulator before proceeding with system development helps overcome user objections and would, of course, require less funding—a significant consideration in the present time of tight money.

Whichever direction the program takes, ONR proponents are convinced they have a winner. "Results so far have exceeded our expectations," says Cundari, "and we have proven such a system is feasible. The next thing we've got to do

is prove applicability."

Package size of an operational system could be cut to one cubic foot, according to the Navy, short-circuiting the argument that it would become a problem in aircraft already loaded with avionics. Alternatively, the system could be placed in the carrier and the image would then be transmitted to the aircraft.

"Ideally, this system would be linked in a one-to-one relationship with the real world and be perfect for bad weather operations," says Cundari.

Beyond Cains

The \$3 million Navy contract to develop the first six Cains (carrier inertial navigation system) has officials at Litton's Guidance and Control Systems division optimistically eyeing \$200 million in follow-on business.

Cains, designated AN/ASN-92, will be installed in the Navy's E-2C, F-14, S-3A, and A-6E aircraft. The first six systems will be delivered in 1970 for the E-2C and F-14. The system aligns an aircraft's inertial navigator with the carrier's inertial system, using a radio link, elimin-

ating flight deck clutter: bulky umbilicals carrying information to aircraft inertial navigators from the carrier's [*Electronics*, Oct. 30, 1967, p. 44].

Roland O. Peterson, Cains program manager for Litton, says that the system will be Government-furnished equipment in future Navy aircraft, and that there is no indication the Navy will seek a second source. Litton will reap the reward for the two years of company-sponsored research and development by producing all five basic Cains elements, including the inertial platform and mount, computer, control and display unit, power supply, and converter-amplifier unit for adapting the system to specific aircraft.

Litton's LN-15 inertial navigation system will be used. Minor modifications will speed reaction time of the platform to meet requirements for quick alignment of the system.

Already at work. The LN-15 is installed in the OV-10 Mohawk and other Army aircraft, and is being used as a reference source aboard B-52's for the Air Force's short range attack missile (SRAM). Existing data links, including the ASW-25B and ASW-27A already aboard some Navy aircraft, will be utilized. The complete system, weighing less than 100 pounds, is fully compatible with the Navy's versatile avionics stop test (VAST) for centralized shipboard checkout of avionics.

The digital interface for the radio link between the ship's computer and the aircraft is described by Peterson as "straightforward digital logic, with nothing glamorous about it."

Litton claims alignment requires less than one-third the time consumed by earlier systems, with improved accuracy. In the past, warmup and alignment times of from 20 to 75 minutes were required; the Navy has sought a five-minute alignment. Litton will say only that it has cut the time required "through thermal management of the inertial platform and a sophisticated statistical filter in the computer."

The Navy is expected to award

U.S. Reports

a separate contract next month for a calibration and maintenance console with computer capability and interface hardware to be used with both Cains and AN/ASN-90, and inertial system made by General Precision's Kearfott Group for the Navy's A-7E.

Manufacturing

Smog gets in your IC's

Like other Californians, engineers at Fairchild Semiconductor in the Bay Area have learned to live with smog; they've come to regard it simply as an eye irritant. Its nuisance value, so they thought, is that it obscures scenery. Therefore it was with some surprise that the engineers learned smog can also ruin the transistors and integrated circuits they make.

They found that photochemical smog, the effect of sunlight on hydrocarbon combustion products, can cause "resist scum," a polymerized-photoresist residue on silicon wafers that interferes with processing. The scum is formed when the photoresist on a silicon wafer is dried. When the wafer is put through the sequence of exposure, development, and etching to delineate the pattern for diffusion of dopants into the wafer, the scum remains in areas that should be completely clear.

Dopants can't diffuse through the scum. And equally important, deposited metal interconnections

won't adhere to it. This results in devices that fall short in both geometry and performance.

The scum takes several forms. It can be a light to heavy webbing; a uniform or wrinkled film; or specks, swirls, or clumps scattered at random.

Detective work. Scum formation, of course, is a problem that has a variety of causes—too much heat during drying of the photoresist or stray light, for instance. But A.E. Engvall, a senior engineer at Fairchild R&D, noticed that even when the causes had been eliminated, the scum remained. "It would come and go," Engvall says. "And it was more common in the summer and fall months. It would appear sometime in the afternoon, then disappear late in the evening." The mid-afternoon hours in the summer and fall months, he discovered, were the periods when the ozone content of smog is at its peak.

Engvall then ran tests with controlled amounts of ozone, and found that an identical scum was formed when his concentration of ozone equalled that of smog. Nitrogen dioxide, the other major constituent of smog, didn't form scum.

Once the culprit had been isolated, the cure was simple: at the peak smog periods, perform photoresist application and drying in a smog-free ambience. "The best ways are with a nitrogen-ventilated hood or with a hood fitted with an activated charcoal filter," Engvall says.

Selective. Smog doesn't affect all photoresists. KPR and, to a lesser

extent KPR-2, are sensitive. Others, such as KMER and KTFR, appear to be immune; they're attacked by ozone but at much higher concentrations than occur in smog.

Engvall can't pinpoint the chemical mechanisms that produce smog scum, but he believes the sensitizer plays a key role. (The chemicals used in photoresist technology include the photoresist itself, a sensitizer that's premixed with the photoresist, and a solvent.) The ozone doesn't act directly on the photoresist. Rather, the sensitizer induces a small amount of cross-linking of the photoresist molecules, and the ozone reacts with these to produce extensive polymerization.

Government

The colossus shifts

A communicator's saw has it that it doesn't make any difference how good your communication system is if you don't have anyone to talk to. That recitation of the obvious is why U.S. diplomats trying to iron out an agreement for the International Telecommunications Satellite Consortium are backing off from some long-held positions. And a weakening of the U.S. position makes Intelsat more attractive to other countries and hence more successful.

While easing the U.S. stand, however, the negotiators are bargaining away some of the powers of the Communications Satellite Corp. (Comsat).

Under a five-year-old interim agreement, Comsat has been the system's sole manager; now, the diplomats are saying they can live with an international secretariat to handle Intelsat's administrative duties. According to the new U.S. approach, Comsat would be hired as technical manager of the system—a far cry from the total responsibility the company has enjoyed. A contract would be awarded to Comsat—probably for seven years—and would be renewable at the option of Intelsat's governing board. The seven-year contract life

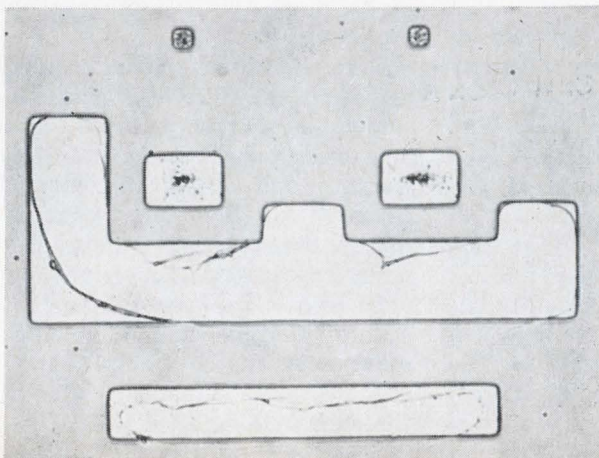

Closeup. Smog scum has almost closed two small cutouts and partly filled two larger ones. KPR photoresist was used.

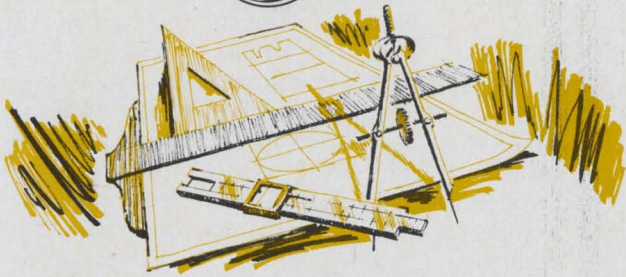

5 more electronic components tailored for designers

General Electric components are engineered for reliability and cost effectiveness. No other manufacturer offers such a wide selection of quality electronic components as General Electric. Specify GE in your designs.

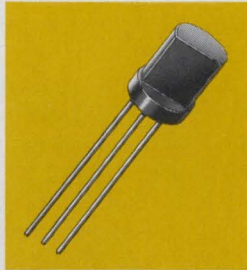

General Electric's programmable UJT lets you control the key parameters

GE's D13T is a programmable unijunction transistor (PUT) with characteristics (η , R_{BB} , I_p , I_v) that can be selected to fit your circuit. Just two circuit resistors give the D13T1 and T2 programmability which permits the designer to:

- reduce a risk of thermal runaway
 - use PUT in battery and other low-voltage circuits
 - use base 2 as low impedance pulse output terminal
 - use PUT in high volume applications.
- Especially suited for long-interval timers, D13T2 features very low leakage and peak point currents. D13T1 is for more general use in high gain phase controls and relaxation oscillators.

Both are 3-terminal planar passivated PNP devices in the low-cost plastic TO-98 case. Circle number **503**.



Pin-sized Lodex magnet

New—Lodex® permanent magnets in microminiature sizes

When designs call for tiny (even less than 1 millimeter) permanent magnets, GE has the answer. GE can produce powerful microminiature magnets at low cost—and in complex configurations, too.

The magnets are made of proved Lodex material that consists of elongated single domain iron cobalt particles bonded in a lead matrix and pressed to final dimensions at room temperature without the use of high temperature fabrication or heat treatment. This exclusive process makes it possible to produce Lodex magnets in very small or intricate shapes meeting extremely tight physical and magnetic tolerances.

Close piece-to-piece physical and magnetic uniformity often eliminates the need for final testing of the end product. These GE magnets are often the perfect answer for such precise applications as reed switches or magnetic pick-ups.

For more information, circle number **504**.

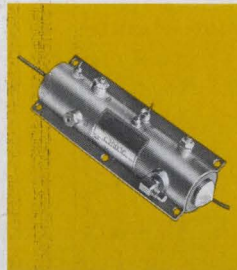

New transmitter design gives high performance to IFF and ATC transponders

GE's new C2003C transmitter is a Micro-wave Circuit Module (MCM) containing a master oscillator and power amplifier using planar ceramic triodes.

It is just one of many MCM's now available from GE to help reduce design cycles, provide retrofit and lead to improved system performance.

Other benefits include: meets performance and military requirements of the transmitter portion of IFF transponder significantly smaller than earlier designs permits two transmitters to function in space formerly used by one light-weight simplified heat sinking excellent frequency stability with wide variations in antenna VSWR.

For more technical information on this and other MCM's from General Electric, circle magazine inquiry number **505**.

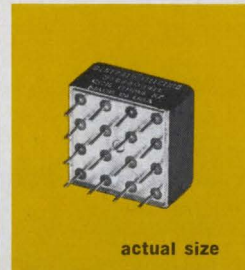

actual size

GE makes the only 150-grid relay that performs the AND-logic function

GE's 3SBR 4-pole relay is the only one available that performs the AND-logic function without any additional circuitry or components. Nine different input conditions control the relay's operation.

The 3SBR is another addition to GE's proved family of 150-grid relays for mil spec applications. It features all-welded construction, small size and a low profile—only 0.32" high. The 3SBR is available with a choice of coil ratings, mounting forms and headers.

For more technical data, circle number **506**.

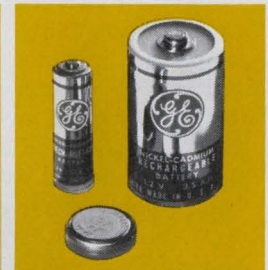

Rechargeable nickel-cadmium batteries give design flexibility—long life

Get lasting battery power and versatility suitable for many industrial and consumer applications. Types include sealed, pressure-relieved and vented cells. Custom designs to your specifications are also available.

Nominal ratings range from 0.1 amp-hours in sealed cells and up to 160 amp-hours in vented types at the one-hour rate.

GE nickel-cadmium cells feature unique construction providing a very high discharge rate capability.

See how GE's proved line of nickel-cadmium batteries can increase your circuit performance. For more information, circle magazine reader card number **507**.

LOOK TO GENERAL ELECTRIC—your best source for more in electronic components.

ELECTRONIC COMPONENTS SALES OPERATION

GENERAL ELECTRIC

285-52

U.S. Reports

was offered to accommodate the Intelsat 4 satellites scheduled to have that life span.

Split up. As technical manager of the 68-nation consortium, Comsat would be charged with design, development, procurement, and operation of the satellite system including the telemetering necessary to keep it functioning. The secretariat-administrative manager, on the other hand, would handle the day-to-day operation of the consortium, budgeting, planning and housekeeping jobs.

Until the recent turnaround, the United States fought to maintain Comsat's role as the system's manager. This issue was the main stumbling block in a meeting of Intelsat countries earlier this year toward working out a permanent agreement.

The shift in U.S. position, if approved by the Intelsat countries, will cost Comsat in prestige, but will not seriously affect its revenues. Comsat, which participated in the talks, is not expected to fight the shift, apparently in the interest of unity.

Aiming high. U.S. negotiators have briefed representatives from 19 countries since the new position was drafted. William W. Scranton, head of the U.S. delegation, has made two trips to Europe to signal the change in U.S. position. Scranton stresses that his first criterion throughout the talks will be the continued high competence and growth of Intelsat and that the U.S. is eager to achieve a quick agreement. He also says that the positions are not totally frozen and that changes can be made.

The formulation of U.S. policy is important. Through Comsat, the U.S. owns slightly more than half of Intelsat's stock. With an American company running the consortium, with its headquarters in Washington, and with the system built around U.S. made space hardware, many countries resent one-country domination.

Drop veto. Most U.S.-proposed modifications involve U.S. domination. Negotiators are willing to give up the U.S. veto over Intelsat actions in the governing board and perhaps grant one-man, one-vote

decision making in the general assembly.

At earlier meeting, the U.S. was silent on the subject of regional systems, but the delegation was clearly against them. Now, the U.S. might be willing to accept some carefully governed regional systems if they are geographically compact, technically coordinated, and not economically harmful to Intelsat.

The U.S. is now bowing to the wishes of several member countries who want a change in Intelsat's legal personality—from a partnership to a corporate-like entity.

Follow the MOL

While the Air Force professed surprise when the Pentagon canceled its manned orbiting laboratory (MOL), and NASA officials were privately joyful over having the only remaining space station project in town, both organizations must have seen the handwriting on the wall. Not only was Congress viewing military spending with growing truculence, but Washington officer's clubs were alive with speculation about which military systems would be liquidated in the Nixon Administration's campaign to get the Safeguard antiballistic-missile system approved by Congress [*Electronics*, June 9, p. 37].

But NASA, now seemingly in the pilot's seat, still faces some problems. Though House passage earlier this month of the space agency's fiscal 1970 authorization included a Nixon-requested boost to \$75 million from \$9 million for the space station, appropriation—the vote that puts the money where the authorization is—still must come. And that may run into flak in the Senate from defense spending critic Stuart Symington, former Air Force secretary, who reversed field with the MOL cut. One of the Missouri Democrat's biggest constituents, the McDonnell Douglas Corp., stands to be hurt most by the chop because it held a \$700 million contract for the space lab plus another \$200 million for modification of Gemini modules for the effort. What's more, 7,200 of its employees are affected.

A chance. Space electronics hardware makers may eventually come out winners, however, since the Pentagon says it wants to keep about \$225 million of the \$300 million sought in fiscal '70 MOL money for other space programs—unmanned reconnaissance and tactical communications satellites carrying heavy instrumentation—plus the MOL experiment package (being handled by General Electric) which is likely to be turned over to NASA for its Apollo applications program (AAP).

Meanwhile, the Apollo applications program, which paralleled the MOL in time and use of already developed hardware, was just barely alive. At least half the originally scheduled missions have been canceled and only five missions still remained—an orbiting workshop, the telescope mount, and three revisits to the original craft. The workshop was originally scheduled for launch in 1968 and the telescope mount for 1969. Both schedules slipped at the same time that hardware and experiments for the programs were cut. The latest schedule from NASA had the first Apollo application mission going in 1972—as late as January of this year NASA was still planning to put the workshop up in 1971.

Hard look. As MOL was canceled, NASA was in the midst of a reassessment of its Apollo applications. Says a NASA spokesman, "The budget situation of recent months has introduced uncertainties into our plans for AAP. Several plans are being examined to determine new ways of saving money while still keeping the program alive." He points out that one plan under consideration at NASA is to launch the workshop and the telescope together on a Saturn 5 booster, as opposed to the present plan which calls for sending each mission on a separate Saturn 1B. Such a plan would also eliminate the need for rendezvous and docking of the two craft.

Ironically, the day before the MOL was canceled and during NASA's period of reassessment, NASA received study proposals from three firms for its multibillion-dollar proposed orbiting na-

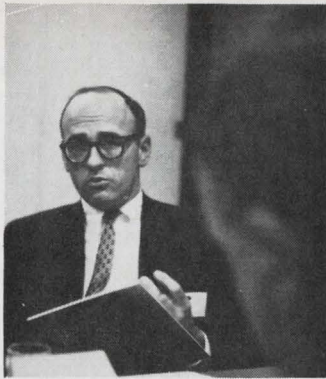

SWITCH CRAFT FORUM

order, stock, assemble and test the cable assemblies you're now using. Compare your total costs with the price we'll

I've been itching for a FORUM on molded cable assemblies. I say you

can't beat the solder or screw connected assemblies when it comes to fast repairs in the field.

How about less repairs to begin with? Failure incident rates have proven to be less with molded cable assemblies. Pull tests show why molded assemblies are 50%-100% stronger than soldered plugs. Solder types, like the one shown in fig. 1 (bottom) broke at forces as low as 24 lbs. In fact, in the tests we've run, the cable itself broke before it would pull out of the molded plug.

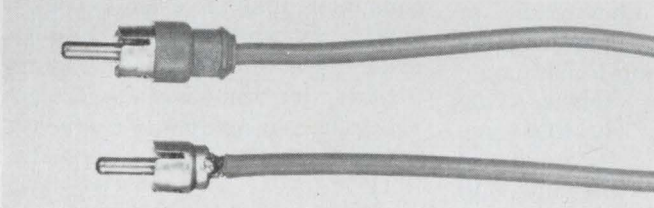

But when it does break, you're finished. That could mean expensive equipment down-time unless it can be quickly repaired.

Let's say the molded assembly does break. If you clip off the damaged plug and replace it, you're still better off than with solder or screw type connectors. You want better aspirin; we say, eliminate the headache in the first place.

Repair costs can be expensive, too. Especially, if the connection is poorly soldered and shows up as an intermittent defect. Add this to the possibility of non-molded plug handles coming loose from vibration, poor shielding from moisture and contaminants, or excessive strain due to plug and cable size mis-matches and you've got yourself a potential profit-killer.

O.K., I'll have to concede your point as far as the cable-plug connection is concerned. But, you'll have to admit that when the molding holds the plug parts together, plastic cold flow can loosen the plug tip and kill reliability.

You're right. That's why Switchcraft doesn't mold the plug components together.

Fig. 2. shows how we start with a one-piece tip rod, connector and insulators, with the rod solidly staked into the tip terminal. After soldering the center conductor, a bridge sleeve is crimped around the cable and connector flange prior to molding. No tip loosening, no cable strain.

I'm almost convinced. Now give me the bad news about the cost of molded cable assemblies vs. solder or screw types.

Brace yourself. Think of what it costs your company to

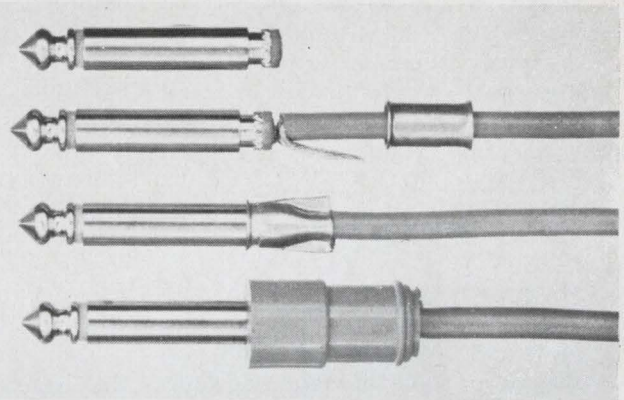

quote for a comparable molded cable assembly, and you'll be money ahead. And that doesn't even include the cost-savings you'll get from the added reliability of our molded cable assemblies.

That's great for phone and phono plugs, but we often get into some pretty oddball applications where we need a different type of connection.

You name it, we can produce it. Most of the time, one of our standard straight or right angle phone or phono plugs, microphone connectors or extension jacks will do the job. If not, Switchcraft has the know-how and high production machinery to run an economical, custom-molded unit to your specs. *Just circle the reader service number for more info on these standard and custom made molded cable assemblies.*

Sounds good, but how can my staff get further technical details on specific applications that back up what you've just told me?

Simple. Have them join the FORUM by writing their questions or comments on your company letterhead. We'll send



our "Forumfacts on Molded Cable Assemblies" handbook, and also add their name to our TECH-TOPICS mailing list. Every other month, they'll receive this engineering application magazine that we're sure will be useful and interesting to them. 10,000 design engineers can't be wrong!!

SWITCHCRAFT[®]
INC.

5587 North Elston Avenue
Chicago, Illinois 60630

U.S. Reports

tional space station to be launched in 1975 [see related story on p. 149]. Says a NASA official: "You can look at it in one of two ways. It's either a bad omen for the space station or a good one. I'll take the biased view that it's good, as Congress may be more attuned to a big space station if fewer small ones are flying."

Consumer electronics

Picture image?

Now that both RCA and Zenith Radio Corp. have brought out their brighter color television picture tubes, industry observers are playing a new game called "Spot the Coincidence." For RCA's Hi-Lite [*Electronics*, June 9, p. 136] and Zenith's Chromacolor are strikingly similar. Both have black masking around the phosphor dots to absorb ambient light; both use nonstandard phosphor dot diameters to achieve a vastly brighter picture and improved contrast.

Says Zenith's Sam H. Kaplan, codeveloper of Chromacolor, "We patented our process back in 1964, and have spent more than \$5 million in research and development since we began working on its design in early 1960, and we intend to see that it's not infringed upon." RCA's Charles W. Thierfelder, manager of tv picture tube engineering, acknowledging the similarities, points out: "In the scientific field

it's not unusual for parallel research efforts to be carried out without the knowledge of either party."

On the track. Although RCA has revealed very little information about its changes in the basic shadowmask system, it's known that both companies altered at least their phosphor dot sizes, developed new phosphors, and built a more efficient electron gun. For example, conventional phosphor dots are larger in diameter than the electron beam. This provides a guard band to prevent color tinting, and makes it easier to establish and maintain white field color purity.

Zenith, essentially, interchanged the beam-dot size relation while maintaining the same guard band. It has made the tube's phosphor dots smaller while increasing the shadowmask opening to accommodate a wider beam. Hence, while maintaining essentially the same active phosphor areas as in the conventional tube, the Zenith screen area is 50% blackened by the deposit of the light-absorbing material. This permits use of a glass faceplate with much higher light-transmission properties, thereby producing a brighter picture with increased contrast.

The use of brighter rare-earth red phosphors such as yttrium oxide and gadolinium oxide, which are 60% brighter than previously used phosphors, allows the effective areas of each color dot in a red-green-blue triad to be sized for the individual phosphor efficiency. Thus, the beam current

need not be reduced to obtain color balancing by equal currents. In addition, each manufacturer claims to be using a new gun with improved spot size for sharper pictures under all brightness conditions.

Although Admiral and Sylvania have also announced tubes they say are 100% brighter, neither will reveal technical details.

Communications

Getting pale

The effect of a high-level Pentagon decree to review U.S. strategic communications systems, both operational and planned, has already been felt by potential contractors for the Navy's Project Sanguine, an extra-low-frequency network—below 100 hertz—for worldwide secure shore-to-ship communications for submarines.

Scheduled to move to contract definition last month, Sanguine, say Navy insiders, may not request proposals for contract definition until September. But some contract competitors—among them GE, RCA, Westinghouse, and Sylvania—are getting nervous about trying to hold project teams together until the fall. All the Navy Electronic Systems Command, which is running the program, will say is that there is money for Sanguine in the budget—an estimated \$20 million for fiscal 1970—and that an award for contract definition will be completed this year.

Tests. RCA is acknowledged leader in the race with a \$4.3 million award to set up and operate a Phase I test facility at the proposed Wisconsin site in Chequamegon National Forest. Those tests are expected to be completed this year, although the slippage in the follow-on awards is likely to hold up subsequent efforts—including construction of the large-scale Phase II test facility in 1970 and the test program planned for the following year.

Also hanging fire is a separate rfp for a development contract for Sanguine receiver design and spec-

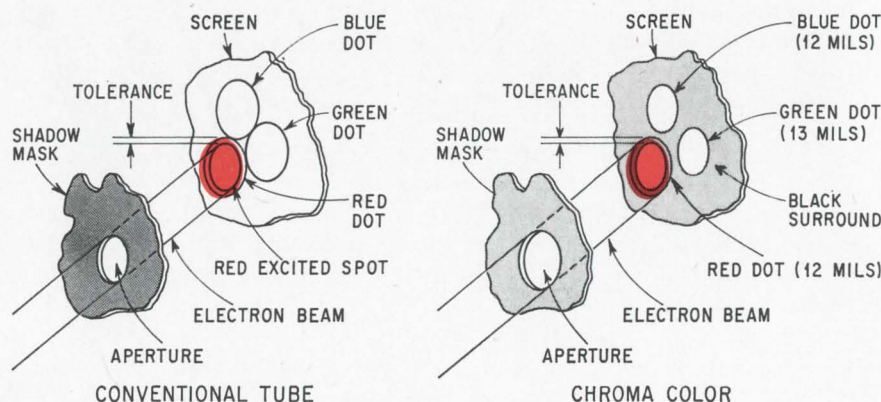

Marking the spot. Zenith's new Chromacolor television picture tube utilizes an electron beam that's wider than the dot, plus a black surround, to give brighter pictures with more contrast.

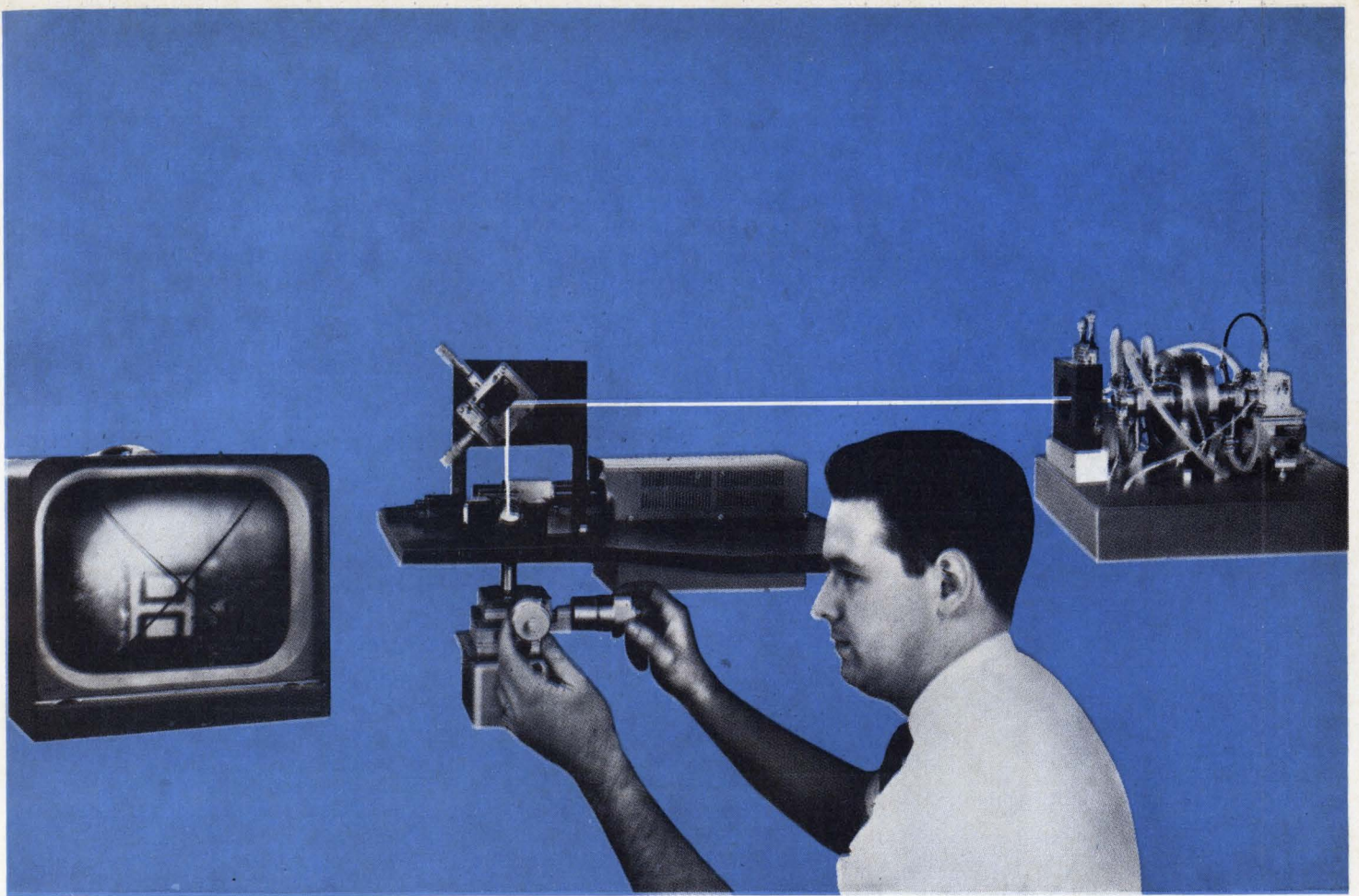

Micromachining with the laser

Bell Laboratories engineers M. I. Cohen and B. A. Unger have developed experimental techniques for using lasers in certain delicate thin-film integrated circuit work: machining circuit patterns, making "gap" capacitors, trimming tantalum thin-film resistors and monolithic quartz resonators, and cutting masks for circuit fabrication.

Our experimental system (above) combines a solid-state YAG (yttrium aluminum garnet) laser, manual positioning of the circuit, and television observation. The optical part of the system was developed by Western Electric's Engineering Research Center, located at Princeton, New Jersey.

The high spectral purity of the continuous-wave YAG laser, invented at Bell Laboratories, lets us focus the light to a very small spot for precision cuts

less than 5 microns (1/5 mil) wide and resistor trimming accurate to better than 0.1 percent. And, through Q-switching, the YAG laser produces high peak power at high repetition rates—over 1,000 pps—giving us the cutting speed necessary for practical circuit work.

Laser beams pass through any transparent atmosphere or material and can be accurately concentrated onto tiny areas. With the proper wavelength, we can machine components inside a transparent encapsulation without damaging it. Also, since we can regulate cutting depth, we can "micromachine" thin films without harming underlying materials.

To make capacitors, for example, Cohen and Unger use a laser to cut (vaporize) a narrow gap between conductors. In gold conductors on sapphire or alumina substrates, they have cut gaps

from 5 microns to 600 microns wide with good control.

Similarly, Bell Labs engineers have adjusted thin-film quartz crystal resonators to frequencies as precise as one part in 10⁸. The laser vaporizes part of the thin-film electrode, raising the resonator frequency to the desired value.

By removing hairline shorts, we have also repaired expensive integrated circuits that could not be reclaimed by standard techniques.

Pioneered at Bell Laboratories and Western Electric, laser micromachining is already in pilot and volume production use at Western Electric and other major integrated

circuit manufacturers.
From the Research and Development Unit of the Bell System—



Bell Labs

**RX Bridge
spans the
500 kHz
to 250 MHz
range
...precisely**



oscillator, bridge and null detector all-in-one

The 250B RX Meter is a self-contained RF bridge that reads impedance in terms of R_p and X_p from 500 kHz to 250 MHz. It consists of an accurate, continuously tuned oscillator, Schering bridge, amplifier-detector and null indicating meter.

Ruggedly constructed, the 250B bridge assures the user of the stability necessary for precise measurements. A front panel control adjusts the RF excitation signal to as low as 20 mV, permitting measurement of input and output "Y" parameters of transistors with the accessory 13510A Transistor Test Jig, and use of the bridge for other low-level measurements. Another accessory, the 00515A Coax Adapter Kit, provides a convenient means for adapting the bridge terminals to type "N" connectors for measuring devices with coaxial connections.

The 250B RX Meter is especially useful in determining electrical characteristics of devices and circuits such as inductors, capacitors, transformers; and filters. Price: \$2050.

For complete information and a copy of the 250B Technical Data Sheet, contact your Hewlett-Packard field engineer or write: Hewlett-Packard, Green Pond Road, Rockaway, New Jersey 07866. In Europe: 1217 Meyrin-Geneva, Switzerland.

HEWLETT  PACKARD
IMPEDANCE INSTRUMENTS

10908

U.S. Reports

ifications. A Navy source says he no longer knows when this rfp can be expected. Similarly, sources are uncertain whether the Navy will be able to upgrade the program's size to include extra-low frequency receivers for fleet aircraft as a substitute for currently vulnerable h-f units. This, too, depends on the outcome of the top level DOD communications program review.

An additional concern to companies anxious to get a piece of Sanguine's estimated \$1.5 billion action is the outcome of an ecological study now in progress at Hazelton Laboratories, Falls Church, Va. Since Hazelton isn't talking, equipment makers can only speculate what this examination of extra-low-frequency electromagnetic radiation generated by Sanguine transmitters will show and what the impact will be. Conservationists in Congress are thinking that extra-low-frequency radiation will do more than foul up television reception and make telephones ring. They speak about possible pollution of the region.

Trepidation. As one industry source says, "All they have to do is report that Sanguine could cause cancer in birds or make deer sterile and we're dead."

Though the threat of such a development is viewed as impossible by engineers following the program, the Navy does have plans to develop a specially-shielded cable for use with the Sanguine transmitters. Currently plans have the cable laid out and buried in a north-south/east-west pattern that will create a 150-square-mile underground checkerboard with individual and separate power generators at each point of intersection.

Contracts

Valhalla for hardware

Though the odds are overwhelmingly against finding life on Mars, NASA has not been deterred from committing almost a billion dollars to investigation of the idea. Two flights have been there, two Ma-

riners spacecraft are on their way to a midsummer Martian orbit, and two more Mariners are scheduled to go in 1971. Currently NASA is busy committing half a billion dollars to the most ambitious Mars venture to date: Project Viking. The program entails launching two spacecraft in mid-1973, each consisting of a Surveyor-type soft lander mated to a Mariner-1971 class orbiter.

Viking is now getting into full swing. NASA and Martin/Denver are negotiating to build the two soft landers and act as technical integrators for the program. The Martin contract, to come by October 1, is estimated to be in the neighborhood of \$280 million. Meanwhile, NASA has decided to give its Jet Propulsion Laboratory the job of constructing the two 6,000-pound spacecraft that will orbit Mars and deposit the 1,000-pound landers on the planet's surface.

The program will involve most of NASA's unmanned space centers. Langley Research Center will handle lander development and act as overall program manager, and the Lewis center will handle the Viking Titan 3D/Centaur launch vehicles. Ames Research Center is now at work on sophisticated life-detection equipment—earlier this year it gave Ball Brothers Research Corp. and the Bendix Corp. contracts for instrumentation development. Goddard Space Flight Center and Electronics Research Center will be given Viking duties as the program gets moving.

Up in the air. Walter Jakobowski, Viking program manager at NASA headquarters, says that the actual contents of the 75-pound experiment package for the lander has yet to be determined. He explains, "We are not going to commit ourselves until we have the results from the two Mariners that orbit this summer. We've set a deadline of December 15 to decide, which will give us a chance to look at the Mariner results and receive the ideas of the scientific community." Currently Jakobowski's office is going on the assumption of a typical payload that can be changed. It would include life-



ERIE

When you want radar as pure and coherent as a laser beam...

Symbolic electronic signal undistorted by EMI —
photographed by Howard Sochurek

bring ERIE in early.

31,000 feet... heavy traffic... ugly weather over the Plains. This isn't the time for "noise" in the radar. But, no sweat! RCA's exciting new AVQ-30X Weather Radar is up front, sweeping the sky... protected from EMI by 39 special ERIE filters. No other airborne radar has ever approached the single or dual system reliability of the AVQ-30. From the start, RCA has called on the outstanding research and component capability of ERIE TECHNOLOGICAL to help in the development of this great new unit. Proof, once again, that it pays to bring ERIE in early.

ERIE TECHNOLOGICAL PRODUCTS, INC.

644 West 12th Street, Erie, Pa. 16512
(814) 456-8592

Better solutions come from DEECO

Try these for starters: TTL. DTL. General Purpose Diodes.

The status quo isn't quo any more on TI's TTL delivery. TI has now substantially expanded its TTL manufacturing capacity and more of these circuits are coming our way. Delivery is better than ever on TI's 17 Series 54L/74L low power circuits, 26 Series 54/74 standard gates and flip-flops, 13 Series 54H/74H high speed circuits and 23 TTL/MSI types. They all come in TI's dual-in-line plastic package; most also come in the military-rated flat-pack and ceramic DIP. With this wide selection to choose from and delivery picking up, TI is your best TTL bet. Call us and find out more.

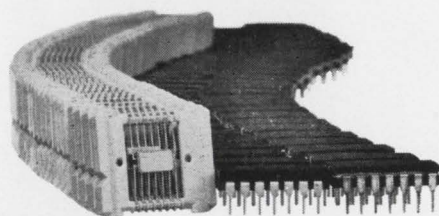

Shave delivery time on TI's DTLs by placing big orders with us. You can now get your big orders for TI's plastic DTLs filled faster. Just contact us directly. Availability of these devices is such that we are primed to accept and handle large DTL orders without delay (and we still welcome small orders). Because TI makes 20 DTL circuit types in the dual-in-line plastic package, we can provide exactly the functions you need. You can count on economy *and*

reliability. Some 1700 users have put more than 30 million TI plastic devices into tough jobs for a total of 30 billion operating hours. Big order or small, for the wide choice in dependable DTLs delivered fast, try us.

General Purpose Diodes — TI's big 12 sub for hundreds. Here's how to save considerable work and worry selecting general purpose diodes.

There are more than 1000 general purpose diodes in the world today, yet a mere dozen TI types — 1N456-58, 1N482-85, 1N645-49 — will do the lion's share of the work. TI's big 12 come in low- and high-conductance types. The

low conductance diodes are now of planar wafer construction, giving higher stability and lower leakage in the pico-amp range. For TI's data sheets on these 12 workhorse general purpose diodes, circle 320 on the Service Card.

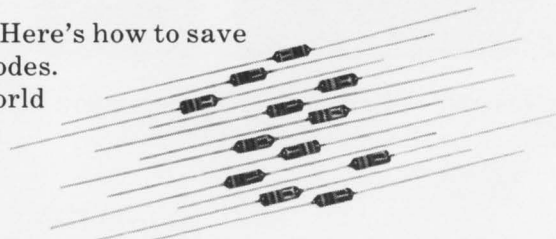

For better solutions, call

DEECO  **Inc.**

DISTRIBUTORS — SERVING INDUSTRIALS EXCLUSIVELY

AUTHORIZED DISTRIBUTOR 

2500 16th Avenue S.W. • Cedar Rapids, Iowa 52406 • Phone (319) 365-7551
Free Wide Area Telephone Service: From Surrounding States Dial: 800/553-5421 • From Within Iowa Dial: 800/332-5478

U.S. Reports

and water-detection systems, equipment for organic analysis, a tv camera, and meteorological equipment.

As the negotiations for the lander are concluded Martin will be lining up its subcontractors. According to Jakobowski, the only member of the team besides Martin that has been determined thus far is RCA, which will handle communications. A Martin spokesman says that it will be about six weeks before it starts getting subcontractors in line, as it still has to work out exact specifications for the lander with NASA.

Meanwhile, NASA's Langley has just asked for bids on the support-services contract for Viking. It will include data management, mission assurances, configuration management, test planning, project administration, and mission design. In all, 37 firms have indicated interest in bidding.

Space electronics

Moon measure

How high the moon? Well, we're going to find out.

When Apollo 11 lands on the moon this summer the astronauts will leave behind a two-foot-square array of fused silica corner reflectors. It will form one end of an optical tape measure that will permit laser ranging to accuracies of about 1.5 meters. Even the best data now available is uncertain by hundreds of feet and, consequently, so are the characteristics of the moon's orbit.

A lunar laser observatory was built about 40 miles north of Tucson especially for the experiment by the Air Force Cambridge Research Laboratories in Bedford, Mass. Although NASA funded most of the observatory's construction, AFCRL's Donald H. Eckhardt will be principal investigator.

The observatory's equipment already is being tested. A key element is a ruby laser capable of 10-joule, 10-nanosecond pulses built and installed by the Hughes Aircraft Co. The laser pulses will pass

through a 60-inch telescope built by the University of Arizona. Although the 10-foot pencil beams of light will have expanded to a diameter of about 2.5 miles at the moon, the corner reflectors will return enough light to enable timing of the pulses' round trip using a cesium clock accurate to 10 nsec.

Refinement. The aim of the experiments is refinement of the lunar orbit which though nearly circular, varies by about 14,000 miles between apogee and perigee. By measuring during many orbits, usually at lunar night to prevent the reflections from being drowned in sunlight, the AFCRL crew expects to get the data needed.

Instrumentation

Failure ferrets

Now that its first phase study showed the effectiveness of techniques proposed to increase system reliability, the Navy has just launched Phase II of its portion of the triservice experiment to increase mean time between failure. It will take 12 months, says Walter Stender of the Electronic Systems Command, compared to three months for the initial phase.

Under the program, originated by the Directorate of Defense Research and Engineering, the Navy says it has established statistical and technical evidence of methods aimed at reliability gains using AN/PPS-6, a Marine Corps tactical radar, as a study base. This is the General Instrument 36-pound, backpack, noncoherent-pulse, doppler unit operating at X band.

The Air Force is running a comparable program using its AN/ARC-34 airborne uhf command transceiver, while the Army is testing its AN/VRC-12 forward area tactical radio. Both, like the PPS-6, are operational systems.

Tests on PPS-6 production units showed an average of 621 hours before failure, indicating a calculated mtbf of 1,870 hours for systems overall.

In its eyes. To achieve a calculated mtbf of 58,800 hours—an

NEW! POWERTEC GR* POWER SUPPLIES

PRICED FROM

\$29⁰⁰



* Guaranteed Reliability

PRICE & QUALITY OPTIMIZED

New low cost family of units for applications with IC's, other digital logic, OP amps and low voltage analog circuits.

Only MIL and computer grade components are used in this versatile family. Calculated reliability per MIL-HDBK-217A exceeds 150,000 hours.

Output voltages are available from 3.6 to 36VDC with $\pm 0.1\%$ regulation in a variety of types including fully adjustable units.

Input: 115VAC 47-440 Hz

Typical Outputs: 0 to 36V at .25A
5.0V at 2.5A
 $\pm 15.0V$ at .5A

The Powertec GR Series is currently available from stock. Detailed specifications and prices are available upon request.

CUSTOM POWER SYSTEMS

Powertec's experts are capable of solving your most difficult power conversion requirements.

POWERTEC DIVISION

9168 DeSoto Ave., Chatsworth, Calif. 91311
Phone (213) 882-0004



AIRTRONICS
INCORPORATED

VALUE- PACKED



GORDON METERS

Only Gordon Panel Meters offer you all these outstanding features:

Sparkling clear high-impact Lexan® covers for optimum visibility, protection

Classic D'Arsonval DC mechanisms, AC rectifier type models, flush or edgewise

Self-shielded Alnico core magnets

Sapphire spring-backed bearings

One-piece bridge for accurate alignment

Easy-to-read scales, lance pointers

Clean-room-built by GORDON to ASA standards in popular sizes and ranges

Custom design capability, backed by over 50 years' instrument know-how

Get the Gordon Meter value package... meters attractively priced and packed in cartons with a touch of gold!

FREE GORDON METERS CATALOG. WRITE TODAY!

PDC GORDON
A SUBSIDIARY OF

PNEUMO DYNAMICS CORPORATION

5710 KENOSHA ST., RICHMOND, ILL. 60071

Export: 2200 Shames Dr., Westbury, N.Y. 11590
Cable CHURCHIN

U.S. Reports

essentially failure-free system in the Navy's eyes—the second and third phases of the program will seek to eliminate as many discrete components as possible by using multichips and monolithic integrated circuits and by substituting high-reliability components developed to NASA specs for the remaining discrete parts.

Additionally, says Stender, there will be overstress testing to guarantee proper design derating for environmental stands of temperature, vibration, and shock; strict parts screening; and use of MIL STD 217 to qualify microcircuits. The Navelex engineer emphasizes, however, that present performance prediction for IC's under 217A "are not only inadequate, but misleading" because of rapid advances in circuit development.

Highest failure rate of modules in the 1,870-hour mtbf calculations for the PPS-6 were in the magnetron and klystron, according to Stender, "of which the magnetron appears to be the most critical unit in the system." (Battery failures were not counted as they're replaceable.)

In general, the Navy feels failure-free radar has been prevented by microwave power sources, high-voltage modulators, scan motors, and waveguide plumbing subsystems.

A solid look. Thus, a design approach beyond the General Instrument system is also being looked at. It's a 25-pound RCA pulsed radar similar to RCA's AN/PPS-9, a continuous wave unit. It contrasts with the PPS-6 in that it uses all-solid-state power generation; stripline power distribution; and all-substrate-mounted solid state, duplex-printed circuit antenna and receiver. RCA, under a Navy test study completed late last year, calculated mtbf at 6,300 hours.

Though the Navy believes it is making headway in its effort to cut logistics support of systems like the tactical radars—costs which sometimes run to 100% of initial hardware costs over a 10-year life span—it recognizes that much more data is needed.

In Phase II, new systems will be built using the new, tighter specs developed from Phase I, and these

will be submitted to operational and environmental tests with an eye to determining cost of ownership on the basis of which have fewer failures.

Then comes Phase III, a six-month effort to demonstrate reliability of equipment within the limited test time to meet the 10,000-hour goal. After that, says Stender, "We'll just dump some of these units into operating commands and see how they perform in real life."

For the record

No more needles. The John Fluke Manufacturing Co., a prime digital voltmeter holdout, will show its first digital model at Wescon (August 19 to 22). Fluke's dvm doesn't have dual-slope integration circuitry—Weston Instruments claims the dual-slope technique as its own. So by using another approach, Fluke expects to avoid licensing problems.

Irresistible. Insiders say that the Bendix Corp. sold its semiconductor operation to Solitron Devices because the division wasn't bringing in the kind of profit Bendix management expected. But Russell D. O'Neal, the new president of Bendix Aerospace-Electronics, says that isn't so. His explanation: "They made us an offer we couldn't turn down."

Full speed ahead. Monsanto intends to get into the automatic industrial controls field by acquiring the Fisher Governor Co. despite objections by the Federal Trade Commission's merger division. At the same time, Monsanto will reorganize its electronics business into a separate division.

Taming the blue yonder. The Federal Aviation Administration has added automatic altitude readout to its Common Instrument Flight Rules Room at New York's Kennedy International Airport. It was accomplished through the activation of a computerized alphanumeric radar subsystem. The added electronic capability reduces the verbal communication neces-

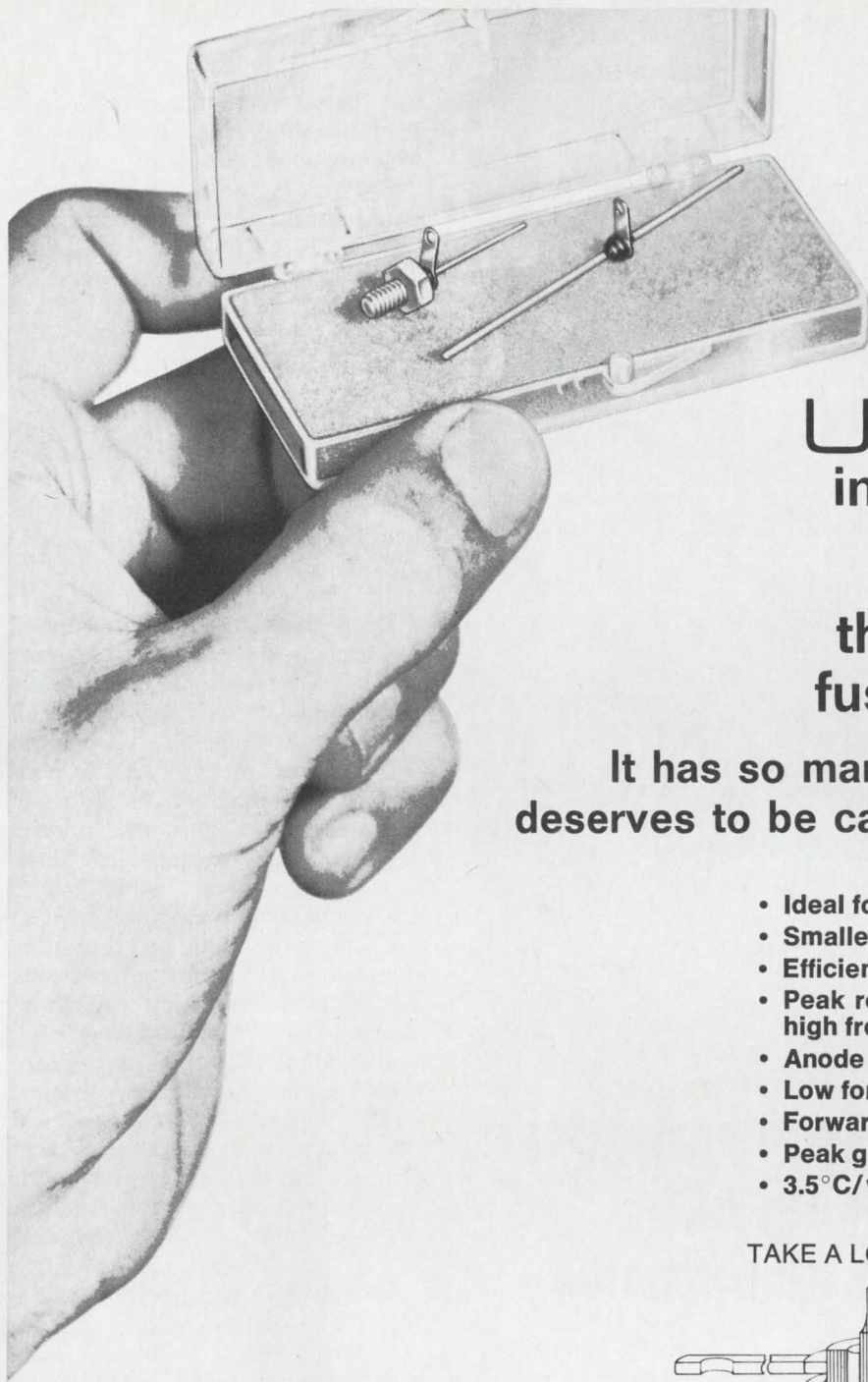

and now...
UNITRODE
 invents the 12 amp
UCR—
 the industry's first
 fused-in-glass SCR.

It has so many superior features it
 deserves to be called "something else".

- Ideal for pulse modulator applications
- Smallest medium-power SCR
- Efficient switching of high pulse currents
- Peak repetitive pulse current 150A in high frequency modulators
- Anode voltage 100 to 600V
- Low forward voltage drop
- Forward current 12A
- Peak gate current 100A
- 3.5°C/watt thermal impedance

TAKE A LOOK AT THE WAY IT'S BUILT

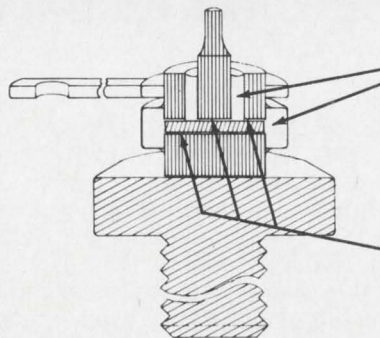

Two fused-in-glass seals melted, wetted and fused to both silicon and metal surfaces permanently protecting and stabilizing the SCR die in a voidless Unitrode package.

Thermal coefficients of glass, pins, and silicon are matched to withstand extremes in temperature shock and cycling.

True metallurgical bonds from terminal pins to the silicon provide rapid heat transfer and high current capability.

580 Pleasant Street, Watertown, Mass. 02172 (617) 926-0404

UNITRODE

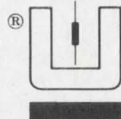

Check off the reply card now for a really comprehensive set of specs, charts, graphs, and curves. Or if you want really fast service, call John McCusker collect at (617) 926-0404.



MEASURES MILLIAMPERES TO PICOAMPERES AND NARROWS THE GAP BETWEEN PRICE AND PERFORMANCE

See the first digital picoammeter above? It's our new \$1495 autoranging Model 445. It simplifies measurements from 10^{-2} ampere f.s. to 10^{-9} ampere and provides both analog and BCD outputs. The second is the Model 440, new too. At \$995, it features 10^{-2} to 10^{-10} ampere f.s. current ranges, has an analog output and an option for BCD.

Both picoammeters are packed with convenience features designed to minimize operator error and maximize performance. Stable to 0.5% of full scale per week, they make low level measurements accurate to 0.2% almost routine. And provide variable display rate to 24 readings per second. But isn't that what you'd expect from a firm with years of analog picoammeter design experience? And an industry-wide reputation for quality? Like Keithley.

See if you don't agree we have the best digital approach to picoampere level measurements. Call your Keithley Sales Engineer for demonstration and details. Or contact Keithley Instruments, Inc., 28775 Aurora Rd., Cleveland, Ohio 44139. In Europe: 14 Ave. Villardin, 1009 Pully, Suisse. Prices slightly higher outside the U. S. A. and Canada.



KEITHLEY

U.S. Reports

sary between pilot and controller. In December, the automatic altitude readout will be installed at the first enroute center for the National Aerospace System in Jacksonville, Fla.

Pushbutton. RCA has installed what it says is the first computer-controlled production system in the consumer electronics industry. A Spectra 70/45 is being used initially to direct design, material control, assembly, and testing of tuners for stereo sets; eventually, it will control manufacture of other items, including television receivers.

Drop at a time. A high-speed printer, to be used by computers over conventional voice-grade phone lines, has been introduced by the A.B. Dick Co. Called the 960 Videojet, the printer is a non-impact type that utilizes a stream of ink droplets to put out 250 characters a second on ordinary business forms; it can automatically answer a Dataphone subset, print the transmitted data, and terminate the call. The company envisions immediate application in time-sharing networks, remote batch processing with local print requirements, message-switching systems, news wire services, and as a local line printer for use with small computers. The 960 will compete for sales with similar printers, such as ITT's Inktronic.

Detective. A \$55 pocket-size detector that can find static charges or leakage current in medical electronic equipment will be marketed this fall. Developed by Roveti Systems and made by the Daniel Woodhead Co., the device can detect current as small as 5 microamps; a diagnostic instrument with as little as 15 μ amp leakage can stop a man's heart. The detector operates on standby duty for about a year on a 9-volt battery. In operation, the hand-held device's antenna is passed closed to the equipment being checked. A go, no-go signal is registered when it detects a potential hazard. Other detectors, costing around \$200, are bulky and have to be plugged into the medical electronic equipment.

MIL-STD-883

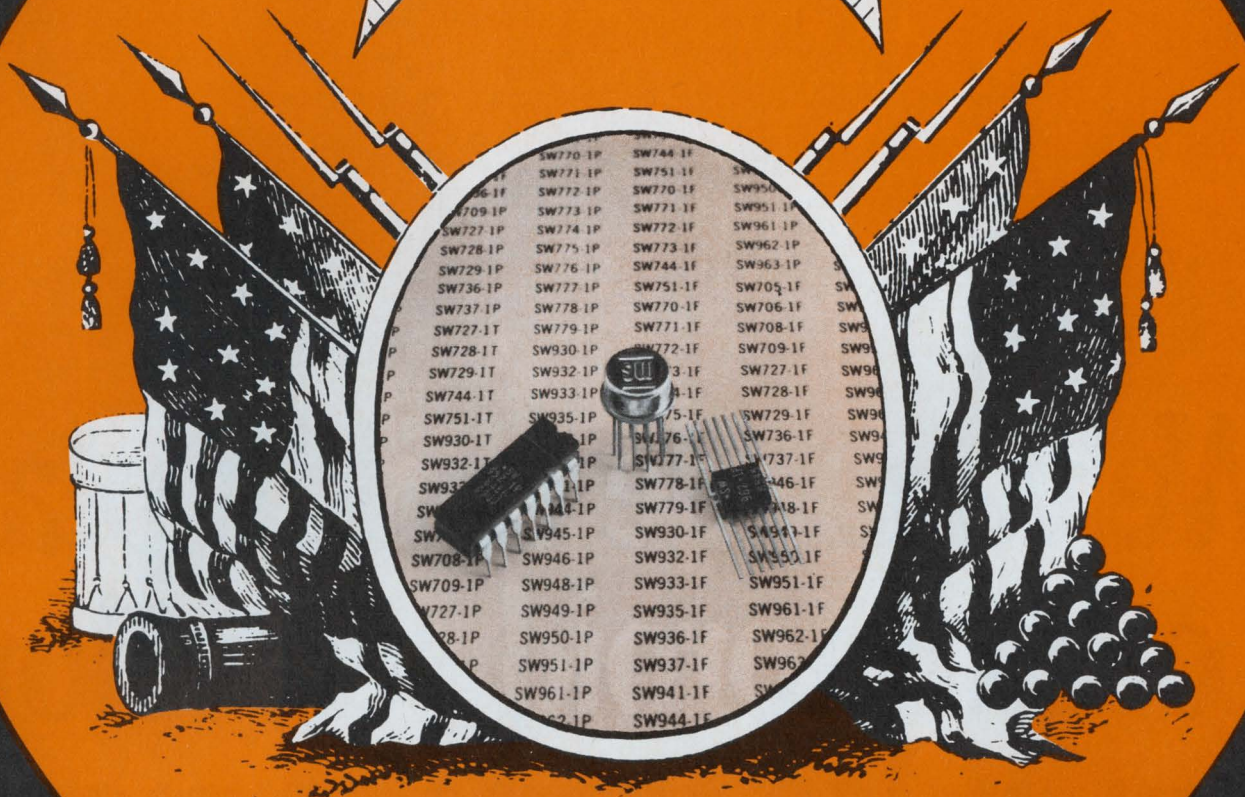

STEWART-WARNER 930 DTL's...

FIRST IN CIRCUITS...FIRST IN QUALITY... AND FIRST IN THE HEARTS OF MILITARY MEN!

By now everyone knows that Stewart-Warner has the broadest line of 930-type DTL's in the industry. But why is this line the preferred choice of military users?

First, there's our new policy for Group B environmental testing. We are now testing to the tough Class A level of MIL-STD-883 by subjecting all military-type production lots to this strict new IC standard on a continuous 6-week sampling basis.* But if you think that's enough, we don't.

So we also put our products through an exclusive triple testing program that ensures the uniform high quality of the line: 100% DC parameter tests at the wafer stage; another 100% classification testing after assembly and mechanical screening; and, at no extra cost, a third 100% testing prior to shipping.

What more could anyone want, except perhaps low price and good delivery? Well, just try us on price; and, for immediate off-the-shelf product delivery, call your local Stewart-Warner Micro-

circuits Distributor. Or for more information on our 930-type products and our hi-rel program, contact us or our local sales representative.

*Except for Reverse Bias Burn-in and Moisture Resistance Vibration.

STEWART-WARNER SYMBOL OF
COMPANIES **SW**
EXCELLENCE

STEWART-WARNER MICROCIRCUITS, INC.
730 EAST EVELYN AVENUE, SUNNYVALE, CALIFORNIA 94086
PHONE 408/245-9200 TWX 910-339-9210

**We've made child's play
out of toroid selection
for pulse transformers.**

INDIANA GENERAL

We make it easy for the design engineer.

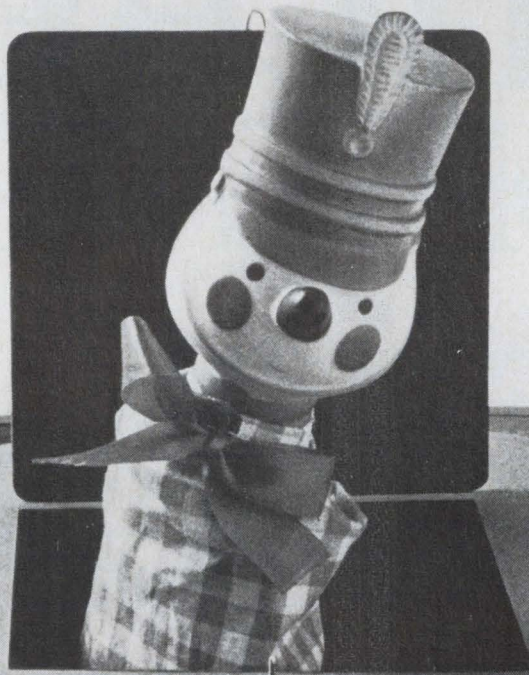

Indiana General's popped up with an end to trial-and-error spec'ing: the first and only toroids with specified characteristics for pulse transformer applications.

Not just the usual irrelevant magnetic properties, either. Each part is designed as a pulse component, and listed by its pulse inductance, pulse magnetizing current and ET product. All according to ASTM methods.

And thanks to our automatic high speed testers, we can guarantee all parameters. Every pulse transformer toroid we make is 100% pulse-tested to performance specifications. So reliability is assured, from samples to production quantities. And all toroids can be coated, to prevent the wire's insulation from being scraped when winding, or penetrated later.

Various toroid sizes from 0.080" are available. Tell us your pulse transformer core problems.

Indiana General Corporation
Electronics Division/Ferrites
Keasbey, New Jersey

Let's see how your pulse-rated toroids can make it easier for me. Attached are details of my pulse transformer core problems.

NAME _____

TITLE _____

COMPANY _____

ADDRESS _____

CITY _____ STATE _____ ZIP _____

more data
transmission
applications for
**ANALOG
SWITCHES
& OP AMPS**

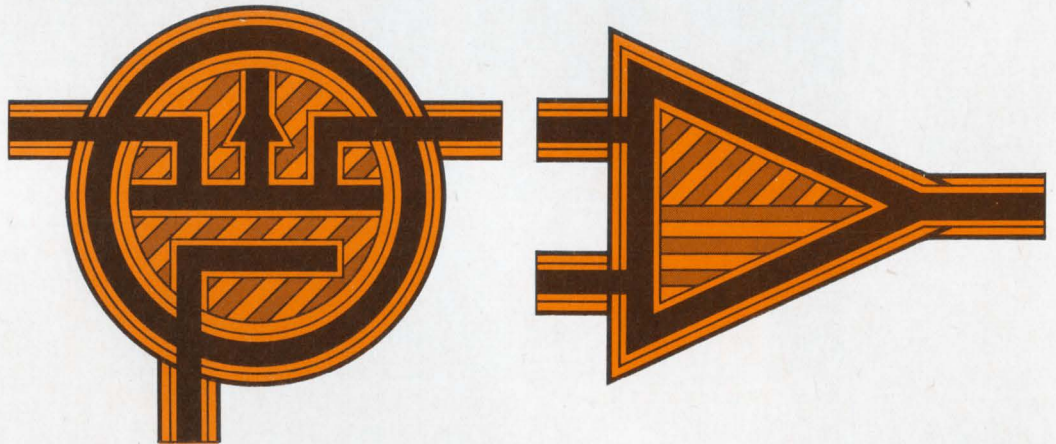

Here are two more examples that illustrate the versatility of Siliconix driver/FET switch packages in data transmission systems.

Functional Description	Channels	Type	Max. $r_{DS(on)}$ (ohms)	Switch Type
 DPST	3	DG120	600	PMOS
		DG121	600	PMOS
 DPST	2	DG122	600	PMOS
		DG132	600	PMOS
 DPST	2	DG126	80	N
		DG129	30	N
		DG140	10	N

Two and three channel packages are available with various ON resistances to meet your specific requirements. Drivers accept standard DTL, RTL, or TTL logic inputs.

Functional Description	Channels	Type	Max. $r_{DS(on)}$ (ohms)	Switch Type	
 DG123	2	DG110	600	PMOS	
		DG111	600	PMOS	
		DG112	600	PMOS	
		DG133	30	N	
		DG134	80	N	
		DG141	10	N	
		DG147	600	PMOS	
		DG148	40	PMOS	
		4	DG116	600	PMOS
			DG118	600	PMOS
5	DG123	600	PMOS		
	DG125	600	PMOS		

One of these driver/switch combinations may be used with your sample-and-hold circuit. These switches may also be used to implement your multiplexer/decoding functions.

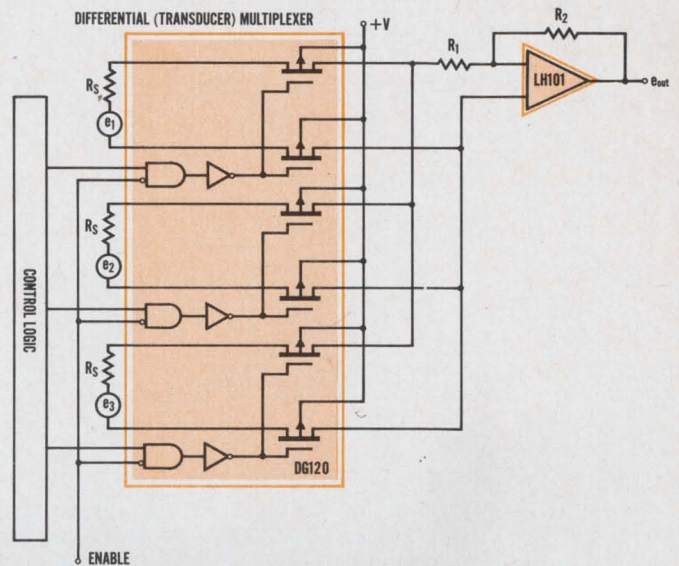

This three channel version of a transducer-multiplexer uses a single DG120 along with an LH101.

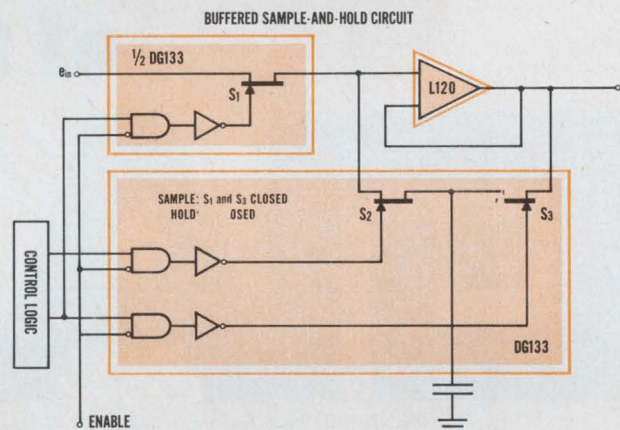

Low input leakage of the L120 OP AMP makes it ideally suited for sample-and-hold circuits. Two channels of this circuit require only three DG133s and one L120. An alternative approach would require two DG129s and one L120 for two channels.

SILICONIX OP AMPS	Max. input offset voltage -55 to +125°C	Max. input current	Min. open loop gain	Output voltage swing	Slew rate	
 LM 101 LH 101 (Internally compensated)	6 mV	500 nA	50K	± 12V	0.25V/μsec.	<ul style="list-style-type: none"> • Operation from ±5 to ±20V power supplies • Low current drain • Continuous short circuit protection • Same pin configuration as 709 amplifier
 L 120						200 mV

Working on data transmission? Write today for complete data on any or all Siliconix driver/FET switch combinations and OP AMPS.

For instant applications assistance, call the number below. Ask for Extension 19.

Siliconix Incorporated
 1140 West Evelyn Ave. • Sunnyvale, Calif. 94086
 Telephone (408) 245-1000 • TWX 910-339-9216

**the first
of the**

GIANTSTM

GENERAL INSTRUMENT ADVANCED NITRIDE TECHNOLOGY PRODUCTS

the first static dual 16-bit shift register directly compatible with TTL, DTL and MOS is also the lowest priced* shift register

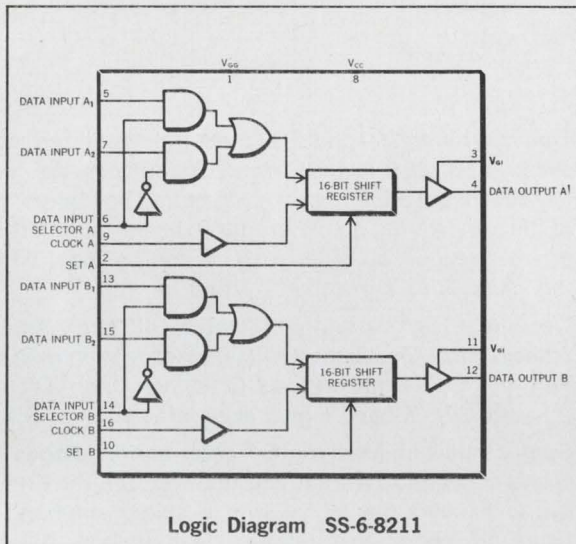

Logic Diagram SS-6-8211

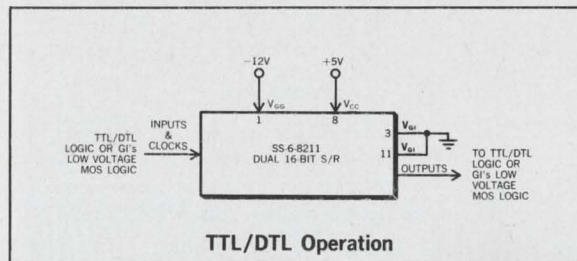

TTL/DTL Operation

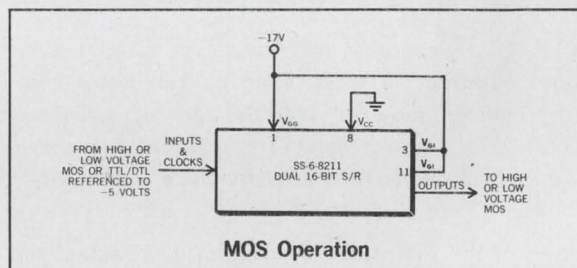

MOS Operation

General Instrument's exclusive **MTNS** process has now been translated into a line of standard General Instrument LSI circuits.

The Dual 16-bit DC Shift Register is the first of the family of **GIANTS** (General Instrument Advanced Nitride Technology Products) to be introduced.

This giant step forward results in LSI devices which are totally compatible with TTL, DTL and MOS, and as in the case of the Dual 16-bit DC Shift Register, lower in price than any other such device available.

The well-known performance and reliability advantages inherent to **MTNS** devices are, of course, present in all **GIANT** LSI circuits. These advantages include: a reduction in the number of system power supplies required, the elimination of interface circuitry, a reduced parts count and fewer interconnections, lower power dissipation, increased operating frequency and an increased operating temperature range.

The most outstanding feature of General Instrument's Dual 16-bit DC Shift Register—and of every standard **GIANT** product—is the exclusive **V_{GI}** terminal, which gives the user a choice of interfacing directly with TTL/DTL or MOS (as shown in the block diagrams above).

This shift register contains two independent 16-bit DC to 2MHz shift registers constructed on a single monolithic chip utilizing **MTNS** P-Channel enhancement mode transistors. Independent

single phase TTL/DTL compatible clock and data inputs are provided for both registers. Each shift register bit is implemented with a cross coupled flip-flop, so that data is stored indefinitely regardless of the logical level of the clock. Data on the input is sampled while the clock is at a "0" level and the register shifts on a "0" to "1" transition. Separate input data selector controls are provided on each shift register. They determine which of the two inputs shall be shifted into the register. Each shift register also has its own set input which forces all stages of the register to a "1" level.

Among the other features of the Dual 16-bit DC Shift Register are: power dissipation of 120 mW, full military temperature range of -55°C to +125°C, high input impedance, stable threshold over time vs. temperature, multiplexible inputs, the need for fewer packages compared to equivalent TTL/DTL circuits, and set control.

The General Instrument Dual 16-bit DC Shift Registers are truly **GIANTS** among shift registers. They are immediately available from your authorized General Instrument Distributor.

For full information write, General Instrument Corporation, Dept. D, 600 West John Street, Hicksville, L.I., N.Y. 11802.

(In Europe, write to General Instrument Europe S.P.A., Piazza Amendola 9, 20149 Milano, Italy; in the U.K., to General Instrument U.K., Ltd., Stonefield Way, Victoria Road, South Ruislip, Middlesex, England.)

*\$7.50 each in quantities of 100 pcs. in a TO-72 package (GI part #SS-6-8212). Also available in a 16-lead dual in-line package (GI part #SS-6-8211) at \$13.80 each in quantities of 100 pcs.





MICROWAVE IC PROGRESS REPORT #7: COMMUNICATION MODULES

Sperry's PACT (Progress in Advanced Component Technology) Program is developing a fully-integrated transmitter/receiver/duplexer module for an airborne communications array at X-band. The program has contractual support from the Air Force Avionics Laboratory, USAF, Dayton, Ohio.

The function of the phased array system is to establish communications between aircraft and synchronous satellite repeater stations, which in turn are linked to a ground station network and to other aircraft. This makes it possible for the crew of an airplane to be in constant contact with anybody, worldwide. Handy for all sorts of missions and indispensable in the event of conflict.

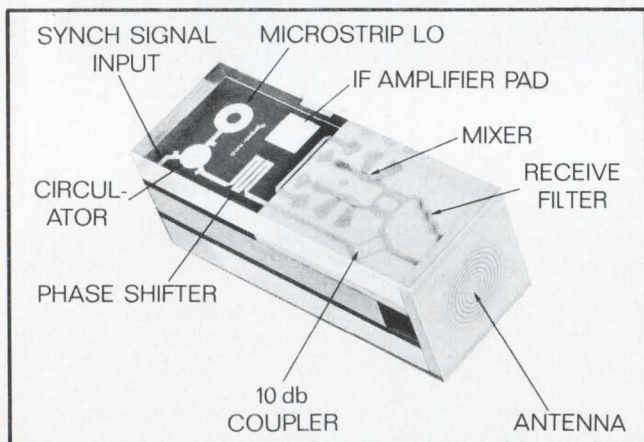

RECEIVER CIRCUIT FOR COMMUNICATIONS MODULE

Within the confines of each phased array element, which is less than an inch square and three inches long, is a complete transmitter/receiver/duplexer. Essentially composed of a signal source, a receiver, a mixer and an antenna, the module utilizes Sperry's advanced thinking throughout.

The rf circuitry is photo etched on metallized ceramic substrates 0.055 inches thick. Conductors are vacuum deposited gold on top of chromium. Follow-up plating produces half-mil thick strips. Transmission efficiency can be gauged by measuring rf energy loss, which, in this case, is no more than 0.15 db per inch.

Transmitter signals are generated by a Sperry Avalanche Transit Time Oscillator (ATTO), discussed in Progress Report #1. Energized by a DC voltage, the ATTO yields a 1-watt CW, X-band signal at an efficiency of 5%.

Sperry's gallium-arsenide Schottky-barrier diodes do the active conversion work in the receiver and the "rat-race" hybrid handles the signal with a single sideband noise figure of better than 6.5 db over a 12% bandwidth. (Sperry hybrid work was discussed in Progress Report #5.) Signal processing and control circuitry design has been materially aided by a Sperry-developed computer program.

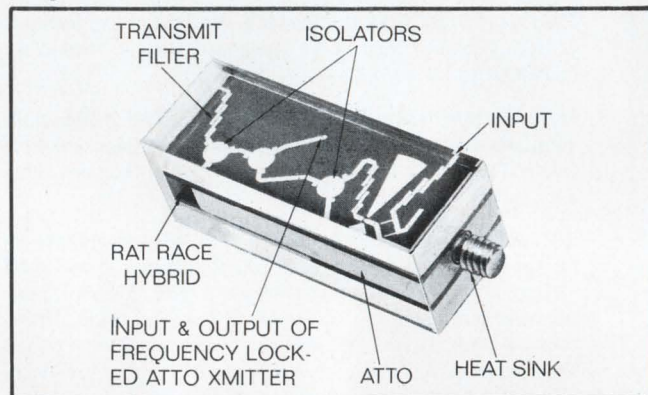

TRANSMITTER CIRCUIT FOR COMMUNICATIONS MODULE

What we have accomplished for the Air Force, we can accomplish for your microwave system, regardless of frequency or operational mode. At Sperry, PACT is more than a clever acronym. Our business is **microwaves**, and our goal is to provide customers with ways of accomplishing microwave functions.

May we hear from you about your system requirement?

*For faster microwave progress,
make a PACT with people
who know microwaves.*

SPEARRY
MICROWAVE ELECTRONICS DIVISION
CLEARWATER, FLORIDA

Washington Newsletter

June 23, 1969

Capital battles rage as new issues rise

Fireworks are everywhere in the capital even though July 4 is still two weeks away. While the Pentagon and the Congress are flailing away at each other, the White House, backed by the Budget Bureau, is anxiously seeking an accommodation on a variety of confusing issues, ranging from poor Pentagon program management and massive contract cost overruns to charges of the DOD's overreaching its power.

While most of the attention is being focused on the larger issues such as ABM, the F-111's Mark 2 avionics system, and the manned orbiting laboratory cancellation, other areas of controversy are in the making.

For one, the naming of the Defense Supply Agency to take over all Government procurement of standard electronic parts and components from the General Services Administration is expected to further antagonize Pentagon critics in Congress.

For their part, industry spokesmen, while generally favoring centralization of parts procurement for all—including civilian—agencies in one shop, agree that the selection of the DSA was poorly thought out and badly timed.

DSA officials, on the other hand, claim that critics of the new ruling have missed the point, and that only parts and components—not complete hardware packages or systems—will be affected when the changeover takes place on September 2.

NASA zeros in on Grand Tour . . .

NASA, meanwhile, is moving quickly in hopes of cashing in on the "Apollo fever" that has gripped the nation.

Coming off the glittering successes of Apollo's 9 and 10, space officials are busily setting the stage for the most ambitious unmanned program yet proposed—the Grand Tour. The program, which would send unmanned probes to the outer planets in the late 1970's, could carry a price tag of better than a billion dollars.

Design studies are already being conducted at the Jet Propulsion Laboratories. Now, NASA wants to get outside studies rolling.

NASA's chief, Thomas Paine, hopes to sell the Administration on the program by first convincing the Space Task Group, headed by Vice President Agnew, that the Grand Tour would prevent the U.S. from falling behind the Soviet Union in space exploration. Another argument is that the planets won't be in line again for such shots for about 180 years.

One omen that portends well for new NASA programs: the House earlier this month voted the agency \$3.9 billion for fiscal 1970. And that's more than was recommended by Presidents Johnson and Nixon.

. . . and considers two missions instead of one

How will the Grand Tour, if approved, shape up? The betting now is on two tours—one trip to Jupiter, Saturn and Pluto, and the other to Jupiter, for a second look, Uranus and Neptune.

Originally, the plan called for a single mission to Jupiter, Saturn, Uranus and Neptune. However, the feeling inside NASA now is that the dual-mission approach would, in addition to adding Pluto to the itinerary, yield data on three planets should one mission fail. Moreover, if both missions succeed, more data would be provided about Jupiter.

According to those opting for the dual-mission approach, two tours would cost only slightly more than a single tour of four planets.

Washington Newsletter

DSRV program could be beached

The Navy's deep submergence rescue vehicle (DSRV) program may be next on the list of those being terminated, now that Sen. William Proxmire (D., Wis.) has gotten the Pentagon to admit that the cost of the Lockheed-built vessels has escalated to \$80 million apiece from an initially projected \$3 million figure.

Equally important to the fate of the program is the growing Congressional awareness that most Navy subs, when in trouble, sink below their maximum depth and—like the ill-fated Scorpion and Thresher—are crushed, leaving nothing for the DSRV's to rescue.

Should the Navy be obliged to scrub the program, sources say the Navy would like to divert the money to a sister project, the deep submergence search vehicle. Both programs have been starved for funds over the past two years because of Vietnam requirements.

Budget Bureau seeks more buying options

Stationing the Bureau of Budget between the Pentagon and Congress is the closest thing to a response the White House has made to Capitol Hill criticism of the military. And the name to remember at the Budget Bureau as a growing influence on defense spending priorities is James R. Schlesinger, former Rand Corp. staffer, critic of a number of procurement policies, and now assistant director for military and international programs.

Schlesinger is touted as an advocate of increased competition at the prototype level as a means of giving the Government the most options—a view now also espoused by Defense research & engineering chief John S. Foster Jr.—plus licensing of production technology as a precondition for R&D contracts to preclude a developer from having a competitive edge in production award competition.

ATS 1 and 2 up for grabs

NASA will turn over its applications technology satellites 1 and 2 for satellite broadcasting demonstration experiments by the end of the year, but the big question is to whom. Thus far, three proposals have been made, but NASA expects to receive a few more before making a decision.

In its proposal, the Communications Satellite Corp. has offered to work with NASA and any potential ATS experimenters to provide a demonstration of domestic satellite services. Comsat is offering its ground stations, satellite expertise and, if needed, room on its Intelsat satellites.

The American Broadcasting Co. and Hughes have teamed up on a proposal to offer a demonstration of live tv news and public affairs broadcasting to Alaska. ABC would provide programming with Hughes offering to put a terminal in Alaska on a temporary basis.

The Corporation for Public Broadcasting, heading a consortium of educational tv interests, for its part, has proposed both educational radio and tv schemes employing ATS. Part of the tv proposal, entitled "The Satellite Cities Demonstration," would use the satellites to show how information on urban problems could get wide exposure.

MIT gets \$1.6 million for Polaris work

The Navy Strategic Systems Project office has quietly made a \$1.6 million award to MIT's Instrumentation Laboratory for additional work on the Polaris missile's guidance system. In view of MIT's self-imposed embargo on new classified research—in force until the college decides what, if anything, to do with its two big defense laboratories—the Navy points out that "this is not a new contract, but a modification of an existing one."

Performance / Efficiency / Size

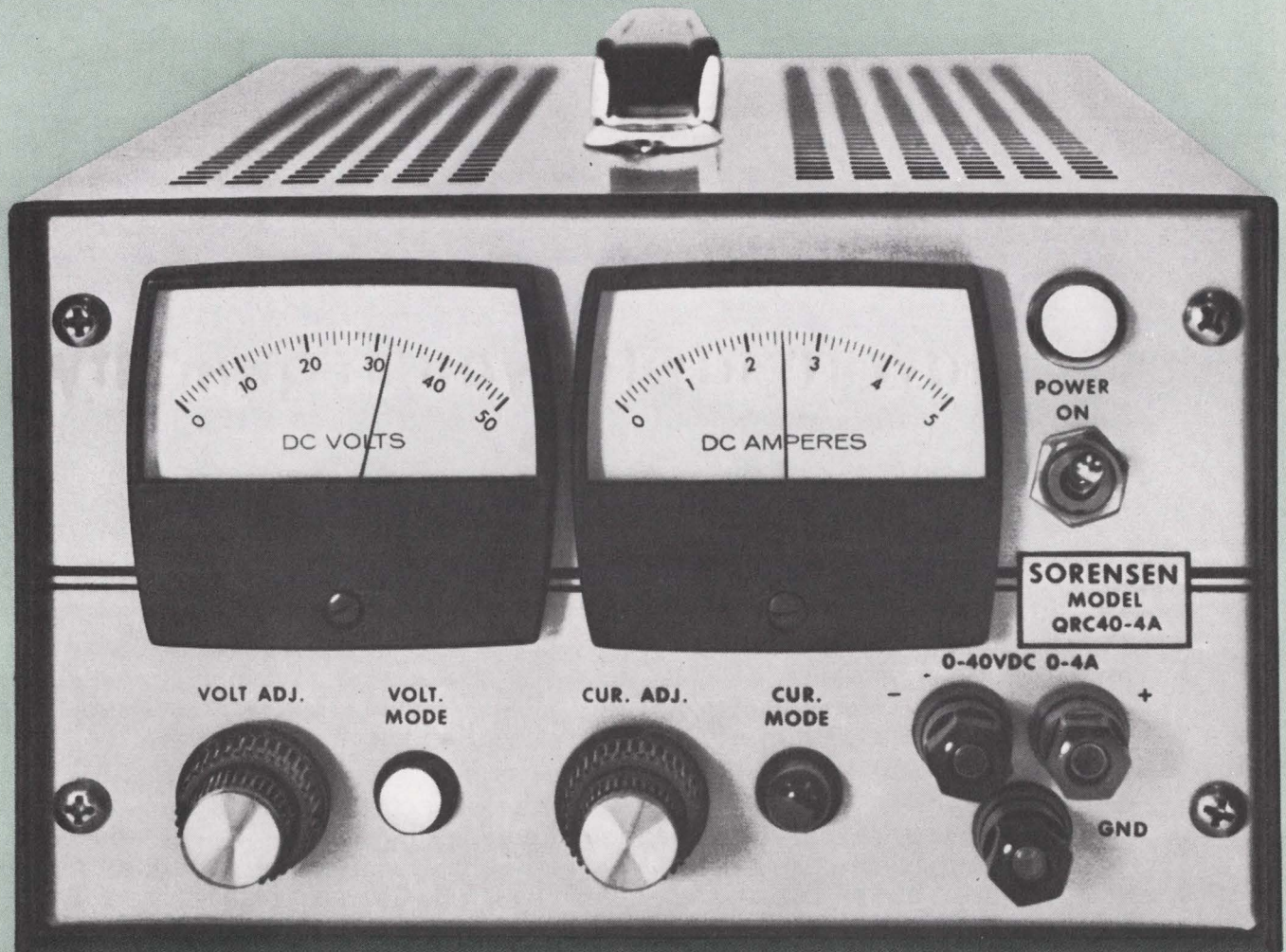

The QRC Series solves the specification/power/volume problem by utilizing all silicon, series regulator techniques with modern high speed transistor switching circuitry.

7 models, all available from stock, cover the voltage ranges of 0-20 and 0-40 Vdc at currents up to 30 amperes with prices starting at \$350 for model QRC 40-4A.

Features include: ■ $\pm 0.005\%$ voltage regulation for line and load changes combined ■ $< 1\text{mV}$ r.m.s. ripple (10Hz-7MHz)

■ 0.01% resolution ■ 25μ sec. response time ■ optional overvoltage protection ■ voltage and current regulation with automatic crossover ■ remote programming and remote sensing ■ -20 to $+71^\circ\text{C}$ operating temperature.

For more information contact your local Sorensen representative or; Raytheon Company, Sorensen Operation, Richards Avenue, Norwalk, Connecticut 06856.

Tel.: 203-838-6571;

TWX: 710-468-2940;

TELEX: 96-5953.

RAYTHEON





Now, ready for you in quantity.

The new Delco Radio DTS-701 and 702 NPN triple-diffused silicon high voltage transistors. They were designed for the tough requirements of off-line deflection in large screen TV.

However, they're built and tested for extra reliability in all high energy circuits. Proved by the surest peak energy capability rating in the business: Pulse Energy Testing.

And right now, they're available in both production and sample quantities.

Why will you want to use the Delco 701 or 702?

For the tough jobs—high inductive load switching or for circuits subject to transients or fault conditions.

For reduction of weight, size and component costs. Circuit complexity and number of components are reduced, so assembly costs go down, too. And fewer components mean higher reliability.

So now you know. The pioneer in high voltage silicon power has done it again.

For prices, samples or complete data, just call us or the nearest Delco Radio distributor listed below.

SEMICONDUCTOR DISTRIBUTORS: **EAST**—BALTIMORE, MD. 21201, Radio Electric Service Co., 5 North Howard St., (301)-539-3835 BINGHAMTON, N.Y. 13902, Federal Electronics, Inc., P. O. Box 1208, (607)-748-8211 CLIFTON, N.J. 07015, Eastern Radio Corporation, 312 Clifton Avenue, (201)-471-6600 NEWTON, MASS. 02195, The Greene Shaw Co., Inc., 341-347 Watertown St., (617)-969-8900 NEW YORK, NEW YORK 10036, Harvey Radio Co., Inc., 2 West 45th St., (212)-582-2590 PHILADELPHIA, PENN. 19114, Almo Electronics, Division of Sterling Electronics, Roosevelt Blvd. at Blue Grass Rd., Northeast Industrial Park, (215)-676-6000 PITTSBURGH, PENN. 15328, RPC Electronics, 620 Alpha Drive, RIDC Park, (412)-782-3770 WOODBURY, L.I., N.Y. 11797, Harvey Radio Company, Inc., 60 Crossways Park West, (516)-921-8700 **SOUTH**—BIRMINGHAM, ALA. 35233, Forbes Distributing Company, Inc., 1416 Fourth Ave., South, (205)-251-4104 MIAMI, FLORIDA 33142, Mountain Electronics, Division of Mountain National Co., 3730 Northwest 36th St., (305)-634-4556 RICHMOND, VA. 23220, Meridian Electronics, Inc., 1001 West Broad Street, (703)-353-6648 WEST PALM BEACH, FLA. 33402, Mountain Electronics, Division of Mountain National Co., 1000 N. Dixie Highway, (305)-833-5701 **MIDWEST**—CINCINNATI, OHIO 45237, United Radio, Inc., 7713 Reinhold Drive, (513)-761-4030 CLEVELAND, OHIO 44125, The W. M. Pattison Supply Co., Industrial Electronics Division, 4550 Willow Parkway, (216)-411-3000 DAYTON, OHIO 45414, F-J-R Ohio, Inc., 5212 North Dixie Dr., (513)-278-9411 INDIANAPOLIS, IND. 46204, Graham Electronics Supply, Inc., 133 S. Pennsylvania St., (317)-634-8486 KALAMAZOO, MICH. 49005, Electronic Supply Corp., P.O. Box 831, (616)-381-4626 KANSAS CITY, MO. 64111, Walters Radio Supply, Inc., 3635 Main Street, (816)-531-7015 MINNEAPOLIS, MINNESOTA 55401, Stark Electronics Supply Co., 112 3rd Ave., North, (612)-332-1325 ROSEMONT, ILL. 60018, F-J-R/Midwest, Inc., 9340 William St., (312)-678-8560 SKOKIE, ILL.

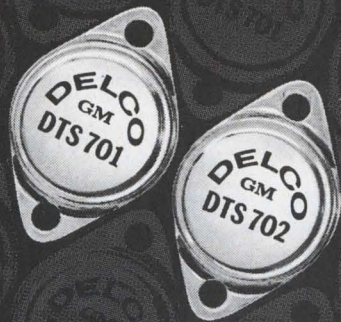

1200V - 3.0A
800V - 0.5A

DTS-701

Collector to emitter voltage (V_{CE0})	800V
Sustaining voltage (V_{CE0} (SUS))	600V min.
Emitter to base voltage (V_{EBO})	5V
Collector current (I_C)	500mA
Base current (I_B)	100mA
Power dissipation (P_T)	25W

DTS-702

Collector to emitter voltage (V_{CEX})	1200V
Collector to emitter voltage (V_{CE0})	1000V
Sustaining voltage (V_{CE0} (SUS))	750V min.
Emitter to base voltage (V_{EBO})	5V
Collector current (I_C)	3A
Base current (I_B)	1A
Power dissipation (P_T)	50W

Available in solid copper. JEDEC TO-3 package.

Kokomoan's Regional Headquarters

Union, New Jersey* 07083
Box 1018 Chestnut Station
(201) 687-3770

Chicago, Illinois* 60656
5151 N. Harlem Avenue
(312) 775-5411

Santa Monica, Calif.* 90401
726 Santa Monica Blvd.
(213) 870-8807

Detroit, Michigan 48202
57 Harper Avenue
(313) 873-6560

Kokomo, Ind. 46901
700 E. Firmin
(317) 459-2175 Home Office

*Office includes field lab
and resident engineer
for application assistance.



THE KOKOMOANS ARE IN POWER

DELCO RADIO
DIVISION OF GENERAL MOTORS
KOKOMO, INDIANA

60076, Merquip Electronics, Inc., 7701 N. Austin Ave., (312)-282-5400 ST. LOUIS, MISSOURI 63144, Electronic Components for Industry Co., 2605 South Hanley Road, (314)-647-5505 WEST—ALBUQUERQUE, N.M. 87108, Hyer Electronics Company, 130 Alvarado Drive, N.E., (505)-265-5767; 87106, Sterling Electronics Inc., 1712 Lomas Blvd., N.E., (505)-247-2486 COLORADO SPRINGS, COLO. 80902, L. B. Walker Radio Company, 9 E. Vermijo St., (303)-636-1661 DALLAS, TEXAS 75201, Adleta Electronics Company, 1907 McKinney Ave., (214)-742-8257 DENVER, COLO. 80219, L. B. Walker Radio Company, 300 Bryant Street, (303)-935-2406 ENGLEWOOD, COLORADO 80110, Hyer Electronics Company, 8101 E. Prentice Ave., (303)-771-5285 FORT WORTH, TEXAS 76102, Adleta Electronics Co., S. Expressway at E. Vickery, (817)-336-7446 HOUSTON, TEXAS 77001, Harrison Equipment Co., Inc., 1422 San Jacinto Street, (713)-224-9131 LOS ANGELES, CAL. 90015, Radio Products Sales, Inc., 1501 South Hill Street, (213)-748-1271 LOS ANGELES, CAL. 90022, Kierulff Electronics, Inc., 2585 Commerce Way, (213)-685-5511 OKLAHOMA CITY, OKLAHOMA 73102, Radio, Inc., 903 North Hudson, (405)-235-1551 PALO ALTO, CAL. 94303, Kierulff Electronics, Inc., 3969 East Bayshore Road, (415)-968-6292 PHOENIX, ARIZ. 85005, Sterling Electronics, Inc., 1930 North 22nd Ave., (602)-258-4531 SALT LAKE CITY, UTAH 84115, Hyer Electronics Company, 1425 South 2nd West, (801)-487-3681 SAN DIEGO, CAL. 92101, Milo of California, Inc., 2060 India Street, Box 2710, (714)-232-8951 SEATTLE, WASH. 98108, Kierulff Electronics, Inc., 5940 6th Ave., South, (206)-763-1550 TACOMA, WASH. 98402, C & G Electronics Co., 2502 Jefferson Ave., (206)-272-3181 TULSA, OKLA. 74119, Radio, Inc., 1000 South Main Street, (918)-587-9124 CANADA—SCARBOROUGH, ONTARIO, Lake Engineering Co., Ltd., 123 Manville Rd., (416)-751-5980

Using spot ties for
wire harnessing?

HERE IS THE
**GUDEBROD
SYSTEM "S"**

—SPEEDS THE WORK—SAVES MONEY, TOO!

GUDE-TIES CUT LENGTHS—Specifically produced for spot knotting these handy cut lengths of Gudebrod Flat Braided Lacing Tape are dispenser packaged for one hand, speedy withdrawal. Available in 6", 8", 10", 12", 15", 18", 20" and 22" lengths (other lengths on order). Meet or exceed MIL-T Specs, no-slip knots hold firmly without cutting insulation.

GUDE-SNIPS—These palm-of-the-hand snips cut cleanly, easily. For right or left hand use, spring action, DuPont Teflon bearing. Allow operator to have free use of fingers without constant reaching for knife or shears. Save motion, save time.

GUDEBROD SWIVEL-TILT HARNESS BOARD MOUNT—Balanced, two dimensional action brings every section of the harness within easy reach. No stretching, no straining. Knots are tied in an easy, natural position. Cuts fatigue—speeds work.

Here you have the Gudebrod System "S" for spot tie lacing, based on the high quality, high speed Gudebrod Lacing Tape—if you're interested in saving money while speeding the harness work, get in touch with us. (For continuous tying, ask about System "C".)



Available also in other types
of Gudebrod Lacing Tapes

GUDEBROD
Electronics Division

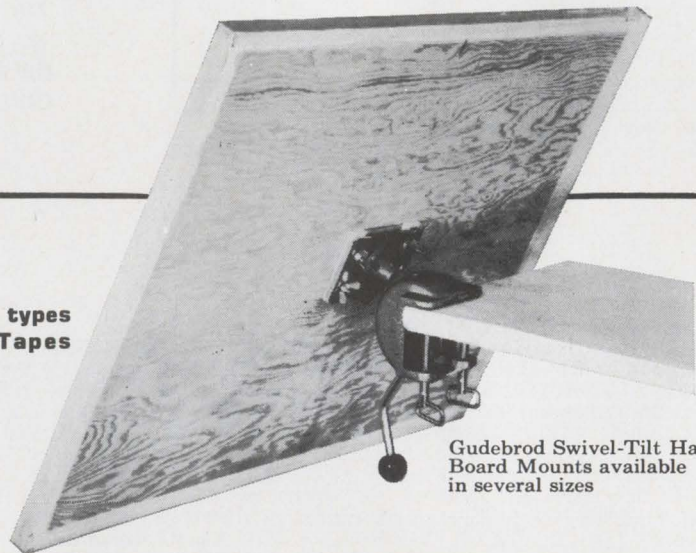

Gudebrod Swivel-Tilt Harness
Board Mounts available
in several sizes

GUDEBROD BROS. SILK CO., INC. Founded 1870, 12 South 12th Street, Philadelphia, Pa. 19107



.000500" GOLD

This is not a typographical error. Burndy's new printed circuit receptacle springs are clad to this thickness at point of contact.

Burndy has found a way to boost the reliability of ultraminiature connectors (.050" contact spacing) without unduly increasing the price.

Specially developed for a major computer manufacturer, the unusually thick gold coating is concentrated

on the springs at point of contact. Applied by Burndy's special "cladding" method, it makes possible a pore-free diffusion-proof surface, unequalled for corrosion resistance. Formed of gold flashed beryllium copper wire, the clad spring provides a connection with unusually stable contact resistance.

Burndy also makes a full line of PSE printed circuit connectors with springs gold plated to .000030 minimum for less critical applications. Samples of both are available for comparison tests.

Just write:

 **BURNDY**
NORWALK, CONNECTICUT

INTERNATIONAL SALES HEADQUARTERS AND MANUFACTURING FACILITIES:

CANADA: Scarboro, Ontario / ENGLAND: St. Helens, Lancs. / BELGIUM: Mechelen / MEXICO: Naucalpan de Juarez / BRAZIL: Sao Paulo / JAPAN: Tokyo / Sales Offices in Other Major Cities

Circle 75 on reader service card

Now from Philco!

MOS1024-bit read-only memory — 4-week delivery!

We'll write your bit pattern into our pM1024 memory, fast and accurately, through the aid of our computerized programs. Send us your pattern of 128 eight-bit words or 256 four-bit words and we'll deliver product in four to six weeks. The built-in chip select feature allows you to stack chips for any desired bit capacity.

The pM1024 chip contains address decoding, memory storage, and output buffers. High-speed output drive bipolar or MOS logic directly.

This high-speed MOS memory has a world of applications:

- lookup tables
- character generators
- microprogrammed computer instructions

- synced 8-signal waveform generators
- code converters
- and many others. Just turn your imagination loose.

The pM1024 is the highest speed, lowest power dissipation MOS memory available in production quantities today —at unit price competitive with any memory product on the market.

Want samples to check out circuitry? We can ship the pM1024 sine lookup table off the shelf.

Get complete facts now, from MOS Marketing, Microelectronics Div., Philco-Ford Corporation, Blue Bell, Pa. 19422.

the NOW people in MOS

PHILCO



IRRAVINTM

INSULATED WIRE

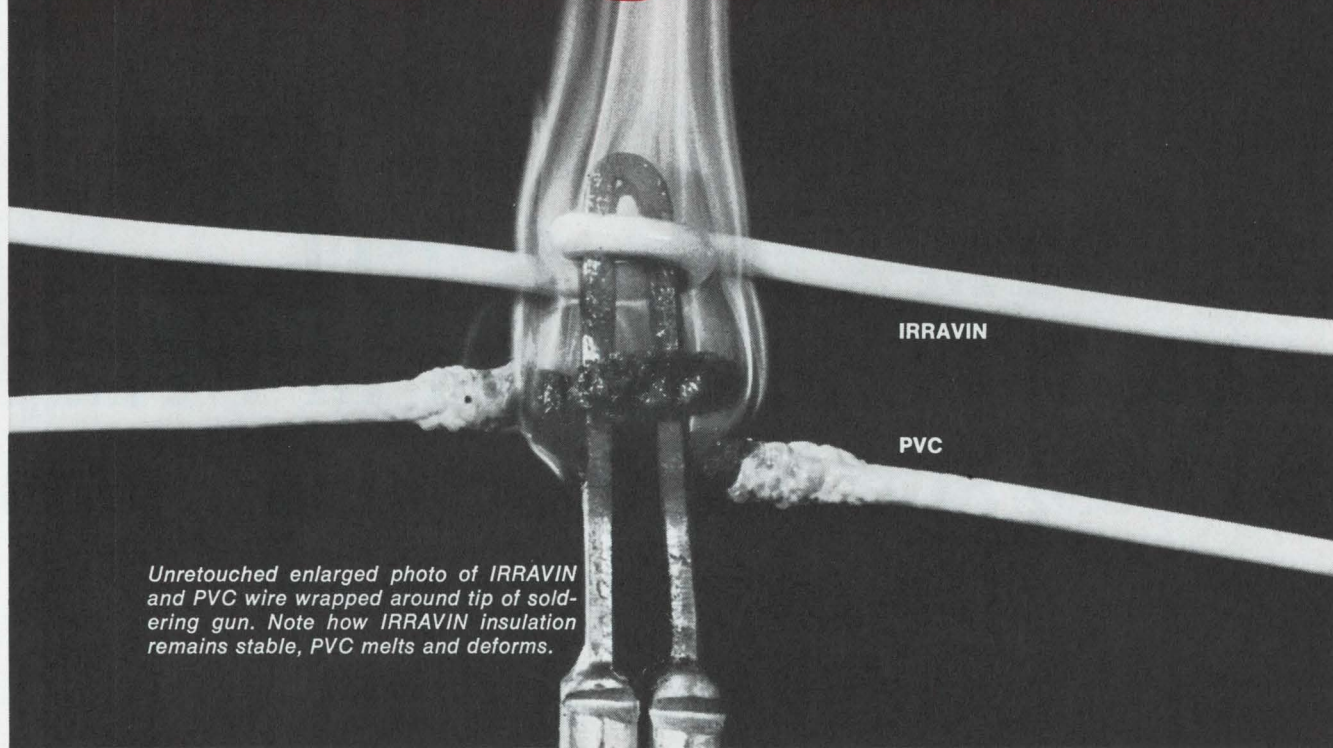

Unretouched enlarged photo of IRRAVIN and PVC wire wrapped around tip of soldering gun. Note how IRRAVIN insulation remains stable, PVC melts and deforms.

Hot problem... cool solution.

IRRAVIN insulation won't melt, flow or shrink back.

This photo was made to demonstrate the solder iron resistance of IRRAVIN insulated hook-up wire, compared with ordinary PVC insulated hook-up wire. It's proof that low-cost IRRAVIN wire suits applications where heat, even direct hot solder iron contact, is encountered. IRRAVIN insulation won't shrink back, or deform. It stays in place to maintain insulation integrity.

IRRAVIN wire can be soldered in snug spaces, even when terminals are

closely set. This, in addition to a small O.D., means space-savings, reduced rework and production time, less scrap.

To get the same product advantages of IRRAVIN wire you would have to specify wire that costs a lot more, two to three times more in fact! With IRRAVIN wire you not only save on time, space and waste. . . . you save on the initial cost too!

Don't just take our word for it. See for yourself with a sample.

It's yours FREE! Write ITT Wire and Cable Division, Surprenant Products, International Telephone and Telegraph Corporation, Pawtucket, Rhode Island 02862. In Europe: ITT Europe-Components Group, Lister Road, Basingstoke, Hants, England.

IRRAVIN—the wire that stops the grumbles.



Have a good application?
Enter our Pot-O-Gold Contest.
Write for your entry form today.

WIRE AND CABLE **ITT**

**The Choice is TTL.
From TI...the leader in TTL.
83 MSI and SSI functions...plus
40% more this year.
3 compatible speeds for
optimum designs.**

Why so many choices from TI TTL? To allow you to build your system to *your* specifications, not your supplier's.

You can get the best combination of compatible speeds to do the job—and the widest choice of functions within these speeds.

Use Series 54H/74H circuits in speed-critical sections of your sys-

tems. You get the benefits of the highest speed available in saturated logic.

In most systems areas, Standard Series 54/74 circuits offer the best speed/power ratio. And the complexity of MSI circuits provides substantial system cost and size reductions.

Then, where power dissipation is more critical than speed, use Series 54L/74L. It is twice as fast as other low-power circuits, and power consumption is only 1 mw per gate.

Low-power circuits greatly simplify power dissipation problems, and reliability problems associated with heat. In addition, they often help lower system cost by reducing cost of power supplies and cooling systems.

By using TI Series 54/74 TTL you can design by choice—a choice of 3 compatible speeds and 83 TTL functions.



TEXAS INSTRUMENTS
INCORPORATED

Best line of TTL integrated circuits.

<p>SN7410N / SN7410J / SN7410I</p> <p>3-input NAND gate</p>	<p>SN5420N / SN7420N SN5420J / SN7420J</p> <p>Dual 4-input NAND gate</p>	<p>SN5430N / SN7430N SN5430J / SN7430J</p> <p>8-input NAND gate</p>	<p>SN5440N / SN7440N SN5440J / SN7440J</p> <p>Dual 4-input NAND buffer</p>	<p>SN7441AN SN7441AJ</p> <p>BCD-to-decimal decoder driver</p>	<p>SN5442N / SN7442N SN5442J / SN7442J</p> <p>BCD-to-decimal decoder</p>
<p>SN7450N / SN7450J / SN7450I</p> <p>Dual 2-wide 2-input AND-OR-INVERT gate</p>	<p>SN5451N / SN7451N SN5451J / SN7451J</p> <p>Dual 2-wide 2-input AND-OR-INVERT gate</p>	<p>SN5453N / SN7453N SN5453J / SN7453J</p> <p>Expandable 4-wide 2-input AND-OR-INVERT gate</p>	<p>SN5454N / SN7454N SN5454J / SN7454J</p> <p>4-wide 2-input AND-OR-INVERT gate</p>	<p>SN5460N / SN7460N SN5460J / SN7460J</p> <p>Dual 4-input expander</p>	<p>SN5470N / SN7470N SN5470J / SN7470J</p> <p>J-K flip flop</p>
<p>SN7481N / SN7481J / SN7481I</p> <p>4-bit read/write memory</p>	<p>SN5482N / SN7482N SN5482J / SN7482J</p> <p>2-bit binary full-adder</p>	<p>SN7483N SN7483J</p> <p>Four-bit binary full-adder</p>	<p>SN5484N / SN7484N SN5484J / SN7484J</p> <p>16-bit read/write memory</p>	<p>SN5486N / SN7486N SN5486J / SN7486J</p> <p>Quadruple 2-input exclusive-OR element</p>	<p>SN5490N / SN7490N SN5490J / SN7490J</p> <p>Decade counter</p>
<p>SN54100N / SN74100N</p> <p>Dual quadruple bistable latch</p>	<p>SN54107N / SN74107N SN54107J / SN74107J</p> <p>Dual J-K Master-Slave flip-flop with preset and clear</p>	<p>SN54121N / SN74121N SN54121J / SN74121J</p> <p>Monostable multivibrator</p>	<p>SN54145N / SN74145N SN54145J / SN74145J</p> <p>BCD-to-decimal decoder-driver with open collector outputs</p>	<p>SN54150N / SN74150N SN54150J / SN74150J</p> <p>16-bit data selector/multiplexer</p>	
<p>SN7405</p> <p>Inverter with open collector output</p>	<p>SN5410 / SN7410</p> <p>Triple 3-input NAND gate</p>	<p>SN5420 / SN7420</p> <p>Dual 4-input NAND gate</p>	<p>SN5430 / SN7430</p> <p>8-input NAND gate</p>	<p>SN5440 / SN7440</p> <p>Dual 4-input NAND buffer</p>	<p>SN5449 / SN7449</p> <p>BCD-to-seven-segment decoder with open collector outputs</p>
<p>SN7472</p> <p>Slave flip-flop</p>	<p>SN5473 / SN7473</p> <p>Dual J-K master-slave flip-flop</p>	<p>SN5474 / SN7474</p> <p>Dual D-type edge-triggered flip-flop</p>	<p>SN5477 / SN7477</p> <p>Quadruple bistable latch</p>	<p>SN5480 / SN7480</p> <p>Gated full adder</p>	<p>SN5481 / SN7481</p> <p>16-bit read/write memory with open collector outputs</p>
<p>SN7495</p> <p>Register</p>	<p>SN54121 / SN74121</p> <p>Monostable multivibrator</p>	<p>SN54152 / SN74152</p> <p>8-bit data selector/multiplexer</p>	<p>SN54180 / SN74180</p> <p>8-bit parity generator/checker</p>		



TI Series 54/74...industry's broadest

Series 54H/74H high speed circuits

<p>SN54H00N/SN74H00N SN54H00J/SN74H00J</p> <p>Quadruple 2-input NAND gate</p>	<p>SN54H01N/SN74H01N SN54H01J/SN74H01J</p> <p>Quadruple 2-input NAND gate with open collector output</p>	<p>SN54H04N/SN74H04N SN54H04J/SN74H04J</p> <p>Hex inverter</p>	<p>SN54H05N/SN74H05N SN54H05J/SN74H05J</p> <p>Hex inverter with open collector output</p>	<p>SN54H10N/SN74H10N SN54H10J/SN74H10J</p> <p>Triple 3-input NAND gate</p>	<p>SN54H11N/SN74H11N SN54H11J/SN74H11J</p> <p>Triple 3-input AND gate</p>	<p>SN54H20N/SN74H20N SN54H20J/SN74H20J</p> <p>Dual 4-input NAND gate</p>
<p>SN54H22N/SN74H22N SN54H22J/SN74H22J</p> <p>Dual 4-input NAND gate with open collector output</p>	<p>SN54H30N/SN74H30N SN54H30J/SN74H30J</p> <p>8-input NAND gate</p>	<p>SN54H40N/SN74H40N SN54H40J/SN74H40J</p> <p>Dual 4-input NAND buffer</p>	<p>SN54H50N/SN74H50N SN54H50J/SN74H50J</p> <p>Expandable dual 2-wide 2-input AND-OR-INVERT gate</p>	<p>SN54H51N/SN74H51N SN54H51J/SN74H51J</p> <p>Dual 2-wide 2-input AND-OR-INVERT gate</p>	<p>SN54H52N/SN74H52N SN54H52J/SN74H52J</p> <p>Expandable 4-wide 2-2-2-3-input AND-OR gate</p>	<p>SN54H53N/SN74H53N SN54H53J/SN74H53J</p> <p>Expandable 4-wide 2-2-2-3-input AND-OR-INVERT gate</p>
<p>SN54H55N/SN74H55N SN54H55J/SN74H55J</p> <p>Expandable 2-wide 4-input AND-OR-INVERT gate</p>	<p>SN54H60N/SN74H60N SN54H60J/SN74H60J</p> <p>Dual 4-input expander</p>	<p>SN54H61N/SN74H61N SN54H61J/SN74H61J</p> <p>Triple 3-input expander</p>	<p>SN54H62N/SN74H62N SN54H62J/SN74H62J</p> <p>4-wide 3-2-2-3-input AND-OR expander</p>	<p>SN54H71N/SN74H71N SN54H71J/SN74H71J</p> <p>J-K flip-flop with AND-OR inputs</p>	<p>SN54H72N/SN74H72N SN54H72J/SN74H72J</p> <p>J-K master-slave flip-flop</p>	<p>SN54H73N/SN74H73N SN54H73J/SN74H73J</p> <p>Dual J-K flip-flop with separate clock inputs</p>
<p>SN54H87N/SN74H87N SN54H87J/SN74H87J</p> <p>4-bit true/complement, zero/one element</p>	<p>SN54H101N/SN74H101N SN54H101J/SN74H101J</p> <p>J-K flip-flop with AND-OR inputs</p>	<p>SN54H102N/SN74H102N SN54H102J/SN74H102J</p> <p>J-K flip-flop with AND inputs</p>	<p>SN54H103N/SN74H103N SN54H103J/SN74H103J</p> <p>Dual J-K flip-flop with separate clock inputs</p>	<p>SN54H106N/SN74H106N SN54H106J/SN74H106J</p> <p>Dual J-K flip-flop with preset and clear inputs</p>	<p>SN54H108N/SN74H108N SN54H108J/SN74H108J</p> <p>Dual J-K flip-flop with preset and clear inputs</p>	<p>SN54H00/SN74H00 SN54H00J/SN74H00J</p> <p>Quadruple 2-input NAND gate</p>
<p>SN54H04/SN74H04</p> <p>Hex inverter</p>	<p>SN54H05/SN74H05</p> <p>Hex inverter with open collector output</p>	<p>SN54H10/SN74H10</p> <p>Triple 3-input NAND gate</p>	<p>SN54H11/SN74H11</p> <p>Triple 3-input AND gate</p>	<p>SN54H20/SN74H20</p> <p>Dual 4-input NAND gate</p>	<p>SN54H21/SN74H21</p> <p>Dual 4-input AND gate</p>	<p>SN54H22/SN74H22</p> <p>Dual 4-input NAND gate with open collector output</p>
<p>SN54H50/SN74H50</p> <p>Expandable dual 2-wide 2-input AND-OR-INVERT gate</p>	<p>SN54H51/SN74H51</p> <p>Dual 2-wide 2-input AND-OR-INVERT gate</p>	<p>SN54H52/SN74H52</p> <p>Expandable 4-wide 2-2-2-3-input AND-OR gate</p>	<p>SN54H53/SN74H53</p> <p>Expandable 4-wide 2-2-2-3-input AND-OR-INVERT gate</p>	<p>SN54H54/SN74H54</p> <p>4-wide 2-2-2-3-input AND-OR-INVERT gate</p>	<p>SN54H55/SN74H55</p> <p>Expandable 2-wide 4-input AND-OR-INVERT gate</p>	<p>SN54H60/SN74H60</p> <p>Dual 4-input expander</p>
<p>SN54H71/SN74H71</p> <p>J-K flip-flop with AND-OR inputs</p>	<p>SN54H72/SN74H72</p> <p>J-K master-slave flip-flop</p>	<p>SN54H73/SN74H73</p> <p>Dual J-K flip-flop with separate clock inputs</p>	<p>SN54H78/SN74H78</p> <p>Dual J-K flip-flop with preset and clear inputs</p>	<p>SN54H87/SN74H87</p> <p>4-bit true/complement, zero/one element</p>	<p>SN54H101/SN74H101</p> <p>J-K flip-flop with AND-OR inputs</p>	<p>SN54H102/SN74H102</p> <p>J-K flip-flop with AND inputs</p>

TI Series 54/74...industry's broa

Series 54/74

<p>SN5400N/SN7400N SN5400J/SN7400J Quadruple 2-input NAND gate</p>	<p>SN5401N/SN7401N SN5401J/SN7401J Quadruple 2-input NAND gate with open collector output</p>	<p>SN5402N/SN7402N SN5402J/SN7402J Quadruple 2-input NOR gate</p>	<p>SN5403N/SN7403N SN5403J/SN7403J Quadruple 2-input NAND gate with open collector output</p>	<p>SN5404N/SN7404N SN5404J/SN7404J Hex inverter</p>	<p>SN5405N/SN7405N SN5405J/SN7405J Hex inverter with open collector output</p>	<p>SN5406N/SN7406N SN5406J/SN7406J Triple 3-input NAND gate</p>
<p>SN5443N/SN7443N SN5443J/SN7443J Excess-3-to-decimal decoder</p>	<p>SN5444N/SN7444N SN5444J/SN7444J Excess-3-gray-to-decimal decoder</p>	<p>SN5445N/SN7445N SN5445J/SN7445J BCD-to-decimal decoder-driver with open collector outputs.</p>	<p>SN5446N/SN7446N SN5446J/SN7446J BCD-to-seven-segment decoder-driver</p>	<p>SN5447N/SN7447N SN5447J/SN7447J BCD-to-seven-segment decoder-driver</p>	<p>SN5448N/SN7448N SN5448J/SN7448J BCD-to-seven-segment decoder-driver</p>	<p>SN5449N/SN7449N SN5449J/SN7449J BCD-to-decimal decoder-driver with open collector outputs.</p>
<p>SN5472N/SN7472N SN5472J/SN7472J J-K master-slave flip-flop</p>	<p>SN5473N/SN7473N SN5473J/SN7473J Dual J-K master-slave flip-flop</p>	<p>SN5474N/SN7474N SN5474J/SN7474J Dual D-type edge-triggered flip-flop</p>	<p>SN5475N/SN7475N SN5475J/SN7475J Quadruple bistable latch</p>	<p>SN5476N/SN7476N SN5476J/SN7476J Dual J-K master-slave flip-flop with preset and clear</p>	<p>SN5480N/SN7480N SN5480J/SN7480J Gated full adder</p>	<p>SN5481N/SN7481N SN5481J/SN7481J 16-bit register</p>
<p>SN5491AN/SN7491AN SN5491AJ/SN7491AJ 8-bit shift register</p>	<p>SN5492N/SN7492N SN5492J/SN7492J Divide-by-12 counter</p>	<p>SN5493N/SN7493N SN5493J/SN7493J Four-bit binary counter</p>	<p>SN5494N/SN7494N SN5494J/SN7494J 4-bit shift register</p>	<p>SN5495N/SN7495N SN5495J/SN7495J 4-bit shift register</p>	<p>SN5496N/SN7496N SN5496J/SN7496J 5-bit shift register</p>	<p>SN5497N/SN7497N SN5497J/SN7497J 8-bit shift register</p>
<p>SN54151N/SN74151N SN54151J/SN74151J 8-bit data selector/multiplexer</p>	<p>SN54180N/SN74180N SN54180J/SN74180J 8-bit parity generator/checker</p>	<p>SN5400/SN7400 Quadruple 2-input NAND gate</p>	<p>SN5401/SN7401 Quadruple 2-input NAND gate with open collector output</p>	<p>SN5402/SN7402 Quadruple 2-input NOR gate</p>	<p>SN5404/SN7404 Hex inverter</p>	<p>SN5405/SN7405 Hex inverter</p>
<p>SN5450/SN7450 Expandable dual 2-wide 2-input AND-OR-INVERT gate</p>	<p>SN5451/SN7451 Dual 2-wide 2-input AND-OR-INVERT gate</p>	<p>SN5453/SN7453 Expandable 4-wide 2-input AND-OR-INVERT gate</p>	<p>SN5454/SN7454 4-wide 2-input AND-OR-INVERT gate</p>	<p>SN5460/SN7460 Dual 4-input expander</p>	<p>SN5470/SN7470 J-K flip-flop</p>	<p>SN5472/SN7472 J-K master-slave flip-flop</p>
<p>SN5482/SN7482 2-bit binary full-adder</p>	<p>SN5486/SN7486 Quadruple 2-input exclusive-OR element</p>	<p>SN5490/SN7490 Decade counter</p>	<p>SN5491A/SN7491A 8-bit shift register</p>	<p>SN5492/SN7492 Divide-by-12 counter</p>	<p>SN5493/SN7493 Four-bit binary counter</p>	<p>SN5494/SN7494 4-bit shift register</p>

line of TTL integrated circuits.

Series 54L/74L low power circuits

<p>SN54H21N/SN74H21N SN54H21J/SN74H21J Dual 4-input AND gate</p>	<p>SN54L00N/SN74L00N SN54L00J/SN74L00J Quaduple 2-input NAND gate</p>	<p>SN54L10N/SN74L10N SN54L10J/SN74L10J Triple 3-input NAND gate</p>	<p>SN54L20N/SN74L20N SN54L20J/SN74L20J Dual 4-input NAND gate</p>	<p>SN54L30N/SN74L30N SN54L30J/SN74L30J Single 8-input NAND gate</p>	<p>SN54L51N/SN74L51N SN54L51J/SN74L51J Dual 2-wide 2-input/2-wide 3-input AND-OR-INVERT gate</p>
<p>SN54H54N/SN74H54N SN54H54J/SN74H54J 4-wide 2-2-3-input AND-OR-INVERT gate</p>	<p>SN54L54N/SN74L54N SN54L54J/SN74L54J 2-2-3-input AND-OR-INVERT gate</p>	<p>SN54L55N/SN74L55N SN54L55J/SN74L55J 2-wide 4-input AND-OR-INVERT gate</p>	<p>SN54L71N/SN74L71N SN54L71J/SN74L71J R-S master-slave flip-flop</p>	<p>SN54L72N/SN74L72N SN54L72J/SN74L72J J-K master-slave flip-flop</p>	<p>SN54L73N/SN74L73N SN54L73J/SN74L73J Dual J-K master-slave flip-flop</p>
<p>SN54H78N/SN74H78N SN54H78J/SN74H78J Dual J-K flip-flop with preset and clear inputs</p>	<p>SN54L78N/SN74L78N SN54L78J/SN74L78J Dual J-K master-slave flip-flop with common clear</p>	<p>SN54L91N/SN74L91N SN54L91J/SN74L91J 8-bit shift register</p>	<p>SN54L95N/SN74L95N SN54L95J/SN74L95J 4-bit shift register</p>	<p>SN54L00R/SN74L00R Quaduple 2-input NAND gate</p>	<p>SN54L04R/SN74L04R Hex inverter</p>
<p>SN54H01/SN74H01 Quaduple 2-input NAND gate with open collector output</p>	<p>SN54L10R/SN74L10R Triple 3-input NAND gate</p>	<p>SN54L20R/SN74L20R Dual 4-input NAND gate</p>	<p>SN54L30R/SN74L30R 8-input NAND gate</p>	<p>SN54L51R/SN74L51R Dual 2-wide 2-input/2-wide 3-input AND-OR-INVERT gate</p>	<p>SN54L54R/SN74L54R 2-2-3-input AND-OR-INVERT gate</p>
<p>SN54H30/SN74H30 8-input NAND gate</p>	<p>SN54H40/SN74H40 Dual 4-input NAND buffer</p>	<p>SN54L55R/SN74L55R 2-wide 4-input AND-OR-INVERT gate</p>	<p>SN54L71R/SN74L71R R-S master-slave flip-flop</p>	<p>SN54L72R/SN74L72R J-K master-slave flip-flop</p>	<p>SN54L73R/SN74L73R Dual J-K master-slave flip-flop</p>
<p>SN54H61/SN74H61 Triple 3-input expander</p>	<p>SN54H62/SN74H62 4-wide 3-2-2-3-input AND-OR expander</p>	<p>SN54L78R/SN74L78R Dual J-K master-slave flip-flop</p>	<p>SN54L91AR/SN74L91AR 8-bit shift register</p>	<p>SN54L95R/SN74L95R 4-bit shift register</p>	
<p>SN54H103/SN74H103 Dual J-K flip-flop with separate clocks</p>	<p>SN54H108/SN74H108 Dual J-K flip-flop with preset and clear inputs</p>	<p>TTL Integrated circuits from Texas Instruments</p>			

New TTL Design Aid. We've just published a new 80-page color brochure that gives valuable data—including design information—on all Series 54/74 ICs. It's yours for the asking. Circle 199 on the Reader Service card for your copy... or write Texas Instruments Incorporated, P.O. Box 5012, M.S. 308, Dallas, Texas 75222.

The Trend is TTL.
TI is the leader in TTL.
In breadth of line. In technology.
In production capacity.
In availability.
Look first to TI.

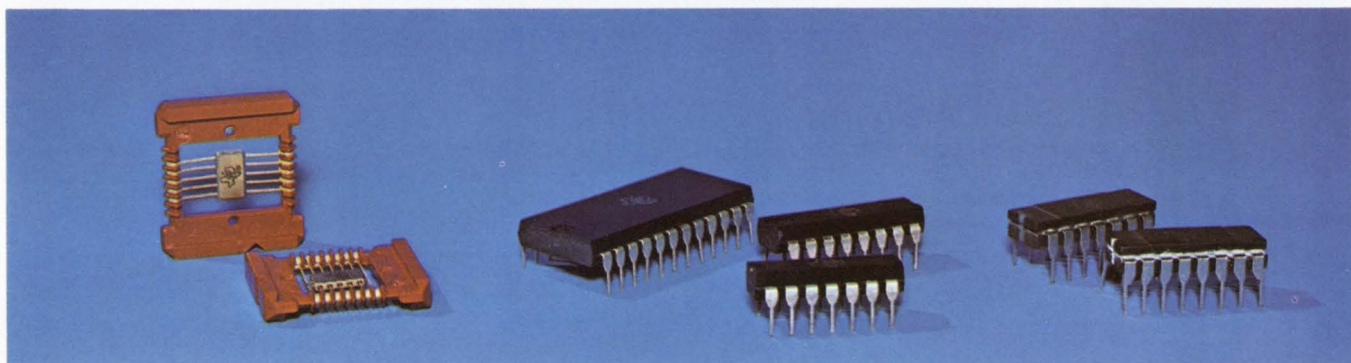

In addition to 83 different circuits, three speed ranges, and a broad selection of MSI circuits, Series 54/74 TTL from TI is offered in three package types.

TI's plastic dual-in-line packages are low in cost, yet rugged. And they are backed by millions of hours of reliability data. Series 54 plastic performance over the full temperature range (-55°C to $+125^{\circ}\text{C}$) is proven by customer usage in temperature critical systems.

Ceramic dual-in-line packages from TI provide all the benefits of

hermetic packages in a design suited to automatic insertion and soldering. Ceramic packages are ideal for severe environments where applications require validation of hermeticity.

TI's flatpacks—best for space-critical applications—are backed by ten years service in all types of military, space, and commercial systems.

When you design with Series 54/74, you have a lot in your favor. A broad range of MSI circuits... three compatible speeds... three package types. Also, good availa-

bility, and second-sources for most circuits.

The widest choice. The dominant trend. Series 54/74 TTL from Texas Instruments.

New TTL design aid

A new 80-page color brochure gives valuable data—including design information—on all TI series 54/74 IC's. Circle 199 on the Reader Service card for your copy...or write Texas Instruments Incorporated, P.O. Box 5012, MS 308, Dallas, Texas 75222.



TEXAS INSTRUMENTS
INCORPORATED

UNION CARBIDE CUSTOM MOS TECHNOLOGY

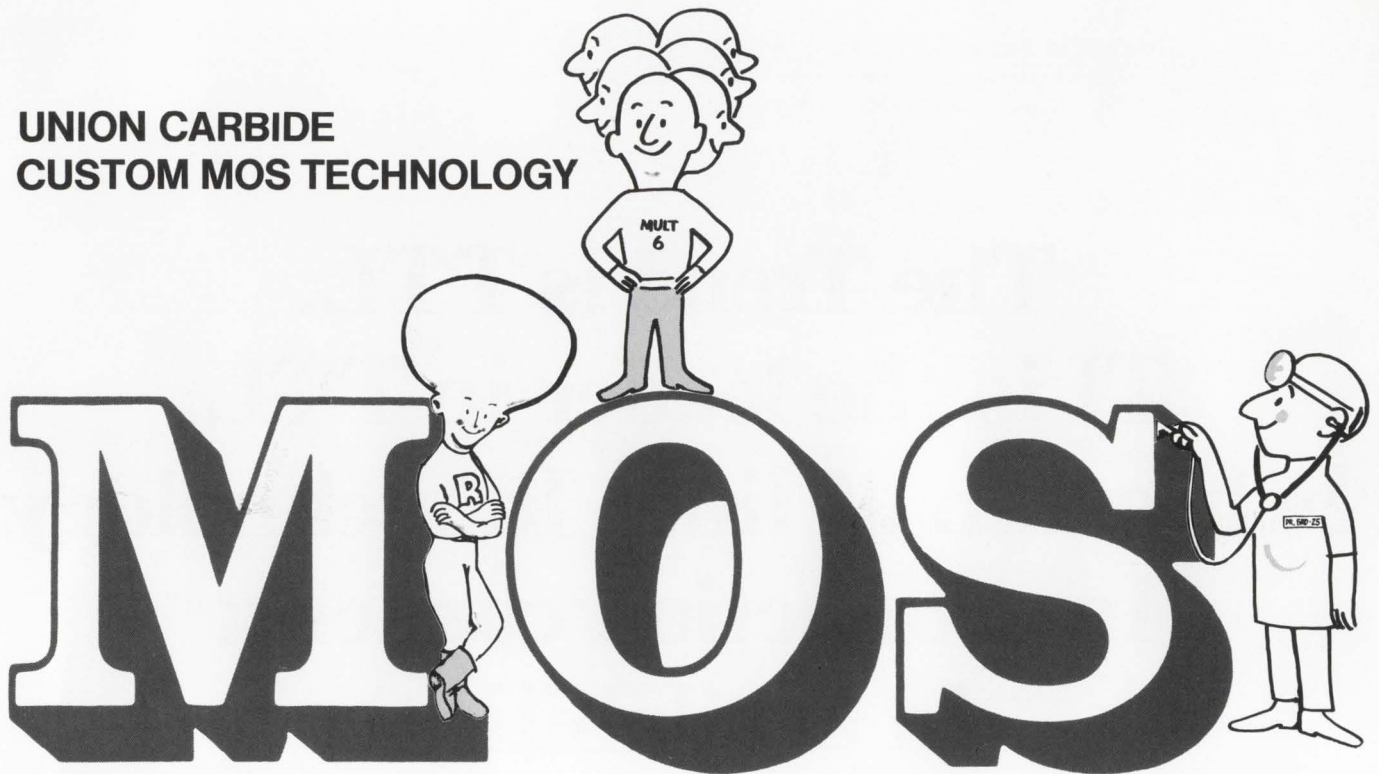

**The revolution continues in San Diego...
where great custom MOS technology breeds great custom products.**

GREAT TECHNOLOGY CAPABILITIES. A P-Channel LOW THRESHOLD process which allows your system to INTER-FACE DIRECTLY with BIPOLAR LOGIC, both at the input and output, is readily available for custom work. Because of Union Carbide's proprietary process LOW THRESHOLD (typically $-1.5V$) and a field inversion of $-30V$ can be produced on a $\langle 100 \rangle$ crystal structure. Our SRD25 (UC7330) shift register is an excellent example of our LOW THRESHOLD process capability. This is part of the revolution in San Diego.

The $\langle 111 \rangle$ P-Channel HIGH THRESHOLD (typically $-4.5V$) process, which is the industry standard, is also available from Union Carbide. Our new LSI ROM1K (UC6500) 1024 bit static Read Only Memory is available to demonstrate this process technology using our state-of-the-art design.

Also available is our state-of-the-art N-Channel enhancement, LOW THRESHOLD technology. This Union Carbide propri-

etary process offers you system advantages such as full BIPOLAR COMPATABILITY, positive voltage supplies, and N-Channel mobility for increased speed and performance. We have a monolithic BCD to decimal decoder that directly drives Nixie tubes which we can demonstrate for you.

GREAT MASKING TECHNOLOGY COMPLEMENTS CUSTOM TECHNOLOGY. Union Carbide offers the finest and tightest in-house masking capability available. Our new mask repeater, a Mann 1480 AF, can step a .3"x.3" chip.

**COME TO WHERE THE MOS CUSTOM REVOLUTION IS—
COME TO SAN DIEGO WHERE THE ACTION IS.** While you are visiting beautiful San Diego, let Union Carbide put its know-how to work integrating your system or circuit. Or if you still want action, but can't visit San Diego, we'll bring it to your doorstep. Just pick up the phone, and call your local sales representative listed below.

ELECTRONICS DIVISION SEMICONDUCTOR DEPARTMENT

P.O. Box 23017, 8888 Balboa Avenue, San Diego, California 92123 • Tel: (714) 279-4500/TWX: 910-335-1211



THE DISCOVERY COMPANY

Union Carbide's Electronics Division is a total supplier to the industrial community through its Semiconductor Department, Components Department, Crystal Products Department, KORAD Department and Instrument Department.

UNION CARBIDE SEMICONDUCTOR SALES OFFICES

CALIFORNIA, Mountain View 94040, 2680 Bayshore Frontage Rd., (415) 969-9390 • CALIFORNIA, Inglewood 90301, 5115 W. Century Blvd., (213) 677-6194 • FLORIDA, Winter Park 32789, P.O. Box 186 (305) 645-3311 • ILLINOIS, Chicago 60601, 120 South Riverside Plaza, (312) 822-7024 • NEW JERSEY, Willingsboro 08046, 1 Shawmont Lane (609) 871-3920 • NEW YORK, Jericho 11753, 333 N. Broadway, (516) 433-8441

Circle 84 on reader service card

Circle 85 on reader service card →

Here's how General Electric's panel meter sales and service army serves you

UNEXCELLED
QUALITY

General Electric's panel meters and meter relays answer the call for faultless performance and high reliability. The quality reputation of your product is sure to be enhanced by using quality engineered instruments from General Electric.

FAST DELIVERY

You can rely on 150 General Electric distributors, 25 modification centers, and factory stock of more than 30,000 instruments to assure you of prompt and, in many cases, same-day delivery service.

FULL LINE OF
PRODUCTS

General Electric offers you a wide choice of ratings, sizes, and mechanisms for The Big Look® and Horizon Line® panel meters and meter relays, not to mention time meters, edgewise panel meters, meter shunts, and low-voltage current transformers.

MODIFICATION
SERVICE

Available throughout the country, General Electric's modification shops are capable of providing regular and emergency service on specials, prototypes, and standard ratings of panel meters and meter relays to match your requirements.

SPECIAL
APPLICATION
ASSISTANCE

General Electric's trained distributor personnel and your local GE sales engineers are always available for any special application assistance you may require. And, if that's not enough, our factory product specialists are on "ready reserve."

SPEEDY
ORDER
FOLLOWING

General Electric's factory communication center provides your local sales office with one-call service regarding the availability, status, and shipment of your order.

General Electric stands ready to gain your instrument business with a total value package: quality you can depend on, fast delivery, a full line, local sales representatives, speedy order-following and most important, a progressive "can do" attitude. Our Sales and Service Army is ready. Just give the order. Contact your GE Electronic Components Sales Office or your dependable General Electric panel meter distributor.

592-37

PICK GEORGIA TECH'S BRAIN.

FREE.

The Georgia Institute of Technology, in cooperation with the Georgia Department of Industry & Trade, has just completed an invaluable study entitled "Electronics Potentials in Georgia." And it's yours free. This comprehensive book will tell you just about everything you need to know about Georgia's position within the Southeastern electronic materials market. It's loaded with graphs, charts, facts and figures about raw materials, transportation, power, training capabilities and labor supplies. So if you're looking for information about additional profits, pick the expert's brain.

Please send me your free book, "Electronics Potentials in Georgia."

Name _____

Title _____

Street _____

City _____ State _____ Zip _____

Mail this coupon to:

Lt. Gen. Louis W. Truman, U.S.A. (Ret.),

P.O. Box 38097, Atlanta, Georgia 30334

EM 1

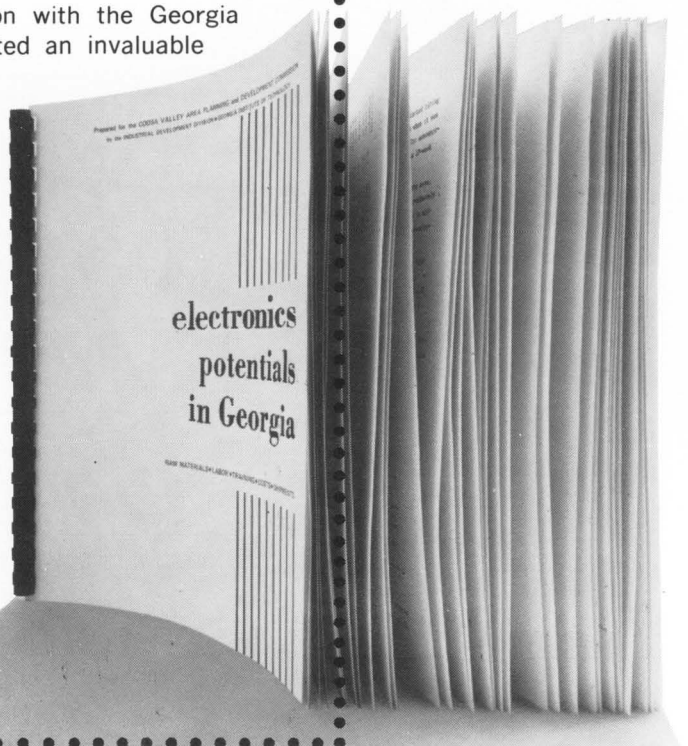

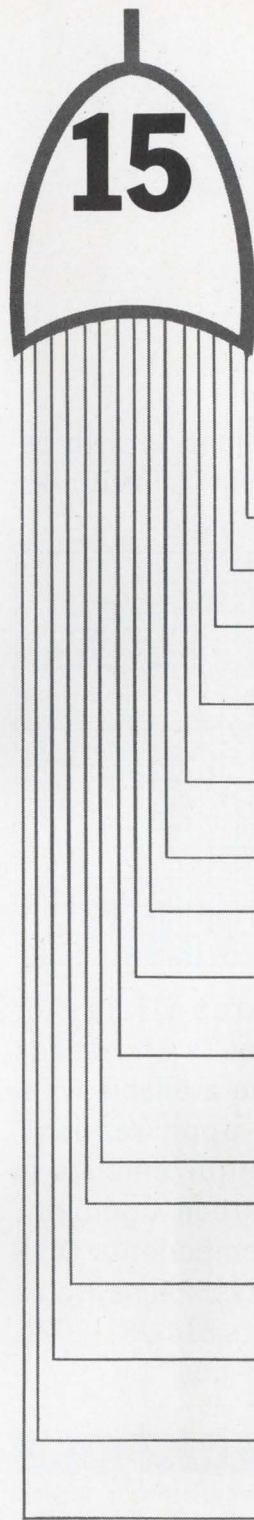

15 TTL solutions to complex problems

For simplified, "low package-count" digital system design, these 15 new Motorola TTL complex functions offer improved circuit performance, lower system costs and are ideal for interfamilary (MDTL, TTL) compatibility.

- **MC4004F, P** **16-BIT SCRATCH PAD MEMORY CELL** — a basic building block for 100 ns scratchpad memory systems.
- **MC4005F, P** **16-BIT SCRATCH PAD MEMORY CELL** — provides 16 words of one-bit memory operating in the NDRO mode.
- **MC4006F, P** **BINARY TO ONE-OF-EIGHT LINE DECODER** — a 3-input/8-output decoder. Inhibit capability provided by the enable line and allows decoder to be expanded for larger systems.
- **MC4007P** **DUAL BINARY TO ONE-OF-FOUR LINE DECODER** — a dual 2-input/4-output decoder consisting of high and low-level gates internally connected for minimum power consumption, maximum driving capabilities.
- **MC4008L** **8-BIT PARITY TREE** — consists of eight 2-input Exclusive NOR gates connected to form an 8-bit Parity Checker/Generator and an extra 2-input gate for expansion capability.
- **MC4010L** **DUAL 4-BIT PARITY TREE** — three Exclusive NOR gates are connected together to form each of two 4-bit parity trees in one package.
- **MC4012L** **4-BIT SHIFT REGISTER** — can be operated in the parallel or serial mode, determined by the logic state of the mode control input.
- **MC5493L/ MC7493L** **4-BIT BINARY COUNTER** — consists of two sections: a simple flip-flop and a divide-by-eight counter. Can be used independently or connected to provide the divide-by-16 function.
- **MC15482L/ MC17482L** **2-BIT FULL ADDER** — each bit performs the logical addition of two binary numbers. The sum outputs, the carry output for the second bit, and Exclusive OR outputs for each bit are available. Look-ahead carry is provided internally.
- **MC25482L/ MC27482L** **2-BIT FULL ADDER** — Exclusive OR outputs can be used for look-ahead carry when adding more than two bits.
- **MC4038P** **INVERTING/NON-INVERTING ONE-OF-EIGHT DECODER** — has a 3-bit binary address with inversion control which selects the desired word for the 8-bit output.
- **MC4039P** **SEVEN SEGMENT CHARACTER GENERATOR** — can directly operate low-voltage lamp indicators, enable inputs can be used for automatic blanking.
- **MC4040P** **BINARY TO TWO-OF-EIGHT DECODER** — has two enable inputs, transforms any 4-bit binary number to a 2-of-8-bit coded number, or can be used as a dual binary to 1-of-4 decoder.
- **MC4041P** **SINGLE-ERROR HAMMING CODE DETECTOR AND GENERATOR** — a programmed 128-bit ROM for a variety of error detection and correction applications.
- **MC7475P** **QUAD LATCH** — consists of four bistable latch circuits in one package. Both Q and \bar{Q} outputs are available on all four devices.

Interested? For detailed specifications on these MTTL complex functions circle the reader service number below or write us at Box 20912, Phoenix, Arizona 85036. We'll also include two newly available application notes on MTTL in system applications. For immediate evaluation units call your local franchised Motorola distributor.

F suffix = TO-86 ceramic flat pack, P = TO-116 dual-in-line plastic, L = TO-116 dual-in-line ceramic.

— where the priceless ingredient is care!



MOTOROLA Integrated Circuits

MOTOROLA SEMICONDUCTOR PRODUCTS INC., P. O. BOX 20912, PHOENIX, ARIZONA 85036

The phenomenal ferrite bead:

Stackpole's simple solution to noise and filter problems.

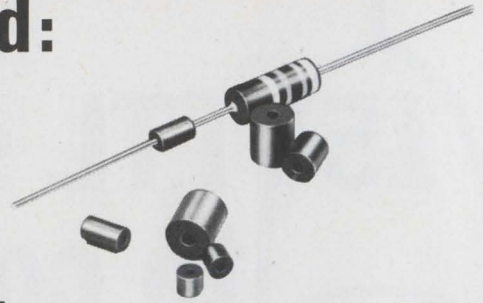

Ceramag[®] ferrite beads offer a simple, inexpensive, yet effective means of obtaining RF decoupling, shielding, and parasitic suppression without sacrificing low frequency power or signal level.

Unlike conventional RF chokes, beads are compact, have no DC losses, and will not couple to stray capacity and introduce detuning or spurious oscillations. Ceramag[®] beads offer an impedance which varies from quite low at low frequencies to quite high at noise frequencies. Beads need not be grounded; however, chassis contact is permissible when desired, as beads possess sufficiently high resistivity to preclude grounding.

Installation of Stackpole

beads is easy. Simply slip one (or several) over appropriate conductor(s) for the desired noise suppression or high frequency isolation. Beads are available in sleeve form in a range of sizes starting at .025 ID, .060 OD, and .400 long. For special compact filtering applications such as cable connectors, beads can be supplied to tight mechanical tolerances.

Several ferrite grades provide a variety of attenuation characteristics. Inductance tolerance is normally $\pm 30\%$ as measured on an LC meter. The performance of a Ceramag[®] 7D bead as a parasitic suppressor is shown in Figure 1.

Other applications might include: decoupling in "B" circuitry; noise suppression; RF isolation in filament circuits;

use in combination with capacitors to form "L" networks.

FIGURE 1

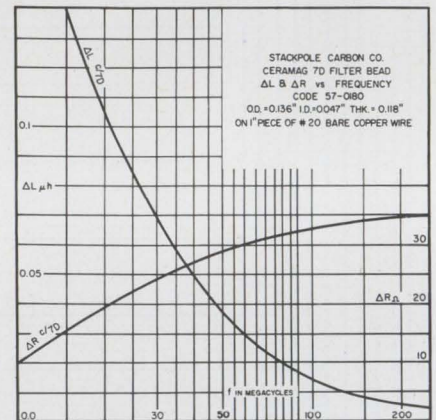

Sample quantities of Ceramag[®] beads and beads with leads are available without charge upon request. Send your requirements to Stackpole Carbon Company, Electronic Components Division, St. Marys, Pennsylvania 15857. Phone: 814-781-8521. TWX: 510-693-4511.



Now available...Ceramag[®] beads with leads

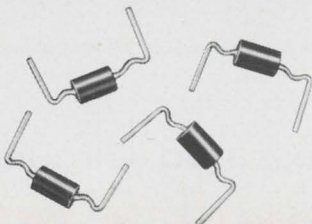

Additional savings in production time and labor costs are now possible by utilizing automatic insertion equipment to install Ceramag[®] ferrite beads in printed circuit boards.

When RCA quietly calls its RF power transistors "reliable," RCA means "highly reliable." Read why.

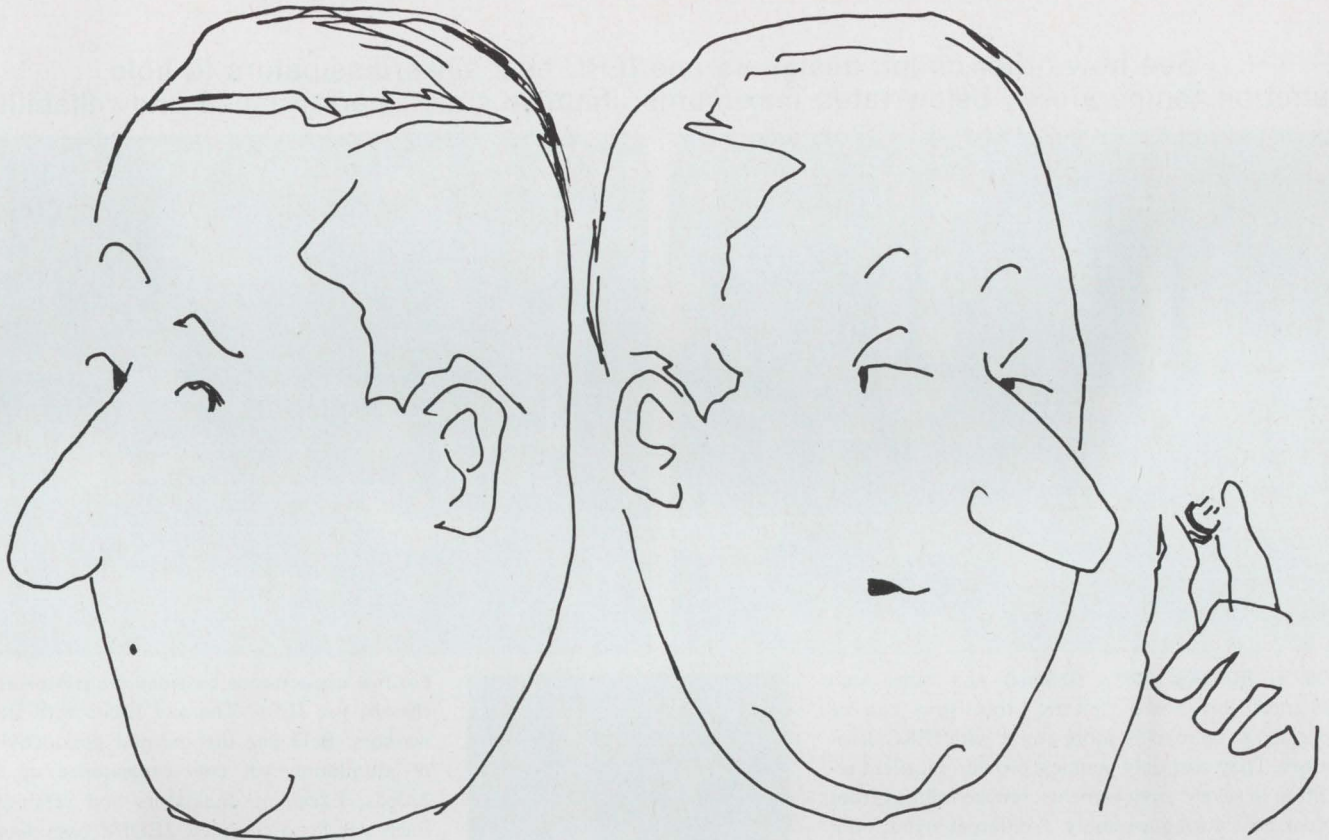

RCA

The reliability of RCA RF Power Transistors is designed-in, built-in and finally proved-in.

Evaluation criteria of every RCA RF Power Transistor are determined initially by design engineering—and are used during the analysis of first yields of prototypes. Procedures include tests to destruction, examination of failure mechanisms, checking the expectability of results, and extensive life tests under various rigorous conditions—all aimed at the final determination that every aspect of the new design is "go" for volume production.

In the second stage of assuring reliability, RCA follows a program of *dual* factory-process control: in-line testing at every major point of manufacturing, plus continuous quality audits on samples. The program consists of life tests, data analysis and failure analysis. Results are fed back to every technical group concerned with each product's evolution—from design through applications engineering.

The final stage, the proving-in of RCA reliability, is high to ultra-high screening. This follows four reliability levels: two meeting MIL-STD requirements and two meeting even more exacting criteria set by RCA—many of which precede the issuance of the military specs. Note the following chart of high-reliability RCA RF Power Transistors—all immediately available.

RCA RF Power Transistors—High-Reliability Types

Parent Type	Jan Type Or Equivalent	Jan TX Type Or Equivalent	High-Reliability Type	Premium High-Reliability Type
2N3553	JAN 2N3553	JAN TX 2N3553	40305	40605
2N4440	JAN 2N4440	JAN TX 2N4440	—	—
2N3632	—	—	40307	40606
2N3375	JAN 2N3375	JAN TX 2N3375	40306	40279
2N3118	JAN 2N1493	—	—	40577
2N3866	TA7090*	TA7327*	—	40578
2N5016	TA7091*	TA7359*	—	40607
2N5071	TA7360*	TA7358*	—	—

*Developmental number; military specification pending

For detailed information on any of these RCA high-reliability RF Power Transistors, see your local RCA Representative or your RCA Distributor. For technical data, write: RCA Electronic Components, Commercial Engineering, Section PN6-3, Harrison, N.J. 07029.

Tips on cooling off hot semiconductors

See how other circuit designers use IERC heat sinks/dissipators to hold junction temperatures below rated maximums, improve circuit performance and reliability

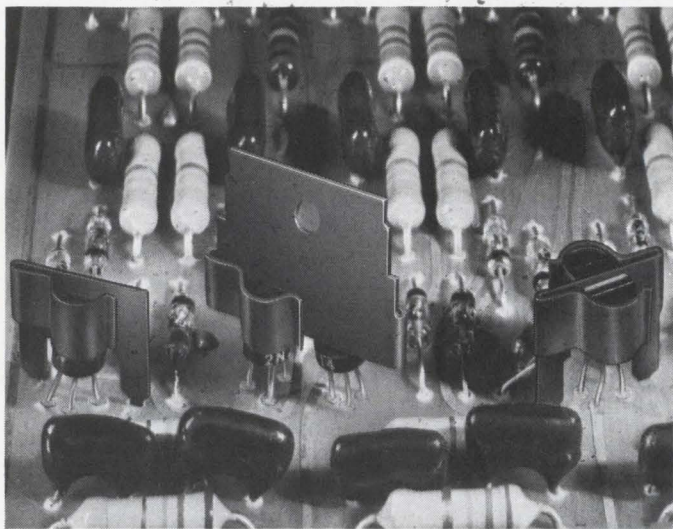

RO97's, RO97A's, X20's (D-Style) and other lead mounted, low power "plastic" transistors can be operated at up to 65% more power with IERC dissipators. They cost only pennies, provide excellent retention in severe environments, reduce failures from solder heat during assembly. 5 different styles; both single and dual models.

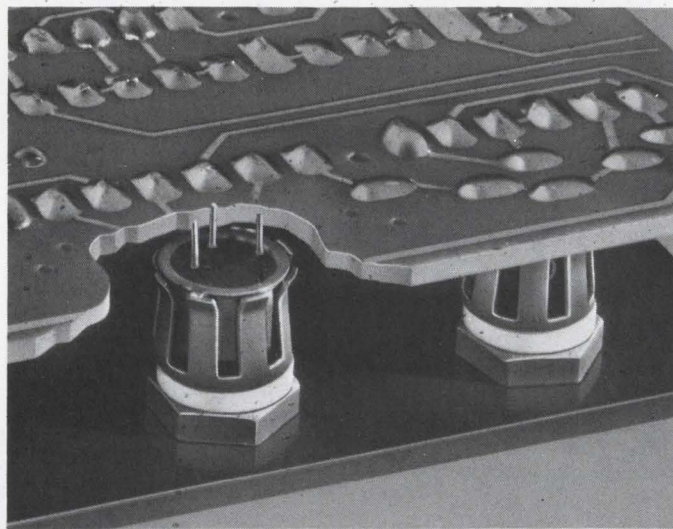

For low capacitance between transistor and chassis, use IERC Thermal Links with BeO washers. BeO has the thermal conductivity of aluminum, yet cuts capacitance up to 2/3rds. Excellent dissipators and retainers. Each size fits a complete JEDEC case diameter range for TO5's and TO18's. Dual and quad models also.

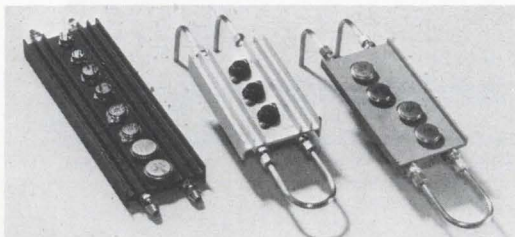

Replace elaborate forced air cooling systems for power devices. IERC fluid cooled systems provide up to 1,000 watts of dissipation in less than 45 cu. in. Parallel or series flow; open or closed loop systems. All standard mounting hole patterns; specials, too. Lengths from 6" to 3' standard.

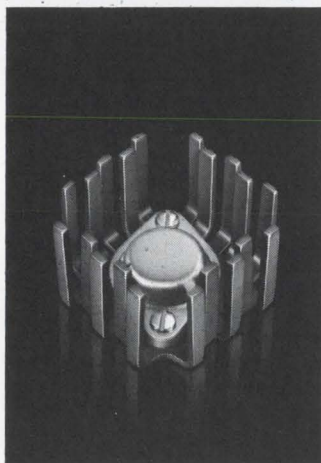

TO3's, TO66's, TO15's and other case-mounted devices can be operated with many times more power when mounted in UP's. In still air, the staggered fingers dissipate by radiation and convection. In forced air, turbulence moves the air around each finger. Efficient in any direction. Outperforms extrusions dramatically.

Is yours a special heat problem? Talk to the thermal specialists at IERC. They have the problem solving experience to come up with a practical, low cost solution.



Free 4-page Short Form Catalog. Complete ordering and pricing information on the world's broadest line of heat sinks/dissipators and retainers for lead and case mounted semiconductors.

Heat Sinks/Dissipators





Solid-State Sweep Oscillator

New 1.0 to 4.0 GHz RF Plug-in covers entire range in one continuous sweep.

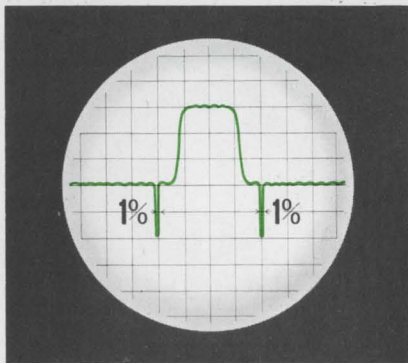

ALL Type 210 Sweep Oscillator is the only one whose markers are always 1% of swept width. You get superior performance and operating simplicity over broad range of 0.25 to 40 GHz. Main Frame price less cabinet: \$1525.

Why switch bands and miss information at crossover points when this new solid-state plug-in gives you full two-octave band coverage in one continuous sweep—with over 30 mW of leveled power?

Why buy different sweep oscillators for various portions of the microwave frequency range when the Type 210 offers a full selection of interchangeable solid-state and BWO plug-ins covering from 250 MHz to 40 GHz?

Why be satisfied with markers that "blow out" and become useless on narrow sweeps when we provide markers that are always 1% of the swept band?

All this and extra features as well—two independent sweeps

fully interchangeable—15 calibrated symmetrical sweeps about four separate CW frequencies—PIN leveling from 250 MHz to 18 GHz.

Fact is, the Type 210 makes other sweepers old fashioned. Try it for yourself. Call our "hot line" to arrange a demonstration. Dial 516-595-3216 during East Coast business hours.



Or write for our new catalog covering ALL's full line of Microwave Instruments.

AIRBORNE INSTRUMENTS LABORATORY
DIVISION OF CUTLER-HAMMER INC./DEER PARK, LONG ISLAND, NEW YORK 11729



hybrid circuits

from

Burroughs

Burroughs is your preferred source for hybrid circuits

Burroughs, a prime producer of high-volume, high-quality hybrid microcircuits, offers the entire circuit package and its components at competitive prices. Circuits are now available in various configurations with screened resistors and capacitors, as well as discrete components including IC and MSI chips. Burroughs does the whole job, and does it right—enabling you to reduce system size with increased reliability.

Every circuit is custom-designed and fabricated under the eyes of experts in complete in-house semiconductor and hybrid operations—assuring you economy, high reliability, quality control and on-schedule delivery.

Buy your hybrid microcircuits NOW from Burroughs, and discover what Burroughs' one-source circuitry capability can do for you.

We also offer hermetic packaging, computer testing, complete environmental facilities. And we are fully documented to MIL Specs.

Call or write Burroughs Corporation, Electronic Components Division, P.O. Box 1226, Dept. H1, Plainfield, New Jersey 07061. Tel. (201) 757-5000, or contact your nearest Burroughs representative or sales engineer.

- 1./ *Semi-automatic dual latch hybrid test unit for efficient, high-speed tests.*
- 2./ *High-speed resistor abrading process assures $\pm 1\%$ tolerances.*
- 3./ *Modern, contamination-free diffusion operation, atmospherically controlled for maximum quality assurance.*
- 4./ *Multifunctional computerized system performs all forms of AC & DC tests.*

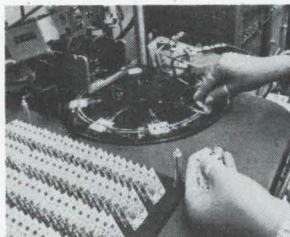

2./

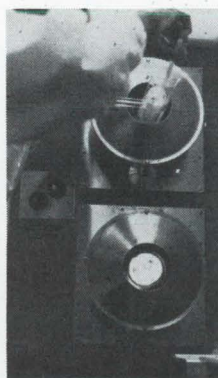

3./

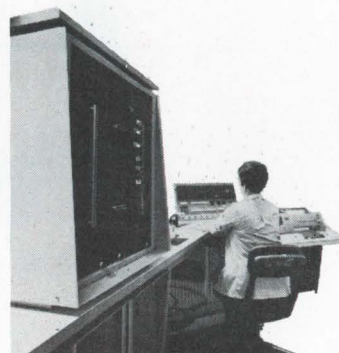

4./



1./



Burroughs



Technical Articles

**PCM: A global
scramble for
systems compatibility**
page 94



The world now agrees on only one fundamental pulse-code modulation parameter—signal sampling rate. But differences exist for every other parameter for basic terminals with the result that many pcm systems in service around the globe cannot exchange messages. Engineers are increasingly worried about this problem, and several groups are hard at it, trying to come up with workable international compatibility standards. Unfortunately, the schedule is tight; telephone traffic among all nations is booming, and it's probable that a commercial pcm satellite will be up and operating by 1971. The photomontage on the cover that symbolizes the difficulties involved was done by artist Jon Henry.

**NASA finds MOS IC's
are as reliable
as bipolars**
page 106

Despite a history of difficulties, MOS integrated circuits have been judged as reliable as bipolar devices by a recent NASA study. Certain failure mechanisms are, however, quite different. For instance, the oxide layer in an MOS assembly is an active part of the device, rather than a protective element. As a result, oxide defects and imperfections play a significant role in MOS reliability.

**Measuring amplifiers'
rejection ratios
more accurately**
page 116

Manufacturers of differential amplifiers typically supply drawings of a test circuit for measuring the common-mode rejection ratio. Rarely, however, do they specify how the ratio varies with power-supply voltage, temperature, or other parameters. Moreover, there's seldom any explanation of how the test circuit was designed, what its limitations might be, and how large an error could result. One practical way to sidestep the limitations of suppliers' spec sheets is to use a circuit that measures an amplifier's common-mode gain; the rejection ratio can then be calculated from this value.

**Computer aids
ground-station design**
page 120

Computer simulation is a key element in the systems approach required to engineer satellite earth stations successfully. For one thing, the designer must see to it that the projected facility meshes smoothly with an international communications network; this involves complying with stringent signal-to-noise ratio standards. For another, whatever the environment of the host country happens to be, the installation must perform reliably at a reasonable cost.

**Helical transmission
lines highlight
new oscilloscope**

Coming

A new 250-Mhz oscilloscope boasts a number of advances. One is a unique cathode-ray tube in which the two vertical deflection plates are helical transmission lines. Another is production of the vertical amplifier's active elements as monolithic transistor arrays.

PCM: A global scramble for systems compatibility

Nation-to-nation differences in such characteristics as line rates and coding could decrease the effectiveness of interconnected systems; but the imminence of pcm satellites is impelling all parties to try and thrash out differences

By William Bucci

Associate editor

Pulse-code modulation, long the telephone companies' wunderkind, is fast becoming an international problem child. Engineers around the world are increasingly worried about the inability of pcm systems in one country to communicate directly with those in another. What's more, there's not much slack in the timetable for coming up with workable standards for international compatibility. Telephone traffic among all countries is booming, and there's every likelihood a commercial pcm satellite system will be operating by 1971.

Unfortunately, compatibility goals are more easily outlined than achieved. In spite of the concern over international matchups, varying national interests lead to pcm designs that primarily satisfy internal needs. At the moment, the world agrees on only one fundamental pcm parameter—the signal sampling rate. Every system built from now on will sample analog voltages 8,000 times a second.

Differences exist on every other parameter of the basic pcm terminals so that many systems in service around the globe cannot exchange messages. To change analog signals into digital form, European countries, for example, follow a different coding law than the U.S. and Japan. As things stand now, the prospects for agreement have to be rated as poor. Moreover, the English handle 24 voice channels on a single line as do the Americans and Japanese, but the Europeans bundle 30 together. And some countries code analog samples into seven binary digits, others into eight.

The recent formation of a pcm study group by the Consultative Committee for International Telegraph and Telephone (CCITT) is but the latest evidence of the urgency surrounding the compatibility problem. An element of the International

Telecommunications Union (ITU)—the organization mandated by the United Nations to recommend worldwide communications standards—the CCITT has been looking at pcm for several years. A small pcm working party, part of a transmission study group, was set up six years ago, and in 1966 Richard C. Boyd, a systems engineer at Bell Labs in Holmdel, N.J., took over as chairman. Boyd now heads the new study group that evolved as a result of the present pcm turmoil; it will meet for the first time this October at ITU headquarters in Geneva.

"Our big job is to get everybody together on all the characteristics of basic pcm systems," says Boyd. "But if they just agreed, as they do about the sampling rate, on the fundamental characteristics—the companding law, load capacity, and the number of digits used for coding—our problem would be a lot simpler. Next in priority are parameters like the number of time slots and channels per frame, line rate, framing and signaling, and transmission codes. If we can't agree on these latter parameters, we could manipulate them in digital interfaces to get world compatibility. Performance wouldn't suffer, and there's no reason to think that the cost of doing so would be prohibitive."

As it happens, however, one of the fundamental characteristics—the companding law—represents the largest stumbling block. It's implemented in the pcm compandor, which consists of a compressor at the coding (transmitting) terminal and an expandor at the decoding (receiving) end. Most commonly, the companding law applies to the compressor, defining part of the transfer characteristic of the input-output signal—from each sampled analog voltage to its coded pulse word. The compressor boosts higher voltage less than lower voltage

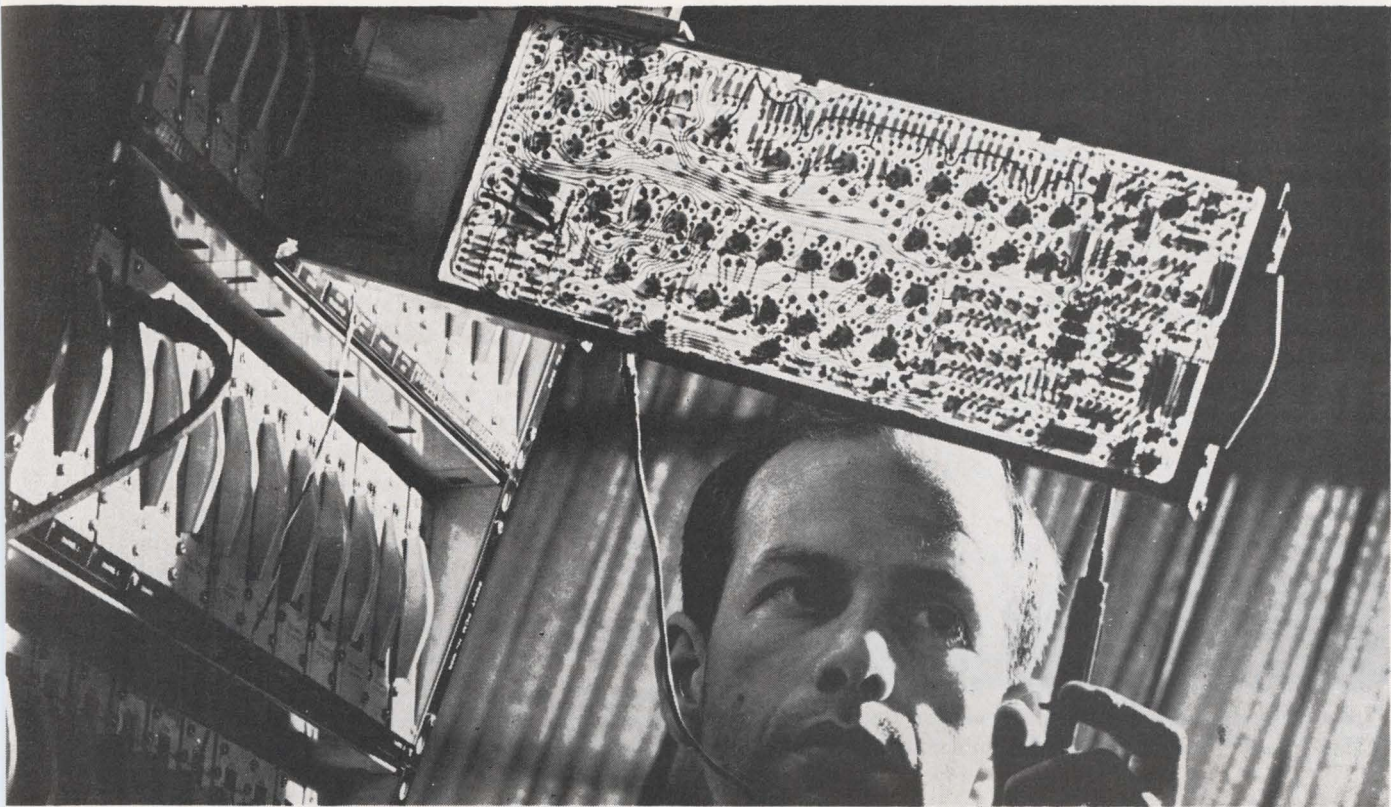

Overseas pcm. ITT engineer tests encoder card in British 24-channel system

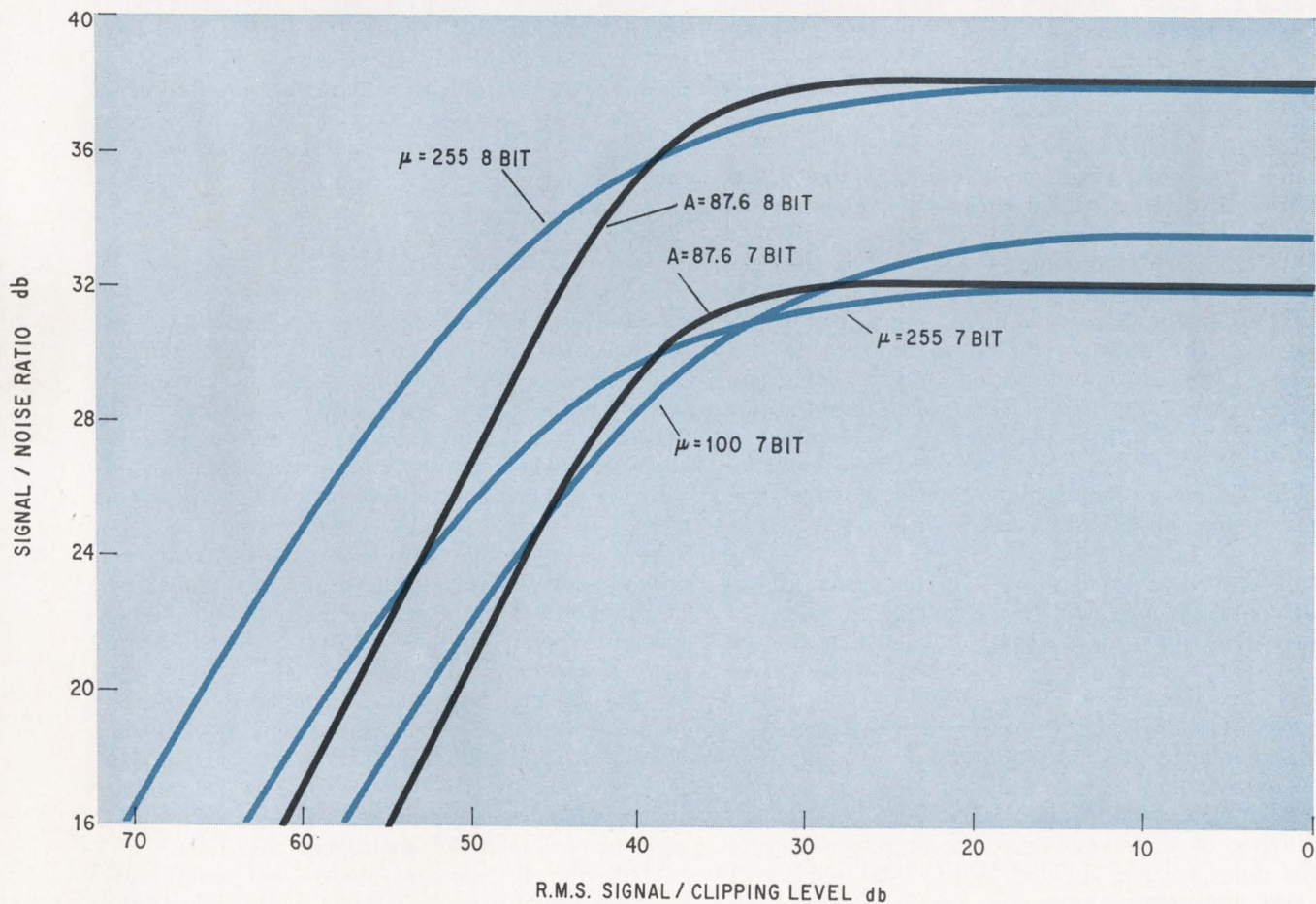

Companding curve. At heart of incompatibility problem are three laws. The μ equals 255 is best at low signal levels, while A law crosses over at high levels. The abscissa shows signal levels in decibels below system clipping level



Export. Pcm systems like this Marconi version are sold by England to such countries as Ireland.

samples, thus "compressing" the voltage range covered by the stronger signals. In AT&T's D1 terminals, part of the T1 system, the compressed signals then pass through a linear coder which measures each against a "quantized" scale of many, uniformly distributed possible amplitudes. The output, a coded sequence of binary digits, designates the division on the scale that's closest to the amplitude of each compressed sample.

Compressing and coding the samples in this way is equivalent to chopping up smaller signals into proportionally more quantizing steps than larger signals. The noise or distortion inherent in this process goes down as more, and thus smaller, quantizing steps are used. Compression keeps noise very low for soft-spoken messages but allows it to increase for loud talkers where it is less noticeable. Moreover, coding the lower voltage signals in small steps suppresses weak interference, such as crosstalk.

The amount of curvature in a companding characteristic defines how higher voltage samples are compressed. For its D1 compander, Bell settled on one known as the mu (μ) equals 100 law. The companding characteristic is expressed by:

$$y = \log(1 + \mu x) / \log(1 + \mu)$$

where x and y are input and output signals respectively; x is the instantaneous input voltage normalized for the peak limited input voltage; y is the number of the quantizing step corresponding to the input voltage, divided by the total number of steps, both starting from the center of the range; and μ is a constant, here 100, that specifies the degree of curvature.

Bell implemented the mu equals 100 law in its D1 companders with diodes, at the time of development the least expensive and most reliable way of doing so. A value of 100 was the highest practically achievable with the technology of the 1950's.

The British, from the first, pointed out the shortcomings of this law. For one thing, so far it's only been implemented inexpensively with diodes. For another, it's tough to make diode companders uniform enough for the characteristics of the compressor of one to match those of an expander in another. It's necessary to make matching adjustments after a system has been installed. Thus, it doesn't look practical to use the D1 terminals for digital switching systems because of the impossibility of matching closely enough the characteristics of all companders in a switching network.

Furthermore, there's no simple relationship in mu equals 100 coders between compression and expansion characteristics and the corresponding quantizing steps. Therefore, it's not possible to use a linear code to digitize an analog sample, then manipulate the word so that it corresponds to a compressed quantizing scale. Yet the ability to do so without converting back to analog is very desirable because, among other things, it means calls can be conferenced on a line digitally.

Saving grace?

When British engineers began designing pcm systems, they looked for a better companding law that could be implemented simply and in a variety of ways with uniformity, and permit simple linear to compressed code conversion.

Their solution is known as the A law and is given by:

$$y = Ax / (1 + \log A) \text{ if } 0 \leq v \leq V/A$$

$$\text{and } y = (1 + \log[Ax]) / (1 + \log A) \text{ if } V/A \leq v \leq V$$

where x and y have the same meaning as in the mu law; v is the instantaneous input voltage; V is the maximum peak-limited input voltage; and A is a constant, 87.6, defining degree of curvature.

Adopted in Europe, the A law is implemented in pcm coders by approximating its curve with 13 connected segments. It's simple with this law to associate quantizing steps with points on the segments. To do so, a linear coder changes a low-voltage sample into a word that matches the appropriate one of a series of small uniform quantizing steps. However, it handles a high-voltage signal differently, skipping some of the small quantizing steps. For example, a coded signal that matches, say, the 40th step will pass unchanged through the compressor. But a signal falling into the 39th or 41st will be transmitted with the same binary code as the 40th. Progressively more steps are skipped at higher voltages. The number is determined by the segment on which the quantizing step falls.

Thus, the British and their Continental colleagues were able to omit Bell's diode compander and, instead, use a linear encoder and the digital equivalent of the compander.

Pcm and its payoffs

Pulse-code modulation systems transmit signals as a coded stream of digits, rather than as a continuous varying wave. Regularly spaced repeaters determine whether a pulse is present in its time interval and, if so, generate a new, clean pulse and send it along the line. The change from analog to pcm involves sampling, quantizing, and coding. Each analog signal is sampled at a rate at least twice that of its highest frequency component, producing a string of pulses whose amplitudes follow that of the analog waveform. Then each pulse is compared to a quantized scale and a coded string of equal-amplitude pulses, matching a step in the scale, is generated. In the case of Bell's T1 terminal, the scale distinguishes between any of 128 distinct amplitude levels.

For that many amplitude levels, each pulse sample is represented by a 7-bit word. The first digit, 0 or 1, identifies the polarity of the sample; the rest pinpoint its amplitude. Each 7-bit word is time-division multiplexed with other 7-bit words, as well as framing and synchronizing bits, then transmitted to the first repeater and thence down the line. At the receiving terminal, pulses are demultiplexed into words and then converted back to analog form.

Plus factors. The advantages of pcm vis-a-vis frequency-division multiplexed systems depend on the application. Short-haul set-ups offer terminal cost savings because carrier bandpass filters aren't required and the modulation overhead can be shared by all channels. As a matter of fact pcm continues to be the cheapest carrier system for distances of from 10 to 100 miles.

Over longer hauls, the economics are still attractive, but engineers tend to emphasize the performance advantages. For example, many kinds of signals—speech, tv, and various kinds of data—can easily be coded and time-division multiplexed with pcm systems. Thus television signals can be transmitted together without intermodulation distortion. Frequency-division equipment, however, can't handle multiplexed tv.

Then too, digital repeaters need not be ultralinear with extremely low harmonic distortion and ultraflat amplitude response characteristics; they have only to regenerate pulses—not amplify analog signals. Long-distance frequency-division systems require thousands of expensive ultralinear repeaters.

Tradeoffs. In the case of atmospheric microwave transmission, pcm uses up bandwidth but conserves power. As a result, where microwave transmitters cannot be separated by long distances from other towers, pcm minimizes interference between systems transmitting at the same frequency. Because Japan's area is limited, forcing microwave installations to operate cheek-by-jowl, it's been the first—and so far the only country—to develop a pcm microwave system. It also appears pcm may be the best way of getting signals through the atmosphere at millimeter wave frequencies. In theory, such a system should be able to transmit hundreds of megabits of information. Bell Laboratories expects to run field trials of atmospheric pcm systems above 11 gigahertz within the next year or two.

With satellites the question is stickier since both power and bandwidth are important. But pcm systems' relative immunity to distortion, along with their capacity for carrying a mixture of signals looks attractive at this point.

But Bell claimed the A law compression curve didn't produce acceptable performance because its slope wasn't as sharp near the origin as the mu equals 100 curve. This meant low-voltage signals weren't encoded in as small steps as with the mu law. The mu equals 100 law offers, says Bell, a 2-decibel advantage over the A law for background noise and crosstalk. On the grounds that its more stringent transmission requirements demanded the extra decibels, Bell stuck with the mu equals 100 law. In the meantime, other European countries were following England's lead while Japan went the mu equals 100 route for their pcm systems.

Recently, the Conference of European Postal and Telecommunications (CEPT) Administration adopted the A law, in either 7-bit or 8-bit form, as a standard. Among the more active CEPT countries are England, France, West Germany, Italy, Sweden, the Netherlands, Belgium, and Switzerland. Meanwhile, the Communications Satellite Corp. (Comsat) has made things hotter for AT&T, one of its board members, by proposing to the International Telecommunications Satellite Consortium (Intelsat), of which it is acting manager, that the A law be standard for the upcoming pcm bird.

The British Post Office contends that the A law was meant from the outset to be an international standard—one that could be implemented variously by manufacturers in different countries. Foreign officials consider the performance levels realizable with the A law perfectly adequate for Europeans.

Second-strike capability

Bell, however, came out fighting for its performance standards, as well as for international compatibility, by proposing that all countries agree on a new companding law. It then changed to this law in its second-generation D2 terminal. With an eye to such technological advances as large-scale integration and op amps, Bell decided to go to a mu equals 255 characteristic that could be approximated with 15 segments and matched simply to the quantizing steps. As a result, both the D2 coder and A law units derive the companded signals by omitting quantizing steps from a linear code.

Europe took this development quietly in stride. According to the British Post Office, a mu of 255 will be tough to specify and implement because it requires very close hardware tolerances. Moreover, Brian Edwards, who heads the digital systems de-

partment at ITT's Standard Telecommunications Laboratories, Ltd, doubts Bell can economically implement a μ of 255 in the 8-bit D2 encoder. In the U.S. where a single outfit runs most of the long-distance network, looser manufacturing tolerances may be tolerable because they can be compensated for by the company, he says. But this doesn't hold true for Europe where there are many manufacturers of pcm systems.

AT&T's Boyd answers: "We agree that going to a μ of 255 instead of 100 takes more than double the precision involved in the smallest step and is beyond the present state of the art. D2 probably will achieve some of the improved noise performance that the law implies. And it won't cost much more than the earlier μ equals 100 D2 terminal. But we're looking ahead to the next generation of coders, with greatly improved precision and lower costs."

David Thomas, head of planning at STL, questions the need for this kind of precision in Europe. "The superior performance might be important in the U.S.," he says. "But I'm not convinced we really need such accurate reproduction at low volumes in Europe." And the British Post Office, supported by such homebred suppliers as Marconi and STL, believe that the A law is better for a European network and that improvements promised from the μ equals 255 law are immaterial and

probably not achievable in Europe.

But if the United States and Japan don't reach an agreement with the Europeans, digital interfaces will have to be used to match up the A and μ laws. Reactions to this prospect vary. Comsat says that the resultant signal degradation would be most undesirable, if not unacceptable. Japan and Bell, on the other hand, take the attitude that distortion wouldn't normally exceed allowable limits; the Japanese feel where it did, voice signals could always be decoded to analog. Likewise, STL's Edwards and Thomas aren't convinced that interfacing μ and A law encoders with digital circuitry will lead to unacceptable distortion levels. Bell prefers such matching to decoding to analog.

Despite the difficulties to be overcome, Thomas assesses the chances for agreement on an international standard for companding as good—at least over the long term. "After all, only one group has to abandon its present position," he says. His colleague, Edwards, isn't as optimistic, anticipating the world will divide into two camps eventually. The consensus in Britain is that regional agreements will be made as necessary among, for example, the U.S. and Canada and the U.S. and Latin American countries, as well as within Europe. The BPO believes that if no definitive international agreement is reached, decoding to audio may prove the simplest solution.

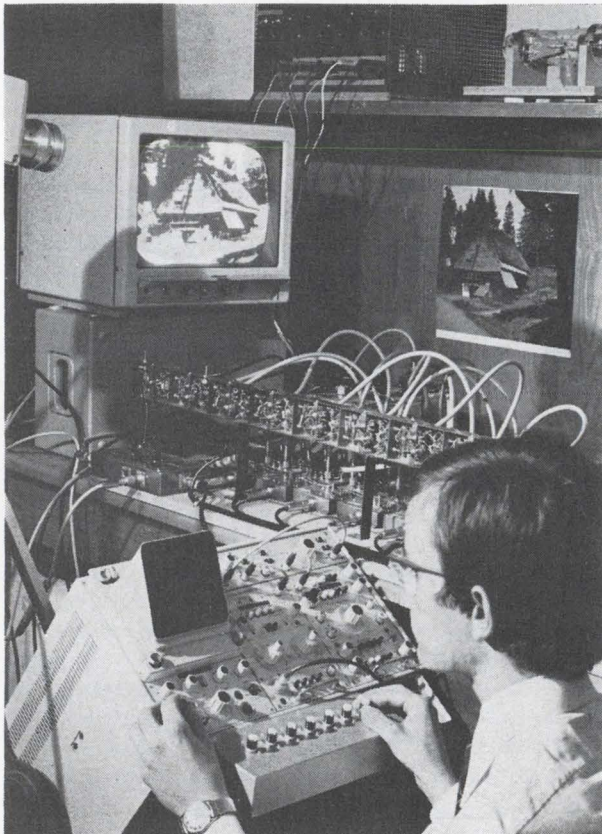

TV signal. Siemens AG experimental set-up in Germany transmits pcm visual signal, which is displayed on screen.

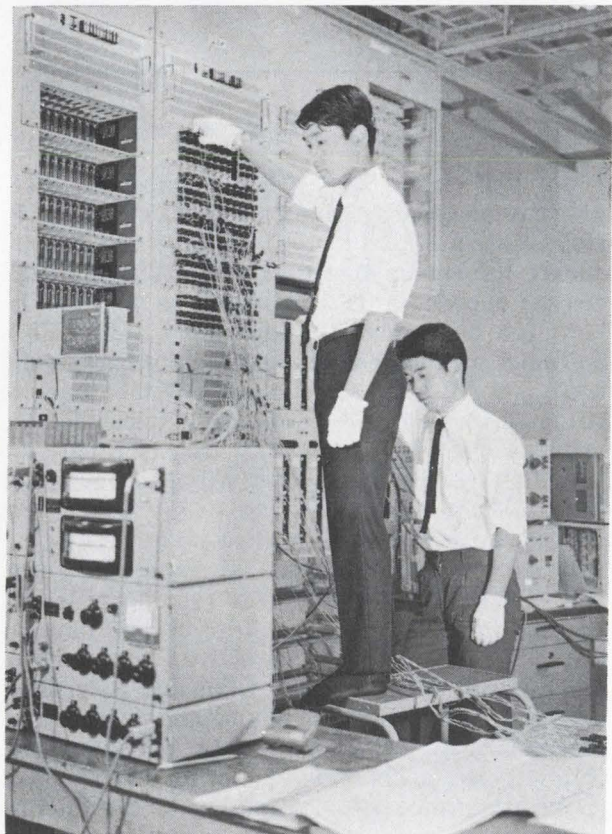

High capacity. At Yokosuka, Japanese adjust pcm equipment for system that transmits 120 voice channels.

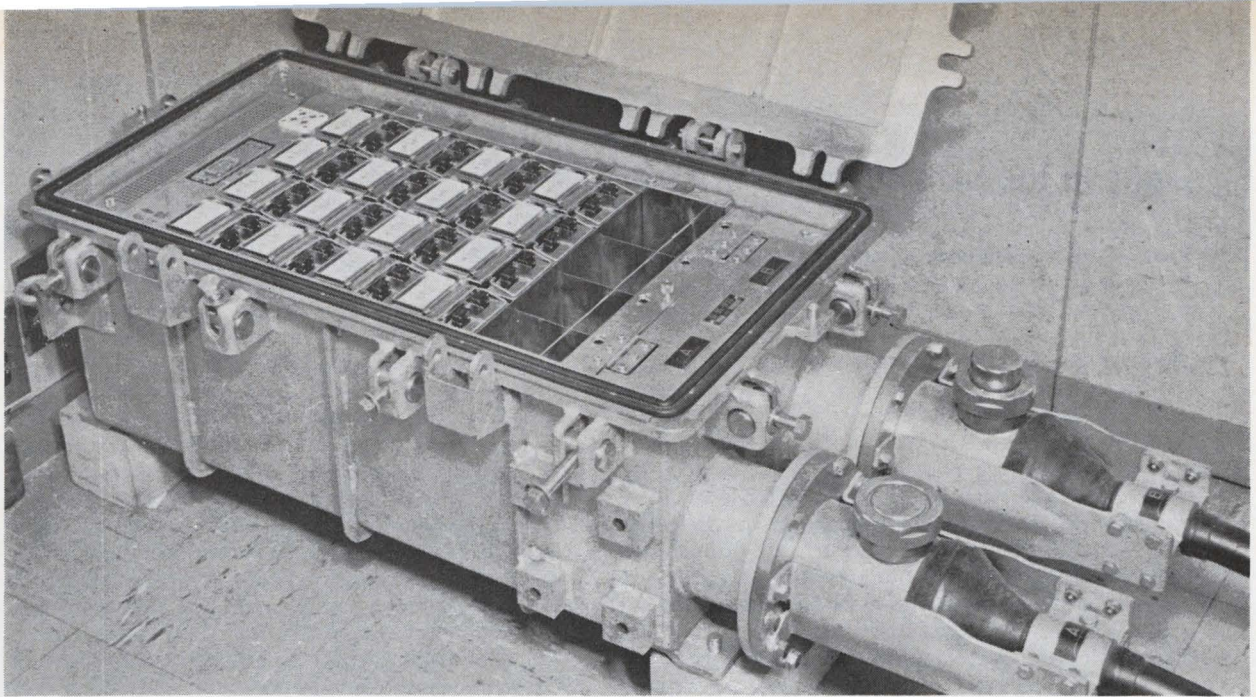

Clean pulses. Japan's 120-channel system transmits 7.876-mbs signal, which is periodically regenerated in repeaters. Case can house 20 such devices.

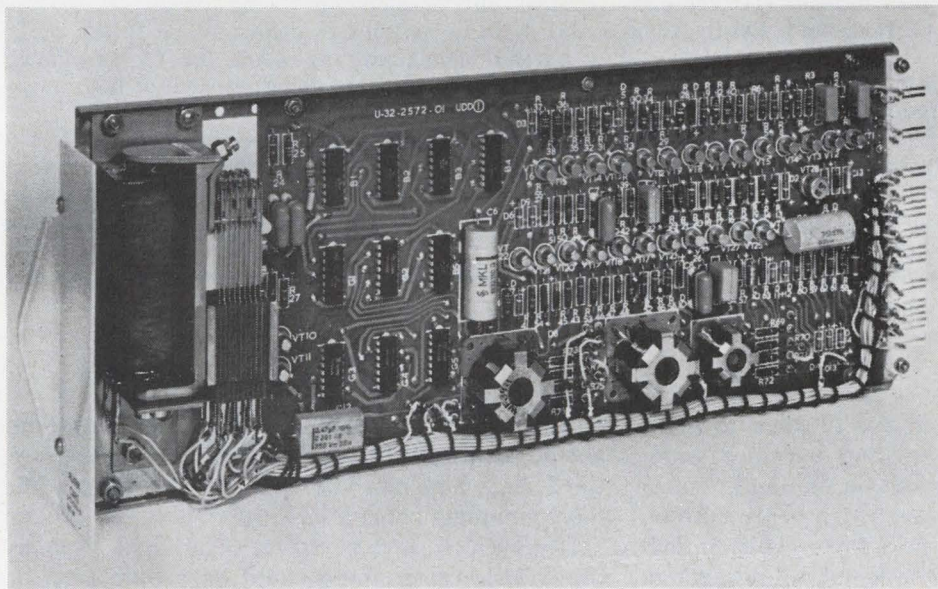

Stacking bits. Marconi multiplexer forms 24-channel line signal. Company says their pcm system uses more ICs than others.

Positions on the number of bits necessary to code analog signals are less partisan than on the compandor question, but they're still diverse. And, ironically, AT&T is faced with a lack of compatibility within its own plant. It now has hundreds of thousands of pcm channels in operation—all of which carry signals coded into seven bits. But toward the end of this year, it will be introducing its 8-bit D2 coders.

Bell admits internal compatibility could pose a problem. Hopefully, when digital switching arrives it will be implemented first between long distance intertoll offices with D2 coders. But if it's economical to install digital switching in an exchange lower in the switching hierarchy, Bell could wind

up with a D1 coder in one office and a D2 in another at the end of the link. Conversion circuitry offers a way out here but is an uninviting prospect because of higher costs and the possibility of degraded performance. Alternatively, a new version of D1 could be brought out and implemented with a compatible law.

Bell is going ahead with the 8-bit D2 coder on the assumption digital switching won't be a big deal in the U.S. for a good long while. One sure clue: At the moment it doesn't even have such a system in development, only under study. In the meantime, Bell says it must offer high-quality pcm service on intertoll calls. Since such traffic normally would pass through several analog-digital

Links in the pcm chain

The original pulse-code modulation system, Bell's T1, is only seven years old, but already the U.S. and several other major countries are criss-crossed by pcm lines. And networks are growing at a good clip—last year AT&T and independent U.S. phone companies put over 6,000 new 24-channel pcm systems into service, a 20% increase over 1967 installations. Western Electric, AT&T's manufacturing arm, now produces more pcm channels than analog. By December, there will be close to 500,000 two-way pcm channels—over 20,000 systems—in the Bell System. General Telephone has over a thousand systems in service and 500 more on the way.

Since Lenkurt Electric, a GE manufacturing unit, came out with its 9001A coder later than Bell's D1, it was able to capitalize on technological advances. The 9001A is smaller, mounts on 19-inch rather than 23-inch racks, and interfaces directly with a switching system, thus avoiding the trunk circuits required with D1 and cutting costs. Nonetheless, Lenkurt's pcm terminal is identical to the D1 at the carrier end so that the two work together perfectly—an object lesson in compatibility. Other U.S. firms that make or plan to make D1 type units are Vicom, Stromberg-Carlson, and Lynch Communications.

AT&T will place its first D2 coders into service this year. These units produce four independent 24-channel output streams—a total of 96 channels. These can be time multiplexed and transmitted on 6-megabit T2 lines. General Telephone has yet to announce its plans for making compatible coders. In the meantime, Bell Labs is developing a 564-megabit system, designated T5. (T3 and T4 lines

don't exist though Bell plans eventually to offer intermediate-capacity multiplexers.) T5 is a coaxial-cable arrangement; T1 and T2 are twisted-pair designs. Bell is also investigating waveguide, as well as atmospheric millimeter-wave pcm transmission.

Foreign affairs. The British have some 300, 24-channel pcm systems in service in the country's phone network; about 500 new systems are being installed annually, and 1,300 should be operating by the end of next year.

Unlike Lenkurt and Bell's units, gear produced by Marconi for the British Post office's system makes extensive use of integrated circuits in coders, decoders, signaling cards, and pulse generators. Standard Telecommunications Laboratories' apparatus relies on resistor-transistor logic for a number of digital-manipulation functions, but the firm points out it would do things differently if it could start all over. The experimental time-division digital-switching exchange dubbed Empress and installed in London also makes extensive use of ic's. The Post Office is doing experimental work to gain experience using medium-scale integration in telephony. There are four to six gates on each chip and some seven or eight chips prewired inside one pack—that is 40 or more gates in a pack. Experimental 24-channel mos shift registers are being developed for use as stores to control crosspoints. While British outfits haven't announced any plans for higher-capacity pcm systems, they are doing research in both microwave and millimeter guided-wave systems.

Purchase orders. France has five pcm systems in service that use 6-bit coding and transmit 36 voice signals in 37 time slots; about 100 such systems are on order and being installed. But future French systems will be of the CEPT 32 time slot type; two or three of these will be in operation at year's end.

stages, Bell says it's imperative to stick to eight bits. But when digital switching becomes widespread such precision may not be required.

The British and Japanese use a 7-bit system, while the CEPT countries now favor 8-bit coding. Comsat has vigorously championed a 7-bit system for Intelsat, one reason being that it permits more channels, and hence higher revenues, than 8-bit gear. Comsat also maintains that digital switching and the increase in "single-hop" calls via domestic satellites minimize analog-to-digital conversions.

General Telephone & Electronics, largest of the U.S. independents, agrees with Bell that 8-bit encoding is necessary for intertoll traffic. However, it has no plans at the moment for such gear because its toll needs are limited.

STL's Thomas isn't convinced that eight bits are necessary in European networks. "Seven's certainly the number now, and eight may be desirable for a short time when long-distance connections are made by multiple links of short-haul pcm lines," he says. "But eventually, say around the year 2000 when switching is generally digital and there are extensive long-line pcm links, six bits may be quite

enough. So it's arguable whether 8-bit systems should be installed now. They may be necessary in the U.S., where the network is much bigger and more complex—but not in Europe."

However, if seven, rather than eight bits are used, Bell argues, there could be a 6-db price to pay in noise during satellite calls.

Meanwhile, France is installing prototype 30-channel pcm systems using 8-bit encoding. France was successful in getting CEPT to accept this as the European standard.

Japan agrees that eight bits might be needed on long-distance calls, say, for seven or so links. But its engineers point out that much of the country's traffic is over short distances. Frequency-division multiplexed carrier systems handle the long-distance load among distant cities, so the need for 8-bit systems is limited.

The Swiss add yet another element to the picture. Their country has a growing cable network with excellent transmission quality; authorities would like to use pcm not only to carry voice but also to pipe high-fidelity music directly into private homes. It's likely, then, the Alpine nation will

If all goes well, 100 or so will be bought annually over the next several years. At least half the circuits in these systems are monolithic IC's. During 1969, the French will begin testing two pcm microwave systems. One system will transmit two, and eventually eight, megabits of information at 2 gigahertz; the other 36 megabits at 7 Ghz.

Germany has four experimental systems under test in its commercial telephone network. One, a 60-channel system with a line rate of 3.84 megabits developed by Siemens, links exchanges in downtown Munich and Pasing, a Munich suburb. Another in Stuttgart, developed by Standard Elektrik Lorenz, transmits 24 channels. This city also has a 24-channel AEG Telefunken System. Finally a 24-channel TeKaDe-FCF system operates between Nuremberg and nearby Fuerth. On order from four firms is equipment for about 50, 32-channel systems to be installed for commercial service in area networks. Delivery will start around the end of the year.

Japan has more than 2,000 24-channel systems, developed by Nippon Tel and Tel; new systems are going into service at the rate of about 1,000 a year. Discrete components are used exclusively in this equipment. Japan is now checking three versions of a 120-channel system at four locations. After completion of tests next year, these systems will be installed in many spans. One version multiplexes five 24-channel streams; another directly codes 120 voice channels; the third encodes a 60-voice-channel, frequency-multiplexed supergroup.

In two locations, four 120-channel pulse streams are modulated onto microwave carriers around the 2.1-to-2.29-Ghz range. Nippon Electric equipment is used at the terminal of a 12-mile link. Fujitsu gear is installed in another span where five 24-channel pulse streams are transmitted.

push for coding with the greater number of bits.

Bit-number difficulties are closely related to the state of the digital-switching art in various countries. Initially, Bell developed and installed pcm to pay off in cities; at the time, however, semiconductor technology was relatively immature. Now AT&T finds itself with a very sizeable pcm plant—and no digital-switching system on the drawing boards. Now being studied, such a project couldn't make a commercial debut for at least several years.

Ironically, GT&E may have a digital-switching capacity in the U.S. before its giant rival, Bell. General System exchanges, islands in the AT&T ocean, have grown to the point where they've got to be connected by tandem-switching centers. Years ago, Bell's solution was use analog switching. But advances in technology suggest to GT&E at least that the digital may well prove a better solution.

Donald Ashford, a senior engineer at GT&E Labs and the company's representative on the CCITT pcm study group, reports that GT&E Labs expects to start work on an experimental digital-switching system by the end of this year. "One difficulty is that you've got to fit pcm switching in with the

existing analog plant," he says. "You've got to get signaling tones off a pcm line, without converting back to analog. One way is to look for digital patterns and employ pattern-recognition. We're hoping that we can accomplish this with software."

Meanwhile, both Europe and Japan are racing ahead with digital switching. West Germany is beginning to develop a telephone-exchange system that will incorporate pcm switching. England—proud of the fact that the old world took digital switching requirements into account from the outset—is running a service trial of its Empress pcm switching system in London. ITT is working on a different electronic version.

Japan's Nippon Telephone and Telegraph has developed an experimental digital-switching system that it's temporarily shelved because analog switching with electronic systems is still cheaper.

France looks towards 1976 when it hopes to put digital-switching equipment into commercial service. Plans for next year include testing of a system designed by the post office's Lannion Laboratory Development Center.

Loaded Question

The other fundamental property of pcm systems—load capacity, the maximum signal that can be handled without overloading—is fortunately more susceptible of international solution than other technical issues. Differentials in this parameter from country to country are at most a db; they can be compensated for by simple adjustments in the analog plant.

Europe has settled on +2 dbm0, America on +3 dbm0. But even though there's no serious difficulty, consensus is still a will-o-the-wisp. Some, for example, claim that designers of European phone systems aren't as critical of load capacity as are those in the U.S. Continental sources deny this.

While other pcm parameters aren't as crucial, there's still plenty of disagreement. "If we have to, we should be able to manipulate signals with a high degree of impunity," says AT&T's Boyd. "We hope that won't be necessary, but if it is you can bet systems designers all over the world will make good on this."

Nonetheless, the CCITT study group will try to hammer out agreements on such "minor" differences in systems characteristics as the number of time slots and channels per frame, line rate, steps in an international digital hierarchy, and methods for signaling, framing, and synchronization.

America, England, and Japan now line up on the side of 24 time slots per frame. England, however, has a slightly different bit rate. Twenty-four channels are optimum for the cables used by the Americans; originally designed to carry voice signals, they were then used for pcm to increase capacity. It's unlikely, then, that America will want to switch to the 32 time slot standard. England, however, uses a different kind of cabling and could go either way.

England's cable is similar to the European stand-

ard—a balanced-quad affair with what's advertised as superior electrical characteristics. Europe is testing this cable as justification for going to 32, instead of 24, time slots. No one quarrels with the cable's better characteristics, but there are those who believe the primary motivation in this case is commercial rather than technical.

British and European interests are potential rivals for pcm systems orders in other countries, and the 32 time slot system now gives the latter a strong selling point. In fact, some predict that England may be pressured by its pcm manufacturers into switching to the CEPT standard.

The French, who started with a 6-bit encoded system are now among the most vocal supporters of the 32 time slot CEPT standard. Telephone officials argue that it's technically superior to the 24 time slot version because 32 is a power of 2 and time-division switching devices will be bipolar.

Germany supports the CEPT system, contending that cost per channel is lower and that the system is compatible with Germany's existing carrier-frequency equipment.

But Japan takes the position that only 30 of the 32 time slots are used for voice, thereby invalidating the argument of 32 being a power of 2. The U.S. agrees. Moreover, both believe the CEPT standard represents an extravagant use of potential channel space.

Because there's little possibility that the two camps will change their minds, efforts are directed primarily at reaching agreement on second-level pcm systems, that is, those of higher capacity.

Meeting of the lines

One of the optimists about an agreement is Antoine Jousset, head of the French post office's pcm program and chairman of the CEPT pcm committee. "The bit rate for a secondary system could be four times the primary multiplex rate (24 time slots) of Britain, three times that of CEPT (32 time slots), and the same as that of AT&T's T2 system (96 time slots)—roughly six megabits," he says.

CEPT countries haven't yet agreed to a secondary multiplex standard, but the nations haven't been shy about voicing opinions. For example, Italy and West Germany are pushing eight megabits while Britain and France are leaning toward six megabits.

Japan, which already has 8-megabit, 120-channel systems in operation, may prove troublesome. The Japanese designed for their own needs, producing a system that would directly encode their 60-channel frequency-multiplexed supergroups and which has the capacity to carry visual telephone signals. AT&T doesn't plan to encode supergroups but will code mastergroup signals on future high-capacity pcm systems. It is convinced six megabits is more than adequate for Picturephone signals.

Another area of difference centers on framing and signaling. Bell fills each of its 24 time slots with speech and signaling, for example, and inserts a framing pulse after the 24th time slot—the 193rd bit. England uses one of the 24 time slots for fram-

ing. The CEPT system sets two of the 32 slots aside, one for framing, the other for signaling.

Bell had originally intended using 194 bits in a D2 frame, dedicating two of these for framing. This resulted in a sampling rate of 7,959 per second, so when the rest of the world agreed to standardize on 8,000, Bell reconsidered. However, its framing technique isn't compatible with the CEPT system.

Another thorny question involves whether Europeans will accede to AT&T's recommendation to insert redundancy information in their pulse streams. This would make it possible to evaluate easily the transmission line performance by measuring the digital error rate and also permit automatic switching to standby lines in case a transmission facility fails. America, but not Europe, currently inserts such redundancy digits on its lines.

Time standards

International pcm networks must, of course, keep the same time. Of the several ways to get them to do so, none seems effective for all. The choices are: synchronize all oscillators to a master clock; derive the clock for every office by averaging the phases of all signals; or, omit synchronization; instead insert noninformation-carrying pulses to match pulse rates of different terminals (pulse stuffing) and remove them at the receiving terminal.

Bell expects to use each method in different parts of its network; the GT&E system will probably emphasize master-clock synchronization. England and France seem to lean toward pulse stuffing. In fact, France's Jousset hopes that this technique will be generally accepted, although he admits that it will make digital switching more difficult to implement.

The Japanese reject synchronizing "slave" clocks to a "master" clock, pointing out that even if all terminals are basically similar and the master clock is rotated from country to country, the set-up would probably not work out internationally. They favor pulse stuffing.

Other questions being debated within the CCITT group include the types of transmission line codes used. In D2, for instance, Bell throws out the code for one of the 256 quantizing steps, which would consist of all zeros, because of repeater-timing problems. But the Europeans retain this code and, instead, invert every other digit in all the codes. They argue that this is the best way of decreasing the likelihood of zeros. Bell disagrees, and it's trying to pin the question down with analysis.

As the CCITT October meeting approaches, many are pessimistic about the prospects for immediate agreement on the really important questions. But there's general optimism that eventually things will come out all right. "Countries disagreed at first about carrier-frequency system specifications," says Theodor Irmer, chairman of the pcm study group at West Germany's postal telephone administration. "But they got together eventually. We may have to wait several years with pcm, but it's got to happen. Otherwise we're going to have some really serious problems with overseas communication." ■

Designer's casebook

Pair of source followers keep a voltmeter steady

By David F. Wadsworth

Plessey Telecommunications Group,
Nottingham, England

Conventional semiconductor components can be used to build a high-impedance voltmeter having superior drift characteristics and a current measuring sensitivity of 1 nanoampere or better.

Two source followers are connected to the meter across their outputs so that drift in one due to temperature changes will be canceled by a similar drift in the other. When an input is applied to the gate of Q_1 , the current change in the transistor causes a change in Q_3 's base current; the change is then amplified by Q_3 and fed back to Q_1 's source, causing it to follow the original input voltage closely. Because the over-all gain is nearly

unity, a directly calibrated meter can be used without modification.

The output to the meter is ± 1 volt at 100 microamps. The level can be increased to 1 milliamp, but with some loss in accuracy.

The input is decoupled by a 0.1-microfarad capacitor that forms the lower part of a capacitive divider for the higher voltage ranges. The advantage of this arrangement over the resistive divider is that an extremely high impedance can be maintained over these ranges. For simplicity, only one additional voltage range is shown here. The range, set by switching to the "attenuate" position, depends on the value of capacitor C.

Current is measured by observing the voltage across a known resistor when the current flows through it. For instance, with a 1,000-megohm shunt, the meter reads 1 nanoamp full scale.

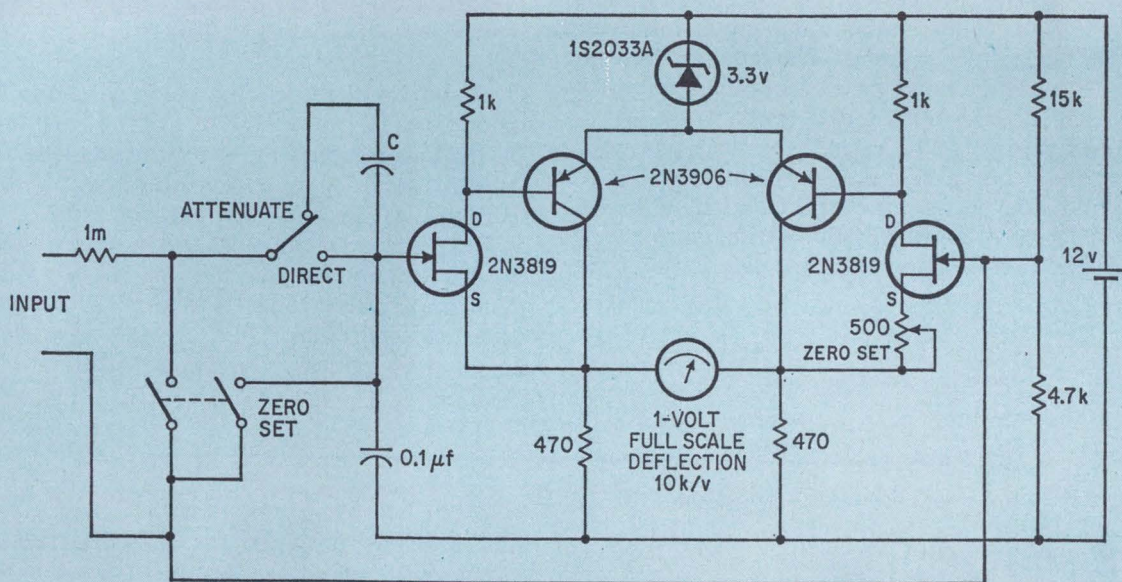

C DETERMINED BY VOLTAGE RANGE

Balancing act. Connecting the meter across the outputs of two source followers assures that the drift in one output due to a temperature change will be offset by a similar drift in the other. The meter can measure currents with a sensitivity of 1 nanoamp or better.

Minimizing common-mode errors in a variable-gain amplifier

By William D. Miller

Analog Devices Inc., Cambridge, Mass.

Many differential amplifier circuits require adjustable gain values so that circuit sensitivity can be matched to input signal levels. No problems arise when discrete gain values are needed; the resistors can be switched into the circuit in accurately matched or pretrimmed pairs. But, problems arise when continuously adjustable gain is required.

The ideal differential circuit provides common-mode rejection if the external components are accurately matched to make R_{1A} identical to R_{1B} , and R_{2A} identical to R_{2B} . If these resistor pairs aren't precisely matched, the amplifier will partially respond to a common-mode input. It's not possible without using exceedingly expensive ganged potentiometers to keep R_{2A} and R_{2B} identical while they're varied over the full gain range. And poor tracking between R_{1A} and R_{1B} will introduce common-mode errors as their resistance values diverge.

The amplifier circuit shown varies gain with minimal common-mode errors by using one variable resistor rather than two. An input attenuation network consisting of fixed resistor R_3 and gain-control resistor R_4 raises output voltage by a factor $(R_4 + R_3)/R_4$ while maintaining equal input and feedback currents, I_{in} and I_f . The smaller the value of R_4 , the higher must be the amplifier output to balance feedback and input current.

Circuit gain could be varied from less than unity to just about any upper limit without affecting the common-mode performance, provided $R_4 \ll R_{2B}$. Thus the ratio of R_2 to R_1 can be trimmed for highest common-mode rejection, then left without further adjustment where

$$\frac{R_2}{R_1} = \frac{R_{2A}}{R_{1A}} = \frac{R_{2B}}{R_{1B}}$$

SCR shift register can take a lot of noise

By Jerome H. Silverman

Union Carbide Corp., Greenville, S.C.

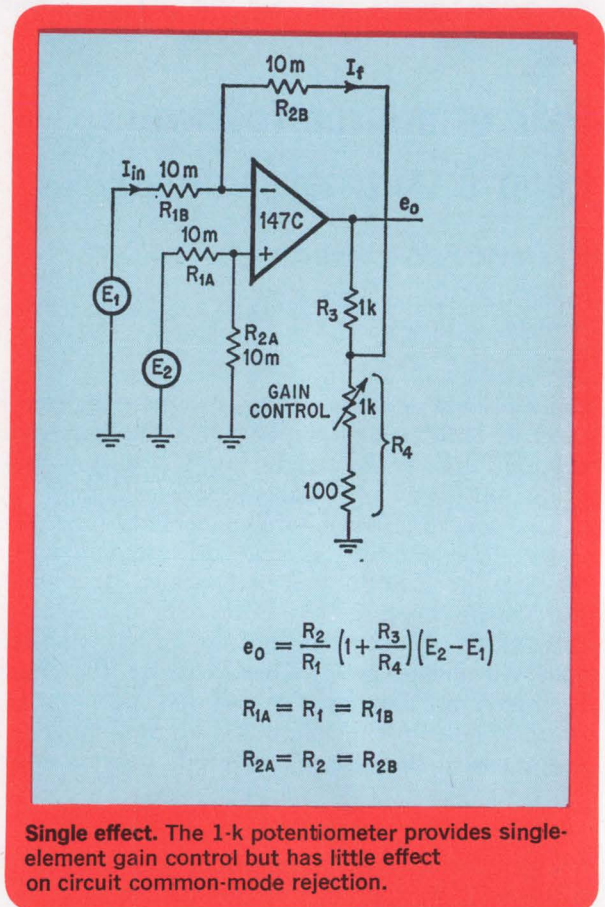

Single effect. The 1-k potentiometer provides single-element gain control but has little effect on circuit common-mode rejection.

Over-all gain of the circuit, using the output attenuator, becomes $e_o = [(E_2 - E_1) (1 + R_3)/(R_4)] R_2/R_1$. This relationship is accurate as long as feedback resistor R_{2B} is appreciably greater than R_4 , and the amplifier has sufficient loop gain.

There are other advantages to this circuit, too. R_1 can usually be selected for higher values of input impedance while R_2 is kept at a reasonable value of resistance. The circuit, however, has higher drift gain and less bandwidth.

Shift registers designed for industrial needs are often used to record data on the disposition of electronic components in an automatic testing machine. The test results are shifted along with the components as they index through the machine with the contents of the registers determining the station at which the parts are ejected. But the noisy electrical environments often encountered in many factories

can inadvertently trigger the registers.

The silicon controlled rectifier shift register shown here, however, is particularly suited to operation under these conditions. It operates solenoids and relays directly and performs well in the presence of high ripple and noise levels.

The first stage is loaded by a positive pulse applied between shift pulses, and the shift is executed when two voltage pulses occur in sequence. First, the anode supply voltage is reduced to zero for a short time period and then restored. This turns off any SCR that may have been conducting. A positive pulse is then delivered to the register line, and the line is coupled through diodes and capacitors to the SCR's gates.

Each coupling capacitor that's connected to a previously nonconducting SCR anode, charges and reverse biases its corresponding diode, thus blocking the retrigger pulse from the next SCR gate. The capacitors connected to conducting anodes are uncharged and therefore don't reverse bias their associated diodes. The retrigger pulse thus reaches these gates, firing the SCR's. In this way, the conducting SCR states are shifted through the register.

The power supply applies a full-wave rectified

voltage to the B+ line of the shift register. Capacitor C_1 charges through diode D_1 and discharges into the B+ line through the first SCR. Its gate is connected to the capacitor through D_2 and R_1 and causes the SCR to automatically trigger every time the rectified B+ voltage drops below C_1 's voltage level. The capacitor need only be large enough to supply holding current to those SCR's that are on in the shift register every time the a-c output of the transformer passes through zero.

To shift information in the register, a shift pulse is applied that turns on Q_1 for the duration of at least one half-cycle of the a-c line voltage. This removes the gate drive to the first SCR and thus erases the B+ voltage. D_2 prevents the SCR from receiving excessive reverse gate bias.

The shift pulse also turns on Q_2 , charging C_2 . When the shift pulse drops to zero, the SCR is restored to normal operation. The reappearance of the B+ voltage and the absence of the shift pulse turns the second SCR on, discharging C_2 into the retrigger line. The second SCR then turns off when C_2 has been discharged. The transfer cycle is completed and the shift register is ready to accept more information.

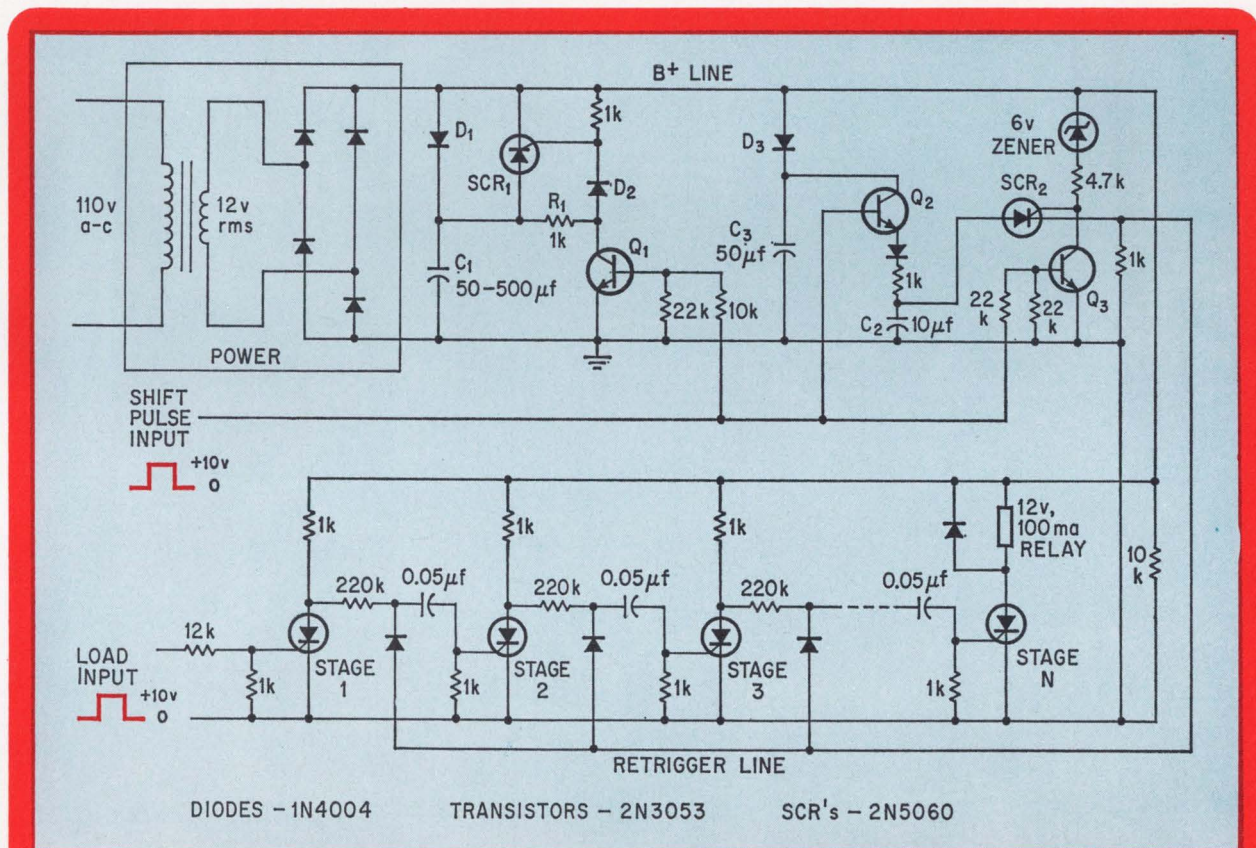

Ripple. The maximum rate at which information can be shifted in this register is 120 hertz—the power-supply ripple frequency. For higher shifting rates, higher power-supply frequencies would have to be used, and the 0.05-microfarad SCR coupling capacitors would thus have to be reduced in value.

Integrated electronics

How reliable are MOS IC's? As good as bipolars, says NASA

Although failure mechanisms differ for MOS because oxide is a functional part of the device, tests indicate failure rates running at 0.016% per 1,000 hours

By Leon C. Hamiter Jr.

National Aeronautics and Space Administration, Huntsville, Ala.

Partial holes. Burned-out portions occur at "partial" holes, where oxide is thinner because of contamination or irregularities on the silicon surface. Here, the oxide ruptured at less than rated voltage.

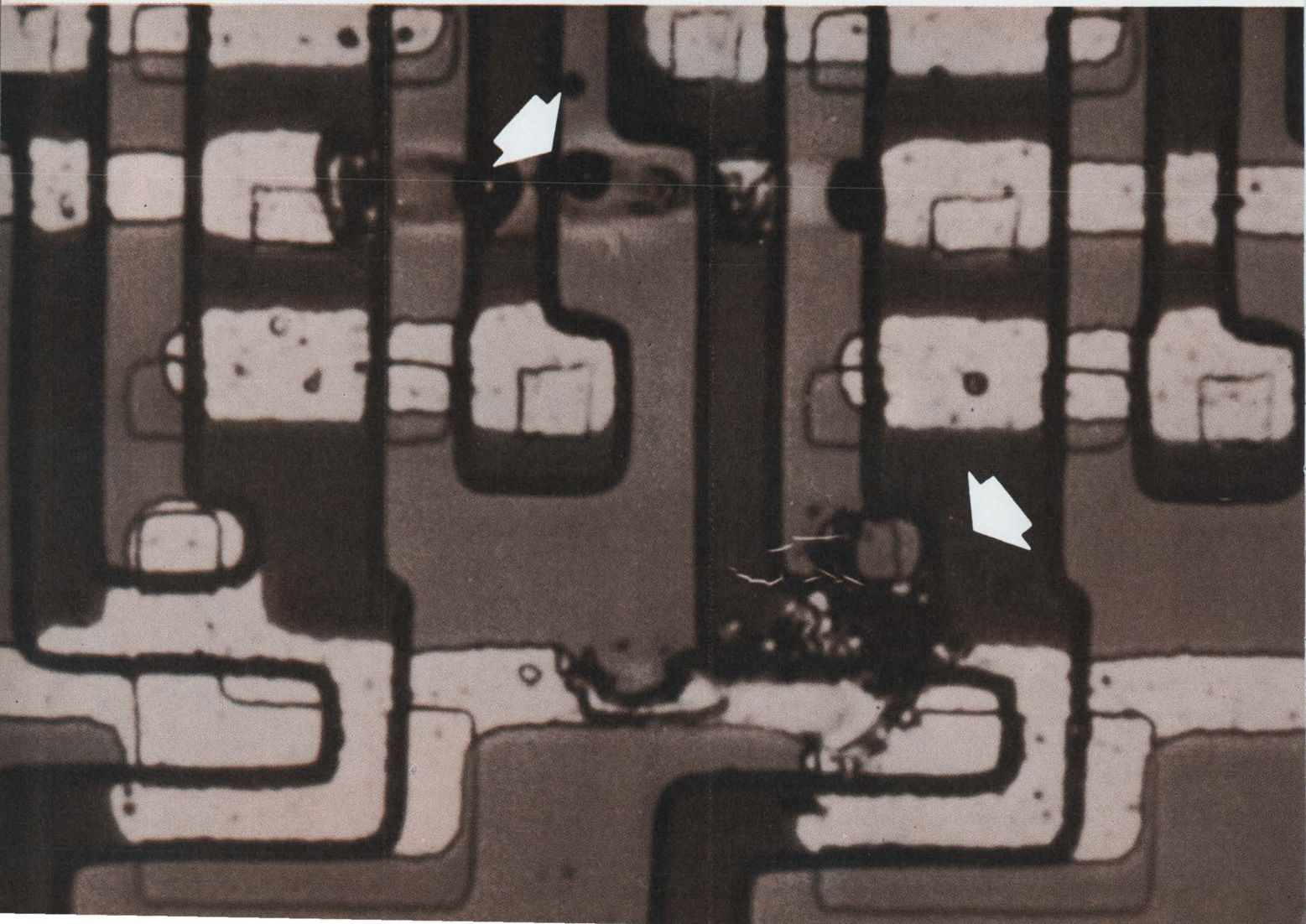

An oxide layer is as much a part of a bipolar integrated circuit as it is of a metal oxide semiconductor IC. The difference is that the oxide in an MOS circuit performs a dual function: protects the semiconductor material and participates in the operation of the circuit. It's this difference that gives the physics of failure of an MOS circuit a different character. Such oxide-dependent failure modes as threshold voltage variations and gate shorts are unique to MOS IC's.

In addition, contamination and certain process parameters are far more critical with MOS. And the dimensions and alignment of masks are more critical, too, because of the much smaller size of transistors and interconnections. (See "Defects in MOS IC's," p. 108.)

The National Aeronautics and Space Administration in Huntsville, Ala., has studied the reliability of MOS IC's and has found that they have become stable and manufacturable products thanks to refinements in growing, etching, regrowing insulating layers on semiconductor substrates, and rigid process controls.

Thousands of MOS IC's from a single manufacturer were tested, for example, at 25°C operating life, 85°C operating life, 125°C reverse bias, 125°C storage, and 150°C storage. Some 4,339,000 circuit hours were accumulated in this group of tests alone, with only three failures—a failure rate of 0.095% per 1,000 hours at maximum stress. If it's assumed that the acceleration factor is eight, these tests are equivalent to 26.4 million operational hours and a failure rate of 0.016% per 1,000 hours at 60% confidence. (Although the stress in an average application is only about 30% of device rating, the NASA tests were conducted at maximum rated temperature and voltage. Some reliability engineers feel that this extra stress accelerates failures by a factor of five, others say it's 20. Therefore, the factor of eight is a conservative estimate of acceleration factor.)

This test experience is comparable to NASA's

experience with operational systems using MOS IC's. The IMP-D and IMP-F satellites, for example, accumulated 19 million MOS circuit hours with two failures for a failure rate of 0.016% per 1,000 hours at 60% confidence. The failures occurred after one year of operation, and indications are that the MOS devices were not the cause of failure. In an information-handling system, 2.5 million MOS circuit hours were accumulated with four failures for a failure rate of 0.016% per 1,000 hours. Significantly, all failures occurred during the first 150 hours of operation, and none of the units were screened previously.

It's now possible to draw these general conclusions about MOS IC reliability:

- MOS and bipolar IC's of equal complexity offer approximately the same failure rates. Variations of failure rates between the two are more a function of application, screening and quality control than technology.

- A complex MOS circuit offers a lower total failure rate than discrete parts or less complex IC's that must be assembled on printed-circuit boards and interconnected to perform the equivalent function. Therefore, increasing the complexity of MOS circuits—to a point—can improve over-all system reliability.

- To obtain high-reliability MOS circuits (and bipolar, too) requires strict quality control, high workmanship standards, careful handling and application, and effective screening and inspection criteria.

- Within their application capability, large-scale-integrated MOS circuits offer tremendous reliability potential, limited primarily by yield and packages.

The NASA study covered the most common kind of MOS circuit—the p-channel, enhancement-mode device. However, it's safe to assume that these conclusions also apply to n-channel depletion-mode and complementary IC's. The IC's in the NASA tests were thick oxides in which the silicon-oxide layer is typically 15,000 angstroms thick except for

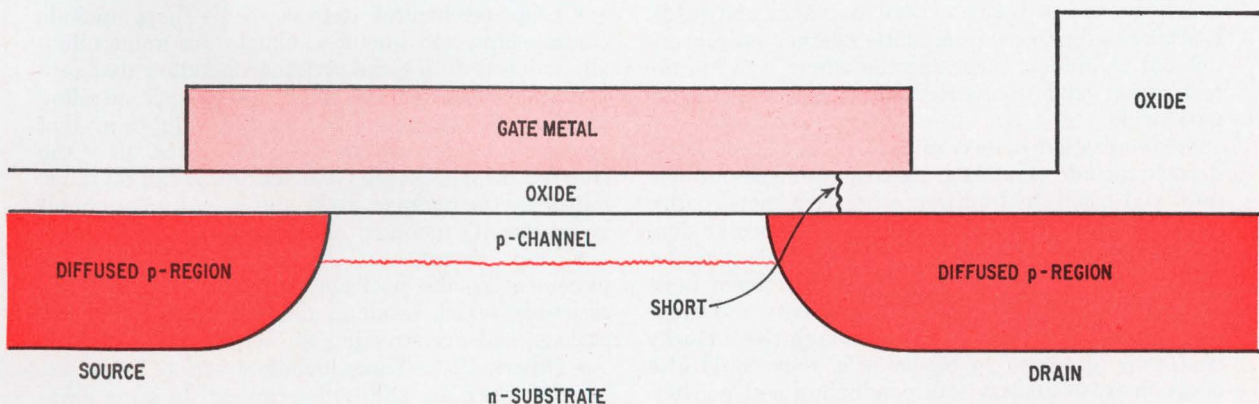

Structure. Basic MOS transistor design provides for overlap of gate metal on the diffused p regions. This assures proper registration. The thinner oxide under the overlap, however, is susceptible to breakdown.

Cause of failure

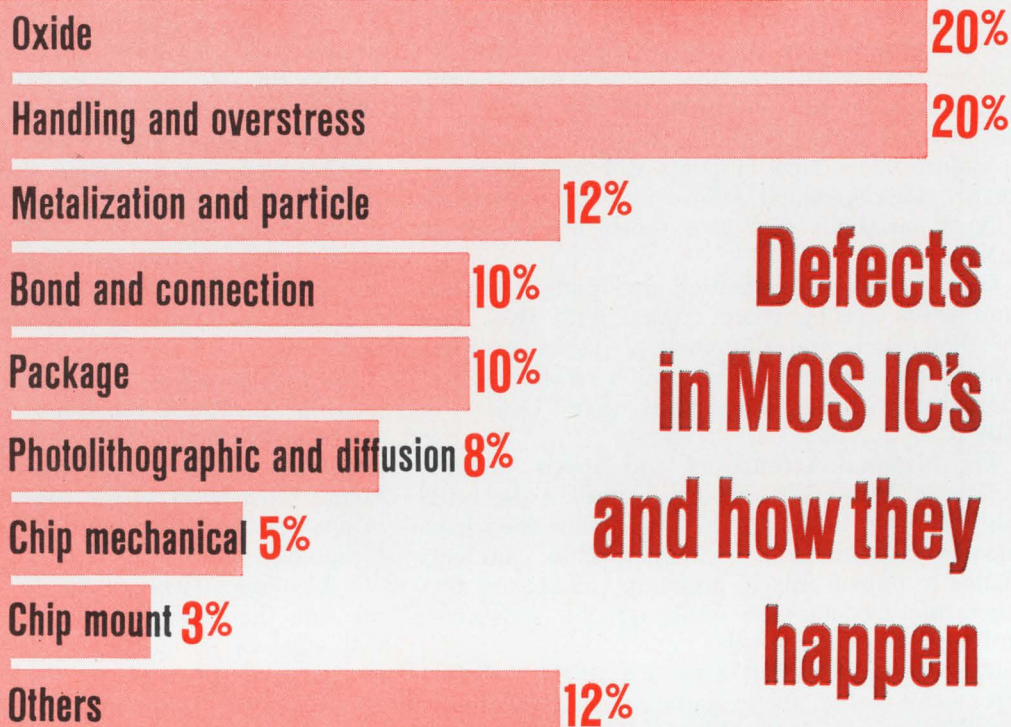

Defects in MOS IC's and how they happen

The major causes of MOS IC failure found by NASA—and their percentage of occurrence in failed circuits—are in these categories:

- Oxide defects, 20%—Flaws in the insulating layer between the silicon and the metal interconnection pattern. Gross defects in this dielectric, or inadvertent removal of it, prior to metalization cause nonfunctional shorted devices. Pinholes are another kind of oxide defect; these are small localized regions in the oxide with low dielectric strength. Such regions have reduced resistance to electrical overstress and can easily become a leakage path or a complete short circuit. Causes of pinholes are dust particles, minute mask flaws, and contamination. Pinholes are scattered at random over the chip. Sites in inactive areas and not under the gate or metalization are of no consequence since they cannot contribute to device failure.

- Handling and overstress, 20%—Poor handling causes broken or badly twisted packages and leads. Electrical overstress—from static charges on personnel and equipment, inserting the wrong leads in the test socket, and transient voltages—can destroy the gate oxide.

- Metalization defects and particles, 12%—These defects include scratches, smears, insufficient thickness, and insufficient clearance between metal paths. Insufficient thickness can cause excess current density while insufficient clearance can enable particles to cause a short circuit. Serious cracks have been observed in metalization over oxide cuts and steps [*Electronics*, April 28, p. 40]. Although these cracks have only appeared in bipolar IC's, they could also occur in MOS circuits. Both conducting and nonconducting particles are found in many IC's. Metal particles big enough to short out two metalization paths

are of primary concern. Such particles include gold wire, aluminum slivers, fragments of silicon, and gold flakes.

- Bonds and connections, 10%—Failures in this area are usually broken wires and separation of the wire from the chip (which appear as open circuits), and sagging and misrouted wires (which appear as shorts).

- Package, 10%—These failures are usually leaks in the seal, lead fatigue, external surface contamination, and marking and plating deterioration.

- Photolithographic and diffusion defects, 8%—These include faulty alignment between one or more of the successive masks, and defects in the mask itself. Typical mask defects are poor definition, variations of intensity, dark spots in clear areas of the mask, and clear spots in areas that could not transmit light. Such defects result in improper oxide removal or improper diffusion.

- Chip mechanical defects, 5%—These include cracks, chips, and fractures. Cracks are unintentionally induced during the scribing operation that separates the chips from the wafer. Every force, bending moment, or torque applied to the chip from that point on could result in a failure. Even after the chip has been packaged, sufficient force can be transmitted by the package itself, and even by the circuit board that it's mounted on, to break the chip.

- Chip mount, 3%—These include improper placement in the package cavity, orientation, and clearance, which result in the chip shorting to the package and overstressing the wires.

- Others, 12%—These include a variety of causes, most of which are still undetermined. In some cases the IC is so badly damaged that it's impossible to pinpoint the original cause.

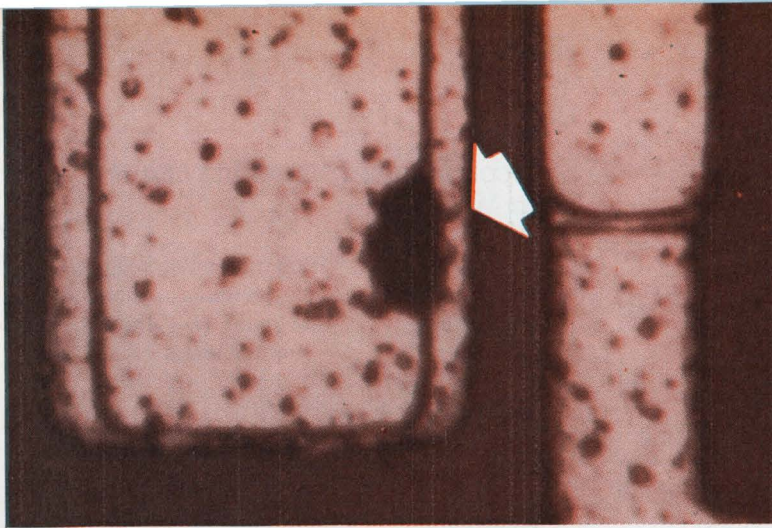

Static stress. The large dark spot is where a rupture occurred, melting away part of the gate metal. This failure was caused by static charge on a test operator; actually the gate self-healed twice before the third jolt produced a permanent short between gate and substrate. Solution: proper handling and a protective zener-diode network on the chip. Electrical symptoms are a 1,000-to-2,000-ohm linear resistance on the gate lead and a soft reverse-diode breakdown of from 5 to 7 volts.



Especially critical. Conducting particles are critical in all IC's, but especially in MOS. In bipolar circuits, the maximum permissible particle size is 0.5 mil, but even particles of this size could cause trouble in an MOS circuit in which the space between metalized paths is 0.3 mil or less. (Above, the largest burned spot—a particle that has short-circuited two metal paths—is 2.8 mils long.) A possible solution is coating the entire chip with glass after metalization.

the gate area, where it's only 2,000 Å, comparable to the oxide in thin MOS circuits.

The MOS structure on page 107 indicates the causes of device degradation and failure. A negative voltage applied between gate and drain establishes an electrostatic field that inverts the n-material under the gate metal to a p-channel between source and drain. The minimum voltage necessary to produce this channel is the threshold voltage, V_T . The high input impedance characteristic of MOS is obtained by the use of an oxide layer between the gate and the substrate.

The metal gate extends beyond the gate into the p-regions to insure that the field-effect channel occupies the entire gate region. (If the gate metal mask is misaligned enough that the p-n junction is

not covered, the conducting channel in the gate region would terminate before it reaches a p-region and the device could not function.) This region of gate metal overlap is the weakest part of the MOS structure, because it imposes high electrical stresses on the oxide.

One failure mode, for example, is rupture of the input-gate insulator by stray voltages. The effect of oxide rupture ranges from degradation of the gate breakdown voltage to complete short-circuiting of the gate. A low-energy transient can produce a silicon-aluminum compound that tends to reduce the breakdown voltage; higher transients, or higher-than-average operating voltages, can completely short the device.

MOS devices are usually rated at 10 to 50 volts, and if they are carelessly subjected to higher voltages—from an ungrounded soldering iron, for instance—the input gate oxide can easily be ruptured.

Another cause of gate rupture is man. By just walking across a nylon-carpeted floor, a technician can build up a static charge of sufficient voltage and energy (up to 5,000 volts on a typical capacitance of 200 picofarads) to destroy the gate oxide.

Gate-oxide rupture usually occurs between the gate metal and the underlying diffused region, rather than between gate and body of the device, since the diffused region has a higher conductivity than the channel region.

The gate-oxide rupture failure mode can be minimized by incorporating an input-protection circuit in the chip—a diode and resistor network, for example. Precautions against static charge build-up on personnel will help, too, of course.

Another major source of failure are defects in the oxide, chiefly pinholes; even with the recent improvements in oxide technology, pinholes still occur. Depending on the mask and etch sequence, the gate oxide under the gate metal overlap can contain a boundary between the SiO_2 thermally grown on n-type silicon and that grown on p-type silicon. This boundary arises from the difference in growth rates for oxide over n- and p-type sections. There is a greater chance for imperfections such as nonuniformity and inhomogeneity at this boundary, and these can start pinholes. A similar boundary occurs between old and new oxide—when oxide

is regrown in an etched-out pit, for example—since the growth rate of an oxide film already in place is different from that of a fresh film.

Such boundary defects in the oxide come in a spectrum of sizes—from a size large enough to cause device failure at first test to smaller defects that grow under stress to cause a failure after prolonged testing or use.

Contamination is also a critical consideration at these intra-oxide boundaries. Distribution of contamination in SiO₂ grown over n silicon is different from that over p silicon. The contamination concentration in that boundary or at the p-n junction beneath the oxide can also lead to crystal-lattice structures that cannot survive prolonged stress in an electric field.

From another standpoint, oxide contamination affects reliability because it affects the fabrication process. Contaminated SiO₂ tends to etch faster than the purer SiO₂, therefore the oxide layers may be thinner than the time-of-etch calculations predict. This leads to a lower breakdown voltage than the device is designed for.

To obtain a low threshold voltage, the gate oxide is kept to minimum thickness, typically 1,000 to 2,000 Å. This is much less than for bipolar circuits. Defects and contamination contribute far more to irregularities in the oxide thickness and variations in its insulating properties. And the severity of these irregularities can be compounded by etching.

SiO₂ reacts with aluminum—the common interconnection metal—in the temperature range of 400° to 500°C. The aluminum tends, at these high temperatures, to be absorbed into the silicon dioxide and the conductive pattern can actually disappear. Circuits are not tested or operated in this temperature range, of course, but MOS devices are sometimes processed in this range and the reaction could be initiated there. And even within the rated operating temperature range, leakage currents through small defects in the oxide can produce local heating that could raise the temperature enough for the Al-SiO₂ reaction to proceed at a rapid rate, resulting in rupture of the oxide film.

This effect is serious because it's an exponential reaction; the more aluminum that's absorbed, the greater the leakage current. The increased leakage sends the temperature climbing and the leakage increases until it constitutes a short circuit—actually an oxide rupture.

Aluminum migration can occur in bipolar IC's, too, but it's far more serious in MOS circuits because of the critical function of the gate oxide.

How can all these sources of failure be detected in finished IC's? Threshold voltage and leakage current are the two most dependable and convenient parameters for monitoring or predicting device reliability. Changes in these parameters can be detected after only a few hours of operation, and units that exhibit the changes nearly always fail. Certainly, life-test data indicates burn-in is essential to eliminate operating failures.

At the chip level, the reliability problems are

Recommended screening sequence for MOS IC's

Die inspection	200X minimum magnification
Precap inspection	40X minimum magnification
Temperature storage	Maximum temperature rating for 96 hours
Temperature cycle	10 cycles, -65° to + 125° C
Constant acceleration	20,000 G
Electrical tests	Read and record critical parameters at 25° C
Temperature and bias	Maximum temp. with circuit back-biased for 24 hours
Electrical tests	Read and record go/no/go at 25° C
Burn in	Maximum temperature for 240 hours
Electrical Tests	Read and record critical parameters Reject devices which exhibit parameter drift greater than: 1. Logic level ±10% 2. Leakage current (a) low logic levels +10 times initial (b) High logic levels +20%
Hermetic seal	Fine and gross
Radiographic inspection	

about the same for both MOS and bipolar circuits. The problems with the die mounting and bonding also are not significantly different. However, there is some difference in package problems. These result from the new and unusual packages, with many more leads, required for the complex MOS microcircuits. Additional leads require more bonds per package, additional area to be sealed with less distance between leads, and smaller cross-sectional area per lead. These requirements tend to make the package more fragile.

Other MOS IC package failures are common to the entire field of semiconductor devices: post-processing surface contamination, contamination migration during die attachment, and gas leaks in the final package are among the most common. And after the device has been successfully packaged, it is still subject to failures during handling.

The tests and screens listed in the table above were selected by NASA as the most effective for detecting and eliminating potential failures in MOS IC's. These screens should cost about the same per MOS package as for a bipolar package. However, since most MOS microcircuits have a higher functional density per package, the screening cost per system of equal complexity should be less for MOS than for bipolar. ■

July

Conference on Nuclear & Space Radiation Effects
July 7-11
Pennsylvania State University

Engineering in Medicine & Biology & International Federation for Medical & Biological Engineering Conference
July 20-25
Palmer House, Chicago



August

Western Electronic Show & Convention (Wescon)
August 19-22
Cow Palace & San Francisco Hilton Hotel, San Francisco

FIRST CONVENTION?

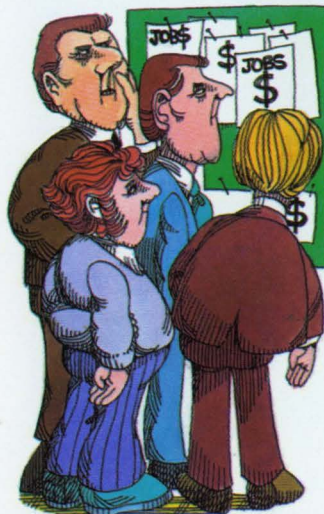

September

Broadcasting Symposium
September 18-20
Mayflower Hotel, Washington

International Telemetry Conference & Exhibition
September 15-17
Sheraton Park Hotel, Washington

At Wescon,
Electronics brings
you a free-wheeling
dialogue between
vendors and users
on circuit/system
interface—Aug. 19

Details of
conferences
on reverse side

conferences

At Wescon, Electronics brings you a free-wheeling dialogue between vendors and users on circuit/system interface—Aug. 19

ation: H.P.
cretary of
ia Matters,
Room 3E-
ton, D.C.

tron

and will it
the ques-
But in keep-
on, the con-
ontinue to
, develop-
engineering,
re. Papers
ed on quan-
devices with
asers; inte-
and technol-
devices such
avalanche di-
stors; imag-
y systems;
on devices.
ation: M.M.
Packard As-
Page Mill
Calif.

reverse side

onics
eering

East Coast,
the two broad
ed develop-
neering, re-
velopment;
ponents, cir-
ware in mili-
or commer-
. The appli-

cations program lists desk-top computers, microwave measurements, device modeling for computer-aided designs, and industrial applications of lasers. Other technical sessions will deal with digital signal processing, high-power solid-state techniques, digital and linear integrated IC's, metal-insulated semiconductors, digital memories, and underwater electronics. For more information: C.J. Peters, Sylvania Electric Products, 40 Sylvan Road, Waltham, Mass. 02154

Fall Joint Computer Conference

November 18-20

Does a good conference have to be dull? The FJCC program committee doesn't think so. It's arranging a prize — in addition to the usual one for best paper — for the best presentation and will hold seminars around the U.S. to aid authors. At the conference, videotapes will be made for later viewing by judges. The prize will be awarded next year—perhaps at the Spring Joint Computer Conference. Although something similar was attempted at this year's SJCC in May, videotapes are a definite escalation. The theme of the conference is "Threshold of the 70's;" papers will describe how the revolutionary concepts of the past 10 years will be implemented and extended during the next 10.

For more information: Eugene Crabbe, TRW Systems, Building R3, Room 2070, 1 Space Park, Redondo Beach, Calif. 90278

Conference on Magnetism and Magnetic Materials

November 18-21

The program committee has asked for papers on basic topics relating to magnetism—experimental and theoretical work, new magnetic materials, and peripheral areas in which magnetics play a major role. And basic or not, there's much of interest to be reported. Interdisciplinary papers will be welcomed—for example, on the applications of magnetics in medicine, geology, or even archeology. New magnetic evidence was recently reported that supports the theory of continental drift; the site of an ancient city was found by measuring minute anomalies in the earth's magnetic field.

For more information: J.D. Blades, Franklin Institute Research Laboratories, Philadelphia, Pa. 19103

National Electronic Conference

December 8-10

For early Christmas shoppers, there will be a product exhibit. In addition, a broad range of subjects in communications technology, IC designs, electronic switching systems, computer applications, instrumentation, and consumer electronics will be discussed at the technical sessions.

For more information: National Electronics Conference, Oak Brook Exec. Plaza #2, 1121 W. 22 St., Oak Brook, Ill. 60521

ferences: July-December

October

**Joint Conference on
Mathematical & Computer
Aids to Design**
October 26-30
Disneyland Hotel, Anaheim

**Electronic & Aerospace
Systems Convention (Eascon)**
October 27-29
Sheraton Park Hotel,
Washington

**Instrument Society of America
Conference & Exhibit**
October 27-30
Astrohall, Houston

**International Electron
Devices Meeting**
October 29-31
Sheraton Park Hotel,
Washington



November

**Northeast Electronics
Research &
Engineering Meeting
(Nerem)**
November 5-7
Sheraton Boston Hotel, Boston

Fall Joint Computer Conference
November 18-20
Convention Center, Las Vegas

**Conference on Magnetism and
Magnetic Materials**
November 18-21
Benjamin Franklin Hotel,
Philadelphia

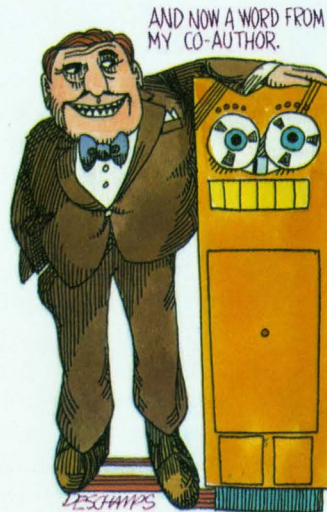

December

National Electronic Conference
December 8-10
Conrad Hilton Hotel, Chicago

**International Symposium on
Circuit Theory**
December 8-10
Mark Hopkins Hotel,
San Francisco



Conference on Nuclear & Space Radiation Effects

July 7-11

This specialized meeting deals with hot stuff—radiation exposure. It will warm up to such subjects as displacement effects produced by neutrons, gamma rays, charged particles, and surface effects.

For more information: E.A. Burke, Air Force Cambridge Research Laboratory, Hanscom Field, Bedford, Mass.

Western Electronic Show & Convention (Wescon)

August 19-22

It's the turn of Baghdad by the Bay to play host as Wescon, which alternates annually between Los Angeles and San Francisco, heads north. There will be 625 company exhibits, 100 papers in 23 sessions, and a session sponsored by Electronics magazine on the circuit/systems interface problem. With IC's due to hog the spotlight, the peninsula will buzz with talk of spider and beam-lead technology, the potential of MOS, and the design of high-power circuits. Add to that computer-aided design, time sharing, and university tv networks—not to mention a session on the problems of starting a business — and you have a typically eclectic Wescon.

For more information: Wescon Office, 3600 Wilshire Boulevard, Los Angeles, Calif. 90005

Joint Conference on Mathematical & Computer Aids to Design

October 26-30

A new stop on the circuit, this conference was created by three scientific and engineering societies. In addition to contributed papers, the program committee plans a series on invited papers on such topics as relevant mathematics and numerical analysis; computer science — graphics, man-machine interaction, and formula manipulation; large-scale systems—urban and utility; and special topics in design — holography, optics, high-energy physics, and aerodynamics.

For more information: J.F. Traub, Bell Telephone Laboratories, Mountain Avenue, Murray Hill, N.J.

Electronic & Aerospace Systems Convention (Eascon)

October 27-29

You'd expect the military and space to get most of the attention, and you won't be disappointed. But the conference is also going to look at the role of technology in the problems of our time. There will be papers on earth resources exploration by satellite and aircraft, aircraft navigation and landing systems, pattern recognition, urban problems and aerospace technology, terrestrial and satellite communication and navigation systems, coding and signal processing, and lunar exploration.

For more information: Gates, Jr., Secretary of the Army for S.E. Asia, The Pentagon, Room 3833, Washington, D.C.

International Electronic Devices Meeting

October 29-31

What's it cost last? These are the questions for 1969. Meeting with traditional conference will cover research, development, design and manufacturing. Papers are being solicited in integrated circuits technology; solid state devices as Gunn and avalanche diodes and transistors; energy conversion. For more information: Atalla, Hewlett-Packard Associates, 1501 California Road, Palo Alto, Calif.

Calendar on

Northeast Electronic Research & Engineering Meeting (Nerem)

November 5-7

A big one for the Nerem will probably cover areas: advances in engineering research, and development and use of computer circuits, and hardware, industrial, and special equipment.

Better safe operating area.*
Rugged reliability.*
Lower lead inductance.*

Type #	V _{CC}	P _{out} (W) @ f (MHz)	G _{PE} (dB) (min)
2N5589	13.6V	3.0 @ 175	8.2
2N5590		10.0 @ 175	5.2
2N5591		25.0 @ 175	4.4
2N5635	28V	2.5 @ 400	6.2
2N5636		7.5 @ 400	5.7
2N5637		20.0 @ 400	4.6
2N5641		7.0 @ 175	8.4
2N5642	28V	20.0 @ 175	8.2
2N5643		40.0 @ 175	7.6

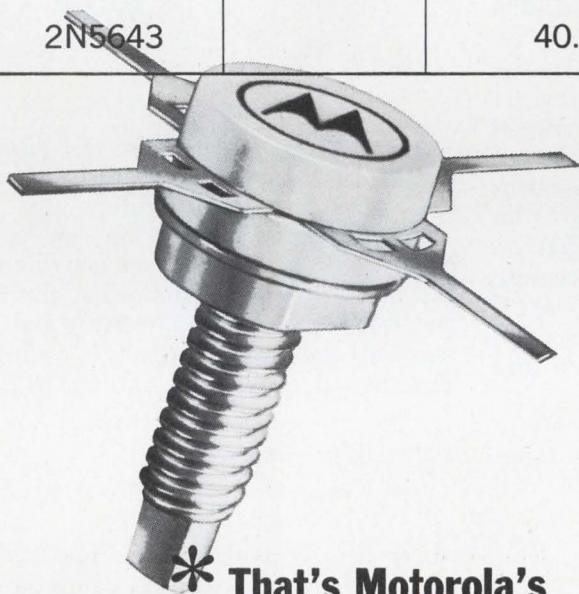

*** That's Motorola's
2N5641 RF Power Transistor.**

And the 2N5641 is just one of nine new RF power types that offer the combined benefits of BET†

†Trademark of Motorola Inc.

- where the priceless ingredient is care!



MOTOROLA
Silicon RF Transistors

Motorola Semiconductor Products Inc. • P.O. Box 20912 • Phoenix, Arizona 85036

balanced emitter transistors in Ceramic Stripline cases.

The broad range of output power at VHF/UHF frequencies for both 12V and 28V designs qualifies these devices for a large variety of AM/FM commercial, industrial, and military applications. Prices are lower, too, as much as 30% less than previous BET transistors in 100-up quantities.

The same concern for versatility and breadth of line shown in these new RF power introductions is also evident in Motorola's complete line of RF transistors, including a full range of small signal low noise and oscillator devices for an equally wide variety of applications.

Detailed new data sheets for the nine types listed here are available for prompt response to your inquiry. Information on any Motorola RF transistor is available from your Motorola distributor or sales office.

Common-mode rejection ratio: what the spec sheet doesn't say

Some critical assumptions, that aren't always true, lurk behind test circuits recommended by amplifier makers

By Frederick Gans

IC Metrics Inc., Oceanport, N.J.

"The common-mode rejection ratio is so many decibels; here's a test circuit if you want to check it out yourself." This seems to be what makers of differential amplifiers are saying on their spec sheets. Rarely does a maker tell how the ratio varies with power-supply voltage, temperature or other parameters. And rarely does he explain how he designed his test circuit, tell what its limitations are, and show how large an error the use of a typical recommended circuit can cause.

For his test circuit, the amplifier maker derives the equation for calculating rejection ratio by assuming that a certain relationship exists between circuit and amplifier resistances. But this relationship doesn't necessarily exist, so using it to calculate an amplifier's rejection ratio usually gives an inaccurate result. What's worse, the user has no way of calculating or measuring how inaccurate it is.

A better way to find the common-mode rejection ratio is to measure the common-mode gain and divide it into the differential gain.

Ideally, a differential amplifier responds only to the difference between the voltages at its input terminals

$$e_o = (e_1 - e_2) A_d$$

where e_1 , e_2 are the input voltages, e_o the output voltage, and A_d the differential voltage gain.

But to some degree, all differential amplifiers are responsive also to the magnitude of the inputs. So in real life

$$e_o = (e_1 - e_2) A_d + \left(\frac{e_1 + e_2}{2} \right) A_c$$

Note that the second term on the right defines

the error. The voltage $(e_1 + e_2)/2$ is the common-mode voltage, and A_c is the common-mode gain. The ratio of A_d to A_c is the common-mode rejection ratio, CM_{rr} .

The circuit to the right is typical of those recommended by differential-amplifier makers for measuring CM_{rr} . According to this amplifier's spec sheet, a differential amplifier's CM_{rr} is

$$CM_{rr} = \frac{R_f e_s}{R_s e_o}$$

where e_s is the input to the test circuit, e_o is the output, and R_f and R_s are resistances in the test circuit, as shown in the figure.

But using this relationship can lead to serious errors. How does the maker get this relationship? His first step is to assume that the input impedances at the amplifier's inverting and noninverting terminals are equal, normally a valid assumption. Then he writes e_1 and e_2 in terms of e_s and e_o .

$$e_1 = K_1 e_s - K_2 e_o$$

$$e_2 = K_3 e_s$$

where K_1 , K_2 , and K_3 are impedance-dependent terms, defined on page 118. Using these two equations and the equation for e_o in terms of A_d and A_c he draws a signal flow diagram, and uses it to derive the test circuit's transfer function.

To here, there has been only one approximation, equal input impedances. Now he makes some more. A_d is usually 100,000 times larger than A_c so the term $\frac{1}{2}A_c$ in the transfer function can go. And A_d is always higher than 1,000 so when K_2 is equal to or greater than 0.1, dropping the 1 from the denominator of the transfer function introduces an error

A little too simple

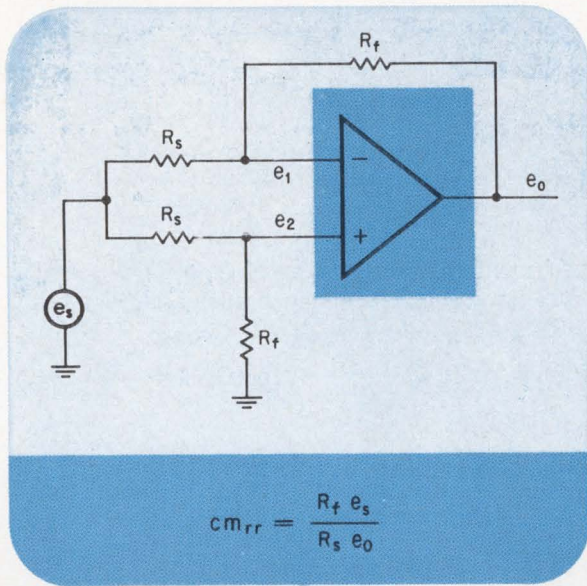

$$CM_{rr} = \frac{R_f e_s}{R_s e_o}$$

$$e_1 = K_1 e_s - K_2 e_o$$

$$e_2 = K_3 e_s$$

$$e_o = (e_1 - e_2) A_d + \left(\frac{e_1 + e_2}{2}\right) A_c$$

$$\frac{e_o}{e_s} = \frac{(K_1 - K_3) A_d + \frac{1}{2} (K_1 + K_3) A_c}{1 + (A_d + \frac{1}{2} A_c) K_2}$$

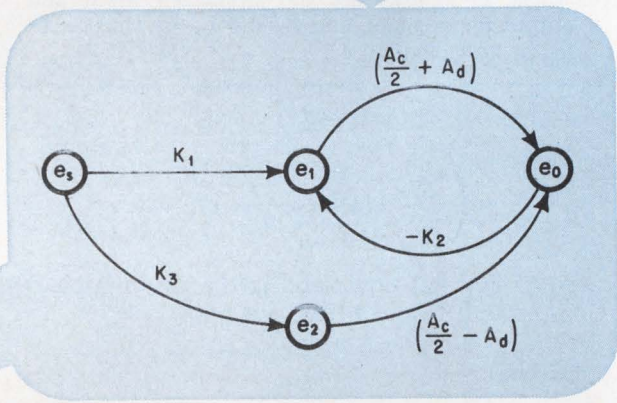

The maker's way. To measure common-mode rejection ratio, CM_{rr} , one amplifier manufacturer recommends using the circuit on the left along with the equation under it. This relation comes from first writing three independent equations; two are network equations and the third a characteristic equation of the amplifier. (K_1 , K_2 and K_3 are the coefficients whose values are given in the panel, A_c is the amplifier's common-mode gain, and A_d is its differential gain.) From these equations a signal flow diagram is drawn out of which comes the circuit's transfer function. When certain assumptions, not always valid, are made, the transfer function is reduced to the equation for CM_{rr} .

no greater than 1%. After these two approximations are made the transfer function is

$$\frac{e_o}{e_s} = \frac{(K_1 - K_3) A_d + \frac{1}{2} (K_1 + K_3) A_c}{A_d K_2}$$

which is still a very accurate representation.

To finally get the equation

$$CM_{rr} = \frac{R_f e_s}{R_s e_o}$$

the maker assumes that

$$K_1 = K_3 \quad \text{and} \quad \frac{K_3}{K_2} = \frac{R_f}{R_s}$$

Here's where trouble comes in. Making the second approximation won't introduce much error but what is the effect of assuming K_1 and K_3 are equal?

Let's examine the approximation more closely. Instead of dropping $(K_1 - K_3)$, use the relationship

$$K_1 + K_3 = 2K_3$$

which also says that K_1 equals K_3 , but allows the carrying along of the difference term. Then

$$\frac{e_o}{e_s} = \frac{R_f}{R_s} \left[\left(\frac{K_1}{K_3} - 1 \right) + \frac{A_c}{A_d} \right]$$

The coefficients

$$K_1 = \frac{\left[\frac{(R_f + Z_o) Z_i}{R_f + Z_o + Z_i} \right]}{\left[R_s + \frac{(R_f + Z_o) Z_i}{R_f + Z_o + Z_i} \right]}$$

$$K_2 = \frac{\left[\frac{R_f Z_i}{R_f + Z_i} \right]}{\left[R_f + \frac{R_s Z_i}{R_s + Z_i} \right]}$$

$$K_3 = \frac{\left[\frac{R_f Z_i}{R_f + Z_i} \right]}{\left[R_s + \frac{R_f Z_i}{R_f + Z_i} \right]}$$

where Z_i and Z_o are the amplifier's input and output impedances, and R_f and R_s are resistances in the test circuit.

$$\frac{R_s e_o}{R_f e_s} = \left(\frac{K_1}{K_3} - 1 \right) + \frac{1}{CM_{rr}}$$

So to find out how valid is the assumption that K_1 is exactly equal to K_3 , evaluate

$$\left(\frac{K_1}{K_3} \right) - 1$$

and compare it with A_c/A_d .

If the test circuit has 1% resistors, the most that each of the sets of matched resistors—the R_f 's and the R_s 's—can be mismatched is by 2%. So, from the definitions of K_1 and K_3 in the panel, the result of a 2% mismatch is

$$K_1 = \frac{(R_f + Z_o) Z_i}{1.02 R_s (R_f + Z_o + Z_i) + (R_f + Z_o) Z_i}$$

$$K_3 = \frac{1.02 R_f Z_i}{R_s (1.02 R_f + Z_i) + 1.02 R_f Z_i}$$

where Z_i and Z_o are the amplifier's input and output impedances.

To further simplify things, choose R_f and R_s so that $R_f = Z_i/10$ and $R_s = Z_i/100$. Then

$$\frac{K_1}{K_3} = \left[\frac{0.1 \left(\frac{Z_i}{Z_o} \right) + 1}{0.11122 \left(\frac{Z_i}{Z_o} \right) + 1.0102} \right] \left(\frac{0.11302}{0.102} \right)$$

If Z_o is assumed to be 0, then (Z_i/Z_o) approaches

infinity. Therefore

$$\lim_{(Z_i/Z_o) \rightarrow \infty} \frac{K_1}{K_3} = \left(\frac{0.1}{0.11122} \right) \left(\frac{0.11302}{0.102} \right) = 0.996262$$

So

$$\left(\frac{K_1}{K_3} - 1 \right) = -37.3 \times 10^{-4}$$

A typical spec-sheet value of CM_{rr} is 80 decibels, or 10^4 . So when the resistance mismatch of the test circuit is 2%, and when Z_o is 0, then

$$\left(\frac{K_1}{K_3} \right) - 1 = -37.3 \times 10^{-4}$$

Now

$$\frac{1}{CM_{rr}} = 10^{-4}$$

So in this example, the term,

$$\left(\frac{K_1}{K_3} - 1 \right)$$

which is dropped to obtain the simplified expression for e_o is 37.3 times larger than A_c/A_d , the term that's kept in the equation.

Equating K's

So only when K_1 equals K_3 does the test circuit measure CM_{rr} accurately. But the user has no way of knowing how close in value K_1 and K_3 are.

Trying to equate these two K's by measuring e_1 and e_2 , and then adjusting one of the R_s 's to make those voltages equal is futile since $(e_1 - e_2)$ is in the low-microvolt or nanovolt region.

Another way could be to make adjustments in the circuit and observe the output. When K_1 equals K_3 , e_o has some specific value. Unfortunately, it's impossible to determine what this value is.

This can be seen by letting

$$e_s = \sin \omega t$$

in the equation

$$\frac{R_s e_o}{R_f e_s} = \left(\frac{K_1}{K_3} - 1 \right) + \frac{1}{CM_{rr}}$$

then

$$\frac{R_s}{R_f} e_o = \left(\frac{K_1}{K_3} - 1 \right) \sin \omega t + \frac{1}{CM_{rr}} \sin \omega t$$

The second term on the right side is in phase with e_o and the first term is either in phase or 180° out, depending on whether K_1 is larger than K_3 .

When K_1 is larger, the magnitude of e_o is some large value. As K_1 decreases, e_o 's magnitude decreases. When K_1 equals K_3 , e_o 's magnitude is still

Measuring A_c

FLOATING-BIAS SUPPLY

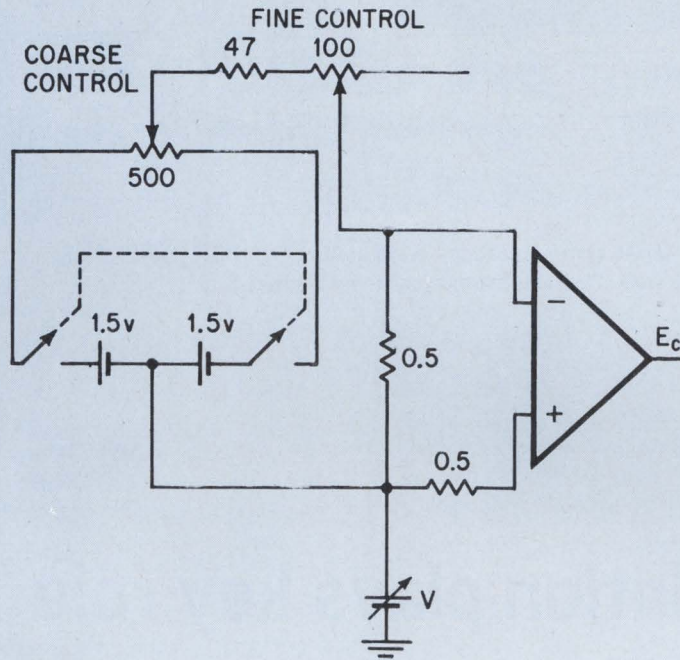

How to measure common-mode voltage gain, A_c .

$$A_c = \frac{E_{o1} - E_{o2}}{\Delta V}$$

- 1 Set V to 0, and use the controls of the bias supply to set E_o to 0.
- 2 Set V to the negative limit of the amplifier's common-mode input range, and measure the output, E_{o1} .
- 3 Set V to the positive limit of the common mode input range, and measure the output E_{o2} .
- 4 ΔV is the difference between the positive and negative limits of the common-mode input range.
- 5 Calculate A_c .

greater than zero. As K_1 continues to decrease, e_o 's magnitude hits zero and then starts to increase. But the user has no way of separating the two sine waves that make up e_o , so he has no way of telling when the coefficient of the first term on the right side is zero.

Also complicating things is the presence of stray capacitance in the test circuit and in the amplifier. When K_1 , K_2 , and K_3 have reactive components, the term

$$\left(\frac{K_1}{K_3} - 1 \right) \sin \omega t$$

is phase shifted relative to

$$\frac{1}{CM_{rr}} \sin \omega t.$$

The result of this shifting is that e_o 's magnitude may not even be a very low value when K_1 equals K_3 .

Get the gain

The best way to measure an amplifier's common-mode rejection ratio is to find its common-mode gain first, and then divide A_c into the differential gain, A_d .

There are several popular ways to measure A_d , but ways to measure A_c aren't that well known. Here's one good approach.

The definition of A_c is

$$A_c = \frac{e_o}{e_c}$$

where e_c is a voltage applied simultaneously to the amplifier's input terminals.

The simplest way to simultaneously apply a voltage to the input terminals is to tie the input terminals together and connect them directly to a d-c supply. However shorting the inputs together like this isn't the most accurate solution because the offset voltage at the inputs multiplied by A_d may drive the d-c output off the linear region of the amplifier's input-output curve. Instead of being shorted directly, the inputs should be shorted through a floating bias supply of low impedance, such as the one shown in the panel above, along with the steps for measuring A_c .

This figure shows only the amplifier's input and output connections. Not in the figure are the power supply, bypass capacitors, and frequency-compensation networks that must be connected to the amplifier, as specified by its manufacturer. ■

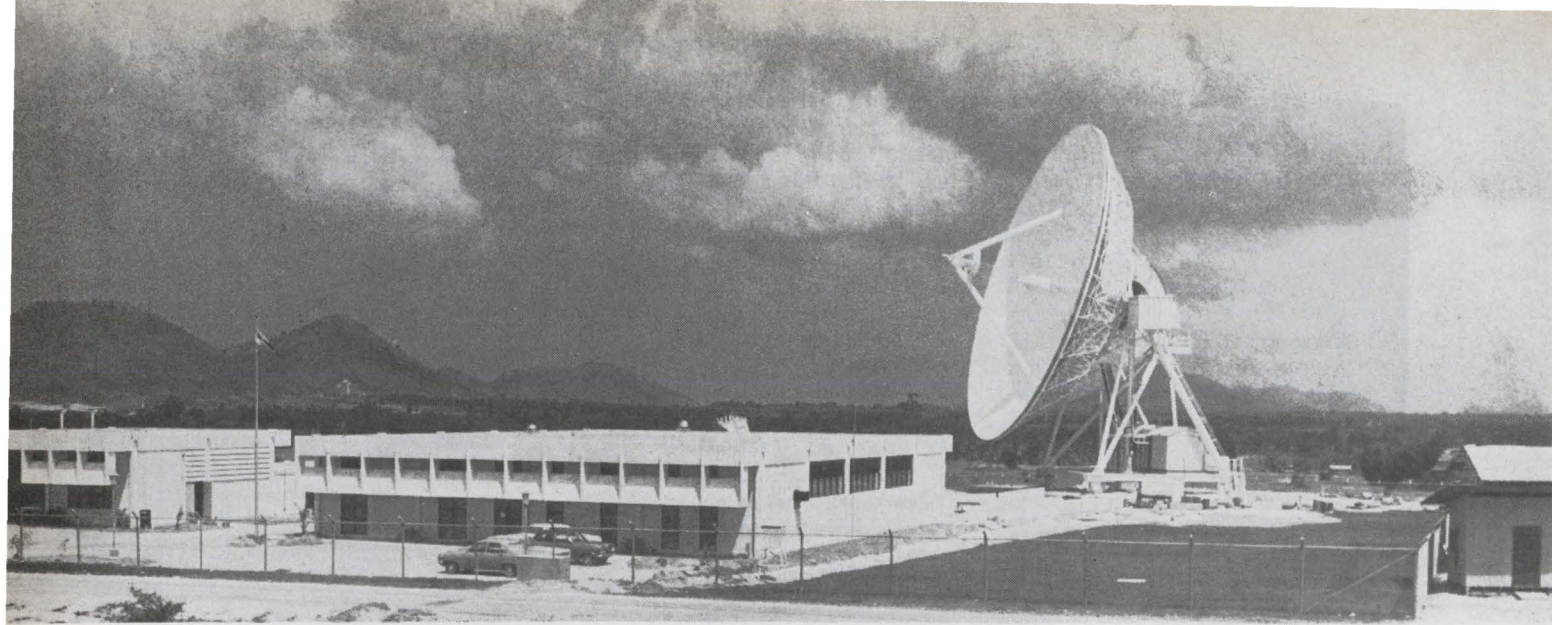

Listening in. Complex interfaces characterize a satellite communications earth station like this Sylvania-designed installation in Thailand. Implementation requires a well-integrated team of systems engineers.

Systems engineering

Computer simulation plays key role in design of satellite earth stations

Systems approach offers solution to complex politico-technical interface problems in ground terminals of global communications network

By Lee B. Zahalka

GT&E International Systems Corp., Waltham, Mass.

If you're going to build a complex system in the face of inhibiting constraints, do it with systems engineering. Few engineers know this lesson better than the designer of satellite ground stations, who has had to contend with tough transmitter-receiver problems that are tied to stiff international standards regulating the compatibility of earth terminals with the global communications system.

Working as a systems engineer, the designer undertakes the total and continuous planning of his station, and relies heavily on computer simulation techniques while using tradeoff and cost effectiveness methods.

Technologically, ground station design has its

complexities. Each station must be designed to withstand extreme local temperatures, winds, and humidity; and each must be worked out in the light of such atmospheric factors as attenuation.

However, the major challenge comes from the fact that each station is a participant and a contributor in a world-wide network shared and operated by a host of countries. The trick is therefore to fit the complicated technology into the context of multinational needs as embodied in the interface requirements between the satellite and earth stations. These requirements have been set down by the Interim Communications Satellite Committee (ICSC). Only an orderly, systematic approach—

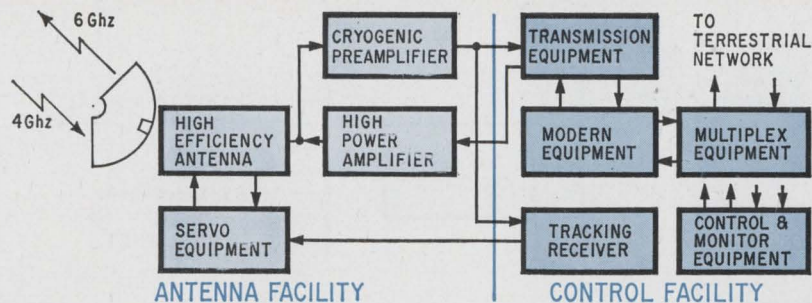

Earth station. Typical satellite communications ground installation is a complex of high-frequency, high power generating equipment and precision servo control, coupled with switching and frequency conversion gear.

Intelsat 3 transmission parameters

Carrier capacity	No. channels	24	60	132
Bottom baseband frequency	khz	12	12	12
Top baseband frequency	khz	108	252	552
Zero dbm test-tone deviation	khz	250	410	630
Multichannel rms deviation	khz	420	830	1,490
Occupied bandwidth	Mhz	4.0	8.0	14.4
Carrier-to-noise temp. at operating point	dbw/°K	-154.8	-151.3	-148.5

Television transmission parameters

Satellite bandwidth allocation, Mhz	40	
Receiver bandwidth, Mhz	25	
G/T total at operating point, dbw/°K	-142	
	American	Foreign
Television standard (lines/frames per sec)	525/60	625/50
Maximum video bandwidth, Mhz	4.2	6.0
Peak to peak deviation, Mhz (15 khz test signal)	9.4	7.9

Transmitting power for operational satellites

	Effective isotropic radiated power
Intelsat 2	
Per voice channel	68 dbw
Television video	90-95 dbw
Intelsat 3	
Per voice channel	61 dbw
Television video	86 dbw

systems engineering—can deal effectively with the demands of such a technical-political entity.

The specification, which the designer gets from the contracting country, is normally generated by the Communications Satellite Corp. (Comsat), which acts as the ICSC's manager. Spelled out in the specification are the functional requirements of the station based on the country's communications needs and ICSC's inter-face standards. The

designer's job is then to translate this order into an equipment specification.

As the global civilian network now stands, the International Telecommunications Consortium (Intelsat) owns and operates the satellites. There are now six Intelsat satellites in synchronous equatorial orbits working with 20 ground stations. Another 50 ground stations are either under construction or being planned. Of the Intelsat 3, latest of the satellite series, there are two aloft, one over the Atlantic Ocean and the other over the Pacific. Launching of a third one scheduled the end of May for a position over the Pacific Ocean is to be followed by moving the earlier Pacific-Ocean satellite to a position over the Indian Ocean. The Intelsat 3 series has a 1,200 two-way voice channel capacity, five times that of the Intelsat 2 series.

Whether owned privately or by the contracting country, the earth stations must comply with ICSC rules on compatibility. These are contained in ICSC document 37-38 E, "Performance Characteristics of Earth Stations," and deal primarily with signal-to-noise performance as advised by the International Radio Consultative Committee (CCIR). Certain requirements must be met before an earth station can be admitted to the global system: for example, transmitting power and receiving sensitivity are dictated by the ICSC.

Transmission requirements, specified in terms of effective isotropic radiated power for satellites now in operation, are listed in the tables adjacent. The power ranges indicated for television accommodate both monochrome and high quality color transmission.

Receiving sensitivity is specified in terms of the ratio of antenna gain to noise temperature (G/T) in decibels per degrees Kelvin. The minimum requirement is $G/T = 40.7 + 20 \log F/4$ (db/°K) where F is a frequency between 3.7 and 4.2 gigahertz, the limits of the bandwidth allocated for satellite receiving use, at antenna elevation angles of 50°.

For Intelsat 3, other major transmission parameters including television data are listed in the adjacent tables.

The components of a typical earth station are shown in the block diagram shown above. The high-efficiency antenna is typically a 30-meter Cassegrain dish driven by a servo for automatic pointing and tracking. Also located at the antenna

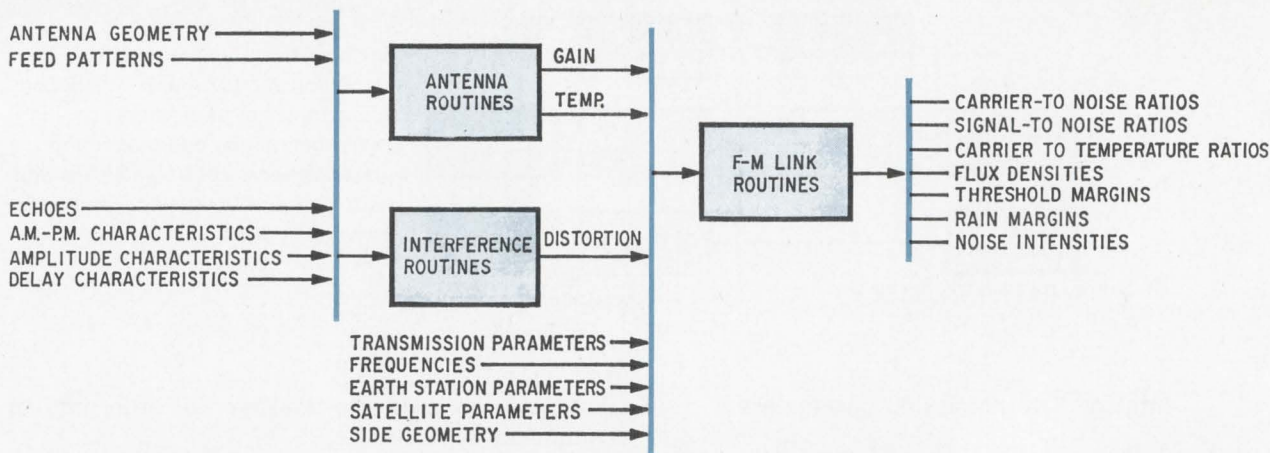

System program. Three basic routines form the computer model, used to determine the performance of a proposed earth station or satellite, by exercising the inputs shown under various environmental conditions. Up-link, down-link, or the system's characteristics can be analyzed as desired.

facility is the cryogenic preamplifier, which provides a receiving temperature of about 20°K and a corresponding noise figure of 0.3 db. The preamplifier has a 500 megahertz instantaneous bandwidth. The remaining equipment in the facility is a high-power amplifier that provides transmission output at the kilowatt level.

In the control facility, the transmission equipment makes the required frequency conversions and provides the necessary gain for signals to and from the modem, a frequency modulation unit similar to those used in microwave relays. The multiplex unit accepts baseband signals from one or a number of terrestrial networks and formats them for transmission on a frequency division basis.

The station's tracking receiver is a conventional phase-locked monopulse unit. Equipment for the station's control functions is located centrally.

Global switchboarding

While it is well within the state of the art, earth station design is not as simple as it might at first appear. The multiple destination nature of global communications places it in sharp contrast with conventional microwave relay systems. Multiple signal carriers are required for disseminating many different messages to different places.

To transmit information to the satellite, each station has a distinct carrier frequency within the allocated 5.925 Ghz to 6.425 Ghz band. Then the satellite receives signals in this range and retransmits them at a carrier between 3.7 Ghz and 4.2 Ghz, shifting the carrier downward by 2.225 Ghz.

A typical earth station is equipped to transmit carriers for television video, television programs, voice messages, and data traffic. The receiving equipment must accommodate not only the tv video and program carriers but also the transmitted carriers for each country in the network. This may require from eight to twelve receivers and demodulators in addition to the tv equipment.

As the requirements for routing hundreds of two-voice channels begin to unfold, the designer begins to see the formidable switching task before him. A large part of his efforts must be devoted to integrating the diverse equipment available into a smoothly functioning system.

Path to optimization

As in other systems, the computer plays a major role in the design stage, permitting detailed investigation of problems that affect system performance, and leading to optimization. Parameters of models representing the station are fed to the computer and optimized for a simulated solution, thus forecasting how the actual system will operate.

Beforehand optimization is important because it takes into account many performance measurements that simply cannot be adjusted after the system is built.

Earth-station design problems can be broken down for computer analysis. The system's performance is determined by the available signal levels and by the effects of distortion due to thermal noise and nonlinearities of amplitude and phase. Generally, the factors of greatest interest are the up-link and down-link signals, and the distortion parameters at the satellite input and the earth station. These factors are all subject to identical computer techniques. The complete communications link can be simulated by iteration.

The computer flow process at Sylvania is subdivided into three basic routines: antenna, interference and f-m link as shown. Each one has many subroutines but only generalized input-output parameters are considered here, to identify the information flow. The appropriate input parameters are selected depending on whether up-link or down-link computations are desired. The system's characteristics are analyzed by looping the outputs for the up-link conditions back through the route.

To show how the antenna's gain, temperature,

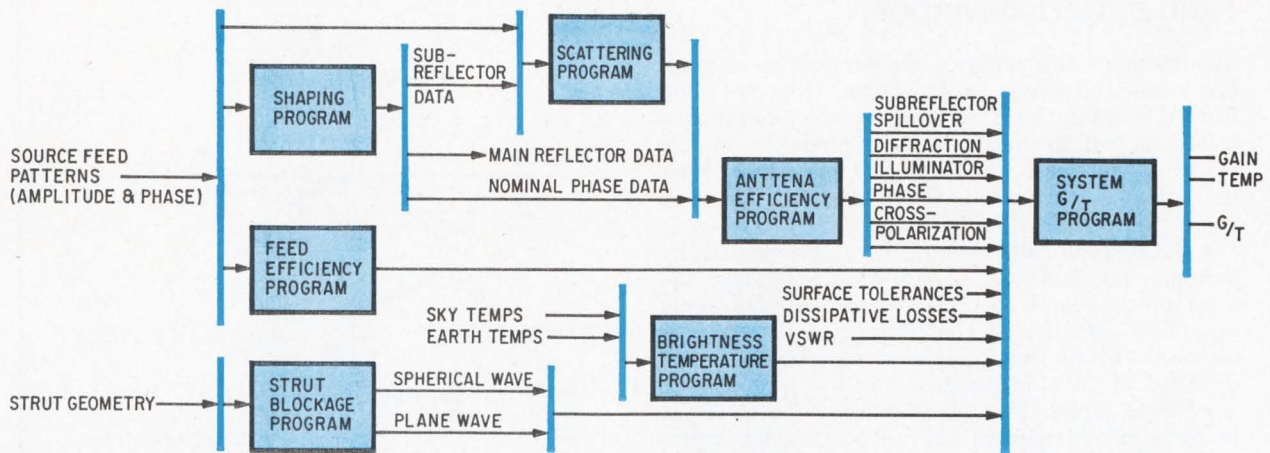

Subsystem program. Antenna subsystem routine operates on input phase and amplitude data obtained from source feed patterns and produces design information that permits the system engineer to optimize on the basis of best gain-temperature ratio.

Antenna G/T calculation for 97-ft. reflector at 90° elevation angle

Feed data

Frequency.....	4.0 Ghz
Subreflector angle.....	19°
Type.....	Polyrod

Strut data

No. of struts.....	2
Strut angle.....	37°

Temperature calculations

Main beam.....	4.20°K
Spillover-subreflector.....	1.05°K
Blocking-strut, plane.....	0.06°K
Blocking-strut, spherical.....	1.48°K
Spillover-main dish.....	0.41°K
Blocking-subreflector.....	0.14°K
Phase center.....	0.02°K
Surface tolerance.....	0.24°K
Cross-polarization.....	0.11°K
Total.....	7.75°K
Noise temperature at flange.....	19.71°K
Receiver noise temperature.....	16.00°K
System noise temperature.....	35.71°K
System G/T at 90° elevation angle =	44.89 db

Gain calculations

Maximum directive gain.....	61.86 db
Spillover efficiency.....	-0.57 db
Spar plane wave blockage eff.....	-0.03 db
Spar spherical wave blockage eff....	-0.12 db
Rear spillover eff.....	-0.01 db
Subreflector blockage eff.....	-0.11 db
Phase eff.....	-0.02 db
Surface tolerance eff.....	-0.19 db
Cross-polarization eff.....	-0.09 db
Aperature eff.....	-0.09 db
Net directive gain.....	60.60 db
VSWR eff.....	-0.03 db
Resistive eff.....	-0.15 db
Net gain at reference flange.....	60.42 db

and G/T are derived, consider the flow diagram above. The antenna routine is associated with seven main programs:

- Feed efficiency
- Shaping
- Strut blockage
- Scattering
- Brightness temperature
- Antenna efficiency
- System G/T

Each program can provide discrete outputs so that any design element in the chain can be optimized: for example, the feed efficiency program provides information on pattern integration of the measured phase and amplitude characteristics.

The main inputs to the antenna routine are the measured source feed phase and amplitude data. These are processed by the shaping program whose output yields the reflector geometry needed to provide the desired illumination function across the

Field pattern deviation

To determine the system's temperature in a satellite communications earth station, the deviation from the design ideal of the antenna's energy distribution pattern must be accounted for in the model. Listed here are the major factors affecting the antenna field pattern which are built into Sylvania's energy distribution model.

▪ **Subreflector blockage.** Energy intercepted by the antenna subreflector is scattered back into the main reflector and concentrated into a solid angle near the main beam. The average sky brightness included in the solid angle is essentially in the direction of the main beam.

▪ **Phase errors.** Nonspherical wave fronts or reflector surface imperfections cause a slight but perceptible broadening of the antenna's main beam. The resulting radiation pattern can be resolved into an unperturbed main beam with slightly reduced amplitude, and into a superimposed pattern produced by the removed energy and concentrated in a region near the main beam. The average sky brightness that must be accounted for is again in the direction of the main beam.

▪ **Subreflector spillover.** Some of the energy radiating from the source feed misses the subreflector and spills out over the sides. The distribution of this spillover energy is derived from the measured feed patterns, weighted by the pervading brightness temperature. This calculation neglects the small fraction of energy diffracted by the subreflector in the main lobe regions.

▪ **Diffraction losses.** Diffraction of some of the energy reflected from the subreflector surface spills over to the rear of the main reflector. The model assumes that this waste energy is contained within a region bounded by the edge of the main reflector and a plane perpendicular to the antenna beam axis. The energy density within this volume is assumed to be uniform (see sketch).

▪ **Subreflector support blockage.** Two additional effects are introduced by the presence of the subreflector support struts. In the transmitting mode, part of the energy contained in the spherical wavefront radiating from the virtual feed is intercepted by the struts before reaching the main reflector, producing a "shadowing" effect. The spherical wave component is scattered back into the dish by reflection. If the strut is circular in cross section, the reflected energy behaves as though radiated from

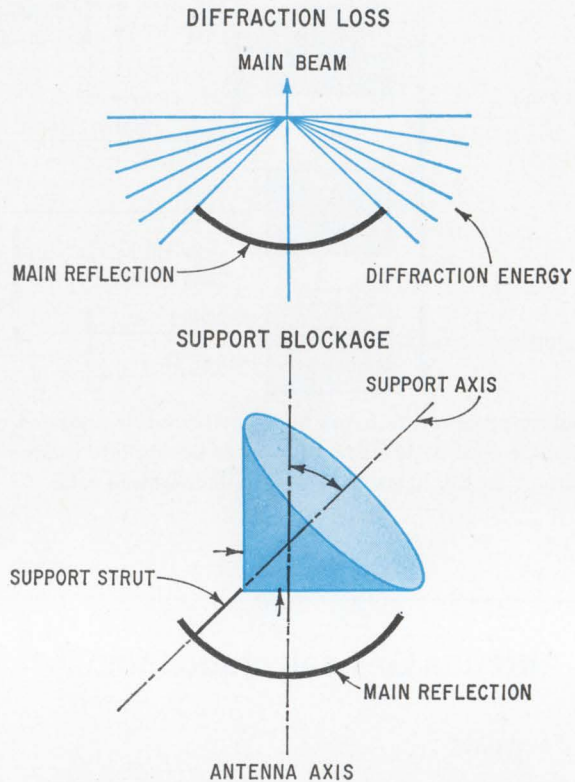

a circular source whose circumference runs through the focal point in the plane normal to the strut.

The resulting far-field pattern is that of a defocused circular source with a maximum intensity following a conic pattern determined by the specific antenna geometry.

Plane wave components reflected from the main reflector are also intercepted by the struts. These too are scattered off the support in a pattern with maximum intensity following a conical geometry, as shown in the sketch.

These energy distributions, suitably weighted by the temperature model, are used to calculate the antenna temperature, and when combined with the dissipative losses, receiver temperature, and various other contributions, produce the system temperature.

main reflector, suitably compensated for phase errors. The illumination function may be selected on the basis of various criteria—maximum gain, minimum temperature, or maximum G/T—by iterating the steps in the program.

The source feed pattern and sub-reflector data are then fed to the scattering program, which provides the virtual feed pattern, consisting of the radiation characteristics of an equivalent radiator at the focal point of the main reflector. The virtual feed radiation pattern and the nominal phase data

from the shaping program are inputted to the antenna efficiency program, an integration routine producing subreflector spillover, diffraction, illumination, and cross-polarization efficiencies. These factors, used to determine antenna gain, are combined with the output of the strut blockage program and data from other routines including wave blockage efficiencies, measurement of voltage standing-wave ratio, and dissipative losses. The combination of all these factors is finally fed to the system G/T program from which antenna gain and

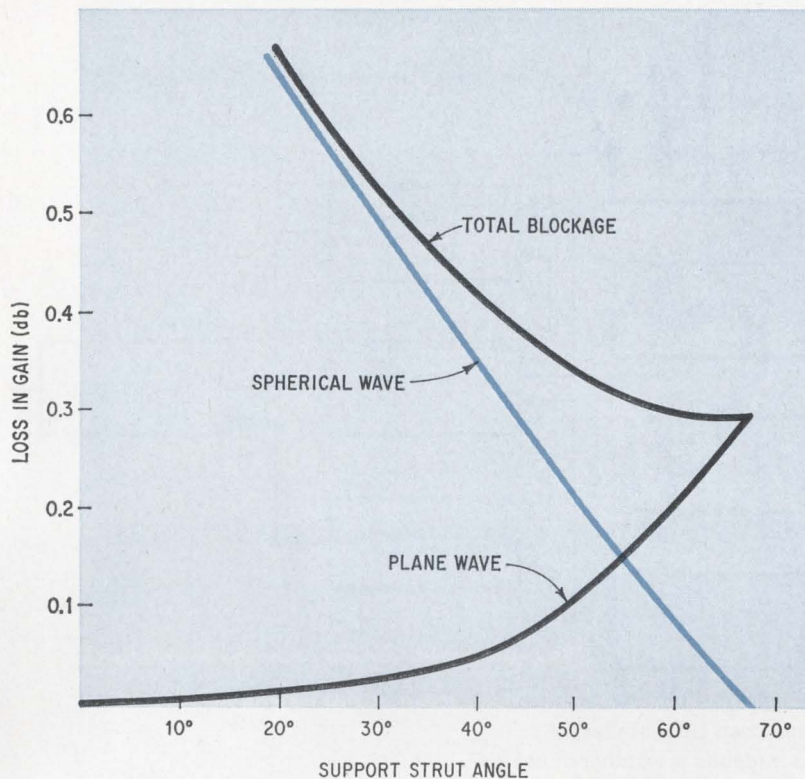

Strut losses. For minimum effect of strut blockage on antenna gain, large support angles are indicated by this plot which shows that spherical wave loss effects dominate at angles smaller than 45°.

temperature are obtained. The temperature, incidentally, can also be calculated from the angular density distribution of the radiation pattern, which is provided with each efficiency factor.

Simplified model

The key to the system G/T model program is the energy distribution model. While it is a relatively easy job to calculate the energy removed from the main beam of a radiating aperture by the presence of the imperfect subreflector surface and its support struts, it is a formidable task to determine the precise distribution of the scattered energy over 4π steradians with the proper polarization. Accordingly, a simplified model has been established and validated by field tests to expedite calculations. Intermediate solutions permit tradeoff studies to be made on individual design elements without exercising all the antenna subsystem routines each time.

Output format for the system G/T program is shown in the tabulation on page 123. First, all input elements such as antenna geometry, support strut geometry, type of source feed, frequency, elevation angle, and receiver are identified. Next efficiency factors that degrade the maximum directive gain for the antenna under study are listed with the temperature contribution. The specific data in this example is for a 90° elevation angle.

The computer output provides useful insight into how various design parameters interact. For example, comparing the main beam temperature contribution of 4.2°K with that of the sky brightness at zenith of 5.5°K shows that 76.3% of the total

available sky noise is intercepted by the main beam. The total antenna temperature, calculated to be 7.75°K at the aperture, shows that spillover is responsible for an increase in temperature of 2.25°K over that of an ideal antenna, or an overall efficiency of 71% at the aperture.

The fact that different aperture efficiencies can be derived, depending on whether gain of temperature is being considered, clearly shows the danger of under-optimization. Any antenna can be optimized with respect to gain and still have poor temperature characteristics, and vice versa.

Sensitivity coefficients

The G/T program finds its major applications in sensitivity studies for the various antenna design elements. This is accomplished by establishing what are called sensitivity coefficients for specific operating points, antenna geometries, and elevation angles. Analyses of these are very useful in determining the effectiveness and priorities of design improvements.

As an example, assume that a particular antenna has the following coefficients at an elevation angle of 0.5°.

▪ Dissipation loss	5 db
▪ Spillover loss	1.8 db
▪ Diffraction loss	1.8 db
▪ Strut blockage loss	2.4 db
▪ All others	1 db

These figures represent changes in the gain-tem-

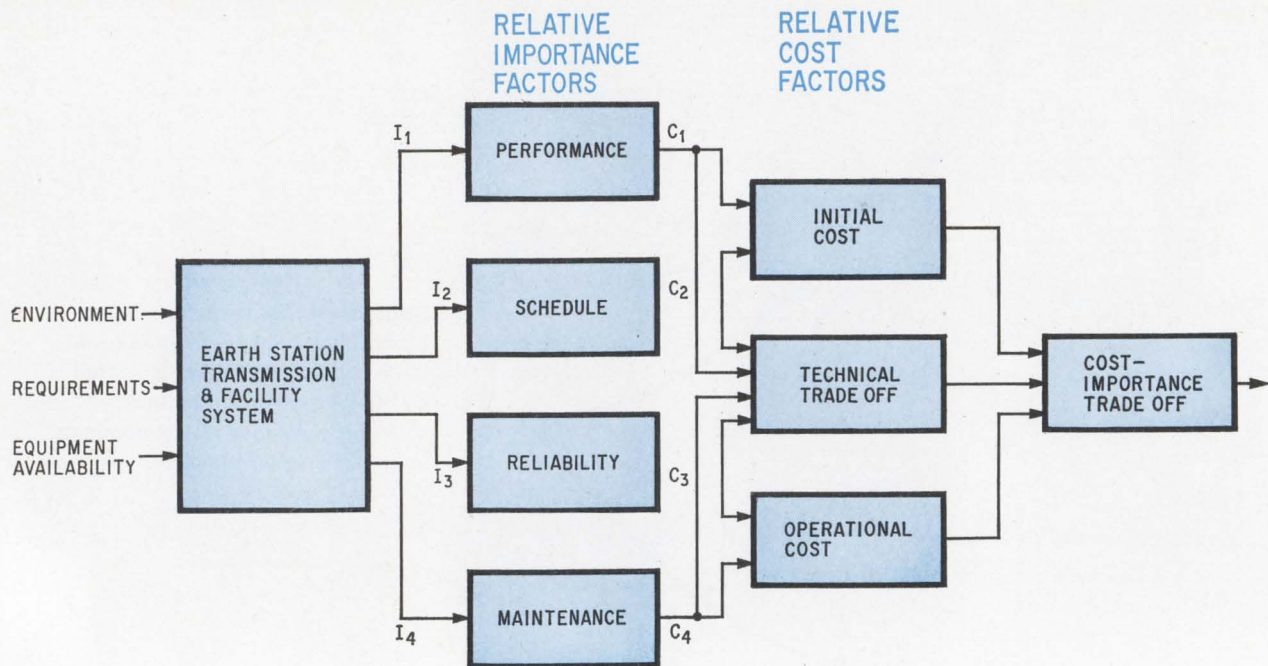

Money talks. System optimization diagram shows relationships between performance, schedule, operational factors and cost. Ultimate test of system engineer's judgment in making these tradeoffs is whether or not his efforts paid off in a contract award

perature ratio achieved by corresponding changes in the tabulated parameters. An improvement of 0.1 db in dissipative loss, for example, improve the G/T by 0.5 db. From the table it can be seen that the best performance payoff can be achieved by improving dissipative loss, strut blockage, spill-over, and diffraction in that order, while little improvement can be derived from refining other parameters.

Receiver location

The high-sensitivity coefficient of strut blockage offers an excellent tradeoff opportunity. Traditionally, the subreflector supports have always been considered part of the mechanical design rather than part of the radio-frequency geometry. However, the G/T program for various strut angles shows a significant effect on antenna gain. The plot seen on page 125 illustrates the loss in gain due to spherical and plane wave components. A region clearly exists where spherical wave losses decrease much more rapidly than plane wave losses increase, indicating that struts placed at large angles relative to the antenna r-f axis are desirable. While it is difficult to pinpoint the condition for minimum loss on the total blockage curve, the plot indicates that strut angles of 45° or more will keep the loss to within 0.1 db of the minimum loss case. The minimum loss takes place when the struts are extended to the rim of the main reflector—a design that is difficult to achieve mechanically in large earth-station antennas.

Still another design tradeoff is required in the

location of the cryogenic receiver. Because receivers of this type require periodic maintenance, they must be readily accessible. The ideal location for the receiver is behind the main reflector. The antenna's r-f geometry is normally determined by matching the radiation characteristics of the source feed with the appropriate subreflector diameter and feed location. A standard rule of thumb is to have the subreflector's diameter about 10% that of the main dish. In practice, the source feed usually gets placed well in front of the main reflector. The designer then has the choice of connecting the source feed to the cryogenic receiver by a length of transmission line or he can move the receiver closer to the source feed, which is impractical from a maintenance standpoint. However, if he fixes the receiver behind the main dish, the designer obtains an additional engineering tradeoff.

Since earth-station contracts are subject to heavy competition, the penalty for over-design is severe. The diagram shown above represents a traditional system optimization flow. It is also structured to reflect cost considerations. The usual systems criteria—performance, schedule, reliability, and maintenance—are weighted by relative importance factors and systems tradeoffs. Cost is still the major consideration in design modification. Initial cost is determined by the performance specs and development scheduling, while operational cost is determined almost entirely by reliability and maintenance considerations. The final tradeoff, cost effectiveness, is subject to the all-important test: can it produce a contract award? ■

Signetics Corporation / 811 E. Arques Ave., Sunnyvale, Calif. 94086 / A subsidiary of Corning Glass Works

More complex magic from Signetics MSI

All three logic diagrams fail to show you what's *really* important about our new DCL arrays. Things like increased system performance. Logic flexibility. Can count savings. And look what else they don't show... 1. **8230/8232 Digital Multiplexer**: three-to-one can count reduction; address-to-output time, 22 ns typically. 2. **8266 Digital Multiplexer**: three-to-one can count reduction; address-to-output time—18 ns typical—provides conditional complement function. 3. **8241/8242 Digital Comparator**: four-to-one can count reduction; high speed TPD = 10 ns typical—8241; TPD = 18 ns typical—8242; 8242 expandable for word comparison up to 100 bits in length.

One final goof: the diagrams take up so much space, we can't show you 11 other MSI's available right now, today, from Signetics. So stop reading this magazine upside down, drop us a line, and we'll rush you all the specs!

ANSWER:

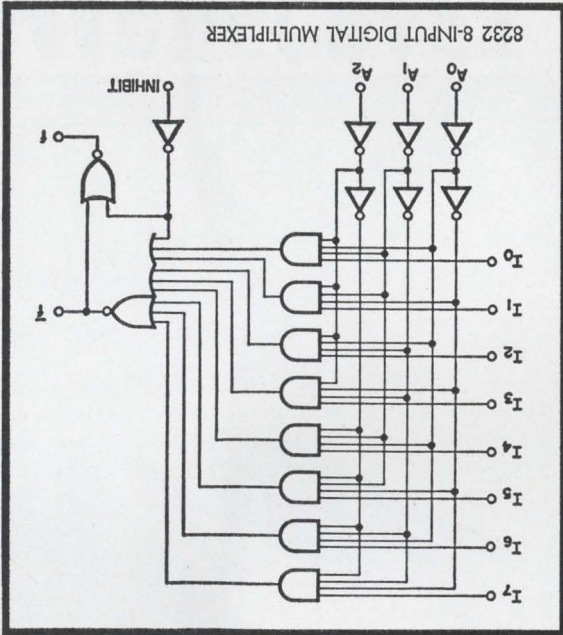
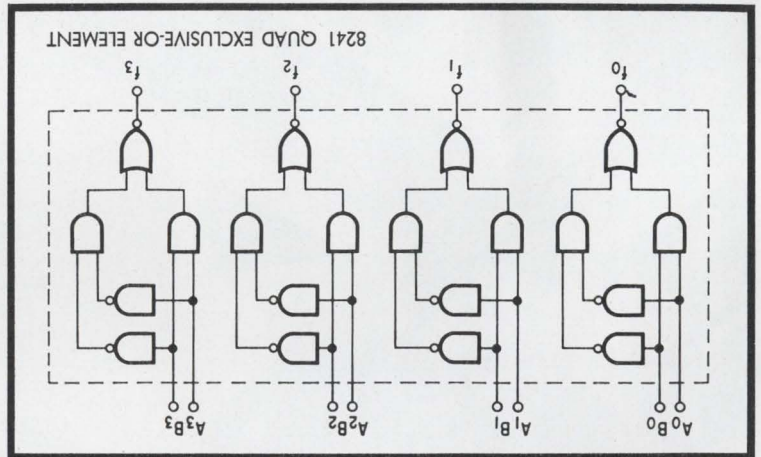
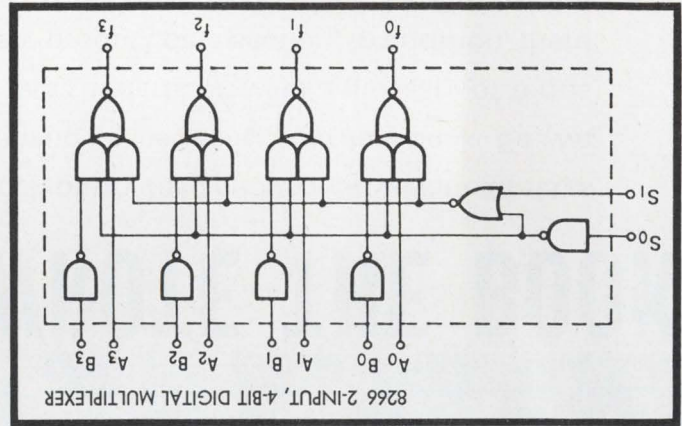

Shown below: three new DCL arrays from Signetics, the leader in MSI devices. Study them carefully to see if you can spot what's missing!

What's wrong with these diagrams?

“WHEN IT COMES TO REED RELAYS,

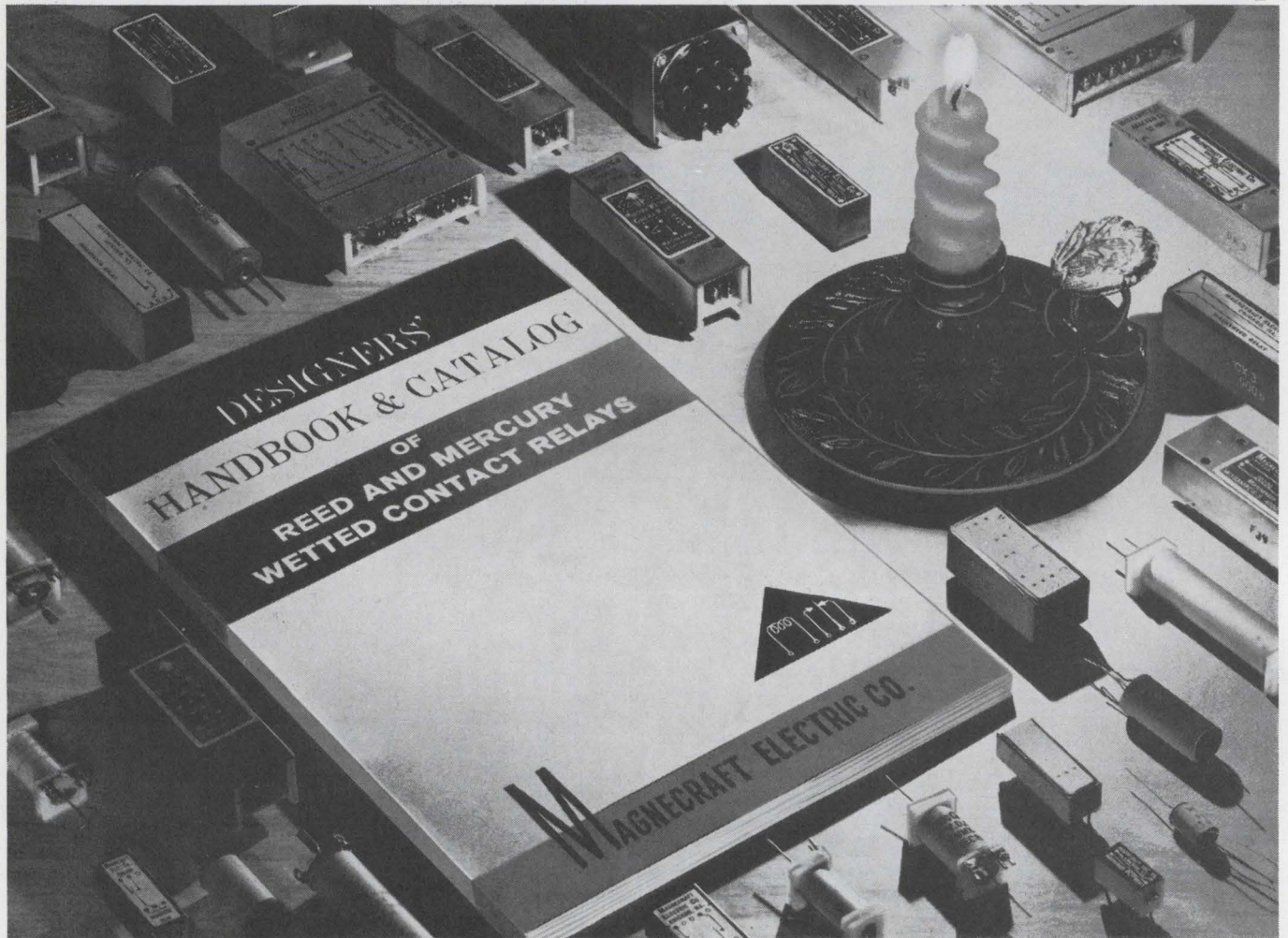

MAGNECRAFT WROTE THE BOOK”!

After developing the largest stock of dry reed and mercury-wetted relays on the market today, we had enough experience to write a book. So, we did! An 80-page handbook, in fact. It starts off with a glossary of terms and carries through to a complete product data section. In addition, there is information on applications and design considerations, how to specify relays, principles of operation and testing procedures.

Free copies are available to qualified circuit designers, engineers and others involved in the electrical or electronic fields. Write for yours. We may never win a Nobel Prize for literature, but if they ever offer one for advancements in reed relay development — well, that's another story.

Manufacturing Stock Relays for Custom Applications

Magnecraft[®] ELECTRIC CO.

5575 NORTH LYNCH AVENUE • CHICAGO, ILLINOIS 60630 • 312 • 282-5500



For half a century, ultrasound was regarded as a curiosity—an obscure principle employed by moths in flight. Then Branson happened. A generation of research and discovery was under way.

Today Branson Ultrasonic Cleaning incorporates every discovery we've made since the early days. Our cleaners are more efficient for the lead zirconate transducer we

pioneered. More useful because our new solid-state Powerpack generator can power an entire series of tanks, automatically adjusting frequency to a different load in each. More versatile thanks to the wide range of models, from small standard and custom units to large systems.

But perhaps you're still just a little bit up in the air about what ultrasonics

can, or cannot do for you. If that's the case, see Branson. We've had time to get our feet on the ground.

Branson Instruments Co., a subsidiary of Smith Kline & French Laboratories, Progress Drive, Stamford, Connecticut 06904

BRANSON

For sound ideas in cleaning, testing and measuring

The silent world of working sound.

Bendix Autosyn 08 Synchros.

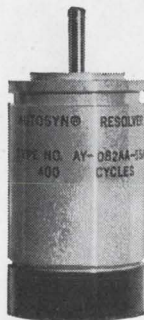

For weight-conscious engineers.

The average weight of Bendix® size 08 Autosyn® synchros is only 1.3 ounces. And their maximum diameter is 0.750". That's a great combination for trimming down servo systems.

There are 16 standard 08 units to choose from. Some are radiation-resistant. Some will perform accurately at sustained temperatures up to 800°F. All have flexible 12" leads, corrosion-resistant construction and aluminum housings.

Stainless-steel housings are avail-

able too. So are hundreds of other Autosyn types in 10, 11, 15 and 22 sizes. As well as Mil-Spec synchros up to size 37. You're almost certain

From Catalog 25	Function	Voltage	Max. Error
AY080AA-40-A1	Transmitter	26/11.8	7'
AY080AA-42-A1	Receiver	26/11.8	—
AY080AA-36-A1	Control Transformer	11.8/22.5	7'
AY083AA-43-A1	Control Differential	11.8/11.8	7'
AY082AA-53-A1	Resolver	26/11.8	7'

to find exactly what you need. And if you don't, we can design one for you. We've been doing it for 40 years. No wonder so many engineers rely on Bendix synchros for performance and dependability. And why you find them in the 747, C-5A and F-111, to name a few. There's no better value anywhere. Ask for our catalog and see for yourself. The Bendix Corporation, Flight & Engine Instruments Division, Montrose, Pennsylvania. Phone: (717) 278-1161.



**Aerospace
Products**

Clairex standard photocells meet 98% of all requirements...

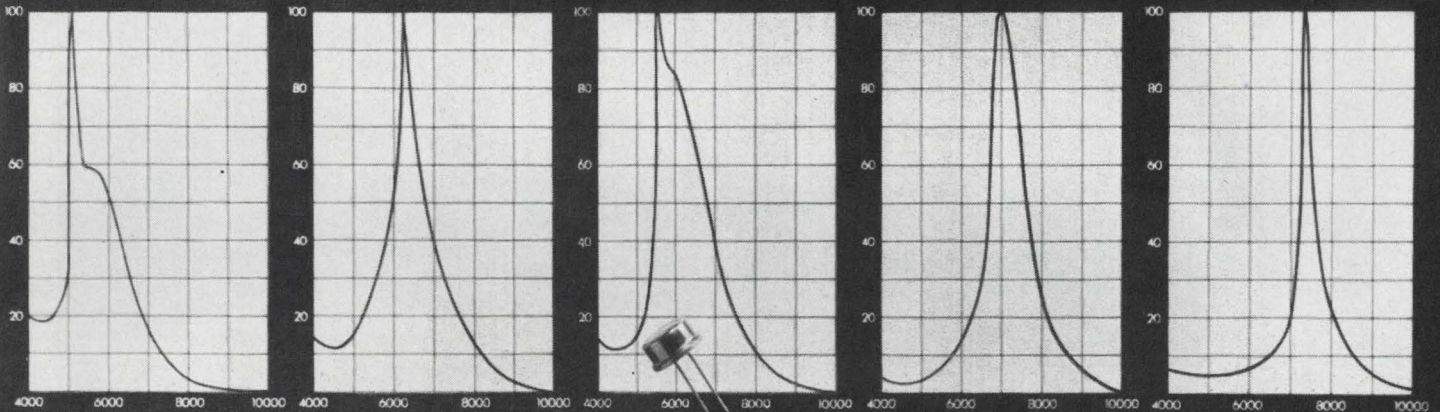

**but if you really
need a special...
we'll design it for you.**

Clairex has the widest line of standard cells available. Light control has been our business since 1953.

For complete information on our stock photocells or for special assistance with your problems call (212) 684-5512 or write Clairex, 1239 Broadway, New York, N. Y. 10001.

CLAIREX ELECTRONICS, INC.

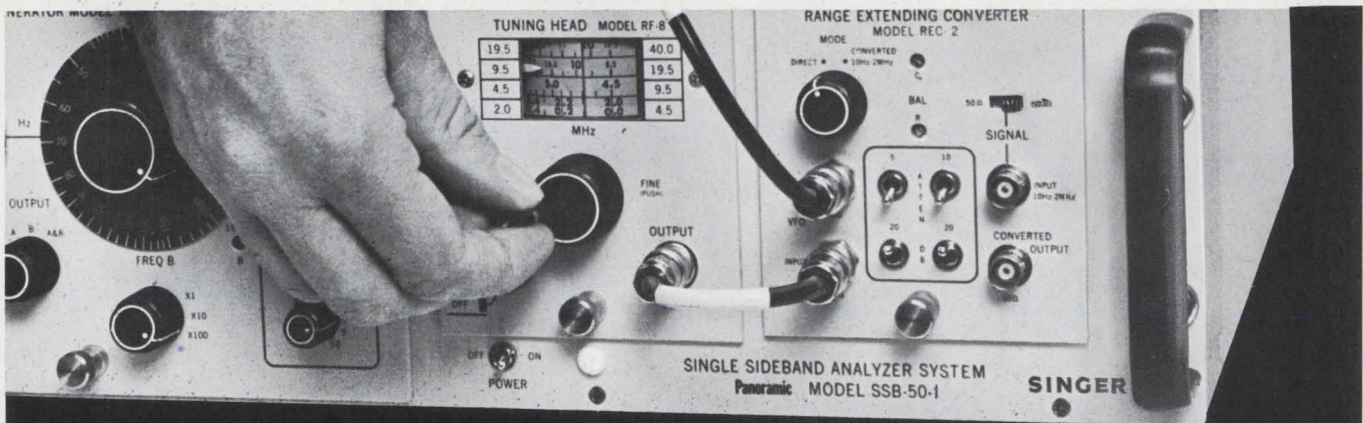

Monitoring tone level in a multiplexed communications system is easy ... with a Model SSB-50-1 Spectrum Analyzer

1. A high resolution spectrum analyzer allows monitoring of any number of multiplexed channels without repetitive meter readings or painstaking adjustments. As a first operating step, the analyzer's accurately calibrated frequency dial is precisely tuned to the center frequency of the channel.

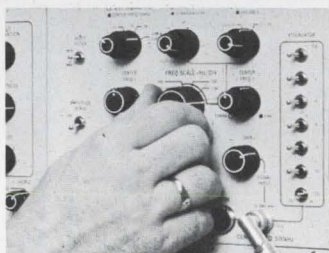

2. A selector knob sets the frequency scale in one of five settings from 15 Hz/division to 1.4 kHz/division. Interlocked circuit functions in the analyzer automatically optimize the display for any setting of the frequency scale.

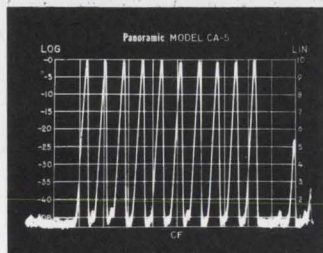

3. The high resolution of the Singer Model SSB-50-1 provides this clear display of the multiplexed channel. The amplitude of each subcarrier is shown as a function of frequency. The display demonstrates complete operational readiness at a glance.

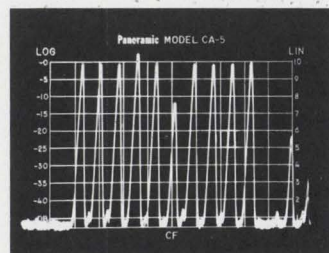

Subcarrier level changes
Often a subcarrier level changes with a resulting communications malfunction. This display on the CRT shows that one subcarrier's level is down 12 dB. Another is over the predetermined acceptable level.

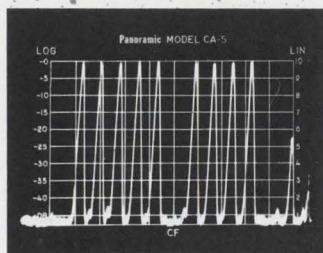

Lost channel
Because the entire spectrum is continuously visible on the display, a lost channel shows up instantly ... A frequency range of 10 Hz to 40 MHz makes the Model SSB-50-1 an invaluable tool for this application and for general laboratory or field use.

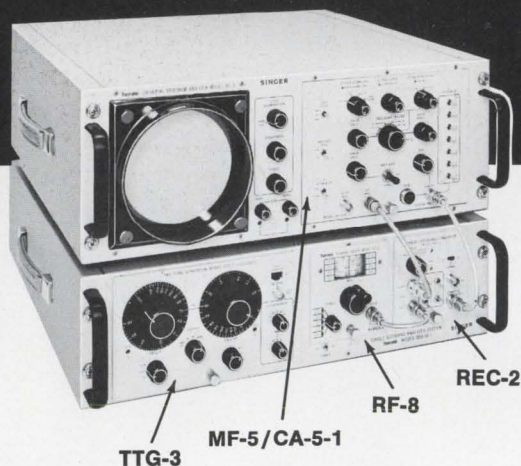

Model MF-5/CA-5-1
Spectrum Analyzer display section
features high resolution/low distortion and 70 dB dynamic range.

Model TTG-3 Two-Tone Audio Generator
20-20,000 Hz frequency range and IM distortion of less than 70 dB for testing single sideband transmitters.

Model REC-2 Range Extending Converter
extends the tuning range down to 10 Hz.

Model RF-8 Tuning Head
is a highly stable LO with coarse and vernier two speed tuning from 2 MHz to 40 MHz ... usable to 200 MHz.

For additional technical information, or for Singer's new Application/Data Bulletin SA-10, contact your nearest Singer Field Representative or write directly to The Singer Company, Instrumentation Division, 915 Pembroke Street, Bridgeport, Conn. 06608.

SINGER

INSTRUMENTATION

Beneath this calm exterior lurks... Supertetrode!

Eimac's sensational new water cooled 50 and 100 kW tetrodes are the world's finest for high power applications. They're ideal for transmitters in HF, FM and broadcast bands, for over-the-horizon radar, distributed amplifiers, high energy physics and high power voltage regulation.

Both tetrodes feature transconductance double anything even we've been able to offer. They have greatly reduced cathode lead inductance and a unique re-entrant anode, permitting a shorter stem and lower input capacitance. Feedback capacitance also is much lower, simplifying tube neutralization and eliminating

any need for a neutralization circuit. In both tubes the screen base is designed to serve as an electrostatic shield.

These tubes have 4 to 5 dB higher gain than comparable tetrodes, yet are very compact. The 4CW50,000E (50 kW model) weighs only 35 pounds. It has 310 pF input capacitance, 52 pF C_{out} and 0.6 pF feedback capacitance. The 4CW100,000E weighs 50 pounds, has 349 pF C_{in} , 60 pF C_{out} and 0.8 pF C_f . For data and application assistance contact your nearest Varian/Eimac distributor or ask Information Operator for Varian Electron Tube and Device Group.



Only one man in a thousand needs this kind of flexibility in a phase angle voltmeter...

(the other 999 breathe easier knowing it's there.)

One to four-frequency operation with $\pm 5\%$ bandwidth. Plug-in modules enable frequency additions or change in the field without recalibration.

Direct readout of total voltage (fundamental plus harmonics); fundamental voltage; in-phase voltage; and quadrature voltage.

Tolerates up to 10x full scale overload without slightest loss of voltage or phase angle accuracy.

Direct readout of phase angle.

Measures from $300 \mu\text{V}$ to 300V in 13 ranges with $\pm 2\%$ FS accuracy, $< 1 \mu\text{V}$ nulling sensitivity.

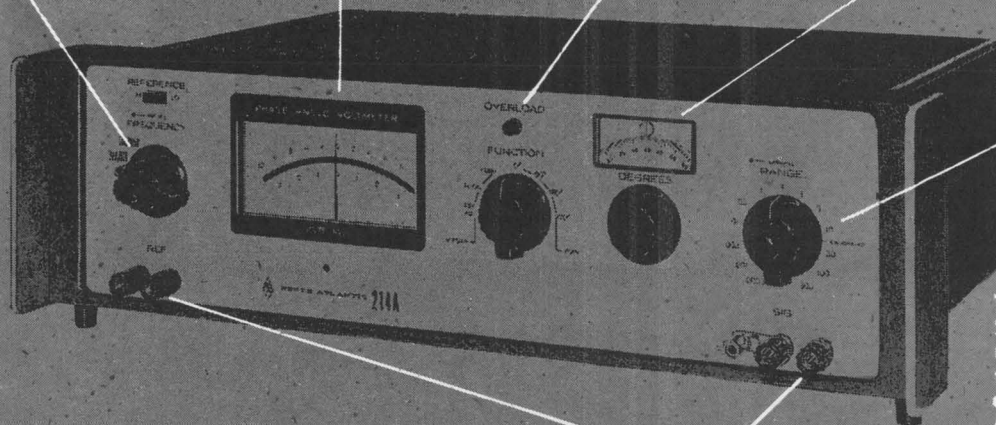

Options of isolated reference and isolated signal inputs.

The North Atlantic Model 214A Phase Angle Voltmeter (shown with optional bench trim kit) is another example of North Atlantic Industries' leadership in versatile and elegant phase sensitive instrumentation and controls.

For additional rewarding details, call a field-engineering representative (see EEM) or call or write North Atlantic Industries, Inc., Terminal Drive, Plainview, Long Island, N.Y. 11803. (516) 681-8600.

 **NORTH ATLANTIC**
industries, inc.

Class Mates

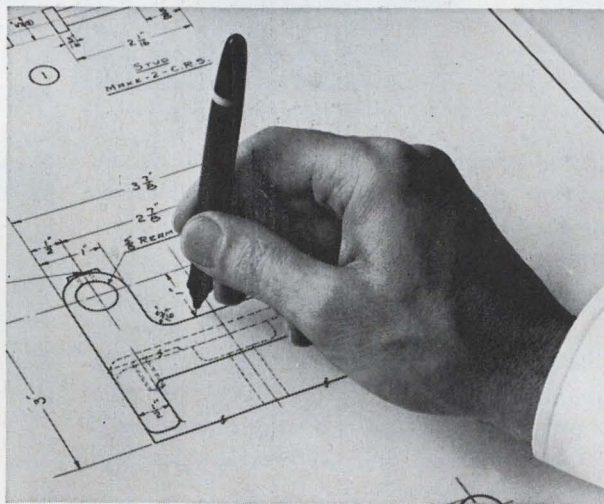

With KODAGRAPH ESTAR Base Films and jewel-tipped pens, you save time and find drafting easier and more efficient.

Use a jewel-tipped pen on KODAGRAPH ESTAR Base Films and you'll discover how easy drafting has become these days. And why so many firms have discarded the familiar pencils and steel-tipped pens in favor of this breakthrough combination.

It's the combination that saves you creative drafting time. Lots of it.

KODAGRAPH ESTAR Base Films make things easy in the drafting room. Photographic line erasure is a

breeze. You get top dimensional stability, sharp blacks. You can reclaim tired drawings in short order, make beautiful second originals, end retracing.

Though Kodak doesn't make jewel-tipped pens, we cite them as a smart investment. They outlast pencils and even standard pens a hundred times over. The longer wear and increased production pay for their initial cost very quickly.

Try these classmates. Contact your Kodak Technical Sales Representative for many other shortcuts possible with KODAGRAPH ESTAR Base Films. Or write us: Eastman Kodak Company, Business Systems Markets Division, Rochester, New York 14650.

Kodak

DRAWING REPRODUCTION SYSTEMS BY KODAK

A word in the hand

or: 20 ways Components, Inc. helps Motorola keep its Handie-Talkie radios handy—and talking

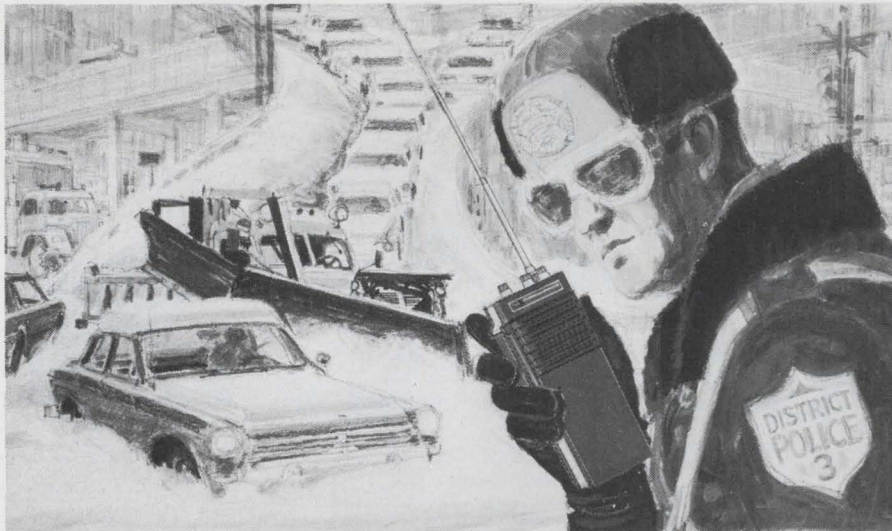

Motorola's new HT-220 Handie-Talkie radio in emergency use. C.I. capacitors helped make it 40% smaller than the previous model.

In emergencies . . . on construction sites . . . in law enforcement . . . on the job in scores of situations calling for dependable 2-way communications, you'll find Motorola's well-known Handie-Talkie personal radios.

How were Motorola engineers able to squeeze so much talking power into a package 40% smaller than their previous model?

Sophisticated design . . . plus 20 microminiature Minitan® capacitors from Components, Inc.

These tiny solid tantalums, literally the world's smallest electrolytic capacitors, were selected because they offer excellent performance, minimum leakage, and the highest possible reliability up to 125°C. They are available in modular and cordwood styles, with

wire or ribbon leads. A complete line of non-polar Minitans® is offered in standard EIA values as well.

Whenever you want to pack a lot of performance into the smallest possible space, call C.I. for your capacitors. We offer more microminiature case styles and ratings than anyone in the business. (Also check us for our complete lines of CS13's, CSR13's, and dipped epoxy products.) We welcome requests for samples, for application assistance, and of course for performance and reliability data. Standard prototypes are normally shipped within 24 hours. Write or call, and tell us what you need.

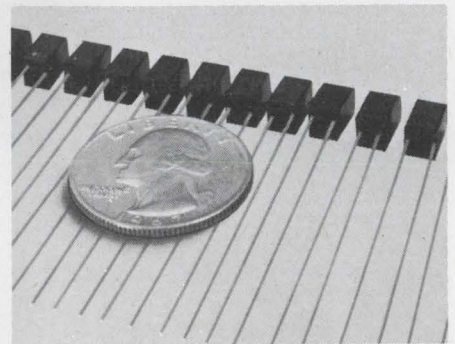

MINITAN MODULAR

(Also available with axial leads)

	U
	F
	M
	L
	S
	J

.47 MFD @ 35 VDC to 220 MFD @ 3 VDC
(Cordwood Series available from .01 MFD @ 50 VDC)

(ACTUAL SIZE)

MINITAN CORDWOOD

Y	
P	
B	
A	
G	

.01 MFD @ 50 VDC to 47 MFD @ 3 VDC
(Modular Series available to 220 MFD)

(ACTUAL SIZE)

 **COMPONENTS, INC.**
CAPACITOR PRODUCTS
BIDDEFORD, MAINE 04005 - TEL: (207) 284-5956 - TWX: 710-229-1559

If the communications system
doesn't track after the big move,
you know who's going to hear about it.

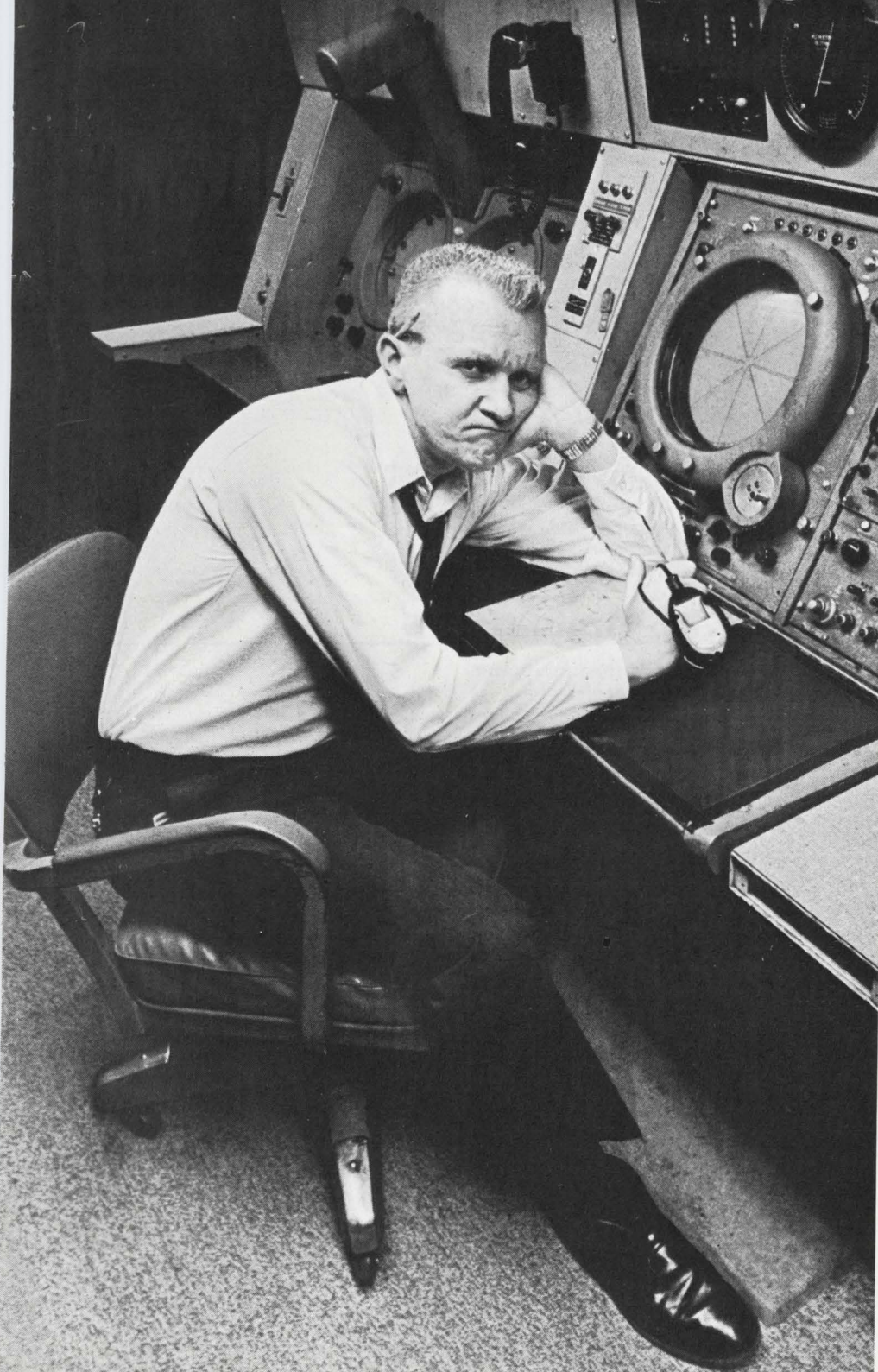

You might receive a few communications that would be banned in Boston (or anywhere else) if the sensitive electronic components go on the blink.

So maybe you'd better communicate with a highly-professional mover who knows how to do the job—Allied Van Lines.

Our Electronic Vans are just as good as our personnel. They have a special bracing that keeps your equipment from slipping . . . an air suspension system that soaks up jolts and bumps along the way.

Call the highly-trained Allied Agent in your area.



ALLIED VAN LINES®

**We make the kind of moves
you never hear about**

United Aircraft

produces... stocks... sells

semiconductor dice

Some call 'em "chips," some call 'em "dice," and others call 'em "wafers"—but if you make hybrid circuits... or communications and microwave equipment... we've got the semiconductor devices to fit most of your needs. For example:

Hybrid Applications

Small signal transistors, P-N diodes, N-P diodes, zener diodes, switching diodes, tantalum nitride resistor networks, silicon dioxide capacitors, TTL integrated circuits. And for...

Microwave Applications

High frequency, medium-power and high-power devices for communication and microwave stripline substrates.

In addition, we'll be happy to provide schedules and methods for the bonding, proper care and handling of these devices.

And we're ready to give you excellent service and fast delivery on any quantity—from a few devices to several million a month!

Contact us for full details.

Electronic Components DIVISION OF **United Aircraft**

TREVOSE, PENNSYLVANIA Tel. 215-355-5000 TWX: 510-667-1717
West Coast Office: 128 E. Katella Ave., Orange, Calif. (714) 639-4030

DESIGNERS AND PRODUCERS OF • RF AND MICROWAVE TRANSISTORS • SEMICONDUCTOR DICE
• CUSTOM HYBRID CIRCUITS • MONOLITHIC INTEGRATED CIRCUITS



product report
curve tracer

New Type 576 Curve Tracer

Advanced Measurement Features for Semiconductor Testing

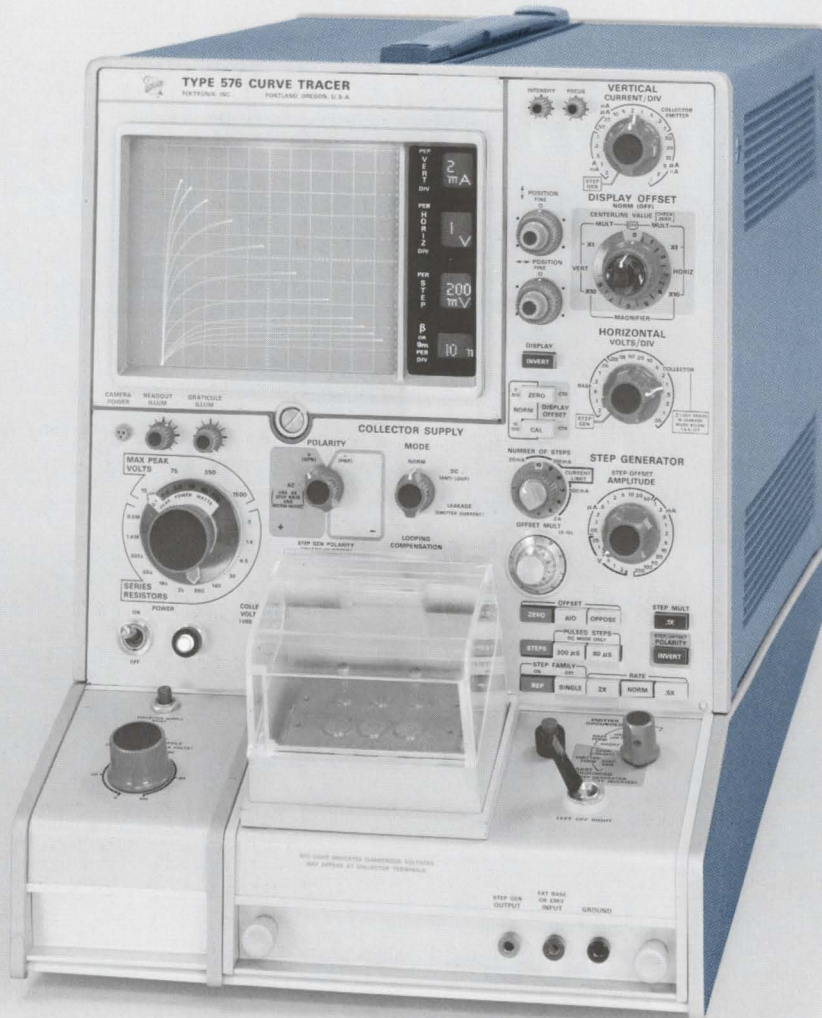

Expanded Viewing Area—combines a 10 cm x 12 cm graticule with fiber-optic readout of scale factors, step amplitude, and Beta/div or gm/div

Swept or DC Collector Supply to 1500 V

Leakage Measurements to 1 nA/div

Multi-function Switching—direct-reading power limits, polarity tracking, auto positioning, mode changes

Calibrated Display Offset—improved accuracy ($\pm 2\%$), increased resolution

Step Generator Range to 2 A or 40 V

Calibrated Step Offset—aid or oppose

Pulsed Base Operation

Kelvin Sensing for high-current tests

Interlock Operator Protection

Provision for Future Expansion

please turn page for additional information

Making the Measurement . . . with the unique performance features of the Tektronix Type 576 Curve Tracer

EXPANDED VIEWING AREA—The large display area (10 cm x 10 cm, 12 cm usable horizontal), internal illuminated graticule, and bright trace bear directly on viewing ease, resolution, and readability.

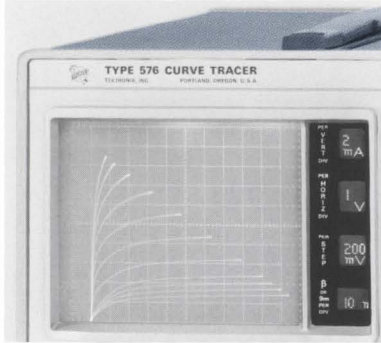

Scale-factor readout effectively labels the display parameters near the CRT for convenient reference during setup and testing. The simple, but bothersome, correction for magnifiers or multipliers is computed and displayed, as is the often used value of Beta/div or g_m /div. Calibration data recording during photography is a prime convenience factor.

SETUP VERSATILITY FOR DIODES, TRANSISTORS, AND FET's—Multi-function switching makes test set-up faster and more understandable. By combining and pre-programming compatible functions, a single switch movement can select several normally-used conditions.

Examples:

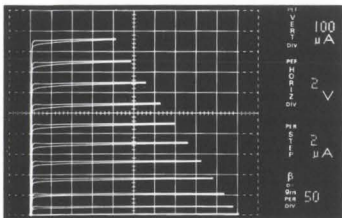

Other than the normal display functions, the NPN transistor waveform (above) required selection of collector range and percent, power limit, polarity and step amplitude. Step generator polarity and positioning is combined with the polarity switch; series resistance is determined by the voltage range and power limit switch.

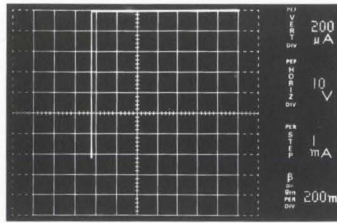

This Zener diode display required settings for collector volts, power limit, and polarity. The negative polarity selection positioned the trace-start to the upper right-hand corner. If desired, the display could be inverted with a single pushbutton. The Zener voltage at 1 mA is 72 V, accurate within 3%.

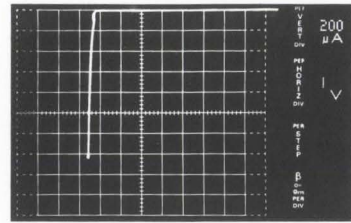

The display above is the same 72 V Zener diode test previously discussed except the display offset and magnifier are used to improve resolution and accuracy. The centerline value is now 70 V but the horizontal deflection factor is 1 V/div. The Zener voltage can now be resolved as 72.6 V within 2%, a X10 increase in resolution and improvement from 3% in absolute accuracy.

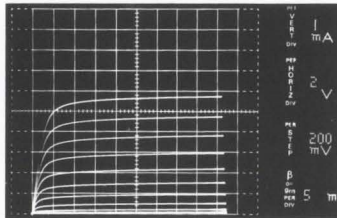

This MOSFET drain family test set-up is the same as for transistors except the step polarity was inverted for operation in the depletion region. The DC step offset could be used to view both enhancement and depletion characteristics by positioning the step-start below the zero bias level.

The calibrated DC STEP OFFSET allows the steps to start on a DC plateau up to X10 the step amplitude setting. It can either AID or OPPOSE the step polarity within the maximum current or voltage limitations of the generator, a control feature which is important to certain tests. One example is the enhancement-depletion FET display previously mentioned.

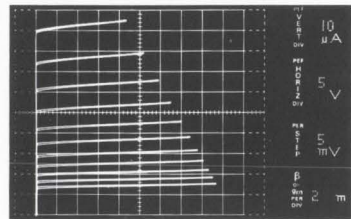

The display above shows a transistor test with voltage drive to the base. The DC STEP OFFSET permits positioning of the small voltage steps within the active region of the transistor base.

RESOLUTION AND CONTROL is enhanced in the Type 576 by the concept of calibrated offset. The DISPLAY OFFSET is a precision positioning control and X10 magnifier which calibrates the graticule centerline value and expands the effective measurement axis to 100 cm rather than 10 cm.

ADAPTABILITY—Connecting the many types of semiconductors to the instrument requires a wide range of adapters. A new line of adapters has been designed for the Type 576 which includes a universal unit for single and bipolar FET's and transistors, guiding long-lead adapters for untrimmed units, high-current adapters with KELVIN sensing, and clip or magnetic axial-lead diode holders.

Your Tektronix Field Engineer will conduct a comprehensive demonstration of the Type 576 on request.

For additional information, contact your local Tektronix Field Office, circle the Reader Service Number, or write Tektronix, Inc., P. O. Box 500, Beaverton, Oregon 97005.

TYPE 576 CURVE TRACER \$2125
U.S. Sales Price FOB Beaverton, Oregon

Measurement Concepts

SEMICONDUCTOR DEVICE MEASUREMENTS

This new concepts book is available through Tektronix Field Offices.

Tektronix, Inc.

committed to progress in waveform measurement

TEKTRONIX PRODUCT REPORT-CURVE TRACER

Viatron—vibrant and probably viable

Brash newcomer's plans for low-priced microprocessor systems shake up suppliers; but what looked like long-shot bets on MOS-LSI technology could be close to a payoff

By James Brinton

Associate editor

Thirty-nine dollars isn't much to pay for the use of a computer; in fact it's little enough to make a lot of people suspicious. But that's the minimum monthly rental Viatron Computer Systems Inc.—a firm that has yet to celebrate its second birthday—announced last fall for its microprogramed System 21 machines. The prospect of bargain-basement pricing policies, along with the company's decision to build its desk-top data-management equipment with giant MOS arrays to keep costs down, has set rumor-mongers' tongues to wagging.

Among the juicier items now making the rounds: There's the possibility of a fiasco like the one that occurred when Victor Comptometer's highly touted electronic calculator failed to get to market because Philco-Ford couldn't come up with the MOS devices [*Electronics*, March 6, 1967, p. 231]. . . . Viatron won't be able to afford, or find, the MOS it needs. . . . The rental figures are a come-on and will rise soon after the first units are delivered. . . . The company's revenues from rentals will be too low to pay overhead. . . . The prototype machines road-showed at several recent industry get-togethers, notably the Spring Joint Computer Conference, are those Viatron plans to produce—but for rental well above the \$39 level.

Viatron's president and board chairman, Edward M. Bennett is undismayed by such reports. "MOS and mechanical parts development for our microprocessors is either on or ahead of schedule," he asserts. "We'll make our announced late-1969 deliveries [*Electronics*, Sept. 30, 1968, p. 48 and April 28,

p. 33], and expect to have about 100 machines operating before the first of the year. By mid-1970 monthly production will have reached 5,000 to 6,000 machines monthly. And by 1972, we plan to have delivered more digital machines than have previously been installed by all computer makers."

Laurence C. Drew, Viatron's manager of development engineering, says: "Some people have been misled by the large number of development contracts. We have 40 to 50 going now and will soon have nearly 70 large-scale integration development programs at various companies. Certain parties believed that we were trying to rescue a bad design or that our machines would use an impossibly large number of circuits. In fact, neither guess is correct; these contracts cover parts for machines other than the System 21 components already announced—peripherals and related gear. In addition, there's some parallel development work on critical circuits which will compete for the same applications." Bennett adds that costs to date are in line with predictions; it might even be possible, after volume production begins, to lower rental costs slightly, he says.

Countdown. But a question still arises as to exactly how many chips go into a System 21 processor. Using the \$39 machines as an example, Bennett and Drew quote a figure of 40 large chips. They believe that while this is a lot of LSI, it's "not the impossibly large number that's been suggested."

"Out of that 40, about 30 circuit types are different; 21 are individually unique random-control logic units," says Drew. "Nine are read-



Tight-fisted. Laurence C. Drew, chief of Viatron's development engineering, bargains hard with MOS-LSI suppliers.

only memories, but only the metalization patterns differ among four basic layouts."

Development of these circuits is under way at eight semiconductor houses. Says Drew: "Work on processor MOS is centered at American Microelectronics; display control logic is being developed at Texas Instruments, General Instrument, and Ragan Semiconductor; main memory MOS is in the works at TI, GI, Ragan, Motorola, and

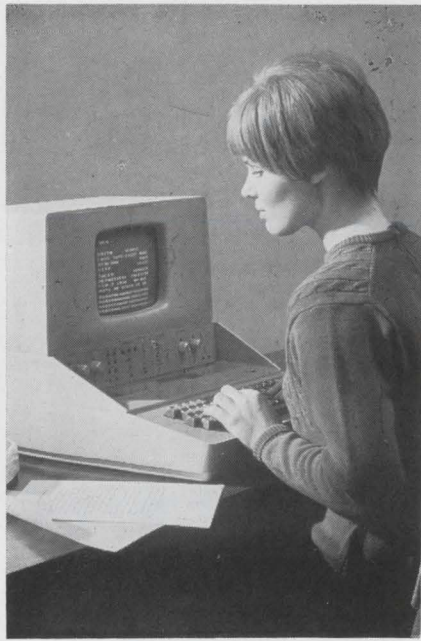

Who needs it

Viatron's System 21 is a set of electronic data processing wares—processors, displays, keyboards, and the like—that can be assembled as desktop microprocessors, interconnected networks, or “intelligent” terminals for large computer input-output applications [*Electronics*, Oct. 14, 1968, p. 193]. The processors are preprogrammed, storing “microinstructions” in read-only memories holding up to 1,024, 12-bit words. Several basic instruction sets handle business operations as diverse as payroll entry and executive information retrieval.

Since the software is hardwired into the computer, the usual costly covey of programmers and systems analysts aren't needed to get a System 21 lash-up operating. In addition, the machines are designed to eliminate business waste. For example, firms today may have clerks rewriting reports from third parties, forwarding them to keypunch operators, who in turn punch cards, which become computer fodder. “We want to do away with error-adding extra steps in data management,” says Joseph Spiegel, Viatron's operations vice president. “The man originating or using the data should have the edp gear.”

Viatron calls this, “distributed data processing.” It would amount to real-time inventory control as, say, a stockroom clerk punches out an order on his System 21 console or an executive checks next year's sales predictions at his desk by punching a short code. Such applications, among many others, have never been economical before.

Autonetics; the latter is also developing much of the control logic for the keyboard and tape sub-assemblies.”

Among the first scheduled peripherals are the so-called typing robot, which converts an IBM Selectric typewriter into a printout device, and a card reader/punch to automate keypunched input and output. MOS for both these units is being developed at Fairchild Semiconductor, and Hughes Aircraft is doing parallel work for the typing robot.

Many of the prototype MOS-LSI circuits have already been delivered and all should be in hand by the end of July, says Drew. At that time he figures on putting together the first two microprocessor systems; they probably won't be identical.

A penny saved . . .

Viatron, as a matter of policy, revises its designs whenever savings look possible. This process has already begun on the System 21's MOS components. “There are three separate MOS lines now, and there will be more. The 40-chip machine might be called a model-one type,” Drew says. “But models two and three are being developed; Autonetics already has delivered some of the chips for model two, beating some of the model-one MOS into

our lab.” Mod one might never be delivered: If the price is right, the company will probably jump immediately to the second design.

“Some of the model-two designs were suggested by semiconductor manufacturers; they said they could do a job more cheaply or on smaller chips,” notes Drew. “But many, if not most, are coming out of our own MOS design group. We've found that while the computer-aided design techniques used by our suppliers are fast, they waste

chip area. We pay for LSI on the basis of real estate. Thus, as we get each new design from our developers we begin to sweat down the size and up the packing density. We've been able to cut chip areas greatly; and often we've put two designs on a single chip by doing our own composites. Both moves cut costs.”

Viatron can afford to continue product improvement as long as its machines are in the field. “With our (projected) volume, engineering

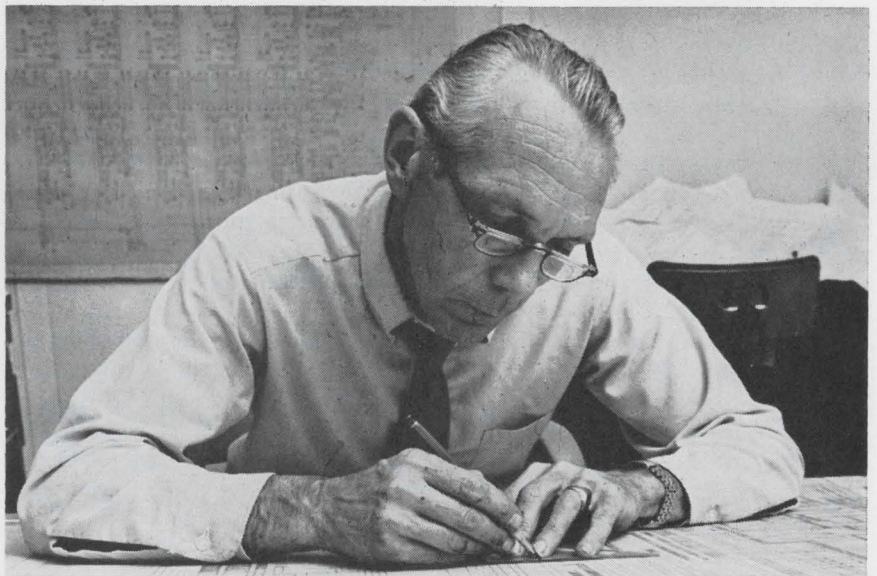

Rework. Charles McLean, a Viatron design engineer, lays out composite for an MOS-LSI array; tightening suppliers' versions saves real estate.

costs are only \$3 to \$4 per machine," says Bennett. He expects 20-year lifetimes, "based on one or two trips to the maintenance depot each year." It would be during these trips that redesigned—and probably less costly—circuit boards would be installed.

"By the end of that 20 year period, we aim to make the MOS something you will have to hunt for; we plan to squeeze LSI onto some pretty small chips," he says.

Tactic. This sort of interchangeability makes it possible for us to take advantage of each new drop in MOS prices, or of each breakthrough in any related technology almost as soon as it appears, according to Bennett. "It's one reason we plan only to rent our machines. By retaining the right to change boards we can force down our parts and maintenance costs and, hopefully, boost reliability. This last will lower depot inventories and ease cash flow."

This doesn't mean that parts costs won't be low to start with—they must be to reach \$39. As a result, Viatron's design engineers are continually aiming for the lowest components and production costs consistent with specifications. According to Joseph Spiegel, operations vice president, they're sometimes very aggressive about it. Drew offers a case in point; his MOS development efforts are slated to be a major source of the needed savings. He's doing things with—and to—the semiconductor industry that have never been tried before and not everybody appreciates his activities. Nonetheless, he says, only three firms have refused to do development with Viatron: RCA (because its complementary MOS capacity was needed for defense work), National Semiconductor (because it had only one MOS designer on board when approached and wanted him to concentrate on standard products), and Signetics (which, Drew says, didn't believe it could deliver what Viatron wanted and said so).

There are, however, other versions to some of these stories. One has it that RCA refused to work with Viatron out of pique—Drew was once among the company's ace MOS engineers. National is said to have been taken aback when Drew announced that he wanted to watch

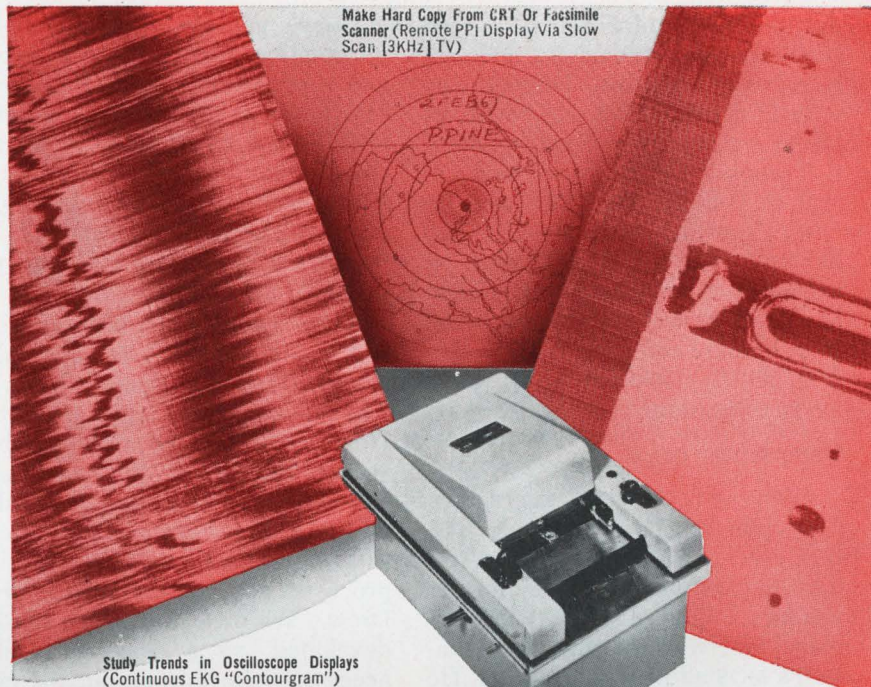

PATTERN, PLOT OR PICTURE

Now . . . with a simple instrument . . . you can reproduce electrical phenomena as permanent records in pattern, plot, or picture form where otherwise the data is presented as transient oscilloscope or CRT displays.

The versatile Alden "Flying-Spot" Helix Recorder, used with Alfax Type A electro-sensitive paper, produces permanent graphic images of repetitive or sequential signals with a wealth of detail and information content not approached by other display and recording techniques.

It is a simple matter to synchronize the Alden Recorder with scanning sensor or transducer (sonar, radar, ultrasonic, infra-red detectors, etc.) to provide a continuous "plot" of the information obtained. The recorder sweep speed (horizontal output) can be varied to provide almost any desired rate of presentation. Paper advance rates can readily be changed to provide time expansion or compression for increased detail, or clearer representation of long-term data trends and improved signal-to-noise ratio.

The Alden Recorder can be used with a broad variety of systems (computers, television, medical instrumentation, facsimile, scanning radiometers, etc.) which produce sequential signals on a constant time base, to provide accurate and instantly visible "picture" or "pattern" information. Images are produced with a dynamic, tonal shading directly proportional to signal strength, providing a "third dimension" of information recording.

To satisfy your exact requirements, Alden "Flying-Spot" Component Recorders, in various printing widths from 4" to 48", along with a wide selection of plug-in drives, recording configurations, signal amplifiers, phasing circuits, and synchronizing accessories are available, designed to provide a simple, economical adaptation of Alden instant recording techniques to your instrumentation.

For more information on the most versatile data recorders available, write today for complete details.

ALDEN

Dept. E 6

ELECTRONICS & IMPULSE RECORDING EQUIPMENT CO., INC., WASHINGTON STREET, WESTBORO, MASSACHUSETTS 01581 — TELEPHONE: (617) 366-8851

ALDEN ELECTRONICS & IMPULSE RECORDING EQUIPMENT CO., INC., WASHINGTON STREET, WESTBORO, MASSACHUSETTS 01581

GENTLEMEN: I am interested in Alden "Flying-Spot" recording techniques.

I would like to investigate Alden Equipment for use in the following application:

I would like data for possible future reference.

NAME _____ TITLE _____

COMPANY _____

ADDRESS _____

CITY _____ STATE _____ ZIP CODE _____

every single wafer probe—a yarn Drew more or less denies and National won't confirm. Negotiations with Philco-Ford, an outfit with an MOS reputation, never really got off the ground. Company sources say that they didn't like the way Viatron's contract was written and elected not to bid. Drew claims he wasn't particularly eager to do business anyway, one reason being that Philco-Ford was out of step with the industry's move to thick-oxide technology.

Comparison buyer

"Volume is the key," says Drew. "We plan to buy so much MOS that even a slim profit margin will mean a good deal of money for our vendors." Volume is also his primary tool for assuring that Viatron's MOS effort won't fall flat. He doesn't want to star in an encore of the Victor Comptometer flop.

Rumors persist that Drew has used his leverage to insist on delivery of unscribed wafers. However, he'll only admit to "asking for complete data on specified wafers within a specified number of runs—usually four runs and ten wafers per run." In Drew's lexicon, complete data involves knowing the full disposition of all wafers—even if they break, he wants either the parts themselves or pictures. Otherwise, he's content with packaged devices.

Given Viatron's considerable in-house MOS capability, such information gives Drew handles on his potential suppliers capabilities—from diffusion depth to yield, he says. The fact that he is succeeding in getting it may be an index of how eager industry is to climb on the bandwagon; but then again it may not be. A source at a large MOS producer says he doesn't mind giving Viatron yield, packaging, and cost data since the company can always use its own resources to find out anyway.

Sensitivity. Some vendors still seem offended: "I've walked into plants and asked for process thresholds on everything one of our suppliers made last month," says Drew. "When they told me it never had happened before, I told them they'd never been part of my system before—and that I certainly wasn't forcing them to do business with me."

"Drew's goal is simply to get the information needed to keep yields and quality high and prices low. "With our in-house resources, total visibility of each vendor's design and production will enable me to learn their tricks and rules right down to the ground. Eventually, I want to be more aware of hiccups in their lines than they are."

As each new circuit is developed, Viatron will make a set of masks which it can run through its own line, affording a back-up capability. However, there's no idea that this set-up will ever supply more than 10% of the company's needs. "Once I've got this escape hatch, I'll make masks adapted to the processes of each supplier," says Drew. "We own the art and masks developed, so a company won't necessarily be turning out the circuit it designed. We'll make decisions based on production rather than engineering ability. Whoever does the work will have masks tailored to their process—and with a contract that says so. This is the only way we could honestly ask companies to guarantee the MOS they build for us; we'd be fools to expect one firm to work with another's masks."

Safety in numbers. This ploy may lay to rest one criticism to the effect that Viatron's highly complex MOS increased the danger of being dependent upon a single source and possibly left in the lurch. Multisourcing, as it happens, is a keystone in the company's procurement policies. "To do business with us, a supplier knows it either has to have its own second source or be able to tell us where to find one." As a result, outfits like American Microelectronics are going so far as to form new subsidiaries to back up their own production. "Second-sourcing is particularly necessary for MOS," says Bennett, "But it's being applied across the board."

Noting the high current cost of risk capital, Bennett says that once Viatron is rolling, it will take a leaf from the auto makers' operations manual, bankrolling some of its subcontractors. A start may already have been made along these lines as Viatron develops captive capacities to make motors, power supplies, keyboards, and related equipment. It's probable these op-



Head man. Edward M. Bennett, president of Viatron, has confidence company will meet delivery dates.

erations will be spun off quickly—either as separate companies or subsidiaries.

After volume production begins, Drew plans on buying LSI at \$5 or less per packaged circuit. He's depending on the leverage created by monthly output of 5,000 to 6,000 processors. This works out to about 2.5 million chips a year—not counting what's used in peripheral equipment and other products. Drew figures to be characterizing, specifying, and negotiating for LSI from now through early September. "By then I'll be able to turn on the spigots and let the circuits run. This will give us three months to get deliveries, and the process lines should be waiting. I don't have any doubt that we'll be getting quantity production well before the end of the year," he says.

Timetable. Five system 21's are to be made from prototype components in October, 45' more in November, and 50 or so in December; the latter will use production MOS. In January the first units to be assembled under subcontract should be ready, and by mid-1970, monthly production should level at 5,000 to 6,000 machines, with Viatron building 1,000 itself.

A traditional problem for low-cost computer makers is peripheral equipment. Obviously, if a user has to rent gear costing several times the rate for the basic machine, the computer begins to look like a poor bargain. Viatron also has had its problems in this area. Spiegel tells of tape deck makers unable to meet Viatron's desired price—about \$1,000 for an item typically listing for almost \$4,000. "This part of the data processing industry goes first class, builds in frills, and sells relatively few machines a year," he says. "We bargained with several companies, and couldn't make enough headway. Finally, we developed our own IBM-compatible deck, which we'll produce for a lot less than \$1,000 each. Apparently, peripheral equipment makers are incapable of judging the cost leverage that high-volume production yields." Viatron's unit borrows freely from audio-deck design, using read-back checking, as well as some proprietary features to offset mechanical deficiencies.

The tape deck also represents some striking examples of Viatron's drive to cut costs. The motors, to be made by the company, cost only about \$4 each, against about \$50 for the nearest commercial equivalent. The motor was designed in less than three weeks by Richard Seeger, manager of machine design. Likewise, the system 21's keyboard has been subject to price paring. Originally, Honeywell's Microswitch division was the supplier. But Viatron found it could build its own photoelectric keyboards at a fraction of Honeywell's price. Even the plastic buttons and knobs used on the keyboard and control panel were scrutinized. Matthew F. Thompson, vice president for manufacturing operations, says he found keyboard buttons priced from 5 cents to 17 cents each. "But we figured out that the manufacturers' unit costs were less than a penny," he says. "Even bargaining hard, we were only able to get cost down to about 2.7 cents each. So, we're going to mold our own, having found we can sell to ourselves for about 2 cents."

Case study. Viatron's typing robot fits over the keyboard of an IBM Selectric and converts it to a

ELGENCO 610A NOISE GENERATOR \$1275

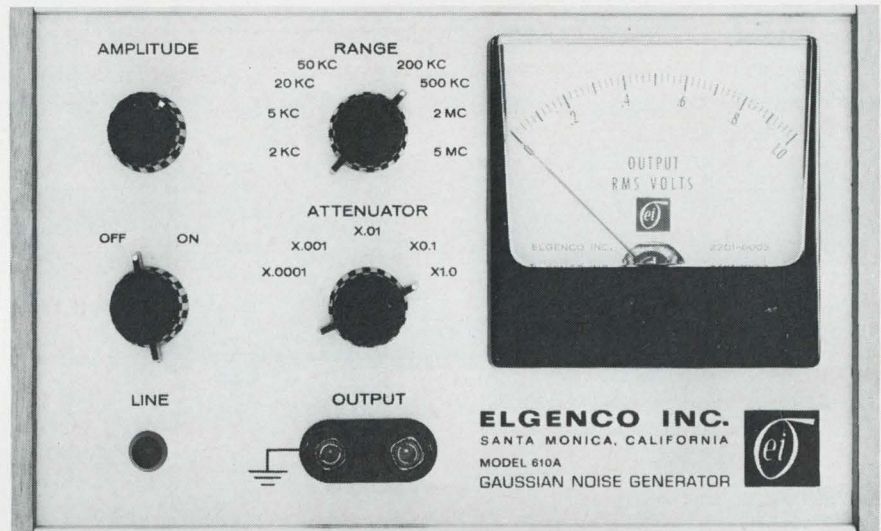

This 5 Hz to 2kHz/5 kHz/20 kHz/50 kHz/200 kHz/500 kHz/2 mHz/5 mHz Random Noise Generator is a precision instrument that has proven itself where lesser equipment is not adequate. All solid state and available from stock. Other Noise Generators covering the range of DC to 30 mHz and Demo Models are available. For name of nearest Sales Rep see EEM or contact Elgenco, Inc., 1550 Euclid, Santa Monica, Calif. 90404, Ph. 213-451-1635.

Circle 231 on reader service card

IC econalyzer!

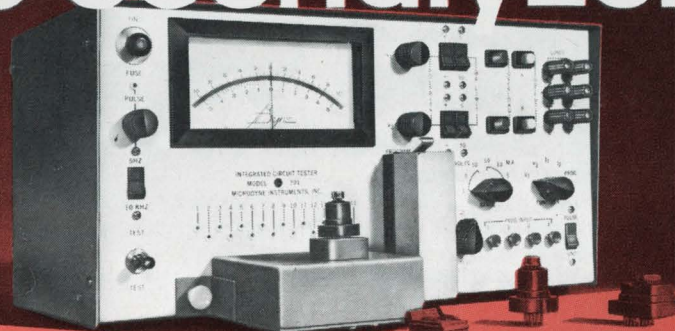

MICRODYNE'S \$675 IC TESTER FOR QUICK, ECONOMICAL DIGITAL CIRCUIT ANALYSIS!

Finally . . . a *truly economical* instrument for rapidly testing incoming digital IC's! Low-cost Model 701 makes D.C. and functional tests of 958 devices a shift. Plug-in program modules used by unskilled operators assure thorough testing, save time, money. From Microdyne . . . the line with the right IC tester for the right job . . . at the right price. Use Coupon.

Dyne SUBSIDIARY OF COMPUTEST CORP.

MICRODYNE
MICRODYNE INSTRUMENTS, INC.

203 Middlesex Tpk. • Burlington, Mass. 01803
Phone: 617/272-5691

MICRODYNE

Please send me Model 701 Bulletin.

NAME _____

TITLE _____

COMPANY _____

ADDRESS _____

CITY _____ STATE/ZIP _____

Dept. EL-63

KROHN-HITE MODEL 4200 VS MAJOR COMPET

MFR	H-P	H-P	G-R	K-H
Model Number				4200
Price				\$350
Frequency Range				10 Hz to 10 MHz
Power Out				500 mw
Waveform Distortion				<0.1%

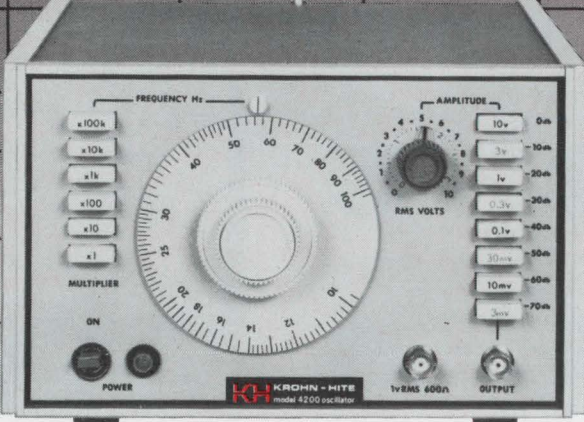

**Stack this
\$350 oscillator
against the
competition**

regardless of price!

You'll be surprised! In spite of its low price, the Model 4200 exhibits extraordinary performance. It excels in those specifications most eagerly sought by men who really know oscillators. Krohn-Hite's twenty years of frequency-generator know-how has produced a unique circuit* that makes low-priced high performance a reality at last.

Here's how the Model 4200 stacks up against several competitors:

BROADER FREQUENCY RANGE: The Model 4200 outranges most of the others, including more expensive units.

MORE OUTPUT POWER: The Model 4200 has from 2.5 to 50 times the power of the other units.

BEST WAVEFORM PURITY: The Model 4200 is unexcelled.

BEST BUY: The \$350 price speaks for itself.

See for yourself. Write for data. Then contact your Krohn-Hite Representative for a no-holds-barred demonstration. The Model 4200 is a lot of oscillator for \$350.

*Patent applied for.

**KH KROHN-HITE
CORPORATION**

580 Massachusetts Ave., Cambridge, Mass. 02139, U.S.A.
Phone: (617) 491-3211 TWX: 710-320-6583

Oscillators / Filters / AC Power Sources / DC Power Supplies / Amplifiers

printout device. It uses about 50 solenoids to punch the keys; how the company bought them gives another good idea of its hard-nosed negotiation practices.

First, the design engineer picked the solenoid and got an original \$1.89 piece price from the producer—Dormeyer Industries. The bargaining continued as the design engineer and the purchasing agent made four passes at the vendor, lowering the quote each time. In the process, they got the unit cut down to Viatron size. A return spring in the relay was dropped; the manufacturer's sticker with part number and logo was removed; the insulation was changed; a cap was taken off one end; and a threaded mount was replaced with one designed for clip insertion. This latter change led to further cuts in production costs. The final price tag was \$1.11.

Automating output

"Even with each part coming in at the lowest possible price, production costs could prove ruinous," says Bennett. "As a result, we decided to automate everywhere we could." This may have been the big reason for hiring Thompson to run things. He formerly worked at Litton on production of the Monroe Epic calculator on which about 84% of manufacturing operations were automated. Thompson figures 80% is about right for Viatron. A greater level would involve tradeoffs that raise costs of the end product, he believes.

"From the moment a circuit board schematic is ready, we begin thinking along with the design engineer," says Thompson. "Manufacturing and design hold hands right down through to production with the result that the circuit boards are designed with axial components parallel, rather than at angles to one another. Parallel component mounting may sound insignificant but a minimum number of flow-solder masks are required. Moreover, with skewed components, the insertion machine must stop to rotate the workpiece, then rotate it back to its original position. Viatron's boards are all designed so the inserter can stitch along like a sewing machine without pausing."

Components are tape-fed into the insertion machines, but prior to this, those containing resistors, diodes, and capacitors are fed into a sorter which not only checks the tolerance or polarity of each device but also retapes them into the insertion sequence. The idea is to inject quality control early in the manufacturing cycle, eliminating costly testing at the end.

Fail safe. Critics claim Viatron can't keep field engineers on the job for the rentals it plans to charge, and Bennett agrees. But then the company never planned to use them in the first place. "If a section of our machine fails, we replace it using stock subassemblies from a nearby depot. Some maintenance may be carried out there, say, replacing one circuit board with another. But repairs will be handled here in Burlington."

Bennett figures that the MOS-LSI chips are going to be too valuable to allow the unskilled to work with them. Thus, the depots will have simple specialized test gear to help get major subassemblies back in operation and out of inventory quickly to speed cash flow. The Burlington facilities will use automated fault-locating apparatus especially designed by the company to deal with LSI.

Spiegel figures that only 7% of monthly rentals will be needed to cover servicing and all associated overhead. Wilford J. Olson, manager of quality assurance, is devising much of the custom test gear. He's already developed a device which may "say it all." This prototype paragon is a multiconductor cable tester which identifies the conductor being probed. It is designed to spot shorts and assure that the right wire gets attached to the right contact. Just what's inside the machine is proprietary, but the number of the conductor is shown when probed; the read-out is red when there's a short. No special training is needed to use the test system. There's another aspect to the tester. In theory it makes color coding unnecessary. Thompson says that color coding always is useful, but maybe—just maybe—the company might be tempted—especially if it were able to cut costs by standardizing on a single hue.

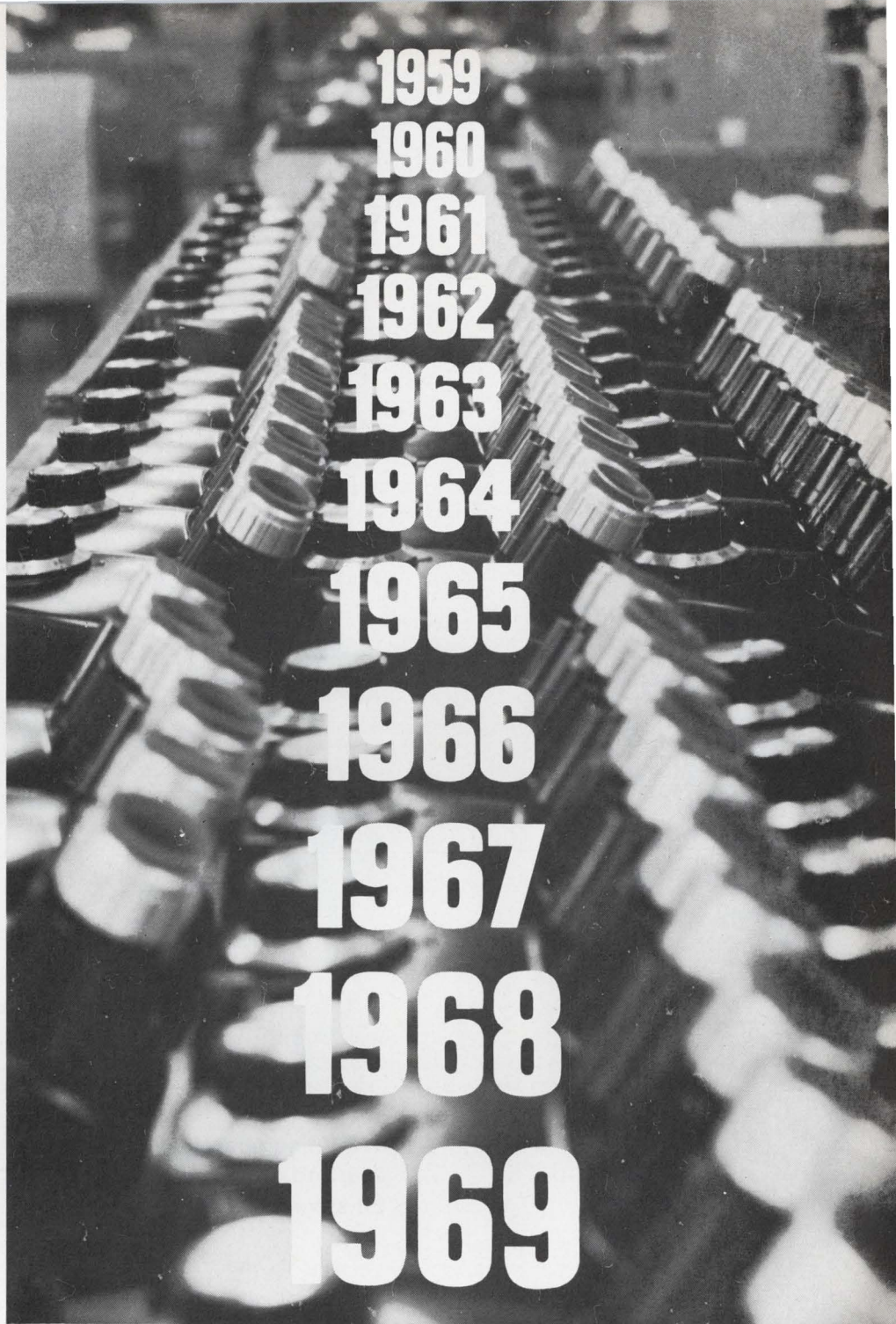

OUR STEREOZOOM® ASSEMBLY LINE IS ELEVEN YEARS LONG

Bausch & Lomb originated the stereomicroscope with zoom optical system eleven years ago. We've spent those years making sure that StereoZoom continues unexcelled in performance and reliability. Only Bausch & Lomb StereoZoom assures you the flattest fields . . . the greatest depth of field . . . locked-in focus throughout the zoom range . . . highest eyepoint eyepieces . . . accurate eye-level magnification readings on the zoom control knob.

Now, there's a new member of the line, the StereoZoom 7, with widest zoom range, sharpest images, highest resolution/magnification.

Get all the facts. Write for our new catalog 31-15. Bausch & Lomb, Scientific Instrument Division, 99718 Bausch Street, Rochester, New York 14602.

BAUSCH & LOMB 
SCIENTIFIC INSTRUMENT DIVISION

400 Hz RCA Triacs— ready to take over!



**120-V line operation and
200- and 400-V repetitive peak
off-stage blocking voltages**

Up in the air about 400 Hz controls? Would you like to forget electro-mechanical relays or switches for such aircraft applications as lighting controls for cabins and running lights; heater controls; motor controls; hydraulic valve controls? RCA has the answer: new 400 Hz triacs ready for your evaluation and inclusion in your circuit designs. Look at the tabulation of units you can work with—at RMS currents from 0.5 A to 40 A and repetitive peak off-state blocking voltages of 200 V and 400 V—all designed for 400-Hz operation and available in two and three-lead modified TO-5, press-fit and stud type packages.

Ask your local RCA Representative or your RCA Distributor for details. For preliminary technical data sheets to aid in your evaluation of these units for airborne controls applications, write RCA Electronic Components, Commercial Engineering, Section RN6-4, Harrison, N. J. 07029.

MAXIMUM RATINGS

0.5 A I_{rms}—In 3-lead modified TO-5				TA7615	400 V	press-fit
TA7654	200 V	10 mA	I_{gt}	TA7616	200 V	stud
TA7655	400 V	10 mA	I_{gt}	TA7617	400 V	stud
TA7656	200 V	25 mA	I_{gt}	15 A I_{rms}—press-fit or stud		
TA7657	400 V	25 mA	I_{gt}	TA7618	200 V	press-fit
2.5 A I_{rms}—2-lead modified TO-5				TA7619	400 V	press-fit
TA7671	200 V	25 mA	I_{gt}	TA7620	200 V	stud
TA7672	400 V	25 mA	I_{gt}	TA7621	400 V	stud
6 A I_{rms}—press-fit or stud				25 A I_{rms}—press-fit or stud		
TA7642	200 V	press-fit		TA7646	200 V	press-fit
TA7643	400 V	press-fit		TA7647	400 V	press-fit
TA7644	200 V	stud		TA7648	200 V	stud
TA7645	400 V	stud		TA7649	400 V	stud
10 A I_{rms}—press-fit or stud				40 A I_{rms}—press-fit or stud		
TA7614	200 V	press-fit		TA7650	200 V	press-fit
				TA7651	400 V	press-fit
				TA7652	200 V	stud
				TA7653	400 V	stud

RCA Thyristors

Proposed national space station will put electronics to the test

Three preliminary design and planning bids are in for this vast undertaking, which will depend heavily on ultrareliable, long-lived components and systems

By Paul A. Dickson

Associate editor

Among the projects the National Aeronautics and Space Administration would especially like to run off as an encore for next month's planned lunar landing is a national space station. A lot of work has already been done with this goal in mind, and earlier this month three bids for design and planning studies were submitted to the space agency. Officials stress that the venture is not simply an upgraded Apollo Applications Program; it is, they say, an effort to strike out in new directions, advancing the state of the art in a number of technologies. In particular, however, electronics and aerospace concerns would be prime beneficiaries should the space station be approved in whole or part.

When NASA was set up over a decade ago, five criteria were established for all new programs: gaining national preeminence in space; enhancing the country's security; increasing scientific knowledge; advancing technology; and achieving economic benefit. Charles W. Mathews, deputy associate administrator for manned space flight and head of NASA's space station task force, says of the proposed venture: "No other program we've ever attempted so broadly satisfies these objectives."

Mathews' assessment of the project as "a renaissance man's space program" may be overstated, but there's no gainsaying the fact that the undertaking is sizable and offers industry a lot of room to grow. The basic station would be launched in 1975 and would house

a dozen men. It would be designed to have an operating life of 10 years. During the first half of the decade, it would grow as new modules were flown to it in reusable spacecraft; eventually there'd be room enough for a crew of 50 or more. Top officials at the Office of Manned Space Flight, say the original station would be the first building block around which a larger base in space for the 1980's would evolve.

NASA sees the station as an orbiting version of an earth-based scientific R&D firm, which also does a little specialized manufacturing. Unique features of orbit—for example, weightlessness, vacuum, and earth and celestial vantage—offer scientists and engineers a wide variety of research and applications possibilities. While certain mundane benefits would accrue, there would also be a grander purpose—the station would provide the needed experience to make the U.S. a truly spacefaring nation committed to interplanetary travel.

The project would be costly. Estimates for R&D alone run between \$4 billion and \$15 billion, with more needed to keep the station aloft for a decade or longer. Since Russia is reportedly planning space platforms as well, the decade-long space race would be kept vibrantly alive. In short, the concept promises a new adventure with all and more of Apollo's grandeur and achievement.

Two to go. The big question now, however, is whether or not there's going to be an okay from

the Administration and Congress. It is a massive commitment and, thus far, NASA stands alone. There are, however, signs that the project is getting serious consideration in the right places. Last month, the House Committee on Science and Astronautics unexpectedly authorized an extra \$66 million on top of an original request for \$9 million to do studies of the station and shuttles. The Presidential task

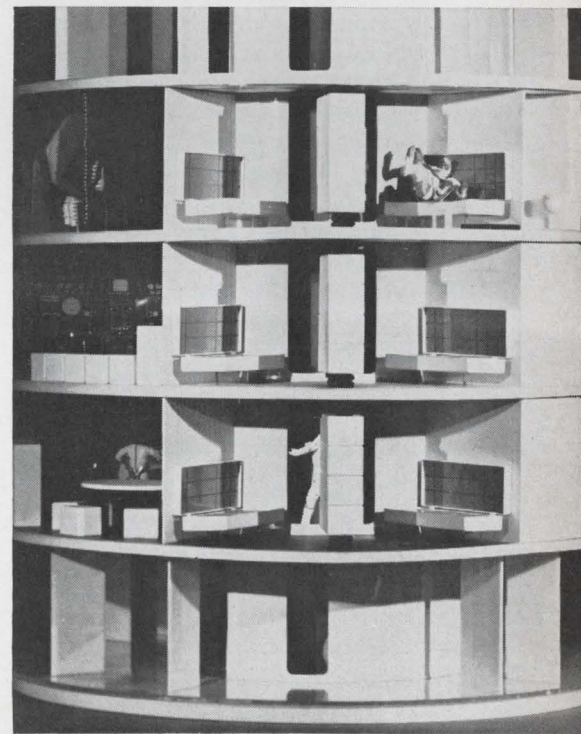

Habitat. Prospective contractors are already doing preliminary designs for NASA's proposed space station; this model was prepared for Grumman by a consulting architectural firm.

... NASA wants to rely heavily on LSI in systems for the space station ...

group on space is taking a hard look at the station before it makes recommendations for the next decade to the President on Sept. 1. NASA Administrator Thomas Paine and Air Force Secretary Robert C. Seamans Jr. are working on the report, and both are strong advocates of the station.

Though the all-important question remains unresolved, the space agency is moving quickly through the early stages of the program. Unlike Apollo, the program is slated to go through the same phased planning reserved for unmanned programs. Preliminary first-phase analysis has been completed and the definition and design phases have begun. Actual development work can start in fiscal 1971, which begins July 1, 1970.

Two of the three groups submitting bids will be selected shortly to perform 11-month studies under cost-plus-fixed-fee contracts. One of the awards will be managed by the Marshall Space Flight Center in Huntsville, Ala. And the other by the Manned Spacecraft Center in Houston. One of the winners will be selected to carry out phase D development, including fabrication, testing, and initial mission operations. Though the amount of money involved in the initial work will not be great, the contractor on the scene should have the inside track in future competitions.

Among the three competing teams, Grumman heads one which includes Lockheed for logistics, TRW for mission operations and the General Dynamics' Convair division for experiments. A second is led by McDonnell Douglas and includes Martin for experiments and IBM for information handling. North American Rockwell captains the third group which includes General Electric for experiments.

Meanwhile, other important studies are already under way. The Air Force's Mitre Corp. is checking information management for the station and Martin has been commissioned to find ways of reducing launch costs. General Dynamics, Lockheed, McDonnell Douglas, and North American

Rockwell are finishing up parallel studies of the proposed reusable launch vehicles. Boeing has finished one study on launch operations and is working on another, as well as a check of earth-orbital emergency entry systems. Marshall will soon contract for a study or studies of the module concept for the station.

At this early stage, NASA has involved most of its other centers in the program. Special groups at headquarters are using the agency's top manned space experts to look at the shuttle and the station. Last week, these units sent recommendations in these two areas to the President's space task group. The shuttle group is working under the direction of associate director George E. Mueller and the station group is working under Mathews, with astronaut Frank Borman acting as space station field director.

Early foot

According to Mathews, the reason that NASA is moving quickly is simply that a lot must be done to get the program off the ground. The space station makes use of new hardware and pushes into new areas of technology. Mathews points out that a variety of disciplines ranging from nuclear power through metallurgy will be pushed. Electronics, he notes, will be an all-important element, since a lot of work must be done in the areas of microelectronics and component reliability.

"We want to rely heavily on large-scale integration in the station and we want the electronics to be reliable," says Mathews. "We don't want to cascade redundancy upon redundancy to get it either." He anticipates tighter specifications and state-of-the-art improvements as the two major factors which will help achieve this goal. He also expects a shift in the way systems are integrated in the station: "With LSI, it should be possible for each black box to be more capable and independent. In Apollo, the tendency was to run all the data through general-purpose computers and make subsystems interdepend-

ent. In the case of the station, we expect to accomplish checkout fault-isolation at the black-box level."

Several factors led NASA in this direction: the size and modular complexity of the station; the potential capability of LSI; the need to be able to plug in new systems for old ones; and persistent problems with simple electrical wiring connections.

By the book. The work statement prepared by NASA for contractors says this: "The space station will use modular concepts in subsystem design and in the placement of subsystems throughout the station. Subsystem modularity will enhance man's ability to maintain, repair, and replace critical elements in orbit. Subsystems will be located to insure compatible grouping; the redundancy needed for safety and reliability considerations; and the capacity to update, repair, and/or replace major subsystems as new technology becomes available and is required..." In plainer English, the station will be a test bed for long-lived subsystems with maximum reliability.

John E. Condon, head of reliability and quality assurance for NASA's Office of Industry Affairs, says that one of the major concerns of his office these days is greater electronics reliability. (This operation, however, is not project oriented, and the greater reliability goals for the 1970's could apply as much to the 11-year-long unmanned missions as to the proposed manned space station.) By the start of next year, at the latest, the Industry Affairs Office will release a set of reliability documents on microelectronics. Condon says that the specifications will become immediately effective and will impose a maximum of controls, inspections, and check points. "Though it will not be used for all systems, we will be moving into the most rigid area, which is assembly line certification," he says. "For important space systems we will actually certify production right from the original cultivation of the chip." Condon points out that such stringency stems from a realization of microelectronics' importance for NASA in its programs in the post-Apollo period.

Condon shares Mathews' con-

cern about such apparently "simple" difficulties as soldering, electrical connectors, batteries, and wiring. He says: "I doubt we'll ever see the day when there'll be an end of the mundane problems. We're going to have to pay meticulous attention to these things as we get into systems with longer lifetimes."

Supplying demand

Prospective space station contractors are also aware of the challenges in the electronics field. Edward F. Gray, assistant to the president in charge of space programs at Grumman, points out that the amount of data generated by the space station will be tremendous, dwarfing even the high rates produced during Apollo missions. He figures that designing the right data-handling set-up will be one of the biggest problems in developing the system. "The Apollo program has a tremendous number of people tied up just monitoring data describing the status of the spacecraft," he says. "Status information will have to be handled in the station itself—by far fewer people—so that the bulk of the data results from the experimental activity."

Reinforcing Gray's point, another source on a competing team says, "NASA has consistently underplayed the data-handling problems in its unmanned space programs. The Goddard Space Flight Center has reams of experimental data taken from spacecraft that no one has even had a chance to look at. On the space station we must make certain the data is rapidly converted, sorted, and used."

Ian Dodds, North American Rockwell's space station program manager, says that the primary thrust in pushing the state of the art will center on the technology of long-lived subsystems involving in-flight maintenance at the black-box level. "Every component is going to have to be operationally tested over a very long time," he says. "You can't afford to have personnel spending time going up to do maintenance work." Dodds notes state of the art advances will also be required in information-management systems, including improved computer interaction with on-board displays to insure that only significant

Rumor-monger

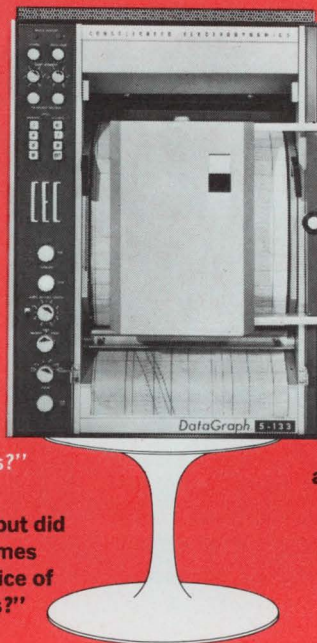

"Did you hear that the 5-133H is the oscilloscope with high impedance galvos?"

"I've heard it eliminates the need for preamps and driver amps."

"Yeah... but did you hear it comes with a choice of nine new galvos?"

"You haven't heard the half of it!"

Create a recording oscilloscope like the 5-133H, and you're bound to hear a lot of talk.

And for these reasons:

- Only Bell & Howell offers an oscilloscope with high impedance galvanometers
- The nine galvos now available for the 5-133H cover a frequency range from 0-100 Hz to 0-3000 Hz.
- Since high impedance galvos do not require preamps or galvo driver amps, important savings can be made in panel space, weight and component cost.
- Over-voltage galvo protection

virtually eliminates galvo repairs. ■ Considerably less setup time is required. ■ Dual galvo magnet assemblies and individually controlled galvo recording lamp intensity permit two data setups to be made at one time and recorded simultaneously—or be made alternately and recorded sequentially utilizing full chart width for each.

For all the specific advantages of the 5-133H and the nine high impedance galvos, call our nearest office. Or write Bell & Howell, Pasadena, Calif. 91109. Ask for Bulletin Kit 3312-X2.

CEC/DATA INSTRUMENTS DIVISION

 **BELL & HOWELL**

**Atec's new
12.5 MHz
universal
counter/timer
measures
Frequency,
Time Interval,
Ratio, Period,
Multiple Period,
and
Totalizes.**

**That's
quite
a bit
for
\$850!**



Atec's new Model 2000 offers more performance for less money than any competitive instrument. Standard features include a 1 MHz crystal-controlled time base stable to one part in 10^8 /day, remote programming, and 1-2-4-8 BCD output. Options include display storage, oven-stabilized crystal, and additional digits (to seven). Modular plug-in design makes it simple to add options at any time.

Input sensitivity is 10 mV (DC to 5 MHz) and 30 mV to 12.5 MHz. Front panel height is only $1\frac{3}{4}$ inches.

For complete specifications or a free demonstration, call your local Atec engineering-sales representative, or write Atec today.

Atec, Inc.

1125 LUMPKIN STREET, HOUSTON, TEXAS • PHONE (713) 468-7971
MAILING ADDRESS: P.O. BOX 19426 • HOUSTON, TEXAS 77024

... the station will give NASA a chance to check sensors ...

data is transmitted to the ground for evaluation.

Payoff. In the coming months the two winners of study contracts will use NASA's work statement as their technological bible in defining the station. Among other things, there's a lengthy list of electronics projects. A sampling of communications challenges includes the following:

- A dedicated satellite-relay system, consisting of three spacecraft at asynchronous altitudes, would become an integral part of the station set-up.

- A television and multichannel voice system would allow investigators aboard the station to consult with colleagues on the ground on a real-time basis.

- Internal communications will provide the basis for the station's data management system. A single coaxial cable will be used to transfer video, digital, voice, and teletype information among all elements of the station, affording flexibility, as well as the means for expansion.

Beyond supplying hardware and support services for the station and its vehicles, there will be other advantages for the electronics industry if the project is approved. Grumman's Gray, for example, points out that the venture would allow the NASA/industry Apollo R&D staff to stay together. In addition, the station will furnish continuing outlets for electronic instrumentation to conduct experiments in eight research areas—biomedicine, astronomy, earth applications, space biology, space physics, engineering operations, materials processing, and advanced technology.

In earth applications, for example, NASA anticipates that the original instrument package will include a metric camera for ground mapping, a system for multispectral photography, two vertical-profile radiometers, and two or three infrared and microwave imagers for sensing surface features. Mathews says, "The station can give us the chance to test sensors for unmanned earth resources satellites. Everything will move more

quickly. The sensors could be flown to the station and tested as soon as they're available. Later, after they've proven out, the unmanned operational satellite could be deployed by one of the reusable craft." He suggests that such integration of manned and unmanned programs will be a commonplace way of operating with the development of the station and its accompanying shuttles.

Possibilities. Finally, the station offers some unique prospects for manufacturing and advanced technology. For example, material processing methods which could be developed in the zero-gravity environment of the station include the cultivation of large crystals with vastly reduced dislocations, achieving the discovery of new alloys, and the exploration of new means of casting metals.

While there is genuine skepticism within NASA as to whether such processes would prove economically attractive due to transportation costs, consideration is being given to offering small quantities of new materials from the station. Says Mathews: "Even if the transportation costs were as much as \$50 to \$100 a pound, there may very well be a benefit in getting them, at least for experimentation, on earth. I would think that the electronics industry would be very interested in having some new alloys to experiment with or some absolutely perfect crystals."

Clearly, NASA and the electronics community have a lot to gain from the acceptance and final realization of the space station. One factor which can make or break the plan will be how the Congress assesses public reaction. However, the planners at the agency feel that the practical nature of the venture will be a big selling help. As for pre-conditioning to the idea, Mathews says, "If you saw the movie '2001,' you have an inkling of how exciting this program is. I think that the space station was the most interesting part of the picture to most people." Recently, NASA Administrator Thomas Paine admitted that he had gone to see the film five times and was still intrigued by it. If the station eventually gets into orbit, producer Stanley Kubrick probably will rate credit for an assist. ■

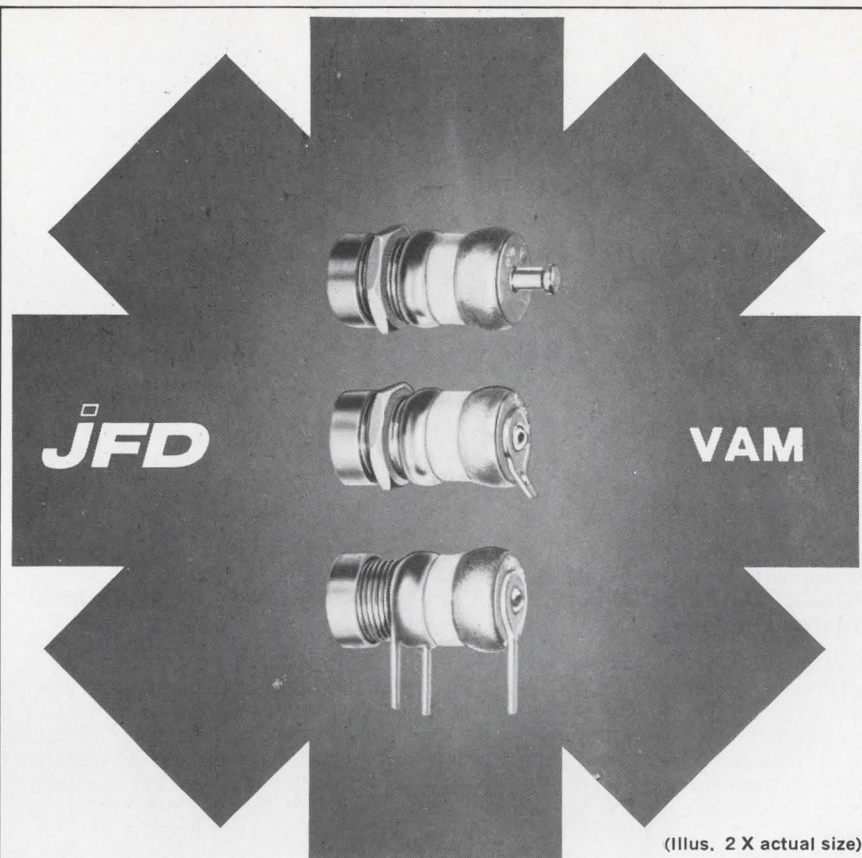

AIR VARIABLES FROM JFD SOLVE YOUR HIGH Q, HIGH FREQUENCY PROBLEMS

The JFD air variable miniature capacitor series — VAM — is specifically designed for high frequency applications that demand extreme stability, small size and high Q (greater than 2,000 measured at 10 pf and 100 MHz). VAM's have rugged construction, measure approx. 1/2" in length and are completely interchangeable with competitive devices.

ELECTRICAL DATA — ALL VAM MODELS

Cap. Range at 1 MHz... 0.8 to 10.0 pf
 Q at 10 pf & 100 MHz... >2,000
 Insulation Res. at 25°C... 10⁶ megs.
 at 500 VDC
 Temp. Coeff. of Cap. (—55°C to +125°C)... 0 ±20 PPM/°C
 WVDC... 250 VDC
 Test Voltage... 500 VDC

ACTUAL SIZES

VAM 010* 
 Panel Mount w/Turret Terminal

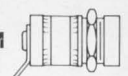
VAM 010M 
 Panel Mount w/Lug Terminal

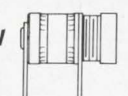
VAM 010W 
 Printed Circuit

*VAM 010 also available as VAM 010H with 4-40 threaded stud replacing turret terminal.

Write for catalog VAM-67-B.

"TODAY'S COMPONENTS BUILT FOR TOMORROW'S CHALLENGES"

JFD JFD ELECTRONICS CO. / COMPONENTS DIVISION
 15th Ave. at 62nd St. • Brooklyn, N.Y. 11219 / Phone 212-331-1000

Offices and subsidiaries in principal cities, world-wide.

"See us at the WESCON Show Booths #3911-3912."

RCA Solid-State Data for Designers

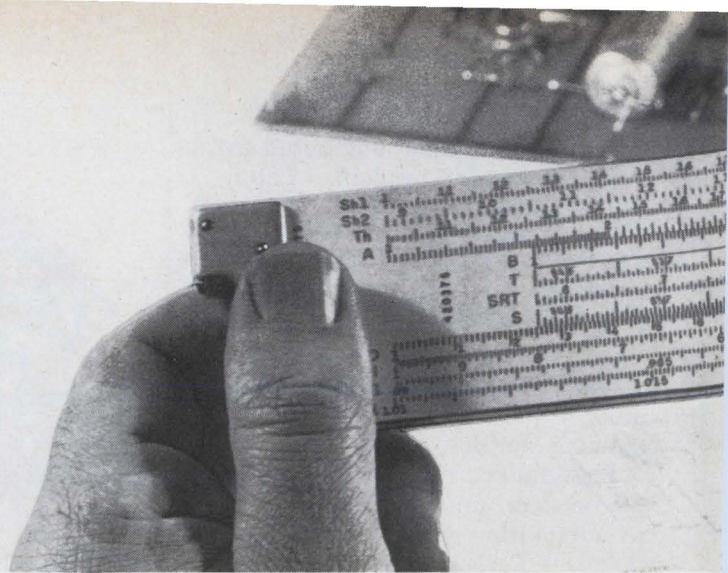

Design with New Dual-Gate MOSFET and Forget About Transient Voltages

RCA's new 40673 permits you to take full advantage of the superior high-frequency performance characteristics of dual-gate MOSFETs without concern for transient breakdown problems. Back-to-back diodes—Transient Trappers—diffused within the same silicon pellet as the MOS Field-Effect Transistor, guard each gate against:

- Static discharge during handling operations without the need for external shorting mechanisms
- In-circuit transients

Typical characteristics of the RCA-40673 are:

- Power Gain (MAG) = 20 dB @ 200 MHz
- Noise Figure (NF) = 3.5 dB @ 200 MHz
- Superior Cross-Modulation Characteristics

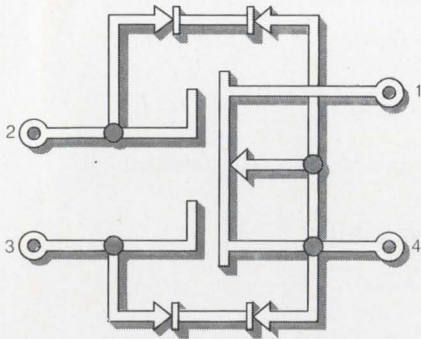

- Wide Dynamic Range Without Diode Current Loading
- Reduced Spurious Response
- Extremely Low Feedback Capacitance = 0.02 pF
- Simplified AGC Circuitry

Recommended for RF Amplifier applications up to 400 MHz, RCA-40673 MOSFETs may also be used as RF Amplifiers, Mixers and IF Amplifiers in:

- TV Receivers
- FM Radios
- Aircraft and Marine Vehicular Receivers
- CATV and MATV Equipments
- Telemetry and Multiplex Equipments

For more detailed information, circle Reader Response No. 225.

5 Transistor IC Array In DIP—CA3046, 98¢ (1000 Units)

For design flexibility and big economy in all types of signal processing systems, from DC to 120 MHz, investigate RCA-CA3046 Linear Integrated Circuit Array. In this five-transistor monolithic array, transistor pairs are V_{BE} matched to within ± 5 mV, with a $2 \mu\text{A}$ Input Offset Current at I_C of 1 mA. Noise Figure is 3.2 dB (typ.) at 1 kHz.

Use this array as five discrete transistors in conventional circuits, or as differential pairs in your custom circuit configurations.

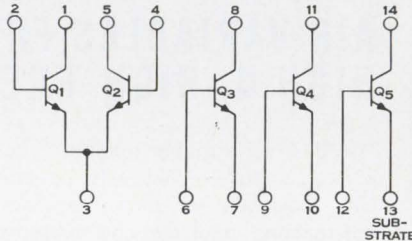

This array is also available in dual-in-line ceramic package at \$1.50 (1000 units) for use over the full military temperature range. Circle Reader Response No. 226 for full information, including pertinent Applications Notes and a copy of "Design Ideas for RCA Linear Arrays."

MSI Adds New Cost Effectiveness To COS/MOS Technology

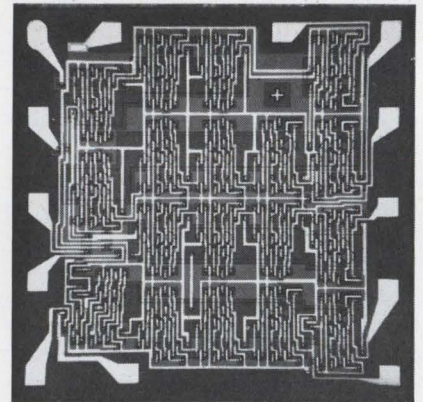

The new RCA-CD4006D, 18-stage Complementary Symmetry MOS Static Shift Register, with over 200 MOS transistors, provides the unique performance advantages of COS/MOS circuits with real-world economics.

The CD4006D @ \$17.25 (1000 units) provides military-temperature range operation at less than \$1.00 per flip-flop. Design features are:

- -55° to $+125^\circ\text{C}$ operation
- 100 nanowatts quiescent dissipation (typ.)
- 18 stages in 4 and/or 5 bit sections
- Static to 2 MHz shift rate
- Single phase clock
- Single 6- to 15-volt power supply
- 4-volt noise margin (10-volt logic)

CD4006D in ceramic dual-in-line package is \$25.00 (1-99 units).

Effective July 1, 1969, CD4006 in ceramic flat pack is \$26.50 (1-99 units).

For technical information, circle Reader Response No. 227.

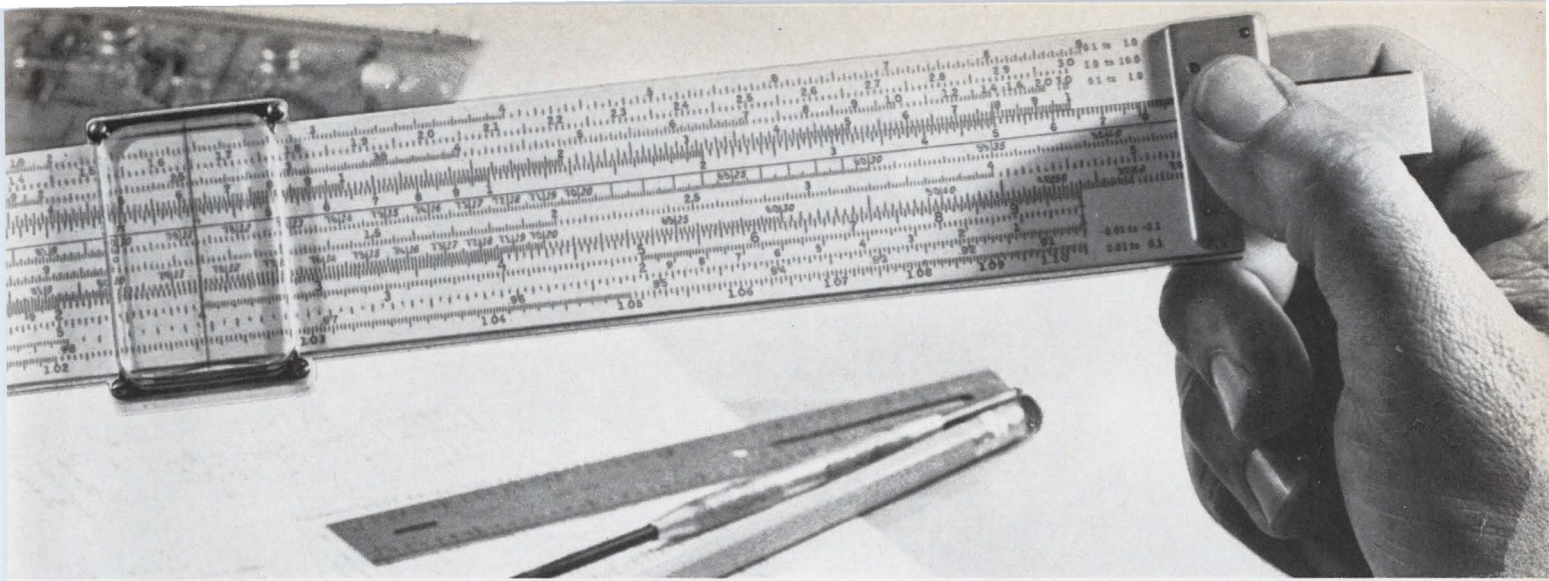

Sock It to These Triacs—at 10 A and 15 A (RMS)

More and more users are finding more and more uses for RCA Triacs. Join them with these additions to the growing RCA line of Thyristors:

10-ampere types 2N5567, 2N5568 (press-fit) and 2N5569, 2N5570 (stud types) handle 10 A (RMS) at T_c of $+85^\circ\text{C}$ and conduction angle of 360° . Repetitive peak off-state voltages are rated at 200 V for 2N5567 and 2N5579, and 400 V for types 2N5568 and 2N5570. Gate characteristics are controlled in all four firing modes.

15-ampere types 2N5571, 2N5572, 2N5573 and 2N5574 have 15 A (RMS) on-state current rating at the same repetitive peak off-state voltage ratings and T_c as their 10 A "brothers."

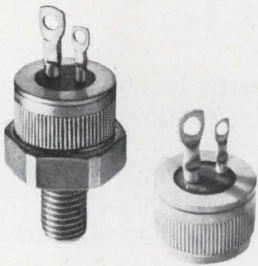

Check RCA for the widest line of Thyristors—from low-signal units to heavy-duty industrial-type devices. And Circle Reader Response Number 228 for details on the complete line.

Top Performance Point for 100 W Silicon Power Transistors

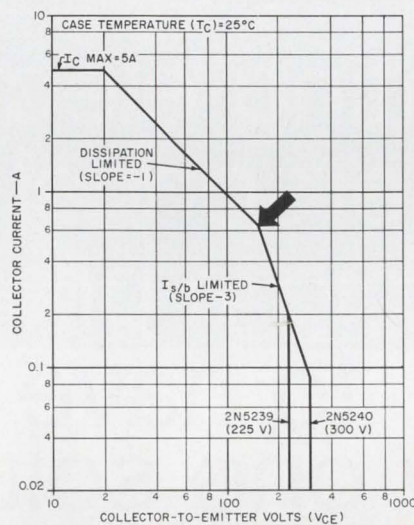

Full second breakdown protection up to 100 W and 150 V—plus safe area rated up to 300 V! That's a power level, performance and reliability no other high-voltage silicon transistor can match.

To you, this means better performing, more reliable performance for high-voltage regulators, series regulators, high-speed inverters for off-the-line operation, switching bridge amplifiers for servo motor controls, and ultrasonic power amplifiers.

Choose between the 2N5240 with a V_{CER} (sus) of 350 V or the 2N5239 with a 250 V rating. Both have an I_C (max.) of 5 A and P_T (max.) of 100 W. Both are in TO-3 packages.

For more information, circle Reader Response No. 229.

For price and availability information on all solid-state devices, see your local RCA Representative or your RCA Distributor. For specific technical data, write RCA Electronic Components, Commercial Engineering, Section No. QM6-3, Harrison, N. J. 07029.

Class C Power for 470 MHz Mobile Communications

Here's a driver-amplifier combination for your mobile two-way radio designs (and anywhere else you can use a 6-W plus output at 470 MHz). Drive with the RCA developmental type TA7408. Use the RCA-TA7409 for the final. Both units are epitaxial silicon n-p-n planar transistors. And both types feature RCA's overlay emitter electrode construction in a hermetically-sealed ceramic-metal package with electrically-isolated mounting stud.

The TA7408 and TA7409 have low-inductance, radial leads which make them particularly suited for strip-line circuits, as well as for lumped-constant designs. Both types operate from a 12-V supply.



Key ratings and electrical characteristics include (for both types): $V_{CBO} = 36$ V; $V_{CEO} = 14$ V; $V_{CES} = 36$ V; and $V_{EBO} = 3.5$ V. Driver unit TA7408 has 0.5 A I_C and P_T rating of 5.7 W. The TA7409 has I_C of 1.5 A and P_T of 10.7 W. The driver offers 7 dB gain at 470 MHz, to take the TA7409 up to its full-rated 6 W minimum output.

Circle Reader Response Number 230 for details.



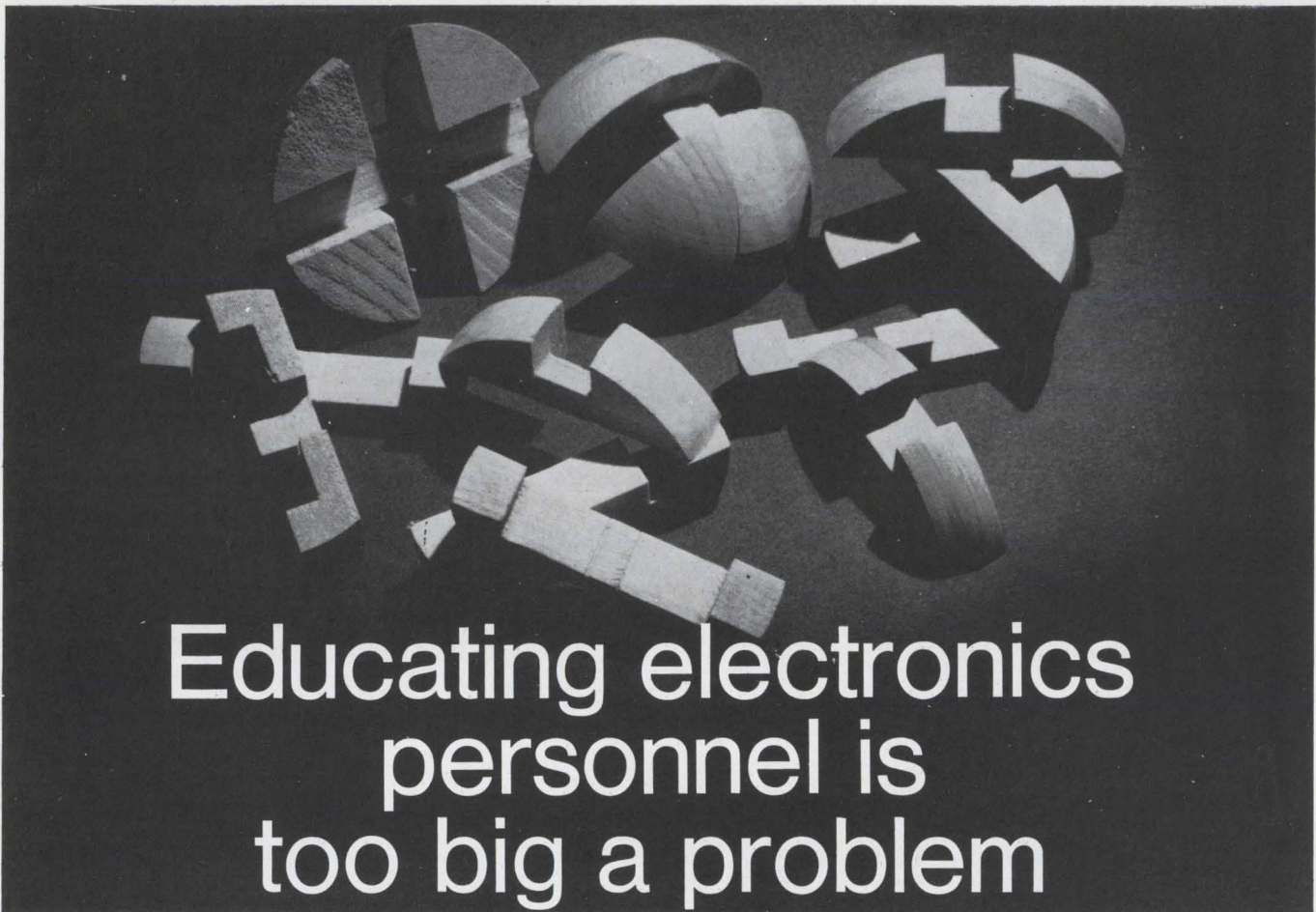

Educating electronics personnel is too big a problem to have only one solution.

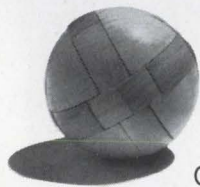

Of course, you're sold on the importance of providing continuing education for your electronics personnel. So rapidly do new developments take place in electronics that knowledge begins to lose its value almost as soon as it is acquired. Valuable men can become outmoded and unproductive almost overnight. And the shortage of technical manpower at both the professional and supporting levels makes it imperative that you utilize fully every man you have.

Perhaps your company conducts in-plant programs of instruction. Or pays all or part of the cost

of evening classes in nearby technical institutes, colleges and universities. Whatever your educational program, we believe it will be more flexible and more effective if you supplement it with CREI Home Study Programs in Electronics.

We've prepared a brochure that tells how CREI Programs can help you update, upgrade and reorient electronics personnel. Use coupon below to send for a copy today.

Founded 1927



Accredited Member of the National Home Study Council

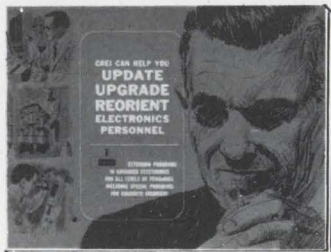

CREI, Home Study Division, McGraw-Hill Book Company

Dept. WTC-06, 3224 Sixteenth Street, N.W.
Washington, D.C. 20010

I want more information on CREI Programs in Electronics and how they can supplement our educational program for electronics personnel. Please send me, without obligation, your descriptive brochure.

Name

Title

Firm Name

Address

City State Zip

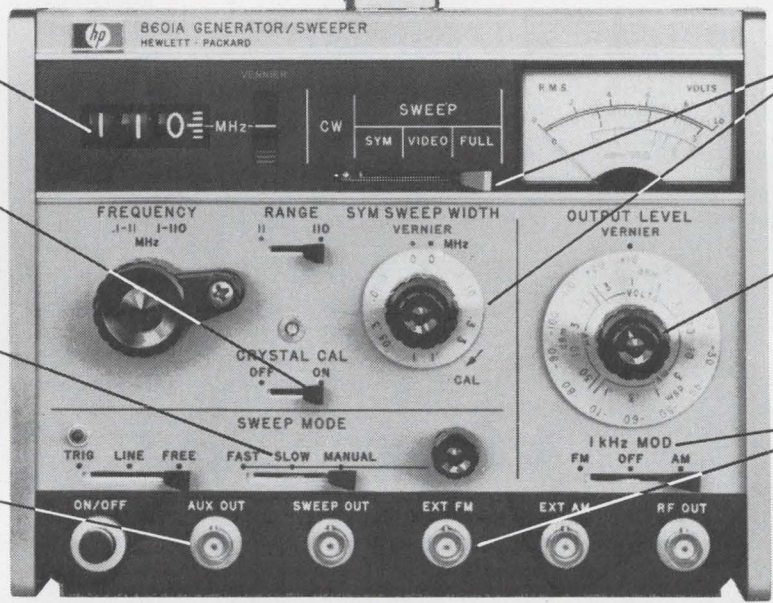

Digital frequency dialing accurate to 1% of frequency

0.01% calibration check at 5 MHz intervals.

Sweep speeds and triggering versatility for all applications.

Monitor frequency to 110 MHz with low-cost 10 MHz counter—HP 5321.

3 sweep functions, each with 0.5% linearity. Go from broad to narrow sweep with the flick of a switch.

± 1 dB output accuracy from 10 dBm to -110 dBm; flatness is ± 0.25 dB from 0.1 to 110 MHz.

Modulation: AM or FM, internal or external. (Internal: 30% AM and 75 kHz deviation FM.)

This 110 MHz sweeper is so accurate you can forget about markers

...and it doubles as a signal generator

Covering 100 kHz to 110 MHz, this all-solid-state 21 lb. instrument is a natural for both lab and production use. Price is \$1975. Call your HP field engineer for complete details on the 8601A Generator/Sweeper. Or write Hewlett-Packard, Palo Alto, California 94304; Europe: 1217 Meyrin-Geneva, Switzerland.



SWEEP SIGNAL GENERATORS

Circle 157 on reader service card

The Great Panel Discussion over Honeywell's new VT-100 digital meter...

... a discussion that's making the VT-100 one of the most talked-about panel meters around!

The VT-100 3½-digit panel meter calls a halt to the expensive problem of service and stocking different meters for different functions. And this deserves discussion.

Now, you need only the low-cost VT-100 with its plug-in card feature. Change its range and function to any one of 20 different configurations – AC and DC volts, AC and DC current and resistance parameters with three-five ranges each – by simply changing the input card. Or, use your own input card for scale factoring, readout in engineering units, etc. Spare plug-in cards provide immediate, on-the-spot repair.

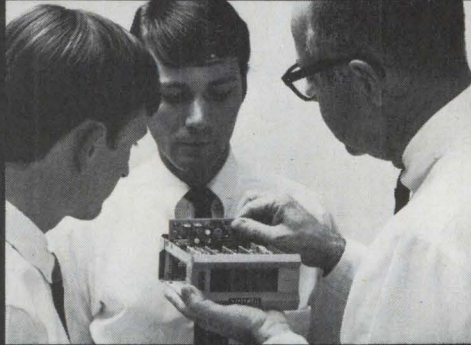

You get quick, accurate, full-scale calibration and automatic zero. It also provides 100% over-range with an overrange digit reading to 1999 (4000 count option to 3999), BCD outputs, remote encoding, print command and an accuracy of .2% of reading ± 1 digit.

Innovative? Yes. Practical? Definitely. At only \$245. (quan. of 1-24 units)

Order your VT-100's today! Call Don Anderson (collect) at (303) 771-4700.

Or write for more information to Mail Station 222, Honeywell, Test Instruments Division, P. O. Box 5227, Denver, Colorado 80217.

Honeywell

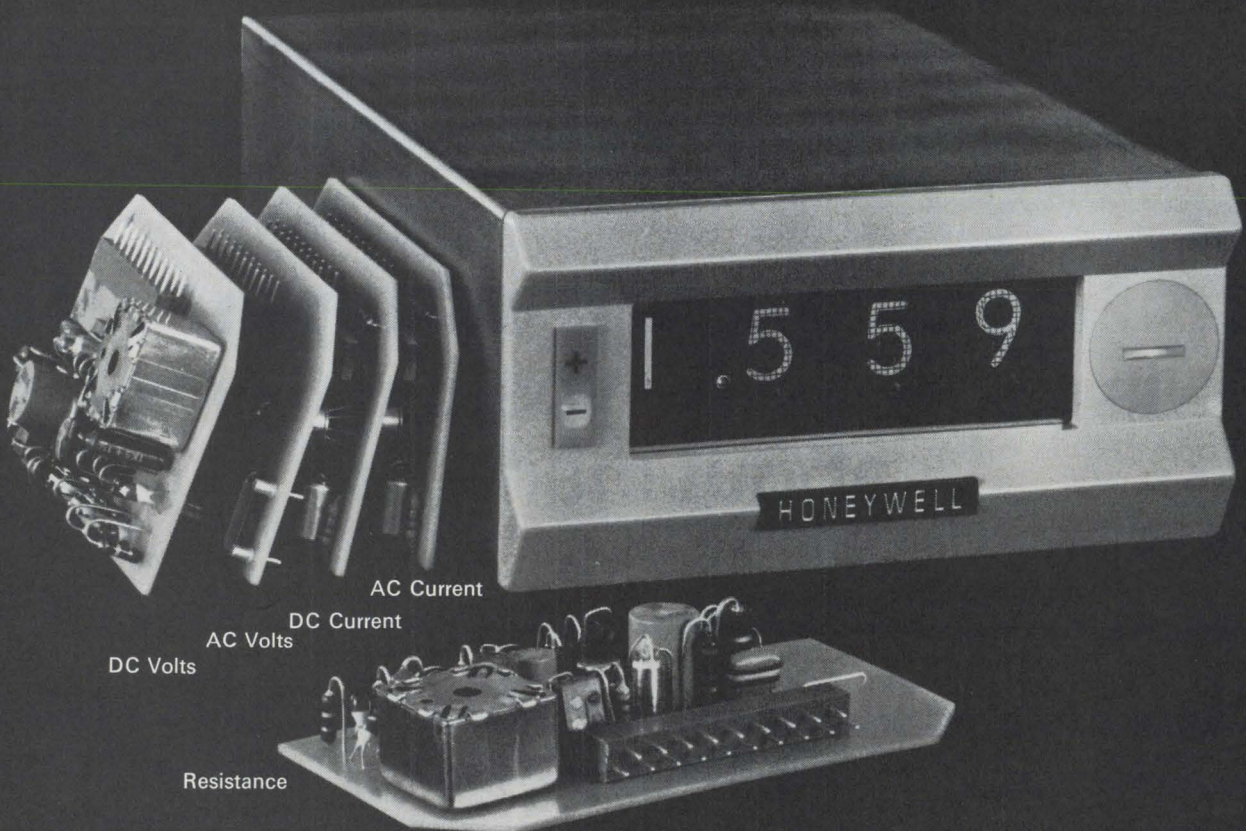

Honeywell engineers sell solutions

You get true multi-function versatility with these NEW Philbrick/Nexus Non-Linear Modules

check the function:

4350/4351 LOG OPERATOR

Log of currents, log of voltages, antilog of voltage with three built-in sensitivities plus built-in amplifier.

- RAISING TO ARBITRARY POWERS OR ROOTS
- LOG RATIO OF TWO INPUTS
- "1/X" LAW COMPUTATION
- LOG COMPRESSION
- LOG EXPANSION



4352 VECTOR OPERATOR

Find $\sqrt{X^2 + Y^2}$ of two input voltages, average of an input voltage, or true rms of input voltage in a single module.

- MULTI-COORDINATE CONVERSION
- TRUE RMS POWER MEASUREMENT
- AC TO DC CONVERSION, AVERAGE OR RMS

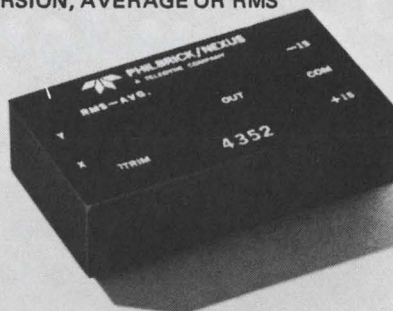

4353/4354 SQUARE LAW ELEMENT

Used with an external amplifier to obtain output proportional to square or square root of input.

- TWO QUADRANT SQUARING
- MEAN-SQUARE AND QUARTER-SQUARE MULTIPLIER
- RMS COMPUTATION
- COMPUTE ABSQUARE OR ABROOT
(ABSQUARE(X) = X · |X|; ABROOT
(X) = X/√|X|)

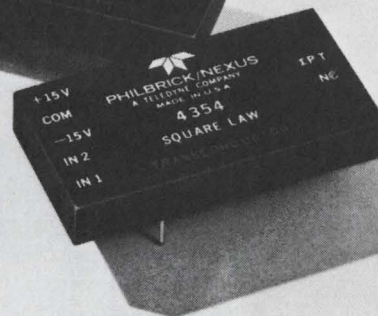
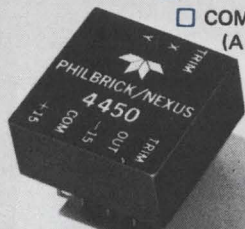

4450 FOUR QUADRANT MULTIPLIER

True four quadrant multiplier whose output represents the instantaneous product of two input signals. Built-in amplifier; only one external component required for operation.

- TRUE POWER MEASUREMENTS
- GAIN CONTROL
- MODULATION
- AUTO CORRELATION
- DIVISION

4850 GATED OPERATIONAL AMPLIFIER

Multipurpose module with operation modes such as Reset, Integrate, and Hold that may be controlled with external digital signals applied to two internal logic comparators.

- CONTROLLED INTEGRATION
- SUMMATION
- TRACKING
- HOLDING
- SWITCHING

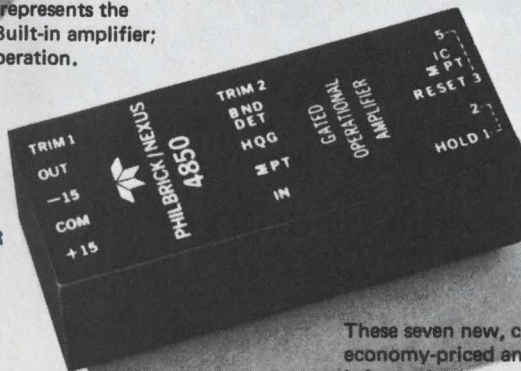

These seven new, compact, encapsulated modules are economy-priced and available immediately. For more information contact your local Philbrick/Nexus field-engineering representative, or write, Philbrick/Nexus Research, 22 Allied Drive at Route 128, Dedham, Massachusetts 02026.



PHILBRICK/NEXUS RESEARCH

A TELETYPE COMPANY

Gyro-tuning.

A new, wideband, high speed tuning technique for coaxial magnetrons.

Gyro-tuning employs a ring gear which drives a set of rotating dielectric paddles within the magnetron coaxial cavity. A high speed synchronous motor drives the entire mechanism, which is external to the tube vacuum envelope. This arrangement provides a high degree of frequency tuning and reliability for coaxial magnetrons used in airborne search, navigation, terrain fol-

lowing and missile seeker radar applications. The complete tuner assembly is compact and adds only $\frac{1}{2}$ pound to the basic magnetron weight.

Gyro-tuning presently achieves tuning rates of 400 Hz at frequency excursions of 250 MHz at Ku-band. It features low tuning drive power and a simple, directly driven, high voltage electrical generator readout technique to reduce local oscillator tracking problems.

Gyro-tuning is reliable. The rotary tuner mechanism provides long operating life and meets relatively stringent shock and vibration specifications. Operation outside the vacuum enhances tube life.

Gyro-tuned magnetrons are now being delivered at the 35 kilowatt level at Ku-band and 70 kilowatt level at X-band. Tubes are in development at other power levels.

For information on Gyro-tuning and other rapid tuning techniques now available or under development, contact: Electron Tube Division, 960 Industrial Road, San Carlos, California 94070. Telephone: (415) 591-8411.



 **LITTON INDUSTRIES**
ELECTRON TUBE DIVISION

McGraw-Hill Invites
Your Participation in a Unique Three-Day

COMPUTER-AIDED DESIGN SEMINAR

AUGUST 5-7, 1969 / LOS ANGELES / THE CENTURY PLAZA HOTEL
SEPTEMBER 9-11, 1969 / NEW YORK CITY

This intensive seminar offers specific design methods... ready-to-use programs... and the opportunity for actual "hands on" experience in designing by computer.

At this seminar, leading authorities in the field explain all practical aspects of initiating, utilizing, and maintaining a computer-aided design activity in your operation computer-aided design. During the course of this meeting you will also have the chance to pose questions concerning your own design problems.

SEMINAR FEATURES

Presentations by acknowledged authorities in computer-aided design an opportunity for actual "hands on" experience with computers completely operational design programs a recent McGraw-Hill reference on computer-aided integrated circuit design a complete set of "take-home" review and reference material.

SEMINAR OUTLINE

- I. Computer Oriented Design Procedures
- II. Computer Oriented Design Procedures
- III. Automated Transistor Bias Circuit Design
- IV. Automated Filter Design
- V. Microwave Network Design by Computer
- VI. Digital Circuit Design

COMPUTER-AIDED DESIGN WORKSHOPS

One of the most valuable features of this seminar is the opportunity to participate in actual computer-aided design sessions using terminals for remote access to time-sharing computers.

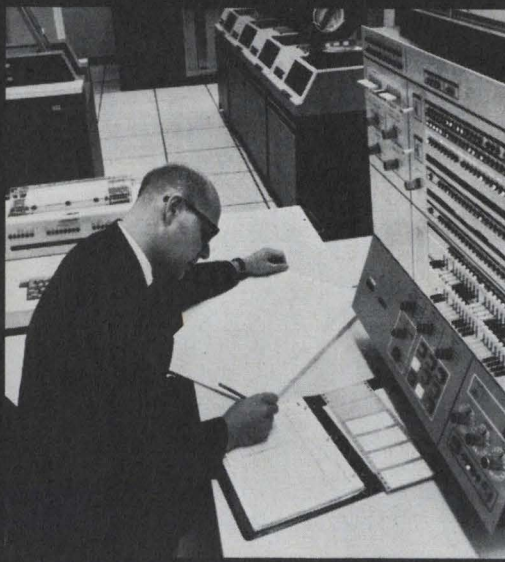

SEMINAR CONSULTANTS AND LECTURERS

Dr. Gerald J. Herskowitz
Associate Professor of Electrical
Engineering Stevens Institute of
Technology

Dr. Marco Murray-Lasso
Systems Science Research Center
Case Western Reserve University

Dr. Richard C. Levine
Associate Professor of Electrical
Engineering Stevens Institute of
Technology

Dr. Ronald B. Schilling
Microwave Electronics Department
RCA Electronic Components Division

WHO SHOULD ATTEND

This seminar was developed specifically for engineers engaged in design or responsible for personnel involved in this function. Registrants should be familiar with writing computer programs with *Fortran*.

REGISTRATION

Use the form below to reserve your place at McGraw-Hill's *Computer-Aided Design Seminar*. Registration must be made in advance, and applications should be mailed as early as possible since McGraw-Hill reserves the right to limit attendance. Although McGraw-Hill does not arrange hotel accommodations, the meeting hotel will keep a limited number of rooms available for attendees.

SEMINAR FEE

The registration fee listed below is payable in advance of the program and includes the cost of luncheons, seminar materials, & attendance at workshop sessions.

Computer-Aided Design Seminar \$395

Attention
John Stockwell, Seminar Manager
McGraw-Hill Book Company
330 West 42nd Street
New York, N.Y. 10036
(212) 971-2388

Please register me in the three-day
Computer-Aided Design Seminar
checked below at \$395.

- Los Angeles Seminar
August 5-7, 1969
 New York City Seminar
September 9-11, 1969

Name _____

Title _____ Company _____

Address _____

City _____ State _____ Zip _____

Phone (Area Code) _____

- Please Bill Company Bill Me
 Check Enclosed

E

It's time you saw a new analyst!

Clevite announces the Surfanalyzer 360. A significantly superior instrument for total surface analysis plus measurement of roundness, squareness, concentricity and other geometric relationships.

Check the points of difference yourself.

Now consider this: the Surfanalyzer 360 may also be used with the Clevite Surfanalyzer 1200 for linear as well as rotary measurement.

And when you add one of Clevite's high performance strip chart Brush Recorders for complete surface analysis on round or flat parts, you'll see why the Surfanalyzer's in a class by itself. Basic system linearity is 1% with extremely high frequency response. Both recorders feature a patented, pressurized inking system that gives you high-contrast, non-smudging traces at all writing speeds. If you really want to see something new in surface analysis and measurement of geometric relationships, phone or write: Clevite Corporation, Gaging & Control Division, 4601 N. Arden Drive, El Monte, California 91731.

CLEVITE

Extremely high response polar recorder shows roundness, roughness, concentricity, squareness and other geometric relationships on an 8½ inch chart with rectilinear trace.

Digital selector automatically programs rpm/diameter ratio to insure true surface-finish analysis.



Surface plate is vibration isolated and has leveling adjustment.

Spindle accuracy, .000001 inch. Coning-effect does not exceed .000003 inch at 12 inches above the table.

Measures ID's as small as .050 inches and OD's to 45", with a 250 lb. load capacity.

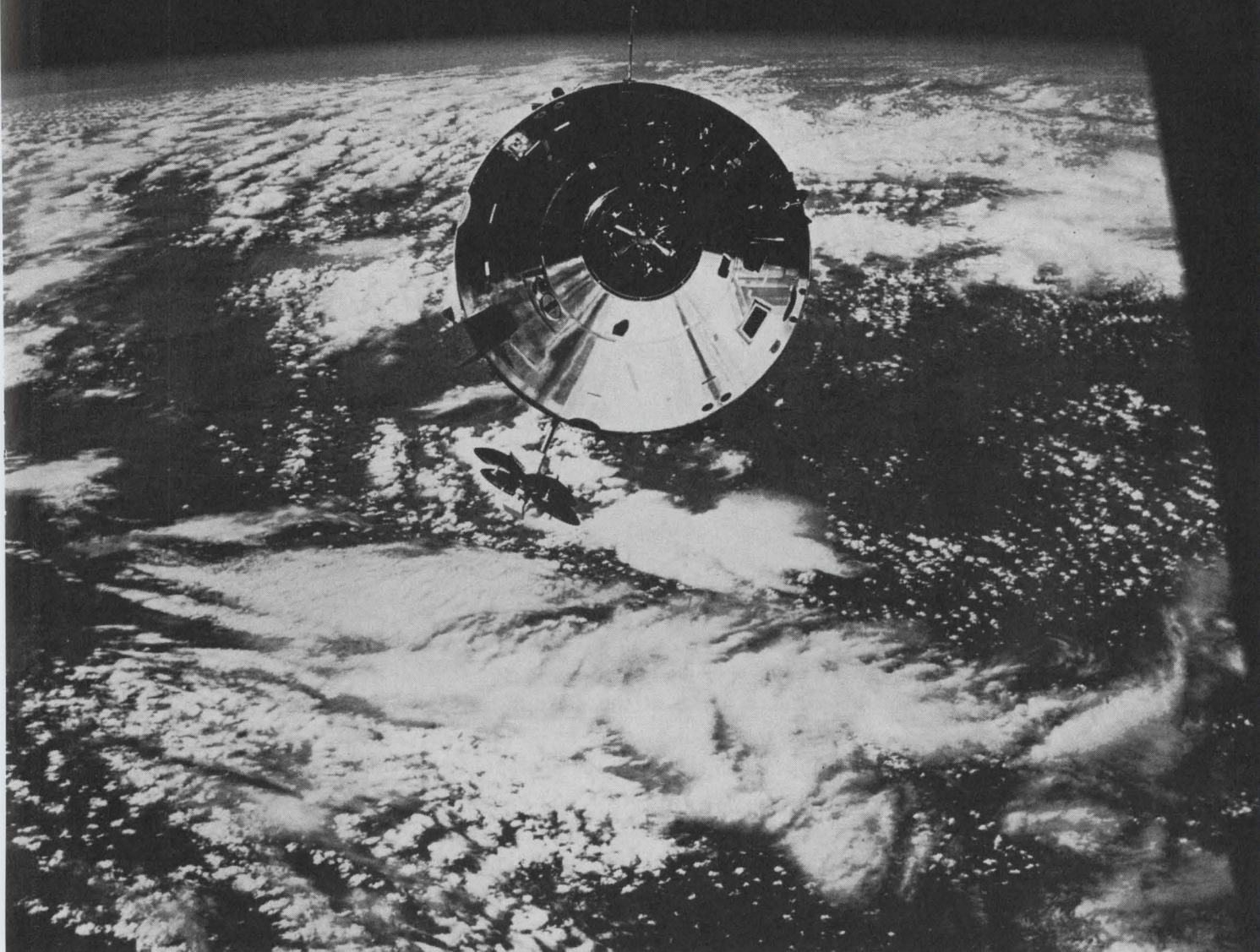

It takes good connections to make it to the moon.

Key to the success of lunar missions: the precise connections, disconnections or reconnections of the Apollo spacecraft modules. And one of the most critical of these connections in the whole NASA mission is when the Command and Service Modules reconnect with the Lunar Module.

All this takes good connections in another sense, too — good electrical connections to the millions of parts in the whole Apollo/Saturn vehicle. And that's where we come in, with a host of ultra-reliable connectors in every stage.

To name a few of the 18 types we supplied: Circulars (CV, RX, KPD, 5015), Rectangulars (D Subminiature, DPK, Double Density D), KPT Hermetic, Micro-D™ connectors and five different umbilical connectors.

The moral? When it comes to a unique combination of versatility and reliability, come to ITT Cannon. Whatever the connector application, you'll be on solid ground. For further information, write ITT Cannon, 3208 Humboldt St., Los Angeles, Calif. 90031. A division of International Telephone and Telegraph Corp.



Circle 163 on reader service card

CANNON **ITT**

AIRPAX

MAGNETIC PICKUPS

*A great selection of types
to meet a wide range of applications*



SEALED POLE
3/4 - 20 UNEF - 2A THD



STANDARD
5/8 - 18 UNF - 2A THD



UL LISTED
For Hazardous Locations
3/4 - 20 UNEF - 2A THD



SUBMINIATURE
1/4 - 40 NS 2A THD



MINIATURE
3/8 - 24 UNF 2A THD



MICROMINIATURE
10-32 UNF 2A THD
(Shown Actual Size)

Illustrated
are a few of the pickups
designed and stocked by Airpax.
Types include units for operating
temperatures to 800° F and outputs
to 600 volts peak-to-peak. If your problem
is Positioning, Counting, Synchronizing,
Slippage Control or just straight Tachometry,
Airpax has the pickup and accessory
modules, including Digital Readout
units, to provide a complete system.
Data on operating principles,
curves, and characteristics
is available on
request.

AIRPAX ELECTRONICS

SEMINOLE DIVISION, FORT LAUDERDALE, FLORIDA 33310
Phone: 305 587-1100 TWX: 510 955-9866 TELEX: 051-4448

Rms measuring time cut to 300 msec

Five-digit voltmeter uses curve-fitting network to compute true rms values; instrument also measures resistances down to 10 ohms, d-c voltage and voltage ratios

By Owen Doyle

Associate editor



High speed. The 5500 computes a true-rms reading electronically, so it's almost 10 times as fast as a dvm that measures rms with thermocouples. And distortion can't fool this meter like it can an integrating dvm.

Take your time or take your chances. This is the usual choice for an engineer measuring the rms value of an a-c signal. If he has time, he uses a digital voltmeter built with a thermal converter; this type of dvm measures rms regardless of the shape of the meter's input, but takes 2 or 3 seconds to do it. If he's in a hurry, he reaches for a dvm that uses an integrating converter. This type is fine as long as its input is a perfect sine wave; but if 60-hertz pickup or other noise distorts the input, the meter's reading, is, at best, inaccurate.

Now Dana Laboratories Inc. is offering a third choice: a dvm built with what the company calls

a computing converter. There are no thermocouples in it, but this converter, according to Dana, allows its new dvm to measure rms as accurately as "true-rms" meters measure. And since the Dana meter calculates electronically, it's as fast as an integrating dvm—a reading every 300 milliseconds.

The rms-reading dvm is just one version of the 5500/135, a five-digit meter Dana will introduce at Wescon.

The term "true-rms" and similar adjectives refer to dvm's built with thermal converters. The standard rms volt is defined in terms of energy dissipated in a standard resistor, so a true-rms dvm runs its input through a thermocouple,

measures the energy dissipated, and then computes and displays the input's rms value.

An integrating dvm, on the other hand, measures the average value of its input and multiplies the average by 1.1 to get rms. This technique is fast; and it works as long as the input is really a sine wave. But input distortion small enough to be undetectable on an oscilloscope can throw an integrating meter's reading off by as much as 5%.

Doesn't matter. But a little distortion doesn't bother Dana's meter because it doesn't take the wave shape for granted. This meter first finds the absolute value of its input by running it through



Bunker-Ramo converts operational requirements to production hardware



BR-700 Information System providing off-line storage and retrieval



Militarized Automatic Map Compilation System

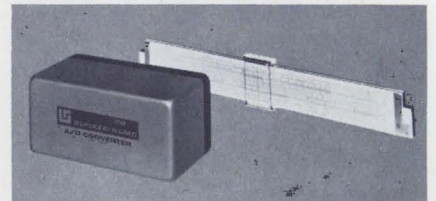

BR-850 Cyclic A/D Converter for video and other high speed requirements

Bunker-Ramo's Defense Systems Division has demonstrated its capability to convert operational requirements into advanced electronic equipment.

Here are significant examples:

The BR-90, combines electronic and photographic displays with stored-program control . . . BR-700, low-cost solution to source-data automation and local data management . . . UNAMACE, a computer-controlled system that automatically

prepares orthographic maps from aerial photographs . . . new techniques which provide faster data acquisition systems using high-speed cyclic analog-to-digital converters . . . new techniques leading toward low power, low cost MOS micro-electronic digital equipment.

If your project requires either special-purpose product design or large-scale systems engineering — or both — contact Bunker-Ramo.

 **THE BUNKER-RAMO CORPORATION**
DEFENSE SYSTEMS DIVISION
8433 FALLBROOK AVENUE • CANOGA PARK, CALIFORNIA 91304

AN EQUAL OPPORTUNITY EMPLOYER

a rectifier. A curve-fitting network then squares the rectified wave, and finally the squared signal is averaged to produce the input's rms value.

According to Dana, its meter can match the true-rms meters in accuracy when the signal being measured is a sine wave subjected to "commonly experienced distortion", such as 60-hertz pickup, harmonic distortion and low-level rfi.

And the Dana meter handles square and sawtooth waves. Says Barton Weitz, Dana's product marketing manager: "If a square wave is fed to an averaging converter, a thermal converter, and a computing converter, the rms reading of the averaging converter would be off by 11%, of the thermal converter between 0.05% and 0.1%, and of our computing converter off 0.1%."

There are cases where the Dana meter can't compete. Since a true-rms meter responds to energy changes, it alone among dvm's can handle weirdly shaped waves.

Other members. Dana's rms-reading meter is part of a family. The basic 5500/135 measures d-c voltages and ratios, and costs \$2,995. Everything in the meter, except the power supply, is on printed-circuit boards. So a user of the 5500 who wants to measure a-c and resistance just gets a few more p-c boards from Dana, and plugs them into the 5500's mother board.

The rms board with the computing converter on it costs \$745; a board that holds an averaging converter costs \$545; and a board containing a resistance-measuring network costs \$445. So, for example, the price of a 5500 that measures d-c, rms, and resistance is (\$2,995 + \$745 + \$445) \$4,185.

The instrument has five d-c voltage ranges—100 and 1,000 millivolts, and 10, 100 and 1,000 volts.

When set at one of the three higher ranges, the 5500 resolves 100 microvolts, and has a temperature coefficient per degree centigrade of $\pm 0.0005\%$ of the reading $\pm 0.0002\%$ of full scale. And at these ranges the accuracy is $\pm 0.005\%$ of the reading $\pm 0.001\%$ of full scale, and the six-month stability is $\pm 0.001\%$ of the reading per month.

Noise rejection is 80 decibels for signals over 59 hertz, and the common mode rejection is 140 db for d-c and 120 db for 60 hz.

At the 10-volt range, the input resistance is 10,000 megohms; and at the 100-volt and 1,000-volt ranges it's 10 megohms.

When set to a millivolt scale, the 5500 resolves 1 μ volt, has a temperature coefficient of $\pm 0.001\%$ per $^{\circ}\text{C}$, and an accuracy of $\pm 0.005\%$ of the reading $\pm 0.002\%$ (1,000 mv) or $\pm 0.01\%$ (100 mv) of full scale.

The noise rejection is 40 db from 59 hz to 300 hz, and 70 db for higher frequencies; and the common-mode rejection is 140 db for d-c and 120 db for 60 hz. The input resistance is 100 megohms.

The 5500's ratio ranges are 1, 10, and 100. The numerator can roam between -1,000 and +1,000 volts, and the denominator between 20 and 110 volts.

In the ratio mode, the 5500 has an accuracy of 0.004% of the reading $\pm 0.001\%$ of full scale, and a noise rejection of 80 db.

For measuring a-c, the 5500 has ranges of 1 volt and 10, 100, and 1,000 volts. It resolves 10 μ volts, and has a frequency range of 50 hz to 100 kilohertz; a more expensive model goes down to 10 hz.

Down and up. Accuracy goes down as the input's frequency goes up; for the three higher voltage ranges the accuracy is between $\pm 0.09\%$ of the reading $\pm 0.09\%$ of full scale and $\pm 0.9\%$ of the reading $\pm 0.1\%$ of full scale. At the 1-volt range, the accuracy is $\pm 0.18\%$ of the reading $\pm 0.02\%$ of full scale for inputs under 10 khz, and $\pm 0.3\%$ of the reading $\pm 0.05\%$ of full scale for higher frequencies.

The 5500 has seven resistance ranges, from 10 ohms to 10,000 kilohms. Accuracy usually goes down as the range goes up. At the 10-ohm setting it's $\pm 0.02\%$ of the reading $\pm 0.02\%$ of full scale and at 10,000 kilohms it's $\pm 0.1\%$ of the reading $\pm 0.001\%$ of full scale.

The 5500 and all its p-c boards will be ready in production quantities by Sept. 1; delivery time is 45 days.

Dana Laboratories, Inc., 2401 Campus Drive, Irvine, Calif. 92664 [338]

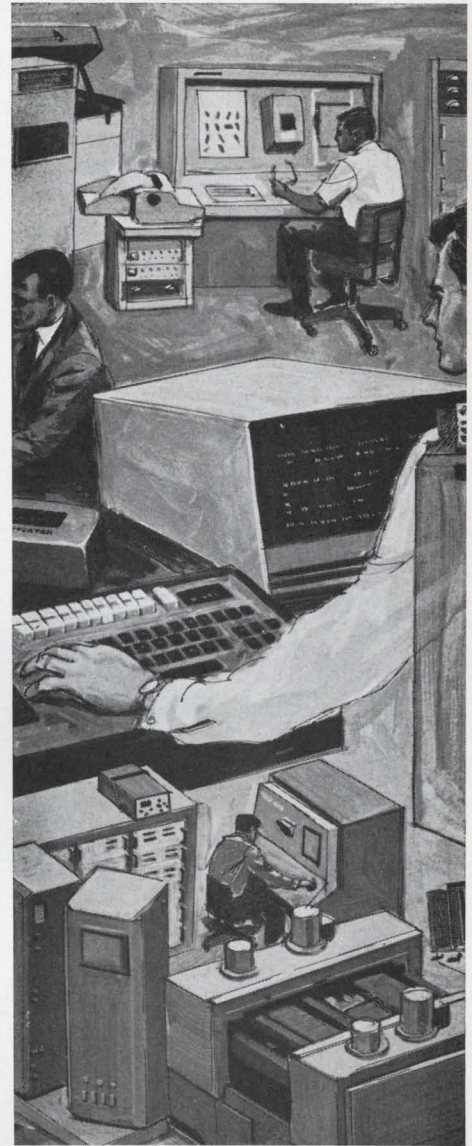

Convert Your Career Goals To Realities

TECHNICAL SPECIALIST — CRT DISPLAYS

Perform conceptual design & development of future generation, computer-driven display systems and sub-systems.

ADVANCED CIRCUIT DESIGN

High-speed linear circuits including thin-film & monolithic — strong experience in A/D converters, semiconductor components & computer-aided techniques.

Call or Send Resume to:

D. T. Kalal
(213) 346-6000



THE BUNKER-RAMO CORPORATION
DEFENSE SYSTEMS DIVISION
8433 FALLBROOK AVENUE • CANOGA PARK, CALIFORNIA 91304

An Equal Opportunity Employer

AU!

Where do you get yours?

Prospecting was once the only source for gold. Not so today! The most modern production techniques, the latest refining methods and the best equipped research laboratories make Williams your one best source for all

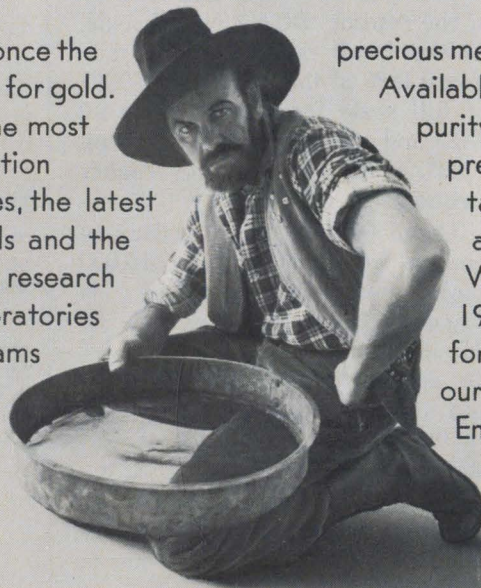

precious metals and their alloys. Available in ultra-high purity sputtering discs, preforms, foil, ribbon, tape, wire, sheet and other forms. Write for our 1969 catalog and for information on our "Instant Engineering" kit.



WILLIAMS PRECIOUS METALS DIVISION OF WILLIAMS GOLD REFINING CO., INC., 2978 MAIN STREET, BUFFALO, NEW YORK 14214

Circle 168 on reader service card

Digital coupler gives 100,000-megohm isolation

Built with thick-film hybrid circuitry, device fits 14-lead dual in-line sockets; it can withstand 500-volt noise spikes and doesn't require a power supply

Coupling digital systems, particularly in electrically noisy environments, is often a difficult task. Usually, designers run into trouble with so-called ground loops or other grounding problems; shielding leaves isolation to be desired, especially where high-speed, sensitive logic is used.

Traditional approaches include elaborate filtering and potentially

costly but noise-immune high-voltage logic. But a new company, Hybrid Electronics Inc., has taken a different approach with what it calls a digital isolator.

The isolator provides input/output isolation of about 10^{11} ohms—100,000 megohms—and only 2 picofarads of input-output capacitance.

According to Richard H. Wagner, the company's applications

manager, the isolator withstands 500-volt noise levels. Sized and pinned to fit 14-lead, dual in-line package sockets, the isolator is built with thick-film hybrid circuitry. It is notable for its small size and short parts list—made possible says Wagner, by hybrids. "It uses two transistors, two diodes and a few capacitors," he points out, "and the largest com-

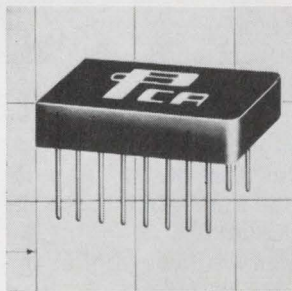

Four separate transformers in a case 1 x 0.4 x 0.225 in. constitute a multi-pack inline transformer module designed to meet computer, telemetry, space and related applications calling for miniaturized components. Available in either 2:1 or 1:1 winding ratio, a typical module has a primary inductance of 500 μ h. PCA Electronics Inc., 16799 Schoenborn St., Sepulveda, Calif. [341]



Metalized polyester Flat-Pak capacitors offer a low profile unit 0.225 in. high. Package width of all units is 0.385 with lead break-out at 0.300 center-to-center. Length varies from 0.100 for the 0.001 μ f unit to 0.900 for the 1 μ f unit. Capacitors come in more than 100 standard values rated at 50 v. Engineered Components Co., 2134 W. Rosecrans Ave., Gardena, Calif. [342]

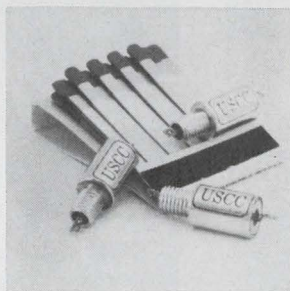

R-f interference on 115 v a-c (0-400 hz) lines can be substantially reduced with miniature L section rf/emi filter series 2320. The low pass filter offers an attenuation of 70 db at the high end of a 10 khz to 10 Ghz operating frequency range. Specified attenuation is guaranteed over the -55° to 125° C temperature range. USCC, 2151 N. Lincoln St., Burbank, Calif. 91504. [343]

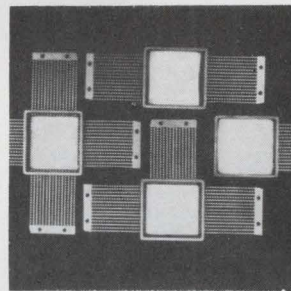

High reliability hybrid circuit flat-pack designated HA-1752 measures 1 x 1 inch square and features an internal depth of 0.125 inch minimum. The package comes with 15, 30, 45 or 60 leads and can be supplied with either bare ceramic, metallized ceramic or kovar base. It is available with sealing preform and lid. Mitronics Inc., 132 Floral Ave., Murray Hill, N.J. 07974. [344]

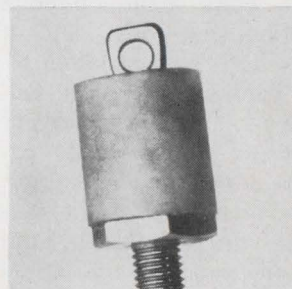

D-c overvoltage protectors prevent the output voltage of a power supply from exceeding a predetermined voltage under any condition of failure. Twenty-five models are available covering a range of nominal trip voltages from 4 to 28 v. Units will handle up to 25 amps over a temperature range of -20 to $+75^{\circ}$ C. Price is \$25. Acopian Corp., Box 585, Easton, Pa. 18042 [345]

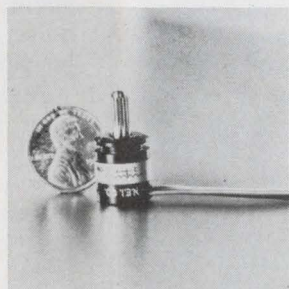

Precision rotary potentiometer is a $\frac{1}{2}$ in. device that utilizes conductive plastic film. It features absolute standard linearities of 0.35%, with special linearities as close as 0.15%, a resistance range of 250 ohms minimum to 130 kilohms maximum, low torque of less than 0.1 inch ounce, and a power rating of $\frac{1}{2}$ watt. New England Instrument Co., Kendall Lane, Natick, Mass. [346]

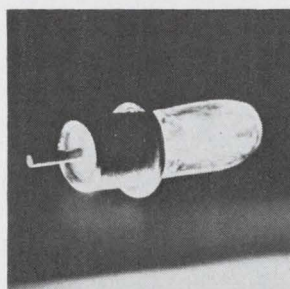

Coaxial contact lamps, only 0.093 in. in diameter, can be driven directly by IC's without buffer transistors. It is an unsupported filament, T- $\frac{3}{4}$ lamp, designed for readouts, indicator, instrument and panel illumination, and other applications where space is critical. Average life ranges from 5,000 to 100,000 hours. LAMPS Inc., 17000 South Western Ave., Gardena, Calif. [347]

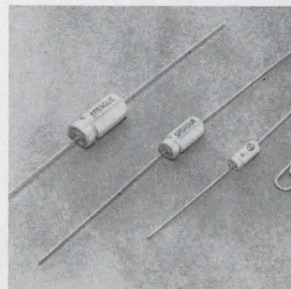

For applications where high volumetric efficiency and quality is desired, type 109D extended-range tubular sintered-anode Tantalex capacitors fill the basic requirements. Units are available in voltage ratings from 6 wdc through 75 wdc and may be operated up to 85° C at the rated d-c working voltage. Sprague Electric Co., 125 Marshall St., North Adams, Mass. 01247 [348]

"The Dirty Fighter"

(Our New Ultra-Pure Cleaning System.)

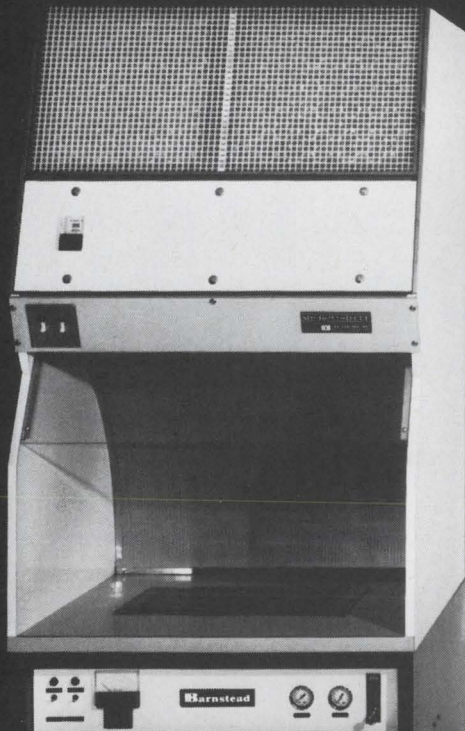

Boy, does it fight dirty. With cascading rinses of ultra-pure hot water pouring over just about any miniaturized component you can name, impurities just don't have a chance. Not even the tiniest ones, down to 0.45 micron, escape the dirty fighter.

Available with or without a laminar flow hood, and in two models with flow rates to 50 gph. The dirty fighter is clean-cut, however; steel cabinetry, recessed controls, sliding access doors, and a plastic-coated working surface.

Sure, our cleaning system fights dirty. You wouldn't want it any other way. Write or call for more information. Barnstead Company, 225 Rivermoor Street, Boston, Massachusetts, 02132, (617) 327-1600.

 **BARNSTEAD**
SYBRON CORPORATION

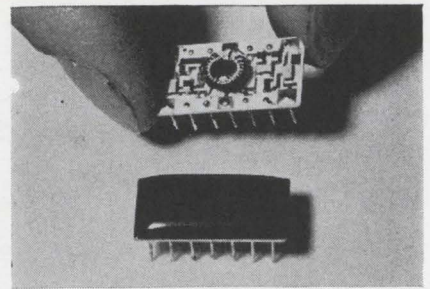

Selective. Coupler rejects noise components in linking digital systems.

ponent of the assembly is a quarter-inch transformer."

The isolator consists of a single-transistor Hartley r-f oscillator that is coupled to a half-wave rectifier through a toroidal transformer. Capacitive filtering at the rectifier output removes the signal's a-c components—including any noise—but passes d-c to an output transistor in the circuit.

Digital route. The isolator doesn't need a power supply; its r-f oscillator runs on the digital input, turning on and off in response to logical "0's" and "1's". The rectifier output turns the output transistor on and off in response to the digital input—but minus its noise component.

"The isolator allows digital operation of equipment that floats at potentials above or below that of ground," says Wagner. This includes such complex gear as programmable power supplies or test equipment, industrial-process controllers and other logic circuits, sample and hold networks, or silicon controlled rectifier switches. "In all cases, the isolator provides about 500 volts common-mode noise rejection," he adds, "and at bit rates as high as 500 kilobits."

Another application for the isolator is as a replacement of driver/receiver pairs often used when signals must be sent over long cables.

Prototype quantities of the digital isolator are available from stock, and are rated for the industrial temperature range of 0° to 70°C. Volume production will begin in five to seven weeks. The isolator is priced at \$25.25 each for one to nine units, \$22.76 in lots of 10 to 99, and \$19.85 in lots of 100-499.

Hybrid Electronics Inc., 7 DeAngelo Dr., Bedford, Mass. 01730 [349]

**Unique, precise,
yet simplistic design;
priced modestly.**



PRECISION SWITCHES — Five new types of precision switches are now available that will be of special interest to those users looking for savings in space and cost, along with long life and high performance characteristics. Design simplifications and unique constructions are such as to assure the switch buyer of large control capacities, the greatly reduced sizes notwithstanding.

TOGGLE SWITCHES; SLIDE, TUMBLER, & ROCKER SWITCHES — Six new patents explain the high performance, long life, and unique construction of four types of heavy-, medium- and light-duty toggle switches. High quality slide, tumbler, and rocker switches are also available in a variety of shapes and colors.

**PRECISION SWITCHES
SUB-MINIATURE MJ SERIES SWITCHES**

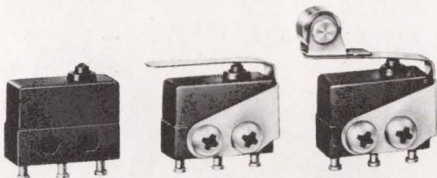

Basic type Leaf lever type Roller lever type

□ Microscopic size and large capacity. □ Long life steel ball mechanism. □ Low contact resistance — gold flashed silver contact. □ Contact — SPDT. □ Ratings — 7A 125V AC/7A 250V AC/7A 28V DC. □ Mech. life, 250,000 operations min. □ Elec. life, 25,000 operations min.

MINIATURE APPLIANCE NA SERIES SWITCHES

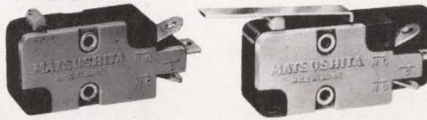

Basic pin plunger type, guardless Hinge lever type, right-hand guard

□ Available in wide range of lock-in actuators with right-hand guard, left-hand guard, and guardless. □ Low price, low operation force for appliance purposes. □ Safe, easy mounting because of molded insulation guard. □ Simple, exact spring mechanism. □ Contact — SPDT. □ Ratings — 3A 125V AC/2A 250V AC. □ Mech. life — 500,000 operations min. □ Elec. life — 50,000 operations min. □ Solder type, lock-in actuator.

GENERAL PURPOSE MZ SERIES MICROSWITCHES



Basic type

□ UL — 22 types □ CSA — 21 types □ Contact — SPDT □ Rating — 15A 125V AC/10A 250V AC/0.4A 115V DC □ Mech. life — 10⁵ operations min. □ Elec. life — 10⁴ operations min. □ Solder and screw types.

MINIATURE GENERAL PURPOSE MV SERIES SWITCHES



Solder type Screw type Q.C. (AMP #187) type

□ Available in wide range of lock-in actuators, operating characteristics, and terminal designs. □ Extra long life: Mech. — 10⁶ operations min.; Elec. — 10⁴ operations min. □ Low price □ High quality □ Interchangeable □ Contact — SPDT □ Ratings — 5A 125V AC/10A 125V AC/3A 250V AC/6A 250V AC.

SUB-MINIATURE GENERAL PURPOSE MS SERIES SWITCHES

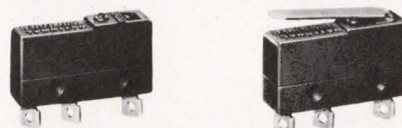

Basic type Leaf lever type

□ Ultra-compact for use in limited space. □ UL — 5 types. □ CSA — 4 types. □ Contact — SPDT. □ Mech. life — 10⁵ operations min. □ Elec. life — 10⁴ operations min. □ Solder type, leaf, roller leaf & simulated leaf types.

TOGGLE SWITCHES

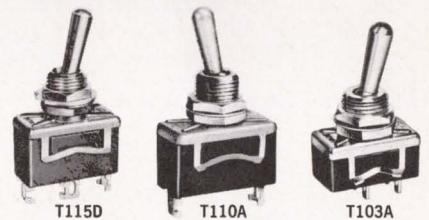

T115D

T110A

T103A

T * 15 SERIES (HEAVY DUTY)
□ 15A 250V AC
□ SPDT, DPDT, 3PDT, 4PDT types

T * 10 SERIES (MEDIUM DUTY)
□ 10A 250V AC
□ SPDT and DPDT types

T * 06 & T * 03 SERIES (LIGHT DUTY)
□ 6A 125V AC/3A 125V AC
□ SPDT and DPDT types

SLIDE, TUMBLER & ROCKER SWITCHES



Slide type
TL 101A
1A 250V AC

Tumbler type
TT 110D
10A 250V AC

Rocker type
TW 110D-C
10A 250V AC

REMVAC COMPONENTS, INC.

37-55 61st Street, Woodside, Long Island, New York 11377 • (212) TW 9-6100

Agents for U.S. sales of components manufactured by

Matsushita Electric Works, Ltd.

Call or write for details:

Circle 171 on reader service card

CTS cermet resistor networks

...with

NEW 16-lead dual-in-line package

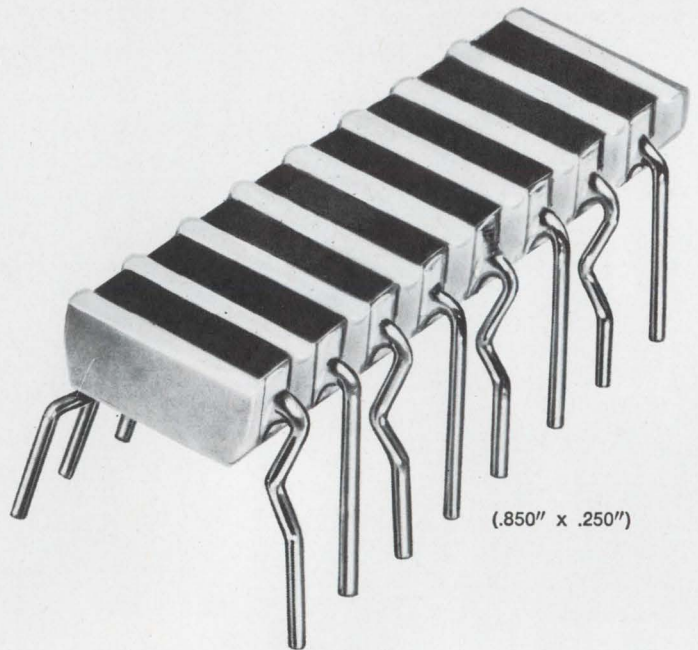

(.850" x .250")

■ Add more circuitry...up to 16-lead dual-in-line packages...with these new CTS space-saver cermet resistor networks. Specifically designed to simplify automatic insertion and reduce your assembly costs. Easy to hand mount, too.

Series 760 DIP Resistor Networks provide ...14 or 16 lead packages...up to 15 resistors per module with an infinite number of circuit combinations...extremely good environmental specifications...5 lbs. pull strength on leads. A natural to combine with active devices to form hybrid circuits. .100" lead spacing.

Series 750 Cermet Resistor Networks offer ...three basic sizes and an infinite number

of circuit combinations...excellent environmental characteristics...5 lbs. pull strength on leads...and are available with or without active devices...lead spacing, .125".

Check CTS low prices and fast delivery schedule...2 weeks for prototypes; 4-6 weeks for production quantities. See the prices listed below!

More flexibility...CTS packages can be delivered without organic cover coat. You trim for circuit balance in your plant.

Ask your CTS sales engineer for data. Or write CTS of Berne, Inc., Berne, Indiana, 46711. Phone: (219) 589-3111.

CTS CORPORATION
Elkhart, Indiana



Quantity	SERIES 750			SERIES 760			
	4-pin 3 resistors	6-pin 5 resistors	8-pin 7 resistors	9 resistors (14 pin module)	11 resistors (14 pin module)	13 resistors (14 pin module)	15 resistors (16 pin module)
10,000 piece price	14.4¢ ea. (4.8¢/ resistor)	19.5¢ ea. (3.9¢/ resistor)	24.5¢ ea. (3.5¢/ resistor)	41¢ ea. (4.5¢/ resistor)	43¢ ea. (4¢/resistor)	45¢ ea. (3.5¢/ resistor)	55¢ ea. (3.7¢/ resistor)
1,000 piece price	28.8¢ ea.	39.0¢ ea.	49.0¢ ea.	82¢ ea.	86¢ ea.	90¢ ea.	\$1.10 ea.

Prices shown are $\pm 2\frac{1}{2}\%$ tolerance, ± 250 ppm/ $^{\circ}$ C from 50 ohms through 1 megohm standard TC. (Also based on circuits with all resistors screened simultaneously on one side of the substrate.)

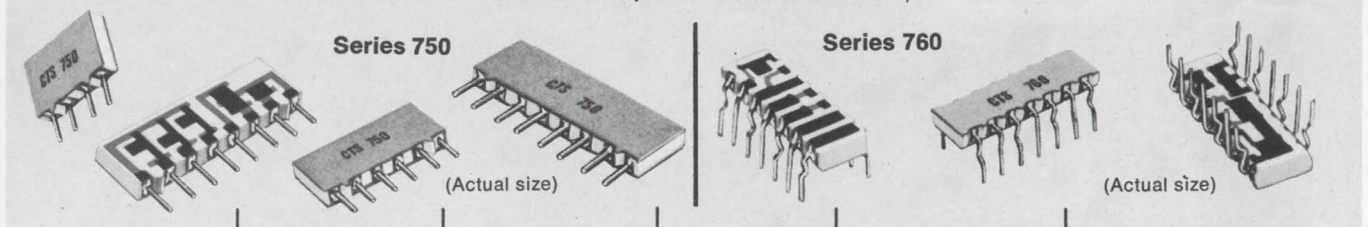

Microelectronic
Circuitry

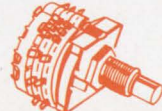

Selector Switches



Trimmers



Potentiometers



Crystals, Oscillators,
and Filters



Loudspeakers

New components

Cooling dual in-lines with dissipator/clip

Conduction base fits
on circuit board; retainer
assures IC contact pressure

Excessive heat is a common cause of failure in integrated circuits. In dual in-line packages, steadily increasing power requirements of from 1 to 5 watts have made efficient heat dissipation mandatory.

International Electronic Research Corp. has introduced a heat dissipator/retainer that it says is the first specifically designed to control heat levels in dual in-line IC packages having up to 14 leads.

The assembly consists of a conduction base that fits between the circuit board and the package case, providing thermal contact with the bottom of the case, and a retainer clip that inserts over the IC to provide proper contact pressure. An optional heat sink/dissipator can be placed between the circuit board and conduction base for additional reduction.

In a typical application, with the General Electric PA 237 linear amplifier, a temperature reduction of 16° at a dissipation level of 700 milliwatts has been attained, using only the retainer clip and conduction base. By adding the staggered-fingered heat sink/dissipator, a temperature reduction of 25° can be attained.

Sockets or solder. The retainer clip and conduction base can be used to retain dual in-line packages either when sockets are used in the assembly, or when IC's are soldered directly onto the circuit board.

Pricing of the conduction base is 7.4 cents in quantities of 100 and 5 cents in quantities of 10,000; for the retainer clip, 25 cents in quantities of 100 and 15 cents in quantities of 10,000; and for the sink/dissipator, 20 cents each for 100 and 11 cents for 10,000.

International Electronic Research Corp.,
Burbank, Calif. 91502 [350]

WE'VE JUST MADE THE INDUSTRY'S BROADEST LINE OF TEFLON* TAPES A LITTLE BROADER

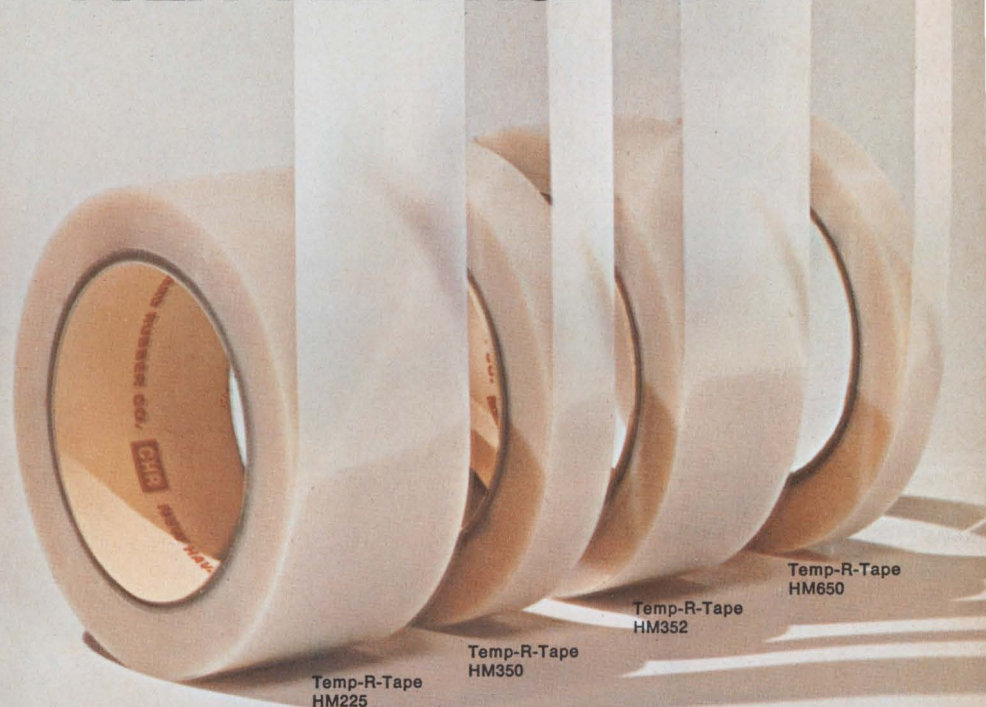

By about a thousandth of an inch.

That's the thickness of the Teflon film used in our new HM225 Temp-R-Tape®. With its silicone polymer pressure sensitive adhesive it mikes out to only .00225".

Along with the super-slipperiness of Teflon, HM225 has low elongation, high strength, easy no-curl handling, outstanding electrical properties and a -100 to +500 F operating range.

You can't buy a thinner Teflon tape that offers this combination of unique qualities.

CHR has a tape of Teflon to match just about any design requirement you may come up with. And with the other new high modulus tapes (see box) CHR has the broadest line in the industry. * TM of DuPont

NEW CHR TEMP-R-TAPE OF TEFLON

Four HM series tapes are available with silicone polymer pressure sensitive adhesive: HM225—2¼ mils, HM350—3½ mils, HM650—6½ mils and HM352—3½ mils with the Teflon surface treated to promote adhesion of varnishes.

For the widest selection of tapes of Teflon in the industry see your nearest CHR distributor for technical assistance and prompt delivery. Look in the Yellow Pages under "Tapes Industrial" or in major industrial directories and microfilm catalogs under CHR. Or write for details and sample. The Connecticut Hard Rubber Company, New Haven, Connecticut 06509.

CHR

Subsidiary of U.S. Polymetric, Inc.



When you're stuck with more wire than space...

Get around the problem, neatly, with Brand-Rex ribbon cables.

These slim space-savers bend into tight corners . . . hug contours around obstacles . . . keep wiring out of the way. They make high density interconnections easier to handle.

Brand-Rex gives you a wide choice of vinyl-insulated ribbon constructions (singles, pairs, shielded wires, coaxials) . . . with 2 to 100 conductors . . . to meet a variety of commercial and military requirements. Conductors can vary in type, size and color (striped wires also) within a given cable. They separate and strip easily, terminate in standard devices.

Write for the facts on Brand-Rex ribbon cable. And ask about any custom design you have in mind. Brand-Rex Division, American Enka Corporation, Willimantic, Conn. 06226.

Connect for tomorrow.

BRAND-REX

British pair checks radiation levels

Gamma monitor measures dose rates over a nine-decade range; six-decade counter helps keep track of isotope activity

One looks for trouble and the other looks for answers. Both are used for looking at radiation. They're a pair of instruments developed by Labgear Ltd., a member of Britain's Pye of Cambridge Group.

The gamma monitor measures gamma-radiation dose rates over a nine-decade range, from 1 milliroentgen/hour to 10^6 roentgens-hour. It's for installations with

nuclear power plants or other source of radioactivity, and can be used either in routine tests or in checks for radiation leakage.

The decade/counter D4151/B is a six-decade pulse counter which works with a detector to measure radiation from isotopes. And isotopes are usually an experimental tool for engineers or scientists and a diagnostic tool for physicians and

medical research workers.

The gamma monitor comprises an indicator, a power supply, and three detectors, each with a particular gamma sensitivity—1mR/hr to 10^3 R/hr, 10 mR/hr to 10^4 R/hr, and 1R/hr to 10^6 R/hr.

A detector can be installed as far away as 100 feet from the monitor. The detector contains an ionization chamber, an electrometer pentode,

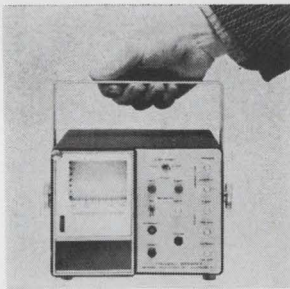

Frequency reference BEWCO 112 features a synchronizing accuracy better than 1 μ sec. It provides 1 Mhz and 100 khz frequency outputs directly traceable to the National Bureau of Standards. Typical applications are for calibrating counter oscillators, oscilloscope time bases, and signal generators. Price is \$495. Beukers Laboratories Inc., 1324 Motor Parkway, Hauppauge, N.Y. [361]

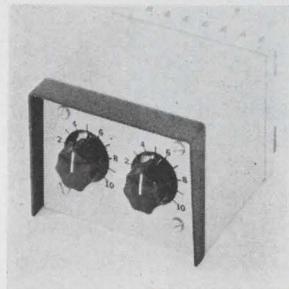

Voltage band monitors series VB protect equipment required to operate between two voltage limits. Solid state voltage sensors determine preselected under or over voltage conditions and deenergize an internal control relay if limits are exceeded. The monitor can be used to sound an alarm, or shut down the equipment. Diversified Electronics Inc., Box 6231, Evansville, Ind. [362]

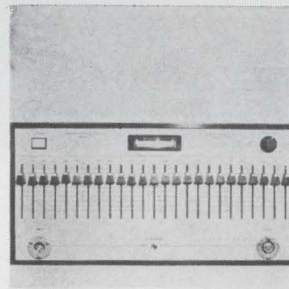

Spectrum shaper model 124 equalizes over-all frequency response curves of audio systems in overlapping 1/3-octave bands between 50 hz and 20 khz. It selectively tailors sounds by attenuation and can also eliminate unwanted noise in audio signals. Uses include broadcast and recording work, and subjective noise analysis. B&K Instruments Inc., 5111 W. 164th St. Cleveland [363]

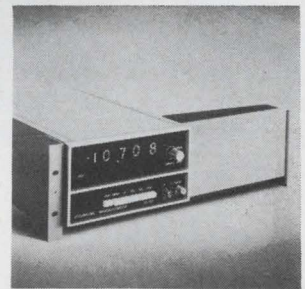

Digital integrating microvoltmeter DS-100 uses the Auto-Zero method of a-d conversion. Actual sensitivity of this automation device is 1 μ v even at speeds of 20 readings per second. Noise is reduced by at least 120 db through the differential input/output guarding techniques. Prices start at \$920. Doric Scientific Corp., 7969 Engineer Rd., San Diego, Calif. 92111. [364]

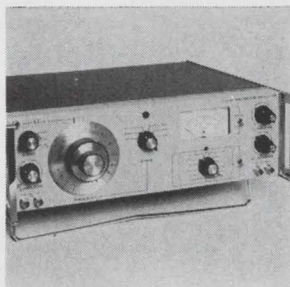

Test oscillator F324A is a 10 hz-10 Mhz unit that features simultaneous square wave output in addition to a low distortion sine wave output. Square wave rise time is less than 10 nsec. A 90 db step attenuator in -10 db steps, coupled with a 3.16 v rms full scale meter, provides precise amplitude control. Price is \$795. Data Royal Corp., 8014 Armour St., San Diego, Calif. [365]

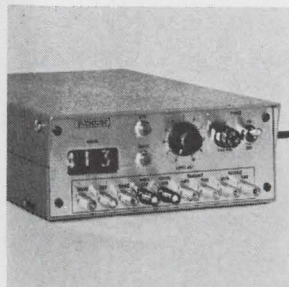

Modem error rate test set TS-100 is for performance testing of modems alone or on the communication channel over which they are operating. Error rate is clearly displayed on a decimal readout. Bit rate is up to 100,000 bps. Test pattern is 32,767 bits in duration. Dimensions are 3 1/2 x 8 1/2 x 15 1/2 in. Rixon Electronics Inc., 2120 Industrial Parkway, Silver Spring, Md. [366]

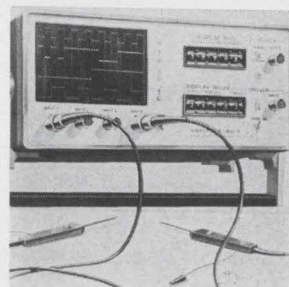

Portable multichannel analyzer Diana is for fast, positive, in-production checkout or field trouble shooting of digital systems. It measures both the direction and the spatial or temporal position of signals in transition from one logic level to another. Price of the standard model 401-S is \$1,595. Data Display Systems, 140 Terwood Road, Willow Grove, Pa. 19090. [367]

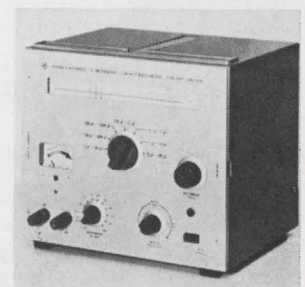

Transistorized meter type KRT measures capacitances in the range from 1 pf to 100 μ f according to the resonant circuit method. The low test voltage of 2 mv to 25 mv permits accurate measurements on voltage-sensitive high-dielectric constant and semiconductor capacitors. Price is \$455; delivery, from stock. Rohde & Schwarz, 111 Lexington Ave., Passaic, N.J. 07055 [368]

NOW...

Hamilton precision metals has added facilities...and is in the Photoformed® Parts business...



BIG!

Hamilton has added a new plant—just to produce precision, Photoformed® parts!

This new facility is equipped with the most modern photo-etching machinery on the market. The new equipment will produce precision parts in large quantities to the highest standard of dimensional accuracy.

Now, you can get from the Precision Metals Division, finished parts to the same degree of precision as world wide metal users have come to expect in Hamilton's strip and foil.

Hamilton offers the advantages of a completely integrated facility controlling every step from melt to finished strip or foil—and *now* to finished parts. This means that you get the same adherence to metallurgical standards and dimensional accuracy that has become the hallmark of Hamilton.

For the complete story on the capabilities of Precision Metals Division and what it can do for you, write for your copy of the Precision Metals catalog. It's yours for the asking—write today!

PRECISION METALS DIVISION
HAMILTON
WATCH COMPANY • LANCASTER, PA. 17604

and a d-c amplifier.

The monitor converts the amplifier's output into a reading of the radiation level at the detector. The amplifier's output also goes to three discriminators which in turn control warning lights on the monitor's

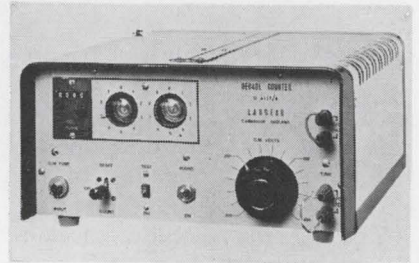

Show . . . The counter's display has four registers and two glow tubes.

front panel and regulate relays which provide the monitor's output signals.

One of the discriminators decides whether certain equipment faults have occurred and the other two make sure that the radiation is within preset limits.

The counter is driven by a pulse amplifier whose gain is 25. The amplifier in turn is driven by radi-

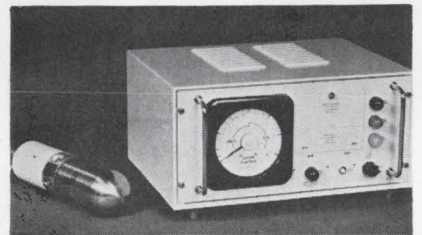

. . . and tell. The monitor warns if radiation is over a limit.

ation detectors. The Labgear counter works with most standard isotope detectors.

Built into the counter is a pulse generator which can be used both for testing the instrument and for converting it into a timer. And this pulser can be controlled remotely with either a mechanical or a photoelectric switch.

The counter's display is made of a four-digit electromechanical register and a pair of glow-transfer tubes.

Price of the monitor is \$1,670 and of the counter \$152.

Labgear Ltd., St. Andrews Rd. Cambridge, England. [369]

LOW COST MULTIPLIER

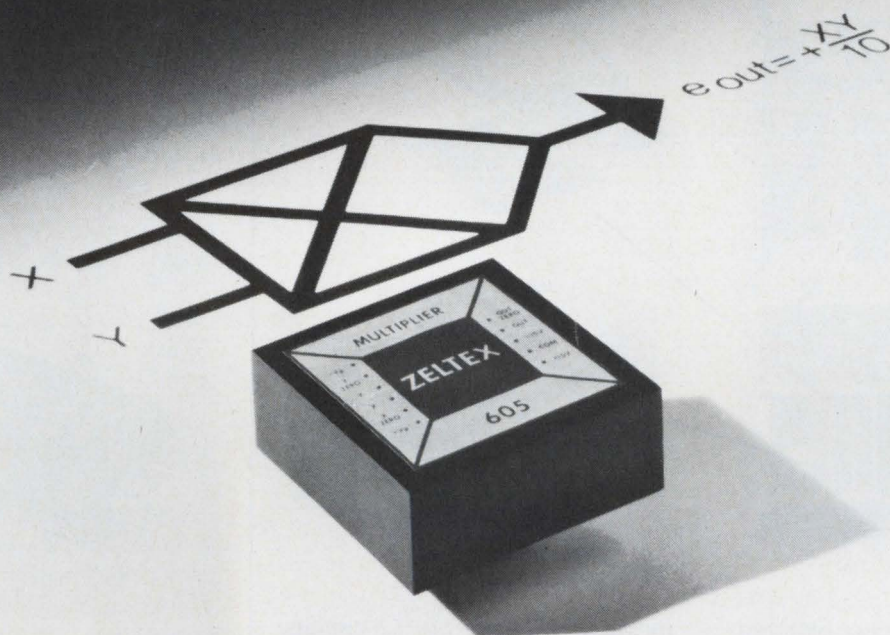

New from
ZELTEK!

A four-quadrant modular multiplier that requires no external amplifiers for

\$48*

- 1% Accuracy ■ 10V, 4mA Output ■ 1mV rms Noise
- 500 kHz Bandwidth ■ 100 kHz Full Output Frequency
- 6V/μs Slew Rate

The Model 605 comes to you from the makers of the industry's most accurate multiplier—the Zeltek Model 601 with accuracy within 1mV (0.005%).

For complete information on these or any other Zeltek electronic products, write or phone today.

*In quantity.



1000 Chalomar Road, Concord, Calif. 94520/(415) 686-6660

Making Testers?

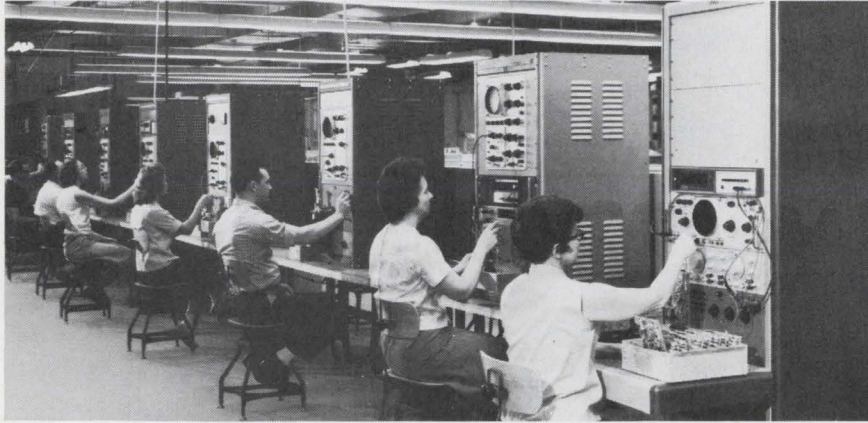

It's just one way to use Elgin's Integrid® Cards and power supplies to solve a design problem.

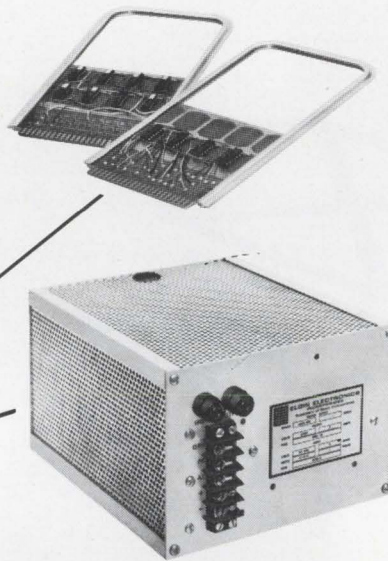
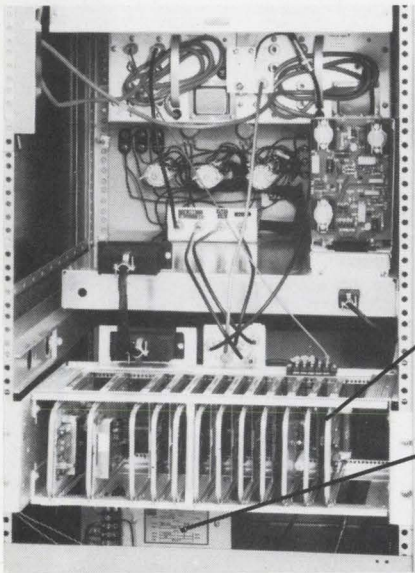

The custom test equipment pictured above demonstrates another use for these Elgin off-the-shelf products when you are faced with a job requiring reliable, low cost components.

Elgin's 5V power supplies in each tester feature exclusive over-voltage and over-current protection. They are available in three basic sizes with output currents of 4, 8 or 16 amps, at low cost with **GUARANTEED PROMPT DELIVERY**—on the way to you within 48 hours after receiving your order.

Inside each tester are 12 circuits assembled on our Integrid Card elements (dual-in-line's above). Integrid Cards are available in multiple patterns, permitting modular use of precisely the type and number of boards required.

The PC Assemblies being checked in the test equipment were made by us, including the printed circuit boards manufactured at our new PC board plant. Circle the reader Service Card for our new Integrid Card and Power Supplies folders.



ELGIN ELECTRONICS
INCORPORATED

Subsidiary of Basic Incorporated
P. O. Box 1318 • Erie, Pa. 16512

New instruments

Checking fluidics the easy way

Rugged and inexpensive, pressure transducer plugs right into oscilloscope

Checking out a fluidics network, with all the tubing involved, can make an electrical engineer uncomfortable. What he wants is a feeling of being at home, not of working with plumbing. And few instruments give the engineer that "at home" feeling more than an oscilloscope. Now, Simmonds Precision Products Inc. offers a device that allows an engineer to check fluidic networks with his scope.

The tester converts fluid pressure changes into electrical signals, and it does this fast enough to produce meaningful waveforms on a scope.

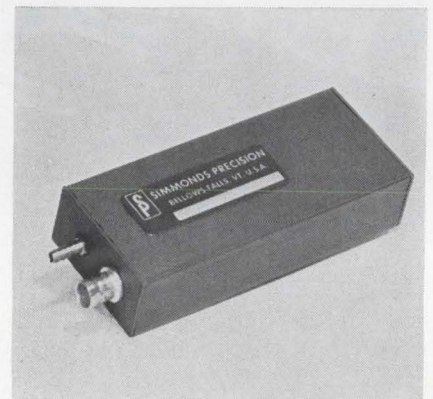

Pressure-prone. The fluidic tester responds to pressure that changes at a rate as fast as 100 kilohertz.

Strain-gage transducers do this too, but they cost as much as \$1,000. Simmonds' tester costs \$219. With a built-in power supply, the price is \$294.

Also, the tester is easy to use. Unlike strain gages, which have four leads and thus require special plug-ins for scopes, the new unit has only two leads. And these leads are plugged directly into the scope's vertical-deflection terminals. The input from the fluidic network being checked comes to



The ultimate in complete wire wrapped panels...from one source

Augat and **Raytheon** Now Combine their Capabilities
To Provide New Economies and Faster Turn Around Time.

An alliance of leaders.

Augat, long recognized for its innovations in IC packaging panels and the quality of its products.

Raytheon, offering the largest, most versatile of wire wrapping service facilities.

Together, we're now producing packaged panels unmatched in reliability, flexibility and fast turn around time.

Let us wrap up your IC and interconnection requirements efficiently and economically.

Contact: Augat Inc., 33 Perry Ave., Attleboro, Mass. 02703, (617) 222-2202.

AUGAT
INC.

Specify LDV

quadrature hybrid couplers

Our line of 3 db Quadrature Couplers features an equal power split with a 90° phase differential between output ports.

There are 5 models in our current line. All use standard 3mm miniature coaxial connectors.

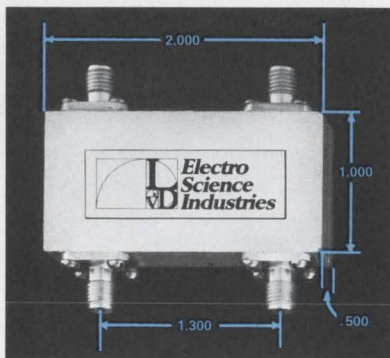

Model	Freq. (GHz)	Typical Isol.	Typical Main Line VSWR
D-5924-L	1-2	28	1.20
D-5924-S	2-4	25	1.20
D-5924-C	4-8	20	1.25
D-5924-X	8-12	18	1.30

Max. Deviation from mean output on all models = ±.5db. Typical mean coupling = 3 + .2 - 0.

LDV also makes connectors, terminators, filters, attenuators, and Radite.



Electro Science Industries

LDV Electro Science Industries, Inc.
300 S. Geddes St., Syracuse, N.Y. 13204
Phone 315-475-2181
TWX: 710-541-0432

... pressure-sensitive transistor is key ...

the tester through a hose, whose inner diameter is either 1/16 or 1/8 inch.

About the size of a package of cigarettes, the device is rugged. "You can drop it or throw it around, and it will still work," says Dino Zampini, a Simmonds engineering manager.

Making the tester rugged was Simmonds' biggest problem. The device's sensor is a Pitran, a pressure-sensitive transistor made by Stow Laboratories Inc. [*Electronics*, Jan. 23, 1967, p. 163]. "We broke quite a few of the sensors before we learned how to handle them," says Zampini.

To protect the transistor, Simmonds engineers pack it into a nylon capsule, and then put the capsule in a shock mount.

Line or lab. Zampini feels that the tester has a place both in the laboratory and on the production line. Potential customers, he says, are makers of fluidic networks and of equipment that uses fluidics.

According to Zampini, the first testers were made for Pitney-Bowes Inc. which used them to check out some of its commercial products.

Simmonds believes it can capture a small segment of the pressure-transducer market with its new device. The tester has neither the range nor the linearity of some strain gages already on the market.

But it does run off a couple of flashlight batteries, so it can be carried around the lab or up and down the production line.

There are three versions of the device, with ranges of 0.25 pound per square inch, and 2 and 5 pounds/square inch respectively. Linearity of all versions is 1%.

A full-range change of pressure causes a 2-volt change in output. And the output range can be set anywhere between 0 and 7 volts.

The tester responds to pressure changing as fast as 100 kilohertz, and reacts to pulses with rise times as fast as 30 microseconds.

The device's temperature coefficient is 200 microvolts per degree C. An optional model has a coefficient of 3 μV/°C.

Simmonds Precision Products Inc.,
Bellows Falls, Vermont [370]

DIALCO DATALITES[®]

mount as close
as 1/2 inch center
to center

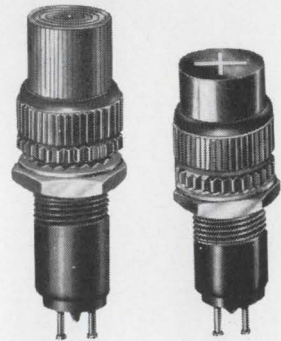

SHOWN ACTUAL SIZE

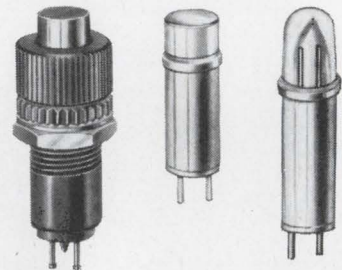

Designed to meet or exceed requirements of MIL-L-3661B.

Replaceable plug-in cartridges: Incandescent for 1.35-120V; neon—high-brightness operation 110-125V AC, and standard brightness operation 105-125V AC-DC.

Wide range of lens shapes, colors and finishes.

Broad selection of positive or negative legends.

Available off-the-shelf for prompt delivery.

Send for free catalog



SAMPLES ON REQUEST—AT ONCE
NO CHARGE

Dialight Corporation, 60 Stewart Ave.,
Brooklyn, N.Y. 11237. (212) 497-7600



Circle 232 on reader service card

Not everyone needs our 5700

Sure it's the most accurate DVM there is — 0.0025%. And the most stable — 0.0065% for a year. But if you don't really need a DVM that's good enough to calibrate other DVMs, don't buy it. Buy one of our 32 others instead.

We make them for labs and production lines, for use on the bench and in systems, militarized models, four digit DVMs and five, from \$1150 to over \$8000. (Actually, with our unique plug-in modules, you can create some 300 different configurations. For every imaginable application. To fit every budget.)

And no matter which of our other 32 you buy, you'll have a DVM made with the same meticulous care as our 5700. With many of the same circuits. By the same people. To give you the confidence you've come to expect from Dana.

Which one suits you best? Ask for the decision maker, our free brochure.

Dana Laboratories, Inc., 2401 Campus Drive, Irvine, California 92664.

DANA®

Circle 181 on reader service card



We tossed out the space wasters.



Now you can reduce the size and weight
of a connector without losing a circuit.

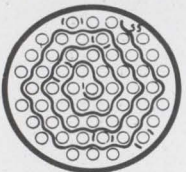

55 #20 contacts, #22 shell.
Area—2.44 sq. in.
Weight—1.3 oz.

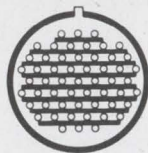

55 #23-22 contacts,
#16 shell. Area—1.58 sq. in.
Weight—.9 oz.

Metal clips stood in the way of better connectors. They limited the number of contacts, scratched plating and robbed essential dielectric wall thickness. So we tossed them out.
Circle 182 on reader service card

Our Astro/348[®], MIL-C81511 connector design replaced them with a contact retention system integral to the dielectric. And an interesting thing happened. Originally developed as a high-density subminiature, Astro/348 turned out to be a better miniature and standard design, too. It packs more contacts into less space than retention devices with metal clips permit.

This simplification created other advantages, too. For example, Astro/348 connectors cost less per circuit than

other present-day connectors. We expect Astro/348 to become the standard connector family for the next decade.

We'd like to demonstrate how the Astro/348 is smaller in size, bigger in performance. Call or write Bob Meade for an appointment. Amphenol Connector Division, 2801 S. 25th Ave., Broadview, Ill. 60153. (312) 261-2000.



AMPHENOL
THE BUNKER-RAMO CORPORATION

High power r-f amplifier operates at 100°C

Designed to provide a building block for sub-kilowatt power addition, module delivers 50 watts c-w with 10-db power gain in 6 cubic inches.

A family of power modules can be used individually or in combination to provide sub-kilowatt power additions over the frequency range of 100-to-150 megahertz.

Developed by Microwave Power Devices Inc. as replacements for power tubes, the modules have a calculated mean time between failure of 15,000 hours. They are designed to function reliably at a

chassis temperature of 100°C, and they provide a 50-ohm interface. The modules are gain- and phase-tracked to within 0.5 decibel and 15° of an average unit, and can be easily combined—using commercially available couplers—to produce up to 500 watts.

The first units of the new series put out 50 watts in a volume of less than 6 cubic inches, although

the transistors are capable of delivering more than 100 watts continuous-wave. For reliability purposes at the high operating temperature, the power amplifiers use only half the power capability of their transistors. And, says the company, as the transistor manufacturers increase the power output of their devices, 100-watt modules should become available

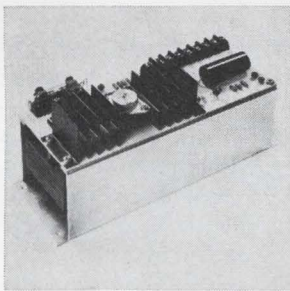

Regulated d-c supply PM728 is designed to provide power for digital IC applications. Output is adjustable from 4.8 to 6.3 v d-c at 3 amps. Line and load regulation is $\pm 0.05\%$ each and ripple and noise is less than 1 mv rms. Prices range from \$124.90 (1-3) to \$84.20 (100 or more). Computer Products, 2709 N. Dixie Highway, Ft. Lauderdale, Fla. [381]

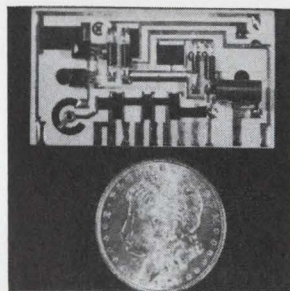

Solid state 8-speed control circuit CX-0595 is for fractional h-p a-c/d-c series wound motors. Over-all dimensions are $2\frac{3}{4} \times 1\frac{1}{2} \times 13/16$ in. The circuit contains 14 cermet resistors, a fired-on thick film trimmer pot for initial factory adjustment of low motor speed, and 7 solid state active devices. Price is \$3. Cermex Div. of Frenchtown/CFI Inc., Frenchtown, N.J. [382]

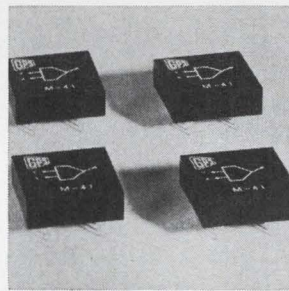

Transconductance type multiplier MU41 provides four quadrant multiplication without the use of external amplifiers. It features medium linearity and bandwidth. Accuracy can be trimmed to $\pm 0.1\%$ with an external potentiometer. Unit is encapsulated in a $1.5 \times 1.5 \times 0.50$ in. package for p-c mounting. GPS Instrument Co., 14 Burr St., Framingham, Mass. [383]

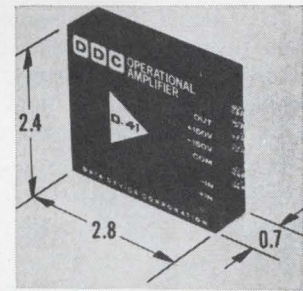

Operational amplifiers series D-41 provide minimum output of ± 215 v at ± 250 ma. The devices are provided with internal current limiting, and can operate from unregulated supplies. Open loop gain at 400 hz is 90 db and differential input impedance 400 kilohms. Input voltage stability is $6 \mu\text{v}/^\circ\text{C}$. Price (1-9) is \$150. Data Device Corp., 100 Tec St., Hicksville, N.Y. [384]

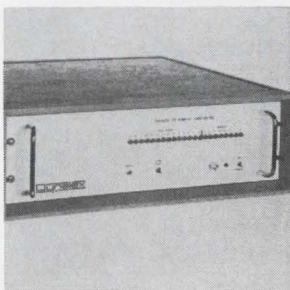

Analog-to-digital converter ADX, when used with the companion differential input multiplexer, provides random or sequential access to as many as 512 analog channels at a rate of 20,000 conversions per second for a 14 bit binary data word. Input impedance is 500 kilohms and system accuracy better than 0.05%. Dynalex Inc., 885 Front St., Burbank, Calif. [385]

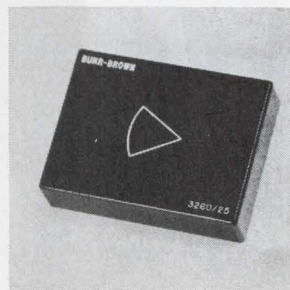

Wideband d-c operational amplifier 3260/25 has a guaranteed slew rate of $500 \text{ v}/\mu\text{sec}$ and settles to 1% of final value in 100 nsec. Rated output is ± 10 v, ± 30 ma. Open-loop gain is 80 db minimum. Unity gain bandwidth is 20 Mhz minimum. Voltage drift is $\pm 25 \mu\text{v}/^\circ\text{C}$ maximum. Burr-Brown Research Corp., Int'l Airport Industrial Park, Tucson. [386]

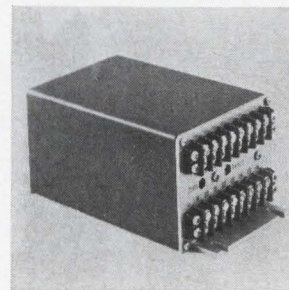

D-c milliamp to frequency converter model DF-101 features three selectable input current ranges, 1 to 5 ma, 4 to 20 ma, and 10 to 50 ma, to provide direct compatibility with pressure transducers, differential pressure transducers, and certain flow meters. Linearity is $\pm 0.025\%$. Analex Instruments Inc., 7833 Haskell Ave., Van Nuys, Calif. [387]

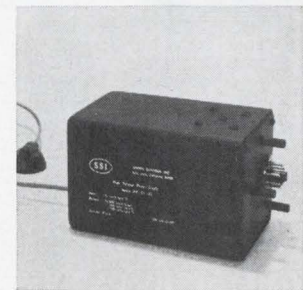

Power supply module HV-01-35 has multiple outputs of +12,000 v, +400 v and -100 v available simultaneously. An internal voltage regulator allows operation of the supply from unfiltered d-c voltages between 35 and 50 v. Ripple is less than 0.1%. Temperature range is 0 to 50°C . Price is \$149.50. Sierra Systems Inc., 2255 Old Middlefield Way, Mountain View, Calif. [388]

PROTOTYPES

We'll ship them immediately—toroids and oscillators* right out of stock—at far below competitive prices.

At Allen Electronics Division, we manufacture these, and other components, in quantity for the world's finest electronic organs. So we constantly maintain a complete stock of high quality frequency sources, and over 150 sizes of toroids. We'll send you the few you need to start your idea; the many you'll need to produce it.

All Allen components are made under the most rigid quality controls, including thorough inspection and testing, at one of the most modern and efficient plants in the country.

Send for complete information on the "Prototypes". Then, when you have an application that requires quality components immediately, at no-penalty prices, you'll know where to get them. Pronto.

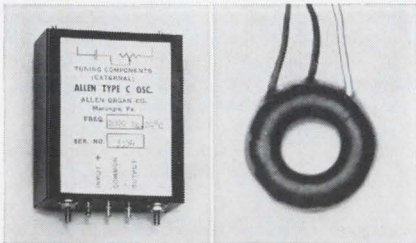

Type C Oscillator
Range: 15 Hz to 10 kHz
Use: Designed for applications having moderate requirements for stability in respect to temperature and frequency drift.

Toroids
Over 150 sizes available from stock include Permalloy, Ferrite and Powdered iron types. Some no-center-tap. Inductance tolerance $\pm 2\%$.

*Allow several extra days for packaging.

ALLEN electronics division



Dept. E 669
Macungie, Pa. 18062

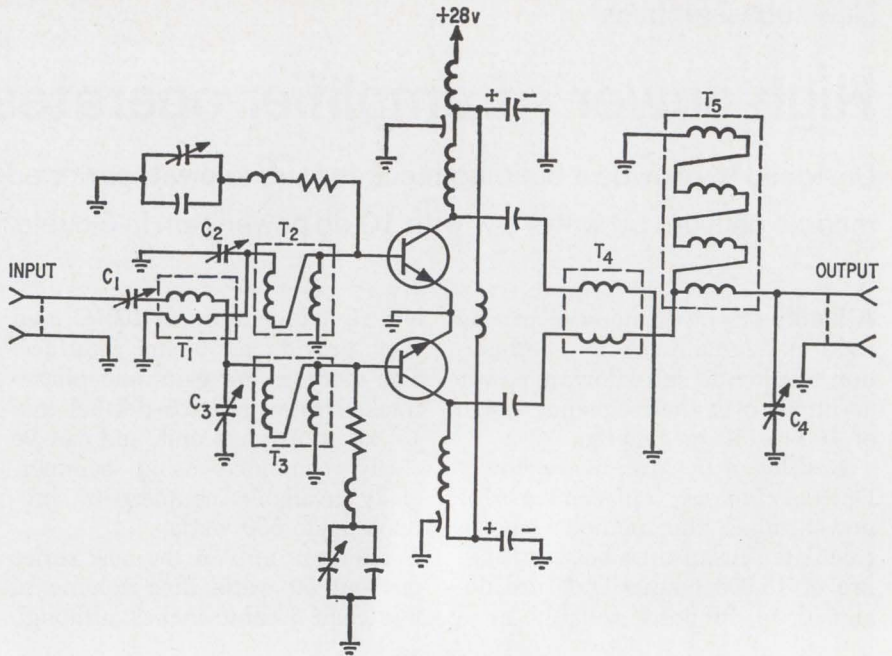

Building block. Typical module uses both power dividers and combiners to deliver 50 watts into 50 ohms with 5 watts of r-f drive.

in the same volume as the 50-watt unit in the series.

Model 150-50-50-5 operates at 150 Mhz, has a bandwidth of 50 Mhz, provides an output of 50 watts into 50 ohms, and has a power gain of 10 db.

In the schematic of the module, transformers T_2 and T_3 match the input impedance of the transistors to the input transformer T_1 , and transformer T_5 sets the output load line of the push-pull pair of

capacitors C_1 through C_4 set the center frequency, and the series inductance-resistance-capacitance networks in the base of each transistor act as parasitic suppressors.

The tunable capacitors in each of these networks is used to minimize any spurious responses.

To meet specifications, the modules must be adequately secured to a heat sink capable of keeping chassis temperature no higher than 100°C at the highest ambient operating temperature.

Prices of the modules depend on the bandwidth and power output requirements. Unit price for the 150-50-50-5 is \$1,900. A low-temperature version is also available at a reduced price. Delivery varies from stock to six weeks.

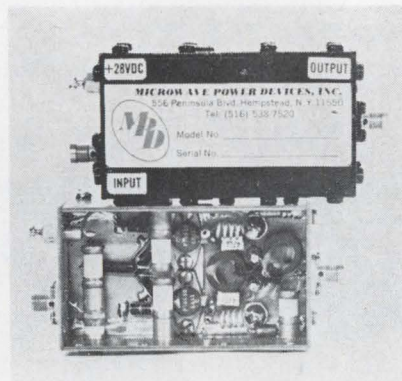

Rugged. Power amplifier operates at high chassis temperature.

PT6672 transistors. Two ferrite balun transformers, T_1 and T_4 , provide the 180° phase shift necessary to split the input power and combine the output power. Ca-

Specifications (model 150-50-50-5)

Center frequency	150 Mhz
1-db bandwidth	50 Mhz
Power gain	10 db
Efficiency (includes r-f drive power)	60% min.
Voltage	+28 v
Harmonics	-20 db min.
Size	$3 \times 1\frac{1}{4} \times 1\frac{1}{8}$ inches
Shock	50g
Impedance	50 ohms
Phase tracking	$\pm 15^\circ$ reference to an average unit
Gain tracking	± 0.5 db reference to an average unit
Environment	Chassis temperature up to 100°C with less than 0.5 db decrease in power output
Connector type	OSM Standard

Microwave Power Devices Inc., 226R Merrick Road, Lynbrook, N.Y. 11563 [389]

A 1-minute look at what's new in relays

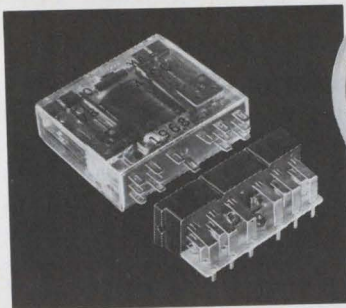

THE PARELCO R40 SLIMLINE® .43" max. thickness

Lowest profile industrial relay available. Higher switching density: .18 cu. inches/Form C. Easy pc board layout. Lower cost, wider switching range (dry circuit to 10A) than dry reed packages. 5 mounting options.

Contacts: 2 and 4 Form C. 5 types from heavy duty 10A silver cadmium oxide to bifurcated cross bar gold — platinum — silver alloy for dry circuits.
Coils: From 3 to 115 vdc.

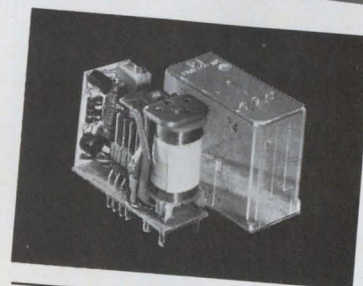

THE PARELCO R12 VARIABLE TIME DELAY RELAY

**1/3rd the size of the relay
you're now using!**

All the R10 features plus a superior delay circuit using silicon transistors throughout. No false operations. Critical timing capacitor meets MIL-specs. Measures only 7.35 x 1.187 x 1.375 (2 pole) or 1.580 (4 pole). Delay range from .1 to 120 seconds — specials to 300 seconds. High resolution, 15 turn pot. The *only* 4 Form C time delay currently available. Three mounting choices.

Contacts: 6 types from dry circuit to 10 amps.
Coils: 12, 24 and 48 vdc.

THE PARELCO R10 RELAY 2 times more pull force

Optimum distribution between magnetic core and pole piece cross sections and coil volume, and a low reluctance armature bearing produces a force-displacement product of 140 gm/mm at .050". The result is higher contact pressure and greater overtravel. Sensitivities to 20 mw/pole.

Contacts: From 2 to 8 Form C. 6 types from heavy duty 10A silver cadmium oxide to bifurcated cross bar gold — platinum — silver for dry circuits.
Coils: 3 to 115 vdc. UL listed.

OTHER STANDARD MODELS

R11 guarded, low capacitance relay for instrumentation.
R30 magnetic latching relays.
R10-T octal base relays. *Custom Coils and contacts* — various mounting modes — special engineering.

Quick Delivery — 110 standard models always in stock. Prototypes in 3 days — production quantities in 3 weeks!

EVALUATION SAMPLES TO QUALIFIED DESIGNERS!

GIVE US:

Time delay range, secs. _____

Input voltage _____

Contact characteristics _____

I'll use _____ relays in the next 12 months. Application _____

Name _____

Title _____ Phone _____

Company _____

Street _____

City _____ State _____ Zip _____



PARELCO, INC.

26181 Avenida Aeropuerto
San Juan Capistrano, California 92675

Phone (714) 493-4507 TWX (310) 596-1412 See EEM Section 4500

They said it couldn't be done!

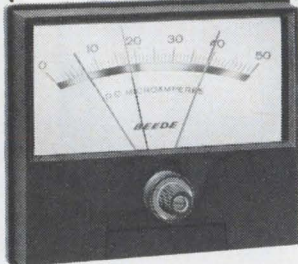
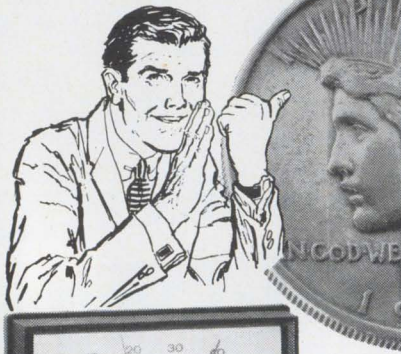

**a CONTROL METER RELAY
with 50% savings and
high performance**

WELL, THEY WERE WRONG! After a year of customer use in the field, our customers report that our units are consistently providing high accuracy and high reliability — and they must be right because they are re-ordering and pocketing cost savings of up to 50%. Why not join our increasing list of satisfied customers now?

Beede's Non-Contacting Control Meter Relay was initially designed to offer a wide choice of design options for the greatest application versatility. For instance:-

- 8 or more choices of power supply
- 4 choices of fail-safe configuration
- 10 or more choices of output mode
- 9 choices of alarm lights and reset switches
- Many special features such as tamper-proof units, fixed set pointers, etc.
- Pyrometers and resistance thermometers

Write for complete literature today!

BUY VALUE / BUY BEEDE

BEEDE

ELECTRICAL INSTRUMENT CO., INC.
PENACOOK, NEW HAMPSHIRE
Area Code: 603-753-6362

New subassemblies

Transmitters accurate to 0.1%

Instruments for control
include auxiliary alarms,
adjustable set points

All standard thermocouples are accepted by a line of process-control transmitters from Deltron Inc. Each of the 15 models can produce a regulated current output proportional—within a 0.1% accuracy—to a thermocouple or millivolt signal.

Output ratings include the three most widely used process current ranges: 1 to 5 milliamps at 0 to 24 volts, 4 to 20 milliamps at 0 to 24 volts, and 10 to 50 milliamps at 0 to 12 volts. Input suppression is adjustable from 5 to 50 millivolts for full-scale output.

The transmitters can be supplied with single and dual auxiliary alarms that produce a contact operation when the input reaches a preset value. The set point is adjustable from 0 to 100% of input range, and in dual alarms both set point adjustments are independent. Adjustable dead band is provided on each alarm.

All of the components in the 15 models of the new line are solid state. The models provide for front-connected field wiring. Deltron says that the transmitters are immune to line fluctuations, that the 0.1% accuracy is independent of load changes, and that calibration will hold for one year. Additional features include thermocouple break protection and little temperature drift.

Three models accept type J thermocouple inputs, three are designed for type K, three for type R, three for type T, and three accept millivoltage signals. Thus the line covers the range of inputs used in process control.

The basic price is \$150 each; with single alarm, \$200; with dual alarm, \$240. Delivery time is four to six weeks.

Deltron Inc., Control Division, Wissahickon Ave., North Wales, Pa. [390]

START

WITH A LENS-END LAMP

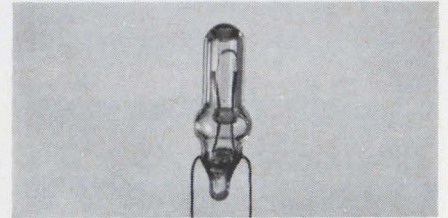

TEST

FOR SPOT SIZE AND
CANDLEPOWER

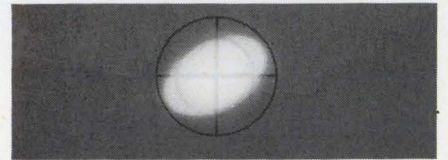

WELD

PINS TO END OF LEAD
WIRES

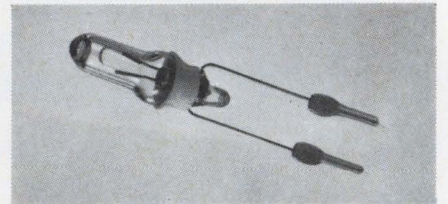

MOLD

TO MAKE A PLUG-IN LIGHT
MODULE THAT WILL ACTIVATE
PHOTO ELECTRIC SENSOR IN
A HIGH SPEED CHECK SORTER

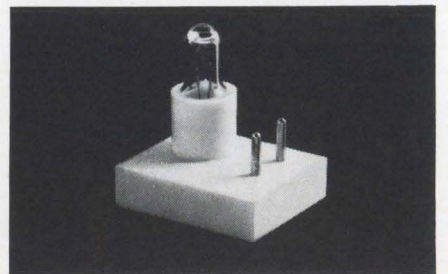

We specialize in finding practical solutions to small applications where cataloged items won't do. Write, describing your requirement. Tung-Sol Division, Wagner Electric Corporation, 630 W. Mt. Pleasant Avenue, Livingston, N.J. 07039. TWX: 710-994-4865. Phone: (201) 992-1100.

TUNG-SOL®

WHERE BIG THINGS ARE
DONE WITH SMALL LAMPS

® Reg. T.M. Wagner Electric Corporation

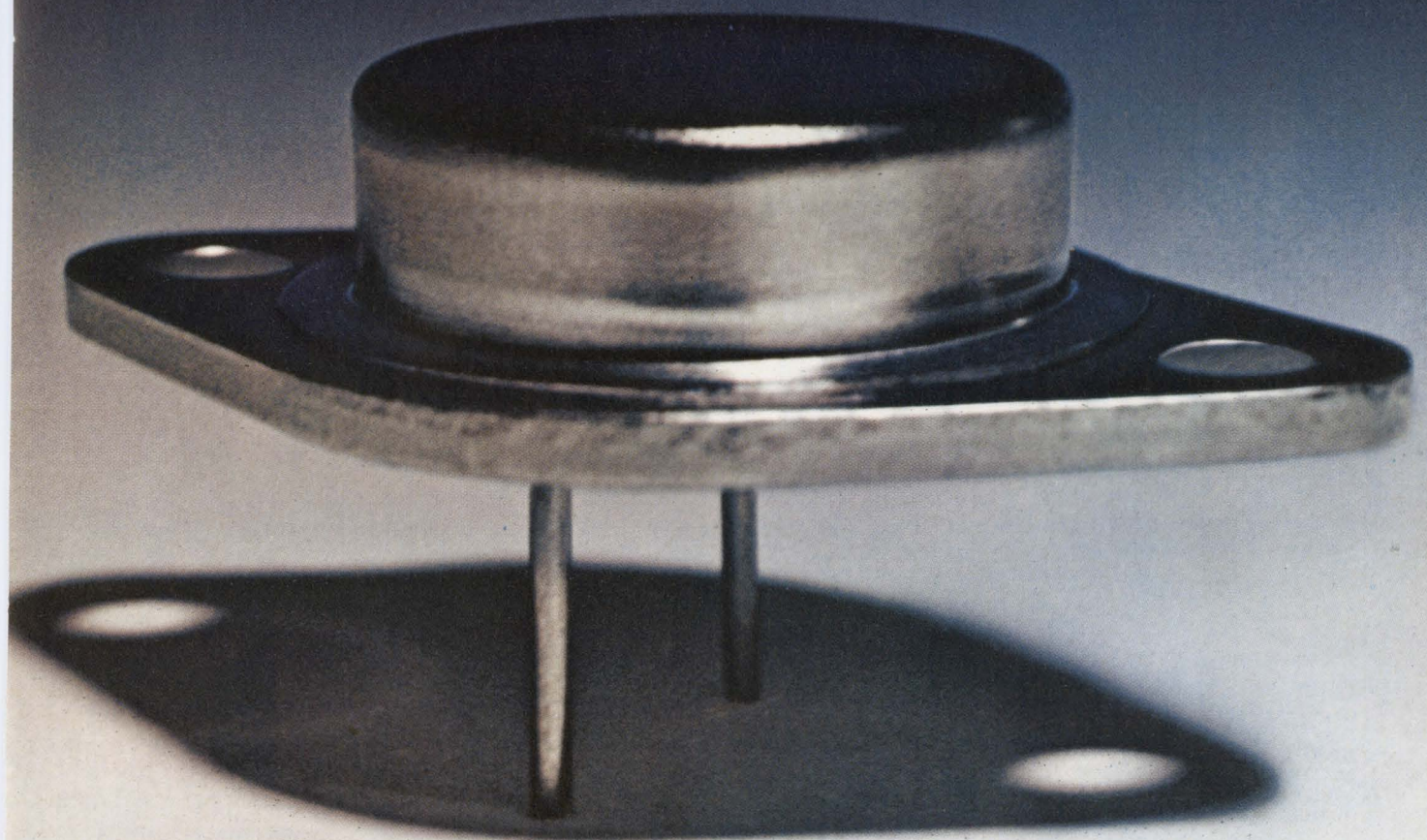

We're available

**Get up to 1000 units of
2N3773 and 2N3054 transistors
in less than two weeks.
Now from Westinghouse.**

What's more, we'll also give you fast service on larger orders. However many it takes to fill your total requirements.

Our 2N3773, 2, 1 (TO3) is a family of 30-amp diffused transistors for high power switching and amplifying applications. They offer a wide selection of voltage and gain.

Our 2N3054 (TO66) is a 4-amp device used to drive our

2N3773, or as the output stage in low-to-medium power applications.

For complete data — and a large ready supply — of any and all of these transistors, contact your local Westinghouse Sales Office or Westinghouse Semiconductor Division, Youngwood, Pa. 15697.

You can be sure... if it's

Westinghouse 

Meet the MICRO SWITCH Quality Assurance Department

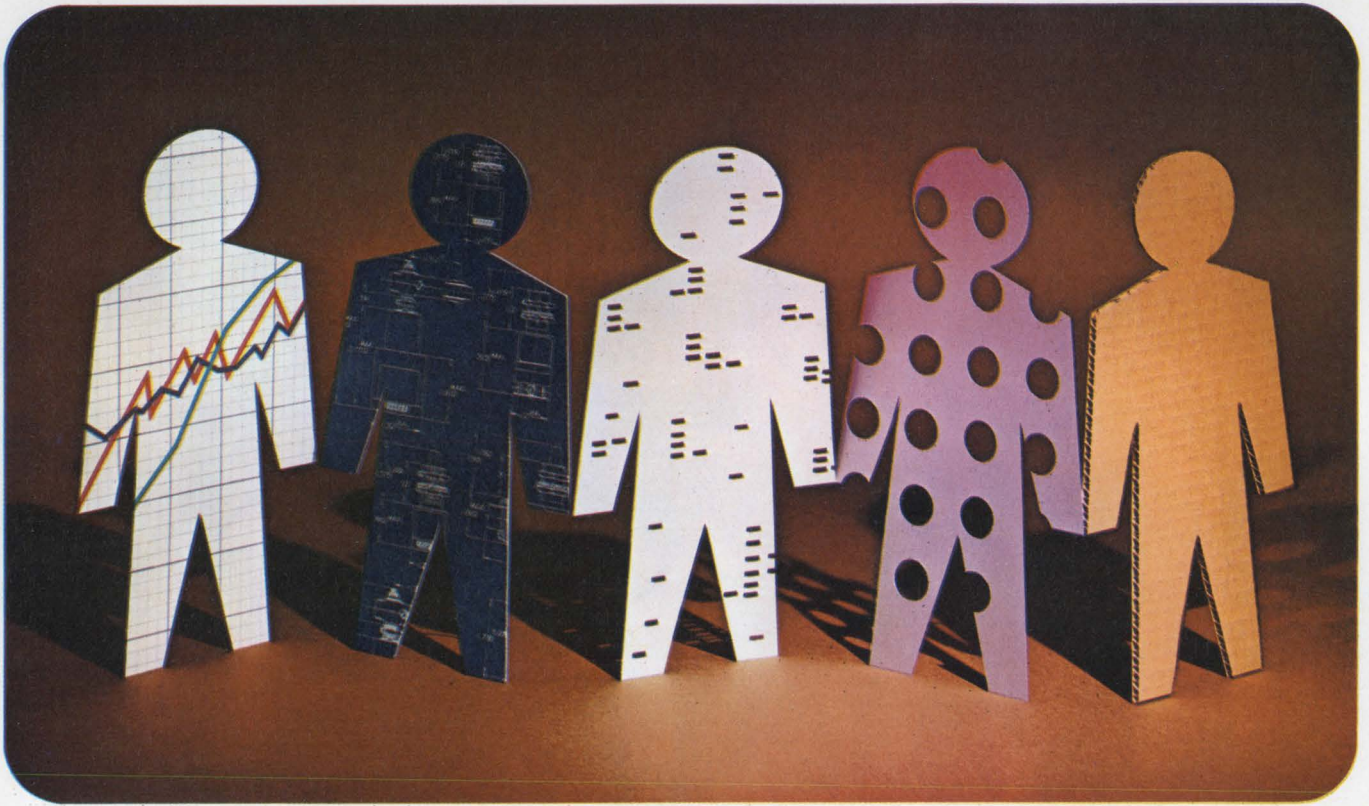

Left to right: vice president, design engineer, computer programmer, punch press operator, and shipping clerk.

Not present for picture: All the other employees of MICRO SWITCH.

Quality Assurance for the customer is everyone's business at MICRO SWITCH. It is the result of a total concern for the details that make up customer satisfaction. It starts with top management and permeates the entire organization, involving every step of manufacture—from raw materials and design on through production and shipping.

The emphasis at MICRO SWITCH is on the prevention of defects, rather than simply their detection.

The Quality Assurance program is designed to assure reliability *before* manufacturing begins. It includes such procedures as: a periodic calibration system for all measuring equipment, a strict vendor rating system, extensive documentation to cover all details in advance, and innovative operator self-checking procedures.

Most important, our experienced, highly trained personnel have a personal concern for customer satisfac-

tion. They know it's the little things that count.

What does this elaborate program mean to you? Dependability. The knowledge that each switch will hold up as well in your equipment as it does in our grueling laboratory tests. We're more careful to make you more sure.

To find out for yourself the many ways MICRO SWITCH is more careful, write for our booklet, "Quality Assurance for our Customers." No obligation, of course.



MICRO SWITCH

FREEPORT, ILLINOIS 61032

A DIVISION OF HONEYWELL

HONEYWELL INTERNATIONAL • Sales and service offices in all principal cities of the world. Manufacturing in United States, United Kingdom, Canada, Netherlands, Germany, France, Japan.

Yig-tuned Gunn oscillators sweep X band

Two companies market solid state replacements for bwo's; reliability, size provide edge in generator applications

Backward-wave oscillators haven't yet had to take a back seat to solid state replacements, but the time may be fast approaching.

A yig-tuned Gunn Effect oscillator has been developed as a product by Varian Associates, and the company bills it as a replacement for a bwo (*Electronics*, Sept. 30, 1968, p. 44). The oscillator sweeps electronically from 8 to

12.4 gigahertz, thus covering all of X band. Minimum power output is 10 milliwatts, and the device can put out up to 40 milliwatts.

Another San Francisco-area company, Physical Electronics Laboratories, has put a yig-tuned Gunn oscillator on the market. Designated the OX-100, it also provides a minimum of 10 milliwatts swept power output over 8 to 12.4 Ghz.

Maximum power deviation is 6 db over the full band, and tuning linearity is 0.1%. The OX-100 is the first of a family being developed to cover the 4-18 Ghz range.

A Gunn oscillator can't match a good bwo in power (bwo's can deliver from 50 to 100 mw); and at \$1,950, Varian's is three times as expensive. But Robert Constable, manager for solid state microwave

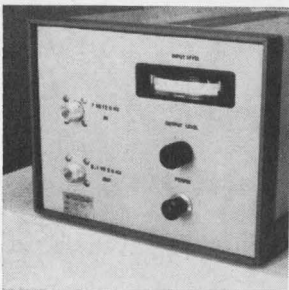

Swept frequency module model CX-12 generates 0.1 to 5 Ghz continuous sweep or any portion of it in one band, with an external unlevelled swept source delivering 10 to 50 mw from 7 to 12 Ghz. The CX-13 generates 4 Ghz continuous sweep or any portion of it in two bands, one extending from 0.1 to 4.1 and one from 4.1 to 8.1 Ghz. Space Kom Inc., Box 235, Goleta, Calif. [401]

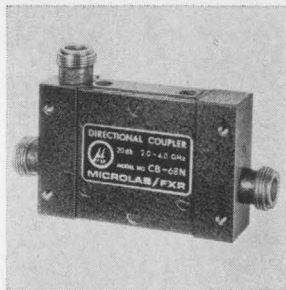

Miniature coaxial directional couplers series CB are 6, 10, 20 and 30 db devices that cover full octave ranges from 2 to 12.4 Ghz, offering flat coupling, high directivity, and low vswr. Maximum insertion loss is 0.2 db; power rating, 100 w average, 3 kw peak; directivity, to 25 db; maximum vswr, 1.30, coupling accuracy, ± 1 db. Microlab/FXR, 10 Microlab Rd., Livingston, N.J. [402]

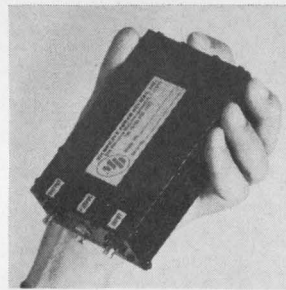

Transistorized amplifier model WA1-225-400-20 has a gain of 33 db with a power output of 20 w. Harmonic response is typically -20 db below rated power output with an over-all amplifier efficiency of 40%. Reliability analysis indicates a mean time before failure figure in excess of 15,000 hours. Microwave Power Devices Inc., 556 Peninsula Blvd., Hempstead, N.Y. 11550. [403]

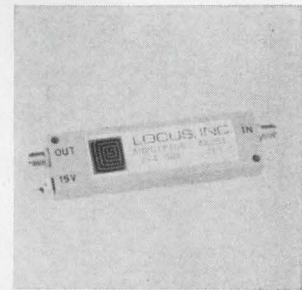

Hybrid thin film r-f amplifiers series 4A are suited for use in severe environments. Frequency range is 500 to 4,500 Mhz; bandwidth, 25 Mhz to several octaves; noise figure, 3 to 12 db; gain, 25 db; power output, to +30 dbm; input/output impedance, 50 ohms; and temperature range, -54° to +71° C. Estimated mtfb exceeds 250,000 hours. Locus Inc., Box 740, State College, Pa. [404]

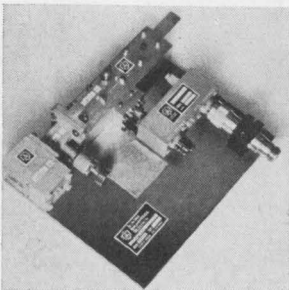

Paramp S-9831 is a narrow-band device (20-50 Mhz), tuning 4 to 8 Ghz in four overlapping bands. GaAs varactors for the unit are available, and are easily replaced in-field. The amplifier comes with either a klystron or solid state pump free of spurious responses, and delivers a gain of 17 db. Sonoma Engineering and Research Inc., 760 Montecito Center, Santa Rosa, Calif. [405]

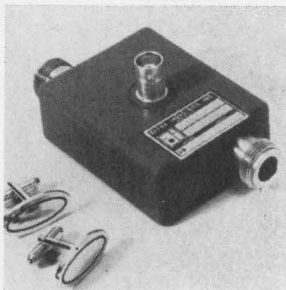

Lightweight voltage variable attenuator model AM7000A is for use as an attenuator, switch or modulator in systems where low vswr and system accuracy are critical requirements. It measures 2.55 x 2 x 0.90 in. (not including connectors) and weighs less than 6 oz. Frequency range is 1 to 4 Ghz. Alpha Industries Inc., 381 Elliot St., Newton Upper Falls, Mass. 02164 [406]

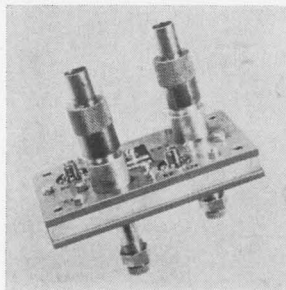

Balanced modulators provide overlapping coverage from 215 Mhz to 10 Ghz. Furnished with crystal caps and r-f tuners, the units can provide carrier suppression greater than 50 db in narrow-band operation. Typical bandwidth is 12%. Input and output impedance is 50 ohms in r-f applications. Units use stripline design. Elpac Inc., 18651 Von Karman Ave., Irvine, Calif. [407]

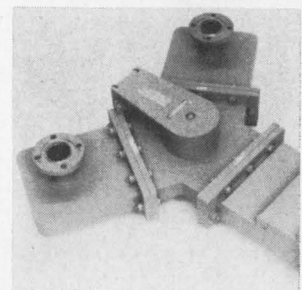

Waveguide junction circulator CLH108 has a peak-power capability of 100 kw and an average power rating of 3 kw. Isolation is 20 db minimum with isolation loss no greater than 0.50 db. Vswr is 1.25 maximum over the operating frequency range of 1,250 to 1,350 Mhz. The unit is designed in a Y-configuration, and needs no special cooling. Raytheon Co., Lexington, Mass. 02173 [408]

Announcing

a
NEW
Generation
of
HALL-PAKS®
—the \$1.00*
Hall Generator—

FH-301 FH-300 FH-302

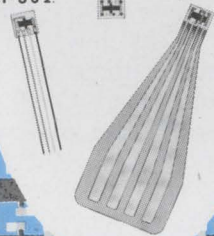

Development of
Thin Film Fabricating
Techniques opens New
Application Areas for
Hall Effect Magnetic
Field Sensors

Three years of intensive research in Bell's Semiconductor Division has resulted in a new generation of HALL-PAKS. Using thin film fabricating techniques, this new line can now be economically applied by High Volume OEM Manufacturers. Typical Applications are: Proximity Switches—Linear/Angular Transducers—Brushless dc Motors—Ignition Systems—Electronic Compasses—Low Torque, high speed Gyro Motors—

The line consists of three (3) basic models; FH-300 Flip Chip, FH-301 with wire leads, and FH-302 with PC lead strip. Typical characteristics of the FH-300-040 are:

Input Resistance, R_{in}	40 — 80 Ω
Output Resistance, R_{out}	1.4 R_{in}
Nominal Control Current I_{cn}	15 mA
Product Sensitivity γ_{is}	1.4 V/A • kG
Magnetic Sensitivity γ_B	20 mV/kG
Temperature Coefficient of V_H	-0.08%/°C
Operating Temperature Range	-55°C to +100°C

Detail Specifications on All Thin Film Hall Generators are available on request.

Send for **SAMPLE EVALUATION KIT!** Contains one each of three thin film HALL-PAKS® with a detail application booklet — \$6.50 plus 50¢ handling charge.

*10,000 units or more

BELL
INC.

1356 Norton Avenue
Columbus, Ohio 43212
614-294-4906 TWX: 810-482-1716

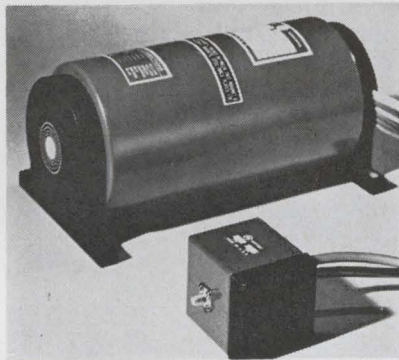
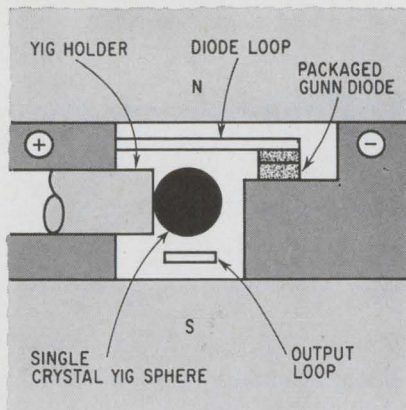

Challenger. Varian's Gunn oscillator is shown in front of a bwo. The Gunn unit's tuning element is a yig sphere—in center of the cross-section drawing.

products, says that Varian's price would go down to a thousand dollars or so for large orders. "Ultimately," he adds, "the Gunn oscillator will be cheaper than the bwo." Physical Electronics Laboratories' unit, temperature-compensated and built for military use, sells for \$3,000.

Constable of Varian stresses that in addition to being smaller and lighter than a bwo, a Gunn unit is less noisy and more reliable. "Bwo's have to be replaced once a year," he says. "There's nothing to fail in the Gunn oscillator but the diode; we have run tests on 16 units, and the results can be expressed as a 25,000-hour mean time between failures, with a 90 per cent confidence level."

Varian and PEL are the first companies to announce Gunn oscillators for X and K bands—though the Hewlett-Packard Co., which could use such a unit in its sweep generators, is expected to market a product soon, and Watkins-Johnson Co. will have a solid-state oscillator at X band within two months. Watkins-Johnson makes the multi-octave source,

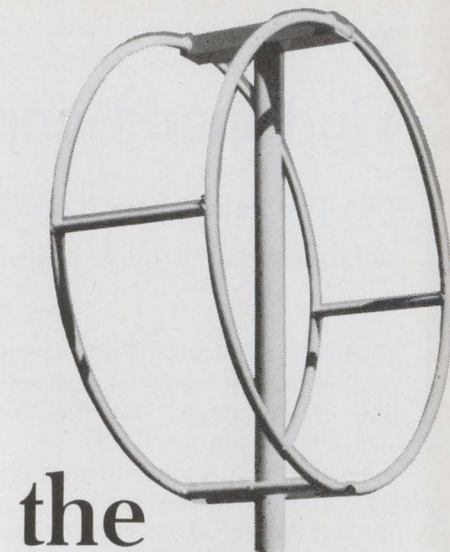

the
newest
shape in
receiving
antennae

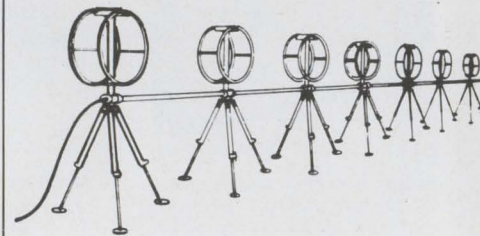

Aperiodic Loop Antennae... in an array composed of eight one-metre diameter untuned balanced loops spaced 13 feet apart... is the newest concept in "active" h.f. receiving arrays developed by E.M.I.

Each loop is fitted with a transistor pre-amplifier in its base, making possible a broad band (2 to 32 MHz) directional array much like a log-periodic or rhombic antenna. The system is only 30 metres long and a few feet wide. As it occupies but a fraction of the space required for conventional passive fixed arrays, it is ideal for applications in areas of restricted space or when quick and simple set-up is important.

The new model 8E13 Aperiodic Loop Antenna Array has us rather excited. We would welcome the opportunity to tell you all about it in detail.

E.M.I. ELECTRONICS CANADA, LIMITED

Dartmouth, Nova Scotia, Canada

Mail: P.O. Box 1005

Phone (902) 466-7491

Cables: EMI CAN

a yig-tuned harmonic generator, that went into the 1 to 12.4-Ghz sweep generator introduced three months ago by the Narda Microwave Corp. [*Electronics*, March 31, p. 147].

Outgrowth. The Varian unit, dubbed the VSX-9070, is the outgrowth of an experimental device built last year by Mashiro Omori and Gene F. Day of the company's central research labs. That unit weighed 1.8 pounds and measured 10 cubic inches; Varian hoped to cut each of those figures in half before announcing a product. Omori now says that Varian did get the oscillator down to 5 cubic inches and under a pound—but the required magnetic shielding brought the measurements right back up again.

Varian succeeded in shrinking the magnet gap, in which the Gunn diode, the yig sphere, and the microwave circuitry must lie, from 200 mils to 90 mils. Tuning power is thus cut to a specified 6 watts, but Omori says it is actually about 3.5 watts. He used microstrip for the circuits, and a packaged Varian diode for the source. Originally, the magnet was a solid core; but Omori found that fast tuning caused eddy currents that heated up the metal, so he switched to a laminated core.

In transferring to production status, Omori says, the principal problem has been teaching operators to align the yig sphere.

The circuitry in PEL's oscillator is also microstrip, in a coaxial configuration. The magnet gap is 100 mils—but the gap on the C-band unit will be 50 mils. The PEL oscillator, which uses a Gunn diode made by Varian, requires a tuning power of about 7 watts. It measures 31 cubic inches and weighs 3.5 pounds. Delivery time is one month.

Specifications (Varian model VSX-9070)

Tuning current, max	1.0 amp
Tuning voltage, max	6 v d-c
Bias voltage range, max	8-12 v d-c
Bias current, max	600 ma
Hysteresis swept either direction, max	50 Mhz
Power variation over band, max	6 db
Size	10 cu. inch
Weight	2 lb.
Availability	75 days

Varian Associates, 611 Hansen Way, Palo Alto, Calif. 94303 [409]
Physical Electronics Laboratories, O'Brien Drive, Menlo Park, Calif. [410]

FAST SWITCHING

POWER TRANSISTORS

from **Solitron**

...with Turn-on Time
Less than 10 Nanoseconds!

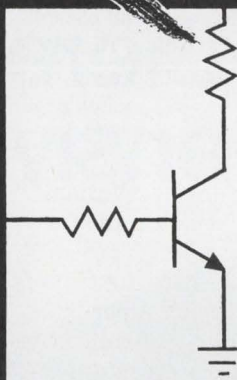

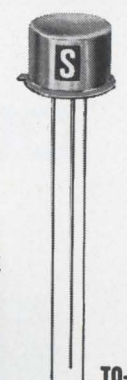

TO-5

SDT6100 SERIES

$V_{CEO} = 40 \text{ V}$

$h_{FE} @ 2.0 \text{ A} = 20 \text{ to } 60$

$V_{CE(SAT)} = 1.5 \text{ V Max}$

$t_R @ 2.0 \text{ A} = 10 \text{ n sec Max}$

$I_C \text{ Max} = 5.0 \text{ A}$

Solitron's new SDT6100 Series of 5.0 Amp fast switching power transistors have total switching time typically less than 60 nanoseconds and rise time less than 10 nanoseconds. They are designed to function in place of many parallel high speed, low current units.

Features of these fast switching transistors include:

- 5.0 AMP CAPABILITIES
- PLANAR CONSTRUCTION
- LESS THAN 10 NANoseconds RISE TIME
- TYPICALLY 500 MHz, f_T

Contact us today for complete information and prices.

Solitron
DEVICES, INC.

1177 BLUE HERON BLVD. / RIVIERA BEACH, FLA. / (305) 848-4311 / TWX: (510) 952-6676

This is the world's smallest all-pluggable DPM.



Weston Model 1290
\$204

Then there's our less expensive model.



Weston Model 1260
\$99.50

We brought out our 3½-digit compact DPM* just last March. It's the one that plugs into a panel slot only seven inches square, and pulls out for servicing or replacement. If you need the accuracy of 3½ digits, Model 1290 is still your best buy. But if you can settle for a digit less, you can have our new Model 1260 at less than half the price. Don't be fooled by the price tag, though . . . there's nothing "cheap"

about this 2½-digit version. Housed in the very same plug-in case and fully compatible with its more sophisticated brother, Weston Model 1260 offers 0.5% ±1 digit accuracy—with far greater resolution capability than mechanical movements provide. Full scale reading is 199, with 25% over and under-range capability, remote command signal and Weston's usual high rejection characteris-

tics. In addition to the convenience of front panel pluggability and circularly polarized viewing, we've included front panel calibration as a built-in bonus feature on the 1260. Write to the originators of the DPM. WESTON INSTRUMENTS DIVISION, Weston Instruments, Inc., Newark, N.J. 01774.

a Schlumberger company
WESTON®

Prices for Models 1290 and 1260 based on quantities of 25.

*U.S. Pat. 3,051,939 and patents pending.

MOS read-write memory goes to market

First standard building block is 128-bit random-access device; 900-nanosecond unit to compete with the cores for 500-1,000 word storage jobs

It's still a matter of speculation in the metal oxide semiconductor business as to what size memories will shake out as standard building blocks. There seems to be a good deal of backing for 256 bits, but no one is delivering standard 256-bit MOS memories. Electronic Arrays Inc., has settled on a 128-bit device organized as 64 words, each 2 bits long; and this appears to be

the first off-the-shelf MOS random-access read-write memory available.

By introducing the EA 1400 this month, Electronic Arrays appears to have stolen the March from American Micro-systems Inc., which is expected to have a standard 128-bit MOS random-access memory available from stock early next month. The EA 1400 is now

available from distributors and off the shelf at the firm's headquarters.

The device has 978 MOS FET's forming 128 storage flip-flops, and also includes address decoding from six input lines, plus out-put buffers, all on the chip. It has a specified read or write time of 900 nanoseconds. EA officials expect it to be used in larger arrays in

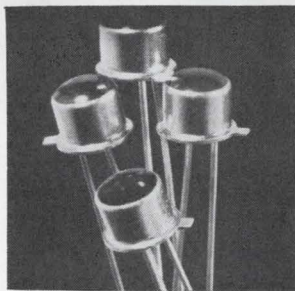

Gallium-arsenide-phosphide light-emitting diodes type 5082-4400 are useful as panel and circuit status indicators where low drive power and high reliability under adverse conditions are important. With only 1.5 mw drive power (10 ma at 1.5 v), they achieve a brightness typically of 120 foot-lamberts. Hewlett-Packard Co., 1501 Page Mill Road, Palo Alto, Calif. 94304. [436]

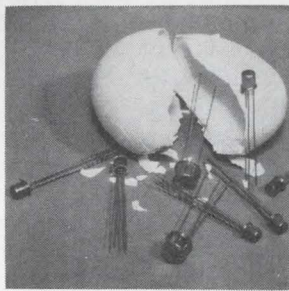

Eight new field-effect transistors include p-channel, insulated gate devices for use as interface units between different forms of IC logic; dual n-channel FETs with improved matching and tracking characteristics; a low-noise, high-gain vhf amplifier; and high-voltage devices designed as vacuum-tube replacements. Texas Instruments Inc., P.O. Box 5012, Dallas 75222. [437]

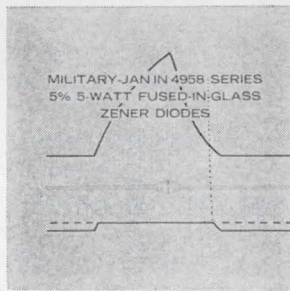

Miniature zener diodes series JAN 1N4958 are 5-watt, 5% tolerance devices in a voltage range of 10 to 220 v. They feature metallurgically-bonded, fused-in-glass, voidless construction which enables them to operate reliably in extreme environments and to absorb surges up to 275 w. Units meet MIL-S-19500/356. Unitrode Corp., 580 Pleasant St., Watertown Mass. [438]

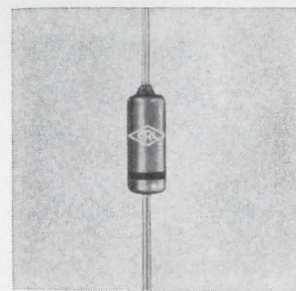

Temperature compensated reference diodes, with temperature coefficients as low as $\pm 0.0005\%$ per° C, are available in JEDEC types 1N4565 through 1N4584A. They are designed to meet or exceed MIL-S-19500 requirements and can operate over a temperature range of -55° to $+100^{\circ}$ C. Centralab Semiconductor Division, 4501 N. Arden Dr., El Monte, Calif. [439]

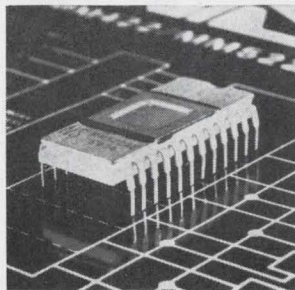

MOS read only memory MM522 is a 1024 bit device arranged as 256 x 4 or 128 x 8 bit words. It is for code conversion, random logic synthesis, table look up functions, and character generators. Device features d-c coupled logic on chip with no clocks required, and high speed operation of less than 1 μ sec. National Semiconductor Corp., San Ysidro Way, Santa Clara, Calif. [440]

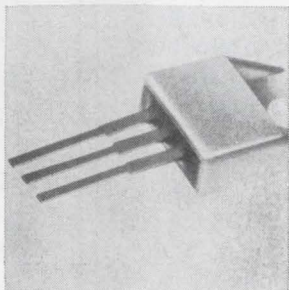

Plastic power transistors designated the B-133000 through B-133008 series feature an electrically isolated collector which eliminates the need of costly insulating hardware and extra handling. They offer TO-66 mounting compatibility. Maximum collector current is 4 amps. Price (100-999) begins at 66 cents each. Bendix Semiconductor Division, Holmdel, N.J. 07733. [441]

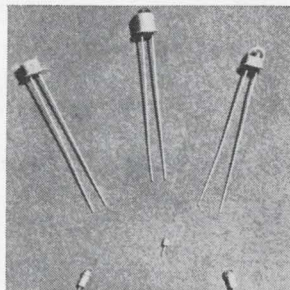

High gain silicon phototransistors and companion continuous or pulsed operating gallium arsenide light emitting diodes can be used in card and tape reading, industrial control, intrusion detection, and character recognition. The 918L/402L pair have a total lens acceptance angle of less than 20°. Electro-Nuclear Laboratories Inc., 115 Independence Drive, Menlo Park, Calif. [442]

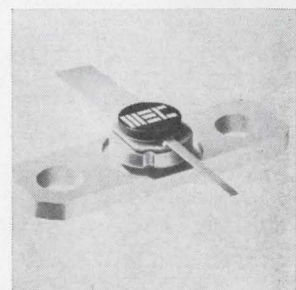

Epitaxial transistor MSC2001, designed for Class A, B and C microwave amplifier or oscillator applications, provides 1 w at 2 Ghz. Maximum power gain and efficiencies at L and S band are achieved through a Matrix pellet structure, which improves reliability by providing the optimum in function passivation. Microwave Semiconductor Corp., 100 School House Rd., Somerset, N.J. [443]

THE GIANT KILLERS

SMALLER TOUGHER

\$19.95*



FOR LESS!

Regulated DC Power Supplies designed — and priced — to solve big problems.

The Computer Products family of DC power supplies — 3.6V 250 MA to 180V 10 MA, P.C. and Octal Plug-in, are consistently smaller, tougher and better-performing than competitors' near-equivalents.

Prices are smaller, too. By about 50%.

Here's a sample:

Output Voltage	15VDC
Input Voltage	115 ± 10VAC
Output Current	100 MA
Line-load Reg. Ea.	± 0.02%
Temp. Co./°C	0.02%
Ripple/Noise	0.5 mV RMS
Output Z @ 10KHz	0.2 ohms
Case size	1.75" x 2.25" x 1"
Model No.	PM576
PRICE 1-9	\$24.95
*10-29	\$19.95

Call or write for complete information . . . or

CALL TODAY FOR 3-DAY SHIPMENT
305/565-9565

Computer Products, Inc.,
P. O. Box 23849
Ft. Lauderdale, Fla. 33307



COMPUTER PRODUCTS

FORT LAUDERDALE

which customers are looking for 500 to 1,000 words of memory. "We believe we'll be competitive with cores in smaller memories," says Earl Gregory, vice president and director of marketing. "And while there's been a lot of talk about 256-bit memories, 32 bits is about the most complex device being delivered. We decided that 128 bits makes for a reasonably functional device that is truly manufacturable in quantity," he adds, "and we've seen some interest in the smaller bit lengths."

Some dynamic cells are refreshed by addressing each bit location individually. In the EA device, a strobe pulse on only one of the six input lines restores data. The line powers each cell in the array. According to EA engineers, even memories with no refresh capability usually require 2 to 3 milliwatts per bit to operate, compared with about 1 mw for the 1400. In a standby condition, the strobe can be operated at intervals of 0.1 microsecond, using only microwatts. **Discriminates.** A chip-select feature on the EA 1400's output enables selection of the next device, in a group of such arrays, that will be activated. This coupling of the outputs to activate another array on the read or write cycle is needed if a number of the devices are combined to build a 500- or 1,000-word memory.

Another feature EA officials cite as important is the 1400's separate input and output lines. Some memories use a common bus, necessitating somewhat complicated gating to switch from reading to writing. This isn't necessary with separate input and output lines.

As with all standard products introduced by the firm to date, the EA 1400 operates on a drain supply level of 12 to 14 volts; the gate voltage is -24 to -28. The output logic level for a "zero" condition is 0 volt minimum and -1.0 volt maximum; for a logical "one", the levels are -10 volts minimum and -14 volts maximum.

Data read rate, data write rate, and strobe repetition rate are all 1 megahertz. The EA 1400 is housed in a 16-pin dual in-line ceramic package. It sells for \$35.60 each in quantities of 100.

Electronic Arrays Inc., 501 Ellis St., Mountain View, Calif. 94040 [444]

STABILITY & QUALITY

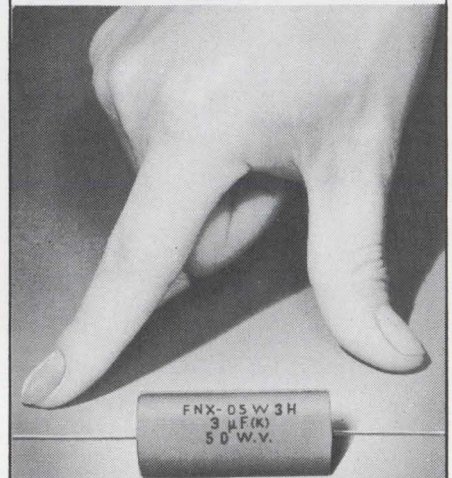

MATSUO

METALLIZED POLYESTER FILM CAPACITOR - "TYPE FNX-H"

Sub-miniature size and oval section ideal for space economy. Lightweight, self-healing and with high insulation resistance. Capacitance values up to 10 MFD. Outer wrap of tough polyester protects against moisture. Perfect in both transistorized and low voltage tube circuits and others where size and cost are paramount.

Specifications:

Operating Temperature Range: -40°C to +85°C
Standard Voltage Rating: 100, 200, 400, 600VDC
Standard Capacitance Value: .1 MFD to 10 MFD.
Standard Capacitance Tolerance: ±20% (available ±10%)

MATSUO'S other capacitors include:

Solid Tantalum Capacitors: MICROCAP

for hybrid ICs, Type TAX hermetically sealed in metallic case, Type TSX enclosed in metallic case and sealed with epoxy resin, Type TSL enclosed in metallic case and sealed with epoxy resin

Polyester Film Capacitors: Type MFL

epoxy dipped, Type MFK epoxy dipped, non inductive, Type MXT enclosed in plastic tube, non inductive.

For further information, please write to:

MATSUO ELECTRIC CO., LTD.

Head Office: 3-5, 3-chome, Sennari-cho, Toyonaka-shi, Osaka, Japan

Cable: "NCCMATSUO" OSAKA Telex: 523-4164 OSA

Tokyo Office: 7, 3-chome, Nishi-Gotanda, Shinagawa-ku, Tokyo

ITS...here today from Deutsch!

A SOLUTION TO A COMPLEX WIRING PROBLEM.

Untangle the electrical wiring maze now! The Deutsch-developed Integrated Termination System (ITS) introduces simplicity and organization into **your** system and eliminates virtually **every** source of possible trouble in high-performance electrical interconnection for man-rated vehicles.

Not only do check-out problems vanish, but so does 10 per cent of the weight, 75 per cent of the bulk, and a lot of cost, time and effort! When total reliability is required—when failure cannot be tolerated, it's time for ITS. Obsoletes 95 per cent of the complicated application tooling—only one crimp tool and one insertion/removal technique. ITS cuts down 65 per cent of the assembly documentation too—you make **every** connection in the same manner.

All ITS components are in production and readily available for almost every interconnection assignment. Let us tell you more. Call your local Deutschman or write for our ITS Data File.

YOU CAN GO ALL THE WAY OR IN STAGES
WITH THE DEUTSCH INTEGRATED TERMINATION SYSTEM.
ONE TYPICAL ITS COMPONENT IS FEATURED BELOW.

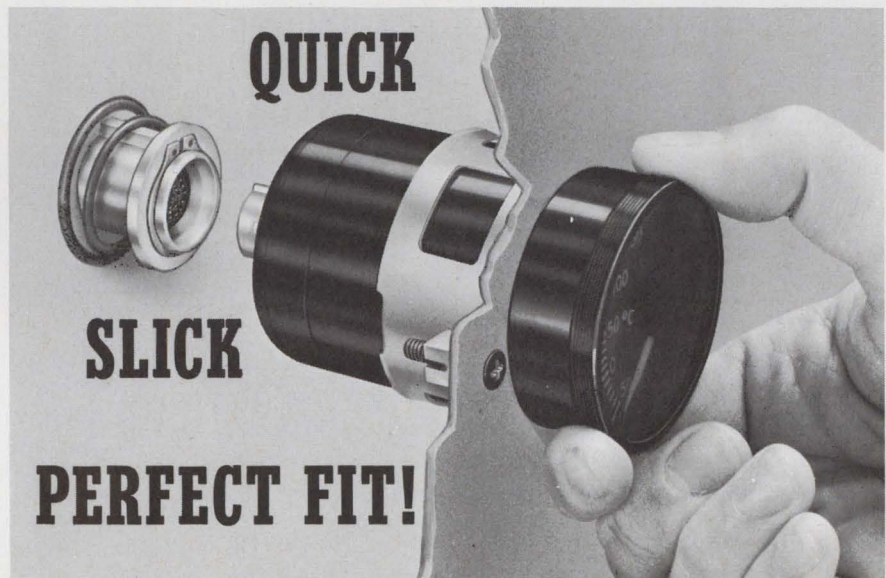

Here's the perfect way to reduce instrumentation downtime. Deutsch spherically-oriented rack and panel connectors mate or release—instantly. Even when misaligned, plug and receptacles compensate automatically, and you get perfect "cork-in-bottle" environmental seals. They're vibration-dampened. Spring loaded. Unaffected by pressure. Available in a full range of miniature and subminiature sizes and insert arrangements. Get the facts now from Deutsch, the "live-wire" leaders in Integrated Termination Systems.



DEUTSCH

ELECTRONIC COMPONENTS DIVISION

Municipal Airport • Banning, California 92220 • Telephone: Area Code 714 • 849-6701

COPYRIGHT, 1969 DEUTSCH ELECTRONIC COMPONENTS DIVISION

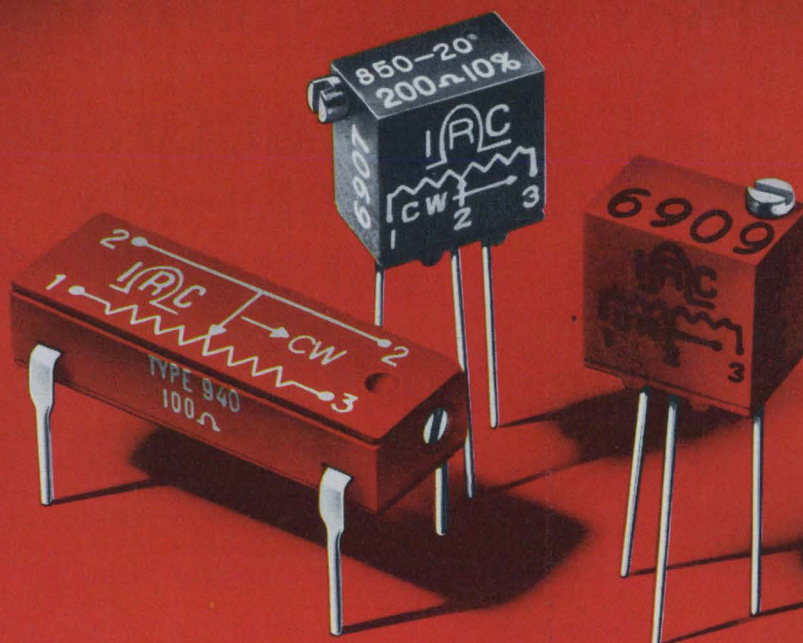

Space-saving trimmers

DIP construction matches IC size. Cuts assembly costs.

5/16" doubles performance of 1/4" trimmer—cuts cost almost in half.

IRC's new precision wirewound trimmer in dual-in-line package simplifies PC board layout. Pin spacing is the same as the popular TO-116 size integrated circuit. It is fully compatible with high-speed automatic inserting equipment.

The sealed, moisture-resistant units meet the environmental requirements of MIL-R-27208. Maximum height is only .200 inches. 1 watt @ 40°C. 10Ω to 20K. ±10% tolerance. TC is ±50ppm/°C.

Pin spacing of these 5/16" square trimmers matches the 1/4" square unit. Only .062" larger on each side they can cut your cost almost in half and give you three times the power rating of the 1/4" and 40% better resolution.

Two types are available—precision wirewound and infinite resolution Metal Glaze. Both are fully sealed and impervious to common industrial solvents because of a silicone rubber shaft seal and epoxy bonding at all seams.

For data and prices, see your IRC Industrial Distributor or write IRC St. Petersburg Division of TRW INC., 2801 72nd Street, North, St. Petersburg, Florida 33733



DIVISION OF TRW INC.

New Books

A hot subject

Infrared System Engineering
Richard D. Hudson, Jr.
John Wiley & Sons Inc., 642 pp., \$19.75

For nearly two decades following Pearl Harbor the vast body of infrared engineering knowledge was locked up in military secrecy. Then, in the late fifties, declassified i-r literature began trickling into the public domain. As more material became known, Hughes Aircraft scientist R. D. Hudson prepared to realize a long-held ambition—to write a practical, lucid text on infrared technology.

His book is probably the last word in the field to date. Its relevance to the equipment designer can be traced to the author's extensive industrial experience with infrared, his appreciation for systems engineering, and the organization of the book, which rests on the principle of a simple block diagram. All i-r systems, according to the author, consist of eight elements: a target (or radiation source), the attenuating atmosphere, an optical receiver, an optical modulator, a detector cooling mechanism, a signal processor to handle the detector's output, and a display.

The author then proceeds to examine the elements chapter by chapter, each one revealing a distinct technology. Natural and man-made sources of i-r radiation (in the spectral portion from 0.75 to 1,000 microns) are investigated as are atmospheric effects on i-r transmission. Optics and the use of rotating reticles as optical modulators are reviewed followed by a chapter on noise and three chapters on detectors, their characteristics, performance, and limitations. At no point does the author dwell on fancy derivations; only equations pertinent to an understanding of the physical and engineering concepts are given.

After a discussion on cooling techniques, signal processing, and displays, the author pulls together the different technologies for a systems analysis, replete with tradeoff studies and advice on the

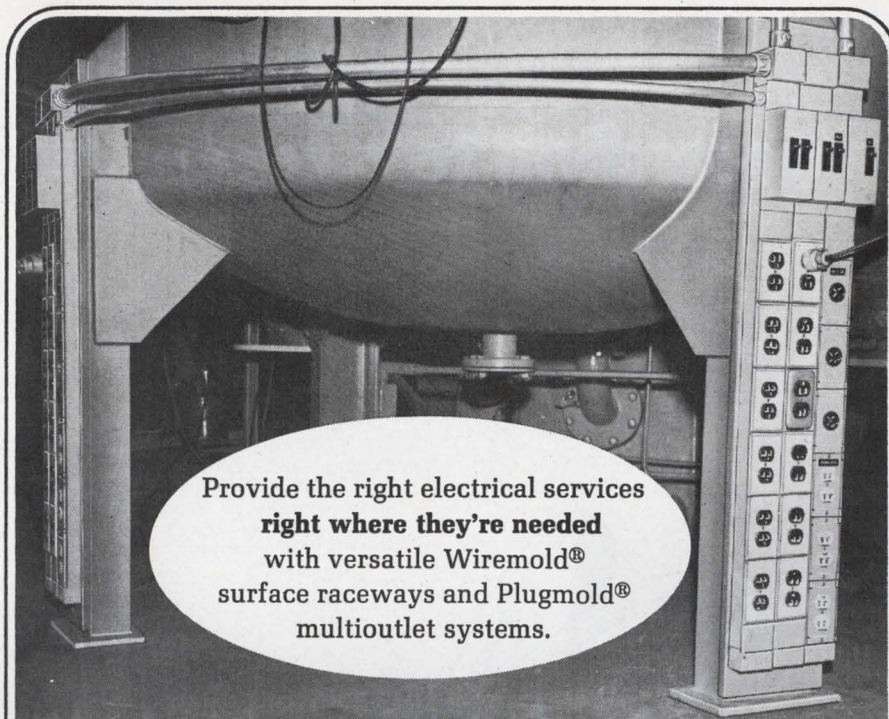

Provide the right electrical services
right where they're needed
with versatile Wiremold®
surface raceways and Plugmold®
multioutlet systems.

Three runs of Plugmold 3000, on each leg of this rotary accelerator, handle various required voltages in G.E. Space Technology Center.



WIREMOLD

THE WIREMOLD COMPANY / HARTFORD, CONNECTICUT 06110

Send for free literature

Circle 236 on reader service card

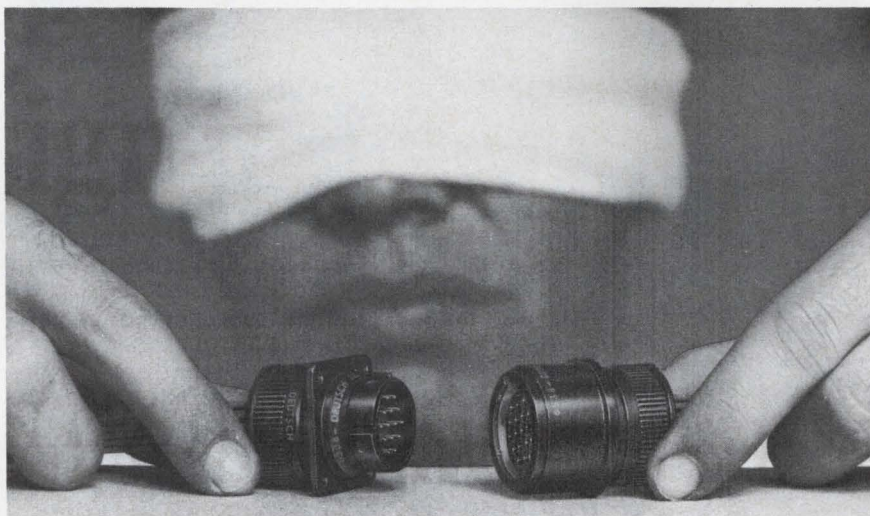

OUT OF SIGHT! A Deutsch DBA 70 connector may be operating away from your line of vision, but you don't have to see it to connect or disconnect properly. There's nothing to turn, twist or thread. Just push to engage; pull to disconnect. Mating is grope-free, **trouble-free!** Environmentally-sealed, the DBA 70 stands up under temperatures ranging from -67° to 392° F. It meets all the performance and reliability requirements of NAS 1599 and works in absolute harmony with the rest of our Integrated Termination System. Out of sight? Maybe! Out of reach? Never! Just pick up the phone and call your friendly Deutschman.



DEUTSCH

ELECTRONIC COMPONENTS DIVISION

Municipal Airport • Banning, California 92220 • Telephone: Area Code 714 • 849-6701

COPYRIGHT, 1969 DEUTSCH ELECTRONIC COMPONENTS DIVISION

The ideal flight recorder according to a recent survey of users:

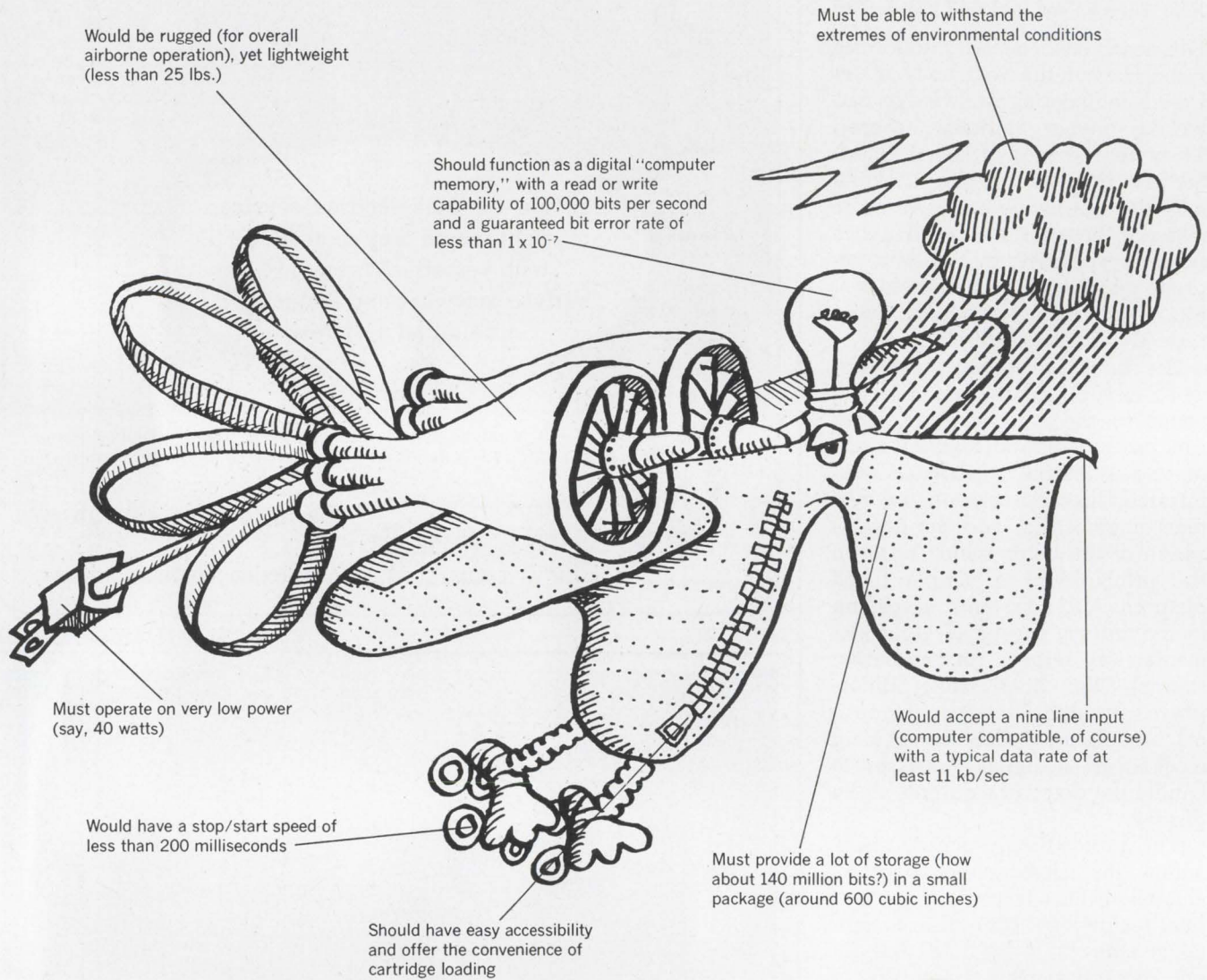

The ideal flight recorder according to Leach:

Thanks to a patented new technique called HDDR® (High Density Digital Recording), our new MTR-8600 is a spec-for-spec match of the recorder-by-consensus (above). And more. And, it's available now in a more conventional package from Leach Corporation, Controls Division, Department A, 717 Coney Ave., Azusa, California 91702 (213) 334-8211.



The MTR-8600

New Books

best systems performance.

If the reader wonders at this point about the dearth of examples, he will find them all contained in the next chapter on the development of an i-r search system for commercial jet transports.

On the applications of i-r techniques, Hudson devotes five chapters to military, industrial, medical, and scientific applications. However, instead of presenting the usual how-to-do-it examples, he annotates some 1,400 references of i-r literature from books, periodicals, declassified government sources, and especially from patent disclosures. Each reference summarizes the content, hardware, and results of the engineering work described. In a later appendix, he directs the reader to unpublished and classified sources.

The book also makes for interesting reading, particularly the introductory chapter where Hudson traces infrared history from its discovery in 1800 by Sir William Herschel, through the Lichtspecher, an i-r communication system used by the Germans in the African desert during major tank battles, down to the Government clam-up on i-r information in the post-war years. Hudson estimates the 1968 market figure of i-r devices to be \$350 million annually, 75% of which go into military applications.

Recently published

Electron Optics, B. Paszkowski, American Elsevier Publishing Co., 305 pp., \$13.00

A graduate level text, this book also presents many practical design curves for electronic lenses and deflecting systems. Subject coverage also includes field distributions and defects of electron-optical imaging.

Bessel Functions with Some Physical Applications, C.J. Tranter, Hart Publishing Co., 149 pp., \$10.00

An up-to-date treatment of applications of Bessel functions, the book also includes many exercises at the end of each chapter. Aimed at mathematicians, it could also be of use to engineers with strong mathematical backgrounds.

BIG PRINT-OUT CAPACITIES COME IN SMALL MDS PACKAGES

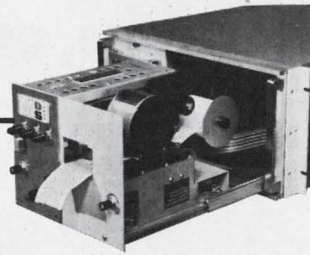

Easy does it!
The complete mechanism slides forward for inspection and paper loading!

MDS 2200 and 3200 Digital Strip Printers are high-speed, parallel entry recorders that give you a choice of 22 or 32 print columns . . . speeds to 40 lps . . . print drums with a variety of character choices . . . and numeric or alphanumeric print-out.

The MDS 3200 series features a two-chassis package. Printer mechanism in one unit, electronics in a separate unit, for local or remote operation of the printer.

On both models, paper loading and inspection are quick and easy . . . the printer mechanism slides out of the cabinet on glide rails.

Ask for: Complete specifications and information available in MDS folder-file.

FOR MORE—MEET YOUR MAN FROM MDS

MOHAWKMS
DATA SCIENCES CORPORATION

OEM MARKETING

P.O. Box 630, Palisade St., Herkimer, N.Y. 13350

Telephone 315/866-6800

Every MDS Office is an OEM Marketing Office

Digital Strip Printers • Buffered Tape Units
High-Speed and Low-Speed Line Printers
Card Punches and Readers

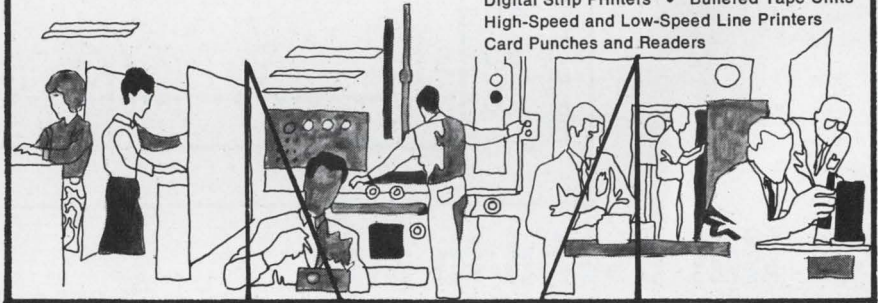

Circle 237 on reader service card

You can put

500

high-performance electrical contacts in this space, and . . .

TAKE THE WORRY OUT OF BEING CLOSE!

Check 'em out! You'll find Deutsch high-density, **rectangular** connectors stack up best from any angle. No other group of connectors can handle as many contacts in so little space. Yet they're easy to work with and provide perfect dielectric separation. One of many components in the Deutsch Integrated Termination System (ITS), these rectangulars are ideal for modular instrumentation packages. Center jackscrew provides visual indication of proper lock and assembly. Also available with center guide pin for rack and panel installation. Environmental and non-environmental models available. Five shell sizes. Many insert arrangements. Write for your Deutsch Data File on rectangulars.



DEUTSCH

ELECTRONIC COMPONENTS DIVISION

Municipal Airport • Banning, California 92220 • Telephone: Area Code 714 • 849-6701

COPYRIGHT, 1969 DEUTSCH ELECTRONIC COMPONENTS DIVISION

Plotting the dielectric constant of a TEFLON resin against frequency, or temperature, or what-not makes a pretty dull-looking graph.

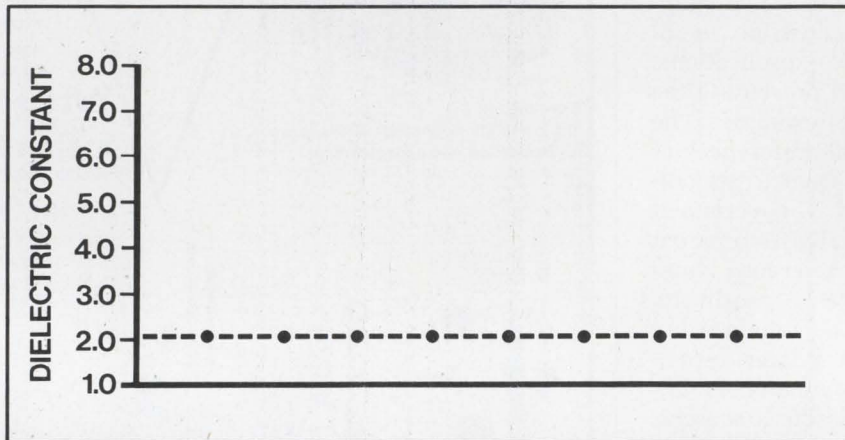

But useful to an electronic designer.

A straight line parallel to the X axis is about all you get when you plot the dielectric constant of a Du Pont TEFLON fluorocarbon resin — over a wide frequency range — and over a wide temperature range. The same stubborn constancy applies also to the other excellent electrical characteristics of TEFLON: a dissipation factor of only 0.0002 and a high dielectric strength (500 volts/mil).

The dielectric constant is in the lowest range of any solid material: between 2.0 and 2.1, depending on the exact TEFLON resin used and its processing.

But once established, it remains a fixed design constant. This is particularly important to designers of RF cable who require the highest propagation velocity and a constant impedance — and to designers of microwave transmission lines.

Some of the typical hazards that may affect the use of conventional insulations but leave TEFLON virtually unaffected include: moisture, fungus, deicing fluids, UV radiation, salt spray, chemical fumes, cleaning agents, fuels and lubricants.

These are some of the reasons why insulations of

TEFLON have established their reliability in use for more than 20 years. When you specify TEFLON, you specify electrical characteristics that can be depended on consistently.

We'd like to send you more detailed information on the electrical properties of TEFLON. Write: Du Pont Company, Room 7314A, Wilmington, Del. 19898.



TEFLON[®]
fluorocarbon resins

Technical Abstracts

Too close for comfort

A proposed low cost proximity warning device for aircraft
L.C. Drew, W.R.L. Thomas, A.G. Atward
C. Park and H. King
RCA
Burlington, Mass.

There's been a lot of talk about proximity warning indicators that set off an alarm when two aircraft fly too close but no one seems to do much with them. Cost has been the big problem: the indicators must be cheap enough so the owner of the smallest aircraft could afford to buy one.

RCA's Defense Electronic Products group, the latest organization to do some talking, proposes a system that detects the visible and near infrared radiation emitted by the xenon strobe lights currently being installed atop aircraft. These pulses last about a millisecond. The system includes silicon detectors, focusing lenses, the signal processing circuitry necessary to discriminate an actual signal from the strong visible and i-r radiation coming from the daylight sky, and a display panel in the cockpit. And, when produced in quantity, it will be low cost. However, no price is yet available.

Calculations show that the range of the system could be as much as six miles in clear daylight conditions, about three miles when conditions are hazy. Flight tests of a device using a single silicon detector have confirmed these ranges.

The system will use 24 silicon detectors, arranged in an immobile circle around the bottom of the xenon strobe. With molded plastic lenses the system views the horizon over a 360° angle, and through an elevation of 15° without scanning.

Pairs of adjacent detectors, each having an area of about one square centimeter, will be connected to a common preamplifier so as to provide 12 horizontal sectors. Each lens will be less than 6 inches in diameter.

An amplitude discriminator in the system sorts the signals received from an intruding aircraft by the detectors. Amplitude is also

New... FROM SPECTRUM CONTROL —
THE PEOPLE WHO THINK *Electromagnetic Compatibility*

Finally... Quality Filters
at **REALISTIC PRICES!**

SUBMINIATURE EMI 100 VOLT dc LINE FILTERS

Why pay high filter costs when Spectrum Control offers sensibly priced EMI Filters that perform the same function as more expensive filters? For example, these subminiature EMI 100 Volt dc Line Filters are high current, broad band, low pass types. An automated production line, plus automated testing facilities permits Spectrum to market these filters at a cost substantially less than comparable units. Our quality is excellent and so is our delivery. Try us!

Write for literature about
Spectrum's 100 Volt dc
Line Filters TODAY or call
John R. Lane
814/474-5593.



SPECTRUM CONTROL INC.

152 EAST MAIN ST. • FAIRVIEW, PENNSYLVANIA 16415

Circle 240 on reader service card



the Solderless Hermetic!

Up to now, hermetic connectors meant soldered contacts. Solder meant smoke, and — **more important** — operator training, time, uninspectable connections, the danger of unreliability, and high costs. Now... Deutsch brings you the solderless rear-release hermetic connector! Not only can you now insert and remove contacts in seconds, but also without any of the old problems of precision soldering. Meets Mil Spec performance requirements. Compatible in contact crimping, terminating, installing and tooling techniques with all components of the Deutsch Integrated Termination System (ITS). Why not break your smoking habit. Write for your Hermetic Data File or contact your local Deutschman.



DEUTSCH

ELECTRONIC COMPONENTS DIVISION

Municipal Airport • Banning, California 92220 • Telephone: Area Code 714 • 849-6701

COPYRIGHT, 1969 DEUTSCH ELECTRONIC COMPONENTS DIVISION

When Only Excellent is Adequate TURN to Grayhill

**for MINIATURE
PUSH BUTTON SWITCHES**

- WIPING, SNAP ACTION and BUTT CONTACTS.
- SPST, SPDT, DPST, DPDT.
- PUSH-PULL — LIGHTED.
- 25,000 to 1,000,000 OPERATIONS.

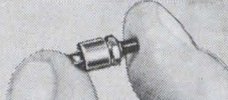

... the Difference Between Excellent and Adequate

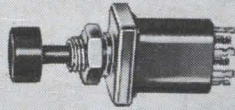

Select Materials

- Contacts — Fine Silver
- Springs — Tinned Music Wire
- Housing — Molded Phenolic per MIL-M-14
- Shorting Bar & Terminals — Fine Silver or Silver Plated Copper Alloy

Typical Specifications:

- ¼ Amp. to 10 Amps., 115 VAC Resistive
- Contact Resistance 10 Milliohms
- Insulation Resistance — 25,000 to 900,000 Megohms

All fully described in Engineering Catalog G-304-A Write



523 Hillgrove Avenue
LaGrange, Illinois 60525
Area Code 312, Phone 354-1040

"PIONEERS IN MINIATURIZATION"

Circle 242 on reader service card

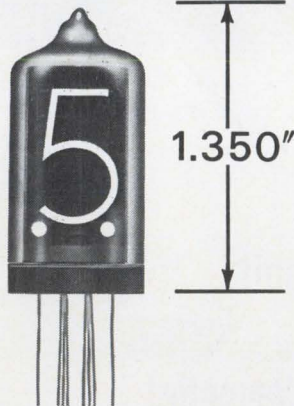

NEW NL-950 READOUT TUBE

Replaces: B-5750 B-5855 B-5859

- made in Geneva, Illinois U.S.A.
- request bulletin

**NATIONAL
ELECTRONICS, INC.**

a varian subsidiary

PHONE: (312) 232-4300 • GENEVA, ILLINOIS 60134

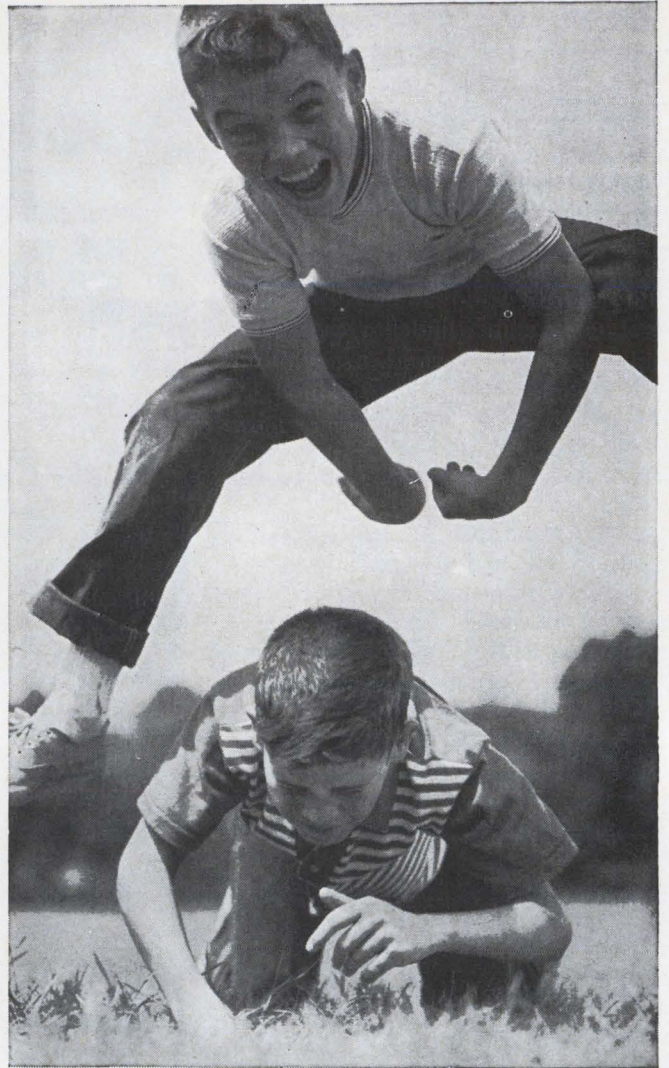

**It's never too early
to start saving their hearts**

Help your children form good health habits now to reduce risk of heart attack later:

- Encourage normal weight; obesity in youth may persist throughout life;
 - Build body health through regular physical activity;
 - Serve them foods low in saturated fats;
 - Teach them that cigarette smoking is hazardous to health;
 - Make medical check-ups a family routine.
- Set a good example. Follow the rules yourself and guard *your* heart, too.

GIVE...
so more will live
HEART FUND

Contributed by the Publisher



Technical Abstracts

an indication of range, and the detectors themselves indicate the direction of the signal. Following this initial sorting, the signal passes through a pulse width filter that rejects pulses whose widths are greater than 1.5 milliseconds. This effectively eliminates the back-ground radiation.

After it is filtered, the pulse is stretched to approximately 11 milliseconds to light indicator bulbs on the cockpit display. This display, which consists of three concentric circles of bulbs, also indicates the direction of an intruding aircraft. A bell could also ring to alert the pilot. It's up to the pilot, then, to look for the intruder and decide on the evasive action to take to avoid a collision.

Large scale integrated circuitry, made with metal oxide semiconductor (MOS) technology could be used to bring costs down. This would also reduce the power requirements.

A self-test feature, using an i-emitting gallium arsenide diode giving millisecond flashes every second could also be included. The output from this diode goes into the lens assembly and is distributed simultaneously to all the detector elements. This lights all of the indicator bulbs on the pilot's display panel at the same time. The test can be made to trigger the audible alarm as well.

Presented at the National Aerospace Electronics Conference (Naecon), Dayton, Ohio, May 19-21.

Bridge building

Crossovers for interconnections on substrates

H. Basseches and A. Pfahnl
Bell Telephone Laboratories Inc.
Allentown, Pa.

Some hybrid integrated circuits have so many elements that it's impossible to interconnect all of them in one plane. Designers then are forced to cross thin film conductors over each other. They do so either by separating the conductors with a dielectric such as silicon dioxide or glass, or by stitch type structure, consisting of electroplating gold wires. Now a third plated pillars and beams, offers

MITSUBISHI Miniature Circulators for VHF, UHF and SHF Bands

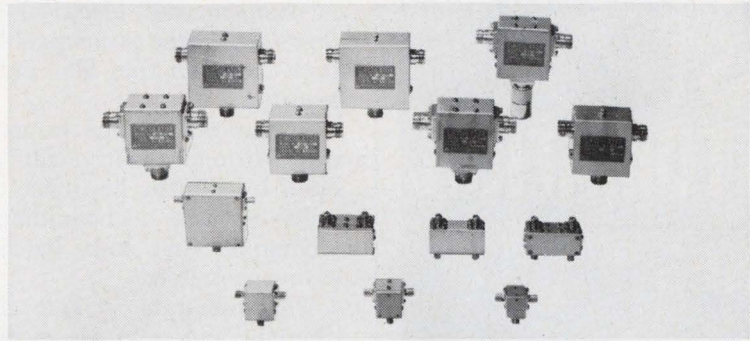

- * Small size with high power handling capacity
 - * Wide band
 - * Wide temperature range
- 3-port model, 1.5GHz; 4GHz; 7GHz
4-port model, 4GHz

■ VHF and UHF Band
High power model
150MHz 125W; 400MHz 100W
Standard 20W model
50MHz; 150MHz; 450MHz

■ SHF Band

For further information, write to:

Chicago Rep.: 119 East Lake Street, Prudential Plaza, Chicago
Tel: (312) 222-1172

New York Rep.: c/o Mitsubishi International Corporation, 277 Park Avenue, New York
Tel: (212) 922-6767

Los Angeles Rep.: Room 319, 606 South Hill Street, Los Angeles
Tel: (213) 623-6079



MITSUBISHI ELECTRIC CORPORATION
Head Office: Mitsubishi Denki Bldg., Marunouchi, Tokyo. Cable Address: MELCO TOKYO

Circle 249 on reader service card

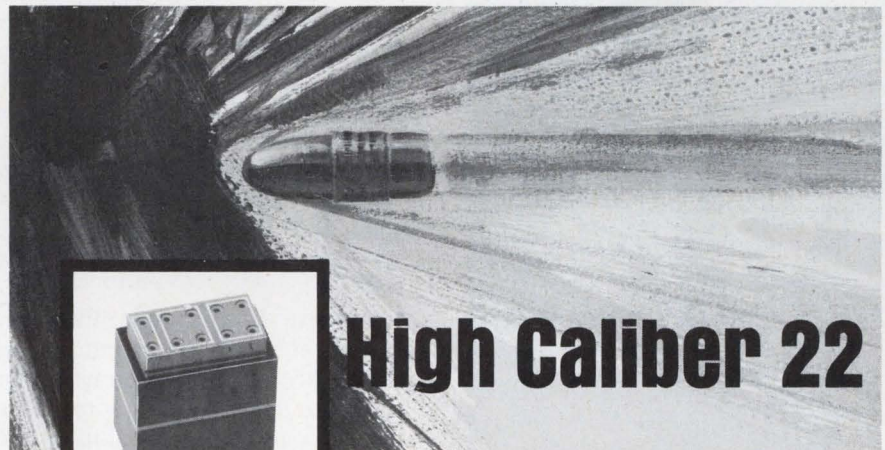

High Caliber 22

You'll get a bang out of it! This new, small bore Deutsch terminal junction module increases your range of termination capability; it accepts wire gauges 22 through 26. As a result, you can set your sights on many new weight saving advantages. The Deutsch 22 loads in the same standard rail chamber as the Deutsch size 20 terminal junction module. So, there's no need to recoil from extra trouble and costs. There aren't any. Just extra cavities! **Plus**—a new opportunity to design smaller, weight-saving wires into your system. The high caliber Deutsch 22 keeps you right on target. And... it's completely compatible with all components of the Deutsch Integrated Termination System (ITS). Write for our TJ Data File, or contact your local Deutschman for added facts.



DEUTSCH

ELECTRONIC COMPONENTS DIVISION

Municipal Airport • Banning, California 92220 • Telephone: Area Code 714 • 849-6701

COPYRIGHT, 1969 DEUTSCH ELECTRONIC COMPONENTS DIVISION

LOW COST AUTOMATION takes many forms

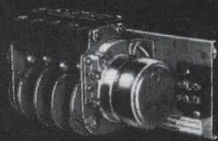
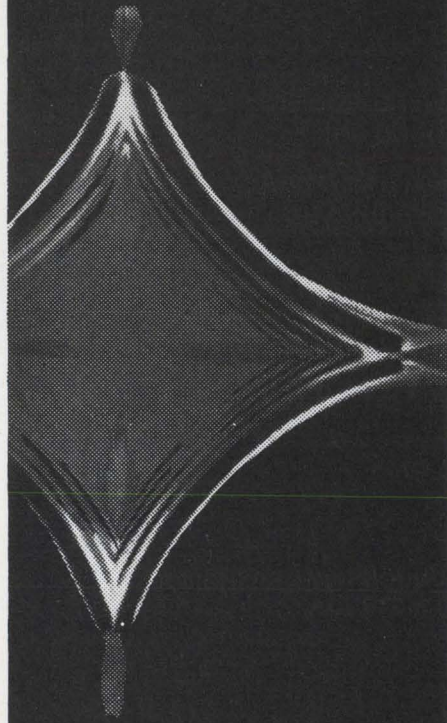

Our MP Repeat Cycle Timers inexpensively control up to 12 SPDT, 10 amp 120 VAC circuits from a common time base. Catalog 15 explains this and 560 other forms of low-cost automation. Send for it.

GW Eagle Signal Division
E.W. Bliss Company
Davenport, Iowa 52803
A GULF + WESTERN COMPANY

Service-In-Depth ...
Local Engineering, Stock, Repair

Technical Abstracts

mechanical and electrical advantages that make it compatible with both tantalum thin film and beam lead ICs.

Preparation of the beam crossover structures—originally developed by Martin Lepselter of Bell Labs—includes photolithographic techniques that make batch processing possible.

The substrate is first cleaned, titanium and gold are evaporated and plated onto it, and the bottom conductor pattern is delineated by etching. Next, the pillars that raise the top conductor, thereby preventing shorts, are formed in three steps. First, by evaporation a sandwich of titanium-copper-titanium is plated on. Then photolithographic techniques are used to etch away the sandwich, leaving only the regions for the pillars and crossover span. Finally, a preferential etch removes the copper spacing layer between the two conductors.

During a test program, 263 substrates were made. The yield was 63%; out of the 75,000 crossovers contained on these substrates, 99.2% were good. Leakage currents were measured at 10^{-11} amps and breakdown voltages ranged from 300 to 400 volts. Encapsulation lowered the leakage currents below this figure at 100 volts and raised breakdown voltages in some cases to over 1,000 volts.

Because beams and pillars are plated at high temperature, the former are under tension when the substrate cools to room temperature. To test beam stability, 103 substrates were cycled ten times from -40°C to $+150^{\circ}\text{C}$. Out of the 3,045 crossovers tested only three were open and four were shorted.

Circuits with the beam type crossovers have been made on the same substrate as Ta_2N resistors. Resistor values hardly changed during crossover fabrication. However, anodizing techniques have been developed to trim the resistors if adjustment is required after the crossovers have been formed.

Presented at the Electronic Components Conference, Washington, D.C., April 30-May 2.

Give Us a Requirement to Build to

Broad Frequency Response?



AMF
VIDEO
PREAMPLIFIER
• f_1 .1 Hz thru f_2 25 MHz

Ultra Low Noise?

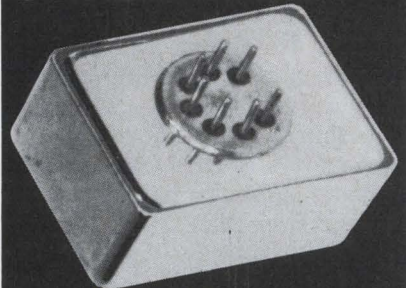

AMF SOLID STATE
MODULAR PREAMPLIFIER
• -165 dBV per cycle

... tailor an AMF
Cybertran
Preamplifier to
fit your needs.

Cybertrans fulfill your needs whether they be ultra-low noise, subsonic requirements or extreme broadband video specifications. The flexibility of our "off-the-shelf" preamplifiers enables AMF to satisfy a wide range of special or standard needs ... we call it Cybertran Technology. This new expertise makes it possible for you to specify your preamplifier requirements and have AMF ship it to you. Write or call Jim Campman, Applied Cybernetics Products, AMF Alexandria Division, 1025 North Royal Street, Alexandria, Virginia 22314 Phone (703) 548-7221. TWX 703-931-4209. Representatives in major cities of U.S.A.

AMF
ALEXANDRIA

FULLY TRANSISTORIZED

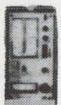

**ACCURACY
RELIABILITY
LITTLE POWER CONSUMPTION
EASY OPERATION
EASY MAINTENANCE
DESIGNED FOR
INTEGRATED AUTOMATION
ELECTRONIC CONTROL SYSTEMS
DATA LOGGERS
(MANUFACTURED UNDER
HOKUSHIN LICENSE — JAPAN)**

GENERAL SPECIFICATIONS

- Unified signal 2 ... 10, 4 ... 20, 0 ... 5, 0 (Input-Output) ... 10, 0 ... 20 mA etc.
- Load resistance 0 ... 3 Kohms
- Ambient temperature —10° ... +60°C (for field instruments)
—10°C ... +45°C (for panel instruments)
- Power supply 200 or 220 V (+10 ... —15%) A.C. or 60 c/s)

ELECTRONIC CONTROL SYSTEMS INCLUDE:

- Temperature transmitters with
 - thermoresistance (—200 ... +500°C)
 - thermocouples (0 ... +1600°C)
 - radiation pyrometer (+600 ... +2000°C)
- Pressure transmitters with
 - Bourdon tube (0 ... 350 kgf/cm²)
 - capsule (0 ... 1 kgf/cm²)
 - bellows (0 ... 1000 mm Hg)
- Differential pressure transmitters with
 - bell (0 ... 100 mm H₂O)
 - bellows (0 ... 400 mm²H₂O)
 - bellows (0 ... 35000 mm H₂O)
- Area type flow transmitters: 0, 24 ... 54, 94 m³/h
- Electromagnetic flow transmitters: 0, 41 ... 1770 m³/h
- Displacement type liquid level transmitters: 0 ... 2000 mm.
- pH transmitters: 0 ... 12 pH
- Water quality, psychrometer, mol ratio, concentration transmitters
- Miniature indicators
- 120 and 250 mm scale one and two point recorders
- Multipoint (2, 3, 6, 12) recorders
- Calculators and accessories: square root extractors, multipliers, dividers, adders-subtractors setters, program setter, integrators, signal limiters, manual control stations etc.
- Controllers
 - continuous (PI-PID) with and without indicators
 - Multipoint on-off controllers
 - Relay amplifiers
- Electro-pneumatic converters
- Computers: —multi-point scanner
—data logger

MASINEXPORT

Bucuresti — România Str. Matei Millo 7
Cables: MASEXPORT — Bucuresti
Telex: 216

Circle 245 on reader service card

RHG OFFERS

FM receivers for S band telemetry

Wideband, tunable 2.2 to 2.3 GHz, all solid state FM receivers are available off-the-shelf. Information bandwidths up to 12 MHz produce low distortion demodulation of high speed video data.

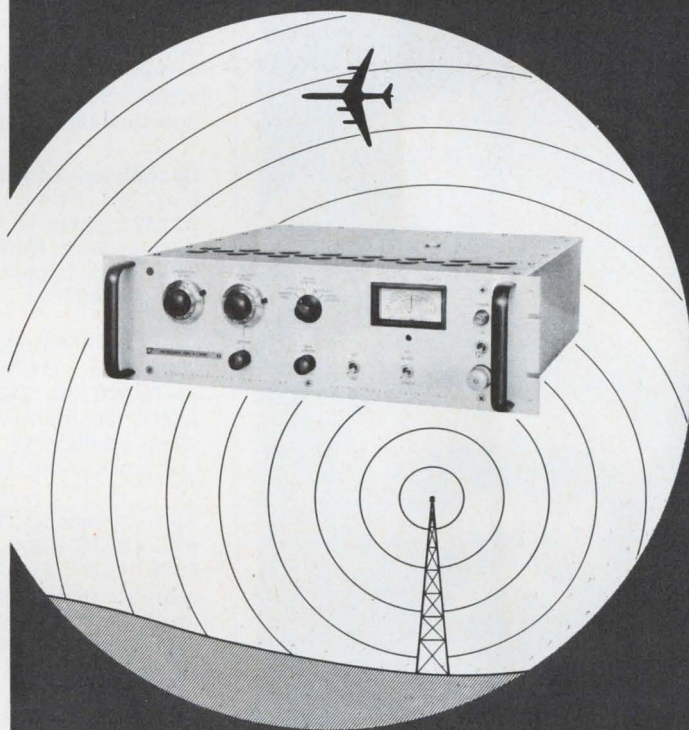

- TUNABLE 2200 to 2300 MHz
- BASEBANDS to 12 MHz
- LOW INTERMODULATION
- LOW NOISE FRONT END

RHG FM receivers include such features as a built-in ferrite isolator, balanced hybrid mixer, and AFC controlled solid state oscillator. They are MIL grade, RFI protected, and may be obtained for ground or airborne use. RHG lists a full line, from 1 to 18 GHz, in Catalog 69A or see EEM section 3400.



**RHG ELECTRONICS
LABORATORY · INC**

94 MILBAR BOULEVARD ■ FARMINGDALE
LONG ISLAND ■ NEW YORK 11735 ■ (516) 694-3100
Microwave Receivers, Transmitters and Components

Circle 205 on reader service card

LOW COST AUTOMATION takes many forms

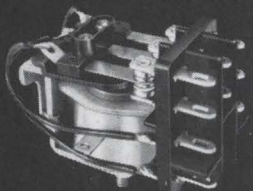
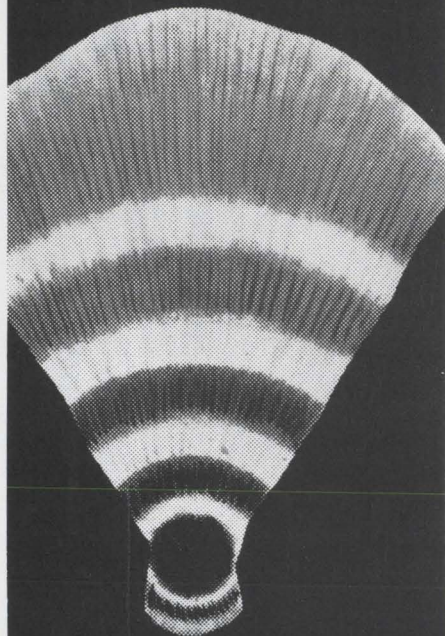

EAGLE control relays last longer!
There are over 3000 models in our catalog RGC-1, ready to prove their superiority in your application. See them all. Send for your copy.

GW Eagle Signal Division
E.W. Bliss Company
Davenport, Iowa 52803
A GULF + WESTERN COMPANY

Service-In-Depth...
Local Engineering and Stock

New Literature

Solderless disconnect system. Thomas & Betts Co., 36 Butler St., Elizabeth, N.J. 07207, has issued bulletin 500.3 on the Connecto-Blok solderless disconnect system for high density wiring used in numerous military and commercial communications applications requiring high reliability. Circle 446 on reader service card.

Indicator lights. Eldema, 18435 Susana Rd., Compton, Calif. 90221. H-Lites, subminiature relampable indicator lights for T-1 bulbs, are described in an illustrated four-page brochure. [447]

Industrial d-c motors. Reliance Electric Co., 24701 Euclid Ave., Cleveland 44117. Sixteen pages of application and performance data, construction features, available ratings and dimensions comprise a buying guide for small industrial rpm d-c motors. [448]

Operational amplifier. Analog Devices Inc., 221 Fifth St., Cambridge, Mass. 02142, offers a data sheet on the model P501 IC operational amplifier with high impedance FET input circuitry. [449]

Magnetic instrumentation. Thomas & Skinner Inc., 1120 E. 23rd St., Indianapolis 46205, has published bulletin A-937 illustrating and describing the latest addition to its line of magnetic instrumentation. [450]

Test chambers. Statham Instruments Inc., 2230 Statham Blvd., Oxnard, Calif. 93030. Choosing the correct test chamber to meet particular requirements is simplified by a compact brochure that features a handy reference chart. [451]

Flying-spot scanner tube. Warnecke Electron Tubes Inc., 175 W. Oakton St., Des Plaines, Ill. 60018. A two-page data sheet provides description, characteristics and voltage ratings of the type RW-12AB, 3-in. diameter crt designed for high-resolution flying spot scanning. [452]

Switch and relay tester. Mason Electric Co., 3839 Verdugo Rd., Los Angeles 90065, has released a data sheet on the model 552 Chatter Monitor, a new switch and relay tester. [453]

Electrostatic recorder. Varian, Electrographics Division, 611 Hansen Way, Palo Alto, Calif. 94303. The Status 3, an 8-channel electrostatic recorder, is described in an eight-page brochure. [454]

Audio amplifier IC. Trans-Tek Mfg. Co., South Plainfield, N.J., has available a catalog featuring a 1-watt audio amplifier integrated circuit. [455]



Model 79 Linear IC Tester

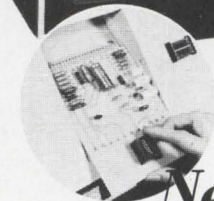
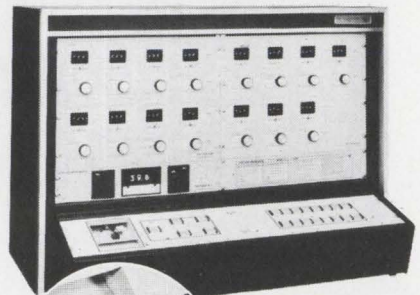

*New
automatic
Linear IC Tester
offers versatility
at low cost*

The wide range of automatic testing capabilities and low cost of the new Model 79 Linear IC (LIC) Tester from Test Equipment Corporation make it ideally suited for production, engineering and quality control applications.

TEC's Model 79 "LIC" Tester is completely automatic with the exception of test limits and range selections and is pre-programmed on performance boards (inset photo above) for up to 15 different test measurements. It provides five dc and eight dynamic tests. In addition, two auxiliary positions are available for customer-specified tests.

The Model 79 also features voltage/current crossover power supplies capable of 100 v/100 ma operation. The tester is capable of low current measurements to 999 pa full scale, low voltage measurements to 99.9 μ v full scale, and test time typically 100 ms or less per test. It accepts all IC package configurations.

Write today for full technical and pricing information on the new TEC Model 79 "LIC" Tester.

Test Equipment

CORPORATION
P.O. BOX 20215, DALLAS, TEXAS 75220 • 214/357-6271

Oxide dust is more costly than gold dust... but who wants it?

Loose oxide shortens the life of magnetic tape heads. It degrades tape. And it breeds still more dust as it is ground into fast-running tape. MS-200 Magnetic Tape Head Cleaner sprays oxide dust away. MS-200 is recommended by leading tape head manufacturers, prescribed by a major broadcasting network, used at hundreds of data processing installations. So, don't lose your head; use MS-200 Magnetic Tape Head Cleaner.

Price: \$2.75/can in cartons of 12 16-oz. cans.

Trial order: 4 cans @ \$3.60/can.

Prices f. o. b. Los Angeles, Chicago or Danbury, Conn.



**miller-stephenson
chemical co., inc.**

Route 7, Danbury, Conn. 06813



U. S. and foreign patents pending.

Circle 247 on reader service card

digital voltage and temperature measurement with...



DIGITEC series 251 & plug-in modules

Your lab can be fully equipped, economically, using the 251 main frame and a wide variety of plug-in modules. Data acquisition capability of the 251 offers unlimited flexibility when used with Digitec system components.

MAIN FRAME:\$445
model 251
.05% DVM PLUG-IN:\$150
±10, 100, 1000 VDC model 251-1

.05% DVM PLUG-IN\$250
±100, 1000mV DC model 251-3

.01% DVM PLUG-IN\$350
±1000mV DC, model 251-4
10, 100, 1000 VDC

-22° to +122°F\$250
Accuracy: ±0.3°F model 551-1
Thermistor Probes available

-30° to +50°C\$295
0° to +100°C model 551-2
Accuracy: ±0.2°C
Thermistor Probes available

-148° to +740°F\$295
Accuracy: ±0.7°F model 551-3
Platinum Resistance Probes available

-100° to +400°C\$295
Accuracy: ±0.4°C model 551-4
Platinum Resistance Probes available

For Complete
Specifications request
new catalog D69

Stocking Representatives Throughout the World



by **UNITED SYSTEMS CORPORATION**

918 Woodley Road • Dayton, Ohio 45403 • (513) 254-6251

LOW COST AUTOMATION takes many forms

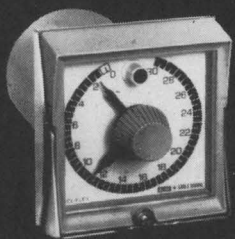
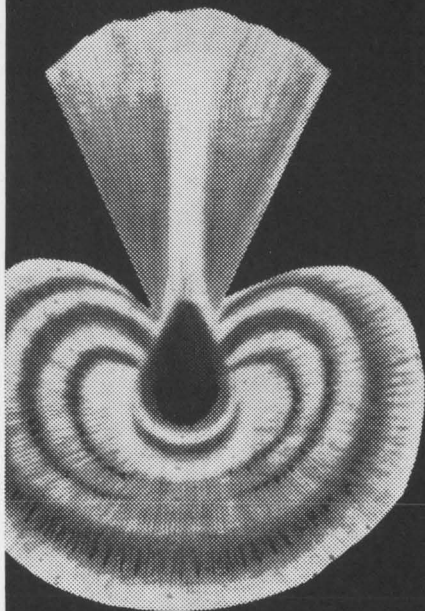

Our famous plug-in Cycl-Flex® electromechanical and solid state time and count controls cut down-time... are replaceable in 5 seconds or less.

Get the facts on these and 560 other forms of low-cost automation. Send for Catalog 15.

GW Eagle Signal Division
E.W. Bliss Company
Davenport, Iowa 52803
A GULF + WESTERN COMPANY

Service-In-Depth...
Local Engineering, Stock, Repair

New Literature

Precise temperature sensing. Texas Instruments, Box 5012, Dallas 75222. Application report CA-125 shows how to use Sensistor precision temperature-sensitive resistors. [456]

Quartz filters. Clevite Corp., 232 Forbes Rd., Bedford, Ohio 44146, offers a data sheet on a new line of coupled mode quartz Uni-Wafer filters. [457]

Spectrum analyzer. Synstron-Donner Corp., 14844 Oxnard St., Van Nuys, Calif. 91409. Model 710/800 portable calibrated spectrum analyzer, offering universal measurement capability from 10 hz to 50 khz, is described in a four-page brochure. [458]

Capacitor catalogs. Del Electronics Corp., 250 E. Sandford Blvd., Mount Vernon, N.Y. 10550, has available a complete set of catalogs for wrap and fill, hermetically sealed, ceramic cased, phenolic cased, and polystyrene capacitors. [459]

Time-sharing systems. General Electric Co., Schenectady, N.Y. 12305. Features of the GE-400 time-sharing systems are described in 28-page booklet GEA-8868. [460]

Linear IC applications. Signetics Corp., 811 E. Arques Ave., Sunnyvale, Calif. 94086, has available a 24-page brochure detailing its line of linear devices and more than 45 specific applications for both the circuit and system designer. [461]

Telemetry components. Applied Research Inc., 76 S. Bayles Ave., Port Washington, N.Y. 11050. Latest developments in an expanding line of telemetry components and modules are described in a 12-page catalog. [462]

Solid state sources. Zeta Laboratories Inc., 616 National Ave., Mountain View, Calif. 94040. A six-page catalog lists performance specifications for high- and low-power crystal-controlled sources, cavity-stabilized sources, comb generators with drivers, and active and passive frequency multipliers. [463]

P-c connectors. Continental Connector Corp., 34-63 56th St., Woodside, N.Y. 11377, has available an 80-page p-c connector catalog covering printed card and tape cable applications. [464]

Transmission line cables. ACI Inc., 206 Industrial Center, Princeton, N.J. 08540, offers a brochure on Signaflo flat transmission line wiring systems designed to offer plug-in adaptability for the most popular digital small and desk-top computers. [465]

P-c materials. Westinghouse Electric Corp., West Mifflin, Pa. 15122, has published a comprehensive guide (B-9542)

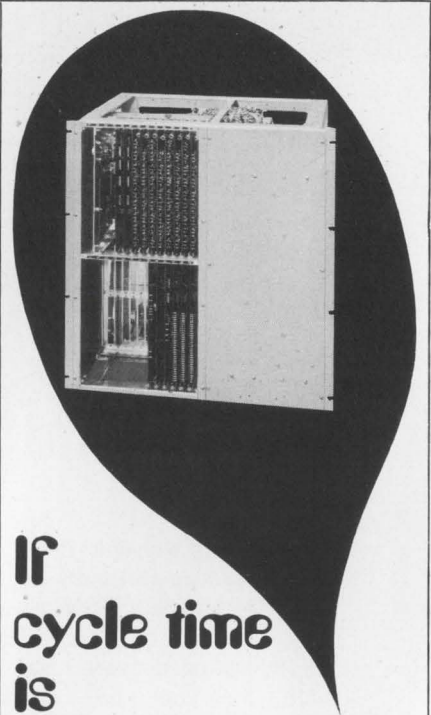

If
cycle time
is
the name of
your
computer game,
read
the good news:

Toko Woven Plated-Wire Memory System HS-500 is now available.

Toko's woven plated-wire memory planes and stacks are already well known for their low-cost, high-performance characteristics. Now to be marketed for the first time is Toko's complete memory system, with a capacity of 4096 words by 16 bits expandable to 8192 words and 20 bits. **Cycle time is a remarkable 500 ns.** Other characteristics are 2D organization, destructive read-out operation, and TTL logic level interface. Cost of the system is remarkably low, and fast delivery can be guaranteed.

Besides this standard woven plated-wire memory system, Toko can undertake the manufacture of custom-made systems according to your specifications. Complete technical details from our New York office.

RC TOKO, INC.

Head Office: 1-17, 2-chome, Higashi-Yukigaya, Ohta-ku, Tokyo, Japan

TOKO N.Y., INC.
350 Fifth Avenue, New York, New York 10001

Now...new micro-inductors at conventional prices

Think you can afford only conventional size coils for your circuit designs? Design in a new CAMBION Micro-inductor instead. They cost no more. And you can choose from several series of micro-miniature fixed and variable inductors covering a wide range of values from .06 to 2000 uH . . . all standard, created specifically for substrate compatibility. Or the world's smallest shielded variable inductor . . . a printed circuit mounting, electrostatically and electromagnetically shielded device measuring just .270" above board and available in 25 EIA mean inductance values covering the range from .08 uH through 1200 uH. Micro-inductors don't cost any more anymore and CAMBION made it happen. For complete details on these and other CAMBION happenings call or write Cambridge Thermionic Corporation, 465 Concord Avenue, Cambridge, Massachusetts 02138. Phone: (617) 491-5400. In Los Angeles, 8703 La Tijera Boulevard 90045. Phone: (213) 776-0472.

Standardize on

CAMBION®

The Guaranteed Electronic Components

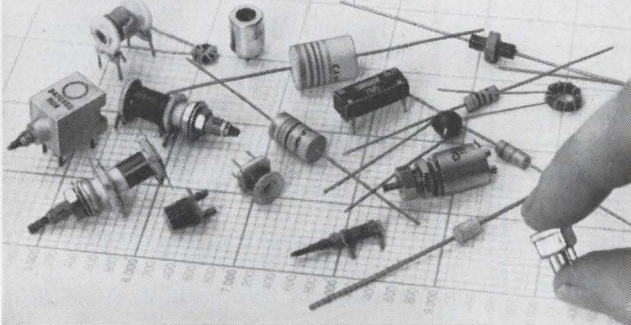

Circle 251 on reader service card

New, press-in indicator lights



**RIB-LOC™ miniature lights . . .
Top Hat or Convex lens . . .
simply press into place**

These new, low-cost indicating lights provide the ultimate in ease of installation. Simply press into place in a .312" diameter round hole. Minimum pressure required, yet ribs bite into sharp edges of hole for positive retention.

Long-life incandescent T 1¾ bulb rated 750 to 20,000 hours or more, depending on bulb and voltage. Available for operating voltages of 4-6, 10-14, and 22-28 volts. Top Hat lens for superior side-angle visibility or Convex lens in clear, red, green, amber, blue or translucent opal. Housing is black molded polyamide. Neon bulb Top Hat version with wire leads also available.

Terminals are 1/16" dia. intended for solder connection or to accept mating receptacles such as AMP #61064-1 or similar types. Insulated sleeving is recommended for receptacle ends.

FREE CATALOG Price data and new design file available giving detailed specifications. See your Johnson representative or write for your copy today.



E. F. JOHNSON COMPANY

3006 Tenth Ave. S.W., Waseca, Minnesota 56093
Providing nearly a half-century of communications leadership

FREE

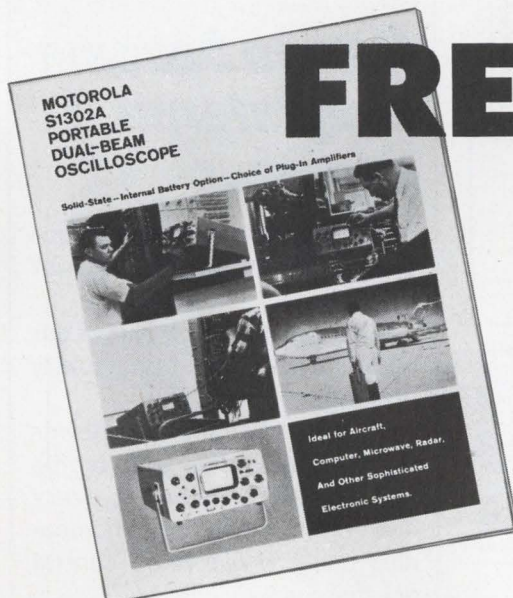

Get technical literature on new solid state, portable dual-beam oscilloscope. Choice of two plug-in Y-amplifiers. Features differential input, internal voltage calibration, and both signal and time delay.

Write to Motorola Communications & Electronics Inc., 4501 W. Augusta Blvd., Chicago, Ill. 60651.



MOTOROLA
Precision Instrument Products

Circle 262 on reader service card

Circle 209 on reader service card

209



EMPLOYMENT OPPORTUNITIES

Last Month PICS COMPUTERS MATCHED 2,217 PEOPLE TO BETTER JOBS

Join PICS' 30,000 Executive, Technical and Professional members who share computer time to zero in on *immediate openings* in today's boiling job market. Employers like Honeywell, Chase Manhattan, National Airlines, Kennecott, Parke Davis, Raytheon and 333 others feed in openings *as they occur*. You receive detailed print-outs describing each opening that matches your career goals, qualifications, salary requirements, etc.

For membership information call (802) 442-3141 Collect—or mail coupon.

NOT AN EMPLOYMENT AGENCY—NO EMPLOYMENT FEES!

PICSystem, Inc., DEPT. 837
BENNINGTON, VT. 05201

Please send details without obligation.

Name _____
(please print)
Address _____
City _____ State _____ Zip _____

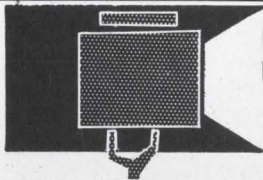

SEARCHLIGHT SECTION

- CLASSIFIED ADVERTISING • BUSINESS OPPORTUNITIES
- USED OR SURPLUS EQUIPMENT

SURPLUS IBM EQUIPMENT

FREE catalog of powers supplies, light & switch panels, semiconductors, test equipment, IC's, optics, etc.

GADGETEERS SURPLUS ELECTRONICS, Inc.
5300 Vine St. Cincinnati, Ohio 45217

CIRCLE 970 ON READER SERVICE CARD

RADAR SYSTEMS GROUND AND AIRBORNE. AUTOMATIC TRACKING ANTENNA SYSTEMS. NIKE AJAX. NIKE HERCULES M-33. MSO-1A. MP5-19. MP5-9. SCR 584. TPS-1D. TPS-28. FAA-ASR-2. AIRBORNE SYSTEMS. APN-84. APN-102. APS-20. APS-27. APS-45. DPN-19. DIGITAL COMPUTERS. IBM 650. IBM 704.

LARGEST INVENTORY OF RADAR AND MICROWAVE EQUIPMENT IN THE WORLD.
RADIO RESEARCH INSTRUMENT CO.
45 WEST 45TH ST. N. Y. 10036 212-JU 6-4691

CIRCLE 968 ON READER SERVICE CARD

Mr. Used Equipment Dealer:

When you advertise in the Searchlight Section . . . You have hired your most persuasive salesman:

He's efficient . . . He thrives on long hours . . . His territory is the entire nation . . . and overseas . . . He doesn't see buyers of used and new surplus equipment: They see him—regularly. They depend on him.

He is Searchlight—The section of this publication where wise dealers advertise and list their stocks for sale.

SEARCHLIGHT SECTION

Classified Advertising Dept.
Post Office Box 12 • New York, N. Y. 10036

RATES

EMPLOYMENT OPPORTUNITIES—\$79.00 per inch, subject to agency commission.

SEARCHLIGHT SECTION—\$39.75 per inch for equipment (Used or Re-sale), business opportunity, etc. advertising appearing on other than a contract basis. Contract rates on request.

UNDISPLAYED (Not available for Equipment Advertising)—\$3.60 per line, minimum 3 lines. To figure advance payment count 5 average words to a line and 1 line for a publication box number.

Position Wanted — undisplayed rate is one-half of above rate, payable in advance.

Send New Ads or Inquiries to:

Classified Adv. Dept.

ELECTRONICS

P.O. Box 12, New York, N. Y. 10036

How to become a registered engineer.

Send a resume of your experience to the Electronics Manpower Register.

That will make you part of our computerized job opportunity program.

The Electronics Manpower Register will match your profile and experience against every opening in a long list of companies using Manpower's central or affiliated services.

All you have to do to get a confidential look at every appropriate chance to advance is send your resume to:

Electronics Manpower Register
Electronics
330 West 42nd Street
New York, N.Y. 10036

New Literature

to its Micarta copper-clad materials for use in rigid, multilayer and flexible printed circuits. [466]

Digital sine generator. Unigon Industries Inc., 200 Park Ave., New York 10017, has issued a data sheet on the model SC-90 all-digital sine generator. [467]

Magnets. Reed Switch Developments Co., 34 Lincoln Ave., Greenwich, Conn. 06830, has published a bulletin describing magnets for reed switching. [468]

Microminiature potentiometer. Minelco, 600 South St., Holbrook, Mass. 02343. Properties and characteristics of the model MP32 microminiature trimmer potentiometer are highlighted in a comprehensive data sheet. [469]

Instrumentation tape and reels. Ampex Corp., 401 Broadway, Redwood City, Calif. 94063. Brochure T-349 describes the low-abrasive characteristics of the 700 series magnetic instrumentation tape and precision design features of the company's tape reels. [470]

Standard relays. Struthers-Dunn Inc., Pitman, N.J. 08071. Catalog C/1010 gives condensed specifications, dimensions, and prices for over 400 stock and standard relays and motor controls available from the company's distributors. [471]

Frequency calibrator. Motorola Communications and Electronics Inc., 1301 E. Algonquin Rd., Schaumburg, Ill. 60172. Brochure TIC 3455 describes the model S1315A frequency calibrator. [472]

Digital memory modules. Electronic Products Division of Corning Glass Works, Corning, N.Y. 14830, has published data sheet MCA-5.07 on its low cost, high speed digital memory modules. [473]

Interchangeable thermistors. Fenwal Electronics Inc., 63 Fountain St., Framingham, Mass. 01701. Catalog L-6 covers Uni-Curve curve-matched interchangeable thermistors. Copies are available upon letterhead request.

Rotary switches. Cherry Electrical Products Corp., 1650 Old Deerfield Rd., Highland Park, Ill. 60035. New lever wheel and thumbwheel rotary switches are described in an eight-page brochure. [474]

Hybrid circuits. Cermex Division of Frenchtown/CFI Inc., 8th and Harrison Sts., Frenchtown, N. J. 08825, has published a four-page bulletin describing company capabilities for the manufacture of custom thick film hybrid circuits. [475]

Meet the Best Contacts!

IN BARNES MINIATURE MF SOCKETS FOR TESTING "TO" PACKAGED I.C.'S



Can a small but hard-working "TO" socket speed up your operation? You bet it can! The reliable Barnes Series MFQ sockets have large pyramidal entrances and spring-tempered, wiping type contacts that mean fast insertion and fast withdrawal — as well as positive contact. Their small size, 50,000 insertion life, and easy board-mounting features, have found them ready employment... in test, breadboarding, aging and burn-in applications. Write for details.

barnes
CORPORATION

Lansdowne, Pa. 19050 • 215/MA2-1525

barnes / THE FIRST WORD IN CARRIERS, CONTACTORS & SOCKETS FOR I.C.'S

Circle 252 on reader service card

Want to be unique in our memory?

It's easy. Enter the Electronics Manpower Register.

We'll feed your professional background into the talent memory of our nationwide computerized recruitment service.

Our computer will match your unique profile against every opening being programmed into it by a long list of electronics companies. You'll automatically be qualified for every logical career opportunity. But we'll only release your availability to those companies you approve.

To enter, send us your resume.

Electronics Manpower Register

Electronics

330 West 42nd Street
New York, N.Y. 10036



NORTON[®]
MAGNETIC
HEADS

MULTITRACK
ERASE
RECORD
PLAY

Send now for complete technical literature.

NORTON

ASSOCIATES, INC.

10 Di Tomas Court, Copiague, N.Y. 11726
Phone: 516 598-1600

Pick the
BEST IC
for the job

Problem: An accurate current-to-voltage conversion is required between a current source and a $2.0K\Omega$ load. Desired full-scale output is ± 12 volts (with a power supply of $\pm 15V$). The circuit must operate with a full-scale accuracy of 0.1% over the temperature range from $-55^{\circ}C$ to $+125^{\circ}C$. The output must be capable of slewing at $2V/\mu s$. Pick the best IC for the job.

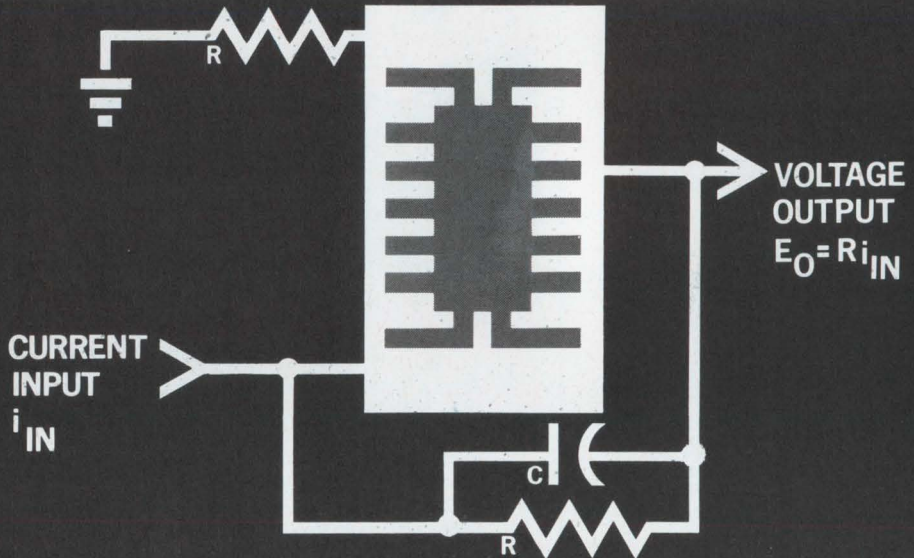

the **BEST** Solution:

THE RA-909 OPERATIONAL AMPLIFIER

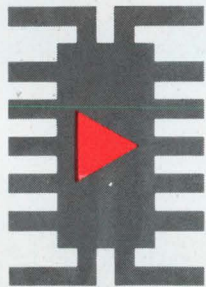

Pick the RA-909 Compensationless Operational Amplifier. Low offset current and offset voltage over the full temperature range allow design of the current-to-voltage converter within 0.1% full-scale accuracy. The RA-909, with dielectric isolation, eliminates the need for external compensation and ensures a slew rate of better than $2V/\mu s$. An added advantage over any 709-type op amp—maximum power dissipation is only 80mW. Obviously, the best IC for the job.

The RA-909 is a direct replacement for all 709-type op amps, so use it in existing current-to-voltage converter circuits and increase their performance, too. Available in both a TO-99 package and a TO-86 flatpack configuration, the RA-909 offers other features such as transient response of 40ns (10 to 90% points) with a 200 millivolt output into a $2K\Omega$ 100pF load in the worst-case unity gain configuration; and a maximum equivalent input noise of $5\mu V$ RMS.

Contact your nearest Radiation sales office. Let us help you pick The Best IC for The Job.

WE MAKE THE **BEST IC** FOR THE JOB



RADIATION
INCORPORATED

SUBSIDIARY OF HARRIS-INTERTYPE CORPORATION
MICROELECTRONICS DIVISION

RADIATION SALES OFFICES: P. O. Box 476, Lexington, Mass. 02173, (617) 862-1055 • 600 Old Country Road, Garden City, N.Y. 11530, (516) 747-3730 • 2600 Virginia Avenue N.W., Washington, D.C. 20037, (202) 337-4914 • P. O. Box 30667, Dallas, Texas 75230, (214) 231-9031 • 6151 W. Century Boulevard, Los Angeles, California 90045, (213) 670-5432 • P. O. Box 37, Melbourne, Florida 32901, (305) 727-5430 • International Sales: Marketing Department, P. O. Box 37, Melbourne, Florida 32901, (305) 727-5412

International Newsletter

June 23, 1969

Cartridge-type vtr to be marketed by Victor of Japan

The decision of the Victor Co. of Japan to market a video cartridge recorder signals the start of a period of competitive maneuvering before consumer electronics manufacturers settle down to a standard vtr format. That's the view of industry observers, who point to the fact that **every Japanese producer of vtr's now uses a different format.**

Victor's announcement comes close on the heels of Sony's decision to put its money on a cassette [*Electronics*, May 12, p. 239]. Victor's, which the company plans to market in the first half of 1970, uses a cartridge measuring 5.51 by 5.51 by 0.91 inches and containing one-half-inch-wide tape. The tape speed is 7.5 inches per second, and maximum playing time is 30 minutes. The tape to be recorded or played back is inserted into a slot and the mechanism inside automatically threads it.

The new cartridge, Victor points out, is about one-seventh the size of Sony's, and the playing time about one-half. The Victor cartridge cannot be removed from the recorder unless it is completely rewound. The recorder, which measures about 18 by 16 by 8 inches and weighs nearly 8 pounds, uses the direct f-m combined recording system announced by Victor last March; this technique permits it to record the 4.5 Mhz NTSC color signal at the slow tape speed. The recorder has a built-in modulator so that color or black-and-white programs can be played back by connecting the recorder to tv antenna terminals. Audio is on dual stereo tracks. The recorder will sell for \$550. Unrecorded cartridges will be priced at about \$27; prerecorded tape, less than double that.

RCA to handle Canadian satellite's production

RCA Ltd., Montreal, looks sure to be prime contractor for the satellite portion of Telesat Canada's communications system. With launching of the communications satellite scheduled for late in 1971, preliminary work is expected to get under way by the beginning of next month.

Meanwhile, the bill setting up a tri-partite corporation to operate the system has gone through its third reading in the House of Commons, and final approval is expected by the end of the current session. Government and common carrier companies will each have a 30% interest in the new corporation, with 40% of the shares to be available to the public.

Although RCA Ltd. will be prime contractor, **negotiations are still in progress on how to allocate subcontracts to retain as much business as possible for Canadian companies.** It's figured that RCA will wind up with about 30% and rival Northern Electric will get about 25% with the balance spread around to other contractors. No details on contract assignments have been disclosed as yet, but Northern Electric is most likely to be given responsibility for the transponder portion. The final contract with RCA is not expected to be signed for at least four months.

Plessey in bid for ILS business

In a move to become a leading international supplier of the next generation of aircraft instrument landing systems, the Plessey Co. has submitted a system proposal to the Radio Technical Commission for Aeronautics in Washington. **An RTCA committee is working on a new ILS specification and has about a dozen proposals, all from U.S.-owned companies except for Plessey's.**

Because about half the world ILS market involves American aircraft,

International Newsletter

the choice of the RTCA committee is likely to be a major factor in determining which spec is eventually accepted as the standard by the International Civil Aviation Organization.

The Plessey proposal is based on a system developed by the Royal Aircraft Establishment and called a correlation-protected ILS. It replaces tone comparison of vhf signals, used on present systems to correct glide path in azimuth and pitch. **Instead, the CPILS compares the time of arrival at the aircraft of microwave pulses or random noise patterns transmitted simultaneously from both sides of the runway and above and below the correct vertical approach path.**

Olympia-Werke calculates on Northern Ireland

West Germany's Olympia-Werke AG is jumping into desk-top calculators in a big way. Hot on the heels of the disclosure that it would buy 30,000 calculators in the next year from Japan's Matsushita Communications Industrial Ltd. [*Electronics*, June 9, p. 201], West Germany's largest maker of office machines revealed plans to start up calculator production in Northern Ireland.

In mid-June, following up on earlier Olympia contacts, Roy Bradford, Northern Ireland's trade minister, visited the main Olympia plant in Wilhelmshaven. **Current company thinking calls for a plant in the Belfast area to open by year-end with a workforce of several hundred.**

Behind the Northern Irish venture, says Olympia, is the foothold it gives the company in the seven-nation European Free Trade Association and its growing market for calculators. **That market is expected to take off when Great Britain changes over to decimal currency—and decimal accounting—in February 1971.** And while details of production are still being worked out, the move to calculator manufacture should provide an in-house market for components made by Olympia's parent, AEG-Telefunken, West Germany's second largest electronics-electrical combine.

Hawker Siddeley wins ESRO 4 job

England's Hawker Siddeley Dynamics will be prime contractor for the European Space Research Organization's 200-pound scientific satellite ESRO 4, scheduled for launch in September 1972.

ESRO 4 will actually be the fifth in the series and will replace the more expensive TD/2 satellite, canceled last year. It will bear close resemblance to ESRO 2, launched in May 1968, **but will have a more sophisticated magnetic attitude control system to allow eight maneuvers under ground control.**

On board ESRO 4 will be five experiments contributed by universities in Britain, Germany, the Netherlands, and Sweden, and originally scheduled for TD/2.

Addenda

Texas Instruments' new plant in Ingolstadt in southern Germany, the company's sixth in Europe, will employ about 500 and concentrate on production of plastic-encapsulated transistors . . . Ampex Corp. will build a plant in Battice, Belgium, to manufacture magnetic tape . . . Yugoslavia's Nikola Tesla factory in Zagreb has a \$16 million backlog of orders for automatic telephone and telegraph equipment to be delivered in 1969. One-third is marked for export . . . **Control Data Corp. is reported pushing hard to win approval for installation of its 6600 in a Japanese computer center . . .** Page Europa, Rome, won a \$6.5 million contract for installation of NATO command communications in Lisbon.

European pacemaker's a pace setter

Seven-nation syndicate on Continent develops long-lived battery that needs less nuclear fuel than U.S., British versions; wristwatch battery may be next

For long-lived nuclear pacemaker batteries, there's a considerable market in the offing and the first to tap it could well be a seven-nation syndicate set up within the European Nuclear Energy Association (ENEA).

The syndicate has developed a battery that needs only half as much plutonium 238 as those of its British and American competitors. What's more, the multinational group, made up of firms and governmental agencies from Austria, Denmark, France, Spain, Sweden, Switzerland, and West Germany, has an edge in time if all goes according to plan. Better still, an offshoot of the Continental battery may one day power wristwatches and open up yet another vast consumer market.

Gallic. The group developing the battery and a pacemaker to pair with it has a strong French accent. France's Commissariat à l'Énergie Atomique, the country's nuclear agency, devised the plutonium fuel source. The other main element in the battery—its semiconductor thermocouple—is the work of France's Société Alcatel. Other major contributors to the project include France's Thomson-CSF and West Germany's Siemens AG.

Largely because of Alcatel's bismuth telluride thermocouple package, the ENEA battery needs only 150 milligrams of Pu 238, compared with more than 300 milligrams for the battery in the works at the U.K. Atomic Energy Authority and the one developed in the U.S. by the Nuclear Materials and Equipment Corp. The ENEA battery generates 700 microwatts and the British battery, 540 μ w [*Electronics*, March 31, p. 180].

Trials on dogs have just begun

in a Paris hospital and the ENEA hopes the pacemaker will be ready for test implants in human patients by early 1970. That's about six months ahead of the British planning. The U.S. nuclear battery too, has been implanted in a dog but doesn't seem likely to get clinical tests until at least 1970 but more probably not before 1971.

Thus far, the electronics in the ENEA pacemaker are standard, but Alcatel is working on new circuitry that is expected to reduce the power-supply level from the 5 volts needed now to the 2 volts the battery develops. That will end the need for a d-c to d-c converter and further reduce the plutonium needs—to less than 100 mg. The converter consumes as much power as the rest of the circuitry.

ENEA officials expect the pacemaker will sell for about \$2,000, about 25% more than nonnuclear versions.

Timing. While ENEA pushes on with the pacemaker, some of the group's members, led by a large Swiss watch producer, are moving toward a long-lived battery for wristwatches. The producer, Baumgartner S.A., has already built a prototype timepiece that is supposed to run for at least 20 years.

Company officials say the battery doesn't just replace a mercury cell. Details are a secret but Baumgartner director Karl Adler does hint that the battery's alpha particles oscillate in conjunction with a quartz crystal.

Baumgartner insists its watch will cost no more than present top-quality watches and says it will radiate less than old-style radium watch dials. The battery operates on tritium, the element now used for luminescent dials. Although

the Swiss firm hopes to start making production models in perhaps two years, nuclear-industry sources are somewhat skeptical. They doubt cost and radiation problems can be solved that quickly.

Japan

Rubbed out

Among electronics components, nothing has withstood the onslaught of change as well as the potentiometer.

Even in the most sophisticated of today's equipment, the pots basically are what they were in the early days of radio—a wiper over a resistance element. Aye, there's the rub that makes a pot wear out.

A way without wear there is, though. Field plates with magneto-

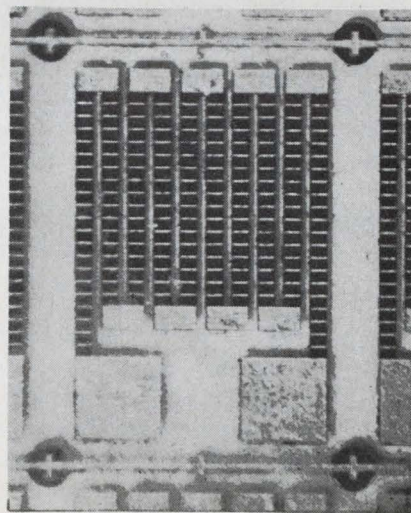

Down the Hall. Tiny contact bars embedded in an indium antimonide meandering resistance path eliminate Hall field that would otherwise build up in magnetoresistor.

resistive material on them make contactless potentiometers when paired with magnets. Siemens AG of West Germany more than two years ago found one way to make practical devices. Even more promising, thinks Shoei Kataoka of the Japanese government's Electrotechnical Laboratory, is a technique—adapted from integrated-circuit making—developed by a group he heads.

Six Japanese companies have shown an interest in Kataoka's work, and he expects to work out a commercial production technique with one or two of them. That should make possible contactless pots for less than \$1.40. The price is too high for mass-produced radios and tv sets, of course; but it's within reason for quality hi-fi gear and for industrial equipment.

Barred. The key to large-resistance swings in field plates is getting rid of the Hall effect—the electric field that develops across a current-carrying conductor when there's a magnetic field present. In a magnetoresistor, the two fields tend to cancel out one another.

Siemens does away with the Hall field by using a semiconductor material combination that has needle-like nickel antimonide structures dispersed in indium antimonide. Kataoka's plates have shorting bars embedded in them. The bars are put down on an InSb single-crystal slab 10- or 15-microns thick by photoetching and then alloying. Roughly, it's the same process used to lay down ohmic contacts on an IC.

Full circle. Because the shorting bars are embedded in the InSb and not part of the crystal structure as the NiSb needles are, the Japanese plates can be made with circular resistance tracks. This is a big advantage, since the variation in a magnetic field can then be handled by a rotating permanent magnet. Linear motion is much harder to obtain since the plates are small, on the order of 5 millimeter-diameter for the circular version.

To get high swings of resistance for its contactless pots, Kataoka's group cascades three elements on

a single plate. The second element's basic resistance is five times that of the first, and the third element's resistance is 25 times that of the first. That way, although the basic change in resistance with magnetic field is 7:1, the ratio of output voltage is 342:1.

Direct drive

Tell a high-fidelity aficionado that a turntable has direct drive and he'll probably sneer at you. The term conjures up cheap phonographs produced before World War 2 that wowed and rumbled along at a speed of 78 revolutions per minute.

Direct drive, however, is on its way back into the hi-fi lexicon. At this month's Consumer Electronics Show in New York, the Matsushita Electric Industrial Co. introduced a turntable having a signal-to-noise ratio better than 60 decibels during playback. This ratio is so high that the noise added by the turntable turns out to be less than a master record's inherent wow and rumble.

Matsushita achieves this performance with a new low-speed motor in which a permanent-magnet rotor is fixed directly to the turntable. The wound stator is powered by three-phase current generated by transistor oscillators that operate off a 15-volt supply.

Best of two worlds. The transistor motor, Matsushita maintains, combines the best features of a-c and d-c motors while it eliminates the need for such mechanical elements as speed changers, idlers, and drive belts.

Like a d-c motor, Matsushita's motor has high starting torque—at 33 rpm, it's up to full speed in half a revolution. Like an a-c motor, Matsushita's new drive has no brush-commutator combination to generate noise, but there's no a-c hum to contend with either.

And there's practically no torque ripple; since the motor speed is either 33 or 45 rpm, any unbalance in the rotor would at worst generate subaudio noise—less than 1 hertz. Fast-running a-c motors generate rumble noise when they're

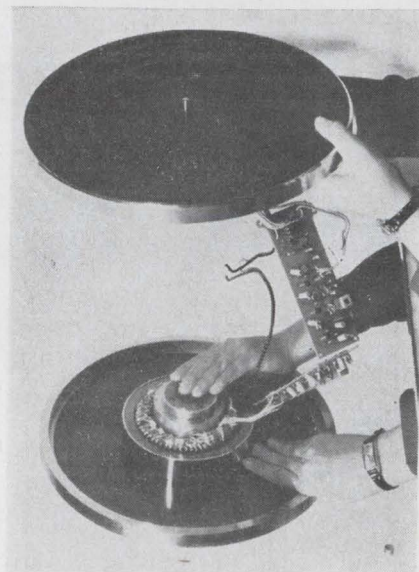

Direct. Turntable with transistor motor has no idlers, belts or pulleys. Its rotor is fixed directly to the turntable.

just slightly unbalanced.

Steady. To achieve precise operation of the turntable, Matsushita employs analog control rather than the on-off signals most often used for transistor motors.

The control signal is picked off three pairs of coils wound in the stator. One coil in each pair has 50-kilohertz signal applied to it; the voltage output of the second coil indicates the rotor position. This is because the coupling between the two coils is varied by a toothed wheel, that spins with the turntable. Speed variation from no-load to load conditions—when the load is 2-grams needle pressure—is a very low 0.15%.

Guarding the gates

Sometimes circuit designers run up against a situation where they'd like to use MOS transistors but don't because voltage surges might damage the relatively fragile transistor gates.

Protection for the gates, of course, isn't hard to come by. A pair of diodes will do the trick. But the extra diodes are a nuisance in some circuits. So there's a niche for transistors with their own protection.

In Japan, the Tokyo Shibaura

Electric Co. (Toshiba) has a transistor with protective diodes on a separate chip in the same package. Going the competition one better, the Matsushita Electronics Corp. has developed an MOS transistor with the diodes integrated on the same chip. The company still has to set a date to start selling the device but has given it a catalog number 3SK36.

Back-to-back. The diodes are integrated into the substrate back-to-back and connected between each gate and the source-substrate common line. The diodes have a breakdown voltage of 20 volts, more than enough to protect the two gates, whose insulation can withstand about 100 volts. Tomisaburo Okumura, who heads the group that developed the transistor, says it suffers no damage when a simulated lightning pulse of 15,000 volts is applied to the antenna terminals of a tv tuner using the transistor.

The two diodes have a pnp configuration and in fact together they resemble a pnp transistor. A simple way of obtaining the diodes, then, would have been to diffuse an n region into the substrate and then put a p region in the center of the n region. But this way the avalanche breakdown voltage in one direction—from the n region to the p region of the substrate—would be about 70 volts, too high for comfort.

To get equally low avalanche breakdown voltages in both directions, Matsushita surrounds the n regions with a common p region. The junction between them is vertical and the common p region is connected by ohmic material through the p substrate to the source-substrate common line.

Belgium

Aluminum's on the beam

Beam leads, almost everyone agrees, are the best way to link monolithic integrated circuits to the outside world. And so far, there's little dispute that the best beam leads are made of gold, using

the technique devised five years ago by the Bell Telephone Labs.

But gold beam leads face a challenge. Manufacture Belge de Lampes et de Matériel Electronique (MBLE), an affiliate of Philips' Gloeilampenfabrieken, had started working on aluminum beam leads about the same time Bell Labs announced its process. Now the Belgian firm has started pilot production at a rate of a million circuits a year.

What's more, MBLÉ has started selling a line of IC-handling and testing equipment. One machine already has been delivered to the Amperex Electronic Corp., a division of North American Philips. An ultrasonic welding unit will follow this month.

A natural. Thierry Neuhuys, MBLÉ's chief engineer for beam-lead work, can cite all kinds of advantages for aluminum leads. "It's the usual contact metal for planar devices," he explains. "Adding beam leads to a classic crystal requires special treatment that modifies electrical characteristics. Aluminum is easy to bond ultrasonically. And there are no reliability problems due to contact of dissimilar metals with aluminum thin-film paths."

Along with aluminum beam leads, MBLÉ has developed a set of auxiliary substrates for hybrid circuits. These subcarriers, glass or ceramic plates a few millimeters square, carry most of the active devices in a hybrid circuit. Because of the interconnections on these subcarriers, crossover is eased for the main substrate.

Windows. In MBLÉ's technique, devices are formed in the basic wafer by the usual planar process. But after opening the contact windows, a layer of aluminum 0.25 mil thick is vacuum deposited on the wafer. The aluminum is engraved by phosphoric acid to get conducting paths from the contact windows that extend about 4 mils beyond the edges of the devices. MBLÉ says the 0.25-mil aluminum is all that's needed for direct connection to interdigitated windows as narrow as 0.2 mil and spaced 0.2 mil apart.

To produce the active-device

subcarriers, MBLÉ starts with a 2-by-3-inch glass plate covered on both sides by aluminum. Then, anywhere from 100 to 300 interconnection patterns are etched on one side, with rectangles—each matching an interconnection pattern—going on the other side. The chips are bonded to the connection-pattern subcarriers in a batch.

The plate is then glued, chip-side down, upon a stainless steel plate. A glue layer thick enough to embed the chips is used. Then the glass is etched out from backside using the aluminum rectangles as masks. When the glue is dissolved, the subcarriers are separated.

Proof. MBLÉ equipment designers put the subcarrier-hybrid technique through its paces to build a digital frequency synthesizer. It provides 10,000 channels in the 2-to-12-megahertz range.

By using the subcarriers, MBLÉ was able to pack the digital circuitry into 10 modules. With conventional hybrid circuits, the same synthesizer needed 42 modules. And the subcarrier hybrids needed only 29 square centimeters of thin-film area compared with 92 for conventional hybrids.

Australia

Outback changeover

Australia's flying doctors, who supply the island continent's sparsely populated outback with emergency medical aid, are facing a crisis: the privately financed service must replace all its double sideband or a-m radio equipment with single sideband gear.

In all, 12 bases must be re-equipped with the newer, expensive equipment, because ssb will ease congestion and it's more powerful. The result will be twice the number of channels for the world's largest h-f network.

New base station equipment must be operating by 1970. The old equipment put out a carrier wave modulated on both sides; the new version will have a double unit—the first will emit an ssb signal plus a carrier so that its trans-

mission can be picked up by both new ssb transceivers and old a-m equipment. In 1975, when all outposts will have converted a switch will be thrown at base stations to cut out the carrier wave and transmit a pure ssb signal. The final system will then be operating on 300 watts while outpost transceivers will work on 25 watts. Frequency range will be 2, 4, 5, and 6 megahertz, with each base station having at least three frequencies.

One drawback of the new equipment will be that many homesteaders with only elementary radio knowledge will find repairs and adjustments more difficult, although the new equipment should require less attention than much of the old gear, some of which dates back to 1930. However, manufacturers will be required to set up service outlets before they will be licensed to sell transceivers.

Great Britain

Hybrids in a hurry

Many an instrument maker would like nothing more than a production line to knock out hybrid circuits in a hurry. Trouble is, instrument runs often are too short to justify setting up an intricate special line.

For a producer of semiconductor production equipment, the instrument makers' problem is a challenge. And a small London company, the Vacwell Engineering Co., has picked up the gauntlet. Vacwell has built a machine that very nearly automatically bonds semiconductor chips, capacitors and like components to substrates. And for the operator, it's just a matter of dialing in different number settings to shift from one kind of hybrid circuit to another.

Vacwell will start evaluation tests shortly, using the machine to make circuits for instrument-making subsidiaries of its parent company, the Electronic Machine Co. If the tests are successful, the company probably will build similar equipment for other firms. Vacwell officials believe the machine could sell for less than \$25,000.

One at a time. Controlled by a semiskilled operator, the machine can put down as many as 18 chips on substrates ranging up to $2\frac{3}{4}$ by $1\frac{1}{2}$ inches. Chip sizes can be as small as 0.015-inch square or as large as 0.25-inch square, and they're positioned with an accuracy of 10 microns.

The substrates are built up one at a time, following a program written for the circuits; each bonding counts as a step in the program.

To set up a bonding sequence,

the operator sets a row of figures on the control panel, matching them to the figures on the program. When this is accomplished, the control electronics position the substrate and move a chip container under a vacuum probe.

At the same time, a television image of the container and probe show up on the control panel, alongside a projected image of the circuits being made up. The operator, with a rolling-ball control, rotates the chip container until there's a chip right under the probe. Actually, the probe is a pair of probes mounted coaxially. The larger of the two is normally retracted unless outside chips are involved.

After the probe drops the chip onto the substrate, a second control is used to align the edges of the chip and the substrate. The operator then checks the chip's configuration against the projected circuit image to make sure the right chip is in the right position.

Fini. Then the machine takes over to make the bond. The substrate is carried in a box heated to about 30°C below the melting point of the solder on the chips. A hot gas jet, directed onto the chip, melts the solder under it. If the bond looks good on the tv monitor, the operator then punches a "finish" button and the next step in the program appears on the panel.

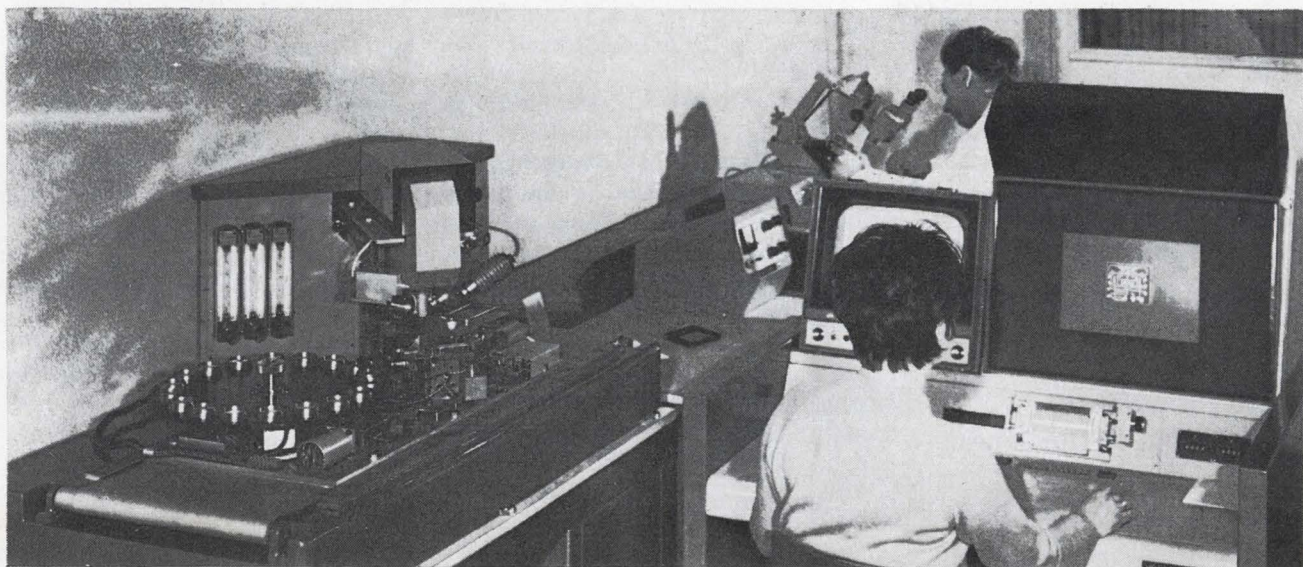

Fast and easy. Chips are bonded onto hybrid-circuit substrates very nearly automatically by new British machine. Operator dials in a row of numbers then has to make only two easy manipulations during the bonding sequence.

Electronics advertisers

June 23, 1969

Airborne Instruments Laboratory Campbell-Mithun, Inc.	91	Deutsch Co. Smith & Hemmings Adv.	195, 197, 199, 201, 203	Keithley Instruments, Inc. Bayless-Kerr Co.	60
Airpax Electronics, Inc. Welch, Mirabile & Co., Inc.	164	Dialight Corp. Michel Cather, Inc.	180	Krohn-Hite Corp. L.K. Frank Co., Inc.	146
■ Alden Electronics Larcom Randall Advertising, Inc.	143	DuPont de Nemours Co., Teflon Div. Batten, Barton, Durstine & Osborn, Inc.	200	LVD Electro Science Industries V.C. Graphics, Inc.	180
Allen-Bradley Co. Fensholt Adv. Agcy.	25, 27	■ Eagle Signal Div. of E.W. Bliss Co.	204, 206, 208	■ Leach Corp. Chiat/Day, Inc.	198
■ Allen Electronics Div., Allen Organ Co. Rex Reichert Assoc., Inc.	184	Eastman Kodak Co., Business Systems Markets Div.	135	Litton Industries, Inc., Electron Tube Div.	160
Allied Van Lines, Inc. Young & Rubicam, Inc.	137	E G & G, Inc. Culver Adv., Inc.	222	MacManus, John & Adams, Inc.	
AMF-Alexandria Div., Applied Cybernetics	204	Elco Corp. Schaefer Adv., Inc.	18, 19	McGraw-Hill Book Co.	161
□ AMP Europe Allardyce Palmer Ltd.	3E, 4E	□ Electrovac Dr. Heinrich Fuchs	14E	■ Magnecraft Electric Co. Mills, Fife, & MacDonald, Inc.	128
■ AMP, Inc. Garceau, Hallahan & McCullough, Inc.	28, 29	■ Elgenco, Inc. Wescó Advertising	145	Masintex Publicom Romanian International Publicity Agcy.	205
Amperex Electronics Corp. Div. of North American Philips Co.	221	Elgin Electronics, Inc. Carr Liggett Adv., Inc.	178	■ Matsuo Electric Co. Ltd. Daiko Advertising Inc.	194
Atec, Inc. Helme Assoc., Inc.	152	E.M.I. Electronics Canada, Ltd. Greiner Harries MacLean, Ltd.	190	□ Metrimex Hungexpo	8E
■ Augat, Inc. Horton, Church & Goff, Inc.	179	Erie Technological Products Co., Inc. Arthur Schmidt International, Inc.	55	Microdyne Instruments Inc. Industrial Public Relations Inc.	145
Automatic Electric Co., Sub. of General Telephone & Electronics Corp.	20, 21	Fanstell, Inc., Metals Div. Reincke, Meyer & Finn, Inc.	43	■ Micro Switch Division of Honeywell N.W. Ayer & Son Inc.	188
■ Barnes Corp. Industrial Public Relations, Inc.	211	General Electric Co., Electronic Components Sales Operation	49, 85	Miller Stephenson Chemical Co., Inc. Michel-Cather Inc.	207
■ Barnstead Co., Div. of Sybron Corp. Creamer, Trowbridge, Case & Basford, Inc.	170	■ General Electric Co., Semiconductor Products Div.	32	■ Mitsubishi Electric Corporation Hakuhodo Inc.	203
Bausch & Lomb, Inc. Wolff Assoc., Inc.	147	■ General Instrument Corp., Semiconductor Products Div.	66, 67	Mohawk Data Sciences Corporation/ OEM Marketing	199
Beede Electrical Instrument Co. S. Gunnar Myrbeck & Co., Inc.	186	General Radio Co. Horton Church & Goff, Inc.	6	■ Motorola Communications & Electronics Inc.	209
■ Bell Inc., F. W. Wheeler, Kight & Gainey, Inc.	190	Georgia Department of Industry Cargill, Wilson & Acree, Inc. Adv.	86	Griswold Eshleman Company Motorola Semiconductor Products Incorporated	87, 115
Bell & Howell, Electronic Instrumentation Group-CEC/Transducer Div.	24, 151	Gordon Co. Merrill, McEnroe & Assoc., Inc.	58	■ National Electronics Incorporated Connor-Sager Associates	202
Bell Telephone Laboratories N.W. Ayer/Jorgensen/MacDonald, Inc.	53	G-R Industries, Inc. Larcom Randall Adv., Inc.	10, 11	National Semiconductor Corp. Hall Butler Blatherwick Inc.	12-13
Bendix Corp., Flight & Engine Instruments Div.	130	Granger Assoc. West Assoc.	7	■ North Atlantic Industries Inc. Ross Roy of New York Inc.	134
Brand-Rex Creamer, Trowbridge, Case & Basford, Inc.	174	■ Grayhill, Inc. Merchandising Adv., Inc.	202	■ Norton Associates Incorporated J.J. Coppo Company	211
Branson Instruments, Inc., Industrial Div.	129	■ Gudebrod Brothers Silk Co., Electronics Div.	74	Parelco Inc. Van Der Boom, McCarron Inc.	185
Bunker-Ramo Corp., The Marsteller, Inc.	182	Hadron, Inc. Di Nucci Graphics, Inc.	16	■ Philbrick/Nexus Research Renaccio Adv. Inc.	159
Bunker-Ramo Co. Diener & Dorskind, Inc.	166, 167	Hamilton Watch Co. Beaumont, Heller & Sperling, Inc.	176	Philco Ford Company, Microelectronics Division	76
■ Burndy Corp. The Gravenson Group, Inc.	75	■ Hewlett Packard, Loveland Div. Tallant/Yates Adv.	2	The Aitkin-Kynett Company Inc.	
■ Burroughs Corp., Electronic Components Div.	92	■ Hewlett Packard, Microwave Div. Lennen & Newell, Inc.	157	Philco Ford WDL Division Hal Lawrence Inc.	23
Cambridge Thermionic Corp. Chirurg & Cairns, Inc.	209	■ Hewlett Packard, New Jersey Div. McCarthy, Scelba & DiBiasi Adv. Agcy., Inc.	15	□ Philips N.V., PIT/EMA Division Marsteller International S.A.	2E
Cinch Graphic Div. of Carr Fastener Co.	26	■ Hewlett Packard, Rockaway Div. Culver Adv., Inc.	54	Powertec Division of Airtronics Cordova Associates	57
■ Clairex Corp. Michel-Cather, Inc.	131	■ Hewlett Packard, Waltham Div. Culver Adv., Inc.	1	■ Princeton Applied Research Corporation Mort Barish Associates Inc.	44
Clevite Corp./Gaging & Control Div. Carr Liggett Adv., Inc.	162	■ Honeywell, Test Instruments Div. Campbell Mithun, Inc.	158	Radiation Incorporated W.M. Zemp & Associates Inc.	212
Components, Inc. Larcom Randall Adv., Inc.	136	■ Indiana General Corp., Ferrites Div. Griswold Eshleman	62, 63	Radio Corporation of America 4th Cover, 9, 89, 148, 154-155	
Computer Products, Inc. Grenman Assoc., Inc.	194	International Electronic Research Corp. Van Der Boom, McCarron, Inc. Adv.	90	Al Paul Lefton Company	
Connecticut Hard Rubber Co. Chirurg & Cairns, Inc.	173	IRC, Inc. Gray & Rogers, Inc.	196	Remvac Components, Inc. Caroe Marketing, Inc.	171
CREI, Home Study Div. of the McGraw-Hill Book Co.	156	■ ITT Cannon Electric MacManus, John & Adams, Inc.	163	■ RHG Electronics Laboratories, Inc. Samuel H. Goldstein, Inc.	205
□ C.R.C. IRP	10E	ITT Wire and Cable MacManus, John & Adams, Inc.	77	□ SGS Signetics Corp. Sub. Corning Glass Works	7E
■ CTS Corp. Reincke, Meyer & Finn, Inc.	172	■ J F D Electronics Co., Components Div. Delphi Adv., Inc.	153	Cunningham & Walsh, Inc.	127
■ Dale Electronics, Inc. Sub. of Lionel Corp.	3rd Cover	Johnson Co., E.F. Martin Williams Adv.	209	□ Silec, Electronic Publicite Y Ch. Lambert	13E
Dana Laboratories, Inc. Smith-Klitten, Inc.	181	■ General Motors Corp. Campbell-Ewald Co.	72, 73	Siliconix, Inc.	14, 64, 65

In electronics it's Electronics magazine to sell used equipment!

Your advertisement will produce Results in Electronics. Engineers turn to Electronics magazine for the latest technical developments — and for the latest buying information. You can reach them inexpensively in Electronics Searchlight Section.

For information:
Searchlight Section
Classified Advertising Dept.
Post Office Box 12
New York 10036



Sperry Rand Corp., Sperry Microwave Electronics Div.	68
Neals & Hickok, Inc.	
Sprague Electric Co.	5, 30
Harry P. Bridge Co.	
Stackpole Carbon Co., Electronic Components Div.	88
Meek & Thomas, Inc.	
Stewart Warner Microcircuits, Inc.	61
Jones, Maher, Roberts, Inc.	
Switchcraft, Inc.	51
Buti-Roberts Advertising	
Sylvania Electric Products, Inc., Electronic Components Group	35 to 42
Doyle Dane Bernbach, Inc.	

■ Tektronix, Inc.	139, 140
Dawson, Turner & Jenkins, Inc.	
Test Equipment Corp.	206
Dean & Bain Adv., Inc.	
Texas Instruments Incorporated, Components Group	56, 78 to 83
Albert Frank-Guenther Law, Inc.	
□ Tig Bicolor AG	11E
Publicitas	
Todd Products Corp.	22
Ira Levine Adv. Assoc., Inc.	
Toko, Inc.	208
Hakuhodo, Inc.	
■ Tung-Sol Div., Wagner Electric Corp.	186
Feeley & Wheeler, Inc.	

Union Carbide Corp., Semiconductor Dept.	84
Windfield, Inc. Adv.	
United Aircraft Electronic Components	138
Cunningham & Walsh, Inc. Adv.	
United Systems Corp.	207
Adv. & Merchandising, Inc.	
■ United Transformer Co., Div. of TRW, Inc.	2nd Cover
Fuller & Smith & Ross, Inc.	
■ Unirode Corp.	59
Silton Brothers, Inc.	
U-Tech, a Div. of Industrial Physics and Electronics Co.	
Ross Clay Adv.	17

Varian Assoc., Eimac Div.	133
Botsford, Constantine & McCarty, Inc.	

□ Watkins-Johnson Co.	5E
William C. Estler Adv.	
Westinghouse Electric Corp., Semiconductor Div.	187
Pritchard Wood Assoc., Inc.	
Weston Instruments, Inc., Newark Div.	192
Arndt, Preston, Chapin, Lamb & Keen, Inc.	
Williams Precious Metals, Div. of Williams Gold Refining Co., Inc.	168
Stahlka, Fallor & Klenk, Inc.	
Wiremold Co., The Charles Brunelle Co.	197

Zeltex, Inc.	177
Helme Associates, Inc.	

- For more information on complete product line see advertisement in the latest Electronics Buyer's Guide
- Advertisers in Electronics International

Electronics Buyers' Guide

George F. Werner, General Manager
[212] 971-2310
Robert M. Denmead, Midwest Regional Manager
[312] MO 4-5800
William A. Capuzzi, New England District Manager
[212] 971-3793
Regina Hera, Directory Manager
[212] 971-2544
Thomas M. Egan, Production Manager
[212] 971-3140

Circulation Department

Isaaca Siegel, Manager [212] 971-6057

Research Department

David Strassler, Manager [212] 971-6058

Advertising Sales Staff

Frank E. LeBeau [212] 971-6464
Advertising Sales Manager

Wallis Clarke [212] 971-2187
Assistant to sales manager

Donald J. Austermann [212] 971-3139
Promotion Manager

Warren H. Gardner [215] LO 8-6161
Eastern Advertising Sales Manager

Atlanta, Ga. 30309: Michael H. Miller, 1375
Peachtree St., N.E.
[404] 892-2868

Boston, Mass. 02116: William S. Hodgkinson
McGraw-Hill Building, Copley Square
[617] CO 2-1160

Cleveland, Ohio 44113: William J. Boyle, 55
Public Square, [216] SU 1-7000

New York, N.Y. 10036

500 Fifth Avenue
James R. Pierce [212] 971-3615
John A. Garland [212] 971-3617
Michael J. Stoller [212] 971-3616

Philadelphia, Pa. 19103:

Jeffrey M. Preston
Warren H. Gardner,
6 Penn Center Plaza,
[215] LO 8-6161

Pittsburgh, Pa. 15222: Warren H. Gardner,
4 Gateway Center, [412] 391-1314
Rochester, N.Y. 14534: William J. Boyle,
9 Greylock Ridge, Pittsford, N.Y.
[716] 586-5040

Donald R. Furth [312] MO 4-5800

Midwest Advertising Sales Manager

Chicago, Ill. 60611: Kenneth E. Nicklas
Ralph Hanning 645 North Michigan Avenue,
[312] MO 4-5800

Dallas, Texas 75201: Richard P. Poole, 1800
Republic National Bank Tower,
[214] RI 7-9721

Houston, Texas 77002: Robert Wallin,
2270 Humble Bldg. [713] CA 4-8381

Detroit, Michigan 48226: Ralph Hanning,
856 Penobscot Building
[313] 962-1793

Minneapolis, Minn. 55402: 1104 Northstar
Center [612] 332-7425

St. Louis, Mo. 63105: Kenneth E. Nicklas,
The Clayton Tower, 7751 Carondelet Ave.
[314] PA 5-7285

James T. Hauptli [415] DO 2-4600

Western Advertising Sales Manager

Denver, Colo. 80202: David M. Watson,
Tower Bldg., 1700 Broadway
[303] 255-5484

Los Angeles, Calif. 90017: Ian C. Hill,
John G. Zisch, 1125 W. 6th St.,
[213] HU 2-5450

Portland, Ore. 97204: James T. Hauptli,
Don Farris, 218 Mohawk Building,
222 S.W. Morrison Street,
Phone [503] 223-5118

San Francisco, Calif. 94111: James T. Hauptli,
Don Farris, 255 California Street,
[415] DO 2-4600

Pierre Braude Tel: 225 85 88: Paris

European Director

Paris: Denis Jacob
88-90 Avenue Des Champs-Elysees, Paris 8

United Kingdom and Scandinavia

London: Oliver Ball, Tel: Hyde Park 1451

34 Dover Street, London W1

Milan: Robert Saidel, Roberto Laureri Jr.
1 via Baracchini Phone 86-90-656

Brussels: F.I.H. Huntiens

27 Rue Ducale Tel: 136503

Frankfurt/Main: Hans Haller

Elsa-Brandstroem Str. 2

Phone 72 01 81

Geneva: Denis Jacob

1 rue du Temple Phone: 31 95 60

Tokyo: McGraw-Hill
Publications Overseas Corporation,
Kasumigaseki Building 2-5, 3-chome,
Kasumigaseki, Chiyoda-Ku, Tokyo, Japan
[581] 9811

Osaka: Akihiko Kamesaka, McGraw-Hill
Publications Overseas Corporation, Kondo
Bldg., 163, Umegae-cho Kita-ku [362] 8771

Business Department

Stephen R. Weiss, Production Manager

[212] 971-2044

Thomas M. Egan,
Assistant Production Manager [212] 971-3140

Dorothy Carmesin, Contracts and Billings

[212] 971-2908

Frances Vallone, Reader Service Manager

[212] 971-2865

... does away with redundant packaging in your D-A converters.

A new quad D-A ladder switch made possible by the Amperex THIN FILM/LID HYBRID PROCESS

- **4 ± 1 ohm on-resistance**
- **1 mV. max. offset voltage**
- **\$9.00 per switch**

...use ATF-451's...

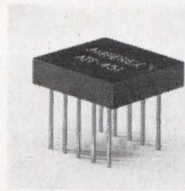

Let's face it — packaging is the name of the hybrid game. And the ATF-451 high-accuracy, matched ladder switch is the latest example of the unique hybrid packaging techniques employed by Amperex. Based on the use of microminiature LID semiconductors and sputtered, thin film ceramic substrates, the ATF-451, measuring only .550 by .550 by .16 inches represents the smallest set of four matched switches ever offered in a single Hybrid IC. It offers the economies of low initial cost, elimination of redundant packaging and the opportunity for combining multiple switches of high accuracy levels in a single circuit.

The ATF-451 at \$9.00 per switch has an on-resistance of only 4 ± 1 ohm from -25° to $+85^{\circ}\text{C}$ and offset of 1mV. max. An identical lower-accuracy version, the ATF-452 with an on-resistance tolerance of ± 3 ohms and maximum offset of 1.25mV. is available at \$8.00 per switch.

These new switches were designed for use in binary and BCD coded voltage summing ladders up to 14 bits with $\frac{1}{4}$ LSB accuracy. Input circuitry is fully compatible with standard DTL and TTL monolithic circuits.

Write for information on the Amperex Thin Film/LID Hybrid Process and for data on the new ATF-451 and '452.
Amperex Electronic Corporation, Microcircuits Division,
Cranston, Rhode Island 02910.

**...and leave the packaging
to us!**

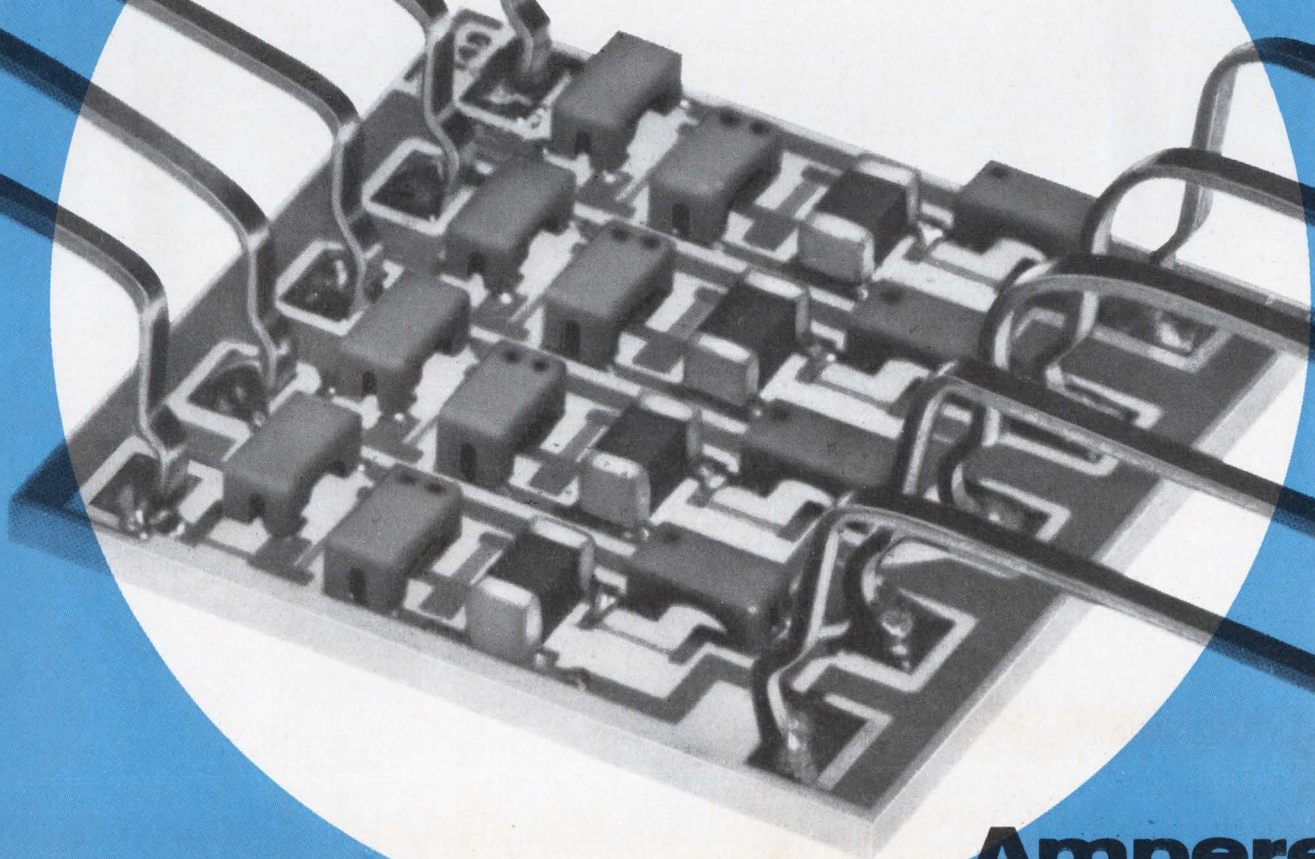

Amperex®

TOMORROW'S THINKING IN TODAY'S PRODUCTS
A NORTH AMERICAN PHILIPS COMPANY

1,000,000 flashes and still going strong...

that's why you'll find **EG&G Xenon Flashtubes and Power Supplies** in the new **Dennison High Speed Copier**

EG&G Xenon Flashtubes and Power Supplies provide the reliable, extremely efficient light output that maintains a consistent level of spectral response . . . flash after flash after flash. Prime considerations for long-lived dependability and fidelity of reproduction in modern office copiers. In addition, EG&G pulsed Xenon Flashtubes and Power Supplies are designed to produce a maximum number of flashes at the least cost per flash.

EG&G capability in this area encompasses the design, development and volume

production of complete Xenon Flashtube systems. This means we can match the flashtube to a compatible electronic flash system to satisfy your total light output requirements.

Through EG&G's continuing program of research and development, the Xenon Flashtube has evolved from a novel device used initially in photographic and stroboscopic applications to an extremely flexible present day tool. Its use in scientific, engineering, industrial and military applications is expanding. You'll find EG&G Xenon

Flashtubes in such diverse applications as laser stimulation, phototypesetting, flash photolysis, warning beacons, oscillograph recorders and microfilm printers.

If you'd like more information on EG&G pulsed Xenon Flashtubes and Systems, or for that matter on any of our products, such as thyratrons, krytrons, spark gaps, transformers, photodiodes, thermoelectric coolers or light instrumentation, write: EG&G, Inc., 166 Brookline Ave., Boston, Mass. 02215. Tel.: 617-267-9700. TWX: 617-262-9317. On west coast telephone 213-464-2800.

 **EG&G**
ELECTRONIC PRODUCTS DIVISION



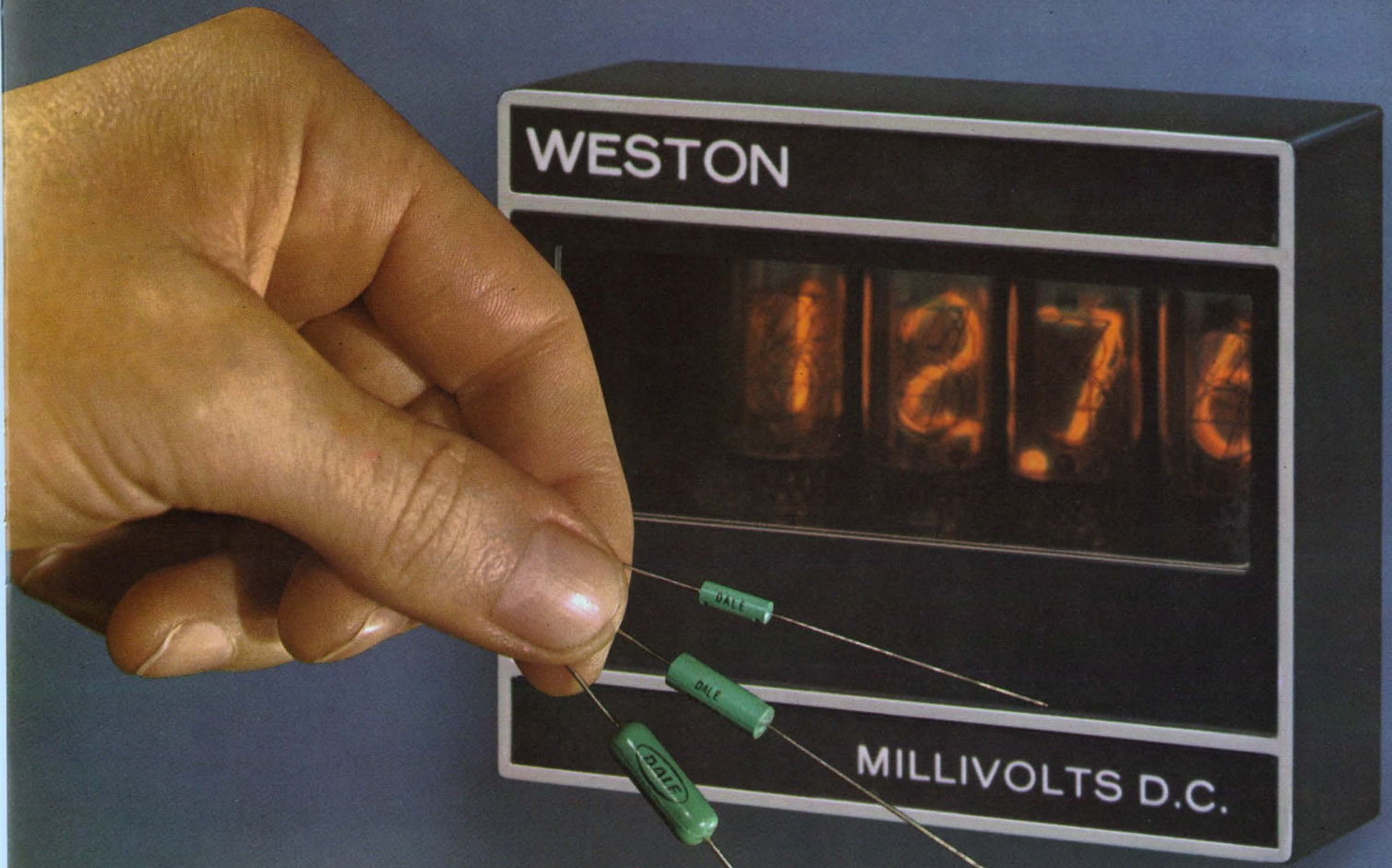

metal film resistors for precision behind the numbers

Wherever precision measurement calls for resistors with good stability, closely-controlled TC and low noise, you're apt to find Dale Metal Film. There are three good reasons: MIL-R-55182, MIL-R-10509 and MIL-R-22684. This versatility has turned a good source into a great one. Whether you want Established Reliability or just want to squeeze more precision into a pennies-per-part budget, Dale Metal Film is the answer.

Call today: 402-564-3131

Weston Instruments growing line of digital panel meters makes broad use of Dale MF resistors. These precision 4-digit meters use Dale RN-60, RN-65 and RN-70 styles to control input resistance and critical bias functions in an amplifier circuit.

DALE MF—THE ALL-PURPOSE LINE

Mil. Spec: MIL-R-55182 = RNR-55, 60, 65; RNC-55, 60, 65; MIL-R-10509 = RN-50, 55, 60, 65, 70, 70F, 75, 80; MIL-R-22684 = RL-07, 20.

Resistance Range: 10 ohms to 10 megohms, depending on size and TC.

Tolerance: MIL-R-55182 = .1% (B), .25%, .5% (D), 1% (F);

MIL-R-10509 = .1%, .25%, .5%, 1%; MIL-R-22684 = 2%, 5%.

Temperature Coefficient: 11 standard TC's available in -55°C to +175°C range.

DALE ELECTRONICS, INC.

1300 28th Ave., Columbus, Nebraska 68601

In Canada: Dale Electronics Canada, Ltd.

A subsidiary of The Lionel Corporation



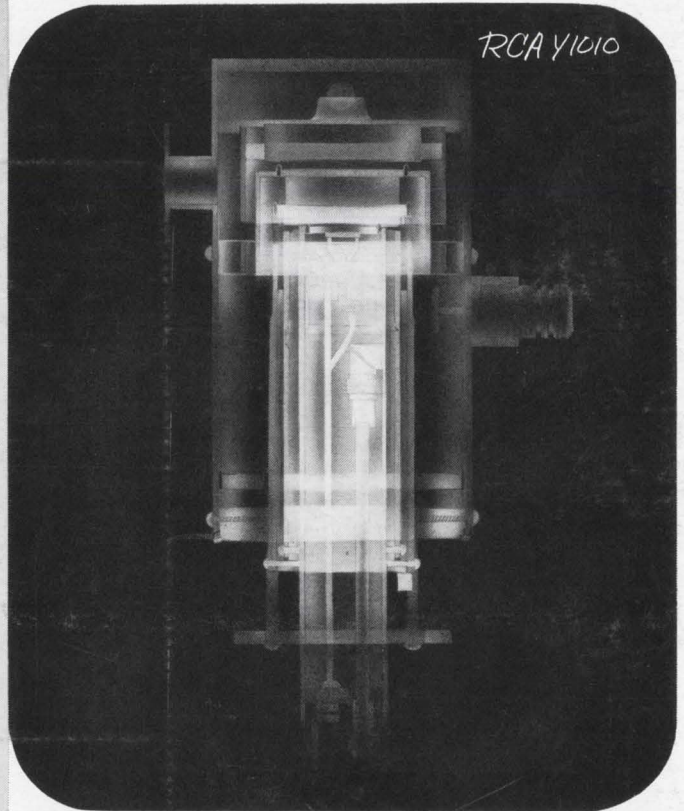
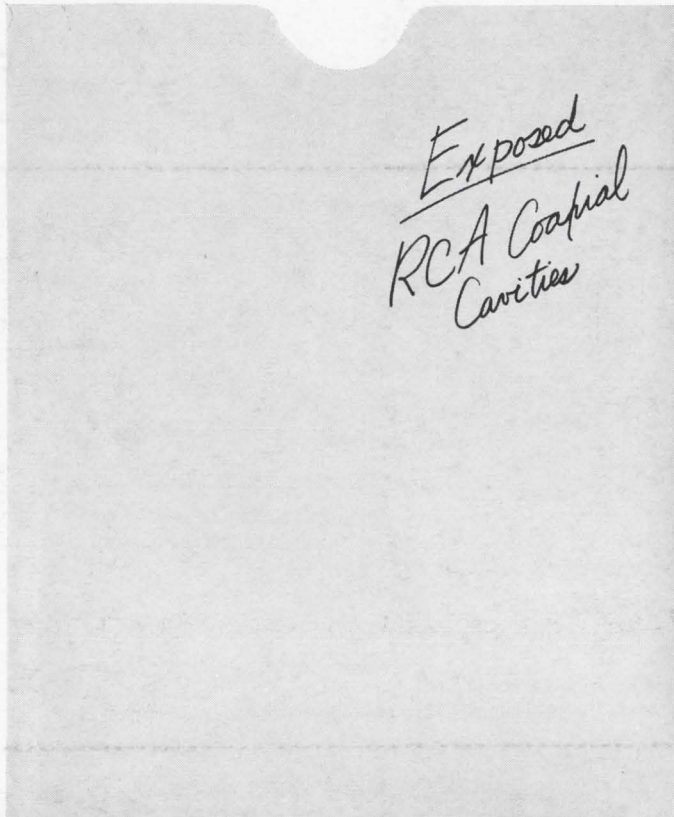

Now—continuing its leadership in the development of electronic products—RCA announces a complete range of coaxial cavities to assure optimum performance from its line of CERMOLox® Power Tubes.

Suitable for use either as complete amplifiers or as oscillators, these cavities assure specified performance with fully engineered circuitry, minimum RF losses, simplified connections, and high overall efficiency.

To fulfill your requirements, cavities are available for frequencies up to L-band and powers up to 10 kW.

The performance, reliability, and efficiency of CERMOLox tubes have been proved. This line of cavities will augment and assure these benefits. In addition, if your requirements call for special parameters, our Application Engineers will gladly modify existing cavities or develop new ones to assure you of optimum equipment performance.

For more information on RCA coaxial cavities and RCA CERMOLox Tubes, see your local RCA Representative. For technical data on specific types, write: RCA Electronic Components, Commercial Engineering Section F-19T-3, Harrison, N. J. 07029.

RCA Coaxial Cavities—Available Off-the-Shelf

RCA TYPE	TUBE	POWER OUTPUT(Watts)	MODE	FREQUENCY(MHz)
Y1010	8226	100	CW	1170
Y1044	8501	10,000	pulse	400
Y1050	7651	5,000	pulse	500
Y1051	8227	450	pulse	500
Y1052	8227	400	pulse	350
Y1054A	7651	5,500	pulse	150
Y1059	7214	12,500	pulse	150
Y1070	7651	6,500	pulse	200
Y1086	7651	375	pulse	200

RCA