

Software patents pro and con 96

\$1.00 A McGraw-Hill Publication

Space needs revive color-wheel tv 114

July 7, 1969

Navy gets new airfaring watchdog 133

Electronics[®]



**CRT's built-in
delay line
speeds up scope**

COVER-UP TREATMENT

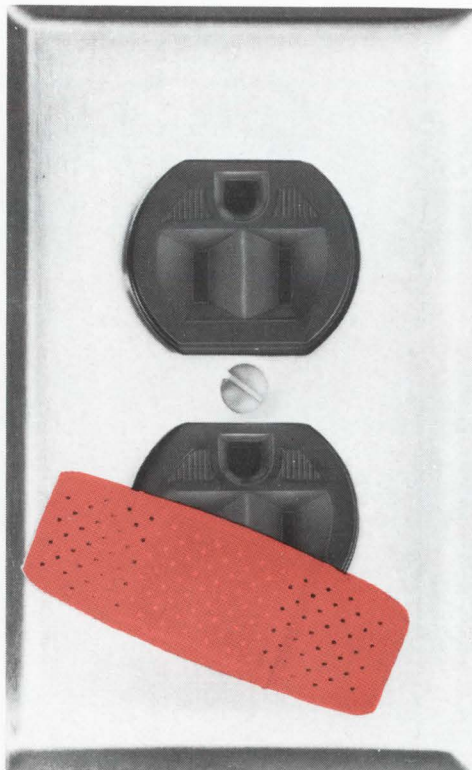

How do you treat line-voltage problems? Certainly not this way, although voltage variations can cause electrical equipment to come down with human-like ailments. You've probably seen it... the motor that suddenly becomes sluggish; the erratic, temperamental instrument; the induction heater that suffers from a "chronic cold", the run-down power supply.

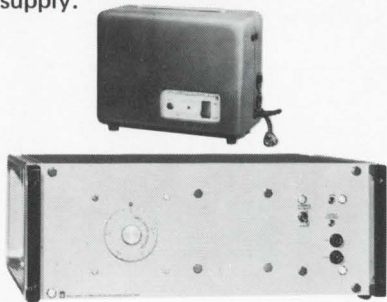

You can return your equipment to good health quickly by treating it

with a steady diet of constant line voltage from a GR Variac® automatic line-voltage regulator. It will provide fast relief to your voltage ills (up to 80 volts/second correction speed) and hold that relief to better than $\pm 0.5\%$. There are no side effects with Variac line-voltage regulators; they never distort line waveform or adversely affect power factor. And, they are rugged; overloads as much as 10 times rated current can be handled. All-solid-state circuitry gives them an extra measure of dependability.

There are more than 30 different models of Variac line-voltage regulators from which to choose. They range in capacity from a small 17-lb powerhouse that will handle 1 kVA to large 20-kVA units for heavy-duty industrial applications. Models are

available for line frequencies of 50, 60, and 400 Hz, single- or three-phase, and nominal line voltages of 115, 230, and 460 volts. Prices start at \$310 in U. S. A.

For complete information, write or call General Radio Company, W. Concord, Massachusetts 01781; telephone (617) 369-4400.

GENERAL RADIO



X 1 0 0

fA pA nA nV μ V

AT 1 Hz BANDWIDTH

+ 0 10 20 30 dB

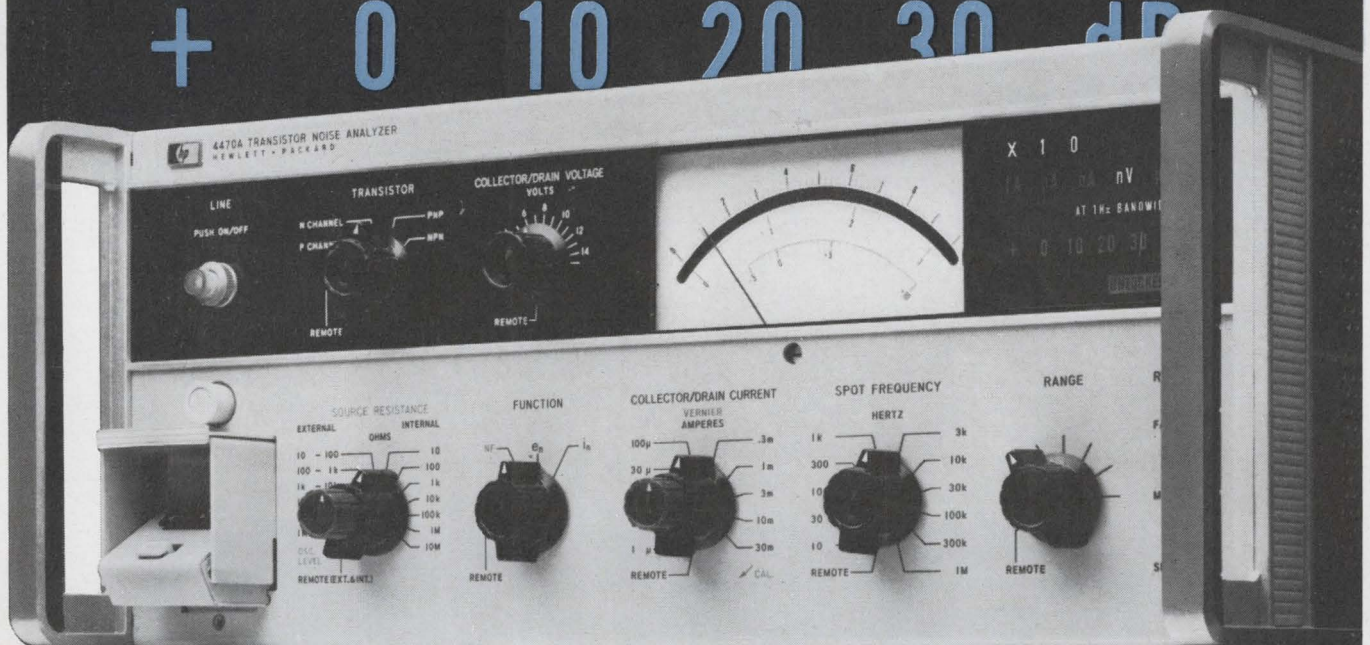

Our singularly accurate transistor noise analyzer tells you the whole story

The singular advantage of Hewlett-Packard's new 4470A is its inherent ability to read out transistor noise voltage (e_n), noise current (i_n) and noise figure (NF), accurate to better than ± 1 dB. And when you tie these factors into one neat package, you end up with the most complete noise performance story ever told. Unless you want accuracy an order of magnitude greater by calculating your measurements with e_n and i_n .

The 4470A was designed for accuracy and convenience in laboratory, for incoming device inspection and for QC testing applications on FET and bipolar transistors. Yet the analyzer is simple enough to be used by production personnel.

Measurements are made at 4 Hz bandwidths, for precise checks at 11 spot frequencies between 10 Hz and 1 MHz. Noise figure is read directly

in dB, using conveniently applied external or internal source resistances.

Since transistor gain varies between devices, an automatic gain control normalizes overall system gain to a fixed value independent of the transistor being used. And the 4470A is completely flexible for biasing transistors under test. The price is just \$4450.

Find out more about the simplicity of measuring transistor noise from your HP field engineer, or write to Hewlett-Packard, Palo Alto, Calif. 94304; Europe: 1217 Meyrin-Geneva, Switzerland.

HEWLETT  PACKARD

When you buy a low-cost electronic counter from us, you get a unique bonus. Us.

With 55 service offices in the United States and Canada and 86 offices worldwide, we're always close by if you need help. And we give the same complete, dependable back-up to customers who spend a few hundred dollars for a counter as we do to those who spend a few thousand. That's a good thing to keep in mind when you're looking for an inexpensive way to solve your counting problems. And when you add the price and service to the performance you can expect from these counters, you know you're onto a real bargain.

For instance the Hewlett-Packard

5321A counts frequencies up to 10 MHz, has a 100 mV sensitivity and 1 M Ω /30 pF input impedance, 4-digit readout with display storage, zero blanking for easier, faster reading. All this is \$425.

The more versatile and more accurate Hewlett-Packard 5321B gives you BCD recorder output, 5-digit readout, frequency ratio and pulse duration measurement, additional gate times and a quartz crystal time base. Yet the price is just \$775.

The Hewlett-Packard 5221A/B Counters are the same in everything but shape. They're higher, narrower and not as long as the 5321A/B.

If you need greater capability, the Hewlett-Packard 5216A will provide it for \$985. This counter will totalize, measure

frequency, period, multiple period averages, ratio, multiple ratios and pulse duration. It has a 7-digit readout, gate times of 0.01 to 10 seconds, 10 millivolt sensitivity, BCD recorder output, and a maximum count rate of 12.5 MHz.

So when you need a low-cost counter, talk to the people who can deliver the goods *and* whatever service you need, whenever you need it. Call your local Hewlett-Packard field engineer for all the details. Or write to Hewlett-Packard, Palo Alto, California 94304; Europe: 1217 Meyrin-Geneva, Switzerland.

HEWLETT  PACKARD
ELECTRONIC COUNTERS

02912

Circle 2 on reader service card

Count on us for as little as \$425.

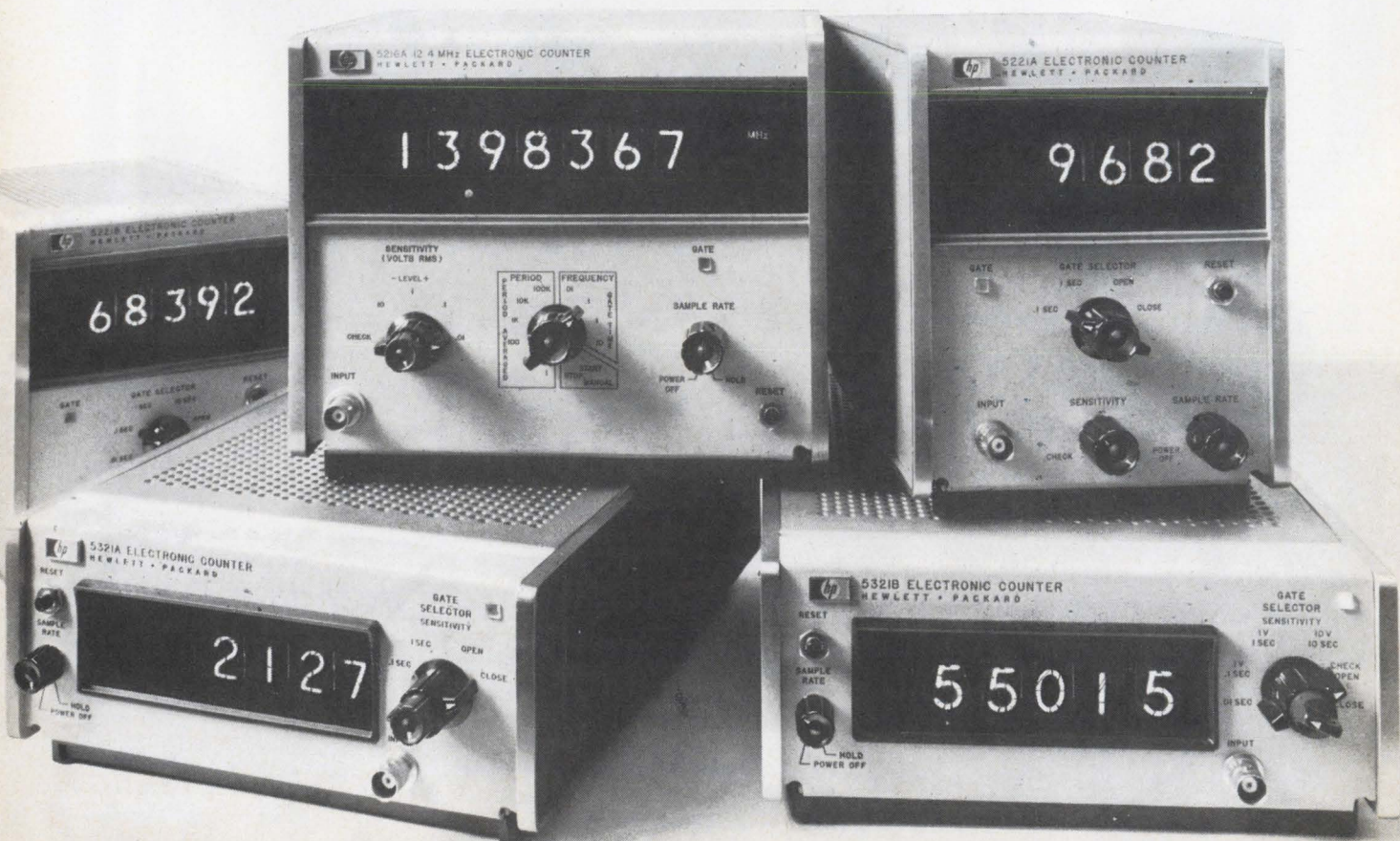

News Features

Probing the News

- 133 **Avionics:** Navy gets a new airborne watchdog
143 **Space electronics:** Canada's satellites shake up research establishment

U.S. Reports

- 45 **Companies:** IBM's unbundling
46 **Components:** Improved failure rate for nitride passivated diodes
48 **Consumer electronics:** HEW teams to check tv X-ray emission
50 **Air traffic control:** ARTS-3 shows promise
50 **Commercial electronics:** Merchandise tag reader
52 **Communications:** Navy's tranceiver of the future
54 **Memories:** Radiation-hardened plated-wire memory for space
56 **Management:** Ex-TI team makes MOS deal with Sprague
58 **Avionics:** NASA readies V/STOL work
60 **For the record**

Electronics International

- 183 **West Germany:** Airport noise monitor
184 **Great Britain:** Bistable circuit works three ways
185 **France:** Giants divide market; microwaves for telephone system
186 **Australia:** Electronics to the aid of the taxi rider
186 **Japan:** Helical antenna for railroad communications system

New Products

- 149 **In the spotlight**
149 Hybrid IC lines go into production
153 **Components review**
153 Cable connectors simplified
155 Switch handles 14 amps
157 **Instruments review**
157 Counters cover 0.05 Hz-500 MHz
158 Controllers have built-in safety
161 **Subassemblies review**
161 Op amp settles in 80 nsec
162 Readout has jumbo characters
165 **Data handling review**
165 Minicomputer is easy to operate
167 Optics control recording rate
168 **Semiconductor review**
168 SiO₂ isolates IC components

Technical Articles

Instrumentation 90

- Helical transmission lines bend the beam** (cover)
Unique deflection system shares the credit for a 250-MHz oscilloscope with a vertical amplifier made with monolithic transistor arrays
Alan J. DeVilbiss, Hewlett-Packard

Opinion 96

- The case for patenting software**
Two patent attorneys question the validity of denying computer programs patent protection, calling such action arbitrary and discriminatory
Michael I. Rackman, Amster & Rothstein, and Howard R. Popper, Bell Telephone Laboratories

Circuit design 105

- Designer's casebook**
▪ UJT gives frequency divider an immunity to input jitters
▪ D-c restorer clamps r-f signals to a reference
▪ Ladder network converts binary input to a-c output
▪ Pulse train frequency varied as duty cycle stays constant

Medical electronics 110

- Circuit monitors energy of laser photocoagulator**
Earl J. Scribner, Stanford Research Institute

Industrial control 111

- Multipoint recorder serves as time-shared amplifier**
Marcel Nougaret, University of Sherbrooke, Quebec, Canada

Communications 114

- Color-tv wheel takes a spin in space**
Digital logic is used to channel serial color signals on separate tracks of multihead disk recorder that reads out in standard format
John D. Drummond, Associate editor

Design theory 118

- Active filters: part 10**
Synthetic inductors from gyrators
Appealing because they can be used in building highly selective filters, gyrators are expected to become even more attractive in IC form
Gerald Aaronson, GT&E Laboratories

Departments

- | | | | |
|----|--------------------------|-----|--------------------------|
| 4 | Readers Comment | 46 | Index of Activity |
| 8 | Who's Who in this issue | 67 | Washington Newsletter |
| 14 | Who's Who in Electronics | 173 | New Books |
| 22 | Meetings | 175 | Technical Abstracts |
| 31 | Editorial Comment | 177 | New Literature |
| 33 | Electronics Newsletter | 181 | International Newsletter |

Electronics

Editor-in-Chief: Donald Christiansen

Senior staff editors

Technical: Stephen E. Scrupski
News: Robert Henkel
International: Arthur Erikson

Managing editor: Harry R. Karp
Art director: Gerald Ferguson

Senior associate editor: Joseph Mittleman
Assistant managing editors: Eric Aiken, H. Thomas Maguire, Howard Wolff
Senior copy editor: Frederick Corey Senior staff writer: John Johnsrud

Department editors

Advanced technology: William Bucci, Richard Gundlach
Communications: John Drummond, Raphael Kestenbaum
Computers: Wallace B. Riley, George Weiss
Design theory: Joseph Mittleman
Instrumentation: Owen Doyle
Military/Aerospace: Alfred Rosenblatt; Paul Dickson (Aerospace)
New products: William P. O'Brien
Solid state: George Watson, Stephen Wm. Fields

Domestic bureaus

Boston: James Brinton, manager; Gail Farrell
Los Angeles: Lawrence Curran, manager; Ralph Selph
Washington: Ray Connolly, manager; Paul Dickson, Lois Vermillion

Foreign bureaus

Bonn: John Gosch
London: Michael Payne
Paris: Arthur Erikson
Tokyo: Charles Cohen

Copy editor: Edward Flinn
Staff writer: Peter Schuyten

Assistant art director: Charles Ciatto
Production editors: Susan Hurlburt, Arthur C. Miller

Editorial research: Virginia Mundt

Editorial secretaries: Lorraine Longo, Claire Goodlin, Barbara Razulis, Vickie Green, Bernice Pawlak, Patricia Bispham

McGraw-Hill News Service

Director: Arthur L. Moore; Atlanta: Fran Ridgway; Chicago: Robert E. Lee
Cleveland: Arthur Zimmerman; Dallas: Marvin Reid
Detroit: James Wargo; Houston: Barbara LaRoux
Los Angeles: Michael Murphy; Pittsburgh: Louis Gomolak
San Francisco: Margaret Drossel
Seattle: Ray Bloomberg; Washington: Charles Gardner, Daniel B. Moskowitz, Herbert W. Cheshire, Seth Payne, Warren Burkett, William Small, William D. Hickman

McGraw-Hill World News Service

Bonn: Robert Dorang; Brussels: James Smith; Hong Kong: Kate Mattock
London: John Shinn; Mexico City: Gerald Parkinson; Milan: Ronald Taggiasco; Jack Star;
Moscow: Jack Winkler; Paris: Robert E. Farrell, Stewart Toy
Rio de Janeiro: Leslie Warren; Tokyo: Marvin Petal

Reprints: Gail Niles
Circulation: Isaaca Siegel

Publisher: Gordon Jones

Assistant to the publisher: Wallace C. Carmichael

Electronics: July 7, 1969, Vol. 42, No. 14

Published every other Monday by McGraw-Hill, Inc. Founder: James H. McGraw 1860-1948.
Publication office 99 North Broadway, Albany, N. Y. 12202; second class postage paid at Albany, N. Y.
and additional mailing offices.

Executive, editorial, circulation and advertising addresses: McGraw-Hill Building, 330 W. 42nd Street,
New York, N. Y. 10036. Telephone (212) 971-3333. Teletype TWX, N.Y. 710-581-4235. Cable address:
MCGRAWHILL N.Y.

Subscriptions solicited only from those professionally engaged in electronics technology. Subscription rates:
qualified subscribers in the United States and possessions and Canada, \$8.00 one year, \$12.00 two years,
\$16.00 three years; all other countries \$25.00 one year. Non-qualified subscribers in the U.S. and
possessions and Canada, \$25.00 one year; all other countries \$50.00. Air freight service to Japan \$50.00
one year. Single copies: United States and possessions and Canada, \$1.00; all other countries, \$1.75.

Officers of McGraw-Hill Publications Company: Joseph Allen, President; John R. Emery, J. Elton Tuohig,
Senior Vice Presidents; Gordon L. Jones, Jr., Group Vice President; Vice Presidents: John R. Callahan, Editorial;
Paul F. Cowie, Circulation; John M. Holden, Marketing; David G. Jensen, Manufacturing;
Jerome D. Luntz, Planning & Development; Robert F. Marshall, Administration; Robert M. Wilhelm, Finance.

Officers of the Corporation: Shelton Fisher, President and Chief Executive Officer; John L. McGraw, Chairman;
Robert E. Slaughter, Executive Vice President; Daniel F. Crowley, Donald C. McGraw, Jr., Bayard E. Sawyer,
Senior Vice Presidents; John J. Cooke, Vice President & Secretary; Gordon W. McKinley, Vice President &
Treasurer.

Title © registered in U.S. Patent Office: © Copyright 1969 by McGraw-Hill, Inc. All rights reserved. The contents
of this publication may not be reproduced either in whole or in part without the consent of copyright owner.

Subscribers: The publisher, upon written request to our New York office from any subscriber,
agrees to refund that part of the subscription price applying to copies not yet mailed.
Please send change of address notices or complaints to Fulfillment Manager; subscription
orders to Circulation Manager, Electronics at address below. Change of address notices
should provide old as well as new address, including postal zip code number. If possible,
attach address label from recent issue. Allow one month for change to become effective.

Postmaster: Please send form 3579 to Fulfillment Manager, Electronics,
P.O. Box 430, Hightstown, New Jersey 08520

Readers Comment

Quite a big byte

To the Editor:

The article on rotating disks and drums [May 26, p. 96] makes a rather misleading statement about Vermont Research's 4.2-megabit drum memory. It has a bit transfer rate of 1.8 megahertz or 225 kilobytes per second—rather than the 225 bytes per second quoted in the article.

Also let me point out that our 8-megabyte drum is available in either bit serial or byte serial configurations with eight read-write amplifiers. The eight-bit parallel format at 2.0-megahertz clock rate gives us a 2 megabytes per second or 16 megabits per second data transfer rate, deskewed and self-clocked.

Please also note that the illustration of the flying head action on page 98 shows the single-reed mounting that is unique to Vermont Research products.

George Marchyshyn
R&D department
Vermont Research Corp.
North Springfield, Ver.

Not the only system

To the Editor:

I noted with great interest the article on pay tv [May 26, p. 123]. While I believe that the report is quite informative, it may give the reader the impression that the Zenith system is the only system under consideration by the FCC. It is my understanding that five organizations submitted to the commission technical details on systems which fall within the FCC definition of subscription television. They are the International Telemeter Corp., Kahn Research Laboratories Inc., the Skiatron Electronics & Television Corp., TeleGlobe Pay-TV System Inc., and Zenith.

No one questions the fact that Zenith has done important pioneering work in this field. However, all of the competitive systems have advantages and disadvantages. Therefore, the statement, "Nor have two or more approaches been vying for acceptance, as was the case with

This Sierra L-F wave analyzer costs \$2,295.

(For about the same money, others can give you a fraction of its accuracy: ± 3 Hz).



(...and about half its range of 20 Hz to 110 kHz)

Short of spending another \$2,000, you cannot buy the accuracy of a Model 301B L-F Wave Analyzer. Nor its broad tunable coverage of the low-frequency spectrum. Nor its convenience and all-around usefulness.

Consider, for example, the benefits of up-to-date readout techniques. Model 301B displays tuned frequency on a five-digit counter, driven by solid-state circuitry. A second digital display presents the algebraic sum of the two attenuator settings, doing away with calculations. A lighted pointer on direct-projected meter scales gives you parallax-free readings of voltage and dBm.

As a wide-range wave analyzer, Model 301B delivers precise data on individual components of complex signals. You can accurately measure fundamental frequencies, harmonic voltages, intermodulation products, and other noise and signal voltages too small to be indicated by other means.

Built-in signal generator

By looping pulse outputs back to the 301B input, you can produce a harmonic signal every 100 Hz or 1 kHz (READ or TUNE position). A built-in 1-MHz clock frequency assures the accuracy of all generated pulse harmonic frequencies in this mode. By tuning the set to any harmonic frequency and locking on AFC, you can operate it as a frequency synthesizer throughout the entire range. In this function, it provides a restored sig-

nal of high frequency accuracy at the restored output terminals.

Among other Model 301B features: dual-selectable bandwidths of 10 and 100 Hz; a meter recording output; an optional bridging line transformer (Model 129-600) that makes measurements of true dBm on 600-ohm lines possible with only 0.1 dB bridging loss.

Product File 369 discloses everything about this remarkable economic development. Write Philco-Ford, 3885 Bohannon Drive, Menlo Park, California 94025. Or call (415) 322-7222, ext. 329.

SUMMARY SPECIFICATIONS

Frequency	
Range	20 Hz to 110 kHz
Accuracy	(20 Hz to 110 kHz) 1 Hz ambiguity, ± 2 Hz error
Input Level Range	
Voltage (Full scale)	$30\mu\text{v}$ to 300 v in 1, 3, 10, 30 sequences
dBm (ref 600-ohm line and 0 dB on meter scale)	+50 to -90
Input Level Accuracy	± 0.5 dB
Selectivity	
Narrowband	10 Hz (6-dB points) 60 Hz (60-dB points)
Wideband	100 Hz (6-dB points) 600 Hz (60-dB points)

PHILCO 

SIERRA ELECTRONIC OPERATION
Philco-Ford Corporation
Menlo Park, Calif. 94025

**We have only
three words
to say about
the reliability
and durability of
HEINEMANN
circuit breakers:**

Five-Year Warranty

Readers Comment

color television," may be misunderstood by your readers.

It is our belief that our patented system is a practical and inexpensive means for providing the public with subscription television. Since decoding equipment cost is a major factor in this field we believe that serious consideration of our proposal will be given by the commission. This system is also free of the problem of aircraft flutter which creates objectionable time delays in picture synchronization in at least one of the proposed systems.

Leonard R. Kahn

President
Kahn Research Laboratories Inc.
Freeport, N.Y.

▪ No slight was intended by the omission of other companies vying for the pay-tv market. Zenith, however, is perhaps furthest down the road thanks to the Hartford experiment and is generally acknowledged as the leader. As things now stand, Zenith's Phonevision system will probably be the first to go on the air.

Standards and style

To the Editor:

I am sure you want your magazine to be as error-free as possible, and I am also sure that you will agree that it is important and desirable to adhere as closely as possible to any recognized national standards that may be applicable.

For these reasons I am writing to draw to your attention a number

of "errors" that crept into the May 26 issue. This not a complete list, but a few examples only.

Reference designations: (USAS Y32.16) on page 91, D should be CR; the numbers are not subscripts, i.e. R3 not R₃.

Unit symbols: (USAS Y10.19) on page 91, μ f should be μ F; on page 107, hz should be HZ, and w should be W.

Graphic symbols: (USAS Y32.2) on page 107, voltage regulator diode—see item 8.5.6.1.

I might also point out, with reference to the schematic diagram on page 107 that the diode type number should be 1N4003 not 1N4003.

Sidney V. Soanes
Ferranti-Packard Ltd.
Toronto, Canada

▪ Mr. Soanes is a member of the IEEE standards coordinating committee for letter and graphic symbols (SCC11), and his points are well taken. However, Electronics uses a style guide set by typographical and aesthetic considerations as well as by recognized committee-set standards. Standards are ignored if we feel that we are communicating better without them. In general, we prefer lower case letters to the upper case letters shown in Mr. Soanes' letter. We feel that a single letter designation is better than a double letter configuration. He is correct on the 1N4003, and on symbols for devices; both were lapses on our part.

NO KLYSTRONS

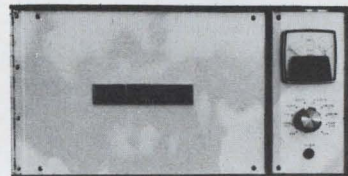

More reliable and using less power than any other equipment type, Farinon microwave is completely solid-state. There is no klystron. Easy to maintain, compact, and versatile systems with capacities of up to 300, 600 or 960 channels meet international standards for performance over distances of more than 1000 miles. They operate in all bands to 7 GHz. Remodulating repeaters provide complete base-band access at each repeater.

With Farinon SS-series microwave, you can have a system that exactly matches your needs. Ask for complete information on performance, terminal arrangements and accessory gear, including fully CCITT-compatible multiplex.

Farinon

Farinon Electric, 935 Washington St., San Carlos, Cal. 94070

SUBSCRIPTION SERVICE

Please include an Electronics Magazine address label to insure prompt service whenever you write us about your subscription.

Mail to: Fulfillment Manager
Electronics
P.O. Box 430
Hightstown, N.J. 08520

To subscribe mail this form with your payment and check new subscription renew my present subscription

Subscription rates: qualified subscribers in the U.S.: 1 year \$8; two years, \$12; three years, \$16. Non-qualified: 1 year \$25. Subscription rates for foreign countries available on request.

CHANGE OF ADDRESS

ATTACH
LABEL
HERE

If you are moving, please let us know five weeks before changing your address. Place magazine address label here, print your new address below.

name _____

address _____

city _____

state _____

zip code _____

Who's Who in this issue

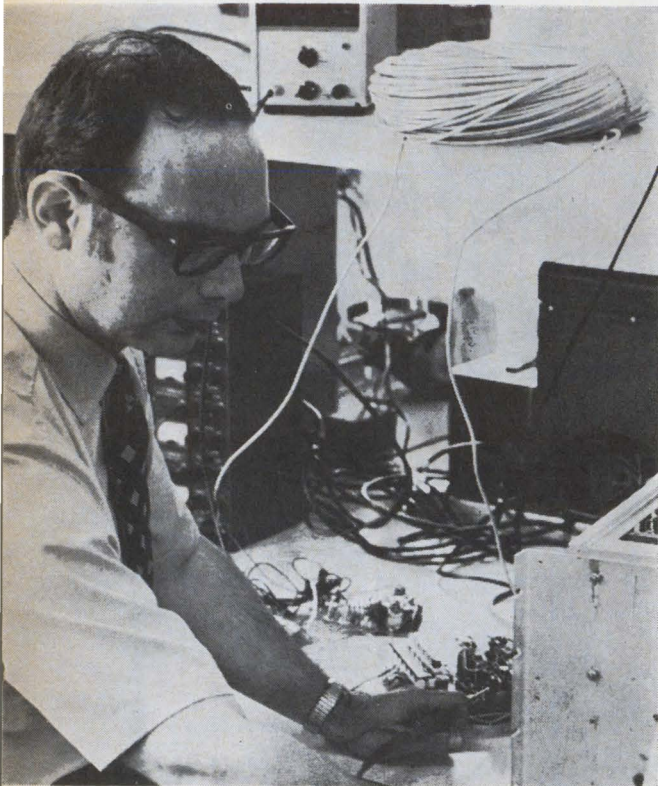

Aaronson

While working on communications equipment at RCA, Gerald Aaronson, who wrote the article on gyrators (page 118), turned to active filters. Now with General Telephone & Electronics Laboratories, he's doing R&D in switch-network remote access computer terminals and telephone systems. Aaronson holds a master's degree from Brooklyn Polytechnic Institute.



Rackman

Now in private patent practice in New York City, attorney Michael I. Rackman has been interested in the question of providing computer programs with protection since the early 1960's when he was at Bell Labs. Co-author of the article on patenting software (page 96), he holds an LL.B. from New York University and an M.S.E.E. from Columbia.

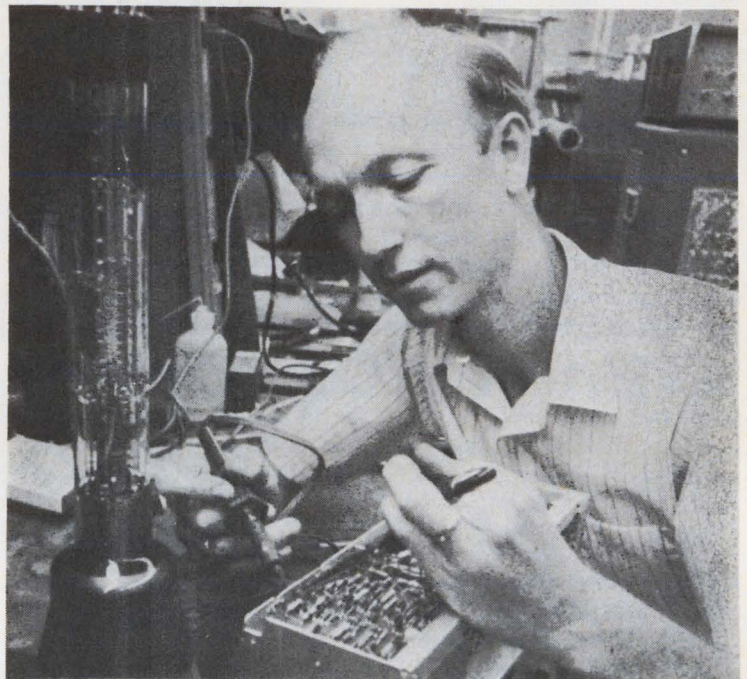

DeVilbiss

"A man for all frequencies" is how one co-worker classifies Alan J. DeVilbiss, author of the cover story on the 250-Mhz scope that begins on page 90. Before joining Hewlett-Packard in 1965, where he helped design the IC's, vertical amplifier, and crt for the company's model 183, DeVilbiss was with NASA's Jet Propulsion Lab. He holds a bachelor's degree from Louisiana Polytechnic Institute and an M.S. from Cal Tech.

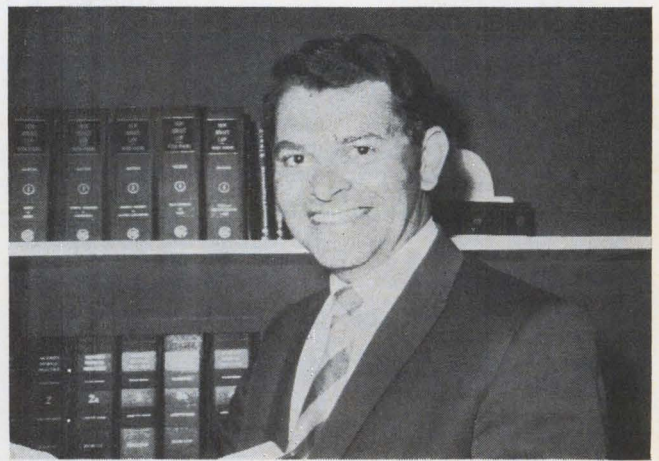

Popper

Versatile Howard R. Popper, co-author of the article on patenting software (page 96), has been a working engineer as well as a practicing lawyer. He won a B.S. from Rensselaer Polytechnic Institute in 1952, later earning an LL.B. from Brooklyn Law School. A Navy veteran, he served as an assistant ship superintendent of navigational electronics.

High Ripple Current in Electrolytic Capacitors

Did you know that electrolytic capacitors can be specifically designed to handle high ripple current applications? Standard lines are not normally designed to optimize this characteristic—if you have had the problem of overheated capacitors in a filter circuit, we think the following information will interest you.

Many electrolytic capacitors used in power supply filter circuits have to handle high ripple currents in high ambient temperatures. In order to provide reliability and long life assurance, electrolytic capacitors could be specifically constructed for these conditions.

Ripple current is the AC component of the current flowing through the capacitor. It causes heating, or heat rise, in the capacitor due to the inherent losses in electrolytic capacitors. The losses are a function of the ripple frequency, construction of the capacitor and the ambient temperature.

The ambient temperature will govern the capacitor's heat dissipation capability. The lower the ambient

**Ripple Current Capability of Specially
Constructed Type FP 450 VDC Mallory Electrolytic**

Size Dia. Ht.	Max. Mfd.	65°C Ambient		85°C Ambient	
		60 Hz	120 Hz	60 Hz	120 Hz
1 3/8" x 2"	80	1.44 amps	1.92 amps	.90 amps	1.20 amps
1 3/8" x 2 1/2"	110	1.84	2.32	1.15	1.45
1 3/8" x 3"	150	2.16	2.64	1.35	1.65
1 3/8" x 3 1/2"	175	2.32	3.04	1.45	1.90
1 3/8" x 4"	200	2.56	3.28	1.60	2.05
1 3/8" x 4 1/2"	225	2.80	3.44	1.75	2.15
1 3/8" x 5"	250	3.20	3.60	2.00	2.25

**Ripple Current Capability of Standard
Construction Type FP 450 VDC Capacitor**

Size Dia. Ht.	Max. Mfd.	65°C Ambient		85°C Ambient	
		60 Hz	120 Hz	60 Hz	120 Hz
1 3/8" x 2"	80	.600 amps	.750amps	.400amps	.500amps
1 3/8" x 2 1/2"	110	.640	.800	.425	.530
1 3/8" x 3"	150	.660	.825	.490	.550
1 3/8" x 3 1/2"	175	.780	.975	.520	.650
1 3/8" x 4"	200	.960	1.200	.640	.800
1 3/8" x 4 1/2"	225	1.080	1.350	.720	.900
1 3/8" x 5"	250	1.200	1.500	.800	1.000

temperature, the greater the dissipation. The greater the heat dissipation, the greater the current carrying capability. In a high ambient temperature, the internal temperature should not reach a run-away heat condition. Ideally, a state of temperature equilibrium should be established that will not cause degradation of the capacitor such as a sharp decrease in capacitance and rapid increase in dissipation factor.

The electrical losses in the capacitor consist of the resistivity of the electrolyte system, the losses in the oxide film on the anode plate, and the tabs and electrical connections. These losses are lumped and expressed in ohms as the ESR. (Equivalent Series Resistance.) The ESR is greater at low frequencies than at high frequencies. Thus, the current carrying capability is greater at 120 Hz than at 60 Hz.

Ripple current capabilities are published for standard construction

electrolytic capacitors. When operated within the published ripple current and maximum ambient temperature conditions, capacitors will provide reliable long-life service. However, when these conditions are exceeded, a much shorter life or even catastrophic failure can be expected.

The tables show the ripple current capabilities of standard construction type FP capacitors compared to the ripple capability of specially constructed FP capacitors for reliable high ripple current performance.

If you have a high ripple current application, specify the R.M.S. current, frequency, ambient temperature, nominal capacitance and capacitance tolerance, working voltage, and surge voltage conditions.

For data, call or write Mallory Capacitor Company, a division of P. R. Mallory & Co. Inc., Indianapolis, Indiana 46206.



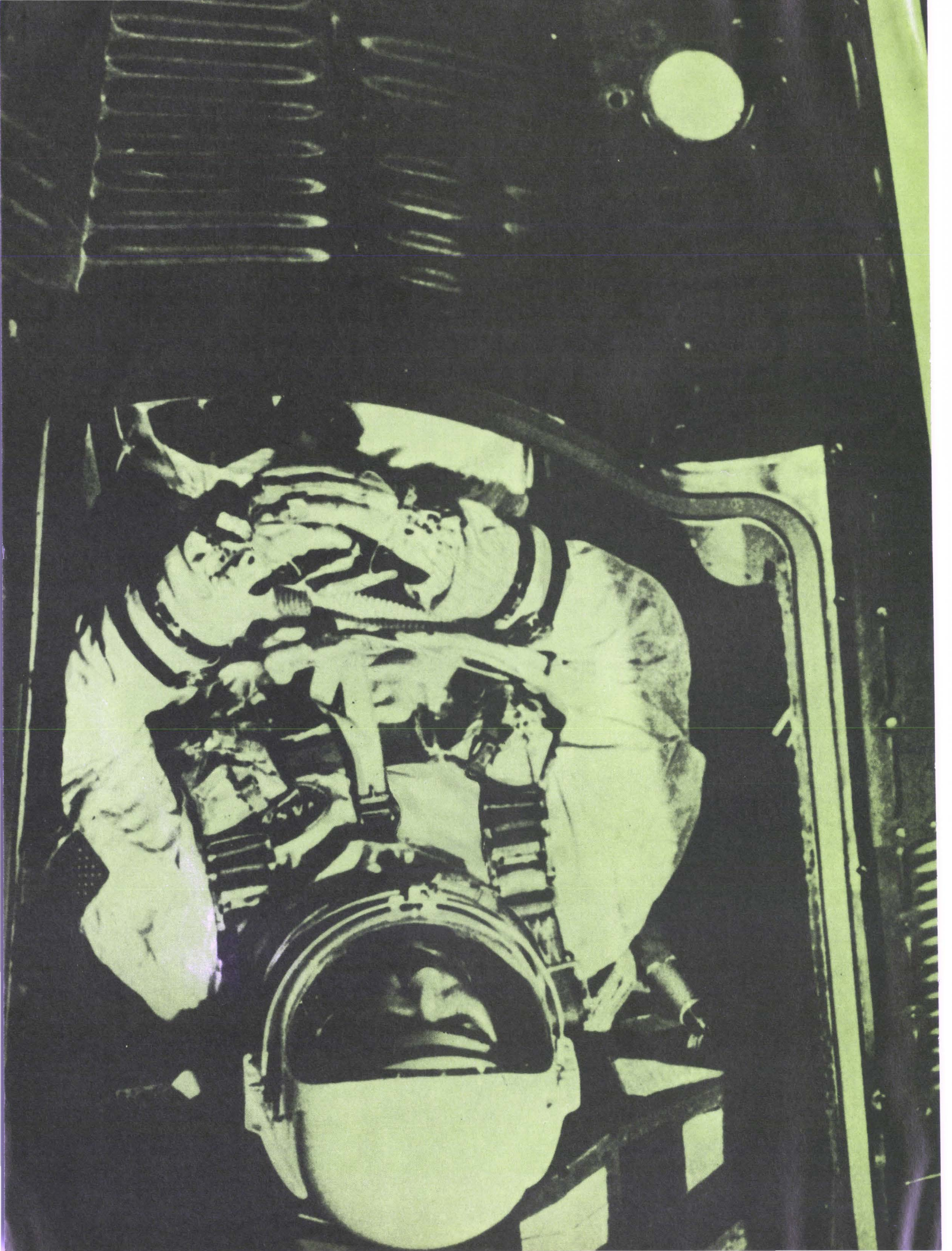



**What is
TRW
doing on
the launch pad?**

TRW is very much on the scene at every major U. S. space launch, even though our nameplate may not appear on the equipment.

TRW communications transistors send signals back from millions of miles in space. TRW capacitors, transformers and miniature motors have operated reliably on the surface of the moon. TRW semiconductors continue to set new standards of performance on Minuteman III.

TRW components are almost everywhere you look. They give you true color on your TV screen and concert hall quality from your stereo. They drive computer tapes and surgical tools. They operate undersea, on land, in the air and in space. And they do it well, because reliability is the name of the game at TRW.

TRW[®]

THE ELECTRONICS GROUP OF TRW INC.—
World-wide manufacturer of components for the
Government, Commercial and Industrial Markets.

NPN POWER SWITCHES AND AMPLIFIERS.



Our first promise was to produce NPN power transistors. So take your pick from this list of 58 NPN power transistors. Built using BI-MESAR™, double-diffused Planar* epitaxial and triple-diffused Planar technologies. And built better because that's the way Fairchild does things.

TO-3	TO-61	TO-5
2N3055	2N2811-14	2N3439-40
2N3232-34	2N4301	2N4300
2N3442	2N5313	2N4877
2N3713-16	2N5315	2N5336-39
2N4913-15	2N5317	2N5729
2N5067-69	2N5319	
2N5732	2N5731	
2N5734		

TO-66	TO-63	TO-59
2N3054	2N3597-99	2N5346-49
2N3441	2N4002-03	2N5477-80
2N3738-39	2N5733	2N5730
2N4910-12		

They're all competitively priced. And available in volume from your local Fairchild distributor. Today.

Fairchild Semiconductor
A Division of Fairchild Camera
and Instrument Corporation
Mountain View, California 94040
(415) 962-5011
TWX: 910-379-6435

*Planar is a patented Fairchild process.



**THE
GREAT
FAIRCHILD
POWER
GRAB**

THE GREAT FAIRCHILD POWER GRAB IS ON!

Last month we promised to brute force the power business. On the preannounced schedule shown below. The facing page is our first delivery on that promise.

JULY

NPN POWER SWITCHES AND AMPLIFIERS

THE GREAT FAIRCHILD POWER GRAB

AUGUST

PNP COMPLEMENTARY POWER SWITCHES AND AMPLIFIERS

THE GREAT FAIRCHILD POWER GRAB

SEPTEMBER

NPN / PNP COMPLEMENTARY POWER SWITCHES

THE GREAT FAIRCHILD POWER GRAB

OCTOBER

TO-66 PLASTIC POWER TRANSISTORS

THE GREAT FAIRCHILD POWER GRAB

NOVEMBER

HIGH VOLTAGE PLASTIC POWER AMPLIFIER TRANSISTORS

THE GREAT FAIRCHILD POWER GRAB

Now watch us move in on the power business. With volume. With price. With products. Watch. And order when you see what you want. We're ready.



THE GREAT FAIRCHILD POWER GRAB

NEW

**ultra
miniature**

**I/C POWER
SUPPLY**

**80%
SMALLER!**

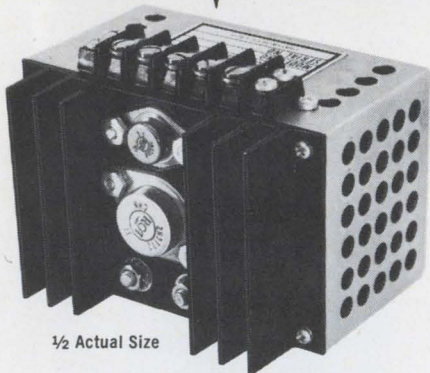

1/2 Actual Size

Powertec's new, ultra-miniature power supply is only 4"x3"x2 5/8" including heatsink.

POWERTEC 9-D SERIES power supplies are specifically designed for use in light weight chassis with IC or other digital logic. Output voltages are available from 3 to 30 volts with .05% regulation.

INPUT: 115 VOLTS 47-440HZ

TYPICAL OUTPUTS:

3 V at 6 A

5 V at 5 A

15 V at 2 A

THE POWERTEC 9-D SERIES is currently available from stock. Detailed specifications and price are available upon request.

CUSTOM POWER SYSTEMS

Powertec's experts are capable of solving your most difficult power conversion requirements.



POWERTEC DIVISION

9168 DeSoto Street
Chatsworth, California 91311

Who's who in electronics

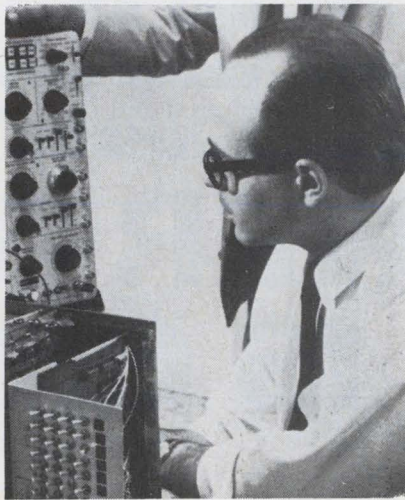

Dinman

"You might call it a product of frustration," says Saul Dinman about the GRI-909 industrial and process control computer. Dinman is the vice president and chief engineer of GR Industries of Newton, Mass., and the computer is the company's first major product.

But it's been coming for a long time. Dinman first worked on computers at RCA in the late 1950's. "After a short stint on missile guidance systems, I worked on the 110, one of the earliest industrial computers," he recalls. "Those were cutthroat days; everyone was in the act and every order was for a custom installation." To ease the competitive stress which was to drive many companies out of the market by the 1960's, RCA formed a joint venture with the Foxboro Co.; "Foxboro did systems marketing while RCA handled software and interfacing with the 110. Once the work on the 110 was finished I found myself spending almost full time on interfacing," says Dinman. When the venture was dissolved Dinman left for Foxboro along with most of RCA's industrial computer systems personnel. With them went a license to make the 110 and its associated electronics.

The way it crumbles. But Dinman tried other computers too; his first systems task was the automation of a cookie dough line with a Digital Equipment Corp. PDP-4. Dinman was program manager for

the contract which eventually covered a system for closed loop control of 13 separate batch processes.

He soon began taking stock of his lessons with the 110 and PDP-4. "Every control system demanded new interfacing," he says, "But the computer always remained the same. It was hard to make a buck in fixed-price custom systems, so we tried to save money by building more flexibility into the interfacing electronics. We tried to reduce all control functions to a denominator which the computer could handle in a common way. Thus, we could save on software, and on some hardware too in the long run." The solution was a generalized input-output technique and a so-called bus buffer box to make data structures similar throughout a system.

Dinman left Foxboro for DEC in early 1969, where he was put in charge of logic modules. At DEC, Dinman came up with the PDP-8S after DEC president Ken Olsen said, "It would be nice to have an under-\$10,000 computer."

Familiar road. Though the 8S succeeded beyond expectations, Dinman was forced to concentrate on his module line. Nor was he able to include in the 8S or any other computer his ideas on software and 110 flexibility. Taking a route followed by many frustrated engineers, Dinman left DEC to form his own company with Samuel Ochlus as partner and president.

Now, after only about 18 months in business, the company is advertising a computer "like none you have ever seen before"—the \$3,600 GRI-909 where course and destination buses extend right into the machine's internal architecture. This makes all external and internal parts of a system directly addressable in a language tailored to the user rather than the programmer.

"Things were going so well that I actually began to think of trying something different," says Burton J. McMurtry, the man who put Sylvania Electric Products into the

What price performance? Not much. These two new solid state DC Calibrators have been designed to satisfy both performance-minded engineers and their budget-battered bosses. Both of these fine instruments offer the kind of specs that will cost you up to fifty percent more elsewhere—and still not give you the performance you always get when the Fluke name goes on the front panel. Check them out.

Model 343A. Here's a calibrator equal in resolution (0.1 ppm) to the most expensive instrument on the market in only 3½" of panel space. Price is \$1695 for an absolute accuracy of 0.003% over a 0 to 1100 volt range. Stability is 0.0005%/hour. Quick amplifier response provides an output within 25 ppm five seconds after any range or setting

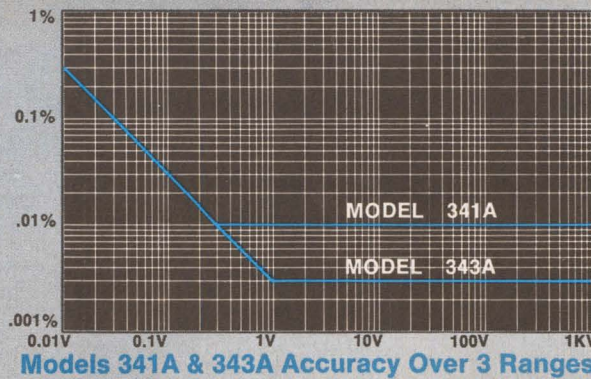

change. Four-terminal floating output is featured. Current is automatically limited at any preset level between 1 ma and 30 ma. Line and load regulation are 0.0005% of setting. Shock, vibration, and altitude specs of MIL-T-21200 are met. The Model 343A is housed in an attractive package for bench use and rack mounting weighing 23 pounds.

Model 341A. Here's the best buy in the calibrator market today. You get an accuracy of $\pm 0.01\%$ over a 10°C range for a low-low price of \$1195. Resolution is 1 ppm. Stability is 0.0007%/hour. All other specs are the same as the Model 343A.

For full details, see your Fluke sales engineer or contact us directly.

MODEL 341A DC
Calibrator

MODEL 343A DC
Calibrator

They're our
new tight
money

DC
Calibrators!



Fluke, Box 7428, Seattle, Washington 98133. Phone: (206) 774-2211. TWX: 910-449-2850. In Europe, address Fluke Nederland (N.V.), P.O. Box 5053, Tilburg, Holland. Phone: (04250) 70130. Telex: 884-50237. In the U.K., address Fluke International Corp., Garnett Close, Watford, WD2 4TT. Phone: Watford, 27769. Telex: 934583.



THREE NEW VOLTAGE TUNED OSCILLATORS

Texscan's VTS series of oscillators are solid state, fundamental RF sources, and voltage tunable over a full octave. They feature exceptionally good voltage versus frequency characteristics and power output capability.

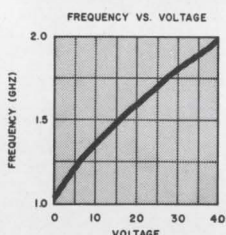
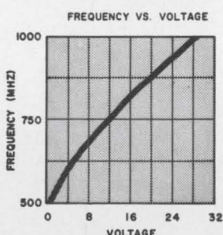
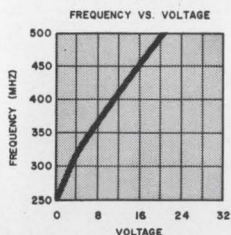
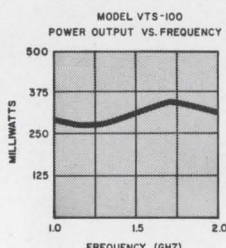
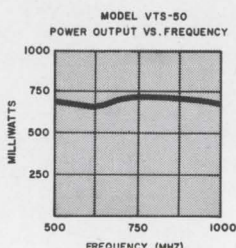
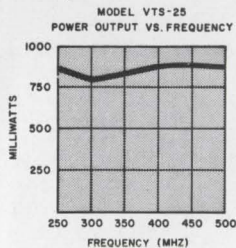

Inquiries for special tuning ranges, power outputs, and mounting flanges are invited.

Model No.	VTS-25	VTS-50	VTS-100
Frequency Range	250-500 MHz	500-1000 MHz	1 - 2 GHz
Power Output Into 50 Ohm	750 MW	500 MW	250 MW
Non-Harmonic Spurious Rejection	50db	50db	50db
Tuning Voltage	+0.5 to +20 VDC	+0.5 to +28 VDC	+0.5 to +40 VDC
Physical Size	1" x 1" x 2½"	1" x 1" x 2½"	1" x 1" x 2½"
Price	\$195.00	\$195.00	\$275.00

TEXSCAN CORPORATION
 2446 N. Shadeland Avenue
 Indianapolis, Indiana 46219
 Telephone (317) 357-8781
 TWX: 810 - 341 - 3184

electro-optics business. He left Sylvania on June 30 after 12 years—though he will serve as a consultant—to enter the venture capital business.

"I felt a great sense of accomplishment," McMurtry adds, "but my interests have always been very strong in new areas. And I'm going into something which is completely new for me and has a greater breadth than just optics."

McMurtry will take none of his Mountain View, Calif., staff with him. In fact, he says, he had a major influence in picking Kenneth L. Brinkman as his successor.

Four hunters. McMurtry will be joining three others in the capital venture business: Jack Melchor, one of the founders of Hewlett-Packard Associates and former general manager of H-P's data acquisitions division; Donald Smith, former division general manager of H-P associates; and Lowell Morse, a bay area businessman.

They will be evaluating opportunities to finance the application of new technology across the entire electronics field. In some cases, the group will finance a new company; in other instances, it will back expansion of established firms.

"We won't be avoiding lasers," notes McMurtry, "but they won't be our prime thrust, either."

McMurtry, 34, started with Sylvania in 1957 in the microwave tube division while a graduate student at Stanford University. Studying under A. E. Siegman at Stanford, he worked with high-speed photo-detectors and ruby lasers.

System approach. After receiving his doctorate, he formed Sylvania's first R&D group in electro-optics in 1961. Under his direction the group grew, and in 1964 it was transferred into the company's system division.

McMurtry became general manager of the electro-optics operation when it was split away as a separate entity with its own management and marketing team. Since its separation, its management staff has grown from 35 to 85, sales have climbed substantially, and the projections appear rosy.

from dc to 3 GHz
with only
one plug-in

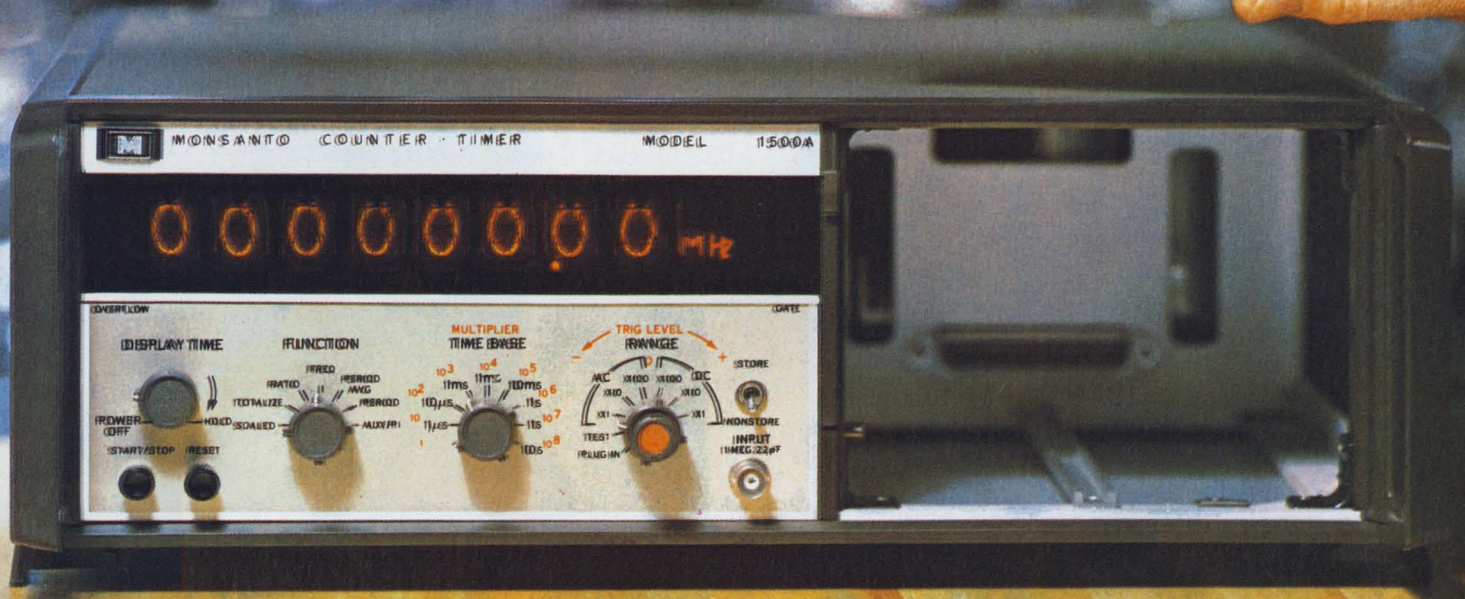

**This new "4th generation"
I-C plug-in counter/timer
Outperforms all others...**

And will for years to come!

Why compromise for less? The Model 1500A has a main frame counting range from dc to 125 MHz (to 3 GHz with a single plug-in). This instrument is fully programmable, has provision for external time base up to 10 MHz, and many other significant features, including the well recognized advantages of Monsanto's "4th generation" 90% integrated circuit design.

Shown above is the Model 1104B 3 GHz frequency converter plug-in. Also available: Model 1100A uncommitted

plug-in; Model 1101A 500 MHz prescale plug-in; Model 1102A 6-digit preset plug-in; Model 1103A 500 MHz frequency converter plug-in; Model 1107A time interval plug-in; Model 1201A DVM plug-in.

Unparalleled performance plus award-winning design make the Model 1500A the ultimate counter for the no-compromise engineer. The price for the main frame is \$2850.00, FOB West Caldwell, N. J. Other models of the 1500 Series offering a wide selection of fea-

tures and capabilities begin at \$1800.00.

Most engineers take Monsanto's reliability for granted because of our 2-year warranty. But, just in case, we maintain 37 Service Centers located strategically throughout the United States and overseas.

For a demonstration, or for full technical details, call your local Monsanto Field Engineer now or contact us directly at: Monsanto Company, Electronic Instruments, West Caldwell, New Jersey 07006, (201) 228-3800.

Circle 17 on reader service card

Monsanto

Worldwide capability

internal connectors

input/output connectors

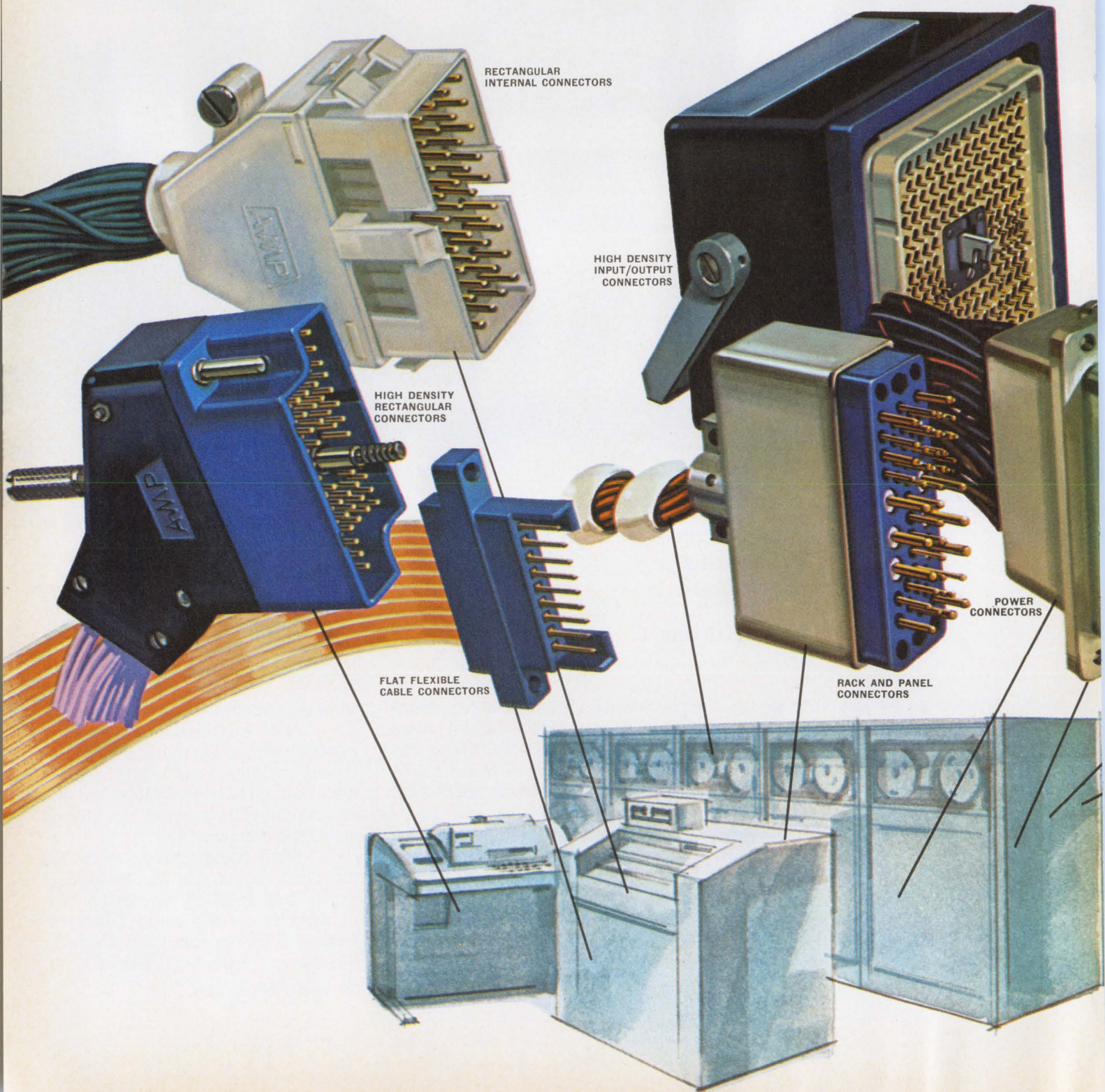

for computers in:

interconnection systems

wired panels

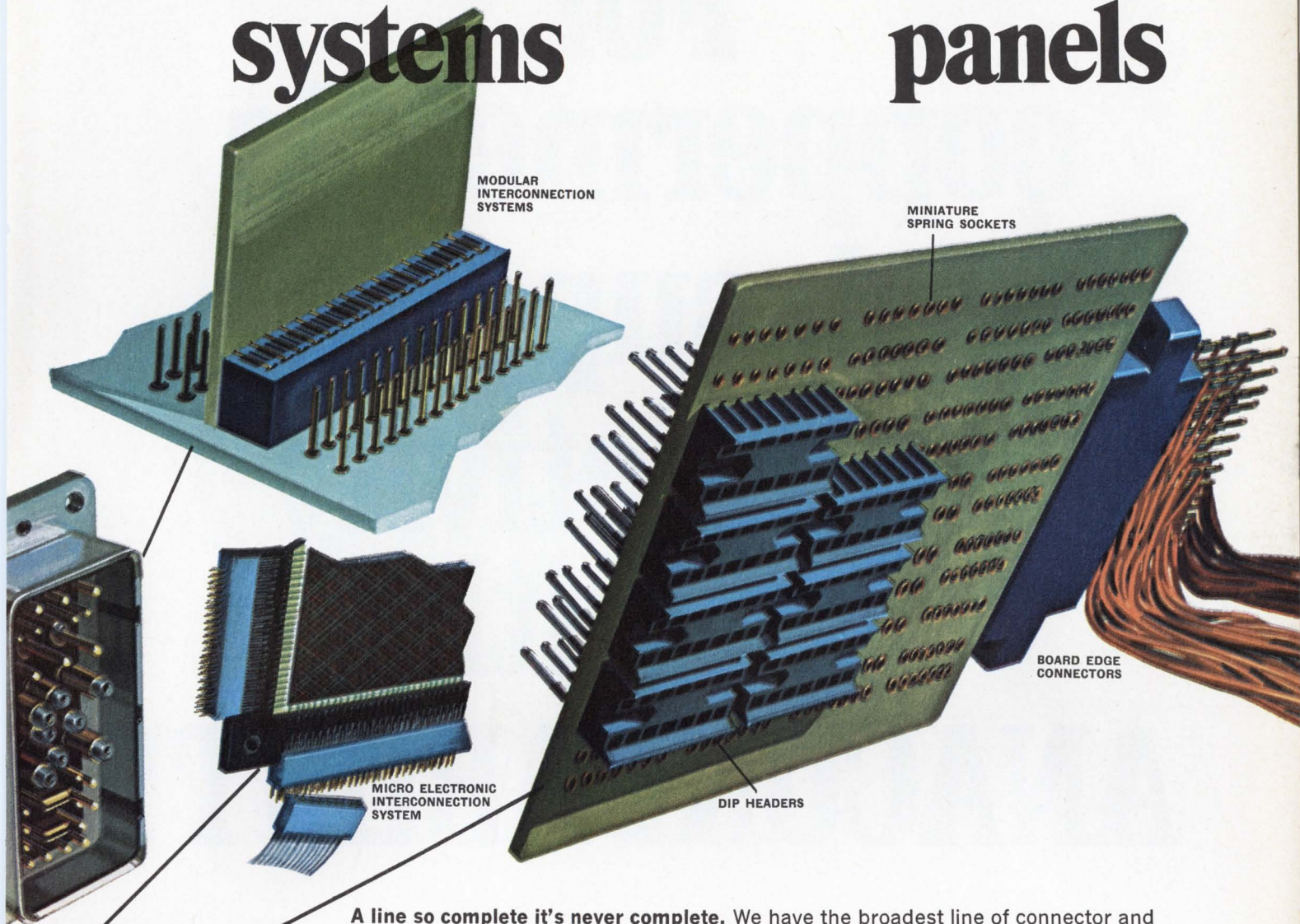

A line so complete it's never complete. We have the broadest line of connector and interconnection techniques for computers and peripheral equipment in the world. And we can design new ones to fit your ever changing needs.

No matter where you are. We're worldwide. In manufacturing, engineering and direct sales representation. And the quality of our products and services never varies.

Some say we're experts. And we think our connectors live up to it. Board-to-board, point-to-point, racked, stacked, panelled or hanging free our connectors are among the most reliable in the world.

How can we do all this and save you money, too? A-MP★ automatic application tooling for use right in your own plant . . . engineered specifically for the A-MP product. This application tooling enables you to realize the lowest total installed cost.

Want more? Write today for complete catalog data on our connector and interconnection products for computers.

INDUSTRIAL PRODUCTS DIVISION, AMP INCORPORATED, HARRISBURG, PA. 17105.

★Trademark of AMP Incorporated

European companies or affiliates refer to International Section

Circle 19 on reader service card

AMP INCORPORATED

For coppermetals with superior conductivity go with **ANACONDABILITY**

Anacondability—our name for the total corporate capabilities of Anaconda—does a lot to generate new application ideas for high conductivity coppermetals.

To assist in the selection of the right copper in the proper form and size for a specific job, Anaconda electrical conductivity specialists stand ready to spell out solutions to problems with the most

complete line of rigid conductors in the industry.

They've also combined copper's other highly desirable properties in a broad range of coppermetals to meet just about any other engineering requirement you may have had in mind.

Got a special sort of a problem in electrical conductivity? You'll find the answer in Anacondability—the unique combination of copper

technology, production know-how and customer service that distinguishes Anaconda coppermetals from all others. **Anaconda squeezes greater electrical loads through smaller conductors—economically.**

Anaconda engineers are experts at increasing the current-carrying capacity of coppermetals in less space, at relatively lower costs. Typical ready-made solutions to many



The package design illustrated is the registered trademark of the Whitman Chocolates Division of Pet Incorporated.

electrical transfer problems are:

Liquid-cooled Hollow Conductors—Now available in standard as well as special order sizes. Designed to meet heavy current density applications, particularly where space limitations are a factor.

Insulated Hollow Conductors—Heavy epoxy insulation

developed by Anaconda eliminates the need for hand-taping of conductors.

Electro-Sheet Copper Foil—Cathode-quality electrolytic copper provides low-cost, low-resistance conductors, and is available in a range of weights.

For technical information send for Publications C-25, D-8, TP-56 covering these products. Write to: Anaconda American Brass Company, 414 Meadow Street, Waterbury, Connecticut 06720. In Canada: Anaconda American Brass Limited, Ontario.

2.8.30

Think copper, think ANACONDA
AMERICAN BRASS COMPANY

Circle 21 on reader service card

There wouldn't have been an electrical failure if a design engineer had used a platinum group metal



Platinum is virtually indestructible, chemically inert, catalytically active, has a high melting point, and has excellent electrical properties. (MBI supplies all forms of platinum. Ask for our catalog.)

MBI

MATTHEY BISHOP, INC.
MECHANICAL DIVISION
Platinum Mechanical Department
MALVERN, PENNSYLVANIA 19355
A Johnson Matthey Affiliate

Meetings

Medicine men face hard times

At many engineering conferences, more can be learned in the hotel lobby, bar, and dining room than at the technical sessions because what's said from behind a rostrum is generally sugar coated. This should be especially true in Chicago from July 19 through 25 at the concurrent International Conference on Medical and Biological Engineering, and the Conference on Engineering in Medicine and Biology.

For one thing, many of the attendees don't know where their next dollar is coming from, though they know it's not likely to come from the National Institutes of Health. Washington's economy drive is hitting NIH hard, and a lot of new and expanded projects will go begging. The most optimistic outlook is that NIH will have a "holding" budget until the war is over.

Danger. Another problem facing engineers in medicine, one that's the subject of increased questioning, is the safety of medical instrumentation. And the questions will be asked at the conference, most likely at the two instrumenta-

tion sessions chaired by the Illinois Institute of Technology's William Reynolds and NIH's Dr. Robert Bowman, and at the patient-monitoring session to be conducted by Northwestern University's Dr. F. J. Lewis.

The IEEE hasn't been able to standardize medical instrumentation, let alone set safety standards. In fact, the Association for the Advancement of Medical Instrumentation (AAMI, pronounced Amy), formed a few years ago to try to bring some standardization to the field, this year for the first time will be one of the sponsors of the conference.

The best-attended sessions will probably be the two dealing with artificial organs. They have the stars: Dr. Michael DeBakey will lead one, Dr. Adrian Kantrowitz the other.

An unusual feature will be the plenary session on Wednesday. The afternoon meeting will have sections on engineering in surgery, oceanography, and the delivery of health services.

For information contact IEEE, 345 East 47 St., New York, N. Y.

Calendar

Conference on Measurement Education, IEE; University of Warwick, Warwickshire, England; **July 8-10.**

Conference on Nuclear and Space Radiation Effects, IEEE; Pennsylvania State University, University Park, Pa.; **July 8-11.**

International Conference on Medical and Biological Engineering, International Federation for Medical and Biological Engineering, Joint Committee on Engineering in Medicine and Biology, IEEE, Instrument Society of America, American Society of Mechanical Engineers, American Institute of Chemical Engineers; Palmer House, Chicago; **July 19-25.**

Annual Conference on Engineering in Medicine and Biology, International Federation for Medical and Biological Engineering, Joint Committee on

Engineering in Medicine and Biology, IEEE, Instrument Society of America, American Society of Mechanical Engineers, American Institute of Chemical Engineers; Palmer House, Chicago; **July 19-25.**

Conference on Instrumentation Science, Instrument Society of America; Hobart and William Smith College, Geneva, N.Y.; **July 28-Aug. 1.**

Seminar on Case Studies in System Control, IEEE; University of Colorado, Boulder; **Aug. 4.**

Joint Automatic Control Conference, IEEE; University of Colorado, Boulder, Colo.; **Aug. 5-7.**

Third Annual Contemporary Filter Design Seminar, University of Missouri, Columbia, Mo.; **Aug. 5-8.**

(Continued on p. 24)

ALLEN-BRADLEY
Metal-Grid resistor networks
combine a new measure of

precision, stability and performance in a sealed, compact package



Precision Metal-Grid resistor network shown
approximately 1½ times actual size

The advanced capabilities—developed from years of manufacturing Allen-Bradley Metal-Grid resistors—are now applied to a new line of resistor networks. This technology enables the production of complex resistive networks on a single substrate.

Allen-Bradley's exclusive simultaneous deposition method is used to obtain the best resistance tolerance and temperature coefficient matching. The reliability of interconnections on the common resistance plane is incomparable. Uniformity and quality are inherent in A-B networks. To illustrate, 2 PPM temperature tracking is normal.

A-B Metal-Grid networks offer a wide range of values—with individual resistances as low as 25 ohms and as high as 2.0 megohms. Both the inductance and capacitance are low, permitting efficient operation at high frequencies.

A-B engineers will be pleased to cooperate in developing networks for your specific need. For additional details, please write to Henry G. Rosenkranz, Allen-Bradley Co., 1201 S. Second St., Milwaukee, Wis. 53204. Export Office: 1293 Broad St., Bloomfield, N.J., U.S.A. 07003. In Canada: Allen-Bradley Canada Ltd.

BRIEF SPECIFICATIONS

Resistor Networks

Tolerances: $\pm 1.0\%$ to $\pm 0.01\%$
Resistance Matching: to 0.005%
Temperature Range: -65°C to $+175^{\circ}\text{C}$
Temp. Coef.: to ± 5 ppm/ $^{\circ}\text{C}$
Load Life (Full load for 1000 hr @ 125°C): 0.2% maximum change

Ladder Networks

Full Scale Accuracy: 10 bits or less, better than $\pm \frac{1}{4}$ least significant bit. More than 10 bits, better than $\pm \frac{1}{2}$ least significant bit.
Frequency Response: Less than 100 nanosecond rise time or settling time
Temp. Coef.: Less than 10 ppm/ $^{\circ}\text{C}$
Temperature Range: -65°C to $+175^{\circ}\text{C}$

ALLEN-BRADLEY
QUALITY ELECTRONIC COMPONENTS

This is our service manager.



He hasn't seen his best relay customer in weeks.

One of our best customers is also the toughest we know when it comes to quality control. The mercury-displacement relays he buys must perform correctly every time. That's why he used to personally check every relay he ordered before a single one left our plant.

But no more. Adlake's quality control checks proved so reliable, his last visit was weeks ago.

What are your relay requirements?

Time Delay Relays, normally open or normally closed, with up to a 30 minute delay; *Load Relays*, to 100 amp capacity; *Dry Reed Relays*, standard and miniature types, with 1 to 4 poles; *Mercury Wetted Contact Relays*, Form C and Form D, 2 amp and 5 amp capacity, both plug-in and printed circuit types.

Find out how Adlake can help you. Write for our *new* catalog. For service, delivery, and *quality*, you can depend on Adlake. Just like our best customers do.

SEE OUR COMPLETE CATALOG IN eem



THE ADAMS & WESTLAKE COMPANY

Elkhart, Indiana 46514 • (219) 264-1141 • TWX (219) 522-3102 • TELEX 25-8458 • Cable ADLAKE

 SUBSIDIARY OF
ALLIED PRODUCTS CORPORATION

Meetings

(Continued from p. 22)

International Photoconductivity Conference; Stanford University, Palo Alto, Calif.; Aug. 12-15.

Western Electronic Show & Convention (Wescon), IEEE; Cow Palace & San Francisco Hilton Hotel, San Francisco; Aug. 19-21.

Symposium on Programing Languages Definition, Association for Computing Machinery; San Francisco; Aug. 24-25.

Defects in Electronic Materials for Devices, Metallurgical Society of the American Institute of Mining, Metallurgical, and Petroleum Engineers; Statler-Hilton Hotel, Boston; Aug. 24-27.

ACM National Conference and Exposition, Association for Computing Machinery; San Francisco Civic Center; Aug. 26-28.

Cornell Biennial Conference on Engineering Applications of Electronic Phenomena, IEEE; Cornell University, Ithaca, N. Y.; Aug. 26-28.

Education and Training Technology International Convention, IEE; London, England; Sept. 2-6.

Electrical Insulation Conference, IEEE; Sheraton-Boston Hotel & War Memorial Auditorium, Boston; Sept. 7-11.

European Microwave Conference, IEE; **International Symposium on Man-Machine Systems**, IEE; St. John's College, Cambridge, England; Sept. 8-12.

Convention of the Society of Logistics Engineers; Cape Kennedy Hilton Hotel, Cape Canaveral, Fla.; Sept. 9-10.

Petroleum & Chemical Industry Tech. Conference, IEEE; Statler Hilton Hotel, Los Angeles; Sept. 14-17.

International Telemetry Conference, International Foundation for Telemetering, Sheraton Park Hotel, Washington, D.C.; Sept. 15-17.

Conference on Trunk Telecommunications by Guided Waves, IEE; London, England; Sept. 15-17.

Solid State Devices Conference, IEE; University of Exeter, Exeter, Devon, England; Sept. 16-19.

Symposium on the Biological Effects and Health Implications of Microwave Radiation, Biophysics Department of the Virginia Commonwealth University, Bureau of Radiological Health, Environmental Control Administration, and U.S. Public Health Service; Richmond Va., Sept. 17-19.

(Continued on p. 26)

New complementary NPN/PNP power transistors from GE

Color-molded to end assembly mix-up

Now available in volume from General Electric . . . two new 1-amp and 3-amp pairs of low-cost complementary power transistors. These NPN/PNP pairs feature low saturation voltage, excellent gain linearity and fast switching . . . all in a sensible package, at a sensible price. GE's flat silicone-encapsulated power tab package is rugged enough to withstand hard use, and *with the new narrow leads (25 mils), can easily be formed to either TO-66 or TO-5 configurations.* To help eliminate NPN/PNP confusion during your assembly, each type is molded in distinctive color. No need for separate storage and production facilities for each type.

GE's new complementary power transistors are ideal for any class B audio application—everything from auto radios, tape players to televisions and stereo phonographs—from 3 to 20 watts output. These new NPN/PNP pairs are also well suited for use as drivers for higher power transistors, regulators, inverters, motor controls, lamp controls, solid-state relays, core drivers and many other applications. The 2.1W P_r free air rating allows simple printed circuit board assembly with no additional heat sinking. With added heat sinking, as much as 12W power

dissipation can be achieved. Performance at these levels is everything you'd expect from General Electric, leader in power semiconductors.

TYPE NUMBER	D40D (NPN)	D41D (PNP)	D42C (NPN)	D43C (PNP)
new				
previous	D28D	D31B	D27C	D27D
I _c (continuous)	1A		3A	
(peak)	1.5A		5A	
V _{CE} (sat.) Max.	0.5V @ 0.5A		0.5V @ 1A	
V _{CEO} (sus.)	30V, 45V and 60V		30V, 45V and 60V	
Total Power Dissipation				
Free air @ 25 C	1.25W		2.1W	
Tab @ 25 C	6.0W		12.0W	
h _{FE} (min.)	50 @ 0.1A/2V 10 @ 1A/2V		40 @ 0.2A/1V 20 @ 1A/1V*	
f _T (typ.)	60MHz		45MHz	

*Types available with h_{FE}=20 min. @ 2A/1V

For more information on these and other General Electric semiconductor products, call or write your GE sales engineer or distributor, or write General Electric Company, Section 220-72, 1 River Road, Schenectady, N.Y. 12305. In Canada: Canadian General Electric, 189 Dufferin Street, Toronto, Ont. Export: Electronic Component Sales, IGE Export Division, 159 Madison Avenue, New York, N.Y. 10016.

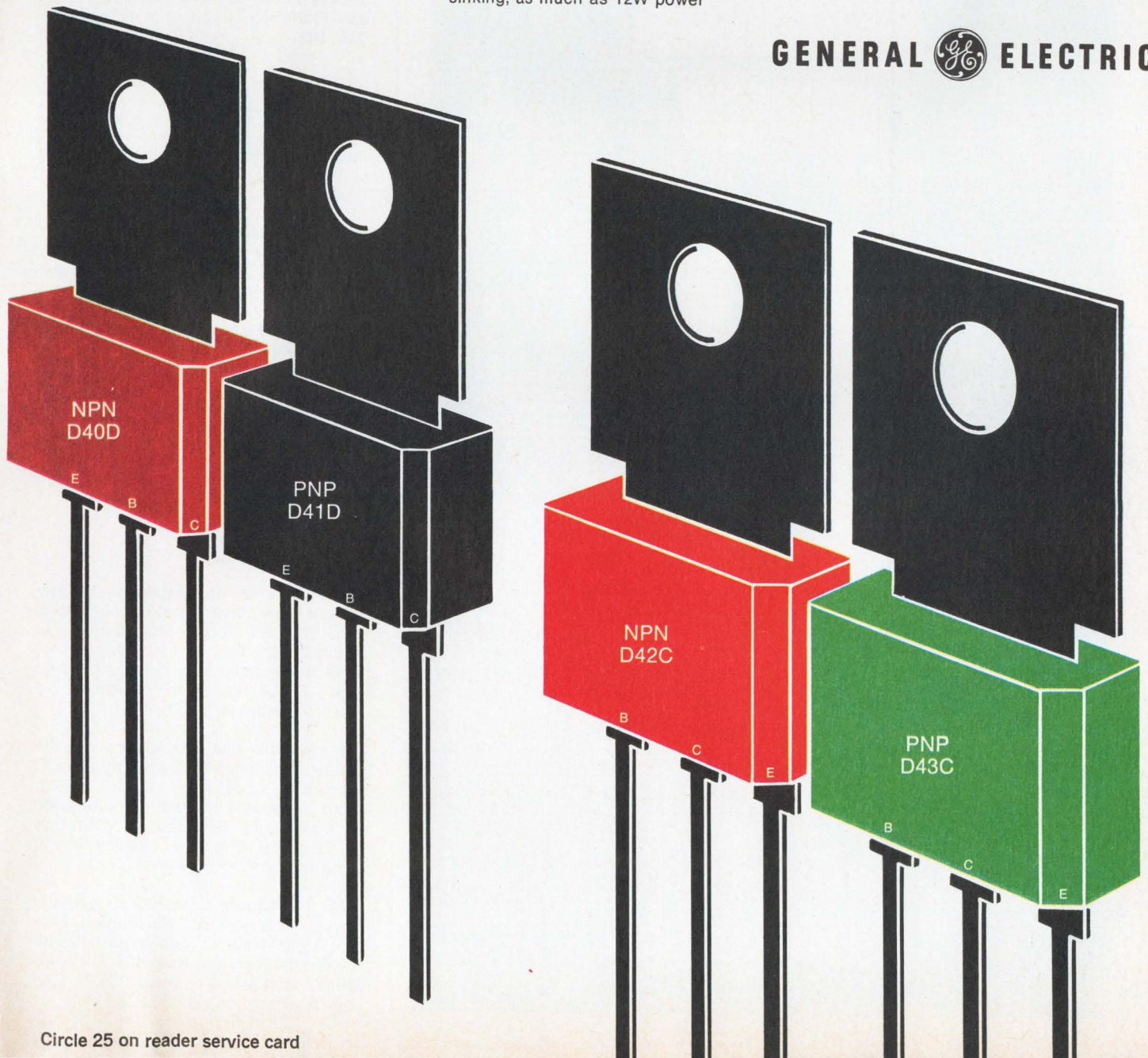

GENERAL  ELECTRIC

The Informer

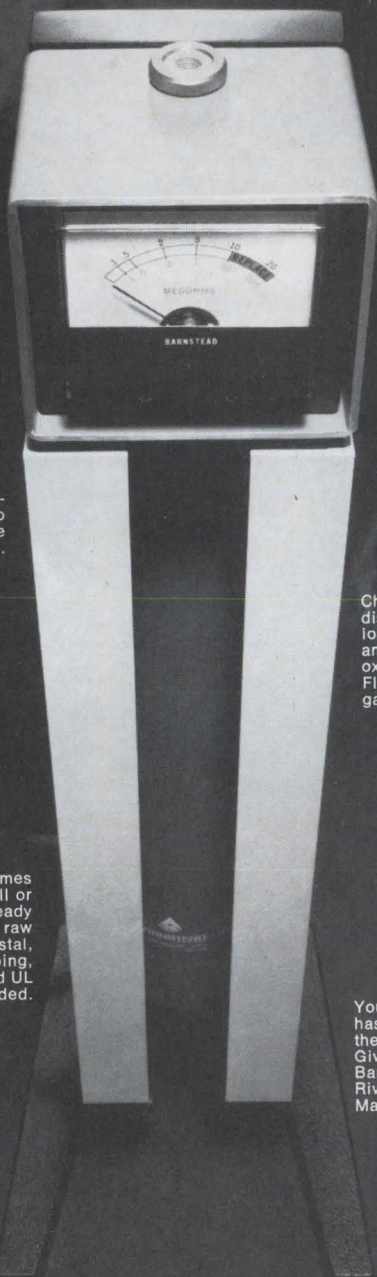

The new Barnstead Bantam lab demineralizer. It tells you more. More precisely.

You get less sub-standard water and no wasted cartridge capacity.

Bantam holder comes complete for wall or bench mounting, ready to attach to your raw water line. Pedestal, inlet, effluent tubing, cord, plug and UL approval included.

It replaces the old "idiot lights" with a meter. With the flick of a switch you get an instant on-stream effluent read-out in parts per million and ohms resistance.

Choose from five different disposable cartridges. For ion exchange (multi-bed and mixed-bed, organic, oxygen or cation removal. Flow rates from 5 to 25 gallons per hour.

Your Barnstead dealer has the information on the entire Bantam series. Give him a call or contact Barnstead Company, 225 Rivermoor Street, Boston, Massachusetts 02132.

 **BARNSTEAD**
SYBRON CORPORATION

Meetings

(Continued from p. 24)

Annual Broadcasting Symposium, IEEE; Mayflower Hotel, Washington
Sept. 18-20.

Joint Power Generation Conference, IEEE, American Society for Mechanical Engineers; Charlotte, N.C.,
Sept. 21-25.

Annual Intersociety Energy Conversion Engineering Conference, IEEE, American Society for Mechanical Engineers; Statler Hilton Hotel, Washington, Sept. 21-26.

Ultrasonics Symposium, IEEE; Chase Park Plaza Hotel, St. Louis, Mo.,
Sept. 24-26.

Annual Convention of the American Society for Information Science; San Francisco Hilton, San Francisco,
Oct. 1-5.

Short courses

Introduction to Digital Logic, University of Wisconsin, Department of Engineering; July 21-25. \$200 fee.

Modern Circuit Theory: Analysis, Synthesis and Computer Methods, University of California at Los Angeles; July 21-Aug. 1. \$375 fee.

Radiation Effects on Semiconductors, University of California at Los Angeles; July 21-Aug. 1. \$375 fee.

Photoelectronic Imaging Devices, University of Rhode Island, Department of Electrical Engineering; July 28-Aug. 8. \$330 fee.

Call for papers

Symposium on Application of Magnetism in Bioengineering, IEEE, Magnetics Group, Israel Society for Biomedical Engineering; Dec. 9-11. **Aug. 15** is deadline for submission of abstracts to E.H. Frei, Weizmann Institute of Science, Rehovot, Israel.

Management and Economics in the Electronics Industry Symposium, IEE; Edinburgh, Scotland, March 17-20, 1970. **Abstracts should be submitted** to Conference Secretariat, Institution of Electrical Engineers, Savoy Place, London W.C. 2, England.

IEEE Transducer Conference; National Bureau of Standards, Washington, May 4-5, 1970. **Nov. 1** is deadline for submission of papers to Robert B. Spooner, IMPAC Instrument Service, 201 E. Carson St., Pittsburgh, Pa. 15219.

We Androids absolutely demand Guardian Steppers

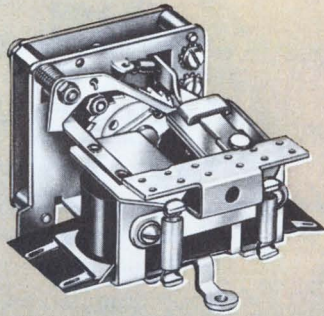

If there's one thing a robot hates it's that embarrassing maintenance check! That's why we want long-life components built for dependable operation. Like Guardian stepping relays (some humans call them rotary stepping switches). They average over five million operations on the life-test rack.

Then, too, Guardian steppers are compact . . . replace relays in series or banks of multiple circuitry . . . so we keep slim.

If you don't want a fat, broken-down android on your hands, specify Guardian steppers. Lots of types available . . . sequence selecting, automatic resetting, pulse multiplying, slave and master, etc., etc. Up to 52 contacts per deck . . . up to 8 undivided circuits. Write for Bulletin F32.

GUARDIAN[®]

GUARDIAN ELECTRIC MANUFACTURING COMPANY

1550 W. Carroll Ave. • Chicago, Ill. 60607



Circle 27 on reader service card

An equal-opportunity contact.

New connectors with universal JT design concepts assure greater standardization for all.



JT connectors with rear-release crimp contacts have a lot of fans. Because they have lots of advantages. But there haven't been many ways to take advantage of these advantages. Until now.

Now, there are all kinds of ways to benefit from rear-release crimp contacts. Because Bendix is now putting them in all kinds of connectors: rectangular, cylindrical, printed-circuit, rack-and-panel. With fixed solder or filter contact options. With all kinds of shell types and sizes. With all kinds of insert patterns with 12-, 16-, 20-, 22- and 22D contacts. With high-density models with up to 128 contacts.

All to give you the opportunity to standardize. To ease operation, installation and maintenance problems in the field. To cut back on spares and application tools. And to reap all the benefits that have become traditional with Bendix JT connectors: compactness, light weight, reliability and long life.

There's another traditional benefit with Bendix connectors: innovation. Bendix is constantly introducing new connectors following the universal terminations concept. Which means you can look forward to even more opportunities to standardize. For details, contact: The Bendix Corporation, Electrical Components Division, Sidney, New York 13838.

Bendix

Electronics

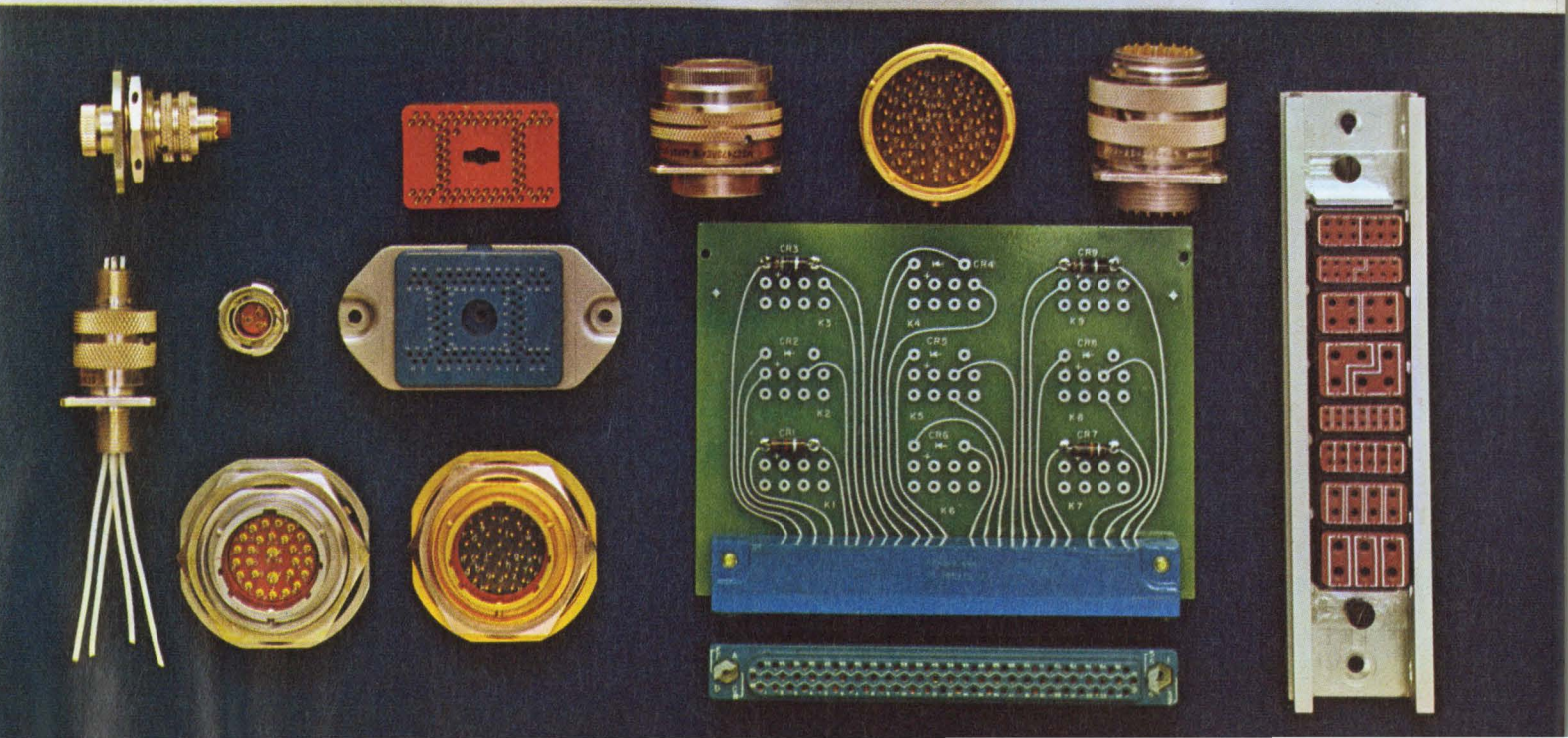
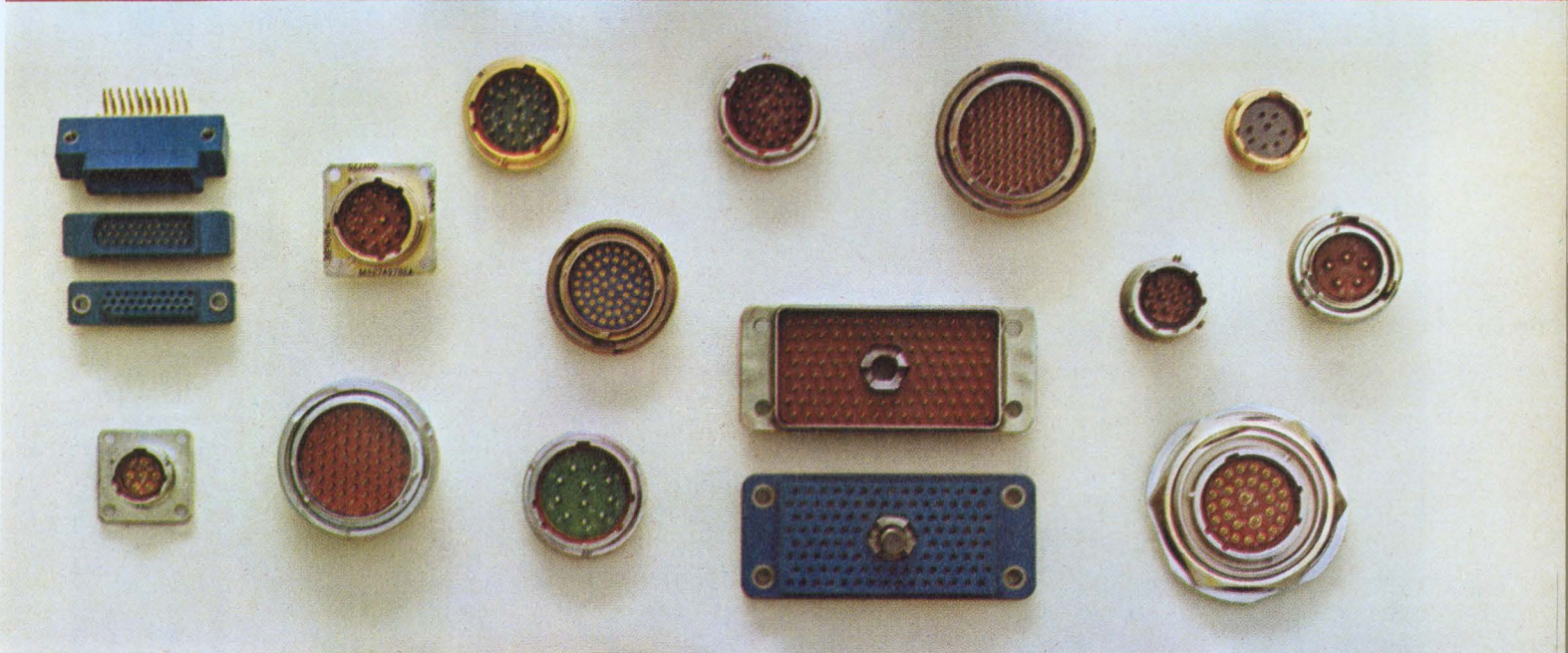
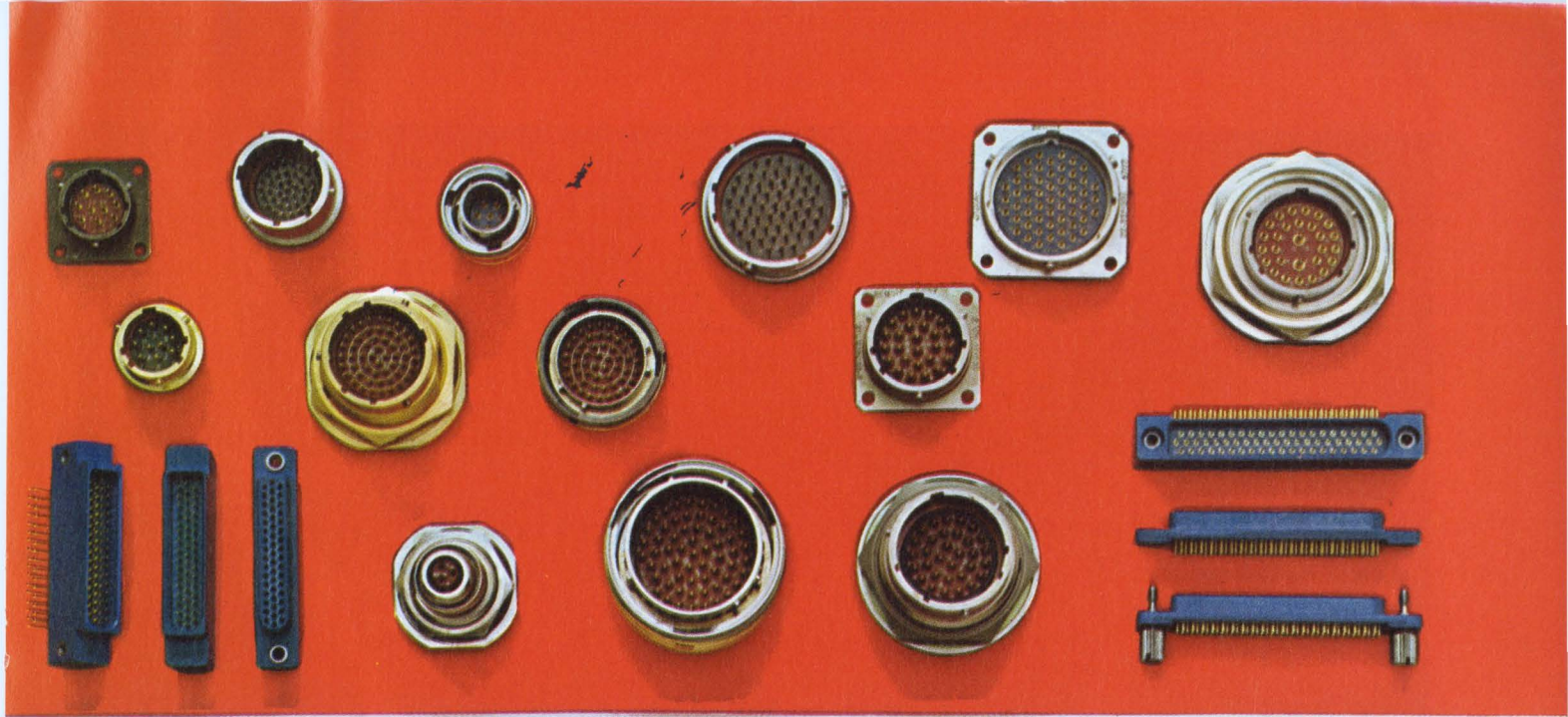

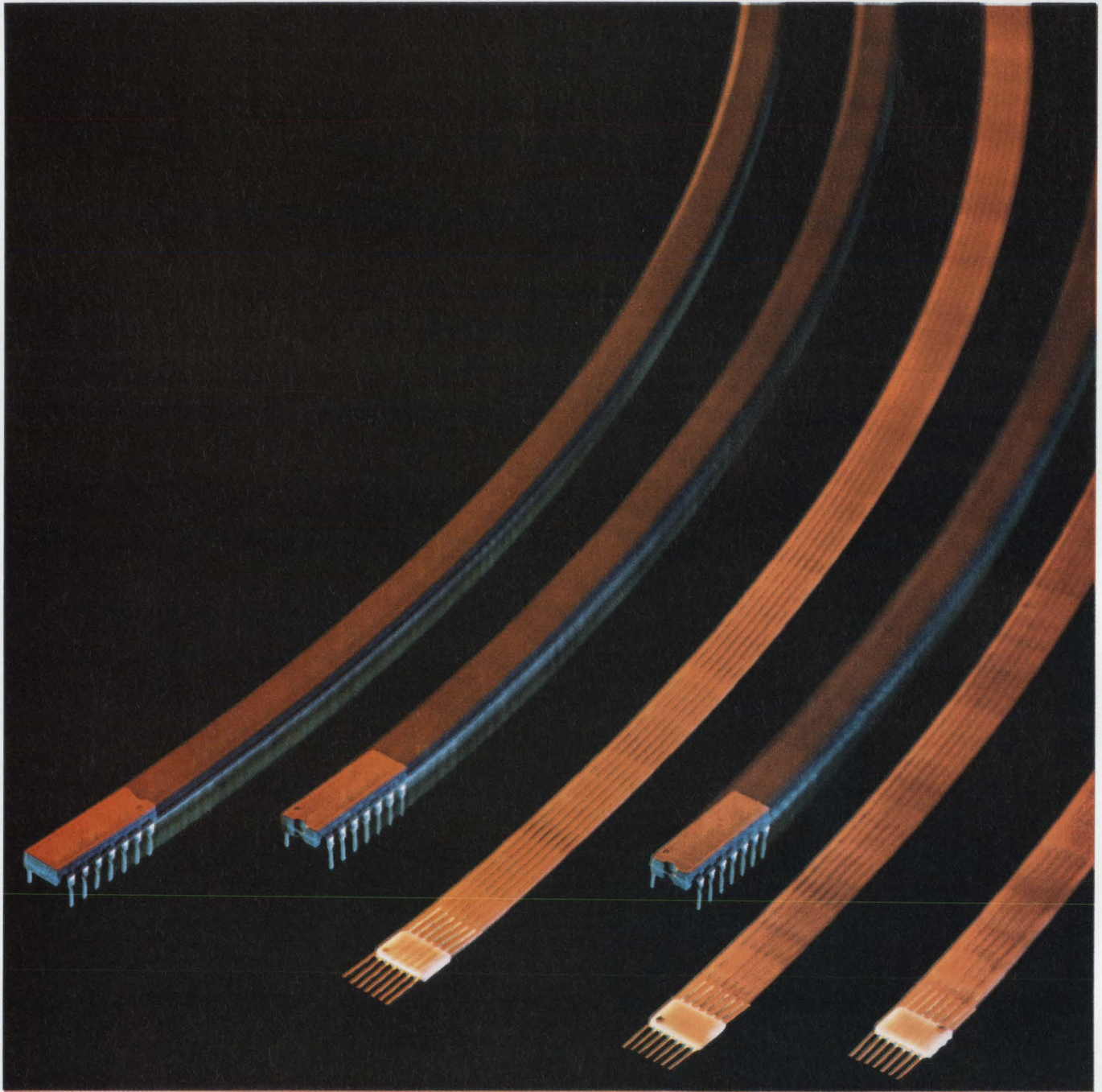

Sprague Digital ICs. Illustration: Series 54H/74H in flatpack and DIP

Just arrived. Series 54H/74H. The fast ones.

Just about the fastest saturated logic circuits around. Series 54H/74H from Sprague. The whole family. Flip-flops and all.

Use them in arithmetic and processing sections, where speed really counts. Mix and match them with Sprague's standard Series 54/74.

Get off to a fast start with Sprague Series 54H/74H.

TYPICAL CHARACTERISTICS	GATES	FLIP-FLOPS
Propagation Delay	6 nsec	17 nsec
Power Dissipation	22 mW	80 mW
Noise Immunity	1 V	1 V
Temperature Range	-55 to +125° C	
Series 54H	0 to +70° C	
Series 74H	DIP or Flatpack	
Packages		

Call Sprague Info-Central (617) 853-5000 extension 5474.

Or call your Sprague industrial distributor. He has them on the shelf.
For complete specifications, circle the reader service number below.

455-9127

30

Circle 30 on reader service card



Electronics | July 7, 1969

Editorial comment

Great expectations . . .

It is beginning to dawn on some sections of the American public that technology per se cannot be blamed for critical social problems. Moreover, they're beginning to realize that most solutions call for manipulation of political, social, and economic factors, as well as technology. Nonetheless technology stands challenged, and the technologist does not always respond in a rational manner. He feels obligated to defend technology itself, oftentimes when what's really involved is unwise application—as, for example, to the wrong problem at the wrong time. There's also the possibility the engineer or the scientist may over-react, proposing advanced or unproven technology where it is not even required. In illustrating this point, William Harris, president of the Engineers Joint Council and director of technology at Battelle Memorial Institute, suggests that the vast majority of today's urban-crisis problems do not require the development of significant new technology; solutions, says Harris, are not research and science limited.

Just what is the role of research and development in today's complex society? One good answer is offered by Donald MacArthur, deputy director for research and technology, DDR&E. Research and development, says MacArthur, is in the "option-creating business." From among the options presented, society represented by government or

industry must select a most favorable alternative. The technologist is rarely able to present the best singlehandedly. He needs help from the economist and from the social scientist. Not surprisingly, then, the skillful management of technology is a talent in great demand. As Ralph Siu, former deputy director of the National Institute of Law Enforcement, puts it, managers of technology and innovation are just as important as technical experts. Such executives must have the added dimension of "practical wisdom," Siu says. They must be excellent "impedance matchers," linking solutions to problems. Despite the recognition of these objectives, guidelines for the wise management of technology are hazy or nonexistent. A panel of scientists representing Federal agencies was recently asked this theoretical question: Where does responsibility rest in limiting the development and sale of a new device that might have deleterious effects on the human environment? The panel could not provide a simple clear answer.

The system for managing research and technology in the U.S. clearly requires an overhaul. What is needed is a revision at the national level, with particular attention paid to the role of the Federal Government in supporting the development of new technology and influencing its application to national goals.

. . . and a fourth dimension

Among the most interesting (and undoubtedly the most controversial) proposals made for revamping the way in which the U.S. sets its goals and then applies technology to their achievement is one calling for the establishment of a fourth branch of the Federal Government. The proposal was most recently and clearly set forth in a paper prepared by Nicholas Golovin, for years a member of the National Bureau of Standards staff. The paper was read to a recent meeting of the National Security Industrial Association.

The new body, to be called the evaluation branch, would probably require an amendment to the Constitution. A primary justification for the separate branch lies in its capacity to provide a heavy dose of objectivity in helping the country determine its goals and adjust priorities. Choices made by the body would be weighted in favor of the general welfare instead of special interests. Since its studies would not be controlled by the executive branch, lawmakers might be more favor-

ably inclined to act on its recommendations. In effect, the new branch would serve as a "national information generator." It would operate as a "sub-system" within the system (the country) to evaluate its progress and generate "error signals." The new branch would include the country's leading analytical minds and would enjoy a status and neutrality on a par with that of the judicial branch.

The fourth branch is not the only alternative to providing an analysis and evaluation mechanism within the Federal Government. Others include an advisory citizens committee on goals and priorities and a cabinet-level department of science and technology. A Congressional subcommittee under the direction of Rep. Emilio Q. Daddario (D., Conn.) is presently examining these alternatives. Whether or not the idea of the new evaluation branch receives sufficient support during current hearings to be seriously considered for further study may be less important than the perspective that the bold idea gives to the problem. ■

If signal analysis from 10 Hz to 50,000 Hz is your concern, Systron-Donner's new spectrum analyzer will simplify your tasks and extend your measuring capabilities as never before.

Our 710/800 gives you absolute amplitude measurements over a 140 dB dynamic range, any 60 dB of which appears on a large 7 x 10 cm high-contrast display. Wave analysis, distortion studies, and spectral display are enhanced by a full 50 kHz scan and a narrow 10 Hz resolution. For measuring EMI and other low-level signals, you get very high sensitivity (calibrated to 30 nanovolts/cm) plus selectable input impedances of 50 ohms, 600 ohms, 10k ohms, and 1 megohm. And you get X-Y outputs, pen lift, sync and sweep inputs, plug-in versatility and many other standard features—all for \$2495.

This spectrum analyzer is truly portable. It weighs only 25 lbs.—or 30 lbs. with an optional internal battery that operates up to 8 hours before recharging.

Write for complete specifications. Ask for a demonstration. Contact Microwave Division, Systron-Donner Corporation, 14844 Oxnard St., Van Nuys, Calif. 91409. Phone: 213-786-1760.

New spectrum analyzer covers 10 to 50,000 Hz with universal measuring capability*

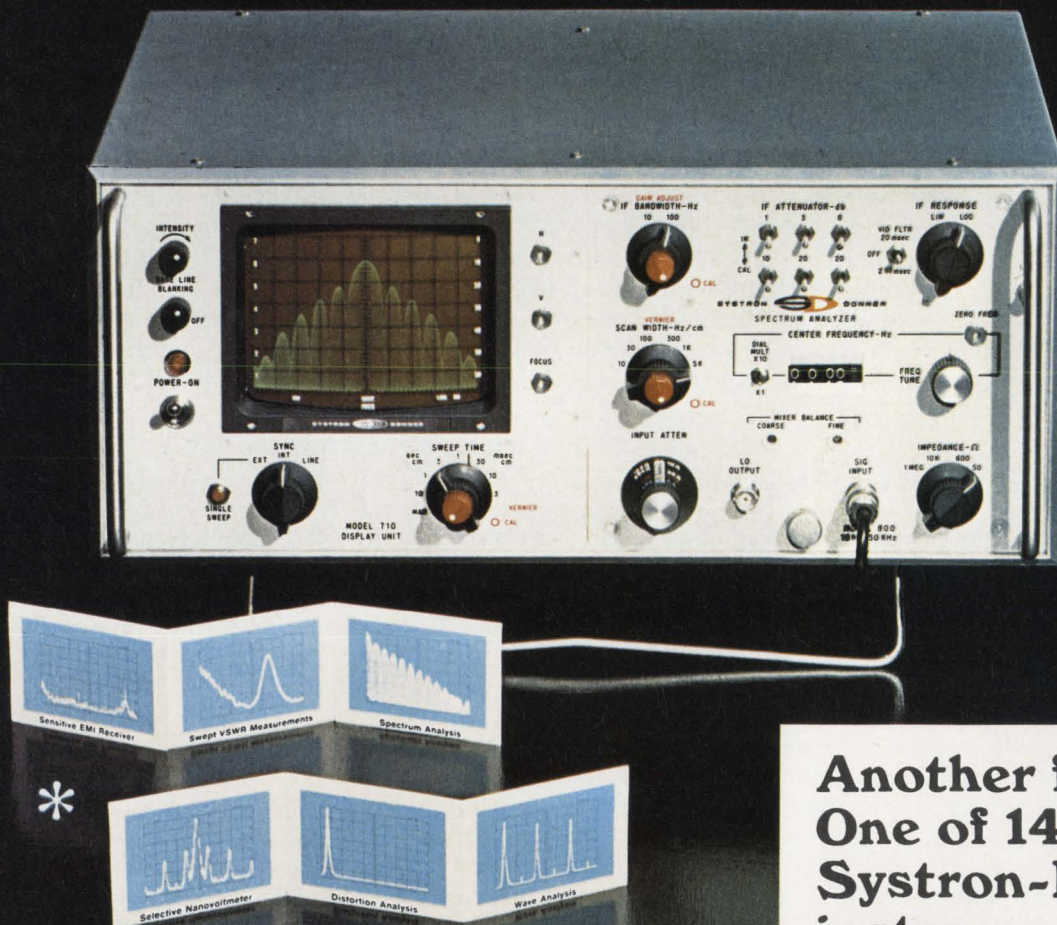

Another first. One of 145 Systron-Donner instruments

Electronic counters	Digital voltmeters
Pulse generators	Spectrum analyzers
Microwave frequency indicators	Digital panel meters
Digital clocks	Microwave signal generators
Memory testers	Laboratory magnets
Analog computers	Data acquisition systems
Time code generators	Microwave test sets
Data generators	

Circle 32 on reader service card

SYSTRON  DONNER

Electronics Newsletter

July 7, 1969

L-1011 navigator to combine simple, complex modules

Lockheed-California has decided to meet the L-1011's navigation needs with a modular system combining a simple design for area navigation with a sophisticated version for long-range requirements.

The simple configuration will probably require two general-purpose digital computers into which up to 500 waypoints can be inserted by magnetic tape to map the shortest, great circle, route between destinations; the alternative would be to have the trijet airliner fly from one VOR (very-high-frequency omnirange) station to another. However, the system will use VOR and DME (distance measuring equipment) inputs.

For fully inertial navigation, it will use two computers and three new inertial platforms designed to give both long-range inertial and area navigation. Today's Arinc Characteristic 561 inertial navigation system, such as Litton's LTN-51 and AC Electronics' Carousel 4, don't provide the area navigation feature. The inertial platforms, following the guidelines of the HAS-2 sensor expected to get Arinc approval, provide pitch, roll, attitude, and heading data, plus latitude and longitude outputs.

Lockheed is considering proposals from a number of avionics companies, one of which will be chosen to work with Lockheed on development and certification of the differing versions of the system. Once an Arinc specification exists for the HAS-2 platform and the area navigation computer, the competition could be reopened for production units. Lockheed expects the area navigation feature to greatly ease pilot workload in terminal navigation, because even terminal waypoints can be programmed into the computers. The system will mean big business for avionics manufacturers (181 of the L-1011's have been ordered) although Lockheed officials won't say what the various combinations may cost.

Motorola to unveil 30 more LIC's . . .

The surge in linear IC development and product introduction continues, with Motorola apparently the leader in quantity. Fairchild will introduce 10 new linears next month [*Electronics*, June 23, p. 33], with three more probably coming before year's end. But Jim Burns, Motorola's manager of linear product marketing and planning, says the Semiconductor Products division will introduce 30 devices the remainder of the year—and now has 90 circuits in development.

Coming soon is the MC1556, touted by Motorola as a "super" general-purpose op amp having a typical input offset of 1 nanoampere and a slew rate of 3 volts per microsecond. Motorola's 1969 line also includes a series of dual line drivers with 15-nanosecond propagation delays, a 7-to-35-volt voltage regulator costing between \$1 and \$2, plus circuits that offer dielectric isolation or beam leads. There also will be both a dielectrically isolated and a beam-leaded version of the 709 op amp.

. . . as it predicts a \$230 million market by 1974

All the linear IC activity is taking place against a background of uncertain market conditions and predictions of much better days ahead. While the total LIC market last year amounted to just \$60 million, Motorola expects it to reach \$70 million this year—despite a first quarter of \$12.7 million—and \$230 million by 1974.

A Texas Instruments spokesman sees the market shifting. Op amps make up 40% to 45% of the total, he says; IC fuses account for another

Electronics Newsletter

10%. But TI is emphasizing the computer interface portion of the op amp area, \$10 million sales picture that the company feels will grow to close to \$50 million within five years. The TI spokesman claims the new Fairchild and Motorola circuits are "fan-outs" from the basic 709 building block.

NASA doubts value of quick life tests

NASA, disenchanted with accelerated life tests, is searching for another method of gauging the reliability of semiconductors. Engineers at the space agency's Electronics Research Center in Cambridge, Mass., say present methods—simulating long-term reliability by testing semiconductor response to increased current, voltage, or temperature—fall far short of yielding meaningful data. Acceleration itself, they contend, may cause failures that wouldn't normally occur under actual operating conditions.

The center is about to order a study that it hopes will come up with new ways of screening silicon semiconductors for time-dependent failure modes. One approach may be based on short-term noise performance.

Tovio M. Liimatainen, acting branch chief at ERC, sees the study as part of the technical groundwork for NASA's Grand Tour—an unmanned probe of the outer planets [*Electronics*, June 23, p. 69]. He feels that the data obtained from present testing methods is insufficient to assure mission reliability.

Casoff/PLRACTA—a rose by any other name

Remember Casoff, the Air Force program to watch in 1967? Never implemented, it would have provided wide-area positional data, noninterfering communications, and identification, friend or foe—thus the name Casoff, for control and surveillance of friendly forces. A study contract was expected early in 1968, but it never came about.

Now Casoff is back, but under a new name—PLRACTA, for position, location, reporting, and control of tactical aircraft. The objectives are the same, except that as PLRACTA, they are incorporated into the thin-thread experimental I/CNI system [*Electronics*, June 9, p. 37]. PLRACTA simply becomes a list of mission requirements rather than a system.

Hugle gets four outside customers assembly lines

The latest company to join the list of firms housing semiconductor assembly operations dedicated to outside customers [*Electronics*, July 8, 1968, p. 129] is Hugle Industries, the Sunnyvale, Calif., manufacturer of wafer fabrication and assembly equipment for the semiconductor industry. Under the terms of four development contracts worth at least \$1.5 million, Hugle will set up four nonmilitary production lines—three to do automatic assembly of hybrid thick-film circuits using flip-chips, and one automating the die attach and wire-bonding operations.

Ray 3 TTL used in new computers

Raytheon's Ray 3 transistor-transistor-logic, the so-called super Suhl [*Electronics*, Dec. 23, 1968, p. 34] has been designed into a family of small and medium Univac computers to be introduced next year. Although Univac denies it, reliable industry sources say the initial order is for 100,000 circuits at \$3 apiece; the total could reach 140 million circuits during the life span of the machines. Fairchild is believed to be a second source, with additional sources to be named later.

SEMICONDUCTOR NEWSBRIEFS

PUBLISHED BY MOTOROLA SEMICONDUCTOR PRODUCTS INC.

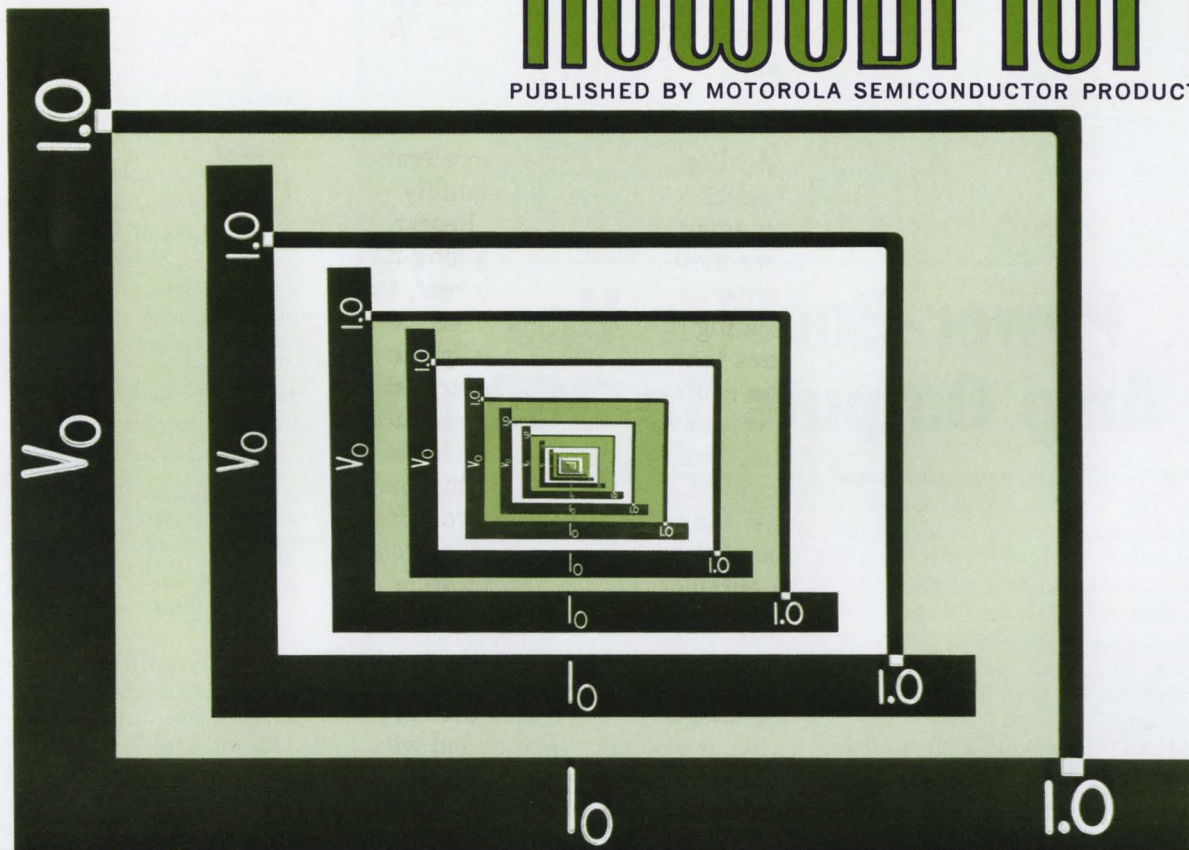

Now ICs That Regulate Voltages Set By External Transistors!

The latest additions to Motorola's growing family of integrated circuit regulators, the MC1566L/1466L, now makes it possible to **regulate any voltage** from zero up to a limit set only by the breakdown voltage of a series-pass transistor at the input (see schematic).

As a result, you can now use just one IC for all your regulation requirements, from millivolt levels to hundreds-of-volts!

Just like its predecessors in Motorola's expanding IC regulator line (MC1560/1460, MC1561/1461), the MC1566L/

1466L offers built-in short-circuit protection and an internal reference/regulator stage. The former protects the regulator under sustained output short-circuiting, while the latter provides regulating characteristics that are essentially independent of output voltage.

The MC1566L and its limited temperature-range counterpart (MC1466L) are ideal for broad-range adjustable power supplies. Line or load-voltage and current can now all be regulated, over a wide spectrum, all from a single system! And, these ICs have tight tolerances too. Line or load voltage regulation is spec'd at 0.01% + 1 mV while current regulation is 0.1% + 1 mA.

Both units are immediately available from distributor stock in the TO-116 14-lead ceramic dual in-line package. 100-up prices: MC1566L — \$24.50; MC1466L — \$8.50.

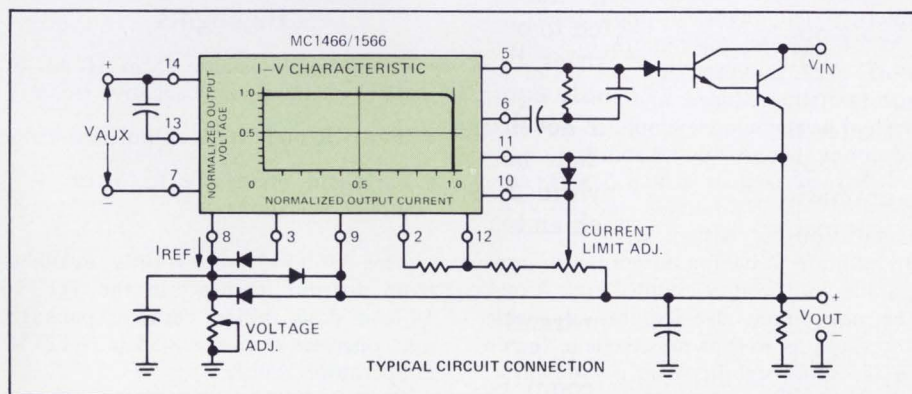

For details circle Reader Service No. 498



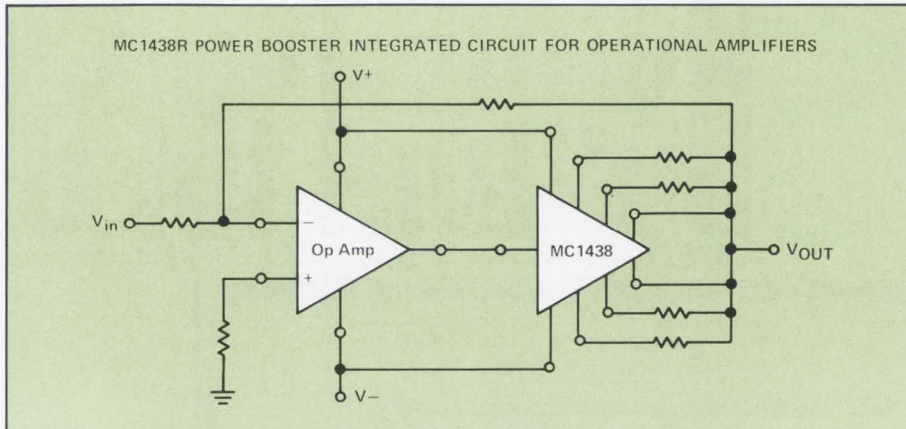

Power-Booster Ups Op Amp Outputs To 300 mA

The MC1438R is a unity-gain isolation amplifier, which is ideally suited to follow and boost the power of an operational amplifier (such as the MC1439). It can drive low-impedance current loads up to ± 300 mA. This new IC booster-amplifier makes it possible to develop completely integrated power systems, thus eliminating the need for discrete-IC hybrid designs.

The MC1438R features a high input impedance of 0.5 Megohm (typ), allowing the gain of an op amp to approach unloaded open-loop gain and thereby reducing thermal drift (the internal power dissipation of the op amp is independent of output voltage). Its low output impedance — 10 ohms, typ. — permits the MC1438R to drive greatly reduced phase-shift capacitive loads with

a substantial increase in output voltage swing. Current limit is adjustable from ± 5 mA to ± 300 mA. The MC1438R also exhibits a power bandwidth which is considerably higher than present operational amplifiers—1.5 MHz, typ. (bandwidth and slew-rate is limited only by the op amp itself). And, it has an excellent power rejection ratio of 1.0 mV/V, typ.

In addition to its ability to operate as a power-booster, the MC1438R can be combined with op amps to form such functions as ramp-generators, supply splitters and voltage-programmable power sources.

Units are available from distributor stock in the 9-pin TO-66 style package, which is capable of handling up to 17.5 Watts. Its 100-up price is just \$6.50.

For details circle Reader Service No. 499

Dual MECL-Output Sense-Amp IC Eliminates Core Memory Interfacing Problems

For the first time, the designer can “leapfrog” interfacing requirements between the sense-amplifier and core memory sections of even the highest speed computers!

The **MC1543L** — An IC Sense-Amplifier with MECL-outputs (emitter-coupled logic) makes it possible to eliminate the need for more costly linear-to-logic conversion circuitry! In addition, because this new circuit has two input channels, you can reduce by as much as one-half, the number of IC Sense-Amp packages required for 0.5

microsecond “memory” applications.

It's a combination that's hard to beat! Both package-count and costs can be substantially reduced and, the over-all system design can be simplified — with a resultant increase in reliability.

Characterized as a dual MECL core memory sense amplifier, the MC1543 is DC coupled with a separate strobe. In addition to having output levels compatible with emitter-coupled logic levels, this new circuit also features adjustable threshold as well as an excellent degree of threshold stability over a wide variation in power-supply voltage.

For details circle Reader Service No. 501

New MC1741C Op Amp Is Both Monolithic And Internally-Compensated!

For years Motorola has offered a variety of top-performance Op Amps. All were monolithic, yet they lacked internal compensation.

So, we introduced the MCH1539 — a hybrid version that featured built-in compensation. Still, it wasn't monolithic.

Now, with the MC1741C Motorola provides the best of both . . . internal compensation and monolithic construction!

As a result, no external frequency compensation is required — saving the cost of a resistor and a capacitor as well as eliminating interconnections. The MC1741C also provides built-in short-circuit protection which further reduces

A large capacitor and a resistor, right on the MC-1741C chip, eliminates the need for external compensation.

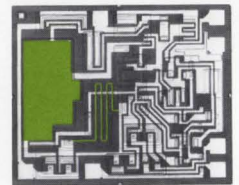

external circuitry requirements and increases reliability. In addition, “latch-up” problems are eliminated.

Some of the other outstanding features of MC1741C include: offset-voltage nulling; low power consumption; wide common-mode and differential-voltage ranges; and, it's pin-compatible with the MC1709.

It comes in the 8-lead, TO-99 metal-can and operates over the 0 to $+70^\circ$ range. Available from stock, the MC-1741C is 100-up priced at just \$3.25.

For details circle Reader Service No. 500

Highlights

- Threshold adjustable from 10 to 40 mV (for positive or negative signals)
- Both OR and NOR outputs available
- Threshold insensitive to + or — supply variations

The MC1543 is currently available from distributor stock, in the TO-116 14-lead dual in-line ceramic package; and, operates over the -55 to $+125^\circ\text{C}$ temperature range.

Price: \$18.00 (100-up).



New MRTL Trio Provides Total IC Digital Counting!

Designers can now utilize a new MRTL threesome to develop completely integrated digital readout systems which are smaller, faster, more reliable and

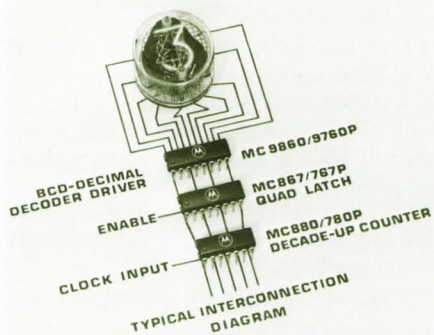

Only three MRTL circuits, costing roughly \$13.50, can actuate a complete decade readout system, thus reducing both design costs and size.

much less costly than discrete or hybrid approaches. The combination of just these three MRTL ICs — the MC9760/9860 BCD-Decimal Decoder/Driver, the MC867/767 Quad Latch and a Decade-Up Counter (MC880/780) — does the total job, thus reducing component density, wiring and PC board requirements (see illustration).

The MC880/780 is a monolithic 1-2-

4-8 Decade-Up Counter, consisting of four flip-flops, internally connected. Memory, or temporary storage is provided by the MC867/767 Quad Latch which "stores" the data while the MC880/780 is proceeding with the count. The MC9860/9760 converts the 1-2-4-8 code into a decimal output with sufficient voltage to drive a Nixie® or other gas-filled readout device.

These new MRTL circuits are supplied in Motorola's economical Unibloc dual-inline plastic package ("P" suffix); in 16-lead versions (MC9860/9760, MC867/767) and 14-leads (MC880/780). The MC700 series types operate over a temperature range of +15 to +55°C, while the MC800 series covers from 0 to 75°C.

All three of these new low-cost, plastic-packaged MRTL integrated circuits are immediately available from your local Motorola franchised distributor's warehouse stock. Order some of these combinations now and have them ready to reduce both the cost and size of your next digital-readout system design.

MRTL Type	Description	Price (1 K-up)
MC767P/867P	Quad Latch	\$3.00/\$3.40
MC780P/880P	Decade-Up Counter	3.00/ 3.40
MC9760P/9860P	BCD-Decimal Decoder/Driver	7.50/ 8.70

For details circle Reader Service No. 502

Dionic Structure Yields New Radiation-Hardened MDTL ICs

Six MDTL radiation-resistant ICs, forerunners of a new line specifically developed for applications requiring a high degree of reliability under severe radiation environments, are now available off-the-shelf. Motorola's Dionic structure (dielectric isolation) minimizes the effects of gamma radiation. As illustrated, individual islands are electrically isolated from the poly-crystalline material (and each other) by a layer of silicon dioxide. In addition, nichrome resistors and a post-metallization passivation process are used to enhance overall radiation resistance.

The result . . . ICs which remain fully functional and meet all pre-radiation electrical specs, even when subjected to gamma dose rates of 10⁹ rads/sec. and cumulative gamma dosage in excess of 5 x 10⁸ rads — as well as neutron exposure levels of 7 x 10¹³ NVT.

They are available in the 14-lead, TO-86 ceramic flat-pack (-55 to +125°C).



Type No.	Circuit Description	Price (100-Up)
MCE930F	Dual 4-Input NAND Gate	\$10.00
MCE932F	Expandable Dual 4-Input Buffer	10.95
MCE933F	Dual 4-Input Expander	7.30
MCE945F	Clocked Flip-Flop	18.00
MCE948F	Clocked Flip-Flop	18.00
MCE962F	Triple 3-Input NAND Gate	10.00

For details circle Reader Service No. 503

Parity-Trees Head List of Six New MTTL Complex Functions

Two new "parity-tree" circuits, which provide economical solutions to overall systems reliability, plus four memory

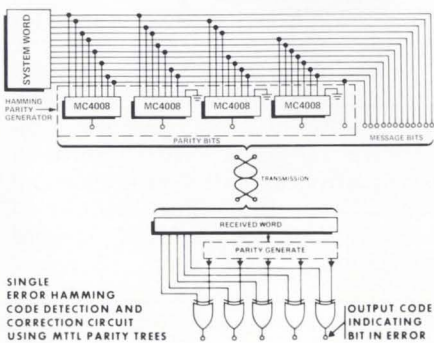

arrays, have been added to Motorola's fast growing MTTL complex functions line.

The MC4008L, an 8-bit parity-checker/generator, features an extra 2-input gate to expand the number of bits handled, or as a parity-bit input checker. The second, a dual 4-bit parity-tree (MC4010L), is ideal for checking 4-bit word lengths or increments of 4-bits. It consists of six 2-input exclusive NOR gates, connected to form two independent 4-bit parity-trees. Using these new MTTL ICs, sophisticated detection and correction systems can be developed (see illustration) which not only recognize that an error has occurred, but can also detect which "bit" is in error.

Both the MC4008L and MC4010L are expandable to as many bits as required without additional "gating" circuitry. These TTL/DTL compatible ICs come in the TO-116 14-pin dual in-line

ceramic package. The 100-up price is only \$7.75 for either unit.

XC-170 128-Bit ROM Derivatives

The MC4038P inverting/non-inverting 1-of-8 decoder has a 3-bit binary address which selects the desired word for the 8-bit output and exhibits address times of less than 45 ns, while the MC4039P is a seven-segment character generator for the direct operation of low-voltage indicators. The MC4040P decoder has two enable inputs and can transform any 4-bit binary number to a 2-of-8 bit code. The MC4041P single-error hamming code detector and generator is a programmed 128-bit ROM. Supplied in the 16-lead Unibloc plastic dual in-line package, the MC4038-41 are priced at \$5.10 each (1K-up).

For An Application Note and Data Sheets circle Reader Service No. 504



Both PNP and NPN monolithic Darlington Amplifiers, in plastic, provide greater low-cost design flexibility.

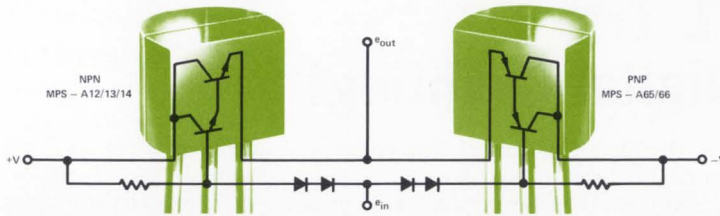

4 More PNP/NPN Unibloc Darlington Add Impetus To High-Gain Economy Designs

If you were enthused when Motorola announced its first low-cost Unibloc plastic Darlington Amplifier entry, the MPS-A12, in the fall of 1968 hold on — that was only the beginning!

Now Motorola makes available both PNP and NPN types (two new ones in each polarity), with minimum gains ranging from 5K to 75K, at unprecedented 20¢ - 30¢ price levels!

Whether you work with PNP or NPN polarities, or combine the two (as shown in the illustration), you can now achieve a substantial reduction in piece-parts, wiring and circuit size — not to mention individual transistor costs. For example, the PNP MPS-A65/A66 (which have minimum betas of 50K

and 75K, respectively), average out costing less than 15¢ per transistor — while the new NPN types, the MPS-A13/A14, cost even less. And, with a wide choice of betas available, you don't have to pay for more than you require.

Additional highlight parameters include: a high breakdown voltage of 30V (min) at 10 mA, low noise figures — 2dB (typ) at 1.0 mA, f_T (min) = 100 MHz (PNP) and 125 MHz (NPN) at 10 mA and leakages that do not exceed 100 nA.

Type No.	Polarity	h_{FE} (min) @ $I_C = 10$ mA	Prices (5,000-up)
MPS-A65	PNP	50,000	27¢
MPS-A66	PNP	75,000	29¢
MPS-A13	NPN	5,000	22¢
MPS-A14	NPN	10,000	25¢
MPS-A12	NPN	20,000	32¢

For details circle Reader Service No. 505

First Micro-T RF FET Expands High-Density Design Options

With the introduction of the MMT-3823 RF N-Channel JFET — the first field-effect transistor to be incorporated into the subminiature Motorola Micro-T package configuration — designers of high-frequency circuits can realize substantial reductions in equipment size without sacrificing efficiency and reliability. The dimensions of the Micro-T's ultra-small body (0.080" dia. x 0.053" thick, nom.) along with its flat, radial leads make it well suited for high-density "drop-in" strip-line PC board mounting and thick-film fabrication.

Although the MMT3823 Depletion Mode (type A) Micro-T JFET can be used as a mixer and switch, its primary applications lie in the RF amplifier area. Among the key parameters of this micro-miniature high-frequency FET is a 100 MHz noise-figure of only 2.0 dB (typ), both low cross-modulation and low intermodulation distortion, a high power-gain of 16 dB (typ) @ 100 MHz, as

well as low transfer and input capacitances of just 1.0 pF and 4 pF (typ), respectively. In addition, its drain and source are interchangeable. And, the MMT3823, like other Micro-T devices, dissipates a full 225 mW @ 25°C, ambient.

Low Noise-Figure (NF) @ 15V/1 Kohms/100 MHz	2.0 dB (typ)
Low Input Capacitance (C_{iss}) @ 15V/1.0 MHz	4 pF (typ)
Low Transfer Capacitance (C_{rss}) @ 15V/1.0 MHz	1.0 pF (typ)
High drain current (I_{DSS}) @ 15V	5 mA (min) 20 mA (max)
High Gate-Source Voltage (V_{GS})	30 V (min)
High Forward Transfer Admittance $ Y_{fs} $ @ 15V/1.0 kHz	3000 μ mhos (min) 8000 μ mhos (max)
Price (100-up):	\$3.50

For details circle Reader Service No. 506

Now a 4A @ 95°C Plastic SCR That Turns-On At 200 μ A—for Only 51¢

Designed for low-cost, higher-current applications in rugged consumer/commercial and industrial speed, light and heat-control circuits, the new MCR406/407 sensitive-gate, SCR series has "the best Thyristor value" written all over it!

This new SCR series offers: **High, 4 Amp RMS ratings!** even when operated at +95°C, case temperature (other 4 Amp SCR's are rated at 20°C -75° lower)! This higher-current-at-higher-temperature performance means you can realize a substantial savings in heat-sink requirements and ease your thermal design considerations.

Triggering at only 200 μ A! The ability to turn-on at low current levels makes them ideally suited for use with photocells, thermistors and other small-signal transducer sources, without additional stages of signal amplification.

THERMOPAD package! It's the only plastic SCR package having a short 0.032" chip-to-heat-sink thermal path

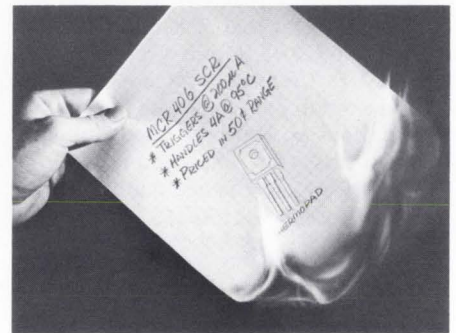

The MCR406 handles a full 4 Amps at 95°C and triggers at only 200 μ A levels — yet it's priced in the 50¢ area!

plus low 2.0°C/W thermal resistance for high dissipation. And, it's low-cost!

Annular die structure! Maximum, long-term dependability and performance, over a -40° to 110°C operating temperature range, is ensured through oxide-passivated junction protection and Annular construction. They also display a low 1.6V @ 4A @ 110°C forward voltage drop.

Series No.	V_{RM} (Volts)	I_T @ 95°C	I_{SM} (Surge)	I_{GT} @ 25°C (max)	V_{GT} @ 25°C (max)	Price* (1,000-Up)
MCR406	30, 60, 100, 200	4 A	20 A	200 μ A	0.8 V	51¢
MCR407	30, 60, 100, 200	4 A	20 A	500 μ A	1.0 V	47¢

*30 V unit

For details circle Reader Service No. 507



Latest Silicon Power Lines Top 200/300W Class

50A, 60-80V Complements Cut Power Circuit Cost/Complexity

Now Motorola gives the designer of high power amplifier circuits a line of silicon power transistors that are the highest rated, TO-3 packaged, PNP/NPN

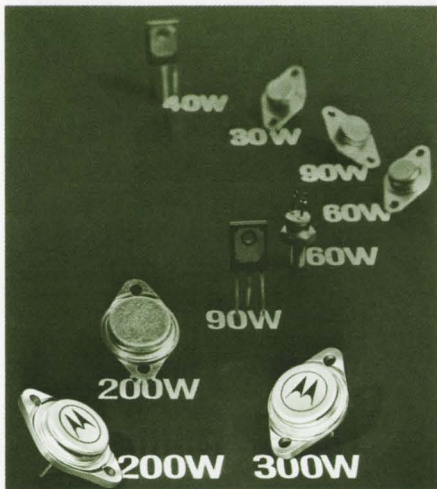

The latest additions to Motorola's ever-growing Silicon Power lines let you develop economical ultra-high wattage amplifier/switching designs.

complements available — the 2N5683-86 series!

This series offers continuous collector-current ratings to 50 Amps, power dissipation to 300 Watts, breakdown voltages of 60 to 80 Volts, high betas, fast switching speeds and low saturation

voltages — all at very high current levels. And, you're assured lighter, less-costly heat-sinking due to their low thermal resistance (θ_{JC}) of only $0.583^{\circ}\text{C}/\text{W}$, max. Used in complementary designs, they can serve to lower costs and complexity by eliminating the need for expensive, impedance-matching transformers in "heavy-muscled" amplifiers.

In addition, they exhibit saturation voltages of less than 1.0 V at 25 A — assuring efficient, low-power-loss performance in high-current applications. And, they are made using Motorola's exclusive EpiBase die-fabrication process which reduces costs while maintaining long-term reliability and stability.

Highlights	2N5683/84	2N5685/86
Polarity	PNP	NPN
High I_C (cont.)	50 A	
High P_D	300 W @ 25°C , case	
High h_{FE}	15-60 @ 25 A	
f_T (min)	2 MHz @ 5 A/10 V	
Prices (100-up):	\$15.00/18.00	\$12.00/15.00

For details circle Reader Service No. 508

Now 100-140V, 10-16A, TO-3 Units Eliminate "Stud" Types

If "high-voltage silicon power" conjures up images of large, cumbersome — and costly "stud" transistors — look again!

Here's inherently-economical low-silhouette, TO-3 packaged, 100-140V, 10-16A — silicon power transistors that can put *tomorrow's* state-of-the-art performance in your rugged, audio/servo amplifier, inverter and chopper designs and switching and series-pass regulators *today* — the NPN 2N5629-31 and 2N-5632-34 series!

With these compact, high voltage/high current silicon transistors you can reduce the size, cost and complexity of input, output and filtering componentry — plus lower your current requirements and eliminate step-down transformers.

Talk about high performance specs! How about P_D 's up to 200 W . . . I_C 's to 16A . . . 100-120-140V — V_{CEO} ratings . . . saturation voltages of one-volt and betas from 25 to 100 at 8 A.

They make nimble switches, too, with a minimum f_T of 1 MHz at 1A/20V (2N5629-31).

And, "punch through" (second breakdown) problems are minimized, due to Motorola's unique diffusion process which allows the transistors to accept very high voltages without detrimental effects.

Highlights	2N5629/30/31	2N5632/33/34
High $V_{CEO(sat)}$	100 V/120 V/140 V	
High I_C (cont.)	16 A	10 A
High h_{FE}	25-100/20-80/15-60 @ 8 A	15-60/20-80/25-100 @ 5 A
High P_D @ 25°C , case	200 W	150 W
Low $V_{CE(sat)}$ — (max)	1.0 V @ 10 A	1.0 V @ 7.5 A
Prices (100-up):	\$4.60/5.10/7.50	\$3.95/4.35/5.10

For details circle Reader Service No. 509

Motorola Adds 25-Amp Muscles To Its MAC Triac Line!

There's a new, husky, 25-Amp addition to Motorola's popular MAC Triac line — and that heftier horse- or house-power control application you've had in mind can almost certainly be filled by one of its 25 to 500-volt versions!

Called the MAC21, this 25-Amp RMS series has been developed for the engineer who needs rugged, reliable versatility for a wide range of medium-power commercial/industrial thyristor-controlled applications. They're plug-in perfect for relay replacement, phase-control, zero-point and on-off switching, light-dimming, motor-speed control, motor starting, heater control, sequential light flashing, voltage regulation and temperature control designs.

Packaged in the low-silhouette, TO-41



MAC21 Triacs, with 25-500V ratings, are packaged in low-silhouette TO-41 cases to provide currents to 25 Amps.

For copies circle Reader Service No. 510

case (TO-3 with lugs) the MAC21 series delivers outstanding performance, as exemplified by a low junction-to-heat sink value, low 1.5V (max) at 35A on-state voltage, a critical exponential dv/dt of $100\text{ V}/\mu\text{s}$ (typ) at $T_J = 110^{\circ}\text{C}$ and a gate triggering current of 20 mA (typ). Use of all-diffused junctions provides enhanced parameter uniformity.

MAC21 prices start at only \$2.90, 100-up (25-volts). Contact your local distributor for delivery of prototype quantities and see for yourself how well these new 2.5-Amp Triacs perform in your critical, medium-current full-wave control designs.

Both a new application note on Triac circuits (AN466) and a data sheet on the MAC21 series are yours for the asking.



NEW LOW-THRESHOLD MOSFET SWITCHES/CHOPPERS

—Offer Stable, Ultra-High Speeds At Low Power Levels!

Combining Motorola-developed Silicon Nitride passivation — which assures stability under high temperature and reverse bias — with threshold-voltages in the low 0.5 - 3.0V area, fast switching times (maximum t_r of just 10 ns and t_f of 15 ns) and high immunity to transients, the new 3N169-171 N-channel enhancement mode (type C) MOSFETs are worthy candidates for a variety of critical low-power, high-speed switching applications. They are packaged in the 4-leaded, TO-72 case.

As demonstrated in the accompanying scope-trace illustration, showing a typical low input-voltage pulse (top trace) and a 4-channel multiplexed output (lower portion), these devices are ideally suited for low-level-input switching and chopper applications in a wide variety of multiplexing, modulation and analog-to-digital converter designs. Highlight parameters include a low $r_{DS(on)}$ of just 200 ohms (max) and capacitance values as low as 1.3pF (C_{rss}) and 5.0pF (C_{iss}) at 1.0 MHz. Prices: 3N169 — \$4.90; 3N170 — \$4.20; and 3N171 — \$3.55 (1,000-up).

For details circle Reader Service No. 511

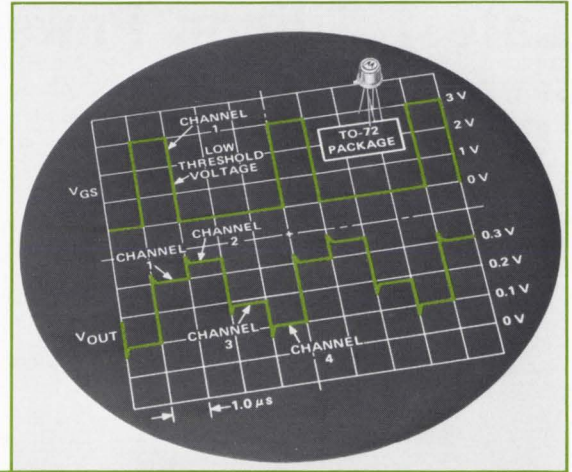

HIGH-CURRENT DARLINGTON-DRIVER HYBRID MICROCIRCUIT

— Provides High Pulse-Rate Power Gains To 1000!

Short-duration pulses up to currents of 5 Amps, from logic level inputs of only 5 mA, are now possible with Motorola's new MCH2005 Darlington-Driver hybrid microcircuit. A transistor-transistor logic input current level of just 5 mA, for example, yields a 5 Amp output pulse — more than adequate to drive high-current ferrite switches in phase-shifter or phase-array radar designs. And, its total turn-on/turn-off time is a fast 800 (max) nanoseconds (switching time spec'd at betas of 1,000)! Priced at only \$8.75, (100-up), this hybrid IC is packaged in a 6-lead, TO-86 ceramic flat-pack.

And, it's available immediately from "off-the-shelf" stock. Contact your local Motorola distributor for units and evaluate this Darlington-Driver hybrid IC now!

For details circle Reader Service No. 512

I/C Hybrid (Thin -Film) 5 Amp Darlington Driver

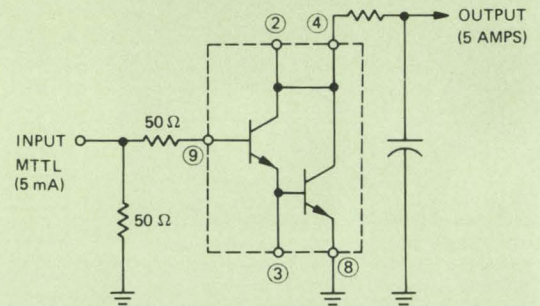

NINE NEW "BET" RF POWER TRANSISTORS

—Available In Ceramic "Stripline" Packages At Lower-Than-Ever Prices!

Nine newly EIA-registered Motorola BET (balanced-emitter) NPN silicon RF power transistors, all packaged in rugged ceramic "stripline" cases, now cover a broad range of output wattage requirements at VHF/UHF frequencies (175 MHz and 400 MHz), in both 13.6 V and 28 V categories. They also exhibit high minimum power-gain (see table), making them ideal for AM/FM power amplifier or oscillator designs in a variety of industrial and military equipment.

And, Motorola has been able to significantly reduce the prices for these new and improved types. For example, the 100-up price for the new 2N5643 is now only \$26.90 (over 30% less than for the previous MM1559).

Multiple-discrete-emitters, each with an attendant Nichrome resistor, provide protection against external destructive factors, such as secondary breakdown, load-mismatching, and mistuning. Their new "stripline" ceramic case structure lowers lead inductances and improves broadband tuning capabilities.

For details circle Reader Service No. 513

EIA TYPE	REPLACES	V _{CC}	P _{out} (W) @ f (MHz)	G _{pe} (dB) (min)	CASE
2N5580	MM1601	13.6 V	3.0 @ 175	8.2	144B
2N5590	MM1602		10 @ 175	5.2	145A
2N5591	MM1603		25 @ 175	4.4	145A
2N5635	MM1549	28 V	2.5 @ 400	6.2	144B
2N5636	MM1550		7.5 @ 400	5.7	144B
2N5637	MM1551		20 @ 400	4.6	145A
2N5641	MM1557	28 V	7.0 @ 175	8.4	144B
2N5642	MM1558		20 @ 175	8.2	145A
2N5643	MM1559		40 @ 175	7.6	145A

LOW-VOLTAGE AVALANCHE ZENER DIODES

—Have Premium-Performance Specs, Tight Tolerances!

The 1N5518-46 low-voltage avalanche zener diode series is particularly well-suited for critical industrial/aerospace applications demanding the tightest possible regulation. These units feature ultra-low noise density (averaging less than one-half any previous available types), as shown in the comparison curves to the right. This premium series, covering a range of 3.3 to 33 Volts, also features zener impedances as low as 18 ohms (1N5521) and low maximum regulation factors (e.g. ΔV_z down to 0.05 V), as well as leakage currents down in the 0.01 μ A region.

In addition, these new precision zener diodes are available in five standard voltage tolerances — 20, 10, 5, 2 and even 1% — and their oxide-passivated junctions, combined with RamRod DO-7 "glass" package construction, assure long-term stable and reliable performance. Your distributor has units in stock.

For details circle Reader Service No. 514

MAXIMUM NOISE DENSITY (1N5518 SERIES VS. STANDARD TYPES)

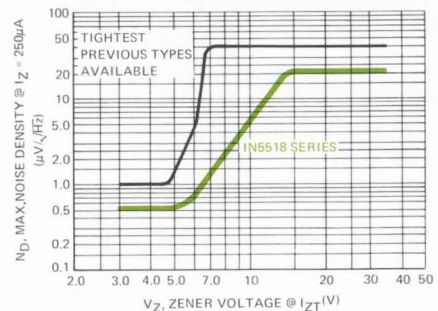

NEW LITERATURE BRIEFS

Over 12,000 Types Covered In Motorola's Most Complete, New 1969 Full-Line Catalog!

The most up-to-date and comprehensive listing of product data in the semiconductor industry has just been published — the 1969 edition of Motorola's full-line condensed catalog! Bigger and more inclusive than ever, it fills 84 pages (20 more than the 1968 edition) and includes over 850 new standard types!

The catalog is divided into sections for quick and efficient reference. For example, the first section consists of a complete alpha-numerical index listing of all standard Motorola types — including both discrete devices and ICs.

The next section (to which 13 pages have been added)



provides tabular listings with highlight characteristics grouped by general application and product areas.

For a copy circle Reader Service No. 515

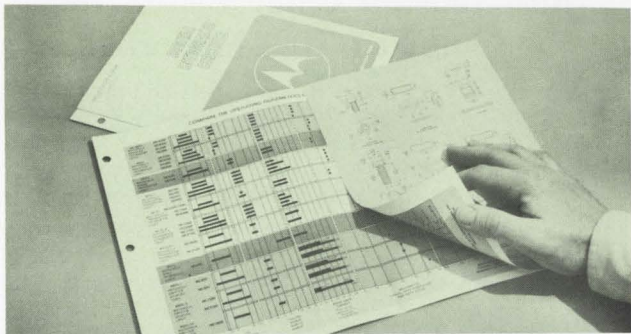

Eleven Logic Families Compared In New Motorola Digital IC Selector Guide!

Covering the broadest line of digital IC families in the industry, Motorola's new "first-of-its-kind" selector guide helps you choose the best possible logic form for your particular requirements . . . at a glance!

To ease comparisons of key parameters, all eleven Motorola logic families have been color-coded by category (MRTL, MDTL, MTTL, MECL, etc.).

Basic operating parameters are shown for the various logic forms and their functions, such as: operat-

ing temperature ranges, power requirements, fan-outs, propagation delay times, toggle-frequencies, power dissipation and noise-margins. In addition, basic "gate" and positive logic diagrams are provided for each of the digital IC families. Detailed package drawings, covering all Motorola's monolithic digital ICs, are also included.

This unique, 3-hole punched, multi-colored chart is flexible to use, too. It can be placed in a binder or mounted on a desk or wall.

For a copy circle Reader Service No. 516



LITERATURE ORDER FORM

NOTICE: Requests for literature on items described in this publication cannot be honored after November 1, 1969.

NEWSBRIEFS No. 6-69

Please circle the Reader Service number of item(s) you are interested in receiving.

E					
498	499	500	501	502	503
504	505	506	507	508	509
510	511	512	513	514	515
516	517	518			

Please Print Clearly

NAME _____

TITLE _____

COMPANY NAME _____

DIVISION _____

DEPARTMENT _____

COMPANY ADDRESS (Street or P. O. Box) _____

CITY _____

STATE _____

ZIP CODE _____

If you wish to receive mail at a different address, fill out below:

ADDRESS _____

CITY _____

STATE _____

ZIP CODE _____

Do you wish a Motorola Representative to contact you?

VISIT

PHONE

Phone No. _____ Area Code _____

Tear Along Perforated Line and Drop in Mail (No Postage Required)

FOLD HERE

FIRST CLASS
Permit No. 2565
PHOENIX
ARIZONA

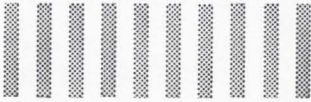

BUSINESS REPLY MAIL

No postage stamp necessary if mailed in the United States

POSTAGE WILL BE PAID BY

Semiconductor NEWSBRIEFS No. 6-69
Motorola Semiconductor Products Inc.
P. O. Box 20924
Phoenix, Arizona 85036

FOLD HERE

For Fast Action!

... on delivery of literature for items described in this publication — fill out this coupon, fold as indicated and drop in the mail.

(NO POSTAGE IS REQUIRED)

NEW LITERATURE BRIEFS

Selector Guide Now "Tunes-You-In" On Motorola's Broad Tuning Diode Line

Over 100 Motorola EPI-CAP abrupt-junction tuning diode types, in four different package configurations and representing nine distinct categories, are described in this first-time-available "Selector Guide." Both tuning-ratios and Q's are presented for every listed type, as are their maximum working voltages and nominal capacitance values. Highlight parameters, keyed to application requirements are also provided.

In addition, a brief yet thorough explanation of voltage-variable capaci-

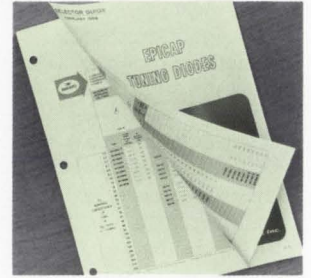

tance tuning diodes and how they operate, as well as a listing of Application Notes covering the subject, is provided on the back of this convenient, easy-to-use selector guide (suitable for use at desk or as a wall chart.)

For a copy circle Reader Service No. 517

New Selector Guide Helps You Find The FET That Fits, Fast!

A brand new comprehensive fold-out chart now provides a concise guide to over 100 Motorola JFET and MOSFET devices.



They are categorized by application, and highlight specifications facilitate selection at a glance. Classifications include multi-purpose amplifiers, RF

amplifiers and mixers, general switching, chopper, matched pairs, and tight (2:1 ratio) I_{DSS} ranges.

Ideal for desk, wall, or binder use, this design aid includes a cross reference listing of industrial types vs. Motorola's nearest equivalent and recommended preferred types. An introductory page describes the Silicon-Nitride passivation process (a Motorola exclusive) which makes high-stability MOS-FETs possible. Also included are FET parameter application charts and a listing of current available FET Application Notes.

For a copy circle Reader Service No. 518

Motorola Semiconductor Products Inc., P. O. Box 20924, Phoenix, Arizona 85036

SEMICONDUCTOR
NEWSBRIEFS

© Motorola Inc. 1969

The circuitry shown external to Motorola products is for illustrative purposes only, and Motorola does not assume any responsibility for its use or warrant its performance or that it is free from patent infringement.

MRTL, MDTL, MTL, MECL, MHTL, Unibloc, Thermopad, BET, EpiBase, RamRod, Micro-T, Dionic, Uniwatt and EPICAP used in this publication are trademarks of Motorola Inc. Annular Semiconductors are patented by Motorola Inc. Nixie is a registered trademark of Burroughs Corp.

NOTE: If coupon is missing use magazine's Reader Service numbers to order literature on items described in NEWSBRIEFS.

Seal Here



New GLASKYD[®] 7100 FR
an alkyd molding compound
with the best
wet electrical properties,
flame, heat and arc resistance,
both flexural and
impact strength,
dimensional stability,
a fast molding cycle
and economy.

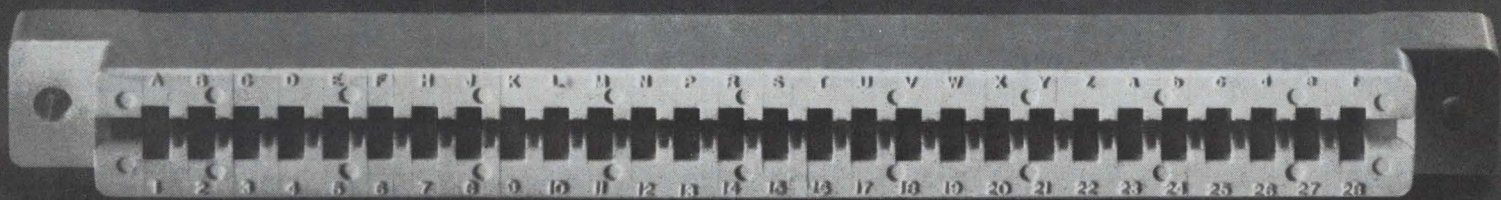

all things considered, it's the
best connector material you can buy!

For additional information about this circuit
saver, write American Cyanamid Company,
Plastics Division, Wallingford, Connecticut 06492.

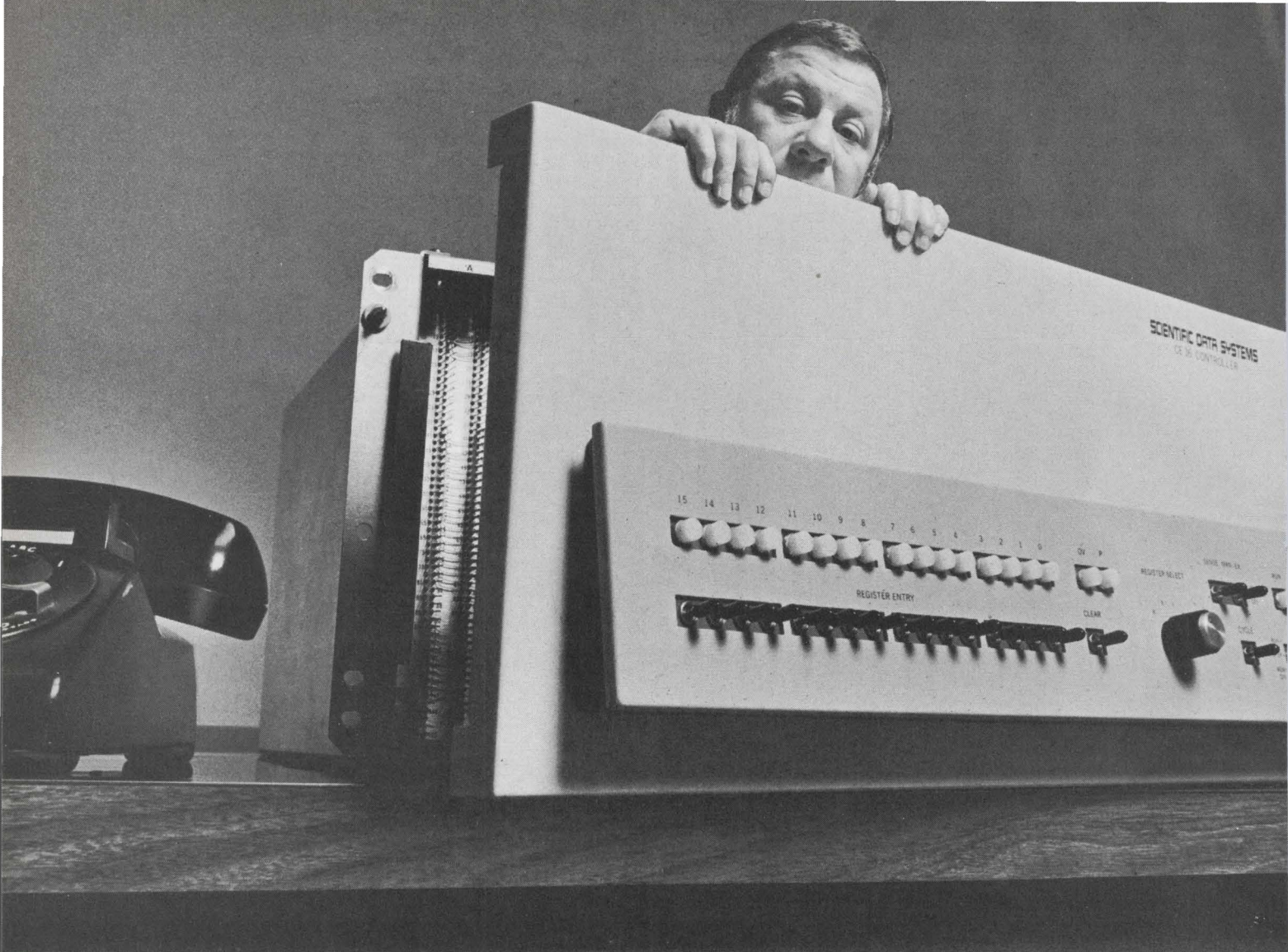

Our new mini-computers have built-in programmers.

Most small computers are designed for programmers. Ours are designed for people.

Just tell our 16-bit machines what you want done. The CE16 and CF16 will do it, because their "built-in programmers" (a comprehensive set of sophisticated instructions) let any engineer use them with ease. For example, the single instruction "scan memory" makes our machines compare a given number with the contents of the entire memory.

The CE16 and CF16 have 125 other heroic instructions that specify comprehensive maneuvers. So you give fewer instructions and use far less core memory than with any other small computer. Problem run times are shortened and Input/Output operations are simplified.

The CE16 and CF16 are designed to control and exchange information with a large number of external devices while doing related computation. Their "automatic I/O" enables them to talk back and forth between memory and a group of interrupting peripherals, in order of priority,

without needing attention from the on-going program.

Automatic I/O isn't a high priced option. Neither is a teletype, nor three priority interrupts, one of which is indefinitely expandable. They're all standard. The only thing you might pay extra for is speed. The CF16 can do a fully signed software multiply in 42 micro-seconds. But it costs a little more than the CE16 which takes 126 micro-seconds (which isn't bad) for the same job.

Don't take our word for all this. Drop us a line asking for:

- A brochure with straight from the shoulder specs so you can compare.
- A representative with more information than could fit in a brochure.
- Or a meeting between our sales engineer and one from any competitor you want, at your office. The competition can even bring a programmer along. We won't have to.

SDS
Scientific Data Systems,
El Segundo, California

Great unbundling sets up new deal

New IBM policy will especially affect peripheral and software areas;
3% hardware price reduction criticized as disguised increase

The computer industry, after holding its breath for six months or more, finally exhaled when International Business Machines Corp. finally made public its plans for "unbundling"—for selling software, systems support, and educational services separately from its computer hardware. But the industry isn't sure yet whether it's breathing easier or just breathing, and it may take a while to find out.

For one thing, IBM's reduction of hardware prices by only 3% was a surprise. The advance betting was that prices would drop anywhere from 10% to 35% (leasing companies already offer such discounts).

"This is really the same as a large price increase," says Richard C. Jones, president of Applied Data Research, a software company. His reasoning is based on a belief that IBM simply is charging enough for software to more than make up that hardware price cut. "As a user of IBM equipment, we think the 3% is ludicrous."

Ups and downs. IBM's only explanation of the 3% cut was that the figure corresponded to "marketing expenses" for services that would no longer be available. IBM did say that the customer's total outlay might either increase or decrease, and that in an increase IBM wouldn't necessarily get it all.

IBM's announcement included the services of system engineers, who assist the customer in setting up a data-processing installation and in running it efficiently, and educational services for executives and employees of IBM customers. Both services were included in the cost of a computer; both will henceforth be charged separately.

But of greatest interest was the

pricing of software separately from hardware. Software no longer included in the price of a computer includes all programs written for a specific application, compilers (programs that translate languages like Fortran and Cobol into machine language), and various utility programs for routine tasks like sorting and merging. All new programs within these categories will be available only through a license, good for just a single specified machine, for which a monthly fee will be charged. The customer won't have the option of choosing a bundle.

These programs, which IBM now calls "program products," won't be for sale. IBM considers them corporate assets that couldn't be protected if they were sold; the license offers a level of protection that is necessary with easily-reproduced program products but unnecessary with pieces of equipment. This distinction, IBM feels,

keeps the licensing agreement from falling under the 1956 consent decree which, among other things, forced IBM to offer its machines for sale as well as for lease.

Program products don't include all software. Previously announced software is still available for the asking. And essential system control programs will continue to be free. Included are various kinds of operating systems, plus supervisory, data management, diagnostic, and maintenance programs that keep a computer running efficiently.

What's to keep a customer from lending or duplicating a licensed program? IBM says it does business in good faith and expects customers to do the same.

But IBM has had experience with "good faith." In 1963, the company installed time meters on its machines—ostensibly to make regular servicing easier. Some say, though, that the real reason was to keep

Here they come

Other manufacturers are almost certain to follow suit in unbundling. Scientific Data Systems, now a part of the Xerox Corp., and Control Data Corp. tried separate pricing of a few sample programs two or three years ago, but haven't done anything radical since then; the original programs are still available. The Burroughs Corp. brought out an accounting machine with separately priced software in February, and announced the availability of separate pricing for two existing machines in June, a week or so before IBM made its announcement. Burroughs is cutting the price of the hardware by about 10% in the latter case. Unlike IBM, Burroughs charges only once for its programs, which can thereafter be used on many different machines. The company says it plans to take further steps in unbundling in the near future.

Still, unbundling will be of most benefit to sophisticated users, many of whom are well qualified to write their own software at all levels, and many of whom, in fact, do write software for themselves or their clients. These organizations, of which System Development Corp. is an example, can simply ignore IBM except as a source for spare parts.

Electronics Index of Activity

July 7, 1969

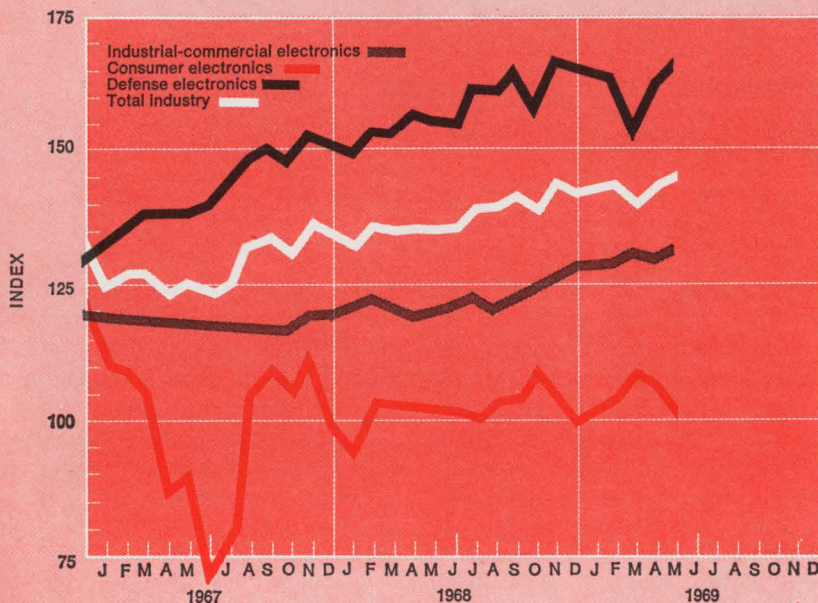

Segment of industry	May 1969	April 1969*	April 1968
Consumer electronics	102.4	107.1	102.2
Defense electronics	166.5	163.5	154.9
Industrial-commercial electronics	132.3	130.7	121.5
Total industry	145.5	144.3	136.1

Total electronics production—up 1.2 points to 145.5—perked up again in May after drooping a bit in April. However, the consumer sector continued its decline, dropping 4.7 points in a month. The defense and industrial-commercial areas helped make up for the consumer electronics down-curve as defense production showed an increase of 3 points and industrial-commercial output rose 1.6 points.

The decreased activity in consumer electronics production came against a report of declining sales in receiving tubes for the first quarter of the year. The Electronic Industries Association reported sales off 10% to a total of 71 million units. Sales to government agencies nearly matched those of last year's first quarter, but the initial equipment, renewal, and export markets fell.

Indexes chart pace of production volume for total industry and each segment. The base period, equal to 100, is the average of 1965 monthly output for each of the three parts of the industry. Index numbers are expressed as a percentage of the base period. Data is seasonally adjusted. *Revised.

tabs on customers who paid for equipment on a single-shift, 5-day-week basis but were running it considerably longer.

Now's the time What does all this mean to the computer industry? There will be ramifications in all areas—hardware and software, among manufacturers and users. In the hardware area, the time is probably ripe for IBM's announcement of the two or more new machines it has been readying [*Electronics*, March 17, p. 51]. Furthermore, the unbundling will probably increase IBM's share of the hardware market, because IBM already can turn out machines faster and cheaper than anyone else. And manufacturers of peripheral equipment who tout their wares as being plug-to-plug compatible with IBM's will be hard hit, because they're no longer fully compatible unless then can also provide software.

Software companies whose existence has depended on being able

to write, for a price, programs that were available free from IBM or other manufacturers, will have their priorities reshuffled. Up to now they've had to produce a product that was a great deal better—or available sooner—than the free variety in order to be able to charge for it. Now their task is easier—except that the number of competing companies will suddenly increase, perhaps by a factor of three or four, then decrease gradually.

Components

Passing marks

Silicon nitride passivation has been used for standard diodes on a limited basis for some time. But while its advantages were well known, an economical and technically feasible method of incorporating the process into large-

scale production remained a major production puzzle.

However, Fairchild Semiconductor of San Rafael, Calif., has solved that puzzle and has started to reap the dividends in the reliability of nitride-passivated diodes. After a year and a half of production and gathering data from more than 14 million device hours, Fairchild engineers report an eight-fold reduction in failure rate per 1,000 hours.

Big lead. "The drop in failure rate from about 4% to less than 0.45% gives us the best standard of reliability for any diode on the market, no matter what the price," says Steve Carmichael, Fairchild's manager of reliability and quality assurance. He estimates the firm is more than a year ahead of the industry in development of volume-produced nitride-passivated diodes.

"Many companies are looking at the possibility of mass producing this kind of diode, but I'm not



BETTER QUALITY AND RELIABILITY THROUGH CONTROL

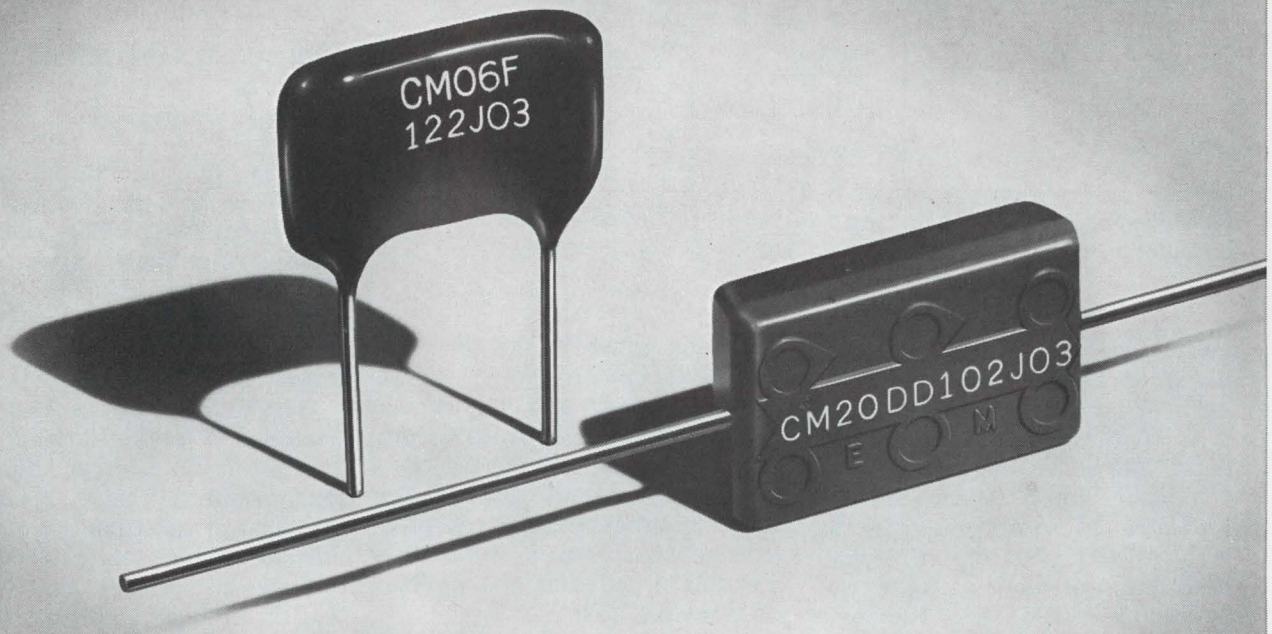

Shown 2½ x Actual Size

Capacitor Problems That Require A Lot Of Self-Control...Chemically Speaking

Problem 1: How to make sure the silver paste composition used for electrodes provides the best results for each electrical parameter in a given capacitor design?

Problem 2: How to improve the recognized moisture reliability of our dipped mica capacitors without adversely affecting life reliability?

Problem 3: How to upgrade the reliability of molded mica capacitors to equal that of dipped mica capacitors so designers can take advantage of body uniformity and axial lead design?

Solution: Chemical self-control! To do this we operate our own chemical manufacturing plant where we formulate silver pastes, phenolic dipping compounds, and epoxy molding compounds — all under strict controls.

Result: Dipped mica capacitors and molded mica capacitors of equally high reliability that operate up to 150°C. Send for technical literature and always insist on El-Menco brand capacitors . . . your assurance of better quality and reliability through control.

THE ELECTRO MOTIVE MFG. CO., INC.

WILLIMANTIC, CONNECTICUT 06226

Dipped Mica • Molded Mica • Silvered Mica Films • Mica Trimmers & Padders
Mylar-Paper Dipped • Paper Dipped • Mylar Dipped • Tubular Paper

West Coast Manufacturers contact: COLLINS & HYDE CO., 900 N. San Antonio Rd., Los Altos, California 94022
5380 Whittier Blvd., Los Angeles, California 90022

ALSO SOLD NATIONALLY THROUGH ELECTRONIC PARTS DISTRIBUTORS

U.S. Reports

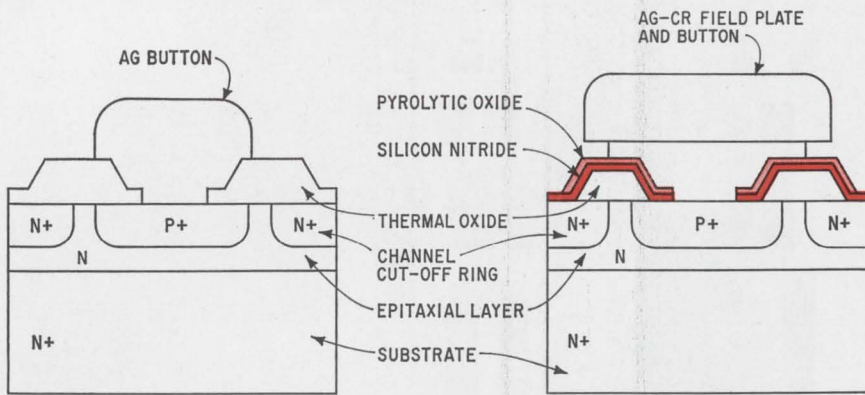

Something old, something new. Here's the Fairchild FDH-6 chip before and after the switch to nitride passivation and addition of a field plate.

aware than anyone is actually doing it on a large scale yet," Carmichael says.

As with many semiconductor firms, Fairchild's research and development group toyed with the problems nitrides presented as early as 1965, but the effort had little thrust or direction. However, in the fall of 1967, four engineers from the diode plant and two from the company's R&D section in Palo Alto, Calif., teamed up to tackle the problem of improving the yield and reliability of the low cost DO-35 package.

Ions out. "When the DO-35 package was developed a few years ago to meet smaller size requirements, we ran into major problems with sodium ion contamination," recalls Trevor Smith, manager of mono-arrays at Fairchild's diode plant. "At the high sealing temperature [750°C] of this package, sodium ions diffused rather easily through the passivation layer.

"These ions, present in the packaging glass (which has a high sodium content) and lead material (coated with sodium tetraborate) accumulated at the interface of the passivation layer and the silicon, causing the diode's performance to deteriorate at an unacceptable rate."

The group experimented briefly and unsuccessfully with a phosphorous glass developed by IBM. It also tinkered with other glasses that cut contamination but were expensive and difficult to apply and control. After more than a month of testing, the group settled

on silicon nitride as the ideal type of passivation.

"It was known as a good barrier, but developing a controllable production process was the big question mark," Smith says. "As it turned out there were no real problems to be solved, it was merely a matter of gathering and applying previous research."

After some experimentation in which silicon nitride was applied directly to the chip, the group went to an oxide-nitride laminate, using a pyrolytic process to deposit a nitride layer on top of a base layer of oxide. A surface oxide layer protects the nitride during etching and masking.

Taking over. When the task force made its report in December 1967, Fairchild wasted little time. By June 1968, 80% of the plant's diodes contained nitride passivation; now the figure is around 95%.

While the nitride passivation process was the prime reason for drastic reductions in failure rate, Smith points out two other changes in the package.

"We improved the back contact metallurgy of the chip to eliminate nonuniform alloying that had occurred and also eliminated some variations of oxide surface contamination by putting a field plate on the oxide surface." By covering the oxide surface with a metal plate, the surface of the oxide can be maintained at the same potential as the reverse bias at all times. This eliminates the charge and discharge of the surface during operation.

Since expensive reliability screening tests were no longer needed, the cost of producing the nitride-passivated diodes did not jump substantially.

Consumer electronics

Factory approved

Late in June, technicians from the Public Health Service's National Center for Radiological Health began moving into the plants of over 20 domestic producers of color television receivers as well as to the receiving points for five major overseas producers.

The purpose of the Federal invasion is to let the National Center see for itself whether or not the manufacturers have licked the problem of radiation emission. An official of the center says: "The manufacturers feel that they've got the problem under control; and it's up to us to make sure that they have, under the provisions of the Radiation Control for Health and Safety Act of 1968."

Rug lifters. Investigators from the National Center are looking at sets in plants, at distribution centers, and in storage areas and measuring them on the spot under various conditions. Out of the many sets that will be subjected to cursory on-the-spot checks, some 200 will be brought back to the center's laboratory in Rockville, Md., for further analysis. Officials at the center plan to have all the test data available by October 1.

Specifically, the tests will include measurement of voltage and current on each component capable of emitting X rays produced by line-voltage changes and set adjustment, measurement of X-ray exposure at accessible locations around the set, and measurement of replacement components recommended by the manufacturer.

According to an official of the center, it is conceivable and desirable that the results will be completely negative—that is, no sets will be found to exceed the recommended safe level of 0.5 milliroentgens per hour. The center will also

IF 10 BRAND-NEW LINEAR ICs WON'T GET YOU TO OUR SEMINAR, MAYBE THE FREEBIES WILL.

FREE ADMISSION

Fairchild is giving a series of 60 free, Linear IC Applications Seminars. And at the seminars we'll be introducing 10 new, never-before-seen linear ICs. We'll go over all the ways that you can plug them into your circuits. And show you how they can make your systems better and simpler.

FREE ADVICE

Then you can start asking questions. And you're not limited to the new devices. If it's a linear problem, we'll try to solve it. This could be your chance to get a few trouble-

some projects off the drawing boards.

FREE HANDBOOK

You'll also get a free copy of our latest Linear Applications Handbook. Complete with information on all our new devices. And a lot of design information that we've picked up while becoming the world's largest supplier of linear integrated circuits.

FREE LINEAR ICs

And we're giving away more than 20,000 linear ICs—both new and standard designs—as door prizes. With the informa-

tion from the seminar, you'll be ready to use them by the time you step out the door.

MAKE YOUR RESERVATIONS NOW

The seminars will be held during the first two weeks in August in major cities across the country. Please call your local Fairchild distributor or sales office for the exact place and time in your area.

Fairchild Semiconductor/A Division of Fairchild Camera and Instrument Corporation/Mountain

FAIRCHILD View, California 94040 (415)
SEMICONDUCTOR 962-5011/TWX: 910-379-6435.

U.S. Reports

be using the study to give it an idea of where to set the safe standard which will eventually become law. The radiation control act calls for a standard which is "reasonable and technically feasible." Says a center official, "The survey will tell us how far below 0.5 we are able to read with the monitoring equipment now available. If a set's radiation is unmeasurable then we've got to assume that we've reached the optimum level."

It's the law. Meanwhile, with a minimum of fanfare, the first in a series of regulations carrying out the provisions of the radiation control act of 1968 have just become law. Among the regulations now in effect: manufacturers who discover that any of their electronic products are defective must notify the Secretary of Health, Education, and Welfare immediately as well as its dealers, distributors, and customers. The maker is required to remedy any defect without charge, replace the product, or refund the cost of the product. The new rules also call for a sampling of imported electronic products to be tested and for the destruction or exportation of imported products which are not remedied.

Air traffic control

State of the ARTS

Given the current air traffic control mess at U.S. airports, it is understandable that more than one cynical airline official has commented that anything the Federal Aviation Administration does to alleviate the problem will be too little and too late. However, the FAA is plugging away, and at least one program looks as though it might offer relief in the not too distant future.

While the FAA's air traffic control development division, in charge of technical development of data-processing and display programs, has several on-going programs, the most promising for modernizing air traffic control is the ARTS-3 (automated radar terminal system) beacon-tracking systems for 64 major airports. Earlier

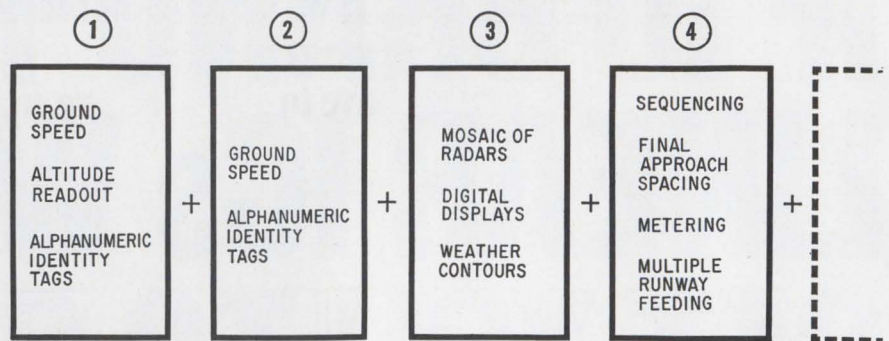

Picturing ARTS. The FAA's beacon-tracking system for 64 airports provides the automation base to permit growth by modular expansion.

this year, Univac got \$35 million for fabrication, testing, delivery, and installation of the systems with deliveries scheduled from May 1970 through October 1972.

ARTS-3 features radarscopes that provide automatic alphanumeric readouts on ground speed, altitude, and identity. Though the ARTS alphanumeric concept has been around for some time, ARTS-3 is now a going concern with some up-to-the-minute concepts. John C. Mercer, chief of the division, says: "As air traffic continues to increase, it's very likely that the most important contribution of ARTS-3 will not be the improved display of radar identity, altitude, ground speed, and other controller aids, but the automation base it provides."

Growth ahead. Under the terms of the contract, Univac must deliver a total hardware-software system, which will consist of a data-acquisition subsystem from Burroughs, a data-processing subsystem provided by Univac, and a data-entry and display subsystem by Texas Instruments. ARTS-3 will be modular; it could be expanded to do more jobs and provide high levels of automation. Moreover, modularity means each system can be tailored to the particular requirements of each airport. The FAA believes that additional expansion of the basic system will yield automatic sequencing, fail-safe capability, digitized map and weather displays, and the other elements needed to give full digital terminal automation.

According to Mercer, work is progressing on computer-aided approach spacing for the system

along with efforts to develop software for a multiprocessor executive monitor. The ARTS-3 metering and spacing system will provide time-to-leave data, suggested initial headings, time-to-turn, and other variables in aircraft operations. In addition, planning is under way for automated all-weather ground guidance and control for the system.

The FAA plans to have the initial ARTS-3 working by November 1970 with the other facilities coming on line rapidly. Meanwhile, the airline industry feels that the FAA is finally moving toward its planned automation of air traffic control. One airline spokesman says: "I think for once we are seeing some real progress in this area by the FAA. The real question is why that progress didn't start sooner."

Commercial electronics

Game of tags

When General Electric announced a \$10 million contract with J.C. Penney, the department store chain, for the Tradar (transaction data recorder), it was claimed that no other on-line, point-of-sale data system was available. But apparently no one had asked Ricca Data Systems of Santa Ana, Calif. That little company (less than \$1 million in projected 1969 sales) has an on-line, point-of-sale system that president Joseph Ricca claims will be much cheaper than Tradar.

More than that, Ricca now has commitments from three large de-

Good heavens. If we still haven't mesmerized you with all the magic arrays Signetics makes, what do we have to do? Conjure up a picture?

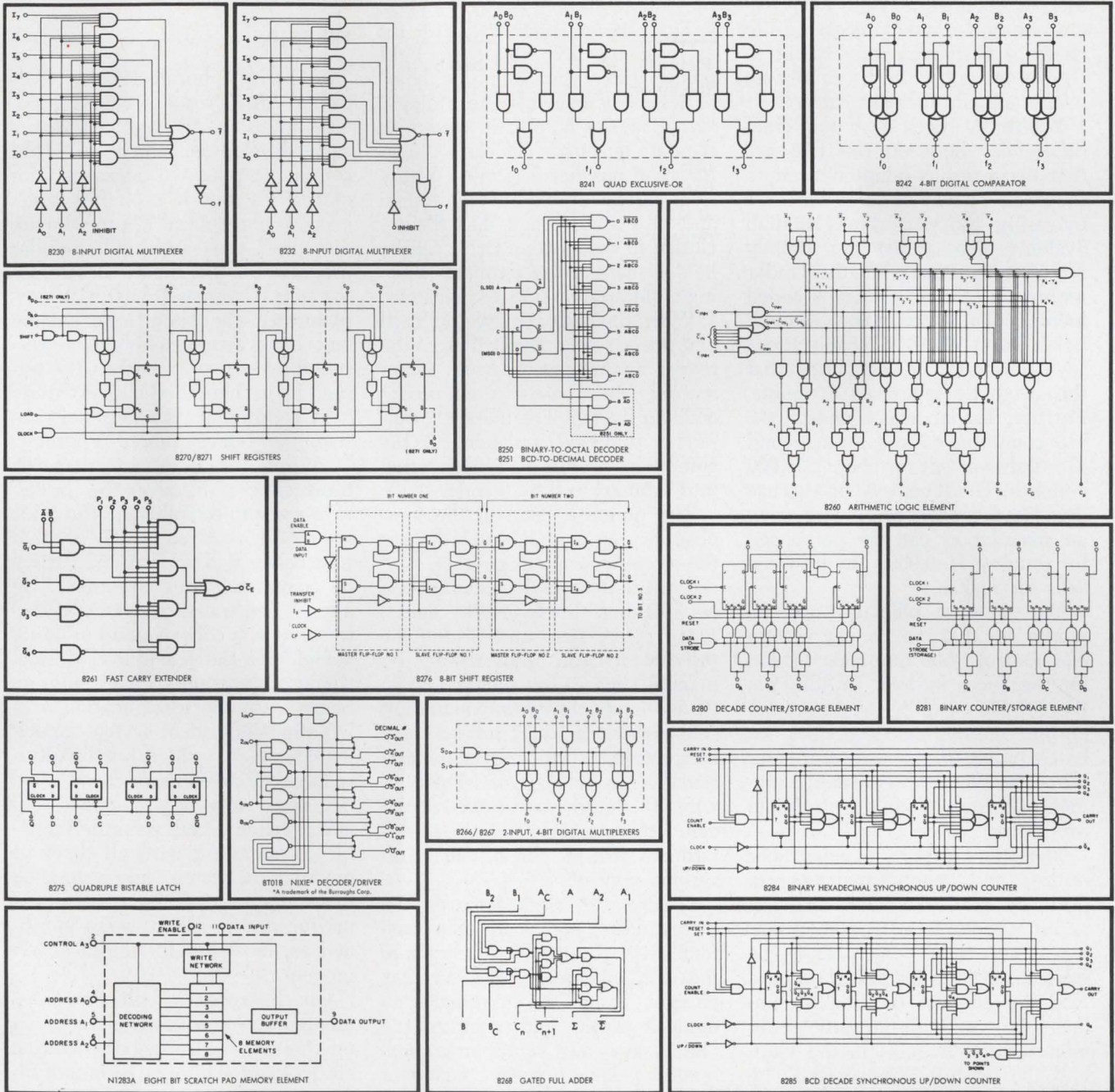

P. S. To keep you posted on our whole array of arrays, we've made a king-sized poster of this ad. (Just the thing for your rumpus room—or your purchasing agent's wall.) Offer limited; send today. And please: stop squinting!

More complex magic from **Signetics** **MSI**
 Signetics Corporation / 811 E. Arques Ave., Sunnyvale, Calif. 94086 / A subsidiary of Corning Glass Works

U.S. Reports

partment store chains for about \$1 million worth of equipment, one of which will be a completely automated point-of-sale system that, like the GE-Penney system, eliminates the cash register. Both systems employ terminals to automatically read merchandise tags, customer credit cards, and sales clerk identification cards. Both incorporate on-line data processing to check a customer's credit and to control inventory. Both can also be used manually for cash sales.

You're it. Ricca says the chief differences between the two are that his firm has adapted itself to the retailer's way of doing business by using the perforated Kimball Systems merchandise tag already in widespread use while the Tradar requires a new, magnetically-coded merchandise ticket. The Kimball ticket costs about 5 cents; Ricca says retailers have estimated that the magnetic tag costs 10 cents. Further, Tradar uses a central GE 415 computer backed by a second 415; the two rent for about \$35,000 a month. The Ricca system can use dual Raytheon 703 computers; such an installation can be purchased for roughly \$140,000. The terminal sells for \$4,000.

One Penney official, however, points out that the Penney system can control 1,500 terminals vs. 128 for the Ricca system. In addition, the GE 415's can be used both for on-line point-of-sale work or for batch processing as a central complex. The Ricca system simply augments the store chain's central data processing center.

The Ricca system marries fiber optics and phototransistors to optically read the cards its terminal accepts. In an operation that takes several seconds, first the clerk inserts her identification card into the one-slot terminal to unlock it. A high-intensity bulb shines through holes in the card, and the light is "transmitted" by fiber-optic lines to the output stage of a Ricca-developed fiber-optic cell, where it is detected by silicon phototransistors. These are furnished by Fairchild Semiconductor, and their output is linear, the current varying according to the presence or absence of light.

In a cell. The fiber-optic cell was developed by Ricca engineers to cope with the close spacing of perforated dots in the merchandise tag. The dots are detected in an area of the cell that is just 60 by 90 mils. Then the 120 fiber-optic lines that bring the light signals out to the photosensors blow up the dots to an area 2.5 by 3 inches.

There is one phototransistor for each of the 120 fiber-optic light points; their "hole" or "no hole" indication is converted to a digital signal in the automatic reader in the data terminal. The clerk's identification number is printed on the sales slip generated by the terminal and also stored in a disk file included in the system. Or, it can be held in core if the terminal is being monitored on-line for inventory.

When the clerk removes her card and inserts the Kimball tag, the reader again goes to work, illuminating the 1-2-4-7 (nonbinary) code on the tag. The transistor output is digitized and sent to the computer, where it is converted into a binary 0-1-2-4-8 code.

The punched code in the merchandise tag contains such data as the store department number, vendor of the item, style, classification (if clothing, dress, skirt, slacks, etc.), color, size, and price. The price, which can be overridden by manual entry for marked-down items, is displayed on a 10-digit cold-cathode readout tube display on the terminal. All the data is carried over a single twisted pair of wires for temporary storage in the computer memory and then goes into the disk file for automatic inventory control.

Finally, the clerk removes the merchandise tag, loads the customer's perforated credit card into the slot, manually enters any tax charges using the terminal's 10 numeric keys, and triggers the "total" key—one of 15 programmed function keys (verify customer credit, verify inventory, and the like). If the customer has exceeded a prearranged credit limit, the terminal will not release the credit card, and a similar terminal in the credit manager's office will indicate which station is balking. This is one of the strongest features of the

system, Ricca says, adding that it can save the user half his bad-debt write-off which could amount to about half the typical after-tax profit of 4%.

Communications

What if . . .

Two Naval laboratories, six electronics firms, and assorted individuals are currently involved in the early development work on a uhf communications transceiver for mid-1970's—but it probably won't even be plugged in. Those who are directing the multimillion-dollar program for the Naval Electronics Systems Command hasten to explain that the Navy isn't casting bait for waste-watching Congressional investigators; rather, it's setting up a hypothetical system to help coordinate its component research and development program.

"While the odds are that the transceiver will never be built," says one project official, "the odds are good that elements of that transceiver will pop up in a variety of communications systems." He adds, "The transceiver is intended to serve as a cohesive and unifying vehicle for the feasibility of electronics components." The program began with the identification of a hypothetically ideal system. Specifications were written for the ultra-reliable (15,000 hours mean time between failures), compact (45 cubic inches), and versatile (capable of operating with all types of modulation) system, and a detailed block diagram of the system was produced. Nine items were identified as necessary for initial development.

On the receiver end the Navy identified the following needs: a microelectronic receiver technique study, gyrator integrated circuit filter development, a 400-megahertz monolithic prescaler, an LSI correlator, an electronic tuning study, a monolithic balance mixed product detector, and an LSI digital frequency synthesizer for uhf. On the transmitter side, it was decided to call for a study of IC's for uhf

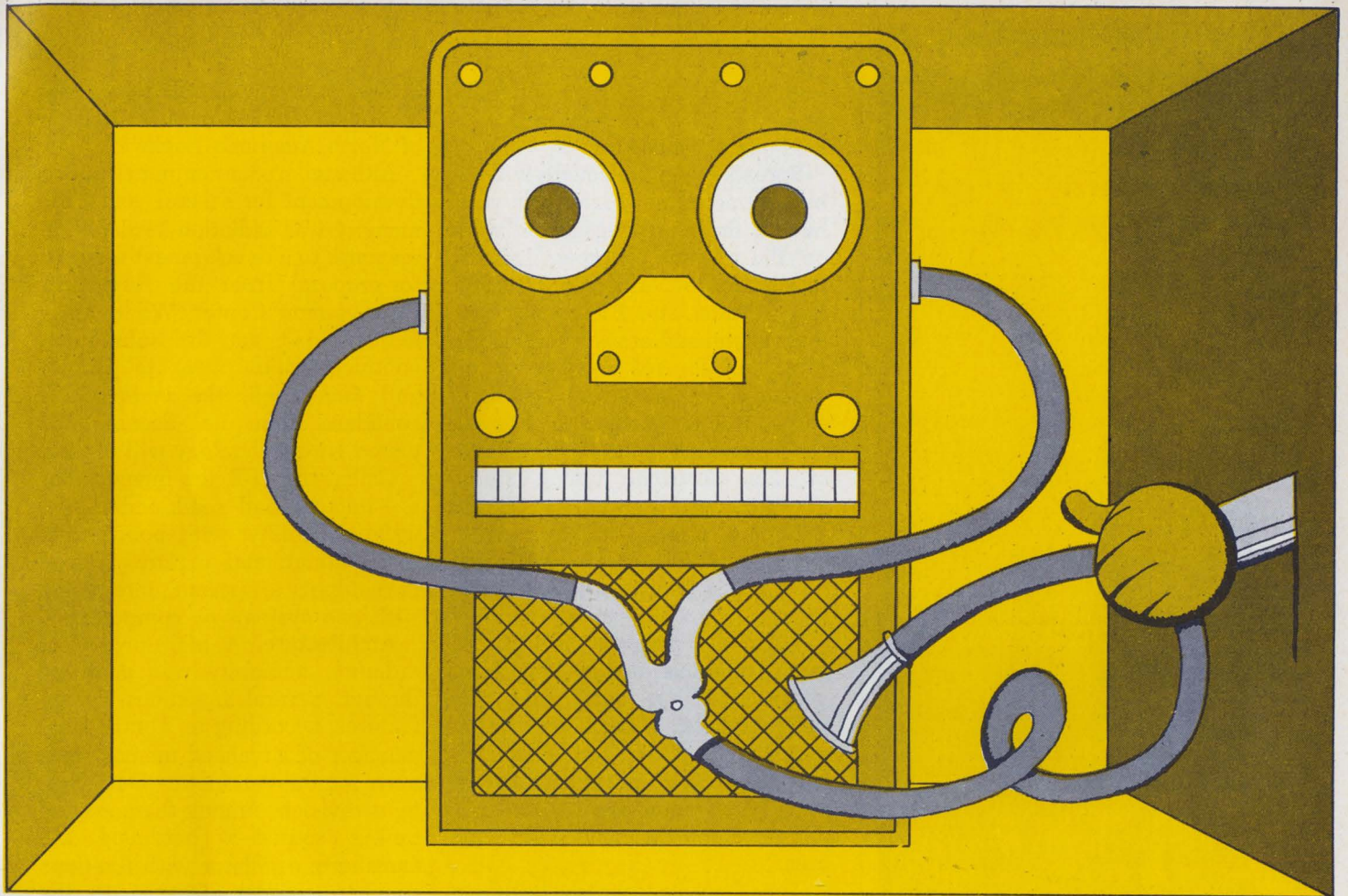

No time for downtime

A machine as complex as the Bell System's new Electronic Switching System (ESS) must help with its own maintenance. Consider, for example, that an ESS installation in a single Bell System central office can perform nearly a billion and a half switching, logic, and memory operations per second. And that we expect it to provide service for 99.999 percent of the next 40 years. Also, that the system employs a totally new concept: "stored program control." That is, each of the many actions in connecting one telephone with another is governed by a central digital data processor which draws upon program instructions and other stored data; new and revised features are incorporated by changing memory content rather than by rewiring.

All of this makes traditional servicing obsolete, and calls for advanced

ideas in reliability and maintenance of electronic equipment.

Vital units such as the central data processor and the memories operate in pairs; if one unit ever falters, its twin maintains service. But, because there is no standby until the defect is repaired, ESS itself helps with the work. For instance, there are three principal fault-detection schemes:

"Match and Check Circuits" constantly compare critical information in duplicated units.

"Audit Programs" check that the system's temporary memory reflects what is actually going on.

"Exercise Programs" use the brief intervals between telephone calls to check all circuits, including those for maintenance.

If a fault is found, alarms operate and "fault recognition" programs take

over. These automatically find the defective unit and reroute the information flow through its duplicate. Or, if the problem is simply a memory error, it is corrected. Such actions take less than a millisecond; office operation is unaffected.

Finally, "diagnostic programs" test any faulty unit, store the results, and print them out with a reference number. A craftsman looks the number up in his "ESS Troubleshooting Manual" and finds a list of possibly defective circuit packs. He replaces one or more of them to clear the problem.

Over half of ESS—circuits and stored program—is devoted to maintenance. But only with modern techniques can so complex a system meet today's communications needs.

From the Research and Development Unit of the Bell System—



Bell Labs

HANSEN'S NEW 900 SERIES

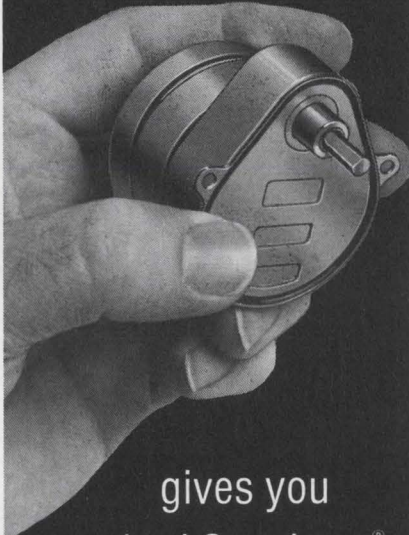

gives you
standard Synchron®
reliability with up
to 98 oz.-in. torque

Now, without sacrificing compact size, you can get high torque even at higher speeds—from 1 to 900 RPM. Synchron® 900 Series has thick, wide gears, specially designed to give the added gear strength that makes full use of its power increase. Highest quality instrument gear train for all speeds below 900 RPM.

The new self-starting hysteresis motor has positive direction of rotation—right or left hand. Plus extra heavy phenolic first gear for low noise level. It can be stalled continuously without electrical or mechanical damage.

Added strength in both the rotor and gear train enables 900 Series to handle your toughest timing and control jobs. Because of its compact dimensions, it is often interchangeable with motors of lower torque. To find out what 900 SERIES can do for you, write or phone today to have a representative contact you.



HANSEN MFG. CO., INC.
Princeton, Indiana 47570

HANSEN REPRESENTATIVES: CAREY & ASSOCIATES, Houston and Dallas, Texas; R. S. HOPKINS CO., Sherman Oaks, Calif.; MELCHIOR ASSOCIATES, INC., San Carlos, Calif.; THE FROMM CO., Elmwood Park, Ill.; JOHN ORR ASSOCIATES, Grand Rapids, Mich.; H. C. JOHNSON AGENCY, INC., Rochester, N.Y.; WINSLOW ELECTRIC CO., Essex, Conn., Villanova, Pa., and New York, N.Y.

EXPORT DEPARTMENT: 2200 Shames Drive, Westbury, N.Y. 11590

U.S. Reports

transmitters and a study of high-power metal oxide semiconductor, field-effect transistors.

Spread. Several elements will not be contracted until later this year, but six firms are engaged in work on the transceiver now. Laboratories at the Naval Air Development Center and Electronics Systems Command are working on the program. General Electric is conducting the receiver technique study, ECI is working on IC's for the transmitters, and Collins Radio on the electronic tuning study. Westinghouse is working on the gyrator IC filters, and Motorola on the monolithic prescaler. TRW Systems is working on the LSI correlator.

With the program still in infancy, opinions already have been generated. "For one," says one project official, "I think it's keeping us away from the 'bandwagon effect' where the tendency is to jump on a bandwagon like LSI and put all development money in one area."

The Navy has already begun to see that there is potential in certain elements—like the LSI correlator—and those elements are being considered for inclusion in advanced systems. Another feeling is that the program keeps component development moving in all areas under a single banner of no small importance is the fact that the hypothetical system acts as a focal point for the attention—and the funds—of the Navy hierarchy, whereas component R&D conducted in the traditional element-by-element fashion might generate less enthusiasm.

Memories

Radiating confidence

Building a hardened plated-wire memory capable of functioning at high gamma and neutron radiation levels in an advanced ballistic missile isn't easy. The technological challenge apparently has been met, however, in a plated-wire memory with a capacity of 16,000 words of 32 bits each and a 500-nanosecond

access time now undergoing final testing at the Autonetics division of North American Rockwell.

Although under company-funded development for several years, the memory was radiation-hardened in response to a development request-for-proposal from the Rome Air Development Center. While Autonetics didn't get the subsequent contract, which went to Univac and Honeywell, the company is confident that its accumulated plated-wire technology will pay off.

Called the M-2, the memory has a 1-microsecond read and 2- μ sec write capability, with nondestructive readout, and features a dual port input to permit interfacing with two systems or computers.

Architecture. A high degree of radiation immunity was achieved through several ingenious design features, according to Tom Bohem, manager of advanced memory systems for the Autonetics Data Systems division. Among them are the timing source—a hardened 20-megahertz oscillator with flip-flops—and a counter. Output to the counter is decoded to generate the time returns. Also, a unique word matrix reduces static bias to zero and prevents loss of stored information while under maximum prompt (γ) radiation. Overdesign of the circuit permits normal operation even when the discrete transistors are radiation degraded.

Photo current and current source shunts are used in the word matrix to protect the memory array from radiation-produced current. A detector of proprietary design activates a four-transistor network circuit clamp, which in turn short circuits the current source.

The sense matrix/selection matrix is off-line from the bit drive; it employs specially developed low-level switches and dielectrically isolated integrated circuit sense amplifiers that take 5-millivolt input signals from the array and amplify them to 4-volt transistor-transistor-logic levels. The off-line arrangement, says Bohem, minimizes the current. He explains that an in-line configuration would require large junction and bias devices to pass the bit current, resulting in leakage to the array. To

TRW Announces Ultra-Linear RF Power Transistors... 2 to 150 MHz

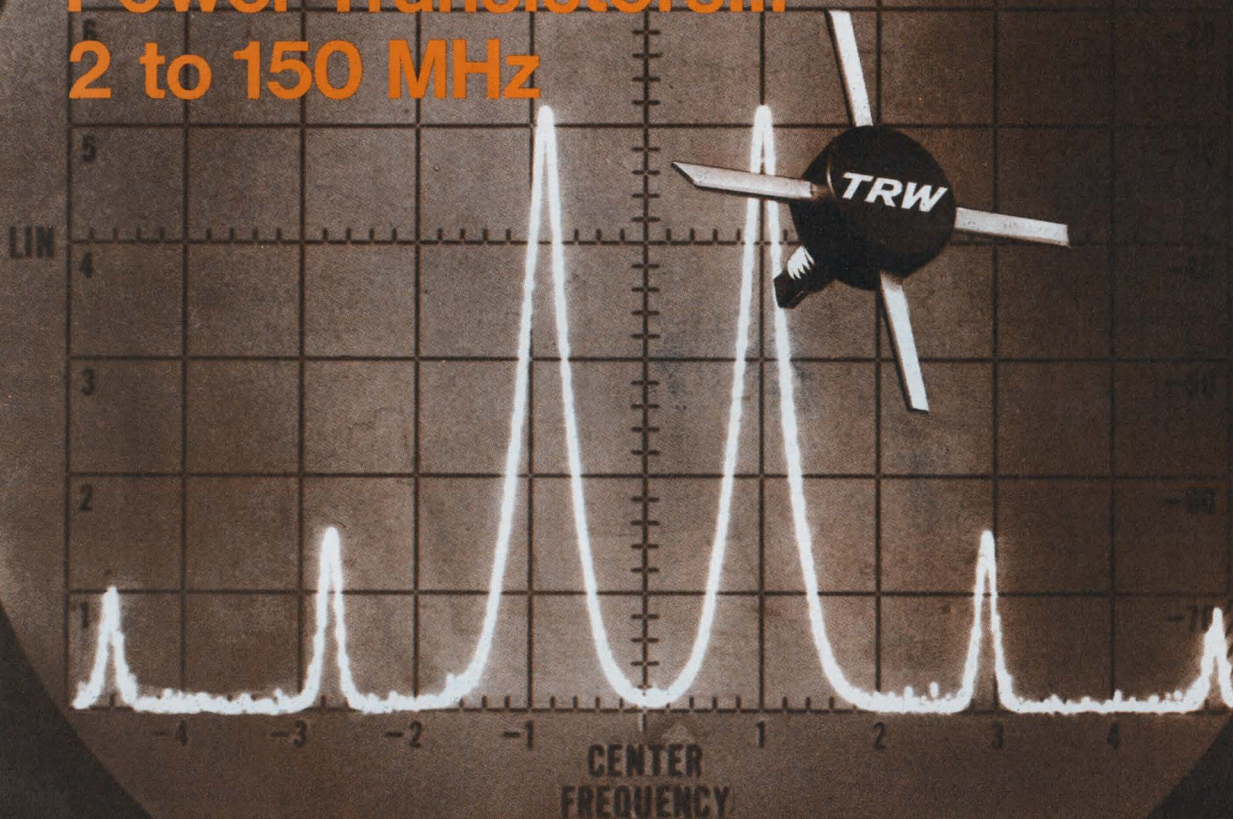

20 to 100 watts...- 32 dB intermodulation guaranteed

TRW offers three new 28-volt RF transistors to meet a range of output power needs in either SSB or CW. All are designed for Class A, Class AB, or Class C operation. All will withstand severe output mismatch. All are available in low profile, strip-line packages.

The 2N5707 provides 20 Watts

P.E.P. in SSB use from 2 to 30 MHz, and 30 Watts CW output to 150 MHz. The 2N5708 provides 40 to 50 Watts respectively over the same frequencies, and the 2N5709 furnishes 80 and 100 Watts in the same operating modes. All three have excellent broadband capabilities.

Contact any TRW Distributor or

TRW Semiconductors, 14520 Aviation Boulevard, Lawndale, California 90260. Phone: (213) 679-4561. TWX 910-325-6206. TRW Semiconductors Inc. is a subsidiary of TRW Inc.

TRW®

Down with the cost of time code generators

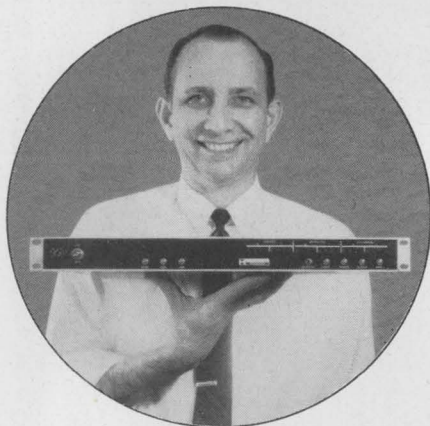

Down to only \$870. That's all you pay for the basic Chrono-log Series 4,000 Integrated Circuit Time Code Generator. Yet it will provide time code information in an IRIG or NASA format in both modulated carrier and shift level codes, simultaneously. It will also provide a parallel 8-4-2-1 BCD output as well as a visual BCD indication of hours, minutes and seconds. And it's only 1 3/4 in. high.

The Series 4,000 Time Code Generator can also be supplied with a choice of low-cost optional features. These include:

- NIXIE digital display
- Choice of IRIG-A, B, C or E format or NASA-36 or -28 bit format
- Operation from 115 or 230 volts ac or 5 volts dc
- Five different time bases ranging from the 60 Hz line to a 1×10^{-7} per week internal oscillator

For the complete low-down, including the down-low prices, write Chrono-log Corp., 2583 West Chester Pike, Broomall, Pennsylvania 19008 or call (215) 356-6771.



U.S. Reports

minimize bit-drive leakage under prompt radiation, the bit-drive matrix transformer is coupled and floating, with the positive and negative bit drivers matched, employing the smallest amount of circuitry possible.

Half means double. Half-word selection in the memory gives alternative capability of 32,000 words of 16 bits each. Organization permits use of only eight TTL packages. Because the memory is multiword organized, it can put many words on one access line, making large array plated-wire memories potentially competitive with core electronics, Bohen says.

Multiplexing from the array is performed by five matched 2N4251 npn radiation-tolerant transistor switches in a single 14-lead package.

The problem of displacement current, which results when incident radiation ionizes materials, has received considerable attention from Autonetics engineers. "We took special care to be symmetrical in the design of our sense line loop so that displacement current doesn't affect the signal-to-noise ratio in the amplifier," says Bohen.

Ground up. Other radiation-resistant mechanical design includes low, matched-impedance power distribution, with power cables carrying 1 ohm or less to permit rapid power-supply recovery. Aluminum-to-aluminum bonding is used for all devices, and materials with low atomic numbers are utilized elsewhere to minimize secondary radiation effects resulting from atomic collisions in heavier metals, such as gold. Finally, wire aging has been effectively reduced through several proprietary changes in processing and in the on-line annealing cycle.

Bohen believes that plated-wire arrays will be competitive with core memories in the near future, both in large-scale, high-speed military computers, and in commercial applications where access times faster than 1 μ sec are required. Semiconductor memories, predicts Bohen, won't make serious inroads into plated-wire applications for six to eight years.

Management

All in the family

When R.L. Petritz, L.E. Sharif, and L.J. Sevin left Texas Instruments it was obvious that they would go into the burgeoning metal oxide semiconductor business—they were key men in TI's MOS operation.

Now their Dallas-based company, Mostek Corp., has made a deal for the manufacture of large-scale MOS arrays at Sprague Electric Co.'s IC facility in Worcester, Mass. Not only that, but Mostek's products will be marketed through Sprague's distribution network.

Investor. The agreement also includes financial backing by Sprague and a provision for sharing research and development efforts to advance the technology of MOS devices as well as new circuit techniques for their application. Petritz, Mostek's president, says: "This joint participation will bring to the MOS field a large manufacturer of components and circuits with a very broad base in both active and passive technology, and one which is not a competitor of potential Mostek products in the equipment and systems field."

Another substantial investor in Mostek is New Business Resources, a Dallas venture-capital partnership formed about a year ago by Petritz and Richard Hanschen, former marketing manager of TI semiconductor operation. It was New Business Resources that got Sprague and Mostek together. However, this wasn't the first time that Sprague and New Business Resources teamed up.

Pirgo Electronics Inc., a manufacturer of power transistors and triacs in Farmingdale, N.Y., got started the same way about seven months ago. And Sprague, happy with its two new children, has found a way to branch out into new areas without taxing its management, engineering personnel, or capital.

TI moves. Meanwhile, back in Texas, TI was left with a few vacancies, so a reorganization was in order. J. Rodney Reese was called back from a subsidiary presidency to head most of TI's semiconductor

SCIENCE/SCOPE

The first five laser rangefinders for the M60 tank were delivered on schedule to the U.S. Army on April 30, and tests are now being conducted at Fort Knox and the Aberdeen Proving Grounds. When the commander selects his target and his gunner flashes the laser at it, the range appears on a readout and can also be fed automatically into the tank's fire-control system -- greatly enhancing the first-hit capability of the M60's 152-mm. gun.

A holographic technique for detecting flaws in honeycomb panels without destruction or contamination of the structure was demonstrated recently by Hughes Research Laboratory scientists. They stressed a fiberglass-aluminum panel and made a reflection interferogram of the strain pattern. The points where fiberglass and aluminum had failed to bond were easy to detect. They used a Hughes-developed stop-action holography system which provides images with photographic resolution, and can record dynamic strain patterns.

NASA's next Applications Technology Satellite, the Hughes-built ATS-5, has completed its environmental testing and is scheduled for launch in late summer. It will carry out a total of 13 experiments. One of the most significant will determine whether L-band frequencies will give better-quality radio communications between aircraft and between ships and shore stations. Another will test the feasibility of the gravity-gradient principle for stabilizing synchronous satellites.

Using heat pipes to cool high-density electronic packages and flatpack circuits is being studied at Hughes/Fullerton. Heat pipes are cooled by liquid evaporation, and can dissipate 1000 times more heat than solid metallic conductors of the same size. Hughes engineers are determining optimum structural geometry, operating fluid, and wick and shell materials for future applications.

More than 100 engineers from 10 nations met at Hughes recently to coordinate their efforts on the Intelsat 4 communications satellite program. They represented 10 companies which, with Hughes, are building four of the satellites under a \$72-million contract awarded by Communications Satellite Corp. on behalf of the 68-member International Telecommunications Satellite consortium. A similar meeting of manufacturing executives is scheduled for September.

Hughes is hiring engineers: Radar Systems, Optical, Electro-optical System Analysis (IR, LLTV, Laser), Digital Systems, Spacecraft Systems, Circuit Design, Missile System & Vehicle Design, Ordnance Specialists (SAF Systems), Electromagnetics Test (EMI/EMC). Requirements: B.S. degree, two years related experience, U.S. citizenship. Please write: Mr. J.C. Cox, Hughes Aircraft Company, P.O. Box 90515, Los Angeles 90009. Hughes is an equal opportunity employer.

The high-reliability component selection programs which Hughes has used for its communications satellites since 1963 have contributed to a phenomenal record: no significant failures in more than 1.5 billion component-hours aboard the 10 Hughes-built satellites now in orbit for DOD, NASA, and Comsat. Programs use Hughes-developed electronic component screening and power aging techniques.

Creating a new world with electronics



Circle 57 on reader service card

TIME DELAY

...The Most
Accurate
At \pm
3% Overall

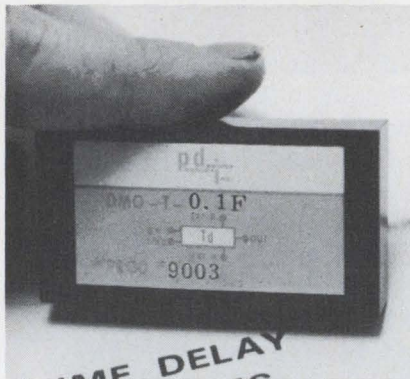

PDI Time Delay Modules

The Most Economical . . . And
Best In Ways That Are Most
Important:

- Delays from 10 millisecond —
300 seconds, $\pm 3\%$
- Repeat accuracy:
 $\pm 0.25\%$
- Solid state
- Fixed or Remote
Programmed Output
- Small enough to fit —
and work — anywhere

Now available from stock at
the Industry's most competitive
price:

\$42 each in quantities from
one to 49

pdesigns
roduct **i**nc.
111 Cardenas NE
Albuquerque, N.M. 87108
(505) 265-3551

U.S. Reports

marketing activity. A new division, called advanced technology and strategic planning, was formed in the components group; it will be headed by Glenn Penisten, a vice president formerly in charge of marketing for the components group. Ray Cotton, who was manager of customer centers, will take over Sevin's former job as the head of the MOS technology customer center. Also, the old materials and services group was split into equipment, components, services, and metallurgical and chemical materials.

Avionics

Short subject

The short-haul airliners developed after 1975 will land and take off with as long a run as seagulls need on a dock piling—and with less of a flap. Called V/STOL's for vertical/short takeoff and landing planes, the aircraft will have to carry advanced avionics gear to assure all-weather landing, navigation, and perhaps flight-control capabilities. Landing on a dime is harder than landing on an airstrip simply because dimes are smaller.

NASA's Electronics Research Center in Cambridge, Mass., is developing the necessary avionics techniques in its V/STOL avionics program, while NASA's Langley Center conducts flight tests as part of a cooperative effort. NASA wants to refine approaches which are economical enough for civil use and then make them public property. Thus, no systems as such are slated to come out of the program, just knowhow.

Since ERC began the V/STOL avionics program in 1967 it has become the center's single largest research area, taking an estimated \$2 million of ERC's fiscal 1969 expenditures [*Electronics*, Dec. 25, 1967, p. 44]. It already has passed through much of the first helicopter flight-test phase at Langley, Va. Phase I should be completed by September 1970, but ERC already is gearing for Phase II with fiscal 1969 money.

Spinoff. Phase I is using Gemini spacecraft guidance and navigation hardware to plot benchmarks for later navigation studies. Thus the performance of the Gemini G&N equipment has been gauged during takeoffs, landings, and other flight situations. The usual procedure has been to track the H-19 helicopter with radar to see where it really went, then to compare this data with the Gemini equipment's estimate. Often radar positional information is used in flight to update the guidance system.

But while very accurate (Richard J. Hayes, an assistant director of ERC, compares it favorably with the best of today's instrument landing systems), the Gemini hardware costs too much for civil use. Perhaps a less costly inertial system would suffice if coupled with Decca, Loran, or other aids.

In Phase II, ERC will begin to investigate computer-aided control as well as navigation, figuring that V/STOL's will be nearly as much work to pilot as today's helicopters; that is, too much.

Proposal requests were mailed this spring and by the end of this month contracts should be signed for a guidance computer, a data adapter (which would translate control commands, navigational data, and aircraft sensor information into digital form), a cockpit control panel for the computer, and a software package.

ERC hopes to have the computer subsystem hardware (including the data adapter and control panel) in hand by late 1969. An inertial sensing unit will be built in house by early 1970, and a complete software package with provisions for computer-aided attitude control, navigation guidance, steering, flight control, and other functions should be on hand by mid-1970.

With the resultant Phase II package, a digital system with both a strapdown inertial reference (developed in-house at ERC) and inputs from radio navigational aids, NASA would investigate computer-aided flight control.

Busy. While the navigational aids would provide positional updates for the computer and inertial refer-



DESIGNERS: AVOID SHOTGUN MARRIAGES

For design freedom, 12 sizes, all 550 Mu

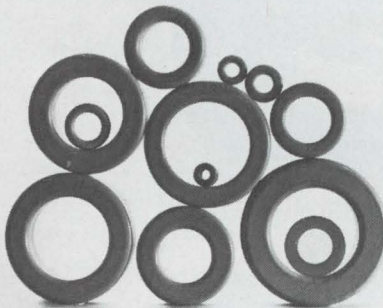

Use Magnetics Inc. 550 Mu Powder Cores

Magnetics Inc. first filled the void between 300 Mu powder cores and nickel laminations with the 550 Mu moly-permalloy powder core. We introduced it in three sizes.

And this perm is still exclusive with us. However, now you can get it in 9 new sizes—an O.D. range of .110" to 1.602". These fixed-gap toroids keep you from being forced into undesirable component marriages, let you tighten design to meet packaging requirements, cut total assembly costs in filters, chokes, transformers, inductors. They also provide: 1. A high inductance-to-size ratio. 2. Reduced d.c. copper resistance. 3. Less distributed capacity. 4.

Greater temperature stability than laminations. Avoid shotgun designing and get more freedom in using magnetic cores for circuit components. Try 550 Mu—we can ship from stock all 12 sizes. For additional information on 550 Mu powder core advantages, write Dept. EL-105 for Bul. FLC-02. Magnetics Inc., Butler, Pa. 16001.

MAGNETICS inc.
®

Tape, bobbin, ferrite, powder cores • Laminations • Photo-etched parts • Specialty metals • Engineered control systems

See where you can't be with COHU TV.

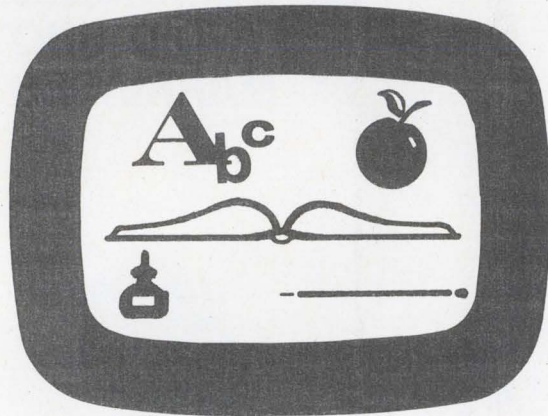

CLASSROOM INSTRUCTION



SPORTING EVENTS

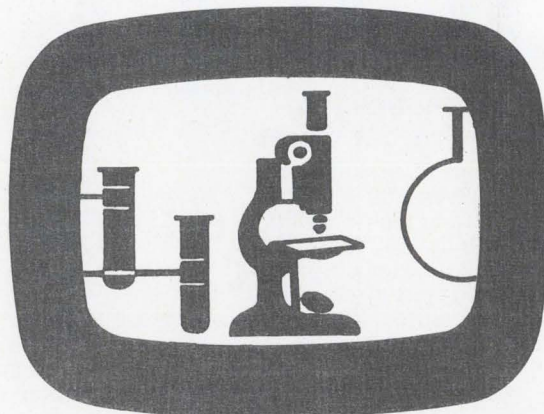

MICROSCOPIC EXAMINATION

For more details contact your nearest Cohu representative or the TV Product Line Manager direct at 714-277-6700, Box 623, San Diego, Calif. 92112, TWX 910-335-1244.

"Cohu Will be at WESCON Booth 2001."



U.S. Reports

ence, the reference and the computer would sense and control aircraft motion and attitude. The pilot would access the computer through a stick much like those used on graphic displays while the computer would fly the helicopter through servo systems.

The result would be reduced pilot workloads and more accurate navigation and control, but accomplishing this is only half the task. The other half is to do it cheaply.

So ERC is going to chip away at cost. With this in mind, the digital system is being made flexible enough to accommodate not only potentially inexpensive strapdown inertial references, but also laser gyros which might not only prove very accurate, but very inexpensive: "Just a matter of boring holes in a quartz block," says an ERC spokesman, "and that makes for very low parts costs. The laser could also be made redundant very easily merely by boring another system of holes in the same block of quartz," he adds.

Some radio aids are almost certain to be necessary and to determine the best price-performance ratio, ERC is prepared to select among Loran-C, Decca, ILS (instrument landing system), Tacan, VOR (vhf omni), DME (distance measuring equipment), and other systems.

For the record

Short tube. Sylvania is taking orders for 1970 delivery of a 3-foot-long CO₂ laser developing 1 kilowatt; efficiency is 10%. The laser is designed for cutting and drilling, though it can be used for radar. Most kilowatt lasers are about 60 feet long; Sylvania's Electro-optics Organization gained high power density with a blower in the vacuum system that sends gas through a heat exchanger transversely across the laser region for cooling. The conventional way is to send it down the entire length of the tube.

TTL surge. The effects of the Texas Instruments price cut for transistor-transistor-logic circuits is



Let's lay our cards on the table

When it comes to Series 54/74 TTL, Transistron holds a full deck . . . twenty-six Series 54 devices, in ceramic DIP (J) or Flat (F) packages, twenty-eight Series 74 devices, in ceramic DIP (J) or plastic DIP (E) packages. The 54/74J and 74E units are pin-for-pin identical, and all circuits in all packages are completely interchangeable with those of the original 54/74 manufacturer. Prices are competitive and we can deal you a pat hand right off the shelf.

Ranging from basic gates to more complex functions such as adders, counters and shift registers, Transistron's family of TTL devices now numbers more than 450, including a broad range of Series I and Series II types.* This gives you breadth of choice virtually unmatched in the industry.

Find out what's in the cards for you. Send for complete data and specifications on the devices that interest you.

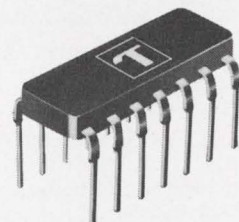

Transistron
 electronic corporation
 168 Albion Street Wakefield, Massachusetts 01880

* Electrically and mechanically interchangeable with SUHL I and II.

telonic's new log amp detector has a dynamic range of 105 dB (without a pit stop)



And that's a long stretch of signal by any standard. This new log amp detector will accept voltage swings as wide as 178,000 to 1, and still provide an output that gives you an on-scale display. Operable over 400 kHz to 130 MHz, the amplifier converts any RF input to a logarithmic value and supplies a linear output for 'scope, meter, or recorder.

Ideal for gain measurement, log plotting, response testing or other applications where the input signal takes wide excursions, this new instrument has built-in Expansion and Reference adjustments to maximize its versatility.



The Model 3353 is a plug-in unit for the 2003 Sweep/Signal Generator

System permitting the user to recover swept or CW signals as low as -85 dBm. This allows the user to display wide ranges of input frequencies and power levels without attenuating or changing the oscilloscope sweep settings.

Other Specifications

Useful Input	
Power Range	-80 dBm to $+20$ dBm
Linear Log Range	-70 dBm to $+20$ dBm
Departure from Ideal Log Response	± 2 dB
Tangential Sensitivity	-85 dBm

Also available is the Model 6001 Log Amp Detector which is a completely self-contained unit, offering the same specifications as called out above as well as an offset control and front panel meter calibrated from -70 to $+20$ dBm.

Write For Details—Complete specifications on both versions plus the 2003 Sweep Generator are available on request. Write the Marketing Department for File 3353.



TELONIC INSTRUMENTS

A Division of Telonic Industries, Inc.
60 N. First Avenue
Beech Grove, Indiana 46107
Tel: 317 787-3231 • TWX: 810 341-3202

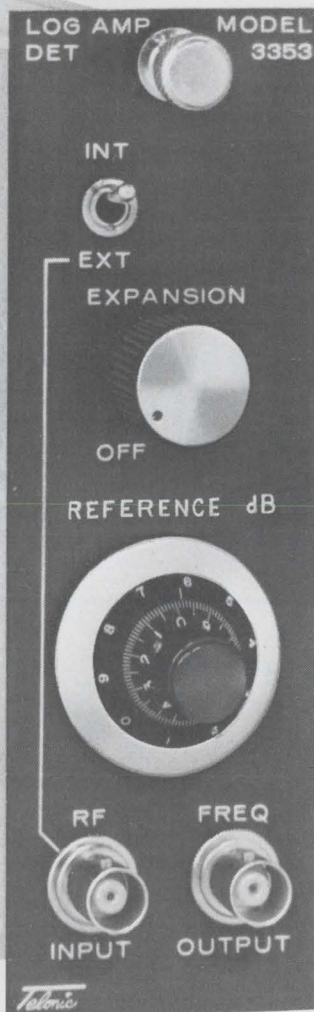

U.S. Reports

being felt already. Not only are Signetics and National Semiconductor pushing TTL, but now Fairchild Semiconductor, in a reversal of earlier strategy, plans to second source the Series 74 line.

Earthlings. Five firms have entered bidder teams for the proposed earth resources technology satellite (ERTS) project. Two parallel study contracts will be awarded in September, with one of those two contractors eventually being selected to build the spacecraft. Bidders are General Electric (with Bendix Aerospace and Wolf R&D); TRW (with IBM Federal Systems and Itek); RCA (with Hughes); Lockheed (with Allied Research Associates); and North American Rockwell (with Ball Brothers Research Corp.).

Bugged bunnies. If you're lucky enough to be driving through northwestern Utah in the next five months don't be dismayed by the sight of jackrabbits bearing portable radios. It's not the heat; just a Utah State University telemetry ranging study, undertaken with the blessings of the Federal Communications Commission, with the rabbits plugged into the 50-to-50.7 megahertz band.

On the moon. The Apollo 11 moon landing mission will have several new electronics systems along. Among them are two by RCA—a vhf communications setup and a collapsible dish antenna—and Ryan Aviation's landing radar. The vhf system, consisting of a backpack for each astronaut, will keep them in touch with the lunar module. The antenna, a 10-foot parabolic model of gold-plated wire mesh that will open like an umbrella, will be pointed at the earth to back up the S-band antenna on the module. And the radar will measure the module's altitude and velocity.

Entry. Fairchild will introduce its FLD-100 light-emitting diode in a few weeks. The gallium arsenide device will emit at 0.9 microns. It will sell for \$1.50 in quantities up to 10,000; usual price is \$3 to \$4.

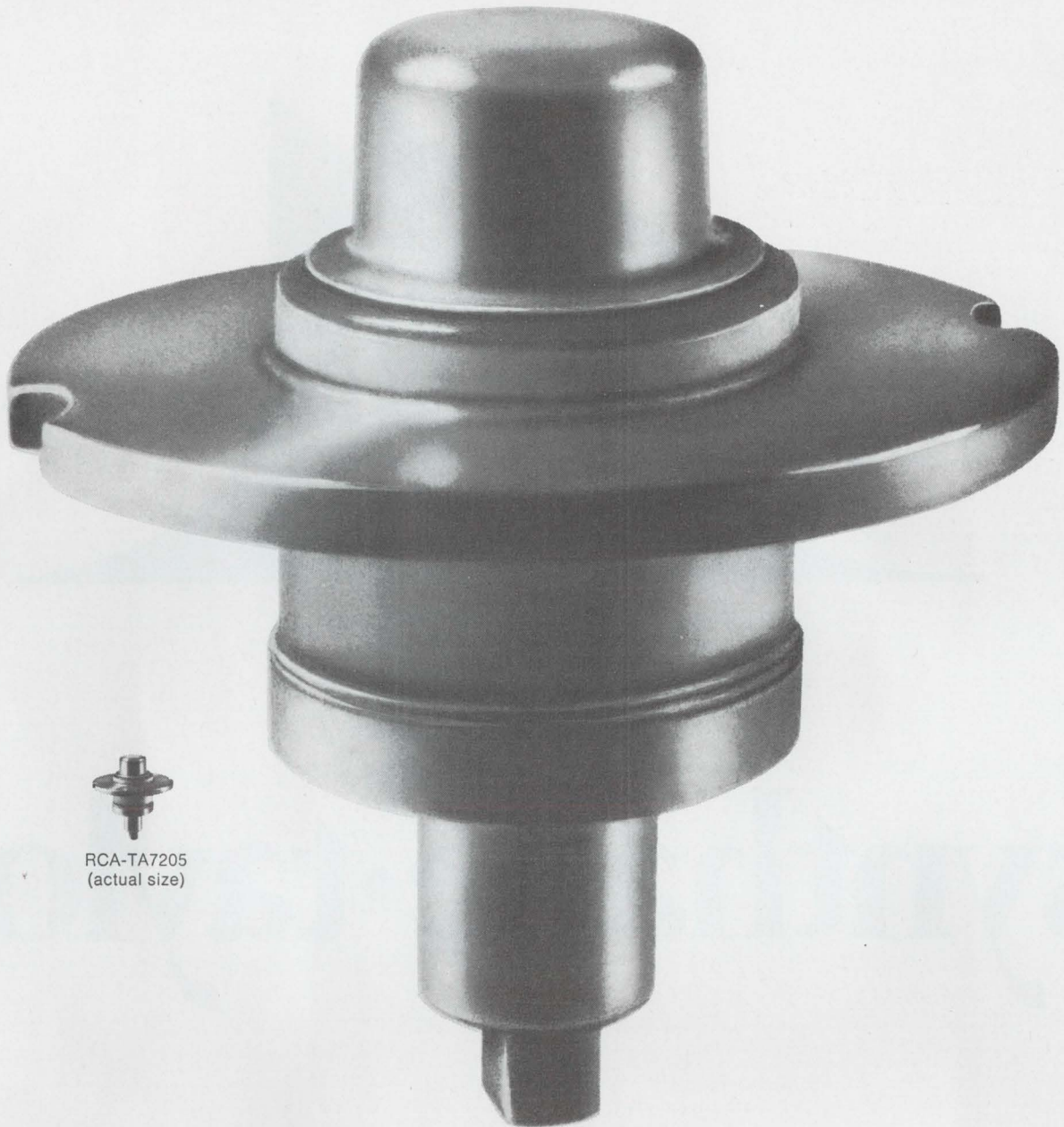

RCA-TA7205
(actual size)

Here—available—is the world's highest power, highest gain, highest efficiency transistor for operation at 2 GHz. In addition to the features above, this silicon n-p-n "overlay" transistor also offers 11-W output with 11.5-dB gain at 1.2 GHz at 60% efficiency.

The package is all new: hermetically-sealed, ceramic-metal, coaxial type that can be used in large signal applications in coaxial, stripline, and lumped-constant circuits.

RCA's multiple-emitter-site "overlay" construction is a feature recently patented.

The RCA-TA7205 is intended for reliable performance in such applications as microwave communications, S-band telemetry, microwave relay link, phased-array radar, distance measuring equipment, and collision avoidance systems.

Ask your local RCA Representative or your RCA Distributor for more detailed information. For technical data, write: RCA Electronic Components, Commercial Engineering, Section PN7-1, Harrison, N. J. 07029.

**5.8-W (typ.) output,
7.6-dB gain,
45% efficiency,
at 2 GHz,
in common-base circuit.
New and now—
RCA-TA7205**

RCA



synthane·taylor

The new mark of quality and the new name
in laminated plastics and fabricated plastic parts

A natural combination combining the resources of two respected names in the field—Synthane and Taylor—in the manufacture and fabrication of laminated plastics.

Together they offer you tangible benefits. One-source savings on a broader range of

products. Pooled research and development talent. Greater productive capacity. Improved availability from three plants—Valley Forge and Oaks, Pa., and LaVerne, Calif.

For uninterrupted service on your orders for plastic laminates, fabricated plastic

parts, copper clad laminates, and vulcanized fibre, call, write, or wire us as usual. See if we don't serve you twice as well.

Synthane-Taylor Corporation
an Alco Standard Company
Valley Forge, Pa. 19481
(215) 666-0300

In a world that offers a million different connectors, who needs 7 more?

We don't want to complicate your life.
We want to make it easier for you.

And we think these 7 printed circuit
connectors are just the ones that can do it.

Each one started as a special order for a
customer like Univac, Automatic Electric,
or Mohawk. Each had so many possibilities
that we got permission to make them for
everybody.

So here's the biggest little line of connec-
tors in the business. Utterly unique, not
available as standard items anywhere else.

216-pin, 8-position

196-pin, 2-position

44-pin, 1-position

27-pin, 1-position

220-pin, 5-position

All connectors are made with our famous
welded gold-dot contact design that puts
gold only where it's needed, yet holds
contact resistance below 5mV drop
at 5A.

Until recently, you couldn't
buy off-the-shelf connectors
like these for love or money.

You still can't buy them
for love. Sylvania Metals &
Chemicals, Parts Division,
Warren, Pennsylvania 16365.

98-pin,
1-position

40-pin, male-connecting module

SYLVANIA
GENERAL TELEPHONE & ELECTRONICS

MICROWAVE

...dimensions that make Andrew's antenna systems capability unique

We sell more microwave antennas than anyone. Two or three times as many. It's this, plus a unique "degree of completeness" that makes Andrew the better buy. It's antennas. *And* waveguide or coaxial cable. Made to work together. *All* the hardware you need. Plus *all* of the software necessary to guarantee performance as specified. It's technical assistance *on an international basis*. Help all the way through the installation if you need or want it. Anywhere in the free world. Like to know more? Communicate with Andrew.

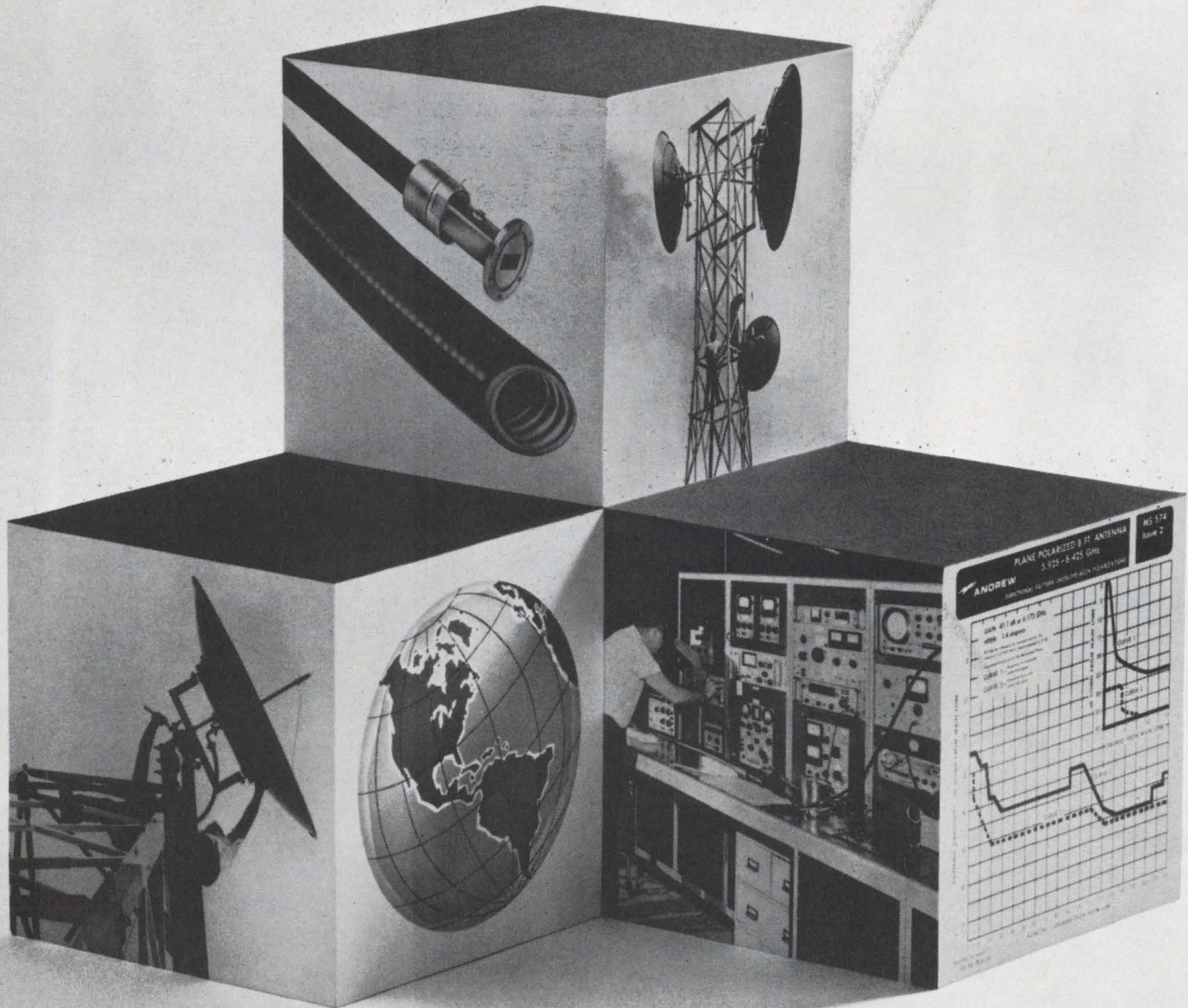

ANDREW

Washington Newsletter

July 7, 1969

MOL layoffs top Air Force estimates

What used to be a tight labor market for the electronics industry is rapidly loosening as a result of layoffs after cancellation of the Air Force's Manned Orbiting Laboratory project—and it may become even looser than the private Air Force estimate of between 16,500 and 17,500 layoffs indicates.

General Electric, for example, which the Air Force estimated would drop between 1,000 and 1,400 workers, recently gave the ax to close to 1,700 of its Valley Forge, Pa., Space Center staff. If Air Force estimates for the other MOL contractors prove equally conservative, the number of layoffs could rise well beyond the 12,500 projected for prime and major subcontractors, as well as the 4,000 to 5,000 estimated layoffs at lower tier vendors.

In addition to G.E., the Air Force is forecasting cuts of 4,500 to 5,000 for McDonnell Douglas at the firm's Huntington Beach, Calif., facility and another 2,000 at its St. Louis plant as well as 1,600 for Martin Marietta.

NASA's budget has its ups and downs . . .

NASA is still riding a budgetary roller coaster for fiscal 1970. It will probably wind up about where it was in fiscal 1969.

Given a lift when the House voted the agency \$3.9 billion [*Electronics*, June 23, p. 69], space officials are girding for another downhill turn because the Senate is expected to hold the line at \$3.7 billion. This means a compromise appropriation will have to be worked out and chances are that the space agency will come out with slightly less than \$3.8 billion.

Even so, NASA will still have \$3.9 billion to spend, thanks to the \$117 million put in reserve during fiscal 1969.

. . . as job mix falls far short of needs

NASA's budgetary problems are giving rise to yet another headache: an imbalance in the mix of professional disciplines is beginning to take its toll in several in-house research programs. Among the programs most seriously affected are those dealing with aircraft-noise abatement, air safety, and biomedicine.

Space officials want to hire additional research talent, but claim they can't unless Congress loosens the purse strings.

FCC investigating its own R&D role

The Federal Communications Commission's small R&D staff is initiating three studies that indicate a more progressive look for the commission in technical planning and the possibility of a bigger research and development push in the future.

A two-year survey of frequency assignments for microwave systems is being negotiated with Communications & Systems Inc., a subsidiary of the Computer Sciences Corp. Estimated contract price is about \$200,000. Also, the commission will turn over an undisclosed sum to the Commerce Department's Institute for Telecommunications Sciences in Boulder, Colo., for a broadband-technique study; the study will determine what kind of impact new technology now in the laboratory will have on communications in the future. The institute, in the course of the study, will assign specific duties to various universities. Finally, Earl Cullum and

Washington Newsletter

Associates of Dallas have been selected for a \$38,000 nine-month study of the current and potential future role of the FCC's R&D lab. One basic question to be answered is how large an in-house R&D capability the FCC should have.

In addition to this flurry of studies, the FCC is one of the Federal regulatory agencies with small R&D staffs considering the establishment of their own think tank, the Institute for Regulatory Agencies [*Electronics*, June 9, p. 75].

Self-destruct IC's sought by Navy

If nothing else, the Pueblo incident has taught the Navy that fire axes—and even hand grenades—are unsuitable destruct mechanisms for sophisticated equipment; the vessel was captured with its electronic gear intact. What the Navy now wants, particularly for its new cryptographic gear, are self-destruct IC's.

The next round of bids is expected to include various destruct techniques. Some possibilities: a hermetically sealed destructive high-voltage source in each circuit and a variety of pyrotechniques.

In other upcoming contracts, the Navy will be zeroing in on functional packaging for LSI, praetersonics, and ionizing radiation as an etching agent for microcircuits.

Samsco chief's image may be hurt by profit probe

Revelations of escalating Air Force costs on the Minuteman, and Senate testimony before Wisconsin Democrat William Proxmire's subcommittee, could shoot down the rising star of Lt. Gen. John W. O'Neill, commander of the Space and Missile Systems Organization. O'Neill has been widely touted as the next commanding general of the Air Force Systems Command.

Most damaging to O'Neill's chances is the Proxmire disclosure that A. Ernest Fitzgerald, the Air Force deputy for management systems who has been blowing the whistle on cost overruns, advised O'Neill in writing more than 18 months ago of the cost problems associated with the Minuteman program.

Weigh Tiros-N for early 1970's

NASA may launch two, not one, Tiros experimental meteorological satellites.

With the launching of Tiros-M still three months away, the space agency is considering launching another—tentatively called Tiros-N—sometime between 1972 and 1974. About \$1.5 million is earmarked for studies to determine whether Tiros-N should be planned.

Also on the meteorological front, NASA plans to issue requests for proposals for prototype synchronous meteorological satellite within six months. The first satellite would be launched in late 1971, and would be used to predict and locate severe storms, analyze cloud movements, and determine wind fields. The satellite would employ hardware developed for the ATS (applications technology satellite) program, and its goal would be near real-time dissemination of weather data.

Addendum

FCC chairman Rosel H. Hyde has confirmed capital reports that he will, at the President's request, stay at his post beyond the expiration of his term [*Electronics*, June 23, p. 34]. He is expected to stay through summer and into the fall.



Investigate New Sources Of Quality Products At
JAPAN ELECTRONICS SHOW '69

Osaka
 Oct. 1-7

JAPAN ELECTRONICS SHOW 1969

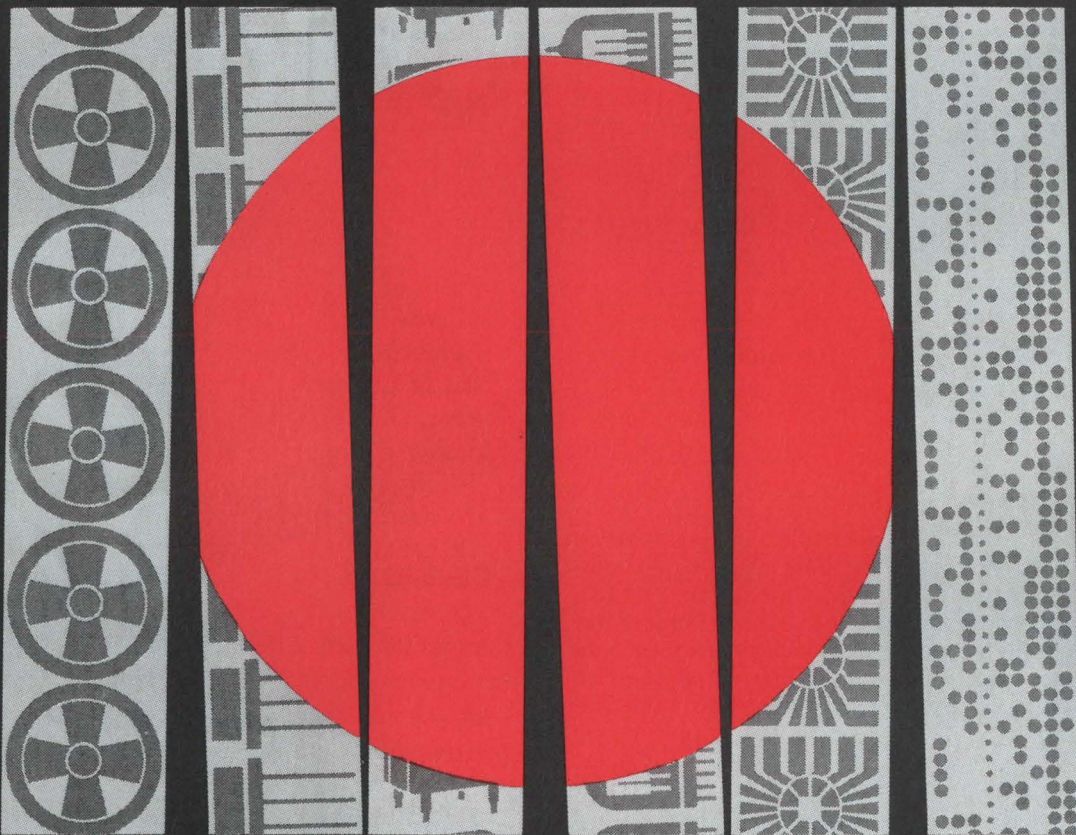

NOW SET ASIDE A DATE

Any date between Oct. 1-7 At the Osaka International Trade Fair Grounds

Booth applications are increasingly being sent in...and about 400 exhibitors (300 domestic & 100 foreign) will display the latest state-of-the-art products in 28,000 square meters of attractive pavilion space.

Started in 1962, the Japan Electronics Show has indeed become international—it's the most prolific market place in the Orient. And a stepping stone for initiating or promoting business ties and technological innovations. Selected a date?

Exhibit Areas are divided by...

CONSUMER PRODUCTS

Televisions, Radios, Stereo phonographs, Tape recorders, etc.

INDUSTRIAL PRODUCTS

Communications, Testing/Measuring equipment, Radio apparatus & associated electronic devices, etc.

COMPONENTS/PARTS

Discrete components (resistors, capacitors, transformers, speakers, semiconductor devices, etc.) Integrated circuits, etc.

Sponsored by

ELECTRONIC INDUSTRIES ASSOCIATION OF JAPAN

Tosho Bldg., 3-14, Marunouchi, Chiyoda-ku, Tokyo, Japan Cable: ELINDASO TOKYO Phone: 211-2765

Overseas Information Offices

Electronic Sec. **JAPAN LIGHT MACHINERY INFORMATION CENTER (JETRO)**

U.S.A.: 437, 5th Avenue, New York, N.Y. West Germany: Dusseldorf, Berliner Allee 32, West Germany

Managed by

JAPAN ELECTRONICS SHOW ASSOCIATION

1970 Japan Electronics Show April 10-20, Tokyo



Investigate New Sources Of Quality Products At JAPAN ELECTRONICS SHOW '69

Osaka
Oct. 1-7

Pulling the nations
of the world
closer together...

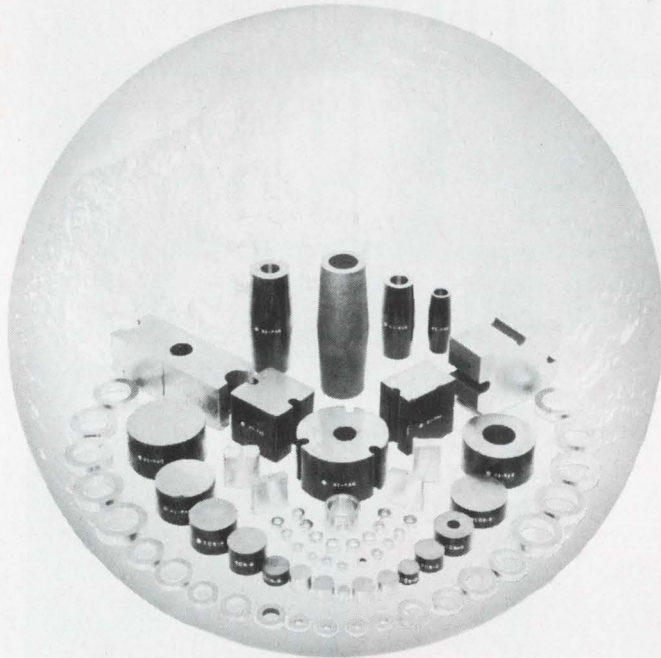

Hitachi Cast Magnets

Today's communications systems could not exist without high-grade permanent magnets. Cast magnets in particular are becoming increasingly important. Hitachi Metals produces some of the best. Cast magnets for microwave communications. Compactly designed and finished to close tolerances. Featuring high coercive force and high energy product plus magnetic field uniformity and stability.

At Hitachi Metals, magnet production is integrated. Backed by decades of experience, and a tradition of quality workmanship. Hitachi Metals makes full use of technology as modern as tomorrow.

The results speak for themselves. In communications equipment around the world.

Typical Hitachi Cast Magnets and Properties

Type	Residual Induction (Br) gauss	Coercive Force (Hc) oersteds	Energy Product (B x H) max. $\times 10^{-6}$
HI-MAG I (ALNICO-5-7)	13,500~14,500	700~750	7.0~8.2
HI-MAG II (ALNICO-5-7)	13,000~14,000	680~780	6.8~8.0
YCM-8B (ALNICO-8)	8,800~9,600	1,380~1,500	4.8~5.5

Hitachi cast magnets are also used in meters, generators, motors, telephone equipment, magnetos and many other types of equipment. For further information, please contact:



HITACHI
Hitachi Metals, Ltd.

Head Office
Chiyoda Bldg., Marunouchi, Tokyo, Japan
Hitachi Metals America, Ltd.
Magnet Materials Sect.
437 Madison Ave., New York, N.Y. 10022,
U.S.A. Tel. 212-758-5255



COMPET: Brain Child



CS-22C



Compet CS-22C. Sharp's high I.Q. problem solver for fast-moving engineers and scientists. The quiz kid so light you can carry it anywhere. Yet the IC construction provides instant answers to a wide range of simple and complex calculations with maximum efficiency.

Silently calculates up to 14 digits and 6 decimal places. Has a memory bank for wide calculation versatility. Carries out exponent and mixed calculations instantly. Automatic successive multiplication and division by a constant. Automatic decimal system, round off and credit balance. Memory indicator and over capacity error light.

Try it. CS-22C. One demonstration and you'll know why Sharp leads the field.

SHARP
HAYAKAWA ELECTRIC CO., LTD. Osaka, Japan

U.S. Subsidiary: SHARP ELECTRONICS CORP. 178 Commerce Road Carlstadt, New Jersey

"Sharp Has a Way of Making it Better"



Investigate New Sources Of Quality Products At **JAPAN ELECTRONICS SHOW '69**

Osaka
Oct. 1-7

**TEC's wide variety of 10-second to 24-hour,
small-size, lightweight, moderately priced
UT series motor timers
now in great demand**



TEC's reliable controllers are also highly popular: ● Air Timers ● Motor Timers ● Solid State Timers ● Auxiliary Relays ● Miniature Relays ● Impulse Counters ● Electronic Counters ● Electromagnetic Counters ● Micro Switches ● Limit Switches ● Push-button Switches ● Indicating Lamps ● Solenoids ● Level Con-

trollers ● Electronic Devices



*the sum of the whole—
technology, economy and
dependability*

TOKYO ELECTRIC CO., LTD.

14-8, 1-chome, Uchi-Kanda, Chiyoda-ku, Tokyo, Japan
Circle 194 on reader service card

SPANNING THE FUTURE

With over 50 years of experience, Japan's largest maker of capacitors knows no time limit. Products for everything from home and electronic appliances to space equipment.

Nichicon. Remember it. We're Japan's biggest!



PRODUCTION ITEMS

Hybrid ICs, Electrolytic, Mini-Mini, Tantalum, Oil, Ceramic, Wax Paper, Metallized Paper, Plastic Film, and Mica Capacitors

Nichicon Capacitor Ltd.

Head Office: Uehara Bldg., Oikedori, Karasuma-higashi-iru, Nakagyo-ku, Kyoto, Japan
Telex: 5422-120 Cable Address: CAPACITOR KYOTO



Circle 195 on reader service card

**NEW
Ceramic
Filter
for
FM
Stereo**

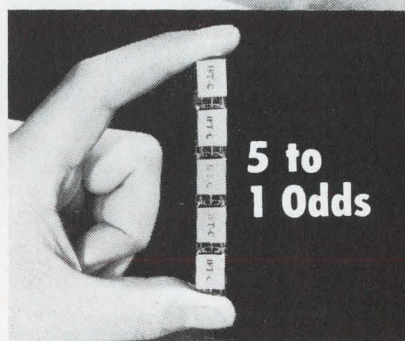

**5 to
1 Odds**

CERAMIC FILTER

Not one or two but five conventional IFTs are replaced with one of the remarkable new Murata Ceramic Filter Model CFP-10.7MA in FM stereo radios!

Odds are not other electronics innovation will do so much to advance IC technology, for the Ceramic Filter is entirely solid state... with no coils, no mechanical couplings... wholly electrical.

Your production costs will show remarkable reductions and there is no need for costly IFT post-assembly alignment—the Ceramic Filter is fix-tured and monocellular, need no alignment.

Model CFP-10.7MA's selectivity curve and its application to FM stereo radio design will amaze you. Just send for the complete specifications of the Model CFP-10.7MA, in our latest technical bulletin.

muRata

Murata Manufacturing Co.

Nagaoka, Kyoto, Japan

Telex: 5422-317 KYO

Cable Address: MURATAKYOTO

Murata Corp. of America

2 Westchester Plaza, Elmsford,
New York 10523

Telex: MURATA EMFD 137332

Phone 914-592-9180

Circle 71 on reader service card

71



Investigate New Sources Of Quality Products At JAPAN ELECTRONICS SHOW '69

Osaka
Oct. 1-7

Perfect Your CCTV System with COSMICAR® lenses



Focal length 15~145mm Aperture f/2.5

A new member to the superb COSMICAR lens family!!

The most efficient **10 : 1 zoom** lens, unmatched for its optimum performance, both optically and mechanically, with impeccable definition and resolution throughout its entire zoom range.

Also available are scores of other lenses, ranging from 8.5mm to 1,000mm telephoto, zoom and those motordriven among them, for immediate delivery, after being tailored to your specifications.



COSMICAR OPTICAL CO., LTD.

568, Shimoochiai, 2-chome, Shinjuku-ku, Tokyo Cable Address: "MOVIEKINO TOKYO"

Circle 196 on reader service card

Kimuden ELECTRIC CONTROL PARTS AND APPARATUS

- Indicator lamps
- Terminal bases
- Push-button switches
- Connectors
- Annunciators

KIMURA ELECTRIC CO., LTD.
Kimuden Bldg., No. 33-10, 1-chome,
Nishi-Gotanda, Shinagawa-ku,
Tokyo, Japan
Phone: 492-8511

RODAN INDICATOR TUBE

GR-111
Miniature
Side Viewing

CD 24
Standard
Top
Viewing

CD 43
Standard
Rectangle

CD 13
Miniature
Top Viewing

**OKAYA ELECTRIC
INDUSTRIES CO., LTD.**
Yasuda Bldg., 8-3, 1-chome, Shibuya,
Shibuya-ku, Tokyo, Japan

YOKOWO TELESCOPIC ROD ANTENNA

● For TV SET

Dipole (SA-106) Dipole (TW-40) Monopole (SA-127A)

● For FM RADIO

Monopole (64R-78) Monopole (D208-98.5) Monopole (YS68336)

YOKOWO MFG. CO. LTD.
No. 5, 7-chome, Takinogawa, Kita-ku, Tokyo, Japan
Tel. 984-3111 Telex: 272-2197
Cable: "SHINEBRIGHT" Tokyo



Investigate New Sources Of Quality Products At
JAPAN ELECTRONICS SHOW '69

Osaka
 Oct. 1-7



120LB (DC-50 MC)

120MB (DC-15 MC)



NEW OSCILLOGRAPH TUBES FROM HITACHI

WHAT THEY HAVE IN COMMON:

These Hitachi tubes are rectangular cathode ray tubes for precision instruments, with electrostatic focus and deflection.

They all use a mesh grid and inside scale, giving them high deflection sensitivity and non-parallax observation.

They're all made by Hitachi — so you know they're good. These two, the 120LB (DC-50 MC) and the 120MB (DC-15 MC) are particularly apt for portable equipment.

ONE MAY BE RIGHT FOR YOUR OPERATION:

Item	120LB	120MB	140LB	Unit
Overall Length	423±7	318±7	466±10	mm
Heater Voltage	6.3	12.6	6.3	V
Heater Current	0.3	0.15	0.3	A
Post Accelerator Voltage	10,000	6,000	15,000	Vdc
Accelerator Voltage	2,000	1,400	2,400	Vdc
Useful Scan	80×48	80×64	100×60	mm ²
Deflection Factors				
Horizontal	12—16	11—16	12—18	V/cm
Vertical	4—7.5	6—10	3—5.5	V/cm

And if these aren't exactly what you're looking for, see the others—including our vidicon tubes and our cathode ray tubes for industry—from Hitachi, the people who make exacting quality available for less.



HITACHI
 Hitachi, Ltd. Tokyo Japan

HITACHI NEW YORK, LTD., CHICAGO OFFICE: 333 N. Michigan Ave., Chicago, Ill. 60601, U.S.A. Tel: 726-4572/5
 ELECTRONIC COMPONENTS DEPT. HITACHI NEW YORK, LTD., 825 3rd Ave. (Room 2620) New York, N.Y. 10022, U.S.A. Tel: 838-7411
 HITACHI, LTD., DUESSELDORF OFFICE: Graf Adolf Strasse 37, 4 Duesseldorf, West Germany Tel: 10846

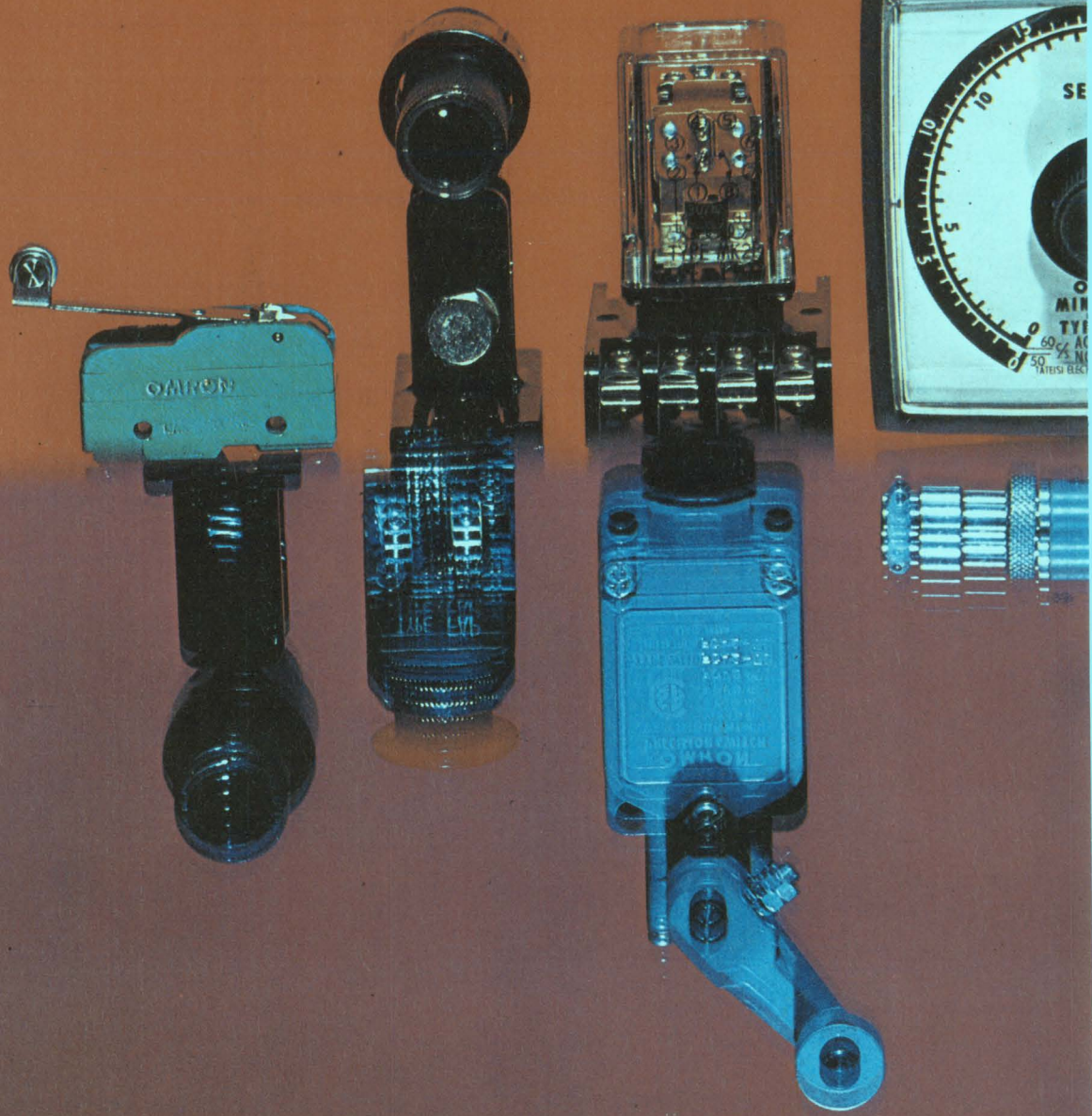

Reflected lately on controls compatibility?

SALES OFFICE / Toa Bldg., 5, Yonban-cho, Chiyoda-ku, Tokyo, Japan Phone (265) 4611 Telex 232-2179 Cable Address OMRONELCO TOKYO
OVERSEAS DISTRIBUTORS: ● AUSTRALIA/H.Rowe & Co., Pty., Ltd. ● AUSTRIA/Carlo Gavazzi-Billman G.m.b.H. ● ITALY/Carlo Gavazzi S.p.A.
● BELGIUM/Carlo Gavazzi Belgium s.a. ● ENGLAND/Keyswitch Relays Ltd. ● FORMOSA/Hai Nan Trading Co., Ltd./Sheng Ching Trading Co., Ltd.
● FRANCE / Billman-Carlo Gavazzi S.A.R.L. ● HOLLAND / Carlo Gavazzi-Billman Nederland N.V. ● SPAIN/Carlo Gavazzi-Reguladores Billman s.a.
● MEXICO/Schultz Y Cia., S.A. ● SWEDEN/Billman Regulator ab. ● SWITZERLAND/Carlo Gavazzi-Billman AG. ● U.S.A./Sigma Instruments Inc.
● SOUTH AFRICA/P.J.Yelland & Co. (Pty) Ltd. ● WEST GERMANY/Carlo Gavazzi-Billman Industriezulieferung G.m.b.H.

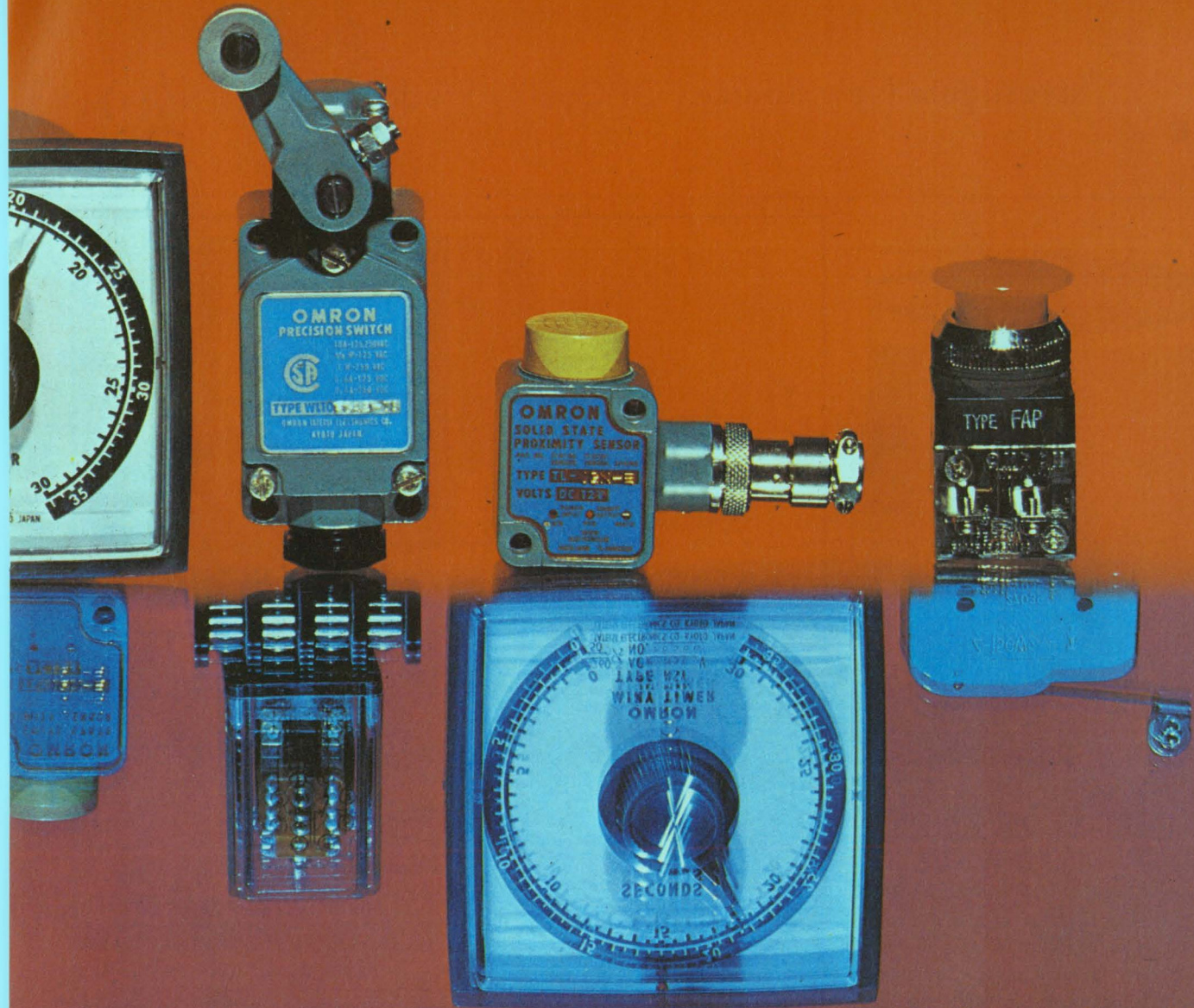

As a specialist maker of switches, relays, timers, and other controls, OMRON is very involved with the problems of inter-relating components. Unusual product-design situations, which one-control manufacturers are often not aware of, are the very starting point of OMRON design thinking. Our design engineers work in independent but closely consulting units; a practice which ensures that every switch, relay and timer is fully design-integrated and more versatile.

This total design approach has led OMRON to conclude that performance relationships between components are often as vital as the components themselves. Think about that a little.

And think of us as the multi-component specialist of world electronics. Because that's exactly what we are.



OMRON

OMRON TATEISI ELECTRONICS CO.



Investigate New Sources Of Quality Products At JAPAN ELECTRONICS SHOW '69

Osaka
Oct. 1-7

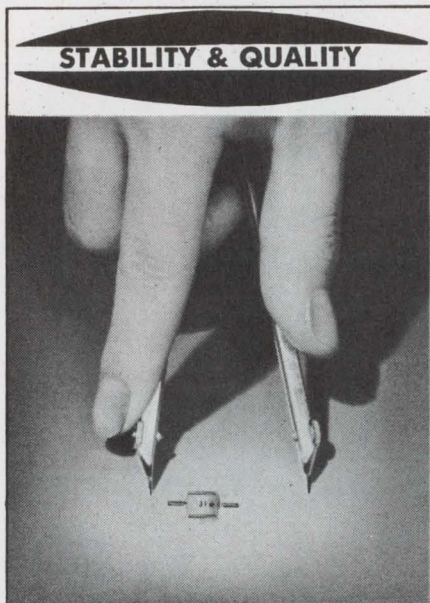

SOLID TANTALUM CAPACITORS FOR HYBRID ICs - "MICROCAP"

Capacitance exceeding 10,000 picofarads obtained despite miniature size. "MICROCAP" features excellent heat resistance, solderability and mechanical strength comparable to conventional discrete components, for easy use in hybrid integrated circuits.

Specifications:

Operating Temperature Range: -55°C to $+85^{\circ}\text{C}$
Standard Voltage Rating: 6.3, 10, 16, 25, 35 VDC
Standard Capacitance Value: .001 to 22MFD (EG series)
Standard Capacitance Tolerance: $\pm 20\%$ (M)

MATSUO'S other capacitors include:

Metallized Polyester Film Capacitor:

Type FNX-H mylar wrapped.

Solid Tantalum Capacitors:

Type TAX hermetically sealed in metallic case, Type TSX encased in metallic case and sealed with epoxy resin, Type TSL encased in metallic case and sealed with epoxy resin. **Polyester Film Capacitors:**

Type MFL epoxy dipped,

Type MFK epoxy dipped, non

inductive, Type MXT encased in plastic tube, non inductive.

For further information, please write to:

MATSUO ELECTRIC CO., LTD.

Head Office: 3-5, 3-chome, Sannari-cho, Toyonaka-shi, Osaka, Japan

Cable: "NCCMATSUO" OSAKA Telex: 523-4164 OSA

Tokyo Office: 7, 3-chome, Nishi-Gotanda, Shinagawa-ku, Tokyo

15dB Gain

MODEL TAM-2S

UHF/VHF/FM ALL BAND TRANSISTOR BOOSTER

45~900MHZ

Best for Colour and Black/White, and FM Radio as well.

DX ANTENNA CO., LTD. MANUFACTURERS, EXPORTERS
CABLE DXANTENNA KOBE, JAPAN

DX ANTENNA

Circle 199 on reader service card

KOKUYO'S MODEL TCT-7C A STANDARD TRANSISTOR CURVE TRACER IN THE WORLD

MODEL TCT-7C

Features

1. Efficiently functions in measuring various transistors, diodes, field effect transistors (combined with Model 7C-1 FET Adapter), PNP and NPN.
2. Stabilized with full solid circuit system.
3. Best for research and quality control.

OTHER MAJOR PRODUCTS

- Semiconductor Automatic Tester
- IC Automatic Tester
- Diode & Thyristor Curve Tracer
- Audio Response Tracer.

KOKUYO ELECTRIC CO., LTD.
1-36-15, OKAYAMA MEGURO-KU TOKYO JAPAN
CABLE ADDRESS "INSTKOKUDEN TOKYO"
PHONE TOKYO 03 (717) 3181(SL)lines

Circle 200 on reader service card

Apollo

THERMAL TIME DELAY RELAYS For Protection of Circuits

Specifications:

* Heater voltage: 1.5~100V, Heater ratings: MT type: 2W, GT type: 4W, RNC type: 0.5W * Contact current: MT type: 3A max., GT type: 5A max., RNC type: 1A max. * Contact resistance: Less than 50 mΩ * Delay time: 2~180 sec. * Temperature compensation: -55 ~ -80°C

* Accepts customers' specifications.

Other Products:

* Electron tubes for tropospheric observation * Miniature high voltage rectifier tubes * Indicating tubes * Special electron tubes.

APOLLO CORPORATION

5-1, Togoshi 6-chome, Shinagawa-ku, Tokyo, Japan
Phone: Tokyo 03-786-2001

Circle 201 on reader service card



Investigate New Sources Of Quality Products At JAPAN ELECTRONICS SHOW '69

Osaka
Oct. 1-7

ANNOUNCEMENT!!

Gentlemen:

It is a pleasure for me to inform you of the recent opening of our new liaison office in New York. We have taken this step so that we may better cope with rapidly increasing trading transactions and at the same time broaden our range of customer services.

As you know, we are, and have been since our establishment in 1925, one of the leading manufacturers of electronic components in Japan. Our success, of course, is due directly to the cooperation customers like yourself have extended over the years. Taking this opportunity, I wish to extend a warm thank you, and express my earnest desire for even greater mutual cooperation through the medium of this new liaison facility.

With kindest regards,

H. Ikeda
President

SHOWA MUSEN KOGYO CO., LTD.

Head Office: No. 5-5, 6-Chome, Togoshi, Shinagawa-ku, Tokyo, Japan.
Cable: "SHOWAMUSEN TOK" Phone: 783-1171
New York Office: c/o Kanematsu-Gosho (U.S.A.) Inc., One Whitehall Street, New York, N.Y. 10004, U.S.A. Phone: Hanover 5-2700

Circle 202 on reader service card

NOBLE COMPONENTS

SMALL MOLDED CAPACITOR (GIMMICK TYPE)

SLIDE VARIABLE RESISTOR

<VJ605>

- EFFECTIVE SHAFT TRAVEL: 60 MM (2.36")
- FOR TINT CONTROL AND VOLUME CONTROL



WIRE-WOUND VARIABLE RESISTOR

<WR181-6K>

- FOR CONVERGENCE CIRCUIT



CARBON-COMPOSITION VARIABLE RESISTOR

<V24L5G (PH)N>

- SMALL TRACKING ERROR

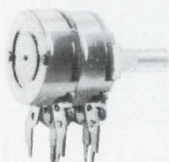

MAIN PRODUCTS: VARIABLE RESISTOR ● ELECTRONIC SWITCH ● CAPACITOR ● FIXED RESISTOR ● COIL & IFT



TEIKOKU TSUSHIN KOGYO CO., LTD.

NOBLE 335, NISHINAKA-MACHI, KARIYADO, KAWASAKI, JAPAN
TEL: NAKAHARA (044) 42-3171 TELEX: 3842-155 CABLE ADDRESS: TEITSU

Circle 203 on reader service card

We've been saying we make more ferrite pot cores than anybody.

P.S. We also make them better than anybody.



The reasons —

First, we're top ferrite core makers to the world's communications industry. We turn out between a million and 1,500,000 cores a month.

Second, few makers can match the number of Mn-Zn and Ni-Zn centered materials we use in our product and which we make ourselves.

Third, we offer the widest choice of IEC and other types of ferrite pot cores—at any and all times.

Send us your specifications. Our 3,000 highly skilled employees and 30 years experience guarantee they'll be filled exactly. Write us—we'll be glad to provide technical literature.

Tokin

Tohoku Metal Industries, Ltd.

Koei Bldg., 10-13, 7-chome, Ginza, Chuo-ku, Tokyo, Japan
Telephone: Tokyo 542-6171 Cable Address: TOHOKUMETAL TOKYO

Main Products: Ferrite Cores, Memory Cores, Memory Matrices, Ferrite Magnetostrictive Vibrators, Pulse Transformers, Permanent Magnets (Cast, Ferrite), Tape Wound Cores, Bobbin Cores, Magnetic Laminations, Fe-Co Alloys, Sendust Cores

Circle 77 on reader service card



Investigate New Sources Of Quality Products At JAPAN ELECTRONICS SHOW '69

Osaka
Oct. 1-7

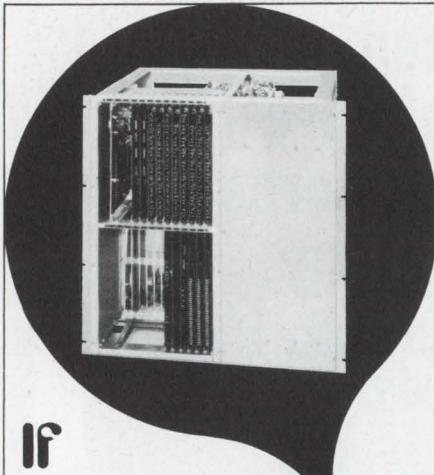

If
cycle time is
the name of
your
computer game,
read
the good news:

Toko Woven Plated-Wire Memory System HS-500 is now available.

Toko's woven plated-wire memory planes and stacks are already well known for their low-cost, high-performance characteristics. Now to be marketed for the first time is Toko's complete memory system, with a capacity of 4096 words by 16 bits expandable to 8192 words and 20 bits. Cycle time is a remarkable 500 ns. Other characteristics are 2D organization, destructive read-out operation, and TTL logic level interface. Cost of the system is remarkably low, and fast delivery can be guaranteed.

Besides this standard woven plated-wire memory system, Toko can undertake the manufacture of custom-made systems according to your specifications. Complete technical details from our New York office.

PC TOKO, INC.

Head Office: 1-17, 2-chome, Higashi-Yukigaya, Ohta-ku, Tokyo, Japan

TOKO N.Y., INC.
350 Fifth Avenue, New York, New York 10001

ECONOMICAL Thin Film!

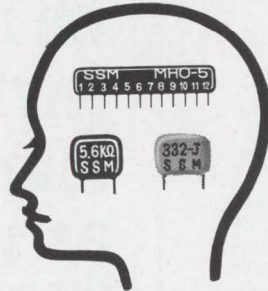

What's needed for memory system is everlasting high accuracy. SSM's components are the very ones satisfying superior reliability.

- Plate-ohm: evaporated metal film resistor.
- Pla-module: thin film modulated C-R circuit.
- Pla-con: organic thin film capacitor by plasma reaction.

SUSUMU INDUSTRIAL CO., LTD.

Minami Bldg. 1-12 Ebisuminami
Shibuya-ku, Tokyo, Japan.
TEL: Tokyo (03) 712-5990
TELEX: No. 246-6270

Circle 204 on reader service card

PRINTED CIRCUIT BOARDS!

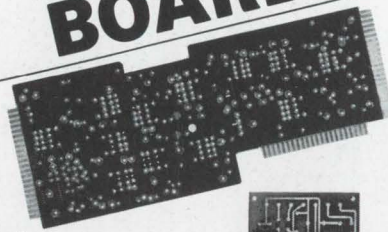

▲ For audio use
▶ For instruments use

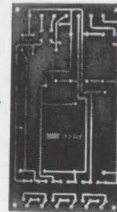

For Tr. Radios, Industrial Measuring
Instruments & Communication Equipments....
(UL Standard Approved No. E-41166)



SHIN-EI INDUSTRIAL CO., LTD.
9-7, Megurohon-cho 4-chome, Meguro-ku,
Tokyo, Japan Tel. Tokyo 714-1651~9

TO USE OR
NOT TO USE
THE MITSUMI COMPONENTS
THAT IS THE
QUESTION
TO IMPROVE YOUR PRODUCTS

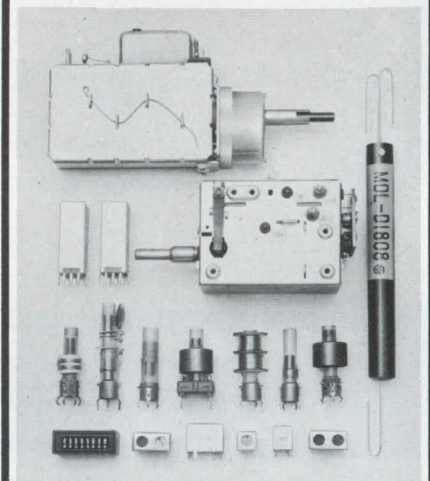

* MITSUMI COMPONENTS are manufactured at the most modern production plants where the latest manufacturing equipment and facilities of automatic system are employed, resulting in perfect uniform quality of the products.

PRODUCTION ITEMS

Thick Film ICs, UHF & VHF TV Tuners, Front-end FM Tuners, Car Radio Tuners, IF Transformers, Various Coils, Polyethylene Variable Capacitors, Magnetic Heads, Micromotors, Synchronous Motors, CdS Photoconductive Cells, Trimmer Capacitors, Semi-fixed Resistors, Switches, Terminals, Fuse Holders, Small Mechanical Components



MITSUMI

MITSUMI ELECTRIC CO., LTD.

Main office: 1056 Koadachi, Komae-machi, Kitatama-gun, Tokyo, Japan. Tel: 489-5333

Europe office: Marienstrasse 12, Düsseldorf, W Germany
Tel: 352701

MITSUMI ELECTRONICS CORPORATION
11 Broadway, New York 4, N.Y. 10004, U.S.A.
Tel: HA-5-3085, 3086

MITSUMI COMPANY, LTD.
302, Cheong Hing Building, 72, Nathan Road, Kowloon, Hong Kong
Tel: 666925



Investigate New Sources Of Quality Products At JAPAN ELECTRONICS SHOW '69

Osaka
Oct. 1-7

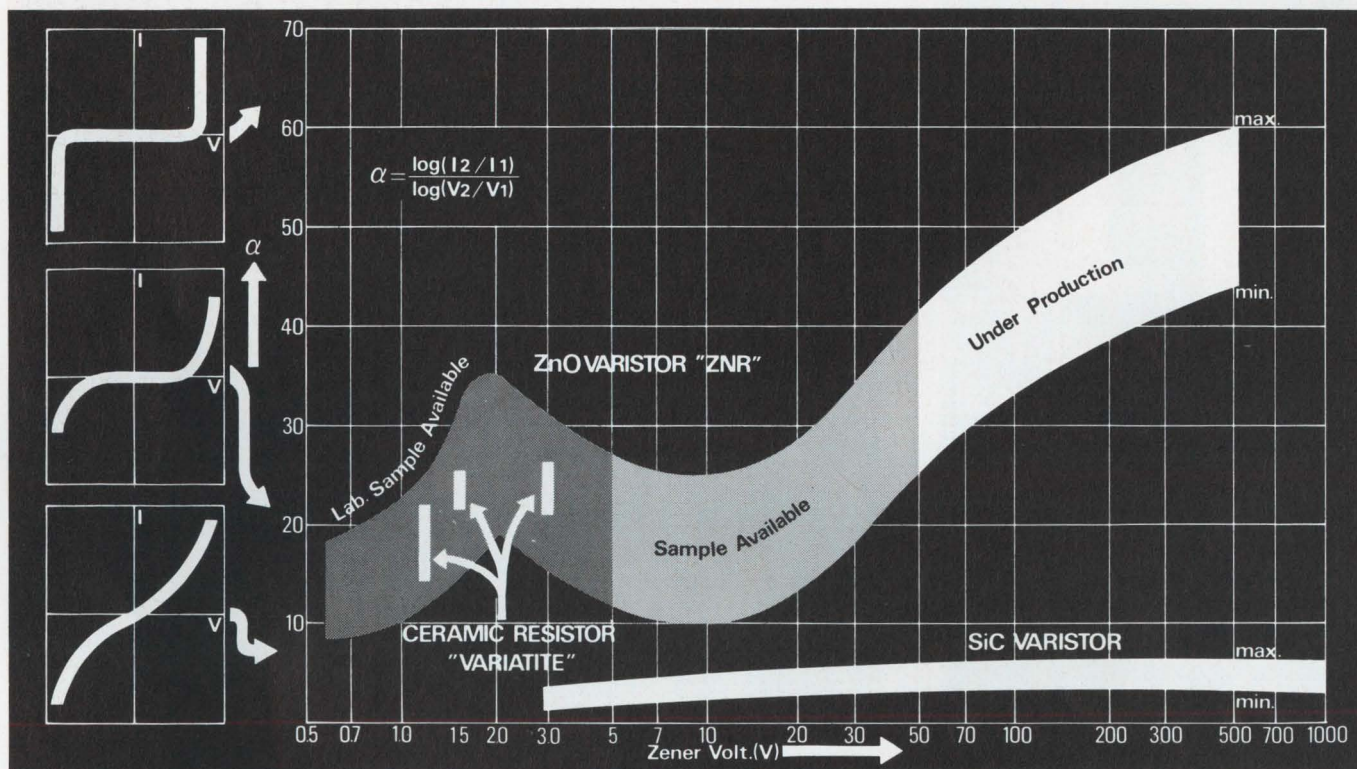

Is high-volt regulation your problem?

If so, here is the answer.

ZNR® Varistor

MATSUSHITA's newly developed ZNR (PAT. PEND.) Varistor, which utilizes ZnO ceramic, makes its debut in the high voltage regulator field. It has unprecedented α , high zener voltage up to 500V and an attractive price.

Generally speaking, with a higher α —a sharply rising V-I curve is desirable for better voltage regulation. In low voltage application, zener diodes are popular because of superb regulation characteristics.

The above graph shows the availability range and the capability of ZNR elements at the present time. 50V to 500V zener voltage with the α as high as 40 to 60 are currently available. 0.68W is the off-the-shelf power rating and greater wattage can be produced by increasing the size. Samples of 0.6V to 50V zener range are available upon request.



In addition to ZNR, MATSUSHITA produces SiC Varistor and VARIATITE as voltage regulator elements.

SiC Varistor

MATSUSHITA's SiC varistor also features a higher α thanks to our unique production method. Available zener volt ranges from 3V to 1KV.

Ceramic Resistor "VARIATITE®"

This is one of the ceramic resistors. A single VARIATITE resistor can perform the bias regulation replacing a number of silicon diodes connected in series. Standard zener voltages are 1.2V, 1.5V and 3V and are available from stock.

PANASONIC®

in the U.S.A. and Canada

NATIONAL

in other countries.

MATSUSHITA ELECTRIC

Components Division, Matsushita Electric
Kadoma, Osaka, Japan

Matsushita Electric Corp. of America
Pan-Am Building, 200 Park Avenue, New York/P.O. Box 3980 Grand Central. Tel: 212 973-5700

Matsushita Electric (Hamburg) G.m.b.H.
2 Hamburg 36, Jungfernstieg 40, F.R. Germany Tel: 34 47 43



Investigate New Sources Of Quality Products At **JAPAN ELECTRONICS SHOW '69**

Osaka
Oct. 1-7

WHEN YOU TURN ON
HOSIDEN

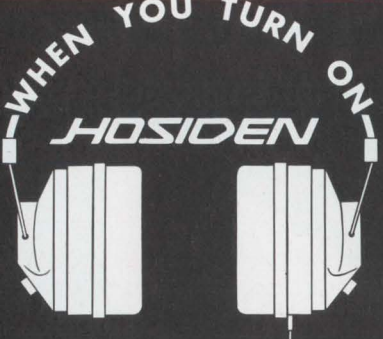

**Quality products
through modern research!**

A wide variety of electronics equipment and components — headsets, microphones, earphones, pickups, receiving tube sockets, connectors, plugs, jacks, switches, etc. 1969 JES Exhibitor.

Overseas Division:
HOSIDEN SHOJI CO., LTD.
1-4-33, Kitakyuhoji, Yao City, Osaka.
Tokyo Business Dept. :555, Imai Minami-cho,
Kawasaki City, Kanagawa Pref.
Manufacturing Division:
HOSIDEN ELECTRONICS CO., LTD.

Circle 207 on reader service card

**THE ONLY COMPANY
IN JAPAN
SPECIALIZING IN THE
MANUFACTURE
OF IC's**

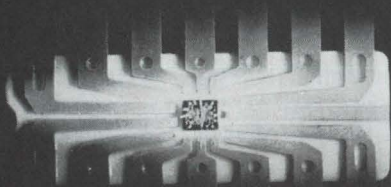

—PRODUCTS—

- * Hybrid IC's
- * Monolithic IC's
- * Diodes
- * Transistors

**IC KYODO ELECTRONIC
LABORATORIES, INC.**

5153 Kamitsuruma, Sagamihara-shi,
Kanagawa-ken, Japan
Phone: 0427-22-6731
Cable: KELIC MACHIDA

WHAT DO YOU KNOW ABOUT HEART ATTACK?

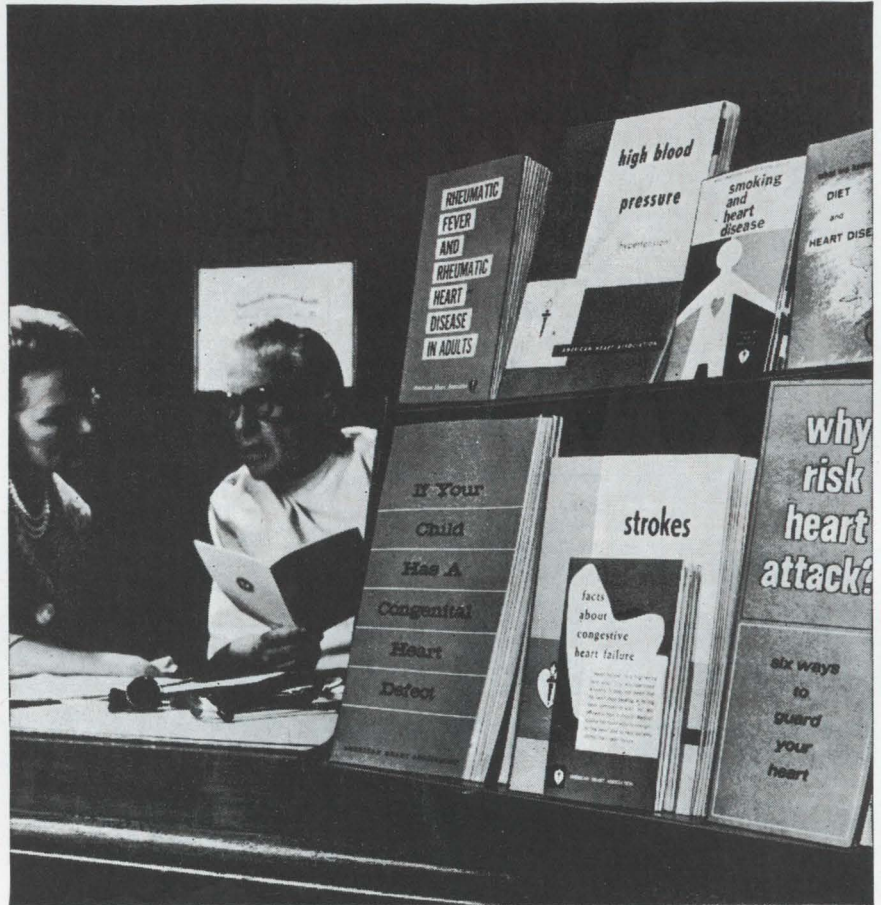

Do you know —

- that heart attack, the Nation's #1 health enemy, causes almost 600,000 deaths at all ages annually?
- that most patients who recover from heart attack return to their jobs?
- that you can reduce your risk of heart attack by controlling high blood pressure and by following a few simple rules in your eating and living habits?

You can learn more about heart attack and other heart and blood vessel diseases in interesting booklets prepared by medical experts. They are free, an educational service made possible by your Heart Fund. Simply visit, write or call your local Heart Association office.

**GIVE...so more will live
HEART FUND** 

Contributed by the Publisher



Investigate New Sources Of Quality Products At JAPAN ELECTRONICS SHOW '69

Osaka
Oct. 1-7



*Solid-state music
charms your ears?
Now,
Let's move to
Hybrid IC.*

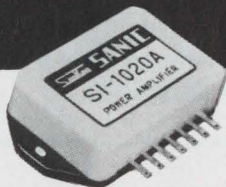

Sanken's Hybrid Audio Power Amplifiers are 25w and 50w

No external component re-
quired. You just put them
and forget about protection
and temperature.

- ★ Distortion is 0.5% at full power level.
- ★ Frequency range 20Hz to 100KHz at 1W output, 20Hz to 30KHz at full power.
- ★ Withstands output short circuit for more than 5sec.
- ★ $V_{cc}: 48V$ $Z_{in}: 70K\Omega$, $Z_{out}: 0.2\Omega$

SANKEN ELECTRIC CO., LTD.
1-22-8 Nishi-Ikebukuro, Toshima-ku
TOKYO, JAPAN.
TLX: 0272-2323

Circle 208 on reader service card

Primo

—A Leader in Microphone Field—

UD-900

UNI-DIRECTIONAL MICROPHONE
(with tone control)



SPECIFICATIONS

- Cartridge: DM-49
- Impedance: 600 ohms
- Sensitivity: -73db $\pm 2db/1\mu bar$
- Frequency Response: 50 to 15000Hz $\pm 5db$
- Dimensions: 50mm dia. 250mm Length

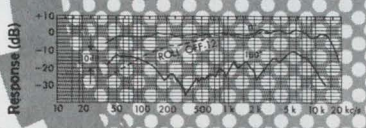

● For catalog write to
PRIMO COMPANY LTD.
Chicago Illinois Office:
A. P. T. No. 204, 530 W. Surf. St., Chicago Illinois
60657, U. S. A. Tel: 312-472-6142
Telex: 25-4225 PRIMO MUS CGOILLUSA
Head Office:
25-1, 6-chome, Mure, Mitatashi, Tokyo, Japan
Tel: 0422-43-3121 ~ 7 Cable: "Primo Musashino Mitaka"
Telex: 2822-326 PRIMO MUS

Circle 250 on reader service card

SUMIDA

SPECIALIST
IN ELECTRONIC COMPONENTS

- MAIN PRODUCTS:
- IF Transformers
- Oscillator Coils
- TV Coils
- Stereo Multiplex Coils
- Tape Recorder's Coils
- Various Inductors
- Ferrite Bar Antenna
- Pulse Transformer
- MAG. Filter
- IF Module

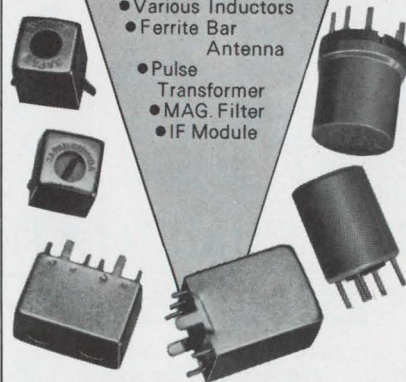

● For more details, write
SUMIDA ELECTRIC CO., LTD.
2-4-8, Kanamachi, Katsushika-ku, Tokyo, Japan
Tel: 03-607-5111
Telex: 262-2051 SUMIDA DENKI TOK
Cable: "SUDENIKOGYO TOKYO"

Circle 210 on reader service card

Hirose — just about your best connection for connectors.

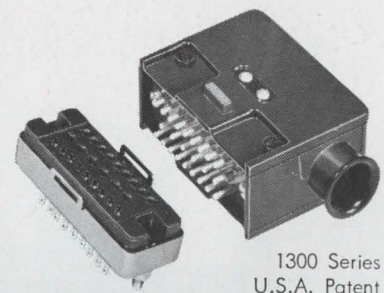

1300 Series
U.S.A. Patent



CR7 Series

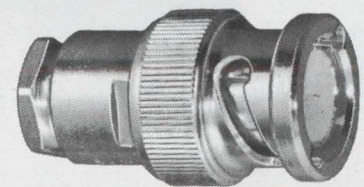

BNC Series

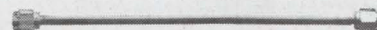

Microminiature Co-axial
Series

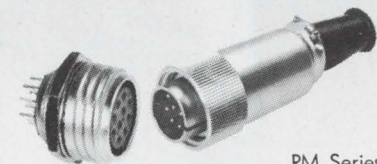

RM Series

Hirose is Japan's leading manu-
facturer of printed circuit con-
nectors, cylindrical connectors,
rack and panel connectors,
co-axial connectors, microminia-
ture co-axial connectors, etc.
Hirose—a good connection for
people in electronics.
Agents wanted.

HRSE
**HIROSE ELECTRIC
CO., LTD.**

No. 5-23, 5-chome, Osaki, Shinagawa-ku,
Tokyo, Japan Tel: Tokyo 491-4541
Cable Address: BESELECONHIROSE
Overseas Agents: Switzerland, Italy
W. Germany

Circle 81 on reader service card



Bring Your Measuring Problems To Tokyo

October 11-15, 1969

13TH JAPAN ELECTRIC MEASURING INSTRUMENTS—AUTOMATION EXHIBITION

13TH JAPAN ELECTRIC MEASURING INSTRUMENT-AUTOMATION EXHIBITION



OUTLINE OF THE EXHIBITION

1. Name: 13th Japan Electric Measuring Instrument-Automation Exhibition
2. Sponsored by: Japan Electric Measuring Instrument Manufacturers' Association
3. Term: 11 (Saturday) — 15 (Wednesday) October 1969 (for 5 days)
4. Place: Tokyo International Trade Center, Harumi, Tokyo
5. Exhibits: Electric Measuring Instruments
6. Exhibitors Approximately 80 Leading Japanese Manufactures of Electric Measuring Instruments

13th Japan Electric Measuring Instrument-Automation Exhibition

Please cut off this invitation and bring it to the Exhibition send it by mail to the following address and you will have an illustrated catalog of Japanese electric measuring instruments:



NAME: _____

FIRM: _____

ADDRESS: _____



JAPAN ELECTRIC MEASURING INSTRUMENTS MANUFACTURERS' ASSOCIATION

Keisoku Kaikan Bldg 20 Shiba-Kotohira-cho Minato-ku Tokyo Japan

Circle 211 on reader service card

The chairman company of JEMIMA

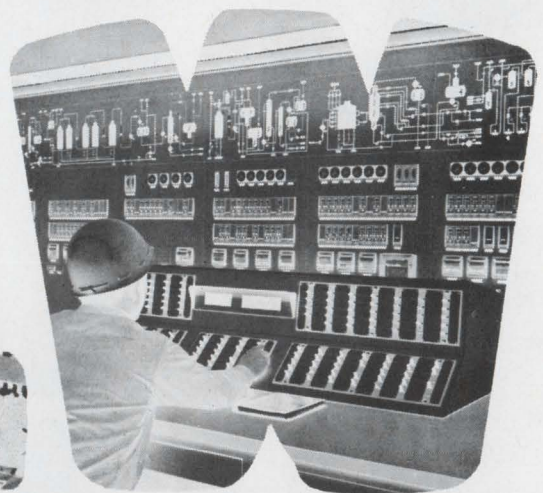
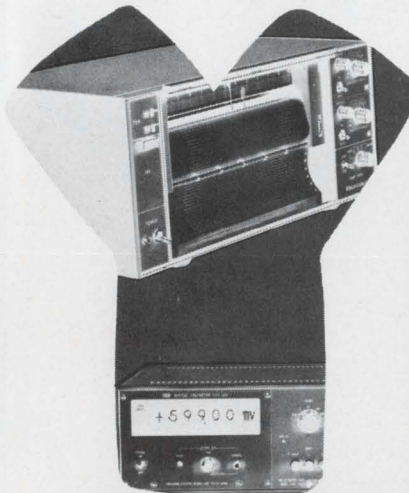

FOR COMPLETE INSTRUMENTATION ...ASSOCIATES OF **FOXBORO** AND HEWLETT **hp** PACKARD

Yokogawa Electric offers complete laboratory and industrial process instrumentation from portable meters to process automation. Proven technology and half a century's experience in instrument manufacture are the basis upon which YEW's worldwide fame and association with Hewlett-Packard (partner of a joint-concern) and Foxboro (partner of mutual technological assistance since 1955) are established.

YEW

YOKOGAWA ELECTRIC
YOKOGAWA ELECTRIC WORKS, LTD.
2-9 Nakacho, Musashino-shi, Tokyo, 180 Japan
YEW EUROPAISCHES VERBUNDUNGSBURO Hamburg, Germany



Bring Your Measuring Problems To Tokyo

October 11-15, 1969

13TH JAPAN ELECTRIC MEASURING INSTRUMENTS—AUTOMATION EXHIBITION

Panasonic Presents Its Sensitive VP-549A Oscilloscope—5mV/cm: DC-150MHz



This carefully constructed solid state model offers a sensitivity from 5mV/cm to 5V/cm throughout a frequency range from DC to 150MHz. 1 mV/cm, DC to 35 MHz with CH1 and CH2 cascaded. Plus a host of advanced innovations.

PANASONIC[®] OSCILLOSCOPE

MATSUSHITA ELECTRIC CORPORATION OF AMERICA

PAN-AM Building, 200 Park Avenue, New York, N.Y. 10017 TEL 212-973-5700

O'HALLORAN ASSOCIATES

SALES REPRESENTATIVES FOR CALIFORNIA, ARIZONA AND NEVADA

Superimposed Noise Problems Solved!



-TR-5589L
250MHz Universal Counter

This counter employs a unique **ANS Circuit** (Automatic Noise Suppressor...patent pending) in its input circuit. If a large signal to be measured and superimposed noises are fed to a counter, the counter may count both the signal and noise since the trigger threshold level is extremely narrow.

The **ANS** solved the noise problems by keeping the input signal level constant at all times regardless of the magnitude of the input, thereby maintaining the trigger threshold level at the optimum value.

When considered from the input side, the trigger threshold level will increase when a large signal is received, or, decrease when a small signal is received. This operation reduces the error due to noise mixed in the input signal. Since the counter has an input sensitivity of 10mV rms, frequency measurement of an extremely low voltage signal is possible, and measurement of 100V rms signal is also possible with the single range without the use of an attenuator because of the 80dB dynamic range.

FREQUENCY RANGE—Counts directly up to 250MHz in decimal, up to 500MHz with prescaler plug-in unit, covers 10Hz to 12.5 GHz with frequency converter plug-in unit.

HIGH STABILITY—Long term stability 5 parts in 10^{10} per day.

HIGH SENSITIVITY—10mV to 100V rms in a single range...wide dynamic range...80dB.

DISPLAY—9-digit storage display.

BCD OUTPUT—8-4-2-1 code output.

PLUG-IN VERSATILITY—9 plug-in units increase the counter's versatility as required.



Takeda Riken Industry Co., Ltd

1-32-1, Asahi-cho, Nerima-ku, Tokyo, 176, Japan.
Tel: Tokyo 930-4111 Telegramme: TRITRONICS TOKYO

Agents:
Litton Precision Products International Inc.—
(West Germany, France, Belgium, Switzerland, England)
Ing. S & Dr. Guido Belotti Ltd.—(Italy)
Nores & Co.—(Finland)
Ingensfirma Carl-Eric Larsson AB—(Sweden)
Semco Semlar & Co.—(Denmark)

Electronics Profit.

How McGraw-Hill's new
Electronics/Management Center
can help you improve it.

We've created a unique information system for the management of companies in and around electronics.

We call it the Electronics/Management Center.

E/MC combines the specialized experience of the publishers of *ELECTRONICS* Magazine, with the broadly-based facilities of McGraw-Hill, one of the world's largest corporations devoted to increasing man's knowledge.

In thirty years of electronics experience, we've accumulated the background and talents to produce the problem-solving tools you need. The kind that are essential when living with lasers, making your way through the implications of Large-Scale Integration, and meeting the technical revolutions yet to come.

Supplement To Internal Systems

For your company, we'll plan, execute, and analyze custom projects—to meet an objective of general, technical, or marketing management. Or to establish a new objective.

Our system is sufficiently diverse to serve as a prime and total information source. Or, it can supplement the most sophisticated company capability. In fact, it may be more efficient to "buy" certain kinds of information from us than it is to "make" it yourself.

Often, we can be faster. Or less

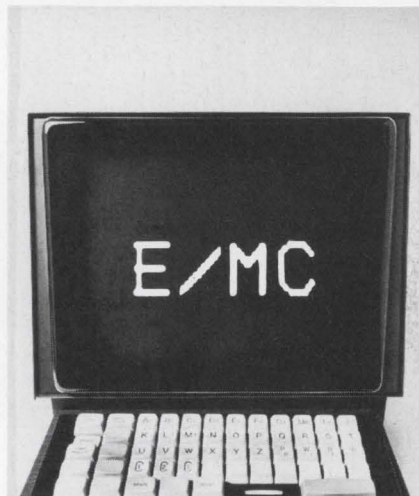

expensive. Always, we can be more objective.

Independent Technical Group

In technical matters, we can provide important assistance without adding overhead or over-loading your present staff. We offer the services of a national organization of university-based scientists and engineers with a long list of accomplishments.

Full Marketing Assistance

We can help you reduce marketing risks, too.

It's difficult to move around the electronics industry without bumping into both customers and competitors in the same corridor. We can probe new market potentials without revealing your identity. Or conduct research in an area not too familiar to your own staff.

We can do it in a neat package that combines access to the market with complete maintenance of confidence.

We can also supply those complex services you'd like to have created outside if you could find someone who speaks your language. Services like seminars, to educate customers, or train technical and marketing staffs, or develop management skills.

Weekly News Service

Management will also find our weekly news service an invaluable working tool. In minimum reading time each week, the *Electronics/Management Advisory Service* can keep your company current on the important electronics developments around the world. Market changes, prices, contracts, finances, significant trends, even a telephone number to call for person-to-person consultation—all the essentials to provide an information base on which to make top management decisions. For the next week. Or the next five years.

If you believe, as we do, that better information can help make your company more profitable, and you would like to know more about our services, write to: Electronics/Management Center, 330 West 42nd Street, New York, New York 10036.

E/MC
Electronics/Management Center
A McGraw-Hill Information Service

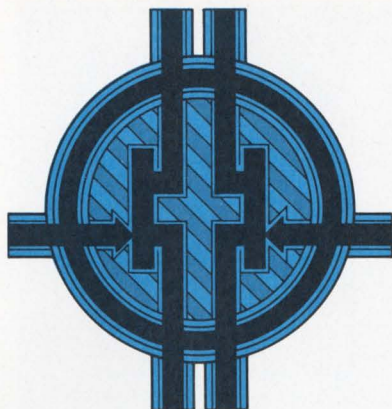

2 NEW DUAL FETs for electrometers and low noise diff amps

Electrometers The low gate current of the U248A series makes them ideally suited for this application. In the circuit shown, input current is typically less than 0.1 picoamp (10^{-15} amp). By operating at lower gate-drain voltages, lower gate input currents may be achieved; the only restriction is that $V_{DG} > V_p$. On special order, we'll select low V_p devices for you.

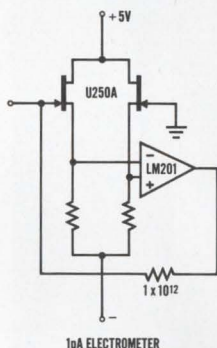

1pA ELECTROMETER

Characteristic	Symbol	Min	Max	Conditions
Gate Current	I_G		1 pA	$I_D = 30 \mu A$ $V_{DG} = 10V$
Transconductance	g_{fs}	50 μmho	150 μmho	
Offset Voltage	$ V_{GS1} - V_{GS2} $		5 mV*	$I_G = 1 \mu A$
Differential Voltage Drift	$\Delta V_{GS1} - V_{GS2} / \Delta T$		5 $\mu V/^\circ C^*$	
Breakdown Voltage	BV_{GSS}	-40V		

* The U248A-U251 series presents a range of devices with offset voltages from 5 mV and drift from 5 $\mu V/^\circ C$.

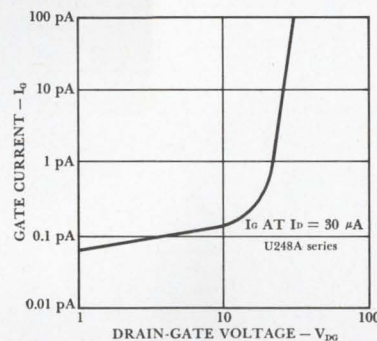

Low Level Differential Amplifiers The 2N5515 series gives you low noise and high common mode rejection. Short circuit input noise voltage is less than 10nv/ \sqrt{Hz} ; common mode rejection ratio (CMRR) is greater than 100 dB. Differential voltage drifts are available from 5 $\mu V/^\circ C$.

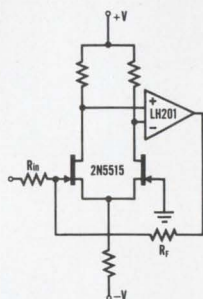

LOW NOISE DIFFERENTIAL AMPLIFIER

Characteristic	Symbol	Min	Max	Conditions
Common Mode Rejection Ratio	CMRR	100 dB		$I_D = 200 \mu A$ $V_{DG} = 10V \text{ to } 20V$
Short Circuit Input Noise Voltage	e_n		15nv/ \sqrt{Hz} @10 Hz (2N5520-24)	$I_D = 200 \mu A$ $V_{DG} = 20V$
Gate Current	I_G		100 pA	
Transconductance	g_{fs}	500	1000 μmho	$I_G = 1 \mu A$
Offset Voltage	$ V_{GS1} - V_{GS2} $		5mV*	
Differential Voltage Drift	$\Delta V_{GS1} - V_{GS2} / \Delta T$		5 $\mu V/^\circ C^*$	
Breakdown Voltage	BV_{GSS}	-40V		

* The 2N5515-2N5524 series presents a range of devices with offset voltages from 5 mV and drift from 5 $\mu V/^\circ C$.

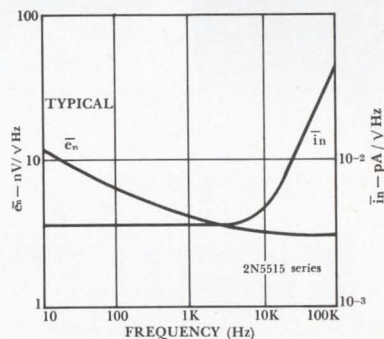

* These are just *two* ways of using *two* series of Siliconix duals. We also have a general purpose series and a high frequency series; If you're involved in any type of design problem requiring duals, just give us a call. We'll deliver the service as well as the goods. That's *applications* power!

Our new address . . .

... in Europe Siliconix Ltd.
Siliconix House
Sketty Park
Saunders Way
Swansea, U.K.



Siliconix incorporated

2201 Laurelwood Road • Santa Clara, Calif. 95054
Telephone (408) 246-8905 • TWX: 910-338-0227

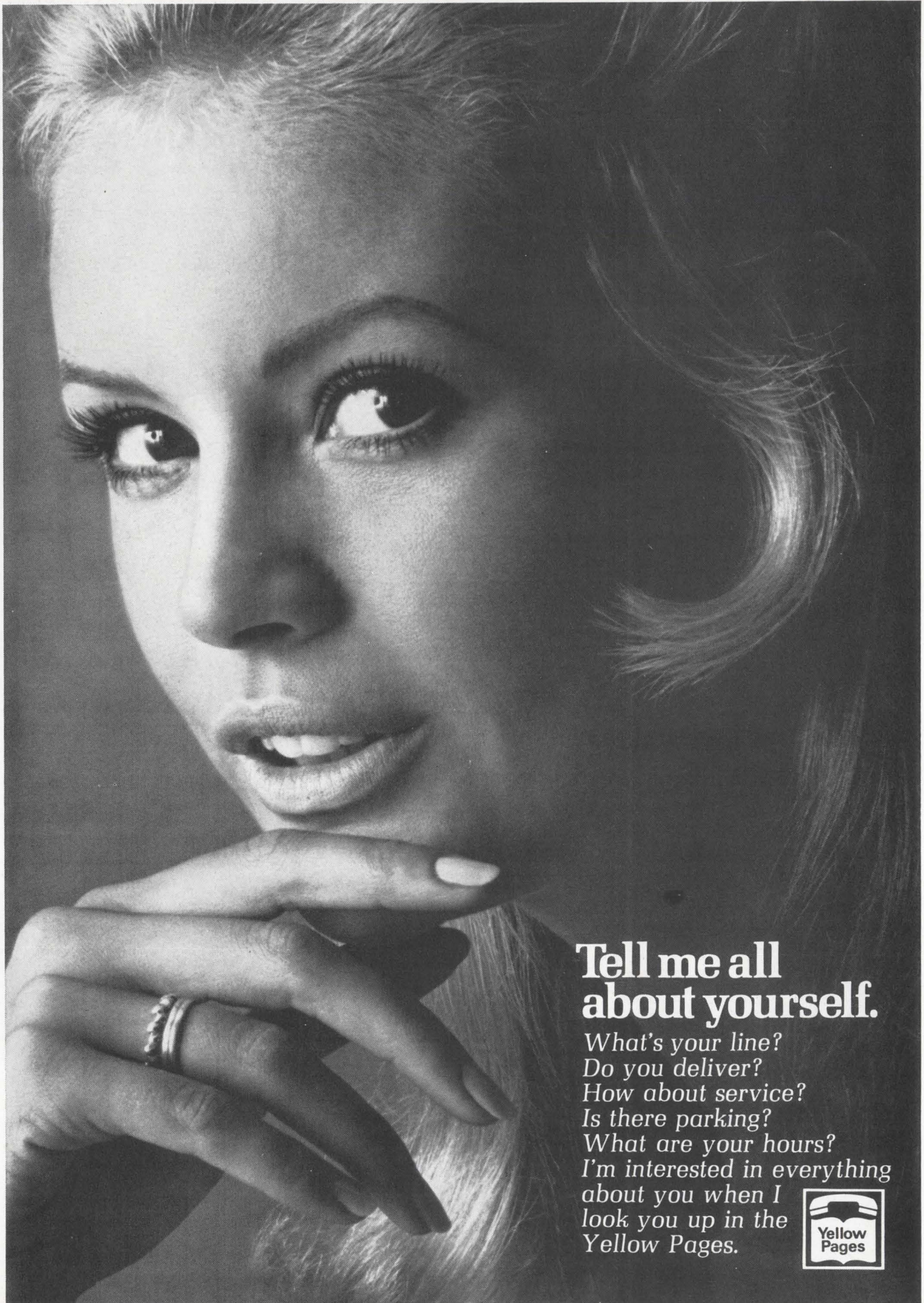

**Tell me all
about yourself.**

*What's your line?
Do you deliver?
How about service?
Is there parking?
What are your hours?
I'm interested in everything
about you when I
look you up in the
Yellow Pages.*



The easy way to tell one microvolt from another... HP's new six-digit DVM



See microvolt readings, without knob twisting and delicate balancing. The new HP 3462A Digital Voltmeter measures dc voltages with $1 \mu\text{V}$ sensitivity, and greater than 1 ppm resolution—the easy way—automatically—for only \$4900!

The 3462A will meet the most exacting bench requirements, and is designed for fully automatic operation in any data acquisition system. It gives you six-digit readout of voltage measurements on any of four ranges, $\pm 1 \text{ V}$ to $\pm 1000 \text{ V}$, full scale. The

seventh digit provides up to 20% over-ranging on any range.

An input impedance of greater than $10^{10} \Omega$ on the 1 V and 10 V ranges allows you to make measurements with virtually no loading errors. You can even monitor standard cells and not have to worry about excessive

HEWLETT  PACKARD
DIGITAL VOLTMETERS

099/16

current drain. Add high accuracy, 160 dB common mode rejection at dc, and BCD outputs, and you have your best DVM buy.

Now is the time to start making your precision dc measurements the easy way with the HP 3462A. Get full information from your nearest HP Field Engineer. Or, write to Hewlett-Packard, Palo Alto, California 94304. Europe: 1217 Meyrin-Geneva, Switzerland.

What this country
needs is a good
nickel cigar...
and a $\frac{3}{8}$ " square
industrial
cermet
trimmer.

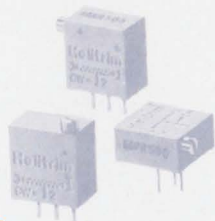

Helipot has the trimmer for \$3.50 list...
now available in local stock.

(But you'll have to find the cigar.)

Beckman®

INSTRUMENTS, INC.
HELIPOT DIVISION
FULLERTON, CALIFORNIA • 92634

INTERNATIONAL SUBSIDIARIES: AMSTERDAM; CAPE TOWN; GENEVA; GLENROTHES,
SCOTLAND; LONDON; MEXICO CITY; MUNICH; PARIS; STOCKHOLM; TOKYO; VIENNA

Technical Articles

Helical transmission lines bend the beam
page 90



Distributing the deflection is the best way to build a cathode-ray tube that can track fast-rising signals. Unfortunately, however, handling the distribution with inductors and small deflection plates involves making a lot of glass-to-metal seals. In a new 250-megahertz oscilloscope, the vertical deflection is distributed by a couple of helical transmission lines. The result

is a crt with only four seals whose cutoff is well over 500 Mhz. An amplifier made of monolithic transistor arrays that can handle signals with frequencies as high as 250 Mhz drives the deflection system. On the cover are views of the transmission lines used as vertical deflection plates in the crt of a new 250-Mhz scope from Hewlett-Packard.

The case for patenting software
page 96

The U.S. Patent Office, which has the support of hardware manufacturers, is under fire for its policy of rejecting software applications on the grounds that they're mental processes. The matter will be resolved by a decision in a pending court case. The authors, both patent attorneys, argue that computer programs are patentable and should be protected, providing they are new, useful, and not obvious.

Color-tv wheel takes a spin in space
page 114

To convert the serial red-blue-green signal received from space missions to standard parallel color television format, engineers at NASA's Manned Spacecraft Center used digital logic circuitry to control a multiheaded magnetic disk recorder that produces a broadcast transmission indistinguishable from that generated by a conventional three-tube color television camera.

Active filters: part 10 Synthetic inductors from gyrators
page 118

By early next year, gyrators should be available in competitively priced integrated-circuit form. Engineers will then be able to make far greater use of this component in designing active filters. Sophisticated communications systems are among the prospective volume applications. Gyrators are attractive elements because they are inherently insensitive to variations of component parameters, and can be used to build filters that are highly selective. Moreover, when used to form a synthetic inductor, these units exhibit high Q.

Coming

Schottky diodes come of age

Schottky diodes offer a lot to digital integrated circuits: faster switching, lower power dissipation, and more functions in less chip area, for example. What's more, they can even help boost yields; they require no special processing to be integrated on a chip with bipolar transistors.

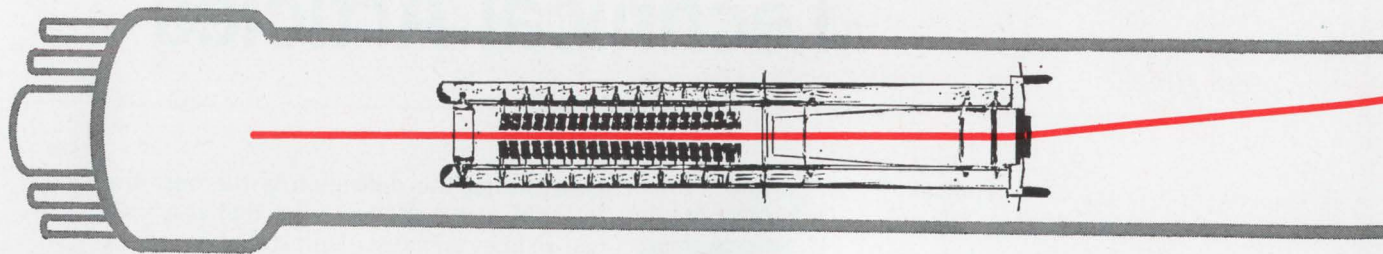

Helical transmission lines bend the beam

Unique deflection system shares the credit for a 250-Mhz scope with a vertical amplifier made with monolithic transistor arrays

By Alan J. DeVilbiss

Hewlett-Packard Co., Colorado Springs, Colo.

Faster! Faster! That's the cry always heard ringing in the ears of oscilloscope makers. But the appeal for speed has taken on new meaning as more and more engineers in the computer and digital-communication fields demand real-time scopes that can handle signals in the high-megahertz range. By modifying the design of cathode-ray tubes and by taking advantage of solid state technology, scope designers have been pushing up the speed—50 Mhz, 100 Mhz, and within the last three years scope speeds that come close to the 200-Mhz mark. Now there's an oscilloscope that displays signals with frequencies as high as 250 Mhz.

Credit for this speedup goes mostly to a few chips and a pair of helical transmission lines. The chips are the monolithic transistor arrays designed specifically for the scope's vertical amplifier. Up to at least 250 Mhz, these arrays aren't troubled by parasitic effects, drift, and thermal problems.

The two transmission lines are the vertical de-

flexion plates in the scope's crt. They provide distributed deflection of the electron beam, giving the tube a high cutoff frequency. And since time delay is built right into transmission lines, this crt is easier to build than tubes that need extra discrete delay elements.

Designing the deflection assemblies as well as selecting operating voltages for any crt is difficult due to the complex interrelationships of many parameters. In this particular case the task was all the more difficult because the design goals require the excellent performance of several parameters simultaneously.

To insure a high writing speed and an ability to display 250-Mhz transients, the tube needs a beam power of 2 watts. Furthermore, compatibility of the tube with the deflection amplifiers requires the horizontal and vertical deflection factors to be low, around 6 and 3 volts per centimeter, respectively. Also, the tube's vertical-deflection assembly needs

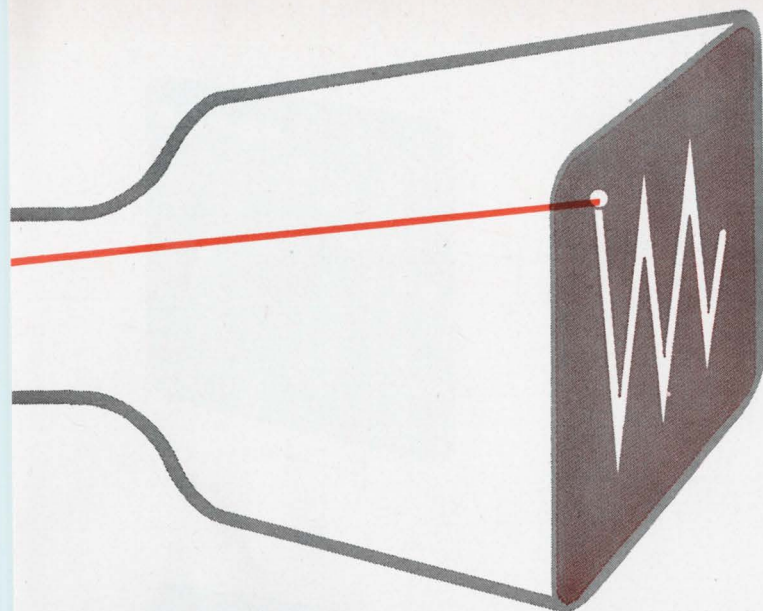

a high cutoff frequency. As it turns out, the frequency response of the scope, 250 Mhz, is limited by the vertical amplifier. The crt's cutoff is well over 500 Mhz.

But how do you design a crt with a response like that? The physical laws governing electron ballistics are cruel; an improvement in any crt parameter is usually achieved at the expense of some other parameter or parameters.

A computer helped to build this crt. First the designers guessed the optimum values of 25 electronic parameters in a crt (e.g. spot diameter, deflection factors, beam power, space-charge defocusing). The computer plugged these values into the ballistic equations and calculated 50 physical parameters (e.g. interelectrode spacing, aperture diameters, electron lens parameters, tube length, and available voltages).

Next, the designers put limits on these 75 parameters, and the computer went to work. First, using the initial values of the parameters, it computed a figure of merit. Then it changed the value of one parameter and computed a new figure; if this figure was higher than the first, the computer kept the change. This process of change-compute-compare was repeated until a maximum figure of merit emerged.

However, several sets of parameter values resulted in this maximum figure. The designers then selected the most important parameters and fed them to the computer to be optimized. With this information, the computer came up with the best set of parameters for the tube. Except for a few changes made to simplify the manufacturing process, the design from the computer was the design used for this crt.

Some of the physical properties of the vertical deflection structure determined by computer optimization are low-frequency deflection factor, physical length, and electron transit time.

Transit time is the key to crt design. It's the time needed by a single electron in the electron beam to pass from one end of the deflection plates to the other.

Once the crt's parameters were set, it was apparent that the specified transit time, 2 nanoseconds, was so long that deflecting the electron beam vertically with a single pair of conventional deflection plates was impossible. These plates are no good at high frequencies.

If the deflection plates, as shown on pg. 92, are of length "a," and electrons move between them at velocity "v," then the transit time T is a/v . Assume that at time t_0 there are five electrons between the plates. As electron 1 leaves the deflection structure, electron 5 enters; and uniformly distributed between them are the other three electrons. Now say that at t_0 the potential difference applied between the two plates goes from 0 to K . Electron 1 never sees K and proceeds to the screen undeflected. Electron 5 and all the electrons that follow it are deflected an angle θ whose value depends on the strength of the electric field between the plates generated by K . But electron 4 is only deflected $\frac{3}{4}\theta$ because it's between the plates only $\frac{3}{4}$ as long as electron 5. Likewise, electron 3 is deflected $\frac{1}{2}\theta$, and electron 2 is deflected $\frac{1}{4}\theta$.

Electron 5 strikes the phosphor screen T seconds after electron 1. Now, a pulse's rise time is the time it takes for the voltage to go from 10% to 90% of the pulse's height. So when a pulse with a rise time of 0 is applied to the vertical deflection plates, the trace on this scope has a rise time of $0.8T$.

Looking for shortcuts

One way to shorten the trace's rise time is to reduce the transit time, either by increasing v or decreasing a . But speeding up the electrons or shortening the deflection plates degrades other tube properties, such as the deflection factors.

Another way to speed up the crt is with a distributed deflection structure, as shown on pg. 92. Each plate is broken in half, and the halves are joined by a delay line. At t_0 , electron 1 is just leaving the deflection structure, and electron 5 is just coming in. Electron 3 is right in the middle, leaving the space between the first pair of plates and entering the space between the second pair. If V goes from 0 to K at t_0 , electrons 1, 2, and 3 aren't deflected since it takes $T/2$ for the step voltage to reach the second pair of plates. By then electron 3 is out of the deflection structure.

From t_0 to $(t_0 + T/2)$, electron 4 is deflected $\frac{1}{4}\theta$, and electron 5 is deflected $\frac{1}{2}\theta$; both electrons are at positions 4' and 5' respectively at $(t_0 + T/2)$. At this time, the step voltage leaves the delay lines and is applied to the second pair of plates. Electron 4 is deflected by another $\frac{1}{4}\theta$ for a total deflection of $\frac{1}{2}\theta$, and electron 5 another $\frac{1}{2}\theta$ for a total deflection of θ . So the rise time of this tube's trace is only $0.8T/2$.

The inclination then is to break the plates into smaller and smaller plates. Theoretically, if each

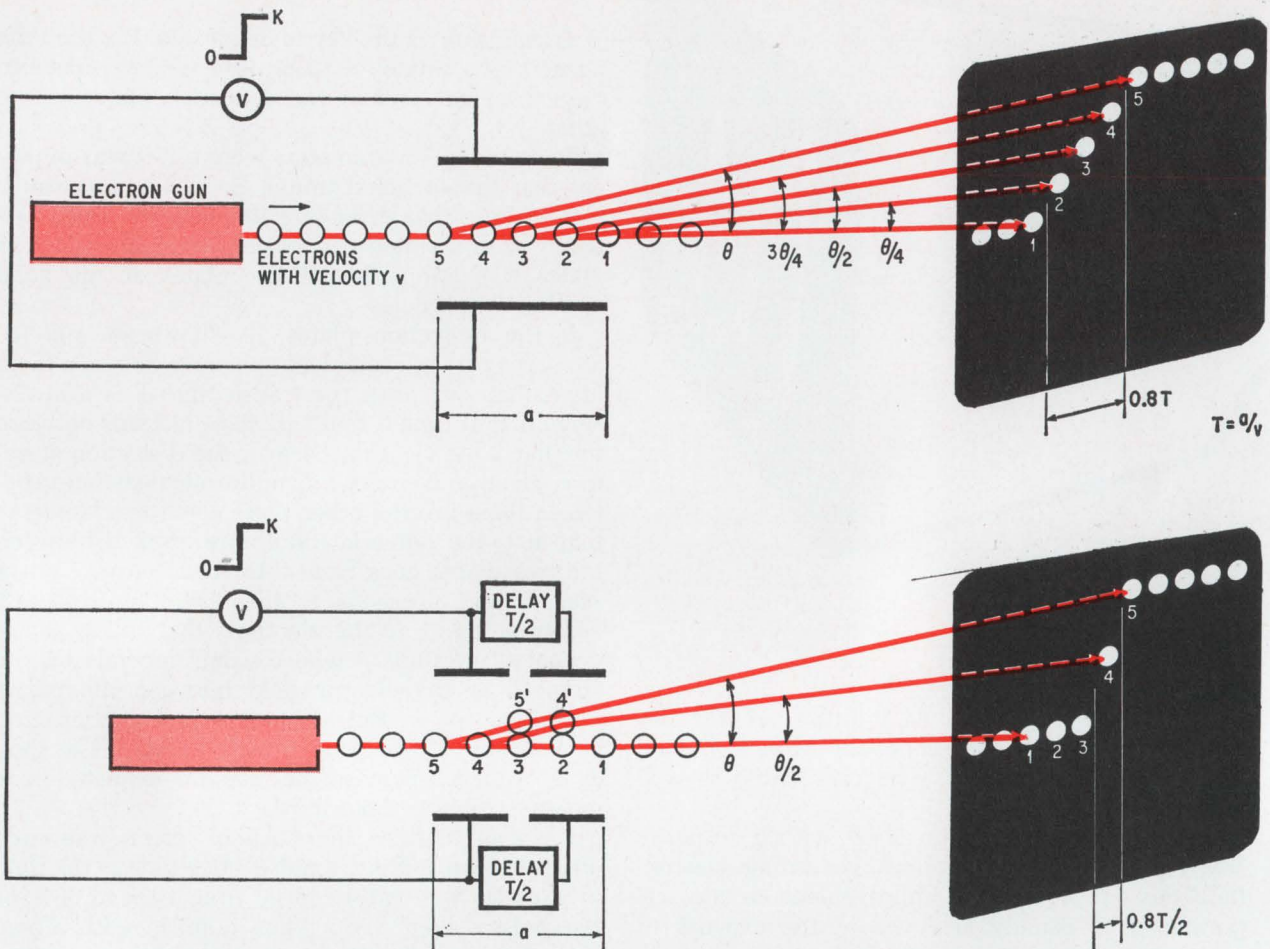

On the rise. The top figure shows a step voltage being applied to a conventional vertical-deflection structure. Electron 1, just leaving the structure when the step is applied, is undeflected; electron 5, T seconds behind electron 1 and just entering the structure, is the first electron to be completely deflected. The rise time shown on the scope face is $0.8T$. If the plates are broken in two and joined by delay lines, as shown in the bottom figure, the rise time is $0.4T$. Theoretically, breaking each plate into " n " pieces and delaying the step T/n at each piece results in a displayed rise time of $0.8T/n$. So the larger n is, the smaller the rise time.

plate is broken into " n " pieces, and if the pieces are connected by elements that delay a signal T/n seconds apiece, the trace's risetime, T_r , will be $T_r = 0.8T/n$, where T is still the transit time through the whole deflection structure.

In many tubes that have segmented deflection plates, the delay element joining adjacent plates is an inductor. Since each opposite pair of plates forms a parallel-plate capacitor, each small plate and inductor forms an LC section, which in turn is a single section of a lumped-parameter delay line. As the number of segments increases, the whole deflection structure takes on the appearance of a distributed transmission line, whose propagation velocity must match the velocity of the electrons in the beam.

Characteristic impedance

The propagation velocity depends on the product of an LC section's capacitance and inductance. The capacitance and inductance also fixes the line's characteristic impedance, R_0 , which in turn affects

the gain of the scope's vertical amplifier. In this scope, the vertical amplifier's output is an almost constant current; so the way to increase the gain is to increase the impedance at the amplifier's output.

This impedance is the parallel combination of R_0 and the amplifier's own output impedance, which is capacitive and whose value is fixed at about 2 picofarads. So for the maximum gain at 250 Mhz, R_0 should be greater than the amplifier's output impedance, about 300 ohms at this frequency. Going way above 300 ohms brings marginal results since R_0 then starts to look like an open circuit compared with the amplifier's output. Besides, in general, the higher a line's R_0 is, the harder the line is to build.

Another factor considered in the choice of R_0 was the compatibility of the crt with existing plug-in vertical amplifiers, which are designed to drive a load capacitance of 8 pf. The crt's transit time is 2 nsec. Because of the scope's configuration, another 0.6 nsec of transmission line is needed to

connect the deflection plates to the vertical amplifier. So the line's total length is 2.6 nsec.

The characteristic impedance of any transmission line is related to its electrical length and total capacitance by $R_0 = x/C$, where C is the total line capacitance in farads, x is the electrical length in seconds, and R_0 is in ohms. On the basis of this relationship and of the gain requirements, the designers chose R_0 to be 330 ohms.

Limiting factors

The number of segments needed in the vertical deflection structure is determined either by the deflection structure's transmission-line characteristics or by the bandwidth limitation arising from the transit time phenomenon.

Look at the transmission-line aspect first. For a constant- k lumped-parameter line, the number of line segments needed to attain a rise time T_r in a line of electrical length x is found by the relationship $n = 1.1 (x/T_r)^{1.5}$. Design goals called for a trace rise time of 0.3 nsec when the input to the vertical deflection structure has a rise time of 0.

Since x is 2.6 nsec, the value for n is about 20. If this value goes into the transit-time equation, $T_r = 0.8T/n$, the rise time is only 0.08 nsec.

Therefore, transmission-line characteristics, not bandwidth considerations, are what limit the ability of a crt with a 20-segment deflection structure to track a fast-rising pulse. And this 250-Mhz scope needs 20 segments.

In a crt built with lumped-parameter deflection structures, the needed inductors are placed on the outside of the tube. In the case of a 20-section line, however, this means 40 glass-to-metal seals—a manufacturing nightmare. In the new crt, since each of the vertical deflection plates is a flattened helix, the inductance is on the inside, an inherent part of the helical transmission lines.

Each helix is analogous to a lumped-parameter line, and each loop of helix may be looked at as two 50-picosecond-long transmission lines of differing characteristic impedances. The half-loop section nearest the tube axis has a low impedance, derived from the ratio L/C . While the inductance in both halves of the loop is the same, the bottom

The speedy scope

Oscilloscopes, unlike race horses, aren't bred for speed alone; a scope has to be versatile. Look at the Hewlett-Packard Co.'s new 183A. With a bandwidth of d-c to 250 megahertz and the ability to track a pulse with a 1.5-nanosecond rise time, the 183A is the fastest real-time scope in its class. But it also does the routine chores. In fact the 183A can do just about anything H-P's older 180 can do, for the simple reason that the 183A's mainframe accepts any 180 plug-in.

And the 183A has the price of a general-purpose scope—around \$3,000 for a complete unit. The main frame by itself costs \$1,750.

Credit for the 183A's speed goes to the scope's unique vertical deflection system and to the wide bandwidth of the vertical amplifier.

The amplifier also gives the scope high sensitivity; the maximum is 10 millivolts per centimeter.

The 1840A time-base unit, designed specifically for the new scope, has sweep speeds from 1.0 nsec to 0.1 second per centimeter. And an external signal as weak as 20 mv peak-to-peak and as fast as 250 Mhz can trigger the sweep.

Engineers will find the scope's speed particularly useful for looking at fast one-shot signals, such as those encountered in nuclear, laser, and digital systems. And photographing these signals is easy since the scope's writing speed is 4 cm. per nsec.

Built into the 183A is a flood gun, used to sensitize film. Flood guns aren't new, but the one in the 183A is connected in an unusual way. It's tied to the sweep circuit, and can be flashed every time there's a sweep.

The 183A's input impedance is 50 ohms; also available, for \$350, is the 1120A probe whose input impedance is 100 kilohms and 3 picofarads for

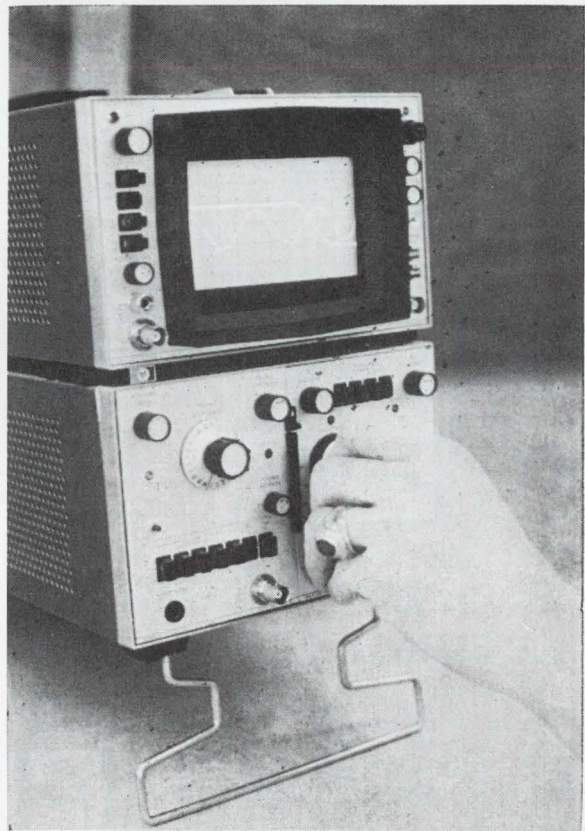

frequencies up to 500 Mhz.

The 183A will bow in at Wescon, and deliveries are scheduled to begin in November.

Hewlett-Packard Co., 1900 Garden of the Gods Rd., Colorado Springs, Colo. [380]

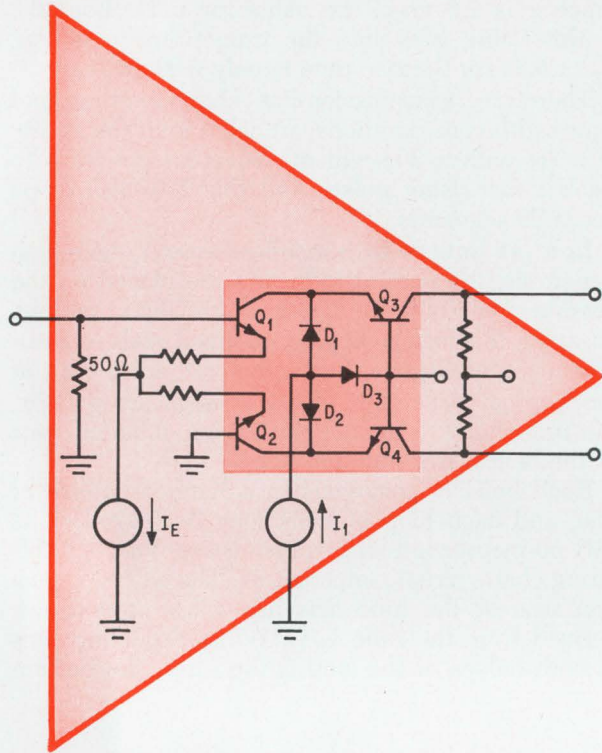

half has a higher capacitance because of its closeness to the other helix. (The capacitance of two parallel plates goes up as the distance between them goes down.) The ratio L/C is therefore lower for the bottom half.

When both halves are considered together, each complete loop has an average characteristic impedance of about 330 ohms.

Each of the two helices is a continuous strip of metal, mounted rigidly to glass beading rods in the electron-gun assembly. Once mounted, the helices need no mechanical adjustments to give them the desired electrical characteristics. And only four feedthroughs in the neck glass of the crt are needed to connect the amplifier to the deflection structure.

Key to wide bandwidth

The performance of the vertical amplifier is, of course, every bit as critical as the performance of the crt. This scope's vertical amplifier, a dual-trace unit pictured below, handles inputs from d-c to 250 Mhz. The key to this wide bandwidth is the performance of the two preamplifiers and of the output amplifier. The performance of these three

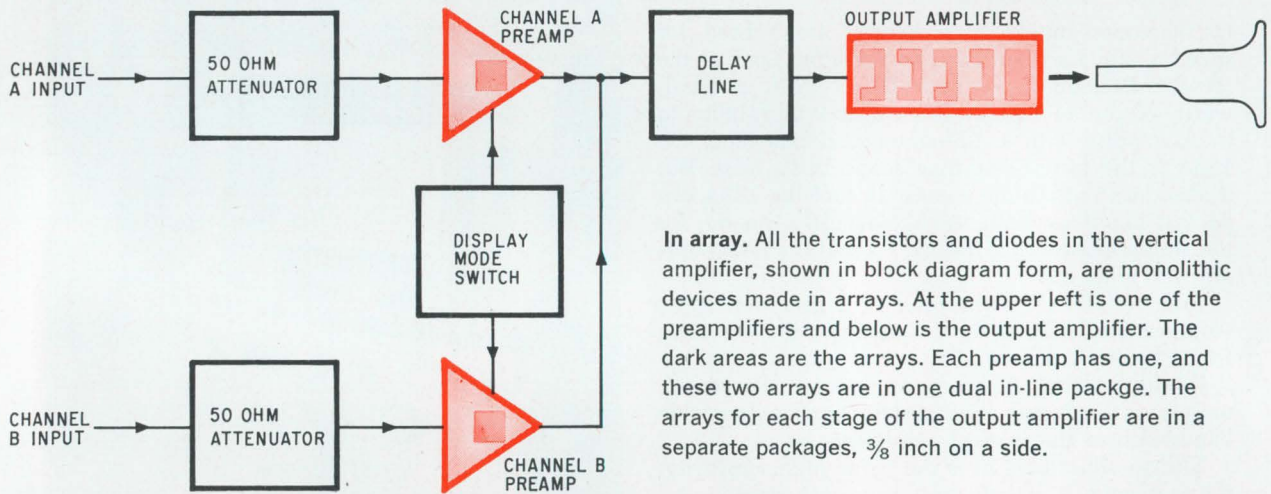

In array. All the transistors and diodes in the vertical amplifier, shown in block diagram form, are monolithic devices made in arrays. At the upper left is one of the preamplifiers and below is the output amplifier. The dark areas are the arrays. Each preamp has one, and these two arrays are in one dual in-line package. The arrays for each stage of the output amplifier are in a separate packages, $\frac{3}{8}$ inch on a side.

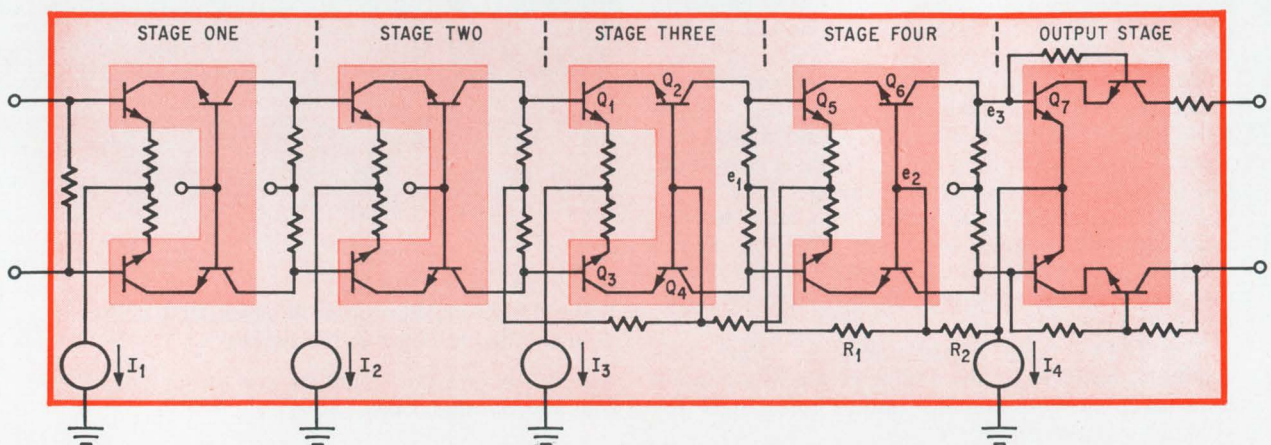

circuits depends on the speed and size of their transistors. All are monolithic, so the three amplifiers have the stability inherent in integrated circuits. At the same time the transistors are very fast; their switching speed is around 0.4 nsec.

The active portions of the two preamps and of each of the output amplifier's five stages are separated monolithic transistor arrays. The preamps are in one dual-in-line package and the five stages are each in a package, $\frac{3}{8}$ inch on a side.

A vertical amplifier built with monolithic arrays yields a number of advantages over one made from discrete devices or as a hybrid integrated circuit. In a monolithic array all the transistors in any one amplifier stage are within a few thousandths of an inch of each other. Crowding the transistors assures the matching of parameters such as beta, offset voltages and temperature coefficients. The closer the transistors are to each other, the smaller the temperature difference between them.

Proximity combined with the high thermal conductivity of an array's silicon substrate also assures that the transistors and diodes work at nearly identical junction temperatures. This rules out almost all amplifier drift and the need to put in the parasitic-producing circuit elements often used to minimize thermal problems.

Each transistor in an array is electrically isolated both from the substrate and other devices. A good thermal connection between all transistors and a heat sink won't increase stray capacitance, as it does when heat sinking is done through a transistor's metal can.

The interconnections between transistors introduce little stray capacitance or series inductance since these connections are made with metalization layers on the surface of the chip.

All on one chip

In a simplified diagram of one of the preamplifiers, shown at the top of pg. 94, transistors and diodes are all on one chip. These form a differential amplifier that has controlled, variable gain, and a constant bandwidth of d-c to 250 Mhz.

If I_1 is 0, this amplifier has a maximum gain. As I_1 goes up, D_1 and D_2 are forward biased and join with the common-base transistors Q_3 and Q_4 to form a current divider. Part of the differential signal current generated at the collectors of Q_1 and Q_2 is shunted through D_1 and D_2 , and the remainder appears as emitter currents in Q_3 and Q_4 . The percentage of the signal current shunted in D_1 and D_2 is determined, approximately, by the ratio of I_1 to I_E . Current source I_1 is controlled from the scope's front panel by the "Sensitivity Calibration" and "Sensitivity Vernier" controls.

If I_1 is greater than I_E , then Q_3 and Q_4 cut off, and D_3 is forward biased. When this happens, all signal current is shunted into D_1 and D_2 , and the input signal is isolated from the preamplifier's output terminals by the reverse-biased emitter-base and collector-base junctions of Q_3 and Q_4 . Current source I_1 is controlled in this mode by the "Display

Mode" switch, which is used for the channel switching functions, such as "Chop" and "Alternate."

The first four stages of the output amplifier, at the bottom of pg. 94, are identical arrays of four transistors in a differential cascode connection. This configuration is an excellent approximation of a unilateral amplifier, which provides high frequency stability and which efficiently uses each stage's high-frequency gain parameters.

At the output

The output stage has a current feedback connection, which minimizes the signal-voltage swings at the stage's input terminals and which divides the output signal voltage among the stage's four transistors. This connection also provides a low output capacitance; so with the proper choice of resistor values in the feedback network, the output stage can have an output impedance that matches the characteristic impedance of the crt's deflection system. The output stage will then absorb reflections from minor discontinuities in the deflection system, giving the scope a smoother pulse response than would otherwise be possible.

A resistive termination, at the output of the amplifier and the input of the deflection system, could also be used to match impedances. However, with this type of termination, the power dissipation in the output stage would be twice as high as it is with the feedback connection.

A low collector-to-emitter breakdown voltage V_{CEO} is better because a high V_{CEO} is usually achieved at the expense of decreasing the high-frequency current gain.

The output amplifier is connected so that the combined collector currents in stage three, I_3 , are a major part of the emitter bias currents ($I_3 + I_4$) in the output stage. This connection significantly cuts the power dissipation in the biasing networks by eliminating stage three's need for an external-collector supply voltage. And the emitters of the output-stage transistors can then use the high collector impedances of stage three as an efficient current source. In addition, the desired bias voltage, e_2 , for the common-base transistors in stage four, is conveniently available in this connection at the base of Q_6 .

Small voltage drops, provided by resistors R_1 and R_2 ($I_3R_1 = I_3R_2 = 1$ volt), keep the transistors in stage four from being saturated under large signal conditions. If the amplifier is overdriven to the point that Q_1 and Q_2 cut off, then the collector current in Q_3 and Q_4 is equal to I_3 , and the base voltage e_3 of Q_7 is at its minimum. Under this condition, the common-base bias voltage e_2 is kept lower than e_3 , and transistor Q_6 is not saturated. Since e_1 is 1 volt less than e_2 , saturation of transistor Q_5 is also prevented.

Whatever the conditions may be, the amplifier transistors will not saturate; this permits rapid amplifier recovery to an on-screen display after the amplifier is over-driven. ■

The case for patenting software

Two patent attorneys question the validity of denying computer programs patent protection, calling such action both arbitrary and discriminatory

By Michael I. Rackman

Amster & Rothstein, Counsellors at Law, New York

and Howard R. Popper

Bell Telephone Laboratories, Murray Hill, N.J.

Submit a computer program to the Patent Office and see what happens. Your application will be turned down. But submit a jumble of wiring diagrams for circuits that do the same job and chances are that you may get a patent. Make much sense? Perhaps not, but it's common practice for the Patent Office to reject any application that is directed to an innovation in data processing and written so that a programmer could understand it. The reasoning is that because a computer performs many processes that can also be done by a human mind, all computer programs are really, at bottom, mental processes and therefore cannot be given patent protection.

This position is unsound. Computer programs are descriptions of machine processes and, provided that the processes are new, useful and not obvious, there is no reason why patents should not be granted. Just because the steps in a program "could be" done mentally does not disqualify the underlying invention from patentability.

But having a direct bearing on the stance taken by the Patent Office is its feeling that treating software as other inventions would entail new search procedures. Moreover, the office feels this would cause other administrative problems.

Nevertheless, opposition to this no-patent policy is growing. And in the wake of the Court of Customs and Patent Appeals overruling the Patent Office last November in the Prater and Wei case, the issue has touched off a heated controversy. Charles D. Prater and James Wei, both of the Mobil Oil Corp., had applied for a patent on a spectrographic process that could be accomplished on a programmed computer. The claims in the application had been turned down and Prater and Wei subsequently appealed this decision to the

court, which overruled the Patent Office. The Patent Office has since petitioned the court for a rehearing, which was granted. The outcome of the rehearing is expected shortly.

Should the court reaffirm its ruling and a patent is eventually granted to Prater and Wei, it would set a precedent that would have vast implications for the electronics industry and other industries in which electronics is an integral part.

Design engineers are becoming increasingly concerned with software. In a system using both software and hardware, significant operating advantages are often gained because of the way the hardware is controlled by the stored program software. Therefore, a reaffirmation of the court's ruling in the Prater-Wei case could lead to design engineers obtaining patents on novel systems designed to incorporate software.

With no law on the books dealing specifically with the patenting of computer programs, the electronics industry is focusing its attention on the Prater-Wei case. Staunchly supporting the Patent Office's present policy are the computer manufacturers, and with good reason. Their business is either selling the machines outright or renting them, not software. Many companies distribute programs free of charge via program-sharing pools to encourage wider use of their computers.

Vigorously opposed to the Patent Office's practice, however, is the growing software industry, whose programs are developed more often than not at considerable cost. Without legal protection, their listings and flow charts are fair game for piracy. A program costing \$100,000 to develop can, in some cases, be copied for less than \$100.

Software is serious business. Since the mid-1950's, it has been responsible for a sizable share



Fig. 4.

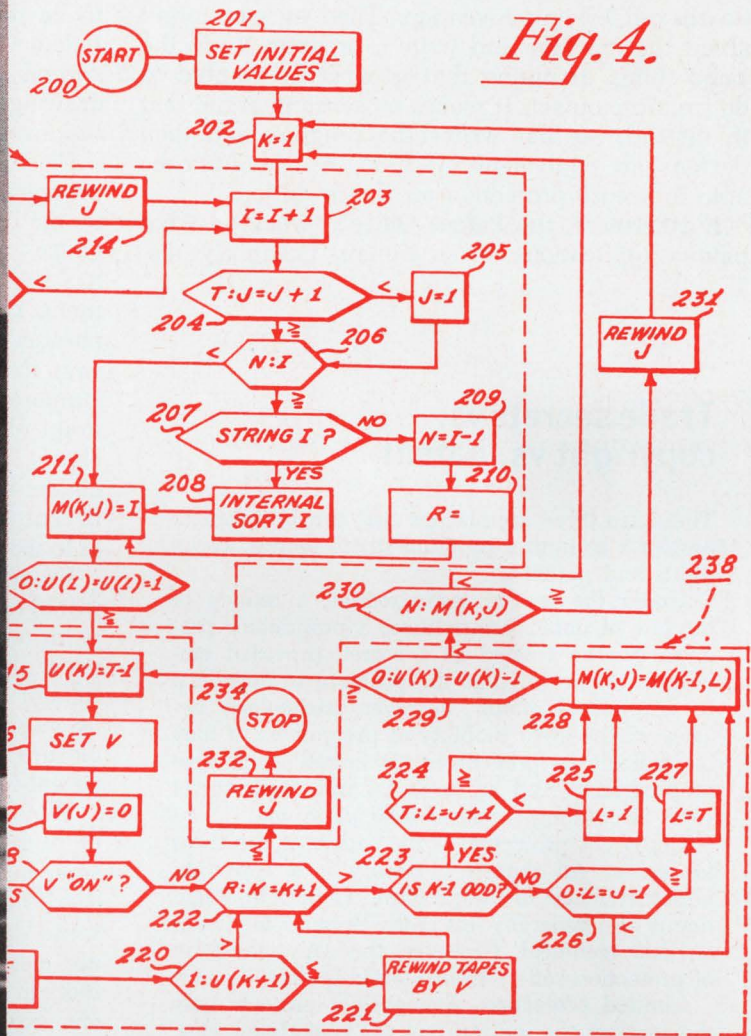

INVENTOR
Martin A. Goetz
BY
William and Jacobs
ATTORNEYS.

Unique. The only acknowledged patent for software—described by flowcharts—was issued to M.A. Goetz of Applied Data Research. The program sorts data on different tapes. But Patent Office policy bars such awards.

of computer research and development costs. It is estimated that today the cost of software development has reached a point where it exceeds that of hardware.

It is evident that software firms need adequate legal protection of their proprietary rights. Without such protection, they cannot be expected to trade their programs for access to the programs offered in the manufacturer-sponsored, program-sharing pools.

In the world of computers, programs and hardware are merely opposite sides of the same coin; tradeoffs between them are commonplace in the

design of any general-purpose machine. Even before the design of a special-purpose computer is set down, the economics of such a machine is weighed against the economics of programming a general-purpose computer for the same function.

Why, then, is there a difference in the way software and hardware are treated vis-a-vis patents? There shouldn't be any. It is arbitrary to deny protection to the programmer and yet grant it to the designer when the basic invention is the same in both its hardware and software embodiments (see "Hardware or software, which should it be?", p. 99). This is particularly true in view of the ill-de-

finer distinction between hardware and software, and precisely because either implementation can be derived from the other. If an engineer first designs a machine, he could secure patent protection on the underlying invention. Then he can forget about the machine and write a program to do the same thing, assuming that is what he wanted to do from the outset. It makes no sense to argue that if, instead, he first writes the program and then designs an equivalent machine, he shouldn't be able to secure protection on the invention.

Furthermore, the Patent Office's policy on what patent applications must contain outrightly dis-

criminates against the little guy who cannot afford a staff of patent engineers to reconstruct a program back into a voluminous set of hardware wiring diagrams. Such an application, however, seems to be the only kind that is acceptable under the Patent Office policy as it has existed for the past several years. Of course, these reams of wiring drawings do not help anyone to understand or use the invention.

Flow charts, which are the kind of drawings that programmers would understand, are not considered by the Patent Office to show "structure" and so the Office, even when it concedes that an invention has been made, refuses to grant claims based on them. The Patent Office won't grant claims to "apparatus" that is based on flow charts because it says that its rules require apparatus claims to be supported by a drawing of "structure." Yet it won't grant claims to the method portrayed in the flow charts, even though case law holds that "method" claims need not be accompanied by any drawing, because the Patent Office holds that all programable methods are mental processes.

From a patentee's viewpoint, method claims would be preferable because they are likely to both point out the real contribution of the program and cover the activities of any would-be infringer. But though the inventor would prefer this approach, he must now follow the ponderous apparatus disclosure route if he hopes to obtain any sort of patent for his invention.

Why the Patent Office goes along with this type of presentation is almost anyone's guess. The answer may lie in the fact that, although apparatus disclosures make for lengthier and more cumbersome descriptions than program flow charts, they are closer to the sort of disclosures patent examiners are accustomed to handling. Or, as some patent experts have suggested, they are acceptable because they tend to hold down the input of new applications; they require much time in writing.

This doesn't mean that apparatus disclosures are always accepted. There are some zealous examiners who, should they suspect the disclosure couches a software invention, would reject such applications out of hand. At times, they even reject applications affecting electronic systems in which software is the furthest thing from the mind of the designers.

This attitude is carried to such an extreme that some claims, drawn to special-purpose machines, are rejected on the grounds that the inventions could be practiced on general-purpose computers and, therefore, cannot be patented. Such a practice, should it become widespread, could just about wipe out protection completely for almost any electronic system. Most systems can be simulated on a general-purpose computer.

Even computer manufacturers would argue against the contention that special-purpose machines are unpatentable if an equivalent program could be written for a general-purpose machine. This contention, should it become Patent Office

Trade secrets vs. copyright vs. patent

There are three approaches that can be taken to protect a computer program—trade secrets, copyrights and patents.

Under the law of trade secrets, a branch of the law of unfair competition, a proprietary program can be treated as a secret, provided employees do not divulge the program to outsiders. As a practical matter, however, particularly because of the great mobility of programmers, it may be difficult to prevent unauthorized disclosures of programs. And as for a lawsuit, trade-secret cases are among the most difficult to win.

Copyright protection is the easiest of the three to secure. All that is necessary is a copyright notice attached to the program. Copyright litigation is also generally less costly because the issues are less technical. However, the copyright form of protection suffers from a basic frailty.

Limited protection. A copyright protects only the form of the writing, not the underlying idea. And, in most cases, the underlying concept far outweighs the writing in importance. Once the basic algorithm becomes known—and it must become known since copyright protection is secured by publishing the material with the attached copyright notice—anyone can write another program to carry out the algorithm without fear of infringing upon the original copyright. And where there are only a limited number of ways of expressing an idea, copyright protection may not be available in the first place.

A patent, on the other hand, can serve to protect the underlying principles of an invention. But compared with copyright protection, obtaining a patent can be expensive; and patent litigation is generally very costly.

However, a patent affords broad protection. Those in favor of patents for "programable processes" (the correct terminology, according to legal scholars) say patents, in most cases, are the only solution to the piracy problem facing the software industry. A patent will give the inventor or his company exclusive rights to the use of his program or, alternatively, permit him to receive royalties from users licensed under the patent.

Hardware or software, which should it be?

To demonstrate the equivalence of hardware and software, consider how the same job can be accomplished by either a wired logic technique or a programmed digital computer.

The problem is to introduce information from a binary signal source into a shift register in such a way that a "1" enters as a "0" if the last stage of the register contains a "0." It is further desired that a counter be used to count the number of successive "0's" entering the register, and then be reset whenever a "1" is entered.

This can be achieved with a circuit comprising an N-bit shift register, an input control gate, an N-bit counter, and a relay that is triggered when the counter reaches the count of N. As in the diagram, there are two inputs: the bit signals from the binary source and the bit signal fed back from the last stage of the shift register.

The input-control gate permits a "1" to enter the register only when the last stage of the register contains a "1." When it doesn't, a "0" is inserted into the register. Initially, it may be assumed that the shift register contains all "1's." Whenever a "0" is stored, the counter is incremented via line 0. Whenever a "1" is stored, the counter is reset via line 1. When N "0's" are counted, the relay "return" is energized to control another circuit.

For the purposes of this discussion, it isn't necessary to ascertain the practical utility of the circuit. It is suffice to say that such a circuit can be built with conventional components.

Program route. The same result—entering binary data into a storage array, the comparing of input and output bits, and the incrementing and resetting of a counter—can be obtained through the use of a stored program.

A program, written in Fortran IV, for example, executes certain logical and arithmetic operations on a digital computer. The arithmetic operations are performed with quantities called indexes, which are used to define the input and output locations of the shift register. Logical operations are performed with the input data bit and with the contents of the output stage of the register defined by an output index. Instead of shifting data bits through the register, for example, arithmetic operations are performed on the indexes, which keep track of the input and output data bits.

Different, but. Although the examples as presented are somewhat simplified, it is apparent that either approach is a practical way toward solving the problem at hand. Both achieve the same results, albeit each in its own way. Assuming both are available to the engineer, his choice of which to employ will depend on economy, size, and speed of operation—and whether a stored-program computer is available.

In light of these examples, authors Rackman and Popper contend that inclusion of a program should not prevent issuance of a patent covering a hardware disclosure. Moreover, they believe the program should in itself lend support to the patentability of the invention.

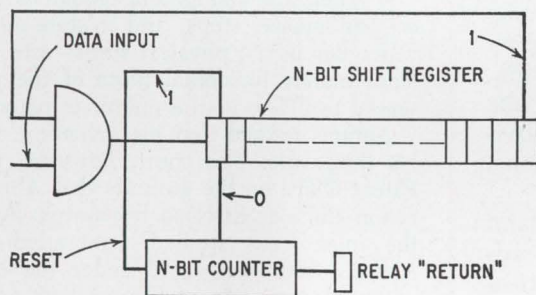

Committed. Hardware like wired-logic shift register, left, can be patented; but software to do the same job can't.

policy, could preclude patent protection for all new apparatus coming out of the computer industry; the operation of practically every new computer could be simulated on an existing machine.

The case against

Those opposing the granting of patent protection for software argue that a claim, particularly a method claim, which defines the steps in an algorithm, necessarily defines the same steps that could be performed in the mind or with pencil and paper. Mental processes, they point out, are not subject matter for patents. If these processes were patentable, the rights afforded by the First

Amendment to the Constitution—namely freedom of speech, as broadly construed—would be abridged. A corollary to this argument is that mathematical formulas are not subject to patents.

This argument certainly appears logical. After all, how can a patent be granted with a method claim that could be construed to cover the practice of an invention with pencil and paper when everyone knows that the First Amendment takes precedence over the patent statutes? In other words, how can exclusive rights be secured for a process that could be accomplished mentally?

The flaw in this argument is in the area of what could be construed as a mental process. And some-

how, software's real contribution to technology is lost in the shuffle.

The answer, of course, is not to construe a programmable process so as to mean anything but a machine-executed process. As for abridging freedom of speech, this contention doesn't ring true.

Just as a computer patent cannot prevent a person from imitating the machine's operation with pencil and paper, a program patent cannot bar anyone from carrying out the program's steps with pencil and paper. The mere fact that a process can be performed mentally neither makes it in itself a mental process nor constitutes an infringement of a patent on the process.

Another argument against patenting software, one that has been voiced quite vigorously, is that a designer of a computer envisions all possible uses of his machine. This includes anticipating all programs that it would require. This contention, however, holds no merit whatsoever. The transistor manufacturer, for example, envisions use of his devices wherever amplifiers, gates, and the like are required. Does this foresight bar the granting of patents on subsequently designed, nonobvious circuits? Of course not! And the same should be true for computer programs. Moreover, the 1952 Patent Act specifically sanctioned the method-type disclosure for claiming a new use of an old machine. And this is precisely what many new computer programs entail.

The distinction between what is obvious and what is patentable subject matter must always be borne in mind. As with any other invention, a program must not be obvious if patent protection is to be granted. If, in the light of other programs or existing machines, a certain program is obvious, it shouldn't be amenable to patent protection. But simply because the majority of programs, like the majority of hardware inventions, may be obvious, it does not follow that all program inventions, per se, are unpatentable.

Still another argument heard often is that a claim directed to the operation of a computer in accordance with a program based on a mathematical principle developed by the inventor should be unpatentable in view of the principle itself. This kind of reasoning could, in effect, bar patent protection for all programs inasmuch as it treats the underlying principle of any program as prior art. It would also follow from this that every digital system is unpatentable. This argument has been rejected by the Patent Office Board of Appeals.¹

But what about the ban against mathematical formulas? This prohibition is certainly valid. The formula $E=mc^2$ cannot be patented. Does it follow, therefore, that an apparatus or method that can be described by mathematics should not be patentable? What must determine the statutory nature of an invention is not the mathematics, which is only a language, but what it describes. In this regard, the Supreme Court² stated 20 years ago:

"While a scientific truth, or its mathematical expression, is not a patentable invention, a novel and

The 'Rules of Abrams'

When it comes to the nonpatentability of mental processes—the argument often used against software—the case usually cited by the Patent Office as the precedent is the Abrams case, which dates back almost two decades.³

Armand J. Abrams sought a patent for an invention that could be used in the prospecting for petroleum deposits. His application was rejected by the Patent Office and the case was appealed to the Court of Customs and Patent Appeals. The court upheld the Patent Office in 1951 and disallowed Abrams' method claims.

These claims included the steps of sinking a number of boreholes, sealing each hole at a specific depth, reducing the pressure in each, measuring the rate of pressure rise, determining the rate of pressure rise at a standard reference pressure, and comparing the rates for different boreholes to detect anomalies indicative of the presence of petroleum deposits.

In the course of his appeal, Abrams and his attorney proposed three rules or guidelines as to what should or shouldn't be patentable. These rules, though never formally adopted by the court, came to be called the "Rules of Abrams" and included:

- When all the steps of a method claim are purely mental in character, the subject matter is not patentable.
- When a method claim embodies both physical and mental steps, and an advance in the state of the art lies in the mental steps, the claim is unpatentable.
- When a method claim embodies both physical and mental steps, and a state-of-the-art advance lies in the physical steps—with the mental steps merely incidental parts of the process essential to define it—the matter is patentable.

Abrams argued that his invention came under his third rule. The court, however, upheld the Patent Office on the grounds that Abrams' application did not disclose apparatus. And even if the rules were applied, contended the court, Abrams' invention came under the second rule—namely, the state of the art was advanced by steps that had to be performed mentally.

Abrams' invention required the exercise of human judgment. However, authors Rackman and Popper contend the opposite is true of a computer program; human intervention is not required. A programmed-machine operation, say the authors, stands in marked contrast to the Abrams invention.

useful structure created with the aid of knowledge of scientific truth may be."

Suppose that the Taylor's series went unknown until now and someone only now discovered how to compute e^x . Should he be granted patent protection on a computer program for calculating the series? Yes! Moreover, he should be allowed to prevent the public from using his algorithm in

either special- or general-purpose machines.

Perhaps software's first breakthrough in the patent field occurred in April of last year when the now-celebrated Goetz patent, assigned to Applied Data Research, Inc., was issued. The patent award to the Applied Data vice president was the very first for a publicly acknowledged programing invention. The program was one for sorting data on a group of tapes. The drawing—eight sheets in all—discloses, in one figure, a block diagram of a system that includes no more than a control unit, a memory, an arithmetic unit, and a group of tape units. Another figure shows the program flow chart, with the remaining figures showing how the data is transferred between the various tapes.

Two claims were made, both of which were directed to apparatus. Each claim, after defining the tape units, the memory, and the arithmetic and control units, sets forth a control system that comprises various iterative control-signal loops, which are used for different functions.

A change in the making

The award of the Goetz patent turned out to be confusing not only to the industry but to the Patent Office [*Electronics*, Sept. 16, 1968, p. 33]. Officials in the Patent Office were unable to explain the award in light of the policy of barring patent grants on computer programs. In October, the office announced a set of guidelines that ruled out apparatus claims for programs. Then, a month later the Court of Customs and Patent Appeals handed down its decision in the Prater-Wei case.

Prater's and Wei's spectrographic process is used to provide accurate data on the proportions of known components in gas mixtures. Using the Prater-Wei process, concentrations of the components are displayed on a spectroscope as traces showing peaks and valleys. The process isolates the optimum set of peaks, thus forming a set of equations that accurately determines the relative concentrations. The record before the court contained no reference showing any prior recognition of this mathematical observation.

The application submitted by the oil-company employees disclosed electrical and mechanical components of a machine that could perform the required steps, and suggested that the process could be accomplished on a digital computer that is properly programed. Several method claims and one apparatus claim were included.

In overruling the Patent Office's arbitrary rejection of the Prater-Wei claims, the court stated:

"... We find nothing to indicate an intent of Congress or the courts to deny patent protection to process claims merely because they could alternatively be read on a process performed through the mind by the use of aids such as pencil and paper. It is therefore an appropriate point to correlate the development thus far traced with our decision in *Abrams*. [See "The 'Rules of *Abrams*'" p. 100.]

"We do not feel our reasoning need be encum-

bered by the so-called 'rules' of *Abrams*. . . . However, it is noted that in *Abrams*, unlike the present situation, the claimed process could only be performed in the mind, so far as was apparent from the specification. The *Abrams* situation may thus be distinguished from that presently before us, in which there is adequate disclosure how the process can be performed without mental calculation. This distinction from *Abrams* leads us to our present holding, which is that patent protection for a process disclosed as being a sequence or combination of steps, capable of performance without human intervention and directed to an industrial technology—a 'useful art' within the intendment of the Constitution—is not precluded by the mere fact that the process could alternatively be carried out by mental steps. . . . For the reasons discussed in this opinion, we reverse the rejection of all the claims before us."

Subsequently, the Patent Office filed a petition for rehearing, which was granted. In a dissenting opinion, Judge Giles Rich took a close look at the rationale and impact of the court's decision:

"It has been suggested that this case is one of the most complicated, technically and legally, with which we have ever had to deal. This is not so. While the technology is perhaps mathematically awesome, the economic impact of our decision tremendous, and the administrative problems of the Patent Office horrendous if it is obligated to abide by our decision, the case really boils down to a simple question or two of law. . . . Should computer programs be patentable? That is the problem the Patent Office presented to Congress, where the question belongs, submitting a bill implementing the recommendation of the President's Patent Commission that they be declared to be not patentable. But we are not at all concerned with what ought to be. We are not a policy-making body but a court of law. The simple question which has been before us is whether appellants' claimed process and apparatus are patentable under the existing statutes."

Judge Rich expressed his opposition to a rehearing by asserting: "We have thoroughly considered the statutes, the cases and the arguments and we have rendered our decision to the best of our ability. If we go through the process again, we can do no more."

Should the court reaffirm its earlier decision and barring any overruling legislation or reversal by the Supreme Court, the way would be clear for the granting of patent protection for all software. The next question, of course, would center on how the electronics industry will react. ■

References

1. Ex parte King and Barton, Vol. 146, U.S. Patent Quarterly, 1964, p. 590, Patent Office Board of Appeals.
2. Mackay Radio & Telegraph Co. vs. Radio Corporation of America, vol. 306, U.S. Reports, 1939, p. 86.
3. In re *Abrams*, Vol. 188, Federal Reporter 2nd series, 1951, p. 165, Court of Customs and Patent Appeals.

Take a look... this counter



speaks for itself

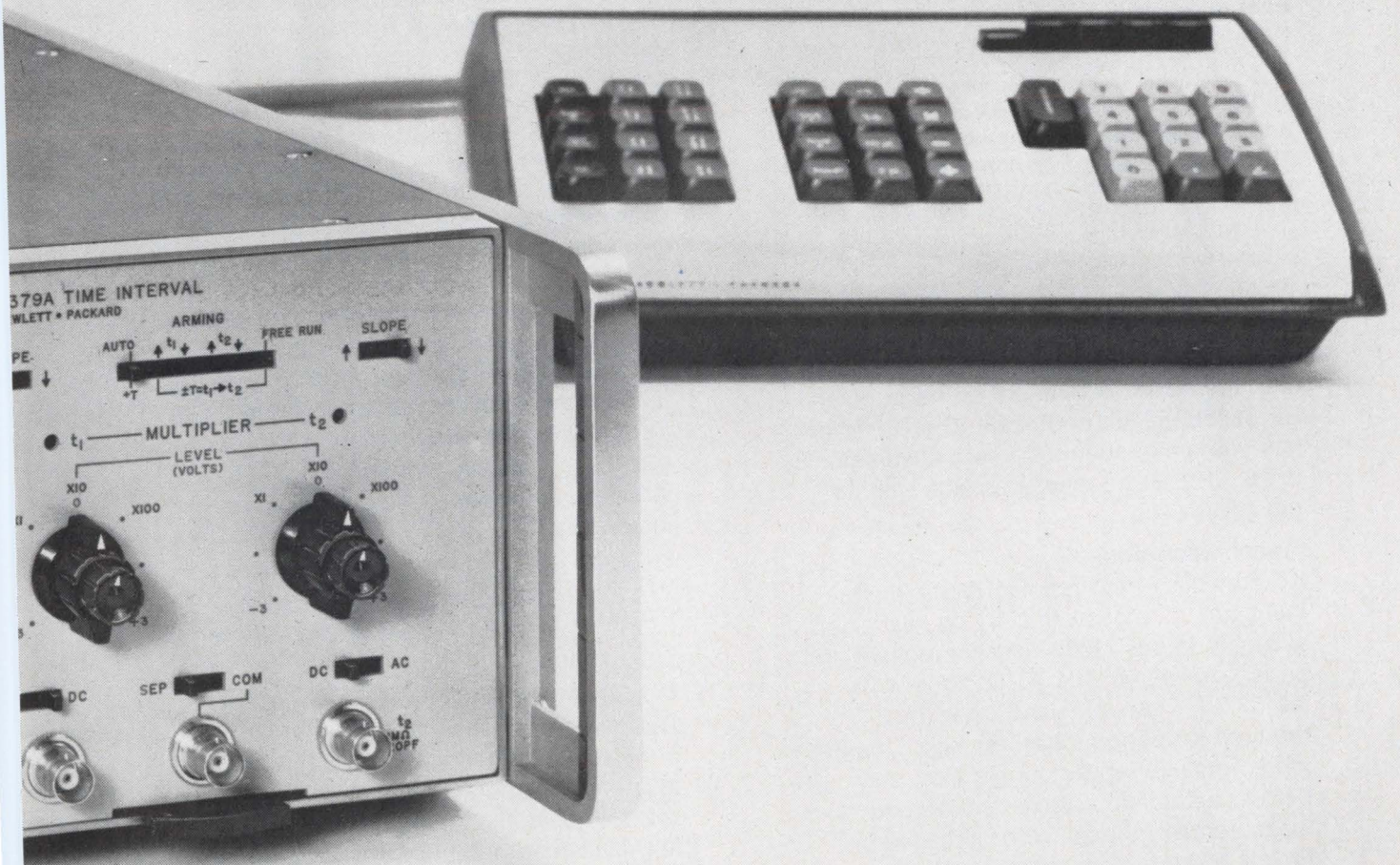

A word from the new HP 5360A Computing Counter:

Measurement and computation

The revolutionary new Hewlett-Packard 5360A Computing Counter, the most significant advance in counter technology since 1952, uses built-in interpolation with computation to eliminate the traditional ± 1 count ambiguity. It combines an IC period-measuring counter and an internal computer in a compact, easy-to-use package. Lets you measure frequency 1000 times faster, much more accurately and over a wider range than ever possible before. Basic measurements, 0.01 Hz to 320 MHz are automatic, with period and time interval resolution to 0.1 ns — a resolution never before offered in a counter. The 5360A's computing capability lets you automatically and in real time solve equations whose variables are the counter's measurements!

Fast and true

Take speed — the 5360A's up to 100 times more accurate than previous counters for the same speed. Take accuracy — it's 3 to 1000 times faster for the same accuracy. The previous ± 1 count accuracy limitation is decreased by a factor of 1000 by interpolators and digital computation within the 5360A.

Widest range

Besides the basic 0.01 Hz to 320 MHz measurement range, the 5360A accepts all the heterodyne converters of the popular HP 5245L, 5246L and 5248L Counters and lets you make spurious-free measurements to 18 GHz. Basic measurements without prescalers, too.

Finest resolution

No previous direct-reading digital instrument has given you the 0.1 ns resolution available in the 5360A for time interval and period measurements. In addition, with the 5379A Time-Interval Plug-in (not required for period measurements) you get more versatile input controls than ever before, automatic error detection and measurement of positive or negative intervals down to zero seconds, at rates over 1000 measurements per second.

Pulsed RF measurement

With none of the tedious transfer oscillator manipulation and calculation, the 5360A will measure pulsed signals up to 320 MHz with pulse length as short as 1 microsecond — and do it automatically and directly. Using the frequency converter plug-ins, you can measure pulsed carriers all the way to 18 GHz. And you can even measure a single burst of signal, which you can't do with transfer oscillators.

Computation

The 5360A and its accessory plug-in program module (available now) or its keyboard (available later this year) let you get direct answers in final form, real-time solutions to equations... without additional costly processing equipment and interface design. Two simple examples are direct readout measurements of phase or the rms value of a series of measurements.

Easy to use

Front-panel controls provide new dimensions of versatility, yet the 5360A is easy to use. There's a new minimum in the need to manipulate controls. Range selection, for example, is automatic over the entire frequency range, no matter what the setting of the Measurement Time switch. The 5360A gives you a fixed-decimal display, with automatic blanking — your reading is always in the same position, with up to three digits to the left of the decimal, up to 11 digits in resolution... all via internal calculation. It's virtually impossible to read the 5360A incorrectly.

Questions?

The 5360A Computing Counter with the 5365A Input Module costs \$6500. The 5367A Time-Interval Plug-in costs \$750. Accessory keyboard, approximately \$1000. Accessory plug-in program module, \$190.

For all the information on this break-through instrument in counter technology, call your local HP field engineer. Or write for our fully illustrated brochure and data sheet: Hewlett-Packard, Palo Alto, California 94304; Europe: 1217 Meyrin-Geneva, Switzerland.

HEWLETT  PACKARD
ELECTRONIC COUNTERS

02907

Designer's casebook

Designer's casebook is a regular feature in Electronics. Readers are invited to submit novel circuit ideas and unusual solutions to design problems. Descriptions should be short. We'll pay \$50 for each item published.

UJT gives frequency divider an immunity to input jitter

By John P. Budlong

Bedford Institute, Dartmouth, Nova Scotia

Although there are many circuits that divide the frequencies of pulse trains, the input frequencies of these circuits must be stable without much jitter. A frequency divider built around a unijunction transistor, however, serves the same purpose while tolerating large amounts of jitter. And by varying

the control voltage to the transistor, the UJT circuit—which operates over a frequency range of from 20 to 150 hertz—divides input pulse trains over a range of from 2 to 20.

Each cycle's trailing edge charges capacitor, C_1 , to a level equal to C_1V_1 where V_1 is the amplitude of the input signal. The following leading edge transfers most of the charge to C_2 . Thus, $C_1V_1 \approx C_2\Delta V_e$ and $\Delta V_e \approx V_1C_1/C_2$ where ΔV_e represents the change in voltage across C_2 . When the voltage at the unijunction's input, V_e , reaches the value ηV_c , where η is the unijunction's intrinsic standoff ratio, the UJT fires, discharging C_2 and producing an output pulse. Since η is a constant, V_e determines the number of input pulses needed to produce one output pulse.

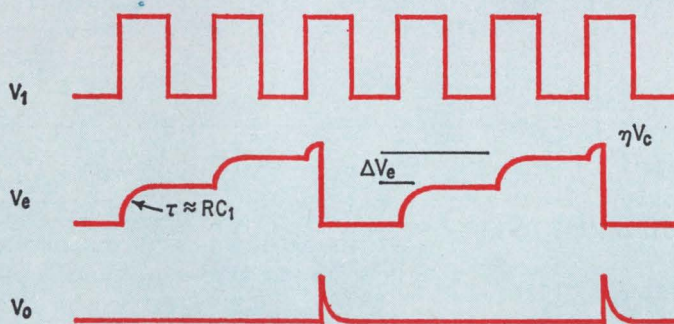
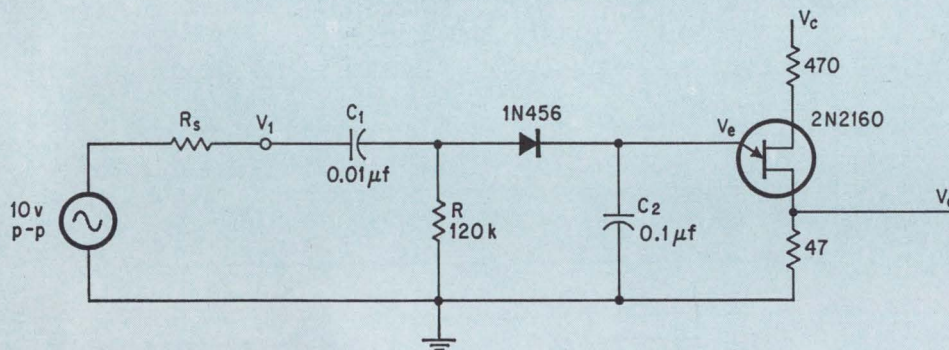

Keeping calm. The supply voltage V_c determines the number of input pulses that will produce one output pulse. By adjusting the values of the components and by using the relation $f=1/10RC_2$, with f being the input frequency, almost any frequency range can be achieved.

D-c restorer clamps random pulses to a reference

By William E. Peterson

ITL Research Corp., Northridge, Calif.

A diode bridge circuit coupled to an astable multivibrator eliminates many of the problems found in the conventional diode-capacitor d-c restorer circuit. Digital signals are clamped to a d-c level without suffering distortion common in the diode-capacitor circuit, especially when the signals are random in frequency and pulse width.

Designed for a specific application, this circuit was used to unblank a cathode ray tube where the grid was biased at -4 kilovolts below ground.

The pulse width determined the duration that the information would be displayed on the screen.

Transistors Q_1 and Q_2 form the astable which oscillates at radio frequency. Q_3 acts as a gate and turns the oscillator on and off according to the input digital signal. The radio frequency pulses from the oscillator are coupled to the diode bridge through two capacitors capable of withstanding a stress of -4 kv.

The bridge is referenced at -4 kv, the level to which the waveform is to be clamped. Capacitor C_3 , located at the output, filters the pulses that are detected by the bridge circuit.

This technique directly couples the digital signal to a d-c level, and thus the input pulse width may be of any length without a loss due to coupling. The entire circuit is easy to assemble because no transformers or other costly parts are used in its construction.

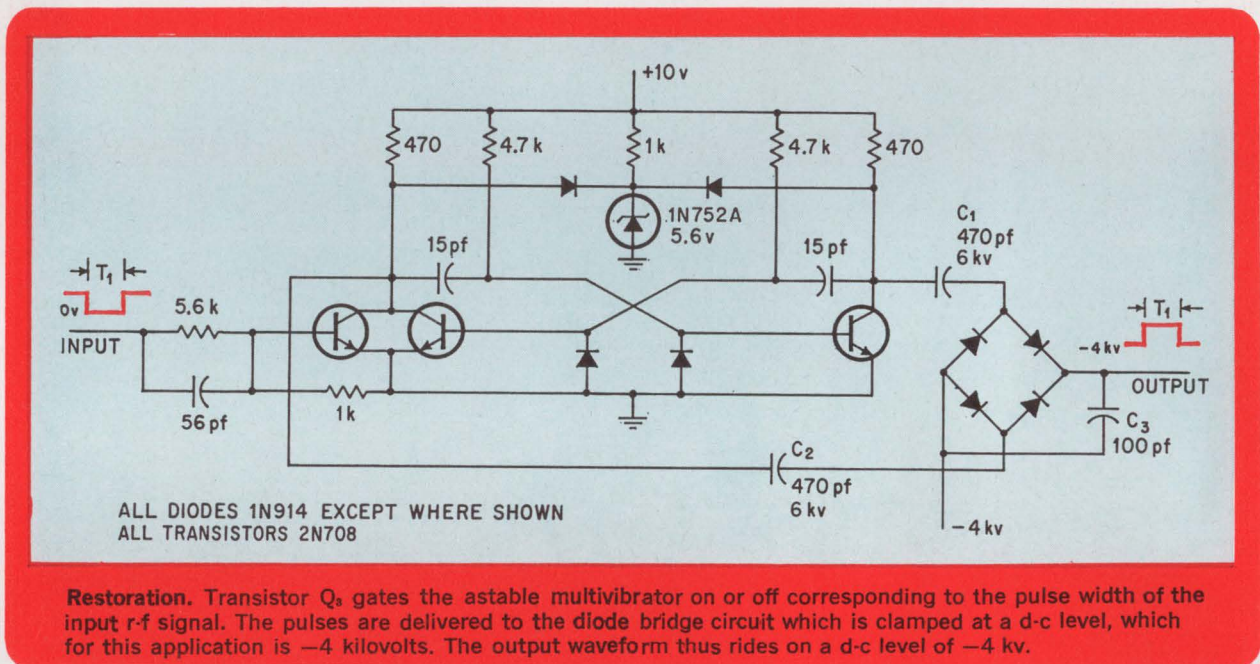

Ladder network converts binary input to a-c output

By Donald J. Gawlowicz
and Robert A. Fisher*

* Now with General Electric Co., Binghamton, N.Y.

When an alternating current output is desired whose amplitude is proportional to the weight of a set of binary inputs, such as may be used in a-c servo systems, a transistor ladder network can be used. The binary input operates upon an a-c input signal having a desired frequency and full scale amplitude.

The a-c input drives the base inputs of transistors Q_7 through Q_{12} . These transistors operate as emitter followers. Binary bits D_1 through D_6 cut

off (logic 1) or saturate (logic 0) the switching transistors Q_1 through Q_6 ; the saturated transistor state short-circuits the a-c signal. The a-c voltage on the emitters of transistors Q_7 through Q_{12} is either the steady state a-c input voltage, or approximately zero. These voltages are then weighted by the same type of resistive ladder network that is conventionally employed in commercial digital-to-analog converters.

To design the converter for a particular application, the following must be considered. The total impedance resulting from the parallel combination of resistor R_4 and the input impedance of a typical emitter follower must be much larger than R_1 to ensure that the a-c input voltage is not attenuated. The impedance of capacitor C at the input frequency plus the series resistance of the saturated input transistor must be much smaller than R_1 to effectively short-circuit the a-c input signal to ground. The peak-to-peak voltage of the

a-c input, $2V_p$, must be less than twice the biasing zener diode voltage to keep the input switching transistors out of saturation when a logic 1 input is applied.

By a-c coupling the collectors of switching transistors to the bases of the emitter followers, the d-c levels at the outputs of the emitter followers are not affected by the state of the switching transistors. Therefore the d-c level at the output of the ladder network is independent of the switching operations. This makes it possible to a-c couple the output without causing switching transient problems.

The circuit can be made phase sensitive for use with a-c servomechanisms by supplying the most significant bit (Q_{12}) with an a-c voltage of the same amplitude and frequency as that used for the other bits, but 180° out of phase. It would then be possible for a two's complement, binary-input code to be used.

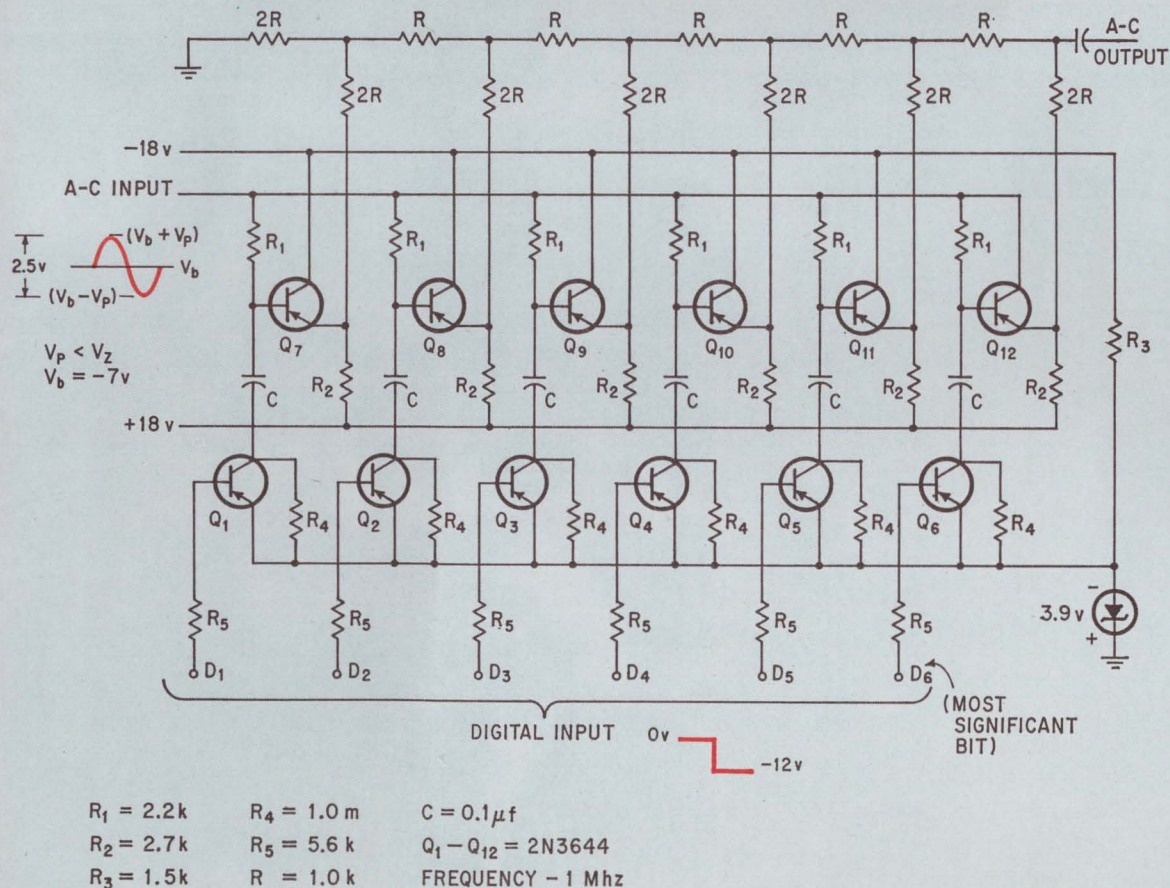

Ladder. Binary D_1 through D_6 saturate or cut off transistors Q_7 through Q_{12} whose bases are driven by an a-c signal. Those transistors that are saturated by the binary inputs, deliver the a-c signal to the output with a voltage weighted by a conventional resistive ladder network.

We'll go to any length to get into your memory

National's capable of going a long way (or short) to get the right MOS shift registers into your memory. The applications are unlimited.

For starters, you get a variety of bit lengths from our standard line, available immediately. Your National distributor's got them on the shelf and waiting.

If you can't find the register length your application requires, give us a call. We'll program your register length into our standard process. We've been making MOS so long, our memory's capable of anything.

Write or call National Semiconductor,
2975 San Ysidro Way, Santa Clara, California
95051. (408) 245-4320. TWX: 910-339-9240
Cables: NATSEMICON

National/MOS

How's that register?

DYNAMIC

Dual-25	MM400	-55°C to +125°C
	MM401	-55°C to +125°C (Internal 20K pull-up resistor)
	MM500	-25°C to +70°C
	MM501	-25°C to +70°C (Internal 20K pull-up resistor)
Dual-50	MM402	-55°C to +125°C
	MM403	-55°C to +125°C (Internal 20K pull-up resistor)
	MM502	-25°C to +70°C
	MM503	-25°C to +70°C (Internal 20K pull-up resistor)
Dual-100	MM406	-55°C to +125°C
	MM407	-55°C to +125°C (Internal 20K pull-up resistor)
	MM506	-25°C to +70°C
	MM507	-25°C to +70°C (Internal 20K pull-up resistor)
Dual-64 Accumulator	MM410	-55°C to +125°C
	MM510	-25°C to +70°C
Triple-60+4 Accumulator	MM415	-55°C to +125°C
	MM515	-25°C to +70°C

STATIC

Dual-16	MM404	-55°C to +125°C
	MM504	-25°C to +70°C
Dual-32	MM405	-55°C to +125°C
	MM505	-25°C to +70°C
8-bit Serial to Parallel	MM408	-55°C to +125°C
	MM508	-25°C to +70°C
8-bit Parallel to Serial	MM409	-55°C to +125°C
	MM509	-25°C to +70°C
Dual-32 Split clock	MM419	-55°C to +125°C
	MM519	-25°C to +70°C

Circuit monitors energy of laser photocoagulator

Ophthalmologists can record the laser energy entering a patient's eye

By Earl J. Scribner

Stanford Research Institute, Menlo Park, Calif.

Monitoring and recording the energy output of a pulsed ruby laser can be done by a simple transistor circuit that includes a zero control (if required for the recorder) and maintains the integrator in a zero condition until a signal is applied to the input gate. This gate signal allows the integrator to function and hold a value for an adjustable period of time (5 seconds or less). The circuit then automatically re-zeros the integrator and prepares the recording instrument for another reading. Firings can thus be made in quick succession

without the need of constantly referring to individual readings.

This circuit was specifically designed for use in a ruby laser photocoagulator. It works with a hot-stylus type recorder to provide an ophthalmologist with a permanent record of energy entering a patient's eye on each laser exposure.

A field effect phototransistor is mounted within the hand-held ophthalmoscope of the photocoagulator. A small fraction of the laser beam is reflected off a dichroic beamsplitter and is then passed

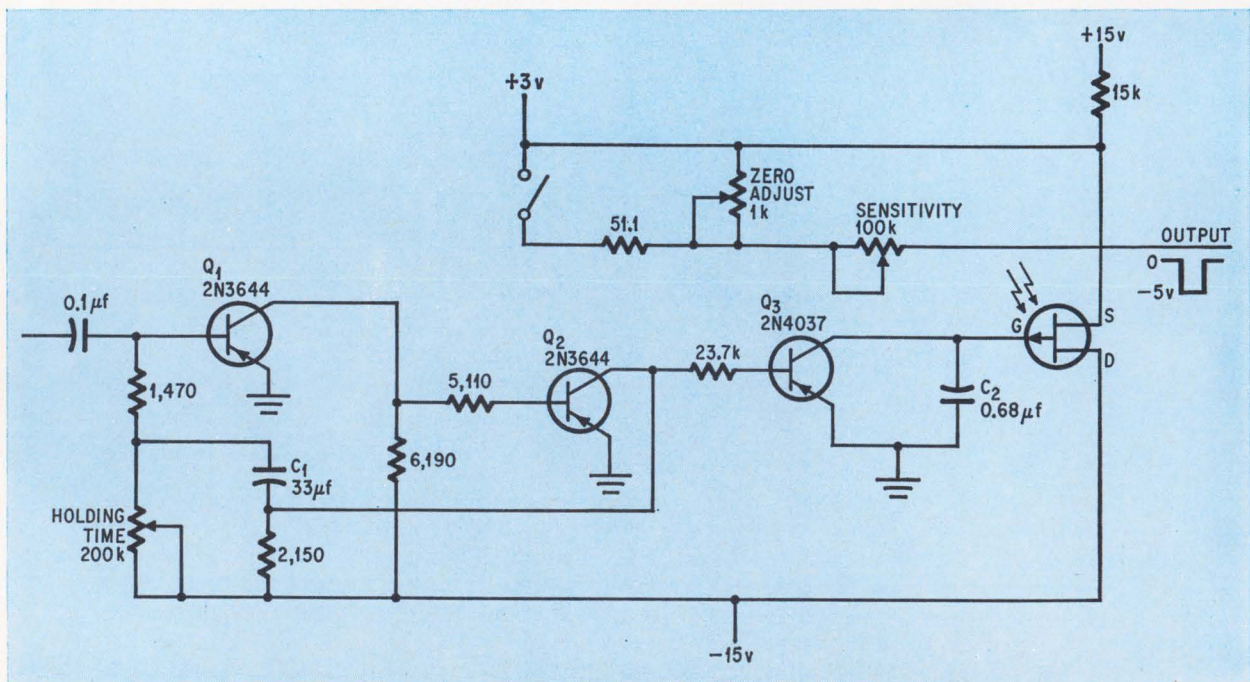

Eyeing the energy. The circuit provides an accurate and rapid method for obtaining the total energy output of a pulsed ruby laser photocoagulator each time it is fired. Thus a permanent record of the total energy entering a patient's eye is available to the ophthalmologist for study.

through a plastic diffuser, a Kodak 70 filter, a neutral-density filter, and an infrared-absorbing filter (Corning I-69), and is applied to the lens of the FET. A narrowband filter could also be used in the optical path. The purpose of the infrared filter in this case is to remove the large amount of infrared radiation from the 150-watt tungsten source used to illuminate the eye.

The circuit for the energy monitor consists of a switching circuit, an internally adjustable monostable multivibrator, and the FET integrator circuit. In the circuit's quiescent condition, switching transistor Q_3 is on, and is thus applying a virtual short circuit across the integrating capacitor, C_2 , and holding the instrument and recorder in a zero condition. When a signal is applied to the input, Q_2 's collector is driven to ground, turning Q_3 off. With Q_3 off, incident light within the sensitive range of the FET generates a photocurrent across the gate-channel.

The FET's high input impedance yields long time constants with small capacitor values. At the same time, the low gate-reverse current gives a minimum of drift to the integrated photocurrent.

Since the integrated photocurrent is proportional

to the total energy in the laser beam, the voltage at the gate of the FET is proportional to the laser photocoagulator's output energy. The output of the FET (taken from the source terminal) is used to drive the recorder. The output voltage should be held to a maximum of 5 volts so that good linearity can be maintained.

At the end of the holding time period—determined by the RC time constant of the trim pot and capacitor C_1 — Q_2 turns off and Q_3 turns on, shorting the integrating capacitor again. The recorder stylus therefore automatically returns to zero and stays there until the laser is again fired.

Any positive pulse occurring before the last laser action can be used to turn Q_1 off at the input gate. This pulse can originate in the laser flashtube ignition circuit.

The amplitude of the output signal is controlled by the sensitivity control adjustment.

Energy calibration is done by comparing the total energy in the output of the photocoagulator, as measured on a thermopile, with the indicated deflection of the trace on the recorder as measured by the phototransistor. Energy levels from 2 to 200 millijoules can be read on the recorder.

Industrial control

Multipoint recorder serves as time-shared amplifier

It saves the need for a low-level multiplexer and a converter

By Marcel Nougaret

University of Sherbrooke, Canada

Many control processes use a digital computer in conjunction with an analog recorder and a controller. In general, process sensors such as thermocouples yield signals in the millivolt range, meaning that a low-level analog-to-digital converter is required to interface between process and computer. It also means that low-level, high-precision d-c amplification is needed in the analog recording system. The costly function of low-level amplifica-

tion is thus needlessly duplicated in the a-d conversion and analog recording.

Use of a coded disk mounted on the shaft of an analog potentiometric recorder avoids the cost of a low-level a-d converter, but coded disks with high resolution are expensive units. A better method that can be used employs the arrangement shown in the diagram.

The electromechanical system of a conventional

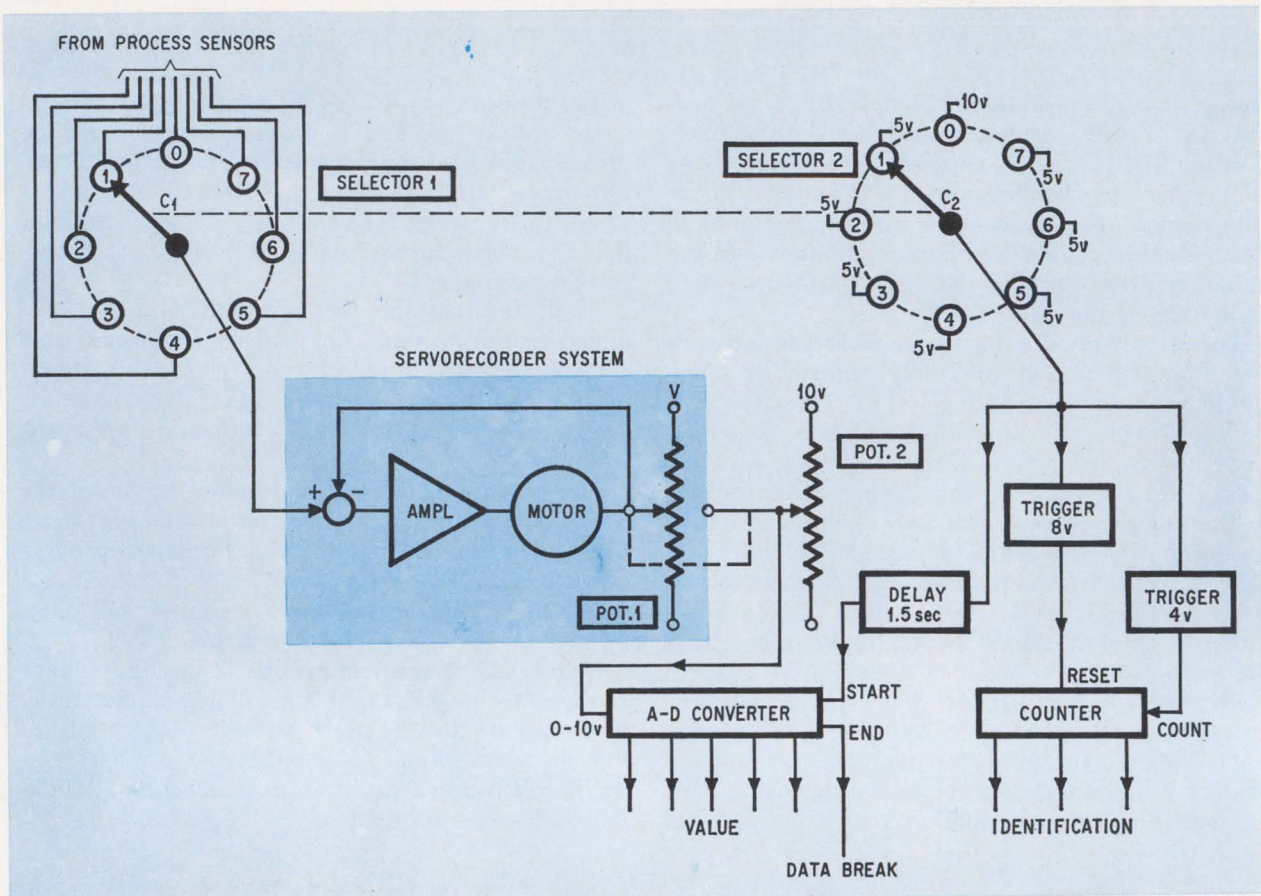

Useful recorder. Each input is sampled for 2 seconds, transmitted to an a-d converter, and then delivered to the digital computer. Different control programs are initiated in the computer by an identification number accompanying each input signal. System timing and synchronization are handled by the second selector.

multipoint recorder, a frequently encountered setup in physical and chemical process controls, is made of a servodriven potentiometer that's time-shared between the different analog inputs (one to eight) to be recorded. Driven by a mechanical cam, wiper C_1 steps from one position to another, remaining approximately 2 seconds at each point to make sure that the transient response of the servosystem has enough time to settle. A rotary printing wheel synchronized with wiper C_1 then prints a symbol identifying each input signal on the paper chart of the recorder. Thus for an eight-point recorder, each input is sampled within about 16 seconds.

For easy numerical control, the recorder system is equipped with an auxiliary potentiometer (pot 2) and a second selector (2) mounted on the same shaft as the input selector (1). The slider of pot 2 is mechanically linked to the servopotentiometer slider; by connecting pot 2 to a reference voltage of 10 volts, the potentiometer delivers a signal proportional to the input. This system can be described as a time-shared amplifier with the added feature that the output signal is totally decoupled from the input signal.

A high-level (0-10 volts) a-d converter is connected to the slider of pot 2 for digital control. The converter has one control input to initiate con-

version and another to emit a logic signal when conversion is completed. The timing and synchronization of the system is ensured by selector 2, each position of which is connected to 5 volts, except point 0, which is connected to 10 volts. The counter, which is connected to the wiper of selector 2, is reset each time wiper C_2 reaches point 0. The counter is incremented once for each position on selector 2 that the wiper moves through.

To avoid picking up the analog signal of pot 2 while the servosystem is in a transient condition, the a-d conversion is initiated for each position after a delay of about 1.5 seconds. When conversion is completed, the converter delivers the signal, the coded process variable, and its identification number (given by the content of the counter) to the digital computer. Different control programs are initiated as specified by the identification number accompanying each input signal.

The advantage of such a system is that it needs no low-level multiplexer and converter. Another advantage is that the computer's electrical system is independent of the process sensing system, thus side-stepping most of the frustrating grounding, shielding, and filtering problems associated with the installation of a digital computer in industrial process control.

Not everyone needs our 5700

Sure it's the most accurate DVM there is — 0.0025%. And the most stable — 0.0065% for a year. But if you don't really need a DVM that's good enough to calibrate other DVMs, don't buy it. Buy one of our 32 others instead.

We make them for labs and production lines, for use on the bench and in systems, militarized models, four digit DVMs and five, from \$1150 to over \$8000. (Actually, with our unique plug-in modules, you can create some 300 different configurations. For every imaginable application. To fit every budget.)

And no matter which of our other 32 you buy, you'll have a DVM made with the same meticulous care as our 5700. With many of the same circuits. By the same people. To give you the confidence you've come to expect from Dana.

Which one suits you best? Ask for the decision maker, our free brochure.

Dana Laboratories, Inc., 2401 Campus Drive, Irvine, California 92664.

DANA®

Circle 113 on reader service card



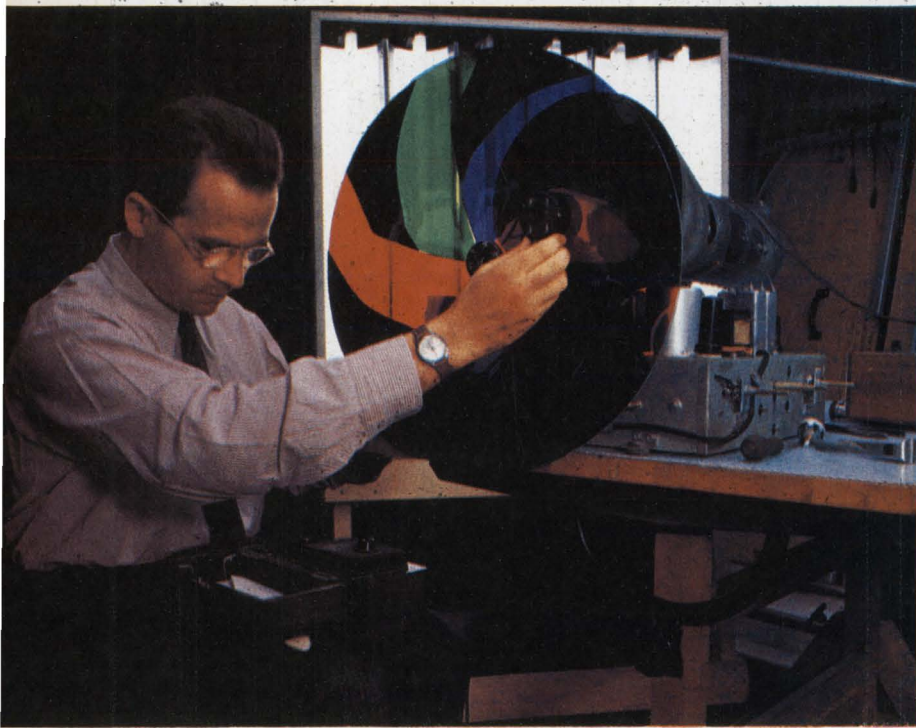

Circa 1940. Peter C. Goldmark, then CBS' chief engineer for tv development, with first color-wheel system.



Spacebound. Westinghouse's color camera weighs a scant 15 pounds.

Communications

Color-tv wheel takes a spin in space

Digital logic is used to channel serial color signals on separate tracks of multihead disk recorder that reads out the signals in parallel format

By John D. Drummond

Associate Editor

When Apollo 10 sent live color pictures of the moon into living rooms around the world in May, it was as much a glorious day for Peter C. Goldmark, President of CBS Laboratories, as it was for the U.S. space agency. For at long last, Goldmark's concept of a field-sequential system for color television proved to be more than the cockeyed scheme his critics thought it was.

True, the system aboard Apollo 10 is far different than the one Goldmark demonstrated in New York back in the early 1940's, but it nevertheless shares

its genesis with the earlier design. The Apollo 10 camera, just as Goldmark's, employed a color filter wheel to produce a color signal.

A field-sequential system uses a rotating filter wheel to expose a camera's pickup tube sequentially, at the desired broadcast scan rate, to the red, blue, and green components of a scene. Thus the need for complex optical paths and color registration adjustment, both of which are akin to commercial color cameras, is eliminated.

Since the output of a field-sequential system is

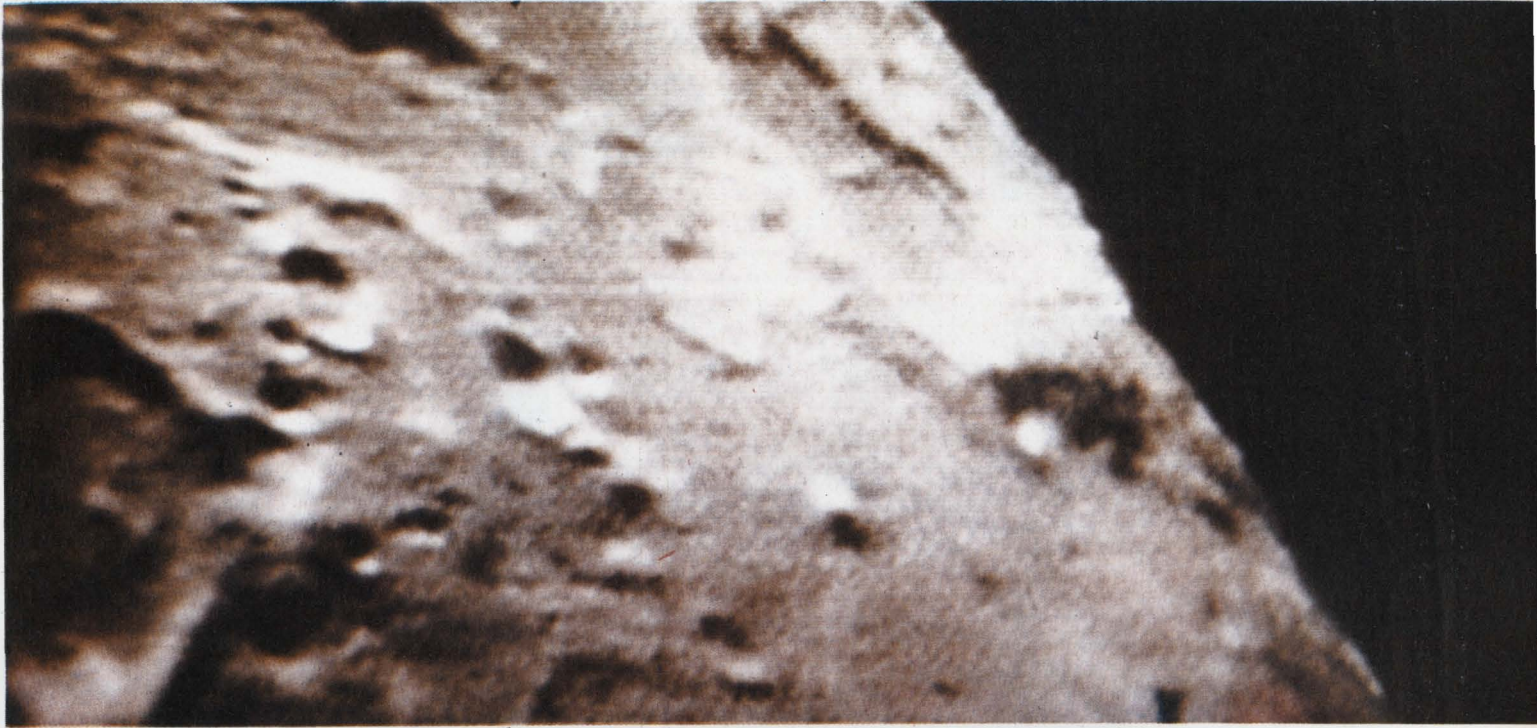

Moonglow. Closeup of the moon taken from the Apollo 10 command module; below, astronauts Stafford and Young in horseplay to demonstrate weightlessness in space while Cernan shoots the picture.

in serial red-blue-green form, it's not compatible with present broadcast standards. Hence, engineers at the Manned Spacecraft Center in Houston were confronted with the problem of making it compatible with the parallel NTSC (National Television System Committee) color tv format so it could be rebroadcast by commercial stations.

The first decision was that the conversion would have to be done on the ground since a converter could not be carried aloft. The second was to use a magnetic disk recorder of the type used for in-

stant replay of sport events. They then came up with a scheme using digital logic to sequence the incoming colors to the appropriate tracks on the recorder, and then read them out, all at once, to obtain a parallel output.

Why pick a simple color scheme, then go through all that trouble to make it compatible? For the simple reason that NASA wanted a light-weight camera that would require very little power and be capable of operating in the low light levels of the command module as well as in the high light

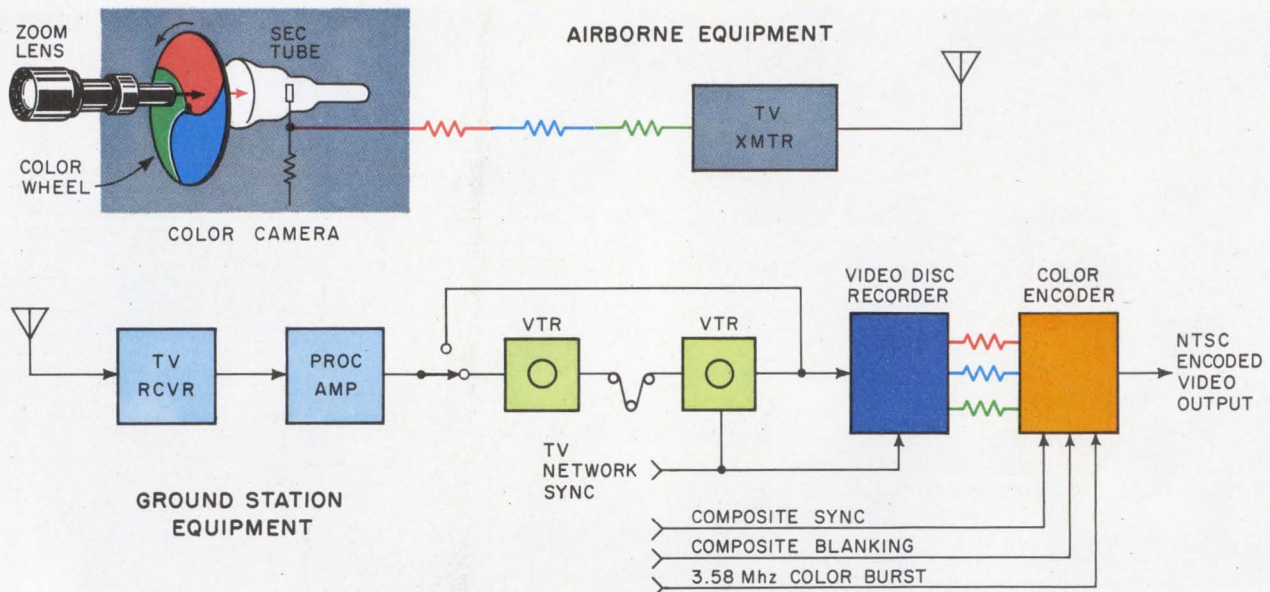

Bridging the gap. The field-sequential tv signals produced by the spinning color wheel, above, are beamed to earth over a 20-watt, S-band transmitter. Ground-processing equipment, below, convert the serial color signals to the parallel color format.

levels of the lunar environment. And, basically, all that's required to convert a black-and-white camera to a field-sequential color camera is the addition of a wheel.

A compatible NTSC color camera couldn't be used either since the weight and size of the package required for beam-splitting optics, dichroic filters and three pickup tubes, plus their associated circuitry, would far exceed both the space and weight limitations of the spacecraft. Furthermore, a limited size NTSC color camera couldn't be expected to have the low light level capabilities of the Apollo camera.

What convinced NASA at the last minute to go color was a demonstration by the Gyro Dynamics Corp. of Salt Lake City, Utah, of a field-sequential system using optical techniques, instead of a whirling wheel, to obtain the separate red, blue, and green signals.

Both the Gyro Dynamics system and a color wheel system from CBS were evaluated at the Houston spacecraft center under conditions simulating tv transmissions from distances in the vicinity of the moon, and both appeared to be acceptable for the Apollo mission.

However, NASA chose the color wheel because it could easily be integrated into a low-light level camera that Westinghouse had already built for another application, within the short time available before the flight. A second camera, an RCA black-and-white type, was carried aboard Apollo 10 as a backup, but it was never used during the flight.

Zooming in on the moon

The heart of Westinghouse's color camera is a secondary emission conduction (SEC) pickup tube, which operates in light levels as low as 0.007 foot-

lambert to as high as 12,600 foot-lamberts, without saturation. The tube has a very low lag, or persistence characteristic, enabling the color exposed during one scan to die down before the start of the next scan. This feature assures color purity.

A last-minute change in the camera specs called for a zoom lens, rather than the quick-disconnect, fixed-focus type used on the Apollo 9 camera. Because of this addition, a monitor was required so the astronaut could zoom in on a target and focus the picture without relying on ground control for directions.

The job was assigned to Westinghouse, who came up with a tiny monitor that could operate on, or off, the camera. It weighed less than four pounds, required about three watts of power, and had a black-and-white screen. It had four operating controls: brightness, contrast, vertical, and horizontal.

The color wheel was put between the SEC pickup tube and the zoom lens. To simplify the problem of synchronization, the scan rate of the wheel, as the color filters pass in front of the pickup tube, must be the same as that of the tv networks, which is 60 fields per second. This was achieved by dividing the wheel into six sections, with the colors arranged in red-blue-green, red-blue-green order, and by driving the wheel at 60 revolutions per second. The motor speed is held constant by the timing of the camera's sync generator.

The serial color signal, which is transmitted by a 20-watt, S-band transmitter on the spacecraft, is picked up and amplified by a receiver at the Houston spacecraft center. It's then clamped in a processing amplifier to restore the d-c component and reestablish the average light value of the reproduced image.

To compensate for the doppler shifts produced

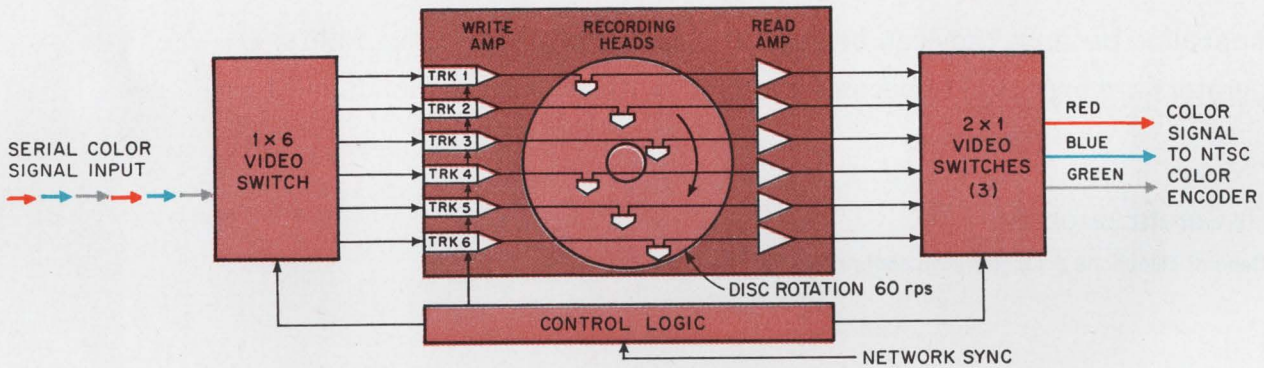
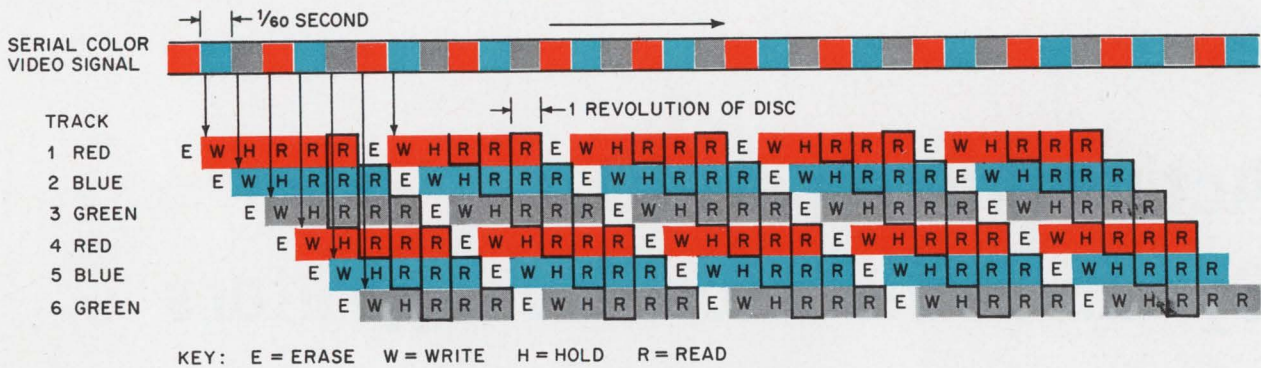

Color converter. Using digital logic to direct the red, blue and green color signals to the assigned tracks, the disk recorder reads out the signal in parallel format. Tracks delivering parallel color output are boxed in.

by the relative velocities of the spacecraft and the ground receiver, the signal is recorded on tape by a recorder whose speed is regulated by the incoming sync pulses. It's then passed through a loop which gives it a maximum 10-second delay before it's played back on a second tape recorder whose speed is synchronized with a 3.579545-megahertz oscillator in the ground processing equipment. By this storage and replay technique, the time base is automatically corrected, and the effects of doppler shifts are cancelled.

The video is now routed through a "gen-lock" to a stabilizing amplifier which removes the incoming sync from the signal. It then goes to a distribution amplifier which feeds the magnetic disk recorder that changes it from field sequential to the simultaneous color format.

The recorder's servo system is synchronized by the horizontal drive or the sync pulses, depending on the selected operating mode. The commutating logic that directs the fields of the sequential color signal to their respective tracks on the recorder is under the control of the system's sync generator which, in turn, is locked to the NTSC color standard.

The colors are put on six different tracks. The red signal is routed to track 1, the blue to track 2, the green to track 3, and so on. When a field of each color has been recorded on its designated track, the three colors are simultaneously read out the same way as the output from a three-tube NTSC color camera to a color encoder which processes it

to form the composite video signal. The tracks are completely erased and updated every 20 revolutions of the disk.

Behind the scenes

Apollo commander Thomas P. Stafford is credited by NASA with providing the impetus that led to the decision to use a color camera.

Project coordination came from Olin Graham, NASA's tv section head, and Max Engert, the space agency's technical supervisor. Westinghouse credits Larkin L. Niemyer for the camera design, and Lloyd B. Gangaware for the monitor.

CBS Laboratories, which served as consultant to Westinghouse and the space agency, credits Renville H. McMann Jr. and Arthur Kaiser for coming up with many of the schemes adopted.

The space agency also credits Lockheed Aircraft's technicians for modification of the basic video disk recorder, and the interfacing of the color equipment with existing station distribution equipment. Taft Broadcasting gets credit for operating the station equipment during the Apollo 10 flight.

Looking ahead

In the Apollo 11 flight, scheduled for July 16, a similar field-sequential color camera will be aboard the command module while a black-and-white camera will be on the hatchway door of the lunar module to send back pictures of the first man—an American—as he sets foot on the moon. ■

Active filters: part 10

Synthetic inductors from gyrators

Appealing because they can be used in building highly selective filters, gyrators are expected to become even more attractive in monolithic-IC form

By Gerald Aaronson

General Telephone & Electronics Laboratories Inc., Bayside, N.Y.

Despite an inherent insensitivity to component parameter variations, gyrator-capacitor active filters are sometimes frowned upon because they tend to be costlier than other filters—both active and passive. But this cost argument is about to be tossed out of a window. Within a matter of months, about six or eight, gyrators are expected to become available in monolithic-IC form, which, aside from reducing size, should bring the cost down to about the same ballpark level as other filters. And when this happens, chances are that designers will make greater use of gyrators in filter networks. Moreover, it should pave the way for applications heretofore untapped by gyrators—particularly in today's sophisticated communications systems.

But regardless of whether in discrete or integrated-circuit form, gyrator filters hold some clear-cut advantages over other types of active filters. Aside from their insensitivity to parameter variations, gyrators exhibit high Q 's when used to form synthetic inductors. This characteristic is essential for highly selective filter networks.

For a high- Q inductor, a gyrator's conductance, g_0 , should be large as should its input and output impedances. When a stable Q is needed, the high Q is attained first and then damped to the desired value. Since even the slightest phase shift in the gyrator loop can lead to oscillations in some high- Q circuits, it's best to add phase compensation.

In the design of most active filters other than a gyrator, the perennial bugaboo confronting the engineer is the circuit's sensitivity to parameter changes. Therefore, the engineer must expend considerable effort in coming up with a scheme that would prevent the circuit's active components from changing their values.

A gyrator, however, is a negative-feedback device

and therefore inherently stable. It has an impedance-inversion property that converts a capacitive load into an inductive reactance. This gyrator-created synthetic inductor replaces the passive inductor in conventional LC filters. Thus, the need for lossy and bulky inductors, particularly in low-frequency applications, is nonexistent.

Filters designed with positive-feedback techniques are produced by cascading two-pole building blocks. This is necessitated by the pole location's sensitivity to changes in the component values. At best, the pole sensitivity is proportional to the Q of the pole-pair; a 1 percent change in a network parameter will cause at least a 10 percent change in pole location in a network whose $Q = 10$. If a four-pole network is synthesized with one active circuit, the sensitivity will be proportional to the product of the Q 's of each conjugate pole.

The gyrator, because of its relative insensitivity, doesn't require such cascading. It enables the designer to directly substitute synthetic inductors for passive inductors in conventional LC filter designs. Therefore, other synthesis techniques are not required. This isn't true for other methods.

A gyrator that is terminated in a capacitor presents an inductive input impedance. Thus, it is possible to tune the synthetic inductor created in this manner with another capacitor. If ideal gyrators and capacitors are assumed, the resultant LC network would be an ideal tuned circuit. For the most part, however, gyrators are far from ideal. They have parasitic components that affect the desired high input and output impedances as well as small loop delay that can cause instability if not compensated.

Consider an ideal gyrator with a parallel RC load. The input impedance, Z_{in} , is

Gyrator connection

BASIC

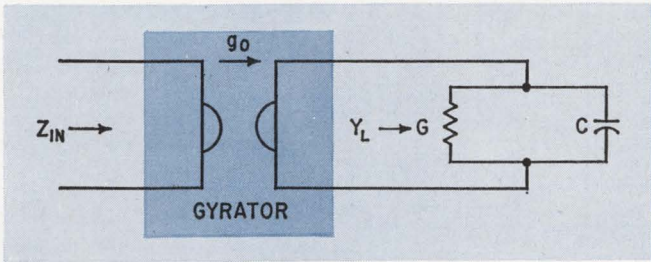

EQUIVALENT

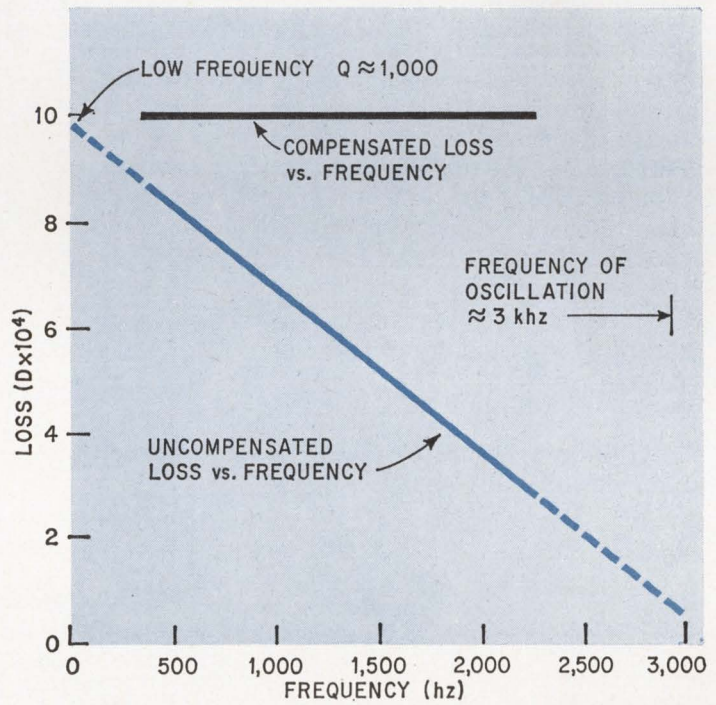
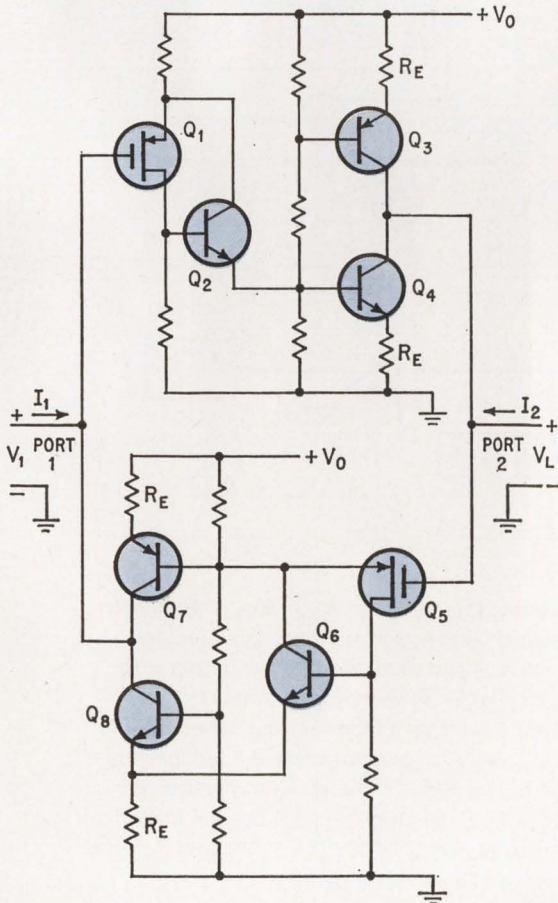
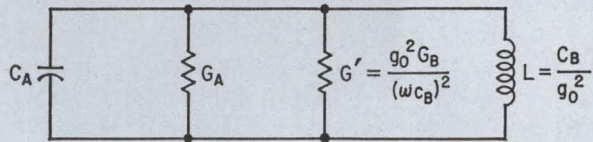
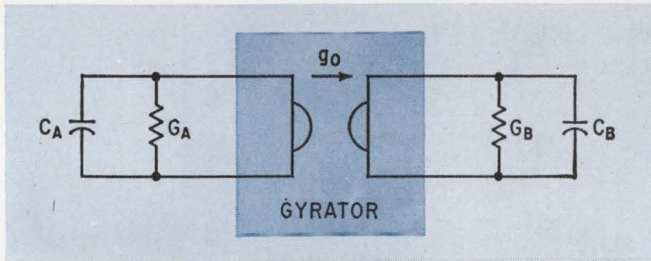
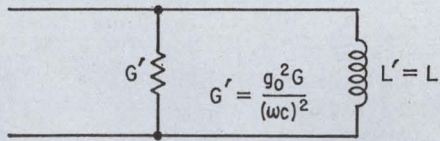
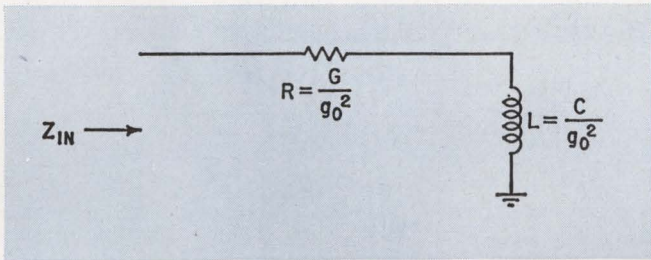
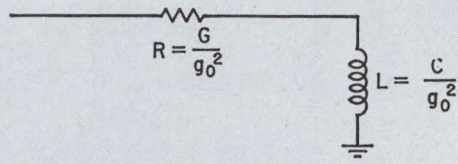

High impedance. FET's Q_1 and Q_5 with their high input impedance, enable the engineer to see only the common-collector impedances of the V-I converters Q_3 - Q_4 and Q_7 - Q_8 at ports 1 and 2, respectively. Plot of loss vs. frequency indicates the compensation necessary to stabilize the gyrator.

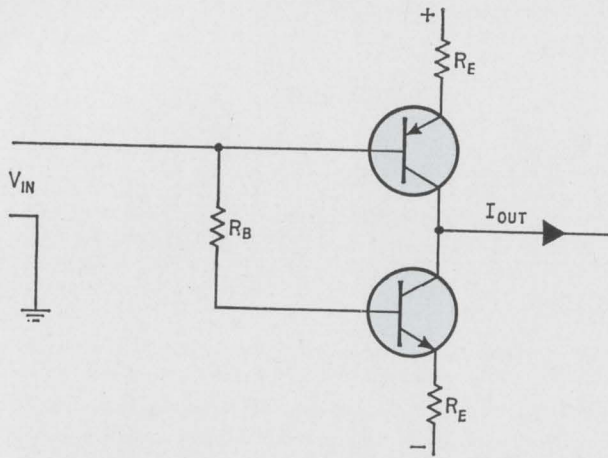

Voltage-current converter. A common-base stage, converter's collector current is proportional to base voltage. Output impedance at the common-collector terminal can be made as high as 6 megohms.

$$Z_{in} = \frac{G}{g_o^2} + \frac{j\omega C}{g_o^2} \quad (1)$$

where g_o is the gyration conductance in mhos, represented by the series RL circuit shown in the top drawing on page 119. If the Q , $\omega L/R$, of the circuit is high it can be represented by an equivalent parallel RL circuit with the values shown in the center drawing on page 119.

Now, consider a turned gyrator-capacitor circuit as shown in the bottom left drawing on page 119 where conductances G_A and G_B represent the parasitic loading of the gyrator circuit. For the moment, the capacitors are assumed ideal, having no dissipation. The tuned circuit is also represented by the network at the bottom right drawing.

The resonant frequency of this circuit is

$$\omega_o = \frac{1}{\sqrt{LC_A}} = \frac{g_o}{\sqrt{C_A C_B}} \quad (2)$$

where $L = \frac{C_B}{g_o^2}$

The Q -ratio of center frequency to the 3-decibel bandwidth-of the circuit is

$$Q = \frac{\omega C_A}{G_A + G'_B} = \frac{\omega C_A}{G_A + \frac{g_o^2 G_B}{(\omega C_B)^2}} \quad (3)$$

From equation 2,

$$\omega C_B = \frac{g_o^2}{\omega C_A} \quad (4)$$

To achieve tuning at a frequency, ω , with g_o and C_A fixed, C_B is adjusted according to equation 4. By inserting equation 4 into equation 3, the designer obtains an expression for Q as a function of C_A . This is represented by

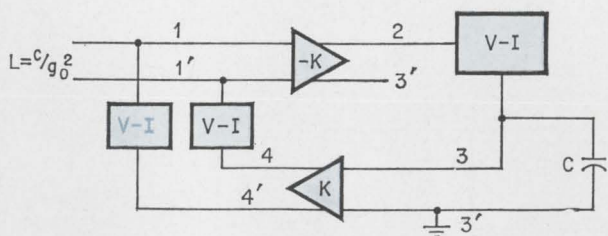
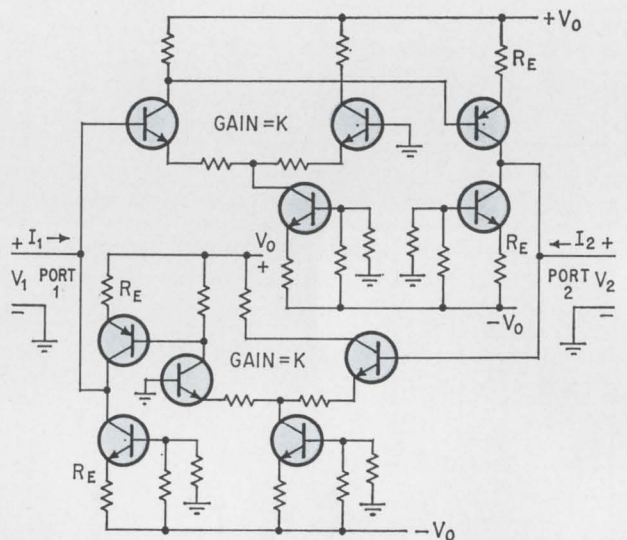
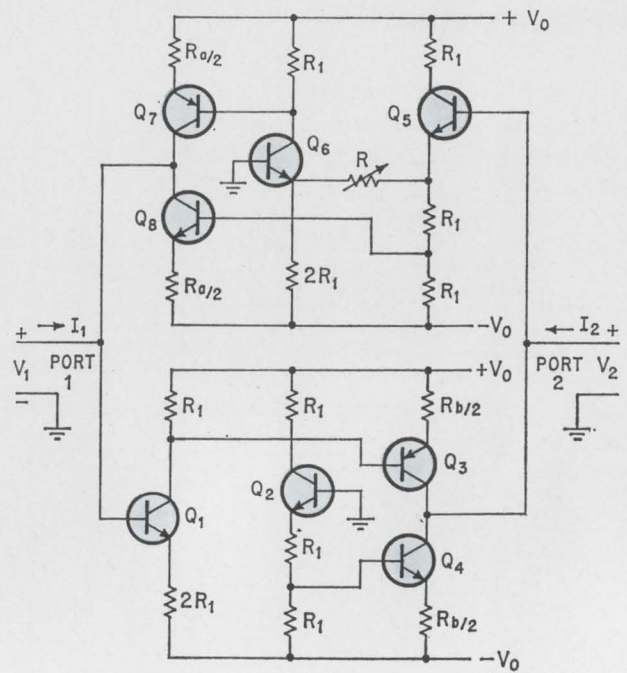

Gyrator variations. Input voltage, V_1 , at top, is applied to transistor Q_1 which acts as an amplifier. Q_1 collector signal drives base of transistor Q_3 , which together with transistor Q_4 form a V-I converter; Q_4 provides d-c bias to Q_3 . Transistor Q_5 acts as a follower and drives V-I converter Q_3 - Q_4 , very high-gain negative d-c feedback loop that stabilizes the transistors' d-c operating points in center circuit, differential amplifiers are used in both the forward and reverse paths. With a third V-I converter, the circuit is changed to a balanced gyrator, shown by the solid-colored letters V-I.

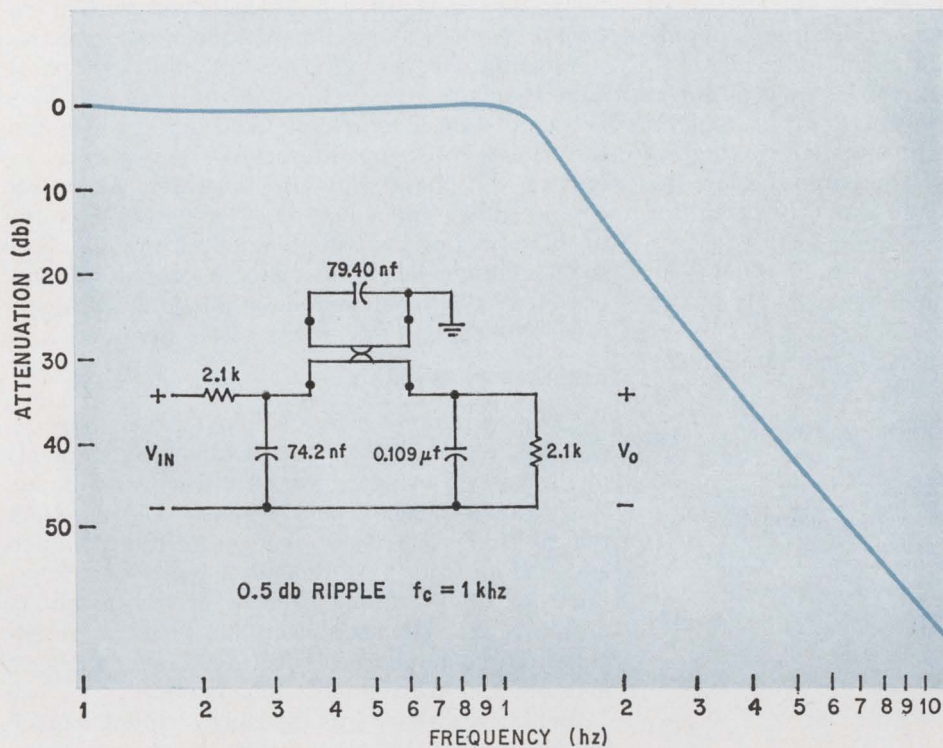

Filter response. In a three-pole, Chebyshev low-pass filter, a gyrator and a capacitor are used to simulate an inductor. Response curve is identical to the theoretical characteristic.

$$Q = \frac{g_o^2 (\omega C_A)}{g_o^2 G_A + (\omega C_A)^2 G_B} \quad (5)$$

For equation 5, Q will be maximum when

$$\omega C_A = g_o \sqrt{G_A/G_B} \quad (6)$$

This maximum value of Q is given by

$$Q_{MAX} = \frac{g_o}{2} \frac{1}{\sqrt{G_A G_B}} \quad (7)$$

The value of C_B needed to produce Q_{MAX} is

$$C_B = \frac{G_B C_A}{G_A} \quad (8)$$

In most practical gyrator designs $G_A = G_B$. To achieve Q_{MAX} the designer should use $C_B = C_A$ as indicated by equation 8.

To obtain the highest Q_{MAX} , the largest value of g_o , and the smallest values of G_A and G_B are required. Parameters G_A and G_B are kept small by designing the gyrator to have high input and output impedances. However, the larger g_o is, the larger C_A must be to tune to a specified frequency, ω , according to equation 6.

Physical considerations—size, geometry, volume, and the like—usually determine the usable range of capacitance, C , which in turn, imposes restrictions on g_o for a given frequency of resonance, ω . With hybrid IC's, for example, the largest value of C is set by allotted volume; with thin-film circuits, C is determined by fabrication factors. By using the largest values of C , the highest Q can be produced. A stable value of Q , required in

many designs, can be readily achieved by starting with a synthetic inductor of very high Q , for example, $Q = 1,000$. To achieve the design value of $Q = 10$, the inductor is resistively and/or capacitively damped. Damping cancels the unstable variations in the high, unloaded Q .

If capacitors C_A and C_B produce significant loss, the Q of the tuned circuit is affected. Assuming the following relationship,

$$Q_C = Q_{CA} = Q_{CB} = \frac{\omega C_A}{G_{CA}} = \frac{\omega C_B}{G_{CB}}$$

the unloaded Q of the network, Q_{UL} , is expressed in terms of Q_{UL} ,

$$Q_{UL} = \frac{Q_{MAX}}{1 + 2 \frac{Q_{MAX}}{Q_C}} \quad (9)$$

As the parasitic gyrator conductances approach zero, Q_{MAX} becomes large, the maximum Q_{UL} becomes $Q_C/2$. This is significant in the design of low-frequency filters in which thin-film components are to be used. Although there has been some progress toward developing low-loss, thin-film capacitors, losses of about 1 percent are still common. This means the unloaded Q is limited to about 50—much too low for some applications. Temperature-stable, ceramic-chip capacitors with dissipation factors less than 0.1 percent are available and can be used in selective-filter designs.

Perhaps the most important parasitic effect is the inherent phase shift that exists around the gyrator loop. This is caused both by delays within the transistor and by the capacitive components

of the transistor reacting with the impedances of the adjacent stages. It produces negative damping that, if large enough, could lead to oscillations. The effects of phase shift are evident at low frequencies. Even in the audio range, for example, a small phase shift is readily apparent in high-Q gyrator-capacitor networks. Therefore, the low frequency model of a transistor can't be used for gyrator design at any time.

Fortunately, the designer can more often than not compensate for a phase shift or simply ignore it in his design.

Consider, for example, that the gain around the gyrator loop is represented by

$$g_1 g_2 e^{-j\theta} = g_o^2 e^{-j\theta} \quad (10)$$

where $\theta \ll 1$

If the gyrator is terminated in a capacitor, the input impedance would be

$$Z_{IN} = \frac{j\omega C}{g_o^2 e^{-j\theta}} \quad (11)$$

For a small value of θ , it can be assumed that

$$e^{-j\theta} = 1 - j\theta \quad (12)$$

so that

$$\begin{aligned} Z_{IN} &= \frac{j\omega C}{g_o^2 (1 - j\theta)} = \frac{j\omega C}{g_o^2 (1 + \theta^2)} (1 + j\theta) \\ &= \frac{-\omega C\theta}{g_o^2} + \frac{j\omega C}{g_o^2} \end{aligned} \quad (13)$$

The second term of this equation represents the impedance-inversion property of the gyrator—an inductor, $L = C/g_o^2$; the first term represents a frequency-dependent negative resistance. The dissipation factor, D_p , of the series RL circuit is represented by

$$D_p = \frac{R}{\omega L} = \frac{-\omega C\theta}{g_o^2} \left(\frac{g_o^2}{\omega C} \right) = -\theta \quad (14)$$

Thus, the loss of a parallel-tuned circuit would be

$$D = D_{UL} - \theta \quad (15)$$

where $D_{UL} = 1/Q_{UL}$. If, for example, $Q_{UL} = 500$, then a value of only $\theta = 2$ milliradians would be sufficient to cancel circuit damping.

This becomes apparent in the plot of loss versus frequency for the gyrator on page 119. Each frequency point was obtained by adjusting $C_A = C_B = C$ so that

$$f = \frac{1}{2\pi} \frac{g_o}{C}$$

The loss is a linearly decreasing function of frequency, which means that $\theta = \omega T$,

a valid approximation when θ is small; T is the delay around the loop.

By introducing an equal but opposite shift in the gyrator loop, a designer can compensate for the loss caused by the phase shift itself. A simple RC

phase-shift network can be achieved with a capacitor placed across the emitter resistance, R_E .

Although compensation for the effects of phase shift is relatively easy to achieve, there are other factors that are interrelated. Consider, for example, the effects of temperature. As temperature increases, the phase shift also increases. And since compensation applied at one temperature is unlikely to hold over a wide temperature range, there is no solution that is absolute. A partial solution, however, is better than none at all. And a designer can accommodate the effects of temperature.

From theory to reality

Early gyrator designs employed negative resistances to cancel the parasitic-damping elements of the basic transistor structure. But by so doing, the gyrators attractiveness dimmed. Despite their relatively insensitivity to changes in transconductance the gyrators were limited to noncritical filtering applications simply because of the instability problems that stemmed from the negative resistances. These gyrators, in effect, held no advantages over other active synthesis techniques.

Another drawback was the large coupling capacitors required at the gyrator ports. In some designs, internal capacitive couplings were also necessary. These were for high-frequency applications.

Within the last several years, however, a number of direct-coupled gyrator circuits have been developed that have intrinsic low-loss characteristics. Equally important, these circuits lend themselves to microelectronic fabrication.

One such gyrator configuration is the shunt-shunt feedback connection of two voltage-to-current converters with signal inversion in one path.

An ideal voltage-to-current converter is described by the matrix

$$Y = \begin{bmatrix} 0 & g_o \\ 0 & 0 \end{bmatrix}$$

in which output current is proportional to input voltage, and input and output admittances are zero.

In a practical design g_o must be stable and the input and output impedances very high to reduce unwanted damping. Moreover, the parasitic phase shift around the loop, caused by interaction between a stage's output impedance and the adjacent input capacitances, must be minimized.

One such converter, shown at top page 120, is essentially a common-base stage in which the collector current is proportional to the base voltage; emitter resistor, R_E provides the constant. A second common-base stage, which supplies d-c power, produces a high impedance at the collector terminal. What results as an output impedance at the common-collector terminal is the collector resistances modified by the emitter and base impedances of the two transistors. With carefully selected transistors, this impedance can be several megohms—models with 6-megohm output impedances have already been achieved.

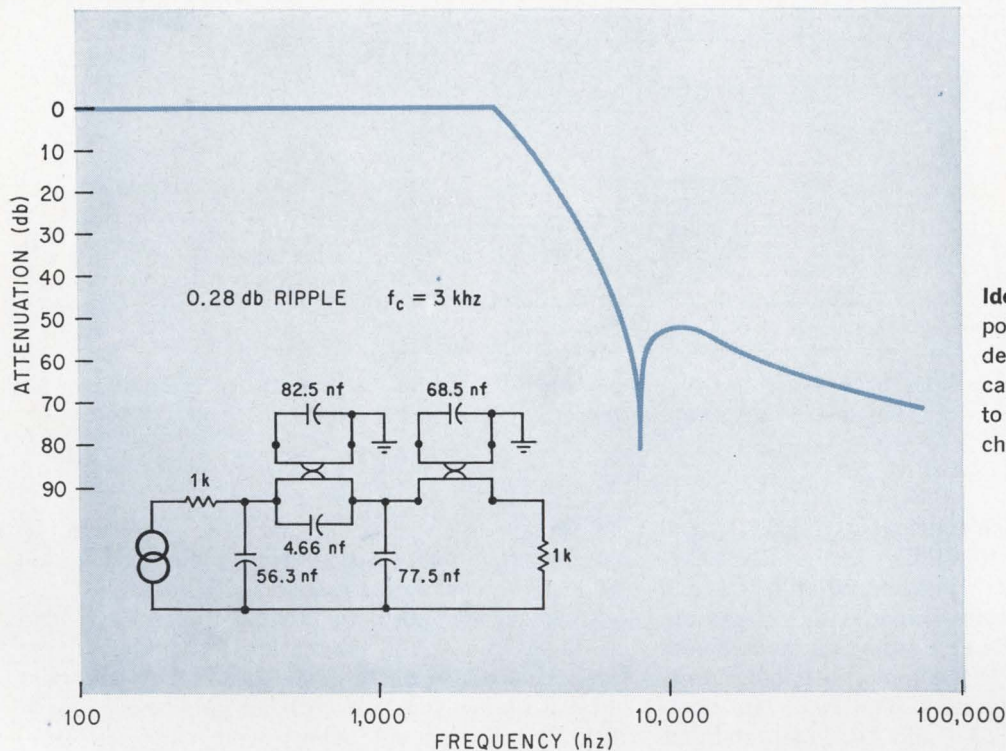

Ideal. Response of a four-pole, Cauer low-pass filter designed with two gyrator-capacitor units is identical to the theoretical response characteristics.

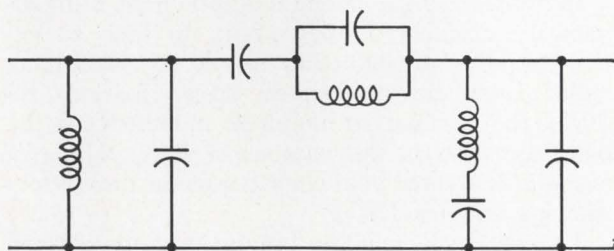
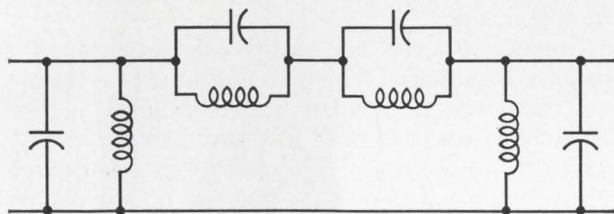
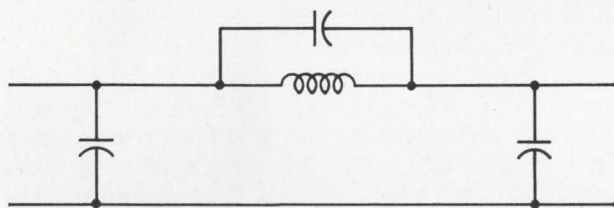

Transforming. With standard techniques, typical elliptic filter, top left, is transformed into a conventional low-pass-bandpass filter, right. But this results in more inductors than needed. With minimum-inductance transformation, however, the inductors do not have a d-c return path to ground, impeding implementation.

In the actual design, an amplifier—whose gain may be greater or less than unity—is inserted before the V-I converter. The net transconductance, the output (in milliamps) divided by the input (in volts), of these cascaded stages is K/R_E where K is the amplifier voltage gain, when only one transistor base is driven.

Three gyrator configurations, and their associated V-I converters are at the right of page 120. In the top schematic, there are three values that contribute to the input impedance at port 1—the input of Q_1 , which is $2R_1$ multiplied by the transistor beta, and the common-collector impedances of Q_7 and Q_8 . For equal-value collector resistors, r_c , of Q_7 and Q_8 connected as shown the input impedance becomes equal to

$$\frac{1}{2} \frac{r_c}{1 + \frac{R_B}{R_E}} + 2\beta R_1$$

where R_E and R_B are the total emitter and base resistances, respectively. The value of this input impedance depends on the transistors used. A 300-kilohm input impedance has been reported in one IC model with the $R_1 = 680$ ohms. Some non-IC designs have had 6-megohm input impedances.

A grounded-gyrator circuit, shown at the bottom of page 120, employs differential amplifiers in both the forward and reverse paths. Here, the operation is similar. The advantage of this configuration, however, is that the gyrator can be balanced simply by having three V-I converters. With the other circuits, a balanced inductor would require two complete gyrators.

In the circuit at the bottom left of page 119, the

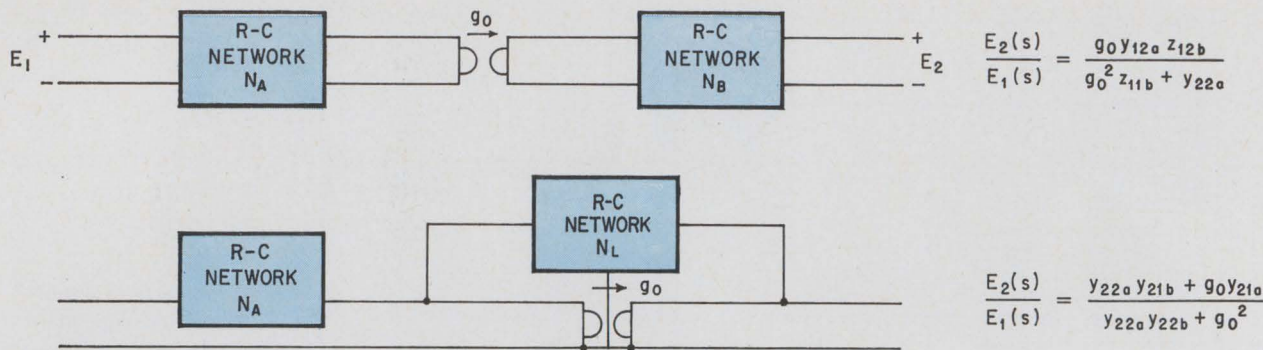

Variety. Several configurations are possible for coupling gyrators to R-C networks. Two possibilities are cascading with a gyrator in the center (top), and another is a parallel arrangement between the two R-C networks.

V-I converters comprise transistor Q_3 , Q_4 , Q_7 , and Q_8 . But the preceding amplifiers are composed of two boot-strapped FET follower circuits, Q_5 and Q_1 ; field effect transistors provide high input impedance. Because of the FET's the only impedances at ports 1 and 2 are the common-collector impedances of the V-I converters. The FET's are boot-strapped by transistors Q_2 and Q_6 which stabilize gain, regardless of the FET transconductance's temperature variations. Moreover, the emitter of Q_6 drives the emitter of Q_8 , thus raising the effective transconductance of the gyrator, while at the same time, reducing the impedance seen at the emitter at Q_8 . The next over-all effect is an increase in the low-frequency Q .

Gyrator-capacitor networks

The gyrator with bootstrapped FET's was tested for frequency and Q stability. The temperature coefficient of g_0^2 was found to be less than 100 ppm/ $^{\circ}\text{C}$ over the range 0 to 50 $^{\circ}\text{C}$. When polystyrene capacitors were used with the gyrator to form a tuned circuit, center-frequency stabilities of less than 50 ppm/ $^{\circ}\text{C}$ were measured at frequencies ranging from 0.3 to 30 kilohertz.

The effect of temperature on the tuned circuit's Q is dependent upon frequency. At low frequencies, where circuit losses are due to the V-I converters' collector impedances, Q decreases with increasing temperature. At frequencies above 3 khz, the parasitic phase shift causes the Q to increase with rising temperature.

In the plot of the phase shift for the gyrator on page 120, the loss versus frequency characteristic decreases linearly with frequency. By extrapolating the loss curve—a measure of the delay around the gyrator loop—back to d-c, the low-frequency loss due to the parasitic resistive loadings at the gyrator ports is about 0.001, or $Q = 1,000$. At about 3 khz, a negative Q of 1,000 is introduced by the phase shift. This results in an oscillatory condition. From the slope of the curve, a compensating phase-shifting network can be calculated. The compensated gyrator loss characteristic is represented at its low frequency value. By changing the compensation, the designer can obtain different loss char-

acteristics as a function of frequency. In IC applications, this phase-shift damping technique is far more convenient than resistive damping.

Gyrator-capacitor networks have been developed as replacements for conventional LC filters. One such network, a three-pole Chebyshev low-pass filter is shown together with its response on page 121. The component values were obtained from standard handbook tables and scaled to the desired impedance level and cutoff frequency. A balanced gyrator and a capacitor were inserted in the circuit to achieve the desired inductor. The measured response was identical to the theoretical.

A second network is a Cauer low-pass filter having four poles. This circuit required two balanced inductors, simulated in the drawing shown at top page 123. Again, the filter's response was identical to the ideal response. Here a transmission zero is created by the parallel-resonant tank circuit. The notch was 80 decibels. Deeper notches are obtainable with further adjustment of the gyrator's Q factors.

Impedance levels are particularly important for balanced gyrators. When two grounded gyrators are connected to simulate one that floats, a low-impedance resistive path to ground must be provided for each gyrator. This path may be through other gyrators if necessary. Because of imbalances in the gyrator transconductances, impedance levels above 15 kilohms tend to produce additional resonances within the filter.

In transforming a low-pass elliptic filter to bandpass the designer usually winds up with an excess number of inductors. A better technique, called minimum inductance transformation, reduces the number of required inductors in the bandpass filter to the number of filter poles. An example is a three-pole elliptic filter in the bottom drawing on page 123.

The center filter at the bottom of page 123 can be built with two floating gyrators since there is a d-c path to ground for each. The transformed network at the bottom of page 123 does not have a ground return for the floating inductor and can't be built with the floating gyrator described.

This problem is solved by a floating power sup-

ply and a grounded gyrator. The drawback to this approach, of course, is the need for a special-purpose supply for each floating gyrator. In turn, these power supplies require large electrolytic capacitors, which precludes microelectronic techniques.

Hybrids and monolithics

The stability of g_o and the parasitic impedances are the prime problems to overcome in developing a monolithic gyrator. Gyration conductance, g_o , is dependent upon both amplifier gain and the emitter resistors of the V-I converters. Stable, low-gain monolithic amplifiers can be fabricated with the gain dependent on the ratio of resistors rather than on the absolute value. The emitter resistors of the V-I converters are critical, however. A diffused resistor, here, would result in a very temperature-sensitive device. Temperature insensitive performance can be produced by using an outboard thin-film resistor evaporated on the silicon substrate. The temperature coefficient of this resistor can then be matched with an equal but opposite temperature coefficient of a capacitor used in conjunction with the gyrator.

Relatively good matching of the temperature coefficients of thin-film tantalum components and hafnium-dioxide components has been achieved, resulting in highly stable synthetic inductors.

A second problem encountered with the monolithic gyrator is the requirement for a good pnp-npn transistor pair for the V-I converter. Good pnp transistors cannot be diffused simultaneously with the npn variety—they require additional diffusion. Lateral pnp transistors can be made at the same time, however. And when used in conjunction with an npn transistor, the result is a three-terminal device that behaves like a pnp transistor. The beta of the lateral pnp transistor is near unity. But when the transistor is connected to an npn transistor, the composite beta then behaves as that of the npn transistor.

The collector resistance, r_c , of the pnp transistor appears as a parasitic load on the gyrator. However, the collector resistance of the lateral pnp-npn composite isn't particularly high and, as a result, significant damping results.

Better performance

A hybrid IC can provide a significantly improved version of the gyrator. But this raises the question of whether hybrid gyrators wouldn't be too good—and too costly—for most applications. Lower-priced monolithic gyrators are likely to be more than adequate. For the hybrid gyrator monolithic sub-blocks are used for the gain stages, FET's for high input impedances, and complementary transistors for the V-I converters. Such a combination of elements yields a gyrator with performance superior to the discrete version that was the model.

Thick- or thin-film resistors can be used in the hybrid version. And, the emitter resistors of the V-I converter transistors could be trimmed to achieve the desired gyration conductance. This, of

course, would eliminate the need for precise gain control that is now necessary with the monolithic type of amplifiers.

Thin-film capacitors, while having desirable temperature characteristics when used with thin-film resistors, suffer from the relatively high loss, about 1 percent. Ceramic-chip capacitors fabricated with npn dielectrics are both temperature stable and have low-loss characteristics. This makes the latter-type capacitors particularly attractive for hybrid circuits, where area or volume isn't always a serious constraint.

Gyrator-created synthetic inductors are usually used as substitutes for inductors in conventional LC designs. But the application of gyrators to network design goes beyond this approach. When viewed as a nonreciprocal network, the gyrator forms the basis of many new network synthesis approaches. A number of such approaches have already been developed, using negative-impedance converters, negative-impedance inverters, nullators, norators and like components.

In the synthesis of RC active filters, gyrators have been used in conjunction with one or more RC networks in various configurations. Synthesis procedures are then developed that are based on the two-port parameters of the RC networks and the gyrator. Some examples of these procedures are shown on page 124. ■

Bibliography

- B.D.H. Tellegan, "The Gyrator, a New Electric Network Element," Philips Res. Rept., Vol. 3, p. 81, April 1948.
- R. Seal, E. Ulbrich, "On the Design of Filters by Synthesis," IRE Transactions on Circuit Theory, December 1958.
- Louis Weinberg, "Network Analysis and Synthesis," McGraw-Hill, 1962.
- T.J. Harrison, "A Gyrator Realization," IEEE Transactions on Circuit Theory, 1963, CT-10, p. 303.
- M.S. Ghausi, F.D. McCarthy, "A Realization of Transistor Gyration," New York University, College of Engineering, Technical Report 400-74, January 1963.
- E.H. Kopp, "Matrices for Basic Two-Port Networks," Electro-Technology, March 1964.
- A.G.J. Holt, J. Taylor, "Method of Replacing Ungrounded Inductors by Grounded Gyration," Electronic Letters, Vol. 1, No. 4, p. 105, June 1965.
- B.A. Sheno, "Practical Realization of a Gyrator Circuit and RC-Gyrator Filters," IEEE Transactions on Circuit Theory, Vol. CT-12, No. 3, September 1965.
- D.F. Sheahan, H.J. Orchard, "Integratable Gyrator Using MOS and Bipolar Transistors," Electronics Letters, Vol. 2, October 1966.
- W.H. Holmes, S. Gruetzmann, W.E. Heinlein, "High-Quality Active-C Filters Using Gyration," Proceedings ISSCC, 1967, p. 122.
- D.F. Sheahan, "Gyrator-Floatation Circuit," Electronic Letters, Vol. 3, No. 1, p. 39, January 1967.
- T.N. Rao, "Integrated Direct-Coupled Gyrator," Electronics Letters, Vol. 3, May 1967.
- D.A. McLean, N. Schwartz, E.D. Tidd, "Tantalum-Film Technology," Proc. IEEE, Vol. 52, p. 1450, December 1964.
- T.N. Rao, R.W. Newcomb, "Direct-Coupled Gyrator Suitable for Integrated Circuits and Time Variation," Electronics Letters, Vol. 2, p. 205.
- D.F. Sheahan, H.J. Orchard, "High-Quality Transistorized Gyrator," Electronics Letters, Vol. 2, p. 274.
- W.H. Holmes, "A New Method of Gyrator-RC Filter Synthesis," Electronics Letters, Vol. 2, p. 1459.
- R.W. Newcomb, T.N. Rao, J. Woodard, "A Minimal Capacitor Cascade Synthesis for Integrated Circuits," Microelectronics and Reliability, Vol. 6, p. 113.



Bendix Autosyn Synchros. Can you afford to buy less?

Not if you need the kind of performance and reliability you get from Bendix® Autosyn® Synchros.

And you have a wealth of types to choose from. Ultrahigh-temperature synchros that perform accurately at sustained temperatures up to 800°F. Ultracompact (size 08), lightweight (1.3-oz.) synchros for critically tight designs. Ultraprecise synchros with tolerances to 50 millionths of an inch. Dependable corrosion- and radiation-

resistant synchros. And there's a complete line of Bendix Mil-Spec synchros, too.

AUTOSYN® SYNCHROS

Size	Max. Diameter (In.)	Typical Weight (Oz.)	No. of Models
08	0.750	1.3	16
10	0.937	1.7	25
11	1.062	3.2	29
15	1.437	4.7	24
22	2.161	18	5

Altogether there are hundreds of types—your largest single source. What's more, our synchro design service can promptly solve your special problems. You can depend on it. As they do at GE, Sperry, RCA, Lear Siegler, Motorola and many other value-conscious firms. Ask for our catalog today. Write: The Bendix Corporation, Flight & Engine Instrument Division, Montrose, Pa. Or phone: (717) 278-1161.

Bendix
Aerospace Products

The ideal flight recorder according to a recent survey of users:

Would be rugged (for overall airborne operation), yet lightweight (less than 25 lbs.)

Must be able to withstand the extremes of environmental conditions

Should function as a digital "computer memory," with a read or write capability of 100,000 bits per second and a guaranteed bit error rate of less than 1×10^{-7}

Must operate on very low power (say, 40 watts)

Would have a stop/start speed of less than 200 milliseconds

Should have easy accessibility and offer the convenience of cartridge loading

Would accept a nine line input (computer compatible, of course) with a typical data rate of at least 11 kb/sec

Must provide a lot of storage (how about 140 million bits?) in a small package (around 600 cubic inches)

The ideal flight recorder according to Leach:

Thanks to a patented new technique called HDDR* (High Density Digital Recording), our new MTR-8600 is a spec-for-spec match of the recorder-by-consensus (above). And more. And, it's available now in a more conventional package from Leach Corporation, Controls Division, Department A, 717 Coney Ave., Azusa, California 91702 (213) 334-8211.



The MTR-8600

TEC CAN SAVE YOU 477* STEPS ON YOUR NEXT DISPLAY PANEL!

*Based on a 60 indicator panel.

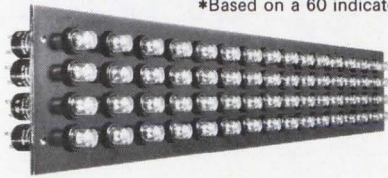

To build a
conventional
panel you'll:

Buy, stock and inspect	60 indicators	Mount	60 indicators
Punch	60 panel holes	Wire	120 terminals
Engrave	60 legends	Inspect	120 connections

TOTAL STEPS 480

To install TEC DATA-PANEL® Display Systems you'll:

Buy, stock and inspect	1 display	Punch	1 panel hole
		Connect	1 connector

TOTAL STEPS 3

You're probably taking advantage of the economics possible with IC's. Right? Then it's time you looked into IP's. IP's—Integrated Panels—are TEC DATA-PANEL Display Systems that convey messages and symbols brilliantly and colorfully in a single viewing plane. Better display, yet costing less per point than individual indicators. And they cut installation work by 50% or more.

DATA-PANEL Display Systems handle any message, any symbol, in any size, in any color. Adaptable to any installation. Flexible. Reliable. Complete. Function as a total input-output system.

TEC DATA-PANEL® Display System

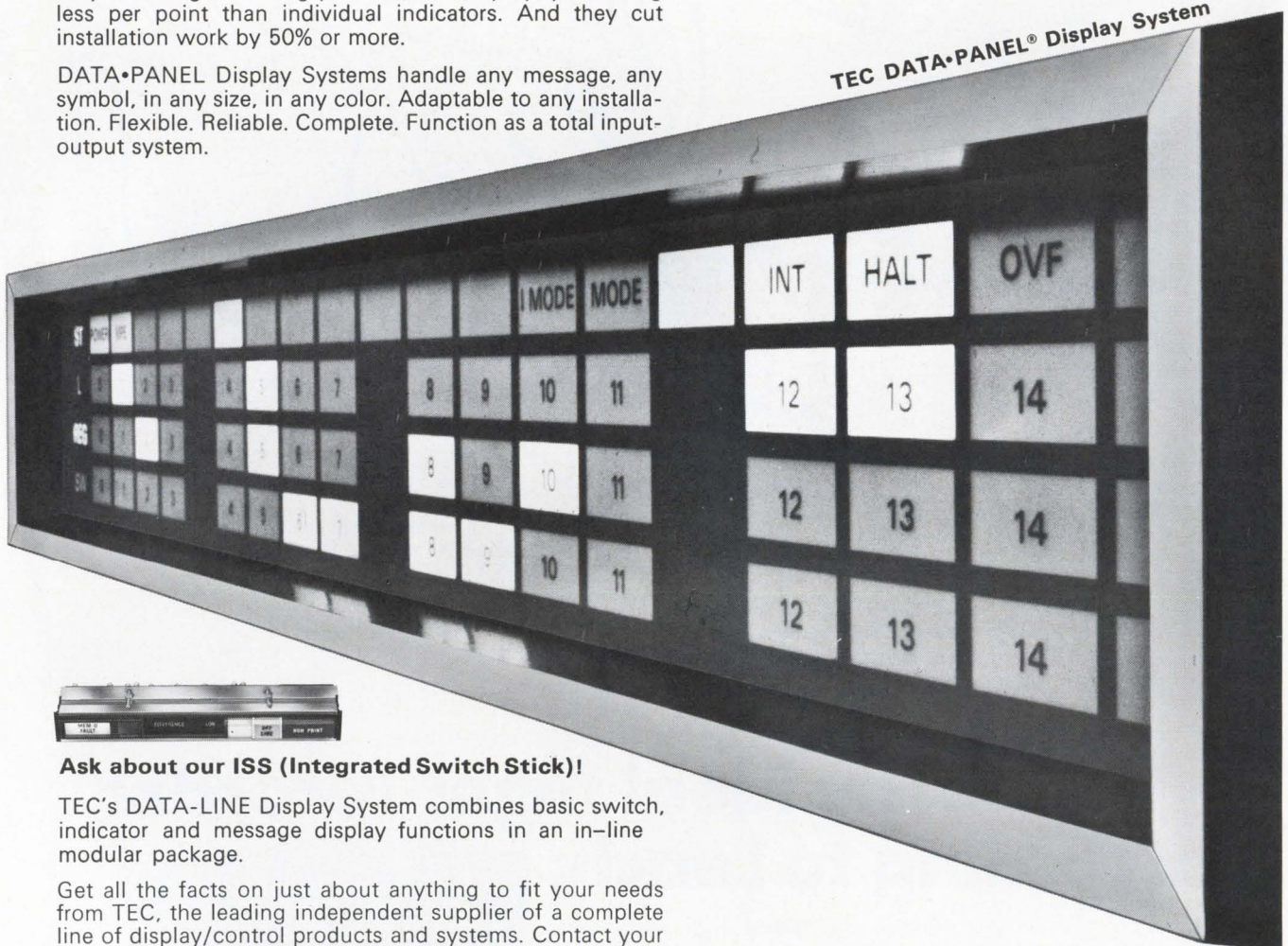

Ask about our ISS (Integrated Switch Stick)!

TEC's DATA-LINE Display System combines basic switch, indicator and message display functions in an in-line modular package.

Get all the facts on just about anything to fit your needs from TEC, the leading independent supplier of a complete line of display/control products and systems. Contact your TEC-Rep or write:



Transistor Electronics Corporation, Box 6191, Minneapolis, Minnesota 55424. (612) 941-1100.

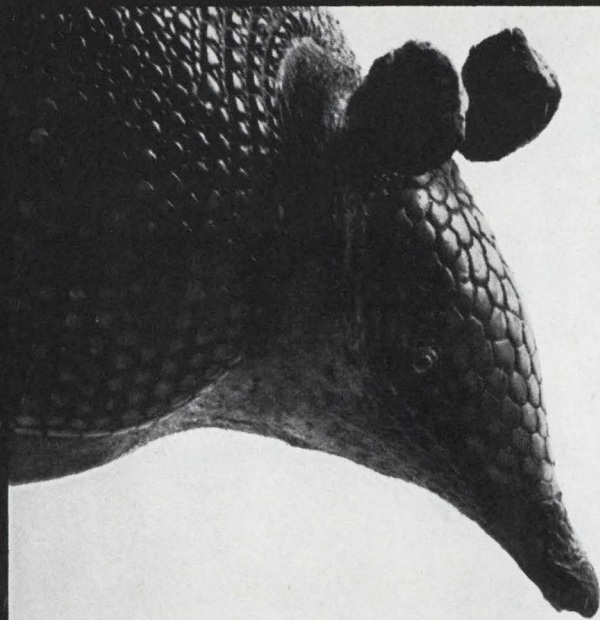

The Armadillo Connector proudly announces Son of Armadillo.

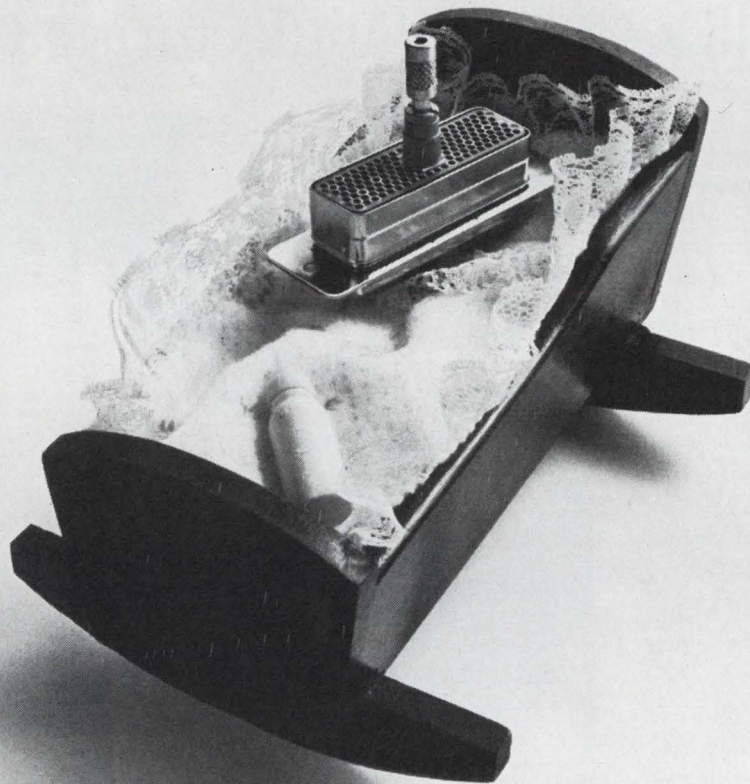

Some baby.

Our smaller, lighter subminiature now comes bundled in real hard-shell protection.

Just like our D Series Connectors. We call them the Armadillo Connectors because we encase them in stainless steel for extra protection against abuse.

Now the little fellows, too, have extra strength to keep them providing the service they were built to provide.

Which is plenty. These W Series

subminiatures are more fully packed. 110 contacts to the inch, without giving up contact size or spacing.

They align and polarize perfectly, with the Hughes PolarHex center jackscrew coupling system. Available in environmental, non-environmental and potting versions.

They come in arrangements to fit your needs, from 14 to 244 size 22 contacts. And they feature crimp snap-in contacts with the

famous Hughes retention mechanism.

You'll find they're more than a happening. They're a Blessed Event.

Write Hughes Aircraft Company,  Connecting Devices, 500 Superior Avenue, Newport Beach, California 92663. Phone (714) 548-0671. TWX 714-642-1353.

HUGHES
HUGHES AIRCRAFT COMPANY

**If it's happening in connectors,
it probably started at Hughes.**

“FREON[®] solvents stopped rejects and cut cleaning costs 97.5%”

—Miles J. Valles, Cinch Manufacturing Co.

Cinch Manufacturing requires that its subminiature connectors be free of all contaminants when examined under a 12-power microscope. Miles J. Valles, Cinch's manufacturing engineer, explains why they use FREON solvents:

“We really didn't have any success in cleaning until we decided to use FREON. We would have to clean many of the parts six or seven times. We find that the FREON solvent removes the contaminants completely with one cleaning. And we have had no rejects from the standpoint of cleanliness since we started using FREON.”

FREON solvents give Cinch Manufacturing greater efficiency and at much lower cost.

“Combined savings in the multiple cleaning and inspection operations have cut our costs in these areas by 97.5% when compared to previous methods.”

FREON also helped to improve working conditions at Cinch. With other cleaners, the people in cleaning and adjacent areas complained of “odors, headaches and even broke out in rashes.” With FREON, this problem has been eliminated.

FREON helped to speed up production as well. No drying time is necessary with FREON—the parts move immediately from the cleaning operation to inspection. Costly time and space requirements have been eliminated. Also eliminated was a problem with delivery schedules.

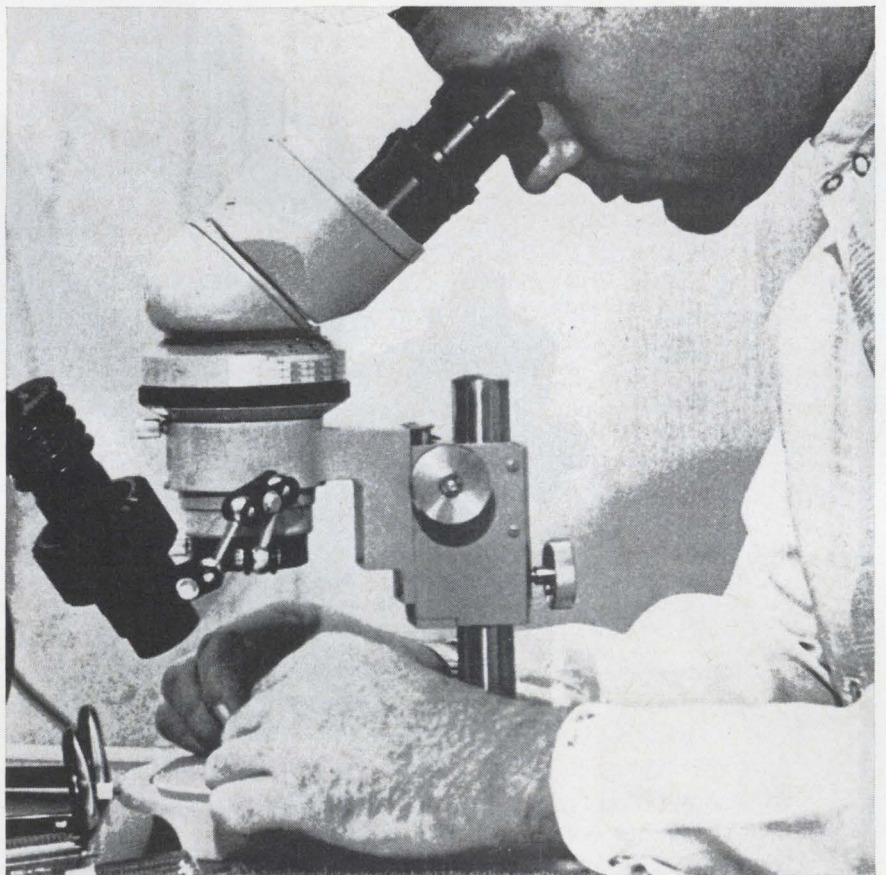

Mr. Valles inspects a cleaned part under the microscope.

“Prior to using FREON it was difficult to accurately predict the time necessary to properly cleanse our connectors in various stages of production. Since the use of FREON we can accurately plot our production schedule and we've literally trimmed weeks from our former production cycles.”

Find out how FREON can do the

job for you. Write today to Du Pont Company, Room 7751-C, Wilmington, Del. 19898. (In Europe, Du Pont de Nemours Int., S.A., FREON Products Div., 81 Route de l'Aire, CH-1211 Geneva 24, Switzerland.)



**This portable will record
more facts in less time, at less cost
than any other 2-channel recorder
on the market.**

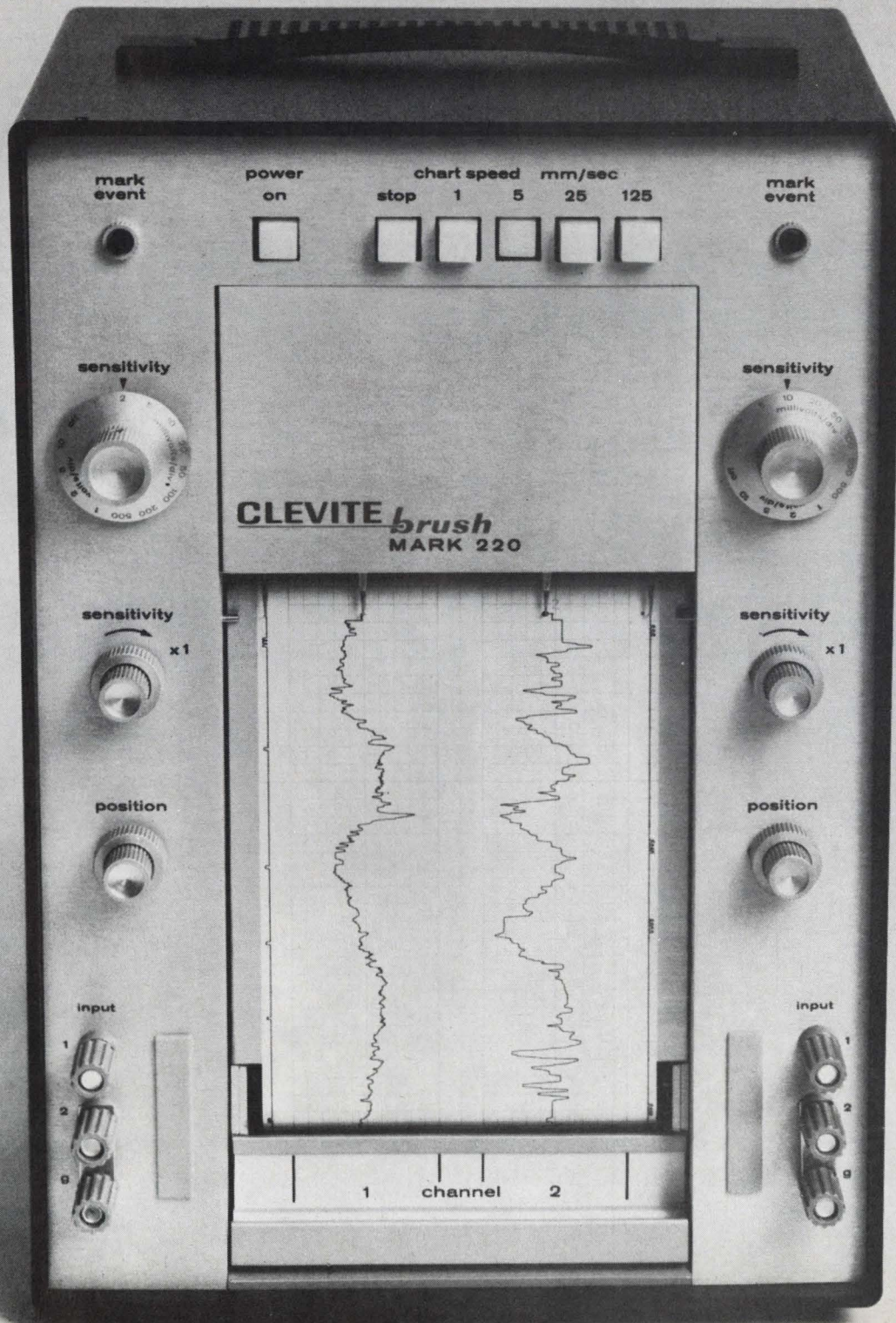

We call it the Mark 220.

And once we put it through its paces for you, you'll call it the most amazing piece of recording gear around.

To begin with, we *guarantee* the Mark 220 to be 99½% accurate. Which is a good deal better than almost anything else on the market . . . regardless of size or price. The pressurized ink-writing system is the same one you'll find in our six and eight channel systems. Instead of laying the trace *on* the

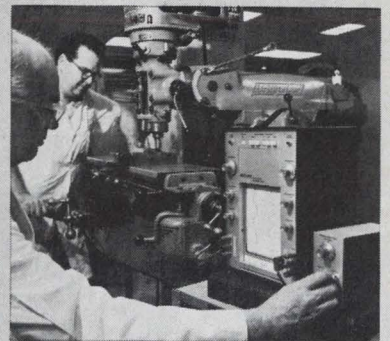

paper, it forces it *in*. Run your finger over it. There's no smear, no smudge. And trace crispness and uniformity is in a class by itself.

Built-in preamplifiers give you measurement range from 1 mV per division to 500 V full scale — and you never have to re-calibrate. Pushbutton controlled chart speeds. Two handy event markers. Ink supply is a disposable cartridge, good for a year.

Yes, for a 25 pound portable that's no bigger than a breadbox, the Mark 220 is quite a recorder. Ask your Brush representative for a demonstration. Or, write for complete details. Clevite Corporation, Brush Instruments Division, 37th and Perkins, Cleveland, Ohio 44114. We'll include our informative booklet "Elimination of Noise in Low-Level Circuits".

CLEVITE BRUSH

Only one man in a thousand needs this accuracy in a synchro-to-digital converter...

(the other 999 sleep nights knowing it's there.)

Tracks both resolver and synchro data up to 2,000°/sec. with minimal velocity error, Kv of 20,000. Converts continuously to digital-data output with 0.001° resolution, and 10 arc-second accuracy.

Accepts both resolver and synchro-angle data from 11.8V to 90V line-to-line at 400Hz. All solid-state design with no moving parts provides essentially inertialess response. Options of 60Hz to 5KHz signal.

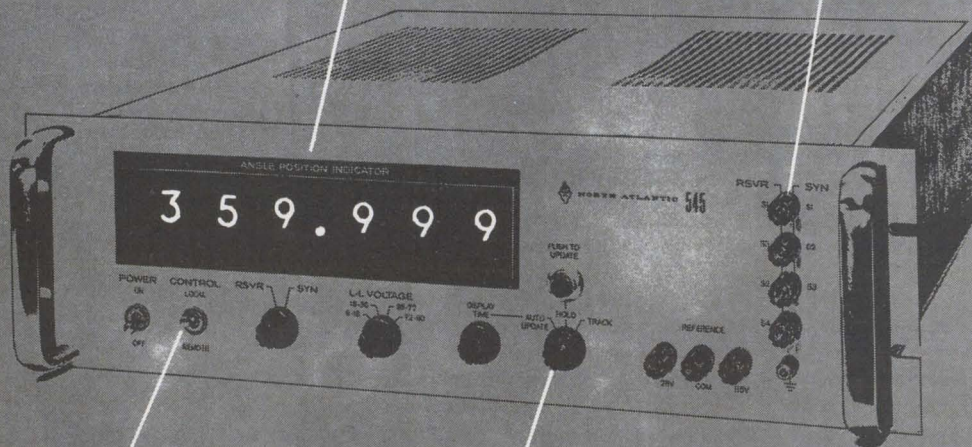

Operating modes may be locally selected or remotely programmed.

Three-mode operation: Continuous tracking; Update (repetitive track/hold sequence with display time variable from 0.3 to 3 secs.); Hold (one-shot track/hold with continuous display).

North Atlantic Model 545 Angle Position Indicator, Shown with 0.001° option, is available in a standard panel-mounting rack. A 16-bit binary version is available in a half-rack configuration, and synchro-to-digital modules are available for MUX systems—all elegant examples of North Atlantic's creativity in automatic test equipment resolver/synchro instrumentation, and computer-interface equipment.

For additional, rewarding details call our field-engineering representative (see EEM), use the reply card, or call or write North Atlantic Industries, Inc., Terminal Drive, Plainview, Long Island, N.Y. 11803. TWX 510-221-1879 or phone (516) 681-8600.



NORTH ATLANTIC
industries, inc.

Navy gets a new airborne watchdog

Service's success with Grumman's E-2A Hawkeye early-warning aircraft prompts development of C version with improved and more reliable avionics equipment

By Alfred Rosenblatt

Associate editor

When Task Force 71 steamed into Korean waters this spring, the big job of guarding it against surface and air attacks fell to a lumbering early-warning aircraft. Unlovely though it may be, the carrier-based, prop-driven E-2A Hawkeye performs its jobs as an airborne sentry and command and control system with such commendable competence and finesse that the Navy has ordered the next model.

The new plane and its complex avionics, to be designated the E-2C, will be built by Grumman Aerospace, Bethpage, N. Y., which delivered 59 E-2A's. The Navy's desire for a more reliable and maintainable system are among the important reasons for the new buy; the E-2A, though useful still is beginning to show signs of age since it was designed in the late 1950's with vacuum tubes and a

drum-memory computer. The hope is for a three-to-one improvement in the overall mean time between failures (MTBF) with certain pieces of equipment reaching a 10-times better level, says William H. Barnard, E-2C program manager. To this end, the new system is being developed around a core-memory computer, using discrete semiconductor components and integrated circuits. In addition, of course, the plane will be able to outperform its predecessor on missions.

Perhaps the most important new feature is the system's long-range search radar, to be based on Grumman's APS-111. This unit will be able to detect aircraft flying over land, as well as over water—an important capability when the fleet is close enough to shore for enemy planes to present a threat that must be detected immediately.

Other new equipment slated for the E-2C includes perhaps the largest-capacity digital computer to be found in an aircraft and a passive detection system that can tune in to electromagnetic emissions. The latter enhances the craft's surveillance and electronic countermeasures capabilities.

The E-2C will be one of the first planes to carry the Navy's Cains (carrier aircraft inertial navigation set); it rapidly aligns the aircraft's inertial guidance system with that of the carrier via radio link. Almost all of the E-2C's electronics equipment—the major exception is the search radar—will be compatible with the Navy's versatile avionics shop test (VAST) system.

The E-2C will also be able to check how its complex avionics is operating with what Barnard describes as the most comprehensive

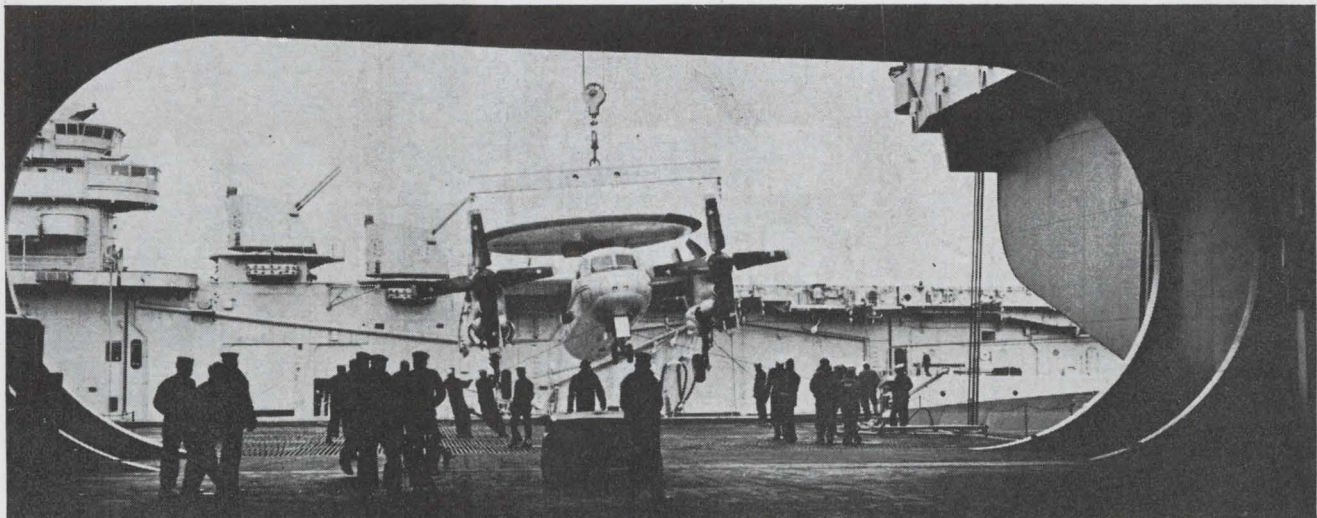

Going down. Carrier-based E-2A Hawkeye, long a workhorse sentry and command and control system for the Navy is slated for replacement by a C version being built by Grumman; the new plane's improved avionics will be of solid state design.

in-flight performance monitor (IFPM) flying. With the monitor, an operator can isolate a fault to a weapons replaceable assembly (WRA) while the plane is still on a mission. A radio call will ensure that a replacement is waiting when the plane returns to its carrier, and a switch can be made quickly.

Grumman received the E-2C development contract a year ago. The Navy is buying the plane as a package through its Air Systems Command so it will have only an indirect say in the specific design of the avionics to be put aboard. The Navy's only concern is that the E-2C meet the performance specifications; it's up to Grumman to decide how to go about it. In the E-2A program, the Navy approved the individual performance of each of the subsystems.

First flight of a developmental E-2C is scheduled for early 1971; a production version will fly in mid-1972. The Navy may order about 28 of the systems through 1974. In the meantime, Grumman has been modifying the E-2A's left in the Navy fleet, replacing the original drum-storage computer with an L-304 digital machine from Litton Industries and making a few changes in the displays. Planes with the new digital computer, which is similar to the one intended for the E-2C, are designated E-2B's.

Clearinghouse

Radar signals in the E-2C system are sent and received through the Rotodome antenna in a flat, round cap mounted atop the fuselage. With its disk-like housing, the antenna will have the same distinctive appearance as the one on the Hawkeye although it's been redesigned by Dalmo Victor, Belmont, Calif., to accommodate the performance requirements of the new radar. The Rotodome unit also handles transmissions for the IFF (interrogation friend or foe) gear to be furnished by the Navy.

There are also associated but separate detector-processor units which tie into the general-purpose digital computer. The one for the IFF radar, built by the Hazeltine Corp., Greenlawn, N.Y., handles raw video data to produce a digital report of the range to an interrogated aircraft, as well as its

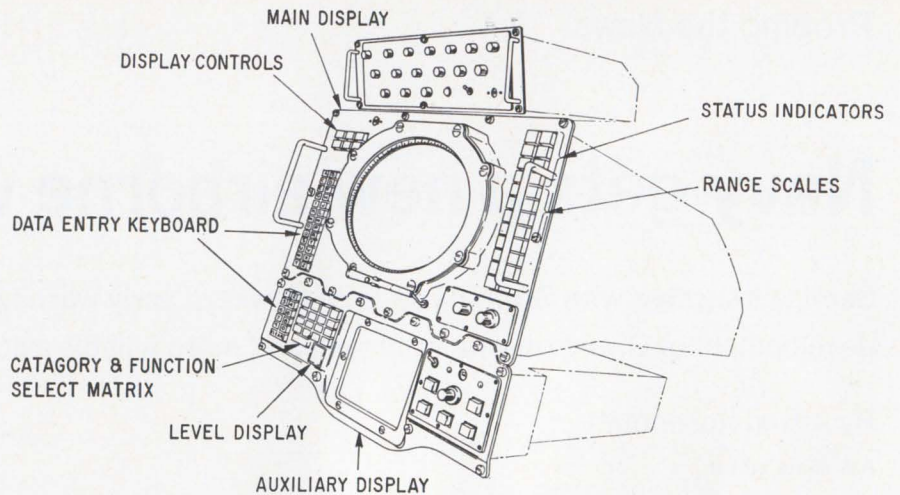

Two views. The probable design for the operator's console in the E-2C will feature a 12-inch main radar scope and a 5-inch auxiliary display.

location. The other for the search radar, which, along with the radar, is being supplied by General Electric's Aerospace Electronics Department, Utica, N.Y., provides real-time position coordinates for each target.

Way station

All available target information is fed to the computer, which stores it and acts as the interface for the other elements of the system. These include three separate display consoles also made by Hazeltine, as well as uhf and hf data links for getting information to the Navy's Tactical Data System and attacking aircraft. Three console operators—the same number as in the E-2A—and two pilots make up the aircraft's crew.

Aside from Cains, navigational

elements aboard the E-2C include a Doppler radar, a heading and attitude reference system (HARS), and an air data computer. Navigational accuracy is extremely important on the E-2C. The problem involves more than being able to fly from point to point; the crew must always know exactly where the plane is so intercepting aircraft can be vectored accurately to the enemy. The doppler-inertial system is the principle navigator, but the E-2C can get along in either mode alone. The HARS gives redundant information which ordinarily comes from the Cains system. The Navy's Omega, navigation satellites, and Loran-C/D are not part of the E-2C system at this time.

The overland capability was added to the new search and track-

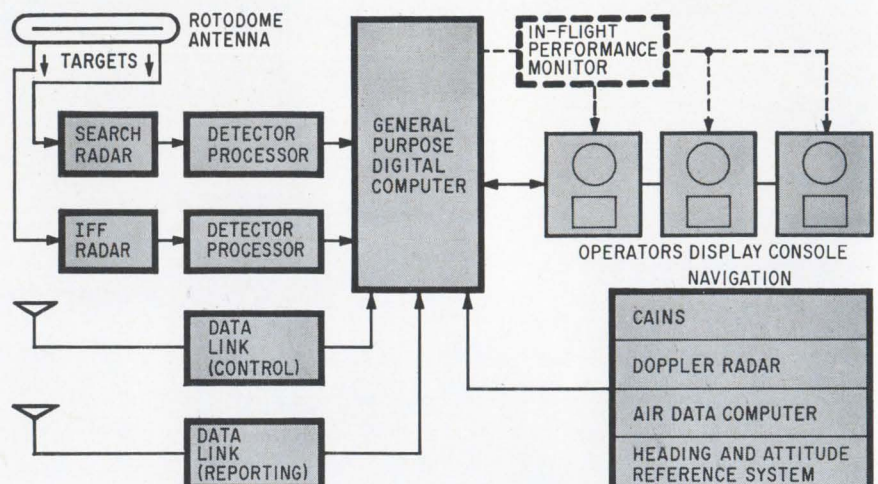

Nerve center. The E-2C's sophisticated avionics are designed around a large-capacity digital computer to be supplied by Litton Industries.

NEW PRODUCT NO. 77

μ A715 HIGH-SPEED OP AMP

The new Fairchild μ A715 is the fastest linear IC op amp available today.

For applications where power bandwidth, acquisition time or slew rate is the prime consideration, the μ A715 stands alone. It's ideal for applications such as wide-band amplifiers, high-speed integrators, precision comparators, sample-and-holds and video or deflection amplifiers. You can start raising the performance of your data acquisition, control, communications or display systems today.

The μ A715 is a 3-stage amplifier, with a Darlington cascode input for optimized ac and dc performance, a differential second stage and a class AB output for low distortion. Bandwidth is 60MHz, open loop gain is 92dB, input offset current is only 80nA and both input and output are short-circuit protected.

And, even though op amps are available with slew rates higher than the μ A715's $60V/\mu s$ ($A_v = 100$), it's *still* the fastest op amp available. The curve shown represents the typical response of any op amp to a step input at time T_o . First, there's a short delay, then the output starts rising to its final value at a rate determined by the slew rate ($\Delta V/\Delta T$). But, in most op amps made, there is first an overshoot, then ringing. The final output value is not achieved until the end of the settling time, when the excursions no longer exceed the bounds of the error band. The total time to achieve the final value (acquisition time) is the sum of the first delay, the rise time and the settling time. In most other op amps, the settling time is measured in microseconds. In the μ A715, the settling time is just 300ns. Combine this with a maximum initial rise time plus delay of 350ns (for a 10V swing) and you've got a total acquisition time of just 650ns. And the fastest op amp made.

You can get it now in quantity from your Fairchild distributor.

To order the μ A715, ask for:

Part No.	Package	Temperature Range	Price
U5F7715312	TO-5	-55°C to +125°C	\$48.00
U5F7715393	TO-5	0°C to + 70°C	15.00

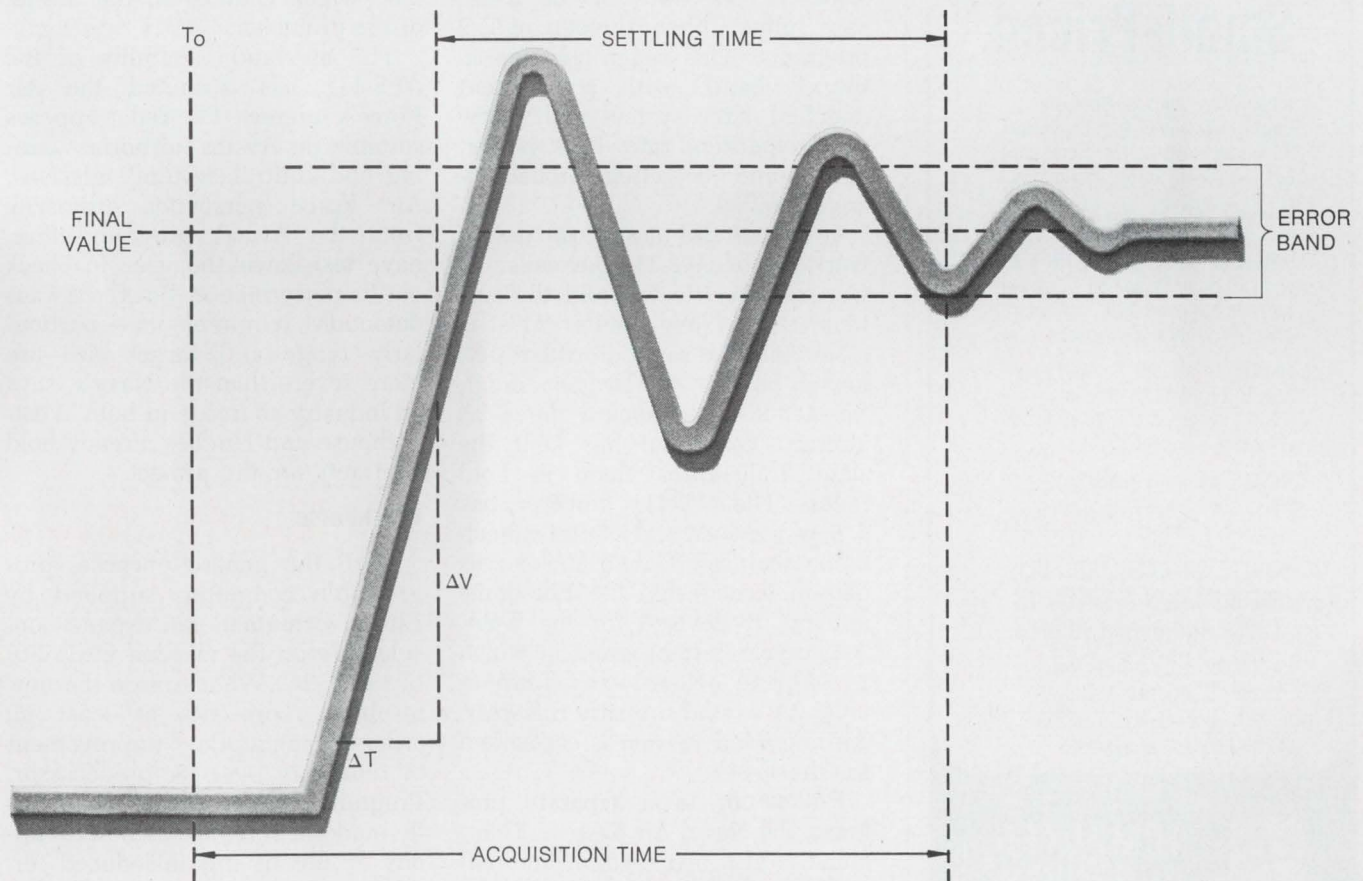

FAIRCHILD
SEMICONDUCTOR

FAIRCHILD SEMICONDUCTOR A Division of Fairchild Camera and Instrument Corporation Mountain View, California 94040, (415) 962-5011 TWX: 910-379-6435

Small Answer to Large Problems

\$84⁴⁰*

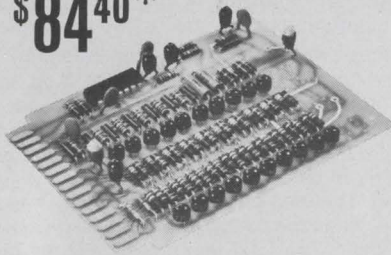

This 10-bit D/A Converter is small. And Small-Priced.

Small is the word for Computer Products' family of D/A Converters. Small size. Small price. Small power demand. Small output impedance.

The new DA025 series has 18 variations with 8, 10 and 12 bit resolution. On PC cards, 2.75" x 4" — up to 16 channels and all DC power supplies can go in a 19" chassis, with 3.5" vertical rack space.

The family includes 6 output ranges to ± 10.24 V into 1K ohm load (10.24 MA) and can drive up to 300' of twisted pair cable.

*DA425, shown, is priced at \$84.40/unit, 10-29 units. Others are equally low. Shipment 3 weeks ARO.

**WRITE OR CALL FOR FULL
INFORMATION & SPECS ON
THESE AND OTHER MODELS**

Computer Products, Inc.
2801 E. Oakland Park Blvd.
Ft. Lauderdale, Fla. 33306
Phone: 305/565-9565



**COMPUTER
PRODUCTS™**

FORT LAUDERDALE

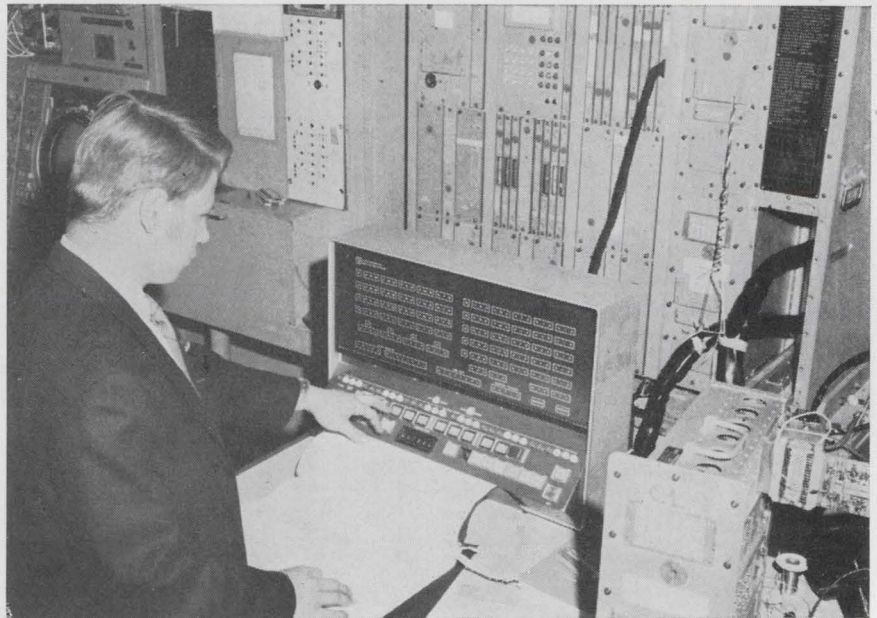

Benchmark. Engineer uses programmer's console to enter the L-304 computer now being retrofitted on E-2A's; similar model will be used aboard the E-2C.

ing radar because clutter return from land is so strong that it's almost impossible for the E-2A's system to pick out a moving target. Grumman studied ways of canceling the clutter, working from the same APS-96 that's in the E-2A, says Julius Cohen, director of E-2 programs. This radar operates in the P band, with a coherent matched filter system and a low pulse-repetition rate. Peak power, range, and detection probability are classified.

Grumman did most of the design work on the APS-111 but called in General Electric to build the system using Navy funds. This is essentially the same procedure followed on the predecessor radar, the APS-96 used aboard the E-2A aircraft. Grumman has kept the same transmitter chain in both radars. The APS-111, however, has a new receiver and clutter-cancellation features. Dalmo Victor was chosen to redesign the Rotodome antenna it devised for the E-2A. A two-year test program in which a complete APS-111 was flown in an E-2A wound up early this year. An improved version is earmarked for the E-2C.

Follow-on. In a separate program, the Naval Air Systems Command is also investigating the feasibility of fully automating the radar's ability to discriminate targets through land clutter. At present, the equipment locates and

tracks targets over water automatically. But overland, an operator has to do this manually on the scope display with a strobe pencil. Contracts have been awarded to GE and Burroughs to study the problem, which centers on the design of the processor.

The overland capability of the APS-111 has attracted the Air Force's interest. The radar appears suitable for Awacs (airborne warning and control system) missions. Air Force personnel, primarily from the Awacs program office, have test-flown the gear to check out its performance. But the Awacs detection requirements — particularly range and target size — are more severe than the Navy's, says an industry source, and both Westinghouse and Hughes already hold contracts for the project.

Workhorse

With the general-purpose, programmable computer, supplied by Litton, Grumman can expand considerably on the mission flexibility of the E-2C. What's more the new machine represents at least an order-of-magnitude improvement in reliability over its predecessor. Program changes can now be readily made in software as new weapons or tactics are introduced, or, when the mission profile is changed. In the case of the E-2A machine, changes are difficult to make because the logic is hard-

wired. The new computer also has a built-in magnetic tape unit which can be called upon for additional tactical and diagnostic programs during a mission.

Capacity of the computer's core memory is 56,000 32-bit words, expandable to 80,000 words by plugging more memory modules into spare drawers. In addition, indirect addressing effectively doubles the capacity.

Double duty. The computer is a dual processor with shared memory banks so that it handles interlaced programs. It operates in real time, with priority interrupts. Depending on the program sequence, and with memory overlap in different banks, the computer can carry out sequential instructions at an 800-nanosecond rate. The pace slows to 2.4 microseconds if access must be to the same bank.

The capacity of the computer gives the E-2C an information display and monitoring capability vastly superior to that of the earlier system, says Lawrence H. Borts, systems engineer in Grumman's mission analysis department. Each console operator has direct access to the computer. Targets are displayed on a main 12-inch cathode-ray tube. In addition, there's a 5-inch-square crt for trouble-shooting data and details about specific missions or targets. Some auxiliary information is available on the E-2A but in more limited form since the readouts are on Nixie tubes rather than crt's. The Nixies present items like target range, bearing, or altitude.

The main display, which is completely digital and under computer control through to the final deflection plates, shows targets in a standard plan-position indicator (PPI) mode or in synthetic video. Symbols and alphanumeric characters can be traced on the scope so that an operator is able, with one or two characters, to give himself a "bookkeeping handle" on any given target, says Borts.

The auxiliary scope displays a wide range of computer-derived information. For example, if a hostile aircraft, selected by the operator on the main display with his light pen, is to be intercepted, it's possible to quickly find out such critical facts as the time it would take for an interception, the fuel

Look fellas! No hands!



with our Automatic Synchro/ Resolver Bridge

If you've ever had to use one hand for the manual synchro bridge and one hand for the error detector while you write down data with your third hand...you'll appreciate our new Automatic Synchro/Resolver Bridge.

Antiques are fine...but not when they waste an engineer's time and divert his attention away from the data he is generating and onto the task of generating it.

Our unit features: Completely automatic nulling Accuracy and resolution of .01° or .001° In-line decimal readout BCD electrical output Accommodates 11.8, 26, and 90 VAC inputs High input impedance Insensitive to quadrature and distortion.

For further information, or a demonstration at your plant, phone or write:

astrosystems, inc. 6 Nevada Drive, New Hyde Park, New York 11040 516/328-1600 TWX 510/233-0411. **West Coast Office** 4341 Commonwealth Avenue, Fullerton, California 92633 714/523-0820.

asi

astrosystems, inc.

It's simple when your IC's do the driving!

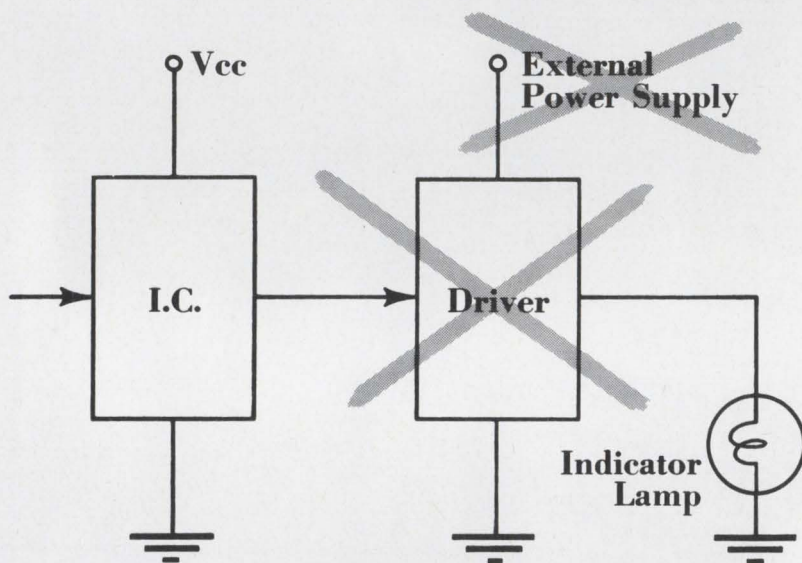

And your indicator lights fit your IC design.

You can save time, trouble and space when you choose from 13 General Electric IC-compatible indicator lamps . . . each of which can be driven directly from common integrated circuits. Their low current requirements make relays or supplemental switching unnecessary.

Your result: a simplified system, in less space. And a lower overall cost, too!

General Electric's IC-compatible Sub-Miniatures range in voltages from 3 to 10. Currents range from .012-.060 ma; in C.P. up to .050; in diameter from 1/8" to 7/32"; in life from 1,000 to 25,000 hours; and in OEM prices from 25¢ to 95¢.

You can get them with either wire terminal or midjet flanged bases. Fact is, there's a lamp available for nearly every IC requirement.

See your General Electric Miniature Lamp Representative before you finalize your design. That's his favorite time to save you money.

For detailed technical data, and application information, write: General Electric Company, Miniature Lamp Dept., M9-3, Nela Park, Cleveland, Ohio 44112. Ask for Bulletin 3-9135.

Miniature Lamp Department

GENERAL  ELECTRIC

remaining in the intercepting aircraft, and the track history of the target—whether it has been turning, going straight, or climbing. This information is spelled out on the 5-inch crt.

Closer watch

The big computer also makes possible expanded performance monitoring. The job of the in-flight performance monitor is not only to find out what's wrong within the avionics and pinpoint the fault to a weapons replaceable assembly but also to help the operator decide on the best possible alternate mode of operation so the mission may continue. For example, if the inertial navigation system should fail, the mission may not have to be scrubbed if it's possible to use information from the heading and attitude reference system.

When monitoring performance, the computer interrogates the various avionic subsystems within the E-2C, assesses their status, initiates subsystem tests through built-in test circuitry, and pinpoints any faults. The test routines are interleaved with the operational programs or called up from the computer's tape memory.

The bottom half of the 5-inch scope indicates, in a 4-by-4 matrix of titles, either the kind of information that can be displayed or the function that's being checked out. The operator selects a category by pressing the corresponding button on a console keyboard that's also laid out in a 4-by-4 matrix. The same button serves any purpose; all that's necessary is for the software to change the titles displayed on the scope face. The top half of the crt presents the data, as either alphanumeric readouts or an actual analog signal.

Feedback. When a fault occurs, a light comes on to alert the console operator. He then interrogates the machine using functional switches to determine what subsystem is faulty. This information is spelled out on the crt.

The operator may then troubleshoot the fault by calling up a matrix that, might, for example, list all the avionics subsystems. He selects the faulty subsystem by pushing the corresponding key on the matrix keyboard. The next display might then list all of the sections

Low Cost AC Calibrator

Don't let the low cost of \$975 fool you. The AC Calibrator HP Model 6921A provides you with a constant voltage or a constant current output. Select from .1 to 280 V rms in 4 ranges or .1 mA to 5A in 5 ranges, all with an accuracy of .25% under load conditions. Power is another plus feature; you get up to 28 watts output. Standard output frequencies of 60Hz, 400Hz or 1kHz are provided, with 50Hz available as an option. Proven applications for the Model 6921A AC Calibrator include calibration of ac meters and ac devices. The relatively high output power of 28 watts and the ability of the calibrator to operate into reactive loads, makes it particularly suitable for calibrating large, moving-vane meters and for multi-unit calibration of meters on the production line.

For complete specifications on the 6921A and other HP meter calibrators, write for our new file folder, or contact your local HP Sales Office. Hewlett Packard, New Jersey Division, Green Pond Road, Rockaway, New Jersey 07866. In Europe: 1217 Meyrin-Geneva.

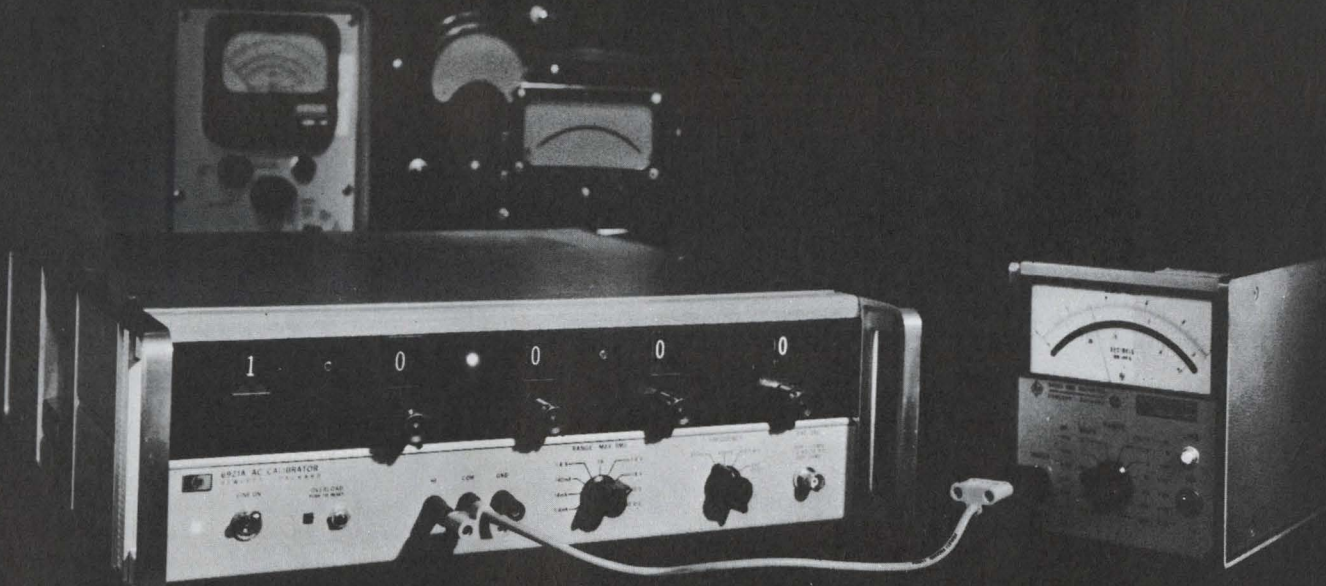

HEWLETT  PACKARD
WORKING STANDARDS

Literature Available Upon Request



AC CALIBRATOR
MODEL 745A
Programmable
Signal Generator



AC/DC METER
CALIBRATOR
Model 6920B
Four Calibrators
In One Case

Circle No. for details 334

335

336

10906

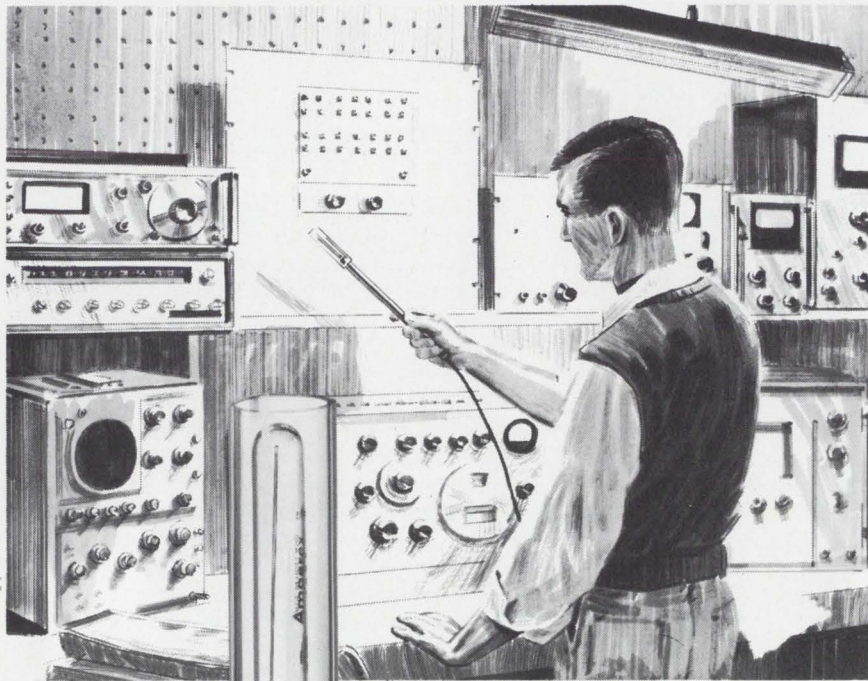

Play it

SAFE! check
microwave radiation hazards

with International's Microlite-287

This handy test light provides an instrument for safety checks in the laboratory or other areas where microwave radiation may be a hazard. The Microlite-287 was designed for testing radiation from microwave ovens at 2450 MHz. In this service it indicates fields of 10 MW/CM² or more. It may be used for testing other ranges of radiation and can be calibrated to indicate glow level. Connect to nearest 115 vac outlet and it's ready to use. Store in drawer or tool box. Unit shipped complete with instructions.

\$29.95 f.o.b. Oklahoma City

Same as above except with certified field intensity for glow ignition at 2450 MHz.....**\$45.00**

Note: Microlites may be recertified at any time by forwarding the unit to International. Price of recertification.....**\$15.00**

Manufacturers of electronic products for industry and the home. Write for catalog.

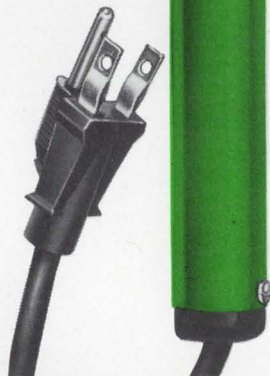

CRYSTAL MFG. CO., INC.
10 NO. LEE • OKLA. CITY, OKLA. 73102

within the subsystem, and the IFPM would check the status of each, relying on built-in test circuitry where necessary. This procedure is followed to lower and lower levels within the equipment until the fault is located exactly. There will actually be as many as 10 levels of data available through branching programs from the auxiliary display, says Borts.

This kind of procedure is followed in the E-2A, but the operator relies on a special manual to detail the various tests. In the new system, the computer will be programmed to conduct the tests automatically. The E-2C operator will also be able to look at certain critical signal points within the avionics; their waveforms will be displayed on an auxiliary test oscilloscope at the operator's console. Seeing the signal shapes and measuring their amplitude will help the operator gauge just how far performance may actually have been degraded by any particular fault.

Some 85% of the avionics in the E-2C will be fault-isolated to a WRA, using the in-flight performance monitor, thereby keeping to a minimum the yellow gear on the carrier flight deck that must be pulled up to the aircraft. Most of the WRA's will be small enough to be easily handled by one man.

Checkpoints. On the carrier, the Navy's VAST system will go to work to isolate faults down to a shop-repairable assembly, and finally to a component or group of components. As a result, a lot of special test points will be needed in the avionics. This shouldn't complicate the design too much because the points will have to meet the same sort of criteria that apply right now when special-purpose test gear is used, says Terrence J. Custer, support project engineer for the E-2C.

Grumman and its suppliers will start applying the VAST requirements as early in the development program as possible, Custer says. And VAST, rather than special factory checkout gear, will be used to ride herd on the E-2C's as they come off the production line, he adds. In effect, this will prove the VAST software—English language programs will be supplied by Grumman—before the equipment goes to the fleet.

When ordinary methods of observing and recording don't deliver



call Kodak

We have a very large staff of photographic engineers qualified to provide photographic solutions to previously unsolvable problems. Together, you and they can probably work out solutions. A few challenges presented to us recently . . .

A research team needed a way to study the combustion of metal droplets. Kodak was able to provide a film just right for high-speed cameras to record exactly what happens at 4000°C . . . and in what sequence (see picture above).

Another group, concerned with impact testing, faced the problem of oscillograph traces which intermixed

hopelessly at the point showing impact. They called Kodak. And found that we had a paper that, when exposed through appropriate filters, would provide multicolored traces. These could be interpreted even with large amplitude variations on narrow paper.

A third group had the problem of projecting computer output on a screen in color. Particularly troublesome was the fact that these data had to be updated and changed every few seconds. They called Kodak. Our engineers answered their problem with an embossed lenticular film originally intended for color kinescope recording. This film not only developed in 20

seconds to stay within their time requirements, but, with appropriate shooting and projecting techniques, produced the necessary color images.

Right now, you may be facing a data-collection problem that seems to defy solution. It may be quite different from those we mentioned. Your best bet could be a conversation with one of our photographic experts. Call Kodak.

Dial (716) 325-2000, Ext. 3257.

**Or write: Instrumentation Sales,
Eastman Kodak Company,
Rochester, N. Y.
14650.**

Kodak

THE MARRIAGE MADE IN MINCOM



PC-500 IN THE FIELD

TICOR III IN THE LAB

This matched pair of Mincom Instrumentation Recorder/Reproducers are truly wedded to their art and to each other. Call them childhood sweethearts, because every Mincom PC-500 and every TICOR III grow up together—literally—and that's why they do the best possible job in data acquisition and reduction. They share telemetry's ultimate compatibility while providing up to 2 MHz on fourteen channels. The rugged PC-500 was designed from the blackboard up to complement TICOR III's flutter suppression performance. In both systems the basic servo design thinking is identical. At the sub-assembly level, electronics and circuits design are the same. Add to this TICOR III's unmatched servo bandwidth, its low $\pm 0.4 \mu$ sec time base error, its highly successful two years of field-test as Mincom's Model 32—and look no further for your complete (and compatible) data team. Write us for more details and specifications.

Mincom Division **3M**
COMPANY
300 SOUTH LEWIS ROAD • CAMARILLO, CALIFORNIA 93010

Canada's new satellite projects shake up research establishment

Military's telecommunications R&D unit is renamed and put under civilian control as government drives to put domestic systems in equatorial orbit by early 1970's

By Charles Law

Toronto News Bureau

Canada's 500-man telecommunications research organization at Shirley Bay, an Ottawa suburb, began the second quarter of 1969 with a new boss, a new name, and a new mission. Before this spring, the operation was known as the Defense Research Telecommunications Establishment. Last year, however, the Trudeau government decided to make Canada's postal department into a full-fledged ministry of communications. To this end it transferred DRTE to civilian control, renaming it the Communications Research Center.

The electronics engineers and scientists who staff the Shirley Bay complex generally welcome the chance to redirect their efforts. The two-decade association with the military, it seems, was not without frustrations. More often than not, the armed forces regarded DRTE as a quick-turnaround development shop to modify existing equipment for special requirements. And while DRTE could point to a number of achievements, it seldom had the opportunity to take on continuing programs where the organization's abilities could be fully mobilized.

Canada's nascent space program gave Shirley Bay a chance to get out of this rut; it became chief design architect of the Alouette-Isis series of polar-orbit satellites, sponsored jointly by Canada and NASA for ionospheric studies. Isis 1 went up this year to join Alouettes 1 and 2; a second Isis is being built.

Ottawa's decision to launch a

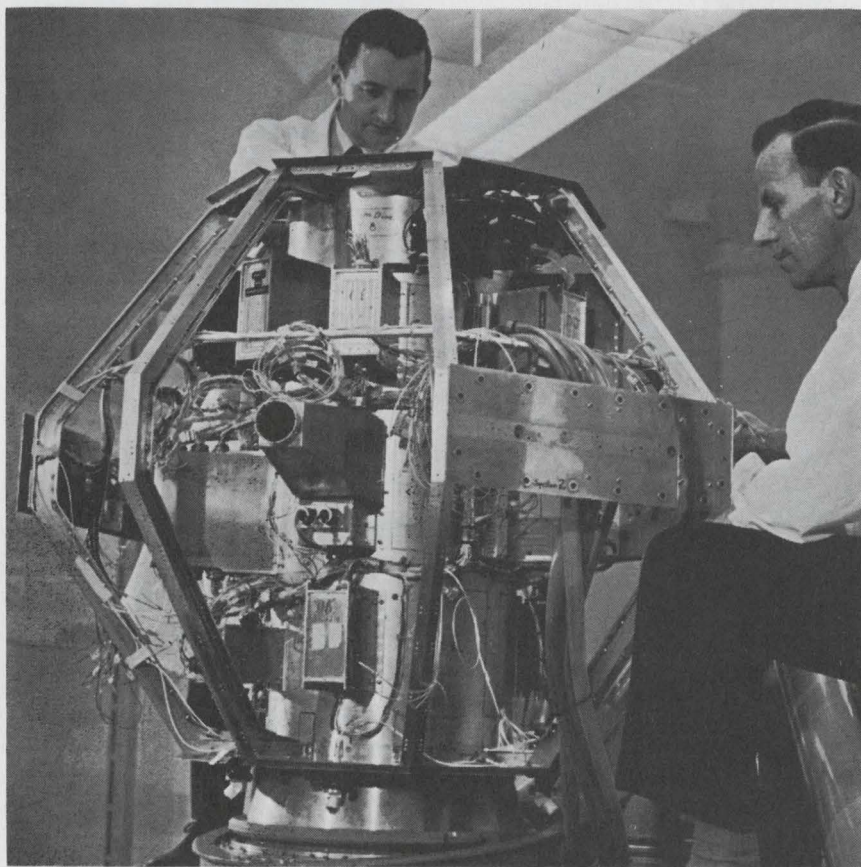

New billet. Canada's Communications Research Center, long a military arm, now concentrates on civilian projects like the Isis series of research satellites.

domestic communications satellite, as well as a new government department, impelled federal officials to turn to DRTE—the only official body with the necessary skills in space technology. At the moment, there's still some concern in top scientific circles as to how well space research is coordinated.

The creation of a Department of Communications brings some order to the scene, but the Science Council of Canada continues to press for an equivalent of the U.S. National Aeronautics and Space Administration.

Lead man. The new director general of the Communications Re-

search Center, R.C. Langille, is not particularly concerned by such worries. A veteran of defense work and one-time head of the electronics laboratory within what was then DRTE, he has been deeply involved in space telecommunications work since the earliest days of the first Alouette. Langille stepped into the top spot when his predecessor chose to stay with the Department of National Defense.

"We have to demilitarize our thinking and learn to work with the universities and intramural laboratories," he says. "CRC has much to contribute; the trick will be to find out what can be done without duplicating the efforts of larger research operations in the U.S. or elsewhere. Canada shouldn't nibble at a lot of things."

Staking a claim. Canada is determined to have a communications satellite in space. (So far, Russia has the only operative domestic system.) Long-term cost estimates are still vague and the country's common carriers are leery of government domination in the prospective corporation, Telesat Canada. But there is no questioning Ottawa's resolution to preempt at least a couple of the six orbital positions around the 95° west longitude that can cover Canada [*Electronics*, Sept. 4, 1967, p. 131].

In May 1966 when the federal government science secretariat commissioned the first comprehensive study of Canada's upper-atmosphere and space programs, J.H. Chapman, deputy chairman of the Defense Research Board, was named to head the four-man group. The so-called Chapman Report reflected the growing industry, university, and government consensus that Canada's requirements encompassed: a control organization for space activities; a domestic "telesat" system by 1970 or 1971; and, eventually, national satellite-launching capability.

Chapman was also closely associated with a task force appointed in July, 1967 to study and advise the government on the question of satellite communications. While noting that the Canadian electronics and communications industries have established competence in all phases of modern technology, the task force's report emphasized effective federal con-



New talent, CRC chief, R.C. Langille, will help shape the role his complex is to play in Canadian space effort.

trol. It also proposed full use of existing government resources for space research and development—for example those involved in the development of the Alouette and Isis satellites.

Fitting in

CRC's role as a satellite designer may well prove transitory. The government as a matter of policy wants to develop an industry presence. In the case of Alouette 1, the extent of outside participation was limited to such items as extendable tubular antennas and telemetry transmitters. But the second Alouette schedule was deliberately set up to have RCA engineers seconded to the Shirley Bay team that actually built the bird. In 1964 the prime contract for management, design, manufacture, and testing of the Isis 1 spacecraft went to RCA, with SPAR Aerospace Products tabbed to work the mechanical aspects of the design. DRTE personnel, though responsible for overall design, had to go to Montreal if they wanted to do any shoulder-leaning on the project.

Being the design authority for

the Alouette-Isis series is only part of the reason the CRC has been brought in to assist in evaluating the RCA and Northern Electric proposals on Telesat 1. The Shirley Bay operation has 20 years experience in high-reliability circuitry. This background should stand it in good stead if it assumes contract management responsibilities.

Make-ready. CRC officials consider their organization more than a source of expert advice to government. A beginning must be made now on the next generation of satellites—assuming that a bird's useful life span is five years and that the subsequent versions will be able to achieve improved performance levels. Engineers at the National Space Communications Laboratory are already investigating the problems involved in, for example, direct broadcasting from satellites to private homes and dual-purpose spacecraft. Far higher power levels will be required for direct tv transmission; more modest levels would suffice if f-m radio programming were the objective. Current plans call for improving reliability in whatever systems fly by extensive use of integrated circuits and electronic scanning techniques.

Langille anticipates satellites will eventually be used for navigation or air traffic control purposes, although again the power supply is a potentially weak link. To sidestep this difficulty, he says, designs may include provisions for expandable structures to widen the array of solar cells. Despite power limitations, earlier versions work so well that they have been a source of embarrassment to the satellite-control center at Shirley Bay. Manpower is still tied up collecting data from Alouette 1 for experimenters who want long series of readings. "A pity we didn't engineer some obsolescence into that bird," says a CRC source.

Solar cells aren't the only way out of the power problem. Fuel cells and nuclear generators have been looked at though both may prove subject to technical and political difficulties. And as it happens, Shirley Bay is home base for an internationally recognized group of battery researchers working under the direction of E.J. Casey. However, this operation is still under the wing of the DRB.

Service record

Under military stewardship, Canada's Defense Research Telecommunications Establishment turned in some impressive performances on what seemed to be a five-year scheduling basis. In 1950, for example, the organization developed narrow-band, low-frequency teletypewriter service for the armed forces. A doppler navigation system for aircraft was the 1955 innovation. It features a scheme of fore-and-aft radar beams that permit display mapping of the terrain being overflown. Five years later, the Defense Research Board, DRTE's overseer, was able to offer Canada's NATO allies a meteor-trail communications system devised by its minion. The system works on a burst technique whereby a meteor's ionized trail is used to temporarily store data; tactical terminals retrieve the information with no fears about security or interception. DRTE's 1960's feat, a civilian venture, was the first Alouette, a polar-orbit craft for ionospheric studies.

D.C. Florida, the white-haired scientist who directs the space work at Shirley Bay, has his own crystal ball on the direction CRC's research will take. For instance, he doesn't favor travelling-wave tubes in a satellite.

But a new solid-state microwave device may be in the making in CRC's electronics laboratory. With its new microelectronic facility and computer-aided design know-how, researchers hope to combine power amplifiers and a low-noise front end on a single chip. Each would have a restricted output, but enough elements could be put into the system with a phased-array antenna to overcome the constraints imposed by the individual component limitations. Says Florida: "One gets graceful degradation instead of calamitous failure."

Thumbs down. Florida also disapproves of the hydrazine-powered axial and radial thrusters used to maintain the spacecraft's correct attitude in synchronous equatorial orbit. A capability for gas exhaustion is part and parcel of this design approach; in contrast, Isis I uses magnetic torquing to counter the effects of solar radiation.

Florida also worries about weight and wonders whether fuel supplies

couldn't be built into the structural elements. The strength specs are designed primarily for vibration forces encountered during the launch, perhaps, says Florida; part of the structure could be sacrificed once the satellite is aloft. From an electronics standpoint, weight is indeed a critical factor. As things now stand the size of both power supply and antenna is limited because their combined weights have to be kept to a definite minimum.

Along these same lines, the configuration of the launch vehicle can dictate design parameters. Thus, a small fairing means a smaller diameter for the solar-cell cylinder and a reduction in the area of the array. Weight considerations are also behind the proposal that the number of nickel-cadmium batteries be restricted to what's needed to maintain two or three channels during eclipse.

Flight plans

Shirley Bay could provide the floor space and manpower to build upcoming satellites if need be. The two Alouettes were made there. At immediate issue are the plans for the remaining birds in the Isis series. Isis B is already in construction at RCA's Montreal space systems laboratory and a C version may be approved before the year is out.

Should Ottawa and Washington buy the Isis C proposal, which may be forwarded this summer, more than one prime contractor may enter the satellite picture. The C model, which is supposed to cap the series, is conceived as a magnetospheric satellite (reaching out at least 10 earth radii) rather than an experimental ionospheric vehicle.

Costs are escalating, but the CRC is pressing ahead to determine whether a unique program of experiments can be devised. Talks involve the French as well as the Americans; the former had satellite plans of their own until the Russians, who were to handle the launching, backed out of the deal.

Isis I, put into a highly elliptical polar orbit, carried 11 experiments. About the same number will be on Isis B, which will become Isis 2 when injected into its circular orbit. But Isis C, also intended for a geocentric course, albeit farther



**ATTENTION,
HEAD
HUNTERS!**

**NORTRONICS
SPEAKS
DIGITAL
DIALECT**

If you're exploring the mini-computer jungle—seeking magnetic heads, for desktop calculators, input/output systems, and other peripheral equipment—beat a path to Nortronics — the world's largest head manufacturer.

Our witch doctors have powerful magic: a complete line of readily available mini-digital recording heads. Any application; cartridge, cassette, 1/4" reel-to-reel, drum, or card stripe formats . . . plus complete market engineering know-how to help you specify.

In the savagely competitive EDP business, the leading manufacturers agree on one thing—Nortronics mini-digital capability. *Call or write today, for our mini-digital guidebook.*

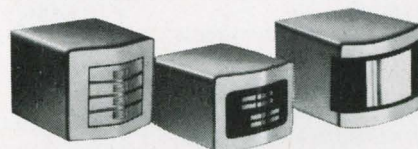

Nortronics
COMPANY, INC.

8101 Tenth Avenue North
Minneapolis, Minnesota 55427
Phone—(612) 545-0401



**MAINTAINABILITY:
Principles and Practices**

Benjamin Blanchard and Edward Lowery. Dealing extensively with maintainability engineering, this authoritative reference is based on all the known procedures and principles currently associated with the discipline, especially the organization, planning, actuation, and control of a company maintainability program. 384 pages, \$12.50



**ELECTRONIC APPLICATIONS
OF THE SMITH CHART**

Phillip Smith. Provides engineers, laboratory technicians, and students with comprehensive and practical guidance on the Smith Chart and its extended uses in waveguide, circuit, and component analysis and synthesis. A unique feature is the description of many previously unpublished parametral "overlays". 224 pages, \$17.50

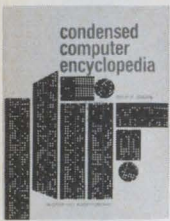

**CONDENSED COMPUTER
ENCYCLOPEDIA**

Phillip Jordain. Covers as many publications as may normally be encountered in an entire computer center. Bridges the gap between elementary computer dictionaries and complicated work manuals, and eliminates the language barrier between management and computer expert. 605 pages, \$14.50

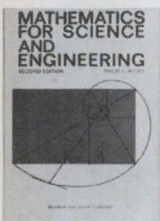

**MATHEMATICS FOR
SCIENCE AND ENGINEERING**

Phillip Alger. Contains all of the mathematical formulas and tables encountered from elementary school through college. Presents these mathematical concepts on an ascending scale of complexity, beginning with arithmetic, and including algebra, trigonometry, calculus, probability, and linear differential equations. 374 pages, \$9.75

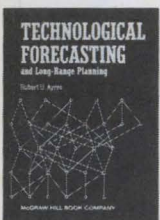

**TECHNOLOGICAL FORECASTING
and Long-Range Planning**

Robert Ayres. Presents a readable and useful approach to the important subject of forecasting the future trends and specific developments in various areas of technology. Covers specific procedures that you can follow to predict which spheres of technology and hardware will be of major concern. 237 pages, \$12.50



**PRINCIPLES OF
HIGH-RESOLUTION RADAR**

August Rihaczek. Featuring a step-by-step development of the theory of radar resolution, this timely book is more comprehensive and up to date than any similar work available. Stresses principles rather than the equipment, and presents the theory of target resolution in detail without resorting to advanced mathematics. 498 pages, \$19.50

AVAILABLE NOW

out, will need a heavier booster. The alternative may be a cutback in the number of experiments.

Ambivalence. Despite CRC's optimism regarding its R&D role in satellite technology, administrators recognize that there is still considerable uncertainty. For example, no one knows yet whether contracts for Telesat birds will be awarded in a fixed-cost or incentive basis. One thing is clear, however. To have a communications satellite in operation by the winter of 1971-72 it will be necessary to use state-of-the-art technology. Therefore, the best that the Shirley Bay establishment can offer immediately is responsible advisories to assure workable coordination between government and industry in what has already been designated a joint venture.

Moreover, there must be some word from Eric Kierans, Canada's pugnacious minister of communications, on how he sees government interfacing with the telecommunications business. He's already on record about the post office's doing more than simply delivering the mail. Some observers speculate that Kierans intends to take a leaf from the British and make the department into a common carrier competing with private interests.

Meanwhile, Shirley Bay will concentrate on satellite technology. Although only 20% of its technical staff is in Florida's national space telecommunications laboratory, the two other labs, along with the two institutes on the premises, have talent that can be called into play. The radiophysics people, for example, as users of the data from research satellites, have a natural interest in the program.

Communications in Northern areas have generally occupied the attention of CRC, and it has given short courses to geologists in oil-company field parties because of its long-standing competence in the high-frequency field. Among current projects are several involving advanced modulation techniques for carrier beams to improve reception in remote northern areas of the country.

Other units at CRC are working on digital systems, coding techniques, telegraphy, and related projects, as well as building their basic knowledge of solid state

At your bookstore or direct from publisher for 10 DAYS FREE EXAMINATION.

McGraw-Hill Book Company
Dept. 23-E-769
330 W. 42nd St., N. Y., N. Y. 10036

- | | |
|---|--|
| <input type="checkbox"/> 3. Jordain
(330381) | <input type="checkbox"/> 4. Alger
(010504) |
| <input type="checkbox"/> 5. Ayres
(026633) | <input type="checkbox"/> 6. Rihaczek
(528901) |

Send me the book(s) checked for 10 days on approval. In 10 days I will remit for the book(s) I keep, plus a few cents for delivery costs and local tax, if any, and return the others postpaid.

- | | |
|---|---|
| <input type="checkbox"/> 1. Blanchard
(058552) | <input type="checkbox"/> 2. Smith
(589309) |
|---|---|

Name _____
 Address _____
 City _____
 State _____ Zip _____
 Offer good only in U.S. and Canada. 23-E-769

physics and components. The physical chemists, for instance, hope to improve processes for making IC's. Their efforts will shortly get a boost with the completion of a "clean room" for specialized circuitry and the availability of a scanning electron microscope, which will be used, among other things, to examine crystal structures, bonding, and the intrusion of impurities. By the end of the summer experimental IC's should be coming out of the in-house microelectronics facility.

Cause and effect. The Isis program pushed Shirley Bay into microelectronics since devices had to be specified. And the only way the designers could argue from strength with the manufacturers was to know as much as possible about how to pinpoint failures. This entailed using microscopy to do proper failure analysis. CAD techniques, another recent specialty of the house, evolved as a result of the desire to shorten the development cycle of new equipment.

Though CRC will have to work its way through the administrative difficulties of switching from one department to another, it is girding itself for a faster growth pace. Langille is all for the mission approach proposed by the Science Council of Canada. Now that his organization is released from a primarily defense orientation, it should be able to devote a lot of stored energy and talent to telecommunications projects in the civilian arena.

Shirley Bay will go on with a few military projects, but hopes to avoid piecemeal work on systems that will never see production. "We never could interface," says Langille. "Occasionally there was a Mark I, but little progress towards developing more sophisticated hardware."

Time will tell whether the rechristened CRC will experience similar clashes with Kierans' department. One consolation has been that in the current period of government austerity CRC has been one agency permitted to expand its staff. But then it's new and there is no doubting Kierans' present intention of maintaining tight government control of the Telesat program. By having an in-house capability, schedules and costs should, he reasons, be well managed. ■

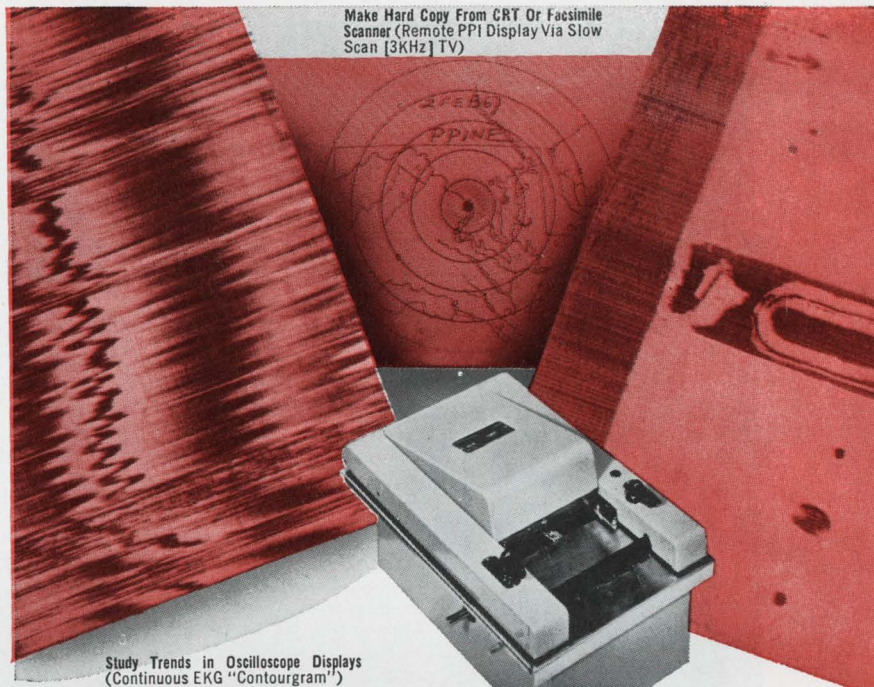

Make Hard Copy From CRT Or Facsimile Scanner (Remote PPI Display Via Slow Scan [3KHz] TV)

Study Trends in Oscilloscope Displays (Continuous EKG "Contourgram")

Plot From Scanning Sensors For Detection And Inspection (Ultrasonic Inspection For Bond Flaws)

PATTERN, PLOT OR PICTURE

Now . . . with a simple instrument . . . you can reproduce electrical phenomena as permanent records in pattern, plot, or picture form where otherwise the data is presented as transient oscilloscope or CRT displays.

The versatile Alden "Flying-Spot" Helix Recorder, used with Alfax Type A electro-sensitive paper, produces permanent graphic images of repetitive or sequential signals with a wealth of detail and information content not approached by other display and recording techniques.

It is a simple matter to synchronize the Alden Recorder with scanning sensor or transducer (sonar, radar, ultrasonic, infra-red detectors, etc.) to provide a continuous "plot" of the information obtained. The recorder sweep speed (horizontal output) can be varied to provide almost any desired rate of presentation. Paper advance rates can readily be changed to provide time expansion or compression for increased detail, or clearer representation of long-term data trends and improved signal-to-noise ratio.

The Alden Recorder can be used with a broad variety of systems (computers, television, medical instrumentation, facsimile, scanning radiometers, etc.) which produce sequential signals on a constant time base, to provide accurate and instantly visible "picture" or "pattern" information. Images are produced with a dynamic, tonal shading directly proportional to signal strength, providing a "third dimension" of information recording.

To satisfy your exact requirements, Alden "Flying-Spot" Component Recorders, in various printing widths from 4" to 48", along with a wide selection of plug-in drives, recording configurations, signal amplifiers, phasing circuits, and synchronizing accessories are available, designed to provide a simple, economical adaptation of Alden instant recording techniques to your instrumentation.

ALDEN For more information on the most versatile data recorders available, write today for complete details. Dept. E 6
ELECTRONICS & IMPULSE RECORDING EQUIPMENT CO., INC., WASHINGTON STREET, WESTBORO, MASSACHUSETTS 01581 — TELEPHONE: (617) 366-8851

ALDEN ELECTRONICS & IMPULSE RECORDING EQUIPMENT CO., INC., WASHINGTON STREET, WESTBORO, MASSACHUSETTS 01581

GENTLEMEN: I am interested in Alden "Flying-Spot" recording techniques.

I would like to investigate Alden Equipment for use in the following application:

I would like data for possible future reference.

NAME _____ TITLE _____

COMPANY _____

ADDRESS _____

CITY _____ STATE _____ ZIP CODE _____

Characters
per second

150

120

60

25

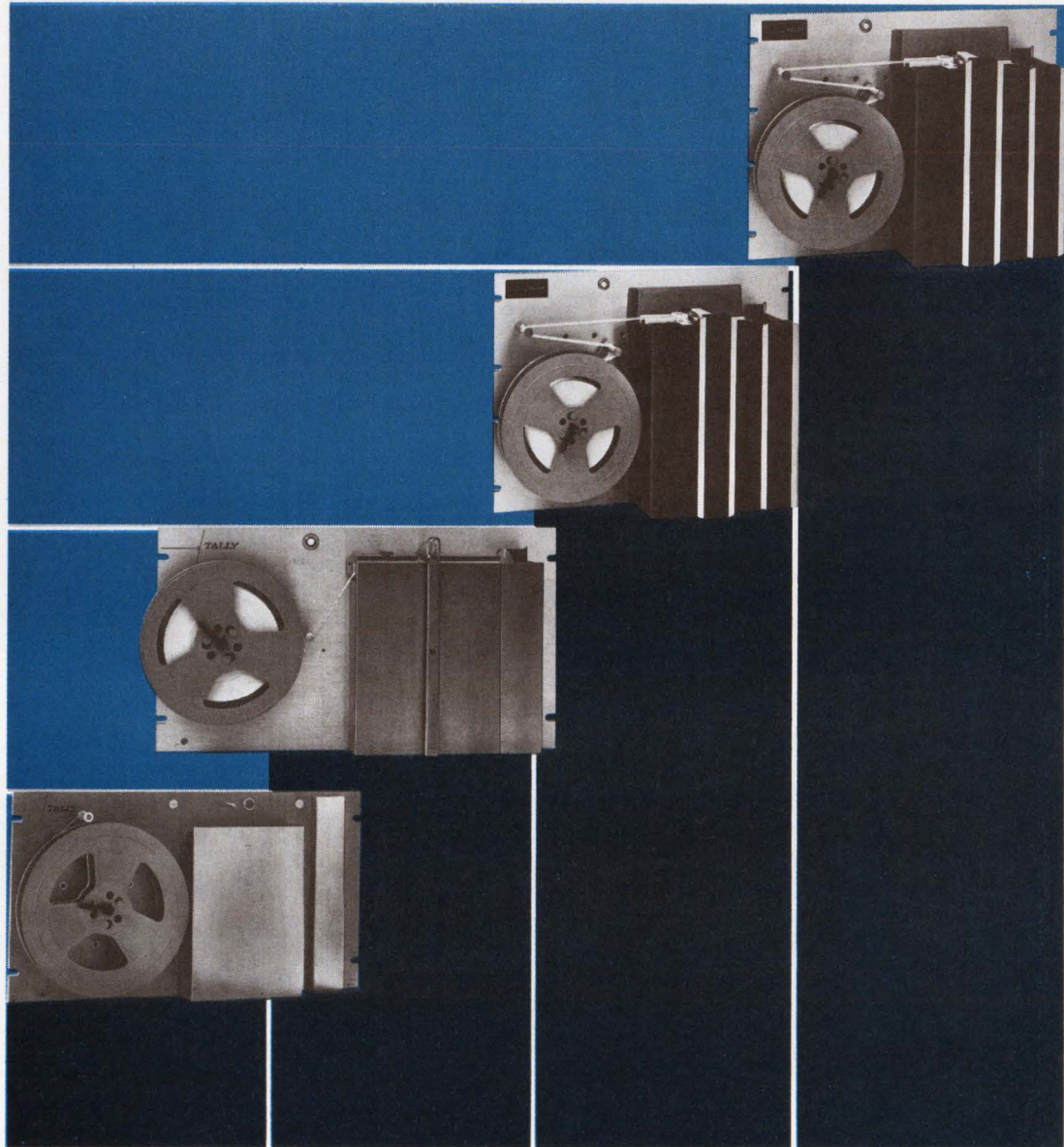

Model
Number P-25

420

P-120A

P-150A

What a line

...of punched tape perforators! And that's only half the story. We've got the toughest, best designed, and most complete line of perforated tape readers too. Take your choice of speed and cost from 25 to 1,000 characters per second. Whatever your needs in perforated tape technology, talk to Tally. Write or call today. Please address Tom Tracy, Tally Corporation, 8301 South 180th Street, Kent, Washington 98031. Phone: (206) 251-5500. TWX: 910-423-0895. In Europe and the U.K., address Tally Ltd., 6a George Street, Croydon, Surrey, England. Phone: (01) 686-6836.



Hybrid IC lines move into production

TI starts with chip-and-wire FET preamp, but will switch to beam leads in fall;
Fairchild turns to flip chip, while Motorola and RCA stay with wire bonding

By Stephen Wm. Fields

Associate Editor

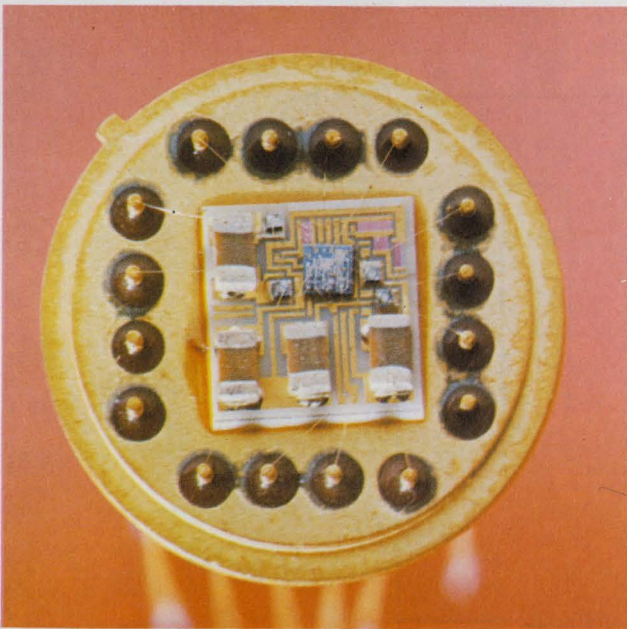

First . . . Chip and wire preamplifier with FET input is TI's first product in a new line of standard hybrid IC's.

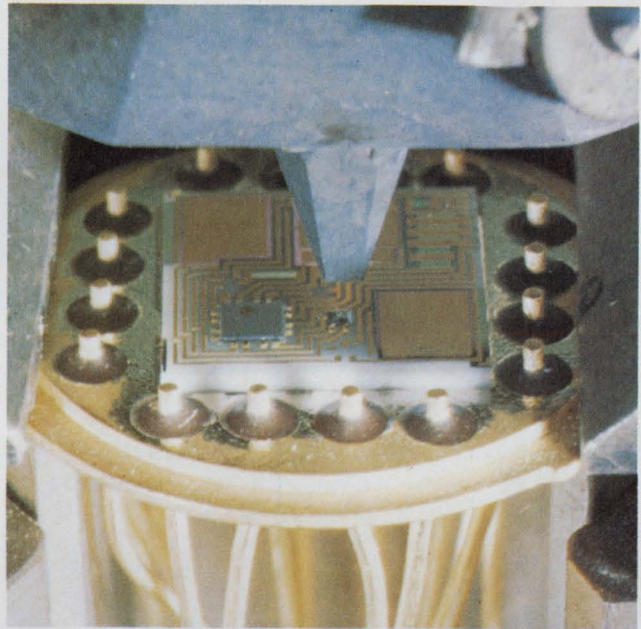

. . . and next. Future products in the line will use semiconductor chips with ultrasonically bonded beam leads.

Beam lead or flip chip: that was the question. What made it irrelevant was the semiconductor industry's realization that the production of hybrids—by whatever method available—is more important. As one industry representative put it: "With hybrids, we don't have to force a single technology to do something it wasn't meant to do. We can combine the best advantages of bipolar and MOS chips, and thick- and thin-film techniques in a single package."

Reflecting this attitude, three companies — Texas Instruments, Motorola Semiconductor and Fairchild Semiconductor—have already launched off-the-shelf hybrid lines with the introduction of their first

products. TI's entry is a low-noise field effect transistor preamplifier; Motorola's first in a series of IC's for interfacing logic circuits with electromechanical devices is a dual power driver; and Fairchild started its line of memory elements with a 128-bit read-write bipolar random-access memory.

Called the HIC-023, TI's preamp is earmarked for oceanographic equipment, such as hydrophones and sonar transducers, and medical gear—primarily electrocardiographic. According to the company, the preamp has a voltage gain of 50 decibels, which is about 20 db better than that of monolithic versions. And although the gain is about the same as that of discrete

preamps, the hybrid's price is about a fifth—\$42 for the hybrid, compared with about \$200 for discrete preamplifiers.

Something special. To some, the price alone would make the hybrid special. But, according to Bud Frye, manager of hybrid products at TI, "The FET preamp is something special in another way." Says Frye: "The first units will be manufactured with chip-and-wire techniques, but by the fall we'll be using beam-lead chips." This will be TI's first commercial hybrid beam-lead product.

"Although hybrid IC's are largely a custom market," he says, "definite requirements exist for standard functional building blocks that

CTS TRIMS CERMET INDUSTRIAL TRIMMER PRICES TO

50¢

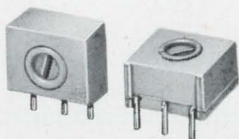

- 50¢ each in 50,000 quantity
- 65¢ each in 1,000 quantity
- \$1.14 each in 100 quantity

for ±20% Tolerance (Add 4¢ for 10% tolerance)

Series 360 single-turn cermet industrial trimmers provide...

- **Setability ±.03%**
- **Environmental performance requirements of characteristic C of MIL-R-22097D**
- ... plus!
 - 1.5% average equivalent noise resistance
 - 0.5% average contact resistance variation
 - Compact, single-turn design
- Top or side adjust
- ½ watt @70° C
- Tolerance to ±5%
- TC ±150 ppm/°C available at no extra cost over most of the resistance range.

Your CTS Distributor will have both styles in stock for fast, prototype delivery. Production quantities to you in 4 weeks.

See your distributor... call your CTS sales engineer... or write for complete data. We'll respond quickly. CTS of Berne, Inc., Berne, Indiana 46711. Phone: (219) 589-3111.

CTS CORPORATION
Elkhart, Indiana





Where
to buy
off-the-shelf
CTS components

ALABAMA
Cramer/Huntsville, Inc.
Huntsville 35801
(205) 536-4493

ARIZONA
Hyer/Cramer Electronics
Tempe 85281
(602) 967-8786

CALIFORNIA
Fortune/Cramer
Electronics
Redwood City, 94063
(415) 365-4000

**Hollywood Radio &
Electronics, Inc.**
Hollywood 90028
(213) 466-3181

**R & C/Cramer
Electronics**
Glendale 91201
(213) 245-7121

**R & C/Cramer
Electronics**
San Diego 92111
(714) 279-6300

Rose Electronics
Burlingame 94010
(415) 697-6100

COLORADO
Hyer/Cramer Electronics
Englewood 80110
(303) 771-5285

Waco Electronics
Denver 80216
(303) 322-7708

GEORGIA
Cramer/Atlanta
Atlanta 30340
(404) 541-5421

ILLINOIS
Hall-Mark Electronics
Corp.

Rosemont 60018
(312) 299-6602
***Semiconductor
Specialists, Inc.**
Chicago 60666
(312) 279-1000

INDIANA
***Semiconductor
Specialists, Inc.**
Indianapolis 46241
(317) 243-8271

MARYLAND
Cramer/Baltimore
Baltimore 21230
(301) 354-0100

MASSACHUSETTS
CompRep Distributors
Needham 02192
(617) 444-2484

MICHIGAN
***Semiconductor
Specialists, Inc.**
Detroit 48240
(313) 255-0300

MINNESOTA
***Semiconductor
Specialists, Inc.**
Minneapolis 55423
(612) 866-3434

MISSOURI
Olive Industrial
Electronics
St. Louis 63130
(314) 863-7800

***Semiconductor
Specialists, Inc.**
St. Louis 63134
(314) 423-6500

NEW JERSEY
Cramer/Penn., Inc.
(See Pennsylvania)
Pennsauken 08110
(215) 224-0120

NEW MEXICO
Hyer/Cramer Electronics
Albuquerque 87108
(505) 265-5767

NEW YORK
Cramer/Rochester
Rochester 14623
(716) 482-7080

Summit Distributors
Buffalo 14202
(716) 884-3450

**Terminal-Hudson
Electronics**
New York 10011
(212) 243-5200

NORTH CAROLINA
Cramer/Raleigh
Raleigh 27604
(919) 832-6441

OHIO
Cramer/Tri-States, Inc.
Cincinnati 45215
(513) 771-6441

***Semiconductor
Specialists, Inc.**
Dayton 45415
(513) 278-9455

Sun Radio Company
Akron 44308
(216) 434-2171

PENNSYLVANIA
Cramer/Penn., Inc.
(See New Jersey)
Pennsauken 08110
(215) 224-0120

***Semiconductor
Specialists, Inc.**
Pittsburgh 15218
(412) 351-3611

TEXAS
Adleta Electronics Co.
Dallas 75201
(214) 742-8257

Adleta Electronics Co.
Fort Worth 76105
(817) 336-7446

***Semiconductor
Specialists, Inc.**
Dallas 75220
(214) 358-5211

**Southwest Electronics,
Inc.**
Houston 77036
(713) 782-3060

UTAH
W. H. Bintz Company
Salt Lake City 84110
(801) 363-5821

Hyer/Cramer Electronics
Salt Lake City 84115
(801) 487-3681

WASHINGTON D.C.
Cramer/Washington,
Inc.

Rockville 20850
(301) 424-2700

WISCONSIN
Hall-Mark Electronics
Corporation
Milwaukee 53226
(414) 476-1270

* Semiconductor Specialists authorized distributors
for CTS off-the-shelf microcircuits only

have a wide application but aren't readily adapted to monolithic approaches." The FET preamp is a good example of this. Two other products that TI is planning to introduce will also fit these requirements—a high-current, high-voltage line driver for interfacing transistor-transistor logic with coaxial signal lines, or read lines in core memories, and a high-power voltage regulator with a capability of 6 or 7 watts.

The beam-lead version of the HIC-023 will carry the same price tag as the chip-and-wire unit, but the price will eventually come down. This will be due largely to the anticipated savings in assembly and testing costs.

The HIC-023 operates on one 24-volt power supply, has a maximum output voltage of 14 volts peak-to-peak, an input impedance of 15 megohms, and an output impedance of 250 ohms. Total power dissipation with no signal applied is 90 milliwatts, and temperature drift is 0.4 db from 25° C to 125° C.

Coupler. Motorola's hybrid combines the best of each of the available technologies. The result is a device that is small, capable of controlling high power, and inexpensive. Called the MCH1002, the dual power driver interfaces high-threshold logic levels with relays and lamps.

For the logic end of the integrated circuit, Motorola engineers used an expandable dual four-input line driver from the MHTL family. To this, they added two high-current, high-voltage discrete switching transistors, and four thick-film resistors. The result is a 14-lead molded plastic plug-in package with a maximum output current of 0.5 amp, a turn-on time of 115 nanoseconds, and a turn-off time of 260 nsec. Price, in quantities of 100 units, is \$7.60 each.

Also available off-the-shelf from Motorola is the MCH2005 Darling-ton power driver. Designed for applications requiring large current pulses for short durations, the MCH2005 converts a TTL output current of 5 milliamps into a current pulse of 5 amps. Total switching time is 800 nsec. The hybrid is housed in a TO-91, 10-lead ceramic flat package and is priced at \$8.75 each in quantities of 100. In both circuits, Motorola uses chip-and-

wire bonding techniques.

LSI approach. In the memory area, hybrids are being used as an approach to large-scale integration. Realizing that bipolar memories are faster than MOS memories and that small chips can be manufactured at a lower cost than large chips, Fairchild moved quickly to capitalize on its existing bipolar memory cells. Its new 128-bit read-write random access memory employs eight 16-bit M μ L9033 cells bonded face down on a ceramic substrate that incorporates two layers of metalization. Called the M μ L4027, the memory has an access time of 35 nsec. Its most likely application is in high-speed scratchpad and buffer memories.

Memory organization is 64 two-bit words with uncommitted collectors, which enable word or bit expansion. Eight x and eight y co-incident-select address lines simplify the organization; all outputs are compatible with DTL and TTL circuitry, and both true and complement outputs are available.

Supplied in a 1-inch square hermetic plug-in package, the memory is priced at \$66 each in quantities of 100 units—52 cents per bit.

Down the road. TI, Motorola, and Fairchild may be the first three firms to announce new hybrid product lines, but they won't be alone for long. By the time TI's beam-lead preamp reaches the market, at least three other semiconductor houses will be marketing either beam-lead devices or complex hybrid circuits—some of which will use beam-lead chips.

General Instrument is reportedly near production of beam-lead chips, and the first application will be in a hybrid-LSI analog-to-digital converter that is slated to be the company's first off-the-shelf hybrid product.

In August, Raytheon will have several lines of beam-lead chips that will be offered off-the-shelf. These chips will more than likely go to systems houses having hybrid capabilities.

And RCA is expanding its semiconductor operation at Mountain Top, Pa. with the intent of making thick-film hybrids. A wire-bonded hybrid product line is already in the offing. One of the first circuits from RCA will be a 100-watt audio amplifier.

**TEFLON: all by itself
the most thoroughly proven,
high-reliability
insulation**

**Now, look at the
extras you get
with TEFLON plus
polyvinylidene fluorides**

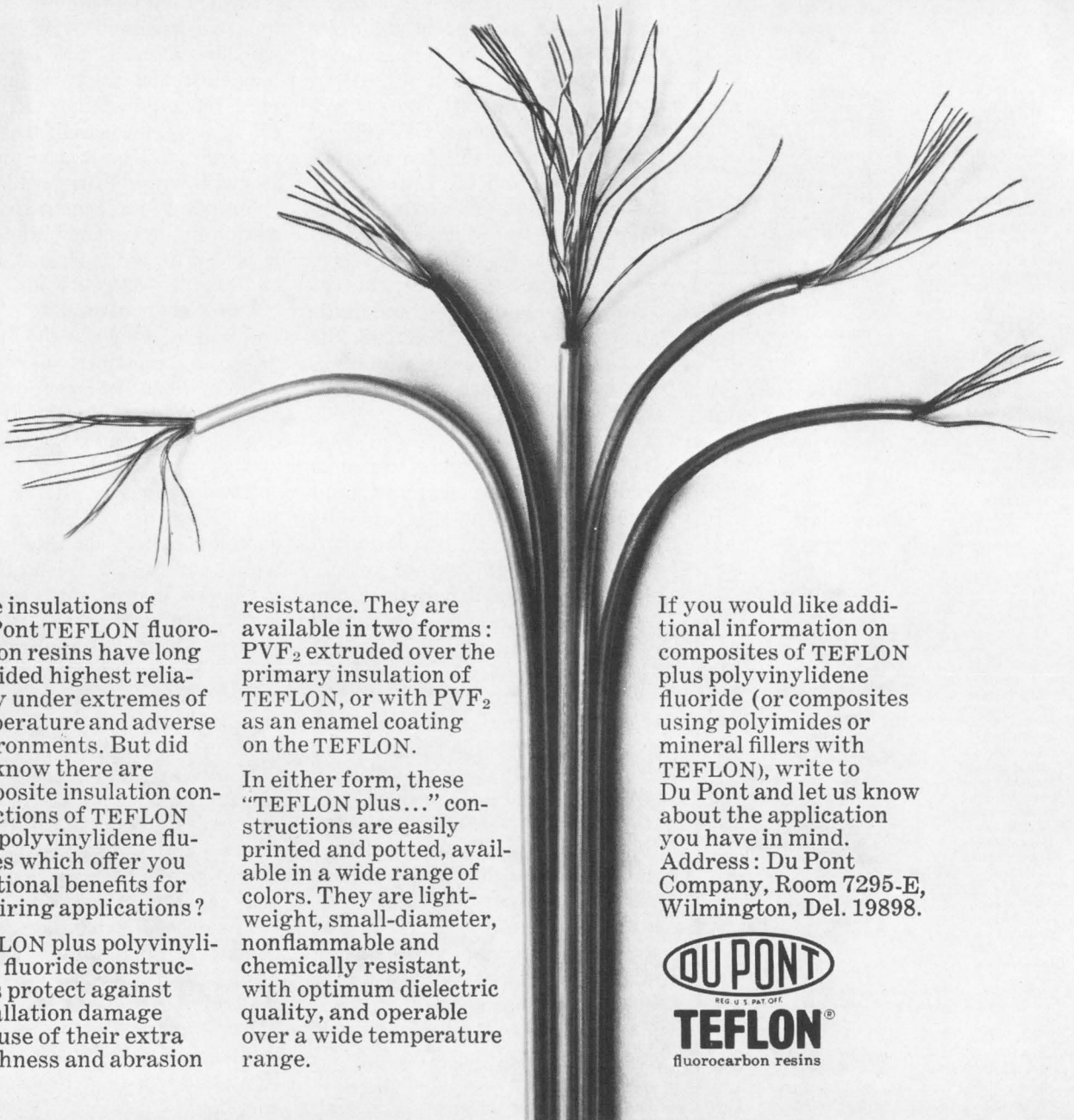

Wire insulations of Du Pont TEFLON fluorocarbon resins have long provided highest reliability under extremes of temperature and adverse environments. But did you know there are composite insulation constructions of TEFLON plus polyvinylidene fluorides which offer you additional benefits for all wiring applications?

TEFLON plus polyvinylidene fluoride constructions protect against installation damage because of their extra toughness and abrasion

resistance. They are available in two forms: PVF₂ extruded over the primary insulation of TEFLON, or with PVF₂ as an enamel coating on the TEFLON.

In either form, these "TEFLON plus..." constructions are easily printed and potted, available in a wide range of colors. They are lightweight, small-diameter, nonflammable and chemically resistant, with optimum dielectric quality, and operable over a wide temperature range.

If you would like additional information on composites of TEFLON plus polyvinylidene fluoride (or composites using polyimides or mineral fillers with TEFLON), write to Du Pont and let us know about the application you have in mind. Address: Du Pont Company, Room 7295-E, Wilmington, Del. 19898.

DU PONT
REG. U. S. PAT. OFF.
TEFLON[®]
fluorocarbon resins

Cable connectors trim out the fuss

Simplified design of coaxial and multicontact units drives down price; assembly can be done by customer and requires only a few basic tools

Industrial and commercial equipment designers tend to shy away from miniature coaxial and multicontact connectors because they're expensive, and they're difficult to assemble. Four connectors manufactured by Microtech Inc. may change this, however. They cost from \$1.75 to \$3.75 in thousand quantities. "And the beauty of it is you can assemble them yourself,"

a Microtech engineer says. To assemble the coaxial connector, "you just trim your cable and thread it in," he says. For the multicontact connector, "all you need is a soldering iron and a razor blade."

This is in sharp contrast to previous connectors. Sizes comparable to Microtech's series D cost \$25 each, and the manufacturer often must connect the cable for the cus-

tomers because special tooling is needed to do the job.

There are two coaxial series in the Microtech line. Series A has 10-32 threads with 1/4 inch outside diameter; series C has 4-48 threads with 1/8 inch outside diameter. Quantity price for each is \$1.75. Over-all length of the small connector is less than 1/4 inch.

And there are two multicontact

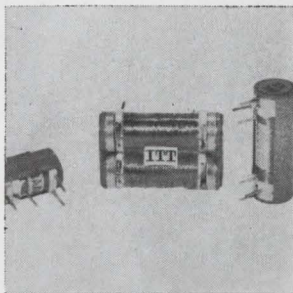

Miniature diaphragm relay JDYA features a moving contact that is a flexible diaphragm sealed in an inert atmosphere. It will interrupt up to 1 amp at 30 v d-c or a-c in either 1-, 2-, or 4-Form-A configuration. The 1-Form-A type is only 0.67 inch long. Units are available as standard coils of 6, 12, 24, or 47 v d-c. ITT Jennings, 970 McLaughlin Ave., San Jose, Calif. [341]

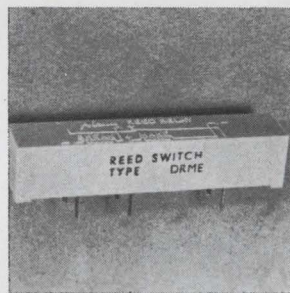

Dry reed relay type DRM features memory contact. Units are supplied with two coils, one to produce the make field, the other to produce the release field. Duration of energizing pulse can be between 10 μ sec and steady d-c conditions. Average coil power is 250 mw for 6, 12, 24 v operation. Measuring Instrument Controls Inc., 438 Springfield Ave., Berkeley Heights, N.J. [343]

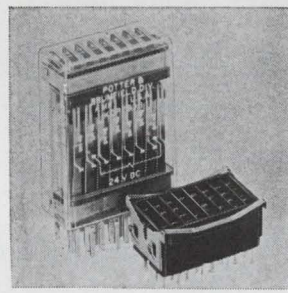

Eight-pole relay series KDP is for high-density packaging in electrical control systems. It measures 1.19 x 0.56 x 1.54 in. Available for 6 to 110 v d-c operation, the units offer a mechanical life of 10 million operations. Contacts are available in 8 Form C arrangement with a rating of 1 amp at 30 v d-c or 0.5 amp at 120 v a-c resistive. Potter & Brumfield, Princeton, Ind. [344]



Mercury thermostats can be fixed set at any temperature between -20° and 200° F. Once calibrated, the unit will maintain the temperature to within 0.05° C over one year or 100,000 operations. It switches 2 amps a-c or d-c and comes with a plastic control housing and an aluminum or stainless steel probe. Philadelphia Scientific Controls Inc., 1135 Cedar Ave., Croydon, Pa. [345]

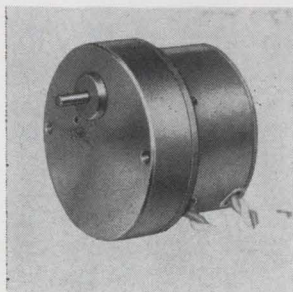

Heavy-duty reversible motor 81400 features high torque and compact design. It delivers an output torque of 2 oz in. at 300 rpm directly from the rotor, at an input of 3 w. Integral gearing provides speeds as low as 1 rpm; the gear train rating is 100 oz in. Rotation may be reversed by changing one connection. A. W. Haydon Co., 232 N. Elm St., Waterbury, Conn. 06720 [346]

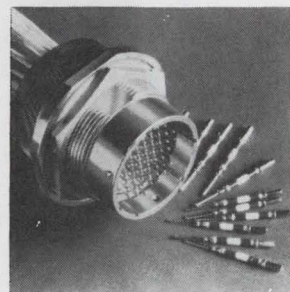

Circular connector series 482 is designed to eliminate conducted and radiated electromagnetic interference. Units have been tested for operational reliability under vibration acceleration forces of 50 g and shock loads of 100 g at temperatures of -55° to 150° C. The device handles a voltage of 200 v d-c or rms. Amphenol Connector Division, 2801 S. 25th Ave., Broadview, Ill. [347]

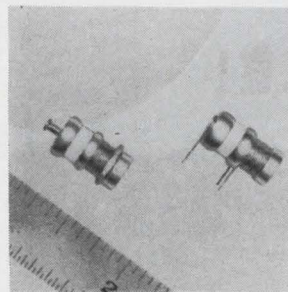

All-metal, air variable capacitors series MVM meet or exceed Mil-C-14409C. They are adjustable from 0.8 pf to 10 pf. The Q factor exceeds 2,000, measured at 10 pf and 100 Mhz. Insulation resistance at 25° C and 500 v d-c is 10⁹ megohms, and temperature coefficient of capacitance is 0 \pm 20 ppm./° C. JFD Electronics Co., 15th Ave. at 62nd St., Brooklyn, N.Y. [348]

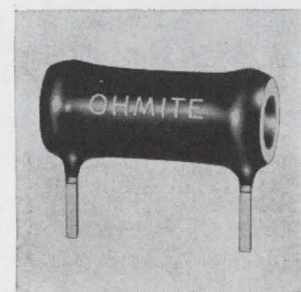

Radial-lead, power wirewound resistors designated PC-58 are available in 3-, 5-, and 8-watt sizes. By eliminating cutting, bending and forming leads, the PC-58 cuts labor costs up to 21.9% with productivity increases of 28.1%. Resistance range is 0.51 to 7,000 ohms. Price of the 3-w unit is 24 cents in lots of 500. Ohmite Mfg. Co., 3601 W. Howard St., Skokie, Ill. [342]



Every Engineer or Draftsman
should have the **NEW BY-BUK**
CROSS REFERENCE GUIDE P-45

(supersedes By-Buk Catalog No. P-42)

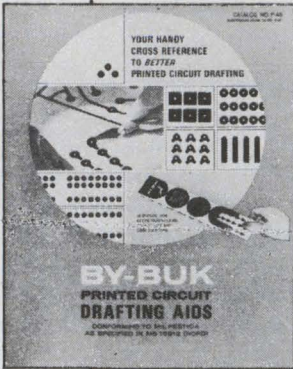

to better printed circuit
drafting.

This **FREE** 24 page booklet contains color-coded standard MIL-SPEC SIZES and design standards . . . plus a newly added numerical index for easy reference to over 2000 pre-cut tapes, pads, shapes, transistor tri-pads, spaced IC

terminal pad sets and other drafting aids for faster, more accurate, distortion-free printed circuit master drawings.

Send for your **FREE** guide today!

BY-BUK COMPANY

4326 West Pico Blvd. • Los Angeles, Calif. 90019 • (213) 937-3511



Circle 213 on reader service card

FAMOUS MAGNELINE® QUALITY

**NEW
COMPACT
SIZE!**

**NEW
LOW PRICE!**



Patwin's Series 18000 indicators operate from pulsed DC voltages in decimal form to display digits or symbols. They have the same reliability, readability and memory as other MAGNELINE models but are more compact and lower in price. The new indicators are only .29" wide and .92" high yet digit size is a full 1/4 inch. Unit price is \$33.80 in quantities of 100.

The Series 18000 has many applications in aviation and general instrumentation, especially where extreme reliability and low maintenance cost are important. Open construction of the unit gives instrument designers a wide choice of mounting methods. Full information available from Patwin, 41 Brown Street, Waterbury, Connecticut 06720. Telephone (203) 756-3631.

PATWIN®
DIVISION OF UNITED-CARR
UNITED-CARR INCORPORATED • A SUBSIDIARY OF TRW INC

**WATERBURY,
CONNECTICUT 06720**

154 Circle 154 on reader service card

connectors. Series D, at \$2.75, has four pins and a 1/4-28 thread; series E, at \$3.75, has seven pins and a 5/16-24 thread. Over-all length is less than 1/2 inch.

To cut the price so drastically, Microtech used a simplified design. "We've been very careful with the number of parts and how they go together," the company reports. In the D series, the pins are in a plastic insert. The cables are soldered to the pin, the insert is backed into the connector, and a snap ring retains it.

In cutting costs, the company hasn't scrimped on materials. For reliability, the bodies and pins are made of gold-plated brass, the sockets are made of gold-plated beryllium, and TFE Teflon is used as the dielectric material.

The multicontact connectors use a special cable. It's available from

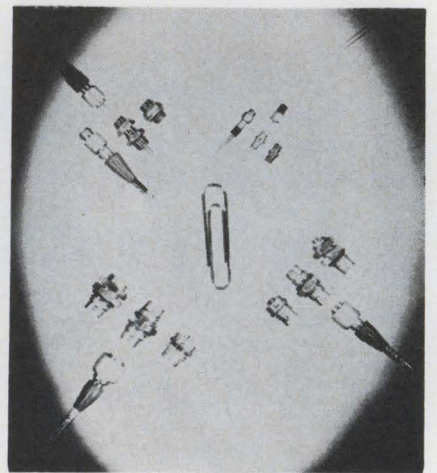

Small economy size. Industrial connectors have outside diameters of 1/8 to 5/16 inch.

cable manufacturers, but since it's an unusual size, Microtech supplies it to customers.

Although Microtech is directing its product to industrial and commercial markets, the company says the connectors perform well in military tests and that they are particularly good in shock and vibration.

The present line is not hermetically sealed, but Microtech will soon introduce a version with a hermetically sealed receptacle.

All series are available from stock.

Microtech Inc., 777 Henderson Blvd., Folcroft, Pa. 19032 [349]

Electronics | July 7, 1969

New components

Solid state switch handles 14 amps

SPST unit, priced at \$20, can be controlled by d-c or a-c signals

The sound of silence is growing louder in switching circuits. Electromechanical relays along with their reassuring clicks are disappearing, and in their place are coming solid state relays, quiet but almost indestructible.

The newest of these solid state switches is the series 6 from Teledyne Relays. A single-pole-single-throw device, the series 6 switches 60-hertz signals of up to 14 amps. A wide range of inputs—3 volts a-c or d-c up to 140 volts a-c or 200 volts d-c—can control this relay. In a typical situation, a 0.3-milliamp, 3-volt signal switches a 2 kilowatt load.

The relay is compatible with transistor-transistor logic, and has a contact resistance of 100 milliohms.

In many applications, the series 6 needs no heat sink. At room temperature, for example, it'll switch 11 amps with no outside help.

Teledyne says that there's no reason why these relays, like other solid state switches, shouldn't live forever since they have no moving parts. Samples of the series 6 under test at Teledyne have passed the million-operation mark, and Teledyne is specifying the relay for 100 million operations.

Teledyne claims that the series 6 is "rugged," and is touting it for a place in industry. Some suggested applications are in level detectors, multivibrators, and transducers. The series 6 is good for controlling lights, adds Teledyne, since it can handle high inrush currents.

The price of samples is \$40; in large quantities, the relay costs \$20. Depending on the size of the order, delivery time ranges from stock to 10 weeks.

Teledyne Relays, 3155 West El Segundo Blvd., Hawthorne, Calif. 90250 [350]

Now! SAGE OFFERS MICROCIRCUITS as good as Sage Miniaturized Resistors!

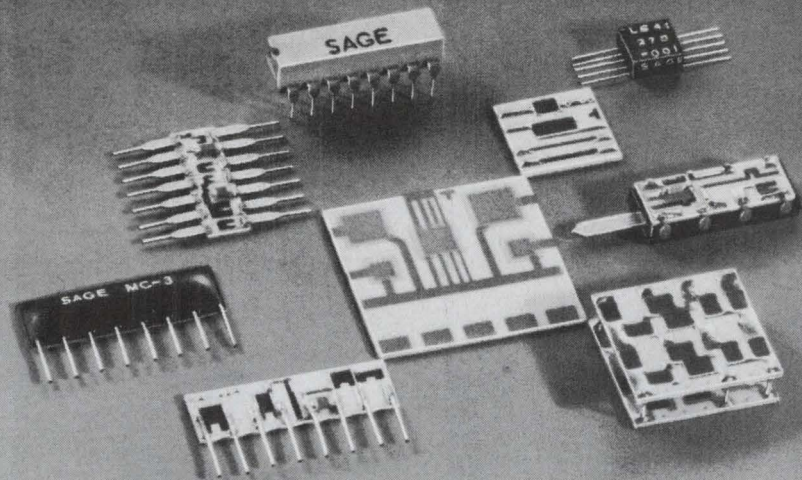

A bold claim, perhaps, but well-founded. For in designing and producing our new Sage Thick Film Hybrid Microcircuits, we apply years of pioneering experience in the field of miniaturized electronic components. The same traditions of quality and technology which have enabled Sage Resistors to set standards of reliability are their birthright.

Among the characteristics of Sage Microcircuits are:

- CUSTOM CIRCUIT DESIGN
- PROVEN RELIABILITY
- HIGH CIRCUIT DENSITY
- PASSIVE AND ACTIVE CAPABILITY
- PACKAGING VERSATILITY

When microcircuitry application demands quality, maximum performance, minimal size, new, improved packaging . . . and economy . . . Sage now offers a completely qualified, reliable source of supply. We welcome the opportunity to discuss your requirements. Sage Electronics Corp., Box 3926, Rochester, N. Y. 14610 Tel: (716) 586-8010

A leader in Microcircuitry

SAGE ELECTRONICS

SUBSIDIARY OF GULTON INDUSTRIES, INC.

Normal Mode Noise Clouding Your Low-Level DC Measurements?

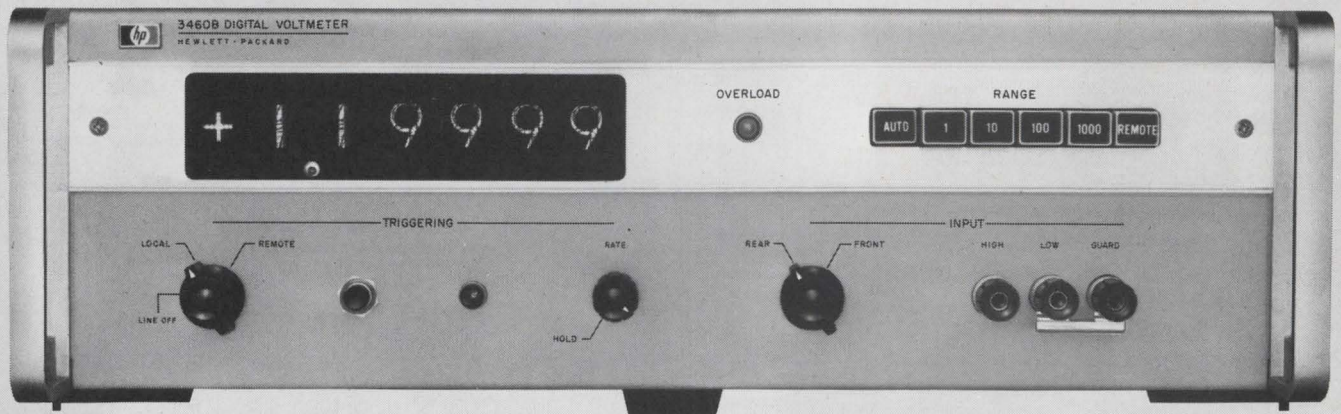

Not Here! The HP 3460B was introduced as a super accurate, 5-digit voltmeter. To make 0.004% of reading accuracy practical, a dual technique was utilized—integrating and potentiometric. The integration technique in itself gave a high common mode rejection of 160 dB at dc.

Now HP has added a filter option which is a programmable filter that cancels out frustrating noise picked up by leads and input devices. This

filter effectively adds 26 dB of ac normal-mode rejection at 60 Hz to rejection provided by integration. Now you can accurately measure low level dc signals with as much as 100% of range (peak) ac riding on the measured dc signal.

Other features of the 3460B include a sixth digit for 20% overranging, automatic polarity selection, four ranges from 1 V to 1000 V, guarded inputs, 15 readings per second (without filter) fully programmable functions with BCD output for systems compatibility.

To make the 3460B a multiple function DVM, add the HP 3461A AC/Ohms Converter-DC Preamplifier. Measure 0.1 V dc voltages with 1 μ V sensitivity, 50 Hz to 100 kHz ac measurements with 10 μ V sensitivity, and resistance measurements from 1

k Ω to 12 M Ω with 10 milliohm sensitivity on lowest range.

If you're interested in a precision DVM, look up the 3460B in your HP catalog. If you're interested in adding the filter option to pick low level dc out of noisy environments, call your local HP field office. (Price HP 3460B, \$3800; 3461A, \$2400. 3460B Option 002 or 003 is required for operation with 3461A. Price option 002 or 003, \$150. Filter option prices on request.) Or for a data sheet, write to Hewlett-Packard, Palo Alto, California 94304. Europe: 1217 Meyrin-Geneva, Switzerland.

099/1

HEWLETT  PACKARD
DIGITAL VOLTMETERS

Counters cover 0.05 hertz to 500 Mhz

Top-of-the-line unit measures radio frequencies as weak as 0.5 mv; coupling circuits for digital logic systems offered as options

There's something for nearly everyone who has to measure frequencies in the new line of automatic counters developed by Dana Laboratories. Designated the series 8100, the family of general-purpose instruments comprises four models ranging in price from \$1,495 to \$3,045 and in frequency from 0.05 hertz to 500 megahertz. All models have eight digits of display.

Dana says its counters are designed to fill a gap between low-cost manual and high-cost automatic counters. The Dana instruments—like other automatic units—are suited for measurement of low frequencies from such sources as flow meters and subcarrier oscillators in telemetry systems. They'll also set up precise audio frequencies for response testing of filters

and amplifiers.

The series 8100 instruments can measure the output of r-f oscillators without requiring a buffer amplifier, and they can measure a transmitter frequency by using a loop antenna in lieu of connections to the transmitter.

Model 8130, the top of the line, measures frequencies from 0.05 hertz to 500 Mhz and resolves

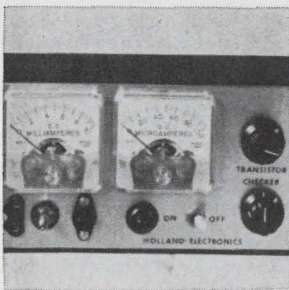

Transistor tester TT285 checks for npn or pnp configurations, shorts, opens and gain. It includes two 1 5/8 in. square ammeters, 0-100 μ a base current and 0-10 ma collector current. A potentiometer, as part of a voltage divider circuit, applies current to the base connection. The unit measures 2 1/2 x 5 3/4 x 3 in. Holland Electronics 842 E. 94th St., Brooklyn. [361]

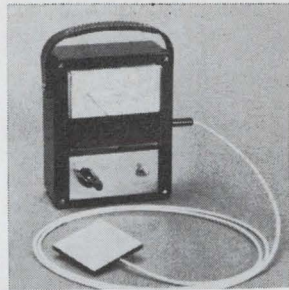

Thermal instrument model H-1 Heatprobe measures heat loss directly. It features 1/2% repeatability, accuracy of 2 1/2% and a maximum testing temperature of 275° F. No power supply is required. Three heat loss ranges provide direct reading between 0-50, 0-500 and 0-5,000 Btu/hr ft². Basic price is \$274.50. International Thermal Instrument Co., Del Mar, Calif. [362]

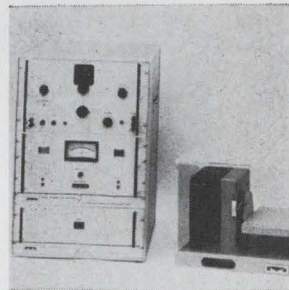

Single-axis portable flight motion simulator model 12A features less than 0.0025° threshold and 0.01° accuracy. It can statically and dynamically test gyros, accelerometers, flight control systems and guidance packages. The equipment can be driven by an analog computer, tape recorder or function generator. McFadden Electronics Co., 8953 Atlantic Blvd., South Gate, Calif. [363]

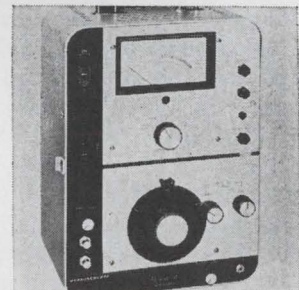

Standard deviation meter 140A is designed to accurately measure the peak frequency deviation of f-m communications transmitters. The output system includes a 750 μ sec de-emphasis network which allows the unit to be used as a standard test receiver. The meter has direct reading ranges of 0 to 5 khz and 0 to 20 khz. Measurements, McGraw-Edison Co., Box 180, Boonton, N.J. [364]



Digital weight readout DS-100-T2 provides readout directly in pounds, kilograms, or other engineering units when connected to strain gage load cells. It contains digital transducer conditioning including bridge excitation, balance and span, and millivolt per volt ratiometric measurement and readout circuitry. Doric Scientific Corp., 7969 Engineer Rd., San Diego, Calif. 92111. [365]

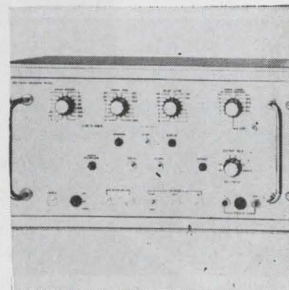

Signal averagers models 101/102 are used to pull out the signal-to-noise ratio of low level repetitive signals buried in a high background noise. Both can sample at intervals as fast as 2 μ sec, yet handle slower sweeps with samples taken up to 100 msec apart. Aperture time is 20 nsec, with resolution to a 7-bit binary. Biomation, 1076 East Meadow Circle, Palo Alto, Calif. 94303 [366]

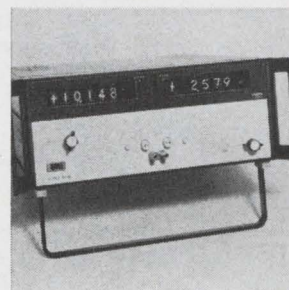

Automatic capacitance bridge C357 is a 1-khz unit with four-digit resolution, five-terminal connections, and an on-range measurement time of only 150 msec. It measures capacitance from 0.1 pf to 15.99 μ f and dissipation factor from 0.00001 to 0.15999. Basic accuracy is $\pm 0.1\%$ for capacitance, $\pm 0.2\%$ for dissipation. Teradyne Inc., 183 Essex St., Boston, Mass. [367]

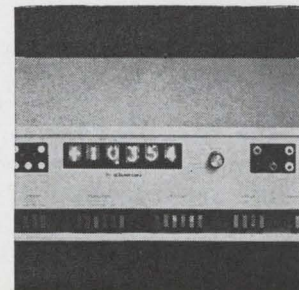

Digital multimeter 6653A is an all IC logic 4-digit instrument with fifth digit, 10% overrange. The basic unit measures d-c and d-c/d-c ratios with an accuracy of ± 1 digit from 0 to 1099.9 v. The unit is standard 19-in. rack mount. Price of the basic unit is \$1,740; delivery, 30 days. Lear Siegler Inc., Cimron Division, 1152 Morena Blvd., San Diego, Calif. 92110. [368]

0.1 microsecond. Its front-panel switches except the power switch, can be remotely controlled by transistor-transistor-logic.

The model 8130 measures to 500 Mhz at signal levels as low as 0.5 millivolt.

The company says that the average accuracy of the new line, 2×10^{-7} of the reading, is about three times better than that available in

manually operated counters over the 10 kilohertz-10 Mhz frequency range, and at a lower cost.

Pricing for the series is: model 8100, 50 Mhz maximum frequency, 10 mv sensitivity, \$1,495; model 8110, 50 Mhz maximum frequency, 10 mv sensitivity, time interval function, \$1,745; model 8120, 500 Mhz maximum frequency, 0.5 mv sensitivity, \$2,395; model 8130, 500

Mhz maximum frequency, 0.5 mv sensitivity, time interval function, \$2,695. All four models are available with digital logic system interface for an additional \$350. Models with the interface are designated 8104, 9114, 9124, and 8134.

Delivery begins in August.

Dana Laboratories Inc., High Frequency Division, 2401 Campus Drive, Irvine, Calif. [369]

New instruments

Controllers have built-in safety

Figuring they have found a way to boost the process-control instrumentation business off the plateau it has been on in recent years, Honeywell officials have taken the wraps off an ambitious line of more than 40 miniature control instruments. The modular units will be marketed under the name VutroniK.

Officials at Honeywell Inc's Industrial division are confident their new series of indicators, controllers and interfacing units will put some steam into their sales. The company has set its sights on a single goal: Woo the chemical processing industry to electronic controls. Chemical and oil firms are wary of anything that would bring electricity—and potentially disastrous sparking and arcing—anywhere near volatile and flammable compounds.

To overcome this fear, Honeywell designed its line with "intrinsic safety" as its basic requirement. This means that in the event of a malfunction, the equipment cannot unleash enough energy to pose a safety hazard. Every unit in the VutroniK line meets the safety standards of the National Fire Protection Association, as well as the recommended practices of the Instrument Society of America.

VutroniK units are the first to be offered with built-in intrinsic safety as a standard feature, says James E. Myers, vice president and general manager of the division. Power supplies, for example, are limited to 30-volt outputs.

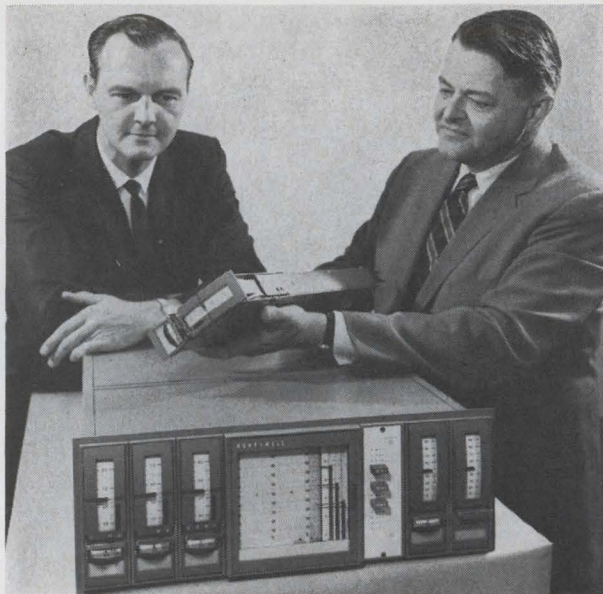

Modular. New line of compact instrumentation for process control is designed to be compatible with computerized systems. Viewing one module are Honeywell vice presidents James E. Myers, right, and Jack T. Teed.

Holding the line. The key to voltage supply limitation is a special power supply circuit. A single-primary, triple-secondary stepdown transformer feeds a-c voltage to a full-wave rectifier and filter, supplies 24 volts for pen recorders, and isolates the control power from a 120-volt line. The filtered d-c is fed to a regulating amplifier that compares it with a reference voltage; a silicon controlled rectifier compensates for any overvoltage. Overcurrent is limited by using the voltage drop across a precision resistor that is inserted in series with the load. When an overcurrent is sensed, a current-limiting amplifier takes over from the voltage regulator. Thus, the output current is kept safe even when the output is

completely shorted out.

Two, not one. Myers says the VutroniK line is the first to offer two control algorithms in its controllers. One controls the dynamics of conventional processes. The other causes a gradual change in output with set-point changes, thus avoiding step changes that could upset critical control loops.

With the exception of the one-, two- and three-pen recorders, which are 6-by-6-inch modules, the rest of the line comprises 2-by-6-inch modules. Included are vertical scale indicators, deviation indicating controllers, manual control stations, direct digital control stations, and ratio/bias stations.

Honeywell Inc., Industrial Division, Fort Washington, Pa. 19034 [370]



TRIMPOT®

Single Turn
POTENTIOMETERS

... ARE SUPERB!!!

We think "superb" is just the right word when we talk about Trimpot single-turn potentiometers. They have outstanding specifications. For instance, our 8 single-turn models range in diameter from 1/4" to 1/2"; have wirewound, cermet or carbon elements; cover the temperature range from -55 to +175°C; are available in resistance ranges from 10 ohms to 1 megohm; and have a power rating from 0.25 watt to 1.0 watt.

Technically, that says a lot for our single-turns. But there's more. There's a Bourns unit to answer every single-turn application . . . competitively priced . . . ready for immediate delivery from factory or distributor stocks.

Find out the entire single-turn story from the factory, your local stocking Bourns distributor, or field representative.



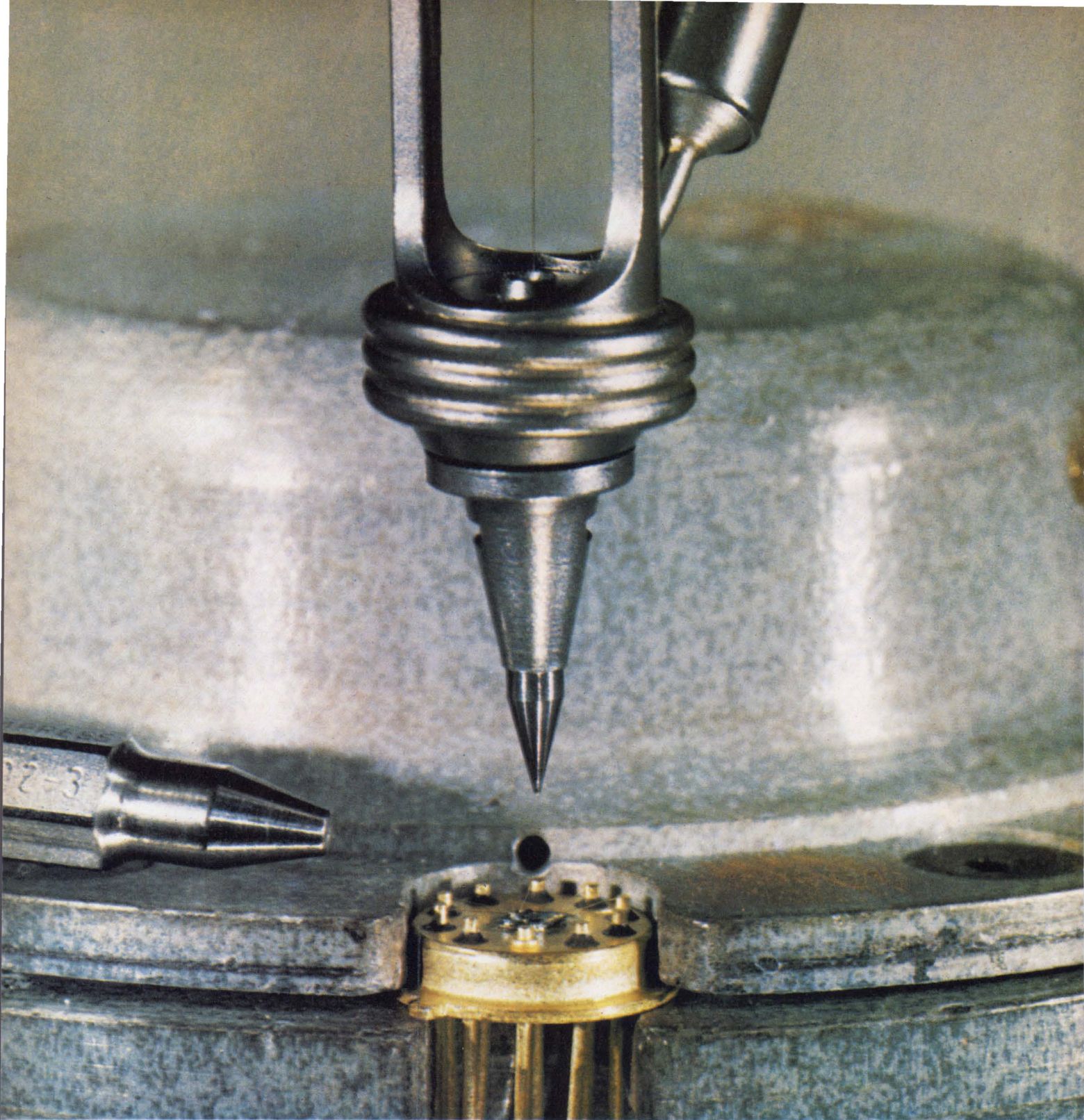

At .0008" Dia. . . . there is no second source

The tungsten carbide capillary tip and its complete family of accessories for thermal compression nailhead bonding was created and introduced by Tempress in 1963. . . . Only from this pioneering source can you purchase the entire system, designed from the beginning to give maximum efficiency: tungsten carbide capillary tip, heated shank and power supply that provides constant capillary temperature from 0° to 350°C, testing pyrometer for the tungsten carbide tip, capillary unplugging fixture and punches, and flame-off torch with sap-

phire orifice insert. Tempress also created and supplied the tungsten carbide ultrasonic bonding tool and pioneered its technology. . . . When you purchase Tempress miniature assembly tools and production equipment, you tap the ultimate source of high precision . . . the Tempress Standard of Excellence. In fields demanding high precision, such as semiconductor manufacturing, there is no second source.



TEMPRESS

Tempress Industries, Inc., 980 University Ave., Los Gatos, Calif. 95030

Op amp settling time is 80 nsec for gain of 1

High-speed inverting device for tv and radar applications
has gain-bandwidth product of 125 Mhz, output of 4 volts

Slewing rate and bandwidth, both important parameters of operational amplifiers, are usually recognized as such, but settling time frequently offers a more meaningful comparison—and this specification is often neglected.

That's why Computer Labs stresses the settling-time spec of its model FS-125. For a closed-loop gain of 1, the op amp will settle

to 0.1% of full scale in less than 80 nanoseconds.

The slewing rate indicates an amplifier's ability to respond to a step-function input. Fast amplifiers will slew at 100 volts per microsecond and above, but op-amp specs don't always include the limitations placed upon the user if he wishes to achieve these slew rates. If the amplifier is an invert-

ing type, as the majority of fast-slewing op amps are, it isn't always possible to get a fast response from the op-amp configuration. This is especially so when the feed forward resistance is high. When it is, even small amounts of stray capacitance can have an adverse effect on the slew rate.

Settling time specifies the amount of time required for the

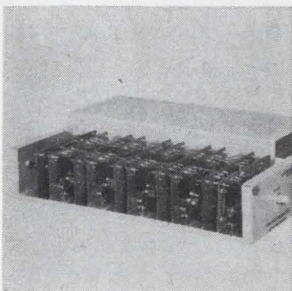

Logarithmic amplifiers series 200 convert 1-f/i-f signals to a d-c voltage that is directly proportional to the log of the input signal level. Units operate over a center frequency range of 100 to 250 khz with a bandwidth of 8 to 24 khz. They have a dynamic range of 80 db at a logarithmic accuracy of 2 db. Aerospace Research Inc., 130 Lincoln St., Brighton, Mass. [381]

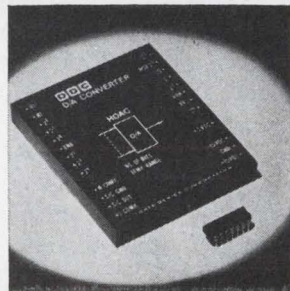

Modular d-a converters series HDAC are 8-12 bit devices that settle to 0.05% of full scale within 1 μ sec maximum. Both output amplifier and reference are internal. The module measures 2.625 x 3.125 x 0.4 in. high and is intended for p-c board mounting. Price (1-9) starts at \$200 each. Delivery takes 2 to 4 weeks. Data Device Corp., 100 Tec St., Hicksville, N.Y. 11801 [382]

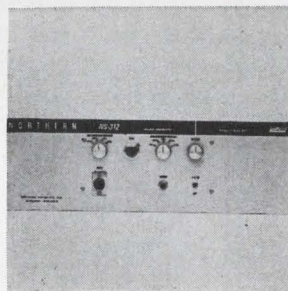

Low-level preamplifier type NS-312 is designed for biomedical applications where the signals are in the microvolt range. It has a maximum gain of 10,500. The low and high frequency cutoff are switch selectable. Common mode rejection is greater than 10,000:1 from 0.2 to 1 khz. Price is \$495. Northern Scientific Inc., 2551 West Beltline, Middleton, Wis. 53562 [383]

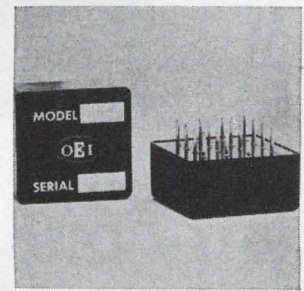

Sinusoidal function module model 5217A comes in a 0.5 cu in. package with a height of 0.5 in. It features $\pm 1\%$ static accuracy, $\pm 3\%$ dynamic error at 10 khz, and 100 khz useful bandwidth. Applications include trigonometric computers, sine and cosine generators, visual display rotation circuits, etc. Price is \$43 each. Optical Electronics Inc., P.O. Box 11140, Tucson [384]

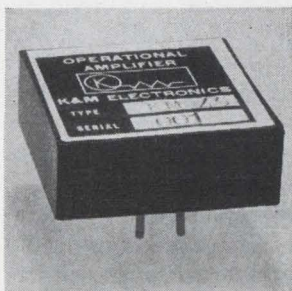

FET operational amplifier KM45 includes internal frequency compensation and short circuit protection. Features include a typical voltage offset drift of 10 μ v/ $^{\circ}$ C, bias current of 10 pa, voltage gain of 10⁶, and input impedance of 10¹² ohms. Unit is for instrumentation, integrator and general purpose application. K&M Electronics Corp., 408 Paulding Ave., Northvale, N.J. [385]

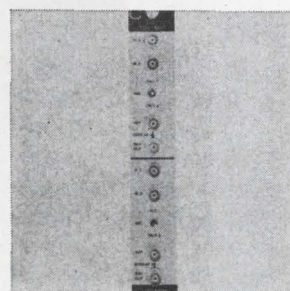

Dual AND model 170 is capable of resolving time coincidence of two inputs to better than 1.5 nsec at 200 Mhz with input widths 2 nsec or wider. Outputs are fast rise/fall time (1 nsec nominal) pulses with widths precisely equal to time coincidence overlap of the two inputs. The two sections are identical. Price is \$350. Chronetics Inc., Mt. Vernon, N.Y. [386]

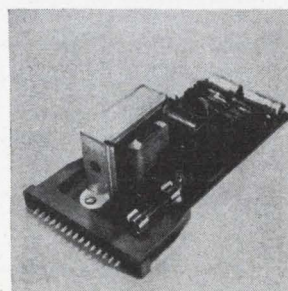

Dual power supply model 222A provides regulated ± 15 v d-c at 50 ma. It also provides unregulated ± 24 v d-c at 100 ma. The ± 15 v units are for use with operational amplifiers and similar equipment. The ± 24 v d-c output can be used to supply power output stages and as a source of unregulated relay drive voltage. California Electronic Mfg. Co., Alamo, Calif. 94507 [387]

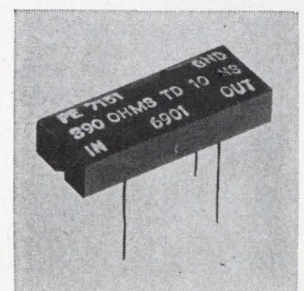

Distributed constant delay lines are designed to be compatible with dual in-line IC packaging. Standard units are available with 100 or 390 ohm impedances and delay times of 5 to 100 nsec. Distortion is 15% maximum; temperature coefficient, approximately 200 ppm/ $^{\circ}$ C. Prices are \$2.05 in 1,000 lots. Pulse Engineering Inc., Robert Ave., Santa Clara, Calif. 95050 [388]



Please send me the brand new 1969 Acopian catalog that lists

**82,000
DIFFERENT
POWER
SUPPLIES**

available for shipment in 3 days.

Name _____

Title _____

Company _____

Address _____

City _____

State _____

ZIP _____

ACOPIAN CORP.
EASTON, PENNSYLVANIA
TEL: (215) 258-5441



output of an amplifier to reach a certain percentage of its final value in response to a step-function input. High slew rates are relatively meaningless, Computer Labs points out, if the amplifier requires an excessive amount of time to settle within 0.1% or less of its final output. This ringing can nullify the speed advantages gained with the fast slew rates. Settling time is a closed-loop parameter and depends on the circuit feedback and gain. The larger the closed-loop gain, the longer the settling time required to reach 0.1% of full scale.

Some circuit designers desire settling time accuracies to 0.01%; however, most op-amp manufacturers are reluctant to specify these accuracies. The main disagreement centers around the precision of test equipment capable of measuring settling times of less than 1.0 microsecond.

No op amp is truly general purpose—in each case, something has to be compromised to gain the specially desired benefits. In the case of the FS-125, speed was not compromised.

The model FS-125 has the following settling times for closed-loop gains of 2, 4, 8, and 16: 150, 200, 400, and 500 nsec, respectively.

With an output voltage range of 4 volts peak-to-peak, the op amp can process a television signal at 1 volt peak-to-peak across 75 ohms, or handle radar signals of 2 volts peak-to-peak across 100 ohms.

The price is \$97 each in quantities 1-9.

Specifications

Gain-bandwidth product	125 Mhz
Slew rate	250 v/nsec
Voltage gain (d-c open-loop)	100,000 with 100-ohm load
Open-loop roll-off	6 db/octave
Output voltage range (± 15 -v supply)	± 2 v into 100 ohms, ± 3.5 v into 1,000 ohms or greater
Output voltage range (± 12 v supply)	± 1.5 v into 100 ohms, ± 2.0 v into 1,000 ohms or greater
Input-output structure	single-ended, inverting only
Input voltage offset	3 mv max (no adjustment required); vs. temperature, $10\mu\text{v}/^\circ\text{C}$
Input current offset	100 na max; vs. temperature, 20 na/ $^\circ\text{C}$
Temperature range (operating)	0 to 50°C
(storage)	-60 to $+125^\circ\text{C}$
Power source	± 12 v to ± 15 v

Computer Labs, 1109 South Chapman St., Greensboro, N.C. 27403 [389]

New subassemblies

Readout says it big and wide

Rear-projection display has characters 2 inches high, 160° viewing angle

Jumbo characters are an additional aid to easy viewing in a rear-projection readout developed by Industrial Electronic Engineers Inc.

The single-plane display module, designated IEE series 360H, can be read easily from more than 50 feet away.

Its characters are 2 inches high, yet the 360H measures only 3 inches high by 2 inches wide by nearly 8 inches deep. The 160° viewing angle permits the display to be read from almost any position in a room.

The 360H has 12 different display positions. Anything that can be put on film, such as numbers, letters, symbols, and words, can be displayed in any combination. White is the standard color, but others are available. Brightness varies from 13 to 40 foot-lamberts depending on the lamp that is used.

Input to the 360H can be straight binary, decimal, or binary-coded decimal.

The company has several driver-decoder models that are designed to match the readout. These units accept a binary coded input, translate it into decimal, and light the proper lamp in the readout to display the desired character. The driver/decoders are available with or without memory, with negative or positive voltage, and with 8, 10, or 12 decoded outputs.

A quick-disconnect lamp assembly makes replacement easy and makes it possible to snap a different readout into position on the present lamps.

Price of the 360H is \$38.50 each for 1-9 units, \$27 for 1000 and more. Delivery time for standard units is 30 days.

Industrial Electronic Engineers Inc., 7720 Lemona Ave., Van Nuys, Calif. 91405 [390]

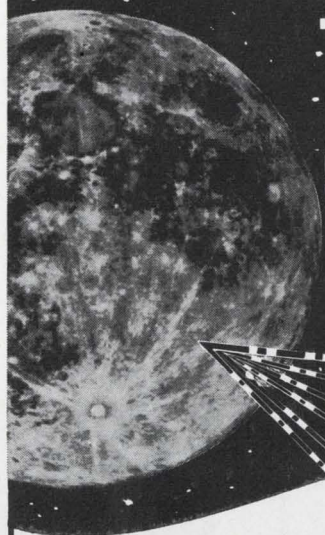

The first
SEISMIC DATA from the

MOON

...will be analyzed
by these
**VARIABLE FREQUENCY
ELECTRONIC FILTERS**
by Rockland Laboratories

NASA's Spacecraft Center and several university data centers will use these filters for real time processing and magnetic tape analysis of seismic data transmitted from the Apollo lunar landing site. Some reasons for choosing Rockland are listed below.

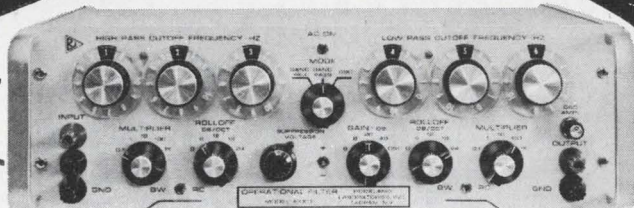

OPERATIONAL FILTER

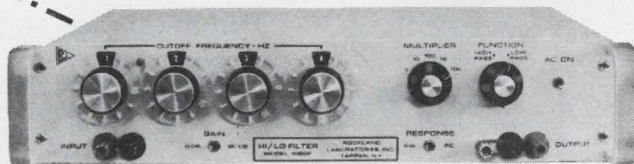

HI/LO FILTER

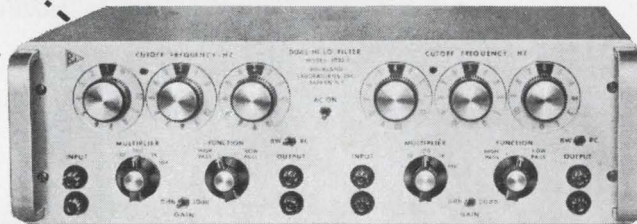

DUAL HI/LO FILTER

OPERATIONAL FILTER

- Functions as a variable filter or sine wave oscillator
- Tuning range: .001 Hz to 11 KHz (bandpass DC to 100 KHz)
- High pass, low pass (DC coupled), band pass and band reject responses with digital frequency selection
- Adjustable rolloffs (0, 6, 12, 24, db/octave)
- Butterworth or RC response
- Variable gain (0, 6, 20, 40 db)
- Zero suppression
- 2% frequency setting accuracy
- Silicon solid state
- AC (115/230 V) or DC operation
- Bench/rack convertible
- Price range: \$1325.00 to \$1650.00

HI/LO FILTER

- High pass or low pass (DC coupled) response with digital frequency selection
- Tuning range: .001 Hz to 111 KHz (bandpass DC to 1 MHz)
- Rolloff: 24 db/octave
- Butterworth or RC response
- Variable gain (0, 20 db)
- 10 megohm input impedance
- 2% frequency setting accuracy
- Silicon solid state
- AC (115/230 V) or DC operation
- Bench/rack convertible
- Price range: \$695.00 to \$745.00

DUAL HI/LO FILTER

- Two identical and independent filters in one chassis. Sections can be used separately or connected in series or parallel
- High pass, low pass, band pass and band reject responses with digital frequency selection
- Tuning range: .001 Hz to 111 KHz (bandwidth DC to 1 MHz)
- Rolloff: 24 or 48 db/octave per filter section
- Butterworth or RC response
- Variable gain (0, 20 db per section)
- 10 megohm input impedance
- 2% frequency setting accuracy
- Silicon solid state
- AC (115/230 V) or DC operation
- Bench/rack convertible
- Price range: \$1325.00 to \$1425.00 for 24 db/octave rolloff \$1825.00 to \$2025.00 for 48 db/octave rolloff

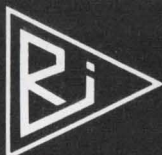

ROCKLAND LABORATORIES, INC.

POST OFFICE BOX 57 • TAPPAN, NEW YORK 10983 • TEL: 914-359-1818

Precision instruments for engineering and the physical sciences

COMPLETE AND COMPACT

W-J's NEW MODEL 112

MICROWAVE RECEIVER

- W-J's first complete, single unit microwave receiver, with modular tuning heads installed with simple hand tools.
- Receives AM, FM and pulse signals.
- Compact. Fits in a standard 19-inch rack. Only 3½ inches high.
- 4 tuning heads. Cover 1 to 2 GHz, 2 to 4 GHz, 4 to 8 GHz and 8 to 12 GHz. An optional head is available to cover 2 to 4.5 GHz.
- 6 IF bandwidths: 500 kHz, 1 MHz, 2 MHz, 4 MHz, 10 MHz, 20 MHz, selectable.
- 2 IF outputs: 21.4 MHz and 160 MHz for both wide and narrow band external monitoring.

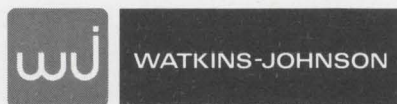

CEI DIVISION

6006 Executive Blvd., Rockville, Md. 20852

World's largest selection of receiving equipment for surveillance, direction finding and countermeasures.

1
to
12
GHz



Computer aids instruments in tasks from a to d

Easy-to-operate miniprocessor for real-time data conversion can be preprogrammed for process-control, scientific, medical inputs

Murphy's law says if something can go wrong, it probably will. Engineers at Beckman Instruments Inc., had this in mind when they designed the model 816 minicomputer. They reckoned that if the computer is easy to operate, chances are that it will be operated correctly. This led to the 816 having only two control switches—an off-off switch with a key to

prevent unauthorized program changes and a four-position switch for load-reset-stop-run functions. Even a relatively unskilled operator can handle the machine without running the risk of fouling up the work.

A general-purpose computer, the 816 has a memory cycle time of 5 microseconds, and add time of 45 μ sec, a store command time of

32 μ sec, and a skip and testing time of from 45 to 52 μ sec.

This makes the 816 slower than others in its class of small general-purpose computers. But, say Beckman engineers, their machine can accept inputs from a wide range of sophisticated analog sources including scientific and medical instrumentation—as well as from process-control sensing devices

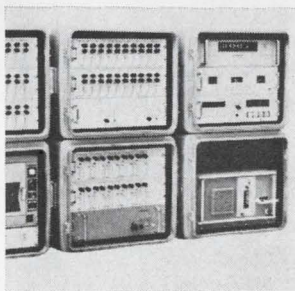

Multichannel transducer data acquisition system model SY-156(P) provides optimum portability. All system components are installed in rugged enclosures that serve as shipping containers by latching the covers in place. The system accepts inputs from strain gages, thermocouples, and can accommodate frequencies and a-c signals. B&F Instruments Inc., Cornwells Heights, Pa. [421]

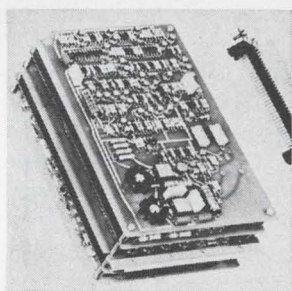

Four-microsecond random access memory system FI-2 is a 1024 word by 8 bit/word ferrite core assembly built on five interconnected circuit cards and designed to slide into a card cage or mounted remotely. Access time is 600 nsec. Power required is ± 12 v at 3 amps. Size 8 $\frac{3}{8}$ x 4 $\frac{7}{8}$ x 3 $\frac{3}{8}$ in. North American Philips Co., Ferroxcube Systems Div., Englewood, Colo. [422]

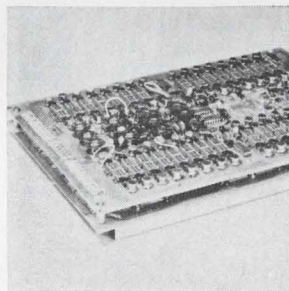

Core memory model 140 features 900 nsec full cycle time and 300 nsec access time. Modular design permits a wide range of word capacity/word size memory systems from this basic building block. Capacity of the module is 4,096 words x 8, 9, 10 bits. Unit measures 8 $\frac{5}{8}$ x 17 $\frac{5}{8}$ x 12 $\frac{1}{2}$ in. and weighs 3.5 lbs. Micro Systems Inc., 644 E. Young St., Santa Ana, Calif. 92705. [423]

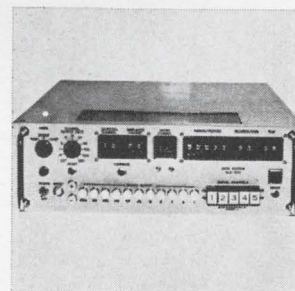

Self-contained data logging system DLS-500 will simultaneously accept and multiplex up to 20 analog and 5 digital inputs and provide outputs in IBM computer-compatible form capable of driving most incremental magnetic tape recorders. Each analog input is converted into digital data 11-bit plus sign. Applied Electro Mechanics Inc., 2350 Duke St., Alexandria, Va. 22314. [424]

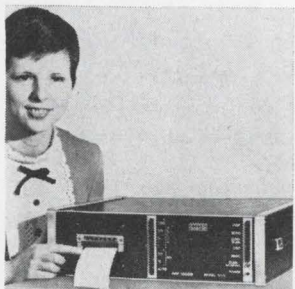

Multichannel data logger model DL-2 provides for automatic and precise measuring and recording. It is designed with a digital display and a printed record of up to 100 different electrical signals. Monitoring speed is normally one signal per second and intervals between scans can be adjusted up to 5 minutes duration. P/P/M Inc., 7016 Euclid Ave., Cleveland 44103. [425]



Noiseless, high-speed display/tape system series 5700 eliminates separate verification and enables ordinary typists to prepare error-free paper tapes. It features a television-like screen which displays an exact replica of a source document and provides visual verification of all typed data before it is punched on tape. Sanders Associates Inc., Nashua, N.H. 03060. [426]

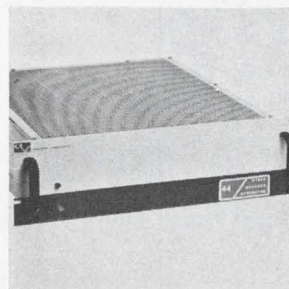

Video message generator series 44 is for communication and data systems. It converts alphanumeric data or messages in the form of standard teletypewriter codes to a visual display on a standard tv monitor or commercial tv set. Only 5 $\frac{1}{4}$ inches of panel space is required and power consumption is less than 35 w. Data Technology Corp., 1050 East Meadow Circle, Palo Alto, Calif. [427]

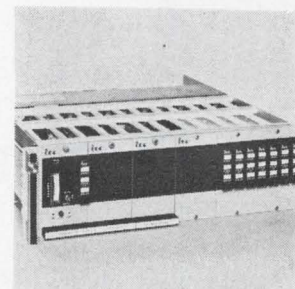

Tape data synchronizer 2755 provides coherent clocks for data processing systems where precise signal analysis or output display is required from unstable data containing record/reproduce errors. The unit tunes to all standard tape playback speeds over input reference frequencies from 3.125 to 400 khz. Interstate Electronics Corp., E. Vermont Ave., Anaheim, Calif. [428]

The geniuses who perfected the Dalic selective plating process certainly had electronic manufacturers in mind.

If Sifco's Dalic process of electroplating had just one reason for existence, one might say it was to make life pleasanter for electronic manufacturers, their operations more profitable. ■ Pleasanter, because the Dalic process is designed to be an integral part of the electronic manufacturer's setup, ready for plating jobs anytime. ■ Profitable, too, because—being portable—it saves masking, dismantling and processing time . . . saves sending parts out and waiting for them to come back. ■ With Sifco's exclusive Dalic process, makers of electronic equipment can spot-plate gold, silver,



rhodium or other metals directly onto conductive surfaces . . . without disturbing the assembled components. ■ The Dalic electroplating process consists of power pack, tools and electrolyte solutions. Applying metal coatings with this "package" is easily mastered with a minimum of training and no previous experience. ■ The thickness of deposited metals can be accurately controlled to as fine as 0.000010 inches. ■ Additional information on the Sifco Dalic process for electronic equipment sent on request.

Sifco Metachemical

935 East 63rd St. • Cleveland, Ohio 44103
Phone 216/881-8600 and 216/431-0306
TWX 810-421-8464

DIVISION OF
SIFCO
INDUSTRIES, INC.

Circle 214 on reader service card



ELECTRO-OPTICS ENGINEERS

Comprehensive knowledge of detectors, optics and scanning techniques. Design of near, intermediate and long-wave IR systems with experience in effects of launch environments on sensor systems. □ For more information please write Mr. H. W. Bissell, Professional Placement Manager, P.O. Box 504, Sunnyvale, California 94088. An equal opportunity employer.

LOCKHEED
MISSILES & SPACE COMPANY
A GROUP DIVISION OF LOCKHEED AIRCRAFT CORPORATION

and numerical control equipment. They claim the 816 has a far greater analog-to-digital and digital-to-analog-conversion capacity than can be found elsewhere.

The computer digitizes incoming data immediately, thus preventing the losses in accuracy usually associated with analog input circuits, says Paul S. Mitzen, head of Beckman's systems application group. Conversation accuracy is ± 0.2 percent.

Optional with the 816 are two inside-the-cabinet plug-in modules for analog scanning and conversion. One module has a 19-bit binary output plus sign. Most computers in the 816's class have 14-bit outputs and black box a-d converters outside the computer frame, according to Mitzen.

The module employs double digitizing for increased accuracy. The first 11 bits are digitized and fed to the a-d converter before the remaining eight bits are digitized and sent along. Analog signals from up to 16 channels are converted at a resolution of 1:500,000; the scan rate is 64 channels per second full scale. For faster scanning (1,000 channels per second) at a lower resolution the optional module having an 11-bit binary output plus sign, can be used.

The computer includes a 2,000-word core memory; optional is an additional 2,000-word memory. A dual d-a converter and storage card operates as two eight-bit units at ± 10 volts full scale or as a single 16-bit unit. An optional universal input card, however, accepts 32 bits maximum (parallel) and operates at 5 volts. Several software packages are available so that the 816 can be completely preprogrammed before delivery.

"Initial loading and testing at the factory eliminates the need for customer loading of a bootstrap program," says Mitzen.

The basic computer is priced at \$8,800 and weighs 60 pounds, with the entire mainframe comprising five 8-by-10-inch printed-circuit boards that plug into a mother board. Fairchild Semiconductor's series 930 diode-transistor-logic is used.

Delivery time is 30 days.

Beckman Instruments Inc., Electronic Instruments division, 2400 Harbor Blvd., Fullerton, Calif. 92634 [429]

Data handling

Strobing signal smooths data rate

Recorder uses optics
to control flow
from temporary storage

The increasing number of digital data sources requires recorders with higher storage capacity, faster recording rates, uniform data packing, and mechanical simplicity and reliability. A system designed by Mobark Instruments with those requirements in mind will be available in September. The new recorder will accept random data from analog-to-digital converters, Dataphones, teletypewriters, and other business and scientific inputs.

The device, known as the syncmental digital magnetic tape recorder, uses an optical system to synchronize the flow of serial data into the magnetic head with the speed of the magnetic tape.

The synchronization technique depends on a slotted disk fixed to a capstan shaft that is driven by a stepper motor. As the disk rotates between a light source and a photocell, the resulting electrical signals govern the current flow through the recording head.

Incoming data enters a buffer, from which it is withdrawn by a strobing signal from the photocell. Because the strobe timing is established by the slotted disk, it is directly related to the instantaneous position of the tape. Thus, the data is recorded densely and uniformly on a magnetic tape with no chance of bit or character overlapping, even though the drive capstan speed may vary slightly.

The system uses standard two-track tape cassettes and can store 140,000 characters per cassette. The writing speed is up to 120 characters per second while the replay speed can be anywhere from 10 to 300 characters per second.

The price will be under \$2,000.

Mobark Instruments Corporation, 1273
Terra Bella Ave., Mountain View, Calif.
94040 [430]

Billy Helms is just one of the 42,146 highly skilled workers trained in state-sponsored technical schools last year.

Trained absolutely free for South Carolina industry.

Trained for the very machines they'll be using.

Trained and ready to go on opening day.

Before you decide where and when that opening day will be, you'll want to know more about plant sites, construction, transportation, electric service, tax rates and Billy Helms.

Find out more.

Mail the coupon today.

Mr. R. H. Kennedy, Vice President,
Area Development
South Carolina Electric & Gas Co.
Box 764 Dept. E
Columbia, South Carolina 29202

He's got the facts.

Name _____

Address _____

City _____ State _____ Zip _____

SOUTH CAROLINA OFFERS YOU IDEAL PLANT SITES, LOW CONSTRUCTION COSTS, GOOD TRANSPORTATION FACILITIES, ECONOMICAL ELECTRIC SERVICE, LOW TAX RATES, AND BILLY HELMS.

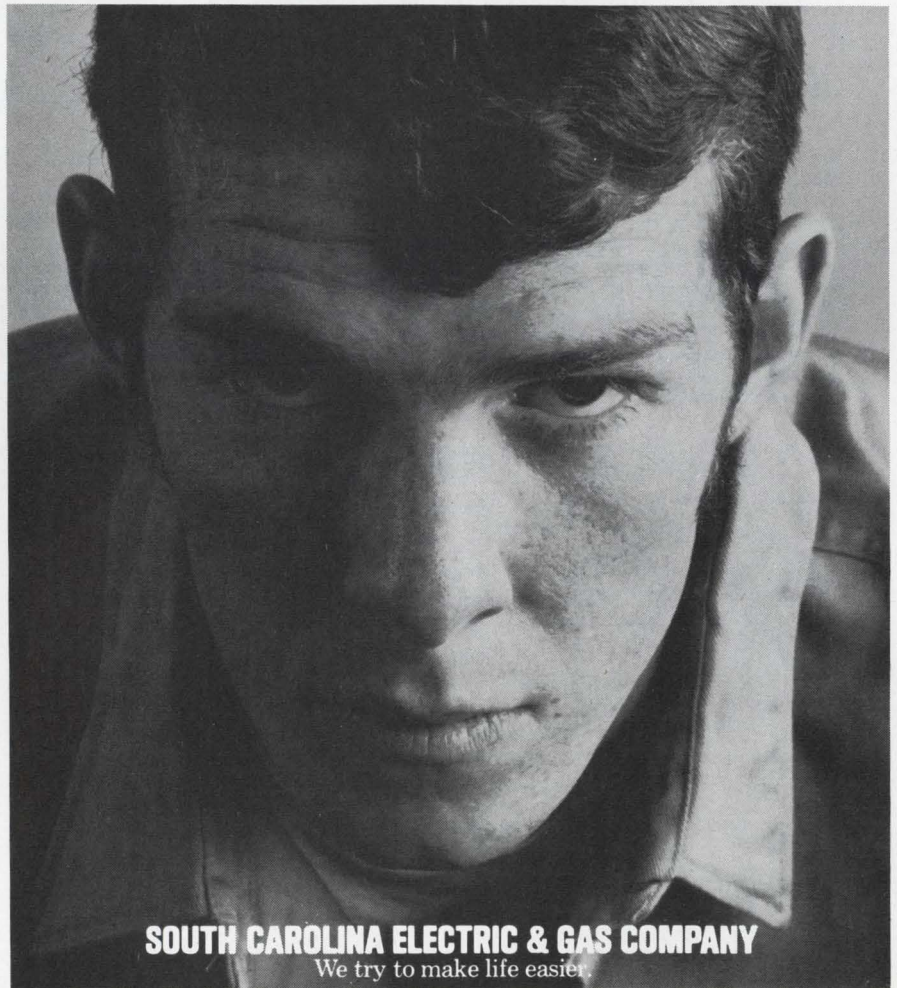

SOUTH CAROLINA ELECTRIC & GAS COMPANY
We try to make life easier.

Dielectric isolation is design key in IC line

Radiation Inc. uses process for component separation in standard circuits; 16-channel analog multiplier heads family of industrial-control devices

There's nothing new about the use of dielectric isolation in the manufacture of radiation-hardened integrated circuits.

But Radiation Inc. has decided that the process of using a thick layer of silicon dioxide instead of a p-n junction to separate components on a chip offers advantages for standard IC's also, despite a little extra cost. The resulting cir-

cuits are simpler in construction, diverse types can interconnect with less trouble, and they can be combined into systems more effectively, the company says.

The result of this conviction, a new family of circuits, represents Radiation Inc.'s initial entry into the commercial IC field. The line, to be introduced at Wescon in San Francisco, Aug. 19-22, includes a

16-channel analog multiplier, a party-line receiver, a high-slew operational amplifier, and an op amp with both accessible bias and offset terminals for precise compensation.

Perhaps the star of the show is the 16-channel analog multiplier, the RS-1000, which accommodates bipolar analog inputs and is compatible with standard DTL and TTL circuits. It's quite flexible: its 16-

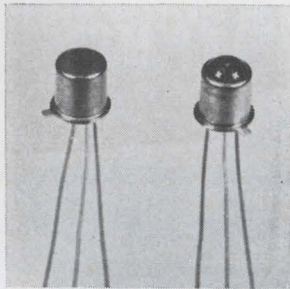
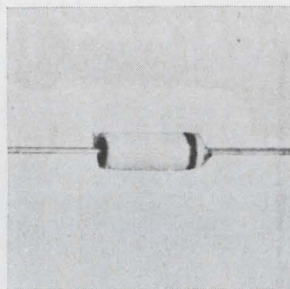
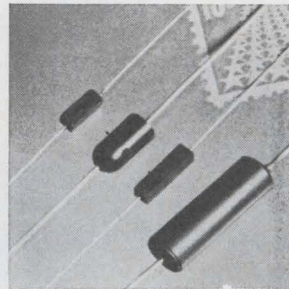

Photo scr's series PR30 and PF30 have a maximum light trigger intensity of 10 and 50 foot-candles respectively and provide high gains. Continuous current rating is 300 ma d-c; surge current, 5 amps. Operating temperature range is -65° to $+125^{\circ}$ C. Applications include tape and card readers, and optical encoders. Solid State Products, 1 Pingree St., Salem, Mass. [436]



Varactors series SQ5461A, by maintaining a leakage spec of less than 4 na at the 30 v breakdown rating, can be conveniently tuned with high impedance voltage sources. The diodes are available in standard nominal capacitance values from 6.8 pf through 100 pf. Price (1-99) is \$9 each; delivery, 2 weeks. MSI Electronics Inc., 34-32 57th St., Woodside, N.Y. 11377. [437]



High-voltage, medium-current avalanche type silicon rectifiers offer standard and fast recovery (300 nsec). They are rated at 100 and 200 ma continuous current from 2,000 to 10,000 v. The low leakage devices are designed for commercial and industrial use where low cost and high reliability are a premium. Atlantic Semiconductor, 905 Mattison Ave., Asbury Park, N.J. 07712. [438]

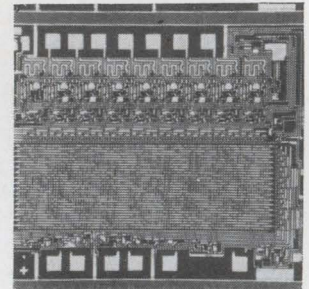

Random access, read only memory EA3000 is organized as 256 words, 9 bits per word (2304 total bits). Features include low power (90 mw typical at 1 Mhz), less than 1 μ sec access time over a temperature range of -55° to $+85^{\circ}$ C, variable output buffer voltage and bipolar output drive capability. Electronic Arrays, Inc., 501 Ellis St., Mountain View, Calif. 94040 [439]

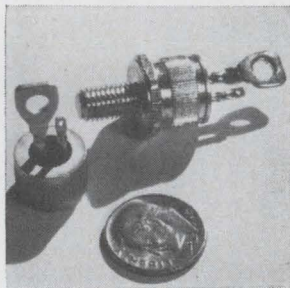

Twenty-five ampere triac thyristors SC60 (stud mounted) and SC61 (press fit package) offer a high surge current of 250 amps peak, high dv/dt and can handle up to 6 kw at 240 v. Voltage range is 200 to 500 v. D-c gate trigger current is rated at 50 ma maximum and d-c gate trigger voltage is 2.5 v maximum. General Electric Co., 1 River Road, Schenectady, N.Y. 12305 [440]

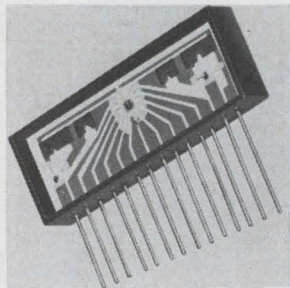

Dual power hybrid IC model MCH1002 is for interfacing high-threshold logic levels with electromechanical hardware. It features a maximum output current of 0.5 amp, a collector-emitter breakdown voltage of 40 v minimum a typical turn-on time of 115 nsec, and a typical turn-off time of 260 nsec. Motorola Semiconductor Products Inc., P.O. Box 20912, Phoenix 85036. [441]

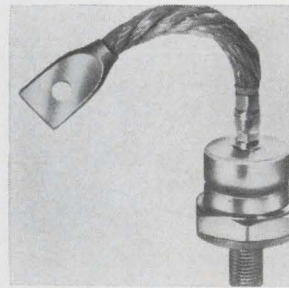

Silicon rectifier diode D0-8 has forward current capability up to 150 amps and prv ratings to 1,000 v. Freedom from thermal fatigue is achieved by use of a hard solder construction and matched thermal coefficients. The design utilizes the Solitron chip which features the hermetically sealed, glass passivated junction. Solitron Devices Inc., 256 Oak Tree Rd., Tappan, N.Y. [442]

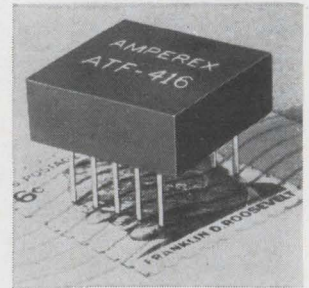

Hybrid IC video amplifier ATF-416 is for industrial applications. It offers a gain of 52+3 db from d-c to 10 Mhz and has a common mode rejection ratio of at least 40 db. Bandwidth with a 1,000 ohm, 20 pf load is 8 Mhz. Unit consists of two separate amplifiers in a single package, and eliminates external 'add-on' components. Amperex Electronic Corp., Cranston, R.I. 02920 [443]

The Standard of Excellence

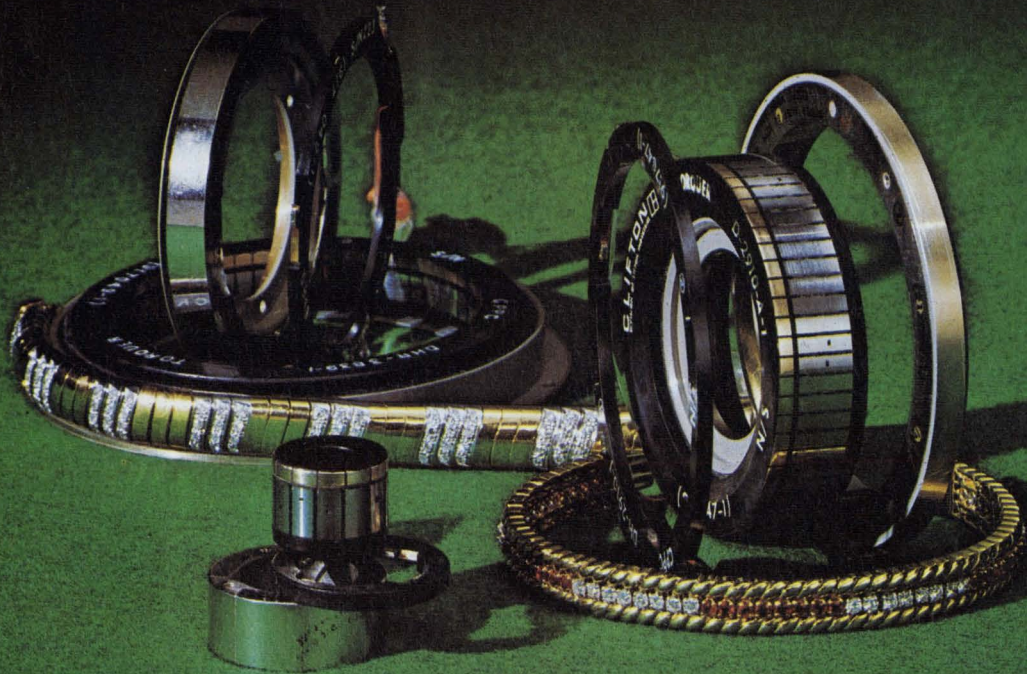

Torquers by Clifton

What makes Clifton torquers inherently excellent? We feel it's materials technology.

Of course, quality fabrication and electrical design are extremely important too. But Clifton long ago mastered the hollow shaft "pancake" configuration and the designing of optimum performance rotating components. It's our materials engineers who have provided our designers with the space-age materials and techniques which enable us to set a very high standard in torquers.

Consider the following characteristics.

□ **DOUBLE INSULATED HI TEMP (200°C) MAGNET WIRE** minimizes leakage current, gives superior insulation characteristics.

□ **MOLDED BRUSH BLOCK ASSEMBLY.** Brush blocks are completely interchangeable. Brush position on commutator is optimized.

□ **BRUSHES MECHANICALLY FASTENED TO BRUSH SPRING IN ADDITION TO SOLDERING** assures optimum brush alignment during soldering operation and a good mechanical and electrical bond between spring and brush.

□ **STABLE HI TEMP MOLDING MATERIAL** minimizes the movement of the windings under temperature variations. Material will not crack, thereby eliminating voids, exposed windings, dirt or humidity traps.

□ **SOLID GOLD ALLOY COMMUTATOR** insures consistent

low brush contact resistance over the life of the unit. Problems encountered in plating, such as gold migration and corrosive salts are eliminated.

□ **SPECIAL MAGNETIC MATERIAL ALLOY** permits higher torque per unit of volume, higher torque to inertia ratio, and will not corrode under high humidity.

Clifton's torquers are operational now in many of our nation's critical defense programs. Why not get Clifton excellence in your program too! Call your Local Clifton Sales Office or 215 622-1000.

CLIFTON 
DIVISION OF LITTON INDUSTRIES

Bracelets by J. E. Caldwell Co., Philadelphia—\$5600.

ECCOFOAM[®]

PLASTICS/CERAMICS FOAM CHART

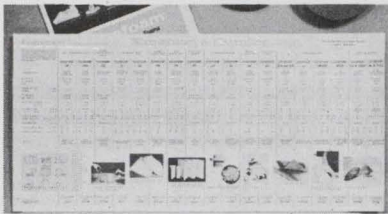

Complete physical and electrical data are displayed for eighteen foams—liquids, powders, sheet stock—plastics, ceramics and even artificial dielectrics. Fold-out chart in full color for notebook or wall mounting is yours.

Circle 495 on reader service card

FREE SAMPLE ECCOSPHERES[®]

Glass Microballoons[®]

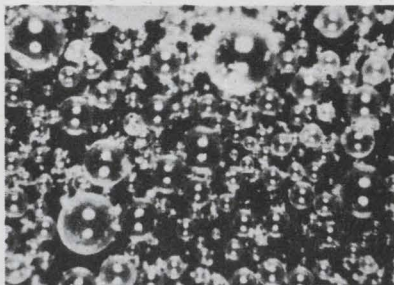

Micron sized hollow particles look like fine sand. Under the microscope they appear as in photo. The ideal filler for low weight and high strength. Excellent electrically and mechanically.

Circle 496 on reader service card

NEW BOOKLET DESCRIBES SURFACE COATINGS FOR ELECTRONICS



ECCOCOAT[®] Surface Coatings include transparents for PC boards and components; dip-coats for transformers and coils; easy-mix and one-part systems for automatic production; and a wide range of special properties such as 500°F capability; resistivities to 10¹⁴ ohms/sq. Several chemical types. Send for copy.

Circle 497 on reader service card

Emerson & Cuming, Inc.



CANTON, MASS.
GARDENA, CALIF.
NORTHBROOK, ILL.
Sales Offices
in Principal Cities

EMERSON & CUMING EUROPE N.V., Oevel, Belgium

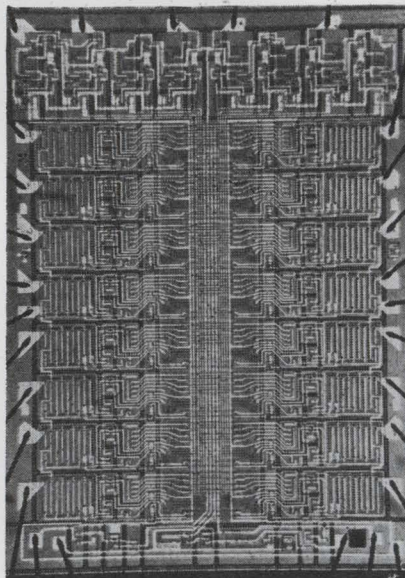
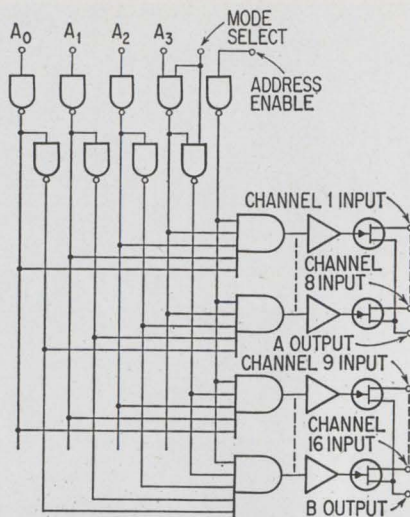

Multiplexer. Chip includes TTL gates, pnp/npn transistors, and junction FETs on single substrate.

analog inputs and 2 analog outputs can be used independently for 8-channel dual or differential operation, or bused together for 16-channel operation.

In addition to multiplexing, the circuit may also be employed as a demultiplexer where a one- or two-line input is commutated to an 8- or 16-line output. Random-access channel selection is accomplished through a 4-bit binary address input; an address-enable input can be used as an address expander for applications employing several multiplexer circuits. A mode control input is used to select either a single or a pair of channels. And an external bias control can be used for faster switching or to conserve power if the user doesn't require the full analog input voltage

range of ± 10 volts.

Highlights. Some of the analog switch parameters are 100 picoamperes input leakage in the "off" channel and 4 picofarads input capacitance; 500 ohms "on" resistance and an output capacitance of 40pf. And a fast access time, about 800 nanoseconds, allows for a commutation rate of 1.3 megahertz—twice that of MOS devices.

The multiplexer operates over the full military temperature range of -55°C to $+125^{\circ}\text{C}$, and the mechanical and environmental requirements of MIL-S-883 are satisfied by packaging in a ceramic, 28-pin, 50-mil centered hermetically sealed flatpack.

The second new IC, a "party-line" triple line receiver, the RA-248, should prove to be a flexible companion to Radiation's RA-245 and RA-246 line driver/receiver. The monolithic device allows the paralleling of many receivers along transmission lines in varying lengths—a capability that's useful in multiple digital transmission systems, and in half-duplex and discrete address operations.

It enables users to fan-out into 10-line receivers from a single RA-245 transmitter. In addition, it gives the designer a choice of either terminating the line externally with the RA-248, or internally using the 100-ohm termination in the RA-246.

The new "party-line" receiver uses a current-switching operating mode that, according to the manufacturer, provides good noise immunity. The company claims that as many as 15-line pairs can be run in a single shielded cable without digital crosstalk. And to make the output look like the standard DTL logic output, 6,000-ohm pull up resistors were used between the output collectors and the positive voltage supply.

Two high speed internally compensated monolithic IC operational amplifiers feature high slew rates and wide signal bandwidths. The RA-2510 has a unity gain slew rate of +150 volts per microsecond, a large signal bandwidth of 500 kilohertz, and a voltage gain of 15,000. The RA-2500 slews at +120 volts/ μsec at unity gain, has a large signal bandwidth of 200 khz and a voltage gain of 35,000.

Both amplifiers are available in either TO-86 or TO-99 package

styles, and have a unity-gain small-signal bandwidth of 15 Mhz, an offset current of 20 na, offset voltage of 2 millivolts, an output impedance of 100 ohms with a +20 ma output current capability. Also, external offset and bandwidth-control points are provided in addition to the internal MOS compensation capacitor.

Two new operational amplifiers, RA-3909 and RA-3909A, have the same characteristics as the RA-2909 and RA-2909A, and include external bias and offset terminals.

The new op amps, in TO-100 packages, like the rest of the 909 family, are internally compensated for stability—particularly in the critical unity-gain configurations—and are guaranteed not to latch-up. The open loop gain is typically per octave to unity gain at 7 Mhz. The output current drive is ± 20 45,000 and rolls off at 6 decibels ma, and the equivalent input noise is 3 μ V/rms. At the normal operating voltage of ± 15 volts, the power dissipation of the op amps is typically 52mw, and they will operate from -55°C to $+125^{\circ}\text{C}$.

Hard line. Five new logic circuits, functionally equivalent to the conventional 54H TTL family but more resistant to degradation in a transient radiation environment, are now available. These circuits, all packaged in TO-86 flatpacks, include: a dual type flip-flop, RD-54H74R; a quad two-input NAND gate, RD-54H00R; a dual two-input and/or invert gate, RD-54H51R; a dual four-input NAND gate, RD-52H20R; and a quad two-input and/or invert gate, RD-54H54R.

The average propagation delay time of a gate is 13 nsec driving a load capacity of 150 pf; power consumption is 22 mw per gate.

Delivery from stock on all units except RA-248 and RA-548 will begin Sept. 1. The RA-248 is now available in either a TO-86 or dual in-line package, and will operate from -55°C to $+125^{\circ}\text{C}$. The commercial version, RA-548, is now available only in the dual in-line package and will operate from 0°C to $+75^{\circ}\text{C}$. In quantities of 100-99, the RA-248 is priced at \$26.40 each and the RA-548 costs \$9.90 each in similar quantities.

Radiation Inc. Melbourne, Fla., 32901 [444]

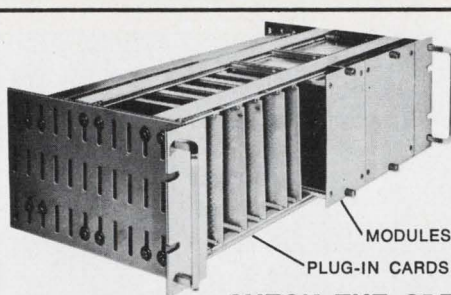

Vector-strut Cages Have Universal Adjustability

- STRENGTH
- HANDSOME APPEARANCE
- QUICK ASSEMBLY
- LOW COST

CHECK THE SPECS AND SEE:

THE VECTOR-STRUT CAGE provides an adjustable aluminum frame which through customer test has proven to be more versatile than other competitive units on the market.

- Mountable on 10", 19" or 24" racks.
- Three standard heights - $3\frac{1}{2}$ ", $7\frac{1}{2}$ ", $8\frac{3}{4}$ ".
- Three standard depths - 8.975", 11.975", 15.725".
- Prototype quantities shipped from stock. Production quantities in minimum time.
- Vertically slotted side walls and adjustable cross member end brackets allow universal height and depth adjustability for cards and module cases.
- Infinite adjacent positioning capability for modules, cards and connectors with extruded fastener holding ducts.

"EFP" ALUMINUM MODULE CASES[®] to fit Vector-Strut Cages

- Sixty (60) standard sizes for circuit cards, featuring $\frac{1}{16}$ " extruded grooves on .150" centers across case width for easy card mounting — no holes required in circuit board.
- Slide out side covers for quick access to cards.
- Front panels with captive thumb screws and rear panels either slotted or closed for user's connector design.

FOR HIGH FREQUENCY Vector Pak plug-in cases provide 90 to 100 DB of shielding with optional side panel gasketing.

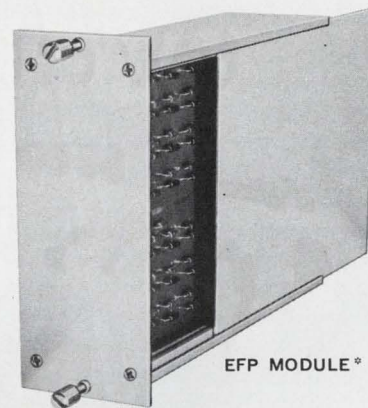

EFP MODULE[®]

[®] Patented Features

Write the factory for specification data and prices.



Vector ELECTRONIC COMPANY, INC.
12460 Gladstone Ave., Sylmar, Calif. 91342

Circle 232 on reader service card

X-Y with a spec of difference

With PLOTAMATIC[™] X-Y analog recorders, the differences are in the specs . . . and in the performance. The Series 600 PLOTAMATIC invites spec-by-spec comparison with any other recorder: Unique servo-amplifier design delivers greater frequency response • Sealed follow-up pots end cleaning of open slide wires • No shifting of preselected zero position when sensitivity vernier is adjusted • Constant

1 megohm input impedance on all ranges • Vacuum paper hold-down eliminates the dust problem of electrostatic methods • Push-button X-Y zero check (no need to remove input signals) • Full scale zero adjustment plus 100% offset • Automatic reset of pen at end of time sweep.

BBN/DE has the largest selection of X-Y recorders . . . over 30 models from which to choose. Write today for complete specs and a personal evaluation test in your own facility.



BOLT BERANEK AND NEWMAN INC., Data Equipment Division,
1762 McGaw Avenue, Santa Ana, California 92705 (714) 546-5300



can't get away for evening classes?



here's a practical way to avoid technical obsolescence

Are irregular hours, travel and family obligations keeping you from attending classes—even though you worry about becoming technically obsolescent? Check into the Special Programs in Electronics for Engineers developed by CREI, the Home Study Division of the McGraw-Hill Book Company.

These are not simply courses, but comprehensive programs in advanced electronics offering major electives in such fields as:

Communications Engineering, Aeronautical and Navigational, Television Engineering, Automatic Control Engineering, Missile and Spacecraft Guidance, Radar and Sonar Engineering, Nuclear Instrumentation and Control, Computers.

Industry-recognized CREI Programs make it possible for you to catch up on new developments in electronics through study in your own home, at your own pace,

your own schedule. Free book gives complete information and details of technical material covered. For your copy, mail coupon below or write: CREI, Home Study Division, McGraw-Hill Book Company, Dept. 1868H, 3224 Sixteenth St., N.W., Washington, D.C. 20010.

Founded 1927



Accredited Member of the National Home Study Council



**CREI, Home Study Division, McGraw-Hill Book Company
Dept. 1868H, 3224 Sixteenth St., N.W.
Washington, D.C. 20010**

Send me free brochure describing CREI Programs in Electronics for Engineers.

NAME _____ AGE _____

ADDRESS _____

CITY _____ STATE _____ ZIP CODE _____

COMPANY _____

TITLE _____

New Books

Well rounded

Microwave Semiconductor Devices and Their Circuit Applications
McGraw-Hill Book Co., 609 pp., \$22.50
Edited by H.A. Watson

Unlike other books that cover only specific devices in the microwave field, this book undertakes to describe both the circuit principles and the semiconductor devices—diodes and transistors—that were used to obtain the desired performance of the microwave circuit. It was authored by 20 top engineers, all members of the technical staff at Bell Labs, and should prove an excellent reference text for engineers and scientists involved in the development of microwave solid state circuits and semiconductor devices. It provides the semiconductor devices designer with an opportunity to understand the circuit's principles, and the dependence of circuit performance on the device characteristics; the circuit designer will find set out the physical mechanisms governing the operation of specific devices, and the physical and technological limitations to achieving better performance.

The full treatment given to both device and circuit performance limitations is needed since microwave semiconductor devices and circuits perform many diverse functions. Moreover, for each of these functions, the design of both the circuit and the semiconductor component is different.

The book, divided into five basic parts, leads off with a review of semiconductor physics. The discussion centers on device behavior and structure, and the transistor techniques that have led to new microwave semiconductor devices.

The next part begins with the Schroedinger wave equation and then goes on to semiconductor crystals, electrical conduction in semiconductors, p-n junction theory, and semiconductor surfaces and ohmic contacts.

Part three, comprising several chapters, covers microwave diodes and circuits quite extensively. It includes p-n junction varactor diodes and applications; p-i-n diodes; microwave switches; limit-

ers; phase shifters; Schottky-barrier devices and circuits; tunnel diodes and circuits; avalanche transit time microwave diodes; and bulk gallium arsenide devices. And this part also discusses the principles of snap diodes, the calculation of varactor characteristics and analyses of their performance in parametric amplifiers, harmonic generators and up-convertors, and the use of varactor at millimeter frequencies. Also covered are p-i-n diode circuits, and some circuit applications such as microwave switches, limiters, phase shifters and attenuators. Moreover, the physical design principles of Schottky-barrier varactors and their use as detectors and mixers are described. Tunnel and backward diodes are treated fully; the same is true for the rapidly evolving technology of avalanche transit time and bulk gallium arsenide devices.

The first chapter of part four is devoted exclusively to a general treatment of microwave transistors; it deals with the technological considerations, package design, and performance and characterization of these devices. The following chapter briefly considers the design principles, details, and fabrication techniques of a 4-GHz transistor amplifier. And although the material is 4 years old, it's still worthwhile.

The final part discusses the present trends of microwave semiconductor devices, comparing such characteristics as noise, power output, and reliability of some of the devices and circuits previously described. And it provides well rounded view of the state of the art together with some estimates as to where the microwave semiconductor field might be heading.

Recently published

Logical Design of Switching Circuits, Douglas Lewin, American Elsevier Publishing Co., 368 pp., \$10.50

This book uses an engineering approach rather than a mathematical one to cover such topics as switching algebra, sequential switching circuits, asynchronous circuits, and methods of automatic design. It is intended as a senior level text and includes many examples and problems.

the twisters

The twist of the fingertips tells the user that he is handling quality.

A lot of effort has gone into making these aluminum knobs the best money can buy. ALCOKNOBS have been painstakingly machined and anodized to a high satin finish. A wide choice of stock knobs are now available to compliment your equipment design. All are available at a reasonable cost and competitive to plastics.

Send for the new ALCOKNOB catalog describing a wide variety of stock knobs and with particulars whereby ALCO can customize knobs to create your own individual image.

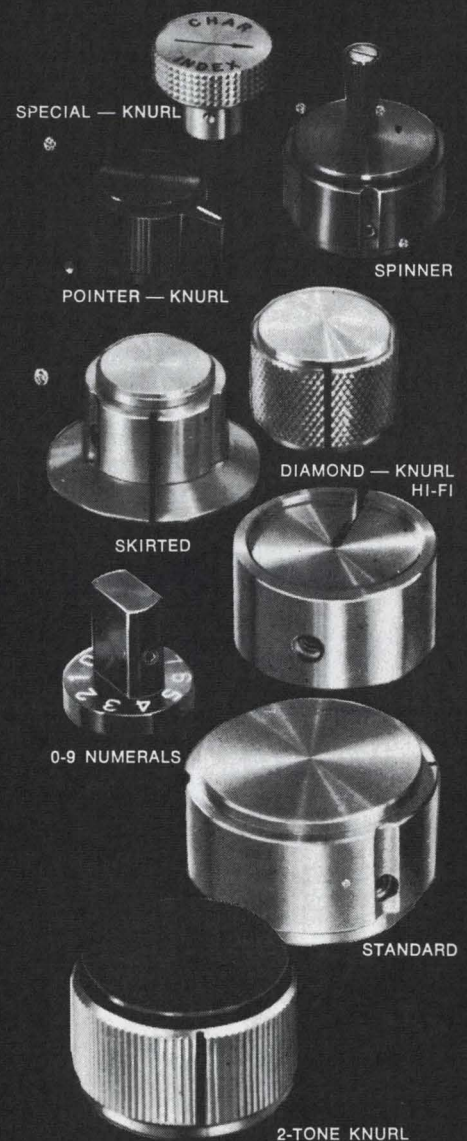

ALCO

ELECTRONIC PRODUCTS, INC.

Lawrence, Massachusetts 01843

Circle 173 on reader service card

60 dB Stop band rejection

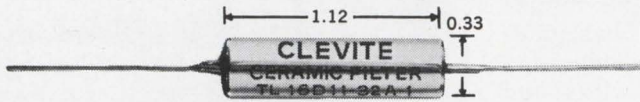

in a mil spec
ceramic filter for
less than \$15.

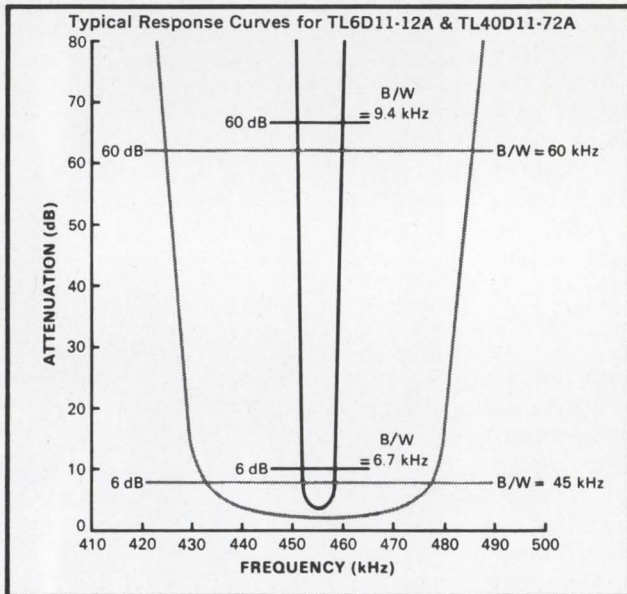

Here's the smallest (less than 0.1 cu. in.), most rugged fixed-tuned filter of its kind on the market today!

Clevite's 11-disc miniature filter is packaged in a hermetically-sealed cylinder, exceeds all military environmental specifications, is ideal for transistorized i-f amplifier circuitry in AM and FM sets plus many other applications that call for a fixed-tuned filter. Stop band rejection: 60 dB. Center frequency tolerance: ± 2 kHz to ± 3 kHz. Stability: within $+0.2\%$ for 5 years; within 0.2% from -40°C to $+85^\circ\text{C}$. Impedance (in and out) 2000 ohms for B/W less than 12 kHz; 1000 ohms for broader bandwidths.

Following models standard at 455 kHz.

Model Number	min. @ 6 dB	max. @ 60 dB
TL6D11-12A	6 kHz	12 kHz
TL10D11-20A	10 kHz	20 kHz
TL16D11-32A	16 kHz	32 kHz
TL20D11-38A	20 kHz	38 kHz
TL30D11-57A	30 kHz	57 kHz
TL40D11-72A	40 kHz	72 kHz

PRICES: 1—\$25 ea; 25—\$20 ea; 100—\$17.50 ea; 500—\$15 ea; 1000—\$13.75 ea; 2500—\$12 ea.
(Prices subject to change without notice)

Send order or request for Bulletin 94029 to: Clevite Corporation, Piezoelectric Division, 232 Forbes Rd., Bedford, Ohio 44146, U.S.A. Or: Brush Clevite Company, Limited, Southampton, England.

CLEVITE

When Only Excellent is Adequate TURN to Grayhill

WHAT'S NEW ABOUT THIS SWITCH?

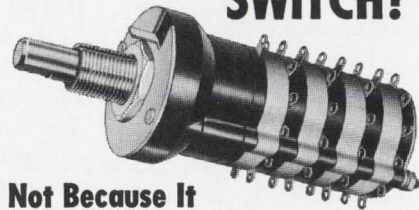

It's Not Because It

- 1) is explosion proof.
- 2) has up to 12 positions/deck.
- 3) could have up to 6 poles/deck.
- 4) comes in shorting or non-shorting versions.
- 5) is available in sealed, military or standard versions.

No...These are Standard Grayhill Rotary Switch features.

IT'S NEW BECAUSE

one or more positions may be ISOLATED from normal shaft turning techniques. It has its own built-in shaft turning SAFETY feature.



For details on this and other Switches Ask for Catalog G-304-A



523 Hillgrove Avenue
LaGrange, Illinois 60525
Area Code 312, Phone 354-1040

The Difference Between Excellent and Adequate

Circle 215 on reader service card

New Motorola frequency calibrator sets two-way radios precisely on frequency in seconds.



Here's a whole new method of frequency calibrating from Motorola. Our all solid-state S1315A frequency calibrator's .00001% accuracy, exceptional speed, and simplicity of operation result in performance that makes other heterodyne type meters obsolete.

This major innovation provides ultra-fast frequency checks of all AM or FM multi-channel units: base stations, mobile telephone system mobile units, citizens band equipment, and marine radio, as well as single-channel mobiles and portables. Low power consumption, fast warm-up, and battery or optional AC line operation make the Motorola S1315A truly versatile and ideal for field use.

At $4\frac{1}{4}$ " high x 8" wide x $11\frac{1}{2}$ " deep, the unit weighs only 7 lbs. Get all the details in our Bulletin TIC 3455. Write to Motorola Communications and Electronics, Inc., Precision Instruments Products Dept., 4501 W. Augusta Blvd., Chicago, Illinois 60651.



Technical Abstracts

Five in one

A five-function IC for tv receivers
Thomas R. Mills
ITT Semiconductors
West Palm Beach, Fla.

Five circuit functions required in a television receiver—sync separator, vertical take off, horizontal oscillator, automatic frequency control, automatic phase control, and noise blanking are combined in a single monolithic chip. The integrated circuit not only does the job better than discrete circuitry, but it does so with about half the number of components. With standard fabrication techniques, 94 components are diffused onto the chip.

Besides the obvious space and power dissipation advantages inherent to all IC's, the circuit also eliminates the need for a feedback winding on the flyback transformer for both phase and horizontal control. Moreover, the oscillator requires no coils or transformers.

From the composite video signal at its input, the IC provides a correctly separated vertical sync pulse that controls the vertical oscillator, as well as a synchronized phase- and frequency-corrected horizontal pulse that controls the horizontal output driver stage. In addition to a sync noise-blanking stage, the circuit contains a switch that keeps the pull-in/hold-in range of the oscillator wide. Thus, there is no need of horizontal hold control.

An external RC circuit sends a modified sync pulse to the IC, which shapes and amplifies the pulse; its amplitude, in the range of 12 to 20 volts, is determined by an external resistor.

A transistor in series with the sync input stage makes up the noise-blanking circuit. The transistor is biased so that noise spikes above some predetermined amplitude will inhibit the sync circuit.

The horizontal oscillator, a RC-type, charges an external capacitor at a constant rate and in a predetermined time, and then discharges in half that time. The capacitor must be a 10-nanofarad, low-leakage device. Small variations in frequency and phase shift are handled by either a positive or a negative correcting voltage. This voltage, ob-

tained from a phase detector-correction circuit, is added to the bias of the oscillator's current sources.

The pull-in/lock-in switch has a coincidence circuit that determines the synchronization of the oscillator's pulse with the horizontal sync pulse. When these pulses are out of synch, the on-off condition of the transistors in the IC is altered.

Presented at the IEEE Spring Conference on Broadcast and Television Receivers, Chicago, June 9-10.

On new terms

Use and management of the electro-space: a new concept of the radio resource
W.R. Hinchman
Institute for Telecommunication Sciences
Boulder, Colo.

A new word—electro-space—describes a way to alleviate spectrum congestion and effectively use the electromagnetic spectrum. The concept rejects the notion that the spectrum is "the radio resource," on the grounds that spectrum denotes only the dimension of frequency. The radio resource is really the electro-space, which has six dimensions: frequency, time, location, intensity, polarization, and direction of propagation. Each of these is an independent variable.

Communications channels could be vastly increased if the electro-space concept were applied to both transmission and reception, since each of the six dimensions can be varied within the state of the art. A radio receiver, for example, would distinguish between directed and nondirected radio signals by recognizing a particular combination of the six characteristics.

As it now stands, 80% of the frequency range up to 1 gigahertz is set aside for Government and television use. But a good percentage of this spectrum band is used in isolated locations and bears little benefit to, say, city dwellers.

By putting all dimensions of the radio resource to work, radio services could be upgraded. The major challenges are to find ways of effectively using electro-space.

Presented at the International Communications Conference, Boulder, Colo., June 9-11

designer's keyboard

SB-033 — INTERLOCK
SB-034 — MOMENTARY

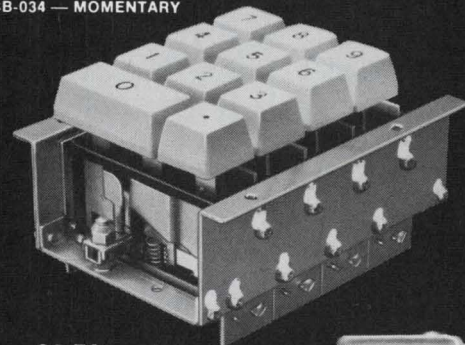

28.50 User Net

The ALCO modular idea is a simple concept for the design engineer to create his own custom push button layouts from "stock" switch modules and assemblies.

The basic modules allow use of up to twelve (shown at right) switches per section. A designer may stack any number of these switch sections in a group by themselves or in conjunction with the ALCO mating 12-segment keyboard assemblies (shown above).

Highly efficient, single pole "normally open" reed switches are used throughout, thus assuring reliability and extremely long life expectancy.

For design-service assistance and price quotations, call (Area 617) 686-3887.

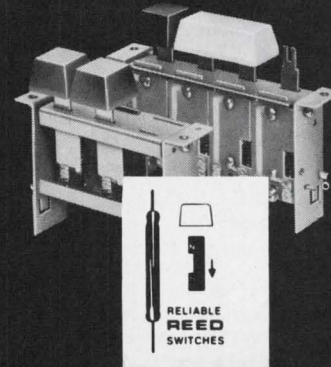

Available as
Momentary
and Interlock

ALCO

ELECTRONIC PRODUCTS, INC.

Lawrence, Massachusetts 01843

Circle 175 on reader service card



Transient Insurance

\$2



New Dale LVP-6 installs quickly, inexpensively to suppress DC overvoltages

For less than \$2 (in quantity), Dale's new LVP-6 prevents DC overvoltages from wiping out IC's and other costly board-mounted components. Its economy is enhanced by the fact that it saves on assembly time—replacing diodes and capacitors now individually installed to handle voltage suppression.

SENSITIVE The LVP-6 handles surges rising as fast as 10,000 volts/ μ sec.—clamps at preset levels from 6.2 to 13 volts.

COMPACT Epoxy molded units (.50"x.50"x.25") with leads for horizontal or vertical mounting across board's DC input.

Clamping Voltages: 6.2, 6.8, 7.5, 8.2, 9.1, 10, 11, 12, 13

Shunt Capacitance: 15 μ fd \pm 10%

Operating Temperature: -55° C to 85° C

Storage Temperature: -55° C to 125° C

For complete information call 605-665-9301 or write...



DALE ELECTRONICS, INC.
SIoux DIVISION Dept. ED
 Yankton, South Dakota 57078
 A subsidiary of The Lionel Corporation

Measure phase easily, directly, and accurately

ACCURACY $\pm 1^\circ$ WITH LARGE SIGNAL-TO-REFERENCE RATIOS... $\pm 0.5^\circ$ WITH SMALL SIGNAL-TO-REFERENCE RATIOS ■ CONTINUOUS 0° TO 360° READINGS ■ EXPANDED SCALES FOR ACCURATE AND EASY READING ■ ACCURACY INDEPENDENT OF ANGLE ■ DIGITAL RATIO-METRIC READOUT AVAILABLE ■ ACTON LABS' 329B PHASE METER.



BOWMAR ACTON LABORATORIES, INC.
 A Subsidiary of Bowmar Instrument Corporation
 531 Main Street ■ Acton, Mass. 01720 ■ (617) 263-7756

Circle 217 on reader service card

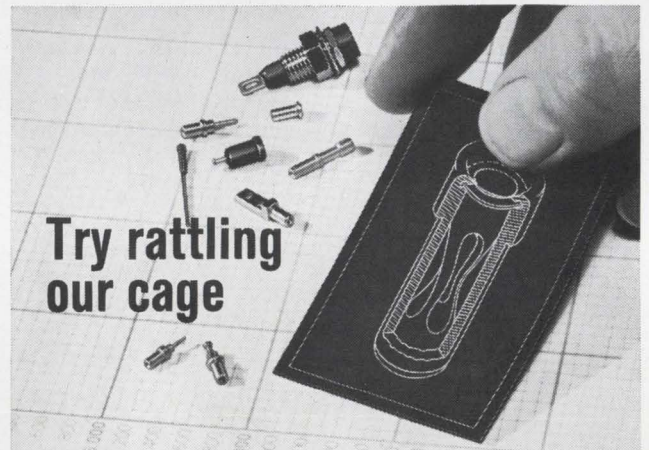

Try rattling our cage

You can't. Millions of operational tests and customer applications have proved the electrical integrity of a CAMBION Cage Jack Connector remains unshakable... even after thousands of cycles of operation. It's that way by design. Made of heat-treated beryllium copper specially selected for uniformity, the unique CAMBION Cage spring has just enough give to accommodate a mating plug while providing consistent contact for repeated insertions and withdrawals. Hundreds of different plug and jack connector combinations in sizes from .016" to .080"... all standard... all in stock ready for immediate delivery. For complete details on the CAMBION connector that best meets your circuit design requirements contact Cambridge Thermionic Corporation, 467 Concord Avenue, Cambridge, Massachusetts 02138. Phone: (617) 491-5400. In Los Angeles, 8703 La Tijera Boulevard 90045. Phone: (213) 776-0472.

Standardize on

CAMBION

The Guaranteed Electronic Components

New Literature

Deflection yokes. Syntronic Instruments Inc., 100 Industrial Rd., Addison, Ill. 60101. Technical details on four stator type high-Q deflection yokes are presented in two-page technical bulletin 69-2.
Circle 446 on reader service card.

Standard machine controller. Information Instruments Inc., 62 Enterprise Dr., Ann Arbor, Mich. 48106. A six-page brochure illustrates and describes the PDQII electronic machine and process controller, a solid state replacement for relay control panels. [447]

Magnetic tape recorder. Genisco Technology Corp., 18435 Susana Rd., Compton, Calif. 90221. Capabilities and applications of the model 10-110 magnetic tape recorder are described in a data sheet. [448]

Trimming potentiometers. Beckman Instruments Inc., 2500 Harbor Blvd., Fullerton, Calif. 92634, offers a data sheet on the Helitrim series 66 trimming potentiometers. [449]

Recorder integrator. Disc Instruments Inc., 2701 S. Halladay St., Santa Ana, Calif. 92705. A four-page brochure on the series 300 integrator covers the unit's application as an integrating device with potentiometric strip chart recorders. [450]

Wire strippers. Eubanks Engineering Co., 225 W. Duarte Rd., Monrovia, Calif. 91016, has published a four-page quick-reference catalog of its line of automatic wire processing equipment. [451]

Crystal filters. Reeves-Hoffman Division, Dynamics Corp. of America, 400 W. North St., Carlisle, Pa. 17013. Two-page bulletin 930-B gives technical data and frequency-attenuation graphs for two high-fidelity crystal filters. [452]

Avalanche diode oscillators. OKI Electronics of America Inc., 500 S.E. 24th St., Fort Lauderdale, Fla. 33316. Low-noise, high-power avalanche diode oscillators are described in a two-page data sheet. [453]

Teflon bushings. Seaelectro Corp., 225 Hoyt St., Mamaroneck, N.Y. 10543, has available a four-page catalog data sheet on Press-Fit Teflon bushings. [454]

Laser applications. Laser Nucleonics Inc., 123 Moody St., Waltham, Mass. 02154. A 16-page brochure contains more than 50 illustrations showing the innumerable applications of laser technology in action. [455]

Sensing devices. Pennsylvania Electronics Technology Inc., 1397 Frey Rd., Pittsburgh, Pa. 15235. Technical data

62-69 gives design parameters for 1/2 watt type 71T Positemp sensors. [456]

Directional couplers. PRD Electronics Inc., 1200 Prospect Ave., Westbury, N.Y. 11590, offers a data sheet describing microwave coaxial directional couplers. [457]

Pushbuttons. MicroSwitch, a division of Honeywell Inc., 11 W. Spring St., Freeport, Ill. 61032, has available a 16-page product sheet introducing a compact, oiltight line of pushbuttons. [458]

Active filters. Polyphase Instrument Co., E. Fourth St., Bridgeport, Pa. 19405. Bulletin AF2000 contains comprehensive computer-aided design information and performance curves on a broad new line of active filters. [459]

Data set. Sangamo Electric Co., P.O. Box 359, Springfield, Ill. 62705. A data set capable of operating over private lines or the DDD network is described in bulletin 5318. [460]

Microwave power measurements. PRD Electronics Inc., 1200 Prospect Ave., Westbury, N.Y. 11590, has published eight-page bulletin 880 describing microwave power measurements. [461]

Panel meters. Mura Corp., 355 Great Neck Rd., Great Neck, N.Y. 11021. A six-page illustrated catalog covers sub-miniature, miniature, and standardized panel meters. [462]

Television programmer. Ampex Corp., 401 Broadway, Redwood City, Calif. 94063, has available bulletin V233 describing the RA-4000 random access television programmer. [463]

FET design ideas. Texas Instruments, Box 5012, Dallas, 75222. Twelve-page booklet CB-101 has been prepared for designers employing field-effect transistors in their circuits. [464]

Flexible fiber optics. The Bendix Corp., Galileo Park, Sturbridge, Mass. 01518, has released a two-page data sheet covering its line of flexible glass fiber optics. [465]

IC testing. Teradyne Inc., 183 Essex St., Boston, Mass. 02111. A 20-page brochure describes the J259 computer-operated IC test system. [466]

CCTV systems. Maryland Telecommunications, Division of KMS Industries Inc., 10534 York Rd., Cockeysville, Md. 21030. Catalog sheet SC-269-1 describes flexible, prepackaged Video Explorer CCTV systems. [467]

Electrical tapes. 3M Co., 3 M Center, St. Paul, Minn. 55101, has available a Scotch brand electrical tape data and sample chart. [468]

build with ALCOSWITCH

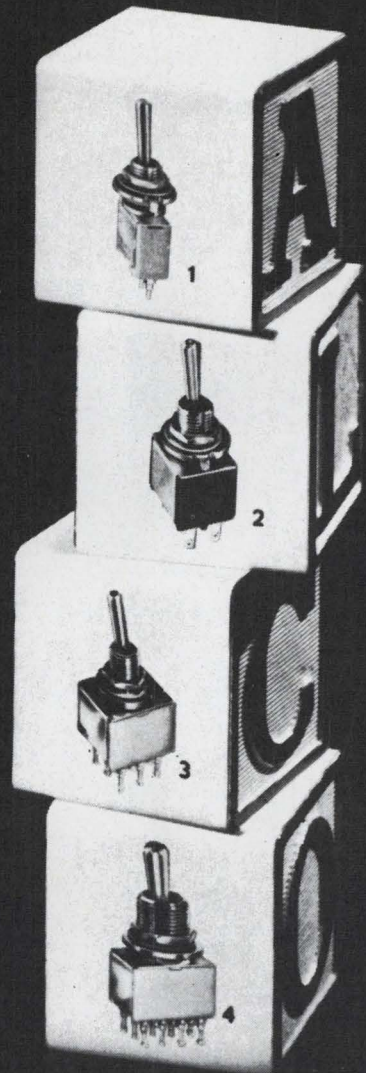

Build quality and reliability into your equipment with top performing ALCO-SWITCH® miniatures. Here are representative models from the many families of ALCOSWITCH® which you can select:

- #1 — SPDT "A" SERIES
- #2 — DPDT "MST" SERIES
- #3 — 3PDT "E" SERIES
- #4 — 4PDT "MUSTANG"

If you are looking to build a fine product you'll find the answer in the broad ALCOSWITCH® line.

There is a miniature switch to fit your particular budget and design.

ALCO

ELECTRONIC PRODUCTS, INC.

Lawrence, Massachusetts 01843

Circle 209 on reader service card

THE SIXTH BRAIN LOBE

It is said that Leonardo Da Vinci had a special little bump on his head — a “sixth brain lobe” which permitted him to make extraordinary logical leaps into future technological ages. Thus he invented such things as a machine to wind bobbin thread evenly, centuries before the sewing machine was invented. And versions of airplanes, helicopters, the parachute, etc.

Engineers at Motorola must have an accurate idea of how Leonardo felt, because they have the “sixth lobe,” too. Working with electronic computers, they can span the gulfs that often separate men from tomorrow. And the product of this remarkable synergism is the product of Motorola: Thinking and working beyond the present to prepare for the future.

It takes good men with good brains — often two each — to do what has to be done. It will be done at Motorola.

Specific opportunities are:

Space Communications Radar Systems Tracking & Telemetry Fuzing Digital Data Transmission Guidance & Navigation Radar Transponders ECM & Elint Coherent Transponders Integrated Electronics Antennas & Propagation Advanced RF & Microwave Techniques Ground Support Equipment UHF/VHF Communications Equipment Display Digital Multiplex Troposcatter Readout Mechanical Design Reliability & Components Offshore Geophysical Exploration Navigation Manufacturing Product Engineering Industrial Engineering Quality Assurance Operations Project Test

 **MOTOROLA in PHOENIX**
Government Electronics Division

Write: Paul Ahler, Recruitment Manager, Dept. 65, Box 1417, Scottsdale, Arizona 85252

An Equal Opportunity Employer M/F

In electronics it's Electronics magazine to sell used equipment!

Your advertisement will produce Results in Electronics. Engineers turn to Electronics magazine for the latest technical developments — and for the latest buying information. You can reach them inexpensively in Electronics Searchlight Section.

For information:
Searchlight Section
Classified Advertising Dept.
Post Office Box 12
New York 10036



— RATES —

DISPLAYED: The advertising rate is \$79.00 per inch for all advertising appearing on other than a contract basis. Contract rates quoted on request.

An advertising inch is measured 7/8" vertically on a column—3 columns—30 inches to a page.

UNDISPLAYED: \$3.60 per line, minimum 3 lines. To figure advance payment count 5 average words as a line. Box numbers—count as 1 line.

Discount of 10% if full payment is made in advance for 4 consecutive insertions.

Not subject to Agency Commission.

Send new ads to:

ELECTRONICS

Class. Adv. Div., P.O. Box 12, N.Y., N.Y. 10036

Make your own break.

You can take a lot of the chance out of your future by including yourself in the Electronics Manpower Register.

When you do, your experience and talents become part of a nationwide computerized placement service.

Our computer is programmed to give every registrant the same

look for every opening. With your prior approval, you'll be considered for every opportunity that matches your resume.

All you have to do is send one to:

Electronics Manpower Register
Electronics
330 West 42nd Street
New York, N.Y. 10036

SEARCHLIGHT SECTION

ELECTRON TUBES

KLYSTRONS • ATR & TR • MAGNETRONS
SUBMINIATURES • C.R.T. • T.W.T. • 5000-
6000 SERIES
• SEND FOR NEW CATALOG A2 •
A & A ELECTRONICS CORP.
1063 PERRY ANNEX
WHITTIER, CALIF.
696-7644

CIRCLE 968 ON READER SERVICE CARD

Remember . . .

MAIL MOVES

THE COUNTRY

but . . .

ZIP CODE MOVES

THE MAIL

AUTOTRACK MOUNT

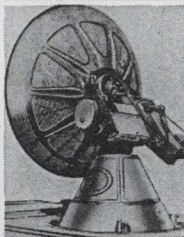

360 degree azimuth, 210 degree elevation sweep with better than 1 mil. accuracy. Missile velocity acceleration and slewing rates. Amplidyne and servo control. Will handle up to 20 ft. dish. Supplied complete with control chassis. In stock—immediate delivery. Used world over by NASA, USAF, MP-61-B. Type SCR-584. Nike Ajax mounts also in stock.

PULSE MODULATORS

MIT MODEL 9 PULSER 1 MW—HARD TUBE
Output 25kv 40 amp., 30kv 40 amp. max. Duty cy .002, .25 to 2 microsec. Also 5 to 5 microsec. and .1 to .5 microsec. Uses 6C21. Input 115v 60 cycle AC. Mfg. GE. Complete with driver and high voltage power supply. Ref: MIT Rad. Lab. Series, Vol. 5, p. 152.

2 MEGAWATT PULSER
Output 30 kv at 70 amp. Duty cycle .001. Rep rates. 1 microsec 600 pps. 1 or 2 msec 300 pps. Uses 5948 hydrogen thyratron. Input 120/208 VAC 60 cycle. Mfr. GE. Complete with high voltage power supply.

250 KW HARD TUBE PULSER
Output 16 kv 16 amp. Duty cycle .002. Pulses can be coded. Uses 5D21, 715C or 4PR60A. Input 115 v 60 cy. AC \$1200 ea.

18 MEGAWATT PULSER
Output 150KV at 120 amps. Rep rate: 50-500 PPS. Pulse length: 5 msec. 15KV 120 amp. into pulse transformer. Rise time 1.5 msec. Filament supply 5V 80 amp. incl. 17.5KV 1.5 amp DC power supply. Input: 220V 60 cy AC.

INDICATOR CONSOLES
AN/SPA-4A, PPI 10", range to 800 mi.
VT-1 PPI 12", Range to 200 mi.
VL-1 RHI 12" to 200 mi. 60K ft.

SCR 584 AUTOTRACK RADARS
Our 584s in like new condition ready to go, and in stock for immediate delivery. Ideal for telemetry research and development, missile tracking, satellite tracking. Fully Desc. MIT Rad. Lab. Series, Vol. 1, pps. 207-210, 223, 234-236. Comp. Inst. Bk available \$25.00 each.



Radio-Research Instrument Co.

45 W. 45th St., New York, N.Y. 10036 • 212-586-4691

CIRCLE 967 ON READER SERVICE CARD

ANTI-AIRCRAFT GUN MOUNT

Will handle 6,000 lbs. rapid slew through 360° azimuth, 180° elevation. Mobile.

MICROWAVE SYSTEMS

200-2400 mc. RF PKG
Continuous coverage, 30 Watts Cw nominal output. Uses 2C39A. Price \$575.

L BAND RF PKG.
20 KW peak 990 to 1040 MC. Pulse width .7 to 1.2 micro sec. Rep. rate 180 to 420 pps. Input 115 vac incl. Receiver \$1200.

200-225 mc RADAR SYSTEM
1 Megawatt output. 200 nautical mile range for long range detection of medium and high altitude jet aircraft as well as general search. AN/TPS-28.

SURVEILLANCE DRONE RADAR SYSTEM
X-Band tracking system with plotting boards. Type AN/MPQ-29. Drone also in stock.

5 MEGAWATT C-BAND
Klystron RF package delivering nominal 5 megawatt pulse RF. Complete with pulser and power supply.

500 KW L BAND RADAR
500 kw 1220-1359 msc. 160 nautical mile search range P.R.I. and A scopes. MTL thyratron mod 5J26 magnetron. Complete system.

AN/GPG-1 SKY-SWEEP TRACKER

3 cm. automatic tracking radar system. Complete package with indicator system. Full target acquisition and automatic tracking. Input 115 volts 60 cycle. New. In stock for immediate delivery. Entire system 6' long, 3' wide, 10' high. Ideal for Infrared Tracker, Drone Tracker, Missile Tracker, R. & D.

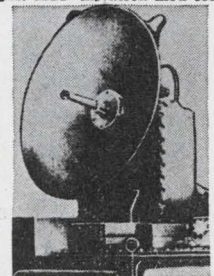

C Band Autotrack

1 Megawatt 10 ft. Parabola. Sperry.

40 KW TRANSMITTER

4 to 21 MHz, 40 kw Telegraphy, 30 kw Voice, can be SSB. New condition. Two systems in stock. Excellent rf source, broadcast or point-to-point.

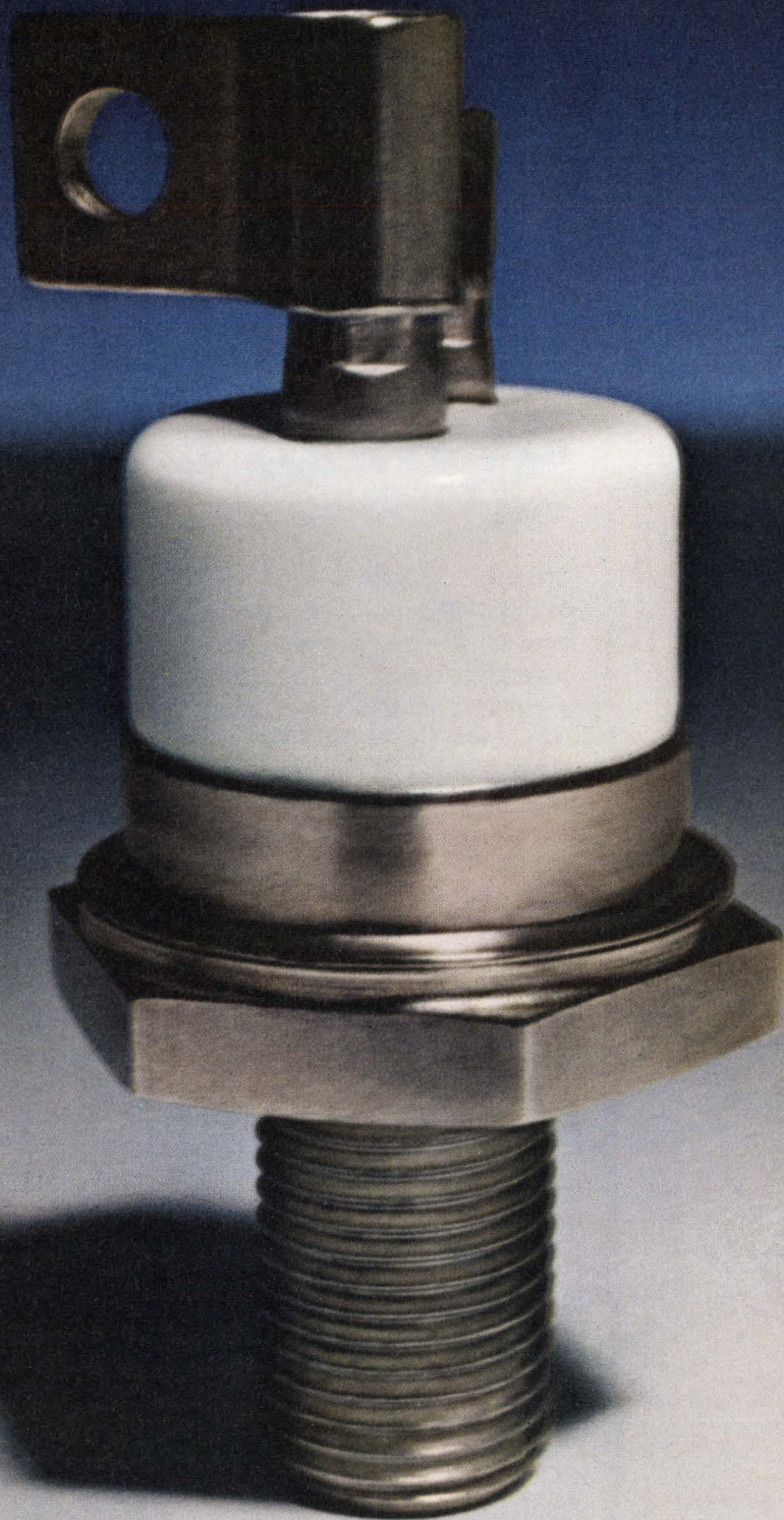

Optimizer

**Off-the-shelf
Full Capacity thyristors
balanced for all parameters
only from Westinghouse.
Try 'em for size.**

With thyristors that meet all critical design parameters — not just a couple—you get reduced equipment size...plus savings on circuit components. And only Westinghouse delivers them.

Our parameter optimization in full capacity thyristors gives you another bonus: more design security. And their compression bonded en-

capsulation (a Westinghouse first) assures low thermal impedance.

Vital statistics: 40 to 550 amps, up to 1500 volts; standard JEDEC and POW-R-DISC packs.

So optimize away! Send for SA-10205. Westinghouse Semiconductor Division, Youngwood, Pa. 15697.

You can be sure... if it's
Westinghouse



International Newsletter

July 7, 1969

East-West trade barriers to be lifted—a little

The Commerce Dept. is quietly preparing to relax its controls over exports to Eastern European communist countries—making it easier for U.S. companies to export a range of electronic equipment, including some computers.

The Office of Export Control will soon:

- Remove a substantial batch of products from the list requiring individual export licenses for shipment to Eastern European countries and the Soviet Union.

- Relax license-granting criteria for another group of products.

- Drop other items from the lists of products requiring a license for shipment to non-communist countries, a rule that aimed at preventing trans-shipment to communist countries.

- Ease criteria for granting such licenses.

- Try to streamline its often-criticized administrative procedures to reduce the time required for processing of license applications.

Export controls are periodically reviewed so in that sense the current review can be considered routine. But this time the Export Control Office is making a special effort to ease controls on products for which the number and value of license applications indicate that there is a significant trade potential. The list of items decontrolled by the Johnson Administration in 1966 was criticized by businessmen who said it contained many items of negligible trade interest.

Details of the projected liberalization of the export control lists are being closely held. But indications are that companies producing data processing equipment, nuclear radiation testing devices and other electronic measuring equipment will benefit. It still will be necessary to obtain licenses for exports of computers, but these should be somewhat easier to get for small machines. Exports of larger data processing equipment almost certainly will continue to be banned because of its potential military uses.

Common Market eyes all-Europe computer project

The project for an advanced European computer has been pushed forward a step with a working committee request for marketing and feasibility studies. Now, it's up to the European Economic Community's Council of Ministers to okay the studies, which would cover possible contributions by countries outside the Common Market—Great Britain, in particular. Committee members and representatives of the major European electronics firms—Philips, Siemens, AEG-Telefunken, CII, Olivetti and Britain's ICL—have been discussing the project for several months. The committee also proposed that the EEC consider setting up a European Institute of Computer Science. However, recommendations on the committee's second current headache—streamlining of the European components industry—have had to be delayed, probably until October.

SGS to invade old partner's territory —the U.S. market

Watch for a move into the United States market late this year or early next by SGS, the Italian semiconductor company that broke off with Fairchild Semiconductor last fall.

The company, now wholly owned by the Italian office equipment giant Olivetti [*Electronics*, May 26, p. 181], has started to scout for an Ameri-

International Newsletter

can partner for its venture. But if they have to go it alone, SGS officials say they will. SGS hopes to nail down a one percent share of the American semiconductor market.

At the outset, SGS will offer a product line of discrete devices and integrated circuits developed jointly with Fairchild. But the company will follow up fast with IC's of its own. It's now producing a line of four packages for color television sets and has another five almost ready to go. Eventually, SGS will have an entertainment IC line of 14 or 15 types. Company officials also hope to add the line of high-noise-immunity logic circuits SGS has developed for industrial controls.

To supply the U.S. market, SGS will rely mainly on the 3,000-worker plant it is readying in Singapore. The company's five European plants have booming regional markets. SGS executives see no end to the current shortage of components in Europe, predict they will continue in short supply until mid 1970 at the earliest.

Paris may offer a helping hand to software industry

France's late-starting software industry, courted by a string of U.S. suitors, may be taken under the government's wing. Government planners are working hard on a Plan Software that would complement the Plan Calcul computer development program—and keep the Americans at bay.

Details have not been worked out yet, but watch for government agencies to start farming out software development instead of doing the work themselves. The French credit the U.S. software lead to fat government contracts. Plan Calcul officials argue that a similar move would strengthen France's software industry both technically and financially, and would thus hasten the nation's computer revolution. Mergers among the two dozen or so software firms might result and closer cooperation would be a distinct possibility.

Although technical cooperation deals with U.S. firms would more than likely be encouraged, Plan Software would seek to bar takeovers by U.S. firms by giving the French firms new muscle.

The plan is to be ready for top level consideration by the end of this year. Robert Lattes, vice president of France's biggest software firm, the Sema-Metra group, says his company hasn't been approached yet on the idea. "But it sounds great," he admits.

Japan's calculators selling worldwide under other's labels

For the Japanese, the desk-top calculator has become as hot an export item as the transistor radio. Japanese firms are rapidly lining up private brand customers around the world to add to the sales they are already racking up around the world under their own brand names. The aim: shaving production costs through high volume.

In the latest deal, Canon Inc. will manufacture calculators for Litton Industries' Monroe division under a U.S. label. Deliveries in the first year alone will total 30,000 machines. Canon puts the value of the contract at about \$10 million.

Other Japanese firms have pinned down similar contracts. Matsushita Communications Industrial Ltd. is supplying West Germany's Olympia [*Electronics* June 9, p. 201]. Hayakawa reportedly is supplying Facit in Sweden, Burroughs in the U.S. and Addo in Switzerland; Hitachi dealing with Friden, Omoron Tateishi with SCM, and Casio with Canada's Commodore.

Computer polices airport noise

West German system blows the whistle when landing and takeoff noise levels in residential areas near Stuttgart airport exceed acceptable values

Until something can be done about reducing the noise made by jet aircraft, there's a good business in just measuring the din. In West Germany, in fact, the government is seriously considering requiring that all big civil airports install noise level measuring and monitoring equipment. With other European governments on the same tack, a market may be opening for automatic noise monitors.

One company that is eagerly eyeing that market is Hewlett-Packard GmbH, the West German subsidiary of the American company. With only some hardware help from the parent company, engineers of the German concern have developed a computer-run noise monitoring system that has already been tapped for installation at Stuttgart's Echterdingen Airport. And, complete with seven stationary noise pick-up stations, one mobile station and an H-P computer, the system cost only about \$90,000.

The system has passed its initial tests at Stuttgart and representatives of a number of other airports, in Germany, Europe, the United States, and Russia have shown interest, as have jet engine makers.

Checking the db. The heart of the Echterdingen installation is a digital computer installed in a noise evaluation center at the airport. Using the inputs from various stationary noise level pickup stations located in residential areas near the airport, the computer continuously compares airport-produced noise against levels prescribed for each station. If the acceptable levels are exceeded, both the amount and duration of excess noise in decibels, together with the date and time is printed out.

Thus, a record is produced telling authorities that a pilot has de-

viated from the proper approach or takeoff course and has flown too close to or too low over residential areas. The only manual function an operator has to perform is jotting down the plane's flight number.

The seven stationary noise pick-up stations are located in residential areas that lie parallel to the approach and takeoff paths of the airport. The key component at each station is a condenser microphone perched on top of a cabinet that houses electronic measuring devices, a power supply, and other equipment. The microphone itself is installed in a heated and wind and weather-proof cape-like housing. To enhance reliability the equipment is automatically calibrated several times a day.

The mobile noise measuring equipment is used to take sample noise measurements at any point

in the airport's vicinity. Results are either tape-recorded for later evaluation by the computer or are sent over telephone lines for immediate evaluation.

Frequency coding. Noise or sound pressure, picked up by the microphone is converted into a voltage. The db level is then determined by a pair of parallel-connected pulse-type sound level meters which measure noise levels from zero to 50 db, with a linearity of better than ± 0.5 db. The dc output voltages are converted into signals whose frequency is proportional to the metered voltages. Signal frequencies vary between 900 and 3,400 hertz. In this 2,500 hz range, a frequency variation of 50 hz corresponds to a 1-db change in noise level. These "frequency-coded" noise level signals are then sent along regular phone lines to



Monitoring noise. At Stuttgart's civil airport, this automatic system samples aircraft noise, prints out details every time pre-set levels are exceeded. Teletype is used to alert authorities to high noise events.

the noise evaluation center. The H-P designers chose frequencies rather than, say, voltages, for coding to minimize distortion that might occur along the phone line.

At the noise evaluation center, a scanning and switching unit scans each outside station several times a second. This unit's scanning rate is controlled by the computer, which also alternately feeds noise level signals to a converter which produces a digital output for subsequent computer processing.

The computer, an H-P 2114 A has a basic storage capacity of 4,000 words with 16 bits each and a cycle time of one microsecond. The computer can be programmed by punched tape to accommodate any of the various noise criteria that different airport authorities or institutes already have or will establish in the future.

Great Britain

Theory and fact

So often in electronics, a theory is elegantly simple, but the development frustratingly complex. Thin film and plated wire memories offer a prime example. They store ones and zeros by opposite polarities, which holds out the tantalizing possibility of using a switched bistable circuit as a combined amplifier, discriminator, and register. The ordinary ferrite store, on the other hand, has a readout signal of large amplitude for ones, and small amplitude for zeros. That means that before the output can be used to set a register, it has to be separately amplified and discriminated.

In theory, a switched bistable circuit can do all that at once. All it takes is a regenerative circuit consisting of two cross-coupled transistors. The circuit is held in an unstable state, with both transistors on or both transistors off, and is released to find one of the two stable states—either transistor on with the other off—at the same time as the signal arrives from the store. If all circuit parameters are in balance and random noise is low, the slight artificial imbalance

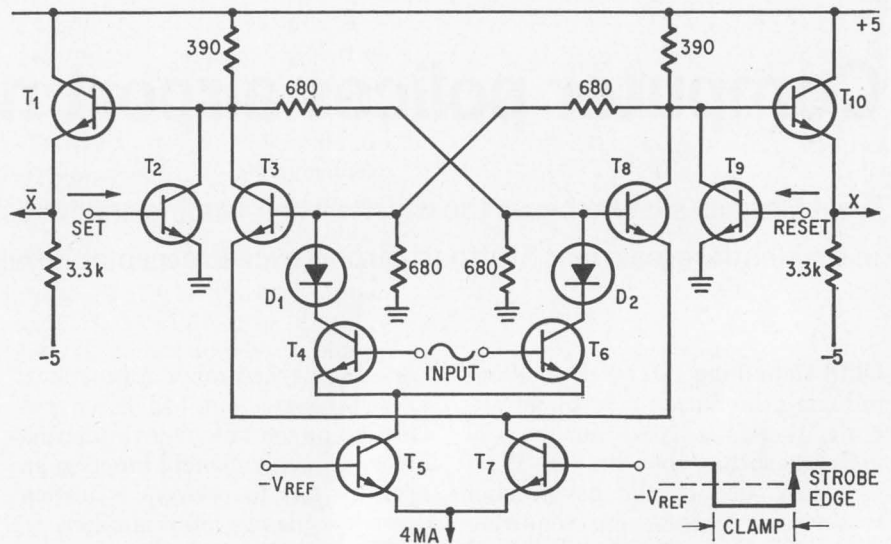

Stable bistable. Using carefully matched transistors pairs, British circuit design is adaptable to mass production, avoids temperature imbalance.

provided by the signal, amplified by the inherent high loop gain during the transition phase immediately after release, will determine which of the two states the bistable chooses.

But it turns out to be another matter to actually get the idea to work—let alone get it into production. For one thing, it's difficult to reduce differential temperature effects below the level where they affect device reliability by unbalancing circuit parameters. For instance, in the computer store application, a sequence of repeated ones means that one transistor is on for a relatively long time while the other is off, and the heat differential generated may alter the transistor characteristics enough to render the device unable to discriminate the small signal inputs, probably about two millivolts.

For another thing, the obvious method of operation is to clamp the circuit unstable by disconnecting the power line, apply the input signal to unbalance the cross-coupled network, and reconnect the power. At this point, the circuit goes straight into stability according to the direction of unbalance. However, power switching is not easily compatible with speed, and high speed is always incompatible with the decoupling necessary to prevent crosstalk.

Solution. Now it looks as if Roy Berry of Britain's Royal Radar Es-

tablishment has found the answer. Berry believes that monolithic integrated circuitry and careful matching of transistors will reduce temperature differentials to unimportant levels, and that power switching can be replaced by switching the tail current, at half volt or so, in a long-tailed transistor pair.

Market. And because plated wire and thin film computer stores should soon be in use on a large scale, Berry foresees a market large enough to justify a monolithic IC bistable. He reported on his work at a computer technology conference at Manchester University last week.

Berry has devised a circuit he considers basically satisfactory and has constructed a hybrid model, using commercially available dual transistor pairs, two transistors diffused into the same chip. This experimental circuit has an offset of approximately one millivolt which Berry has cancelled out with an external balancing resistor so that he can check the ultimate sensitivity of the circuit.

Berry believes that production monolithic circuits could be made economically with about the same offset but without the need for external balancing since plated wire and thin film signals are typically in excess of two mv so that circuit offset would not affect bistable decision. Berry found that the experi-

mental circuit could detect 10 nano-second pulses of ± 0.5 mv, when a 60 nsec clamping period was used to enable the circuit to forget its previous state before being asked to make a decision about the next. With common mode noise of 0.5 volts present, which Berry says would most likely correspond to a realistic situation, 20 nsec pulses at ± 1 mv could be detected with 60 nsec clamping period, equivalent to sensing at 10 megahertz repetition rate.

Tailing. In Berry's circuit (see diagram), the cross-coupled transistor (T_3 and T_8) are a long-tailed pair. The tail current is fed through transistors T_4 and T_6 to clamp the circuit in the unstable state, when T_3 and T_8 are non-conducting. When the input signal appears between the bases of transistors T_4 and T_6 , it is amplified using this current and applied as a differential bias signal to the bases of the bistable transistors. At the instant of release from clamping, which is arranged to coincide with the peak of the input signal, the tail current is switched by transistors T_5 and T_7 to the bistable. The high regenerative loop gain of the bistable quickly grasps the input signal and switches the bistable according to input polarity.

In the hybrid experimental circuit, matched dual transistors are used for the bistable pair, the input pair, the switching pair, the output emitter follower pair (T_1 and T_{10}) and a pair of isolating diodes included to insulate the bistable from write-in digit disturb noise.

France

Cartel blanche

Imagine an RCA and a General Electric deciding to divide up their markets, one company to get all the electronics business, the other to get all the higher power business. In the United States, anyway, the first result of such an agreement would be angry howls from government trustbusters. But in France, the government, eager to strengthen the country's industrial

base, is solidly behind just such a move being made by the two big French electrical/electronics companies. The Thomson-Brandt group, already France's major electronics firm, will increase its dominance in this field. Compagnie Générale d'Electricité (CGE) will become undisputed leader in its specialty, heavy electrical equipment. Both will continue making radio and tv sets and other consumer products, but they'll cooperate in marketing.

Give and take. A key provision of the agreement is that Thomson-Brandt, through its Thomson-CSF subsidiary, will take over management of the state-subsized computer company, Compagnie Internationale pour l'Informatique (CII). Thomson-CSF and CGE each own one-third of CII, while the big steel and heavy equipment maker, Schneider S.A. holds slightly less than a third—a situation which has made for "collegial management, with too many long discussions of detail taking place at the top level," says Edouard Guignonis, commercial director of Thomson-CSF.

In exchange, Thomson-Brandt is giving CGE similar management control over Societe Alstom, a firm with whom CGE jointly owns its heavy electrical equipment subsidiaries but in which Thomson-Brandt is the major shareholder with 23%. CGE will now integrate the subsidiaries into Alstom and then take 40% of Alstom's stock.

CGE will turn over some of its radio equipment business to Thomson-Brandt, and the two companies plan to form a joint subsidiary to build telephone data processing equipment. Other cooperative accords may come later.

Laying cable to rest

France has laid its last long-distance telephone cable. It's not that the French are throwing up their hands in despair over their severely overtaxed phone system. They're going to build microwave relays—lots of them—in an effort to come to grips with what has

become a very hot political potato. In fact, France's new president George Pompidou and all the other presidential candidates promised during the campaign to solve the telephone mess.

The state-run telephone system—the PTT—admits most of its trunk lines have an "efficiency rate" of 40% or less, meaning an average call must be placed three times before it finds a clear circuit.

The PTT blames lack of funds, and that's where the microwave relays come in. The cost of such links in France has dropped by half over the past decade, estimates Yves Fargette, microwave chief of the PTT. For new installations, microwave is now cheaper than coaxial cables. And since total transistorization became the rule in France a year or so ago, upkeep costs have fallen, too.

Modernizing. All this means microwave will give the PTT more circuits for its money and the PTT is launching an ambitious construction program that will quadruple its microwave system over the next two and a half years.

Microwaves now account for 2.7 million kilometer-circuits, only 15% of the total phone system. By the end of 1971 microwaves will total 10.7 million kilometer-circuits, or 30% of the whole. Cable circuits will be doubled by adding new modulation equipment to take advantage of existing cable capacity.

Most of the new microwave systems will be built between provincial cities, where traffic jams are the worst because of past concentration on hookups to Paris.

The cost. This new microwave construction will mean a bonanza for electronics companies of some \$13 million next year and a still greater amount in 1971. This year's microwave expenditures will total around \$7.6 million.

PTT's contract award system is in for a modernizing, too. To streamline red-tape and cut costs further, the PTT plans to abandon its present policy of negotiating contracts whenever a microwave system is to be built, which necessitates 20 or 30 contract sessions a year. Instead, it will award contracts at the beginning of each year

for all the work to be done that year. The PTT thinks this will help suppliers plan longer production runs and reduce costs. The PTT will also try awarding "turnkey" contracts that will give one firm responsibility for entire systems, from electronics to power supply to building construction.

Australia

Fare Enough

From Times Square to the Ginza, the lot of the taxi rider is not a happy one. Besides traffic jams, there's the din of two-way radios crashing out messages. Even the squelching jangles. Then there's the problem of reading the fare, which is often indicated in tiny numbers. And when rates change, the numbers on the meter may just kick off a search through printed sheets showing the new charges, leaving the rider feeling he's the victim of some con game.

In Sydney, however, the harried traveler is due for a couple of electronic assists. One is an electronic taximeter. The other is a selective two-way radio system. The two work together part of the time.

The electronic taximeter, a development of Standard Telephones and Cables Australia Ltd., has a wired-in memory containing the fare structure. Every time the speedometer cable revolves, a sensor sends an impulse to the taximeter; here the impulses are counted and compared with fare-structure information. The computed fare is continuously dis-

played using large cold-cathode readout tubes, a boon for the late night cab rider.

Modular. The taximeter plugs into a cab's dashboard rather like a portable car radio. When fare changes are made the meter can be removed to adjust the memory wiring—a job that takes an hour at most. And that's an important consideration in Australia where the cab fares, fixed by government authority, change frequently due to changes in driver wage scales, the price of gasoline, and maintenance costs. With mechanical meters, the whole taxi is down.

Through a connection with the cab's two way radio, the meter can also be directed by the taxi radio room to add a surcharge for relaying a customer's address to the driver. In Sydney, there's a 15 cent fee for calling a cab by phone. Selective commanding is made possible by a new communications system between base stations and cab fleet that turns on the receiver output only in the particular car called. Developed by the Plessey Pacific Control Research Laboratory in Melbourne, the system uses silicon IC's to decode a taxi's call number and turn on the output when the right call number is sent.

Japan

New from old

A Japanese company, competing for an automatic train control job, has pulled some new tricks from a bag of old technologies. What has emerged is an induction radio system using a novel transmission line and antenna loop couplers. The system holds down induced noises and unwanted radiation in the transmission line and antenna loops, beating by a noise-suppression factor of 40 decibels the conventional system of parallel lines coupled with single-loop antenna.

Designed for the bustling Japanese National Railway, the communication system features a transmission line with conductor sandwiched helically between two polyethylene cylinders for protection

against rain and snow. The line is laid out beside the tracks to move control signals between train station, wayside station, and train.

Confident. Under development by Sumitomo Electric Industries of Osaka, the network is one of three competing systems contracted by the Japanese National Railways for automatic train control. The first uses a leaky coaxial cable; the second, a leaky waveguide. The radio induction system is the cheapest of the three. Sumitomo engineers modestly estimate that their system, nearing test completion, has more than a 50% chance of being selected by the government for production.

Copper tape was chosen for the conductor in the line (which operates from 50 kilohertz to over 1 megahertz) because its width is easily altered to change the characteristic impedance. Reduction of the impedance is the key to minimizing coupling loss between train station and wayside stations strung along the tracks.

Pairs of tapes are twisted helically around the polyethylene core at constant pitch. At the transmitting and receiving points, the antenna loops are a fraction of pitch apart. For example, in Sumitomo's quadruplet line (two pairs of tapes), the loops are set a half pitch apart; they are connected so that their coupled signals are superposed. A signal to or from the transmission line goes through a phase shifter in which a signal in a conductor pair is phase-shifted.

Even. In this way, phase and amplitude of noise are uniformly distributed over several pitches along the line. Therefore, noises inducted at two points on the line at a distance of a half pitch have a phase difference of π and cancel each other. The unwanted radiation from a line is also suppressed since the radiation from a half-pitch section gets canceled by that from the adjacent half-pitch section.

Signals transmitted to the line from the antenna will not radiate into space—since the loops are arranged at intervals of odd multiples of a half twist pitch and are inversely connected.



Taxiing. Fast changes in fare rates, easy reading featured in new taximeter.

Electronics advertisers

July 7, 1969

■ Acopian Corp.	162	□ Fairchild Semiconductor	5E	Nichicon Capacitor Ltd.	71
Mort Barish Associates		Southern Adv., Ltd.		Dai-ichi International Ltd.	
Acton Laboratories, Inc.	176	Farinon Electric	7	■ North Atlantic Industries Inc.	132
Impact Adv., Inc.		Jack Herrick Adv., Inc.		Ross Roy of New York Inc.	
Adams & Westlake Co.	24	■ Fluke Mfg. Co., John	15	■ Nortronics Company Inc.,	145
Jai Herbert Adv.		Bonfield Associates		OEM Division	
□ Adret Electronique	20E	General Electric Co.,		Stral Advertising Company Inc.	
Perez Publicite		Miniature Lamp Div.	138	Okaya Electric Industry Co. Ltd.	72
□ Alcatel	17E	Batten, Barton, Durstine & Osborn, Inc.		Diamond Agency Co. Ltd.	
Agence Rene Sicard		General Electric Co.,	25	Omron Tateisi Electronics Co.	74-75
Alco Electronic Products, Inc.	173, 175, 177	Semiconductor Products Div.		Dai-ichi International Inc.	
Marketronics Advertising		Robert S. Cragin, Inc.		Patwin Electronics	154
■ Alden Electronics	147	General Radio Co.	2nd Cover	Graceman Advertising Inc.	
Larcom Randall Adv., Inc.		Horton Church & Goff, Inc.		Philco Ford Corporation	
Allen-Bradley Co.	23	■ Grayhill, Inc.	174	Sierra Electronics Operation	5
Fensholt Adv. Agcy.		Merchandising Adv., Inc.		Hal Lawrence Inc.	
American Cyanamid Co.,		■ Guardian Electric Mfg. Co.	27	■ Pomona Electronics Co.	188
Plastic & Resins Div.	43	K & A Advertising		Buxton Adv. Agcy.	
Wilson, Haight & Welch, Inc.		■ Hansen Mfg. Co.	54	Powertec Division of Airtronics	14
American Telephone & Telegraph Co.,		Keller-Crescent Co.		Cordova Associates	
Yellow Pages	86	Hayakawa Electric Co., Ltd.	70	■ Primo Co., Ltd.	81
Cunningham & Walsh, Inc. Adv.		Dai-ichi International, Inc.		General Adv. Agcy.	
■ AMP, Inc.	18, 19	Heinemann Electric Co.	6	Product Designs, Inc.	58
Garceau, Hallahan & McCullough, Inc.		Thomas R. Sundheim, Inc.		Geha-Paskind & Assoc., Inc.	
□ AMP Europe	11E, 12E	■ Hewlett Packard, Frequency & Time Div.	2, 102, 103, 104	Radio Corporation of America	4th Cover, 63
Allardyce Palmer, Ltd.		Lennen & Newell, Inc.		Al Paul Lefton Co.	
Anaconda American Brass Co.	20, 21	■ Hewlett Packard, International Div.	1	Rockland Laboratories, Inc.	163
Wilson, Haight & Welch, Inc.		Lennen & Newell, Inc.		J.J. Curran, Inc.	
Andrew Corp.	66	■ Hewlett Packard, Loveland Div.	87, 156	Sage Electronics Corp.	155
Fensholt Adv., Inc.		Tallant/Yates Adv.		Mathison Adv., Inc.	
Apollo Corp.	76	■ Hewlett Packard, New Jersey Div.	139	Sanken Electric Co., Ltd.	81
General Adv. Agcy., Inc.		McCarthy, Scelba & DiBiasi Adv. Agcy., Inc.		Seikosha Adv., Inc.	
Astrosystems, Inc.	137	Hirose Electric Co., Ltd.	81	□ Schlumberger SIS	3E
Don Alt and Assoc., Inc.		New Asia Trading News Agcy., Ltd.		Sodipa	
■ Barnstead Co., Div. of Sybron Corp.	26	Hitachi, Ltd.	73	□ Schlumberger Ltd. EMD	2E
Creamer, Trowbridge, Case & Basford, Inc.		Dentsu Advertising		□ Schneider R.T.	19E
■ Beckman Instruments, Inc., Helipot Div.	88	Hitachi Metals, Ltd.	70	Noirclerc Publicite	
N.W. Ayer/Jorgensen/MacDonald, Inc.		Asia Adv. Agcy., Inc.		Scientific Data Systems	44
Bell Telephone Laboratories	53	Hosiden Electronic	80	Doyle, Dane, Bernbach, Inc.	
N.W. Ayer & Son, Inc.		Daiyusha, Inc. Adv.		Shinei Industrial Co., Ltd.	78
Bendix Corp.,		Hughes Aircraft Co.	57, 129	General Adv. Agcy., Inc.	
Flight & Engine Instruments Div.	126	Foot, Cone & Belding		Showa Musen Kogyo Co., Ltd.	77
MacManus, John & Adams, Inc.		■ International Crystal Mfg. Co.	140	General Adv. Agcy., Inc.	
Bendix Corp., Electrical Components Div.	28, 29	Robert V. Freeland & Assoc.		Sifco Metachemical	166
MacManus, John & Adams, Inc.		Japan Electric Measuring Instruments Manufacturers' Association	82	The W.N. Gates Co.	
Bolt Beranek and Newman	171	Kokokusha Kabushiki Kaisha		Signetec Corp., Sub.	
Cochrane Chase & Co., Inc.		Kimura Electric Co., Ltd.	72	Corning Glass Works	51
Bourns, Inc., Trimpot Div.	159	Showa Adv. Service, Inc.		Cunningham & Walsh, Inc.	
The Lester Co.		Kokuyo Electric Co., Ltd.	76	Silliconix, Inc.	85
■ Brush Instruments		Tokyo Adv., Inc.		Graphics West	
Div. of Clevite Corp.	131	Kyodo Electronics Laboratories, Inc.	80	□ Solartron Electronic Group Ltd.	8E-9E
Carr Liggett Adv., Inc.		General Adv. Agcy., Inc.		T.B. Browne Ltd.	
■ Bussman Mfg. Div. of McGraw Edison Co.	190	□ L T T	14E, 15E	□ Solartron Electronics Group Ltd. Hybrids Div.	4E
Henderson Adv. Co.		Promotion-Venta-Publicite		T.B. Browne Ltd.	
By-Buk Co.	154	■ Leach Corporation	127	South Carolina Electric & Gas Co.	167
Albert Frank Guenther Law Adv., Inc.		Chiat/Day, Inc.		Cargill, Wilson & Acree Inc. Advertising	
Cambridge Thermionic Corp.	176	Lockheed Missiles & Space Co.	166	Sprague Electric Company, The	30
Chirurg & Cairns, Inc.		McCann-Erickson, Inc.		Harry P. Bridge Company	
Chrono-Log Corp.	56	McGraw-Hill Professional & Reference Book Div.	146	Sumida Electric Co. Ltd.	81
Mort Barish Assoc., Inc.		■ Magnetec, Inc.	59	General Adv. Agency Inc.	
■ Clevite Corp., Piezoelectric Div.	174	Lando Adv. Agcy., Inc.		■ Susumu Industrial Co., Ltd.	78
Carr Liggett Adv., Inc.		■ Mallory & Co., P.R., Mfg. Div.	9	Kyokuto Kikaku Co., Ltd.	
■ Clifton Precision Products Co., Div. of Litton Industries	169	Aitkin-Kynett Co.		Sylvania Electric Products Inc.	65
Ivey Adv., Inc.		□ Marconi & Co., Ltd.,	10E	Parts Division	
Cohu Electronics, Inc.	60	Radio Communication Div.		Doyle Dane Bernbach Inc.	
■ Computer Products, Inc.	136	Hampshire House, Ltd.		Synthane-Taylor Corporation	64
Grenman Assoc., Inc.		■ Matsuo Electric Co., Ltd.	76	Gray & Rogers Inc.	
■ Cosmic Optical Co., Ltd.	72	Daiko Adv., Inc.		■ Systron-Donner Corporation	32
Matsushita, Inc.		■ Matsushita Communication Industrial Co., Ltd.	83	Bonfield Associates Inc.	
CREI, Home Study Div. of the McGraw-Hill Book Co.	172	Standard Adv., Inc.		Takeda Riken Industry Co. Ltd.	83
Henry J. Kaufman & Assoc.		■ Matsushita Electric	79	Shinwa Advertising Co. Ltd.	
■ CTS Corp.	150, 151	Dentsu Adv., Ltd.		Tally Corporation	148
Reincke, Meyer & Finn, Inc.		Matthey Bishop Inc.	22	Bonfield Associates Inc.	
■ Dale Electronics, Inc., SIOUX Div.	176	Richardson, Thomas & Bushman Inc.		Techn (Cambridge) Limited	188
Swanson, Sinkey, Ellis, Inc. Adv.		■ Micro Switch Division of Honeywell	3rd Cover	Harrison Wright Associates Limited	
Dana Laboratories, Inc.	113	N.W. Ayer & Son Inc.		Teikoku Tsushin Kogyo Co. Ltd.	77
Smith-Klitten, Inc.		Minnesota Mining & Mfg. Co.		Diamond Agency Co. Ltd.	
□ Dow Corning International, Ltd.	6E, 7E	Mincrom Division	142	Telonic Instruments	62
Marsteller International S.A.		Reach McClinton & Co.		Jansen Associates Inc.	
DuPont de Nemours & Co., Freon Div.	130	■ Mitsumi Electric Company Ltd.	78	Tempress Research Company Inc.	160
N.W. Ayer & Son, Inc.		Sanko Tsushinsha Ltd.		Hal Lawrence Inc.	
DuPont de Nemours Co., Teflon Div.	152	Monsanto Company	17	■ Texscan Corporation	16
Batten, Barton, Durstine & Osborn, Inc.		Michel Cather Inc.		Burton Browne Advertising	
■ DX Antenna Co., Ltd.	76	■ Motorola Communications & Electronics Inc.	174	■ Tohoku Metal Industries Ltd.	77
Sanko Sha Adv. Agcy. Co., Ltd.		Griswold Eshleman Company		Hakuhodo Inc.	
Eastman Kodak Co.,		Motorola Semiconductor Products Incorporated	35 to 42	Toko Inc.	78
PCIM Market Development	141	Lane & Bird Advertising Inc.		Hakuhodo Incorporated	
Rumrill Hoyt, Inc.		■ Murata Mfg. Co. Ltd.	71	Tokyo Electric Co., Ltd.	71
Eldorado Electrodata Corp. of Concord	189	AMO Inc.		ALinc./Export Advertising	
Moore-Mayhew Adv.		National Semiconductor Corp.	108-109	Transistor Electronics Corp.	128
■ Electro Motive Mfg. Co.	47	Hall Butler Blatherwick Inc.		Steverson & Assoc., Inc.	
Reynolds & Foster, Inc.		Watkins-Johnson Co.	164	Transitron Electronic Corp.	61
Electronic Industries Association of Japan	69	William C. Estler Adv.		Larcom Randall Adv., Inc.	
Asian Advertisers, Inc.		Vector Electronic Co, Inc.	171	TRW Semiconductors, Inc.	55
E/MC Electronics/Management Center	84	Buck Advertising		Fuller & Smith & Ross, Inc.	
Slesar & Kanzer, Inc.		Watkins-Johnson Co.	164	Fuller & Smith & Ross, Inc.	10, 11
Emerson & Cuming, Inc.	170	William C. Estler Adv.		Vector Electronic Co, Inc.	
Edwin F. Hall				Buck Advertising	
Fairchild Semiconductor, Inc.	12, 13, 49, 135				
Chiat/Day, Inc.					

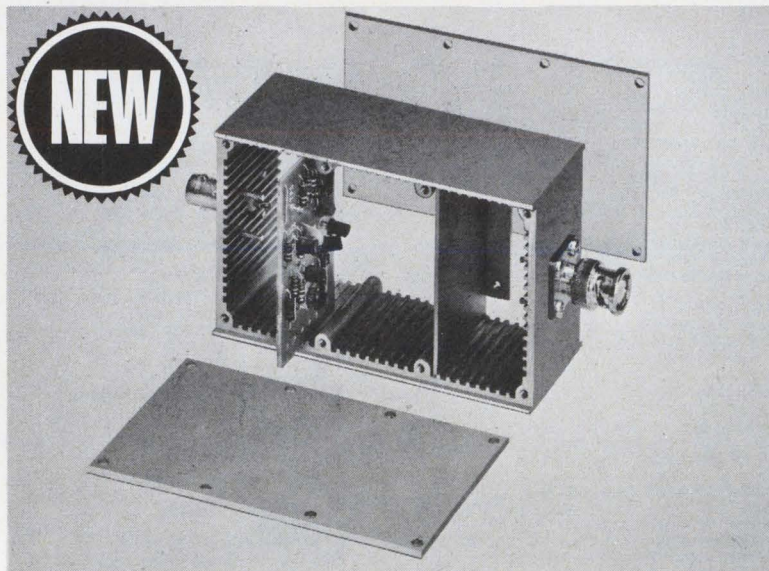

SHIELDED BOXES with CARD GUIDES

Rugged die-cast aluminum boxes, slotted to accept $\frac{1}{16}$ " circuit boards and shielding dividers. Excellent for packaging electronic circuitry. Boxes have removable top and bottom covers. Useable inside space: 4"x2"x1 $\frac{1}{2}$ ". Several models with various connectors.

Write for 1969 Catalog



POMONA ELECTRONICS CO., INC.
1500 E. Ninth Street, Pomona, California 91766

Circle 219 on reader service card

Advertising Sales Staff

Frank E. LeBeau [212] 971-6464
Advertising Sales Manager

Wallis Clarke [212] 971-2187
Assistant to sales manager

Donald J. Austermann [212] 971-3139
Promotion Manager

Warren H. Gardner [215] LO 8-6161
Eastern Advertising Sales Manager

Atlanta, Ga. 30309: Michael H. Miller, 1375 Peachtree St., N.E.
[404] 892-2868

Boston, Mass. 02116: William S. Hodgkinson
McGraw-Hill Building, Copley Square
[617] CO 2-1160

Cleveland, Ohio 44113: William J. Boyle, 55 Public Square, [216] SU 1-7000

New York, N.Y. 10036
500 Fifth Avenue

James R. Pierce [212] 971-3615

John A. Garland [212] 971-3617

Michael J. Stoller [212] 971-3616

Philadelphia, Pa. 19103:

Jeffrey M. Preston

Warren H. Gardner,

6 Penn Center Plaza,

[215] LO 8-6161

Pittsburgh, Pa. 15222: Jeffrey M. Preston,

4 Gateway Center, [412] 391-1314

Rochester, N.Y. 14534: William J. Boyle,

9 Greylock Ridge, Pittsford, N.Y.

[716] 586-5040

Donald R. Furth [312] MO 4-5800

Midwest Advertising Sales Manager

Chicago, Ill. 60611: Kenneth E. Nicklas

Ralph Hanning 645 North Michigan Avenue,

[312] MO 4-5800

Dallas, Texas 75201: Richard P. Poole, 1800

Republic National Bank Tower,

[214] RI 7-9721

Houston, Texas 77002: Robert Wallin,

2270 Humble Bldg. [713] CA 4-8381

Detroit, Michigan 48226: Ralph Hanning,

856 Penobscot Building

[313] 962-1793

Minneapolis, Minn. 55402: 1104 Northstar

Center [612] 332-7425

St. Louis, Mo. 63105: Kenneth E. Nicklas,

The Clayton Tower, 7751 Carondelet Ave.

[314] PA 5-7285

James T. Hauptli [415] DO 2-4600

Western Advertising Sales Manager

Denver, Colo. 80202: David M. Watson,

Tower Bldg., 1700 Broadway

[303] 266-3863

Los Angeles, Calif. 90017: Ian C. Hill,

John G. Zisch, 1125 W. 6th St.,

[213] HU 2-5450

Portland, Ore. 97204: James T. Hauptli,

Don Farris, 218 Mohawk Building,

222 S.W. Morrison Street,

Phone [503] 223-5118

San Francisco, Calif. 94111: James T. Hauptli,

Don Farris, 255 California Street,

[415] DO 2-4600

Pierre Braude Tel: 225 85 88: Paris

European Director

Paris: Denis Jacob

88-90 Avenue Des Champs-Elysees, Paris 8

United Kingdom and Scandinavia

London: Oliver Ball, Tel: Hyde Park 1451

34 Dover Street, London W1

Milan: Robert Saidel, Roberto Laureri Jr.

1 via Baracchini Phone 86-90-656

Brussels: Denis Jacob

27 Rue Ducale Tel: 136503

Frankfurt/Main: Hans Haller

Elsa-Brandstroem Str. 2

Phone 72 01 81

Geneva: Denis Jacob

1 rue du Temple Phone: 31 95 60

Tokyo: McGraw-Hill

Publications Overseas Corporation,

Kasumigaseki Building 2-5, 3-chome,

Kasumigaseki, Chiyoda-Ku, Tokyo, Japan

[581] 9811

Osaka: Akihiko Kamesaka, McGraw-Hill

Publications Overseas Corporation, Kondo

Bldg., 163, Umegae-cho Kita-ku [362] 8771

Business Department

Stephen R. Weiss, Production Manager

[212] 971-2044

Thomas M. Egan,

Assistant Production Manager [212] 971-3140

Dorothy Carmesin, Contracts and Billings

[212] 971-2908

Frances Vallone, Reader Service Manager

[212] 971-2865

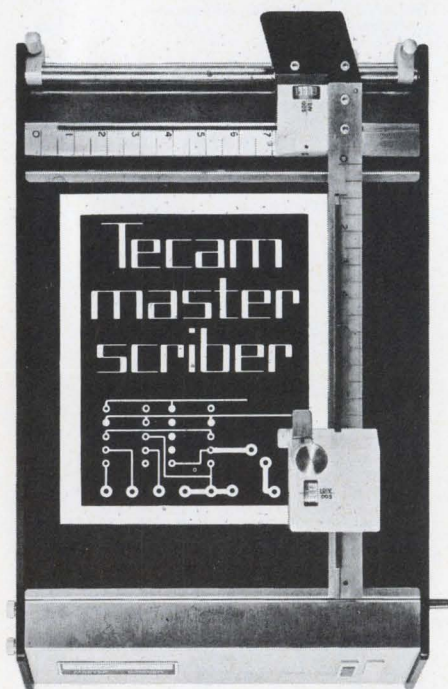

the quick way to printed circuits
for full details write to

Techne Incorporated 661 Brunswick Pike
Princeton New Jersey 08540 USA
Telephone (609) 452-9275

- **Watkins-Johnson Co.** 13E
William C. Estler Adv.
Westinghouse Electric Corp.,
Semiconductor Div. 180
Pritchard Wood Assoc., Inc.
- Yokogawa Electric Works, Ltd.** 82
General Adv. Agcy., Inc.
- **Yokowo Mfg. Co., Ltd.** 72
General Adv. Agcy., Inc.

Classified & Employment Advertising

F.J. Eberle, Manager

212-971-2557

EMPLOYMENT OPPORTUNITIES 178

Motorola 178

EQUIPMENT
(Used or Surplus New)
For Sale

A&A Electronics 179

Radio Research Instrument Co. 178

■ For more information on complete product
line see advertisement in the latest Elec-
tronics Buyer's Guide

□ Advertisers in Electronics International

Electronics Buyers' Guide

George F. Werner, Associate Publisher

[212] 971-2310

Robert M. Denmead,

Midwest Regional Manager

[312] MO 4-5800

William A. Capuzzi,

New York, New England District Manager

[212] 971-3793

Regina Hera, Directory Manager

[212] 971-2544

Thomas M. Egan, Production Manager

[212] 971-3140

Circulation Department

Isaaca Siegel, Manager [212] 971-6057

Research Department

David Strassler, Manager [212] 971-6058

**ELDORADO INVENTED THE INTERPOLATING
TIME INTERVAL COUNTER TECHNIQUE**



- TIME INTERVAL GENERATOR
- 1 NANO SEC. INCREMENTS
- 100 PICO SEC. ACCURACY
- \$4500

- 1 NANO SEC. AVERAGING TIME INTERVAL COUNTER
- 10 NANO SEC. SINGLE EVENT
- \$1750

- 1 NANO SEC. SINGLE EVENT TIME INTERVAL COUNTER
- FULL SIGNAL CONDITIONING
- \$5500



SEE US AT WESCON BOOTH 1722-23

GSA LISTED

ELDORADO

ELDORADO ELECTRODATA CORPORATION
601 CHALOMAR ROAD • CONCORD, CALIF. 94520 U.S.A. • TEL. (415) 686-4200

Circle 189 on reader service card

PLAY IT SAFE: Start now to save their hearts



Help your children form good health habits now to reduce risk of heart attack later:

- Maintain normal weight; obesity in youth may persist throughout life
- Encourage regular physical activity
- Serve them foods low in saturated fats;
- Teach them that cigarette smoking is hazardous
- Make medical check-ups a family routine

Do as a good parent should. Set a good example. Follow the rules yourself, and guard *your* heart, too.

**GIVE ... SO MORE
WILL LIVE**



HEART FUND

BUSS QUALITY

SMALL DIMENSION FUSES and FUSEHOLDERS

FOR THE PROTECTION OF ALL TYPES OF
ELECTRONIC & ELECTRICAL CIRCUITS & DEVICES

The complete BUSS line of fuses includes dual-element "slow-blowing," single-element "quick-acting" and signal or visual indicating types . . . in sizes from 1/500 amp. up—plus a companion line of fuse clips, blocks and holders.









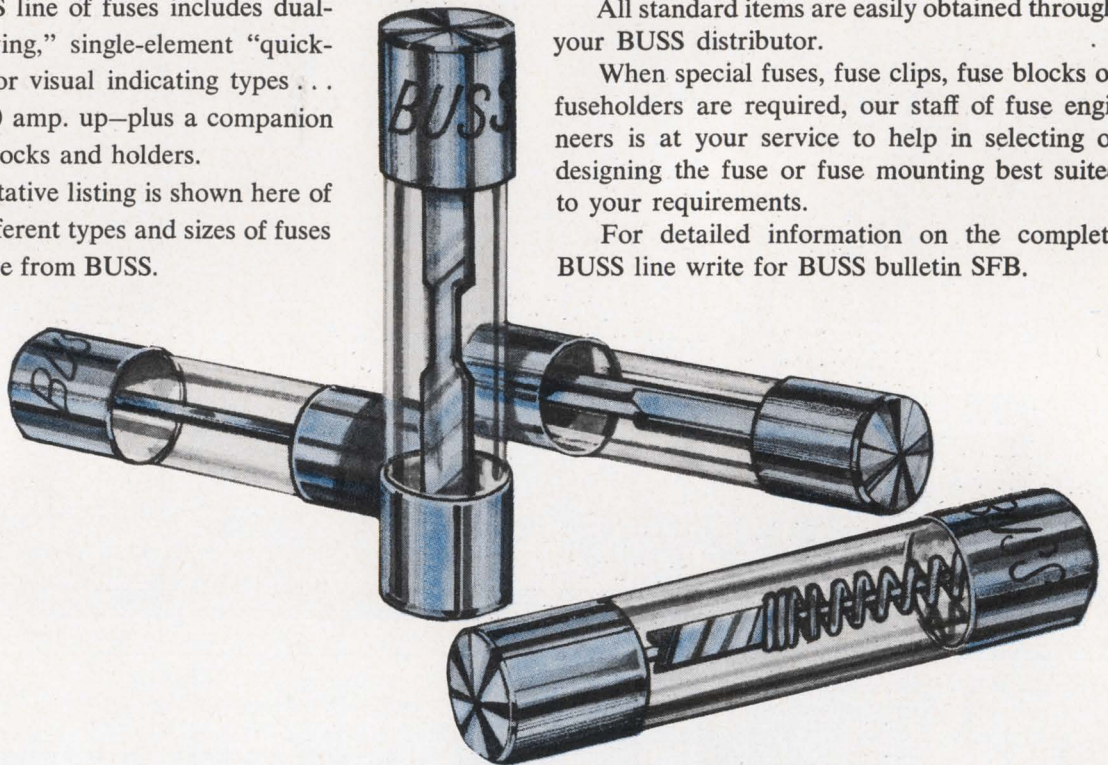







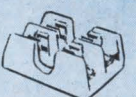



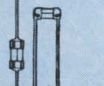





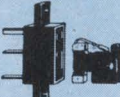

Only a representative listing is shown here of the thousands of different types and sizes of fuses and holders available from BUSS.

All standard items are easily obtained through your BUSS distributor.

When special fuses, fuse clips, fuse blocks or fuseholders are required, our staff of fuse engineers is at your service to help in selecting or designing the fuse or fuse mounting best suited to your requirements.

For detailed information on the complete BUSS line write for BUSS bulletin SFB.

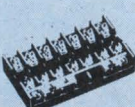

 Buss AGX Fast Acting Fuses	 Buss AGC and MTH Glass Tube Fuses	 Fusetron FNM Fibre Tube Fuses	 Fusetron FNA Indicating Fuses	 Buss In-the-Line or Panel Mounted Fuse/Holder	 Buss Panel Mounted Holders	 Buss Screw or Solder Terminal Fuse Blocks	 Buss Porcelain Base Fuse Blocks
 Buss AGC Glass Tube Fuses	 Buss Indicating Fuses	 Buss Sub-miniature Fuses and Holders	 Tron Sub-miniature Pigtail Fuses	 Buss HPC Holders	 Buss Lamp Indicating Holders	 Buss Silicon Rectifier Fuse Blocks	 Buss Indicating Aircraft Fuses
 Fusetron MDL Fuses	 Buss ABC Ceramic Tube Fuses	 Buss GMT Fuse and HLT Holder	 Buss High Voltage Fuses	 Buss Space Saver Holders	 Buss Shielded Holders	 Fusetron ACK Stud Mounted Fuses	 Limitron KTK High Interrupting Capacity Fuses
 Buss GJV Pigtail Fuses	 Buss SFE Standard Fuses	 Fusetron Type N Fuses and Holders	 Buss In-the-Line Holders	 Buss HLD Visual Indicating Holders	 Buss Signal Fuse Blocks	 Tron Rectifier Fuses	 Buss Miniature Glass Tube Fuses

BUSSMANN MFG. DIVISION, McGraw-Edison Co., ST. LOUIS, MO. 63107

A big part of developing our new keyboard was in helping the operator operate faster. Without goof-ups.

Here's what we came up with:

Two-key rollover. This allows "burst-speed" typing. An electronic interlock eliminates errors when two keys are pushed at the same time.

That old typewriter feel. Key spacing is the same as on office typewriters. And spring loading simulates typewriter touch.

Shift lock. A handy option for dual applications that require

extensive typing in the shifted position.

And several choices. Sloped or stepped key rows. Standard and custom key character sets. Over 500 legends (and we're continually developing more to meet your growing needs). A whole bunch of button colors as well as several button shapes.

They're all part of another thing we came up with, the world's first use of an integrated circuit as a keyboard switching element.

This micro-miniature circuit eliminates mechanical linkages.

Electromechanical parts. Moving contacts. Black boxes. And a big price tag.

But it retains the reliability of our other keyboards. Proven by tens of thousands of operators, in hundreds of applications.

"Condensed Keyboard Guide" briefly discusses MICRO SWITCH keyboards and options. Become a fast operator.

Write for a copy.

MICRO SWITCH

FREEPORT, ILLINOIS 61032
A DIVISION OF HONEYWELL

**Our new all solid-state keyboard.
It makes even fast operators
operate faster.**



4 Amplifier High Gain "Building Block" Array

Here you are—four identical linear amplifiers built on a single IC chip and mounted in the new 16-lead dual-in-line plastic package ready to plug into your design plans. Use them as AF feedback amplifiers; equalizers; in 2- or 4-channel audio applications. Figure them into linear signal mixer designs; as oscillators; as low frequency high gain amplifiers and as multivibrators.

The "matched set" of four is the RCA-CA3048. It provides 57 dB (typ.) voltage gain per amplifier or 114 dB (typ.) when two amplifiers are cascaded. Each amplifier features a Noise Figure of 2 dB (typ.)

at 1 kHz, -3 dB bandwidth of 300 kHz, and an input resistance of 90 k Ω (typ.).

Ask your local RCA Representative or your RCA Distributor for full details. Or write for technical data to RCA Electronic Components, Commercial Engineering, Sec. ICN7-1, Harrison, N. J. 07029.

If you need an array with greater bandwidth—check: **RCA-CA3035**—Three individual general-purpose amplifiers with gain-bandwidth externally adjustable. \$1.50 (1,000 units)

RCA-CA3048 in 16-lead dual-in-line plastic package, \$2.45 (1,000 units)

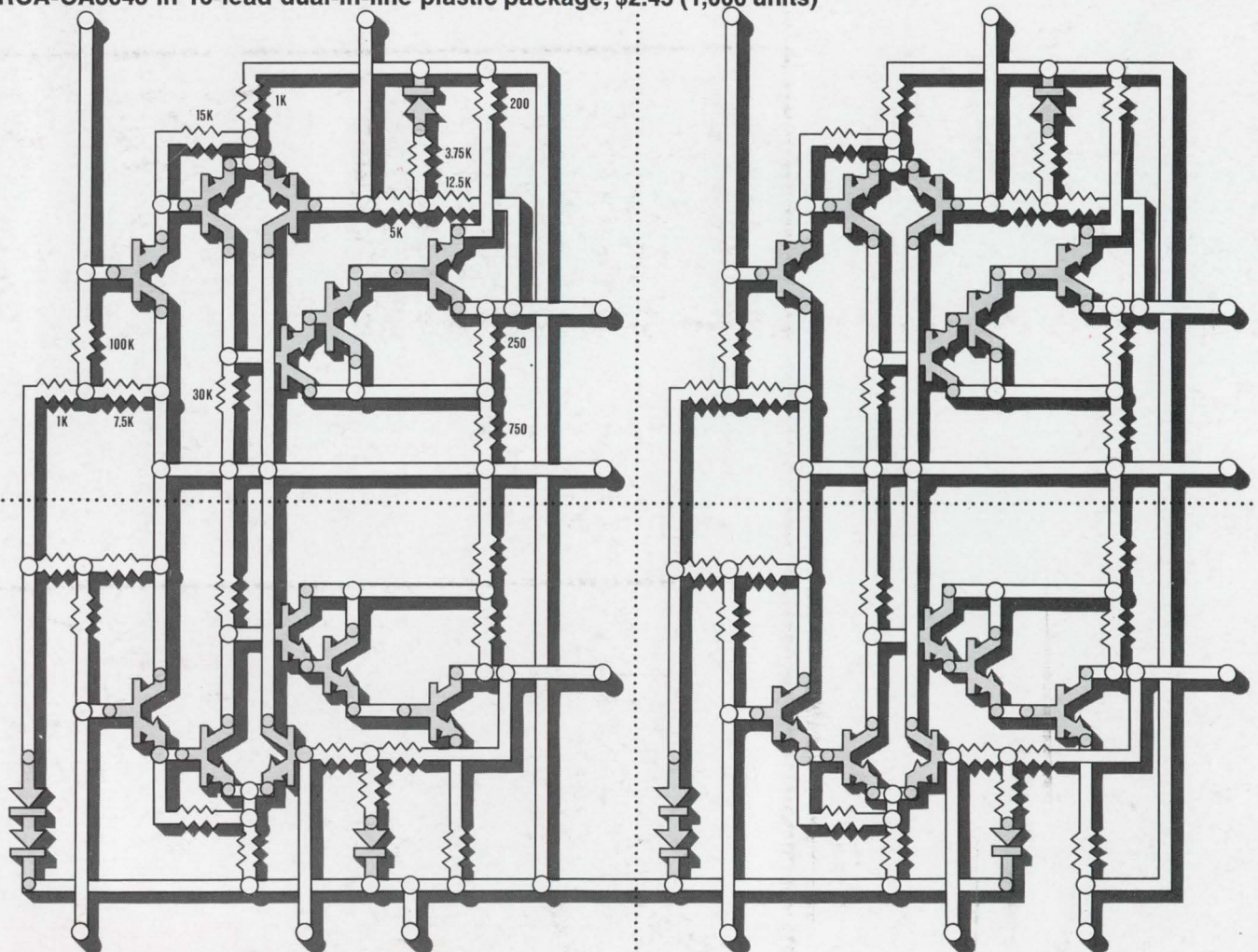

RCA Integrated
Circuits