

CAD and Circus — improving flexibility 86  
Shipboard electronics fit for a queen 104  
Giving thermocouples a digital ice bath 116

\$1.00 A McGraw-Hill Publication

February 2, 1970

# Electronics®

**Arc-plasma spray...**

**A borrowed  
technique  
bursts onto  
the IC scene**

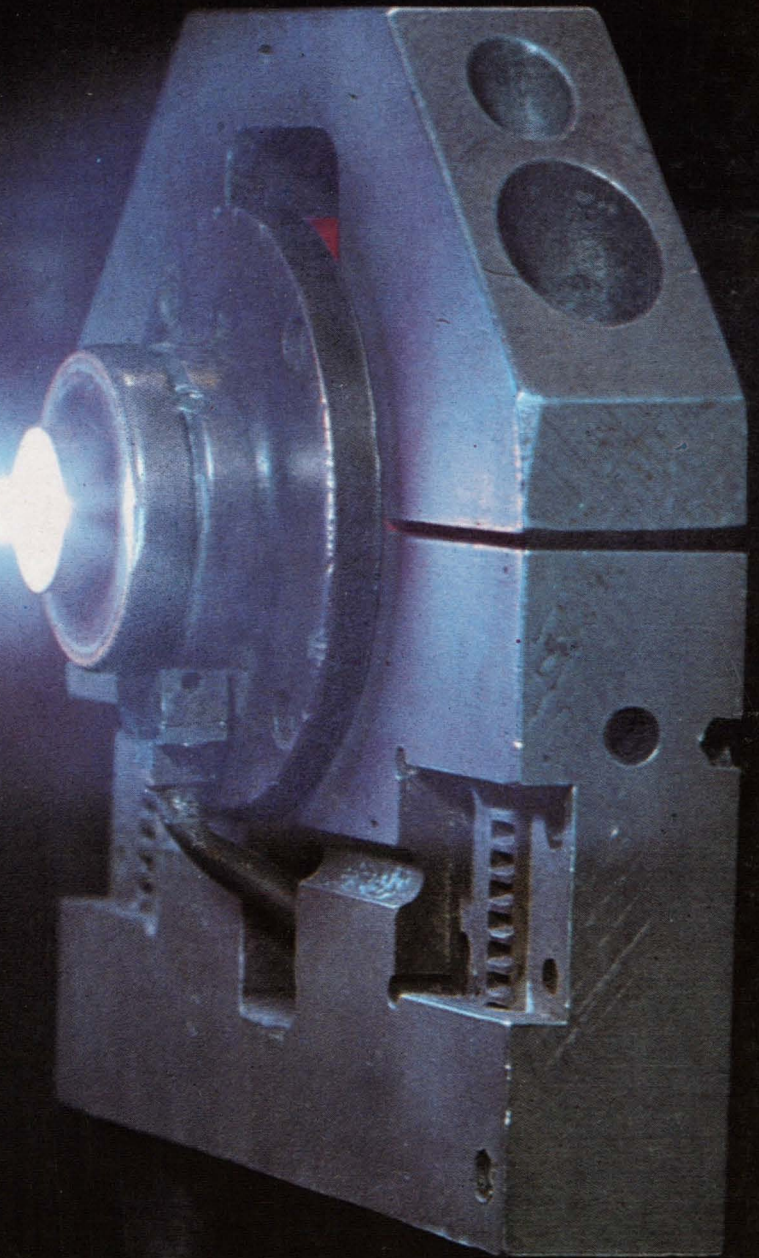

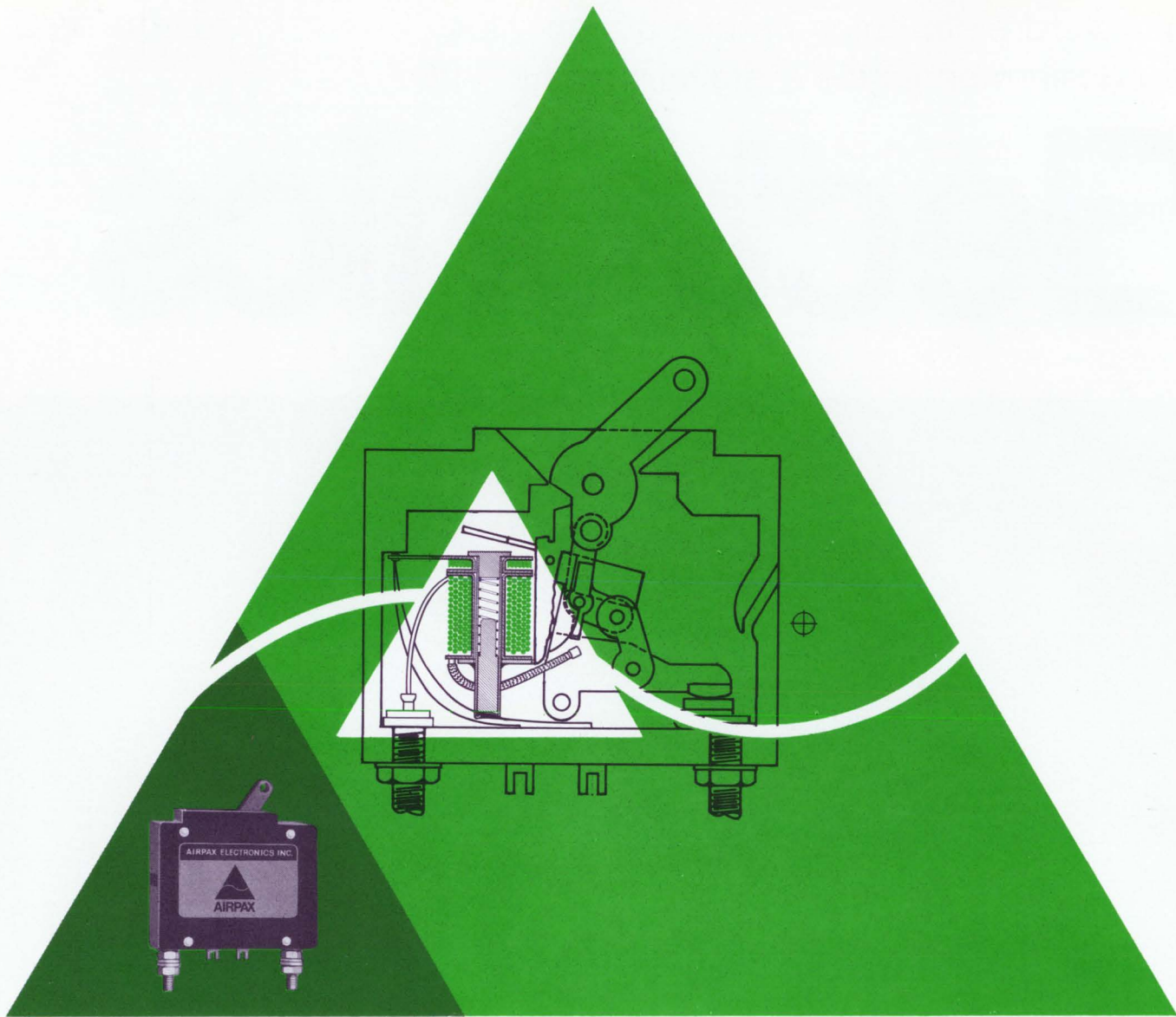

## Smaller, lighter, less expensive circuit protector reacts to both voltage and current.

Airpax engineers have developed a single-pole magnetic circuit protector that reacts like a two-pole breaker but it is smaller, lighter, and less expensive. The new dual coil protector is both voltage and current sensitive and can also be connected as a wattage-sensitive device. **Another Airpax component of confidence!** □ In addition to conventional circuit protection, the new device can be used in conjunction with a temperature transducer to protect heat-sen-

sitive equipment such as power supplies. By connecting a sensing device to the voltage coil of the circuit protector, it can be used in interlock circuits or can react to pressure, flow, weight or fluid level.

□ The current coil ratings are from 0.050 to 50 amperes at 50 VDC or 250 VAC maximum, 60 or 400 Hz. For more detailed information, call or write **Airpax Electronics, Cambridge Division**, Cambridge, Maryland 21613. Phone (301) 228-4600. Telex: 8-7715. TWX: (710) 865-9655.

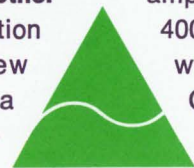

**AIRPAX** ... components of confidence.

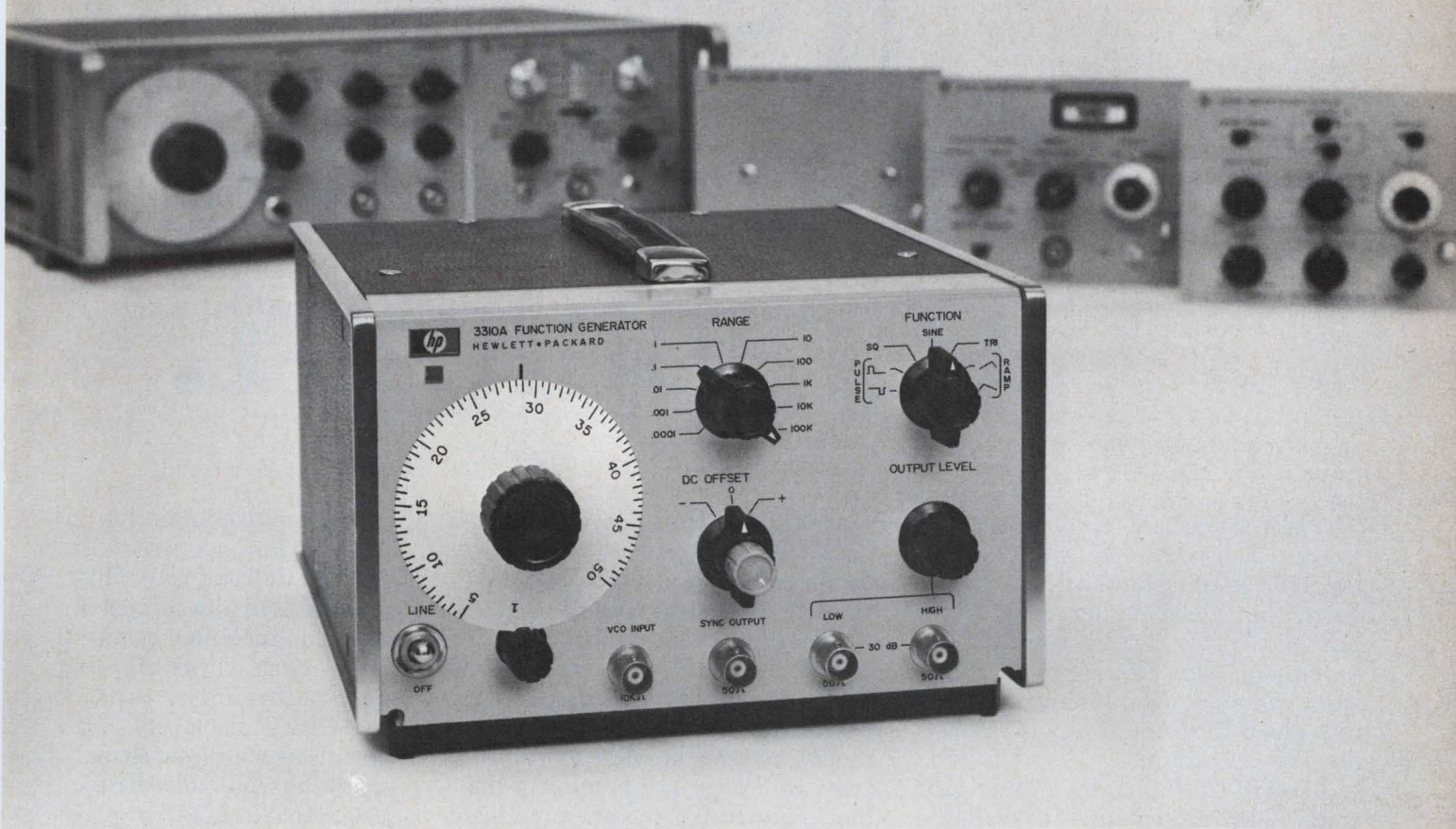

## Need a function generator? Don't waste your money!

Make sure you get the function generator that best fits your needs... in both price and capability. It's that simple.

Or at least it sounds simple. Then you sit down to make a list of all your technical requirements... present and future. Next you try to match those requirements against all of the instruments available. Finally, you make trade-offs of specific performance features versus X dollars saved.

When you are all done, hopefully you wind up with a function generator that has the best performance/price ratio for your particular needs and budget.

### But there is an easier way!

HP manufactures, sells and services a complete line of function generators with a long history of proven performance. Even the newest function generators take advantage of HP's experience and conform to the high quality standards you have come to expect in any HP instrument.

To get all the information you need to determine exactly what you want in a function generator... just turn to page 267 of your 1970 HP catalog. You get more than just a list of products, you get the background information you want to determine your specific needs.

If you need a low-cost general purpose function generator, pay special attention to the HP 3310A. This one does so much that it's actually more than just a function generator.

You not only get the usual sine, square and triangle functions—but both positive and negative going pulses and ramps. Add dc offset, a frequency range of 0.0005 Hz to 5 MHz, all solid-state reliability and a price tag of only \$575 and you will see why we say this one is more than just an ordinary function generator. You save both money and space.

With the HP 3310A you can test and demonstrate the response of differentiator and integrator circuits. Use the triangle output to show how a

sine wave may be synthesized. Use the ramps to demonstrate the action of a comparator circuit.

You can even use a combination of pulses and ramps to simulate the action of a mechanical function to an analog computer. This is a function generator with such potential that you'll be using it for more applications than any other signal source you now own.

If you need more information, just call your local HP field engineer. He will be glad to help you solve any measurement problem you may have. Or, write to Hewlett-Packard, Palo Alto, California 94304. Europe: 1217 Meyrin-Geneva, Switzerland.

090/4

**HEWLETT  PACKARD**  
S I G N A L   S O U R C E S

Circle 1 on reader service card

# It's made time-sharing a graphic art.

The new time-share terminal. Hewlett-Packard's answer to the graphic time lag. HP's graphic terminal picks up where the Teletypewriter leaves off and provides a revolutionary new capability: in-house graphic plotting of all time-share computer data. Instantly. Accepts time-share EIA ASCII inputs from the Teletypewriter..

The HP 7200 Graphic Plotter generates visual presentations of mathematical and engineering functions, no matter how sophisticated. Or it plots business computations like bar graphs and pie charts. It can spot a trend, prove a theory, compare data, generate engineering designs. It lets the time-share user get more use out of a

terminal because he can get more use out of the numbers. He instantly comprehends typewritten data in smooth, clear plotted form.

HP's versatile new Terminal for time-share systems plots points or lines. Each data point is defined by its X-Y coordinates and the 7200 is a vector plotter, plotting absolute coordinates from all inputs. The position of the plot is adjustable and any preprinted grid or blank paper can be used. No special training is required to operate the 7200.

Check out Hewlett-Packard's new

7200 Graphic Plotter. It's available through time-share services. Call and learn how simple it is to plot computer-resolved problems — points, curves, circles, lines, ellipses, contours, bar or pie-charts. You name it. Look into expanding your time-share capability. Any time-share service that hasn't heard about the 7200 should talk to us.

HEWLETT  PACKARD

GRAPHIC RECORDERS

Circle 2 on reader service card



## Features

### Probing the News

- 125 **Communications:** Door opening for domestic communications satellites  
133 **Companies:** GE's strikebound EE's find they're drivers or welders

### U.S. Reports

- 37 **Avionics:** F-15 subsystems to be simple  
38 **Communications:** Bell hopes mm waveguides will break jam  
39 **Government:** NASA slips and stretches to make ends meet  
40 **Companies:** Automated semiconductor-memory line; Viatron is doing it  
44 **Management:** Draper wishes he'd said no to FIT  
44 **Computers:** Not-so-special-purpose 16-bit machine  
46 **Displays:** Fluidic controls for plasma screen  
49 **For the record**

### Electronics International

- 63 **France:** Ion implanter dopes chips with up to four impurities  
64 **Japan:** Kilowatt FET's loom large on the horizon  
65 **Italy:** Olivetti steps back into computers with a new accounting machine  
66 **Great Britain:** 2- and 4-Ghz wavemeter yields 14-microsecond digital readout

### New Products

- 141 **In the spotlight**  
141 Computer carries calculator price tag  
145 **Instruments review**  
145 Scope plug-in has 1,500-volt isolation  
146 Counter handles odd-shaped signals  
151 **Subassemblies review**  
151 System displays 16 inputs at a time  
155 **Production equipment review**  
155 MOS LSI tester runs at 2 Mhz  
159 **Semiconductor review**  
159 Self-contained hybrid regulators  
164 **New Materials**

Title R registered U.S. Patent Office; © copyright 1970 by McGraw-Hill Inc. All rights reserved, including the right to reproduce the contents of this publication in whole or in part.

## Articles

- Design theory** 86 **Circus means versatility as a CAD program**  
Based on the actual physical makeup of the semiconductor, Circus requires just one model for a variety of analyses  
C.D. Root,  
Raytheon
- Circuit design** 98 **Designer's casebook**  
▪ A dynamic lead tester for regulated power supplies  
▪ P-i-n diode T switch consumes little power  
▪ Regulator holds temperature of chip's substrate constant
- Communications** 104 **Her majesty, Elizabeth 2**  
Britannia's all-electronic floating resort has a collision-avoidance system, a satellite-navigation system, and a central computer  
Roger Kenneth Field,  
*Electronics* staff
- Advanced technology** 108 **Arc-plasma deposits may yield some big microwave dividends**  
Capable of accommodating a wide variety of deposition and substrate materials, arc-plasma spraying technique lends itself to the fabrication of thick-film IC's  
D.H. Harris and R.J. Janowiecki,  
Monsanto Research Corp.
- Industrial** 116 **Digitized thermocouple compensation yields direct reading for data logger**  
Cumbersome analog methods used for determining temperatures at cold junctions can be eliminated by using a new technique  
Jacek H. Kollataj,  
Nokia Electronics, Finland

## Departments

- |                             |                             |
|-----------------------------|-----------------------------|
| 4 Editorial Comment         | 40 Index of Activity        |
| 5 Readers Comment           | 61 International Newsletter |
| 9 Who's Who in this issue   | 79 Washington Newsletter    |
| 14 Who's Who in electronics | 168 New Books               |
| 22 Meetings                 | 179 Technical Abstracts     |
| 33 Electronics Newsletter   | 172 New Literature          |

# Electronics

Editor-in-Chief: Donald Christiansen

## Senior staff editors

Technical: Stephen E. Scrupski

News: Robert Henkel

International: Arthur Erikson

Art director: Gerald Ferguson

Assistant managing editors: H. Thomas Maguire, Howard Wolff, William Bucci, Richard Gundlach, Frederick Corey  
Special projects editor: Roger Kenneth Field  
Senior staff writer: John Johnsrud

Reader communications manager: John Drummond

## Department editors

Senior associate editors: Joseph Mittleman, Harry R. Karp; **Advanced technology:** Laurence Altman; **Communications:** Leon M. Magill; **Computers:** Wallace B. Riley, George Weiss; **Design theory:** Joseph Mittleman; **Industrial electronics:** Harry R. Karp; **Instrumentation:** Owen Doyle; **Military/Aerospace:** Alfred Rosenblatt; **New products:** William P. O'Brien; **Solid state:** George Watson, Stephen Wm. Fields

**Copy editors:** Edward Flinn, William S. Weiss  
**Assistant art director:** Charles Ciatto  
**Production editors:** Susan Hurlburt, Arthur C. Miller; **Editorial research:** Virginia Mundt; **Editorial secretaries:** Claire Goodlin, Bernice Pawlak, Barbara Razulis, Vickie Green, Terri O'Neill.

## Field bureaus

**Boston:** James Brinton, manager; Gail Farrell;  
**Los Angeles:** Lawrence Curran, manager; Ralph Selph; **New York:** Peter Schuyten; **San Francisco:** Stephen Wm. Fields, Marilyn Howey; **Washington:** Ray Connolly, manager; Robert Westgate, Lois Vermillion; **Frankfurt:** John Gosch; **London:** Michael Payne; **Paris:** Arthur Erikson; **Tokyo:** Charles Cohen

**Reprints:** Virginia Mundt; **Circulation:** Isaaca Siegel

**Publisher:** Gordon Jones

**Associate publisher:** Dan McMillan

**Assistant to the publisher:** Wallace C. Carmichael

February 2, 1970

## Cushioning the cutback crash

● Predictions that military cutbacks would have only a modest impact on the electronics and aerospace industries undoubtedly were over-optimistic. What was supposed to result, according to some expert observers, was merely a dip in production of expendable items. Development of new and more exotic weapons systems was supposed to proceed—indeed, increase—with the shift of available funds away from the expendables. Instead, there have been some complicating factors, including both a re-examination of national goals and the budget squeeze.

So managers and technologists alike who had been lulled by comforting generalities in reports describing the relative ease of converting to a peacetime economy were shocked to hear Defense Secretary Melvin Laird casually predict the demise of 1,250,000 jobs within the military and defense-related industries by mid-1971. Granted, 600,000 of the jobs represent cutbacks in the armed forces. But 150,000 civilian jobs within the military establishment will be cut, as well as 500,000 more in defense-related industries.

Upon reflection, it seems impossible that it could happen otherwise. At the very least, shifting from a hot-war to a cold-war economy demands a reordering of priorities and a corresponding restructuring of the defense industry. Even including the cuts, 3.3 million workers still will be employed in defense jobs, and another 1.1 million civilians will continue to hold jobs within the military.

Optimists observe that the unemployment could be more than offset by jobs opening up in projects involving environmental protection, housing, and transportation. What they fail to note is that the Federal Government has

shown few signs of supporting such endeavors on a grand scale. For example, water pollution, crime control, mass transit, and housing are earmarked for only modest spending increases. Furthermore, it is not certain how many of those who would land on the unemployment rolls because of the defense cuts could readily adapt to new occupations. One indication that military-project skills are not easily converted to civilian-oriented capabilities is derived from studies made in recent years by the Battelle Memorial Institute. Those studies indicate that a defense-oriented company is likely to be more successful in diversifying away from the defense business through acquisition rather than through startups of new businesses from scratch. Further, such a company generally is more successful in starting up a new defense-oriented business than it is in trying to start a non-defense firm. The implication is clear: the particular management skills needed in the nondefense area differ from those available in the military-defense sector. Moreover, military hardware and that needed for consumer products often differ radically—so much so that direct transfer of technologies becomes difficult, if not impossible.

At the precise time military spending and personnel cuts are being factored into the Federal budget, Secretary Laird observes that the Soviet buildup of its SS-9 missile force, if continued at the present rate, could enable the USSR to destroy 95% of our 1,000 Minuteman missiles even before the 1974 deadline which he predicted earlier. The result could be pressure from the Pentagon to build advanced Polaris-type submarines and new strategic bombers.

In addition, Laird notes that the Safeguard program has

Published every other Monday by McGraw-Hill, Inc. Founder: James H. McGraw 1860-1948. Publication office 99 North Broadway, Albany, N. Y. 12202; second class postage paid at Albany, N. Y. and additional mailing offices.

Executive, editorial, circulation and advertising addresses: Electronics, McGraw-Hill Building, 330 W. 42nd Street, New York, N. Y. 10036. Telephone (212) 971-3333. Teletype TWX N. Y. 710-581-4235. Cable address: MCGRAW HILL N. Y.

Subscriptions solicited only from those professionally engaged in electronics technology. Subscription rates: qualified subscribers in the United States and possessions and Canada, \$8.00 one year, \$12.00 two years, \$16.00 three years; all other countries \$25.00 one year. Non-qualified subscribers in the U.S. and possessions and Canada, \$25.00 one year; all other countries \$50.00. Air freight service to Japan \$50.00 one year. Single copies: United States and possessions and Canada, \$1.00; all other countries, \$1.75.

Officers of McGraw-Hill Publications Company: Joseph H. Allen, President; John R. Emery, J. Elton Tuohig, Senior Vice Presidents; Gordon L. Jones Jr., Group Vice President; Vice Presidents: John R. Callahan, Editorial; John M. Holden, Marketing; David G. Jensen, Manufacturing; Jerome D. Luntz, Planning & Development; Robert F. Marshall, Administration; Robert M. Wilhelmy, Finance; Director of Circulation: Ralph Blackburn.

Officers of the Corporation: Shelton Fisher, President and Chief Executive Officer; John J. Cooke, Senior Vice President and Secretary; Gordon W. McKinley, Vice President and Treasurer.

Title © registered in U.S. Patent Office © Copyright 1970 by McGraw-Hill, Inc. All rights reserved. The contents of this publication may not be reproduced either in whole or in part without the consent of copyright owner.

Subscribers: The publisher, upon written request to our New York office from any subscriber, agrees to refund that part of the subscription price applying to copies not yet mailed. Please send change of address notices or complaints to Fulfillment Manager; subscription orders to Circulation Manager, Electronics at address below. Change of address notices should provide old as well as new address, including postal zip code number. If possible, attach address label from recent issue. Allow one month for change to become effective.

Postmaster: Please send form 3579 to Fulfillment Manager, Electronics, P.O. Box 430, Hightstown, New Jersey 08520.

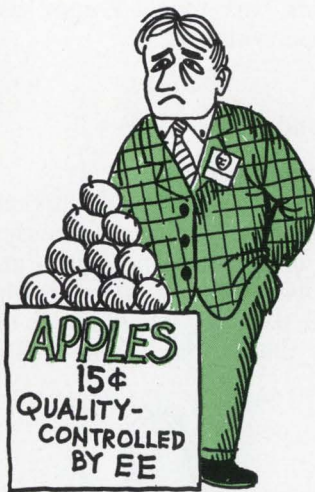

fallen six months behind schedule, while the Chinese pursue a program that could give them 15 to 40 long-range missiles between 1976 and 1978.

So it seems reasonable to predict that, in spite of the budget cuts and the complexities of national priorities that make it so difficult even to pin down the central issues, defense spending probably will continue at much the same pace it has in the past. That thought probably is of little solace to those managers and engineers whose projects are slated to be phased out. Nor is it likely to comfort those who believe that success in the arms-control talks hinges on subdued U.S. military planning.

If there is a bright side at all to the solemn business of war plotting, it may be found within the Defense Program Review Committee, a group created last fall by the President to coordinate national defense priorities with those of the rest of the government. The committee comprises David Packard, Deputy Defense Secretary; Elliott Richardson, Under Secretary of State; Gen. Earl Wheeler, chairman of the Joint Chiefs of Staff; Richard Helms, director of the CIA; Robert Mayo, director of the budget; Paul McCracken, chairman of the Council of Economic Advisers; it is chaired by Henry Kissinger, the President's aide.

The new committee may foster defense planning through a recognition of realistic needs, rather than on a "see-how-much-we-can-get" basis. If so, it is possible that fewer duplicative programs will be undertaken, and that programs that are going nowhere will be phased out more rapidly, leading, in the end, to less violent dislocations in the defense establishment.—D.C. ●

To the Editor:

In what otherwise was an excellent job, your special report on communications [Nov. 24, 1969, p. 73], had a glaring omission—international shortwave broadcasting. While international shortwave broadcasting lacks glamor, can we afford to totally ignore its very existence—and future?

Hundreds of millions of people all over the world will never be able to share in the wonders of tomorrow's advanced communications. Only one communications medium will be available to them—international broadcasting. The report indicates that we as Americans are interested in nothing but fancy multipurpose hardware. Something must be amiss when hundreds of international broadcasters operating in a multitude of languages and reaching millions of people are ignored completely.

If communications experts seek a real challenge, I suggest that they do something to correct the chaos that inadequate research and abominable planning have created in the international broadcasting bands.

Oliver P. Ferrell

President,  
Gilfer Associates  
Park Ridge, N.J.

**Speaking up**

To the Editor:

I was greatly surprised that your special report on communications [Nov. 24, 1969, p. 73] stated that there are only three types of terminal or input/output devices—those allowing people to communicate with people, those that communicate with each other, and those that enable people to communicate with machines. Apparently, this generalization omitted the type most common—the device that allows the machine to communicate with the user through audio responses.

This omission was unfortunate, since this is one of the first basic steps, and certainly an obvious one in terms of future usage. The Speechmaker division of Cognitronics Corp. has been providing this audio response capability to the computer and instrumentation industries for many years, and hundreds of such installations are in operation at the present time.

Edward J. Gushue

General manager,  
Speechmaker division  
Cognitronics Corp.  
Mount Kisco, N.Y.

▪ The problem of electronically creating sound for machine-to-man communications  
(continued on p. 6)

**McGraw-Hill News Service**

Director: Arthur L. Moore; Atlanta: Fran Ridgway; Chicago: Robert E. Lee; Cleveland: Arthur Zimmerman; Dallas: Marvin Reid; Detroit: James Wargo; Houston: Barbara LaRoux; Los Angeles: Michael Murphy; San Francisco: Margaret Drossel, Tyler Marshall; Seattle: Ray Bloomberg; Washington: Charles Gardner, James Canan, Herbert W. Cheshire, Seth Payne, Warren Burkett, William D. Hickman; Bonn: Robert F. Ingersoll; Brussels: James Smith; Hong Kong: Kate Mattock; London: John Shinn; Mexico City: Gerald Parkinson; Milan: Jack Star; Moscow: Jack Winkler; Paris: Robert E. Farrell, Stewart Toy; Tokyo: Marvin Petal

Are you sure  
 $H_{(BEEP)} P_{(BEEP)}$   
 started  
 this way?

No.  
 They didn't  
 have an instrument  
 that would  
 log true rms  
 for only \$950.

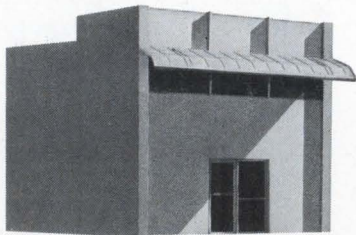

PM's Model 1020 AC/DC Log Converter. True rms detection, 0.5 dB accuracy, 80 dB dynamic range, 0.5 Hz to 100 KHz frequency range. Calibrated offset and fast response. Fabulous dc



PACIFIC  
 MEASUREMENTS

performance, too. All for \$950. Let you-know-who match that! For specs: Pacific Measurements, Inc., 940 Industrial Avenue, Palo Alto, California 94303. We gotta be better.

## Readers Comment

was not overlooked in the special report. On page 92, speech synthesis was touched upon as was music synthesis.

### 'Sound pen'

To the Editor:

Your New Products section carried an article that discusses the use of a "sound pen" in a graphic display input system [Dec. 22, 1969, p. 151]. I would like to inform you that I have held a French

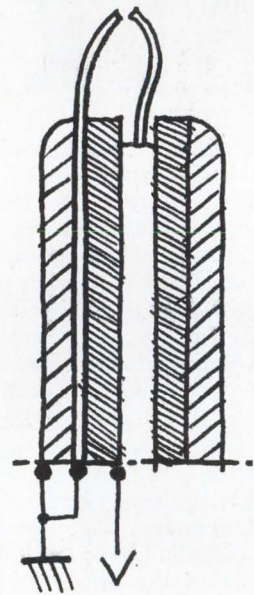

Sparker. In Zajde's system, sound of a spark causes an image on a screen.

patent, No. 137 377, on this sound pen system since January 1968. At the moment, I am in discussion with Albert Whetstone from the Science Accessories Corp. about eventual commercial rights.

Charles Zajde

University of Paris  
 Orsay, France

### SUBSCRIPTION SERVICE

Please include an Electronics Magazine address label to insure prompt service whenever you write us about your subscription.

Mail to: Fulfillment Manager  
 Electronics  
 P.O. Box 430  
 Hightstown, N.J. 08520

To subscribe, send us your address with your payment and indicate whether it is a new subscription or a renewal. Subscription rates: qualified subscribers in the U.S.: 1 year, \$8; two years, \$12; three years, \$16. Non-qualified: 1 year, \$25. Subscription rates for foreign countries available on request.



**For proven performance...small size...moderate cost...**

## order METFILM® 'E' ORANGE DROP® CAPACITORS

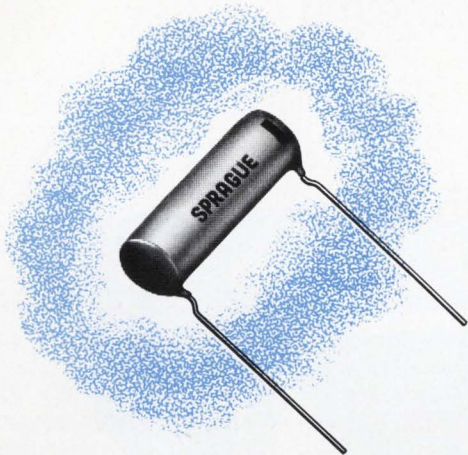

INFORMATION RETRIEVAL NO. 515

- Space-saving metallized PETP polyester-film capacitors with excellent capacitance stability, high insulation resistance
- Capacitor sections assembled under controlled atmospheric conditions and protected against moisture by a wax-free conformal coating of epoxy
- Radial leads, straight or crimped, for mounting on printed wiring boards
- Voltage ratings, 100 thru 600 volts d-c
- Operating temperature range, -55 C to +85 C
- Request Engineering Bulletin 2040

45C-9159

**For low-cost capacitors to cope with corona...**

## use HIGH-VOLTAGE TELECAP® DIFILM® CAPACITORS

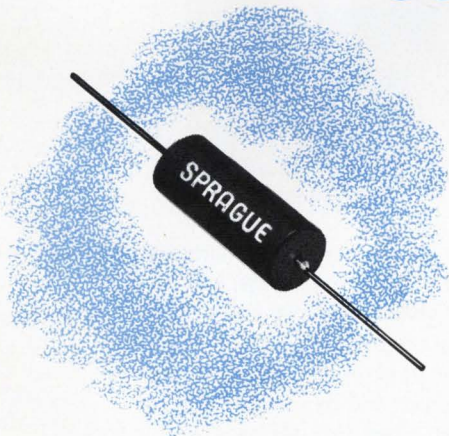

INFORMATION RETRIEVAL NO. 516

- Expressly designed to minimize corona effects in high voltage circuits
- Well suited for oscilloscopes, power supplies of electronic precipitators, electrostatic copying machines, and similar devices
- Series-wound paper/PETP-polyester film dielectric section provides higher ripple voltage capability than conventional extended-foil construction
- Thick-walled pre-molded phenolic case prevents oil seepage
- Voltage ratings: 3000 thru 10,000 volts d-c
- Request Engineering Bulletin 2011

45C-9160

For Engineering Bulletins as noted above, write to:  
Technical Literature Service, Sprague Electric Co., 35  
Marshall Street, North Adams, Massachusetts 01247

**THE BROAD-LINE PRODUCER OF ELECTRONIC PARTS**



'Sprague' and '®' are registered trademarks of the Sprague Electric Co.

**WHAT'S THE  
POINT OF  
MEASURING  
CAPACITANCE  
HERE?**



**Use the 1682 1-MHz Automatic  
Capacitance Bridge  
from General Radio--  
with accuracy specified  
at the unknown!**

At 1-MHz, the typical 3-terminal capacitance tester, with a 4-foot cable to a 1000-pF unknown, adds about a 4-percent error to the readout. GR's 1682 has four-terminal Kelvin connections that minimize lead-impedance effects and preserve the accuracy of the bridge *at the component*, even with low-impedance unknowns. And an additional guard terminal provides a similar safeguard for high impedances, whose measurement might be affected by stray capacitance to ground.

The true accuracy of the 1682 is 0.1% of the unknown value from 1 to 2000 pF and 1% up to 20 nF. Conductance accuracy is 1% from 1 to 2000  $\mu$ mhos; 10% up to 20 millimhos. The front panel displays 5 digits of capacitance and 4 digits of conductance simultaneously, plus automatic decimal points and units of measurement.

**IF  
ACCURACY IS  
SPECIFIED  
HERE!**

20 measurements per second can be made for  $\pm 10\%$ -of-full-scale differences in unknowns, and up to 50 per second for closer tolerance components. An internal bias of 0 to 100 V is supplied; up to 200 V can be applied externally. Low-level or high-level BCD output and remote programmability can be added. Test fixtures are available for axial leads and GR900® or GR874® terminals. Prices in U.S. start at \$3940; quantity discounts are available for lots of two or more. For more information write General Radio Company, West Concord, Mass. 01781 or telephone (617) 369-4400. In Europe write Postfach 124, CH 8034 Zurich, Switzerland.

**GENERAL RADIO**



# Who's Who in this issue



Janowiecki

Harris

**Old pros** in arc-plasma technology, Richard J. Janowiecki and Douglas H. Harris, authors of the article beginning on page 108, have done much to improve the arc-plasma spray facilities at Monsanto Research Corp. in Dayton, Ohio. Janowiecki has used many experimental designs, methods, and analyses to optimize APS variables and to correlate process parameters with product properties. He also has worked on fabrication of various films and structures used in the technology. While his colleague was busy with design, Harris was devising applications. He initiated Monsanto's activities in the area and helped develop them for application to a broad spectrum of ferrite materials.

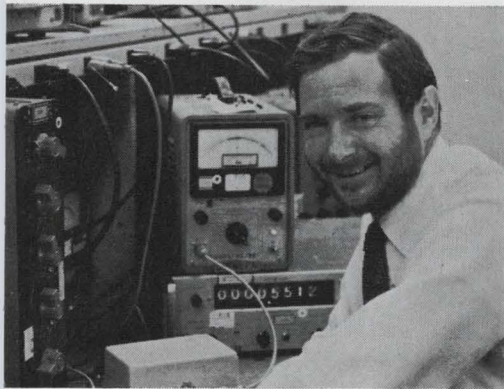

Root

**A specialist** in semiconductor failure analysis, C. David Root, who wrote the article that starts on page 86, feels that understanding the subtleties of device operation is valuable to computer-aided design of electronic circuits. Also blended into his approach to semiconductor improvement is his past experience in device R&D. A graduate of the University of Massachusetts, he is employed at the Sudbury, Mass., operation of Raytheon's equipment division.

**Roger Kenneth Field** was on board the Queen Elizabeth 2 only a short time before he realized his report on the ship's electronics, which starts on page 104, would involve more than just a once-around-the-decks tour. It took two trips to the ship, a phone call to QE2's captain at sea, and a volley of wires to *Electronics'* London bureau to put it together.

**Jacek H. Kollataj**, who wrote the article beginning on page 116, may be familiar to *Electronics'* readers. Two years ago he co-authored an article that was part of the series on IC's in action. Kollataj holds a degree from Politechnika Slaska in Gliwice, Poland. He specializes in data-logging systems at Nokia Electronics, Helsinki, Finland.

## Applications Power \*



# BINARY DECODE DRIVERS

**Problem:** Decode binary counter output into separate lines to drive indicator lamps or FET switches.

**Solution:** Siliconix D132L for the lamps, D129L for MOS FET switches. Both drivers provide four output channels, inputs are compatible with most TTL or DTL logic circuits, and outputs are capable of 50 volt switching.

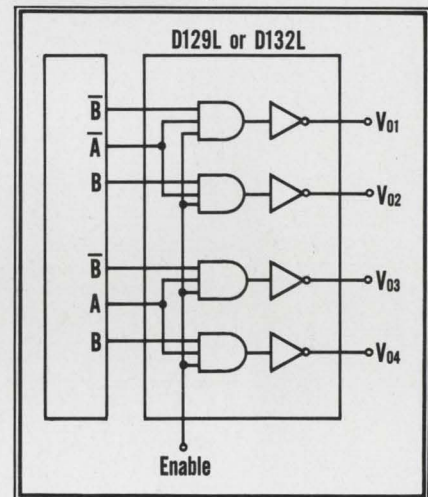

TRUTH TABLE

Counter State		Output			
A	B	V <sub>01</sub>	V <sub>02</sub>	V <sub>03</sub>	V <sub>04</sub>
0	0	0	1	1	1
0	1	1	0	1	1
1	0	1	1	0	1
1	1	1	1	1	0

Write for complete data. For instant information and applications assistance, call the number below.

**Siliconix**  
incorporated

2201 Laurelwood Rd. • Santa Clara, Calif. 95054  
(408) 246-8000 Ext. 201 • TWX: 910-338-0227

**\* Applications Power: Providing the product and service to make your product serve better!**

**This new keyboard  
will give you  
some idea  
of just how much  
our computerized  
counter can do.**

Our 5360A Computing Counter is much, much more than a counter. A computerized digital measuring system would be more accurate, because it measures frequency, period, and time interval at speeds and resolutions never before possible.

And now this unique measuring system can be even more useful to you, with the addition of the 5375A Keyboard.

You can enter programs and have the keyboard learn and run them automatically. For example, phase, standard deviation, ranging, rate-of-change, FM deviation, VCO linearity, residual FM, averages. In fact, this keyboard lets you program the counter to display, in real time, solutions to equations whose variables are the measurements made by the counter.

As you can see in the photograph, the keyboard will handle all basic math, including root, branching and looping within the program.



In short, it's designed to keep up with the capabilities of the counter.

This is quite a feat in itself. The counter makes measurements to 320 MHz on its own, and goes all the way to 18 GHz with plug-ins. Another plug-in affords the first 100 picosecond time interval resolution ever available in a counter. Besides being faster and more accurate than any previous instrument of its kind, the 5360A has eleven-digit resolution, with fixed decimal display, automatic units and blanking, to give you error-free readout.

You'll find that the 5360A Computing Counter makes measurements you could never make before. And it saves you time and the expense of setting up elaborate measuring systems. It will do all this for just \$6500, plus \$1350 for the 5375A Keyboard.

For all the data and applications, call your local HP field engineer. Or write to Hewlett-Packard, Palo Alto, California 94304; Europe: 1217 Meyrin-Geneva, Switzerland.

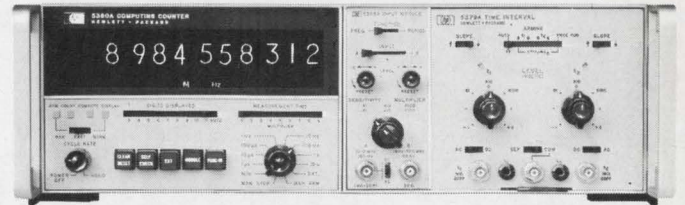

**HEWLETT  PACKARD**  
ELECTRONIC COUNTERS

Circle 11 on reader service card



# How to get the world's first monolithic dual FET.

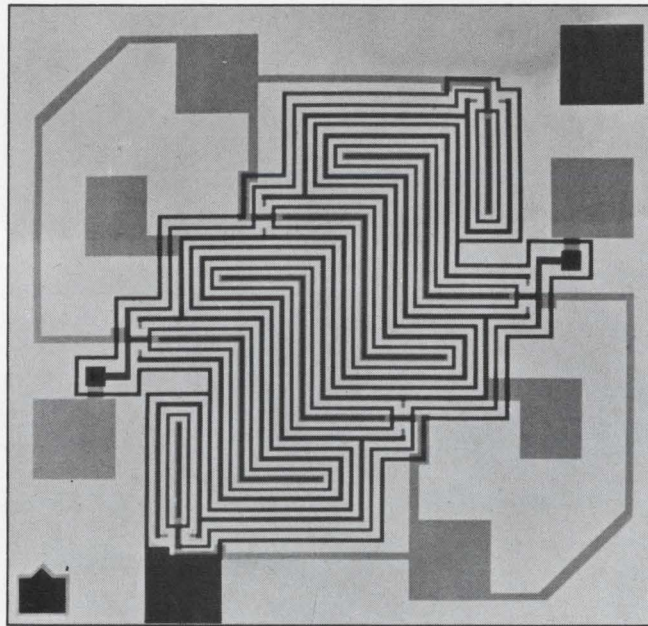

**By design.**

# By tomorrow.

There's never been an N-channel dual FET remotely like it. We should know. With FETs by the millions under our belts, this little 2-in-1 device is something else again.

It's monolithic. It's matchless. It's National's FM3954. Wipes out the sticky problem of matching two separate FETs for identical specs. This revolutionary new dual eliminates the entire costly, time-consuming process. By designing both FETs on a single chip, the match is built in to stay.

Our monolithic marvel's a unique performer too. Even the best discrete matched duals can't touch its track record; offset voltage (5mV max.), temperature drift (5 $\mu$ V/ $^{\circ}$ C max.), from 50 $\mu$ A to 500 $\mu$ A.

Not to mention its flexibility of use or the reliability advantage because it's monolithic. And because it's National.

Available now. No maybe's about it. We've got monolithic dual FETs packed on the shelves, ready to ship without delay. Priced from \$2.40 to \$15.00 in hundred lots.

Write or call for complete spec data. We'll throw in a brief listing of our hundred or so other discrete FETs. National Semiconductor, 2900 Semiconductor Drive, Santa Clara, California 95051 (408) 732-5000 TWX: 910-339-9240  
Cable: NATSEMICON

## National/FET

If you don't  
find it here,  
give us a call.

# SILICON RECTIFIERS

Ask about our many  
types of custom  
rectifiers and rectifier  
assemblies.

FULL WAVE BRIDGE RECTIFIERS*		
50V	$I_0$	1.99
W 111	1A	.95
<b>100V</b>		
VE 18	1A	1.00
VS 148	2A	1.00
VH 148	6A	1.93
<b>200V</b>		
VE 27	1A	1.20
VE 28	1A	1.10
VS 247	2A	1.20
VS 248	2A	1.10
VH 247	6A	2.25
VH 248	6A	2.15
IN 4436	10A	4.15
VT 200	25A	5.35
<b>400V</b>		
VE 47	1A	1.30
VE 48	1A	1.20
VS 447	2A	1.30
VS 448	2A	1.20
VH 447	6A	2.59
VH 448	6A	2.49
IN 4437	10A	5.45
VT 400	25A	7.00
<b>600V</b>		
VE 67	1A	1.59
VE 68	1A	1.49
VS 647	2A	1.60
VS 648	2A	1.50
VH 647	6A	2.98
VH 648	6A	2.88
IN 4438	10A	7.45
VT 600	25A	9.85

\*Available with fast recovery characteristic



SEMICONDUCTOR DIVISION, 1000 N. SHILOH  
ROAD, GARLAND, TEXAS 75040 (214) 272-4551

## Who's Who in electronics



Jack S. Kilby

**Unhappy with the way** things were working out at Centralab in Milwaukee back in 1958, Jack S. Kilby went job-shopping at Motorola, IBM, and a few other places finally landing at Texas Instruments. It was a perfect landing for both Kilby and TI because it gave TI a head start in integrated circuits in the 1960's.

At Centralab, Kilby had designed and developed ceramic-based silk-screen circuits. But he had ideas for developing monolithic IC's that TI's chief, Pat Haggerty, liked. So Kilby was put in the company's semiconductor research and engineering group with full backing to pursue his thinking. By late 1958, Kilby had developed the monolithic IC and put TI in the IC business.

His inventive work and contributions to IC's were recognized recently when President Nixon named him to receive a National Medal of Science award, one of six given by the Federal Government as its highest award for distinguished advancement in science.

**Nitty gritty.** Kilby, now manager of the customer requirement department of TI components group, is less involved in direct research. He believes, however, that semiconductor technology has developed to where "our problems are much more economic" than in the past decade.

"We are in a phase now where things are open-ended," Kilby says. "There are no natural barriers to what we can do. We know how

to build very sophisticated devices. The question now is to find economical applications."

After his IC concept became an actual production item, Kilby was made responsible for developing IC assemblies. In 1960, he was appointed manager of engineering for what TI then called "Semiconductor networks."

From 1962 until 1967, while manager of TI's IC effort, he worked with the Autonetics division of North American Aviation to design the first military system utilizing IC's—the Minuteman missile. He has seen his early IC work develop into a \$400-million-a-year business.

**Getting together.** As IC technology moved forward into medium-scale and large-scale circuits, Kilby remained manager of development. More recently, he has directed the TI customer requirement center, an effort to help provide interfaces with customers who use the complex devices.

Kilby sees this as the big challenge for the immediate future. "We have proved how complex we can make the circuits. We can get to almost any numbers in circuit complexity. Now, we have to work with customers and help them to design the sophisticated devices into their equipment."

**Men who leave** large companies to do their own thing are legion, but their reasons for leaving aren't always easily explained. A case in point is Tom Segar, who left Litton Industries less than two years ago with three co-workers to form Teller Industries Inc., a circuit-board manufacturing firm.

Looking back, Segar, now president of Teller, says there was "a general restlessness at Litton to go out and do it for ourselves. It was a combination of people, talents, and informal discussions that sparked the idea." And, he recalls, it only took about 15 days. We started with a very balanced team



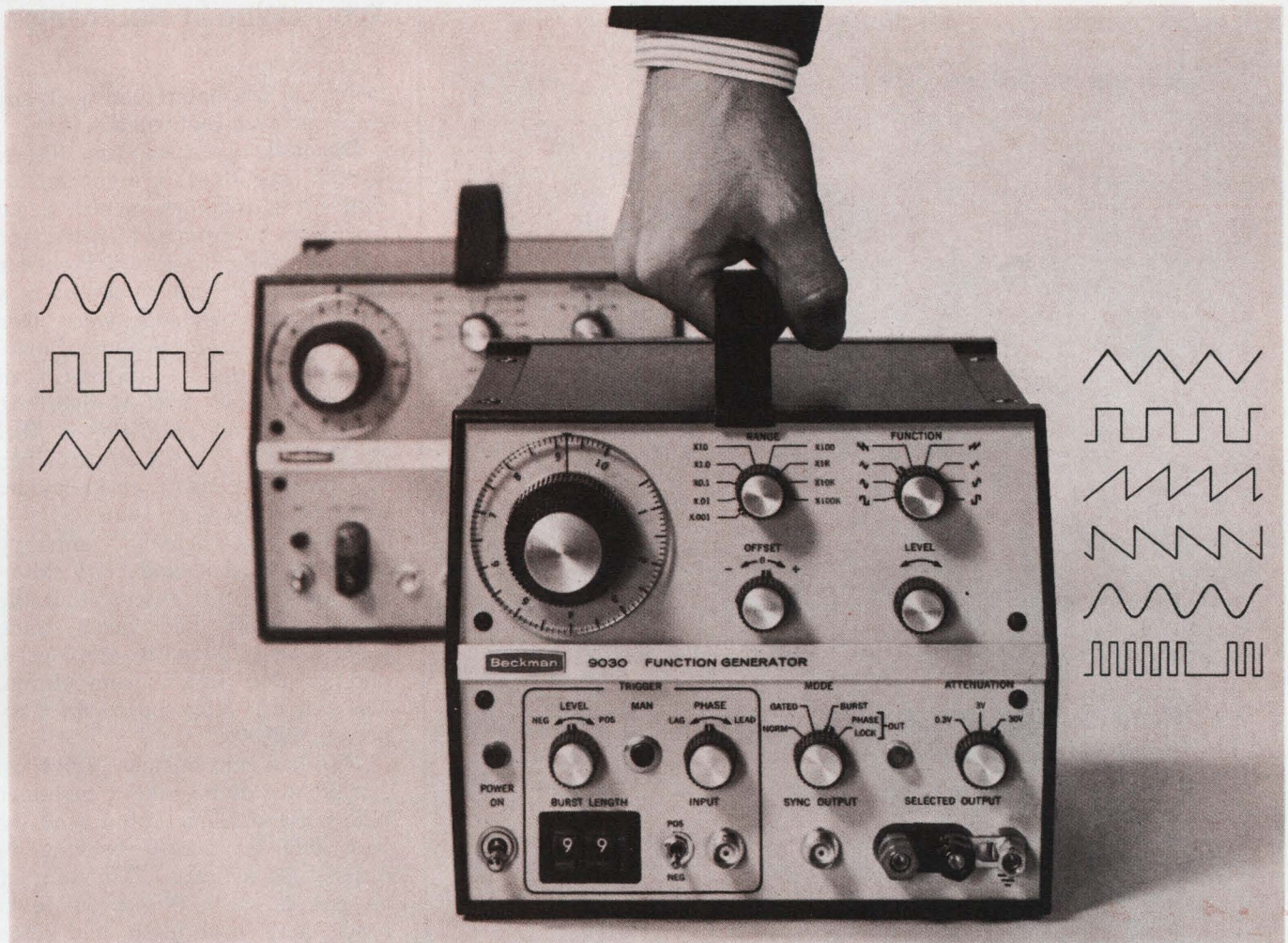

## Take a good look...

### at the Beckman Models 9010 and 9030 Function Generators.

If you're looking for an exceptional low-cost function generator, take a look at the Beckman 9010; a tough little competitor (sine, square, and triangular waves at 0.005 Hz to 1 MHz, with external VCO control and dc offset for \$495.00).

But if you want much more, and your requirements include:

- four basic functions *and* their complements, with an external GATE control mode, continuously variable over a frequency range from 0.0005 Hz to 1 MHz,
  - eight unipolar and bipolar outputs, adjustable to 30 volts p-p in three attenuator steps, in addition to dc offset and external VCO control,
  - a BURST mode to generate 1 to 99 positive and negative waveforms upon receipt of a trigger input,
  - a PHASE LOCK mode to synchronize the instrument in frequency and phase with an external signal from 10 Hz to 1 MHz,
- then take a *good* look at the Model 9030 (only \$895.00).

Like the 9010, the 9030 is rugged enough for any production or bench environment. It's drip proof, dust proof and shock proof, and stackable, portable and rackable. (8½" H x 7" W x 10" D.)

For your system or component testing, use a 9010 to initiate the burst functions of the 9030 — and rack them together with standard Beckman hardware.

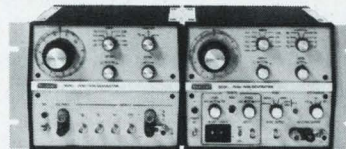

Now that you've seen what the 9010 and 9030 Function Generators can do for you, there's no need to keep looking. Just contact your local Beckman office, sales representative or factory direct. (A special 3½" rack chassis is available for both instruments upon request.)



INSTRUMENTS, INC.  
ELECTRONIC INSTRUMENTS DIVISION  
RICHMOND, CALIFORNIA • 94804

**Have a load to position?**

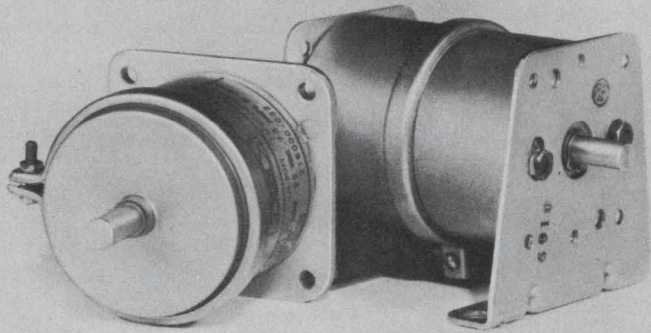

**Five things you'll like about these new Ledex Stepping Motors**

**High torque-to-size ratio.** Breakaway torque of up to 160 ounce-inches...drive a constant friction load of up to 64 ounce-inches. An exclusive new tooth clutch, with positive grip-action drive makes this high torque output possible.

**Unidirectional and bidirectional models available.** Choice of 18 (20°) and 12 (30°) step models for remote load driving. Bidirectional models let you position loads CW or CCW.

**Minimum Life of 3 Million Steps** (in both directions on bidirectional models). From design through production, they're built-to-perform. All working parts fully enclosed.

**Uniform Stepping Accuracy ( $\pm 1^\circ$ ).** Entirely non-accumulative. Then consider other Ledex Series 50 stepping motor features like the ability to add rotary switches and position remotely or manually in either direction, response to simple square wave input (no expensive logic circuitry required) and their ability to meet military environmental requirements. Practical pricing too (under \$15 unidirectional; under \$21 bidirectional in 500 lots).

**Twenty stock models available to help you get a quick start on your prototype.**

Write for this new catalog. Or, tell us about your application and we'll recommend a solution.

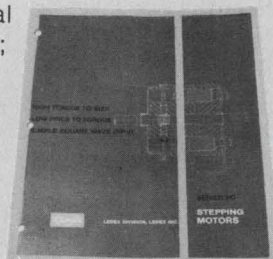

*Specialists in remote positioning*



**LEDEX DIVISION, LEDEX INC.**

123 Webster Street, Dayton, Ohio 45402 • phone (513) 224-9891

**Who's Who in electronics**

of people who interfaced well, and everyone was motivated."

**Dovetail.** Each of the former Litton executives brought talents that fitted together nicely. Segar had been a group executive and vice president for Litton Precision Products. The other three, now Teller vice presidents, were: Don Westerberg, formerly general manager of Litton's Printed-Circuit Board division; Bob Hungerford, an engineering manager in that division; and Bruce Cathcart, then vice president and general manager of Litton's Useco division.

Litton, predictably unhappy about the exodus, filed a suit claiming, among other things, that the new company had taken trade secrets, proselytized its employees, and created unfair competition. The suit was later settled for a reported \$25,000.

"We had zero business when we started; we didn't take a customer with us, and when Litton sued we had only an \$8,000 backlog in orders," says Segar. "The four of us put in \$105,000 of our own funds, and, in addition, had some good investment advice from Hambrecht and Quist, a San Francisco investment-brokerage firm. They were able to raise an additional \$400,000 in outside money. We weren't smart enough to know it couldn't be done, and we did it," adds Segar.

The company now employs 170 people, and has just added a new 7,500-square-foot production facility that will make room for another 100 employees. Current sales are about \$3.5 million per year, with 85% of the boards going to the industrial computer market and the rest to military customers. Burroughs and Marchant are Teller's two major commercial customers.

**Bending.** "We also have started in the flexible circuit-board business," Segar notes, "and have acquired three other companies, including Cermatron, a San Diego firm that makes ceramic substrates, and California Microcircuits, which makes thick-film hybrid devices. We're not ready to talk about the third acquisition yet [it's not yet complete], but it's in a related area."

# Allen-Bradley cuts space requirements with new sealed type Z cermet trimmers

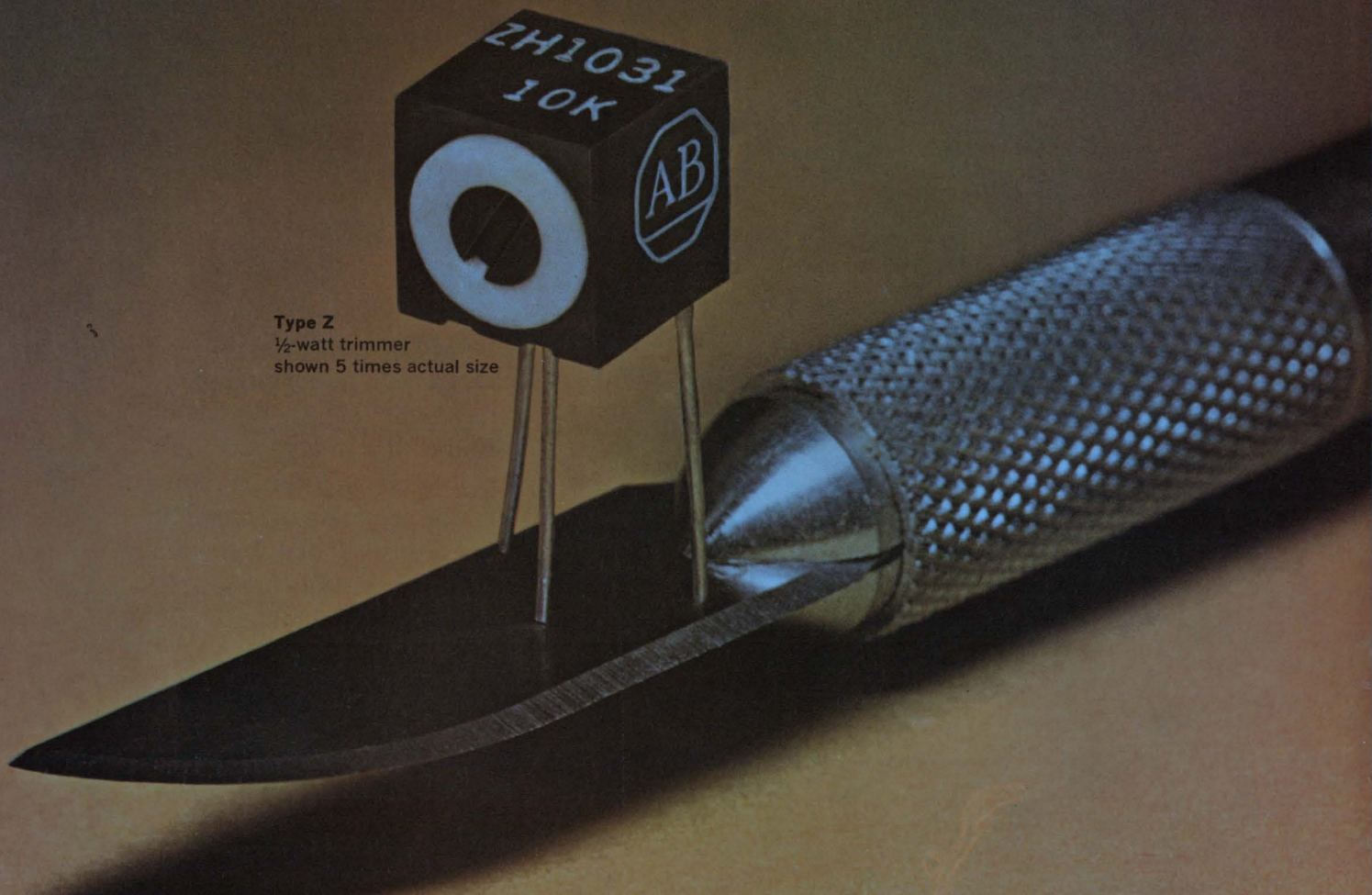

Type Z  
½-watt trimmer  
shown 5 times actual size

this latest addition to the Allen-Bradley line of cermet trimmers...the type Z...affords high performance in an especially compact package

The cermet material — an exclusive formulation developed by Allen-Bradley — provides superior load life, operating life, and electrical performance. For example, the full load operation (½ watt) for 1000 hours at 70°C produces less than 3% total resistance change. And the temperature coefficient is less than  $\pm 250$  PPM/°C for all resistance values and throughout the complete temperature range ( $-55^{\circ}\text{C}$  to  $+125^{\circ}\text{C}$ ).

The Type Z is ruggedly constructed to withstand shock and vibration. The unique rotor design ensures smooth adjustment and complete stability under severe environments. The leads are permanently anchored and bonded. The connection exceeds the lead strength — opens cannot occur. Leads are weldable.

The enclosure is *SEALED*. It is both dust-tight as well as watertight and can be potted. Mounting pads prevent moisture migration and also post-solder washout. You can get immediate delivery at factory prices from your authorized A-B industrial electronics distributor. Or write: Marketing Dept., Electronics Div., Allen-Bradley Co., 1201 S. Second St., Milwaukee, Wis. 53204. Export Office: 1293 Broad St., Bloomfield, N. J., U. S. A. 07003. In Canada: Allen-Bradley Canada Limited.

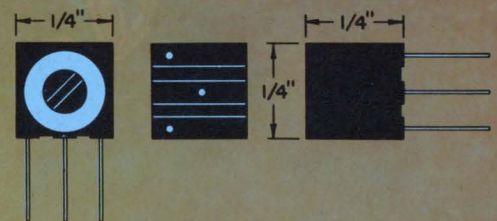

#### SPECIFICATIONS SUMMARY

- Adjustment:** Horizontal or vertical.
- Temperature Range:**  $-55^{\circ}\text{C}$  to  $+125^{\circ}\text{C}$ .
- Resistances:** 50 ohms through 1 megohm.  
Lower resistances available.
- Tolerances:**  $\pm 20\%$  standard,  $\pm 10\%$  available.
- Resolution:** Essentially infinite.
- Rotational Life:** Less than 2% total resistance change after 200 cycles.
- Rotation:**  $300^{\circ}$  single turn.
- End Resistance:** Less than 3 ohms.



**ALLEN-BRADLEY**

QUALITY ELECTRONIC COMPONENTS

# The new small rack and panels with the big difference.

Bendix is the difference.

The difference in distribution, delivery and supply. The difference that means you can get the rack and panels you need when you need them.

A big difference. A big advantage. But there are others. Bendix Regal B subminiatures are built to MIL-C-24308. Application potentials are practically unlimited. Use them in switching circuits, computers, business machines. In industrial equipment, communications, test equipment. And in rack and panel modular or printed circuit technology.

The selection of mounting options is just about endless, too. Choose from among .120 or .154-inch diameter, straight-through holes, clinch nuts, float mounts, lock posts, plain flange and through-bulkhead types. Neoprene spacers or grommets. And solder or printed circuits. Even a crimp version with rear-release contacts comes in a variety of shell sizes and mounting configurations. All interchangeable with existing rack and panel connectors.

For more details, write: The Bendix Corporation, Electrical Components Division, Sidney, New York 13838.

**Bendix**  
  
**Electronics**

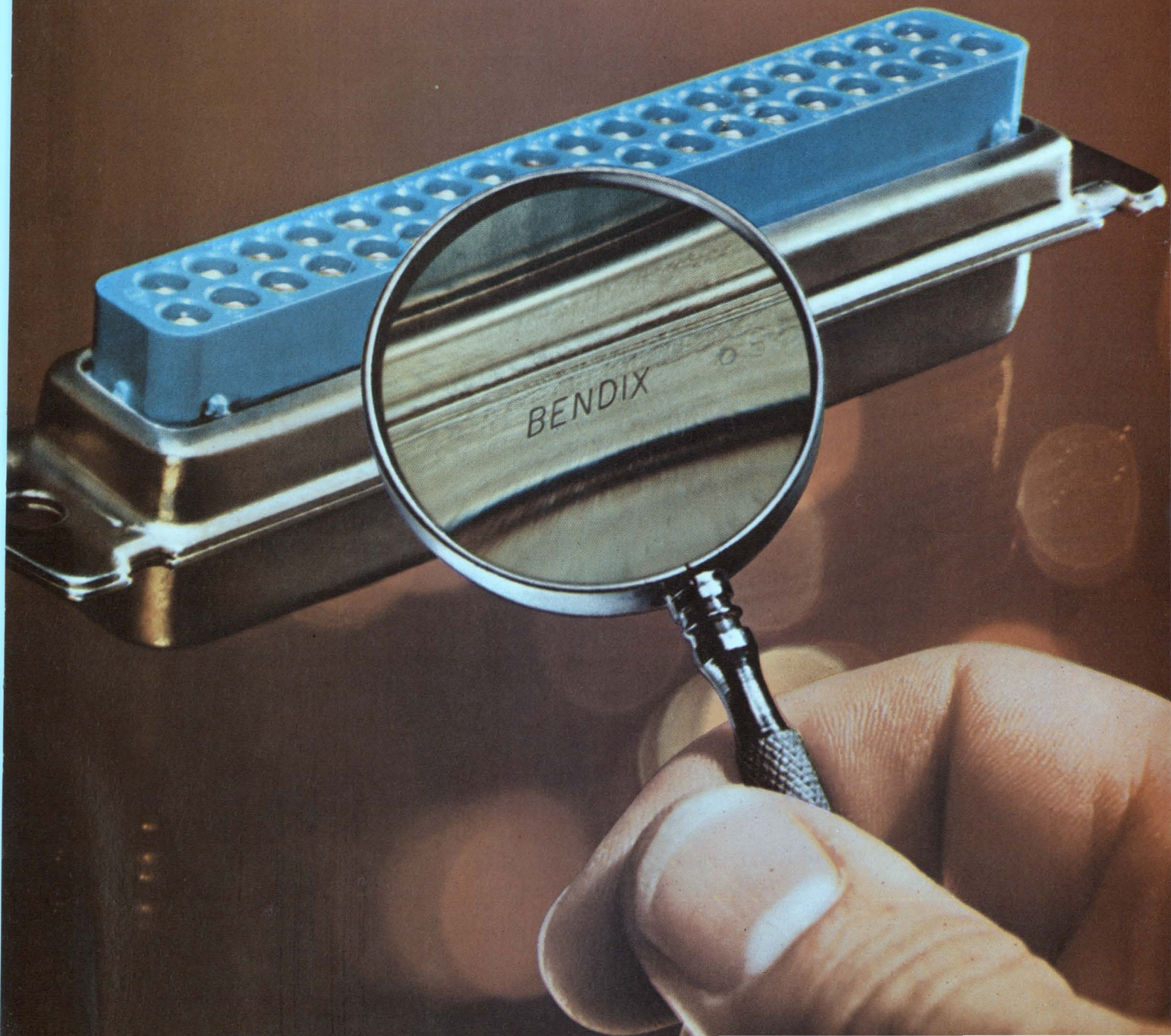

BENDIX

# Introducing The Electronics Network.

## Channel 1: Sells the decision-making market.

Electronics is the worldwide electronics marketing channel. Use it to build a market position for your products. To create acceptance for your advanced technology. Or simply to sell ideas.

Many of Electronics 81,000 subscribers cannot be reached through any other publication. Sixty-seven per cent buy anywhere from \$10,000 to over \$1,000,000 worth of products each year. And many of them never see salesmen.

40 skilled editors located in the key market areas and an annual editorial budget in excess of \$1,000,000 provide Electronics readers with broadband technical information to help them do their jobs better.



## Channel 2: Covers the mass market.

Electronics New Product Preview is the low-cost, mass-coverage channel to the U.S. market (where approximately 70% of the worldwide market is located). Use it as cooperative direct mail to merchandise off-the-shelf products, promote established low profit-margin items. Or use it to generate quick inquiries for your catalogs and specification sheets. (Our first issue produced over 50,000 inquiries.)

ENPP reaches 100,000 U.S. recipients (without duplicating the circulation of Electronics). It publishes more new-product information than any other electronics publication and presents it in ten product sections.



Four channels  
designed to work together  
to make your  
advertising budget  
go farther.

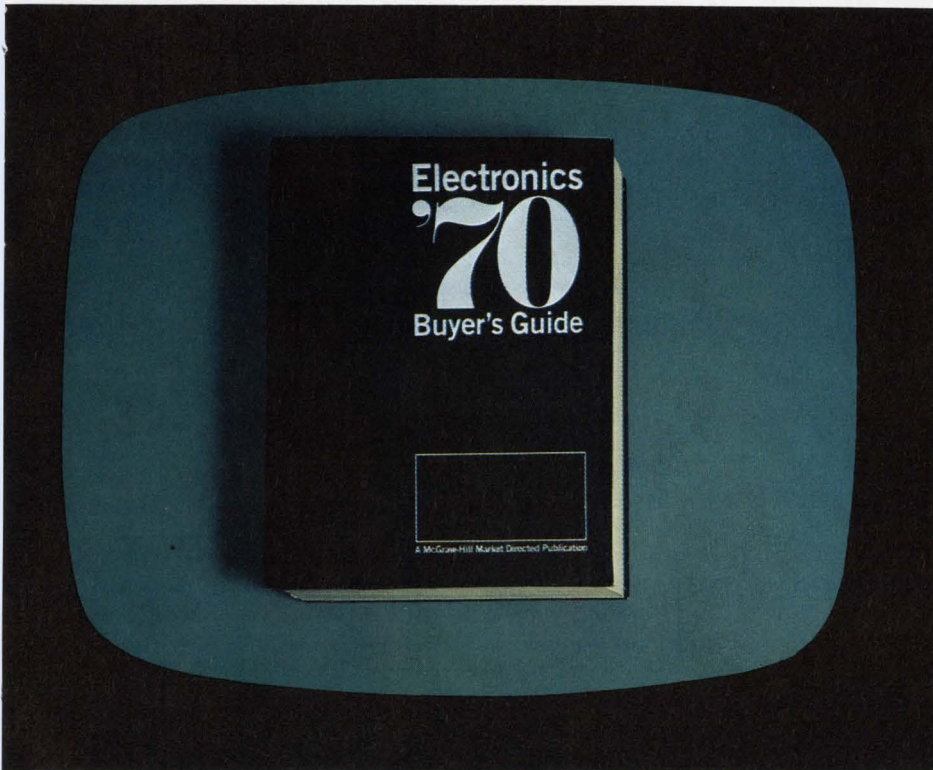

**Channel 3:  
Reaches the ready-to-buy market.**

Electronics Buyers' Guide is the channel to use for reaching customers who are actively seeking sources of supply. EBG goes to 85,000 engineers and purchasing men, but is used by more than 375,000 of them. (It's borrowed a lot.) The "yellow pages" gives the buyers all the information they need in one reference: sources, product and advertisements. Prime users tell us they prefer EBG two to one over all other directories, catalogs and registers because it is so complete and easy to use.



**Channel 4:  
Provides custom marketing services.**

Electronics/Management Center can develop a customized information program to help you reach your markets. It can probe market potentials, test new product ideas, improve old products, even design a complete marketing strategy.

Electronics/Management Center has the people and facilities to provide you with custom-information in the areas of management, marketing and engineering consultation.

Write for the E/MC brochure, "A full-circle information resource!"

*The Electronics Network.  
A market-directed communications  
service from McGraw-Hill.  
Electronics. Electronics New Product Preview.  
Electronics Buyers' Guide.  
Electronics/Management Center.  
330 West 42nd Street, New York, N. Y. 10036.*



SOLVING  
electro-optical  
problems  
is Optron's  
ONLY business....  
SO, WE HAVE  
TO BE GOOD!

You can count on Optron for high interest and undivided attention to your most exacting optoelectronic device requirements. And, you'll get product design, development and manufacturing benefits that only Optron experience can offer.

For example, through continuous process monitoring made possible by the use of diffusion lot traceability, Optron maintains the highest possible reliability. Still other special Optron manufacturing techniques make possible optimum device performance in variable light and temperature conditions. You get sensors with a lens/device relationship previously thought impossible.

Versatile OP 600 Series NPN planar silicon light sensors eliminate cross-talk and are ideally suited for high density arrays. In addition, these small, rugged devices will satisfy virtually any application requirement in optical character recognition. But, if your application isn't standard, you'll especially like Optron's fast reaction to your custom programs, too.

Write today for Optron product technical data and the name of your nearest sales representative.



**OPTRON, INC.**

1201 Tappan Circle  
Carrollton, Texas 75006  
214/242-6571

## Meetings

### Technology's marriage broker

**For whom** does the infant Information Industry Association speak? Not for the hardware or software sectors, nor for makers or users. "I don't think the answer can be defined in those traditional media forms," contends IIA executive director Paul G. Zurkowski. "If anything, the Information Industry Association is an instrument of change," he asserts. "We're assisting the 'goony bird' information service environment in adjusting itself to the electronic information service environment." Putting it another way, Zurkowski says: "We are to computers and the electronics industry what the airlines are to the airframe industry."

Presumably, aiding in the adjustment will be the IIA's second national meeting and exhibition beginning March 23 at Washington's Shoreham Hotel. Titled Info-Expo '70, the three-day conference will treat what Zurkowski calls the information implosion in science, industry, and government, emphasizing the user's need to control the growing mélange of available data.

From his cubbyhole in the capital where the IIA set up shop a little more than a year ago, Zurkowski acknowledges the association meeting is not big in a physical sense. Attendance should run between 600 and 1,000, he says, and only 11 exhibitors are lined up right now. Nevertheless, he says, the meeting will hear some high-

powered discussion of policies and technologies affecting the information industry. Topping the speakers' list is Rep. Emilio Q. Daddario (D., Conn.), chairman of the House subcommittee on science, research and development, and patents and scientific inventions. There will be sessions treating the relationship of evolving information technologies with proprietary rights; the Government in its role as both a user and source of information; information and the Congress and the role of the commercial and non-profit segments of the information community.

**Showcase.** As for exhibits, Zurkowski believes the New England-based DASA Corp. will make its first showing of a \$50 microfiche reader it is developing under contract to the Office of Education in the Department of Health, Education, and Welfare.

The meeting, Zurkowski suggests, will appeal largely to planners and product developers who have to stay abreast of technological change and the role electronics will play in disseminating the information.

How, for example, can a Government nearing "a crisis in information dissemination" perform that function with help from the private sector? "We'll explore that," says Zurkowski.

For further information contact Paul G. Zurkowski, IIA, 1025 15th St., N.W., Washington, D.C. 20005.

### Calendar

**Second National Conference and Exposition on Electronics in Medicine, Electronics/Management Center, Electronics, Medical World News, Modern Hospital, Postgraduate Medicine;**  
Fairmont Hotel, San Francisco,  
Feb. 12-14, 1970.

**International Solid State Circuits Conference, IEEE, University of Pennsylvania; Sheraton Hotel and University of Pennsylvania,**  
Philadelphia, Feb. 18-20, 1970.

**Symposium on Management and Economics in the Electronics Industry, IEE; University of Edinburgh, Scotland,**  
March 17-20, 1970.

**International Convention, IEEE; New York Hilton Hotel and the New York Coliseum, March 23-26, 1970.**

**Meeting of the Association for the Advancement of Medical Instrumentation, Statler Hilton Hotel,**

(Continued on p. 25)



Need a fast, accurate solution to an IC problem? E-H Research Laboratories, Inc. teams up with Iwatsu Electric Company, Ltd. to offer you the ideal test instrumentation.

E-H breaks through with the **E-H 129 pulser** which is capable of driving the fastest digital logic circuits. Until this compact, all solid-state instrument came along, no practical commercial pulse generator offered repetition frequency capability beyond 200 MHz. The E-H 129 offers 500 MHz, 2-volt pulses with less than 500 ps risetime and such extras as baseline offset, pulse-top/baseline inversion function, and synchronous gating.

And the ideal mate for this instrument is the **Iwatsu 5009B sampling scope** which allows you to observe and control the waveforms you generate. The Iwatsu 5009B with 18GHz bandwidth lets you evaluate fast circuits with high accuracy—in fact, direct measurements on 100 ps edges with less than 2% display error. Features include less than 20 ps risetime, sensitivity from 10mV/cm, dual-trace performance with seven operating modes, separate miniature sampling heads, big CRT and triggering to full bandwidth for extra convenience.

If these two instruments can't solve your problems, E-H can offer you E-H and Iwatsu instrumentation that can. Contact an E-H representative and get a fast solution. Today.

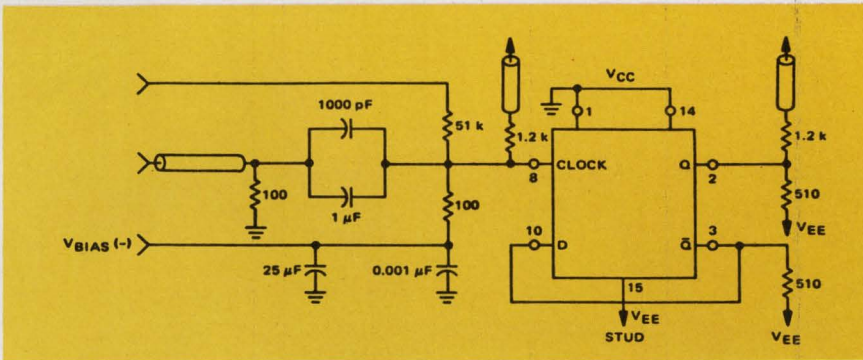

# E-H the fast solution

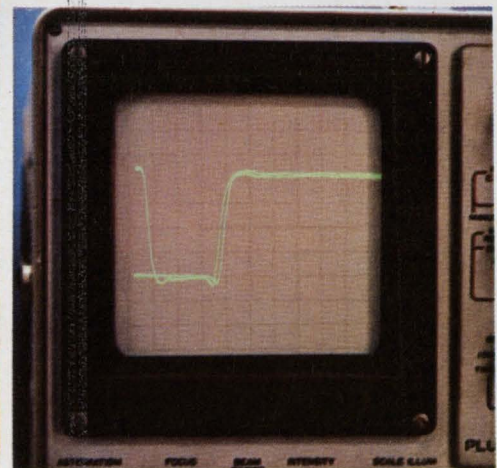

**E-H RESEARCH LABORATORIES, INC.**

515 Eleventh Street • Box 1289, Oakland, California 94604 • Phone: (415) 834-3030 • TWX 910-366-7258  
 In Europe: E-H Research Laboratories (Ned) N.V., Box 1018, Eindhoven, The Netherlands, Telex 51116  
 In Japan: Iwatsu Electric Company, Ltd., 7-41, 1-Chome Kugayama Suginami-Ku, Tokyo 167, Japan

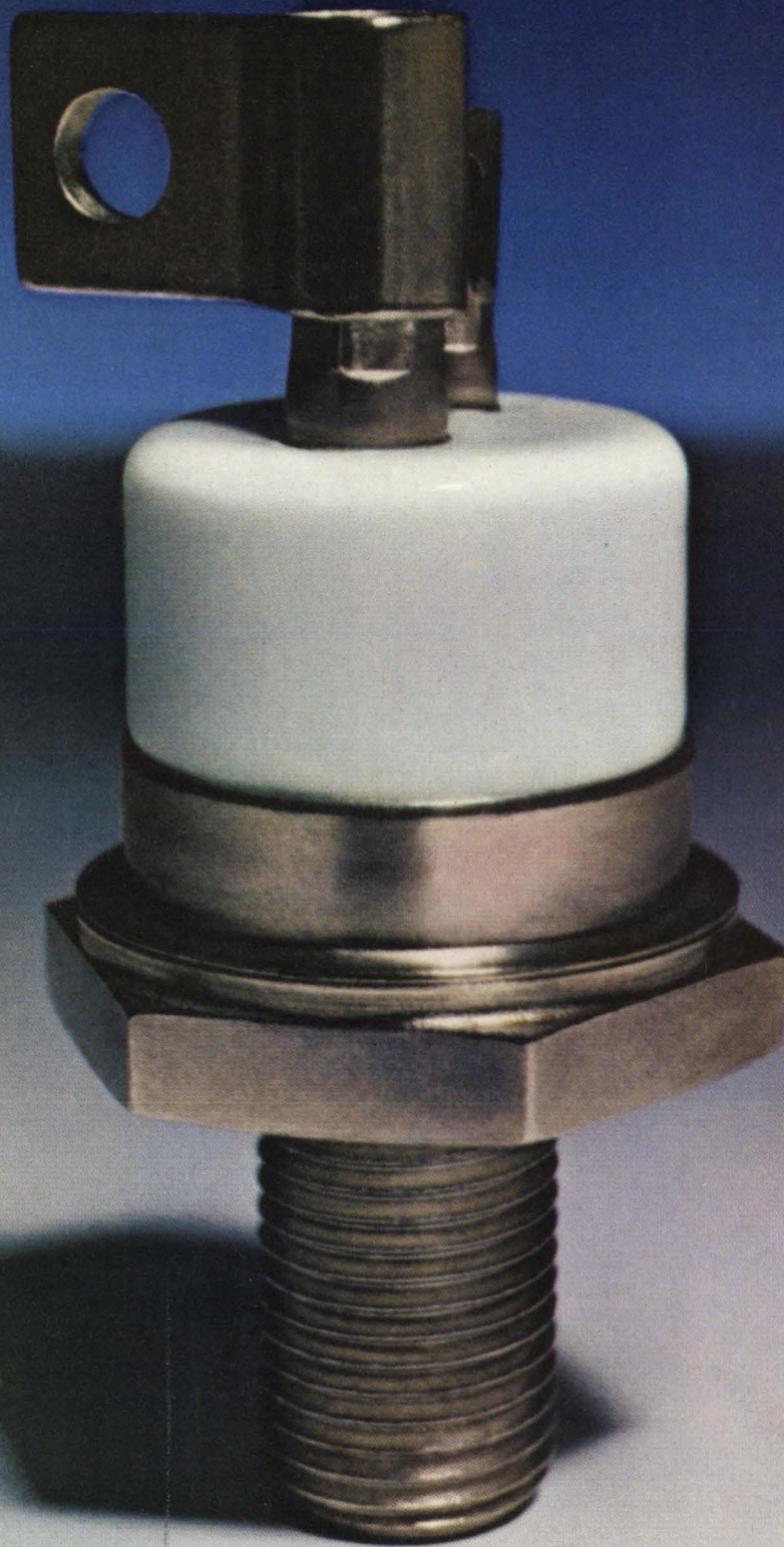

## Design Security

**Off-the-shelf  
Westinghouse thyristors  
balanced for all  
critical parameters.  
Try 'em.**

With thyristors that meet all critical design parameters—not just a couple—you get more design security. And Compression Bonded Encapsulation (a Westinghouse exclusive) to assure low thermal impedance. Our parameter optimization gives you another bonus: reduced equipment size . . . plus savings on

circuit components.

Vital statistics: 40 to 550 amps, up to 2000 volts; standard JEDEC and POW-R-DISC packs.

For complete data and prices, contact your local Westinghouse Distributor (see adjacent listing) or Westinghouse Semiconductor Division, Youngwood, Pa. 15697.

**You can be sure . . . if it's Westinghouse**



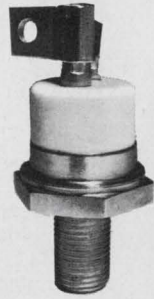

## Westinghouse Industrial Semiconductor Distributors

### Alabama

ACK Semiconductors, Inc.  
Birmingham 205 322-0588  
Electronic Wholesalers, Inc.  
Huntsville 205 534-5722

### Arizona

Hamilton Electro of Arizona  
Phoenix 602 272-2601  
Kierulff Electronics Corp.  
Phoenix 602 273-7331

### California

Newark Electronics  
Inglewood 213 674-8440  
Hamilton Electro Sales  
Los Angeles 213 870-7171  
K-Tronics  
Los Angeles 213 685-5888  
Elmar Electronics, Inc.  
Mountain View 415 961-3611

Hamilton Electro Sales—North  
Mountain View 415 961-7000

Hamilton Electro of San Diego  
San Diego 714 279-2421

### Colorado

Electronic Parts Co.  
Denver 303 266-3755  
Hamilton Denver  
Denver 303 934-5508

### Connecticut

Cramer Electronics, Inc.  
North Haven 203 239-5641

### Florida

Cramer Electronics, Inc.  
Fort Lauderdale 305 566-7511

Electronic Wholesalers, Inc.  
Orlando 305 841-1550

### Georgia

Specialty Distributing  
Atlanta 404-873-2521

### Illinois

Semiconductor Specialists, Inc.  
Chicago 312 279-1000  
Pace/Avnet Electronics  
Schiller Park 312 678-6310

### Indiana

Fort Wayne Electronics Supply, Inc.  
Fort Wayne 210 742-4346  
Ra-Dis-Co.  
Indianapolis 317 637-5571  
Radio Distributing Co.  
South Bend 210 287-2911

### Maryland

Pyttronic Inc.  
Baltimore 301 727-5100  
Hamilton Electro Sales  
Baltimore 301 796-5000  
Cramer Electronics, Inc.  
Rockville 301 424-2700

### Massachusetts

Cramer Electronics, Inc.  
Newton Ctr. 617 969-7700

Schweber Electronics  
Waltham 617 891-8484

### Michigan

Semiconductor Specialists, Inc.  
Detroit 313 255-0300

### Minnesota

Semiconductor Specialists, Inc.  
Minneapolis 612 866-3434  
Stark Electronic Supply  
Minneapolis 612 332-1325

### Missouri

Electronic Components for  
Industry Co.  
Kansas City 816 421-8400

Electronic Components for  
Industry Co.

St. Louis 314 647-5505  
Hall-Mark Electronics Corp.  
St. Louis 314 521-3800

### New Jersey

General Radio Supply Co., Inc.  
Camden 609 964-8560  
Angus, Inc.  
Moorestown 609 235-1900  
Sterling Electronics, Inc.  
Perth Amboy 201-HI 2-8000

### New Mexico

Kierulff Electronics Corp.  
Albuquerque 505 247-1055

### New York

Stack Industrial Electronics  
Binghamton 607 723-6326  
Summit Distributors  
Buffalo 716 884-3450  
Cramer/Eastern  
East Syracuse 315 437-6671  
Schweber Electronics  
Long Island 516 334-7474  
Milgray Electronics, Inc.  
New York 212 989-1600

### Ohio

Sheridan Sales  
Cincinnati 513 761-5432  
Sheridan Sales  
Cleveland 216 524-8120  
Hughes-Peters, Inc.  
Columbus 614 294-5351  
Mentronics, Inc.  
Mentor 216 946-3058

### Oklahoma

Hall-Mark Electronics Corp.  
Tulsa 918 835-8458

### Pennsylvania

Cameradio Company  
Pittsburgh 412 391-4000

### South Carolina

Sawyer Electronics Corp.  
Greenville 803 235-0438

### Texas

Hall-Mark Electronics Corp.  
Dallas 214 231-6111  
Midland Specialty Co.  
El Paso 912 533-9555  
Hall-Mark Electronics Corp.  
Houston 713 781-6100  
Lenert Company  
Houston 713 225-1465  
The Altair Co.  
Richardson 214 231-5166

### Washington

Hamilton Electro Sales of the  
Pacific Northwest  
Seattle 206 624-5930  
Kierulff Electronics Corp.  
Seattle 206 725-1550

### West Virginia

Charleston Electrical Supply  
Company  
Charleston 304 346-0321

### Wisconsin

Taylor Electric Company  
Milwaukee 414 964-4321

### Canada

Canadian Westinghouse  
Hamilton, Ontario 416 528-8811

### European Headquarters

Westinghouse Electric  
International, S.A.  
London, S.W. 1 Whitehall 2704

Westinghouse Semiconductor Division  
Youngwood, Pennsylvania 15697

## Meetings

(Continued from p. 22)

Boston, Mar. 23-25, 1970.

**Symposium on Submillimeter Waves,** IEEE, Polytechnic Institute, Brooklyn, New York, March 31-April 2, 1970.

**Communications Satellite Systems Conference,** American Institute of Aeronautics and Astronautics; International Hotel, Los Angeles, April 6-8, 1970.

**Reliability Physics Symposium, IEEE;** Stardust Hotel and Country Club, Las Vegas, Nevada, April 7-9, 1970.

**Meeting and Technical Conference,** Numerical Control Society; Statler Hilton, Boston, April 8-10, 1970.

**Computer Graphics International Symposium, IEE;** Uxbridge, Middlesex, England, April 13-16, 1970.

**International Geoscience Electronics Symposium, IEEE;** Marriott Twin Bridges Motor Hotel, Washington, April 14-17, 1970.

**USNC/URSI-IEEE Spring Meeting;** Statler Hilton Hotel, Washington, April 16-19.

**American Power Conference, IEEE;** Sherman House, Chicago, April 21-23, 1970.

**International Magnetism Conference (INTERMAG), IEEE;** Statler Hilton Hotel, Washington, April 21-24, 1970.

**Southwestern IEEE Conference & Exhibition;** Memorial Auditorium, Dallas, April 22-24.

**Annual Frequency Control Symposium,** U.S. Army Electronics Command; Shelburne Hotel, Atlantic City, N.J., April 27-29, 1970.

**National Telemetry Conference, IEEE;** Statler Hilton Hotel, Los Angeles, April 27-30, 1970.

**National Relay Conference, Oklahoma State University and the National Association of Relay Manufacturers;** Oklahoma State University campus, April 28-29, 1970.

**Transducer Conference, IEEE;** National Bureau of Standards, Washington, May 4-5, 1970.

## Short courses

**Safe-Life Design Practices: Practical Applications of Fracture Mechanics,** Engineering 879.4; Boelter Hall, Room 4442, University of California, Los

(Continued on p. 26)



**Compatible...  
Moisture Resistant...  
Hysol Makes Epoxy  
and Urethane Compounds  
to Sink, Fly and Click  
Anywhere...**

Solve your electronic component insulation and protection problems now with the same HYSOL materials that have been found to be completely compatible in space, underseas and computer components. HYSOL meets or exceeds the most rigid specifications for electronic component protection with a complete line of molding powders and liquids, coating powders and printed circuit coatings. When your program calls for epoxies or urethanes, check HYSOL. Have assurance that HYSOL recommended materials have been thoroughly tested on live components under environmental conditions defined in MIL-STD 750 and MIL-STD 202 in HYSOL's Electronic Testing Laboratory.

**D** **HYSOL DIVISION**  
**THE DEXTER CORPORATION**  
Write, wire or call HYSOL, Department EM-270  
Olean, N.Y. 14760 for application  
engineering assistance.

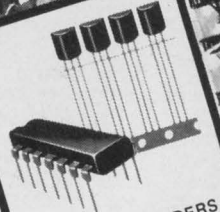

MOLDING POWDERS



COATING POWDERS

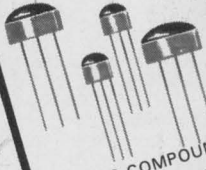

CASTING COMPOUNDS

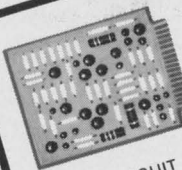

PRINTED CIRCUIT COATINGS

**Meetings**

(Continued from p. 25)

Angeles, March 16-20, \$285 fee.

**Aerospace and Marine Corrosion**, Engineering 868.9; Boelter Hall, Room 4442, University of California, Los Angeles, April 20-24. \$285 fee.

**Laser Fundamentals and Communications**; Rice University, Houston, Texas, May 4-6. \$300 fee.

**Modern Application of Semiconductors**, University Extension, University of California; Boelter Hall, Room 5704, Los Angeles campus, March 23-April 3. \$395 fee.

**Introduction to Optimization Techniques—Emphasis on Nonlinear Programing Techniques**, Engineering and Physical Sciences Extension, University of California; Boelter Hall, Room 5704, Los Angeles campus, March 30-April 3. \$285 fee.

**Control Systems**, University Extension, University of Wisconsin; Madison campus, April 14-15. \$70 fee.

**Call for papers**

**International Conference on Engineering in the Ocean Environment**, IEEE; Panama City, Fla., Sept. 21-24, 1970. **March 3** is deadline for submission of abstracts and summaries to C.B. Koesy, Code P750, Naval Ship Research and Development Laboratory, Panama City, Fla. 32401.

**Conference on Applications of Simulation**, IEEE, Association for Computing Machinery, American Institute of Industrial Engineers, The Institute of Management Science; Waldorf-Astoria, New York, Dec. 9-11. **March 31** is deadline for submission of papers to Michel Araten, Celanese Chemical Co., 245 Park Ave., New York 10017.

**Fall Joint Computer Conference**, IEEE, American Federation of Information Processing Societies; Astrohall, Houston, Nov. 17-19. **April 10** is deadline for submission of papers to L.E. Axson, Chairman, Technical Program Committee, 1970 Fall Joint Computer Conference, P.O. Box 6-449, Houston 77061.

**Symposium on Adaptive Processes: Decision and Control**, IEEE; University of Texas, Austin, Dec. 7-9. **May 1** is deadline for submission of papers to Prof. D.G. Lainiotis, Department of Electrical Engineering, Engineering Science Building 502, University of Texas, Austin 78712.

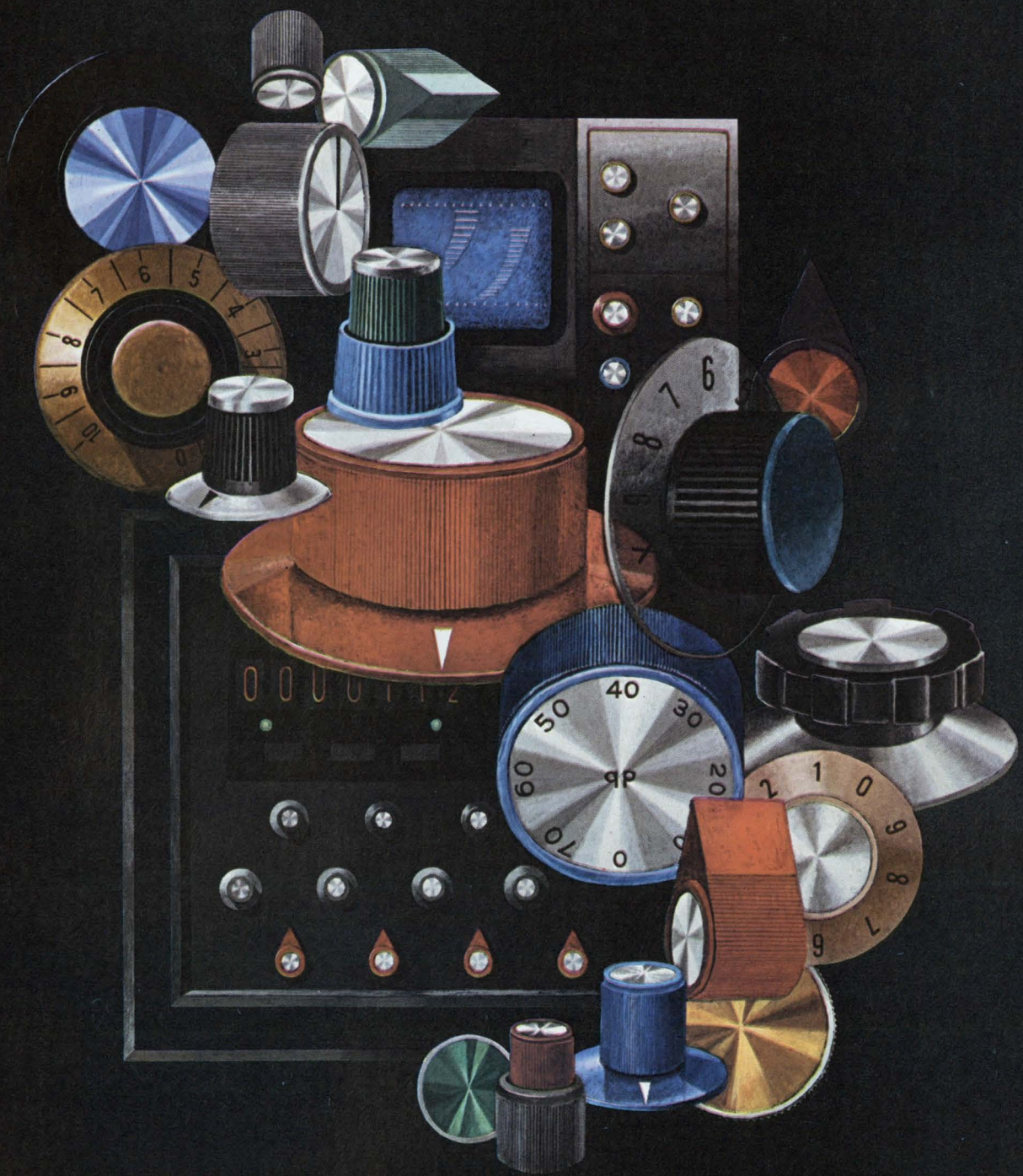

# RELIABILITY

Sets the pace in product performance — quality — service. And, when it comes to control knobs and dials, the reliable name is Rogan . . . the pace-setter of the knob industry since 1939.

Outline your requirements for quotation and free knob sample. Write for free color catalog.

**Rogan**

BROTHERS, INC.

8019 N. Monticello Ave. Skokie, Illinois 60076  
Phone: (312) 675-1234

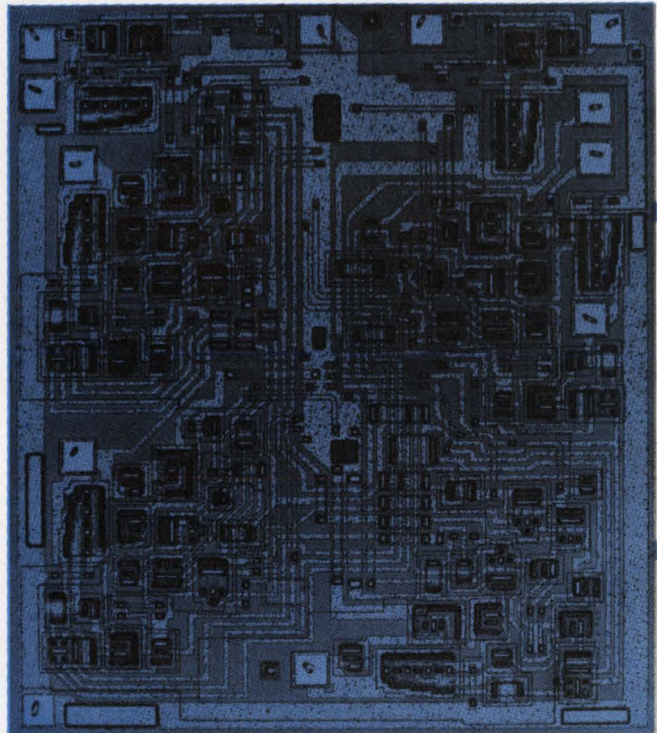

MC7490

# You're in the (NIXIE<sup>®</sup>) drivers seat

## CHECK THESE 54/74 MSI CIRCUITS ...

### *Available Now*

MC7441A BCD-To-Decimal  
Decoder Driver  
MC7475 Quad Latch  
MC7480 Gated Full Adder  
MC7490 Decade Counter  
MC17482 2-Bit Full Adder  
MC27482 2-Bit Full Adder  
w/Exclusive OR Outputs  
MC7493 4-Bit Binary Counter

### *Coming Soon*

MC7442 BCD-To-Decimal Decoder  
MC7443 Excess-3-To-Decimal Decoder  
MC7444 Excess-3-Gray Code-To-  
Decimal Decoder  
MC7446 Seven Segment Decoder  
MC7447 Seven Segment Decoder  
MC7448 Seven Segment Decoder  
MC7449F Seven Segment Decoder  
MC7483 4-Bit Full Adder  
MC7491A 8-Bit Shift Register  
MC7492 Divide-By-Twelve Counter  
MC7495 4-Bit Universal Shift Register

*- where the priceless ingredient is care!*



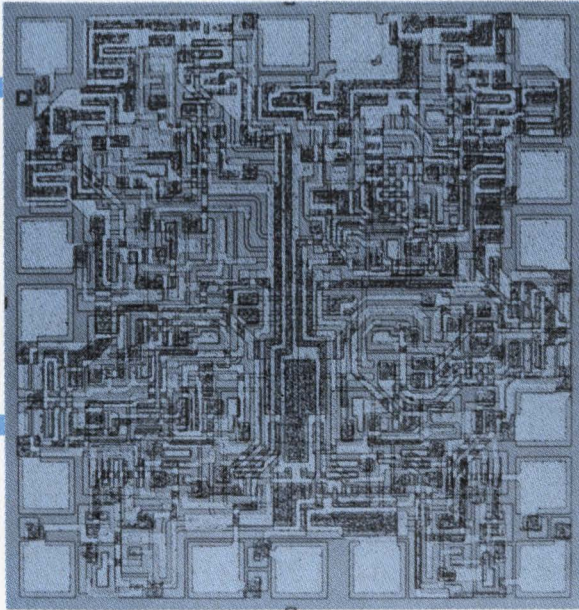

MC7475

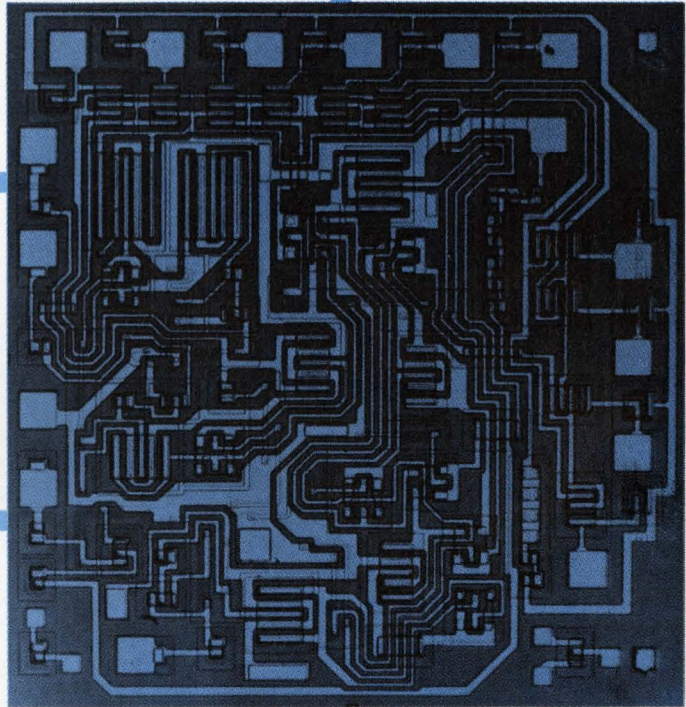

MC7441A

## with these MTTL complex functions

Now you can develop completely integrated read-out systems with the intrinsic advantages of reduced circuitry, lower costs, and increased reliability. Design flexibility is yours when you consider the numerous configurations possible. For example, take one BCD-TO-DECIMAL DECODER AND HIGH-LEVEL DRIVER (MC7441A) and include a DECADE COUNTER (MC7490) to provide a basic counter-readout operation. Pin compatibility allows the two devices to be mounted side by side and no external logic or additional components are required. Additional decades may be added and the display can be provided with a sequential pulse train into the first decade for use as a multi-digit counter or timer, or many other applications.

Or add a QUAD LATCH (MC7475) and the MC7490 can follow the input sequence and, at specified intervals, the count is strobed through the latch and presented to the MC7441A. In this

way the display tubes are not continuously cycling and are easier to read at specific times. Provide a zero suppression circuit and all unused tubes will remain blank making it easier to read actual numbers.

And, by designing in four MC4004 16-BIT SCRATCH PAD MEMORIES you can expand the counter-readout concept to an economical multiplexing operation. In this case one driver is utilized to display a given number on the readout tubes thereby eliminating the sequential counting sequence.

These are only a few of many potential uses for the MC7490, MC7475 and MC7441A. Each device is a versatile design tool and can be used in varied applications to develop new systems or extend present ones.

Detailed specifications on these MTTL complex functions and a newly available application note "Direct Digital Display Using MTTL Complex Functions" are yours for the asking. Simply write to us at P. O. Box 20912, Phoenix, Arizona 85036 and ask for MOTOROLA TTL DESIGN KIT #1. Let Motorola's growing TTL capability work for you.

MTTL Trademark of Motorola Inc.  
NIXIE Trademark of Burroughs Corporation

# MOTOROLA

# 5400 / 7400 TTL

# LSI/DRA





# Wait no longer... LSI is here!

(And Texas Instruments brings it.)

Here's the dawn of a new day for electronics.

LSI/DRA (Large Scale Integration/Discretionary Routed Arrays) are here *now!* They are designed into the LSI computer shown (below left). This working computer was developed to demonstrate the practicality of LSI/DRA.

But it's more than just practical. LSI/DRA is already economically feasible for new designs.

TI engineers and scientists have solved the many manufacturing problems involved.

And they've been so successful that costs—already less than for similar functions built up from conventional military ICs—will be competitive with many industrial function costs within the span of the new product design time.

With both production and cost problems on the way to solution, it's time for forward-looking manufacturers to start learning how to work with LSI/DRA. Some have already started.

It's easier than it seems, too, be-

cause you don't have to start from scratch with a new design. TI offers standard products that you can evaluate as a starter. Here they are:

## DRA 1001

### Digital differential analyzer

This integrator features high speed (orders of magnitude above available competition), complete stability, and a one part in 2048 output resolution (10 bit binary plus sign).

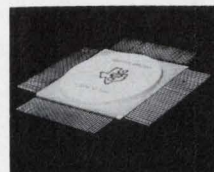

Two DRA-1001s will provide the incremental solution to the sine and cosine functions.

They can operate with a typical clock rate of 2 MHz, and they can compute the magnitude of any angle in less than a millisecond. Power dissipation is only typically 2.5 watts per array.

## DRA 2001 to DRA 2003 Serial-in serial-out static shift registers



These DC to 10 MHz TTL shift registers are available in three standard types—dual 253, dual 349, and dual 501-bit units. Special internal circuitry gives

greatly reduced power dissipation without loss of speed, and short internal connections minimize noise coupling.

## Custom designs

You can evaluate LSI/DRA at low cost with standard units, but you'll undoubtedly require custom arrays to meet your individual design requirements. We can help you there, too.

Many special arrays may be made simply by providing custom interconnection patterns on one of the three standard logic wafers. Other requirements may be met with custom wafer designs as well.

Either way, TI's computer-aided design techniques reduce design costs and lead time to new lows.

## Get the economic story



Since economics is the chief consideration in deciding when to go LSI, we've prepared a special bulletin that gives you all the

facts as they appear now. For your free copy, send a request for the LSI/DRA bulletin on your letterhead or business card to Texas Instruments Incorporated, P.O. Box 66027, M.S. 333, Houston, Texas 77006.



The TI LSI computer (below left), developed under Air Force contract, employs only 34 LSI arrays to perform the same functions as the standard TI 2502 (above left) which uses 1735 IC flat packs.

# TEXAS INSTRUMENTS



**Free. More than a decade  
of keyboard technology  
with every keyboard you buy.**

MICRO SWITCH all solid state keyboards are a solid investment. Immediately, you net a return of more than a decade of experience and leadership in the rapidly changing field of keyboard technology.

1957-1964—Developed and manufactured highly reliable mechanical keyboard switches.

1964—Introduced the KB modular switch. Mechanical switching and encoding in a single switch.

1965—Introduced the first reed switch keyboard.

1967—Introduced the first reed switch keyboard featuring integrated circuit encoding.

1968—Introduced the all solid state keyboard. Pioneered the use of an integrated circuit as a switching element.

1969—Introduced the first solid state MOS encoded keyboard.

MOS adds a new degree of flexibility in providing up to four codes per key. In addition, discrete components are reduced by a factor of nearly one hundred. This increases reliability and lowers maintenance costs.

Dollars just can't buy the experience we've gained in these 12 years. But you can buy the product of this experience. Our MOS encoded keyboard.

Let's get together and discuss keyboard technology or any other part of the business you consider important. Dollars. Compatibility. Reliability. Delivery. They're all important to us. Call or write us and see.

## **MICRO SWITCH**

FREEPORT, ILLINOIS 61032

A DIVISION OF HONEYWELL

---

# Electronics Newsletter

---

February 2, 1970

## Gray market opens in LSI packages

Packages for large-scale integrated circuits have been getting harder to find since late in November, and semiconductor makers and systems houses now are facing what their spokesmen call a package crunch. It's often necessary to go to a "gray market" contact—usually at an IC house which stocked up, or ordered large amounts before the crunch. **The current finder's fee varies from a flat dollar or so a package to 5% to 10% of package cost.**

Semiconductor and package vendors blame the crunch on lack of deliveries from materials suppliers. At Hughes Aircraft, the word is that output "will be affected to some extent" by the shortage.

Dick Abraham, in charge of advanced products for Motorola Semiconductor, denies there is any basic shortage. Referring particularly to laminated ceramic packaging, he says, "The people who make them are holding the price up—it's a seller's market at this point."

## ECL grabs 8% of digital market ...

Emitter-coupled logic, which even some of its strongest backers at Motorola believe was introduced prematurely in 1962, has come of age. Final 1969 sales figures are expected to show that ECL accounted for \$25 million, or about 8% of total digital IC sales of about \$331 million. But bullish sources at both Motorola, which pioneered ECL, and Texas Instruments look for ECL's share of the digital IC market to reach between 15% and 30% by 1973 to 1975, as new computers with ECL central processors reach the market. One TI spokesman puts the potential as high as 30% in three or four years.

Motorola's Michael Callahan, manager of IC research and development, predicts total digital IC sales of \$1 billion by 1975. He expects ECL to command about 20% of that market.

## ... as Fairchild poises for plunge ...

Motorola and TI are shipping ECL products now, with Stewart-Warner second-sourcing some of Motorola's MECL line and Signetics set to do the same. Motorola engineers look for Fairchild to join the ECL club this spring. Walter Seelbach, co-holder of the ECL patent with Motorola's Jan Narud, left Motorola for Fairchild more than a year ago, and a Motorola source says he can't see Seelbach "sitting there and not doing anything with ECL."

Others gearing up or already supplying ECL include RCA (which supplies some of its own needs for the Spectra 70 computer series), Siemens and AEG-Telefunken in Europe, and Hitachi in Japan. IBM, as usual, is making its own ECL as well as using outside sources for two models of the 360 series—the 85 and the 195—and also uses ECL in the new System 3.

## ... and 500-Mhz flip-flop is due

Motorola's MECL 4 plans are beginning to jell [*Electronics* Dec. 8, 1969, p. 34]. The Semiconductor Products division hopes to introduce a 500-megahertz flip-flop in the new family by midyear for use in pulse generators and counters. Counter manufacturers continually seek to divide by as high a frequency as they can get, so a super-fast flip-flop should find an instrumentation market. MECL 3 flip-flops have recommended safe-toggle frequencies of 350 Mhz or less.

---

# Electronics Newsletter

---

**Univac taking  
a hard look . . .**

Univac, which has been sticking to transistor-transistor-logic circuits for its computers, is looking at emitter-coupled logic for the future. An advanced-development group has put together a small ECL processor to check out the hardware design using ECL, and the results were favorable. One group member said: "We were very pleased with the results and the ease with which we put it together." However, Univac's next large machine, the 1110, will use TTL—Raytheon's Ray 3. That decision was made before the ECL processor was built.

**. . . as logic race  
barrels along**

While Univac and others study emitter-coupled logic for faster computers of the future, Raytheon Semiconductor is working on Ray 6, the latest in its transistor-transistor-logic family. Raytheon says Ray 6's speed is equal to that of the best ECL available—and the key word is "available." Equally significant is the fact that Ray 6 will use Schottky diodes. While Ray 6 will have the same power dissipation as Ray 2 and Ray 3—22 milliwatts per gate—it will have a speed of 2 nanoseconds, compared to 5.5 nsec for Ray 3 and 10 nsec for Ray 2. And unlike Ray 2 and 3, which use gold doping to increase speed, Ray 6 will utilize Schottky diodes. What's more, where Ray 2 has 0.15-mil tolerances and Ray 3 has 0.10 mil, Ray 6 will have on-size contacts with a tolerance of 0.03 mil.

As far as comparisons are concerned, Motorola has attained speeds of 0.9 nsec in MECL 4 with power dissipation of just 13 mw per gate—but neither MECL 4 nor Ray 6 is available yet.

**TI's big computer  
may be ready in '72**

Texas Instruments may be ready as early as 1972 to introduce the big, general-purpose computer it plans to make and market. A spokesman says the machine is being designed for seismic work, an area in which TI is prominent. But, the spokesman adds, the computer "could, of course, be put to other uses."

The machine has been code-named the ASC. Explains the same spokesman: "ASC stands for advanced seismic computer or advanced scientific computer. People [at TI] have called it both." Either way, it makes sense for TI to mask its intentions—one of its biggest customers for semiconductors is the world's biggest maker of general-purpose computers, IBM. And TI sells semiconductors to other computer firms too, meaning that the ASC could put it in competition with its own customers.

**Tv makers burned up  
by fire hazard rules**

What constitutes a fire hazard in a color tv receiver? Counsel for irate television manufacturers contend that the criteria of the National Commission on Product Safety are so vague that its listing of 122 potentially hazardous models of 11 manufacturers is "misleading, inaccurate, ill-conceived, and patently incorrect."

Arnold B. Elkind, chairman of the NCPS, set up by Congress as a fact-finding and study group without regulatory powers, concedes some of the listed models might not have defective parts. Indications are that no repair or recall action is planned by most makers, though RCA says it will offer free service for cited models.

In descending order, the commission findings list these manufacturers with a greater-than-industry average of 0.12 incidents per 1,000 sets: Lear-Siegler's Olympic brand, Packard Bell, Magnavox, Sylvania, Philco-Ford, and RCA.

# You Can't Get This Kind of Performance From Any Other Op Amp:

for **\$17.85\*** | for **\$27.25\***

RA-2600

Input Bias Current = 2nA

Input Impedance = 200 M $\Omega$

Voltage Gain = 200,000 V/V

Slew Rate =  $\pm 7$  V/ $\mu$ s ( $A_v=1$ )

Input Offset Voltage = 2mV

Fully Compensated

Short Circuit Protected

RA-2520

Slew Rate =  $\pm 120$  V/ $\mu$ s ( $A_v=2$ )

Input Offset Voltage = 4mV

Voltage Gain = 15,000 V/V

Large Signal Bandwidth = 200 kHz

Input Impedance = 100 M $\Omega$

Our RA-2510 has a slew rate of  $\pm 60$ V/ $\mu$ s and our RA-2500 has a slew rate of  $\pm 30$  V/ $\mu$ s with similar characteristics and equally low prices.

\*100 unit price

We're calling our linear line the no-compromise op amps because you don't have to compromise your design to stay within budget. In fact, with performance characteristics such as we offer, your design job is easier, and you end up with a more reliable circuit, too.

Get off-the-shelf delivery of these monolithic op amps that exceed hybrid performance. We build them to full military temperature range and to comply with MIL-STD-883. (If you don't need military temperature range, our commercial version, 0°C to +75°C, devices are available at even greater savings.)

Ask your nearest Radiation sales engineer about our no-compromise linear line. He'll help you *pick the best IC for the job.*

Lexington, Massachusetts (617) 862-1055  
Norwalk, Connecticut (203) 853-3646  
Frederick, Maryland (301) 662-5400  
Oaklawn, Illinois (312) 423-6010  
Dallas, Texas (214) 231-9031  
Albuquerque, New Mexico (505) 268-3549  
Palo Alto, California (415) 321-2280  
Long Beach, California (213) 426-7687  
P. O. Box 37, Melbourne, Florida 32901 (305) 727-5430

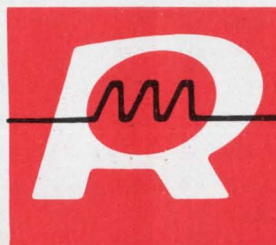

**RADIATION**  
INCORPORATED

SUBSIDIARY OF HARRIS INTERTYPE CORPORATION  
MICROELECTRONICS DIVISION

# Unprecedented Computer Power for the Lab

The new PAR™ Model 131 Instrument/Computer Interface System brings the full power of interactive time-sharing computers to the laboratory. So you can take advantage of the problem-solving capabilities of large-scale computers, no matter how complex – or simple – your experiment may be. And use easy-to-program languages such as BASIC or FORTRAN, to save more time and add to efficiency.

You can use the Model 131 to process analog or digital data from 1 to as many as 90 similar or different instruments. Data is sent over the telephone to a remote time-sharing computer while the experiment is running. The computer interacts immediately to reduce, correlate, or interpret the data in accordance to programs and data bases previously stored in its memory.

With the Model 131, the time-sharing computer can operate in the Question/Response mode. In answer to the computer's requests, you can input varying parameters for the experiment to obtain new test results from the same set of data. You can also use the time-sharing computer to monitor and control experiments. And it can even amplify the power and capabilities of certain laboratory instruments.

The Modularized Model 131 System is easily expanded as your instrumentation and data processing requirements grow. Price of a typical system consisting of an analog multiplexer, analog to digital converter, a system interface, and teleprinter is less than \$5,500.

For more information, ask for P.A.R. Bulletin T-206A. Write Princeton Applied Research Corporation, Box 565, Princeton, New Jersey 08540, or call (609) 924-6835.

**PAR** PRINCETON APPLIED RESEARCH CORPORATION

```

RUN FOURIR
***NAME THE FILE THAT CONTAINS THE DATA..... PSBYC.DAT
***INPUT NUMBER OF POINTS IN FILE TO BE USED..... 350
***TYPE THE TIME IN SECONDS REPRESENTED
    BY 1.0 IN THE TIME CHANNEL. USE E FORMAT..... 1E0
***GIVE THE UPPER FREQUENCY YOU WISH ANALYZED TO
    AS A FRACTION OF THE NYQUIST FREQUENCY..... 0.99
THE NUMBER OF LINES IN THE FILE IS: 101
NO FORMAL ERROR IN INPUT PARAMETERS
    
```

FREQUENCY	COS SPECTRUM	SINE SPECTRUM	POWER SPECTRUM
0.000000E+00	0.359462E	0.0000000	0.1292133
0.1010101E+01	0.4182314	0.3105132	0.2713360
0.2020202E+01	0.2326632	0.2764665	0.1305659
0.3030303E+01	0.1504027	0.2295188	0.3752998
0.4040404E+01	0.1107771	0.1932658	0.0496232
0.5050505E+01	0.3855935	0.1624469	0.0337667
0.6060606E+01	0.0691139	0.1409283	0.0247049
0.7070707E+01	0.0405814	0.1261493	0.0190881
0.8080808E+01	0.0556471	0.1091779	0.0150164
0.9090909E+01	0.0499526	0.0987555	0.0122479
0.1010101E+02	0.0454340	0.0889968	0.0099847
0.1111111E+02	0.0428711	0.0797007	0.0081965
0.1212121E+02	0.0426423	0.0733000	0.0073268
0.1313131E+02	0.0391647	0.0681921	0.0061640
0.1414141E+02	0.0381194	0.0626162	0.0054002
0.1515152E+02	0.0374556	0.0592862	0.0049178
0.1616162E+02	0.0378951	0.0556111	0.0045286
0.1717172E+02	0.0352628	0.0513224	0.0038775
0.1818182E+02	0.0351489	0.0474765	0.0034895
0.1919192E+02	0.0346981	0.0447226	0.0030320
0.2020202E+02	0.0337435	0.0430067	0.0029682
0.2121212E+02	0.0342696	0.0393157	0.0027201
0.2222222E+02	0.0331835	0.0376853	0.0025213
0.2323232E+02	0.0336812	0.0350578	0.0023635
0.2424242E+02	0.0332670	0.0332720	0.0022141
0.2525253E+02	0.0328700	0.0310124	0.0020422
0.2626263E+02	0.0330911	0.0276619	0.0018702
0.2727273E+02	0.0336914	0.0274123	0.0018665
0.2828283E+02	0.0320479	0.0259930	0.0017027
0.2929293E+02	0.0319779	0.0245959	0.0016275
0.3030303E+02	0.0314581	0.0233183	0.0015334
0.3131313E+02	0.0314051	0.0224895	0.0014921
0.3232323E+02	0.0328815	0.0216788	0.0015776
0.3333333E+02	0.0315860	0.0198572	0.0013866
0.3434343E+02	0.0323981	0.0170726	0.0013406
0.3535354E+02	0.0321242	0.0167472	0.0013124
0.3636364E+02	0.0330013	0.0159084	0.0013422
0.3737374E+02	0.0324368	0.0138085	0.0012628
0.3838384E+02	0.0319411	0.0120691	0.0011659
0.3939394E+02	0.0330850	0.0124336	0.0012494
0.4040404E+02	0.0324060	0.0116688	0.0011863
0.4141414E+02	0.0326275	0.0093791	0.0011525
0.4242424E+02	0.0336669	0.0087804	0.0012106
0.4343434E+02	0.0326221	0.0060118	0.0011003
0.4444444E+02	0.0330828	0.0063268	0.0011345
0.4545455E+02	0.0318096	0.0053907	0.0010409
0.4646465E+02	0.0323753	0.0041354	0.0010453
0.4747475E+02	0.0337702	0.0036903	0.0011287
0.4848485E+02	0.0336656	0.0022161	0.0010982
0.4949495E+02	0.0342637	0.0022214	0.0011789

DO YOU WISH A PLOT? 1=NO 2=YES..... 1

DO YOU WISH TO ANALYZE ANOTHER FILE? 1=NO 2=YES ..... 2

```

***NAME THE FILE THAT CONTAINS THE DATA..... BXTST.DAT
***INPUT NUMBER OF POINTS IN FILE TO BE USED..... 200
***TYPE THE TIME IN SECONDS REPRESENTED
    BY 1.0 IN THE TIME CHANNEL. USE E FORMAT..... 1E0
***GIVE THE UPPER FREQUENCY YOU WISH ANALYZED TO
    AS A FRACTION OF THE NYQUIST FREQUENCY..... 0.50
THE NUMBER OF LINES IN THE FILE IS: 151
NO FORMAL ERROR IN INPUT PARAMETERS
    
```

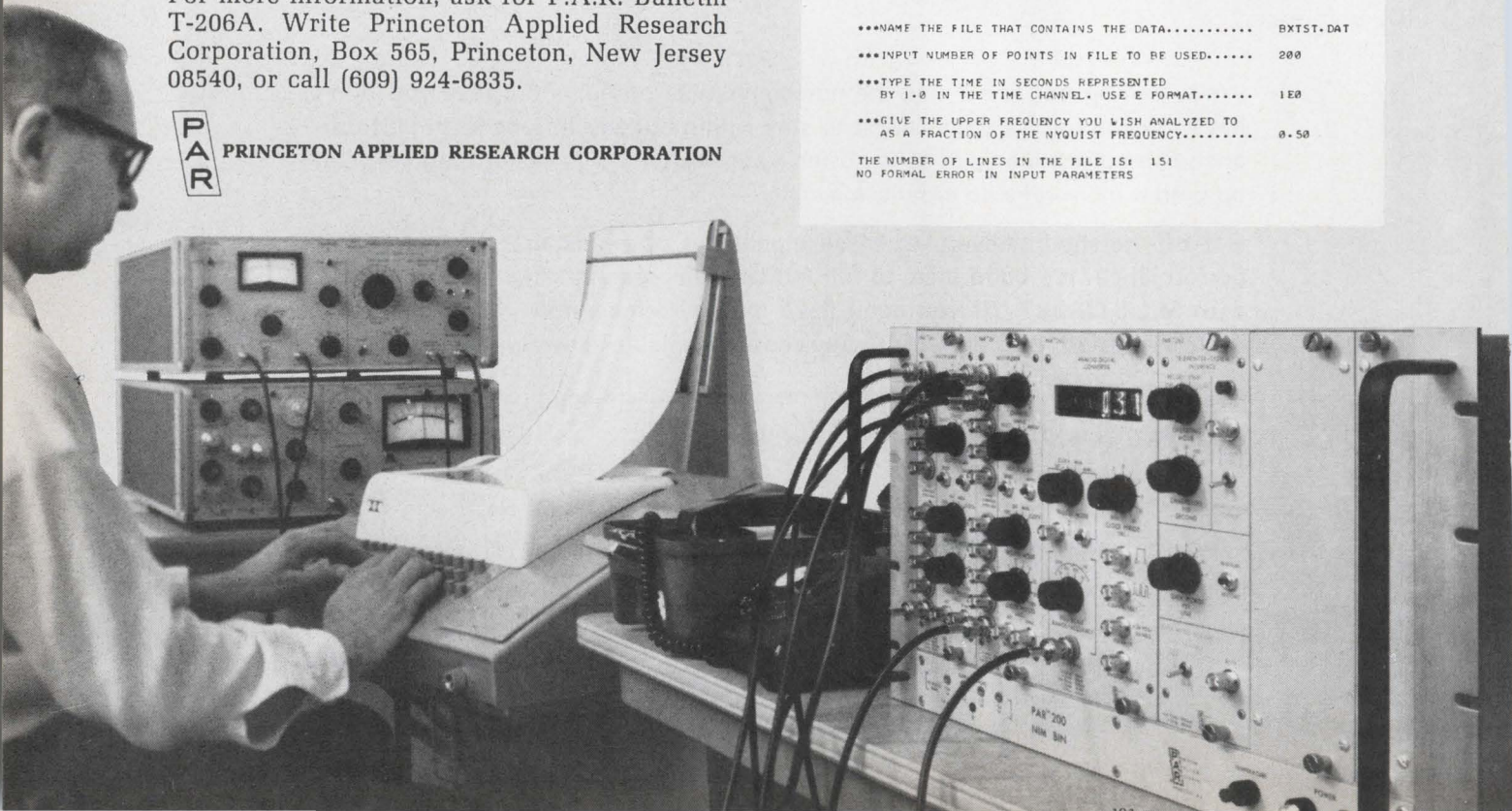

# F-15 avionics to have austere touch

Contractors for simple five-piece package to be named in two months; subsystems will account for third of plane's total cost

**Wary** of a critical Congress and prodded by a cost-conscious Pentagon, the Air Force now seems almost proud of the relatively simple, five-piece avionics package it will mount in its new air-superiority fighter, the F-15. The McDonnell Douglas Corp. says it will name avionics subsystems contractors within two months—perhaps early April—following negotiations, now in progress.

Final selection of a supplier for the F-15's most significant piece of avionics, the attack and fire-control radar, will not come before the end of summer, however [*Electronics*, Jan. 5, p. 79]. Engineering models will be tested in flights over the same range, using the same targets, in RB-66's loaned for the purpose. Considerations of economy sought by the Department of Defense required the Air Force to cut the radar's classified range specification "by around 20%."

**What's left.** "Originally, we were thinking in terms of a more complex avionics suit," one official

concedes, "and we had different degrees of complexity." Now, estimates of the final costs for the F-15's have been cut 20% to 40% compared to the package initially proposed. In addition to the attack radar with its digital-signal processor—the first to fly—the modified system will include a separate, rather straightforward central computer; a head-up display; a fairly simple, off-the-shelf inertial navigation system with a limited capability of three nautical miles; a standard radio-communications system, and a telescope for confirming target identification. The Air Force would also like to have the Honeywell-developed helmet-mounted sight plugged into the system for automatic targeting and fire control.

Apart from that last option, the 1,100-pound avionics package is expected to account for much less than one-third of the total aircraft cost. The F-15 price tag per production model is being put at \$13.5 million, a figure that could scale

down to near \$10 million if all 700 planes proposed are eventually purchased. Of this, avionics is expected to account for about 20% to 25%. But, the Air Force clearly wants to avoid repeating the mistake of pushing technology to the limit, as it did with the expensive and ill-fated Mark 2 avionics for the F-111. Also, a larger percentage of the Air Force's F-15 money will be pumped into areas such as high propulsion and airframe structural integrity—essential elements for air superiority. At the same time, the high fuel capacity requirement to give the F-15 extended loiter time in combat has cut into space that might normally be devoted to avionics systems. Thus, the Air Force Systems Command had to cut out its initial plans to give the fighter's radar an air-to-ground mapping and blind bombing capability in addition to its air-to-air attack role. Also dropped was a second central computer planned for purposes of redundancy. And, instead of a complex system for target identification, F-15 pilots will simply have to use their telescopes.

**What's new.** The avionics are relatively simple, stressing ease of maintenance, reliability, and one-man operation. Nevertheless, the system does have an integrated capability for communication, navigation, identification, threat warning, armament control, attack steering, and mission operation computations such as target range and range-rate measurement.

To achieve high reliability, the Air Force is segregating subsystems within the total package and assigning specific mean times between failure for each element. Further, it sought less complex systems to permit inclusion of an automatic fault detection and isolation

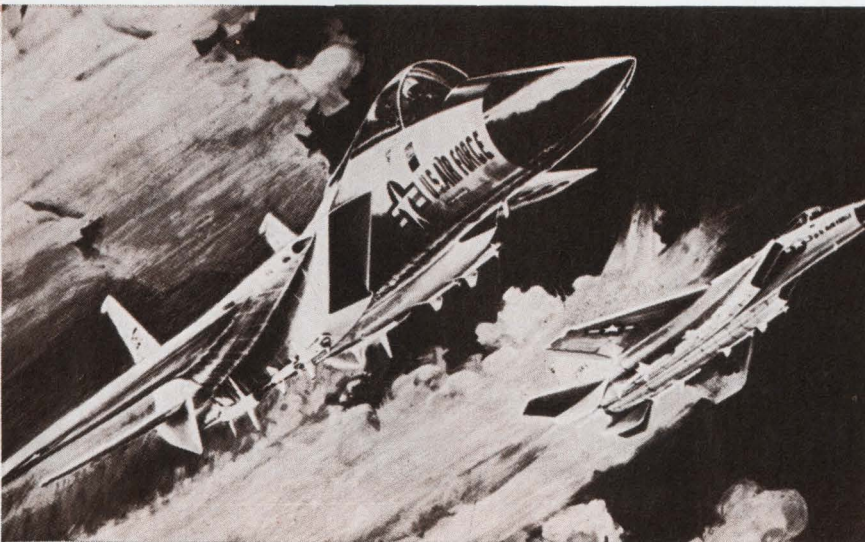

**Keep it simple.** That's the credo for the F-15's avionics designers as the Air Force reacts to Congressional criticism and tight budget policy.

## U.S. Reports

capability among the avionics subsystems.

Of particular technological interest are the attack radar and the airborne central computer. In addition to reducing range capabilities, the consolidation of such functions as scan conversion and acquisition aids within the set also cut the complexity and cost of the radar. The system's ability to separate low-flying targets from ground clutter is expected to benefit from earlier efforts by both Hughes and Westinghouse in developing the long-delayed Airborne Warning and Control System (Awacs). "There is a better radar operation" in terms of nose-on capability, an official concedes, "but none with better overall qualities, including side-on and tail-on" attack capabilities.

**Turn and run mode.** Radars now under test use monolithic circuitry, but no large- or medium-scale integration. Eventually, though, they may go MSI or LSI as the technology progresses. "The principal functions of the radar," an official explains, "are to look down, shoot down, and be easily operated by one guy. It has a mode where it will do the automatic search and super-search, and it will search to a minimum range of 10 miles with automatic lock-on." These are targets the pilot can accept or reject and move on to the next target. However, the Air Force is no longer talking of simultaneous tracking and targeting of multiple threats as it once did. As one project official explains it, "If a pilot sees four or five targets coming at him, you know what he ought to do: he ought to turn and get out of there."

## Communications

### Groundwork

Everyone knows that telephone service isn't what it used to be. And chances are that it's going to get worse before it gets better. Not only is demand for voice channels increasing, but wideband data-processing users will soon be jamming the lines between big cities.

And there will be Picturephone to reckon with: a single black-and-white hookup will fill about 100 voice channels.

AT&T is betting that its planned millimeter waveguide system will get it back on the track. The system, with a buried 2-inch-diameter pipe and regenerative repeater "manholes" about every 20 miles, would carry 250,000 voice channels per pipe across the country. This would mean an increase by a factor of eight in the capacity of the newest long-haul coaxial cable now in the ground.

**Jersey bounce.** Impressed by Japan's millimeter system working near Tokyo, Bell planners, after a hesitant start, are now committed

to go ahead at full speed. A trial 20-mile link will be built in New Jersey; it will include waveguide and regenerative repeater. If all goes well, it will be a prototype for installations across the country by the end of the decade.

Bell's confidence can be judged by the nature of the trial. Not only will the pipe and repeater be installed, but the entire range of transmission—voice, data, television, and Picturephone—will be tested. Although there's no firm schedule for the trial, the tentative timetable calls for a complete, one-channel repeater breadboard by fall 1970 operating in the 55 gigahertz range, with 110 Ghz the ultimate aim. Then would come the

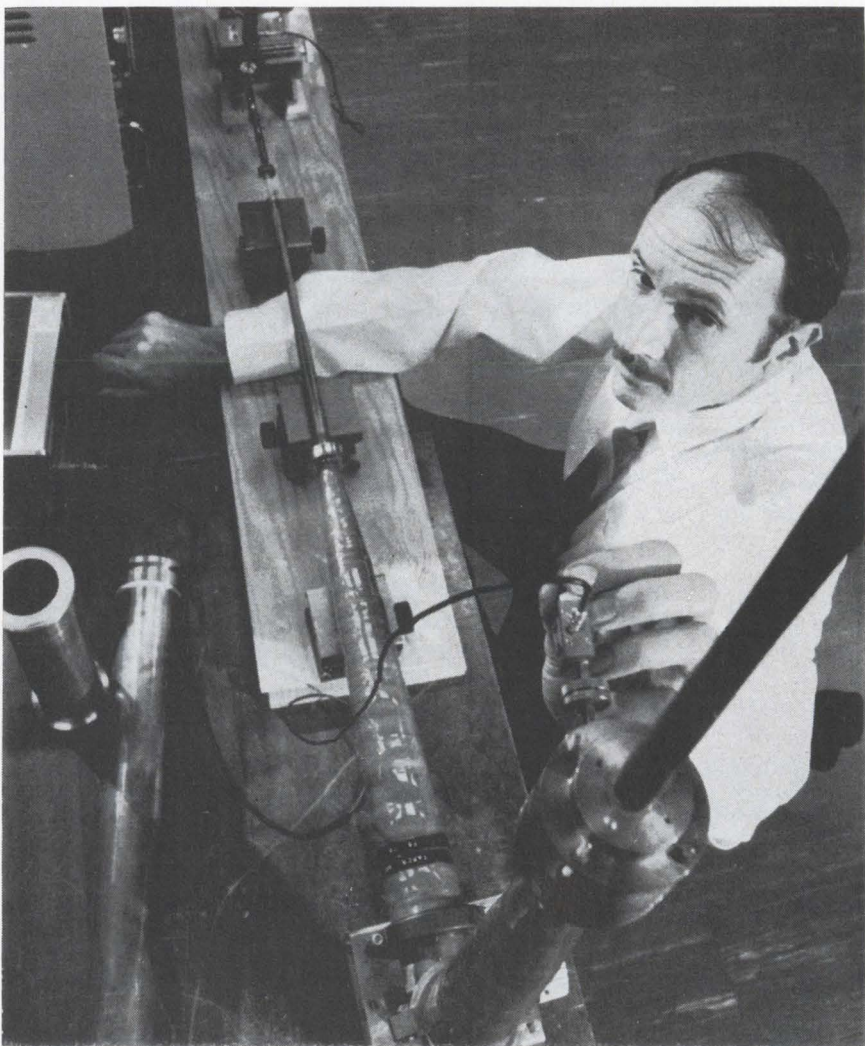

**Guiding hand.** Signals will travel from repeater to repeater down a two-inch waveguide in Bell's millimeter-wave system. To obtain the low-loss circular electric mode of transmission, a transducer length of pipe, which forms that mode, connects generator and line.



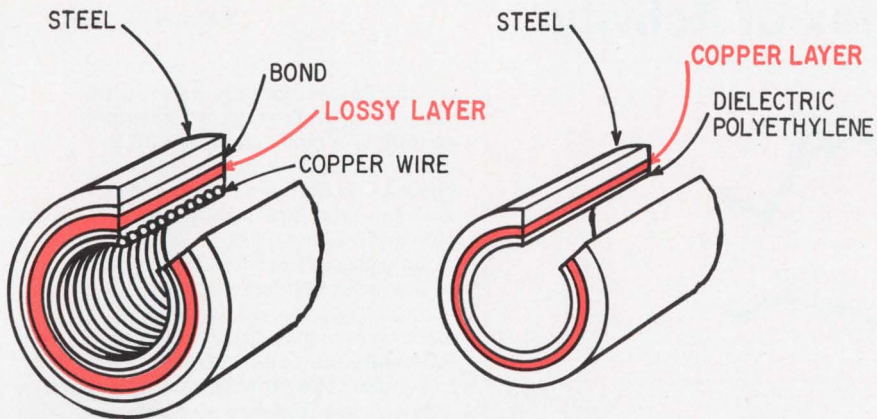

**Double indemnity.** Two types of waveguide sections can be used to kill unwanted modes. The helix-wound version at the left traps those modes in its circular configuration, prohibiting movement down the waveguide. The dielectric-lined section converts signals into heat, which is then dissipated in the walls of the pipe.

brassboard and, finally, tests would start in 1974.

The trials are expected to confirm some vital information on various trade-offs involved in a coast-to-coast network. For example, if attenuation can be minimized, then the distance between repeaters can be increased. If stations could be placed 25, rather than 20 miles, apart, the cross-country line would require, say, 35 fewer stations—and each station is expected to cost several million dollars.

**Into the unknown.** Success will depend on much untried complex equipment. The repeater, all solid state, must be able to handle 59 one-way channels plus one backup, with a frequency range of 40 to 110 Ghz. Bell's work of the past 10 years with mm-wave sources such as the Impatt and limited-space-accumulation mode diodes may bear fruit if the repeaters operate successfully. The thinking now is that the Impatt will do the job because, though it's lower in frequency, it presents fewer materials difficulties.

In actual operation the repeater must take the 56 channels from the waveguide, pass them through a channel-dropping network and then through a down-converter to obtain reasonable operation frequencies, probably around 1,300 megahertz. Before detection is possible, i-f amplification of 50 to 60 db gain will be required. After detection, the signal is regenerated and

boosted back to the carrier frequency. After that step, the signal is passed through a shaping circuit and oscillator. Having been shaped, the signal enters a channel-adding network where it is recombined with the other channels for transmission.

Aside from the repeater, the waveguide will undergo tests to determine its effectiveness in carrying the signals. At the test frequencies transmission along pipes is a very touchy matter. Because of attenuation, only the low-loss circular electric mode is practical. But as transmission proceeds, other unwanted modes form; these, traveling at different velocities, will reconvert again to the circular mode, causing severe signal noise. To make matters worse, the slightest bend or irregularity in the waveguide greatly increases unwanted mode production. Bell figures that, at best, only 400-foot radius of curvature bends can be tolerated between any part of repeaters.

## Government

### Going nowhere

Though Richard M. Nixon got to be President in time to capitalize on man's first lunar landing, space spending ranks low among his economic priorities. Thus, the National Aeronautics and Space Administra-

tion—and its industry contractors—will get less money in fiscal 1971 than it received in fiscal 1970, confirming the initial report just before Christmas [*Electronics*, Dec. 22, 1969, p. 62].

Because of the sharp escalation of Washington rumors about the future of the space program—and the drop in morale they were producing among NASA and aerospace industry personnel—NASA Administrator Thomas O. Paine felt constrained to call an unprecedented prebudget briefing to discuss the direction his agency will take in fiscal 1971. Nevertheless, he refused to say anything about the budget request of \$3.5 billion, down from the current \$3.7 billion.

**Stretch.** Apollo flights will be stretched out to six-month intervals, except for 1972 when the first Apollo Applications Program three-man workshop will be launched with the Saturn 5 vehicle from the canceled Apollo 20.

Work will continue on the NASA-Atomic Energy Commission Nuclear Energy Engine (Nerva) project; the earth resources, meteorological, and communications satellites; the two unmanned Mars orbiters for 1971; the 1972 Jupiter probe and the 1973 single-mission Venus-Mercury flyby. And design study contracts will be awarded for the six-to-12-man orbital space station, and the orbital and booster stages of the space shuttle.

Production of the Saturn 5 launch vehicles beyond the 15th under construction has been stopped. The landing of the two heavily instrumented Viking life probes on Mars has been postponed until at least 1975. A decision about a 1976 or 1978 proposed Grand Tour (Jupiter, Saturn, Uranus, Neptune, and Pluto) will be made later.

The stretch-outs, cancellations, and closing of the Electronics Research Center by June 30 and possibly others, including the Michoud Assembly Facility and the Mississippi Test Facility [*Electronics*, Jan. 19, p. 39], will mean a slash of 50,000 contractor, university, and NASA employees. In-house workers will be hit last and lightest, probably mostly through attrition—ex-

# Electronics Index of Activity

February 2, 1970

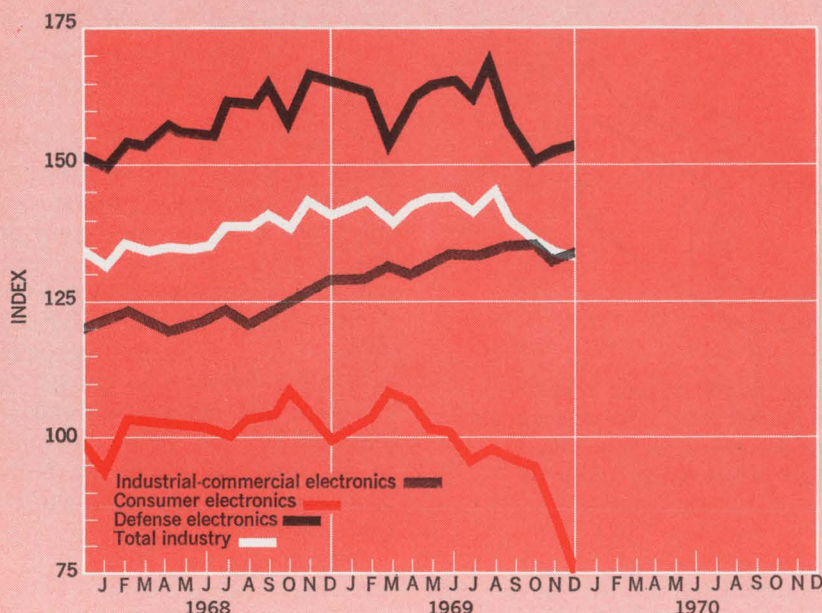

Segment of Industry	Dec. 1969	Nov. 1969*	Dec. 1968
Consumer electronics	75.5	85.0	100.7
Defense electronics	152.9	152.4	166.1
Industrial-commercial electronics	133.7	132.4	128.2
Total industry	133.9	134.9	143.8

For the fourth month in a row, total electronics production in December was off. The index stood at 133.9 compared to November's revised figure of 134.9. Viewed against the year-ago total, the decrease was almost 10 index points.

Only one of the three components of the index fell, but that was enough to do the job. Consumer electronics was the culprit, sliding 9.5 points from November to December. The other two components actually rose. Defense electronics gained 0.5 points to 152.9, while the industrial-commercial area climbed 1.3 points to 133.7. The industrial-commercial increase was its first month-to-month gain since August 1969.

Indexes chart pace of production volume for total industry and each segment. The base period, equal to 100, is the average of 1965 monthly output for each of the three parts of the industry. Index numbers are expressed as a percentage of the base period. Data is seasonally adjusted. \*Revised.

cept for those at ERC. When the work being done at Michoud and MTF is completed, Paine hopes that NASA can "keep the teams together."

**Highball.** MTF lost one round in its battle to stay alive when the Department of Transportation decided to build its test track for high-speed trains on a site near the Pueblo, Colo., Ordnance Depot, instead of at Michoud. MTF was never in the final running, a Transportation Department spokesman said [*Electronics*, Jan. 19, p. 41].

Paine doubts any top personnel will quit to protest the budget cut-back and stretch-out. But some people feel the slimmer budget indicates the Administration's refusal to commit itself strongly enough to the advancement of space investigations in the 1970's.

He believes that he is in a sound position to bargain with Congress. But, he adds, "you can carry out space programs for the U.S. at a large number of different levels. I think the level we have now is a

level in which we can take great pride. And, I think the country in the 1970's will be very proud of the achievements NASA will turn in."

## Manufacturing

### SEMI all the way

Probably the most highly automated semiconductor facility outside the Northeast will go into operation by the end of this month. The plant, built by Semiconductor Electronic Memories Inc. in Phoenix, Ariz., will go on stream with the delivery of packaging equipment. When SEMI starts shipping memory systems in August, company president William Arnold will be on the road toward his goal of "leading the industry in the manufacture and sale of semiconductor memory systems and components." He adds, "I won't be satisfied unless we're doing \$100 million in sales in 1974."



Arnold's team has its work cut out for it. But his is a team with impressive credentials. Arnold was technical assistant to the director of product assurance at IBM's Components division before leaving last June and founding SEMI.

He brought with him five others who have contributed to IBM's semiconductor processing and assembly automation operations: Arthur Mones, co-inventor of solidlogic technology, who is SEMI's technology vice president; Frederick Kost, former manager of automated test technology at IBM's components division, engineering vice president; George Cherniack, developer of joining techniques used in bonding IBM's monolithic chips, who is SEMI's module and packaging operations manager; Y.S. Kim, formerly IBM's medium-scale integrated semiconductor process engineering manager, who is semiconductor process development manager at SEMI; and John Fairfield, a SEMI technical staffer who worked in semiconductor process

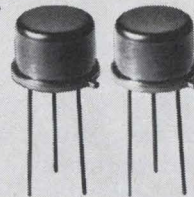
Depend on RCA  
reliability in  
complementary  
medium-power  
transistor  
pairs...







hermetically sealed for broader applications.

Now...RCA covers the industrial  spectrum with general-purpose, p-n-p/n-p-n  transistor complements...and they're all hermetically sealed in TO-5 packaging to give you greater design flexibility and reliability. Choose any of these broad-spectrum device families — the  p-n-p

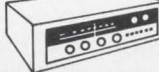
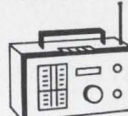

2N5781, 2N5782, 2N5783, or the n-p-n 2N5784, 2N5785 and 2N5786.

They can fit a host of switching and amplifier  applications — in computers, for example, as well as in oscilloscopes, radar, missiles, hi-fi equipment, marine radios and satellite  communications systems. RCA silicon p-n-p and n-p-n medium-power transistors all feature low saturation voltages, high breakdown voltages and high  $h_{FE}$  (min.) at  high current. And they're beta controlled to 1.6 A, with collector-to-emitter sustaining voltages ( $V_{CER}$ ) up to 80 V available.  $V_{CE}$  (sat.) is 1.0 V max. at 1.6 A. For complete  details, see your local RCA representative or your RCA distributor, or write RCA Electronic Components,  Commercial Engineering, Section **IN2-1**, Harrison, N.J. 07029. In Europe: RCA International Marketing S.A., 2-4 rue du Lièvre, 1227 Geneva, Switzerland.

**RCA**

## U.S. Reports

ess development for 11 years at IBM's Components division.

**Teammates.** In addition to the ex-IBM men, Arnold has hired two designers of widely accepted semiconductor memories. Both Peter Economopoulos and Tom Hart brought out their designs when they were with Honeywell's Electronic Data-Processing division. Economopoulos put together a 64-bit transistor-transistor logic random-access memory, and Hart designed a widely used 16-bit TTL random-access memory. Hart, however, had only to move across town to join SEMI—at that time he was product manager of IC memories at Motorola's Semiconductor Products division. Now he's manager of product design at SEMI.

Arnold reached into the San Francisco semiconductor circle to pluck Donald Winstead, his vice president for marketing, from Signetics Corp., where he had been marketing manager.

The heftiest chunk of financial backing came from Electronic Memories and Magnetics (formerly Electronic Memories Inc.), the acquisition-minded firm best known for its own core memory products. Trude Taylor, EM&M's president, "wants to lead the industry in memory products," Arnold says, "and he recognized the need for semiconductor memories."

Arnold feels the semiconductor memory market will exceed \$500 million by 1975—when it still will be in its infancy.

The firm's first products will use bipolar arrays, although metal oxide semiconductor storage chips are being designed. Winstead says SEMI chose bipolar elements initially "because we know they can be made and we're convinced they can compete with cores." But the key to SEMI's approach is standardization of parts to make automated assembly workable.

**Good mixers.** There are just three basic parts, and they may be assembled into a variety of memory systems. The memory module, the support module, and a printed-circuit board. Four memory modules, each consisting of 256 bits of storage (two 64-bit-by-two-word arrays) and four support modules,

can be put on one board to form the smallest system SEMI will make initially—the RAM 18A—a 128-word-by-eight-bit system with a cycle time of 200 nanoseconds consuming 1.6 watts. Winstead says this unit will sell for about 20 cents a bit.

But he feels the RAM 88B will be the best initial seller.

It's an 8,000-word system—1,024 words by eight bits; 8,192 words by one bit; 4,096 words by two bits; or 2,048 words by four bits. This unit will cost about 10 cents a bit. Winstead figures this one, using 32 memory modules and four support modules on a board, will find quick acceptance because it can be used as a refresher buffer memory for cathode-ray tube displays. These have been difficult to obtain at a cost competitive with cores, he says.

The unit, like all of SEMI's initial systems products, also has a 200-nsec cycle time. It consumes just 4.4 watts compared with 35 watts for a comparable core system, Hart says, or 64 watts for other bipolar memories with similar performance. SEMI plans four other memory systems with greater capacity than the RAM 18A but less than the RAM 88B, and one slightly larger than the RAM 88B at 1,024 words by nine bits.

The support module contains a three-bit address register; a three-in, eight-out decoder; eight address drivers; two sense amplifiers and two digit drivers plus logic to allow addressing of the sense amplifiers. SEMI chose to use a separate decode chip to reduce system cost and power requirements rather than to put decoding on the same monolithic chips with the storage elements.

**Machine-made.** SEMI expects to shine in solid-logic technology-based assembly of 94-mil-square standard chips with solderable mounts on 630-mil substrates with mating mounds. Arnold calls the process liquid-phase joining. The chips are hermetically sealed, minimizing packaging costs.

"The module process is entirely automated," Arnold explains. "We use a printing press to put the inks on the ceramic substrates, then au-

tomatically rivet the pins into place, and dip-solder to get the solder pads on the substrate."

The chips are then joined to the substrate in a belt-fed furnace in which surface tension causes the chip mounds and substrate mounds to automatically align and form a unified bond. Then a silicon protective cover is applied, and, finally, a metal lid is automatically crimped into place over the entire module.

"I think automation can beat the pants off coolie labor," Arnold asserts. "We won't need offshore plants."

## Companies

### It can be done

They said it couldn't be done. But Viatron Computer Systems Inc. is proving them—Viatron's competitors—wrong. At issue was whether Viatron could make deliveries of its System 21 data-entry consoles because they depend heavily on MOS chips. The competition claimed Viatron would require "impossibly large" amounts of metal oxide semiconductors.

"Deliveries come in spurts but we don't lack for chips," says Edward M. Bennett, president of the Bedford, Mass., firm. The only delay related to large-scale integration was a short-term lack of packages; one of its suppliers couldn't package the LSI it was ready to deliver and this cost Viatron a week or two.

More important to production than cyclic LSI deliveries were such prosaic problems as:

▶ A temporary shortage of tape heads for cassette decks caused by the vendor's milling machine clogging with soft alloy. This was overcome by the use of steel instead of the alloy.

▶ An unusually high rate of error symbols printed out by the device. This was overcome by tightening the tolerance of the tape-drive spindles.

▶ Poor workmanship on many of the early circuit boards off the production line. These were reworked and passed on, but now the com-

# 12 MIL-SPEC TRIMPOT® POTENTIOMETERS

## MIL-R-39015



RTR12\*

## MIL-R-27208



RT10



RT11



RT12

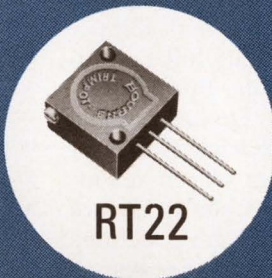

RT22

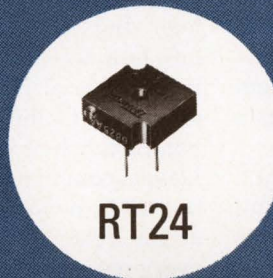

RT24

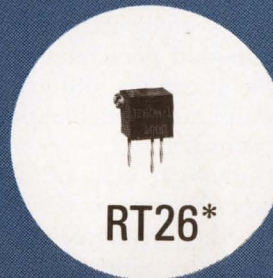

RT26\*

## MIL-R-22097



RJ11



RJ12



RJ22

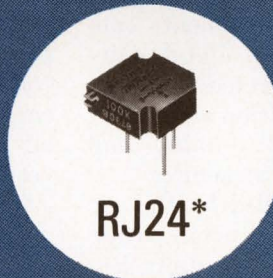

RJ24\*

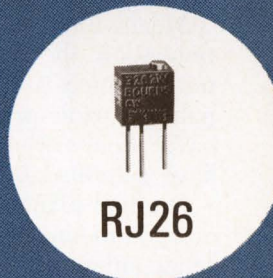

RJ26

## BOURNS HAS MORE POTENTIOMETERS ON DESC'S QPL THAN ANY OTHER MANUFACTURER!

### Available from your local Bourns Distributor!

Bourns is the world's largest manufacturer of adjustment potentiometers, with 18 years of leadership. Bourns is also the largest manufacturer of Mil-Spec potentiometers, backed by a total of 12 RT, RJ and RTR models in our line.

The 6 RT, 5 RJ and 1 RTR models not only meet the specifications of MIL-R-27208, MIL-R-22097 and MIL-R-39015, but each is designed and manufactured to consistently exceed each facet of these requirements.

As in the past, you can depend on Bourns to deliver the potentiometer you need. In this tradition of service we now offer the Mil-Spec unit you may need for your next critical application with 12 RT, RJ and RTR models.

\* Not yet stocked in depth by distributors.



## U.S. Reports

pany is converting to automatic assembly, which should improve matters.

▶ Humming in the console power supplies. This problem continues, with the vendor replacing the rejects.

**Onward.** Bennett pegs production at a "comfortable 200 units per month and growing." And as the firm converts to hard tooling, and from hand to automated assembly, Bennett projects an in-house production capacity of up to 1,000 units per month by May. At that point, Viatron will begin phasing in outside contractors. If these assembly shops get going quickly, says Bennett, the growth in production could exceed the estimate—2,200 units per month by October.

Do users like it? Lawrence C. Brown, accounting manager at New England Telephone and Telegraph Co.'s Northeast accounting office at Salem, Mass., says, "The System 21 is great and we're now bringing in staff personnel to show them what it can do, and ask them to think up new benchmark tests for the console.

"The only real item of doubt," according to Brown, "is the staying power of the terminal. And we really won't be able to find out how long one will last until we get experience with large numbers in house."

Meanwhile, development continues on the firm's 16-bit computer, which is expected to be capable of triple-precision arithmetic, have dual-arithmetic units, and have a unified bus structure.

Original plans called for the use of complementary metal oxide semiconductors in the unit. But now, plans call for the production units to use silicon-gate MOS. The reasoning is simple. "We'll immediately be able to second-source ourselves with our own silicon-gate capability," says Bennett. "And the investment in time and plant made by Fairchild and others will promise faster, more dependable delivery than now possible with C/MOS."

But as soon as it is practical, Viatron plans to switch to C/MOS to take advantage of its high speed and low power dissipation.

## Management

### Finding a FIT

"I should have said 'No, no, no,'" says Charles Stark Draper, founder of the Massachusetts Institute of Technology's Instrumentation Laboratory. An announcement from the Florida Institute of Technology in Melbourne, naming him president of its Charles S. Draper Research Center [*Electronics*, Jan. 19, p. 51], implies that Draper will move to the Florida center. "Actually," says Draper, "I'm not going there, although I've been associated with [Jerome P.] Keuper, the president of FIT, for years."

Ten years ago, Keuper worked for RCA at what was then Cape Canaveral. He decided to start an engineering night school and recruited teachers from NASA, Patrick Air Force Base, and other organizations. It was called Brevard College, but as it grew and Keuper left RCA to devote his full time to it, the school became Brevard Engineering College. Draper became involved when a friend, Gen. Lee Davis, commanding officer at Patrick AFB, persuaded him to lecture at the school. "So I gave lectures every year for five or six years," says Draper.

**Plans.** "The only thing that has happened now," asserts Draper, "is that the school, now the Florida Institute of Technology, has received some swampland to build on." It's only in the planning stage, he notes, and no one's working very hard because there's no money—"there are just a few interested people." For now, Draper's status as president of the center is purely honorary, since the center has yet to be built and he receives no salary. Draper plans to continue his work in Cambridge, where he is senior adviser and director of major projects at the Charles Stark Draper Laboratory, as the instrumentation lab has been renamed.

Draper agreed to the job because he's interested in helping out. "A lot of people have lost work at the Cape and the center is well placed to take advantage of people who want to stay in Florida but need something useful to do," he says.

And the location is convenient for research in space and oceanography. The center's charter also indicates others areas of research, such as meteorology, electronics, and navigation.

## Computers

### Not so special

Many small, special-purpose computers are optimized for one or two tasks, but fail to measure up when they're asked to do more. A step toward a broader-application special-purpose machine has been taken by General Automation Inc. with its 16-bit SPC-16. This computer has program control at 500 kilohertz, direct memory access at 1 megahertz. It saves memory capacity and access time by performing logical and arithmetic operations in eight general-purpose accumulator/index registers.

According to Ben H. Auten, computer products manager for the company's Automation Products division, the instruction repertoires are optimized for solutions in four key applications, including real-time communications, data acquisition and process control, laboratory data acquisition and analysis, and manufacturing and production automation.

**Good view.** A unique debugging aid for real-time programs permits the operator to visually monitor the execution of the program on an oscilloscope plugged into the computer. This monitoring is accomplished by a built-in digital-to-analog converter that converts each digital bit in a program into a different voltage, which can be programmed by the operator.

A hardware register, controlled by a program, drives the 16 indicator lights on the computer's data-display panel. Each light has a different voltage value. The operator can display from one to 16 bits at a time on the oscilloscope, and can instruct the computer to display whatever portions of a program he wants to see.

He can store a number of programs, and direct the computer to

# NOW... A HAND-SIZE V-O-M WITH 10 MEGOHM INPUT RESISTANCE

With a 10 megohm input resistance and a high-sensitivity (0.3 V DC full scale) meter, this handy little Triplet Model 310-FET can handle practically any in-circuit electrical measurement you may need.

For instance, the voltage ranges cover from 0.005 to 600 V DC in 6 steps at 10 megohms and 0.1 to 600 V AC in 5 steps at 5,000 ohms per volt . . . 4 resistance ranges from 1 ohm to 5000 megohms with 50 ohms at the centerpoint of the low resistance scale . . . current in 2 ranges from 0.002 to 1.2 mA DC. With its optional clamp-on ammeter attachment, the Model 310-FET will read AC from 0.2 to 300 A in 6 steps. Accuracy on DC ranges is 3% . . . 4% on AC.

Never one to stand short when it comes to offering features and real value in its instruments, Triplet has even equipped the Model 310-FET with a rugged suspension-type meter to soak up the hard knocks and a polarity-reversing switch to simplify operation.

Value? It's priced at only **\$74** suggested USA user net, and it's available right now at your Triplet distributor. Ask him or your local Triplet sales representative for a demonstration. Triplet Corporation, Bluffton, Ohio 45817.



*The World's most complete line of V-O-M's . . .  
choose the one that's just right for you*

Shown actual size

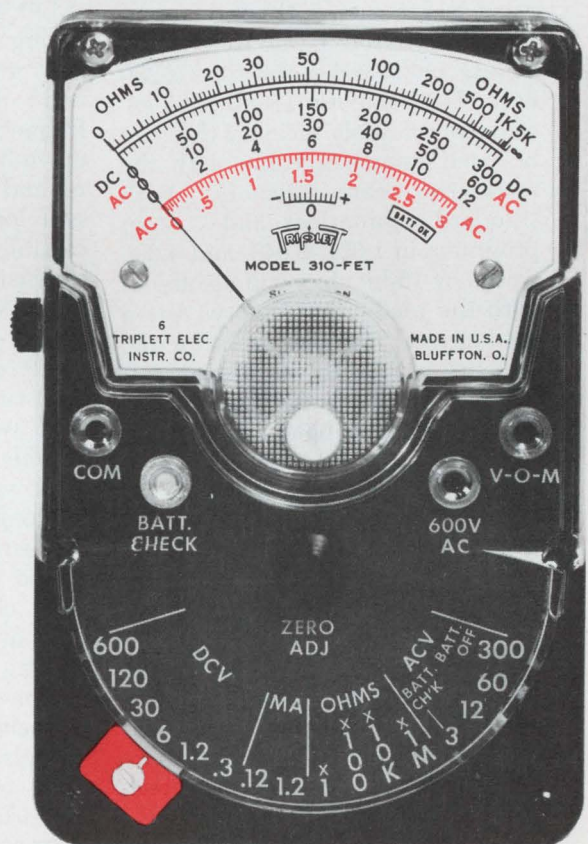

1. All Solid-State (F.E.T.) with 10 Megohm input resistance, battery operated.
2. High sensitivity (300 mV DC fs) for transistor bias measurements, resistance measurements to 5,000 Megohms.
3. Hand-size with single selector switch and provision for attaching AC clamp-on adapter.

## U.S. Reports

output a particular program for display. This feature can also be used to monitor process control. An unskilled operator, for example, can place a template over the oscilloscope to detect any departure from a programmed process, such as a clogged valve. As an output device, it could also display the performance parameters of turbines or other machinery.

Both byte and bit addressing are used. Since the computer can load and store all eight registers as well as four status registers of one bit each with a one-word instruction, there is a low interrupt overhead. "Because the SPC-16 has eight registers, it takes less memory; in most single- or two-register machines 40% of the average program is load-store instructions," says Auten.

In standard versions, the computer comes with a 3-D, three-wire core memory of 4,096 words, expandable to 32,768 words in 4,096-word increments. Lithium cores of 22 mils are used. Cycle time is 960 nanoseconds, and access time is 250 nsec. The computer also has an extra-cost read-only memory that can be used interchangeably with the read-write core memory. Both standard subroutines and custom programs in 1,024, 2,048, and 4,096 words by 16-bit sizes will be offered with the read-only memory. Auten says several manufacturers for the memory are being considered, but that an E-core linear transformer type is currently being used.

### Displays

#### Flow chart

Plasma displays seem simple enough to build at home. They're not. Because of control and reliability problems, they're available in small models, in small quantities, and at relatively high prices.

But development work done on fluidic controls for NASA's Electronics Research Center by Martin-Orlando, promises solutions to many of the problems pestering makers of plasma displays. Among them are the high cost of power

supply and switching electronics, and subsequent unreliability. Occasionally, unsuspected voltage spikes, lurking in the capacitive display screen, strike with a sound like a pistol shot, destroying insulation, shorting circuits, blowing switching transistors, and, perhaps, damaging the display screen itself.

**Trigger.** Many of these problems stem from the electronic approach used to fire display cells. Most plasma screens consist of a three-layer glass sandwich, with the middle layer holding neon-filled cells; the outer two layers support row and column electrodes and seal the screen.

To turn on a cell, the voltage applied to a pair of row and column electrodes is cranked up, and a plasma arc occurs in the cell where they cross. The voltage, then, can be lowered, and the emission will sustain itself. The plasma display's big advantage is that it needs no refreshment.

But, even so, the user may not be saving much. Display control voltages are high—100 to 400 volts or more—and worse, they're at radio frequencies of from 40 kilohertz on up to 300 khz. The combination of r-f and voltage has blown many a switching transistor, and transistors capable of handling this stuff are expensive.

The cells themselves try the patience of engineers. Acting like small capacitors, large arrays of cells can store enough stray charge from switching spikes to blow vulnerable parts of a system to smoke. This vulnerability is one reason that engineers haven't yet produced wall-sized plasma displays.

The impedance of an array of cells changes as more or fewer cells are lighted, loading and unloading the power supply. This impedance variation forces designers to spend more effort on regulation, and also causes unwanted cells to light, which yields blurs or lines instead of dots.

**Smooth control.** But Jacq Van Der Heyden, Martin-Orlando's principal investigator, hopes he solved these problems with fluidics. While cells normally are voltage controlled, they also can be controlled by changing the pressure

within them. Thus, Van Der Heyden uses fluidics for control, relies on a relatively inexpensive constant voltage power supply, and needs no transistor switching matrix at all.

Martin-Orlando will soon deliver to ERC a five-by-nine plasma dot matrix controlled by fluidics. It's just a feasibility model, but it holds promise, especially for large area displays.

Using neon, Van Der Heyden pressurizes cells at about 7.75 pounds per square inch to light them, and uses approximately 10.25 psi to extinguish the plasma. The system is straightforward, using either tanked gas or a pump system to supply pressure.

For the transistor matrix, Van Der Heyden substitutes fluidic logic blocks. Outwardly, the result is a slightly thicker assembly that isn't transparent, which is the case with similar, but electronically controlled, devices.

Even though destructive voltage spikes are no longer a problem in large arrays, an impedance change as the cells light might still excite some unwanted cells. To prevent this, Van Der Heyden came up with a double cell structure.

**Gagged.** With one cell behind the other, and with both cells needing equivalent pressure and voltage to fire, it's possible to avoid crosstalk in two ways. The back cell of the pair can be controlled and used to create a conducting path to the front cell. Or, one layer of cells can be used as row triggers, and the other as column triggers. Either way, stray voltage from adjacent cells is far too low to excite emission; or, if it's high enough, pressure conditions prevent firing.

While working on the fluidically controlled display, Van Der Heyden also tried to increase the brightness of emissions over former levels. He used an r-f excitation of about 712 megahertz, much higher than any formerly used. He also developed an electrode that is etched out of solid copper into something like a flange around the edge of the cell. There's a hole in the center through which the light can pass freely. This contrasts with





# 25 years in the thick of it

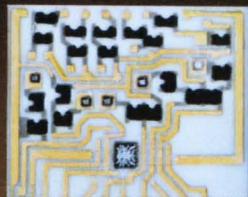

**Centralab introduced thick film technology in 1945.**

**The result — microcircuits with superior design and performance today.**

No one offered thick film microcircuitry as a serious answer to reliability and miniaturization requirements 25 years ago. But Centralab got right into the thick of it. And it's difficult to catch someone with a 25 year head start. In numbers alone our lead is commanding. We've produced more than 500,000,000 units, with some 5,000 custom designs. No one can approach this production record. In material selection our experience again gives us a sharp edge. Ceramics, metallizing compounds, resistor inks, glaze and sealing materials have all been

specially developed by Centralab's Material Sciences Group to our specifications for durability in processing and application. The Semiconductor Division is a ready source for a wide variety of chips. We even manufacture our own ceramic substrates through an exclusive thin sheet process that is superior to any other method in the industry. And our computer-aided analysis service provides prompt, practical answers to circuit design problems. We don't mean that thick film chip hybrids are the answer to every problem in microcircuitry.

But you'll be surprised at how many solutions these low-cost custom units provide. For more information on how you can get into the thick of it with Centralab, turn the page.



**CENTRALAB**

Electronics Division  
GLOBE-UNION INC.

5757 NORTH GREEN BAY AVENUE  
MILWAUKEE, WISCONSIN 53201

# 1945-1970

## A quarter century of technology on your side



First use of Centralab's thick film microcircuit

Centralab pioneered thick film microcircuitry in 1945 when we developed a miniature oscillator-amplifier circuit for a mortar shell proximity fuse. This first-of-a-kind unit, admittedly crude by today's standards, consolidated carbon composition resistors, silver-ceramic capacitors and silver circuit paths screened onto a ceramic substrate, which met tough shock requirements. The completely sealed unit was about 3 inches in diameter and 4 inches long.

carbon composition resistors, silver-ceramic capacitors and silver circuit paths screened onto a ceramic substrate, which met tough shock requirements. The completely sealed unit was about 3 inches in diameter and 4 inches long.



100,000,000th microcircuit

This assembly, which became known as a Packaged Electronic Circuit (PEC), opened the door to an entirely new technology. By 1959, we had produced our 100,000,000th unit. A plaque commemorating this historic production is on permanent display at the Smithsonian Institute, a milestone in the electronic industry.

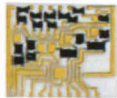

Centralab's new thick film chip hybrid

PECs are still being used extensively for industrial, military and consumer applications. But continued technological developments have brought a new degree of sophistication to the art of thick film microcircuitry. So we've developed our new thick film chip hybrid microcircuits. Chip active devices — diodes, transistors, and ICs — are combined with fired on resistors, wiring and capacitors to provide a reliable circuit module. These are smaller, harder working, more sophisticated devices that are custom designed for specific applications.

We're uniquely qualified to provide thick films because our 25 years of experience have given us an intimate knowledge of materials, technology, design, production and service. Following, in more specific terms, is what we mean:

### Materials to service: The Centralab capability

Basic to the ultimate performance of thick film chip hybrid microcircuits is the evaluation, selection and development of materials that will withstand sophisticated manufacturing processes as well as demanding applications. The Centralab Material Sciences Group of specialized technical personnel determines what materials will best support the special requirements of our design and production facilities.



Materials developed specifically by Centralab

One example of the work of this group is the ceramic substrate used in our thick film circuits. To meet design parameters for maximum thermal conductivity and mechanical strength, as specified by our engineers, an exclusive thin sheet ceramic production process was developed that produces substrates of unexcelled surface finish and reliability. These are so superior to others available, that Centralab is a leading supplier to other microcircuit manufacturers. Our ceramic capability has also provided high performance hermetic packages.

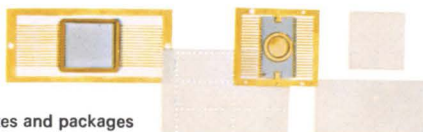

Centralab substrates and packages

Another joint effort of our materials and engineering development personnel resulted in a monolithic chip capacitor (Mono-Kap) that has virtually eliminated pin holes that destroy capacitor reliability and long life.

Micrographs of Mono-Kaps and competitive units

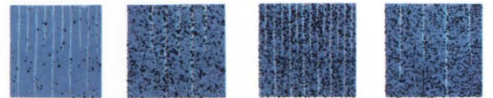

Mono-Kap Competitor A Competitor B Competitor C

We've also produced molybdenum/gold substrates with amazingly complex pattern geometry. These substrates, and our proprietary process (patent applied for) for producing them, permit thicker gold deposits and are ideally suited to ultrasonic and thermocompression bonding methods.



Molybdenum/gold substrates

Our computer-aided design and circuit analysis services can provide optimum design to minimize failures, enhance performance, and reduce cost. Our comprehensive thick film background gives us another head start in being able to program our computer so that improved design is assured at the most reasonable cost.

All of our experience and technological skills are reflected in the design and production of Navy Standard Hardware Modules. These plug-in modules combine circuit functions to constitute a complete electronic system that is reliable, flexible and economical.

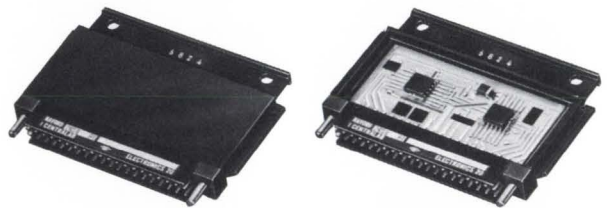

Navy Standard Module

One more thing. With all our capabilities, we realize that speed is often the most important criteria for judging a thick film microcircuit manufacturer. That's why we are geared to provide production samples to your specifications in as little as three weeks; production quantities eight weeks after prototype approval.

It all adds up to one fact: No other manufacturer is better qualified to help you find the most efficient use of thick film chip hybrids in your circuit design. And if you'd like to find out precisely how we can help you, send your requirements or circuit design to Centralab Application Engineering. There's no better way to get into the thick of it.



**CENTRALAB**

Electronics Division  
GLOBE-UNION INC.

5757 NORTH GREEN BAY AVENUE  
MILWAUKEE, WISCONSIN 53201

## U.S. Reports

some schemes which use semi-transparent electrode depositions that attenuate light.

The combination allowed him to achieve about 1,300 foot lamberts of brightness. However, it's possible that the etched electrode will prove to be even more interesting; it's far less costly to make and far more rugged than deposited electrodes.

### For the record

**Coming down.** The predicted price cuts for optoelectronic devices appear to be gathering steam. Now Texas Instruments has announced reductions at the same time that it decided to broaden its line. Industry observers have been saying that prices would drop as big semiconductor houses entered the marketplace [*Electronics*, Dec. 22, 1969, p. 117]. TI plans to add improved gallium-arsenide light emitters that are compatible with its LS600 light sensors, new optically coupled isolators, and improved light-emitting diodes and displays. A phototransistor line was announced earlier.

**Joyful.** The sale of Union Carbide's Semiconductor operation to Solitron Devices for a reported \$5 million is producing jubilation, not gloom, among management and engineering personnel at the San Diego, Calif., facility.

The reason, says one spokesman, is that Solitron plans to broaden MOS and linear IC lines, and will place stronger emphasis on research and development in new MOS technology and related fields.

**On the air.** ITT has received a \$3.4-million contract to produce 285 transceivers and accessory equipment for the automatic communication systems at the FAA's 21 air-route traffic control centers. ITT's Aerospace/Optical division in Fort Wayne, Ind., will deliver the 150 vhf and 135 vhf transceivers plus necessary control stations, audio transfer panels, processors, and other control equipment for installation by the end of the year.

# a complete digital system

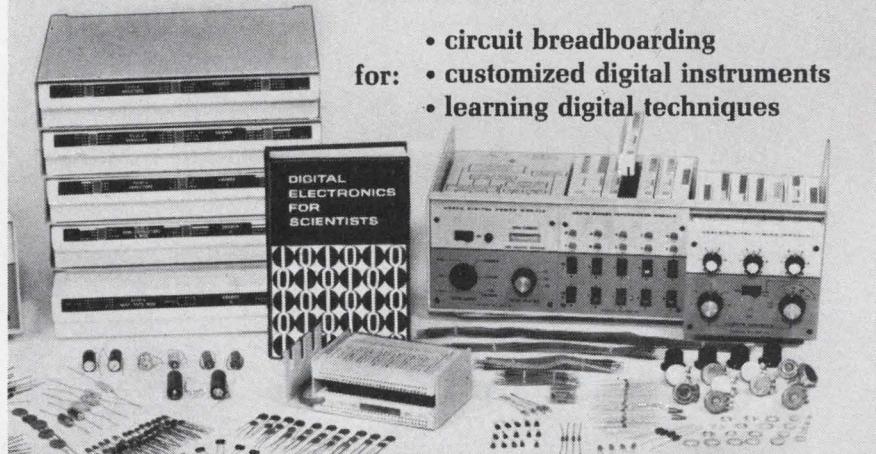

- circuit breadboarding
- for: • customized digital instruments
- learning digital techniques

## HEATH 801 Digital System...

buy the complete system or discrete components

**Now . . . A Complete System to Enable You to Get the Most Out of Digital Electronics.** Here is a system that is revolutionizing instrumentation in labs and classrooms throughout the world. The basic design concepts of Professors H. V. Malmstadt and C. G. Enke combined with the engineering of Heath's scientific instrument group have resulted in the unique 801 Analog Digital Designer (ADD) and the EU-51A breadboard and parts group. This versatile system can perform equally well in constructing high performance research-quality instruments, in performing hundreds of experiments in the teaching laboratory, in rapid testing of new digital ideas, or in interfacing to computers.

**Start . . . By Learning the New Digital Electronics.** Drs. Malmstadt and Enke have written a pioneering new text "Digital Electronics for Scientists" (published by W. A. Benjamin, Inc.) that provides a systematic introduction to the digital circuits, concepts and systems that are basic to the new instrumentation — computation revolution. The book is written for engineering and science students and for practicing engineers, scientists, and technicians so that all may effectively utilize the startling recent advances in digital electronics.

Never before have the latest "state-of-the-art" methods been made so rapidly and conveniently accessible through an integrated combination of new text and versa-

tile equipment. The experimental section of the text is written specifically for utilizing the Heath 801A and 51A to provide experience and working knowledge with hundreds of digital and analog-digital circuits, instruments and systems.

**Write . . . for Complete Information on Cards, Modules and Parts in the Heath Digital System.** The basic Analog-Digital Designer (EU-801A) contains 3 modules (power supply, binary information, and digital timing) and 13 circuit cards including TTL gates, flip-flops, monostable MVs, relays, op amps, and V-F converter. The EU-51A Experimental Parts Group is a highly flexible breadboard system for circuit design and teaching. The group includes a desk chassis, 493 components, a patch card accepting these components, and a power patch card.

The system is open-ended. New cards and modules are continuously being introduced so you can construct your own special frequency meters, counters, timers, DVMs, rate meters, and many dozens of other instruments.

**Take . . . advantage of the digital revolution — order your Heath Digital System now.**

**EU-801A**, Analog-Digital Designer . . . . \$435.00\*  
**EU-51A**, Experimental Parts Group . . . . \$135.00\*  
**EUP-19**, text "Digital Electronics For Scientists" by H. V. Malmstadt and C. G. Enke (published by W. A. Benjamin, Inc.) . . . . . \$9.50\*

### FREE Heath Scientific Instrumentation Catalog



Describes these and other precision instruments for laboratory, engineering, education and R & D applications. Send for your FREE

copy now . . . just write on your school or company letterhead.

**HEATH COMPANY, Dept. 580-04**  
 Benton Harbor, Michigan 49022



Please send FREE Heath Scientific Instrumentation Catalog

Name \_\_\_\_\_

Address \_\_\_\_\_

City \_\_\_\_\_ State \_\_\_\_\_ Zip \_\_\_\_\_

Prices and specifications subject to change without notice.  
 \*Mail Order Prices; F.O.B. Factory

EK-278

# Learn how electronics is working to change the practice of medicine.

2nd National Conference & Exposition  
on Electronics in Medicine.

February 12-13-14, 1970  
Fairmont Hotel  
San Francisco, California

Presented by  
Electronics/Management Center  
in association with  
McGraw-Hill Publications

Electronics/Medical World News  
Modern Hospital/Postgraduate Medicine

How much change will be brought about by the successful applications of the electronics technology to the modern needs of medicine?

Will the physician without a working knowledge of the employment of electronics as an administrative and clinical tool be obsolete in five years? Will the high efficiency, high reliability procedures predicted for the seventies increase or decrease the role of the individual physician? What will be its impact on the medical team and the medical center? Can electronics through automation improve the nation's overall health levels?

These are some of the questions now being answered by eminent physicians and technologists in many of our nation's most respected institutions where electronics is being actively applied to benefit hospital, doctor, and patient.

How well these programs are working, what's right and what's wrong with electronics will be explored in depth in the 2nd National Conference & Exposition on Electronics in Medicine.

The format of the three day program is based on the enthusiastic response to the First National Conference on Electronics in Medicine and the request by its attendees to provide for a broad interchange of ideas.

In morning sessions, authorities in both medical and electronic disciplines will present their knowledge and experience on subjects of major interest; instrumentation, computers, information systems, monitoring, diagnosis, therapy, and administration.

These meetings will provide the backdrop for afternoon work-sessions in which each attendee will become an active participant in the discussion of problems and solutions. All work sessions will be conducted to bring the maximum knowledge and experience of the group as a whole to each of the participants. Attendees will have the opportunity to join at least two of the six sessions being offered.

While meetings and work sessions will explore the most recent ideas with attendees, exhibits will present physicians and hospital administrators with the latest hardware available, providing an important opportunity for demonstration and a "hands-on" familiarization of the newest features and capabilities of electronics products designed specifically for medical application.

## Meetings:

Keynote address

*George Burch, M.D., Ph.D., Tulane University Medical School, New Orleans, La.*

"Instrumentation and Common Sense"  
*Robert D. Allison, Ph.D., Director, Vascular Laboratories, Scott & White Clinic, Temple, Texas.*

"Computers: A New Order for Medical Data"  
*Arnold Pratt, M.D., Director, Division of Computer Research & Technology, National Institutes of Health.*

Address:

*Hon. Roger O. Egeberg, M.D., Assistant Secretary for Health and Scientific Affairs, Dept. of Health, Education and Welfare.*

"Medical Engineering: Problems and Opportunities"  
*George N. Webb, Asst. Professor, Biomedical Engineering, The Johns Hopkins University School of Medicine.*

"The Medical/Engineering Interface"  
*Donald Lindberg, M.D., Chairman, Dept. of Information Science, University of Missouri.*

"What's New in Medical Information Systems"  
*William Chapman, M.D., Palo Alto Medical Clinic (Selected films will be shown as part of Dr. Chapman's presentation.)*

"Getting Medical Electronics from Research into the Real World"  
*Irving Selikoff, M.D., Director, Environmental Sciences Laboratory, Mt. Sinai School of Medicine.*

Address:

"Is Science for Real? Or will the American public ever demand the medical care it deserves and find true happiness?"  
*Richard Bellman, Ph.D., Professor of Mathematics, Electrical Engineering and Medicine, University of Southern California.*

How Hospitals Evaluate and Purchase Medical Electronic Equipment:  
"Selection of cardiac care unit monitoring equipment"  
*James A. Stark, M.D.*  
*H. Aileen Atwood, R.N.*

"Data Processing Comes to Merritt Hospital"  
*Howard Scott, Hurdman & Cranstoun Penney and Co.*

"Selecting Equipment for the Clinical Pathological Laboratory"  
*R. Thomas Hunt, M.D.*  
*Floyd Oatman, A.T. Kearney & Co. Inc.*

"Boosting Hospital Efficiency through Electronic Aids"  
*Oscar M. Powell, M.D.*  
*S.R. Wickel*

## Work Sessions:

On-line Computer Applications.  
The role of the computer in medical record-keeping, data analysis, and history-taking in the office and the hospital.

Automating the Clinical Laboratory.  
This session will attempt to pinpoint the major test requirements of the clinical laboratory, evaluate the available equipment for automatic testing and determine future requirements.

Problems in Intensive Care Monitoring.  
A discussion of problems in intensive care, available instrumentation, and what's needed for improved patient monitoring.

Multiphasic Screening: Pros and Cons.  
How effective are automated screening techniques in preventive medicine for large groups? How much data is needed, and what associated hardware and software are required?

Problem Clinic  
A forum at which doctors and engineers will have the opportunity to discuss specific medical/

engineering problems and point the way to feasible solutions.

Buying, Selling and Maintaining Medical Electronic Equipment.  
Marketing and maintenance are key problems in developing the role of medical electronics. On this panel, experts will discuss current practices and develop ways to improve them.

## Exhibits:

This year, there is a new emphasis on exposition. One which reflects the increasing number of electronics products being accepted as practical, progressive, working tools by more and more hospitals and physicians. Exhibits will include many products related to the program of discussions and work sessions. Demonstrations of product features will help attendees explore new applications for the latest electronics equipment.

Here is a partial list of the companies which will be presenting their most recent achievements.

Avtel Corporation • Bio-logics, Incorporated • Birtcher Corporation • The DeVilbiss Company • Federal Pacific Electric Company • General Electric Company • Graphic Controls Corporation • Honeywell, Incorporated • Mead-Johnson Laboratories • Laser Systems & Electronics, Incorporated • Medidata Sciences, Incorporated • Ohio Medical Products • Parke-Davis • Remler Company • Richard Manufacturing Company • Spacelabs Incorporated • Statham Instruments Incorporated • Technicon Corporation • Wang Laboratories, Incorporated • Registrants of the 2nd Annual Conference & Exposition on Electronics in Medicine will be encouraged to invite their professional associates to regular exhibit sessions. Other members of the medical profession in the western region will also receive special invitations to visit the exhibits.

Registration Fee: \$150  
(Includes all sessions, exhibits, luncheons, reception, and copy of the proceedings when published.)

Note: Only those fully paid in advance will be admitted to meetings and work sessions.

Mail registration and make checks payable to:  
2nd National Conference and Exposition on Electronics in Medicine.  
330 West 42nd Street, New York, New York 10036

A number of rooms is being held at the Fairmont Hotel for registrants. Make reservations directly with the hotel, identifying yourself as a Conference attendee.

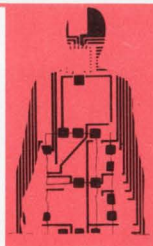

Advance Registration  
2nd National Conference & Exposition  
on Electronics in Medicine  
February 12-13-14, 1970  
Fairmont Hotel, San Francisco, California

Name \_\_\_\_\_ Title \_\_\_\_\_

Address \_\_\_\_\_

City \_\_\_\_\_ State \_\_\_\_\_ Zip \_\_\_\_\_

Hospital or Company affiliation \_\_\_\_\_

Check enclosed \_\_\_\_\_ Send invoice \_\_\_\_\_

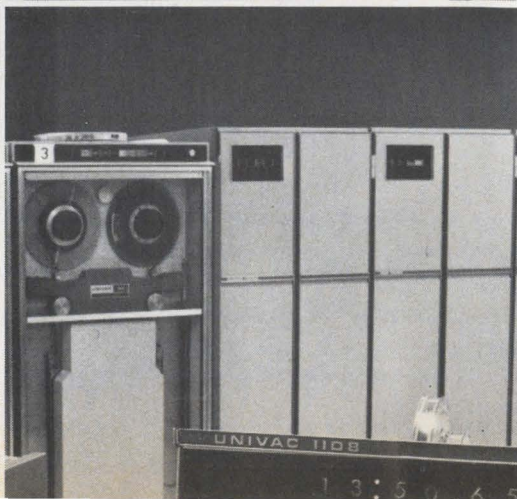
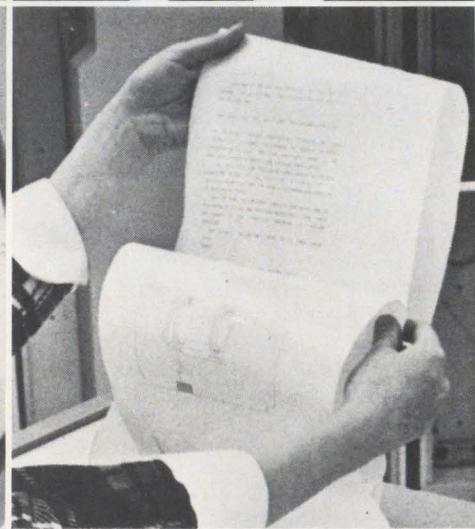
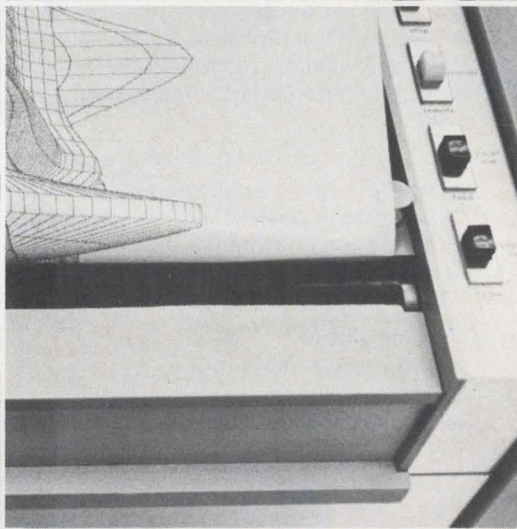
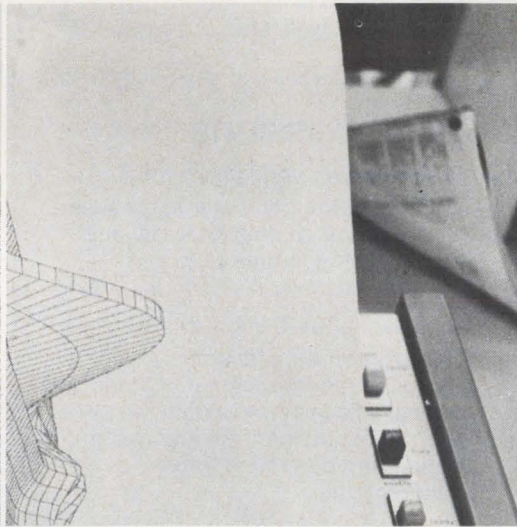
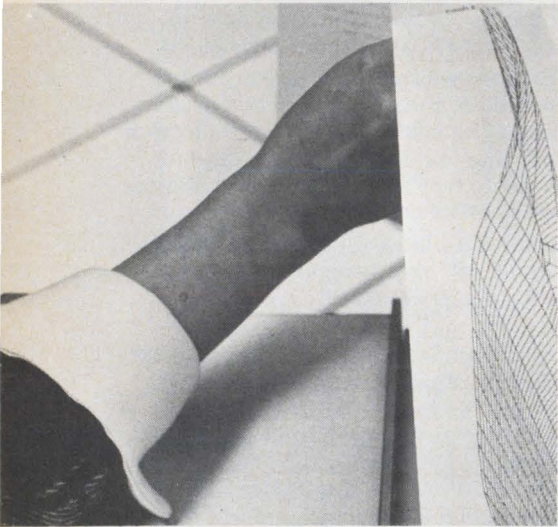
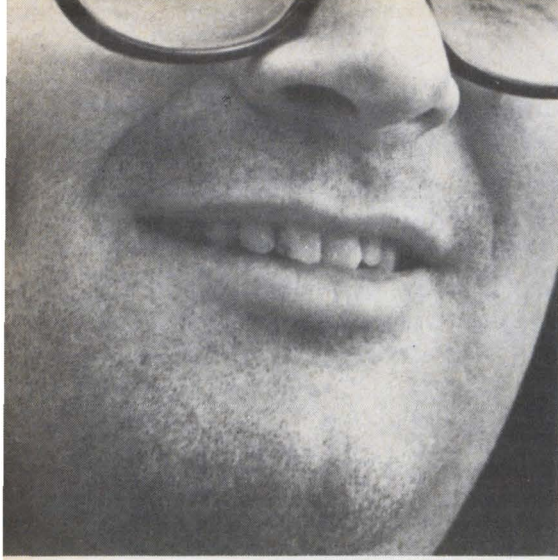

# "The Clevite electrostatic printer increases our printout capability anywhere from eight to two hundred times."

That's how Mr. Stanley Y. Curry, President of Chi Corporation sums up their experience with the Clevite 4800 hardcopy printer.

A Cleveland-based computer service firm founded by Case Western Reserve University, Chi wanted a fast, versatile printer to complement its third generation Univac 1108. Chi uses its Clevite 4800 printer to perform a wide variety of highly sophisticated scientific and engineering computations, for both the university and over 100 customers currently using the firm's many services.

Here are some more of Mr. Curry's observations . . .

"We use the Clevite 4800 in three principle areas . . . text editing; intermixing text and pictures; circuit diagrams, plotting and perspective drawings. Currently, we're experimenting with applying it to our billing procedures and are exploring its use for high-speed label printing. It looks as if the printer is useful for just about any output.

"Take text, for example. The 4800 is ideal because of the speed with which it provides copies. Change, delete, add, then program the computer accordingly. Almost instantly the electrostatic printer provides a clean copy of the edited material.

"Our experience with core dump has been quite impressive. Here is an area where the printer's diagnostic

ability really comes to play. Our computer stores some four million binary bits of information, and core dumping used to take around twenty minutes.

With the Clevite Printer, we're now completing a core dump in just two minutes," Mr. Curry concludes.

#### **MORE FACTS ON THE CLEVITE 4800**

Clevite 4800 reproduces signals from any source of digital input or data transmission by telemetry, radio microwave, and/or land line. It produces accurate printouts of both alphanumerics and graphics almost as fast as the computer supplies them.

A productivity rate of 412,000 characters per minute means fast-acting computers are no longer hampered by mechanical equipment, noisily hammering out a few hundred lines per minute.

No other printer gets as much out of your computer as fast as Clevite 4800. And no other printer is so economical. The Clevite 4800 reduces capital investment, because conventional equipment costs more per unit. Also, there are few moving parts, reducing the need for constant maintenance and servicing. Clevite 4800. It's faster, more versatile, quieter, and more dependable than anything else you can buy.

Drop us a line to find out how it fits into your computer room. Graphics Division, Gould Inc., 3631 Perkins Ave., Cleveland, Ohio 44114.

## GOULD CLEVITE

Clevite 4800. The next generation of high-speed printers.

# It took us years to develop the best stereo microscope.

## Now give us a few minutes to prove it.

Let us compare our StereoStar/ZOOM to any stereoscopic microscope in your lab.

Our microscope offers high resolution, larger fields of view, greater working distance. We have as wide a magnification range as you're likely to need: a full 6 to 1 zoom range with magnifications from 3.5 X through 210 X. The zoom control knob is coupled—so that it's conveniently located on both sides, for either left or right-hand operation. And the entire head is easily rotatable through 360°.

135 years of optical excellence went into the AO StereoStar/ZOOM. Let us compare it to any stereo microscope in your lab. After all, if it's worth your money, it's worth your time.

Call your AO Representative. Or write for our convincing 24-page brochure.



**AMERICAN OPTICAL  
CORPORATION**

SCIENTIFIC INSTRUMENT DIVISION • BUFFALO, N.Y. 14215

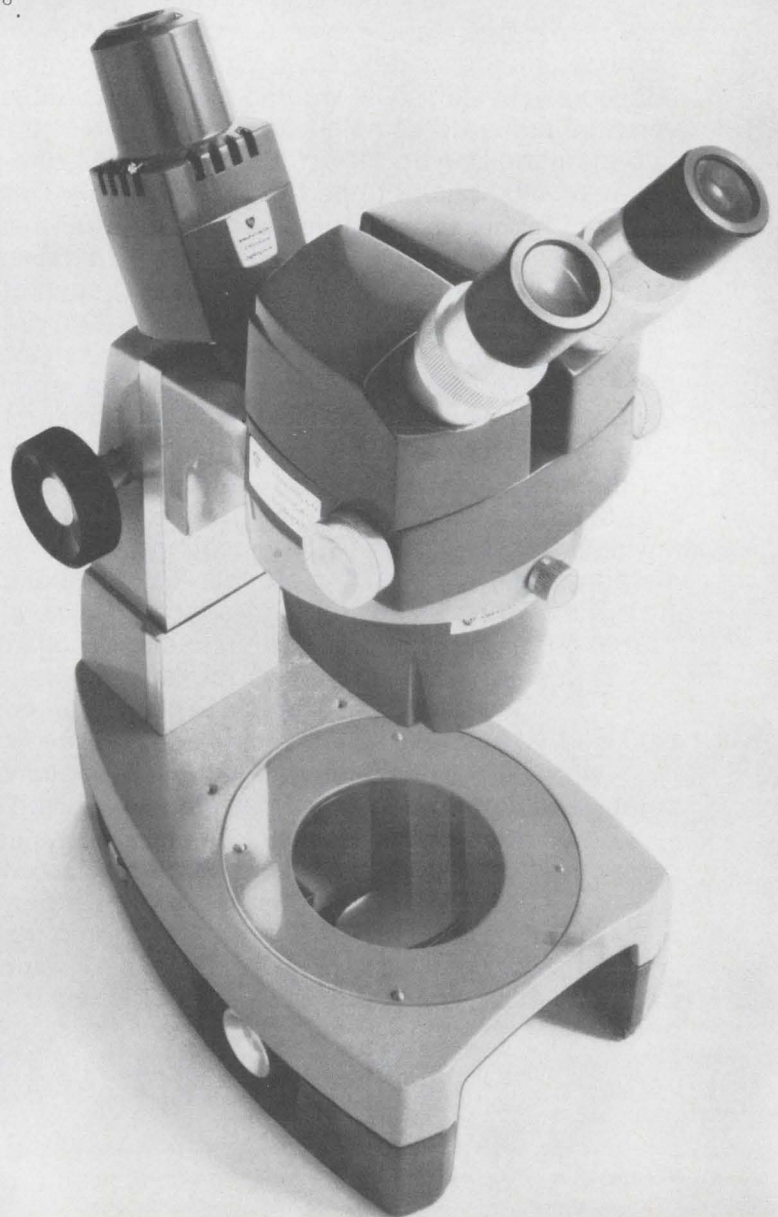



# new mil-performance square cermet trimmers from CTS

Now... with CTS Cermet Multi-Turn Square Trimmers you get Characteristic C Mil-spec performance for all military applications. All new series 165 (style RJ24) and series 175 (style RJ22) meet tough Characteristic C of Mil-R-22097C. These same environmental characteristics are available... at lower cost... for commercial and industrial applications.

Both small  $\frac{3}{8}$ "-square series 165 and compact  $\frac{1}{2}$ "-square series 175 trimmers assure infinite resolution over a 20 ohm to 2.5 megohm range... and power rating of  $\frac{1}{2}$  watt @ 85°C. TC  $\pm 150$  ppm/°C for 2k ohms and above.  $-0 +175$  ppm/°C from 50 ohms through 250 ohms and  $-0 +250$  ppm/°C from 500 ohms through 1k ohm. All available at no extra cost.

Low cost\*, proven quality, and top performance—combined with **fast distributor delivery**—make CTS your best industrial trimmer choice. Can't use one of our standard series? Ask how we can solve specific application problems. Call or write for complete details to CTS of Berne, Inc., Berne, Indiana 46711. Phone (219) 589-3111.







\*Check these prices for 4-6 week production delivery. (Small quantities from stock)

	Series 165		Series 175	
Quantity	25-49 (each)	1000 (each)	25-49 (each)	1000 (each)
Commercial (=20% Tol.)	\$4.55	\$3.25	\$4.20	\$2.95
MIL-type (=10% Tol., Char. C)	5.30	3.80	5.10	3.65

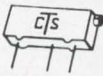

**CTS CORPORATION**  
Elkhart, Indiana

Other CTS Cermet Trimmers include:

						
<b>Series 185</b> 1- $\frac{1}{4}$ " x .290" x .364" multi-turn	<b>Series 190</b> $\frac{3}{4}$ " x .160" x .310" multi-turn	<b>Series 340</b> $\frac{1}{4}$ " x $\frac{1}{4}$ " square x .270" high—single-turn	<b>Series 360</b> $\frac{1}{16}$ " x $\frac{1}{16}$ " x $\frac{1}{16}$ " x $\frac{25}{64}$ " single-turn	<b>Series 385</b> $1\frac{1}{32}$ " round x .225" high—single-turn	<b>Series 660</b> $\frac{3}{8}$ " round x $\frac{1}{4}$ " high— single-turn	<b>Series 630</b> $\frac{1}{2}$ " round x $1\frac{1}{32}$ " high— single-turn

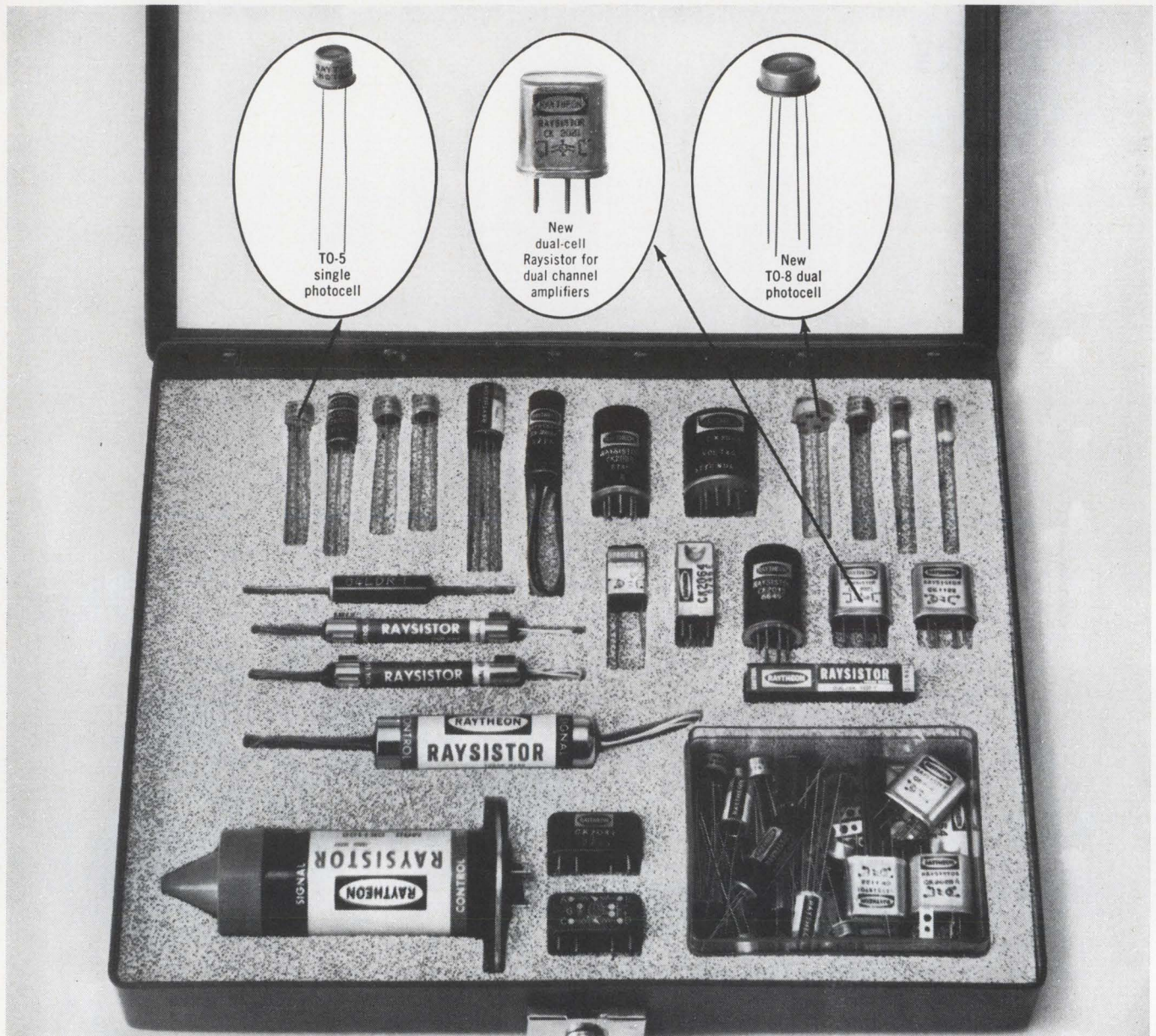

## Which Raytheon optoelectronic device can improve your product, cut its cost?

We make more than 200 different types. And we price many of them in the 60¢ to \$1.00 range in production quantities. So, one of them certainly can improve your product and cut its cost.

**Our 100 different Raysistor® types** operate on the principle of controlled light acting on a photoresistive element. No electrical or mechanical connections between control and signal circuits.

They can be used to provide a variety of control functions. Inherently rugged devices, they have long application life (20-50,000 hours) as variable resistors, solid-state switches, relays, voltage or signal isolators.

Raysistors are available with a

wide range of electrical characteristics. And in an assortment of case types (TO-5, crystal cans, metal tubes) with single or multiple sensors. Low cost and easily mounted.

**Our standard and special photocells** feature rugged mechanical construction, small size, light weight, and low noise. They're available with single and dual cadmium sulfide or selenide sensors. TO-5 or TO-8 case or glass-vial packaging.

Completely ohmic light-dependent variable resistors, their characteristics and high voltage capabilities ensure fast switching, temperature stability, and linear response to illumination. For example: our CK1201 features 150 ohms resistance at 100 ft. candles, rise-

fall time of 3 and 60 ms, 75 mw power dissipation (max.). Our CK1266 features 2500 ohms resistance at 100 ft. candles, rise-fall time of 1.5 and .6 seconds, power dissipation of 100 mw (max.).

**For samples, write describing your application** on your company's letterhead. Or, send reader service card for data.

*Raytheon Company, Industrial Components Operation, 465 Centre Street, Quincy, Massachusetts 02169.*



# ultrasonically assembled

at

# Micro Switch



length 2 3/4"

Precision parts need precise assembly . . . that's why Micro Switch, Division of Honeywell, uses ultrasonic assembly for more than 20 electronic components. It assures quality parts that meet rigid performance specifications.

All assembly functions are electronically programmed to provide consistent results, eliminate operator error, reduce rejects and increase production. Ultrasonic assembly is cleaner, faster and more economical than conventional bonding methods. Find out more about ultrasonic assembly. Write for bulletin S-889. Send unassembled parts or prints for a free evaluation.

Technical centers in major cities.

Overseas offices—Paris ; Geneva ; Frankfurt ; Soest, N.V. ; Tokyo

**BRANSON SONIC POWER COMPANY** 91 Eagle Road, Danbury, Conn. 06810

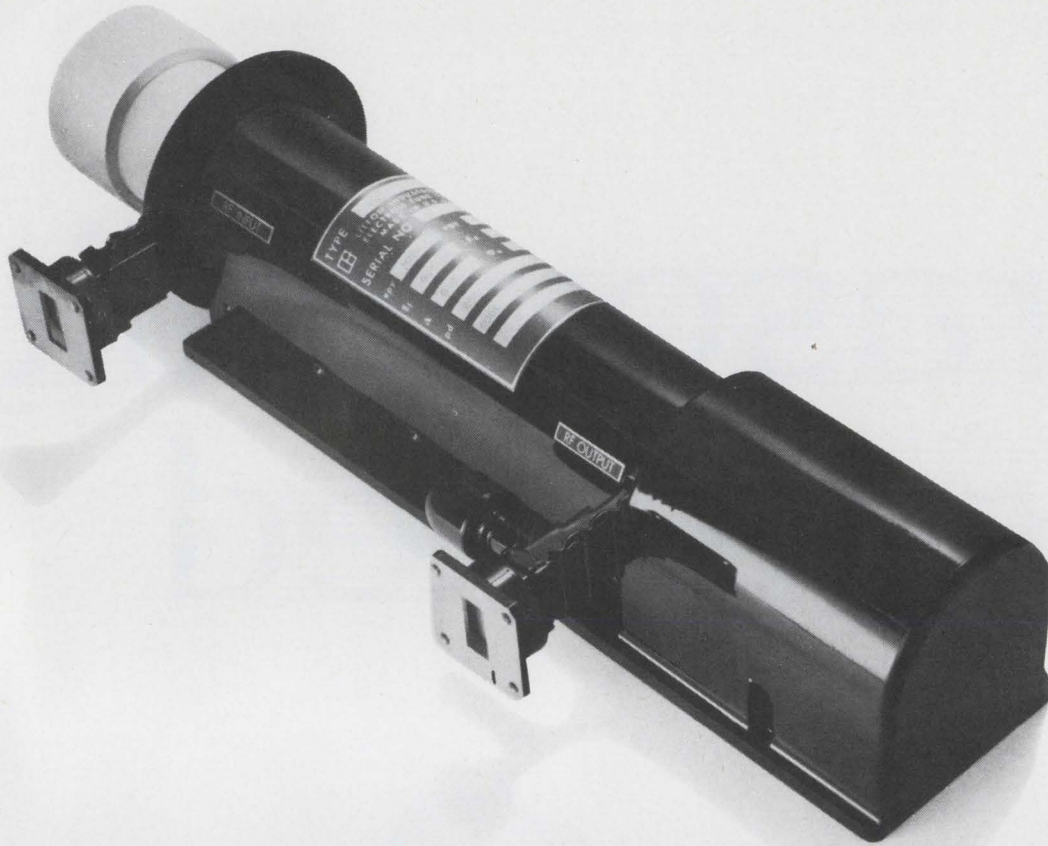

# Lightweight airborne radar becomes lighter...with Litton's new coupled cavity TWT's.

Litton's new Traveling Wave Tubes are 25% lighter and smaller than other high-power TWT's. Designed for the demanding MIL-E-5400 Class II environment, our CONDUCTION-COOLED coupled cavity tubes are focused with Alnico PPM magnets and achieve high efficiency with depressed collector operation.

Our TWT Model L-5253, shown above weighs only 17 pounds and achieves 40 kilowatts power output with 45 db gain in the X-band frequency range. The tube is cathode pulsed and operates at duty cycles up to 0.5%.

Other models in this class operate at frequencies from 8.7 to 10.2 GHz, producing 15 to 40 Kw power outputs, with gains up to 50 db, and duty cycles to 2.5%. In addition to cathode pulsed tubes, Litton offers a line of grid pulsed TWT's featuring a non-intercepting control grid. This feature assures reliable grid pulsing at high peak and average powers.

For more details on our new TWT line, write Electron Tube Division, 960 Industrial Road, San Carlos, California 94070. Or call (415) 591-8411.



**LITTON INDUSTRIES**  
ELECTRON TUBE DIVISION

# TWO ENGINEERS WITH THE SAME PROGRAMMING PROBLEM

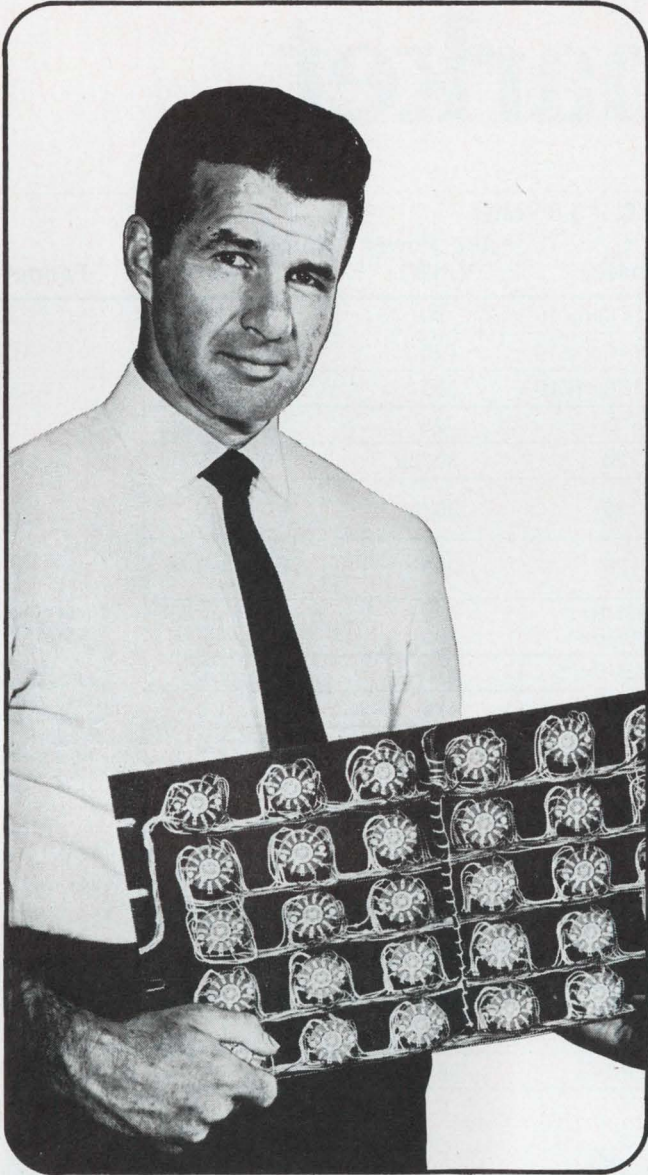

**USING ROTARY SWITCHES** requires 330 soldered joints . . . over 8 hours of labor . . . occupies 293 square inches of panel space . . . costs \$88.00 installed.  
(That's \$0.29 per switching point.)

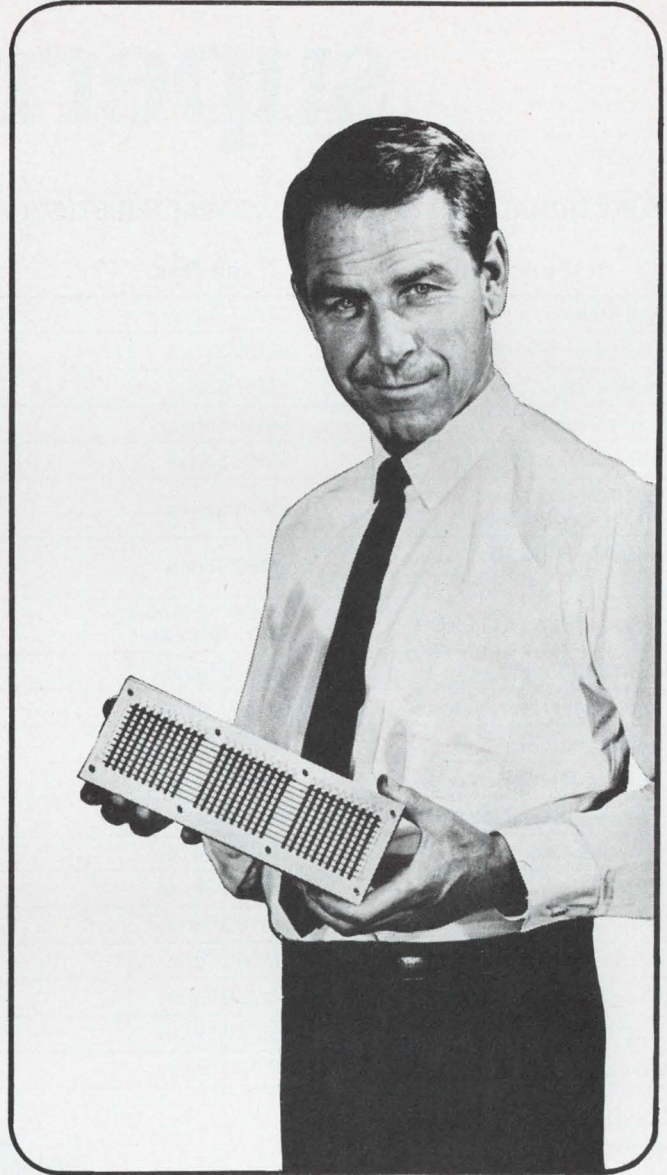

**USING CHERRY SELECTOR SWITCH** requires no soldering . . . less than 5 minutes of labor . . . occupies 41 square inches of panel space . . . costs \$32.95 installed.  
(That's \$0.11 per switching point.)

**WHICH ONE WOULD YOU LIKE TO CHECK FOR A MISTAKE IN WIRING?**

**WRITE TODAY** for full details on the totally new Cherry Selector Switch. It may change all your old ideas about programming devices.

**CHERRY** 

CHERRY ELECTRICAL PRODUCTS CORP. • 1656 Old Deerfield Road • Highland Park, Illinois 60035

# Sylvania introduces the MSI supermarket.

## FUNCTIONAL ARRAYS, TYPICAL CHARACTERISTICS (+25°C, +5.0 Volts)

Function	Type Nos.	$t_{pd}$ (nsec)	Avg. Power (mW)	Noise Immunity +(Volts)-	Fanout
Full Adder	SM10 Series	Sum 22 Carry 10	90	1.0 1.0	These arrays are available in fanouts up to 15 and are completely compatible with SUHL I and SUHL II integrated circuits.
Dependent Carry Fast Adder	SM20 Series	Sum 22 Carry 10	125	1.0 1.0	
Independent Carry Fast Adder	SM30 Series	Sum 22 Carry 10	125	1.0 1.0	
Carry Decoder	SM40 Series	2	25	1.0 1.0	
4-Bit Storage Register	SM60 Series	20	30/bit	1.0 1.0	
Bus Transfer Output 4-Bit Storage Register	SM70 Series	20	30/bit	1.0 1.0	
Cascade Pullup Output 16-Bit Scratch Pad Memory	SM80 Series	25	250	1.0 1.0	
Decade Frequency Divider	SM90/92 Series SM91/93 Series	35MHz 30MHz	125 85	1.0 1.0	
4-Bit Shift Register	SM110 Series	25MHz	120	1.0 1.0	
Parity Generator/Checker	SM120 Series	22	125	1.0 1.0	
Comparator	SM130 Series	17	120	1.0 1.0	
Programmable Binary Divider	SM140 Series	25MHz	150	1.0 1.0	
Programmable Decade Divider	SM150 Series	25MHz	150	1.0 1.0	
Binary Counter	SM160 Series	25MHz	135	1.0 1.0	
Decade Counter	SM170 Series	25MHz	135	1.0 1.0	
Binary Up/Down Counter	SM180 Series	25MHz	205	1.0 1.0	
Decade Up/Down Counter	SM190 Series	25MHz	205	1.0 1.0	
BCD to 7-Segment Translator	SM200 Series	85	280	1.0 1.0	
Dual 4-Bit Multiplexer	SM210 Series	10-20	130	1.0 1.0	
Demultiplexer	SM220 Series	9-14	225	1.0 1.0	

Sylvania Electronic Components,  
Semiconductor Division,  
Woburn, Mass. 01801

**SYLVANIA**  
GENERAL TELEPHONE & ELECTRONICS

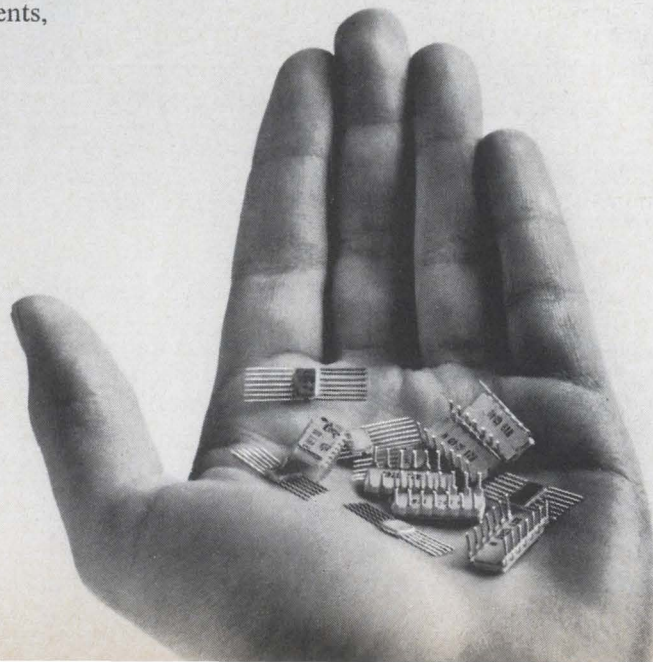

---

# International Newsletter

---

February 2, 1970

## Alloys Unlimited sought by Plessey

Plessey's bid for Alloys Unlimited, a diversified materials-oriented company, is calculated to strengthen the British heavyweight's toehold in U.S.—and its position in the world-wide electronics market. So far, Plessey only makes some avionics products in the U.S.—mechanical actuators and fractional horsepower motors, for example—although it sells British-made IC's and Garrard record changers.

If Plessey's \$188 million share exchange offer is accepted by Alloy's stockholders and approved by U.S. tax authorities—which must exempt the bid from interest equalization tax—Plessey will gain control of Alloy's 26 subsidiaries. Of top interest to Plessey is the takeover of integrated circuit technology, represented by such products as ceramic substrates, and IC packaging and sealing materials. Other electronics goodies in the Alloys package are the E-Cell, an electrolytic timer developed by the Bissett-Berman Corp.; automated plated-wire machinery; and etching and plating expertise.

The deal, if it comes off, will place about a quarter of Plessey's operations in the U.S. Plessey will not only gain an American base for expanded IC activity and control a major source of packaging materials, but it will acquire technology which John Clark, Plessey managing director, says, "would be uneconomic for us to attempt to learn."

## International basis of Intelsat program slowly broadens

Coincidental with the long-delayed launch and successful entry into commercial transatlantic operation of its sixth Intelsat 3 synchronous satellite, the Communications Satellite Corp. took a step toward broadening foreign participation in the Comsat-managed Intelsat consortium. The move was a \$37,747 award to Siemens AG, Munich, to develop an engineering model of a microwave filter-equalizer. Although some of the 71-nation Intelsat group criticize Comsat's foreign contracting as tokenism, the Intelsat manager says latest available figures show nearly 20% of the \$122.1 million in contracts were placed with non-U.S. companies in the three years ended in 1968.

The new F-6 satellite, which replaces the F-2 in transatlantic service, was the first insured against launch failure. But the insurance policy wasn't needed. Like three of its five predecessors, F-6, when it finally was launched, achieved its operating goal. The two that failed were lost in Delta rocket launch failures, while the other three are still in orbit over the Atlantic, Pacific, and Indian Oceans.

## German chemical firm to compete in peripherals

Chemical giant BASF plans to become an important factor in electronics. BASF—the initials of West Germany's Badische Anilin- und Soda-fabrik AG—is already a big name in magnetic tapes and magnetic disks. What's more, it has been steadily enlarging its interests in computer accessories since 1964. One reason: to tie up safe markets for its chemical products, such as the plastic base for computer tapes. Its latest move was the acquisition of a license from Century Data Systems, subsidiary of California Computer Products, to produce drive mechanisms for magnetic disk stacks used by large computers.

BASF last year reaped about \$70 million from electronics products; up a hefty 40% over 1968. The company expects to double such sales during the next three years and counts on the CDS-designed drive

---

# International Newsletter

---

mechanisms alone to add \$25 million a year once production gets under way. Until then, BASF will import the drive units from the U.S.

## British to market traffic control computers in U.S.

Buoyed up by a juicy traffic-control computer contract at home, Britain's big GEC-Elliott is looking abroad for more fields to conquer. It's expected that the next big push will be in the U.S., where there is both more traffic and relatively less work being done on computerized traffic control.

The push—through the associated company, the English Electric Corp., of New York City—will try to capitalize on the systems and software that the company has developed for expressway traffic control during hazardous situations. That work has just landed the company a \$1.15 million contract from Britain's Ministry of Transport. Under the contract, GEC-Elliott Traffic Automation Ltd. will supply 10 Elliott Arch 9050 process control computers for control of 800 miles of expressway. When there's an accident or other traffic hazard the system automatically posts progressively lower speed limits and detour directions on roadside signs.

## East Germany eyes Greek tv plant deal

East Germany, picking up a cue from the Western nations, is taking a hard look at the political and economic rewards of exporting electronics plants. And, it seems to have one order almost sewn up.

Heim Electronics, an East Berlin organization which acts primarily as an export agency for East German electronic products, is reported to be currently negotiating with a firm in Greece. **At issue in the bargaining is a television assembly plant to be set up somewhere in Greece.** The Greek partner in the talks is the Athens-based company, G.D. Saliaris.

The deal would call for imports of tv components from East Germany and exports of finished receivers back to East Germany, as well as to other countries. Initial investment in the new assembly plant is believed to total about \$150,000.

## GE to market 600 computers —through Toshiba

Toshiba is planning to offer more computers based on General Electric machines. It already offers its Tosbac 5400 series using GE's 400 models as the jumping off point. Now, it will bring a more powerful series 5600 to market, built on GE's 600 computers. Toshiba was planning to go it alone in larger computers, but GE's developments were so close to what it wanted that it was more economical to stay with GE.

## Varadyne represents SGS in America

SGS's plans for invading the U.S. electronics market [*Electronics*, July 7, 1969, p. 181] are firming up. The Italian company, which pulled out of its joint venture with Fairchild in 1968 and is now wholly owned by Olivetti, has signed an agreement to have Varadyne Inc. to represent it in the U.S.

According to Renato Bonifacio, group manufacturing director of SGS, Varadyne was selected because of its growth rate, experienced marketing team, and a product range that complements SGS's offerings. Bonifacio also indicated that the two companies are now studying the possibility of SGS representing Varadyne in Europe.



# Machine promises assembly-line ease for ion-implantation doping process

To be built in France and sold by Veeco Instruments, accelerator can dope chips with up to four impurities and operate maintenance-free for 200 hours

**Ion implantation** allows highly accurate semiconductor doping—and hence better yields of high performance devices. Trouble is, it's a technique that has hardly emerged from the laboratory, let alone found its way onto the assembly line. Now the French have come up with a sophisticated ion-implantation machine that can dope semiconductor chips with up to four different impurities at the flick of a button, run without major maintenance for 200 hours—versus five hours in competing machines—and take orders from a computer.

Its designers feel the machine may play a major role in making ion implantation a precision mass-production process. Both diffusion and ion implantation, as practiced up to now, have forced semiconductor engineers to be "mostly chemists," says Aimé Richardt, head of the French subsidiary of Veeco Instruments, holder of world distribution rights. The French

machine, he maintains, "will let them return to worrying about electronics."

The machine was designed by Thomson-CSF, collaborating with the French Atomic Energy Commission's Electronics Laboratory under a contract from France's Military Research Agency, which became interested in ion implantation because of its fast logic-circuit potential.

Thomson-CSF will build the machine, but has turned over world sales rights, even for France, to Veeco. Thomson-CSF cites Veeco's highly developed sales and service network as the reason. But Veeco, a maker of pumps and vacuum equipment, is looking for a firm more in touch with the electronics industry to handle U.S. sales—perhaps a maker of diffusion ovens, Richardt says.

With a pricetag of \$100,000 delivered in Paris, the ion implanter is not destined to become a high-

volume item overnight. But, even though a formal sales campaign will be cranked up only this month, European electronics firms—Germany's AEG-Telefunken reportedly among them—already have placed orders for six machines. Richardt looks to Eastern Europe as a potentially strong market. What's more, the United States alone may account for up to 10,000 machines once the technology catches on.

**Ionization.** As in lab machines, ions are created by breaking apart atoms of a doping gas in an electric field inside a small vacuum chamber. An oxide filament supplies electrons for the ionizing process. An accelerator then speeds up a beam of these ions to high energies. An electromagnet bends the beam to sort out impurities, which bend at varying angles depending on their charge—and ions plow into a silicon or other semiconductor target. Their speed determines penetration depth and thus the

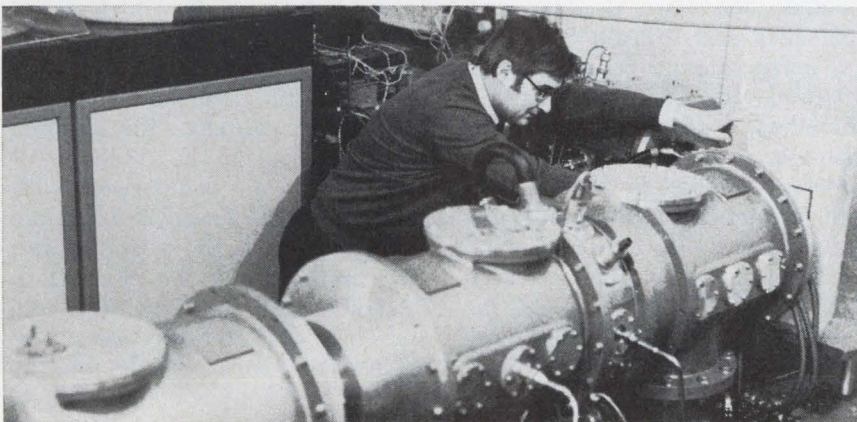

**Plantation punch.** Like an atom-smasher, Thomson-CSF's new machine accelerates particles for bombardment of a target, in this case semiconductor wafers. Simple controls allow in-plant use.



electrical qualities of the circuit.

Ionization causes most of the headaches in existing machines. Since only a tiny percentage of doping-gas atoms actually are ionized, the rest condense as a metal on the insulators between the anode and cathode of the ionizing circuit, causing a short-circuit after four to five hours. Work must be halted while the ion source's vacuum is broken, and the insulators are cleaned, and the fragile filament is replaced.

French designers avoided this nuisance by moving the dopant ionizing process into a smaller, separate chamber.

First, inert helium is ionized in the main chamber. A plasma of helium ions and electrons then is directed into the smaller chamber, where they, in turn, ionize the doping gas. With no residue left in the first chamber, steady use can be guaranteed for 100 hours and in practice, up to 200 hours, or until the filament wears out.

Moreover, instead of using an already gaseous doping element, the French machine heats solid metal doping agents as high as 2,000°C until they vaporize. This is difficult in conventional machines because of possible damage to the ionizing electrical elements.

Working with a pure metallic gas is a distinct advantage, say the French. Metals like aluminum are difficult to find in gaseous form, and others, like boron and gallium, exist in such unpleasant combinations that gaseous metallic compounds "are always delicate to work with," says J.R. Warnecke, the Thomson-CSF research chief who developed the new design. Some ion implanters manage to use solid sources for certain dopants, but the French unit is the only one to use solid dopants exclusively.

**Computer potential.** The solid bits of metal are contained in a revolving magazine that can hold up to four different dopants. This permits instantaneous switching from one impurity to another and mass production of, for example, the different sections of a complex integrated circuit or entirely different circuits in a series of succes-

sive shots. Unlike conventional ion sources, the French unit has no "memory" of the dopants that previously passed through it. This flexibility will help users program the machine for eventual computer control, says Warnecke.

The accelerator in the French unit covers the 30-to-150-kilo-electron-volt range, though Thomson-CSF says it eventually will offer a 300-keV unit. As in all ion implanters, varying this power permits minuscule penetration changes. The French have managed to dope wafers as little as 0.2 micron below the surface.

## Japan

### FET power

Kilowatt FET's anyone? One Japanese research group feels that it's well on the way to achieving that kind of power in a field effect transistor and has already reported a FET handling 40 watts of power. The researchers think a wide range of industrial users—including makers of induction heating systems for melting metal—would snap up such devices.

The research into these high-power FET's is being led by Jun-ichi Nishizawa at Japan's Semiconductor Research Institute. Because the usual FET configuration is not suited for high power levels due to low voltage tolerance and small power-dissipating area, Nishizawa harnessed analog transistor theory to field effect technology.

**Same idea.** Two decades ago, Nishizawa and William B. Shockley, independently of each other, proposed the analog transistor, which resembles a vacuum tube. Nishizawa's new approach includes an intrinsic layer to achieve high voltage ratings. The analog FET operates with current flowing vertically through the chip—or even through an entire wafer—in the manner of large thyristors and, thus, gives large current handling capability.

Nishizawa's initial units have operated at up to about 200 volts at currents of 200 milliamperes.

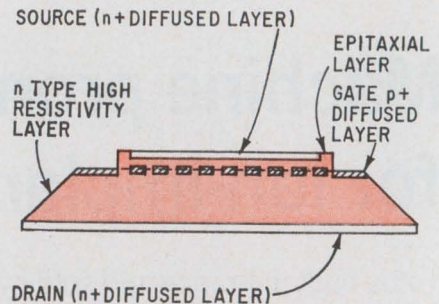

**Pyramid.** Thick intrinsic layer between gate, drain gives high power rating.

The experimental FET, with an area measuring 2.5 by 2.5 millimeters, has an extremely high transconductance of 100 milliohms. The goal is to build units capable of operating at up to about 3,000 volts at currents in the ampere range.

The developmental units differ from analog transistors in one important way: the region between the gate and the drain consists of a thick n-type intrinsic semiconductor layer. This raises the breakdown voltage to the kilovolt range, enabling operation at high voltages.

**Latticed.** The new FET is fabricated on a chip of intrinsic material about 150 microns thick. The gate is made by selective p diffusion to give a latticed-shaped p region with round or square n islands that form the vertical channels. This lattice must be several microns thick to keep gate resistance low.

Over the lattice, an n layer, perhaps 10 microns thick, is grown by the vapor epitaxial process. Then n+ diffused layers are added at the top and bottom to form the source and drain. The intrinsic region has a bevel to increase the voltage breakdown rating over the surface of the semiconductor.

In the usual FET, the channel is fairly long, in the direction of carrier flow, in comparison with channel width. There is an ohmic voltage drop in the channel, and an increase along the channel in the voltage difference between gate and channel in the direction of the drain. Depletion layer spreading is proportional to the voltage difference between gate and channel, and therefore, the pinch-off region occurs in the portion of the chan-

nel closest to the drain. With this configuration, the maximum frequency of operation is limited by the time constant of the input capacitance and the series resistance between the source and the pinch-off region.

In the new FET, the distance between the source and the pinch-off region is less than 10 microns, which keeps the series resistance extremely low. This configuration brings the source almost to the pinch-off region. And the intrinsic semiconductor between gate and drain keeps the gate capacitance low, further reducing the time constant.

**Through the gate.** In the region past the gate, the charge carriers are traveling at near saturation velocity under high voltages and, thus, do not add to device series ohmic resistance. The transit time in this region is analogous to the transit time in the once popular drift transistor—or vacuum tube—and doesn't affect performance at the frequencies at which operation is envisioned. However, operation at microwave frequencies would be degraded.

Experiments have shown that a uniformly diffused p layer on a substrate made of intrinsic material, with an overlying n epitaxial layer, has a breakdown voltage of thousands of volts. With present selective diffusion, though, breakdown voltage is on the order of several hundred volts.

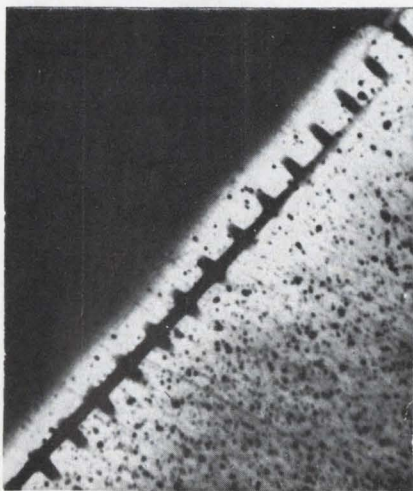

Cross section. Slightly angled slice through wafer shows gate's profile.

## Italy

### Stepping-stone computer

Italy's Ing. C. Olivetti has taken one step closer to manufacturing computers, a field it left when it sold out its interest in Olivetti-GE, which now makes the GE 115. In an almost natural progression, Olivetti went from its desk-top mini-computer—the Programma 101—to an alphanumeric electronic calculator, to a video terminal with some calculating capability. Now, the company has thrown itself into the computer fray with a new accounting machine that falls between small computers and existing accounting equipment.

Called the Auditronic 770, the machine is aimed for the multimillion-dollar market in small- and medium-sized companies which may have thought about installing a computer, but didn't want to pay for more capacity than they actually needed. Olivetti also sees its new system providing batch-processor functions in large companies. There, it can do jobs that are uneconomic to run on large computers or those that fit in where decentralization is planned.

Olivetti also is planning to market the Auditronic as a terminal for central computers, not for real-time use, but just for batch processing. For starters, the Bank of Italy has just purchased more than 200 of the units. They will be linked to regional IBM 360/20's, which, in turn, will be hooked up to a central 360/50.

**On account.** Essentially, the Auditronic is an accounting machine designed to provide visible administrative records. Its computer section functions with two quick-change, magnetic-tape cassettes, each with its own reading and recording heads. One acts as data file and the other as a programmer. The units store 74,000 characters.

One of the key features of the new unit is that it can carry out all interrelated procedures simultaneously on each item of data. The print unit alone can produce four different types of documents at once. Inputs are fed through a three-keyboard unit consisting of

a standard typewriter keyboard, a basic numeric keyboard, and a control keyboard.

In addition to the memory and instruction cartridges, the Auditronic is equipped with four operational registers holding a total of 134 characters, and a central processing unit with a total capacity of 841 characters. The moving print heads contain 96 characters and can print 206 characters per line.

To keep costs down, and also be consistent with Olivetti's longstanding use of modular construction, the basic electronics are discrete components mounted on 30 plug-in printed-circuit boards. Says Massimo Samaia (director of systems marketing services), "Olivetti's principle is that its service men need not be electronics specialists, that they can locate the problem board, replace it and send it back to a central electronic workshop for trouble shooting."

**Program notes.** Each cassette contains three basic programs, each of which has a double branch. Greater flexibility can be obtained by using code numbers. But, Olivetti has found that the flexibility of the program under average conditions is more than enough to meet client needs—and avoids introducing the possibility of error by additional coding. The operator feeds in variable data at a signal from the computer. To efficiently utilize operator time, new data can be fed in while the computer is performing other functions.

Introduction of this machine was held up until Olivetti could develop a general program to fit the diverse bookkeeping methods of Continental Europe, the United Kingdom, and the U.S.

Changes in the basic program can be made simply, without the use of the computer, directly onto the magnetic tape in an instruction cartridge. These changes are made by an Olivetti specialist and are locked in to keep any operator from changing them. Olivetti has made studies of accounting procedures in all Western nations—and apparently also the Eastern Bloc inasmuch as cyrillic characters can be provided. Alternates to the ba-

sic programs can be prepared by nonprogrammers who merely check off changes on an Olivetti form.

The basic prices for the Auditronic will be roughly \$10,000 in Italy and about \$12,000 in the U.S. Olivetti believes the machine to be only slightly more expensive than large shift-register accounting machines. Auditronic, however, has the added advantages of magnetic tape, cartridge loading, and the ability to provide inputs to a management-information system. The basic system can be supplemented by attachments for magnetic-ledger cards, tape punching, and edge-punch cards. Add-on units also allow transmission control of on-line connections.

### Great Britain

#### Frequency sleuth

For defense purposes, a conventional wavemeter is just not fast enough in pinpointing a signal. For laboratory purposes, speed may not be vital, but a microsecond response nevertheless can be handy.

To help satisfy both these needs, engineers at Mullard's Research Laboratories have developed a wavemeter that will identify a frequency between 2 and 4 gigahertz, and yield a digital output signal within 1  $\mu$ sec. What's more, the input pulse can be as brief as 250 nanoseconds.

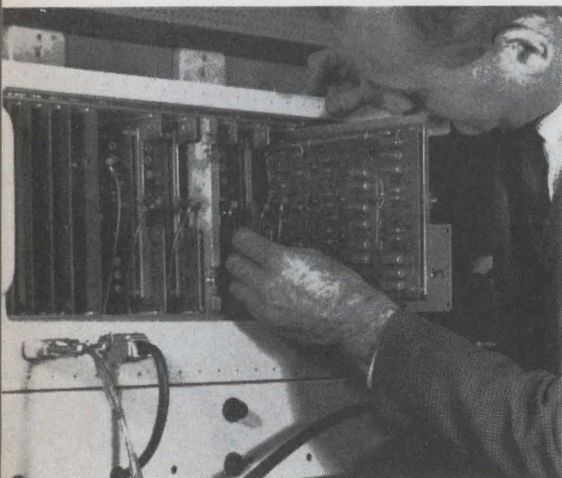

On board. Mullard technician checks delay-line components of wavemeter.

In the prototype equipment, a nine-bit binary number is used to provide readout. Thus, resolution is equal to the bandwidth divided by 512, or just under 4 megahertz in absolute terms. All Mullard will say about the main application is that this resolution is adequate for "microwave intercept systems." However, the company is developing a 10-bit modification.

The instrument is said to be insensitive to system noise and the effects of interference. Simple pre-amplification provides the wavemeter with a dynamic range of from -70 dbm to +10 dbm without losing accuracy. Production units will be sold through MEL Equipment Co., which, like Mullard, is a Philips subsidiary. The wavemeter will cost about \$20,000 to \$25,000. MEL expects quantity sales where wavemeters will be incorporated into larger systems.

**Split screening.** The instrument works by splitting the input signal into equal fractions and feeding the portions in parallel into delay lines of different lengths. Each delay line is followed by a broadband phase discriminator. Because a signal's phase shift in a delay line is proportional to its frequency, the overall pattern of phase shifts across the delay lines is unique for each frequency. Each shift is detected and measured by a diode-bridge arrangement, and the overall pattern is sorted out using IC logic, which supplies the output.

There are seven delay lines on the prototype, each made of semi-rigid coaxial cable with solid copper outer and inner elements, so that it is nondispersive. The length of the shortest line determines the operating bandwidth of the instrument. In this case, a 2-Ghz bandwidth equals the shortest line—approximately 12 centimeters. The next line is twice the length of the shortest, and so on.

The longest line is critical for fixing the accuracy of the incoming signal's frequency. If the line's length and delay characteristics are known precisely, the phase shift and, therefore, the frequency can be closely pinpointed. However, phase shift along the line will give ambiguous readings. By taking into

account the phase-shift pattern in the other lines, the ambiguity is resolved.

Each discriminator circuit, effectively a four-diode bridge, takes an input from each end of the delay line and gives four continuous d-c outputs proportional to the phase shift in the line. These outputs are amplified and fed into a bistable memory, which needs only to detect whether the output of each amplifier is positive or negative. Thus, there are eight possible binary configurations to indicate phase shift.

**Sampling.** The binary states are sampled for 50 nsec starting 200 nsec after the signal is first detected at the incoming splitter. This time span is necessary for the delay lines and the amplifiers to operate.

The logic network, mainly transistor-transistor-logic NAND gates, takes another 300 nsec to operate, and the output gates, which also are TTL and feed 50-ohm line drivers, take 400 nsec. Thus, total time is about 1  $\mu$ sec. As a result, the instrument should be able to put out the frequency of a radar pulse while the pulse is still coming in.

Mullard claims the high redundancy inherent in its construction—the bistable circuits provide a 28-bit number, but only a nine-bit number is required—will allow use of inexpensive components, including microwave diodes. And because there's so much redundancy, up to 16.5° of phase-measurement error between any two discriminators makes no difference in measurement accuracy. This is enough to neutralize all normal system noise and signal interference effects, says Mullard. The company is experimenting with longer delay lines as a means of improving accuracy.

Engineers working on the instrument say the limit is set by the need for the input pulse to be available simultaneously at both ends of the longest line. This means the longest delay cannot be longer than the pulse length plus the time taken to measure the phase shift. However, they think that an accuracy of  $\pm 1$  megahertz on a pulse length of 200 nsec is possible with nine delay lines and 11-bit readout.



Find Out Who's Who In The Japan Electronics Industry . . .

# JAPAN ELECTRONICS SHOW '70

Tokyo  
Apr. 10-20



## APRIL 10-20 JAPAN ELECTRONICS SHOW (JES)

### 1970 IS THE YEAR...FOR JES AND EXPO '70

The ninth Japan Electronics Show will open a new decade of brilliant advancement in the ever-progressing world of electronics. The year 1970 is also of special significance, in that Japan will host the first world exposition ever to be held in Asia. And JES will be geared to the central theme of Osaka's Expo '70— "Progress and Harmony of Mankind".

Over 400 applications for participation in the JES have already been received from leading international electronics firms in a dozen countries, as well as from their counterparts in Japan.

The JES will again provide an excellent opportunity to inspect the latest electronics technology and products, and to promote business ties on an international scale.

Exhibit areas will be divided by:

Consumer products=Television, radios, stereo phonographs, tape recorders, etc.

Industrial products=Communications, testing/measuring equipment, radio apparatus, associated electronics devices, etc.

Components/Parts=Discrete components (resistors, capacitors, transformers, speakers, semiconductor devices, etc.), integrated circuits, etc.

Foreign participants from: U.S.A., Canada, France, West Germany, Holland, Italy, Sweden, Denmark, Austria, and others.

Sponsored by

**ELECTRONIC INDUSTRIES ASSOCIATION OF JAPAN**

Tosho Bldg., 3-2-2, Marunouchi, Chiyoda-ku, Tokyo, Japan

Overseas Information Offices

Electronic Sec. **JAPAN LIGHT MACHINERY INFORMATION CENTER (JETRO)**

U.S.A.: 437, 5th Avenue, New York, N.Y.

Managed by

**JAPAN ELECTRONICS SHOW ASSOCIATION**

Cable: ELINDASO TOKYO Phone: 211-2765

West Germany: Duesseldorf, Berliner Allee 32, West Germany

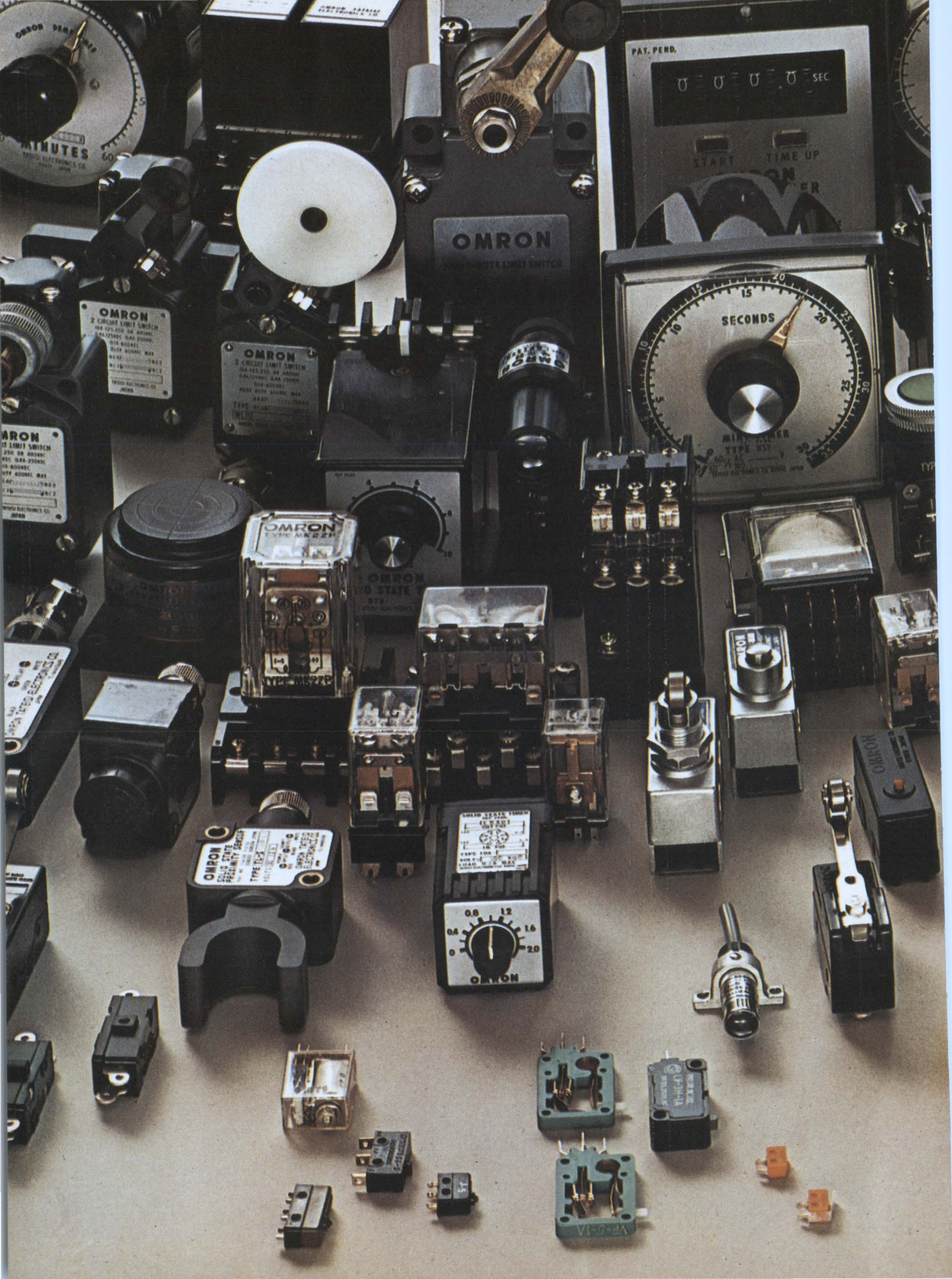



# OMRON and the '70s. Totally oriented controls.

To keep systems manufacturing costs down you need components that stand up. It's your business.

Our business is building just such components. In fact, we are Japan's and the world's largest multi-controls specialist. A state of affairs due largely to our unique R&D system which is a Japanese adaptation of MIL-Q5923C. We call the system PESIC.

This highly original R&D principle and our talented young engineering brains have developed a range of components that for quality and straight ingenuity of design has no peer. And, where necessary, each control carries UL, CSA, SEC and SECV international authorization.

See and evaluate Omron components. You'll be doing yourself — and your systems — a favor.

Components, Control Devices, Systems. An original world of electronics.



**OMRON TATEISI ELECTRONICS CO.**

SALES OFFICE/Toa Bldg., 5, Yonban-cho, Chiyoda-ku, Tokyo, Japan  
Phone (265) 4611. Telex 232-2179 Cable Address OMRONELCO TOKYO  
OVERSEAS DISTRIBUTORS: ● AUSTRALIA/H. Rowe & Co., Pty., Ltd.  
● AUSTRIA/Carlo Gavazzi-Billman G.m.b.H. ● ITALY/Carlo Gavazzi S.p.A.  
● BELGIUM/Carlo Gavazzi Belgium s.a. ● ENGLAND/Keyswitch Relays Ltd.  
● FORMOSA/Hai Nan Trading Co., Ltd./Sheng Ching Trading Co., Ltd.  
● FRANCE/Billman-Carlo Gavazzi S.A.R.L.  
● HOLLAND/Carlo Gavazzi-Billman Nederland N.V.  
● SPAIN/Carlo Gavazzi-Reguladores Billman s.a. ● MEXICO/Schultz Y Cia., S.A.  
● SWEDEN/Billman Regulator ab. ● SWITZERLAND/Carlo Gavazzi-Billman AG.  
● U.S.A./Sigma Instruments Inc. ● SOUTH AFRICA/P.J. Yelland & Co. (Pty) Ltd.  
● WEST GERMANY/Carlo Gavazzi-Billman Industriezulieferung G.m.b.H.

Circle 69 on reader service card



Find Out Who's Who In The Japan Electronics Industry . . .

# JAPAN ELECTRONICS SHOW '70

Tokyo  
Apr. 10-20

## Perfect Your CCTV System with COSMICAR® lenses



Focal length 15~145mm Aperture f/2.5

### A new member to the superb COSMICAR lens family!!

The most efficient **10 : 1 zoom** lens, unmatched for its optimum performance, both optically and mechanically, with impeccable definition and resolution throughout its entire zoom range.

Also available are scores of other lenses, ranging from 8.5mm to 1,000mm telephoto, zoom and those motordriven among them, for immediate delivery, after being tailored to your specifications.



## COSMICAR OPTICAL CO., LTD.

568, Shimoochiai, 2-chome, Shinjuku-ku, Tokyo

Cable Address: "MOVIEKINO TOKYO"

Circle 179 on reader service card

## DISCOVER A NEW WORLD OF SWITCHING WITH SANKEN PHOTOCELL-LAMP MODULES SPL SERIES

Hermetically sealed Sanken Photoconductive Cells are combined with incandescent glow lamps and packaged in a durable cylindrical case. Contactless and, therefore, clickless. . . . . they will completely solve your switching problems. That is exactly what you've been missing in your circuit.

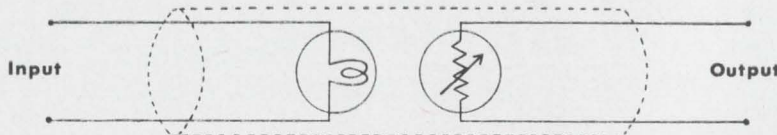

For more information about Sanken Photocell-Lamp Modules SPL Series, please contact:



### SANKEN ELECTRIC CO., LTD.

1-22-8 Nishi-Ikebukuro, Toshima-ku, Tokyo, Japan.

Telex: 272-2323 SANKELE TOK

Cable: SANKELE TOKYO

Phone: 986-6151





Find Out Who's Who In The Japan Electronics Industry . . .

# JAPAN ELECTRONICS SHOW '70

Tokyo  
Apr. 10-20

**Hirose** —  
just about your best  
connection for connectors.

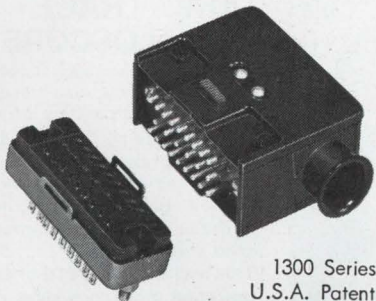

1300 Series  
U.S.A. Patent



CR7 Series

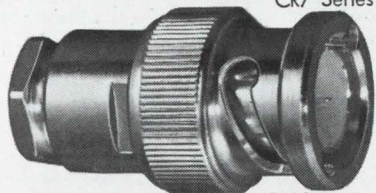

BNC Series

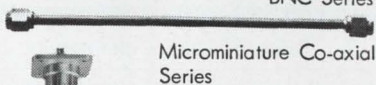

Microminiature Co-axial  
Series



RM Series

Hirose is Japan's leading manufacturer of printed circuit connectors, cylindrical connectors, rack and panel connectors, co-axial connectors, microminiature co-axial connectors, etc. Hirose—a good connection for people in electronics.

**HRSE**

**HIROSE ELECTRIC  
CO., LTD.**

No. 5-23, 5-chome, Osaki, Shinagawa-ku,  
Tokyo, Japan Tel: Tokyo 491-4541  
Cable Address: BESELECONHIROSE  
Telex: TK6269

Overseas Agents: Switzerland, Italy  
W. Germany and Australia

# ASK A Micro COMPET

Now ask a Micro Compet. At last you can. Our extensive development of ELSI (Extra Large Scale Integration) specifically for use in electronic calculators (Electronics 11/11/'68) has paid off. The result you can see. Micro Compet QT-8D.

It's hand-sized and weighs just 3 lbs. Silently performs  $+$   $-$   $\times$   $\div$  and mixed calculations up to 8 digits. Answer response is fast and clear on a new green read out.

We think Micro Compet is a design breakthrough. It's compact, stable and easy to use. It should be good. We made the first solid-state electronic calculators and today make more than anybody else.

Ask to see Micro Compet QT-8D soon.

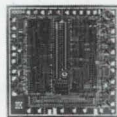

A single 1/8" square ELSI does the work of 1875 electronic components. With 4 ELSIs Micro Compet ensures maximum performance in ultra-miniature dimensions.

**Magnified ELSI  
by 50 times**



**Model  
QT-8D**

Hayakawa Electric Co., Ltd. changed its name to Sharp Corporation on January 1, 1970.

**SHARP**

SHARP CORPORATION Osaka, Japan

U.S. Subsidiary: SHARP ELECTRONICS CORP. 178 Commerce Road Carlstadt, New Jersey



Find Out Who's Who In The Japan Electronics Industry . . .

# JAPAN ELECTRONICS SHOW '70

Tokyo  
Apr. 10-20

**Token is  
either the world's first  
or second largest maker  
of ferromagnetic pot cores.**



**Token couldn't care less.**

It's not making more pot cores than anybody that's important to us—it is making them **better** than anybody else that matters.

This is the way we feel about each of our products, from metal magnetic and ferrite cores right on up to memory systems. You could say that the history of magnetic material manufacture in Japan is the history of Token—a good reason to want to keep our reputation as Japan's largest and most advanced magnetic material manufacturer.

Let us send you products brochure: Token, suppliers of quality materials to the electronics and communications industries.

**Token**

**Tohoku Metal Industries, Ltd.**

Koei Bldg. 13-10, 7-chome, Ginza, Chuo-ku, Tokyo, Japan  
Telephone: Tokyo 542-6171 Cable Address: TOHOKUMETAL TOKYO

Main Products: Ferrite Cores, Memory Cores, Memory Matrices,  
Ferrite Magnetostrictive Vibrators, Pulse Transformers, Permanent Magnets (Cast, Ferrite),  
Tape Wound Cores, Bobbin Cores, Magnetic Laminations, Fe-Co Alloys, Sendust Cores

## EASY OPERATION COMPACT, LOW COST

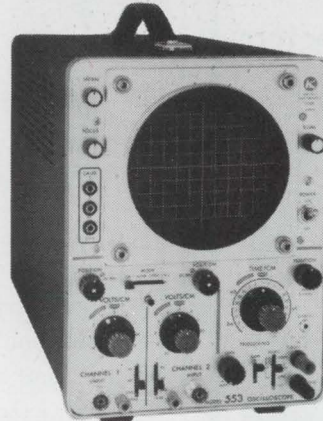

### MODEL 553 (133mm) DUAL-TRACE OSCILLOSCOPE

The "KIKUSUI Triggerscope, Model 553" is a dual-trace oscilloscope incorporating a trigger sweep system features light-weight compact, easy operation as well as high reliability by employing a highly sensitive 5 INCH Cathode-ray tube and numerous solid state designs.

This oscilloscope is of 2 channel operation mode, providing a vertical differential DC amplifier for bandwidth of DC~7 MHz, where-

by the dual-trace system displays either channel separately, alternates between channels, or choppers between channels. With a wide sweep range, further, extending from 1 sec~1 $\mu$ s, this model is advantageously suited for many measurement uses and waveform monitoring.



**kikusui**

KIKUSUI ELECTRONICS CORP.

3-1175, SHINMARUKO-HIGASHI, KAWASAKI-CITY, KANAGAWA-PREF., JAPAN  
TELEPHONE: (044) 41-0111, CABLE ADDRESS: "KIKUSUIDE" KAWASAKI

Circle 181 on reader service card

## NOBLE COMPONENTS

### SMALL MOLDED CAPACITOR (GIMMICK TYPE)

#### SLIDE VARIABLE RESISTOR < VJ456 >

- EFFECTIVE SHAFT TRAVEL: 45MM (1,772")
- FOR TINT CONTROL AND VOLUME CONTROL

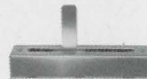

#### WIRE - WOUND VARIABLE RESISTOR < WR181 - 7K >

- FOR CONVERGENCE CIRCUIT



#### CARBON - COMPOSITION VARIABLE RESISTOR < V24L5G (PH)N >

- SMALL TRACKING

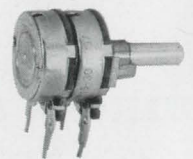

MAIN PRODUCTS: VARIABLE RESISTOR ● ELECTRONIC SWITCH ● CAPACITOR ● FIXED RESISTOR ● COIL & IFT



**TEIKOKU TSUSHIN KOGYO CO., LTD.**

NOBLE 335, NISHINAKA - MACHI, KARIYADO, KAWASAKI, JAPAN  
TEL: NAKAHARA (044) 042-3171 TELEX: 3842-155 CABLE ADDRESS: TEITSU

Circle 182 on reader service card



Find Out Who's Who In The Japan Electronics Industry . . .

# JAPAN ELECTRONICS SHOW '70

Tokyo  
Apr. 10-20

## Primo

- A Leader in Microphone Field -

### UD-909

**NEW!!** for Broadcasting & Recording  
**UNI-DIRECTIONAL DYNAMIC MICROPHONE**  
(with tone control)



Features all the essential conditions of a good microphone and suitable to use in broadcast stations, recording studios and where high quality is imperative. Mechanical noise is shut-out to the minimum.

**SPECIFICATIONS:**  
 \* Sensitivity..... -77dB ± 2dB/μbar \* Impedance.....200ohm ± 20% \* Frequency Response.....40~15,000Hz  
 \* Cartridge.....DM-49 \* Dimensions.....50<sup>φ</sup> (Dia.) × 209 (Length) m/m \* Finish.....Finished with aventurine nickel finish which gives such decency and calm.

\* For catalog write to:  
**PRIMO COMPANY LTD.**  
 Chicago Illinois Office:  
 530 W. Surf. St., Chicago Illinois 60657  
 Tel. 312-472-6142 Telex: 25-4225 PRIMO MUS CGOILLUSA

Head Office:  
 25-1, 6-chome, Mure, Mitakashi, Tokyo, Japan  
 Tel. 0422-43-3121 Cable: "PRIMO MUSASHINOMITAKA"  
 Telex: 2822-326 PRIMO MUS

Circle 183 on reader service card

### KOKUYO MAKES STANDARD TRANSISTOR CURVE TRACER THAT TOPS THEM ALL

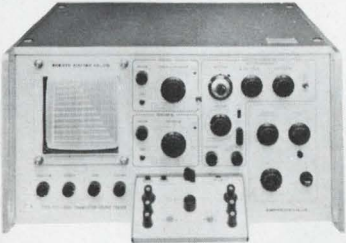

MODEL TCT-2001

- All solid state, 2000V.
- Universal type
- MODEL TCT-7C  
Standard type
- MODEL TCT-9  
Popular type
- OTHER MAJOR PRODUCTS  
Semiconductor Automatic Tester  
IC Automatic Tester  
Diode & Thyristor Curve Tracer  
Audio Response Tracer.

**KOKUYO ELECTRIC CO., LTD.**  
1-36-15, OOKAYAMA, MEGURO-KU TOKYO JAPAN

Circle 184 on reader service card

### ECONOMICAL Thin Film!

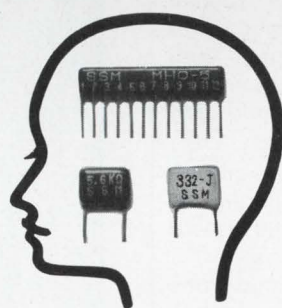

What's needed for memory system is everlasting high accuracy. SSM's components are the very ones satisfying superior reliability.

- Plate-ohm:  
evaporated metal film resistor.
- Pla-module:  
thin film modulated C-R circuit.
- Pla-con:  
organic thin film capacitor by plasma reaction.

**SUSUMU INDUSTRIAL CO., LTD.**  
 Minami Bldg. 1-12 Ebisuminami  
 Shibuya-ku, Tokyo, Japan.  
 TEL: Tokyo (03) 712-5990  
 TELEX: No. 246-6270

Circle 185 on reader service card

## Measures TRUE RMS VOLTAGES Digitally

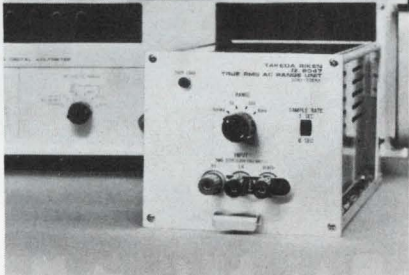

-TR- 6047 True RMS AC Range Unit is capable of True RMS AC voltage measurement of all types of waves: sine, triangular, rectangular, pulse and other sophisticated wave forms. Main unit: -TR- 6515 autoranging, integrating digital voltmeter.

#### Specifications

Range: ..... 500mV to 500V rms  
 Max. Sensitivity: ..... 100μV rms  
 Accuracy: ... ± 0.12% of rdg. ± 0.04%  
 of f.s. (from 45Hz to 5KHz)  
 Frequency:.....30Hz to 20KHz

**TR Takeda Riken  
Industry Co., Ltd.**

1-32-1, Asahi-cho, Nerima-ku, Tokyo 176, Japan  
 Tel: Tokyo 930-4111  
 Cables: TRITRONICS TOKYO

#### Agents:

Litton Precision Products International Inc.  
 Germany, France, Holland, Belgium,  
 Luxemburg, England, Switzerland.  
 Ing. S & Dr. Guido Belotti Ltd.....Italy  
 K. Juul Hansen.....Denmark  
 E. Nores ..... Finland  
 Carl-Eric Larsson ..... Sweden

Circle 73 on reader service card



Find Out Who's Who In The Japan Electronics Industry . . .

# JAPAN ELECTRONICS SHOW '70

Tokyo  
Apr. 10-20

**Pulling the nations  
of the world  
closer together . . .**

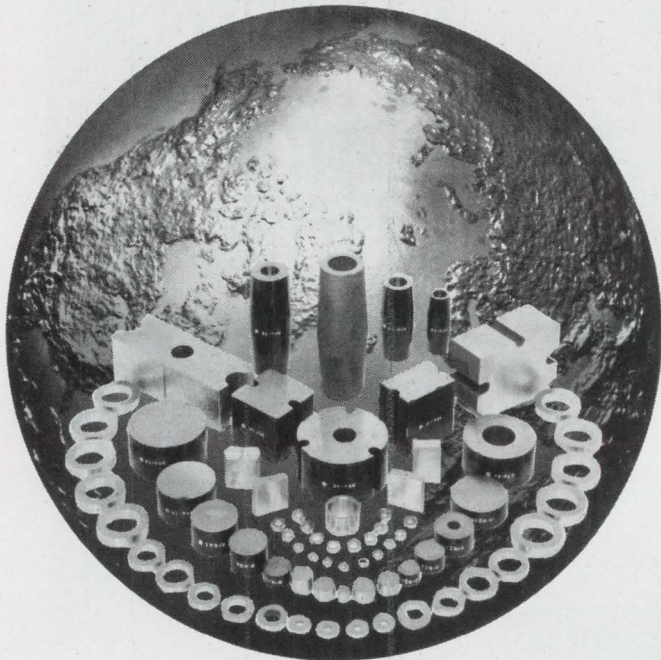

## Hitachi Cast Magnets

Today's communications systems could not exist without high-grade permanent magnets. Cast magnets in particular are becoming increasingly important. Hitachi Metals produces some of the best. Cast magnets for microwave communications. Compactly designed and finished to close tolerances. Featuring high coercive force and high energy product plus magnetic field uniformity and stability.

At Hitachi Metals, magnet production is integrated. Backed by decades of experience, and a tradition of quality workmanship. Hitachi Metals makes full use of technology as modern as tomorrow.

The results speak for themselves. In communications equipment around the world.

### Typical Hitachi Cast Magnets and Properties

Type	Residual Induction (Br) gauss	Coercive Force (Hc) oersteds	Energy Product (B×H)max. × 10 <sup>-6</sup>
HI-MAG I (ALNICO-5-7)	13,500~14,500	700~750	7.0~8.2
HI-MAG II (ALNICO-5-7)	13,000~14,000	680~780	6.8~8.0
YCM-8B (ALNICO-8)	8,800~9,600	1,380~1,500	4.8~5.5

Hitachi cast magnets are also used in **meters, generators, motors, telephone equipment, magnetos** and many other types of equipment. For further information, please contact:



**HITACHI**  
Hitachi Metals, Ltd.

**Head Office**  
Chiyoda Bldg., Marunouchi, Tokyo, Japan  
**Hitachi Metals America, Ltd.**  
Magnet Materials Sect.  
437 Madison Ave., New York, N.Y. 10022,  
U.S.A. Tel. 212-758-5255

*Leading Manufacturer in Acoustics*

## TOP CLASS!! WIRELESS FM MICROPHONE



WIRELESS CONDENSER MICROPHONE WX-197



WIRELESS DYNAMIC MICROPHONE WX-172



WIRELESS DYNAMIC MICROPHONE WX-127



### JAPAN PIEZO CO., LTD.

1-12-17 KAMIRENJAKU MITAKA TOKYO JAPAN  
TELEPHONE: TOKYO 0422-51-3151 〒181  
CABLE ADDRESS: "PIEZO" MUSASHINO TOKYO

Circle 186 on reader service card



give...so more will live  
**HEART FUND**



Find Out Who's Who In The Japan Electronics Industry . . .

# JAPAN ELECTRONICS SHOW '70

Tokyo  
Apr. 10-20

**STABILITY & QUALITY**

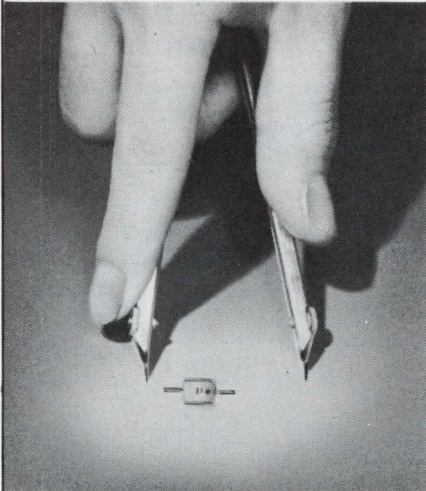

## SOLID TANTALUM CAPACITORS FOR HYBRID ICs - "MICROCAP" -

Capacitance exceeding 10,000 picofarads obtained despite miniature size. "MICROCAP" features excellent heat resistance, solderability and mechanical strength comparable to conventional discrete components, for easy use in hybrid integrated circuits.

**Specifications:**

- Operating Temperature Range: -55°C to +85°C
- Standard Voltage Rating: 6.3, 10, 16, 25, 35 VDC
- Standard Capacitance Value: .001 to 22MFD (E6 series)
- Standard Capacitance Tolerance: ±20% (M)

MATSUO'S other capacitors include:

**Metallized Polyester Film Capacitor:**

Type FNX-H mylar wrapped.

**Solid Tantalum Capacitors:**

Type TAX hermetically sealed in metallic case, Type TSX encased in metallic case and sealed with epoxy resin, Type TSL encased in metallic case and sealed with epoxy resin.

**Polyester Film Capacitors:**

Type MFL epoxy dipped, Type MFK epoxy dipped, non inductive, Type MXT encased in plastic tube, non inductive.

For further information, please write to:

**MATSUO ELECTRIC CO., LTD.**

Head Office: 3-5, 3-chome, Sennari-cho, Toyonaka-shi, Osaka, Japan  
Cable: "NCCMATSUO" OSAKA Telex: 523-4164 OSA  
Tokyo Office: 7, 3-chome, Nishi-Gotanda, Shinagawa-ku, Tokyo

## PA Systems, Components: TOA has just what you need



Everything from powerful, solid-state amps to wireless mikes, underwater speakers and mobile broadcast/tape units.

With over 35 years as PA systems and component specialists, TOA offers more than 250 items, including a wide range of specialized mikes, speakers, amps, junction boxes, BGM and chime units, full-system cabinet racks—everything to round out any PA system, or build one from scratch.

For details on the superior design and durability of the whole TOA cost-cutting line, please write:



*Specialists in PA Systems*  
**TOA ELECTRIC CO., LTD.**

U.S. Office:  
1367 Post St. #5  
San Francisco, Calif. 94109  
Tel. (415) 776-8955

Head Office:  
2-1 Takamatsucho, Takarazuka, Hyogo,  
Japan Tel. 0797-(87) 2211

## Looking for a memory system with low cost per bit, but fast cycle time/access time, and high reliability in one compact package?

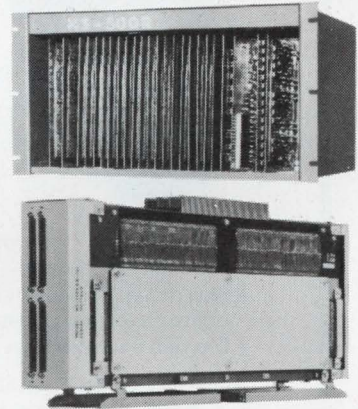

Look no further. TOKO's new, improved Woven Plated-Wire Memory System HS-500R is now available.

TOKO's HS-500 memory system has won praise and popularity for its low-cost, high-performance characteristics. Now ready to be marketed is improved Model HS-500R with the following features:

**Compact size:** 10"(H) x 19"(W) x 13-1/3"(D)

**Access time:** 250ns

**Memory capacity:** 8K bytes—32K bytes (4096 words—16384 words)

**Flexible operation:** Linear selection organization for multi-word operation; 8 bytes are simultaneously written and read in one word; required bits or bytes are then selected at the interface; thus a variety of memory capacities is made possible.

**Low cost**

Model HS-500R also shares with its predecessor such outstanding features as fast cycle time of 500ns; wide operating temperature range without any current compensation: 0°C to 50°C; and low power dissipation of 100W.

TOKO can also undertake the manufacture of custom-made systems according to your specifications. Complete technical details from our New York office.



**TOKO, INC.**

Head Office: 1-17, 2-chome, Higashi-Yukigaya, Ohta-ku, Tokyo, Japan  
**TOKO N.Y., INC.** 350 Fifth Avenue, New York, New York 10001



Find Out Who's Who In The Japan Electronics Industry . . .

# JAPAN ELECTRONICS SHOW '70

Tokyo  
Apr. 10-20

## DAITO Fuses for Alarming

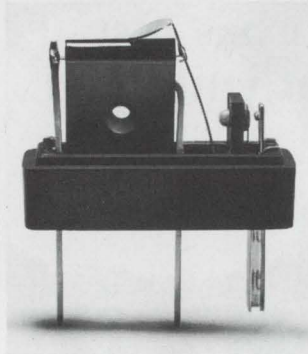
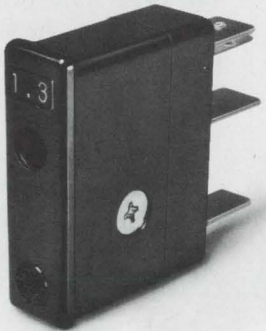

- \* Alarm Circuit — instantly activated
- \* White Mark Indicator — easily visible
- \* Plug-in Type Fuse — quickly replaceable
- \* Contamination and Metallic Contacts — eliminated
- \* Blowing Characteristics — little deviation

Applicable for carrier systems, telephone switchboards, electronic computers, automatic controls, military systems, and the like.

*Distributor wanted!*

For details, please write:

**UCHIDA YOKO CO., LTD.**

1-3, Takaracho, Chuo-ku, Tokyo, Japan Phone: 535-3111 Cable: UCDCOY TOKYO

Utility Patent Law No. 522516

Circle 189 on reader service card

## ELFIN<sup>T.M.</sup> NEON INDICATORS

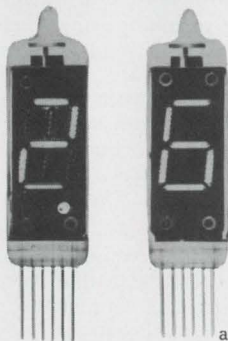

actual size

1. Single Plane
2. Brighter Display
3. Wide Viewing Angle
4. Smallest in Size
5. Low Power Consumption

**RODAN OKAYA ELECTRIC INDUSTRIES CO., LTD.**

Yasuda Bldg., 3-8-1-chome, Shibuya-ku, Tokyo, Japan

Distributed by: **ALCO ELECTRONIC PRODUCTS, INC.** Lawrence, Mass. 01842 (617)686-3887  
Cable Address: Altronics

## THE ONLY COMPANY IN JAPAN SPECIALIZING IN THE MANUFACTURE OF IC's

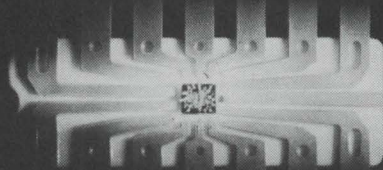

### —PRODUCTS—

- \* Hybrid IC's
- \* Monolithic IC's
- \* Diodes
- \* Transistors

**IC KYODO ELECTRONIC LABORATORIES, INC.**

5153 Kamitsuruma, Sagami-hara-shi, Kanagawa-ken, Japan  
Phone: 0427-42-6731  
Cable: KELIC MACHIDA

Circle 190 on reader service card

## Do You Need!

What kind of electronic components?

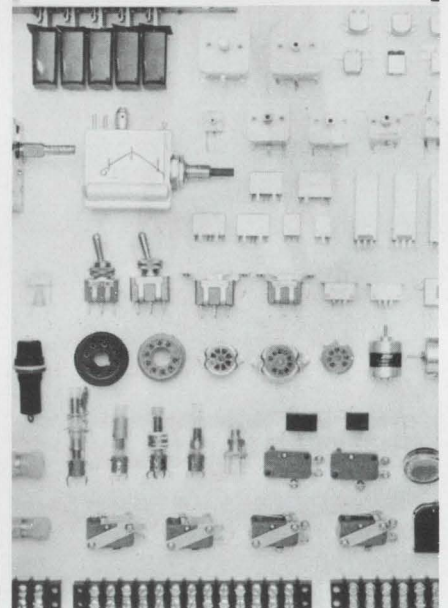

We have a wide range of standard products for electronic components effectively, and most of them meet or exceed your specs. They are available off the shelf. Shown here is only a representative sampling of our products. When you need, reliable and dependable components, Ask For Mitsumi.

We will provide anything you want.

### PRODUCTION ITEMS

Thick Film ICs, UHF & VHF TV Tuners, Front-end FM Tuners, Push-button Tuners, IF Transformers, Various Coils, Polyethylene Variable Capacitors, Magnetic Heads, Micromotors, Synchronous Motors, CdS Photoconductive Cells, Trimmer Capacitors, Semi-fixed Resistors, Switches, Terminals, Fuse Holders, Small Mechanical Components.



**MITSUMI ELECTRIC CO., LTD.**

Main office: 1056 Koadachi, Komae-machi, Kitatama-gun, Tokyo, Japan. Tel: 489-5333

Europe office: Marienstrasse 12, Dusseldorf, W Germany. Tel: 352701

**MITSUMI ELECTRONICS CORPORATION**

11 Broadway, New York 4, N.Y. 10004, U.S.A.  
Tel: HA-5-3085, 3086

**MITSUMI COMPANY, LTD.**

302, Cheong Hing Building, 72, Nathan Road, Kowloon, Hong Kong.  
Tel: 666925

Circle 191 on reader service card

76 Circle 76 on reader service card



Find Out Who's Who In The Japan Electronics Industry . . .

# JAPAN ELECTRONICS SHOW '70

Tokyo  
Apr. 10-20

## SPANNING THE FUTURE

With over 50 years of experience, Japan's largest maker of capacitors knows no time limit. Products for everything from home and electronic appliances to space equipment.

Nichicon. Remember it. We're Japan's biggest!



### PRODUCTION ITEMS

Hybrid ICs, Electrolytic, Mini-Mini, Tantalum, Oil, Ceramic, Wax Paper, Metallized Paper, Plastic Film, and Mica Capacitors

## Nichicon Capacitor Ltd.

Head Office: Uehara Bldg., Oikedori, Karasuma-higashi-iru, Nakagyo-ku, Kyoto, Japan  
Telex: 5422-120 Cable Address: CAPACITOR KYOTO



Circle 192 on reader service card

## Richest in variety from indoor type to UHF series

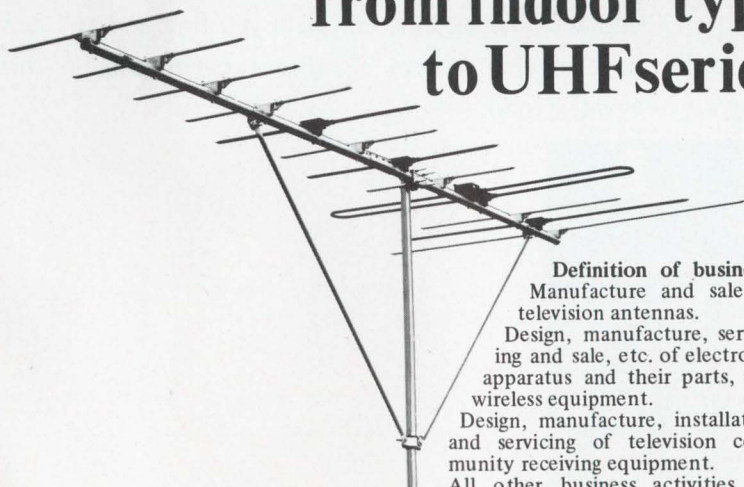

**Definition of business:**  
Manufacture and sale of television antennas.  
Design, manufacture, servicing and sale, etc. of electronic apparatus and their parts, and wireless equipment.  
Design, manufacture, installation and servicing of television community receiving equipment.  
All other business activities annexed to the above.



**DX ANTENNA CO., LTD.**  
CABLE DXANTENNA KOBE, JAPAN

**DX ANTENNA**

Circle 193 on reader service card

## CREATE A NOISE-FREE AGE



If your business is radios, TV sets, stereo receivers, or transceivers, make sure they are noise-free. An easy check is whether or not they use ceramic filters.

Ceramic filters are now replacing conventional IFTs and the more expensive quartz filters in the products of such well-known manufacturers as Sony, Motorola, Hitachi and Toshiba.

A city in the size range of Los Angeles or New York may have 20 or more FM stations. Only a set using ceramic filters can provide the selectivity, stereo separation, capture ratio and freedom from distortion which are absolute requirements for satisfactory reception of today's FM broadcasts.

Murata today is the only manufacturer in the world capable of marketing ceramic filters for use in FM and TV sets. This is a result of more than 10 years of research and development on this and other useful solid-state devices.

Be sure the next set you design has noise-free Murata ceramic filters. Avoid the ordinary. Help create a noise-free age!

**murata**

**MURATA MFG. CO., LTD.**

Nagaoka, Kyoto, Japan  
Telex: 5429-901 MURATA KTN  
Cable Address: MURATAKYOTO

**MURATA  
CORP. OF AMERICA**

2 Westchester Plaza, Elmsford,  
New York 10523  
Telex: MURATA EMFD 137332  
Phone 914-592-9180

Circle 77 on reader service card

# Meet decision makers in medical electronics

Physicians, hospital administrators, biomedical engineers, educators, researchers, system design engineers who attend the 2nd National Conference & Exposition on Electronics in Medicine represent real buying power. We know because we asked the attendees at the first conference last spring how much they spent on medical electronics and their responses added up to a whopping \$36 million—about ten per cent of the 1968 market.

## buying and specifying influence

What's more, the second conference has been designed to meet the overwhelming demands of the earlier attendees for direct exposure to actual hardware. We're inviting manufacturers of medical electronics gear to take advantage of this unprecedented opportunity by exhibiting at the exciting 2nd National Conference on Electronics in Medicine in San Francisco. Through a carefully crafted program of invited papers by leaders in the field, and discussion group sessions on vital questions, the Conference will attract the people manufacturers want to meet most—the men who make the buying and specifying decisions in a \$400 million market. The 2nd National Conference & Exposition on Electronics in Medicine is presented by McGraw-Hill's Electronics/Management Center in association with the McGraw-Hill publications: Electronics/Medical World News/Modern Hospital/Postgraduate Medicine/Scientific Research. It is managed by National Expositions Co., Inc., the highly regarded exposition management firm based in New York.

prestige sponsorship

aggressive promotion

Full page ads, dynamic editorial coverage and a comprehensive mail campaign will find every buying and specifying influence in medical electronics wherever he works—hospital, research laboratory, consultant's office, university, clinic or private practice. He'll be reached repeatedly and effectively with our message. And that message is—the Second National Conference and Exposition on Electronics in Medicine is the place to discuss his urgent requirements first-hand with you—the people with expertise who can fill them.

opportunities for marketers

The Second National Conference and Exposition on Electronics in Medicine can help you find and sell new customers, create impressive lists of new, valuable contacts and achieve significant penetration in this exploding market. Space is limited, so make your reservation now.

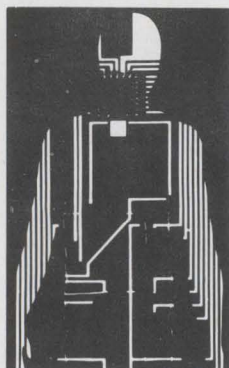

## 2nd National Conference & Exposition on Electronics in Medicine

FAIRMONT HOTEL, SAN FRANCISCO, CALIF. • FEBRUARY 12, 13, 14, 1970

Write or call for brochure, floor plan: Jerry Brown, Exhibit Manager, National Expositions Company, Inc.

14 West 40th St., New York, N.Y. 10018, 212/564-8714



---

# Washington Newsletter

---

February 2, 1970

## Commands get bigger role in military R&D

Industry efforts to find support for military research and development programs in the coming year should be directed at military commands, rather than the Pentagon. The reorganization of the Directorate of Defense Research and Engineering will result in a staff shrinkage of about 25 people, according to DDR&E chief John S. Foster Jr. Most R&D projects "will originate in the services and be approved by the Defense Department. Primary responsibility for their conduct will rest with the services," says Foster.

The new DDR&E structure, planned for June 20 completion, is in line with Deputy Defense Secretary David Packard's view that more responsibility should be delegated to lower levels. Foster's reorganized group will deal with missions rather than functions.

## Warning to FCC: leave space for new uses of satellites

Sole reported industry caveat to the new White House position paper on domestic satellites (see p. 125) comes from a senior communications specialist. The FCC, he contends, should block out some satellite spectrum space for new uses, and not consider private, domestic systems merely as an extension of existing communications.

Otherwise, the White House recommendation is generating substantial Washington support, particularly for the simple, effective way it sets aside the issue of spectrum scarcity and consequent threat of interference by multiple, special-purpose systems. "The issue has been overstated to a significant degree," says White House aide Peter Flanigan. Acknowledging the finite nature of spectrum capacity, the White House view is that it is still "greatly expandable through administrative, technological, and operational considerations."

## Anti-pollution plans face political infighths

The rough politics of an election year is shaping up as the biggest threat to expansion of anti-pollution programs. Congressional protagonists of pollution control are seen taking President Nixon's "quality of life" recommendations [*Electronics*, Dec. 22, 1969, p. 61] and voting far more than the Administration wants for openers. One case in point: Where the President wants an Interior Department reorganization to give pollution control powers to Secretary Walter Hickel, Sen. Edmund Muskie (D., Me.) wants to combine all current pollution-oriented Federal offices into a new agency that would spend all the money appropriated for control programs.

## Leakage law: how tough will HEW get?

Manufacturers of a broad range of consumer and industrial products are keeping careful watch on the way the Department of Health, Education, and Welfare exercises broad new regulatory powers covering radiation leakage.

The new rules, which went into effect the beginning of the year, state that products made after Oct. 18, 1968, will be considered defective even if they only create "a risk of injury," and must be repaired, replaced, or their cost refunded.

The regulations give HEW the extra clout it needs, especially in its dispute with the makers of microwave ovens, who claim no evidence has yet been found of direct harm to humans from radiation leakage.

---

# Washington Newsletter

---

For many months the oven makers have been fighting a proposed HEW emission standard of 1 milliwatt/cm<sup>2</sup>; the industry-accepted safety level for microwave ovens is 10 mw/cm<sup>2</sup>.

Other products affected by the new legislation include X-ray machines, lasers, electron microscopes, tanning and therapeutic lamps, welding equipment, vibrators, and oscillators.

## Consumer sales dip as economy cools

The prospect that 1970 consumer electronics sales will slide downhill as the economy cools gets statistical support in new data from the EIA. Though EIA cautions that the sales volume in November was affected by the strike at the General Electric Co. it also acknowledges that it took more than that to bring black-and-white tv receiver sales to their lowest point in 20 years. Similarly, phonograph and radio sales were down to their lowest point since 1963 and 1964 respectively, in the month before Christmas.

## EIA consumer unit still may bolt

Consumer electronics manufacturers may yet pull out of the Electronic Industries Association and form their own trade group. They're weighing the action even though they were able to override EIA president George Butler's dismissal of Jack Wayman, Consumer Products division vice president [*Electronics*, Jan. 5, p. 47]. Wayman is now back at his desk.

The deciding factor will be how much independence the EIA division will have to pursue its own legislative, regulatory, engineering, and marketing programs. It also wants the right to hire and fire its own staff. Division sources say the group will push the loose-federation idea contained in last year's EIA reorganization plan, but are less than optimistic about its success. The consumer group will test this autonomy soon, and the odds are that the first time Butler clamps down, the group will pull out.

The issue will be on the board of governors' agenda when they meet in Washington in March. EIA sources speculate that the upshot may be a more comprehensive reorganization than that voted last year, possibly with a new EIA president to carry it out.

## FAA to farm out more R&D work

The industry can expect more research, development, and systems prototype production contracts following an internal reorganization of the Federal Aviation Agency's systems R&D office. This word comes from Joseph Blatt, 57, who is retiring as associate FAA administrator for development.

The FAA will have to be "more dependent on industry" because the tightening of Federal personnel budgets this year will likely reduce its already limited engineering staff. This will be a real challenge for the FAA in making more effective use of industry and its personnel, Blatt believes. One trend he sees is toward more purchasing of complete systems rather than individual components, a move he says began last year with the \$2.5 million instrument landing system award to the AIL division of Cutler-Hammer.

Blatt also intimates that his temporary replacement, Gustav E. Lundquist, may permanently take over the agency's systems R&D shop. Lundquist currently heads the agency's national airspace program office.

# Have coils gone about as far as they can go?

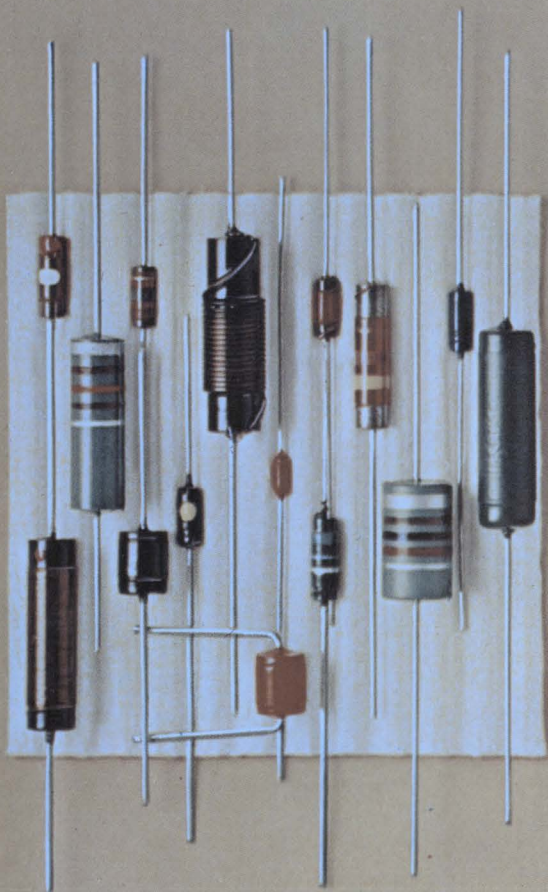

Chances are, you're using some pretty darned good coils right now. So you may have decided that you'll never be able to find any better ones.  Nonsense.  If you aren't using our brand at the moment, the solution is simple. Switch. You'll get a noticeably higher degree of reliability. (After all, we've been the leader in R. F. chokes ever since the days we helped establish the military specifications for inductors.) We also deliver a greater depth of technical assistance. And our prices? Very competitive.  Or perhaps you're already using our coils. If so, the future is still promising. Because we'll be continuing to improve our present models and develop new ones.  For a sample order of our pace-setting coils, write AIRCO SPEER ELECTRONIC COMPONENTS, St. Marys, Pennsylvania 15857.  Then see where they go from here.

Ask the passive innovators at **AIRCO** Speer

Speer resistors  Resistor and conductor paste  Jeffers JC precision resistors  Jeffers JXP precision resistors and networks  Jeffers inductors  Jeffers capacitors  PEC variable resistors and trimmer potentiometers.

## Using spot ties?

# GUDE-TIES, replacing plastic wraps, cut yearly material cost more than 75%

"GUDE-TIES", CUT LENGTHS of Gudebrod Flat Braided Lacing Tapes, are specifically produced for spot tying—in production harnessing or for on-site work. A comparative engineering analysis found that material costs for Gude-Ties was 76.7% less than for plastic wraps on a yearly production basis, and harness weight was reduced also. In aviation and other important applications weight of the harness is important, and gaining more importance. Gude-Ties are dispenser packaged for one hand, easy withdrawal. Meet MIL-T Specs, make firm knots. Available in 6", 8", 10", 12", 15", 18", 20" and 22" lengths (other lengths to order).

8769  
STYLE 18  
18" LENGTH  
100 PIECES

**GUDEBROD  
GUDE-TIES**

NYLON TYPE 1  
MIL-T-43435

FINISH B  
MIL-T-713A

GUDEBROD BROS. SILK CO., INC.  
PHILADELPHIA • NEW YORK • BOSTON  
CHICAGO • BURBANK • CHARLOTTE

## Try GUDEBROD'S SYSTEM "S"

In spot tying when you combine Gudebrod Gude-Ties with Gudebrod Gude-Snips and the Gudebrod Swivel-Tilt Harness Board Mount you're really streamlining the production of wire harnesses. Gude-Snips, palm-of-the-hand snips cut cleanly, easily—right or left hand. Spring action, Du Pont Teflon bearing. Eliminate constant reaching for knife or shears. The balanced, three dimensional action of the Gudebrod Swivel-Tilt Harness Board Mount brings every section of the harness within easy, comfortable reach.

Cuts fatigue — speeds work. Ask for full information about Gudebrod System "S" for spot tie lacing. (For continuous tying, ask about System "C".)

Gudebrod Swivel-Tilt  
Harness Board Mounts  
available in several sizes

**G**UDEBROD

*Electronics Division*

GUDEBROD BROS. SILK CO., INC. Founded 1870, 12 South 12th Street, Philadelphia, Pa. 19107

1870—100 Years of Quality—1970

*It takes a while  
to achieve excellence*

*It takes forever  
to maintain it*

*Excellence is a complex thing, composed of many parts. It isn't achieved overnight . . . not by anything or anyone. We've devoted almost fifty years to developing the complete line of Markel insulating sleeveings, wire and cable . . . a total of some 3,500 different types and sizes. Each was painstakingly perfected to meet specific needs. It also took a lot of work to design the processes and equipment to manufacture these products in volume to sell at reasonable prices. In addition, we've built and trained an outstanding sales organization to make Markel products and know-how readily available to you. Over the years, Markel products and service have earned a solid reputation for excellence. But we know we have to keep on earning it . . . product by product . . . day by day . . . from now on.*

ONE SOURCE FOR EXCELLENCE  
in Insulating Tubings and Sleeveings  
High Temperature Wire and Cable



L. FRANK MARKEL & SONS, INC., NORRISTOWN, PA. 19404 • PHONE: 215/272-8960

Circle 83 on reader service card

# BURROUGHS DEVELOPS... SELF-SCAN<sup>TM</sup> PANEL DISPLAY

## the most significant development in electronic display

Burroughs, the originator of NIXIE<sup>®</sup> tubes, now revolutionizes display technology with the first commercially practical dot matrix display system. It took SELF-SCAN panel display, the remarkable Burroughs invention that takes the electronics out of the present electronic display ... reducing costly drive circuitry up to 90%.

With a minimum number of leads and drivers, Burroughs' system automatically scans data input into in-plane readout characters formed by glowing dots ... making possible a totally new combination of readability, minimal packaging and cost advantages.

The new flat-panel display is basically a matrix of small gas discharge cells hermetically sealed between heavy glass plates in a sandwich configuration. The matrix itself, formed of insulating material, has small grooves on its top surface to allow positioning of information anode wires which intersect each hole. Cathode conductors behind the center sheet intersect at each cavity with a second set of anode wires.



0123456789+-E.

By utilizing the phenomena of preferential glow transfer and glow shifting, the initial glow caused by cathode ionization in the dot matrix may be moved through selected holes to a visible position on the top surface. A sequential flow of light is thus achieved without separate drivers for individual columns and rows.

Burroughs' alphanumeric SELF-SCAN panel displays are available with or without memory for any application requiring 16 or 18 digit readout.

Write today for descriptive brochure, Burroughs Corporation, Electronic Components Division, P. O. Box 1226, Plainfield, New Jersey 07061. Tel.: (201) 757-5000.

Circle 84 on reader service card

Burroughs 

# Technical Articles

---

**Circus means versatility as a CAD program**  
page 86

Unlike most computer-aided design programs, Circus can obtain initial conditions and transient solutions for networks containing bipolar and field effect transistors, as well as those with conventional, tunnel, and zener diodes, and four-region devices. One model suffices; it's based on the physical makeup of the semiconductor, not inflexible boundaries. The program works for both silicon and germanium transistors, and for large- and small-signal circuits.

**Her Majesty, Queen Elizabeth 2**  
page 104

Fun cruises don't succeed by sunlight alone. And on board the Queen Elizabeth 2, Cunard Lines' new supership, is a highly sophisticated array of electronics gear that keeps things running smoothly—including a collision-avoidance system, satellite-navigation gear, and a central computer. The Queen had some problems with her notch antennas that have since been resolved. However, the antennas still are in the shakedown phase.

**Arc-plasma spraying promises substantial microwave dividends**  
page 108

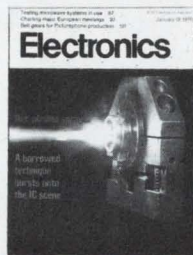

High-performance, planar thick-film IC components are hard to come by because present screen-printing methods can't produce them with good enough quality for most applications. At Monsanto Research Corp. in Dayton, Ohio, an arc-plasma spray technique holds out great promise for depositing films. With APS, materials are applied at low temperature, with uniform geometry and density, and with close control of chemical and electromechanical parameters. Thus, the process can handle substrates that are normally difficult to work with because of temperature sensitivity.

**Digital compensation of thermocouples yields direct readings**  
page 116

About \$25 to \$30 worth of integrated circuits and some design time are all it takes to obtain a digital temperature reading that adds a thermocouple's reference-temperature value to the measured value. This arrangement works directly into a digital voltmeter used in industrial data loggers and automatically yields corrected process temperatures scaled and calibrated for display and readout in actual temperature units.

**Predicting LSI costs**

## Coming

Confronted by a multiplicity of IC's, the designer faces a tough time deciding how complex the circuit should be. But a confident choice can be made based on cost per function now and projected cost when the equipment is produced. It all depends on the IC manufacturer's yield now and what it will be in the future.

# Circus means versatility as a CAD program

Based on the actual physical makeup of the semiconductor, Circus requires just one model for variety of analyses; C.D. Root of Raytheon tells how to obtain parameter values required for the design of any transistor circuit

● Like its namesake in the entertainment world, Circus, a digital computer-aided design program for transistor circuit analysis, may be the most versatile medium in its field. The program requires only one model, which is based on the physical makeup of the semiconductor itself rather than on an arbitrary boundary condition. Unlike other CAD programs, which require several models, the Circus model can be modified to perform a variety of analyses. And this model can be applied to both silicon and germanium transistors, as well as large-signal and small-signal circuit behavior.

Unlike most other CAD programs, Circus can help obtain both the initial conditions and transient solution for networks containing bipolar and field effect transistors; conventional, tunnel and zener diodes, and four-region devices. The program works directly from any network schematic including these semiconductors, and the necessary resistors, capacitors, inductors, and sources.

Although developed specifically for studying nuclear radiation effects on electronic circuits, Circus is applicable to any design problem having an electrical analog. Among its features are:

► Stored semiconductor models and a device parameter library. The designer only has to specify the terminal connections of a given device and either request the program to obtain the device data from a

Circus model. Typical computer model for an npn transistor used with the Circus program. Equations 1 through 6 define the branch currents and capacitors. If a pnp transistor were used the current directions would be reversed.

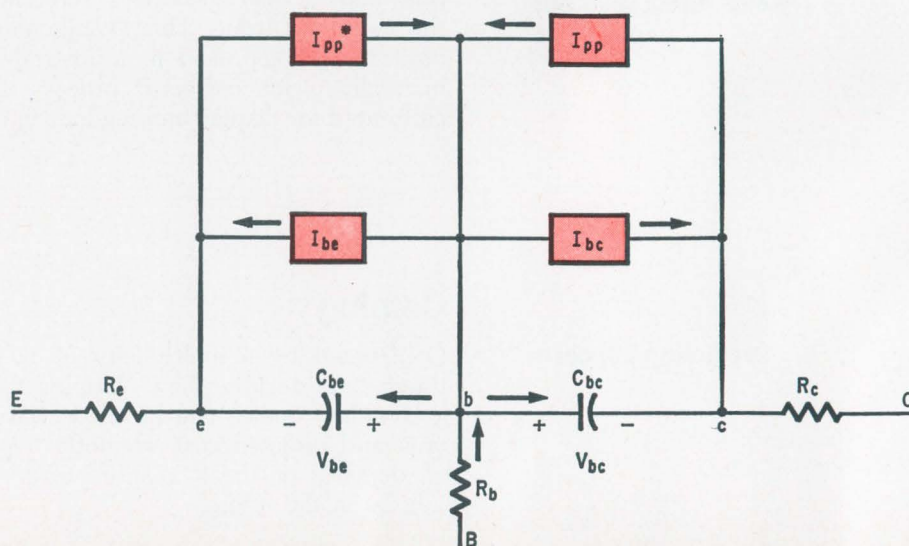



library or supply the device model's component values as input.

► Special-purpose parameter variations and multiple analysis. Circus permits in a single computer run, multiple analyses of a given topology with arbitrary changes in any or all element values. A Circus analysis permits parameters to be changed at any time during the run. In low-frequency circuits, this is particularly useful in altering parameters that affect short time constants after fast transients have passed. This then permits rapid calculations.

► Output options. In addition to all node voltages and element currents, the user may request internal device currents and voltages, a check on voltage, current, or power dissipation in any element, the sum or difference of any two node voltages, or any variable less its d-c value. The variables selected will be printed only at intervals determined by the user. Circus also can plot any variable versus time.

► Computational efficiency. The Circus program attains computational speed by taking advantage of the built-in model. For example, Circus was the first large-circuit analysis program to use the economical exponential integration method.

► Machine independence. 98% of Circus is in Fortran IV and the program has been adapted to a variety of computers. For several years computer operators claimed

that some of the vital operations in a large circuit analysis program only could be performed in the language of the particular machine in use.

As in most analysis programs, Circus' input language is in a problem-oriented format natural to a circuit designer. But several special features make it especially useful for design studies. Among these features are: multiple reruns with parameter changes, a restart mode to continue analysis, stored models for convenient device descriptions, and relatively error-free operation.<sup>1</sup>

**The Circus model** is completely defined through a series of six equations. Once the constants are determined, the user can feed this data into the computer and completely design his circuit.

Each junction of the Circus model is comprised of a current generator  $I_{be}$  or  $I_{bc}$ , and a capacitance  $C_{be}$  or  $C_{bc}$ , which is composed of transition capacitance (voltage dependent) and diffusion capacitance (current dependent).

When transient radiation effects on the transistors must be considered—X ray, or light—photo-current generators  $I_{pp}^*$  or  $I_{pp}$  are used; these are provided in parallel with each junction.

In most popular computer programs, such as Net-1, all currents are specified exponentially. While this is adequate for older germanium-type transistors, it is not suited to the physical properties of silicon semiconductors. In Circus, only the currents for  $I_N$  and  $I_I$  are specified exponentially. These simple mathematical expressions accurately relate the currents to the physical properties of silicon devices. And Circus has the advantage of application to both semiconductor types.

To understand the meaning of the currents in the model, consider the following: In one case, forward bias is applied to the base-emitter junction with  $V_{be} = 0$  volt. In the zero-bias condition there is no excess or deficiency of minority carriers at that junction. For the other case, forward collector-base bias is applied with  $V_{bc} = 0$  volt. The resulting currents are shown diagrammatically in the top figure on the left hand side of page 89.

Each capacitor is made up of a transition and a diffusion capacitance component. The former results from the space-charge region of any junction, whether forward- or reverse-biased. Since the total width of the space-charge region is a function of d-c bias, the tran-

$$I_{be} = \left(\frac{1}{\beta_N} + 1\right) I_N - I_I, (1)$$

$$I_{bc} = -I_N + \left(\frac{1}{\beta_I} + 1\right) I_I, (2)$$

$$I_N = I_{es} [\exp(\theta_N V_{be}) - 1], (3)$$

$$I_I = I_{cs} [\exp(\theta_I V_{bc}) - 1], (4)$$

$$C_{be} = \underbrace{\frac{a_1}{(\phi_1 - V_{be})^{n_1}}}_{\text{TRANSITION CAPACITANCE}} + \underbrace{\theta_N T_{CN} (I_N + I_{es})}_{\text{DIFFUSION CAPACITANCE}}, (5)$$

$$C_{bc} = \underbrace{\frac{a_2}{(\phi_2 - V_{bc})^{n_2}}}_{\text{TRANSITION CAPACITANCE}} + \underbrace{\theta_I T_{CI} (I_I + I_{cs})}_{\text{DIFFUSION CAPACITANCE}}, (6)$$

$$\beta_N = h_{FE_N} = f(I_N)$$

$$T_{CN} = f(I_N)$$

$$\beta_I = h_{FE_I} = f(I_I)$$

$$T_{CI} = f(I_I)$$

$$I_{pp}^* = K_e (d\gamma/dt)$$

$$I_{pp} = K_c (d\gamma/dt)$$

$$d\gamma/dt = \text{RADIATION DOSE RATE}$$

## Defining the CAD terms

Parameter	Units	Definitions	Applicable equation	How obtained
$I_{bo}$	amps	Current in emitter-current generator	$I_{bo} = \left(\frac{1}{\beta_N} + 1\right) I_N - I_i$	Not measured
$\beta_N$	—	D-c current gain under normal operation ( $h_{FE(N)}$ )	—	Direct measurement
$I_N$	amps	Collector current obtained with $V_{cb}=0$ , and $V_{eb}$ forward biased	$I_{bo} = -I_N + \left(\frac{1}{\beta_1} + 1\right) I_i$	Measurement ( $I_i=0$ )
$I_i$	amps	Emitter-base current obtained with $V_{eb}=0$ , and $V_{cb}$ forward-biased	$I_{bo} = \left(\frac{1}{\beta_N} + 1\right) I_N - I_i$	Measurement ( $I_N=0$ )
$I_{bc}$	amps	Current in collector-current generator	$I_{bc} = -I_N + \left(\frac{1}{\beta_1} + 1\right) I_i$	Not measured
$\beta_1$	—	Inverse operation current gain ( $h_{FE(I)}$ )	—	Direct measurement
$I_{es}$	amps	Emitter saturation current. (This current does not necessarily bear any relation to the current of the reverse-biased diode)	$I_N = I_{es} (\exp \Theta_N V_{be} - 1)$	Graphical: the y axis intercept on an extrapolated $I_N, V_{be}$ semilog plot
$I_{cs}$	amps	Collector saturation current; above remarks apply	$I_i = I_{cs} (\exp \Theta_1 V_{bc} - 1)$	Graphical: the y axis intercept on an extrapolated $I_i, V_{bc}$ semilog plot
$\Theta_N$	volts <sup>-1</sup>	Coefficient of exponential term for $I_N$ , theoretically equal to $q/KT$	$I_N = I_{es} (\exp \Theta_N V_{be} - 1)$	Slope of $I_N$ line
$\Theta_1$	volts <sup>-1</sup>	Coefficient of exponential term for $I_i$ , equal to $q/KT$	$I_i = I_{cs} (\exp \Theta_1 V_{bc} - 1)$	Slope of $I_i$ line
$V_{be}$	volts	Voltage directly across emitter-base junction	—	Direct measurement
$V_{bc}$	volts	Voltage directly across collector-base junction	—	Direct measurement
$C_{bo}$	farads	Emitter-base junction capacitance, including both transition and diffusion capacitance	See $C_{bc}$ below	Direct measurement
$C_{bc}$	farads	Collector-base junction capacitance, including both transition and diffusion capacitance	See $C_{bo}$ below	Direct measurement
$a_1$	volt <sup>(<math>n_1-1</math>)</sup> coulomb	Proportionality constant for transition capacitance component of $C_{bo}$	$C_{bo} = \frac{a_1}{(\Phi_1 - V_{be})} N_1 + \Theta_N T_{CN} (I_N + I_{es})$	Log-log plot of reversed bias $C_{bo}$ vs $V_{be}$ ; $a_1$ is intercept value on 1 volt axis
$a_2$	volt <sup>(<math>n_2-1</math>)</sup> coulomb	As for $C_{bc}$	$C_{bc} = \frac{a_2}{(\Phi_2 - V_{bc})} N_2 + \Theta_1 T_{C1} (I_i + I_{cs})$	As $C_{bo}$ but for $C_{bc}$
$\Phi_1$	volts	Built-in voltage of emitter-base junction	—	Estimated; usually between 0.8-1.2 volts for Silicon
$\Phi_2$	volts	Built-in voltage of collector-base junction	—	As above
$N_1$	—	Grading constant of emitter-base junction	$C_{bo} = \frac{a_1}{(\Phi_1 - V_{be})} N_1 + \Theta_N T_{CN} (I_N + I_{es})$	Slope of line $C_{bo}$
$N_2$	—	Grading constant of collector-base junction	$C_{bc} = \frac{a_2}{(\Phi_2 - V_{bc})} N_2 + \Theta_1 T_{C1} (I_i + I_{cs})$	Slope of line $C_{bc}$
$T_{CN}$	seconds	Time constant associated with diffusion capacitance for normal operation; a function of $I_N$	$T_{CN} = \frac{1}{2\pi \alpha_N f_{TN}}$	Direct measurement of $\alpha_N$ and $f_{TN}$
$T_{C1}$	seconds	Time constant associated with diffusion capacitance for normal operation; a function of $I_N$	$T_{C1} = \frac{1}{2\pi \alpha_1 f_{T1}}$	Direct measurement of $\alpha_1$ and $f_{T1}$ (or $f_{hfb1}$ )
$I_{pp}^*$	amps	Current from emitter photo current generator; a function of radiation dose rate ( $d\gamma/dt$ )	—	Not measured
$I_{pp}$	amps	Current from collector photo current generator; a function of radiation dose rate ( $d\gamma/dt$ )	—	Not measured
$K_e$	coulomb/unit	Proportionality constant relating emitter photo current with dose rate	—	Not measured
$K_c$	coulomb/unit	Proportionality constant relating collector photo current with dose rate	—	Not measured
$R_e$	ohms	Extrinsic emitter resistance	$V_{co} = \Theta^{-1} \ln \frac{1}{\alpha_1} + IR_e$	C-e voltage, zero collector current and e-b junction forward biased; measurement taken at high current where $IR_e$ term dominates
$R_c$	ohms	Extrinsic collector resistance	—	As above, but with transistor reversed
$R_b$	ohms	Extrinsic base resistance	—	$V_{eb}$ forward bias, collector open

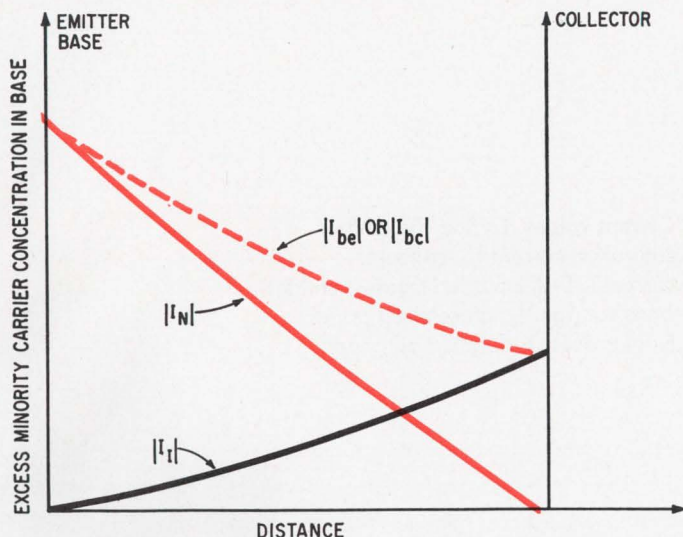

**Concentration.** Currents are proportional to the slope or gradient of the concentration lines for this npn transistor. Uniform base-doping is assumed and high injection effects are ignored. Current,  $I_N$  is proportional to slope of colored line at collector-base junction.  $I_I$  is proportional to slope of black line at emitter-base junction;  $I_{be}$  is proportional to slope of dashed line at emitter-base junction;  $I_{bc}$  is proportional to slope of dashed at collector-base junction.

sition capacitance is a function of d-c bias level.

The term  $\phi$  represents the built-in voltage that creates some space charge even when no bias is applied. The term  $n$  is the grading constant and  $a$  is a proportionality constant. Forward bias tends to reduce the denominator and hence increase transition capacitance; reverse bias has the opposite effect.

**The diffusion capacitance** results only from forward junction bias. As it varies so do the number of minority carriers in the base. These excess minority carriers are balanced by oppositely charged majority carriers. Since these excess carriers represent stored charge, there is a capacitive effect.

Extrinsic resistors,  $R_b$ ,  $R_e$ , and  $R_c$ , are those associated with the base, emitter, and collector of the transistor, respectively. The emitter and collector resistors tend to remain constant over a wide range of bias conditions. The base resistance tends to vary with operating conditions. Bias conditions for  $R_b$  are given later.

Intrinsic-junction resistances are related to the a-c impedances of the current generators  $I_{be}$  and  $I_{bc}$ , and although they are not directly necessary for this model,  $r_e$ , intrinsic-emitter resistance, will be discussed later.

The photo-current generators,  $I_{pp}$  and  $I_{pp}^*$ , are associated with the emitter-base and collector-base junctions. They represent the current that occurs as the junctions collect excess carriers created by radiation.

In this model, they are functions only of the radiation dose rate, not junction voltages.

To evaluate the  $I_{be}$  and  $I_{bc}$  currents, the parameters for  $\theta_N$ ,  $I_{es}$ ,  $\theta_I$ , and  $I_{cs}$  must be determined first. These parameters are obtained from d-c measurements of  $I_e$ , and  $I_c$ . If a  $V_{be}$  bias is applied, and  $V_{bc}$  is held at zero, the current equations are written:

$$I_N = I_{es} [\exp(\theta_N V_{be}) - 1]$$

$$I_I = 0$$

$$I_{be} = \left( \frac{1}{\beta_N} + 1 \right) I_N$$

$$I_{bc} = -I_N$$

Since collector current  $I_{bc}$  or  $I_c$  can be used to determine  $I_N$ ,  $I_N$  versus  $V_{be}$  may be plotted. On semilog paper this is a straight line, and if it is extrapolated back to the zero-voltage axis, the intercept gives  $I_{es}$ . The value of  $\theta_N$  is derived from the slope of the line. In practice, the value of  $\theta_N$  is very close to the theoretical value of  $38.9 \text{ volts}^{-1}$ , which is  $q/kT$  when measured at  $25^\circ\text{C}$ . The value  $q$  represents charge,  $k$  is the Boltzmann's constant, and  $T$  is the absolute temperature. Values for  $I_I$  and  $\theta_I$  are found by holding  $V_{be}$  at zero,

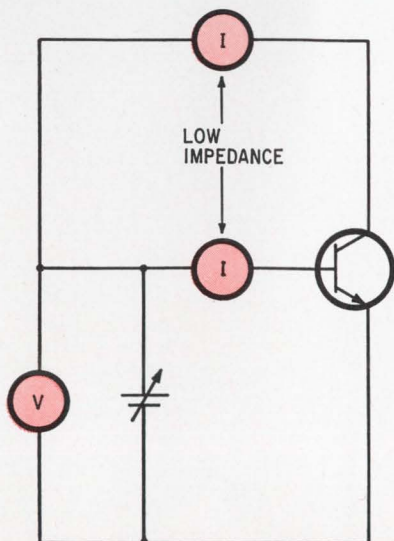

**D-c measurements.** Two low-impedance current meters are used to measure current gain under normal circuit operation. Meters short the base and collector, and assure accurate readings.

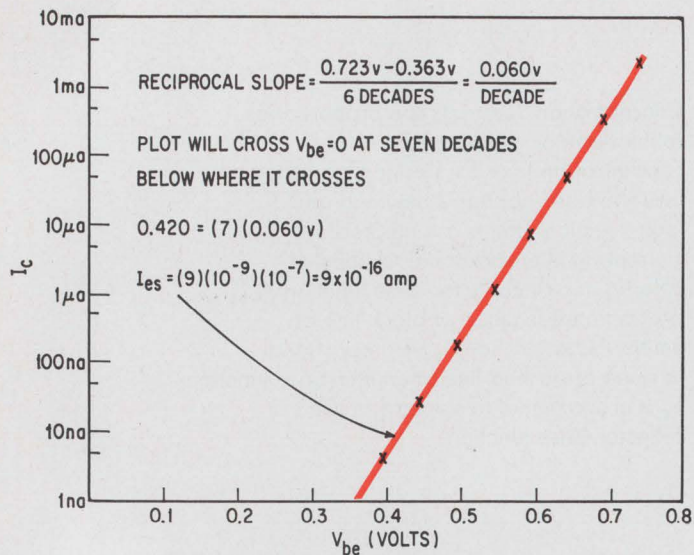

**Current values.** To find the emitter-saturation current  $I_{es}$ , collector current  $I_c$  first is plotted against emitter base voltage  $V_{be}$  on semilog paper. Final process is detailed on graph.

applying a  $V_{be}$  bias, and measuring  $I_e$ .

The circuit used for these measurements is shown at the bottom of page 89. The current meters must have very low impedances so that base and collector are effectively shorted. In this case meters were used that had a 1-millivolt drop at full scale. With a meter for both base and collector current  $h_{FE}$  ( $\beta$ ) also may be obtained. A typical semilog plot of  $I_c$  versus  $V_{be}$  is shown directly above. While  $I_{es}$  can be obtained graphically, in most cases mathematical extrapolation is more accurate.

The value of  $\theta_N$  is obtained from the plot as follows:

$$I_c = I_{es} [\exp(\theta_N V_{be}) - 1] \approx I_{es} (\theta_N V_{be})$$

$$\ln \frac{I_c}{I_{es}} = 2.303 \log \frac{I_c}{I_{es}} \approx \theta_N V_{be}$$

$$\theta_N \approx 2.303 \frac{\Delta \log \frac{I_c}{I_{es}}}{\Delta V_{be}}$$

The slope of  $I_c$  vs.  $V_{be}$ , plotted on semilog paper, may be used. The slope is one decade for each 0.060 volts. The reciprocal times 2.303 gives  $\theta_N = 38.5$  volts $^{-1}$ . The slight deviation from the theoretically anticipated value at 25°C of 38.9 volts $^{-1}$  is due to measurement and plotting inaccuracies and a small deviation from 25°C at the time of measurement.

**The values of  $\beta_N$  and  $\beta_I$**  can be determined in several ways. For current levels up to 1 milliamp it's simplest to use the data employed determining  $I_{es}$ ,  $I_{cs}$ ,  $\theta_N$ , and  $\theta_I$ . The collector and base currents in the d-c measurement circuit can be used to yield  $\beta_N$  as a function of  $I_N$ . If emitter and collector are reversed,  $\beta_I$  may be determined. At higher current levels,  $\beta_N$  may be measured on a transistor analyzer such as the Birtcher Model 70. Pulsing minimizes heating effects. Measurement of  $\beta_I$  at higher current levels can be a problem because the values are often too low to be measured on the Birtcher. In these cases, single-family pulsing on a Tektronix curve tracer is adequate.

Usually, when measuring  $\beta$  on a curve tracer or a pulse testers,  $V_{ce}$  should be just adequate to keep the device out of voltage saturation unless a specific application indicates otherwise. This may be difficult at high currents where the edge of saturation is poorly defined.

In most transistors with headers the collector is

mounted on the header with base and emitter leads passing through glass eyelets. This often results in package capacitance from collector to base and from collector to emitter. This package capacitance is between the header and the base and emitter lead as it passes through the glass eyelet. It measures about 1 picofarad.

**Package capacitances** are measured by deliberately overloading the device to burn out both emitter and base bonding wires, and then measuring the residual package capacitance. This measurement includes some capacitance between the base and emitter leads as well, and is themselves usually not too high. However, it is also present when making measurements on the unblown devices, so that correction for the measured package value gives a true junction indication.

The basic transistor arrangement is as shown at the top of the facing page. Extrinsic emitter, base, and collector resistances have been omitted because at the measuring frequency of 140 kilohertz (used on the Tektronix Type 130 L-C Meter) the resistances do not have an appreciable effect on the measurements. Values measured without shorting the other junction result in parallel-package and voltage-variable junction capacitance.

Ideally, the package capacitances would be subtracted out to analyze the transistor junctions, and then added back in as external circuit elements. But this requires

# Determining package capacitances

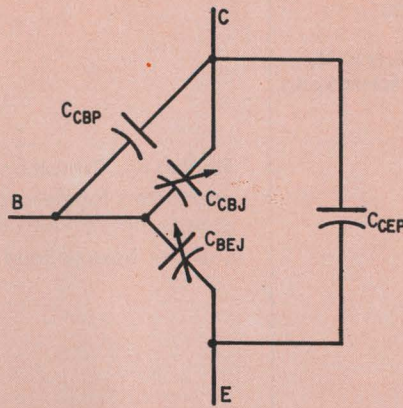

- $C_{CBP}$  = COLLECTOR-BASE PACKAGE CAPACITANCE
- $C_{CEP}$  = COLLECTOR-EMITTER PACKAGE CAPACITANCE
- $C_{CBJ}$  = COLLECTOR-BASE JUNCTION CAPACITANCE
- $C_{BEJ}$  = BASE-EMITTER JUNCTION CAPACITANCE

Typical transistor in can package

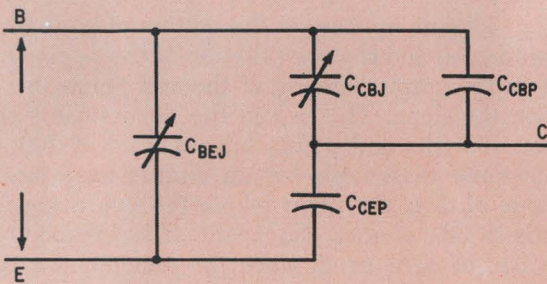

Base-emitter capacitance measured with collector-base not shorted.

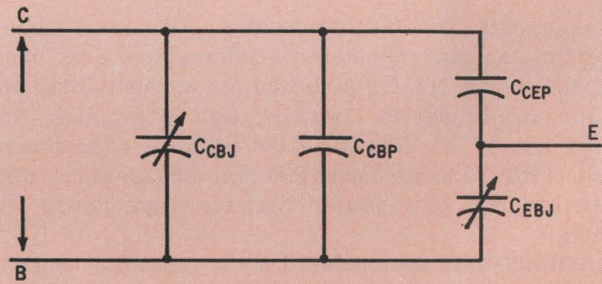

Collector-base capacitance measured with emitter-base not shorted.

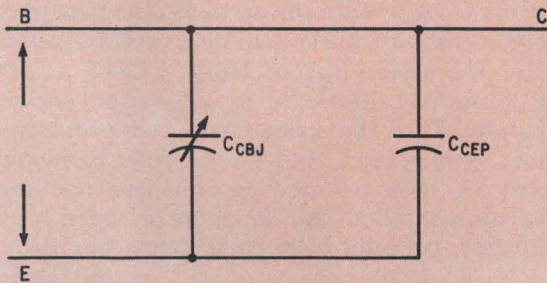

Base-emitter capacitance measured with collector-base shorted.

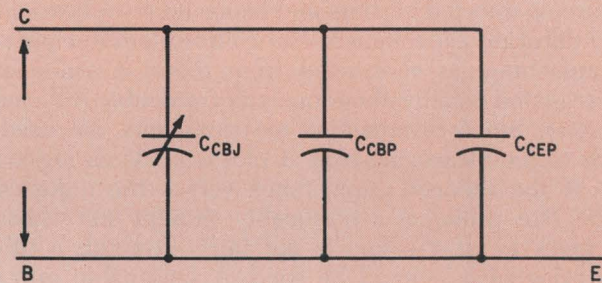

Collector-base capacitance measured with emitter-base shorted.

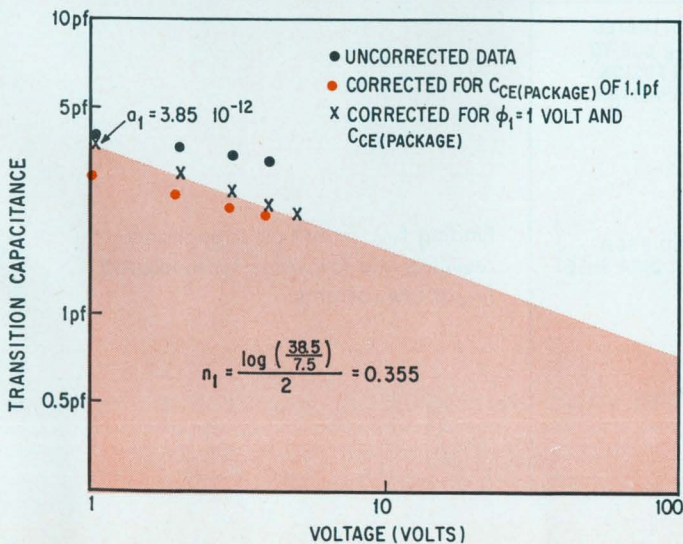

Evaluating  $a_1$  and  $n_1$ . Emitter-base parameters for the transition capacitance are obtained from a plot of transition capacitance versus base-emitter voltage.

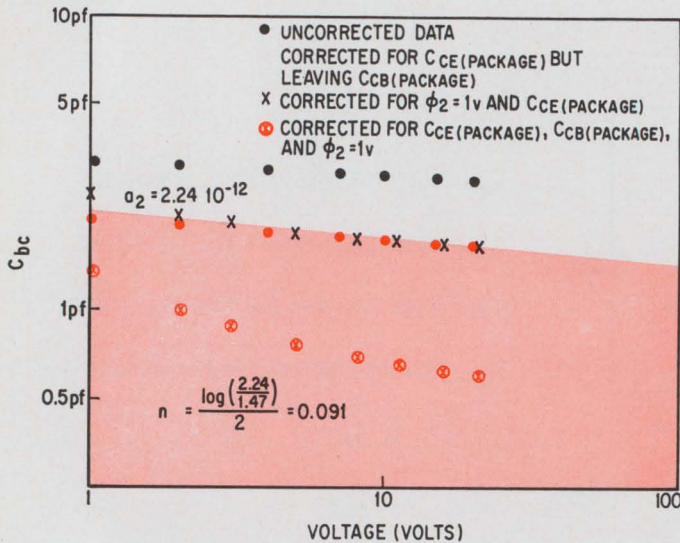

**Finding  $f_{TN}$ .** Transition capacitance parameters for the capacitance are obtained from a plot of  $C_{bc}$  versus collector-base voltage.

more computer time to represent a given real time—putting the package capacitances external to the extrinsic device resistance creates a short time constant that the computer is obliged to consider. But in practice, the engineer leaves the collector-base package capacitance lumped with collector-base junction capacitance, and ignores the collector-emitter package capacitance altogether.

**The emitter-base parameters** for the transition capacitance ( $a_1, \phi_1, n_1$ ) are obtained as follows: The capacitance is read as outlined previously at several reverse bias values (including zero bias) from emitter to base, with collector-base shorted. Only reverse bias is used, since there are no injected carriers and hence no complications due to diffusion capacitance. The collector-emitter package capacitance is subtracted from these. A value of  $\phi_1$  is estimated usually about one volt for double-diffused transistors. Since reverse-bias measurements are used,  $\phi_1$  adds to the measuring bias. A plot is made on log-log paper of the reduced capacitance versus the adjusted voltage. This produces a reasonably straight line whose slope gives  $n_1$ . If the line is not fairly straight, a different value of  $\phi_1$  should be tried. A reasonable range of  $\phi_1$  values is from 0.8 to 1.2 volts in silicon.

A typical plot for showing raw measured data, data corrected for collector-emitter package capacitance, and data corrected for collector-emitter package capacitance

and  $\phi_1 = 1.0$  volt, appears at the bottom of page 91. The fit is quite good and the computation of the  $n_1$  constant is shown on the graph. The log of the end points are used to obtain the slope. The two in the denominator comes from log 100 (the end points have a ratio of 100). The value is quite reasonable for an emitter-base junction. The value of  $a_1$  is the point where the line through the collected points crosses the 1-volt axis, irrespective of what value of  $\phi_1$  is used, since the denominator of the transition capacitance equation is unity at that point.

The collector-base junction is a more difficult problem. First it is not feasible to determine the collector-base package capacitance. Second, the collector-base junction often consists of a diffusion into an epitaxial layer of fairly high resistivity, backed up by a very low resistivity substrate. The result: space charge widens as reverse voltage is applied, until the space charge encounters the substrate. Then the space charge widens very little as voltage is increased. And even a fully corrected  $C_{bc}$  (corrected for both package capacitances and for  $\phi_2$ ) does not always follow the equation provided.

**Fortunately, collector-base capacitance** has its major effect—turn-on delay time—in most circuits when the junction is reverse biased. When the junction is forward-biased, the diffusion capacitance usually far outweighs the transition capacitance. Thus, an approximation of the reverse bias case is valid in most instances.

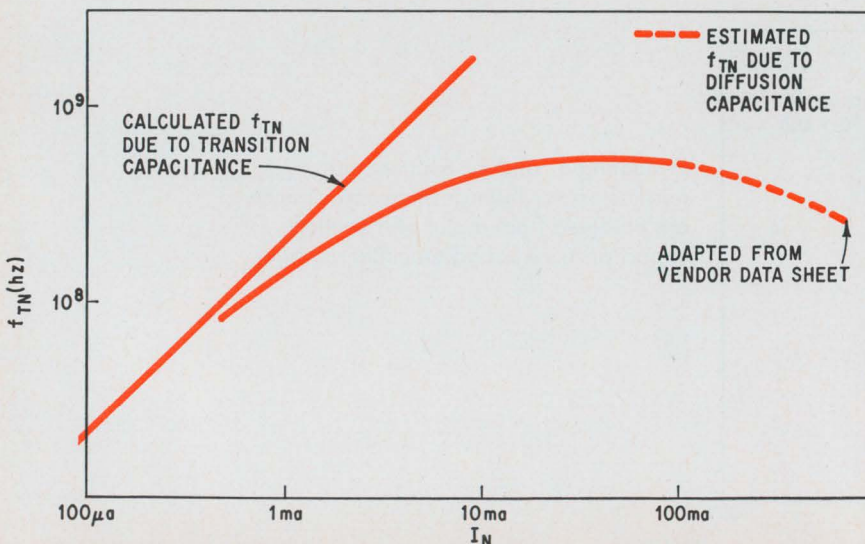

**Finding  $f_{TN}$ .** Transition capacitance resulting in a low value for measured  $f_{TN}$  at low currents.

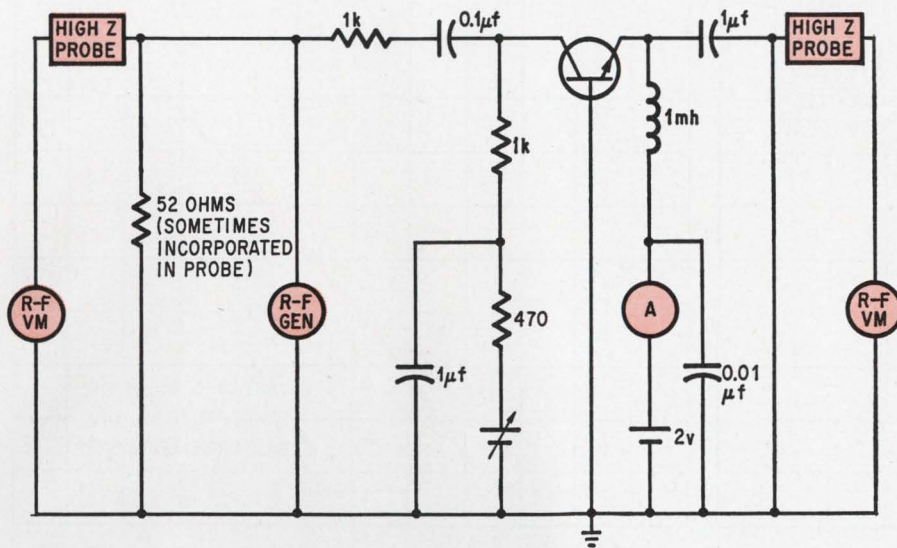

Measuring  $f_{hfbI}$ . Inverse alpha cutoff,  $f_{hfbI}$ , is obtained by providing a constant r-f signal at the collector and increasing its frequency until the output signal at the emitter drops by 3 db.

Raw and corrected data are plotted at the top of page 92. The line is drawn to approximate the data corrected for collector-emitter package capacitance and  $\phi_2$ . The value of  $\phi_2 = 1$  volt was arbitrarily selected. No reasonable value of  $\phi_2$  will give a straight line, and a value of  $\phi_2 = 1$  volt is high enough to prevent the denominator of the equation from becoming negative under normal conditions—the collector-base forward bias is not likely to exceed 1 volt. The plot of fully corrected data (circled X) shows that the junction follows the inverse-square law, which is expected for the collector-base junction with no interference from substrate material. This is true up to the 2-volt point, but from then on the slope decreases as the space charge encounters a somewhat diffused substrate.

**The basic equation** relating the diffusion capacitance time constant  $T_{CN}$  to a more frequently used parameter is:

$$T_{CN} = \frac{1}{2\pi \alpha_N f_{TN}}$$

where  $\alpha_N$  is the alpha, and  $f_{TN}$  the  $f_T$ , both for the transistor under normal operation. Parameter  $f_T$  is the frequency at which  $h_{fe}$  (a-c gain) goes to unity. It can be measured at a fixed frequency if the value is in the region where gain is dropping at 6 decibels/octave. In

this case,  $f_T$  equals the measured  $h_{fe}$  times the measurement frequency; both  $\alpha_N$  and  $f_{TN}$  are functions of current. In this case it is  $I_N$ , almost exactly collector current. The  $\alpha_N$  values may be obtained from  $h_{fe}$  measurements. Many  $f_T$  test sets only have a meter to check d-c emitter current. However, since the d-c emitter current is very near the d-c collector current if the  $\alpha_N$  is very close to unity—usually at moderate current levels—the d-c emitter current will be sufficiently close to  $I_N$ . A collector-emitter voltage of one volt is reasonable for these measurements.

**A typical plot** of  $f_{TN}$  versus  $I_N$  is shown at bottom of page 92. The plot verifies that the initial increase of  $f_{TN}$ , starting from low currents, results from the emitter and collector transition capacitances and the dynamic emitter-base junction resistance  $r_e$ . The capacitance remains relatively constant as current and emitter-base voltage are increased, but the dynamic resistance is inversely proportional to the current. This may be derived as follows:

$$I_N = I_{es} (\exp \theta_N V_{be}) - 1 \approx I_{es} (\theta_N V_{be})$$

$$\frac{1}{r_e} \approx \frac{dI_N}{dV_{be}} \approx \theta_N I_{es} \exp (\theta_N V_{be}) \approx \theta_N I_N$$

$$r_e \approx 1/\theta_N I_N$$

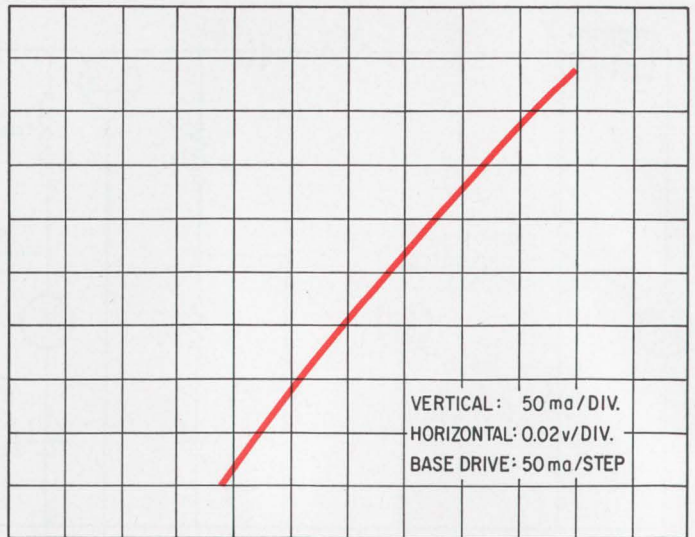

That  $r_e$  causes  $f_{TN}$  to be low at low currents may be checked by using the emitter-transition capacitance computed at several forward-bias levels; the collector transition capacitance at the collector-base voltage ( $V_{ce} - V_{be}$ ); and  $r_e$  at the appropriate current, to calculate a cut-off frequency due to transition capacitance. The effects of diffusion capacitances alone are found by computation:

$$f_{TN} (\text{diffusion}) = \frac{f_{TN} (\text{transition}) \times f_{TN} (\text{measured})}{f_{TN} (\text{transition}) - f_{TN} (\text{measured})}$$

The calculations of  $f_n$  are plotted. In this case the plot indicates a low current value at  $f_{TN} = 5.2 \times 10^8$  hz—due to diffusion capacitance. Rather than performing rigorous calculations in each case, it is usually sufficient to use the peak of the measured  $f_{TN}$  curve for the low current value of  $f_{TN}$  due to diffusion. The dropoff of  $f_{TN}$  above the measured peak is due to high injection effects.  $T_{CN} = f(I_N)$  is calculated from the equation using  $\alpha_N = f(I)$  and the diffusion capacitance component of  $f_{TN} = f(I_N)$ .

The basic equation for  $T_{CI}$  is the same as for  $T_{CN}$ , except that inverse alpha ( $\alpha_I$ ) and inverse  $f_T$  ( $f_{TI}$ ) values are required. But in the inverse direction the gain ( $h_{fe}I$ ) often is less than unity at all current levels, even at low frequencies. This makes the  $f_{TI}$  definition—the fre-

quency at which  $h_{feI}$  falls to unity—rather meaningless. Even when  $h_{fe}$  is sufficiently high,  $f_{TI}$  usually is unmeasurable on most standard sets which use a measurement frequency of 100 Mhz. For these reasons, inverse alpha cut-off ( $f_{hfbI}$ ) is a better method for determining the inverse frequency characteristics, and it is easily obtained. In relating  $f_{hfb}$  and  $f_T$  this correction is necessary:

$$f_T = \frac{f_{hfb}}{1.22}$$

A circuit for these measurements is shown on page 93.

Since diffusion capacitance effects normally far outweigh those of transition capacitance on most diffused transistors,  $f_{hfb}$  usually is constant at low currents, dropping off at higher values because of high carrier injection effects. Thus, both effects may be assumed due to diffusion capacitance and the measured values can be used directly.

**The best way** to get the time constant for diffusion capacitance,  $T_{CI}$ , at higher current levels is to apply a simulated storage-time test and compare actual storage-time measurements with calculated storage time from computer runs. Then, adjust  $T_{CI}$  at high currents to give acceptable correlation. For example, if the actual measured storage time is longer than the indicated computer



**Collector-emitter voltage.** Typical plots for two current ranges of  $V_{CE(SAT)}$  with no collector current (horizontal) versus base current (vertical). The slope of the straight-line portion at higher currents is used to determine  $R_e$ .

runs, then  $T_{CI}$  should be increased to increase the time constant.

To find  $R_e$ , the collector-emitter voltage should be measured with zero collector current and the emitter-base junction forward-biased. The collector-emitter voltage will be made up of two components—that due to the current flowing through  $R_e$ , and an intrinsic component.

At low currents, this intrinsic component is dominant and varies somewhat as  $\alpha_T$ . At high currents, the drop across  $R_e$  is dominant, while at the same time the intrinsic component is relatively constant. Resistor  $R_e$  is independent of current, so that at high values a linear current-voltage region is obtained, the slope of which may be used to get  $R_e$ . The following six steps provide a convenient way to make the measurement on a Tektronix Type 575 Curve Tracer:

**Step 1.** Attach the device to the curve-tracer as in measuring normal common-emitter characteristics.

**Step 2.** Set the peak-volts range switch at 0 to 20 volts, with the variable control counterclockwise (low voltage).

**Step 3.** Set the load resistance at 100 kilohms. (The second and third steps insure a minimum deviation from zero-collector current.)

**Step 4.** Place the vertical control in the base-current or base-source volts position.

**Step 5.** Set the horizontal control at a low voltage of 0.01 volts.

**Step 6.** Move the base drive-step selector initially to the lower part of the current drive region and place the toggle switch in the repetitive position.

Step 4 causes a pattern to appear on the scope face that represents base current vertically and  $V_{CE(SAT)}$  at zero current horizontally. To derive  $R_e$ , the base-drive current must be increased so that the voltage drop across the resistance is large compared to the intrinsic value of  $V_{CE(SAT)}$ . Plots of the  $V_{CE}$  versus  $I_b$  characteristics for a device for two different current ranges are shown on the facing page.

The left drawing at the top of the facing page, showing a relatively low current region, illustrates the change of intrinsic  $V_{CE(SAT)}$  due to variations of  $\alpha_T$ . Drawing at right of facing page, taken at higher current levels, shows a region of nearly linear increase of  $V_{CE(SAT)}$  with increasing current. Although the inherent of  $V_{CE(SAT)}$  may be changing slightly in this range, the slope of the line is a good indication of the emitter extrinsic resistance,  $R_e$ . In this case, the resistance is

$$R_e \approx \frac{9.0 (0.02) \text{ volts} - 6.0 (0.02) \text{ volts}}{8.8 (0.05) \text{ amps} - 5.1 (0.05) \text{ amps}} = \frac{0.06 \text{ volts}}{0.185 \text{ amps}} = 0.32 \text{ ohms}$$

Resistor  $R_c$  may be determined by the same process with the device inverted—collector and emitter interchanged.

The model is based on a fixed value of  $R_b$ . In practice it can vary tremendously as bias conditions are changed. Measurement for  $R_b$  should be made depending on the circuit in which the device is to operate. In switching circuits, for example,  $R_b$  can affect turn-on delay and turn-on time, during which period the value of  $R_b$  is high. However, if the base drive is a good current source, the  $R_b$  effect will be minimal. In any event, substituting a high value of  $R_b$ , of say 1 or 2 kilohms, to take care of this condition would result in unrealistically high  $V_{BE(SAT)}$  values of about 2 volts in the on condition.

For switching applications, the best method for determining  $R_b$  would be to use the Circus computer program to determine  $V_{BE(SAT)}$  with  $R_b = 0$  under the specific conditions of  $I_C$  and  $I_B$  which are to be used in a proposed circuit. The  $V_{BE(SAT)}$  indicated by the com-

puter is compared with actual  $V_{be(SAT)}$  measurements made under the same conditions on the device.  $R_b$  then is calculated from:

$$R_b =$$

$$\frac{V_{BE(SAT)}(\text{measured}) - V_{BE(SAT)}(\text{by computer with } R_b = 0)}{I_B}$$

This process gives the most accurate value for  $R_b$  in the on condition. Alternatively  $R_b$  can be found by measuring the emitter-base forward characteristics with the collector open. Here, the collector-base junction becomes forward-biased due to excess minority carriers. Although actual conductivity modulation under these conditions is not the same as when the device is in voltage saturation, the results for  $R_b$  are good. The forward emitter-base characteristics with collector open, when plotted on semi-log paper, has a straight-line region at moderate currents, which shows tenfold increase in current for a voltage increase of about 59 millivolts. At higher currents, the characteristic plot begins to curve off to a lesser slope, due to the effects of  $R_b$ ,  $R_e$ , and/or high carrier-injection effects. If the straight-line segment, with an approximate slope of one decade in 59 millivolts, is extrapolated to higher currents, this indicates the device's behavior with  $R_b = R_e = 0$ . The difference in voltage between the extrapolated line and the actual measured characteristics at a particular value of  $I_B$  may be used to calculate  $R_b + R_e$  at that base current:

$$R_b + R_e = \frac{\Delta V}{I_B}$$

where  $\Delta V$  is the difference in voltage between the two maximum points of both curves.

The previously determined  $R_e$  then may be subtracted out. An example of such a plot and calculation is given at the left. Resistor  $R_b$  is a function of current; hence for best results, the measurement should be made at a current close to the saturated-base drive value because this represents the on condition.

When a device is to be used in the active region, as in a class A amplifier, then  $R_b$  may be derived from hybrid h parameters:

$$R_b = \frac{h_{rb}}{h_{ob}}$$

The values of  $R_b$  measured in the active region are also a function of bias. For a class A amplifier this would be the quiescent point ●

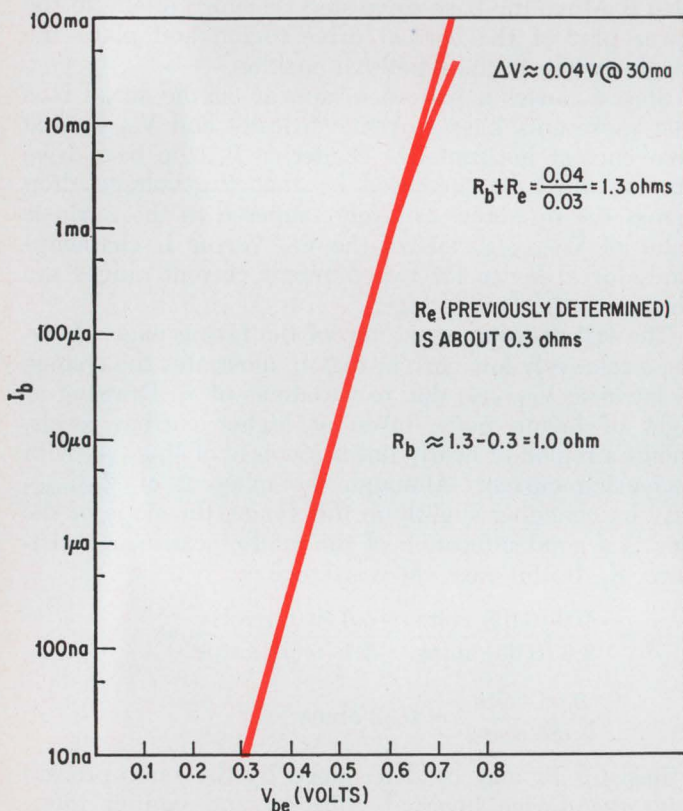

Resistance values. Resistors  $R_e$  and  $R_b$  can be evaluated graphically from a plot of  $I_b$  versus  $V_{be}$ .

## Bibliography

- Franklin F. Kuo, Waldo G. Magnuson, Jr., *Computer Oriented Circuit Design*, Prentice-Hall, Inc., pp. 361-362.
- J.J. Ebers and J.L. Moll, "Large Signal Behavior of Junction Transistors," *Proc. IRE*, Vol. 42, December 1954; also in "Transistor Technology," Vol. II, D. Van Nostrand Co. Inc., Princeton, N.J., 1958.
- C.T. Sah, "Effect of Surface Recombination and Channel on PN Junction and Transistor Characteristics," *IEEE Transactions on Electron Devices*, Vol. ED9, No. 1, pp. 94-108; January 1962.
- A.F. Malmborg, F.L. Corwell, and F.N. Hofer, "Net-1 Network Analysis Program," 7090/94 Version (LA3119), Los Alamos, N.M.: Los Alamos Scientific Laboratory, 1964.
- L.D. Milliman, W.A. Massena, and R.H. Dickhaut, "Circuc, A Digital Computer Program for Transient Analysis of Electronic Circuits, User's Guide," prepared for Harry Diamond Laboratories (346-1) by The Boeing Co., January, 1967.

# Show Us High Volume Needs For Plastic Zener Diodes Cheap As $\frac{1}{2}$ W Surmetic 20's

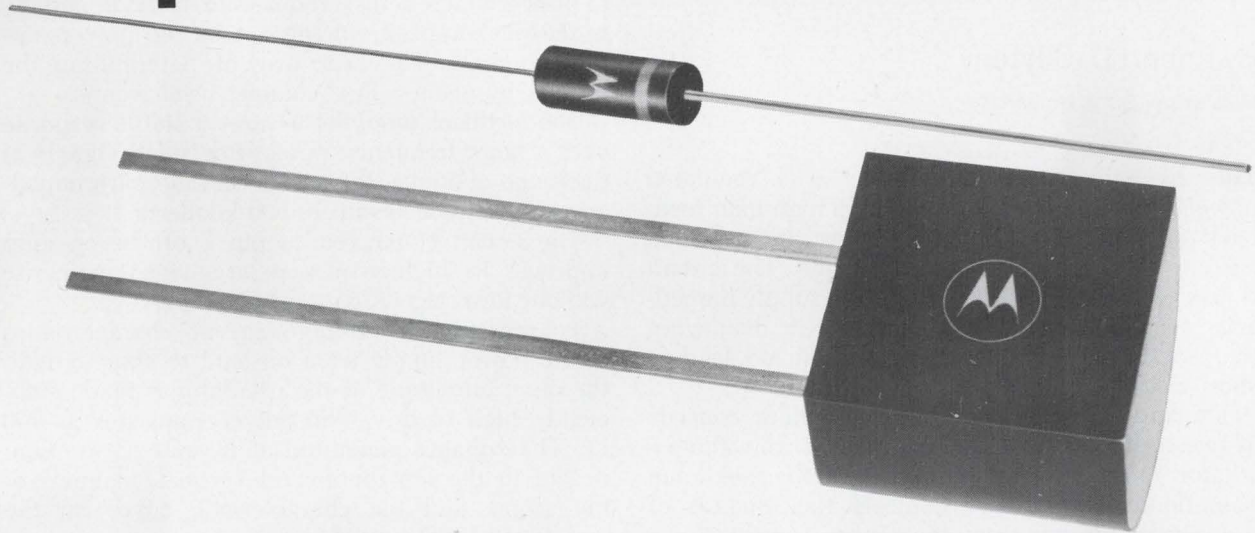

## And We'll Show You New, $\frac{1}{2}$ W Unibloc Zener Diodes!

Now — with the MZ92 zener diodes — you can get all the quality, performance and reliability of popular, Surmetic 20 zeners in a package that clamors for completely automated, device insertion techniques!

Both the new MZ92 Uniblocs\* and 1N5221 Surmetic 20's\* have identical 2.4 to 200 V regulation capability . . . the same performance stability through passivated junctions . . . similar economical plastic production techniques . . . virtually equivalent electrical specs . . . and twin 38¢† prices.

But . . . the MZ92 family is cased in the popular, single-ended, TO-92 plastic transistor package . . . **ideal** where selecting, setting and soldering by hand is unwanted . . . and where you're looking for all the cost and labor-savings you can get from mass production.

Specifically, the MZ92 series will dissipate 500 mW with  $\frac{1}{4}$ " leads held to 55°C . . . and easily handle up to 600 mW with  $\frac{1}{8}$ " leads. Reverse leakage is spec'd down to 0.1  $\mu$ A and typical Unibloc temperature coefficients low as 0.010%/°C ensure stable operation under various ambient conditions.

Voltage tolerances include 1, 2, 5, 10 and 20% for your optimized regulation requirements.

Let us show you the complete technical side of Motorola low-cost zener diode voltage regulation . . . send to Box 20912, Phoenix, Arizona 85036 for data sheets on both the new Unibloc and popular, axial-lead Surmetic 20 series.

Then ask to be shown evaluation units on either by your franchised Motorola distributor.

\*Trademark Motorola Inc.

†1,000-up, 2.4 to 33 V

*— where the priceless ingredient is care!*



**MOTOROLA**  
Zener Diodes

# Designer's casebook

*Designer's casebook is a regular feature in Electronics. Readers are invited to submit novel circuit ideas and unusual solutions to design problems. Descriptions should be clear. We'll pay \$50 for each item published.*

## A dynamic load tester for regulated power supplies

By Robert D. Guyton

Mississippi State University

The dynamic output impedance of a regulated power supply can be measured by a high-gain feedback amplifier that accurately sets the a-c load current over a broad frequency range. The circuit is useful for measuring the power-supply impedance as a function of frequency or in displaying the voltage-current characteristic from no load to short circuit on an oscilloscope.

The input to the operational amplifier consists of two components: an a-c component from the oscillator and a d-c component set by the 20-kilohm potentiometer. The pot controls the amount of d-c current drawn from the power supply. Since

the a-c voltage across the 1-ohm resistor is proportional to the a-c current through it, the impedance of the power supply can be obtained simply by calculating the ratio  $E_2/E_1$ , where  $E_1$  is the peak-to-peak voltage across the 1-ohm resistor and  $E_2$  is the peak-to-peak voltage across the power-supply terminals. The best way of determining the ratio is by using a dual-channel oscilloscope.

The feedback amplifier assures a stable response over a large frequency range. For small signals in the range of 50 ma, the circuit can measure impedances at frequencies up to 500 kilohertz.

The circuit connected to pin 7 of the op amp improves its high-frequency large-signal response without lowering its gain appreciably.

To measure the voltage-current characteristics of the power supply from no load to short circuit, the input amplitude of the oscillator is made sufficiently high to drive the power transistor at 100 hz. The voltages generated at  $E_1$  and  $E_2$  are connected to the horizontal and vertical channels of the scope, and the characteristic curve on the screen can be observed.

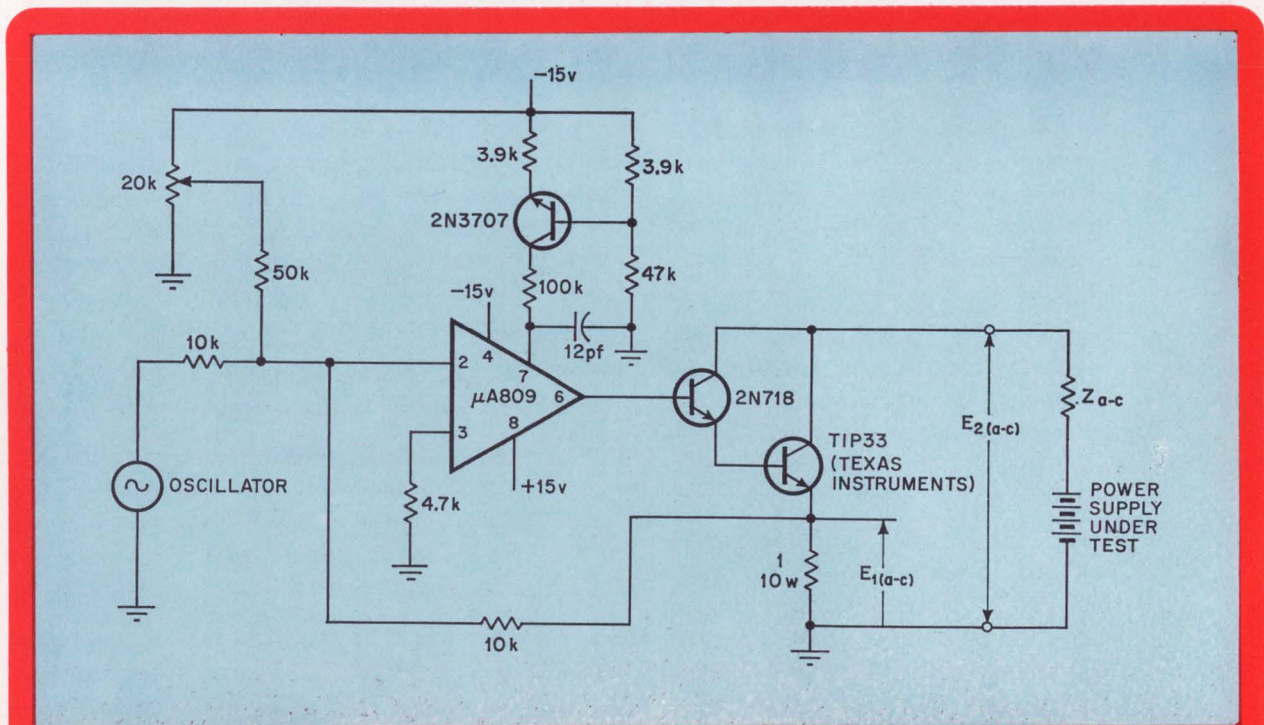

**Impedance.** An a-c component from the oscillator and a d-c component from the potentiometer are delivered to the input of the op amp. The power transistor forces an a-c voltage across the 1-ohm resistor from which the power supply's impedance,  $Z$ , can be readily determined from the relation  $Z = E_2/E_1$ .

# P-i-n diode T switch consumes little power

By Roland J. Turner

General Atronics Corp., Philadelphia, Pa.

High isolation and low insertion loss is usually difficult to achieve in the familiar balanced-bridge radio-frequency switching circuits because of the voltage offset and capacity of the diodes. Better performance can be obtained with the single-ended configuration that uses three p-i-n diodes connected as a T switch. With this setup, only a small current drive of 2 milliamperes is needed for each diode, thus allowing many gates to be handled by one driver circuit at a lower power consumption than other switching circuits.

The circuit is normally on with no switch-off pulse present. Thus the two-transistor control circuit is off while the shunt constant-current circuit draws 4 ma from the diode T switch. The two

back-to-back diodes in series each conduct 2 ma while the shunt diode remains off. At this current level, each conducting diode has a forward resistance of about 10 ohms, which accounts in part for the circuit's low insertion loss of 1.3 decibels at a frequency of 60 megahertz. Higher control current would decrease diode resistance but increase the needed driver power.

The T switch employs a wideband toroidal transmission-line type transformer which converts the 50-ohm transmission line characteristic impedance at the center tap to 200 ohms, thus minimizing the insertion loss effects of the diode resistance at the low control current used.

When a 6-volt positive pulse appears at the gate's input, both transistors in the gating circuitry turn on, generating 6 ma of current at the output. Thus a net current of 2 ma is forced into the diode switch, back-biasing the series diodes and forward-biasing the shunt diode. The switch opens and the signal is blocked.

At higher frequency levels the p-i-n diodes must be driven harder, turned on by 10 ma, to achieve insertion losses below 1 db and isolations in excess of 50 db at 600 Mhz.

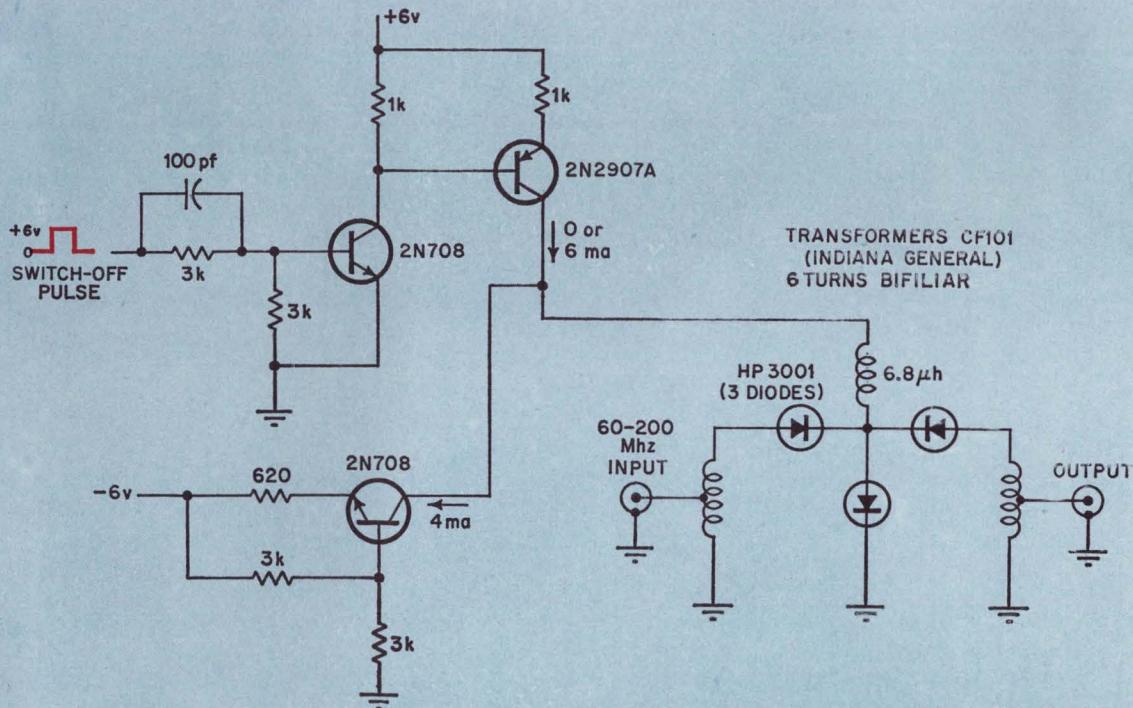

**Low bias.** The T switch needs less control current and, therefore, less power to switch radio-frequency signals. In its normally on condition, the constant-current circuit draws 4 milliamperes from the diode T switch. The two back-to-back diodes are in series, with each conducting 2 ma while the shunt diode remains off.

# Regulator holds temperature of chip's substrate constant

By D.P. DeAngelis and M. Palumbo

Dynell Electronics Corp., Melville, N.Y.

Many monolithic transistor arrays containing matched transistor pairs also incorporate a substrate temperature regulator on the same chip. This regulator is useful in building low-drift differential amplifiers. However, the matched transistors in the circuits now available commercially have bandwidths limited to 40 megahertz, which may not be large enough for some applications. Other arrays without the regulators, such as the RCA CA3045, have transistor pairs with bandwidths of 300 Mhz; an external temperature regulator can be built to take advantage of this wide bandwidth.

In the array, transistor  $Q_1$  serves as the temperature-sensing element for the heated substrate; its base and collector are tied together to act as a diode. The base-emitter voltage varies linearly

with temperature. Transistors  $Q_2$  and  $Q_3$ , connected in a constant-current mode, provide the power to heat the substrate to the desired ambient temperature, and  $Q_4$  and  $Q_5$  are the matched transistor pair with the 300-Mhz bandwidth.

The external temperature regulator consists of the op amp—LM 101 and its associated circuitry—which detects a voltage corresponding to the substrate's temperature and compares it with a voltage set initially to correspond with the desired ambient temperature. The differences between these two voltages is amplified and delivered to  $Q_2$  and  $Q_3$  on the chip, which in turn heats the substrate.

The voltage divider, composed of  $R_1$ ,  $R_2$ , and  $R_3$ , is set to a voltage corresponding to the maximum desired substrate temperature. When the ambient temperature goes down, the feedback from the regulator pumps more power to the chip to heat it.

The substrate is biased at  $-1.5$  volts by  $R_4$  and  $R_5$  to maintain the proper p-n junction isolation between the transistors on the chip.

The circuit operates over an ambient temperature range of  $0^\circ\text{C}$  to  $70^\circ\text{C}$ . The input offset voltage of the matched transistor pair does not exceed 5 millivolts over the 300-Mhz bandwidth.

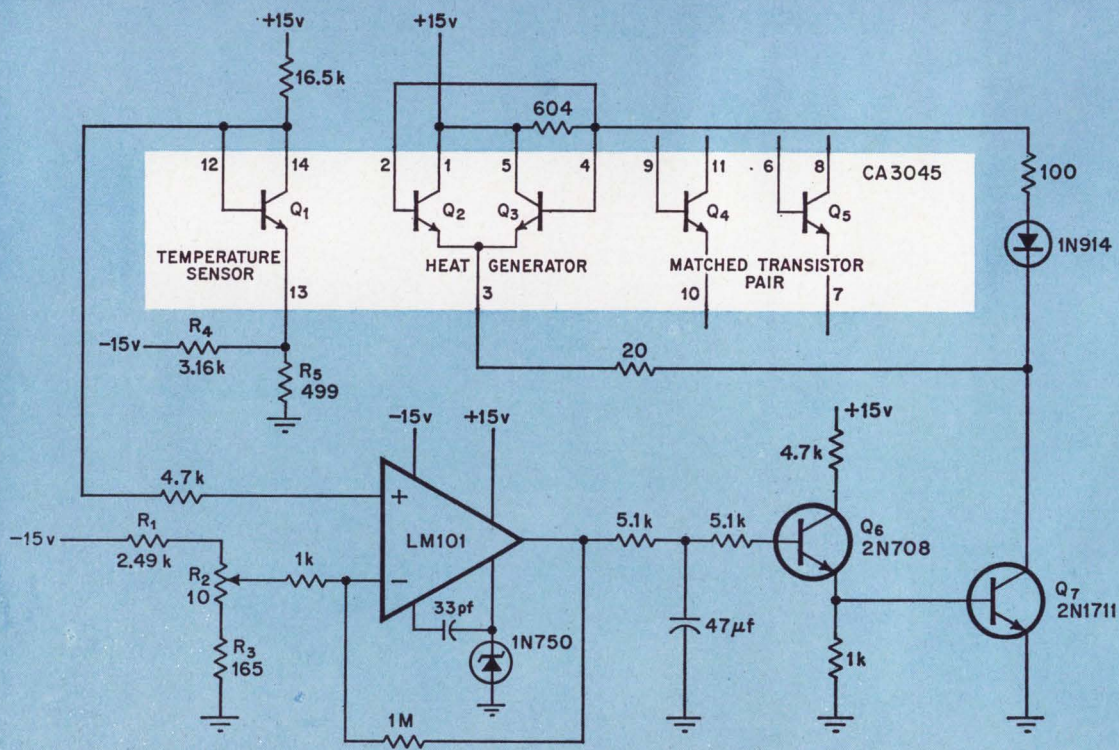

**Good Match.**  $Q_1$  senses the substrate's temperature and delivers the corresponding voltage to one input of the op amp. The other input is set to the voltage equivalent of the desired temperature. This voltage difference drives the current regulator,  $Q_2$ - $Q_3$  which heats the chip to hold its temperature constant.

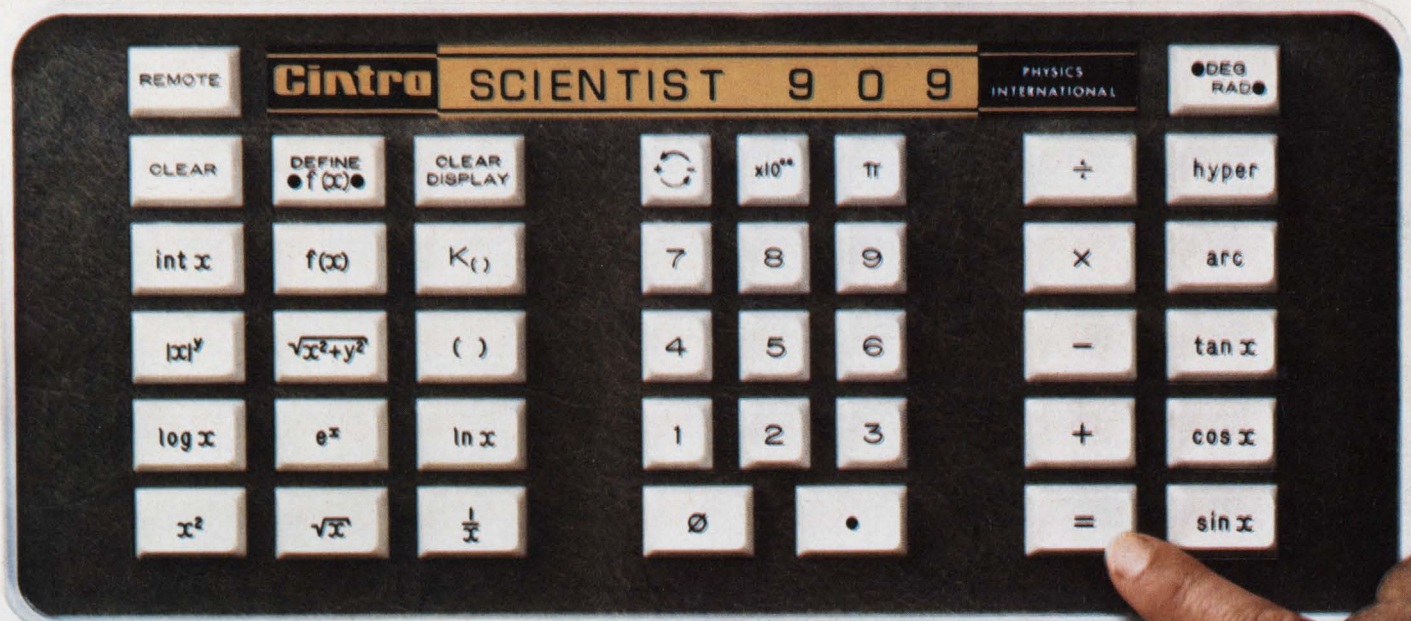

# Talk to me, Cintra Scientist.

## What should I ask you?

**Ask a lot.** Ask, for example, the solution to  $(A + B \times C)^{(D+E \times F)} =$ , where A, B, C, D, E and F can be data or any combination of keyboard functions such as  $\sin X$ ,  $\log X$ ,  $e^x$ , etc. Just key it in exactly as written and you'll have the answer by the time your finger is off the equals key. The Scientist's dynamic range is 200 decades with 10 significant figure accuracy.

**Try it yourself.** Take an everyday slide rule operation such as  $286.4 \times 10^{20} \div .004612 \times 10^{12} =$ . The answer is immediate! Your entered data can be in scientific notation, floating point or combinations of both. The Scientist will keep track of decimal points and exponents for you. All keys are hardwired, and note how logically they're arranged. Power? **Ultra-power** is more like it.

**Stored constants?** You get 26 with the basic model, up to 122 optional.

**No machine language** to learn! The Cintra Scientist talks your language. Press the keys and find out for yourself in just five minutes.

**Behind the keyboard?** Hermetically-sealed MOS/LSI and integrated circuitry assures reliable, trouble-free performance.

**Can you operate as a computer, too?** Certainly. With the Cintra Model 927 Programmer, up to 25,600 consecutive steps can be performed automatically in addition to loops, branches and subroutines. Further-

more, the modular design allows expansion into a mini-computer with peripherals such as the Cintra 941 Printer, plotters, and A to D converters for on-line/off-line applications.

Just \$3,780 puts the power of the Cintra Scientist at your fingertips. Now ask yourself a question. Shouldn't I find out more about the Cintra Scientist?

### Look at these unique keys

**$|x|^y$**  **Ultra-powerful.** Includes all 10-digit integer and non-integer values of x or y.

**$x10^{**}$**  An **order of magnitude** more versatile. Enter floating point and scientific notation data, or any combination interchangeably.

**=** **Equate the value.** Press the key and immediately see the result of a long complicated expression.

**( )** **In a bracket by itself,** this key allows any other key to operate on a group of terms.

**DEFINE f(x)**

**f(x)**

Use this **highly functional** 84-keystroke programmer for series expansions, transcendental equations, operational analysis, etc. Define f(X) as any function up to 84 consecutive steps; thereafter execute this defined function with one f(X) keystroke (254 steps opt.).

**K()**

**Constantly works for you.** Set constants equal to  $K_1$ ,  $K_2$ , etc. To reuse any constant in any equation, simply key  $K_0$  and the subscript thereafter. Stores up to 26 (122 optional) 12-digit constants including exponent and signs.

**$\sqrt{x^2+y^2}$**

**Statistically proven** most useful for least square sums, RMS, and vector magnitudes, etc.

**DEG RAD**

View your data from a **better angle.** Keylight shows which trigonometric units you are using.

**REMOTE**

This **far out** key lets you communicate with up to 99 instruments: printers, plotters, computers, A to D converters, etc.

Your answer is the Cintra Scientist—the 24-pound computer at your fingertips.



**Cintra**  
Physics International

440 Logue Avenue  
Mountain View, California 94040

(415) 969-9230

Cintra Incorporated—a subsidiary  
of Physics International Co.

# Describe your needs in power tubes. Westinghouse can fill them.

We have over 700 tube types from rectification to RF heating to control diodes to fill your power tube needs. Most of them like RF oscillators, RF amplifiers, pulse, ignitrons, thyratrons, rectifiers, ionization gauges, and ion pumps are available from over 200 stocking locations. Two new additions are WL-8170/4CX5000 and WL-8171/4CX10000 tetrodes. They're backed by over 40 years experience in power tube design and manufacturing.

We'd like to help you decide on the right power tube for your application. For more information, write Westinghouse Electronic Tube Division, Elmira, N.Y. 14902.

ET-4-69





You can be sure...if it's Westinghouse



Circle 103 on reader service card

# Her Majesty, Elizabeth 2

Britannia's all-electronic floating resort has a collision-avoidance system, a satellite-navigation system and a central computer

—but her notch antennas are still in the shakedown phase

By Roger Kenneth Field  
*Electronics staff*

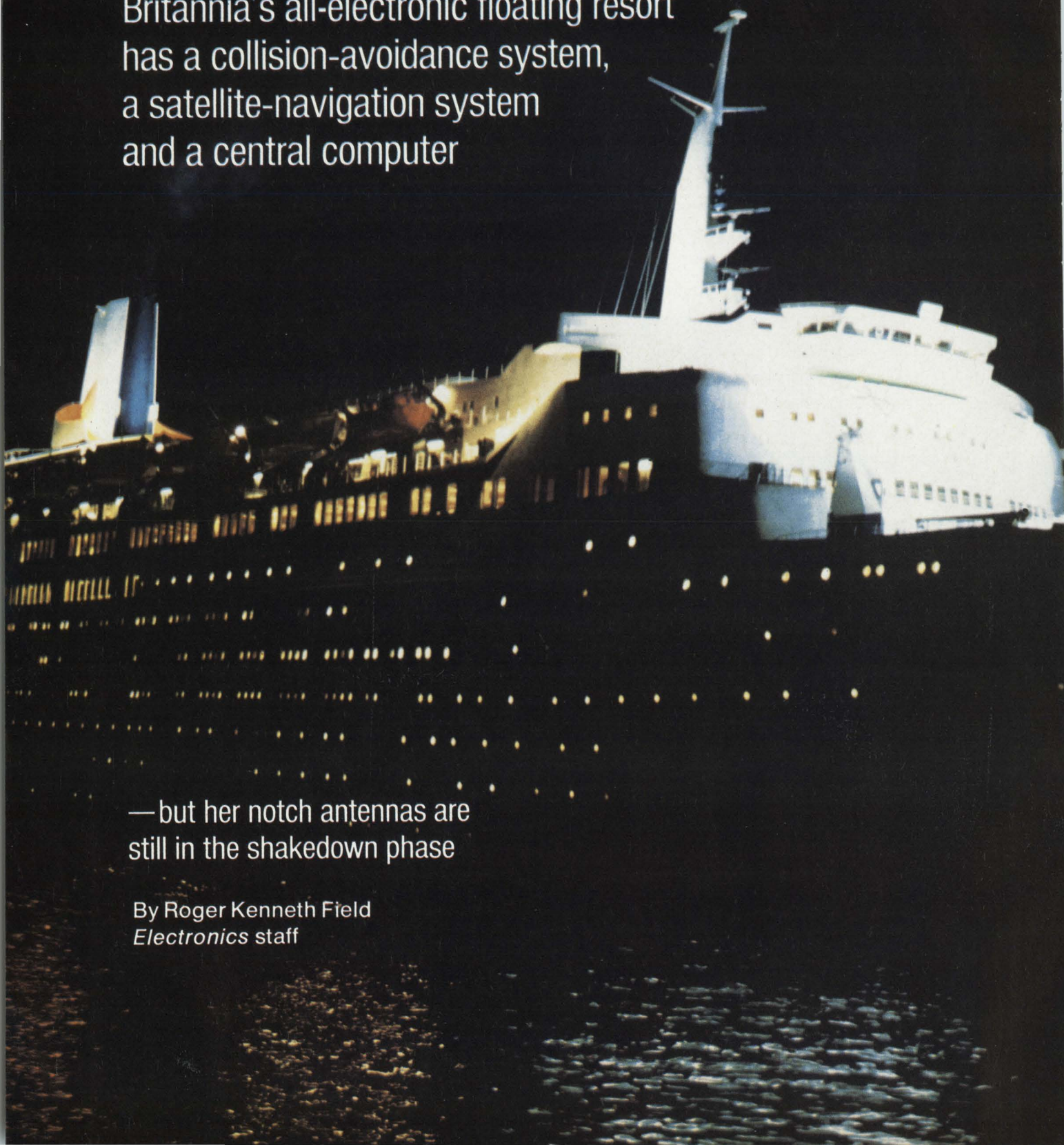

**Ultramodern.** Main control room aboard the QE2 reflects up-to-date design and engineering that characterize the entire ship. Computerization and easy-to-read instrumentation layout reduce the number of officers required to monitor and log essential data. Alarms are sounded automatically when critical operating parameters are exceeded.



**Shooting the satellites.** A navigator checks weather map reproduced on a Muirhead facsimile machine from a radio transmission on shore. On his left is ITT Aerospace's satellite navigation system, which contains its own PDP-8/1 computer made by Digital Equipment Corp. The ITT/DEC combination contacts one of several Navy navigation satellites for an hourly position fix. The fixes are accurate to a tenth of a nautical mile—about 600 feet. That's within the ship's length—963 feet.

● Can electronics and hedonism coexist peacefully within a resort hotel that follows the sun? For Cunard Lines' new supership, Queen Elizabeth 2, the answer is yes—after a period of adjustment. Embodied in the design of this elegant sea-going lady is an extraordinary complement of sophisticated electronic systems that makes fun cruises safer and more convenient for passengers, and more efficient for Cunard.

On board the QE2 are collision-avoidance radars, photo-typesetting equipment for publishing a daily newspaper, a satellite-navigation system, a central telephone exchange that can place four calls simultaneously anywhere in the world, and a central computer. These, as well as many other highly complex electronic systems and units (see table p. 106) were installed smoothly and with minimal debugging. Ironically, a cluster of four simple notch antennas, intended for ship-to-shore transmission, proved the most troublesome components.

The choice of notch antennas—essentially open-ended slot radiators—hardly represented a daring decision. Notches had been used for years on British aircraft. And Cunard itself had used them on other ships—the Franconia and the Carmania.

The notches have a number of features Cunard finds attractive. They are omnidirectional, providing a strong signal regardless of the ship's direction. Unlike wire antennas, they don't shield each other or affect each other's

## For the Queen, king-sized electronics

ITEM	COMPANY	REMARKS
Gyro compass (2)	Sperry	Model MK XXX
Course recorder	Sperry	
Steering control	Sperry	SSC duplex gyropilot
Satellite-navigation system	ITT Aerospace	68 minutes between fixes
Navigation computer	Digital Equipment Corp.	Model PDP-8/1
Collision-avoidance system	GEC-AEI Ltd.	
Echo sounder	Kelvin Hughes	
Echo sounder	GEC-Marconi	
Long-range position indicators (2)	IMRC	Loran A; Loran C
Automatic direction finder	GEC-Marconi	Lodestar 2
Submerged log speed and distance indicator	Sal Jungner	
Track computer radar	GEC-AEI Ltd.	A/4 Escort 658
Weather chart	GEC-Marconi	649/L/DA
Bridge wing controls		
Lifeboat transceivers	IMRC	
Ship-to-shore radio-telephone	GEC-AEI Ltd.	Lincompex non-fading or Vocad
Notch antennas	BAC	
Self-tuning transmitter	IMRC	
Teleprinters	ITT Creed	
Telephone exchange	STC	PA BX type 3
Receivers for daily news	GEC-Marconi	"Piccolo"
	Plessey	PT 200
Photograph transmitter	Muirhead	
Vhf radio-telephones	Standard Electric A/S	
Sound system	Tannoy Products	
Diathermy	Erbotherm	
Ultrasonic vibrator	Reditron	Mark 2
Dental X ray	Oralix	
Infrared/ultraviolet	Therakin	
Magnetic-tape transports (4)	Ampex	
Central computer	Ferranti	Argus 400
Whistle	Kockums	ElectroTyfon

The above electronics inventory is color-coded as follows: orange, navigation; purple, communications; green, hospital; yellow, computer.

**Sidewalk superintendent.** Passengers can play navigator by watching the face of a bright red microfilm reader (above), which displays a chart of the QE2's route. The Daily Telegraph, a morning newspaper delivered to each passenger's door, is written and composed in England, and sent by wireless to the ship, which picks it up on a Marconi receiver (middle). It's called a "Piccolo" because characters are transmitted as audio tones, which sound much like its musical namesake. A Ferranti Argus 400 central computer (below) logs data from shipboard machinery, and keeps track of enormous foodstuff and supply inventory.



**Do-it-yourself kit.** In case QE2 must dock without the aid of tugboats, two fiberglass communications consoles and a gyro repeater help ship's officers to keep the dock in view while maintaining contact with the ship's personnel.

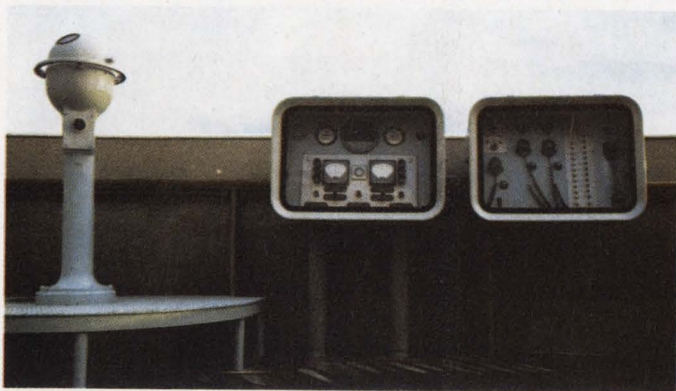

**EDP everywhere.** Even the radar console has its own computer. The pilot room, though, is still called the wheelhouse.



strength of reception. And notches are inconspicuous, whereas wire antennas are ugly and detract from the clean lines of a modern streamlined ship.

But notches have one inherent drawback: heat dissipation in the antennas or their coupling circuitry, usually attributable to impedance mismatch. Typically, a notch with an impedance of 0.01 ohm at 2 megahertz might have to be matched to a transmitter with a 50-ohm output. This mismatch can dissipate enough heat through the coupling circuitry to cause drift.

But heat generated by the hf notches on the QE2 was attributed to causes beyond mismatching. Due to a misunderstanding between International Marine Radio Co. of Croydon and Cunard, the British Aircraft Corp. supplied notches for the QE2 that could not take the power put out by the IMRC transmitters in the 2-to-4-Mhz band. According to Cunard, BAC was asked to supply notches capable of handling 200 watts, double sideband (and therefore continuous wave) at 2 to 4 Mhz—and BAC's notches were designed to handle twice that. But the transmitters can put out more than 600 watts cw in this range. On experiments with a trial notch prior to installation, so much heat was dissipated that the bolts holding the notch reportedly glowed red. The design that was actually installed still ran too hot, causing low-frequency capacitors in the coupling circuit to disintegrate and a set of relay contacts to fail. Upgrading

these components staved off failure.

But evidently the heat problem in the notches persisted. At one point, when the ship's engines were run during radio transmission, several crewmen noticed a plume of steam issuing from the notch antennas' vicinity. This happened because moisture in the smokestack crept into the notches through the same holes that carry in cables. Sealing the cable holes stopped the steam.

**Although Cunard is now pleased** with the notches, they aren't being put to use. Surrounded by automatic self-tuning transmitters, but with notch antennas and their coupling networks that are neither automatic nor self-tuning, the radio communications crew is unwilling to hop back and forth trying to tune the couplers and notches to the transmitters. So the notches remain idle, while practically all transmissions leave the QE2 on one of the four wire antennas that have been added to the two required for the emergency and main transmitters. And as for the wires screening each other and affecting reception, "Oh, we just got out there and rearranged them a little bit," says a crew member. "Now, mates in the radio room can put through calls to New York and the U.K. while chewing an apple."

Fortunately, the sophisticated equipment aboard the Queen Elizabeth 2 did not run aground. Some of that interesting nautical electronic gear appears in the accompanying portfolio of photographs. ●

**Looks aren't everything.** Notch antennas (white, box-like structures below) nestle inconspicuously at the base of QE2's smokestack. But they're seldom used. Rather than retuning the notches' coupling circuitry manually for each transmission, radio crewmen prefer to transmit over wire antennas (left)—which the notches were supposed to eliminate.



# Arc-plasma deposits may yield some big microwave dividends

Capable of accommodating a wide variety of deposition and substrate materials, arc-plasma spraying technique lends itself to the fabrication of thick-film IC's; *D. H. Harris* and *R. J. Janowiecki* of Monsanto Research Corp. explain how



**Long memory.** The 16-bit read-only memory, mounted in a test board, has a flexible clad-fiberglass etched to form drive lines, one set on a side, which have areas of coincidence corresponding to the bit pattern. The assembled drives have a 30-nanosecond readout capability. Future devices could use low-cost ceramic substrates with increased bit densities.

● Designers of microwave integrated circuits, as well as users, have generally settled for hybrids because today's planar fabricating techniques don't offer them the performance they require. But surprisingly, where the newest techniques have failed, an old technique commonly used to spray protective coats on airplane engine components may finally hold the long-sought key to monolithic-type high-frequency circuits. The process uses an arc-plasma spray (APS) to produce low-loss films for a variety of applications.

What makes APS so attractive is that it can be used with a wide range of materials. And it combines the capability of thin-film deposition techniques, which yield high-quality films, with thick-film processes which yield high-rate buildups.

Among the materials APS can handle are: metals and metal alloys for stripline and microstrip conductors; metal oxide and cermets (mixtures of metals and ceramics such as molybdenum-spinel) for resistors; dielectric materials for capacitors (including barium titanate that also can be used in piezoelectric transduction); semiconductor material combinations (doped germanium-silicon, for example) for thermoelectric power generators; and ferrimagnetic ceramics for microwave circulators, isolators, phase shifters, magnetic logic and memories.

In addition to the variety of materials it can handle, APS has important processing advantages over other

planar techniques. Deposition rates range from 4 microns per minute per square inch to 2 mils, enabling the easy growth of films less than 1 micron thick to those hundreds of mils thick on a wide variety of substrates.

The process does not rely on high-temperature bonding. As a result, even plastics are suitable substrate materials. And because plastics can be used, it is possible to envision depositions of polycrystalline materials on polycarbonate for electronic components in applications where inexpensive rugged structures are required. Even hard-to-handle substrates, such as beryllium oxide, an extremely good thermal conductor, can be utilized for high-power applications.

**The hallmark of APS** is quality. High-density films can be obtained that are almost physically and electromagnetically identical with the bulk material. Density of deposited ferrite, for example, is within 99% of theoretical, and intrinsic hysteresis, coercivity, and saturation magnetization are in equally good agreement. Further, dielectric loss tangents of ferrite composites—the measure of microwave performance—are as low as 0.0002 and depend exclusively on the contribution of the separate loss tangent of the composite materials.

Another important property of APS films is that there is no loss caused by the interface. Equally important, uniformity of the deposition is within 10% tolerance on films between 0.5 and 20 mils thick. Refinements

**Spray torch.** Operating with argon arc gas, this APS equipment from Plasmadyne can emit a 30,000° F. plasma jet that melts the particles of the deposition material and implants them onto the substrate. The equipment's operation was modified for IC component deposition.



## APS—how it's done

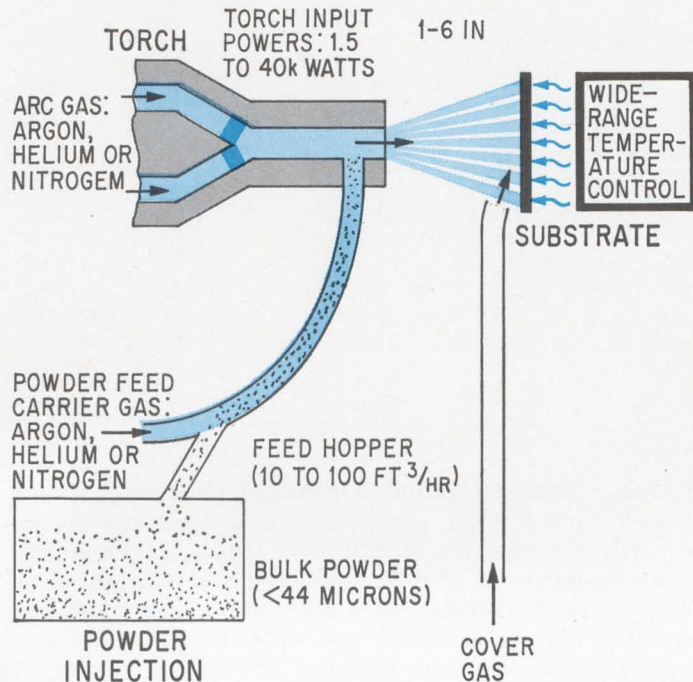

**Torch setup.** An inert gas, passing through a d-c arc produced by concentric water-cooled electrodes, is heated to a high-energy plasma. Particles, which are carried by a gas stream to the plasma, are melted and sprayed onto the substrate.

**Fine art.** Melt characteristics of a material are examined over a broad range of torch parameters by rapidly passing the torch across a series of glass microscope slides mounted at fixed distances from the torch.

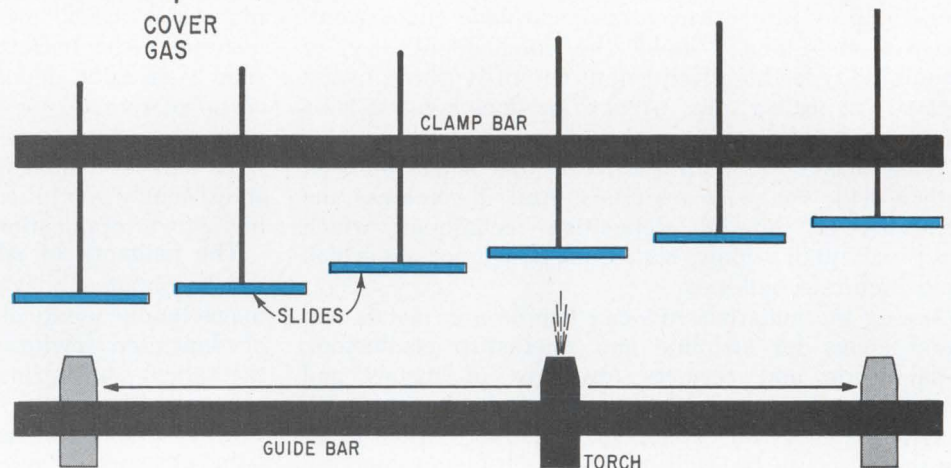

First developed to provide metal and ceramic coatings for exposed metal surfaces, the arc-plasma spraying (APS) process uses a high-temperature gas stream to convert powder into molten particles, which then are formed into a coating film. It's used by the aircraft industry to coat jet aircraft engine blades.

Unlike vacuum methods, the deposition technique is mechanically quite simple. The substrate is mounted on a temperature-controlled holder located in front of the spraying torch. The powdered material then is fed through the torch nozzle where it is melted and carried to the substrate by the plasma jet. X-y rastering of either the torch or the substrate assures uniform coating.

The **plasma generators** are vortex-stabilized torches that swirl plasma gases between two water-cooled electrodes—a copper anode which serves as a nozzle, and a thoriated tungsten cathode axially positioned within the anode. An arc between the electrodes produces the plasma, or high-temperature ionized gas stream, when an inert gas, such as argon, is fed through the arc and out the nozzle. In general, powders are transported in a carrier gas. Although commercial torches may provide alternate powder injection sites, none has been found that demonstrates efficient, complete, and uniform melting of injected particles over the range desired for electronics applications.

Therefore, such parameters as electrode geometry, powder size, plasma and powder flow rates, and the time the powder remains in the plasma, all must be optimized with presently available equipment.

Particle-melting studies are used to determine optimum process parameters. In this empirical procedure a series of glass slides mounted at different distances from the torch are sprayed under different processing conditions. Then the slides are microscopically examined for melting uniformity. Further operating-condition refinements are obtained through optimum-seeking methods to correlate process conditions with film properties.

This **correlating ability** allows a film to be tailored to particular applications, a property unique to APS. For example, grain size, density, and magnetic saturation of ferrite films can be adjusted for the intended operation as in the case of high-power devices in which smaller grain size improves performance.

Similarly, capacitor films, deposited under the proper conditions, yield the desired chemical and lattice constants for high dielectric-constant films, while undesirable properties such as amorphous content, porosity, and dissipation factors can be minimized. In resistors, grain size, density, and surface finish—parameters which affect resistivity—can be adjusted for the desired properties.



**Resistors.** Made from moly-disilicide, planar resistor films range from 25 to 500 ohms per square and are easier to process than screen-printed resistors that use high-temperature firing for bonding film to substrate. Resolution of the checker pattern is 2 mils. Thickness of the large square is controlled to within  $\pm 5\%$  over the entire surface. U-shaped resistor patterns, useful for IC's, can be deposited readily.

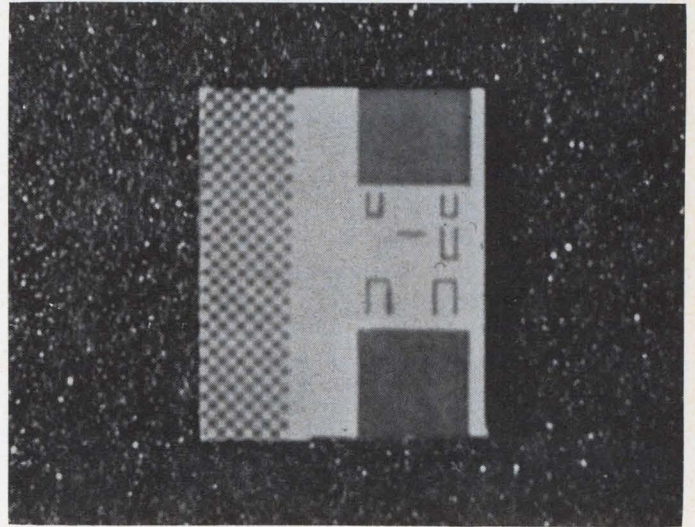

in the process should bring this level below 5%.

Like r-f sputtering and other vacuum deposition processes, APS lends itself to masking, so that, using metal masks, circuit geometry can be achieved during the process. Thus, active components can be installed and then masked out during film deposition, an important consideration for production line fabrication. Furthermore, the process can be used to apply films to complex shapes. For example, mandrels can be used to build up circular layers such as ferrite cores.

**Alternate feed** is yet another advantage of APS. With alternate feed, different material layers can be built up automatically once the feed cycles are established. This capability points to multilayered components, such as capacitors, or to substrates in which each layer may contain planar components.

Besides alternate feed, APS can be used with simultaneous feed in which two or more materials are deposited on a single substrate at the same time. Simultaneous feed means that components requiring a mixture of materials can be readily made with APS. For example, mixtures of metals and ceramics can be fed into a plasma torch, melted, and deposited as a film with the desired resistivity. Thus, by feeding and controlling each spray powder independently, alternate layers of metals and ceramics can be applied to base materials to form resistors, inductors and capacitors—connected

either in series or parallel—that can be deposited over each other. In this way monolithic packages are possible with a greater number of components per unit area of substrate.

The spray technique also allows graded films of cermet with specific composition profiles. This offers low-loss smooth transitions from metal to ceramic even with materials significantly different in thermal expansion characteristics.

Masks of copper, stainless steel, tantalum, molybdenum and Elinvar are used to form the required circuit patterns by using standard photographic techniques. With parallel line patterns, components 2 mils wide on 4-mil centers have been deposited.

During the spraying cycle, uniformity of thickness and dimension is assured by maintaining a uniform powder feed and an x-y traverse of the torch or substrate. In addition, reasonably uniform feed-particle sizes must be used. This does away with trimming and polishing, and eliminates costly post-deposition fabricating steps common to other deposition methods. And since a linear buildup per second is obtained, simple timing mechanisms can be used to obtain desired film thickness. In future spraying systems, contact-type remote sensors, such as capacitor or optical sensors, may be employed to accurately regulate thickness.

As an example of film composition uniformity, an

**Capacitors.** These mixed-oxide dielectrics can be used in IC's when the requirements call for planar capacitors having dielectric constants up to 2600 and loss factors as low as 0.03%. The two end structures are barium titanate on alumina, which has been previously metallized with palladium-gold to form an electrode.

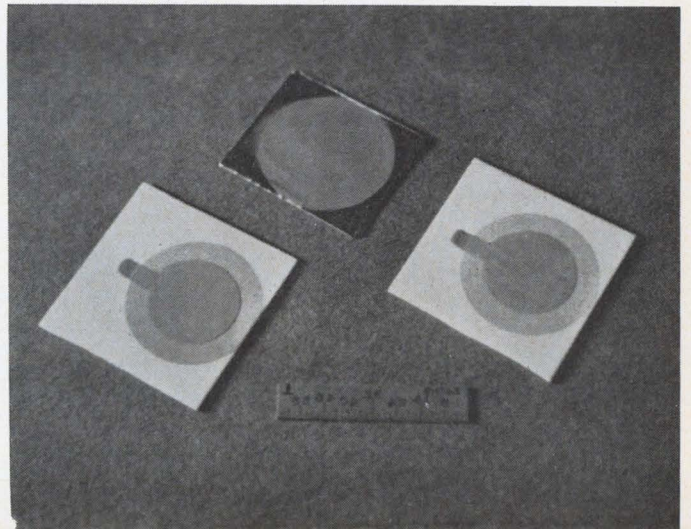

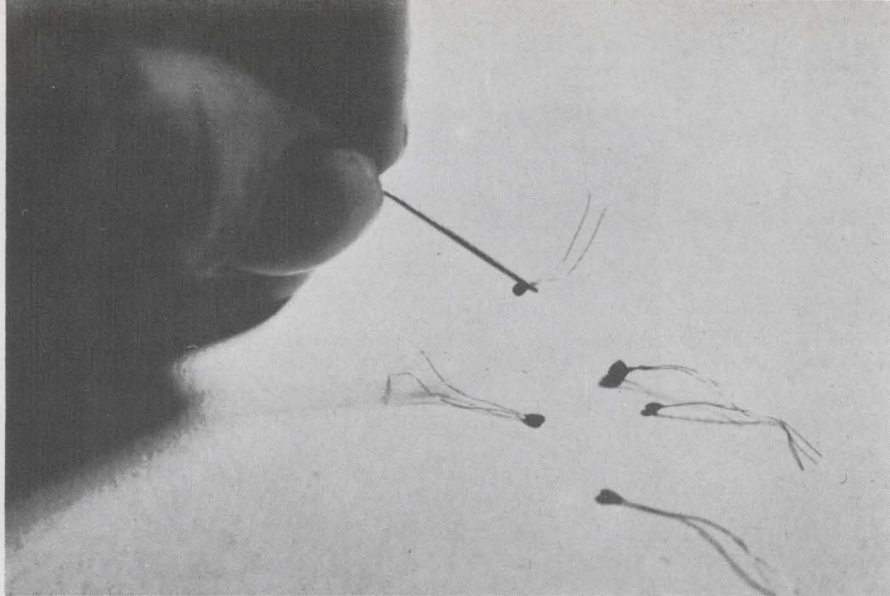

**Inductors.** Single and multiple microinductors, whose values range between 70 and 90 microhenrys, are encapsulated by nickel-zinc ferrite. They can be used as hybrid insertion pieces in circuits where space is at a premium.

electron microprobe analysis of magnesium-manganese ferrite deposited at 2-micron film thicknesses on nine uniformly distributed spots showed no difference in composition within the limits of the instruments used. This indicates that APS films are essentially homogeneous over the entire deposited area.

Smooth film surface—essential for low loss, especially at microwave frequencies—is easily achieved by controlling the particle size of the feed powder and by polishing the substrate surface. For example, ferrite starting powder of a few microns, applied to metallic foils and to ceramic plates, yields films with finishes as good as 8 microinches rms, without polishing. This compares with conventional plasma-spray deposition finishes, in the range of 100 to 500 microinches rms, which require grinding and polishing.

APS films have been analyzed for microstructure, porosity, homogeneity, and uniformity by using optical metallographs and scanning electron microscopes. In addition, X-ray diffraction has been used to determine the composition structure and crystalline structure of sprayed ferrite-oxides and metals for thin films.

For example, a plasma-sprayed alumina was found to consist mostly of gamma alumina with a cubic spinel-type structure, a crystallite size of 0.03 micron, and a lattice constant of 7.89 angstroms. The true density of this material, calculated from X-ray data, was 3.42 grams

per cubic centimeter and was identical to that measured by the displacement technique.

**A potential application** for APS may be for microwave conductor deposition. These deposits require the metalization of substrates where surface finishes are critical, high-resistance interface materials are undesirable, and intrinsic high-conductivity metals to prevent “copper loss” are essential. APS satisfies these requirements by applying pure metals, alloys, and intermetallics directly to ceramic, glass, and plastic substrates without the need for interface materials.

In contrast, screen printing must use glass frits to increase adherence, and these degrade electrical performance—especially at high frequency. With APS, adherence to most substrates is usually mechanical; however, films of gold, palladium, molybdenum, and other alloys deposited on beryllium oxide (BeO) and aluminum oxide ( $Al_2O_3$ )—two popular substrate materials—have been successfully heat-cycled up to 900°C-1,200°C with no measurable degradation.

Using APS, metal conductors can be deposited on substrates that are normally difficult to handle because of temperature-sensitivity. A brief experiment with GaAs indicated aluminum applied by APS adhered to surface finishes of less than 2 microinches. This points to the possibility of fabricating electrodes on GaAs, which could replace heavy-doped GaAs in devices.

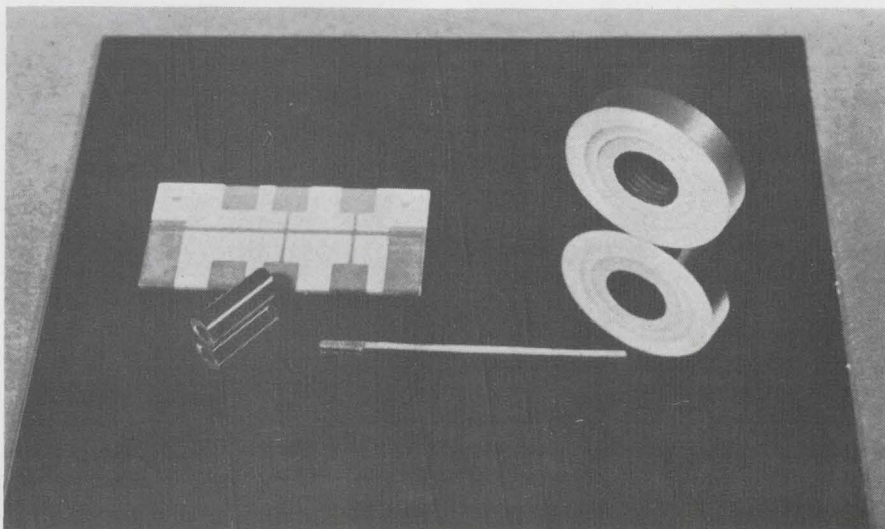

**New substrate.** Metals and ceramics that usually require high-temperature deposition can be applied at low temperature on plastics and GaAs substrates with APS. This paves the way for the use of new IC substrates. The large square substrate is dense alumina on polycarbonate deposited at about 200° F and holds out the promise of impact-resistant IC's. This plastic would lose its strength at higher temperatures. The smaller square is gold metalization on polycarbonate, and was deposited at the same temperature. Circulator-type aluminum conduction patterns on polished GaAs wafers deposited at low temperature may replace heavy-doped GaAs in future device constructions.

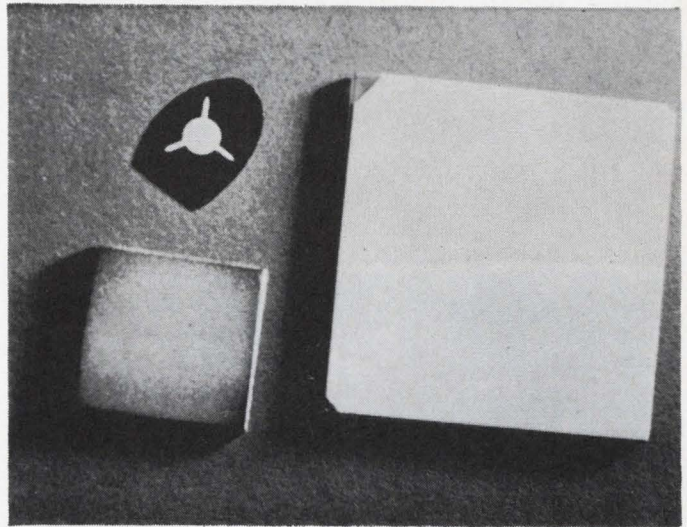

Besides GaAs, other temperature-sensitive materials normally not considered substrate candidates become feasible for APS deposition. Since substrate temperatures are kept below 150°C, excellent conductive films can be deposited on plastics, providing low-cost, large-area substrates with a laminating capability. Conductive, resistive, and dielectric compositions can be applied in layers, thus holding out the promise of low-cost IC's. With plastics, however, there is a minimum-thickness limit, since the high-velocity molten particles of APS may distort thin plastic films.

The low temperature of the APS process offers yet another possibility: temperature-sensitive semiconductor devices which require conducting patterns can be metalized after they have been bonded or deposited in place. Thus, all circuit metalization can be done at one time with significant production-line savings.

It is essential to note that APS is not restricted to low-temperature materials. Refractory metals, such as tungsten and molybdenum, and noble metals, such as platinum and palladium—all good conductors at temperatures greater than 1,400°C—have been routinely deposited on a variety of substrates. Used as conductors in thermoelectric power generators, these metal films were cycled between 20°C and 1,200°C without film adherence failure. Also, extremely stable materials, such as moly-disilicide (MoSi<sub>2</sub>), can be applied as an en-

capsulating protection layer on circuits which must operate in oxidizing, high-temperature atmospheres. And in cases where high impedances are required, MoSi<sub>2</sub> can be used directly as the conductor. In addition, high-temperature measurement devices can be fabricated using metal-alloy thermocouples on BeO, thus providing rugged IC devices in place of fragile thermocouples.

**Resistive films for IC's,** from tenths of an ohm to megohms, also have been deposited by APS. This technique is far superior to screen printing, where the mechanical application of paste is difficult to control. Moreover, the high temperature firing needed for screened resistors changes the resistivity of the film from that of the paste. The resistivity is affected by the various screen-print parameters and often necessitates the trimming of resistors to final value. With APS, however, resistor compounds are applied dry, at low temperature, and with uniform geometry and density, and with control of the resistor value during deposition. In addition, new resistive compositions that may be totally unsuitable for screen printing, such as nickel-nickel oxide and molybdenum-spinel, can now be handled. New material families with high resistivity and low-temperature coefficient of resistivity are envisioned. Moreover, such oxides as Al<sub>2</sub>O<sub>3</sub> and BeO used in cer-mets offer planar resistors with good bonding to heat-sinking substrates such as alumina and beryllia and

**Thermoelectrics.** These elements are germanium-silicon compositions used in thermoelectric devices. The needle structure has n and p legs that are separated by an alumina wall 5 mils thick. The film structure is molybdenum on zirconia, with germanium-silicon deposited over the metal pattern. Allowing easy access to any point on the surface, this structure is used for temperature measurements up to 1,000° C. The donut and cylindrical structures are made by spraying doped germanium-silicon on a graphite mandrel, which could be burned away at 800° C. The donut structure, which was used in test thermoelectric power generators, has inner and outer layers of different thermoelectric compositions, and generates a d-c voltage when a temperature gradient is present.

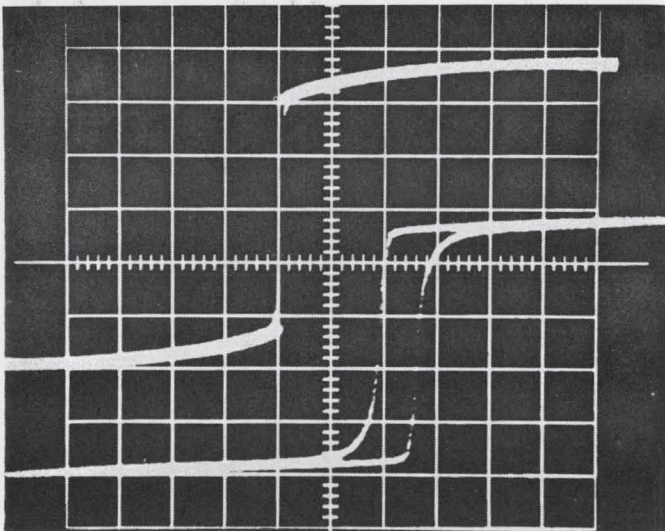
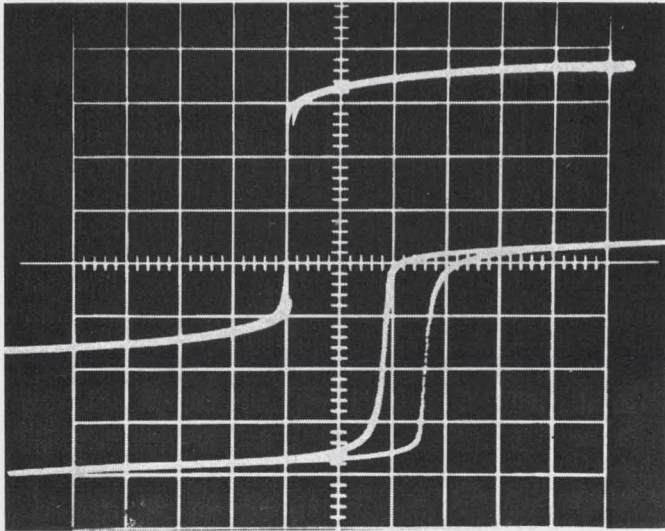

**Enhanced.** Top figure, hysteresis trace of bulk TT1-390 at a 400-oersted drive field shows a remanence ratio,  $M_r/M_s$ , of 0.67. The trace of the deposited film (bottom figure) made with same material has enhanced ratio of 0.82. Lower traces in each figure, expanded 500 times, show the deposited film with a squarer loop than the bulk material.

forecast high power capabilities in small substrate areas.

Dielectric materials—particularly the mixed oxides—have been made into IC fine-grain capacitor elements. Barium titanate, for example, is used in films from 1 micron to 10 mils thick with dielectric constants of 100 to 2,600, and loss tangents from 0.0024 to 0.057. The fine grain nature of these barium titanate films—nominally 0.1 micron—is useful for low-loss, high-dielectric-constant applications.

Semiconductor devices in a variety of geometries—from thin films to donut shapes—have been deposited for use in thermoelectric power producing devices. Since most power producing devices require the construction of bulk items, APS's high rate of deposition, together with its ability to handle circular shapes—thermoelectric devices are built up on graphite mandrels—make the process attractive for these applications.

Equally attractive are depositions using permanent magnetic (p-m) materials, such as rare-earth cobalt compounds. Processed into films, p-m materials allow microminiaturization of electromechanical hardware, or can be used in magnetostrictive transducers and signal processors for built-in magnetic bias. Time and code markers, and read-only memories are other possibilities.

APS is now being applied to ferrite deposition for microwave devices. A number of composite circulators have been fabricated using magnesium-manganese fer-

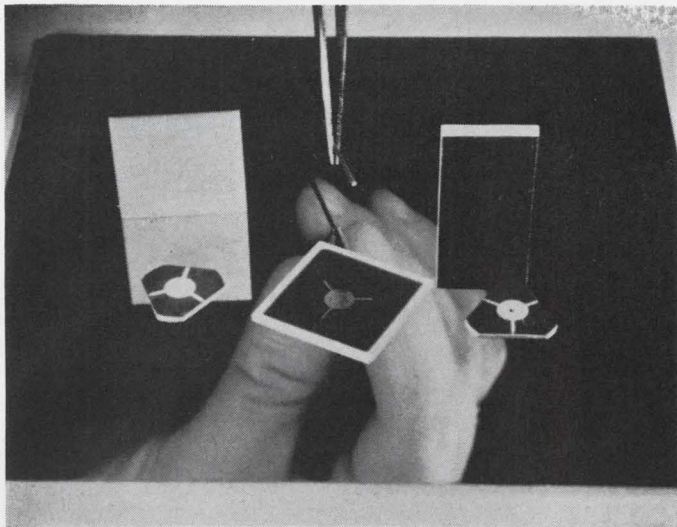

**Ferrites.** APS ferrite deposits take many shapes. The rod is a 32-mil diameter of  $Al_2O_3$  that has a 5-mil-thick coating of ferrite for experiments in coaxial cables and millimeter devices. The gold-plated structure (top left), is a deposited dielectric-ferrite composite that is electrolessly plated with 100 microinches of copper and 40 microinches of gold. The three circulator patterns were fabricated by different methods. At left, the ferrite is deposited on a previously shaped mg titanate substrate. The center pattern is a multiple deposition, where a 3-mil-thick palladium film is embossed with a 6-mil-thick ferrite film. This construction could reduce radiation losses by reducing edge effects on the conductors, pointing to the structure's use as microstrips. The third pattern is stamped out of a composite sheet similar to that shown above it before the circulator conduction was fabricated.

rite (Trans-Tech TT1-105 and TT1-390) and Trans-Tech's D-13 substrate, a magnesium titanate composition. After deposition, the circulators—10-mil films on 10-mil substrates—are ultrasonically stamped from a 1-by-1-inch composite and metalized with aluminum deposited through an etched metal mask. Electrically, the devices have good characteristics: insertion loss, 0.8 decibel, isolation, 20 db, and bandwidths of 16% at X-band with no external compensation used to broaden the band.

**To apply APS** to a broad range of microwave devices, many different deposits of X-, C- and K-band materials—such as Mg-Mn ferrites, nickel-zinc ferrite and yig—have been studied. With these deposits, chemistry and crystal structure in the “as deposited” films were identical to those of the bulk materials. And, for the most part, the microwave properties were duplicated: K values (at 9.4 gigahertz) showed only a 10% reduction from bulk, and the magnetic remanence ratio, determined by the use of a Weiss hysteresiograph, actually showed an increase. In fact, deposited Mg-Mn ferrite TT1-390 has shown remanence ratios as high as 0.87, which is identical with the theoretical limit. The norm for bulk material is 0.67. This means that higher figures-of-merit can be obtained for microwave latching devices.

At microwave frequencies, however, the ultrafine grain in a deposited structure contributes to circuit losses. Therefore, it is necessary to anneal films to

increase grain size for system applications. But this offers another possibility: films of Mg-Mn ferrites can be thermally quenched at virtually any temperature during anneal, locking the cation distribution and the corresponding saturation magnetization to predetermined values. This means that magnetic-logic devices, nondestructive readout memories, and analog phase shifters are feasible with tailored magnetic properties—perhaps after the device is fabricated.

Since all ferrites must undergo an anneal cycle to expand grains to useful dimensions, suitable substrates for these ferrites, which must exhibit good dielectric properties, must also have thermal expansion matched to the deposited films, and be chemically stable.

**High-K dielectrics** can be combined with ferrites to form a stripline configuration. Thus, by making integrated structures that replace discrete-component configurations, reliability and ruggedness will improve, pointing to composite monolithic IC's. Also, memory arrays could be obtained by using discrete ferrite spots as inductive couplers for intersecting drive lines. The addition of permanent-magnetic biasing materials, which may be magnetized or demagnetized at will, may provide a novel approach to low-cost, electrically-alterable arrays. Furthermore, nondestructive read-out memories could be fabricated using multilayer ferrites with composition differences or controlled coercivity levels. ●

**By the batch.** The MIC composites (top left and lower right) consist of ferrite films on single crystal MgO. Showing loss-tangents of less than 0.0002, these composites can be batched-processed to form MIC components such as the circulator shown. The 16-bit read-only memory array (bottom left) is Mg-Mn ferrite on single crystal MgO.

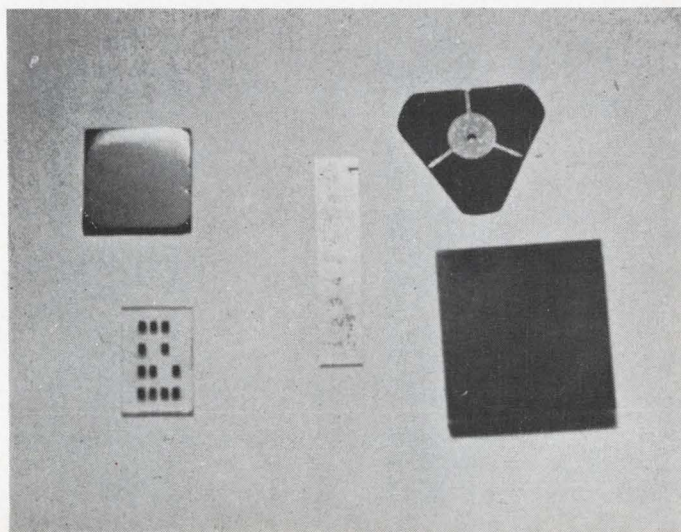

# Digitized thermocouple compensation

Cumbersome analog methods used for determining temperatures at cold junctions can be eliminated by a new technique developed by *Jacek H. Kollataj* of Finland's Nokia Electronics; it's inexpensive, too

● Despite the rapid acceptance by industry of data loggers that centralize the digital readout of hundreds of analog input signals, one problem remains. Cumbersome, inflexible, and sometimes expensive analog methods still are being used to perform the cold-end compensation required in measuring temperatures with thermocouples. Now a wired logic circuit—called a digital reference-junction simulator—can perform the compensation efficiently, and can be easily connected to the data logger, making it completely digital.

Made up of about \$25 to \$30 worth of integrated circuits, the simulator receives its control, timing, and clock-pulse signals from a digital voltmeter that's already a central part of a data logger, and converts the logger's analog inputs to a decimal format. The simulator also drives the dvm's binary-coded-decimal counter and numeric display to yield the desired reading directly in degrees Fahrenheit.

Determining a thermocouple's cold-end, or reference, junction temperature is essential to determine the actual temperature sensed at the thermocouple's hot-end, or measuring, junction. Since the thermocouple's millivolt-level output actually depends on the difference between the temperatures at the two junctions for accurate measurement of the hot end, the reference-junction temperature must be algebraically added to the thermocouple's differential temperature.

The digital reference-junction simulator allows this algebraic addition—compensation—to be made directly in temperature units, whereas analog methods do it with millivolt-level signals. Adding in the millivolt level requires a separate compensator for each type of thermocouple and introduces some nonlinearity error.

The simulator replaces analog cold-end compensation techniques (two of which are shown on the facing page) that cost more, consume power, require stabilized power supplies, degrade common-mode rejection, and may need frequent calibration and adjustment. A major advantage of the digital reference-junction simulator is that one unit can compensate for many different thermocouple types.

Using the simulator doesn't require any new procedures when installing a bank of measuring thermocouples. The thermocouple wires are run from the measurement sites into a field-mounted junction box maintained at a uniform temperature (isothermal) and are connected to copper terminals. Copper wires carry the signals back to the data logger. Each pair of terminals forms the reference junction of a thermocouple circuit.

In the analog compensation methods shown on the facing page, isothermal-box temperature is measured by an additional sensor, either another thermocouple referenced to a constant-temperature bath, or a resistance temperature detector in a bridge circuit.

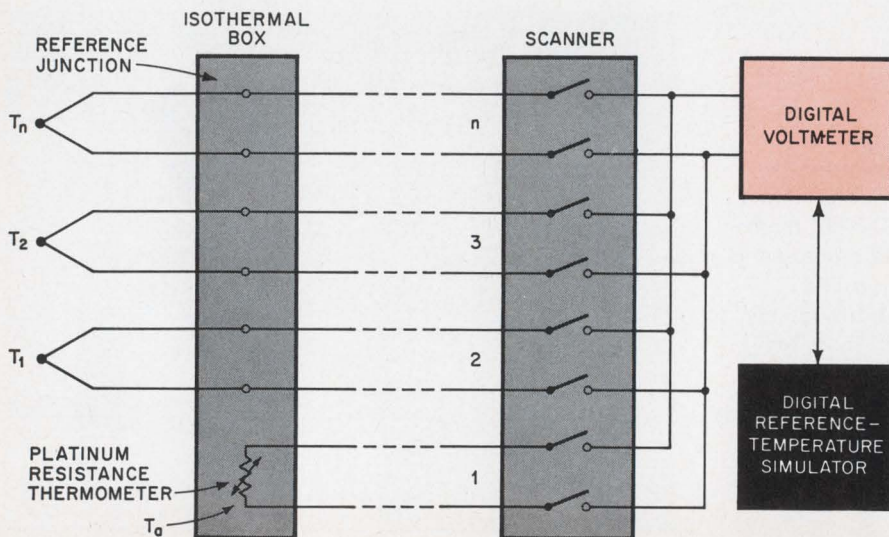

**Bits replace summing.** In new digital technique for thermocouple reference-junction correction (left), temperature of isothermal box, stored as bits in simulator, is added to thermocouple's temperature, stored in digital voltmeter. Analog compensation methods (at the right) involves the summing of millivolts representing reference and thermocouple signals.

# yields direct reading for data logger

The constant millivoltage developed by such a reference-junction sensor is added to or subtracted from the measurement thermocouple's output millivoltage. The resulting analog voltage signal then is converted to binary-coded-decimal format by a digital voltmeter, to be read out by the data logger. But combining voltages can introduce errors because a measuring thermocouple's millivolt output is nonlinear with respect to temperature. In the new digital simulator, however, the reference-junction compensation is done in temperature units, not millivolts. The reference-junction temperature is measured by a resistance detector; its signal is converted by the dvm directly to temperature units and stored in the simulator's memory. Then, after one of the measurement thermocouples has been scanned, its millivoltage also is converted to temperature units relative to the reference junction. Logic elements in the digital simulator cause these two values to be added algebraically, so the data system's dvm displays the actual measured temperature.

Most data loggers use a digital voltmeter operating with a voltage-to-time or voltage-to-frequency conversion technique. Such dvm's are ideally suited to convert analog signals to binary-coded-decimal value and display these values for readout. The simulator uses a dual-slope integrating dvm not only because of its own inherent features, but also because it produces several

types of signals needed by the simulator. During its first slope, or integration period, the dvm integrates an input analog voltage, and the output logic turns on a gate to let a fixed number of clock pulses into the dvm's bidirectional binary-coded-decimal counter. During the second integration period a reference voltage in the dvm of opposite sign to the input voltage is integrated and drives the analog integrator's output back toward 0. The gate remains open and previously stored pulses are subtracted from the counter.

When the integrator's voltage returns to 0, the number of pulses remaining in the dvm's bed counter represents the input voltage—in this case, the thermocouple's output. With proper scaling, the dvm's numeric display can read out directly in temperature units. The digital voltmeter is multiplexed in sequence to each of the data logger's channels. The first channel assignment is to convert and store the temperature's digital value determined by a reference-junction resistance thermometer.

The resistance thermometer is excited by a constant current to produce a millivoltage proportional to temperature. As in the measuring thermocouples, the dvm can read this millivoltage directly in temperature units. Within the range 0°F to 100°F, a platinum resistance thermometer is linear to within 0.1°F, which is adequate for most industrial applications.

A base temperature, 0°F, is chosen to facilitate addi-

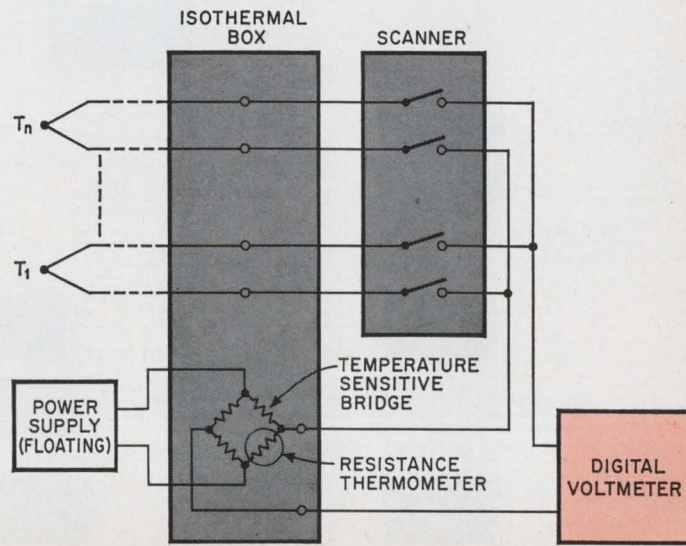
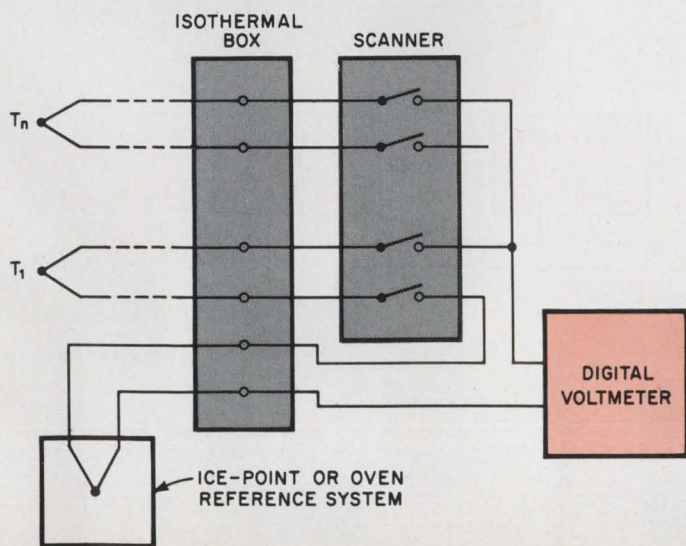

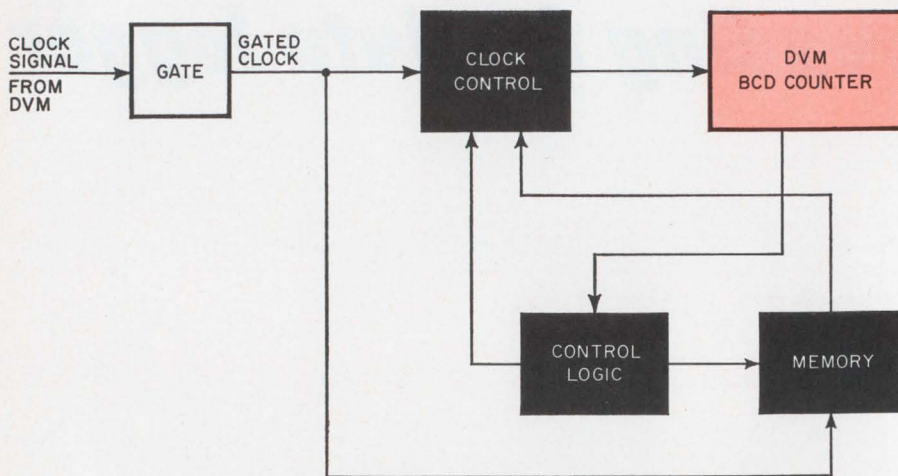

Three functions. Basic actions of digital reference-temperature simulator (dark boxes) coordinate with clock signals and functions (colored boxes) in digital voltmeter.

tion or subtraction of measured and reference-junction temperatures and to allow the dvm to produce the net temperature's correct sign. But the resistance thermometer will produce a millivoltage at 0°F. A correction, or offset, must be made by the simulator's logic.

The zero-offset temperature can be derived from available data on the thermometer's resistance-temperature curve. For example, a commercial platinum resistance thermometer has a normalized resistance of 1.000 ohm at 70°F, 0.857 ohm at 0°F, and 1.061 ohms at 100°F. Extending the resistance curve back to the zero-resistance axis, the curve would cross at -420°F. This is the zero-offset temperature, equivalent to saying the thermometer has zero resistance at -420°F.

Now assuming each clock bit from the dvm represents an increment of 1°F, 420 bits would be required to go from -420°F up to 0°F. Then 0°F results in 420 bits and 100°F in 520 bits. Thus, the first 420 bits from the platinum thermometer reading must be ignored in the dvm. Then leftover bits, sent into the simulator's counter A, equal the temperature reading directly in degrees Fahrenheit.

How the zero-offset correction is made can be determined from the figure at the bottom, the block diagram of the reference-junction simulator. During the first integration period a control signal obtained from the dvm inhibits gate 5. When the second integration period

begins, the bcd counter starts at 0 and totalizes clock bits. When 420 bits, representing the resistance thermometer's digital zero offset, have been accumulated in the counter, the diagram shows that the "4" signal from the third decade of the dvm's bcd and the "2" signal from the second decade open gate 5. Then gate 5's output resets the bcd counter to 0's and turns on gate 1. Now all the subsequent bits, representing the reference-junction temperature,  $T_a$  in degrees Fahrenheit, are accumulated—until the end of the second conversion—in the simulator's counter A.

Next, the logger sequences to the first temperature-measuring channel. The digital voltmeter converts the analog signal from the thermocouple and stores in the dvm's bcd counter a temperature reading that is the difference between actual temperature and the reference junction temperature— $(T_n - T_a)$  bits. This reading must be corrected to take into account the reference-junction temperature.

Correcting the dvm's reading to actual temperature is done by adding or counting up in the dvm's counter the  $T_a$  bits stored in the simulator's counter A. That is,  $(T_n - T_a) + T_a = T_n$ , provided that  $T_n > T_a$ .

However, if  $T_n < T_a$ , the signal applied to the digital voltmeter is negative. The dvm senses this and produces a -sign-signal, signifying that measured temperature is colder than the reference-junction temperature. In this

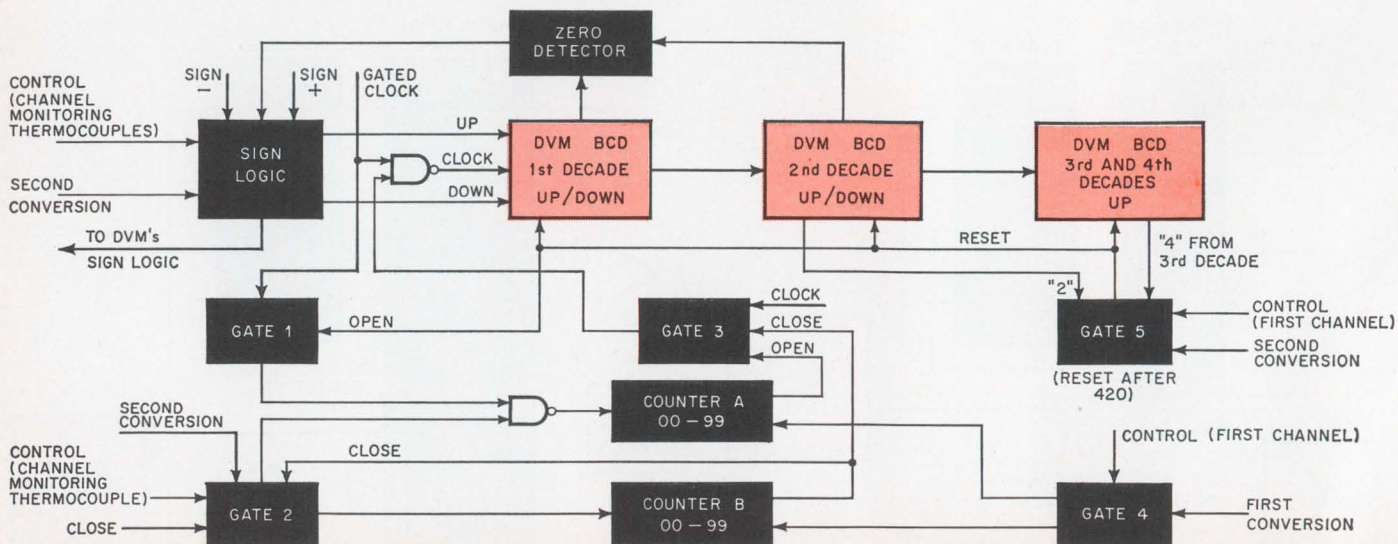



is up to 100 different bits—from 00 to 99. Now counter A already has stored  $T_a$  bits. At the instant counter A overflows—returns to 00—counter B has stored  $(100 - T_a)$  bits. The overflow signal from counter A opens gate 3 and clock bits start flowing to the bcd counter; clock bits continue to flow to counters A and B.

If the uncorrected dvm reading representing  $(T_n - T_a)$  is positive (sign+), the simulator's sign logic instructs the bcd counter to count up the bits flowing through gate 3. When  $T_n$  clock bits have passed to counters A and B and to the bcd counter, then counter B overflows, so  $(100 - T_a) + T_a = 100 = 00$ , and this overflow signal closes gates 2 and 3, and no more bits flow to the bcd counter.

Thus the final reading of the dvm is  $(T_n - T_a) + T_a = T_n$ , the actual measured temperature.

The number of bits stored in the simulator's counter A again is  $T_a$ . And the simulator's counter B has been reset to 00. Both counters are at their initial conditions and are ready to compensate the next thermocouple channel in the logger's scanning sequence.

If the uncorrected dvm reading representing the thermocouple's differential temperature is negative (sign -), the bcd counter counts down the bits flowing through gate 3 until the overflow signal from counter B appears.

However, if the bcd counter registers 0 before the overflow signal occurs, the sign logic changes from a counting-down to a counting-up operation. Counting up continues until the overflow signal closes gates 2 and 3. When 0 is detected the polarity for display and printout also is changed from negative to positive.

The digital simulator's logic and memory automatically accomplish the reference-junction compensation of a group of thermocouples to display actual measured temperatures. When the next data-logger scanning cycle starts, the reference-junction temperature is measured, converted, and stored in counter A. This value is used for the rest of the multichannel scan period. ●

## Bibliography

Jacek H. Kollataj and Teuvo Harkonen, "Integrated circuits in action: part 10—Linearizing sensor signals digitally," *Electronics*, March 4, 1968, p. 112.

case correction requires counting down  $T_a$  bits from  $-(T_n - T_a)$ .

Consider three different temperature ranges for correcting a thermocouple's readout stored in the dvm's counter:

▶  $T_a = 25^\circ\text{F}$ ;  $(T_n - T_a) = 100^\circ\text{F} > 0$ . When the analog-to-digital conversion for  $(T_n - T_a)$  is completed, 25 bits for  $T_a$  then are counted up. The final reading is  $T_n = 125^\circ\text{F}$ .

▶  $T_a = 25^\circ\text{F}$ ;  $(T_n - T_a) = -150^\circ\text{F} < 0$ . When the conversion is completed, 25 bits are counted down. The final reading is  $T_n = -125^\circ\text{F}$ .

▶  $T_a = 25^\circ\text{F}$ ;  $(T_n - T_a) = -20^\circ\text{F} < 0$ . When the conversion is completed, 20 bits are counted down, zero is detected, the sign logic changes, and then 5 bits are counted up. The final reading is  $T_n = 5^\circ\text{F}$ .

The reference-junction temperature,  $T_a$ , sensed by the platinum resistance thermometer, has been stored in the simulator's counter A. And the measured-channel's temperature,  $(T_n - T_a)$ , was stored in the bcd counter.

The process of finding the actual temperature,  $T_n$ , starts at the end of the measured-channel's second integration interval. The dvm's second conversion signal turns on gate 2; clock bits start flowing through this gate to both counters A and B. Each counter's capacity

**Bit-by-bit.** Dark boxes, representing circuits in the digital reference-temperature simulator, respond to clock bits and control signals from the dvm. The simulator controls the bits going to the dvm's four-decade binary-coded-decimal counter, shown as colored boxes. On completion of a thermocouple measurement cycle, the bcd counter contains, in temperature units, the thermocouple's actual measured temperature as compensated for cold-end temperature by the simulator.

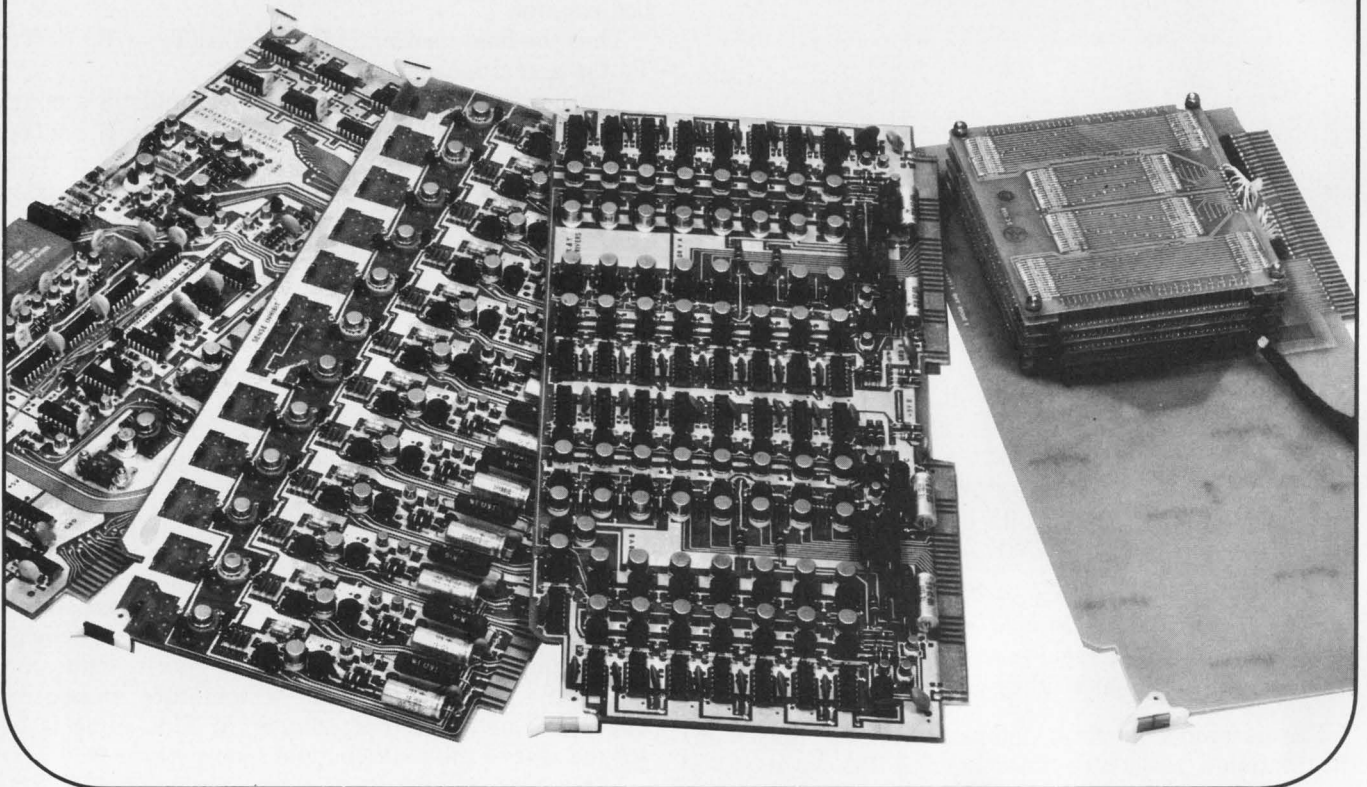

## Datacraft's DC-34 Core Memory: 4K x 18 capacity, 750 nSec cycle. A revolution at \$1776 each\*.

Our DC-34 core memory is a bunch of cards waiting for a frame that has sockets and a couple of power supplies. You tick off the configuration and we shuffle the cards. We'll work with any length word up to 40 bits and still stick with our standard core planes. And we'll stack our planes up against your total memory requirement — the sky's the limit. Speed is your option, not ours. Go ahead and test us. We haven't found any track too fast for our DC-34. The make-or-buy decisions are all on our side. Buy.

Describe your Central Processor and we'll give you a memory. Let your engineers see their families this weekend: Datacraft already figured out how to build your CPU memory.

\*Price quoted is for quantities of 100 or more, plus applicable taxes and options desired.

Call your nearest  
***Datacraft***  
 Memory Man.

Datacraft Corporation • P. O. Box 23550, Ft. Lauderdale, Fla. • (305) 933-2651  
 Southeast: (305) 423-7615 • Mid-Atlantic: (215) 265-5800 • New York: (516) 482-3500 • New England: (617) 245-9530 • East Central: (216) 243-6500 • West Central: (312) 775-7594 • Southwest: (713) 643-2114 • Rocky Mountain: (303) 794-4231 • Far West: (213) 542-5515



# OLYMPUS CORPORATION OF AMERICA

PRECISION INSTRUMENT DIV. DEPT. E  
2 Nevada Dr., New Hyde Park, N.Y. 11040

Send information on Olympus stereo microscopes, including  JM,  XL-4,  SZ-III,  X-TR and  microscope cameras,  X,  VT-II,  VA-II,  MTX. My applications include:

\_\_\_\_\_  
\_\_\_\_\_  
Name \_\_\_\_\_  
Title \_\_\_\_\_  
Address \_\_\_\_\_  
City \_\_\_\_\_  
State \_\_\_\_\_ Zip \_\_\_\_\_

# The Olympus stereo microscope line.

## It puts things in perspective.

We now offer a stereo microscope for almost every purpose. Which may give you a new perspective on us, if you've known Olympus only for our metallurgical microscopes, our metallographs, or our medical and research instruments.

A closer look will reveal some surprising features: working distances to 18", dark-field illumination, and the only trinocular optical system (for simultaneous viewing and photography) in the stereo field. And you can see their quality even before you look through precision optics.

Olympus stereos fit your budget as easily as they fit your applications. Tell us what those applications are. We'll give you the full perspective on the Olympus microscope that suits them.

**FOR MICROCIRCUIT FABRICATION,  
IN-PROCESS INSPECTION AND Q.A.**

- A. Model JM dark-field zoom.
- B. Model XL-4 long (8 1/2") working distance (shown on VS-V universal arm stand).
- C. Model SZ-III extra-long (5.7:1) zoom range (shown on VS-IV universal arm stand).
- D. Model X-TR Trinocular for viewing and photography (shown with PM-7 camera).
- E. Model X with convenient turret magnification selector (shown on transilluminating stand).
- F. Models VT-II, VA-II priced for use throughout your plant. (VT-11 shown with LSG epi-illuminator).
- G. Model MTX (not shown) with 18" working distance. Camera accessories available.



from

**EDWARDS**

# VERSATILE VACUUM COATERS with matched modular accessories

This new Edwards series does everything, does it better, changes over faster, and accommodates its matched modular accessories just the way the ultimate in vacuum coaters should. The Thin Film Thickness Monitor, with its water-cooled crystal mounts, measures film deposition rate and thickness. The Automatic Evaporation Deposition and Rate Control system not only provides fully automated cycling but also enables semi-automatic and manual control as well. The Film Resistance Control Unit monitors resistance films during deposition and actuates an automatic source shutter at pre-determined values. The Modulated Beam Photometer provides a method for controlling the optical thickness of multilayer or single layer depositions. And all these can be mounted with room to spare in the free standing console that leaves the evaporator top free as work space. Then, too, there are the 12 patented design features that contribute to achieving the lowest ultimate vacua, measured in the bell jar where it counts. Edwards technical paper, "Evaporation Techniques For Materials Used in Three Layer Anti-Reflection Coatings" available on request.

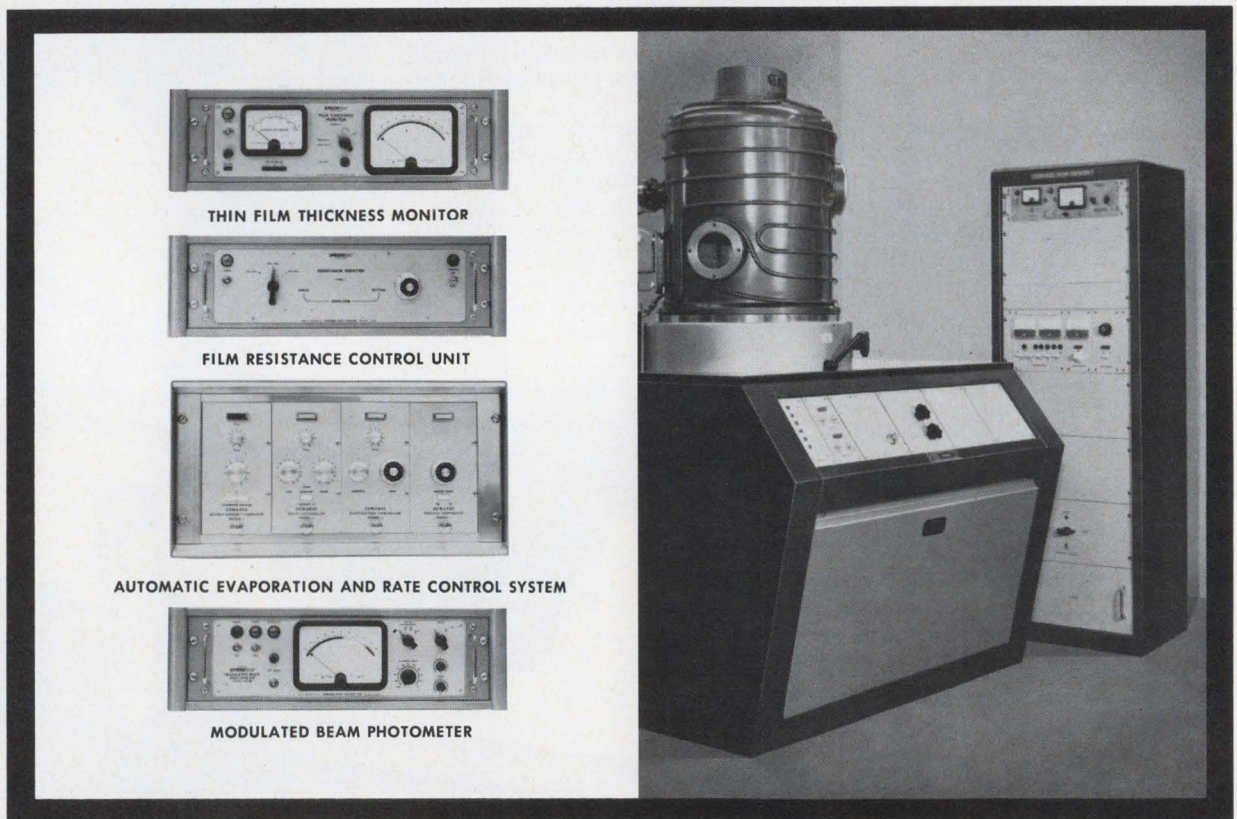

## EDWARDS HIGH VACUUM INTERNATIONAL LIMITED

EDWARDS HIGH VACUUM LTD.  
Manor Royal  
Crawley, Sussex, England

EDWARDS ALTO VUOTO S.p.A.  
Via Pisacane ang. Via Dante  
Pero (MI), Italy

EDWARDS HOCHVAKUUM GMBH.  
Frankfurt/Main — Niederrad,  
Hahnstrasse 46, Germany



## High Vacuum, Inc.

GRAND ISLAND, NEW YORK 14072  
IN CANADA: OAKVILLE, ONTARIO

# Weston does its own thing: an AC/DC, Volts/Amps/Ohms, bench/panel/portable DMM...

Nobody does it like Weston, because nobody else has as much metering and digital experience.

That's why our new Model 1240 multi-meter is not just an assemblage of stock components fitted to a package, but a custom-designed instrument embodying the very latest in technology by the leader in precision measurement.

From its rugged, glass-filled thermo-plastic case down to its feather-touch pushbuttons, this is proprietary engineering at its finest.

Versatility? The Weston 1240 goes anywhere. It will fit your attache case, weighs only four pounds when carried by its self-contained handle (which doubles as a tilt stand for bench use), and comes completely equipped for

mounting in a standard 3½" panel. No extras to buy.

An external switch provides for 115V or 230V operation, and if you're in the boonocks you can plug in an optional battery pack.

Other user exclusives . . . complete circuit overload protection, fuses replaceable from outside the case, recessed controls, in-house designed positive-detent range switch, pluggable Nixie\* tubes, automatic polarity and outrange indication.

Performance-wise, the Model 1240 is a 3½-digit, high-impedance unit with ten DC, ten AC and six Ohms ranges, plus full voltage and current measuring capability. Accuracy is 0.1% of reading  $\pm$ .05% F.S. on DC volts.

Weston engineered features include patented dual slope\*\* integration and shunt circuitry, ultra-reliable gold-on-gold switch contacts, and non-blinking display with automatic decimal positioning.

Also available at less cost is our Model 1241 DC volt/ohm meter. Both models are in stock now for immediate delivery. See them at your Weston Distributor, or ask us about the "going thing" in measurement . . . the Model 1240 DMM by Weston.

WESTON INSTRUMENTS DIVISION,  
Weston Instruments, Inc., Newark, N.J.  
07114, a Schlumberger company

## WESTON®

\*Registered trademark, Burroughs Corp.  
\*\*U.S. Pat. #3,051,939 and patents pending.

for  
**\$379.<sup>50</sup>**  
complete.





### Solid state displays

The MAN 1 is a seven-segment light-emitting all-semiconductor alpha-numeric readout.

Put the attention-demanding red light from electrically excited GaAsP to work in your digital displays for industry, computer peripherals, or avionic/marine instrumentation. Our MAN 1 is shock-resistant and long-lived. Offers styling advantages because it's flat, parallax-free and visible within 150°. Reads out all numbers plus A, C, E, F, H, J, O, P and U. Available now. Any quantity.

Brightness: 200 ft-lamberts @  $I_f = 20$  ma, 3.4V, per segment

Compatibility: directly interfaces with off-the-shelf IC decoder/drivers

Price: ~~1-9, \$48; 1,000 or more, \$25~~

*Contact distributors for new prices!*

## GaAsLITE Update

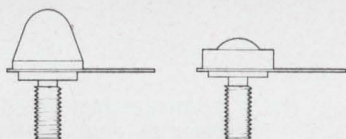

### 12 mW @1A IR emitters

New high power low cost 9000 Å GaAsLITEs give you extra mW for your \$.

Design these powerful infrared sources into your next card or tape readers, intrusion alarms, or calibration units. Anything that uses silicon detectors wants our ME 2 and ME 5 GaAs infrared emitters. They give you a 2500-mil<sup>2</sup> emitting area with either lambertian (ME 2) or collimated (ME 5) radiation patterns. Guaranteed minimum output: 10 milliwatts at 1 amp. (Less expensive ME 2A and 5A versions radiate 7.5 mW.)

Peak forward current: (1µs pulse width, 300 pps) 25 amps

Forward voltage: 1.3 V typ ( $I_f = 1.0$  A)

Rise time: 10 nanoseconds

Prices: ME 2, 5: 1-9, \$30; 1,000, \$12.50

ME 2A, 5A: 1-9, \$14.75; 1,000, \$8.00



### GaAsLITEs by the millions

Bright red solid state lights are here. And affordable!

Want high performance and low price? Immediately? Order our new MV 50:

750 ft-lamberts @ 20ma; thousands ready to be shipped from your Monsanto distributor at \$1.50 each.

Finally, a price that lets you justify GaAsLITEs for high volume applications. MV 50s can replace miniature and sub-miniature lamps down to the T3/4 size. Their solid-state reliability makes them ideal for indicator lights in computer systems, data processing equipment, communications systems, and as diagnostic lights on pc boards. And just think what you could do with them in large arrays and in optical logic systems. . . .

Size: 0.10" diameter

Output: 750 ft-lamberts (6500 Å) @ 1.6V, 20 ma

Switching time: 1 nanosecond

Price: 1-9, \$2.30; 1,000, \$1.50

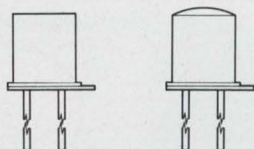

### The superfast detector

Our 500-picosecond silicon PIN photodiodes, MD 1 and MD 2, complement our light-emitting diodes.

High speed optical switching has all kinds of sexy uses today: Laser detecting, for instance, and optical encoding. Even simple burglar alarms can use it.

Their half-a-nanosecond response cycle makes them perfect mates for Monsanto GaAsLITEs. And they work with other sources, too. Packaged in standard transistor cans, they're easy to handle and mount. Available with either flat lens or built-in optics.

Rise time: .5 nanoseconds ( $V_R = 20V$ ;  $R_L = 50\Omega$ )

Breakdown voltage: 50V ( $I_R = 10\mu A$ )

Sensitivity: MD 1 1.5 µA/mW/cm<sup>2</sup> (min) (.9 microns,  $V_R = 20$  volts)

MD 2 3.0 µA/mW cm<sup>2</sup> (min) (.9 microns,  $V_R = 20$  volts)

Price: 1-9, \$6.25; 1,000, \$3.40

## Monsanto

All available through Schweber, Semiconductor Specialists, Kierulff or K-tronics. For additional technical information and world-wide distributor list, write Monsanto Electronic Special Products, 10131 Bubb Road, Cupertino, California 95014. (408) 257-2140

# Domestic communications satellites: Tests increase, but still no go-ahead

Now, after the long-awaited White House study recommended a competitive approach, it's up to the FCC to make policy; several systems, rather than one, are proposed

By Robert Westgate

*Electronics staff*

**It's been** a long wait for the green light on U.S. domestic communications satellites. But the White House finally got around to setting the ground rules late last month. Even so, the FCC still has to act on the proposal and establish standards. Though international satellite relays have been around since 1965, several plans for U.S. domestic systems have been gathering dust for years.

Everyone—industry, the White House, Congress, other Government agencies, and the Communications Satellite Corp., which holds the U.S. franchise for international satellite communications—is blaming the other guy. Meanwhile, France and Germany are jointly developing their own system; Canada has a mid-1972 target date for its domestic system; India, using a NASA satellite, will begin an ambitious educational-tv satellite relay experiment in late 1972 or early 1973; and Comsat early next year will begin launching its second-generation worldwide communications satellite system, Intelsat 4.

Even the Soviet Union, which was off to a much later start than the U.S. in the development of communications satellites, now has an operating domestic system.

The real obstacle to a U.S. system has been politics. This was evident in hearings held recently by Rep. Joseph E. Karth (D., Minn.), who is a strong supporter of direct taxpayer benefits from the space program.

A clear, Presidential-level direction for policy, the real stumbling block, finally was announced Jan. 23. Instead of a single domestic satellite system, the White House recommended a competitive, unregulated approach, which is certain to spur a variety of special-purpose systems [see "Any number can play," p. 128].

The problem had been buck-passed within Government for more than five years. President Johnson tried to solve it and other communications problems through a task force on communications policy. But the group did not present its recommendations until Dec. 8, 1968—after Richard M. Nixon was elected President. Nixon wasn't about to accept a Demo-

cratic plan, so he appointed his own White House working group—headed by Clay T. Whitehead—

to make its own study. It took them a while; their conclusions were scheduled for release last Oct. 1. The study represents a giant step back from Federal regulation of communications. It not only urges a three- to five-year interim policy "to allow competition to act within well-defined limits" in protection of the public interest, but adds that "competitive pressure, rather than regulatory constraints" should be the factor in determining rates for satellite services.

This move toward laissez-faire communications policy is extraordinary—it breaks completely with FCC tradition.

For a long-waiting electronics industry, the word from the White House should mean more customers and more business.

**Domestic test.** Though transmitting television internationally by satellite is now routine, the three U.S. commercial tv networks used the satellite for the first time domestically in a test last October. This test was to determine whether local stations could receive network tv transmissions directly by satellite by using a much smaller, less expensive antenna than the \$3 million, 85-foot-diameter dishes employed in international satellite communications. The question is still unanswered.

The tests were made from the National Aeronautics and Space Administration's Rosman, N.C., station to the Hughes Aircraft Co.'s 30-foot antenna at El Segundo,

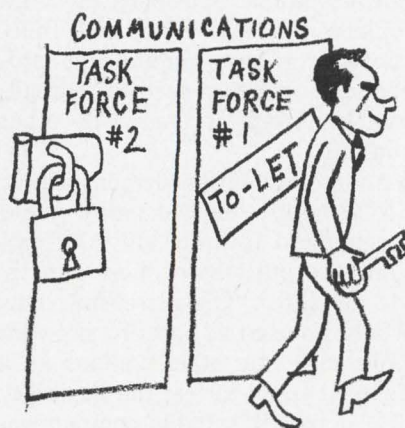

cratic plan, so he appointed his own White House working group—headed by Clay T. Whitehead—

Calif. The video transmissions were "pretty good, certainly recognizable, but definitely not of broadcast quality," according to one network engineering vice president. He added wryly that "the most that can be said about the results is that they were inconclusive."

Only color bars were transmitted. Problems were attributed to the ATS-1 position (on the horizon, hovering over Brazil) and to the location of the receiving antenna, which is in an area surrounded by mountains and numerous sources of interference. Also, NASA's Applications Technology Satellite (ATS-1) has only about one-tenth the power that any operating system would likely require.

**ETV Test.** An experimental satellite relay of tv transmissions of the Corporation for Public Broadcasting, originally scheduled to begin last Dec. 16, is symbolic of the slow pace in applying satellite technology to domestic communications. The 16-week NASA experiment finally got under way Jan. 4 with what apparently was less-than-enthusiastic cooperation from

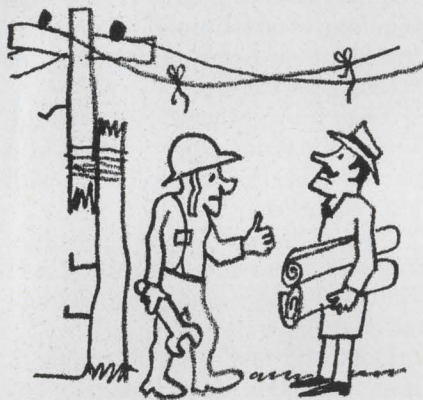

the American Telephone and Telegraph Co. AT&T found it was too short of men and equipment to make the test hookup by the original starting date.

NASA's ATS-3 relays the tv signal from the 85-foot Rosman ground station to the space agency's 40-foot Mojave, Calif., ground station. From there, the signal is carried by microwave to station KCET-TV in Los Angeles. At the educational-tv station, the satellite-relayed audio and video signal is compared with a duplicate signal sent over AT&T's land lines.

An engineer from Public Broadcasting says the color has been "superb" thus far in the satellite-relayed tv. "The few technical hitches we had were traced to AT&T equipment," he adds.

Later this year Public Broadcasting plans three additional ATS experiments:

▶ A remote production demonstration. This test would explore and evaluate use of mobile tv transmit-

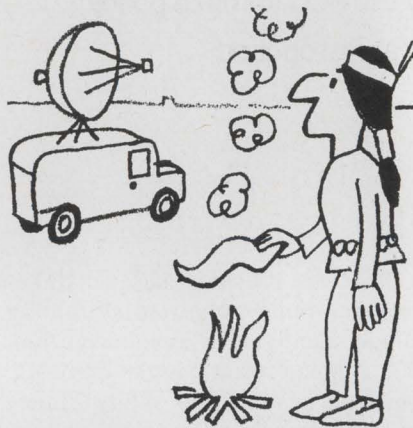

ters in remote and relatively inaccessible areas to pick up and relay events not now available in real time on short notice, and to receive programs that are not now available to isolated communities. At present, this isn't economically feasible.

▶ Educational radio. Relay of educational-radio programs to noncommercial stations—including those in Alaska, Hawaii, and Puerto Rico—for tests aimed at a future national interconnected educational radio network made up of 100 high-power stations. This network could replace the expensive and time-consuming tape duplicating procedure now being used to rebroadcast programs originated by other stations.

▶ A satellite cities demonstration. Six yet-to-be-selected cities would receive and transmit entire tv programs or portions of them directly via satellites. These transmissions would be used as part of a network program using other stations on a delayed basis to test the flexibility of a domestic satellite communications system.

**Cooperative.** Both the American Broadcasting and Columbia Broadcasting tv networks, which have applied to FCC and NASA to make

more comprehensive tests, are anxious to see how the results will affect—if at all—their separate applications. All three tv networks want to operate a cooperative domestic satellite tv relay system, with 100 ground stations, and Comsat wants to set it up. But all have complained that Comsat is being held back by FCC and White House inaction.

Rep. Karth, who repeatedly has complained that "the use of satellite technology for improvement of communications seems to have lagged far behind its potential in the U.S.," seemed to have deliberately scheduled a four-day hearing on domestic satellite communications to begin on Dec. 16, the same day the NASA-Public Broadcasting experiment was to have begun.

Almost all the witnesses at the hearing—sometimes very carefully coached by Karth and other committee members—called for a White House-formulated national communications policy which would spell out where the nation is going, especially in domestic satellites. At the end of the hearing, Karth produced a White House memo from Presidential assistant Peter M. Flanigan which called for abolition of what's been described as the ineffectual Office of Telecommunications Management and its replacement by a stronger Office of Telecommunications Policy [*Electronics*, Jan. 5, p. 45]. William Plummer, acting director of the office, seemed stunned by Karth's disclosure at the hearings and declined comment.

Testimony from several of the witnesses centered around the proposed Alaskan communications demonstration experiment. Richard B. Marsten, NASA's director of communications programs, explained that the Alaska experiment calls for using ATS-1 to retransmit educational and other public tv programs from a 42-foot station at the University of Alaska in Fairbanks to ground stations at three relatively heavily populated areas around Kodiak, Nome, and Fort Yukon.

A 75-watt vhf, f-m transceiver built by the Communications Co. in Coral Gables, Fla., will also be located at Alaska U. Initially the transceiver will broadcast to a similar transceiver at Bethel for re-



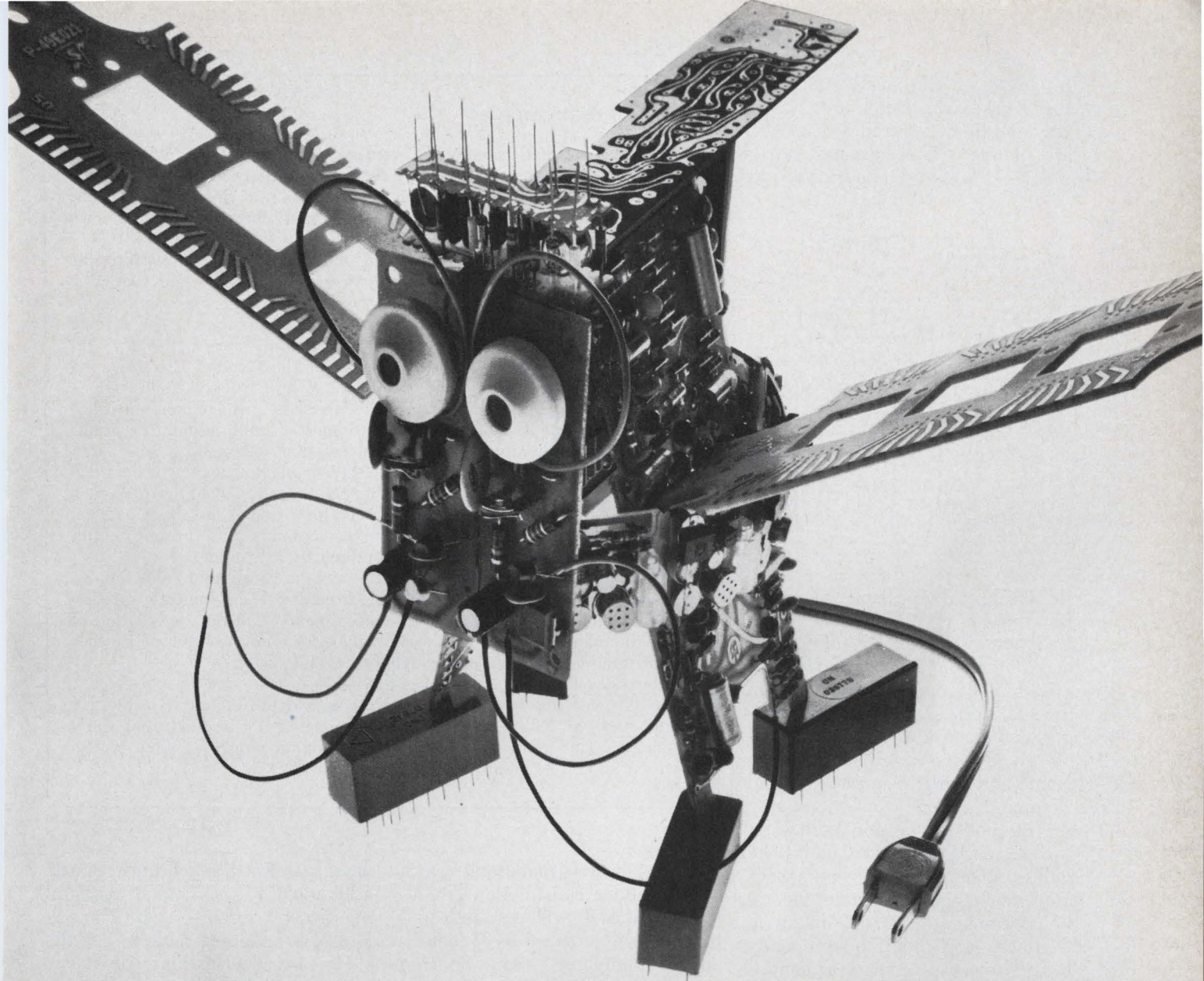

## Nobody has asked for this one yet, but if they do we're ready.

We've just given birth to a new operation that's ready for anything.

It's called Sylvania Circuit Modules and it can handle anything in hybrid microelectronics, simple and complex circuit boards, and complete circuit assemblies.

We've always had these capabilities. Now we've put them all into one operation.

To make it easier for you.

Now you don't have to shop around for high volume capabilities in printed circuit boards. And you don't have to

worry about which approach is best for custom assemblies.

We handle them all.

And we can tell you which is the best technique for your application at the best price.

We've designed and assembled everything from low-cost controls for children's toys up to complex precision boards for large-scale computers.

We've designed and built over 80 different types of NAFI modules for the Poseidon missile system.

And if package size is one of your

problems, we have complete facilities for thick-film hybrid microcircuitry.

We've got the production capability and the engineering know-how to solve any circuit module problem.

Even if it's a circuit no one has asked for yet.

*Sylvania Electronic Components, Circuit Module Operation, Muncy, Pa.*

**SYLVANIA**  
GENERAL TELEPHONE & ELECTRONICS

Circle 127 on reader service card

broadcast to the small villages in the Kuskokwin Delta area. Two-way public safety radio tests also are planned. The antennas, cross-polarized Yagis, will be supplied by

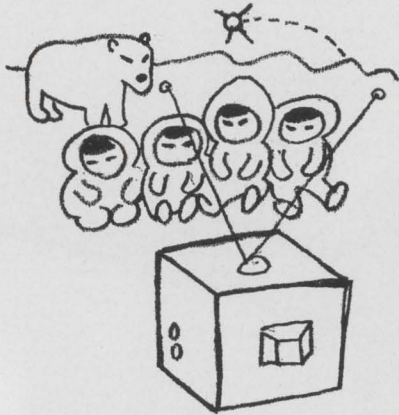

the Technical Appliance Corp., of Sherburne, N.Y.

**Donors.** Comsat has offered to make available for the experiment a 42-foot station initially used in the Philippines and two 32-foot experimental stations now being built by Raytheon, which will go to Nome and Fort Yukon. RCA Global Communications Inc. will supply the 40-foot station for Kodiak; it was formerly used on Guam. The radio transmission tests are scheduled to begin in March. Operational transmissions will begin in October, and continue to early 1971, subject, of course, to continued ATS-1 operation.

The experiment depends on FCC approval, and although the agency has said there should be no problem with a formal application, Alaska has submitted none. FCC has said it would warn Alaska not to spend too much money on earth stations for use with the possibly short-lived ATS-1, unless it knows another satellite will be available.

The two new transportable earth stations scheduled for use at Nome and Fort Yukon are two of the three KTR-10S remote frequency control systems being manufactured for Comsat by the Raytheon Co.'s Equipment division in Norwood, Mass., under a \$725,000 contract. The small-aperture, unmanned stations are equipped with 32-foot-diameter antennas and don't provide for automatic tracking. They are designed to receive only, but a plug-in transmit capability can be added later.

## Any number can play

The Federal Communications Commission seems certain to go along with the long-awaited White House recommendation that literally anyone with the money and the technology can launch and operate a domestic satellite system—provided standards of compatibility are met and anti-trust laws aren't violated.

A proliferation of filings for special purpose satellites is expected as soon as FCC policy is established. Some expected uses: television distribution by the three tv networks; computer-to-computer data transmission; air traffic communications and navigation (such as that studied by Aeronautical Radio Inc.); and the "big private lines in the sky" for corporate communications along the lines of the General Electric filing with FCC last year.

With one important exception, reaction within the communications industry to competitive development of domestic satellite communications was favorable. The exception of course, was the Communications Satellite Corp., whose position still is that "the establishment of a commercial satellite system by any U.S. entity other than Comsat would require new legislation." While Comsat says it will file for a domestic service as soon as FCC procedures are established, it still contends it is the only entity authorized by Congress to launch communications satellites.

Presidential assistant Peter Flanigan says, however, that "We find no public-interest grounds for establishing a monopoly in domestic satellite communications." In fact, the study recommends that no combination of users—broadcasters or computer companies, for example—exclude another of the same group from leasing satellite circuits.

How does AT&T feel? It believes the White House view is "consistent" with its own. Recalling long lines vice president Richard R. Hough's recent Capitol Hill testimony, the carrier notes it argued that "any organization or group seeking to use communications satellites for its own use should be permitted to do so."

The "fourth-generation" earth station under construction at Talkeetna, Alaska, will cost \$4.5 million. It will employ a 97-foot-diameter antenna with de-icing equipment on the reflector.

Joseph V. Charyk, Comsat president, points out Comsat is working closely with representatives of Alaska and RCA, the purchaser of the Alaskan communications system, with a plan to provide satellite services in Alaska "as soon as possible." But the best long-term solution to Alaska's communications needs, according to Charyk, is a U.S. domestic satellite system.

RCA is buying the Alaska system from the Air Force for \$28.4 million. Under the agreement, RCA will invest an additional \$27.6 million over three years to expand facilities and improve service. As a result, RCA has its foot in the domestic communications market door—a door AT&T understandably would like closed.

Although the accusation has been denied by Richard R. Hough, vice president of AT&T's long lines department, several of the key wit-

nesses at Karth's hearings repeatedly spoke of overloaded overland microwave circuits via Canada and over undersea cable to Seattle.

Howard R. Hawkins, president of RCA Global Communications, says that in the RCA proposal to purchase the Alaska system, "major emphasis was placed on the role of satellites in the development of interstate and intrastate telephone, data, tv transmission, and other services." RCA is presently developing a comprehensive satellite master plan for Alaska.

**Decisions, decisions.** If it is decided that a satellite should be part of the Alaska communications system, it must be determined whether Alaska should have its own dedicated communications satellite, or whether the state's system should be fully integrated into a U.S. domestic system.

On one hand, some argue Alaska's communications needs are so urgent and so many that the state should have its own satellite—or at least use channels through Intelsat 3 over the Pacific. AT&T's Hough doesn't feel one satellite

For victory over multi-layer circuit problems...

# Call on the Lint-Pickers!

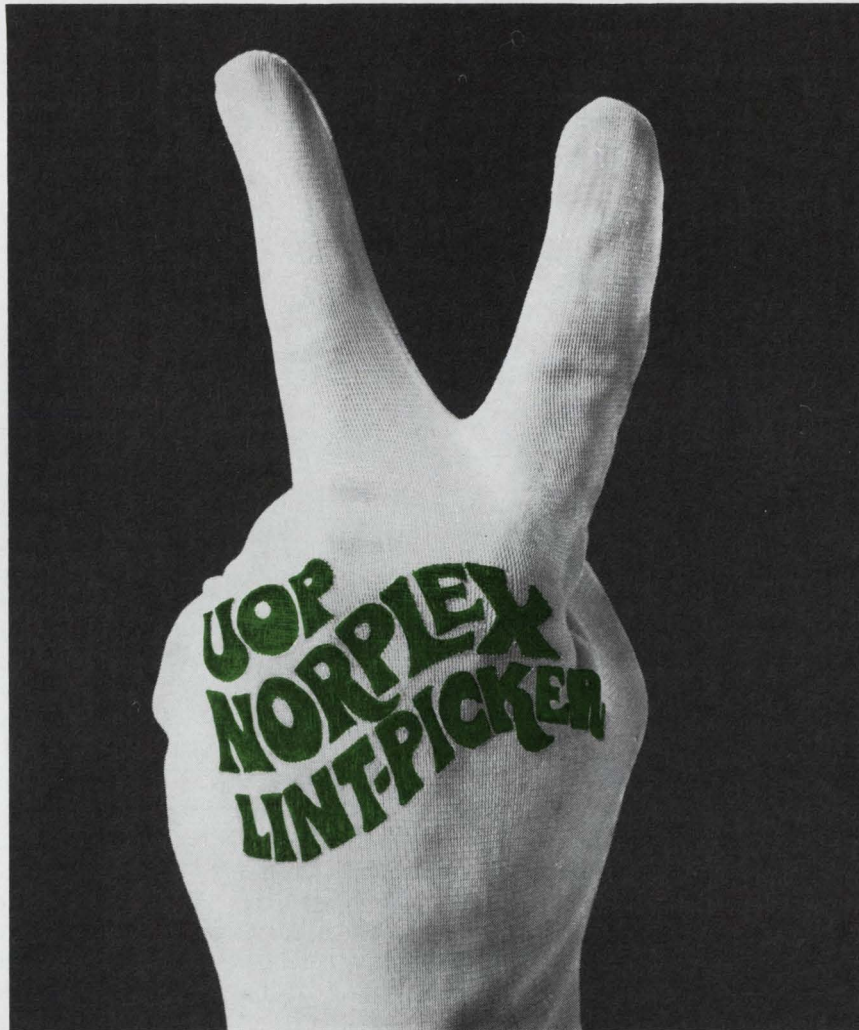

Multi-layer circuits can cause multi-layer headaches. But not when you bring your copper-clad laminate problems to the "Lint-Pickers". That's because UOP Norplex is super-critical about quality.

Ultra-thin laminates and prepreg are checked, rechecked, tested, retested . . . all the way from raw material to finished product. In fact, Norplex quality is so well accepted that a number of customers no longer do their own in-coming product testing.

In addition, Norplex copper-clad laminates and bonding sheets are available in a wide variety of materials, sizes and thicknesses. And all from those most particular people, the "Lint-Pickers".

UOP Norplex is a division of Universal Oil Products Company, a half-billion dollar company busy making life better through research and product innovation around the world.

Write for our latest catalog. It's designed to help engineers select the right laminates for every need. UOP Norplex Division, LaCrosse, Wisconsin 54601. 608/784-6070.

#### Major Check Points in Norplex's Quality Assurance Program

1. Evaluation of suppliers.
2. Establishment of raw materials specifications.
3. Verification of suppliers' conformance to Norplex specifications.
4. Inspection of incoming raw materials.
5. Monitoring of critical processing steps.
6. Accumulation of chemical, electrical and mechanical performance data for statistical computer analysis.
7. Laboratory testing to assure all MIL and NEMA specifications are met.
8. Final examinations by inspection department to verify compliance to MIL, NEMA and customer requirements.



could effectively cover both Alaska and the rest of the nation. And he believes a communications satellite solely for Alaska would be prohibitively expensive, adding that the planned satellite systems for Canada and France-Germany also will be very uneconomical.

On the other side, Comsat and others maintain that any satellite link for Alaska must be integrated with a similar domestic system, primarily for economic reasons.

**Scores Government role.** Congressman Howard W. Pollock (R., Alaska) claims Comsat and the common carriers are "justifiably reluctant to make a significant high-risk investment" in a domestic satellite program. This is due not only to the lack of national policy, but because the initiative and incentive for undertaking such development has been removed from the private sector. Pollock says this results from delegating "to inappropriate agencies [later identified as the Department of Commerce and the Budget Bureau] the authority for guiding development." The Budget Bureau says it is merely an observer in a nine-month, \$400,000 study being conducted by the Commerce department's Office of Telecommunications.

AT&T's Hough has stressed more than once that "there are no communications services which could be offered by satellites which cannot now be offered over terrestrial facilities. Even on the transcontinental routes," claims Hough, "it now appears that the cost per circuit mile of the L-4 and (the upcoming) L-5 cables would be substantially less than for Intelsat 4."

**Opposite corner.** Comsat's Charuk, of course, disputes AT&T's arguments. He claims the investment cost per circuit year for the Intelsat 4 will drop to \$600 per voice circuit when it becomes operational next year. That's quite a drop from Comsat's first satellite, Early Bird, which cost \$16,000 per circuit year.

For a domestic tv satellite system covering the entire U.S. mainland, including Alaska, Comsat says the "revenue requirement"—or annual income expected from the system—would have to be between \$30 million and \$40 million, he says. A 24-channel tv satellite in stationary orbit over Los An-

geles would handle 200 to 250 domestic U.S. ground stations and 14 Alaskan stations. Such earth stations may cost about \$200,000 each, he estimates. A backup satellite also would be put in orbit. By comparison, the three tv networks pay \$65 million a year for present terrestrial service.

NASA's Marsten says the future trend of domestic communications satellites is primarily in the specialized information networks such

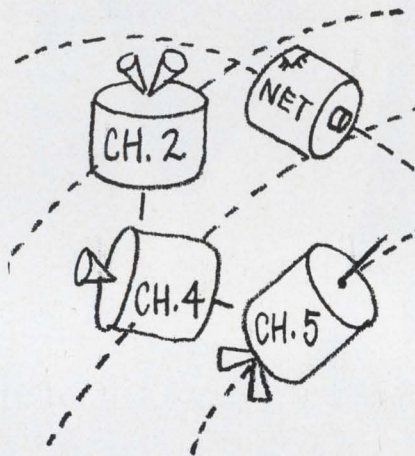

as tv networks, educational tv, data collection and transfer, and air traffic control. The practicality of such specialized information networks, he says, "may depend on continued improvements in the efficiency with which we can further narrow our antenna beams and point our satellite antennas toward selected portions of the earth's disk. Voice and data transmission, and position-locating experiments using these directive antennas have shown that relatively simple and inexpensive ground and aircraft equipment can work with satellites using this technology."

By putting a 30-foot, narrow-beam antenna in space with ATS-F and ATS-G, NASA hopes to improve transmission efficiency by a factor of 300 over ATS-1 and ATS-3. Fairchild Hiller and General Electric have completed their 13-month studies on design proposals for the construction of the satellites, and NASA expects to select the contractor from these two firms early this year.

ATS-F experiments applicable to a domestic satellite will include measurement of r-f interference in the commercial satellite frequency

bands to permit development of criteria for sharing these frequencies between space and terrestrial uses. Also to be studied will be the basic effects of the atmosphere and ionosphere on very wideband signals to determine some of the basic limitations on transmissions from satellites to earth stations.

When most of the data for these experiments are obtained, NASA will move ATS-F to a spot over Western or Central Europe, from where it can "view" the Indian subcontinent. Then, NASA and the Indian government will conduct an instruction tv experiment. From the existing ground station at Ahmedabad, television will be transmitted via ATS-F to about 5,000 widely scattered villages.

The experiment will cost India an estimated \$10 million to \$15 million. This will include the purchase and installation of the 5,000 village receiving stations and tv sets. U.S. expenses of \$1.5 million to \$1.9 million will pay for moving the satellite to Europe and operation for one year, plus \$1 million for the 80-watt uhf transmitter and associated portion of the ATS-F transponder and feed system.

If the experiment is a success, the service may be expanded to 560,000 rural villages in India, creating a tremendous market for producers of small earth stations and manufacturers of allied communications equipment. A joint NASA/India study estimates the expanded service could cost \$233 million initially, plus \$8.8 million in annual costs.

This February, RCA Victor Co., Ltd. expects to complete a \$3 million program definition phase contract for Canada's new Telecommunications Satellite Corp. (Telesat). Telesat's mission is to establish a Canadian domestic satellite communication system. John Almond, Telesat's director of engineering, says the 1,200-pound craft will relay six broadband channels to 30 earth stations.

How much will Canada's entry into the domestic satellite communications field cost? "It's hard to say," Almond says, "but I'd guess about \$75 million." Some experts have estimated Canada's yearly operational expenses for the system will be about 25% of the system's capital cost.

NO

GO

NO

0008  
EVENTS

0031  
EVENTS

0194  
SECONDS

0026  
SECONDS

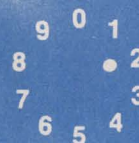

Now just passed you by.

Just now<sup>1</sup>. And now<sup>2</sup>. There goes another one. Now<sup>3</sup>. Nothing is more fugitive than now<sup>4</sup>. That's where Minelco comes in—with miniature electronic, electromagnetic, electromechanical components that tell you a lot about now<sup>5</sup>. *BITE (Built-in test equipment) indicators* that pinpoint circuit faults, tell circuit conditions now<sup>6</sup>. *Trimmer potentiometers* that correct to proper tolerances now<sup>7</sup>. *Rotary switches* that turn you on now<sup>8</sup>, to one of as many as ten different phases. *Elapsed time indicators* that tell you how long from the first now to the present now<sup>9</sup>. And *events counters* that count the nows<sup>10</sup>. Think of how many nows have passed just since you began reading this ad—25 seconds ago!

And all those other nows. Shouldn't you get in touch with Minelco now<sup>11</sup>?

For additional information, contact:

**MINELCO**

SPACE & SYSTEMS DIVISION  GENERAL TIME

(BITE indicators, potentiometers, switches)  
600 SOUTH STREET, HOLBROOK, MASS. 02343  
(617) 963-7717

(Elapsed time indicators, events counters)  
1200 HICKS ROAD, ROLLING MEADOWS, ILL. 60008  
(312) 259-0740



Circle 131 on reader service card

# Signal and system analysis at a glance.

**Compare data streams and records. Characterize noisy, random signals. Detect periodic signals buried in noise. Identify vibration sources in structures and isolate different transmission paths and times. Completely characterize components in complex systems by impulse response measurements and frequency spectral analysis.**

You can do all this and more with Hewlett-Packard's new all-digital 3721A Correlator — on-line, and at a price you can afford.

It's a powerful, portable signal analyzer. It offers cross-correlation for comparison of two signals in noise, without a sync pulse. Auto-correlation for

comparison of a signal with itself. Signal recovery. And statistical probability measurement.

And it's as easy to use as an oscilloscope.

The time span across the CRT can be varied from 100  $\mu$ S to 100 seconds (to infinity with external clock). Maximum resolution is 1  $\mu$ S. An optional delay offset facility enables you to look at up to 1000 points of time scan. And a unique quick look feature gives you an almost immediate indication of the final value of the function being computed.

Remember, HP's 3721A is all digital. This gives you tremendous averaging versatility and power. The averaging time constant is changed at the flick of a

switch — over a range of 36 milliseconds to over 100 days. And for maximum convenience, our new correlator can be interfaced directly to a computer for frequency spectrum analysis and other types of data manipulation.

The price? Just \$8325. For comprehensive signal and systems analysis at a glance, call your Hewlett-Packard representative. Or call or write Hewlett-Packard, Palo Alto, California 94304; Europe: 1217 Meyrin-Geneva, Switzerland.

**HEWLETT  PACKARD**

**SIGNAL ANALYZERS**

Circle 132 on reader service card

18911

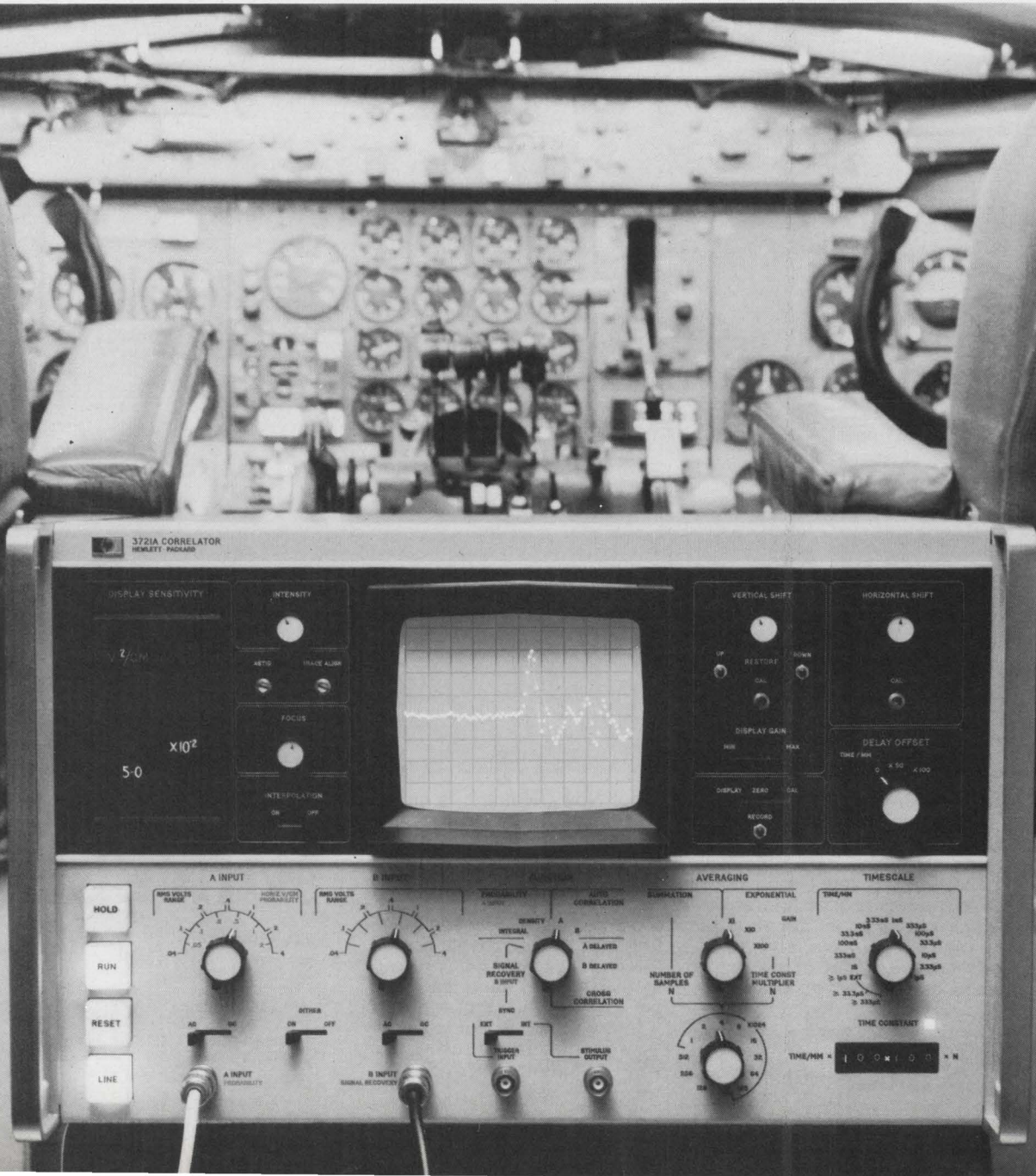

# Impact of GE strike widens —but EE's stay on the job

Some engineers, though, work as drivers and welders; labor pact should set a pattern for electronics industry

By Peter Schuyten

Electronics staff

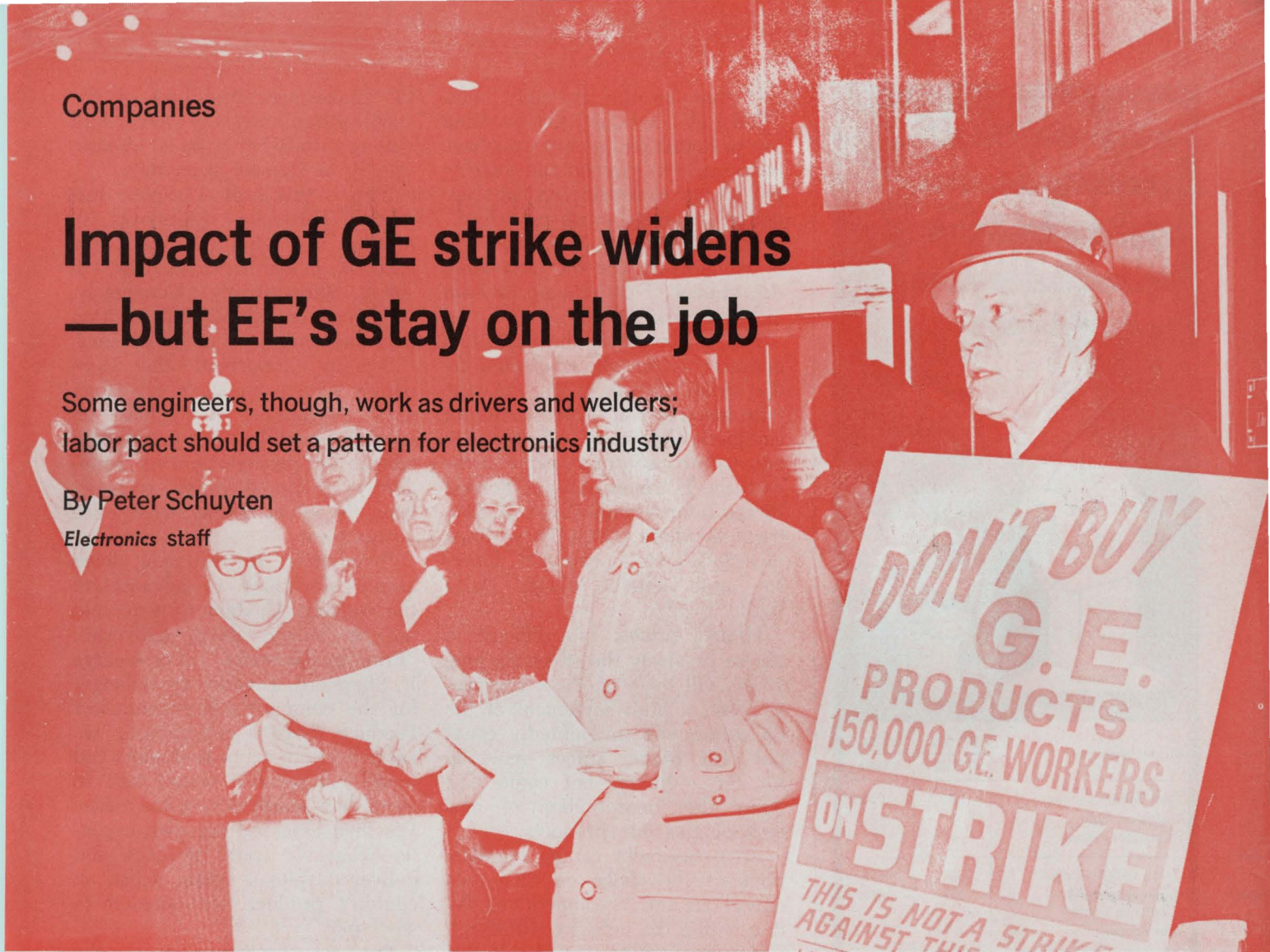

**Workers-turned-strikers** have been picketing 150 General Electric Co. plants in 33 states for a full 14 weeks now, and with each passing day the impact of the strike on GE operations, its customers in the industry, and the nation's economy grows substantially. But, for thousands of GE's electronic engineers—even the company doesn't know how many—the impact has been slight.

None of the engineers are on strike, none were locked out of plants—except for a brief period at isolated locations around the country in December—and none have been laid off.

But, many EE's, particularly in production facilities, have been asked to do different jobs, such as running heavy equipment including trucks, cranes, lathes, and welders. A side effect of this, maintains William T. Cleary, director of industrial relations for the American

Federation of Technical Engineers, is an increase in the number of in-plant injuries. GE says it has received no reports that confirm this statement.

Little evidence of a drop in

morale can be found, though recently several engineers are reported to have quit over their new duties. But in many cases, insists a GE spokesman, a lot of them have been getting a kick out of doing

## Issues but no answers

General Electric says the union's demands, if granted, would create a "super-inflationary" wage spiral. Officials of the International Union of Electrical Workers, on the other hand, point to GE's 11% profit last year, saying the company should tighten its own belt. Further, asserts the union, GE is resorting to Boulwarism instead of negotiating. This negotiation tactic, recently outlawed by the courts, works on the principle that management is in the best position to allocate the company's resources and determine employee needs. Under it, the company makes one, and only one offer.

On October 7 the union rejected GE's first, and so-called final offer. The contract expired October 26, and the union went out on strike. Then in an unexpected move, GE came to the bargaining table with a second offer; that was on December 6. December 7, that offer was also rejected by the union. Both sides admit that since then, little in the way of constructive negotiations has taken place.

# CHECK NORTRONICS HEAD SPECS FOR YOUR MINI-DIGITAL APPLICATION—



Model Number	BQQN	W2R
	B3187	B1884
Tape Width—Inches	.250	.150
Tracks on Tape	4	2
Channels in Head	4	2
Track Width—Inches	.037	.056
Channel Spacing (Center to Center)	.071	.088
Gap Spacer	0.5 Mil	0.2 Mil
Inductance, 1 KHZ	85 Mhy	10 Mhy
Resistance, D.C.	290 Ohms	39 Ohms
Saturation Current—ma. to Produce 90% Peak Output @ 200 BPI (Measured Zero to Peak, Alternate Polarity)	0.9	2.7
Write Current—ma. 150% Saturation Current @ 200 BPI	1.4	4.0
Read Output—mv. P-P (Open Circuit) 3.75 ips.	11.8	4.2
NRZI @ 200 BPI 15 ips.	44	15
Read Output—mv. P-P 800 BPI Ref. 200 BPI	85% min.	85% min.

These and  
7 MORE  
NOW AVAILABLE  
Request Bulletin #7253  
and Supplement #7310

available free from the  
World's Most Experienced Manufacturer of  
Magnetic Heads

**Nortronics**  
COMPANY, INC.

8101 Tenth Avenue North  
Minneapolis, Minnesota 55427

odd jobs on the assembly lines. "Generally, we are not working longer hours, and no attempts have been made to prevent our entering the plants to work. Our jobs are going on pretty much as before," concludes Bernard Buus, manager of engineering for the large-lamp department of GE's Lamp division in Nela Park, Ohio.

But, if the lot of the individual engineer is largely unaffected by the strike, this is hardly the case with managers of other electronics companies now in or about to enter into contract negotiations with the 11-union coalition headed by the International Union of Electrical Workers (IUE). These firms include Westinghouse, RCA, Emerson, and General Motors' Delco Radio division.

**Higher prices.** It's difficult to assess precisely the effect the long strike will have on these companies; but, a high settlement of the GE strike will undoubtedly cause not only higher prices generally for the industry, but could also delay the incorporation of new technologies into products.

An assessment of the ramifications of the strike on GE's own operations and its competitive position within the industry is difficult, if not impossible to make at this time. On October 26, the day when union workers walked off the job, an official curtain of silence descended on all but a handful of

GE spokesmen. And, out of the small group, most of those still willing to talk either do so circumspectly or request anonymity.

Nor, is this wall of silence surprising. The union, by its own admission, is playing a waiting game with GE, in the hopes that GE will suffer competitively. Conversely, GE's reticence about that position may undermine the union's stance. Equally important, the company's silence forestalls the effect such revelations would have on customer confidence. A month ago, official GE pronouncements confidently predicted quick recovery from the effect of the strike, once it was over.

Inventories, for example, were amply stockpiled in advance of the walkout. Customers were told not to worry about deliveries. "Prior to the strike," says George E. Shepherd, a marketing manager for the company's Semiconductor Products division in Syracuse, "we sat down with major customers and found out what it would take to meet their needs during the strike. We then assessed our own capacity—what we could produce and deliver despite a strike. What we couldn't produce we decided to stock-pile."

But, this confidence is on the wane. Hardly anyone, with the possible exception of the union leaders, expected the strike to last so long. A spokesman for GE's

## Union demands

The union has asked for a 35 cent wage increase in 1969, 30 cents in 1970, and 25 cents in 1971. Above that it is asking for a full cost of living clause in the contract as defined by a 1955 contract agreement: for every 0.4% rise in the cost of living index, as assessed every three months, the workers would get a 1 cent per hour raise in pay.

Fringe benefits would include a pension of, \$7.50 per month for every year of service (currently, it is \$4.50 per month), seven days paid sick leave, two more paid holidays (the worker now get nine), five weeks vacation for 20 years of service, a union shop, and binding arbitration for plant grievances.

## GE's second offer

For the first year of the contract GE offered its workers a 20 cent an hour increase, plus 5 cents to 25 cents an hour more for highly skilled workers. This would be followed by a 3% increase in each of the next two years, with provision for an additional 2% in accordance with a consumer price index formula, defined as a 0.5% increase for every 1% rise in the index between 2% and 5%.

Fringe benefits would include two paid sick days after five years of service, three days after 10, and four days after 15 or more years, to take effect in January 1972. GE also stipulated a pension of \$5 per month per year of service, a fifth week of vacation for 30 years of service.



# Buckbee-Mears offers the biggest variety of flexible circuits on the market today!

*We also produce the best.*

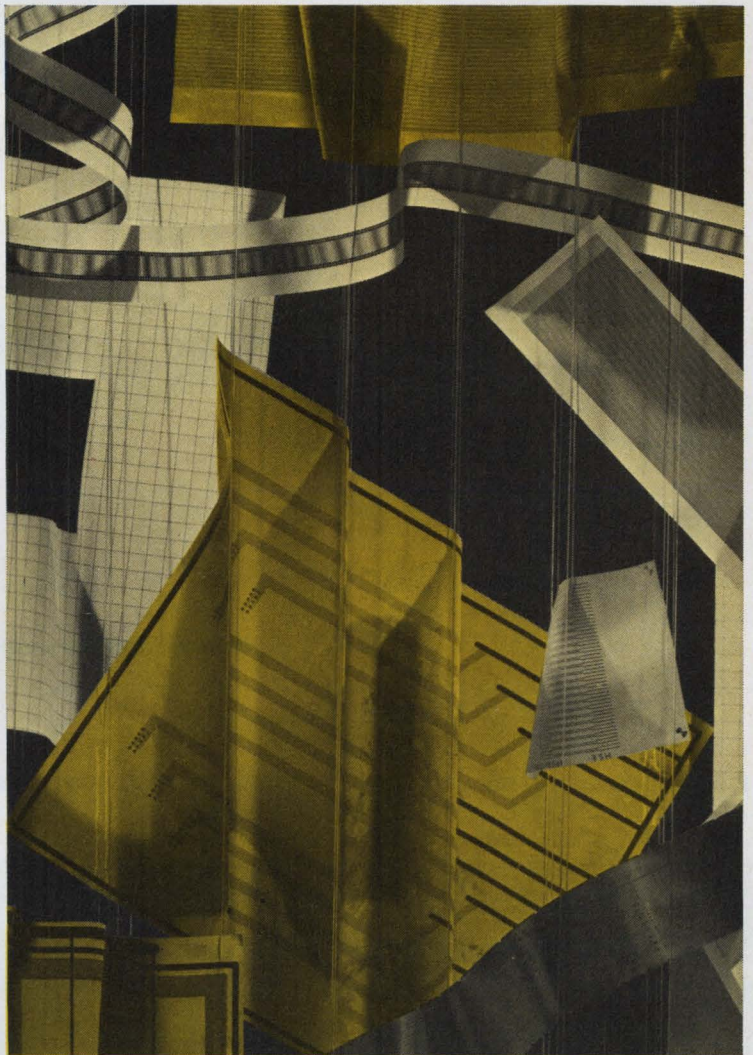

The most flexible, accurate way to produce flexible circuits is by precision photomechanical reproduction. As it happens, Buckbee-Mears invented the photomechanical technique. Our facilities are larger and more advanced than anyone else's.

Using the photomechanical process, we offer sharp definition and close tolerances in both Mylar\* and Kapton\* base circuits. We produce smaller wires to two mils apart on four mil centers. We also produce very large circuits. Once, for example, we etched two sided circuits that were five feet square. Another time we etched a single sided flexible circuit six feet long by just three inches wide. Most important, we hold tolerances to  $\pm .0002$  inches on wires and space. You can't buy a more accurate circuit.

There are other advantages to having Buckbee-Mears produce your flexible circuits by photomechanical reproduction. We etch holes through the dielectric material, saving a drilling or punching operation. After etching the

holes, we can pull the wire down through the holes, or leave them hanging out for pin connectors.

The holes can be plugged with a conductive material for a good electrical path from top surface to bottom surface. We offer gold, 60% tin and 40% lead, or pure lead plating over the conductors. The plating can be done selectively or over the entire circuit. We guarantee shrinkage control on any flexible circuit pattern we produce.

More and more industries are finding applications for flexible circuits today. Major users include computer manufacturers, the auto industry and microcircuit packaging. But anyone who has a space or weight problem can use Buckbee-Mears flexible circuit technology.

If we can help you, call or write Bill Amundson, our industrial sales manager. He has a staff of experts in flexible circuitry who can solve your particular problems. Bill's phone number in St. Paul is 612-227-6371.

\*DuPont trademark

PRECISION METAL AND GLASS ETCHING • ELECTRO FORMING • AUTOMATED DESIGN  
**bmc** BUCKBEE-MEARS COMPANY  
SAINT PAUL, MINNESOTA 55101

# YOKE SPECIFYING PROBLEM?

**ASK AN  
EXPERT...**

## **A SYNTRONIC DEFLECTION YOKE SPECIALIST**

Since we make more types of yokes than anyone else, it's natural enough for our team of experts to know more about yoke design, application engineering, and quality control.

Specifying can be a challenging problem, and with this in mind, we put our experience at your disposal. Don't hesitate to call or write us when you're puzzled as to the right deflection yoke for your display.



*syntronic*

**INSTRUMENTS, INC.**

100 Industrial Road, Addison, Illinois  
Phone: Area 312, 543-6444

Circle 217 on reader service card

computer operations, which buys components from Syracuse, admitted early in the strike that inventories would last only as long as January. "If the strike lasts into February, we're in trouble." Now, adds another, "We're having problems trying to qualify some second sources for components we were getting elsewhere in GE." While GE's Milwaukee X-ray plant has been able to meet all its contract commitments, a local company spokesman says it has lost some business in new orders, although he would not place a figure on the amount of the loss.

In San Francisco, the word from a GE regional vice president's office is that the company is having trouble keeping up with delivery schedules on big ticket items more than on consumer goods. And, another company source, this one in GE's Lynn, Mass., facility, admits that lately some customers have been lost, and some critical contracts had to be farmed out to be finished.

Compounding delivery problems on contracts undertaken before the strike began is the dilemma the various divisions find themselves in when it comes to bidding on new contracts. One spokesman at the Lynn plant indicates that GE continues to bid on most contracts that come in. "If we don't get contracts, there won't be any work to do when the strike is over." But the danger here, as many GE spokesmen are quick to admit, is that if the strike continues to drag on, GE won't be able to perform on these new contracts.

As Semiconductor Products' Shepherd puts it, "We're continuing to solicit business, but we're also being frank with potential customers when we think we won't be able to perform. My biggest concern right now is turning off customers."

Another crucial problem voiced by Shepherd and other GE marketing and project managers is the effect of the strike on the company's entrance into new technologies. According to Shepherd, his department is in the process of reassessing future inflationary trends in both labor costs and materials. "Unfortunately, our technological priorities may shift somewhat. Longer range programs may have

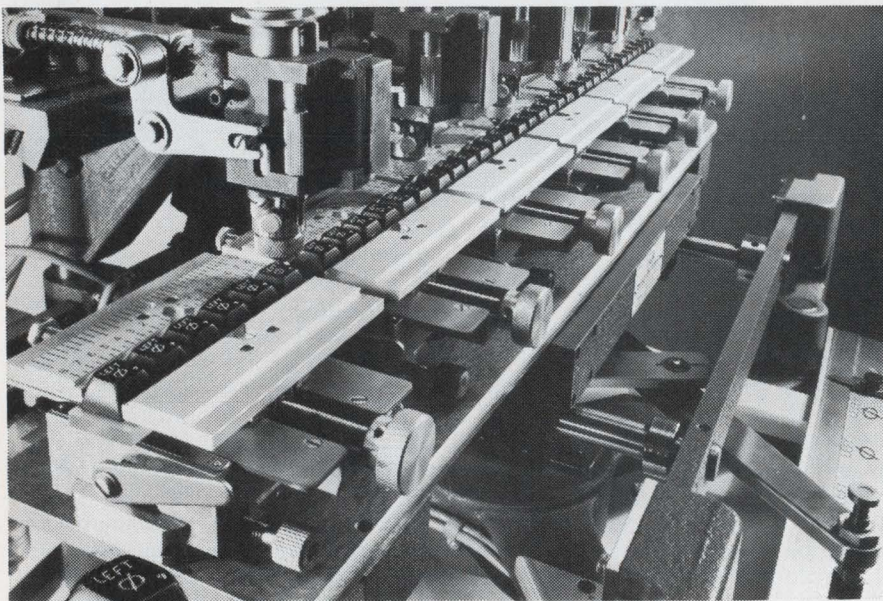

### **6 will get you 36**

Now, new 6-spindle New Hermes engraves up to 36 machine keys with one set-up.

Any unskilled worker simply guides the pantographic tracer on this pneumatically-operated engraving

machine. Each spindle has an automatic depth-regulator, guaranteeing uniform depth and width of engraving over the complete contour of the key.

Write for detailed brochure No. 197.

*new hermes engraving machine corp.*

20 Cooper Square, New York, N. Y. 10003

Chicago, Atlanta, Los Angeles, Dallas, Montreal, Toronto, Mexico City

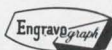

# SCIENCE / SCOPE

A new launcher for the Phoenix missile now being built by Hughes has a fail-safe device that prevents accidental separation of missile from launcher during aircraft maneuvers. It uses no exotic or critical materials, weighs only two-thirds as much as an earlier model, and can be installed on either side of the fuselage.

A self-cleaning gas system makes it unnecessary to remove the launcher for maintenance after each mission. Hughes is building the launcher for the U.S. Navy's new F-14A fighter under contract to Grumman Aerospace Corp.

An imaging photopolarimeter for the Jupiter probe is being developed for NASA's Ames Research Center by Santa Barbara Research Center, a Hughes subsidiary, for the Pioneer F and G spacecraft to be launched in 1972 and 1973. Instrument will map the density and distribution of "asteroidal debris", measure the gas above Jupiter's cloud layers, and send back two-color spin-scan images of the planet.

Los Angeles has turned to aerospace technology for help in meeting the increasing demands for police, fire, and ambulance service. The city council recently chose Hughes to make a one-year study of the city's over-burdened services and to draw up a plan for a command-&-control system that would provide rapid pinpointing of field forces, computer dispatching, automated status displays, computerized information files, individual communications for hazardous-duty personnel, and automatic transmission and signaling for police vehicles.

NASA's Atmosphere Explorer satellite, now under study at Hughes, will carry a propulsion system that will enable it to climb to an apogee of 2500 miles in its variable orbit around earth. Every two hours it will dip back into the upper atmosphere for 10 to 20 minutes, swooping within 90 miles of earth.

The "yo-yo" satellite's scientific objectives will be to obtain data on the behavioral relationship of the upper and lower atmosphere, solar energy absorption, density of the atmosphere's charged-particle structure, and the diurnal bulge that appears to circle the earth as the sun heats the atmosphere.

Career opportunities for engineers at Hughes include: Signal Processing Systems Analysts, Computer Software Analysts, Radar Systems Engineers, and Circuit Designers. B.S. degree, two years of related experience, and U.S. citizenship are required. Please write: Mr. J. C. Cox, Hughes Aircraft Company, P.O. Box 90515, Los Angeles 90009. Hughes is an equal opportunity employer.

A laser proximity fuse and larger fins are being given to the U.S. Air Force Falcon in a program now underway at Hughes to make the air-to-air missile more effective against maneuvering targets. The proximity fuse's optically focused laser beam, which is reflected off the target, cannot be confused by electronic countermeasures and is virtually impossible to detect.

Because the laser gear is extremely compact, it can be tucked into a collar around the nozzle of the Falcon's rocket motor, leaving space in the missile for a larger and more powerful warhead.

Creating a new world with electronics

**HUGHES**

HUGHES AIRCRAFT COMPANY

# LIFE ASSURANCE!

## BARNES QUICK-INSERTION LONG-LIFE SOCKETS FOR RAPID DUAL-IN-LINE PRODUCTION TESTING

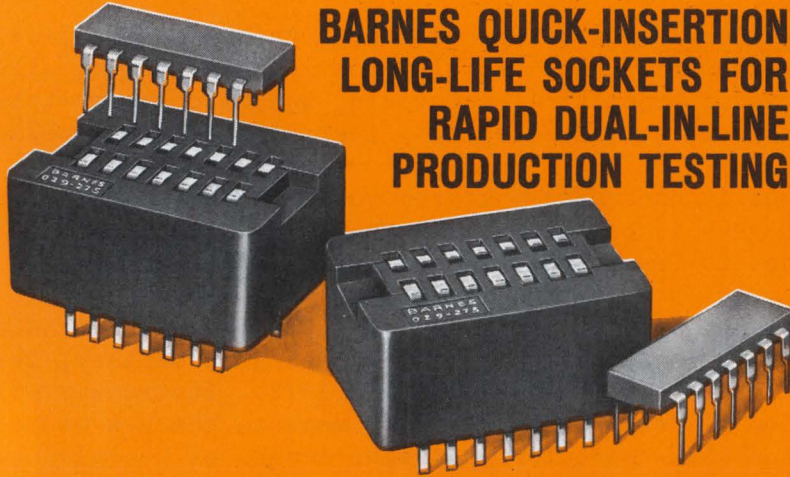

Faced with having to check out large quantities of DIP's . . . quickly and reliably? No problem! The large tapered lead entrances and highly flexible contacts in Barnes 029-275 sockets permit fast and easy device insertion and withdrawal for a typical life of 50,000 to 100,000 cycles. No deformation of lead taper . . . yet reliable electrical contact is maintained for round or flat leads. Available for 14 or 16 lead DIP's, and with Kelvin contacts. Write for data.



Lansdowne, Pa. 19050 • 215/MA2-1525

**barnes** / THE FIRST WORD IN CARRIERS, CONTACTORS AND SOCKETS FOR I.C.'S

Circle 195 on reader service card

*New*

## MICRO-VECTORBORD AND D.I.P. PLUGBORDS ARE HERE!

Save time — Save work — Save money

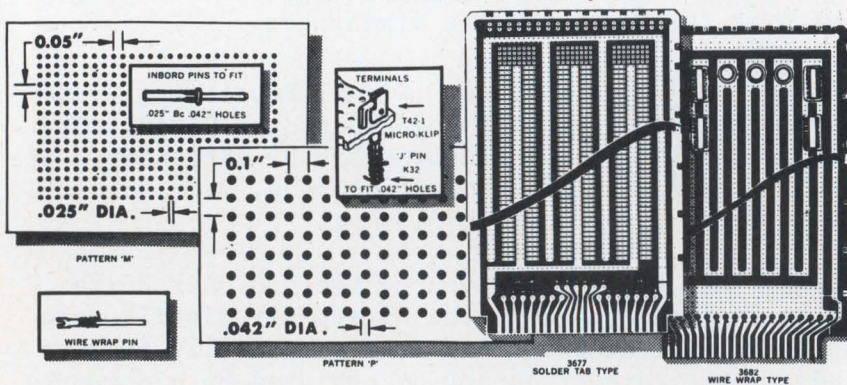

### WIDE SELECTION OF SIZES AND MATERIALS

**MICRO-VECTORBORD "P"** .042" holes match D.I.P. leads. Epoxy glass or paper, cop. cld. also 1/64" to 1/16" thk.

**MICRO-VECTORBORD "M"** .025" holes match Flat-Paks, 1/32" Epoxy glass, cop. cld. also or .007" Mylar.

**NEW SOLDER-PAD D.I.P. PLUGBORDS** — 3677 Series Epoxy glass, "P" pat., 1/16" thick with 44 etched plug contacts (2 side total) power, ground

busses, pads for up to 24 D.I.P.'s (14's). Also 21 units 16-leads D.I.P.'s, T-O's and discretes.

**NEW WIRE WRAP D.I.P. PLUGBORDS** — 3682 Series Similar to above but closely spaced bus lines for higher density. Up to 48-D.I.P. 14 lead wire wrap sockets mountable or T-O's and discretes.

**TERMINALS** — Micro-Klips, Mini-Wire-Wraps, Rd. Pins, Patch Cords, etc., available.



Send for complete literature

**ELECTRONIC CO., INC.**

12460 Gladstone Ave., Sylmar, California 91342  
Phone (213) 365-9661 • TWX (910) 496-1539



to be postponed while we work hard to keep supplying customers."

Dwight V. Jones, a consulting engineer at the Syracuse plant and acting manager of the Semiconductor Products engineering applications group feels that the worst feature about the strike is that "new product development will be retarded. We just won't be as strong as we would have been had there been no strike." Nor is he alone in this feeling. Bernard Buus of GE's Lamp division points out that all work during the strike is related only to production, and his group is concerned about what will happen to nonproduction-related development. "However, we are trying to keep future projects going so we will not be in a situation of not having new engineering work to do when the strike does end," he explains.

**Brawl.** Still, perhaps the greatest effect of the GE strike—its impact on the rest of the electronics industry—is yet to be felt. Like the biggest man in the barroom, GE was deliberately chosen as the union's first target, because, the reasoning goes, if GE falls, the rest of the industry will go along more or less compliantly. Westinghouse, for example, whose contract was up the same time as GE's, is still operating at full throttle while negotiations continue because, as William Bywater, president of IUE local 3 in New Jersey puts it: "We didn't want to take on two large corporations at once—a two front war as it were. Besides, with Westinghouse operating, it puts the onus on GE to settle faster."

While most of the other companies are very quiet about the upcoming negotiations, it's a safe bet that the GE settlement will set the tone for the other contracts.

As one RCA spokesman indicates: "We are watching this thing with more than a casual interest, and not only our corporate people either. Our product managers and marketing people are in the process now of looking at the possible effects of a high settlement on the prices of not only our present product lines but also the future of new technologies. It's not beyond comprehension that a high enough settlement could force the industry to postpone some new technological developments."

# The most for your money: in 8 channel recorders, it's the new Brush® 480.

Minimum cost per channel and maximum data presentation.

That's the cost/performance package called the Brush 480... most versatile, least expensive 8-channel recorder of its kind.

It's the economical solution to your problem of analyzing eight variables on a common time base.

The Brush 480 has eight 40 mm channels, two event markers, and twelve pushbutton-controlled chart speeds that run from 0.05 to 200 mm/second. It's available as a compact portable or can be rack mounted.

Although small in size, the 480 has all those familiar Brush exclusives. Like a patented pressurized ink system that puts crisp rectilinear traces

right into the paper. So there's no smudging, no puddling. And messless throw-away ink cartridges can be replaced in minutes.

The 480 comes factory-calibrated and, thanks to our special pen-position servo system, we guarantee 99½% accuracy. Frequency response at 50 divisions is flat within  $\pm 2\%$  of full scale from d-c to 40 Hz.

And the Brush 480 is compatible with our multi- and single channel signal conditioners so you can select the conditioning best suited for your measurements, whether it's temperature, pressure, strain, voltage, current, position, velocity or what have you.

The Brush 480. It's one of the few bargains left. For more information,



write for bulletin 934-18. Brush Instruments Division, Gould Inc., 3631 Perkins Avenue, Cleveland, Ohio 44114, or Rue Van Boeckel #38, Brussels 14, Belgium.

**GOULD BRUSH**

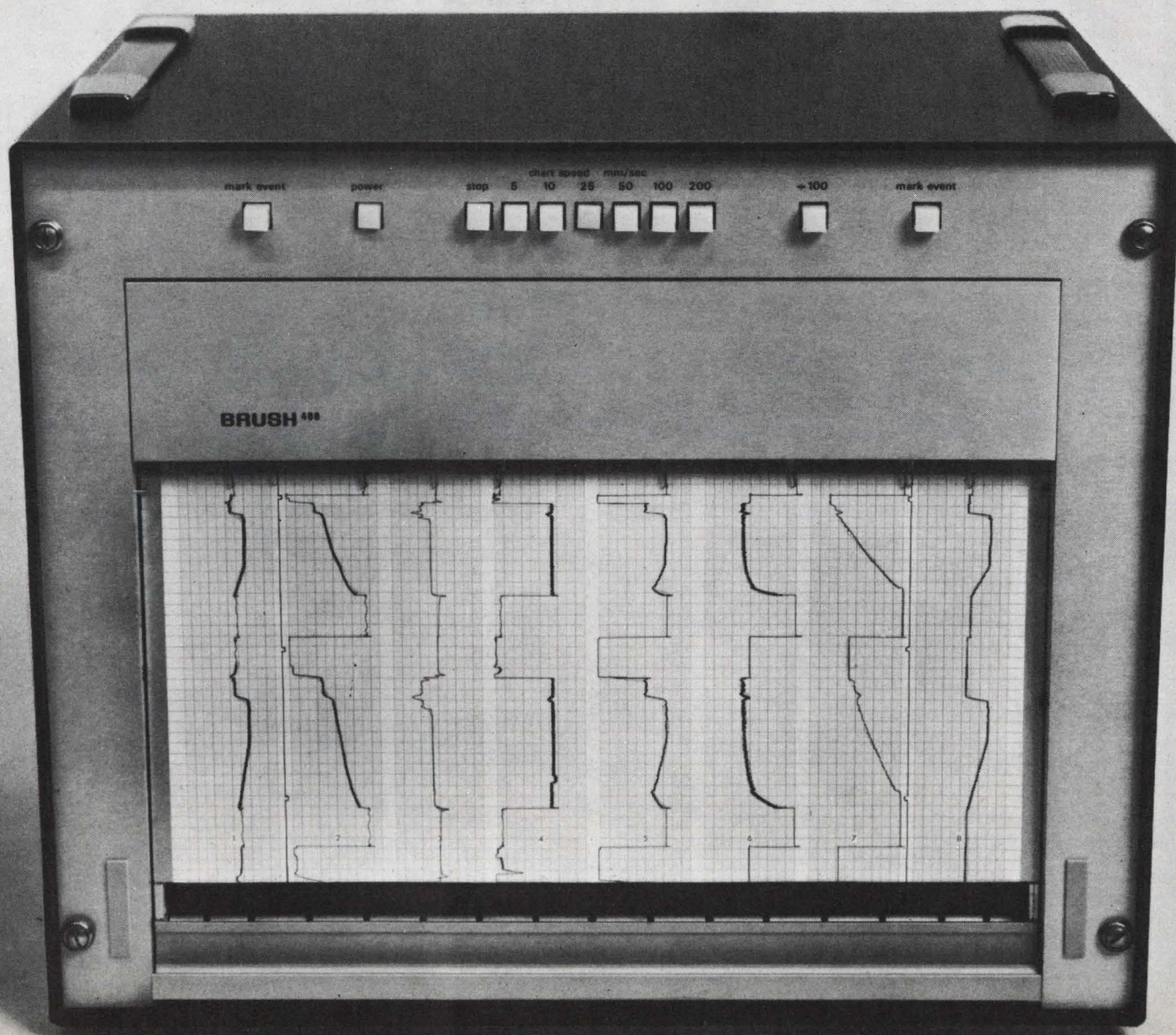

# USE TRON RECTIFIER FUSES TO PROTECT



**VARIABLE SPEED DRIVES**  
... as used in machine tools and conveyor controls.

**INVERTERS**  
... wherever it is necessary to produce alternating current from direct current, such as non-interruptable power supplies.

**BATTERY CHARGERS**  
... used to charge batteries of industrial trucks, forklifts, etc.

**PLATING POWER SUPPLIES**  
... used to furnish direct current for electro-plating processes.

**POWER CONTROLS**  
... as used for heating, cooling and temperature control applications.

... or wherever a fast-acting fuse is needed in the protection or isolation of electronic or electrical components.

*TRON fuses offer you a complete line—1/2 to 1000 amps.—voltages up to 1500.*

They are designed for the protection of solid state devices such as semi-conductor rectifiers, thyristors, SCR's—wherever extremely fast opening and great limitation of let-through current is needed.

*For full information on TRON Rectifier Fuses and time-current characteristic charts, write for BUSS Bulletin TRFS.*

**BUSSMANN MFG. DIVISION,  
McGraw-Edison Co.,  
St. Louis, Mo. 63107**

SUPPLIED THE ECONOMICAL WAY...  
THRU DISTRIBUTORS  
**BUSS QUALITY**  
FUSES

**FOR FUSES AND FUSEHOLDERS OF UNQUESTIONED HIGH  
QUALITY FOR EVERY PROTECTION NEED...**

# Computer has calculator price tag

Eight-bit time-sharing system aimed at in-house applications serves 16 users simultaneously, performs decimal arithmetic

By James Brinton

*Electronics staff*

When the price and capability of a company's products bump the bottom of the next higher order of machine, there's a strong likelihood that a new line will evolve. Wang Laboratories Inc., long a major competitor in the calculator field, pushed its programable machines upward into the minicomputer market, both in price and capability. Its model 700 was less a calculator than a microprogramed, time-sharing, special-purpose computer.

So it should surprise no one that the firm is now going to market with an 8-bit computer system capable of handling up to 16 users simultaneously. And, though the model 3300 is aimed at engineering, scientific, and industrial applications, its software library includes programs that make it a true general-purpose computer.

Though the move was a simple extension of its market, Wang looked before it leaped into design. The company's market researchers found that:

- ▶ Almost 75% of the tasks demanded of a costly time-sharing system could be performed with a calculator; but users were willing to pay for that extra 25% flexibility gained by time-sharing.

- ▶ Despite all the programming languages available, more than 40% of users adopted Basic because of its simplicity and similarity to mathematical expression.

- ▶ Most time-sharing users were paying an average of \$9 to \$11 per hour for port time—plus costs for telephone lines, and storage of programs and data bases. The lowest rate was about \$5 per hour.

The 3300 system is designed to sell at a price low enough to fit

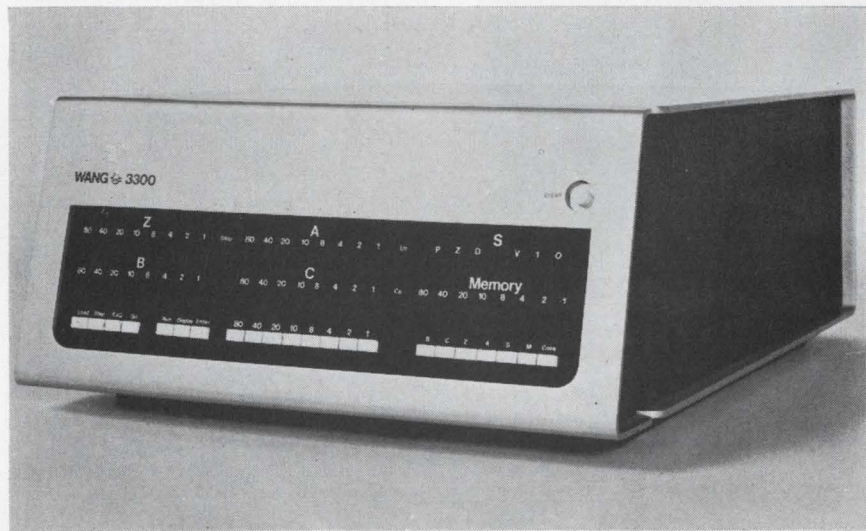

**Time-sharer.** Computer for in-house systems uses Basic language for scientific, engineering, and commercial applications.

the in-house time-sharing market, competing effectively with service bureaus. The 3300 costs \$15,250 up. It also competes in price with other in-house time-sharing systems like those built around the PDP-8L, which at about \$20,000 minimum is the lowest priced of Wang's competitors, though it serves fewer users.

Beyond this point, costs escalate; the time sharing PDP-8I runs from about \$40,000 upward, and typical systems built around Hewlett-Packard's HP-2000 cost about \$80,000 minimum.

In a four-user configuration, the 3300 costs \$21,250. This, in effect, prices each of its teletypewriter terminals at \$5,312.50. Hewlett-Packard's HP-9100 programable calculator costs \$4,400—plus \$975 for a companion printer—for a total of \$5,375. Wang's model 700 costs a basic \$4,900. Thus a time-sharing

general-purpose computer system can cost less per terminal than a set of calculators.

Leasing a 3300 system for less than \$600 monthly, a user will pay only about 75 to 80 cents per hour for port time, estimates John F. Cunningham, 3300 marketing manager. "That's a tenth the cost of service bureau time," he says, "and there are no telephone or other charges to add." Thus, Cunningham claims, the 3300 is a good buy even though its data storage capabilities are more limited than those of a service bureau, and its overall capabilities—like those of other in-house systems—encompass only 50-60% of a service bureau operations.

Finally, the 3300 system uses a modified Basic that permits the user to do mathematical operations as easily as with a calculator, to use a teletypewriter or Selectric output as a stand-in for a plotter,

## MOS ALUMINUM

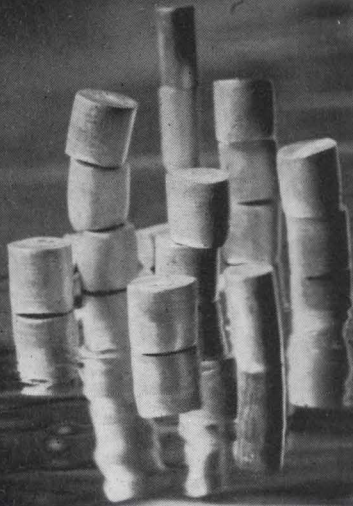

**For higher yield,  
99.9999%  
purity alone  
is not the answer.**

We only claim 99.999% purity for our MOS aluminum. ■ Others are not so conservative. Yet our five nines may be more meaningful than their six nines. We take out sodium that causes junction leakage and instability of device parameters. ■ Our zone refining process also removes virtually all gas, so you don't get spattering problems and loss of material. ■ The result is higher yield and fewer rejections. A probability we'll back up with our guaranteed sample program. Call or write us about it. We won't outclaim anybody. We will outperform them. For our latest thin film materials catalog write MRC, Orangeburg, N.Y. 10962—phone 914-359-4200.

**MATERIALS RESEARCH  
CORPORATION**



and perform business-oriented operations, as well. Wang already has on the shelf about 200 calculation programs and expects to add another 200 to 250 soon, covering 50 "unique disciplines," Cunningham says.

Wang's software is "unbundled." The company charges a \$1,500 fee for the Basic compiler and for system setup. Thereafter, users pay \$10 per month per terminal to cover the cost of a program library maintenance and updating program. Robert S. Kolk, software applications manager, says that the availability of up-to-date, relevant programs has been a shortcoming of other in-house time sharing systems, and the library policy should circumvent it. Users are to be mailed a list of the library's contents regularly, and the programs themselves are to be available at from \$5 to \$10 per cassette. "We just want to ask enough to pay for labor and materials," says Kolk.

**Unique?** The 3300 can do both binary and decimal arithmetic, something perhaps unique in minicomputers. Kolk says the decimal capability allows computations more accurate than those possible with 16-bit computers operating at double precision.

Wang stores numbers in five byte locations, one giving binary notation, and the other four bytes each storing two decimal digits. "We're willing to pay the premium in core space this costs us in return for the increased accuracy," says Kolk.

But Wang's use of memory probably makes the penalty easy to bear. Core expands from the basic system's 12,288 words in 4,096 increments to a total of 65,536—twice the amount possible with most minicomputers.

For second level storage, Wang plans to offer disks as well as its present cassette deck line. A dual cassette deck is offered for use with the 3300 at \$1,400; pricing hasn't been set for the disk system, although it is said to be patterned after the fluidically controlled DDR-1 of the Digital Information Storage Corp. of Berlin, Mass. [*Electronics*, Oct. 13, 1969, p. 149].

**Close fit.** The 3300's cpu is a simple-seeming mainframe which manages to accomplish fairly impressive tasks through its close fit

with the Basic software package.

The processor appears to be small; it has only one accumulator register, a single accumulator extension register, and one addressable status register, for example. But, in its handling of lists, loops, and nested subroutines, it is more like DEC's PDP-11 in that all its core addresses are open for use as temporary registers—and up to 65K of core can be accommodated.

Also, though the processor is an 8-bit machine, it is said that use of double memory reference and arithmetic instructions provide instruction logic equivalent to that found in many 16-bit machines.

Its addressing modes include immediate addressing that lets the cpu shift into a calculator emulation mode when the Basic line number is omitted, and indirect addressing, which allows auto-incrementing, auto-decrementing, and push-down stack uses with either 1- or 2-byte instructions.

Accenting the simplicity of software operation are features like automatic error detection: if an error in syntax, or an illegal operation or an overflow appears, the next line printed out points to the exact location of the error in the statement above and tells its column number and the type of error made. Also, the user can put more than one Basic statement on a line; the 3300 saves them as entered for ultimate execution. In addition, statements can be easily corrected: if the user catches his own error, he can backspace to erase it, or using the appropriate symbols—selectively correct individual characters within a statement.

**Built-in check.** Perhaps most important to the new or inexpert user is the Trace feature built into the 3300 system. The Trace mode allows the computer to follow the programmer through his entries. Also, whenever a variable receives a new value during program execution, the Tracer mode reads back data. This read-back ability proves useful when a program transfer is made to another sequence of statements, such as when the computer is diverted to a new subroutine by Fortran-like IF-THEN, or GO-TO branching commands.

Delivery is 90 to 120 days.

Wang Laboratories Inc., 836 North St., Tewksbury, Mass. 01876 [338]



# Restore... don't redraw.

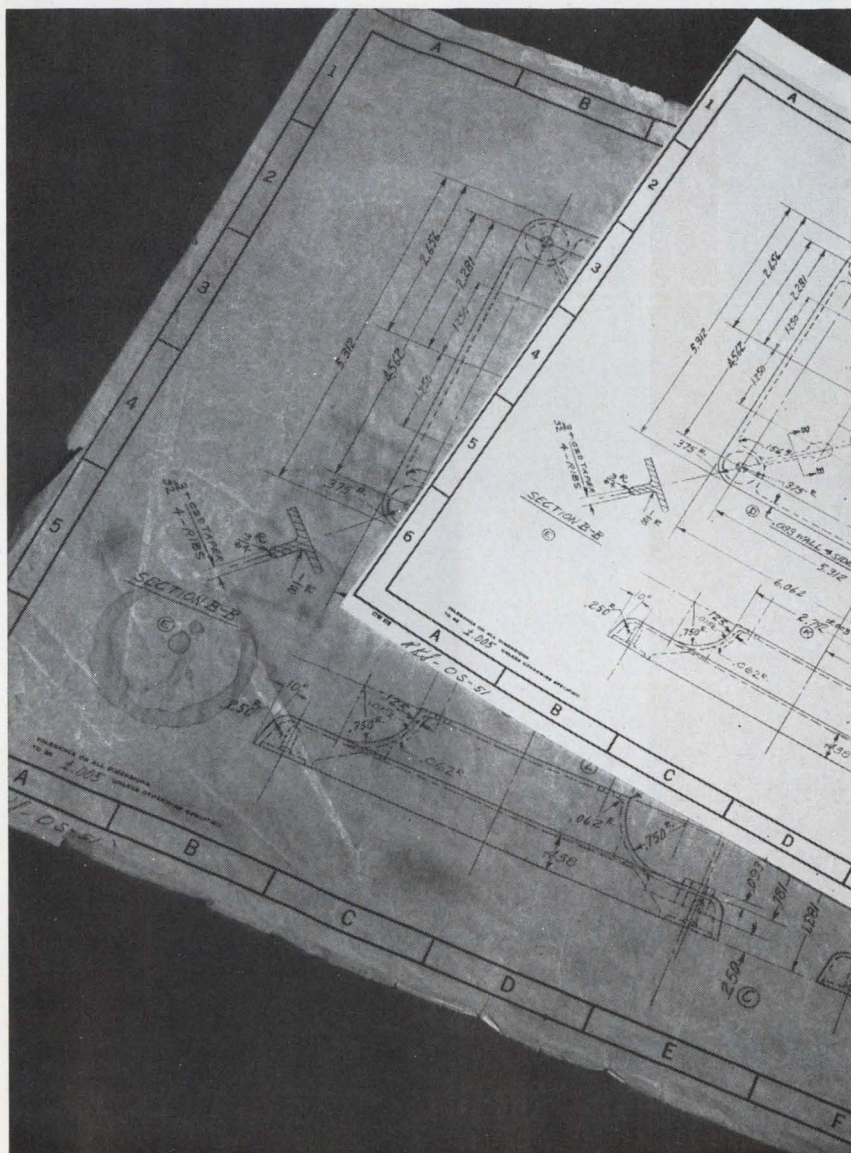

**KODAGRAPH Films and Papers spare you costly hours of tedious retracing.**

You've got a beat-up, stained original on your hands, and you're getting ready to retrace it. Don't.

Send it to your local blue-printer or in-plant reproduction department—let *them* restore it for you with Kodagraph materials. When they return your "second original" on KODAGRAPH ESTAR Base Film, creases and stains will have all but disappeared; faint details will have come back sharply.

What do you do while your drawing is being restored? Move on to a new project. You'll be amazed at how much more time you have for creative work when you let photography take the drudgery out of drafting.

Get the details from your Kodak Technical Sales Representative. Or write Eastman Kodak Company, Business Systems Markets Division, Rochester, N.Y. 14650

**DRAWING REPRODUCTION SYSTEMS BY KODAK**

Kodak

# Why Intel uses Teradyne J259's to test memory devices

When we asked Intel's test supervisor, Les Vadasz, what he liked most about the Teradyne J259 computer-operated IC test system, he smiled and said: "It runs."



"Just running" is no small matter, as any IC producer can tell you. It's especially vital when you're testing 256-bit silicon-gate MOS memories like Intel's. When your devices are that exotic, you want the most unexotic test system you can find. One that doesn't go off the air once a week. One that doesn't need periodic calibration. One that "just runs."

How dependable are Intel's J259's? So dependable that Intel finds it hard to put a number on downtime, but estimates that less than 1 percent of its test-facility downtime is attributable to the Teradyne systems.

And Intel's J259's work hard. They make as many as 10,000 functional and parametric tests on each 256-bit

MOS memory. They also test all of Intel's new Schottky-barrier bipolar memories. They test packages. They test wafers. They classify devices. They datalog test results. They generate test summary sheets and distribution tables. Since everything is done on a time-shared basis, it all adds up to an awesome test capability per J259, hour after dependable hour.

Intel's new lines of memory devices mark the company as a leader in its field. So does its choice of test equipment—equipment that, in the best Teradyne tradition, "just runs."

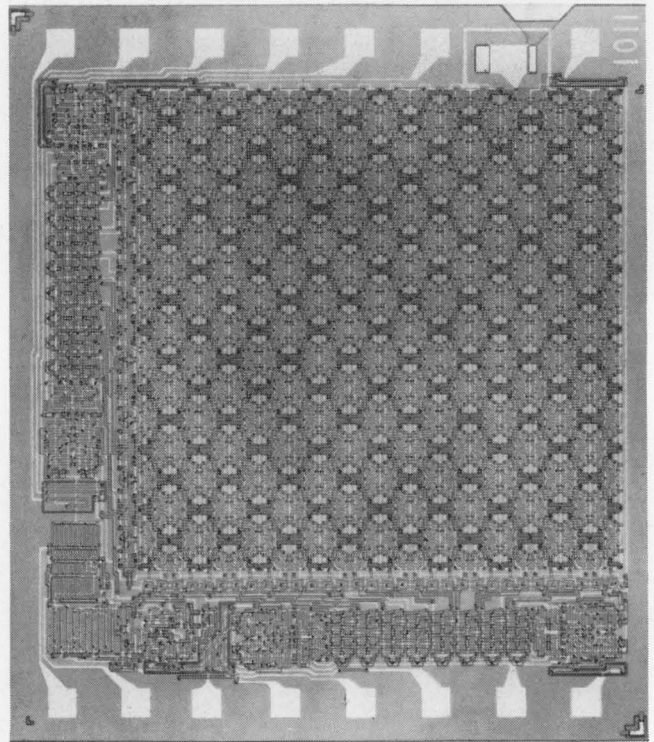

Teradyne's J259 makes sense to Intel. If you're in the business of testing circuits—integrated or otherwise—it makes sense to find out more about the J259. Just use the reader service card or write to Teradyne, 183 Essex St., Boston, Massachusetts 02111.

## Teradyne makes sense.

# Scope plug-in provides isolation

Unit employs light-emitting diodes and fiber optics to give instrument at least 1,500 volts protection

**Use of light-emitting diodes** and fiber optics for signal isolation isn't novel, but applying them to an oscilloscope plug-in is. That's what Develco Inc. has done; its 6150 plug-in is intended for use with Tektronix series 540 and 550 oscilloscopes, and provides up to 1,500 volts isolation into the scope.

According to John Frier, product manager at Develco, the 6150 can

be used for broadband data on pulse measurements as well as for stable, sensitive measurements of d-c and low-frequency signals from transducers. This includes monitoring control voltages several kilovolts above ground; patient monitoring, where ground loops can be a danger and isolation of the patient and the monitor is needed; and for aligning equipment in the

presence of r-f fields.

Because the input signal is coupled to the scope by a fiber-optic light guide, the unit is "virtually immune to r-f and electromagnetic interference," says Frier—common mode rejection is better than 100 decibels. And to assure against coupling through the power supply, the "transmitting" section of the 6150 is powered by two solar

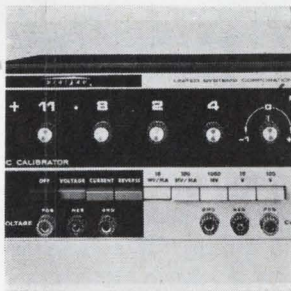

Precision calibrator model 311 offers 0.01% accuracy in both voltage and current. Five voltage and two current ranges are available. Current resolution is 1  $\mu$ a and voltage resolution is 1  $\mu$ v. Operational features include illuminated readout of setting, and pushbutton mode and range selection. Price is \$650. United Systems Corp., 918 Woodley Rd., Dayton, Ohio 45403 [361]

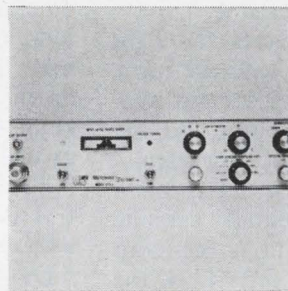

Frequency synchronizer/sampling detector LFS spans 50 khz to 4 Ghz. It may be used to phase-lock any oscillator exhibiting some degree of voltage tunability, or as a narrow band coherent receiver across its range. Sampling/lock spacing of 0.1, 1, 5 and 20 Mhz are selectable from the front panel of external 3 line logic inputs. Microwave/Systems, East Syracuse, N.Y. 13057 [362]



Digital pyrometer eliminates conformity errors with a multiple track scanning disk that is read optically. Units cover 3 temperature ranges—300° to +700°F, 0 to 1400°F and 0 to 2400°F—in standard models. The pyrometer consists of a basic readout module, designated DPM740, and a plug-in thermocouple sensor adapter. Consolidated Ohmic Devices Inc., Carle Place, N.Y. [363]

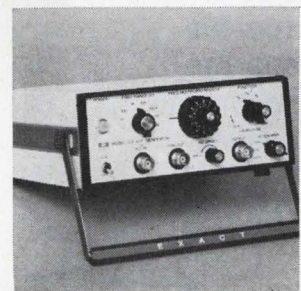

Miniature waveform generator model 123 features voltage controlled frequency over a 1,000:1 ratio and a bandwidth from 0.1 hz to 3 Mhz. It produces sine, square and triangle wave forms, as well as a sync pulse. Output voltage for all waveforms is at least 20 v p-p into an open circuit or 10 v p-p into a 50-ohm load. Price is \$345. Exact Electronics Inc., Hillsboro, Ore. [364]

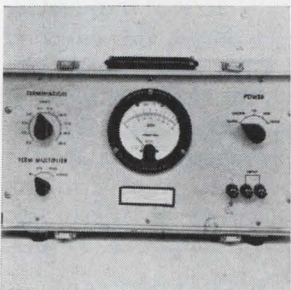

Output power meter model PM-2 is a passive device for determining the power output of audio-frequency generators, transducers, amplifiers and transmission lines while terminated with a known impedance. Power range is from 1 mw to 100 w. Impedance range is 2.5 to 20,000 ohms, and frequency range is 10 to 20,000 hz. Aul Instruments Inc., 139-30 34th Rd., Flushing, N.Y. [365]

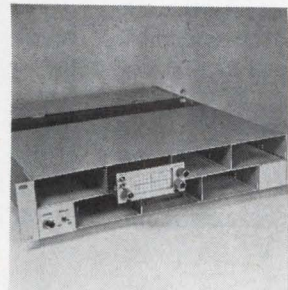

Up to seven series MS200 monitor oscilloscopes (10 Mhz bandwidth) can be plugged into a 3½ x 19 in. rack-mountable chassis for use in providing a continuous monitor of analog and digital signals. Input sensitivity is 0.1-10 v rms per in. Accuracy (vertical) is less than  $\pm$ 3% full scale. Sweep rate is 10 hz-1 Mhz. Vu-Data Corp., 7595 Convoy Court, San Diego, Calif. [366]

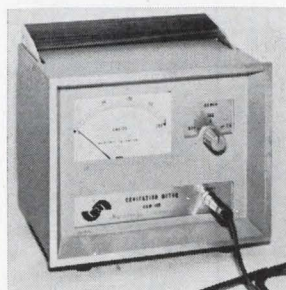

Cavitation meter model CVM-100 gives direct measurements for a broad range of research and testing applications in ultrasonics and many other technologies. It is the size of a small table radio and is simple to operate. Frequency is from 10 hz to 1 Mhz. Reading response time is under 2 sec. Price is \$395. Macrosonics International Inc., 12 Calvin Rd., Watertown, Mass. [367]

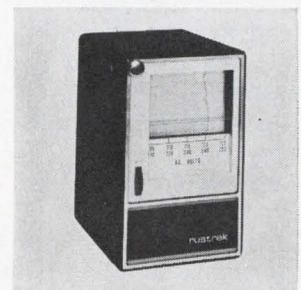

Voltage recorder model 2186 for high resolution line monitoring is an expanded scale recording voltmeter with low end of scales suppressed. Scales centered on nominal commercial line voltages have a resolution of 0.5 v per division on the basic range and 2 v per division in the 460 v a-c range. Rustrak Instrument Division of Gulton Industries Inc., Manchester, N.H. 02103 [368]

# SCHAUER

# 1%

tolerance

## 1 WATT ZENERS ARE A REAL BUY!

ANY voltage from 2.0 to 16.0  
at the industry's LOWEST  
PRICES!

Quantity	Price each
1-99	\$1.07
100-499	.97
500-999	.91
1000-4999	.86
5000 up	.82



## THE HI-RELIABLE!

No fragile nail heads.  
Silicon junction aligned between two, parallel, offset tantalum heat sinks . . . great lead tension strength.  
All welded and brazed assembly.  
High pressure molded package.  
Gold plated nickel-clad copper leads.  
Write or phone for Form 68-4 for complete rating data and other tolerance prices.

Semiconductor Division

### SCHAUER MANUFACTURING CORP.

4514 Alpine Avenue  
Cincinnati, O. 45242  
Ph. (513) 791-3030

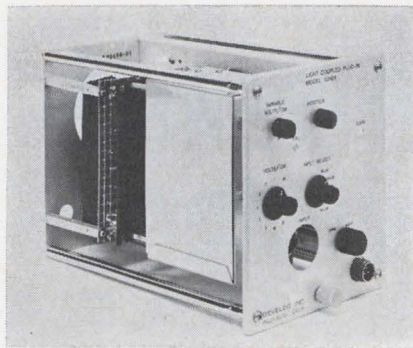

cell batteries—two internal 25-watt bulbs supply light.

The plug-in consists of two units, the transmitter and the receiver, which are coupled by a light pipe. The transmitter amplifies the input signal, and applies it to a light-emitting diode. Power for the transmitter—6.8 volts at 35 milliamps—comes from the solar cells, so that the entire transmitter circuit is floating with respect to the chassis ground of the oscilloscope.

The receiver converts the light signal back to its electrical form, amplifies and shapes it, and supplies a differential output to the oscilloscope. The receiver circuit consists of a differential receiver amplifier, a differential cascode output amplifier, and a regulator which receives  $\pm 9$  volts from the oscilloscope and provides  $\pm 6$  volts for the receiver amplifier circuit. The receiver also obtains  $+100$  volts from the scope for the receiver light-diode bias and  $+75$  volts as a reference for the cascode output amplifier.

Frequency response is d-c to 35 megahertz at the 3-dB point; common-mode rejection is 160 dB at 315 Mhz and 80 dB at 35 Mhz. Input impedance is switch-selectable for either 1 megohm in parallel with 30 picofarads, or 50 ohms in parallel with 30 picofarads; input coupling is switch-selectable for a-c, d-c, or ground. Deflection factor is 50 millivolts per centimeter to 20 volts/cm in nine calibrated steps. Maximum input voltage is 600 volts peak-to-peak a-c or d-c at the 1 megohm setting; maximum signal voltage-to-ground isolation is 1,500 volts peak-to-peak, either a-c or d-c.

The 6150 is priced at \$1,450, and delivery time is about four weeks.

Develco Inc., 2433 Leghorn St., Mountain View, Calif. 94040 [369]

New instruments

## Counter handles odd waveforms

Unit with 2-Mhz range  
measures time intervals  
with resolution of 1  $\mu$ sec

When integrated circuits became available for counters, most manufacturers jumped the frequency limit from 2 megahertz to 12.5 or 25 Mhz and the price from about \$800 to about \$1,200. Time Systems Corp. has a different idea: a 2-Mhz IC unit that sells for \$850.

One of the most important features of the instrument, designated the TSC 400-1, is that it can make time interval measurements of periodic, odd-shaped wave forms. Two independent input channels determine the time interval's start and finish. Each channel has its own slope, level, and attenuator controls as well as selection of either a-c or d-c coupling. The trigger-level control is adjustable from 0 to  $\pm 1$  volt and the attenuator switch extends this by 1, 10 or 100 times.

Says Frank Burge, Time Systems' marketing manager: "We're aiming at the user who doesn't need a 20-Mhz unit and doesn't want to pay for one." Besides time interval measurements, the TSC 400-1 measures frequency, period, multiple-period average, ratio, multiple-ratio average, total count, and scaling.

Period-average measurements improve accuracy at low frequencies because, says Burge, the effect of the trigger error and the  $\pm$  one count ambiguity of the readout is reduced proportional to the number of periods averaged. And since the 400-1 has a resolution of 1 microsecond, the effect of these two errors is almost negligible. Period-average measurements near the top of the counter's frequency range are comparable in accuracy to direct frequency measurements.

For ease of maintenance, all of the counter's components are mounted on two printed-circuit cards.

Time Systems Corp., 265 Whisman Rd., Mountain View, Calif. 94040 [370]

*(continued)*

# 30 features that make Sierra a leader in R-F power measurement

Discover the full line of 50-ohm coaxial loads and termination wattmeters by Sierra. All with excellent stability and low VSWR. Use them with CW, AM, FM, TV and radar transmitters as well as with power sources. Many come with Sierra's exclusive "Twist-Off" connectors for fast field changes. For information write

Philco-Ford Corporation, Sierra Electronic Operation,  
3885 Bohannon Drive, Menlo Park, California 94025.  
Or call (415) 322-7222, extension 329.

**PHILCO** 

The Better Idea People In Instrumentation.

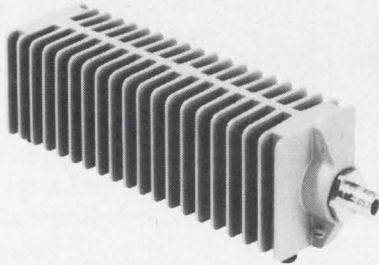

### Model 160 Series Dry Coaxial Loads

- Power ratings of 1, 5, 20, 50 and 100 watts.
- Frequency ranges from DC to 11 GHz.
- VSWR: 1.2 or less up to 4 GHz; 1.1 DC to 1 GHz.
- Impedance, 50 ohms.
- Dry construction, no dielectric coolant.
- Operate in any position, field or lab.
- "Twist-Off" connectors on 50 and 100 watt models.
- 1600-watt model (160-1600), oil filled.

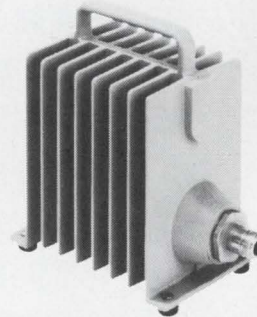

### Model 160B Series Silicone Dielectric Coaxial Loads

- Power ratings of 150, 300, 600 and 1000 watts.
- Frequency coverage to 5 GHz.
- Impedance, 50 ohms.
- Sealed aluminum housings; no leaks.
- Long-life, non-carbonizing silicone dielectric coolant.
- Up to 1/3 smaller than comparable loads.
- "Twist-Off" connectors on all models.

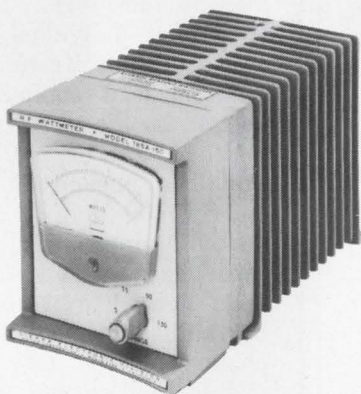

### Model 185A-150 Termination Wattmeter

- Frequency coverage: 20 to 1000 MHz.
- 4 Power ranges: 0-3, 0-15, 0-50, 0-150.
- VSWR less than 1.2.
- Accuracy:  $\pm 5\%$  full scale.
- Detachable read-out meter.
- Sealed termination element.

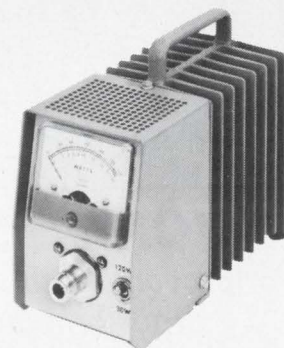

### Model 401A Series RF Termination Wattmeters

- Power ratings: 120, 250, 500 watts.
- Single-knob switching of power ranges.
- Frequency ranges from 30 to 500 MHz.
- Accuracy:  $\pm 5\%$  full scale.
- Maximum VSWR: 1.2.
- Partially expanded meter scale simplifies measurements in low power ranges.
- Sealed terminations (no bellows, no air vents).
- Long-life, non-carbonizing silicone dielectric coolant.
- "Twist-Off" connectors on all models.

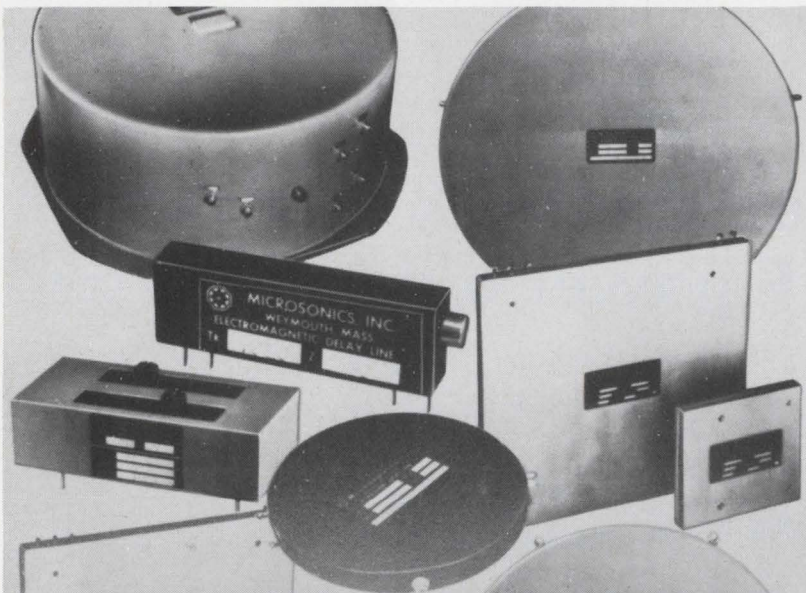

**LC & DC • DISPERSIVE • DIGITAL  
MAGNETOSTRICTIVE • QUARTZ  
GLASS • VARIABLE • TAPPED  
LC & DC • DISPERSIVE • DIGITAL  
MAGNETOSTRICTIVE • QUARTZ  
GLASS • VARIABLE • TAPPED  
LC & DC • DISPERSIVE • DIGITAL  
MAGNETOSTRICTIVE • QUARTZ  
GLASS • VARIABLE • TAPPED  
LC & DC • DISPERSIVE • DIGITAL  
MAGNETOSTRICTIVE • QUARTZ  
GLASS • VARIABLE • TAPPED  
LC & DC • DISPERSIVE • DIGITAL  
MAGNETOSTRICTIVE • QUARTZ  
GLASS • VARIABLE • TAPPED  
LC & DC • DISPERSIVE • DIGITAL**

## **MICROSONICS**

*for proven design, reliability &  
performance in*

## **DELAY LINES**

*Serial Memories*



Write for Bulletins today

**MICROSONICS**

60 Winter Street, Weymouth, Mass. 02188

Tel: 617 337-4200

A division of the Sangamo Electric Company

New instruments

## **System tests**

### **100 capacitors**

Short-circuit, open-circuit  
failures indicated  
by lights on panel

**A capacitor test system** probes up to 100 capacitors simultaneously and provides a lighted indication for any units that fail due to short-circuit or open-circuit for any period exceeding 0.5 millisecond.

The system, designated model 5330 and offered by Micro Instrument Co., meets requirements of MIL-C-39022A-3.14. It consists of a d-c bias supply, an a-c signal source and internal reference supply, individual channel circuit cards equipped with two lamps (one for short-circuit indication and one for open-circuit), and a reset switch.

The basic unit includes 20 channels in two 19-inch-wide rack-mounted chassis, each 5¼ inches high by 14 inches deep. Additional channels may be added, up to a maximum of 100. Capacitance range is 100 picofarads per channel to 1,000 microfarads maximum for all channels.

Capacitors to be tested are mounted in a fixture, with one end of each component connected common to all others. The common lead plus individual leads from each capacitor are terminated in a multiple lead connector or connectors on the test system.

When one or more capacitors exhibit a short-circuit or open-circuit for more than 0.5 msec, a lamp on the appropriate channel circuit card lights up. The lamp will remain lighted until manually reset by individual switches on each channel card.

The basic system, including the a-c signal source, reference, and system power supply capable of testing 20 channels, is priced at \$4,200. Additional channels are available at \$120 each. Delivery time is six weeks.

Micro Instrument Co., 12901 Crenshaw Boulevard, Hawthorne, Calif. 90250  
[371]

# new add/subtract

## Miniature Pushbutton Switches

... push one button to add—  
push the other button  
to subtract

... only  $\frac{1}{2}$ " panel  
space per  
module

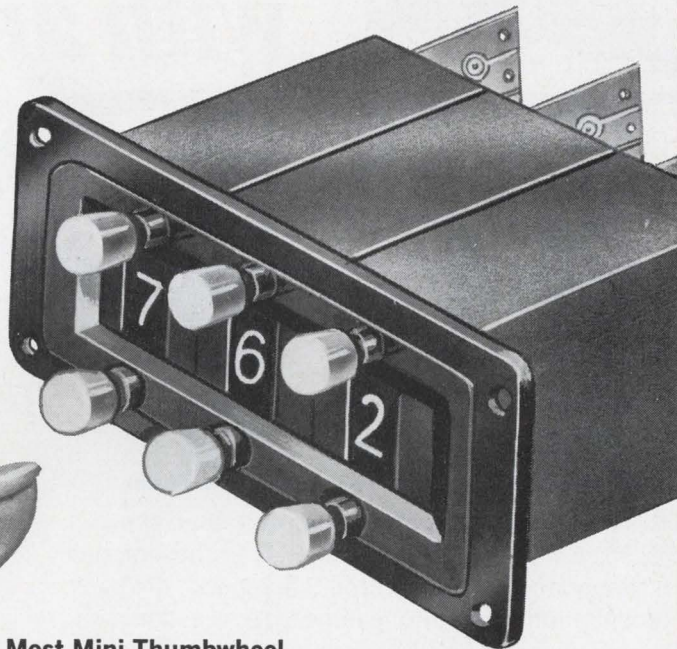

### Retrofits Most Mini Thumbwheel Switch Panel Openings

- 10-Position; 8 & 12 positions available on special order.
- Simply push one button to add, the other to subtract.
- Over 1,000,000-operation service life.
- Each decade mounts on  $\frac{1}{2}$ " centers.
- Total panel height,  $1\frac{3}{16}$ "; behind-panel dimensions (depth),  $1\frac{7}{8}$ ".
- Fully sealed against hostile environments.
- Available in decimal, binary and binary with complement outputs.
- Internal lighting if desired.



(Actual Size)

Also available in single-pushbutton model for unidirectional operation. Write for free descriptive literature: Series MPB-AS-27000, add/subtract; Series MPB-A-27000, unidirectional.

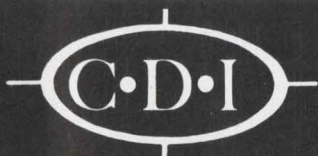

# CHICAGO DYNAMIC INDUSTRIES, INC.

PRECISION PRODUCTS DIVISION 1725 Diversey Blvd., Chicago, Illinois 60614. Phone 312, 935-4600



*Who ever heard  
of a computer  
with an*

# EPU?

Unlike any other computer you've ever seen, the GRI 909 Computer, a Direct Function Processor, has an expandable instruction set. Starting with the basic configuration of nearly one hundred instructions, it can be expanded with firmware modules to literally thousands of instructions.

Typical units in our standard library of plug-in firmware operators are "Multiply/Divide", "Byte Swap/Pack", "Byte Comparator", and "General Purpose Registers". And, if you prefer, you can make up and plug in your own proprietary operators.

This is a true hardware expansion of the processor unit . . . not merely a read-only memory execution of subroutines. (Although the GRI 909 can handle that too, of course.)

Don't box yourself in. Get the GRI 909. It's a family of computers within a single processor unit.

For more information on the Direct Function Processing technique write:

**GRI Computer Corp.**

**gn** 76 Rowe Street,  
Newton, Mass. 02166  
(617) 969-7346

\* EXPANDABLE PROCESSOR UNIT

**gn-909**  
THE NEW BREED

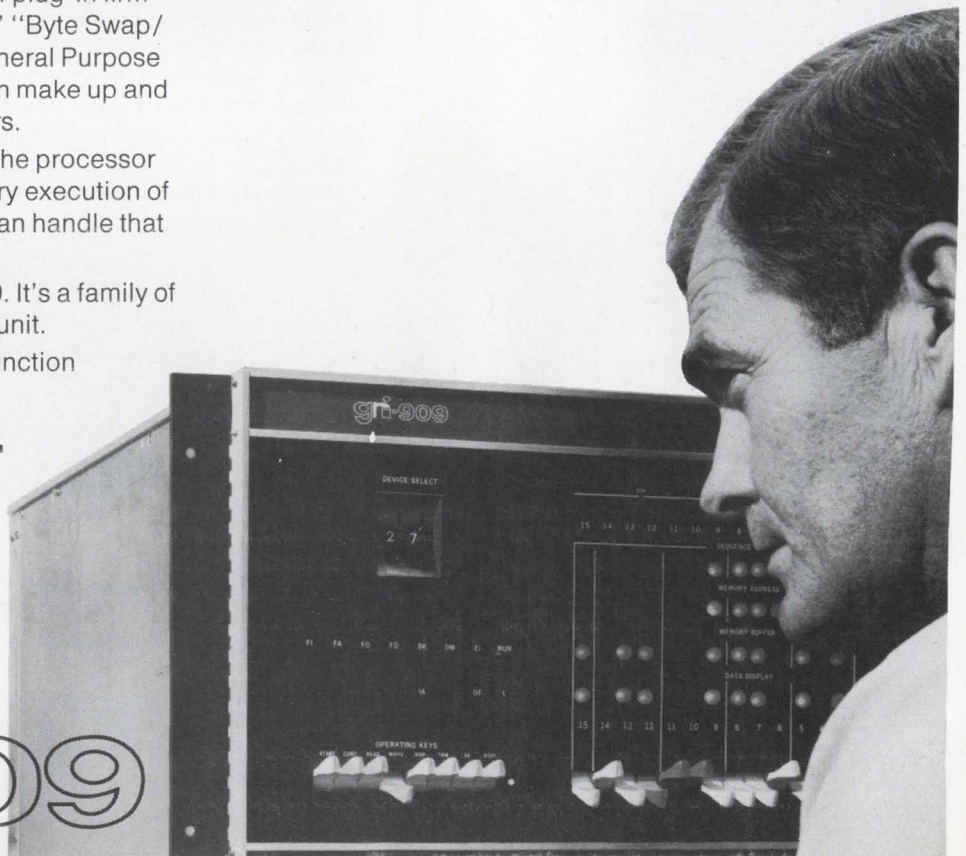



# At-a-glance digital monitoring

Instrument system for industrial data or laboratory measurements accepts 16 inputs from remote sources for simultaneous display

The military isn't the only group that wants to determine status-of-forces at a glance. This capability is also desirable in industrial data monitoring and in some laboratory instrument projects—but without the expense of wall-size displays.

A digital instrument system, (DIS) developed by QED Systems Inc. accepts up to 16 analog or digital measurements from remote

sources, converts those inputs that are analog, and displays all inputs simultaneously on a 5-inch cathode-ray tube. The portable, modular system provides the convenience of a single visual reference site and costs about \$5,000 to \$6,000, depending on the type of plug-in modules needed.

These include a variety of signal conditioners for conversion of pres-

sure, temperature, strain, flow, and other signals into normalized voltages. Also, there are plugs-ins for special functions such as digital curve tracing, limit detection, and frequency- and period-counting.

After multiplexing, the voltages are converted to digital form, displayed, and identified on the scope by means of a two-character alphanumeric label for each of the 16

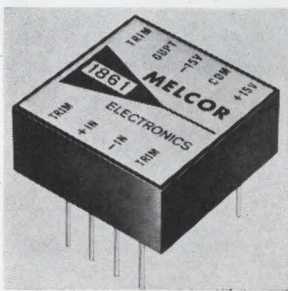

Amplifier model 1861 features a FET input stage combined with an IC. All shaping networks are internal, with no extras required except a zeroing potentiometer, if desired. Other features include an output of  $\pm 10$  v  $\pm 5$  ma minimum, minimum d-c gain of 15,000, and unity gain bandwidth of 1 Mhz. Price (1-24) is \$10. Melcor Electronics Corp., Farmingdale, N.Y. [381]

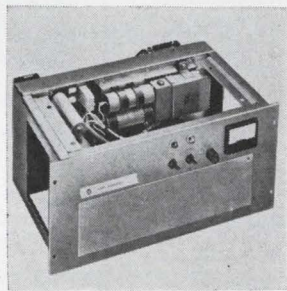

Uhf amplifier A80U is an 80-w unit for use with a fixed station transmitter to form a high power base station. It can also be used with uhf link and multiplex transmitters operating in the 440-470 Mhz frequency range. It requires a drive power of 5 w at 50 ohms impedance to provide a f-m r-f output of 80 w. Pye Communications Inc., U.S. Highway 46, Mountain Lakes, N.J. [382]

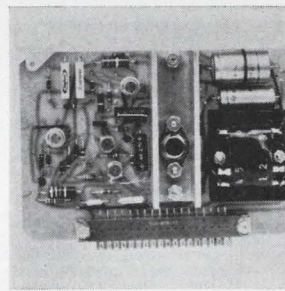

Programmable d-c voltage source model VS-510, designed for use as a system module, is packaged as a 4x6 in. p-c board assembly. Output voltage is 0 to 32 v d-c. Current rating is 100 ma. Line regulation is 0.005%; load regulation, 0.01%; and temperature coefficient, 0.01%/°C. Price is \$103.50; delivery, from stock. North Hills Electronics Inc., Glen Cove, L.I., N.Y. 11542 [383]

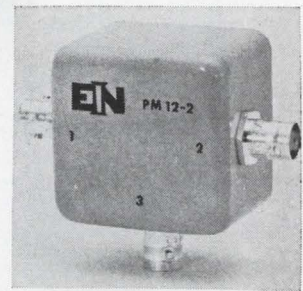

Power multicoupler model PM12-2 is a two-way hybrid coupler covering the range of 250 khz to 110 Mhz. Unit is capable of handling up to 12 w of average r-f power at +65°C ambient temperature. Maximum insertion loss is 0.4 db; amplitude balance, 0.1 db, phase balance,  $\pm 1^\circ$ ; vswr, 1.1:2 maximum. Electronic Navigation Industries Inc., 1337 Main St. East, Rochester, N.Y. [384]

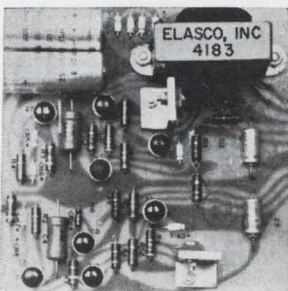

Dual output power supply model 2Q15-250PC operates from 105-125 v a-c, 60 to 400 hz, and furnishes  $\pm 15$  v d-c with 250 ma capability from each side. Line and load regulation is held to 0.1% maximum with ripple and noise held to 2 mv rms max. Price (1-9) is \$47 each. Delivery takes less than 2 weeks. Elasco-Eastern Inc., 5 Northwood Rd., Bloomfield, Conn. 06002 [385]

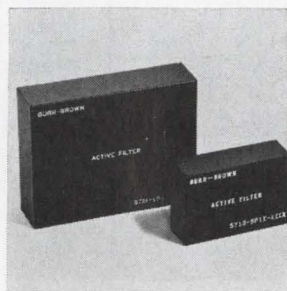

Low-pass active filters are designed for Butterworth response. Model 5720 is the 2-pole version at \$25 each. Cutoff frequency range is 10 hz to 20 khz. Model 5721 is the 4-pole version with a frequency range of 1 hz to 20 khz and a price of \$45. Both units have an output impedance of less than 20 ohms. Burr-Brown Research Corp., Int'l Airport Industrial Park, Tucson [386]

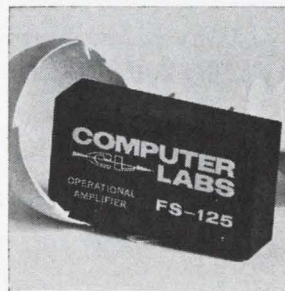

Operational amplifier model FS-125 is designed for fast settling on step function input signals. With a closed-loop gain of 1, the unit will settle to within 0.1% of full scale less than 80 nsec after the input is applied. It can be accurately calibrated with d-c. Price in small lots is \$97; delivery, stock to 30 days. computer Labs, 1109 S. Chapman St., Greensboro, N.C. [387]

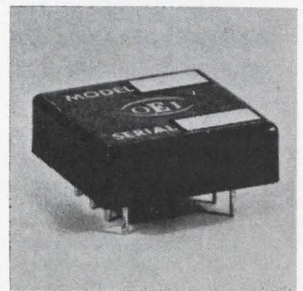

Hybrid operational amplifier model 9706 comes in an 8-lead jumbo dual in-line package measuring 0.32 in. high and 1 in. square. It features 60 db typical open loop voltage gain;  $\pm 360$  v/ $\mu$ sec typical slewing rate; 1,300 Mhz typical gain bandwidth product; and 10,000 megohm input impedance. Price (1-2) is \$54 each. Optical Electronics Inc., P.O. Box 11140, Tucson 85706 [388]

# What happened when doctors and engineers got together:

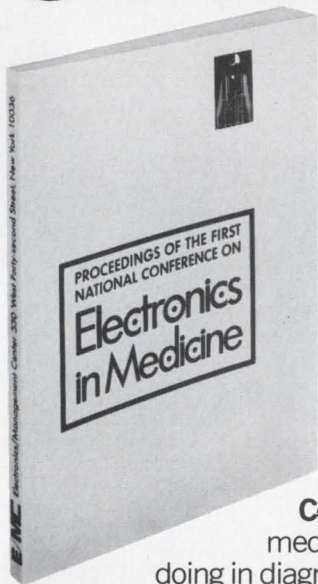

Doctors told engineers how they were using electronics and revealed their most urgent needs. Engineers described and demonstrated their newest equipment for diagnosis, treatment, and prevention. And hinted at things to come.

Their complete dialogue, with illustrations, makes pretty informative reading on a vital and growing market.

Here are some of the things it contains:

**Computers:** How they're joining the medical team. What computers are doing in diagnosis. In communications. The small computer as a paramedical aid.

**Instrumentation:** What's needed. What's available. Patient management. Protection. Standards and safety.

**Electronics in the Hospital:** The surgeon, the hospital, the instruments. What the administrator wants. Prescription for large-scale health care. The surgery department.

Electronics/Management Center  
330 West 42nd Street, New York, N.Y. 10036

Enclosed is \$12 for a copy of the Proceedings of the First National Conference on Electronics in Medicine.

Send the Proceedings and bill me later. P.O. # \_\_\_\_\_

Name \_\_\_\_\_

Company \_\_\_\_\_

Address \_\_\_\_\_

City \_\_\_\_\_ State \_\_\_\_\_ Zip \_\_\_\_\_

quantities. Digital inputs are displayed without the need for conversion. The DIS will translate input voltages directly into pounds per square inch, degrees Centigrade, or other units. Thus, reference to conversion tables is not required. When nonlinear relationships are involved, corrective interpolation can be done by the DIS.

When linked to a computer, the system displays the computer's binary outputs in numeric form, permitting a continuous data flow to be monitored. "Or pressure and temperature readings can be sent to the computer, which can then calculate volume, and return this number to the display," says Irv-

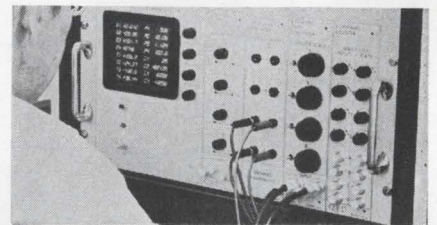

Over-all view. Up to 16 values from remote sources can be displayed simultaneously.

ing Cohn, engineering vice president at QED. Cohn predicts that the principal markets for the DIS will emerge from this kind of industrial data monitoring and from laboratory systems where, for example, a group of 10 or more thermocouples must be monitored simultaneously.

To a limited degree the DIS can serve as the "front end" to a data acquisition system, freeing computer time for more complex tasks as well as eliminating some programming. DIS can perform addition, multiplication, and division, and then digitize and display the result—and analog signal.

An alarm circuit triggers a flashing signal if the normalized  $\pm 1$ -volt DIS range is exceeded by 20%. Besides flashing the digitized value, the DIS can show its rate of change, allowing countermeasures to be taken.

The DIS can drive a printer or plotter for hard copy, and an adapter permits attachment of a laboratory-type scope camera.

QED Systems Inc., 515 Washington Ave., Pleasantville, N.Y. 10570 [389]

# On the average, our engineers stay with us for 7.83 years.

Now, that couldn't be true if we gave them humdrum assignments.

It couldn't be true if the electronics research and development field weren't pretty stable.

But it is true. 7.83 years' tenure on the average for our engineers in applied R & D.

We must be doing something right.

For one thing, we do have challenging assignments. And a wide array to choose from—currently, 115 R & D projects.

We're working in sophisticated aerospace and electronics areas. Developing products and systems that will contribute to the growth of the country, the peace of the world.

We even have a good place

for our engineers to bring up their families: Southern California.

Why not consider us for 8 years or so? You may like it well enough to stay on.

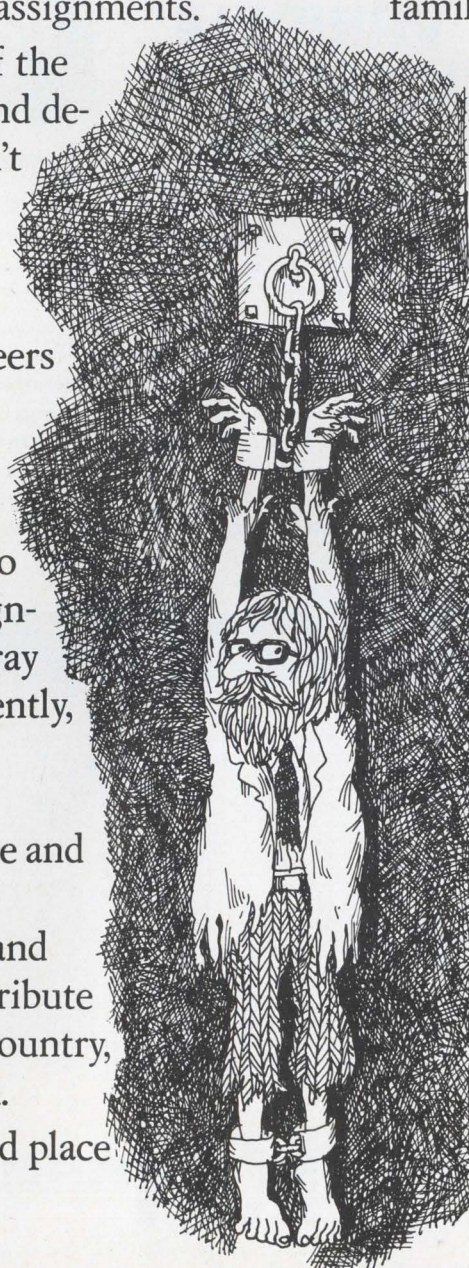

We now have openings for such specialists as:  
*Computer Software Analysts*  
*Radar Systems Engineers*  
*Circuit Designers*  
*Signal Processing Systems Analysts.*

Please airmail resume to:  
Mr. Robert A. Martin  
Head of Employment  
Aerospace Divisions  
Hughes Aircraft Co. Dept. 53  
11940 W. Jefferson Blvd.  
Culver City, Calif. 90230

**HUGHES**

HUGHES AIRCRAFT COMPANY

Equal opportunity M/F employer.  
U.S. citizenship is required.

# FROM THE WAVE MAKERS:

## THE FINEST IN VARIABLE ELECTRONIC FILTERS

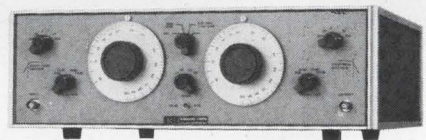

New multifunction Tunable Filter, Model 3750.

Krohn-Hite pioneered the development of reliable, variable electronic filters. These filters can offer a variety of functions such as low pass, band pass, high pass and band reject in a single instrument. They also provide complete flexibility of adjustment for both high and low cutoff frequencies over a frequency range of six decades. Since both cutoff frequencies can be independently varied over wide limits, the center of the pass band or rejection band can also be placed at any desired frequency.

Since Krohn-Hite filters are active, they provide an overall gain of unity (no insertion loss). They offer very high input impedance, require no appreciable signal power and are

not sensitive to the value of source impedance. Their low output impedance makes the frequency response independent of the load impedance. Lowering the load impedance merely reduces the maximum output voltage obtainable, due to maximum current limitation of the output stage.

Every Krohn-Hite filter provides a choice of Butterworth or Low Q (transient free) transfer characteristic. These filters represent the optimum

practical approach to ideal filter characteristics, combined with versatility to give unsurpassed performance.

Yes, Krohn-Hite, innovators in filter design for over twenty years, is making waves again!

The table below lists all of the important features of the complete Krohn-Hite variable electronic filter line.

Frequency Range	Filter Model*	Function				Add. Feature	Freq. Acc. %	Attenuation Slope db/octave	Hum and Noise (RMS)	Max. Attenuation	Output Volt./Amps (RMS)	3 db Points	Approx. Shipping Weight lbs./kgs	Price U.S.A. Only
		B	B	H	L									
		P	R	P	P									
.001 Hz - 99.9 kHz	3320		X	X		Batt. Op.	2%	24	0.5 mv	80 db	5v/50ma	dc - 1 MHz	24/11 \$ 725	
.001 Hz - 99.9 kHz	3322	X	X	X	X	Batt. Op.	2%	24/48	0.5 mv	80 db	5v/50ma	dc - 1 MHz	34/16 \$1395	
.001 Hz - 99.9 kHz	3340			X	X	Batt. Op.	2%	48	0.5 mv	80 db	5v/50ma	dc - 1 MHz	27/12 \$1075	
.001 Hz - 99.9 kHz	3342	X	X	X	X	Batt. Op.	2%	48/96	0.5 mv	80 db	5v/50ma	dc - 1 MHz	40/18 \$2075	
.01 Hz - 99.9 kHz	3321			X	X	Batt. Op.	2%	24	0.5 mv	80 db	5v/50ma	dc - 1 MHz	24/11 \$ 635	
.01 Hz - 99.9 kHz	3323	X	X	X	X	Batt. Op.	2%	24/48	0.5 mv	80 db	5v/50ma	dc - 1 MHz	34/16 \$1225	
.01 Hz - 99.9 kHz	3341			X	X	Batt. Op.	2%	48	0.5 mv	80 db	5v/50ma	dc - 1 MHz	27/12 \$ 995	
.01 Hz - 99.9 kHz	3343	X	X	X	X	Batt. Op.	2%	48/96	0.5 mv	80 db	5v/50ma	dc - 1 MHz	40/18 \$1825	
.02 Hz - 2 kHz	330B		X				5%	24	0.1 mv	80 db	10v/1ma		35/16 \$ 595	
.02 Hz - 20 kHz	3750	X	X	X	X	Batt. Op.	5%	6, 12, 18, 24	0.2 mv	80 db	10v/2ma	dc - 1 MHz	26/12 \$ 850	
.2 Hz - 20 kHz	3700		X			Batt. Op.	5%	24	0.2 mv	80 db	5v/1ma		19/9 \$ 550	
2 Hz - 200 kHz	3550	X	X	X	X		5%	24	0.2 mv	60 db	5v/10ma	.2 Hz - 3 MHz	15/7 \$ 525	
10 Hz - 1 MHz	3100	X					5%	24	0.1 mv	80 db	3v/10ma		17/8 \$ 590	
10Hz - 3 MHz	3103	X					5%	24	0.15 mv	80 db	3v/10ma		17/8 \$ 640	
20 Hz - 200 kHz	3500		X				10%	24	0.2 mv	60 db	5v/10ma		14/7 \$ 395	
20 Hz - 2 MHz	3200			X	X		5%	24	0.1 mv	80 db	3v/10ma	dc - 10 MHz	16/8 \$ 450	
20 Hz - 2 MHz	3202	X	X	X	X		5%	24/48	0.1 mv	80 db	3v/10ma	dc - 10 MHz	22/10 \$ 795	

BP - Band Pass BR - Band Reject HP - High Pass LP - Low Pass \*Add suffix "R" for Rack mounting

For complete details, write: The Wavemakers:  
Krohn-Hite Corporation, 580 Massachusetts Avenue,  
Cambridge, Mass. 02139 U.S.A.



OSCILLATORS / FILTERS / AC POWER SUPPLIES / AMPLIFIERS

Circle 154 on reader service card

# MOS LSI production tester runs at 2 Mhz

Buffer/comparator circuitry kept close to probe head, eliminating excessive capacitance and noise problems

William Mandl knows what he himself wants in an MOS LSI tester, so he and his boss, William Mow, president of the Macrodata Co., believe they can give their customers what they'll need to test complex metal oxide semiconductor parts when they introduce their MD200 tester next month [*Electronics*, Jan. 5, p. 34]. The unit is said to be the fastest d-c and functional MOS

tester on the market.

Mandl is Macrodata's director of LSI development. Both he and Mow, Macrodata's founder, came from the Guidance and Control systems division of Litton, where they were brought in late in the game in an unsuccessful attempt to bail out the dragging, block-oriented computer program [*Electronics*, Sept. 29, 1969, p. 33]. There

they learned that testing is the biggest stumbling block to more widespread application of MOS LSI. "The technology is here today, with good complexity," Mow asserts, "so why aren't more sophisticated things being done with it?" It's the lack of adequate testers, he says.

'Bad' were good. Mandl learned when he was designing MOS cir-

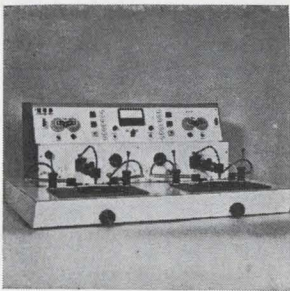

Dual resistor trimmer model DT-5 for use with thick film circuitry is a semiautomatic unit capable of trimming resistors to 0.1% accuracy from 10 ohms to 1 megohm. An X-axis adjustment of the work surface and Y-axis adjustment of the cutter nozzle enables the operator to accurately position the substrates. Modern Printing Methods Corp., 9 Harvey St., Cambridge, Mass. [421]

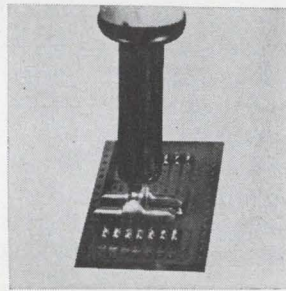

DIP soldering tip model 4918 is easily inserted in a standard 3/8-in. screw-type soldering gun of 35 w or more. Grooved and channeled for 10, 14, or 16 lead dual in-line packages, the tool will effectively desolder a complete 16-pin DIP in one pass. Unit also has end tips shaped for straightening bent connector pins. Techni-Tool Inc., 1216 Arch St., Philadelphia 19107 [422]

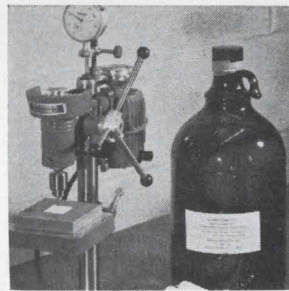

Accu-Drill 3300 kit includes all the equipment and materials necessary to drill holes from 0.025 in. diameter to 0.113 in. diameter in fired ceramic substrates used in IC's. Included in the kit are a sensitive drill press and a variable speed motor control necessary in controlling spindle speeds. Aremco Products Inc., P.O. Box 145, Briarcliff Manor, N.Y. 10510 [423]

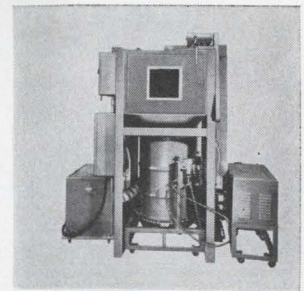

Varnish coater for electric motors and coils provides high reliability coatings, while cutting production time and material requirements in the process. The unit, which uses a powdered epoxy, imparts uniform, tack-free coatings in less than 7 minutes, and eliminates need for cleanup of the component prior to final assembly. Armstrong Products Co., Argonne Rd., Warsaw, Ind. [424]

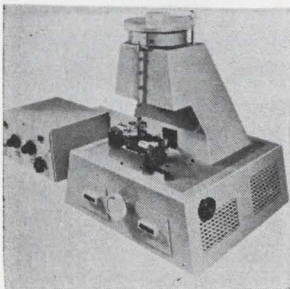

Automatic core handler model X-13 is used with a core tester to electrically test 14 to 30 mil outside-diameter ferrite memory cores at rates from 200 to 1,300 cores a minute. The handler transports the core to a test station where programed current generators determine the core's acceptability. Horex Electronics Inc., 1729-21st St., Santa Monica, Calif. 90404 [425]

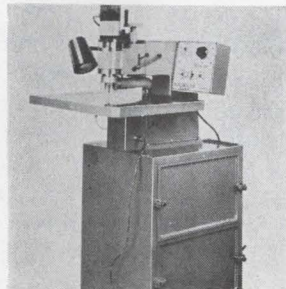

Precision pin router, the Acro-Router, for circuit board profiling and inside routing, features a constant torque spindle. Spindle speed is infinitely variable to 40,000 rpm max. Peak power is 0.6 h-p at 24,000 rpm. An integral dust collector sucks up chips and dust, keeps work and table surface clean. Aetna Mfg. Co., 245 Park Ave., Bensenville, Ill. [426]

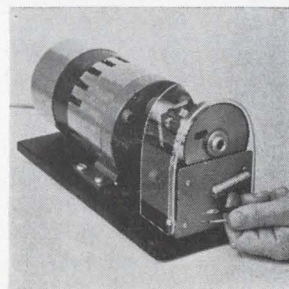

Motorized coaxial cable stripper model CX-2's operation consists of inserting the end of a co-ax cable into the rotating cable holder, and turning a handle which engages the 3 cutters to cut the insulation and shielding. Upon removal, end of cable is prepared with a 3-step strip for appropriate connector. Western Electronic Products Co., San Clemente, Calif. [427]

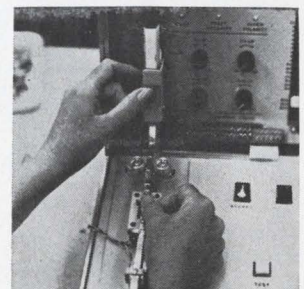

Semiautomatic DIP chip handling accessory permits operators of the model 997 IC tester to triple production test speeds achieved by manual methods for handling individual IC devices. Besides handling both 14- and 16-pin chips, the unit eliminates all extraneous sorting and handling time before and after testing. Beckman Instruments Inc., Richmond, Calif. [428]

# NEW FROM PACE. COMPLETE SYSTEMS FOR REWORK AND REPAIR.



## Bench-Top Rework Center

Portable, self-contained System for rework and repair of electronic modules in one integrated package.

SODR-X-TRACTOR (TM) for removal of all solder joint configurations.

LAPFLO SOLDERING (TM) for hi-strength reflow soldering.

THERMOPART (TM) for thermally parting conformal coatings.

MINICHINE (TM) for grinding, drilling, abrading and cutting.

COM FORM I (TM) for accurately forming components.

Available as an integrated system or as separate systems.

# PACE

INCORPORATED

Systems and training for rework, repair and modification

9337 Fraser Street  
Silver Spring,  
Maryland—20910  
(301) 587-1696

Bring all your rework and repair problems to Nepcon West. Booth 568-570.

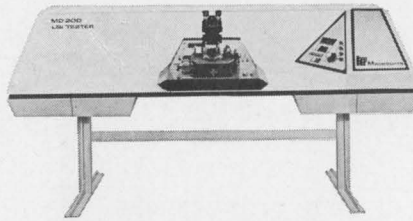

MOS tester. The MD200 does functional testing at a speed of 2 Mhz

circuits at Litton that good circuits were testing out as bad because of tester shortcomings. The test probe, and the buffers and comparator units checking the wafer were too far apart, allowing excessive capacitance to build along the line from the probe head to the comparator, while cross-coupling problems developed between multiple wires leading to the probe head. This caused noise, often falsely indicating a good device as bad. Mandl had to get the test circuitry as close to the probe head as possible to prove that the circuits he designed were good.

This is one of the strongest features built into the MD200, Mow says. The buffer/comparator essentially sits right on top of the probe head, eliminating the capacitance associated with the usual long lines from the probe to the test circuitry. The distance from the probe head to the buffer/comparator circuit card is the length of the probe head itself, and cross-coupling has been eliminated by separating each of the possible 64 probe heads that the MD200 can handle by at least 0.25 inch from its nearest neighbor. These features enable the unit to do functional testing at the wafer probe point at a speed of 2 megahertz. Mow says the fastest production tester for MOS LSI he knows of runs at 500 kilohertz for functional testing. The new unit also can do d-c parameter testing.

The tester also winds up with just 8 picofarads of input capacitance to the buffer, vs. 20 to 50 pf for other MOS LSI testers. In addition, Macrodata provides 300 megohms of input impedance compared with about 10 megohms for some other testers; where other equipment employs separate buffers and comparators, the MD200 combines this circuitry. Macrodata will specify a combined rise, fall, and delay time through the buffer-

comparator of 50 nanoseconds. Other testers, Mow says, usually specify 50 nsec for the buffer and about 70 nsec for the comparator, and the two are connected by wires that introduce additional capacitance.

**Right now.** The buffer/comparator has a differential amplifier front end with a field effect transistor input. Its output is a logic level compatible with transistor-transistor logic. "The actual level [a logical 1 or 0] of the device under test," Mow explains, "is compared with the desired level under computer control, and all this is happening with virtually no delay and no capacitance." If the test device is good, the output will be a 1; a 0 output indicates a bad device.

The functional testing operates in three modes. In one mode, the tester may be programmed to "or" all of eight channels of data, and if a 0 results, the central processor control is interrupted, the bad device is inked, and the probe head moves to the next cell, again under computer control. The second mode will allow the operator to dial in the test sequence for a given wafer using the control console, initiate the test, and terminate it when an indicator on the console shows the test is completed, when all rejects on the wafer have been inked. A wafer yield map can be produced by an optional printer that will be offered with the MD200. The first and second modes are for production testing. The third mode is for engineering testing.

The basic tester package includes an Interdata Model 4 computer with 16,384 words of memory, a disk memory with 2 million bytes of storage, a teletypewriter, 16,384 bits of buffer storage in the tester's pattern synthesizer, Macrodata's test-oriented interactive language (TOIL), and the tester's interrogation unit. The latter consists of three cards: one for the buffer/comparator, one for the control logic to interface with the computer, and a third containing control electronics for d-c parameter testing. Mow says he's shooting for a price of \$200,000 to \$225,000 for this combination.

The first production tester is slated for late-April delivery.

Macrodata Co., 20440 Corisco St., Chatsworth, Calif. [429]

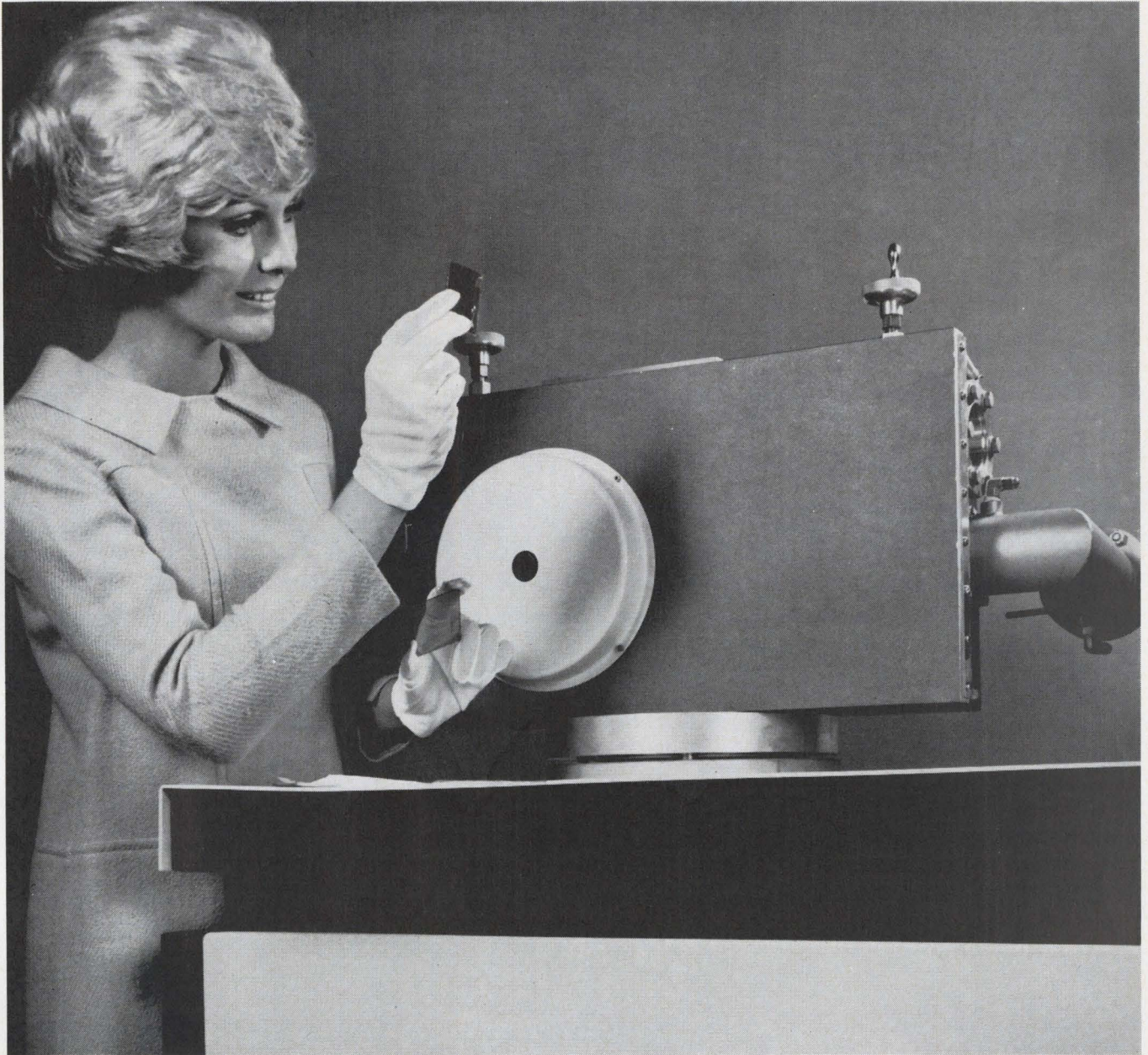

## If you're looking for a versatile sputtering unit, you can stop looking.

It's the new AST-150A, versatile enough to handle all sputtering modes: DC diode, DC triode, RF diode, RF triode. Sputter cleaning and etching, too. All of which makes it an ideal tool for thin film-research in deposition of metals, insulators, cermets, dielectrics, the works.

The AST-150A installs easily on any six-inch vacuum system. It boasts modular power packages. Multiple sputtering stations, a movable shutter and removable substrate carrier team up to make the AST-150A a natural for sequential sputtering.

And because there's no bell jar, you get shorter pump-downs. There's even a unique RF coupling so you can use a single RF power supply for high-deposition rates at two sputtering stations.

The AST-150. Never before has a new sputtering unit done so much for so little. For details, write: Scientific Instruments & Equipment Division, The Bendix Corporation, 1775 Mt. Read Blvd., Rochester, N.Y. 14603.

Scientific Instruments & Equipment Division is part of Bendix Aerospace-Electronics Company.

**Bendix**

# Introducing: build-a-still

It's a revolutionary new idea. And, like many revolutionary ideas, basically simple.

Here's how it works. The basic parts of the still come as separate modules you can add on to one another. So the still expands as your needs grow.

The basic Thermodrive™ Distillation System comes in a 50 gph configuration. When you need more, you simply bolt on another 50 gph module . . . again and again . . . all the way up to 1,000 gph. No need to tear down your old system. No need for major reinvestment. You expand.



The standard system puts out pyrogen-free water in the 1 to 1.5 megohm range. For higher purity, and an organic count below measurability, simply add on the Hi-Purity Chamber. Either way, Thermodrive produces distillate faster than anything before. Within seconds after start-up.

Another revolutionary idea: an optional air-cooled condenser. It completely eliminates the need for cooling water. So it pays for itself. Fast. Price? At 300

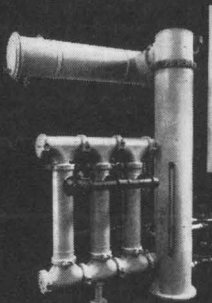

gph, Thermodrive costs 38% less than comparable conventional systems.

The Thermodrive Distillation System is a major advance in pure water technology. You ought to know about it. Call or write for our comprehensive catalog. Barnstead Company, 225 Rivermoor Street, Boston, Massachusetts 02132

Tel: (617) 327-1600.





# Hybrid voltage regulators stand alone

High-reliability thick-film units for avionics jobs require a minimum of external componentry

While many monolithic voltage regulators are available, there's a catch: some outboard circuitry is required to make them work. Often needed are an output voltage divider, a resistor to set the limit current, a stabilization capacitor to prevent oscillation, and other external components to fit a specific application.

Beckman Instruments avoided

this problem in designing its models 828 (positive) and 838 (negative) hybrid thick-film regulators. George Smith, manager of research and development in the microcircuits operation, and designer of these circuits, contends that the trend emerging in the regulator business will see the monolithic houses winning out in high-volume, low-cost applications,

but hybrid manufacturers will get the bulk of the specialized business.

"This is our kind of market," he says of the more customized applications, "and we have a pretty good handle on what the customers want. We've tried to incorporate in the 828 and 838 all the things we've learned in 3 years." The two hybrids are identical in

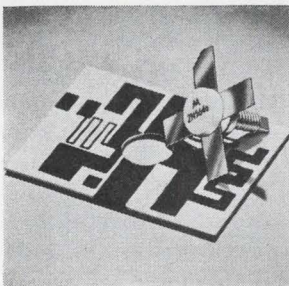

Balanced-emitter r-f power transistors 2N5644-2N5646 can provide 12 w in the 450-470 Mhz band with a 12.5-v power supply. They are for use as power amplifier stages of mobile transmitters in the uhf f-m band. Units come in the 3/8-in. ceramic stripline opposed-emitter package. Price (100-999) ranges from \$8.30 to \$22.50. Motorola Semiconductor Products Inc., Phoenix [436]

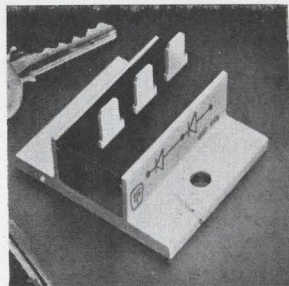

Silicon rectifiers series S6276 can be used singly as half-wave voltage doublers or paired to form full-wave bridge circuits. They are available in 8 piv ratings from 100 to 800 v. All units are rated for 50 amp continuous duty at case temperatures up to 60°C and will withstand surge currents up to 400 amps. Sarks Tarzian Inc., 415 N. College Ave., Bloomington, Ind. [437]

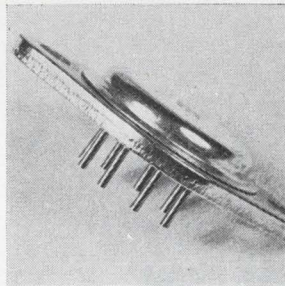

High-power d-c voltage regulator HCCA 100 features regulation of 0.05% maximum, 0.01% typical, no load to 1 amp load. The voltage range is 8 v to 50 v with maximum output current of 3 amps. Unit has 25 w dissipation at 25°C with heat sink and a temperature coefficient of less than 0.005%/°C. Solitron Devices Inc., 1177 Blue Heron Blvd., Riviera Beach, Fla. 33404 [438]

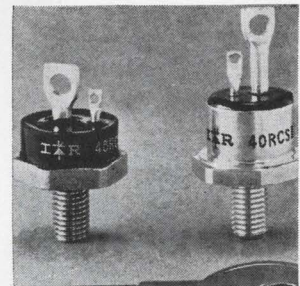

Silicon controlled rectifiers series 40RCS are new 40 amp devices available in two versions: epoxy package, up to and including 600 v rated units; and glass-to-metal sealed units rated from 700 v through 1200 v. Applications include d-c motor controls, power supplies, heater controls, and airborne and mobile converters. International Rectifier, 233 Kansas St., El Segundo, Calif. [439]

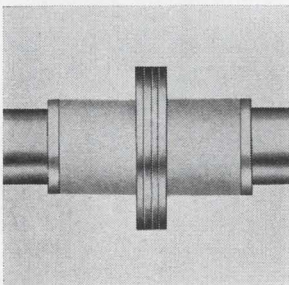

Back-to-back varactors DEP1712-1726 are for electronic tuning. They come with nominal capacitance values from 1.2 pf through 12 pf, with Q's of over 1500 measured at 50 Mhz. In the back-to-back configuration, one bias voltage supply, either a-c or d-c, is applied to the common flange contact with other contacts on ground. MSI Electronics Inc., 57th St., Woodside, N.Y. [440]

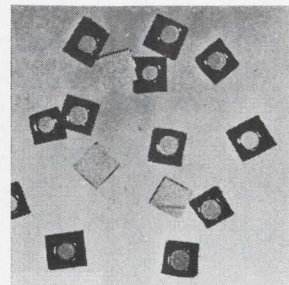

Silicon glass passivated mesa diode dice are available. Typical computer die sizes are 16.5 x 16.5 x 5 mil, with specifications at less than 2 pf capacitance and recoveries at less than 4 nsec. The dice meet or exceed MIL-S-19500 and MIL-STD-202 reliability specs without further treatment or encapsulation. Micro Semiconductor Corp., 11250 Playa Court, Culver City, Calif. [441]

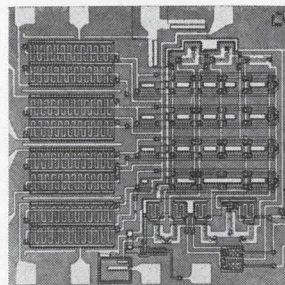

Eight-channel multiplex switch 3708 uses silicon gate technology. It offers channel switching of 0.4 μsec typically and interfaces directly with npn current sinking logic elements without the need of level shifting circuitry. The 3708 comes in a unit that multiplexes at -5 v to +5 v and in another that multiplexes at 0 to +5 v. Fairchild Semiconductor, Mtn. View, Calif. [442]

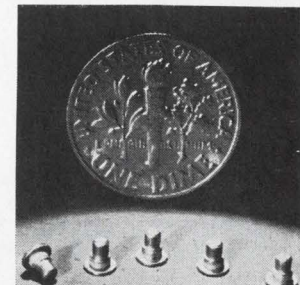

Snap varactor MA-43005 has low thermal resistance and high reliability in multisystem environments. It guarantees 0.25 w output at 10 Ghz. Typical breakdown voltage is 30 v; total capacitance is 0.65 pf minimum and effective minority carrier lifetime is 10 nsec. It is for circuits requiring high output power from 5 to 12Ghz. Microwave Associates Inc., Burlington, Mass. [443]

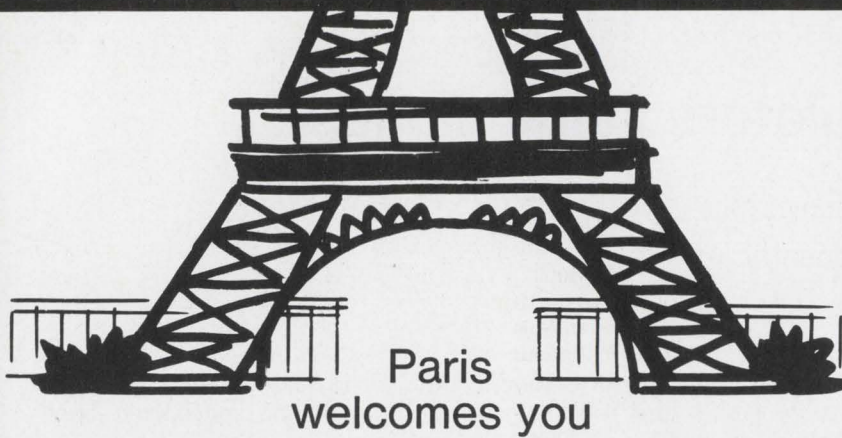

Paris,  
the meeting place of all  
the world's electronic experts

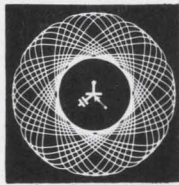

## SALON INTERNATIONAL DES COMPOSANTS ELECTRONIQUES

FROM 3rd TO 8th APRIL 1970 - PORTE DE VERSAILLES - PARIS



## INTERNATIONAL CONFERENCE ON MICROELECTRONICS

This conference will bring together users  
of integrated circuits and specialists  
in the design and manufacture of such circuits.

FROM 6th TO 10th APRIL 1970  
MAISON DE L'UNESCO - 125, AV. DE SUFFREN - PARIS

S.D.S.A. - RELATIONS EXTERIEURES - 16, RUE DE PRESLES - 75 - PARIS 15<sup>e</sup> - FRANCE - TEL. 273 24.70

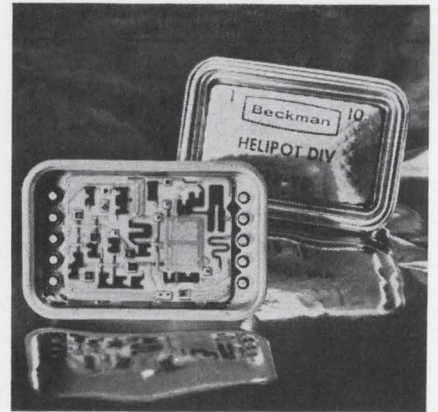

electrical characteristics; the only difference is that one operates from positive supplies and the other from negative sources.

"We wanted a regulator that's complete in one package, without a lot of external components, and, since it's aimed at the high-reliability market, we wanted to guarantee our specifications," Smith says. He point out that most data sheets for voltage regulators quote typical specifications and don't guarantee all of them. Typical specifications cited by manufacturers usually apply to operation at 25°C. "We've tried to write a spec that's comprehensive," Smith says. "It applies over the full military temperature range -55°C to +125°C."

**Variety of voltages.** Noise at high temperature is specified on the 828/838 data sheet (it isn't on most data sheets) as typically 0.003% and a maximum of 0.005% either with no load at +125°C or with full load at +25°C. The regulators are available from stock with preset output voltages of 5, 6, 9, 12, and 15 volts; other output levels are available as custom devices, and Beckman already has gone as high as 32 volts on one order.

Output voltage tolerance is a maximum of  $\pm 0.5\%$ .

Output voltage stability after 1,000 hours operation at full load puts the reading for the models 828/838 within  $\pm 0.5\%$  of the initial reading. Smith says other suppliers don't provide this specification, principally because it depends on the stability of the external output voltage divider usually required. Temperature coefficient of the output voltage is another characteristic usually listed as a typical and maximum figure, the latter

PUBLI-SERVICE

FRENCH TRADE SHOWS - 1350 Avenue of the Americas - New York N.Y. 10019 - Phone (212) 682-4960  
OFFICIAL AIR-LINES OF THE EXHIBITION CALL FOR INFORMATION - AIR FRANCE

# WANTED: ELECTRONICS MANUFACTURER

who desires to fill a  
dependable supply of  
government contracts

Excellent opportunity for growth-minded electronics manufacturer to locate in Texas and help meet the needs of the government and the third fastest-growing state. Stable, productive labor. Incomparable tax advantages. Lowest living costs. For Texas Fact Book, write or call:

James H. Harwell, Executive Director  
**TEXAS INDUSTRIAL COMMISSION**  
Capitol Station Box JJ-E  
Austin, Texas 78711  
Telephone 512/475-4331

Circle 196 on reader service card

LAUNCHING  
THE  
SPECTACULAR



IN ELECTRICAL and  
ELECTRONICS ENGINEERING



## 4 Floors of Exhibits

NEW YORK COLISEUM / 10 a.m.-8 p.m. 4 Days.

## 50 Technical Sessions

NEW YORK HILTON / 10:00-12:30; 2:00-4:30 5 Days.

Registration — Good all days — Technical Sessions and exhibits. In and out privileges. IEEE Members \$4.00. Non-members \$8.00. Ladies \$2.00. High School Students \$3.00 if accompanied by adult (One student per adult). Thursday only — limit of 3 students per adult.

IEEE INTERNATIONAL  
CONVENTION and EXHIBITION  
MARCH 23-26, 1970



## KEPCO TALKS POWER SUPPLY TECHNOLOGY:

**THERMAL REGULATION IS THE REAL  
MEASURE OF A POWER SUPPLY**

It has long been recognized that a power supply's line and load regulation can, by feedback and very high gain, be reduced to infinitesimal proportions. With high gain, wide-band amplifiers providing nearly complete isolation from the effects of line or load variations, the limiting factor on performance becomes noise. Noise, in this context encompasses a whole spectrum of continuous or random unwanted deviations, including impulse or spike noise in the megahertz region, "ripple" in the audio-frequency band, jitter in the subcycle region, and over the longer term: drift. Filtering and shielding techniques, work at the higher frequencies, but jitter and drift being mainly thermal effects, their reduction is accomplished only by reducing the thermal sensitivity or the *thermal regulation*.

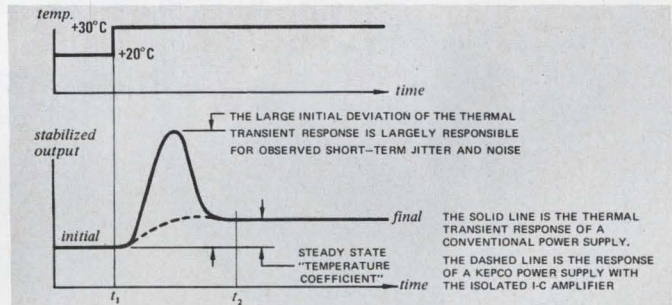

Every element in a power supply has a temperature coefficient, the reference, the sampling resistors, the amplifier. . . Their net steady-state value is reported as the "temperature coefficient" on the spec sheet. Some elements in the supply, however, also exhibit a *transient response* to temperature changes, a large initial deviation which recovers slowly to the steady-state temperature coefficient. In these elements, coefficients of change are balanced against others so that only the differential change appears in the steady-state coefficient. Unequal or localized heating or cooling - even a very small amount - will cause major perturbations which decay only as the elements regain thermal equilibrium.

Conventional, discrete construction, because of the physical separation of the elements, gives rise to the kind of thermal disequilibrium that makes the transient thermal regulation the *largest single cause* of low frequency jitter, noise and short-term drift.

By using a linear I-C control amplifier, Kepco has significantly reduced this effect. Our amplifier chips are buried in 0.8 cubic inches of thermally conductive epoxy, to form a thermal low pass filter, filtering out the sudden temperature fluctuations caused by drafts. The monolithic control amplifier sees only slow homogeneous temperature changes, affecting all parts of the chip simultaneously and eliminating differential heating as a cause of the transient thermal regulation effect. The improvement is several orders of magnitude!

Kepco makes a number of fine power supplies with the thermally isolated I-C regulator; all of the models in our JQE and CPS series (quarter-, half- and full-rack sizes), the voltage regulators of the PAT, PCX and PCX-MAT group, the current regulating CC models and our high-speed OPS units. We'd like the opportunity to tell you more about individual models

WRITE DEPT. DF-14

# KEPCO®

KEPCO, INC. • 131-38 SANFORD AVENUE • FLUSHING, N.Y. 11352  
(212) 461-7000 • TWX # 710-582-2631

Circle 197 on reader service card

Circle 161 on reader service card

161

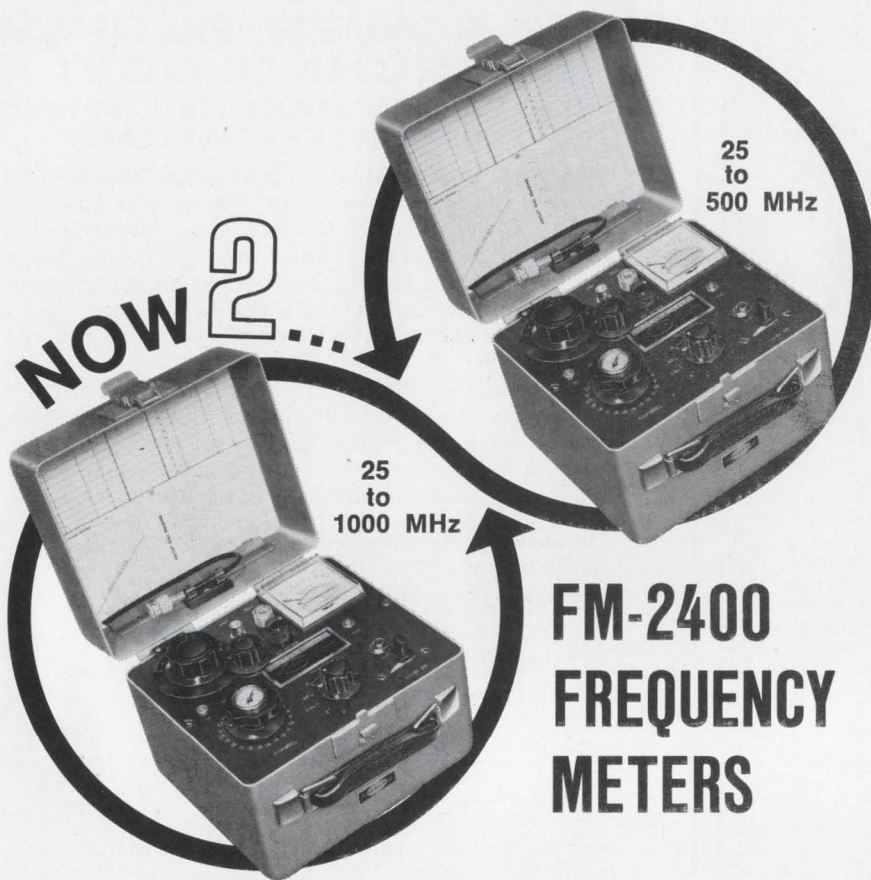

## FM-2400 FREQUENCY METERS

### FM-2400CH (New)

- Tests Predetermined Frequencies 25 to 1000 MHz
- New Extended Range Covers 950 MHz Band
- Pin Diode Attenuator

### FM-2400C

- Tests Predetermined Frequencies 25 to 500 MHz

The new FM-2400CH and the FM-2400C provide an accurate frequency standard for testing and adjustment of mobile transmitters and receivers at predetermined frequencies. The FM-2400CH with its extended range covers 25 to 1000 MHz. The Model FM-2400C covers 25 to 500 MHz. The frequencies can be those of the radio frequency channels of operation and/or of the intermediate frequencies of the receiver between 5 MHz and 40 MHz.

Frequency Stability:  $\pm .0005\%$  from  $+50^\circ$  to  $+104^\circ\text{F}$

Frequency Stability: with built-in thermometer and temperature corrected charts.  $\pm .00025\%$  from  $+25^\circ$  to  $+125^\circ$  (.000125% special 450 MHz crystals available)

Both the FM-2400CH and the FM-2400C are self contained in small portable cases. Complete solid state circuitry. Rechargeable batteries.

FM-2400CH (meter only).....\$595.00

RF crystals (with temperature correction)..... 24.00 ea.

RF crystals (less temperature correction)..... 18.00 ea.

IF crystals.....catalog price

FM-2400C (meter only).....\$445.00

RF crystals (with temperature correction)..... 24.00 ea.

RF crystals (less temperature correction)..... 18.00 ea.

IF crystals.....catalog price

Write for catalog



CRYSTAL MFG. CO., INC.  
10 NO. LEE • OKLA. CITY, OKLA. 73102

$\pm 0.01\%^\circ\text{C}$ . That level, combined with the specified noise figure, allows the 828/838 to be used in such applications as supplying power to high-gain intermediate-frequency strips in which low noise is a big factor, Smith says.

**Low drop.** Regarding input voltage, Smith points out that the lower the voltage drop across the regulator, the better the circuit's efficiency. Beckman specifies  $+3.5$  volts minimum and  $+45$  volts maximum. Smith adds that a 3.5-volt drop at  $-55^\circ\text{C}$  is particularly difficult to meet, and again, this parameter is usually listed as a typical number and only at  $+25^\circ\text{C}$  on most data sheets. The input regulation level of 0.01% maximum is said to be better than for any available monolithic regulator. Smith says it's also difficult to meet that level and still achieve the low minimum voltage drop of 3.5 volts.

The circuits offer a maximum load regulation of  $\pm 0.01\%$ ; line regulation is the same. Smith notes that load regulation and output impedance are related, and the maximum load regulation level means that with a 10-volt regulator, the output would change only one millivolt as the load changed from zero to 500 milliamperes, the units' maximum output load current.

Another parameter Beckman specifies is the reverse output voltage—1.2 volts maximum—which isn't usually spelled out on voltage-regulator data sheets. "But we provide a reverse clamp diode across the output as an applications device. This is needed," Smith notes, "if you use the regulators with positive and negative loads, such as operational amplifiers operating at  $+15$  volts to  $-15$  volts." He's quick to point out, though, that the 828 or the 838 can be used independent of the other.

The units are housed in a 10-pin metal package that's cold-welded to provide a hermetic seal, and then tin-plated, which makes it easily solderable into circuit boards.

Models 828/838 are available from stock, and are priced at \$40 in quantities from one to nine.

Helipot Division, Beckman Instruments Inc., 2500 Harbor Blvd., Fullerton, Calif. 92634 [444]

# Smallest Tubing in the World

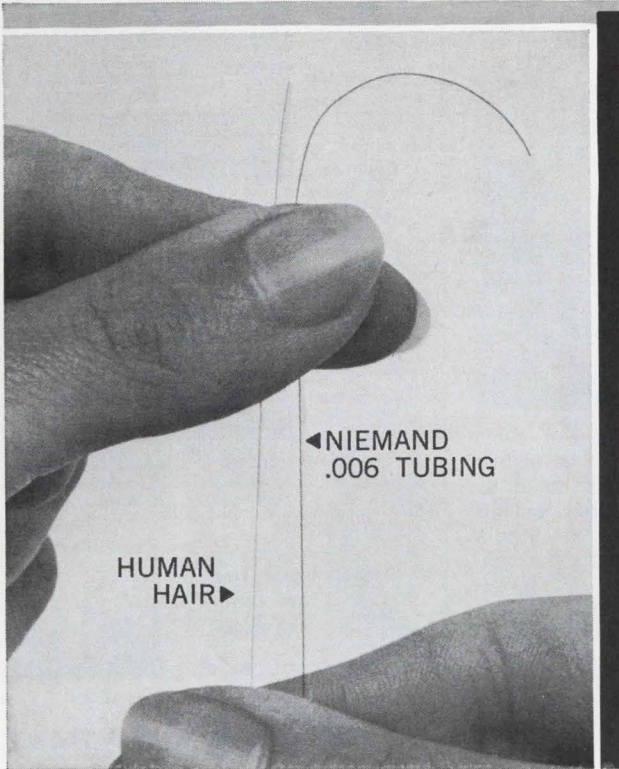

## NIEMAND'S MICRO-ML

I.D.'s from .....	.006" to .020"
Wall thickness from .....	.00075" to .001"
High heat resistance .....	300°C
Dielectric strength .....	4,000 volts
Non-burning .....	Chars at 850°C
Tensile strength .....	20,000 psi

Made from polyimide polymer, for use as insulation in slip-ring terminations, spacers for high density packing areas in computers, slip-ring assemblies, miniature thermoelectric probes and for wire insulation in high reliability relays. Write or phone for full details and samples.

## NIEMAND BROS. INC.

**NB** TECHNICAL PRODUCTS DIVISION  
45-15 94th Street, Elmhurst, L.I., N.Y. 11373  
Tel. (212) 592-2300

Sales Representatives: Atlanta (404) 422-4420 • Burbank (213) 849-6848 • Charlotte (704) 873-6364 • Chicago (312) 539-1820 • Cleveland (216) 247-4245 • Dayton (513) 277-3221 • Denver (303) 777-4381 • Ft. Wayne (219) 447-1158 • Indianapolis (317) 356-3001 • Pittsburgh (412) 823-8310 • St. Louis (314) 965-7650 • Seattle (206) 623-5705

Circle 198 on reader service card

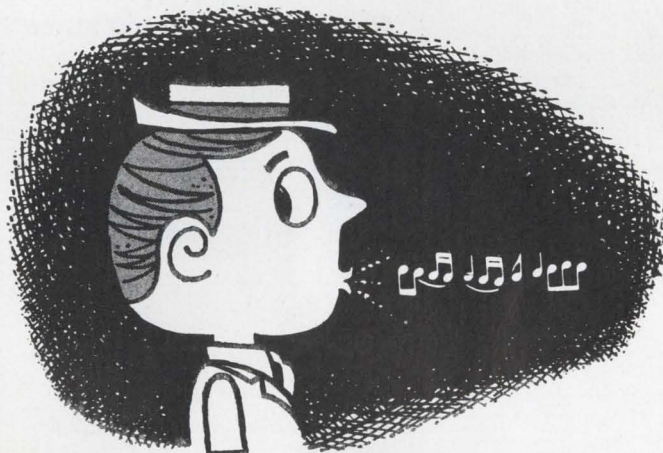

**YOU'RE WHISTLING IN THE DARK...**

if you think that heart disease and stroke hit only the other fellow's family.

**GIVE ... so more will live  
HEART FUND**



Contributed by the Publisher

**SWITCH 1800 WATTS WITH GRAYHILL**

**POWER  
TAP  
SWITCH**

(Rated 15 Amps.—  
125 VAC Resistive)

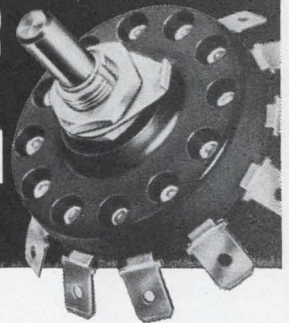

**TYPICAL  
SPECIFICATIONS**

- UL Listed
- 30° Angle Of Throw
- 2 To 11 Positions
- Solder Lug Or "Faston" Terminals
- Non-shorting Contacts
- Voltage Breakdown 2500 VAC
- Available With Special Shafts, Bushings And Other Modifications
- Life Expectancy Over 50,000 Cycles Of Operation At Rated Load

For your Grayhill Engineering Catalog offering complete technical data—contact



523 Hillgrove Avenue  
LaGrange, Illinois 60525  
Area Code 312, Phone 354-1040

... the Difference Between Excellent and Adequate

ELECTRONICS  
INSTRUMENTATION

# Rentronix Is Guaranteed Freedom From Obsolescence!

Rentronix is the answer to capital needlessly expended on electronic equipment which rapidly becomes obsolete or which is infrequently used. Rentronix has one of the largest, most modern pools of name-brand instrumentation and small computers available for short-term rental. Rentronix is where your need ends, and so do your costs.



**FREE**

48-page catalog covering hundreds of electronic instruments and small computers available for short-term rental.

# Rentronix

A Division of Inmark, Inc.  
11501 Huff Court  
Kensington, Maryland 20795

New materials

## Sealant prevents cable corrosion

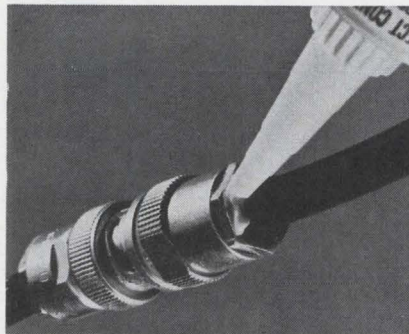

Long-term corrosion of coaxial cable connectors used in base and mobile antenna installations is eliminated by application of silicone rubber sealant 732 to the made-up connection. Application of the material renders the connection completely vapor and water-proof and yet allows easy disconnection and reconnection of the connector. The material is applied in a thin bead at the cable-connector joint and over the external mating surfaces of the connector. Dow Corning Corp., Midland Mich. 48640 [491]

Potting epoxy called Epoxy 225 is for high-temperature electronic applications. It is recommended for protection and low-cost packaging of semiconductor components, electronic devices, and circuit assemblies. It meets specifications for electrical potting compounds as well as MIL specifications. Price of the epoxy is \$3.25 per pound. Transene Co., Route One, Rowley, Mass. 01969 [492]

Rapid cleaning solution SC-200, for tarnished silver, gold and copper parts, leaves no residue on the cleaned material that would affect bonding and soldering operations. Oxidation and tarnish instantly disappear when the parts are immersed in the nonflammable solution. Applications to the brightening of conductor lines on ceramic hybrid IC packages are indicated. Additional uses are the cleaning of p-c boards, relay contacts, bus bars, terminals and switch contacts. Product is packaged in pint containers at \$1.98 each or a case of 12 for \$19.50. Star-netics Co. 10639 Riverside, N. Hollywood, Calif. 91602 [493]

Electronic grade cleaner and rosin flux remover Reliasolv 1001 effectively cleans electronic assemblies before and after soldering operations without attacking delicate components or markings. It is safe for use on many of the newer types of plastics used on p-c boards, including the polycarbonates. Alpha Metals Inc., 56 Water St., Jersey City, N.J. 07304 [494]

FASTENERS FROM



DIE CAST  
ZINC ALLOY



Wing Nuts



Cap Nuts



Thumb Nuts



Thumb & Wing Screws



Screws



Hex Nuts



Washers



Screw Insulators



MOLDED NYLON & DELRIN

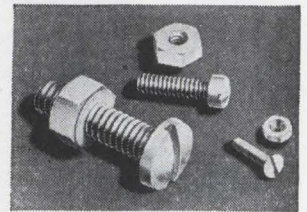

## NYLON SCREWS AND NUTS

also available in Delrin

MACHINE SCREWS from miniature #0 thru 1/4" in wide range of lengths and head types.

Also SET SCREWS, NUTS from #2 thru 5/16".

GRC's exclusive methods—die casting zinc alloy or molding Nylon and Delrin fasteners in one high speed automatic operation—assure high quality at lowest possible cost.

Write, wire, phone TODAY for SAMPLES, prices, your copy of GRC's NEW INDUSTRIAL FASTENER CATALOG



GRIES REPRODUCER CO.

Division of Coats & Clark Inc.

World's Foremost Producer of Small Die Castings  
151 Beechwood Ave. New Rochelle, N.Y. • (914) 633-8600  
Plants in: New Rochelle, N.Y.; Warren, R.I.; Toocoo, Ga.

Circle 199 on reader service card

# SAN-E

MSP-4 full four track stereo  
R/P head for auto-reverse  
cassette system



MSP-4 1/4 track full 4 heads R/P  
head for phillips cassette tape  
PE-M AC bias eraser for MSP-4  
head

Other product  
8 track (MS-8) stereo head  
for home & car stereo

\* write immediately  
for further details

**SAN-E DENKI COMPANY, LIMITED.**

110-1 Minami-Kawahori-cho, Tennoji-ku,  
Osaka, Japan  
phones: 779-1591  
cable: SANMAGNETICS

Circle 200 on reader service card

# We'd like to give you a Snow Job



In Treasure Chest Land we have arranged with nature so you can have your cake and eat it too. We get all kinds of snow in our high mountains (where we've strategically located numerous ski resorts). But minutes away, down in the valleys, we don't get so much. Just enough to remember it's winter. And come March and April, we'll give you a special treat. Ski in the morning, then play golf in 65 degree temperatures in the afternoon. It makes a fascinating day.

Fascinating days of fun are what keep people happy and enthusiastic in Treasure Chest Land. Maybe that's why one new manufacturer reports labor productivity up 2 to 3 times over his previous location.

Interested? Write:

Ask for our new 28 page Brochure

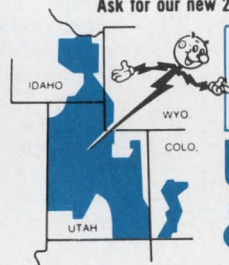

"A Treasure Chest in the Growing West"

Wayne F. Mulcock  
Director, Area Development  
P.O. Box 899, Dept. E-1a  
Utah Power & Light Co.  
Salt Lake City, Utah 84110

## Utah Power & Light Co.

Circle 201 on reader service card



### A new concept in laboratory load simulation featuring...

- Instant dial-a-load control
- Static and dynamic load simulation up to 100 watts
- Front panel voltage and current read-out
- Light weight, compact, and portable
- Available in rack mount or bench configuration
- Immediate delivery

Constant current, non-inductive load characteristics make the VEL ideal for testing transformers, inductors, relays, etc. Send for FREE application notes. Use the inquiry card in this magazine for additional technical data or call direct.

 SPECIAL PRODUCTS  
Data Systems Division • Litton Industries  
9001 Fullbright Ave., Chatsworth, Calif. 91311

#82

#82

SCR Phase Control Trigger Circuit  
See Circuit Diagram on  
Page 168



#230

90 Minute Precision Timer  
See Circuit Diagram on  
Page 168

#230



# General Electric's Programmable Unijunction Transistor

#406

Low Voltage Oscillator  
See Circuit Diagram on  
Page 169

#406



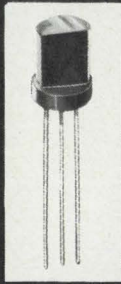

The key to PUT's versatility is what we call programmability.

General Electric's D13T programmable unijunction transistor is an extremely versatile, general-purpose triode thyristor that continues to fascinate the designer. Because it is programmable, you can make it act practically any way you like. With just two circuit resistors, you can control key parameters ( $\eta$ ,  $R_{BB}$ ,  $I_p$ , and  $I_V$ ) of the PUT. It's like being able to design the ideal component for your circuit. GE's PUT offers several other advantages as well. Its low leakage current and low peak point current permit use in long interval timer circuits. And it's an excellent SCR trigger device thanks to its fast, sure high-output pulse. Packaged in the low-cost plastic TO-98 case, GE's D13T is a three terminal, planar-passivated PNP device that just invites new applications. We've included circuit drawings on the next few pages to demonstrate PUT's versatility. If you need an oscillator, a sensing or a high gain phase control circuit, why not give the PUT a try. We'll make it easy by sending a sample. Just ask on your firm's letterhead, and we'll send the ideal component for your circuit. The programmable unijunction transistor . . . from General Electric.

# ...we're still finding new uses for it

For more information about the PUT or other General Electric semiconductor products, call or write your GE sales engineer or distributor, or write General Electric Company, Section 220-81, 1 River Road, Schenectady, N. Y. 12305. In Canada: Canadian General Electric, 189 Dufferin Street, Toronto, Ont. Export: Electronic Sales, IGE Export Division, 159 Madison Ave., New York N. Y. 10016.

#321

Variable Duty Cycle, Variable Frequency Pulse Generator  
See Circuit Diagram on Page 169

GENERAL  ELECTRIC

Circle 167 on reader service card

#321

PUT  
Oscillators

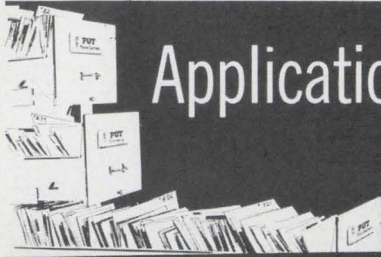

# Application #82

SCR  
phase control  
trigger circuit

featuring  
General Electric's  
programmable  
unijunction transistor  
(PUT)

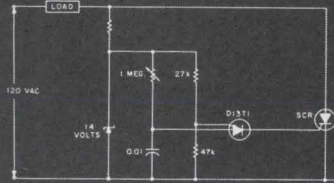

An excellent example of circuit simplification made possible by the D13T is the SCR Phase Control Trigger Circuit.

In this circuit the PUT is used as a unijunction. Notice the low value of capacitance (.01 $\mu$ F) that is used, and the fast rise time of the PUT pulse which insures "Hard" SCR turn-on from the small capacitor. Also note that the total power consumption of the control circuit is considerably less than that using standard unijunctions.

As you see from this circuit, the PUT can be used to crack many design problems. Consider it for your circuit, then write us on your firm's letterhead—we'll be pleased to send you a D31T. The proof is in the performance. Turn back to our two-page ad for details.

**GENERAL ELECTRIC**



220-82F

Circle 202 on reader service card



# Application #230

90 minute  
precision timer

Featuring  
General Electric's  
programmable  
unijunction transistor

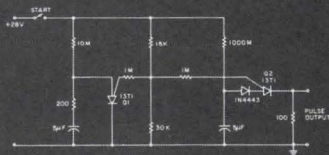

The versatile D13T makes possible the 1½ hour time delay sampling circuit shown above. The sampling circuit lowers the effective peak current of the output PUT, Q<sub>2</sub>. By allowing the capacitor to charge with high gate voltage and periodically lowering gate voltage when Q<sub>1</sub> fires, the timing resistor can be a value which supplies a much lower current than I<sub>p</sub>. The triggering requirement here is that minimum charge to trigger flow through the timing resistor during the period of the Q<sub>1</sub> oscillator. This is dependent on capacitor leakage and stability, not on capacitor size.

Give GE's programmable unijunction transistor a try in your circuit. Turn back to our two-page ad for details on getting a free sample of the D13T, the ideal component, because it lets you control key parameters.

**GENERAL ELECTRIC**



220-82D

168 Circle 168 on reader service card

## New Books

### CAD comes on strong

Computer-Oriented Circuit Design  
Franklin F. Kuo and Waldo G.  
Magnuson Jr.  
Prentice-Hall, Inc.  
561 pp., \$14.50

With the advent of time-shared computers and on-line graphical input-output devices, the computer has become a real-time partner in the creative processes of engineering design. Indeed, the entire concept of computer-aided design using programs to perform circuit analysis, graphical inputs and outputs, and printed or integrated circuit layout—is fast becoming the common denominator in all engineering fields.

The ingredients that comprise computer-aided design programs for electronic circuits are: network topology, state-space techniques, numerical analysis, modeling of solid-state devices, optimization techniques, graphic-data processing, and automated-circuit layout. This text covers all of these in sufficient depth to familiarize the reader enough to develop special-purpose programs for his own use or for use with some existing program.

To bring the reader up to date and to set the scene, the first chapter surveys the field of computer-aided analysis and design of electronic circuits. The coverage emphasizes breadth rather than depth. In the next three chapters the basic computer-based methods of network analysis are presented. These cover such elements as topology of circuit analysis, both the connectivity and the algebraic properties associated with linear graphs; matrix equations and their relationships to state-space concepts, and nonlinear analysis by computer.

Chapters 5 and 6 deal with optimization techniques in circuit design. These eventually may lead to completely automated circuit design by computer, wherein no decisions are left to the engineer in the design process.

Insertion-loss filter design is treated here, since it is an area which is now handled exclusively by computer. In precomputer days,

an elaborate insertion-loss filter design could have taken days to complete—now, the computer reduces the design to a matter of minutes. Moreover, the computer design is more efficient and accurate than the human design.

The remainder of the book concentrates on computer graphics as applied to circuit analysis and design. Both the graphic language and the application programs utilizing the language are described.

### Recently Published

**Advances in Information Systems Science**, edited by Julius T. Tou, Plenum Press, 303 pp., \$14

First in a series covering current topics in information science and technology, this volume should form the foundation for further advancement and be valuable to all those in computer management and information science. Concentrating on fundamental principles and mathematical techniques, text discusses the theory of algorithms and discrete processors, programming languages, formula manipulation, engineering principles of pattern recognition, and control systems.

**Proceedings of the First National Conference on Electronics in Medicine, Electronics Management Center, McGraw-Hill, 212 pp., \$14.50**

Sponsored by Electronics, Medical World News, and Modern Hospital magazines, these transcriptions of a conference on the potential of electronics in medicine cover paramedical aids, diagnosis by computer, new electronics equipment, and the role of the Federal Government in medicine. Discusses electronics in hospitals, the safe use of electrical equipment there, and other topics, such as remodeling surgery departments.

**Radar Design Principles**, Fred Nathanson, McGraw-Hill, 626 pp., \$22.50

Explores the relationship between radar signals and the total radar environment. Surveys and analyzes the reflectivity of both material and man-made targets, and describes various signal processing techniques in use or proposed for future radar systems.

**Thin-film Resistors**, Andrew Tickle, John Wiley & Sons, 144 pp., \$9.95

Covers thin-film active devices, physics of thin-film semiconductors, conduction and modulation, fabrication, analysis, optimization, and behavior. Wherever possible compares thin-film transistors to MOS devices.

## Application #321

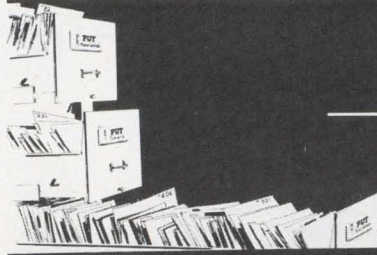

### Variable duty cycle, variable frequency pulse generator

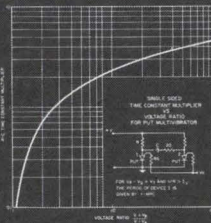
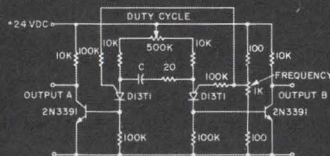

General Electric's Programmable Unijunction Transistor makes possible the highly controllable duty cycle in this circuit. Using the low holding current and high gate breakdown voltage in a pulse generator gives rep rates from seconds to microseconds and duty cycles from a few per cent to almost 100 per cent. Frequency programming over a decade range is provided by varying the gate resistor divider ratio while the duty cycle is controlled by varying the anode resistance of each device while keeping the total constant. Decade frequency changes are accomplished by switching the timing capacitor. The output is transistor isolated and can be taken from either or both of the PUT's. When this circuit is built in a fixed duty cycle form, the duty cycle is dependent upon the anode resistors and not the capacitor. Thus, it provides a highly controllable duty cycle with low cost, high precision components. To learn more about GE's versatile PUT, and how to obtain a free sample, turn back to our two-page advertisement.

**GENERAL ELECTRIC**  
220-82E

Circle 203 on reader service card

## Application #406

Low voltage oscillator

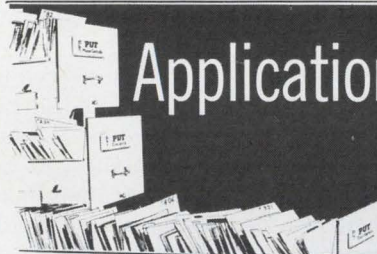

### Featuring General Electric's programmable unijunction transistor

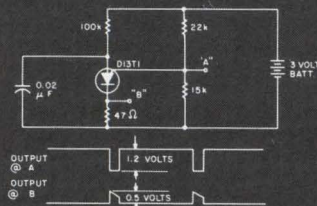

GE's D13T programmable unijunction transistor is widely applicable in relaxation oscillators which operate from a low voltage battery source. This particular oscillator operates at a frequency of approximately 1KHz from a 3 volt battery cell.

Perhaps the most important feature of this oscillator is its low effective interbase resistance of about 37K. This means that the battery drain can be as small as one tenth of that in normal unijunctions. Note the low intrinsic standoff ratio designed for this circuit, which allows for the diode drop associated with the anode to anode gate during firing.

Just one of countless circuits possible with General Electric's D13T programmable unijunction transistor. Turn back to our two-page ad to learn how you can obtain a free D13T.

**GENERAL ELECTRIC**  
220-82G

Circle 169 on reader service card

169

# The first plug-in curve tracer costs 1/3 less!



With U-Tech's plug-in and console units, any X-Y oscilloscope becomes a curve tracer displaying the dynamic characteristics of both NPN and PNP transistors, N Channel and P Channel junctions, FET's, MOS-FET's, bipolars, unijunctions, diodes, tunnel diodes and SCR's. You have curve tracer capabilities, without buying a complete curve tracer unit. In so doing you pay up to:

## 1/3 less!

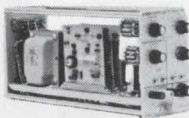

U-Tech plug-in **MODEL 681**: \$655.00\*. For use with Tektronix† 560 Series Oscilloscopes.

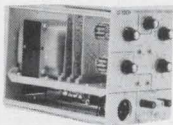

U-Tech plug-in **MODEL 682**: \$675.00\*. For use with Tektronix† 530, 540, 550, 580 Series Oscilloscopes.



U-Tech console **MODEL 683**: \$685.00\*. For use with any X-Y Oscilloscope.

Ask your distributor about these U-Tech curve tracer units or order direct from:

## U-TECH

A DIVISION OF INDUSTRIAL PHYSICS AND ELECTRONICS COMPANY  
4190 SOUTH STATE STREET,  
SALT LAKE CITY, UTAH 84107  
(801) 262-2663

†Registered trademark Tektronix Inc.

\*Prices apply to purchase and shipments within U.S.A. fob Salt Lake City, Utah

## Technical Abstracts

### Weather conditioning

An adaptive multiple access satellite communication system at millimeter wavelengths  
S. Nishida, J. Murakami, S. Asakawa, and N. Goto  
Toshiba Research and Development Center, Tokyo Shibaura Electric Co. Kawasaki, Japan

Although still fairly new, satellite communications systems have attracted so many users that severe problems are already being encountered in the allocation of channels. One way to alleviate the congestion is to move up into previously unused millimeter-wave bands—those above 20 gigahertz.

But these frequencies present new problems: the signals are so severely attenuated by clouds and gasses and particularly by rain in the atmosphere that many believe the millimeter waves cannot be used. However, it is feasible to develop a large-capacity, multiple-access satellite communications system by applying adaptive techniques to compensate for the attenuation due to rainfall.

The adaptive techniques serve to keep the carrier signal-to-noise ratio above a certain value. Four adaptive control techniques, to be applied to the communication links when weather conditions are bad, have been investigated. They are:

- Control of transmission rate, which keeps the carrier-to-noise ratio constant by decreasing the transmission bandwidth according to the value of the path attenuation.

- Control of satellite transmission power to put more power into the link between the satellite and the earth station that is suffering objectionable attenuation.

- Control of redundant time slots. With this technique, an extra portion of a frame is reserved for the link affected by rain.

- Control of satellite antenna gain. In this approach, a high-gain antenna with an extremely narrow beam-width covering only a single earth station is installed in the satellite, plus the regular antennas.

Presented at the International Conference on Digital Satellite Communication, London, Nov. 25-27, 1969.

### Transformer CAD

Computer-aided power transformer design  
G.I. Larson  
Hewlett-Packard Co.  
Palo Alto, Calif.

Power transformers have joined the ranks of components more easily designed by computer than by pencil, paper, and slide rule. Using a new program written specifically for power transformers, a computer can come up with a design within six minutes, while a designer working alone would take hours to do it.

Before the program runs, the computer's memory gets four data files: a library of standard transformer structures described in terms of bobbin dimensions, core dimensions and weights, and approximate volt-ampere ratings; data about wire of sizes from 45 gauge to 6 square gauge; a listing of the cost of wire and other costs.

With this data in hand the computer asks the designer to indicate the operating frequency, the number of windings on the primary, the primary voltage, and the number of secondaries and their voltages.

The computer then calculates the required volt-amperes of the secondaries, and sets the operating flux density. Next it calculates core dissipation and exciting volt-amperes to find the right wire sizes.

Taking these sizes into account and knowing the parameters set by the designer, the computer makes a tentative design by calculating the dimensions of the windings and their voltage drops, and the number of turns at each secondary. The computer then makes sure that its proposal is in line with all of the designer's parameters.

When satisfied that the design and the parameters are compatible, the computer calculates copper weights, costs and losses, no-load voltages, core cost, temperature rise, and circular mils per amp for each winding. If core loss turns out to be more than 1.15 times the copper loss, the computer lowers the operating flux density, and starts the design steps over again.

Presented at NEC, Dec. 8-10, 1969.

# Motorola VIBRASPONDER Resonant Reeds

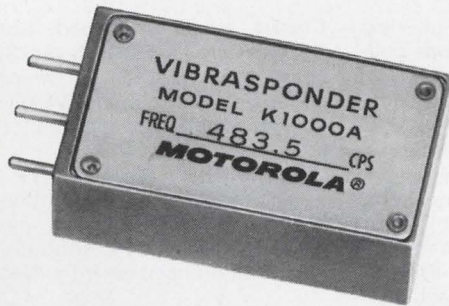

Performance proven, they're the industry's smallest and most rugged reeds.

Proven in thousands of remote control and signaling applications, VIBRASPONDER reeds provide unlimited potential in supervisory control, aerospace, military, and telemetry applications, or whenever selective tone signaling or stable audio tones are required.

Special construction gives VIBRASPONDER reeds maximum protection against shock and vibration. Contactless design allows its use as either a tone generator or a decoder. Multiple reeds may be used for sequential coded tone applications.

Over one hundred-fifty standard tone frequencies are available from 67 Hz to 3150 Hz. Other frequencies available on request.

For more information on VIBRASPONDER reeds, write for Bulletin TIC-3521 to Component Products Dept., Motorola Communications & Electronics, Inc., 4501 W. Augusta Blvd., Chicago, Illinois 60651. Or call (312) 772-6500.



Circle 204 on reader service card

# FREE!

## TA'S Instrument Case Engineering Manual

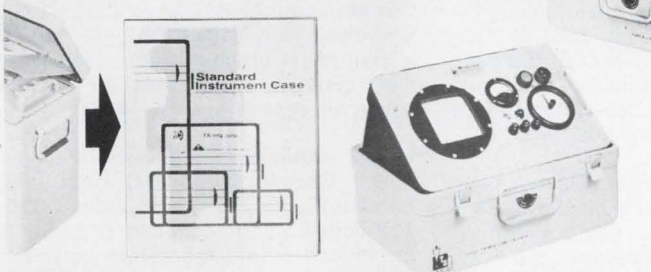

### Makes you a packaging expert!

This one-of-a-kind booklet contains everything you need know to select the proper case for **your particular** packaging requirements. ■ Save money for your firm by selecting one of TA's standard cases rather than going to the expense of designing a custom case to package your product. ■ Huge warehouse stock for fast delivery at low prices... no tooling charges. All TA cases are designed to surpass Mil-Spec requirements... completely dust and waterproof. Free vellum service and panel templates. ■ Write or phone for a quotation and let us put our staff of case engineers to work for you today. Send for your free case manual now.

**TA MFG CORP**  A DAYCO COMPANY

4607 Alger Street, Los Angeles, California 90039 ■ Phone 213-245-3748/  
TWX 910-497-2065 L. A./WUX CAT L. A., Calif.

Circle 205 on reader service card

# LSI

## The Changing Interface

Medium and large scale integration are slated to have major impact on the electronics industry. The effects are already being felt — not only on systems and component design — but on fundamental, traditional relationships between equipment builders and component suppliers.

Important trends that will affect your profession, your job, your company, are explored in LSI: THE CHANGING INTERFACE, a 100-page illustrated volume published by McGraw-Hill's Electronics/Management Center.

In THE CHANGING INTERFACE, leading design engineers and managers, the men responsible for guiding their companies through the next generation of electronics, discuss the problems that LSI/MSI are stirring up — and offer their solutions.

Here are some of the vital topics covered.

- Implications of LSI on the Electronics Market
- The Rationale for an In-House IC Capability
- The Component Maker's Responsibility vs. the System Builder's Responsibility
- Masks and Computer-Aided Design at the Interface
- The Testing Interface
- How IBM and Bell Laboratories Deal with the Interface Problem
- Controversies and Future Trends in LSI

Copies of LSI: THE CHANGING INTERFACE are available now at \$10 per copy. Fill in and return the coupon below. If you send a check now, we'll pay the cost of postage and handling.

Electronics/Management Center  
330 West 42nd St.  
New York, N.Y. 10036

Attn. Mr. Wayne Cowart

Please send \_\_\_\_\_ copies of LSI: THE CHANGING INTERFACE at \$10 per copy.

Name \_\_\_\_\_ Title \_\_\_\_\_

Company \_\_\_\_\_

Company Address \_\_\_\_\_

City \_\_\_\_\_ State \_\_\_\_\_

Check enclosed for \_\_\_\_\_  Bill me

Bill Company, P.O. Number \_\_\_\_\_

Circle 171 on reader service card

171

New Raytheon  
self-locking devices  
hold instrument  
settings  
against...

**VIBRATION  
&  
SHOCK  
SHOCK**  
with infinite  
resolution and zero  
backlash.

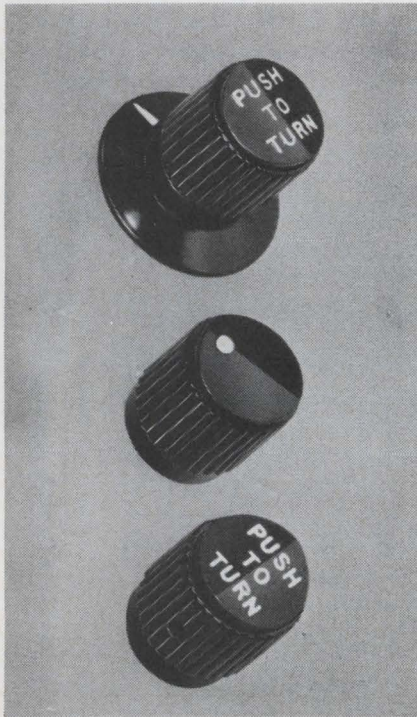

Pushed in, these Raytheon self-locking mechanisms can rotate control shafts in either direction to precise settings. Released, they automatically lock the shaft against vibration, shock, accidental turning. Their simplified, rugged packaging complies with MS91528C and MIL-K-3926B.

Available from your Raytheon distributor, or write for data and prices. *Raytheon Company, Industrial Components Operation, 465 Centre Street, Quincy, Massachusetts 02169.*



## New Literature

**Single crystals.** Ventron Corp., Materials Division, Bradford, Pa. 16701, has published its new Datalog, a customer product and information source on single crystals.

Circle 446 on reader service card

**Synergetic processor.** Redcor Corp., 7800 Deering Ave., P.O. Box 1031, Canoga Park, Calif. 91304. A four-page brochure describes the RC77 system, incorporating two processors, each with its own memory, so that real-time tasks are run in the real-time processor, and batch jobs are simultaneously run in the batch processor. [447]

**Tungsten metal powder.** General Electric Co., 21800 Tungsten Road, Cleveland, Ohio 44117. General catalog 1100 offers technical information on tungsten metal powder. [448]

**Facilities brochure.** Philco-Ford Corp., C & Tioga Sts., Philadelphia 19134. A 20-page full color brochure describes the firm's activities in space, defense, industrial electronics, education, and consumer product areas. [449]

**Tachometers.** Dynalco Corp., 4107 N.E. 6th Ave., Ft. Lauderdale, Fla. 33308. An eight-page technical manual covering electronic tachometers, describes their application to flow rate, rpm and linear speed measurement. [450]

**Small metal parts.** Magnetics Inc., Butler, Pa. 16001, offers illustrated folder F3-248 showing how its photofabrication can save 58% of the cost of making small metal parts over conventional methods. [451]

**Components catalog.** Merrimac Research and Development Inc., 41 Fairfield Pl., W. Caldwell, N.J. A 100-page catalog contains complete price and technical information on a line of r-f, i-f and microwave components. [452]

**Production line vibrator.** Ogden Technology Labs Inc., 573 Monterey Pass Rd., Monterey Park, Calif. 91754. A four-page brochure describes the Rotocan, a low cost, production line vibrator for finding mechanical defects in electronic assemblies. [453]

**Transducers.** Honeywell Test Instruments Division, P.O. Box 5227, Denver, Colo. 80217, offers a 20-page booklet describing Statham transducers. It lists representative industrial and biomedical applications and shows photographs of actual test setups. [454]

**Power supplies.** Lambda Electronics Corp., 515 Broad Hollow Rd., Melville, N.Y. 11746, has issued a 72-page general catalog of power supplies for systems, laboratory, test equipment and OEM applications. [455]

**Crystal oscillator.** Solid State Electronics Corp., 15321 Rayen St., Sepulveda, Calif. 91343. A two-page data sheet covers the model VCXO-541 voltage-controlled crystal oscillator. [456]

**Photosensitive devices.** ITT Electron Tube Division, 3700 E. Pontiac St., Fort Wayne, Ind., 46803, has available a short form catalog entitled "Special Purpose Photosensitive Devices." [457]

**Digital process controller.** Louis Allis Co., 427 E. Stewart St., Milwaukee, Wis. 53201, has issued bulletin 209B on the 500G digital process controller. [458]

**Quartz crystals.** Reeves-Hoffman Division, Dynamics Corp. of America, 400 W. North St., Carlisle, Pa. 17103, offers a brochure on operational parameters of various quartz crystal types. [459]

**Teflon spacer/bushings.** Sealectro Corp., 225 Hoyt St., Mamaroneck, N.Y. 10543, has available a catalog describing the most efficient way of mounting p-c boards to metal panels and chassis, using Teflon spacer/bushings. [460]

**Digital memory modules.** Corning Electronics, Memory Products Dept., Raleigh, N.C. 27602. Four-page application note MAN-7 covers digital memory modules at low speeds. [461]

**General-purpose relay.** C.P. Clare & Co., 3101 W. Pratt Blvd., Chicago 60645, has published engineering data sheet 1300 providing engineering and application data on a new general-purpose relay. [462]

**Custom assemblies.** Clairex Corp., 1239 Broadway, New York 10001, has issued a four-page brochure describing and illustrating its capabilities for custom electronic assembly work. [463]

**Image orthicon tv cameras.** Westinghouse Electric Corp., P.O. Box 868, Pittsburgh, Pa. 15230. Bulletin DB95-152 covers image orthicon tv cameras for industrial and laboratory cctv systems. [464]

**Time-delay relays.** Ohmite Mfg. Co., 3601 Howard St., Skokie, Ill. 60076. A complete line of solid state variable time delay relays—featuring external knob adjustment for a delay range of 0.1 to 10 sec, 0.6 to 60 sec, or 1.8 to 180 sec—is described in catalog 709. [465]

**Air trimmer capacitors.** Voltronics Corp., West St., Hanover, N.J. 07936, has issued an illustrated technical data sheet on a complete line of nonrotating concentric ring air dielectric trimmer capacitors that cover all types of high-frequency, precision applications. [466]



## EMPLOYMENT OPPORTUNITIES



We have been placing B.S., M.S. and Ph.D.

### ELECTRONIC ENGINEERS

in fee paid positions throughout the U.S. since 1959. Send resume today or request confidential application. We are graduate engineers, working full time . . . for you.

### ATOMIC PERSONNEL, INC.

Suite L, 1518 Walnut St., Phila., Pa. 19102  
AN EMPLOYMENT AGENCY FOR ALL TECHNICAL FIELDS

CIRCLE 966 ON READER SERVICE CARD

#### POSITION VACANT

**Electrical-Electronic Engineers. Salaries \$10-\$25,000.** We specialize in developing nationwide job search programs to fit your particular position objective and location flexibility. Project, Design, R&D, and management openings in all fields. Fees Company Paid. 85 affiliate offices to serve you. Send resume in confidence with present and desired salary, reason for desiring change and location flexibility to Leonard Personnel, 310 Empire Bldg., Pittsburgh, Pa. 15222.

*"Put Yourself in the Other Fellow's Place"*

## TO EMPLOYERS TO EMPLOYEES

Letters written offering Employment or applying for same are written with the hope of satisfying a current need. An answer, regardless of whether it is favorable or not, is usually expected.

**MR. EMPLOYER,** won't you remove the mystery about the status of an employee's application by acknowledging all applicants and not just the promising candidates.

**MR. EMPLOYEE** you, too, can help by acknowledging applications and job offers. This would encourage more companies to answer position wanted ads in this section.

We make this suggestion in a spirit of helpful cooperation between employers and employees.

This section will be the more useful to all as a result of this consideration.

**McGRAW-HILL INC.**

Classified Advertising Dept.

330 West 42nd St., New York, N. Y. 10036

# Electronics careers to match your individuality



### A Wide Range of Disciplines Related To . . .

precision voltage regulators and power supplies • A/D and D/A converters • sample and hold circuits • operational amplifiers and voltage comparators • transducer interface circuitry (thermocouples, pressure transducers, pulse pick-ups, etc.) • servo amplifiers for 400 cps motors, d-c motors, torque motors • servo analysis • linear integrated circuits • digital integrated circuits • logics design • computer interface circuitry • analog multiplexing circuitry using MOS, JFETS, and bi-polar devices • product test and development • instrumentation • development of test/check-out equipment.

### In a Variety of Product Groups . . .

spacecraft environmental control systems • medical monitoring systems • power conditioning systems • flight management systems • engine control systems • environmental control systems • digital data systems • guidance & control systems • computer-controlled monitoring and diagnostic test systems. Tired of trying to fit your talents into a job that's just not quite right? Then let us tailor a career opportunity in electronics to *your* individual skills and preferences. As you can see, we have the broad scope in disciplines, skills, and product groups to come up with the exact career combination you're seeking. Actively engaged in the design and development of systems for advanced aircraft/spacecraft and commercial/industrial products, we're geared for growth. Come and grow with us.

**LET'S GET TOGETHER.** Come and talk over the details with some of our key people, and get a first-hand look at the wonderful living conditions in Connecticut. Just forward your resume, stating present salary, to Mr. A. O. Fehlber, Personnel Department, Hamilton Standard, Windsor Locks, Connecticut 06096.

An Equal Opportunity Employer

# Hamilton Standard



CIRCLE 967 ON READER SERVICE CARD







It's the era of the mini-skirt and electronic miniaturization!

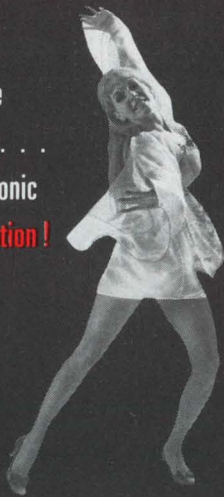

Now the newest and smallest multi-pin connector puts meaning into miniaturization!



**Meet Navajo:** The miniature multi-pin that complements your miniaturization program. This is the industry's first miniature, circular multi-pin connector series offering 3, 5, 7 and 9 pin-contact versions all in one 1/2" maximum diameter shell size. (Also available are combinations of coaxial and power contacts.) Five key polarization. Shell and contacts gold over nickel plating. Threaded 1/16"-28 THD coupling. Contacts fused into glass or molded into thermo-setting compound per MIL-M-24325. Contacts are closed entry design with one amp rating. Seven and nine pin versions' contact solder pots accept 22 gauge wire. Three and five pin versions accept 18 gauge wire. Receptacles available in various mounting configurations. Typical mated parts weigh less than 1/2 oz. These connectors are moisture-proof and extremely resistant to shock, vibration and corrosion.

Navajo was designed for you. So before you finalize your next design, learn more about the miniature multi-pin connectors that really are miniature. Ask about our complete line of coaxial connectors, too. They're not ordinary, either. Contact:



**MANUFACTURING CORPORATION**  
11415 Johnson Drive  
Shawnee Mission, Kansas 66203

<b>Ted Manufacturing Corp.</b> Lane/Travis/Pollard Inc.	176
<b>Teikoku Tsushin Kogyo Co. Ltd.</b> Diamond Agency Co. Ltd.	72
<b>Teradyne Inc.</b>	144
Quinn & Johnson Advertising Inc.	
<b>Texas Industrial Commission</b> The Pitluk Group Advertising	161
<b>Texas Instruments Incorporated,</b> Components Group	30-31
Albert Frank Guenther Law Inc.	
<b>Toa Electric Co., Ltd.</b> Hakuhodo Incorporated	75
■ <b>Tohoku Metal Industries Ltd.</b> Hakuhodo Inc.	72
<b>Toko Inc.</b> Hakuhodo Inc.	75
<b>Triplett Electrical Instrument Company</b> Byer & Bowman Advertising	45
<b>Uchida-Yoko Co. Ltd.</b> Dentsu Advertising Ltd.	76
<b>Universal Oil Products, Norplex</b> Division	129
Campbell-Mithun Inc.	
<b>Utah Power and Light Company</b> Gillham Advertising Inc.	165
■ <b>U-Tech, A Division of Industrial Physics</b> and Electronics Company Ross Clay Advertising	170
■ <b>Varo Inc.</b> Tracy-Locke Inc.	14
<b>Vector Electronic Co., Inc.</b> Buck Advertising	133
<b>Westinghouse Semiconductor</b> Division	24-25
Ketchum, MacLeod & Grove Inc.	
<b>Westinghouse Electronic Tube</b> Division	102-103
Ketchum, MacLeod & Grove Inc.	
<b>Weston Instruments Inc.</b> Newark Division	123
Arndt, Preston, Chapin, Lamb & Keen Inc.	

#### Classified & Employment Advertising

F.J. Eberle, Manager  
212-971-2557

#### EMPLOYMENT OPPORTUNITIES . . . . . 231-233

Atomic Personnel Inc. . . . .	173
Hamilton Standard, Div. of United Aircraft Corp. . . . .	173
Electronics Manpower Register . . . . .	174

#### EQUIPMENT

(Used or Surplus New)  
For Sale

Radio Research Instrument Co. . . . .	174
---------------------------------------	-----

■ For more information on complete product line see advertisement in the latest Electronics Buyer's Guide  
□ Advertisers in Electronics International

#### Electronics Buyers' Guide

**George F. Werner**, Associate Publisher  
[212] 971-2310

**Robert M. Denmead**,  
Midwest Regional Manager  
[312] MO 4-5800

**Cliff Montgomery**,  
New York District Manager  
[212] 971-3793

**Regina Hera**, Directory Manager  
[212] 971-2544

**Thomas M. Egan**, Production Manager  
[212] 971-3140

**Carol Gallagher**,  
Assistant Production Manager [212] 971-2045

#### Circulation Department

**Isaaca Siegel**, Manager [212] 971-6057

#### Research Department

**David Strassler**, Manager [212] 971-6058

#### Advertising Sales Staff

**Dan McMillan III** [212] 971-3468  
Associate Publisher

**Wallis Clarke** [212] 971-2187

Advertising Sales Service Manager

**Tomlinson Howland** [212] 971-6792  
Promotion Manager

**Warren H. Gardner** [212] 971-3139  
Eastern Advertising Sales Manager

**Atlanta, Ga. 30309:** Michael H. Miller, 1375  
Peachtree St., N.E.  
[404] 892-2868

**Boston, Mass. 02116:** William S. Hodgkinson  
McGraw-Hill Building, Copley Square  
[617] CO 2-1160

**Cleveland, Ohio 44113:** William J. Boyle, 55  
Public Square, [216] SU 1-7000

**New York, N.Y. 10036**  
500 Fifth Avenue  
**James R. Pierce** [212] 971-3615  
**John A. Garland** [212] 971-3617  
**Michael J. Stoller** [212] 971-3616

**Philadelphia, Pa. 19103:**

**Jeffrey M. Preston**  
6 Penn Center Plaza,  
[215] LO 8-6161

**Pittsburgh, Pa. 15222:** Jeffrey M. Preston,  
4 Gateway Center, [412] 391-1314  
**Rochester, N.Y. 14534:** William J. Boyle,  
9 Greylock Ridge, Pittsford, N.Y.  
[716] 586-5040

**Donald R. Furth** [312] MO 4-5800  
Midwest Advertising Sales Manager

**Chicago, Ill. 60611:** Kenneth E. Nicklas  
Ralph Hanning 645 North Michigan Avenue,  
[312] MO 4-5800

**Dallas, Texas 75201:** Richard P. Poole, 1800  
Republic National Bank Tower,  
[214] RI 7-9721

**Houston, Texas 7702:** Richard P. Poole  
2270 Humble Bldg. [713] CA 4-8381

**Detroit, Michigan 48226:** Ralph Hanning,  
856 Penobscot Building  
[313] 962-1793

**Minneapolis, Minn. 55402:** 1104 Northstar  
Center [612] 332-7425

**St. Louis, Mo. 63105:** Kenneth E. Nicklas,  
The Clayton Tower, 7751 Carondelet Ave.  
[314] PA 5-7285

**James T. Hauptli** [415] DO 2-4600  
Western Advertising Sales Manager

**Denver, Colo. 80202:** David M. Watson,  
Richard W. Carpenter  
Tower Bldg., 1700 Broadway  
[303] 266-3863

**Los Angeles, Calif. 90017:** Ian C. Hill,  
Bradley K. Jones, 1125 W. 6th St.,  
[213] HU 2-5450

**Portland, Ore. 97204:** James T. Hauptli,  
Don Farris, 218 Mohawk Building,  
222 S.W. Morrison Street,  
Phone [503] 223-5118

**San Francisco, Calif. 94111:** James T. Hauptli,  
Don Farris, 255 California Street,  
[415] DO 2-4600

**Pierre Braude** Tel: 727 73 01: Paris  
International Director

**Paris:** Denis Jacob  
17 Rue-Georges Bizet, 75 Paris 16, France  
Tel 727 33 42, 727 33 60

**United Kingdom and Scandinavia**

**London:** Oliver Ball, Tel: Hyde Park 1451  
34 Dover Street, London W1

**Milan:** Robert Saldel, Roberto Laurerl Jr.  
1 via Baracchini Phone 86-90-656

**Brussels:** Denis Jacob  
27 Rue Ducale Tel: 136503

**Frankfurt/Main:** Hans Haller  
Elsa Brandstroem Str. 2  
Phone 72 01 81

**Geneva:** Pierre Braude  
1 rue du Temple Phone: 31 95 60

**Tokyo:** Noboru Matsumoto, McGraw-Hill  
Publications Overseas Corporation,  
Kasumigaseki Building 2-5, 3-chome,  
Kasumigaseki, Chiyoda-Ku, Tokyo, Japan  
[581] 9811

**Osaka:** Akihiko Kamesaka, McGraw-Hill  
Publications Overseas Corporation, Kondo  
Bldg., 163, Umegae-cho Kita-ku [362] 8771  
**Australia:** Warren E. Ball, IPO Box 5106,  
Tokyo, Japan

#### Business Department

**Stephen R. Weiss**, Manager  
[212] 971-2044

**Thomas M. Egan**,  
Production Manager [212] 971-3140

**Maury D'Gongora**,  
Assistant Production Manager [212] 971-2045

**Dorothy Carmesin**, Contracts and Billings  
[212] 971-2908

**Frances Vallone**, Reader Service Manager  
[212] 971-2865

# now Established Reliability costs less...

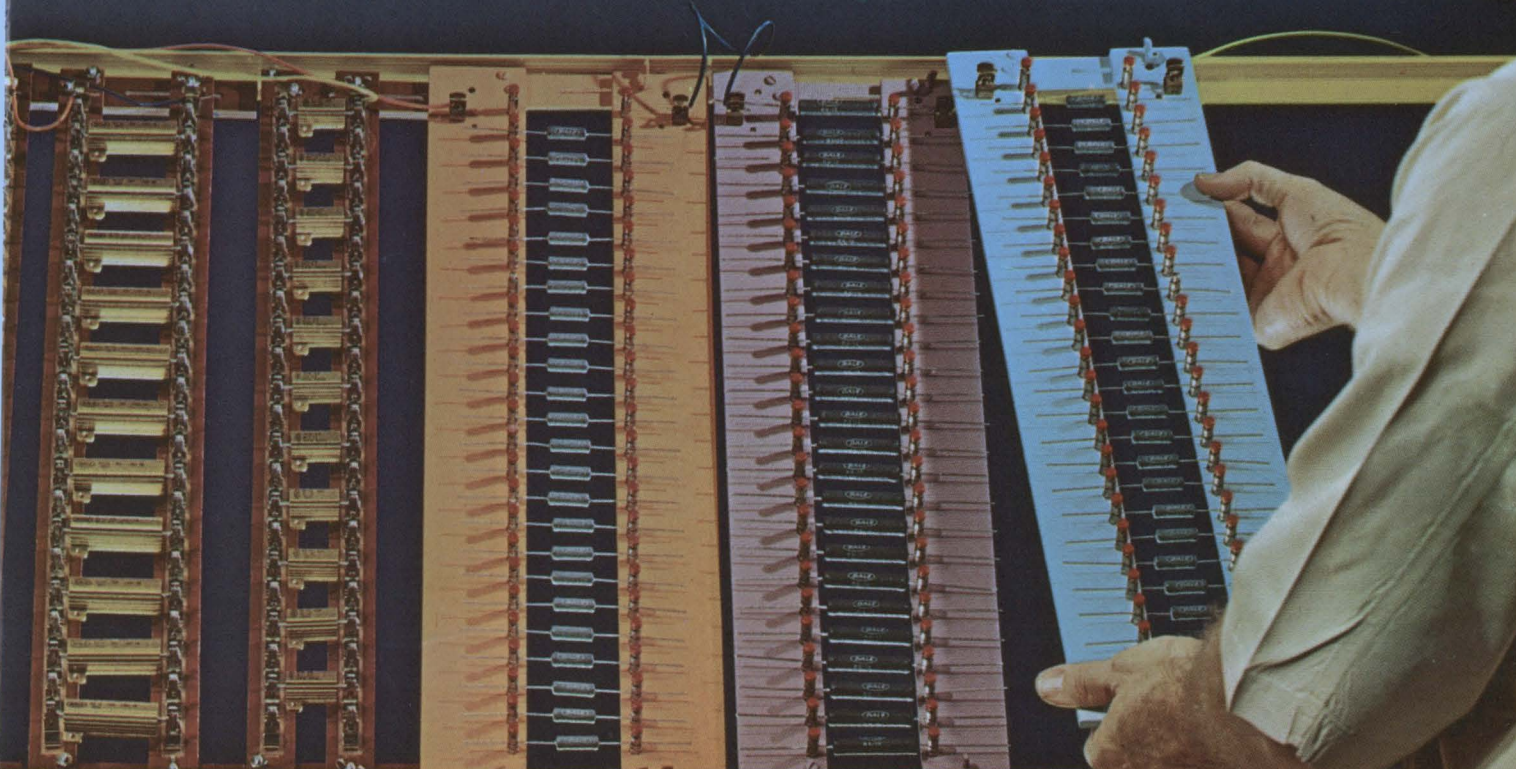

## ...when you buy Dale Wirewounds at MIL-R-39000 levels

Dale has just made it a lot easier and less expensive for you to obtain MIL-R-39007 and 39009 parts. By qualifying our ESS, EGS, ERH and non-inductive ENH styles to these specifications, we automatically moved established reliability price and delivery quotes down toward standard precision wirewound levels. In the bargain, you get resistors with a reliability background no other wirewounds can match. From them, we developed our ARS, AGS and ARH lines—with documented failure rates as low as .00054% per 1,000 hours. To them we added everything we've learned about building-in inherent reliability. Very interesting—and very competitive, too.

PHONE 402-564-3131 FOR PRICE AND  
DELIVERY DETAILS Write for Catalog A

**DALE ELECTRONICS, INC.**  
1300 28th Ave., Columbus, Nebr. 68601  
In Canada: Dale Electronics Canada, Ltd.  
A subsidiary of The Lionel Corporation



### ESTABLISHED RELIABILITY SPECIFICATIONS

	DALE TYPE	MIL. TYPE	MIL. RATING	RESISTANCE RANGE (Ohms)			
				MIN.			MAX.
				1%	.5%	.1%	
MIL-R-39007	ESS-2B	RWR-89	3 W	.1	.499	4.12K	
	ESS-5	RWR-74	5 W	.1	.499	12.1K	
	ESS-10	RWR-78	10 W	.1	.499	39.2K	
	EGS-1	RWR-81	1 W	.1	.499	1K	
	EGS-2	RWR-82	1.5 W	.1	.499	1.3K	
	EGS-3	RWR-80	2 W	.1	.499	2.67K	
MIL-R-39009*	ERH-5	RER-60	5 W	.1		3.32K	
	ERH-10	RER-65	10 W	.1		5.62K	
	ERH-25	RER-70	15 W	.1		12.1K	
	ERH-50	RER-75	30 W	.1		39.2K	

Dale ESS, EGS and ERH resistors meet the above specifications at the "M" level which specifies a failure rate not to exceed 1% per 1,000 hours at 100% rated power at 25° C. ESS and EGS resistors are available with solderable or weldable leads.

\*Ratings shown are for appropriate chassis mounting. Non-inductive (ENH) versions—Types RER-40, 45, 50, 55—also available. For complete specifications and test reports, contact Dale.

