

A response to designer's call for better ICs 78  
Special: How to select digital-to-analog converters 84  
Interfacing peripherals and minicomputers 92

# Electronics®

LIBRARY



**NEW ROLE FOR  
IEEE?**

Skinner

# 14 NEW Lowest Cost Spectrum Analyzers

From Sub-Audio to Microwave

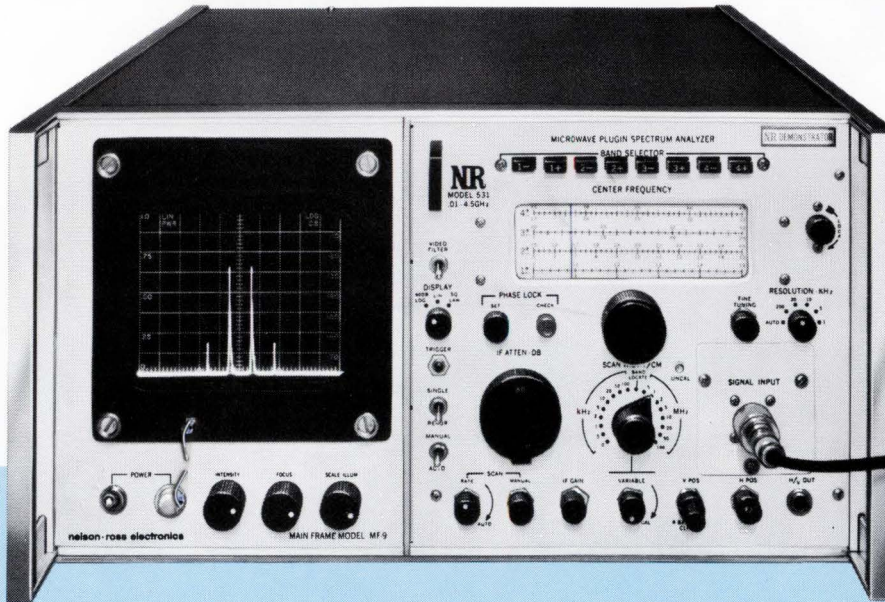

## Nelson Ross Spectrum Analyzer Model 531

10 MHz to 4.5 GHz  
Dispersion 0-1 GHz  
Phase locked 1 KHz resolution  
Price: \$3,000

Nelson Ross, the specialist in Spectrum Analyzers, has the **Biggest Selection, Most Versatile Specifications and Proven Reliability . . . All This For The Lowest Prices.**

Now you can select a Spectrum Analyzer from 0.5 Hz to 6.5 GHz which is just right for your application. And, with Nelson Ross you'll save 50% or more by not paying for unnecessary extras that you'll probably never use.

The versatile Spectrum Analyzers illustrated here are typical of 14 complete analyzers and more than 30 plug-in analyzers available from Nelson Ross.

The complete instruments include the new MF-9 Calibrated Display Main Frame which provides bright, long persistence

8x10cm readouts, adjustable scale illumination and camera mount facility.

Our plug-in analyzers come in 3 complete series: • for the Tektronix "540/550 letter" series scopes • for the Tektronix 560 series scopes • for the HP 140/141 series scopes and the Nelson Ross MF-9 Display Main Frame.

Compare specifications, quality, ease of use and price. We're sure you'll join the thousands who have been selecting Nelson Ross Spectrum Analyzers for more than a decade.

Call, write or circle the Reader Service Number to get your new 44-page Nelson Ross Spectrum Analyzer Catalog. Then you can compare and save.

### Typical Plug-In Spectrum Analyzers for Nelson Ross MF-9 Display Main Frame or HP 140/141 series scopes.



**Sub-Audio: Model PSA-036**  
0.5 Hz - 2 KHz  
0.5 Hz Resolution  
Plug-In: \$1,100  
With MF-9: \$2,100

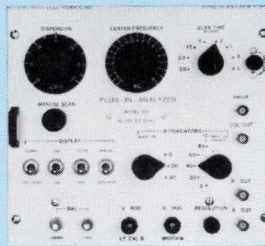

**Broadband: Model PSA-235**  
1 KHz - 25 MHz  
200 Hz Resolution  
Plug-In: \$1,600  
With MF-9: \$2,600

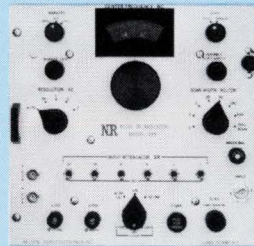

**Audio: Model PSA-031**  
10 Hz - 20 KHz  
10 Hz Resolution  
Plug-In: \$ 800  
With MF-9: \$1,800

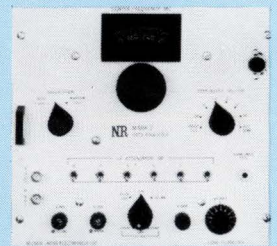

**RF-TV: Model CATV**  
1 MHz - 300 MHz  
Plug-In: \$1,500  
With MF-9: \$2,500

### Typical of more than 25 Plug-In Analyzers for use with Tektronix scopes.



For "540/550 letter" series  
**SSB Narrow-Band RF Model PSA-201**  
0.6 - 36 MHz  
10 Hz Resolution  
\$1,600



For 560 Series  
**Ultrasonic Model PSA-023**  
0.15 - 500 KHz  
150 Hz Resolution  
\$800

## nelson • ross electronics

A DIVISION OF POLARAD ELECTRONICS CORP.  
5 Delaware Drive  
Lake Success, New York 11040  
516 - 328-1100 • TWX: 510 - 223-0414

141T Variable persistence and storage. Gives bright, high-resolution traces at slow scans, \$1800. Also available: economical normal persistence and large screen displays.

8556A Tuning Section, 20 Hz—300 kHz, with built-in tracking generator, \$1690.

8553B Tuning Section, 1 kHz—110 MHz, \$2200.

Tracking generators for wide dynamic range, swept frequency response measurements.

8443A 110 MHz Tracking Generator/Counter, \$3500 (\$1975 w/o Counter).

8444 A/B 1300 MHz Tracking Generator, \$2950.

8554L Tuning Section, 0.5—1250 MHz, \$3500.

8555A Tuning Section, 10 MHz—40 GHz, \$5975.

8445A, 18 GHz Automatic Preselector, for wide scans, free from unwanted responses, \$2000.

8552B High Resolution IF Section has 10 Hz bandwidth, manual scan, two log plus linear scales, \$2900. Lower cost unit (8552A, \$2200) also available.

# HP's Family Plan: or how to add extra value to spectrum analysis.

With HP's neatly-interrelated spectrum analyzers, you can take your choice of tuning sections, displays and companion instruments to tailor a system for your measurement needs — all the way from 20 Hz to 40 GHz. Then, as your requirements expand, re-configure your system simply by adding the related piece of equipment. That's the value of our family plan.

By themselves, any of the 4 spectrum analyzers give you unparalleled signal analysis capability made possible by absolute amplitude calibration, low distortion, high resolution, and wide frequency scans coupled with the ability to zoom down to a narrow scan.

And the family value really multiplies when you add the companion instruments.

For example, the tracking generators combined with the analyzers make swept measurements over a 120 dB range thus forming precision swept frequency test systems.

And our automatic preselector for the microwave tuning unit does away with image, multiple and spurious responses.

All in all, HP's family of spectrum analyzers gives you the greatest depth and breadth of performance and the best value in signal analysis equipment available anywhere. For more information, call your local HP field engineer or write to Hewlett-Packard, Palo Alto, California 94304; Europe: 1217 Meyrin-Geneva, Switzerland.

HEWLETT  PACKARD

04111

SIGNAL ANALYZERS

Circle 1 on reader service card



# Norden Encoders perform for you!

Look at these new additions to Norden's line. More are on the way.

	Total Count	Revolutions for Full Count	Diameter"	Model Number
<b>NEW! Optical Absolute</b>	10,000	50	2.25	OADC-23/4/BCDQ-200L
<b>NEW! Optical Absolute</b>	1,000	1	2.25	OADC-23/3/BCD-1000L
<b>NEW! Optical Incremental:</b> Series now available with shaft seal—permits drenched operation.				
<b>NEW! Contact Size 11</b>	8,192	32 or 64	1.06	ADC-11/13/BNRY-256L
<b>NEW! Contact Size 11</b> Altitude Reporting Encoder	1,280	16	1.06	ADC-11-ALT-1280
<b>NEW! Contact Size 11</b>	10,000	100	1.06	ADC-11/4/BCDX-100
<b>NEW! Contact Size 11</b>	3,600	36	1.06	ADC-11/4-36/BCDX-100
<b>NEW! Rugged Industrial Grade Optical Incremental Encoders</b>				
All available with quadrature and internal squaring circuit options	2,000 Pulses	1	3.500	OADC-35/2000/INC
	1,500 Pulses	1	3.500	OADC-35/1500/INC
	1,250 Pulses	1	3.500	OADC-35/1250/INC
	1,000 Pulses	1	3.500	OADC-35/1000/INC
	600 Pulses	1	3.500	OADC-35/600/INC
	500 Pulses	1	3.500	OADC-35/500/INC
	300 Pulses	1	3.500	OADC-35/300/INC
	200 Pulses	1	3.500	OADC-35/200/INC
	100 Pulses	1	3.500	OADC-35/100/INC
<b>Optical Incremental Encoders</b>				
All available with index marker, quadrature outputs and internal squaring circuit options. Other counts on special order	100 Pulses	1	2.250	OADC-23/100/INC
	250 Pulses	1	2.250	OADC-23/250/INC
	256 Pulses	1	2.250	OADC-23/256/INC
	336 Pulses	1	2.250	OADC-23/336/INC
	500 Pulses	1	2.250	OADC-23/500/INC
	512 Pulses	1	2.250	OADC-23/512/INC
	1,000 Pulses	1	2.250	OADC-23/1,000/INC
	1,024 Pulses	1	2.250	OADC-23/1,024/INC
<b>IC-Compatible Encoders. For direct interface with TTL &amp; DTL circuits</b>				
Binary	128	1	1.750	ADC-ST7-BNRY-E/L
	8,192	64	1.750	ADC-13-BNRY-E/L
	524,288	4,096	1.750	ADC-19-BNRY-E/L
<hr/>				
Binary-Decimal Code	100	1	2.250	ADC-ST2-BCD/L
	1,000	10	2.250	ADC-3-BCD/L
	10,000	100	2.250	ADC-4-BCD/L
	100,000	1,000	2.250	ADC-5-BCD/L
	1,000,000	10,000	2.250	ADC-6-BCD/L
	360	1	2.250	ADC-3-36BCD-E-360L
	3,600	10	2.250	ADC-4-36BCD-E-360L
	36,000	100	2.250	ADC-5-36BCD-E-360L
	360	1	3.250	ADC-ST3-36-BCD/L
	3,600	36	2.250	ADC-4-36-BCD/L
	36,000	360	2.250	ADC-5-36-BCD/L
	360,000	3,600	2.250	ADC-6-36-BCD/L
<hr/>				
<b>External Logic V-Scan Binary Encoders</b>				
	128 or 256	1	1.750	ADC-7/8-BNRY-XB
	8,192 or 16,384	64	1.750	ADC-13/14-BNRY-XB
	524,288 or 1,048,576	4,096	1.750	ADC-19/20-BNRY-XB
<hr/>				
<b>Single Turn Gray Code Encoders</b>				
Available with various levels of RFI suppression	256	1	1.066	ADC/11/8/GRAY
	256	1	1.750	ADC-ST8-GRAY
	512	1	2.250	ADC-ST9-GRAY
	1,024	1	3.062	ADC-ST10-GRAY
<hr/>				
<b>Multiturn Gray Code Encoders</b>				
Available with various levels of RFI suppression	1,024	4	1.062	ADC-11/10GRAY256
	1,024	16	1.062	ADC-11/10GRAY 64
<hr/>				
<b>Low Cost Magnetic Noncontacting Encoders</b>				
Incremental	128	1	1.750	MADC-18/128/INC
Binary	128(V scan)	1	1.750	MADC-18/7/BV
Binary	8,192(V scan)	64	1.750	MADC-18/13/BV
Binary	524,288(V scan)	4,096	1.750	MADC-18/19/BV

For more information and detailed specs, write Norden, Att: Components Dept. 1000 Helen Street, Norwalk, Conn. 06856. Phone (203) 838-4471 TWX: 710-468-0788.

**Norden** DIVISION OF UNITED AIRCRAFT CORPORATION  

---

## 31 Electronics Review

COMMUNICATIONS: Radio hams fight industry takeover bid, 31  
INTEGRATED ELECTRONICS: IG-FET gets a bipolar output, 32  
INDEX OF ACTIVITY: 32  
COMPANIES: Wyly pledges UCC assets to Datran and Penisten, 34  
OPTOELECTRONICS: Rectangular waveguide brightens laser light, 34; National in LED business, 36  
MANUFACTURING: Laser vs diamond saw—jury still out, 36  
SPACE ELECTRONICS: NASA pares Grand Tours to economy class, 38  
SOLID STATE: Fairchild aims 95100 ECL at mainframe houses, 41  
GOVERNMENT: Customs plans national computer-terminal network, 42  
FOR THE RECORD: 46

---

## 61 Technical Articles

SPECIAL REPORT: IEEE at the crossroads: leaders ask directions, 62;  
IEEE to consider application of technology to society's ills, 66;  
Optimism heralds IEEE show, despite dropoff in exhibitors, 69  
CIRCUIT DESIGN: Designer's casebook, 74  
SOLID STATE: Functional digital ICs: devices to delight the systems man, 78  
COMPONENTS: Digital-to-analog converters: trading off bits and bucks, 84  
COMPUTERS: The T-box: a low-cost software-based interface, 92

---

## 109 Probing the News

YOU AND YOUR CAREER: Job roller coaster starts climb, 109  
GOVERNMENT: Coast Guard to direct harbor traffic, 116  
CONSUMER ELECTRONICS: New calculator firms favored, 120  
MANAGEMENT: Teledyne Semiconductor profits from change, 129

---

## 135 New Products

IEEE SHOW PRODUCT PREVIEW: Tantalum capacitors packaged in plastic, 135; Generator also shapes pulses, 136; Gas-discharge readouts challenge LEDs, 136; Data system for low-power jobs, 137; Ratiometer measures to 1 ppm, 138  
IN THE SPOTLIGHT: 8-bit parallel processor offered on a single chip, 143  
INSTRUMENTS: X-Y recorder uses laser pen, 145  
DATA HANDLING: Modem packed into pc board, 151; Cassette recorder aimed at remote-terminal jobs, 151  
PACKAGING & PRODUCTION: Handler sorts 5,000 DIPs an hour, 159; Reloader handles 3,000 substrates an hour, 159  
SEMICONDUCTORS: Arithmetic logic unit and latch put on a chip, 167

---

## 183 Electronics International

WEST GERMANY: Laser link hops 3.4 miles in nearly all weather, 183  
GREAT BRITAIN: Automating mobile radio transceiver testing, 183  
GREAT BRITAIN: Multiplexing scheme cuts error rate as channels increase, 184  
JAPAN: Two-speed sheet recorder runs TV telephone system, 185  
FRANCE: TI harvests technological crop of ideas in Europe, 186

---

## Departments

Publisher's letter, 4  
Readers comment, 6  
40 years ago, 8  
People, 14  
Meetings, 22  
Electronics Newsletter, 25  
Washington Newsletter, 51  
Washington Commentary, 52  
New Literature, 176  
International Newsletter, 181

# Electronics

EDITOR-IN-CHIEF: Kemp Anderson

EXECUTIVE EDITOR: Samuel Weber

MANAGING EDITORS: Lawrence Curran, *News*;  
Arthur Erikson, *International*

SENIOR EDITORS: John Johnsrud,  
H. Thomas Maguire, Stephen E. Scrupski

ART DIRECTOR: Fred Sklenar

ASSOCIATE EDITORS: Richard Gundlach,  
John N. Kessler, Howard Wolff

## DEPARTMENT EDITORS

*Aerospace*: William F. Arnold  
*Circuit Design*: Lucinda Mattera  
*Communications & Microwave*:  
Lyman J. Hardeman  
*Computers*: Wallace B. Riley  
*Consumer*: Gerald M. Walker  
*Industrial*: Alfred Rosenblatt  
*Instrumentation*: Michael J. Riezenman  
*Military*: Ray Connolly  
*New Products*: H. Thomas Maguire  
*Packaging & Production*:  
Stephen E. Scrupski  
*Solid State*: Laurence Altman  
*Special Issues*: Harry R. Karp

COPY EDITORS: Margaret Eastman,  
Everett C. Terry

ART: Charles D. Ciatto, *Associate Director*

PRODUCTION EDITORS:  
Patricia Cybulski, Arthur C. Miller

EDITORIAL ASSISTANT: Marilyn Offenheiser

EDITORIAL SECRETARIES: Vickie Green,  
Nancy Baldasare, Julie Gorgoglione

## FIELD EDITORS

*Boston*: James Brinton (Mgr.), Gail Farrell  
*Dallas*: Larry Armstrong (Mgr.)  
*Los Angeles*: Paul Franson (Mgr.)  
*New York*: Alfred Rosenblatt (Mgr.)  
*San Francisco*: Stephen Wm. Fields (Mgr.),  
Roberta Schwartz  
*Washington*: Ray Connolly (Mgr.),  
William F. Arnold  
*Frankfurt*: John Gosch  
*London*: Michael Payne  
*Paris*: Arthur Erikson  
*Tokyo*: Charles Cohen

## McGRAW-HILL WORLD NEWS

*Director*: Walter A. Stanbury; *Atlanta*: Stan Fisher; *Chicago*: Mike Sheldrick; *Cleveland*: Arthur Zimmerman; *Detroit*: James Wargo; *Houston*: Robert E. Lee; *Los Angeles*: Michael Murphy; *Gerald Parkinson*; *San Francisco*: Margaret Drossel; *Seattle*: Ray Bloomberg; *Washington*: James Canan, Herbert W. Cheshire, Seth Payne, Warren Burkett, William D. Hickman; *Bonn*: Robert Ingersoll; *Brussels*: James Smith; *London*: Marvin Petal; *Milan*: Peter Hoffmann, Andrew Heath; *Moscow*: Axel Krause; *Paris*: Stewart Toy, Michael Johnson; *Stockholm*: Robert Skole; *Tokyo*: Mike Mealey

PUBLISHER: Dan McMillan

ADVERTISING SALES MANAGER: Pierre J. Braudé

ADVERTISING SALES SERVICE MANAGER:  
Wallis Clarke

BUSINESS MANAGER: Stephen R. Weiss

CIRCULATION MANAGER: George F. Werner

RESEARCH MANAGER: David Strassler

MARKETING SERVICES MANAGER:  
Tomlinson Howland

**C**hanging roles, the theme of this week's cover story on the IEEE (see page 62), also fits the institute's president, Robert H. Tanner. First, he has thrown himself into a constant round of travels from his Canadian home to the U.S. to visit IEEE groups. His schedule is so tight that at one point our consumer editor, Jerry Walker, had to meet Tanner at LaGuardia Airport in New York in order to catch him for an interview.

That's about par for the course. In the past few years, our reporters have had to grab interviews with IEEE presidents in taxis on the way to airports, in hotel lobbies just before a fast trip to an airport. We even arranged to accompany one peripatetic president on an intercity plane flight, but poor weather converted that into a conventional office interview.

When he's not winging across the U.S., Tanner is also carrying on as the director of information for the newly-formed Bell-Northern Research organization in Ottawa, Ontario, though the company has given him leeway to attend to IEEE business.

And when he's not too busy at these roles, Tanner also keeps up with his spare-time favorite—architectural acoustics. During Jerry's interview, Tanner handled a telephone call—from a contractor seeking advice on the acoustics of a new building. Previously Tanner carried out the acoustical design for the Stratford Shakespearian Festival, the Expo Theatre in Montreal, Sir George Williams University, and Manitoba Theatre Centre in Winnipeg.

Among the roles Tanner and the

IEEE are trying out has to do with assisting jobless EEs. Agreeing with one of the conclusions in our article on the job market (see page 109), the IEEE head points out that neither the institute nor the bureaucracy of the Labor department can create jobs. But the IEEE may be able to help indirectly. After talking to Tanner, Jerry observed, "maybe someone with three jobs is the best man to work on the unemployment problems."

**O**pinion, criticism, controversial issues, individual points of view—we strive to keep our pages open to them all. With our wide readership, we are a natural forum for the airing of the diverse viewpoints that keep the electronics industries vital, constantly changing, and strong. This issue, on page 78 in our technical articles section, we've printed yet another "opinion piece." This time, it's a rebuttal to a previous article, one which criticized IC makers for not designing what the user really needed, but what was easy to manufacture or looked good in spec sheets. We think you'll be interested in the debate—and the ones yet to come.

**T**he 1971 index of articles published in *Electronics* will be sent to any interested reader who circles number 340 on the reader service card, just inside the back cover, and mails it in. Since the supply now available is limited, this is the last time we'll mention the offer.

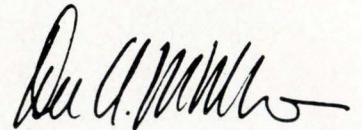

March 13, 1972 Volume 45, Number 6  
89,815 copies of this issue printed

Published every other Monday by McGraw-Hill, Inc. Founder: James H. McGraw 1860-1948. Publication office 330 West 42nd Street, N.Y., N.Y. 10036; second class postage paid at New York, N.Y. and additional mailing offices.

Executive, editorial, circulation and advertising addresses: Electronics, McGraw-Hill Building, 330 West 42nd Street, New York, N.Y. 10036. Telephone (212) 871-3333. Teletype TWX N.Y. 710-581-4235. Cable address: MCGRAW HILL N.Y.

Subscriptions limited to persons with active, professional, functional responsibility in electronics technology. Publisher reserves the right to reject non-qualified requests. No subscriptions accepted without complete identification of subscriber name, title, or job function, company or organization, including product manufactured or services performed. Subscription rates: qualified subscribers in the United States and possessions and Canada, \$8.00 one year, \$12.00 two years, \$16.00 three years; all other countries \$25.00 one year except Japan \$50.00 per year including air freight. Limited quota of subscriptions available at higher-than-basic rate for persons outside of field served, as follows: U.S. and possessions and Canada, \$25.00 one year; all other countries \$50.00. Single copies: United States and possessions and Canada, \$1.00; all other countries, \$1.75.

Officers of the McGraw-Hill Publications Company: John R. Emery, President; J. Elton Tuohig, Senior Vice President—Services; Donald B. Gridley, Group Vice President; Vice Presidents: Ralph Blackburn, Circulation; John R. Callahan, Editorial; David G. Jensen, Manufacturing; Jerome D. Luntz, Planning & Development; Joseph C. Page, Marketing; Robert M. Wilhelmy, Finance.

Officers of the Corporation: Shelton Fisher, President; Joseph H. Allen, President, Publications and Business Services Group; John J. Cooke, Senior Vice President and Secretary; Ralph J. Webb, Treasurer. Title registered in U.S. Patent Office. Copyright 1972 by McGraw-Hill, Inc. All rights reserved. The contents of this publication may not be reproduced either in whole or in part without the consent of copyright owner.

Subscribers: The publisher, upon written request to our New York office from any subscriber, agrees to refund that part of the subscription price applying to copies not yet mailed. Please send change of address notices or complaints to Fulfillment Manager; subscription orders to Circulation Manager, Electronics, at address below. Change of address notices should provide old as well as new address, including postal zip code number. If possible, attach address label from recent issue. Allow one month for change to become effective.

Postmaster: Please send form 3579 to Fulfillment Manager, Electronics, P.O. Box 430, Hightstown, N.J. 08520.

# SIMPLE VOLTAGE STABILIZATION

## your key to low cost reliability

The ferroresonant voltage stabilizing principal depends on the saturation of a portion of the transformer's iron by the use of a resonating capacitor. The squarish waveform in the tank winding is amplitude isolated from the primary winding (and, therefore, the line's noise) and will collapse if overloaded to protect itself and your load.

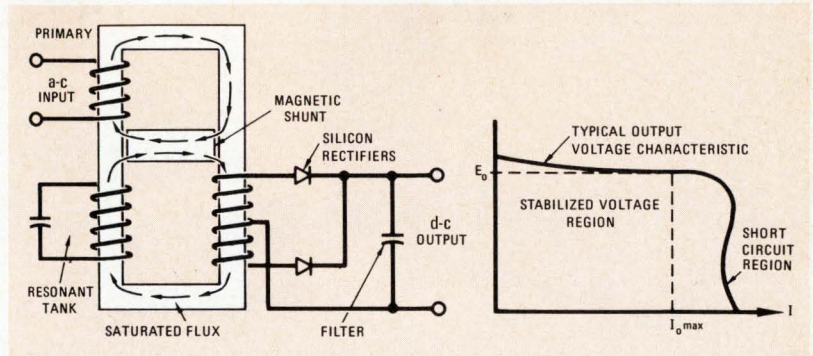

Why do things the hard way? There's a nice, easy way to provide stable, transient-free, d-c voltages in your system . . . the Kepco PRM modules. Low cost power supplies which, by their elegant simplicity, yield rich dividends in reliability and longevity.

There's no clamped-down high voltage to break out of its regulator and mess up your circuits; no noise-generating switches or oscillators to confuse your logic; no delicate transistors requiring elaborate protection. Kepco's PRM power supplies use a self-stabilizing resonant transformer, oil-filled a-c capacitor, some silicon rectifiers and husky aluminum electrolytic filters. That, plus some copper wire is it!

Voltage is controlled by the saturation flux of the transformer's iron lamination. You can't get more rugged than that. There's no need for auxiliary overvoltage crowbars, trigger circuits, current limiters or even fuses! PRM's are inherently protected for every sort of abuse.

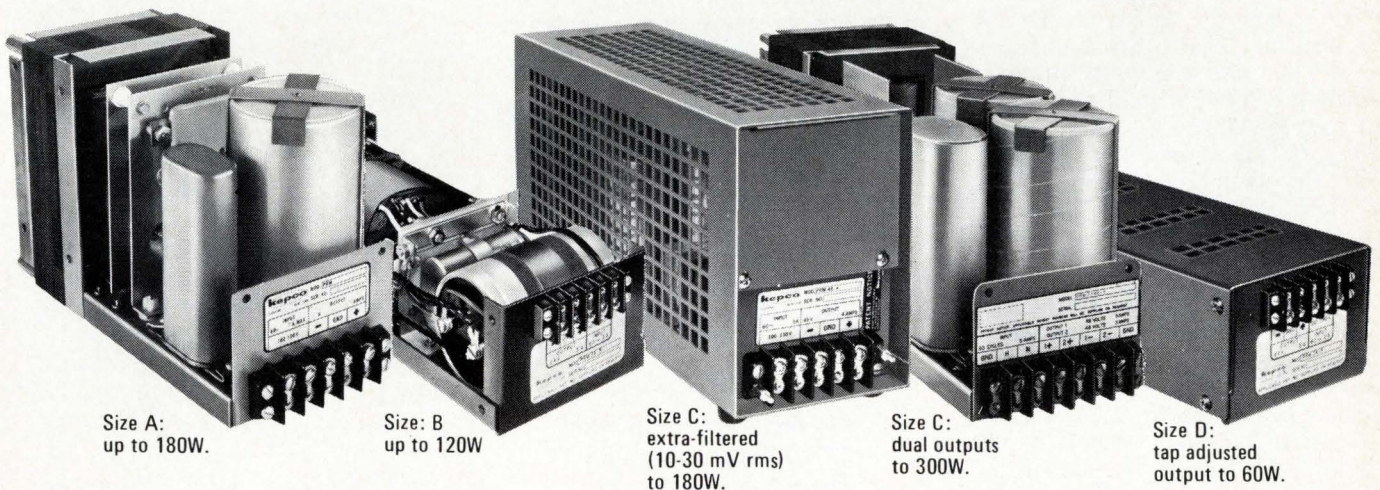

Size A:  
up to 180W.

Size B:  
up to 120W

Size C:  
extra-filtered  
(10-30 mV rms)  
to 180W.

Size C:  
dual outputs  
to 300W.

Size D:  
tap adjusted  
output to 60W.

- $\pm 1\%$  source effect (the "line regulation" for a 100-130V a-c unstable source).
- 100-300 mV rms ripple, spike free! Rejects line noise by more than 120 dB.
- Outputs from 4.5V d-c to 240V d-c.
- Built to exceed 200,000-hour service life.

For complete specifications and applications notes, write Department O-14

# KEPCO®

KEPCO, INC. • 131-38 SANFORD AVENUE • FLUSHING, N.Y. 11352 • (212) 461-7000  
TWX #710-582-2631 • Telex: 12-6055 • Cable: KEPCOPOWER NEWYORK

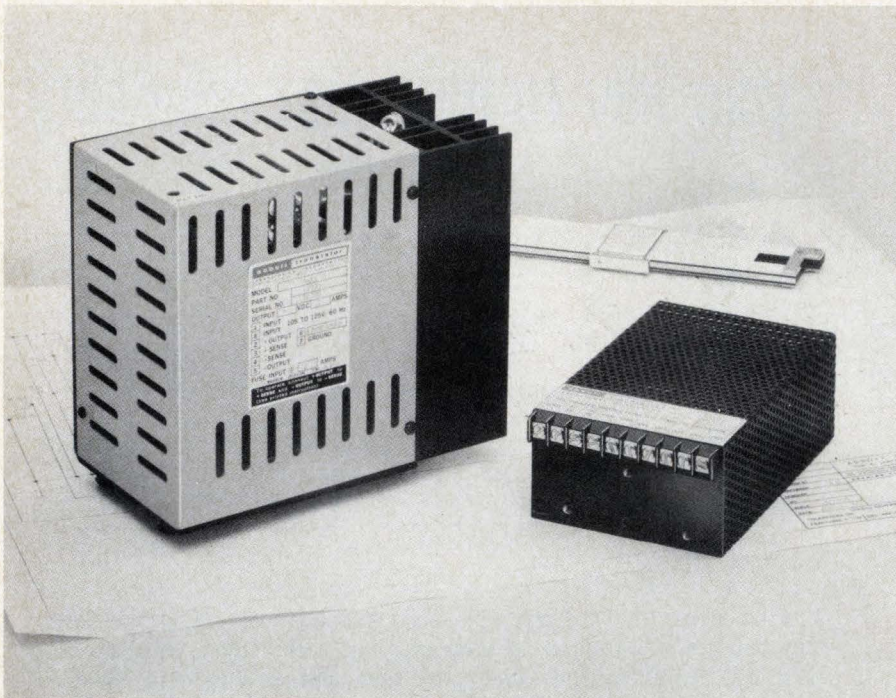

## Reduce Your Power Supply Size and Weight By 70% for \$49

A new way has been found to substantially reduce power supply size and weight. Consider the large power supply shown at left in the above photo — it uses an input transformer, into a bridge rectifier, to convert 60 Hz to 5 volts DC at 5 amperes. This unit measures 6½" x 4" x 7½" and weighs 13 pounds. It sells for \$170 in small quantities. For just \$49.00 more, Abbott's new model Z5T10, shown at right, provides the same performance with 70% less weight and volume. It measures only 2¼" x 4" x 6" and weighs just 3 pounds.

This size reduction in the Model Z5T10 is primarily accomplished by eliminating the large input transformer and instead using high voltage, high efficiency, DC to DC conversion circuits. Abbott engineers have been able to control the output ripple to less than 0.02% RMS or 50 millivolts peak-to-peak

maximum. This design approach also allows the unit to operate from 100 to 132 Volts RMS and 47 to 440 Hertz. Close regulation of 0.15% and a typical temperature coefficient of 0.01% per degree Centigrade are some of its many outstanding features. This new Model "Z" series is available in output voltages of 2.7 to 31 VDC in 9 days from receipt of order.

Abbott also manufactures 3,000 other models of power supplies with output voltages from 5 to 740 VDC and with output currents from 2 milliamps to 20 amps. They are all listed with prices in the new Abbott catalog with various inputs:

- 60  $\text{AC}$  to DC, Regulated
- 400  $\text{AC}$  to DC, Regulated
- 28 VDC to DC, Regulated
- 28 VDC to 400  $\text{AC}$ , 1  $\phi$
- 24 VDC to 60  $\text{AC}$ , 1  $\phi$

Please see pages 618 to 632 of your 1971-72 EEM (ELECTRONIC ENGINEERS MASTER Catalog) for complete information on Abbott modules.

Send for our new 56 page FREE catalog.

# abbott transistor

LABORATORIES, INCORPORATED  
general offices eastern office

5200 W. Jefferson Blvd./Los Angeles 90016  
(213) 936-8185 Telex: 69-1398

1224 Anderson Ave./Fort Lee, N.J. 07024  
(201) 224-6900 Telex: 13-5332

## Readers comment

### To market

**To the Editor:** Your item in the International Newsletter of Feb. 14 erroneously states that SGS is withdrawing from European markets. SGS is not withdrawing from any market but is, thanks to the association with ATES and the powerful backing of STET, Fiat, and Olivetti, in a better position than ever to serve markets in Europe and the rest of the world.

The closure of the Swedish and German factories, the combined production of which never exceeded 10% of total group production, was a regrettable but necessary step to rationalize the production activities of the total group.

Nils Djurklou  
International Advertising Manager  
SGS  
Agrate  
Italy

### Eurocontrol displays

**To the Editor:** Your article, "Air traffic control," [*Electronics*, Jan. 31, p. 31] does not mention what has already been done by Eurocontrol for its air traffic control system. Two color displays have already been put to service, and another 10 displays will be added to the system by July 1972.

These displays are manufactured and sold by C.I.T. Alcatel, a subsidiary of Compagnie Générale d'Electricite in its Villarceaux Center. Main features are four colors—green, yellow, orange, and red (corresponding to 14, 11, 9, and 7 kilovolts, respectively); an exceptionally fast patented switching device that reduces power consumption to less than 10 watts and switching time to less than 50 microseconds in the worst case (red to green and conversely); and a 4,096 16-bit-word processor allowing for the display of some 3,500 ½-inch vectors, or around 4,000 characters, or a combination of both (extension to 8,192 words is available).

F. S. deMorant  
Compagnie Industrielle  
des Telecommunications  
Departement Transmission  
Centre de Villarceaux  
France



# the p.c. holes per penny game stops here:

The most economical way to drill 1 to 12 hole sizes at 40,000 to over 300,000 precision holes per hour is with Excellon's rugged new

**OPEN-END**

## **MONOMATIC/7**

printed circuit drilling systems with automatic drill changing!

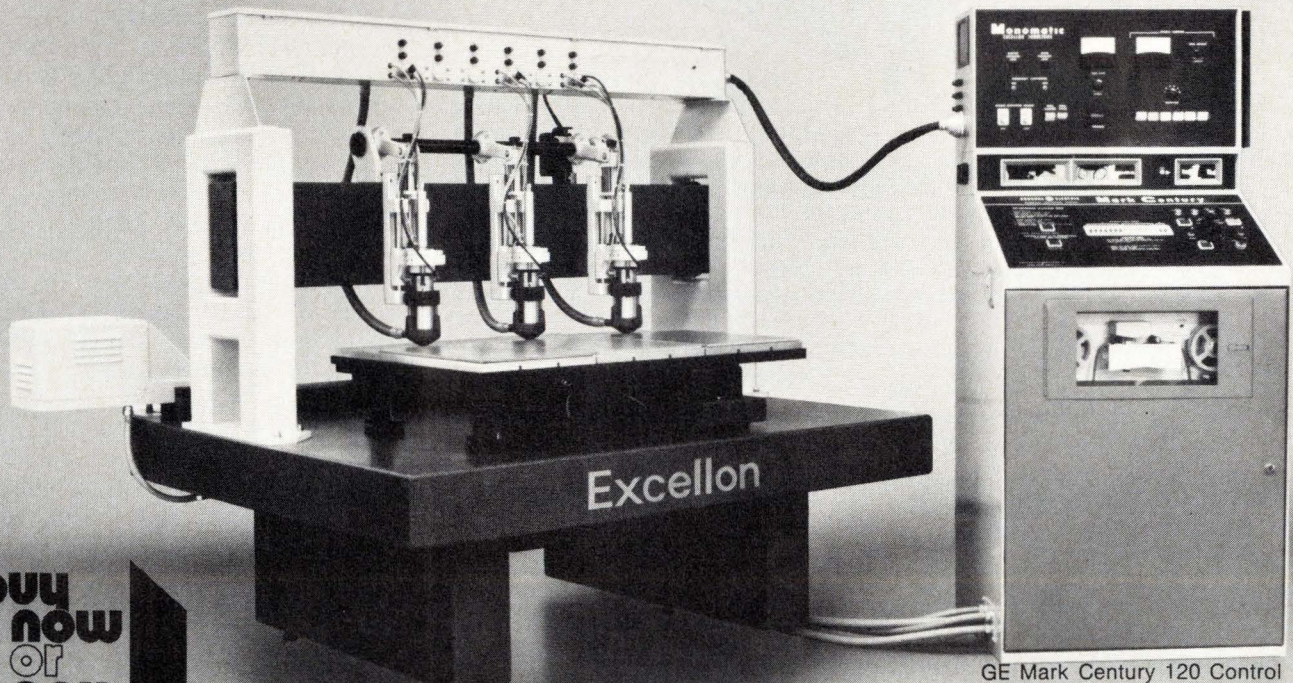

GE Mark Century 120 Control

buy  
now  
or  
pay  
later

*Where variety is the problem,  
versatility is the answer. Let's talk about it.*

**Excellon**



EXCELLON INDUSTRIES  
23915 GARNIER / TORRANCE, CALIFORNIA 90505  
Phone: (213) 325-8000  
Telex: 674562 - Cable: EXCELLON Torrance

Excellon Sales and Service in ENGLAND • FRANCE • SCANDINAVIA • W. GERMANY • SPAIN  
HOLLAND • ITALY • ARGENTINA • ISRAEL • AUSTRALIA • HONG KONG • TAIWAN • JAPAN

Circle 7 on reader service card

# New! ONE Relay that compacts 21,600 switch points with modular ease... at \$1 per pole!\*

## Meet the T-BAR® "PLUGGABLE"®

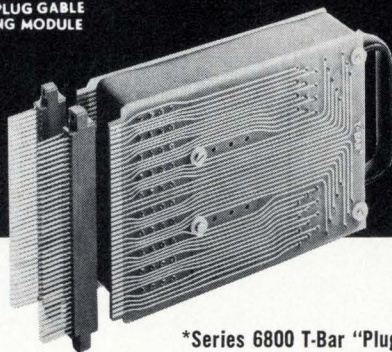
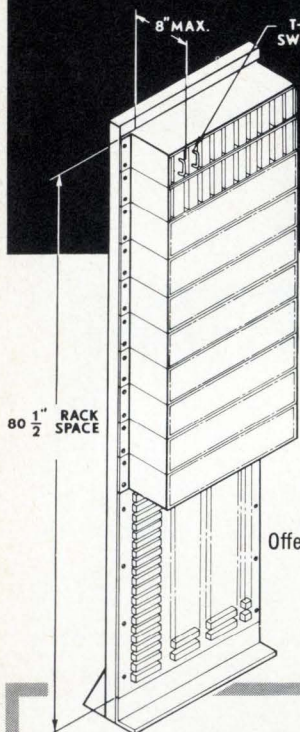

**\*Series 6800 T-Bar "Pluggable" Relays**  
... new T-Bar Switch/Relays mounted on or between printed circuit boards for **direct plug-in** to card-edge connectors in a standard card frame ... with the same mounting ease as any solid-state module ... with extremely high density of up to 21,600 switch points packaged into a 19" rack, 7' high ... for as little as \$1.00 per pole. Offering 36-72 poles, the "Pluggables" are ideal to interface switch computer-to-computer, computer-to-peripheral, or computer-to-modem ... while cutting packaging and hardware costs, eliminating component wiring, simplifying component scheduling and easing incoming inspection.

Features new Data-Rite™ T-Bars with unique **EDGE-TO-DOME™ Bifurcated Contacts** ...

Wipes in two directions across a dome shaped contact that is as effective as a **SOLID GOLD** Contact Set.

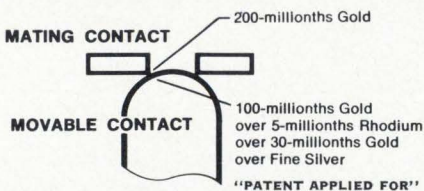

Want more facts on the "Pluggables"? Write or phone today for complete literature and prices on 6800 Series and other T-Bars ...

**T-Bar**  
INCORPORATED  
SWITCHING TECHNOLOGY

141 Danbury Road, Wilton, CT 06897  
phone: 203/762-8351

## 40 years ago

From the pages of *Electronics*, March 1932

Probably it has been the view of many that the close connection of electron diffraction to the complex theories of wave mechanics makes this subject a matter solely of theoretical interest. The article in this issue, however, would seem to thoroughly dispel this erroneous idea. Electron diffraction should prove of fundamental and practical importance to industrial processes of many kinds.

With Mr. Phillips' clear presentation of electronic refraction one more tool is given to commercial analysts and industrial operators.

Musical tones of a sweetness and purity never before produced; instruments permitting a range and delicacy of touch to do justice to which a new generation of composers will be required; violins that turn into French horns at the twist of a switch—these are among the revolutionary new electronic musical instruments now being demonstrated before the public and attracting wide interest among both musicians and laymen. Dr. Walter Damrosch discussed the future of these new instruments from the musician's standpoint at a meeting in New York last month. Dr. Leopold Stokowski has been making use of similar electronic oscillators.

Thus, for the first time in the history of music, it is now possible to create any desired quality of musical tone by scientific analytical methods. When one comes to think of it, all musical devices of the past have been mere accidental contraptions of hammers, skins, cat-gut, horsehair, brass pipe, strings, etc. For ages, musicians have had to use what they could get, with the crude means at hand. Our musical mechanisms thus have been hardly more than one step removed from the tomtom.

But the new electronic oscillators make it possible for the musician to create any wave-form, timbre, or tone effect he desires, and they afford a delicacy of control and touch, undreamt of with our present gross musical mechanisms which are operated by pounding, scraping or blowing!

# THE PATH OF LEAST RESISTANCE

True 4-wire ohm measurements, fully autoranging over **9-complete ranges** (1 ohm to 200 M ohms) in only **20 msec**... with 0.01% accuracy  
... Plus, only Dana's exclusive ohms guard allows  
in circuit measurements.



This is only one of the many features making Dana's 4800, premium performance DVM, a truly unique 4 digit measuring device.

Make **RMS AC measurements** of distorted signals... and not only pure sine waves... over a **1 MHz bandwidth** in only 350 msec with 0.03% accuracy. This outstanding performance is assured by Dana's remarkable RMS Distortion Insensitive AC Converter.

For DC measurements, 5 ranges are standard with **0.005% accuracy**... add a plug-in preamplifier and a 10 mV range becomes available with **1  $\mu$ V resolution**. Selectable filtering, in this mode, further extends application flexibility.

We didn't stop there, though... the 4800 is more than just specifications. We added many features which you, the user, directly benefit from: 100% overrange in all functions and on all ranges, full autoranging, complete solid-state **isolated BCD** and **programming**... no more troublesome slow relays... front panel override... protects against unauthorized and accidental tampering... programmable front/rear input, illegal operation indicator, built in programming timeouts, plug-in IC's and accessories, and analog output.

Whether you need a basic DVM or a full multimeter, don't follow the wrong path in searching for a premium performance instrument... let Dana guide you to the 4800.

**DANA**

*When Test and Measurement Count*

Dana Laboratories, Inc.  
2401 Campus Drive, Irvine  
California 92664 (714) 833-1234  
Circle 9 on reader service card

# The Am2506

An ALU with an internal latch that effectively has zero propagation delay and zero power dissipation.

You can build a 16-16-bit register arithmetic system that runs at 11 MHz using just 11 packages, and save 650 mW.

Write us, and we'll send you a data sheet.

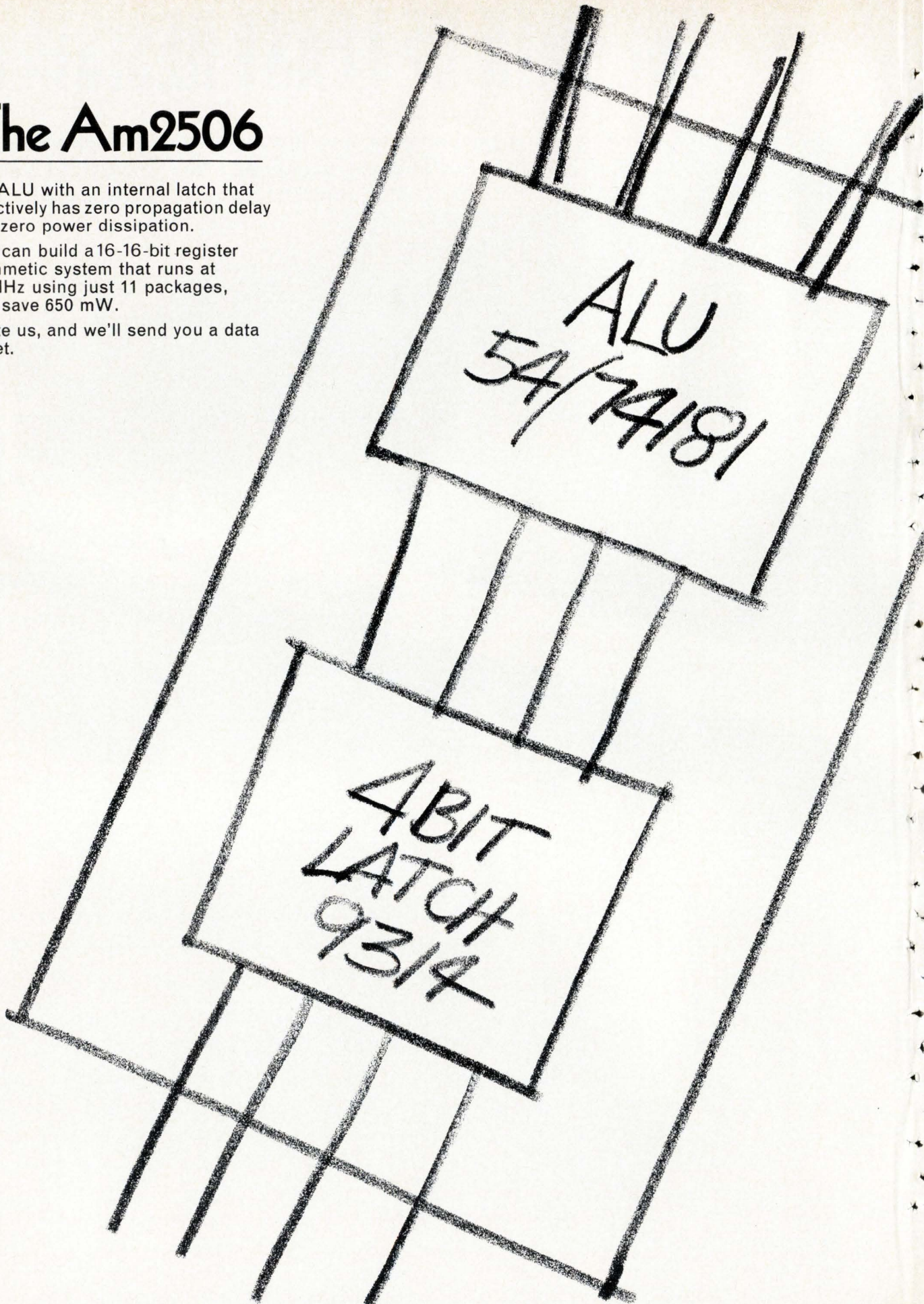

**An ALU with a built-in latch.  
The Am2506. Made for solving  
systems problems. Saves power.  
Saves logic time. Saves packages.  
First of its kind anywhere.  
Fits in nicely with our standard ALU's—  
Am9340, Am9341, Am54/74181,  
Am54/74182 and Am9342.**

**Who's #1 in ALU's?**

**We are.**

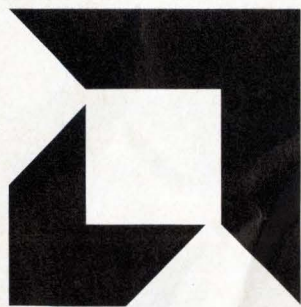

**Advanced Micro Devices, Inc.**

Distributed nationally by Hamilton/Avnet and Cramer Electronics. Telephone 800-538-7904 toll free, and ask for Shel Schumaker, or in California 408-732-2400. In Los Angeles, Steve Zelencik at 213-360-2102. In Mid-America, Chuck Keough at 312-297-4115. In the eastern United States, Steve Marks or Bill Seifert at 212-343-2220.  
901 Thompson Place, Sunnyvale, California 94086/TWX 910-339-9280/TLX 346306.

# They said no one could build and sell a computer-controlled LSI/IC test system for under \$100K...

## then along came Macrodata!

"Once upon a time test equipment manufacturers convinced each other that \$250K wasn't too much to pay for a computer-controlled DC/IC test system. In fact, they even convinced their customers.

"Then along came Macrodata. First off, for only \$200K, they built and delivered the first high-speed LSI test system, the MD-200. Then they set their sights on a system that could sell for about one-third of that price.

"No sooner said than done—they called it the MD-150. And within the first two months, many systems were purchased by leading IC manufacturers—installed and at work testing devices.

"The MD-150 is a cascaded, computer-controlled system designed to test all types of LSI/IC devices at functional speeds up to 5 MHz. It tests RAM's, ROM's, shift registers, and semiconductor memories, as well as random logic. It lets you test both MOS and bipolar devices optimally because of its unique interchangeable pin electronics and Macrodata's 'firmware' packages, and testing can be done at the wafer level and/or in the final package.

"When you buy the system, here's what you get: (1) *an MD-50 Sequencer*, which includes a computer and tape cassette that control the execution of a variety of test programs;

(2) *an MD-100 Tester*, which performs functional testing and supplies control information to the device under test at 5 MHz; (3) *an MD-83 Automatic Parameter Tester*, which is capable of running a full complement of DC functional/parametric tests for single-pin or multiple-pin testing; (4) *an MD-73 Programmable Clock*, which consists of up to six, one-nanosecond, programmable 'clocks,' with rep rates of 11 MHz; (5) *an MD-44 Programmable Power Supply*, with up to nine, precision, programmable units; (6) *Pin Electronics*, with up to 42 channels, which can be configured for LSI.

"In plain talk, the MD-150 is here today, ready to work for you now. It is packed with many third-generation design features, and provides 5 MHz performance at half the price of other so-called competitive units, for as little as \$60K. It requires no special software or add-on boxes, so you can launch right into a 'zero overhead testing' program immediately."

So much for Chapter II of the Macrodata Story. Look for the next exciting chapter soon. Meanwhile, for a free copy of the MD-150 brochure, use the reader service card; and if you can't wait, just call us directly.



## Chapter Two. The Macrodata Story.



**Macrodata Company, Test Systems Division, 20440 Corisco Street, Chatsworth, California 91311, (213) 882-8880**

Sales Offices: San Jose Area Tel. (408) 268-7714 • Philadelphia Area Tel. (609) 228-1325 Telex: 83-1496 • New England Tel. (617) 862-5700 • Southeast Area Tel. (205) 883-0140  
Dortmund, West Germany Tel. (231) 52 80 65 Telex: (841) 822-382 • Milan, Italy Tel. 871988 - 899248 Telex: (843) 34314 • Tokyo, Japan Tel. 03 985 5266 Telex: (781) 272-2171

# Everyone was tired of the old concepts, the old machines, the DC systems with the software hassle in IC testing...

## then along came Macrodata!

"Once upon a time—not very long ago—you had to pay too much for a computer-controlled IC test machine. And upon delivery, your troubles were just starting—with the software and other overhead headaches.

"Then along came Macrodata! Having already solved the LSI testing problem, they tackled the DC problem and came up with the MD-183—a tester capable of fully characterizing devices. Here was a fully automatic DC functional/parametric test system selling for about half the price of the old computer-controlled test machines. Still, it gave you a data memory, a logic section, a control panel, a tape cartridge unit, an automatic parameter tester, and programmable power supplies.

"But the MD-183 wasn't too good to be true. The users discovered that the

data memory was capable of holding all the data necessary for a complete device test. They liked the way the 183 performed sequential testing, binning, and logging automatically. And they were pleased to note that the logging counters track all passes and failures, as well as actual test values, and that the sequencing of tests on a particular device is computer-controlled with no software headaches. They could see the advantages of multivariable device characterization 'firmware' that was available off the shelf.

"So here at last was an automatic tester that could be set up for either single-pin or multiple-pin testing, capable of running a full complement of DC functional and parametric tests, including stress, leakage, continuity, and threshold—and you could buy it for as little as \$34,520! As the news got out, the users were eager to get their hands on one. How about you? ? ?"

This is Chapter III of The Macrodata Story. Look for another exciting chapter soon. Meanwhile, for more information, just use the reader service card; or if you want to get your hands on a 183 now, call us directly.



## Chapter Three. The Macrodata Story.



**Macrodata Company, Test Systems Division, 20440 Corisco Street, Chatsworth, California 91311, (213) 882-8880**

Sales Offices: San Jose Area Tel. (408) 268-7714 • Philadelphia Area Tel. (609) 228-1325 Telex: 83-1496 • New England Tel. (617) 862-5700 • Southeast Area Tel. (205) 883-0140 Dortmund, West Germany Tel. (231) 52 80 65 Telex: (841) 822-382 • Milan, Italy Tel. 871988 - 899248 Telex: (843) 34314 • Tokyo, Japan Tel. 03 985 5266 Telex: (781) 272-2171

**New commercial versions of RCL's MINIATURE ROTARY SWITCHES**

as low as

**\$196**  
each  
in quantities of 1,000

**DELIVERY FROM STOCK**

**6 Separate Series 6-10-12-24 Position**

(Price Applies to All Multi-Deck Miniature Switches)

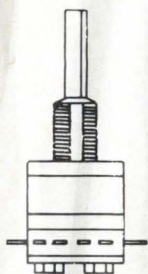

Completely automated facilities and mass production tooling now makes RCL highly competitive in commercial applications with "obsolete" wafer-type open frame switches.

Material and tooling are modified to further reduce cost, but equivalent performance is maintained to correspond with "instrument type" switches.

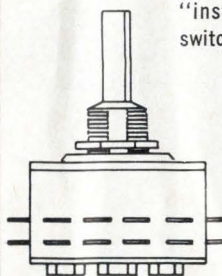

- Up to 12 poles per deck
- As many as 12 decks may be specified.
- Life expectancy in excess of 50,000 mechanical operations.

• Available modifications include spring return feature, and "push-to-turn" and "pull-to-turn" spring loaded action.

(U.S. Pat. #3352979)

**RCL**

General Sales Office  
**RCL ELECTRONICS, INC.**  
700 South 21st Street  
Irvington, New Jersey 07111

**People**

Berezin tells how to get into swim of MOS

Many engineers can tell war stories about the hazards of designing with large-scale MOS, but it takes courage to stand before an audience at the IEEE convention and deliver a talk entitled "How to Jump into MOS Without Drowning." And that's just



**Berezin:** Redactron couldn't find a garage.

what Evelyn Berezin is going to do. Ms. Berezin is president of Redactron Corp. in Hauppauge, N.Y., which makes editing typewriters—systems that may include more MOS/LSI chips per pound of product than any other. And for her, getting to know how to swim has involved a 25-year career as physicist, logic designer, marketing executive, and product planner.

She went from a Ph. D. candidate at New York University (she was one of the first to win an Atomic Energy Commission fellowship back in 1946) to a logic designer of computers—"using tubes," she points out. By 1965 she was in charge of the systems department at Digitronics Corp., a firm that specialized in such things as on-line banking, racetrack totalizing, and hotel reservations systems.

There followed four years in marketing and product planning until finally, in November 1969, she

helped organize Redactron. Its original core of seven people moved—not into that fabled garage of so many corporate histories—but into a modern 20,000-square-foot facility.

"It was an accident, really," she says. "Long Island was booming to such an extent at the time that we couldn't find a garage, which is what we looked for."

**Adding space.** Redactron has 160 employees now and is finishing a second 30,000-sq-ft manufacturing building. By summer, Ms. Berezin hopes to be turning out 100 editing typewriters—called Data Secretary—each month. The machines, which store letters on magnetic tape or cards so they can be edited and then typed out automatically at top typewriter speed, sell for upwards of \$6,400 each. The Data Secretary is built around the typing head of an IBM Selectric; six standard and 13 custom-designed MOS/LSI chips are included to give the machine its extensive storage, retrieval, and control capabilities.

Redactron is supplying the operating assemblies of the editing typewriters being marketed by the Remington Rand division of Sperry Rand Corp. Ms. Berezin predicts that the total market for these machines will reach \$500 million a year by 1975.

What about designing with MOS? "Don't leave it to your vendor," Ms. Berezin warns. "This can be a disaster because they can't possibly understand all of your problems." The tradeoffs are radically different from those involved with ordinary ICs, she continues, adding that the starting point is the total system and its physical implementation, not the logic design to make the system work.

Downing to hammer at space applications

Some NASA program managers must have breathed easier when Joseph E. Karth, the relentless Minnesota Democrat, announced he was resigning the chairmanship of the House Space Sciences & Appli-



# NEW OP AMP CHAMP.

The new LM118 may well be the ultimate true differential operational amplifier. It not only has the fastest slew rate ever offered (a minimum of 50 volts per microsecond at  $A_v=+1$ ), but *guarantees* it for every single device. In writing.

As if that weren't enough, the highly versatile LM118 is pin for pin compatible with general purpose op amps, has a 1MHz full power bandwidth, a unity gain crossover frequency of 15MHz, is internally compensated, can be offset nulled to zero with a single potentiometer, doesn't sacrifice dc performance for speed, comes in a TO-5 package and will soon be second sourced. (Once again giving testimony to the now-famous National

Linear Circuit Motto: "*In order to be followed you have to lead.*")

Naturally, the entire LM118 series is available for immediate delivery at the following (100 up) prices: LM318H, \$9.95; LM218H, \$19.95; LM118H, \$29.95.

For more information, contact your nearest National distributor. Or write, phone, TWX or cable us direct.

National Semiconductor Corporation, 2900 Semiconductor Drive, Santa Clara, California 95051. Phone (408) 732-5000. TWX: (910) 339-9240. Cable: NATSEMICON.

## National

# New SOLID-STATE FET-INPUT MULTIMETER

from  
**SIMPSON**  
of course

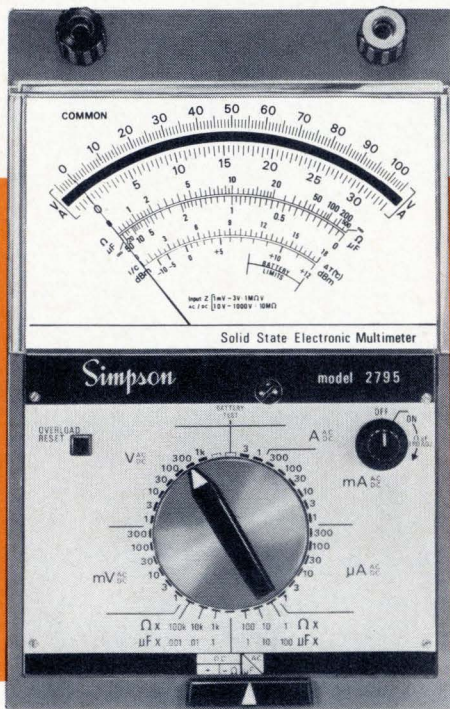

**Model  
2795**  
**PORTABLE,  
LABORATORY  
ACCURACY,  
SOLID-STATE  
ELECTRONIC  
MULTIMETER**

- 68 Switch Selectable Functions:
  - 13 AC and DC Voltage Ranges (as low as 1 MV, full scale)
  - 14 AC and DC Current Ranges (as low as 1  $\mu$ A, full scale)
  - 6 low power (IC compatible) Resistance Ranges
  - 6 completely self-contained Capacitance Ranges
- Plus 12 Output Ranges
- Circuit Breaker Overload Protection
- High FET-Input Impedance
- $\pm 1\%$  Accuracy for AC and DC
- Negligible Voltage Drop
- Simple, Straight-Forward Operation
- Size: 8.07" High, 5.04" Wide, 3.94" Deep. Only 3.3 lbs.

**2795 MULTIMETER** supplied complete with batteries, test leads and operator's manual. Complete accessories available.

**\$250<sup>00</sup>**

WRITE FOR BULLETIN L-1010 . . . OR CONTACT YOUR SIMPSON INSTRUMENTATION PRODUCTS DISTRIBUTOR FOR OFF-THE-SHELF DELIVERY

**Simpson**  
INSTRUMENTS THAT STAY ACCURATE

## SIMPSON ELECTRIC COMPANY

5200 W. Kinzie Street, Chicago, Illinois 60644

Phone (312) 379-1121  
EXPORT DEPT.: 400 W. Madison St, Chicago, Ill 60606. Cable Simelco  
IN CANADA: Bach-Simpson Ltd., London, Ontario  
IN INDIA: Ruttonsha-Simpson Private Ltd., International House,  
Bombay-Agra Road, Vikhroli, Bombay



## People

cations subcommittee for another assignment. But their relief could prove short-lived because he's been succeeded by Thomas N. Downing (D., Va.) in overseeing the space agency's unmanned space programs. And that seven-term house veteran believes that NASA isn't putting enough emphasis on applications, meaning that program managers can expect some sharp questioning on that score.

Downing says, "It is obvious that NASA is not applications-minded. Much more can and should be done in this area." The agency "is going to have to show the practical benefits of planetary and space science," he says, adding that space science has its place "if it can show applications."

"I'd like to see them dive in on the practical needs and benefits," the gray-haired representative says. "We've got to give the taxpayer something he knows and can use, like laser surgery." When the taxpayer questions the space program, he doesn't realize that miniature TV sets and heart pacemakers came out of it, Downing contends. It's a failure the congressman lays at the door of NASA's press agents, whose performance, he says, "has been really sorry in getting the message out to the public."

**Good mood.** NASA's specific problems are its specific programs like the now-canceled Grand Tour and the proposed \$5.5 billion space shuttle, in Downing's assessment. The "mood" of the full House Science & Astronautics Committee is "favorable" toward the shuttle, he believes, but "the economics of the shuttle are hard to justify." In putting a man on the moon, "it was the goal that counted, and we were all swept up in it," he observes. But with NASA's present budget and its public image resting on "a plateau, now is the time to apply technology for all mankind."

The 53-year-old congressman believes that the country can have a "vibrant" space program at the \$3 billion-a-year level NASA is proposing for the rest of the decade, but its "difficult job is to direct its goals within that limited figure."

# For built-in reliability, design with "Scotchflex" Flat Cable/Connector Systems.

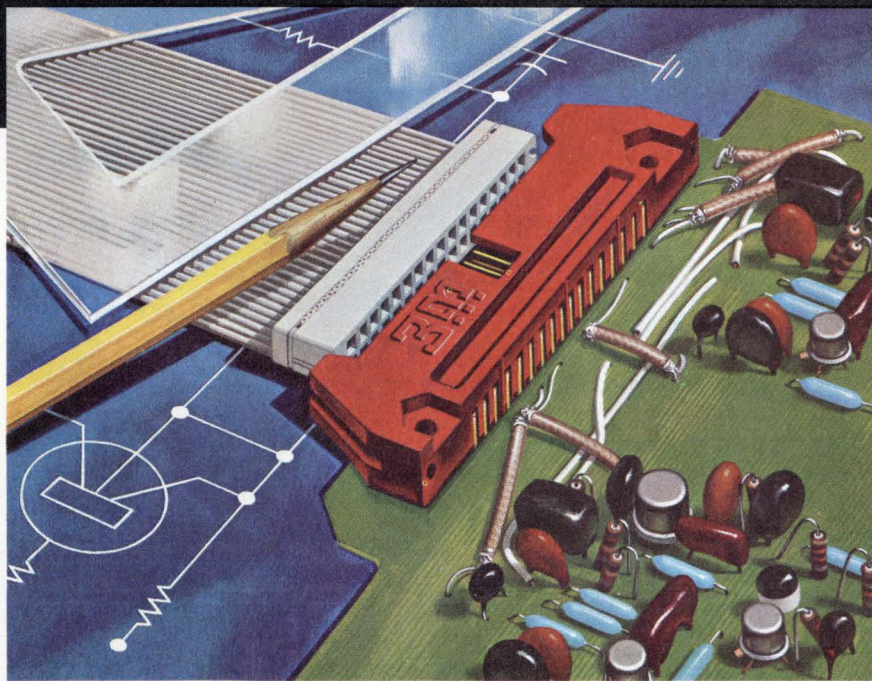

"SCOTCHFLEX" IS A REGISTERED TRADEMARK OF 3M CO.

"Scotchflex" Flat Cable and Connectors can offer you trouble-free packaging for your next generation equipment.

There's built-in reliability for your circuit inter-connects. Our flat, flexible PVC Cable has up to 50 precisely spaced conductors. The gold plated U-contacts are set into a plastic body to provide positive alignment. They strip through the insulation, capture the conductor, and provide a gas-tight pressure connection.

Assembly cost reductions are built-in, too. "Scotchflex" Connectors make up to 50 simultaneous connections without stripping or soldering. No special training or

costly assembly equipment is needed.

Off-the-shelf stock offers you flat cable in a choice of lengths and number of conductors from 14 to 50. Connector models interface with standard DIP sockets, wrap posts on .100 x .100 in. grid, or printed circuit boards. Headers are available to provide a de-pluggable inter-connection between cable jumpers and printed circuit boards (as shown). Custom assemblies are also available on request.

For full information on the "Scotchflex" systems approach to circuitry, write to Dept. EAH-1, 3M Center, St. Paul, Minn. 55101.

**3M**  
COMPANY



# Accept No Substitutes!

**The New HP Series 9800** is the best programmable calculator system now—and in the foreseeable future. Price. Performance. Simplicity of operation. No matter what criterion you use, there is absolutely no other system on the market that can match the Series 9800.

## **Only HP Offers You All This For The Low Price Of \$2975**

To build your personal desk-top computing system, start with the Series 9800/Model 10 Programmable Calculator. Your basic Model 10 comes with standard equipment that is either not available, or available only as an extra-cost option, on other machines.

If bad experiences have taught you that basic is synonymous with stripped—have no fear. The *basic* Model 10 can perform a complete regression analysis, or solve a system of 10 simultaneous equations.

## **Only HP Offers You A Fully Modular Calculator**

The unique, modular/plug-in architecture of the Model 10 lets you “design” your own problem-solving system. You can expand the memory, add peripherals, or change the keyboard of your existing Model 10, at any time.

## **Only HP Gives You A Fully Expandable Dual Memory**

The Model 10 has a unique dual memory system—one memory for programs and one for data. You can expand from the basic 500 program steps *and* 51 data registers to 2036 program steps *and* 111 data registers.

Beware of simple number comparisons with other calculators. The refinements in the memory design and the keyboard make the Model 10 so efficient that in most cases it requires *fewer steps to execute a given problem.*

## **Only HP Lets You Design Your Own Keyboard**

Interchangeable keyboard plug-in blocks give you a choice of powerful *Statistics* or *Mathematics* functions, complete with their own memories, under single keystroke command. Another option, the *User Definable Function* plug-in, lets *you* customize individual keys with operations uniquely important to *you*.

## **Only HP Offers An Alphanumeric Printer**

By simply inserting the *exclusive HP Alphanumeric Printer Plug-in*, you can automatically generate labels, program instructions, or messages—in English—right on the printer tape.

## **Only HP Gives You A Wide Choice of Sophisticated Peripherals**

The I/O bus of the Model 10 lets you plug-in a Marked Card Reader, Paper Tape Reader, Digitizer, Typewriter, Tape Cassette, or the *exclusive* X-Y Plotter that plots linear, log-log, semi-log, or polar plots, and writes alphanumerics.

## **Only HP Offers You A Totally New System**

The Series 9800 is no paper tiger. It's available now to free you from the drudgery of problem-solving so you can get on with your job of innovative thinking and designing. For more information or a “hands-on demonstration” at your desk, write: Hewlett-Packard, P.O. Box 301, Loveland, Colorado 80537. In Europe: 1217 Meyrin-Geneva Switzerland.

CO91/5

HEWLETT  PACKARD

CALCULATOR PRODUCTS

# Westinghouse Delivers!

## Fastest high-power semiconductor delivery in the industry

Only one kind of delivery counts. The kind that's on time . . . on target. Yet with the unpredictability that used to surround power semiconductors, on-time delivery was more the exception than the rule.

Now, the new Westinghouse breakthrough in power semiconductors has changed all this.

We seal and stabilize the semiconductor element by passivating it with a unique Westinghouse process. This prevents degradation, even in assembly, and permits element stocking indefinitely.

We also use special and exclusive test devices and procedures like the concurrent tester, spreading resistance probe, HV test lab, and computer models to predict characteristics.

Then we assemble the element into a package with our exclusive compression-bonded encapsulation (CBE) process. This prevents thermal fatigue by eliminating the need for solder.

And our pace-conveyor assembly system enables us to assemble high-power rectifiers and thyristors (and special assemblies) faster than anyone else in the industry.

Advantages: For a start, a prearranged delivery schedule of more than 1500 different types of high-power semiconductors in our catalog. This includes customizing the package to your form factor and voltage rating. You can forget costly power semiconductor inventory, excessive lead time on orders, and plant downtime.

We'll also stock *your* power semiconductor elements for you. With your order, we'll give you your own storage area and maintain your inventory. In case of an emergency, we'll deliver on a guaranteed shipment basis.

Our "breakthrough" in high-power semiconductors is just the start. Ask about the benefits of Westinghouse research and development leadership in high-power semiconductors. For more information about "breakthrough," phone 412 925-7272 or write Paul E. Lego, General Manager, Westinghouse Semiconductor Division, Youngwood, Pa. 15697.

SC-2-72

You can be sure...if it's Westinghouse







This  
part of  
Teledyne Post's  
Ultra T-Square  
is Plenco 548.

This part  
is glad  
of it.

If you're going to build a T-square, build one that lies flat and true.

Because everything else on drawing boards everywhere is going to depend on it. The Teledyne Post people, Des Plaines, Ill., who have been producing precision drafting equipment for a lot of years, know this as well or better than anybody.

Enter Plenco. Our easy flow, very fast cure, general-purpose 548 phenolic compound.

Offering excellent hot rigidity and low die-wear. Used in this application for the molded head of the T-square, primarily to assure dimensional stability and non-warping characteristics. The molder: Norco Plastics, Div. of the Valspar Corp., Milwaukee.

It all squares up.

**PLENCO**  
THERMOSET PLASTICS

PLASTICS ENGINEERING COMPANY  
Sheboygan, Wis. 53081

Through Plenco research . . . a wide range of ready-made or custom-formulated phenolic, melamine, epoxy and alkyd thermoset molding compounds, and industrial resins.

## Meetings

**International Electronic Components Exhibition:** FNIE, Parc des Expositions, Porte de Versailles, Paris, April 6-11.

**International Conf. on Magnetism (INTERMAG):** IEE, Kyoto International Conference Hall, Kyoto, Japan, April 19-21.

**International Symposium on Circuit Theory:** IEEE, Sheraton-University Hotel, Universal City, Calif., April 19-21.

**Southwestern IEEE Conf. & Exhibition (SWIEEEO):** IEEE, Baker Hotel & Dallas Mem. Aud., Dallas, Texas, April 19-21.

**Conf. on Computer Aided Design:** IEEE, IEE, University of Southampton, Southampton, England, April 25-28.

**National Telemetry Conf.:** IEEE, Houston Shamrock Hilton Hotel, Houston, Texas, May 1-5.

**Electrochemical Society Spring Meeting:** Electrochem. Soc., Shamrock Hilton, Houston, Texas, May 5-12.

**International Electronics Conf.:** IEEE, AIP, OSA, APA, Queen Elizabeth Hotel, Montreal, Canada, May 7-11.

**International Semiconductor Power Converter Conf.:** IEEE, Lord Baltimore Hotel, Baltimore, Md., May 7-10.

**Spring Joint Computer Conf.:** IEEE, Convention Center, Atlantic City, N.J., May 15-18.

**Aerospace Electronics Conf.:** IEEE, Sheraton Dayton Hotel, Dayton, Ohio, May 15-17.

**Electronic Components Conference:** Electronic Industries Assn., IEEE, Statler-Hilton Hotel, Washington, D.C., May 15-17.

**International Microwave Symposium:** IEEE, Arlington Park Towers Hotel, Chicago, May 22-25.



# What the industry taught us about data communications.



## A rose by any other name...

Everybody's got a data communications processor, right? Total capability. Complete systems. Full line. The whole schtick.

Everybody, that is, who has a general-purpose processor, a stop-gap communications program or two and an extra nameplate.

## Earn while you learn.

Everybody's anxious to solve your data communications problem, too. They may never have tackled one like yours, but they're willing to learn. Especially when you're paying for it. After all, the risk is all yours.

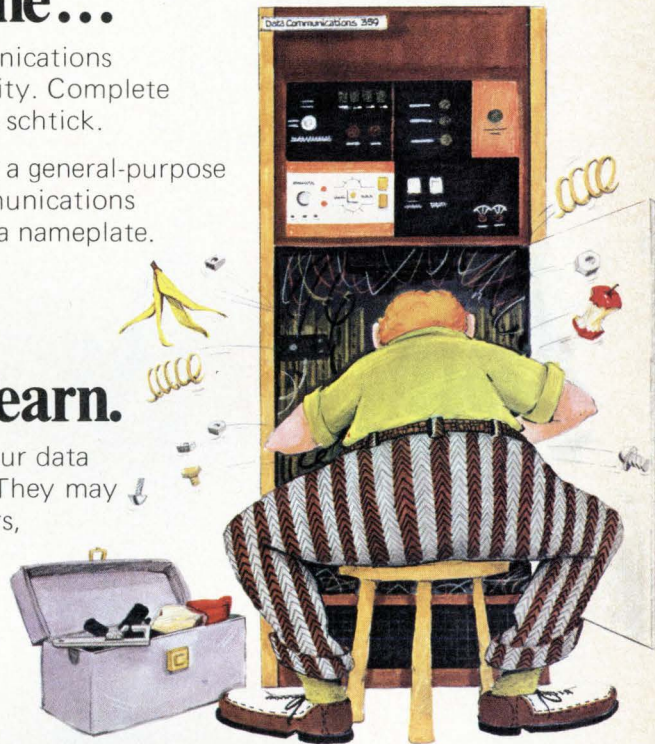

## Introducing the Interdata Models 50 and 55. What you see is what you get.

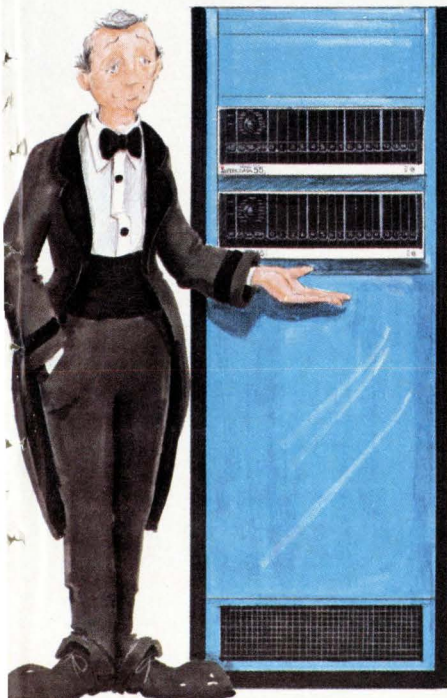

Our two newest data communications processors\* really are data communications processors. With both hardware and software specially designed to give you up to 5 times the speed, power and data handling capacity of a minicomputer.

They have their own comprehensive data communications instruction sets. So they perform common tasks at hardware speeds — without taking up valuable space in core.

They have their own programmable data set adapters, too. So they're flexible enough to work well with a wide variety of communications facilities and terminal protocols.

And they have their own track record — more than 50 actual data communications installations. So whether you need a total system or modular components, you can rest assured we can efficiently solve your data communications problems.

You get something extra from Interdata.

 **INTERDATA®**

2 Crescent Place, Oceanport, New Jersey 07757 (201) 229-4040. Atlanta — (404) 288-7000. Boston — (617) 890-0557. Chicago — (312) 463-9080. Dallas — (214) 238-9656. Detroit — (313) 356-5515. Los Angeles — (213) 640-0451. Palo Alto — (415) 328-0783. Washington — (704) 525-4806. Toronto — (416) 678-1500. United Kingdom — Uxbridge 51483. Sydney — NSW 439-4155. West Germany — 0811/160031. Tokyo — 270-7711.

\*Basic 8KB Model 50 — \$6800. \$4828 with OEM discount (quantity of 15)  
Basic 16KB Model 55 — \$15,900.

# Make the simple move

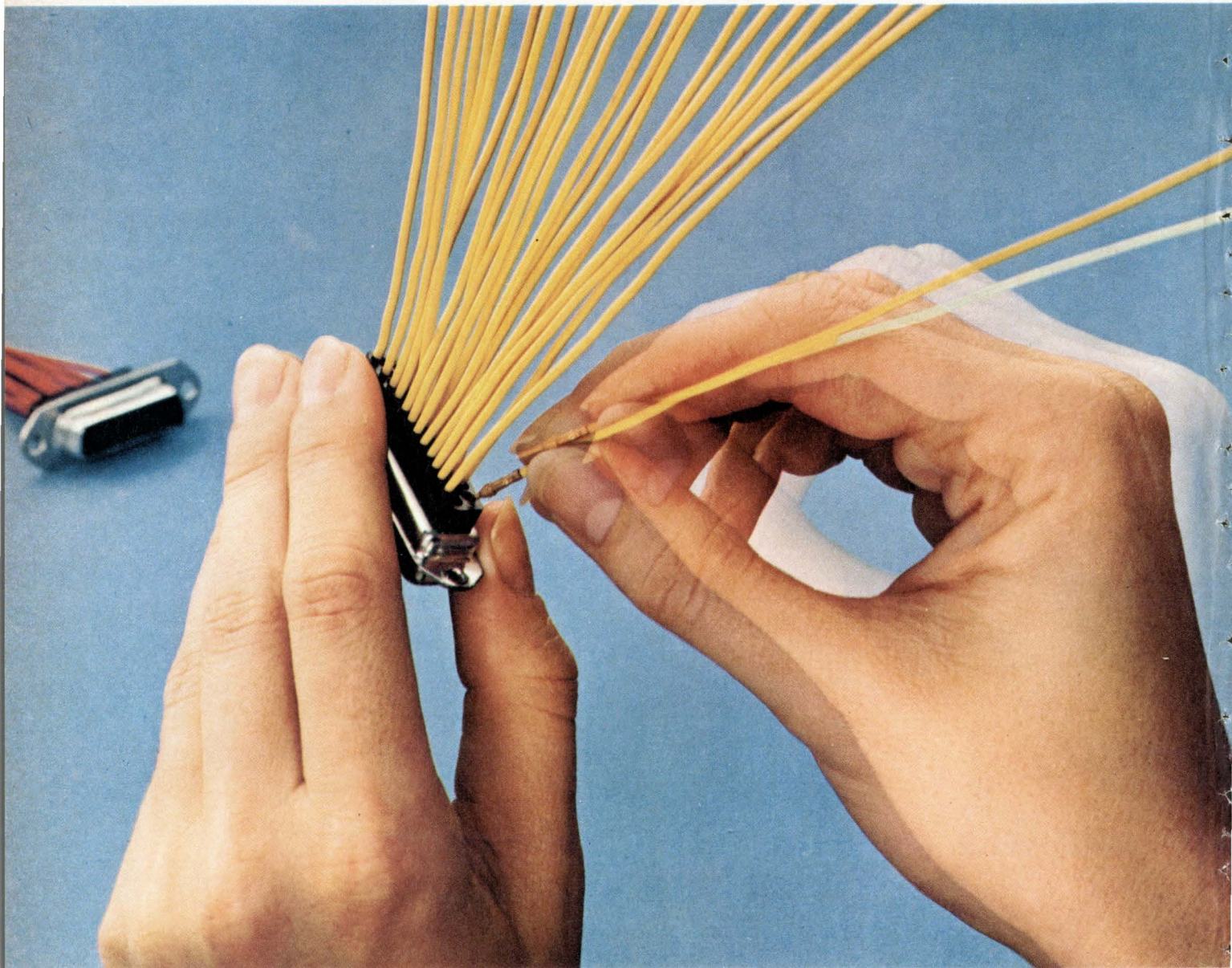

## to less assembly time.

Do it the easy way with Amphenol's 17 Series miniature rear-release connectors.

A gentle push from the back of the connector and the contact snaps securely in place. No tools or broken fingernails, just easy fingertip assembly. And to remove the contact for fast field servicing, insert a simple plastic tool in the back of the connector and out pops the contact.

You can have a choice of screw-machine contacts in bulk packaging, or stamped and formed contacts on a carrier strip. Semi-automatic crimping or hand tools available for either type of contact.

The Min-Rac® 17 Series connectors are available in 9, 15, 25, 37, and 50 contact configurations. All meet EIA Standard RS-232C for data communications input-output connectors. And all are intermountable and intermateable with other Min-Rac 17 Series connectors as well as competitive "D" type connectors.

Find out how simple it really is. Just write Dick Colt asking for the whole story on our Min-Rac 17 Series rear-release connectors. Amphenol Industrial Division, Bunker Ramo Corporation, 1830 South 54th Avenue, Chicago, Illinois 60650.

**BUNKER  
RAMO** AMPHENOL

---

# Electronics Newsletter

---

March 13, 1972

## Army going state of the art with S-band radar R&D

The Army's Antiballistic Missile Defense Agency will award two highly significant R&D contracts in the next few months. Not only will the agency be buying developmental S-band amplifier modules that will help decide the shape of future S-band phased-array radar **but also it is writing specifications around what can be achieved with present state-of-the-art devices instead of following the usual practice of aiming at pie-in-the-sky performance.**

One device spec calls for transistors, the other for any high-power, high-efficiency two-terminal device that can do the job. Although the spec demands 10-watt average power for both, minimum efficiency of 12% is required for the two-terminal devices, 25% for the transistors. **The military is being realistic and concerning itself with power on the target by specifying peak energy rather than peak power.** This permits the assembly using transistors to function as it can best—producing high average power with long duty cycles—and lets the two-terminal device deliver high peak power for shorter periods.

Though Gunns and Impatts are still in the two-terminal derby, **knowledgeable sources give the inside track to the more efficient complementary Trapatt**, which has a p epitaxial layer grown on a p+ substrate and then an n+ layer diffused onto that. The Raytheon Corp. has reported on a 10-watt, 1-gigahertz version with 35% efficiency, and work in the complementary area is also being done by Sperry-Sudbury, RCA, and Hughes among others.

## Holographic memory to be marketed

A 12-megabit nonvolatile read-only holographic memory **is to be introduced as a commercially available product** within the next month by Optical Data Systems Inc. of Mountain View, Calif. The expected small-quantity price will be \$1,500.

A cassette carrier holds the film, and any block of information on the film can be accessed within 3 seconds. Data-transfer rate is 100,000 bytes per second.

As a stand-alone unit, the memory can be used to store programs for minicomputers. However, with the addition of a small keyboard and some logic, **the holographic ROM becomes a credit-card verification system** that, in its present configuration, can store information on up to 250,000 "hot" cards.

AIL division of Cutler Hammer Inc., Deer Park, N.Y., is readying a 3-d radar for air traffic control at commercial airports. Originally developed under a military contract, one experimental version of the radar has been tested for over a year. A great advantage of a 3-d radar is that **it can display on a traffic controller's radar console the altitudes of all aircraft in his vicinity**, not just those equipped with the relatively expensive beacon transponders.

The AIL radar incorporates in a single unit mechanical scanning for azimuth and electronic scanning for height. Usually, either beacons or a separate radar system—the latter used almost exclusively by the military—perform the height-finding function. **Mitsubishi Electric Corp. of Japan announced last year it was testing a single-package commercial 3-d radar** [*Electronics*, June 21, 1971, p.68].

---

# Electronics Newsletter

---

"Advanced signal-processing techniques," is all an AIL spokesman would say in describing how the radar determines altitude. The unit is under control of a minicomputer that also makes the height computations and drives the alphanumeric radar display.

## Mostek combines self-alignment, depletion loading

Researchers at Mostek Corp., Worcester, Mass., have succeeded in **combining the accepted MOS self-alignment processes with ion implanted depletion loads**—and depending on the end applications, the payoff could lie in increased functional density, lower power requirements, higher speed, or a combination of these. "Compared to n-channel silicon gate MOS, for example, **silicon gate with depletion loads should yield two to five times better speed-power products,**" says Robert Palmer, director of research and development.

Speed-power products should improve almost regardless of which self-alignment technique is combined with depletion loading, Mostek says, and functional density should almost always exceed that possible with self-alignment alone. In slower applications the new "hybrid" breed MOS **should get within one or two orders of magnitude of complementary MOS power needs,** while noise immunity should be about equal to that of C/MOS.

No products have been announced yet to take advantage of the approach, but Palmer says that n-channel chips ranging from LSI random logic to large random access memories (about 4K) are under investigation. And because the process is simple, yields should be about the same as with Mostek's present line.

## Rand automation study may revamp production lines

Radical changes in plant automation may result from a study under way at the Rand Corp., Santa Monica, Calif., for the Advanced Research Projects Agency of the Department of Defense. Although the project is in its infancy, **one of Rand's first proposals is to mount automated subassemblies on pallets that would move around the factory floor.**

The idea is not only to get away from the standard fixed assembly lines, but permit rapid production of prototypes. The use of robot devices will be a major factor in the study, according to an ARPA official.

## Instrumentation amp is first monolithic version

What it claims is the "first true monolithic instrumentation amp" is due soon from Analog Devices Inc., of Norwood, Mass. Unlike building block op amps that sometimes are combined to emulate instrumentation amps, **the AD520 was designed from start as such a "system,"** say Analog spokesmen. They add that in such applications, op amps often have low common mode rejection, nonlinear gain, and input impedance that varies with gain.

To offset this, **the AD520 uses different design rules to make possible a typical bias of 30 nanoamperes, and nonlinearity is limited to 0.02% over a gain range of 1 to 1,000.** CMR between dc and 100 hertz, even with a 1,000-ohm input imbalance, ranges from 70 decibels at unity gain to 110 dB at a gain of 1,000. This spec alone makes the AD520 a potentially good circuit for electrically noisy electrocardiograph and electroencephalograph front ends. Input impedance independent of gain is about  $2 \times 10^9$  ohms.



## The best data recorders in Japan.

They come from Lockheed. Apparently the Japanese figure nobody makes data recorders that measure up to ours. Not even the Japanese.

Take the Lockheed 417 recorders used for precision data recording.

They're the only ones light enough to carry in one hand (28 lbs.), small enough to fit under an airplane seat (17" x 15" x 7"), and rugged enough to work under vibration and in any position. Yet they're as accurate as large, ungainly rack machines.

The 417s come in intermediate or wideband models. And they record on up to 7 channels simultaneously, IRIG compatible. Direct frequency response ranges from 100 Hz to 375 KHz. FM frequency response is DC to 100 KHz at 30 ips.

For power (normally 13w) a 417 can use its self-contained battery. Or, with accessories, it can use any power: 12 to 28v DC, 110 to 220v AC, 50 to 400 Hz.

The Japanese also picked one of our many custom-designed precision recorders to ride in their

ionosphere research satellite. This particular recorder stores data at 565 bits per inch on 5 tracks, then plays it back at 26 times normal speed. Yet it weighs only 10 lbs. and gets by on 1/20 the power of a home tape recorder.

But for more down-to-earth uses, 417s are the answer. And back in the U.S.A. they go for as little as \$7,000.

For more specs on any of our data recorders, write Earl Nadeau, Dept. 413-301, Lockheed Electronics Company, Plainfield, New Jersey 07061. Or call him at (201) 757-1600.

### Lockheed Electronics

A Subsidiary of Lockheed Aircraft Corporation

# Introducing SuperMOS.

## The fastest shift registers you can buy.

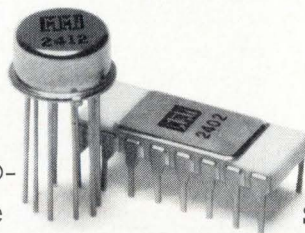

Now, from Monolithic Memories — an advanced silicon gate technology that gives you product features you can't find anywhere else. Like shift registers with a guaranteed data rate of 60 Hz to 10 MHz at only 50 $\mu$ W per bit. Operating temperature range from  $-55^{\circ}$  to  $125^{\circ}$ C. And full MIL-spec design in seven DTL/TTL-compatible configurations from dual 100 up to 1024 bits in standard packaging. In fact, we even have a shift register which

doubles bit density and speed in the same package. Our MMI 3412. It's a pin-for-pin replacement for the 1405. In fact, MMI gives you pin-to-pin compatibility with any of the 1400 series you may be using now.

But don't take our word. Compare for yourself. That's why we've included the handy chart. It just goes to show we're not in MOS to be a me-too company. Even when it comes to price.

# Proof:

	Register Organization	Temp. Range	Data Rate		Power @ 1 MHz	Unit Price @ 100Qty.
			Typical Min.	Typical Max.		
1402A MM3402 <b>MM2402</b>	Quad 256 Multiplexed output	0 to 70°C 0 to 75°C -55 to +125°C	10 Hz to 10 MHz 5 Hz to 20 MHz 5 Hz to 20 MHz	500 Hz to 5 MHz 60 Hz to 10 MHz 60 Hz to 10 MHz	100 μW/bit 50 μW/bit 50 μW/bit	\$8.10 9.00 18.00
1403A MM3403 <b>MM2403</b>	Dual 512 Multiplexed output	0 to 70°C 0 to 75°C -55 to +125°C	10 Hz to 10 MHz 5 Hz to 20 MHz 5 Hz to 20 MHz	500 Hz to 5 MHz 60 Hz to 10 MHz 60 Hz to 10 MHz	100 μW/bit 50 μW/bit 50 μW/bit	7.20 8.00 16.00
1404A MM3404 <b>MM2404</b>	Single 1024 Multiplexed output	0 to 70°C 0 to 75°C -55 to +125°C	10 Hz to 10 MHz 5 Hz to 20 MHz 5 Hz to 20 MHz	500 Hz to 5 MHz 60 Hz to 10 MHz 60 Hz to 10 MHz	100 μW/bit 50 μW/bit 50 μW/bit	7.20 8.00 16.00
1406 <b>MM2406</b> MM3406	Dual 100 Open Drain	-55 to +125°C -55 to +125°C 0 to 75°C	10 Hz to 3.5 MHz 2 Hz to 8 MHz 2 Hz to 8 MHz	500 Hz to 2 MHz 30 Hz to 5 MHz 30 Hz to 5 MHz	400 μW/bit 200 μW/bit 200 μW/bit	2.25 5.00 2.50
1407 <b>MM2407</b> MM3407	Dual 100 20K	-55 to +125°C -55 to +125°C 0 to 75°C	10 Hz to 3.5 MHz 2 Hz to 8 MHz 2 Hz to 8 MHz	500 Hz to 2 MHz 30 Hz to 5 MHz 30 Hz to 5 MHz	400 μW/bit 200 μW/bit 200 μW/bit	2.25 5.00 2.50
1405A MM3405 <b>MM2405</b>	512 bit Recirculating	0 to 85°C 0 to 75°C -55 to +125°C	8 Hz to 2.5 MHz 2 Hz to 6 MHz 2 Hz to 6 MHz	200 Hz to 2 MHz 30 Hz to 4 MHz 30 Hz to 4 MHz	300 μW/bit 100 μW/bit 100 μW/bit	3.60 4.00 7.20
<b>MM2412</b> MM3412	1024 bit Recirculating	-55 to +125°C 0 to 70°C	2 Hz to 6 MHz 2 Hz to 6 MHz	30 Hz to 4 MHz 30 Hz to 4 MHz	75 μW/bit 75 μW/bit	14.00 7.00

**Get your SuperMOS today.  
Your distributor or rep will ship what you want  
before he locks up tonight. Any quantity.**

**REPRESENTATIVES:** ALABAMA: Col-Ins-Company, Inc., Huntsville (205) 539-1771; ARIZONA: Howe & Howe Sales Inc., Phoenix (602) 264-7971; CALIFORNIA: DeAngelo, Rothman & Company, Whittier (213) 945-2341; William J. Purdy, Burlingame (415) 347-7701; COLORADO: William J. Purdy, Littleton (303) 794-4225; FLORIDA: Col-Ins-Company, Orlando (305) 423-7615; ILLINOIS: Carlson Electronic Sales, Chicago (312) 774-0277; INDIANA: Robert O. Whitesell, Indianapolis (317) 359-9283; KENTUCKY: Robert O. Whitesell, Louisville (502) 893-7303; MARYLAND: J. R. Daniel & Company, Lutherville (301) 825-3330; MASSACHUSETTS: Circuit Sales, Inc., Lexington (617) 861-0567; MICHIGAN: Robert O. Whitesell, St. Joseph (616) 983-7337; MINNESOTA: HMR, Inc., Minneapolis (612) 920-8200; NEW JERSEY: R. T. Reid Assoc., Teaneck (201) 692-0200; NEW YORK: Mar-Com Associates, Syracuse (315) 437-2843; OHIO: Robert O. Whitesell, Cincinnati (513) 521-2290; PENNSYLVANIA: J. R. Daniel & Co., Glenside (215) 674-3850; TEXAS: Compatible Components, Dallas (214) 233-4489.

**FOREIGN REPRESENTATIVES:** MMI European Mgr. Chris Carli, Amsterdam, Holland: Phone 100178; ENGLAND: Analog Devices, Ltd., London: 01-546-6636; FRANCE: Radio Equipments, Paris: 737-54-80; SWITZERLAND: Omni Ray AG, Zurich: (051) 47 8200; ISRAEL: STG International, Tel-Aviv: 53459; SWEDEN: AB Svensk Teleindustri, Johanneshov: 08-91 0440; ITALY: Comprel Elettronica S.R.L., Milano: 40.44.291; NETHERLANDS: Famatra Benelux, Breda: 01600-50249; NORWAY: Henaco A/S, Oslo: (02) 224150; GERMANY: Neumuller & Co. GmbH, Munich: 592421; FINLAND: SW-Instruments, Helsinki: 738265; JAPAN: Marubeni-Iida, Osaka (271) 2231; Tokyo (216) 0111.

# Monolithic Memories, Inc.

1165 East Arques Avenue, Sunnyvale, CA 94086 (408) 739-3535 TWX: 910-339-9229 Telex: 346 301

**When your memory has to be perfect**

MMI 72-B

# First truly new function generator in years digitally synthesizes waveforms to bring you higher accuracy, greater stability plus the capability to stop- and-hold waveforms almost indefinitely.

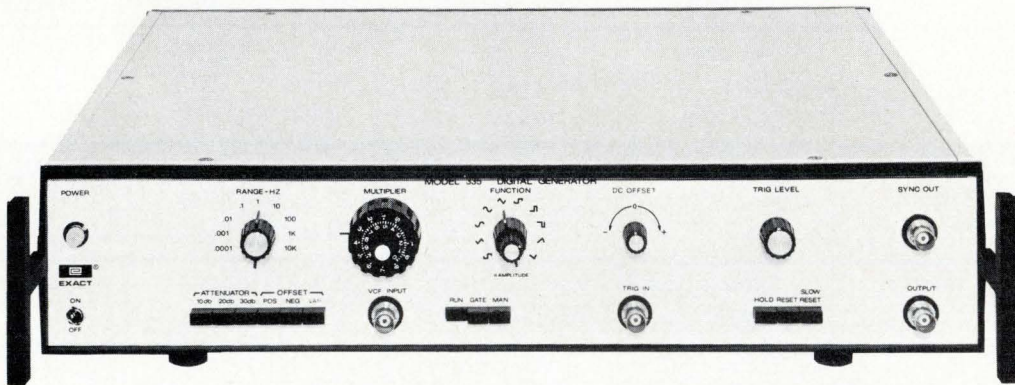

## Naturally it's from EXACT

Each cycle of every waveform produced by our new Model 335 Digital Function Generator—sine, square, triangle, ramp, and pulse—is synthesized with nearly 2000 bits of digital information. This brand new but thoroughly proven approach gives you unparalleled control of frequency and amplitude—and you can stop and hold any waveform at any one of the bits (allowing ramps, for example, to be stopped and held at a given level and then allowed to continue). All the waveforms necessary to drive mechanical test systems, for geophysical and medical work, or for use as a general purpose laboratory tool are available.

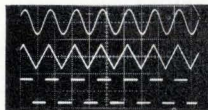

Sine, triangle and square.



Ramp caught and held twice, and allowed to complete the cycle.



Sine wave caught and held at three different points.

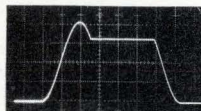

Sine square pulse held at one point.

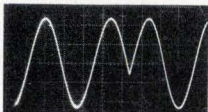

Shift quadrants, instantaneously.



Triggered triangle started at  $-90^\circ$ , second cycle has been held at one point.

### Check These Other Features...

- Voltage controlled frequency input for remote analog frequency control, frequency sweeping, or modulation.
  - Single shot (trigger) or burst (gated) operation by front panel push button or by external trigger or gate applied to the trigger input connector.
  - Fixed and variable dc offset.
  - 80 db step attenuator in 10 db steps, with 20 db continuously variable.
  - Stability, 0.01% for 10 minutes, 0.02% for 24 hours.
  - Kelvin Varley divider frequency multiplier gives 10-turn setability and accuracy for frequency settings.
  - 0.00001 Hz ( $10\mu\text{Hz}$ ) to 50 KHz frequency range.
  - Push button stop and hold; catch and hold any waveform manually from the front panel and then allow it to continue from that point to complete the cycle. Catch it again and again at any time.
- Price: \$1250

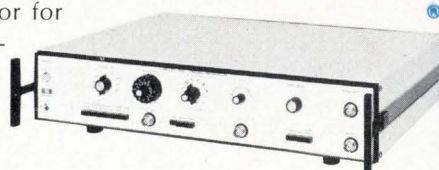

P.O. Box 160, Hillsboro, Oregon 97123 • 503/648-6661



## Citizens' radio called big market if FCC okays fm band

Approval of EIA's suggested conversion of part of the 220-225-MHz range could mean \$300 million market

If the FCC clears the remaining jurisdictional hurdles, citizens' band radio in three years could explode into a \$300-\$500 million annual market—10 times its existing size at retail. So says the Electronic Industries Association, which also claims that the FCC's blessing of its proposal to convert citizens' radio from am to fm would give U.S. producers an advantage over Japan and would eliminate some Federal spending on the development of an emergency mobile radio service (see box on this page).

As the FCC shows signs of action on EIA's year-old proposal, it is be-

ginning to encounter opposition, too. Leading opponent of the plan to convert 2 megahertz of the 220-225-megahertz amateur band to citizens' radio is the 85,000-member American Radio Relay League, which would lose 40% of its assigned bandwidth.

Opposition from the amateur operators surfaced months after the EIA request got an indirect lift with a disclosure of the White House Office of Telecommunications Policy. OTP reported that the Defense Department, which has first claim on the frequency, was willing to consider release of the 220-225-MHz band for a secondary usage such as citizens' radio. FCC approval is still required, of course.

**Compromise?** Now the commission has submitted a proposal to the White House policy group for DOD consideration. Though OTP won't detail the plan, industry sources be-

lieve it is a 1-MHz compromise of the EIA plan to create an 80-channel fm service called Class E, plus a possible expansion of the existing am Class D service at the 26.96-27.23-MHz bandwidth.

Despite that reported cutback in the request, some EIA members say privately that even the 40 fm channels that 1 MHz would provide would go far toward eliminating the well-known problems of heterodynes now generated by am transmitters. More important, say others, is that fm at 220-225 MHz would prevent the abuse of citizens' radio for long-distance transmission that arises when am signals reflect (or skip) off upper layers of the geosphere.

Opponents, on the other hand, say manufacturers are simply trying to create a new equipment market artificially, and argue that fm transmissions at the proposed bandwidth

### Making a market grow 10 times bigger

Expanding a market by a factor of 10 is no mean feat. Here's how the Electronic Industries Association says it can be done with citizens' radio after a two-to-three-year startup:

Class E radios installed at \$200 each in one of every 10 cars sold annually in the U.S., a 10-million car market, would account for \$200 million. John Sodolski, EIA vice president for the communications and industrial division, calls it a conservative estimate. Another \$100 million would be generated by sales of base stations to one out of every two of these car owners, including such self-employed persons as doctors, plumbers, electricians, salesmen, farmers, and service-station operators. Pleasure boat operators, campers, motel operators, and others anxious to capitalize on business from mobile users would account for the remainder of the \$500 million market estimates. Sales could begin as soon as three months after approval.

Manufacturer Gus Wirth, president of Echo Communi-

cations Inc., Cedarsburg, Wis., foresees modification of car radios "with one integrated circuit" to make one pushbutton an fm citizens' radio transmitter. Wirth not only foresees organizations like oil companies offering highway guidance, weather, and accident assistance services to mobile users, but also believes such services would do away with the need for expensive emergency broadcast systems now under investigation by the Department of Transportation. "Class E could resolve all of this," says Wirth, "and it wouldn't cost the taxpayers a dime."

Both Wirth and Sodolski believe Class E technology would give U.S. producers an initial advantage over Japanese manufacturers who have taken over much of the Class D equipment market with their own radios or those sold under a U.S. brand label. "At the moment," Sodolski says, "It is an established fact that U.S. manufacturers have some advantage in development and manufacture of Class E-type equipment."

## Electronics review

could be jammed in as many as 14 states where the Pentagon still operates some of its older high-power radars.

### Integrated electronics

#### Insulated-gate FET gets a bipolar output

The insulated-gate field-effect transistor, the basic MOS device and a building block of many shift registers, operational amplifiers, and the like, has developed new muscle: high-current output. Bell Laboratories engineers at Allentown, Pa., have turned the trick by giving the IG-FET a hybrid structure that combines a FET input and bipolar output right in the same device.

The new device—dubbed BIG-FET—is built for use in driver/decoders to interface with

light-emitting-diode displays. It takes the FET's low power dissipation, modest power needs, and high packing density essential for decoding a LED display, and adds the high current needed to drive LEDs. In fact, the hybrid approach promises power savings of 30% to 90% over equivalent all-bipolar circuits.

**Traffic cop.** G.T. Cheney and T.F. Thomasco of Allentown's digital IG-FET circuits group say that the new circuits just went into production at Western Electric factories, and soon will be installed in a new Traffic Service Position System—Bell's name for a computer-controlled operator console that eliminates many of the manual functions of the old switchboards. Bell will replace the Nixie cold-cathode tube readouts with LED displays, and the new circuits will save power-supply costs and space.

The BIG-FET structure is elegant—the drain current in the FET struc-

ture doubles as the bipolar base current, because an  $n\bar{\nu}$  region is diffused into the drain of a p-channel FET. The FET's drain acts, at the same time, as a base in an npn bipolar transistor. The channel current of the IG-FET becomes the base current of the bipolar transistor in the structure.

The display can be connected to the drive/decode circuit in parallel or series. In the parallel, or shunt, arrangement, the LED is connected from the collector of the bipolar transistor (which is the substrate of the IG-FET) to the emitter, which communicates to ground through a resistor. Here, the current drawn from the power supply is essentially constant: when the LED is on, the bipolar transistor is off, and the current is controlled by the drop across the LED and resistor to ground. When the LED is off, the bipolar transistor is on and the current path is from the power supply, through

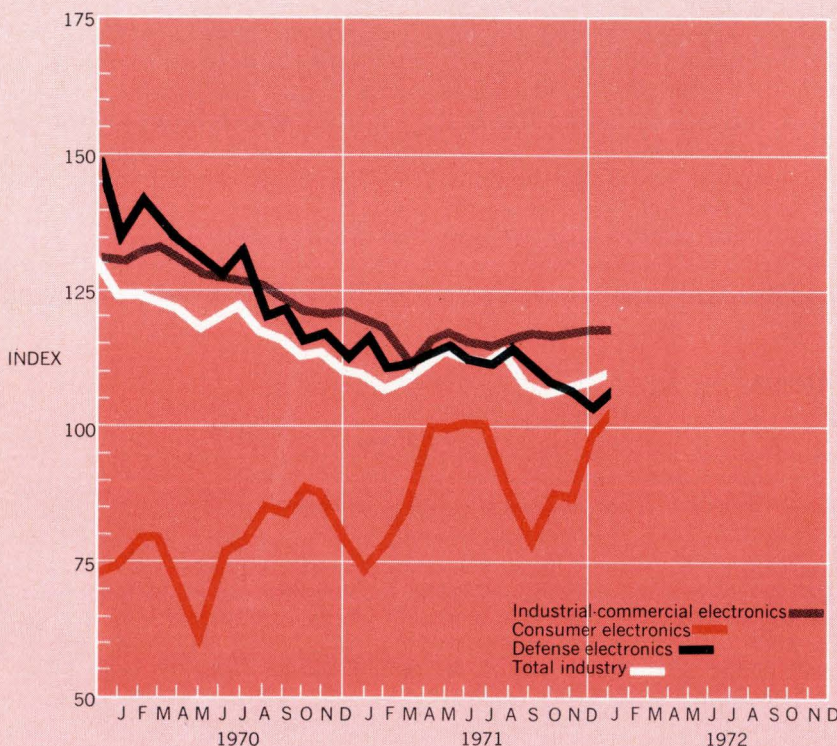

## Electronics Index of Activity

March 13, 1972

No category of the index fell during January, so the overall total climbed slightly more than 2% for the month, a mere 0.6% behind the January 1971 result. The monthly increase also was the fifth in a row.

Consumer posted the biggest gain, 4.1%, leaving it 29.1% ahead of its year-ago figure. Industrial-commercial, which held even in January, was down 1.6% from a year ago. Defense, posting its fourth consecutive monthly increase, rose 2.6% while remaining 7.5% behind last January.

Segment of Industry	Jan. '72	Dec. '71*	Jan. '71
Consumer electronics	103.4	99.3	80.1
Defense electronics	107.7	105.0	116.4
Industrial-commercial electronics	118.8	118.8	120.7
Total industry	110.4	108.2	111.1

Indexes chart pace of production volume for total industry and each segment. The base period, equal to 100, is the average of 1965 monthly output for each of the three parts of the industry. Index numbers are expressed as a percentage of the base period. Data is seasonally adjusted.

\* Revised.

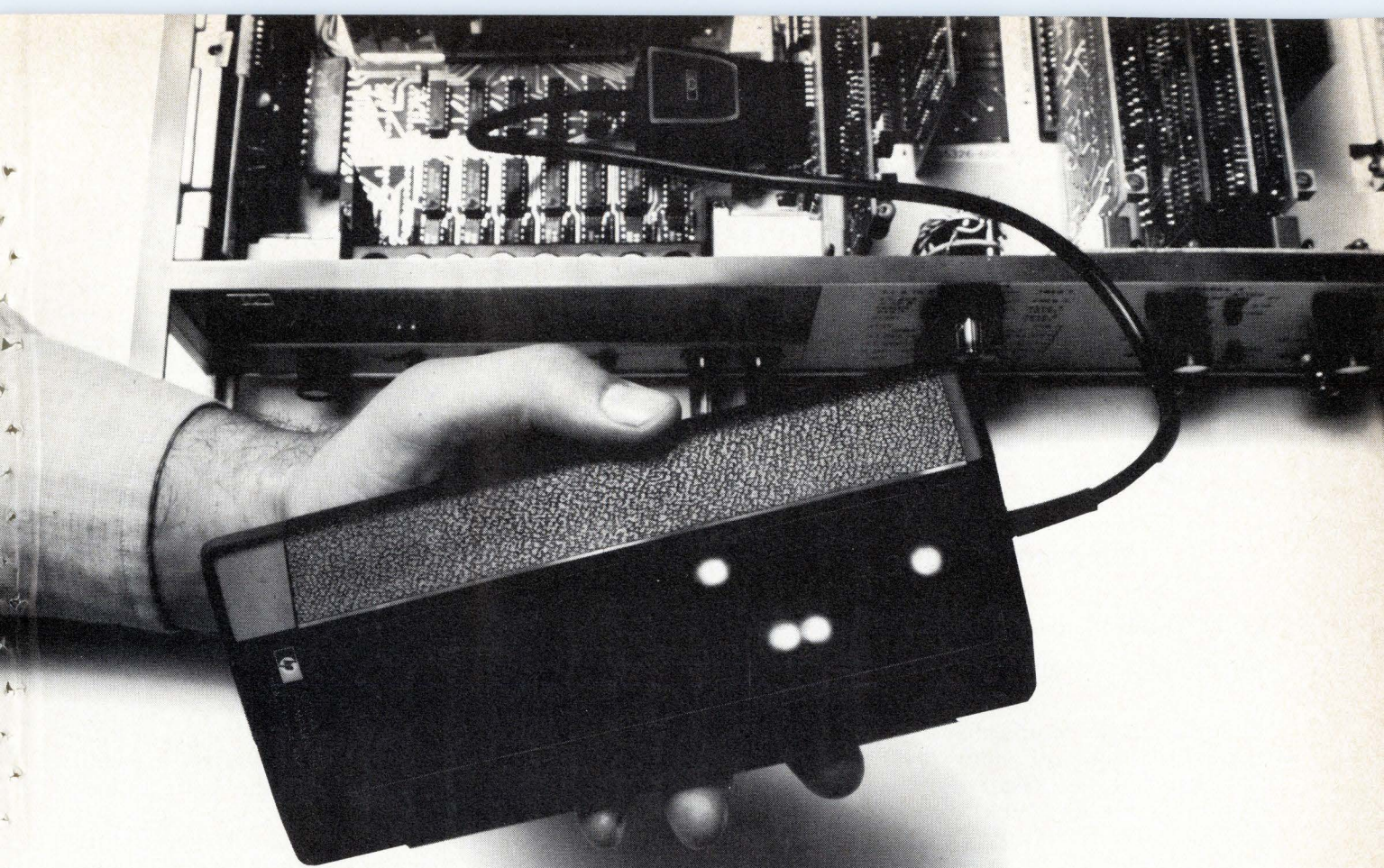

# The IC troubleshooters march on.

## This one tells a bad IC from a good one in 5 seconds or less.

Here comes the latest member of HP's Troubleshooters searching out faulty ICs. Just clip the HP 10529A Logic Comparator onto an in-circuit TTL or DTL IC. If the logic function isn't what it should be, bright red LEDs light up indicating which pins are at fault. A clever comparison scheme uses the circuit's power and input stimulus to do all this. Even dynamic errors as brief as 200 ns are stretched and displayed.

It comes complete with a self-test board, operating manual and all accessories packed in a handy case. It costs only \$295.

We're thinking ahead. Because the case is also designed

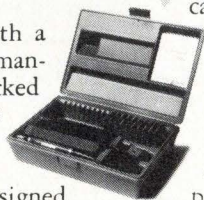

to hold our other two Troubleshooters — the HP10525A Logic Probe and the HP 10528 Logic Clip. The probe lets you trace pulses through integrated circuits simply by touching a pin. The probe's tip flashes a signal for pulses as narrow as 25 ns, and indicates pulse polarity, pulse trains and logic states. It's almost like having an oscilloscope squeezed into a ball-point pen. \$95.

The clip is a convenient state indicator. It slips over your DTL or TTL package and bright LEDs display the



static state of all 16 (or 14) pins at a glance. It operates like 16 binary voltmeters. \$125.

You can buy all three as the HP 5010A for \$495, saving you time, aggravation and \$20.

The IC Troubleshooters march on. Wait until you see what we're working on now! Just call your HP field engineer to get your hands on them right away. Or if you want to know more, write Hewlett-Packard, Palo Alto, California 94304; Europe: 1217 Meyrin-Geneva, Switzerland.

HEWLETT  PACKARD

---

## Electronics review

---

the bipolar transistor and resistor to ground.

Thus, the same current is drawn from the power supply at all times—a saving in power supply requirements, because it's not necessary to regulate for large swings.

In the series configuration the circuit offers maximum power conservation because now the power is dissipated only when a LED is to be energized.

---

## Companies

---

### Wyly pledges UCC assets to Datran and Penisten

Communications securities analysts periodically question how Data Transmission Co. (Datran) will manage to last until 1974, when its proposed 35-city switched digital data network goes on the air [*Electronics*, July 5, 1971, p.77]. In fact, to the industry and Government officials who prowl the halls of the FCC, the engineering data in Datran's proposal has always seemed more impressive than its financial plan.

**Penisten:** Get Datran back on cash track.

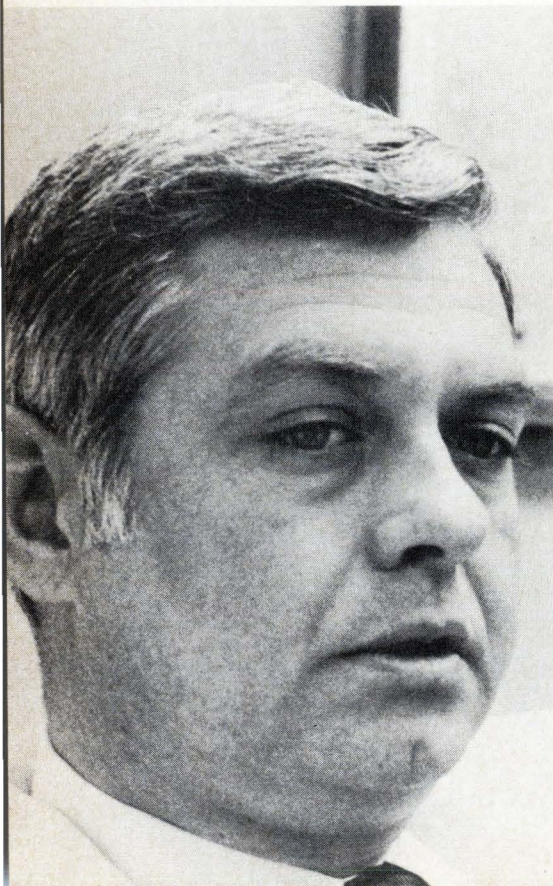

Sam Wyly, chairman and founder of University Computing Co. of Dallas, which owns Datran, appeared to have the answer when the question surfaced again after his appointment of Glenn Penisten, from Texas Instruments, as Datran's president and chief executive. "We are behind Datran 100%, and would be willing to sell some of UCC's equipment and other assets in preference to selling Datran."

Among those other assets, Wyly listed some of the Gulf Insurance properties, a large revenue producer that includes Gulf Atlantic Life and Security Life, and all or part of UCC's Computer Leasing Co.

The reaction in the communications industry was that income generated from disposal of the Gulf properties alone would be sufficient to keep Datran going at full tilt for two more years until it begins producing its own revenues. The company expects to get its first construction permits from the FCC by April and then begin to build the first part of the net from California to Texas, linking San Francisco, Los Angeles, Phoenix, and Dallas.

**Texas touch.** As for the 40-year-old Penisten, his role as vice president and manager of the New Enterprises division of TI's components Group marked him as a product management heavyweight. "Glenn Penisten is a major loss for TI," says one official at the company, from which departing executives rarely receive such bouquets. "I consider Penisten the man largely behind our successes in TTL, opto-electronics, power semiconductors, and MOS."

Despite the fact that Penisten must still demonstrate his ability to transfer his product performance expertise to a service-oriented communications company, Sam Wyly clearly foresees no problems. "Penisten has been responsible for the performance of several thousand people and for sales objectives of several hundred million dollars," points out Wyly, "and that's the size I expect will be in a few years." Moreover, he sees a parallel between Datran's system and the introduction of TI's semiconductor, Boeing's 707, and the Xerox copier.

All required "breakthrough strategy, both technologically and in terms of market penetration."

Datran says it has achieved one breakthrough of sorts—a cut in its systems costs—by moving from reed matrix switching technology to solid state, with Stromberg Carlson developing a switch to be used in conjunction with Comten controllers.

**Financing.** Despite these economies, Datran's system will still cost about \$400 million and require an estimated \$300 million financing scheduled in four phases. The first \$35 million phase, using company and privately raised funds, was scheduled for completion this winter. Though UCC has sunk \$12 million into the operation to date and expects to continue funding Datran at \$500,000 to \$600,000 a month, negotiations for the first plan have yet to bear fruit. Earlier talks with Raytheon Co. and United Utilities Inc., among others, were broken off when, financial community sources report, the buyers pushed for controlling interest, rather than the 30% equity represented by the \$35 million.

Thus a major Penisten task appears to be getting Datran back on its financial timetable. This includes completion of a second phase equity offering of \$70 million by this fall, of which UCC is pledged to pick up half. The biggest economic hurdle will come in the spring of 1973, however, when Datran seeks upwards of \$85 million through debt with warrants, some of which is expected to be sought through equipment vendor financing. The fourth and final phase is proposed for the winter of 1973-74, with a public offering of \$100 million more.

---

## Optoelectronics

---

### Rectangular waveguide brightens laser light

The military laser market last year amounted to a whopping \$50 million, more than half the total laser market of \$90 million, and may get a further boost from a newly imple-

Give our CHIP capacitor customers something to cheer about.

DIP,  
CHIP,  
ARRAY

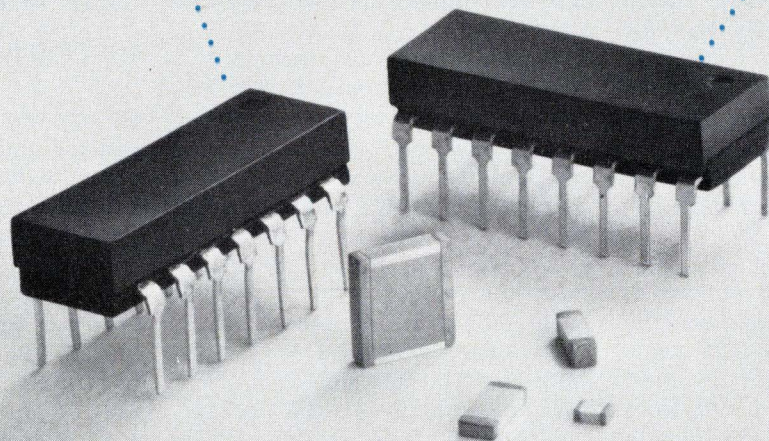

And you'll cheer too, when you learn how inexpensively you can have custom designed chip arrays to meet your specific application requirements. AVX can provide prototype quantities for your evaluation using standard chips mounted in preformed packages.

Or, for production quantities, we can fabricate the entire capacitor array as a single monolithic structure with multiple lead connections to the lead frame giving you higher component density and greater reliability at low, low cost. In addition, we offer interconnect, crossover, resistance network capabilities, both thick film and thin film.

Looking for reliable assistance in designing your multiple capacitor arrays? Cheer up, call or write Aerovox today for answers that will put a smile on your face and save you money in the bargain.

**STANDARD DISCRETES AVAILABLE AS FOLLOWS:**

AVX TYPE EIA STYLE	L	W	T	CAP. RANGE IN PF - 50 VDC TEMP. CHAR			
				NPO	X7F	X7R	Z5U
ULA-11	.085	.060	.050	120 to 560	820 to 2,200	5,600 to 15,000	10,000 to 47,000
0805	.065	.040	.020				
ULA-70	.180	.070	.060	330 to 1,800	2,700 to 6,800	18,000 to 47,000	22,000 to .15 $\mu$ f
1805	.160	.050	.020				
ULA-78	.190	.090	.060	560 to 3,900	4,700 to 15,000	33,000 to .10 $\mu$ f	47,000 to .27 $\mu$ f
1808	.170	.070	.020				
ULA-60	.230	.255	.060	2,700 to 15,000	22,000 to 56,000	.15 $\mu$ f to .47 $\mu$ f	.47 $\mu$ f to 1.5 $\mu$ f
2225	.210	.235	.020				

**AVX** Aerovox®

AEROVOX CORPORATION, NEW BEDFORD, MASSACHUSETTS 02741 • TEL. 617-994-9661  
PLANTS IN: NEW BEDFORD, MA., OLEAN & FRANKLINVILLE, N.Y., MYRTLE BEACH, S.C. AND HAMILTON, ONT., CANADA

mented method of coupling diode lasers in illuminating systems.

The Army's Night Vision Laboratory at Ft. Belvoir, Va., is using rectangular fiber-optic waveguides to couple the outputs of a 200-element gallium-arsenide-diode laser illuminator, increasing the average radiant emittance of the system by a factor of 20 over illuminators coupled by conventional waveguides.

Because GaAs diode lasers are small and cheap they are ideal as the source of energy for infrared illuminators in ranging, guidance, and tracking systems. But small as diodes are, the projection optics needed to beam the energy out of the cavity and into the field are large. This heavy front end optical system has added weight and size to the illuminator—especially bad for large-element arrays. With rectangular fibers, however, the cross section of the waveguide can be made to match the rectangle of the laser's cross section, dramatically reducing the size of the projection system.

**Bright and light.** Using RCA lasers and Sperry waveguides, workers at Belvoir managed to increase the radiant emittance from 0.25 watts per square centimeter to 4.84 watts/cm<sup>2</sup> and average power from 80 to 100 milliwatts. What's more, a computer model indicates that, with this technique, a working system with a 200-diode array is possible that will supply 1,200 watts peak power, or 600 milliwatts average

power, with a lens system only 1.92 inches in diameter and weigh only 1.17 pounds.

### National in LED business with four versions

Convinced that light-emitting diodes will replace incandescent bulbs as indicators in instruments and computers, National Semiconductor Corp. has jumped into the market with four LED products. Floyd Kvamme, director of marketing, says "A large percentage of repair calls on computers is to replace front-panel lamps, and because LEDs have a much longer life expectancy than bulbs, we feel that the LED lamp business will be excellent."

The first products include two point sources—one with a clear lens and one with a red lens—and two diffused emitters, one clear and one red. Gallium arsenide phosphide is used in all four. The package configuration is similar to Fairchild's FLV 100, essentially a two-LED TO-106 transistor package with a ceramic bead and a clear or red plastic top.

**Package.** Kvamme says that, since National has had years of experience with the TO-106 package, the company was able to get its product to market in a much shorter time than if it had developed a new package from scratch.

As for the competition, Kvamme maintains that the TO-106 package

provides better contrast than the cast plastic packages employed by Monsanto and Litronix, and that the National parts are as bright as, if not brighter than, anything on the market. Price is also on a par—in single quantities, the lamps cost \$1.03 each; this drops to 59 cents in quantities of 1,000.

As of now, LED displays are not in the picture at National. As Kvamme puts it, "We will concentrate on getting our normal share of the lamp business." For National to get involved with LED displays, Kvamme says, "It will take the development of a dollar-per-digit device."

### Manufacturing

#### Laser vs diamond saw: scribing jury still out

Despite the lure of the laser's bright lights, diamonds still are a semiconductor wafer's best friend—at least if you ask people like Matt Pennings, president of Tempres division of Sola Basic industries Los Gatos, Calif. Tempres is about ready to ship to several semiconductor makers the first production models of its diamond wafer-dicing saw. At \$12,500 apiece, Pennings figures he can convince even more semiconductor houses that his saw is a more economical way to improve scribe-and-break yields than the more than \$50,000 it takes to install a laser scriber.

However, the first big user of laser scribers, Motorola Semiconductor Products division in Phoenix, Ariz., is committed even more heavily to the laser. Assuming that expected capital equipment appropriations come through, it could easily add five systems within the next year to the five already installed, according to Stanley Kleban, Motorola's group operations manager for discrete products.

**Blade is key.** The key element in the Tempres saw is the 1-mil-wide blade—a nickel disk impregnated with diamond—that's mounted on an aluminum disk for greater strength. The saw can cut through a

**Market booster.** Rectangular waveguides used at the Army's Night Vision Lab in a new method of coupling diode lasers could give push to the military laser market. In 200-element illuminator, average radiant emittance is increased by a factor of 20.

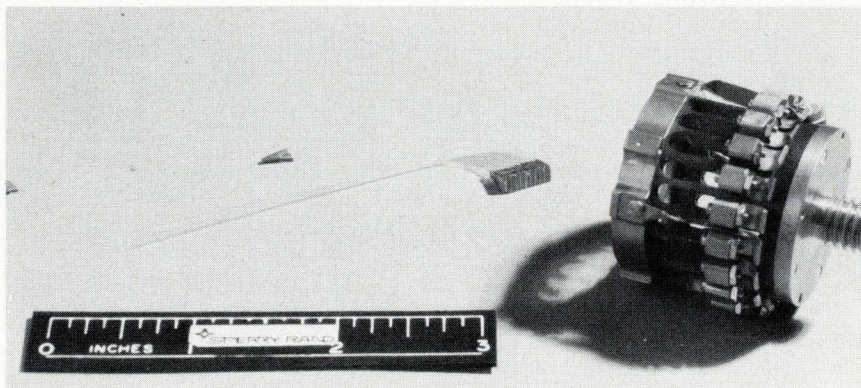

# Data Conversion Modules

# Performance...

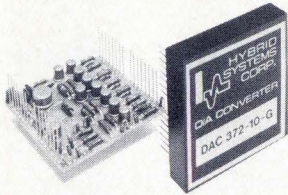

## General Purpose, High Reliability D/A Converters Series 372

- 8 thru 12 bits
- All hermetically sealed active components
- High stability, thin film resistors
- 72 hr. min. factory burn-in

Circle 201 Reader Service Card

**\$9.90**

in singles

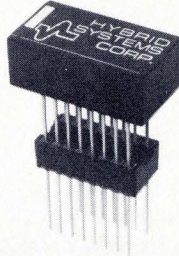

## 8-Bit, Economy D/A Converter Model 371-8

- Plugs into single IC socket
- 950nSec settling time
- All hermetically sealed active components

Circle 202 Reader Service Card



## High Speed, Multiplying D/A Converters Series 390

- Settles in 50nSec
- Optional built-in reference
- All hermetically sealed active components

Circle 203 Reader Service Card

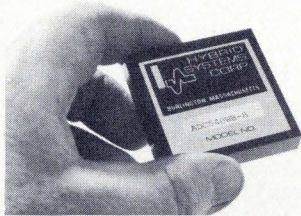

## High Speed A/D Converter Model 540

- 8 Bits
- 5 $\mu$ Sec conversion
- Compact — 2" x 2" x 0.4"
- \$95 (in singles)

Circle 204 Reader Service Card

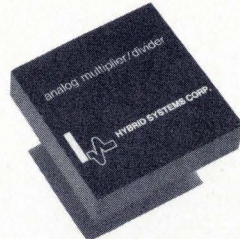

## Multiplier/Dividers Series 100

- Accuracies to 0.1%
- Multiply/divide/square/square root
- From \$39

Circle 205 Reader Service Card

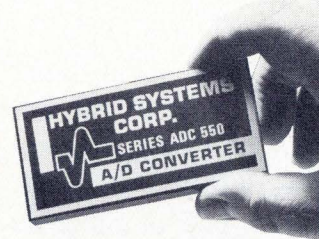

## General Purpose A/D Converters Series 550

- 20 $\mu$ Sec conversion
- To 12 bits
- From \$99

Circle 206 Reader Service Card

# Plus...

## 3 yr. warranty on these & other Hybrid Systems' modules

Hybrid Systems offers a full line of function modules, as well as applications assistance, including our free "Data Conversion Handbook." For more complete information, evaluation units, etc., contact us.



**HYBRID SYSTEMS CORP.**

87 Second Avenue, Burlington, Massachusetts 01803  
Telephone: 617-272-1522 • TWX: 710-332-7584

# KERONIX, INC.

## PLUG-TO-PLUG COMPATIBLE MEMORIES FOR THE MOST POPULAR MINIS



KERONIX, INC. is the leader in expanding memory capacity in the main frame for mini computers.

- 8K in same space as 4K
- Just plug in — no conversion
- Low current consumption
- High electrical margins
- One year warranty
- Great savings
- 30 days delivery
- The most complete memory line available

KERONIX, INC. welcomes END USER and OEM inquiries; besides expansion memories, KERONIX, INC. has an OEM line of memory systems to suit your specific requirements. Our engineering staff will custom design to your needs.

WRITE TO:  
GEORGE FOLDVARY  
Vice-President, Marketing

## KERONIX, INC.

1752 CLOVERFIELD BOULEVARD  
SANTA MONICA, CALIFORNIA 90404  
PHONE: (213) 829-3594  
TWX: 910-343-6480



Representatives throughout  
the U.S.A.

Circle 38 on reader service card

## Electronics review

wafer at the same speed that a diamond scribe moves across the wafer, while still preserving the orientation of the dice—a prerequisite for automated handling systems. The blade leaves a kerf only 1.6 mils wide, says Pennings, which is well within the usual street left for conventional diamond scribing. Pennings adds that other types of saws—wires and slurries—leave kerfs up to 4 mils wide.

The Tempress saw can also be used as a scribe with the same kerf loss, but its advantage over the diamond scribe is that it cuts more deeply and produces clean, square corners on the separated dice. The blades, however, do wear out—but Pennings says they're good for "many cuts," a good ballpark figure is 40 wafers per blade—and must be replaced at about \$12.50 each if they're bought in large quantities.

Nevertheless, Motorola's Kleban, without intentionally punning, says he sees "a very bright future for lasers," whose advantages over scribing as well as sawing make them the "number one method of dicing." He points out that one laser scribe has replaced four diamond scribes at Motorola, and this has been done while he's still involved in smoothing out the setup time for the laser. Once the lasers are running full

steam, he says, the advantage will be even greater.

Kleban acknowledges that a heat-damage zone is inevitable with the laser scribe, but he says that he's able to scribe easily within the 3-mil-wide streets normally set up for diamond scribes, and he can even use the laser on devices that have junction areas as close as 1 mil to the laser scribe edge.

## Space electronics

NASA pares Grand Tours  
to economy class

NASA, forced to scrub the proposed unmanned Grand Tours to the outer planets because only the planetary scientists liked the program, has come up with an economy plan. The White House and Congress thought that \$700-\$900 million was too much to pay for more information about Jupiter, Saturn, Uranus, Neptune, and Pluto, and other scientists feared the far-reaching program would divert tight NASA money away from their own programs [*Electronics*, Jan. 31, p. 79].

Now NASA is planning a budget tour costing "no more than \$360 million," which it hopes should

**Clean cut.** As the debate over whether lasers or diamond saws make better scribes continues, Tempress is about to ship its diamond wafer-dicing saw. Kerf is only 1.6 mils wide.

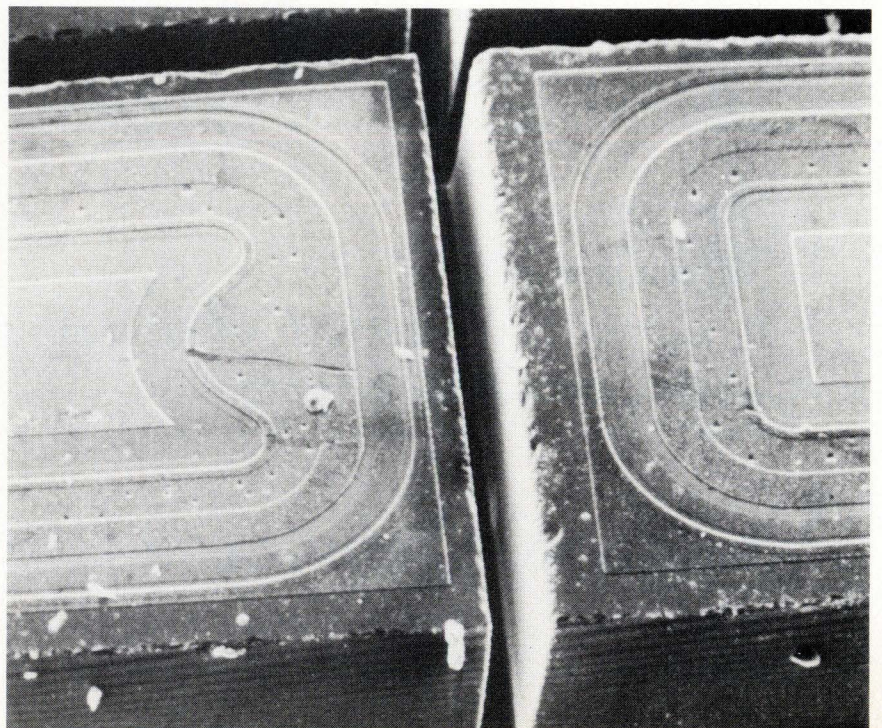



**goes where  
hands can't**

**ties in less  
than a second**

**adjusts  
automatically  
to bundle  
diameter**

**NOW tie  
faster than ever before**

We've eliminated hands from the wire tying and harnessing operation—the tool does it all. Now the operator simply applies the tool to a wire bundle, squeezes the trigger and a nylon TY-RAP® Tie feeds itself around the bundle, tightens to a preset tension, locks securely and the excess nylon is neatly snipped off flush to the tie's head . . . in 8/10 of a second. There is no tool adjustment needed regardless of bundle diameter from 1/32" to 5/8". The tool is cartridge loaded with 50 standard ties (MIL-S 23190A and MIL-M 20693A). Now you can get the reliability of TY-RAP Ties with production speed.

Write for complete information and see how this TY-RAP tool will substantially reduce costs. The Thomas & Betts Co., Elizabeth, N. J. 07207. (201) 354-4321. In Canada, Thomas & Betts Ltd., P.Q.

**Sold only through authorized T&B Distributors**



**THOMAS & BETTS**

Division of Thomas & Betts Corporation

Circle 39 on reader service card

# CUSTOM, HIGH PERFORMANCE MOS

Low-voltage CMOS and high-speed PMOS. Built by the people who introduced ion implantation to MOS processing technology.

## CMOS

- Low operating voltage—down to one volt.
- Complex, high density circuits—no channel stoppers, even at 1.5 volts.
- Low, matched and selectable threshold voltages—as low as 0.5 volts on both N and P channels.
- Tight threshold voltage control—within  $\pm 0.2$  volts.

## PMOS

- High-speed at low power—low capacitance through zero gate overlap—example, 10 MHz shift register at 200  $\mu$ W per bit.
- Single power supply—operating voltage as low as 3 volts with ion implanted resistors.
- High circuit density—advanced photolithographic technology.

## PLUS...

- Full silicon nitride passivation plus overglass protection.
- TTL/DTL compatibility.
- Full MIL STD temperature range.
- 100% screening to MIL STD 883.

If our custom capability appeals to your high performance requirements, write us. We're taking orders now.

Hughes Aircraft Company, Microelectronic Products Division, 500 Superior Avenue, Newport Beach, CA 92663  
Telephone: (714) 548-0671.

**HUGHES**

HUGHES AIRCRAFT COMPANY  
MICROELECTRONIC  
PRODUCTS DIVISION

Hughes Industrial Electronic Products

## Electronics review

please everyone. But, of course, at bargain rates you don't always get the longest itinerary or the newest type of equipment. Robert S. Kraemer, director of planetary programs, explains that the new outer-planet missions would use just two spacecraft to be launched in 1977 to Jupiter and then Saturn. The craft would use a lot of electronics equipment designed for the Mariner and Viking orbiter series, as well as for the aborted Thermoelectric Outer Planets Spacecraft (TOPS) programs [*Electronics*, March 30, 1970, p. 108] that were to form the Grand Tours.

**Big contract.** Even so, the project would be a sweet plum to a contractor. The request for proposal for an estimated \$150 million is expected to be issued mid-1973, Kraemer says. The space agency hasn't given up exploring the outer planets, and is thinking about other missions, which because of their complexity could cost more. "Clearly, the company doing this project has a leg up," he says, because any follow-on tours would probably be sole-source contracts.

Passage of the 1977 Jupiter-Saturn mission seems almost certain. NASA Administrator James C. Fletcher is expected to give the program his formal approval shortly, and Congressional reaction is reported favorable. The new program will cost only \$7 million for fiscal 1973 because NASA has \$10 million left over from the previous year, Kraemer says, adding that NASA also has promised Congress that

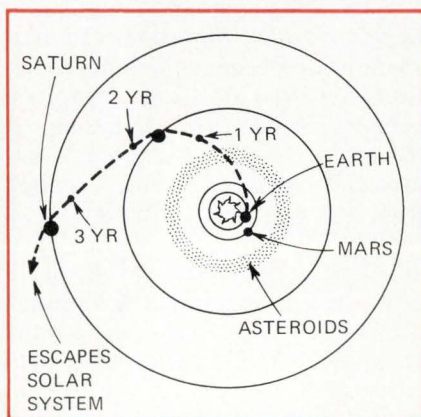

**Round and round.** Not-so-Grand Tour proposed by NASA would have two craft launched in 1977 to Jupiter and Saturn.

peak funding in fiscal 1976 will be less than \$90 million.

Although NASA is finishing design concepts, Kraemer points out that the 100-pound scientific payload of the Mariner 1973 Venus/Mercury craft "looks pretty good" as a basis. "One shouldn't be too surprised if this mission is similar," he says. "If industry wants to get started on studies, it should look at that payload and work from that." The Boeing Co., Seattle, is building the craft under Jet Propulsion Laboratory, Pasadena, Calif., project management.

## Solid state

Fairchild aims 95100  
ECL at mainframe houses

Fairchild Semiconductor, in a new marketing thrust, has developed a family of emitter-coupled logic—labeled 95100—designed for the mainframe builder. This is a change in philosophy. When Fairchild introduced its 9500 ECL series last year, its feeling was that the mainframe houses would prefer to go to a custom product line; the result was that the standard line was aimed at the small-system builder.

Tom Longo, vice president and general manager of the Digital Products division, says that Fairchild made ECL easy for the small-system builder to use by making it temperature-compensated. This meant that the user didn't have to worry about keeping all the ICs at the same operating temperature. But to make a standard family for the mainframe builder, Fairchild decided that there was still a greater problem—power supply variation.

The result is that the 95100 family is both voltage- and temperature-compensated. Longo says that what changed the thinking of the large computer houses was the 7400 transistor-transistor logic series, which showed them the advantage of a standard logic family. And Motorola's success with its MECL 10,000 series may also have had something to do with it: the speed-power factor

# Hughes is more than electronic components and equipment.

## It's systems, too.

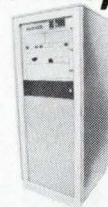

Numerical control systems (RS 220)



Wire terminating and harness laying systems (RS 221)

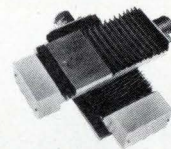

N/C positioning tables and systems (RS 222)

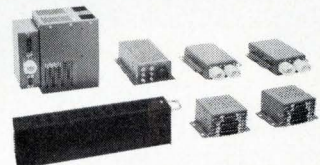

Multiplex systems for remote communications/control (RS 223)



FACT automatic circuit testers (RS 224)

For complete information, write Bldg. 100, Mail Station C-512, Culver City, CA 90230. Or request by Reader Service (RS) numbers.

**HUGHES**  
HUGHES AIRCRAFT COMPANY

Industrial Electronic Products

# AIRPAX ZERO- VELOCITY DIGITAL TRANSDUCERS

- Measure from zero (dc) velocity to 10,000 Hz.
- Sense presence or absence of ferrous discontinuities as well as rotational direction.
- Provide outputs compatible with TTL inputs.
- "Blind-end" design allows use in hazardous locations.



**MODEL 4-0001 . . . Zero-Velocity**

Combines "Hall-effect" principles with solid-state circuitry to provide constant amplitude logic pulses from zero to very high speeds. Unique in that output depends solely on "POSITION" of ferrous object and not its "VELOCITY."



**MODEL 4-0002  
Zero-Velocity Plus Bi-Directional**

Provides "DIRECTION" as well as "FREQUENCY" sensing capability in a single unit. Built-in direction sensing computer produces a constant level output; +3.5 volts (nominal) clockwise and zero volts counter-clockwise. Ideal for "up-down" counting applications.



**MODEL 4-0004  
Mini Zero-Velocity**

A true zero-velocity transducer even though it does not produce a digital output. Provides constant level output independent of speed and measures only  $\frac{1}{16}$ " in diameter by  $1\frac{1}{2}$ " in length.

Send for our complete catalog today.

## AIRPAX™

**AIRPAX ELECTRONICS  
CONTROLS DIVISION**

6801 W. Sunrise Blvd.  
Fort Lauderdale, Florida 33313  
Phone: (305) 587-1100

## Electronics review

of the 95100 is 45 picojoules; for the 10,000 it's 50 pJ. Both offer 2-nanosecond-per-gate propagation delay.

**Variation.** Longo says, with totally compensated 95100 ECL devices, the usual ECL design requirement to regulate supply voltages within a  $\pm 2\%$  range can be relaxed to  $\pm 10\%$  if operating on a nominal 5.2-volt supply. If a 5.5-v supply can be used,  $\pm 15\%$  variation can be tolerated. This is greater than the variation that can be tolerated in standard TTL logic. To the user, the wider supply tolerances mean that less expensive power supplies can be used and that, in most cases, on-card regulation can be eliminated.

Power supply compensation was achieved by building an on-chip voltage regulator. The trick, according to Longo, was to keep it extremely simple and small so that it didn't take up too much chip area. The circuit chosen is similar to one used in the  $\mu A$  746 voltage regulator. The  $V_{be}$  drop of a diode is compared with the  $V_{be}$  drop of an emitter follower, and the resultant signal is applied to the voltage reference circuit normally included in an ECL circuit. (Since ECL circuits are current switches, each gate level contains a current source that is fed by a voltage reference.)

"It's the type of thing that, once

you've done it, you ask yourself 'Why didn't I do it before,'" says Longo. In the 746 voltage regulator, the implementation of their concept takes many more components than could be used on an ECL chip, but Longo points out that in the 746 the voltage available was only 1.2 v, "but in the 95100 series circuits we have 5 v to work with, and this enabled us to shrink the parts count."

The first devices available in the new family include the 95102, 95103, and 95104 dual, triple, and quad OR/NOR gates, priced at \$1.80 in quantities of 100. These will be followed in the second quarter of 1972 by a 260-megahertz dual D and J-K flip-flops and a line of MSI building blocks, such as 200-MHz counters and a four-bit arithmetic logic unit, decoders, and multiplexers.

## Government

Customs plans national computer-terminal network

As American companies automate their import activities, the job of the U.S. Customs Bureau becomes both larger and more complex. Last year Customs processed 8 million detailed entries, and the number alone is growing 10% a year. As a result, the agency wants to turn to computer terminals to keep up with the growing mountain of data and regulations.

What Customs has in mind ultimately is AMPS—for automated merchandise processing system, a nationwide \$60 million computer network using 1,800 terminals. It would be the "most complex commercial system ever to be installed from a design point of view," states John W. Edwards. He was director of corporate systems for Polaroid Corp. before he joined the Customs Bureau last year as assistant to the commissioner for automatic data processing.

The off-the-shelf system would use four computers with an "upper medium range, one megabyte, third-and-a-half generation ma-

## Test snafu

Even as Fairchild announced its new 95100 ECL family, Motorola admitted that it had recalled all but four varieties of its MECL 10,000 from distributors because of a problem in final testing. Jack Miller, manager of digital ic marketing, says certain tests were performed incorrectly, raising the possibility of excessive leakage current. The recall started Feb. 21, with all recalled devices to be retested and back on the shelves by March 10.

Miller says that the problem was not reliability or packaging. He points out that parts won't deteriorate, so that if they are working properly now, there is no need for concern.

If our DC IV arrives in the morning, your technician will be testing digital circuit boards and assemblies by lunch time. And in a few days he'll be writing programs for complex systems.

Why so quick? Because Digital General has the right idea about automatic test systems. Keep it simple.

Take programming. Our DC IV uses a conversational test oriented language (CONTEST). Simple?

And your technician will appreciate our fault display that shows signal lines in error by program step and pin number. With pulse-detection capability, he can test timing circuits and detect intermittent faults as short as 40 nanoseconds. Also, to save costs, programmable line assignment ac-

commodates complete families of test subjects with a single test fixture.

If 32 pins and the 4K memory aren't enough for your job, add options to expand pin capacity to 4080 and the memory to 32K! Add a burst generator. Magnetic tape storage.

High speed tape reader. Add a general purpose interface for mixed logic families, or programmable instrumentation for linear and hybrid circuit testing. Don't add a self-test feature, it's built in.

And all the while have what you started with. Simplicity. Simplicity that only a company who specializes 100 per cent in automatic test equipment can offer you.

To discover more good reasons why

customers have selected the DC IV for their production and engineering test requirements, call Stu Daniels at (216) 721-0440, or write: Digital General Corporation, 11000 Cedar Avenue, Cleveland, Ohio 44106.

**DIGITAL** / *general*  
CORPORATION



# the un-complicated automatic test system from Digital General Corporation

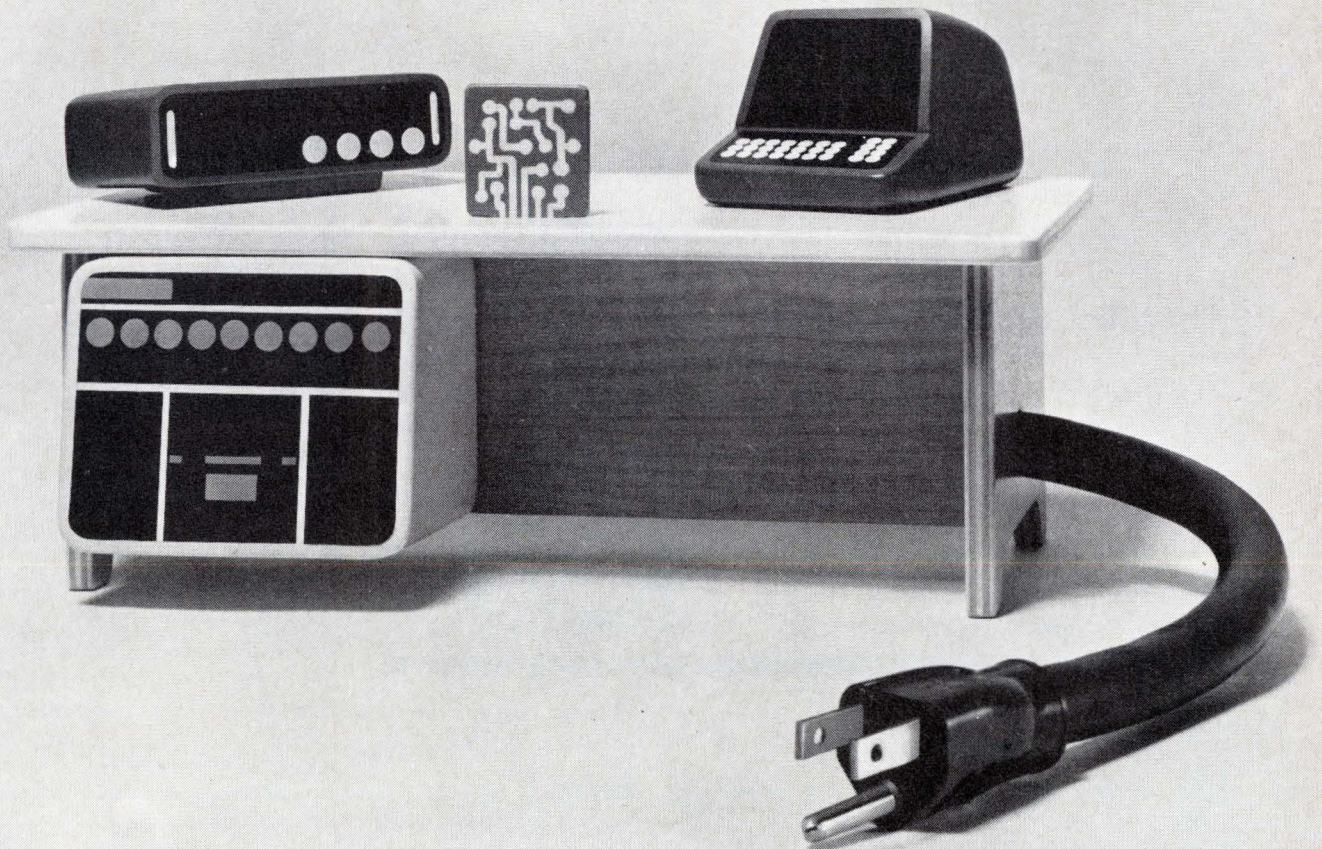

# Compare Mini-Mox to whatever film resistor you're using now.

## Our Miniature Metal Oxide Resistors Can Give You up to 10,000 Megs and 5000 Volts in 1/10th the Space.

Compared to metal film resistors our tiny Mini-Mox can give you greater power handling capability and substantially better resistance to size or voltage to size ratios. Mini-Mox reliability is unmatched under high voltage conditions.

Mini-Mox outstrips conventional carbon film in every category: 100 ppm TCR; voltage to size ratio; stability; power handling capability; initial tolerance and reliability, particularly under extreme environmental conditions.

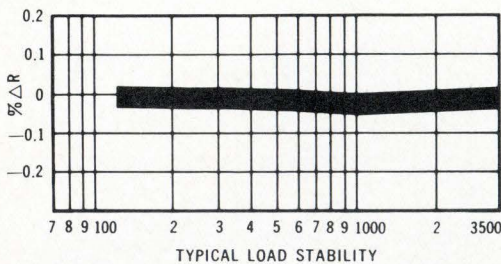
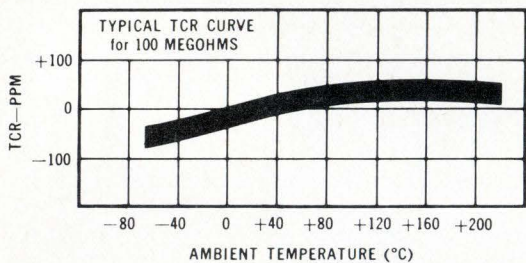

Mini-Mox resistors offer a new degree of design freedom in stable and dependable high voltage circuitry. They are available in a range of sizes and we stock them for prompt delivery.

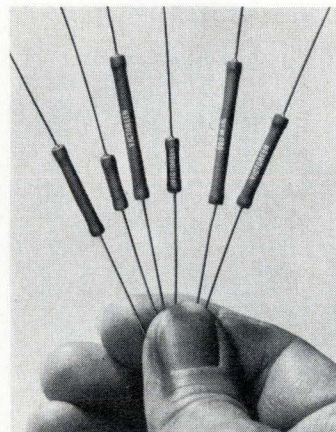

Model	Resistance	Rating @70°C	*Max. Oper. Volts	Length Inches	Diameter Inches
MOX-400	1-2500 megs	.25W	1000V	.420	.130
MOX-750	1-5000 megs	.50W	2000V	.790	.130
MOX-1125	1-10,000 megs	1.00W	5000V	1.175	.130

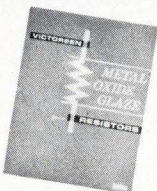

For detailed specifications on Mini-Mox send for this technical bulletin. Victoreen Instrument Div. of VLN Corp., 10101 Woodland Avenue, Cleveland, Ohio 44104. Telephone: 216/795-8200

DMA 683



Expertise in high voltage.

## Electronics review

chine" in Washington as the key-stone, he says.

Customs will set up its system in carefully planned phases, Edwards says. In May the service will issue requests for proposals for the Washington computer, a smaller field computer, and proprietary software, and in July it will select a vendor. After a year of evaluation and training, a second 15-month operational testing phase will begin at the port of Seattle, with the two computers connected. If in 1974, after the Seattle trial, the bureau decides that the hardware can handle Customs' complex rules and regulations, it will go out to industry for bids on the national system to be phased in over three to five years.

**Terminals.** As terminals are an integral part of the proposed network, the Treasury department agency this summer will also issue RFPs for various types of terminals. The service plans to buy programable, CRT, and other types for operational tests. "We're 100% confident that the hardware can do the job," Edwards says, "but we want to make sure that the system we designed matches our needs."

The planned system will have these subsystems: classification and value, codifying valuations and duties; central quotas, keeping track of limited import items; "information on tap," accessing issues that arise after disputes; and a management information system, which would in part provide trade statistics to the Departments of State and Commerce. "To get the data collection as close as possible to the source," Edwards says the bureau would offer use of the terminals to large shippers and brokers to put their data directly into the system.

**Wideband.** For the future, the service is considering modifying the national network, Edwards says, for instance, by using concentrators, mass switching, and wideband capabilities between computers so that files could be transferred between computers on short notice. A by-product of the system, Edwards points out, is that it can be used for criminal intelligence to trace the possibly illegal actions of importers.

# If you're not a statistician or a market researcher, don't read this page.

Model 1766. The Statistician. Available everywhere in the USA and Canada. Call (800) 631-1971 free for the Monroe office nearest you. In New Jersey call (800) 962-2804.

Single key summation of  $x$ ,  $x^2$  and  $n$ .



Two-key automatic summation of grouped data.



Two-key automatic summation of paired data accumulates  $xy$ ,  $n$ ,  $x$ ,  $x^2$ ,  $y$ , and  $y^2$  factors.



10 completely separate storage registers with complete entry, recall, transfer and accumulation flexibility.



Up to 256 steps of decision-making learn-mode programming. Accessory card reader available for automatic entry of programs.

Special keyboard functions for:

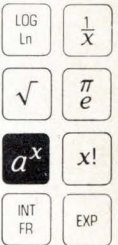

Single-key computation of mean and standard deviation from automatically accumulated data.



Selective printout of entries and answers.

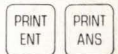

**Monroe. The Calculator Company.**

550 Central Avenue, Orange, New Jersey 07051  
81 Advance Road, Toronto 18, Ontario, Canada

# NEW!

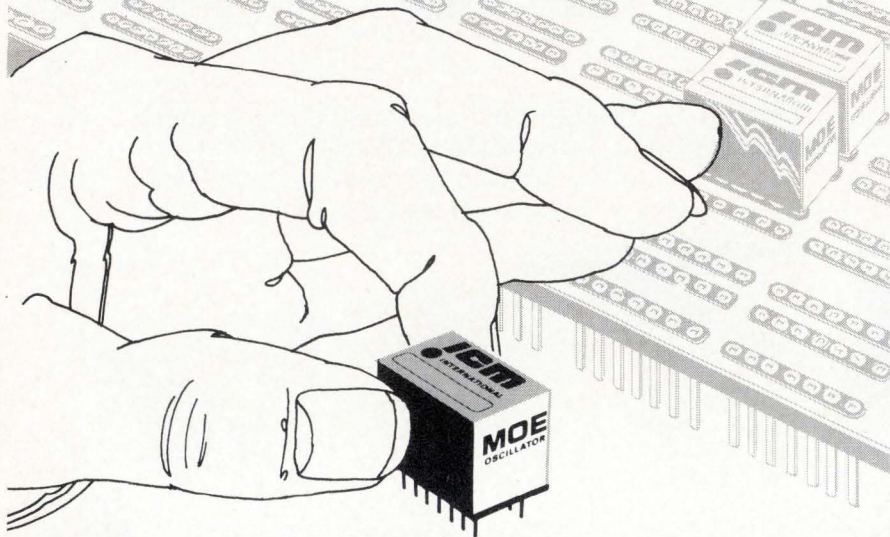

## INTERNATIONAL'S MOE Crystal Oscillator Elements provide a complete controlled signal source from 6000 KHz to 60 MHz

The MOE series is designed for direct plug-in to a standard dip socket. The miniature oscillator element is a complete source, crystal controlled, in an integrated circuit 14 pin dual-in-line package with a height of 1/2 inch.

Oscillators are grouped by frequency and temperature stability thus giving the user a selection of the overall accuracy desired. Operating voltage 3 vdc to 9 vdc.



**INTERNATIONAL**  
CRYSTAL MFG. CO., INC.  
10 NO. LEE • OKLA. CITY, OKLA. 73102

TYPE	CRYSTAL RANGE	OVERALL ACCURACY	25°C TOLERANCE	PRICE
MOE-5	6000KHz to 60MHz	+ .002% -10° to +60°C	Zero Trimmer	\$35.00
MOE-10	6000KHz to 60MHz	+ .0005% -10° to +60°C	Zero Trimmer	\$50.00

But he adds that the system will be data-secure and fully in accord with Federal regulations protecting the rights of individuals.

### For the record

**Two specials.** Two new computers appeared only a day apart earlier this month when General Electric Co. and IBM announced a process-control minicomputer and a communications controller.

GE's new GEPAC 3010/2, replacing its earlier GEPAC 3010, is intended for both utility and industrial applications. Existing software, operator consoles, and peripheral equipment can be used with the new machine, as well as new disk and tape units and a new card punch.

IBM's new communications controller, dubbed 3705, coordinates the operation of 352 telephone lines—twice as many as IBM's largest previous controller—and relieves the central computer of many routine tasks associated with data transmission.

**TI consumer?** In response to reports that it is getting into the consumer calculator market, Texas Instruments has admitted that "the possibility certainly exists that we may find it desirable to some day be in the calculator end equipment business."

**Sited.** With the Army award of a 60-month, \$382 million prototype demonstration program of its Hardsite ABM system to McDonnell Douglas Astronautics Co., the program also got a new name. Now called SIM—for site defense of Minuteman—the package has an \$800 million potential with the inclusion of modified Spring missiles by Martin Marietta.

McDonnell Douglas gets \$10 million as its first increment. Its five subcontractors are expected to share roughly this way: GE terminal defense radar, \$78 million; CDC computers, \$31 million; GTE Sylvania command and control communications, \$9 million plus; Braddock, Dunn & McDonald engineering, \$1.5 million; TRW systems planning, \$100 million.



# If you're not an engineer, scientist or technician, don't read this page.

Model 1666. Available everywhere in the USA and Canada. Call (800) 631-1971 free for the Monroe office nearest you. In New Jersey call (800) 962-2804.

Programming: Choose either 128 or 256-step models.



Accessory card reader available for automatic entry of programs and additional functions not available through keyboard.

Dynamic range of  $10^{+99}$  to  $10^{-98}$  in either preset or scientific notation.

10 completely separate storage registers with complete entry, recall, transfer and accumulation flexibility.



Automatic special functions for:



Complete program library covering every scientific and engineering discipline available to Monroe users.

**Litton** **Monroe. The Calculator Company.**

550 Central Avenue, Orange, New Jersey 07051  
81 Advance Road, Toronto 18, Ontario, Canada

# If you haven't read pages, please

Programmable models with accessory card reader for automatic program entry.

Printing models from under \$300.00.  
Non-printing models from \$395.00.



The world's largest selection of  
electronic calculator models.  
Over 30 to choose from.

Special calculators and programs for  
special functions in literally every  
facet of business and science.

Dedicated specialists. Your Monroe man  
sells nothing but calculators.  
He knows them and your needs best.

# any of the preceding read these two.

Service where you need it. From over  
350 company-owned branches coast-to-coast.

Service when you need it.  
Over 2000 full time servicemen offer  
same-day service in every branch office.



Extra services: Your Monroe  
man stays with you long  
after the sale, training  
your staff and putting  
your calculators to work for you.

 **Monroe.**  
Litton  
**The Calculator Company.**

550 Central Avenue, Orange, New Jersey 07051  
81 Advance Road, Toronto 18, Ontario, Canada

# The most versatile multicolor CRT's on display

Special multicolor screens with different color renditions provided by changing voltages make these up-to-the-minute CRT's especially useful in the latest display applications. Air traffic control systems, electronic test equipment, computer displays and many other applications are possible for these tubes. You can get any of our CRT's (from 4.5" to 25" diagonal) with bicolor or multicolor display screens, a monochrome screen with different persistence phosphor layers, or multicolor screens with variable persistence phosphor layers.

You'll also specially appreciate the high brightness and picture contrast. And you'll like the high resolution, a major feature with THOMSON-CSF cathode ray tubes.

Moreover, your circuit engineer will have the benefit of the low voltage swing required to switch from one color to the other.

For complete information on these and all the tubes in our wide CRT line, circle the Reader Service Card or contact us direct.



See us at IEEE, booth 2232



**THOMSON-CSF**

THOMSON-CSF ELECTRON TUBES, INC. / 50 ROCKEFELLER PLAZA / NEW YORK, N.Y. 10020 / (212) 489-0400

France - THOMSON-CSF Groupement Tubes Electroniques / 8, rue Chasseloup-Laubat / 75 PARIS 15<sup>e</sup> / Tél. 566.70.04

Germany - THOMSON-CSF Elektronenröhren GmbH / Am Leonhardsbrunn 10 / 6 FRANKFURT/Main / Tel. 70 20 99

Italy - THOMSON-CSF Tubi Elettronici SRL / Viale degli Ammiragli 69 / ROMA / Tel. 63 80 143

Sweden - THOMSON-CSF Elektronrör AB / Box 27080 / S 10 251 STOCKHOLM 27 / Tel. 08/22 58 15

United Kingdom - THOMSON-CSF Electronic Tubes Ltd / Bilton House, Uxbridge Road, Ealing / LONDON W5 2TT/Tel. 01-579 1857

---

# Washington Newsletter

---

March 13, 1972

**B-1 avionics switch  
seen jeopardizing  
whole program . . .**

**Postponement until May 31 at the earliest of an Air Force B-1 avionics integration contract award** is jeopardizing the B-1 advanced manned bomber program's future, say Congressional Defense Committee sources, who note it "has always been a chancy thing politically." In addition to being subject to compromise in strategic arms limitation talks with the Soviet Union, the B-1 has been the target of defense-spending critics, who are expected to become still more vocal now that the service has decided to revise the avionics package. **The change is generally viewed as delaying the program, and escalating the unit cost of the first three planes above the \$50 million level.**

**. . . amended RFP  
separates offense,  
defense units**

At the end of February, the AF Aeronautical Systems division distributed a 25-page amendment to its request for proposal to the four competitors for the avionics award—Boeing Corp., Hughes Aircraft, IBM Corp., and the Autonetics division of North American Rockwell, the aircraft's builder. **The amendment calls for two identical computers for use in navigation and weapons display in the B-1's offensive system, plus an identical or similar computer for such defensive uses as electronic countermeasures.** Bidders are to submit a 75-page revision to their proposals no later than March 15, and **the computer options they propose must all be deliverable, either currently or within 12 months** if qualified for development in another major program. The Air Force expects a 45-day review period after its own contractor selection by April 15.

All the competitors, except IBM reportedly, included the Univac 7532 computer in their proposals. It's a radiation-hardened version of the firm's 1832 model chosen for the Navy's S-3A antisubmarine warfare plane. **Univac contends the 7532 is still in the competition because the processor "is off-the-shelf** by our interpretation of the Air Force criteria." But the logical alternatives would be such existing processors as IBM's 4-Pi or AP-1, the latter being developed for the Air Force F-15 fighter, or Autonetics' SRAM.

**FAA to develop  
ground station for  
time-frequency CAS**

Requests for proposals are expected to be issued very shortly by the FAA for a developmental model of a ground synchronization station that will test the concept of time-frequency-based collision avoidance systems. **RFPs also are due out for a study on the number and location of stations needed for a national time-frequency CAS.** Developed by McDonnell-Douglas and backed by the airlines' Air Transport Association, the approximately \$400,000 ground station development also would include the testing of airborne synchronization hardware. **The FAA estimates that a time-frequency CAS would require 65 stations by 1981 at a cost of about \$30 million.**

But whether time-frequency or RCA's Secant interrogator/transponder technique should be the national standard is a decision the FAA has yet to make. The agency recently told the Senate aviation subcommittee that it wouldn't be able to estimate when it could decide until January 1973. **Both the FAA and the Defense Department told the committee that more testing is needed of all CAS systems** [*Electronics*, Jan. 31, p. 29]. However, **the FAA repeated its preference for ground-based systems over airborne units such as time-frequency or Secant.**

---

# Washington Commentary

---

## Communications chaos brands FCC a disaster . . .

The Federal Communications Commission is a shambles, an example of all that can go wrong when politics mixes with technology. **Presidential appointment of the seven commissioners is invariably motivated more by political friendship** than communications expertise. And the FCC's static budget has never permitted it to grapple effectively with the communications explosion that began after World War II. Even now, for example, six years after the Common Carrier Bureau determined to examine the economics of the Bell System in order to regulate its profits, the commission is still questioning whether it is equipped to do the job. The answer, of course, is that it is not.

**Fundamental to the FCC's problems is that it has lacked the leadership necessary to build strong policies.** Instead, it has functioned largely as a fireman, dealing with individual crises as they arose. The consequent communications snarl reduces groups seeking to improve their lot to operating like purse snatchers, grabbing what frequencies they can and running. This, for example, is how the American Radio Relay League depicts the latest effort of citizens' radio makers and the Electronic Industries Association to clean up citizens' band [p. 31].

## . . . leaving field to White House

It is no wonder, therefore, that **Washington has produced a new man-on-horseback charging to the rescue of the commission and the communications industry.** He is the Office of Telecommunications Policy's **Clay T. Whitehead.** Styled by one national newsweekly as a Federal czar who comes on like a small-town Jaycee, Whitehead's detractors at the FCC prefer to think of him as "a small-town Jaycee who wants to be a czar." And that is proving their biggest mistake.

Though young and soft-spoken, Whitehead comes on like the Rand Corp. alumnus he is, shooting down a Transportation Department's proposal for an internationally produced aeronautical services satellite or negotiating a cable television compromise for the long term. **Whitehead says he wants to "rewrite the Communications Act of 1934"** that created the FCC. And given a Nixon reelection in November, he will have another four years to try it.

With his 65-man, \$3 million operation—miniscule by Federal agency standards—the OTP director will need it. Rewriting the communications act is not only technically difficult, it is politically tricky since it assumes a restructured FCC. And there is the rub for some communications professionals: the commission is an independent regulatory agency, a creature of the Congress, but the OTP and its head are responsible to the White House.

Advocates of Whitehead's philosophy of regulation by policy say there is no threat, of course. The FCC's independence, they argue, is illusory since the White House controls its budget. Moreover, Congress still must pass on White House proposals to alter the status quo.

Whitehead's critics, who see him as a benevolent despot pretending to a larger communications throne, may be right, of course. The telecommunications policy office is his creature, born of a reorganization he directed while on the White House staff. At the moment, however, he represents just one organization in the communications struggle attempting to bring order out of chaos. **The fact that OTP is having more success than the FCC these days says less about the commission** than about Whitehead's ability effectively to exploit the principle that nature abhors a vacuum.

—Ray Connolly

# Right for the times!

Here's why these new counters—offered in four frequency ranges of **50, 200, 512 MHz** and **3 GHz**—are right for today's requirements:

## New 6150 series expandable universal counter-timers.

S-D developed this line to handle almost every counter/timer requirement—bench and systems. Four basic models cover frequency ranges of 50, 200, 512 MHz, and fully automatic 3 GHz. Buy for current requirements and upgrade frequency range at any time. These instruments were designed from scratch for **programmability**: single line or binary, total control including attenuators, and analog or digital trigger level control.

**6150 options and features:** Choice of 100 nsec or 10 nsec TIM resolution—choice of five oscillators—four types of BCD output—up to 9-digit readout—versatile remote programming—3½" height in full rack width—10mV rms resolution to 0.1 Hz.

**Expandability.** The expandable counter concept satisfies many needs, present and future. Why? Because it's so simple and economical to **upgrade** the frequency range of your counter and add options. BCD output, additional readout digits, and a 200 MHz frequency range (in place of 50) are added by inserting new plug-in PC cards right inside your lab in minutes. Go to 512 MHz or 3 GHz, higher stability oscillators, 10 nsec TIM resolution (on 6150 universal series), and remote programming—all are offered as expandable option kits installed by your local S-D service center.

	50 MHz	200 MHz	512 MHz	3 GHz
<b>Universal Model:</b>	<b>6150</b>	<b>6151</b>	<b>6152</b>	<b>6153</b>
<b>Counters</b>	Price: \$1195	\$1495	\$2150	\$2995

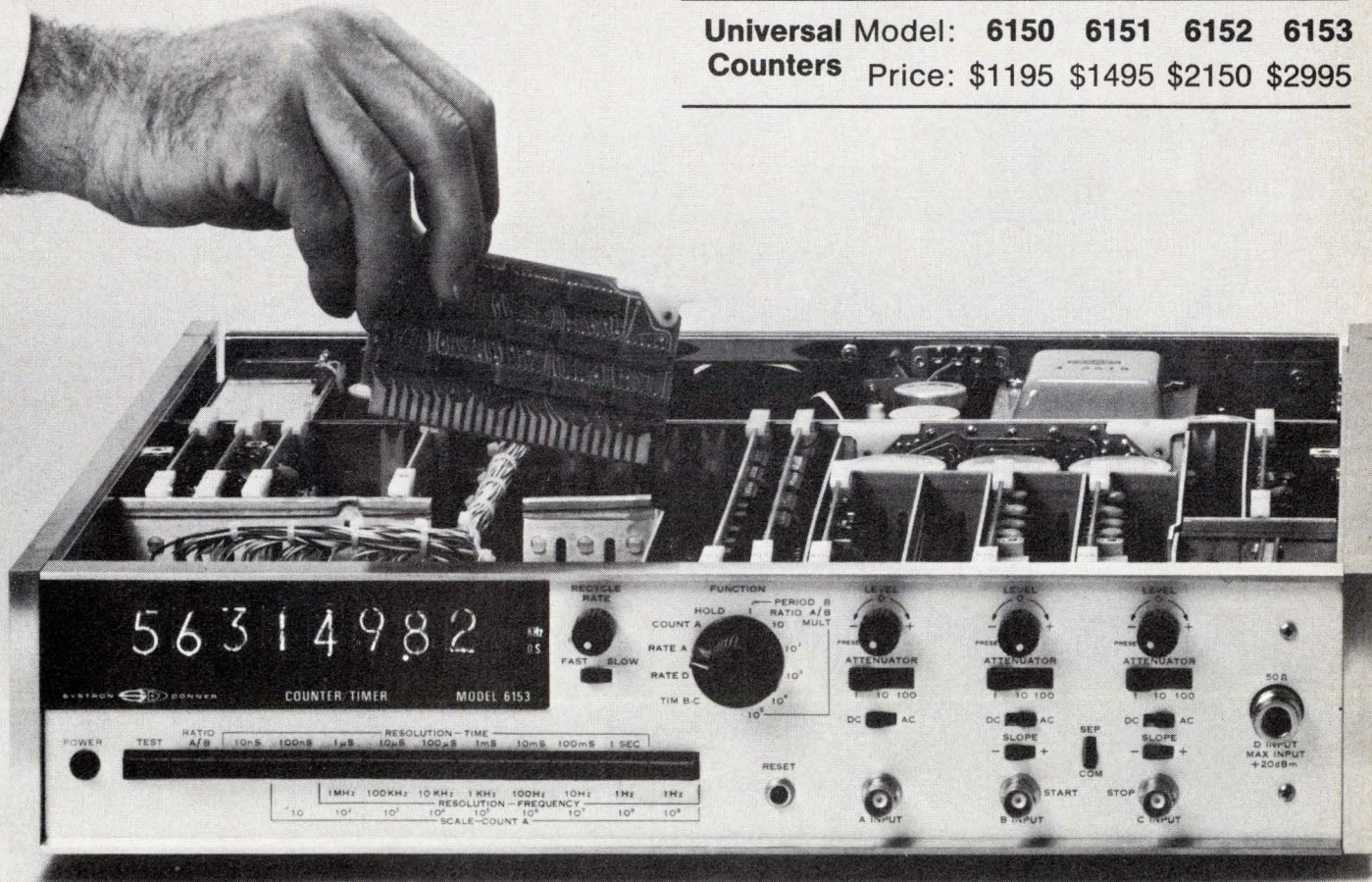

**SYSTRON**  **DONNER**

Concord Instruments Division, 888 Galindo Street, Concord, CA 94520. Phone: (415) 682-6161

Circle 53 on reader service card

**Reliability is a single-sided frame,  
a ball and a cricket room.**

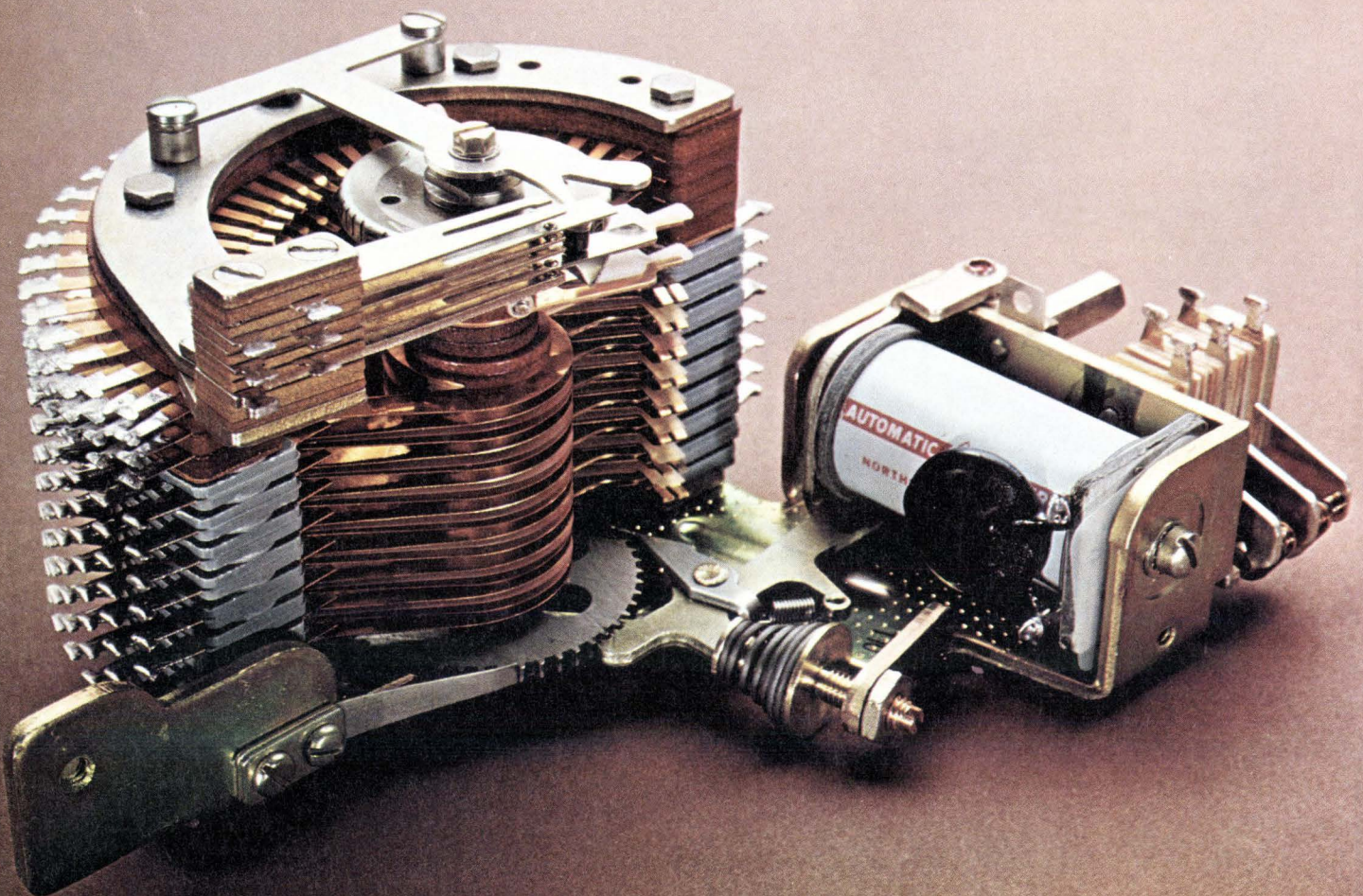



Our Type 45 rotary stepping switch is made to be forgotten. We build them to work hard, fast and long without constant fiddling or adjusting. They've got to be able to work in heat or cold, take bumps and grinds and still click-click along with close-spaced consecutive operations.

**We start out really flat** To keep everything on the level we start our assembly with an open-type, one-piece frame. Thick and really flat. Some manufacturers use two thinner frames. But we found that starting with a single thick frame eliminates problems of matching the switch parts. Everything stays in line. And a single-sided frame takes a lot less room—the switch is only as wide as need be.

**A lube job that lasts a lifetime** The entire wiper assembly rotates on a large-diameter stainless steel shaft around a full-length hub bearing. We lubricate this bearing and seal it during assembly. So throw away the oil can.

**Then we supply a pinch that's just right** Each pair of wipers is tension-adjusted during assembly. As they click around the bank levels on a flat plane, we want each pair to pinch the contact just the right amount. Too hard a pinch and the contacts will wear out quickly. Too soft a pinch will cause a poor connection. We teach our wipers to pinch just right.

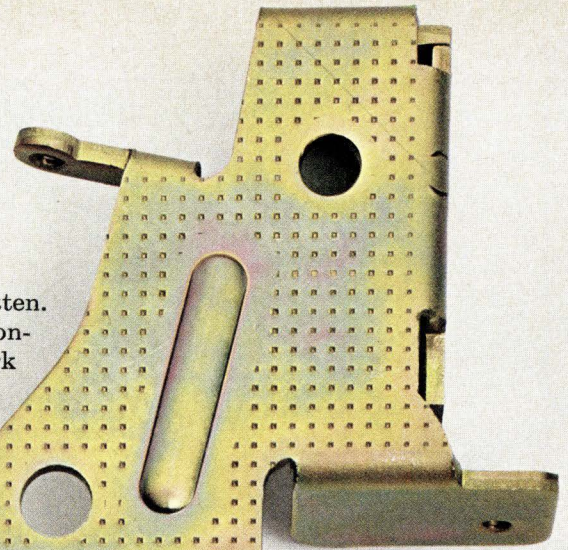
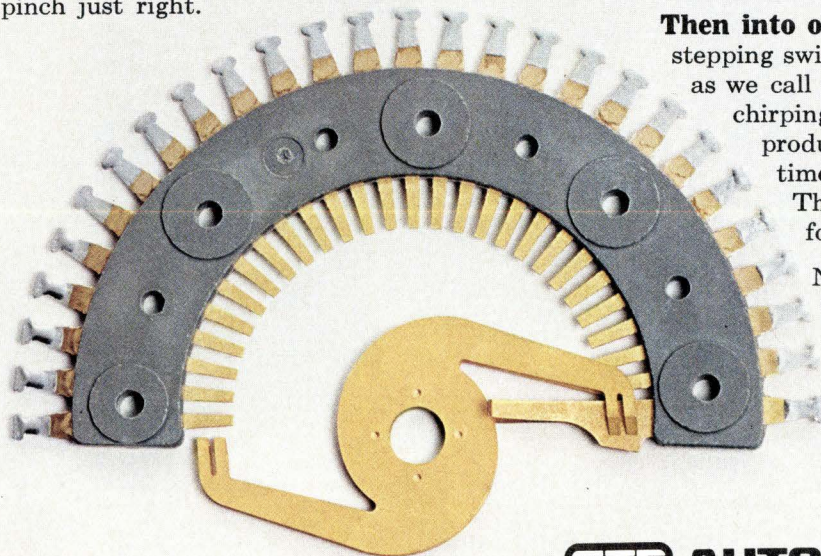

**Then comes our big wheel** The entire wiper assembly is turned by the ratchet wheel. It's big and it's strong and it has 52 flat case-hardened teeth. Why flat teeth? So when they mesh with the teeth on the ratchet wheel they mesh tight. No banging, wiggling, or scraping. And as the teeth wear, they just mesh deeper in the grooves.

**Ball bearing anchor for good measure** The armature assembly has to be securely fastened to keep it from wiggling up and down, or everything goes out of whack. So we choose a big stainless steel pin and secure it with wide bearings to the armature yoke. To make sure this pin never slips out of the yoke, we drill a hole in both ends. Then we force a steel ball bearing into these holes. This expands the walls of the pin into and against the walls of the armature and the whole assembly is anchored for life. We're the only ones that do it this way. So we're the only ones that offer a lifetime fit.

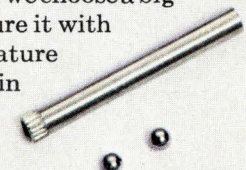

**Then into our cricket room** Every single AE stepping switch goes to the run-in test room. Or, as we call it, the cricket room, because of the chirping noise all the switches we're testing produce. Here, every switch is tested 50 times a second for 45,000 operations. Then, and only then, are they ready for delivery to our customers.

Now that we've explained all the little things we do to make our Type 45 reliable, put it through your own tests. GTE Automatic Electric, Industrial Sales Division, Northlake, Illinois 60164.

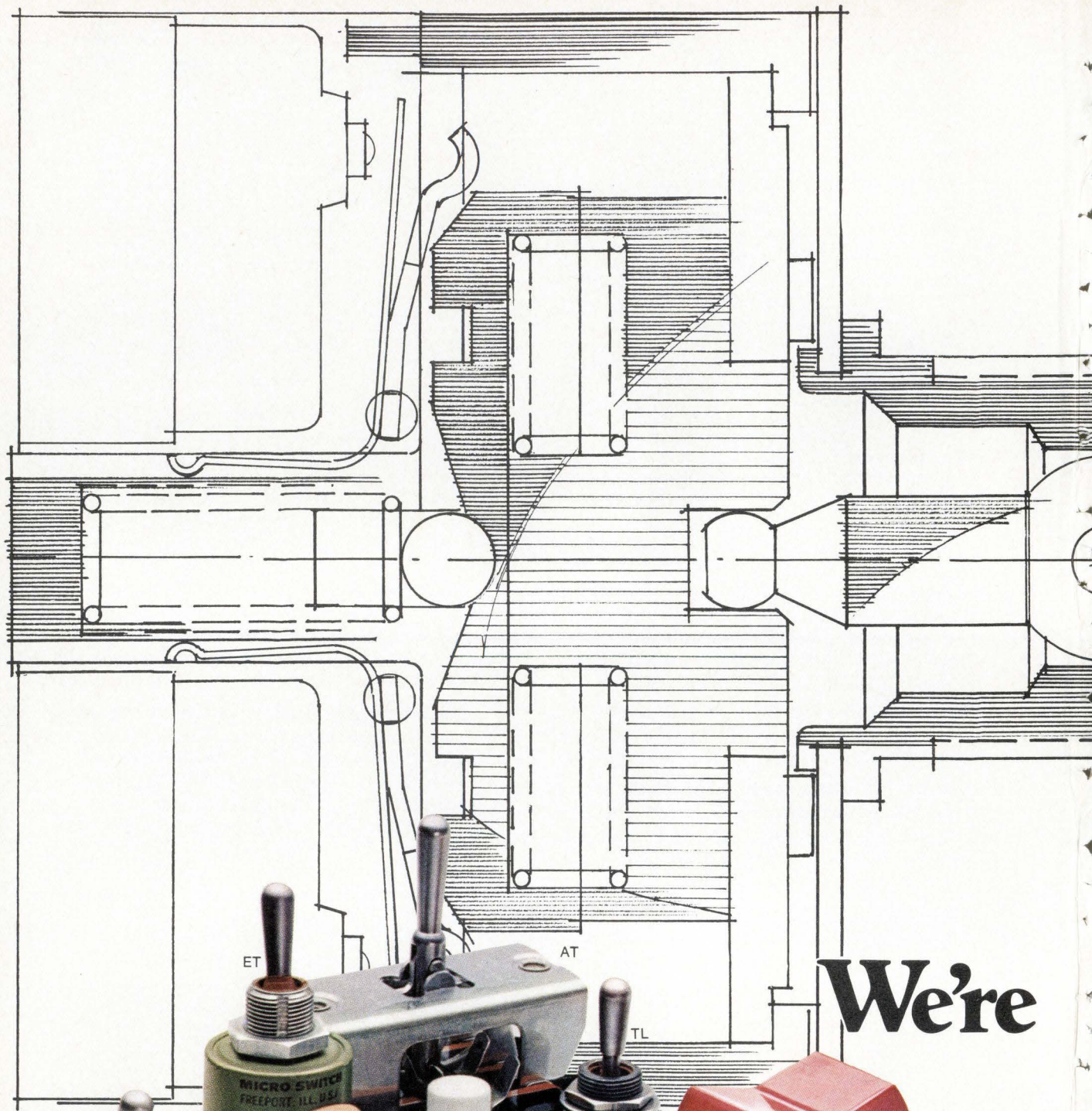

**We're**

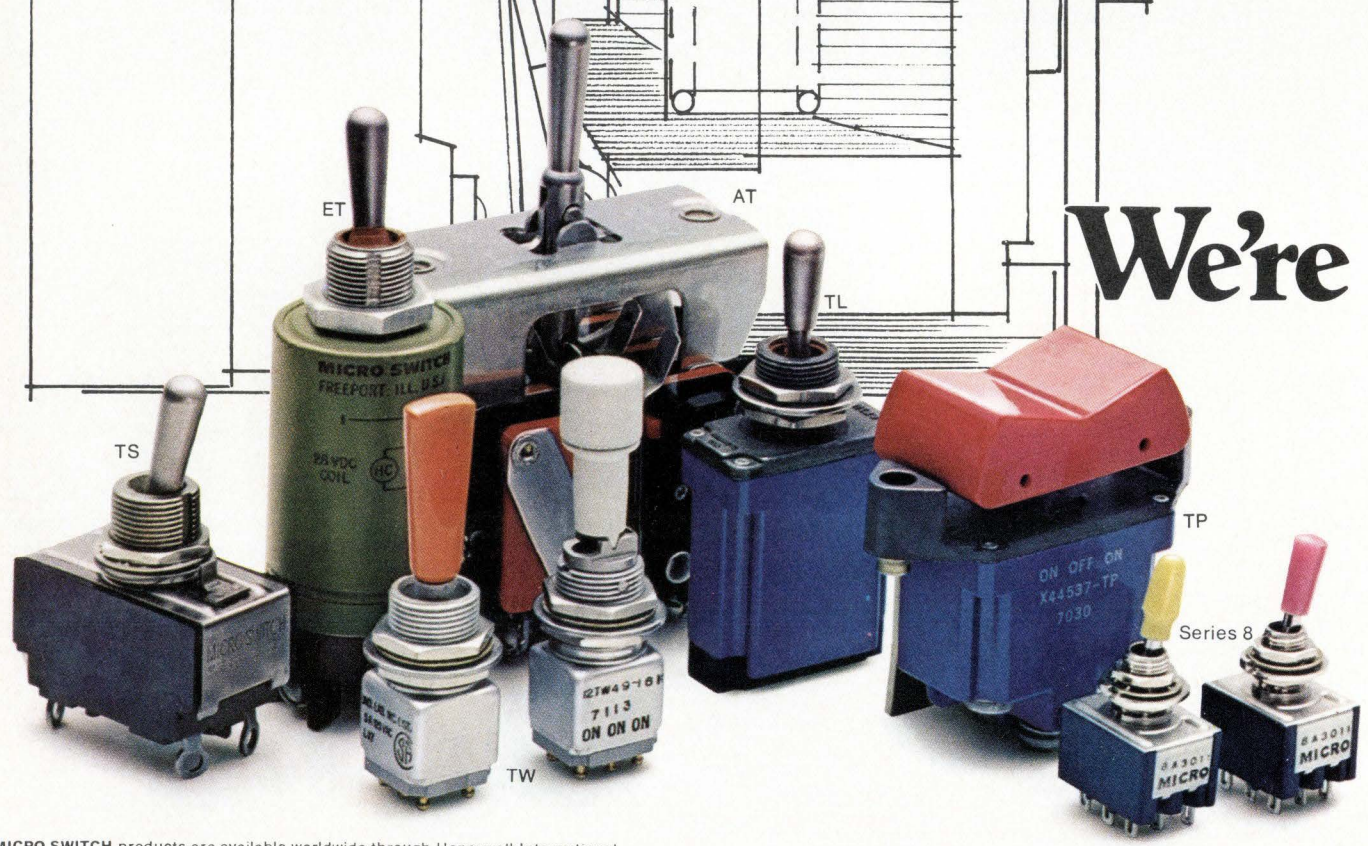

MICRO SWITCH products are available worldwide through Honeywell International.

**T**hink MICRO SWITCH when you're in the market for toggle switches. Because we offer one of the biggest selections in the world. With an almost limitless choice of size, circuitry, capacity and toggle action.

#### CHOICE NOT CHANCE.

If space is a problem, miniature TW's can provide versatility comparable to many larger switches. When cost is a problem, the new Series 8 features quality construction at a low cost. Standard-size TS toggles are excellent, moderately-priced switches available for both military and commercial use.

For environmental sealing, consider either the magnetically held ET (MIL-E-5272 and MIL-S-3950A) or the tough TL (MIL-S-3950A).

If you're looking for the versatility and styling of pushbuttons, but require toggle circuitry, take a long look at the TP or our new Series 8 rocker switches.

#### A CHOICE OF ASSEMBLIES, TOO.

AT toggle assemblies use snap-action switches to perform the switching operation. Up to twelve switches can be operated by one toggle. Choose from subminiature, high capacity, as well as sealed types.

There are plenty more. For information on any or all of them, see your MICRO SWITCH Branch Office or Authorized Distributor (Yellow Pages, "Switches, Electric"). Or write for our literature.

*MICRO SWITCH makes your ideas work.*

## **MICRO SWITCH**

FREEPORT, ILLINOIS 61032

A DIVISION OF HONEYWELL

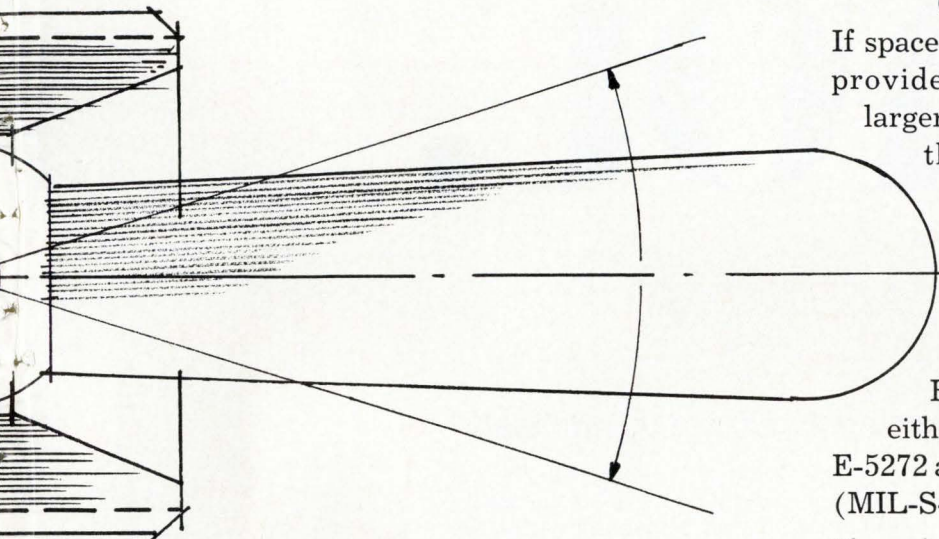

# big in toggle switches.

# NOBODY ASKED YOU.

## *Are you going to put up with that??*

There has always been a tendency for the test industry to design products, give them the "bally-hoo" treatment, then find someone to sell them to. We intend to reverse this trend by finding out what your needs are **before** we start designing. Instead of talking about our own function generators and pulsers, we're going to sit back and listen to you. We'll be at IEEE and other industry conventions, and we'll listen. You can phone in your gripes, and we'll listen. You know what you want, and we'll listen to what you have to say. The essential thing is to set us straight about what's really important to you.

The questionnaire on the facing page was designed to let you be frank, specific, and critical. By taking time to help us build a dialog that's **going somewhere for a change**, you will be benefitting not only yourself and IEC, but the entire industry. We'll stand by our promise to get back to you with a report on the results of this communication, and what we plan to do about it.

Now it's your move — if you want what's coming to you.

### **TAKE A COFFEE BREAK AND FILL US IN.**

**It will take you 1 cup of coffee to fill out the "sound-off" sheet on the following page, and for doing so IEC will send you this FREE COFFEE MUG.\* Or see IEC at IEEE, Booth 2633, and have your say. (We'll let you have the coffee mug, either way.)**

\*Quantities are limited! Forms will be acknowledged in the order they are received, and must be submitted by May 15, 1972. Offer limited to U.S.A.

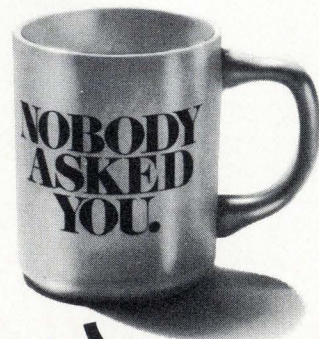

**You bet I've got something to say...**

**... about Function Generators**

- ( ) Who needs a function generator? My RC oscillator does everything that I need to do.
- ( ) I'm content with the function generators available today. Models that I like best are \_\_\_\_\_
- ( ) **Wide Frequency range** is ( ) extremely critical ( ) important ( ) not significant for my needs. The narrowest frequency range that I would consider for my requirements is \_\_\_\_\_ Hz to \_\_\_\_\_ MHz.
- ( ) **Output Voltage** is ( ) extremely critical ( ) important ( ) not significant for my needs. The narrowest voltage range I would consider for my requirements is \_\_\_\_\_ mv to \_\_\_\_\_ v into a \_\_\_\_\_ ohm load.
- The Function Generator waveforms that are important to me (order of importance) are:
- ( ) Square wave                      ( ) Triangular wave                      ( ) Sine wave
- ( ) Pulses                              ( ) Ramps                              ( ) \_\_\_\_\_
- I'm not sold on function generators. What bugs me most is \_\_\_\_\_

**... about Pulse Generators**

- Pulse repetition frequency range** is ( ) extremely critical ( ) important ( ) not significant for my needs. The narrowest PRF range that I would consider for my requirements is \_\_\_\_\_ Hz to \_\_\_\_\_ MHz.
- Rise/Fall Time** is ( ) extremely critical ( ) important ( ) not significant for my needs. The slowest rise/fall time that I would consider for my requirement is \_\_\_\_\_ ns.
- Pulse amplitude is ( ) extremely critical ( ) important ( ) not significant for my needs. The narrowest amplitude range that I would consider for my applications is \_\_\_\_\_ mv to \_\_\_\_\_ v into a \_\_\_\_\_ ohm load.
- The other Pulse Generator capabilities that are important to me (in order of importance) are:
- ( ) External Trigger                      ( ) Baseline Offset                      ( ) Adjustable Pulse delay
- ( ) Adjustable Rise/Fall Time                      ( ) Gated Output                      ( ) \_\_\_\_\_
- ( ) I'm not sold on Pulse generators. What bugs me most is \_\_\_\_\_

**... about Test Instruments in general**

- Unique applications that have developed in my use of test instruments include: \_\_\_\_\_
- My biggest gripe about test instrument manufacturers and their products are: \_\_\_\_\_
- But once in a while, you guys **do** do something right: like \_\_\_\_\_

NAME: \_\_\_\_\_

JOB TITLE: \_\_\_\_\_

COMPANY NAME: \_\_\_\_\_

ADDRESS: \_\_\_\_\_

CITY, STATE: \_\_\_\_\_



Mail to: "IEC SOUND-OFF,"  
P.O. Box 3117, Anaheim, California 92803  
(714) 772-2811

**OK. NOW SEND ME MY COFFEE CUP!**

Fluke problem solvers

# The New .005% 8300A DVM: Bare Bones, \$1195; 5 Ranges DC, \$1295; 5 Ranges DC & 5 Ranges of Ohms, \$1445



Remember the original great Fluke 8300A... the first reasonably priced 5½ digit high accuracy DVM ever offered.

Now, after two years' high production and plenty of time on the learning curve, we've come up with a whole new family of 8300A's with lower prices overall and package deal prices on the most popular configurations.

There's the basic 0.005% unit with three ranges of dc (10, 100, & 1000 volts). It's the 8300A-00. It sells for a miserly \$1195. If you need millivolt dc ranges (0.1 & 1.0 v) added, we'll give you the 8300A-10 for just \$1295. For a few dollars more we'll give you the 8300A-20 with five ranges of dc volts and five ranges of ohms for \$1445.

So here's your chance to get famous Fluke quality at new low prices. And because we use single mainframe

construction throughout, you can add all the other options to make a full bench multimeter or systems box in the field an option at a time, anytime.

And remember, only Fluke can use the patented recirculating remainder A-to-D conversion technique with up to five times fewer parts than comparable DVM's for greater reliability and the best MTBF in the industry.

So, if you're looking for a very fine 5 digit DVM with 0.005% accuracy, plenty of low cost options, including ac voltage, external reference (ratio), fully isolated outputs, remote programming and complete systems compatibility including timing signals and ready indicator at package deal prices, take advantage of Fluke's great new DVM deal right away. For details, call your nearest Fluke sales engineer today or contact us directly.

Fluke, Box 7428, Seattle, Washington 98133. Phone: (206) 774-2211. TWX: 910-449-2850/In Europe, address Fluke Nederland (N.V.), P. O. Box 5053, Tilburg, Holland. Phone: (04250) 70130. Telex: 884-52337/In the U. K., address Fluke International Corp., Garnett Close, Watford, WD2, 4TT. Phone: Watford, 33066. Telex: 934583.



# Technical articles

---

## **Special report: IEEE bends to the winds of change: p.62 (cover)**

New directions are being initiated by the IEEE leadership in response to members' discontent, reports Gerald M. Walker. See page 62.

Social problems are the focus of many IEEE technical sessions this year, writes Alfred Rosenblatt—and marketing techniques also rate discussion. See page 67.

Exhibits now are emphasizing applications, not components. Despite foreign defections, the number of exhibitors will probably be a respectable 400. See page 70.

The cover: The militancy of the IEEE's membership can be read into the Institute's arrow-in-circle symbol.

## **ICs shape up to current systems needs: p.78**

Off-the-shelf ICs were designed for yesterday's systems, and in today's context are often not very appropriate. Authors Richard Percival and Jerry Gray describe some new devices that take systems needs into account and that are generally more flexible and versatile than their predecessors. Counters with an edge-sensitive hold state and a combination D and J-K flip-flop are among the circuits discussed.

## **Digital-to-analog converters for the unconverted: p.84**

There's a lack of standardization in the manufacture of digital-to-analog converters that turns evaluating products from different makers—and even from the same maker—into a bothersome business. Understanding the rationale of the devices, though, allows the designer to make intelligent price/performance comparisons, and editor Harry R. Karp has worked out the best way of going about the analysis.

## **At last—a software-based inexpensive interface, the T-box: p.92**

Instead of costly hardware controllers, the peripheral devices linked to a mini-computer can use software-based T-boxes. And different peripherals can all use the same type of T-box, explain authors David H. Chung and Don B. Hay. In this situation, the processor takes over some of the normal controller functions.

## **And in the next issue . . .**

Principles of digital rf bandpass sampling . . . where isolation amplifiers can be very useful . . . quasi-millimeter-wave communications.

# SPECIAL REPORT



## IEEE at the crossroads: leaders ask directions

Beset by membership apathy and disunity, institute brass reappraises professional goals and tests feasibility of socio-economic action—but the extent of new programs hinges on how much members will pay

by Gerald M. Walker, *Consumer Editor*

□ There's a certain irony in an English-born Canadian assuming leadership of the Institute of Electrical and Electronics Engineers when the most pressing problems are U. S.-born. But President Robert H. Tanner, director of information for Bell-Northern Research in Ottawa, Ont., may just bring it off.

As Tanner, an expert in architectural acoustics, digs into his third month in office, it's clear that he's going to be a good listener. He and the rest of the leadership are trying to find out how the until-now silent majority of members in the six United States districts want the institute to proceed on socio-economic issues and hope that, for better or worse, the passive mass will speak up.

Both the militants who want sweeping changes in

goals to reflect the EE's professional interests and the conservatives who prefer the traditional technical information base were heard from during the political infighting that led to the eventual defeat of a controversial amendment to the IEEE constitution last fall. The outcome last November was close, but two-thirds majority was needed to pass. Although a record 36% of members voted, 64% chose to ignore the ballot. The amendment, generated by an unprecedented petition of members, would have changed the emphasis of the IEEE from a technical information center to a full-time career booster. (See "After Galindo, what?" p. 65) Approximately 18% voted for the change and 18% against, including the four non-U. S. districts. [*Electronics*, Jan. 31,





p. 29.] The strength of the pro ballots shook up the board of directors enough to cause them to recognize that something had to be done to move the creaking IEEE organization into new, broader activities.

The first outward sign of new life was a lengthy questionnaire mailed to U. S. members late last year. Its purpose was to find out what new activities, such as political action and pension plans, engineers want IEEE to pursue and, more important, to find out how much they are willing to pay to get these changes. As of a month ago, more than 50,000 returns were in—more than the combined total of ballots on the constitutional amendment—indicating that the moribund members are at last deciding that IEEE is something more than a motherly dispenser of technical publications.

In some respects Tanner and company are not waiting for the final results to begin tooling the institute's ponderous machinery for new tasks. Tanner has the optimistic vigor of a Canadian, but retains the cool of an Englishman that will serve him well as he tiptoes through the political spectrum represented on his board of directors. Although moves initiated by the national headquarters have been flavored with caution, nonetheless, they represent significant new directions. At the same time, Tanner is quick to reassure everyone that the goal is to broaden, not alter, the technical information function of IEEE.

### Service is aim

"More than ever, our abiding philosophy is to serve the needs of the members," Tanner affirms. "This means maintaining technical activities at a high level and doing whatever we can to help the under-employment and unemployment situation. Other agencies far bigger than IEEE are saying they cannot pull jobs out of the air. This is going to be a complex task."

Besides the poll of U. S. members, headquarters has taken other steps with potentially far-reaching implications. These include:

- A change in by-laws to permit individual districts to carry out district-level programs paid for by special assessments of the district, but monitored by the board.
- Formation of the U. S. activities committee by the six regional directors.
- Establishment of an IEEE office in Washington, to be headed by Dr. Ralph Clark, a chairman of the Joint Technical Activities Council.
- Set up of local offices in Los Angeles and Toronto, reporting directly to New York headquarters, to communicate directly with members.
- An intellectual effort by a special committee to define the purposes of the IEEE in today's environment.

This last activity may or may not lead to an amend-

## Tanner answers gripes

Some complaints about the IEEE have been around almost as long as the society. Here are a few of the better-known criticisms and responses from IEEE President Tanner.

*Complaint 1. The IEEE is too company-oriented—at the expense of individual members.*

Reply: "This is mentioned over and over, but anyone who looks at the organization and sees the trouble we go through to serve members and how little formal contact we have with industry would realize this is nonsense. In fact, we have found a need to increase company management's awareness of the institute to improve understanding of its value to engineers."

*Complaint 2. The IEEE is too academically oriented, too ivory-tower.*

Reply: "We are an educational institute and research-oriented, but the the number of academics on the board of directors is only about five out of 28, which is not excessive. We welcome the participation of academic members, for it gives us a window on the universities to find out what is currently being taught. On the other hand, the academic members also pick up experience about industry."

*Complaint 3. IEEE does not communicate with grass-roots members adequately.*

Reply: "I don't see how we could make the channels of communication any shorter. Every member can reach headquarters either through the local section chairman or through his specialty group president. Both sources lead back to the board. However, this communication is like the telephone—it's there, but you have to pick it up to use it."

*Complaint 4. The IEEE has not done enough to get the engineer's contributions to society recognized by the outside world.*

Reply: "This is true for one major reason. After studying what it would take to mount an effective public relations program to the media, we found it would be too costly. But it is not a dead issue. A lot of institute activities have been overlooked by the press and television, so public relations has got to be in two stages—first, convince the media that the engineer is newsworthy, and then get coverage. There was lots of interest in stories about out-of-work engineers, but when we announce something more constructive, it's not deemed news by the media."

ment to change the constitution. The leadership is trying to establish whether or not these plans are within the boundaries of the constitution, and, if not, how the boundaries should be changed. The important first step was loosening constraints on the regions to act independently on local programs, which essentially means con-



## SPECIAL REPORT



centrating on unemployment assistance. It also means that the six U. S. districts can band together for a national project, such as retraining, without ruffling the feathers of Canadians and Europeans because these efforts will be paid for by the participating regions.

The office in Washington reflects the complexity of political involvement by a group such as the IEEE and, to a degree, acknowledges that combined efforts by united engineering groups cannot satisfy all the demands of individual participants. James H. Mulligan Jr., the energetic immediate past president, believed in linking arms with other engineering organizations to influence Washington on the socio-economic issues and was instrumental in getting seven societies into a joint effort to prod the Government to action on engineering unemployment programs.

As Donald Fink, IEEE's affable general manager, explains, "We have more to gain by banding together and little to lose. Joint action tends to make us visible."

### Pooling Sought

"The idea was to pool capabilities so that we don't have to duplicate some program that another engineering organization is doing," he adds. For example, the National Society of Professional Engineers, a long-time Governmental activist, has become the lobbying arm for IEEE. And Fink feels that the joint effort has paid off in the Nixon Administration's apparent interest in funding more research and development. Still there are special subjects that IEEE wants to attack through its own Washington office.

First, Tanner stoutly maintains that this will not be a lobbying operation. The objective is to provide a two-way channel of information on technical matters between the institute and influential members of Congress, as well as Federal agencies. Nor will this office concentrate on unemployment, though its activities could have an indirect effect on hiring more EEs. An example of its activities might be a Federal program to monitor environmental pollution. The Washington representative would make sure that experts recruited by IEEE provide technical information to the congressmen preparing legislation or funding for the program. These experts might also testify at hearings so that nontechnical lawmakers and bureaucrats recognize the technical consequences of their decisions. The Washington office will also feed back information to members concerning the impact of Government projects on EE jobs.

The offices in Los Angeles and Toronto are also information-gathering centers reporting to headquarters. Headed by Jerry Goldenstern and George Armitage, respectively, these field locales are part of Tanner's grass-

### After Galindo, what?

Embittered by the defeat of the constitutional amendment that he helped put before the membership last year and pessimistic about the future of EEs, Dr. Victor Galindo has not given up his cause. At the beginning of the year, he moved from TRW Systems group in Redondo Beach, Calif., to a professor's chair at Virginia Polytechnic Institute, Blackburg, Va., to fulfill a long-time desire to teach.

The proposed amendment called for two objectives—"the primary purpose of the IEEE," it stated, would be "to promote and improve the economic well-being of the membership." The second purpose would be "scientific, literary, and educational."

He feels that the so-called Galindo amendment should have passed. But because of a combination of political naïveté on his part and outright hostility by some on the board of directors, the membership did not get a clear understanding of what the vote was all about, he contends.

Now Galindo says that he'll be back—if not in the front row, at least somewhere—in the effort to revive the amendment. "I'm really a very poor politician," he confides, "but I've learned a lot from this experience. It is possible to start another petition for an amendment, and this time I would see that the proposal is worded more cleverly than the last one. I've also learned that it's impossible to work with a reluctant board—some support on the board is needed."

He admits that the wording of the amendment was a political mistake because it was so easily misinterpreted, but does not forego the intent of the amendment. "In light of the board's condemnation in 1970 of political action for IEEE, I felt the strong wording of the amendment was valid to push the board in 1971. This hurt us because some chose to interpret the amendment wording, 'the primary purpose,' to mean a reduction in the technical functions. This was not intended, and to interpret it otherwise was dishonest."

Galindo denies that the amendment was a bluff to shake up the leadership. "The intention was to have it passed," he states. "Many were surprised that it did not pass, for it wouldn't have done any harm."

Now the IEEE militant has another shakeup for consideration by the society. He believes that there should be a change in the way the board members are nominated and elected. Galindo is thinking of offering an amendment that would make it impossible for a current board member to nominate new members because the process tends to perpetuate leadership of like thinking.

This concept may not sound like the best way to win needed friends on the board, but some now serving supported the first Galindo amendment and may be inclined to help give him another day in court.—GMW

roots movement. Other field offices will be opened elsewhere if the two experimental stations are successful in getting members to communicate more effectively.

But as in everything else, you don't get something for nothing, which is part of IEEE's current dilemma. Invariably members need a society most when times are hardest. As a consequence, the technical and socio-economic programs already voted by the board of directors have put the society into a deficit for this year. At

the same time, membership has leveled, and operating costs have risen. Student memberships are down nationwide by 8 to 10%. Equally ominous, freshman EE enrollment at 79 engineering schools is off by 11%, a decline that may come to haunt IEEE membership in two or three years. There is little doubt that these factors spell a dues increase, just when many IEEE members are questioning if they are getting enough for their money.

### Dues draw gripes

Judging from the reactions from some members, higher dues will not be accepted easily. Complains Egon Loebner, department head of the special projects section of the Hewlett-Packard Co. Solid State Laboratory, Palo Alto, Calif.: "There's no inflow of new, younger members. The organization has grown old and is experiencing hardening of the arteries." An active member for nearly 20 years, he adds that, although IEEE "has lots of money," it has not apportioned it properly.

Loebner would like to see the dues structure altered so that payments would depend on ability to pay and type of services rendered to the individual. For some members, the cost of even the traditional services of IEEE—publications and technical meetings—seems inordinately high, despite their consistently high standards. One of the dissenters is Dr. Stephen K. Burns, associate professor of electrical engineering at Massachusetts Institute of Technology, who admits he is in the IEEE solely for access to the journals and meetings. Burns has been in, out, and back again as a member. Now chairman of the Boston chapter of the Professional Group on Electronics in Medicine and Biology, he doubts the value of IEEE as a political action group.

### Activism advocated

By contrast, Carl Kramer, sales manager for Hybrid Systems, Inc., Burlington, Mass., a 13-year member, believes that the functions of information center and career booster go hand-in-hand. Though uncertain about what specific activities IEEE should pursue, Kramer plans to remain a member "because I think it will change and become more politically active as it should have been years ago." He would like to see more "commenting on the value of things" and thinks the society should be more critical of Government spending plans.

While the national organization agonizes over new programs, local sections feel less constrained. The Long Island section, for example, is ahead of the national membership in its move toward socio-economic programs. This section has increased membership, despite the hard times for Long Island's electronics firms, and has initiated meetings devoted to career issues. Last year the group invited all the congressional candidates from the area to address the members on what can be done in Washington to help Long Island engineers.

Though section chairman Joel Snyder, an engineering consultant for the last nine years, continues to work from within IEEE, he is becoming more militant. "I wouldn't mind having the six U. S. districts split off to form a U. S. society of EEs that would be an affiliate of IEEE," he states. "That way, the national group would be responsible for ethical and professional standards of U. S. members, and the international group could con-



**North of the border.** Canadian Robert H. Tanner, IEEE president, feels he can cope with U.S. problems—if members will help.

centrate solely on technical information."

Snyder contends that Tanner is the ideal president to accomplish this split, since as a Canadian he cannot be accused of "taking the U. S. out of IEEE." Part of the reason for a separate U. S. organization would be to oversee the quality of EEs. "Let's face reality," he observes, "there's a surplus of engineers, and the only way we're going to keep everyone employed is to insist on qualifications. I'm not advocating control of the number of engineers—only control the standards of education. There should be an IEEE seal of accreditation on courses and rules of acceptance at schools. What we don't need is more poor engineers," Snyder emphasizes.

### Apathy cited

Despite this section's success at handling both technical and political programs, it shares with the rest of IEEE the frustration of dealing with apathetic members. "It's difficult to respond to members who don't surface," complains New York section chairman Alexander Kohan, an engineering manager for American Telephone & Telegraph Co., New York. "Our biggest problem is to generate enough interest to make members active. If a member comes forward and makes noise, his participation will give him an outlet to get results. We can't do much with people who deride the whole operation from the sidelines with no alternatives to add," he frets.

Disagreeing, Robert McClure, a 20-year member and chairman of the board of Telpar Inc., Dallas, contends that many members aren't apathetic, just frustrated.

**Meditating militant.** Career activities have been too slow in coming, VPI Prof. Victor Galindo charges. He wants IEEE to change now.

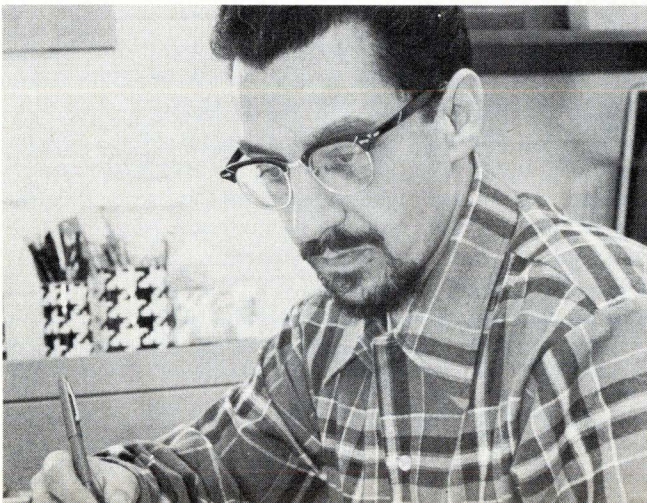

## SPECIAL REPORT



"IEEE has had essentially no value to most of its members, but we're coming to a crossroads," he comments. "The survival of the profession literally dictates that IEEE will have to adopt a more activist posture, such as the approach taken by the American Bar Association, the American Medical Association, and the American Institute of Certified Public Accountants. These organizations not only serve as a medium of communication within the profession, but control the value of their people by controlling the supply part of the supply and demand curve. They make a code of ethics binding upon their memberships, with violation leading to possible expulsion. The IEEE must develop this right to speak for its members on a wide variety of issues and should not be afraid to take controversial positions," McClure contends.

Many members do not agree with these sentiments,

however. A Midwestern member echoes the feelings of this segment of IEEE opinion, warning, "A politically oriented society with an apathetic membership letting the leaders speak for everyone is dangerous." Pointing to the activities of labor unions and the AMA, he adds, "Such organizations could put the interests of members above those of the rest of the country. I prefer to protect myself on an individual basis."

All of this turmoil indicates that the situation is fluid, but the betting is that an overwhelming majority of members will favor socio-economic activities and a more politically oriented organization. However, there is a gap between finding the will of the majority and implementing it, with strong inertial forces acting against immediate changes.

Acting against the forces of inertia is soft-spoken president Tanner, who early on set a fast tempo for his tenure at the top of the organization. In one eight-day stretch he had direct contact with 17 different IEEE groups. It's also apparent that he has made himself available to discuss local problems by phone at any time the caller can find him in his office. The question is, can a Canadian actually handle the U. S. problem?

"I find it an advantage," says Tanner. "When speaking to Washington officials I'm neutral in U. S. politics, so they listen." Turning on his ever-present dry wit, Tanner smiles, "It worries me that the Canadians may think I've deserted them." □

---

# IEEE to consider application of technology to society's ills

---

Intercon '72 schedules discussion on civil problems and marketing, as well as an upgrading of presentations for the technical sessions, with time set aside for give-and-take with the speakers

---

by Alfred Rosenblatt, *New York bureau manager*

□ Responding to the criticism that engineers should do more to combat technology's unhappy side-effects—and harness it for social good—the technical program committee has focused a significant portion of Intercon '72 sessions on the myriad problems that technology has either caused or could help cure. More than a dozen of the 79 sessions in the technical program fall in this category—dealing with subjects such as the ecology, urban planning, education, law, and public health.

However, more than three dozen sessions will concentrate in five conventional technical areas—communications, computer technology, transportation, automated testing, and microwave systems. And to help members promote sales, the program presents a half-dozen sessions dealing with the marketing problems confronting electronics industries executives.

As in previous years, the technical program is divided

into two parts—a 55-session "technical" section at the New York Hilton Hotel, and a 24-session "applications" section at the New York Coliseum, where the exhibits are housed.

However, an unusual feature this time around is that scheduling only three prepared papers for most of the 2½-hour sessions at the Hilton allows at least an hour for a panel-type discussion in which speakers may question each other and accept questions from the floor. The aim is to promote informal contact among those attending the meetings—à la the smaller special-focus technical conferences such as last month's International Solid State Circuits Conference.

As for the quality of the papers, which at past IEEE shows have been noted for once-over-lightly approaches to their subjects, there's been a conscious effort to upgrade them. "We wanted 'real' technology, so we asked

the IEEE's professional groups to help organize the sessions," says J.L. Jatlow, chairman of the technical program committee. "The result is that we have the advanced papers usually reserved for the groups' meetings."

Also associated with the Intercon '72 program will be a special two-day symposium at the Americana Hotel on "Engineering in the Hospital," featuring a paper by consumer advocate Ralph Nader on problems of working with medical electronic equipment, and five one-day courses on circuit design and network analysis subjects, offered at IEEE's New York headquarters.

### Priority shift

By devoting so much of its technical program to environmental problems, the IEEE is, of course, acknowledging the shift in national priorities away from the science and technology of recent years. More to the point, however, the organization is also reacting to the decrease in the number of jobs available for electronics engineers.

What is learned at the convention will, Jatlow hopes, "broaden the engineer's perspective" and encourage him to pursue a career in one of the new types of industries. A worthwhile hope, certainly; but industry observers say there is little evidence that this application of EES to other fields will occur very rapidly.

Civilization's situation vis-a-vis its environment will be presented at Intercon '72's highlight session, "Ecology—Problems and a Technical Approach to Solution," on Tuesday evening at the New York Hilton. Speakers from the U. S. Environmental Protection Agency and the United Nations Conference on the Human Environment will explore the problems faced in this country and abroad. And at least one solution will be suggested when E.M. Bradburd, of ITT, proposes "A Plan for a Nonprofit Environmental Control Engineering Corporation."

Also in a problem-discussion mood will be session 6E, "Technological Effects on Society—an Open Forum," on Wednesday afternoon at the New York Hilton. And how engineers might consider the role they play in society will be discussed by Steven H. Unger, a professor of electrical engineering at Columbia University, in "Personal Responsibility of Engineers for Their Work." In a like vein, session 2C, "Philosophy of Electrical and Electronic Technology," on Monday afternoon at the Hilton, will be devoted to a discussion on how concern about social impact might be incorporated into a "philosophy of technology." Featured on the panel will be Dennis Gabor, the Nobel prize winner in physics.

Considerable attention is also paid in the technical program to the field of communications. Eight sessions will be devoted solely to this topic, including land-mobile and satellite communications, together with community antenna television systems. Some of the program's most celebrated participants will be at session 2A, "CATV—What's Happening?" on Monday afternoon at the Hilton. Federal Communications Commission chairman Dean Burch will consider the effects of Federal regulation on the growth of the CATV industry.

At the session, the president of Comsat Corp., Joseph V. Charyk, will discuss a proposed system for setting up a CATV network via satellite. Peter C. Goldmark, vet-

eran electronics inventor and president of Goldmark Communications Corp., will describe how a combination of satellites and community television could lead to a deurbanization of the nation and "The New Rural Society." Also speaking at the session will be representatives from two commercial CATV organizations, Computer Television Corp. and TelePrompTer Corp.

The system techniques to be applied to the 900-megahertz band recently assigned to land-mobile services by the FCC will be discussed by a panel at session 6A, "900 MHz—A New Horizon in Land-Mobile Communications," on Wednesday afternoon at the Hilton.

Another panel (session 3F, "Telecommunications Policy and Society—a Case Study, Data Networks of the Future") Tuesday morning at the Hilton will examine the impact on society of future communications systems. Panelists include representatives from the White House Office of Telecommunications Policy and AT&T.

Other communications-oriented sessions will include 4F, "Looking Ahead at Data Communications in Canada and United States," and 4G, "Regional Satellite Communications Systems," on Tuesday afternoon at the Hilton, and 5E, "New Areas in Communications" on Wednesday morning.

The application of circuit-design techniques to communications systems will also be considered. Session 3H, "Precision Hybrid Microelectronics in Telecommunications and Instrumentation," on Tuesday morning at the Hilton, will be concerned with the use of thin-and thick-film circuits, and session 7CJ, "Application of Microwave Technology to Today's Communication Systems," on Thursday morning at the Coliseum, will review microwave advances.

The opening session Monday morning at the Hilton will detail examples of memory hierarchies and how

**Notables.** Joseph V. Charyk, left, president of the Communications Satellite Corp., and Dean Burch, chairman of the Federal Communications Commission sit down Monday afternoon, March 20, at session 2A to discuss: "CATV—What's Happening?" At the same time, Nobel prize winner Dennis Gabor, bottom, will participate in session 2C: "Philosophy of Electrical and Electronic Technology."

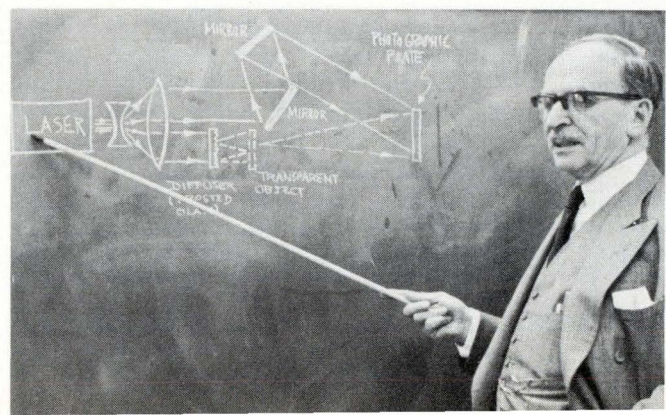
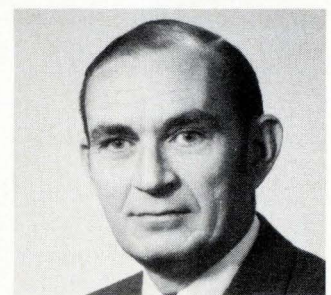

## SPECIAL REPORT



their performance can be measured and adjusted. The gamut of mass memories will be covered in session 3C, "Large Capacity Storage—Users and Technology," on Tuesday morning at the Hilton. Starting with a discussion of user requirements by an IBM man, speakers will go on to describe new systems being developed. These include a laser recorder memory from Precision Instrument Co., a holographic memory from RCA Laboratories, the Masstape magnetic memory from Grumman Data Systems Corp., and an optical disk memory from Ovonic Memories, Inc. Computer technology will be covered in roughly nine sessions altogether, with memory technology getting particularly close scrutiny. Session 5A, "Main Memory Technologies Through the '70s," on Wednesday morning at the Hilton, will present an overview by industry spokesmen.

### Computer conflict

In an unfortunate program conflict, a second session concerned with computer technology has been scheduled for the same time. Session 5F, "Trends in Computer Hardware," deals with what the next five years will bring in that area. Among the speakers will be Robert Noyce, president of Intel Corp., who will discuss trends in semiconductors, and K.H. Olsen, of Digital Equipment Corp., who will outline trends for small systems.

Memory devices and systems applied to current computer designs will be discussed in session 6CI, "Memory Devices and Systems Applied," on Wednesday afternoon at the Coliseum.

And some of the general problems facing system designers applying MOS technology will be covered in still another session, 4CI, "MOS User Problems," on Tuesday afternoon at the Coliseum. For example, Evelyn Berezin, president of Redactron Corp., will tackle things headon with her paper, "How to Jump into MOS Without Drowning."

Session 7C, "A Multistream Computer Architecture for Large Systems," on Thursday morning at the Hilton, will be devoted to examining ways to arrange processors, high-speed memories, and peripheral equipment in different approaches to large systems.

Minicomputers and peripheral gear will be tackled at three applications-oriented sessions at the Coliseum. Session 3CH, "Matching Minicomputers and Peripherals" on Tuesday morning, is concerned with how minicomputers can be matched to available peripherals and how a simple processor may be used as an interface. Session 4CH, "Applications of Minicomputers to Industry," on Tuesday afternoon, will be devoted to several specific applications of the small machines—to commu-

nications, signal processing, and computer-aided design. There also will be an evaluation, by a system engineer from Foxboro Co., of software for industrial applications.

And finally, at session 5CK, "Advanced Instrumentation—the Built-in Computer," on Wednesday morning, speakers will tell how computers can be applied to extracting data in measurement applications.

A sampling of the session titles in the applications-oriented portion of the program at the Coliseum speaks for the coverage. Session 2CK, "Introduction of New Products—Coordinated Approach for the Marketing-Engineering-Manufacturing Interface" will lead things off on Monday afternoon. Tuesday morning, session 3CJ, will tell "How to Build a Marketing Organization." Session 5CJ, "Communication Techniques in Marketing," on Wednesday morning, will be devoted to advertising and public relations, and session 6CJ, "International Marketing," is to follow in the afternoon.

For the engineers working on controlling rapid-transit vehicles or who are interested in what's happening with aircraft landing systems, the program organizers have included session 3B, "Automatic Controls in Transportation" on Tuesday morning. Other presentations will include a Sperry Rand Corp. representative describing a street traffic control system for Washington D.C.

### Microwave technology

Design of microwave system components also gets a fair share of session time. Session 6B, "Advanced Ferrite Components for Reliable Microwave Systems," on Wednesday afternoon at the Hilton, will feature ferrite materials and devices. At session 7B, "Advances in Microwave Solid-State Amplifiers," the following morning, C- and X-band solid-state amplifiers will be examined.

Over at the Coliseum, microwave integrated circuits will get a thorough overview at session 5CI on Wednesday morning. Subjects include lumped versus distributed microwave ICs, stripline, and packaging of ICs for system applications. Other system applications will be handled in session 6CK, "Microwave Technology in Transportation Systems."

Automated testing enthusiasts will have three applications sessions to choose from at the Coliseum—session 5CH on Wednesday morning will deal with "The Economics of Automatic Testing," and session 6CH in the afternoon with "Testing Digital Modules." The precise adjustment of hybrid electronic circuitry will be examined in session 7CI,—"The Art and Science of Hybrid Electronic Circuit Processing and Testing," on Thursday morning.

Some individual subjects may tickle the convention-goer's fancy. Consider, for example, these sessions at the Coliseum: 2CH, "Tooling Along with Lasers," on Monday afternoon; 3CI, "Optoelectronic devices—Problems and Pitfalls," the following morning; and 4CK, "Integrated Circuits for Electronic Power System Applications," on Tuesday afternoon. And at the Hilton on Monday morning will be the first IEEE session ever to have been organized with the help of a Russian scientist. It's session 1E, "Control of Large Power Systems in the U.S.S.R. and U.S."

# Show spotlights pervasiveness of electronics in all industries

Number of companies exhibiting is down 15% from 1971 total, but IEEE managers see this as bottoming-out year for show; optimism is spurred by emerging applications of technology

□ One of the biggest off-Broadway productions every year is the IEEE International Convention and Exposition, which opens March 20 at the New York Coliseum for its 1972 four-day run.

But it won't be as big as in 1971, when 35,228 visitors ambled through the Coliseum. And it will be nowhere near the peak year, 1962, when 74,734 persons sampled the products of 1,307 exhibitors. This year the show managers hope to welcome 30,000 patrons to the exhibits of 400 companies, 15% fewer than in 1971.

Still, IEEE officials are optimistic. "We think we've bottomed out, and we'll pick up at an even greater rate than the industry itself," says William J. Hilty, IEEE's director of convention and publishing services. "We would have been in good shape this year if not for the drop in overseas exhibitors."

Hilty and Joseph M. Doblmeier, exposition manager, attribute the defection of foreign exhibitors—there will be only 25 this year, compared to 90 in 1971—to the import surcharge imposed Aug. 15 by President Nixon, one effect of which was to muddy the competitive situation here of electronics made abroad. The November announcement removing the surcharge and effectively devaluing the dollar, came too late for foreign companies to change their minds.

"The show lags behind industry trends by about six months," explains Doblmeier, who expects the improvement in the industry's health to be fully reflected in next year's show. "But even this year we're getting some last-minute decisions to expand exhibit space," he says.

Another barometer that buoys the outlook of IEEE managers is the volume of exhibitor cancellations. In 1971, they got hit with nearly 50. This year, the total was about 10, one month before showtime. "And

they're not principally for economic reasons," says Doblmeier, "but because of imminent mergers, reorganizations, or product lines not being ready."

The IEEE is not looking for the attendance and exhibitor curves to swing upward to the peaks of the 1960s. "It's a different industry now—and it's a different world," says Hilty. "There are many more defined specialties in the industry now, and electronics no longer sells to itself on the scale that it once did." The pervasiveness of the electronics technology is reflected in the institute's listing of electronic applications areas in its exhibit prospectus: they include appliances, chemicals, communications, medicine, manufacturing, optics, and transportation, as well as the traditional ones.

## The tradeoff: cost versus exposure

Instruments—in the broadest sense—are recognized as the solid base of the IEEE exposition, and Hewlett-Packard Co. expanded its exhibit this year after cutting back in 1971. "We have a lot more new products, and are looking for media exposure," says Robert Boniface, vice president of marketing.

Another instrument maker—E-H Research Laboratories of Oakland, Calif.—finds that the IEEE Show has decreased in importance. "Five years ago if you weren't exhibiting, people would have assumed you had gone out of business. Now, they just notice you're not there," says Larry Hahn, a marketing manager. He sees a trend away from the big shows: "People are weighing the expense versus what you get back, and often finding it's not worth it." Nonetheless, E-H continues to exhibit at IEEE and Wescon because, says Hahn, "we hope it will help us, but it's a gamble."

The high cost has already discouraged Ballantine



## SPECIAL REPORT



### It's a buyer's market

Recruitment activities will be permitted at this year's IEEE Show, but that doesn't mean a return to the "flesh-peddling" that led to a recruitment ban in the 1960s.

The decision by the IEEE executive committee to allow posting of jobs-available notices was accompanied by restrictions. The move is "temporary." The recruitment must be done "with professional and ethical standards approved in advance." And it can be done by "reputable" personnel agencies as well as by companies and institutions. The bulletin boards will be in the outer registration lobbies at both the Coliseum and the New York Hilton.

Also in recognition of the job shrinkage, IEEE members who are unemployed may attend without paying a fee. This policy was begun last year.

Laboratories, Boonton, N.J. "It's strictly a value tradeoff," says president Fred Katzmann. "If IEEE were cheaper, it might become more attractive."

The sales manager of Wavetek Inc., San Diego, thinks this may be the company's last year at IEEE. "It just doesn't pay off for us," says Thomas G. Kurtz. "More and more it's becoming just a regional show. Wescon is no better. We'll probably be attending more of the smaller shows, where for \$300 instead of \$10,000 you can make a splash."

Another kind of splash, the spillover of electronics technology into more and more non-electronic industries, is a primary reason for cheerfulness about the future of both electronics and its biggest exposition. The evolution of the technology into an applications-oriented one was pointed up recently in an IEEE survey among 100 chief engineers—50 of them in electronics companies and 50 in non-electronic industrial classifications. They were asked: would you recommend to your engineers that they attend the IEEE Show? "The yes and no answers were in about the same proportion among non-electronic companies as in the electronic ones," says the IEEE's Hilty. "Electronics cannot easily be defined as an industry, he adds. "The operative question is: can an engineer apply electronics in whatever it is he's doing?"

One result of this applications emphasis is heightened interest in the show among minicomputer makers. Digital Equipment Corp., Maynard, Mass., the biggest in the field, chose the IEEE show this year for introduction of its PDP-16/M, which is aimed at OEMs. "The show provides the best sounding board for product announcement," says Robert Van Naarden, a marketing

specialist for DEC. "It is attended by a good cross-section of the industrial market."

On the other hand, the big semiconductor companies are now conspicuously absent from the IEEE and other general electronic shows. "You don't exhibit in the industry you grew up in," is the explanation of the IEEE's Hilty. "In a business equipment show, you don't find pencils, sharpeners, or other commodities. Semiconductors have now become commodities. If you're marketing custom designs, you simply live in your customers' plants. In the case of a high-volume shelf item, the marketing weapons are price and delivery capabilities."

"The semiconductor people will all be here, though not as exhibitors," Hilty adds. "They know this is where their customers and potential customers will be."

Though international in subject matter, the IEEE convention is admittedly regional in the geographical profile of its attendees—like most conventions, IEEE officials point out. An analysis of the 1971 registration shows that 63.7% of the visitors came from New York-New Jersey-Pennsylvania, and the next largest contingent, 13.7%, from New England. Robert Cunningham, director of exhibits for Wang Laboratories, Tewksbury, Mass., sees the geographical profile as a plus. "The technological market is pretty heavy in New York, New Jersey, and New England," he says. But Cunningham adds a note of qualified optimism that typifies a large group of exhibitors: "We want sales, and in the past the IEEE show has produced pretty good leads and sales. There has been a falloff in attendance in recent years, and I'm looking for a better show this year with bigger attendance—if not, it will be in real trouble." □

### A nice place to visit, but . . .

"It no longer looks like a reward when you send people to New York."

That comment from a West Coast electronics manager sums up the disenchantment of some with the traditional locus of the IEEE Show.

It's not only the cost that bothers engineers and managers. They cite crime, the surliness of hotel and restaurant employees and cab drivers, labor troubles, and union harassment of exhibitors. "It's a big hassle, since New York is totally under control of the unions," says Larry Hahn of E-H Research Laboratories. "If you even want to change a light bulb, the unions damn near picket the booth—an electrician has to come."

IEEE officials say that no one has ever presented any solid evidence to back up a suggested move out of New York City. And taking over a Chamber of Commerce role, they claim that things have changed for the better in the megalopolis during the last year or so. The economic squeeze has hit midtown hotels and restaurants, the IEEE's Hilty points out, and the employees realize that tourists and conventioners "won't come back if they're not treated courteously."

Union members, too, have become "more cooperative," according to exposition manager Doblmeier. Union problems were one of the reasons behind the "package exhibits" introduced this year. Exhibitors may rent a completely installed exhibit from among six standard designs, and for one price the IEEE will take care of everything except placing the products.



...AND WHEN TECHNOLOGY FALLS

# A Guide to New York

**For those intending** to paint the town red during IEEE week, a warning—bring a big brush. Manhattan offers a plethora of things to see and do, and highlighted below are the week's events and doings in town.

**Exploring** New York's neighborhoods is an adventuresome departure from the business atmosphere of the midtown area. Chinatown, where Canal Street crosses Broadway, is a bit of Hong Kong in Manhattan, and immediately north is colorful Little Italy, centered around Mulberry St. Farther north, the blooms may have withered a little, but the flower children and bohemia of Greenwich Village are holding forth east, west and south of Washington Square. On the gaudy side, Times Square shines dangerously where Broadway crosses 42nd Street, and uptown, catch a glimpse of New York's fast disappearing Germantown—have a beer and hear an oomp-pah-pah on Street, east of Lexington.

**New York and theater** naturally go together, but unless your company has secured tickets, you may have difficulties seeing the biggies like "Applause," at the Palace Theater, "Follies," at the Winter Garden, "Jesus Christ Super Star," at the Mark Hellinger, and "No No, Nanette" at the 46th Street Theater. But somewhat easier to find tickets for are these current winners: "Lenny," at the Brooks Atkinson, "The Prisoner of Second Avenue," at the Eugene O'Neill, "Two Gentlemen of Verona," at

the St. James, and "Vivat! Vivat, Regina!" at the Broadhurst.

A meander off-Broadway will provide several other excellent theater offerings, including "Godspell" at the Promenade Theater, "Kumquats" (the "world's first erotic puppet show"), at the Village Gate, "The Basic Training of Pavlo Hummel," at the Public, "One Flew Over the Cuckoo's Nest," at the Mercer Street Theater, and "The Fantasticks," now in its second decade, at the Sullivan Street Theater. For the really adventuresome, a trip off-off-Broadway will lead downtown to "John Wayne Doesn't Hit Women" at the famed New York Theater Ensemble, the "Musical Drunkard" at the 13th Street Theater, and the far out "Hooded Gnome" at the Playbox.

**The nightclub scene** will be in full swing, and appearing at the Americana's Royal Box on a double bill will be Pat Cooper and George Maharis. Elsewhere, Dusty Springfield sings at the Plaza's Persian Room, Peggy Lee hypnotizes at the Waldorf's Empire Room, and Gordon MacRae charms the ladies at the St. Regis Maisonette. The Temptations will be swinging at the Copacabana, and Johnny Ray adds to the nostalgia of the Rainbow Grill. For piano-lovers, Bobby Short is an institution at the Cafe Carlyle, and—for the game—improvisation is a West-Side spot featuring spontaneous entertainment.

If the feet and spirit are both willing, dancing—mild and tame—can be had at

Hippopotamus, Directoire, Shepherds, Thursday's, Wednesday's and Tuesday's, and every night, also, at Wheels, Nicos, and the Cafe Pierre. And everyone should be able to tell his grandchildren he's been to the oldest established permanent dance hall in New York—Roseland Dance City.

**Music**—long- and short-haired—echoes around town in varied strains. Edgar Winter will be at the Academy of Music, Sly and the Family Stone at the Apollo Theater, Bobbie Kolack at the Bitter End, and Sonny Rolands will be followed by Faro Sanders at the Village Vanguard. Beginning on March 18, Philharmonic Hall will feature Carlos Montoya, followed by Andre Watts, the Clancy Brothers, the Philadelphia Orchestra, and the New York Philharmonic Orchestra. At Carnegie Hall, Bread appears on March 18, and during the week, the Hall will offer the Beach Boys, the Ohio State University Concert Band and the Carnegie Mellon Kilt Pipe Band.

**Opera buffs** have a choice of "Salomé," "Falstaff," and "Fidelio" during the week at the Metropolitan Opera at Lincoln Center, or "Tosca," "La Traviata," "Susanna," "Summer and Smoke," "Maria Stuardi," and "Julius Caesar" at the New York State Theater, also in Lincoln Center. And although the New York State Ballet will be absent, ballet aficionados will be able to catch the Joffrey Ballet company with a varied repertoire at City Center.

There's enough in town to keep the sportsman busy

too. On the 19th the New York Rangers meet the Toronto Maple Leafs; on the 22nd the exciting New York Knickerbockers play ball; and boxing fans in town on the 24th can experience the Golden Gloves finals. All three events take place in multi-faceted Madison Square Garden. And equiphiles will be able to bet on the trotters at Yonkers Raceway and watch the sport of kings as the horses are off and running at Aqueduct Racetrack.

**New York is the center** of the art world, and the city's museums are a cultural delight. For the modern-minded, there is the Museum of Modern Art, the Solomon R. Guggenheim Museum, the Whitney Museum, the Museum of Contemporary Crafts, the New York Cultural Center, and the Jewish Museum. For those whose tastes run to the masters, old-world charm is captured at the Metropolitan Museum of Art and the Frick Collection. The Museum of the City of New York, in addition to chronicling the city's history, runs a varied fare of contemporary exhibits, and also of interest are the Museum of Natural History and the South Street Seaport Museum. Many of these museums show special film programs as well.

And if the spirit and/or flesh need reviving, the Dharmadhatu Meditation Center is serenely located at 12 E 18th St., but for easier access to Midtown, the Yoga Therapy Center is an island of calm at 36 West 26th Street.



leading minicomputer OEM's and users agree...this Analogic "break-through" design provides...

- Greatest Flexibility
- Lowest Cost
- Optimum Performance
- Highest Reliability

# FOR MULTIPLEXER/ ANALOG TO DIGITAL TO ANALOG COMPUTER/CONTROLLER INTERFACING

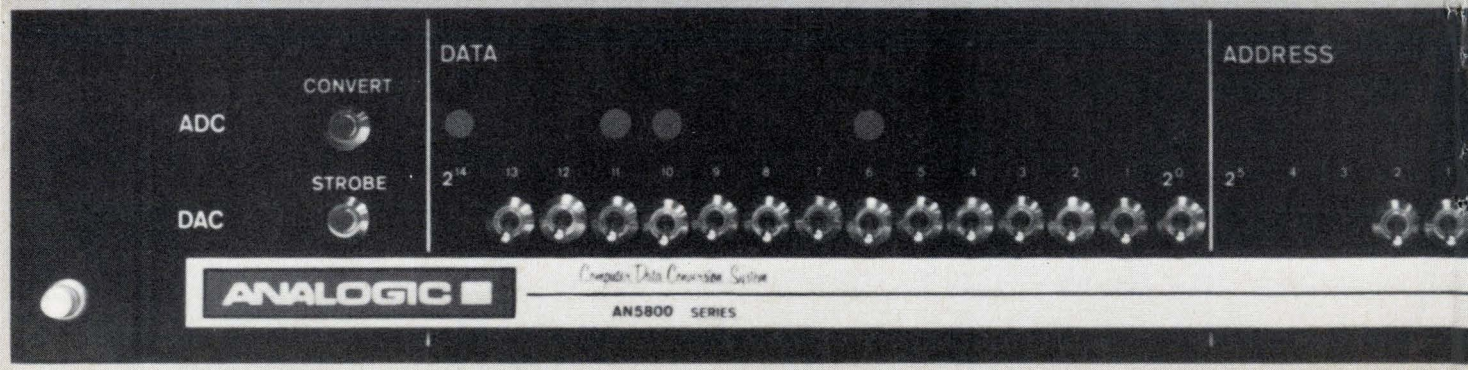

# Here's what our latest breakthrough means to you:

To put it simply, Analogic's new AN5800 Series systems are, at the same time, the *most flexible, highest performance and lowest priced A/D/A interfaces* ever offered to the computer and/or control-system designer. In most applications they will save you from 30 to 45% over conventional designs.

Series AN5800 is not just a system; it's a large and diversified *family* of designs, ranging from a single computer-interfaced Multiplexer/Analog to Digital Converter to the most elaborate arrays of Multiplexer/Sample and Hold/Analog to Digital Converter/Digital to Analog Converter combinations with hundreds of input channels, power supplies, and complete front panel executive and monitoring capabilities.

Series AN5800 is the first new design approach to computer-compatible A/D/A systems in years. The essence of this new approach is our "Universal Motherboard," which is, we believe, a truly creative approach to modularity. The AN5800 Universal Motherboard is the result of thousands of man hours of extensive design, testing, and redesign.

It achieves *optimum* interconnection of modules in hundreds of discrete and practical combinations. For most A/D/A systems assembled on the Universal Motherboard, production cost is dramatically reduced . . . and *reliability and performance are significantly enhanced*. Unlike backplane-wired systems, this approach provides optimum signal and power-supply properly routed, guarded, and shielded, to sustain consistently high S/N ratios, minimum propagation delays, minimum pulse degradation, and near-ideal Analog-to-Digital isolation.

## OEM Variations

The AN5800 motherboard design *anticipates* your need for OEM variations. System function or capacity changes usually require only changing or adding cards, not rewiring. (For example, to change from 64 single-ended to 32 differential input channels does *not* require rewiring — it is accomplished simply by plugging in a differential amplifier instead of a single-ended amplifier!) Channel capacity is *easily expanded* . . . to a total of 2048 with compatible expansion hardware.

And it's worth repeating that the interconnections are optimum interconnections —

virtually eliminating debugging, improving S/N ratios, preventing anomalous states, and indirectly (but significantly) extending the MTBF of the system, by providing unusually generous margins for both analog and digital circuits.

## Creating Specific System Architectures and Capacities

By selecting from the very wide range of Analogic modules (a range that includes just about every system element used in high-level data acquisition) you can create an almost endless variety of systems. Here is a *very condensed list*:

- **A/D Converters** — successive-approximation, 8 to 15 bits, various speeds up to 200 kHz throughput, providing a full range of price/performance tradeoffs.
- **D/A Converters** — 8 to 14 bits, various speeds up to 200 nanoseconds settling time, including "glitch-free" designs. Here again a wide range of price/performance tradeoffs is provided.
- **Sample-Holds** — low droop 0.01% designs, with aperture uncertainty as low as 10 nanoseconds; including high-input-Z designs.

## System Diagram

Shown here is the organization of a representative, large Series AN5800 system. Behind the single 3½" x 19" panel area: 64 channels of single-ended MUX (or 32 channels of 2-wire differential); high performance Sample-and-Hold; A/D conversion (*with a wide choice of resolutions, speeds and accuracies*) including polarity, decoding, and converter-programming features; 8 D/A converters; power supplies; *plus direct computer I/O* interface for most standard minicomputer applications.

## Some Typical AN5800 Specs

- **Accuracies:** ±0.006% to ±0.05%, consistent with bit and speed resolutions.
- **D/A Channels:** Up to 14-bits. Outputs, ±10v @ 10mA. May be addressed sequentially or randomly. Buffers and latches provided.
- **Digital Interfacing:** LOGIC: All inputs and outputs DTL/TTL compatible. A digital interface accepts up to 6 lines of addresses for selecting up to 64 channels plus sequential or random address strobe lines. Up to 15 bits of digitized data plus E.O.C. serial data and clock outputs.

**RIGHT-HAND BIT JUSTIFICATION:** Allows A/D and/or D/A data bits to be right-hand justified by having the LSB (rather than MSB) always in the same position, independent of number of bits. Directly compatible with most computers.

## To Sum Up . . .

After all else has been said, the most compelling reason for switching to the AN5800 design is that

you can, *without compromising performance* — indeed, while getting significantly improved performance, reliability and flexibility — you can **increase your profit on any minicomputer or computer-control application by \$1000 to \$2000 per installation, and sometimes more.**

## To Get Started:

Call Perry Pollins or Dick Conant at (617) 246-0300 to arrange for a demonstration. Or write for complete Series AN5800 information. Analogic Corporation, Audubon Road, Wakefield, Massachusetts 01880.

**In Europe:** E. Furst, Baslerstrasse 88, CH-4123 Allschwil, Switzerland. Tel. (061) 39 87 40

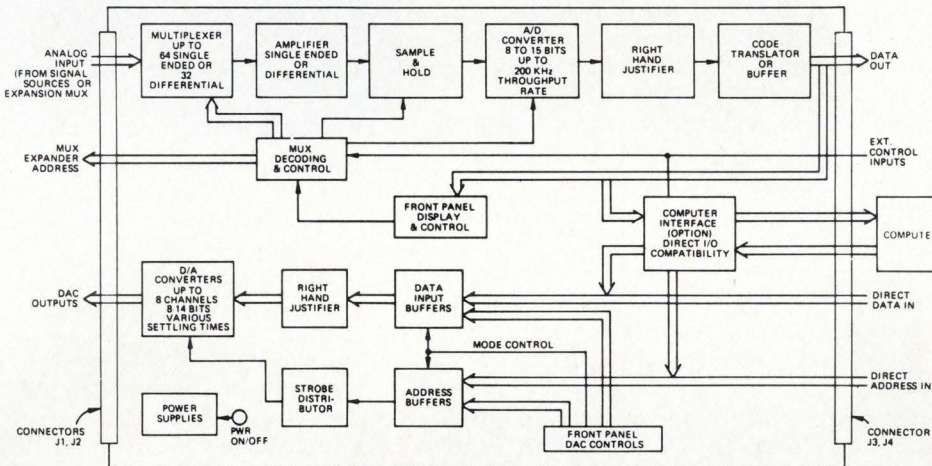

- **Multiplexers** — 8 to 16 channels per card, ultra-high-Z, with address decoding and expansion circuitry, differential as well as single ended MUX configurations.
- **Direct Computer I/O Interfaces** for most standard minicomputers.

## Complete Thoroughly Tested Systems

AN5800 Series equipments are delivered (4-6 weeks) as complete, thoroughly tested systems, the overall accuracy of which is, in fact, higher than that predictable by summing the performance of the individual modules.

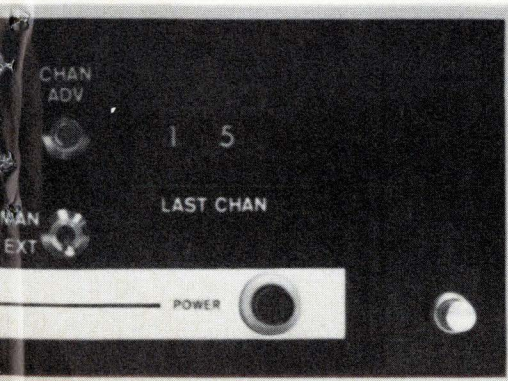

# ANALOGIC

## ...The Digitizers

# Designer's casebook

## Stable voltage reference uses single power supply

by Mahendra J. Shah  
University of Wisconsin, Madison, Wis.

When an integrated circuit differential operational amplifier is used in a voltage reference source, two supplies usually are needed—both positive and negative. Moreover, additional circuitry is generally required to establish output polarity. But if one supply line is grounded, only one supply becomes necessary—the one that gives the desired output polarity.

So long as the non-inverting input of the operational amplifier is maintained at some positive potential, even a tiny one, the output of the reference source will also be positive. Similarly, small negative potentials at the non-inverting input will result in negative outputs.

The voltage reference source shown employs a single 15-volt supply to give a positive output. To produce a negative output voltage, the positive supply line is grounded, the negative supply line is run to -15 v, and zener polarity must be reversed.

Zener diode  $D_Z$  establishes the reference voltage ( $V_Z$ ) and the reference current ( $I_Z$ ) for the circuit so that a constant-current source is provided by resistor  $R_1$  and the buffering action of the op amp. Zener current is:

$$I_Z = V_Z R_2 / R_1 R_3$$

Due to the configuration of the op amp's output stage, circuit output voltage ( $E_o$ ) will always be greater than 0.5 v when a positive 15-v supply is applied and the negative supply line is grounded. Therefore, a few tens of millivolts will always appear at the op amp's non-inverting input, making the output positive:

$$E_o = V_Z(1 + R_2/R_3)$$

With the positive supply line grounded and -15 v at the negative supply input,  $E_o$  will always be less than

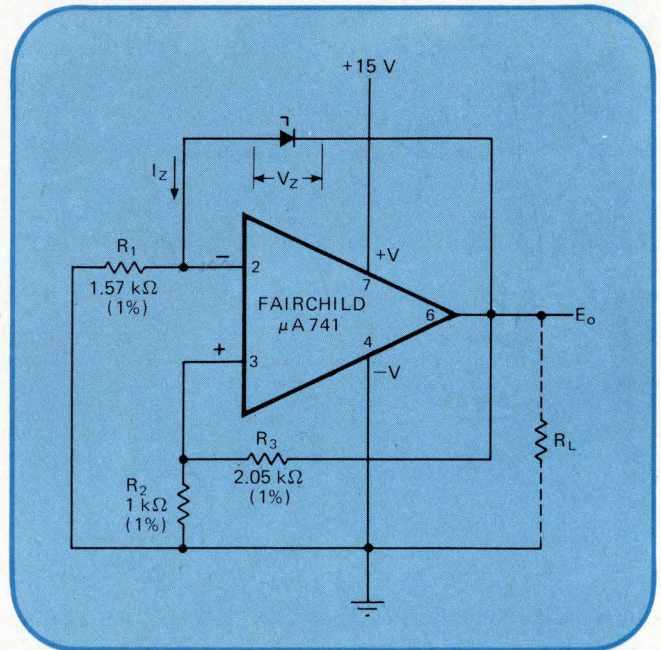

**Eliminating dual supplies.** Voltage reference source has either positive or negative output, depending on polarity of supply used to bias op amp. Positive supply results in positive voltage at op amp's non-inverting input and, therefore, positive output. Negative supply produces negative output. In either case, final output voltage is about 10 volts. Zener diode acts as reference.

-0.5 v. The negative voltage at the op amp's noninverting input causes a negative output:

$$E_o = -V_Z(1 + R_2/R_3)$$

The reference zener voltage of 6.4 v yields a zener current of about 2 milliamperes. For a positive supply, output voltage is 9.547 v; temperature coefficient, 1.9 parts per million/°C; voltage stability, 9.5 ppm/v; and output impedance, 53 milliohms. For a negative supply, temperature coefficient remains the same; but output voltage becomes -9.560 v; voltage stability, 2.6 ppm/v; and output impedance, 21 milliohms.

## Fast-switching modulator reverses uhf signal phase

by R.N. Assaly  
Massachusetts Institute of Technology, Lexington, Mass.

In just a few nanoseconds, a modulator for shaping transmitted ultrahigh-frequency radar signals can switch a signal through three states. The signal can be

turned on or off, and while it is on, the phase can be reversed between 0° and 180°. An off signal is attenuated by at least 35 decibels.

The modulator (a) consists of a tri-state driver and a double-balanced mixer, which allows the rf signal to be controlled by video commands. Three values of control current—-30 milliamperes, 0 mA, and 30 mA—are generated by the driver for the three modulator states—0° phase, off, and 180° phase, respectively.

The transition times of the two input logic signals, designated as code Q and gate P, are enhanced by a dual four-input AND gate. (The gate-P input turns the rf

signal on and off, performing a gating function; the code-Q input reverses the phase of an on signal, thereby coding signal phase.) A line driver then produces the outputs labeled A and B:

$$A = \overline{PQ} \text{ and } B = \overline{P\overline{Q}}$$

At the tri-state driver output, a difference signal, B-A, is used to provide the three desired states, as shown in the truth table.

To obtain this difference signal, transistor Q<sub>1</sub> inverts the A output of the line driver to produce signal C. And output B passes through transistor Q<sub>2</sub> without inversion, keeping the circuit balanced and resulting in signal D. A resistor network averages signals C and D, which are then applied to output transistors Q<sub>3</sub> and Q<sub>4</sub> that drive the double-balanced mixer.

Since Q<sub>3</sub> and Q<sub>4</sub> do not conduct if their base voltage is less than 0.6 volt, the resistor network holds bias voltage to about 0.5 v during the off state to reduce any delay during driver state transitions. Also, because a large base voltage must be applied either to Q<sub>3</sub> or Q<sub>4</sub> for conduction to occur, mixer current can be held to a very low value. If mixer current increases, to even just a few microamperes, the attenuation of an off signal becomes less than the desired 35 dB. For instance, attenuation degrades to about 30 dB when mixer current becomes approximately 10 microamperes.

Inductors and capacitors in the circuit are simply used to speed up state transitions. The turn-on of a 430-megahertz signal is illustrated in (b), while (c) shows a phase reversal. These transitions took less than 10 ns.

**Uhf modulation.** Three-state modulator (a) turns off uhf signals or reverses their phase between 0° and 180°. AND gate improves input signal transitions. To balance circuit, line driver output A is inverted by Q<sub>1</sub>, while B passes through Q<sub>2</sub> without inversion. Transistors Q<sub>3</sub> and Q<sub>4</sub> drive mixer with difference signal of B-A. Turn-on (b) and phase reversal (c) traces are for 430-megahertz signal.

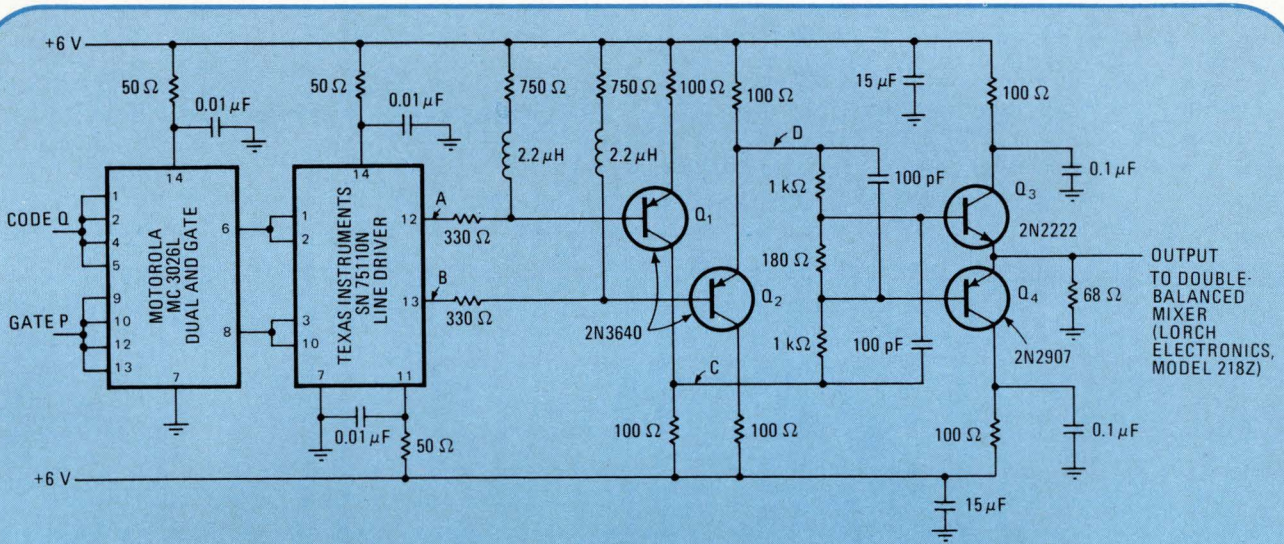

(a)

P	Q	A	B	B - A
0	0	1	1	0
0	1	1	1	0
1	0	1	0	-1
1	1	0	1	1

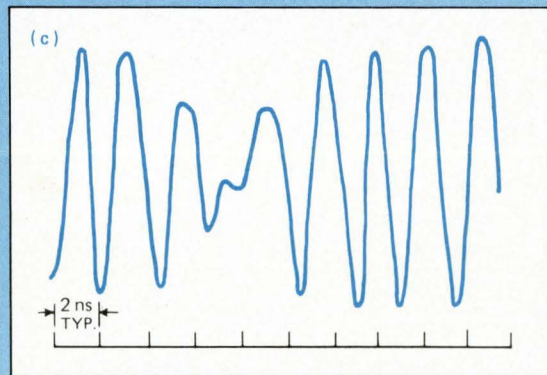
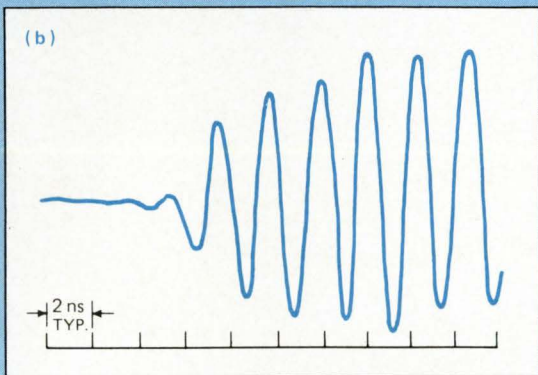
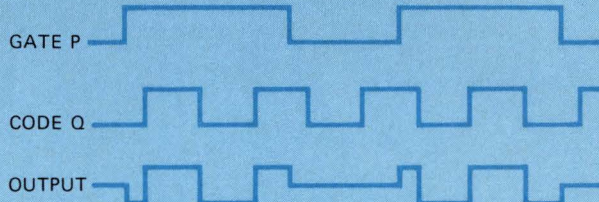

# ECL gates stretch oscillator range

by William Blood  
 Motorola Semiconductor Products Inc., Phoenix, Ariz.

The frequency range of crystal-controlled oscillators can be extended easily with emitter-coupled logic gates. Selecting the proper crystal and the right number of frequency doublers results in accurate frequency signals over the range of 150 to 250 megahertz. Standard crystals are normally limited to less than 150 MHz because of the number of crystal overtones required to achieve higher frequencies.

A 200-MHz crystal-controlled oscillator that is built with only two integrated circuit packages is shown in the diagram. Two types of ECL gates, one with a propagation delay of 1 nanosecond and the other with a 2-ns delay, are used for best performance.

In the oscillating section of the circuit, the crystal is in series with a feedback loop from the NOR output of a

2-ns gate,  $G_1$ . The LC tank circuit tunes the 100-MHz crystal overtone, and also acts as a fine-tuner. Another 2-ns gate,  $G_2$ , from the OR output of  $G_1$ , buffers the oscillating section and provides a complementary output.

The frequency doubler section of the circuit consists of two 2-ns gates ( $G_3$  and  $G_4$ ) performing as phase shifters, and two high-speed 1-ns NOR gates ( $G_5$  and  $G_6$ ) operating as summers. For a 50% output duty cycle, the complementary 100-MHz signals should be delayed one-fourth of a cycle, or 2.5 ns. This may be done precisely with delay lines, or approximated with gates  $G_5$  and  $G_6$ , as shown. The gating method is easier to implement and causes only a slight offset in output duty cycle. Gates  $G_5$  and  $G_6$  combine the four-phase 100-MHz signals, yielding a 200-MHz output frequency, when their outputs are wired-OR.

A third 1-ns gate  $G_7$  is used as a bias generator for the crystal oscillating section. Tying the output of this NOR gate back to its input assures that the oscillating section remains biased in the center of its linear region over wide temperature and power supply extremes.

Designer's casebook is a regular feature in Electronics. We invite readers to submit original and unpublished circuit ideas and solutions to design problems. Explain briefly but thoroughly the circuit's operating principle and purpose. We'll pay \$50 for each item published.

**Speeding up crystal oscillators.** Emitter-coupled logic gates can increase the frequency output of crystal-controlled oscillators to 250 megahertz. For 200-MHz output, LC tank tunes 100-MHz overtone of crystal, while gate  $G_2$  forms complementary 100-MHz signals. Phase shifters  $G_3$  and  $G_4$  and wired-OR summers  $G_5$  and  $G_6$  then delay and double these signals. Gate  $G_7$  provides buffered bias supply for gate  $G_1$ .

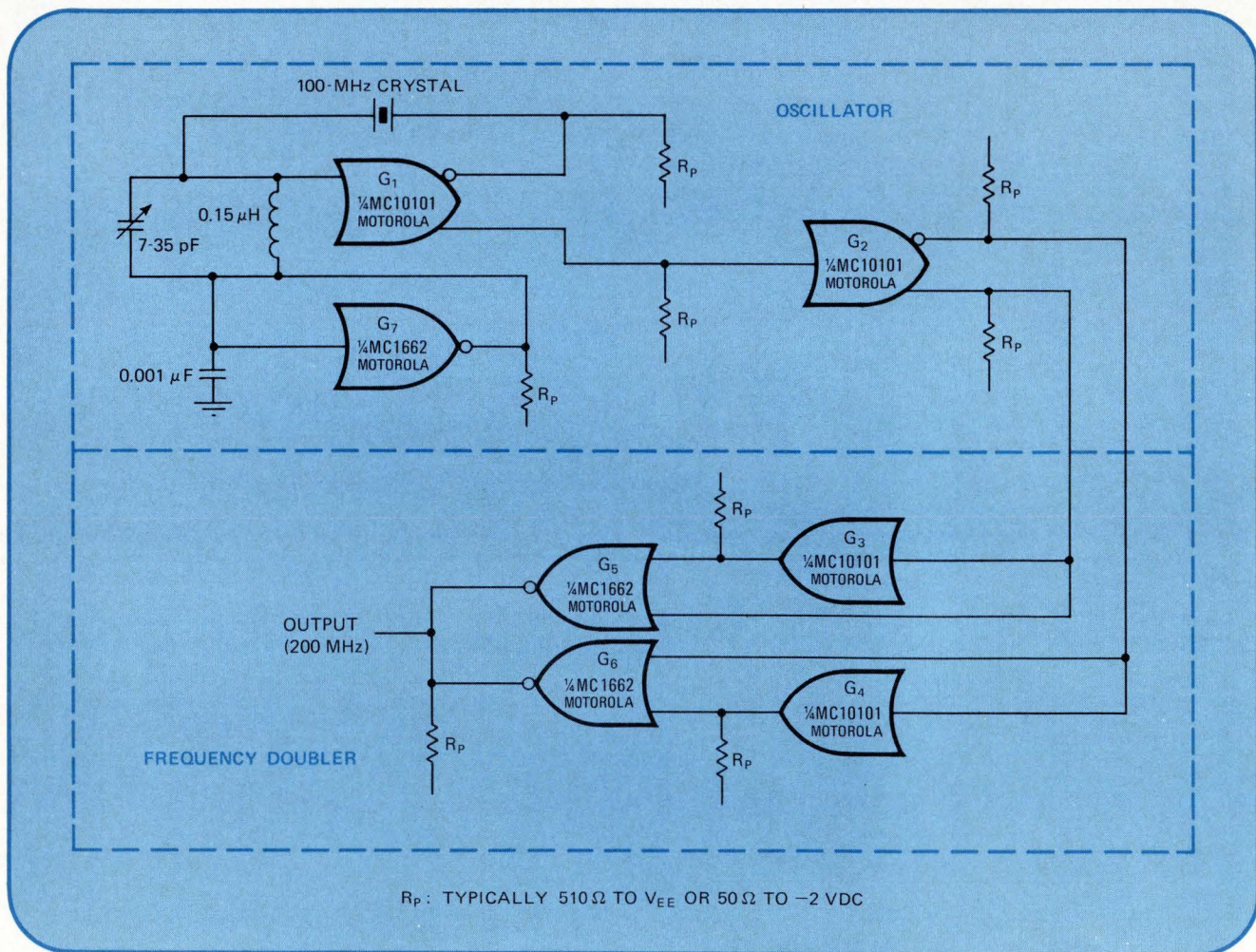

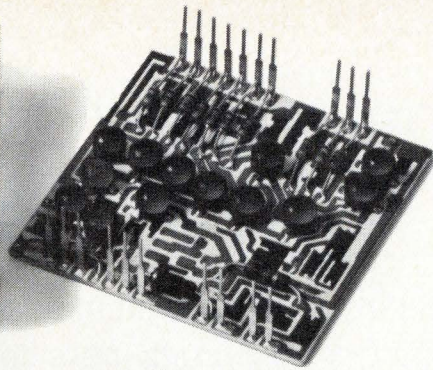

# Ours. A bit ahead of theirs.

Another \$19 DAC? But, don't put us down until you've tried it.

Competition gives you exactly what you pay for... a \$19 circuit... no more, no less. Ours is based on Philbrick's famous 4006/4007 digital to analog converters selling originally for \$70 to \$75.

Combined thick-film and re-flow techniques have endowed our 4020/4021 8-bit model with higher performance than you'll get from any competitive unit. Things like — linearity of  $\pm 1/2$  LSB with a settling time of  $25 \mu\text{sec}$  and temperature coefficient of  $40 \text{ ppm}/^\circ\text{C}$ .

Match this with any other \$19 DAC and you'll know why we say it's a bit ahead of theirs.

Looking for a 10-bit model?

Then compare our 4022/4023 \$29 version with anybody's. We welcome the comparison. Evaluation samples are yours for the asking. While you're asking, request our new 1972 Product Guide.

Ask your local Philbrick representative or write, Teledyne Philbrick, Allied Drive at Route 128, Dedham, Massachusetts 02026. For toll-free ready data dial (800) 225-7883. In Mass., (617) 329-1600.

## Philbrick Data Converters. The good ones.

# Functional digital ICs: devices to delight the systems man

Circuit designers consider the system builder's viewpoint to develop a new breed of integrated circuits more flexible and versatile than older designs to streamline solution of many problems now encountered

by Richard Percival and Jerry Gray, National Semiconductor Corp., Santa Clara, Calif.

□ System designers are discovering that they are getting too much of a good thing in today's off-the-shelf integrated circuits. Although they were clamoring for many of these ICs just a short while ago, in the context of systems they were designing at that time, system men are finding that today's ICs often include features they can't use, or—worse yet—actually create new problems.

Dilemmas like these were pointed out recently by Bert Forbes, of Hewlett-Packard Co. [*Electronics*, Dec. 6, 1971, p. 70]. He appealed to semiconductor houses to design ICs for maximum utility, rather than for easy manufacture or a better specmanship rating.

A new approach combines the best qualities of the old ICs with the latest criteria of system design. Several semiconductor manufacturers are beginning to produce circuits that follow some of Forbes' recommendations; in particular, National Semiconductor Corp. will shortly have a specific IC he asked for, a dual circuit combining a type D flip-flop with a J-K version. Other devices in the forthcoming line include dual and quad type D flip-flops for temporary storage and four-bit digital and binary counters with an edge-sensitive hold state.

Nothing is more annoying to a system designer than, in trying for maximum speed, to find that an input must be held off for tens of nanoseconds while a previous input settles—because the IC designer included what he considered a desirable additional feature that only messes up the whole system's operation. Often, glitches like this don't show up on the data sheet because the circuit designer didn't realize that such extras could cause problems.

## Clock pulses

But close attention to detail by the circuit designer avoids passing difficulties along to the system man. Both know that the shortest possible time between the leading edges of two clock pulses that the IC can handle is obviously the worst-case sum of five quantities: the propagation delay of the clock gate, the width of the clock pulse itself, the propagation delay from the clock gate input to the circuit output, propagation delay through random logic circuits driven by the circuit in question, and the data set-up time that the next clocked-synchronous element requires before the leading edge of the next clock pulse.

Clearly, if the first two quantities are eliminated and the last is minimized, the system in which the elements

are used should be capable of faster performance. The third and fourth items are not dependent on clock-synchronous design, but on efficient internal logic design.

The functions performed by the new elements described here are the same as those of their predecessors—waiting, sequencing, storing, or computing. Except for the computing function, which uses clocks only indirectly, these new circuits should be faster to operate, easier to use, and less numerous in any given design than the older ones.

In a system with a continuously running clock, the key to effective waiting is the edge-sensitive hold state. This state is established with control signals that tell the IC, just before the clock pulse arrives, to maintain the status quo instead of changing to a new state. The control signals themselves may be the output of a hold state; although not tightly synchronized, they were generated by a ring counter—or perhaps a read-only memory—at a previous clock pulse and may change again as a result of the just-arriving pulse.

Newer devices with such a hold state coming on line include four-bit binary and decimal counters DM 8555 and DM 8556, available soon from National. In either device, the clock can increment the counter or preset it from an external bus, or the clock can be ignored.

As shown in the logic outline (Fig. 1), in each of these two devices a line called "write disable", one of three control lines, specifies whether the clock increments or presets the counter. After the presetting action, if "write disable" comes up to inhibit further presetting, the newly loaded data can appear at the same pins through which it was loaded, thus driving the same bus from which it came; an output disable line controls this section through a set of Tri-State gates. Meanwhile, the data also appears on four conventional counter output pins. If these pins are directly connected to a read/write processor memory, or a ROM containing a microprogram, either device becomes a program counter. Or, in general, the devices can perform any synchronous sequencing function.

## Temporary storage

Most systems require temporary storage for both data and control signals. Temporary storage for data can be implemented with the DM 8551 quad D flip-flop, the first member of the synchronous system or bus-connectable family of parts [*Electronics*, Sept. 14, 1970, p.78].



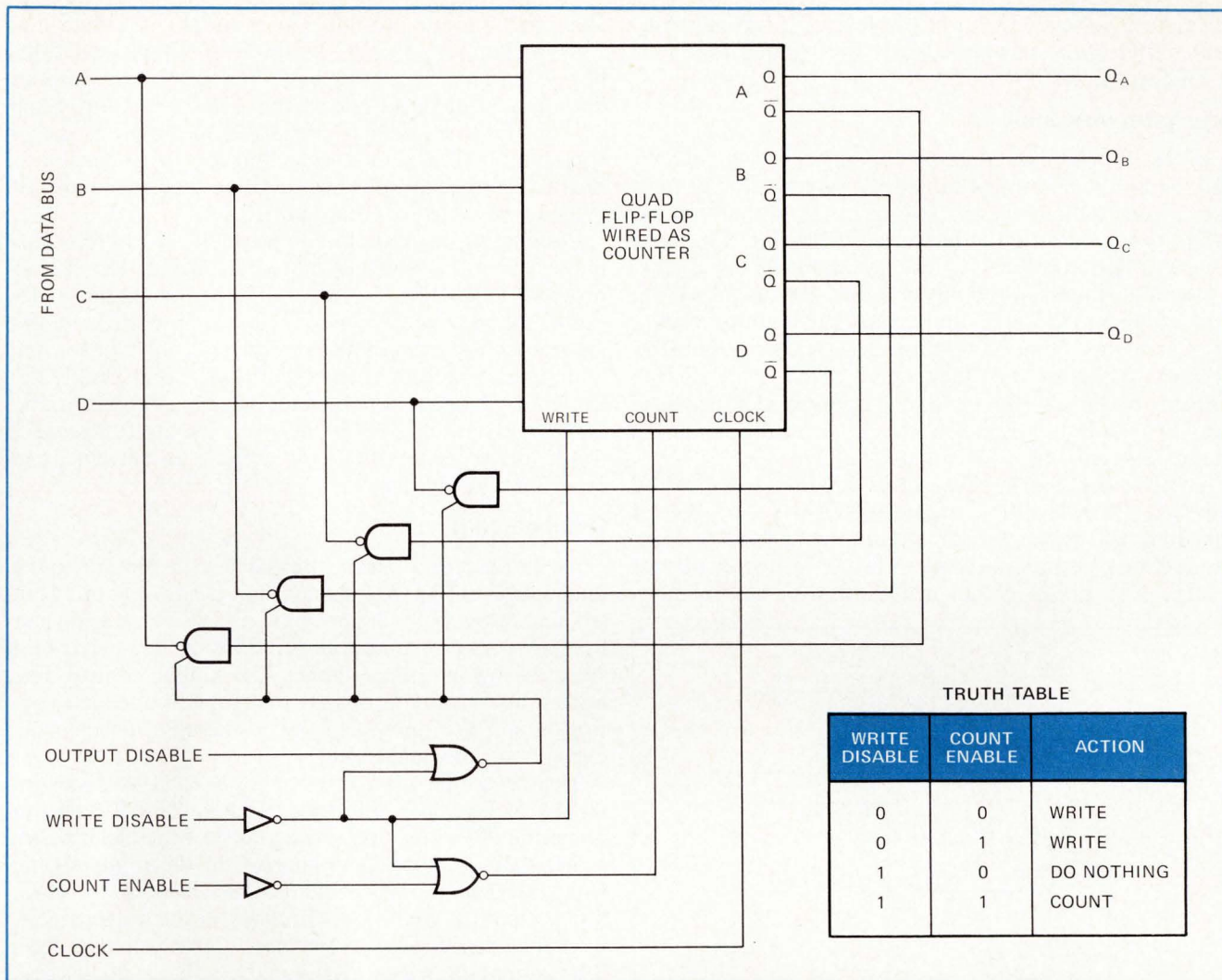

**1. Counter.** Available in either of two forms, binary or decimal, this circuit either can be incremented or preset by a clock pulse. Also, if write disable is up and count enable is down, the circuit ignores the clock pulse. It can be a computer's program counter.

**2. Dual D.** Two of these flip-flops are found on a single chip, the DM 7511. The circuit accepts data only when both gate input lines are down. Counters or data registers can be assembled from it. A similar circuit, DM 7613, is identical except that it has four flip-flops on a chip, and only one gate input per flip-flop; it also shares its clock and clear signals with the other flip-flops.

Bert Forbes cited this circuit in his article as an example of a well-designed device, from the system man's point of view.

But the DM 8551's input gates are common to all four sections for its intended application—storing data in a parallel-bus system. This commonality is inconvenient in a random-control environment, because a system is unlikely to have four different control signals, or even two, that require the same input gating.

Furthermore, the DM 8551 has Tri-State outputs—a capability rarely needed in a control environment. The inputs to the gates that make the third state possible and the gates themselves render the DM 8551's packaging inefficient for a control application.

However, random control does require micro-programmed timing control of single bits, for which the dual gated-D flip-flop DM 7511 shown in Fig. 2 is use-

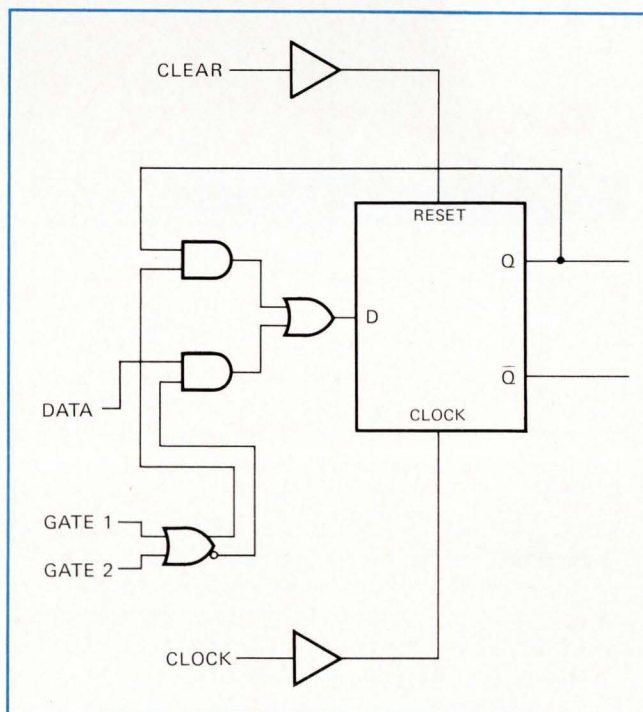

ful. It can be applied, for example, in a processor controller that must start and stop many latched functions at different times.

### One gate, one input

In this flip-flop, the data can be entered in the circuit only when the circuit is enabled by the low state of both gate inputs. Otherwise the Q output is internally gated to the input, causing the bit stored in the flip-flop to be recycled with every clock pulse. (Without this feedback, a 1 would remain in the flip-flop only for one clock period.) Thus the flip-flop can be used in a counter or data register to store binary words without either internal or external gates for the clock signal. This is a valuable feature, because a system that has ungated clock lines can always run faster and with more versatility than one that uses gated clocks for any reason.

The two-input NOR gate in this circuit is just like the one that controls all four inputs of the DM 8551, except that here one gate controls one input instead of four. This feature permits the gate to be connected as part of a large X-Y array so that a minimum of control lines

can select a single flip-flop. For example, one data line could be connected to the D inputs of 100 gated-D flip-flop (50 DM 7511 packages); then only two decimal decoders could select one of the 100 for loading. Each output of one decoder would drive one input of corresponding NOR gates in a horizontal row of 10; each output of the other decoder would drive the other input of the gates in a vertical column of 10.

Connecting one data line to as many as 100 flip-flops may seem to be a rather extreme fan-out. But it's no problem at all. On the contrary, the D gating is designed so that when the gate is closed, practically all the current from the gate flows out through the control line and very little through the data line. As a result, the fan-in is reduced to a point that permits one Darlington pair at the output of a TTL gate to drive up to 128 unselected inputs. (When the gate is open, no current flows out through either line.)

### Quad gated-D

A quad gated-D circuit, the DM 7613, is similar to the dual circuit in DM 7511, except that it has only one control line instead of two per input, and its clock and clear lines are common to all four flip-flops in the package instead of being independent. The single control line makes the circuit appropriate for use with un-coded control signals, as opposed to the X-Y coding used in the example for the dual circuit.

This circuit has some advantages over its predecessor, DM 7475. First, it is edge-triggered, so that the output remains stable after the leading edge of the clock pulse, rather than responding to changes in the input all the while the clock pulse is present. Also, although the clock line is common to all four flip-flops in the package, the D-enable feature permits the clock signal to be ignored, thus eliminating clock gating and resultant clock skew. These were two of the requirements that Forbes asked for in his article.

This quad gated-D flip-flop can be used as a formatter for incoming serial data, every sequence of which begins with a 1 as a starting signal, as in the standard teletypewriter code. Two packages can be coupled together as an eight-bit shift register; the Q output of the eighth stage is fed back to the D-enable input of the first seven and the serial data line connected to the data input of the first stage. Then data is loaded into the register and shifted along its length until the data arrives at the eighth stage, when the full register shuts off further inputs. The same D-enable input also triggers other circuitry that transfers the eight bits in parallel out of the register and then clears the register asynchronously, making it available to accept more serial data.

A similar circuit with an important additional feature is the DM 7512 combination D and J-K flip-flop, a dual circuit, diagramed in Fig. 3. Forbes specifically asked for this circuit. The single mode-control line performs the same function as the D-enable line does in the quad gated-D, but when mode control disables the data input, the circuit becomes a J-K flip-flop. It turns on when it receives a J input, turns off with a K input, and changes state if J and K are simultaneous. Unlike the old master-slave J-K flip-flop, the DM 7512 is triggered by the leading edge of the clock pulse.

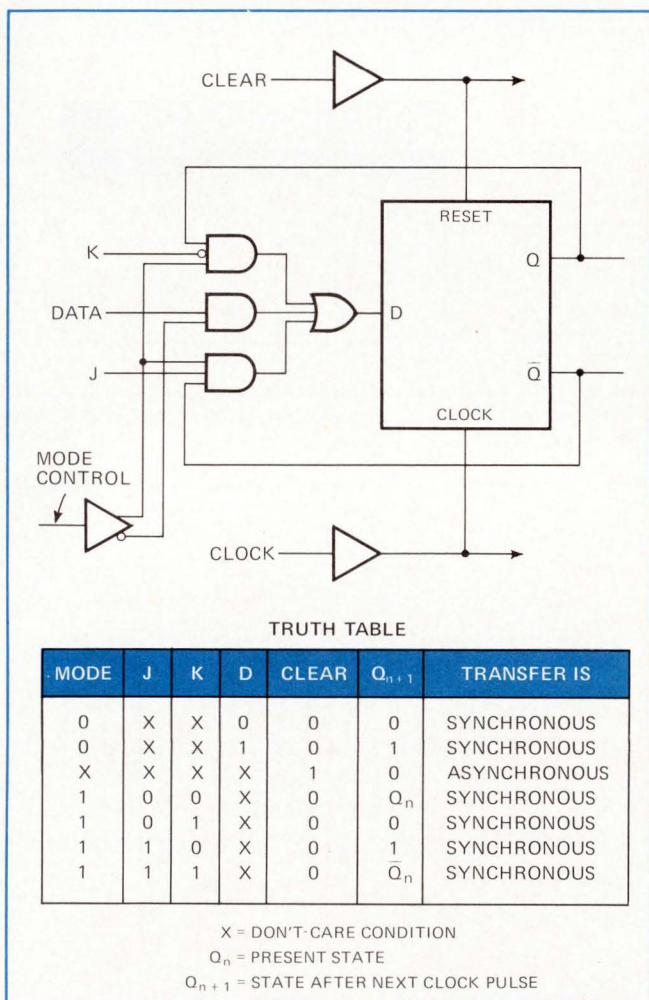

**3. Combination.** A flip-flop with both D and J-K functions comes two on a chip. The mode control line is equivalent to the gate inputs of simpler flip-flops, but defines whether the circuit operates in the D mode or the J-K mode. The truth table describes the circuit's function under various input conditions. Note that the K line is inverted at the input to its AND gate.

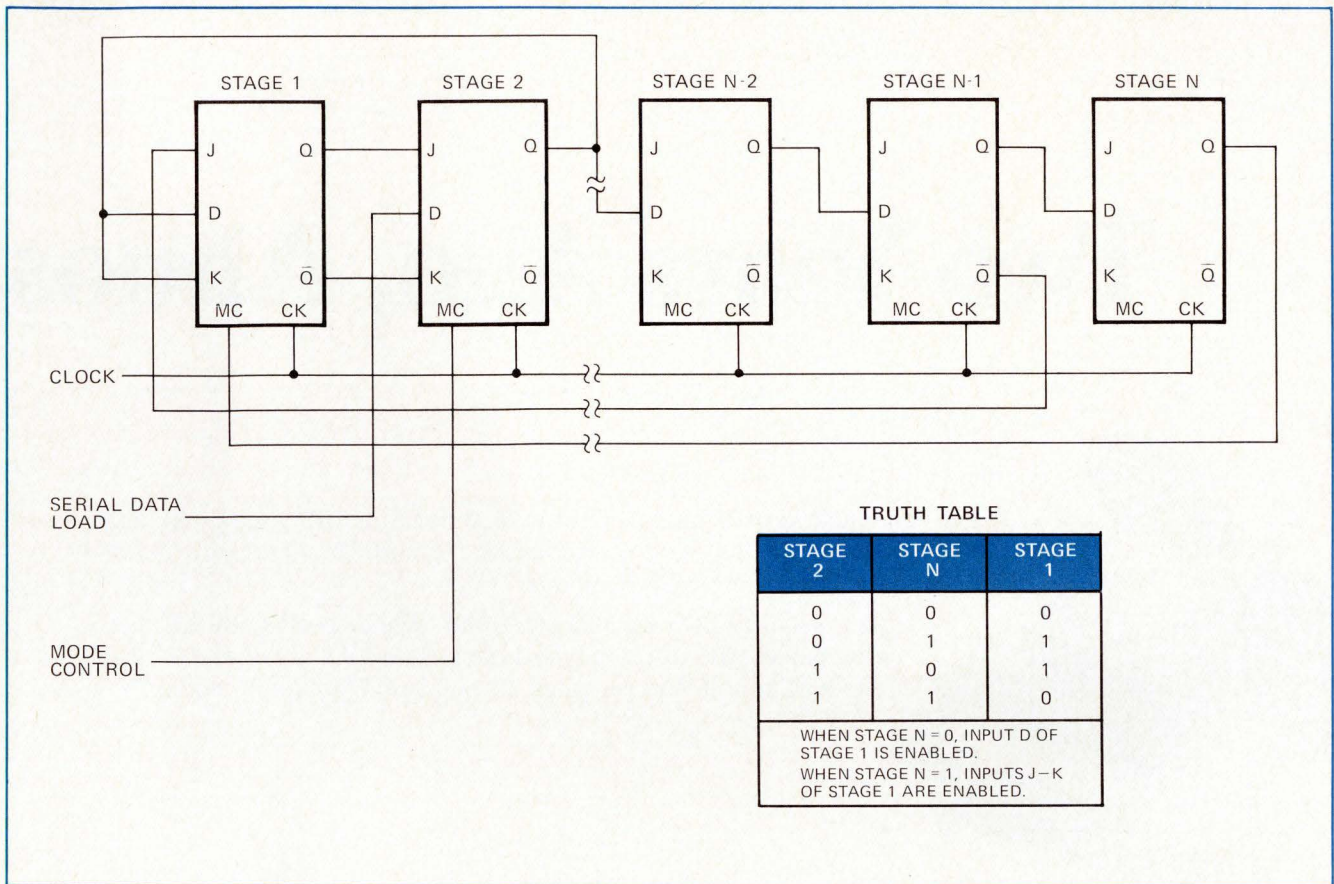

**4. Workhorse.** Connected into a feedback shift register, the flip-flop of Fig. 3 can detect and locate errors in cyclically encoded data, generate pseudo-random sequences of bits, or, with an AND gate, divide the clock frequency by  $2^n - 1$ .

This circuit offers several options. For example, if the J-K feature is not needed, the J and K inputs can be connected to ground and the circuit used as an ordinary gated-D flip-flop with the mode control becoming the gate. Or the D input can be connected to the Q output, creating a gated J-K flip-flop. Or, if the D input is connected to the  $\bar{Q}$  output, the flip-flop becomes a toggle, changing state with every clock pulse when the mode-control line is down.

### Many applications

This component has a great many applications for the system designer. For example, it can be used in a synchronously presettable counter, or as a J-K input counter that can shift its contents left through the D inputs—equivalent to multiplying a binary number by 2. Or it can be used as a counter that functions as a shift register when signaled to do so by the mode control. If the J and K inputs are connected to the Q and  $\bar{Q}$  outputs respectively, the circuit becomes part of a general-purpose register that complements its outputs under program control—via the mode line.

Several of these ICs can be connected as a feedback shift register, as shown in Fig. 4, to serve as a decoder for cyclic error-correcting codes, or as a pseudo-random sequence generator, or as a modulo  $2^n - 1$  divider.

As a decoder, the register causes an error-free code word of n bits, loaded serially and circulated exactly once through the feedback loop, to end up as a string of 0s. Had any error been present in the code word, 1s in

the register after the circulation would have permitted corrections to be made to the word, held in a parallel register.<sup>1</sup>

As a pseudo-random sequence generator, the register allows all n positions of the register to be loaded with an arbitrary sequence of 1s and 0s (but not all 0s) and then shifted  $2^n - 1$  times through the feedback loop. During this shifting operation, the register has contained all possible sequences of n bits and has returned to the originally loaded sequence; the process can be repeated indefinitely.

Furthermore, the contents of any flip-flop viewed as it passes through the states of  $n + 2^n - 1$  of these shifts will contain all  $2^n - 1$  possible combinations of the n bits (excluding all 0s), but will have the appearance of a random sequence of bits—hence the designation “pseudo-random.” In this application the register acts like a counter, but its successive states do not represent consecutive numbers.

As a modulo  $2^n - 1$  divider, the register operates the same as in the pseudo-random sequence generator, except that only one recurring combination is of interest—typically when all the flip-flops contain 1s. If all their outputs are connected to an AND gate, then this gate will produce an output once every  $2^n - 1$  shifts—effectively dividing the frequency of the clock by  $2^n - 1$ . □

### Reference

1. W.W. Peterson and D.T. Brown, “Cyclic Codes for Error Detection,” Proceedings of the IRE, January, 1961, p. 228.

# Two Years Ago, Almost

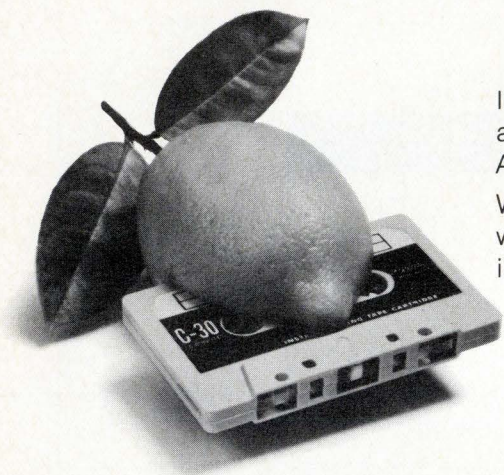

Including us. A digital cassette recorder. Seemed like a great idea at the time. But there was too much garbled info. And lousy reliability. A bumper crop of real lemons.

Well, we licked our wounds along with everyone else. But we also went back to the drawing board because we still thought the basic idea was sound. And we came up with a unit that really works.

## A Whole New Concept

To get super reliability, we reasoned, you have to control that tape. So, we started from scratch. Got rid of the traditional pinch rollers, belts, solenoids, levers and mechanical linkages from the transport. Took out the head guide forks.

Eliminated the need for pressure pads. Those were the main cause of head and tape wear, oxide shed and dropout.

Then, instead of just pushing the head up to the tape as it rolls by, we decided to get the tape out of the cassette. (That way the cassette is just a tape holder.) So we designed two little fingers that pull the tape down past the head, over a precision guide and around a capstan. That maintains optimum head wrap angle—critical for read-after-write operation. And it's all done automatically as you load. (We've got a patent pending, in case you're interested.)

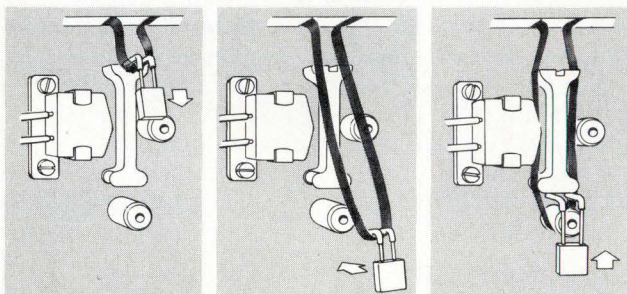

## The Insides

Next, we put in three DC motors. One for the capstan and one for each reel. Servos positively control tape tension on both sides of the capstan. And tension sensors confirm proper loading to BOT—no writing on tape leader. There's no drag on the tape. Ever.

So now we have high bi-directional tape speed, fast start/stop times, precise start/stop distances.

Reel motor torque is automatically reduced when EOT or BOT is sensed to prevent pulling tape from cassette reel hubs or other possible tape damage.

All modular electronics. Plug in PC boards. Logic and interface that're TTL compatible.

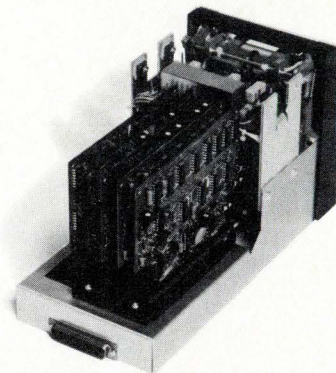

# Everybody Brought One Out

## The Outsides

All these components are mounted in a cast aluminum frame. Very, very rugged. So it works for any number of EDP OEM applications. And we supply it for users in a handsome case with straightforward, push-button controls.

## Real Reel to Reel Performance

Our basic Model 240 has 2 tracks, selectable data rates from 2 to 20 ips, with start/stop times of 15-30 msec. Same start/stop times for 50 ips search or fast forward/reverse. It operates in incremental and/or continuous modes, and in several combinations of recording codes/data channel selections. Test data indicates: calculated MTBF in excess of 2,000 hours. Thousands of passes without tape damage.



## Options

All sorts of options. Like two selectable read/write speeds. Dual gap read-after-write head. Separate read-after-write heads. Power supply. Rack mount kit. Automatic tape cleaner. Etcetera.

## Don't Wait. Order Now

Now that we've really licked performance and reliability problems, we figure our recorder's a natural for business machine manufacturers, terminal makers, mini computer builders.

And users. A great replacement for punched paper tape. Even some reel to reel mag tape applications. Especially at the price. About \$500 to \$600 in bunches.

## Bell & Howell & a Digital Cassette Recorder That Works

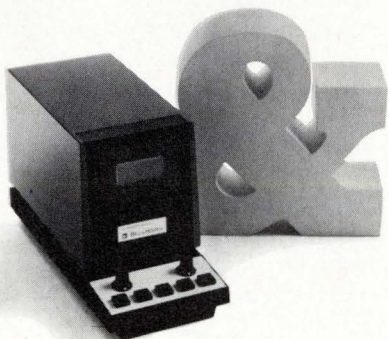

- Send me all the specs.
- Send a guy around for a demo.
- Here's my P.O. You fill in the blanks.

Name \_\_\_\_\_

Title \_\_\_\_\_

Company \_\_\_\_\_

Address \_\_\_\_\_

City \_\_\_\_\_ State \_\_\_\_\_ Zip \_\_\_\_\_

Bell & Howell—Electronics & Instruments Group,  
360 Sierra Madre Villa, Pasadena, California 91109

ELECTRONICS & INSTRUMENTS GROUP

 **BELL & HOWELL**

# Digital-to-analog converters: trading off bits and bucks

A multiplicity of makers, plus a dearth of standards, creates a bewildering array of options. But the engineer who can define his needs will find there is a d-a converter to match them

by Harry R. Karp,  
Special Issues Editor

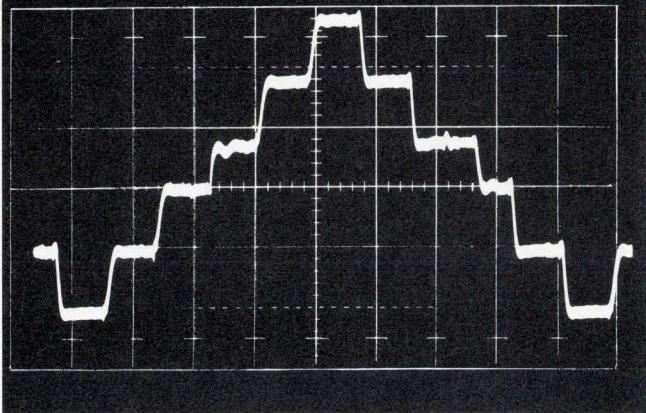

□ What electronics device has proven so cost-effective over such a range of applications that six times as many are in use today as there were three years ago?

What device is widely accepted without makers having any common agreement about how to produce them and without benefit of any industry standards? Nor has a single maker developed a clearly superior design, nor is there one user large enough to dictate specifications.

Finally, what device, with estimated sales of 120,000 units this year and more growth expected, has moved into the market with low-cost models to anticipate volume requirements and competitive pressures—yet given rise to products with marginal performance? (Or so say some makers about some competitors).

The answer is the digital-to-analog converter (DAC) module.

Once exclusively a measurement and control systems component, the DAC now goes more into such products as X-Y plotters, cathode ray tube display terminals, programmable power supplies, and analog-to-digital converters. But lack of electrical, packaging and terminal-connection standards, poor definition of real costs in

terms of performance, and technical complexities of the module put the electronics engineer at risk in determining DAC parameters and selecting the proper unit.

All this means that price alone is no guide to the selection of a DAC. By and large, two DACs of the same bit length usually differ in many electrical and performance parameters and options, as well as terminal arrangements, whether they come from different vendors or from two families of DACs made by the same vendor.

Consequently, choosing a DAC module—and so opting to deal with a particular vendor—means the system designer has to lay out the circuit board for a sole-source unit. However, if he is concerned about continued availability or long-term performance of the sole-source DAC, the designer can go to the expense of adding extra conductors and holes to his circuit board to make it compatible also with a “second-source” DAC. Or he can search out another vendor who can adapt his unit to be compatible with the first selection.

While competition has little effect on pricing, therefore, the major price determinants are completeness and freedom from error. By completeness of DAC modules is meant whether all of the electronic niceties required to convert a digital data word into a usable analog signal are actually in the package or whether outboard components—an input register or an output amplifier are examples—must be added and paid for by the user.

## Six performance parameters

There is a very sharp increase in price as DAC performance improves. The major performance parameters are resolution, accuracy, linearity, temperature stability, settling time, and freedom from switching transients.

In performing conversion, the DAC turns a parallel  $n$ -bit data word into  $2^n$  discrete levels of analog output. Thus, a 10-bit DAC has  $2^{10}$ , or 1,024, output levels. The reciprocal of the number of output levels is the DAC's resolution. Thus, the resolution of a DAC is implicit in the number of input bits (see table of Resolution Equivalents). Because the smallest change in analog output results from the binary change (from a 1 to an 0, for example) of the least significant bit (LSB) in the data word, the term “1 LSB” is a customary way of stating resolution, since it is independent of the bit-length of the data word. The LSB is equivalent to stating the percent of full scale for the analog output.

The DAC's accuracy refers to net error in the analog output for a given input code. For example, if a 10-bit DAC ought to have a 10-volt output for a full-scale digital word but yields only 9.5 volts because of poor calibration, the error is 5%. While the DAC will provide the necessary 1,024-step resolution, each step will be correspondingly inaccurate. Customarily, accuracy is specified in terms of  $\pm\frac{1}{2}$  LSB error, meaning the accuracy remains consistent with the DAC's resolution capability. Practically speaking, accuracy cannot be better than resolution, but it can be worse.

Linearity defines the constancy of the input-output ratio of the full range of values. A DAC can be linear, but inaccurate.

Changes in the DAC's operating temperature create output error. The better the temperature stability, the wider the temperature range that it is possible for the

DAC to tolerate without producing excessive error.

*Settling time* expresses the delay between introduction of the data word and the analog output reaching some final value. The shorter the settling time, the faster the throughput rate for data conversion.

Switching operations inside the DAC cause transient spikes known as *glitches*. For some applications it's necessary to add a deglitcher circuit to remove them.

An indication of how the parameters relate to price can be gained from Fig. 1, which is based on information obtained from many manufacturers and charts the lowest and highest prices for DACs ranging from 6 to 16 bits. This price structure reveals the cost to the user of the technological demands placed on the maker to satisfy specific applications. The lowest price for each DAC size can be interpreted as the basic cost of obtaining conversion and resolution. The top of each bar can be construed as the maximum cost of providing maximum completeness, nominal accuracy, temperature stability, deglitching, and so forth. It is interesting to note that this extra cost, about \$200, is almost independent of the DACs bit size—except for 6-bit DACs.

The cost trend for increased resolution is clearly dem-

onstrated in Fig. 2, which uses the data of Fig. 1 to plot cost per bit vs bits from the data. As expected, the cost per bit goes up with the number of bits—first gradually, then sharply—reflecting both the increased cost of higher-quality components and more exacting manufacturing and testing procedures.

Figures 1 and 2 also show that 6-bit, 14-bit, and 16-bit DACs are each in a class by itself, while 8-bit, 10-bit, and 12-bit DACs together form another class. In fact many makers offer 8-, 10-, and 12-bit DACs in the same family of devices, having started with a 12-bit design and then modified the design to make lesser-bit units.

DACs having 14 and 16 bits provide so much resolution that they are most often used in exotic laboratory and scientific investigations and for applications having a wide dynamic range of digital values—65,536-to-1 for a 16-bit DAC.

The accuracy of a 10-bit DAC, equal to 0.05% of full-scale, equals or betters many types of analog meters and recorders. Such a unit is suited to drive, for example, a strip-chart recorder with outputs from a computer or other digital source. A 12-bit DAC provides sufficient resolution to match the accuracy of an X-Y plotter. And

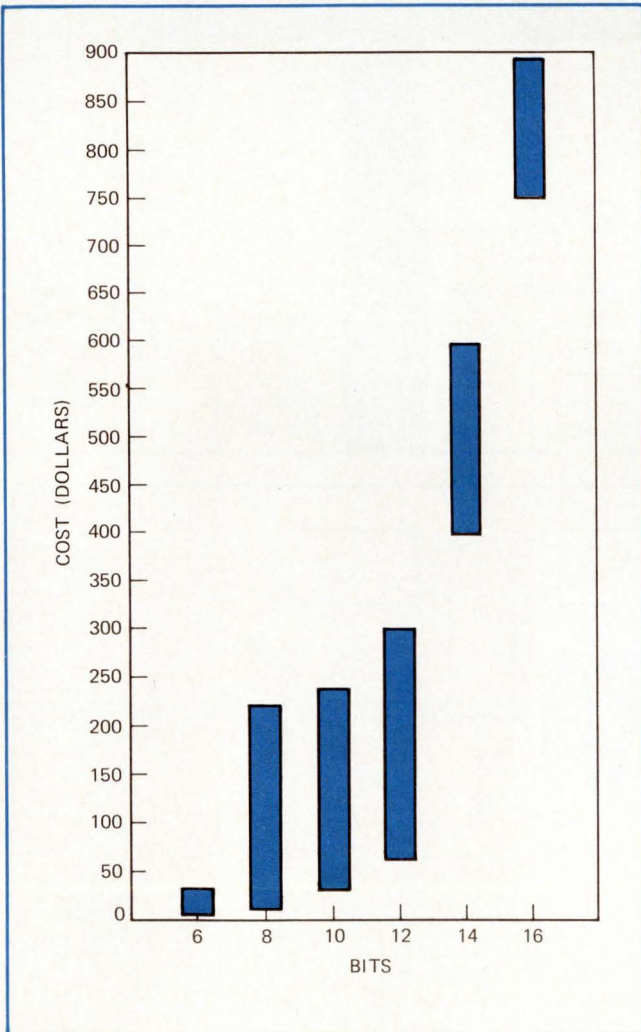

**1. Insight.** Price structure for digital-to-analog converters, based on bit-length, or resolution, reveals sharp rise in cost for more resolution and precision. Height of bar reflects cost-range for performance features over and above that for basic conversion.

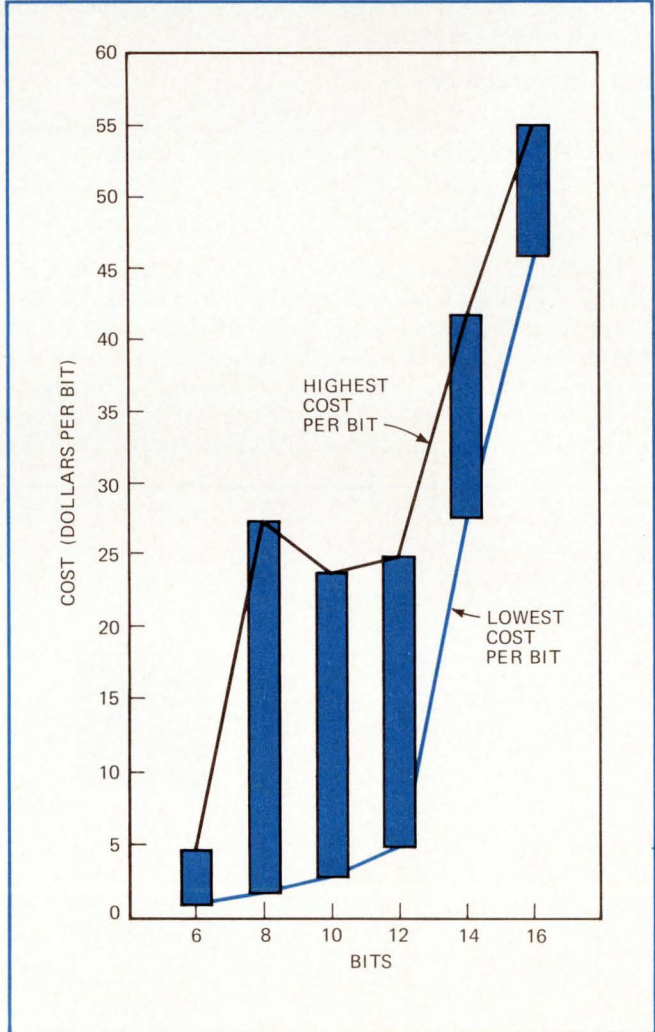

**2. Premium.** Cost-per-bit data, based on Fig. 1, emphasizes the cost increment for attaining and maintaining DAC precision. The gradual price increase for lesser-bit DACs results from volume production and less stringent demand on component tolerances.

an 8-bit DAC could be used to drive a low-accuracy analog meter whose purpose is, for example, to give a test operator a quick but not too accurate look at ongoing results.

The 6-bit DAC produces an analog output having only 64 discrete steps, or a resolution of 1.6%. Because of this low resolution, the 6-bit DAC is not normally used in measurement and control applications as are the higher-bit DACs. Instead, the 6-bit DAC programs the output of power supplies, provides multi-level outputs for modems in data communications links, and so on.

For each application, the system designer must develop a set of specifications for such major parameters as resolution, linearity, accuracy, and settling time. And this means answering such questions as: over what temperature range must the DAC operate satisfactorily? For example, a 10-bit DAC required to have 10-bit resolution and 10-bit accuracy could degenerate to yield 10-bit resolution but only 9- or 8-bit accuracy—but 10-bit resolution with 8-bit accuracy might be adequate.

Does the application require a current output or a voltage output from the DAC? If voltage, is the performance of the output amplifier supplied with the DAC good enough, or should the user provide a higher-performance outboard amplifier?

### The infrastructure

There is a wide enough range of DACs and options available from about 20 manufacturers to meet almost any user requirements. Choosing a DAC wisely, though, involves an understanding of how they operate and how they're made.

The kernel of any DAC is a set of switches and a resistance network, as shown by the colored blocks in Fig. 3. Two popular configurations are shown in some detail in Figs. 4 and 5. Each transistor switch is opened by a 0 level or closed by a 1 level at a corresponding bit-position of the input digital data word. (Or the logic convention might of course reverse this correlation.) Thus, in

the case of a 6-bit DAC, the input binary word

**1 0 1 0 1 0** Binary  
1 2 3 4 5 6 Bit number

would mean the switches for bits 1, 3, and 5 are closed and 2, 4, and 6 open. Here bit 1 is the most significant bit (MSB) and bit 6 the least significant bit (LSB).

The analog output corresponding to **101010** is  $1 \times 2^{-1} + 0 \times 2^{-2} + 1 \times 2^{-3} + 0 \times 2^{-4} + 1 \times 2^{-5} + 0 \times 2^{-6}$  or 21/32 of full-scale value. Here, the MSB contributes one half the analog output.

### Basic circuits

One common way of converting a binary input word to an equivalent analog output is shown in Fig. 4. When the bit-1 switch closes, the reference voltage creates a current through R of, say, 1 milliampere. Since the resistor associated with bit 3 is 4 R, then its current contribution is ¼ milliampere. And so on. The sum of these currents goes to the input of an operational amplifier which in turn produces an output voltage equivalent to the value of the applied digital word.

RESOLUTION EQUIVALENTS					
1 LSB RESOLUTION		BITS	½ LSB RESOLUTION		ANALOG OUTPUT STEPS
%	PPM		%	PPM	
6.25	62,500	4	3.125	31,250	16
3.125	31,250	5	1.563	15,625	32
1.563	15,630	6	0.781	7,810	64
0.781	7,810	7	0.391	3,910	128
0.391	3,910	8	0.195	1,950	256
0.195	1,950	9	0.0977	977	512
0.0977	977	10	0.0488	488	1,024
0.0488	488	11	0.0244	244	2,048
0.0244	244	12	0.0122	122	4,096
0.0122	122	13	0.00610	61	8,192
0.00610	61	14	0.00305	31	16,384
0.00305	31	15	0.00153	15	32,768
0.00153	15	16	0.000763	8	65,536

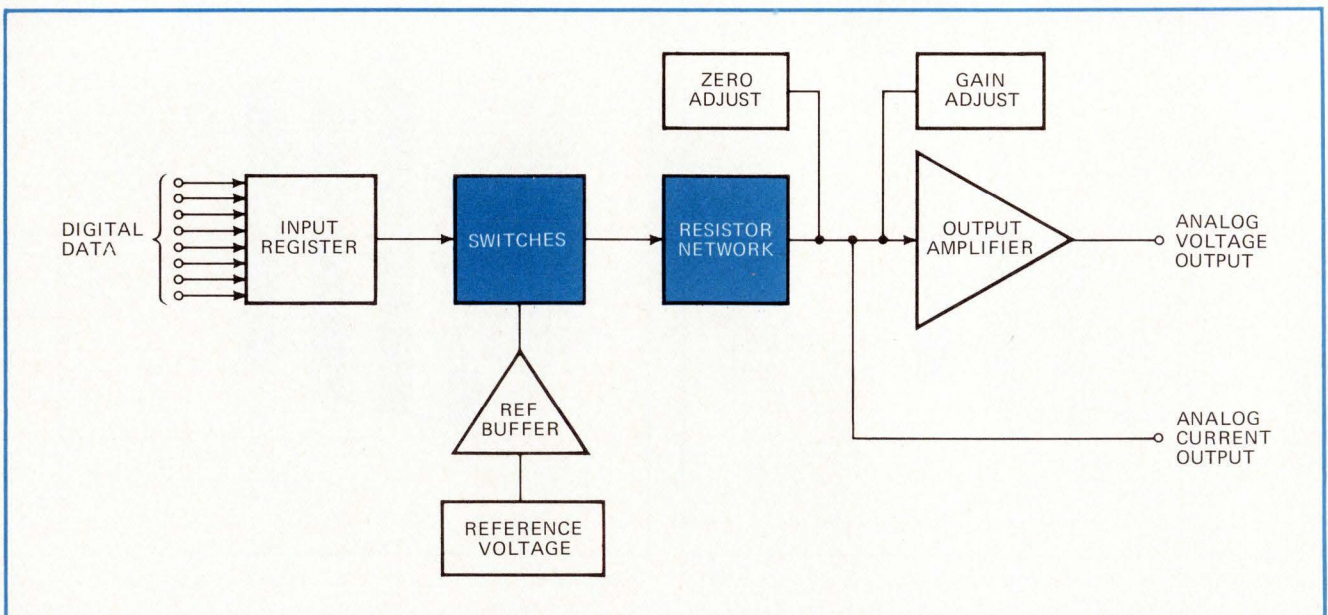

**3. Necessities and niceties.** Every DAC contains switches and resistors (colored blocks) essential to conversion process, as well as other functions and features selectable for the performance required for the application.



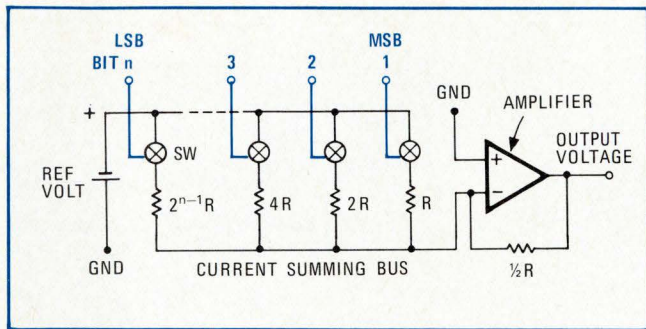

**4. Adding up.** Binary input either opens or closes transistor switches, thereby producing binary-weighted currents that are then summed to equivalent current output or voltage output.

This configuration features one resistor for each bit. However, since each resistance is related to its neighbor by a factor of 2, a DAC with a large number of bits requires a very wide range of resistance values. In a 12-bit DAC, for example, the range is over 4,000-to-1.

Furthermore, if linearity and accuracy are not to fall short of  $\pm 1/2$  LSB, the tolerance of  $R$ —including a resistance variation due to temperature change—must not be allowed to exceed  $2^{-(n+1)}R$ . In other words, any variation in the current through  $R$  (for the MSB) due to a change in the nominal design-value of  $R$  should not exceed half the current through the LSB resistor. This is why the allowable tolerance of the resistors decreases rapidly as the number of bits increases in the DAC.

To reduce the number of resistance values for higher-bit DACs, the quad circuit has been developed. The quad is essentially a 4-bit DAC requiring four different resistance values, as in Fig. 4. An 8-bit DAC is obtained by connecting two quad units, with a suitable current-attenuating resistor in the summing bus. In this case, the attenuating resistor reduces the contribution of the quad containing the LSB by 16 (or  $2^4$ ) relative to the quad containing the MSB. The two quads are similar, except that the tolerance of the resistors in the MSB quad must be correspondingly tighter than the tolerances in the other unit.

Another way of performing digital-to-analog conversion uses the  $R$ - $2R$  network (Fig. 5). This conversion circuit also yields binary weighted analog contributions when each bit-position switch is closed. While it needs two resistors instead of one for each bit, it also requires only two different resistance values. But again, tolerances are important.

#### A heating problem

During conversion, single-pole double-throw transistor switches connect each resistor to the reference voltage or to ground. Some voltage drop occurs across the transistor and, ideally, this can be accounted for in the basic design so that the actual current through the resistors remains binary related. However, the transistor's sensitivity to temperature variations can have an effect on the actual current. As with the resistors, transistor-switch performance becomes more critical as the bit-length of the DAC increases. For this reason, makers often include temperature-compensation in the transistor-switch circuits.

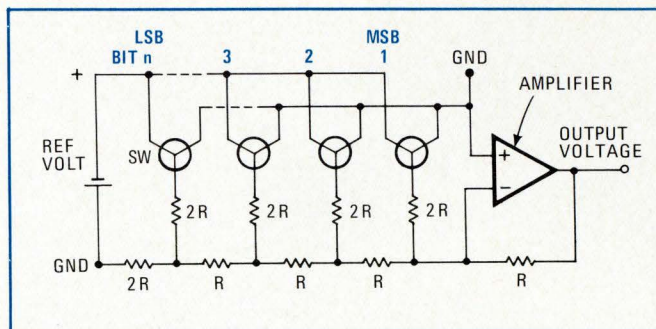

**5. Network.** A common d-a conversion method uses the  $R$ - $2R$  network to produce binary currents. This technique needs only two values of resistances, but takes two resistors per bit.

Irrespective of the kind of resistor network, the addition of an internal zener reference, driven by a power supply, provides a regulated voltage to develop the summed currents (see Fig. 3). If the power supply rejection ratio (PSRR) (in percent output change per percent supply voltage change) isn't satisfactory, a reference buffer amplifier helps to stabilize the zener's operating point further, making the DAC even more immune to changes in power supply voltage.

Some DACs come without a zener reference, allowing the user to add his own when he wants a reference common to the whole system or when overall system performance requires a better regulation than ordinarily provided in the DAC package.

As the switches open and close as the data word changes, the difference in transistor turn-on and turn-off times and the resulting shifts in analog signal level, together with residual capacitance, create spikes called glitches (Fig. 6). The maximum amplitude of the spike, 50% of full-scale value, occurs when all the bit-positions switch simultaneously—as when an input data word changes from **0111** to **1000**. Such a code change occurs when a DAC having a bipolarity output—for instance, from +5 V to -5 V—goes through zero.

The glitch can last for several hundred nanoseconds. If the DAC is driving a relatively large time-constant device, such as a d'Arsonval meter for a quick-look display, the effect of the glitches will go unnoticed. However, in a fast-response application—a CRT display—such a spike can be disturbing to the viewer since the glitch energy will "rattle around" in the tube and cause jitter in the displayed characters. For such high-speed applications, makers provide, for a price, a deglitcher that cuts the spike to about 0.02% of full scale value.

When bits in the parallel-bit data word do not actually arrive at the DAC at the same time, each transistor will then switch at a different time. This nonsimultaneous switching can also cause glitches. The situation can be ameliorated by adding a register in front of the switches. The data word is loaded into the input register, and then a strobe command connects the data word in the register to drive all switches simultaneously.

The register also serves as a data hold. Here, the computer loads the register and goes on to other tasks. At a later time, determined by system needs, a strobe command initiates the conversion.

Settling time, one of the DAC's major parameters, de-

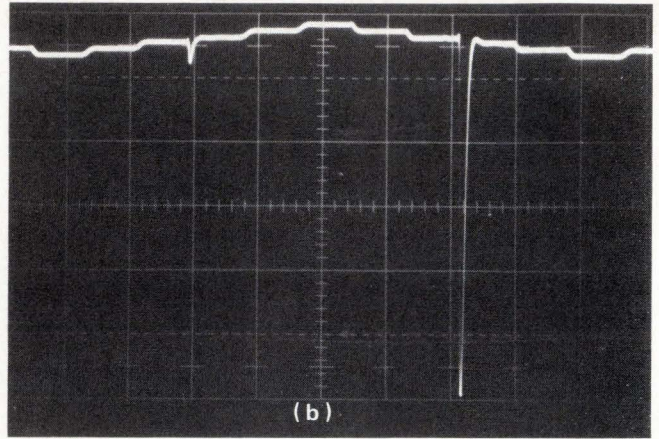
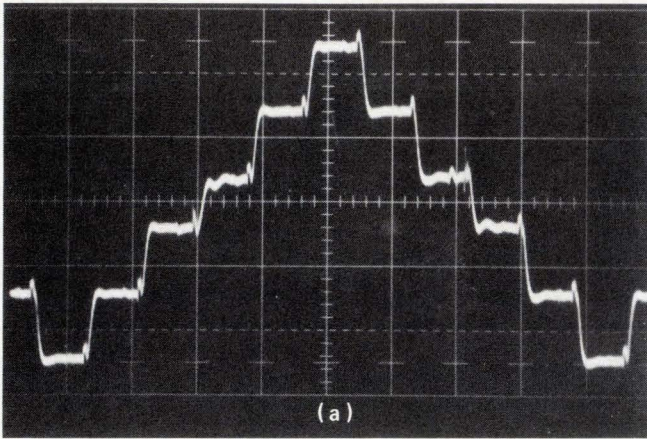

**6. Deglitching.** Oscilloscope A shows spikeless output when deglitcher circuit is added to a 10-bit high-speed DAC. In oscilloscope B the vertical gain has been reduced by a factor of ten, revealing magnitude of the glitch. Photos, courtesy Analog Devices Inc., have been retouched.

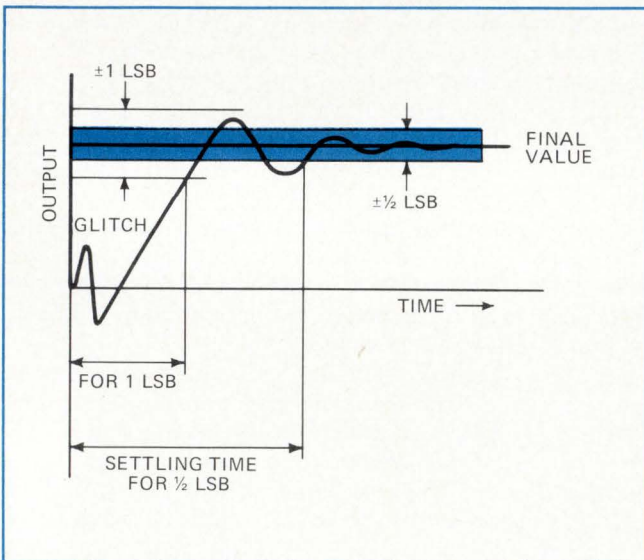

**7. Settling time.** The time interval between initiation of switching operations and attainment of some prescribed final value of analog output is called the settling time.

termines the fastest rate at which successive data inputs can be converted without losing accuracy due to premature cutoff of the transient analog output. By definition, it's the interval between the loading of a new data word into the switches and settling of the output to within some error band bracketing the final value (Fig. 7).

Its actual duration depends on the magnitude of the change between successive data words, the presence (or absence) of major code transitions that may create glitches, and the slewing rate and damping of the output amplifier (if any).

#### Plus and minus an amplifier

This amplifier, as Fig. 3 shows, is not necessary in DACs with a current output, which is available directly from the current summing bus. When a voltage output is needed, an output amplifier transduces the output current to an equivalent voltage. Staying with current output means the settling time is shorter, and the DAC will probably cost less because there's no amplifier in the module. However, analog devices driven by a DAC often require voltage inputs, so it may be more conve-

nient to buy a DAC with the internal output amplifier at the slight additional cost.

By and large, the settling time stated by makers is based on a full-scale change in the input data word and an error band of  $\pm\frac{1}{2}$  LSB. This value would be much smaller, and therefore appear better, if the error band were  $\pm 1$  LSB, because of the exponential approach to final value. Thus, to compare settling times, the user must make sure the error bands are within same tolerances.

For current-output DACs, the times quoted range from about 100 to 1,000 nanoseconds, due primarily to switching delay. However, with an integral amplifier the net settling time stretches to many microseconds.

This increase arises from the amplifier's inherent rise time, which occurs in response to the step change in current resulting from a change in the input digital word. Despite its duration, the settling time of most voltage DACs is generally adequate. But when the application needs it to be shorter, the user can add a higher-performance amplifier, one having a wider bandwidth, to speed up the output response.

The output amplifier also contributes to the error budget of the overall DAC. Therefore, a high-performance outboard amplifier can be employed not only to improve settling time, but also to reduce zero drift and changes gain in with time and temperature. High-performance amplifiers add appreciably to the overall cost of performing fast, accurate, and repeatable digital-to-analog conversion.

#### Sources of error

Besides the operating functions available in or with a DAC, the other aspect of DAC performance is the error budget. Some error is left in during manufacture, as indicated by the values on maker's spec sheets for various parameters. Additional error can show up during operation—particularly when the DAC is mounted in a warm or cold environment.

Changes in component values cause several types of error, which may be more or less important in different applications. Suppose it were possible to have an ideally linear and accurate DAC (Fig. 8). Here, the "transfer function" would be a straight line that started at true zero and finished at true full scale. As a result, when the digital input was stepped 1 bit-value at a time, the digi-

tal-to-analog conversion process would produce a uniform-incremental-step staircase output. Figure 8 shows the effect on this output when the transfer function becomes nonlinear, which can occur, for example, when temperature change modifies component values so that the summed currents are no longer related in a binary fashion. The resolution remains, but accuracy decreases: the staircase steps are no longer uniform.

The nonlinearity in Fig. 8 is monotonic, in that increasing bit values yield an increasing-value staircase output and there is a unique analog value corresponding to each digital word. However, the transfer function could degenerate into a non-monotonic nonlinearity, as shown in Fig. 9. Here, the nonlinearity reverses direction. The presence of an excessive non-monotonic nonlinearity means that two different input codes produce the same analog output—which could have serious consequences. For example, it could cause a digital servo to hunt (oscillate) continuously, because of the servo's inability to settle on a single-valued null point. (The nonlinearity in Figs. 8 and 9 has been exaggerated for graphic contrast).

Two other kinds of error, gain error and offset error, are shown in Fig. 10. The former, in which the slope of the transfer function changes and does not go through the ideal full-scale point, is caused by changes in reference voltage, amplifier gain, and resistor values. Offset error, in which the slope does not go through the ideal zero point, is caused by resistor changes and amplifier drift. Some higher-resolution DACs include extra terminals for connection of resistor trimmers, to permit out-board recalibration of offset and gain functions when the DAC ambient is of high or low temperature.

While the effect of temperature change on individual components is to alter nonlinearity, gain, and offset errors, the important thing to the user is the net effect of temperature on the overall unit. This effect on accuracy is specified by the maker as a temperature coefficient (tempco) in parts per million per °C (or as its equivalent percent per °C, see table of Resolution Equivalents). The impact of temperature change on DAC accuracy can be determined from the three charts in Fig. 11. Here, a DAC ambient temperature different from nominal temperature (usually 25°C) results in a certain ppm error—depending on the DAC's tempco—and this in turn is translated into the equivalent ½ LSB error for each DAC size from 6 to 16 bits.

Suppose a 12-bit DAC has a 100 ppm/°C tempco and must operate at 35°C (or a Δ°C of 10). Figure 11b shows the resulting error is 100 ppm. Since 100 ppm falls within the colored band for the ½ LSB for 12-bit DAC, the DAC retains its ½ LSB accuracy under these conditions. However, in the case of a 14-bit DAC with a 10 ppm/°C tempco (see Fig. 11c), a change of only 4°C is enough to push accuracy past the ½ LSB limit, so that the DAC has 14-bit resolution but only 13-bit accuracy under these conditions. And a change of 10°C would reduce the DAC to 12-bit accuracy.

All this brings the user right back to the cost information in Fig. 1. Does he really need a 14-bit DAC that must operate with 14-bit accuracy and, if so, can he maintain the unit's temperature within a relatively narrow band? If yes, the cost is about \$500. If, however, 12-

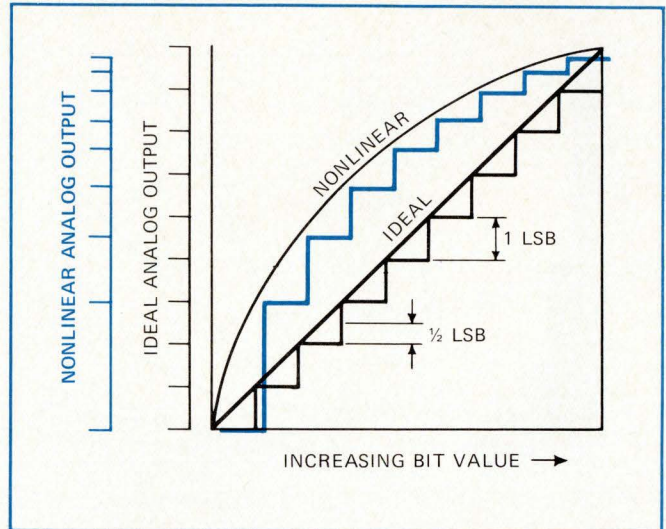

**8. Nonlinearity.** Any nonlinearity in the DAC's transfer function produces non-uniform steps in the analog output.

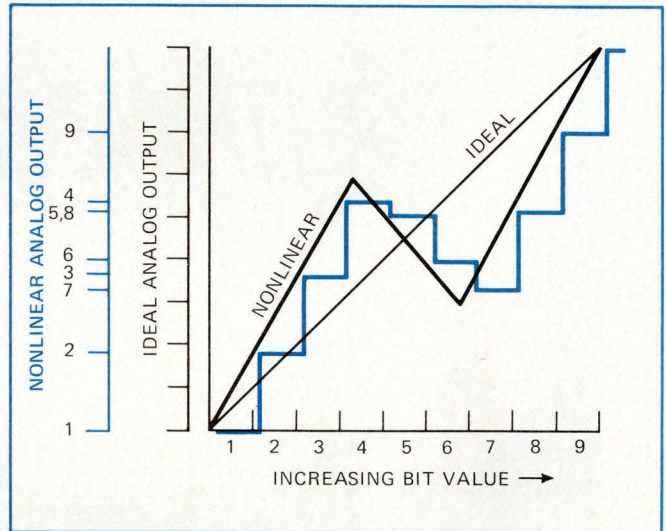

**9. Non-monotonicity.** When the DAC's transfer function reverses direction, output steps will go down when they should go up.

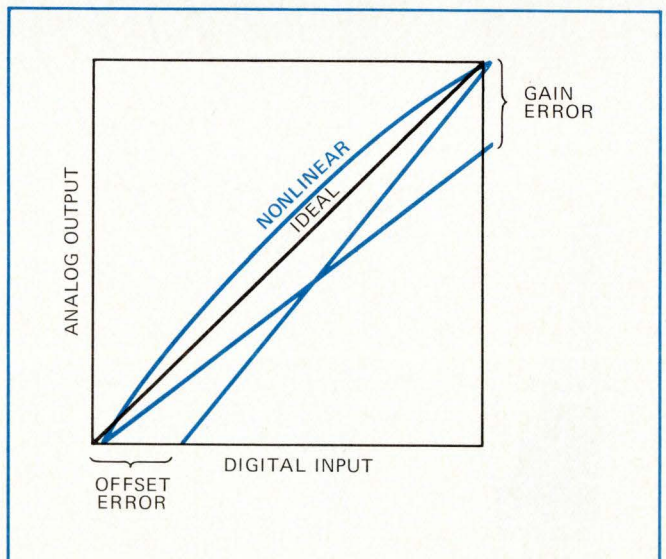

**10. Erroneous.** Two causes of reduced accuracy in a DAC are gain error and offset error. External correction is possible in some DACs.

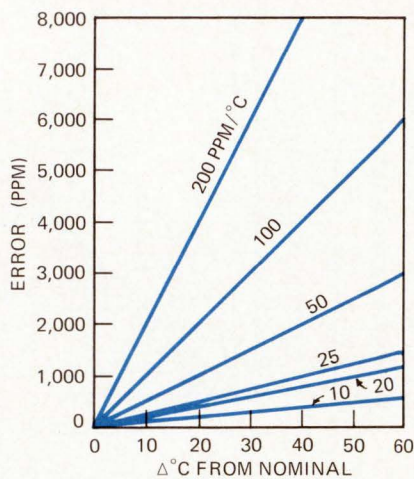
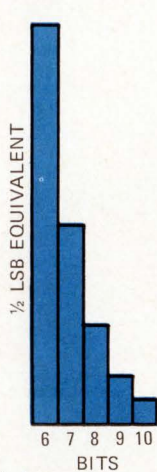

(a)

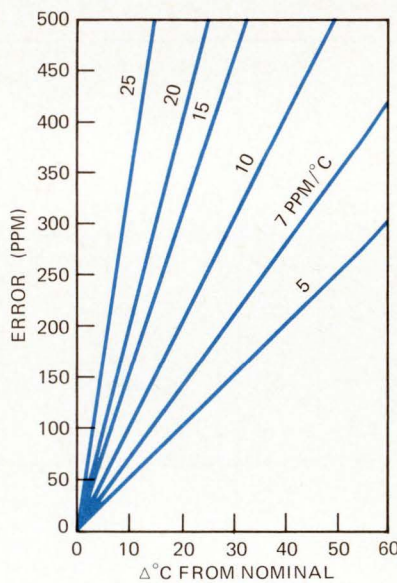
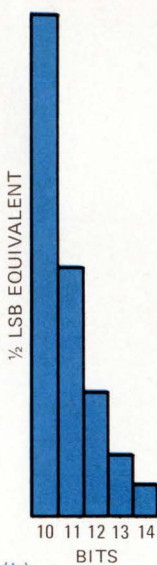

(b)

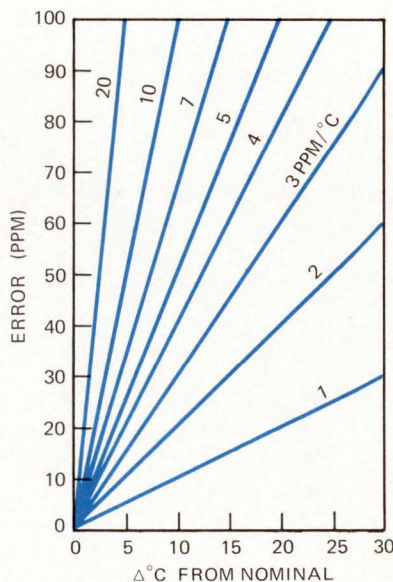
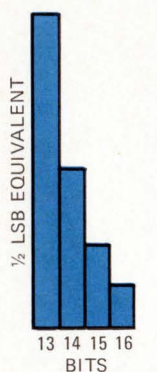

(c)

**11. How temperature affects DAC accuracy.** When a DAC operates at a temperature different from the nominal design temperature, an error in parts per million may result. Its value depends on the DAC's temperature coefficient and ambient temperature. Here, the error is related to the corresponding 1/2-least-significant-bit criterion for each DAC size. If the temperature-induced error falls within the appropriate colored bar, the DAC retains nominal accuracy.

bit accuracy is satisfactory and he can also settle for 12-bit resolution, the cost drops to about \$200.

In some applications accuracy less than equivalent resolution can be a definite specification, not a compromise. For example, suppose a wide range of digital values requires the code combinations available in a 16-bit word for their representation, but the analog output need only be accurate to 0.05%, equivalent to the ±1/2 LSB accuracy of a 10-bit DAC. Asking the manufacturer for a 16-bit DAC with a 10-bit accuracy eases his production and testing problems since acceptable ±1/2 LSB error can be within 500 ppm rather than less than 10 ppm; the cost drops from about \$750 to \$200.

### Method of manufacture

Interpreting the information on spec sheets, however, is just one factor in coming up with a performance rating. The second factor—design and manufacturing method—may weigh heavily in the ultimate selection because it could affect the long-term performance of the relatively low-cost DAC in an expensive electronic system. As the plethora of hybrid, discrete-component, and monolithic DACs reveals, manufacturers themselves have not agreed in the best way to make a DAC—and at the present there may be no single way that's best for every application. The user should add his own judgment, in the light of his particular needs, and then relate the outcome to price.

Many interrelated considerations go into the way the maker chooses to produce his unit. Among these are the DAC's bit length, the conversion method, the expected selling price, and production volume. The bit length sets the accuracy requirements and this in turn determines, for example, whether thick-film resistors can provide the required range of resistance values and tempco for the bit-length of the DAC, or whether the unit should use more precise, discrete wirewound resistors. The conversion method determines, among other things, the parts count of the resistors, and thus affects the decision of whether it's less costly to buy discrete resistors or to deposit them at one time as a thin-film or thick-film network. Production volume can affect whether the maker wants to invest in a hybrid or semiconductor facility, or save on capital investment but opt for higher labor cost in assembling discrete-component DACs.

In general, higher-bit DACs don't enjoy a high volume but do require high precision, and so they are produced from discrete, high-accuracy, low-tempco resistors. Lesser-bit DACs, with higher production volume, are made in a variety of hybrid or discrete designs. The latest innovation in DACs, the 100% monolithic design, may eventually pose a threat to other methods, but so far this approach has resulted in a 6-bit DAC on one chip in a dual in-line package. However, 8- and 10-bit monolithic DACs should be announced soon. □

# Out of Sight at ~~\$495~~ \$395.

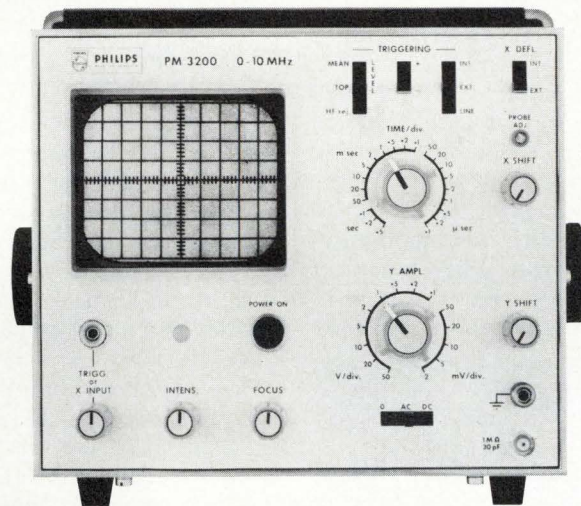

At \$495, the Philips PM3200 offered the best price/performance ratio of any portable 10MHz scope. You can get the same PM3200 now for \$395. This is what you'll get: frequency coverage to 10MHz, 2mV sensitivity, fully automatic triggering, battery or line operation, 5 million-to-one sweep range, drift free at 2mV sensitivity.

Compact, light; weighs only 11 lbs.  
Leather carrying case (optional).

Call Dick Rude, National Sales Manager, Test & Measuring Instruments:  
914-664-4500. He has 25 PM3200 sales offices at your service.

**PHILIPS  
ELECTRONIC  
INSTRUMENTS**

750 S. FULTON AVE., MT. VERNON, N.Y. 10550  
A DIVISION OF PEPI, INC.

# The T-box: a low-cost software-based interface

A low-cost connector module and easily installed cable can use idle minicomputer time or a dedicated machine to substitute for the major functions of a peripheral device controller with minimum preparation

by David H. Chung and Don B. Hay, *United Technology Laboratories, Garland, Texas*

□ Each peripheral device connected to a minicomputer normally requires its own unique controller or adapter to generate the required operating signals. This controller usually translates and buffers the signals and data flowing back and forth between the device and the computer. But controllers are expensive and take up valuable space in the processor frame.

However, an inexpensive generalized interface, called the T-box, is available for many applications, allowing the minicomputer itself to control the peripheral equipment through software. The T-box takes up little or no space in the processor, and—best of all—the same type of T-box can be used for many different kinds of peripheral devices.

The T-box reduces hardware design to laying out a cable to connect it to the peripheral—a task usually requiring two to three hours, compared to the days or weeks necessary to design a controller. Design of the necessary software to operate the T-box can be completed in weeks, at most.

As in all technological developments, the T-box involves trade-offs. It must be used with a minicomputer in an application that allows the processor to take over some of the functions normally performed by a peripheral controller. This implies that the processor can spare

Device	Conventional interface		T-box method	
	Interface	Cost	T-box	Cost
Mag. tape unit	Formatter	\$ 1,500	2	\$ 800
Modem	Modem interface	2,250	1	400
Line printer	Printer controller	11,500	1	400
CRT terminal	Terminal controller	2,000	1	400
Card reader	Reader controller	850	1	400
Plotter	Plotter controller	1,500	1	400
Totals		\$19,600	7	\$2,800
Dedicated minicomputer				3,000
Software				1,200
<b>Grand Total</b>		<b>\$19,600</b>		<b>\$7,000</b>

some time from its basic tasks; or equivalently, that the processor can be dedicated to input-output operations—perhaps as a controller in a network.

With the already low and continuously decreasing prices of minicomputers, such dedicated use becomes feasible. An example of savings possible with the T-box is shown in Table 1. But the T-box is suitable only for smaller systems or for large networks of peripherals that have very low duty cycles for each peripheral.

The device can handle data formats from one to 16 bits per word. The time interval between words must be sufficient to permit bits to and from the minicomputer to be spaced at least 50 microseconds apart, corresponding to a maximum data rate of 20 kilobits per second. This rate would permit the T-box to control nearly any peripheral device, except high-speed disk files or magnetic tape drives.

Although two T-boxes have been combined to control a magnetic tape unit, the usual functions of a formatter in a conventional system, such as computing parity bits, checking characters, monitoring tape motion, and the like, are transferred to the minicomputer. These functions would probably prevent it from doing anything else while controlling the tape unit.

## Two versions built

Two versions of the T-box have been built—one for use with transistor-transistor logic levels, and one with signal specifications of the Electronic Industries Association's RS-232 interface. Synchronization and timing ca-

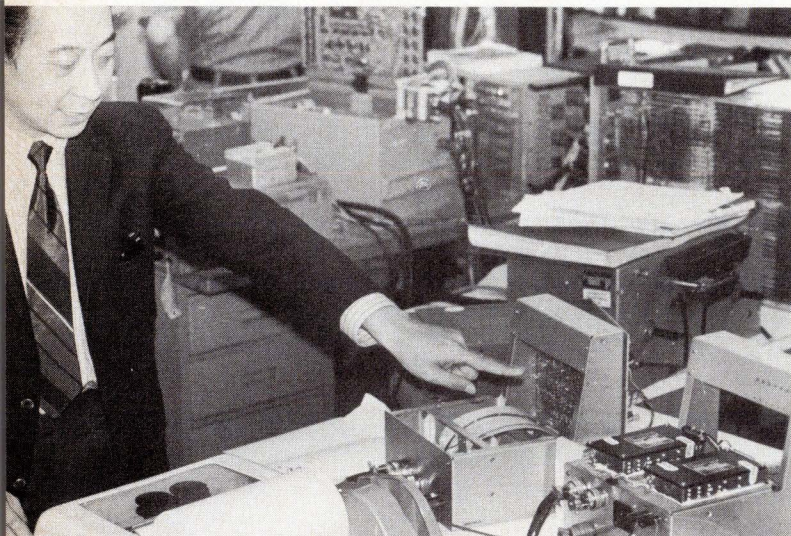

**1. Small and simple.** Author Chung points at some prototype T-boxes on a bench at United Technology Labs. The boxes plus computer software replace large, expensive input-output controllers.

pabilities are defined by those of the minicomputer with which it is used. The T-box depends on the minicomputer's interrupt capability (assuming that the minicomputer can accept interrupts—most can) and the execution time of a single instruction, which establishes a lower limit on the smallest time increment that the T-box can resolve. This is not a constraint on most peripherals used with minicomputers.

Starting with a single minicomputer and the memory modules appropriate for a particular application, the options are to attach the necessary peripheral units to the minicomputer through a series of conventional controllers or to set up a dedicated minicomputer in parallel with the parent machine and attach the peripherals through T-boxes. In the Table 1 example, seven T-boxes are necessary—two for the magnetic tape unit and one each for all others; to this expense, the cost of the extra minicomputer and the software is added. The cost difference is clearly in favor of the T-box.

The T-box is currently in use in all of the computers being marketed by United Technology Laboratories [*Electronics*, Aug. 30, 1971 p.28]. As implemented in these computers, it is not really a "tee" but consists of about 70 integrated circuits, two thumb-wheel switches, and a connector—all mounted as part of the system. If it were built as a separate single unit, it would have three connectors and could be contained in an ordinary printed-circuit board with a small housing for the connectors and switches (see Fig. 1). One implementation houses eight T-boxes in a box 3½ by 19 by 20 inches. But logically, the box has the configuration of the letter T (see Fig. 2), hence its name; it is plugged in between two lengths of cable (the top of the T) with a peripheral unit connected to the side (the stem of the T).

The ICs are relatively simple; the design appears to be amenable to being integrated on a single chip, in which form it could fit inside a modified conventional BNC T-connector. The three connectors are called "in," "out," and "drop." The in and out connectors each carry 10 twisted-pair signal lines and three dc power lines; at the in connector, these come either from the minicomputer or the preceding T-box, and at the out connector they are passed along to the next T-box or to an impedance-matching terminator plug at the end of the line. Through the drop connector pass the signal lines to and from the peripheral unit. There is a maximum of 39 of these lines. Sometimes a single T-box can service more than one peripheral unit, and sometimes a single peripheral unit will require more than one T-box to handle its communications with the minicomputer. Some typical examples appear in Fig. 3.

### T-box shown

A block diagram of the T-box and its electrical signal lines is shown in Fig. 4. Two amplifiers serve every signal line passing through the T-box—five lines from in to out, four from out to in, and one both ways. Each of these signals is transmitted in a balanced mode on a twisted pair; the amplifiers are differential line drivers and receivers.

The individual lines are defined in Tables 2 and 3. Serial/parallel conversion, which requires the clock line, is performed on data when a peripheral unit accepts or

generates several bits in parallel; the T-box in and out connectors have only one data line, which is used for serial transmission.

Three dc power lines pass through the T-box along with the signal lines. They carry a positive and a negative voltage and ground for the logic circuits in the T-box; voltage regulator circuits in the T-box adjust the voltage levels if necessary, particularly along long cables. These power lines do not supply the peripheral device itself.

Only the fastest peripheral units would use all 32 data lines available at the drop connector; slow devices, such as teletypewriters, would use only one line each way.

One of the four output strobe lines carries an unconditional pulse. It is used after a read operation to acknowledge receipt of the character from the peripheral unit, or before a write operation as a signal that the character to be written is available. The other three strobes are conditioned by bits 0, 14, and 15, respectively, in the T-box output buffer. By setting and resetting these bits at appropriate times, the computer can use them for any purpose. All four strobe pulses are nominally 500 nanoseconds in duration, but can be varied over a considerable range by adjusting a monostable circuit in the T-box.

The thumb-wheel switches define the address of each peripheral unit on the bus by translating the numerical address into an eight-bit binary address. Three bits define one of eight groups of units; four define a particular one of 16 units in the group; and the eighth defines whether the operation that follows the address concerns a data transfer or an interrupt inquiry. This eighth bit isn't strictly an address bit, but goes out with the address in the same operation. As many as 128 peripheral units can share a single input-output channel of the minicomputer, each with its own T-box, within the constraints of the addressing scheme. Electrical or operational considerations, such as the computer's bandwidth, may impose a lower maximum number of peripheral units in particular cases.

When an address, identified by the rise of the address gate, is sent out on the data line at the beginning of an operation, it automatically goes to every T-box, regard-

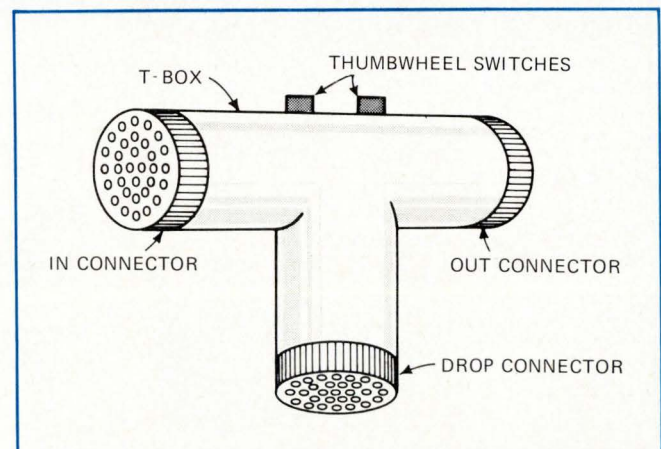

**2. Simplicity.** This schematic representation emphasizes the T-box's simple nature. A cable common to many peripherals passes through it, between the "in" and "out" connectors. Internal logic processes signals to and from peripheral via "drop" connector.

less of the setting of the thumb-wheel switches. When the eighth bit has been set into the output register of the T-box, the entire address is compared with that T-box's thumb-wheel switch settings. If the address doesn't match the setting, the T-box ignores the following instruction, the end of which is signaled by the fall of the data gate line. Only one T-box should be set to a matching address.

The eighth bit—actually the first bit to go to the T-box—defines whether the operation to follow concerns data or an interrupt. If this bit is 0, the operation will transfer data to or from the minicomputer, as specified by the input-output line. If it is 1, the minicomputer is either inquiring about the interrupt status of the

T-box, or it is supplying a mask bit to disable that interrupt, again as specified by input-output. When a particular T-box has had its interrupt disabled, but the interrupt line is still up, the computer knows that the interrupt is coming from a different T-box.

The computer can query or mask the interrupts from 16 T-boxes at once. If the first address bit indicates an upcoming interrupt query or mask, all the T-boxes in a particular group—up to 16—stay on line; the four address bits that identify them are not checked for match or mismatch against the thumbwheel addresses. Then when data transfer begins, each T-box transmits its interrupt status bit or accepts a mask bit during a time slot identified by these four address bits. The 16 bits travel along the data line, just as in normal data transfer, but each one comes from or is destined for a different T-box.

The data gate and clock signals, unlike the others in

Table 2 T-BOX IN AND OUT LINES	
Line name	Definition
Address/Data	Bidirectional line for serial transmission of address or data bits
Address Gate	Identifies address bits on Address/Data line
Data Gate	Identifies data bits on Address/Data line
Clock	Timing pulses for serial/parallel conversion in T-box
Input/output	Defines direction of data flow
Master reset	Clears all data and status bits in T-box to initialize it
Data Gate Return	Return path for Data Gate signal
Clock Return	Return path for Clock signal
Interrupt	Requests unscheduled or asynchronous operation
Ready	Addressed unit is available for use

Table 3 T-BOX DROP LINES	
Line name	Definition
Input data	Up to 16 lines, carrying data from peripheral unit to T-box
Input strobe	Advises T-box that data is on input bus; sets T-box input buffer
Interrupt	Advises T-box of exceptional condition in peripheral unit
Ready	Peripheral unit is available for use
Output data	Up to 16 lines, carrying data from T-box to peripheral unit
Output strobe	Four lines for signaling the peripheral unit

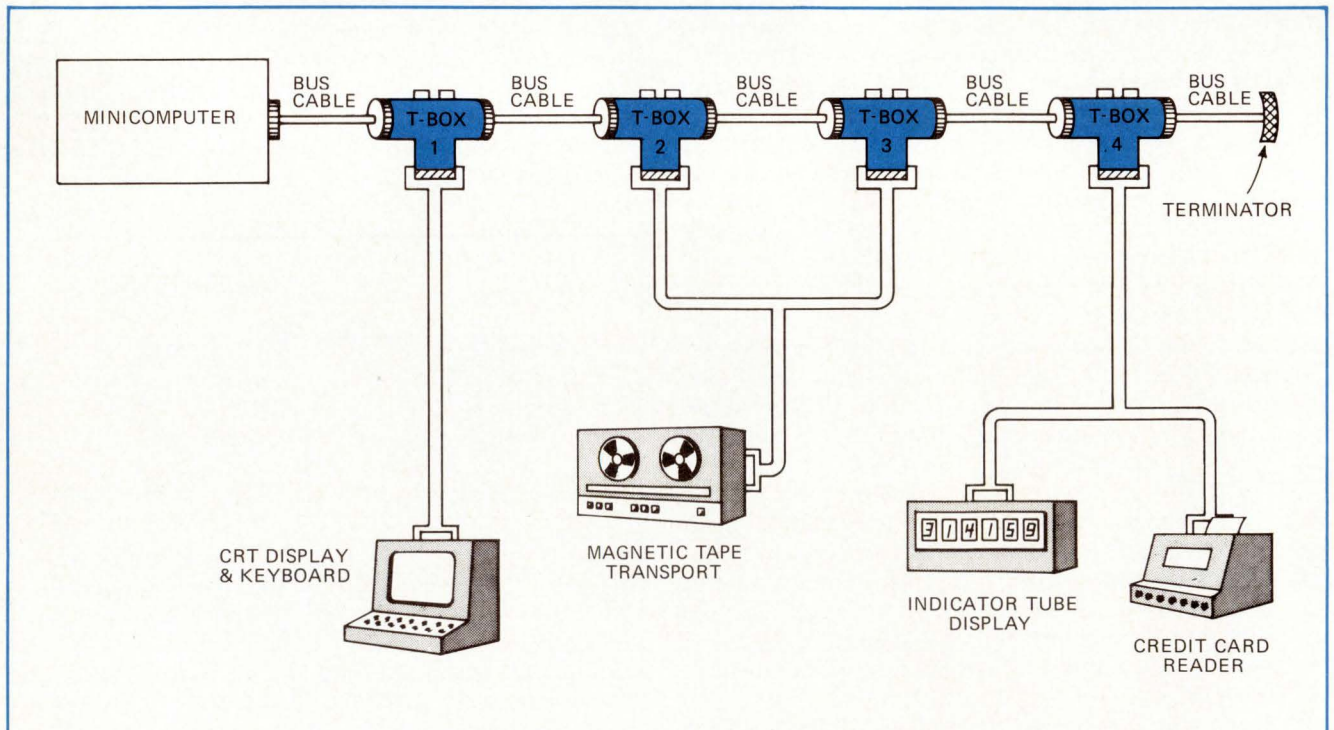

**3. Anything and everything.** Any kind of low-speed peripheral device can be connected to a minicomputer through a T-box. The more complex ones, like magnetic tape units, may require two T-boxes; whereas one T-box can sometimes handle two very simple devices.



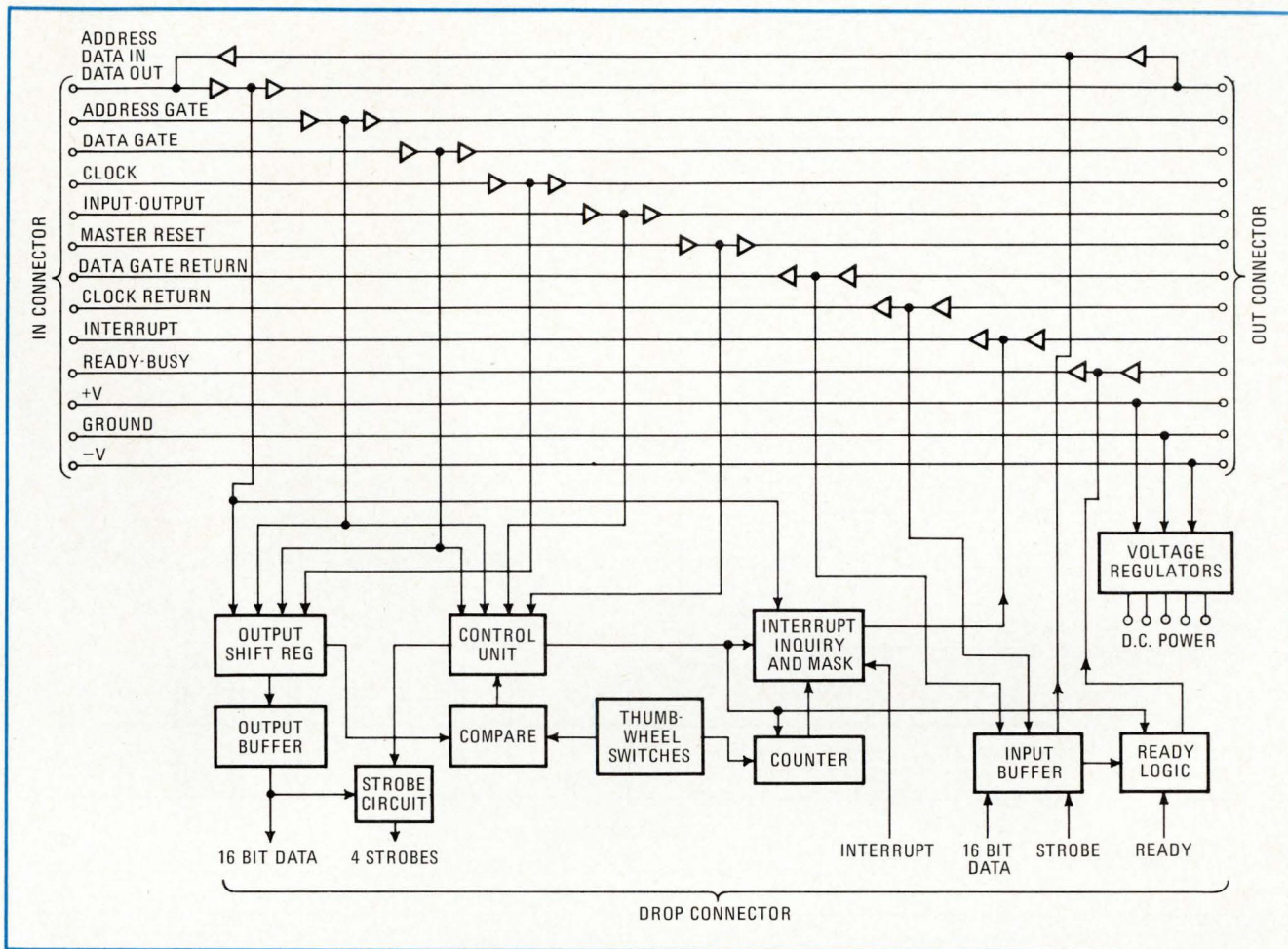

**4. Lines and logic.** Amplifiers boost the bus signals so they can be used on long cables, if necessary. Between receiver and driver, signals are tapped for local manipulation and for forwarding to the local peripheral unit, attached through the "drop" connector.

the bus, are not terminated at the end of the cable but are short-circuited to data gate return and clock return, respectively, which are terminated at the minicomputer. If the cable is very long, a great many microseconds may elapse at a T-box near the computer between the passage of these signals out and back. No T-box can put data on the data line until the data gate signal has passed both ways.

To understand why this restriction is designed into the T-box, suppose that two widely separated peripherals, with addresses 0 and 1, interrupt the computer at the same time. Suppose further that unit 1 is closer to the computer and that the propagation delay between unit 0 and unit 1 is  $10 \mu\text{s}$ . Unit 0 correctly inserts its interrupt status bit on the data line during time slot 0, and unit 1 does likewise during time slot 1. If these responses occurred immediately upon the rise of data gate, unit 1, being closer to the computer, would respond  $10 \mu\text{s}$  ahead of unit 0, and the computer would receive unit 1's status bit  $20 \mu\text{s}$  early. But by responding upon the rise of data gate return, the bits are inserted on the data line in the proper order and are so received at the computer. The only timing requirement for these proper responses is for the skew between clock, gate, and data to be less than one clock period. As long as this time relationship is maintained, the propagation delay of the cable is not a factor.

The ICs in the T-box include amplifiers for every signal passing between the in and out connectors. The devices permit lengthy cabling between successive T-boxes so that peripherals may be strung out over a distance of several miles, if desired.

### Teletypewriter control

Suppose the T-box is used with an asynchronous data transmitter, such as a teletypewriter. Each character from the teletypewriter arrives at the T-box in the form of a series of pulses, perhaps similar to that shown in Fig. 5. The T-box responds to the negative transition—representing the character's start pulse—by generating an interrupt signal to the minicomputer, which in turn responds by starting its internal timer.

At prescribed intervals, the minicomputer interrogates the T-box for each incoming bit. For machines such as the standard ASR-33 Teletype, which transmits 10 characters per second, the sampling interval is 9.09 milliseconds.

One character comprises 11 pulses—namely a start pulse, eight data bits, and two stop pulses. Start pulses and 0 bits are both negative or "space" levels; stop pulses and 1 bits are positive or "mark" levels. Each bit is transmitted into the minicomputer, where it is assembled into a complete word and placed in memory.

This software overhead may take five to 10 times as

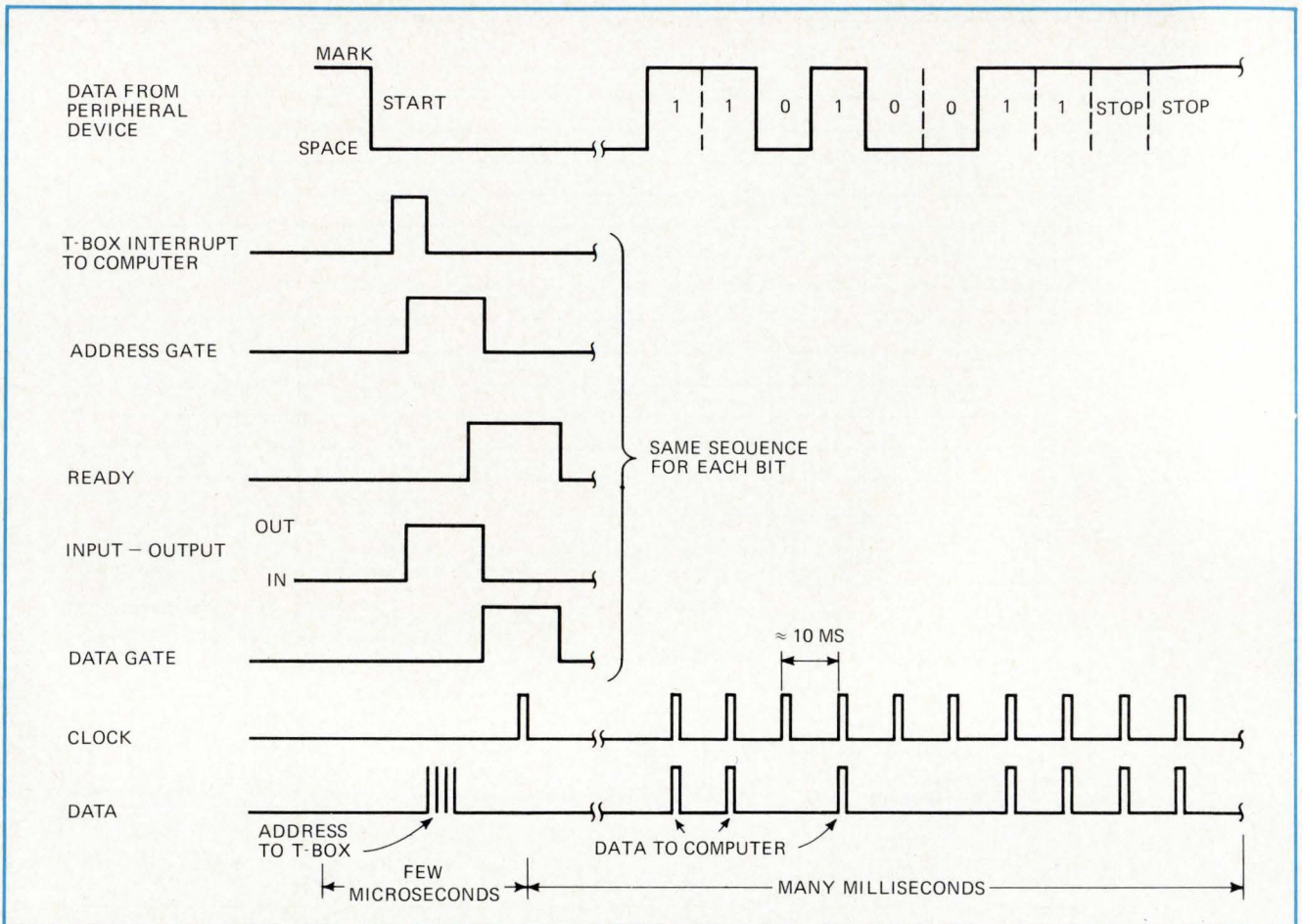

**5. Slow and asynchronous.** Signals between T-box and computer in typical low-speed application show sequence for each bit transferred. Left side of timing chart represents periods of 10 to 100  $\mu$ s; but bits are perhaps 10 ms apart, so time scale at right is condensed.

long as the actual bit-fetching, which is only a few microseconds. If the servicing of each bit, including the fetching and overhead, takes 100  $\mu$ s, but bits arrive only once every 9.09 ms, then only a little more than 1% of the minicomputer time is taken up by this operation, and the need for special interface hardware is avoided.

However, this example shows one of the limitations of the T-box. If as many as 100 peripherals were connected with T-boxes strung out along a single bus, all of them capable of transmitting at the same rate as the teletypewriter and all of them going at once, the minicomputer could not keep up with them without the assistance of an external controller.

### Tape drive control

But the T-box is not limited to teletypewriters and similar devices. It has been used successfully with a magnetic tape unit transferring data at 10 kilobytes per second, corresponding to 80 kilobits per second—about four times the maximum mentioned earlier. This was achieved by using a formatter with the tape unit and by cutting the software overhead to the bone.

Ordinarily, manufacturers of tape units also supply those formatters or even control units to go with the mechanical tape drives. Minicomputer manufacturers are usually obliged to build interface units to match these formatters to their own machines. The combined cost of the formatter and an interface unit is likely to be \$2,500

or more. But the two units can be replaced by two T-boxes, as shown in Fig. 2 and in Fig. 5.

Since the tape unit is a more complex device than a teletypewriter, at least in the sense of using more instructions, it requires a more complex interconnection with the minicomputer. This is why two T-boxes are required. One of them is devoted primarily to forwarding data to and from the tape unit in much the same way the T-box is used with the teletypewriter. The other takes care of control instructions to the tape drive, such as backspace, rewind, or unload, and status information from the tape drive such as ready, end of file, or file protect (a status assignable to individual reels or cassettes that prevents writing and therefore prevents destruction of vital information by writing over it).

There is more of this control and status information than the 32 data lines of a single T-box can handle. Therefore, from the addressing point of view, control and status information is related to a different peripheral unit than read and write information. Functions that the formatter usually performs in conventional systems, such as computing parity bits, checking characters, and monitoring tape motions, such as backspacing and rewinding, are transferred to the minicomputer. These functions would keep the minicomputer considerably busier than receiving data from a teletypewriter and probably would prevent it from doing anything else while controlling the tape unit. □



## From The Datacraft DC-38 Building Block Comes A True Planar Design 8K Single Card Memory

Today at Datacraft you can buy an 8K X 18 magnetic core single card memory in a true planar design...all electronic components and core plane array connected to the single plane of a printed circuit card.

This is a design with no compromise. There are no stacked components...no qualifications.

Like our 4K single card memory, the 8K single card is also available two ways. The 8K single card can be expanded up to 64K X 18. Take the two card approach and you can get one timing and control card to drive eight 8K X 18 digital stack boards. Then you can expand even further in banks of 64K.

But a big bonus is that the 4K and 8K digital stack boards are interchangeable in the same chassis with no internal wiring. Both the 4K and 8K DSB use the same timing and control board. Or, if your application calls for it, the 8K single board memory is also interchangeable with the 4K single board memory with no internal wiring.

The 8K single board memory is about 25 per cent less than two 4K printed circuit boards.

Here is truly a memory system you can get in just the right combination of price and performance to match your exact specification.

The 8K single board memory is simply another example of how we use the modular design of the DC-38 as a basic building block.

Just clip the coupon for more information on any Datacraft memory. And if you don't see the configuration you need, then just give us a call...we're probably working on it.

**Datacraft Corporation**  
Post Office Box 23550  
Fort Lauderdale, Fla. 33307

Please send me specifications for the configuration I have checked:

- 4K X 18 Single Card Memory
- 4K X 18 digital stack boards with separate timing and control card
- 8K X 18 Single Card Memory
- 8K X 18 digital stack boards with separate timing and control card
- Call me about another configuration.

NAME:.....

TITLE:.....

COMPANY:.....

CITY:.....STATE.....ZIP.....

# *Datacraft*



## Deionized Water Essential To Texas Semiconductor Manufacturer



INTEGRATED BRIDGE RECTIFIERS

Typical silicon rectifiers made by Varo Incorporated.



Close-up view of cleaning booth, where assembly is being rinsed with deionized water.

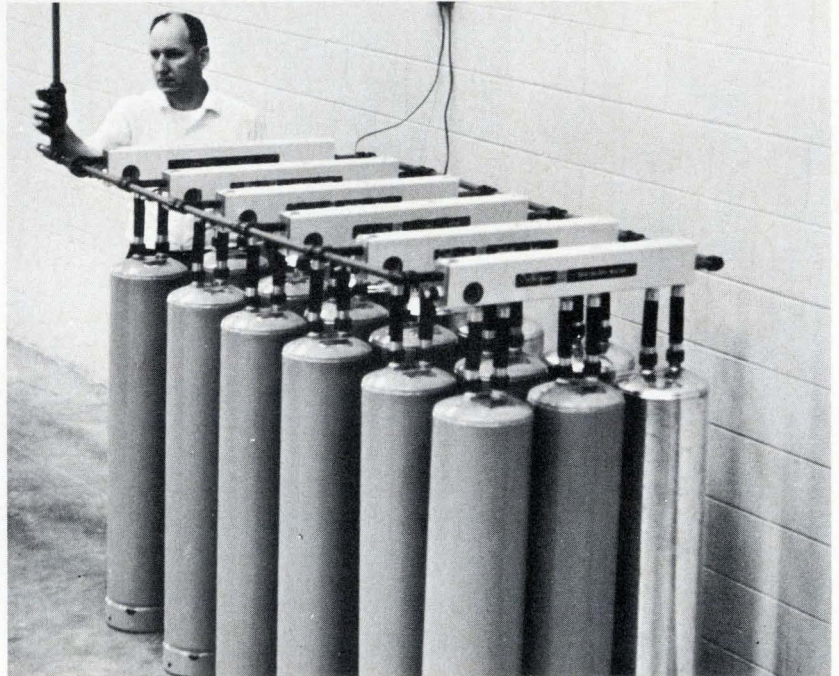

Eighteen-tank Culligan system in use at Varo. System supplies deionized water for use in manufacture of semiconductors.

□ If a manufacturer of semiconductor devices can't get high quality water, then it isn't a matter of product quality—it's a matter of product life or death. "And by very high quality," says Jan Collmer, General Manager of Varo, "we're talking far beyond one or two parts per million; we mean water quality in the 15 to 18 megohm range."

To meet Varo's exacting standards, the local Culligan Man supplied a deionizer system, utilizing 9-inch exchange service tanks. The decision to use portable exchange rather than automatic packaged

deionizers was made for two reasons: economics and convenience.

The Culligan Man put the economics reason this way: "When the flow volume demand is low, you use portable exchange. Naturally, you reach a point in gallonage where you must balance the cost of purchase against the cost of leasing equipment. But you can't make a universal rule about it; each customer's demands are different."

As for convenience, Collmer adds, "We're not interested in becoming water experts. Our main concern is having high quality water available at all times,

and we want to limit our involvement to paying the invoice each month.

We pay only for the water we use. If we have a plant shutdown or if production drops for any reason, we can reduce or cut off the supply of deionized water immediately."

For detailed information and additional case histories, write to Will Sanders for our 4-page Job Reports 103, 119 and 120—or call your local Culligan Man for a consultation. □

Culligan USA, One Culligan Parkway, Northbrook, Illinois 60062.

**CUSTOMER:** Varo Incorporated

**PROBLEM:** Need for high quality water for manufacture of semiconductors

**SOLUTION:** 15-megohm water with exchangeable tanks

**EQUIPMENT:** Culligan deionizer tanks and carbon filters

LET'S START AT THE  
BEGINNING. WITH TELEVISION.  
STACKPOLE DID.

SINCE 1947, STACKPOLE  
HAS BEEN A LEADING  
SUPPLIER OF CRT YOKES  
CORES TO THE TELEVISION  
INDUSTRY. FIRST  
AND WHITE

## At the core of yoke technology

cores to the television industry. First, black and white. Now color. This makes us the oldest ferrite yoke core manufacturer in the U.S.

Now this knowledge and experience have been applied to the precision components necessary for CRT information displays. Whole rings. Quarter segments. Stator yokes.

What you get is a greater choice. First, tooling. Many configurations are already available. If not, Stackpole can develop precision tooling for you. Secondly, a family of ferrite materials permits greater flexibility in design, tighter control over results.

Stackpole also offers machining facilities for grinding to close tolerances.

### TYPICAL CERAMAG® MATERIALS FOR INFORMATION DISPLAY YOKES

	7B	11	12	24
Initial Permeability	450	125	35	2500
Saturation Flux Density	2600	2550	2400	4500
Residual Flux Density	1650	1420	750	1700
Coercive Force	0.48	2.8	4.7	0.25
Curie Temperature	160	385	450	205

We've been around cathode ray tubes for a long time. Why not take advantage of the technology that can be yours at Stackpole. We may have the answer you've been looking for, or know how to get it. Simply contact: Stackpole Carbon Company, Electronic Components Division, St. Marys, Pa. 15857. Phone: 814-781-8521. TWX: 510-693-4511.



### Stackpole Ceramag® Ferrite Yoke Cores for CRT Displays

Let's start at the beginning. With television. Stackpole did.

Since 1947, Stackpole has been a leading supplier of CRT yoke



**STACKPOLE**  
ELECTRONIC COMPONENTS DIVISION

# CRT

# DISPLAY SYSTEMS DISPLAY DEVICES

CELCO

ALPHA-NUMERIC DISPLAYS

INFORMATION RETRIEVAL

## DEFLECTION YOKES



Best resolution, speed, sensitivity.  
Low residual and LI<sup>2</sup>.

## FOCUS COILS



Static and Dynamic for  
sharp, round, small spots.

## DEFLECTION DRIVERS

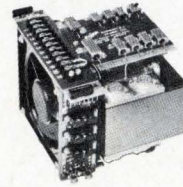

Up to 120 V p-p, 16 A.  
Wide Bandwidth.

VIDICON CAMERAS

COMPUTERS

WRITING

READING

## CORRECTIVE FIELDS



Coils for centering, correction of  
astigmatism, pincushioning.

## CIRCUIT CARDS



Plug-in cards provide primary and  
secondary beam control circuits.

## LOW COST POSITIONERS

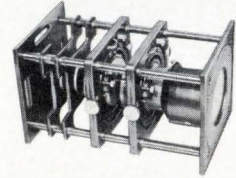

Low cost coil and tube positioners.  
Positive spatial control.

ELECTROSTATIC PRINTING

SCAN CONVERTERS

BRIGHT DISPLAYS

## MAGNETIC SHIELDS

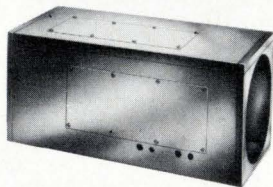

Positive exclusion of all stray magnetic fields.

## RAMP GENERATORS



Dual X-Y ramps, 10  $\mu$ sec to 100 msec.  
Variable rasters.

IMAGE ORTHICON CAMERAS

ELECTRON BEAM MACHINES

## CRT SPOT ANALYZER

Determine CRT spot  
characteristics,  
phosphor noise, etc.,  
on tube face.



## COMPLETE DISPLAY SYSTEMS

Hi-Resolution X-Y monitor.  
Linear to 0.1%,  
fast, flexible.

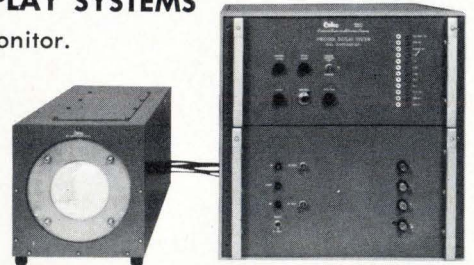

RASTER DISPLAYS

LINE SCANS

SPIRAL SCANS

MONITORS

CELCO

CONSTANTINE ENGINEERING LABORATORIES COMPANY

MAHWAH, N.J. 07430  
201-327-1123  
TWX 710-988-1018

UPLAND, CAL. 91786  
714-982-0215  
TWX 910-581-3401

# PTM. First in the series of new modulars from Sorensen

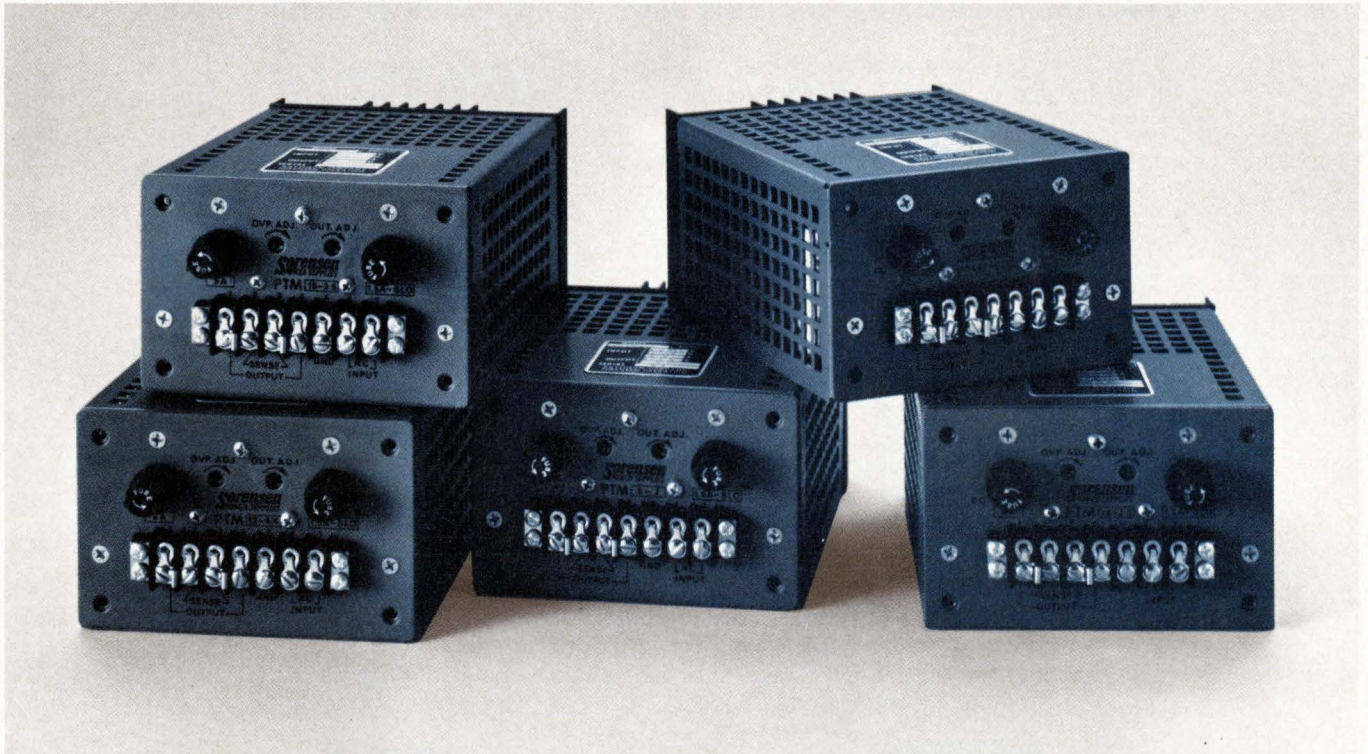

Our new PTM modular line is tailored to be more than just another black box. For one thing, it's blue. For another, it has state-of-the-art power density. Built-in overvoltage protection on every model.

Adjustable automatic current limiting. Regulation of 0.05% + 5mV. Ripple and noise of 1 mV RMS, 5mV pk-pk. Operating temperature range from 0 to 71°C. □ PTM. The first part of our new modular line. There's a lot more coming. For more data, write Sorensen Power Supplies, Raytheon Company, 676 Island Pond Road, Manchester, N.H. 03103. Telephone (603) 668-1600. Or TWX 710-220-1339.

Package size II: 3 <sup>5</sup> / <sub>8</sub> x 5 <sup>1</sup> / <sub>8</sub> x 6 <sup>1</sup> / <sub>2</sub>							
Model	Adjust. Range (VDC)		Current Rating (A)				Price*
	Min.	Max.	40°C	50°C	60°C	71°C	
PTM3-7	2.8	3.5	7.0	6.3	4.9	2.8	\$119
PTM5-7	4.8	5.5	7.0	6.3	4.9	2.8	\$119
PTM12-4.4	11.4	12.6	4.4	4.0	3.1	1.8	\$119
PTM15-3.5	14.25	15.75	3.5	3.1	2.5	1.6	\$119
PTM24-2.3	23	25	2.3	2.1	1.7	1.1	\$119
PTM28-2	27	29	2.0	1.8	1.5	1.0	\$119
Package size III: 3 <sup>3</sup> / <sub>8</sub> x 5 <sup>1</sup> / <sub>8</sub> x 9 <sup>1</sup> / <sub>2</sub>							
PTM3-11	2.8	3.5	11.0	9.6	7.8	4.4	\$139
PTM5-11	4.8	5.5	11.0	9.6	7.8	4.4	\$139
PTM12-6.5	11.4	12.6	6.5	5.7	4.6	2.7	\$139
PTM15-5.5	14.25	15.75	5.5	4.9	3.9	2.5	\$139
PTM24-4	23	25	4.0	3.6	2.9	1.9	\$139
PTM28-3.5	27	29	3.5	3.1	2.6	1.8	\$139

\*USA List

**Sorensen**  
POWER SUPPLIES

*snap,  
lock,  
index,  
punch...*

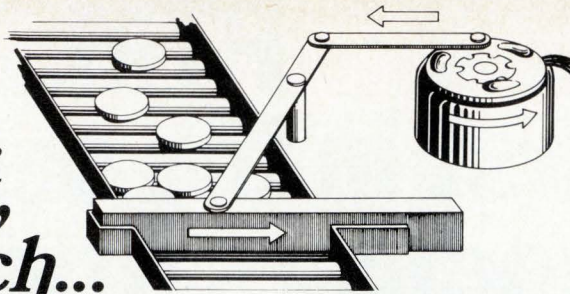

To move a load in an arc or a straight line  
... consider a Ledex rotary solenoid

**A Ledex rotary solenoid gives you a down-hill solution to an up-hill problem.**

The force of an electromagnet is inversely proportional to the square of the distance between the pole faces. Most solenoids live with this problem, which means less force in the beginning, where you need it, and wasted energy at the end, where you don't need it.

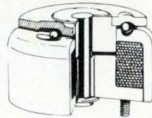
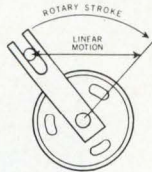

The Ledex rotary solenoid starts off working where the force is really at, about .030" between the pole faces. Then the armature rides a helical ramp, to distribute the force over the stroke you need. It gives you efficient, direct rotary action and uniform linear movement.

The Ledex rotary solenoid delivers a lot of power for its size. That's because it works in the tiny area where magnetic attraction is highest. It's efficient because it spreads this high concentration of energy over a longer useful stroke.

For rotary or linear positioning it's hard to beat its simplicity and high output. Choose from a family of eight models, with strokes from 20° to 95° and torque to 117 pound-inches. For a quick prototype, there are over 250 shelf models. Then, for a custom snap / lock / index / punch solution, you just talk to our positioning technology people.



*the total technology people*

**LEDEX INC.**  
123 Webster Street  
Dayton, Ohio 45401  
(513) 224-9891

**POSITIONING · SWITCHING · MICROELECTRONICS**

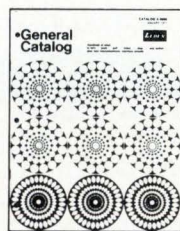

Over 400 ways to turn ... push ... pull ... index ... step ... and switch, plus new microelectronic interface circuits. All from the shelf.

Ask for Catalog A-9500

*new things  
keep  
happening  
at Ledex*

**... like this 2-in-1  
thick film hybrid**

**± regulator**

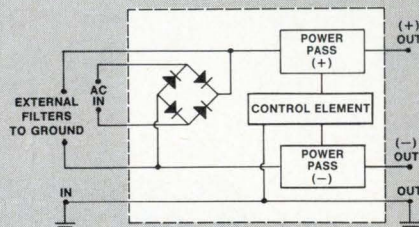

**LMR-11 PLUS-MINUS VOLTAGE REGULATOR**

AC in, positive or negative DC out. Bridge rectifier, current limiter, and regulators are all in a TO-3.

**OUTPUT**  
adjustable from -8 to +23 vdc. ±15 vdc standard.

**CURRENT**  
1 ampere per side (Supplied to meet provisions of MIL-STD-883 when required.)

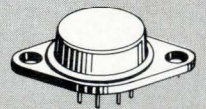

**GET THE LMR-11**  
from the shelf at  
\$74 (1-9), \$25 in  
1,000 lots.



The CIP/2200 is the newest, most powerful Cincinnati minicomputer to date. It is a microprogrammable general purpose minicomputer with an amazing list of new features. The CIP/2200 performs decimal arithmetic just like the big computers for handling business data, while retaining all the benefits of

a mini. In addition, the CIP/2200 exercises its new power with such features as RPG compiler, variable length operations, control stack facility for automatic state switching, bi-directional string moves, bit manipulation instructions, translation under mask and editing, plus a user instruction capability.

All these advantages and many more are available right now from Cincinnati Milacron's new, more powerful CIP/2200. Write or call (513) 494-5444, now, for complete details to: MINICOMPUTERS, Process Controls Division, Cincinnati Milacron Lebanon, Ohio 45036.

# this year, there's something really new in minicomputers ...Cincinnati Milacron's CIP/2200

CIP/2200 is brand new. It performs functions that heretofore could be done only by larger computers. See copy above.



minicomputers

**CINCINNATI MILACRON**

Machine Tools  
Process Controls  
Chemicals  
Plastics  
Plastics Processing Machinery  
Abrasives



## Now, Helipot offers covered cermet trimmers for low-budget projects.

There's not much sense in using cheap wirewound or carbon trimmers anymore. Not when the new Helipot Series 91 Cermet Trimmers are available *off-the-shelf* for a few cents more.

These single-turn,  $\frac{3}{8}$ " , covered trimmers come in 10 different mounting styles and 19 standard resistance values from 10 ohms to 2 megohms. Covered construction helps protect against moisture, corrosive atmospheres, dust, oil and other

contamination. Which means, in addition to cermet stability and better resolution, you get long-term dependable performance.

The breakthrough price is just 35¢ each in the 50,000 piece quantity, and they're equally well-priced in other quantities.

Send now for complete data on the Series 91 Trimmers... the finest of their class. We've made them for your projects where the budget may be tight, but you don't want to compromise performance.

**Beckman®**  
INSTRUMENTS, INC.  
HELIPOT DIVISION  
Fullerton, California

HELPING SCIENCE AND INDUSTRY IMPROVE THE QUALITY OF LIFE

INTERNATIONAL SUBSIDIARIES: AMSTERDAM, CAPE TOWN, GENEVA, GLENROTHES, SCOTLAND, MEXICO CITY, MUNICH, PARIS, STOCKHOLM, TOKYO, VIENNA

Circle 104 on reader service card

# Essential Books In A Changing Industry

## ENCYCLOPEDIA OF INSTRUMENTATION AND CONTROL

Editor-in-Chief, Douglas M. Considine.  
1,000 pp., \$29.50

A ready reference designed for comprehensive coverage and ease of use, this alphabetical Encyclopedia represents a major step towards coordinating the most interdisciplinary and varied of the applied sciences—instrumentation and control technology. Because the field is so broad, the book meets the needs of the engineer or technical manager for a review of basic concepts, principles, and equipment types. Contributors are outstanding authorities in their particular fields, and their explanations are clear, practical, and fully illustrated.

## ELECTRONIC COMPUTER MEMORY TECHNOLOGY

By Wallace B. Riley. 288 pp., \$14.50

An indispensable book for electronic engineers, computer designers, engineering managers, systems analysts, and computer programmers who manage, conceive, plan, or implement any phase in the use of computers and computer memories, this book provides in-depth discussions of the newest developments in computer memories, and gives the latest economic information, plus up-to-date illustrations. Based on articles that appeared in *Electronics* magazine, it covers every recent development in the field.

## COHERENT OPTICAL COMPUTERS

By Kendall Preston, Jr. 352 pp., \$16.50

Profusely illustrated, this is the first in-depth treatment in one single source of the growing technology of coherent optical computers. A most timely book, it provides a historical background, a survey of the basic types of coherent optical computers, and a discussion of key applications. Much of the material appears here for the first time in print, and some has been specially released by the military for publication in this book. Applications are explained by many practical examples drawn from results furnished the author by designers, workers, and researchers throughout the world.

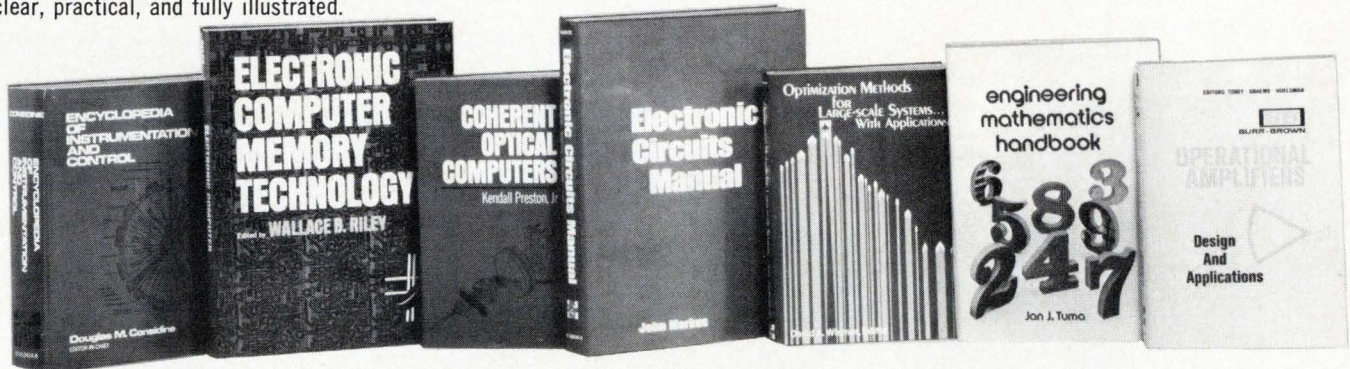

## ELECTRONIC CIRCUITS MANUAL

By John Markus. 892 pp., \$19.75

Written primarily for the electronic circuit design engineer, this manual will have immense value for the man whose function includes the design, development, and testing of new circuits for new application or new performance requirements. Often a circuit that meets the need can be found as is, but just as often the reader will find a circuit that he can modify easily to meet his needs. Highly praised by reviewers upon publication, the book contains 3,181 electronic circuit diagrams and their respective component values. A perfect companion volume to the author's earlier *Sourcebook of Electronic Circuits*.

## OPTIMIZATION METHODS FOR LARGE SCALE SYSTEMS

David A. Wismer, Editor. 352 pp., \$19.50

With an increasing amount of research directed toward the solution of optimization problems for large systems, this unique book incorporates the currently available techniques—many by world-renowned authorities and the features of international conferences—bringing you much material that has not appeared in print before. For most engineering problems of practical importance, the traditional tools of optimization break down. But this book can solve such problems—and give you optimal solutions. A **practical** book with considerable **theoretical** importance.

## ENGINEERING MATHEMATICS HANDBOOK

By J. J. Tuma. 320 pp., \$9.95

Designed like a modern cookbook, this extraordinary primer offers the reader ultimate ease of reference and use. All pages have been carefully laid out in facing spreads to constitute complete conceptual and visual units, and two-color printing is used throughout to emphasize significant features. The treatment is simple and easy to grasp, and it progresses from algebra and geometry through such advanced topics as Laplace transforms and numerical methods. Its coverage is completely up-to-date, and its approach is 100 per cent practical. A first-of-its-kind handbook.

And, in case you missed this best seller from Burr-Brown . . . OPERATIONAL AMPLIFIERS: Design and Applications

By The Engineering Staffs, Burr-Brown Corp. 512 pp., \$15.00

Because interests in operational amplifiers is becoming so widespread today, and because this is the first complete book on the subject (except for the promotional handbooks of manufacturers), it will appeal to the widest possible audience, in and out of the design field. Not only design engineers, but many varied readers in all areas of electronics (process, medical, aerospace instrumentation, and the academic community) will find it offers a sure and ready ability to evaluate, measure, and use operational amplifiers, plus a large number of circuit applications.

### 10-DAY FREE EXAMINATION OFFER

McGraw-Hill Book Company  
330 West 42nd Street, N.Y., N.Y. 10036

Please send me the book(s) checked below on a 10-day free examination basis, after which time, I will remit the full price, plus local tax, postage, and handling for the book(s) I keep, and return any other book(s) postpaid. I understand that if I remit in full with this order, plus local tax, McGraw-Hill pays all postage and handling, and that return privileges still apply. (This offer good only in U.S., and is subject to acceptance by McGraw-Hill).

- (124248) Encyclopedia of Instrumentation and Control
- (529159) Electronic Computer Memory Technology
- (507856) Coherent Optical Computers
- (404445) Electronic Circuits Manual
- (711542) Optimization Methods for Large Scale Computers
- (654301) Engineering Mathematics Handbook
- (649170) Operational Amplifiers

Name \_\_\_\_\_

Address \_\_\_\_\_

City \_\_\_\_\_

State \_\_\_\_\_

Zip \_\_\_\_\_

Please Initial \_\_\_\_\_

23-L3132

# The FUJITSU quality for sale in By-Pass Capacitors for high speed TTL and ECL.

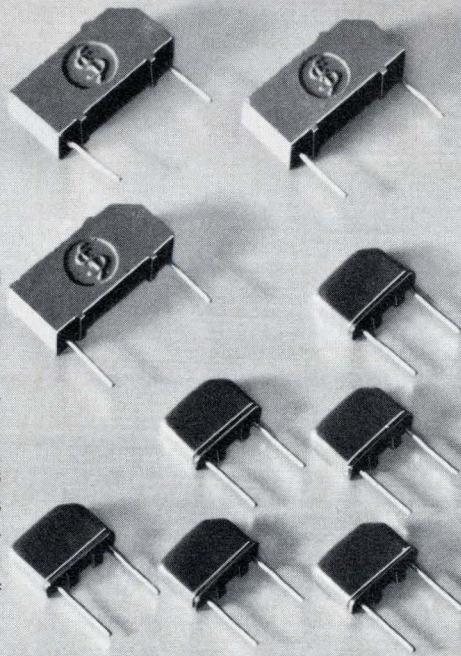

High speed and ultra high speed pulse logical circuit noiselimiters:

- Aluminum solid electrolytic capacitor . . . . . High speed pulse.
- Tantalum solid electrolytic capacitor . . . Ultra high speed pulse.
- These solid electrolytic capacitors have been developed as by-pass capacitors to by-pass noises generated in power supply by logical elements during rise and fall of high speed pulse in the circuit.

- Low Equivalent-Series-Resistance (E.S.R.) against rise and fall of high speed pulse.
- Low inductance.
- Small in size yet large in static capacity.
- Lead pitch the same as that of terminals for Dual-In-Line package IC.
- Widely utilized in FUJITSU FACOM computers with excellent results and outstanding reliability.

## RATINGS AND SPECIFICATIONS:

	Static Capacity	Static Capacity Tolerance	Rated Volt.	Body Dimensions (Terminal pitch)	Operating Temp. Range	Permissible R.H.	Dissipation Factor (Tan $\delta$ )	Leakage current	E.S.R.	Inductance
High Speed (Aluminum)	1.0 $\mu$ F	-20% + not specified	16V DC	12.7 x 5.75 x 4.3 mm (0.40 inch)	-55°C to +85°C	95% Max.	8% Max. at 120Hz.	3 $\mu$ A Max.	1.7 $\Omega$ Max. at 10 MHz.	Typical 10 nH at 200 MHz.
Ultra High Speed (Tantalum)	3.3 $\mu$ F *		10V DC	7.0 x 6.0 x 2.5 mm (0.20 inch)			10% Max. at 120Hz.	1 $\mu$ A Max.	0.5 $\Omega$ Max. at 10 MHz.	Typical 5 nH at 200 MHz.

 **FUJITSU LIMITED**  
Communications and Electronics  
Marunouchi, Tokyo, Japan

MAIN PRODUCTS  Telephone Exchange Equipment  Carrier Transmission Equipment  Radio Communication Equipment  Space Electronics Systems  Auto Radios & Car Stereos (TEN)  Electronic Computers & Peripheral Equipment (FACOM)  Telegraph & Data Communication Equipment  Numerical Control Equipment (FANUC)  Remote Control & Telemetering Equipment  Electronic Components

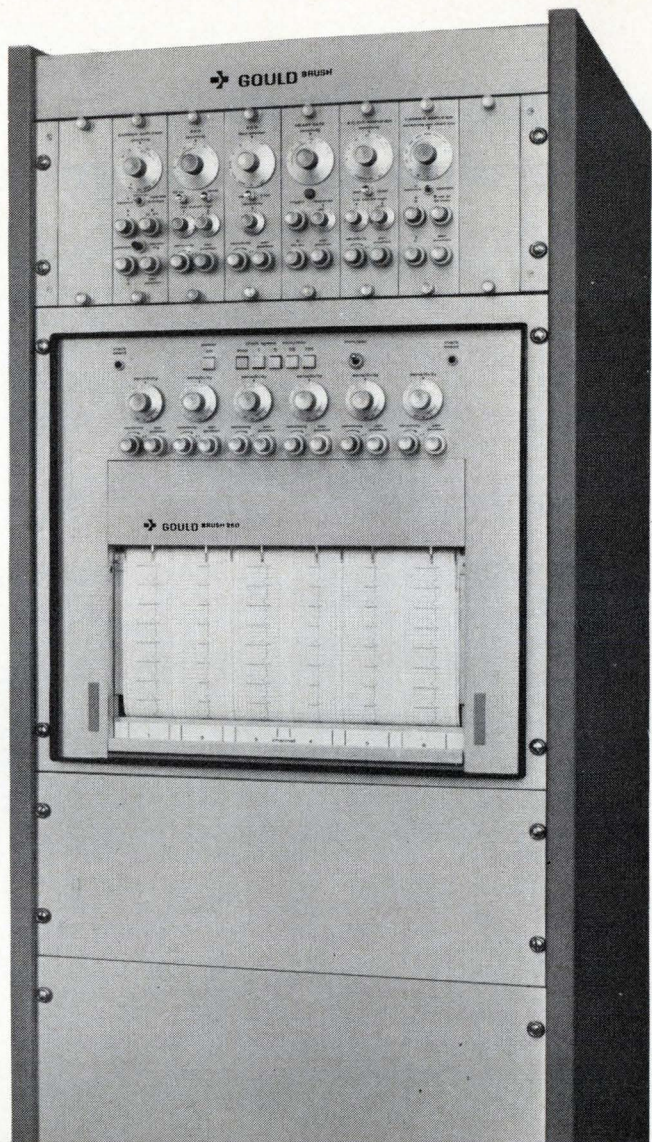
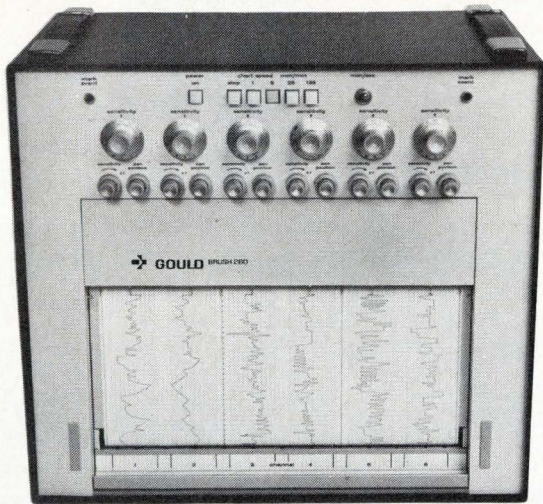

### FREQUENCY RESPONSE AND AMPLITUDE

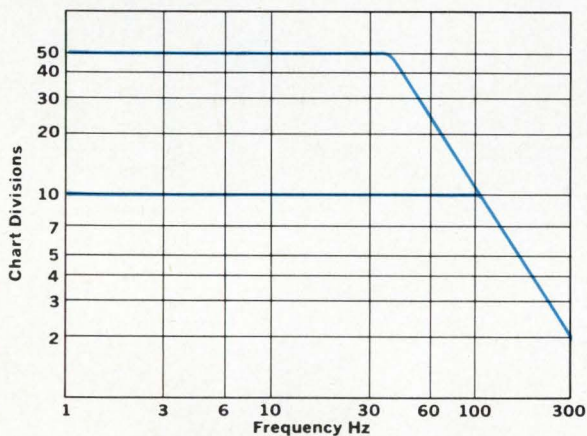

## The Brush 260 is one of the few bargains left.

Because the Brush 260 6-channel recorder gives you the most accurate, reliable data at the lowest cost per channel.

The 260 also gives you all the important Brush exclusives. Like a pressurized ink system. Which eliminates smudging, puddling, and priming. So traces are always crisp, clear, and uniform. And a throw-away plastic cartridge which holds a year's supply of ink.

Another Brush exclusive is our Metrisite® non-contact servo-loop feedback device. The Metrisite makes the 260 so accurate we guarantee 99½% linearity.

And the 260 has built-in preamps which provide a

measurement range from 1mV/div. to 500V full scale. Frequency response for the 260 at 50 divisions is flat within  $\pm 2\%$  of full scale from d-c to 40Hz.

Add in six 40mm analog channels and four event markers. Plus eight pushbutton chart speeds from 1.0 to 125mm/second and mm/min. And you can use the 260 as a portable unit, rack mount it or put it in a roll-around cart.

The Brush 260. It's a good way to get the most for your money. For more information, write: Gould Inc., Instrument Systems Division, 3631 Perkins Avenue, Cleveland, Ohio 44114. Or Rue Van Boeckel 38, Brussels 1140, Belgium.

BRUSH INSTRUMENTS

 **GOULD**

# Centralab hybrids... in line with your design requirements

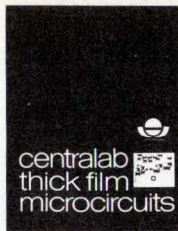

Write  
Centralab  
for  
Bulletin  
No. 1429H2

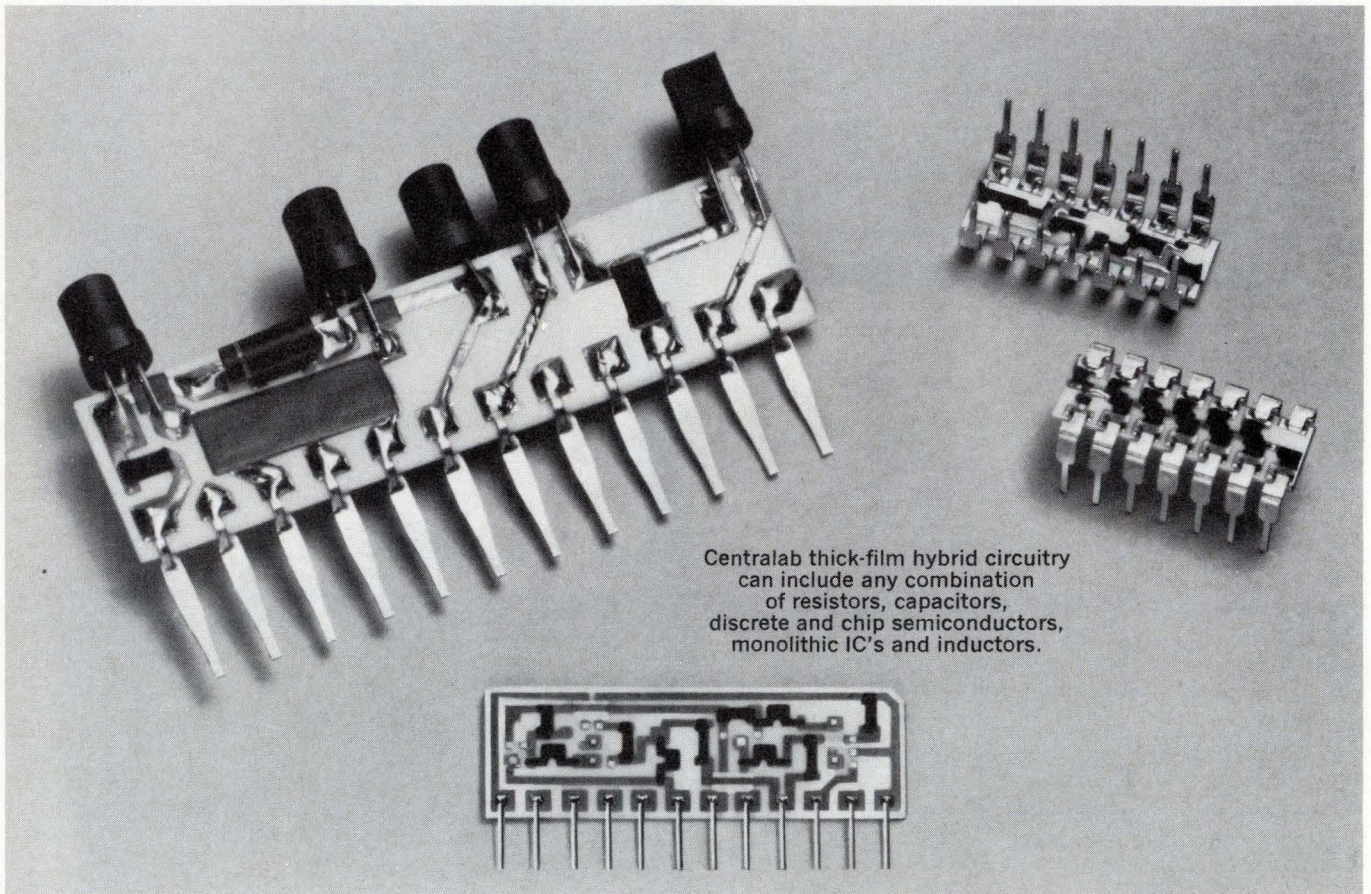

Centralab thick-film hybrid circuitry can include any combination of resistors, capacitors, discrete and chip semiconductors, monolithic IC's and inductors.

## Come to us for thick-film capability

When you come to Centralab for custom thick-film hybrid circuits you have the assurance of over 27 years of experience in design and production. As the pioneer in hybrids we have developed over 50,000 custom designs. Today, no other manufacturer can offer you as much flexibility—in packaging, in circuit function and in reliability.

No other 300 mil. DIP, for example, can give you higher package power—up to 3 watts per package. Only Centralab offers you networks with as many resistors—28 in a 16 lead DIP, 24 in 14 lead configurations. Compare resistor tolerance, as low as .5% and TC of  $0 \pm 100$  ppm and you'll see that our kind of customized circuitry is unmatched anywhere.

Chip hybrids that combine fired-on resistors, capacitors and interconnections with diodes, transistors and IC's

are small in size but big in reliability.

Discrete networks were our first hybrids—in 1945. Our expertise is your assurance you'll get circuits that save space and reduce costs of assembly and provide improved reliability as well.

Custom designs meet the most demanding specifications such as complex functions or power drivers.

Our specialized designs include resistor values to 1 gigohm, voltages to 50 kV and resistor value ranges from 10 ohms per square to 10 megohms per square.

If you've a special application for hybrids, call Centralab. We have the capability to give you the performance and reliability that meet your specs—with delivery that meets your requirements. Write or call, A. R. Wartchow, Marketing Manager, Electroceramic Products, Centralab.

### GET CENTRALAB THE "IN" LINE FOR YOUR DESIGN

Hybrid Microcircuits  
Pushbutton & Rotary Switches  
Capacitors  
Potentiometers  
Technical Ceramics  
Ceramic Packages  
Semiconductor Devices



**CENTRALAB**

Electronics Division  
GLOBE-UNION INC.

5757 NORTH GREEN BAY AVENUE  
MILWAUKEE, WISCONSIN 53201

# Probing the news

Analysis of technology and business developments

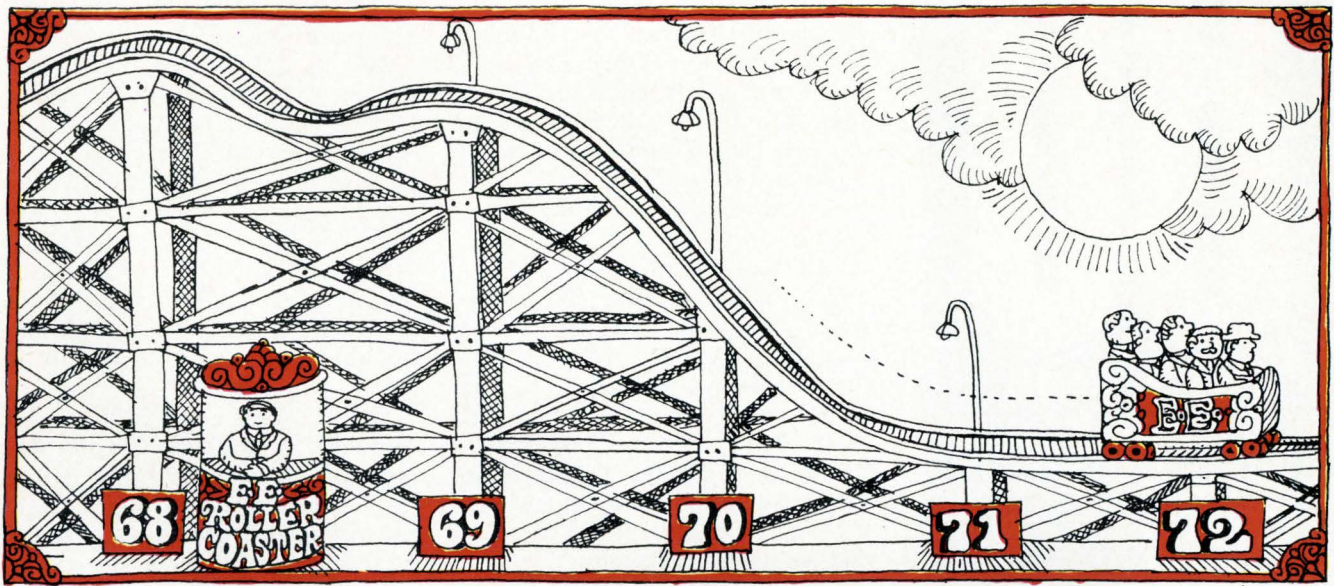

## Job roller coaster starts climb

More openings may end downhill plunge; but new graduates land jobs while many unemployed engineers are stalled

by Gerald M. Walker, Consumer electronics editor

Vivid in the memories of many engineers at IEEE show time are the buses hauling loads of eager job hoppers from the exhibit hall to recruiting offices where they would pick among new employers begging for their services. But times have changed, and at showtime 1972 (March 20-23), EES can expect only a slight improvement in a three-year job drought. In fact, unemployed IEEE members, who will be able to enter the show free, are likely to be looking more carefully for employers than for products, despite a ban on "repeated solicitations" and circulation of resumes.

Now that companies are picking and choosing, the EES are taking what they can get. The rub for many is that while the recession—led by the aerospace/defense sector of the industry—caused layoffs, the improvement in business expected in this recovery year has not yet triggered a rash of hiring.

The job situation is mixed, partially because many companies are not confident enough about the

strength of their recovery and partially because sales improvements do not automatically call for more engineers. Appearances indicate that new graduates will have less trouble finding jobs; that salaries have remained unchanged; and that the greatest demand is for communications, microwave, and power specialists. While aerospace EES may continue to be out of work, few companies dispute the contention that there will be another shortage of engineers in the second half of this decade, which confounds placement officials and employment agents, not to mention concerned EES.

**From Boston.** From the electronics concentration around Boston, for example, Thomas Heffernan, placement manager for the Administrative and Technical division of Dunhill of Boston, Inc., says the job market has been very quiet, except at Raytheon Co., Bedford, Mass. He reports openings there "in radar and over-the-horizon sensor systems, shipboard electronics systems, traf-

fic control, radar displays, ballistic missile guidance systems, aerospace data systems, and military communications."

By comparison, Nelson Gildersleeve, head of Professional Placement Consultants, Waltham, Mass., paints a brighter picture. "In the last three months I've definitely seen more jobs," he states. Microwave equipment and system engineers are in demand, he says. "Overall, communications equipment is the largest area of activity," particularly for engineers with three to five years of experience.

Though mentioned as a company in a hiring mood, Raytheon says only that it is doing the same amount of recruiting this year as last—113 visits to 89 schools. On the West Coast, Edward Shaw, dean of placement and the career planning center at the University of California at Los Angeles, says that the number of job orders "has increased significantly over the past six to eight months"—well over 10% ahead of last year. Yet two aerospace em-

# \$86

**BUYS THIS  
12-BIT  
BINARY A/D  
CONVERTER**



Model 53B12

**WITH  $\pm 0.01\%$   
ACCURACY  
AND  
50ppm/C°  
STABILITY**

Here's more A/D converter for your money than ever before! Gralex integrating A/D converters are available in 8, 10 or 12-bit and 2 or 3-digit BCD—priced as low as \$59 in single quantities. Input voltages include  $\pm 0.1V$ ,  $1V$ ,  $10V$ —uni or bi-polar. Shielded or unshielded construction. Design and performance features include: high noise immunity; high input impedance; flexibility of output data formats; buffered analog output for recorder use; external and internal trigger.

Send for complete tech data today, and put your money where the value is!

**GRALEX**  
INDUSTRIES  
155 MARINE ST., FARMINGDALE, N. Y.  
516-694-3600  
DIVISION OF GENERAL MICROWAVE CORP.

## Probing the news

ployers in the area, the Autonetics division of North American Rockwell Corp. and Hughes Aircraft Co., indicate only slight increases for working level designers and little interest in managerial EEs.

At the Consumer Products division of Motorola Inc. in Chicago, which had booming sales during 1971, the engineering department hardly changed, and only a slight increase is expected this year. Robert B. Hansen, manager of consumer products engineering, explains that mass producing products has little effect on EEs; it is the emergence of new technology—such as color TV or the integrated-circuit chassis—that creates jobs.

Further in the vanguard of technology than consumer goods, the Texas Instruments Components group, Dallas, is busier on campus this year, hiring more candidates for master's degrees than for baccalaureate degrees, says group staffing manager James J. McKeen. "As master's programs become more and more sophisticated, the EE gets closer and closer to what we really need. They also seem to be more available," he explains.

TI will be hiring three to four times as many engineering grads this year as they did last year. But

McKeen points out that this doesn't reflect a change in basic need, but a realization that the components group must be increased.

Like TI, employment at Fairchild Camera & Instrument Corp., Mountain View, Calif., is higher than in 1970 for EEs, but not booming. Fairchild will hire at least 35 new graduates this year, compared to six last year; will cover 33 schools around the country, compared to only 18 in California and neighboring states during 1971; and raise starting salaries slightly to \$890 per month for EEs.

For the MSEE, starting salary will be \$1,000 to \$1,050 a month. The emphasis in recruiting will be on solid state, and Fairchild leans toward the engineer with a graduate degree. Raises, which come after a year, are  $5\frac{1}{2}\%$  to  $6\%$  on the average, but vary depending on merit ratings. As for the experienced engineer, Leo L. Contois, group director industrial relations, estimates that 100 to 125 will be needed this year, compared with 75 hired last year. Contois comments, "This has been a disappointingly slow turnaround, but we expect a moderately steady increase in business and employment."

Other electronics firms across the country report similar hiring intentions—a slight increase for beginning-level engineers and virtually

## EE grads do better in job scramble

According to a special survey of 835 employers, including the Federal Government, engineers graduating this year have a better job outlook than either business majors or liberal arts students.

Engineering school placement has also increased over last year, according to the College Placement Council. This situation contrasts with the scare started by engineering placement officials two years ago when they interpreted a decline in the number of on-campus interviews as a decline in the number of jobs.

Although there were 26% fewer job offers for all 1971 graduates, EE graduates were absorbed without difficulty. However, they did not have the luxury of choosing from among several offers as in past years.

The council expects a 10% increase for engineers to 12,250 new jobs. Business administration will climb 9%, but liberal arts majors will find 3% fewer jobs waiting.

For each degree category, the council reported that engineers can expect a 1% increase for bachelors, no change in masters, and a 61% jump for Ph.Ds.

Among the company types represented by the 835 employers, electronics and instruments firms revealed a 34% increase in openings. This contrasts sharply with metals, down 41%, and both utilities and transportation, down 15%.



# Complete RF Network Analysis

# 115 dB

400 kHz to 500 MHz with 115-dB dynamic range and 0.005-dB resolution. Precise measurements of transmission and reflection properties — magnitude, phase, group delay, and S-parameters — all direct reading and neatly displayed on a built-in scope. Complete characterization of filters, amplifiers, cables, antennas, delay lines, transistors, or most anything else that comes to mind — all at the push of a button.

**115 dB!** A full 115-dB dynamic range with 80 dB displayed and the ability to measure absolute as well as relative levels — at the twist of a knob. There's more, of course, including computer-controlled systems or other versions tailored to your needs. Look into it. Better yet, see it — in action — in your application.

For a demonstration of this remarkable system, call your local GR center. The price for the basic 1710 RF Network Analyzer? Only \$6850 (*truly remarkable*).

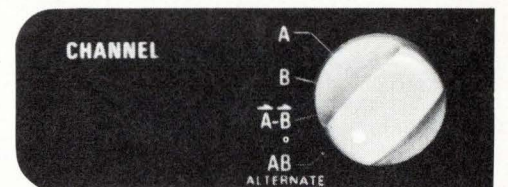
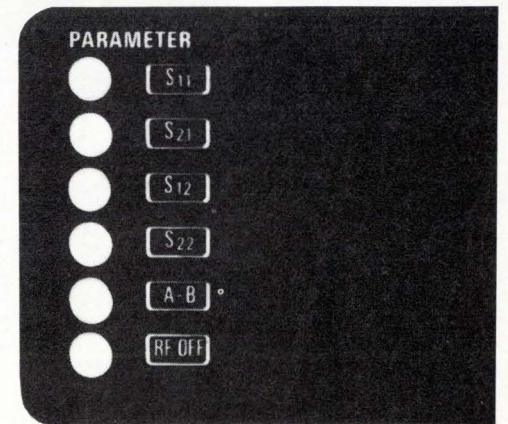
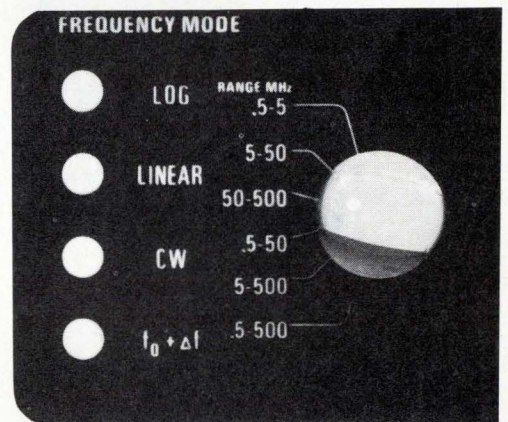
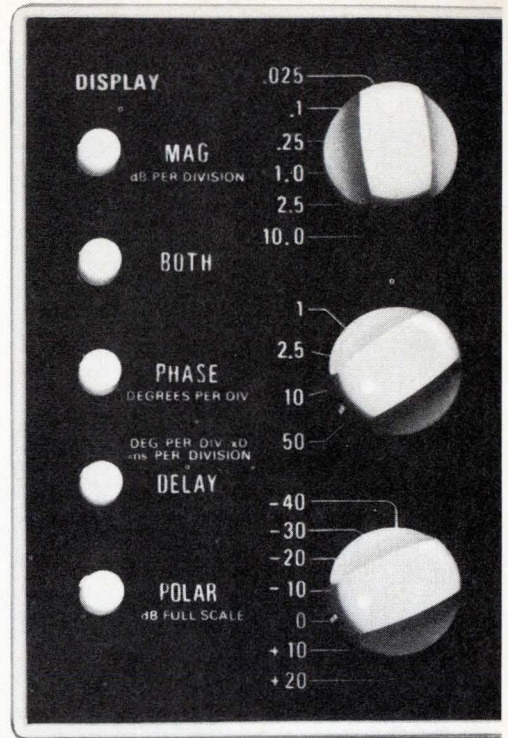

For High-Frequency Measurements

 **General Radio**

300 BAKER AVENUE, CONCORD, MASSACHUSETTS 01742  
 NEW YORK (N.Y.) 212 964-2722 (N.J.) 201 791-8990 • BOSTON 617 646-0550  
 CHICAGO 312 992-0800 • WASHINGTON, D.C. 301 881-5333 • LOS ANGELES 714 540-9830  
 TORONTO 416 252-3395 • ZURICH (01) 55 24 20  
 GRASON-STADLER 617 369-3787 • TIME/DATA 415 327-8322

# OUR ANGLE: High Speed Accurate and Automatic Angle Position Indicators

## WHAT'S YOUR ANGLE?

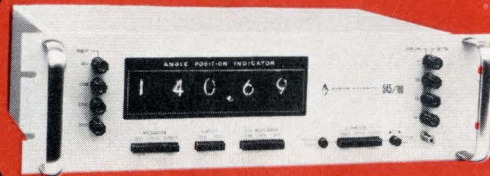

MODEL 545/100

If you're converting synchro/resolver data to digital format, you need both speed *and* accuracy to keep pace with today's data explosion. Only one converter meets both these requirements without compromise. And for under \$4K. . . . North Atlantic's Model 545/100.

The solid-state Model 545/100 converts both resolver and synchro data with  $0.01^\circ$  accuracy and resolution. And continuously digitizes input angle data at  $20,000^\circ$  per second in the face of real-life noise, harmonics and quadrature levels. BCD output is available at the rear connector. Conversion can be stopped by a data freeze command. If multiplexed signals are your bag, acquisition time is less than 30 ms.

Options? Other models offer many options, including  $0.001^\circ$  resolution with 10 arc-second accuracy; data frequencies from 60Hz to 2.4kHz, binary output, small size.

No matter what your conversion problem, if you require ultra-fast, ultra-accurate tracking, contact your North Atlantic sales engineering representative today. He'll show you a better angle.

NI  
AI

**NORTH ATLANTIC**  
*industries, inc.*

See us at IEEE Booth # 2123

200 TERMINAL DRIVE, PLAINVIEW, NEW YORK 11803  
cable: noatlantic / twx: 510-221-1879 / phone: (516) 681-8600

## Probing the news

no interest in managers, coordinators, and the like. This situation bodes ill for many middle-aged engineers unemployed by previous cutbacks. Generally, these EEs have come from supervisory positions and cannot easily return to designing at the bench. As a former department head, aged 50, complains, "Engineering is almost impossible to start over, once you've moved into managerial slots and away from day-to-day designing. We're also finding out that aerospace experience doesn't equip us for any other industry."

**Federal failures.** The problem of middle-aged unemployment has thus far resisted Federal efforts, such as retraining, partly because the Government's efforts have been largely superficial. At the heart of the matter is the unanswerable question: what can the Department of Labor do for jobless engineers if the Department of Defense, NASA, and other agencies are not generating new employment?

Self-help programs, both Federally and privately supported, have unearthed a startling lack of understanding among the unemployed about how to find a job or even write a resumé. Yet once the job applicants learned the ropes and undertook retraining, they found that few jobs were available through the self-help organizations. The result has been that a significant number of EEs are leaving engineering entirely.

The Engineering Manpower Commission of the Engineers Joint Council last fall reported that of the unemployed pool in 1970, 18% (mostly aerospace and electrical engineers) remained unemployed in 1971, 11.7% went into non-engineering jobs, 4.9% took up management and business administration, and 4% entered computer, mathematics, or science positions. In short, almost 39% of all engineers not practicing in 1970 were still not practicing in 1971.

This trend prompted the Council to issue a rather stern blast at Washington earlier this year. It states, "In the commission's judgment, corrective action in order to be more effective

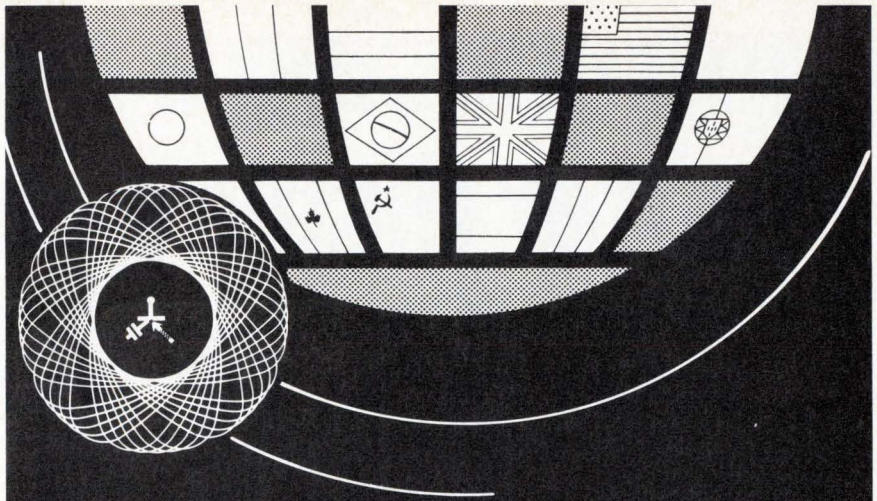

PARIS, APRIL 6, 7, 8, 10 AND 11, 1972  
PORTE DE VERSAILLES

# 15<sup>th</sup> INTERNATIONAL ELECTRONIC COMPONENTS EXHIBITION

The world's most important event  
in the electronic field.

Organized by the S.D.S.A.

For further information and complimentary entrance card please contact :  
French Trade Shows, 1350 Avenue of the Americas,  
New York, N.Y. 10019. Tel. (212) 582.4960



Detach here

I would like to receive information on the 15th Paris International Electronic Components Exhibition, as well as an entrance card.

Name \_\_\_\_\_ Title \_\_\_\_\_

Company \_\_\_\_\_

Address \_\_\_\_\_

Zip code \_\_\_\_\_

Please send this coupon to : FRENCH TRADE SHOWS, 1350 Avenue of the Americas,  
New York, N. Y. 10019.

W

PUBLI-SERVICE

# Introducing a new and better display panel... "UTOVUE" by NEC

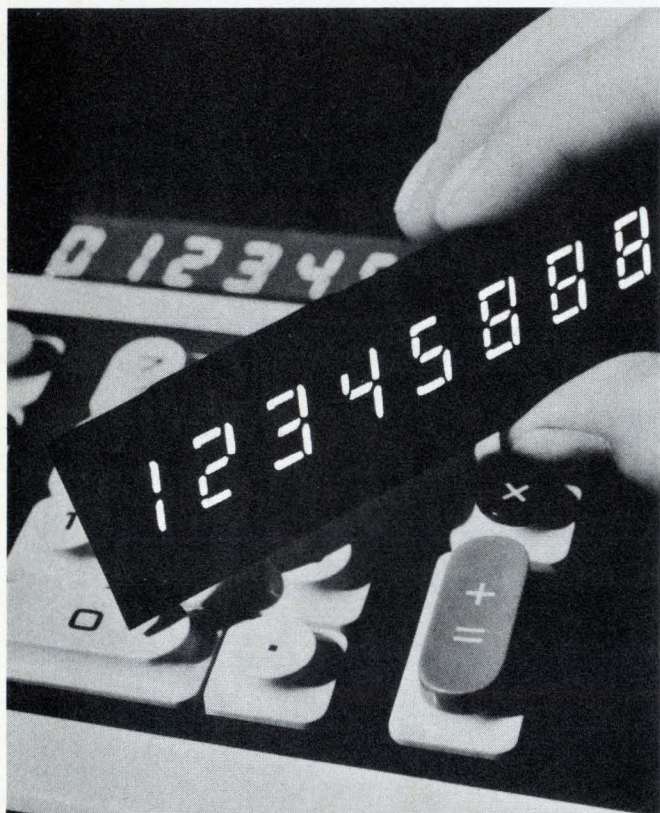

**A 7-segment, multi-digit plasma display device employing thick film IC techniques, its unique features make it ideal for electronic calculators and various instrumentation indicators.**

Now in production, the LD8026 (shown left) is a 12 digit unit, 0—9 and decimal point per digit. Its dimensions are 149mm x 30mm x 5mm. Future models will include 8, 10 and 16 digits ranging in size from 50mm x 20mm to 500mm x 500mm. In every case, thickness is a startlingly thin 5mm (excluding exhaust pipe).

Regardless of size, all models share the same, practical advantages. *Lower installation cost* through fewer digit connections (only 24 in the 12-digit model). *Easy to read* even under unfavorable ambient light conditions and extreme visual angles. *Thin and compact* for vital space economies and new styling opportunities. *High reliability with long life* . . . over 10,000 hours!

**Be sure to visit the NEC booth at New York Coliseum's IEEE Show, March 20-23**

NEC is looking forward to the opportunity of showing you their new UTOVUE units, light emitting diodes and many, many more of their electronic products. You'll find them at Booth 3112.

**Exhibits will include these NEC products—**

Zener Diodes, Silicon Diode Varistors, 1 Amp Hermetic Sealed SR, Avalanche guarantee, Operational Amplifiers, Silicon Vidicon, Selfoc laser beam guide.

**NEC AMERICA INC.** Suite 4321, Pan Am. Bldg., 200 Park Avenue, New York, N.Y. 10017 Tel. New York (212) 661-3420 Cable Address: "NIPPELECO NEWYORK" Telex Address: NECA UR 234936

**Chicago Office:** Room 410, 500 North Michigan Avenue, Chicago, Illinois 60611 Tel. Chicago (312) 828-9494/5 Telex Address: NIPPELECO 910-221-2101

**Los Angeles Office:** Tishman Airport Century Bldg., (TAC-3), 9841 Airport Boulevard, Los Angeles, California, 90045. Tel. 213-776-5923/4 Cable Address: NIPPELECO LOS ANGELES CALIF Telex Address: NIPP ELEC LA 910-328-6574

**Washington D.C. Office:** Suite 508, Crystal Mall Bldg., No. 1, 1911 Jefferson Davis Highway Arlington, Virginia 22202 Tel. 703-920-8228/9 Telex Address: 89-2486 NIPP ELECO WASH

**Products for today—  
Innovations for tomorrow**

**NEC**  
Nippon Electric Co., Ltd.  
Tokyo, Japan

## Probing the news

tive should be directed more toward the creation of job opportunities and the reorientation of personnel within their broad fields of competence and less to retraining personnel in new and differing fields. Retraining engineers for jobs that turn out to be nonexistent is a waste of resources and a source of frustration to the trainee."

Companies scheduled fewer college campus calls for recruiting in order to cut hiring costs, and apparently this year there will also be fewer interviews scheduled at colleges. Reflecting this trend, the number of companies recruiting EEs at the Massachusetts Institute of Technology has been declining for the past few years, says director of placement Robert K. Weatherall. In 1969-70, 198 companies visited the campus, in 1970-71 the number dropped 17% to 164, and thus far this school year, it has dropped another 33% to 110.

**Off with the old.** Weatherall adds that the type of company interviewing is also changing. "Firms in the old manufacturing areas that used to come have dropped out because the students are less interested in them. They are interested in state-of-the-art technology, and companies in this category draw well." In all, Weatherall says, "the signs are that we have hit bottom, and things are getting better. We have had some new firms sign up, taking the place of those who have cancelled, and we're glad to have them."

Joseph Bruns, director of engineering assistance at the University of Texas, Austin, sums up the placement situation as "confused," but says it looks better than last year. "We have 10% to 15% more companies scheduled than last semester.

At one time, we had about 30% more, but many have cancelled, and many of those were electronics firms," he points out. Companies are more choosy in the recession, says Bruns. "They are looking only at the straight-A students, although many of them don't have the types of jobs that would keep a straight-A student interested." □



Meet the "Mite".  
Only .218" diameter. The toughest ceramic disc trimmer capacitor its size.

New from E. F. Johnson. And it's this small:   
Designed for printed circuit applications where space is at a premium. Stator of High Alumina for greater shock and vibration resistance. The rotor plate is encapsulated in ceramic for environmental stability and long life. The Q factor at 1 MHz is 500 minimum. Precision lapped bearing surfaces give you smooth linear tuning. Pick from a wide capacitance range: 1.0-3.0 pF, 2.5-9.0 pF, 3.5-20.0 pF, 5.0-25.0 pF. Designed to meet or exceed applicable requirements of MIL-C-81A.

Return the coupon today for information on Johnson's new Micro-J.™ And if you have a special capacitor need, we'd like to work with you. The same engineering that made our air variable capacitors the standard of excellence goes into every new Johnson product.

E. F. JOHNSON COMPANY/3003 Tenth Ave. S.W./Waseca, Minnesota 56093

- Send product specification information on new Micro-J capacitor.  
 Include information about your full capacitor line and other Johnson components.

NAME \_\_\_\_\_

TITLE \_\_\_\_\_

FIRM \_\_\_\_\_

ADDRESS \_\_\_\_\_



CITY \_\_\_\_\_

STATE \_\_\_\_\_

ZIP \_\_\_\_\_

**E. F. JOHNSON COMPANY**

Government

# Coast Guard to direct harbor traffic

First system in San Francisco will test semiautomated ship monitoring provide basis for other port systems, and spark new electronics market

by William F. Arnold, Aerospace Editor

**The U. S. Coast Guard** is on its way toward becoming a maritime counterpart of the Federal Aviation Administration. Congress, concerned over the hazards of collision and oil spillage created by huge tankers and freighters navigating the nation's harbors, has initiated legislation to increase the Coast Guard's authority to direct marine traffic. And the Coast Guard has turned to automated radar systems to provide the tools for this control.

That's why the service will begin to install a semiautomated vessel monitoring and control system this summer in San Francisco harbor. The system, which will include radars, computers, and displays, is expected to be the forerunner of greater sophistication in harbor safety.

Ports in other parts of the world also are meeting harbor traffic problems with electronic systems. Tokyo, Osaka, Rotterdam, London, and Hamburg use radar-radio networks, and the latter three are considering computerization of their systems, the Coast Guard says.

The service claims it has the power, by executive order, to control water traffic, and pending legislation in Congress would expand the Guard's authority to "establish, operate and maintain vessel traffic services and systems" [*Electronics*, Jan. 17, p. 43].

**Test bed.** The 9.4-to-9.5-gHz computer-driven San Francisco harbor radar complex, called the Marine Traffic System (MTS), is intended "to find out what we need in traffic systems," says Lt. Andrew F. Hobson, Coast Guard research & development project officer. "MTS is the test bed for everything the Coast Guard

is doing," he adds. Particularly, the service wants to look into requirements for radar surveillance integration (between antennas, computers and scopes), communications, graphics, and displays.

The MTS consists of two shore-based radars—one outside and the other inside the harbor—video processors, three computers and various display consoles. With computer processing, the full system will determine every ship's course and speed, as well as predict possible collisions, Lt. Hobson says. This way, a traffic operator will be able to alert ships by radio that they may collide or run aground. Keeping inbound and outbound traffic in proper lanes will be easier, too, he says.

Key to the full system is the traffic computer, which will give the

MTS operator information similar to that which an FAA air traffic controller sees on his displays. Besides potential collisions and congestion, an operator can also request such computer analyses as relative position, closest point-of-approach, and traffic projections.

Each of the two operator stations will have a 17-inch primary cathode-ray tube display produced by Imlac Corp., Waltham, Mass.; four Imlac 14-inch satellite CRTs; and two 10-inch ship status alphanumeric CRTs made by Ann Arbor Displays Inc., in Michigan. The Imlac equipment consists of combined alphanumeric and graphic displays refreshed from a minicomputer with a vector generator.

Each station will also have a keyboard to query and direct the computer and a trackball, used to posi-

## The marine traffic system

As the test bed for future harbor traffic systems, MTS is a simply conceived but sophisticated design employing two marine radars, three small computers, and electronic display consoles for ship monitoring.

Each of the two MTS radars sends data to its own radar video pre-processor (RVP), which, with a radar computer, combine to spot ships automatically, follow their progress, and keep track of their location, speed, and course. The RVP separates the ships from clutter for subsequent computer processing. Each Honeywell radar computer, with an 8,192-word memory, not only correlates scan-to-scan information, but performs such tracking functions as range and bearing, track updating, ship length computations, and coast logic, which estimates a ship's progress when it becomes obscured by a bridge or an island.

The third Honeywell DDP-516 computer analyzes the data from the radar units and displays the results to the MTS operators through the terminals. Its automatic alert functions include warning operators of potential collisions, anticipating traffic congestion in critical areas, detecting vessel departures from designated traffic lanes, spotting possible groundings, and showing the drift of buoys or anchored ships from their assigned stations.

The two AIL radars were specifically designed for MTS. Their features include switchable antenna polarizations, 50 nanosecond pulses, and logarithmic i-f amplifiers.

# Count on Monsanto to help you count faster.

Our Model 120A counter/timer is the racehorse of the Monsanto line. Frequency range is from DC to 150 MHz, with 512 MHz available as an option.

Full complement of functions include "Burst Mode," in which the counter automatically senses burst width and selects the appropriate time base for a true readout of burst frequency. Time-base autoranging means convenient hands-off operation. Other

significant features: TTL compatible BCD output, 8-digit solid state numeric (LEN) display, programmability, extensive use of MSI.

Price is a big feature too: \$1545 for the 150 MHz version, \$1795 for the 512 MHz. With Monsanto's 2-year warranty, that's the lowest cost of usership in the counter field. Ask for complete data. United Systems Corp., a subsidiary of Monsanto Co., 918 Woodley Road, Dayton, Ohio 45403.

All Monsanto instruments are available for rental or lease through Rental Electronics, Inc.



# Monsanto

**NEW AUTORANGING  
DIGITAL MULTIMETER...  
IN-PROBE DISPLAY,  
HIGH-SPEED READOUT,  
BATTERY OPERATION...  
\$325.**



For AC or DC voltage, resistance and even current, our Model 167 with unique in-probe readout lets you make time-saving measurements directly at the point of measurement. With up to 3-month battery life. The Model 167's combination probe/readout, with 3½ digit LED display, automatically indicates decimal point, polarity, range and function. Front panel terminals and probe receptacle allow alternative use as a bench instrument. The neat, sweet-to-hold 167 Auto-Probe DMM is only \$325 (less in quantity). Check it out and get our latest "How Sweet" button.

**Measures easily ...** 1 mV to 1000 VDC  
• 1 mV to 500 VAC RMS • 1 ohm to 20 megohms

**with the convenience of ...** 55 megohms input resistance • 2-sec. reading time to rated accuracy • 1200 volts overload protection • Complete choice of accessories.



**KEITHLEY  
INSTRUMENTS**

U.S.A.: 28775 AURORA ROAD, CLEVELAND, OHIO 44139  
EUROPE: 14, AVENUE VILLARDIN, 1009 PULLY, SUISSE

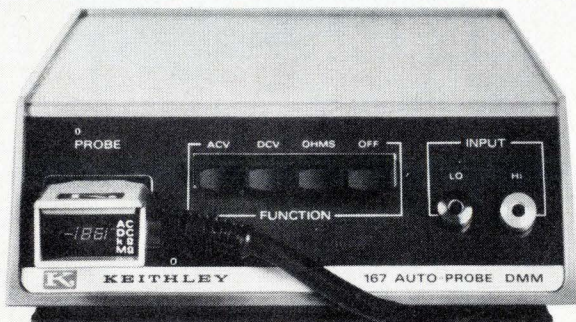

The Model 167... another how-sweet-it-is Keithley Multimeter

**Probing the news**

tion an electronic symbol over a blip so that the computer can analyze the blip. The two stations will share two backup radar plan position indicators (PPIS) and a radar console with five PPIS—all built by AIL.

The working display, highlighting one of seven coverage areas, will show such symbols as buoys, ship size in one of three categories, traffic lane center lines, and tags on identified ships. Satellite displays will show other coverage areas, and ship status displays will provide the operator with an alphanumeric list of identified ships in the system.

Installation of the \$3.2 million system will begin this summer, with a semiautomated system operating by January 1973 and the full system scheduled to come on line in July 1973. Johns Hopkins University's Applied Physics Laboratory is performing the systems integration, including the displays, radar video processor and the automatic tracking, says Lt. Hobson. AIL division of Cutler-Hammer Inc., is building the high-precision radar. The computers are Honeywell DDP-516s.

**Problems.** In designing the system, APL had to overcome the effect of sea clutter caused by false returns from whitecaps that confuse the radar. Using high-resolution radar with vertical polarization proved "the basic approach to beating clutter," says APL systems engineer Alfred J. Cote. Because ships appear differently, depending how they face a radar antenna, APL has had to devise beam interpolation studies to decipher ship sizes. APL solved this by establishing a profile word that would be a preliminary estimate of the ship's size, he says. Subsequent sweeps of the radar further fix the ship's true tonnage.

The Coast Guard "will develop MTS on a modular basis" says Lt. Hobson. Each harbor is unique, and each system will be tailored to that harbor, he explains. Two areas the Guard is looking at now are the Houston, Texas, ship channel and New York harbor, he says. MTS itself is an outgrowth of a "patchwork" system used in San Francisco for the last two years, he comments. □



# Pretend you never heard of Panasonic.

Imagine a different company. One of the world's largest battery manufacturers, selling batteries in more than 120 countries. A company whose research is revolutionizing the battery industry.

Now imagine another company. One that produces the world's most complete line of VTR/CCTV equipment. One whose diplomacy led to the first real standardization in video. Whose engineering skill is paving the way for pre-programmed cartridge video in the home.

Both of those companies are Panasonic.

Sometimes our reputation in consumer electronics makes people overlook our achievements in other fields. That means they

overlook a lot of our achievements.

Take video. Panasonic's new  $\frac{1}{2}$ " Cartridge Video Recorder is a practical solution to the problem of home video. It conforms to both the EIAJ black and white recording standard and the new recommended color standard.



And standardization will make pre-programmed cartridge video in the home a reality rather than a dream.

On top of that, there's our VTP SYSTEM. The quickest,

most reliable, most economical system available for duplicating  $\frac{1}{2}$ " video tapes.

Now take batteries. Panasonic has the latest. A new lithium High Energy Battery, with an energy density four to five times (in some cases ten times) greater than conventional batteries. And we've also got "Panaquick," our new device for rapid charging of batteries without the dangers of over-charge, gas generation or other damaging side effects.

Achievements like these shouldn't be overlooked. For a memorable experience, come visit us at this year's IEEE Show, booths 2814-2815. And when you do, pretend you never heard of Panasonic. You'll get to know us all over again.



**Panasonic**  
just slightly ahead of our time

Circle 119 on reader service card



Consumer electronics

## New calculator firms favored

Odds for success in under-\$100 machines give edge to small companies that adapt latest electronics technology and marketing strategies

by Stephen Wm. Fields, San Francisco bureau manager

The great consumer calculator race is underway, and several agile companies have leaped to the forefront with electronic machines that have already dipped below the \$100 consumer price milestone. The pace set by the contenders is so fast that some of the old-line business machine companies—handicapped by organizational inertia and overhead—are finding it difficult to get out of the starting gate. And, as advanced technology cuts components costs further and the market expands, most manufacturers look to see the price of calculators drop to \$70 in the not-too-distant future.

Much of the thrust behind cheaper electronic calculators comes from the higher levels of MOS LSI integration and the lower cost of such chips. But better MOS yields and reduction in four-function machines from between four and six chips to one aren't the only factors driving calculator prices down. Keyboard and display costs also are being reduced, although it isn't clear now that any single display technology—gas discharge tubes, light emitting

diodes, or liquid crystals—will become dominant.

**Larger firms handicapped.** It is apparent that more startup companies or smaller firms are finding it easier than the larger business machine companies to move up fast with new technologies. Indeed, the simple \$99 calculator seems to be the divider between the upstart low-overhead technology opportunists and established firms in the electromechanical business machine market. Some of the latter will participate in the low-price market only with imported machines.

But as fewer parts are required for calculators, there's less reason to assemble them overseas. The bigger companies counting on imported machines to win them a piece of the consumer market may be deluding themselves as U. S. competition heats up. L. J. Sevin, president of Mostek Corp., the Carrollton, Tex., MOS supplier, thinks the Japanese "will be hard-pressed" to compete in the consumer market, (which he calls the toy market) because there's so little labor in the low-priced ma-

chines. He adds that the realignment of the monetary system will also mitigate against the Japanese because of the new import duties they'll have to pay. Sevin says flatly that the consumer calculator "will be a \$25 toy in a year or two."

And Charles Kovac, vice president-marketing at North American Rockwell Microelectronics Co. Anaheim, Calif., further underscores the shift away from Japanese dominance of the U. S. market for calculators selling for less than \$150. Although the Japanese had a lock on the multichip calculators when they sold for more than \$300, Kovac looks for most of the single-chip machines to be made here.

He predicts that 1.5 million calculators will be sold in this country this year, of which 500,000 to 700,000 will be consumer machines. Of the latter total, Kovac believes American companies will sell 300,000 to 400,000. He looks for the Japanese to remain strong in industrial calculators, however. And Kovac goes further: he predicts that some 9 million consumer machines,

# Bendix puts an end to the bends.



You know the bends. That's when connector pins are bent or damaged during mating by misaligned plug and receptacle.

The bends just can't happen with Bendix SJT connectors. Pins are recessed. Stronger, too. And that makes them 100% scoop proof. You get positive protection whether the pins are in receptacle or plug.

You get five-key polarization, too. And that makes mismatching a thing of the past.

Consider, too, Bendix SJT connectors meet

the performance and mounting characteristics of MIL-C-38999 and are available with all insert and contact configurations covered by that specification. Lightweight shell sizes from 8 to 24 with from 3 to 128 crimp type contacts accommodating wire gauges from 12 to 28.

Now then. Like to put an end to the bends? Write for our new SJT catalog.

The Bendix Corporation, Electrical Components Division, Sidney, New York 13838.





### SIGNETICS • TABLE OF CONTENTS

SECTION	TITLE	PAGE
1	GENERAL INFORMATION	1
2	PRODUCTS	2
3	VOLUME REGULATORS	3
4	LINEAR INTEGRATED CIRCUITS	4
5	PHASE LOCKED LOOP	5
6	MICROPOWER OPERATIONAL AMPLIFIER	6
7	FET INPUT OPERATIONAL AMPLIFIER	7
8	DUAL OPERATIONAL AMPLIFIERS	8
9	TIMER	9
10	ANALOG VOLTAGE COMPARATOR	10
11	CHROMA DEMODULATOR	11
12	INDEX	12

### LINEAR INTEGRATED CIRCUITS

**DESCRIPTION**  
The LM109 and LM309 are complete 5-volt regulators. The LM109 is a precision 5.0V regulator and the LM309 is a precision 3.0V regulator. Both regulators are designed to load 100mA and are capable of supplying 500mA. They are available in TO-18 and TO-9 packages. The LM109 is available in TO-18 and TO-9 packages. The LM309 is available in TO-18 and TO-9 packages.

**FEATURES**  
• OUTPUT CURRENTS EXCEED 500 mA  
• INTERNAL THERMAL OVERLOAD PROTECTION  
• INTERNAL CURRENT LIMITING  
• NO EXTERNAL COMPONENTS REQUIRED

**ABSOLUTE MAXIMUM RATINGS**  
Power Dissipation (Max)  
Operating Junction Temperature Range  
Lead Temperature (Soldering Iron)  
Storage Temperature Range  
Lead Temperature (Soldering Iron)

**EQUIVALENT CIRCUIT**

### LINEAR INTEGRATED CIRCUITS

#### LINEAR OPERATIONAL AMPLIFIER **LM747**

**DESCRIPTION**  
The LM747 is a set of high performance operational amplifiers designed for use in a wide variety of applications. It consists of a precision 100V operational amplifier and a precision 10V operational amplifier. Both amplifiers are designed to load 100mA and are capable of supplying 500mA. They are available in TO-18 and TO-9 packages. The LM747 is available in TO-18 and TO-9 packages.

**FEATURES**  
• 100V FREQUENCY COMPENSATION REQUIRED  
• EXCELLENT COMMON MODE REJECTION  
• LARGE COMMON MODE AND DIFFERENTIAL MODE INPUT RANGE  
• NO LATCHUP

**ABSOLUTE MAXIMUM RATINGS**  
Power Dissipation (Max)  
Operating Junction Temperature Range  
Lead Temperature (Soldering Iron)  
Storage Temperature Range  
Lead Temperature (Soldering Iron)

**EQUIVALENT CIRCUIT**

### LINEAR INTEGRATED CIRCUITS

#### PHASE LOCKED LOOP **LM565**

**DESCRIPTION**  
The LM565 Phase Locked Loop (PLL) is a self-contained integrated circuit which provides the functions of a phase-locked loop. It consists of a phase detector, a low-pass filter, a voltage controlled oscillator, and a divider. The LM565 is available in TO-18 and TO-9 packages.

**FEATURES**  
• EXTREME FREQUENCY OF CENTER FREQUENCY  
• INTERNAL FREQUENCY DIVIDER  
• ZERO-DRIFT, ZERO-BIAS, ZERO-DRIFT DIVIDER  
• ZERO-DRIFT, ZERO-BIAS, ZERO-DRIFT DIVIDER

**ABSOLUTE MAXIMUM RATINGS**  
Power Dissipation (Max)  
Operating Junction Temperature Range  
Lead Temperature (Soldering Iron)  
Storage Temperature Range  
Lead Temperature (Soldering Iron)

**EQUIVALENT CIRCUIT**

### LINEAR INTEGRATED CIRCUITS

#### MICROPOWER OPERATIONAL AMPLIFIER **LM137**

**DESCRIPTION**  
The LM137 is a low power operational amplifier designed for use in a wide variety of applications. It consists of a precision 100V operational amplifier and a precision 10V operational amplifier. Both amplifiers are designed to load 100mA and are capable of supplying 500mA. They are available in TO-18 and TO-9 packages. The LM137 is available in TO-18 and TO-9 packages.

**FEATURES**  
• 100V FREQUENCY COMPENSATION REQUIRED  
• EXCELLENT COMMON MODE REJECTION  
• LARGE COMMON MODE AND DIFFERENTIAL MODE INPUT RANGE  
• NO LATCHUP

**ABSOLUTE MAXIMUM RATINGS**  
Power Dissipation (Max)  
Operating Junction Temperature Range  
Lead Temperature (Soldering Iron)  
Storage Temperature Range  
Lead Temperature (Soldering Iron)

**EQUIVALENT CIRCUIT**

### LINEAR INTEGRATED CIRCUITS

#### FET INPUT OPERATIONAL AMPLIFIER **LM107**

**DESCRIPTION**  
The LM107 is a low power operational amplifier designed for use in a wide variety of applications. It consists of a precision 100V operational amplifier and a precision 10V operational amplifier. Both amplifiers are designed to load 100mA and are capable of supplying 500mA. They are available in TO-18 and TO-9 packages. The LM107 is available in TO-18 and TO-9 packages.

**FEATURES**  
• 100V FREQUENCY COMPENSATION REQUIRED  
• EXCELLENT COMMON MODE REJECTION  
• LARGE COMMON MODE AND DIFFERENTIAL MODE INPUT RANGE  
• NO LATCHUP

**ABSOLUTE MAXIMUM RATINGS**  
Power Dissipation (Max)  
Operating Junction Temperature Range  
Lead Temperature (Soldering Iron)  
Storage Temperature Range  
Lead Temperature (Soldering Iron)

**EQUIVALENT CIRCUIT**

### LINEAR INTEGRATED CIRCUITS

#### DUAL OPERATIONAL AMPLIFIERS **LM324**

**DESCRIPTION**  
The LM324 is a set of four operational amplifiers designed for use in a wide variety of applications. It consists of four precision 100V operational amplifiers. All amplifiers are designed to load 100mA and are capable of supplying 500mA. They are available in TO-18 and TO-9 packages. The LM324 is available in TO-18 and TO-9 packages.

**FEATURES**  
• 100V FREQUENCY COMPENSATION REQUIRED  
• EXCELLENT COMMON MODE REJECTION  
• LARGE COMMON MODE AND DIFFERENTIAL MODE INPUT RANGE  
• NO LATCHUP

**ABSOLUTE MAXIMUM RATINGS**  
Power Dissipation (Max)  
Operating Junction Temperature Range  
Lead Temperature (Soldering Iron)  
Storage Temperature Range  
Lead Temperature (Soldering Iron)

**EQUIVALENT CIRCUIT**

### LINEAR INTEGRATED CIRCUITS

#### CHROMA DEMODULATOR **LM187**

**DESCRIPTION**  
The LM187 is a chroma demodulator designed for use in a wide variety of applications. It consists of a precision 100V chroma demodulator. The LM187 is designed to load 100mA and is capable of supplying 500mA. It is available in TO-18 and TO-9 packages. The LM187 is available in TO-18 and TO-9 packages.

**FEATURES**  
• 100V FREQUENCY COMPENSATION REQUIRED  
• EXCELLENT COMMON MODE REJECTION  
• LARGE COMMON MODE AND DIFFERENTIAL MODE INPUT RANGE  
• NO LATCHUP

**ABSOLUTE MAXIMUM RATINGS**  
Power Dissipation (Max)  
Operating Junction Temperature Range  
Lead Temperature (Soldering Iron)  
Storage Temperature Range  
Lead Temperature (Soldering Iron)

**EQUIVALENT CIRCUIT**

...for 230 more pages of the new **SIGNETICS LINEAR HANDBOOK Vol. 1**, call your local distributor now.

Just two bucks to your distributor gets you this invaluable collection of complete specs, diagrams and data on both proprietary and industry standard parts. Plus a big Bonus-Offer coupon, good for one FREE part—your pick from any device listed in the Handbook. To experiment with, wire in...or keep on your desk to doodle with. Linear Handbook Vol. 1, with Bonus coupon: only \$2 from your distributor.

**Signetics: total capability linear.**  
811 E. Arques Avenue, Sunnyvale, California 94086

## SIGNETICS

**Linear Handbook Vol. I,  
with Bonus coupon,  
\$2.00 from your distributor:**

ARIZONA  
Phoenix: Hamilton/Avnet Electronics  
(602) 269-1391  
CALIFORNIA  
Burbank: Compar Corp.  
(213) 843-1772  
Burlingame: Compar Corp.  
(415) 347-5411  
Culver City: Hamilton Electro Sales  
(213) 559-3311  
El Monte: G. S. Marshall  
(213) 686-1500  
Los Angeles: KT/Wesco Electronics  
(213) 685-9525  
Mountain View: Hamilton/Avnet Electronics  
(415) 961-7000  
Palo Alto: Wesco Electronics  
(415) 968-3475  
San Diego: G. S. Marshall  
(714) 278-6350  
San Diego: Kierulff Electronics  
(714) 278-2112  
CANADA  
Downsview: Cesco Electronics, Ltd.  
(416) 638-5250  
Montreal: Cesco Electronics, Ltd.  
(514) 735-5511  
Ottawa: Cesco Electronics, Ltd.  
(613) 729-5118  
Quebec: Cesco Electronics, Ltd.  
(418) 524-3518  
COLORADO  
Denver: Hamilton/Avnet Electronics  
(303) 433-8551  
FLORIDA  
Hollywood: Hamilton/Avnet Electronics  
(305) 925-5401  
Orlando: Hammond Electronics  
(305) 241-6601  
ILLINOIS  
Elmhurst: Semiconductor Specialists, Inc.  
(312) 279-1000  
Schiller Park: Hamilton/Avnet Electronics  
(312) 678-6310  
MARYLAND  
Hanover: Hamilton/Avnet Electronics  
(301) 796-5000  
Rockville: Pioneer Washington Electronics, Inc.  
(301) 424-3300  
MASSACHUSETTS  
Burlington: Hamilton/Avnet Electronics  
(617) 272-3060  
Needham Heights: Kierulff/Schley  
(617) 449-3600  
MICHIGAN  
Livonia: Hamilton/Avnet Electronics  
(313) 522-4700  
Detroit: Semiconductor Specialists, Inc.  
(313) 255-0300  
MINNESOTA  
Minneapolis: Semiconductor Specialists, Inc.  
(612) 854-8841  
MISSOURI  
Hazelwood: Hamilton/Avnet Electronics  
(314) 731-1144  
NORTHERN NEW JERSEY  
Cedar Grove: Hamilton/Avnet Electronics  
(201) 239-0800  
SOUTHERN NEW JERSEY  
AND PENNSYLVANIA  
Cherry Hill: Hamilton/Avnet Electronics  
(609) 662-9337  
Cherry Hill: Milgray-Delaware Valley  
(609) 424-1300 Phila. (215) 228-2000  
NEW YORK  
Buffalo: Summit Distributors, Inc.  
(716) 884-3450  
Hauppauge: Semiconductor Concepts, Inc.  
(516) 273-1234  
Woodbury: Harvey Radio  
(516) 921-8700  
New York: Terminal-Hudson Electronics  
(212) 243-5200  
OHIO  
Cleveland: Pioneer Standard Electronics  
(216) 587-3600  
Kettering: Arrow Electronics  
(513) 253-9176  
TEXAS  
Dallas: Hamilton/Avnet Electronics  
(214) 638-2850  
Dallas: Solid State Electronics Company  
(214) 352-2601  
Houston: Hamilton/Avnet Electronics  
(713) 526-4661  
WASHINGTON  
Seattle: Hamilton/Avnet Electronics (206) 624-5930

## Probing the news

including simple teaching machines and true calculators selling for about \$100, will be sold in this country in the next three years. That's almost a \$1 billion market.

The U. S. calculator makers say, however, that they can't build and market machines profitably unless the selling price is about four times the cost of components—assuming that they're selling through business machine dealers or direct salesmen. Going to low-overhead operations and selling directly to retail outlets lowers the price to three times the components cost.

Early last year, MOS chip sets for four-function calculators consisted of three to five arrays that sold for a total of about \$40. The other principal part costs broke down this way: keyboard, \$20; display, \$20; power supply and other electronics, \$10; and case, key caps and other external hardware, about \$5. This adds up to about \$95, dictating a selling price of \$395.

Most calculator makers agree that to produce a machine designed to retail for \$99, it must have a parts cost of \$25. This means that in quantity the single MOS LSI chip must cost about \$5; the keyboard, \$2; display, about \$8; power supply and other electronics, about \$5; and case and other hardware, about \$5. Labor and overhead boosts the cost to between \$36 and \$40. Calculator manufacturers say such a machine can be sold to chain stores for \$65 and can retail for \$99. One East Coast department chain, Alexander's, has gone so far as to buy a machine for \$94 (parts cost of \$50,

which should boost the retail price to \$150), and sold it by mail order for \$99.

**Prices continue downward.** That doesn't leave much profit margin, but there are signs that the \$25 parts cost goal is reachable, which would boost the profit. The companies talking about a \$99 calculator agree that \$5 or \$6 LSI can be had. Texas Instruments and Mostek, Dallas, General Instrument, Hicksville, N.Y., and Caltex, Santa Clara, Calif., are the only announced suppliers of one-chip calculator circuits. The chips are publicly priced at \$12 to \$15 in large quantities. But at least five other LSI makers are vying for business, and at least one of these has signed a multi-million dollar contract to deliver one-chip calculator circuits this year at \$5 each.

North American Rockwell is building a circuit for Sharp Electronics Corp. in Japan (and is reportedly building a complete machine for Sears); American Microsystems Inc., Santa Clara, Calif., is building a chip for Unicom, an AMI subsidiary; Nortec Electronics Corp., Santa Clara, Calif., is building one for Omron Tateisi Electronics Co., in Japan, a newcomer; Standard Microsystems is building a chip for Commodore; and Caltex is fabricating a chip for Eiko. With this competition, most suppliers will probably be willing to sell four-function-plus-constant and either fixed- or floating-point calculator chips for \$5 or \$6 in high volume. And TI, now supplying Eldorado Electrodata Corp., Concord, Calif., and Bowmar/Ali, Inc., Acton, Mass., with chips, will probably meet the \$5 price.

This leaves the maker of a \$99

**A calculated market.** The Eldorado model 8M is aimed to fill mass consumer needs. It is a four-function machine with a floating decimal point and an eight-digit display.

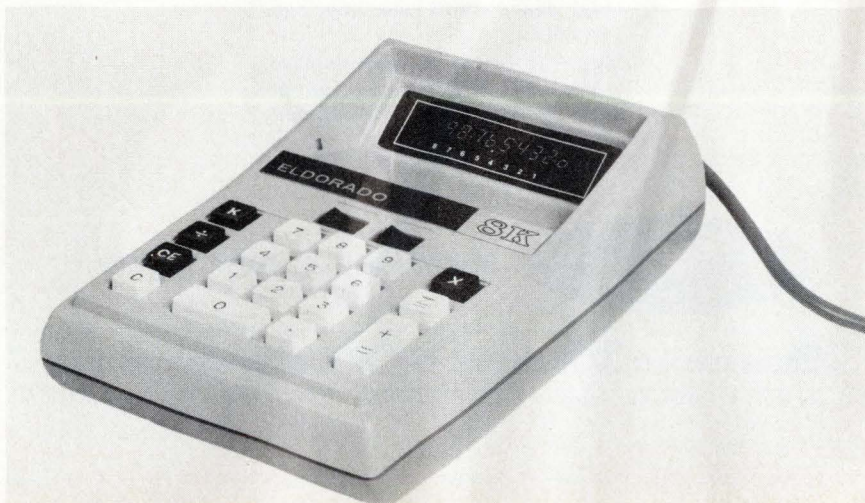

# right On...

## with AEL's SPST Switches

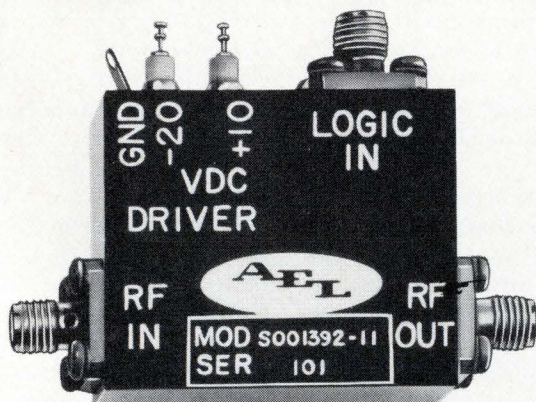

The AEL S00 1392 series is the latest in solid state switches for applications in ECM, Radar and Communications systems. Optimized for isolation and insertion loss, power handling and switching speed, these are the ones that feature:

- Frequency coverage from 100 MHz to 12.4 GHz in five bands
- Integral bias network and dc blocks
- Optional integrated HMC Switch driver
- MIC construction with 3mm connectors

Contact AEL, or our representative, for more information about our new SPST Switches and other components up to 18 GHz.



**Microwave capability now.**

**A**merican **E**lectronic **L**aboratories, Inc.

P. O. Box 552, Lansdale, Pa. 19446 • (215) 822-2929 • TWX: 510-661-4976, Cable: AMERLAB

calculator the task of finding a manufacturer of 10¢-per-switch keys and \$1-per-driven-digit displays, or finding the technology to build them in-house. One well publicized example of the latter is Ragen Precision Industries, North Arlington, N.J. Their machine, with its complementary MOS logic and liquid crystal display, has progressed to a model that turns on the display, but doesn't do any calculating.

As of the end of February, Alexander's, had not seen a working model. "If they send them, we'll sell them," says Alexander's vice president, Jerome P. Germain. For its part, Ragen promises to have calculators "on the shelves" by the first week in April.

In the meantime, Germain, shopping around for another pocket calculator, has ordered 20,000 from a Toronto, Ont., company, Rapid Data Systems & Equipment Ltd. Its Rapidman 800, somewhat larger than Ragen's machine, is expected to sell for under \$100. Ragen is the only low-priced calculator producer that makes everything except the mercury power cells. However, the company won't reveal what percentage of the total cost each part represents.

Another company that is counting on in-house technology to launch a \$99 calculator by this summer is Omron Tateisi. This Japanese company has an American partner called Omron R&D, headed by Bernard Jacobs. Omron R&D has developed a keyboard that Jacobs says will cost about 8 cents per key, which he is counting on to bring keyboard costs down from \$10 to \$2. And like Ragen, Omron has developed a liquid crystal display for its low-cost machine. While Jacobs won't comment on the display, sources at Omron in Tokyo imply that their cost target is \$5 to \$8. One of Omron's present machines, being marketed by Unicom and Commodore, is retailing for \$138. It's a three-chip machine employing display tubes made by ISE in Japan. But by changing to an in-house liquid crystal display and an in-house keyboard with a single calculator chip, Omron should make its \$99

# Sperry explodes the LED myth

There has been a lot said in recent months about LED's representing the most significant advance in display technology and how they are destined to dominate the digital display market. We feel it's time to explode the myth and set the record straight. So, here's a direct, point-by-point, comparison of Sperry seven segment gas discharge planar displays† vs LED displays.

## COST

For the price of a single 1/4" LED digit you can buy three 1/2" or three 1/3" Sperry display digits\*. And, in the future, the Sperry displays should continue to be less expensive than LED displays. Gives you something to think about, doesn't it?



## SIZE Let the size speak for itself.



## READABILITY

Have you tried to read a 1/8" or even a 1/4" LED display at 20'? On the other hand, the Sperry 1/3" display is easy to read at that distance and the 1/2" model can be read at up to 40'. See the difference?



## COLOR

With LED's, you have the choice of red, red or red. Not so with Sperry. They come in an eye appealing orange — with amber and red available with filters. If you like red, why pay more for a LED?



## APPEARANCE

Which do you prefer — looking at individual red dots on LED devices or at continuous unbroken Sperry figures. The choice is yours.



## BRIGHTNESS

Sure you can read LED's indoors, but how about in bright light or direct sunlight? LED's fade fast while Sperry displays stay clearly legible with no appreciable loss in brightness. And, Sperry devices won't poop out when it gets hot!



Sperry advantages don't stop here either. The small Sperry package is only a shade larger than a LED and nearly as thin. Sperry power dissipation is also significantly lower. And, Sperry reliability is so good that they have proven fail-safe in stringent, high performance aircraft applications including the Boeing 747. There are no wire bonds to go bad, either. Don't just take our word for it. Arrange for a comparison demonstration and see for yourself what the difference will mean to your particular application.

For complete technical information on Sperry displays, use this publication's reader service card or phone or write: Sperry Information Displays Division, P.O. Box 3579, Scottsdale, Arizona 85257, Telephone (602) 947-8371

# SPERRY

INFORMATION DISPLAYS

## It's a whole new ball game in display devices!

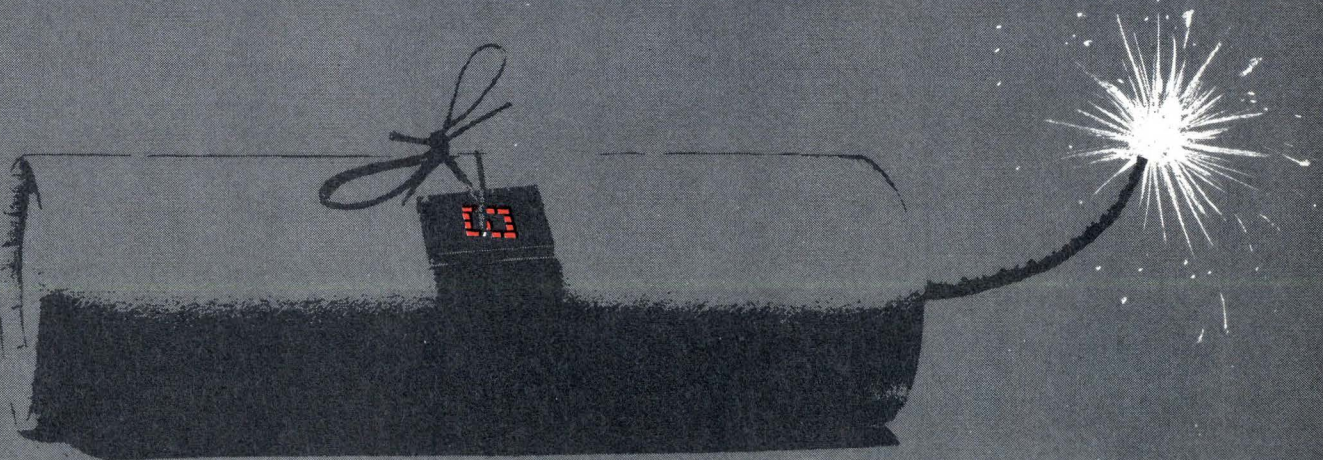

† Patents pending

\*based on 1,000 digit quantity, and above. Sperry displays are available in 3 digit, 2 digit, and 1 1/2 (7 segment character and a 1 with + and -) digit models in both 1/3" and 1/2" sizes.

**SPERRY RAND**

Circle 125 on reader service card

## Probing the news

target. As for quality, Jacobs says that, out of a lot of 200,000 machines, the failure rate, including field repairs and cosmetic rejects, has been only 0.3% with the \$138 machine.

**Elastic keyboard.** But there is also hope for companies that want to buy rather than build inexpensive keyboards and displays. For ex-

ample, Alps Electric Co. of Japan has just announced a low-cost, elastic keyboard that is expected to sell for around 13 cents per key, including key top. The switch has a piece of conducting rubber that makes a connection between two contacts on a printed circuit board when a key is depressed. Another piece of rubber returns the key when pressure is removed.

While other low-cost keyboards are sure to follow the Alps develop-

ment, the display competition is still up in the air. Most of the publicity has centered around light emitting diodes and liquid crystal displays. But there's still no machine on the market with a liquid crystal display. Ragen's may be the first. The Monroe division of Litton Industries, Orange, N.J., gets around the problem of high cost in its Royal Digital III pocket calculator by providing only a four-digit readout.

The Royal Digital III was intended to retail for \$139, but is selling for \$99. It employs four General Electric Co. vacuum fluorescent display tubes. Instead of a keyboard, the operator uses a stylus to tap labeled squares—gold contacts in the printed circuit board—to close each circuit. A single chip made by General Instrument provides the logic.

The magic number in displays is about \$1 per driven digit—the display plus the driving circuitry. And while LED makers and the liquid crystal proponents fight it out, the gas discharge people are slipping in and taking the business. As one major U.S. calculator maker puts it, "Burroughs says that they will match any realistic display price with their Panaplex" [see p.136] In volume, this calculator maker continues, the display can be bought for \$1 per digit (not driven), and Burroughs reportedly has something new in the works that should come out at \$1 per driven digit.

**Liquid crystal.** Liquid crystal advocates say that, since the display can be driven directly from an MOS chip [*Electronics*, Jan. 31, p.66], the cost per driven digit will be the lowest. But LED backers such as Ian S. McCrae, TI's optoelectronics marketing manager, say that, since the material cost is still the most significant cost of the display, "LEDs could be made even more attractive by reducing the character size from 0.1 inch to 0.07 inch and using a 1.2× magnifier." Hewlett-Packard Co., Palo Alto, Calif., did this in its new display [*Electronics*, Jan. 17, p.64]. The H-P digit is 0.08 in. high; a 1.4× magnifier brings it up to 0.112 in. high. H-P says that, although the display is now \$2.25 per digit in quantities of 100,000, the price is expected to drop to \$1 per digit as "demand reaches the millions of digits." □

# NEW LOW PRICE!

Your acceptance of our custom-designed, 4 cu. ft., temperature test chamber has been so great that we have incorporated its most popular features into a production line model, EL-1200. This enables us to offer immediate delivery from stock...at a lower price than ever before. You won't find a better chamber for the price... *anywhere!*

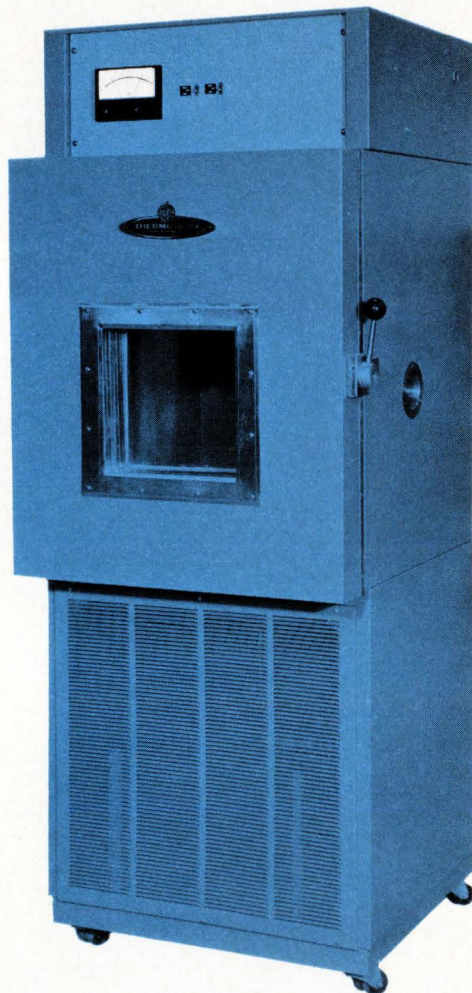

**Temperature range:**  
-73°C. (-100°F.) to +177°C. (+350°F.)



# THERMOTRON CORPORATION

WORLD HEADQUARTERS: Holland, Michigan 49423 U.S.A. • Phone: (616) 392-1492 • TWX No. 810-292-6164  
WEST COAST: 7033 N. Canoga Ave. • Canoga Park, Calif. 91303 • Phone (213) 883-6680 • TWX No. 910-494-1926



# SAINT LOGIC

## The best thing to come along since sliced bread

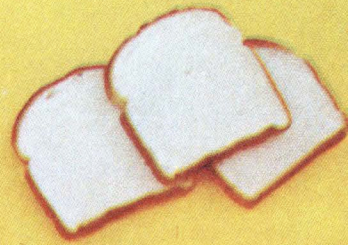

The state-of-the-art has not permitted any significant break-through in DVM logic until now. In the present DVMs on the market, certain trade-offs or sacrifices are necessary. For example, accuracy is given up for speed in many cases; speed is given up for accuracy; accuracy and speed have been given up for a lower price; accuracy and speed are given up for noise rejection.

The new Cimron DMM 50 is a five digit digital multimeter and is first in a family of multimeters to be introduced by Cimron this year. The Cimron DMM 50 offers high quality, high accuracy, high noise rejection and high speed at the same time.

In order to provide such a meter Cimron has employed a logic we call "SAINT." We've taken two logics and combined them resulting in one very powerful instrument. We use Successive Approximation (SA) logic for speed and integrating (INT) logic for its inherent noise rejection.

Each reading on the Cimron DMM 50 starts with an "Automatic Set Zero," then we examine the most significant of the five decades. Any part of a digit from zero through eleven is subtracted. This is called

our "subtractive digit" operation. The most significant decade can be zero through eleven. Next we integrate the four least significant decades.

The four operations of the "SAINT" technique are (1) automatic zero set; (2) subtractive digit; (3) integrate compare "one"; (4) integrate compare "two." This means the DMM 50 can operate at greater than 20 readings per second with a rejection of 60 dB at 60 Hz. An additional 60 dB of noise rejection may be switch selected.

Multimeter capabilities include: 5 ranges of DC and DC/DC ratio; 4 ranges of AC; 5 ranges of resistance; optical coupled data output and remote programming. Priced from \$1200.

Other Cimron products include AC Power Sources and Line Conditioners; Data Acquisition Systems; Pulse Generators; and a complete line of high performance DVMs.

For detailed specifications and demonstration contact your local Cimron Representative or Chuck Hasley at 714-774-1010, Lear Siegler, Inc., Cimron Instruments, 714 North Brookhurst Street, Anaheim, California 92803.



LEAR SIEGLER, INC.

CIMRON INSTRUMENTS



IEEE Booth #2101

Circle 127 on reader service card

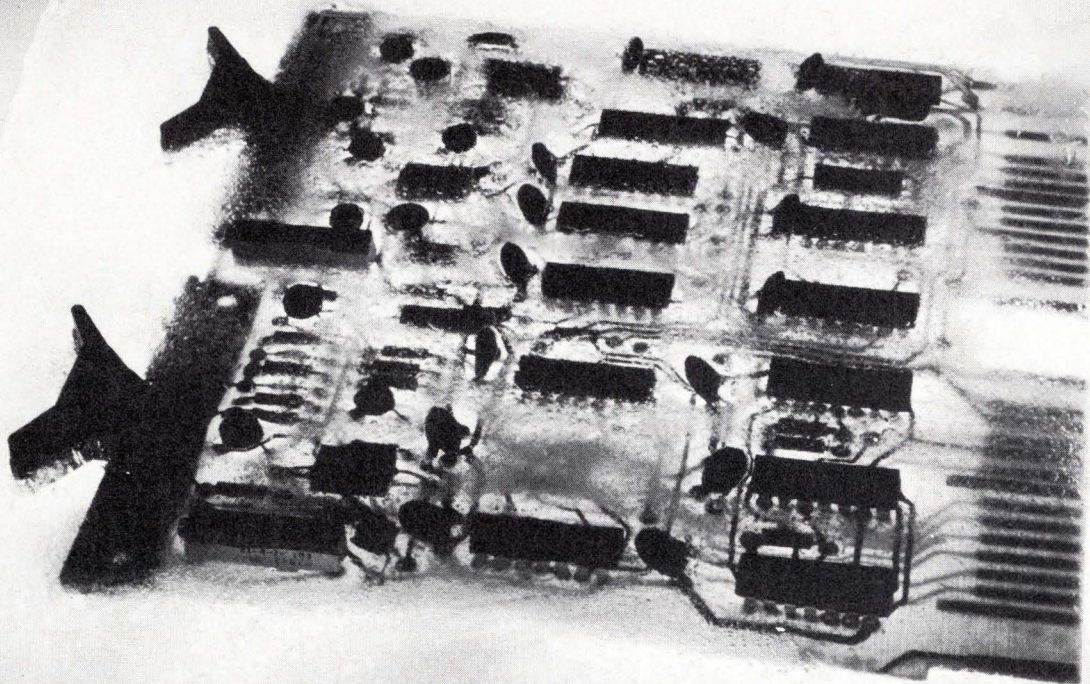

## Augat asks: are you freezing your circuits in a block of ice?

Consider the printed circuit board. Cheap. Reliable. Compact. So where's the fuss?

It's simply that soldered PC boards are terribly expensive and time-consuming to change . . . less reliable, and far less compact than wire wrapped socket panels.

It's enough to start you wondering about your commitment to printed circuit boards.

◦ Augat's dual-in-line wire wrapping panel is leading a revolution in another direction. No wonder. The plug-in flexibility of an Augat panel gives you the chance to make component and wiring changes in minutes. In breadboarding. Prototypes. Production. With Augat you get a big competitive edge because at a time when changes are happening faster than ever, you're not

forced to freeze a design.

But flexibility isn't all you get. Our exclusive (tapered-entry) socket gives you integrity unsurpassed by any other interconnecting method, including solder. And our high density pattern arrangement gives you up to three times the density of planar P.C. boards.

◦ All of which are some of the reasons why Augat sales have zoomed to thousands of panels a week. Call us today at (617) 222-2202. Or write. We have a new brochure that gives you the facts on panels versus P.C. boards: *Augat Challenges The P.C. Board*. We'll also send you literature on our complete product line. Augat Inc., 30 Perry Avenue, Attleboro, Massachusetts 02703. Our representation and distribution is international.

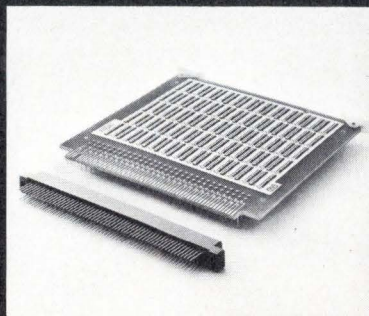

**Plug into Augat® instead.**

Management

## Teledyne Semi profits from change

By reorganizing the product lines to aim at the industrial market, top management has revitalized the company

by Stephen Wm. Fields, San Francisco bureau manager

### All plug-in panels are not the same.

It's one thing to want plug-in flexibility in your circuit. It's another to get flexibility plus all the other things you'd like in a dependable point-to-point system.

Like easier IC insertion. Precision-machined contacts. Tighter contact retention. Greater reliability (we'll prove it). Unique tapered entry sockets (patent pending). Lower profile. Plus the versatility to accept 14, 16, 18, 24, 28, 36 or 40 pin IC's in a choice of panel sizes.

And we offer virtually any panel you'll need, in any number of patterns, plane-mounted or edge-connected, off the shelf or custom.

We'll also give you single-source supply for sockets, enclosures and accessories—even automatic wire wrapping whenever you need it.

The Augat way? It's a better way. Call us at (617) 222-2202. Or write for our catalog. Augat Inc., 30 Perry Ave., Attleboro, Mass. 02703. Our representation and distribution is nationwide and international.

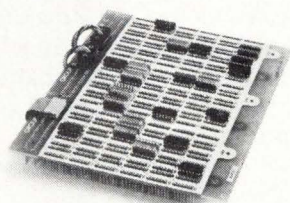

Plug into Augat\* instead.

The new sense of direction felt at Teledyne Semiconductor these days normally goes with a sign in the window proclaiming "under new management." But the triumvirate responsible for the change at the Mountain View, Calif., company has been in place for almost a year.

In that time, Eugene A. Blanchette, president, Robert F. Graham, vice president and director of marketing, and A. Gene Ladamato, vice president operations, looked hard at their existing product lines, decided there were some losers mixed in with the strong families, and reordered priorities at the former Amelco Semiconductor. Blanchette is a veteran of the semiconductor wars at Fairchild and Motorola. Graham came to Teledyne via Intel and ITT Semiconductor. Ladamato is a former Motorola who came to Teledyne from Fairchild with Blanchette.

**Definite goal.** The result is a newly integrated product plan: the company is going after the industrial semiconductor market with a line built around its HiNil family of high-noise-immunity logic. HiNil is a DTL-based logic that works with a 12-volt supply. It offers a 3.5-v noise margin, can tolerate a 1-v ripple in the supply, and has a voltage swing of 8 v. To complement it, new products are to be introduced in all lines including silicon gate MOS designed for compatibility with 12-v operation and linear ICs with high noise immunity. The one thing HiNil lacks is speed—but that, says Graham, works in Teledyne's favor in an industrial environment.

"We presently have about 25 Hi-

Nil circuits in our catalog, and we will soon add 16 new ones," says Graham. "These include some MSI parts such as up-down counters, multiplexers, and multivibrators."

There will also be a series of HiNil interface circuits. Graham points out that at any interface, whether it is between people and machines or machines and machines, there is something analog to be sensed and something analog to be driven. "And we will have the parts so that our customers can sense, calculate, and drive with HiNil logic."

Teledyne includes the former Amelco product lines, plus those of the former Continental Device Corp. The latter has long been a diode and transistor manufacturer in Hawthorne, Calif. Amelco was

**First person.** Teledyne's president, Eugene Blanchette, believes the firm's DTL know-how is an invaluable asset.





# Indianapolis... city with talent

We're a city filled with talent. Our most valuable resource is the skill of our men and women in all walks of life. Every trade, science, and profession, from medicine to manufacturing, boasts talented, dedicated workers. They explore, experiment and create . . . contributing to progress in commerce, education and industry . . . in Indianapolis.

**City full of opportunity.** With almost 1200 industries located in and around Indianapolis, it's no surprise we boast one of the brightest employment pictures in the country. Salaries and wages are reasonable and the fields of opportunities are endless.

**Get the facts on Indianapolis.** Write John Hardy, Area Development Director, Department 213, Indianapolis Power and Light Company, 25 Monument Circle, Indianapolis, Indiana 46204. He can help you in the areas of marketing and answer your questions about plant construction on the over 10,000 acres of available plant sites. Write today for the fact-filled brochure, *Data On Indianapolis*.

**INDIANAPOLIS  
POWER &  
LIGHT**

## Probing the news

the chip producer for the hybrid MEMA (microelectronics modular assembly) module for military avionics systems and also had discrete and IC product lines.

Before formulating a five-year plan, Blanchette has been intent on maximizing short-term returns on the best "inherited" product lines, while also pruning marginal product areas.

"We're a good house in diodes," he asserts. Teledyne makes double-plug computer switching diodes, whisker diodes and zeners. "But the computer switching-diode market dried up in the last few years," he notes, "and prices are very low. The whisker diode business is better, as is the zener business." In zeners, he figures his only competitor is Motorola's Semiconductor Products division. Generally, Blanchette characterizes Teledyne Semiconductor's diode line as solid and profitable, and he intends to retain it.

**FETs favored.** In transistors, Teledyne was in everything from rf power to small signal and switching devices. Blanchette has retained the logic transistor business with duals, quads, and hi-rel parts. And he hasn't tampered with the field effect transistors, either. He calls them "the most successful line in Mountain View." His house cleaning elsewhere, though, has done no harm: "the transistor line is selling more now than five to six months ago on far fewer products," Blanchette notes.

The hybrid facility has remained untouched, being almost all high-priced, high-reliability military work. But among the monolithic products, which include both digital and linear ICs, Blanchette shut off an MOS line he says was in trouble. He plans to get back into the field this summer, however, and expects to go with a silicon-gate, p-channel process, even though he thinks that the future is in ion-implanted n-channel and silicon gate n-channel. "The only way for Teledyne to go is with a proprietary MOS line," he says. It will probably be one that's easily compatible with the company's HiNil voltage supply and input-output levels. □

# Discover the value of power...



## and how it saves you money on your mini.

Discover the all-new SPC-16 family of minicomputers. The first minis to save you substantial money in system implementation. They're from General Automation... the fast-growing, pace-setting mini maker.

If you compare SPC-16's with those other two much-ballyhooed brands of minis, you'll discover it's no contest. In overall performance, SPC-16's win every time. And no wonder. The SPC-16's ultra-fast interrupt response system for multilevel interrupt response is one winning feature. Another is base relative addressing. Another is a unique one-word Load All Registers/Store All Registers capability. Plus eight (16 optional) true general purpose registers that can save you up to 4K (about \$2500 worth) of core. And much more.

Including the right price, the best quantity discounts in the industry and the easiest OEM buying policy of all.

SPC-16's are available as I/O and memory-integrated models for dedicated in-house applications. Or as unbundled versions for OEM users or large system applications requiring up to 65K of memory. Six models in all, in three speeds.

No other minis come close to SPC-16's in giving you so much performance for your money. Give us a benchmark, we'll prove it. Meantime, send today for a detailed brochure.

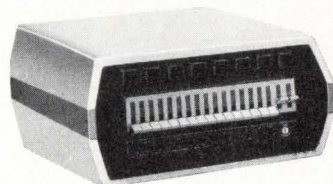

**GENERAL AUTOMATION, INC.**  
'Discover The Value Of Power'

1055 So. East Street, Anaheim, Ca. 92805 (714) 778-4800 TWX 910-591-1695

Circle 131 on reader service card

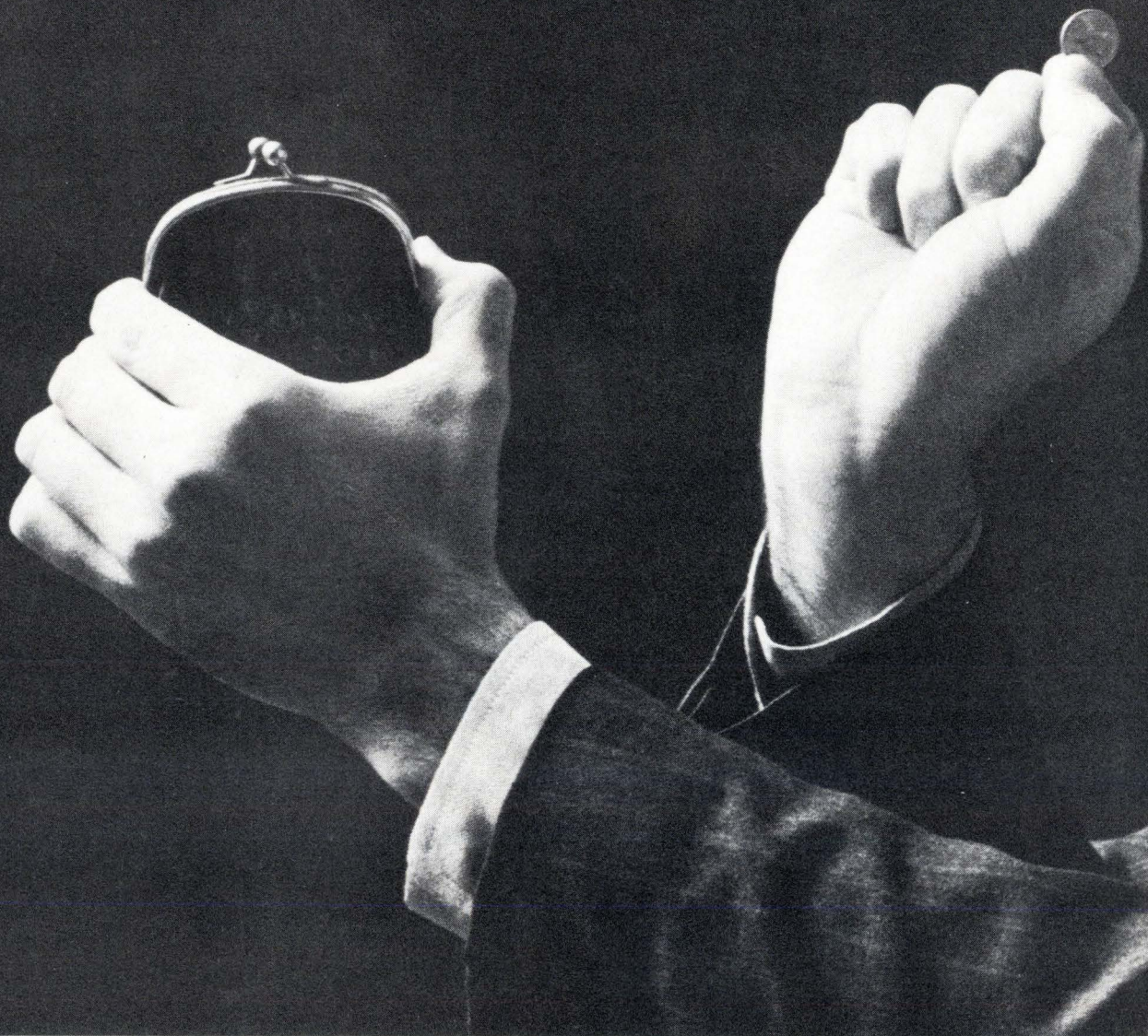

# PDP-8. PDP-11. For OEM's

A few months ago, we came out with new low cost versions of our PDP-8 and PDP-11 families for the OEM.

With prices as low as \$2436. In quantities of 50.

We made sure they'd have the features, architecture and compatibility that make PDP-11 and PDP-8 the most popular, most imitated minis ever.

We must have hit on the right combination. We've been mixing it up with some of the toughest OEM's around. And coming away with their business.

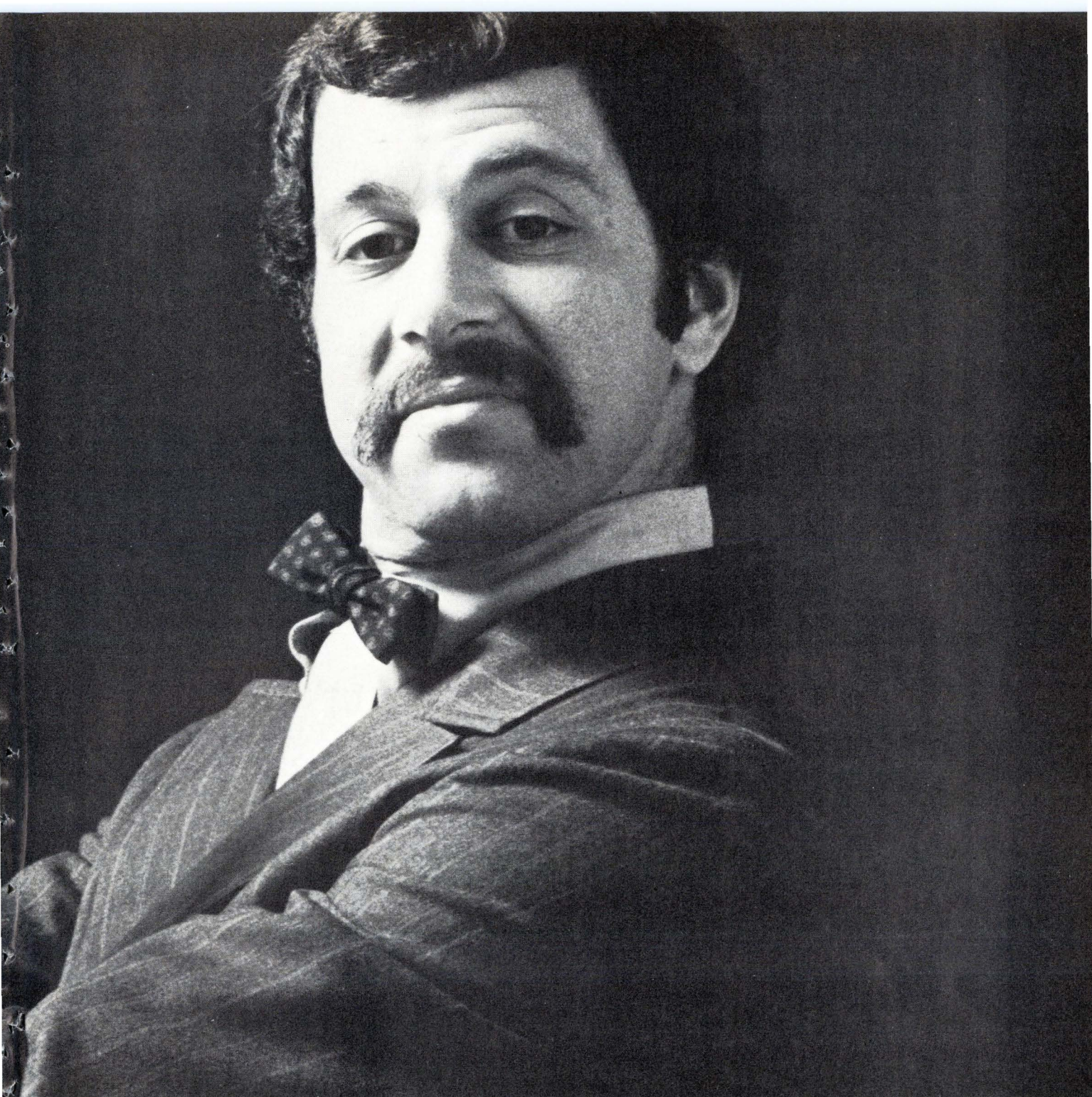

# who hate to spend money.

We're after your business, too.  
Because now we have the right  
computers. At the right prices.  
From the right company.  
Come and get 'em.

Digital Equipment Corporation,  
146 Main Street, Maynard, Mass.  
01754. (617) 897-5111.

**digital**

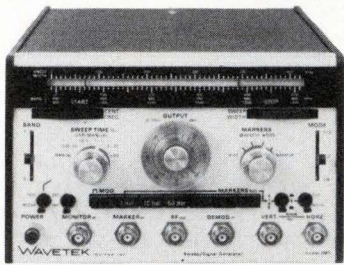

1 MHz to 1400 MHz.

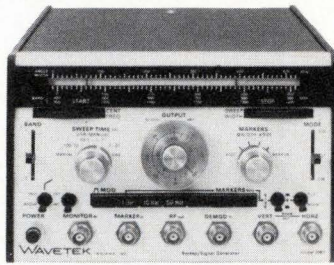

Calibrated output system provides precise power outputs from +10 to -80 dBm.

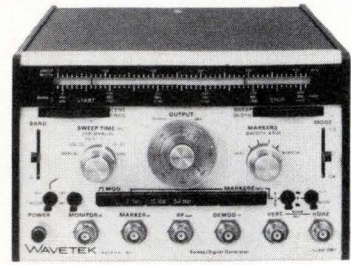

Complete marker system allows accurate frequency measurements of  $\pm 0.005\%$ .

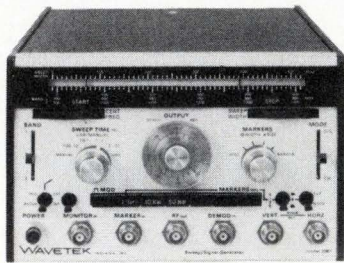

Solid-state, varactor-tuned and swept oscillator permits zero to full-band sweep width and FM modulation.

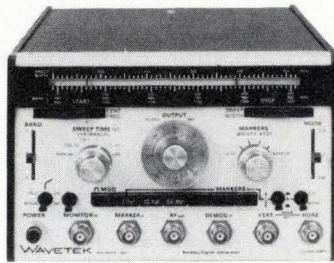

P.I.N. diode attenuation and leveling allow amplitude and pulse modulation.

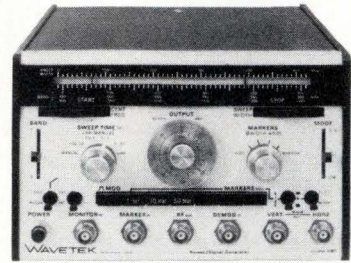

P.I.N. diode band switching.

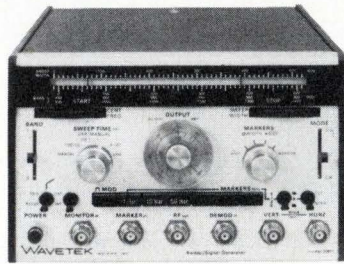

Programmability and/or remote control of frequency, bandwidth and output level.

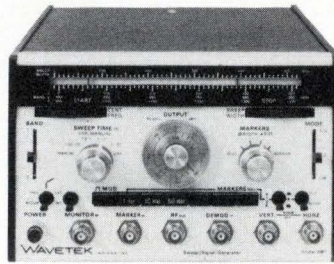

Compact and lightweight:  
5¼" x 8" x 12".

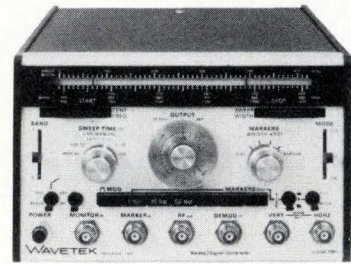

Model 2001 Sweep/Signal Generator: \$1695

# The more you know about the 2001, the smaller the price looks.

## WAVETEK®

INDIANA INCORPORATED  
P.O. Box 190, 66 North First Avenue  
Beech Grove, Indiana 46107  
Tel. (317) 783-3221 TWX 810-341-3226



## New products

# IEEE '72 showcase: the theme is new industrial markets

Instruments and components have traditionally dominated the product exhibits at the IEEE International Convention and Exposition. They do it again this year—but with a difference. Visitors to the New York Coliseum, March 20-23, will find that many of these products—along with data processing, production and other equipment—are neatly tailored to demands of the industrial and commercial marketplace: they offer low price, adaptability to automatic production and testing, and reliability without gold-plating. Further, the visitor will notice that electronics industries are expanding their horizons to include applications in virtually every non-electronic segment of industry and commerce.

In the pages that follow are some of the more significant products that will be introduced at Intercon '72.

## Tantalum capacitors are packaged in plastic

Plastic transistors were a boon in commercial applications: with their inexpensive packaging and adaptability to automatic insertion, they not only lowered the cost of many electronic subassemblies, but broadened the transistor market as a whole.

Now the Sprague Electric Co., North Adams, Mass., has developed a similar packaging scheme for solid electrolyte tantalum capacitors that may offer many of the same advantages, especially in parts cost and manufacturing savings. The new series is the Econoline Tantalex type 198D, and just as plastic transistors are molded in a shape that assures location of base emitter and collector, the Sprague capacitors are molded with a flat side and a notch at the top. This makes polarity unambiguous and speeds visual quality-control inspection on the production line.

The case also has 0.02-inch standoffs on its underside to prevent moisture, dirt, or other foreign material from collecting during assembly; but most importantly, the

standoffs permit complete defluxing after assembly. Rosin flux especially collects moisture during assembly procedures, often causing almost untraceable short circuits in the equipment.

The new package shape is designed to do more than compete with the dual in-line packages now available.

Its very packaging material, a flame-retardant epoxy, is said to have no discernible temperature coefficient over a temperature range of  $-55^{\circ}$  to  $+85^{\circ}$ C. Spokesmen say, though Sprague doesn't advertise it, that the package could meet environmental requirements of military specifications.

And because both leads emerge from the same end, unlike simple axial capacitors, there is less self-inductance in tightly packed circuit-board installations—normally, axial capacitors are mounted perpendicular to the board with one lead bent and led  $180^{\circ}$  to a board contact point beside its brother, adding an often pesky inductive reactance to the desired capacitive reactance de-

signed into the device itself.

Two case sizes are available, one with straight leads 0.1 in. apart, the other with crimped leads spaced 0.2 or 0.25 in. apart. High-quality tantalum pellets and solid electrolyte are used to assemble capacitors with working voltages from 4 to 50 volts dc and capacitance ratings of 0.1

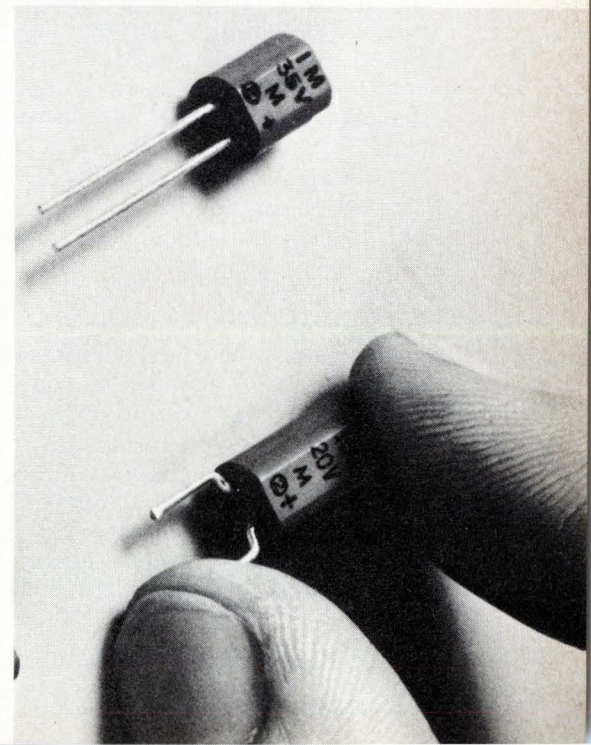

## New products

microfarad to 100 $\mu$ F; tolerances are  $\pm 10\%$  or 20%.

The type 198D capacitors are now

being delivered in sample quantities, and they soon will be available from stock. Price varies with

quantity ordered. IEEE booth 3500. The Sprague Electric Co., North Adams, Mass. 01247 [341]

## 200-MHz generator also shapes pulses

One trouble with high-speed logic circuits is that they're difficult to test. Hewlett-Packard's Model 8008A pulse generator should make that job a little easier since its repetition rate is variable all the way from 10 Hz to 200 MHz.

The pulser has two complementary outputs, each of which can supply up to 4 volts into 50 ohms. In its normal mode of operation, the pulser is triggered by its internal rate generator at any rate from 10 Hz to 200 MHz. Front-panel controls allow the operator to vary the delay between the trigger and the outputs from 25 nanoseconds to 0.5 millisecond. Similarly, the pulse width can be varied from 2.5 ns to 0.5 ms. The pulse's rise and fall times are fixed at less than 1 ns.

In addition to its normal mode, the instrument can operate from an external trigger, in a gated mode

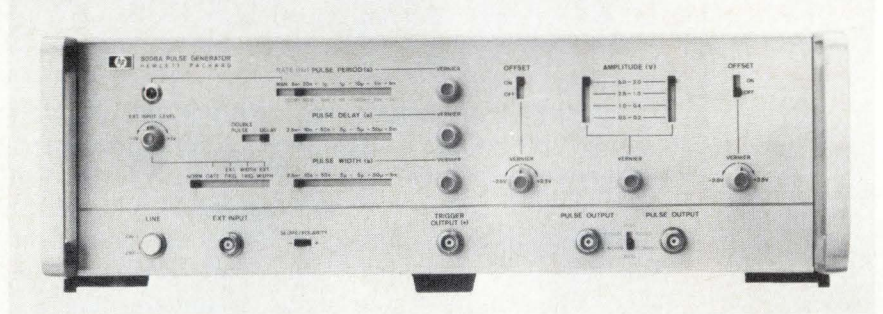

(produces pulses as long as an externally applied gate signal is present), and as a pulse shaper (where it controls the pulse output, polarity and transition time, but the external source controls the timing and the pulse width).

The generator also has a double-pulse mode in which each trigger signal generates two pulses; the interval between pulses is controlled by the instrument's delay control. In

this mode, the maximum triggering rate is 100 MHz.

Each output of the 8008A has its own amplitude and offset controls, with the offset of each output variable from -2.5 v to +2.5 v.

H-P will also introduce, at IEEE Island 2400, a digital gain-phase meter, an 18-GHZ automatic counter, and four new oscilloscopes.

Hewlett-Packard Co., 1601 California Ave., Palo Alto, Calif. 94304 [342]

## Gas-discharge display nears dollar-a-digit mark

A gas-discharge display for handheld calculators that offers large characters in a small, inexpensive package should give light-emitting-diode displays a run for their money. At least that's what Burroughs Corp. hopes to do with the latest addition to its Panaplex II line, an eight-digit model with each digit measuring 0.2 inch—twice the size of the most popular LED display, says Burroughs' Electronic Components division.

These latest models in the Panaplex II line, which includes panels with 0.25-, 0.4-, and 0.7-in. digits, comes close to the magic dollar-a-digit figure—Burroughs quotes a price of \$1.10 per digit in quantities of 50,000 eight-digit monolithic displays.

This eight-digit panel, furthermore, measures 2.65 in. long, 0.69

in. high, and is only 0.197 in. thick—not including the tubulation projecting from the rear, a relic of the process of evacuating the individual digit tubes and filling them with neon gas. Connectors for energizing the segments of each digit are along the bottom edge of the display.

The panel is also quite economical in its power dissipation. It requires only 0.35 to 3.0 milliwatts per

segment, depending on the brightness needed, and typically will use less than 1 mW per segment. This corresponds to a maximum of 7 mW per digit or 56 mW for the entire panel, when everything is lighted; but on the average, perhaps no more than five digits of five segments each are on, reducing the average dissipation to 5 mW per digit or 25 mW for the panel. At this rate,



four standard carbon-zinc batteries, AA size, would last about 200 hours.

In one test, Burroughs engineers purchased a small calculator and replaced its LED display with the new Panaplex unit. This reduced the calculator's total power requirements for display and computation from 800 mW to 350 mW.

In most hand-held calculators made with metal-oxide-semiconductor circuits, no interface drivers are necessary. Even though the Panaplex II panels are 170-volt gas-discharge devices, their anodes can be driven with voltage swings and current that conventional MOS cir-

cuits can provide—sometimes even through passive components instead of transistors.

Panaplex technology is basically the same as that of the old familiar Nixie cold-cathode tubes, differing primarily in their low-cost mode of construction. Their life is expected to be as good—some Nixie tubes are known to have operated continuously for over 120,000 hours, or 14 years. They contain no wire bonds—the interconnections that are most likely to fail first in some LED designs.

Like Nixies, the Panaplex panels emit an orange-red light, which is

spread over a relatively broad part of the visible spectrum and is centered near the middle of the perception range of the human eye. Therefore, the panels can be viewed continuously for long periods without discomfort, and are not difficult for color-blind persons to read, as are some bright-red LED displays, which cover a narrow spectral range.

Production quantities of the new 0.2-inch-digit panels will be available in June. IEEE booth 2711.

Burroughs Corp., Electronic Components Division, Mt. Bethel Road, Plainfield, N.J. 07061 [343]

## C/MOS cuts data system's size, power drain

As more industrial operations lend themselves to computer control, the so-called data-acquisition systems market is growing. The latest entry comes from Datel Systems Inc. Called the N-series of data-acquisition systems, it's aimed at applications where space, power requirements, and cost must be minimized.

While the N-series' small size is due in great part to careful packing of modular subassemblies on and between its two dual-sided printed circuit boards, credit also is due the use of complementary MOS and other integrated circuits. The C/MOS is said by Datel's Ronald P. Petrelli, an applications engineer, to be especially important in low-power applications, such as remote monitoring of operations like drilling or pipeline equipment. The C/MOS makes it possible to power the data-acquisition system with a dc-to-dc converter and a battery.

Datel spokesman says that the N-series systems are, among the smallest of their type. "Most of them are built for rack mounting, and thus generally are about 19 inches wide; the N-series is contained on only two glass epoxy printed circuit boards about 6 by 6 inches. The whole 28-cubic-in. assembly plugs directly into dual pc board edge connectors," says Petrelli.

Into that 28 cubic in., Datel has managed to cram an 8- or 16-channel multiplexer, sample-and-hold electronics, a 12-bit analog-to-digi-

tal converter, and—for control and interface logic—a system sequencer. Petrelli notes that most of these elements are in module form, so that they can be removed and replaced for on-site maintenance. He thus expects the N-series to move well in markets where low down-time is important.

The devices take inputs in any one of four voltage ranges; 0 to +5 volts, 0 to +10,  $\pm 5$ , and  $\pm 10$ . Output coding is either three-digit BCD, or 8-, 10-, or 12-bit binary words; throughput is a function of word length with the highest rate achievable with the shortest words—100 kilobits per second at 8 bits; a

16-bit module has a potential throughput of 50 kb/s.

Since the N-series is expected to find its way into some fairly primitive applications, the needed control signals may not be as sharply defined in rise time and amplitude as those a minicomputer would yield. Thus, Datel has designed a "front end" to regenerate control signals, even though they may come from a pushbutton, an approach that should simplify system interfacing.

Petrelli claims that here is no competitor to the N-series in size versus price. An eight-channel, 12-bit version is priced at \$595.

Other features of the N-series in-

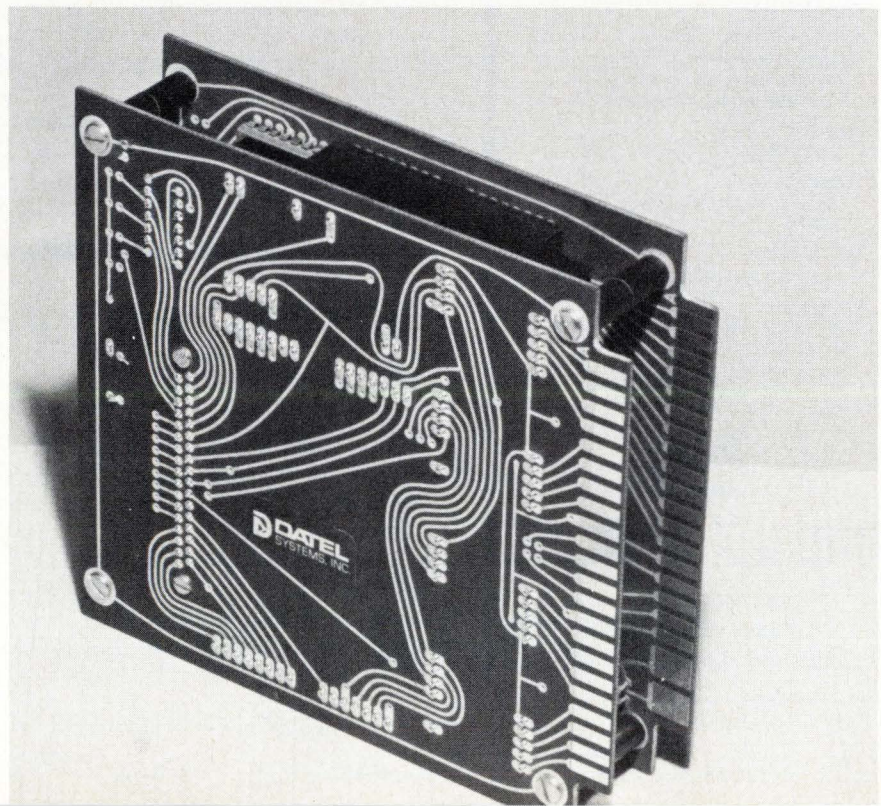

# Highest Speed A/D in Its Class!

(2  $\mu$ s for 12 bits)

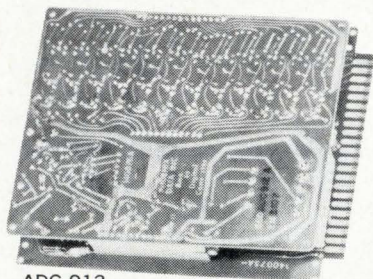

ADC 912

Designed to provide an exceptional speed/performance ratio, units in Phoenix Data's new ADC 900 Series offer fast, accurate, successive-approximation conversion with excellent repeatability, linearity, and monotonicity.

#### FEATURES:

##### High Speed Conversion

- 2 Microseconds for 12 Bits.
- 1 Microsecond for 10 Bits.
- 800 Nanoseconds for 8 Bits.

##### Accuracy

$\pm 0.025\%$  of Full Range — ADC912.

##### Versatility

Binary, pin-compatible with 700 and 70 series.

##### Self-Contained

Including precision reference voltage.

##### Repairable

No potted active circuitry.

Call or write today for the complete ADC 900 Series story.



## PHOENIX DATA, INC.

3384 West Osborn Road  
Phoenix, Arizona 85017

Ph. (602) 278-8528. TWX 910-951-1364

## New products

clude random or sequential access of channels by user command, an input impedance of 100 megohms, a  $\pm 30$  ppm/ $^{\circ}$ C temperature coefficient that is maintained over its operating

range of 0 to 70 $^{\circ}$ C, and TTL-compatible control inputs and outputs. IEEE booth 2108

Datel Systems, Inc., 1020 Turnpike St., Canton, Mass. 02021 [344]

## Ratiometer measures to 1 ppm

It is time-consuming to test a line of digital-to-analog converters by using a manual bridge, but there hasn't been an alternative because digital multimeters weren't accurate enough.

Now Julie Research Laboratories has developed a digital ratiometer, the DM-1000, with accuracy and linearity errors that are less than 0.0001% (1 ppm) of full scale. And it's a completely automatic (self-balancing) unit that requires only 1.5 seconds to make a measurement at its rated accuracy. The instrument's display consists of seven digits: six significant digits plus a seventh for 20% over-ranging.

The key to the instrument's long-term accuracy and stability is use of high-quality electromechanical switches and stable wire-wound resistors in its automated divider. A high-performance unbalance detector and the necessary logic control circuitry complete the ratiometer.

The price of the basic ratiometer is \$5,995. However, by itself it cannot measure voltage or resistance. Thus a reference voltage source is needed to convert the unit into a digital voltmeter and a resistance add-on is needed to convert it into an ohmmeter. A two-range (0 to 1.2 v and 0 to 12.0 v) voltmeter add-on

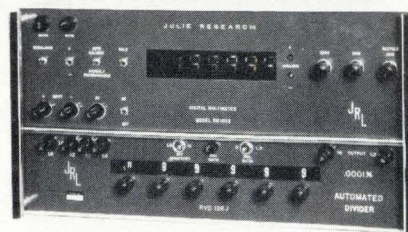

is available for \$490, and a combination of the voltmeter and a 1.0-milliohm to 1.2-megohm resistance-measuring add-on costs \$990. Current, of course, can be measured by measuring the voltage drop across a precision resistor. Thus, a complete digital multimeter costs about \$7,000.

A valuable feature of the DM-1000 is its ability to be self-calibrated without the need for expensive auxiliary equipment. A few simple checks are all that is needed to permit the user to calibrate the unit against NBS-certified standards.

The ratiometer is available in both bench and panel-mounting styles, and weighs 40 pounds. Its dimensions are approximately 19 by 10½ by 8¾ inches. Delivery time is 30 days.

Julie Research Laboratories, Inc., 211 West 61st St., New York, N. Y. 10023 [345]

## Analyzer is programable

A fully programable waveform analyzer developed by Automated Measurements Corp., a subsidiary of E-H Research Laboratories, is a high-speed, 1-gigahertz-bandwidth instrument capable of making digital time and amplitude measurements on pulse, rf, or complex waveforms. Designated the AMC system 1010, it is designed for appli-

cations in automatic test systems.

In time measurements, the 1010 is accurate to within 1% over full-scale ranges from 2 nanoseconds to 1 second. In voltage measurements, it is accurate to within 2% of full scale, with ranges from 20 millivolts to 2 volts.

System 1010 offers programing capability from a variety of data



**\$950.\***

You may already own the best VHF sweep on the market:  
**KAY 159D 1-300 MHz.**



**\$1195.\***

But have you seen the best **600 MHz** wide sweep: **KAY 160A?**



**\$1495.\***

Or have you heard about the best **1000 MHz** UHF sweep: **KAY 162A?**

- One continuous sweep!
- No band-switching!
- No add-ons!

See these and other exciting Kay instruments at  
**BOOTH 2310, IEEE Show**

**KAY** Elemetrics Corp

MAPLE AVE., PINE BROOK, N.J. 07058  
 (201) 227-2000

Circle 139 on reader service card

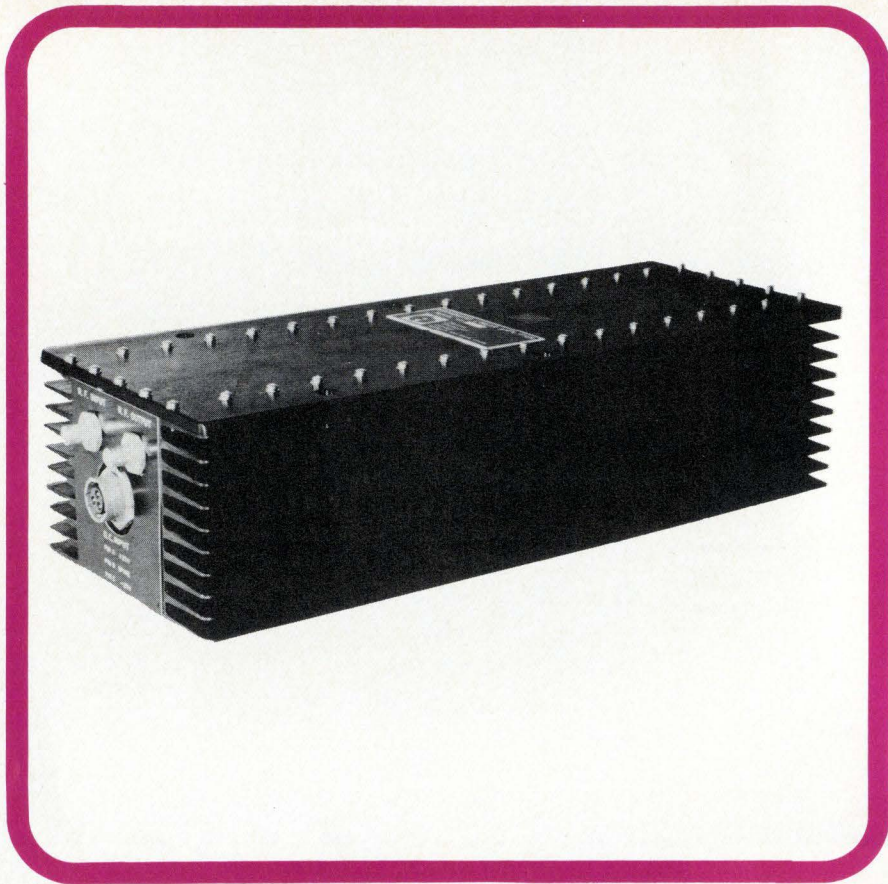

## KEEP PLUGGING

A highly reliable solid state high frequency transmitter — 'build it in the field'.

Hermes Electronics Limited manufacturers a 100W Broadband linear amplifier which replaces tubes in power output stages.

The 100W modules may be used singly or in groups to provide power output levels from 100 watts to many kilowatts. The amplifier has interface compatibility with the transmitter used in the majority of MANPACK systems, and with most mobile, airborne and fixed ground transmitter excitors.

It covers the frequency range 2MHz to 32 MHz and in combination can achieve power outputs to 5KW.

- ★ unique cooling system gives high reliability under adverse conditions
- ★ constructed for vehicular use
- ★ embodies overload protection

Hermes Electronics Limited can plug you into a wide range of HF equipment.

### ASK US

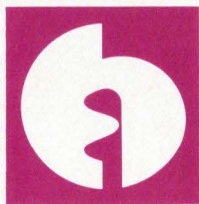

**Hermes Electronics Limited**  
 Suite 315  
 2020 F. St., N.W.  
 Washington, D.C. 20006  
 Telephone 202 296 2978  
 TWX 710 822 1106

## New products

sources, including keyboard, tape reader, and computer providing ASCII alphanumeric output.

Remote sampling units give the basic dual-channel capability, with

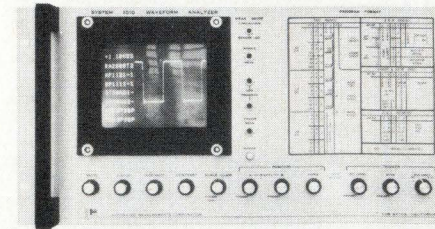

provisions for multiplexed probes to give 100-channel capability. IEEE booth 2732.

E-H Research Laboratories Inc., 163 Adeline St., Oakland, Calif. [346]

## 5-digit meter

**First in a new line** of digital multimeters from Lear Siegler's Cimron Instruments, the 5-digit DMM 50 uses a combination of analog-to-digital conversion techniques to provide sampling rates as high as 20 times per second, even in the presence of noise.

Successive approximation is used for the most significant decade (including overrange, 0 to 11), with dual-slope integration providing the other four digits. Charles N. Hasley, product manager, says this approach was taken to avoid heavy filtering or integration of all digits, with slower speeds resulting. Cimron's approach gives 60-dB common mode noise rejection at 20 readings per second.

Maximum dc voltage reading and input is 1199.9 v; on ac, the limit is 750 v. Maximum resistance is 1199.9 kilohms. Accuracy is to within 0.001% of full scale plus 0.005% of reading for 30 days minimum.

The instrument uses light-emitting diodes as annunciators to indicate function ranges, and Sperry gas-discharge readouts. Prices start at \$1,200. IEEE booth 2101

Lear Siegler Inc., Cimron Instruments, 714 Brookhurst St., Anaheim, Calif. 92803 [347]

# Near and far-sighted Spectrum Analyzer.

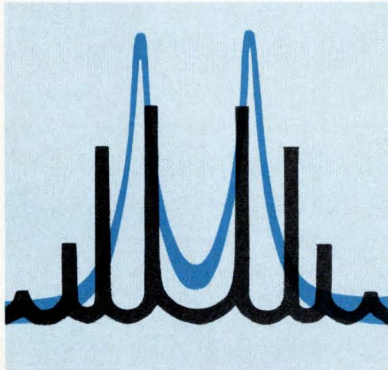

Whether you need a bay-window scan or a microscopic display of two very closely spaced signals, the SA-70 series provides near-perfect vision between 500 kHz and 1300 MHz. And it does it over a 141 dB range with signal

formance, ease of operation, and low cost:

- Phase lock for stable displays; indicator light for unambiguous amplitude measurement; 300 Hz resolution for close-in side-by-side signal analysis.
- Internal markers every 100 MHz for precise frequency determination.
- Additional plug-ins for frequency coverage over 20 Hz to 27.5 MHz range.
- Priced to make others seem expensive.

levels down to  $-121$  dBm!

This instrument offers a unique combination of per-

If you need variable persistence and display storage, ask for the SA-71A, otherwise, select the SA-70A. Both are described in our data bulletin. Send for one. It's the far-sighted thing to do.

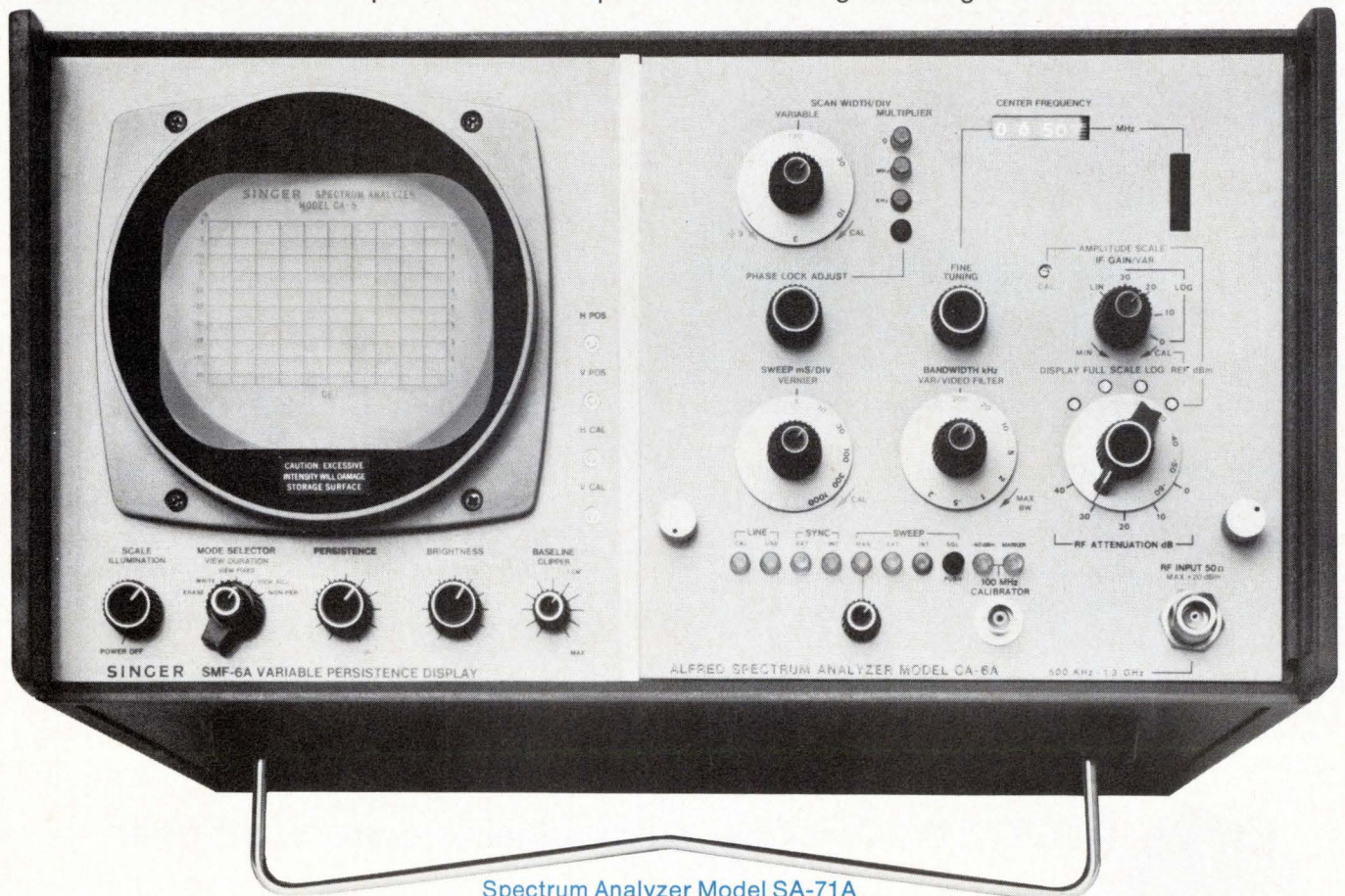

Spectrum Analyzer Model SA-71A

**SINGER**  
INSTRUMENTATION

The Singer Company, Palo Alto Operation • 3176 Porter Drive, Palo Alto, Calif. 94304 • Telephone (415) 493-3231

# Isolate It Optically

...solid-state lights on using the ideal switch - optoelectronic couplers

## Pulse Stretcher

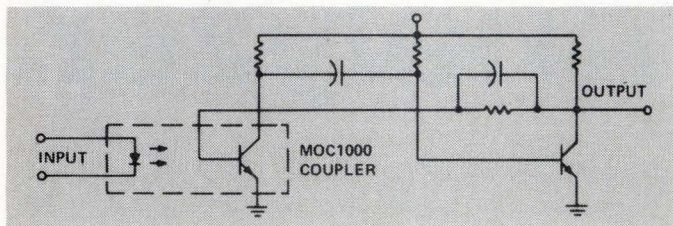

Very short input pulses can be adjusted to any desired pulse width in this circuit with the output completely independent of the input.

## Load-To-Logic Translation

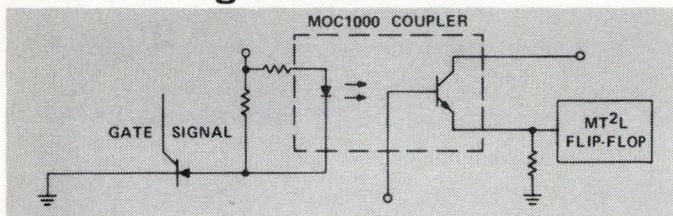

Monitoring an SCR-controlled load with an optical coupler provides a count of load operations each time the flip-flop is toggled through load activation.

## Computer/Peripheral Interconnect

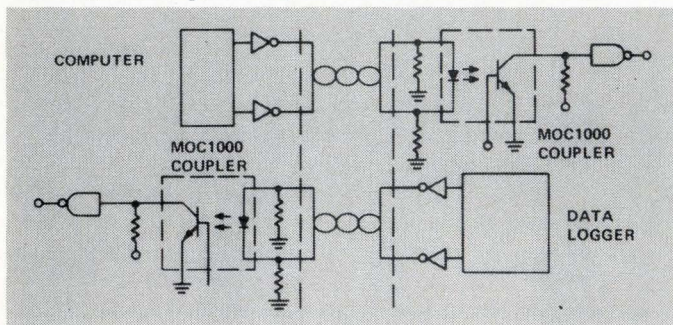

Couplers detect differential signals from twisted-pair lines and translate to single-ended output which provides complete ground-loop isolation.

## Power Amplifier

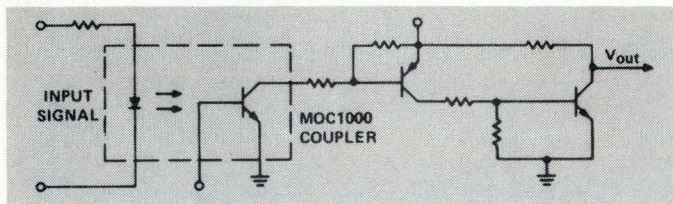

Couplers amplify low-level logic to drive large loads and accomplish interfacing between logic power supplies and load power supplies.

## Logic-To-Load Translation

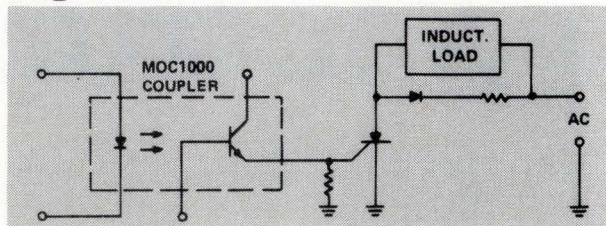

When the T<sup>L</sup> gate input goes high, the SCR is activated and logic-to-load translation is achieved through optical coupling.

## Logic-To-MOS Interfacing

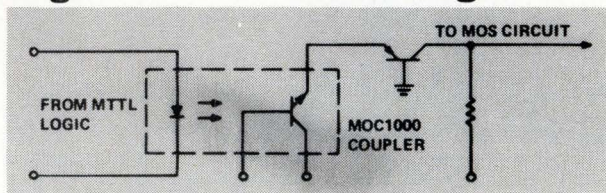

Easy interfacing between various logic forms (in this case T<sup>L</sup>-to-MOS circuitry) can be achieved through optical coupling without regard to differences in logic swings.

Lights on: switch on. Lights off: switch off. Quickly. Simply. Reliably.

Optoelectronic couplers give you nearly perfect input/output isolation . . . 100 billion ohms. They afford 1,500 V minimum dielectric isolation. They provide 300 kHz typical frequency response and 60% typical transfer ratios. They furnish complex signal transmission without RFI at micro-second speeds. They offer low coupling capacitance: 1.3 pF typical.

They don't wear out, they don't use much power and they're immune to bouncing, arcing, shock and vibration. They're light, compact and have closed construction. They're IC-compatible and cost as little as \$3.35, 100-999.

They're obvious replacements for mechanical relays. Use them in interface and coupling systems, phase and feedback controls, amplifiers and general purpose switching.

To find out how, there's a new data sheet waiting through Box 20912, Phoenix, AZ 85036. Complete specs and a lot of applications information.

See your Motorola distributor or factory representative for prototype or production needs.

Lightly switch on today.

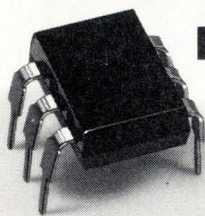

## MOC1000 - the optoelectronic coupler



**MOTOROLA OPTO**  
*Let There Be Light* ¶ ¶



Semiconductors

# 8-bit parallel processor offered on a single chip

by Stephen Wm. Fields, San Francisco bureau manager

P-channel silicon-gate CPU for intelligent terminals is designed around data bus and housed in 18-pin DIP

The concept of replacing many small-scale and medium-scale integration devices with one or two large-scale chips has been proven with the electronic calculator. Now, Intel Corp. is trying to prove it with the new 8008, a complete central processing unit for use in any arithmetic, control, or decision-making system, such as a smart terminal.

The p-channel silicon-gate metal-oxide semiconductor chip, which measures 125 by 170 mils and is mounted in an 18-pin dual in-line package, can be interfaced with up to 16,384 bits of semiconductor memory of any type or speed, including read-only memories, random-access memories, and shift registers. All inputs, including the clocks, are transistor-transistor-logic-compatible, and all outputs are low-power TTL-compatible.

Internally, the 8008 is organized around an 8-bit data bus. All communications within the CPU and with external components go through this bus in the form of 8-bit bytes of address, instruction, or data. The processor determines when the bus sends or receives data.

Hal Feeney, customer applications engineer and one of the designers of the 8008, says that a complete system employing the 8008 would contain the CPU, memory, and interface circuits to allow the CPU (which talks in 8 parallel bits) to communicate with the memory, which could be serial or parallel. A typical machine cycle consists of five states—two in which an address

is sent to memory, one for the instruction or data fetch, and two for execution of the instruction.

This CPU contains six 8-bit data registers, an 8-bit accumulator, two 8-bit temporary registers, four flag bits, and an 8-bit parallel binary arithmetic unit that implements addition, subtraction, and logical operations. A memory stack containing a 14-bit program counter and seven 14-bit words is used internally to store program and subroutine addresses. The 14-bit address permits the direct addressing of 16,384 words of memory.

Two separate dynamic memories are used—the pushdown address stack and the scratch pad. The address stack contains eight 14-bit registers providing storage for eight lower and six higher order address bits in each register. The scratch pad contains the accumulator and six additional 8-bit registers. All arithmetic operations use the accumulator as one of the operands. All registers are independent and may be used for temporary storage.

All arithmetic and logical operations are carried out in the 8-bit parallel arithmetic unit, which includes carry-look-ahead logic. Two

temporary registers are used to store the accumulator and operand for arithmetic-logic-unit operations. In addition, the registers are used for temporary address and data storage during intra-processor transfers. Four control bits are set as the result of each arithmetic and logical operation. These bits provide conditional branching capability through call, jump, or return on condition instructions. In addition, the carry bit provides capability to do multiple precision arithmetic.

The input-output buffer is the only link between the processor and the rest of the system. Each of the eight buffers is bidirectional and under control of the instruction register and state timing. Each of the buffers is low-power TTL-compatible on the output and TTL-compatible on the input.

To help systems designers work with the 8008, Intel has designed a prototyping board, the SIM801.

The 8008 is available now in sample quantities at \$200 each. Production quantities will be available in May. The SIM8-01 board will cost from \$750 to \$1,000.

Intel Corp., 3065 Bowers Ave., Santa Clara, Calif. 95051 [339]

**All together.** Central processing unit on a chip performs the functions that formerly required 300 devices. Addition of a memory and interface circuits completes a system.

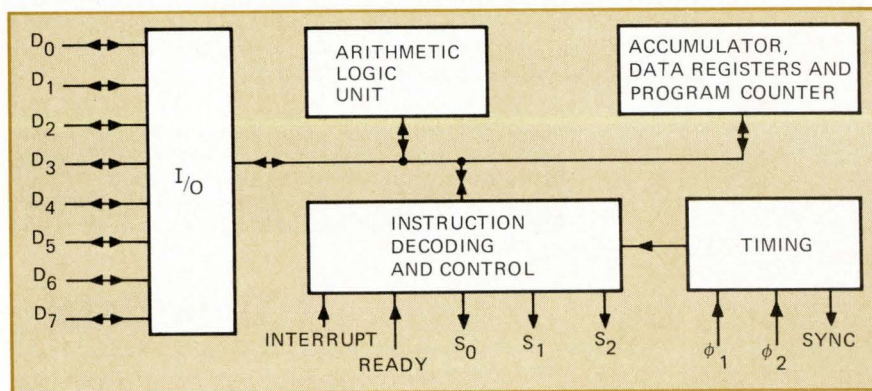

# Be in command of your time-series analyzer

Time/Data saves you valuable time with single, pre-programmed pushbuttons for all widely used functions. No program. No keyboard. No human error. Just a button.

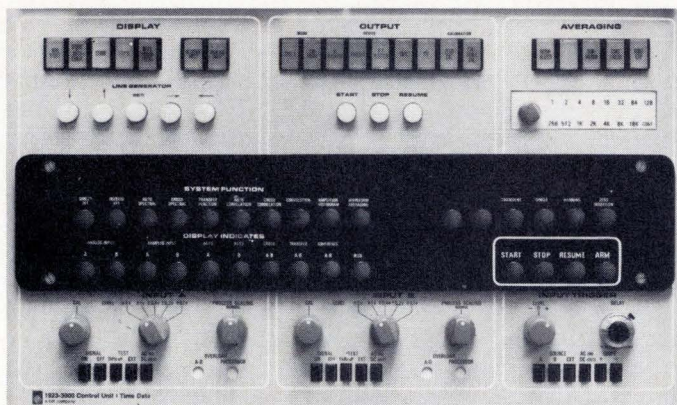

Single, pre-programmed pushbuttons for all these functions:

Direct Fourier Transform	Auto Spectral Cross Spectral	Waveform Averaging	Spectral Averaging
Inverse Fourier Transform	Transfer Function Coherence Function	Auto Correlation Cross Correlation	Linear Exponential Normalized

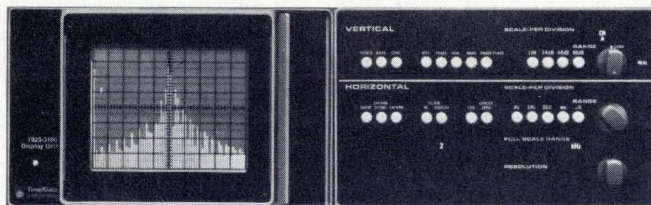

Full, calibrated 24, 48, or 96 dB display (pushbutton selectable)

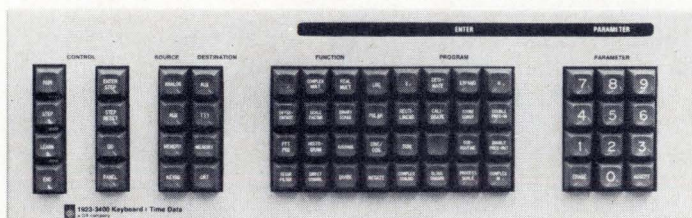

Of course, if you wish to construct additional functions or a program of your own, use our plug-in keyboard. It utilizes a high-level language for time-series functions, arithmetic functions, and digital processing. It can even call the pre-programmed control panel functions for added speed and simplicity.

There are still more convenience features in every TIME/DATA 1923 system. See them in action. Write or call your nearest General Radio sales engineer, or GR Concord, Mass. 01742, or Time/Data, 490 San Antonio Road, Palo Alto, Calif. 94306; Europe, write General Radio, Postfach CH 8034, Zurich, Switzerland.



**Time/Data**  
A GR COMPANY

490 SAN ANTONIO RD., PALO ALTO, CALIFORNIA 94306 • 415 327-8322  
BOSTON 617 646-0550 / CHICAGO 312 992-0800 / LOS ANGELES 714 540-9830  
NEW YORK (N.Y.) 212 964-2722 (N.J.) 201 791-8990 / WASHINGTON, D.C. 301 881-5333  
TORONTO 416 252-3395 / ZURICH (051) 47 70 20

### Instruments

# X-Y recorder uses laser pen

Unit has frequency response up to 250 MHz, can project data onto wall 15 feet away

It's not unusual when a company develops still another X-Y recorder that writes on paper. But when the same machine also uses a gas laser as a writing implement, has a frequency response that goes up to 250 hertz, and can project data onto a wall 15 feet away or onto a luminescent screen for direct see-through viewing like an oscilloscope—that's something else.

These unusual features are incorporated in a new X-Y recorder built by Siemens Corp., and designated Oscilloreg MO 2017. The

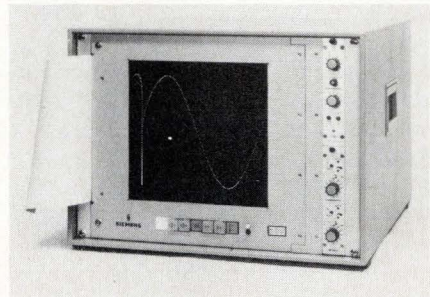

unit's fast response—X-Y recorders ordinarily are limited to only a few hertz—is possible because it writes with the laser's zero-mass light beam, instead of the conventional pen-and-ink stylus. And the laser beam's deflection system is inherently fast and sensitive. Writing speed is almost 2,400 inches per second over a 10-by-10-inch writing area. This compares with the tens of inches-per-second maximums of conventional recorders.

The new recorder doesn't replace or compete directly against any other single piece of equipment, says Lane Gorton, marketing manager of Siemens' Scientific Measuring division. Conventional X-Y recorders are much too slow, and light-beam galvanometers—oper-

ating upwards of 1 kilohertz—record in one dimension only.

"With the Oscilloreg, Siemens has combined the function of the usual X-Y recorder with features of a low-frequency oscilloscope and a moving-light-beam galvanometer," Gorton points out. The new machine opens the low-frequency dynamic measurement spectrum to real-time display. This area involves measuring, for example, dynamic mechanical phenomena, such as shock, vibration, resonance, and stress-strain relationships. One recorder has been sold, Gorton reports, to a German automobile manufacturer who is using it in testing the design of shock absorbers and leaf springs.

In addition, the recorder can be used in the research laboratory for such things as investigating and analyzing closed- and open-loop servo systems. For these applications, the recorder makes a hard copy of the input waveform on ultraviolet-light-sensitive paper.

Alternatively, the waveform can first be displayed for a "quick look" on the luminescent screen. When the waveform is in position, the paper can be substituted to produce a hard copy. The Oscilloreg also can be used like a movie projector, focusing the input waveform over a 6-foot-square area in technical presentations for customers and staff.

For writing, the low-power laser beam is deflected by a pair of galvanometer-driven mirrors. The X-axis deflection mirror is controlled either by the input, via an amplifier, or from a plug-in time-base generator. This adjustable generator moves the beam over the full recording area in sweeps of 5 milliseconds to 1 minute.

Price of the Oscilloreg 2017 X-Y recorder, which measures 20 by 14 inches by 23 inches deep, is \$6,600. The 78-pound unit can be supplied with either of two twin-channel amplifiers. A 1-millivolt full-scale unit is priced at \$800; a 100 mV unit is \$250. The 1-mV amplifier has an input impedance of 2 megohms and a measuring range of  $\pm 1$  mV to  $\pm 100$  V in 10 ranges. The 100-mV range has an input impedance of 100 kilohms. In addition, a time-base generator

plug-in costs \$750.

The Oscilloreg can be operated from 220 to 120 V on 60 Hz ac.

Siemens Corp., 186 Wood Avenue South, Iselin, New Jersey, [351]

### Voltmeter remembers peak value of transients

A four-channel transient voltage recorder has a response from dc to 50 nanoseconds on all channels. It is used in systems work for multiphase power line applications. The strip-

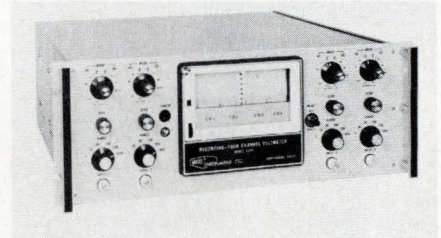
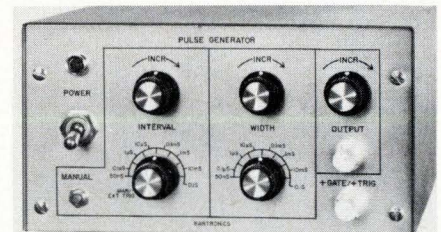

chart recorder circuitry permits detection of spikes and transients. Peak amplitudes of transients are held in the memory circuits, permitting the recorder to respond. They are then periodically cleared from the memory. Price of the model 5205 is \$3,900.

Micro Instrument Co., 12901 Crenshaw Blvd., Hawthorne, Calif. 90250[353]

### Generator's interval, width are independently controlled

A pulse generator with a range of 50 nanoseconds to 0.1 second provides independent control of both interval and width. The output is short-circuit protected, has an active pull-up



for driving capacitive loads, and is adjustable from 0 to +7 volts into 50 ohms (or +9 volts into an open circuit). A manual trigger provides a single-pulse capability. The instru-

# OPTOELECTRONICS

## Optoelectronics School and Conference presents the technology of light emitting materials and devices.

Not since the unparalleled growth of the silicon technology for semiconductors of the late 1950's has there been such an immediate and total commitment made to a technology requiring the development of new materials and processes.

The rapid and seemingly unlimited growth of optoelectronics now demands the dissemination of the voluminous material and process data acquired through intensive research.

Consequently, Materials Research Corporation has gathered the leading technologists to impart to you their knowledge of this important subject.

This concise, yet complete, presentation of the facts make this required education and exposure for those contemplating entry and those newly entered into the field of optoelectronics.

### Features of the Course

The 3-day program is (to the best of our knowledge) the most complete ever offered in this particular field. Its overall coverage is broad, but its treatment of each individual subject is detailed. All sides of the problem are presented from crystal growth and liquid phase epitaxial techniques to the future of optoelectronic devices. In short, the Course is designed to provide you with a working knowledge of optoelectronics.

We have gathered together a group of men who are experienced specialists in optoelectronics — and who have the unique ability to teach their specialties.

### Speakers Will Include:

Dr. R. Burmeister  
Hewlett-Packard Corp.  
Palo Alto, California

Mr. J. Wenckus  
Arthur D. Little, Inc.  
Cambridge, Mass.

Dr. Robert Haisty  
Texas Instruments, Inc.  
Dallas, Texas

Dr. S. Weinig  
Materials Research Corp.  
Orangeburg, N.Y.

Dr. L.A. Cambey  
Materials Research Corp.  
Orangeburg, New York

Dr. Malcom Russ  
Motorola, Inc.  
Phoenix, Arizona

Dr. J.J. Tietjen  
David Sarnoff  
Research Labs  
RCA Corp. Princeton, N.J.

And Others

### Conference Location

Del Monte Lodge is located on California's Monterey Peninsula. Its guest rooms look out across the famed 18th green at Pebble Beach, to Carmel Bay. It's just a few miles west of California's major North-South highway and is convenient to all West Coast cities. Both United and Pacific airlines service the Monterey Airport.

### Registration

The registration fee of \$325.00 per person for in-resident conferees includes all meals, refreshments, double occupancy accommodations, Conference and school transactions. Plan now to set aside May 14 through 16th 1972 so that you may attend this important and unusual school. Just call or write to reserve your place in the growing optoelectronic industry.



School and Conference • Materials Research Corp.  
Orangeburg, New York 10962 • 914 - 359-4200

## New products

ment is suitable for use in the laboratory. Price is \$150.

Bartronics, 10507 S.E. 30th St., Bellevue, Wash. 98004 [354]

Modulator provides pulses, square waves, and ramps

A modulator, called the model 1020, provides pulses, square waves, and ramp waveforms. It is intended as an accessory to the company's line of microwave signal generators in the range of 0.95 to 21 gigahertz.



Adjustable pulses, square wave, a-m, and sawtooth fm are provided from 10 to 10,000 hertz, and pulse widths range from 0.2 to 20 microseconds. Sync pulse delay is up to 2,000  $\mu$ s. Price is \$475. When ordered as an accessory to the microwave signal generator, the price is \$240.

Polarad Electronic Instruments Div., 5 Delaware Dr., Lake Success, N.Y. 11040 [355]

Sweep generator covers 220-to-1,000-MHz range

The model 2361 sweep generator, when used with the company's model MT9694 ultrahigh-frequency plug-in accessory, covers the range of 220 to 1,000 megahertz. Features of the complete sweeper system are high spectral purity and flatness of better than  $\pm 0.1$  decibel at 25



# New D/A converters from Burr-Brown

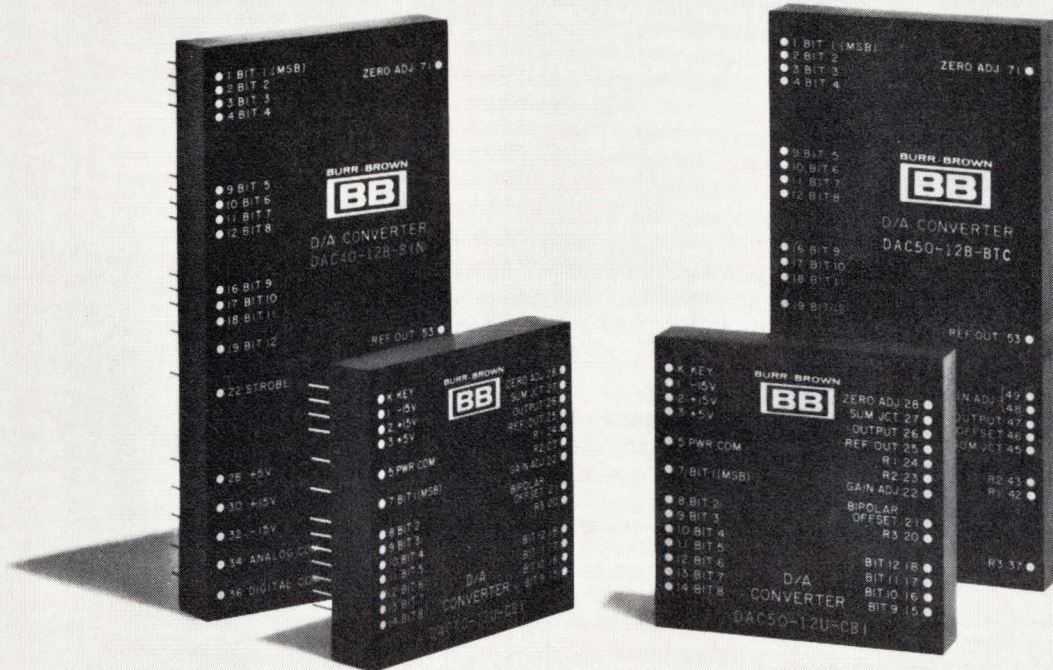

## just a little bit better!

Premium performance combined with Burr-Brown quality make the new DAC-40 and DAC-50 digital-to-analog converters just a bit better. The optimum performance comes from the use of Burr-Brown monolithic current switches designed for tight temperature tracking and Burr-Brown thin film resistor networks developed for tight ratio tracking.

Burr-Brown quality is evident in the comprehensive specifications which include test details. All critical specs are fully-tested over the standard 0 to +70°C specification temperature range — including gain, offset, and linearity.

A variety of optional features are available in these competitively priced series; Binary or BCD codes, optional input buffer register, +5V, +10V,  $\pm 2.5V$ ,  $\pm 5V$  and  $\pm 10V$  output voltage ranges and current output options. The DAC-40 series offers 8-, 10-, and 12-bit resolutions and accuracies. The DAC-50 is available in 10- and 12-bit models.

**NEW BURR-BROWN BOOK** "Operational Amplifiers — Design and Applications", over 470 pages, 300 illustrations. Written by Burr-Brown application-engineering staff, published by McGraw-Hill. U.S. price, 15.00 dollars. Order from Burr-Brown.



### GUARANTEED MAXIMUM SPECIFICATIONS

	DAC-40 Series	DAC-50 Series
Low Temperature Coefficient	$\pm 3$ ppm/°C	$\pm 5$ ppm/°C
Linearity (8-, 10-bit)	$\pm 5$ ppm/°C	$\pm 10$ ppm/°C
Gain 12-bit	$\pm 7$ ppm/°C	$\pm 12$ ppm/°C
Gain 8-, 10-bit		
Linearity (over 0-70°C range; 12-bit)	$\pm \frac{1}{2}$ LSB	$\pm 1$ LSB
Conversion speed	5 $\mu$ sec to .01%	5 $\mu$ sec to .01%
Power Supply Rejection	0.002%/V <sub>S</sub>	0.002%/V <sub>S</sub>
Resolution	8-10 or 12 bits	10 or 12 bits

Models available with Input Buffer Register.

For complete information on the DAC-40 and DAC-50 series digital-to-analog converters, use this publication's reader service card or contact your Burr-Brown Representative.

**BURR-BROWN**  
RESEARCH CORPORATION  
International Airport Industrial Park • Tucson, Arizona 85706  
TEL: 602-294-1431 • TWX: 910-952-1111 • CABLE: BBRCORP



**No if's, and's,  
or butts!**

It's good business to do business with Permag. In stock and in service, Permag can solve your magnetic materials problems quickly, completely and economically. Look to Permag for all types of permanent magnets, assemblies, electrical alloys, flexible magnets, soft magnetic materials, ferrites and new, high-energy rare earth magnets. Also, special precision grinding and cutting. And full magnetizing and engineering facilities.

YOUR NO. 1 SOURCE  
FOR ALL MAGNETIC MATERIALS

**PERMAG**

ALL ACROSS THE COUNTRY

**SAN FRANCISCO • LOS ANGELES  
• DALLAS • CHICAGO • TOLEDO •  
BOSTON • NEW YORK**

*Consult your Yellow Pages for  
address and telephone number of  
Permag near you.*

Circle 148 on reader service card

# Minnesota

**"The forests abound with fish and game and silence." \***

A man can re-create on weekends. He comes back a more productive man. He likes living in Minnesota, and it shows in his work.

*\*Quoted from an article in "Western's World"*

## FACTS IN 48 HOURS

STATE OF MINNESOTA Dept. of Economic Development  
Industrial Development Division, Suite 212  
51 E. 8th Street, St. Paul, Minn. 55101

I'm interested in Minnesota. Send me facts.

NAME \_\_\_\_\_ TITLE \_\_\_\_\_

FIRM \_\_\_\_\_

ADDRESS \_\_\_\_\_

CITY \_\_\_\_\_ STATE \_\_\_\_\_ ZIP \_\_\_\_\_

All inquiries held in strict confidence.

**It's good to be in Minnesota**

148 Circle 200 on reader service card

## New products

kilohertz to  $\pm 0.25$  dB at 1,000 MHz, which with the differential facility enables measurements to be made to within 0.01 dB.

Marconi Instruments, Englewood, N.J. 07631 [356]

## Modular pulse generator is priced at \$55

A pulse generator, designated the model PG1, provides a pulse rate of 1 pulse per second to 400 kilopulses per second, adjustable by decade and vernier. The main output has adjustable amplitude, optional inversion, and either zero-volt or -6-volt baseline. Outputs are DTL-TTL-compatible. The PG1 can also be expanded to produce pulse trains of any required complexity. Price is \$55. Delivery is from stock.

Scientific Instruments Inc., 2945 Central, Wilmette, Ill. 60091 [357]

## Active filter's cutoff tunable over wide range

A digitally tuned, variable active filter designated the series AF-400 features a cutoff frequency from 0.001 hertz to 99.9 kilohertz, with an accuracy to within  $\pm 2\%$  on all ranges. Other specifications are high-pass, low-pass, bandpass, band-reject, and bypass functions, and hum and

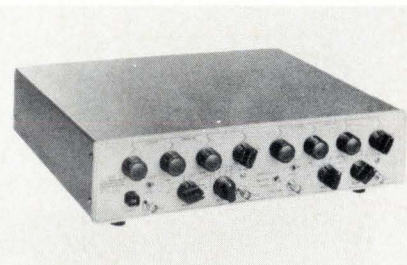

noise below 100 microvolts rms maximum. The unit also has close phase tracking between independent channels and input impedance of 100 megohms. Output impedance is 50 ohms, and attenuation is 80 decibels minimum to 1 megahertz.

Multimetrics Industries, 120-30 Jamaica Ave., Richmond Hill, New York 11418 [358]

# Teradyne's L100 Automatic Circuit Board Test System speaks for itself.

<pre> PASSED  GOOD: 43 BAD:  8         </pre>	<pre> FAILED FAILURE COUNTERS (BAD/TOTAL): FTEST  0/36 MTEST  5/83 BTEST  0/1 TTEST  0/2         </pre>
<pre> MT44 D8 THIS TEST PASSED  MTEST ON PINS: M  LIMIT :+ 500. MV ACTUAL:+ 248. MV         </pre>	<pre> TT39 THIS TEST FAILED  TIME FROM PIN 18 TO 21 ACTUAL:      00.195 US TMIN:        00.050 US TMAX:        00.190 US         </pre>
<pre> FT35 THIS TEST FAILED &lt;ALARMS&gt;S1 FAILING PINS: 20 Z K         </pre>	<pre> FT15 THIS TEST FAILED  FAILING PINS: S R P N M L J         </pre>

If you test circuit boards, you get the message. The L100 doesn't just tell you a bad board is bad. It helps you find out why. And in a fraction of the time you'd usually spend troubleshooting. We'd like to send you a brochureful of reasons why the L100 is the most money-saving system you can buy.

Write: Teradyne  
183 Essex Street  
Boston, Mass. 02111

**TERADYNE**

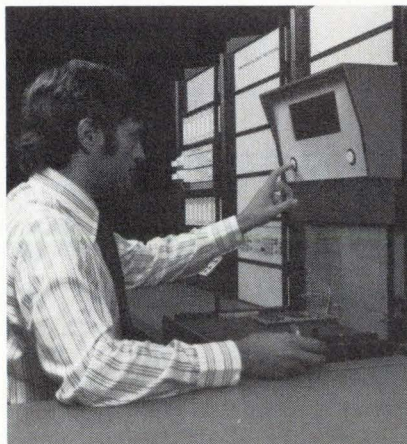

See the L100 at the IEEE Convention, New York Coliseum, Booth 2332, March 20-23.

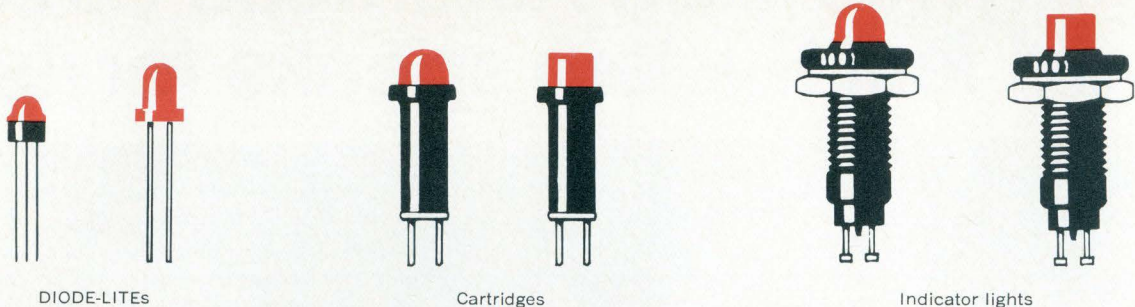

DIODE-LITEs

Cartridges

Indicator lights

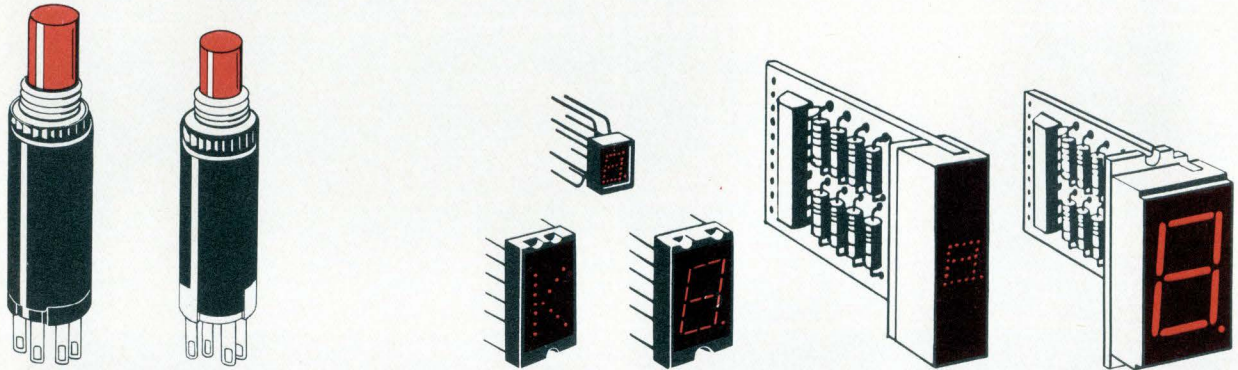

Lighted push button switches

Readout modules and packages

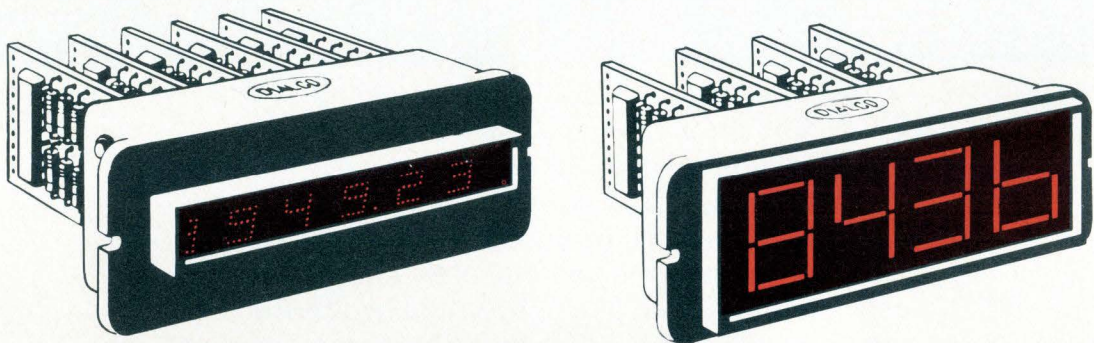

Readout assemblies

## LED displays? Talk to the specialists at Dialight first. You won't have to talk to anyone else.

Whether you're looking for LEDs as light sources for build-your-own displays or for a variety of products that utilize LEDs, bring your requirements to us. Dialight is a major supplier of both LEDs (we call ours DIODE-LITE™) and of indicator lights, readouts and lighted push button switches that incorporate

DIODE-LITEs. We can even give you a contactless solid state switch that uses a DIODE-LITE in the circuit to provide cleaner, faster switching than any mechanical switch. Dialight can help you do more with LEDs than anyone else because we've done more with them. Write for LED Data File.

**DIALIGHT** DIALCO

DIALIGHT CORPORATION, A NORTH AMERICAN PHILIPS COMPANY • 60 STEWART AVENUE, BROOKLYN, N.Y. 11237 • (212) 497-7600

150 Circle 150 on reader service card

Electronics/March 13, 1972



### Data handling

## Modem packed into pc board

Three Bell-201 types aimed at OEM market; error rate is less than one bit in  $10^6$

The market for independent modem makers has been growing rapidly since the Caterfone decision in 1967 opened public telephone networks to private suppliers. Independent manufacturers cornered an esti-

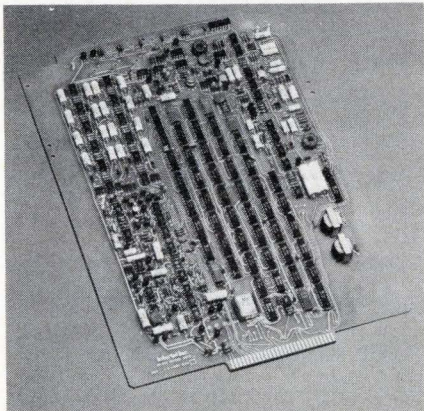

mated 25-35% of the \$100 million modem market in 1971, and Intertel Inc. hopes to capture 10-12% of the independent market this year with its three series IN201 modems.

The model 2010, designed principally for unconditioned private lines, transmits at 2,400 bits per second, and is fully compatible with Bell's 201B. The other two modems are for switched network use; the 2011 can transmit at 2,000 b/s and is compatible with Bell's 201A. The 2012 is the same as the 2011, but can perform at 2,400 bps.

Alvin L. Polinsky, marketing support manager, claims that the IN201 is the only Bell 201 type available on a printed-circuit board; other makers design them in a box. The modems are also available in single rack-powered enclosures with either single or multiple modems.

Polinsky says the units can transmit or receive data from any other 201-type modem. "We transmit the

total signal exactly as Bell transmits it," he claims, "So we are compatible with all 4-phase differential phase-shift-keyed type modems."

The company claims its error rate—less than one bit in  $10^6$  at a signal-to-noise ratio of dB over an unconditioned line with 20° peak-to-peak phase jitter at a rate from 0 to 180 hertz—is superior to that of any other 2,400-b/s modem available. Intertel says this accuracy is attained by what it calls data-derived timing. Other modems carry timing information on the sidebands, where noise, delay distortion, and phase jitter are at a maximum. Intertel reads both timing information and data from the central bandwidth, although timing information is also transmitted on the sidebands to insure compatibility.

The received sidebands are removed by what Polinsky claims are "the narrowest and sharpest narrow-band filters being used for this purpose," restricting the incoming signal to between 1,200 and 2,400 Hz. Active filters are used throughout.

To lessen error further, Intertel uses coherent demodulation, which compares incoming signals with a stable reference carrier. However, Intertel uses a Cartesian-coordinate approach that it says is simpler and less expensive to implement than existing methods. Fixed statistical equalization is employed to allow maximum versatility in the types of transmission lines used. The IN201 series also has an optional 150 reverse channel.

The 2010 is \$1,050 in small quantities, and models 2011 and 2012 are \$1,125. Powered enclosure for a single modem is \$200 extra.

Intertel Inc. 6 Vine Brook Park, Burlington, Mass. 01803 [361]

### Cassette recorder aimed at remote-terminal jobs

Tackling the data acquisition terminal market on a new front, Memodyne Corp. has beefed up its model 101 cassette recorder with a version that has higher capacity, packing

density, and price tag. The 101E sells for \$389.

Battery-powered, it uses 2 microamperes at 12 volts on standby and 52 mA when recording, compared to the earlier model's 1 A at 5 V or 0.5 A at 12 V [*Electronics*, July 5, 1971, p. 87]. Packing density is 615 bits per inch, versus 120 b/in. for the 101, and capacity is 4 million bits instead of 432,000. Because of its low power requirement, the 101E's top speed is 200 bits/second compared to 300 b/s for the 101.

The new unit is specifically designed for off-line data logging and storage for environmental and industrial systems, and it is compatible with analog instrumentation.

The 101E's electronics, consisting of C/MOS logic, is packaged in a flat module on a pc board attached to the rear of the tape transport.

By slowing clock rate and running two bits per step, the recorder's density can be doubled to 1,230 b/in. and the capacity to 8 million bits. Memodyne recommends, however, a speed of 200 b/s. Error rate is one bit in  $10^7$ .

Memodyne Corp., 369 Elliot St., Newton Upper Falls, Mass. [362]

### Direct-access disk file reads, writes interchangeably

A direct-access disk file, called the model 650, is designed for digital applications, and can read and write disks interchangeably from unit to unit at a transfer rate of 200 kilobits per second. In the file is incorporated a cartridge that is composed of 7½-in. Mylar coated with magnetic oxide and encased in a flexible plastic envelope. Primary use is the distribution and loading of microcode or diagnostic programs. Others in-

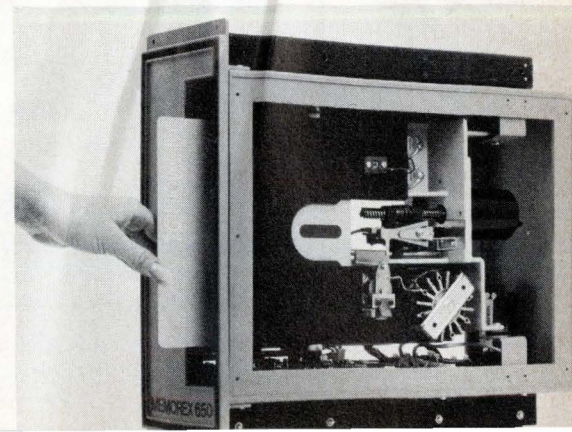

# Now get a firm grip on your lead-mounted semi's and heat problems, too

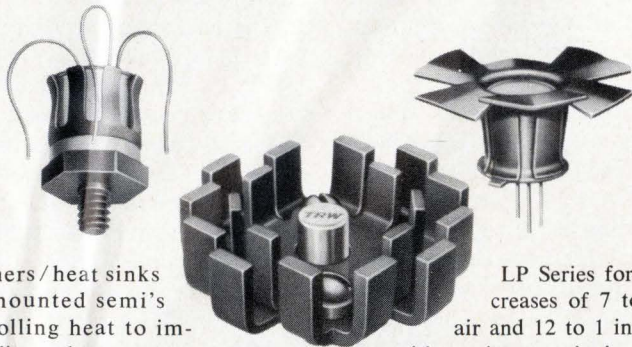

IERC retainers/heat sinks hold lead-mounted semi's while controlling heat to improve reliability or let you operate at higher power levels. Our TXB's for Mil-spec environments are excellent retainers on p-c boards or serve as efficient thermal links between case and heat sink. BeO washers are available for electrically-hot-case applications. Use our staggered-finger

LP Series for power increases of 7 to 1 in still air and 12 to 1 in forced air with no increase in junction temperature. And, if your semi's are already mounted, slip on a Fan Top and get higher wattages for just pennies. Send for catalog. IERC, 135 W. Magnolia Blvd., Burbank, Calif. 91502, a Corporate Division of Dynamics Corporation of America.

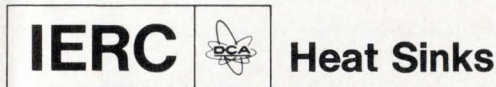

Circle 152 on reader service card

## WE WROTE THE BOOK ON MINICOMPUTERS.

We think we're pretty well qualified to write the book. We're the No. 2 company in the business, and we've installed over 2,000 minicomputer systems.

Section I of our book has questions and answers you should think about before buying anybody's minicomputer.

Section II stacks our products against the questions raised in Section I.

After you've read the whole book, we think you'll be more likely to buy something from us. That's how we plan to become No. 1.

Send me your free book, "How to Buy a Minicomputer."

**FREE.**

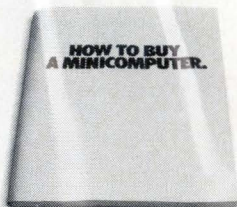

Name \_\_\_\_\_

Company \_\_\_\_\_

Address \_\_\_\_\_

City \_\_\_\_\_

State \_\_\_\_\_ Zip \_\_\_\_\_

**DATA GENERAL**

Southboro, Massachusetts 01772  
Tel. (617) 485-9100

### New products

clude remote terminal data acquisition, data logging, and key-entry recording.

Memorex Corp., San Tomas at Central Expressway, Santa Clara, Calif. 95052 [363]

### Punched-tape reader-spooler has self-cleaning read head

The model TRS9300BB punched-tape reader-spooler incorporates a proportional servo, stepping motor, phototransistor sensing and a self-cleaning read head. Search and rewind speed is 700 characters per second, and stop-on-character reading is at 300 characters per second. The 5½-in.-diameter reel accommodates up to 150 feet of tape of any standard 5-, 6-, 7-, or 8-level type with as low as 40% opacity. The unit is DDT, RTL, and TTL compatible.

Electronic Engineering Co. of Calif., Electronics Products Div., 1441 E. Chestnut Ave., Santa Ana, Calif. 92701 [364]

### Speech/filter unit permits voice, data on same line

A new speech-plus-filter assembly permits transmission and reception of voice and data on the same tele-

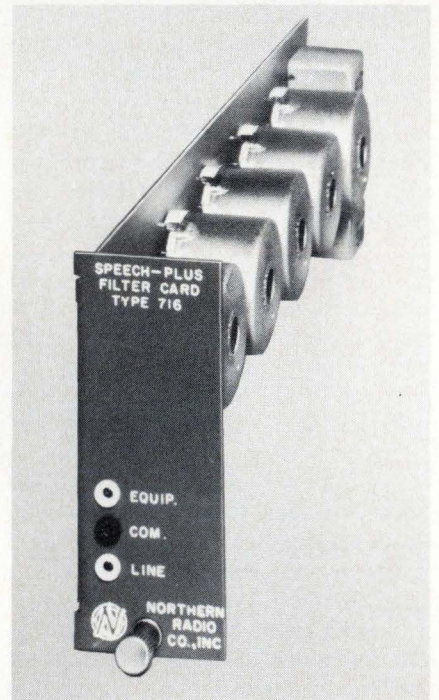

NEW INTRODUCING  
**NICOLET 1090**

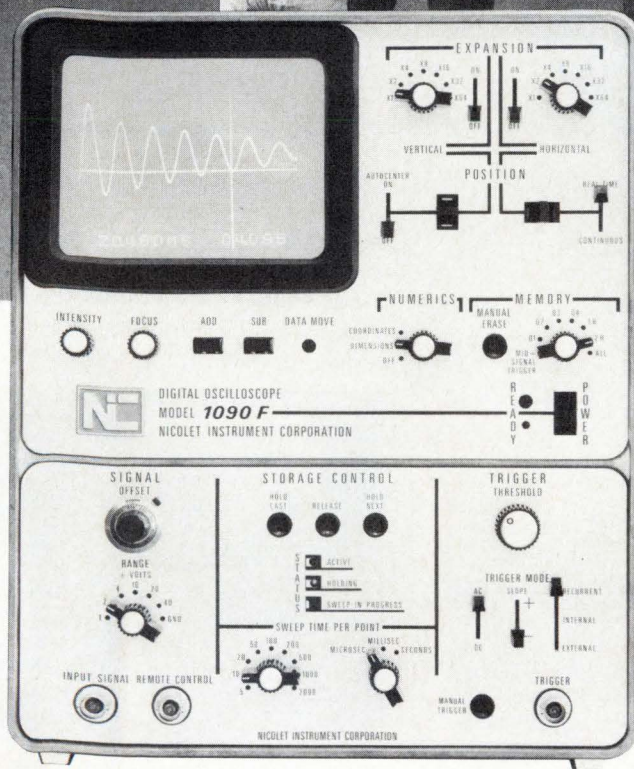
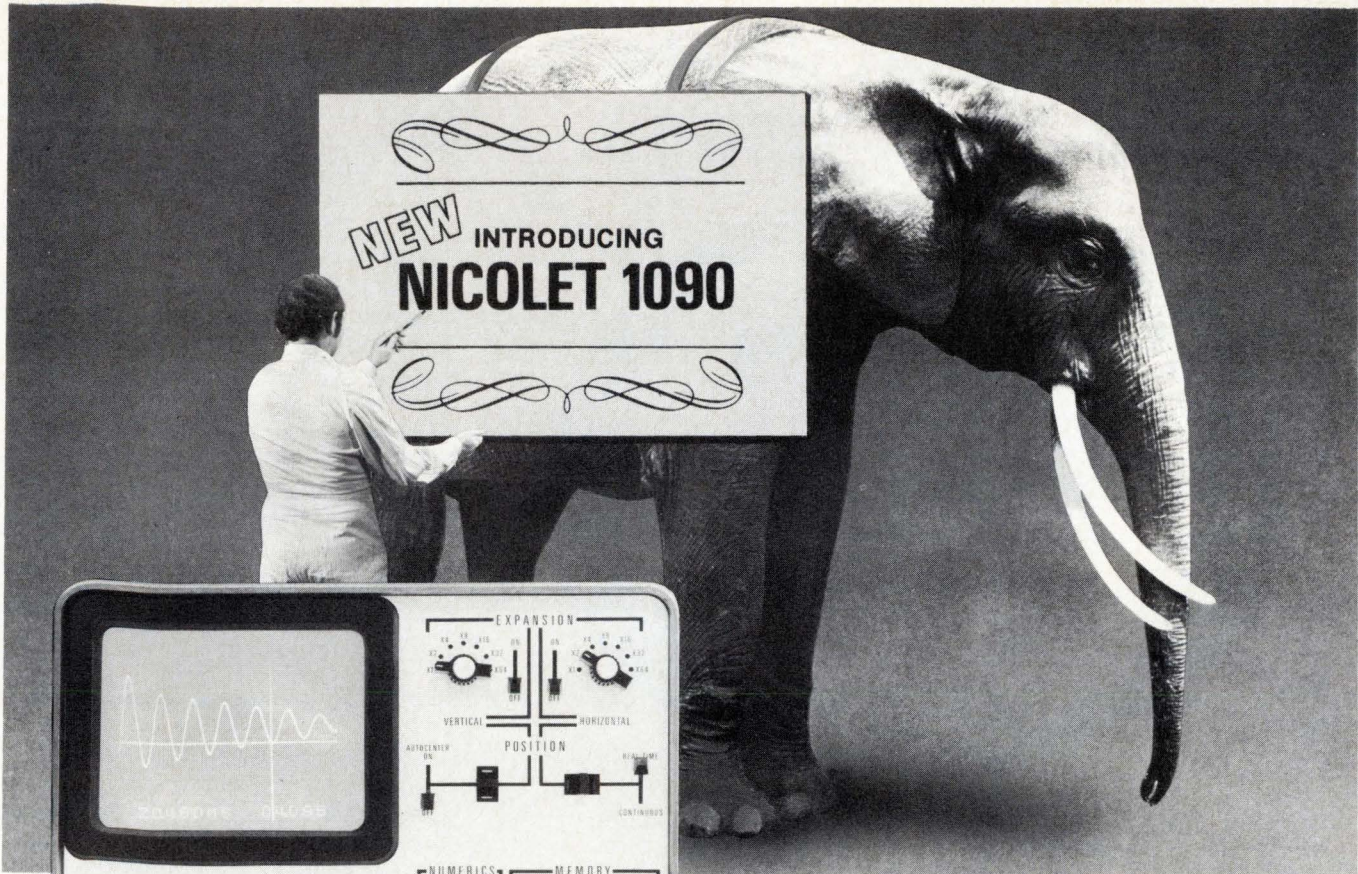

- VOLTAGE ACCURACY 0.05%
- TIMING ACCURACY 0.01%
- DIGITAL STORAGE RESOLUTION 4096 x 4096
- NON-VOLATILE STORAGE
- TIME AND VOLTAGE VALUES DISPLAYED
- EASY OPERATION

## World's Highest Precision Oscilloscope

This is the first digital instrument specifically designed as an oscilloscope. More than a digital recorder, it is a direct replacement for low-frequency, general-purpose oscilloscopes and storage oscilloscopes. It is much easier to use, has almost two orders of magnitude greater accuracy in both time and voltage, and is far more versatile.

Comprised of a main frame and plug-in unit, it has a 100 kHz real-time bandwidth with 12-bit precision, with sweep times that range to as long as several days per sweep.

The 4096 x 4096 storage resolution makes it possible to record as much information about a single waveform as 160 storage oscilloscope screens, with higher equivalent real-time writing speeds, without loss of information with time, without need for an erase operation, and without enhancement adjustments. A touch of a button allows the present, preceding, or following signal to be held (whichever is desired) and another touch returns the operation to real time. Several waveforms may be stored and superimposed, with digital scale magnifications up to 64 times in both dimensions. Stored waveforms may be adjusted vertically for more accurate comparisons.

The numerical readout shows both time and voltage values for any selected point, normalized for sensitivity and sweep speed settings.

But this is only part of the story. Write for complete information about this revolutionary oscilloscope.

**NICOLET INSTRUMENT CORPORATION**

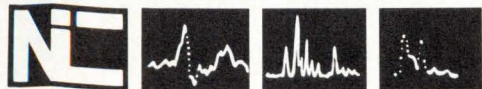

5225 Verona Road, Madison Wisconsin 53711  
 Phone 608/271-3333 TWX: 910-286-2713  
 (formerly Fabri-Tek Instruments, Inc.)

See the 1090 at Booth 2643 at the IEEE Conference in New York City starting March 20, 1972.

# Design tomorrow's circuits...today...

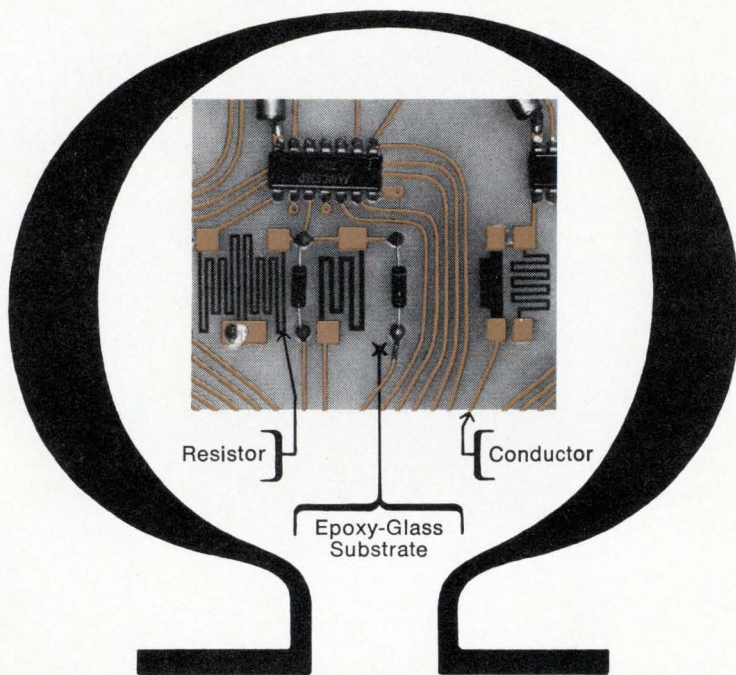

## with Micaply Ohmega— A new resistive-conductive circuit board laminate that extends PC technology to thick and thin film applications

After years of developmental effort, Micaply Ohmega affords circuit designers and fabricators exciting **new dimensions** in combining conductors and resistors in the same circuit. And it's available now in 8" x 12" min. sheets. This unique new material is an epoxy-glass substrate completely covered on one or both sides with a bi-layer cladding. The layer against the substrate is resistive, the top layer is conductive. Using conventional printed circuit production techniques, patterns of conductors and re-

sistors can be etched to produce circuits complete with integral resistors. The entire process is subtractive — no screening, firing, or vacuum equipment is required!

For many printed circuit board applications it means the cost of discrete resistors can be eliminated. For many thick and thin film circuits it eliminates the cost of expensive substrates and deposition techniques, and enables the use of economical step-and-repeat methods on large sheets of Micaply Ohmega.

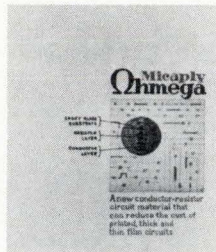

### Micaply Ohmega™

The Mica Corporation / 4031 Elenda St., Culver City, Ca. 90230 / (213) 870-6861  
TWX: 910-340-6365, Cable: Micaply  
Micaply International / Silloth, Cumberland, England / Silloth 571  
Telex: 85164120 / Cable: Micaply Silloth

\* Trademark for polyfunctional laminates made by The Mica Corporation.

## New products

phone line. The unit is designed for use with the company's series 700 frequency division multiplex equipment, and for equipment utilizing a type 3002 dedicated line and applications involving switching. Two models offer different bandpasses. The model 1 has a speech band from 300 hertz to 2,200 Hz  $\pm 3$  decibels and a data band from 2,325 hertz to 3,000 Hz. Model 2 has a speech band from 300 Hz to 2,700 Hz  $\pm 3$  dB and a data band of 2,825 Hz to 3,000 Hz. Price is \$150. Delivery of the assembly is from stock.

Northern Radio Co., Melbourne, Fla. 32901 [365]

## CRT computer terminal has on-site editing capability

A message-oriented CRT computer terminal is compatible with teletypewriters and has on-site editing capability. Features include stand-alone operation, a full alphanu-



meric keyboard, numeric key pad, a 40- or 80-character-per-line display, switch-selectable transmission control, and a multiple interface capability. The model 4390 can also be used for on-line data entry and retrieval systems, regardless of size or complexity.

Bendix Corp., Bendix Center, Southfield, Mich. 48060 [366]

## Cassette tape transport has only two moving parts

A bidirectional, reel-to-reel-drive cassette tape transport has two moving parts, dc motor-tachs. The de-

## A CAMBION® Double "QQ" Product Line

Coils with high "Q" values have always been available from CAMBION. You've probably come to expect them as a matter of course.

What you may not have known, is that they are available, off-the-shelf, in substantial quantities, with identical performance characteristics to the prototype units you may have purchased for design development. Making quality coils available in quantity is the CAMBION Double "Q" approach.

You can be choosy, too. Large families with overlapping inductance ranges or EIA nominal values can satisfy your individual circuit needs. Shielded or unshielded units for chassis or printed circuit mounting. Variable inductances,

fixed chokes, L-C filters, balun transformers, toroids, micro-miniature types as small as .075" x .170" (1/10th the size of a TO-5 transistor). All come with fully guaranteed ratings.

We've got a catalog full of 'em. It's yours for the asking. And if, by chance, you can't find just the right one, we'll custom design one for you and guarantee to deliver additional identical units **in quantity**. That's just one more way CAMBION shows that the quality stands up as the quantity goes on. Cambridge Thermionic Corporation, 445 Concord Avenue, Cambridge, Massachusetts 02138. Phone: 617-491-5400. In Los Angeles: 8703 La Tijera Boulevard. Phone: 213-776-0472.

# At Cambion, coils have a Double "QQ"





## Sapphire substrates. More for less.

Polished, single crystal sapphire substrates cut from sapphire ribbon stock. Standard lengths from 1/4 to 4 inches. Standard widths in 1/4, 1/2, 3/4 and 1 inch sizes. For thin film and epitaxial requirements. Available with 1102 orientation for SOS work. Free of microvoids. Low in cost. Check 'em out. Call Frank Reed, Marketing Manager, for price and delivery.

**LYCO saphikon division** 16 Hickory Drive • Waltham, Mass. 02154 • (617) 890-2400  
Circle 156 on reader service card

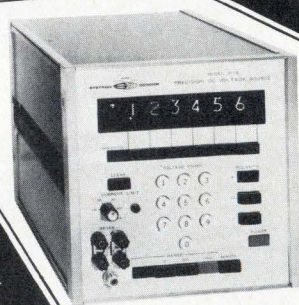

# Unique precision voltage source

- 6-digit resolution and readout—0-1,000 VDC in four ranges with 0.003% accuracy, 0.001% stability, 0.0002% regulation.
- You control all functions by pushbutton or program them with DTL/TTL input. BCD output available.
- Unique circuit\* limits signal flow to analog section—output voltage is independent of switch characteristics or quality.
- You can change any decade of a selected voltage individually.
- 100 millisecond programming speed in either polarity.
- Output current 50 ma from 0-100 volts, 5 ma from 100 to 1K volts.

The Alpha M106 Precision Digital Voltage Source has no equal for automatic test and process control systems. Its low cost, dependability and ease-of-use make it the best instrument for all calibration applications.

For full information, contact your nearest Scientific Devices Office or Alpha Scientific, P. O. Box 2044, Oakland, CA 94604. Phone (415) 635-2700.

**ALPHA**  
SUBSIDIARY

**SYSTRON DONNER**

\*Patents pending

See us at IEEE Booth 2532  
156 Circle 214 on reader service card

## New products

sign eliminates capstans, belts, solenoids, pinch rollers, and mechanical clutches. The model 260 offers cassette interchangeability between transports and uses cassettes complying with ANSI, ECMA or ISO stan-

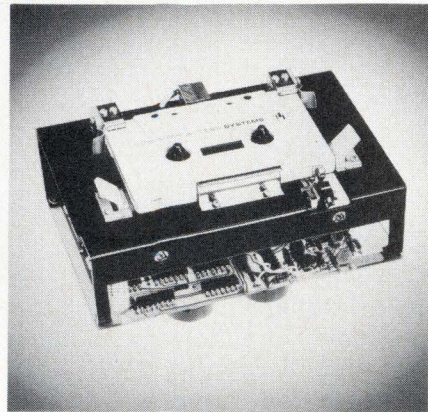

dards. Tape speed variation from transport to transport is less than  $\pm 1\%$ , and read and write speeds are between 5 and 40 inches per second. The recording method is single-track phase-encoded, with densities to 800 bits/second. OEM price is less than \$300 in 500 lots.

Computer Access Systems, 2645 E. Buckeye Rd., Phoenix, Ariz. 85034 [367]

## Precision power source is computer-controllable

A computer-controllable voltage standard and power source called the CSC-701 Compu-Dac is designed for automatic test, laboratory, and manual setup applications. The unit



is relay-free, and settling time is 100 microseconds. As a voltage standard, it provides six-decimal-digit resolution on  $\pm 100$ -volt ranges, organized to provide useful linearity to within  $\pm 0.5$  ppm. Price is \$2,795. Compu-Systems Co., Audubon Rd., Wakefield, Mass. 01880 [368]

*For all types of 1/4 x 1 1/4" fuses and fuseholders:*

# BUSS YOUR ONE SOURCE

**Normal Blowing Fuses**

**AGC GLH MTH**  
From 1/500 to 30  
amps, for 32V, 125V,  
or 250V

**Time Delay Fuses**

**MDL MDX**  
From 1/100 to 30 amps,  
for 32V, 125V, or 250V

**Visual Indicating Fuse**

**GBA** (Red Indicating  
Pin)  
From 3/4 to 5 amps,  
125V

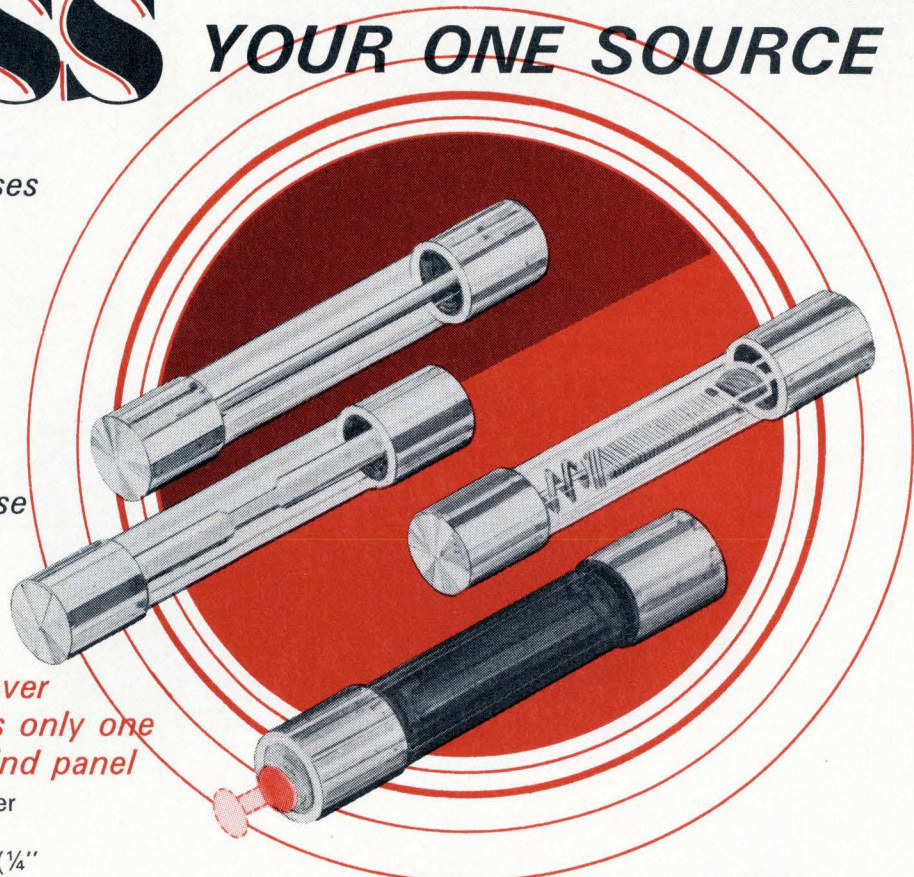

**Space-Saver**  
—projects only one  
inch behind panel

**HTA** (Solder  
Terminals)  
**HTA-HH** (1/4"  
Quick-Connect  
Terminals)  
**HTA-DD** (3/16"  
Quick-Connect  
Terminals)

**HLD** (Solder  
Terminals) **HLD-HH** (1/4"  
Quick-  
Connect Terminals)

**HKP** (Solder Terminals) **HKP-HH** (1/4" Quick-Connect Terminals)  
**The Fuseholder for All-Purpose Applications**

**Visual Indicating Fuseholder**

**HKL** (Octagon Knob) **HKL-X** (Flat-Sided Knob)  
**Lamp Indicating Fuseholder**

**FUSEHOLDERS**

*All Have These Features in Common* • Rated for 15 amps at 250 volts • Dielectrically capable of withstanding 1500 volts a.c. between terminals and between terminals and panel • Bayonet-type knob grips fuse so that fuse is withdrawn when knob is removed; strong compression spring assures good contact • Made for installation in D-hole to prevent turning in panel • Terminals are mechanically secured as well as soldered in holder

This is only a sampling — use the coupon below to get a full description of the complete BUSS line of fuses and mounting hardware.

**BUSSMANN MFG. DIVISION, McGraw-Edison Co.**  
St. Louis, Missouri 63107 E 372

*Please send me a copy of BUSS Bulletin SFB*

Name \_\_\_\_\_  
Title \_\_\_\_\_  
Company \_\_\_\_\_  
Address \_\_\_\_\_  
City \_\_\_\_\_ State \_\_\_\_\_ Zip \_\_\_\_\_

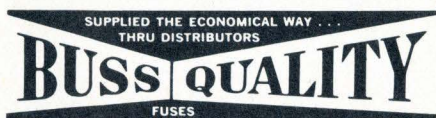

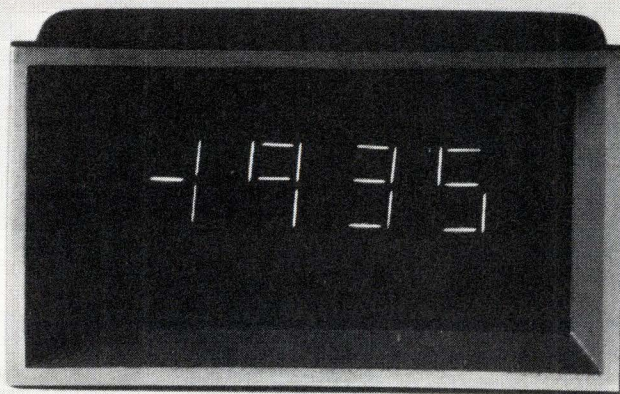

(actual size)

# If we hadn't made it smaller, simpler and better we wouldn't have made it.

There was no way we could introduce a regular size digital panel meter at a regular size price.

We're the world's largest maker of analog to digital converters. With a little more experience than anyone else in the business.

That's why our AD2001 is the world's smallest and least expensive 3½-digit panel meter. It's just under 8 cubic inches in volume. \$89 in 100's. And we're delivering it now.

This is the DPM that's a component.

It's reliable because we made it with fewer parts. Eliminated multi-

level power supplies. Used long-life RCA Numitron display tubes. And built in over voltage protection.

It provides 0.05% accuracy. Has a temperature coefficient of  $\pm 50$ ppm/°C. All the interfacing signals are standard. And we make the two critical analog components ourselves.

Each meter is burned-in for 7 days prior to shipment and warranted for one full year. You can send for our complete brochure and order an evaluation sample right now.

Watch for the appearance of our

2½ and 4½ digit DPM's. They'll be smaller, simpler and better with the same performance and reliability as this one. Or we won't make them.

Analog Devices, Inc., Norwood, Mass. 02062. Tel. (617) 329-4700.

**AD2001.**  
**\$89 in 100's.**

 **ANALOG  
DEVICES**

AD2001 DIGITAL PANEL METER. SIZE: 3" wide, 1¾" high, 1½" deep. Overall volume just under 8 cubic in. DISPLAY: Auto Polarity, Overrange, Out-of-Scale indication. Automatic zero. Programmable decimal points. DATA PROCESSING SIGNALS: External Trigger and External Hold, 3-digit BCD outputs, Overrange, Out-of-Scale, and Polarity signals are all standard. INPUT: Bias Current less than 1nA. Impedance—1000MΩ. Over Voltage Protection. ACCURACY: 0.05% reading. Temperature Range—0°C to 60°C operating. Temperature Coefficient— $\pm 50$ ppm/°C. POWER: Single power source. +5VDC input.

Circle 158 on reader service card



## New products

Packaging and production

### Handler sorts 5,000 DIPs/hr

Simultaneous test-sort  
operations speed process;  
fluidic logic minimizes rfi

A redesigned contact assembly and provisions for mechanical sorting while testing has raised the speed of a handler for dual in-line packages from 4,000 devices an hour to 5,000. The handler, built by International

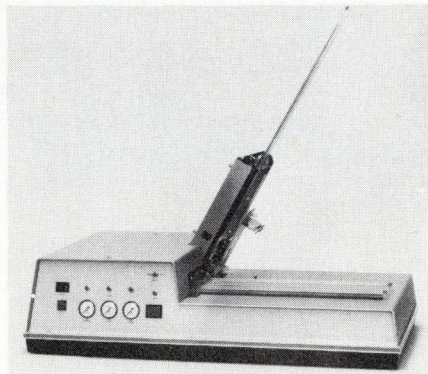

Production Technology and designed the model 600C, provides Kelvin contacts to DIPs with 0.300-inch lead-row spacing and up to 18 leads. The 600C works from stick carriers and sorts devices into two or three categories under instructions from the automatic tester that would be used with the sorter.

Pneumatically driven fluidic logic is used in the sorter shuttle to improve mechanical reliability and minimize electrical interference. In an earlier version of the machine, devices were tested and sorted individually from a contactor assembly on the base plate. In the new version, sorting is performed on one device while the next one is being tested in a contact assembly on the input tower, where it is readily accessible for more rapid changes.

The beryllium-copper spring contacts, of a new design, close with a slight scrubbing action on each side of the DIP lead just below the neck. Other contact assemblies grip the

shoulder, which sometimes is covered with plastic flash from the molding operation, preventing electrical contact.

The machine also is available with up to seven sort positions for use in a semiconductor plant. Owners of the company's earlier model 600 can have that handler updated to 600C specifications for a nominal charge. Price of the 600C machine is under \$8,000.

International Production Technology, 185 Evelyn Ave., Mountain View, Calif. 94040 [391]

### Magazine reloader handles 3,000 substrates an hour

One of the bottlenecks in the manufacturing of thick-film hybrid circuits is at the output end of the drying oven or firing furnace. The substrates leave there neatly laid out next to one another, but for further screening they often must be stacked in a magazine to be fed back into the automatic screen printer. For such applications, Weltek division of Wells Electronics Inc. has built a magazine reloader that attaches to the end of the oven or furnace and, handling each piece so that there is no abrasive action, reloads them in the magazines at a rate of 3,000 pieces per hour.

Any size substrate from 0.5 by 1

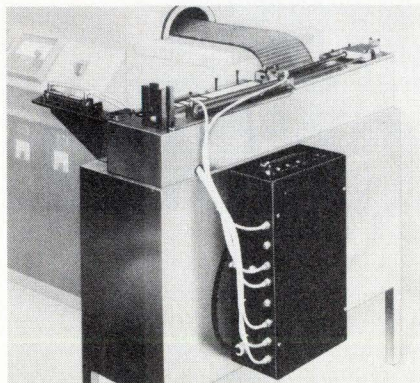

inch up to 3 by 3 inches can be accommodated; the basic machine price of \$4,800 includes one set of tooling. Design of the delivery system from furnace or oven belt to handling mechanism also requires matching to the diameter of the

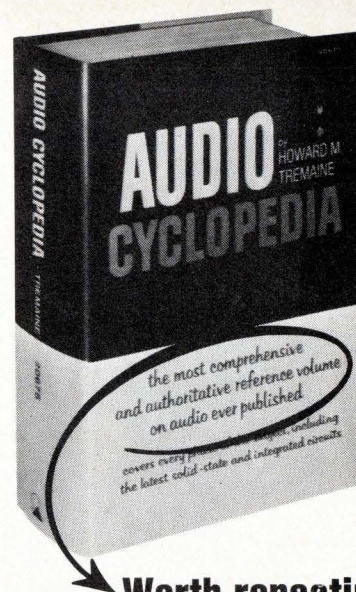

Worth repeating:

**“The most comprehensive and authoritative reference volume on audio ever published!”**

Updated 2nd Edition

## AUDIO CYCLOPEDIA

By Dr. Howard M. Tremaine

- 1758 fact-filled pages
- Covers more than 3500 topics
- Over 1800 illustrations
- Completely updated content

It's a library in one handy volume! Fully updated to include latest developments, right down to the newest solid-state and integrated circuits. Gives you concise, accurate explanations of all subjects in the fields of acoustics, recording and reproduction... with each subject instantly located by a unique index and reference system.

It's the indispensable, complete reference book for anyone associated with or interested in the audio field. **20675—\$29.95**

**25 sections!** Contents include: basic principles of sound; acoustics, studio techniques and equipment; constant-speed devices, motors and generators; microphones; attenuators; equalizers; wave filters; transformers & coils; sound mixers; VU meters; tubes, transistors & diodes; amplifiers; disc recording; cutting heads; recording & reproducing styli; pickups; magnetic recording; optical film recording; motion picture projection equipment; speakers, enclosures, headphones & hearing aids; power supplies; test equipment; audio-frequency measurements; installation techniques; special charts & tables.

### 10-day FREE EXAMINATION

Howard W. Sams & Co., Inc.  
4300 West 62nd St.  
Indianapolis, Indiana 46268

E 032

Send me AUDIO CYCLOPEDIA (20675) for 10-day examination, without cost or obligation. I will send \$29.95, or will return the book within 10 days. (Include sales tax where applicable.)

I enclose \$29.95 payment. Send my copy postpaid with full 10-day refund privilege. (Include sales tax where applicable.)

Name (Print) \_\_\_\_\_

Address \_\_\_\_\_

City \_\_\_\_\_ State \_\_\_\_\_ Zip \_\_\_\_\_

**\$160.**(1-9)

## 3-OUTPUT OEM POWER SUPPLIES

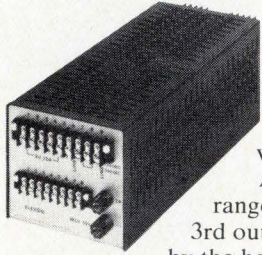

**Low-cost power is an idea whose time has come.** It's here now in our MLV Series. Each MLV consists of 3 computer-grade supplies in a single case. For one low price, you get 3 outputs and your choice of 256 possible voltage/current combinations.

All with no derating over the full temperature range, even with a 50 Hz input (optional on 2nd and 3rd outputs). With regulation, ripple and noise specified by the book. With short-circuit protection, spike-suppression and remote sensing standard, not expensive options. With off-the-shelf delivery for most configurations.

And if the MLV-105 isn't exactly what you need, one of our other single- or multiple-output supplies could be.

Check it out today. Call (714) 833-2950.

**MLV-105**

**Outputs:** 5V/15A plus any two others from 3V/3A to 28V/0.5A

**Temp range:** 0-55°C

**Line & load reg:** 0.1%

**Ripple & noise:** 0.1%

## ELEXON POWER SYSTEMS

18651 Von Karman, Irvine, Calif. 92664

An Elpac division. 

Circle 160 on reader service card

# ENGINEERS WHO KNOW TANTALUMS SPEC DICKSON

Because Dickson is a specialist in solid tantalum capacitors! This specialization means more quality in every unit produced from MIL-C-39003 types to low-cost commercial units. With over 4,000 standard catalog items, you can always depend upon Dickson to supply the right tantalum unit at the right price. Try us! Write, today, for our 6-page Tantalum Capacitor Short Form Catalog.

"The Specialists"



"Where Quality Makes The Difference"



**DICKSON**  
ELECTRONICS CORPORATION

PHONE (602) 947-2231 TWX 910-950-1292 TELEX 667-406  
P.O. BOX 1390 • SCOTTSDALE, ARIZONA 85252

## New products

roller on the end of the belt, so Weltek asks for dimensions of the furnace or oven.

Weltek Division, Wells Electronics Inc., 1701 S. Main St., South Bend, Ind. 46623 [392]

## System generates pc artwork masters automatically

A self-contained system for the generation of pc artwork masters is designated the PC-740. The machine enables the user to produce finished masters, starting with only a rough-gridded layout of the circuit board. All processing is done within the



minicomputer. The system consists of a digitizer connected to a customer-supplied card punch, a stored-program model 700 control unit, a high-speed photoelectric card reader, and a model 400 precision plotting table. Price is \$75,000.

The Gerber Scientific Instrument Co., 83 Gerber Rd., South Windsor, Conn. 06087 [394]

## Packaging system fits Navy standard hardware program

A set of basic hardware pieces for assembly of electronic packages is for almost any piece of electronic equipment being configured in accordance with the Navy's standard

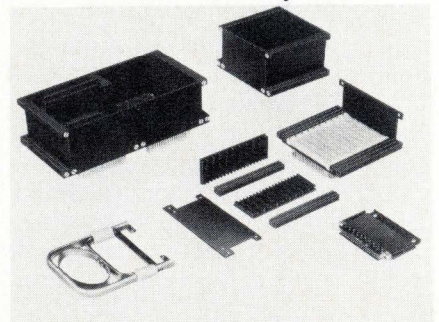

THIS IS ALL WE ASK:

# COMPARE OUR NEW OSCILLOSCOPES WITH SCOPES YOU'RE USING NOW.

	Our 3100	Your Comparable Scope	Our 4100	Your Comparable Scope
Bandwidth & sensitivity	DC-35MHz @ 5mV/div	?	DC-75MHz @ 5mV/div	?
CRT Size	8 x 10 Cm	?	8 x 10 Cm	?
Fastest Sweep	20ns/div	?	5ns/div	?
Calibrated Sweep delay	Standard	?	Standard	?
List Price	\$1675.00	?	\$1825.00	?

## WE LET THE FACTS DO THE TALKING

For more of the facts behind these superior designs, write Raytheon Company, Instruments Operation, 175 Middlesex Turnpike, Bedford, Mass. 01730.

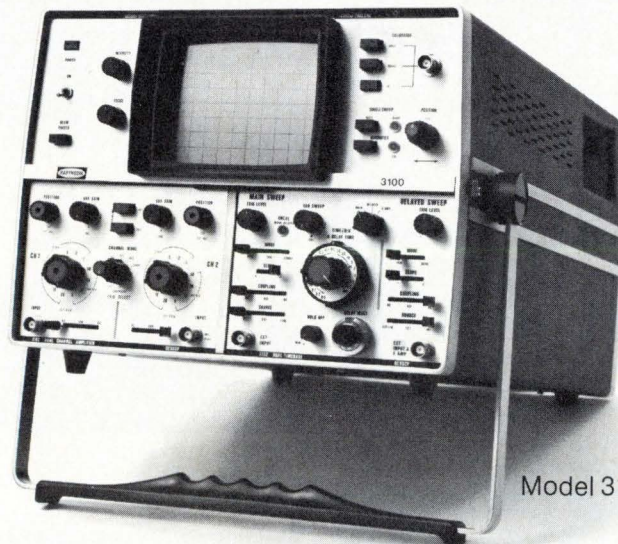

Model 3100

**72**  
1972 Booth 2602

# Roll Out the Red Carpet — For Toko's New Low Cost High-Speed Memory System

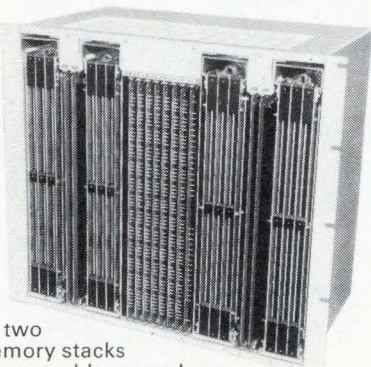

Here's a real eye-opener for computer designers—Toko's new 65K byte memory system, HS-400L. It's constructed with two basic sub-assemblies—woven-plated-wire memory stacks and electronics packages. Designed for medium and large scale computers, the HS-400L offers high reliability, easy maintenance and a flexible arrangement of word lengths.

General Specifications: ● Memory Capacity: 32,768 words—18 bits (Internal Organization is 8K words—72 bits) ● Access Time: 220 ns Random Access ● Cycle Time: Clear/Write 450 ns Read/Restore 450 ns ● Operating Mode: Destructive Read-Out ● Temperature Range: 0° C to 50° C (Operating) ● Measurement: 16.5(H) x 19.0(W) x 10.0(D) ● Interface Level: TTL compatible ● Power Dissipation: 0.3 m W/bit max.

For further information, just call or write



**TOKO, INC.**

**Head Office:** 1-17, 2-chome, Higashi-Yukigaya, Ohta-ku, Tokyo, Japan  
**New York:** Toko New York Inc.  
 350 Fifth Avenue, New York, N.Y. 10001 U.S.A. Tel: 565-3767  
**Los Angeles:** Toko, Inc. Los Angeles Liaison Office  
 1830 West Olympic Blvd., Los Angeles, 90006 Cal. U.S.A. Tel: 380-0417  
**Düsseldorf:** Toko, Inc. Europe Liaison Office  
 4 Düsseldorf, Kolner Straße 246, Düsseldorf, W. Germany Tel: 78-7064

Circle 162 on reader service card

## tones to CONTROL ALERT SIGNAL



over phone lines,  
P.A. systems & radio channels

- **HIGH STABILITY ENCODER** generates precision control tone for transmission on audio channel.
- **VOICE IMMUNE DECODER** detects control tone on audio channel and energizes output relay. Highly selective audio filter plus tone timing circuit prevents false response to voice or music signals.
- **BRAMCO GIVES YOU FLEXIBILITY** with complete tone systems, building-block modules, and custom sub-assemblies for O.E.M. use. Ask for Catalog 303.



**BRAMCO CONTROLS**  
DIVISION OF LEDEX INC.

COLLEGE AND SOUTH STREETS, PIQUA, OHIO 45356  
513-773-8271 · the tone technology people

Circle 216 on reader service card

## HIGH RELIABILITY MORIRICA PHOTOCELL-LAMP

### QUALITY OF THE FIRST ORDER

- Type: MCL-703C**
- **Input (Lamp)**  
Voltage: 10V  
Current: 16mA
  - **Output (CdS cell)**  
ON-resistance: 400Ω ± 50%  
OFF-resistance: 5MΩ (after 10sec.)  
Max. power dissipation 80mW

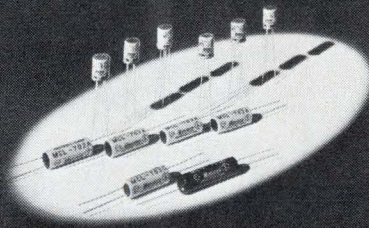

\* For catalog, please write to:  
**MORIRICA ELECTRONICS, LTD.**  
205, Tozuka-machi, Tozuka-ku, Yokohama, Japan  
Tel: 045-881-2331 Cable Address: MORIRICA YOKOHAMA

Circle 217 on reader service card

## New products

hardware program. The system is designed to hold any circuit module in any number and is said to cost less than custom-packaged electronics. The packaging system is made up of six basic hardware pieces, from which the user selects proper quantities. Assembly is accomplished with a screwdriver.

International Electronics Research Corp.,  
135 W. Magnolia Blvd., Burbank, Calif.  
91504 [395]

## DIP socket has press-in attaching buttons

A line of 14- and 16-pin soldered and wire-wrapped dual in-line sockets features tapered, press-in molded buttons for assembly simplification. The sockets are pushed into the mating holes in the board and the buttons hold them in place prior

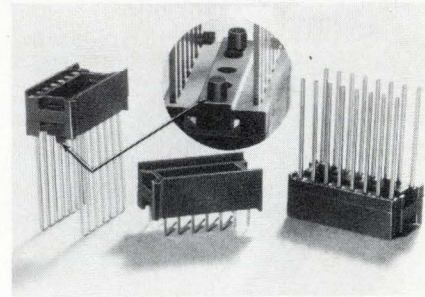

to wave or dip soldering. This eliminates screws, rivets or other attaching hardware. The sockets are molded from glass-filled nylon, and the bronze, gold, or tin-plated contacts are bifurcated. Price is from 29 cents to \$1 depending on quantity and plating type.

Aries Electronics Inc., P.O. Box 231,  
Frenchtown, N.J. 08825 [396]

## Tester automatically identifies wire loops in cable

A cable tester called the Maze Master identifies, on a light-emitting diode display, the source and termination points of wire loops in cable harnesses. Identification is made in less than one second per termination. The unit is capable of identi-

Electronics/March 13, 1972

# The 19¢ GaAsLITE

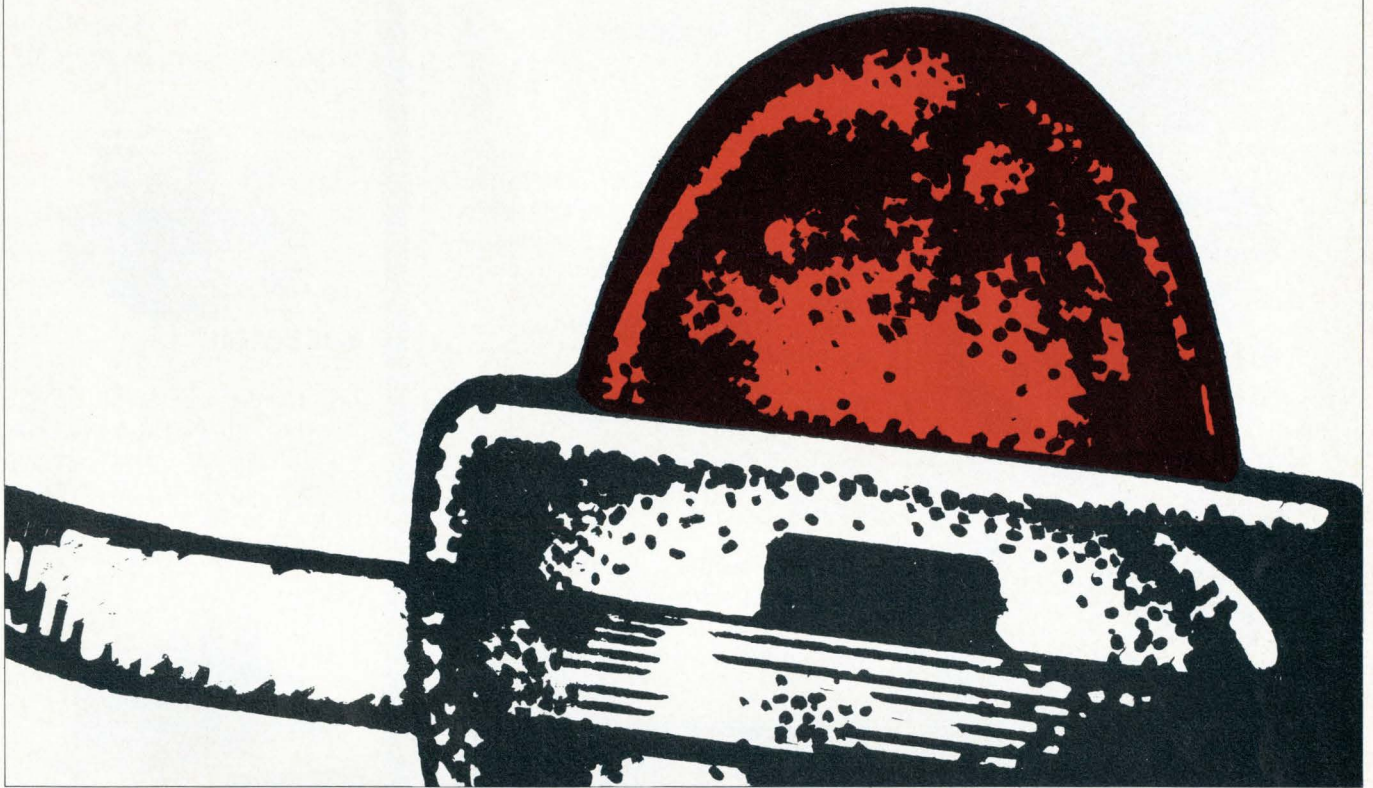

The million-part buyer can now get the first under-20¢ GaAsLITE, the MV50, with a red lens for high contrast. And there will be a lot of million-part buyers at this price. People who are looking for a bright new unit for diagnostic and other applications. Designers who want scintillating arrays. Automotive guys who want dashboard flashers that keep flashing. And many more.

19¢ each, for a lamp with the long life and reliability of solid-state? Quite a milestone. And an indication

## New GaAsLITEs:



### MV54

Our MV50 with a red lens for good contrast at a low, low price.

### MV5026

a new lens design gives this pop-in panel light extremely high contrast between on and off conditions. 65¢ in 1000's.



of the way things are going in the solid-state light bulb business. At Monsanto volume is up, so price is down. You can even try us on a quote for larger quantities.

We will be glad to take your orders in any quantity. For convenience, we have distributors throughout the world. For applications ideas, call us at (408) 257-2140. Monsanto Commercial Products Co., Electronic Special Products, 10131 Bubb Road, Cupertino, CA 95014.

# Monsanto



There's a new multiplier that will save you \$ and provide you with better performance . . .

#### THE NEW MODEL 551

**Total Error:**  
 at 25°C ±0.25% max  
 vs. Temp ±0.015%/°C max  
**Nonlinearity:** ±0.1% max  
**Size:** 1.5" x 1.5" x 0.4"  
**Unit Price:** \$98 (1-9 Qty.)

And you don't have to add any external trims to meet these specs! Forget expensive averaging-type multipliers — this new type of transconductance multiplier obsoletes them.

**So try a 551 . . . the accuracy and stability will amaze you!**

Call or Write Today!



**FUNCTION MODULES, INC.**  
 2441 Campus Drive  
 Irvine, California 92664  
 (714) 833-8314

## New products

rying 99 single-ended or 49 double-ended wire terminations, and a verify mode identifies connector terminations at both ends of wired-in ca-

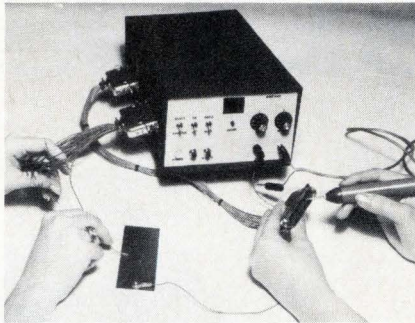

bles. A visual and audible short circuit alarm operates during random identifications. Price is under \$600.

Addison, 1101 Bristol Rd., Mountainside, N.J. 07092 [397]

### IC component mounting board is universal

A line of modular boards for dual in-line packaging assemblies accepts any socket strip or components having standard wire-wrapped pins.

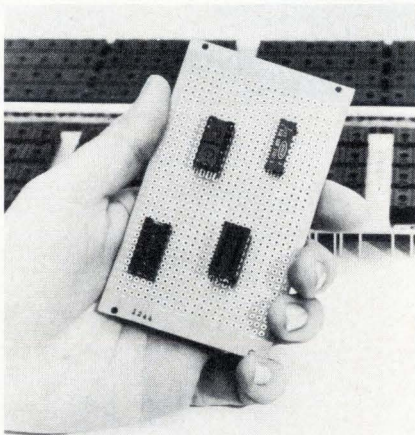

Called the H-2939 series, the glass epoxy boards have through-hole plating over etched copper rings so that components and sockets can be soldered in position. The board measures 0.062 in. thick by 2.45 in. wide by 4.14 in. high

Electronic Engineering Co. of Calif., Electronic Products Div., 1441 E. Chestnut Ave., Santa Ana, Calif. 92701 [398]

# 20% - 30%

## MORE PERFORMANCE IN STANDARD BRIDGE PACKAGES

The packages are standard size. It's the current ratings and forward surge ratings that are larger. They give you added performance reliability—and at no additional cost!

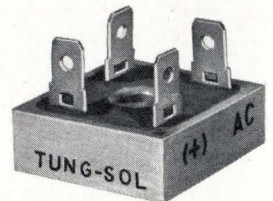

### B-10 series

DC rating — 30A @ 55°C. Forward surge rating—400A @ rated load. B-10 series replace similar bridges rated from 8 to 25A and from 50 to 1,000 PRV per leg.

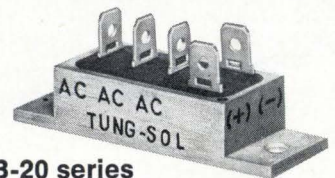

### B-20 series

DC rating — 35A @ 55°C. Forward surge rating—400A @ rated load. B-20 series replace similar bridges rated up to 25A and from 50 to 1,000 PRV per leg.

## SILICON POWER RECTIFIERS

*Tung-Sol makes a complete line of high reliability silicon power rectifiers in the DO-4, 5, 8, 9 and 21 configurations.*

WRITE FOR TECHNICAL INFORMATION. SPECIFY BRIDGES, OR POWER RECTIFIERS.

SILICON PRODUCTS SECTION  
**TUNG-SOL DIVISION**  
**WAGNER ELECTRIC CORPORATION**

630 West Mt. Pleasant Ave. Livingston, N.J. 07039  
 TWX: 710-994-4865 PHONE: (201) 992-1100  
 (212) 732-5426

Trademark TUNG-SOL Reg. U. S. Pat. Off. and  
 Marcas Registradas

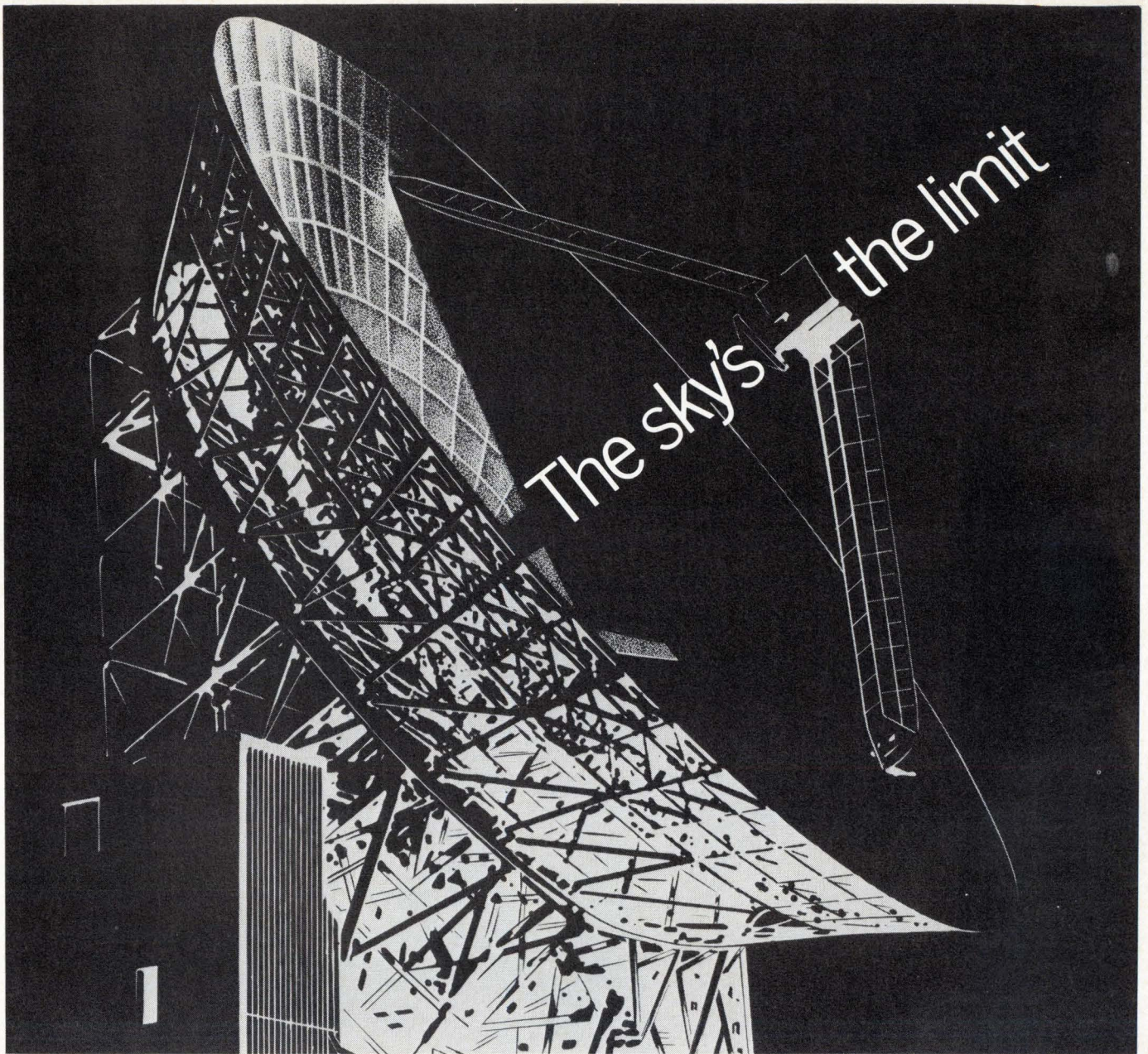

## International Instruments, Electronics, Automation Exhibition Olympia London 8-12 May 1972

Keeping up with developments in this fast moving industry can be difficult. That's why the IEA Exhibition was born and why you should seize this opportunity to visit the only international show this year to cover the field.

25% of the exhibitors come from 18 overseas countries and for the first time there will be special sections: one for process control instrumentation and one for electronic components.

Equipment and techniques need to be examined carefully, especially when they change radically and relentlessly.

The Intelsat project is a classic

example. This project is big business — it costs \$30,000,000 per match to blue touchpaper. 82 countries are involved and U.K. is the second largest contributor. The IEA Exhibition means business.

See you there.

The IEA Exhibition is sponsored by the 5 trade associations of the industry. Tickets available only from exhibitors or at 30p at the door.

Open: 10.00 — 18.00, Wed. and Thurs. 20.00.

For further information please return this coupon to: Industrial Exhibitions Limited, 9 Argyll Street, London W1V 2HA, England.

Please send me catalogues 50p. each including p & p (published 3 weeks before opening day).



### Travel and Accommodation Arrangements

An official exhibition travel agent has been appointed. They can provide a complete travel service from the London office or through their representatives around the world: inclusive or individual rates for booking air, rail and sea journeys, vehicle hire, guides, accommodation and other services from their comprehensive range.

Please indicate the number of persons in your party and whether you wish to deal with London office or a local agent.

Number of persons \_\_\_\_\_  
London office/local agent.

Name \_\_\_\_\_

Company \_\_\_\_\_

Address \_\_\_\_\_



# Look out Mountain View, here comes Westminster.



Where?  
Westminster.  
What's there?  
Silicon General.  
Silicon Who?

Not too many years ago it was Fairchild who? Then along came National who? Now, it's Silicon who!

We're after top billing in the semiconductor business and we know what it takes to get it: performance.

What's in it for you? Right now just about the broadest selection of linear ICs ever assembled in one place. Need delivery now on a super op amp or voltage follower? It's yours. Looking for a reliable source for LM's? That's us, too.

The same goes for dual tracking regulators, or for that matter, any IC regulator. That's our trump. Want help with a linear idea? Our engineers make house calls. Processing to 883, Level A? Available. Right here in Westminster.

There's more. Here. For you.  
Give us a call. Give us an order.  
We want to prove who's who.

**Silicon who?**  
**Silicon General.** About 400 miles due south of Silicon Gulch.

Silicon General, 7382 Bolsa Avenue, Westminster, California 92683, (714) 892-5531 TWX: 910-596-1804

**Ala.:** Cramer/EW, (205) 539-5722 **Ariz.:** Cramer, (602) 263-1112; Kierulff, (602) 273-7331 **Calif.:** Cramer, (415) 365-4000, (213) 243-6224, (714) 279-6300; K-Tronics/Wesco, (213) 685-9525; Kierulff, (415) 968-6292, (714) 278-2112 **Colo.:** Cramer, (303) 758-2100; Kierulff, (303) 343-7090 **Conn.:** Cramer, (203) 239-5641 **Fla.:** Cramer/EW, (305) 894-1511, (305) 923-8181 **Ga.:** Cramer/EW, (404) 448-9050  
**Ill.:** Bodelle Co., (312) 468-1016; Cramer, (312) 593-0230 **Md.:** Arrow, (301) 247-5200; Cramer/EW, (301) 354-0100 **Mass.:** Cramer, (617) 969-7700; Gerber Electronics, (617) 329-2400 **Mich.:** Bodelle Co., (313) 273-6920 **Minn.:** Cramer, (612) 881-8678; Industrial Components Inc., (612) 927-9991 **N.J.:** Cramer, (201) 687-7870 **N. Mex.:** Cramer, (505) 265-5767, Kierulff, (505) 247-1055 **New York:** Arrow, (516) 694-6800; Cramer, (516) 231-5600, (716) 275-0300, (315) 437-6671, (607) 754-6661; Ossmann Components, (716) 442-3290 **N.C.:** Cramer/EW, (919) 725-8711, (919) 876-2371 **Ohio:** Arrow, (513) 253-9176, (216) 464-2000; Cramer, (513) 771-6441, (216) 248-7740 **Okla.:** Cramer, (918) 836-3371 **Penn.:** Arrow, (215) 534-3200; Cramer, (215) 923-5950 **Texas:** Cramer, (214) 350-1355; Kierulff, (214) 271-2471; Sterling, (214) 357-9131, (713) 623-6600 **Utah:** Cramer, (810) 487-3681 **Wash.:** Kierulff, (206) 763-1550 **Wis.:** Cramer, (414) 462-8300 **Canada:** Cramer, (416) 781-6631; Future Electronics, (514) 735-5775.



## New products

Semiconductors

### ALU and latch put on chip

Bipolar MSI device allows designers to save power and get increased speed

Monolithic arithmetic logic units, such as the 54/74181 and the 9341, have been widely accepted by designers because they're easy to use—and they work. In most systems, the unit is used with a latch circuit; the unit and the latch, with an accumulator generally, are combined in a loop so that the result of a calculation can be stored temporarily in the latch for use in the next calculation.

But the latch requires power and introduces a delay of about 20 nanoseconds. That is why circuit designers at Advanced Micro Devices have combined the arithmetic logic unit and latch into one bipolar MSI device. The result is the Am2506, the first such device in the industry. The four-bit arithmetic logic unit section of the 2506 is functionally identical to the Am54/74181, but has the four-bit latch on the device outputs. Thus, where a latch is required for temporary storage in arithmetic functions, an external package isn't needed.

Because the two functions are combined on one chip, the latch portion offers essentially zero propagation delay as well as zero power dissipation. The designer thus saves power as well as getting increased speed. For example, in a 16-word configuration the 16-bit arithmetic register slice would require 13 packages if it had external latches. With the Am2506, 11 packages do the job—with 20% more speed and 15% less power. And the built-in latch adds only \$1 to the cost of the logic unit at a price of \$17.50.

The 2506 performs two functions commonly used together. It is a four-bit ALU with a four-bit latch on the outputs.

Like the 9341 and 74181, the device performs addition, subtraction, or any logic function on two four-bit words. The operation is determined by the mode control line, and the four select lines. The chip produces the carry look-ahead functions as well as a carry-out signal, and all signals are located on the same pins as the corresponding signals on the 9341 or 74181.

Also provided is a latch-enable pin: as long as it is high, data from the arithmetic logic unit appears directly on the output pins, and operation is identical to the Am9341's in all respects including switching speeds. The only difference is that the A=B output of the 9341 has been replaced by the latch-enable pin in the 2506. But when the enable goes low, the data on the outputs latches and no further changes occur. This allows the inputs to the device to change without destroying the output data from the previous operation.

Because of the built-in latch, the 2506 can help designers save time in many configurations. For example, when the Am2506 is combined with the Am2505 2's-complement multiplier circuit [*Electronics*, Sept. 13, 1971, p. 125], the time required to multiply two 16-bit numbers can be reduced from, typically, 275 nanoseconds to 95 ns.

The Am2506 is available from stock in small quantities. The commercial version, in an hermetic dual in-line package, is priced at \$17.50 in quantities of 100.

Advanced Micro Devices Inc., 901 Thompson Place, Sunnyvale, Calif. 94086 [412]

### Line driver features internal inhibit and slew control

A line driver called the 9616 links DTL-TTL data terminals and communications equipment. The triple line driver is implemented by an and/or/invert function instead of a positive NAND function, eliminating the need for external gating to perform the inhibit function. The unit also features an internal slew rate control that eliminates the need for

for  
**rapid  
reaction**

**INQUIRY > QUOTE  
ORDER > DELIVERY**

**Specify**

**CUSTOM**

**Mica Capacitors**



CMR Type

For hermetically sealed or potted in applications.

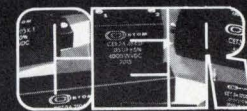

CER Type

For specialized mounting arrangements and operation under selected environmental parameters.



CEM Type

For specialized form factors and operation under environmental extremes.

Custom Electronics can fill your mica capacitor requirements in minimum reaction time (inquiry; to quote-order-to delivery). Meet your design engineer's requirements for higher voltage, higher temperature and greater reliability by calling on Custom Electronics for Mica Capacitors.

The greatest single cause for capacitor failure is a short in the dielectric material. Consequently, we precisely inspect and grade all of our dielectric material **before** production. The result is the finest quality capacitors of their kind available today.

**Write or call on your application today!**

**CUSTOM**  
The QC Fanatics

**CUSTOM ELECTRONICS, Inc.**  
Browne St., Oneonta, N. Y. 13820  
PH: 607-432-3880 TWX 510-241-8292

# Touched by human hands

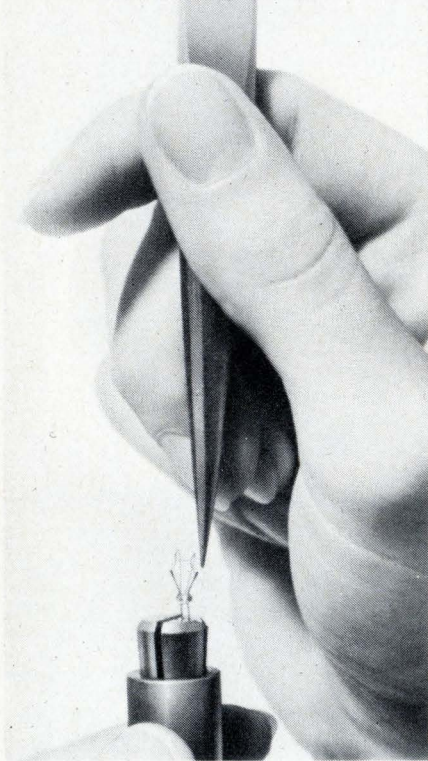

## That's the secret ingredient

that makes IEE subminiature lamps live longer, the ingredient you can't buy in any other lamp.

Before aging, before selection, such human controlled operations as hand mounting of Swiss tungsten filaments assures precision placement. Thus, we destine our subminiature lamps to serve you more faithfully than any lamp you can buy at twice the price.

Now you can buy these IEE MIL-spec-beating lamps with average life spans up to 100,000 hours and more off-the-shelf world-wide.

That's why IEE is catching up fast on everybody in subminiature lamps.

DISTRIBUTOR INQUIRIES WELCOMED

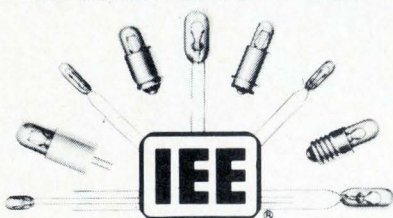

Industrial Electronic Engineers, Inc.  
7720 Lemona Ave., Van Nuys, Calif. 91405

168 Circle 168 on reader service card

## New products

an external capacitor for each driver. Price in 100 to 999 quantities in a 14-pin ceramic DIP is \$4.50

Semiconductor Component Group, Fairchild Camera & Instrument Corp., 464 Ellis St., Mountain View, Calif. 94040 [413].

## Precision IC comparator offers low offset current

A low-input current comparator called the CMP-02 can maintain total input errors of less than  $\pm 1$  millivolt in circuits with up to 2.0 megohms of source resistance, without the requirement for offset nulling. The unit operates from  $\pm 5$ -volt to

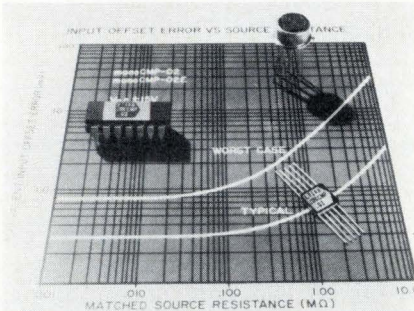

$\pm 18$ -v supplies or from a single +5-v logic supply. The output is capable of driving eight TTL loads without requiring an extra pull-up resistor, and has wired-OR capability. Price, depending on quantity, temperature range and packaging, varies from \$3.15 to \$23.25.

Precision Monolithics Inc., 1500 Space Park Dr., Santa Clara, Calif. 95050 [414]

## FET operational amplifier requires bias of only 10 pA

An operational amplifier incorporating a dual-FET front end and packaged in a TO-99 case is designed for applications requiring accuracy in fast or high-impedance circuits. The model 1421 offers a bias current of 10 picoamperes, and a common mode voltage of  $\pm 12$  volts. Output current is 10 milliamperes, and unity-gain bandwidth is 1 megahertz. The unit is directly interchangeable with the company's models 741 or 740, and incorporates

# Have you found out how to ship out of Rochester?

The eternal problem: Getting your raw materials in and your finished products out. With cost options and emergency alternatives. Here, in a fertile, dynamic 9-county area of Western New York, you take your choice. Ship by air, ship by rail, ship by truck. Even ship by ship. (Did you know we are a seaport?) Could you use some solid information on transportation . . . or any aspect of site or plant selection? If so, call collect or write to Bob Hall, Director of Area Development, Rochester Gas & Electric, 89 East Ave., Rochester, New York 14604 (Telephone: 716-546-2700). Nobody knows more about this area than we do. And because we make money selling energy to industry, we're eager to share our knowledge with you.

**Bausch & Lomb made it here.  
How about you?**

**RGE** ROCHESTER GAS AND ELECTRIC

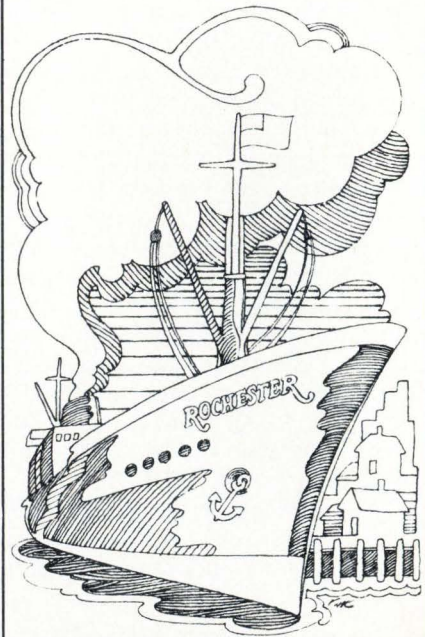

Circle 218 on reader service card



# If you need more than just a simple answer.



Any calculator can give you answers. But if you need more — if you need solutions — then bring on your toughest problems and see what Wang calculators have to offer.

Power, for one thing. Power to whiz you through interest rates or static values of pre-stressed concrete bridges. Or just about anything in between.

Versatility: each Wang calculator is field-expandable to fit your changing needs, to handle more difficult challenges.

And value: each Wang calculator has the greatest performance/price ratio in its respective class.

Wang is the largest American calculator manufacturer and offers the most extensive line of calculators in the world. We've earned a reputation for excellence and we intend to protect that reputation with superior products and factory-direct service.

So think about it: do you need answers?  
Or do you really need us instead?



# WANG

LABORATORIES, INC.

836 North Street  
Tewksbury, Massachusetts 01876  
Telephone: (617) 851-7311  
TWX 710-343-6769  
Telex 94-7421

Dept. E-3

"But right now, the only commercially available microwave FETs are made by Plessey."

Electronics/January 17, 1972

## The PLESSEY GAT 1 and GAT 2

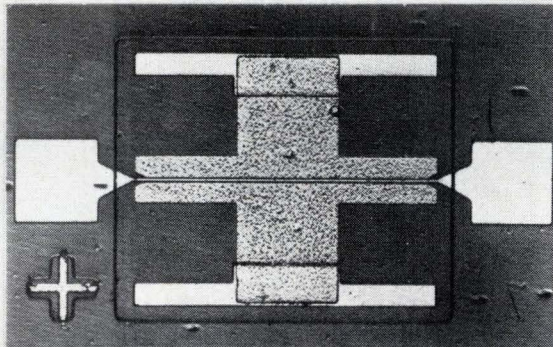

The GAT 2 (magnified 125 times).

- Low Noise
- High Gain
- From TV frequencies through C-Band

### GAT 1

10dB Gain  
4dB Noise figure } at 1GHz  
Cut-off frequency: 4GHz

### GAT 2

8dB Gain  
5dB Noise figure } at 3GHz  
Cut-off frequency: 8GHz

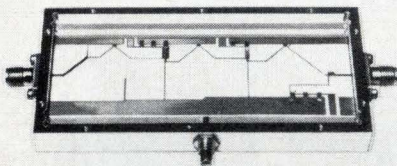

L-Band amplifier  
Bandwidth 1.4-1.6GHz  
Gain 24dB  
Input & output VSWR better than 1.5:1  
Noise figure 4.5dB

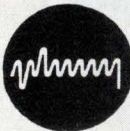

Call us for information on other hybrid microstrip amplifier designs from 1-6GHz

# PLESSEY Semiconductors

See us on STAND 3620 at the IEEE

USA Plessey Electronics Corp., 170, Finn Court, Farmingdale, Long Island, New York 11735. Tel: 516-694-7377

UK Plessey Semiconductors, Opto-electronics & Microwave Division, Woodburcote Way, Towcester, Northamptonshire. Tel: 03275 312. GERMANY Plessey Bauelemente Vertriebs GmbH, 7, Stuttgart 1, Olgastrasse 111, Tel: (0711) 64 3631. Neumuller & Co. GmbH, 8000 Munchen-2, Karlstrasse 55, Tel: 592421. FRANCE Plessey France SA, 16/20 Rue Petrarque, Paris 16, Tel: 727 43 49 Societe Nauder, 23 Rue Boissiere, 75, Paris 16, Tel: UPR 7049480. ITALY Plessey Italiana SpA, Via Soperga 4, Casella Postale 3681, 20127, Milan, Telephone: 209349, 228588 & 228619. JAPAN Cornes & Co. Ltd., Maruzen Building, 2-6 Nihonbashi-Tori, Chuo-Ku Tokyo, Tel: 272 5771. SWEDEN Hammar & Co AB, Vanadsvagen 24, Stockholm Va, Tel: 08.31.14.81 SWITZERLAND Plessey AG, Thurgauerstrasse 119, 8052 Zurich, Telephone: 83.49.44.

## New products

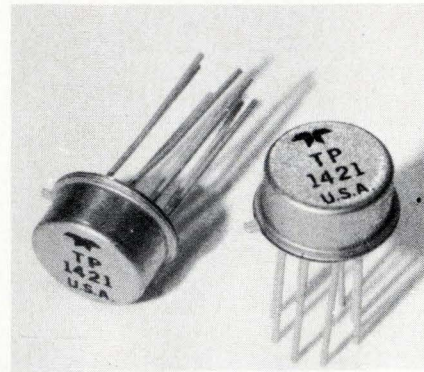

output short-circuit protection and input fault protection.

Teledyne Philbrick, Allied Dr. at Rte. 28, Dedham, Mass. 02026 [415]

### Vhf-uhf power transistor

delivers 30 W cw at 400 MHz

A vhf-uhf power transistor, designated the 2N6104, delivers 30 watts continuous-wave with a 5-decibel gain at 400 megahertz. It is designed

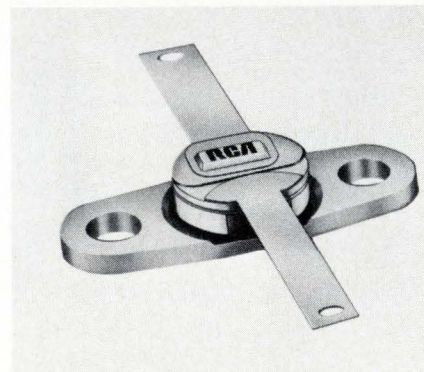

for use in large-signal, high-power cw and pulsed amplifiers at frequencies from 200 to 600 MHz, and operates from a 28-volt supply. The unit also features overlay multiple emitter site construction and emitter ballasting resistors. Price is \$33 in 1,000-unit quantities.

RCA Solid State Div., Box 3200, Somerville, N.J. 08876 [416]

### Thin-film ladder networks

track within 1 ppm/°C

Eight-, 10-, 12-, and 14-bit R-2R thin-film resistor ladder networks feature a tracking characteristic of



## BUILDING FOR THE FUTURE

"The foundation upon which the future will be built was laid in the past."

That is the real significance of our fiftieth anniversary.

A half-century of experience in electrical insulations gives us a sound base for anticipating and meeting the requirements of industry and science in the future. We invite you to bring your insulation problems to us. If we don't have the solutions, we'll find them.

**L. FRANK MARKEL & SONS, INC., NORRISTOWN, PA. 19404**

*Pioneers in Electrical Insulations Since 1922*



Circle 171 on reader service card

# Whatever you're looking for in mercury wetted relays

## look to wabash

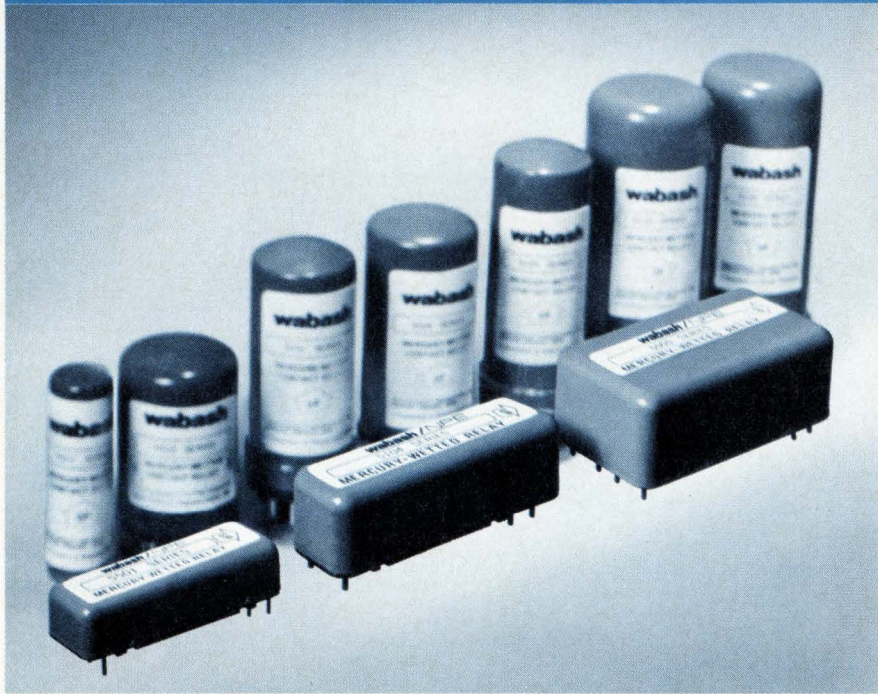

Our growing line of mercury wetted contact relays combines new technology with consistent Wabash quality and reliability. We now offer a full variety of plug-in and low profile p.c.-mount types, all delivering bounce-free switching for up to  $10^9$  operations. Single-side or bi-stable. Sensitive C, D and heavy duty D contact forms. Miniature to large 2-switch versions (3-switch available in plug-in). But quality and variety are only part of the story. We offer a responsive field force, fast turnaround, prompt delivery, and the many other important features of concerned customer service. Let us prove it to you.

## wabash

NPE/New Product Engineering, Inc.  
a subsidiary of Wabash Magnetics, Inc.

First and Webster Streets, Wabash, Indiana 46992  
Phone 219/563-2191 TWX 810-290-2722

### New products

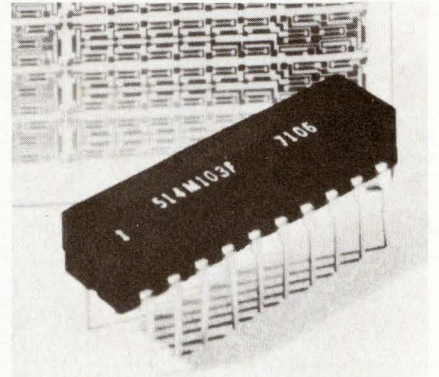

less than 1 ppm/ $^{\circ}$ C. Ladder transfer linearity for the 8-bit network is 0.05%, for the 10-bit, 0.03%; for the 12-bit, 0.01%; and for the 14-bit, 0.005%. Characteristic resistance of all networks is 1.0% at  $-55^{\circ}$ C to  $+125^{\circ}$ C maximum. Settling time to 0.1% of full scale is less than 50 nanoseconds typical. Delivery of the units is from stock.

Hybridyne Inc., 3150 Pullman St., Costa Mesa, Calif. 92627 [417]

### MOS read-only memory is electrically programmable

A metal oxide semiconductor read-only memory is electrically programmable and, in one version, erasable and reprogrammable. Called the model MM5203, the 2,048-bit static device is made with silicon

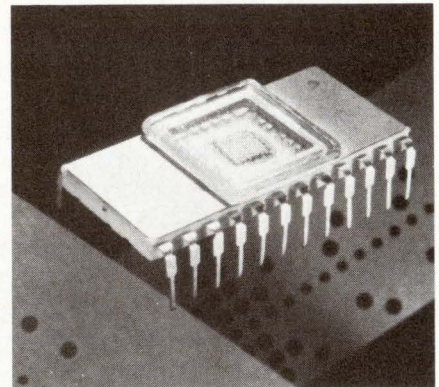

gate technology and has a maximum access time of 1 microsecond. Other characteristics include bipolar compatibility, three-channel outputs for high-speed operation on data buses, and chip-enable output control.

National Semiconductor Corp., 2900 Semiconductor Dr., Santa Clara, Calif. 95051 [418]

# How to live within your budget!

Money for new test equipment is tight. If you're looking for a 15 to 50-MHz scope — like the 422, 453A or 1700 — you owe it to your company to try Hickok.

Because, with a Hickok scope, you get quality performance while saving money.

With Hickok, you receive dual and single-channel models, 25-MHz bandwidth, stable triggering beyond 50 MHz, 10-mV sensitivity, and built-in delay line.

The value-priced 5000A and 5002A are the results of Hickok's experience in producing more than 20,000 scopes for reliable operation in rugged military environments. These performance-packed scopes are ideal for lab applications: clean pulse response; 4 screen width horizontal and 3 screen height vertical deflection; sharp, bright trace. And for field use, lightweight, compact design.

These are features usually found on models costing up to \$2100. And this brings us back to economy — the 5000A single-channel scope is \$595 and the 5002A dual channel is \$845. Call Hickok to take a look at these scopes in your lab.

## HICKOK

**the value innovator** Instrumentation & Controls Div.  
10514 Dupont Avenue/Cleveland, Ohio 44108/(216) 541-8060

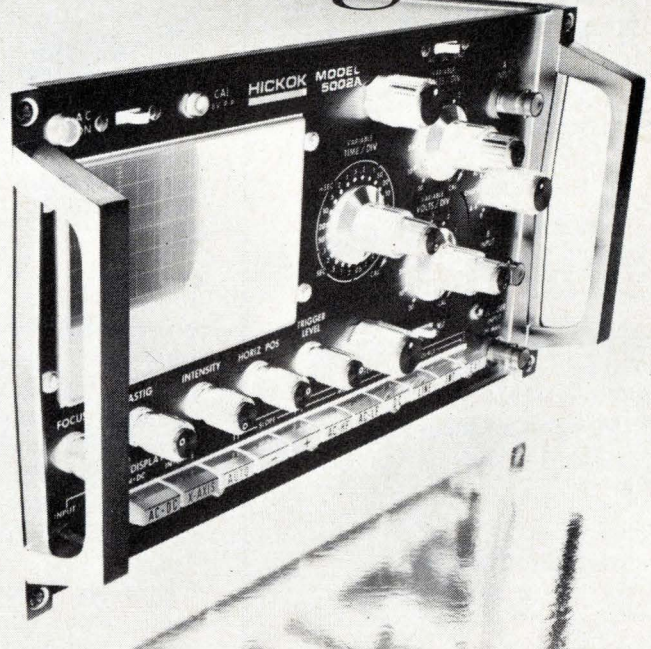

Circle 173 on reader service card

**TEST CLIPS**  
After 100,000 wire insertions and removals contact resistance registered less than .001 ohms.

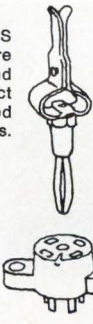

**BI-PIN LAMP SOCKETS**  
Features 4 point PC mount for stability.



**TRANSISTOR SOCKETS**  
Minimum insulation resistance of 500,000 meg-ohms at 100 VDC.

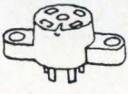

**BINDING POSTS**  
Caps won't melt at soldering temperature.

## Even hardware can be different

Grayhill is in termination hardware because our customers wanted something different.

And products and features shown above reveal only part of the picture.

Grayhill makes 100 other items of termination hardware — developed for superior insulation, dielectric strength, minimum contact resistance. And if what you need isn't in our line now, we can design and make it for you.

For our latest Engineering Catalog write or phone:  
Grayhill, Inc., 523 Hillgrove Ave.,  
La Grange, Illinois 60525.  
(312) 354-1040.



Circle 240 on reader service card

## 100 MHz-269.95

New Heathkit IB-1101 Frequency Counter is the one you've been waiting for! With full 5-digit readout, 8-digit capability when using the range selector and overrange circuitry. The exclusive solid-state circuitry accepts inputs from less than 50 mV to over 200 V, depending on frequency, without damage. And the IB-1101 has automatic decimal, overrange & gating lights, one megohm input impedance & low input capacitance to minimize circuit loading. Stable time-base crystal has better than  $\pm 3$  ppm from 17°-32° C. You get it all together in an easy 10 hours. Now that the price is right, why not get a better counter?

Kit IB-1101, 8 lbs. .... 269.95\*

Your FREE '72 Heathkit Catalog contains the world's largest selection of kit-form instrument values.

Use this coupon to order your FREE '72 Heathkit Catalog. Now there are more than 350 kits to choose from.



**HEATHKIT**  
Schlumberger

**HEATH COMPANY, Dept. 53-3**  
Benton Harbor, Michigan 49022

Please send FREE Heathkit Catalog.  
 Enclosed is \$ \_\_\_\_\_, plus shipping.  
Please send model(s) \_\_\_\_\_

Name \_\_\_\_\_  
Address \_\_\_\_\_  
City \_\_\_\_\_ State \_\_\_\_\_ Zip \_\_\_\_\_

Prices & specifications subject to change without notice. \*Mail order prices; F.O.B. factory.  
TE-258

Circle 219 on reader service card

173

From Advanced  
Thyristor Technology

# HUTSON'S 30A & 40A TRIACS

with  
**GLASS-PASSIVATED  
CENTER-GATE CHIPS**

For motor, heating, cooling and lighting controls, the Hutson 30A and 40A triacs feature greatly improved  $dv/dt$  ratings and  $di/dt$  characteristics for faster turn-on and lower switching losses.

Improved thermal characteristics and current-carrying capabilities allow these triacs to withstand surges of up to 400A.

### Di-Mesa\* Construction

This patented construction eliminates operational cycling failures resulting from dicing-induced passivation fractures.

### Immediate Delivery

Press-fit, stud, and TO-3 outline mounting. 30A & 40A [ $I_{T(RMS)}$ ]; 50V to 600V ( $V_{DROM}$ ).



**3/4" PRESS-FIT SERIES. ELECTRICALLY ISOLATED. GLASS-PASSIVATED, CENTER-GATE**



**1/2" PRESS-FIT SERIES. GLASS-PASSIVATED, CENTER-GATE**

OTHER HUTSON TRIAC'S AND SCR'S FROM 3A SENSITIVE GATE AND IN ALL POPULAR PACKAGE CONFIGURATIONS



\*T.M. HUTSON INDUSTRIES

## HUTSON INDUSTRIES

2019 W. VALLEY VIEW LANE  
DALLAS, TEXAS 75234 (214) 241-3511  
TWX 910-860-5537

### Distributed by:

BODELLE COMPANY, Chicago, Ill.  
312/468-1016 ■ NEWARK ELECTRONICS  
CORP., Inglewood, Cal. 213/678-0441  
THOR ELECTRONICS, Elizabeth, N.J.  
201/354-2420

Canada: WEBER-SEMAK ELECTRONICS, Downsview, Ont.

### European Marketing Director:

30 Rue Pierre Semard, Yerres, 91 France  
Tel: Paris 925-8258 TELEX 21-311

### Distributed in Europe by:

Switzerland: D. LEITGEB, Dubendorf  
Sweden: ELEKTROFLEX, Sundbyberg  
Spain: BELPORT, Madrid  
Holland: RODELCO, Den Haag

## New Products/Materials

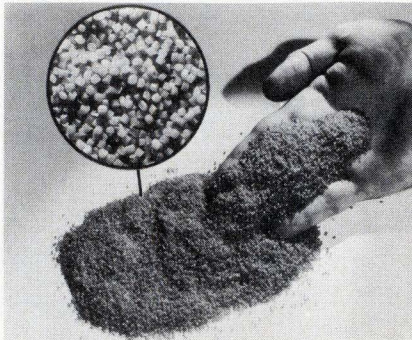

**Alloyed plastic material** is for deburring metal and plastic parts and for cleaning electronic connectors and circuit boards. Called Blas-Tic, the material has high tensile, compressive and flexural strength, combined with comparatively low hardness. It is dust-free and rounds rapidly into an operating mix. Blas-Tic is sold in 50-pound bags and 250-pound drums.

Media Technology Corp., 4916 Leafdale Blvd., Royal Oak, Mich. 48073 [476]

**Thermally conductive adhesive** can increase the efficiency of high-wattage semiconductors by providing a low-heat-resistance bond to heat sinks. Designated type 341, the material is a two-part adhesive that can be used where glue lines of 0.001 in. or less are required. Price is about \$15 a gallon.

Castall Inc., Weymouth Industrial Park, East Weymouth, Mass. 02189 [477]

**Silicone material** acts as a moisture barrier in electronic applications and is designed to stabilize semiconductor junctions and surfaces of diodes, transistors, integrated circuits, and thick- and thin-film circuit modules. Price is \$12 per pound.

Transene Co. Inc., Route 1, Rowley, Mass. 01969 [478]

**Silver-filled silicone adhesive** called 190-3 is formulated especially for rf shielding applications. It contains both pure silver and silver composite fillers and is a ready-to-use one-component material that cures at room temperature. The material is also noncorrosive to metals, and is available in squeeze tubes or plastic cartridges.

Ablestik Laboratories, 833 W. 182nd St., Gardena, Calif. 90248 [479]

TRY SOME  
FREE SAMPLES  
OF BY-BUK  
PROFESSIONAL  
QUALITY  
ELECTRONIC  
CIRCUITRY  
DRAFTING  
AIDS.

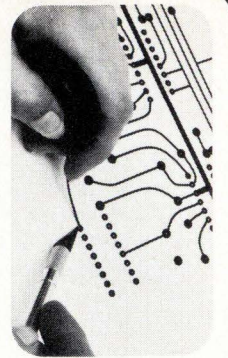

It's our way of proving that artwork layout accuracy can be accomplished in seconds with By-Buk pressure sensitive drafting aids.

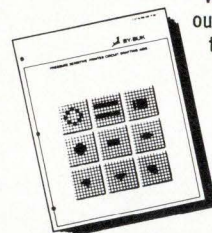

We'll also send you our catalog featuring thousands of ideas in individually die cut artwork patterns and conductor line tapes to connect them with.



**BY-BUK COMPANY**  
A SUBSIDIARY OF WEBTEK CORPORATION  
4326 W. Pico Blvd., Los Angeles, CA 90019  
(213) 937-3511

Circle 241 on reader service card

Advertisement

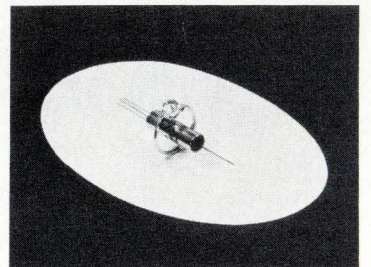

## Low-price reed relay

A new low-cost reed relay is being offered for as low as 29¢ (1 million quantities). Other price breaks are: 39¢ for 100,000; 56¢ for 10,000; and 80¢ for 1000 quantities. This new relay features MIL-Q-9858A specifications, a magnetic shield for high-density packing and contact resistance of less than 100 mΩ. Its contacts are rated at 1A or 250-V switching at 20 W. Coils are available for 1, 3, 5, 6, 10, 12, 15 and 24 V. The relay's size is 0.275-in. in outside diameter by 0.95-in. long. Free samples are available.

Electronic Applications Company  
2213 Edwards Ave.  
South El Monte, Calif. 91733

Circle 242 on reader service card



# There's a FUTURE in FUEL CELLS for you!

The initiation of new fuel cell research and development activities and the expansion of present activities by this leading manufacturer in the northeast have created several challenging positions. Individuals interested in technical challenge, an innovative organization with intriguing growth possibilities and a truly professional environment should investigate these positions.

## ELECTRICAL POWER CONVERSION ENGINEER

BSEE/MSEE for advanced development and design of solid state power conversion equipment for commercial use. Major activity will be with low cost 50-60 Hz thyristor inverters (5-500 kva) using high-frequency, pulse-width modulation techniques. Applicants must have an ability to direct a small technical group, 5-15 years experience overall with 3-10 years in solid state power conversion including inverters.

## ELECTRICAL SYSTEM DEVELOPMENT ENGINEER

BSEE/MSEE to analyze and develop commercial on-site power generation systems for utilities, the military and others. Responsibilities will include both active participation and direction of others in determining application requirements, synthesis of alternate circuits, comparative analysis of performance, efficiencies, reliability and costs. Experience range: 5-20 years with 3-10 years in the analysis, development and application of electric power systems.

Salary levels will be commensurate with experience and professional stature. Please send your resume (including salary requirements) to Mr. H. M. Heldmann, Office A-46, Pratt & Whitney Aircraft, East Hartford, Conn. 06108. An equal opportunity employer.

**Pratt & Whitney Aircraft**

**U  
A**  
DIVISION OF UNITED AIRCRAFT CORPORATION

# motion detector



The CVI Motion Detector 304 used with conventional CCTV cameras and systems provides a unique automatic alarm triggered by variations in brightness.

### Security

the 304 allows free movement of personnel until a restricted area is entered

### Production Monitoring

the 304 automatically monitors status boards, meters, level gauges, conveyor belts, traffic

### Fire Protection

the 304 detects most types of smoke, giving added fire protection to secure areas

### Indoor/Outdoor

the 304 is ideally suited for outdoor use because it does not respond to slow variations in light level

### Fail Safe

alarm and latch detect loss of power, loss of video or abrupt changes in light level

If you're moved by the 304 story so far, circle our reader service number, drop us a line or call for more specifics.

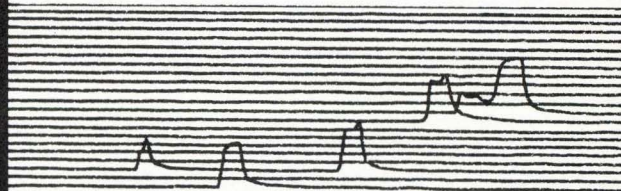

Typical vehicular/pedestrian traffic log

Colorado Video Inc.  
**cv**  
P.O. Box 928 Boulder, Colorado 80302 (303) 444-3972

# Try us on the parts they say can't be molded of plastics

The fact is, when many electronics manufacturers have augmented their engineering and production people with our specialized staff in the design, development and material selection, plastics usually is the answer to a superior product. These same manufacturers rely on us to proceed with mold making integrated to production on our own in-plant injection, compression or transfer molding machines. Deliveries are always on a satisfactory schedule regardless of the precision and volume demanded by the customer. Thermoplastic or thermoset—our versatility in design engineering, mold making and production is unlimited. Sophisticated electronic parts often require precise, secondary operations—drilling, tapping, grinding and polishing—all provided by Del-Val. In addition, parts are ultrasonically cleaned before delivery to assure better parts, uncontaminated and ready for assembly. If you've been thinking plastic components, think Del-Val—the people who offer the most comprehensive service in the plastics industry.

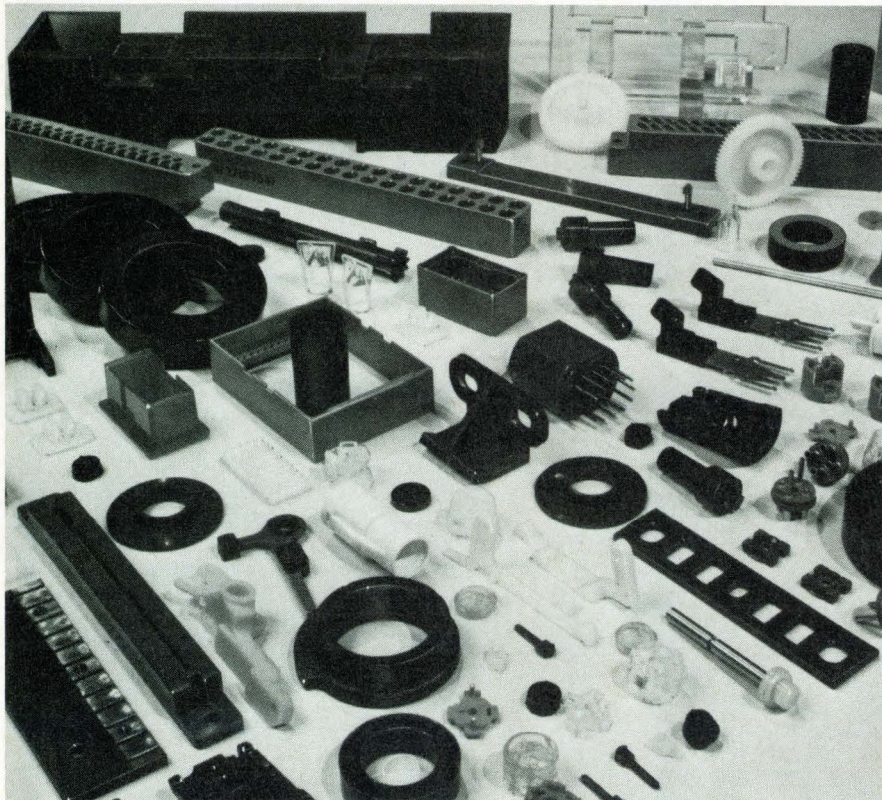

## DEL VAL PLASTICS

DIVISION OF WEHCO PLASTICS, INC.  
Box 108, River Road, Tullytown, Pa. 19007  
(215) 949-2777 • Phila. (215) 627-5590

Circle 176 on reader service card

## The new McGraw-Hill Building

in Rockefeller Center

### Eight floors available

Approximately 330,000 square feet available for sub-lease. Choice location at 1221 Avenue of the Americas in Rockefeller Center. 51 stories high, plazas, promenades, underground concourses. Unequaled operational standards. IND Subway Station "in the building." Theatres, restaurants, hotels and stores just minutes away. Modular office design provides ultimate layout flexibility. 280 seat auditorium. 1,200 seat cafeteria.

### Rental information

Contact McGraw-Hill's real estate consultants, James D. Landauer Associates, Inc., 200 Park Avenue, New York, N.Y. 10017, telephone (212) 687-2323; or your own broker; or John M. Holden, Vice President, McGraw-Hill, Inc., 330 West 42nd Street, New York, N.Y. 10036, telephone (212) 971-2382.



## New literature

**Power switch and pilot light.** Airpax Electronics, Cambridge Div., Cambridge, Maryland 21613, has published an 11-page bulletin describing the type 203 electromagnetic circuit protector power switch and pilot light. The comprehensive information includes diagrams and charts. Circle 421 on reader service card.

**Optical systems.** General Electric, Semiconductor Product Dept., Electronics Park, Syracuse, N.Y. 13201, has available an application note on how to evaluate light emitters and optical systems for light sensitive silicon devices. [422]

**Broadband oscillators.** Two backward wave oscillators are described in a four-page technical paper available from the Siemens Corp., 186 Wood Ave. South, Iselin, N.J. 08830. [423]

**Printed-circuit board equipment.** Electrovert Inc., 86 Hartford Ave., Mount Vernon, N.Y. 10553. A four-page brochure includes the company's line of wave soldering, infrasoldering, cleaning, pc board assembly, soldercoating and fusing, solderability testing and armature soldering equipment. [424]

**Instrumentation.** The Singer Co., 3211 S. La Cienega Blvd., Los Angeles, Calif. 90016, has published a 16-page brochure describing the company's line of 33 products. They include several signal generators, antennas, rf current probes and meters. [425]

**Microminiature indicators.** A four-page brochure describes the line of microminiature indicators available from Shelly Associates, 1562 Reynolds Ave., Santa Ana, Calif. [426]

**Component networks.** An eight-page brochure from Corning Glass Works, Corning, N.Y., highlights a line of resistor-capacitor-diode networks. Included are advantages in design flexibility, component density and pc board space requirements. [427]

# Need efficient cooling in a tighter-than-tight spot?

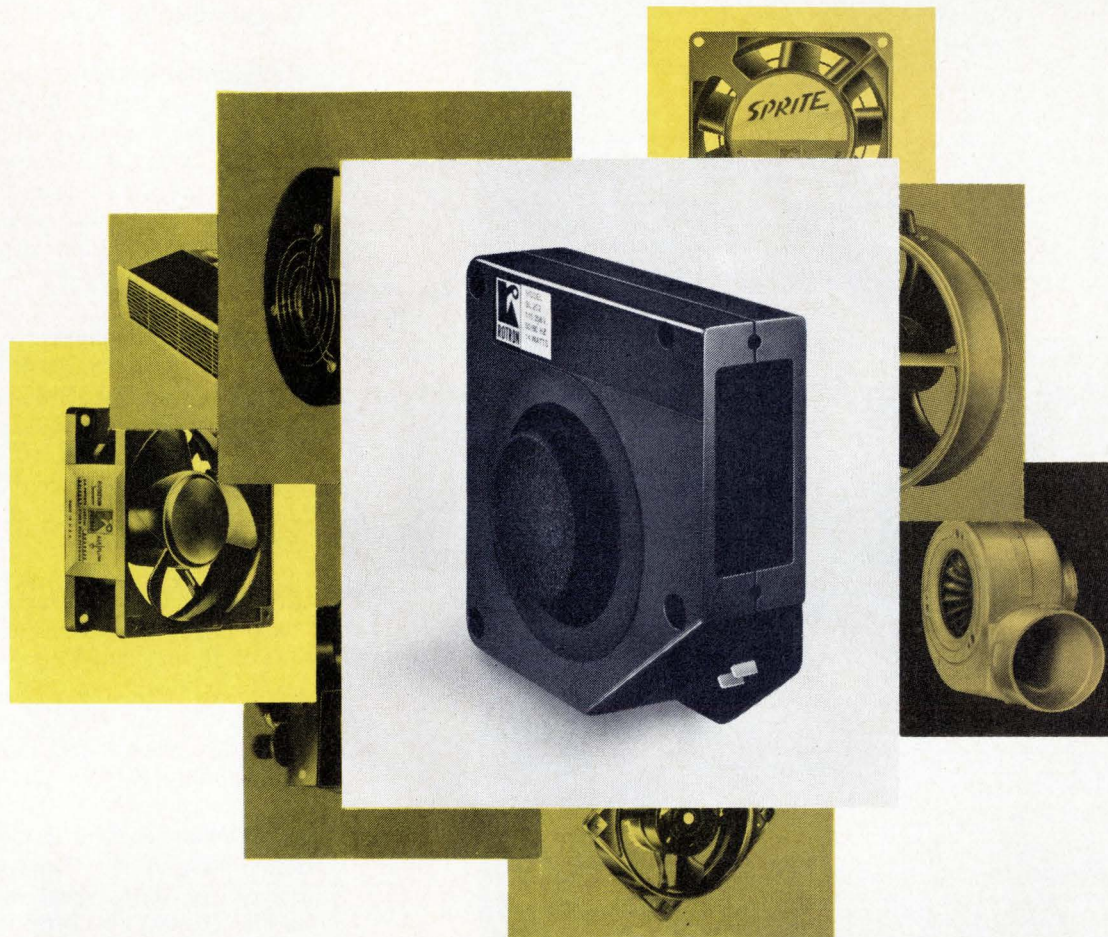

## Rotron® has the answer.

The **BISCUIT®** – Rotron's high performance centrifugal blower that is only 1 $\frac{1}{16}$ " thick. It works in really tight spots where no other can. It's the only 50-60 Hz air moving device that will fit inside a 1 $\frac{3}{4}$ " rack panel instrument.

Built around the proven features of the multi-million-installation Muffin® fan, the Biscuit is ideal where cooling air must be forced through tight passages or directed at high velocity over a hot component. It's impervious to moisture or dust, and will run reliably, quietly, and continuously for years without maintenance of any kind. It delivers up to 25 cfm for rack mounted instruments, projector lamps, power supplies, heat exchangers and sinks, core memories, computer terminals, and many office equipment applications.

Whatever your cooling or air moving need, next time you have one, take it to Rotron. As the world's leading manufacturer of precision air moving devices, Rotron has the answer to just about any problem you can pose. And at competitive prices that may surprise you. Ask and see. For more information right now, send for Biscuit Catalog Sheet H-3360.

*Why settle for less when the best costs no more?*



**ROTRON INC.**, Woodstock, N. Y. 12498 ☐ 914 • 679-2401 ☐ TWX 510-247-9033  
Pacific Div., Burbank, Cal. 91506, 213•849-7871 • Rotron N.V., Breda, Netherlands, Tel.: 49550, Telex: 844-54074

14992

**New, authoritative  
and indispensable . . .**

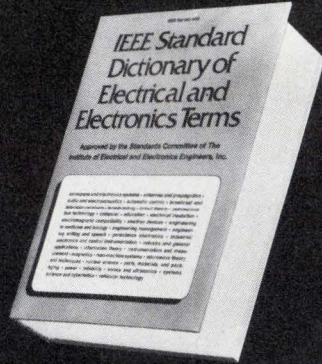

## IEEE STANDARD DICTIONARY OF ELECTRICAL AND ELECTRONICS TERMS

The product of decades of labor by thousands of engineers, scientists, and teachers, the *IEEE Standard Dictionary of Electrical and Electronics Terms* defines 13,000 technical words from every area of electrical and electronics engineering. Each definition is an official standard of The Institute of Electrical and Electronics Engineers Inc. The dictionary contains hundreds of new terms as well as revisions of earlier ones, making it the most up-to-date and complete single-volume reference of its kind.

### Here are some of its special features:

- **13,000 technical definitions, embracing the total technical language of electrical and electronics engineering**
- **over 700 pages, including more than 140 illustrations**
- **compilation by leading authorities in 31 fields of specialization**
- **extensive revision of previously published definitions to eliminate duplications and to reflect recent developments**
- **hundreds of new terms never before found in dictionary form.**

Just published 736 pages 142 illus. \$19.95

**WILEY-INTERSCIENCE**, Dept. 093-A 2697-WI  
a division of JOHN WILEY & SONS, Inc.  
605 Third Avenue, New York, N.Y. 10016



I'd like \_\_\_\_\_ copies of the *IEEE Standard Dictionary of Electrical and Electronics Terms* (0 471 42806-X) @ \$19.95 each.

- My check (money order) for \$\_\_\_\_\_ is enclosed.  
Wiley-Interscience will pay postage and handling
- Bill me. I will pay postage and handling.

Name \_\_\_\_\_ Title \_\_\_\_\_

Company \_\_\_\_\_

Address \_\_\_\_\_

City \_\_\_\_\_ State \_\_\_\_\_ Zip \_\_\_\_\_

**WILEY-INTERSCIENCE**

## New Literature

**Recorder.** Kontron Inc., P.O. Box 702, Princeton, N.J. A laboratory-type strip chart recorder is described in a product brochure. [428]

**Pc terminal boards.** A design guide is available from Kulka Electric Corp., 520 S. Fulton Ave., Mount Vernon, N.Y. 10551, covering technical data on four series of terminal strips for use with printed-circuit boards of the type designed for wave soldering. [429]

**Inductive components.** Cambridge Thermionic Corp., 445 Concord Ave., Cambridge, Mass. 02138. A 20-page bulletin includes design advice on the selection of filter types and a glossary of filter terms in addition to specifications of inductive components. [430]

**Keyboards.** Sixty-six-key and 53-key ASCII coded keyboards are detailed in a bulletin from Cherry Electrical Products Corp., 3600 Sunset Ave., Waukegan, Ill. 60085. Included are legends, formats and panel cutout dimensions. [431]

**Light beam recorder.** Gulon/Tecni-Rite, Rte. 2, E. Greenwich, R.I. 02818. A data sheet details the model TR-180 LB portable 18-channel light beam recorder. Information includes specifications, charts, and data on accessories. [432]

**Panel meters.** A handbook of digital panel meters is available from Digilin Inc., 1007 Air Way, Glendale, Calif. 91201. The comprehensive manual contains 60 pages of specific information on how to use DPMS, pitfalls related to common applications, and various forms of analog-to-digital conversion. Add-on options are also shown, including amplifiers, active filters, and linearizers. [433]

**Pollution monitor.** Theta Sensors Inc., 1015 North Main St., Orange, Calif. 92667. A technical data sheet is available describing the model SP-1000 source emission sample conditioning system that can be used as a fixed or a portable unit in air-pollution monitoring. [434]



## EMPLOYMENT OPPORTUNITIES

### SENIOR R&D ENGINEER

A multinational manufacturer in a strategic midwestern location has several extraordinary opportunities available for Senior Research Engineers.

The successful candidate will conceive, develop and carry out programs for exploration and exploitation of basic physical phenomena to create new and useful devices and/or subsystems.

These positions require a record of accomplishment with specific application experience in electronic devices, electro-optics, optics logic or circuitry research. The ideal candidate will be a creative, analytical individual who has had several patents or publications, a MSEE or PhD and at least three years applied research experience.

Are you interested in joining some of the world's outstanding scientists and engineers?

If so, send your resume plus complete salary history in complete confidence to:

**P-7072**

ELECTRONICS, Class. Adv., P.O. Box 12, N.Y., N.Y. 10036  
An Equal Opportunity Employer M/F

### POSITIONS VACANT

**Electronic Technicians, Relay Technicians**  
—Rapidly growing southwestern utility has immediate openings for qualified electronic and relay technicians. Electronic technicians must have a minimum of three years experience in installation, testing and troubleshooting all types of telemetering, supervisory, load control, power line carrier, microwave and mobile radio systems. First or second class F.C.C. license is required. Relay technicians must have a minimum of three years experience in installation, testing and troubleshooting all types of protective relaying, plant and substation control equipment. Experience with solid state relays desirable. Starting rate of both positions is \$5.49 per hour with excellent fringe benefits. Address complete resume of experience and education in confidence to: P-7004, Electronics. An Equal Opportunity Employer.

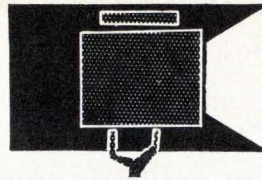

## SEARCHLIGHT SECTION

- CLASSIFIED ADVERTISING • BUSINESS OPPORTUNITIES
- USED OR SURPLUS EQUIPMENT

### AUTOTRACK MOUNT

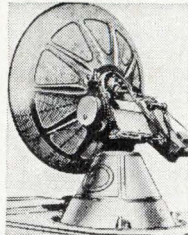

#### AUTOTRACK SCR-584 RADARS

360 degree azimuth, 210 degree elevation sweep with better than 1 mil. accuracy. Missile velocity acceleration and slewing rates. Amplidyne and servo control. Will handle up to 20 ft. dish. Supplied complete with control chassis. **ALSO** in stock—10 cm. van mounted radar system. Conical scan. PPI. 6 ft. dish. Ideal for S band telemetry, weather, balloon trk, missile trk, rocket trk, ECM range. Write for complete data. 600 pg. instr. bk. avail. at \$25 ea.

#### HAWK MISSILE DOPPLER RADAR

CW low power illuminator. AN / MPQ-33. Dual antenna on single mount. Van mounted. Complete X band doppler tracker.

#### PATH LOSS MEAS. FACILITY

Mfg. REL For establishing max. xmsn paths for tropo and microwave links. 2 heli-hut vans. Covers 1-2-5ghz bands. 20 to 120 watts CW output.

#### PHOENIX MISSILE SYSTEM

10" PPI. 5" B and C displays, and complete digital computer consoles.

#### IBM 704 SCIENTIFIC COMPUTER

w / peripherals & programs. Cost \$2,000,000. Our price \$10,000.

#### MIT MODEL 9 PULSER 1 MW—HARD TUBE

Output 30 kv at 70 amp. 30kv 40 amp. max. Duty cy. .002. .25 to 2 microsec. Also 5 to 5 microsec. and .1 to .5 microsec. Uses 6C21. Input 115v 60 cycle AC. Mfg. GE. Complete with driver and high voltage power supply. Ref. MIT Rad. Lab. Series, Vol 5, p. 152.

#### 2 MEGAWATT PULSER

Output 30 kv at 70 amp. Duty cycle .001. Rep. rates, 1 microsec. 600 pps. 1 or 2 msec. 300 pps. Uses 5948 hydrogen thyratron. Input 120 / 208 VAC 60 cycle. Mfr. GE. Complete with high voltage power supply.

#### 2 MEGAWATT HARD TUBE PULSER

Output 40kv at 50 Amps. Duty cy. .0038. Var. pulse width. Compl. with driver and HV power supply. Input 208V 60 hz.

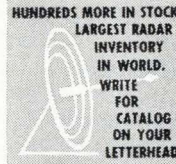

### RECON DRONE CONTROL RADARS

X Band systems autotrack and search complete with plotting boards. Fully mobile van mounted. Gives PPI, slant range, altitude data. Ground to air control links and beacons also in stock. AN / MPQ-29 & AN / UPW-1

#### AUTOMATIC TRACKING SYSTEM

SCI. ATL. MOD. 3101-J70 Antenna Pedestal. AZ-EL 15 deg. per second rated speed. 23 inch dia. bearing. Complete w / control console & mag. amplifiers.

#### SPARE PARTS IN STOCK

Nike Ajax, Nike Hercules, M-33, MPS-19, TPS-ID, TPS-10D, FPS-6, SPS8, SCR-584, HIPAR.

#### RADAR & RF PKGS.

34ghz 40kw Pulse RF pkg  
24ghz 40kw Pulse bomb toss system  
16ghz 130 kw Pulse B-58 search radar system  
**X BAND AUTOTRACK 250KW PULSE M-33**  
compl w / plot boards  
**X BAND AUTOTRACK 50KW PULSE B-47**  
fire control complete

#### C BAND 5 MEGAWATT PULSED KLYST.

AN / FPS-26 Ht. Finder

#### C BAND 1 MEGAWATT AUTOTRACK

10ft dish mortar locator MPQ-21

#### C BAND 285KW PULSE Search AN / SPS-5 / 10

S BAND 1 MEGAWATT COHERENT AN / FPS-18

#### S BAND 1 MEGAWATT PULSE NIKE ACQ.

L BAND 1 MEGAWATT PULSE AN / UPS-1

#### L BAND 500KW PULSE AN / TPS-ID / E

#### L BAND 5 to 20KW PULSE

400mhz 1KW CW AN / FPS-23

225mhz 1 MEGAWATT PULSE AN / SPS-28

2-30mhz 100KW PULSE

CW .950-5ghz 150 WATTS

CW 1.5mhz-10.5ghz 5 WATTS

CW S & X BANDS 300-600WATTS

#### AN / GPG-1 SKYSWEEP TRACKER

3 cm. auto. tracking radar system. Comp. pkg. w / indicator sys. Full target acquisition & auto. tracking. Input 115v 60 cy. new. In stock for immed. del. Entire sys. 6' x 3' x 10'. Ideal for infrared tracker, drone tracker, missile tracker, R & D.

#### CATV-COLOR MICROWAVE LINKS

Ratheon type KTR-1000. Fullcolor bandwidth as well as studio audio. Rack mounted. Complete trans-recvr racks in stock.

## Radio-Research Instrument Co. INC.

3 Quincy St., Norwalk, Conn. 06850 • 203-853-2600

CIRCLE 951 ON READER SERVICE CARD

### Somebody— Somewhere

needs your idle equipment! Reach that buyer quickly and economically thru the

### "SEARCHLIGHT SECTION"

The meeting place of Used Equipment Buyers and Sellers

### Radiation Devices Co.



OEM'S — BROADCASTERS  
UNIVERSITIES — SERVICE COMPANIES

Review Our Economical Line of Instruments, Accessories, and Signal Processing Components Spanning The Frequency Range From D-C to 2 GHz. To Get Best Value For Your Electronics Dollar. Brochures and Application Notes Are Available Upon Your Request.

RADIATION DEVICES CO., BOX 8450, BALTIMORE, MD. 21234

CIRCLE 952 ON READER SERVICE CARD

### FREE CATALOG

#### HARD-TO-FIND PRECISION TOOLS

Lists more than 1700 items—pliers, tweezers, wire strippers, vacuum systems, relay tools, optical equipment, tool kits and cases. Also includes four pages of useful "Tool Tips" to aid in tool selection.



JENSEN TOOLS and ALLOYS  
4117 N. 44th Street, Phoenix, Arizona 85018

CIRCLE 953 ON READER SERVICE CARD

BUSINESS

PERSONNEL

SELLING

EQUIPMENT

FINANCIAL

### OPPORTUNITIES

May Be Sought From, or Offered To, the Readers of This Publication Through Its Classified Section

The Searchlight and Employment Sections

Variable compression  
mica capacitors:

# Small, Inexpensive, Wide-range, Go-anywhere Capacitance Packages

(Try 'em . . . you'll like 'em!)

Do you need a capacitor you can adjust from 1400 to 3055 pF (or almost *any other* range down to 0.9 to 7.0 pF)? As small as  $\frac{3}{8}$ " x  $\frac{1}{32}$ "? That mounts by *any* method, in *any* location, including PC applications? That has a high Q, smooth adjustment, low inductance, excellent thermal stability and resistance to shock, vibration and humidity?

*And that you can buy in quantity, off the shelf, typically for 15¢ each?*

It will pay you to look into EI-Menco variable compression mica trimmers and padders—the "old reliables" whose highly developed characteristics and extremely wide line today make them the capacitors of choice in hundreds of state-of-the-art communications, instrumentation, audio and military electronics equipment. For example: in RF, oscillator and FM antenna circuits . . . HF bias (tape) from 85 to 95 kHz . . . phase control circuits . . . compensation for other components . . . SSB 2.0 MHz channel strips. And perhaps one of these possibilities gives you an idea: coax cable line termination, pulse transmission, an equalizing/matching network, a low-Q tone generator, or padding in a TV circuit, power supply or home appliance.

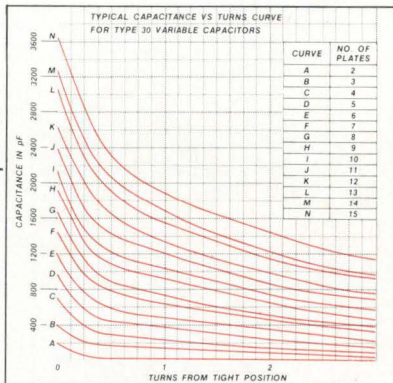

WRITE FOR COMPREHENSIVE TECHNICAL DATA:

a recent technical article reprint  
and a 29-page set of data sheets  
are yours for the asking.  
Send request directly to:

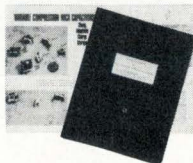

**EI-Menco**

**THE ELECTRO MOTIVE MFG. CO., INC.**

Willimantic, Conn. 06226

West Coast: Collins and Hyde Co.  
Nationwide: Arco Electronic Distributors

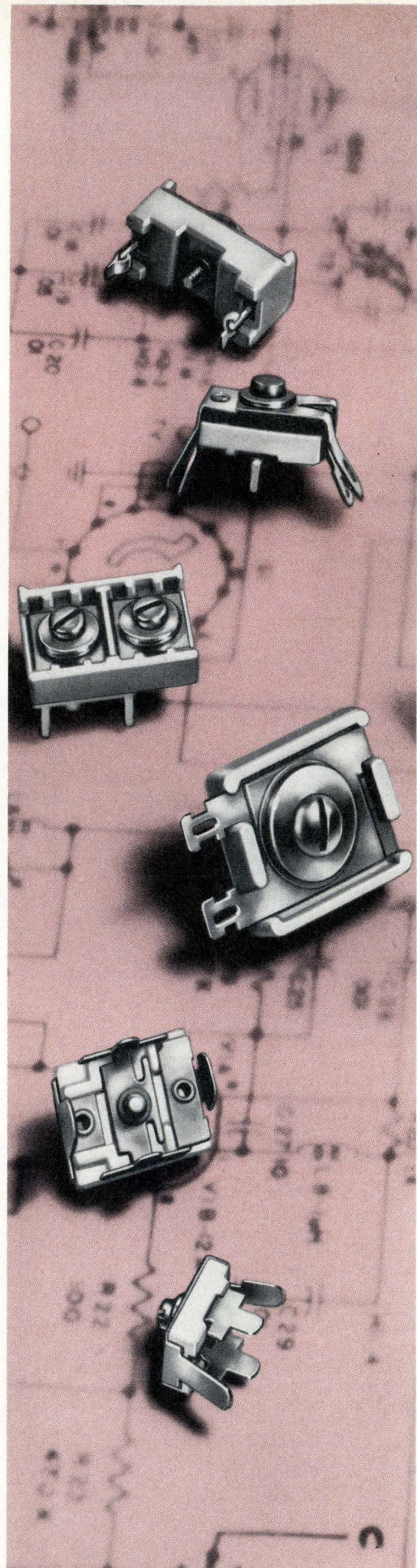

---

# International Newsletter

---

March 13, 1972

## IBM reduces prices in Germany, Japan

IBM heated up the competition in Japan and Germany by decreasing prices in effect since September 1969 on System/370, 3, and 7 mainframes and peripherals. **In Germany, prices were reduced 3.8%, effective March 1 for purchases and April 1 for rentals.** In Japan, reductions were effective March 1, for both rentals and purchases of the System/370 mainframe and some attachments, the System 3/6 mainframe and a number of peripherals, the System/7, and the model 129 data recorder. **Reductions in Japan averaged 1.3% for the System 370 CPU and 8.6% for I/O devices,** a spokesman said, with variations according to the equipment. Reductions on a complete System/370 average 3%, he added, although prices abroad are still higher than they are in the U. S.

## Thin film used for alterable memories

Another avenue to alterable holographic memories has been paved by development of a thin film of arsenic selenium germanium glass by the Musashino Electrical Research Laboratory of the Nippon Telegraph & Telephone Public Corp. Information can be stored in holograms or in any other format possible with ordinary photographic plates at about the same resolution. The thin film is composed of glass evaporated on a substrate as a 0.5- to 1-micrometer-thick layer. In its annealed state, it has fairly high light transmission capability. **For writing, a light beam with energy density of about 0.1 joule per square centimeter darkens the material to a contrast ratio on the order of five or six to one, also changing the refractive index slightly.** Holograms thus produced are brighter than those based on density difference. **A light beam with energy density of several joules per square centimeter can erase selectively, or an entire plate can be erased by heat annealing.**

## Japanese to buy Philips computers

Philips has received the largest single foreign computer contract in its history. Worth nearly \$2.4 million over the next three years, the order came from a Japanese electric company, a spokesman in Germany says, but he declined to identify the customer. The order is for 200 small programable models, P850, P855, and P860, to be used primarily for technical-scientific problem solving, process control, and intelligent terminals. **The P800 computers are built by Philips Electrologica,** a subsidiary of the Dutch Philips Gloeilampenfabrieken.

## Facsimile uses compression. . .

Subscribers using a new high-speed digital facsimile system between Tokyo and Osaka, Japan, will save enough on leased-line charges in a year to pay for the new equipment, says the developer, Fujitsu Ltd. **The system uses bandwidth compression on ordinary telephone lines with a bandwidth of 0.3 to 0.4 kilohertz, rather than the 48-kHz bandwidth required with present high-speed analog systems.** The company, now taking orders, plans to begin shipping equipment in June or July. The new system sends data at 4,800 bits per second, with resolution of six lines per millimeter.

Using a so-called run-length system, a digital signal indicates distance along a scanned line from the last previous change. Two lines are scanned at a time, with pick-up of two picture elements on each line.

---

# International Newsletter

---

## **. . .to transmit on telephone lines**

Three of these elements are considered references, and the fourth element is a check to assure that it has the value predicted by the algorithm from the other three. If the value differs, that signal is sent.

Information sensed in excess of transmission capability is stored in memory until it can be sent. The system uses a one-line n-channel MOS buffer memory of about 8 kilobits and a supplementary memory of several tens of kilobits to store data in excess of a modem's transmission capability. **Transmission time averages 40 to 50 seconds for an ordinary printed page of book size.**

## **International group to build ESRO satellite**

**West Germany's Messerschmitt-Boelkow-Blohm GmbH will head a consortium to develop and build the \$23 million gamma ray research satellite, COS B, for ESRO, the European space research organization.** Members of the consortium are the U.K.'s British Aircraft Corp., Spain's Construcciones Aeronautica SA, Belgium's Etudes Techniques et Construction Aerospatiale, Italy's Selenia, and France's Société Nationale d'Industrie Aerospatiale.

**COS B, weighing 280 kilograms, is to be launched into orbit Sept. 1, 1974, from Kourou, French Guiana, aboard a Europa 2 launch vehicle.** The main objective of the satellite is to study gamma radiation, especially energy spectrum, intensity, and distribution of direction of incoming radiation. The scientific payload weighs about 120 kg.

## **Philips Plumbicon is Toshiba target**

Toshiba, taking dead aim at the color TV vidicon market now dominated by Philips Plumbicon tubes, has launched its Hisensicon E5040 series, made with a lead oxide photoconductive layer. **Toshiba says its tube is a plug-in replacement for the 30-mm Plumbicon, but does not infringe on Philips patents.**

## **New computers due from East Germans**

**Watch for the East German electronics industry to unveil the initial model of a third-generation computer family and a third-generation process computer March 12-20 at the Leipzig Spring Fair.** The new series from state-owned VEB Kombinat Robotron, will succeed the country's workhorse Robotron R300 second-generation machine. Western experts say the new computers have been developed at the urging of the East German government. **Development is said to have been coordinated with other East-bloc countries to avoid duplication of designs.**

## **IR vidicon operates at room temperature**

**Infrared TV Vidicon tubes that operate at room temperature are being offered by English Electric Valve Ltd. in sample quantities for \$2,600 each.** The company, seeking to overcome the requirement for nitrogen-cooled point detectors with mechanical scanning, has been working for many years on the development [*Electronics*, International, Nov. 9, 1970].

**The tube, 6¼ by 1½ inches, is said to achieve thermal resolution near 1°C in the 8-14-micrometer waveband, producing a 100-line TV picture at standard frame rates.** For static scenes, the tube needs a chopper in front because the pyro-electric target gives an output only when the radiation incident on it is changing.



## Laser link hops 3.4 miles, even in poor weather

Siemens connects two Munich plants with a 14-inch beam that diverges to 6 feet

**Scrapping the popular** image of a laser beam as a pencil of light with a nearly uniform diameter from one end to the other, engineers at Siemens AG have deliberately widened the beam to build a virtually all-weather communications link.

Over an experimental 3.4-mile link connecting two Siemens facilities in Munich, researchers have achieved excellent communications even at atmospheric attenuation levels of 8 decibels/kilometer—much higher than the level at which other laser links falter.

The most striking physical feature of the Munich link is its unusually thick laser beam. More than 14 inches in diameter when it leaves the transmitting station, the beam diverges to nearly 6 feet at the receiver. This divergence, together with the use of a carbon dioxide laser, accounts for the link's high immunity to atmospheric conditions.

**Window.** The infrared ray of the CO<sub>2</sub> laser is far less weather sensitive than is the visible beam of a helium-neon laser because its wavelength falls within an atmospheric "window." The link's laser has a wavelength of 10.6 micrometers, and output power is 5 watts.

The large beam divergence insures that even under unfavorable conditions at least part of the transmitted laser energy arrives at the receiving terminal, where the beam

may shift as a result of disturbances by as much as three feet before it misses altogether.

Only when atmospheric disturbances cause an attenuation exceeding 8 dB/km has the present setup failed to function satisfactorily. Above that level, Siemens says, even a CO<sub>2</sub> laser beam is subject to meteorological factors, such as absorption of water vapor and carbon dioxide in the air, scattering of light by minute water or dust particles, or air turbulences resulting from lateral wind currents or solar radiation. These factors cause the beam to bulge out, to shift, or to vary in intensity.

**More to come.** The Siemens researchers are confident, however, that with certain system refinements, the limiting atmospheric influences can be made to have a less critical effect. They are considering the use of heterodyne principles together with optical narrow-band filtering. Another idea is to employ a higher powered laser. Such design factors should result in a five-fold improvement in performance, making possible laser communications through the free atmosphere at attenuation levels of 40 dB/km, or 200 dB over the 3.4-mile link.

At its present state of development, the experimental system allows communications at visibility distances as small as 1,000 yards—in other words, communications are possible even through heavy haze, moderate rainfall, fog, or snow. The link which is set up between two Siemens facilities in Munich's Oberseending and Giesing sections, crosses one river, two heavily-used traffic arteries, and three streetcar lines. Most other experimental links,

a Siemens man says, are set up in flat terrain and in more favorable environments.

The 3.4-mile experimental link consists of two terminal stations using Cassegrain telescopes in their optical antennas. Each telescope is made up of a concave objective mirror lens about 14 inches in diameter and a convex ocular lens measuring roughly 1.25 in. in diameter. The distance between lenses is 70 in.

**Path.** The modulated laser beam goes through an axial opening in the objective lens to the ocular lens, which reflects and at the same time fans out the beam. It then bounces off the objective lens and is finally radiated from the telescope.

The information to be transmitted is modulated at the sending terminal onto the CO<sub>2</sub> beam by way of a gallium-arsenide modulation crystal, which converts the electrical signals into intensity-modulated laser signals. At the receiving end, a small focusing lens projects the beam coming from the receiving telescope onto the detector. This detector, a germanium semiconductor type doped with gold atoms and cooled by liquid nitrogen, changes the received laser signals back into electrical signals using its inherent photoconduction effect.

---

### Great Britain

---

Automating check-out of mobile radio transceivers

With its output of mobile radio transceivers expanding at a 10% to 15% annual rate—and demand rising at least as fast—Pye Tele-

communications Ltd. had a hard time finding enough trained personnel for its check-out staff. So it decided to find another answer.

Now on line is completely automatic test gear that can check out transceivers all the way up to transmission frequencies, which in Britain can reach 470 megahertz. The old check-out routine called for automatic testing at dc and low-frequency ac—up to 450 kilohertz. But all radio frequency tests were done manually or semiautomatically. Pye's new equipment, developed with Marconi Instruments Ltd. and Honeywell Ltd., relieves a bottleneck in production, which last year totaled about 70,000 transceivers.

Marconi has supplied two complete auto-testers and Honeywell one. All are designed to process between 7,000 and 8,000 printed circuit boards or about 800 complete sets in a 60-hour week. So far, one Marconi tester is fully operational, checking out about 400 transceivers and 3,000 boards a week.

**Two-way improvement.** John Churcher, Pye's quality assurance manager, says its performance so far indicates a rate of return on investment of about 30% from two improvements alone—a reduction in final test time for a complete set from 30 minutes to 3 minutes, and a much lower defect rate at final test due to vastly improved printed circuit board testing.

The fault rate at final test has dropped from an average of approximately one per transceiver to one per six transceivers. This rate of return on investment does not count spin-off benefits such as fewer warranty service claims due to more accurate testing or the improved feedback from production to design because full test result print-outs are available.

Churcher says that as far as he knows no mobile radio maker has automated testing above 10.7 MHz—a common i-f frequency. At the final test stage, auto-testing means that approximately twice the number of tests can be applied—about 45—with an order of magnitude greater accuracy, and in an order of magnitude less time. For board tests it's not so

easy to generalize, but roughly speaking Pye has doubled the number of tests per board, which can be done in 25% less time. Both time comparisons include loading and unloading.

Because auto-testers can be operated by relatively unskilled workers, it has been possible to move the small number of more highly skilled testers up from testing to fault diagnosis, easing one of Pye's other labor problems. These men use the auto-test print-out to locate faulty components.

**Some handwork.** Alignment of transmitter and receiver is still carried out manually, because it's not possible to automate that function completely and semiautomation wastes a disproportionate amount of autotester time. Thus, Churcher says, the best economic tradeoff is to do it entirely manually.

Churcher cautions that anybody wanting to automate testing ought to do some deep thinking to determine where best in the production process to do the tests—and how many to do—to get the best return on the large capital outlay involved.

The best distribution of tests, says Churcher, is ultimately determined by the incidence of statistically random component failures, which the test systems engineer must know. Pye started off applying a blanket check involving about 40 tests to an average board, but by re-arranging the tests into a graded sequence based mostly on probability, Churcher has cut the average to about 15 without increasing defects in assembled equipment.

---

### Multiplexing cuts error rate as channels decrease

Two electronics teachers, applying what they teach, have built a digital data multiplexer working on a new principle. They've taken up an idea proposed by a German engineer, Henning Harmuth of Leopoldshafen, that information can be carried in modulated code words.

The way the two men—Robert Barrett and John Gordon of Hat-

field Polytechnic at Hatfield, Hertfordshire—have worked it out, the system has an advantage over time-division and frequency-division multiplexing. Its transmission error performance improves automatically, without any manipulation or extra circuitry, as the number of channels in use falls off from the maximum available. If a system is built for standard error performance with all channels in use—which will cost no more than for TDM or FDM, according to Gordon—there is a bonus of free extra reliability during off-peak periods.

The work has been financed by the Defence Ministry's Signals Research and Development Establishment (SRDE), which may take it up at some future time. For the military, the potential advantage is that deliberate suppression of some channels could provide a very high degree of freedom from errors, if that were necessary. On the snag side, an individual system is at present limited to seven channels, so that there may be problems in fitting it in with conventional 12-channel systems.

**In code.** Basically, a digital code word transmitted unaltered represents a 1 and transmitted inverted represents a 0. The received signal is demodulated by comparing it with the original code word. Obviously, transmitting a whole code word of several bits to represent a single data bit is grossly wasteful.

The achievement of the two researchers is in working out how to reduce the number of transmitted bits to equal the number of data bits, plus an allowance for synchronizing bits. They claim the data content of the pulse stream is the same as for tdm, and they lose nothing in obtaining better error performance at part capacity, at least in a seven-channel system.

Each of the seven channels has its own individual code word, seven bits long, which is repeated indefinitely together with an eighth synchronizing bit. The seven words are exactly parallel, in the same time slot. Each is a combination of three 0s and four 1s, which is reversed when the word is inverted to trans-

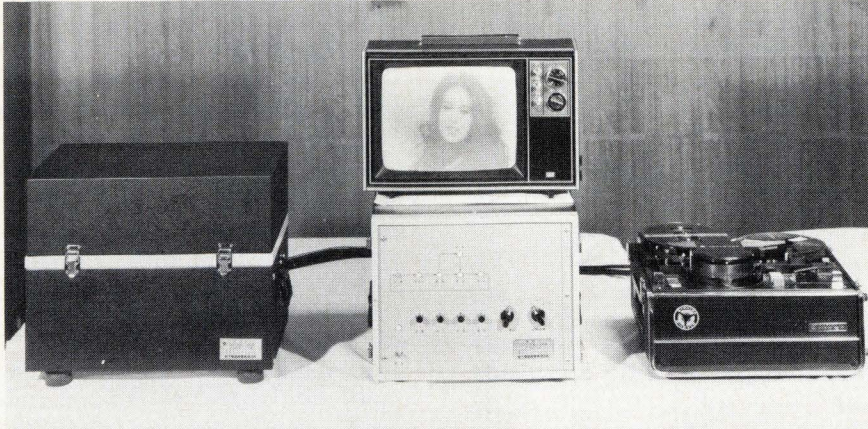

**Black box.** Two-speed magnetic sheet recorder is the heart of narrowband telephone TV system. Both transmitting and receiving station (above) have one.

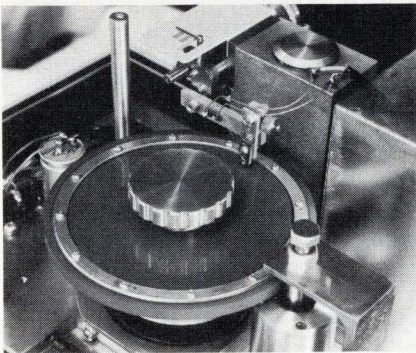

ter and comparing it with the code word hard-wired into a majority gate. The gate produces an output if there are more like characters than unlike. Hence there are seven demodulation gates, one per channel.

Gordon has a laboratory setup to demonstrate that this system of multiplexing by majority vote and demultiplexing by comparison and majority vote works accurately. However, he can't find more than seven code words that give unambiguous results. And he hasn't worked out a theory of why the error self-correction properties of the system improve as the number of channels in use decreases.

But by introducing deliberate random errors, he shows that performance improves until, when only three channels are in use, all single-bit errors in received seven-bit frames are corrected automatically in demodulation. When only one channel is being used, incoming frames can have up to three bits wrong and the demodulated data is still correct.

## Japan

### Video sheet recorders drive narrow-band TV telephone

While telephone administrations the world over debate on the future of television telephones and the re-

quired bandwidth, engineers at Matsushita Electric Industrial Co.'s Wireless Research Lab have developed an efficient method of transmitting television pictures over ordinary telephone lines.

The limited information transmission capacity of the telephone line restricts the system to still pictures, but there is no requirement that the object or diagram being televised be stationary because the still picture can be an instantaneous snapshot of the moving image picked up by a camera.

A single field extracted from a camera signal is stored in a video sheet recorder at the sending end. After the field has been recorded, its time scale is lengthened from the normal 1/60 second to 30 seconds by slowing down the recorder. This conversion decreases the maximum frequency sufficiently so that a signal can be transmitted over a normal 0.3- to 3.4-kilohertz telephone channel.

**Fields.** At the receiver, another sheet recorder records the incoming signal at the slow time scale and then reproduces it in the normal time scale. The signal is then recorded on a video tape recorder that has had its mechanism modified for intermittent motion of the tape. The tape, stationary for the recording and playback of individual fields, advances between fields. This permits continuous reproduction of individual fields, which appear as stationary images on the monitor until the next field has been completely received and transferred from the sheet.

The tape recorder acts as a file memory for the fields that have been received. Fields are displayed continuously for about 50 seconds, which includes the 30 seconds required for transmission of each succeeding field and the 12 seconds needed to accelerate the sheet recorder up to the normal-time-scale speed.

The system only transmits one of the two fields making up each frame of the television picture. This is a compromise between resolution and shorter transmission time. The bandwidth of the video signal is lim-

mit a data 0. The code words are generated in parallel in a function generator, pass through a modulator where they are inverted or left alone, and then, still in parallel synchronism, pass bit by bit into a majority voting gate.

This gate scans the first bit of all seven words, and puts out a 1 if there are more 1s than 0s in the seven leading bits, and a 0 if there are more 0s than 1s. Because there are seven channels, there must always be a clear majority. This action is repeated for the second bits, third bits and so on. Thus, the majority gate puts out a seven-bit word representing the seven parallel data bits in the seven channels. It is this word that is transmitted.

At the receiving end, the transmitted word is compared, bit by bit, with all seven unmodulated code words. If the transmitted word is more like a code word than it is unlike, a transmitted data 1 is registered. If it is more unlike than it is like, a data 0 is registered.

The demodulation is done by feeding the transmitted word into a seven-bit parallel-output shift regis-

ited to somewhat more than half that of the original signal, both to give equivalent resolution in horizontal and vertical directions and to achieve a further saving in transmission time.

**Retaining resolution.** Overall resolution of the transmitted picture is at least 200 lines horizontally and 170 lines vertically. The signal-to-noise ratio of received pictures is at least 30 decibels, which is more than sufficient for transmission of head images of individuals or even groups of several persons, large letters, and even not too complex diagrams.

Scan conversion is performed by a newly developed video sheet recorder. In this unit, the head remains at the same location until the track underneath it becomes worn out, and then the head is advanced to the next track manually. However, track life is extremely long because the head merely rests on the sheet, with a force of several grams supplied by gravity. When all tracks become worn out, replacement of the magnetic sheet is simple.

The sheet provides the required scan conversion by rotating at 3,600 revolutions per minute for recording or playback of standard television signal, and 2 rpm for playback or recording of the narrow-band video signal.

**Two-motor drive system.** The turntable is mounted directly on the shaft of an induction motor used for high-speed drive. A sheet with a magnet embedded at one point rotates on the same shaft and operates a reed switch, which senses both speed and phase of the turntable to control motor slip. Low-speed drive consists of a brushless dc motor, which drives a rubber tire on the turntable rim.

A single field signal is initially recorded as a frequency modulated carrier that has frequency of 3.5 megahertz at sync pulse peaks and 5 MHz at white peak. Because the original video signal has frequency components up to about 3 MHz, there are sidebands that make the spectrum of the modulated signal extend from about 0.5 MHz to about

6.5 MHz. However, much of the upper sideband is cut off because it exceeds the frequency capabilities of the recorder.

When the turntable is switched to low, reproduced frequencies become 1/1,800 of their original frequency, reducing the white peak to 2.78 kilohertz and the sync pulse tips to 1.94 kHz. The lower sideband—which extends down to about 278 Hz—is almost completely transmitted, but much of the upper sideband exceeds the capability of the telephone transmission line.

---

### France

---

#### TI harvests technological crop of ideas in Europe

Texas Instruments is reaping unexpected bonuses from its widespread European operations as its own foreign employees contribute technology that can be applied in other TI plants. Two recent examples are a new process for automatic gate alignment originated by the French staff and a new highly-automated bonding machine designed and built by the German staff of TI-Deutschland, with an assist from U.S. specialists.

And the French are especially proud that TI's new SATO process, for self-aligned thick oxide, [*Electronics*, Jan. 3, p. 89] for use in large-scale integration MOS circuitry was developed in large part from work done in the laboratory at Ville-neuve-Loubet, just up the French Riviera from Nice. "Admittedly, the reverse is more often true," says one Frenchman who helped conceive the process. "Usually we are the beneficiaries of advancements made on the American side."

The French R&D team spent about three years working out its so-called Samnos method, for self-aligned metal nitride oxide semiconductor. TI in Dallas followed the French work closely as it was reported in the regular monthly technical reports that foreign plants make to the home office. U.S.-based TI engineers also looked in on Sam-

nos progress on their periodic visits to the French plant.

The American researchers took up a parallel project and emerged with SATO, which was put into production commercially a few months ago. Exactly how much the Americans borrowed and how much they developed on their own remains a delicate subject in the atmosphere of rivalry that resulted between the two contributing teams.

The French say the two techniques are "very similar" except that the French were using metallic masking techniques. "Our work was valued by Dallas," one researcher says, "and there's no doubt we were ahead much of the way and played a key role in SATO's development."

SATO is being promoted as a process that beats the other three standard methods of MOS LSI gate self-alignment—silicon gate, molybdenum gate, and ion implantation. In SATO, the gate electrode overlaps the source and drain region but is separated from the diffusion by thick oxide. TI says its "significant departure" from the other three self-alignment methods was the use of silicon nitride as a diffusion and oxidation mask. The high density of silicon nitride makes a 1,000-angstrom layer sufficient to serve as an effective mask.

**Bonder.** On the mechanical side, TI's German staff came up with plans for a new bonding machine. Dallas liked the idea well enough to provide special development funds for the project about a year ago. The result is a still-secret bonder that, according to TI-France production manager Bernie Yurin, increases production 260% on 14-pin circuits. It is being built in Germany, Italy, France, Formosa, and Singapore and machine installation already is well under way.

Stewart Carrell, TI's vice president in charge of European operations, is a believer in multinational input in the electronics industry. Aside from technical benefits, Carrell says, he likes individual plants to have a mixture of "nationalities and mentalities" in management. "It enhances communications immensely," he says.

# LOW-COST, MODULAR CONTROL SYSTEMS

numerical & computer



Quickly built with field-proven modules customized to your exact need, but giving you the benefit of production-type economies. Open and closed loop control types, pluggable integrated circuits. Operator training, field service furnished. Software and optional equipment available. Prompt quotations, fast delivery. Free literature and technical bulletins on request.

**ELECTRONICS HOUDAILLE**

ELECTRONICS DIVISION, HOUDAILLE INDUSTRIES, INC.  
9023 Wehrle Dr., Clarence, N.Y. 14031 716-632-8412

Circle 243 on reader service card

# BUCKEYE

Buckeye Instrument Knobs are made in matching series to give your instruments quality and continuity in design. Available in six basic sizes and six styles with colors and variations to match specifications. The ideas, cooperation and reliable service of our knob craftsmen to supplement the quality of fine knobs demanded by leading instrument manufacturers -- is at your "beck and call." Write today for free selector guide and tell us of your knob requirements.

the **BUCKEYE** stamping co.

555 Marion Rd., Columbus, Ohio 43207

"QUALITY PRODUCTS  
SINCE 1902"

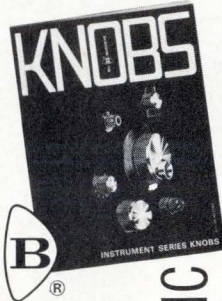

# KNOBS

Circle 244 on reader service card

Send your electrical contact requirements to—

# NEY

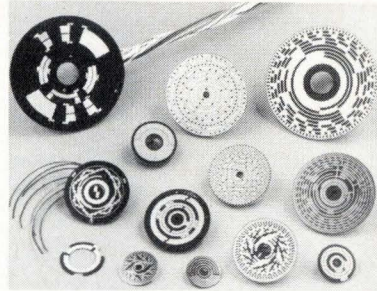

**NEYETCH  
COMMUTATORS  
AND SLIP RINGS**

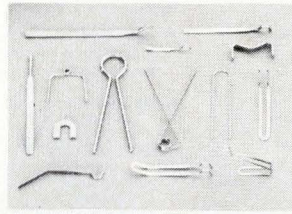

**WIRE FORMS**

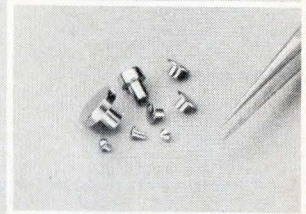

**HEADED CONTACTS**

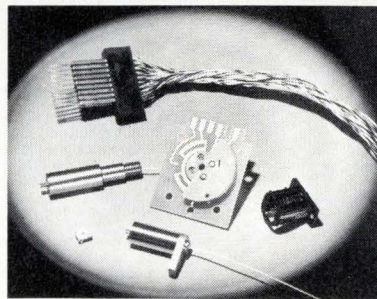

**ASSEMBLED  
COMPONENTS**

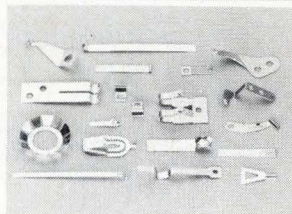

**STAMPED AND  
FORMED CONTACTS**

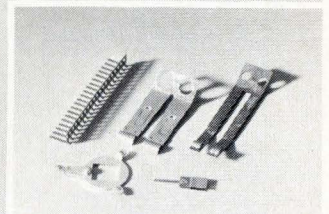

**WELDED AND  
STAKED ASSEMBLIES**

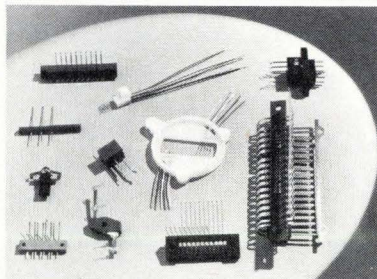

**MOLDED  
CONTACT  
ASSEMBLIES**

PALINEY®, NEYORO® ALLOYS

62 PAGE CATALOG ON REQUEST

**THE J. M. NEY COMPANY**

Maplewood Ave., Bloomfield, Conn.  
TEL. HARTFORD 242-2281 (area 203)

# NEY

Circle 187 on reader service card

D1

# Electronics advertisers

March 13, 1972

■ <b>Abbott Transistor Labs., Inc.</b> Technical Adv. Agency	6	<b>General Automation, Inc.</b> Jordan Advertising & Marketing Services, Inc.	131	■ <b>New Product Engineering</b> The Charles Brunelle Company	172
■ <b>Advanced Micro Devices</b> Keye/Donna/Pearstein	10-11	■ <b>General Radio Co.</b> GRAD Associates	111, 144	■ <b>Ney and Company, J. M.</b> Peck Adams, Inc.	D1
■ <b>AEG Telefunken</b> Werbeagentur	26E	■ <b>Gould, Inc., Instrument Systems Division</b> Carr Liggett Adv., Inc.	107	■ <b>Nicolet Instruments Corp.</b> Hagen Advertising, Inc.	153
■ <b>Airpax Electronics/Controls Division</b> Van Mourik and Associates, Inc.	42	■ <b>Grayhill, Inc.</b> Carr Liggett Advertising, Inc.	173	■ <b>Nippon Electric Co., Ltd.</b> Hakuhodo, Inc.	114
■ <b>Allen Bradley</b> Hoffman York, Inc.	17	■ <b>Grelex Industries Division of General Microwave Corp.</b> Industrial Marketing Associates	110	■ <b>Norden Division of United Aircraft Corp.</b> Cunningham & Walsh, Inc.	2
■ <b>Alpha-Systron Donner</b> Bonfield Associates	156	■ <b>Heath/Schlumberger Scientific Instruments</b> Advance Advertising Services	173, D3	■ <b>North Atlantic Industries, Inc.</b> Helme Associates, Inc.	112
■ <b>American Electronic Laboratories, Inc.</b> Ernest William Greenfield, Inc.	124	■ <b>Hermes Electronics Ltd.</b> Public & Industrial Relations Limited	140	■ <b>Olympus Optical Co. Ltd.</b> FUJI Agency	39
■ <b>Amphenol Industrial Division, Bunker Ramo Corp.</b> Marsteller, Inc.	24	■ <b>Hewlett-Packard</b> Dorland Advertising Ltd.	19E, 21E, 22E, 23E	■ <b>Panasonic Battery &amp; VTR Div.</b> Dentsu Corporation of America	119
■ <b>Analog Devices, Inc.</b> Kalo & Schneider, Inc.	158	■ <b>Hewlett-Packard/Loveland Calculator Division</b> Tallant/Yates Advertising, Inc.	18-19	■ <b>Permag Corporation</b> Schneider, Allen, Walsh, Inc.	148
■ <b>Analogic Corporation</b> Grover and Erickson, Inc.	72-73	■ <b>Hewlett-Packard</b> Richardson, Seigle, Rolfs & McCoy, Inc.	1	■ <b>Philips Electronics Instruments</b> J + M Condon, Inc.	91
■ <b>Anritsu Electric Co. Ltd.</b> Diamond Agency Co. Ltd.	29E	■ <b>Hewlett-Packard</b> Richardson, Seigle, Rolfs & McCoy, Inc.	33	■ <b>Philips Gad Elcoma</b> Tag-Intermarco delamar	43, 101, 14E-15E
■ <b>AOIP</b> DP Industrie	11E	■ <b>Hickok Electrical Instrument Company</b> Key Marketing Associates	173	■ <b>Philips N. V. Pit/T &amp; M Division</b> Marsteller International S. A.	2E
■ <b>Asahi Glass Co. Ltd.</b> Asia Advertising Agency, Inc.	104	■ <b>Hitachi Metals Ltd.</b> Asia Advertising Agency, Inc.	D4	■ <b>Phoenix Data</b> Craig Miller Advertising	138
■ <b>Augat</b> Creamer, Trowbridge, Case & Bastford, Inc.	128-129	■ <b>Houdaille Inds., Inc., Electronics Div.</b> John E. Hayes Co., Inc.	D1	■ <b>Plastics Engineering Company</b> Kuttner & Kuttner, Inc.	22
■ <b>Automatic Electric Co., Sub. of General Telephone and Electronics Corp.</b> Marsteller, Inc.	54-55	■ <b>Hughes Aircraft Company</b> Foote, Cone & Belding	40-41	■ <b>Plessey Semiconductors</b> Roles & Parker, Ltd.	170
■ <b>AVX/Aerovox Corporation</b> Lescarboura Advertising, Inc.	35	■ <b>Hutson Industries</b> Warren Associates	174	■ <b>Pratt &amp; Whitney Div. of United Aircraft Corp.</b> B. E. Burrell & Assoc.	175
■ <b>Beckman Instruments, Inc., Helipot Div.</b> N. W. Ayer/Jorgensen/MacDonald, Inc.	104	■ <b>Hybrid Systems Corp.</b> Susan E. Schur	37	■ <b>Raytheon Company</b> Cossar Instruments Operation	161
■ <b>Bell &amp; Howell Electronics &amp; Instruments Group</b> Coordinated Communications, Inc.	82-83	■ <b>IEL/ITF IEA Exhibition</b> Clements Frankis Powell, Ltd.	165	■ <b>RCA Ltd.</b> Marsteller, Ltd.	12E-13E
■ <b>Bendix Corporation, Electrical Components Div.</b> D'Arcy-MacManus-Intermarco, Inc.	121	■ <b>Indianapolis Power &amp; Light</b> Ruben, Montgomery & Associates, Inc.	130	■ <b>RCL Electronics, Inc.</b> Morvay Advertising Agency	14
■ <b>G &amp; E Bradley Ltd.</b> Hyde and Partners Ltd.	24E	■ <b>Industrial Electronic Engineers, Inc.</b> Van Der Boom, McCarron Advertising	168	■ <b>Rochester Gas &amp; Electric Advertising Group</b> Hutchins Advertising Company, Inc.	168
■ <b>The Buckeye Stamping Company</b> Wheeler Kight & Gainey, Inc.	D1	■ <b>Interdata</b> Shaw Elliott, Inc.	23	■ <b>Rohde &amp; Schwarz</b> Rotron, Inc.	5E 177
■ <b>Burr-Brown Research Corp.</b> N. A. Winter Advertising Agency	147	■ <b>Interelectronics, Inc.</b> Samuel H. Meyer Advertising	D4	■ <b>Howard W. Sams &amp; Co.</b> Aitkin-Kynett Co., Inc.	159
■ <b>Bussmann Mfg. Division of McGraw Edison Co.</b> Henderson Advertising Company	157	■ <b>International Crystal Mfg. Co.</b> Robert V. Freeland & Associates	46	■ <b>Schlumberger Solartron</b> Scott MacTaggart Advertising	31E-34E
■ <b>By-Buk Company, Sub. of Webtek Corp.</b> J. R. Bloome Company	174	■ <b>International Electronic Research Corp.</b> Van Der Boom, McCarron, Inc., Advertising	152	■ <b>S. D. S. A.</b> Public Service	113
■ <b>Cambridge Thermionic Corporation</b> Chirurg & Cairns, Inc.	155	■ <b>Interstate Electronics Corp.</b> Leland Oliver Company, Inc.	58-59	■ <b>Selenia</b> Tilligraf	103
■ <b>CELCO (Constantine Engineering Laboratory Co.)</b> Stano Advertising	100	■ <b>Johnson Company, E. F.</b> Martin Williams Advertising	115	■ <b>Signetics Corp., Sub. of Corning Glass Works</b> Hall Butler Blatherwick, Inc.	122-123
■ <b>Constantine Engineering Laboratory Co. (CELCO)</b> Stano Advertising	100	■ <b>Kay Elemetrics Corp.</b> Josephson, Cuffari & Company	139	■ <b>Silicon General</b> Semper/Moser & Associates	166
■ <b>Centralab, Div. of Globe Union, Inc.</b> The Brady Co.	108	■ <b>Keithley Instruments, Inc.</b> Bayless-Kerr Company	118	■ <b>Simpson Electric Co.</b> Amerad Advertising Services, Inc.	16
■ <b>Cincinnati Milacron, Process Controls Division</b> David K. Burnap Advertising	103	■ <b>Keppo, Incorporated</b> Weiss Advertising	5	■ <b>Singer Instrumentation-Alfred</b> N. W. Ayer/Jorgensen/MacDonald, Inc.	141
■ <b>Clairex Corporation</b> Michel-Cather, Inc.	4th cover	■ <b>Keronix, Inc.</b> George Foldvary Associates	38	■ <b>Sorenson AG</b> Mossa-Annoncen AG	28E
■ <b>Colorado Video, Inc.</b> O'Connell-Colburn, Inc.	175	■ <b>Lambda Electronics Corp.</b> Michel-Cather, Inc.	3rd cover	■ <b>Sorenson Operation Raytheon Company</b> Provandie Eastwood & Lombardi, Inc.	101
■ <b>Culligan USA</b> Alex T. Franz, Inc.	98	■ <b>Lear Siegler/Cimron Instruments</b> Manning/Brown and Associates	127	■ <b>Sperry Winter Displays Division</b> N. A. Winter Advertising Agency	125
■ <b>Custom Electronics, Inc.</b> Laux Advertising, Inc.	167	■ <b>Ledex, Inc.</b> Mervar Advertising	102	■ <b>Stackpole Carbon Company</b> Electronic Components Division	99
■ <b>Dana Laboratories, Inc.</b> Image Advertising and Public Relations	9	■ <b>Ledex, Inc., Branco Controls Division</b> Mervar Advertising	162	■ <b>State of Minnesota—Dept. of Economic Development—Industrial Development</b> Chuck Ruhr Associates Advertising, Inc.	148
■ <b>Datacraft Corporation</b> Advertising Art Services	97	■ <b>Lockheed Electronics Company</b> McCann-Erickson, Inc.	27	■ <b>Syston Donner Concord Instruments</b> Bonfield Associates	53
■ <b>Data General Corporation</b> The Advertising Group	152	■ <b>LTT</b> Publibel	27E	■ <b>T-Bar, Inc.</b> The Robert A. Paul Advertising Agency, Inc.	8
■ <b>DEL VAL</b> Seymour Charles Advertising, Inc.	176	■ <b>Joseph Lucas, Ltd.</b> McGraw Hill Professional & Reference Book Division	6E	■ <b>Teledyne Philbrick</b> Ingalls Associates, Inc. Advertising	77
■ <b>Delta Design, Inc.</b> NKS Ltd.	16E	■ <b>Macrodota Company</b> JMR Advertising	12-13	■ <b>Teradyne Components</b> Quinn & Johnson, Inc.	149
■ <b>Dialight Corporation</b> Michel-Cather, Inc.	150	■ <b>L. Frank Markel &amp; Sons, Inc.</b> George Moll Advertising, Inc.	171	■ <b>Thermotron Corporation</b> Enterprise Advertising	126
■ <b>Dickson Electronics Corporation</b> N. A. Winter Advertising Agency	160	■ <b>Materials Research Corporation</b> Matresco Advertising Associates	146	■ <b>Thomas &amp; Betts Company</b> McCarthy, Scelba, DeBiasi Advertising Agency, Inc.	39
■ <b>Digital Equipment Corporation</b> Creamer, Trowbridge, Case & Bastford, Inc.	132-133	■ <b>The Mica Corporation</b> Robert A. White Advertising	154	■ <b>Thomson CSF</b> Bazaine Publicite	50
■ <b>Digital General Corporation</b> Dix & Eaton, Inc.	43	■ <b>Micro Switch Division of Honeywell</b> N. W. Ayer & Son, Inc.	56-57	■ <b>Toko, Inc.</b> Hakuhodo, Inc.	162
■ <b>Electro Motive Mfg. Co., Inc.</b> Culver Adv., Inc.	180	■ <b>3M Electro Products Division</b> Batten, Barton, Durstine & Osborn, Inc.	17	■ <b>Tung Sol Division, Wagner Electric Corp.</b> Winius Brandon Company	164
■ <b>Electro Scientific Industries</b> Com/Mark Communications Group	25E	■ <b>Monolithic Memories, Inc.</b> Richardson Seigle Rolfs & McCoy, Inc.	28-29	■ <b>Tyco, Saphikon Division</b> Robwood Associates, Inc.	156
■ <b>Electronic Applications Co.</b> Art Wroobel & Associates	174	■ <b>Monroe, The Calculator Company</b> Division of Litton Industries	45, 47, 48, 49	■ <b>Victoreen Instrument Division</b> Dix & Eaton, Inc.	44
■ <b>Elpac, Inc.</b> Elxon Power Systems Div.	160	■ <b>Monsanto Company</b> Michel-Cather, Inc.	117	■ <b>Wang Laboratories, Inc.</b> WLI Associates Advertising	169
■ <b>Exact Electronics</b> Com/Mark Communications Group	30	■ <b>Monsanto Commercial Products Co., Electronic Special Products</b> Advertising Promotion Services	163	■ <b>Wavetek</b> Chapman Michetti Advertising	134
■ <b>Excellon Industries, Inc.</b> Elgin Davis, Inc.	7	■ <b>Moririca Electronics Ltd.</b> General Advertising Agency, Inc.	162	■ <b>Westinghouse Semiconductor</b> Ketchum, MacLeod & Grove, Inc.	20-21
■ <b>Fluke Manufacturing Co., John Bonfield Associates</b>	60	■ <b>Motorola Semiconductor Products, Inc.</b> E. B. Lane & Associates, Inc.	142	■ <b>John Wiley &amp; Sons</b> Ed McLean & Co., Inc.	178
■ <b>Fujitsu Limited</b> Asian Advertisers, Inc.	106	■ <b>National Semiconductor Corp.</b> Chiat/Day, Inc. Advertising	15		
■ <b>Function Modules, Inc.</b> Leon Richman Design	164	■ <b>Nelson Ross Electronics, Div. Polarad Electronics</b> McCarthy-Scelba-DeBiasi Advertising Agency, Inc.	2nd cover		

## Classified & Employment Advertising

F. J. Eberle, Manager 212-971-2557

<b>EQUIPMENT (Used or Surplus New) For Sale</b>	
Jensen Tools & Alloys	179
Radiation Devices Co.	179
Radio Research Instrument Co., Inc.	179

■ For more information on complete product line see advertisement in the latest Electronics Buyer's Guide  
# Advertisers in Electronics International

**Advertising Sales Staff**

**Pierre J. Braudé** [212] 971-3485  
Advertising Sales Manager

**Atlanta, Ga. 30309:** Joseph Lane  
100 Colony Square, 1175 Peachtree St., N.E.  
[404] 892-2868

**Boston, Mass. 02116:** James R. Pierce  
607 Boylston St. [617] 262-1160

**Chicago, Ill. 60611:** Robert W. Bartlett  
Kenneth E. Nicklas, 645 North Michigan  
Avenue, [312] MIO 4-5800

**Cleveland, Ohio 44113:** William J. Boyle  
[716] 586-5040

**Dallas, Texas 75201:** Richard P. Poole  
1340 Republic National Bank Building  
[214] RI 7-9721

**Denver, Colo. 80202:** Harry B. Doyle, Jr.  
Tower Bldg., 1700 Broadway  
[303] 266-3863

**Detroit, Michigan 48226:** Robert W. Bartlett  
2600 Penobscot Building  
[313] 962-1793

**Houston, Texas 77002:** Richard P. Poole  
2270 Humble Bldg. [713] CA 4-8381

**Los Angeles, Calif. 90017:** Robert J. Rielly  
Bradley K. Jones, 1125 W. 6th St.,  
[213] HU 2-5450

**Minneapolis, Minn. 55402:** Kenneth E. Nicklas  
1104 Northstar Center [612] 332-7425

**New York, N.Y. 10036**  
330 W. 42nd St.  
Warren H. Gardner [212] 971-3617  
Michael J. Stoller [212] 971-3616

**Philadelphia, Pa. 19103:** Warren H. Gardner  
6 Penn Center Plaza,  
[215] 971-3617

**Pittsburgh, Pa. 15222:** Warren H. Gardner  
4 Gateway Center, [412] 971-3617

**Rochester, N.Y. 14534:** William J. Boyle  
9 Greylock Ridge, Pittsford, N.Y.  
[716] 586-5040

**St. Louis, Mo. 63105:** Kenneth E. Nicklas  
The Clayton Tower, 7751 Carondelet Ave.  
[314] PA 5-7285

**San Francisco, Calif. 94111:** Don Farris  
Robert J. Rielly, 425 Battery Street,  
[415] 362-4600

**Paris:** Alain Offergeld  
17 Rue-Georges Bizet, 75 Paris 16, France  
Tel: 720-73-01

**Geneva:** Alain Offergeld  
1 rue du Temple, Geneva, Switzerland  
Tel: 32-35-63

**United Kingdom:** Keith Mantle  
Tel: 01-493-1451, 34 Dover Street, London W1

**Milan:** Robert Saidel, Roberto Laureri  
1 via Baracchini Phone 86-90-656

**Brussels:** Alain Offergeld  
23 Chaussee de Wavre  
Brussels 1040, Belgium  
Tel: 13-65-03

**Stockholm:** Brian Bowes  
Office 17, Kontor-Center AB, Hagagarten 29,  
113 47 Stockholm. Tel: 24 72 00

**Frankfurt/Main:** Fritz Krusebecker  
Liebigstrasse 27c  
Phone 72 01 81

**Tokyo:** Masaru Wakeshima, McGraw-Hill  
Publications Overseas Corporation,  
Kasumigaseki Building 2-5, 3-chome,  
Kasumigaseki, Chiyoda-Ku, Tokyo, Japan  
[581] 9811

**Osaka:** Ryji Kobayashi, McGraw-Hill  
Publications Overseas Corporation, Kondo  
Bldg., 163, Umegae-cho Kita-ku [362] 8771

**Australasia:** Warren E. Ball, IPO Box 5106,  
Tokyo, Japan

**Business Department**

**Stephen R. Weiss, Manager**  
[212] 971-2044

**Thomas M. Egan,**  
Production Manager [212] 971-3140

**Carol Gallagher**  
Assistant Production Manager [212] 971-2045

**Dorothy Carter,** Contracts and Billings  
[212] 971-2908

**Frances Vallone,** Reader Service Manager  
[212] 971-6057

**Electronics Buyers' Guide**

**George F. Werner,** Associate Publisher  
[212] 971-3139

**Regina Hera,** Directory Manager  
[212] 971-2544

# COUNTER REVOLUTIONARY



If you're on the verge of open insurrection over frequency counters that deliver too much price and not enough performance . . .

## Join the Heath/Schlumberger Counter Revolution!

We believe counters should provide more performance at a lower price . . . and we've got the products to back up that radical philosophy . . . our SM-104A and SM-105A 80 MHz Frequency Counters:

**Choice of time bases.** If you want the best stability and time base accuracy you can buy at a modest price, choose our SM-104A with built-in TCXO that provides a 1 MHz  $\pm 0.1$  Hz time base and  $\pm 1$  ppm/year stability. It also provides 5 digits of BCD output, overrange and print command. If you don't need this much time base or BCD output, order the SM-105A which uses a 1 MHz crystal accurate to  $\pm 2$  Hz with overall time base accuracy of  $\pm 10$  ppm. Both counters share the following features.

**80 MHz capability at a 15 MHz price . . .** delivers instant, accurate counting from 10 Hz to over 80 MHz without prescaling. Time base switch and overrange indicator allow an 8-digit measurement with resolution down to the last Hz  $\pm$  clock accuracy.

**High sensitivity . . .** triggers up to 50 MHz with input levels as low as 100 mV . . . to 80 MHz with only 250 mV. And FET input completely eliminates input attenuators.

**Other features include 5-digit LED readout . . .** superspeed Schottky TTL . . . rugged aluminum chassis . . . handy gimbal mount . . . and quick switch-selection of 120 or 240 VAC operation.

Order your SM-104A or SM-105A now...and join the Heath/Schlumberger Counter Revolution!

**Assembled SM-104A, 6 lbs., (less cables & connectors),**  
available . . . . . **500.00**

**Assembled SM-105A, 6 lbs., (less cables & connectors),**  
available . . . . . **350.00**

**SM-104A/SM-105A SPECIFICATIONS** — Frequency range: 10 Hz to over 80 MHz. Sensitivity (after 5 minutes' warmup): 100 mV RMS, to 50 MHz; 250 mV RMS, 50 MHz to 80 MHz. Input Impedance: 1 megohm shunted by less than 15 pF. Maximum Input Voltage: 15 V RMS (max. DC input is  $\pm 50$  volts). Time Base: SM-104A: 1 MHz  $\pm 0.1$  Hz, 1 ppm maximum change from 0-40° C ambient. 0.25 sec stability  $\pm 1 \times 10^{-9}$ . 1-yr. stability,  $\pm 1$  ppm. SM-105A: 1 MHz  $\pm 2$  Hz;  $\pm 10$  ppm, 0° C ambient reference to 25° C. Readout: Five 7-segment light-emitting-diode displays plus one light-emitting-diode for overrange indication. Power Requirements: 120/240 V, 50/60 Hz, 12 watts. Dimensions: 9 1/4" D x 6 3/4" W x 2 1/4" H.

HEATH	
<b>Schlumberger</b>	
Heath/Schlumberger Scientific Instruments Department 501-423 Benton Harbor, Michigan 49022	
<input type="checkbox"/> I want to join the counter revolution. Enclosed is \$_____ for _____ (model number)	
<input type="checkbox"/> I'm not a revolutionary yet, but try to convince me with your 1972 Instrumentation catalog.	
Name _____	
Company/Institution _____	
Address _____	
City _____ State _____ Zip _____	
EK-327	

Go ahead,  
dream  
your impossible dream....

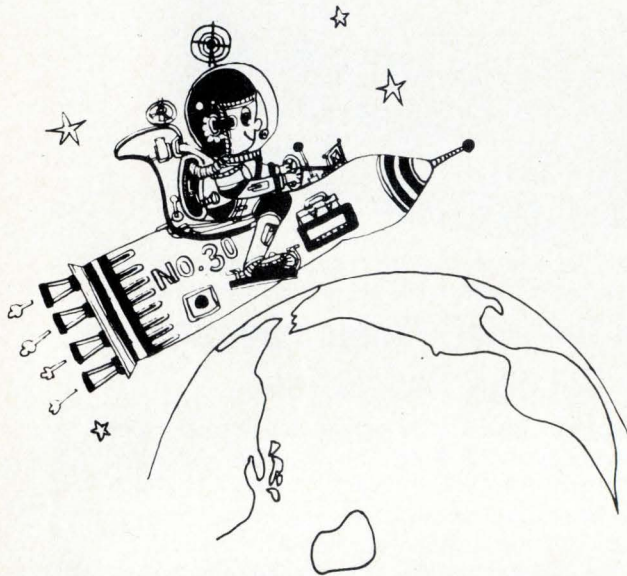

Stopped by the need for a permanent magnet better than any that now exists? Maybe Hitachi Metals can help. At our magnetic and electronic materials research center and other laboratories, our experts are hard at work making magnets do more things than anyone thought possible. Developing new magnetic materials such as rare-earth cobalt, and finding new uses for magnets. No one knows what they'll come up with next. But it just might be the answer to your impossible dream.

Devotion to improvement, added to integrated production backed by years of experience, is behind the quality of Hitachi magnets. Quality that means cast magnets designed and finished to close tolerances. Featuring high coercive force; big energy product; magnetic field uniformity and stability. And cast in any shape—no matter how intricate.

Here are some typical examples.

Type	Residual Induction (Br) gauss	Coercive Force (Hc) oersteds	Energy Product (B×H) max. × 10 <sup>-6</sup>
HI-MAG (ALNICO-5-7)	13,000-14,500	700- 800	6.8- 8.2
YCM-8B (ALNICO-8)	8,800- 9,600	1,380-1,550	4.8- 5.5
YCM-8D (ALNICO-8)	7,500- 8,300	1,700-1,850	5.5- 6.5
YCM-8E (ALNICO-8)	7,500- 8,500	2,000-2,150	5.5- 7.0
YCM-9B (ALNICO-9)	10,000-11,000	1,350-1,500	9.0-11.0

For full details about Hitachi magnets, write.



**HITACHI**  
Hitachi Metals, Ltd.

Head Office: Chiyoda Bldg., Marunouchi, Tokyo, Japan

**Hitachi Metals America, Ltd.**

New York (Head Office): Magnet Materials Sect., 437 Madison Ave., New York, N.Y. 10022. U.S.A. Tel. 212-758-5255

Chicago: 2200E. Devon Ave., Des Plaines, Ill. 60018. U.S.A. Tel. (312) 299-0031

Detroit: Suite 375, 24300 Southfield Road, Southfield, Michigan 48075. U.S.A. Tel. (313) 557-7142

Los Angeles: Suite 870, 1901 Ave. of the Stars, Los Angeles, Calif., 90067 U.S.A. Tel. (213) 553-6649

**PROVEN RELIABILITY—**  
**SOLID-STATE POWER INVERTERS,**  
over 260,000 logged operational hours—  
voltage-regulated, frequency-controlled,  
for missile, telemeter, ground support,  
135°C all-silicon units available now—

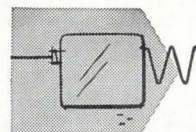
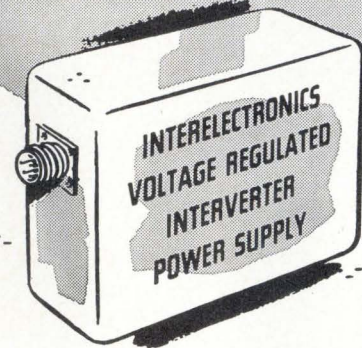

Interelectronics all-silicon thyatron-like gating elements and cubic-grain toroidal magnetic components convert DC to any desired number of AC or DC outputs from 1 to 10,000 watts.

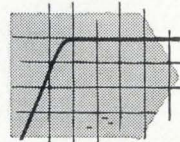

Ultra-reliable in operation (over 260,000 logged hours), no moving parts, unharmed by shorting output or reversing input polarity. High conversion efficiency (to 92%, including voltage regulation by Interelectronics patented reflex high-efficiency magnetic amplifier circuitry.)

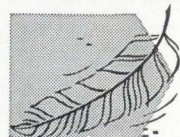

Light weight (to 6 watts/oz.), compact (to 8 watts/cu. in.), low ripple (to 0.01 mv. p-p), excellent voltage regulation (to 0.1%), precise frequency control (to 0.2% with Interelectronics extreme environment magnetostrictive standards or to 0.0001% with fork or piezoelectric standards.)

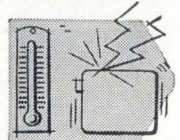

Complies with MIL specs. for shock (100G 11 msec.), acceleration (100G 15 min.), vibration (100G 5 to 5,000 cps.), temperature (to 150 degrees C), RF noise (I-26600).

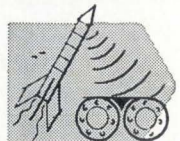

AC single and polyphase units supply sine waveform output (to 2% harmonics), will deliver up to ten times rated line current into a short circuit or actuate MIL type magnetic circuit breakers or fuses, will start gyros and motors with starting current surges up to ten times normal operating line current.

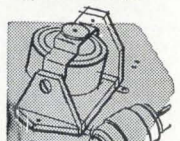

Now in use in major missiles, powering telemeter transmitters, radar beacons, electronic equipment. Single and polyphase units now power airborne and marine missile gyros, synchros, servos, magnetic amplifiers.

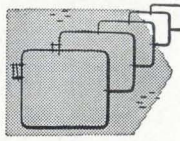

Interelectronics—first and most experienced in the solid-state power supply field produces its own all-silicon solid-state gating elements, all high flux density magnetic components, high temperature ultra-reliable film capacitors and components, has complete facilities and know how—has designed and delivered more working KVA than any other firm!

For complete engineering data, write Inter-electronics today, or call 914 Elmwood 8-8000.

**INTERELECTRONICS CORP.**

700 U. S. Route 303 Congers, New York 10920