

- 98 Monolithic op amps with field-effect-transistor input
- 106 Thin-film memory competes with disks and drums
- 115 Precision amplifier processes analog signals for computer

LIBRARY  
STATE TECHNICAL INSTITUTE  
AT MEMPHIS

# Electronics®



**A  
NEW  
LOOK  
AT OPTICAL  
MEASUREMENTS**

1420 TCH598 MCSA1 JUN73  
ST TECHNICAL INST  
LIBRY  
5983 MACON COVE  
MEMPHIS TN  
38128



**8,000 bit  
ROM'S**

**performing  
at 2.5 MHz**

**the new  
"202X"**

**SERIES OF  
READ-ONLY  
MEMORIES  
NOW  
FROM**

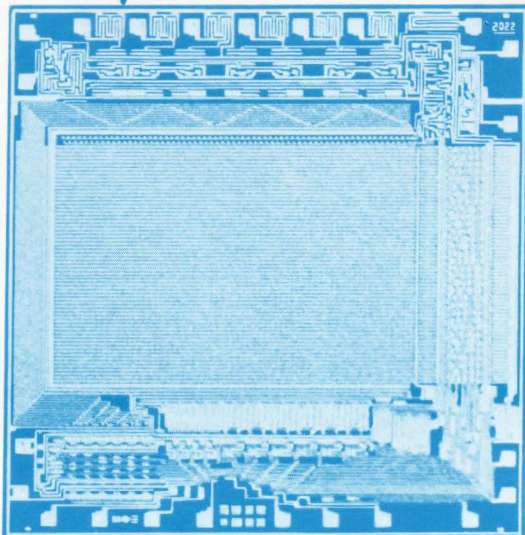

Working with character (row or column scan) generators? Combination logic trees? Micro-program storage, display symbol or mathematical function generators? We've got a new series of READ-ONLY MEMORIES just made for you. We're fast — at 2.5 MHz. Dense — 8,000 bits. Flexible — with a variety of organizations to meet your specs for total memory capacity. We can interface with TTL, DTL or MOS. Function at lower power: 330 mw is maximum.

The new "202X" series — monolithic low voltage MOS P-channel arrays utilizing en-

hancement mode MOS transistors. ROMS that offer "wire-or" connection of several arrays through use of a chip inhibit signal that disables all outputs but those of the selected ROM. Full address decoding within each ROM for a simple address buss to access to all ROMS in the group.

**THE NEW "202X" SERIES**

No. Outputs	No. Address Bits	Configuration	Part No.
7	11	7 x 9 x 128	MCS 2022
8	10	8 x 1024	MCS 2023
9	10	9 x 7 x 128	MCS 2024
10	10	10 x 768 (10 x 12 x 64)	MCS 2025

**WE TURNED A TECHNOLOGY  
INTO A COMPANY**

**CONTACT US DIRECT**

**EASTERN REGIONAL  
SALES DIRECTOR**

Mr. William Whitehead  
MOS TECHNOLOGY, INC.  
88 Sunnyside Blvd.  
Suite 307  
Plainview, N.Y. 11803  
Phone: (516) 822-4240

**CENTRAL REGIONAL  
SALES DIRECTOR**

Mr. Alan Mattal  
MOS TECHNOLOGY, INC.  
10400 W. Higgins Rd.  
Suite 631  
Rosemont, Ill. 60018  
Phone: (312) 298-2035

**WESTERN REGIONAL  
SALES DIRECTOR**

Mr. Jack Turk  
MOS TECHNOLOGY, INC.  
2172 Dupont Drive  
Suite 221, Patio Bldg.  
Newport Beach, Calif.  
92660  
Phone: (714) 833-1600

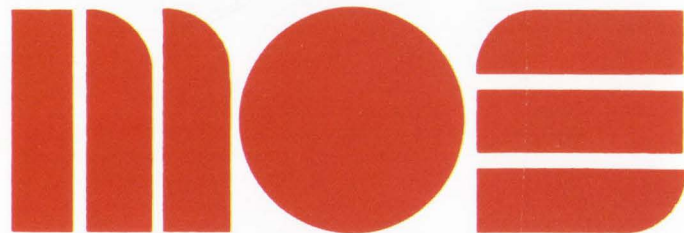

**MOS TECHNOLOGY, INC.**

VALLEY FORGE INDUSTRIAL PARK, VALLEY FORGE, PA. 19481 • (215) 666-7950

an affiliate of ALLEN-BRADLEY





# What do you get when you cross a signal source with a calculator?

**Automatic testing** with HP's new 3330B AUTOMATIC SYNTHESIZER. In this one outstanding instrument, you get a flexible synthesizer, a top-performing sweep generator, and a precision level generator—all under digital control. Its built-in controller adds computer flexibility—you can forget about tying up an external computer for your automatic testing on the production line, and for the first time make this level of testing economically feasible in your lab.

For man-machine interfacing, 3330B's convenient swing-out keyboard, coupled with 9-digits of frequency and 4-digits of amplitude readout, gives you complete flexibility for setting up your test routines.

As a frequency synthesizer spectral purity is exceptional. Spurious is down 70 dB, and harmonics at least 40 dB below the carrier. Through its easy-to-use keyboard, you can, with 0.1 Hz resolution, set in any frequency between 0.1 Hz and 13 MHz, then automatically or manually increment (tune) that frequency by any amount. Each point has the synthesizer stability of  $\pm 1$  part in  $10^8$ /day.

You can repeat the same automatic or manual sweeping operation with amplitude level. Its 100 dB range, 0.01 dB resolution and flatness of  $\pm 0.05$  dB make the 3330B a precision level generator.

Call on Model 3330B for your sweep generator needs, and you'll get performance levels of accuracy, linearity, and resolution never before available. That's because the internal serial microprocessor controls digital sweeping of synthesized frequencies or precise amplitudes. Through its keyboard and front-panel controls, you enter all sweep parameters—your 3330B takes it from there.

Systems Designers will find the standard 3330B fully programmable—ready for low-cost interfacing to other ASCII instruments and controllers, like marked card programmers, calculators, and computers.

Price? If you think about it, you would have bought a synthesizer, a sweeper, a marker generator, a counter, a programmable attenuator, and some computer time to come anywhere close to solving the same problems now done by the 3330B. At \$6000 for a complete frequency lab, we think you'll agree that the price-performance ratio of the 3330B is great. (Model 3330A, priced at \$5100, performs identically to the 3330B but has manual amplitude control and 13 dB range.)

For further information on the 3330A/B, contact your local HP field engineer. Or, write Hewlett-Packard, Palo Alto, California 94304. In Europe: 1217 Meyrin-Geneva, Switzerland.

A092/1

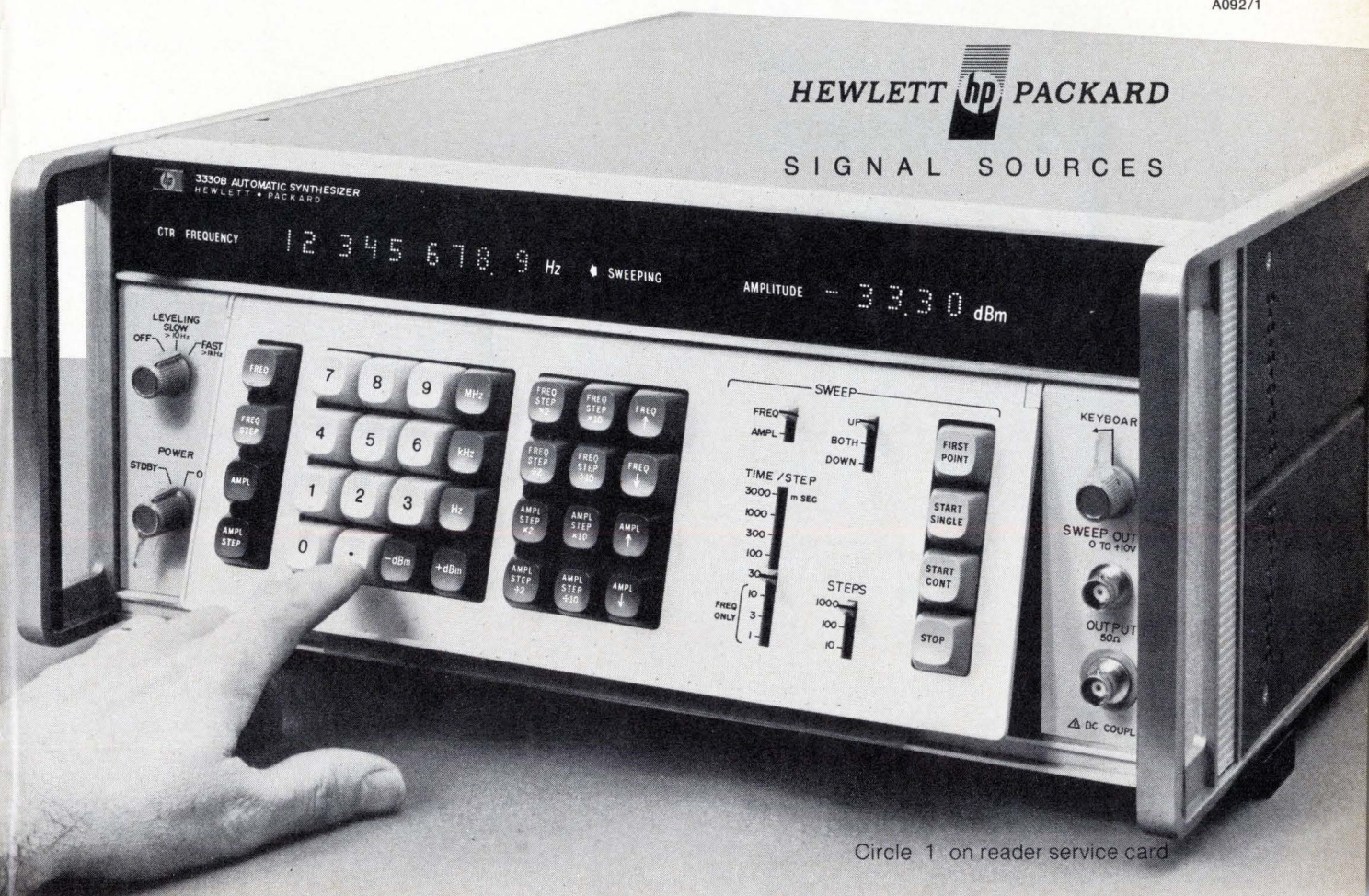

Circle 1 on reader service card



*New  
from HP...  
Modular  
Power Supplies*

# today

*for those who  
think about  
tomorrow!*



HEWLETT  PACKARD

POWER SUPPLIES

21201

Value has always been synonymous with HP power supplies, and these new 62000-series modular power supplies are no exception. They're competitively priced (with quantity and OEM discounts), reliable, systems compatible, and available now. Coverage is from 3 to 48 volts, at up to 200 watts, with performance assured to specifications. Best of all, HP offers applications assistance and service support before and after the sale. It's all backed up with an international network of 220 offices to serve you. For detailed information, contact your local HP field engineer. Or, write: Hewlett-Packard, Palo Alto, California 94304. In Europe: 1217 Meyrin-Geneva, Switzerland.



## 31 Electronics Review

SOLID STATE: Hybrid vidicon imager emerges, 31  
SOLID STATE: Laser opens way to single diffusion, 31  
AUTOMOTIVE ELECTRONICS: Radar "crash center" may be answer, 32  
AUTOMOTIVE ELECTRONICS: Mini runs electrical tests, 32  
AUTOMOTIVE ELECTRONICS: Ampex technique finds defect, 33  
SPACE ELECTRONICS: Rest of world watches Anik shot, 33  
COMPUTERS: Next wave: a network of networks, 34  
COMPUTERS: How to update tapes without recopying, 36  
COMPUTERS: Computer, gages tell rain story, 36  
OPTOELECTRONICS: Laser cleans, helps preserve statues, 38  
INTEGRATED ELECTRONICS: C-MOS used for majority logic chip, 39  
INDEX OF ACTIVITY: 40  
MEMORIES: Hybrid technique yields mass memory, 41  
COMMERCIAL ELECTRONICS: LED shortage to extend into 1973, 44  
COMMERCIAL ELECTRONICS: Point-of-sale point of view, 44  
MEETINGS: WEMA Monterey session gains popularity, 45  
PACKAGING: Epoxy bonding makes gains, 46

## 55 Electronics International

JAPAN: Color TV player uses audio cassette, 55  
WEST GERMANY: Compact transceiver ends "helium speech," 55

## 68 Probing the News

GOVERNMENT ELECTRONICS: Adding zip to the mail, 67  
COMPANIES: Firm wins calculator gamble, 70  
MEDICAL ELECTRONICS: Medical engineering: prognosis fair 76  
MANAGEMENT: WEMA unites on electronics trade, 82

## 91 Technical Articles

OPTOELECTRONICS: Shedding needed light on optical measurement, 91  
SOLID STATE: Understanding FET operation yields J-FET op amp, 98  
DESIGNER'S CASEBOOK: MOSFET acts as multiplexing switch, 102  
Stepper drive circuit boosts motor torque, 103  
Voltage-tuned filter varies center frequency linearly, 104  
MEMORIES: Film a few atoms thick promises huge mass memories, 106  
INSTRUMENTATION: Precision amplifier conditions computer inputs, 115  
ENGINEER'S NOTEBOOK: Suppression networks for SCR converter, 120  
Testing power supplies quickly and cheaply, 121  
Comparing coaxial cable shielding effectiveness, 121

## 133 New Products

IN THE SPOTLIGHT: Calculator has full Basic capability, 133  
INSTRUMENTS: Servo upgrades audio recorders, 136  
PACKAGING & PRODUCTION: Memory tester is programmable, 140  
DATA HANDLING: Terminal offers four data rates, 144  
SEMICONDUCTORS: C-MOS rate multiplier draws only 250 nW, 146  
MATERIALS: 152

## Departments

Publishers letter, 4  
Readers comment, 6  
40 years ago, 8  
People, 14  
Meetings, 22  
Electronics newsletter, 27  
Washington newsletter, 51  
Washington commentary, 52  
International newsletter, 57  
Engineer's newsletter, 125  
New literature, 152

## Highlights

### Post Office becomes big electronics buyer, 67

Over the next six years the U.S. Postal Service plans to spend \$2.4 million on electronic gear that will automate handling of perhaps 75% of the mail. Volume mailers are expected to add to this market by investing in complementary equipment.

### Luminance, illuminance, illumination, 91

Do these terms have the same meaning, or two or three different meanings? The terminology of light measurement is confusing and often arbitrary, and the techniques are sometimes unfamiliar to EEs who now need to be able to make intelligent use of optoelectronic devices. This article explains the language and some procedures.

### The thinner the film, the larger the memory, 106

A fast mass memory, which outperforms disks and drums and costs less, too, is being developed around a permalloy film only 100 angstroms thick. Its bit-density is 100 times that of conventional thin-film memory arrays.

### A calculator as clever as a computer, 133

When a calculator can talk Basic like a mini-computer and can perform much like a mini-computer, the distinction between them blurs. From the user's viewpoint, however, the new calculator is still much the easier to operate.

### And in the next issue . . .

Report from Japan on the Japanese electronics industries . . . electronic organ building made simple with C-MOS.

### The cover

Tektronix J16 digital photometer-radiometer takes the measure of a light beam.



EDITOR-IN-CHIEF: Kemp Anderson

EXECUTIVE EDITOR: Samel Weber

MANAGING EDITORS: Lawrence Curran, *News*;  
Arthur Erikson, *International*

SENIOR EDITORS: John Johnsrud,  
H. Thomas Maguire, Laurence Altman

ART DIRECTOR: Fred Sklenar

ASSOCIATE EDITORS: Richard Gundlach,  
John N. Kessler, Howard Wolff

DEPARTMENT EDITORS

*Aerospace*: William F. Arnold  
*Circuit Design*: Lucinda Mattera  
*Communications & Microwave*:

Lyman J. Hardeman

*Computers*: Wallace B. Riley

*Consumer*: Gerald M. Walker

*Industrial*: Alfred Rosenblatt

*Instrumentation*: Michael J. Riezenman

*Military*: Ray Connolly

*New Products*: H. Thomas Maguire

*Packaging & Production*: Stephen E. Grossman

*Solid State*: Laurence Altman

*Special Issues*: Harry R. Karp

COPY EDITORS: Margaret Eastman,  
Everett C. Terry

ASSISTANT EDITOR: Marilyn Offenheiser

ART: Charles D. Ciatto, *Associate Director*

PRODUCTION EDITORS:  
Patricia Cybulski, Arthur C. Miller

EDITORIAL SECRETARIES: Janet Annunziata,  
Julie Gorgoglione, Penny Roberts

FIELD EDITORS

*Boston*: James Brinton (Mgr.), Gail Farrell

*Los Angeles*: Paul Franson (Mgr.)

*Midwest*: Larry Armstrong (Mgr.)

*New York*: Alfred Rosenblatt (Mgr.)

*San Francisco*: Stephen Wm. Fields (Mgr.),  
Judith Curtis

*Washington*: Ray Connolly (Mgr.),  
William F. Arnold

*Frankfurt*: John Gosch

*London*: Michael Payne

*Paris*: Arthur Erikson

*Tokyo*: Charles Cohen

McGRAW-HILL WORLD NEWS

*Director*: Walter A. Stanbury

*Bonn*: Robert Ingersoll;

*Brussels*: James Smith;

*London*: Marvin Petal;

*Milan*: Peter Hoffmann, Andrew Heath;

*Moscow*: Axel Krause;

*Paris*: Stewart Toy, Michael Johnson;

*Stockholm*: Robert Skole;

*Tokyo*: Mike Mealey

PUBLISHER: Dan McMillan

ADVERTISING SALES MANAGER: Pierre J. Braudé

ADVERTISING SALES SERVICE MANAGER:  
Wallis Clarke

BUSINESS MANAGER: Stephen R. Weiss

CIRCULATION MANAGER: George F. Werner

MARKETING SERVICES MANAGER:  
Tomlinson Howland

**H**and-held calculators are coming of age as a consumer product. But the day is still to come when they will be considered as indispensable a feature in the American household as, say, a radio or a cassette recorder. Nonetheless, the compact electronic calculator, now entering the steepest part of its growth curve, is having a significant effect on the electronics industries.

Take the example of Bowmar/ALI, a company that has hitched its wagon to the calculator growth curve. As Gail Farrell of our Boston bureau reports in the article on page 70, it was only a year ago that the company made the decision to go with consumer calculators. Now, turning out 2,000 units a day, the company can call itself the world's largest producer. And its appetite for components, especially light-emitting diodes and circuits, has been one of the main reasons for the nationwide shortage in those items.

Gail, who has been helping us cover electronics around Boston for the last four years, says that Charles Krakauer, president of the Acton, Mass., company, is as surprised as anyone about the suddenness of the public's acceptance of pocket-sized calculators.

A year ago, he found a lot of resistance to the machines when he took home some developmental models and tried to loan them to his neighbors for a field trial. Many people said that they just could not think of anything significant to do with them, but he urged them to try anyway. A few weeks later, he had as hard a time getting the prototypes back, as many of the neigh-

bors wanted to keep them, asking how much he would sell them for.

Since then, the company has undertaken a number of marketing studies and has found that business use accounts for a major share of sales. Yet letters from satisfied consumers keep coming. One of the best is from a family that uses a company calculator to keep track of the complicated statistics of its big leisure-time activity—skeet-shooting.

**T**he leading edge of technology, even in these times of relative austerity, is broad. On page 106 you'll find an article about a development at the leading edge of ultrahigh-density-memory work. What's more, development of the so-called "oligatomic" memory is sure to have repercussions up and down the frontiers of memory and computer technology. In fact, last year, when our computer editor, Wally Riley was working on the "Computers in the '70s" special report, he was told by J. Presper Eckert, co-inventor of the pioneering Eniac computer, that oligatomic memory work was one of the important areas to watch. We have been not only watching, but working with the technique's developers to bring you yet another in-depth report on leading-edge technology.



November 6, 1972 Volume 45, Number 23

89,753 copies of this issue printed

Published every other Monday by McGraw-Hill, Inc. Founder: James H. McGraw 1860-1948. ePublication office 1221 Avenue of the Americas, N.Y., N.Y. 10020; second class postage paid at New York, N.Y. and additional mailing offices.

Executive, editorial, circulation and advertising addresses: Electronics, McGraw-Hill Building, 1221 Avenue of the Americas, New York, N.Y. 10020. Telephone (212) 997-1221. Teletype TWX N.Y. 710-581-5234. Cable address: MCGRAWHILL N.Y.

Subscriptions limited to persons with active, professional, functional responsibility in electronics technology. Publisher reserves the right to reject non-qualified requests. No subscriptions accepted without complete identification of subscriber name, title, or job function, company or organization, including product manufactured or services performed. Subscription rates: qualified subscribers in the United States and possessions, Canada, and Mexico \$8.00 one year, \$12.00 two years, \$16.00 three years; all other countries \$25.00 one year except Japan \$50.00 per year including air freight. Limited quota of subscriptions available at higher-than-basic rate for persons outside of field served, as follows: U.S. and possessions and Canada, \$25.00 one year; all other countries \$50.00. Single copies: United States and possessions and Canada, \$1.00; all other countries, \$1.75.

Officers of the McGraw-Hill Publications Company: John R. Emery, President; J. Elton Tuohig, Senior Vice President—Services; Donald B. Girdley, Group Vice President; Vice Presidents: Ralph Blackburn, Circulation; John R. Callahan, Editorial; John B. Hoglund, Controller; David G. Jensen, Manufacturing; Jerome D. Luntz, Planning & Development; Joseph C. Page, Marketing.

Officers of the Corporation: Shelton Fisher, President; Wallace F. Traudt, Group President; McGraw-Hill Publications Company, John J. Cooke, Senior Vice President and Secretary; Ralph J. Webb, Treasurer.

Title registered in U.S. Patent Office; Copyright 1972 by McGraw-Hill, Inc. All rights reserved. The contents of this publication may not be reproduced either in whole or in part without the consent of copyright owner.

Subscribers: The publisher, upon written request to our New York office from any subscriber, agrees to refund that part of the subscription price applying to copies not yet mailed. Please send change of address notices or complaints to Fulfillment Manager; subscription orders to Circulation Manager, Electronics, at address below. Change of address notices should provide old as well as new address, including postal zip code number. If possible, attach address label from recent issue. Allow one month for change to become effective.

Postmaster: Please send form 3579 to Fulfillment Manager, Electronics, P.O. Box 430, Hightstown, N.J. 08520.



# For \$395 how many functions should a Function Generator generate?

Fifteen. That's the number of waveforms you can get with Krohn-Hite's Model 5100A. How? A unique Symmetry Control that allows pulse rep rate to be set independently of pulse width and also provides independently adjustable triangle slopes. You can skew any of the basic sine, square, triangle and ramp waveforms by as much as 99% to produce 10 additional functions. Frequency range of 0.002 Hz to 3 MHz can be manually tuned or externally controlled for VC of 1000:1. When you compare the 5100A with the rest, there's quite a generation gap. For fast action, call The Wavemakers at (617) 491-3211, TWX 710-320-6583 Krohn-Hite Corporation, 580 Mass. Ave., Cambridge, Mass. 02139.



**KH KROHN-HITE CORPORATION**

OVERSEAS SALES OFFICES: AUSTRIA, Universal Elektronik Import; AUSTRALIA, Warburton O'Donnell Limited; BELGIUM, C. N. Rood s. a.; DENMARK, SC Metric A/S; ENGLAND, Allied International Limited; FINLAND, INTO O/Y; FRANCE, Antares; GERMANY, Nucletron Vertriebs-GMBH; HOLLAND, C. N. Rood n. v.; INDIA, Bali International Agencies; ISRAEL, R.D.T. Electronics Engineering, Ltd.; ITALY, Vianello S.P.A.; JAPAN, Shoshin Shoji Kaisha, Ltd.; NEW ZEALAND, H.M.Z. Ltd.; SOUTH AFRICA, Protea Physical; SPAIN, Rema Leo Haag, S.A.; SWEDEN, Teleinstrument; SWITZERLAND, Megax Zurich GMBH.





**Our  
lightweight  
portable  
isn't much of a  
financial  
burden, either.  
\$995.**



\$995 for Dual trace, Delaying Sweep and Portability.

- 14 lbs (you don't have to pretend it's light — it really is light.)
- Lowest cost delaying sweep
- Push button Controls
- 10 MHz
- Full auto triggering

Where else can you get all this in a portable for \$995.

Write for all the Details —

DUMONT OSCILLOSCOPE  
LABORATORIES INC.  
40 Fairfield Pl., West Caldwell, N. J. 07006  
(201) 575-8666; TWX (710) 734-4308

**DUMONT**  
OSCILLOSCOPE LABORATORIES, INC.

## Readers comment

### Matsushita widens ZNR activity

**To the Editor:** The box, "Turning the tables" [p.94] in the article entitled "Metal-oxide varistor: a new way to suppress transients" [*Electronics*, Oct. 9, p.91], states, "Matsushita is producing zinc-oxide ceramic devices (ZNRs) only for installation in its own consumer electronic equipment," and then it goes on to say that, "although Matsushita would like to sell its devices in the American market, the company has no plans to do so at this time."

These statements differ from the present status of Matsushita's activities in ZNRs. These devices have been installed in both consumer and industrial electronic equipment that is being produced, not only by Matsushita, but also by other Japanese companies. Moreover, Matsushita has prepared to sell the ZNRs in the world market—including the United States.

Yoshio Iida  
Assistant director

Wireless Research Laboratory  
Matsushita Electric Industrial Co.  
Osaka, Japan

### SCM calculators made in U. S.

**To the Editor:** We were very interested in your article, "U. S. homes in on calculators," [*Electronics*, Sept. 25, p.69]. However, the statement that reads, "Hitachi makes units for Unicom and Singer, Brother for Singer, Casio for SCM, and Canon for Monroe," is not accurate with respect to SCM.

SCM is presently procuring all of its calculators from production within the United States; further we have never purchased any units from Casio.

Our entire marketing effort is directed toward utilization of American technology, American labor, and American designs. SCM Marchant is procuring all of its calculators on a "made-in-U.S.A." basis.

Matthew E. Meek  
Vice president and general manager  
Marchant Group  
Business Equipment division  
SCM Corp.  
New York, N. Y.

# NEW

## multi-channel touchtone FILTERS



No. 0322-00  
8-Channel  
Band Pass  
Filter



No. 0321-00  
2-Channel  
Band Reject  
Filter

**saves time, money and board space**

CONOLOG's new TTD Series saves you design time and money. Both units are ideal for touchtone frequency data transmission. Both have stability from  $-10^{\circ}\text{C}$  to  $+65^{\circ}\text{C}$ .

Part #0322-00 — 8 Filters in one housing. 600 Ohm input impedance; 8 separate high impedance outputs matched to 0.4 db.

Part #0321-00 — 2 Filters with Channel 1 at 800Hz and Channel 2 at 1400Hz. Impedance in and out — 1000 ohms. Operating level is  $-40\text{ dbm}$  to  $+20\text{ dbm}$ .

Both are hermetically sealed in long life flat pack cases,  $1\frac{1}{4}$ " high, to save you board space. These units can be made to meet your own design specifications.

CONOLOG can meet your specifications for all your other L-C filter, toroidal transformer and inductor needs.

**Conolog**  
CORPORATION  
5 COLUMBIA ROAD, SOMERVILLE, N. J. 08876  
TELEPHONE: (201) 722-8081



# EPOXY B SKEPTICS TEST.

Very simply stated, epoxy B is far better than any molded package solution we've ever tested.

As in the past, many other semiconductor manufacturers will soon follow our lead.

chart form, pencil and free National device with which to conduct your very own temp cycle test.

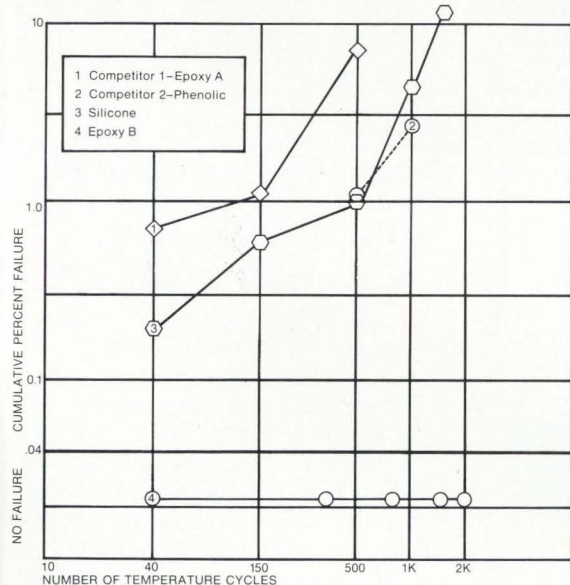

Among other things, epoxy B eliminates intermittent opens which means fewer field failures and substantial savings in service calls.

So every product we make now comes packaged in epoxy B.

thermal intermittance. (As you can see in the temp cycle test chart, the failure rate for epoxy B even after

2,000 cycles is still zero!) Our kit also contains a

For your Epoxy B Skeptics Test Kit, just call any of the sales offices listed below.

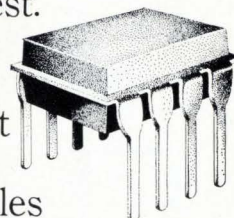

Our only restriction is that you are a bona fide purchasing agent, quality control or reliability engineer. Or for those of you who'd simply like more information, we'd be happy to send you our new Epoxy B Reliability Brochure.

Call (408) 732-5000.

Or write National Semiconductor Corporation,



2900 Semiconductor Drive, Santa Clara, Calif. 95051.

## National

Scottsdale, Ariz. (602) 945-8473	Mountain View, Calif. (415) 961-4740	Sherman Oaks, Calif. (213) 783-8272	Miami, Florida (305) 446-8309	Chicago, Illinois (312) 693-2660	Indianapolis, Ind. (317) 255-5822	Lenexa, Kansas (816) 358-8102	Burlington, Mass. (617) 273-1350
Glen Burnie, Md. (301) 760-5220	Farmington, Mich. (313) 477-0400	Englewood Cliffs, N.J. (201) 871-4410	Syracuse, N.Y. (315) 455-5858	Cleveland, Ohio (216) 961-5300	Beaverton, Oregon (503) 643-5445	Dallas, Texas (214) 233-6801	



Simplify board layout...  
Cut package count...  
Reduce equipment size...with

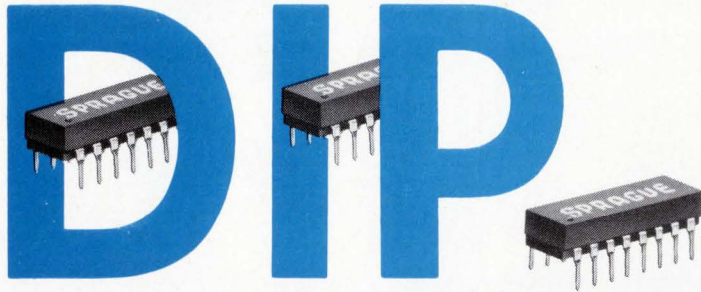

## THICK-FILM RESISTOR NETWORKS

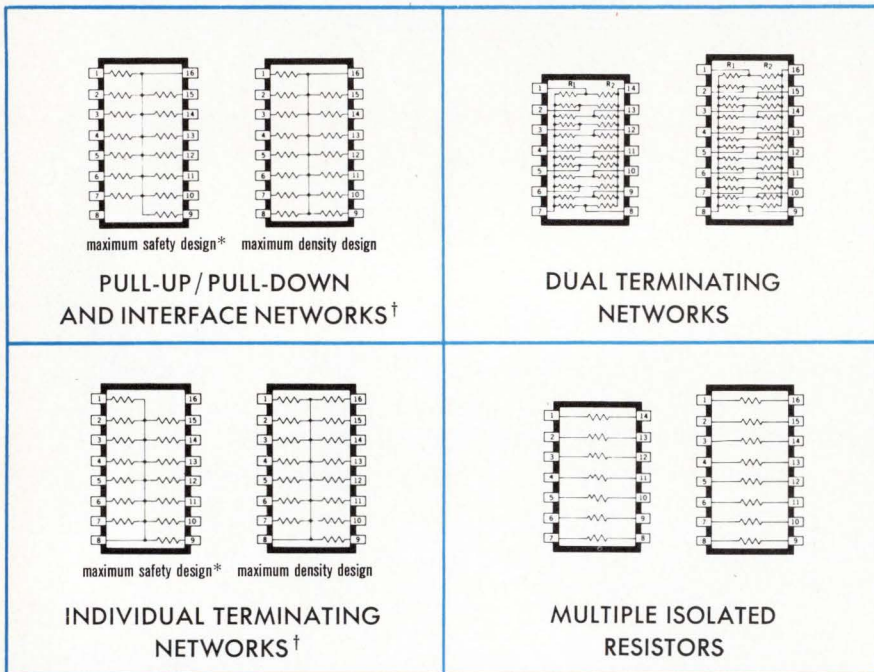

POPULAR OHMIC VALUES IN THESE STANDARD RESISTOR NETWORKS ARE AVAILABLE FOR PROMPT DELIVERY FROM YOUR STOCKING SPRAGUE INDUSTRIAL DISTRIBUTOR

\*This configuration prevents circuit damage if accidentally reversed during insertion  
†Also available in 14-pin package

## Sprague puts more passive component families into dual in-line packages than any other manufacturer:

- TANTALUM CAPACITORS
- CERAMIC CAPACITORS
- TANTALUM-CERAMIC NETWORKS
- RESISTOR-CAPACITOR NETWORKS
- PULSE TRANSFORMERS
- TOROIDAL INDUCTORS
- HYBRID CIRCUITS
- TAPPED DELAY LINES
- SPECIAL COMPONENT COMBINATIONS
- THICK-FILM RESISTOR NETWORKS
- THIN-FILM RESISTOR NETWORKS
- ION-IMPLANTED RESISTOR NETWORKS

For more information on Sprague DIP components, write or call Ed Geissler, Manager, Specialty Components Marketing, Sprague Electric Co., 35 Marshall St., North Adams, Mass. 01247. Tel. 413/664-4411.



THE BROAD-LINE PRODUCER OF ELECTRONIC PARTS

## 40 years ago

From the pages of Electronics, November 1932

Radio manufacturers go into a final 1932 spurt offering more technical tricks than were considered possible two years ago, and at prices which cannot be compared with those of the same period. It is true that some of these new circuits are not necessary, but neither are six-cylinder engines, four-wheel brakes or balloon tires.

It is conceivable that some ultra-conservatives exist who prefer to tune a 1929 or 1930 set without benefit of avc, or, better still, quiet avc, or acoustically compensated volume control, or the still-to-be announced automatic tone control—but they must be compared with those who still prefer a one-horse shay.

The first fishing schooner to be fitted with an electronic fathometer is the Boston vessel "Joffre" which returned there recently with 100,000 lb. of halibut.

By using the electronic depth-finding apparatus, the "Joffre" was able to take soundings in rapid succession, accurately and while the vessel was under way.

Component parts manufacturers have complained bitterly in recent months of excessive chiseling indulged in by purchasing agents of the larger set manufacturers.

No one who has a broad view of any industry can consider super-chiseling as anything but practices destructive to manufacturing pride and profit, as deterrents to research and experiment, and in the final analysis as adversely affecting quality.

But there is another practice which large-quantity buyers lay at the doors of the components people. Quoting a low price on thousand lots, the parts maker actually make a few hundred more than the thousand, sells these few hundred to small buyers at the same price given the large buyer. The large buyer, getting no advantage by his heavy buying, demands a still further reduction in price on his next purchase, thereby forcing the price to lower level. Thus the circle is completed.





# Better system protection against transient voltages

## ... Better than selenium

Both DC and AC models now available.

GE-MOV™ metal oxide varistors make use of a new technology. They provide tight voltage clamping and high energy absorption . . . better than selenium. Present models offer AC voltage ratings from 100 to 1000V. Energy absorption ratings range from 10 to 160 watt-seconds (joules).

Prices are as low as \$.70 in quantity lots. For more information, including a FREE EVALUATION KIT, call your local authorized GE semiconductor distributor . . . or write to General Electric Company, Semiconductor Products Department, Building 7, Mail Drop 49, Electronics Park, Syracuse, N. Y., U.S.A.

### GE-MOV SUPERIOR FEATURES:

- Clamping Ratio
- Size
- Peak Current
- Energy Density

### COMPETING SELENIUM SUPPRESSORS

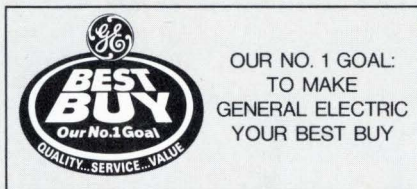

Mfrs.	Commercial or Trade Names	Device Nomenclature			
		Selenium Suppressors			
		1 inch Square	2 inches Square	4 inches Square	5" x 6"
IR (W)	Klip-Sel Volt-Trap	KSA ----	KSL ----	KSP ----	KSF ----
		SO1, 2AA --	SO3AA ----	SO6AA ----	SO9AA ----
Syntron Sarkes Tarzian	Surge Stop Klip Volt	SD1544 --	SD2650 --	SD2411 --	SD2452 --
		2KV26 ---	5KV26 ---	7KV26 ---	10KV26

GENERAL  ELECTRIC

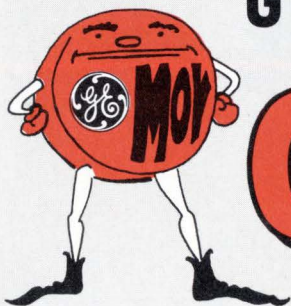

# GE-MOV™ VARISTORS

ASSURE YOUR EQUIPMENT WILL ENDURE



## Get less for your money.

Less packages, less wiring, less cost, less space and weight, less power needed.

The Am 2502: An 8-bit successive approximation register for serial or parallel data output.

The Am 2503: An 8-bit SAR for expandable parallel data output with input enable.

The Am 2504: A 12-bit SAR for serial or parallel output.

**There's more.** 20MHz response. Synchronous start capability. Easy adaptation for truncation. MIL-STD-883.

If you're doing A-to-D conversion, recursive techniques, ring counters, serial to parallel conversion, you've got to let us introduce you to our SAR family.

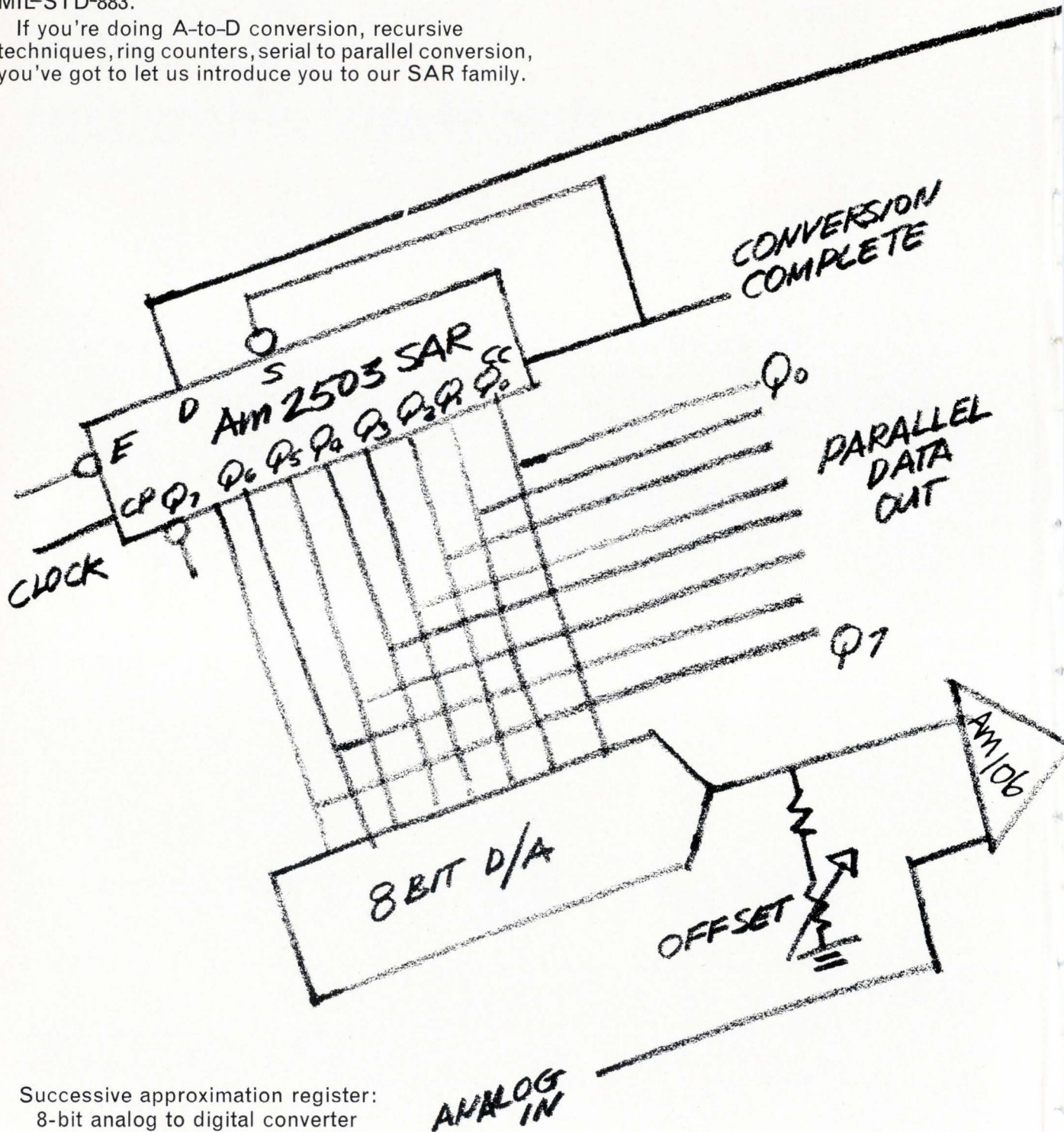

Successive approximation register:  
8-bit analog to digital converter



**All the logic for an  
A-to-D converter in one chip,  
one package.**

**(Eight or twelve bits.**

**Serial or parallel data**

**outputs.) More reasons**

**why we're going to be the**

**sixth largest integrated**

**circuit company in the**

**United States by 1975.**

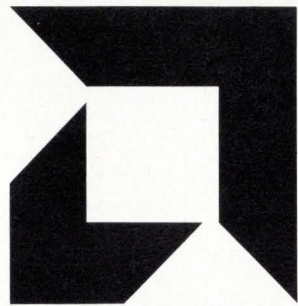

**Advanced Micro Devices, Inc.**

**(We're going to be #6)**

Distributed nationally by Hamilton/Avnet and Cramer Electronics. Telephone 800-538-7904 toll free, or in California 408-732-2400. and ask for Shel Schumaker. In Los Angeles, Steve Zelencik or Russ Almand at 213-360-2102. In Mid-America, Chuck Keough at 312-297-4115. In the eastern United States, Steve Marks or Bill Seifert at 516-676-4500, and Stu Cohen at 516-482-9320. 901 Thompson Place, Sunnyvale, California 94086/TWX 910-339-9280/TLX 346306.

Circle Bingo #203



# 5 LINEAR MONOLITHIC SUBSYSTEMS





**Subsystems: highly complex functions on a single chip. That's where it's happening in linear today. Where Fairchild is. In op amps, voltage regulators and interface.**

Look at the facts. In the last 6 months alone 5 new Fairchild monolithic linear subsystems were introduced and are now in volume production.

**New 791 High power op amp**

Our latest monolithic op amp subsystem has 1 amp output at  $\pm 12$  volts and automatic circuit protection. Everything is on one chip, so installation's easier. Fewer external connections, testing's easier, less external electronics. Naturally, system costs go down, system reliability goes up. Internally protected against short circuits, power and thermal overloads. 100-piece price: \$12.50.

**750 Dual comparator**

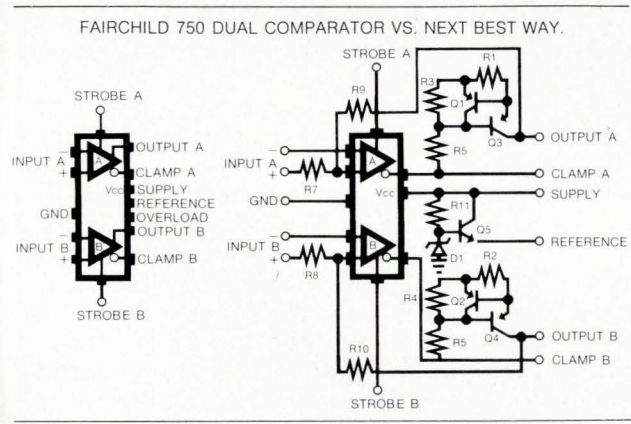

The world's first monolithic comparator subsystem. Eliminates up to 17 discrete components other comparators require for equivalent function and drive capability. A totally-self-contained subsystem consisting of two high-output current, independent comparators on a single chip. Eliminates the external components, board space, and virtually all the engineering calculations necessary to make other comparators function reliably and safely in complex control applications. 100-piece price: \$5.95.

**776 Programmable op amp**

This subsystem is the closest thing to a universal op amp yet devised. Already an industry standard, it's a high quality device that, with the addition of a simple external resistor, can be tailored for optimum performance over an enormous span of applications. The wide range of programmable characteristics make it one of the most versatile and useful op amps to appear in years. Applications range from a nanowatt amplifier to a high-accuracy sample and hold amplifier. 100-piece price: \$3.00.

**7800 3-terminal voltage regulator**

Seven members (5V, 6V, 8V, 12V, 15V, 18V, 24V) compose this family – the first with complete voltage regulation on one chip. The first high quality, sophisticated, versatile, yet simple way of solving VR design problems. At a price so low they can be inventoried in

quantity, for use as required. Complete and self-contained in one TO-220 or TO-3 package. And fully self-protected: internal current limiting, thermal shut-down, safe area compensation protect device from current, power, temperature fluctuations. Typical 100-piece price: \$1.75.

**9616 EIA line driver (& 9617 receiver)**

Our 9616 triple line driver subsystem has both internal inhibit and slew rate control. And it's all on one chip. Our 9617 EIA triple line receiver completes the set. They meet all EIA RS-232-C specs. And more.

Together, they provide the simplest low-cost solution to problems at the interface in data terminal equipment and data communications. 100-piece price is \$4.50 for the 9616; and \$3.50 for the 9617.

COMPARISON OF EIA DRIVERS.

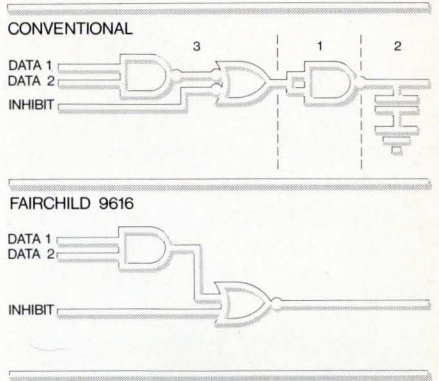

Conventional EIA Driver (1) requires external slew rate control capacitor (2) and external gating for inhibit function (3). 9616 EIA Driver requires neither.

**93 Linear products in all**

Can any other linear-maker make that claim? No way. Whatever your linear needs, the answers are MADE IN FAIRCHILD.

- Industrial controls: 1-Amp op amp; high current comparator, AC control.
- Op amps: general purpose; low input current; high speed; low drift.
- Voltage regulators: general purpose; high current; high and low voltage.
- Interface: drivers/receivers; comparators; D/A conversion; memory.
- Consumer: TV systems; entertainment systems; communications.
- Custom: automotive; consumer; military.

Check us or your friendly Fairchild distributor for products and literature.





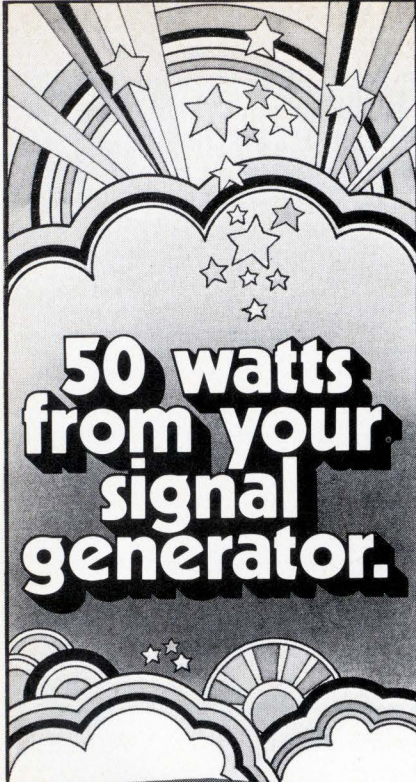

**50 watts  
from your  
signal  
generator.**



The ENI Model 350L RF power amplifier provides more than 50 watts of linear power and up to 90 watts of pulse power, from 250 KHz to 105 MHz. This all-solid-state unit will supply more than 30 watts at frequencies up to 120 MHz and down to 120 KHz. With a flat 50 dB gain, the amplifier can be driven to full power by a wide variety of signal sources and signal generators. AM, FM, SSB, TV and pulse modulations are faithfully reproduced by the highly linear output circuitry. The 350L is immune to damage due to load mismatch or overdrive, and constant forward power can be delivered to loads ranging from an open to a short circuit. This compact, portable instrument is complete with an integral AC power supply and RF power output meter.

Write for complete information:  
ENI, 3000 Winton Road South,  
Rochester, New York 14623  
Call (716) - 473-6900, TELEX 97-8283.

**ENI ELECTRONIC  
NAVIGATION  
INDUSTRIES**

**ENI . . . The world's leader  
in solid-state power amplifiers.**

## People

Sharif finding spot  
for Collins MOS work

Louay Sharif hopes to find the right niche for the MOS operation he's heading at Collins Radio Co., but it's likely to be quite different from that of MOS maker Mostek Corp., which he helped found, or of Texas Instruments, where he earlier ran an MOS operation.

Sharif, 40, was born in Iraq, but



**Sharif:** MOS a good business for Collins.

his more than 20 years in Texas (even his Ph.D. in physical chemistry is from the University of Texas) have given him the manner and accent of a Texan. So his move to Newport Beach, Calif., to head Collins' component operations from a staff job in Dallas, is apparently being made with the regret of a Texan leaving Texas. Sharif will certainly notice differences in the Collins MOS approach at Newport Beach where, unlike at TI and Mostek, MOS is a sideline.

Many large corporations have MOS operations, but few of them seem completely successful. Those that serve the corporations have often remained as expensive laboratories, while those with charters to make money have generally had to do more than serve sister parts of their companies. Collins' MOS operation has felt this tension.

Originally set up because outside suppliers have shown little interest in low-volume, high-reliability

work, the Collins group has also tried to work with other companies. One way was to offer standard parts, including some acquired from Philco-Ford when it gave up its MOS operation. Another approach was to offer extensive computer-aided-design capability, including training courses, but this also attracted little industry attention.

The latest, and perhaps most surprising, activity has been processing low-cost, high-volume chips for such calculator companies as Commodore and Eldorado. Sharif says: "This is a good business for us now. We can be competitive because we have very high yields—our customers say ours are the highest of their suppliers. But I don't expect it to be a long-term business. The industry is greatly increasing its MOS capacity, and prices will be dropping again on these popular parts." A case in point is Cal-Tex, a Collins customer, which is now establishing its own plant in Houston.

Instead, Sharif is expecting to emphasize two major areas, both clearly tied into other activities at Collins. One is custom business. To service this market, he says, "Collins has developed automated techniques to reduce design costs, and even though parts designed this way use more silicon area than average, this is not a problem in low-volume applications, where design costs are more significant."

His other interest is communications, and here the group hopes to draw on the expertise of other parts of Collins for guidance. Sharif says that the MOS group is designing a family of standard parts that he hopes will satisfy most requirements and greatly reduce design costs.

Willey has big plans  
for credit-checking system

Even though Credit Systems Inc. of Colmar, Pa., has been a successful small company among giants, new president James T. Willey is aiming to add to the company's stature. Credit Systems, a maker of credit-authorization terminals, is a sup-



## EA1500 N-CHANNEL Si GATE TAKES ON BIPOLAR.

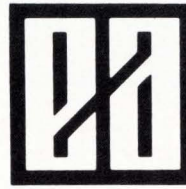

electronic  
arrays,  
inc.

501 ELLIS STREET  
MOUNTAIN VIEW, CALIFORNIA 94040  
(415) 964-4321 TWX: 910-379-6985

There's a lot of noise these days about RAMs and new super, bipolar processes. Well, we'd like to challenge all those bipolar claims. In fact, you can too. All one needs to do is pick up the data sheets and compare.

You may have heard or read that MOS is slower than bipolar. The fact is that the EA1500 N-channel silicon gate 1K RAM has an access time of 85nsec—worst case, including voltage variation, over the 0° to 70°C temperature range. Our "fair" competition also specs their 1K bipolar RAM at 85nsec—but at a nominal voltage and a junction temperature of 25°C!

OK, let's just assume it's a standoff in speed. In power dissipation, the EA1500 with a maximum, worst case, guaranteed .220mW/bit wins right out. The 93415 draws .684mW/bit at 75°C case temperature. That would take a whole bunch of air conditioning if you're going to use more than one.

Then, of course, there's price. The EA1500 sells for about one-third less than the 93415. That's 2.4¢/bit vs. 6.8¢ per bit in 100 up quantities. Just add up your bits and add up your savings. Finally, when you come to EA, you can get it. Because we don't tout it until we got it.



# THE GREAT RAM CHALLENGE: N-CHANNEL VS. BIPOLAR.



plier to major retail outlets such as Macy's, Abraham and Strauss, and J.C. Penney.

"A major concern for us now," says Willey, "is point-of-sale. Although POS is not a direct competitor, it's a market we would like to be in. Unfortunately, we are a small company and don't have the finances." Willey, who was promoted to president from marketing vice president, figures there are two ways to get a share of the POS market. The first is to go in on a limited basis. "We can do this for about a million dollars," he calculates. "We would have a limited system geared to the small store owner, such as a hardware store." Willey also says that several larger companies have said they're interested in merging with Credit Systems. A third alternative, he says, is to go public.

Another innovation instituted by the 38-year-old Willey was to expand the company's sphere of interest from retail markets to banking. The company recently introduced an authorization system that stores checking account information. A teller, instead of phoning for the information, can use the calculator-sized system to authorize checking. It is tied into Credit Systems' central processor in New York City. Willey says the system could be linked to a bank's main computer, but "it is less complicated to tie it into our own central processor."

Willey is also aiming to penetrate more markets with the check system. "There are 15,000 banks in the United States," he says, "and if we got 10% that would be a large market. But we think there are other markets too, because actually banks do less check cashing than other outlets. For example, there is the insurance business, and this credit system would be ideal for actuarial work."

Another Willey concept is a small-scale credit authorization system for small companies. The system is an in-house unit in which the retailer has credit terminals tied into an in-store minicomputer. "This," adds Willey, "could enable several little companies to share the same minicomputer."



**When it comes  
to Synchro Converters,  
if we don't make it ...  
you won't find it.**

Fact is, we've got the broadest line of synchro converters on the market. Single and "building-block" modules with errorless tracking . . . single and multi speed converters of high resolution . . . multiplexed converters going D/S or S/D . . . synchro to linear converters . . . DC angle or invariant sin/cos. Chances are, the very device you need is sitting right here on the shelf. But let's face another fact. Could be, you've got a problem application that a standard product won't meet. That's where our technical staff comes in. Ready to work with you. To design an individual module, or a total system to solve your digital or analog interface requirement. And more times than not, simple modification of existing products will do the job.

You see, if we don't have it, we'll make it. That's the attitude that made us "Number One" in the Synchro Conversion field.

For product or technical applications information, write or call Steve Muth or Jim Sheahan. They're engineers, so they talk your language.



**ILC DATA DEVICE CORPORATION**

100 TEC STREET, HICKSVILLE, N. Y. 11801 • PHONE: (516) 433-5330



Fluke problem solvers

# The new multimeter with advanced L.S.I. for more function power. 26 ranges, 5 functions.

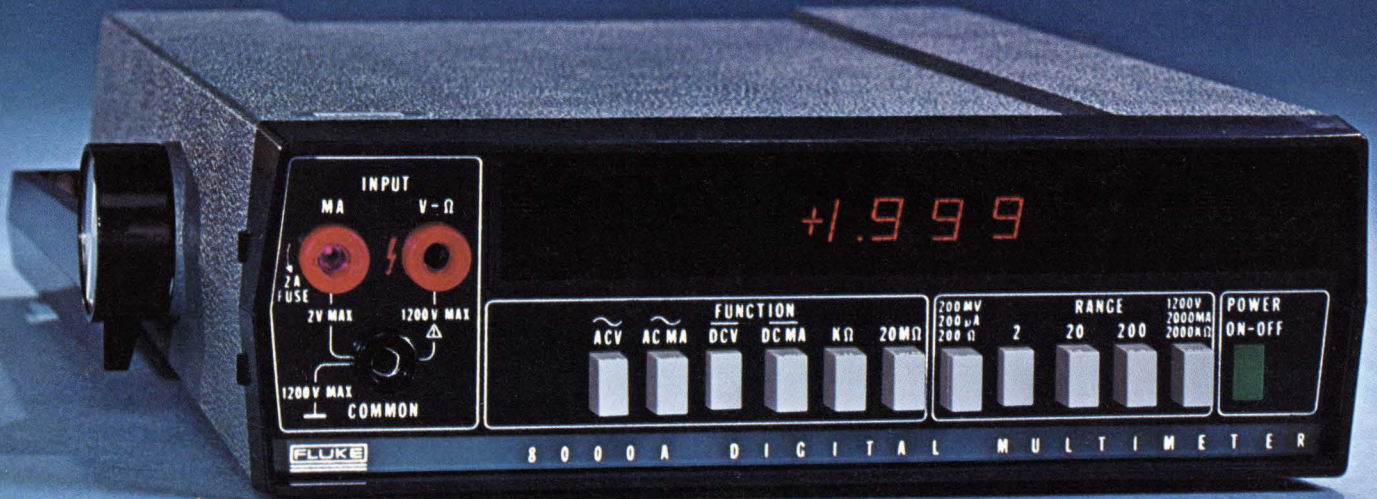

## \$299... Fluke's new 8000A, Try one for fifteen days, no obligation.

Now you can put the unmatched quality of Fluke instrumentation to work for you at the price of an ordinary multimeter.

Here's the DMM with more function power. It's got 26 ranges, including five ranges of ac and dc volts, five ranges of ac and dc current, and six

ranges of resistance. Push button control gives you the simplest most reliable error-free operation possible. The new Fluke 8000A is the only multimeter using an A-to-D converter with inherent self-zeroing to completely eliminate offset uncertainty.

More details are on the next page, but

we think you'll want to try this low-priced measurement system now. Fill in the coupon; we'll do the rest. The new Fluke 8000A is available now from local stock in Montreal, Toronto, Ottawa and Vancouver.

Circle 240 for more information.

Ship me a Fluke 8000A for \$299 plus \$\_\_\_\_\_ for additional options checked below. Add duty and sales tax. I prefer the following payment plan.

- Bill against the attached company purchase order for the full amount plus \$5 shipping and handling.  
 Cash order. My check for the full amount is enclosed. ACA pays shipping and handling.

Return within 15 days for full refund if not delighted.

#### Add the following options:

- |  |   |
|--|---|
| <input type="checkbox"/> Rechargeable Battery—\$50 | <input type="checkbox"/> Universal Test Leads—\$5     |
| <input type="checkbox"/> BCD Data Output—\$75*     | <input type="checkbox"/> Carrying Case—\$15           |
| <input type="checkbox"/> RF Probe—\$75             | <input type="checkbox"/> Dust Cover—\$8               |
| <input type="checkbox"/> AC Probe 20A & 200A—\$50  | <input type="checkbox"/> Rack Kit-Center—\$30         |
| <input type="checkbox"/> HV Probe—\$25             | <input type="checkbox"/> Rack Kit—1/2 Rt or Left—\$30 |

\*Not available on unit with rechargeable battery.

Send me literature only at this time.

Name \_\_\_\_\_ Title \_\_\_\_\_

Company/Institution \_\_\_\_\_

Address \_\_\_\_\_

City & Province \_\_\_\_\_ Zip \_\_\_\_\_

For even more convenience, let your nearby ACA office handle the details. In Montreal phone 514-670-1212. Ottawa, 613-725-3354. Vancouver, 604-253-7136. Toronto, 416-678-1500.

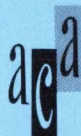

Distributed throughout Canada by  
**Allan Crawford Associates Ltd.**



# When you look inside you'll find the same high technology and quality we put in our \$3000 DVM's.

Take a look inside. The LSI chips, equivalent to over 3,000 circuit elements, are the most advanced proven semiconductor devices on the market today. Fluke is the only manufacturer using **both analog LSI and digital LSI** to give you increased reliability at lower cost with fewer parts. The Fluke 8000A has only  $\frac{1}{3}$  the number of parts used in a typical  $3\frac{1}{2}$  digit multimeter.

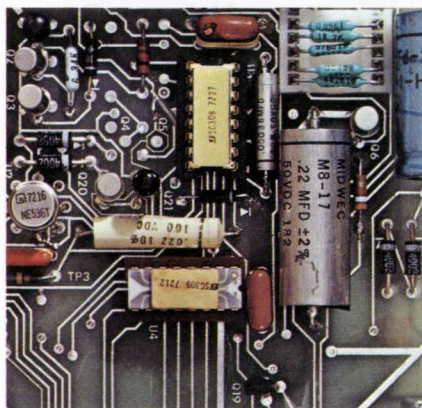

## A simple guarantee

You can understand our 12-month guarantee. It's straightforward and honest. And you can believe we live up to it. If anything happens to your 8000A, take it or send it to your nearest factory service center. We'll give you 48-hour turnaround service in the U.S., Canada, Europe and the Far East.

## Specs to work by

The new Fluke 8000A has a dc accuracy of 0.1% when you buy it. We guarantee it will still measure within that accuracy without recalibration a year later.

The case is rugged and tough. Drop this multimeter from a bench. Nothing happens to the works inside. We guarantee it.

## Wide range of measurements

Measurement flexibility is broad enough to meet all the situations you're likely to encounter. The Fluke 8000A gives you 26 ranges to measure ac and dc voltages from 100 microvolts to 1200 volts, currents from 100 nanoamps to 2 amperes; and resistance from 100 milliohms to 20 megohms.

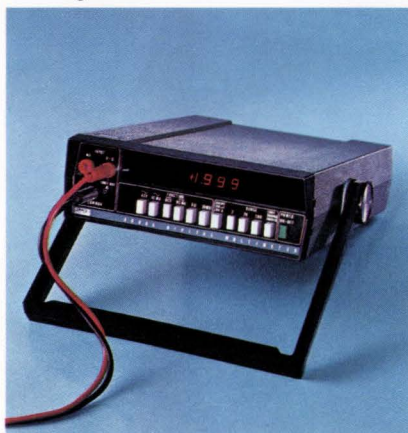

## Wide choice of options

For a few dollars more, you can add a rechargeable battery pack to give you completely portable operation for over eight hours. And when you're back on the line, the batteries will recharge automatically. Other options include digital printer output, deluxe test leads, high voltage probe, rf probe, 200-amp ac probe, carrying case and rack mount kits.



## A complete digital multimeter

But with or without options, the Fluke 8000A comes complete with test leads and spare fuses. It all adds up to an instrument you can count on day after day, year after year. Isn't this what you want in a digital multimeter at any price? Fluke thinks so.

PRINTED IN U.S.A.

8 Cents  
Permit 18061  
Canada

## BUSINESS REPLY MAIL

No Postage Stamp Necessary if Mailed in Canada

Eight cents postage will be paid by

Allan Crawford Associates Ltd.  
1627 Northam Drive  
Mississauga, Ontario

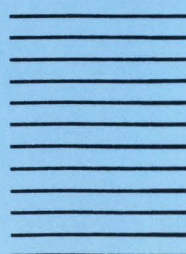



# “Scotchflex” Flat Cable Connector System makes 50 connections at a time.



“SCOTCHFLEX” IS A REGISTERED TRADEMARK OF 3M CO.

Build assembly cost savings into your electronics package with “Scotchflex” flat cable and connectors. These fast, simple systems make simultaneous multiple connections in seconds without stripping or soldering. Equipment investment is minimal; there’s no need for special training. The inexpensive assembly press, shown above, crimps connections tightly, operates easily and assures error free wiring. Reliability is built in, too, with “Scotchflex” interconnects. Inside of connector bodies, unique U-contacts strip through flat cable insulation, grip each conductor for dependable gas-tight connections.

“Scotchflex” offers you design freedom, with a wide choice of cable and connectors. From off-the-shelf stock you can choose: 14 to 50-conductor cables. Connectors to interface with standard DIP sockets, wrap posts on standard grid patterns, printed circuit boards. Headers for de-pluggable connection between cable jumpers and PCB. Custom assemblies are also available on request.

For more information, write Dept. EAH-1, 3M Center, St. Paul, Minn. 55101.



**“Scotchflex”.**  
**Your systems approach  
to circuitry.**





**Passive components  
are alive and well and  
living in Morristown,  
San Diego and  
Mineral Wells...**



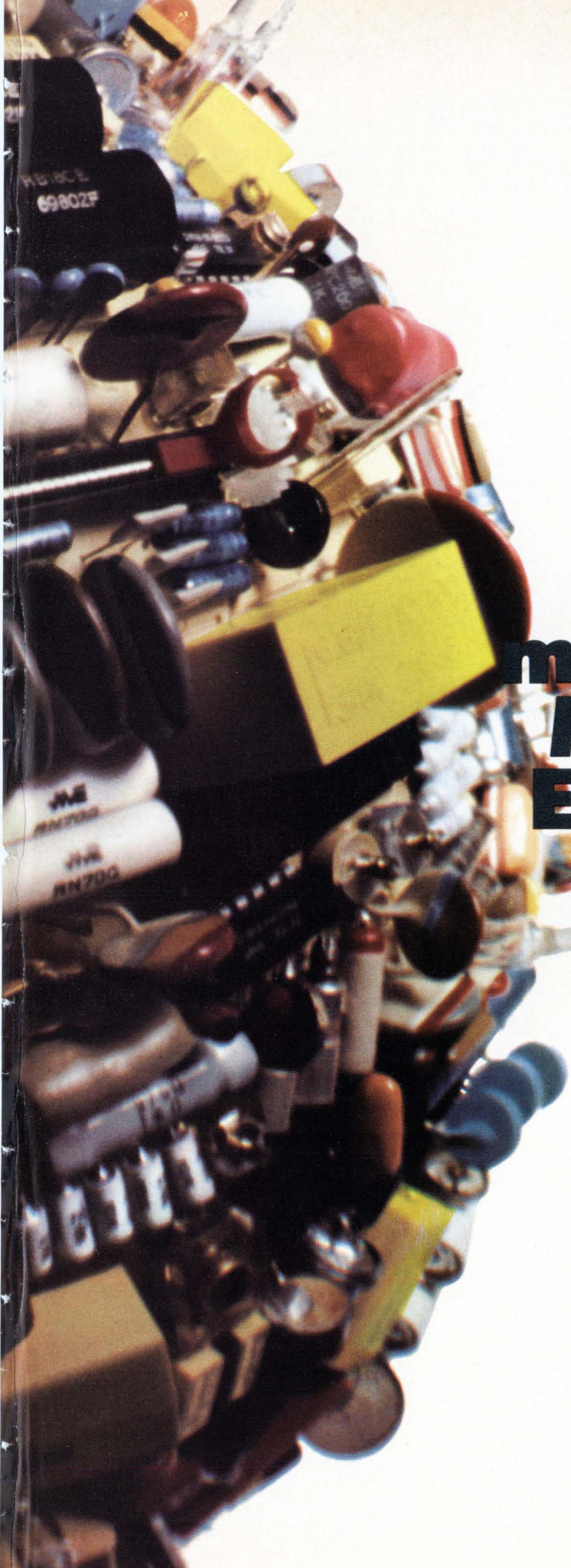

In the component OEM jungle, just staying alive is all some companies ask for. At MEPCO/ELECTRA we've got a different story to tell. In the last five years, while a lot of the competition has marked time and worried about the economy, we've tripled our volume.

We've got a lot going for us. Like our service... we can deliver from a 30,000,000 piece shelf inventory. Or if you need it, we've got versatility, too. We can produce almost any volume—from high production runs to the small quantity, high technology jobs. Plus we're big enough to supply your total passive component needs.

So whether you're buying resistors, capacitors or microcircuits for EDP, consumer equipment, communications or military programs, check with the big one, MEPCO/ELECTRA, first. Give us a call today... you'll find out why we're alive and well and really living.

# Talk to the man from MEPCO/ ELECTRA



MEPCO/ELECTRA, INC.  
A NORTH AMERICAN PHILIPS COMPANY

SOLD  
THROUGH  
NORTH  
AMERICAN  
PHILIPS  
ELECTRONIC  
COMPONENT  
CORP.

**Factory locations:**  
Columbia Road,  
Morristown, New  
Jersey 07960.

11468 Sorrento  
Valley Rd.  
San Diego,  
Calif. 92121.

P.O. Box 760 Mineral  
Wells, Texas 76067.





# Which of these General Electric lamps can help you most?

## New Green Glow Lamp!



Actual Size

Finally, a broad spectrum bright green glow lamp from General Electric, that gives you greater design flexibility than ever before. It emits green and blue light with suitable color filters. It is called G2B.

What's more, the G2B is directly interchangeable electrically and physically with our high-brightness C2A red/orange/yellow glow lamp.

So you can use the G2B alone for 120 volt green indicator service. Or together with the C2A to emphasize multiple functions with color. For example: for safe/unsafe functions, dual state indications and to show multiple operations in up to 5 colors.

And remember. Both the G2B and C2A save you money because of their low cost, small size and rugged construction.

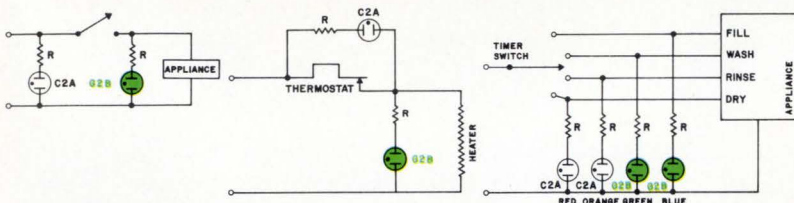

## New Sub-Miniature Wedge Base Lamp.

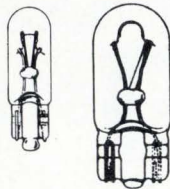

If space for indicator lights is your problem, this new GE T-1 $\frac{3}{4}$  size all-glass wedge-base lamp is your solution. It measures less than  $\frac{1}{4}$ " in diameter.

The filament is always positioned

in the same relation to the base. It won't freeze in the socket, which virtually ends corrosion problems. And like its big brother — the T-3 $\frac{1}{4}$  wedge base lamp — it features a simplified socket design.

## Three Potent Infrared Solid State Lamps (LEDs).

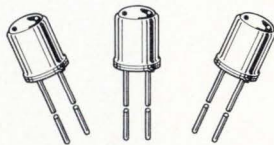

Get more than twice the useful output of other GE solid state lamps with GE SSL-54, SSL-55B and SSL-55C.

The increased energy concentrated in a narrow 20° cone allows you to use less sensitive detectors. Or to operate the lamps at lower current. Or to space lamps and detectors

To get free technical information on any or all of these lamps, just write: General Electric Company, Miniature Lamp Products Department, Inquiry Bureau, Nela Park, Cleveland, Ohio 44112.

farther apart.

All are excellent matches for GE photodetectors and can be used in many photoelectric applications. They're also particularly useful in applications demanding an infrared source capable of withstanding severe shock and vibration.

**GENERAL**  **ELECTRIC**

## Meetings

**Electronica 72:** Munich Fair Grounds, Munich, West Germany, Nov. 23-29.

**Int. Conference on Digital Satellite Communications:** Intelsat, Unesco Building, Paris, Nov. 28-30.

**International Conference on Magnetism and Magnetic Materials:** AIP, IEEE, et al., Hilton, Denver, Nov. 28-Dec. 1.

**National Telecommunications Conference:** IEEE, Astroworld, Houston, Dec. 4-6.

**International Electron Devices Meeting:** IEEE, Washington Hilton, Washington, D.C., Dec. 4-6.

**Annual Fall Conference:** IEEE, Sheraton-O'Hare, Chicago, Dec. 4-5.

**Fall Joint Computer Conference:** AFIPS, Convention Center, Anaheim, Calif., Dec. 5-7.

**Nuclear Science Symposium:** IEEE, Deauville Hotel, Miami Beach, Fla., Dec. 6-8.

**Aerospace Sciences Meeting:** AIAA, Sheraton-Park, Washington, Jan. 10-12.

**International Solid State Circuits Conference:** IEEE, Marriott, Philadelphia, Feb. 14-16.

**Aerospace and Electronic Systems (Wincon):** IEEE, Sheraton-U. of Pa., Philadelphia, Feb. 13-15.

**IEEE International Convention (Intercon):** IEEE, Coliseum and New York Hilton, March 26-29.

**Southwestern IEEE Conference and Exhibition (Swieeco):** IEEE, Houston, Texas, April 4-6.

**International Symposium on Circuit Theory:** IEEE, Four Seasons Sheraton, Toronto, Canada, April 9-11.

**International Magnetics Conference (Intermag):** IEEE, Washington Hilton, Washington, D.C., April 24-27.



A CAMBION DOUBLE "QQ" PRODUCT LINE

# Color your IC systems Cambion.

You can let your imagination soar, and still keep your most advanced IC packaging concepts practical. With Cambion's growing line of digital products, state of the art design ideas become a reality. And we can meet your needs with repeatable Quality, no matter how great the Quantity. Our variety of components is so extensive you won't have to think "specials".

Just take a look at our new Catalog 119. It features advanced new Cambi-Cards<sup>®</sup>, card files, drawers, universal panels with and without premounted socket strips and power planes, specific logic function cards, general purpose and discrete component cards, plus strip connectors, cable assem-

blies, integrated socket strips, component socket adapters, cable cards and card extenders.

We also offer a complete NC wrapping service to speed economical production of your IC system designs.

Develop your system ideas to their fullest potential *without component restriction*. Get your own copy of the new Cambion Catalog. It has 22 more pages than its predecessor showing more new products to keep ahead of your design needs. And they all have the Cambion Double "QQ" approach: the Quality stands up as the Quantity goes on. Order your copy today. Cambridge Thermionic Corporation, 445EM Concord Avenue, Cambridge, Mass. 02138. Phone (617) 491-5400. In Los Angeles, 8703 La Tijera Blvd. 90045. Phone (213) 776-0472.

Standardize on

## **CAMBION**<sup>®</sup>

... the Guaranteed Digital Products





# The end of hit-n-miss

Signetics SUPR-DIP guarantees .15% AQL.

Finally, digital circuits you can rely on. New SUPR DIP: Signetics Upgraded Plastic Reliability program. Guaranteed at .15% AQL. Already proven in the field. Available in quantity.

The first ICs you can choose and still sleep at night. And not just because they're guaranteed.

SUPR DIP saves you time, money, equipment and man power.

You achieve tremendous cost savings for a mere pennies more per part.

Your total costs go down because SUPR DIP ends any need for 100% pretesting. It ends extra preconditioning before board assembly. It screens for opens, shorts and all other anomalies at high temperature. It reduces system field failures. (Which not only saves you money on re-calls, but may save your reputation.)

SUPR DIP can cut your board reworking by a factor of 10. And can improve your standard AQL six times. We guarantee it:

# 0.15%

TEST	CONDITION	AQL	CUMULATIVE
Electrically Functional	25°C	0.15%	0.15%
	100°C	0.15%	
DC	25°C	0.65%	2.5%
	At Temperatures	1.0%	
AC	25°C	1.0%	
Mechanical	Major	0.25%	1.0%
	Minor	1.0%	

What's our secret? We utilize the best provisions of several user specs; plus add a few of our own.

What do you get? Top-notch standards:

- Visual die sort inspection, MIL-STD-883. Method 2010, Condition B Criteria.
- Preseal visual inspection, MIL-STD-883. Method 2010, Condition B Criteria.
- 100% thermal shock, MIL-STD-883. Method 1011, Condition A Criteria.
- 100% production electrical testing.
- 100% high temperature functional testing.

In addition, outgoing lot quality acceptance testing includes a .15% AQL for functionality; and a 1.0% to .15% AQL for mechanical and other electrical criteria.

Having tough requirements like those means we can deliver tough performance.

One EDP user, for example, didn't believe us and tested 100% of his order. Result? Instead of his usual 1+% defects, he got .08%. Now he only does random lot acceptance testing.

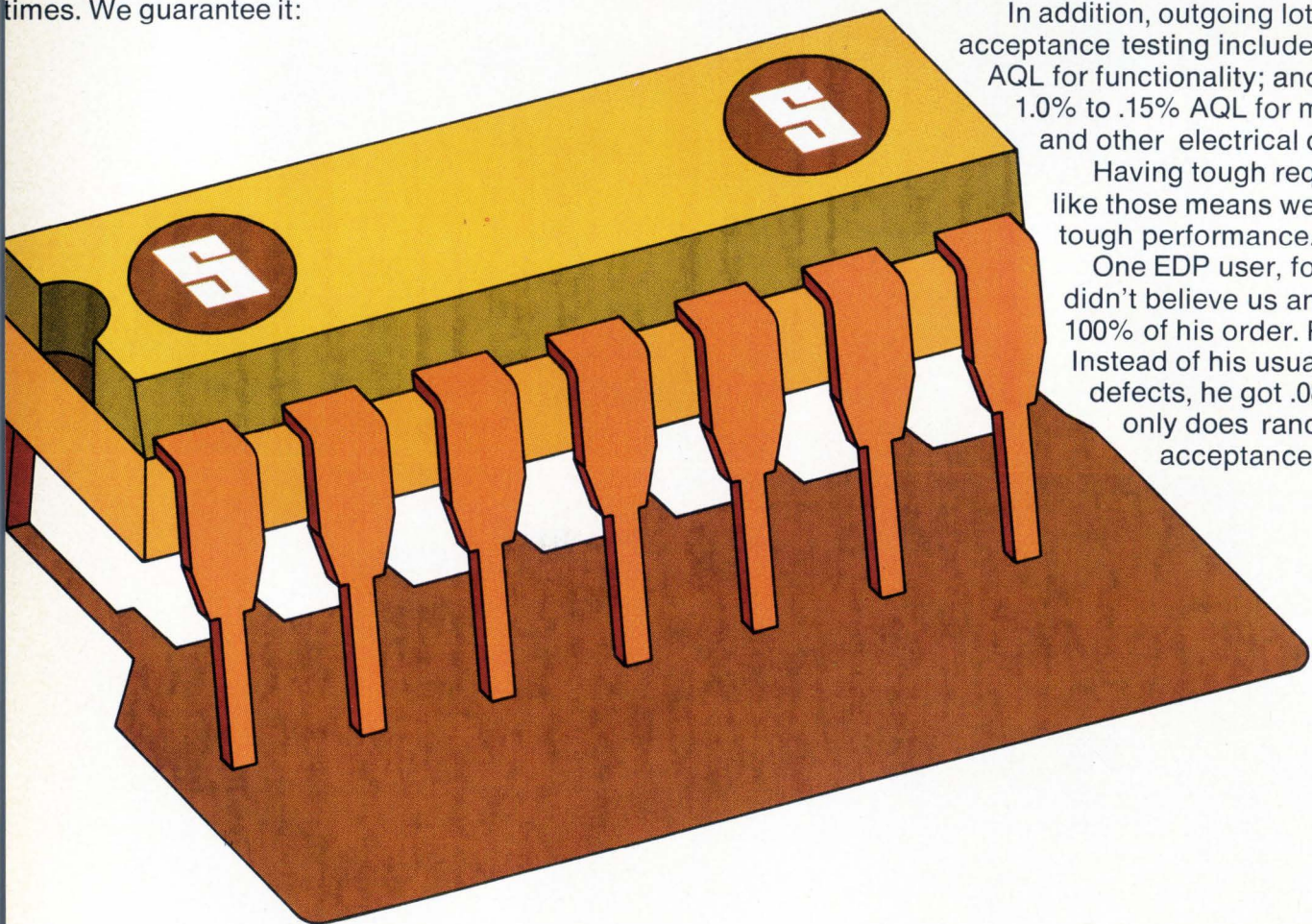



# Standard ICs.

Another customer concerned with board reworking bought 70,000 parts, specially identified them and inserted them into boards. After final shipment records all systems built with SUPR DIP were collected, he added up the results. There were only .001% defects. Out of 70,000 parts! And, finally, the customer who bought 4,000 SUPR DIP parts and tested them over temperature. He ran the test from zero to 100°C and back to zero again: And found that many failures — zero.

Just check the number of devices per board you assemble on the chart below; then read off the percentage of board reworks at the standard AQL (point A) and at 100% pretesting (point C).

Then compare it to the dramatic savings you'll get with SUPR DIP (points B, D).

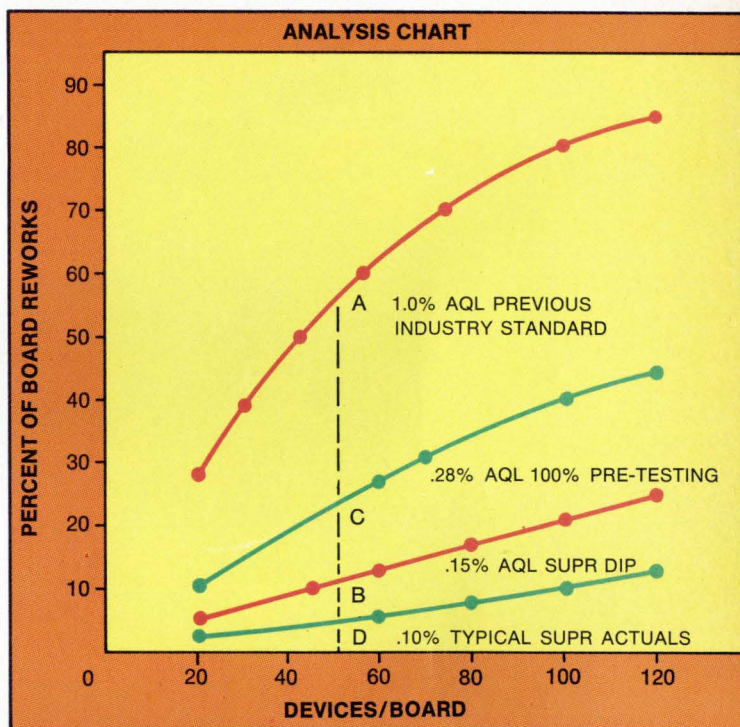
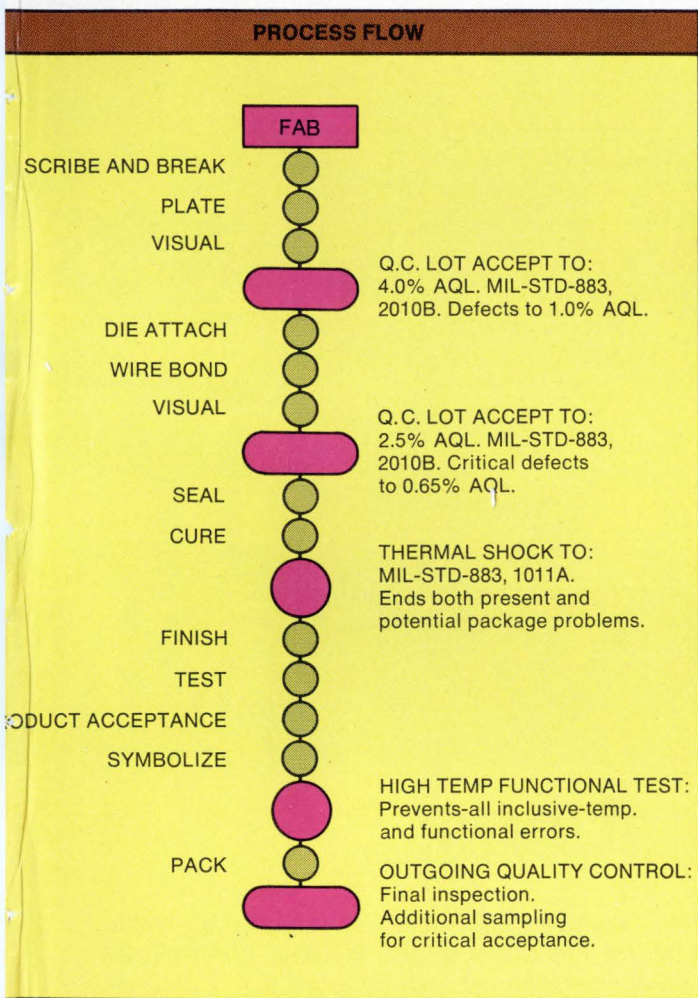

If you'd like further proof and information, just send us the coupon below. We'll tell you all about SUPR DIP. And we'll also include a pocket size AQL and LTPD Chart for handy reference.

Signetics  
811 E. Arques Avenue  
Sunnyvale, California 94086.

Send me all the literature, specs and data on SUPR DIP. And don't forget my free pocket size AQL and LTPD Chart.

Name

Title

Company

Address

City

State

Zip

Telephone

Signetics Corporation—A subsidiary of Corning Glass Works.

**signetics**

Study our Process Flow Chart and you'll understand how we can guarantee the highest quality commercial products in the business. SUPR DIPs aren't hit-n-miss devices because our work standards aren't hit-n-miss levels.

The dollars you'll save aren't hit-n-miss estimates either.

Especially on board reworking.

And we can prove it.

Or better still, you can prove it. Using your own work procedures.



# Amphenol sets your contacts straight

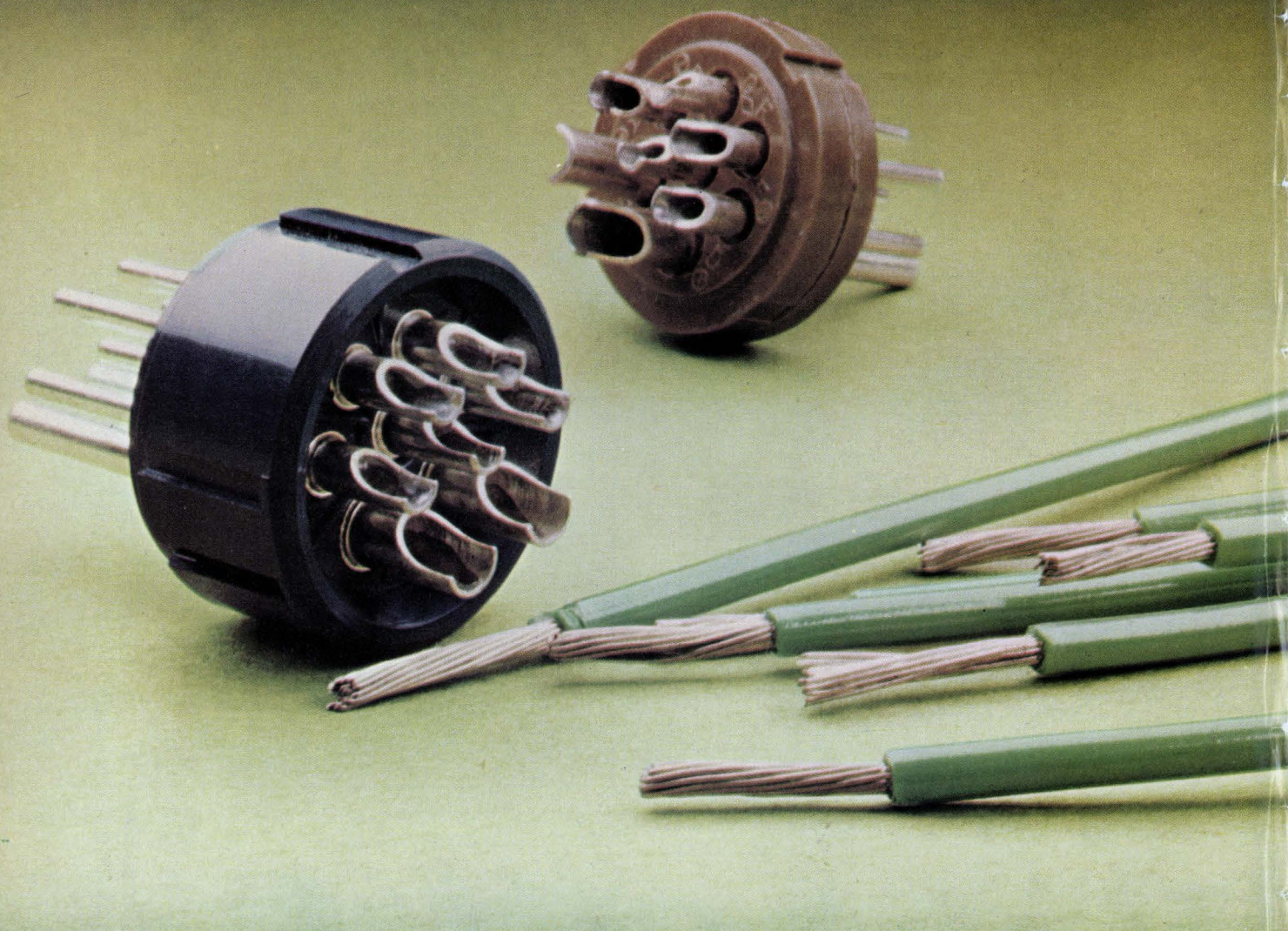

## for 30% faster terminations.

With Amphenol 97 Series connectors, the contacts *don't rotate* within the insert. They're pre-aligned—to stay aligned—so the solder cups are uniformly positioned for quick, easy soldering.

Test ours against the competition's. You'll find the soldering 30% faster, with less wasted motion, giving you lower termination costs. Our inserts are thicker, too. For extra strength and reliability. These benefits mean fewer scrapped parts during assembly, longer product life.

The 97 Series is basically the same connector as our original "Old Vet" AN (MIL-C-5015). In com-

mercial applications such as computers, traffic controls, dynamometers and welding controls, 97 Series connectors are lowering costs.

On-the-shelf inventory at your Amphenol distributor's means fast delivery, less for you to stock. Of all the orders we ship, 90% are straight from stock. Another good reason to specify Amphenol "97 Series" right on your drawings.

Get the "straight" story from our salesman or your Amphenol Industrial Distributor (AID). Amphenol Connector Division, 2801 South 25th Avenue, Broadview, Illinois 60153.

**BUNKER  
RAMO**

**AMPHENOL**



## **AMI developing one-chip auto distributor CPU**

American Micro-systems Inc., Santa Clara, Calif. is developing a **one-chip MOS central processor unit that will replace the automobile engine's distributor.** Present distributors with mechanical and vacuum spark-advance systems make generalized guesses as to the best time to ignite the sparkplug. But the CPU would calculate exactly the proper moment for each cylinder by taking into account fuel mixture, engine torque requirements, and piston position. The result would be increased performance with decreased emissions, since no fuel would be wasted by badly timed ignition. AMI says it is working with "a major automotive supply company."

## **Display shortage expected to lengthen**

Not only is there a shortage of light-emitting-diode displays for the personal-calculator market [see p. 42], but the industry can look forward to another pinch—**this one in gas-discharge and vacuum fluorescent panel displays for desk calculators.**

That's the forecast of Texas Instruments' Ian McCrae, optoelectronics marketing manager for the Semiconductor group in Dallas, who expects the shortage to extend through the first half of 1973. As a result, "TI has developed cost-competitive hybrid LED displays," he says. "They're bigger than 0.2 inch and, to conserve material, they're composed of either solid bar segments or dots that are optically enlarged by the package surface."

And there's an advantage in staying solid-state, he says. "The manufacturer can take the guts of the personal calculator and drive the larger displays in desk machines; the only differences are in the keyboards and case." **TI has customers committed to this approach, adds McCrae, that plan to introduce the new calculators early in 1973.**

## **National puts clock, driver in one package**

One-chip calculators and one-chip CPUs make system design easier, but they still require many external components—such as the clock generator and driver. **But a new IC from National Semiconductor puts this function in a single package.** The new circuit combines an oscillator, pulse-shaping network, high-current driver, and a current-limiting circuit in a single dual in-line package. It supplies a two-phase clock drive and operates at MOS or TTL voltage levels.

**The circuit requires no external components at all—the frequency is programmed by a single pin connection.** If the pin is left unconnected, the frequency is 200 kilohertz. If it is connected to the high rail (+12 volts in an MOS system, for example), output frequency is 500 kHz; and if it is connected to the low rail (-5 V in an MOS system), the frequency is 50 kHz. A second version, with a frequency range of from 200 kHz to 2 MHz is also expected to be available.

## **LED lamps give 2-color display**

A new series of light-emitting-diode lamps, developed by Monsanto, may lead to increased use in commercial and military applications. **The lamps offer two advantages not available before—two colors, and ac operation.** Basically, the lamps consists of two LED chips in a single diffused epoxy header. Different color combinations of red, green, and yellow chips can be ordered.



## AT&T files for DUV network

AT&T wants to compete in the digital data business with such special-service common carriers as Datran and the MCI companies by setting up a 96-city net by 1976 using DUV—its data-under-voice technique. AT&T has asked the FCC to approve the first five-city microwave link (Boston, New York, Chicago, Philadelphia, and Washington, D.C.) for 1974. It would use data rates of 2.4, 4.8, 9.6, and 56 kbits/s.

## Hybrid scan matrix eyed for ESS

Bell Laboratories is looking into a hybrid scan matrix for its electronic switching systems as a replacement for the scan circuits now using ferrite cores coupled to sense amplifiers. A scan matrix provides the interface between the high-noise input and the central processor.

**Bell figures it can save money and increase reliability with the new hybrids, which are better equipped to handle the 500-volt input and heavy noise characteristics of real-time ESS applications.** The hybrid scan circuit consists of eight thin-film resistor-capacitor networks interconnected to an eight-scan-point IC. The IC consists of 26 transistors, 33 diodes, and 34 resistors. Beam leads are used for interconnection on the substrate. Each package can withstand maximum power dissipation of 500 milliwatts, and can operate in a 0° to 70° environment.

## Adhesive LSI seal promises plastic prices for ceramic

DuPont has developed an adhesive seal for LSI packages that it says **could help bring the price of ceramic packages down to 25 to 45 cents in quantity.** This would make them competitive with the 30-cent price usually quoted for premolded plastic packages. With the new seal, said to be a hundred times better than old adhesive methods, duPont says it can get leak rates as low as  $10^{-8}$  centimeters per second, which meets the hard-to-attain Military Standard 883.

DuPont says that the new adhesives seal packages, with epoxy die bonding, could bring prices down into the range of premolded plastics.

## Dietzgen to sell \$695 electronic slide rule

A well-known maker of traditional slide rules, the Dietzgen Corp. of Chicago, is going electronic. **It is now market testing in Chicago a Japanese-made desktop machine that will begin retailing later this month for \$695.** William T. Laube, sales vice president for Dietzgen, says the machine will offer more than Hewlett-Packard's \$395 H-P 35—hyperbolic functions, cube roots, degree-radian conversion, and automatic conversion to decimals from degrees, minutes, and seconds.

## Addenda

Hewlett-Packard has turned up an algorithm error in one of the functions of its H-P 35 electronic slide rule. **A company spokesman says the error rate is less than 1%,** and it occurs when the machine is performing the exponential function. H-P has told purchasers it will fix things free. . . . NRMEC's planned \$100 one-chip slide rule [*Electronics*, April 10, p. 36] is back on the drawing board because the chip got too big for economical production. New target date: February or March. . . . A process for making hot-pressed ferrite recording head cores promises to be a boon for computer peripherals makers. National Micronetics Inc. has acquired the proprietary process, and president Ned Buoymaster says **the technique will cut the price of hot-pressed ferrites for these applications from about \$100 per cubic inch to between \$5 and \$10."**



# the toughest nut to crack!

## Systems Integration ...



Let's face facts. Debugging the hardware, writing the system software, checking the whole system out . . . in a nutshell, what it costs to get the computer to perform . . . has been the biggest problem facing system users.

The fact is, labor dependent system software and engineering development costs often add up to many times the system hardware costs.

The new GRI-99 series addresses itself directly to the systems integration dilemma; minimizing post-purchase problems and maximizing the inherent advantages of the minicomputer.

Today's real-time applications call for more efficient ways to put information into a computer and get it out again.

A Functional Minicomputer\*, the GRI-99 offers a new dimension in modularity — the original Universal Bus System — and a unique combination of functional programming and real-time software, to greatly enhance the system designer's ability to utilize computer controls effectively and economically.

So crack a nut. And while you're at it, crack a smile too. Because an 8K 16-bit model costs just \$2,800 in OEM quantity.

For a copy of our new book "If Minicomputers Are the Answer, What Was the Question?", please respond on company letterhead.

GRI Computer Corporation  
320 Needham Street, Newton, MA 02164  
Phone (617) 969-0800  
Cable: GRICOMP

**gri**  
GRI Computer  
CORPORATION

\*Patented





# MOSTEK's new digital clock circuit... A CLOCK FOR ALL REASONS

Designing clock systems? Say, alarm clocks? Clock radios? Calculator clocks? Calendar clocks? Stop watches? Industrial timers?

Then meet our MK 5017 P digital clock circuit. It's microprogrammable so we can tailor it to your exact application. Three standard versions are already available: the MK 5017—AA alarm clock; MK 5017—AN alarm clock/clock radio; and MK 5017—BB calendar clock. Look at these key features:

- 4 or 6-digit 7-segment display plus AM/PM indication (all versions)
- Clock radio features including sleep delay (AN)
- 12 or 24-hour operation and display (all versions)
- Snooze feature (AA, AN)
- Quick, convenient time and alarm setting (all versions)
- 50 or 60 Hz input—standard line or

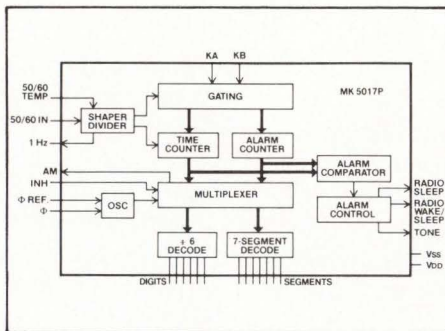

from our MK 5009 P time base circuit (all versions)

- Alarm tone generated on-chip; no external oscillator required (all versions)

Interfacing with your display is easy. If you're using luminescent anode tubes, our 5017 will drive your display *directly* (no driver transistors necessary). Or, you

can interface with LED, incandescent, gas discharge tube or light emitting film displays with minimal additional circuitry. And if you're using some other type, check our latest applications literature to shed some light on your problem.

It's easy to make time work for you. Just contact your nearest MOSTEK sales office, distributor or representative... today!

## MOSTEK

**MOSTEK Corporation**  
1215 West Crosby Road  
Carrollton, Texas 75006  
(214) 242 0444

© Copyright 1972 by MOSTEK Corporation

**REGIONAL SALES OFFICES:** Western: 11222 La Cienega Blvd., Inglewood, Calif. 90304 (213) 649-2888; Eastern: 60 Turner Street, Waltham, Mass. 02154 (617) 899-9107; Central: 8180 Brecksville Rd., Brecksville, Ohio 44141 (216) 526-6747.

**INTERNATIONAL:** Europe: Mostek GmbH, 7 Stuttgart 80, Breitwiesenstrasse 19, West-Germany 0711-731305; Japan: System Marketing Inc., Center News Bldg., 1-3-11 Sotokanda, Chiyoda-ku, Tokyo, Japan; Far East: Imai Marketing Assoc., Inc., 525 W. Remington Dr. # 108, Sunnyvale, Calif. 94087 (408) 245-3511; Hong Kong: Astec Components Ltd., Golden Crown Court, Flat "C," 5th Floor, 70 Nathan Rd., Kowloon, Hong Kong; Mid East: Racom Electronics, 60 Pinkas St., Tel Aviv, Israel.



## Old technique spawns hybrid vidicon imager

Westinghouse gets TV quality with 200,000 phototransistors and hybrid scanning, control panel in unit built for NASA

For years, engineers have been attacking the stubborn problem of how to get the bulky high-voltage electron-beam scanning system out of the otherwise solid-state-target video camera. One solution applies the new technology of charge-coupled-device imaging, which uses simple MOS clock-scanning techniques. But now an older technology—the culmination of an effort under way for more than a decade—has entered the picture.

Built by the Westinghouse Defense and Electric Systems Center for NASA, the latest all-solid-state imager achieves TV quality with an imaging surface of 200,000 phototransistors and a hybrid scanning and control panel. Together they form a novel array camera—completely self-contained and needing only 110 volts. And the camera's output fits into conventional TV studio-type display monitors.

The phototransistors are organized in an X-Y matrix of 400 rows by 500 columns. The sensors are made by standard silicon processing on a 2.5-inch slice, with individual devices on 2-by-2.5-mil centers, adding up to a resolution of 200 line pairs in the vertical direction and 250 in the horizontal.

The scan circuit, built by hybrid bare-chip techniques, takes the raw serial video image and, with separate blank and synchronization pulses, converts it to a 1-V EIA compos-

ite video signal. Scan synchronization is from a digital generator, while master clocking is from either a 9.45-megahertz crystal-controlled source or an externally variable source that allows the system scan rate to be tailored to the application.

Camera power and weight are still high—12 watts and 5 pounds—but newer models are expected to be reduced to 1 w and 1 lb. □

## Laser opens way to single diffusion

Monolithic power Darlington transistors have been available for about two years. But until now, no single-diffused Darlington, with their much higher safe area than epi-

taxial-base and triple-diffused versions, have been made. Motorola Semiconductor and Solitron Devices have just announced the first such parts, opening the possibility for even lower power-transistor costs.

The first Motorola parts have output devices similar to the popular 2N3771. Paradoxically, however, the Darlington version, which incorporates two transistors in a series configuration, uses significantly less silicon than the lower-gain single part—220 by 180 mils instead of 240 mils square. According to Leo Lehner, Motorola power operations manager, this opens the door to large cost savings when the process gets into high gear. Not only will the supplier's costs be less, but there'll be a savings of one complete package and mounting.

The reason for the smaller size is that conventional single-diffused

**Solid.** Westinghouse has built for NASA this solid-state imager using 200,000 phototransistors and hybrid controls. It needs 110 volts and its output fits studio-type TV monitors.

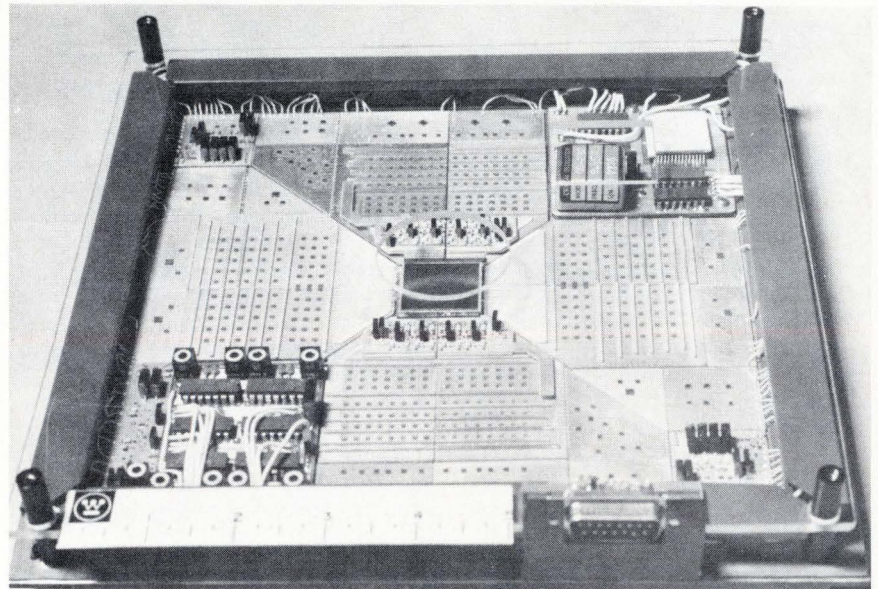



parts are gain-limited rather than current-limited. The newer parts, however, maintain their gains to 20 rather than only 10 amperes. "We cram base current like crazy into the second transistor," says Lehner.

Two new developments were necessary to make the parts practical, says Lehner. One was laser-scribing. "You can't scribe and break these parts because you would have to go over a bump in the surface, and that doesn't work." The only alternatives to the laser would be sawing or deep etching, both time-consuming methods that would require up to 15 mils waste between the parts instead of the few mils required by the 1-mil laser kerf.

Lehner says that a new method of making an internal or monolithic contact for the input base resistor also was necessary. It actually goes under the emitter, using the diffused high resistance beneath the lower resistivity emitter. The circuit also includes an unusual output diode, a

notch in the diffusion that provides a local short from the output collector to the emitter. This protects against reverse-emitter spiking with a positive-going signal.

The price of the parts is still higher than the two equivalent parts it replaces (\$3.30 for the 2N6355, its type number, vs \$3.10 for a 2N3771 and 2N3054, all 100-up prices), but that figure should come down with volume, says Lehner. Coming up soon will be a Darlington version of the popular 2N3055 and high-voltage triple-diffused Darlington. □

### Industrial electronics

## Mini runs electrical tests

What fails most often in a new car? The electrical system, one of the big three American auto makers discov-

ered, which has to be repaired at the manufacturer's cost, and owner's inconvenience, under the car's warranty. To reduce the failure rate, the auto maker is borrowing a technique familiar to the electronics industries—automated, minicomputer-directed testing of the finished product.

The test system, called VETS (Vehicle Electrical Test System), was developed by a minicomputer manufacturer, General Automation Inc. This firm's Automotive Industries Division in Southfield, Mich., has been concentrating on applying its machines to chores in the auto factories.

VETS is essentially a programmed go/no-go tester and information store. It presents written test instructions on a 10-by-24-inch display panel that hangs in front of the windshield of the car as it moves down the assembly line. Peering through the windshield from inside the car, a worker reads the instruc-

## Radar 'crash center' may be a better answer to car safety than radar braking, says DOT

Braking radar just may not be practical for the automobile of the next decade or so, according to a study conducted at the Department of Transportation's Transportation Systems Center, Cambridge, Mass.

Researcher J.B. Hopkins, in reviewing the results of the study, notes wryly that collision-avoidance radar systems will be "challenging developments" if they are possible at all. Instead, Hopkins suggests the adoption of radar crash centers to trigger passive restraint systems like air bags—a job they would do more effectively than the electromechanical systems now being studied.

The problem with braking radar is simple: the environment is too complex for it. It would have to be too powerful, its signals would require too much processing, and in the end it could be quite costly. In addition, drivers might well disable it because of false alarms and consequent sudden deceleration.

On the other hand, crash centers could become part of automotive equipment lists before 1980, estimates Hopkins. Today in most experimental systems an accelerometer is used to trigger inflation of air bag restraints. The accelerometer begins working at the instant of impact, and operation of the whole restraining system takes about 50 milliseconds.

The advantage of a radar-like crash center would be in its advance warning. Accelerometer-equipped cars are "safe" only up to about 30 miles per hour now, but the radar center's one or two meters of warning would be enough to increase the safe speed of a restraint-equipped car to about 60 miles per hour.

The center has worked out a parts list for such a system—a bplanar array antenna, LSI signal processor, Gunn diodes, and mixer—and has priced it at \$10 to \$20 in

volume. But that is only parts cost, and installation, test, handling, and margin for profit could easily raise system cost to \$75 or more. Adding in customer-paid inspection and maintenance would raise the ante to about \$150; in what is becoming a typical 10-million-car sales year, the crash center system market would total about \$1.5 billion dollars, of which 10% would be a market for electronics firms.

As envisioned by the center, such a sensor would probably be a continuous-wave doppler radar with a range of a couple of meters. It would not be much of a radiation hazard as radiated power at the antenna would be only about a quarter of a milliwatt per square centimeter and 0.002 milliwatt a meter away. Nor would the crash center be as prone to false alarms as the more powerful braking radars: it just wouldn't have the range to mistake a tree trunk for a trailer truck.



tions and puts the car manually through its electrical paces. Instructions are generated on the basis of punched-card data describing the electrical options in each car.

Whether each part of the electrical system—such as the headlights, or the air conditioner's blower motor, or the motors driving the windshield wipers or windows—performs satisfactorily is determined by sensing the current supplies from the auto's storage battery and comparing it with data on permissible limits stored in the computer's core memory. If the current is within limits, VETS goes on to the next test. But if the current falls out of limits, a no-go indication is given, and the fault is identified and printed out on a teletypewriter. At the end of each day, management has a complete report on faults found in all cars coming off the line.

In addition to a clamp probe that hooks up to the car, the General Automation system includes an analog-to-digital converter; the company's SPC-16 minicomputer with 8,192 words of core memory; the display panel which projects as many as 64 test and go/no-go instructions printed on slides; and a hand switch with which the operator signals the test results so that the system may proceed to the next test. An out-of-bounds current calls for a retest before a fail message is stored in the computer.

So far, General Automation has delivered "several" of the VETS system to be tried on assembly lines both in this country and at a plant in West Germany. □

## Ampex technique finds auto defect

A new twist on an old theme is undergoing tests at Ampex Corp. in Redwood City, Calif. For the past several years Ampex has been experimenting with optical data-processing techniques for processing essentially acoustical information [*Electronics*, Nov. 8, 1971, p. 75]. Previous Ampex work with the Of-

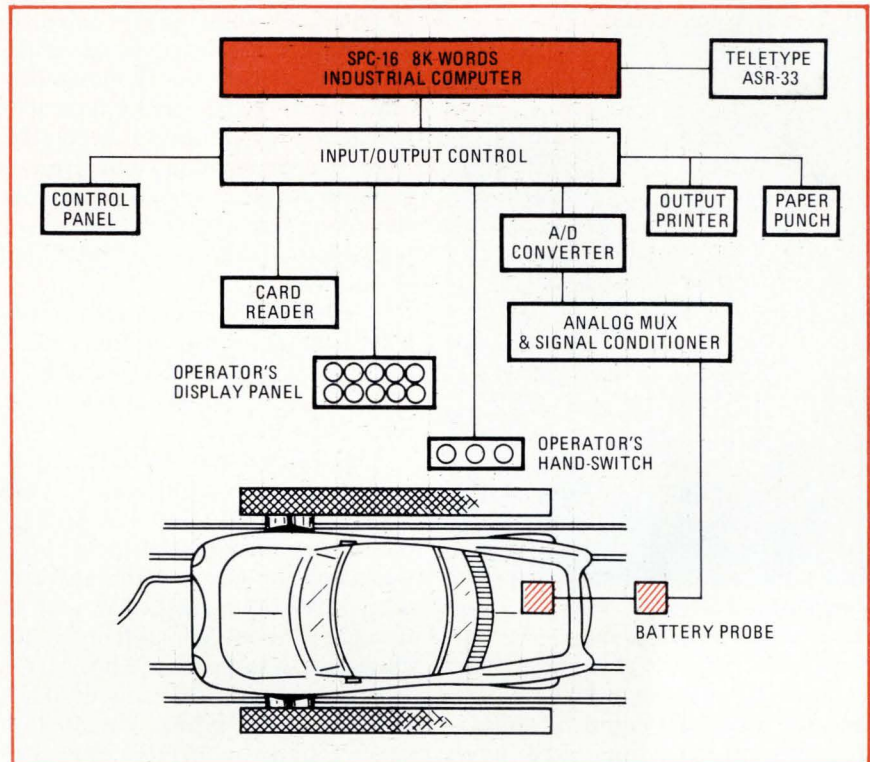

**Under the hood.** General Automation's VETS does go/no-go testing and information storage on an auto's electrical system as car passes down the production line. Mini directs the job.

fice of Naval Research and with NASA's Langley Research Center has been aimed at finding mechanical failures in jet engines and airframes. But now, according to Ampex, the auto industry is interested.

One of the Big Three in Detroit has contracted with Ampex to develop a system for determining if certain parts are missing from auto engines as they come off the assembly line. Tests to date have been with bearing inserts, and David Rodal, one of the engineers on the project, says, "We've been very successful."

Basically, the Ampex technique compares the frequency spectrum from the engine under test with one that is known to be complete. The audio signal from the engine under test is picked up by a microphone and is fed to an electron-beam recorder that "writes" the signal in a raster pattern across photographic film. The laser beam is then passed through the film and onto another piece of film, and through a lens. The second image is actually the Fourier transform of the original signal, and thus it is a plot of the full

frequency spectrum that was present in the original signal but not visible on the time vs frequency plot.

Since each dot and blip on the transformed photo represent something in the engine under test, and since the parts are alike in all engines of the same type, a comparison of the photos can easily indicate a missing part.

To make the system truly useful, each part in the engine must be identified as a blip on the photo. The next stage at Ampex is to try out the equipment's success at spotting a missing piston ring. □

## Space electronics

### Rest of world watches Anik shot

When the West's first domestic satellite goes up this week—launch is scheduled for Nov. 9—it will do more than supply Canada with television, voice, and data communi-



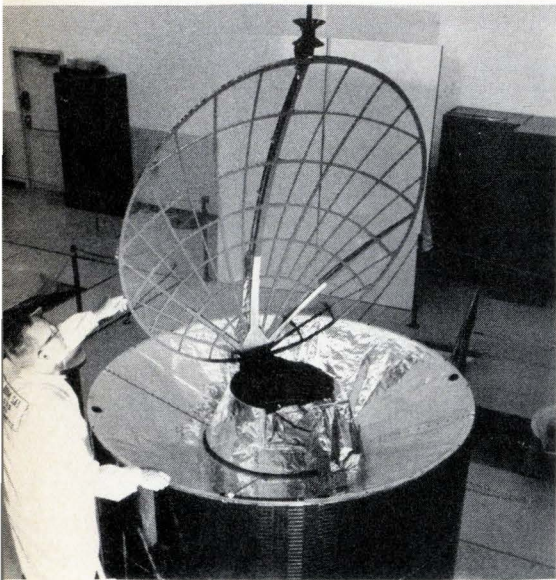

**Looking up.** Canadian domsat Anik 1 takes its name from the Eskimo word for brother.

cations. It will also provide a test-bed for ideas that could revolutionize communications and even society in underdeveloped nations.

According to Harold A. Rosen, manager of commercial satellite operations at Hughes Aircraft Co. in El Segundo, Calif., many countries are apparently waiting to see whether Anik 1, built for Telesat Canada, fulfills its promise of providing practical communication to the remote regions of northern Canada. They should know soon, for operation is expected to start in January. In the U.S., Hughes has already found a buyer in Western Union for its proposed domestic system, and Rosen also expects to sell to at least one other domsat company.

Two Aniks are scheduled to go into synchronous orbit (one as backup) to provide coverage of Canada, with a third held on the ground in reserve. They will connect a ground network incorporating two conventional heavy-route stations with 30-meter antennas in Toronto and Vancouver, a tracking and command station, two northern telecommunications stations with TV receive and two-way message capability, six network TV stations for TV relay, and 24 remote TV receiving stations.

Added to this will be about 20 thin-route stations providing two-

way message channels for native villages and other installations in the far north, where conventional microwave or line communications would be prohibitively expensive. This varied capability offers much promise to other countries without the complete telecommunications networks of the U.S., Japan and Western Europe.

The Hughes birds, which incorporate substantial subassemblies made by Canadian firms Northern Electric Co. and Spar Aerospace Products [*Electronics*, Aug. 1, 1970, p. 152], offer much of the capability of the much larger Intelsat IVs built for Comsat by Hughes. But Anik incorporates a number of innovations that keep the size, weight, and systems cost down—the total cost to Canada is about \$60 million for satellites, earth stations, and boosters.

Among these are a unique dual-mode antenna system designed to cover Canada, and orbit control to  $\pm 0.1^\circ$  to permit use of low-cost non-tracking antennas on earth. The 12 36-megahertz channels do not have redundant traveling-wave tubes, but two channels are considered spares in the design, and the receivers are fully redundant. The spacecraft an-

tenna uses a new gold-plated aluminum honeycomb with graphite exterior. The thin reflective mesh is transparent to solar pressure, but not to the 4- and 6-gigahertz operating frequencies. Total height is 11.6 feet, diameter 75 inches, and weight 1,200 lb at liftoff, compared to the 17.5 ft, 93.5 in. and 3,100 lb of the Intelsat IV with its similar 12 channels.

For future domestic satellites, Rosen anticipates interest in adding capability for the newly authorized 2.5-gigahertz band for community broadcasting. Though not suitable for direct transmission to an unmodified home receiver, this range could be used with a 10-ft dish and simple transistor converter for a \$1,000 station—a long way from the \$100,000 versions that will be used with Anik. For this use, Hughes has developed a special high-efficiency TWT that can put out 50 watts at over 50% efficiency. Further off in the concept stage could be direct broadcast at 12 GHz, where unlimited power is allowed, and a 1-meter dish and small mixer for TV reception. In both cases, Rosen sees direct broadcast of less interest in the U.S. than overseas. □

## Computers

### Demonstration heralds next wave: connecting a network of networks

Now that plain computer time-sharing has been replaced by networks of computers as the newest important trend in extending computer power, it's inevitable that somebody would take the next step—hooking up a network of networks. And that's what was done as part of last month's International Conference on Computer Communications in Washington.

One of the highlights of the conference was a demonstration of the Advanced Research Projects Agency's Arpanet [*Electronics*, Dec. 20, 1971, p. 64]. This is a coast-to-coast network of about 20 large computers at various Government,

university, and private research centers, interconnected by wideband telephone lines at 50,000 bits per second. Each computer's connection to the network is through an Interface Message Processor, a small Honeywell computer modified by Bolt, Beranek, and Newman Inc. In addition, a few centers have terminal IMPs, or TIPS, which provide access to the network but do not furnish computational capability to it.

For the demonstration, a TIP was set up in the hotel and 29 terminals, of almost that many different kinds, were connected through the TIP to Arpanet. Using any of these terminals, conference attendees had ac-



# SOMEONE FINALLY MADE A SIMPLE-TO-USE MOS RAM.

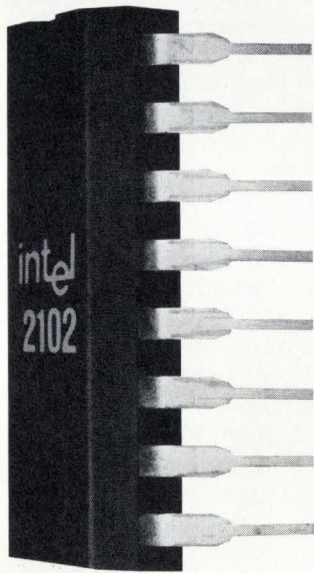

- NO EXTRA SUPPLIES (+5V ONLY)**
- NO CLOCKS (IT'S STATIC!)**
- NO REFRESH CIRCUITS**
- NO DECODING CIRCUITS**
- NO DRIVERS**
- NO LEVEL SHIFTERS**
- NO PULL-UP RESISTORS**
- NO TTL INTERFACE CIRCUITS WHATEVER**

**YES** it's in distributor stock now.

Ask for Intel 2102, the static 1024-bit N-channel MOS RAM with one microsecond access.

intel<sup>®</sup>  
delivers n-channel



cess to any of the computers in the Arpanet.

Another TIP in Arpanet is at NASA-Ames Research Center in Mountain View, Calif. Ames is also a customer of Tymshare Inc., a commercial time-sharing concern whose headquarters are in Cupertino, Calif. Tymshare operates its own commercial computer network under the name Tymnet. Tymnet's lines are an order of magnitude slower than Arpanet's and the system works under a different set of rules, but in many other ways the two are quite similar. Corresponding to Arpanet's IMPs, for example, are Tymnet's Tysats, satellite computers that provide an interface between the computers and the communication lines.

With an interconnection between Ames' TIP and Ames' Tysat, Tymnet users had access to Arpanet facilities, and Arpanet was able to use a Tymnet computer facility in Paris, via transatlantic cable—the first time Arpanet has gone beyond the continental U. S.

The hookup was intended to show feasibility only, and under regulations of the Federal Communications Commission was to be dismantled after the conference. But since the experiment succeeded, and since ARPA wants to spin off the network as a self-sustaining operation, probably under private ownership, the link can easily be restored at some future time, and other links can be established between other computer networks.

Meanwhile, with the great interest in computer networks indicated by the many sessions on this topic at the conference and the crowds in the Arpanet demonstration room, networks clearly are the wave of the future, just as time-sharing was the wave of the future only six or seven years ago.

"In the next few years you'll see a proliferation of private computer networks, just like the time-sharing companies that sprang up in the late 1960s," says Frank E. Heart, director of the Computer System division at Bolt, Beranek and Newman. In fact, Heart reports many inquiries from companies thinking of buying

IMP-like machines for terminals, and BB&N itself is looking into the possibility of establishing a private network. And of course the company, as builder of the IMPs and TIPS, is actively soliciting business from other interested parties.

"We've had lots of bites," says Heart, "but we don't have any fish in the frying pan yet." But a couple of dozen groups from foreign countries en route to or from the conference have been touring his laboratory in the weeks preceding and following the meeting. □

## How to update tapes without recopying

One of the difficulties with using magnetic tape as a storage medium lies in the mechanical characteristics of tape and of tape drives—they don't permit a new record to be written directly on the tape between two previously written records. To add new data, the whole reel must be read, the appropriate records processed, and everything rewritten on a different reel.

This rewriting is no longer necessary, claim engineers at the Boeing Co.'s data systems group in Seattle, Wash., who have found a way to update records directly. There's a price, of course—inefficient use of the "real estate" on the tape, and thus of the time required to read records—but this can be less inefficient than copying a reel.

In standard usage, a 0.6-inch gap separates tape records. When the tapes stop, the read/write head is somewhere near the middle of this gap, which provides room for deceleration and acceleration without losing data. Often all the records on a reel are divided into groups or files, each of which is terminated by a special one-character record called a file mark plus a special 3-in. gap.

The new technique worked out at Boeing assigns a number to each record. The record and its number become two separate records that together form a file, followed by the standard file mark and 3-in. gap.

Thus, to update a numbered record known to be somewhere on a reel of tape, the reel is searched for that number. The revised record is written directly over the old one, immediately after the number, a new file mark is added, and a new 3-in. gap created behind it. As all records are the same length, this stops the tape just in front of the identifying number for the next data record.

The cost in terms of tape inefficiency is easy to calculate. Suppose each data record consists of the equivalent of 10 ordinary punched cards, or 800 characters. These occupy an inch of tape, and in conventional recording would be followed by the 0.6-in. inter-record gap. The total length of tape occupied by a single record is thus 1.6 in., of which 1.0 in. actually stores data, making the efficiency 62.5%. Double the record length gives 77%.

But with the Boeing technique, the inch of tape storing data would be accompanied by a short record of a few characters labeling the data, a one-character file mark, two standard inter-record gaps, and a 3-in. file gap—a total length of 5.2 in. and an efficiency of 19.2%. In this case, doubling the record length increases the efficiency only to 32.2%.

A similar approach has been used by Digital Equipment Corp. for many years with its DECTape units. However, DECTapes come only in reels of a few hundred feet, compared to the standard 7-in., 2,400-foot reels. They have no inter-record gaps, and the drives have to be used with a controller, which compensates for the lack of gaps, recognizes the record numbers, and searches along the tape either forward or backward for a particular record. Corresponding functions are by software in the Boeing method. □

## Computer, gages tell rain story

Everybody talks about the weather, but the municipal government of at least one city is doing something—if not about the weather itself, then





**like  
cats and  
dogs!**

**We're  
Thundering  
with FETS**

**DUALS • N-CHANNEL • P-CHANNEL • SPECIALS**

Give us a quick call today, and test our producibility or call your local Distributor listed below.

**Solitron** DEVICES, INC.

Solitron Devices, Inc., P.O. Box 1416  
San Diego, California 92112

Telephone 714/278-8780  
TWX 910-335-1221

**CALL SOLITRON OR YOUR LOCAL DISTRIBUTOR LISTED HERE**

**EAST**

Florida, Orlando  
Hallmark Electronics  
(305) 855-4020  
Alabama, Huntsville  
Hallmark Electronics  
(205) 539-0691  
Maryland, Baltimore  
Radio Electric Service  
(301) 823-0070  
Savage  
Pytronics, Inc.  
(301) 792-7000  
Massachusetts, Boston  
DeMambo Electronics  
(617) 787-1200

Needham Heights  
Kierulff/Schley  
(617) 449-3600  
New York, Binghamton  
Federal (607) 748-8211  
Hauppauge  
Semiconductor Concepts  
(516) 273-1234  
Hicksville  
Kierulff/FJR  
(516) 433-5530  
Buffalo, New York  
Summit Distributors, Inc.  
(716) 884-3450  
North Carolina, Raleigh  
South Eastern Radio  
(919) 828-2311

Pennsylvania, Trevoise  
Hallmark (215) 355-7300

**MIDWEST**

Colorado, Denver  
Intermark Electronics  
(303) 936-8284  
Kierulff (303) 343-7090  
Illinois,  
Elk Grove Village  
Lakeland (312) 595-1000  
Ohio, Dayton  
Kierulff (513) 278-9411  
Kettering  
Arrow (513) 253-9176

Texas, Dallas  
Component Spec.  
(214) 357-4576  
Houston  
Component Spec.  
(713) 771-7238

**WEST**

Arizona, Phoenix  
Kierulff (602) 273-7331  
California, Culver City  
Avnet (213) 836-7200  
Los Angeles  
Kierulff (213) 685-5511  
Menlo Park  
Bell (415) 323-9431

San Carlos  
Intermark Electronics  
(415) 592-1641  
San Diego  
Intermark Electronics  
(714) 279-5200  
Kierulff (714) 278-2112

Santa Ana  
Intermark Electronics  
(714) 540-1322  
Van Nuys  
Intermark Electronics  
(213) 782-0362  
Utah, Salt Lake City  
Alta  
(801) 486-7227

Washington, Bellevue  
Farwest (206) 747-1515  
Seattle  
Intermark Electronics  
(206) 767-3160  
Kierulff (206) 763-1550

**CANADA**

Quebec, Montreal  
Prelco Electronics, Ltd.  
(514) 389-8051  
Toronto  
Carsten Electronics  
(416) 751-2371

Circle 37 on reader service card



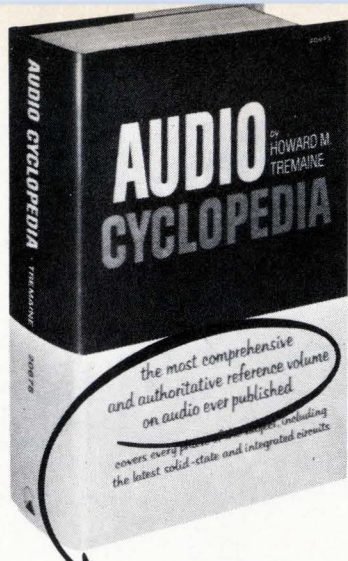

**Worth repeating:**  
**"The most comprehensive and authoritative reference volume on audio ever published!"**

Updated 2nd Edition

# AUDIO CYCLOPEDIA

By Dr. Howard M. Tremaine

- 1758 fact-filled pages
- Covers more than 3500 topics
- Over 1800 illustrations
- Completely updated content

It's a library in one handy volume! Fully updated to include latest developments, right down to the newest solid-state and integrated circuits. Gives you concise, accurate explanations of all subjects in the fields of acoustics, recording and reproduction... with each subject instantly located by a unique index and reference system.

It's the indispensable, complete reference book for anyone associated with or interested in the audio field. **20675—\$29.95**

**25 sections!** Contents include: basic principles of sound; acoustics, studio techniques and equipment; constant-speed devices, motors and generators; microphones; attenuators; equalizers; wave filters; transformers & coils; sound mixers; VU meters; tubes, transistors & diodes; amplifiers; disc recording; cutting heads; recording & reproducing styli; pickups; magnetic recording; optical film recording; motion picture projection equipment; speakers, enclosures, headphones & hearing aids; power supplies; test equipment; audio-frequency measurements; installation techniques; special charts & tables.

## 10-day FREE EXAMINATION

Howard W. Sams & Co., Inc.  
 4300 West 62nd St.  
 Indianapolis, Indiana 46268

E 112

Send me AUDIO CYCLOPEDIA (20675) for 10-day examination, without cost or obligation. I will send \$29.95, or will return the book within 10 days. (Include sales tax where applicable.)

I enclose \$29.95 payment. Send my copy post-paid with full 10-day refund privilege. (Include sales tax where applicable.)

Name (Print) \_\_\_\_\_

Address \_\_\_\_\_

City \_\_\_\_\_ State \_\_\_\_\_ Zip \_\_\_\_\_

## Electronics review

about the havoc too much weather can create.

In San Francisco, plagued by winter rainfall problems for many years, the problem is complicated by the city's famous hills, which tend to concentrate the runoff from a rainstorm—sometimes in unexpected places. But the department of sanitary engineering is using a computer in conjunction with an array of rain gages and sewage gages to establish just where in the city rain falls most heavily, what kind of load the rainfall places on storm sewers, and how and where new sewerage facilities should be built to prevent overflows.

With the results, the computer can print an outline map of the city, showing where the rain fell most heavily at any particular time during a storm; a series of maps showing the rainfall pattern at intervals a few minutes apart shows the storm working its way across the city, with occasionally heavy downpours occurring at isolated spots.

Like most other cities, the local government relied for many years on a single rain gage at a central point. After every storm, or at intervals during an extended storm, somebody from the weather bureau would look at the gage and note the amount of rainfall in inches. Then the department of sanitary engineering would try to relate this number to the difficulties encountered with flooded streets and inconvenienced citizens—usually without much success.

**Thirty gages.** When it was decided that this system was inadequate, 30 rain gages were installed at strategic points throughout the city along with 120 sewage gages—following a good deal of preliminary experimentation and some political diplomacy. Each rain gage consists of a pair of small vials mounted at an angle on a common pivot. One of the vials is upright; when it collects 0.01 inch of rain, it overturns, dumping out the water, bringing the other vial into the upright position, and transmitting a pulse on a telephone line to the computer.

Each sewage gage is a device that

blows bubbles of air into the liquid flowing past the monitoring point, with just enough pressure to keep the bubbles bubbling. The deeper the water, the higher the pressure.

The pressure also controls the position of a lever arm riding on a motor-driven cam. When the pressure is low, the cam barely touches the lever once in each revolution, but when the pressure is high, the lever is in contact with the cam during a longer part of each revolution. The result is a pulse-width-modulated signal transmitted to the computer, which interprets the widths of the pulses in terms of pressure and, therefore, depth. □

## Optoelectronics

### Laser cleans, helps preserve statues

A California oceanographer has developed a laser technique to clean and protect priceless works of art, make perfect images for posterity, and detect faults.

It started when the W. H. Munks—he is a professor at the University of California's Scripps Institution of Oceanography in La Jolla and she is a sculptress—visited Venice, a city where polluted air is

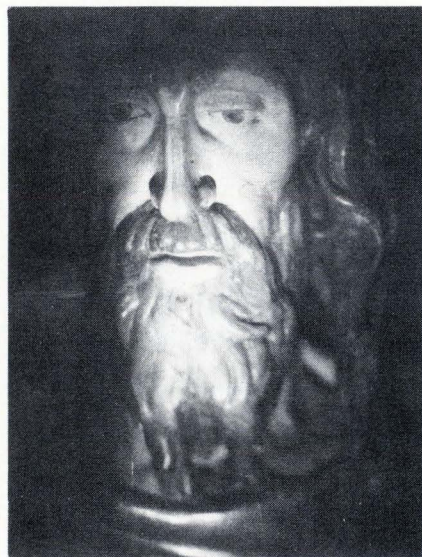

**Scrubbed.** In laser experiment, holograms were made of Donatello's John the Baptist.



slowly deteriorating priceless sculptures. After his wife interested him in the problem, Munk, with J. F. Asmus of Science Applications Inc. and R. F. Wuerker of TRW Systems, took holographic apparatus to Venice last spring.

Wuerker says most restorers feel that their most important single result was in the statuary cleaning, and the Italians have bought a laser for this use. But the team also hopes that eventually holograms could be placed on display so that actual pieces wouldn't be subjected to attacks like the one on the Piéta, and holograms could provide templates for restoration. The low-budget project was partly funded by a \$7,000 grant from ENI, the Italian Petroleum Institute, which operates some of the refineries that cause the pollution.

Laser bursts seem ideal for cleaning marble pieces, which are typically almost black with a corrosive mixture of carbon, soot, chalk, calcium carbonate, iron oxides, and silicates as much as a centimeter thick. Present methods of cleaning are either very slow or unselective in removing parts of the statue as well as the crust. According to Wuerker, however, the ruby laser used removes the dark deposit, but has little effect on the light-colored marble beneath.

Unexpectedly, the dark color of the subjects interfered with attempts to provide enough light to make holograms of the complete pieces. Wuerker estimates that a laser more powerful than the 1-joule ruby model used could do the job. □

### Integrated electronics

## C-MOS used for majority-logic chip

The C-MOS boom is accelerating as designers make the technology more attractive. First, the performance of standard C-MOS product lines was boosted by dielectric and polysilicon isolation fabrication techniques [*Electronics*, Oct. 9, p. 127], and now

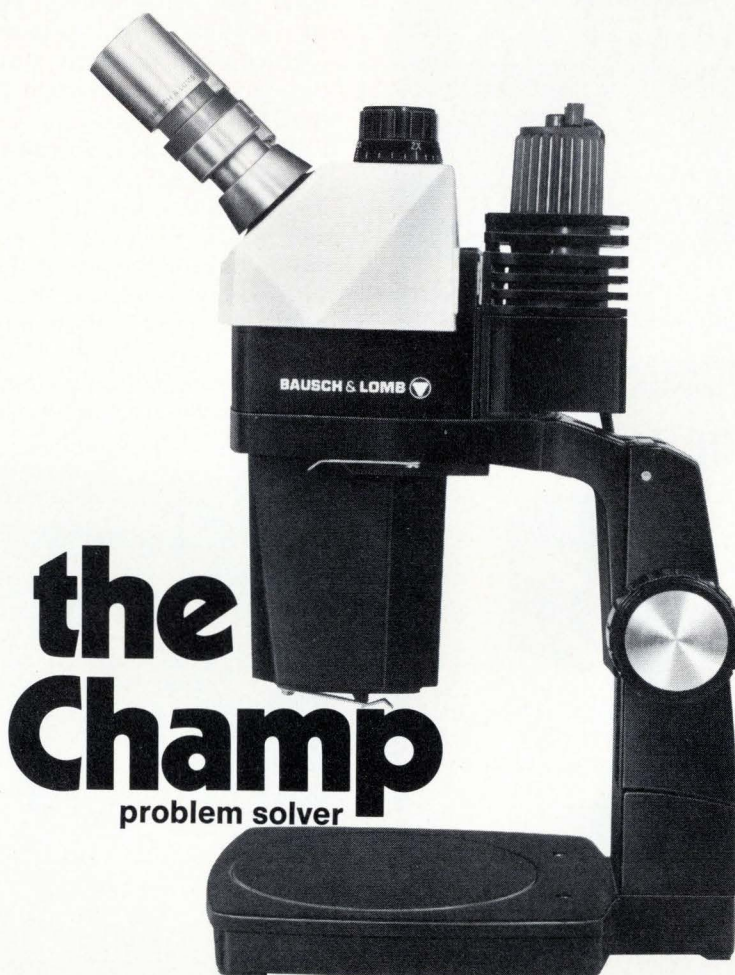

Bausch & Lomb StereoZoom 7 Microscope with Coaxial Illuminator is the answer to your need for full field, full aperture illumination; full color, high contrast imaging and better resolution of micro-miniature detail.

This unique form of incident illumination eliminates surface glare from highly reflective surfaces and also effectively illuminates low contrast objects.

You zoom over a magnification range of 15X through 280X. Field diameter ranges from 0.55 in. through 0.03 in. Full working distance is 3.0 in. through 0.56.

**FREE DEMONSTRATION . . . in your own lab with your own most difficult specimens or slides. Seeing is believing and, in this case, it's also thrilling. Send today for our catalog 31-15 and our FREE DEMONSTRATION offer.**

StereoZoom. Reg. T.M. Bausch & Lomb

# BAUSCH & LOMB

Scientific Instrument Division

61411 Bausch Street, Rochester, New York 14602





# HIGH-FREQUENCY OP AMP SOLUTIONS

FROM



**1GHz** UNITY GAIN FREQUENCY  
GAIN — BANDWIDTH

**300MHz** CLOSED LOOP  
BANDWIDTH

**1000V/μS** SLEWING  
RATE

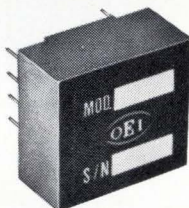

MODEL 9816 is available in a standard 1.125" sq. X 0.5" high module.

Price: \$36. each in quantities of 1, 2.



FOR THE SAME SPECS IN A SMALLER MODULE, ask about MODEL 9491A: 1.0" sq. X 0.31" high. Price: \$36. each in quantities of 1, 2.

For line driving, video, and pulse applications, our MODEL 9804 in the larger module and MODEL 9412 in the smaller module feature:

±10V at ±200mA output

±250V/μS

500MHz gain — bandwidth

Price: \$30. each in quantities of 1, 2.

Optical Electronics, Inc., manufactures a complete line of Op Amps, analog function modules, and 3-D displays.



**OPTICAL ELECTRONICS INC.**

P. O. Box 11140 - TUCSON, ARIZ. 85706  
Phone (602) 624-8358 TWX (910) 952-1283

## Electronics review

flexibility will be added by a different kind of logic, called majority logic. Motorola plans to introduce the industry's first C-MOS majority-logic chip in December—a five-input device that could replace 25 standard transistor-logic gates.

The chip is undoubtedly flexible. It can be used for all the common logic functions, like AND, NAND, OR, and NOR, as well as the basic combination and comparison functions and their inverses. More significantly, it can be used in arrays to perform correlation functions—such as comparing multiple samples with a test bit—or sequential functions in

which the output is determined by the character of the inputs. For example, there's the two-input flip-flop that will change state only when the inputs agree, or a unique three-input condition.

Lane S. Garrett of Motorola, one of the key developers of the chip, feels that this type of logic has not been used throughout the industry because its usefulness is not generally understood. Also, it makes a fairly complex MSI chip, containing a total of 88 devices (44 n-channel, 44 p-channel) on a die 59 by 67 mils. Garrett sees the device finding its way into many standard military

## Electronics Index of Activity

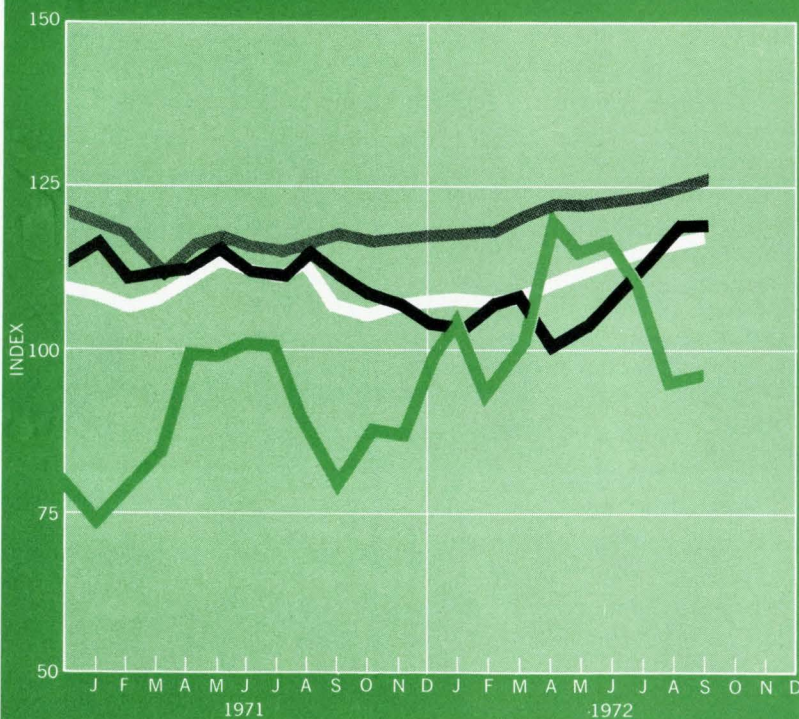

Segment of Industry	Sept. '72	Aug. '72*	Sept. '71
Consumer electronics	97.0	95.3	99.3
Defense electronics	120.0	120.0	105.0
Industrial-commercial electronics	127.7	125.9	118.8
Total industry	118.4	117.6	108.2

The index recovered a little in September by inching upward 0.7% to 9.4% above its year-ago level. Consumer electronics, up 1.8%, was 2.3% below its corresponding 1971 month. Defense, unchanged, was 14.3% ahead of its September 1971 performance. Industrial-commercial rose 1.4%, putting it 7.5% ahead of its year-ago level.

Indexes chart pace of production volume for total industry and each segment. The base period, equal to 100, is the average of 1965 monthly output for each of the three parts of the industry. Index numbers are expressed as a percentage of the base period. Data is seasonally adjusted.

\* Revised.



and industrial applications, and points to character recognition as a prime example. □

## Memories

### Hybrid technique yields mass memory

The prospect of semiconductor mass memories—several million bits—based on hybrid techniques is growing brighter with the success of a C-MOS memory and logic subsystem built by the Westinghouse Electric Corp. for the Naval Air Development Center. This type of hybrid subsystem, which has 192 words by 32 bits, could serve as a building block for a 3.6-million-bit memory.

The C-MOS unit, which meets military specs, contains C-MOS random-access memories built by Westinghouse and standard off-the-shelf decode and logic C-MOS chips. What's innovative is that they're all put down as bare chips on one substrate, so that each package is a self-contained unit that includes memory, address, and decode. By comparison, conventional semiconductor memories are built up with dual in-line RAMs and peripheral circuitry in separate packages.

In a mass memory, each Westinghouse substrate would actually house 256 words of 18 bits each and be wire-bussed to others to form one package—in this case a 4,096-word by 18-bit section. Finally, these packages may be wire-bussed to build up memory modules of 32,768 words by 18 bits.

Now that this approach to mass memory has been operating successfully at the NADC labs since June 1971, Westinghouse plans to replace the C-MOS RAMs, which occupy a great deal of chip and have n-channel leakage difficulties, by nitride MNOS RAMs. These would have the advantage of being nonvolatile, but would require more power. Interestingly, the same C-MOS logic—with some level shifting—could be used with the MNOS units.

While the early work was done

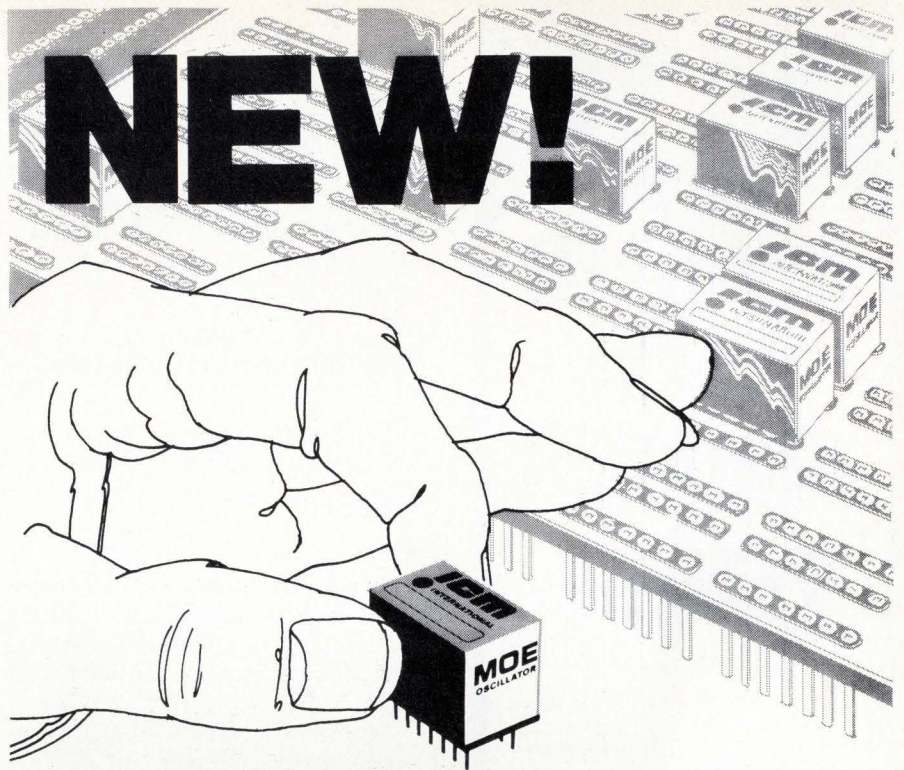

## INTERNATIONAL'S MOE Crystal Oscillator Elements provide a complete controlled signal source from 6000 KHz to 60 MHz

The MOE series is designed for direct plug-in to a standard dip socket. The miniature oscillator element is a complete source, crystal controlled, in an integrated circuit 14 pin dual-in-line package with a height of 1/2 inch.

Oscillators are grouped by frequency and temperature stability thus giving the user a selection of the overall accuracy desired. Operating voltage 3 vdc to 9 vdc.



**INTERNATIONAL**  
CRYSTAL MFG. CO., INC.  
10 NO. LEE • OKLA. CITY, OKLA. 73102

TYPE	CRYSTAL RANGE	OVERALL ACCURACY	25°C TOLERANCE	PRICE
MOE-5	6000KHz to 60MHz	+ .002% -10° to +60°C	Zero Trimmer	\$35.00
MOE-10	6000KHz to 60MHz	+ .0005% -10° to +60°C	Zero Trimmer	\$50.00



# NEW SHORTER CASE! SCHAUER 1-WATT ZENERS

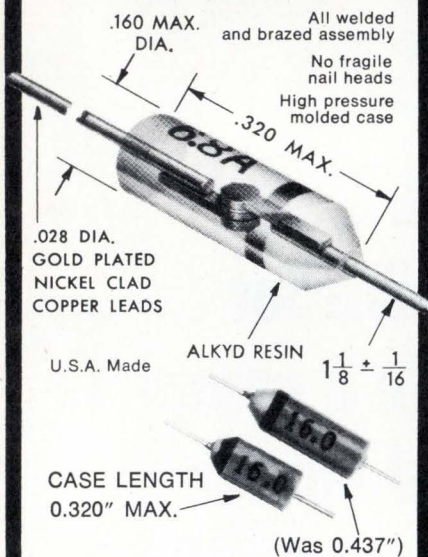

**SAME LOW PRICES FOR  
1% TOLERANCE ZENERS  
ANY VOLTAGE  
FROM 2.0 TO 18.0**

Quantity	Price Each
1-99	\$1.07
100-499	.97
500-999	.91
1000-4999	.86
5000 up	.82

### IMMEDIATE SHIPMENT

Send for rating data and 20%, 10%, 5% and 2% tolerance prices.

Semiconductor Division

## SCHAUER

MANUFACTURING CORP.

4514 Alpine Ave., Cincinnati, Ohio 45242  
Telephone 513/791-3030

## Electronics review

under a \$25,000 Navy contract, the MNOS effort will be performed under an 18-month contract of \$570,000 from the Army Electronic Systems Command, Ft. Monmouth, calling for demonstration and development of reliability data. □

## Commercial electronics

### LED shortage to extend into 1973

The personal-calculator industry is beset by a shortage of light-emitting diodes—and suppliers and users expect the deficit to continue into 1973.

Monsanto's Hank Carbajal, product marketing manager for displays in Cupertino, Calif., says two factors led to the situation. First, "Many calculator makers were counting on liquid-crystal displays; when liquid crystal didn't come about, the makers switched to LEDs." Second, there's a material shortage.

The shortage could affect prices. "The eventual price of consumer calculators is to a large extent dictated by the availability of displays," says Ian S. McCrae, optoelectronics marketing manager at Texas Instruments. "Basically, it's a materials problem—the price and availability of the gallium-arsenide-phosphide chip. And people buying gallium-arsenide wafers and doing their own epitaxial work are finding a basic shortage of GaAs." TI's solution is to convert customers from the 100-mil digit to a 70-mil size.

In Santa Clara, Calif., National Semiconductor's LED display production is heavily committed to the NSN-33 three-digit cluster. National's experience with that product is typical of what's happening with LEDs today. Paul Pagnini, LED product marketing manager at National, says the NSN-33 never has been announced as a product. National simply sampled a few customers, and the orders came in faster than they could be handled. "We had a massive backlog even before we started production."

Charles Krakauer, president of Bowmar/ALI Inc. of Acton, Mass., says, "One interesting guessing game is when capacity will reach demand. We keep pushing the date ahead. It could be well into '73 before supply catches up with demand." Bowmar itself was short of LEDs for a while, and had to go outside. Production has risen, however, so that Bowmar has once again become a supplier as well as a user. And the GaAs shortage is getting less acute, Krakauer says.

Monsanto's Carbajal agrees. He says material shortages should be eased somewhat by construction of additional manufacturing facilities at Monsanto, TI, and Litronix. In fact, a Litronix marketing manager says, "We're in pretty good shape—we're meeting our commitments—because we significantly increased our capacity over the past six months." But, says Dan Davis, manager of Litronix' Consumer division, "We can't build for stock—we have no cushion."

Some optimism is being emitted by Bell & Howell in Pasadena, Calif. There, Robert D. Burr, prod-

### Number of numbers

What's the light-emitting diode market for calculators? James Lovette, LED marketing manager at Fairchild's Microwave and Optoelectronics division, puts it at \$20 million to \$26 million for 1972. At an average price of \$2 a digit, that comes to 10 million to 13 million digits. Lovette, who says Fairchild is doing more LED-display business by dollar volume than anyone else, places the total shipping rate for all suppliers at about 2.5 million digits a month. From talks with several industry sources, the shipping rate in digits per month looks like this:

TI	500,000
Litronix	500,000
Fairchild	450,000
Bowmar	350,000
H-P	300,000
Monsanto	250,000
Others	300,000
TOTAL	2,650,000



# Complete RF Network Analysis — GROUP DELAY

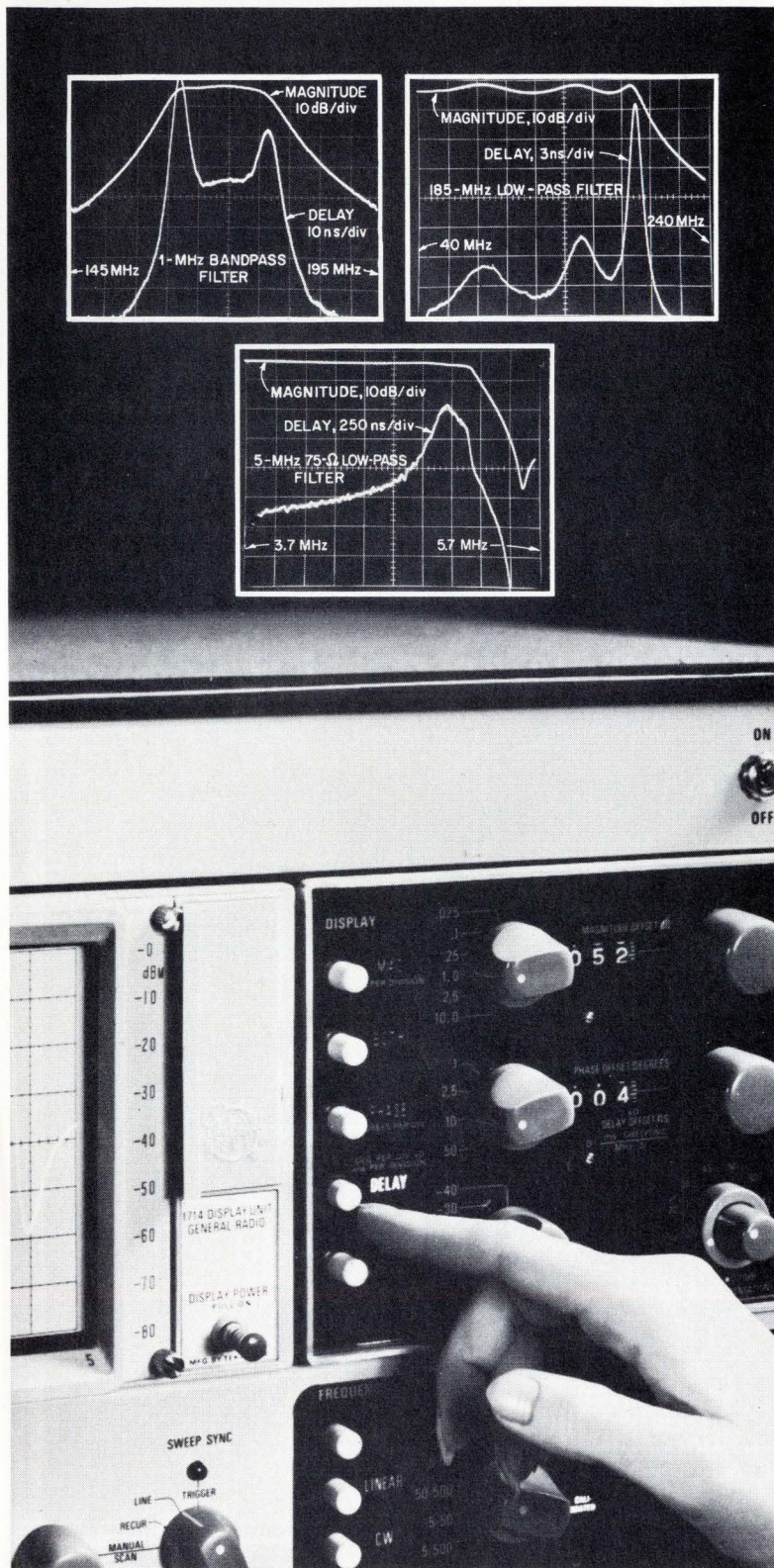

**YOU** may recognize group delay ( $-\Delta\phi/\Delta\omega$ ) as a prime consideration, especially in the communications field (a non-uniform delay, for example, causes data-transfer errors in PCM systems and color distortion in TV systems).

**YOU** may also recognize group delay as something difficult and expensive to measure. Specialized equipment can measure it (but can do little else), some sweep-frequency analyzers can measure it (with a computer or over special frequency bands), or a manually tuned system can measure it (if you have a slide rule and plenty of time). Today, that's all changed.

**YOU** can now determine group delay simply, quickly, and inexpensively — a 295-dollar option to the GR 1710 RF Network Analyzer provides direct-reading group-delay measurements from nanoseconds to milliseconds over a frequency range of 400 kHz to 500 MHz.

**YOU** have to invest in a basic 1710 also, of course, but how could \$6850 be better spent? You'd have a compact system that provides measurements of nearly any transmission and reflection property and provides them from 400 kHz to 500 MHz with a 115-dB dynamic range and 0.005-dB resolution!

**YOU** should look into it.

 **General Radio**

NEW YORK (N.Y.) 212-964-2722, (N.J.) 201-791-8990 • BOSTON 617-646-0550  
CHICAGO 312-992-0800 • WASHINGTON, D.C. 301-881-5333 • LOS ANGELES 714-540-9830  
TORONTO 416-252-3395 • ZURICH (01) 55 24 20

GR COMPANIES • GRASON-STADLER • TIME/DATA • TECHWARE COMPUTING CORP.  
GR ASSOCIATE • MICRONETIC SYSTEMS INC.



# The Elegant Transformer Kits

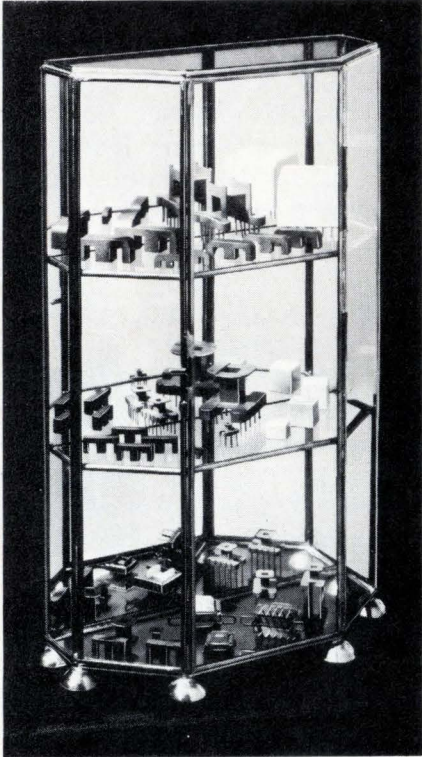

Select from 157 kits. To find the exact match for your needs. Plus ready-made economies. With ferrite cores. Steel frames. Cases. And bobbin/coil forms that pin precisely into standard printed-circuit grid patterns.

Six materials: fluorocarbon, nylon, glass-reinforced nylon, DAP, polyester and epoxy. For stability at temperature ranges from 105 to 200 C.

The complete collection expresses the craftsmanship you expect from EPC as an EAI component company. Look to EPC also for custom-molded parts. Or to EAI for thick-film audio amps. Capacitors. Custom coils. Solenoids. Active filters. Analog/digital converters and other special function modules. Plus a growing list of other elegantly crafted etceteras.

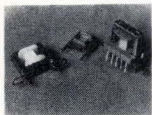

## EPC

Electrical Plastics Corporation  
500 Long Branch Avenue  
Long Branch, New Jersey 07740  
Tel. (201) 870-9500

A Subsidiary of Electronic Associates, Inc.

## Electronics review

uct manager for the Electronic Materials division, doesn't see the materials shortage as a long-term proposition. "It shouldn't last more than three or four months." □

## Point-of-sale is a point of view

No doubt about it, the point-of-sale market has begun to bloom; what appeals to retailers is the basic premise of POS: it saves them money. But D.C. Leonard of the TRW Systems Application Center, asserts that it isn't that clear-cut. Like everything else in electronics

and engineering, there are tradeoffs.

According to his figures, there already are 30,000 credit-checking POS terminals in operation, and growth is projected at 250,000 by 1976. In addition, there are 3 million to 4 million cash registers in the United States, and many are potential candidates for replacement by POS terminals. However, questions arise—are users asking too much, and can makers supply POS systems that are both cost-effective and profitable?

In Leonard's study, POS systems break down into three families: verification systems separate good account numbers from bad; authorization systems enable transactions in amounts above so-called local

## News briefs

### H-P cuts mini prices

Hewlett-Packard has cut prices of end-user and OEM minicomputer prices by up to 35%. The reduction, says William Nilsson, marketing manager for the Data Systems division, is due mostly to reduced core costs. Another factor, he says, is volume discounts. The price cuts may be expected to shift H-P's traditional end-user emphasis somewhat more toward the OEM.

At Data General and Digital Equipment Corp., spokesmen profess to be unimpressed. A DEC official says H-P systems will still be more expensive than DEC's; Data General believes that if H-P is attempting to use the new prices as an entree to the OEM market, it may not have much luck.

### Asbestos-free phenolic

As of the first of the year, all phenolic supplied by GE for molding will be asbestos-free. The material, a thermosetting plastic, has been used for 40 years in terminal blocks, tube sockets, and connectors. The asbestos enhances heat resistance of the molded product. About 40 million pounds a year are used by the electronics industries. Now, the Occupational Health and Safety Administration has targeted asbestos for regulation due to its toxicity.

### Lawrence finds a builder

The ultrafast printer capable of spewing out 30,000 lines a minute, which Lawrence Livermore Laboratory was looking for last year [*Electronics*, July 19, 1971, p. 32], is to be built by Honeywell Information Systems in its plant at Oklahoma City. Honeywell won't talk about how it plans to do the job—the old machine, built by Radiation Inc., formed the characters with tiny black spots burned into special paper by arcs from a row of electric styluses—but figures on being ready to deliver to the laboratory by the third quarter of 1973.

### Teradyne to buy printer

Printer Technology Inc.'s PT-100, which at 100 characters a second is billed as three times faster than any other serial, full-character impact printer, has won its first significant contract—\$200,000 from Teradyne Inc., the test-system maker.

Printer Technology of Woburn, Mass., expects the \$2,200 PT-100 to fill the gap between the 30 character-per-second serial full-character models and the much faster, but more expensive, line printers.



floor-release limits; and transactional systems enable entry and display of any data needed to make and record transactions. The verification systems are the least complex, and generally cost the least, while the transactional systems, the most costly and complex, are the focus of POS development.

On-line POS system communications problems are like those of telephone systems because the capacity to handle peak load periods during the business day ensures under-utilization of the communications network during off hours. Leonard figures that peak traffic levels can be as much as five times as high as average levels.

**Speed needed.** Also, a good POS system must offer fast response. While this isn't much of a problem with simple terminals, transactional systems can take almost half a minute to respond during peak traffic periods, while clerk and customers trade glares. Human factor studies, Leonard says, show that terminal operators get "upset" when response time exceeds about 15 seconds. This places more stress on the speed of communications and, in turn, translates not only into a need for a more capable network—and further under-utilization—but also into electronic switching, rather than less costly rotary switches and dials.

Thus, both the POS terminals and the communications nets that link them to their central computers bid fair to cost a great deal. □

### Meetings

## WEMA's Monterey attendance rises

To the young and growing electronics company, proper exposure to the financial community, while essential, is generally hard to come by. If the company goes to the financial press or analysts, it is accused of pumping; but if the small company has to wait to be "discovered," Wall Street may never hear of it.

This is especially a major problem

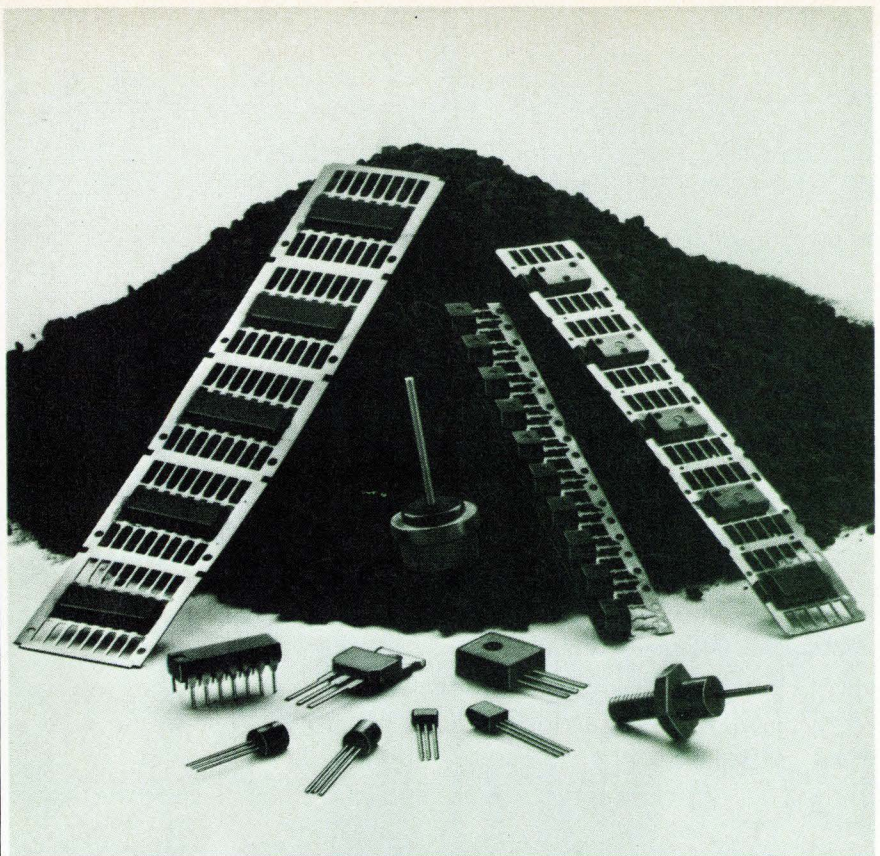

# WHAT'S WRONG WITH THIS PICTURE?

Nothing. Because everything was made with HYSOL MH 17 epoxy molding powders. A NEW HYSOL epoxy transfer molding powder that's better than anything you can use for encapsulation.

Better because it's moisture resistant. It has excellent moldability, low moisture permeability, salt-spray resistance, temperature cycling resistance . . . just about everything you need to encapsulate semiconductors. And it's been proven by major manufacturers to be superior. You couldn't ask for more except maybe excellent lead adhesion, low thermal expansion or elevated temperature stability. And MH 17 has that, too.

There's nothing wrong with this picture. With MH 17, your picture could look just like it.



**HYSOL DIVISION • THE DEXTER CORPORATION**  
 OLEAN, NEW YORK / LOS ANGELES and PITTSBURG, CALIFORNIA  
 TORONTO / LONDON / MUNICH / TOKYO / MEXICO CITY



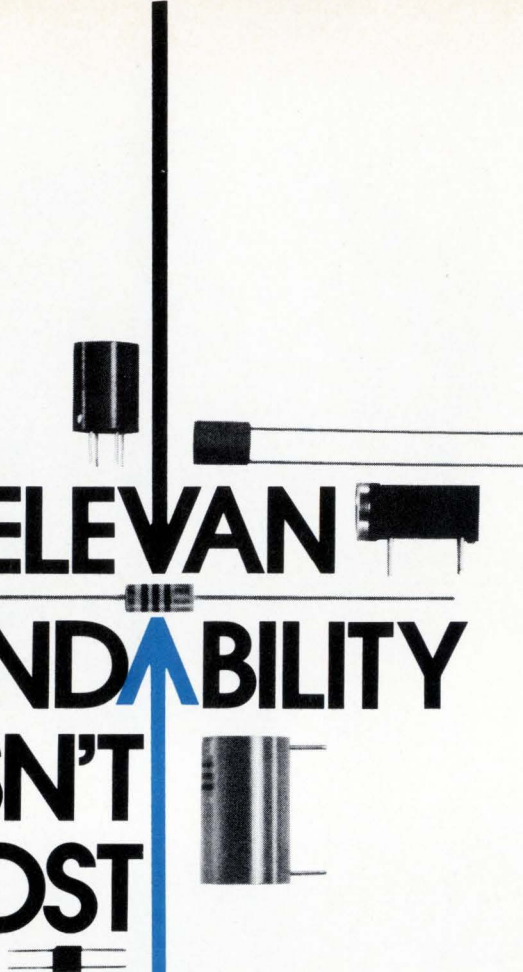

# DELEVAN

## DEPENDABILITY

### DOESN'T COST

There's a lot more than meets the eye in Delevan's lineup of miniature RF inductors and transformers. Like the unmatched dependability built into each component. Thanks to a lot of things that go on at the factory. Hard-nosed quality controls . . . complete material analysis . . . advanced in-plant environmental testing . . . automated techniques for winding, soldering and molding . . . and conscientious people who take pride in true "no-fault" production. And of course, the dependable delivery and service you always get from Delevan.

# IT PAYS

Remember . . . the proven reliability of these superior made-in-U.S.A. inductive devices means greater reliability for the products and assemblies *made from them*. Sure, you can save a few pennies by using cheaper components. But this could be expensive in terms of premature failure of the finished product. When your company's reputation is on the line, you can't afford *not to use* Delevan components. Their premium performance more than justifies their use . . . because Delevan dependability pays for itself. Why not prove it to *yourself!*

**Delevan**  **AMERICAN PRECISION INDUSTRIES INC.**  
*Division*

270 QUAKER RD. / EAST AURORA, N. Y. 14052  
 TELEPHONE 716/652-3800 TELEX 091-293  
 OTHER DIVISIONS OF AMERICAN PRECISION INDUSTRIES INC.:  
 BASCO • DUSTEX • MOELLER INSTRUMENT CO. • OXFORD CORP.

in the San Francisco Bay area, with its plethora of small high-technology companies. WEMA, the West Coast association serving the electronics and information technology industries [see p. 82], has started what it calls the "annual Monterey conference." E.E. Ferrey, executive vice president of WEMA, says that the conference, which was first held last fall, is designed to let security analysts meet with executives from companies they follow.

Held in the low-keyed environment of Monterey, Calif., famous for the Pebble Beach golf course, and other natural wonders, the meeting has advantages for both sides—a comparison of last year's attendance figures with those for this year's Oct. 16 to 18 meeting backs this claim. Last year, 56 analysts talked with the presidents of 36 companies; this year, 105 analysts (one-third from the East Coast) talked with executives from 50 companies. Ferrey asserts that the reaction to last year's meeting was so good that several companies wanted to join WEMA, just to get into the meeting.

The actual format consists of panel sessions—on the outlook for medical electronics, trends in MOS technology, and the effects of IBM's changing strategy—and scheduled meetings for one to five analysts to confer with one president in parlor rooms.

Besides the requirement that the companies be WEMA members, all must be publicly held, and about one-third are listed on the American and New York stock exchanges. □

### Packaging

## Epoxy bonding making gains

Some 80% of semiconductor die bonds are performed by the eutectic process, experts estimate, but epoxy bonding is starting to come on faster. The reason is that manufacturers are beginning to overcome their proprietary tendency and talk



# HOW MANY SPECIALTY GAS MANUFACTURERS DO YOU KNOW THAT HAVE SEVEN DISTRIBUTION POINTS IN WYOMING?

Just one, right? Linde. And we've got 526 others located throughout the rest of the country. Plus five plants in key geographic locations. One near you, so you'll always save on delivery charges. To find out a lot more about Linde Specialty Gases and services, write us for a free copy of the 108-page "Linde Specialty Gas" catalog. Union Carbide Corporation, Linde Division, Dept. LJB, 270 Park Ave., N.Y., N.Y. 10017.

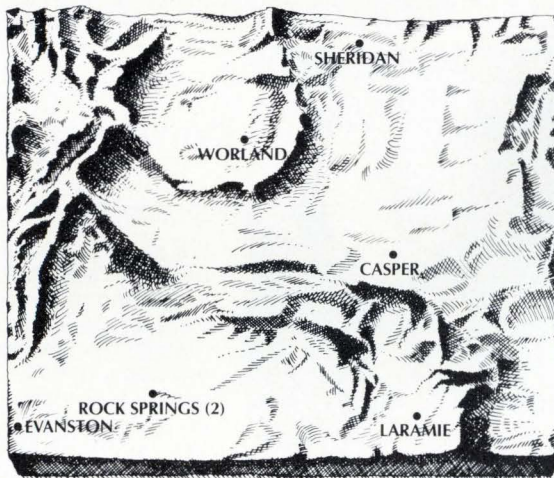

Linde is a registered trademark of the Union Carbide Corporation.



## ERIE FREQUENCY CONTROL

### The Need:

A 1.22880 MHz CRYSTAL TO MEET  
100 G SHOCK AND +50 G VIBRATION

#### PROBLEM-SOLUTION #14

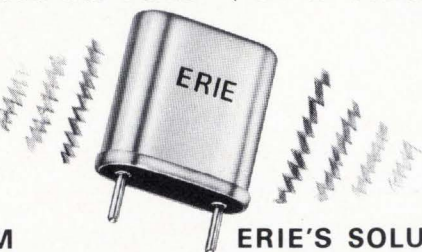

#### PROBLEM

The military demanded a miniature 1.22880 MHz crystal be designed to resist a shock of 100 G and 50 G vibration guaranteed through continuous monitoring during test, while maintaining all frequency and resistance tolerances.

#### ERIE'S SOLUTION

Erie designed a special welded mount which clamped the crystal without restricting the free vibration of the piezoelectric plate, enabling it to meet this rugged performance criteria.

### CRYSTALS . . . CRYSTAL FILTERS . . . OSCILLATORS

Write for our fully illustrated catalog and send us your Frequency Control problem for solution.



# ERIE

## ERIE FREQUENCY CONTROL

453 LINCOLN ST., CARLISLE, PA. 17013 (717) 249-2232  
DIVISION OF ERIE TECHNOLOGICAL PRODUCTS, INC.

Circle 48 on reader service card



## Pur-r-r-fect!

It's good business to do business with Permag. In stock and in service, Permag can solve your magnetic materials problems quickly, completely and economically. Look to Permag for all types of permanent magnets, assemblies, electrical alloys, flexible magnets, soft magnetic materials, ferrites and new, high-energy rare earth magnets. Also, special precision grinding and cutting. And full magnetizing and engineering facilities.

YOUR NO. 1 SOURCE  
FOR ALL MAGNETIC MATERIALS

# PERMAG

ALL ACROSS THE COUNTRY

SAN FRANCISCO • LOS ANGELES  
• DALLAS • CHICAGO • TOLEDO •  
BOSTON • NEW YORK

Consult your Yellow Pages for  
address and telephone number of  
Permag near you.

48 Circle 160 on reader service card

## Electronics review

about their epoxy bonding processes.

In the words of Daniel D. Zimmerman of the Applied Physics Lab at Johns Hopkins University, "the rumors in support of epoxy have been enthusiastic, but the hard facts just haven't been available." For last week's conference in Washington of the International Society for Hybrid Microelectronics, Zimmerman prepared a paper dealing with compatibility of various epoxies used in hybrid assemblies. He also discussed their electrical and mechanical characteristics when used with nonpassivated chips in thick and thin film.

It's estimated that 100 of the 500 makers of hybrids in the U.S. have been using epoxies for the past year. At Motorola Semiconductor, the reason is that in eutectic bonding the die has to be mounted in a collet for scrubbing. This often chips or scratches the die. Says Michael Clayton, manager of process engineering at Motorola's Mesa, Ariz., plant, "Epoxy bonding requires no scrubbing and so yields have increased dramatically."

National Semiconductor Corp., Santa Clara, Calif., is using epoxy die attach for light-emitting-diode display products. The reason: most LED displays consist of slivers attached to a substrate—a single digit has seven slivers (or segments) and a dot for the decimal point. Thus, eight die-attach operations must be performed; on three-digit clusters, such as those used in calculators, there are 24 die-attach operations.

Pierre Lamond, vice president, engineering, says: "You can't employ eutectic die attach because the substrate would have to be heated up for too long a time to make all of the bonds, and with eutectic die attach, the slivers tend to float out of position—and in a display, position is critical. But with epoxy, no heating is involved—except maybe for a few minutes at 200° for curing, but this isn't like the 400° to 800° needed for eutectic—and the die stays put." An added feature is that the epoxy can be screened onto the substrate assuring precise chip placement. □

Electronics/November 6, 1972



# DIGITAL MICROWAVE COMMUNICATION SYSTEMS

*THE BETTER WAY FOR YOU  
TO MEET THE CHALLENGE  
OF TO-DAY'S FAST-EXPANDING  
COMMUNICATIONS REQUIREMENTS.*

*MCS 6900 digital radios  
with PCM voice and TDM data  
multiplexers...from Canadian Marconi Company.*

*Contact us to-day for more details.*

**CANADIAN MARCONI COMPANY**   
TELECOMMUNICATIONS DIVISION · 2442 TRENTON AVE., MONTREAL 301, P.Q., CANADA  
TEL.: (514) 343-3411, TELEX NO. 05-267563, TWX NO. 610-421-3564, CABLE: ARCON MONTREAL

Circle 49 on reader service card



# Right for the times!

Here's why these new counters—offered in four frequency ranges of **50, 200, 512 MHz** and **3 GHz**—are right for today's requirements:

## New 6150 series expandable universal counter-timers.

S-D developed this line to handle almost every counter/timer requirement—bench and systems. Four basic models cover frequency ranges of 50, 200, 512 MHz, and fully automatic 3 GHz. Buy for current requirements and upgrade frequency range at any time. These instruments were designed from scratch for **programmability**: single line or binary, total control including attenuators, and analog or digital trigger level control.

**6150 options and features:** Choice of 100 nsec or 10 nsec TIM resolution—choice of five oscillators—four types of BCD output—up to 9-digit readout—versatile remote programming—3½" height in full rack width—10mV rms resolution to 0.1 Hz.

**Expandability.** The expandable counter concept satisfies many needs, present and future. Why? Because it's so simple and economical to **upgrade** the frequency range of your counter and add options. BCD output, additional readout digits, and a 200 MHz frequency range (in place of 50) are added by inserting new plug-in PC cards right inside your lab in minutes. Go to 512 MHz or 3 GHz, higher stability oscillators, 10 nsec TIM resolution (on 6150 universal series), and remote programming—all are offered as expandable option kits installed by your local S-D service center.

	50 MHz	200 MHz	512 MHz	3 GHz
--	-----------	------------	------------	----------

<b>Universal Model:</b>	<b>6150</b>	<b>6151</b>	<b>6152</b>	<b>6153</b>
<b>Counters</b>	Price: \$1195	\$1495	\$2150	\$2995

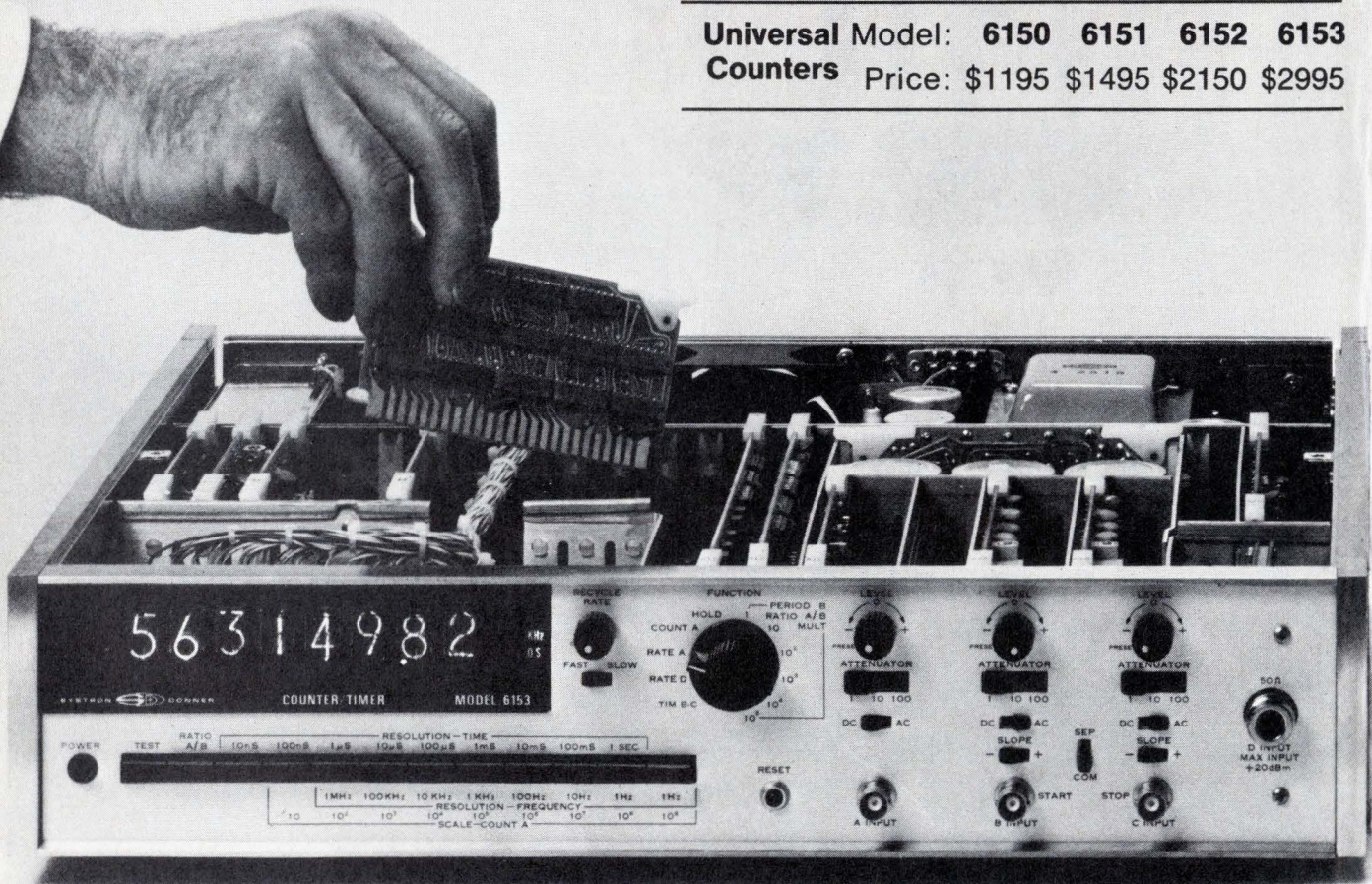

**SYSTRON  DONNER**

Concord Instruments Division, 888 Galindo Street, Concord, CA 94520. Phone: (415) 682-6161

Circle 50 on reader service card



## **DOD encouraged that lasers can counter EMP . . .**

When a nuclear missile warhead reenters the earth's atmosphere, the **electromagnetic radiation from its explosion may be "contained within a hemisphere" of laser beams** created by multiple prismatic deflection of the pulsed output of extremely high-power systems operating in the 10.6-micrometer region. This is the encouraging conclusion drawn by U.S. military researchers from experiments at the Army's White Sands Missile Range near Albuquerque, N.M. If increased funding of the program proves out the concept, it will **eliminate the long-standing threat of the EMP effect—the blackout of antimissile radars** by the expanding cloud of electromagnetically pulsed radiation that is generated by an exploding warhead and permits later ICBMs to reenter the atmosphere undetected. The program's potential was reportedly **an important consideration in the U.S. agreement with the USSR to limit ABM missiles to 200 per nation.**

## **. . . but job cuts after election disturb military**

U.S. military and civil service leaders are upset by National Security Council approval of a plan to **begin sharp reductions next year in the number of military and civilian jobs** throughout the defense establishment. The aim is to cut back in the number of U.S. bases, to relocate some Washington-area organizations like the Army Security Agency to lower-cost labor markets, and to replace many uniformed employees by civilians.

Goal of the program, which is **unrelated to a Vietnam settlement**, is to hold down soaring defense personnel costs in order to maintain adequate funding for technology R&D and hardware procurement in an inflated economy. Reportedly scheduled for disclosure in the period after the election but before the convening of the new Congress, the job cuts could reduce defense-related military employment by as much as 20% over a period of a year in the Washington area alone. Defense Secretary Laird, recently **conceding that the fiscal 1974 budget now in preparation will exceed the \$76.5 billion passed this year**, says most of next year's cost increases will come from pay increases and increased retirement benefits for uniformed military personnel.

## **Nixon to implement Haggerty plan for science council**

A plan to reorganize the White House Office of Science and Technology and the whole science advisory structure is ready for post-election unveiling. Completed some time ago at President Nixon's request by a task force headed by Patrick Haggerty, Texas Instruments chairman and close Nixon associate, the plan gives **equal prominence to industrial use of technology and the academic interests of pure science.**

The reorganization will replace the single science adviser to the President, a post now held by Bell Laboratories alumnus Edward David, with a council headed by a troika representing the interests of industrial technology, science, and engineering. Candidates for the new top jobs include Bell Labs president William C. Baker, now chairman of a science and engineering council of the Committee for the Re-election of the President, and William Magruder, a special consultant to the President who got mixed reviews in earlier assignments as director of the New Technological Opportunities Program and as overseer of the defunct supersonic transport effort.



## The problem of peace

Whether your first reaction to Henry Kissinger's White House briefing on a Vietnam settlement was a positive "Peace, at last!" or a querulous "Peace, at last?"—and there were more of the latter in his Oct. 26 audience—the inseparable political and economic possibilities demand examination. To restrict that look to no more than technology in general and its electronics community in particular would be ludicrous—as absurd as attempting to examine the future of America without looking at the rest of the world.

It is an absurdity born of electronics technology. Who can dispute, for example, that communications satellites, which daily brought the horrors of war into America's living rooms in living color, made a major contribution to the evolution of Vietnam as a major political issue? Unable to escape it, citizens were obliged to think about it. That technology was not available when the United States first began its Vietnam adventure more than 16 years ago.

### No short-term threats

Current Washington estimates are that a Vietnam settlement will be as protracted as that of the Korean War, despite the different circumstances. Yet most of the spending cuts associated with military electronics for Asia have already come. Over-all defense costs for the war will run to \$7.1 billion in fiscal 1973, the Pentagon points out, about one-quarter of the fiscal 1969 peak. Some significant cuts are still to come in some areas—ordnance, for example, and its microelectronic fuzes and laser guidance systems—yet industry expects offsetting outlays to replenish inventories in antisubmarine warfare, tactical and strategic communications, and strategic weapons in general.

Management members of the Electronic Industries Association concluded at their annual Government market outlook on Oct. 31 that there will be a steady but conservative period of growth in the military market through 1980 that will maintain pace with inflation but not much more. Drawing heavily on Pentagon estimates of the economic crunch [*Electronics*, Aug. 28, p. 25], as well as inputs from EIA's top military members, Sylvania Electronic Systems group marketing chief Clifford Bean concludes that Government contracts' electronic dollar growth will match forecast inflation, maintaining the Federal position as the largest market for technology, even though it is no longer viewed as an expanding one.

For industry that must therefore look to pub-

lic non-Government markets for growth, there are some problems. Such business is more fragmented and less uniform in both its industrial and consumer segments. It is a business that presidential science adviser Edward David defines as one where "the human aspects of technology become much more important." And its base is a "worldwide public in many cases."

### The American image

However, the expansion of that base by U.S. electronics industries that can now see beyond national boundaries faces problems more severe than market fragmentation requiring increased venture capital. Those problems are the long-term consequences of the rootless pragmatism of unilateral international actions by the White House. They are actions ranging from the melodrama of a presidential trip to China to the international monetary negotiations of a year ago that were pulled without warning like rabbits from a hat—actions that left much of the world believing that U.S. policy is erratic and egocentric and that its principles are no more than self-serving.

They are actions that have left Japan, labeled "our most important ally" by President Nixon in February 1971, with the feeling it had been betrayed when it learned a few months later that Henry Kissinger had been negotiating secretly with China's Chou En-lai preparatory to a visit to Peking by President Nixon.

Similarly, the President's decision later last summer to unpeg the dollar from gold and slap a 10% surcharge on imports was a unilateral move, taken without prior consultation with allies who believed it a violation of existing trade agreements. And that action, designed to improve the American trade and payments balances that had been turned into deficits by the drain of Vietnam, left allies such as Canada with a larger U. S. trade deficit of its own as it moved toward its own national elections. Canadian officials, who contend they have yet to recover, are now more inclined to view the United States with mistrust, rather than as the mainstay of world stability.

These are the serious intangibles that electronics and other technologies seeking to diversify their world base will have to face in the months and years ahead. They are admittedly less easily dealt with by engineers and their managers than are the problems of manufacturing and marketing and their capital requirements. Yet they are part of the package that will come with peace.

—Ray Connolly



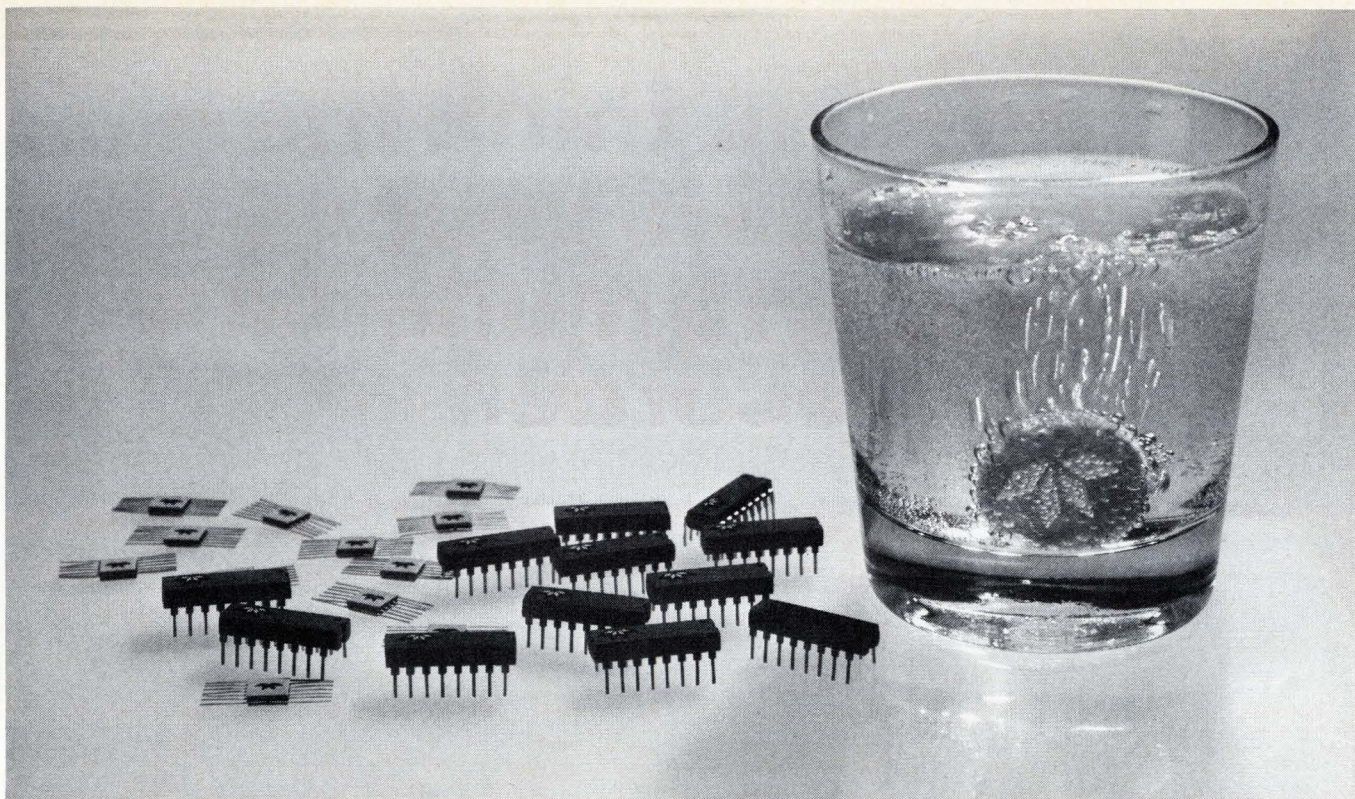

# Try it. You'll like it.

## HiNIL, High Noise Immunity Logic

Nothing can be more upsetting than trying to design sensitive digital equipment that's headed for a noisy industrial application. Try Series 300 HiNIL, Teledyne's high noise immunity logic.

**HiNIL offers MSI.** Included in the Series 300 are such complex functions as BCD to decade decoders and drivers, Nixie® drivers, decade and hexadecimal counters, a quad latch and a 4-bit comparator.

**HiNIL is slow.** HiNIL is one of the slowest logic families since relays. It has a nice 100-nanosecond propagation delay, so it is unperturbed by high voltage transient noise. HiNIL won't switch falsely when a fork lift rolls by or a lathe turns over.

**HiNIL is easy to use.** There are very few system interfaces that cannot be handled simply with HiNIL devices. The open-collector devices

in the family, including the simple gates, have ample output sink and drive currents to operate a small lamp or relay.

For *output* interfaces to TTL, DTL or MOS—you simply connect an open collector output through a pullup resistor to the desired high logic level.

**HiNIL is versatile.** Every IC in the Series 300 family comes in a 16 pin dual-in-line package, providing better than 10% more functional utility than you get with most standard TTL circuits. Vcc and Ground take up two of the pins, leaving 14 for functional use compared with 12 for TTL. You can do more with HiNIL.

**HiNIL is priced right.** It's priced competitive with TTL. Need we say more?

Write for a free copy of our 64 page HiNIL handbook. Save yourself from those embarrassing noise problems—use Series 300 HiNIL.

 **TELEDYNE SEMICONDUCTOR**

1300 Terra Bella Avenue Mountain View, California 94040 (415) 968-9241 TWX: 910-379-6494 Telex: 34-8416

\*Nixie is a registered trademark of Burroughs Corp.



# Why we think the Brush 816 is your best choice in a multipoint recorder.

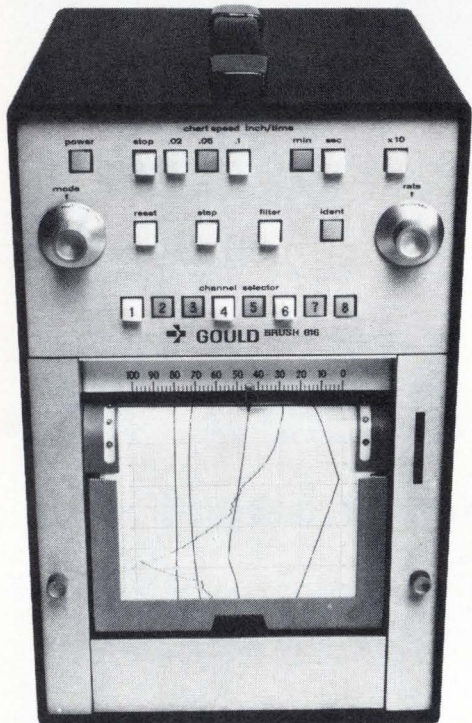

**SPEED.** If it's speed you need, you've got it. The 816 is not just 3, 5 or 10 times faster, but fully 16 times faster than conventional multipoints. It really moves. To scan and display up to 8 channels of data. With uncanny reliability.

**VERSATILITY.** Buy the 816 and you've got it. The 816 can do things like record both high and low level inputs on the same chart. And when you use our optional signal conditioners, you stretch the versatility even further. So you've got a recorder for any kind of trend recording.

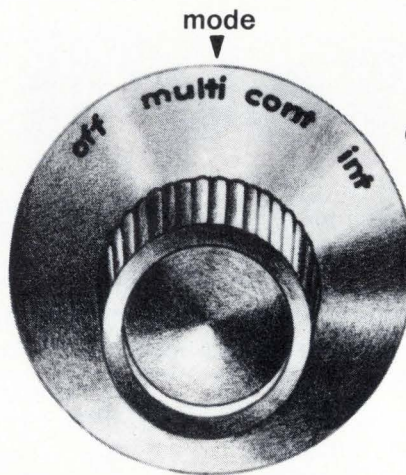

## QUICK MODE-CHANGING.

Don't you wish everybody used dials like we do? Just turn one on the 816 and you've changed modes. Just like that, you're ready for multipoint sampling, intensified sampling, or continuous single channel recording.

## MORE FEATURES.

Like rectilinear presentations on a 4-1/2" grid. And a choice of 12 push-button chart speeds from 0.02 inches per minute to 1 inch per second.

chart speed inch/time



**CONVENIENT ACCESSORIES.** Like stack-to-stack Z-fold paper. And a drawer that collects those Z-folds below the writing table.

We think you probably want more information on this and our other recorders. So drop us a note. Gould Inc., Instrument Systems Division, 3631 Perkins Avenue, Cleveland, Ohio 44114, or Rue Van Boeckel 38, Brussels 1140, Belgium.

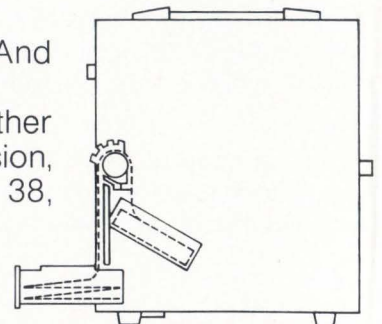

BRUSH INSTRUMENTS

 **GOULD**

Electronics/November 6, 1972



## Color-TV player shows single frames and uses audio cassette

The best markets for video tape recorders today are in education and sales applications. And Matsushita Electrical Industrial Co. is betting it can expand this market many times with a new type of color television cassette player that gives one still picture every 3.6 seconds. Developed by engineers at the Wireless Research Laboratory, the player uses a standard Philips audio cassette, but with two video tracks running in the center of the tape between the usual audio tracks.

For applications where continuous motion is not really necessary, this system can provide up to 1,000 separate pictures on a standard 1-hour cassette, which operates 30 minutes in each direction. Although Matsushita now can only guess at the program costs, it estimates they will run between 5% and 10% of standard video tapes. It says that in Japan, unrecorded video tape costs about \$30 an hour, while blank audio cassettes sell for between \$1.67 and \$3. Matsushita also says it will try to sell the color cassette player at 50% to 66% the price of a color video tape player.

**Tracks.** The tape in the standard audio cassette is 3.8 millimeters wide. If stereo, it has two 600-micrometer-wide tracks in either direction for stereo, but if monaural, it may have only one double-width track in either direction. A guard band 600-700 micrometers wide separates the directional tracks, and it's in this space that Matsushita puts the two video tracks, each 200 micrometers wide. These tracks are played back by heads whose speed with respect to the tape is somewhat more than 10 meters per second, about the same relative speed as in usual video tape recorders. The video signal frequency format is similar to that used in helical-scan video tape recorders in Japan.

The drum carries three video

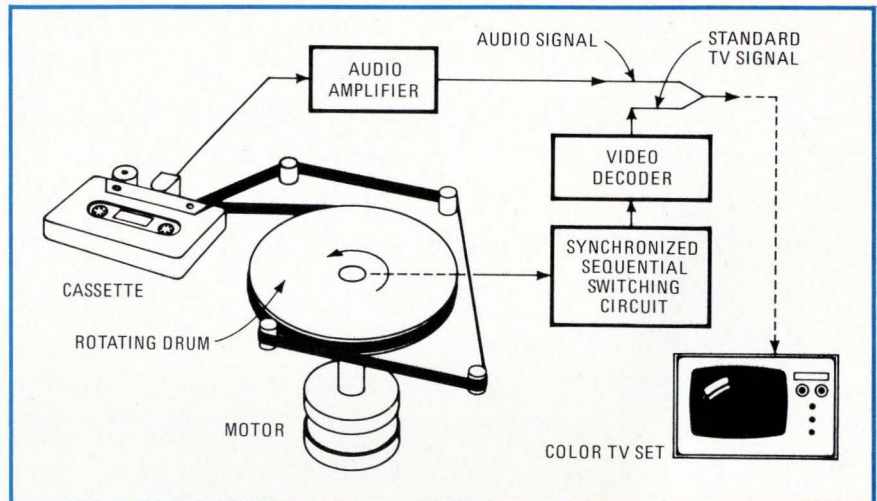

**Slide show.** Using a standard Philips cassette, Matsushita single-frame color player sends both audio and video signals to a TV set.

heads spaced equally around its periphery. It is designed to allow an air film to form between tape and drum, reducing the drag on the narrow tape. The drum rotates 20 times a second. Switching circuits permit playback in succession from the three heads giving an output at the standard rate of 60 fields per second. Since all heads reproduce the same track, though, the fields are not interlaced, and the vertical resolution is lower than for standard video tape recorders. □

### West Germany

## Transceiver ends "helium speech"

The "helium speech" distortion that plagues divers breathing a no-nitrogen helium-oxygen mixture is due to an upward shift of the vocal tract's resonance frequency. The speech's resulting Donald Duck quality often confuses underwater communications.

The various attempts to solve this

problem with voice unscrambling techniques or channel vocoder principles unfortunately calls for fairly bulky and expensive equipment—and even then the human voice cannot be faithfully reproduced. But now, under a project sponsored by West Germany's Ministry for Science and Education, researchers at AEG-Telefunken's laboratories in Ulm have come up with a small inexpensive unit that can restore helium speech to the naturalness of telephone speech.

The new equipment uses delta pulse-code modulation, where only the difference values between two subsequent signals are processed, obviating the need to handle individual signal content as a whole. The difference values are quantized and coded before transmission.

The Ulm researchers have implemented their approach in a prototype two-way intercom system that is made up of a pair of identical transceivers, each no larger than a pocket radio. By using integrated-circuit and multilayer-design techniques, the company says, it can reduce the transceiver's dimensions to cigarette-pack size. □



# Cincinnati Milacron now offers you the bare minimum

It's called the Strippable CIP. The new CIP/2002 is the minimum hardware framework from which you can build your own minicomputer.

You get only the basic components you need to build your own dedicated system. The CIP/2002 can save OEM users considerable cost because all but the most essential hardware has been stripped away. Only the control board, two data boards, and the frame remain. This allows the system builder to use the power of the minicomputer creatively. Incorporating and adapting the unit to your needs is vastly simplified. Best of all, the variety of options lets you pick just those you need. You don't pay for "frills" you don't need. And the price is very low as a result.

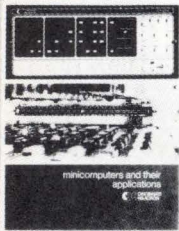

Send today for our free idea booklet entitled "Minicomputers And Their Applications" and get full details on how the Strippable CIP can save you money. Write or call (513) 494-5444, MINICOMPUTERS Cincinnati Milacron, Process Controls Division, Lebanon, Ohio 45036.

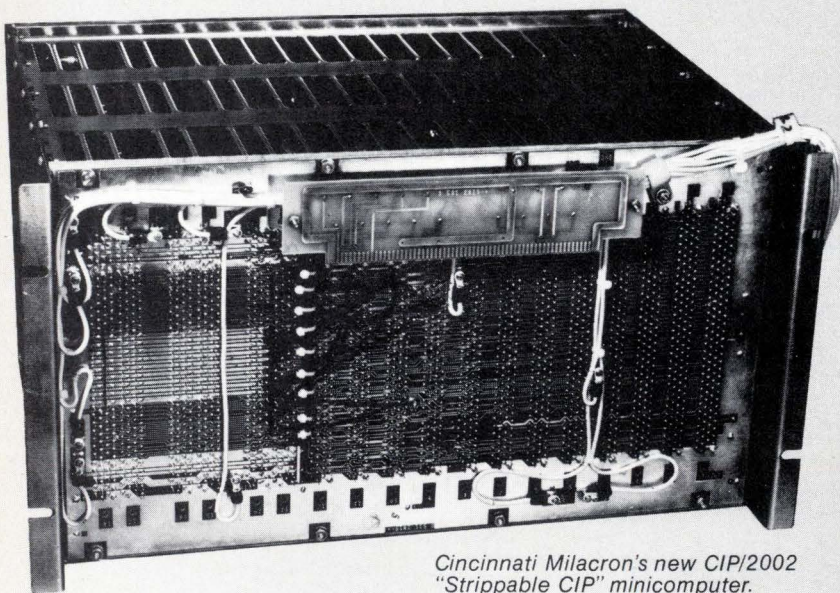

*Cincinnati Milacron's new CIP/2002  
"Strippable CIP" minicomputer.*

**minicomputers**



**Machine Tools**  
**Process Controls**  
**Chemicals**  
**Plastics**  
**Plastics Processing Machinery**  
**Abrasives**



## **Philips proposes cassette changes for high-energy tapes**

Philips Gloeilampenfabrieken has launched a **bid to standardize compact consumer cassettes loaded with chromium dioxide and similar high-resolution tapes**. The Dutch company, through the Netherlands delegation to the International Electrotechnical Commission, proposed at a late summer subcommittee meeting that time constants for high-energy tape be standardized at 70 microseconds and 3,180 microseconds. These constants—times at which recording correction networks switch in an out—compare to 120 and 1,590 microseconds for regular tapes.

**Philips has paired with the time-constant proposal a second one covering the cassettes themselves**. It calls for sensing holes in the rear edge of the cassette, alongside the knockout lugs already there to prevent inadvertent recording over a previously recorded tape. For cassettes loaded with high-energy tapes, the added holes would make possible automatic switch-over from standard correction characteristics to high-energy characteristics. **Philips and the West German tapemaker BASF already use the added holes**, and Philips thinks it's a sure thing that IEC will adopt both proposals.

## **Sweden moves to back native computer maker**

**The Swedish government is negotiating with Saab-Scania AB on formation of a joint development company in the computer field**. This move is part of a surprise decision that gives Saab-Scania a contract for two military computers, despite strong recommendations by the defense department that the order go to IBM [*Electronics*, Oct. 9, p.65]. Details on the development company plans were not given, but it has been known that the government is interested in working out deals with private companies to give support in fields where large investments are needed to keep Swedish industry internationally competitive.

## **Toko, AMS to trade memory know-how**

Toko Inc. and Advanced Memory Systems Inc. have received Japanese government approval for an exchange of semiconductor- and plated-wire-memory know-how. Toko has been in plated-wire memories for over 10 years, and is the leading independent manufacturer in the field, supplying memory stacks and systems to various computer manufacturers all over the world. AMS has been a leader in semiconductor memories in the U. S. and is now selling devices and systems worldwide.

**Toko plans to produce memory chips under license from AMS at Kyodo Electronic Laboratories Inc.**, a subsidiary. Toko will package the devices and build the packages into memory systems at its own memory division. **AMS intends to explore expansion of its product line with the addition of Toko's plated-wire memories**.

## **British develop film sensitive only to electron beam**

Researchers at the Runcorn, Cheshire, laboratories of Imperial Chemical Industries Ltd. have developed a film sensitive to an electron beam but not to light. **It produces an instant image with no wet processing and with resolution similar to high-quality silver halide film**—about 1,000 lines per millimeter at 30% contrast transfer function. Thus, the technique should make possible real-time recording on film of electronic



ally generated data without the usual optical stage. Initially the film is yellow; the exposed areas turn blue. The main snag to development now is that beam power required is relatively high: about  $2 \times 10^{14}$  electrons per square inch. But ICI is actively investigating marketing possibilities.

## **Sony gears up for cartridge TV player production**

Sony Corp, is stepping up production of the company's video cartridge player, the U-Matic. The corporation is opening a new plant in Japan to produce 100,000 players in 1973. Production for 1972 was scheduled at 40,000 units. The increase is credited to the success of the U-Matic during a test-bed year. In June, the only other commercially available video player, Cartridge TV Inc.'s Cartrivision, was introduced to the consumer market.

## **U.S. TV hops to Europe via digital converter**

If final tests work out all right, an entirely digital transatlantic television standards converter built by Britain's Independent Broadcasting Authority will get its first operational use this week. Several European broadcasting organizations in the European Broadcasting Union hope to use it to convert their coverage of the U.S. presidential elections. **The tests include the ability of the converter to produce a Secam-compatible output as well as PAL signals, which are already proved.**

The system uses eight-bit quantization and a 10.7-megahertz sampling frequency. To convert the U.S. 60 fields per second to the European 50 fields per second, **the digitized equivalents of the five consecutive field pairings in six consecutive U.S. fields are used to construct by interpolation five fields that together last the same time.** Similarly, an extra line is added to the 525-line picture approximately every five lines by interpolating from the digital equivalents of the three surrounding lines in each interlacing field. IBA engineers maintain that compared to the two other existing conversion techniques—electronic analog developed by the British Broadcasting Corp. and optical by Fernseh of West Germany—their digital system has less noise, better resolution, and fewer scintillation effects on sloping edges. It should also cost less and need no setting up. IBA will follow the present one-way converter with a two-way machine and license manufacturers to make them for sale.

## **Quartz clocks appear in Europe's cars**

The automotive electronics market is getting a boost of sorts, now that a West German car accessory maker has started large-scale production of quartz clocks for dashboard installation. The new clocks, from VDO Adolf Schindling GmbH, a leading European dashboard equipment producer, are for all Mercedes-Benz cars now being made, but can also be fitted in certain BMW models. VDO says other car manufacturers are considering using its quartz clock in the near future.

**The VDO clocks contain an integrated circuit that incorporates an oscillator, several divider stages for frequency reduction, and an output stage for the synchronous motor.** All active components in the power supply are also integrated. Under normal ambient temperatures the clocks have a time deviation of less than 1 second per day. The company says the new clock sells for about \$21 if exchanged for a conventional car clock.



**goes where  
hands can't**

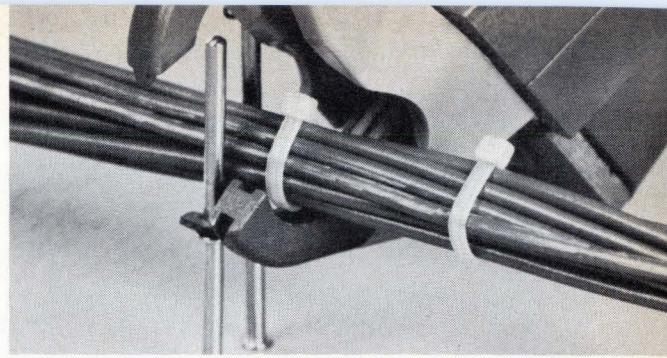

**ties in less  
than a second**

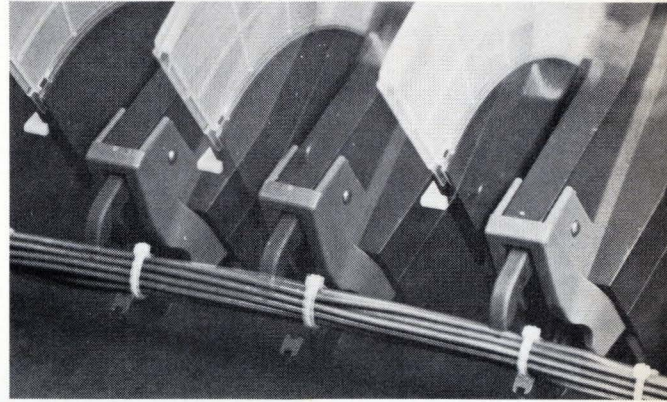

**adjusts  
automatically  
to bundle  
diameter**

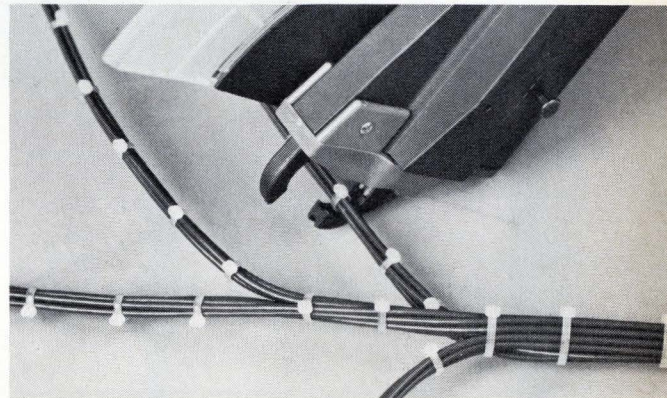

**NOW tie  
faster than ever before**

We've eliminated hands from the wire tying and harnessing operation—the tool does it all. Now the operator simply applies the tool to a wire bundle, squeezes the trigger and a nylon TY-RAP® Tie feeds itself around the bundle, tightens to a preset tension, locks securely and the excess nylon is neatly snipped off flush to the tie's head . . . in 8/10 of a second. There is no tool adjustment needed regardless of bundle diameter from 1/32" to 5/8". The tool is cartridge loaded with 50 standard ties.

Write for complete information and see how this TY-RAP tool will substantially reduce costs. The Thomas & Betts Co., Elizabeth, N. J. 07207. (201) 354-4321. In Canada, Thomas & Betts Ltd., P.Q.

**Sold only through authorized T&B Distributors**



**THOMAS & BETTS**

Division of Thomas & Betts Corporation

Circle 59 on reader service card.



# If you can't find the lowest-cost optical coupler, relay, switch, translator or interface you want here...

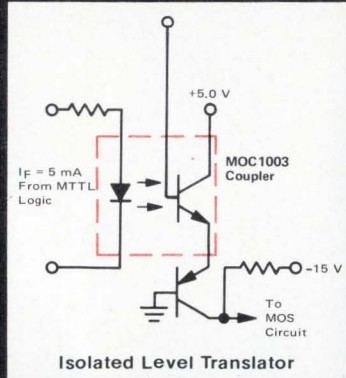

**Type:** MOC1003 Coupler  
**Price:** 99¢  
**Features:** 500 V Isolation  
 30% Transfer Ratio

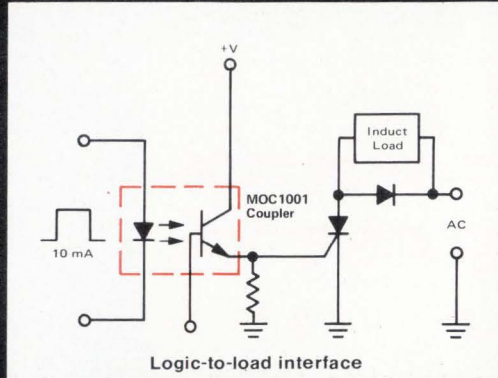

**Type:** MOC1001 Coupler  
**Price:** \$1.95  
**Features:** 2,500 V Isolation  
 60% Transfer Ratio

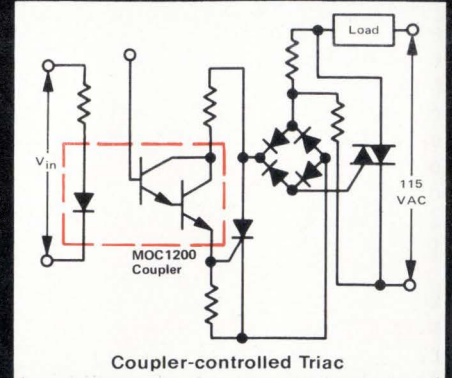

**Type:** MOC1200 Darlington Coupler  
**Price:** \$1.95  
**Features:** 1,500 V Isolation  
 200% Transfer Ratio

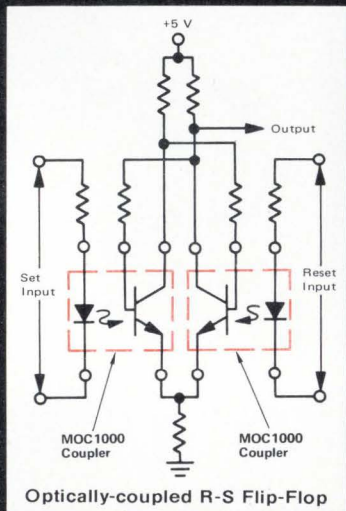

**Optically-coupled R-S Flip-Flop**

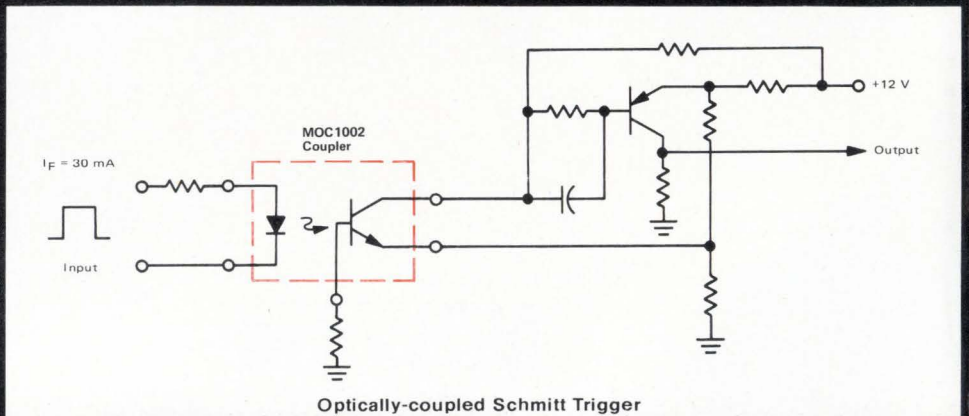

**Type:** MOC1000 Coupler  
**Price:** \$1.75  
**Features:** 1,500 V Isolation  
 60% Transfer Ratio

**Type:** MOC1002 Coupler  
**Price:** \$1.50  
**Features:** 1,500 V Isolation  
 30% Transfer Ratio

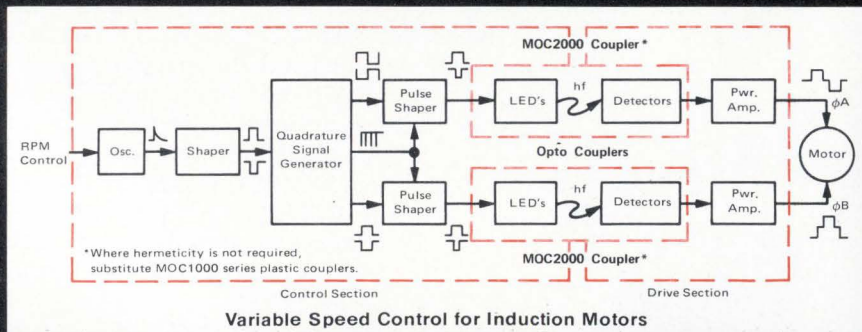

**Type:** MOC2000 Hermetic Coupler  
**Price:** \$3.10  
**Features:** 1,500 V Isolation  
 3.0% Transfer Ratio

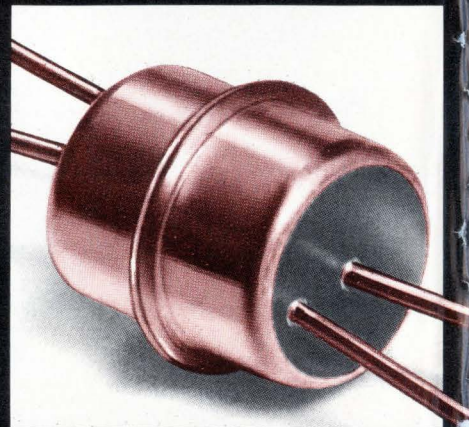



# better have your isolation examined.

Optical couplers offer design engineers new freedom in designing circuits and systems. They're the only devices around that transfer, relay, couple, switch or isolate an electrical signal through the medium of light. They offer excellent input/output isolation . . . 100 billion ohms . . . and up to 2,500 V isolation voltage.

Call them what you will, they're versatile, quick, simple, reliable. And more economical than ever — Motorola prices now start at just 99¢, 100-up!

Problems such as ground loop isolation, common mode noise rejection, voltage level translation and many more can be solved or simplified using couplers.

In electro-mechanical relay replacement they offer unbeatable advantages. With no contacts,

they're immune to arcing and pitting and provide half the size and 1,000 times the speed of relays. There's no shock or vibration problems and they can be mounted in any position. Their inherently high isolation voltage permits operation in interface systems at different voltage levels and they're compatible with integrated circuits such as MOS, TTL, op amps and regulators.

Various responses can be achieved through linear modes of operation with feedback possible for inductive and reactive loads such as make/break timing designs. And with non-degrading solid-state operation, they're truly lifetime circuit performers.

Although of closed construction, they're simplicity itself. Coupler input is connected to a light emitter

and the output is a photodetector transistor. The elements are separated by a transparent insulator and housed in a light excluding package. Once assembled, the device is completely electronic in nature, eliminating the designer's need for knowledge of optics.

For information about how they can fit into your system designs, write on your company letterhead to Motorola Semiconductor Products Inc., Box 20912, Phoenix, AZ 85036. We'll send three just-published design aids: OPTOELECTRONICS AT WORK, AN571 — Isolation Techniques Using Optical Couplers and AN575 — Variable Speed Control System For Induction Motors. Circle the reader number for data sheets.



## **MOTOROLA COUPLERS** *—lighten your industrial load*

All prices shown are 100-999.



### **1 FREE OPTICAL COUPLER**

. . . is yours when you contact the Motorola distributor nearest you. Call him or send the coupon for a free MOC-1003 optical coupler ready for evaluation and prototyping — do it now!

To (distributor) \_\_\_\_\_

Send me my free Motorola MOC1003 optical coupler immediately!

Name \_\_\_\_\_

Title \_\_\_\_\_

Company \_\_\_\_\_

Div. \_\_\_\_\_

Address \_\_\_\_\_

City \_\_\_\_\_

State \_\_\_\_\_ Zip \_\_\_\_\_

(Offer expires January 31, 1973)



**If TRW can deliver  
twice the expected HP  
from precision motor systems**

**...think what TRW can do for you  
in miniature transformers,  
multi-layer circuits  
and microwave transistors.**

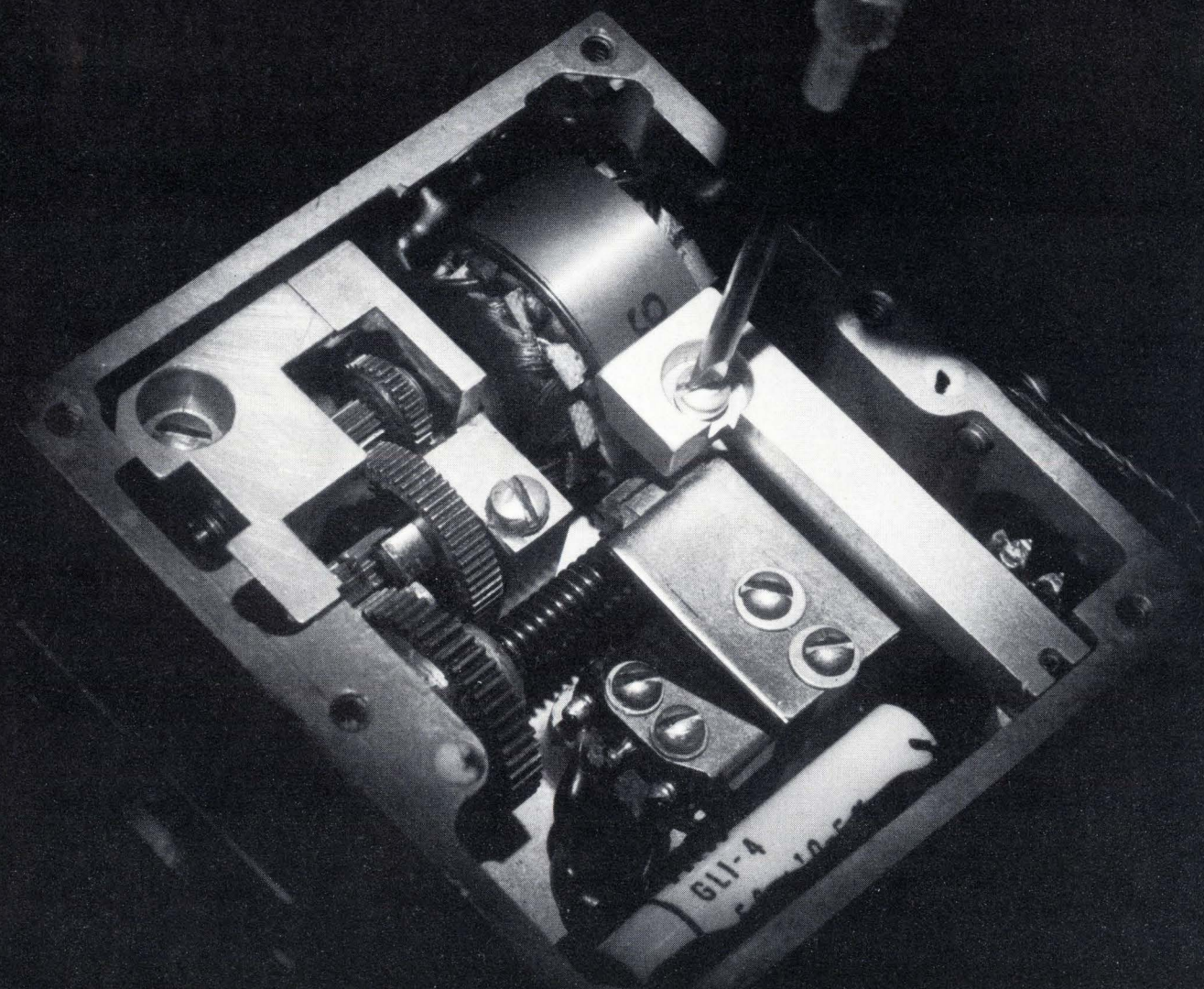



**The TRW/Globe integral gearmotor** shown here will operate over the widest voltage and frequency ranges in the world, and deliver twice the expected hp for its size. It will operate over 10,000 hours maintenance-free. More than just transmitting torque, the highly efficient gear train functions as a mechanical servo because of its precisely controlled friction characteristics. TRW/Globe motors, gear trains, fans and mechanical assemblies are used in the latest military, industrial and commercial systems. (For more information, circle 101 on the reader service card.)

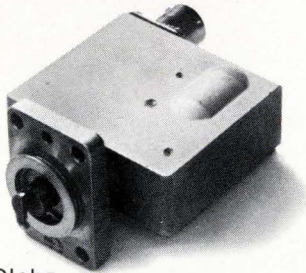

**The TRW/UTC BIT-250 line of audio transformers and inductors** represent the ultimate in fine-wire winding technology. Significant size reduction without loss of performance has been achieved by major reduction of air gaps in the magnetic circuit. Core permeability approaches the theoretical maximum. Power transformers, pulse transformers, high-Q inductors, electric wave filters and magnetic amplifiers are some other examples of TRW/UTC advanced capabilities in iron core inductive devices. (For more information, circle 102 on the reader service card.)

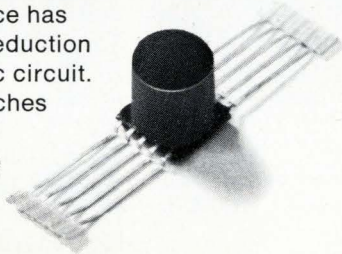

**The Cinch-Graphik multi-layer circuits** shown here are typical of TRW capabilities in the manufacture of single-sided, double-sided and multi-layer PC boards for communications, computer, commercial, industrial and military applications. State-of-the-art testing, using fully computerized circuit testers assures 100% performance of multilayers. (For more information, circle 103 on the reader service card.)



**TRW's J- $\theta$  series microwave transistors** feature instantaneous octave bandwidths from 30 to 1000 MHz with output power to 60 watts. TRW RF power transistors offer the industry's highest power at frequency with outstanding reliability all the way out to 4GHz. Power switching transistors, high speed diodes, power hybrids and varactor diodes (Varicaps) are some other areas where TRW semiconductor technology can match your exact requirements. (For more information, circle 104 on the reader service card.)

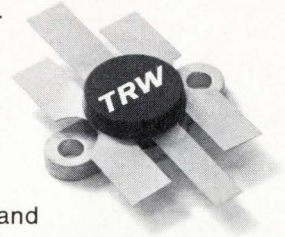

**What else do we make?** Just about every type of electronic component in the books from actuators to zeners. Plus amplifiers, cable, capacitors, chokes, connectors, diodes, filters, inductors, oscillators, RF modules, potentiometers, pumps, rectifiers, resistors, trimmers, tuners, wiring harnesses, color convergence yokes...and more.

**One source — your local TRW representative** — offers you all of these product lines and can supply almost all of your needs. With a direct pipeline to all of our plants, he can assure you fast delivery, applications assistance, custom designs and special engineering help whenever you want it.

**Think what TRW can do for you.** Then call or write TRW Electronic Components, 10880 Wilshire Boulevard, Suite 1700, Los Angeles, CA 90024. Phone (213) 475-6777.

**TRW**<sup>®</sup>  
ELECTRONIC COMPONENTS



# Harris

Here are the first eight of our new growing DI/CMOS family—the fastest low-power devices of their kind available today.

If you're joining the big move to CMOS, we've got your device. Or soon will have. Because we've committed ourselves to dielectrically isolated CMOS (DI/CMOS) development on a major scale. The first eight are available now. These devices offer speeds twice as fast as any comparable ICs, typically 10ns with 10-volt power supplies. They also offer a wide power supply range (3 VDC to 18 VDC), while providing large noise immunity, typically 45% of supply voltage. In terms of chip reliability, our engineers currently report more than 230,000 device hours at +125°C without failure.

All of the new devices are available in 14-pin dual in-line packages except the HD-4009 and HD-4010, which come in 16-pin packages. Because of their compatible pin-out configurations these circuits will replace or interface with the CD 4000A series. For details see your Harris distributor or representative.

## 1

HD-4000 Dual 3 NOR Gate

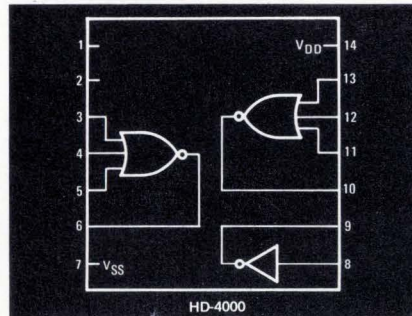

Pin for pin compatible with CD 4000A.

High speed 10ns  
Low power 1nW

100-999 units  
-40°C to +85°C \$1.00  
-55°C to +125°C \$3.10

## 3

HD-4009 HEX Inverter

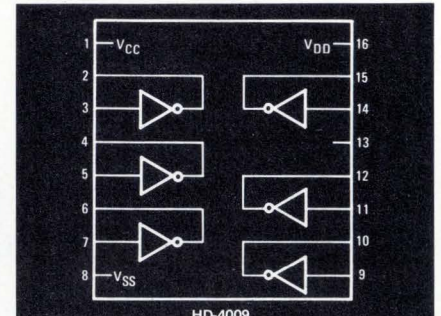

Pin for pin compatible with CD 4009A.

High speed 10ns  
Low power 50nW

100-999 units  
-40°C to +85°C \$2.20  
-55°C to +125°C \$5.25

## 2

HD-4001 Quad 2 NOR Gate

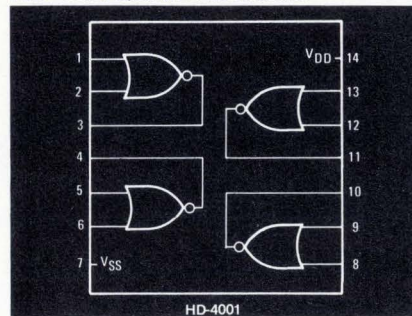

Pin for pin compatible with CD 4001A.

High speed 10ns  
Low power 1nW

100-999 units  
-40°C to +85°C \$1.00  
-55°C to +125°C \$3.30

## 4

HD-4010 HEX Buffer

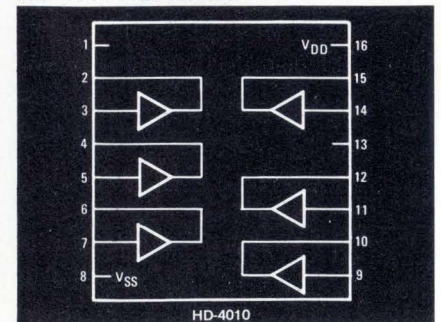

Pin for pin compatible with CD 4010A.

High speed 10ns  
Low power 50nW

100-999 units  
-40°C to +85°C \$2.20  
-55°C to +125°C \$5.25



# CMOS.

## 5

HD-4011 Quad 2 NAND Gate

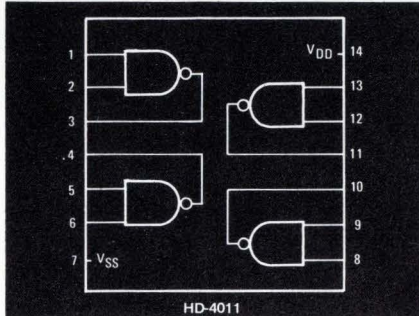

Pin for pin compatible with CD 4011A.

High speed 10ns  
Low power 1nW

100-999 units  
-40°C to +85°C \$1.00  
-55°C to +125°C \$3.30

## 7

HD-4013 Dual "D" Flip Flop

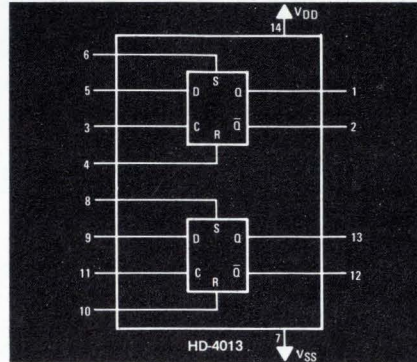

Pin for pin compatible with CD 4013A.

High speed 18MHz typical toggle rate  
Low power 50nW

100-999 units  
-40°C to +85°C \$2.10  
-55°C to +125°C \$4.75

## 6

HD-4012 Dual 4 NAND Gate

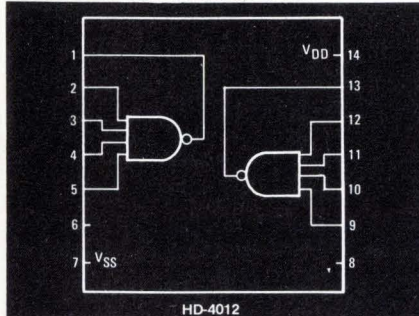

Pin for pin compatible with CD 4012A.

High speed 10ns  
Low power 1nW

100-999 units  
-40°C to +85°C \$1.00  
-55°C to +125°C \$3.45

## 8

HD-4809 Triple/True Complement Buffer

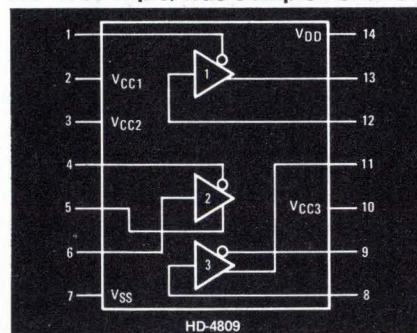

A Harris proprietary device.

High speed 10ns  
Low power 50nW

100-999 units  
-40°C to +85°C \$2.25  
-55°C to +125°C \$5.30



**HARRIS**  
**SEMICONDUCTOR**

A DIVISION OF HARRIS-INTERTYPE CORPORATION

P.O. Box 883, Melbourne, Fla. 32901  
(305) 727-5430

**WHERE TO BUY THEM:** ARIZONA: Phoenix—Liberty, Weatherford; Scottsdale—HAR (602) 946-3556  
CALIFORNIA: Anaheim—Weatherford; El Segundo—Liberty; Glendale—Weatherford; Long Beach—HAR (213) 426-7687; Mountain View—Elmar; Palo Alto—Weatherford, HAR (415) 321-2280; Pomona—Weatherford; San Diego—Weatherford, Western  
COLORADO: Denver—Elmar, Weatherford  
WASHINGTON, D.C.: HAR (202) 337-3170  
FLORIDA: Hollywood—Schweber; Melbourne—HAR (305) 727-5430  
GEORGIA: Atlanta—Schweber  
ILLINOIS: Chicago—Semi-Specs, Schweber; Palos Heights—HAR (312) 597-7510  
INDIANA: Indianapolis—Semi-Specs  
MARYLAND: Rockville—Schweber  
MASSACHUSETTS: Lexington—R&D; Waltham—Schweber; Wellesley—HAR (617) 237-5430  
MICHIGAN: Detroit—Semi-Specs  
MINNESOTA: Minneapolis—Semi-Specs  
MISSOURI: Kansas City—Semi-Specs; St. Louis—Semi-Specs  
NEW MEXICO: Albuquerque—Weatherford  
NEW YORK: Melville—HAR (516) 249-4500; Syracuse—HAR (315) 463-3373; Rochester—Schweber; Westbury—Schweber  
OHIO: Beachwood—Schweber; Dayton—Semi-Specs  
PENNSYLVANIA: Pittsburgh—Semi-Specs; Wayne—HAR (215) 687-6680  
TEXAS: Dallas—Weatherford, Semi-Specs, HAR (214) 231-9031  
WASHINGTON: Seattle—Liberty, Weatherford  
WISCONSIN: Wauwatosa—Semi-Specs.

**LEGEND FOR HARRIS SALES OFFICES & DISTRIBUTORS:** Harris Semiconductor (HAR); Elmar Electronics (Elmar); Harvey/R&D Electronics (R&D); Liberty Electronics (Liberty); Schweber Electronics (Schweber); Semiconductor Specialists, Inc. (Semi-Specs); R. V. Weatherford Co. (Weatherford); Western Radio (Western).



# Teradyne's L100 Automatic Circuit Board Test System speaks for itself.

PASSED

GOOD: 43  
BAD: 8

FAILED  
FAILURE COUNTERS (BAD/TOTAL):  
FTEST 0/36  
MTEST 5/83  
BTEST 0/1  
TTEST 0/2

MT44 D8  
THIS TEST PASSED

MTEST ON PINS: M

LIMIT :+ 500. MV  
ACTUAL!+ 248. MV

TT39  
THIS TEST FAILED

TIME FROM PIN 18 TO 21

ACTUAL! 00.195 US  
TMIN! 00.050 US  
TMAX! 00.190 US

FT35  
THIS TEST FAILED  
<ALARMS>51  
FAILING PINS: 20 Z K

FT15  
THIS TEST FAILED  
FAILING PINS: S R P N M L J

If you test circuit boards, you get the message. The L100 doesn't just tell you a bad board is bad. It helps you find out why. And in a fraction of the time you'd usually spend troubleshooting. We'd like to send you a brochureful of reasons why the L100 is the most money-saving system you can buy.

Write: Teradyne  
183 Essex Street  
Boston, Mass. 02111

In Europe:  
Teradyne Europe  
S.A., 11 bis, rue  
Roquépine,  
75 Paris 8°, France.  
Tel. 265 72 62.

**TERADYNE**

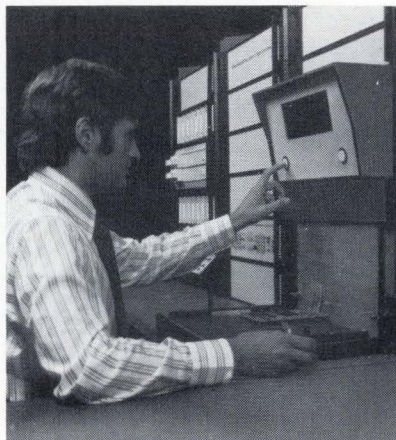



# Probing the news

Analysis of technology and business developments

## Electronics will add zip to mail

Multibillion market is seen for processing gear; manufacturers build automation equipment for mass-mailing firms and post offices

by William F. Arnold, Aerospace Editor

After years of planning and testing electronic mail-handling equipment, the U. S. Postal Service (USPS) is on the verge of spending an estimated \$2.4 billion during the next six years for electronic and electronic-related equipment. This equipment, being sought to speed up service and cut costs, includes computers, mini-computers, optical character readers, code and address readers, sorters, and canceller-printers.

The electronics gear is part of a \$6 billion modernization program that the USPS board of governors is expected to approve, possibly by December, says Harold F. Faught, senior assistant postmaster general, Mail Processing group. Contracts are expected to go out for the first equipment within a year, adds Kent H. Comegys, manager of the Code-letter Mail Systems division.

But the market doesn't end with the Post Office. Automation of the postal system will create a revolution in the mail rooms of large-volume mailers, such as telephone, insurance, and credit-card companies. By using electronic equipment to address, encode, sort, and further process their bills, these mailers can cut down the time it takes for their customers to receive and pay their bills, explains E. E. Lang, advanced postal systems manager of the Garland, Texas, divisions of E-Systems Inc., a postal equipment maker [*Electronics*, Sept. 11, p. 30].

What's more, postal officials are considering preferential treatment for volume mailers who encode and sort their mail before sending to the post offices. Because 75% of all letter mail is "major-mailer-generated," Comegys says that USPS is urging mass mailers to cooperate by adding

a binary bar code in the address area of all envelopes. Precoded originating mail processors (POMP) at the postal centers will read and transfer this bar code to the lower right-hand portion of the envelopes for standard processing.

Toward that end, Cincinnati Bell Telephone Co., Ohio Casualty, Blue Cross, and United Shield are cooperating in an experiment for the Cincinnati Postal Service test bed. Participants are developing computer programs so that the bar code can be formulated for each piece of mail, and they are modifying high-speed printers to handle the additional bar code. USPS is asking companies to add the bar code to return envelopes, which make up 10% of the total mail stream.

The bar-code reading technique is to be added to the sorting system already under test. The entire program is built around two systems—one for bulk mail and the other for preferential—or letter, mail. Most of the electronic equipment will be used in the \$4 billion preferential-mail network that will include 180 to 200 regional mail centers, Faught explains.

**First preference.** The basis for the preferential-mail centers is the letter-mail code-sort system (LMCSS) now in operational development at Cincinnati. The LMCSS is set up as a three-tier system for processing mail. The first tier consists of reading and processing bar-coded letters; the second is reading the address, extracting, and printing the code; and "the court of last resort," says Comegys, is manual intervention, whereby an operator sitting at a code desk encodes pieces that are rejected by readers.



LMCSS can use any of several systems. One built by the Rohr-Plessey Co., Clark, N. J., is being tested at the Cincinnati post office. The integrated mail-prep system, which routes mail into the three tiers described earlier, is controlled by a Digital Equipment Corp. PDP-14 minicomputer. The \$200,000 prototype system has an air culler, direct-feed system, single output facer-canceller, code detector/reader, and a transport system to funnel mail at a fast clip. Andrew Morrison, program manager, predicts that the entire market for postal automation equipment will be in the billions during the next five years.

Already the number of companies producing equipment for postal services and large mailer markets is sizable. In addition to Rohr-Plessey and E-Systems, they include A. B. Dick, Chicago; Burroughs Corp., Paoli, Pa.; Data Card Corp., Minneapolis; Business Machines division of Kenco Corp., Cherry Hill, N. J.; IBM Federal Systems Center, Gaithersburg, Md.; NCR Postal Systems division, West Columbia, S. C.; Pitney-Bowes Inc., Stamford, Conn.; Philco-Ford, Willow Grove, Pa.; US Envelope Mail Systems divi-



sion, Homestead, Fla.; Fairchild Industries, Pasadena, Calif.; Postal & Data Systems Corp., Fairfield, N. J.; Xerox Corp., Rochester, N. Y., ITT Corp., New York City, and FMC Corp., Santa Clara, Calif. And just this month Emerson Electric's electronics and space division, St. Louis, Mo., was awarded a \$4 million contract by the USPS to design, manufacture, and install two computerized printing systems for routing mail to post offices.

**Optical precision.** These companies produce a wide range of mail-handling equipment. But one of the toughest technological problems they face is developing the optical character readers to read addresses and sort letters. The OCRs have to read 240 different type fonts, and check misspellings. Advanced OCRs by Recognition Equipment and IBM's Federal Systems Center are being tested by postal officials in New York City. Philco-Ford also has its OCR-2 under test in Boston.

The advanced OCR is designed to read and sort up to 86,000 envelopes an hour by mail carrier, building, firm, or post office box number. In addition, it can sort outgoing mail by city and region without using zip-code information. The equipment searches a 2.9-in. band on the face of an envelope to see if there is a machine-printed address block, explains J. L. Poitevent, vice president for postal marketing at Recognition Equipment. At the read station, two types of logic are combined: template matching (which compares the unknown character with prestored patterns) and feature analysis (which compares combinations of features, such as stops, intersections, and curves to a matrix). "We use both techniques and send the results through a voting algorithm," says Poitevent.

The Postal and Scanning Systems Operations group of Philco-Ford has supplied 21 of the 23 OCR units now used by the Postal Service. In addition, Philco has an \$84,500 contract to modify two of its OCR-1 mail-sorting devices being used by the New York City post office to read bar codes as well. And, it is

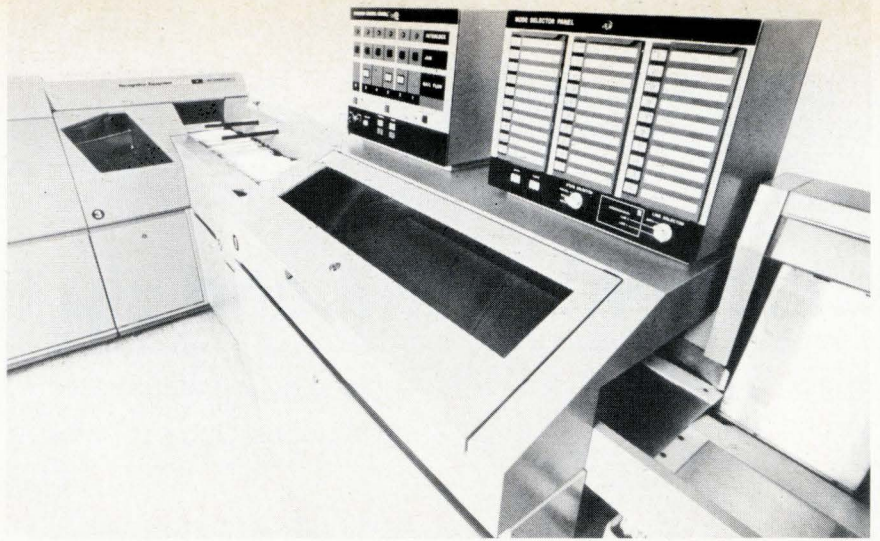

**Eyeballing mail.** The code sort optical character reader, developed by Recognition Equipment, is typical of the equipment needed by the USPS in the next six years.

possible, says Frank A. Teklits, manager of Philco postal systems engineering, that all 20 of the company's machines will be modified to read bar-code addresses.

Also being developed by the company—this time with Philco's own funds—are a dedicated bar-code reader and a solid-state scanner to replace the flying-spot scanner tube used in the OCR-1 and OCR-2 machines. The bar-code reader has been breadboarded in the laboratory and should be brought to market in early 1973, says market planner Charles Bradley.

A new step in automation is the computer-driven carrier sequencer. One such unit, built by Burroughs, is now being tested by the Postal Service, but the USPS will go out on competitive bid when it is ready to buy production models, Comegys says. The carrier sequencer receives already encoded and sorted mail and then re-sorts the mail in accordance with the way a letter carrier walks his route.

**Code readers, a hot item.** Code readers will be installed throughout the system to cull out precoded mail from the mail-prep system, verify already encoded information in the code-sort OCRs and the POMPs, and process mail in the carrier sequencer. Fairchild Industries, FMC Corp. and Postal & Data Systems already have provided the USPS with prototype systems, Comegys says.

Postal and Data Systems, a 2½-year-old subsidiary of Intelcom Industries, has three readers differing in such parameters as fields of view,

error rates, and the ability to distinguish bars printed with various inks and paper. The price of the readers ranges between \$3,000 and \$10,000, depending on quantity and the versatility desired, says Geoffrey Haigh, director of electro-optics.

All of the readers are solid-state, using as a reading element a monolithic array of silicon diodes. Letters move past the array at 200 inches per second, equivalent to about 15 mail pieces per second.

**Six in a second.** FMC Corp. derives about 30% of its business from postal service contracts, according to David G. Curphey, manager, Controls group. The most successful product, says Curphey, is the bar-half-bar code reader, which can read six letters per second, six times faster than a human. Curphey says that the new technology involved in the code reader is called "interpretive"—the reader uses code-tracking logic that allows the reader to determine what mail is readable and what is not. The machine decides where each pile of mail is to go, depending on how it was addressed.

FMC has four code readers undergoing field tests in Cincinnati, and one in New York City's main post office. FMC hopes to sell about \$4 or \$5 million in mail sorters, says Curphey. This year, though, the company hopes to reach the \$500,000 level, he says. Curphey calls the code mail-sorting system the "hottest thing going" and the best funded because of its widespread acceptance by postal officials. □



# ...it's SUPERDAC!

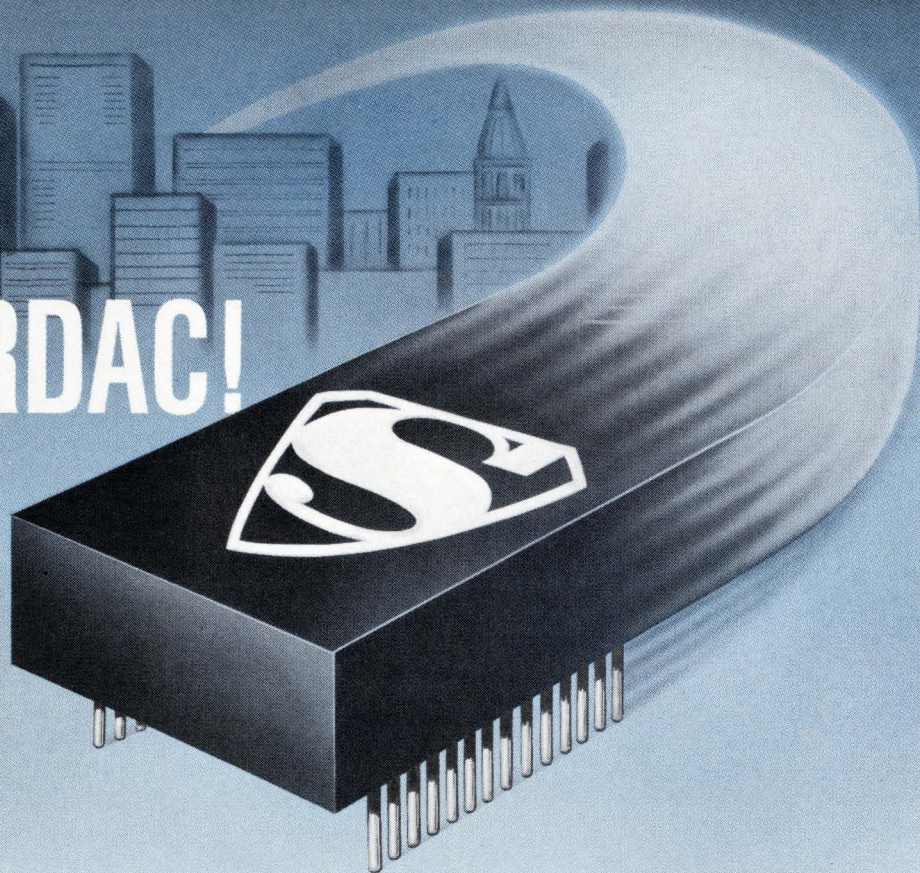

There are quite a few manufacturers of D/A Converters today. Some large, some small. They come and they go. But there aren't many who can give you the benefits of seven years of experience in this technology . . . benefits such as reliability, long life, stability.

Sprague SUPERDACs from 8 to 12 bits with settling times to 2  $\mu$ s are in full production. Reference voltage adjustable to +18V. They're priced competitively with discretely—with this difference: the performance, precision, and stability inherent in a well-engineered product are free. Here's your chance to gain from Sprague's sophistication in D/A Converter design and manufacture.

**UP WITH PERFORMANCE** . . . All internal devices hermetically-sealed and designed to meet the most stringent environments or exceed MIL-STD-883 requirements.

**UP WITH PRECISION** . . . Voltage offsets less than 5 mV. Resistors laser-adjusted to achieve typically  $\pm 0.1\%$  resistance tolerance and matching to within  $\pm 0.01\%$ . Proprietary monolithic IC ladder switches and buffer amplifiers are also featured.

**UP WITH STABILITY** . . . Operating temperatures are  $-55$  C to  $+125$  C for  $\pm 1$  LSB accuracy, or  $-25$  C to  $+100$  C for  $\pm 1/2$  LSB accuracy.

. . . **AND AWAY WITH DISCRETE PRICES** . . . Compare Sprague's price/performance/size with those of any other manufacturer. Prices are as low as \$2.50/bit. Then choose SUPERDAC . . . for signal processing, servo position, process control, and modems, to name a few applications.

Sprague Catalog Number	Resolution	Settling Time to $\pm 1/2$ LSB ( $\mu$ s)	External Reference Voltage	Full Scale Output	Temp. Coeff. <sup>(1)</sup> (ppm/ $^{\circ}$ C)	Unit Price (1-24)
<b>FIXED REFERENCE</b>						
UHM-532A	12-bit/3-digit	15	-10	-10	1	\$42.20
UHM-533A <sup>(3)</sup>	12-bit/3-digit	15	-10	$\pm 10$	3	50.40
UHM-503A	10-bit	2	-10	-10	1	36.00
UHM-506A <sup>(3)</sup>	10-bit	2	-10	$\pm 10$	3	42.20
UHM-523A	8-bit/2-digit	2	-10	-10	1	28.80
UHM-526A <sup>(3)</sup>	8-bit/2-digit	2	-10	$\pm 10$	3	36.00
<b>4-QUADRANT MULTIPLYING <sup>(2) (3) (4)</sup></b>						
UHM-412	12-bit/3-digit	20	$\pm 10V/20V$ p-p	$\pm 10$	3	86.33
UHM-409	10-bit	20	$\pm 10V/20V$ p-p	$\pm 10$	3	71.92
UHM-408	8-bit/2-digit	20	$\pm 10V/20V$ p-p	$\pm 10$	3	57.53

<sup>(1)</sup>  $\pm 1/2$  LSB Linearity

<sup>(2)</sup> DTL/TTL/CMOS (Neg. Logic) Input Compatible

<sup>(3)</sup> Includes Op Amp

<sup>(4)</sup> Multiply D/A Output Swing Adjustable to  $\pm 18V$  Max.

**Standard Size:** 1 1/2" x 2" (1" x 1 1/2" Available on Special Order).

**Inputs Available:** Binary, BCD and on Models with Op Amp, Offset Binary.

**Power Supply:**  $\pm 15V$  (Fixed Reference DACs Available with +4, -20V supply), Multiplying D/A Accept Reference Variable to  $\pm 18V$ .

The same technology that makes this series provides a complete family of successive approximation A/D converters, with current-summing capability and custom engineering as well.

For complete information, call or write Ron Beck, Semiconductor Division, Sprague Electric Co., 115 Northeast Cutoff, Worcester, Mass. 01606. Tel. 617/853-5000.



Analog Products for Signal Processing



Consumer electronics

## Firm wins calculator gamble

Bowmar Instrument, unable to sell its LEDs, put them in its own calculators and got a jump on that market; sales have doubled since '71

by Gail Farrell, Boston bureau

Two thousand pocket-size calculators a day come off the assembly line at Bowmar/ALI, Acton, Mass., reportedly the world's largest producer. Yet it was only a year ago that Bowmar decided to enter the consumer calculator market.

"We never dreamed in our wildest dreams it would be as big as it is," says Charles Krakauer, Bowmar/ALI president. The calculator is the first consumer product turned out by Bowmar Instrument Corp. of Fort Wayne, Ind., which was founded in 1951 by Edward A. White when he was 23.

The company's original product line was tiny, high-precision gear trains and counters for the aerospace industry. By 1962, following the purchase of a potentiometer manufacturer, sales were at \$13 million. A year later, the industry fell on hard times, and White was forced to close some plants and take "some wicked losses."

In 1961, however, Bowmar had already started placing outside research and development contracts for solid-state displays. By the mid 1960s, these orders led to the establishment of an optoelectronics facility, Bowmar Canada Ltd., Ottawa, Ontario. And this company became Bowmar's springboard into calcu-

lators, the product that is largely responsible for Bowmar's fiscal '72 sales of about \$26 million.

During the early 1960s, Bowmar also acquired Acton Laboratories Inc., makers of telephone instrumentation equipment and data-transmission testers; this became Bowmar/ALI. Last year, when it came to making a decision about calculators, Krakauer says that White "was willing to gamble; it was like 'bet your company.'" That gamble has paid off, and Bowmar now finds itself in the enviable routine of being able to sell as many units as it can make—the only immediate limit to its growth appears to be availability of parts.

**Light on LEDs.** Ironically, Bowmar is a major cause of the shortages of light-emitting diodes and MOS LSI circuits that now plague the calculator industry. Bowmar, however, isn't suffering from shortages because Bowmar Canada supplies most of the LED displays. Bowmar/ALI also depends on LEDs from Monsanto and Hewlett-Packard.

And long before LSI chips had become a supply problem, Bowmar had contracted with TI to supply a chip containing a 3,520-bit read-only memory, a 182-bit random-access memory, a decimal arithmetic

logic unit, and control, timing, and output decoders.

This chip, made to Bowmar's specifications, is at the heart of the Bowmar 901B calculator, but the LEDs are the reason for its existence. In 1970, Bowmar Canada was ready to make production quantities of LEDs, but Bowmar chief Ed White couldn't find anyone to buy them. White tried to push the idea of using LEDs in such hand-held devices as calculators and meters, but "U.S. and Japanese calculator makers could buy a vacuum-tube display for 54 cents, while ours cost \$2."

So he and Krakauer decided to make calculators themselves in the Acton plant. "We built a few by hand, estimated the cost, and concluded, here's something people can use," recalls Krakauer. "The big companies said it would never sell, and when I heard that I was tickled to death."

By May 1971, Bowmar had some samples ready to show New York retailers who received them favorably. Production went full speed ahead, and the first units were sold last October.

In August, Bowmar/ALI started producing the 905 calculator to be sold under the Sears logo for \$99.95. The \$119.95 price on the earlier 901B model has been reduced \$20 by using fewer components and reducing the amount of wiring.

Even though Bowmar was early into the market with the personal calculator, company officials realized that the Japanese would be strong competition before long. However, Krakauer doesn't regard



**On line.** Only an hour is needed to assemble and test Bowmar's calculators.



# Raytheon plus Telefunken.

## A whole new world of quality CRT's.

In the past, you've had a pretty slim choice in high quality CRT's from any single source. Now things are different. You can order any Telefunken CRT directly from Raytheon. In fact, considering Raytheon and Telefunken together, there is no broader line of high quality CRT's available.

This is a great marriage of U.S. and European technology. The outstanding Telefunken line plus the equally outstanding Raytheon line. Both sold and serviced exclusively by Raytheon's nationwide support organization.

The total Telefunken electrostatic deflection CRT line is available, every size and shape. You can now get the very best performance —



brightness, deflection sensitivity, post-deflection magnification, spot size, resolution — in very flat faced CRT's. You can also get a full line of accessories such as shields, sockets, anode caps, special graticules and a complete range of phosphors.

Samples can be delivered immediately, and you can expect rapid turnaround on production orders.

Commercial and military instrumentation, medical electronics, or whatever your field — Raytheon has the CRT's. For further information, specifications or applications assistance write or call us today. Raytheon Company, Industrial Components Operation, 465 Centre Street, Quincy, Massachusetts 02169. Telephone (617) 479-5300.

**RAYTHEON**



# api ULTIMETER: The ultimate meter relay

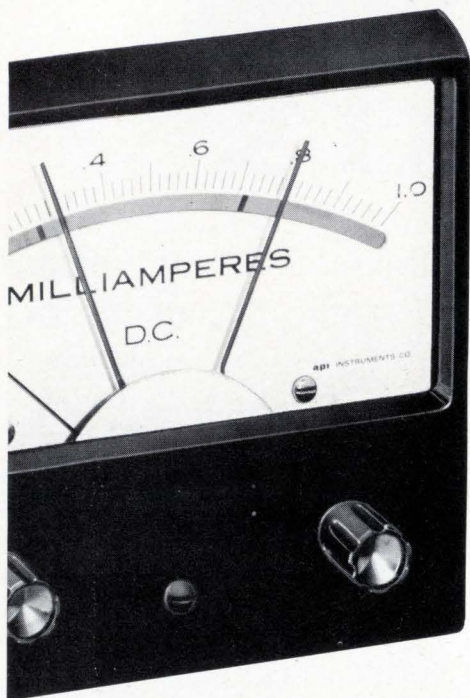

Unique, state-of-the-art API Ultimeter® controls upgrade any instrument using separate meters and setpoint pots. Ultimeters combine precise 1% linear indication with accurate potentiometer setpoint — for control independent of meter movement, for ultimate reliability. Ideal building block for control, test or monitoring equipment. Rectangular or edgewise package, 10 sizes from 3" to 6".

**Optical** (non-contacting) meter relays also available with separate control modules or as complete controllers, for fast, fail-safe, reliable control. **Contacting meter relays** come in locking-coil and magnetic models.

Choose from 45 models. Write for bulletins or phone (617) 890-2000. LFE Corporation, 1601 Trapelo Road, Waltham, Massachusetts 02154.



Process Control Division

Circle 72 on reader service card

## Probing the news

the \$60 calculators made by Japan's Casio and Busicom as direct competition. "These have only six digits, no decimal point, and they are larger than pocket size," he says.

In contrast, the Bowmar calculator is a four-function machine that performs chain or mixed multiplication and division. It has eight digits for entry and readout, full floating decimal point, plus or minus sign capability, and indicators that denote power on, low battery, overflow, error, and negative result. It measures about 5x3x1 in.

Bowmar does not intend to respond to Japanese units by cutting its prices. When and how far down the price goes, Krakauer says, is a function of what the components makers do. Bowmar/ALI marketing manager James White says that his firm has offset the low labor rates of the Japanese by designing the calculator with a minimum number of parts for maximum production automation. Bowmar keeps unit production time to about an hour.

### Meanwhile, in the U.S. . . .

There's also the matter of American competition. North American Rockwell Microelectronics Co. is supplying Sears, Bowmar's star customer, with a desk-top machine having a liquid-crystal display for \$99.95. But because the machine is a desk unit, Bowmar officials don't consider NRMEC a competitor even though the price is the same as the hand-held Bowmar 905 calculator Sears is selling.

But other competitors have stung Bowmar's stock, if not their sales. TI has come out with a hand-held unit and Solitron Devices Inc., San Diego, Calif., expects to market a pocket-sized calculator by the end of the year.

According to Research Institute Investors Service, New York, Bowmar's stock rose from a low of 11¼ in February 1972 to a peak of 46¾ in August. Then, the stock fell back 50% "as concern over the effects of competition mounted."

As for TI competition, Krakauer says, "We were smart enough to see the market in the first place. We feel smart enough to handle TI."

"The big plum is Sears," beams

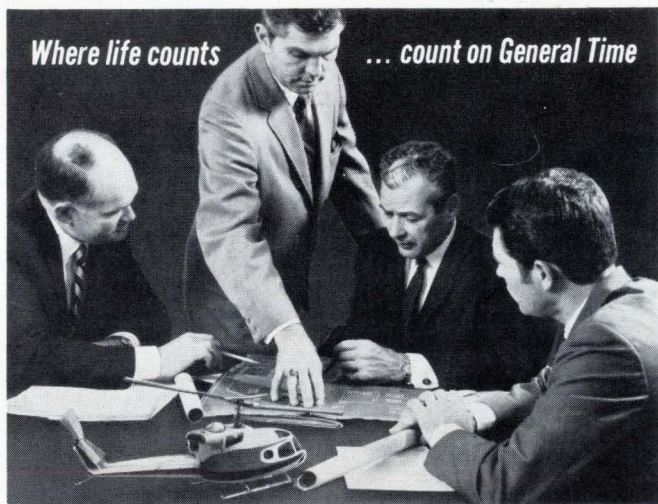

*If you've designed equipment where time and events mean life . . . we have the indicators to assure it . . . or we'll design one to your specifications.*



Write for Catalog 136 today. 1200 Hicks Road • Rolling Meadows, Illinois 60008

General Time subminiature Elapsed Time Indicators and Events Counters are your assurance of human or equipment life. Each provides a built-in record of any critical function. Proven reliability/30 million test hours. 400 Hz or 28v DC systems. Precise. Dependable. Digital or dial readouts. All meet military specifications.



**GENERAL TIME**  
A TALLEY INDUSTRIES COMPANY  
SPACE AND SYSTEMS DIVISION



# Four new linear integrated circuits worth talking about. Again.



Maybe you remember our ads which introduced some of our new integrated circuits this year.

Better yet, maybe you sent for our product information and evaluation samples.

A lot of people did because sales have been excellent.

And that's because everything we said about their

performance was absolutely true.

Our AD508. No one else gives you this kind of long term drift performance.

Our AD520. The world's first and only I.C. instrumentation amplifier. A complete system all by itself.

Our AD523. It has the lowest bias current of all high performance I.C. operational amplifiers.

Our AD830 dual monolithic FETS.

Their performance is so revolutionary, we gave them a new name and came up with a new way to measure them.

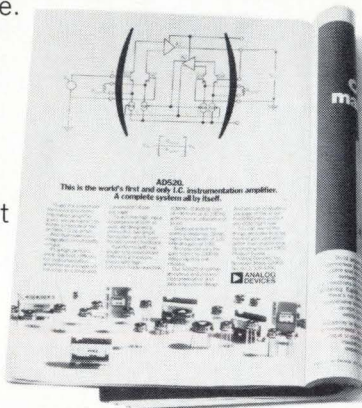

They're all worth talking about again so you'll get an idea of the kind of linear I.C.'s we make: multipliers, FET input op amps, high performance op amps, A/D and D/A conversion components, dual monolithic transistors.

And so you'll know what to expect from us.

We'll be using innovative FET, bipolar, and CMOS technology to give you the special and often unique performance you're looking for. At a reasonable price.

It isn't going to be all that hard to do when you look at what we've already done.

We enjoy the leadership position in analog circuitry.

We'd be happy to send you all the details on our four new integrated circuits. As well as our Product Guide which shows the rest of our

I.C. line and all the other things we make to solve more of your problems better than anyone else. Analog Devices, Inc., Norwood, Mass. 02062 (617) 329-4700.

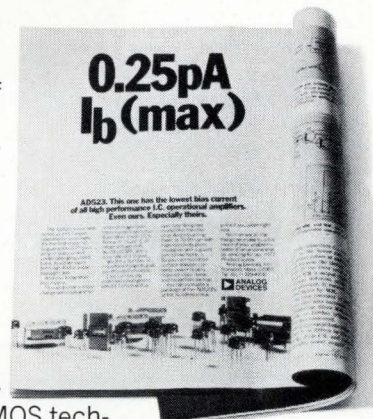



# THIS READER PACKS A PUNCH.



... a printing punch! With dual inputs and outputs, the 9645 Printing Reader Punch performs a wide variety of card processing operations for OEM systems and terminals. It reads 300 cpm, punches and/or prints at 60-120 cpm. And while the 9645 is big in versatility and reliability, it's compact in both size and price. Two more benefits typical of Decision Data's complete family of 96 column products for the OEM: we give you the wherewithal to compete.

**THE 9645: Another SuperMachine from Decision Data.**



**DECISION DATA**  
COMPUTER CORPORATION

100 WITMER ROAD, HORSHAM, PENNA. 19044  
(215)674-3300 □ TELEX 83-1471

Circle 74 on reader service card

## MERGER, MINORITY OR MAJORITY PARTICIPATION, PARTIAL CESSION,

(from US \$ 75,000.00, without cash too), and all other possibilities exist with small group of companies, - located in Belgium, Germany, the Netherlands, etc. -, being in a leading position in some fields of **photo-electronics, optoelectronics, microelectronics and electronic calculators.**

**Research and development, design and engineering, manufacturing, export-import of components and devices.**

Unusually high rentability, due to advantageous long term agreements with small, medium and large German, Swiss, Liechtenstein, U.S.A., Japanese, etc. firms.

Possibility of headquarters relocation. Planned extension into all major European countries and in the U.S.A. and Japan in 1973/74. Suitable opportunity both for active associates (franchised dealers), and investors.

Very interesting special opportunities.

Reply to **General Trust Corporation - Ref. B.G. - P.O.B. 34.722 FL - 9490 Vaduz, Liechtenstein.**

TRY SOME  
FREE SAMPLES  
OF BY-BUK  
PROFESSIONAL  
QUALITY  
ELECTRONIC  
CIRCUITRY  
DRAFTING  
AIDS.

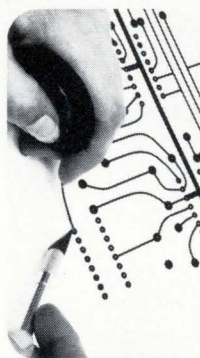

It's our way of proving that artwork layout accuracy can be accomplished in seconds with By-Buk pressure sensitive drafting aids.

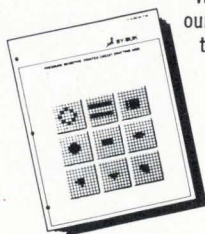

We'll also send you our catalog featuring thousands of ideas in individually die cut artwork patterns and conductor line tapes to connect them with.



**BY-BUK COMPANY**  
A SUBSIDIARY OF WEBTEK CORPORATION  
4326 W. Pico Blvd., Los Angeles, CA 90019  
(213) 937-3511

Circle 165 on reader service card

74 Circle 164 on reader service card

## Probing the news

Krakauer. But starting in January, the 905, now being made only for Sears, will be marketed through all Bowmar distributors. Recalling early days, Jim White points out, "When we got to the place where we knew we had a good product, we realized we didn't have the knowhow to sell it." So rights to distribute to electronics outlets were granted to the Craig Corp., Los Angeles, which markets the calculator under its name. Star Case Inc., of New York also markets Bowmar units to quality consumer stores, as well as special models that were made for Commodore Business Machines.

Calculator sales are having a salutary effect on Bowmar's employment record and its earnings. The number of people employed at Bowmar/ALI has quadrupled in the past year and a half. Sales for fiscal 1971 were \$13,353,000, with net earnings of \$333,000. In the first nine months of fiscal 1972, which started in October 1971, when the calculator was introduced, sales were \$20,093,890, and earnings were \$801,655. White says sales for 1972 are "over twice the sales of last year."

**Future.** No one at Bowmar is willing to estimate how large the potential market is, Krakauer says. Some equate the sale of personal calculators with the sale of portable typewriters, which is 2.5 million a year.

A figure of 4 million units is predicted by Jay Rodney Reese, vice president of TI's Solid State division. He says the average price will be \$100 each.

Bowmar's Jim White agrees with TI's Reese and Tadashi Sasaki, executive director of Japan's Sharp Industrial Instruments division, that the consumer calculator market is nowhere near saturation. And Bowmar/ALI will soon introduce a 10-digit machine and a desk-size model.

"Given our 'druthers,'" says Krakauer, "we want to provide machines to consumers and expand our production line to business purposes, single-memory calculators, and hard print-out. We're trying to bring high technology to the consumer marketplace." □



# How much did it cost you last month

Four thousand dollars? That would be less than a 1% slipthrough of defective IC's for a relatively small application working with smaller PC Boards. Ten or twenty thousand dollars? The numbers increase drastically with greater volumes and higher complexity Boards. And we use a conservative \$25.00 estimate for replacement of a defective IC in a PC Board.

Packed into most IC shipments, from the most meticulous manufacturer, you'll find a nominal percentage of defective devices, due to transit damage, handling, or human error.

And did your supplier's tests fully cover your own tight functional parameters? Marginal-operating circuits can mean extensive trouble-shooting, rework and expensive replacement parts, just as often as catastrophic failures. And it costs real money either way.

OK, so inspection pays off, as a general rule. But how do you get down to specifics—what can testing do for you? We can help. Fairchild Systems, the leader in semiconductor test systems, offers a mathematical tool for determining the economic feasibility—and the financial justification—of pre-use testing your semiconductor parts. The name of the game is SAVE. Short for System Analysis of Value Economics: a computer-based procedure that knows how to simulate your particular operations over a broad spectrum of test inspections—incoming, QA, PCB, wafer and final production testing.

SAVE enables you to detail, step-by-step, all your applications, configurations, number of stations and daily work shifts. Types and quantities of devices used are accounted for, with your average rate of untested defectives balanced in.

After completed forms are run through Fairchild Systems' SAVE-programmed computer, you get the readout. Hard-nosed data on total

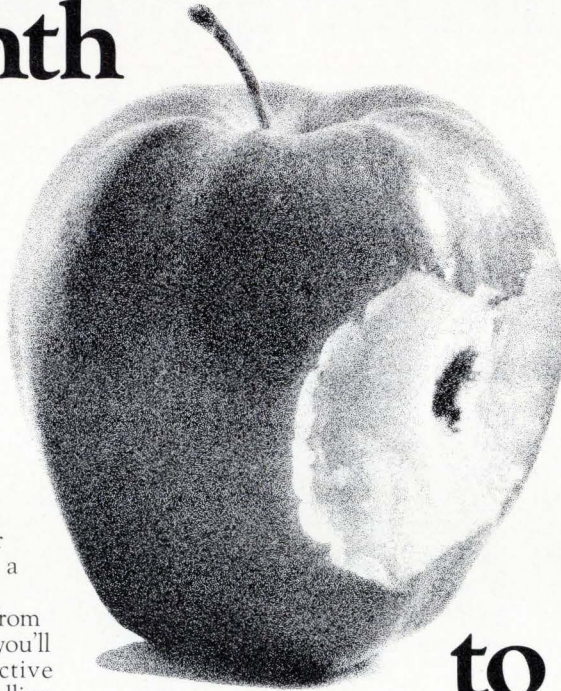

## to find out nobody's perfect?

comparative costs for testing; including a breakdown of operating expenses, system costs, test equipment replacement, payback period, plus actual net savings realized.

You'll also use SAVE's figures for evaluating alternative system configurations to provide cost-effective solutions. And many plant designers take advantage of the in-depth operational simulation for "fine tuning" systems for optimum performance and maximum software/hardware utilization.

And SAVE's computerized analysis helps you determine the most productive, most economical level of test equipment from our advanced Sentry series—the large-scale Fairchild System with unbeatable speed, sophistication and flexibility. From MOS to bipolar, from IC's to discretes, or LSI—with software compatible to all, and the lowest throughput costs in the field—the Sentry family offers you total semiconductor testing capability with enormous expansion and adaptability options. And SAVE shows you how to make the most of it...and make your world just a little more perfect.

<b>FAIRCHILD</b> SYSTEMS TECHNOLOGY	Fairchild Systems 3500 Deer Creek Road Palo Alto, California 94302
<input type="checkbox"/>	Please send us your SAVE Economic Analysis Kit for semiconductor test systems.
<input type="checkbox"/>	with details on your modular testers.
<input type="checkbox"/>	with details on your Sentry Systems.
<input type="checkbox"/>	Call us immediately for individual application assistance.
Name _____	
Title _____	
Company _____	
Street _____	
City _____ State _____	
Zip _____ Telephone _____	

# Fairchild Systems

Fairchild Systems Technology, a division of Fairchild Camera & Instrument Corporation.



Medical electronics

# Medical engineering: prognosis fair

Because of their financial structure, few hospitals can now afford bioengineers; new health care laws should open jobs there and in industry

by Paul Franson, Los Angeles bureau manager, and John N. Kessler, Associate Editor

**Medical engineering**, once prescribed as a cure for aerospace unemployment, needs nursing by the Government before it achieves real vitality. And even then it faces career problems.

While nearly four million people are employed in health care, only 4,000 of these are engineers, reports a recent U.S. Department of Labor study conducted by the National Society of Professional Engineers, Washington, D. C. Nor will many more than 1,000 of the 65,000 unemployed engineer-scientists from aerospace find jobs as medical engineers over the next three years, the society adds.

The key to the rapid growth of medical engineering as well as health care delivery services lies with Congress, says Charles W. Garrett, executive secretary of the committee on the interplay of engineering on biology and medicine, National Academy of Engineering,

Washington, D. C. "One of these days," he says, "Congress is going to pass a bill creating and funding national health care delivery service." Such legislation Garrett believes will provide the influx of dollars that will, in turn, create a market for medical engineers.

**Obstacles.** The major problem at the moment is the way in which payment for hospital services is structured. As Clifford D. Ferris, acting director of the bioengineering program at the University of Wyoming in Laramie, points out, "a smaller hospital cannot afford to hire a medical engineer." Garrett explains an engineer's costs come out of a hospital's overhead—and the hospital administrator is concerned with cash flow from third-party insurers, which does not affect overhead but would absorb any cost savings effected by the engineer. But this will change radically when legislation for national health care de-

livery services is passed by Congress.

The second factor that will expand medical engineering, Garrett believes, is medical device safety legislation. Right now, the Food and Drug Administration is embarking on a program for developing standards for medical device safety. When these recommendations are incorporated into a law, hospitals will be required to employ medical engineers if they use electronic equipment.

The third factor, says Garrett, includes the whole range of health care maintenance organizations which are just beginning to be established. These, typified by the Kaiser Foundation Health Plan in California, will increase as the Federal Government, community groups and unions push for the amalgamation of medical services.

The time frame for significant growth, in Garrett's opinion, is

about five years. Today, there are about 160 academic institutions which offer programs in biomedical engineering, according to the Institute of Electrical and Electronics Engineers' group on biomedical engineering. And the total opportunities this year for employment in this field are only 395. But by 1973-75, thanks

## Systems engineering for health?

Both Bruce A. Barkalow (left), a medical engineer at Sutter Community Hospital in Sacramento, Calif., and Albert M. Cook, coordinator of bioengineering at Sacramento State University, believe that the major problem with the retraining of aerospace engineers is that they are too specialized. But, says Cook, the engineer may regard himself as an expert in some narrow field, when in fact he may have had excellent training that could be applied to seemingly unrelated, but actually similar tasks.

Barkalow points out that medical research and care are much less organized than the space program. Workers study independently, he says, without prior planning or the need to report results to others in the field. Even on the local level, research and treatment are often poorly planned, with no systems engineering applied. This may be the area in which aerospace engineers have the most to offer.





# MEDIUM, WELL DONE.



By now, you should expect it. When Data General goes to work with a new medium, we do it well.

Our new Nova Cassette is the most innovative and reliable on the market.

Essentially, we've solved a lot of the reliability problems that have plagued cassettes in the past by relying on electronics, not mechanical systems, to handle the hairy jobs.

Most cassettes have a complicated system of capstans and pinch rollers to move the tape past the heads at constant speed.

The Nova Cassette uses read/write electronics smart enough to disregard variations in tape speed. It's a simpler, less expensive, much more reliable solution.

Similarly, we finessed the tricky tape guidance problem by recording data on one track across the whole width of the tape, and reading from only the inner 80% of the tape.

A little skew (or a little edge wear, or a little dust) just doesn't get in the way. And you can write on one Nova Cassette transport and read on another. Reliably.

We use a read-after-write head configuration that automatically verifies the data you're writing, without backtracking and reading over. That saves your tape and your time.

Average capacity is 100,000 bytes per cassette. Data transfers at 1660 bytes per second (through Direct Memory Access channel, so it doesn't have to interrupt the processor). Average

speed is 30 inches per second. One, two, or three transports, power supply, and drive electronics fit in 7 inches vertical. A control for eight transports mounts on one p.c. board.

One drive is \$2,000. The second and third are \$750 each. A control for eight is \$1,500. Software is free.

If you're an OEM, take up to 40% off everything.

When Data General does a job, we do it well.

These days, that's rare.

 **DATA GENERAL**  
Southboro, Massachusetts 01772



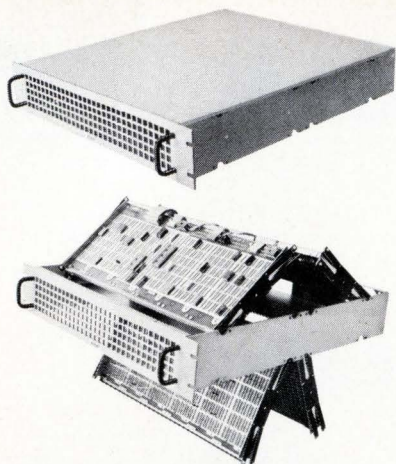

## Augat enclosures. You can do a lot with 3½ inches.

Example: Augat's 3½-inch-high drawer assembly will package up to 720 DIP's. That's a lot. What's more DIP's are always in easy reach. Panel frames have unique two-way hinges for accessibility or removal.

Augat rack assemblies also give you plenty of packaging density. Plus flip-up access to panels for fast repairs or design changes.

Smallest of all, our new mini-rack assembly — with small racks and plug-in panels — lets you subdivide logic more flexibly than before.

Whichever way you want to go, you can count on Augat for all your enclosure needs. And probably pay less money than you're paying now, thanks to our off-the-shelf supply.

Augat. The ones who pioneered the plug-in panel. Call us for panels (with automatic wire wrapping available), enclosures, sockets, accessories. Or write for our catalog.

Augat Inc., 30 Perry Avenue, Attleboro, Mass. 02703. (617) 222-2202. Our representation and distribution is nationwide and international.

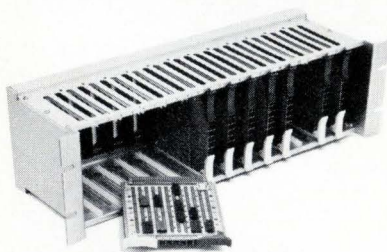

Plug into Augat®

## Probing the news

largely to growth in instrumentation and appliance manufacture, employment opportunities will grow to 2,955, to quote estimates from the National Society of Professional Engineers report.

Consequently, the Federal Government's retraining programs will have an insignificant impact on medical engineering—not only because of the few people opting for retraining, but because of the inherent limits on employing medical engineers today. And beyond the fact of numbers, is the scope of education required for biomedical engineers. As Ferris at the University of Wyoming puts it, "The problem with retraining aerospace engineers is that their training has been in a very narrow field. Bioengineering is very broad, requiring knowledge in physics, basic engineering, and biological sciences." Ferris feels that younger engineers can be successfully retrained, but that it is more difficult with older engineers who "have forgotten a lot of the basics."

**Two programs.** Two retraining programs in biomedical engineering specifically for unemployed aerospace engineers have recently been conducted under the sponsorship of the U.S. Department of Labor. One, taught at Los Angeles Valley College in California and directed by Bruce S. Angwin, has found jobs for most of the 15 engineers enrolled. Participants were virtually assured of jobs by lining up employers before the course, and were provided with subsistence living costs, transportation, and other costs. The nine-week program has been completed so recently that conclusions are hard to draw, but Angwin regards the course as a prototype that he hopes will lead to retraining on a larger scale in the future.

The other program started this fall at two colleges in Florida. Marvin Olsen, a TRW executive, is coordinating it as the on-loan executive director of the regional Environmental Training and Research Organization Inc., Cocoa, Fla. "We are banking on a broad engineering background that can be utilized, plus courses to fill in those areas needed for specific jobs in medical

engineering," says Olsen. He emphasizes that students spend 40 hours on campus, and that the training is rigorous.

At Florida Institute of Technology in Melbourne, 19 students are enrolled in a program of medical systems engineering, aimed at developing managers who can evaluate the computer needs of hospitals and recommend and implement EDP systems.

Nineteen students are also enrolled in the medical data-processing supervisor program at Brevard Community College, in Cocoa, Fla., which is training technicians to evaluate hardware and integrate a system of minicomputers and computer terminals with a central computer. Also at Brevard is a program aimed at former aerospace technicians; the 15 students look forward to careers as biomedical equipment-repair technicians—who can maintain and repair electronic equipment, such as electrocardiographs and blood cell counters.

Each program is to run for 34 weeks, and Olsen says there will be much more emphasis on the placement of engineers than is the case with most engineering colleges. Studies have been made of the needs of various local hospitals, he explains, adding that better than 95% of engineers in similar retraining programs in environmental control have found jobs.

**On the job.** Once an EE gets a job in bioengineering, his biggest need, says Bruce S. Angwin, medical-engineer-program director, technology utilization project, National Society of Professional Engineers, is to learn the language of physicians. Also needed is a certain amount of anatomy and physiology, and an understanding of the way the health field is organized.

A basic problem is that biological systems seem foreign to the typical physical engineer. "Not only are biological systems very complex," says Bruce A. Barkalow, bioengineer at Sutter Community Hospital in Sacramento, "but their basic nature is little known. Much research and practice in medicine involves trying to analyze simultaneously varying data while attempting to find patterns and causes, unlike physical phenomena, where the



# For every electronic protection need **BUSS**<sup>®</sup> has a quality Fuse & Fuseholder



1/4 x 1 1/4 inch  
Time Delay Fuses  
From 1/100 to 30 amps,  
**MDL MDX**  
for 32V, 125V, or 250V

1/4 x 1 1/4 inch  
Normal Blowing Fuses  
**AGC GLH MTH**  
From 1/500 to 30 amps,  
for 32V, 125V, or 250V

*Space-Saver Fuseholder for 1/4 x 1 1/4 inch fuses projects only one inch behind panel*

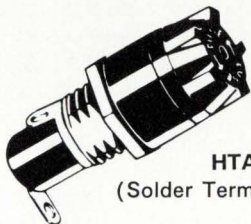

**HTA**  
(Solder Terminals)

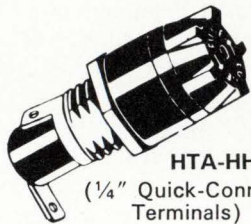

**HTA-HH**  
(1/4" Quick-Connect  
Terminals)

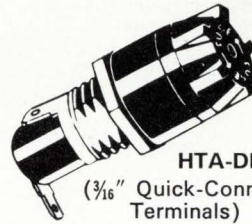

**HTA-DD**  
(3/16" Quick-Connect  
Terminals)

## ALL FUSE HOLDERS HAVE THESE FEATURES IN COMMON

- Rated for 15 amps at 250 volts
- Dielectrically capable of withstanding 1500 volts a.c. between terminals and between terminals and panel
- Bayonet-type knob grips fuse so that fuse is withdrawn when knob is removed; strong compression spring assures good contact
- Made for installation in D-hole to prevent turning in panel
- Terminals are mechanically secured as well as soldered in holder.

The BUSS line of small dimension fuses and mounting hardware covers the complete spectrum of electronic applications. Use the coupon at right to order the complete catalog.

BUSSMANN MFG. DIVISION, McGraw-Edison Co.,  
St. Louis, Mo. 63107

SUPPLIED THE ECONOMICAL WAY  
... THRU DISTRIBUTORS

# BUSS QUALITY

## FUSES

BUSSMANN MFG. DIVISION, McGraw-Edison Co.  
St. Louis, Missouri 63107

Please send me a copy of BUSS Bulletin SFB

NAME \_\_\_\_\_  
TITLE \_\_\_\_\_  
COMPANY \_\_\_\_\_  
ADDRESS \_\_\_\_\_  
CITY \_\_\_\_\_ STATE \_\_\_\_\_ ZIP \_\_\_\_\_



# Have you heard about Rochester's smaller successes?

Sure, you know about the big ones. In copiers and cameras. In microscopes and men's wear. But a lot of smaller businesses are on their way up in this fertile, dynamic 9-county area of Western New York. Would you like to know who they are, how they're growing . . . and how to find just the plant space or site where your company can make it big, too? Could you use facts about labor, and educational, recreational and transportation facilities? If so, call collect or write to Bob Hall, Director of Area Development, Rochester Gas & Electric, 89 East Avenue, Rochester, N. Y. 14604 (Telephone: 716-546-2700). Nobody knows more about this area than we do. And because we make money selling energy to industry, we're eager to share our knowledge with you.

**R.F. Communications made it here. How about you?**

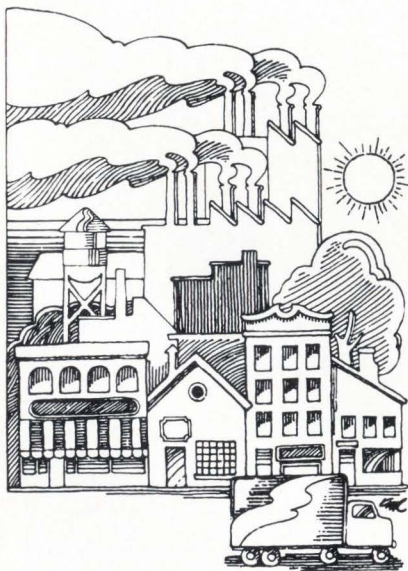

**RGE** ROCHESTER GAS AND ELECTRIC

## Probing the news

principles are generally understood."

Experiences of engineers who work at hospitals differ considerably. Barkalow, a 30-year old Ph.D., finds his work interesting and satisfying. Among his experiences, he mentions, "We can modify existing equipment to meet current legal and medical standards. Before, the hospital had to throw it out and get new equipment, an expensive proposition. Alternatively, we can pick industrial equipment that is cheaper and often more suitable." He says that relations with the MDs are good, particularly since Sutter is a community hospital where the atmosphere is not academic. "It hasn't been a real problem. We have to work with them and show them how we can solve their problems. The demand from physicians sold the administration, in fact." Having a Ph.D. helps, he admits, but he feels that interest in the work is the most important trait a bio-engineer can have.

Less enthusiastic is Donald L. Behrendt, who describes himself as a "typical refugee from 20 years in aerospace," and who is working—on his own time and money—for a master's degree. Behrendt contends that professional engineers don't fit into hospitals. For example, he finds it hard to convince the administration and researchers of concepts that are widely accepted in the electronics industry, like periodic calibration of instruments, or the need for continuing education or conference attendance.

**Why not try a minicomputer?** Behrendt also mentions a researcher collecting vast quantities of analog data on instrumentation recorders, then laboriously analyzing it by hand, when a system based on a minicomputer would be much cheaper and more efficient. Yet in spite of recommendations, the man recently bought a \$13,000 recorder rather than giving serious consideration to the digital equipment. He finds that, although medical people spend a great time in school, "in spite of what they sometimes think, they don't learn everything about everything." □

# Murata Ceramic Ladder Filters are Sharp...

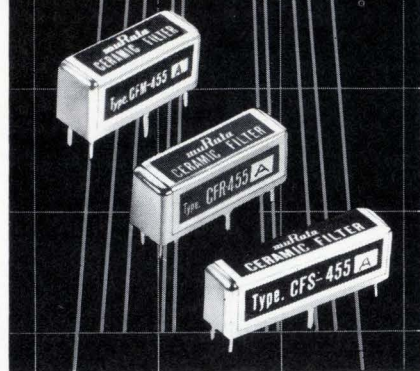

*in response,  
in price and  
in reliability.*

Murata's complete line of 455 KHz ceramic piezoelectric filters are designed to provide exceptional performance and reliability in communications receiver applications. Models offering bandwidths from 50 dB at  $\pm 30$  KHz to 70 dB at  $\pm 4.5$  KHz and with up to 15 ladder connected lead zirconate-titanate ceramic elements, provide an unexcelled selection to meet every application requirement.

These units are particularly suited for use in transistorized communications equipment where their unusually small size and light weight, combined with low impedance and high selectivity, may be used to best advantage.

To find out how these filters can perform for you, write for our new technical data.

**muRata**

**MURATA CORPORATION OF AMERICA**  
2 Westchester Plaza, Elmsford, New York 10523  
Telex: Murata EMFD 137332  
Phone: 914-592-9180  
Subsidiary of Murata  
Manufacturing Co., Ltd., Japan





## IBM System/7 installed at Dale Electronics to speed production.

A sensor-based IBM System/7 computer has gone into operation at the Norfolk, Nebraska, plant of Dale Electronics, a subsidiary of The Lionel Corporation. Dale expects that use of the System/7 will double its output of high-reliability film resistors.

All such resistors must undergo repeated tests to insure that actual resistances do not deviate more than 1% from rated values. Formerly, differences between pre-test and post-test values were calculated by hand, creating a production bottleneck.

Now, test instrument readings are entered directly into the System/7, which singles out for removal resistors failing to meet specifications. All readings for resistors which meet specifications are then transmitted directly to an IBM system at Dale headquarters

in Columbus, Nebraska.

Upon completion of endurance testing, the resistors are again measured. The system at headquarters computes the differences between readings and transmits a list of resistors which failed to qualify back to the System/7 in Norfolk.

In addition to speeding resistor throughput, Dale plans to use the System/7 for order tracking and monitoring and control of testing and production machinery.

Full information on the System/7 is available through your IBM representative or local office. Or write IBM Data Processing Division, Department 807-E, 1133 Westchester Avenue, White Plains, N.Y. 10604.

**IBM**®

Circle 81 on reader service card



Management

# Unity is key to WEMA success

No longer limited to West Coast membership, the 683-member organization boasts a growing list of activities and a growing impact on legislation

by Stephen Wm. Fields, San Francisco bureau manager

While the Electronic Industries Association recently lost one prominent member because of an inability to take a unified industry position on matters like international trade [*Electronics*, Sept. 11, p. 25], WEMA, the Palo Alto, Calif.-based trade association, has quietly gone ahead expanding its membership and influence. And the key to WEMA's success has been its members' common viewpoint, particularly on international trade.

Although chartered as the West Coast Electronics Manufacturing Association in 1943, WEMA has dropped geographical requirements for membership. Now the letters of its name do not even denote specific words, but stand for 683 members and associates allied by a major interest in the future of electronics and its effect on international trade.

This commonality of viewpoint, says E.E. Ferrey, WEMA's executive vice president, is what has made the organization especially successful in Washington. But there are other reasons for its success:

- WEMA has liberalized its membership requirements and now permits companies in businesses related to electronics—such as banks, venture capital companies, and electronic-components distributors—to join as associate members. And companies producing computer software are allowed full membership.

- Membership in WEMA runs from just a few hundred dollars to a maximum of \$1,500—less than what some private consulting firms charge for a salary survey.

- WEMA puts emphasis on what is pertinent to running a business in the form of studies, surveys, and seminars.

WEMA's impact on Federal legislation is exemplified by the effect of testimony by Earl Wantland, president of Tektronix Inc., Beaverton, Ore., during Congressional "oversight" hearings on the Export Administration Act of 1969. Wantland, sent to testify by WEMA, charged that Government policies were handicapping many U.S. firms in competing effectively in the East European and the new Chinese markets. As a result of this and other industry statements, proposals by Sen. Robert Taft (R., Ohio) to ease the control of electronic exports were added as amendments to the act.

Not limited to Government affairs, WEMA has made available to its members what is considered a benchmark wage and salary survey. It has produced an operations-ratio report, which allows a company to compare itself with others of similar size and product interest, or even by the percentage of sales that are commercial vs Governmental. And an upcoming study will be devoted to executive compensation. Such reports are particularly useful to young companies, which may have difficulty in affording the cost of these studies from private consultants.

**Pertinent.** How does WEMA determine what is "pertinent" to its membership? The ideas come from committees made up of industry people, not WEMA staff members—although staff people help get things going. For example, a seminar on East-West trade slated for Dec. 12 got started because small-company members don't know how to do business with the East. In the planning stages is a seminar on the nuts

and bolts of international trade—to be explained by executives with first-hand experience who will "tell how to do it," says Ferrey.

Generally, he says, "the seminars and reports are the result of a melding of ideas. The staff tries to assess suggestions from members and also at board meetings we try to determine what our member companies need." Ferrey points out that a "financial-affairs committee was set up because of concern about such matters by our members." Results of this committee were the mergers and acquisition seminar, an upcoming session on the strategy in corporate finance, an annual Monterey conference bringing together small-company executives and securities analysts (see p. 45), and the operations-ratio survey.

**Activity.** Alan J. Grant, executive vice president at Aerojet-General Corp., El Monte, Calif., and a WEMA vice president, says, "WEMA is a service association to the electronics industries. It provides a forum for key executives to get together and discuss things of common importance." The WEMA group in Los Angeles, at a recent dinner meeting attended by 400 corporate executives, hosted Soviet embassy officials, who spoke about what the Russians wanted to buy from the U.S., and how to go about it.

R.S. "Sam" Carlson, president of North American Rockwell Microelectronics Co. in Anaheim, Calif., found the meeting "very revealing." He also finds WEMA's services useful: NRMEC uses the local compensation studies, operations-ratio surveys, financial studies, and seminars on market strategy, for example. □



# 4½ Digit Data Tech DMM Spikes Competition at \$495

SANTA ANA, CALIF. — Data Technology Corporation today announced a new 4½ digit Multimeter that gives high performance at a rock bottom price. Not a stripped-down version, the Model 40 provides fourteen AC, DC and ohms ranges with 0.02% and 0.03% accuracy. The \$495 price is significantly below the current price of comparable Dana 4300 and Fluke 8100.

## High Performance

The Data Technology instrument's DC measuring speed of 0.2 sec. is considerably faster than most 4½ digit models. AC speed and ohm speed is 2 sec. and 500 ms respectively. The fully guarded DMM has 50-60 Hz NMR and 90-100 db CMR. Resolution is 10 microvolts. A 1200 V overload, AC or DC, on any range prevents damage under all but the most severe conditions.

## User Convenience

The Model 40's easy-to-read display is both attractive and functional. Based on the Sperry unit, the bright one-half inch numerals have no distracting segments and can be viewed from a wide 150° angle. The display's aesthetic appeal has been confirmed by a nationwide survey. The many important user benefits have not been overlooked. A spare fuse and circuit card connector, for testing, are housed behind a rear entry panel. The panel opens easily with a pop-release button but, for safety, only after the line cord is disconnected. There are no screws to remove when opening the case for service. Two pop-release buttons make disassembly quick and easy. In fact, the entire unit can be field-

stripped in less than 5 seconds! The calibration chart is even silk screened inside the Model 40 case, so it can't be mislaid. The unit operates in any convenient position, horizontally or vertically. A snapout stand tilts the meter for better bench viewing.

## Detailed Specifications

Model 40 has five DC ranges from 100 mv to 1000 V, four AC resistance ranges from 1 V to 1000 V and five 10 Megohm. Input resistance is 10<sup>10</sup> ohms on all ranges. Input Impedance for AC is one megohm shunted by 50 pf on all ranges. Voltage across "R" is 5 V at full scale. 100% overrange is standard. Accuracies, specified for 90 days: 25°C ± 5°C range for DC to ± (0.02% rdg + 0.02% range) for resistance; six month, 25°C ± 10°C range from ± (0.05% rdg + 0.02% range) for DC to ± (0.25% rdg ± 0.02% range) for 10 meg. For more information, contact John Dunn, Product Manager, Data Technology Corporation, 2700 South Fairview Road, Santa Ana, Calif. 92704. Phone (714) 546-7160.

the new data technology corp.



2700 SOUTH FAIRVIEW ST., SANTA ANA, CALIF. 92704



# If you think interconnection technology lags behind tomorrow's design...

## you haven't talked to AMP.

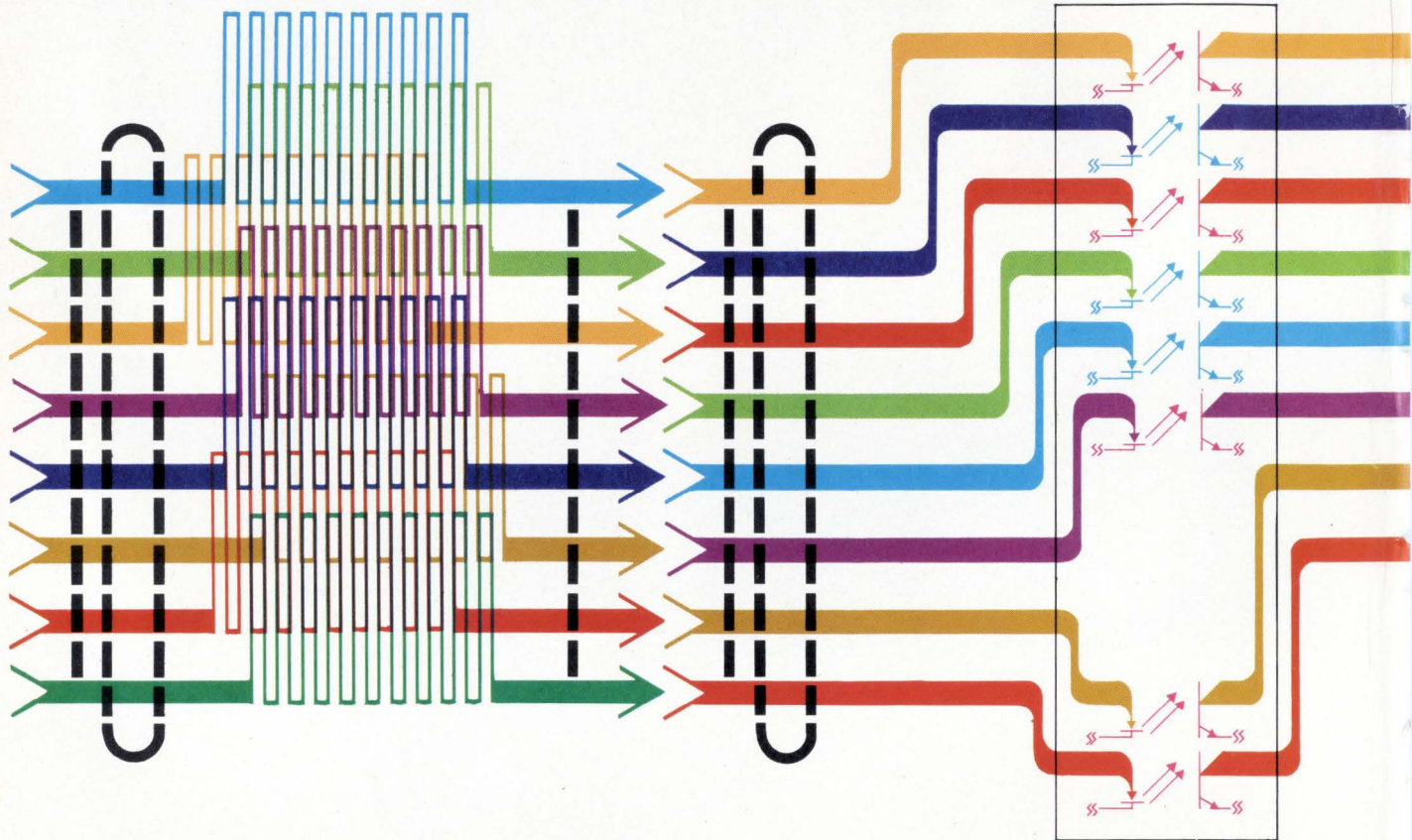

It's time you did. And don't be surprised to learn we're right in step with your own thinking on the next generation. Maybe even a step ahead.

**Talk to us about a shielded, matched-impedance interconnection system.**

We'll tell you how we can achieve speeds in the picosecond range. With a totally new interconnection system with the shielding, impedance matching and thermal management you need for next generation equipment. And packaging densities far greater than those of today's systems.

**Talk to us about high-density DIP micro relays.**

We'll show you how to pack more into subminiature devices than you have seen to date. For example, with our new, compact multifunctional relay that provides maximum signal/ground independence in peripherals. The design fits two double-pole relays into a standard, low-profile, 16-pin DIP header.

**Talk to us about subminiature DIP switches.**

We'll show you an easier, less costly way to program addresses, control command characters and program prewired logic. Our 4 to 10-pole, subminiature DIP switches can be plugged into standard DIP headers or flow-soldered into PC boards, reducing front-end costs. Field service costs are also reduced by eliminating hand soldering changes and strapping.

**Talk to us about high-speed automated application machinery.**

We'll show you how to lower your applied costs for next generation equipment through automation. With machines that will terminate twisted pairs . . . and standard cables at speeds up to 25,000 an hour. Or insert up to 50,000 posts an hour for dense circuit wiring. Or . . . you name it. We either have it, or we'll work with you to develop it.



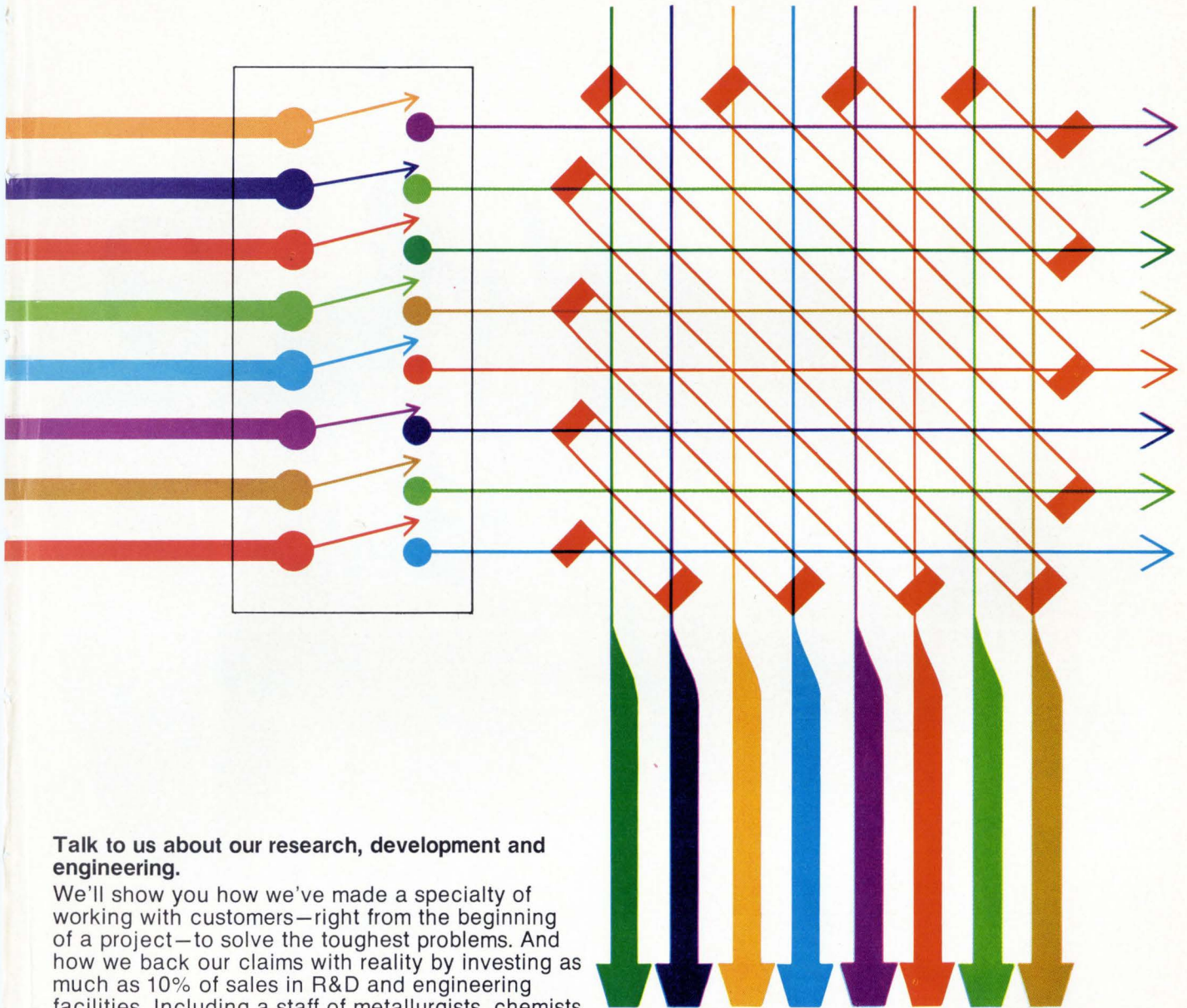

**Talk to us about our research, development and engineering.**

We'll show you how we've made a specialty of working with customers—right from the beginning of a project—to solve the toughest problems. And how we back our claims with reality by investing as much as 10% of sales in R&D and engineering facilities. Including a staff of metallurgists, chemists and designers who devote full time to studying materials, new design concepts and fabrication techniques, and provide prototyping, test and analytical services.

**But talk to us now . . .**

while your next generation designs are in their early stages and we can help you most. Challenge us. Call our local sales engineer or write **AMP Incorporated, Industrial Division, Harrisburg, Pa. 17105. Refer to "Generation Challenge."**

# AMP INCORPORATED

Manufacturing and direct sales facilities worldwide: Barcelona, Brussels, Buenos Aires, Frankfurt, London, Mexico City, Paris, Puerto Rico, Sao Paulo, s'Hertogenbosch (Holland), Sydney, Stockholm, Tokyo, Toronto, Turin, Vienna.

Circle reader service number  
84 Please send literature—possible future interest.  
85 Please send literature—immediate interest.



# Remember the commitment we made to "883" in this '69 ad?

MACH IV



Let TI's special HI-REL Task Force take you through the turbulent sometimes uncharted universe of MIL-STD-883.

We'll keep you on course.

### Scout's honor.

Others have called 883 a lot of confusion, a word that, and some "unprintable words." But we have tried to keep our mouth shut, our shoulder to the wheel, and our nose to the grindstone.

While our best minds solved the problem, TI has committed itself to 883. Money, manpower and facilities.

And we're ready to deliver "in accordance to MIL-STD-883."

In fact, we've been achieving 100% tested ICs for years. Millions of them for Minuteman, Sprint, Frontier, P-111 and other programs.

And some of these had even tighter requirements than 883.

From this experience, TI has organized special HI-REL Task Forces to help you meet 883. A special Task Force has been organized for TTL, semiconductor, and the one pictured here for TTL ICs.

The members are made of TI's top

managers in the areas of reliability engineering, process engineering, product sales, military marketing, product planning, product engineering, quality control engineering, manufacturing and HI-REL assembly.

They're specialists in Series 54 and 565 TTL ICs, now available from TI in both 8-pin and 14-pin dual-in-line packages — standard for 883 Classes A, B and C.

The Task Force's assignment starts with your problem, determining the specific test procedures and leads you'll need to satisfy 883 requirements.

Once the most practicable test plan has been defined, the Task Force sees it through. Thousands of TI personnel in many departments may be involved in your program, but the Task Force is responsible for its success.

So, if you need more than one task force, contact them across departmental boundaries, step on toes and crack heads, if need be, to keep your program on

course. In addition, you have the industry's best test facilities going for you at TI. From more than 50,000 product sockets to environmental shaker, raster and roll labs, to IR meters, microscopes, ball-and-socket data loggers.

One thing more.

TI has prepared a complete 40-page data sheet on 883 specifications. Incorporating MIL-STD-883 requirements, it's implemented by 100 pages of detailed product specifications. Form 2002, **883 SPECIFICATIONS FOR TTL ICs**.

Line it up with your course, and TI's HI-REL Task Force will keep you on 883's honor.

Write for "MACH IV High Reliability Procurement Specification MIL-STD-883, Texas Instruments Incorporated," P.O. Box 9813, Dallas, Texas 75209. THERE'S NO CONFUSION. No unprintable words.

TEXAS INSTRUMENTS INCORPORATED





# Now it's JAN ICs.

Series 54 TTL, developed by TI, has been chosen as the standard. And the same HI-REL Task Force that helped you stay on course through 883 and 38510 (with the MACH IV program) can do it again with JAN.

## Scout's honor.

In 1969, TI made industry's biggest commitment to MIL-STD-883. We developed the first clear-cut procurement program—MACH IV—and established a special HI-REL Task Force to see it through. When MIL-M-38510 came along, we expanded MACH IV and kept the same Task Force on the job.

Now comes JAN-M-38510 with its new challenges and uncertainties. And the same Task Force is still on the job. This same group of managers who worked for you in '69 are still working for you today, along with some new members. Together, they bring more than 120 man-years of HI-REL experience to the task—in the areas of reliability and process engineering, product planning, product engineering, marketing, quality control, manufacturing and HI-REL assembly. The Task Force is fully committed to making JAN IC availability a reality—and TI has committed the money, facilities and manpower to support the team.

### Full qualification program underway

Already you have a broad choice of JAN ICs from TI, and the list is growing rapidly under an aggressive qualification program. Our objective is to lead the industry.

It's an objective we are confident of reaching. After all, TI is the leader in developing and delivering Series 54/74 TTL—the series chosen as the JAN IC standard for TTL logic. And JAN IC qualifications are simplified by TI's extensive experience in 38510/

MACH IV processing. Incidentally, TI's 38510/MACH IV program supplements the JAN IC program, where JAN slash sheets have not been written or JAN ICs are not available.

### High-volume production facilities

We've been delivering MACH IV ICs, in volume, for nearly three years—and high reliability military ICs for more than a decade. So squarely behind our new JAN effort are TI's unmatched 54/74 HI-REL domestic production facilities in Houston and Dallas. From 150,000-plus burn-in sockets to environmental shake, rattle and roll labs, to scanning electron microscopes, IR scanners, microprobes, Radiflo and computer data acquisition.

You'll find our JAN ICs already on distributors' shelves. You can count on TI's production strength to maintain excellent JAN IC availability.

### Send for procurement aids

We've prepared a booklet answering common questions about JAN ICs, as well as a handy pocket card which lists existing JAN IC specs, the corresponding standard TI type numbers, and explains the JAN numbering system. They're both yours by circling 242 on the Service Card. Or write Texas Instruments Incorporated, P.O. Box 5012, M/S 308, Dallas, Texas 75222.



TEXAS INSTRUMENTS  
INCORPORATED



**Every day of every year we compete  
for OEM business on the basis of price.**

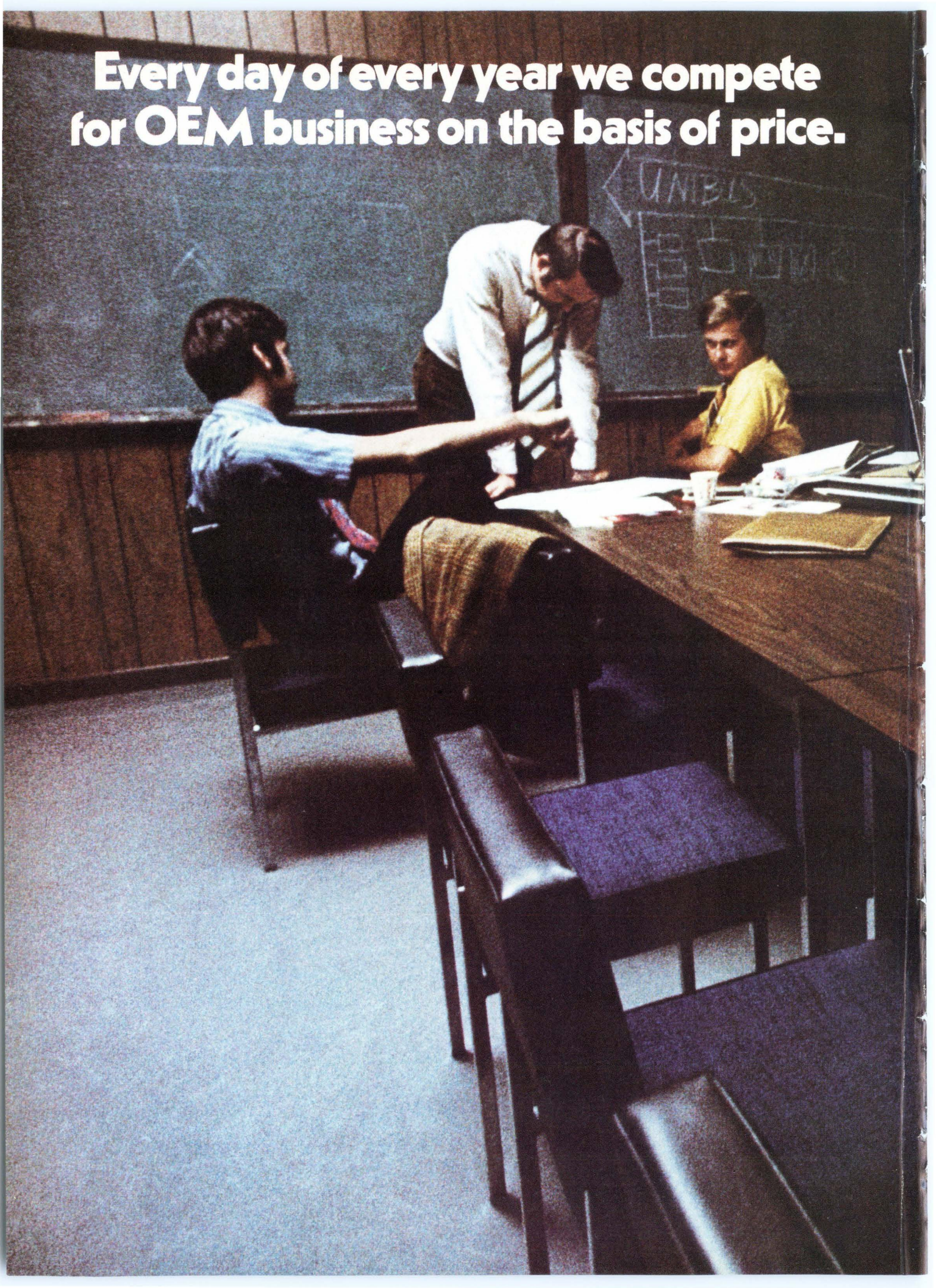



**And every day of every year, more  
OEM's buy more computers from us  
than all our competitors combined.**

**digital**

Digital Equipment Corporation, Maynard, Mass. 01754. (617) 897-5111. European headquarters:  
81 route de l'Aire, 1211 Geneva 26. Tel: 42 79 50. Digital Equipment of Canada Ltd.  
P. O. Box 11500, Ottawa, Ontario, K2H 8K8. (613) 592-5111.

Circle 89 on reader service card



**Fixed resistor  
difference  
is visible to  
the naked eye.**



**If you're really  
serious about cost,  
be serious about quality.**

Paying the lowest price for fixed resistors doesn't mean they're costing you less. Split an A-B resistor apart and discover the difference between Allen-Bradley and all the others. Our exclusive hot molding process forms the elements into an integral structure. Physically strong. With a densely packed, uniform resistance track. Note

how the leads are firmly and thoroughly imbedded to reduce circuit noise. Hot molding is just one way we have engineered more quality into our resistors. Consistent A-B quality that can lower your installed costs and put more reliability into your products. If you think all resistors are the same, read "7 ways to tell the difference in

fixed resistors." See your A-B electronic distributor, or write Allen-Bradley Electronics Division, 1201 South Second Street, Milwaukee, Wisconsin 53204. Export: Bloomfield, New Jersey 07003. Canada: Allen-Bradley Canada Limited, Galt, Ontario, United Kingdom: Jarrow, County Durham NE32 3EN.





# Shedding some needed light on optical measurements

To take maximum advantage of recent developments in optoelectronics, it is more important than ever for electronics engineers to master the techniques and terminology of photometry and radiometry

by Michael A. Zaha, *Tektronix Inc., Beaverton, Ore.*

□ Light-emitting diodes, lasers, self-scanned photodiodes, and other optoelectronic devices offer attractive new solutions to many electronic design problems. But they will not be used to their best advantage until engineers have become familiar with the terminology and techniques of light measurement.

Unfortunately, there is more misunderstanding about radiometry and photometry than about measuring any other portion of the electromagnetic spectrum. The difficulty lies not in the basic concepts, which are fairly straightforward, but in deficiencies in terminology—especially in photometry.

To make sense of the situation, therefore, it is best to grasp the underlying theory before attempting to assimilate the sometimes arbitrary systems of measurement. Finally, it is also desirable to have some idea of the practical problems that will be encountered in the actual taking of measurements.

### Radiometry vs photometry

Radiometry is concerned with the measurement of radiation for all wavelengths within the so-called optical spectrum—that is, ultraviolet radiation, visible light, and infrared radiation. An ideal radiometric detector has a flat spectral response. The basic unit of power in radiometry is the watt.

Photometry, on the other hand, deals only with the measurement of visible light, which falls between the wavelengths of 380 and 750 nanometers. An ideal photometric detector has a spectral response that approximates the response of the average human eye. The basic unit of power in photometry is the lumen.

An occasional complication in photometry is the existence of two average human-eye responses. At normal levels of illumination, the eye's response is determined by the cone-shaped cells in the retina, and the eye is said to exhibit a photopic response. At very low light levels, the retina's rod-shaped cells take over and cause a shift in the response curve (Fig. 1) to what is referred to as scotopic vision. Rod cells are insensitive to color, so that color vision is lost at very low light levels.

Unless otherwise specified, photometric measurements are based upon the photopic eye response, which peaks at 555 nm. At this wavelength, and at this

wavelength only, 1 watt of radiant power is defined as the equivalent of 680 lumens of luminous power. (For those people who like to work in the dark, the scotopic lumen has been invented. One watt of radiant power is equivalent to 1,746 scotopic lumens at the peak of scotopic vision—507 nm.)

### Converting measurements

To convert a radiometric power measurement into photometric units, the spectral-response characteristics of the human eye and the spectral output of the light source being measured must be taken into account. Then the conversion can be accomplished by multiplying the energy radiated at each wavelength by the relative luminosity factor at that wavelength and summing the results.

Mathematically, total luminous power ( $\Phi_v$ ) is equal to the maximum luminous efficacy factor ( $K_m = 680$  lumens/watt) times the integral of the product of the relative luminosity function— $V(\lambda)$ —and the radiant-power function— $\Phi_e(\lambda)$ —over the wavelength interval from 380 to 750 nm. That is,

$$\Phi_v = K_m \int_{380}^{750} V(\lambda) \Phi_e(\lambda) d\lambda$$

Notice that this basic equation can be modified for

**Digital.** Jurgen Meyer-Arendt of Pacific University here uses a Tektronix J16 digital photometer to make an illuminance measurement.

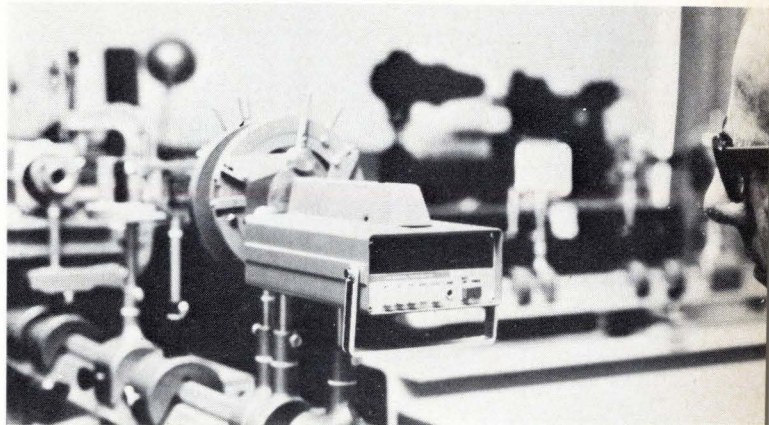



use with detectors other than the human eye, such as vidicons and photographic film, by replacing  $V(\lambda)$  by the appropriate relative luminosity function.

Since analytic expressions for relative luminosity functions are not easy to come by, the basic equation is usually evaluated by numerical methods, often using a computer. Graphical methods are occasionally employed as in the following calculation of the luminous efficiency of a 48-inch, standard cool white (T-12) fluorescent lamp. (Fig. 2). The spectral output, rated power consumption, and luminous output (3,200 lumens) for the lamp can be found in the Illuminating Engineering Society (IES) Handbook.

The area under the lamp spectral output curve in Fig. 2 is proportional to the quantity of radiant power a radiometric detector would measure. This curve, multiplied by the relative luminosity curve of Fig. 1, yields the curve showing the photometric spectral output of the lamp. The colored area under this last curve represents the relative amount of power a photometric detector would see—that is, the luminous output of 3,200 lumens. The colored area is about 50% of the lamp spectral output area, indicating that only about one-half of the lamp's total radiant output is detectable by the human eye. The total radiant power output is thus:

$$\Phi_e = \Phi_v / K_m V, \text{ or}$$

$$\Phi_e = 3,200 \text{ lumens} / (50\% \times 680 \text{ lumens/w}) = 9.4 \text{ w, approx.}$$

The lamp thus consumes 40 w of electrical power to produce 9.4 w of radiant power, half of which the eye responds to as 3,200 lumens of luminous power (or 4.7 so-called "lightwatts"). The luminous efficiency of the lamp is thus 4.7/40, or about 12%. The luminous efficiency figure is only a percentage. If it is necessary to relate the lamp's input to its output in lumens, the desired

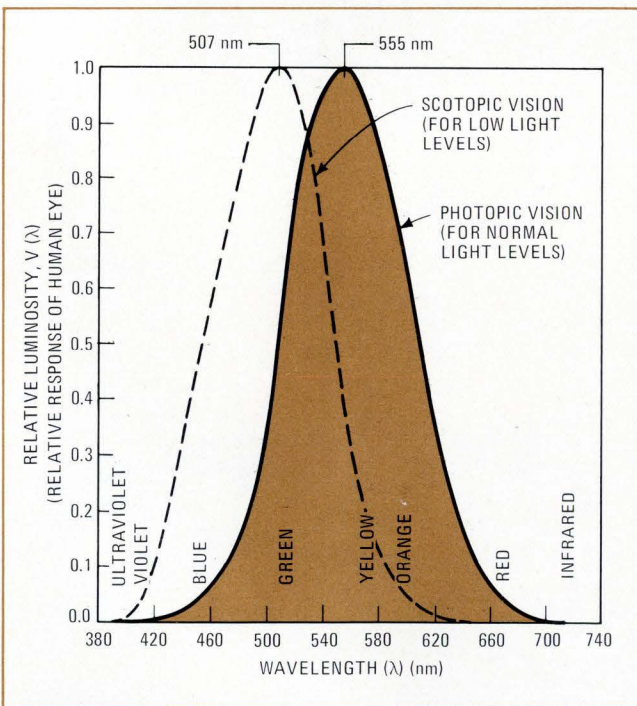

**1. Shift.** The dark-adapted (scotopic) eye has a peak response about 50 nm below that of the light-adapted (photopic) eye. There is no color perception under scotopic conditions.

quantity is the lamp's luminous *efficacy*. In this case, the lamp's efficacy works out at 3,200 lumens/40 watts, or 80 lumens/watt.

Sometimes the efficacy referred to is not relative to the electrical input power, but to the radiant output power. In the preceding example, this radiation efficacy would be 3,200 lumens/9.4 w or 340 lumens/w. Obviously, if all of the power is radiated at 555 nm, the luminous efficiency is 100% and the radiation efficacy is 680 lumens/watt (the equivalent of  $K_m$  in the basic equation).

### Terms and definitions

Since it is almost impossible to collect and measure the total power output of a source, many terms have been developed for more limited measurements of propagating radiant energy. The concepts underlying these terms are almost identical for radiometry and photometry; the terminology differs only in that the adjective *radiant* is used for radiometric terms and *luminous* for photometric terms.

TABLE I:  
RADIOMETRIC AND  
PHOTOMETRIC EQUATIONS  
AND UNITS

Definition	Equation	Radiometric		Photometric	
		Name	Unit (SI)	Name	Unit (SI*)
Energy	$Q$	radiant energy	joule	luminous energy	lumen-sec
Energy per unit time = power = flux	$\Phi = dQ/dt$	radiant flux	watt	luminous flux	lumen
Power input per unit area	$E = d\Phi/dA$	irradiance	$W/m^2$	illuminance	$lm/m^2$ (lux)
Power per unit area	$M = d^2\Phi/dA$	radiant exitance	$W/m^2$	luminous intensity	$lm/m^2$
Power per unit solid angle	$I = d\Phi/d\Omega$	radiant intensity	$W/steradian$	luminous intensity	candela
Power per unit solid angle per unit projected	$L = dI / (dA \cos \theta)$	radiance	$W/m^2 \cdot steradian$	luminance	candela/m <sup>2</sup>

\*International System of Metric Units

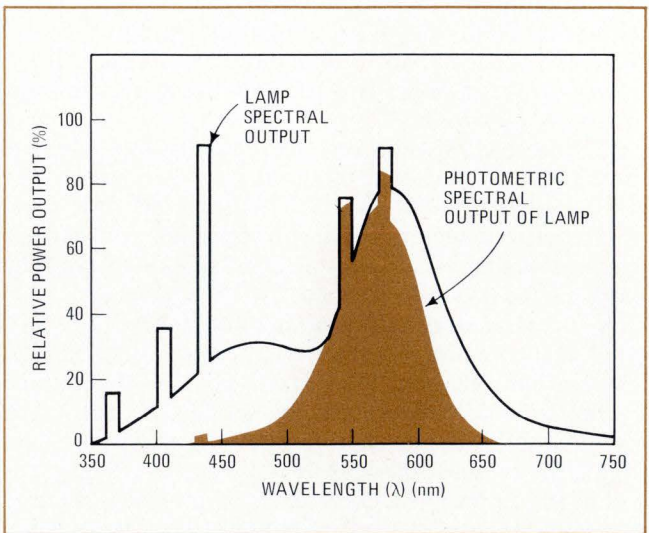

**2. Conversion.** Calculating the luminous efficiency of a fluorescent lamp requires the conversion of its photometric output into radiometric units. Sometimes, as here, this is done graphically, although it is more usual to use numerical methods.



The radiometry terminology that follows is more logical and coherent, and it is illustrated in Fig. 3.

**Radiant energy ( $Q_e$ )** is energy traveling in the form of electromagnetic waves and is measured in *joules*.

**Radiant power ( $\Phi_e$ )**, also called radiant flux, is the time rate of flow of radiant energy. It is expressed in joules/second or *watts*.

**Irradiance ( $E_e$ )** is the density of radiant power incident on a surface. It is generally measured in *watts/square meter*.

**Radiant exitance ( $M_e$ )** is the density of radiant power emitted from, transmitted through, or reflected from a surface. It was formerly known as radiant emittance, and is measured in *watts/square meter*.

**Radiant intensity ( $I_e$ )** is the radiant power per unit solid angle, traveling in a given direction. It is measured in *watts/steradian*. (By definition, one steradian of solid angle originating from the center of a sphere of 1-meter radius will subtend an area of 1 square meter on the surface of that sphere, as shown in Fig. 4.)

**Radiance ( $L_e$ )** is the radiant intensity per unit area leaving, passing through, or arriving at a surface in a given direction, where the surface area is the projected area as seen from the specified direction. It is measured in *watts/steradian-square meter* (Fig. 5).

The photometric terminology is exactly parallel (see Fig. 6).

**Luminous energy ( $Q_v$ )** is simply light energy. It is measured in *lumen-seconds*, where 1 lumen-second equals 1 talbot.

**Luminous power ( $\Phi_v$ )** is light-energy flow per unit time. It is also called luminous flux and is expressed in the basic unit of photometry: the *lumen*.

**Illuminance ( $E_v$ )** also called illumination, is the density of luminous power incident upon a surface. One lumen per square meter equals 1 *lux*, which is also known as 1 meter-candle. (See Fig. 7 for a comparison of the metric units described thus far and their English equivalents.)

**Luminous exitance ( $M_v$ )** is the luminous power leaving a unit area of surface. It is measured in *lumens/square meter*. It was formerly called luminous emittance.

**Luminous intensity ( $I_v$ )** is the luminous power per unit solid angle, traveling in a given direction. One lumen of power per steradian is called one *candela* of intensity.

**Luminance ( $L_v$ )** is the luminous intensity per unit area leaving, passing through, or arriving at a surface in a given direction. The surface area is the projected area, as viewed from the specified direction. Luminance is measured in *lumens/steradian-square meter* or *candela/square meter*. Luminance is sometimes called photometric brightness and is a widely used quantity. Five of its main units are:

- 1 stilb = 1 candela/square centimeter
- 1 lambert =  $1/\pi$  candela/square centimeter
- 1 nit = 1 candela/square meter
- 1 apostilb =  $1/\pi$  candela/square meter
- 1 footlambert =  $1/\pi$  candela/square foot

The footlambert is still commonly used in engineering applications in the U.S.

For a perfectly diffusing surface, luminance can be

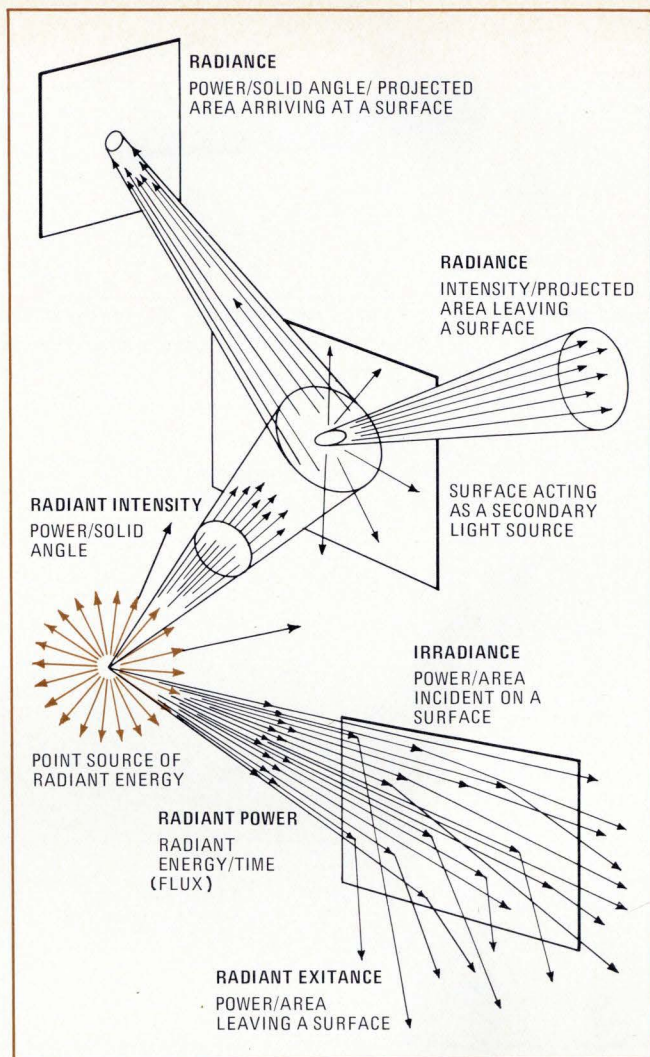

**3. Radiometry.** The concepts all start simply with a uniformly radiating point radiation source. But, since the quantities of interest are usually dependent upon power densities at different angles and directions, all of the illustrated additional terms become necessary.

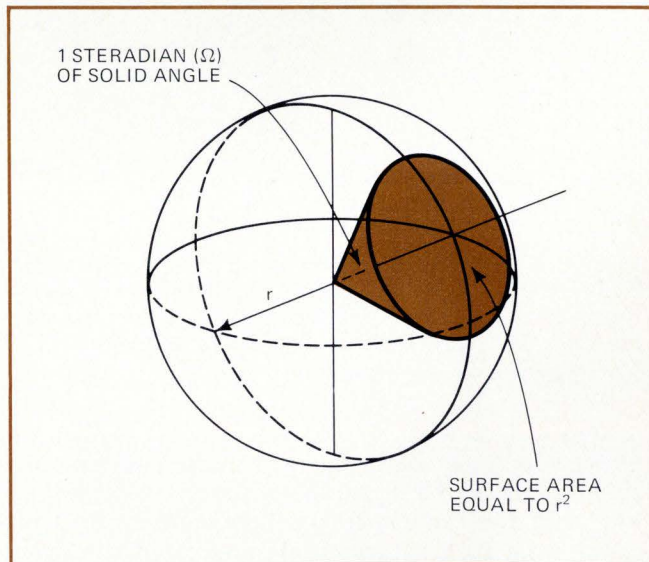

**4. The steradian.** Since the total surface area of a sphere is  $4\pi r^2$ , a point source uniformly emitting one watt per steradian will emit a total radiant flux of  $4\pi$  (12.57) watts.



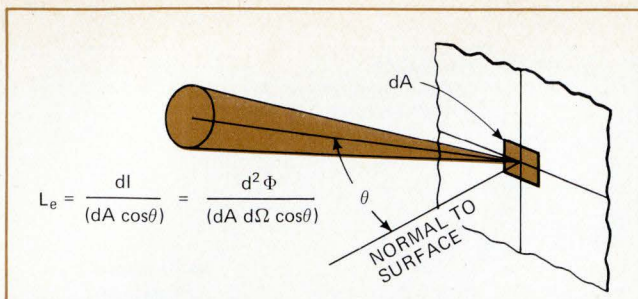

**5. Radiance.** The key to understanding radiance is to realize that its definition refers to the radiant intensity per unit area over a projected surface area as viewed from a specified direction.

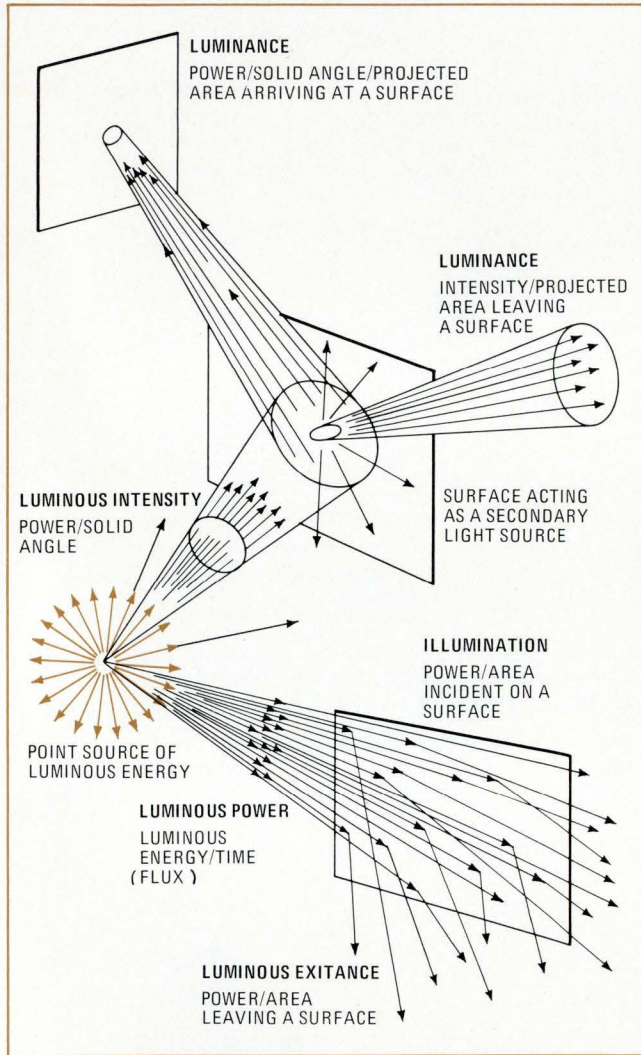

**6. Photometry.** It's not just the output of a light source that counts. The reader of this page is more interested in the luminance of this paper than in its illuminance or in the power consumption of the bulbs (if any) that provide the light.

related to luminous exitance, since such a surface will disperse light per solid angle in a uniform and predictable way. It can be shown that 1 lumen/ft<sup>2</sup> of exitance will yield 1/π candela/ft<sup>2</sup> (or 1 footlambert) of luminance from such a theoretical surface. Of course, no perfect diffusers exist, but they are the rationale for the luminance terminology.

Attempts are being made by the International Com-

**TABLE 2: ILLUMINATION CONVERSION FACTORS**

1 lumen = 1/680 lightwatt (at 555 nm)    1 watt-second = 1 joule = 10<sup>7</sup> ergs  
 1 lumen-hour = 60 lumen-minutes    1 phot = 1 lumen/cm<sup>2</sup>  
 1 footcandle = 1 lumen/ft<sup>2</sup>    1 lux = 1 lumen/m<sup>2</sup>\*

Number of Multiplied by Equals number of	Footcandles	Lux*	Phots	Milliphots
Footcandles	1	0.0929	929	0.929
Lux*	10.76	1	10,000	10
Phots	0.00108	0.0001	1	0.001
Milliphots	1.076	0.1	1,000	1

\*Recommended SI units.

**TABLE 3: LUMINANCE CONVERSION FACTORS**

1 nit = 1 candela/m<sup>2</sup>\*  
 1 stilb = 1 candela/cm<sup>2</sup>  
 1 apostilb (international) = 0.1 millilambert = 1 blondel  
 1 lambert = 1,000 millilamberts

Number of Multiplied by Equals number of	Foot-lamberts	Candelas / m <sup>2</sup> *	Milli-lamberts	Candelas / in. <sup>2</sup>	Candelas / ft <sup>2</sup>	Stilbs
Footlamberts	1	0.2919	0.929	452	3.142	2,919
Candelas/m <sup>2</sup> *	3.426	1	3.183	1,550	10.76	10,000
Millilamberts	1.076	0.3142	1	487	3.382	3,142
Candelas/in. <sup>2</sup>	0.00221	0.000645	0.00205	1	0.00694	6.45
Candelas/ft <sup>2</sup>	0.3183	0.0929	0.2957	144	1	929
Stilbs	0.00034	0.0001	0.00032	0.155	0.00108	1

\*Recommended SI units.

mission on Illumination (CIE) to standardize the preceding mass of redundant units. Table 1 summarizes the definitions and the International System of Metric Units (SI), which are recommended for use in optical measurements.

Since many other units are currently used in engineering practice, Tables 2 and 3 are provided for convenient reference. Also, to provide an intuitive feeling for photometric units, Tables 4 and 5 present the illuminance and luminance of some natural scenes and various light sources.

### Practical considerations

Those accustomed to measuring voltages to within 0.01% or better, and who routinely make nine- or 10-place frequency measurements, may be surprised to learn that optical measurements with errors of less than 1% are very rarely made. To get an accuracy within 5% is difficult; a knowledgeable practitioner with good equipment can probably keep his errors between 10% and 20% on a routine basis, but a small error in technique can easily introduce errors in excess of 50%.

Typically, large errors are caused by using detectors (and matching filters) with the wrong spectral response



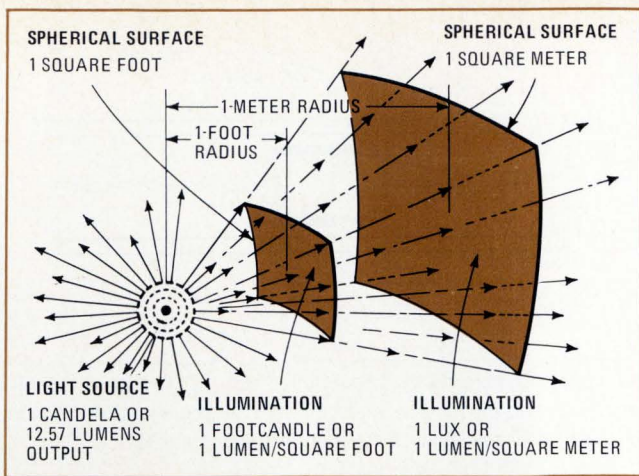

**7. Confusion.** Footcandles—that is, lumens per square foot—replace lux when English units are used. The point that ties it all together is the 4π factor relating candelas and lumens: a uniform point source with an intensity of one candela will radiate one lumen onto a one-square-foot surface placed one foot from the source.

for the radiation source. It is essential to know the detector's spectral response within the wavelength range of the measurement to be made. A "good" detector may be specified as being "within 1% of perfect (CIE) photopic response which generally means that the area under the detector's response curve approximates the area

under an idealized response curve within 1%. However, this can be misleading, because mismatches at specific wavelengths may deviate considerably more and can cause large errors.

Fig. 8 shows the responses of two detectors to a red LED's output. The photometric device responds approximately 25% too high, the radiometric detector about 3% high; therefore, errors of +25% and +3% result here from spectral mismatches alone. Moreover, since most photometric detectors are not as accurate at 650 nm as the one shown, even greater errors are likely, unless great care is taken to determine their actual responses. (While photopic detectors exhibiting better red response are available, their over-all response is usually less accurate for general-purpose photometric measurements.)

Additional sources of error come from detector aging and filter deterioration (drifts of 2% per year are not uncommon), nonlinear detector responses, nontemperature-compensated circuitry, and stray light. Periodic calibration is absolutely essential if high accuracy (within 1% to 5%) is needed.

### Some direct measurements

The illuminance (or irradiance) of a surface can be measured directly by placing a calibrated detector in the position of that surface. To avoid errors, it is essential that the complete area of the calibrated detector be illuminated, because illuminance is a measure of flux

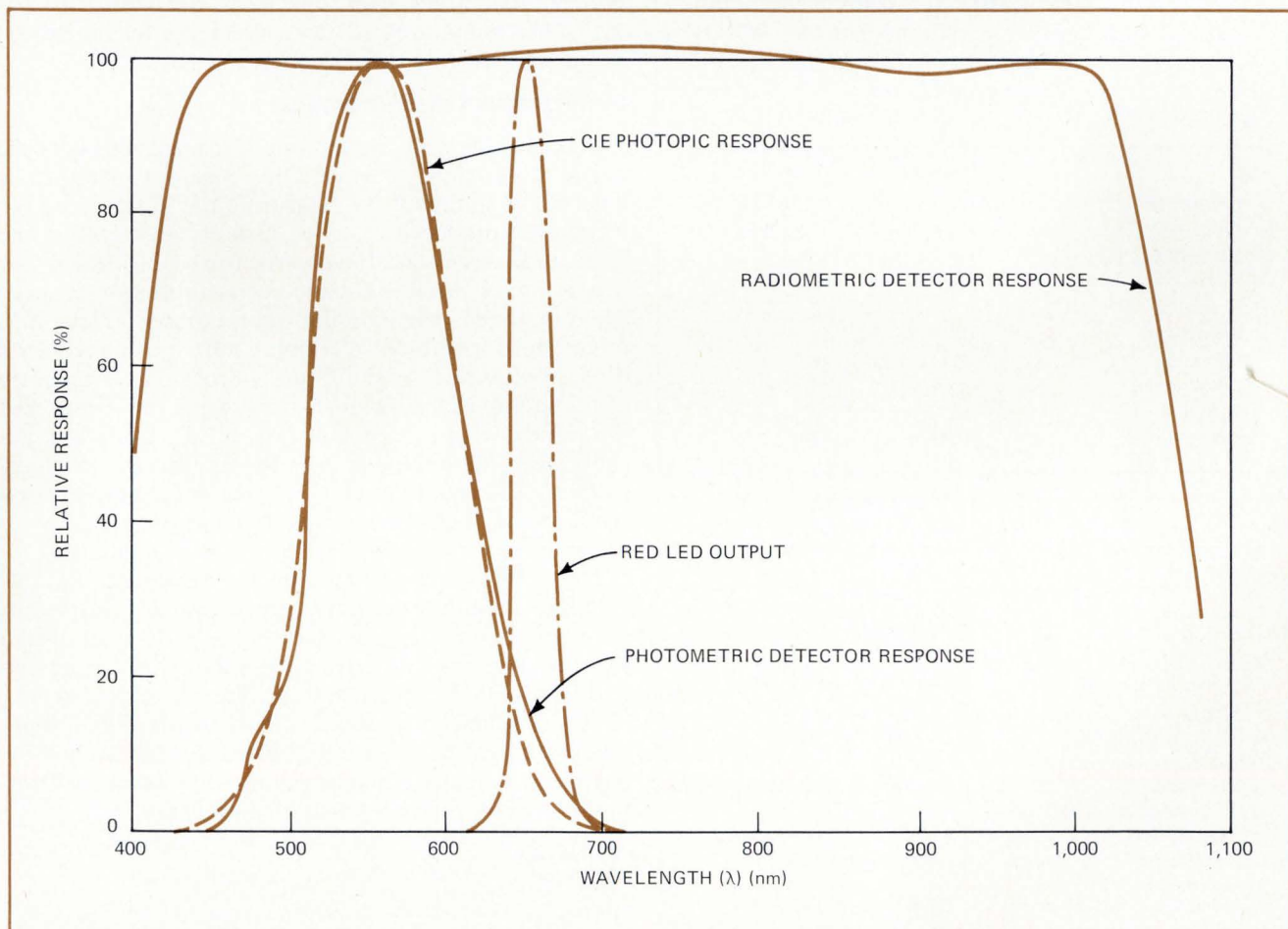

**8. Errors.** Even though the photometric detector provides a rather close match to the ideal (CIE) photopic response, it introduces an error of +25% when it's used to measure the output of a red LED. The radiometric detector shown is only 3% high at the red LED wavelength.



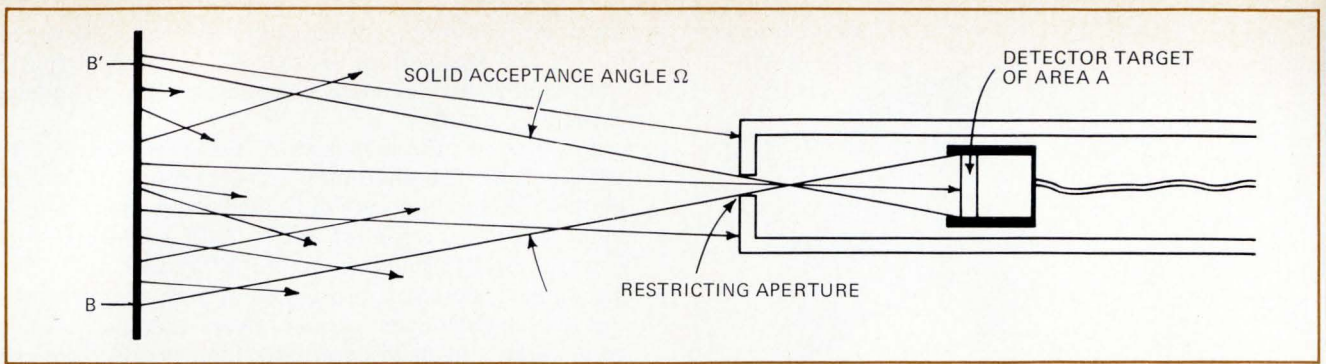

**9. Compensation.** If the source isn't large enough to fill the acceptance angle of the luminance photoprobe—that is, if it doesn't extend at least from B to B—then its light will not completely illuminate the detector target and the measurement will be in error unless the actual acceptance angle is determined and compensated for. An alternative, in this case, is to make an indirect intensity measurement.

density per defined area. If at all possible, the detector should be oriented normal to the incident flux to avoid modification to the detector's projected area and to minimize reflections from the filters in front of the detector. If it is not possible to have most of incident flux strike the detector perpendicularly, then an angular sensitivity plot for the detector system must be used to avoid large errors.

Attempting to measure the illumination on a surface by measuring the exitance from it is not recommended because exitance is a function of the surface's spectral reflectivity. Also it is impractical to collect all of the light without interfering with the incident illumination.

A typical luminance (or radiance) probe works by

measuring the incoming light intensity per unit area arriving at a detector surface. The acceptance angle of the detector is restricted as shown in Fig. 9. However, the simple measurement assumes that the external source has sufficient area to fill the probe's acceptance angle. If it doesn't, there are two possibilities: either the measurement can be corrected by taking the actual viewing angle of the probe into account, or the source can be treated as a point source and an intensity measurement made, by using an illuminance probe and applying the inverse-square law to calculate intensity.

The second option is never as accurate as the first. Experience shows, however, that when dealing with LEDs and other miniature radiators, much confusion can be avoided by treating them as point sources.

**TABLE 4:**  
APPROXIMATE LEVELS OF NATURAL SCENE ILLUMINATION

	(Footcandles)	(Lumen/meter <sup>2</sup> )
Direct sunlight	1.0–1.3 × 10 <sup>4</sup>	1.0–1.3 × 10 <sup>5</sup>
Full daylight	1–2 × 10 <sup>3</sup>	1–2 × 10 <sup>4</sup>
Overcast day	10 <sup>2</sup>	10 <sup>3</sup>
Very dark day	10	10 <sup>2</sup>
Twilight	1	10
Deep twilight	10 <sup>-1</sup>	1
Full moon	10 <sup>-2</sup>	10 <sup>-1</sup>
Quarter moon	10 <sup>-3</sup>	10 <sup>-2</sup>
Starlight	10 <sup>-4</sup>	10 <sup>-3</sup>
Overcast starlight	10 <sup>-5</sup>	10 <sup>-4</sup>

**TABLE 5:**  
APPROXIMATE VALUES OF LUMINANCE FOR VARIOUS SOURCES

	(Footlamberts)	(Candela/meter <sup>2</sup> )
Atomic fission bomb (0.1 ms after firing, 90-ft-diameter ball)	6 × 10 <sup>11</sup>	2 × 10 <sup>12</sup>
Lighting flash	2 × 10 <sup>10</sup>	6.8 × 10 <sup>10</sup>
Carbon arc (positive crater)	4.7 × 10 <sup>6</sup>	1.6 × 10 <sup>7</sup>
Tungsten filament lamp (gas-filled, 16-lumen/watt)	2.6 × 10 <sup>5</sup>	8.9 × 10 <sup>5</sup>
Sun (as observed from the earth's surface at meridian)	4.7 × 10 <sup>3</sup>	1.6 × 10 <sup>4</sup>
Clear blue sky	2,300	7,900
Fluorescent lamp (T-12 bulb, cool white, 430 ma medium loading)	2,000	6,850
Moon (as observed from earth's surface)	730	2,500

### Some indirect measurements

Some of the most common optical measurements are not made directly, however. Intensity, for example, is determined indirectly by measuring the illuminance (or irradiance) produced on a test surface. (Remember, the luminance discussed above is measured in lumens per square meter, while illuminance or illumination is measured in lumens per steradian-square meter.) Now, illumination of a surface by a point source of light varies directly with the intensity of the source (I) and inversely as the square of the distance, d, between the source and the surface—that is,  $E = I/d^2$  or  $I = Ed^2$ . Therefore, if a calibrated illumination detector measures 10 footcandles of illuminance at a distance of two feet from a point source, then the intensity of the source is

$$I = Ed^2 = 10 \text{ footcandles} \times 2 \text{ ft}^2 = 40 \text{ candelas.}$$

The point source assumed in inverse-square law calculations is seldom encountered in practice. However, an error of only approximately 1% will result if the source diameter is restricted to less than 10% of the distance between the source and the illuminated surface.

This selection of procedures, though simplified, illustrates the ideas basic to optical measurements. The bibliography suggests further reading: the book by Prof. Meyer-Arendt is particularly recommended. □

### BIBLIOGRAPHY

- John W. T. Walsh, "Photometry," Dover Publications, 1965.
- "Electro-optics Handbook," Radio Corporation of America, 1968.
- Boris Merik, "Light and Color of Small Lamps," General Electric Co., 1971.
- "Radiometry: Selected Reprints," the American Institute of Physics, 1971.
- Jürgen R. Meyer-Arendt, "Introduction to Classical and Modern Optics," Prentice-Hall Inc., 1972.
- "IES Lighting Handbook," 5th ed., Illuminating Engineering Society, 1972.



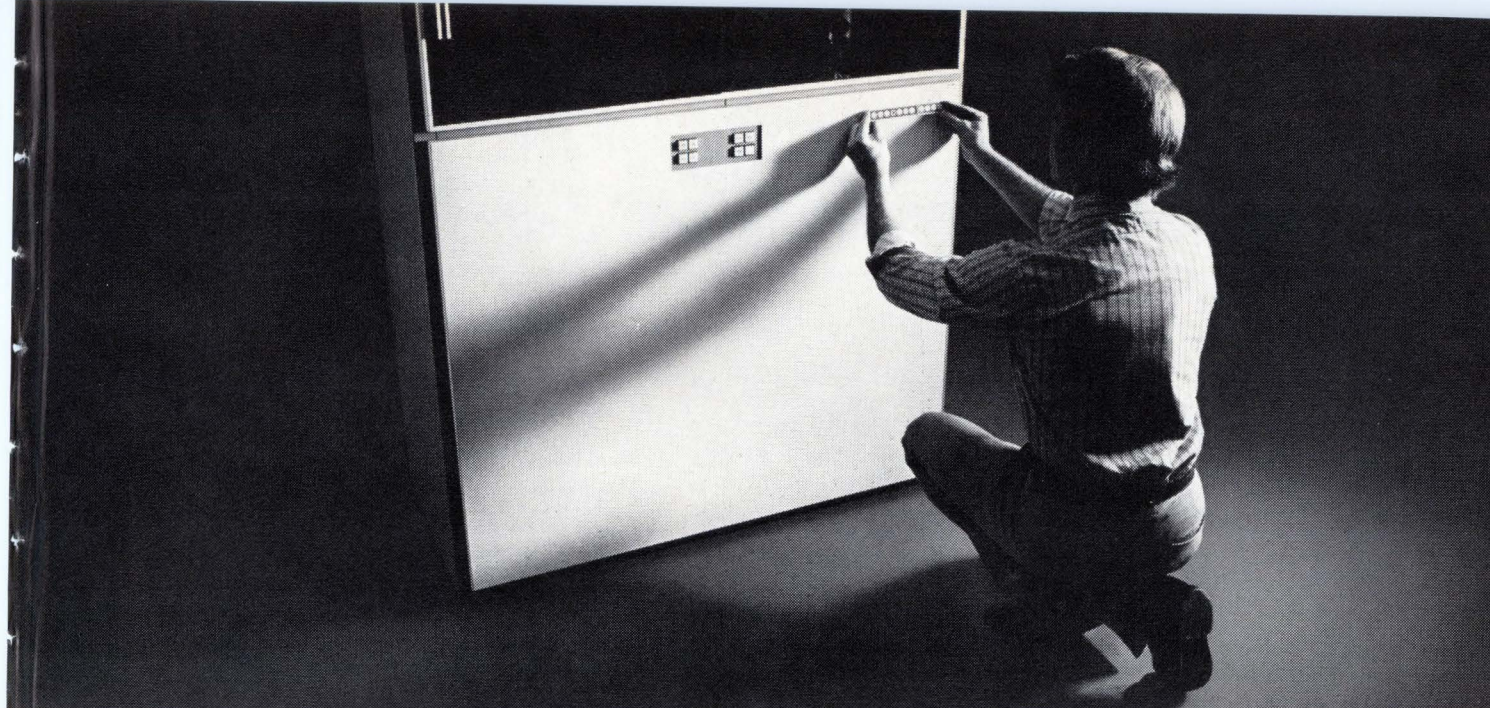

# The leader in computer graphics has never made a low cost COM System.

## The wait was worth it.

Until now, most of the makers of low cost COM printers have been film manufacturers, companies that don't know software, and small companies that couldn't service what they made.

CalComp had not made a low cost system.

We were too busy perfecting our 1675. We think it is now the finest plotter/printer in the world.

Our experience with the 1675 COM System now enables us to make this remarkable 2100 COM Printer.

It leases for a base monthly price of \$888.

And it earns its keep. It prints ten to fifteen times as fast as the printer it's designed to replace. (The IBM 1403.) It works on line. Or off line.

It's compatible with IBM 360 and 370 computers.

It prints in four basic formats. Push button control selects them.

And like all our equipment, the CalComp 2100 COM Printer is serviced by 52 sales and service offices around the world.

The wait was worth it.

Call your local CalComp office, or contact California Computer Products, Inc., EM-11-72, 2411 West La Palma Avenue, Anaheim, California 92801. (714) 821-2011.

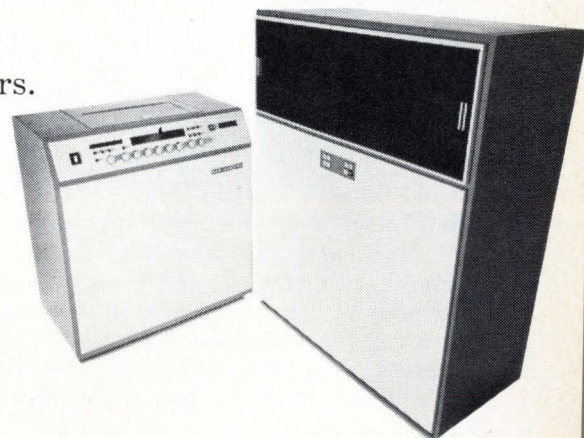

# CALCOMP

Circle 97 on reader service card



# Better understanding of FET operation yields viable monolithic J-FET op amp

Input current in the nanoampere range, together with low offset voltage, enables a monolithic op amp to do jobs that were once delegated to hybrid devices; the result is to bring higher accuracy within the range of less expensive systems

by David Fullagar, *Intersil Inc., Cupertino, Calif.*

□ Although monolithic operational amplifiers have been around for almost a decade, the analog designer invariably turns to an expensive hybrid device when he builds a system intended for accurate data acquisition.

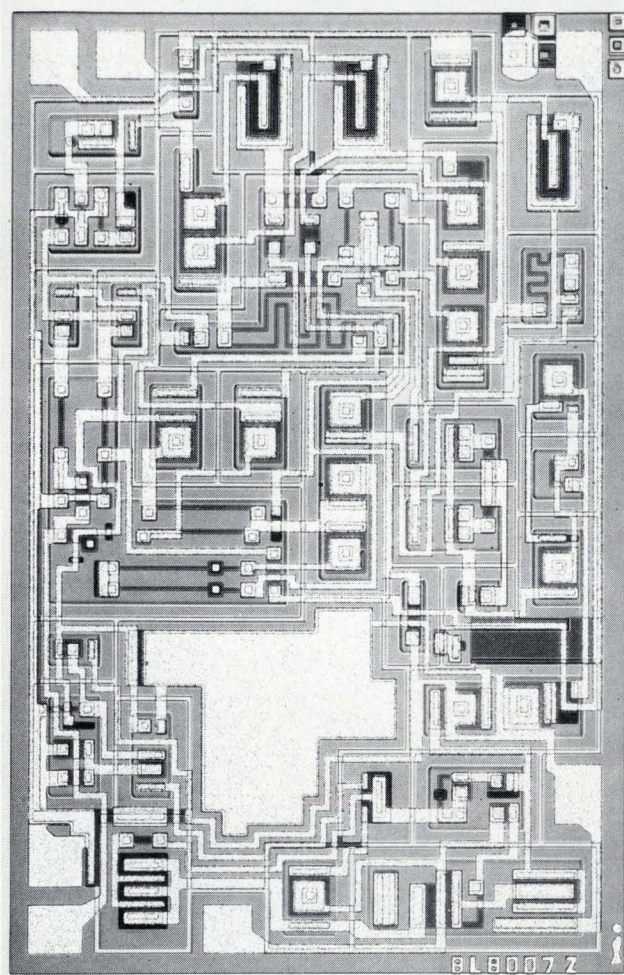

**Small draw.** Monolithic op amps with field-effect transistors at their input can now compete with hybrid modules in precision amplifier applications. The J-FET inputs, which allow an op amp to operate at extremely low bias currents, are shown in the center on the extreme left of this photomicrograph. A third J-FET (upper left) is used for biasing. The chip, 83 by 54 mils, incorporates designs that minimize input current at high gain, while maintaining stability. Sample-and-hold, log, and photocell circuits will benefit.

Usually it's a two-chip design with junction field-effect transistors to provide low input currents. In contrast, the monolithic J-FET approach has always run into problems of excessive input currents, excessive drift, and faulty biasing techniques.

An improved J-FET circuit design, however, results in a monolithic device that combines the input and stability features of the hybrids at about half the hybrid's price. At last the monolithic J-FET-input op amp can take its place alongside such familiar, all-bipolar products as the 741 and the 101A. It should all but replace modules in op amp applications such as log and antilog amplifiers, photocell amplifiers, peak detectors, sample-and-hold circuits, high impedance buffers, and active filters.

## Why J-FETs?

The J-FET input can operate with extremely small input currents, plus fairly low offset voltages, which can be nulled to zero. Such conditions allow small signals to be detected with practically no distortion. In two-chip hybrids one chip is used for the input and a second for the rest of the amplifier. This approach separates the touchy input structure from the gain stages of the device, and makes the design of the front end much easier. For a successful monolithic equivalent the trick is to integrate both the J-FET input stage and the bipolar gain

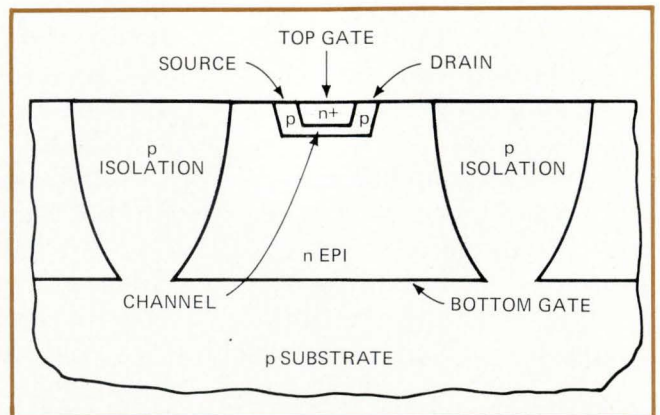

**1. Basic J-FET.** Junction FET, built with standard p-channel processing, has n-type emitter diffusion and epi collector material which becomes top and bottom gates of the two-gate structure. For high gains and low leakage the back gate must be tied to the source, thus removing the leakage path between back gate and substrate.



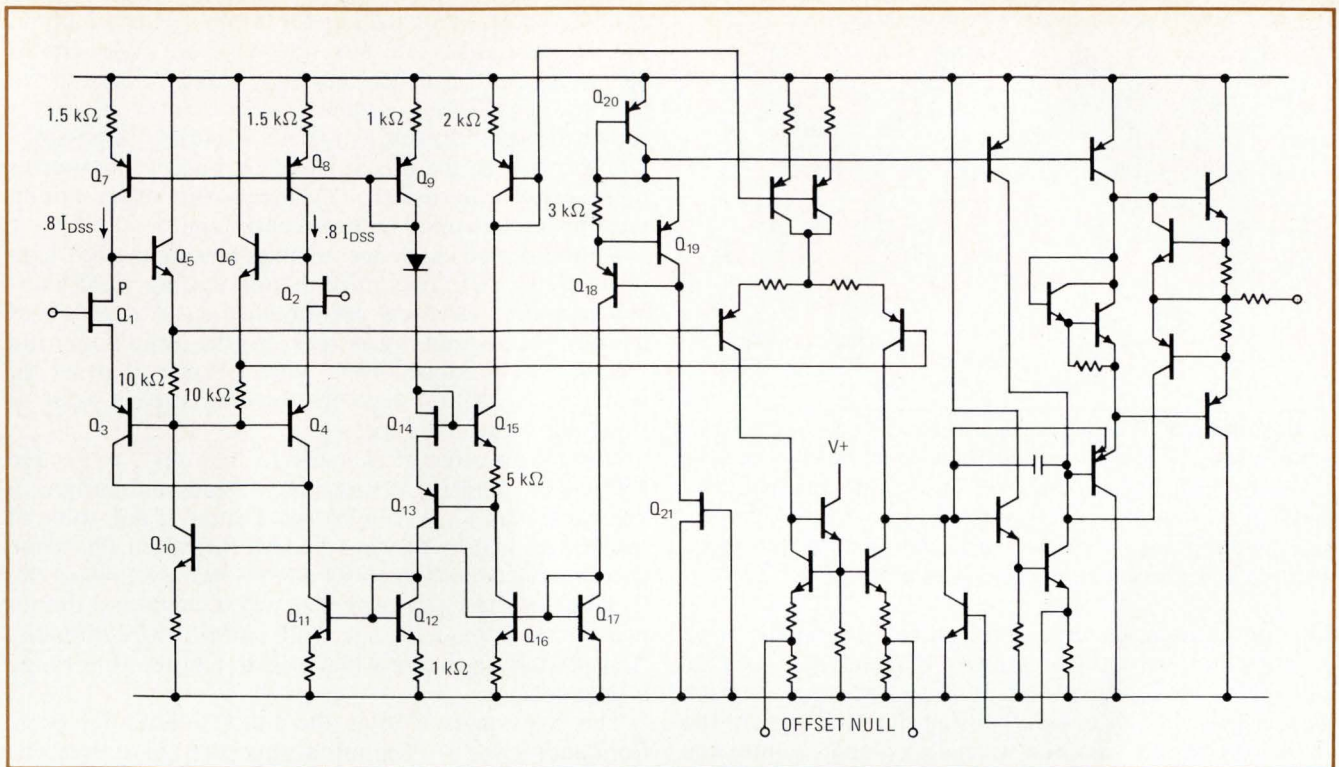

**2. Getting protection.** Schematic of the 8007 shows method of protecting the input stage. Transistors Q<sub>3</sub> and Q<sub>4</sub> protect the input J-FETs from voltages in excess of 6.3 volts. Notice that offset nulling is done in the second pnp stage, minimizing voltage drift in J-FET-input stage.

stages onto the same chip without degrading the performance of either.

Unfortunately, integrating J-FETs is no easy job, although many attempts have been made and versions of such a device have been available for about three years. The fundamental problem has been circuit design, resulting from the failure of designers to fully comprehend the nature of the J-FET structure and its relationship to the rest of linear bipolar processing.

Indeed, early monolithic op amps with J-FET inputs suffered from three major problems. Input currents were often too large for many applications, especially charge-storage circuits such as sample-and-hold circuits, peak detectors, and so on. The offset drifted with temperature, especially after initial null setting. And poorly designed bias networks in the front end often resulted in acute manufacturing yield problems.

### Integrating J-FETs

In general, the excess input current in any J-FET structure is a function of both the particular FET geometry chosen and the inherent leakage of the process. The most convenient method of making a junction FET, with only minor changes to a standard bipolar process, is to build the p-channel device shown in Fig. 1. Here the base diffusion forms the channel, while the n-type emitter diffusion and the epitaxial collector material become the top and bottom gates respectively.

Unfortunately, a J-FET so formed has several limitations. First, its transconductance—typically 300 micromhos—is inherently lower than that in equivalent discrete devices, but when the device is used as a source follower, the low  $g_m$  is no problem. Also, its drain-gate breakdown voltage is only 6.3 volts and to some degree

**TABLE 1: OPERATING PARAMETERS OF 8007 OP AMP**

Parameter	Typical value
Input bias current	0.3 pA
Input offset voltage	15 mV
Input resistance	$10^{12} \Omega$
Offset voltage drift	$20 \mu\text{V}/^\circ\text{C}$
Common-mode rejection	90 dB
Input voltage range	$\pm 12 \text{ V}$
Slew rate	$6 \text{ V}/\mu\text{s}$
Output swing	$\pm 12 \text{ V}$

complicates the front-end biasing circuits. Worst of all is the excess gate current that occurs if the two gates are tied together.

At first sight, it is tempting to do this in order to maximize the transconductance,  $g_m$ . But the effect is to create a disastrously large gate current. This is because in monolithic form the back-gate-to-substrate junction has a very large surface area, giving rise to excessive leakage currents between it and the negative supply. This leakage current adds to the J-FET-input bias current, which becomes large in its turn and renders the J-FET input ineffective for sensitive measurements.

A better way of achieving low leakage while max-

**TABLE 2: AMPLIFIER NOISE COMPARISON**

Type	$e_n$ (at 10 Hz)	$i_n$ (at 10 Hz)
8007	$300 \text{ nV}/\sqrt{\text{Hz}}$	$0.01 \text{ pA}/\sqrt{\text{Hz}}$
741	$25 \text{ nV}/\sqrt{\text{Hz}}$	$0.7 \text{ pA}/\sqrt{\text{Hz}}$



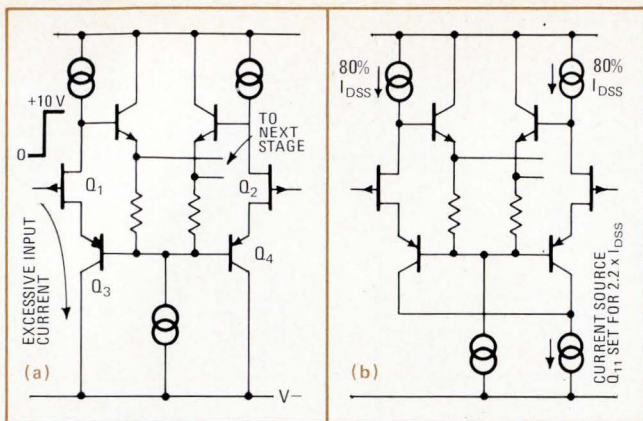

**3. Setting limits.** The 8007's input stage is protected against high currents should the input transistors break down under fast transient conditions. In other monolithic J-FET op amps, a high-speed 10-V pulse could cause transistors  $Q_3$  and  $Q_4$  to return directly to the negative supply, forcing high current to ground. Shown in (b) is the 8007 answer to this problem—to limit this current with  $Q_{11}$ .

imizing transconductance and gain is to tie the back gate to the source, thus removing the back-gate leakage path from the input current. In this case, since the back gate is more lightly doped than the channel, most of the depletion region goes the wrong way, that is, into the gate. The result: a small reduction in  $g_m$  (by about only 10%), and most significantly a great reduction in leakage.

### Getting the drift down

Once high gains at low input currents are achieved, it's necessary to go after low drifts. Unfortunately, the J-FET has inherently worse drift performance than its bipolar counterpart. However, just as there are design techniques for minimizing the drift of bipolar transistor pairs, so there are equivalent techniques for minimizing the drift of J-FET pairs.

But merely following the bipolar example leads to trouble. In the case of the bipolar transistor pairs, the first-order drift terms can be minimized by mismatching the collector current  $I_c$  until the base-to-emitter voltage differential,  $\Delta V_{BE}$ , equals zero. In the equivalent J-FET

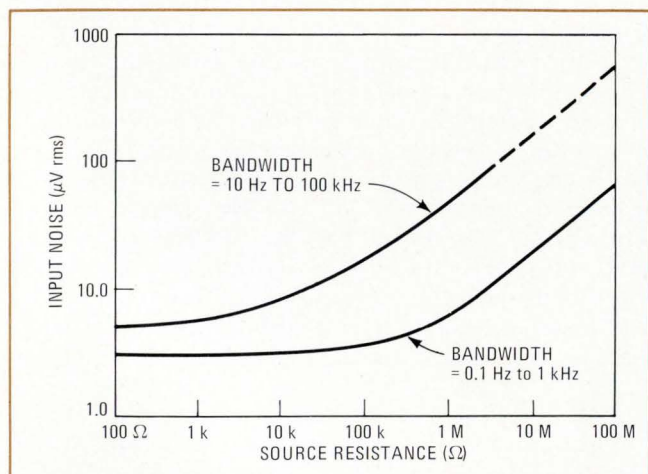

**4. Noise.** Common to all amplifiers is the increase in noise as the source resistance goes up. The noise structure of the 8007 is shown at two typical bandwidth values.

case, however, mismatching the drain current  $I_D$  until the differential in gate-to-source voltage,  $\Delta V_{GS}$ , equals zero will result in overwhelmingly large voltage drifts. The key to achieving minimum drift with J-FET pairs is rather to match the drain currents as closely as possible, and to perform the offset nulling in such a manner as not to disturb this match. This means that offset nulling must be implemented in the second stage.

A third design challenge involves biasing the J-FET input stage so as to maximize manufacturing yield without degrading electrical performance. Over a period of months, run-to-run variations in the manufacturing process will produce J-FETs with a range of drain-to-source current ( $I_{DSS}$ ) from one third the typical value to triple this value, a 9:1 spread.

Now, if an attempt is made to bias the J-FET stage with a fixed current, as was done in some old designs, a value less than  $I_{DSS(\min)}$  must be selected. If not, some of the devices will be forward-biased. But when this same current is used to bias those J-FETs that are toward the high end of the  $I_{DSS}$  range,  $V_{GS}$  will be high and the input common-mode range will suffer proportionally. And matters get worse when a wide temperature range is involved.

The solution is to bias the J-FET differential stage from another J-FET. The input stage J-FETs are then operated at about 80%  $I_{DSS}$ .  $V_{GS}$  is always low, thus ensuring an exceptional common-mode range for a J-FET amplifier. There is no danger of forward-biasing the J-FET, and the scheme assures these conditions hold good over wide temperature ranges.

### The outcome

These design features have been incorporated into the Intersil monolithic 8007 op amp, shown in Fig. 2. The sensitive input J-FETs,  $Q_1$  and  $Q_2$ , are protected from voltages in excess of 2.5 volts (well below breakdown) by the bootstrap loop comprising  $Q_3$ ,  $Q_4$ ,  $Q_5$  and  $Q_6$ . This loop maintains a fixed drain-to-source voltage across the J-FETs regardless of the input voltage, and also contributes toward the exceptional common-mode rejection of the circuit. Notice that the offset nulling in the pnp gain stage has no effect on the drain current match of the first-stage J-FETs.

A key feature of the circuit is the operation of transistors  $Q_{14}$  and  $Q_{15}$ , which serve to generate the bias current for the input stage.  $Q_{14}$  is a p-channel J-FET connected so as to generate a suitable drain-to-source current. This current is scaled down by about 20% by the resistors in the emitters of  $Q_7$  through  $Q_9$ , in this way insuring that transistors  $Q_1$  and  $Q_2$  will not be forward-biased.

Another input feature of the 8007 is the current source  $Q_{11}$ , which limits the input current should either  $Q_1$  or  $Q_2$  break down under fast transient conditions. Consider, for example, the effect of a high-speed positive pulse on one input, as shown in Fig. 3a. If the pulse were of sufficient amplitude, and if  $Q_3$  and  $Q_4$  were returned directly to the negative supply, excessive currents could flow through the path indicated in the figure. At best, there is a danger of latch-up—an input J-FET would remain in a breakdown state. The current source shown in Fig. 3b, on the other hand, eliminates



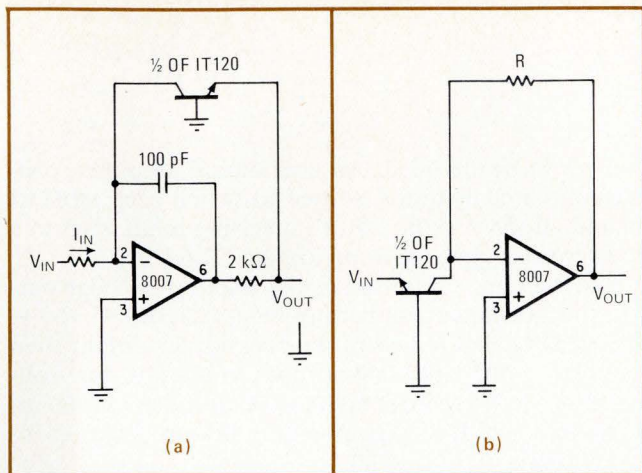

**5. Logging it in.** In typical log amplifier (a) and antilog amplifier (b), the low bias current of the J-FET op amp increases the sensitivity of the log range. Typically nine decades can be accommodated when a low-leakage IT120 transistor is used with the op amp.

the problem. Here the output stage is of conventional design, being very similar to the stage which is used in the 741.

### Performance tells the story

The circuit performance of the 8007 is summarized in Table 1. Note particularly that the typical input current is substantially less than 1 picoampere at 25°C, well within the design specifications of even the best J-FET-input modules. Equally important is the 8007's ability to perform with low noise. The total mean-square noise of an operational amplifier for a bandwidth  $\Delta f = f_2 - f_1$  is given by

$$e_T^2 = \int_{f_1}^{f_2} e_n^2 df + R_s^2 \int_{f_1}^{f_2} i_n^2 df + 4KTR_s \Delta f$$

where the critical terms are: the source resistance,  $R_s$ ; the input noise voltage generator,  $e_n$ ; and the input noise current generator,  $i_n$ .

Typical values of the 8007 for  $e_n$  and  $i_n$  are compared in Table 2 with figures for the general-purpose 741 op

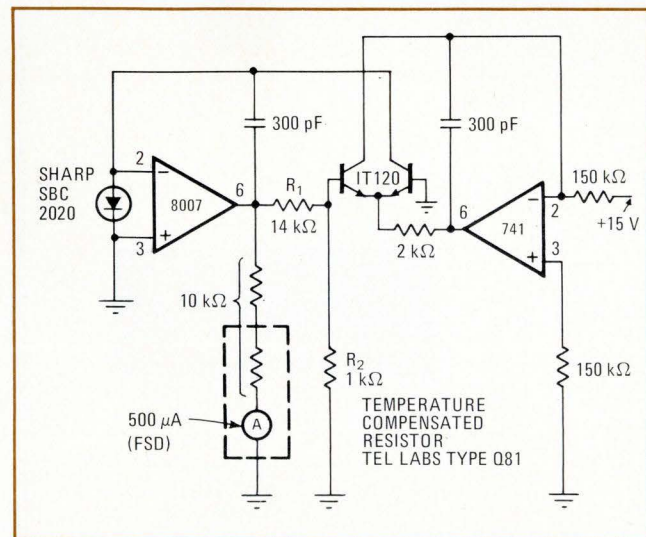

**6. Lightly.** Low input current of the J-FET op amp is useful for photocell circuits where microamp sensitivity is required.

amp. It is clear that for general-purpose applications, where high source resistance ( $R_s$  greater than 1 megohm) and low input noise are requirements, the J-FET input is superior to the standard bipolar design. The details of the total input noise of the 8007 as a function of source resistance are shown in Fig. 4.

### One of the 8007's uses

An application which illustrates the advantages of the low input current of the 8007 is the log circuit of Fig. 5a and its antilog counterpart, Fig. 5b. In this setup, a low-leakage discrete transistor, such as the IT120, is connected across the op amp. This transistor has accurate logarithmic relationship between  $V_{BE}$  and  $I_C$  over a remarkably wide range of collector currents—10 decades (0.1 pA to 1 mA) are possible. At the low end of the current range, the accuracy of the circuit is primarily dependent on the ability of the amplifier to function. The 8007 with its picoamp bias currents becomes an ideal choice in this situation.

The photocell amplifier circuit of Fig. 6 can also profit from the 8007's input parameters. In this circuit, a light meter directly displays the log of the light intensity as an exposure value. (An Exposure Value is a photographic term, each unit change in which corresponds to a factor-of-two change in light intensity.) To minimize leakage errors, the silicon cell is operated at zero voltage. Any current drawn by the op amp will directly subtract from the photocell output and show up as an error. This is especially true at low light levels, where the cell current may be only a few tens of picoamps. Thus the picoampere range of the 8007 again makes it a natural choice of photocell circuits.

### Another use

An application that relies on the high slew rate of the 8007 is the Wien bridge oscillator, which can be used to generate large signal oscillations over a wide band of frequencies. When general-purpose amplifiers, such as the 741, are used to obtain signals with amplitudes greater than about 100 millivolts, the slew rate (the maximum rate at which the output voltage can change) is the parameter that determines the upper operating frequency. If the amplifier slew rate is less than a critical threshold, distortion will occur. For example, for a sine wave above about 10 kilohertz, an amplifier with 0.6 V/s slew rate (the 741, for example) will not handle a 20-v peak-to-peak signal.

Typically the 8007 has a slew rate of 6V/ $\mu$ s, and thus offers an operating-frequency range that is 10 times the 741's. Indeed, using the 8007 in a typical Wien Bridge oscillator provides a 20-v peak-to-peak output at 40 kHz. In this circuit, the amplitude may simply be controlled by  $R_1$ . For smaller output swings, correspondingly higher frequencies can be obtained. □

### BIBLIOGRAPHY

- W.L. Paterson, "Multiplication and Logarithmic Conversion by Operational Amplifier-Transistor Circuits," *The Review of Scientific Instruments*, Vol. 34, December, 1963.
- A.H. Hoffait and K.D. Mornton, "Limitations of Transistor dc Amplifiers," *Proc. IEEE*, February, 1964.
- D. Fullagar, "A New High-Performance Monolithic Operational Amplifier," *Fairchild Semiconductor Application Brief*, May, 1968.
- R.J. Widlar, "IC Op Amp with Improved Input Current Characteristics," *EEE*, December, 1968.
- R. Dobkin, "Logarithmic Converters," *National Semiconductor Application Note AN-30*, November, 1969.



## Gated MOSFET acts as multiplexing switch

by Glen Coers  
Texas Instruments, Dallas, Texas

A four-terminal MOSFET makes a handy series analog gate for time-multiplexing either ac or dc signals. An array of these MOSFETs can, for instance, be used to gate a number of voltages that are being monitored periodically by a chart recorder or a voltmeter, as shown in the figure. Here, the BCD-to-decimal decoder switches one MOSFET analog gate at a time for a given interval before switching another.

The decoder outputs are high except for the output

number being decoded. An operational amplifier, connected as a comparator, is used to switch each MOSFET on and off. Each comparator's inverting input is set to a dc reference voltage of approximately 1.6 volts.

When a logic 0 appears at the selected decoder output, the associated comparator's output goes to -14 v. The MOSFET that is tied to the comparator output then conducts, gating the analog input voltage to the voltmeter or chart recorder. When the decoder output returns to logic 1, the comparator output switches to 14 v, turning off the MOSFET.

Since MOSFETs are bilateral devices, they can handle both positive and negative voltages. For this circuit, the maximum input voltage swing is  $\pm 10$  v, but can be extended by raising the level of the positive and negative supply voltages that bias the MOSFET's gate terminal. The multiplexer circuit has good isolation and leakage properties. □

**MOSFET gate.** Analog signals can be gated selectively by using a BCD-to-decimal decoder to switch array of MOSFETs. All decoder outputs are high, except for the one selected to be the output number. When selected decoder output goes low, output of associated comparator also goes low, turning on MOSFET and permitting analog input to pass to circuit's output. Both positive and negative inputs can be gated.

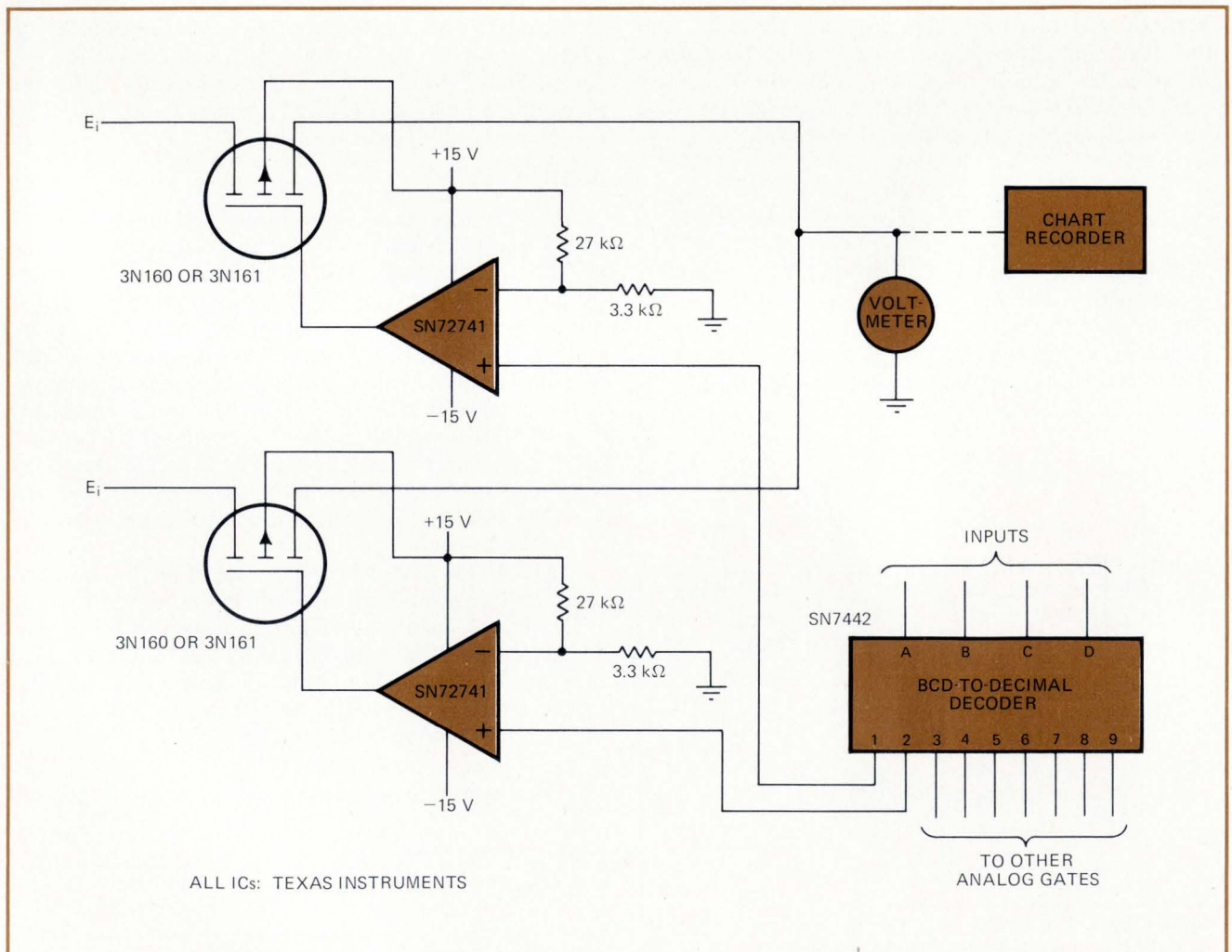



# Stepper drive circuit boosts motor torque

by E. Wolf  
Redactron Corp., Hauppauge, N.Y.

The output power of a stepping motor can be boosted when it's stepping, while the dissipated power during its dwell (holding) intervals is minimized, by effectively doubling the supply voltage of the motor-drive circuit with capacitor charge. The boosted drive circuit shown is intended for four-phase 28-volt motors.

During the dwell intervals, the drive circuit supplies the pair of motor coils that were energized during the previous clockwise step. Transistor  $Q_1$  is on, but conducts only leakage current because transistors  $Q_2$  and  $Q_3$  are off. This permits capacitor  $C_1$  to charge to the supply voltage of 24 v. (Transistors  $Q_1$  and  $Q_2$  form a complementary Darlington transistor pair.)

The motor's advance sequence is dictated by a pulse stream that increments the motor's winding-sequence counter and also triggers the monostable multivibrator at the input of the drive circuit. When the  $\bar{Q}$  output of this one-shot goes low, its Q output goes high, turning off transistor  $Q_1$  and turning on transistors  $Q_2$  and  $Q_3$ .

Since diode  $D_1$  is reverse-biased, the potential at  $Q_2$ 's collector rises to about 24 v, and the capacitor is restricted to a discharge path through the motor windings. Therefore, the voltage available for the coil common lead is nearly two times the supply voltage—or approximately 48 v. With this boosted voltage, motor-winding current rises rapidly to enhance available torque.

Once the current buildup time is over, the one-shot completes its timing cycle, turning off transistors  $Q_2$  and  $Q_3$ , while turning on transistor  $Q_1$ , which is current-limited by resistor  $R_1$ . Capacitor  $C_1$  recharges to the supply-voltage level. This cycle repeats for every stepping pulse.

The timing of the one-shot is not critical. A reasonable timing period would be half of the shortest period between advance pulses. □

**Stepping up torque.** Drive circuit for stepping motor boosts available stepping power without increasing supply voltage. During motor dwell time, capacitor  $C_1$  charges to 24-volt supply level. When advance pulse triggers one-shot, transistor  $Q_1$  turns off while transistors  $Q_2$  and  $Q_3$  turn on. Coil common voltage then builds to twice the supply level because  $Q_2$ 's collector voltage rises by 24 v.

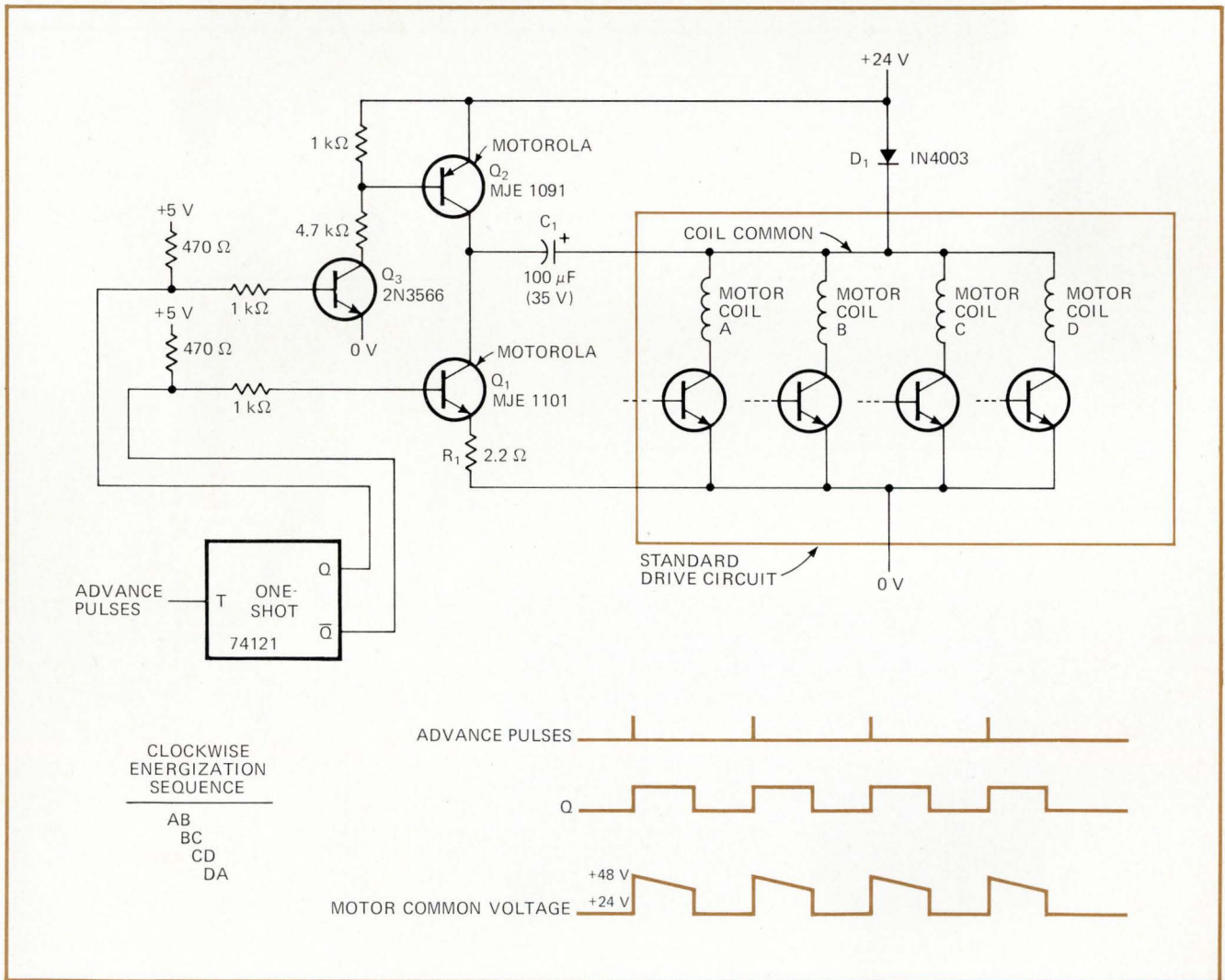



# Voltage-tuned filter varies center frequency linearly

by Vassilios J. Georgiou  
University of Massachusetts, Amherst, Mass.

Although a voltage-tunable multiple-feedback active filter generally offers constant gain and constant bandwidth throughout its tuning range, its tuning curve for center frequency versus control voltage is usually highly nonlinear for extended frequencies. This is due to the nonlinearity of the field-effect transistor, which is used as a variable resistor, and because the center frequency varies inversely with the square root of the FET's drain-source resistance. Employing feedback, therefore, to linearize the FET's behavior is not a solution.

Instead, a modified version of the diode function generator can be used to drive the FET's gate terminal. For the voltage-tunable bandpass filter shown, center frequency remains nearly linear for changing control volt-

age over a center-frequency range of 4.5:1.

Resistor  $R_1$  and supply voltage  $V_{GG}$  bias the FET at  $-3$  volts, thereby setting the filter's first breakpoint for  $V_C = 0$  at 1,460 hertz. For negative values of control voltage, only diode  $D_1$  conducts, and the gain of the amplifier is determined by resistors  $R_2$  and  $R_3$ .

For positive control voltages, diode  $D_2$  conducts, and amplifier gain is about half the value it is for negative control voltages. As a result, the lower portion (right-hand side) of the filter's tuning curve tilts upward and aligns with the upper portion (left-hand side) to form a linear characteristic.

Diodes  $D_3$  and  $D_4$  define the second filter breakpoint—at  $V_C = 2.4$  v—by further reducing amplifier gain and extending linear operation to 570 Hz. Preferably, the germanium diodes,  $D_1$  and  $D_2$ , should be gold-doped so that they have a low forward-voltage drop. □

### BIBLIOGRAPHY

G. Deboo and R. Hedlund, "Automatically Tuned Filter Uses IC Op Amps," EDN/EEE, Feb. 1, 1972, p. 38.

Designer's casebook is a regular feature in Electronics. We invite readers to submit original and unpublished circuit ideas and solutions to design problems. Explain briefly but thoroughly the circuit's operating principle and purpose. We'll pay \$50 for each item published.

**Straight-line tuning.** Modified diode function generator (in color) drives FET variable resistor for voltage-tunable bandpass filter, causing center frequency to vary linearly with control voltage over 4.5:1 frequency range. Gain of function-generator amplifier is reduced for positive control voltages to raise lower section of (uncompensated) tuning curve. Compensated filter remains nearly linear.

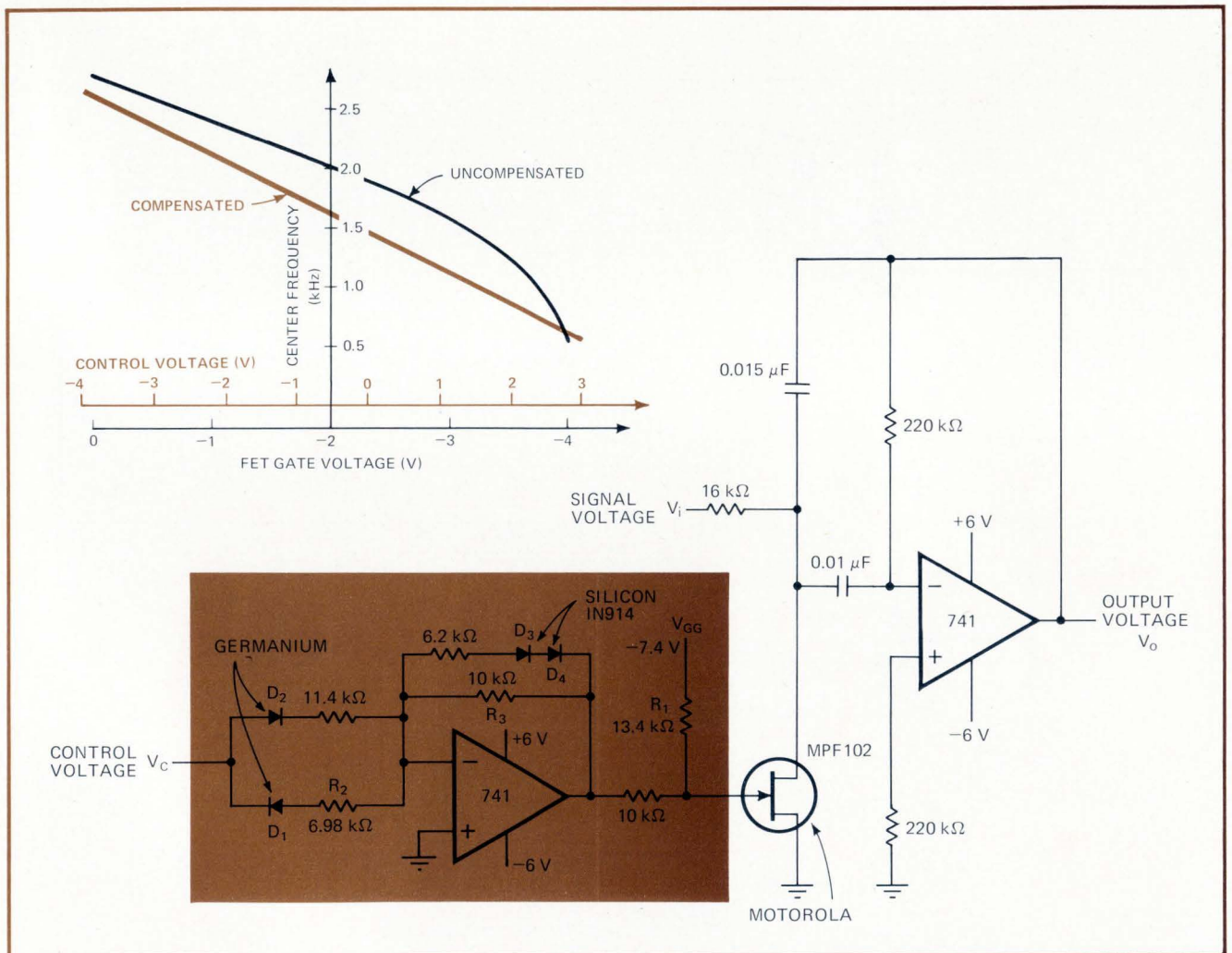



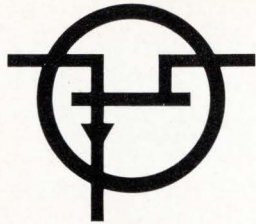

P-Channel  
JFET

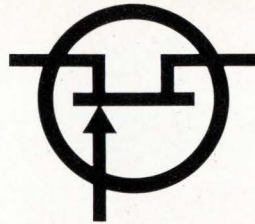

N-Channel  
JFET

Since 1962, Siliconix has evolved FET technology and applied it to a complete line of singles, duals, arrays, and ICs. So what's new?

# Economy Epoxy FETs

Siliconix, the world's leading supplier of FETs, now brings you a full line of plastic encapsulated field-effect transistors—at economy prices as low as 32c each in 1000-unit quantities. Why be concerned over alternate sources? Call on the FET leader for quality devices at rock-bottom cost.

The Siliconix line of epoxy products includes

- FETs for general purpose amplifiers
- FETs for VHF/UHF amplifiers and mixers
- FETs for switches, choppers, and commutators
- FET pairs for differential amplifiers
- FET diodes for current limiters and regulators

Use these new epoxy FETs with the same confidence you have placed in Siliconix products in the past—they are typed, manufactured, and tested specifically for the industrial and commercial markets.

A copy of our new epoxy FET cross-reference guide and full line catalog is yours for the asking. Just circle the bingo card number or call your nearest Siliconix distributor.

## Write for Data



**Siliconix incorporated**

2201 Laurelwood Road, Santa Clara, California 95054



# Film only a few atoms thick promises very large mass memories

Permalloy film less than 50 atomic diameters thick achieves data storage at 100 times the density of other films, has random access at microsecond speeds; yet it costs no more per bit than a head-per-track drum does

by E. J. Torok, *Univac Defense Systems Division, St. Paul, Minn.*

□ A new type of thin-film memory has so much larger a bit capacity than conventional thin-film memories that it qualifies for use as a mass memory. It is faster than many present mass memories, but is very small and light, and dissipates little power. In addition, it could easily replace fast head-per-track disks and drums, being not only competitive in price but vastly superior in performance.

A feasibility model of the new memory, called an oligatonic film memory, has been tested by the National Aeronautics and Space Administration at its Marshall Space Flight Center, Huntsville, Ala., and further development is under way at Univac Defense Systems division. Although its first use is likely to be in aerospace applications, where its ruggedness, non-volatility and compactness make it especially desirable, calculations of cost versus performance show that it can also be valuable in commercial equipment.

Present thin-film arrays are used primarily as main memories in computers. The oligatonic film memory, however, can serve as a much larger main memory in a high-speed computer system that uses a cache memory. The parameter values that make this possible are listed in the table on p. 108.

## A few atoms thick

An oligatonic film has a thickness of only a few atomic diameters—less than 50. The prefix, “olig-,” is from the Greek for few, and the whole word was coined by the German scientist Ulrich Gradmann, who studied the magnetization and surface anisotropy of layers between 2 and 200 angstroms in thickness.<sup>1</sup> (In permalloy, the atomic diameter is 3.5 angstroms, and most magnetic films are several hundred to a thousand or so angstroms thick.)

A typical magnetic oligatonic film consists of a 100-

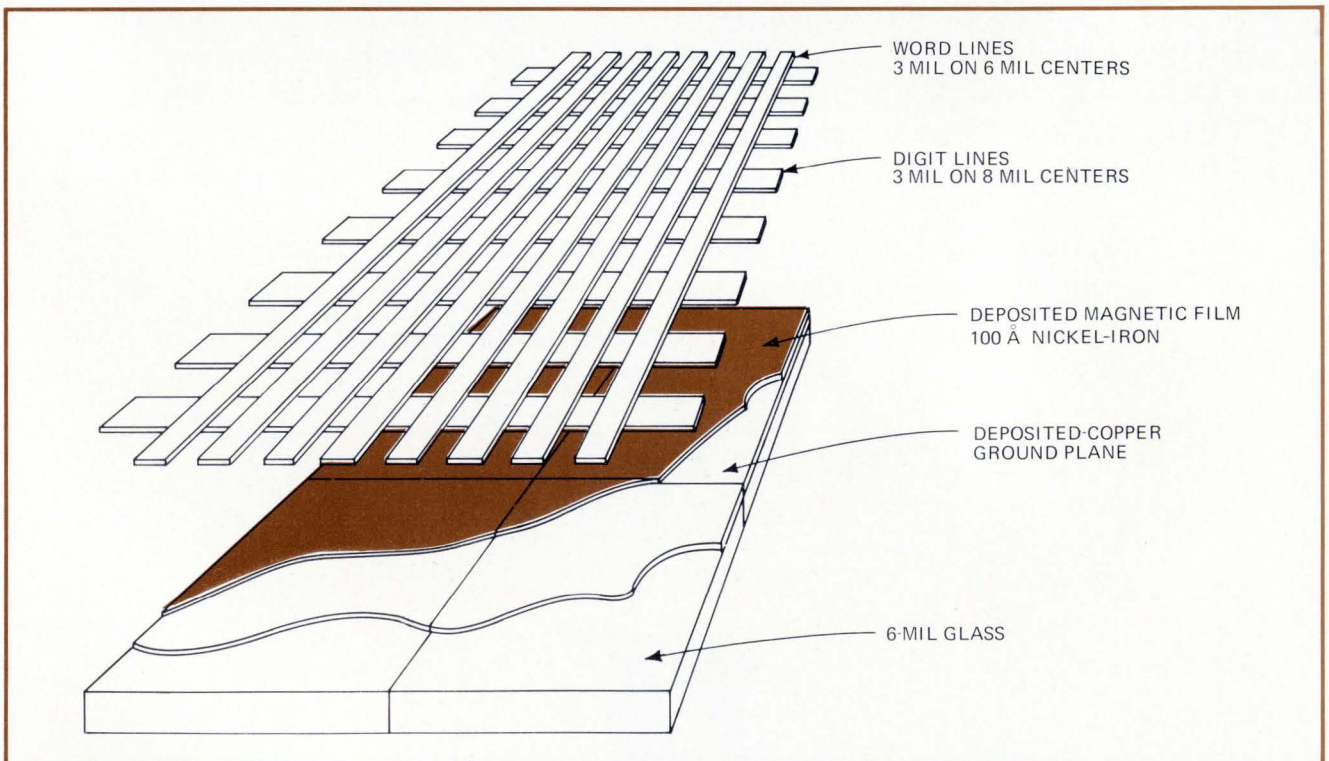

**1. Oligatonic structure.** The deposited magnetic film is only 100 angstroms thick, compared to about 1,000 for conventional films. Overlays are glued to film. Cost per bit is minimal because extreme thinness permits very high bit packing density.



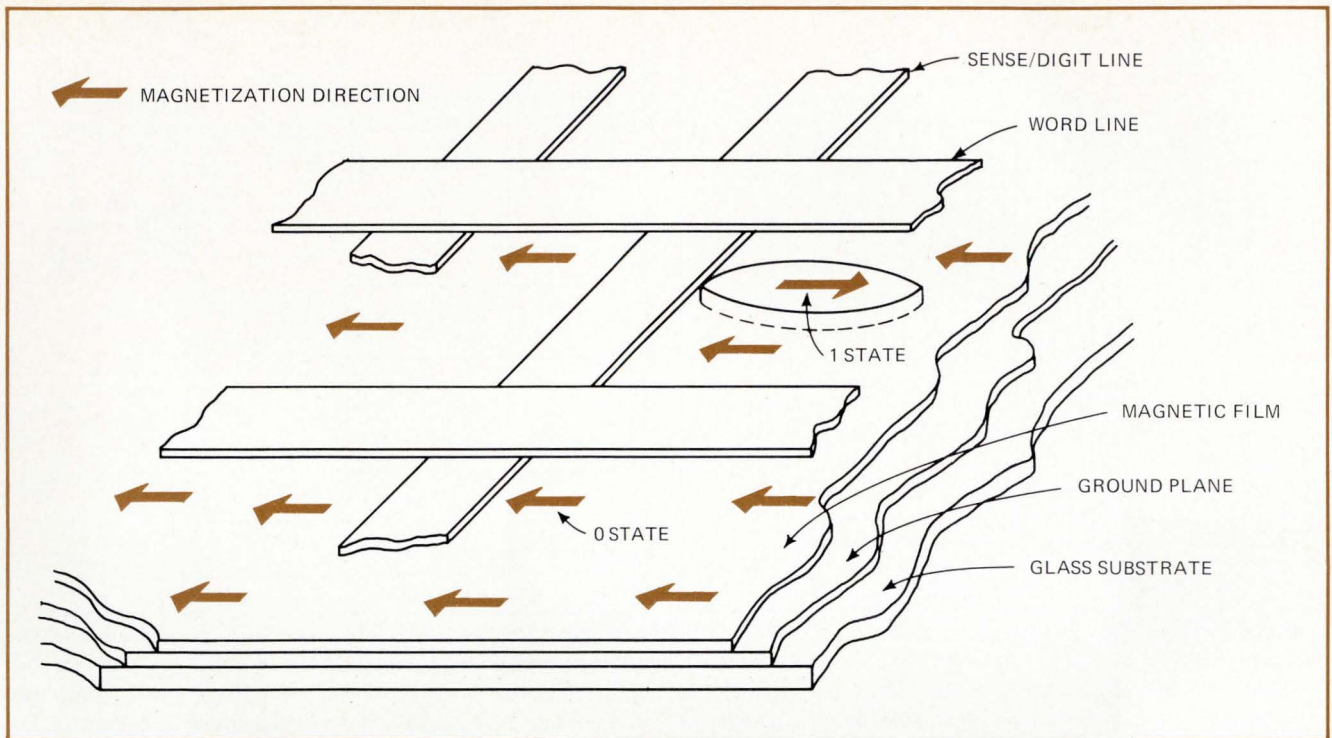

**2. Thin film storage element.** Colored arrows show normal magnetization along film's easy axis storing binary 0s. The one reversed arrow designates an area that has been switched, and therefore stores a 1. Word current rotates magnetization perpendicular to easy axis.

angstrom layer of permalloy, which is deposited on a 2-by-3-inch copper substrate in a vacuum in the presence of a magnetic field. This field imposes an easy axis upon the film. When magnetized, later, the film is in its lowest energy state when the magnetization vector is either parallel or anti-parallel to this easy axis. If an external magnetic field is applied perpendicular to the easy axis, but parallel to the plane of the film, the magnetization vector of the film will rotate to follow it, but returns to its original orientation when the external field is removed. Simultaneously applying a magnetic field in both hard-axis and properly oriented easy-axis directions causes the film magnetization vector to switch—that is, to reverse its direction.

These external fields are applied by passing current through one of two sets of copper overlays (Fig. 1), made by etching a copper-polyimide laminate. One of the two overlays forms a set of parallel word lines, the other a set of parallel sense/digit lines at right angles to the first set; each intersection defines a bit location.

If the whole film is initially magnetized in a given direction, and if direct current pulses of the appropriate polarity are then applied to one word line and one sense/digit line, there appears under the intersection a boat-shaped magnetic domain magnetized in the opposite direction to the rest of the film (Fig. 2). This domain is about as wide as the word line and rather longer than the sense/digit line is wide.<sup>2</sup> A current in the word line alone twists the magnetization in the domain to one side, and the resulting flux change generates a signal in the sense/digit line.

However, because the oligatomic field is so thin, the total flux linking the sense/digit line is very small. Therefore, to get a usable signal in the sense/digit line, an alternating current is used in the word lines. (The

reasons for using an ac signal are discussed more fully later.) The alternating word current, which has a frequency of 10 megahertz, causes the magnetization in the domain to rock back and forth with a similar frequency, so that the flux in the hard-axis direction fluctuates at this frequency. However, as the hard-axis flux increases, the easy-axis flux decreases, and vice versa; in the absence of an applied easy-axis field, the easy-axis flux always returns to its original orientation regardless of the direction of the hard-axis flux.

The result is an easy-axis component of the total flux oscillating between a peak value and zero at twice the frequency of the word current. When the easy-axis flux is at its minimum—essentially zero—the hard-axis flux is at a positive or negative maximum. But the easy-axis flux links the sense/digit wire and the hard-axis flux does not. Therefore the sense signal generated by the changing flux is also generated at 20 MHz, twice the frequency of the word signal.

Furthermore, the phase of the 20-MHz signal depends on the orientation of the magnetization vector. Labeled a binary 0, the vector parallel to the film's original easy axis produces an output 180° out of phase from the antiparallel magnetization vector, called a binary 1.

### Signal alternation

This alternating sense signal is of the greatest importance, because it permits the use of tuned sense amplifiers that respond only to a narrow band of frequencies. With a 10-MHz drive, the 20-MHz amplifier rejects noise coupled from the word line at 10 MHz, as well as most of the thermal noise generated by the film itself. In conventional thin-film memories, the word noise is sometimes larger in amplitude than the data signal.

The general arrangement of the electronic circuitry



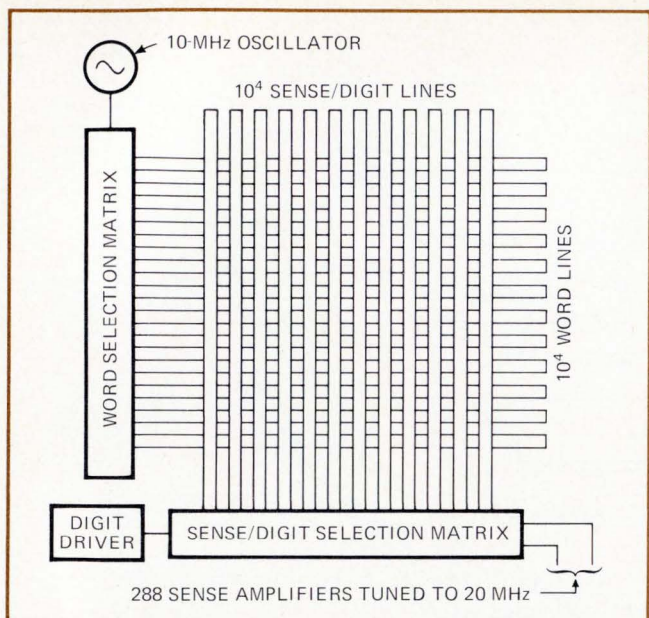

**3. Memory layout.** This oligatomic film layout holds  $10^8$  bits in a square format, with selection matrixes on two adjacent edges. Such a format minimizes electronic-circuit cost. Sense gates permit the number of sense amplifiers to be much less than the number of sense lines; but the 288 indicated are enough to move an eight-word block from the film to a cache memory in one 3-microsecond cycle.

used with an oligatomic film memory is shown in Fig. 3. The array is approximately square. Along one edge a word selection matrix directs the output of a 10-MHz oscillator into one of approximately 10,000 word lines. A sense/digit selection matrix lies along an adjacent edge, and performs two functions: it directs digit currents into some of the approximately 10,000 sense/digit lines when writing, or it picks up sense signals from the lines, compares them with reference signals, and routes them to a set of 288 tuned sense amplifiers.

The reference signal originates in a reference line (Fig. 4) that serves eight sense/digit lines. The thin film under the reference line is always in the 0 state; its 20-MHz output is essentially identical to the output from the sense/digit line when a data 0 is read. When these two signals drive a differential amplifier, its output is nearly zero. But the reference signal is  $180^\circ$  out of phase with the sense/digit signal for a binary 1, and the differential amplifier output in this case is nearly twice that of the directly read signal for the 1. The differential amplifier's output drives the tuned sense amplifier.

The spikes that often occur between successive read signals originate at the gates in the sense/digit selection matrix. They occur in conventional film memories too, where they come along with the data signal and have to be lived with. But in the oligatomic film memory with its ac signals, the data keeps coming and detection can wait until the selection noise dies out.

Although a sense amplifier with several stages of tuned circuits was used in the module built for NASA, a better and less expensive sense amplifier has been built since then. It is a phase angle voltmeter using a balanced demodulator, and has an easily adjustable bandwidth and better noise rejection. Having no tuned circuits or inductors, it can be built as a hybrid circuit for

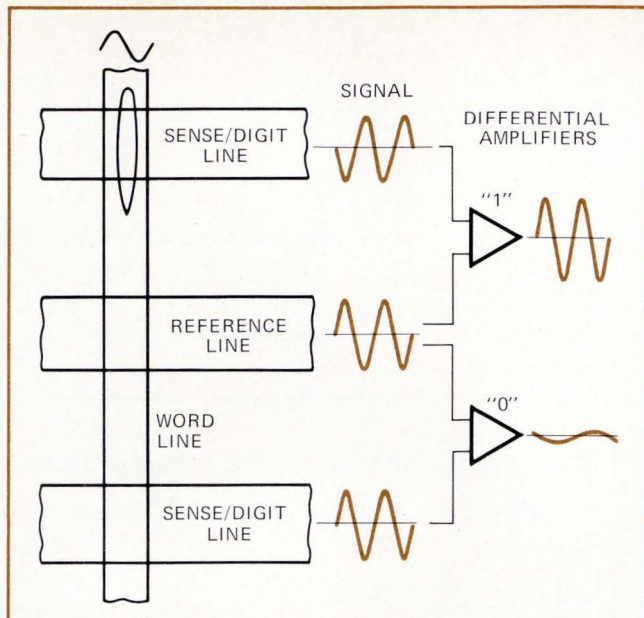

**4. Sensing scheme.** The 20-MHz sense signal is compared with the signal from a reference line, which lies over a region of the film that always stores 0s. When the sensed data is also 0, the two signals are in phase and the output of the differential amplifier is almost nil; but for a stored 1, the signals are  $180^\circ$  out of phase and the amplifier's output is nearly doubled the amplitude of the two inputs.

**TABLE 1: OLIGATOMIC VERSUS CONVENTIONAL FILMS**

PARAMETER	OLIGATOMIC FILM MASS MEMORY	CONVENTIONAL FILM MAIN MEMORY
Bits per module	100 million	1 million
Cost per bit	0.1¢	4¢-10¢
Access time	3 $\mu$ s	0.75 $\mu$ s
Drive current	30 mA	600 mA
Power dissipation	98 W	150 W
Volume	2 ft <sup>3</sup>	0.75 ft <sup>3</sup>
Weight	90 lbs	50 lbs

less than a tenth the cost of the former amplifier. This makes it economically possible to provide enough sense amplifiers in the memory system to read out several hundred bits in parallel—a desirable capability when the oligatomic film memory is used with a cache.<sup>3</sup>

#### Whys and wherefores

The extreme thinness of the film and the ac signals represent departures from conventional film memory design. They were dictated by the purpose of the oligatomic film memory: to provide a large random-access storage capacity at the lowest possible cost in a small volume. The desired capacity—about 100 million bits—is two orders of magnitude larger than the capacity of a conventional film module, such as Univac's mated-film memory, as used in the Navy's developmental anti-submarine warfare aircraft, the S-3A. Therefore the memory needed a bit density two orders of magnitude greater if the same volume was to be retained.

Getting this high density presents a serious problem—a field, created by magnetic poles at the edges of mag-



netic domains, which tends to demagnetize the domain and therefore to erase the stored information.

One way to eliminate the demagnetizing field is to use a film configuration in which the lines of magnetic flux, which are always closed loops, lie wholly within magnetic material. This is the approach used in the mated film, and also in plated wire, but in these designs the closure is in only one dimension. Obtaining good flux closure in two dimensions presents great practical difficulties in fabrication; essentially it requires that two film areas be placed face to face with the smallest possible air gap between them.

The only alternative way of reducing the demagnetizing field requires the pole strength to be correspondingly reduced. Since the magnitude of the poles is proportional to the film thickness, the latter had to be reduced by a factor of ten.

Making the film so much thinner brings mixed blessings. Ordinarily, two thresholds are associated with thin magnetic films: a rotational switching threshold and a creep threshold. To switch the film requires an external magnetic field of greater strength than the rotational switching threshold, while to guarantee that the film remains unaffected, the field must remain below the creep threshold. But repeated applications of a field in the no-man's-land between the two thresholds cause the magnetic state of the film to fade away gradually.<sup>4</sup>

However, in an oligatonic film, the creep threshold is nearly equal to the rotational switching threshold, for magnetostatic reasons.<sup>5,6</sup> Because of this, the magnetization can be continually rocked back and forth many times without becoming demagnetized by creep.

On the other hand, the reduced film thickness provides a very low signal output. The signal is proportional to the flux change, and the flux is proportional to both the film thickness and the width of the domain; both of these have been reduced by a factor of 10.

To get around the small-signal problem, the tuned amplifier was used in place of the conventional wideband pulse amplifier. In conventional memories, a single dc pulse in the word line rotates the film magneti-

zation into the hard direction, and this induces a single pulse in the sense/digit line. The wideband amplifier amplifies this pulse—plus the accompanying thermal noise and capacitively coupled word noise. But the tuned amplifier can be designed to reject all but the signal frequency and to use a microvolt rather than millivolt signal. In fact, oligatonic films 100 angstroms thick with word lines 3 mils wide can develop 50  $\mu\text{V}$  at 20 MHz—a very comfortable signal for a tuned amplifier.

### New gates

Of course, the change to a tuned sense amplifier required a corresponding change in the design of the gates driving the word lines and the sense/digit lines. Conventional word gates work with unipolar dc pulses only. But bipolar radio frequencies are involved in the oligatonic film memory, so that low-distortion rf techniques were necessary in the gate design (Fig. 6). Showing that these new designs work was one of the most important things accomplished by the NASA tests.

The high bit density in the film requires very narrow word lines. But the magnetic field at the surface of a conductor is proportional to the current density in that conductor. Thus, to produce a field of a given strength around a conductor of a given thickness, a stripline 3 mils wide requires only one-tenth the current that a 30-mil line would require. Furthermore, such narrow conductors are more easily made if they are also thinner.

Consequently, while conventional wire and film memories require about 500 milliamperes for the word current, the oligatonic film memory requires only 28 mA. Such small currents bring the whole device potentially well within the current-supplying capabilities of large-scale integrated circuits.

Calculating the cost per bit of different memory tech-

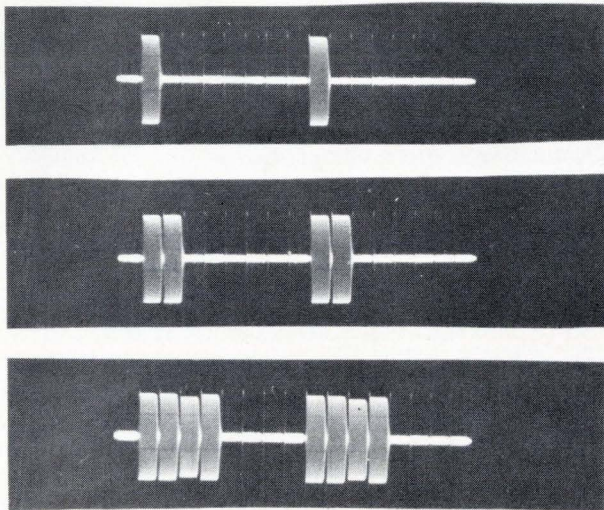

5. Sense line outputs. Scope traces show a sequence of one, two, and four 1s followed by 0s (sweep time is about 20 microseconds).

### Pricing problems

Although the cost per bit of a memory technology is one of its most important parameters, few numbers are less reliable than the cents-per-bit predictions made by advocates of a particular technology—regardless of what that technology may be. In the past, such predictions have been off by as much as two or even three orders of magnitude. Moreover, different organizations define their costs differently. Some commercial firms find that their selling prices have to be three times their "cost" in order not to lose money, while, by law, military suppliers must sell at a price only slightly above "cost."

A nonpartisan manufacturing department can usually estimate the cost of a memory technology fairly accurately, provided it is given the detailed design information. But another way to arrive at comparative figures for various technologies is to calculate the costs of those parts that are used in large numbers in a single memory—selection gates, overlays, and sense amplifiers, for example. Furthermore, even though these repeated parts may differ in detail from one technology to another, their costs remain so nearly constant that correct cost ratios of various technologies can easily be obtained.



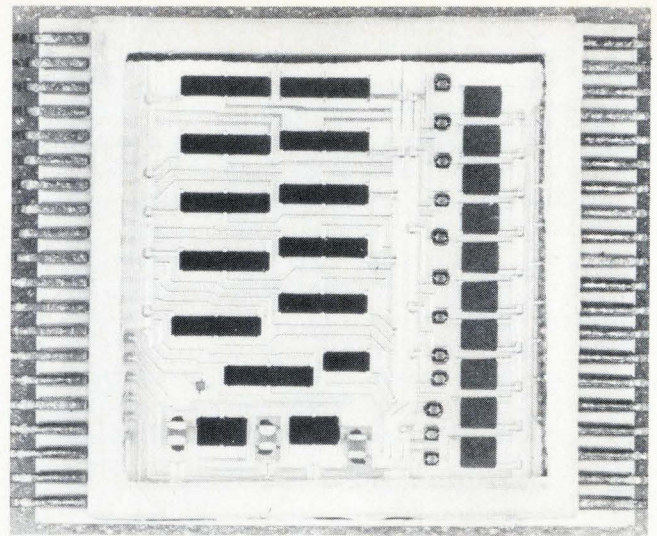
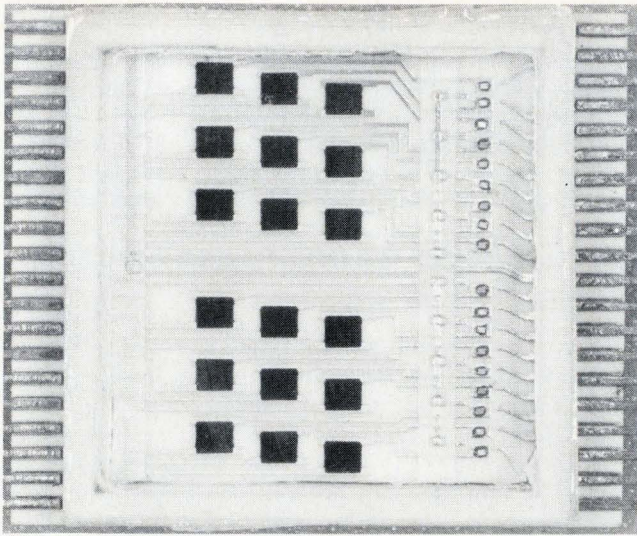

**6. Hybrid packages.** Word gates are in hybrid IC containing 18 large square patches (resistors); package is 125 mils across. Other package (both square and oblong resistor patches) contains 12 sense/digit gates, measures 160 mils across. In both ICs the small black spots are field-effect transistors—18 in one, 12 in the other.

nologies, for purposes of comparison, is at best tricky; but with some educated guesses and an assumption or two, as outlined on page 109, the relative costs can be predicted. Four such calculations yield the comparison shown in Fig. 7, which shows the cost of the oligatonic film memory to be very much lower than that of mass plated-wire, mass ferrite-core, or large metal-oxide-semiconductor arrays.

### Cost analysis

The designs evaluated for this comparison are derived from present-day technology, since that of several years in the future would involve too much speculation. For that reason, the module capacities chosen for mass wire and mass core are 65,536 words—today's state of the art. Future designs for plated wire will probably use simpler support structures, thinner films, and higher bit densities; their module sizes will therefore be larger and their cost per bit lower.

Semiconductor memories, on the other hand, do not benefit from economies of scale as do magnetic memories. As a result, they are most useful in small sizes, such as buffers and caches, while magnetic memories are better for main-frame and mass memories.<sup>7</sup> This distinction is reflected in the choice of the 32,768-word semiconductor module for the comparison in the diagram.

The cost per bit of the oligatonic film memory is determined by the costs of film deposition, of photo-etched overlays, of selection gates, of interconnections, and of sense amplifiers. Film deposition and photoetching costs are determined by area, not by the number of bits or conductors. Thus by increasing the density by a factor of 100, the cost per bit of these factors is decreased by the same factor. Of course, above a certain density the yield plummets, and the cost increases again; but at the present time the oligatonic film is well below this critical point.

In a square memory organization, where the numbers of word lines and sense/digit lines are equal, the costs of selection gates and of interconnections are each inversely proportional to the square root of the memory's

capacity. Gates and interconnections are both arranged along the periphery of the memory array. The photoetched overlays for the lines can be made in long strips and connected only at the edges of the array. This low interconnection cost, incidentally, just cannot be achieved with semiconductor memories.

Finally, the number of sense amplifiers equals the number of bits read out of the memory at any one time, that is, the memory's word length, and remains the same whether the memory stores 100 such words or 100,000. As a result, the total cost of sense amplifiers depends on the word length, but is independent of module capacity. Since the total cost is a constant as capacity varies, the cost per bit of the memory system contributed by the sense amplifiers is inversely proportional to module capacity.

In the same way, the cost per bit can be calculated for non-random-access memories, such as drums, disks, bubble memories, domain tip propagation devices, and ferroacoustic memories. In all of these memories access time is traded for fabrication cost—they are very inexpensive per bit, but they are also very slow. But ignoring access time for the moment, the cost per bit of oligatonic films is slightly less than that of commercial head-per-track drums, about the same as magnetic bubbles, and much more than movable-head drums—at today's state of the art for all these technologies.

Proponents of bubble technology expect (probably justifiably) drastic reductions in the costs of substrates, depositions, and sense amplifiers. However, the costs of overlays and selection matrixes for oligatonic film memories are also sure to drop, especially with LSI. As a result, oligatonic films and bubbles will probably cost much the same as each other over the long run, and will approach movable-head disks and drums. The difference is in the performance, because the film is random-access and the bubble memory is serial.

Two revolutions in recent computer history are profoundly affecting memory design: the use of a cache memory, and multiprogramming. The cache revolution has replaced the concept of a large, fast main memory



with a combination of a small, fast buffer and a large, relatively slow and inexpensive backing store.<sup>8,9</sup> The multiprogramming revolution is eliminating the input-output-boundedness of most older computers by storing several programs at once in the main memory, thus enabling the processor to work continuously on several programs in turn, instead of being halted whenever the program demands information stored on a drum.

### The place for oligatomic films

When a cache memory is used, its size is likely to be between 2,000 and 8,000 words, and its speed is fast enough not to limit the processor's operation—typically 15 to 200 nanoseconds. Meanwhile the backing store used in conjunction with a cache is likely to have a capacity of 32,000 to 500,000 words and an access time of 0.5 to 40 microseconds. When the processor needs data from memory, it looks first in the cache. Since the word is usually there, the average access time over the long run is only slightly greater than the actual access time of the cache. Meanwhile the capacity of the system is that of the less costly backing store.

Calculations made with the aid of readily available formulas<sup>3,10</sup> show that the performance of a computer system containing both a cache memory and an oligatomic film backing store is much better than any remotely competitive present-day technology. Figures of merit, shown in the table below, are based on the number of accesses per second per dollar of memory cost.

The other revolution, that of multiprogramming, is re-

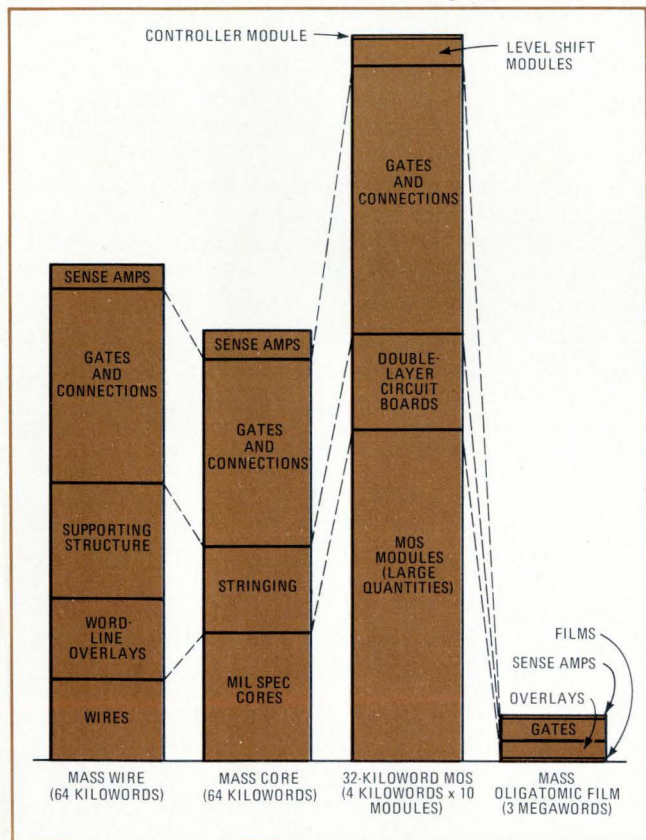

**7. Cost comparison.** These relative costs per bit of four memory technologies are calculated by rules discussed in panel, p. 109. They are figured on the basis of defense and space project costs, not commercial; and they reflect present, not future, prices.

lated to the cache revolution. Basically, multiprogramming is a technique in which many different programs are stored in the main memory. At any particular time, only one of them is running. But when that program requires the use of a piece of input-output equipment—for example, the program requires a page of information from a disk—the I/O operation proceeds independently while the computer, instead of standing idly by, switches to another program. Several programs may be stacked up and run a little at a time, either in rotation or according to a priority arrangement.<sup>11,12,13</sup>

But the several programs and their data bases may require as much as  $10^9$  or even  $10^{10}$  bits—far more than any physical main memory can hold today. The overflow is stored on drums and disks, which, being rotating devices, have a latency of 3 to 100 milliseconds. (Low latency is characteristic of the most expensive head-per-track machines; the higher values are found in some moving-head units.)

An example shows the effect of latency on processor performance. Suppose a processor is running a mix of programs that requires access to a disk on the average of once every 8,000 instructions. In monoprogrammed mode, executing one instruction each microsecond, the disk access request would occur once every 8 ms. But if the disk has a 40-ms latency, the machine spends 83% of its time idling, waiting for the disk.

If the processor, still monoprogrammed, were multiplied in speed by a factor of 5—by adding a cache or by other means—throughput would be improved by only 14% and the 40-ms idle time would be increased to 97%.

This takes into account only the delay in transferring data to or from the disk. If the program uses other input/output equipment as well, latency effects are combined with the mechanical delays of other equipment.

But the throughput can be increased by using a larger main memory that stores many programs at once—that is, by multiprogramming. Then while one program waits for the disk, the processor can execute another program. The higher the multiprogramming level, the better the performance improvement, because the probability is lower that all programs are waiting for the disk.

In an attempt to keep the memory size down, a system designer might try using fast drums for part of his

TABLE 2: FIGURES OF MERIT

Technology	Access	Cost/bit	Total cost	Accesses/second <sup>1</sup>	Accesses/second/S <sup>2</sup>
A. Bipolar	80 ns	20¢	\$1,677,722	$12.5 \times 10^6$	7.45
B. Main core	600 ns	2¢	167,772	$1.67 \times 10^6$	10
C. Mass core	1 $\mu$ s	1¢	83,886		
D. 4K x 32 cache	80 ns	20¢	26,214		
C + D combined <sup>3</sup>	103 ns		110,100	$9.7 \times 10^6$	88
E. Olig. film	3 $\mu$ s	0.1¢	8,389		
D + E combined <sup>3</sup>	149 ns		34,603	$6.7 \times 10^6$	194

1 This column is the reciprocal of the one headed "Access time."  
 2 This column is the quotient of "Accesses/second" divided by "Total cost."  
 3 These rows use formula from Meade<sup>10</sup> for average access time as a function of access times of cache and backing store; Meade is somewhat more conservative than Mattson<sup>3</sup>.



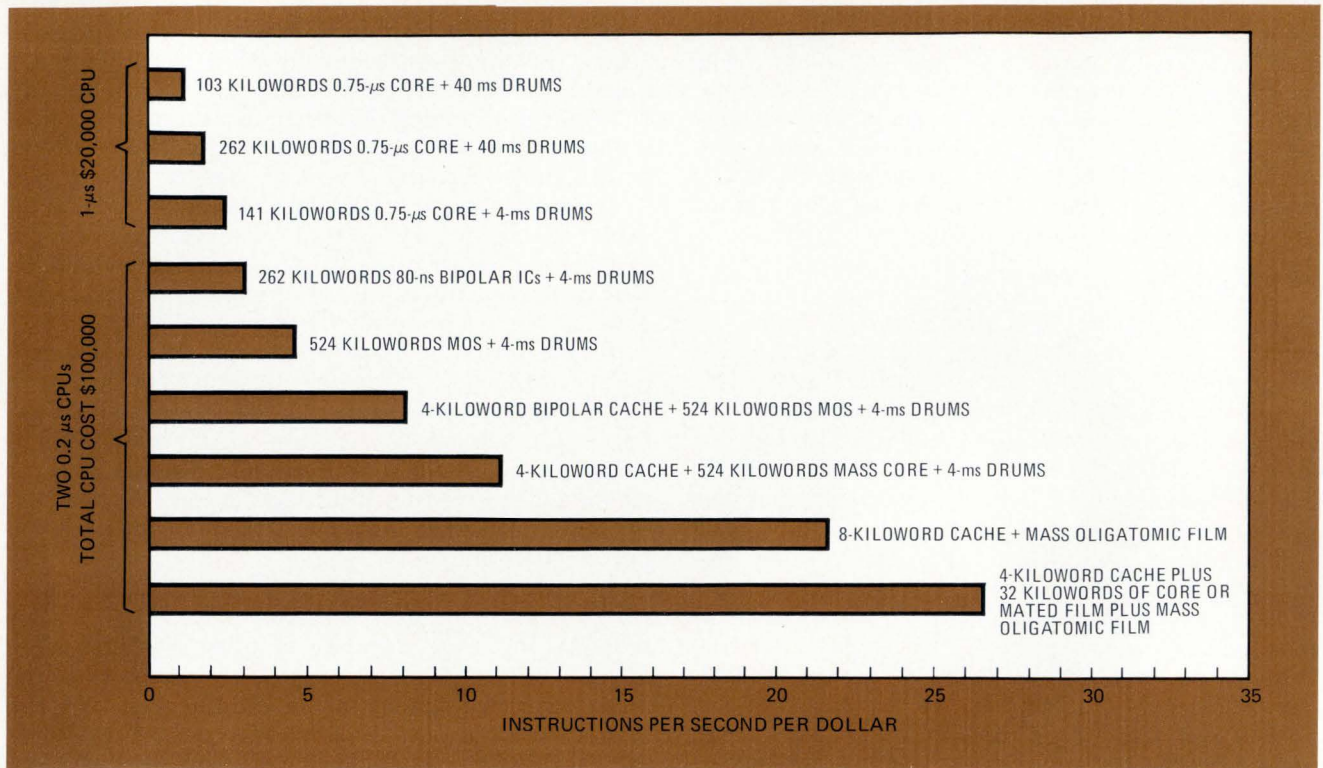

**8. Cost/performance comparison.** All examples represent 200 million bits of storage, executing a program mix of 70% business applications and 30% scientific applications. Individual costs per bit and access times are discussed in the text.

input-output requirements. This works pretty well up to a certain point. But when an improved processor comes along, perhaps as a multiprocessor system in which two separate machines share the work load of several programs stored in a single memory, the problem returns. To keep both machines busy all the time, with a substantial level of I/O, requires a very high level of multiprogramming and an extremely large memory.

Even this isn't adequate if the multiprocessor is to be used in a real-time transaction application. An example of this is an airline reservation system, which has many remote terminals and an I/O demand rate five to 10 times that of an ordinary business application.<sup>14</sup>

But with its extremely low cost per bit, used in conjunction with a cache memory, the oligatonic film memory can serve the needs of even the largest multiprogrammed multiprocessor system at a reasonable cost. Its performance/cost characteristics are shown in the bar chart (Fig. 8) in comparison with various other technologies and combinations. The chart contains several assumptions: a total capacity of 200 million bits; a cost of \$20,000 for a processor capable of executing a million instructions per second and \$50,000 for one five times as fast; an average program size of 38,000 words and an executive of 65,000 words; I/O access every 8,000 instructions; and costs per bit of 4¢ for mainframe core, 2¢ for 300-ns MOS, 1¢ for 1- $\mu$ s mass core, 0.1¢ for 3- $\mu$ s mass oligatonic film, 0.1¢ for a 4-ms head-per-track drum, and 0.01¢ for a 40-ms movable-head drum.

In every case the systems that use cache memories are better than systems of similar size without a cache. The faster drum, even at an order-of-magnitude higher cost per bit, is better than the slower one. And even though the oligatonic film mass memory costs the same as the

head-per-track drum, its performance is so much better that the difference in cost-effectiveness is enormous.

In the bar chart, the bottom bar represents a three-level hierarchy—one level more than is ordinarily used today. At the bottom level, the bipolar memory is a cache for the conventional main memory, which can be core in a commercial machine or mated-film in an aerospace application; the main memory, in turn, is a cache for the oligatonic film mass memory. The cost-performance of this three-level hierarchy is nearly two and a half times as good as the best conventional two-level hierarchy, shown by the third bar from the bottom. □

#### REFERENCES

1. V.M. Benrud et al., "Oligatonic Film Memories," *Journal of Applied Physics*, March 15, 1971, p. 1,364.
2. E.J. Torok, J.A. Krawczak, H.N. Oredson, and W.J. Simon, "A Local Theory for Calculating Domain Configurations and Magnetization Distributions in Continuous Film Magnetic Memories," *Proceedings, Conference on Magnetism and Magnetic Materials*, 1971.
3. R.L. Mattson, "Evaluation of Multilevel Memories," *IEEE Transactions on Magnetics*, 1971, p. 814.
4. William M. Overn, "Controlling creep and skew in thin-film memories," reprinted from *Electronics in Wallace B. Riley, "Electronic Computer Memory Technology," McGraw-Hill, 1972, p. 45.*
5. G.P. Gagnon and T.S. Crowther, "Thickness Dependence of Creep Switching in Magnetic Films," *J. Applied Physics*, March, 1965, p. 1,112.
6. A.L. Olson and E.J. Torok, "Magnetization Creep in Thin Nickel-Iron Films," *J. Applied Physics*, March, 1965, p. 1,058.
7. A.V. Pohm, "Competitive High-speed Memory Technologies," *Proceedings, Conference on Magnetism and Magnetic Materials*, 1971.
8. Robert M. Meade, "How a cache memory enhances a computer's performance," *Electronics*, Jan. 17, 1972, p. 58.
9. Donald H. Gibson and W. Lee Shevel, "'Cache' turns up a treasure," reprinted from *Electronics in Wallace B. Riley, op.cit., p. 235.*
10. Robert M. Meade, "On Memory System Design," *AFIPS Conference Proceedings*, Vol. 37 (Fall Joint Computer Conference), 1970, p. 33.
11. Kurt Fuchel and Sidney Heller, "Considerations in the Design of a Multiple Computer System with Extended Core Storage," *Communications of the ACM*, Vol. 11, 1968, p. 334.
12. M.M. Lehman and J.L. Rosenfeld, "Performance of a Simulated Multiprogramming System," *AFIPS Conference Proceedings*, Vol. 33 (Fall Joint Computer Conference), 1968, p. 1,431.
13. D.P. Gaver Jr., "Probability Models for Multiprogramming Systems," *Journal of the Association for Computing Machinery*, July, 1967, p. 423.
14. S.R. Arora and A. Gallo, "The Optimal Sizing, Loading and Re-loading in a Multilevel Hierarchy System," *AFIPS Conference Proceedings*, Vol. 38 (Spring Joint Computer Conference), 1971, p. 338.



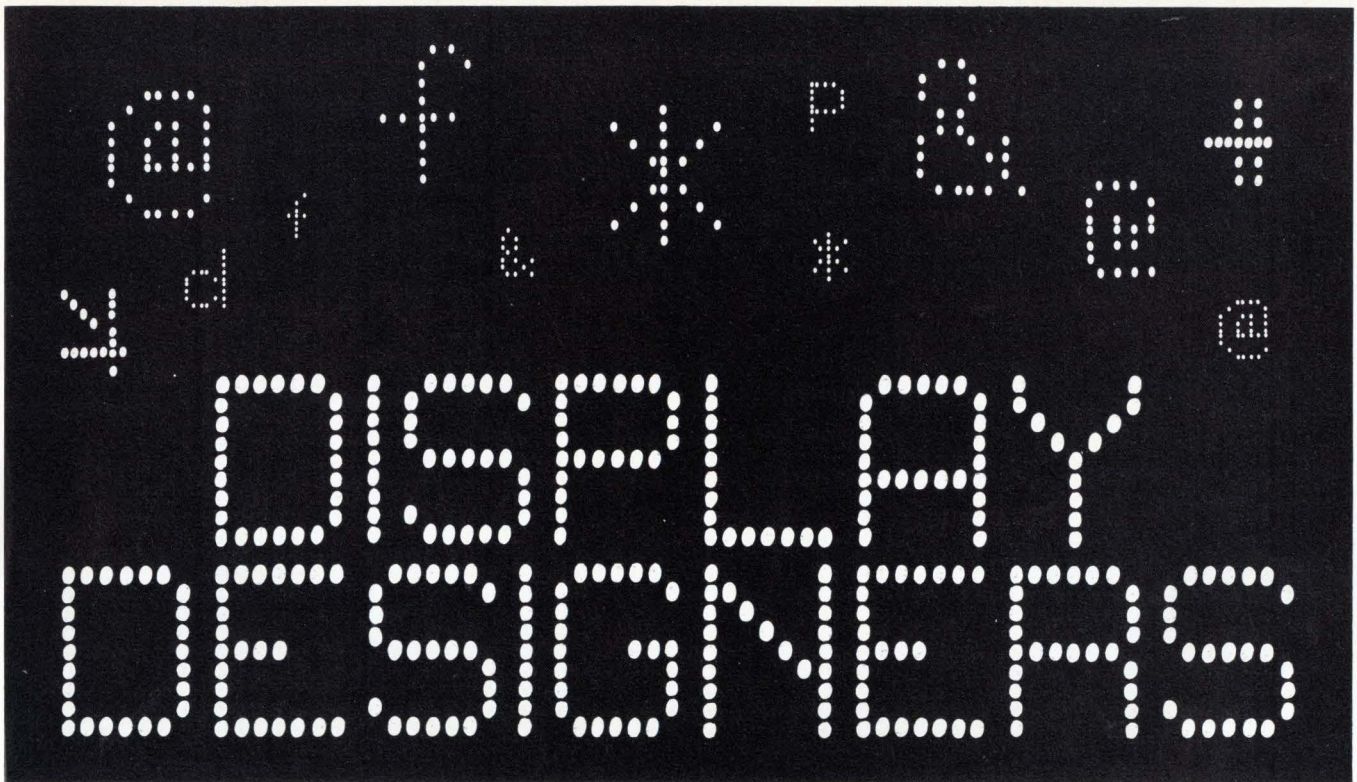

## MMI breaks the character density barrier—128 characters, 9x9 resolution, in one 24-pin DIP. Bipolar!

Who but the memory industry leader could bring you this kind of character generator selection?

Look what you get with MMI character generators:

- Highest character density per package (even *more* than with MOS). Yea! Fewer packages on your boards, lower system cost.
- Up to 128 characters in a single package and in any character organization up to 9 x 9 for better display resolution.
- Bipolar speed you can rely on—access times to 35 nsec.
- Lower power dissipation—450 mW per package. What's more, no clocks are required and the whole family is made to meet



(Japanese characters for Banzai)

MIL specs. Cost is low; interfacing is simple as TTL.

Somewhere in the MMI family are just the characters you want for your CRT or LED displays. They're standard ASCII definition. Format is 5 x 7 or 7 x 9 in either column or row scan.

Custom characters use 35 ns MMI ROMs for stroke writing techniques or MMI high density (128-character) ROMs for foreign language characters or special symbols. Get all the custom info from—ready?—Customer Service.



Just think what you could custom generate with a 10x13 matrix! Our custom MM5255 can handle it.

### Meet the whole family:

MONOLITHIC MEMORIES ASCII CHARACTER GENERATORS (BIPOLAR)	MMI Part No.	DESCRIPTION		SCAN	ACCESS ns	Pkg. Pins
		Character Size	No. of Characters			
	MM6051	5x7	32	Row	35	16 DIP
	MM6052	5x7	32	Row	35	16 DIP
	MM6055	5x7	64	Row	50	18 DIP
	MM6056	5x7	64	Column	75	24 DIP
	MM6061	5x7	128	Row	75	24 DIP
	MM6062	5x7	128	Column	75	24 DIP
	MM6071	7x9	64	Row	75	24 DIP
	MM6072	7x9	128	Row	50	24 DIP
	MM6073	7x9	128	Column	50	24 DIP
	MM6074	7x9	64	Column	50	24 DIP

Call, write, TWX or Telex us today.

# Monolithic Memories, Inc.

1165 East Arques Avenue, Sunnyvale, CA 94086 • (408) 739-3535 • TWX: 910-339-9229 • TLX: 346301



Representing your best buy in memories: ALABAMA, Huntsville (205) 539-1771; ARIZONA, Phoenix (602) 264-7971; CALIFORNIA, Los Angeles (213) 945-2341; San Diego (714) 747-3015; Palo Alto (415) 369-4671; COLORADO, Denver (303) 623-8713; CONNECTICUT, New Haven (203) 239-9762; FLORIDA, Orlando (305) 423-7615; ILLINOIS, Chicago (312) 455-5100; INDIANA, Ft. Wayne (219) 744-4331; INDIANAPOLIS (317) 844-3241; IOWA, Cedar Rapids (319) 362-8155; KENTUCKY, Louisville (502) 893-7303; MARYLAND, Baltimore (301) 825-3330; MASSACHUSETTS, Boston (617) 653-3158; Needham (617) 444-2484; MICHIGAN, Detroit (313) 358-2020; Grand Rapids (616) 451-8901; MINNESOTA, Minneapolis (612) 929-6721; NEW JERSEY, Teaneck (201) 692-0200; NEW YORK, N.Y.C./L.I. (201) 692-0200; Utica (315) 735-5566; NORTH CAROLINA, Raleigh (919) 834-6591; OHIO, Cincinnati (513) 521-2290; Dayton (513) 298-9546; Columbus (614) 888-9396; Cleveland (216) 228-7525; OREGON, Portland (503) 292-5656; PENNSYLVANIA, Willow Grove (215) 674-3850; Pittsburgh (412) 242-0100; TEXAS, Dallas (214) 233-4489; Houston (713) 783-1872; WASHINGTON, Bellevue (206) 455-2778.



# The most versatile multicolor CRT's on display

Special multicolor screens with different color renditions provided by changing voltages make these up-to-the-minute CRT's especially useful in the latest display applications. Air traffic control systems, electronic test equipment, computer displays and many other applications are possible for these tubes.

You can get any of our CRT's (from 4.5" to 25" diagonal) with bicolor or multicolor display screens, a monochrome screen with different persistence phosphor layers, or multicolor screens with variable persistence phosphor layers.

You'll also specially appreciate the high brightness and picture contrast. And you'll like the high resolution, a major feature with THOMSON-CSF cathode ray tubes.

Moreover, your circuit engineer will have the benefit of the low voltage swing required to switch from one color to the other.

For complete information on these and all the tubes in our wide CRT line, circle the Reader Service Card or contact us direct.



See us at FJCC, booth 4518-20



**THOMSON-CSF**

THOMSON-CSF ELECTRON TUBES, INC. / 50 ROCKEFELLER PLAZA / NEW YORK, N.Y. 10020 / (212) 489-0400

France - THOMSON-CSF Groupement Tubes Electroniques / 8, rue Chasseloup-Laubat / 75 015 PARIS / Tél. 566.70.04

Germany - THOMSON-CSF Elektronenröhren GmbH / Am Leonhardsbrunn 10 / 6 FRANKFURT/Main / Tel. 70 20 99

Italy - THOMSON-CSF Tubi Elettronici SRL / Viale degli Ammiragli 71 / ROMA / Tel. 63.80.143

Japan - THOMSON-CSF JAPAN K.K. / Kyosho Building / 1-9-3 / Hiraoka-cho / Chiyoda-ku / Tokyo 〒 102 / Tel. (03) 264-6341

Sweden - THOMSON-CSF Elektronrör AB / Box 27080 / S 10 251 STOCKHOLM 27 / Tel. 08/22 58 15

United Kingdom - THOMSON-CSF Electronic Tubes Ltd / Bilton House, Uxbridge Road, Ealing / LONDON W5 2TT / Tel. 01-579 1857



# Instrumentation amplifier conditions computer inputs

Two-stage amplifier detects more than 100 multiplexed signals at computer-speed scanning rates with minimum noise over wide frequency range; signal levels can range from microvolts to volts

by Thomas C. Lyerly, IBM General Systems Division, Boca Raton, Fla.

□ Since the job of data gathering has become so complex that computers are needed to process measurement information, increasingly stringent performance requirements are being placed on the instrumentation amplifier. A single instrumentation amplifier must frequently accept more than 100 multiplexed signals with levels ranging from a few microvolts to several volts. The amplifier must also reject unwanted noise signals from dc to hundreds of megahertz, as well as provide a noise-free, properly scaled, single-ended output signal that can be sampled quickly for processing.

Precision low-level signal conditioning can be achieved with a two-stage amplifier that employs cascode transistor pairs, degenerative feedback, and balanced frequency compensation to provide exceptional gain-bandwidth performance without gain-adjustment potentiometers. Even in noisy environments, this amplifier can detect microvolt signals at high scanning rates. It can also be adapted for programmable gain selection.

The environment for the precision amplifier is the

computer analog input subsystem, such as the typical one shown in Fig. 1 for the IBM System/7 computer. As many as 128 analog input signals may be connected through single-pole low-pass filters to the multiplexer, which is made up of p-channel MOSFET switches. The multiplexer can handle up to eight parallel groups of signals, with each group consisting of up to 16 parallel channels.

The differential output of the multiplexer is connected to an instrumentation amplifier through a balun transformer that serves as a high-frequency noise filter for the amplifier. Multiplexed analog input signals must be accurately processed by the amplifier at scanning rates as fast as 20 kilohertz without any adverse effects from noise sources that are both external and internal to the analog input subsystem.

External noise may be separated into two types—common-mode, and normal- or differential-mode signals. Differential-mode noise is the easier to reject. It can be filtered by passive low-pass networks located at

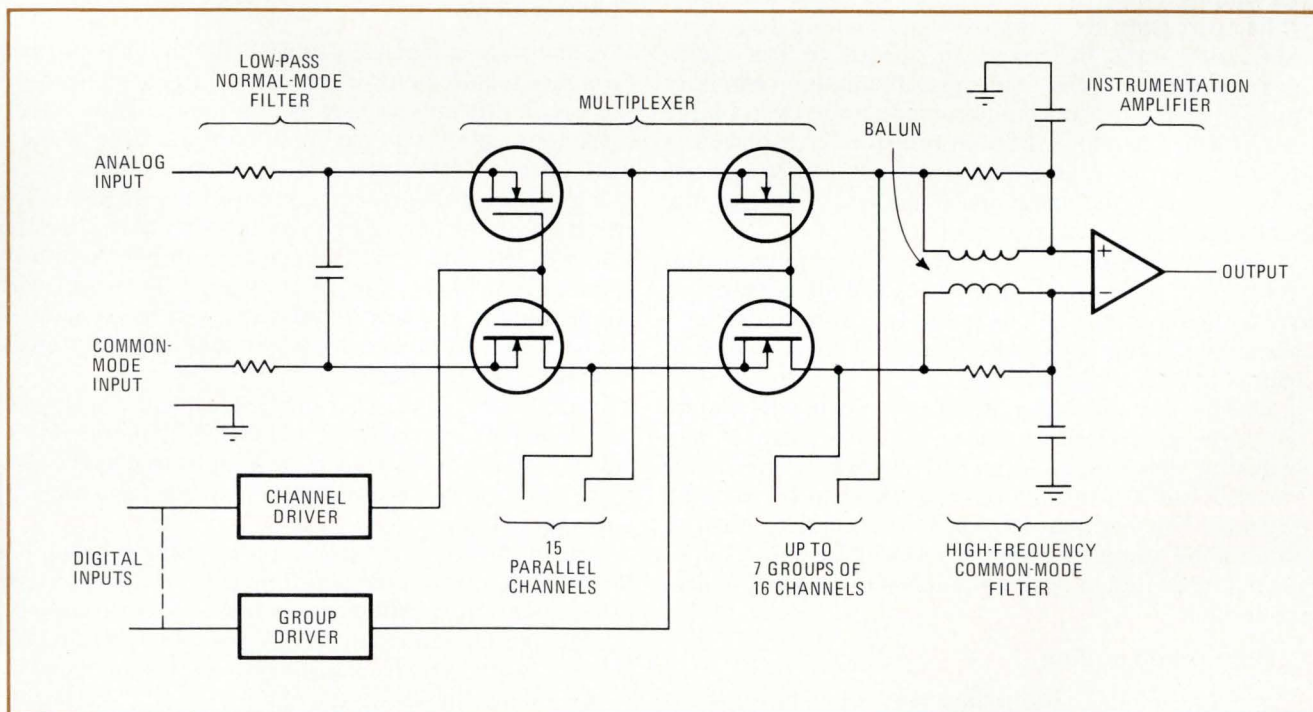

1. The environment. Analog input computer subsystem challenges the instrumentation amplifier. Data is filtered before being multiplexed to eliminate normal- or differential-mode noise. Balun transformer acts as high-frequency common-mode noise filter for the amplifier.



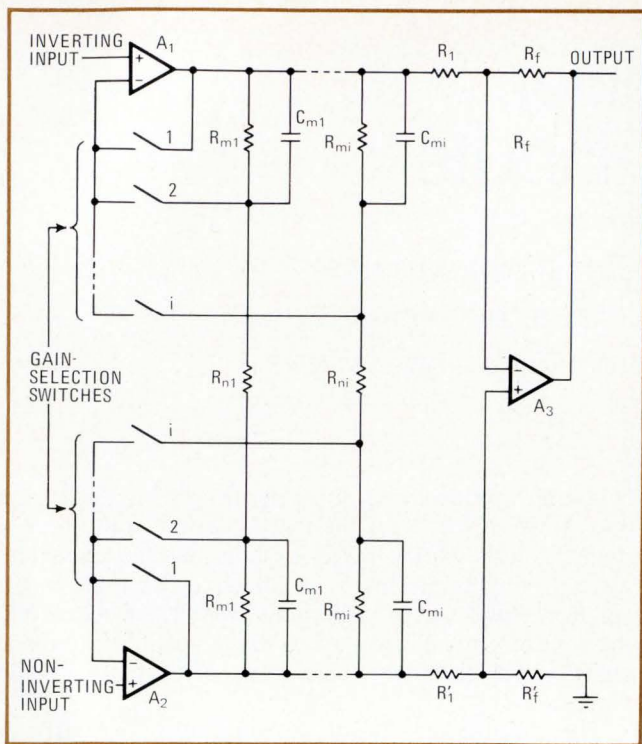

**2. Basic amplifier design.** Double-amplifier input eases demands on individual amplifiers  $A_1$  and  $A_2$ . Amplifier  $A_3$  rejects unwanted common-mode noise signals by subtracting balanced common-mode signals from  $A_1$  and  $A_2$ .

the multiplexer inputs, as shown in Fig. 1, since a given channel is generally sampled at a rate that is much slower than the speed at which the amplifier scans the channels.

Common-mode noise is more difficult to reject because low-frequency common-mode filtering reduces the multiplexer's ac common-mode rejection ratio, while increasing its common-mode settling time. For the analog input subsystem to operate at fast multiplexer-scanning rates, the instrumentation amplifier must be able to reject common-mode noise over a large bandwidth. Therefore, a balun transformer is placed at the amplifier input as a high-frequency common-mode filter to reject the common-mode noise beyond the bandwidth of a practical amplifier.

(This noise is filtered to prevent the amplifier from rectifying rf noise on the input lines and effectively producing dc offset errors. The balun transformer of Fig. 1 is a low-pass common-mode filter with a bandwidth of approximately 5 megahertz.)

Noise within the analog input subsystem, which takes the form of capacitively coupled noise signals and switching transients, is primarily caused by the multiplexer because of the device capacitance of the MOSFET switches. This internal noise source appears to the amplifier to be primarily common-mode noise as a result of the balanced design of the multiplexer and the low-pass input filter.

### Configuration outline

An instrumentation amplifier that provides excellent rejection of unwanted common-mode noise is sketched in Fig. 2. The circuit also offers good gain-bandwidth

characteristics and can be adapted for programable gain selection.

Amplifiers  $A_1$  and  $A_2$  provide the desired input characteristics and signal ranging. A third amplifier,  $A_3$ , acts as an inverting unity-gain device for differential inputs and operates as a precision broad-bandwidth subtractor for unwanted common-mode signals. To reject common-mode signals over a large bandwidth,  $A_1$  and  $A_2$  must perform as broadband unity-gain amplifiers, generating balanced common-mode signals for subtractor amplifier  $A_3$ .

The common-mode rejection ratio of the over-all amplifier can be expressed as:

$$CMRR = \frac{(R_f/R_1)(1 + 2R_m/R_n)}{[(1/CMRR_1 \pm 1/CMRR_2)(1 + 2R_m/R_n)(R_f/R_1) + (R_f/CMRR_3)(R_1 + R_f) + R_f/(R_1 + R_f) - R_f'/(R_1' + R_f')]/R_1'(R_1' + R_f')}$$

where  $CMRR_1$ ,  $CMRR_2$ , and  $CMRR_3$  are the individual common-mode rejection ratios of amplifiers  $A_1$ ,  $A_2$ , and  $A_3$ , respectively.

Other common-mode input errors, not included in this equation, are caused by the voltage-divider effect between the source impedance of each analog input line and the common-mode input impedance of its amplifier. To prevent common-mode signals from being converted into differential signals from source imbalance at the input of the over-all amplifier, amplifiers  $A_1$  and  $A_2$  must maintain a high common-mode input impedance over a large bandwidth.

The high impedance of these two amplifiers also helps the over-all amplifier to reject the transients generated when the multiplexer channels are switched. These transients are caused by common-mode voltages, sometimes as high as 10 volts, that are switched into the instrumentation amplifier inputs at rates that can approach several hundred volts per microsecond.

### The first stage

A first-stage design that satisfies the tough input performance requirements is illustrated in Fig. 3. Basically, the circuit attempts to eliminate amplifier input errors caused by offset voltage, bias current, offset-voltage drift, offset-current drift, and input impedance.

Input offset voltage can be reduced to less than 2 microvolts with the nonlinear potentiometer network of resistors  $R_1$ ,  $R_2$ , and  $R_3$  and the voltage divider set up by resistors  $R_4$  and  $R_5$ . The input-offset voltage drift with temperature is also low because the difference between the base-emitter voltage drops of matched input transistors  $Q_1$  and  $Q_2$  is nearly zero.

Additionally, input bias current can be adjusted to less than 1 nanoampere by parallel potentiometers  $R_6$  and  $R_7$ , which are driven by the high-impedance constant-current source, consisting of cascode transistors  $Q_3$  and  $Q_4$  and resistor  $R_8$ . The potentiometers are also driven by the common-mode input voltage through a feedback network in the emitter circuit of the  $Q_1$ - $Q_2$  input transistor pair. The network, made up of transistors  $Q_5$ ,  $Q_6$ , and  $Q_7$  and resistor  $R_9$ , supplies a constant voltage for biasing resistors  $R_{10}$  and  $R_{11}$  that is independent of the common-mode input voltage.

The input-impedance component of the amplifier from the feedback bias network is several thousand







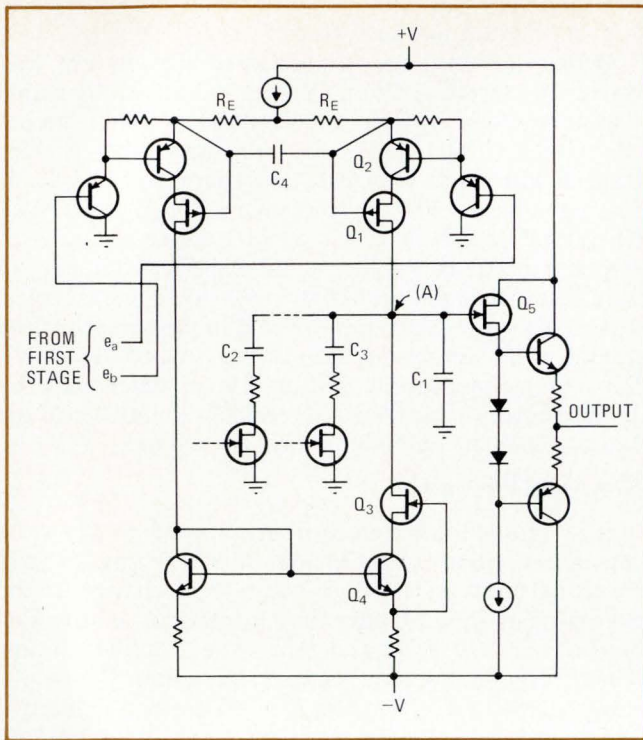

**4. Second stage.** Since this stage can attain voltage gains of several million without losing gain accuracy, gain-adjustment potentiometers are not needed. Circuit gain approximately equals the resistance ratio of high-impedance node A and resistor  $R_E$ .

a relatively high open-loop input impedance.

In a practical amplifier, one that must operate over a wide range of closed-loop gains, the fastest possible response time is achieved for large closed-loop gains by extending the natural break frequencies of the open-loop amplifier to obtain the largest possible gain-bandwidth product. Amplifier capacitance, which determines bandwidth, can then be kept small, and the slew rate, which is also fixed by amplifier capacitance, can be held at a large value.

A high open-loop gain presents a difficult frequency-compensation problem when a fast unity-gain closed-loop response is needed. For example, suppose the same bandwidth must be available from a single-pole 6-dB/octave amplifier for unity-gain operation and for a closed-loop gain of 512. To do this, the amplifier's open-loop gain must be reduced by a factor of 512 at the desired bandwidth by increasing the internal compensation capacitance by a factor of 512. The increase in capacitance decreases the slew rate by a factor of 512 and degrades the unity-gain time response. One solution to the problem is to select the appropriate frequency-compensation components digitally so that the settling time for each gain setting is optimized.

The simplified Bode plots of Fig. 5 show the individual frequency responses of the over-all amplifier, along with the closed-loop responses for unity gain and a gain of 512. The bandwidth for a closed-loop gain of 512 is determined primarily for first-stage capacitors  $C_1$  and  $C_2$  and second-stage capacitor  $C_1$ , all of which assume small values. The 125-kilohertz upper frequency limit is determined by the RC networks of Fig. 2.

The capacitive component and the resistive compo-

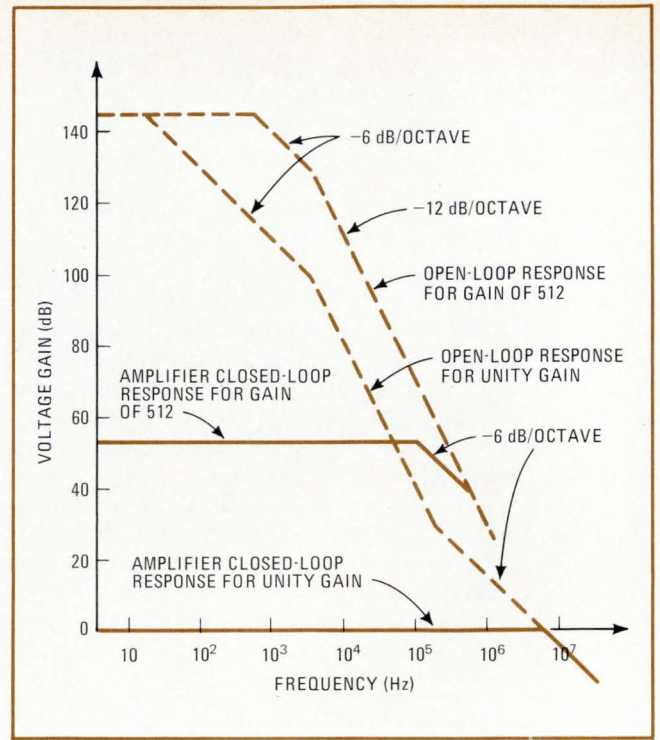

**5. Response curves.** Cascaded first and second stages result in amplifier that maintains its unity-gain bandwidth of almost 10 megahertz over wide range of closed-loop gains. For instance, the upper frequency breakpoint is 125 kilohertz for a closed-loop gain of 512.

nent of high-impedance node A of the second stage establish the first break point of the amplifier. Since the resistive component is very large, the first break point occurs at a relatively low frequency with only a small value of capacitance, thereby permitting slew rates of several hundred volts per microsecond to be realized.

The second break frequency, at around 4 kHz, is determined by time constants  $R_{13}C_1$  and  $R_{14}C_2$  in the first stage. The resulting two-pole response reduces the open-loop gain at a rate of 12 dB/octave, which increases slew rate and the high-frequency loop gain more than the 6-dB/octave rate.

The unity-gain bandwidth can be determined by a lag-lead network that is digitally selected at the high impedance node of the second stage, as shown in Fig. 4. This type of unity-gain compensation has the advantage of a 12-dB/octave rolloff. Unlike the compensation for a gain of 512, the unity-gain compensation increases bandwidth while decreasing slew rate so that the settling times for the two gain settings are approximately the same. Similarly, opposing compensation networks can be traded off for gain values between unity and 512.

Two additional lead-compensation networks in the first stage (time constants  $R_{15}C_1$  and  $R_{16}C_2$ ) and one in the second stage (time constant  $2R_EC_4$ ) complete the over-all amplifier's internal frequency compensation. These three lead networks cancel poles in those cascode transistor pairs that have two natural poles.

The gain degeneration employed throughout the amplifier design stabilizes the lag and lead compensation networks, and provides an over-all gain-bandwidth performance that is determined by passive components, instead of sensitive semiconductor parameters. □



It's either  
**HALF THE PRICE**  
or  
**TWICE AS MUCH**  
for your money...

**OmniScribe™**

10" Strip Chart

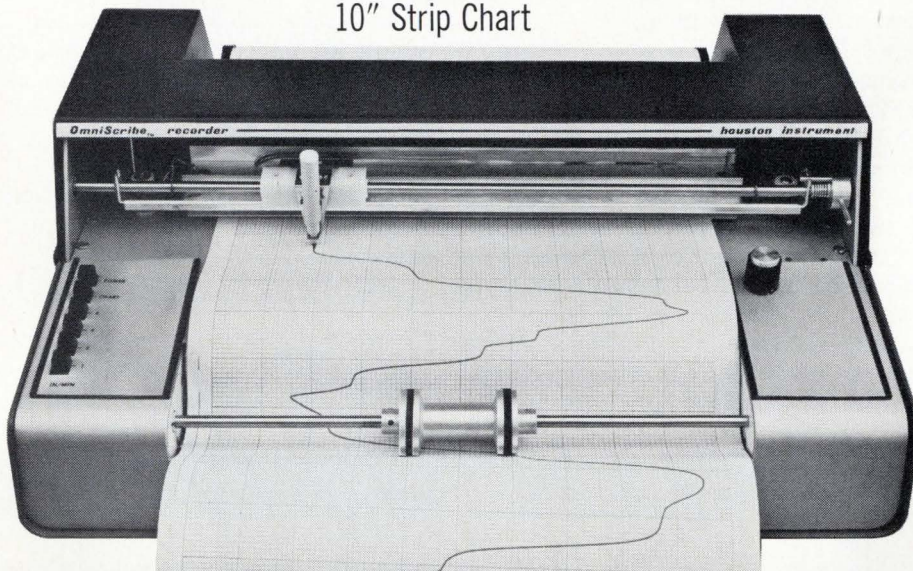

**LOOK CLOSELY & DECIDE**

- 1.** The multi-speed chart drive is the equal of any competitor on the market today. Further, the **OmniScribe™** is field adjustable, precisely for English/Metric scaling. Quick, fast, convenient.
- 2.** Houston Instrument has perfected sprocketless paper drive. It's accurate. It's self-aligning. It works!
- 3.** A unique operating feature is the non-contact re-balance potentiometer. It eliminates cleaning and trace "glitches" forever. It's beautiful!
- 4.** Did we mention the price? Just \$395 for single pen; \$595 for dual pen. With options to \$1400. What's more, all models are available off-the-shelf for immediate shipment.

**THE FULL PRICE IS \$39500**

\*For single pen model

Write today for your complete brochure and price list. The **OmniScribe™** is either half the cost or twice as much for your money. You decide.

**houston  
instrument**

4950 TERMINAL AVENUE, BELLAIRE, TEXAS 77401  
(713) 667-7403 CABLE HOINCO.



## Choosing the best suppression network for your SCR converter

by L.R. Rice  
Westinghouse Power Semiconductor Division, Youngwood, Pa.

Although a wide variety of schemes exists for suppressing the energy transients in semiconductor converters, unfortunately there is no single circuit that fits all needs. Instead, the design engineer must select that network that best suits his particular requirement.

Transients in most power systems arise from rapid electrical-circuit changes, such as energizing and de-energizing of a reactive circuit. Conventional RC suppression circuits will limit the magnitude or rate of rise of transient waveforms, but thyristor circuits generally require controlling the slope of transients. Diodes use shaping to reduce recovery losses.

Inductance is a convenient point to start looking for transient generation. In any practical circuit, a finite inductance exists. This may be caused by the wiring bus, transformer leakage reactance, or an inductance purposely designed into the circuit, such as the transformer windings or a filter choke used in the power supply.

Voltage transients can be caused by interruption of the power-transformer magnetizing current (either opening or closing the on-off switch in the primary winding) by a switching rectifier with an inductive load across the input, or by load switching. Also a  $dv/dt$  switch transient can be caused by closing of primary switch or when operating with a fuse, but without a filter network. Load-generated transients, such as over-voltage due to switching of motor load and resulting regeneration, however, pose less of a problem, since they can be easily suppressed by clamping diodes or a dissipative network.

In thyristor circuits, an inductor may cause false anode firing via  $dv/dt$  transients. For many circuits, simple RC filters may not sufficiently suppress the transient. This is especially true for converters operating from high-kVA transformerless connections. In these instances, the high device impedance and low bus inductance do not provide enough of a voltage drop, and  $dv/dt$  transients as high as 1,000 volts/microsecond can occur. □

### BIBLIOGRAPHY

- "Westinghouse SCR Designers' Handbook," 2nd ed., 1970.
- John B. Rice, "Design of Snubber Circuits for Thyristor Converters," Proceedings of IGA, 1969, pp. 485-489.
- J. B. Rice and P. G. Phillips, "A System for Recording Thyristor and Rectifier Current Waveforms," IGA Transactions, 1968.

Engineer's Notebook is a regular feature in Electronics. We invite readers to submit original design, applications, and measurement ideas. We'll pay \$50 for each item published.

### FUNDAMENTAL SUPPRESSION AND PROTECTIVE SCHEMES FOR SCR CIRCUITS

Circuit									
Use	Clamps voltage across SCR to less than its rated forward blocking voltage, $V_{DRM}$	Varistor to increase dissipation with high voltage	Convert transient voltage to charging current and lower transient magnitude	Same as capacitor, but controls $dv/dt$ shaping with lower $di/dt$	Similar to RC types, but on high kVA sources, the induction provides regulation to allow the RC to work and lower surge current	Similar to linear inductor but sat. reactor lowers size and cost	Same as RC types, but allows high charging current and low $di/dt$	Same as capacitor-type for series connection where $R1 \gg R$ , and $C2 \gg C1$	Same as RC circuit, but with overvoltage protection that causes SCR to turn on before $V_{DRM}$ is reached
Circuit limitations	Does not control $dv/dt$	Does not control $dv/dt$	Causes high $di/dt$ and peak current, needs some line impedance to slow down $dv/dt$	Requires a compromise between allowable amounts of $dv/dt$ and $di/dt$	If reactor must support large line voltage and current loads, it will be expensive and bulky	Usually requires large reactance to minimize initial current surge. This can be expensive and bulky	D1 recovery time must be $< 1 \mu s$ or a high $di/dt$ results	Diodes in the bridge must have recovery times $< 1 \mu s$ to minimize $di/dt$	C1 and C2 must be selected to trigger SCR; large values of C2 can cause $di/dt$ problems
Size <sup>1</sup>	6	7	9	8	1	3	5	2	4
Cost <sup>1,2</sup>	5	6	9	8	1	3	7	2	4
Complexity <sup>1</sup>	6	7	9	8	4	5	3	1	2

Notes: 1. Ranked in descending order 2. 100-A rms device



# Testing power supplies quickly and cheaply

by L. Tatapudi  
Washington State University, Pullman, Wash.

In only a few minutes, the line and load regulation of a precision regulated power supply can be measured with an inexpensive test circuit. Usually, expensive test equipment is needed to detect a change of a few millivolts in the supply's output of a few tens of volts. The test circuit shown, (parts less than \$30), permits accurate measurements to be made with a dc voltmeter by amplifying the change in power-supply voltage.

The output voltage of the operational amplifier is nulled to zero by adjusting potentiometer  $R_P$ .

$$V_o = V_2(1+G) - V_1G$$

where  $V_1$  represents the output of the supply under test,  $V_2$  the null reference voltage, and  $G$  the closed-loop gain of the op amp. If the supply's load and/or line voltage changes, the op-amp's output becomes:

$$V_o = V_2(1+G) - (V_1 - \Delta V_1)G = \Delta V_1G$$

which is simply the change in supply voltage,  $\Delta V_1$ , amplified by op-amp gain  $G$ .

To measure load regulation, adjust potentiometer  $R_P$  until a null is obtained at the circuit's output with switch  $S_1$  open. Then close the switch, read the volt-

meter, and divide this reading by op-amp gain  $G$  to find the change in supply voltage. Similarly, line regulation is measured by leaving switch  $S_1$  open, changing the supply's ac line voltage from one value to another, and then dividing the resulting voltmeter reading by  $G$  to determine the supply's output change.

Op-amp gain, of course, is simply the ratio of feedback resistance to input resistance:

$$G = (R_f + R_{fp})/R_1$$

For the component values noted, a gain of 100 can be obtained. The circuit equations are accurate within 0.01%, even for a gain of 1,000, provided that the op-amp's open-loop gain is about 100 decibels.

The reference supply voltage,  $V_{REF}$ , should be at least equal to the output voltage of the supply under test. To measure supply stability, a standard cell can be substituted for  $V_{REF}$  and the test run in a reasonably constant ambient environment. Also, components that have low temperature drift should be chosen.

Measuring the supply's temperature coefficient is similar to the regulation measurement. The test circuit should be removed from the test power supply and kept at a reasonably constant ambient temperature.

If an op amp with a drift of 2 microvolts/ $^{\circ}C$  is used, and if temperature varies by  $50^{\circ}C$ , then the circuit's offset voltage drifts by  $10 \mu V$ . This change is considerably less than the output-voltage shift of most precision supplies over an eight-hour period or over a temperature range of  $0^{\circ}C$  to  $70^{\circ}C$ . The error introduced by the circuit, therefore, becomes practically negligible. □

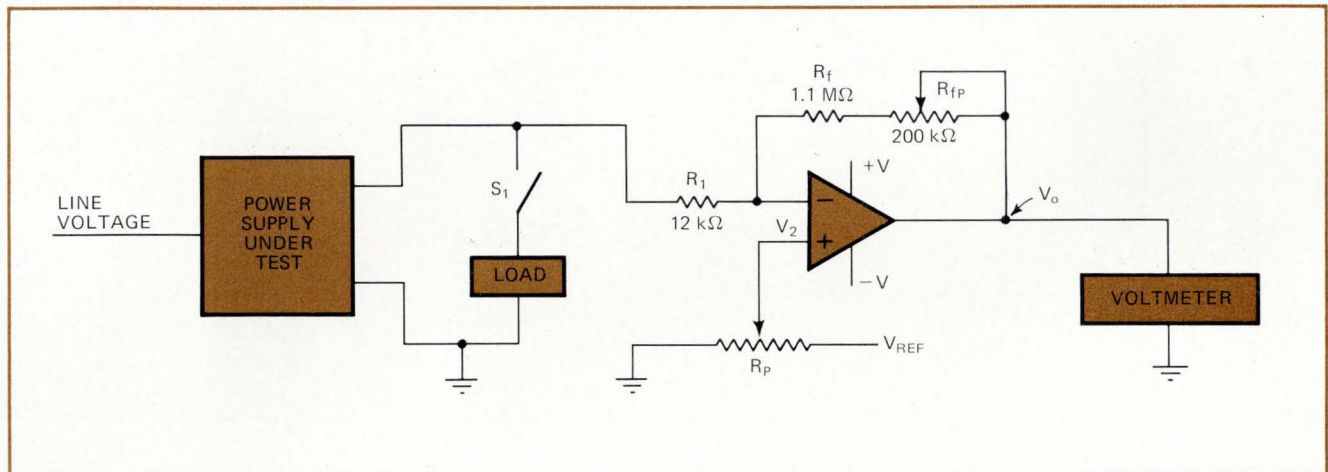

**Regulation check.** Power-supply line and load regulation can be accurately determined by amplifying supply's output voltage change.

# Comparing coaxial cable shielding effectiveness

Radiation from coaxial cables has always been a concern of design engineers. That concern has been intensified by the most recent FCC document on cable TV sys-

tem radiation, which all CATV systems must now meet. And although these requirements apply to the CATV system as a whole (the cable, connectors, splitters, amplifiers, and other components), the allowable radiation levels for coaxial cables must be kept to a minimum for good shielding effectiveness.

Whether you're looking for a low-cost coaxial cable for short runs that will meet the FCC specification, or merely comparing effectiveness of the different shielding configurations, the following curves should prove helpful. The curves supplied by Belden Corp.'s Electronic division, Chicago, show the results of shielding



effectiveness tests on RG/59/U-type CATV drop cable (for short runs from main cable to a subscriber's house) from 5 megahertz to 270 MHz.

The top curve illustrates the relative effectiveness of a shielding configuration consisting of Belden Duofoil film-sandwiched aluminum foil, plus a 61% shield coverage of tinned copper braid. The other two curves detail the isolation performance of 59/U-type CATV drop cables without foil and with different amounts of tinned-copper-braid shield.

The middle curve details isolation versus frequency

for a cable with 94.5% coverage braid (this kind is usually specified by the military services). The lower curve illustrates the shielding effectiveness of the same grade and style of cable, but with a relatively open 55% coverage braid.

All the curves dip in their values of isolation at about 70 MHz and 200 MHz. These dips result from quarter-wave resonance inherent in the 3-foot cable sample. Changing the sample length does not eliminate these resonance dips—it only alters the frequencies at which they occur. □

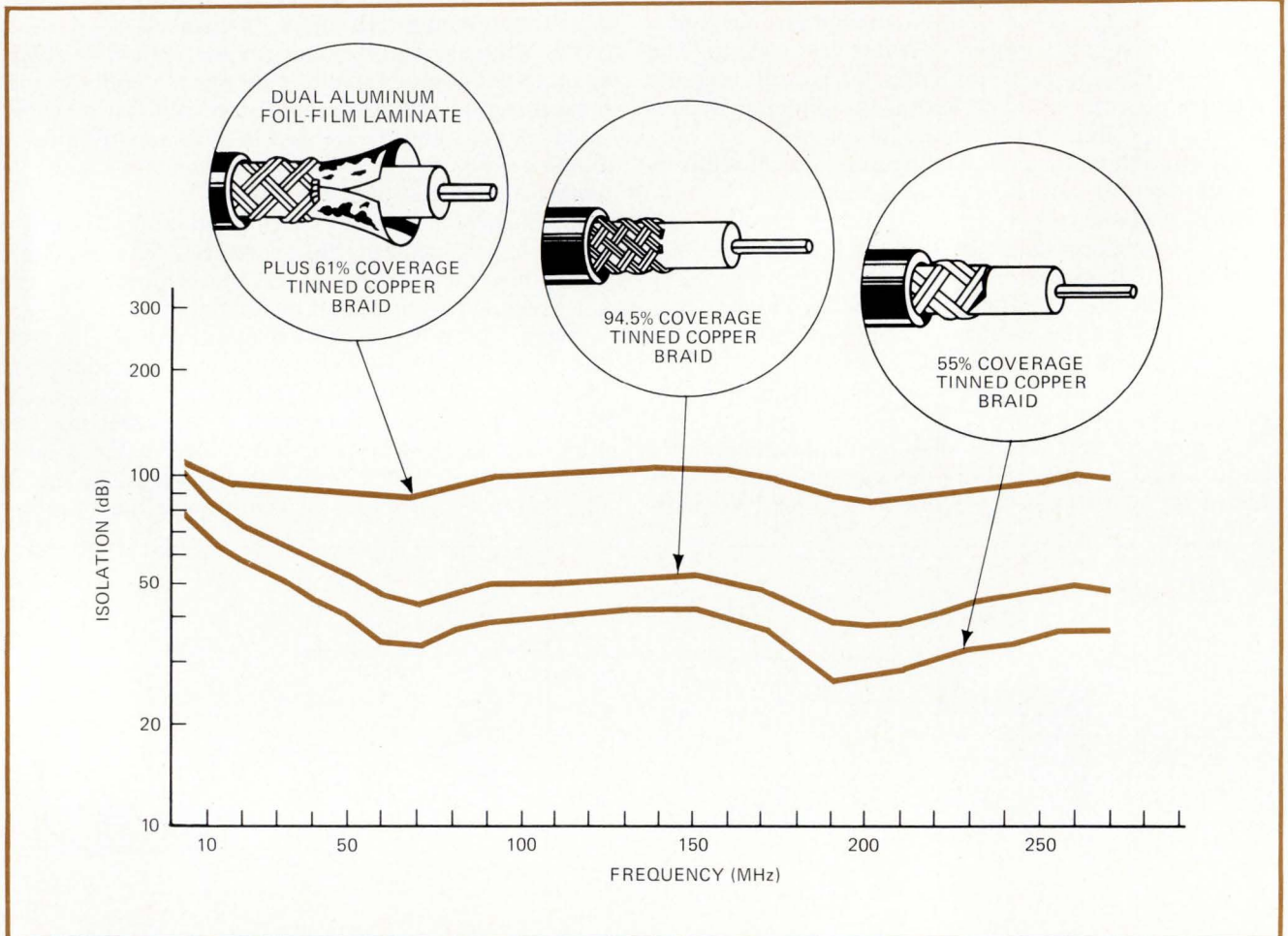

The *Electromagnetic Spectrum Chart*, published in the Sept. 25, 1972 issue of *Electronics*, contained several errors. Corrections for the more significant of these are listed in the table below, which can be clipped and affixed to the bottom of the chart for permanent reference.

FREQUENCY ALLOCATION	CORRECTION	FREQUENCY ALLOCATION	CORRECTION
640 & 1240 kHz	Delete reference to Civil Defense stations.	466 MHz	Change to 460 MHz.
(21.870–22.0)MHz	Change note "Also aero fixed" to "Aero fixed only."	(460–470)MHz	Should indicate land-mobile and meteorological satellite. Delete mobile satellite allocation. Band is non-Government only.
(121.975–123.075)MHz & (123.575–136)MHz	Should indicate both aeronautical mobile and aeronautical mobile satellite.	(1535–1660)MHz	See correction to 15.4–15.7-GHz allocation.
(137–138)MHz	Should show meteorological satellite instead of mobile satellite	(2500–2535)MHz	Should show broadcast satellite, fixed and fixed satellite uplink only. Delete amateur-satellite designation.
(225–328.6)MHz	Add mobile satellite.	(15.4–15.7)GHz and (15.7–17.7)GHz	Notes should be applied to bands between 1535–1660 MHz. Notes "Proposed collision-avoidance systems" and "Radar altimeters" should be applied to band 1558.5–1636.5-MHz.
(335.4–399.9)MHz	Change amateur satellite to mobile satellite.		
(406–406.1)MHz	Change note "Meteorological satellite" to "Mobile satellite."		



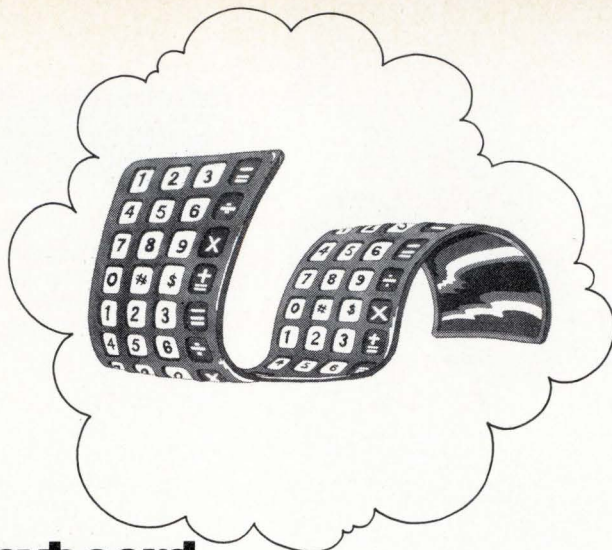

## Tomorrow's keyboard.

(We left most of the key parts out.)

All the moving parts, for example.

And most of the expensive ones.

Instead we used unique, highly conductive elastomer materials, and thereby ushered in a new era.

We call this the Chomerics EF Keyboard. It's fail-proof, less than 3/16" thick, and it comes in any configuration you want to dream up.

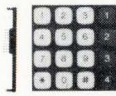

For calculators, communications equipment, special function terminals. For a price you won't believe.

The EF is the most revolutionary design/function keyboard in the world. Pretty soon everybody will be trying to make keyboards like it.

Meanwhile you'll have to come to us.

**CHOMERICS** 77 Dragon Court,  
Woburn, MA 01801 / (617) 935-4850

Chomerics knows keyboards like a book. You can have copies of our literature for the asking.

Circle 167 on reader service card

**TEST CLIPS**  
After 100,000 wire insertions and removals contact resistance registered less than .001 ohms.



**BI-PIN LAMP SOCKETS**  
Features 4 point PC mount for stability.



**TRANSISTOR SOCKETS**  
Minimum insulation resistance of 500,000 meg-ohms at 100 VDC.



**BINDING POSTS**  
Caps won't melt at soldering temperature.



## Even hardware can be different

Grayhill is in termination hardware because our customers wanted something different.

And products and features shown above reveal only part of the picture.

Grayhill makes 100 other items of termination hardware—developed for superior insulation, dielectric strength, minimum contact resistance. And if what you need isn't in our line now, we can design and make it for you.

For our latest Engineering Catalog write or phone:  
Grayhill, Inc., 523 Hillgrove Ave.,  
La Grange, Illinois 60525.  
(312) 354-1040.



### NEW Heathkit 2½ Digit DMM

only **79<sup>95\*</sup>**



A compact, solid-state multimeter with digital readout — at a fantastic kit-form price. The new Heathkit IM-1202 has four overlapping ranges to measure voltages from 10 mV to 1000 V on DC (either polarity), 10 mV to 700 V rms on AC, 10 uA to 2.5A on AC or DC current. Five resistance ranges measure from 1 ohm to 2.5 megohms. Front panel polarity switch reverses inputs without changing leads. 6 lbs.

### NEW Heathkit 30 MHz Counter

only **169<sup>95\*</sup>**



The Heathkit IB-1100 gives 1 Hz to over 30 MHz counting on a full 5-digit readout with 8-digit capability. The lighted overrange indicator makes misreading virtually impossible. Stable time-base circuitry assures accuracy better than ±3 ppm from 22° to 37° C. Diode protected J-FET gives improved triggering over 100 mV to 150 V input range. Solid-state circuitry mounts on one large board for easy assembly. 6 lbs.

### Send for FREE '73 Catalog

HEATH COMPANY, Dept. 53-11  
Benton Harbor, Michigan 49022

HEATHKIT  
Schlumberger

- Please send FREE Heathkit Catalog.  
 Enclosed is \$ \_\_\_\_\_, plus shipping.  
Please send model(s) \_\_\_\_\_

Name \_\_\_\_\_  
Address \_\_\_\_\_  
City \_\_\_\_\_ State \_\_\_\_\_ Zip \_\_\_\_\_

Prices & specifications subject to change without notice.  
\*Mail order prices; F.O.B. factory.

TE-275

Circle 168 on reader service card

Circle 123 on reader service card 123



# Three Simple, Safe



## Temperature Indicators for Electronics

Let you know when rated temperature is reached . . . with an accuracy of  $\pm 1\%$

**1. TEMPILABELS<sup>®</sup>:** self-adhesive temperature monitors consisting of one or more heat-sensitive indicators sealed under transparent, heat resistant windows. The centers of the indicator circles turn from white to black irreversibly at the temperature ratings shown on the label. Tempilabels<sup>®</sup> are available in several sizes, and in single or multiple temperature ratings from 100° to 500°F. Accuracy is within  $\pm 1\%$  of the stated rating. They are particularly useful for monitoring operating temperatures of equipment or processes; obtaining temperature data of components as a guide to design and material selection; safeguarding temperature-sensitive materials in storage or transit. To serve as a permanent record, Tempilabels<sup>®</sup> can be removed from the surface and attached to a report.



**2. TEMPILAQ<sup>®</sup>:** materials of calibrated melting points suspended in an inert, volatile non-flammable vehicle. Available in over 100 systematically spaced temperature ratings from 100° to 2500°F. Tempilaq<sup>®</sup> indicates its temperature rating by liquefying within  $\pm 1\%$  of its rating. Available in bottles or spray cans.

**3. TEMPILSTIKS<sup>®</sup>:** temperature-indicating crayons of calibrated melting points. Available in over 100 systematically spaced temperature ratings, Tempilstiks<sup>®</sup> cover the range from 100° to 2500°F. Tempilstiks<sup>®</sup> indicate the specified temperature, by liquefying with a tolerance of  $\pm 1\%$  of its rating.

Detailed data and price sheets as well as samples are available upon request.



**Tempil<sup>®</sup>** DIVISION, BIG THREE INDUSTRIES, INC.

Hamilton Blvd., South Plainfield, N. J. 07080  
Phone: 201 • 757-8300 • Telex: 138662

15914

# COMPRESSED VIDEO

- Starts with a standard CCTV camera
- Ends on the screen of a standard CCTV monitor
- Uses "dial up" voice grade telephone circuits in the middle
- Is a highly flexible alternative to facsimile or the Picture Phone

The CVI 200 series Video Converters provide for single frame TV picture transmission over audio bandwidth circuits. Options include multiple image storage, hard copy, computer I/O, and color.

Video instruments for data acquisition, processing, transmission, and display.

**cv**i

Colorado Video, Inc.  
Box 928 Boulder, Colorado 80302  
(303) 444-3972

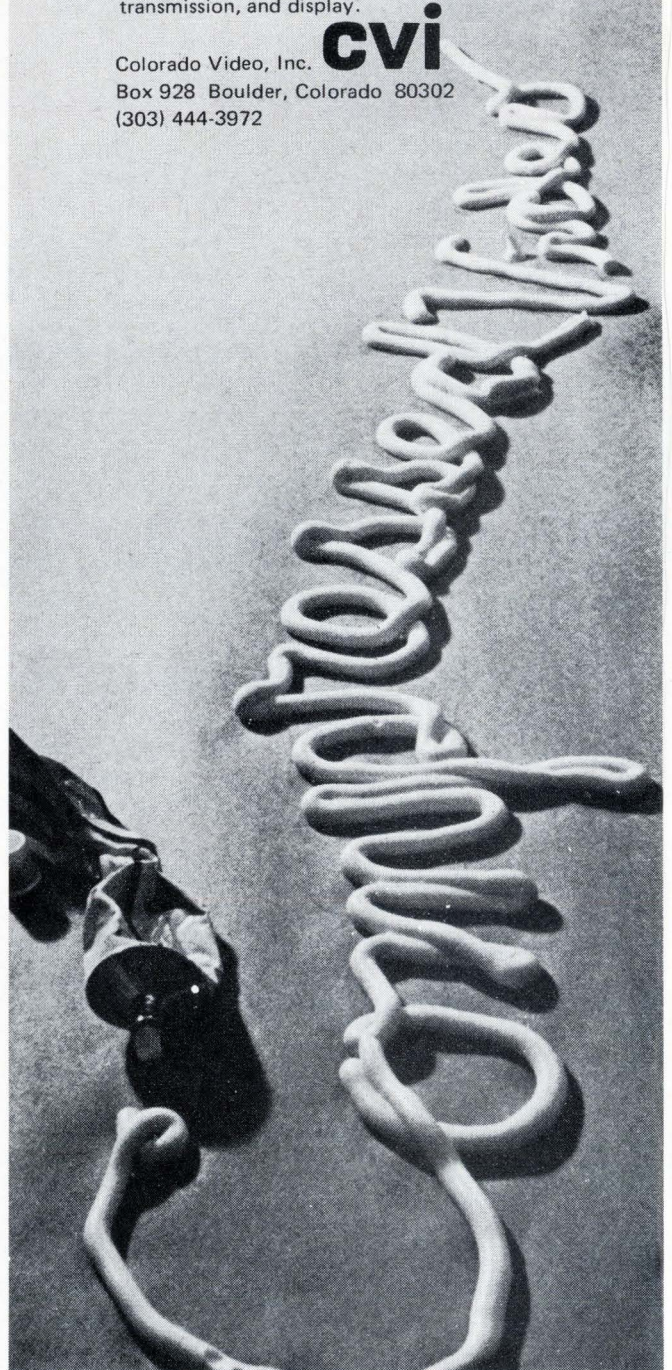



## Computerized data bank offered for power transistors

If you need a power transistor, Motorola Semiconductor has a new computerized information bank available to anyone with a time-sharing computer terminal and telephone coupler. **There are actually two services**—if you have some specs and need to find a type number, you feed in typical parameters—such as  $I_c$ ,  $V_{ce0}$ , and  $h_{FE}$ —and the computer lists a number of devices, along with other relevant parameters. Conversely, if you key in a type number, including house numbers from other companies, the computer supplies suitable substitutions with specs—including transistors with relaxed parameters, but consequent lower cost.

The access number is 602-949-7000 (10 characters per second) or 602-949-4221 (30 characters per second), and the computer gives the instructions after you push the originate button on your terminal. **There's no charge, other than for the telephone call.**

## Guide available to control systems

Designers of electromechanical control systems should be interested in a new 12-page guide to electric and electrohydraulic automation that is being offered without charge by Honeywell's Apparatus Controls division, 2727 South Fourth Ave., Minneapolis, Minn. 55408. Entitled "Factory Machinery Controls," **the illustrated guide consists mainly of schematic diagrams of systems for controlling such factors as speed, position, force, power, torque, and pressure.**

Each diagram is accompanied by a brief description of system operation and key design considerations. Two pages of the guide are devoted to applications formulas and conversion data. Another two pages contain Honeywell catalog information.

## Glass-free gold pastes aid bonding

A new family of glass-free gold conductor pastes for application directly on alumina and beryllia ceramics is available from the Electronic Materials division of Owens-Illinois in Toledo, Ohio. The line is called Au 99+.

Glass-free pastes have many advantages. **Since there's no glass to interfere with bonding at the upper surface, silicon die bonding and thermo-compression wire bonding are easier.** The elimination of glass also does away with the major contributor to resistor and dielectric incompatibility. What's more, the absence of glass at the gold-ceramic interface avoids the significant thermal barrier usually found in thick-film pastes. This, says Owens-Illinois, permits up to 30% greater dissipation of heat.

## Seminar scheduled on sampled-data techniques

Attention, all cost-conscious computer users: a seminar called "Recent Developments in Modern Numerical Methods" can help computing costs by teaching you how to use sampled-data techniques to simulate either continuous or discrete processes. The three-day seminar, which will be held in Los Angeles from Dec. 11 to 13, **will cover digital and hybrid simulation, digital and hybrid control systems, problem solving on minicomputers, and applied numerical analysis.** Software Research Corp., P.O. Box 24564, St. Louis, Mo., is sponsoring the course. The fee is \$235.



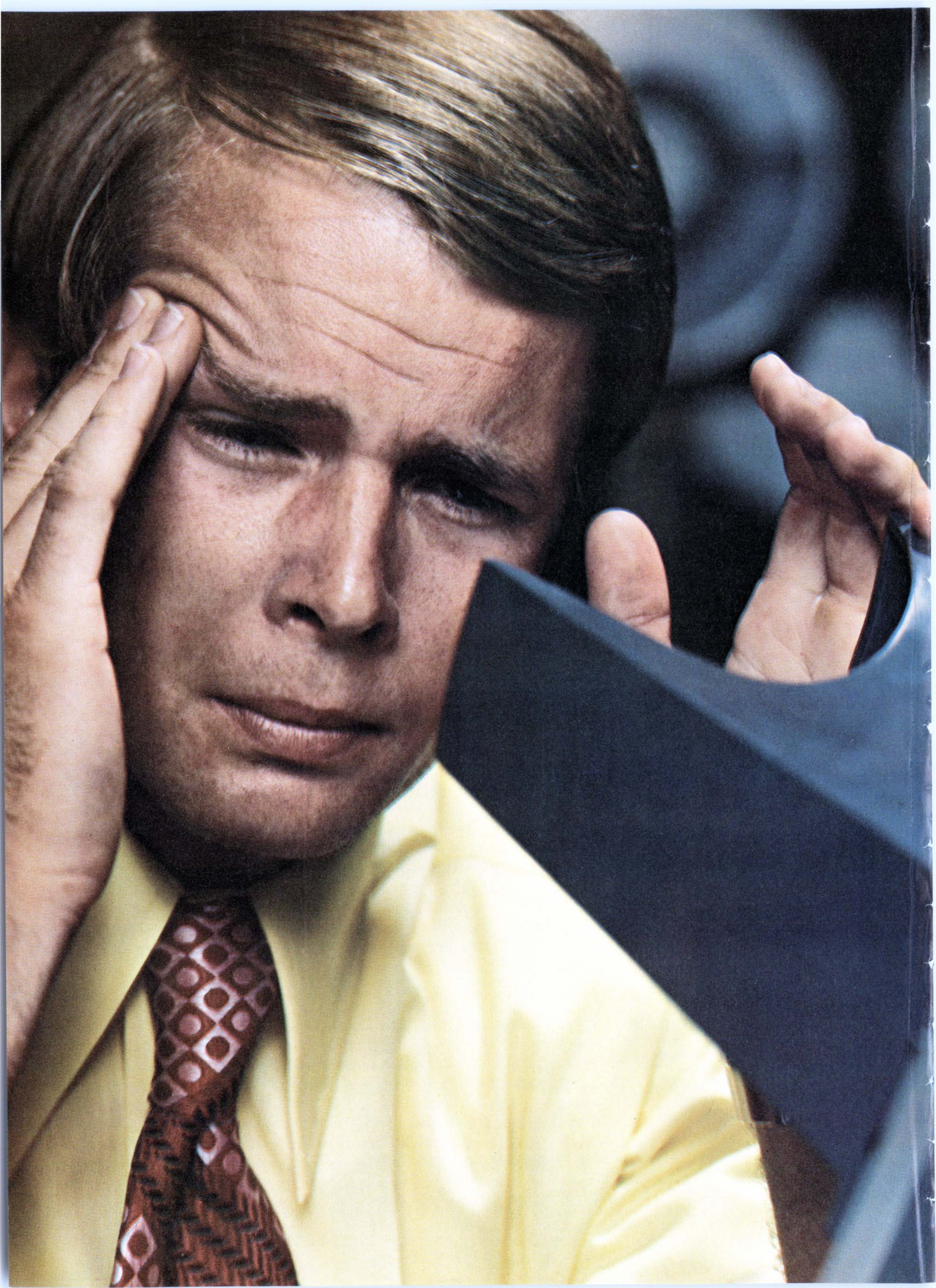



# Think Twice:

## What's one of the biggest measurement problems in the computer industry today?

### Low Duty-Cycle Measurements—

Making timing-pulse adjustments, and finding noise pulses in, or locating missing bits from low duty-cycle digital signals. Countless lost hours and eye-strain have resulted from this problem—trying to view low rep-rate signals like those found in disc, tape, or drum peripheral units. But with your refresh cycle occurring at such long intervals, coupled with short phosphor persistence, it's no wonder that you've spent an inordinate amount of time making such measurements. And it's no wonder that you often came out from under your scope hood rubbing your eyes. Well, no more!

**Storage CRT With Unmatched 400 cm/μs Writing Speed.** Hewlett-Packard just made it possible for you to throw away your scope hood by developing a new bright, burn-resistant, high-speed, variable-persistence CRT—available in either 100 cm/μs or 400 cm/μs writing speeds. Placing these new CRT's into an all new mainframe that's optimized for high-writing-speed storage measurements, HP now gives you a new dimension in storage scopes—the HP 184A. This unique combination offers the highest writing speed available, and a display with brightness as great as you can find anywhere. For the first time you can find those elusive transients that before were too fast for your storage scope to follow—like nanosecond noise pulses.

**Display True Replicas of Your Waveforms.** You'll appreciate being able to adjust persistence down to 0.2 seconds; that's 75 times lower than a major competitive unit. For those measurements that require faster sweep times, you'll know you are displaying true replicas of your waveforms when you're using an HP 184A. Capture low duty-cycle pulse trains, through repetitive sweeps, simply by adjusting the persistence to

“maximum,” to build up the intensity of dim traces. This feature in the new 184A oscilloscope lets you do many jobs you previously allocated to expensive, single-shot scope/camera systems.

**Variable-Persistence Storage and Standard in One Scope.** Further, you'll find that your 184A is a true general purpose scope that offers you the capability to choose, by way of plug-ins, all the functional features of the HP 180 Series of oscilloscopes, including such items as selectable-input impedance, and sampling to 18 GHz. And for simplicity of operation, we think you're in for a pleasant surprise when you compare the 184A against the competitive unit.

**Superior Technology.** HP believes the most important part of a scope system is the CRT—the interface between you and your measurement. As the pioneer in practical applications of dome-mesh magnification, HP was first to expand the size of high-frequency CRT's to 6 x 10 cm; first to 8 x 10 cm; and first to 10.4 x 13 cm—all in high-frequency mainframes. HP was also the first to use dome-mesh technology to substantially lower power requirements for CRT deflection (making possible the only line of 35 and 75 MHz portable scopes with built-in battery packs—scopes that really are portable).

**From The Storage Leader.** HP was first with variable-persistence mesh storage for commercial applications—to give you a stored trace many times brighter than bi-stable tubes, and without annoying flicker. Variable-persistence, with its ability to build up waveform brightness, was the first CRT innovation that gave you a trace bright enough to let you tackle most single-shot or low rep-rate measurements problems. All you do is adjust persistence until the integrating storage effect brings your waveform up to a bright, clear display.

**Burn-Resistant CRT's.** HP placed variable-persistence in many of its scopes including the 181A, 1702A, and 1703A storage units. And now HP has developed, for its current line of storage instruments, carefree CRT's so highly burn resistant they require little more care than conventional CRT's. The new 184A high-writing-speed scope also has unprecedented inherent resistance to burns.

**Yes, Scopes Are Changing.** How many times have you wished for a scope that could display a low rep-rate digital signal brightly and clearly, and one that could also be used for a variety of general purpose measurements. That scope is here now in HP's 184A storage mainframe, \$2200 (for only \$500 more, you can boost your 184A's writing speed to 400 cm/μs), with plug-in capability to 100 MHz real time, or 18 GHz sampling. Think twice; put away your scope viewing hood and call your local HP field engineer for a demo today. Or write for our “No Nonsense Guide to Oscilloscope Selection.” It covers the other members of HP's variable-persistence storage scopes. Hewlett-Packard, Palo Alto, California 94304. In Europe: P.O. Box 85, CH-1217 Meyrin 2, Geneva, Switzerland. In Japan: YHP, 1-59-1, Yoyogi, Shibuya-Ku, Tokyo, 151.

**Scopes Are Changing;  
Think Twice.**

HEWLETT  PACKARD

OSCILLOSCOPE SYSTEMS



# New from Amphenol's Spectrum

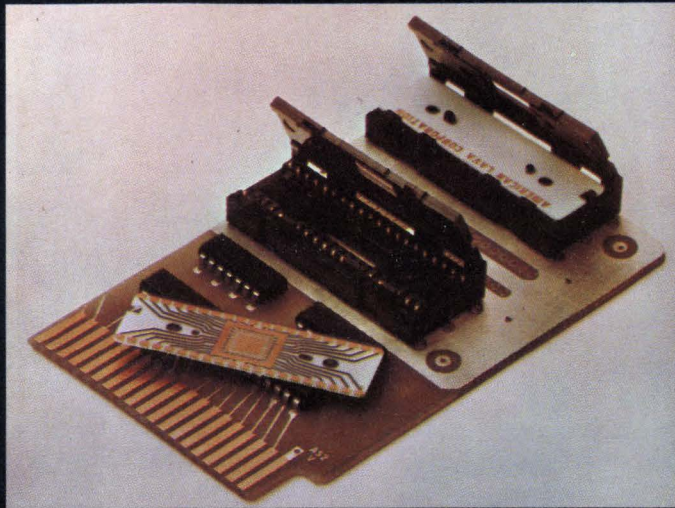

**level 1** MOS/LSI Planar Plug-In connectors (above) for leadless, flat mount ceramic substrates. Permits fast, easy replacement of IC package, no screws, has snap-down lid. ■ Free-standing terminal (below) terminates IC's to PC boards for lowest total systems cost.

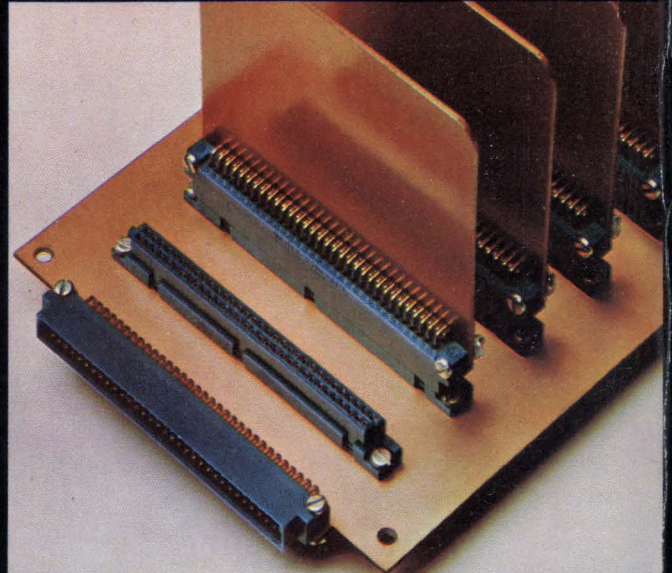
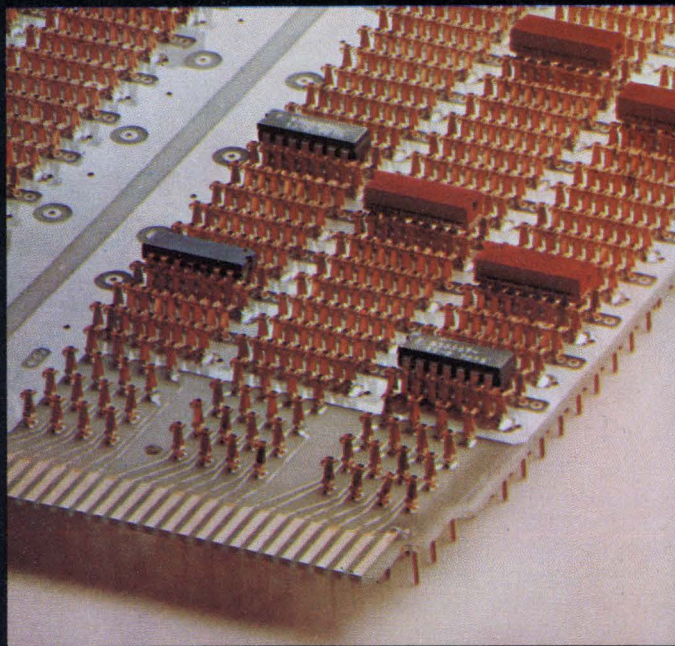

**level 2** Box contact connectors (above) intermate with .025" square or round contacts. Low insertion force. Terminations for crimp, wire wrapping or wave solder. ■ Zero insertion force connectors (below) improve PC board and connector life by eliminating strain and wear.

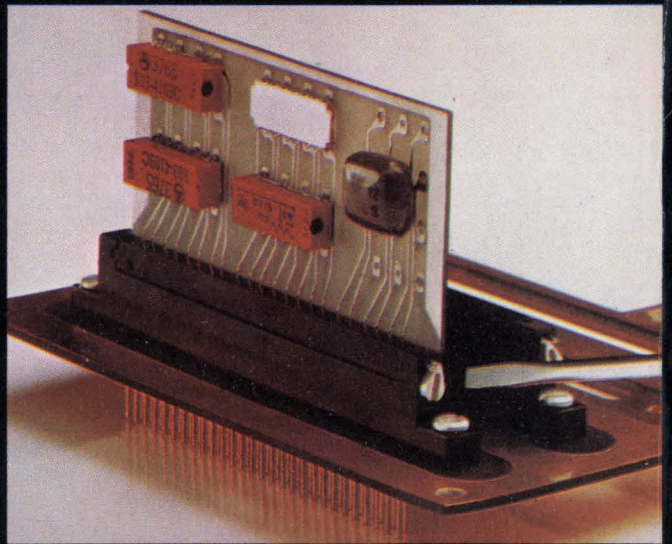

Above are seven new ideas from Amphenol Industrial Division's Spectrum of interconnection capability.

Amphenol's SPECTRUM offers you *all four* levels of interconnections from our unmatched breadth of product line:

**Level 1 . . . DEVICE TO BOARD OR CHASSIS.** We offer interconnections for components such as tubes, relays, transistors, IC packages, trimmers, resistors or capacitors to a PC board or chassis.

**Level 2 . . . BOARD TO MOTHERBOARD OR BACK PLANE.** We offer interconnections for PC boards or

other sub-circuit modules to a motherboard or to a back plane.

**Level 3 . . . MOTHERBOARD OR BACK PLANE WIRING.** We offer interconnections for levels to each other and to other sub-circuits with multi-layer circuit boards, wire wrapping, clip terminations, jumper techniques and dip-soldering.

**Level 4 . . . INPUT/OUTPUT CONNECTIONS.** We offer interconnections for power and signals to and from a system. This interface may be between sub-assemblies within the same enclosure or between individual units.



# of interconnections.

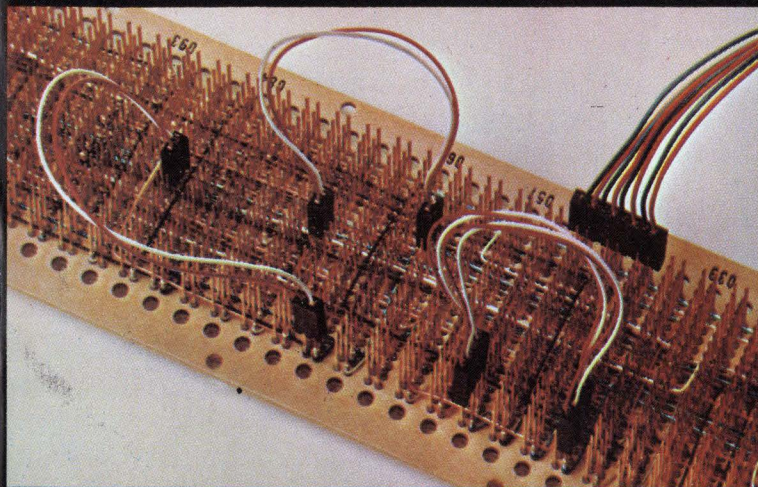

level **3**

Low cost strip connectors (above) are used as jumpers in back plane wiring. Intermates with .025" square or round posts. ■ Circuit Concentration Bay (below) consists of wire wrappable panels that are five times as compact as the telephone distribution frames they replace.

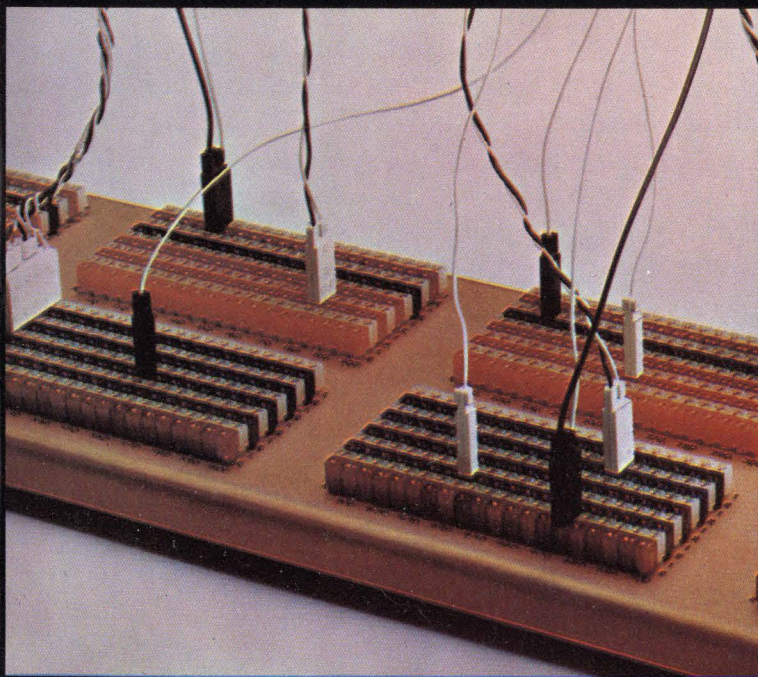

level **4**

Modular Integral Connector concept lets you make your own pin & socket connector to fit your needs. Five contact sizes, thousands of combinations. Sufficient components for six connectors in handy MIC-KIT. Design and assemble your own prototypes.

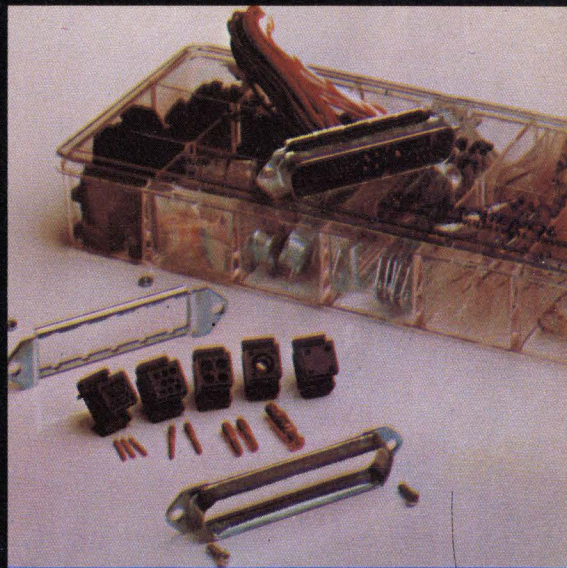

From the simple tube socket—to a myriad of electrical/electronic connectors—to complete and complex termination systems . . . SPECTRUM.

But SPECTRUM is far more than products. It is a depth of capability in engineering, manufacturing and quality control. Amphenol's SPECTRUM is a new height of service, availability and distribution backed by seven Amphenol interconnection-oriented divisions.

Amphenol can fulfill your total interconnection requirements because we are not limited to specifics such as one or two product lines, one or two levels.

Therefore we approach your interconnection needs with complete open-mindedness.

For more new ideas and specific information, write for your copy of "SPECTRUM." Amphenol Industrial Division, Bunker Ramo Corp., 1830 South 54th Ave., Chicago, Illinois 60650.

**BUNKER  
RAMO**

# AMPHENOL



# Do you own a

**I**f you do, you are fortunate.

If you do not, you are unfortunate. Because whether you own one or not, you are most assuredly helping to pay for one.

Somebody has to. A featherbed is an unnecessary job that pays somebody for doing nothing. And for every somebody who is paid for *not* working, there has to be a somebody who *does* work, to foot the bill.

There are all kinds of featherbeds in this rich and benignly negligent country.

The most visible, and the most publicized, carry a union label. They are the result of quite open and perfectly legal agreements to pay some specially favored people for doing nothing—or as next-to-nothing as human ingenuity can devise.

But there are others. Some of the plushiest of all featherbeds are to be found, cleverly camouflaged, in executive suites. Some of the snuggest are built into the very structure of federal, state and local bureaucracies. Some of the coziest are discreetly tucked away in the private recesses of the various professional establishments. And some of the most sumptuous are those precious family heirlooms that are generously handed down from generation to generation.

No one knows how many featherbeds there are in the U.S. No one knows how much the total bill for featherbedding actually comes to. But there are some things we do know, and others we can surmise.

In the construction industry, for example, we know that featherbedding is open, unabashed and rampant. According to a survey by *Engineering News-Record*, anywhere from 15% to 40% of the construction payroll dollar goes to pay for work not done. For time wasted in adherence to restrictive work rules, or for time spent in meaningless, un-

productive activities.

The cost of this sanctioned, legalized waste in the construction industry is an estimated \$16-billion a year. Which is \$16-billion added, unnecessarily, to the cost of everything built in this country—homes, apartments, stores, factories, roads, highways, bridges, schools, churches and hospitals.

**E**xecutive and white-collar featherbedding is less visible and hopefully, less prevalent. But it is painfully apparent that, judging by the results, somebody, somewhere, has too often been paid too much for doing too little. At a cost reckoned in inefficient and ailing companies, lagging and troubled industries, and spectacular failures and bankruptcies.

With regard to the ancient and apparently ordained institution of bureaucratic featherbedding, we know that the combined federal, state and local government payroll has increased 88% in the last ten years, to a total of \$110-billion. Today there are more government employees (14.4-million of them), making more money (average salaries up 64%). But if there has been a corresponding increase in bureaucratic efficiency, or the quality of government services, it has escaped the attention of most taxpayers.

Featherbedding in the professions is, in the nature of things, a moot question. Mere laymen can only guess at what goes on behind the impenetrable screen of fraternal solidarity and lofty mystique. But even mere laymen, when they pay their bills, are painfully aware that, of all the costs of living in a fantastically expensive world, the cost of professional services has increased the most, with the most devastating impact.

Finally, we know that the American economy as a whole has become markedly less productive, at a cost in terms of lost output of about \$60-billion in the last two years. Part of the decline in productivity, and part of the



# featherbed?

\$60-billion loss, surely must be charged against the featherbed account.

Any attempt to define the nature and suggest the extent of featherbedding in our society runs the risk of misinterpretation. In spite of the very obvious fact that the overwhelming majority of union members, of business men and white-collar workers, of government employees, and of doctors, lawyers, engineers and educators, belong to and make up the working majority.

Any attempt to quantify the total cost of featherbedding in the U.S. runs an even greater risk. It is almost certain to be wrong.

But at whatever risk, it must be said. The real extent of featherbedding, and the real cost, can be summed up in two words—too much!

Because featherbedding, whatever else it is, is clearly waste. Deliberate, purposeless, wanton waste of time, money, energy, effort, talent and spirit.

And no economic system, whatever its strengths and capacities, can tolerate endless and unlimited waste. At some point, the system becomes not just markedly less productive, but fatally less productive. Costs mount, prices and taxes rise—and keep on rising, ever faster, until the system breaks down.

**T**he American economic system is not at, or near, the breakdown point. But it is at the point where most of us are finding that, in every area of our lives, we are paying progressively more and more for less and less.

Part of what we are paying is the cost of deliberate, needless waste, with its cancerous effect on productivity. So that the real problem with featherbedding becomes clear.

The problem is not that some people, by

hook or by crook, are getting something for nothing. It is that a lot of people—most Americans—are increasingly getting nothing for something.

The problem is not that featherbedding is a cynical con game, played by a favored few at the expense of the tolerant and permissive many. The problem is that it is a *losing* game, played or permitted at the common and disastrous expense of us all.

So that the question for the working majority is not, how much featherbedding will we accept? But, quite simply, how much featherbedding can we *afford*?

And the issue for the working majority—and for featherbedders and would-be featherbedders as well—is, even more plainly and directly, how much farther can we go with a losing game?

The answer in both cases is clear and compelling.

No more! And no farther!

---

*We at McGraw-Hill believe in the interdependence of American society. We believe that, particularly among the major groups—business, professions, labor and government—there is too little recognition of our mutual dependence, and of our respective contributions. And we believe that it is the responsibility of the media to improve this recognition.*

*This is the fifth of a series of editorial messages on a variety of significant subjects that we hope will contribute to a broader understanding.*

*Permission is freely granted to individuals and organizations to reprint or republish these messages.*

*John R. Emery*  
John R. Emery, President  
McGraw-Hill Publications Co.





# the light fantastic

## New gallium phosphide LEDs from Microsystems International —in red and green.

That's right, a line of red and green LEDs offering low, low operating current levels of 5mA–10mA, I.C. compatibility and bright (the brightest you've ever seen) with wide viewing angles of 90° each side of normal. All this made possible by Microsystems' gallium phosphide technology and unique optical designs.

At the top of the line, our panel-mount MA2300 series (the one in the foreground of the photo), with its built in lens/reflector system produces a sparkling 2.0mcd luminous intensity at  $I_f = 5\text{mA}$ . On its left is the MA2200 series, the same lamp, but with axial leads.

Just behind the MA2300, is the MA2400 series in the industry accepted panel-mount package. It produces a glowing 1.5mcd at 10mA—compare this with other standard lamps. At the far right is the MA2500 series in a standard TO-18 header, and putting out 0.4mcd at 10mA.



For the colour conscious designer there are optional: clear, clear diffused, tinted clear, or tinted diffused epoxy packages. Just about any colour and package combination for your signal and indicator lamp applications—and they're available now at competitive prices.

Seeing is believing, so why not drop around to any of the Microsystems outlets listed below and see our LEDs. Or give us a call and we'll bring our demo unit to show you—the Light Fantastic.

## gallium phosphide LEDs from the performance leader

microsystems international limited, box 3529 station c, ottawa, canada — montreal, ottawa, toronto, brussels, stuttgart, london, palo alto, philadelphia.

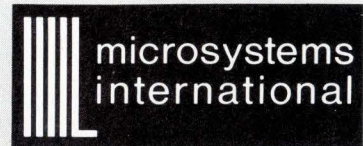

For further information — call or write your nearest Microsystems sales office or distributor.

**U.S.A. MICROSYSTEMS INTERNATIONAL SALES OFFICES:** CALIFORNIA — Orange, Phone 714—637—2330. Palo Alto, Phone 415—493—0848. ILLINOIS — Schaumburg, Phone 312—894—7660. MINNESOTA — New Hope, Phone 612—544—1802. NEW HAMPSHIRE — Nashua, Phone 617—762—8298. PENNSYLVANIA — Philadelphia, Huntingdon Valley, Phone 215—W1 7—5641/2.

**SALES REPRESENTATIVES:** ARIZONA — Scottsdale, Erskine Associates, Phone 602—263—7654. CALIFORNIA — Los Altos, W.W. Posey, Phone 415—948—7771. Santa Ana, Rical Associates, Phone 714—557—6543. CONNECTICUT — New Canaan, Stan Pierce Inc., Phone 203—966—4630. FLORIDA — Indialantic, Tech—Rep Associates, Phone 305—723—9140. Largo, Tech—Rep Associates, Phone 813—595—2834. GEORGIA — Chamblee, Tech—Rep Associates, Phone 404—939—8339. ILLINOIS — Itasca, Lou Bacher & Associates, Phone 312—773—1810. INDIANA — Indianapolis, R.E. Marquart & Associates, Phone 317—253—3997. MARYLAND — Baltimore, L.H. Kolman Co., Phone 301—752—8756. MASSACHUSETTS — Norwood, Stan Pierce Inc., Phone 617—762—3164. MISSOURI — St. Louis, Pem Sales Co., Phone 314—427—7200. NEW YORK — Cicero, Advanced Components Inc., Phone 315—699—2671. New York, ABC Electronics Sales, Phone 516—747—6610. OHIO — Columbus, Tom Mulligan & Associates, Phone 614—457—2242. PENNSYLVANIA — Philadelphia, ABC Electronics Sales, Phone 215—464—2275. TEXAS — Addison, Campion Sales, Phone 214—239—9196. WASHINGTON — Seattle, Carlyle Technical Sales, Phone 206—632—4290.

**DISTRIBUTORS:** ARIZONA — Phoenix, Kierulff Electronics, Phone 602—273—7331. CALIFORNIA — Gardena, Santa Monica Bell, Phone 213—321—5802. Los Angeles, Wesco, Phone 213—685—9525. Menlo Park, Bell Electronics, Phone 415—323—9431. San Carlos, Sterling Electronics, Phone 415—592—2353. San Diego, Kierulff Electronics, Phone 714—278—2112. COLORADO — Denver, Kierulff Electronics, Phone 303—343—7090. FLORIDA — Clearwater, Southland Electric, Phone 813—443—4514. LONG ISLAND — Freeport, Milgray Electronics Inc., Phone 516—546—6000. MARYLAND — Baltimore, Arrow Electronics Inc., Phone 301—247—5200. MASSACHUSETTS — Dedham, Gerber Electronics, Phone 617—329—2400. Watertown, Sterling Electronics, Phone 617—926—9720. NEW JERSEY — Haddonville, Mid-Atlantic, Phone 609—428—8288. NEW YORK — Rochester, Simcona Electronics, Phone 716—328—3230. NEW MEXICO — Albuquerque, Kierulff Electronics, Phone 505—247—1055. TEXAS — Dallas, Semiconductor Specialists Inc., Phone 214—358—5211. WASHINGTON — Seattle, Kierulff Electronics, Phone 206—763—1550.

**CANADA — MICROSYSTEMS INTERNATIONAL SALES OFFICES:** ONTARIO — Ottawa, Phone 613—828—9191. Toronto, Phone 416—279—1358. QUEBEC — Montreal, Phone 514—875—2814.

**SALES REPRESENTATIVES:** BRITISH COLUMBIA — Vancouver, A.W. Bleue, Phone 604—685—7914. **DISTRIBUTORS:** BRITISH COLUMBIA — Vancouver, R.A.E. Industrial Electronics Ltd., Phone 604—687—2621. ONTARIO — Malton, Semiconductor Specialists (Canada) Ltd., Phone 416—678—1444. QUEBEC — Montreal, Cesco Electronics Limited, Phone 514—735—5511.



# Calculator has full Basic capability

H-P's top-of-the-line 9830 can access time-shared computers directly; 40-kilobyte desktop unit comes with built-in cassette memory

by Stephen Wm. Fields, San Francisco bureau manager

**Calculators** have been rapidly approaching the capability of small computers. One recent development [*Electronics*, Sept. 25, p. 129] is a calculator that has special keys that perform program functions in Basic, a high-level language. And now Hewlett-Packard Co. has developed a calculator that is completely Basic-compatible—in fact, the machine performs more like a computer with a keyboard and display than a calculator; yet, it is as simple to use as a calculator.

The new model 7830, which bridges the gap between traditional calculators and minicomputers, employs H-P Basic (the same as GE Basic), has an alphanumeric keyboard and display, and comes complete with a built-in cassette memory. An optional high-speed, page-width printer is also available.

As the top of the H-P 9800 calculator line, the 40-kilobyte system is described as the world's most powerful desktop calculator. It has a 15-kilobyte operating system built in and ready to run as soon as the calculator is turned on. This feature, implemented in read-only memory, means that the user can immediately use the system—the calculator need not be loaded prior to use. The model 30 is equivalent to a 10- or 12-kilobyte minicomputer that must store its compiler in read/write memory.

**LED display.** Instructions and programs in the Basic language are typed in through the standard typewriter keyboard and displayed on the 32-character, light-emitting-diode alphanumeric display. A built-in memory, with a capacity of 80 kilobytes in each cassette, stores data and programs in a file structure

that the calculator user specifies.

The cassette also has read/write ability so that the user can read a file, modify it if desired, and return it to the same location. The cassette, with bidirectional search, has interrupt capability, which permits simultaneous calculator operation and cassette file search.

The built-in cassette is for program, data, or special-function key storage. In addition to the internal cassette, up to nine peripheral cassettes (H-P model 9865A) can be operated with the calculator.

**Quiet.** The new 9866A page-width printer, designed specifically for the model 30, is a quiet thermal printer capable of printing 80 alphanumeric characters per line at 250 lines per minute, or more than 330 characters per second. Characters are generated from a 5-by-7 dot matrix. The printer, which mounts on top of the calculator, may be added at any time. It also may be replaced by a 9861A typewriter with no change in software.

Calculator memory is expandable both by adding the user's read/write memory, and by plug-in ROM blocks pioneered by H-P in previous desktop calculators. A wide range of peripherals is also available. The model 30 calculates results to 12 significant digits. All trigonometric functions are built in—a special plug-in ROM block is not required.

Numbers may be entered from the typewriter keyboard or, for easier and faster numerical entry, through a duplicate set of keys in the standard adding-machine format to the right of the keyboard. A set of 10 special function keys completes the keyboard.

The machine has several pro-

gram-editing features. With editing keys, the user can delete, modify, or correct program lines or individual characters within a line—there is no need to retype an entire line to change one character.

Errors are detected immediately, with an error note appearing on the display. Any part or all of a program may be listed in the printer for error analysis, and any line may be recalled to the display by the "fetch" key. If an error note appears as a line is entered into the calculator, the "recall" key brings it back into the display for analysis and correction.

A 32-character LED display indicates keyboard entries, program steps, instructions, and results of calculations. It consists of 9/16th-inch-high characters made up of a 5-by-7 matrix, and not bar segments. Thus, numbers, letters, and symbols are more easily read.

**End of line.** When more than 32 characters are entered, the display automatically shifts to the left as ad-

**Power.** The H-P 7830 calculator performs like a computer with a keyboard and display.





Now available to help you:

# Secrets of SUCCESSFUL JOB HUNTING

Looking for a better job?

Out of a job?

Over forty and worried?

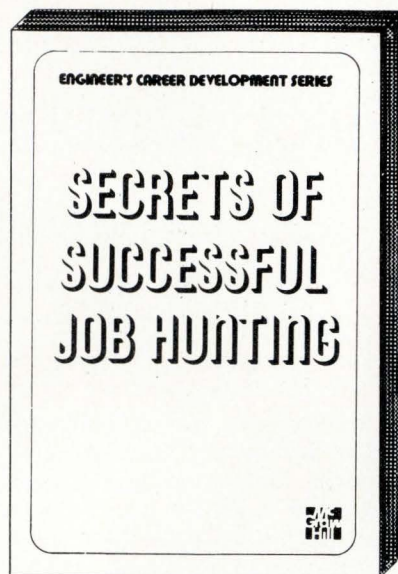

Compiled from the pages of CHEMICAL ENGINEERING, *Secrets of Successful Job Hunting*, brings you the combined wisdom of 11 job-hunting specialists. In its pages you'll learn how to find and generate job offers . . . how to launch a job-hunting campaign, either in person or by mail . . . how to negotiate your salary . . . how to prepare for and handle your interviewer . . . how to evaluate the job offers you get. But most of all you'll learn the real secret of successful job hunting: How to *sell* yourself.

**Here's what you get:**

- So You're Job Looking
- An Engineered Approach
- Your Portfolio
- How to Use Your Resume
- How To Get Job Offers
- References Are Checked
- Which Job Is for You?
- If You're Over Forty
- Fringe Benefits?
- How to Negotiate Your Salary
- How Your Wife Can Help
- Who's Interviewing Whom?
- Where To Find Help

108 pages, paperback, indexed  
\$4.95, postpaid

Your Job-Hunting EQ*	TRUE	FALSE	VARIABLE
1. It's bad taste to "sell" your qualifications . . . . .	<input type="checkbox"/>	<input type="checkbox"/>	<input type="checkbox"/>
2. Every resume should have a photo with it . . . . .	<input type="checkbox"/>	<input type="checkbox"/>	<input type="checkbox"/>
3. List with as many employment agencies as possible . . . . .	<input type="checkbox"/>	<input type="checkbox"/>	<input type="checkbox"/>
4. Your personal interests will bore an interviewer . . . . .	<input type="checkbox"/>	<input type="checkbox"/>	<input type="checkbox"/>
5. Always state your exact salary requirements . . . . .	<input type="checkbox"/>	<input type="checkbox"/>	<input type="checkbox"/>
6. A quick thank-you note makes you seem overanxious . . . . .	<input type="checkbox"/>	<input type="checkbox"/>	<input type="checkbox"/>
7. Questions about fringe benefits are "unprofessional" . . . . .	<input type="checkbox"/>	<input type="checkbox"/>	<input type="checkbox"/>
8. Enthusiasm will make you appear overeager . . . . .	<input type="checkbox"/>	<input type="checkbox"/>	<input type="checkbox"/>
9. Ask for a 10-20% salary increase in a new job . . . . .	<input type="checkbox"/>	<input type="checkbox"/>	<input type="checkbox"/>
10. Type as many carbons as possible of your resume . . . . .	<input type="checkbox"/>	<input type="checkbox"/>	<input type="checkbox"/>

\*Effectiveness Quotient. Answers will be found in  
Secrets of Successful Job Hunting.

Attention: Miss Janice Ruvere  
ELECTRONICS  
1221 Avenue of the Americas  
New York, N. Y. 10020

Yes, I want to know the secrets of successful job hunting. Enclosed is my check (money order) for \$\_\_\_\_\_ for \_\_\_\_\_ copies (\$4.95 each, postpaid) of *Secrets of Successful Job Hunting*. I understand that if I am not completely satisfied with the book, I can return it within 10 days and my money will be refunded.

NAME \_\_\_\_\_

STREET ADDRESS \_\_\_\_\_

CITY \_\_\_\_\_ STATE \_\_\_\_\_ ZIP \_\_\_\_\_



## New products

ditional characters are keyed in. To go back to the beginning of a line, a right-hand arrow key is pressed; a left-hand arrow key moves the display in the opposite direction.

Ten special-function keys (in the upper left of the keyboard) can each have two special functions assigned for a maximum of 20 special functions. These keys may be defined in three ways. Each may be defined as a string of commonly used characters, such as print, go to next, and SQR. Pressing a key causes the mnemonic to be typed on the display, which saves typing each mnemonic into the calculator letter by letter.

Each key may also represent single or multiline functions. Different parameters can be passed to the function from the main program, or between functions. Each key may also store an entire program. Programming and editing rules are the same as those for normal programming. A template, with blanks in which the user can write his key definitions, is provided. All special functions can be stored on the cassette. Thus, the model 30 has all of the advantages of a "keyboard Basic" machine, but it also has a full alphanumeric keyboard.

**Add-on.** The memory of the model 30 can be expanded in two ways. The user read/write memory can be expanded from 4 kilobytes to 8 kilobytes. ROMs can be added in 4-kilobyte increments to a total of 16.

The model 30 offers the user flexibility that has never been available before. Probably most important is that, since the model 30 is completely Basic-compatible, it can be interfaced with other Basic systems, such as time-shared computers, to take advantage of their large memories.

The machine's capability can also be increased through the plug-in ROMs. Eight of these can be used with the model 30—five plug into a compartment in the side of the calculator, and three go inside the machine. Plug-ins are available either in the cigarette-package size for the five outside slots, or as printed-circuit cards for more permanent installation inside. The ROMs are also easy to use—there are no keys specifically assigned to plug-in blocks; in other words, the use of the ROM blocks is not keyboard-limited. The user simply calls for the function from the alpha keyboard as if it were hard-wired into the machine.

ROMs are available for matrix operation, string-variable operation, X-Y plotter control, and an extended I/O ROM that permits instruments and other peripherals to be connected. Thus the calculator can be the heart of a complete test system, including voltmeters, counters, and plotters. A fifth ROM, one that will allow the model 30 to be connected to other computer systems via a modem, will be available early in 1973.

The basic model 30, complete with 4 kilobytes of read/write memory, cassette drive, keyboard, and display, sells for \$5,975; the optional full-width page printer sells for \$2,975; optional read/write memory is \$1,475 for another 4 kilobytes, and the add-on ROMs sell for \$485 each. Delivery is scheduled for early 1973.

Inquiries Manager, Hewlett-Packard Co., 1501 Page Mill Rd., Palo Alto, Calif. 94304 [338]

THE NEWEST DESIGNS  
THE WIDEST SELECTION

# Linear & Logarithmic IF Amplifiers

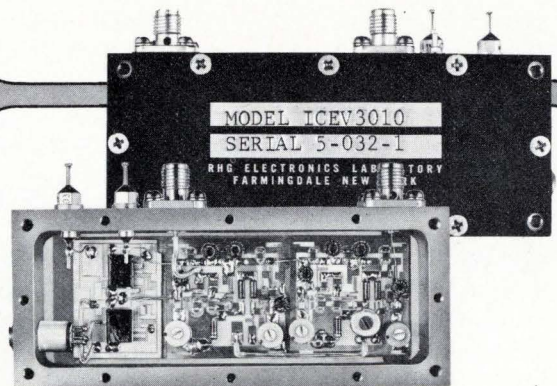

**New!**

## HYBRID IC MODELS

3 1/2" x 1 7/16" x 5/8"

### RANGE OF SPECIFICATIONS

	LINEAR	LOGARITHMIC
Center Frequency	30 to <del>70</del> <sup>160</sup> MHz	30 to <del>70</del> <sup>330</sup> MHz
Bandwidth	to 20 MHz	to 20 MHz
Risetime	to .05 μsec	to .05 μsec
Output	IF and Video	DC Coupled Video
Noise Figure	<4 db	<10 db
Dynamic Range	40 db	80 db

Over the years the industry has come to depend upon RHG for a steady stream of innovations and improvements in its various product lines.

This year is no exception, and in the IF Amplifier line alone RHG is offering

- A new line with "IF output only" at \$295.00
- A new line of Hybrid IC Lin & Log IF Amps
- A new line of constant phase shift limiters
- A new line of IC preamps in <1 cubic inch
- A new line of highly accurate & super stable log amps
- 33 new features/improvements/reduced prices

**RHG**

**RHG ELECTRONICS  
LABORATORY · INC**

94 MILBAR BOULEVARD ■ FARMINGDALE  
NEW YORK 11735 ■ (516) 694-3100 ■ TWX 510-224-6493

for Reliability, Innovation and Service



Instruments

## Servo upgrades audio recorder

Kit transforms unit for instrumentation-quality recording up to 20 kHz

There are many high-quality instrumentation tape recorders on the market, but many applications don't require an \$8,000 machine. For example, people working on acoustic testing, vibration analysis, or transient-performance testing can use a high-quality audio tape recorder for their work if the timing accuracy is good and if the tape flutter is low. However, most audio tape recorders don't meet those requirements.

But by taking one of the industry's leading audio tape recorders—the Ampex AG 440—and adding a capstan servo kit to it, Ampex engineers have come up with an economical solution to recording instrumentation quality signals in the 30-Hz to 20-kHz range. The servo is available either as an option on new machines or as a kit for field installation on existing recorders.

Basically, the servo consists of a dc capstan motor, which is driven

by a high-frequency oscillator. Thus, fluctuation associated with line variations is eliminated. To further reduce speed errors, a single shaft is used to mount the dc motor, tachometer, and tape-drive capstan—there is no belt slippage because there are no belts. Mark Sanders, designer of the servo, claims that this combination of isolation from ac line voltage variations, plus direct drive, provides tape speed accuracy to within  $\pm 0.08\%$ . Unweighted flutter at 7.5 inches per second is typically 0.03%.

Besides operating from an internal reference, the servo can be connected to an external 9,600-Hz source. Sanders points out that servos have been used with audio transports before, "but these have been velocity servos," he says. "The velocity servo is not as accurate as the comparator servo that is used in the 440, because with the velocity servo there is some error signal."

The servo is available on new machines for \$325, in addition to the \$2,250 to \$3,500 for the 1/4-in.-tape versions of the AG 440. The retrofit kit sells for \$650. Delivery time is 90 days.

Ampex Corp., Professional Audio Products Division, 401 Broadway, Redwood City, Calif. 94063 [351]

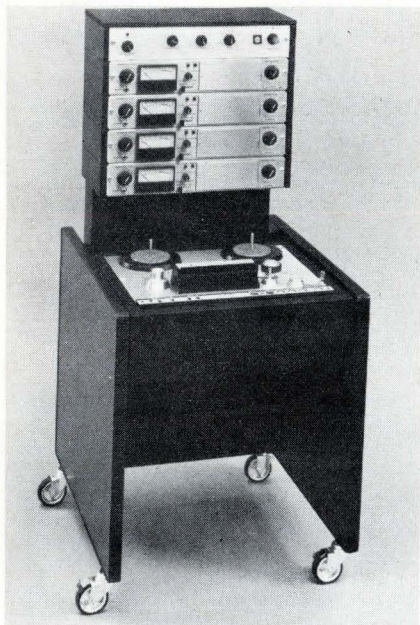

## Oscilloscope plug-in offers delay by time and by events

Delay by time and delay by number of events are features offered by a 7000 series oscilloscope plug-in, the 7D11 digital delay unit. These delays enhance scope waveform viewing and are available as output signals for other applications. In delay time, following a trigger and after a preselected time, the unit will give a delayed trigger output. The delay time is indicated on the scope CRT readout and is displayed along with the measured signal. In delay by events, following a selectable number of events after a master sync or index pulse, the unit provides delay outputs. Accuracy is to within 0.5 part per million  $\pm 2$  nanoseconds. Jitter is less than 2.2 ns, delay time

is 100 ns to 1 s, and resolution is 1 ns. Price is \$1,475.

Tektronix Inc., P.O. Box 500, Beaverton, Ore. 97005 [353]

## Voltage calibrator/reference offers standard-cell accuracy

The model MV115/B calibrator-transfer standard provides full-scale voltage ranges of from 11.111110 vdc to 1.111110 vdc to accuracies within  $\pm 0.005\%$ —within unsaturated standard-cell error tolerances. Features include a circuit condition indicator to warn the operator of short

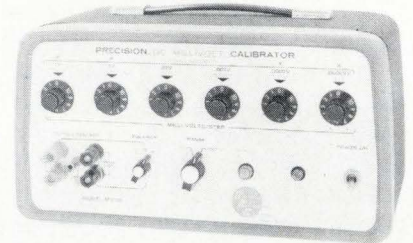

circuit or malfunction. A polarity switch permits reversal of output polarity between floating terminals for zero voltage reference check, and provides a method for checking ambient temperature references in dc thermocouple applications. Price is \$820. A rack-mounted version is \$835.

Electronic Development Corp., 11 Hamlin St., Boston, Mass. 02127 [354]

## Recorder provides eight extra-wide channels

A portable, direct-writing, eight-channel recorder is designated the Super 8 and is a complete unit, including high-speed galvanometer,

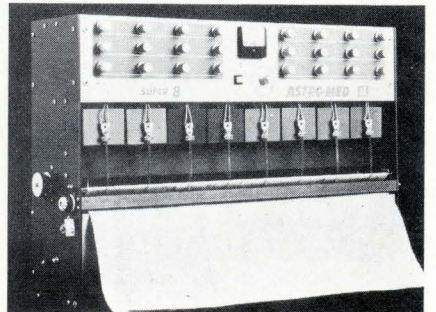



- Q.1 Who's got a primerless, non-corrosive adhesive/sealant?
- Q.2 Is there an easy way to improve TV reception?
- Q.3 How can I cut prototype mold costs by 25%?
- Q.4 What's a practical way to protect delicate parts from shock?

**A1** We do. GE's ready-to-use, one-part RTV-162 (White) and RTV-168 (Clear) are odorless, paste-like, room temperature curing adhesive/sealants that bond to most materials without primer. They meet the non-corrosive requirements of MIL-A-46146, and come in tubes, caulking cartridges or bulk-type containers. Circle Reader Service No. 91.



**A3** Use GE RTV-700, the strong, two-part silicone mold-making compound that needs no postbake, cures in 24 hours and has the high tear strength and elongation to reproduce precision parts quickly and accurately. Circle Reader Service No. 93.

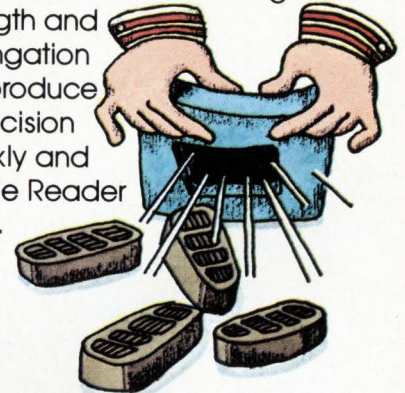

**A2** Definitely. With GE Silicone Rubber. It improves TV set performance because its electrical properties are far superior to those of other elastomers. And because it takes less material to do the job with silicone rubber, you save space and weight. Fire resistance? GE Silicone Rubber meets all the latest TV industry safety requirements. It's perfect for wire insulation, corona rings and anode caps. Circle Reader Service No. 92.

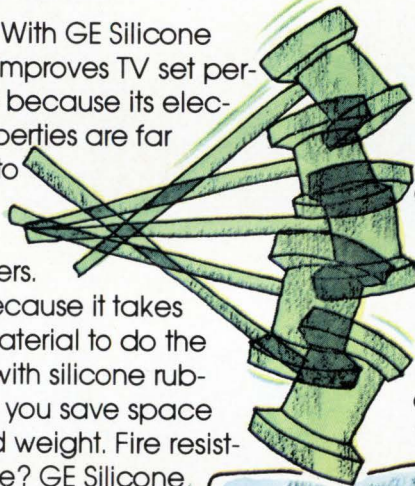
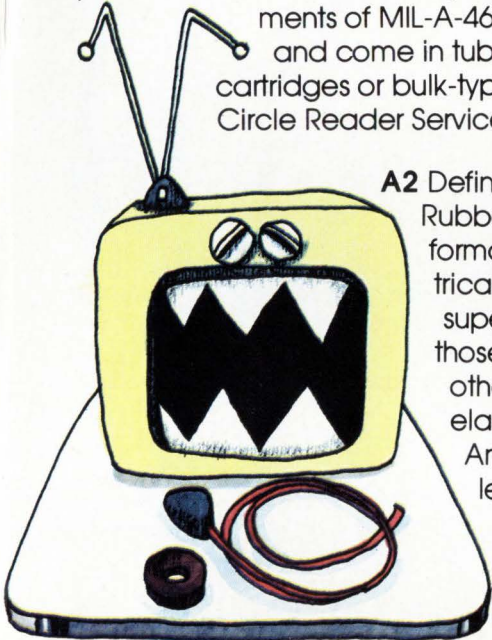

**A4** With GE RTV-619 Silicone Gel. It cures at room temperature into a clear, resilient, dielectric gel cushion for circuitry and for protecting electronic assemblies. RTV-619 cures without exotherm and can withstand temperatures from  $-65^{\circ}\text{C}$  to  $+150^{\circ}\text{C}$ . Circle Reader Service No. 94.

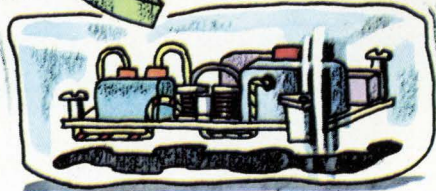

For all the details, write: Section N 11374  
Silicone Products Dept., General Electric Co., Waterford, N.Y. 12188.

**GENERAL  ELECTRIC**

**GE silicones.  
The answer.**



New solid-state lifetime switches are Magic Dot's contribution to state of the art. They operate on a capacitance principle, have *no moving parts*—and last a lifetime.

Unique design advantages include:

- Will not jam, wear or change characteristics
- Logic compatible with zero bounce
- Completely sealed for continuous performance in hostile environments
- Flexibility in size, shape and output characteristics
- No 'behind panel' space and 1/4" to 1/2" height

New Magic Dot switches can give you the competitive edge by significantly enhancing the performance, reliability and packaging of your product, while they permit the mere touch of a finger to become man-to-electronics interface. Write or call today for detailed technical and applications information.

**these  
switches  
don't know  
switches  
fail!**

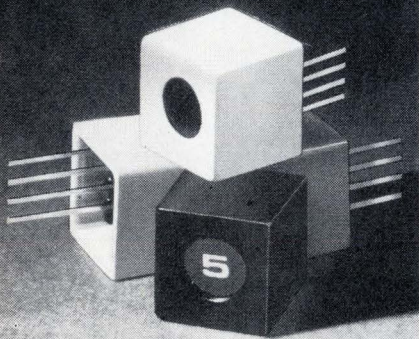

**Magic  
dot**

**MAGIC DOT, INC.**  
40 Washington Avenue South  
Minneapolis, Minnesota 55401  
612/333-8161

## New products

amplifier, power supplies and multispeed chart drive. The unit offers full 50-mm-wide channels so that resolution of the data being recorded is enhanced. The operator can also select a number of chart speeds. Inkless recording is performed by a heated stylus on inexpensive heat-sensitive paper. Price is \$3,388.

Astro-Med, A Division of Atlan-Tol Industries Inc., West Warwick, R.I. 02893 [355]

### Portable ohmmeter checks low resistance values

The circuitry of a precision micro-ohmmeter sends through its pulse probes a 50-ampere, 10-millisecond pulse to the test device or component once every second. The unit is designed for nondestructive resistance measurements, and employs a four-terminal measuring technique. Due to the current-pulsing tech-



nique used, the unit simulates an actual circuit condition for determining the quality of electromechanical properties of component heat-sink modules and for detecting high-resistance joints caused by poor contacts or corrosion.

Anderson Power Products Inc., Power Equipment Div., 145 Newton St., Boston, Mass. 02135 [357]

### Wattmeter measures pulsed rf systems, is portable

Operation from ac lines or batteries is offered by the model 4314 portable peak- or average-reading directional wattmeter. In addition to continuous-wave, average-power

measurement, the unit is designed to measure pulsed-rf systems such as radar, telemetry, air navigational aids, television, command and control, and single-sideband peak envelope power. To read the peak of



power pulses, the peak read button is depressed and locked, an action that inserts a peak reading servo amplifier between the demodulated pulse delivered by the plug-in sensing element and the meter. Price is \$625 and the plug-in elements range from \$32 to \$75.

Bird Electronic Corp., 30303 Aurora Rd., Cleveland, Ohio 44139 [356]

### Generator offers ramp times from 1,000 s to 1 μs

The model 180 is a pulser containing two independent ramp generators with ramp times from 1,000 seconds to 1 microsecond. The generators may be operated independently or synchronized for 1:1, 2:1, and 4:1 interlace. Two independent power amplifiers offer  $\pm 10$  V of variable dc offset, 80-decibel step attenuation in 10-dB steps and 20 dB continuously variable between steps. Trigger and gate modes are provided allowing independent single-shot and burst operation by

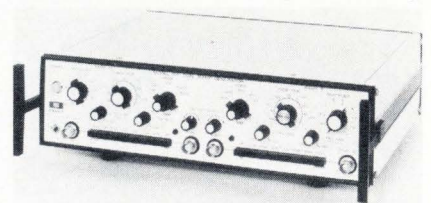



application of an external trigger or gate, or by depressing a front-panel pushbutton. Price is \$845.

Exact Electronics Inc., 455 S.E. Second Ave., Hillsboro, Ore. 97123 [358]

### Digital voltmeter operates up to 800 megahertz

A digital voltmeter called the model PM2422 offers three-digit resolution and an overrange digit in any of five ranges of ac or dc current and voltage, and six ranges of resistance. Accessories extend the unit's measuring capabilities to 800 MHz for rf potentials as high as 16 v rms, to 30 kv dc and 100 amperes at 400 Hz. Maximum ac measurement error is  $\pm(0.2\%+2 \text{ digits})$  over most of the instrument's bandwidth of 30 Hz to 30 kHz with a maximum error of 1.0% at 30 kHz. Price is \$395. Accessories range from \$20 to \$40.

Test & Measuring Instruments Inc., 224 Duffy Ave., Hicksville, N.Y. 11802 [359]

### Spectrum analyzer extends range of time compression

A series of real-time spectrum analyzer/digital integrators features an extended time-compression range, increased dynamic range, and digital exponential averaging in

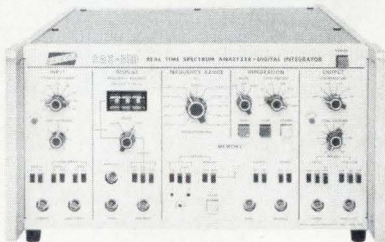

the integrator. The models 51B-54B provide time-compression analysis up to 50 kHz in addition to a 1-MHz scale and increased dynamic range through the use of a 10-bit analog-to-digital converter. Also included in the integrator are linear and peak hold modes.

Signal Analysis Industries Corp., 595 Old Willets Path, Hauppauge, N.Y. 11787 [360]

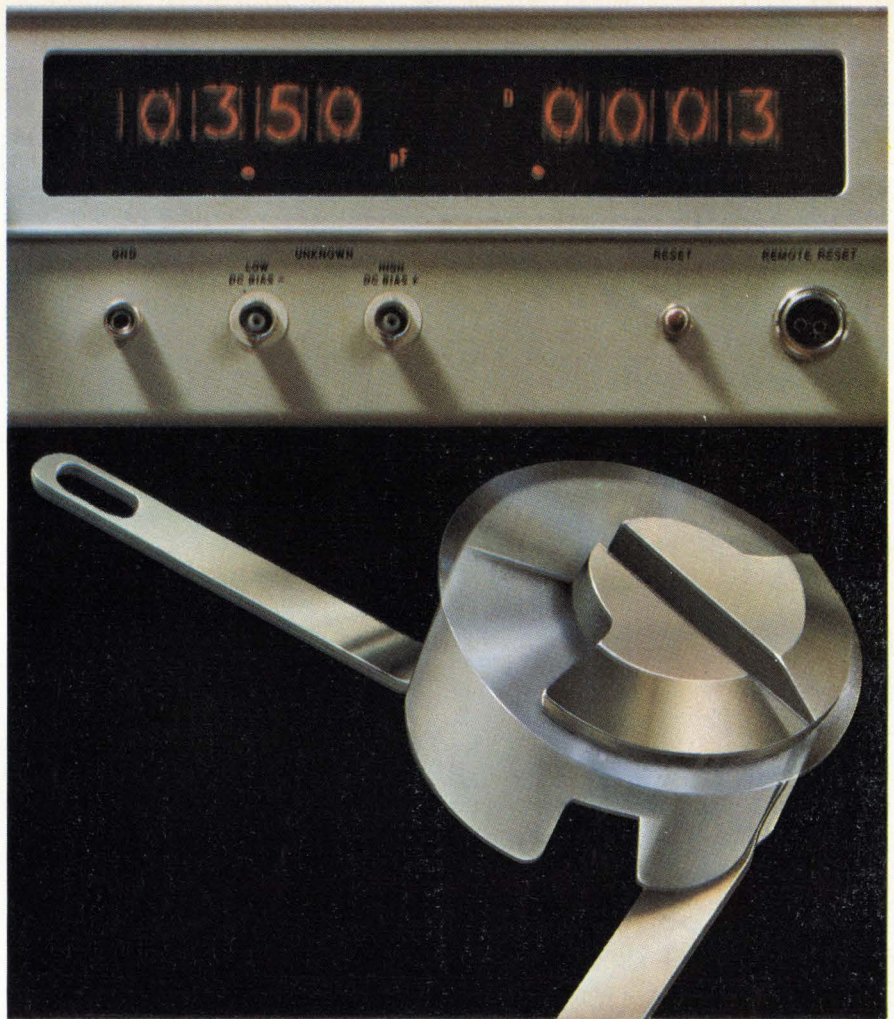

### Teflon\* gives you capacity to save a lot of money!

1.1 to 3.5 is a fairly narrow capacity range. But many applications fall within it.

And within that range, our new Teflon dielectric trimmer capacitors are every bit as reliable as capacitors costing a lot more money. So it makes sense to design with them in mind.

We make them for both stripline and PC mounting. And we make them miniature—just 0.250" diameter. With Q typically 2500 at 1MHz and temperature characteristics like these:

Max. % Capacitance Change from value at 25°C.

-55°C		+85°C		+125°C		 Actual Size
Max.	Min.	Max.	Min.	Max.	Min.	
+3.0	-0.5	+1.0	-3.0	0	-5.0	

Worth looking into? All it costs is a stamp.

\*Registered trademark of DuPont.

E. F. JOHNSON COMPANY/ 906 Tenth Ave. S.W./ Waseca, Minn. 56093  
Please send technical information and test samples of your new low-cost Teflon dielectric trimmer capacitors.

NAME \_\_\_\_\_

FIRM \_\_\_\_\_

TITLE \_\_\_\_\_

ADDRESS \_\_\_\_\_

CITY \_\_\_\_\_

STATE \_\_\_\_\_

ZIP \_\_\_\_\_



**E. F. JOHNSON COMPANY**



Packaging & production

## Tester is programable

---

Designed for semiconductor memory users, it exercises whole array or any section

---

A user of semiconductor memories needs test equipment that takes care of three requirements—engineering evaluation, quality assurance, and production testing. All three needs can be filled by a programable exerciser, called the model 4604, introduced by Technitrol Inc. The unit, designed primarily to test semiconductor memories, will test anything that can be plugged into it.

The exerciser is a special-purpose computer, programmed by a series of instructions that specify the testing pattern—a pattern of any necessary degree of complexity that may cover the entire memory array or any part of it. Complex patterns are programmed and executed by a relatively simple program that contains one or more iterative loops, by which the program works its way step by step across the array.

The first time a program is loaded into the 4604, it must be set up manually by the switches on the console. The program can then be stored on a tape cassette.

Each test consists of a sequence of binary word pairs; the first word is the instruction, and the second contains the address on which that instruction is performed. Each word contains 40 bits. Each instruction-word bit corresponds to a separate instruction, and 20 bits in the address word refer to a maximum of 1,048,576 locations. These 20 bits, however, are divided into four different fields that can refer, for example, to address segments, such as the row and column on a chip, or to specific cards in a system. The other 20 bits are unused. No instruction coding is necessary.

Tests are executed at any speed from 50 kilohertz to 10 megahertz,

as determined by a switch setting on the console. When stored in the cassette, this setting is represented as part of a program. If the dynamic memory being tested must be refreshed from time to time, the refresh cycle can be programmed to occur with priority over other testing cycles. These refresh intervals are specified by another switch setting, which can be either manual or become part of the program. This enables the memory to be tested to ensure that it operates properly at the minimum refresh rate specified by the manufacturer.

The basic machine has a capacity of 16 words or eight instruction-address word pairs, expandable up to 128 words or 64 pairs. Price range is \$29,000 to \$39,000, depending on the program memory size.

Technitrol Inc., Automated Measurements Division, 1952 E. Allegheny Ave., Philadelphia, Pa. 19134 [391]

---

## Positive artwork used to make prototype boards

Making prototype circuit boards can be a frustrating and time-consuming operation, but Vector Electronics has developed a method that can eliminate much of the bother—the need for making a negative of the artwork. The technique, which can be used for multiple copies, provides high resolution with minimum undercutting.

The Vector method requires artwork to be prepared directly on a clear Mylar sheet for exposing the board. This artwork can be changed easily. The key to the process is Vector's direct-positive resist coating for the boards. Vector supplies boards precoated with this type of resist at a price similar to that for conventional photoresists. The boards are supplied, either punched or unpunched, in both phenolic and epoxy-glass materials, and in numerous shapes and sizes.

The boards can be exposed by sunlight or by conventional photolamp bulbs, then developed with a special developer supplied by Vector. Each step can take as little as a

few minutes, depending on the ultraviolet content of the light. Etching procedure is conventional; the kits include plastic bags of etchant to be mixed with hot water for use in this application.

The artwork can be prepared in a number of ways on the Mylar: the Vector kits include opaque film, pre-printed patterns, tape for conductors, and transfer resist that can also be used on the boards themselves. Two kits are available, a sampler (32X) at \$8.95 and a larger one (32XA) at \$24.95. The larger kit includes five phenolic boards, etchant, developer, glass plate, clear Mylar film, artwork materials, touchup resist, and grid paper. The materials are also available in bulk.

Vector Electronics Co., 12460 Gladstone Ave., Sylma, Calif. 91342 [392]

---

## Mounting trays provide predrilled, tapped rails

To accommodate high-density packaging of integrated circuits, mounting trays provide predrilled and tapped rails for direct socket mounting in side-butting positions. Socket density of a 20-inch tray is 117 de-

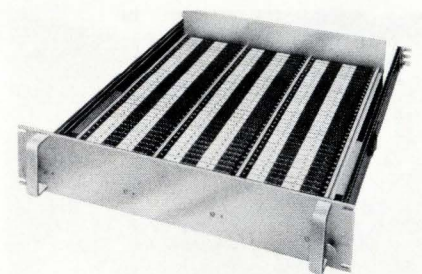

VICES maximum, while maximum IC density is 585 units. Seventeen-inch trays are also available, and both sizes come with or without straight or tilted sides.

Cambridge Thermionic Corp., 445 Concord Ave., Cambridge, Mass. 02138 [394]

---

## Parts collection system is for use with hand test fixtures

A parts collection system, designated the Auto Collector model 008, is designed for use with hand test



# Are you getting static?

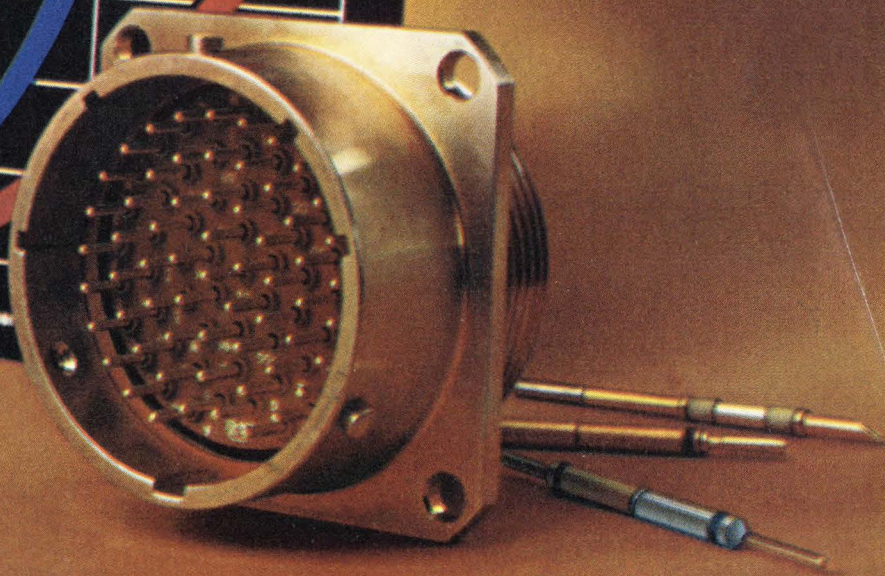
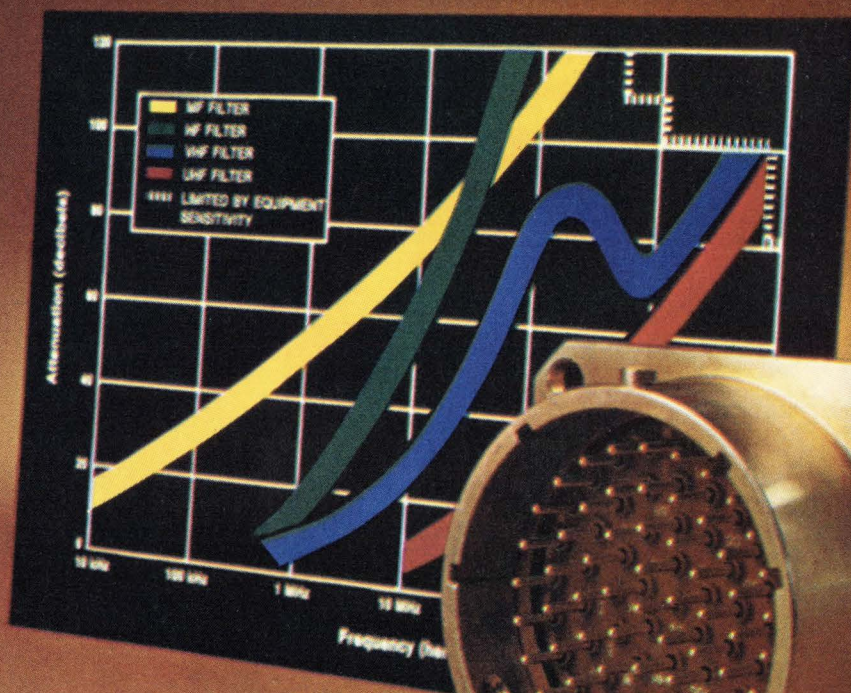

Our filter connectors are designed to eliminate interference from your circuits. See those attenuation curves? They are just a part of our selection. We can mix and match filters to solve your low pass filtering requirements. Small wonder Bendix filter connectors are first choice in the fight against electronic noise pollution.

Bendix filters come packaged in connectors intermateable with MIL-C-26482, MIL-C-83723, MIL-C-38999 and

MIL-C-5015 connectors. In addition, filter contacts can be packaged to mate with other popular connector types including rectangular in military, industrial and commercial applications. There's sure to be one to meet your attenuation and frequency requirements.

You'll like the price, too.

Delivery? We won't give you any static there, either. Write for our brochure. The Bendix Corporation, Electrical Components Division, Sidney, New York 13838.

**Bendix**



# CERAMIC SUBSTRATES- QUICK FROM COORS

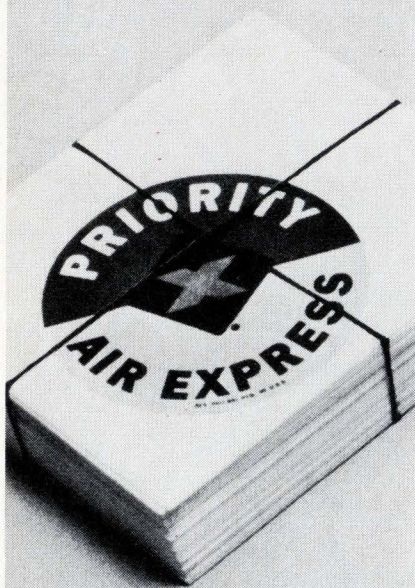

**You get ceramic substrates quickly from Coors, regardless of order size.** That's because we're one of the largest producers of ceramic substrates. And have one of the most modern production facilities. And lots of experience in the business.

These factors mean you get best prices, too.

To dependable deliveries and competitive prices, add a reputation for alumina and beryllia ceramics of highest quality and you come up with only one logical source for ceramic substrates.

Quick now, who is it?

Right.

**Coors Porcelain Co.**  
600 Ninth Street  
Golden, Colorado 80401  
Telephone (303) 279-6565

Send for our substrate bulletin today.

**Coors CERAMICS**

## New products

fixtures or can be integrated into automatic handling systems by the user. The unit is available with a choice of standard categories up to 13. It is self-powered or can be

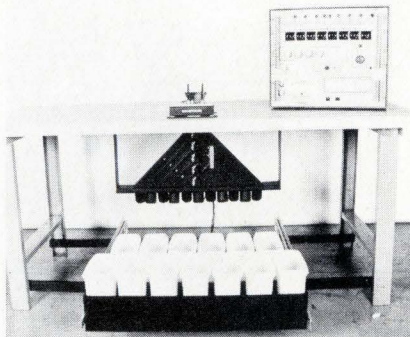

directly programmed by the tester via switch closures. The 008 is a positive binning system and can provide 13-category sort rates to 10,000 per hour with test times of about 100 ms.

Engineered Automation, Division of A-B Tool and Mfg. Inc., High Bridge, N.J. 08829 [395]

## Microscope designed for device production line

Optical inspection of semiconductors on the production line is possible with the model KK08 semicon-

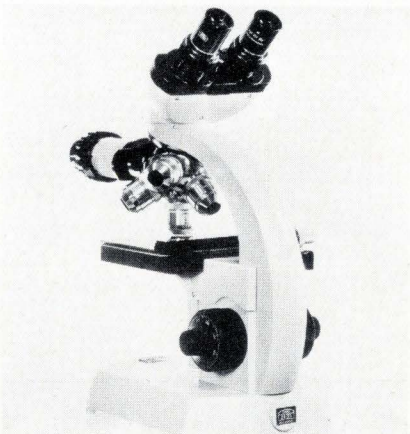

ductor microscope. The optics attached to the microscope provide bright-field, dark-field, and interference contrast, and the unit uses a high-intensity halogen source for the vertical illuminator. Defects such as pinholes, stacking faults, alignment errors, mechanical damage, bonding defects, and etching

problems are detectable in three dimensions or in color.

Carl Ziess Inc., 444 Fifth Ave., New York, N.Y. 10018 [396]

## Connectors use individual pressure-sensitive seals

Connectors, designated series C-21, are designed to provide moisture-sealing capability by means of individual pressure-sensitive seals that are attached to each contact. Two other seals are included—one at the rear where the wire is attached to the contact, and the other at the link between the pin and the socket. Both seals are designed so that a pressure differential between the inside and the outside of the connector, which is normally a cause of sealing failure, will, instead, improve the seal. The units are designed for use in airborne equipment, shipboard and undersea applications, and in deep space and electronic equipment requiring highly reliable moisture-sealing in harsh environments.

Hughes Connecting Devices, 500 Superior Ave., Newport Beach, Calif. 92663 [393]

## Laser scribe operates with continuous stream of pulses

The model 900 mini Laserscribe is a semiconductor wafer-scribing system that employs a continuous stream of focused, high-intensity and overlapping laser pulses. This rapidly heats the surfaces of the semiconductor materials above their vaporization point. The unit can scribe all types of semiconductor wafers including silicon, germanium, gallium arsenide, and gallium

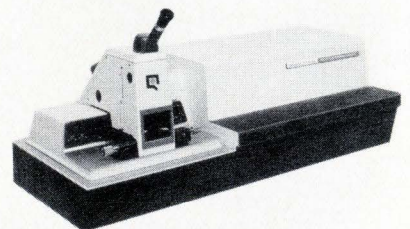



phosphide. It can also scribe passivated or coated wafers such as oxides, nitrides, and metal film and glass overcoats. Price is \$22,500, or \$19,900 if the purchaser can supply a Tempres model 1713C laser system for modification and integration with the new one.

Quantronix Corp., 225 Engineers Rd., Smithtown, N.Y. 11787 [397]

### Computer hook-up wire uses new insulation

A computer hook-up wire is extruded from Tefzel, a material that has characteristics similar to those of Teflon. Tefzel provides a high-temperature thin-wall wire, suitable for wire-wrapping applications. The wire has high cut-through, abrasion resistance and long flex life. The dielectric constant is 2.6, and temperature range is from -100 to +150°C continuous.

Apha Wire Corp., 711 Lidgerwood Ave., Elizabeth, N.J. 07207 [398]

### Wire-wrapped connectors are for dense packaging

In a series designed specifically for dense-packaging applications, wrapped-wire connectors have a 0.025-inch-square cross-section. The 30/60 pin types offer replaceable

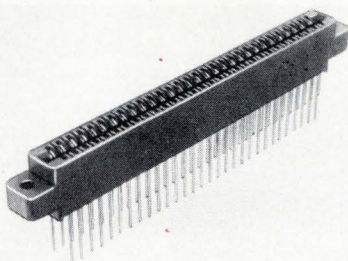

contacts with bifurcated mating surfaces for low contact resistance and high reliability. The contacts are on 0.125-inch centers, and over-all length is 4.555 inches. Removable polarizing keys may be placed between the contacts as required. Price is as low as \$1.41 each.

Methode Electronics Inc., 7447 West Wilson Ave., Chicago, Ill. 60656 [399]

## SWITCH/INDICATORS

### THE FIRST TRULY SUBMINIATURE LED SWITCH/INDICATOR



ACTUAL SIZE

Extremely compact TEC-LITE SSBL Series combines LED and SPST-NO-DB switch in a low cost, highly reliable unit for a variety of display and control functions... especially where space is limited. The .360 diameter, anodized aluminum body protrudes just 3/16" behind panel, including terminals. Mounts in 1/4" hole on 3/8" centers.

Red LED is mounted high in lens for maximum visibility. Replaces incandescent or neon lamps for low current, solid state applications. Internal resistor adapts unit for 5 or 6.3 VDC operation. Switch life is one million operations at 20 mA. In 3 lens colors. \$4.10 each in quantities of 100.

**Matching Indicator.** SSIL Series LED with resistor for 5-28 VDC operation. \$3.10 ea., 100 quantities.

**Write:** TEC Incorporated, 9800 N. Oracle Road, Tucson, Arizona 85704; or call (602) 297-1111.



INCORPORATED

Circle 143 on reader service card

## Silicon Rectifiers

**IBR**

### SILICON AVALANCHE INTEGRATED BRIDGE RECTIFIER



- 10A and 25A (Io)
- 100, 200, 400, 600 V (V<sub>RM</sub>)
- 250V, 450V, 650V. min. avalanche voltages
- Fast recovery time series
- Press fit, stud mount, TO-3 outline mounting options
- \$2.50 ea (10A, 200V, TO-3 outline, 1000 qty)

**EBR**

### EPOXY BRIDGE RECTIFIERS

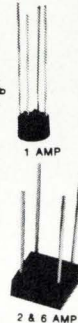

- 1A, 2A, 6A (Io)
- 100, 200, 400, 600 V, (V<sub>RM</sub>)
- Controlled avalanche and fast recovery time series
- Min. size and max mounting ease
- 91¢ ea (1A, 200V, controlled avalanche, 1000 qty)

### HIGH VOLTAGE SILICON RECTIFIERS

- 1 KV to 40 KV in a wide range of min. sizes.
- 5mA to 100 mA (Io)
- All series available with fast recovery characteristics.
- High reliability at economical cost
- \$1.49 ea (VG20, 20KV PRV, 1000 qty)



VARO

**Design us in; we'll stay there**  
**WRITE FOR NEW CATALOG**  
(Also Cataloged in EEM & REM)

**VARO SEMICONDUCTOR, INC.**

P.O. BOX 676, 1000 N. SHILOH, GARLAND, TEX. 75040, 214/272-4551, TWX 910-860-5178

*Distributed by:*

**ALLIED ELECTRONICS**, Chicago, Ill. 312/421-2400. **THE ALTAIR CO.**, Richardson, Tex. 214/231-5166. **BELL ELECTRONICS**, Menlo Park, Cal. 415/323-9431. **BLUFF CITY DIST. CO.**, Memphis, Tenn. 901/725-9500. **BRIDGEFIELD SUPPLY**, Twinsburg, Ohio 216/425-4209. **CRAMER ELECTRONICS**, Nationwide; Newton, Mass. 617/969-7700; Rochester, N. Y. 716/275-0300. **ELECTRONIC PARTS CO.**, Denver, Colo. 303/266-3755. **FARWEST, INC.**, Bellevue, Wash. 206/747-1515. **MERQUIP ELECTRONICS**, Skokie, Ill. 312/965-7500. **MERRILL ELECTRONICS**, Chicago, Ill. 312/286-2525. **MILGRAY ELECTRONICS**, Freeport, N. Y. 516/546-6000. **WESTATES ELECTRONICS**, Chatsworth, Calif. 213/341-4411.

*In Canada:*

**ELECTRO SONIC**, Toronto, Ont. 416/924-9301. **R. A. E. IND. ELECTRONICS**, Vancouver, B. C. 604/687-2621. **WESTERN RADIO SUPPLY**, Hamilton, Ont. 416/528-0151.



Data handling

## Terminal offers four data rates

---

Automatic send-receive unit with non-impact printer includes twin cassettes

---

Extending its Silent 700 series of electronic data terminals, Texas Instruments has added a low-priced keyboard send-receive model plus a twin-cassette automatic send-receive type. Both include thermal printers. At the same time, TI announced reductions in prices for existing models in the Silent 700 series.

The new 733 KSR model, selling for \$1,500 in single quantities, can be upgraded to the second new model, the 733 ASR, with the addition of an upper cassette module. The ASR version, at \$2,750, features switch-selectable data transmission rates of 10, 15, 30 and, optionally, 120 characters per second. In addition, the twin-cassette model offers simultaneous transmit and receive and on-line transmission, and off-line data preparation.

The ASR "is roughly half the cost of ASR terminals on the market today," says Jim Butterworth, a data terminal marketing manager at TI's Houston-based digital systems division. The economies over competitive models, including earlier Silent 700 versions, spring from a simpler lift-and-step print driver mechanism, and a new internal architecture similar to the firm's 980A minicomputer. "Instead of a bit-parallel machine," he says, "the new machine has a serial electronic architecture." The serial data bus gives the user flexibility in adding options to change the terminal function without changing the basic logic within the terminal. Options, priced from \$100 to \$300, can be added via printed-circuit cards interfacing directly to the data bus.

Options include 120-characters/second transmission, answer-back memory, an automatic device

controller for remote operation, an automatic off-line record locator, and a full ASCII keyboard. The standard terminals use a Teletype-compatible keyboard, but since an identical thermal printhead is used for the entire series, the standard equipment can receive and print both upper- and lower-case characters.

Standard features also include complete off-line data editing by block or character, high-speed (250-characters/second) tape duplication, switch-selectable parity generation, selectable record or playback on each cassette.

Deliveries will begin in January, with options available in March. The 733 ASR is priced at \$2,750 and



leases for \$120 a month, the 733 KSR sells for \$1,500 and leases for \$75 a month.

Texas Instruments, Digital Systems Div., P.O. Box 1444, Houston, Texas 77001 [361]

---

### Assembly of modules generates display vectors

Most makers of precision graphics systems build their own vector generators. But manufacturers now can buy a vector generator subassembly—a 7- by 8-inch printed-circuit board with 12 interconnected function modules already on the board—and plug it into a standard 44-pin edge connector. This VG110 unit, developed by Intronic Inc., will sell for about \$750.

The VG110 accepts either analog or digital instructions, and when operating digitally, can do spot blanking while new vector position inputs

are fed from the VG110's delay converters. The generator is a random-scan device, with the electron beam in the cathode-ray-tube display responding to deflection outputs of its X and Y axes instead of to repetitive raster-sweep signals. And even though the VG110 boasts a constant write rate, the beam can be slewed at the maximum speed allowed by associated electronics in the VG110's "fast-write" mode.

Vectors, whether graphics or sections of alphanumeric characters, are written in a single stroke, with only the two end points specified. In most applications, digital words, either 10 or 12 bits long, will be generated to describe the end points of a vector—two words for each end point, for a total of four. Digital-to-analog converters at the VG110's input change these to voltages within  $\pm 5$ -volt range; the first two words are stored as the start point of each vector, and a so-called "hold-position" command is applied at the appropriate input terminal. Then the words corresponding to the end point of the vector are entered, the voltage on the command terminal is removed, and the VG110 unblanks the beam and scans it.

The generator's input voltage range is nominally  $\pm 5$  v, but because of the need to fill the corners of rectangular displays, the composite output swing at the generator's X and Y terminals exceeds 7 v.

Although constant after installation, the VG110's write rate is preselectable over a range of from 1.5 millivolts per microsecond to 30 mv per  $\mu$ s, the rate of deflection-voltage change. Thus the user gets a combination of fast writing, and the vectors have constant brightness along their lengths. In addition, write rate is constant to within 5%.

Intronic Inc., 57 Chapel St., Newton, Mass. 02158 [362]

---

### Card reader is aimed at data-terminal applications

Designed for data-terminal applications and matched to mini-computer performance, the model



8020 card reader offers reading speed geared to the data-transfer rates commonly used for data communications. Reading only full-size 80-column cards at 200 cards per minute, the unit is priced at \$980 in OEM quantities. Another model, the 8045, which reads pencil-marked or punched 80-column cards, sells for \$2,265; and a third, the model 8803, for IBM Systems/3 users, handles 80-column cards and stubs, 96-column cards and 96-column stubs. It is priced at \$6,800.

Two options are available for the 8020: a mark/hole reading capability and an RS232C communications interface.

Bridge Data Products Inc., 738 South 42nd St., Philadelphia, Pa. 19104 [363]

### Data terminals built for remote job entry, batching

The DT1000 series of data terminals is designed for applications in remote job entry and batch processing. The units, which are IBM-compatible, can also be used as data-entry keystations and for media conversion, in addition to applications in optical character readers, magnetic-link character readers, point-of-sale, and factory data-collection systems. The basic DT1000 consists of a data-entry keyboard, a control panel to select operating modes, a display panel, communications electronics, and a magnetic-tape drive. Input/output peripherals include a card reader, paper-tape reader, line printer, and serial-character printer. Price for the basic con-

figuration ranges from \$4,000 to \$6,000.

Pertec, 10880 Wilshire Blvd., Los Angeles, Calif. 90024 [364]

### Card reader transmits pertinent data only

Remote entry of card data to time-shared computers is provided by the model 100 card reader. The unit transmits only leading spaces and data, suppressing trailing spaces so that only pertinent data is transmitted. Data conversion from Hollerith code to eight-bit ASCII is standard, and interfacing is EIA RS-232C compatible, with a choice of even, odd, or no parity. Trans-

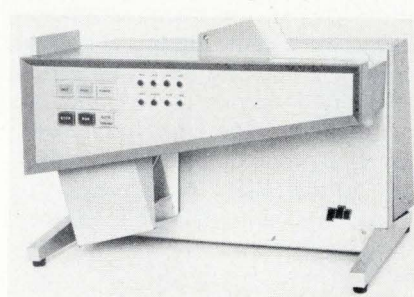

mission rates are from 110 baud to 1,200 baud in either half- or full-duplex. Fully programable automatic codes accompany transmissions to provide control characters to the computer. Price of the card reader is \$2,875.

Omega Data Processing, 180 Valley Rd., Wayne, N.J. 07470 [366]

### Graphics system stresses display-function flexibility

Built for a wide range of users, the Vectographics 11 graphics terminal implements in hardware many display functions usually left to software. Functions such as scaling, rotating, and translating images in two or three dimensions are implemented by a single change in memory. Software includes a Fortran drawing package, an on-line drawing package, and a graphics file-management package. Typical terminal configurations include a

basic graphics system, multiple monitoring and controller systems, and disk operating systems. A basic



system, interfaced with a Digital Equipment Corp. PDP-11 having 4,000 words of memory and a model 33 Teletype, costs \$39,000. More advanced systems can cost up to \$80,000.

Vector General Inc., 8399 Topanga Canyon Blvd., Canoga Park, Calif. 91304 [367]

### Magnetic heads permit drive speeds to 300 in./s

A line of digital heads for tape drives provides increased access time and higher transfer rates, in addition to greater storage capacity per tape reel and self-threading capability. The units operate at speeds to 300 inches per second with a density of 3,200 bits per inch, phase-encoded, at a bit transfer rate of 960 kilohertz. A head profile maintains head-to-tape contact over the entire

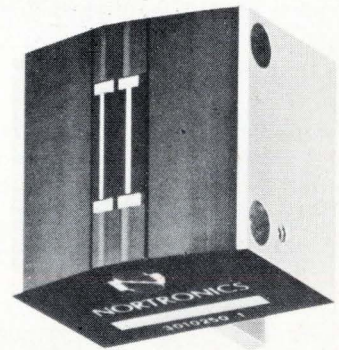

speed and tension range to provide minimum spacing loss and good forward/reverse signal ratio.

Nortronics Co. Inc., 8101 10th Avenue North, Minneapolis, Minn. 55427 [368]





Semiconductors

### Rate multiplier draws 250 nW

Low-power C-MOS device performs arithmetic and algebraic functions

Taking advantage of the low power characteristic of complementary-metal-oxide semiconductors, Motorola has developed a binary-coded-decimal rate multiplier that performs arithmetic and algebraic functions, and draws only 250 nanowatts quiescent at 5 volts dc and 25°C.

Designated the MC14527, the multiplier has two inputs, one for a pulse frequency, and the other for a BCD number. The output is proportional to the product of the two; for example, six pulses emerge for every 10 input pulses if the BCD number is six. This property can be used to add, subtract, divide, raise to a power, and to solve algebraic and differential equations. It can also be used to generate trigonometric functions and natural logarithms.

The MC14527 can also be used in digital filtering, motor speed control, and frequency synthesis applications.

In addition to its low power drain, the new multiplier has high noise immunity, typically 45% of the drain voltage, and a supply voltage that can be as low as 3 v, or as high as 16 or 18 v.

The part is internally synchronized for high-speed operation (up to 5 megahertz typically). A strobe input permits the output to be inhibited or enabled, and the device output count occurs on the convenient, positive-going clock input. Complementary outputs are provided, and the device can operate in either fixed- or variable-rate mode. Two or more of the parts can be operated in cascade, and a special "9" output is available for this use.

Maximum zero-output level at 25°C and 10-v drain supply is 0.01

v, and minimum one-output level is 9.99 v. Output drive current is typically -0.9 mA at 9.5-v output (p-channel) and 1.6 mA (n-channel).

Two versions of the MC14527 are supplied, both in 16-pin ceramic dual in-line packages, one with an AL suffix, for -55°C to +125°C, and one with a CL suffix, for -40° to +85°C. The 100-quantity prices are \$11.85 and \$6.60.

Motorola Semiconductor Products Inc., Technical Information Center, P.O. Box 20924, Phoenix, Ariz. 85036 [411]

### Chip drivers designed for gas-discharge readouts

The increasing popularity of Panaplex-type gas-discharge displays in calculators and digital clocks has created a demand for a new type of integrated-circuit driver—one that can generate the high voltages that are characteristic of discrete transistors, rather than ICs. To meet that need, the mono DRV-01 has been built by Precision Monolithics Inc., Santa Clara, Calif. The device is an array of five high-breakdown cathode-segment drivers constructed on a single monolithic chip. Each driver consists of a high-voltage—145 volts minimum guaranteed breakdown—transistor, along with two resistors and a diode that provides dc restoration when the device is employed in ac-coupled multiplex configurations. The input of the -01 is compatible with MOS logic levels.

Garth Wilson, engineering vice president, explains that standard IC processes cannot provide transistors with 150-volt breakdown ratings. And while a dielectric-isolation process could be employed, this would add to the cost and mean that the wafers could not be run through the company's standard linear processing line. But the DRV-01 can be built on that standard line. The new rules call for deeper and wider diffusions, as well as thicker epitaxial layers that are lightly doped. As a result, while some density is sacrificed, the higher breakdown voltage is easily achieved.

The mono DRV-01, available

from stock, sells for \$2.95 each in quantities of 100.

Precision Monolithics Inc., 1500 Space Park Dr., Santa Clara, Calif. 95050 [412]

### Dual-voltage translator links TTL, DTL with MOSFET

A dual-voltage translator is a second-source integrated circuit to the DM7800/DM8800 now on the market. The new device, called the SN55/75180, is for use in temperatures from -55 to 125°C, and is a plug-in replacement for the 7800. An industrial model, the SN75, is a replacement for the 8800. The translator is designed for linking TTL and DTL voltage levels to those levels associated with high-impedance junc-

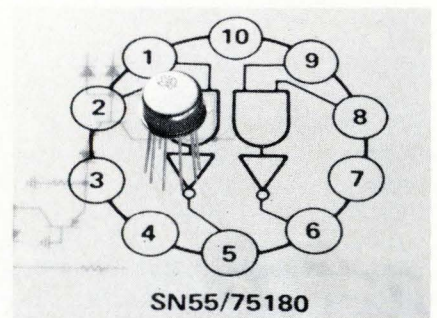

tions or MOSFET-type devices. The circuit design allows the user a choice of power-supply voltages, thus providing control of the output swing. The input-logic stage operates from a standard 5-volt supply and dissipates 1 milliwatt typically in the normal-input low state. The type SN55/75180 is available in a 10-pin metal can. Delivery is from stock. Price in 100 lots for the 55 is \$7.20, and for the 75 it is \$2.40.

Texas Instruments Incorporated, P.O. Box 5012, M/S 308, Dallas, Texas 75222 [413]

### SCRs, diodes incorporate 2½-inch silicon slice

A family of high-power SCRs and diodes each incorporates a 2½-inch-diameter silicon slice. The family, designated type D1200, is offered in a capsule package or in a flat-base package for single-sided cooling.



# cablebility

CABLEBILITY — "The specialized skill of designing and producing quality electrical and electronic cables to meet the sophisticated requirements of today's industry."

Our word yes, and our definition — but we think it aptly describes our ability to provide the best possible solution to your multi-conductor cable problems. But CABLEBILITY is even more than that. It's a blend of experience and technical know-how combined with the virtually unlimited resources and facilities of Cities Service . . . your assurance of dependable and practical cable constructions to fulfill your most exacting requirements.

## **CITIES SERVICE COMPANY**

CHESTER CABLE OPERATIONS  
CHESTER, NEW YORK 10918





# cablebility

## proven by performance

Leading manufacturers in such fields as electronics, automation, nucleonics, communications and electronic data processing have learned to depend on Cities Service quality cables. This industry-wide acceptance has resulted in four expansion programs since 1945 to keep pace with increasing customer demands. Thanks to enlarged research and development facilities, exceptional technical manpower and the latest production equipment, we furnished more than 1,000,000 miles of insulated cables and wires to our customers last year.

Today, our CABLEBILITY is your assurance that Cities Service CITCO brand cables will meet your specifications . . . be competitively priced and will be delivered to you on time. No matter what your requirements . . . check first with Cities Service . . . we know you'll be glad you did.

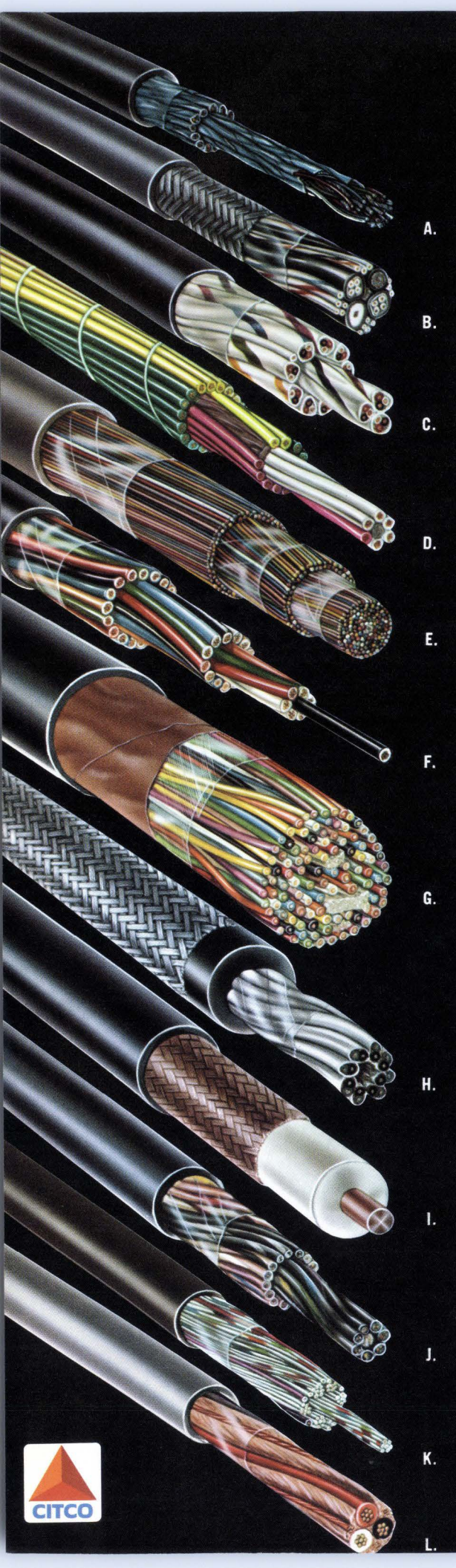

- A. **CITCO AUDIO SOUND CABLE:** 25 shielded pairs, stranded copper conductors, low loss insulation, twisted with uninsulated drain wire, isolated aluminum tape shields, cabled PVC jacket.
- B. **CITCO TV CAMERA CONTROL CABLE:** Camera control cable for Audio and Video signals: a composite of PVC and polyethylene insulated conductors, cabled, overall braid shield, PVC jacket.
- C. **CITCO AIRCRAFT CONTROL CABLE:** 12 triples shielded jacketed, stranded copper conductors, PVC insulated, individual shield jacket color coded, cabled overall PVC jacket.
- D. **CITCO ELEVATOR CONTROL CABLE:** 35 conductors, stranded copper, PVC insulated, conductors coded by colors and printed numbers, cabled with open binder; individual conductors U/L listed.
- E. **CITCO INTEROFFICE COMMUNICATION CABLE:** 250 conductor interoffice communication and signaling cable: solid bare copper, PVC insulation, paired, cabled, PVC jacket; U/L listed.
- F. **CITCO STATION CONTROL CABLE:** 37 conductors, stranded polyethylene and PVC insulated, color coded, cabled, overall tough PVC jacket; per NEMA/IPCEA Specifications.
- G. **CITCO MUNICIPAL COMMUNICATION CABLE:** 50 pairs, polyethylene insulated, cabled, continuous layer of copper shielding tape, PVC jacket; per spec. IMSA-19-2, 600 volts.
- H. **CITCO SHIPBOARD CABLE:** Stranded conductors, nylon-jacketed PVC insulation, pairs shielded and jacketed, cabled, PVC jacket, and aluminum braid armor overall; per spec. MIL-C-915.
- I. **CITCO COAXIAL CABLE:** Type RG-218/U, solid copper conductor, polyethylene insulated, copper braid shield, PVC jacket; per spec. MIL-C-17/79.
- J. **CITCO REMOTE CONTROL BROADCASTING CABLE:** Stranded conductors, polyethylene insulation, pairs and triples shielded and jacketed, cabled, PVC jacket overall.
- K. **CITCO COMPUTER CONTROL CABLE:** 55 conductors, stranded copper conductors, PVC insulated, formed into 7 groups of 7 conductors, cabled, PVC jacket; U/L listed.
- L. **CITCO BUS DROP CABLE:** 3 PVC insulated stranded conductors, with split uninsulated grounding conductor, cabled, overall PVC jacket; U/L listed; per NEC.

### OTHER CITIES SERVICE WIRE & CABLE PRODUCTS

APPLIANCE WIRE • BUILDING WIRE • FLEXIBLE CORDS • FIXTURE WIRE  
GAS TUBE SIGN CABLE • HIGH VOLTAGE CABLE • HOOK-UP WIRE  
LEAD-IN CABLE • MACHINE TOOL WIRE & CABLE • SHIELDED WIRES  
WEATHER-PROOF WIRE • DEEP-WELL SUBMERSIBLE WATER PUMP CABLE  
LOW ENERGY CIRCUIT CONTROL CABLE • GASOLINE & OIL RESISTANT WIRE

## CITIES SERVICE COMPANY

CHESTER CABLE OPERATIONS

CHESTER, NEW YORK 10918

Phone: (914) 469-2141 TWX (914) 469-9801





## New products

The SCRs, which have current ratings of up to 1,500 amperes, can handle transient voltages to 3.5 kilovolts and surges up to 16,000 A. The

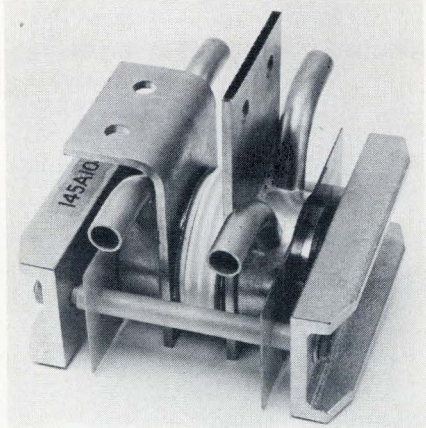

diodes have current ratings up to 1,500 A, transient voltage ratings to 3 kV and surge current ratings up to 33,000 A.

Westcode Semiconductors, 282 Belfield Rd., Rexdale 605, Ont., Canada [414]

### Beam-lead diodes supply large-volume applications

Applications for which large volumes of high-frequency diodes are required may be supplied by the model 5082-2837 beam-lead diode. The unit has epitaxial, planar-passivated construction, its leads are coplanar gold-plated, and it measures 4 mils wide by 1/2 mil thick. Breakdown voltage is 70 volts, and reverse leakage current is 200

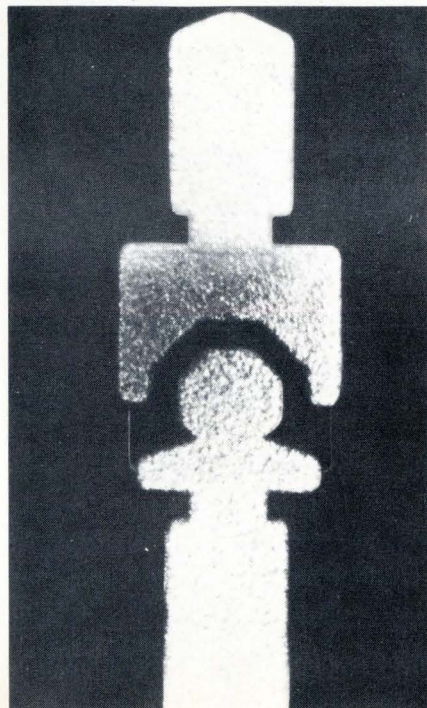

nanoamperes. Capacitance is 2 picofarads, and effective minority-carrier lifetime is 100 picoseconds maximum. Price is 99 cents in quantities of 1 to 99.

Hewlett-Packard Co., 1501 Page Mill Rd., Palo Alto, Calif. 94304 [418]

### Tracking regulators power operational amplifiers

Constructed to supply the voltage required by operational amplifiers and analog multipliers in control and instrumentation circuitry, the model MC1568 voltage regulator is preset for  $\pm 15$  volts, accurate within  $\pm 200$  millivolts. It may be programmed to outputs of  $\pm 14.5$  v through  $\pm 20$  v by adding two suitable external resistors. At  $\pm 15$  v, the

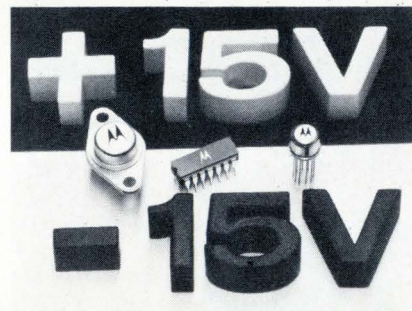

absolute value of output voltages agrees within a maximum of 1%. Output current of up to  $\pm 100$  milliamperes may be obtained without external current-boosting transistors, while maximum unregulated input voltage is  $\pm 30$  v. Price in 100-piece quantities ranges from \$2.80 to \$7 depending on temperature range and package styles.

Motorola Inc., Semiconductor Products Division, P.O. Box 20912, Phoenix, Ariz. 85036 [417]

### Schottky diodes operate in uhf to Ku bands

Schottky barrier diodes, both silicon and gallium-arsenide types, are specifically designed for mixer, detector, and switching applications in the uhf to Ku bands. The series A2G170 and A2G130 gallium-arse-



**YOU'VE  
VISITED THE  
SMOKIES...**

**WHY NOT  
LOCATE YOUR  
PLANT HERE?**

#### Business reasons:

- Low tax base
- Plentiful, willing workers
- Farm-based economy
- Ready transportation
- Technical college nearby
- No labor problems

#### Personal reasons:

- Stupendous trout fishing
- Small, honest colleges
- School system — ranks 10th of 152 N. C. counties
- Deer and bear hunting
- National forests
- Eight ski areas
- Excellent golfing

Put your new plant in the heart of Carolina's Smoky Mountains — and enjoy vacation-like living the year 'round. Madison County's climate is ideal for business, for workers, and for management. Join us in a good life!

To: Madison County Industrial Development Commission  
Courthouse Marshall, N. C. 28753

Yes, please sell me on Madison County, N. C.

Name \_\_\_\_\_

Company \_\_\_\_\_

Address \_\_\_\_\_

City, State, ZIP \_\_\_\_\_



**NEW**  
**HUTSON CERMA-CEL\***  
**TRIAC's & SCR's**



- 8 Amp ( $I_{T(RMS)}$ )
- 200V, 300V, 400V ( $V_{DRM}$ )
- Miniature size — requires only slightly more space than direct chip mounting
- Thyristor die bonded to ceramic cell and secured within nickel-plated steel housing
- Can be reflow soldered. Correct amount of solder on housing head.
- Void-free-glass passivated, hermetically sealed chip
- Di-Mesa\* construction for maximum operational reliability
- Extremely low-cost

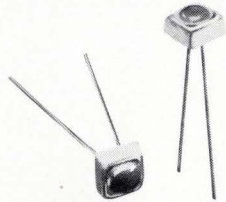

Hutson's complete thyristor line includes 3A sensitive gates to 40A ( $I_{T(RMS)}$ ) • 50V to 600V ( $V_{DRM}$ ). All popular packages & chip form



WRITE FOR FREE CATALOG

\*T.M. HUTSON INDUSTRIES

**HUTSON INDUSTRIES**

BOX 34235 • 2019 W. VALLEY VIEW, DALLAS, TEX. 75234 (214) 241-3511 TWX 910-860-5537

*Distributed by:*

ALTA-LAND ELECTRONICS, INC. Salt Lake City, Utah. 801/486-7227 ■ BODELLE CO., INC., Chicago, Ill. 312/468-1016, Detroit, Mi. 313/273-6920 ■ THOR ELECTRONICS, Elizabeth, N. J., 201/354-2420 ■ In Canada: WEBER-SEMAE ELECTRONICS, Downsview, Ont. 416/635-9880.

*European Marketing Director:*

30 Rue Pierre Semard, Yerres, 91 France Tel: Paris 925-8258 • TELEX 21-311

*Distributed in Europe by:*

Belgium: C. N. ROOD S.A. Brussels 02-352135 ■ Denmark: E. V. JOHANSEN A/S, Copenhagen (01)\* 295622 ■ Holland: RODELCO, Den Haag 647808 ■ Spain: BELPORT, Madrid 234.62.62 ■ Sweden: ELEKTROFLEX, Sundyberg 08-29 50 40 ■ Switzerland: D. LEITGEB, Dubendorf 051 85 2201 ■ UK, CLAUDE LYONS, LTD, Hoddeston, Hertfordshire (09924) 67161

Circle 150 on reader service card

**New products**

nide varieties provide a 5.5-decibel noise figure for X band and 6.0 dB for Ku band. The series A2G100 silicon types are for such applications from C to Ku band as strip-line, coaxial, and waveguide circuits. The A2S200 diodes, which operate from C to Ku bands, are optimized for tangential sensitivity, and the A2S300 types are designed

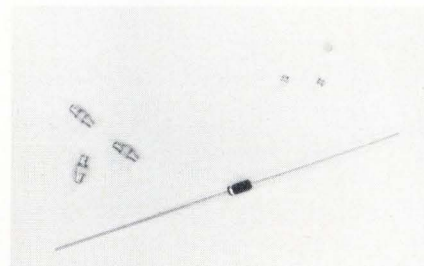

for ultrafast switching. The A2S600 diodes are glass axial diodes for frequencies through X band. Price is from \$3 in small quantities.

Aerotech Industries, 825 Stewart Dr., Sunnyvale, Calif. [419]

Panel-mounting LED is about 1/3 inch long

The L-series of light-emitting diodes features a replaceable LED that snaps into a panel-mounting plastic bezel. The red diffusing lens cannot be misread when struck by an external light source, and the unit, 21/64 inch long, is mounted with a clip

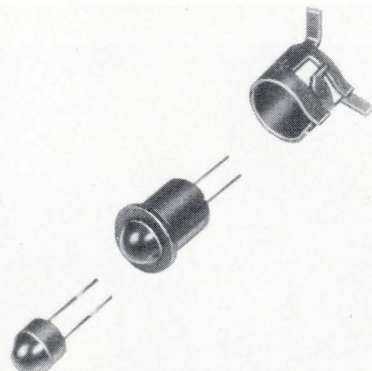

that is provided. Connections may be soldered directly to gold-flashed leads that eliminate the tarnishing factor in low-current circuitry. Price is \$1.40 in quantities of 1 to 99.

TEC Inc., 9800 N. Oracle Rd., Tucson, Ariz. 85704 [420]

**ENGINEERS WHO KNOW TANTALUMS SPEC DICKSON**

Because Dickson is a specialist in solid tantalum capacitors! This specialization means more quality in every unit produced from MIL-C-39003 types to low-cost commercial units. With over 4,000 standard catalog items, you can always depend upon Dickson to supply the right tantalum unit at the right price.

Try us! Write, today, for our 6-page Tantalum Capacitor Short Form Catalog.

"Where Quality Makes The Difference"

"The Specialists"



**DICKSON**

ELECTRONICS CORPORATION

PHONE (602) 947-2231 TWX 910-950-1292 TELEX 667-406 P. O. BOX 1390 • SCOTTSDALE, ARIZONA 85252



U.S. POSTAL SERVICE  
STATEMENT OF OWNERSHIP, MANAGEMENT  
AND CIRCULATION

(Act of August 12, 1970: Section 3685, Title 39,  
United States Code).

- Title of publication: ELECTRONICS.
- Date of filing: October 1, 1972.
- Frequency of issue: Bi-weekly.
- Location of known office of publication: 1221 Avenue of the Americas, City, County and State of New York—10020.
- Location of the headquarters or general business offices of the publishers: 1221 Avenue of the Americas, City, County and State of New York—10020.
- Names and addresses of publisher, editor, and managing editor: Publisher, Daniel A. McMillan, III—1221 Avenue of the Americas, New York, N.Y.—10020; Editor, Kemp Anderson—1221 Avenue of the Americas, New York, N.Y.—10020; Managing Editor, Samuel Weber—1221 Avenue of the Americas, New York, N.Y.—10020.
- The owner is McGraw-Hill, Inc., 1221 Avenue of the Americas, New York, New York 10020; Stockholders holding 1% or more of stock are: Donald C. McGraw, Elizabeth McGraw Webster, Donald C. McGraw, Jr. & Harold W. McGraw, Jr., Trustees under Indenture of Trust m/b James H. McGraw, dated 1/14/21 as modified; Donald C. McGraw, Trustee under an Indenture of Trust m/b James H. McGraw, dated 7/1/37 as amended; Donald C. McGraw, individually; Donald C. McGraw & Catharine McGraw Rock, as Trustees of the Estate of Mildred W. McGraw, all of 1221 Avenue of the Americas, New York, New York 10020; FirJer & Co. c/o First National Bank of Jersey City, 1 Exchange Place, Jersey City, New Jersey 07302; Harwood & Co. c/o State Street Bank and Trust Company, P.O. Box 5006, Boston, Mass. 02101; Perc & Company c/o Northwestern National Bank of Minneapolis, Minneapolis, Minnesota 55480; Pratt & Co. c/o Boston Safe Deposit and Trust Company, 1 Boston Place, Boston, Mass. 02106; Way & Co. c/o The Bank of New York, 110 Washington Street, New York, New York.
- Known bondholders, mortgagees, and other security holders owning or holding 1 percent or more of total amount of bonds mortgages or other securities: None.
- Permission requested.
- Not applicable.
- Extent and nature of circulation:

Average No. Copies Each Issue During Preceding 12 Months	Copies of Single Issue Published Nearest To Filing Date
90,243	89,941

A. Total No. Copies Printed.  
B. Paid Circulation

1. Sales through dealers and carriers, street vendors and counter sales		
2. Mail subscriptions	86,094	86,500
Total Paid Circulation	86,094	86,500
D. Free distribution by mail, carrier or other means:		
1. Samples, complimentary, and other free copies	3,119	2,828
2. Copies distributed to news agents, but not sold		
E. Total Distribution	89,213	89,328
F. Office use, left-over, unaccounted, spoiled after printing	1,030	613
G. Total	90,243	89,941

I certify that the statements made by me above are correct and complete.

McGraw-Hill, Inc.  
By JOHN J. COOKE,  
Senior Vice President & Secretary

Don't forget the

## BOX NUMBER

... when answering the classified advertisements in this magazine. It's our only means of identifying the advertisement you are answering.

### AUTOTRACK MOUNT

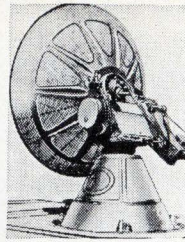

#### AUTOTRACK SCR-584 RADARS

360 degree azimuth, 210 degree elevation sweep with better than 1 mil. accuracy. Missile velocity acceleration and slewing rates. Amplidyne and servo control. Will handle up to 20 ft. dish. Supplied complete with control chassis. ALSO in stock—10 cm. van mounted radar system. Conical scan. PPI. 6 ft. dish. Ideal for S band telemetry, weather, balloon trk.

missile trk, rocket trk, ECM range. Write for complete data. 600 pg. instr. bk. avail. at \$25 ea.

#### PATH LOSS MEAS. FACILITY

Mfg. REL For establishing max. xmsn paths for tropo and microwave links. 2 heli-hut vans. Covers 1-2-5ghz bands. 20 to 120 watts CW output.

#### MOD IV HIGH RESOLUTION TRACKER

Instrumentation radar; freq. 8.5-9.6 GHz, Pwr: 250 KW, .1 mil tracking accuracy. 6' Fresnel lens antenna with 4 horn monopulse feed. Tracking range 50 or 200 miles. Formerly used as range safety radar at Cape Kennedy.

#### MIT MODEL 9 PULSER 1 MW—HARD TUBE

Output 25kv 40 amp., 30kv 40 amp. max. Duty cy. .002, .25 to 2 microsec. Also 5 to 5 microsec. and .1 to .5 microsec. Uses 6C21. Input 115v 60 cycle AC. Mfg. GE. Complete with driver and high voltage power supply. Ref: MIT Rad. Lab. Series, Vol 5, p. 152.

#### 2 MEGAWATT PULSER

Output 30 kv at 70 amp. Duty cycle .001. Rep. rates. 1 microsec. 600 pps. 1 or 2 msec. 300 pps. Uses 5948 hydrogen thyratron. Input 120/208 VAC 60 cycle. Mfr. GE. Complete with high voltage power supply.

#### 2 MEGAWATT HARD TUBE PULSER

Output 40kv at 50 Amps. Duty cy. .0038. Var. pulse width. Compl. with driver and HV power supply. Input 208V 60hz.

#### HV POWER SUPPLIES

5KV @ 1 Amp; 20KV @ 1.3 Amps; 35KV @ 1.5 Amps; 28KV, 70MA; 12KV @ 800MA; 18KV @ 2.25 Amps; 17.5KV @ 1.8 Amps.

### RECON DRONE CONTROL RADARS

X Band systems autotrack and search complete with plotting boards. Fully mobile van mounted. Gives PPI, slant range, altitude data. Ground to air control links and beacons also in stock. AN / MPQ-29 & AN / UPW-1

#### PARAMETRIC AMPLIFIER

Collins type. 2.3 Ghz, 30 Mhz band width, 1.7 DB noise figure, 20 DB gain, 5-way power splitter output.

#### SPARE PARTS IN STOCK

Nike Ajax, Nike Hercules, M-33, MPS-19, TPS-ID, TPS-10D, FPS-6, SPS8, SCR-584, HIPAR.

#### RADAR & RF PKGS.

34ghz 40kw Pulse RF pkg  
24ghz 40kw Pulse bomb toss system  
16ghz 130 kw Pulse B-38 search radar system  
X BAND AUTOTRACK 250KW PULSE M-33 compl w/ plot boards  
X BAND AUTOTRACK 50KW PULSE B-47 fire control complete

#### C BAND HEIGHT FINDER

AN/FPS-26 5 megawatt output.  
AN/TPS-37, 1 megawatt output.

#### C BAND 1 MEGAWATT AUTOTRACK

10ft dish mortar locator MPQ-21  
C BAND 285KW PULSE Search AN / SPS-5 / 10  
S BAND 1 MEGAWATT COHERENT AN / FPS-18  
S BAND 1 MEGAWATT PULSE NIKE ACQ.  
L BAND 1 MEGAWATT PULSE AN / UPS-1  
L BAND 500KW PULSE AN / TPS-ID / E  
L BAND 5 to 20KW PULSE

400mhz 1KW CW AN / FPS-23  
225mhz 1 MEGAWATT PULSE AN/TPS 28  
2-30mhz 100KW PULSE

CW 950-5ghz 150 WATTS  
CW 1.5mhz-10.5ghz 5 WATTS

### AN / GPG-1 SKYSWEEP TRACKER

3 cm. auto. tracking radar system. Comp. pkg. w/ indicator sys. Full target acquisition & auto. tracking. Input 115v 60 cy. new. In stock for immed. del. Entire sys. 6' x 3' x 10'. Ideal for infrared tracker, drone tracker, missile tracker, R & D.

#### CATV-COLOR MICROWAVE LINKS

Ratheon type KTR-1000. Fullcolor bandwidth as well as studio audio. Rack mounted. Complete trans-recv racks in stock.

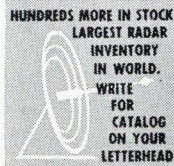

HUNDREDS MORE IN STOCK  
LARGEST RADAR  
INVENTORY  
IN WORLD.  
WRITE  
FOR  
CATALOG  
ON YOUR  
LETTERHEAD

## Radio-Research Instrument Co. Inc.

3 Quincy St., Norwalk, Conn. 06850 • 203-853-2600

CIRCLE 951 ON READER SERVICE CARD

## HELP!

Q. How do I reply to a box number ad?

A. Address an envelope with the box number indicated in the ad, c/o Electronics, Class. Adv. Dept., P.O. Box 900, NY, NY 10020

Q. Whom do I contact or call to re-new my classified ad or make corrections?

A. Write Electronics, Class. Adv. Dept., P.O. Box 900, NY, NY 10020 or call: (212) 997-6585 or 6586. Give full company name, size of ad, & date or dates it is scheduled to appear.

**Minifluid DISPENSER**  
AIR OPERATED  
for miniature potting and encapsulating  
Available in 3 sizes  
6cc - 12cc - 30cc  
\$34.00 UP  
PHILIP FISHMAN COMPANY  
7 CAMERON ST., WELLESLEY, MASSACHUSETTS 02181

CIRCLE 952 ON READER SERVICE CARD

**FREE CATALOG**  
HARD-TO-FIND PRECISION TOOLS  
Lists more than 1700 items—pliers, tweezers, wire strippers, vacuum systems, relay tools, optical equipment, tool kits and cases. Also includes four pages of useful "Tool Tips" to aid in tool selection.  
JENSEN TOOLS  
4117 N. 44th Street, Phoenix, Ariz. 85018

CIRCLE 953 ON READER SERVICE CARD

## One Story 100,500 Sq. Ft.

Acreage • Virginia

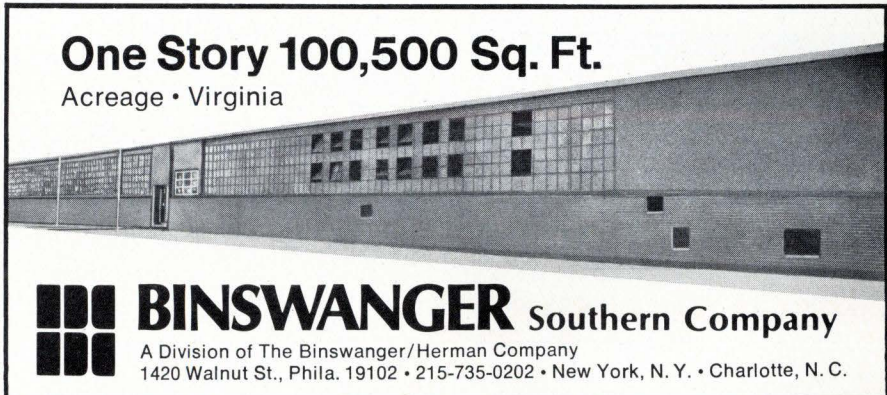

## BINSWANGER Southern Company

A Division of The Binswanger/Herman Company  
1420 Walnut St., Phila. 19102 • 215-735-0202 • New York, N. Y. • Charlotte, N. C.

CIRCLE 954 ON READER SERVICE CARD



# IOWA HAS WORKERS WHO WORK

Iowans are intelligent, well-educated and take a midwestern pride in their work. And they add value to the products they make — over \$2,000 more value annually, per worker, than the national average. For information, send this coupon.

Iowa Development Commission  
250 Jewett Bldg., Dept. E-11  
Des Moines, Iowa 50309

Please send me information of  
industrial opportunities in Iowa

NAME \_\_\_\_\_  
PHONE \_\_\_\_\_  
FIRM \_\_\_\_\_  
ADDRESS \_\_\_\_\_  
CITY \_\_\_\_\_  
STATE \_\_\_\_\_ ZIP \_\_\_\_\_

 **Iowa**  
a place to grow

## New products/materials

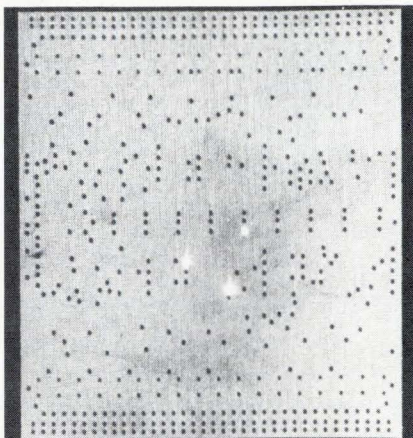

A **glass-epoxy** copper-clad laminate permits faster, more reliable inspection of through-hole plating of printed-circuit boards. The laminate, designated Quick-Spec, fluoresces upon exposure to ultraviolet light, and after a copper-clad panel has been drilled, sensitized, and copper-plated, it is examined under ultraviolet light. Voids in copper show up as luminescent spots.

Norplex Division, Universal Oil Products Co.,  
1300 Norplex Drive, LaCrosse, Wis. 54601  
[476]

**Electrically conductive**, pure-silver-filled epoxies are designated CON/EPOX-I-S and CON/EPOX-I-G. The one-part systems cure at temperatures between 150°C and 175°C and will not outgas. Both systems can be used in automatic dispensing units and die bonders. The I-S system may be silk-screened through a 250-mesh screen if thinned 5% by weight with toluene or alcohol. The epoxies provide strong, stable bonds.

Technical Wire Products Inc., 129 Dermody St., Cranford, N.J. 07016 [478]

A **neutral flux** contains no acids or free fluorides. The flux fumes are not harmful to eyes, lungs, or nasal passages. No. 6 flux can be used for brazing, hard-soldering, and silver-soldering both ferrous and non-ferrous metals and alloys. Hot water will remove excess flux or residues. Another flux, No. 30, is specifically for radio, telephone and electronic parts work, particularly printed-circuit boards.

Superior Flux & Mfg. Co., 1536 St. Clair Ave., Cleveland, Ohio 44114 [479]

## New literature

**Semiconductors.** A multiple semiconductor catalog is available from Texas Instruments Incorporated, P.O. Box 5012, Dallas, Texas 75222. The 96-page publication highlights devices with more than one chip in a package and describes the packaging of diodes and transistors in integrated-circuit-compatible packages. Circle 421 on reader service card.

**Peripherals.** Datum Inc., 170 East Liberty Ave., Anaheim, Calif. 92801. A 12-page catalog contains a brief description of the company, specifications for typical magnetic tape input/output systems, digital cassette drives and mass-memory devices, all with software and interfacing to a range of minicomputers. [422]

**Communications.** The use of microwaves to provide extended control

for retail business is outlined in a brochure published by Motorola Inc., Communications Division, 1301 Algonquin Rd., Schaumburg, Ill. 60127. The 10-page brochure describes how retail-management problems are being solved through voice, visual, and alarm control, as well as data-communications systems linking cities. [423]

**Converters.** An application note on digital-to-analog conversion using the company's CD4007 C-MOS integrated circuit, a dual complementary pair plus inverter, is available from RCA, Solid State Division, Route 202, Somerville, N.J. 08876 [424]

**Control devices.** A line of solid-state control devices, including timers, photoelectronics, resistance-sensing relays, and multipole relays, is described in a condensed catalog sheet



being offered by Regent Controls Inc., Harvard Ave., Stamford, Conn. 06902 [425]

**Disk drive.** Mohawk Data Sciences Corp., Palisade St., Herkimer, N.Y. 13350, has available literature for the models 2900/2800/2500 disk drive system and for the 8420 tape transport, 8803 controller, and 2007 drive. [426]

**Video delay line.** A product bulletin issued by the Corning Glass Works, Memory Products Dept., Raleigh, N.C. 27602, describes how a video delay line is used to store analog signals for television vertical enhancement and other analog image-processing functions. [427]

**Magnetic test system.** A 36-page brochure from Computest Corp., 3 Computer Dr., Cherry Hill, N.J. 08002, details the Delta 400 stored-program magnetic test system. The brochure includes sections on cost advantages, operating data, data acquisition, and software, in addition to application notes. [428]

**Instrumentation recorders.** Test & Measuring Instruments Inc., 224 Duffy Ave., Hicksville, N.Y. 11802. A 36-page brochure discusses the Ana-Log 7 and Ana-Log 14 portable cartridge instrumentation recorders for fundamental and applied research. Technical descriptions, accessories and background information are included. [429]

**Connectors.** A catalog describing cylindrical, subminiature rectangular, crimp-removable cylindrical, and filtered contact connectors is available from General Connector Corp., 80 Bridge St., Newton, Mass. 02158. [430]

**Proximity switch.** Product sheet 10FL, published by Micro Switch, a division of Honeywell Inc., 11 West Spring St., Freeport, Ill. 61032, describes a solid-state proximity switch, listing dimensions, applications, and specifications. [431]

**Microelectronics.** A four-page brochure from Tegal Corp., 815 S. 10th

St., Richmond Calif. 94804, discusses chemistry applications in microelectronic and optics. Photoresist stripping, substrate cleaning and etching, and optical-surface preparation are described. [432]

**Sockets.** Augat Inc., 33 Perry Ave., Attleboro, Mass. 02703. A 16-page technical catalog on sockets for testing and packaging integrated circuits and components includes specifications, schematics, dimensions, and photographs. [433]

**Pulse generator.** The model 10433 pulse generator is detailed in a specification sheet available from MCL Inc., 10 North Beach Ave., La Grange, Ill. [434]

**Variable resistors.** A short-form catalog describes the specifications and dimensional data for resistors with 1/2-inch diameter conductive plastic and 1 1/8-inch diameter carbon elements. The catalog is available from Reon Resistor Corp., 420 Lincoln Highway, Frazer, Pa. [435]

**Thermistors.** A revised and expanded 12-page catalog from Yellow Springs Instrument Co. Inc., Box 279, Yellow Springs, Ohio 45387, describes precision interchangeable thermistors. [436]

**Connector assemblies.** Ansley Electronics Corp., Old Eastern Rd., Doylestown, Pa. 18901, has issued data sheet 208 on flex-strip flat-edge cable connector assemblies. [437]

**Rf components.** Werlatone Inc., East Branch Ave., Brewster, N.Y. 10509. Radio-frequency and intermediate-frequency components are discussed in a four-page data sheet. The products include power dividers, hybrid junctions, directional couplers, phase shifters and mixers. [438]

**Digital printer.** A two-page technical bulletin from Veeder-Root, 70 Sargeant St., Hartford, Conn. 06102, provides information on the series 7703 digital printer. Applications, specifications, options, and dimensions are given for this solid-state impact-type device. [439]

# So you want to handle everyone's DIPs...

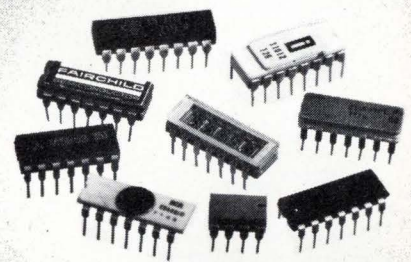

You can, with our new test handlers. They handle 8 to 40 lead packages.

For more information on how you can save money in your test area, contact:

**International  
Production Technology**

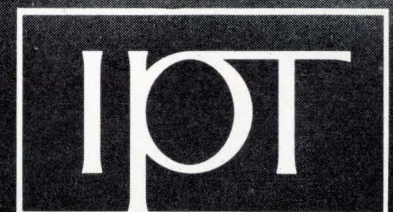

185 Evelyn Avenue  
Mountain View, CA 94040

• (415) 961-9521 •  
HOT LINE (415) 961-2458



* Adret	9E	■ General Electric Co., Miniature Lamp Div.	22	North American Rockwell, Electronics Group	156
Advanced Micro Devices Keye/Donna/Pearlstein	10-11	Carr Liggett Advertising, Inc.		Campbell-Ewald Company	
* Advanced Micro Devices Keye/Donna/Pearlstein	20E	■ General Electric Company (Plastics Dept.-Silicone Products Dept.)	137	* Ohmic	13E
* AEROCOM Grant Advertising, Inc.	59	Ross Roy of New York, Inc.		Promoazur	
Alco Electronic Products, Inc. Marketronics Advertising	156	■ General Electric Co., Semiconductor Products Department	9	Optical Electronics	40
Allen-Bradley Company Hoffman, York, Baker & Johnson, Inc.	90	Advertising & Sales Promotion Syracuse Operation		Craig Miller Advertising	
AMP, Incorporated Aitkin-Kynett Co., Inc.	84-85	* General Instrument Europe S. P. A.	30E	* Oscilloquartz SA, Neuchatel	10E, 25E
■ Amphenol Industrial Division, Bunker Ramo Corp.	26, 128-129	Studio Hedy		M. R. Hofer Werbeagentur BSR/EAAA Bern	
Analog Devices, Inc. Schneider Parker Guy, Inc.	73	General Radio Co. GRAD Associates	43	■ Permag Corporation	48
■ Augat Creamer, Trowbridge, Case & Basford, Inc.	78	General Time Corporation- Space & Systems Division	72	Schneider, Allen, Walsh, Inc.	
Bausch & Lomb, Inc. Wolff Assoc., Inc.	39	Adhouse		* Philips N. V. Pit/T & M Division	56
* Bayer AG. Roston, Kremer and Slawter	29E	■ Gould, Inc./Instrument Systems Division	54	Marsteller International S. A.	
■ Bendix Corporation, Electrical Components Div.	141	Carr Liggett Adv., Inc.		* Phillips Elcoma	4E, 16E, 35E
D'Arcy-MacManus-Intermarco, Inc.		■ Grayhill, Incorporated Carr Liggett Advertising, Inc.	123	Tag-Intermarco delamar	
■ Busmann Mfg. Division of McGraw Edison Co.	79	GRI Computer Allied Advertising Agency, Inc.	29	* Racial Instruments Ltd.	27E
Henderson Advertising Company		Harris Semiconductor Tucker Wayne & Company	64-65	Nicklin Advertising Ltd.	
By-Buk Company, Sub. of Webtek Corp. J. R. Bloome Company	74	■ Heath/Schlumberger Scientific Instruments Advance Advertising Services	123	* Radiometer Copenhagen	28E
California Computer Products Dailey & Associates Advertising	97	* Heinzinger Technik Marketing	31E	* RAFI	24E
■ Cambridge Thermionic Corporation Chirurg & Cairns, Inc.	23	■ Hewlett Packard Tallant Yates Adv. Inc.	126-127	OSW-Werbeagentur	
Canadian Marconi Company, Telecommunications Division	49	■ Hewlett Packard Tallant Yates Adv. Inc.	1	Raytheon Company, Industrial Components Operation	71
Telecommunications Advertising		■ Hewlett Packard McCarthy Scelba, and DeBlasi Adv. Agcy. Inc.	2	Provandie Eastwood & Lombardi, Inc.	
Chester Cable Operations, Cities Service Company	147-148	Houston Instrument Ray Cooley and Associates, Inc.	119	■ RHG Electronics Laboratory, Inc.	135
Lewis Advertising Agency		Hutson Industries Warren-Guild	150	Samuel H. Goldstein	
Chomerics, Inc. Van Christo Associates, Inc.	123	Hysol Div., The Dexter Corp. Sialnik, Falter & Klenk, Inc.	45	Rochester Gas & Electric- Advertising Group	80
* C. I. I. Interplans-Publi Action	23E	IBM Data Processing Division Geer, Dubois & Co., Inc.	81	Hutchins Advertising Company, Inc.	
‡ Cincinnati Milacron, Process Controls Division	56	ILC Data Device Corporation Marchin Weltman Advertising, Inc.	16	* Rohde & Schwarz	1E, 7E
David K. Burnap Advertising		Intel Corporation Bonfield Associates	35	Howard W. Sams & Co. Aitkin-Kynett Co., Inc.	38
■ Colorado Video, Inc. O'Connell-Columb, Inc.	124	■ International Crystal Mfg. Co. Robert V. Freeland & Associates	41	Schauer Manufacturing Corp. Nolan, Keeler & Stites	42
Creative Business Communications		International Electronic Research Corporation Van Der Boom, McCarron, Inc., Advertising	155	* Schneider R. T. Intermedia	22E
* Communications Associates, Inc. Caroe Marketing, Inc.	32E	* Intersil Herrick Associates, Inc.	2E-3E	* Sescosem Perez Publicite	17E
Conolog Corporation	6	Iowa Development Commission Creswell, Munsell, Schubert & Zirbet Inc.	152	Signetics Corp., Sub. of Corning Glass Works	24-25
Coors Porcelain Company Frye-Sills, Inc.	142	IPT Corporation ROY MINOR/Graphic Arts	153	Hall Butler Blatherwick, Inc.	
Dale Electronics, Inc., A Sub. of The Lionel Corporation	4th Cover	■ Johnson Company, E. F. Martin Williams Advertising	139	Siliconix Incorporated Paul Pease Advertising	105
Swanson, Sinkey, Ellis, Inc. Advertising		Krohn-Hite Corporation Impact Advertising, Inc.	5	Solltron Devices, Inc. Sol Advertising Agency	37
Data General Corporation The Advertising Group	77	LFE Corporation, Process Control Division Culver Advertising Inc.	72	* Sorel Gerard Micaud	32E
Data Technology Corporation Rose Associates Advertising & Public Relations	83	■ Lambda Electronics Corporation Michel Cather, Inc.	3rd Cover	* Sorensen AG. Mosse-Annoncen AG.	26E
Decision Data Computer Corporation Jordan Frederick & Company	74	* LTT Publibel	33E	* Souriau & Cie Ariane Publicite	21E
■ Delevan Division, American Precision Industries, Inc.	46	Lumina Houwart Hollander & Deneef	74	Sprague Electric Company Harry P. Bridge Company	8, 69
Comstock Advertising, Inc.		McGraw-Hill, Inc.	130-131	■ Systron Donner Concord Instruments Bonfield Associates	50
Dickson Electronics Corporation N. A. Winter Advertising Agency	150	Madison County Industrial Development Commission	149	TEC, Inc. TEC-AD	143
■ Digital Equipment Corporation Creamer, Trowbridge, Case & Basford, Inc.	88-89	Western Reserve Advertising Agency, Inc.		* Teledyne Relays S. Michelson Advertising	19
* D. Olivetti & C. Spa Studio ECO	14E	Magic Dot, Inc. Division of S. J. Groves, Inc.	138	Teledyne Semiconductor Regis McKenna, Inc.	53
Dumont Oscilloscope Laboratories, Inc. Barbetta Miller Advertising, Inc.	6	Fischbein Advertising, Inc.		Tempil Ind, Div. of Big Three Ind. Black-Russell-Morris	124
Electronic Arrays, Inc. Regis McKenna, Inc.	15	Master Appliance Klau-Van Pietersom-Dunlap, Inc.	156	Teradyne Inc. Quinn & Johnson, Inc.	66
■ Electronics Associates, Inc. Gerald Clarke, Inc.	44	■ MEPCO/ELECTRA INC. Welborn Advertising, Inc.	20-21	■ Texas Instruments Incorporated, Components Group	86-87
■ Electronic Navigation Industries Hart Conway Co., Inc.	14	Microsystems International Ltd. Media Advertising Ltd.	132	Albert Frank Guenther Law, Inc.	
■ Erie Technological Products Co., Inc. Altman Hall Associates Advertising	48	* Microwave & Electronic Systems Ltd. Hall Advertising Ltd.	19E	‡ Thomas & Betts Company McCarthy, Scelba, DeBlasi Advertising Agency, Inc.	59
* European Electronic Products Frank E. Galusha, Jr. Advertising & Marketing Services	34E	† 3M Electro Products Division Batten, Barton, Durstine & Osborn, Inc.	19	Thomson CSF Bazaine Publicite	114
Fairchild Semiconductor, Inc. Carson/Roberts, Inc. Adv., Division of Ogilvy & Mather, Inc.	12-13	Monolithic Memories, Inc. Paul Pease Advertising, Inc.	113	■ TRW, Electronic Components Division The Bowes Company	62-63
Fairchild Systems Technology Hall Butler Blatherwick, Inc.	75	MOS Technology, Inc. Henry S. Goodsett Advertising, Inc.	2nd Cover	Union Carbide Corp., Linde Division Young & Rubicam, Inc.	47
* Fairchild, Wiesbaden Impuls Werbung	11E	■ Motorola Semiconductor Products, Inc. E B Lane & Associates, Inc.	60-61	Varo Semiconductor, Inc. Warren-Guild	143
■ Fluke Manufacturing Co., John Bonfield Associates	17-18	Mostek Corporation Continental Communications Incorporated	30	* Wandel und Goltermann Werbeagentur	12E
		Murata Corp. of America Kenmarc Advertising, Inc.	80		
		■ National Semiconductor Corp. Chiat/Day, Inc. Advertising	7		

## Classified & Employment Advertising

F. J. Eberle, Manager 212-971-2557

EQUIPMENT (Used or Surplus New) For Sale	
Binswanger Southern Co.	151
P. Fishman Company	151
Jensen Tools & Alloys	151
Radlo Research Instrument Company	151

■ For more information on complete product line see advertisement in the latest Electronics Buyer's Guide  
\* Advertisers in Electronics International  
‡ Advertisers in Electronics domestic edition



### Advertising Sales Staff

**Pierre J. Braudé** [212] 997-3485  
Advertising Sales Manager

**Atlanta, Ga. 30309:** Joseph Lane  
100 Colony Square, 1175 Peachtree St., N.E.  
[404] 892-2868

**Boston, Mass. 02116:** James R. Pierce  
607 Boylston St. [617] 262-1160

**Chicago, Ill. 60611:**  
645 North Michigan Avenue  
Robert W. Bartlett (312) 751-3739  
Paul L. Reiss (312) 751-3738

**Cleveland, Ohio 44113:** William J. Boyle  
[716] 586-5040

**Denver, Colo. 80202:** Harry B. Doyle, Jr.  
Tower Bldg., 1700 Broadway  
[303] 266-3863

**Detroit, Michigan 48226:** Robert W. Bartlett  
2600 Penobscot Building  
[313] 962-1793

**Houston, Texas 77002:** Charles G. Hubbard  
2270 Humble Bldg. [713] CA 4-8381

**Los Angeles, Calif. 90010:** Robert J. Rielly  
Bradley K. Jones, 3200 Wilshire Blvd., South Tower  
[213]487-1160

**New York, N.Y. 10020**  
1221 Avenue of the Americas  
Warren H. Gardner [212] 997-3617  
Michael J. Stoller [212] 997-3616

**Philadelphia, Pa. 19103:** Warren H. Gardner  
6 Penn Center Plaza,  
[215] 971-3617

**Pittsburgh, Pa. 15222:** Warren H. Gardner  
4 Gateway Center, [212] 971-3617

**Rochester, N.Y. 14534:** William J. Boyle  
9 Greylock Ridge, Pittsford, N.Y.  
[716] 586-5040

**San Francisco, Calif. 94111:** Don Farris  
Robert J. Rielly, 425 Battery Street,  
[415] 362-4600

**Paris:** Alain Offergeld  
17 Rue-Georges Bizet, 75 Paris 16, France  
Tel: 720-73-01

**Geneva:** Alain Offergeld  
1 rue du Temple, Geneva, Switzerland  
Tel: 32-35-63

**United Kingdom:** Keith Mantle  
Tel: 01-493-1451, 34 Dover Street, London W1

**Milan:** Robert Saidel  
1 via Baracchini Phone 86-90-656

**Brussels:** Alain Offergeld  
23 Chaussee de Wavre  
Brussels 1040, Belgium  
Tel: 13-65-03

**Stockholm:** Brian Bowes  
Office 17, Kontor-Center AB, Hagagarten 29,  
113 47 Stockholm. Tel: 24 72 00

**Frankfurt/Main:** Fritz Krusebecker  
Liebigstrasse 27c  
Phone 72 01 81

**Tokyo:** Masaru Wakeshima, McGraw-Hill  
Publications Overseas Corporation,  
Kasumigaseki Building 2-5, 3-chome,  
Kasumigaseki, Chiyoda-Ku, Tokyo, Japan  
[581] 9811

**Osaka:** Ryji Kobayashi, McGraw-Hill  
Publications Overseas Corporation, Kondo  
Bldg., 163, Umegae-cho Kita-ku [362] 8771

**Australasia:** Warren E. Ball, IPO Box 5106,  
Tokyo, Japan

### Business Department

**Stephen R. Weiss, Manager**  
[212] 997-2044

**Thomas M. Egan,**  
Production Manager [212] 997-3140

**Carol Gallagher**  
Assistant Production Manager [212] 997-2045

**Dorothy Carter,** Contracts and Billings  
[212] 997-2908

**Frances Vallone,** Reader Service Manager  
[212] 997-6057

### Electronics Buyers' Guide

**George F. Werner,** Associate Publisher  
[212] 997-3139

**Regina Hera,** Directory Manager  
[212] 997-2544

# Now get a firm grip on your lead-mounted semi's and heat problems, too

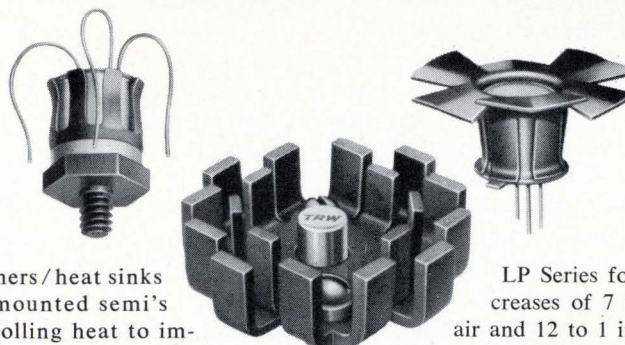

IERC retainers/heat sinks hold lead-mounted semi's while controlling heat to improve reliability or let you operate at higher power levels. Our TXB's for Mil-spec environments are excellent retainers on p-c boards or serve as efficient thermal links between case and heat sink. BeO washers are available for electrically-hot-case applications. Use our staggered-finger

LP Series for power increases of 7 to 1 in still air and 12 to 1 in forced air with no increase in junction temperature. And, if your semi's are already mounted, slip on a Fan Top and get higher wattages for just pennies. Send for catalog. IERC, 135 W. Magnolia Blvd., Burbank, Calif. 91502, a subsidiary of Dynamics Corporation of America.



## Heat Sinks

Circle 155 on reader service card

## Presenting in your corner: THE ELECTRONICS BOXER!

Why mess around when you can have the ELECTRONICS BOXER clean up your copies—keep them in top condition.

And, it's easy and inexpensive to keep the ELECTRONICS BOXER in your corner. Just complete the coupon and mail. Your order will be processed immediately, postpaid.

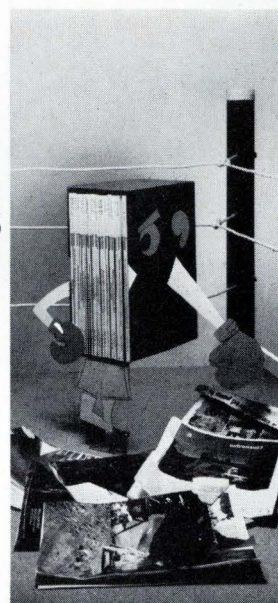

### ELECTRONICS BOXER

**Jesse Jones Box Corporation**

2250 E. Butler St., Philadelphia, Pa. 19137

Please send me:  boxes @ \$4.25 each;  
 3 boxes @ \$12.00;  6 boxes @ \$22.00  
My check or money order is enclosed.

Name \_\_\_\_\_

Address \_\_\_\_\_

City \_\_\_\_\_ State \_\_\_\_\_ Zip \_\_\_\_\_



# Goodbye jackknife.

We've figured out a way to keep big highway rigs under control on wet and icy roads. Our Skid-Trol® brake system electronically monitors and synchronizes wheel deceleration to prevent jackknifing. Key to Skid-Trol's development is the MOS/LSI chip we developed for the on-board computer.

There are many more examples of what we're doing in advanced electronics—enough to amount to a half-billion dollars annual business in everything from computer braking systems to the inertial navigation system for the Navy's Polaris/Poseidon submarines.

Want to hear more? Or how we can apply electronics to your product lines? Write us in Anaheim, California 92803. Or phone 714/632-4195. We'd like to prove that when it comes to sensing, processing, storing, displaying or transmitting data, nobody knows electronics like North American Rockwell.



North American Rockwell  
Electronics Group

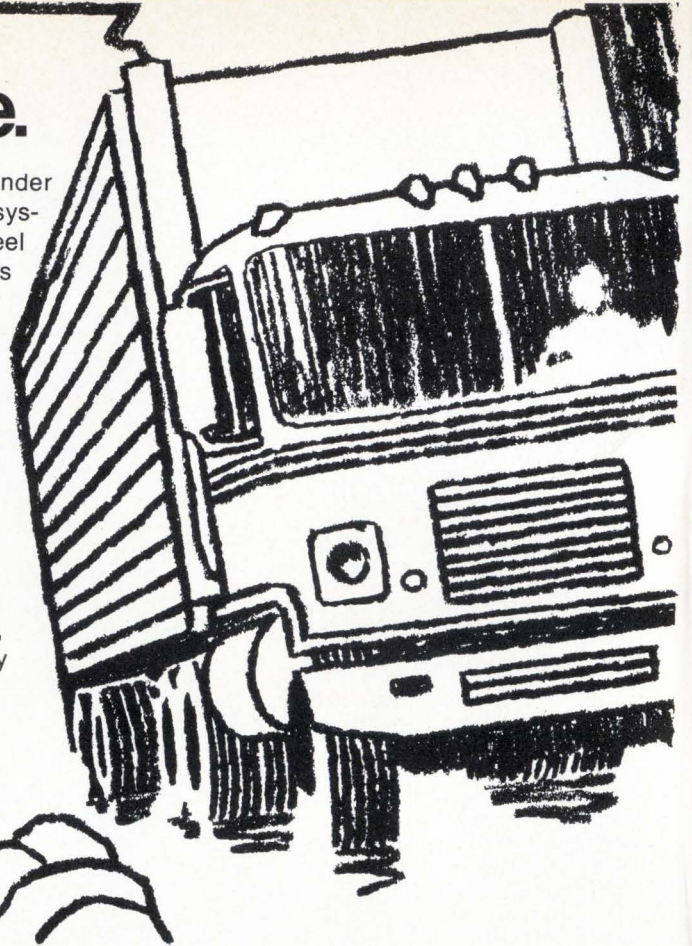

Circle 156 on reader service card

## ROCKER & PADDLE MINIATURES

New "snap-in" switches have high 6 amps rating. Features ease of installation in rectangular hole. Choice of SPDT & DPDT. 4 colors add distinction to front panel. Molded "silver" terminals & contacts. Decorative frames are available.

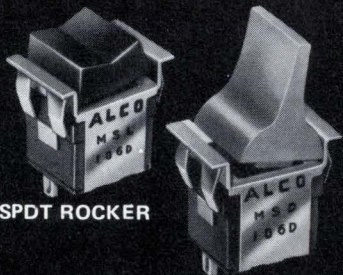

SPDT ROCKER

SPDT PADDLE

**ALCOSWITCH®**

DIV. OF ALCO ELECTRONIC PRODUCTS, INC. NORTH ANDOVER, MASS. 01845

Circle 172 on readerservice card

## SLIDE & TOGGLE MINIATURES

Two new economy low amp switches give the operator an unusual positive feel. Silver terminals adaptable to hand wiring or printed circuit applications. Sealed to prevent wicking. Contacts are self-cleaning. Rated .3 amps @ 125V.

MAKE-BEFORE-BREAK  
Double Pole, Double Throw

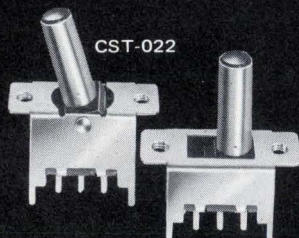

CST-022

CSS-022

**ALCOSWITCH®**

DIV. OF ALCO ELECTRONIC PRODUCTS, INC. NORTH ANDOVER, MASS. 01845

156 Circle 173 on reader service card

## flameless 1000° heat

Instant, precise heat for 1001 uses — shrink tubing, soldering-desoldering, forming, bonding, deburring, drying, setting adhesives.

World's most complete line.

Models from 200-1000°F.

Send for new free Catalog 75.

## you can hold in your hand



U.L. listed

**MASTER > HEAT GUNS**

1745 FLETT AVE., RACINE, WI 53403

Circle 174 on readerservice card