

MAY 15, 1975

HOW ELECTRONICS FIRMS COPE WITH INDUSTRIAL SPIES/63

The expanding world of voltage-to-frequency converters/91

Logic state analyzers for exploring the data domain/103

RECEIVED

JUN 9 1975

NATURAL SCIENCES
LIBRARY

FOUR DOLLARS A MCGRAW-HILL PUBLICATION

Electronics®

GOING PLACES



He just completed half a day's testing before his morning coffee break.

The secret? His new 3312A Function Generator – the new-generation source that's actually two function generators in one box. It took the hassle out of his input-signal set-ups. He simply pushed a few buttons and had the functions he needed. No custom equipment... or a kludge of instruments to get a complex waveform.

Because the 3312A has a main generator that can be triggered by a built-in modulation generator, it let him select sweep or gated functions, AM, FM, FSK, or tone bursts with pushbutton ease... plus dozens of other functions he never thought he could get. He got better performance too. Like square waves that didn't become sine waves at 10 MHz. And all for only \$900*.

So enjoy your morning coffee break. But have the satisfaction of some valuable testing under your belt first. Your local HP field engineer can give you all the details on this new-generation instrument. He'll also be happy to tell you about the other members of our source family. From our low-cost, general-purpose function generator to our automatic synthesizers. Give him a call today.



3330B Automatic Synthesizer



3320B Frequency Synthesizer



3311A Function Generator

3310A Function Generator

HEWLETT  PACKARD

Sales and service from 172 offices in 65 countries
1501 Page Mill Road, Palo Alto, California 94304

*Domestic USA price only.

Circle 900 on reader service card

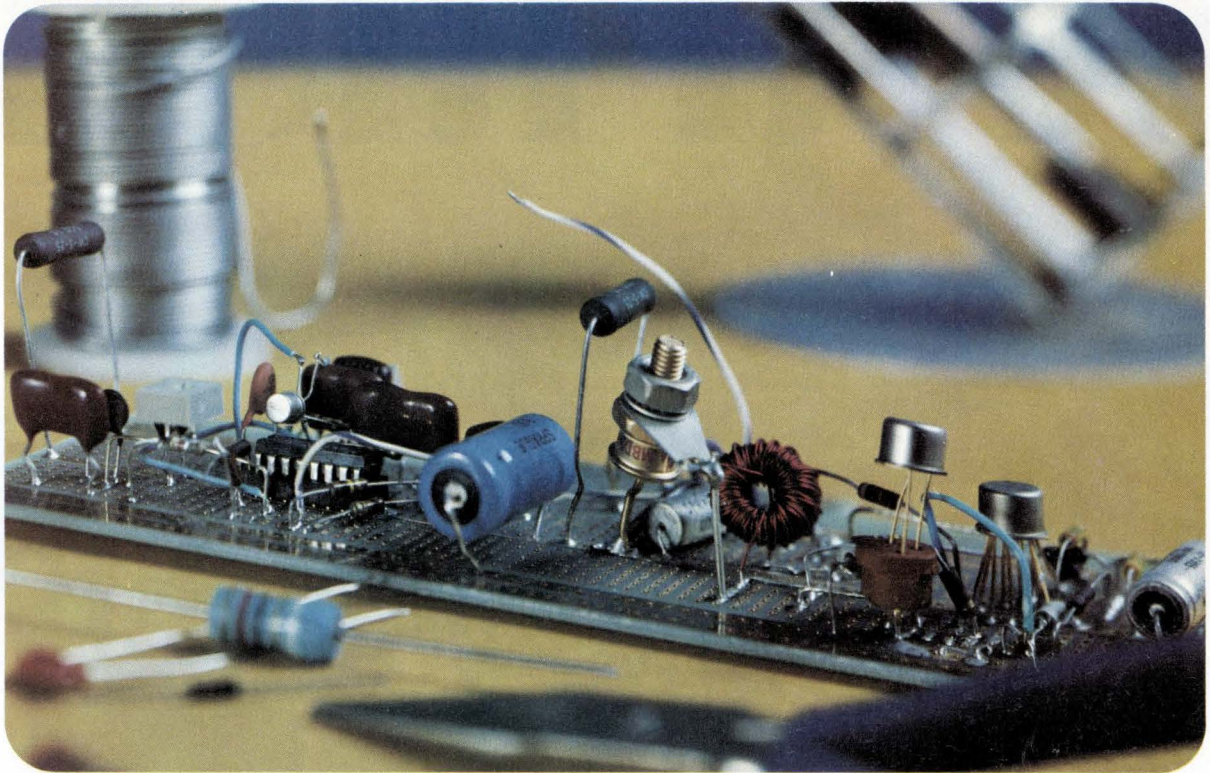

Analyze your designs before you build them.

Before you build another breadboard, spend a few minutes with our HP 9830 Calculator-Aided Design System. You'll find it's a better, faster way to work out your design concepts.

In the time it takes to round up parts, tools, and test equipment this calculator system will draw a Bode diagram of your circuit, show you the effects of changing component values, and automatically document your results. The 9830 gives you a complete analysis of your design and tolerances—before you spend time and money on prototypes. And your circuit descriptions can be stored on tape for fast reentry into the system any time you need them.

This 9830 system also shortens engineering schedules and stretches budgets by letting you solve computer-size problems right at your desk. You get answers in minutes—at a fraction of big-machine cost. On those occasions when you really need the help of a big computer, the 9830 can still save you time and money by serving as the timeshare terminal.

Whether you're designing control systems, transformers, doing network analysis or wrestling other electronic design problems, the 9830 makes

your job easier. It gets you out of trial-and-error engineering. And it shows you design alternatives you'd never have had the time or means to explore.

So call your local HP Sales Office and let our engineers show you how the 9830 can speed your current engineering projects. Or send in the coupon and we'll rush you detailed information on the HP 9830 Calculator-Aided Design System.

095/12

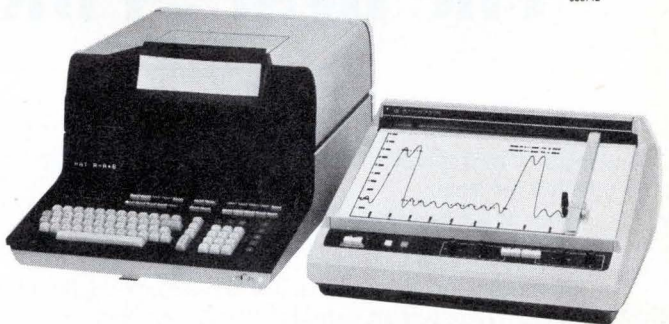

Sales and service from 172 offices in 65 countries.
P.O. Box 301, Loveland, Colorado 80537

Please send more information on your HP 9830 Calculator-Aided Design System.

Information only. Please contact me.

My principal engineering applications include: _____

Name _____

Address _____

City _____ State _____

Zip _____ Phone _____

HP Calc., P.O. Box 301, Loveland, Colorado 80537

816L

SURPRISE!



The first 24 mcd LED lamp!

And that's 24 mcd at only 10 mA for our brightest red lamp. At 20 mA you can get over 48 mcd of light output.

| | RED | YELLOW | GREEN |
|-----------------------|--------------|--------------|--------------|
| NARROW BEAM 5082 - | 4658 4657 | 4558 4557 | 4958 4957 |
| WIDE BEAM 5082 - | 4655 4650 | 4555 4550 | 4955 4950 |

HP's new high efficiency material makes these new bright LED's possible. With our brightest yellow you get 16 mcd at 10 mA. Our brightest green offers 16 mcd at 20 mA.

Three colors, two beam angles, and two luminous intensity categories are available in the popular T 1-3/4 package. Twelve new LED's, one just right for your application.

All are available for immediate delivery, just \$0.89* each or \$1.15* each at the 100 piece level, depending on brightness category.

Contact Hall-Mark, Schweber, Wilshire or the Wyle Distribution Group (Liberty/Elmar) for immediate delivery. Or, write us for more details. They offer you new ways to apply solid-state technology in your products.

HEWLETT  PACKARD

Sales and service from 172 offices in 65 countries.
1501 Page Mill Road, Palo Alto, California 94304

01502 *Domestic USA Prices Only.

33 Electronics Review

FIBER OPTICS: Fiber-optic field attracting new cable, connectors, 33
Optical cables get hologram couplers, 34
INDUSTRIAL: Mines to get new communications/monitoring system, 34
COMMUNICATIONS: Mobile radio networks get digital boost, 35
AVIONICS: Will F-16 avionics fit the Navy's new F-18? 36
MANAGEMENT: Welty plans more changes at Motorola, 38
MILITARY: NATO weighs Awacs; Air Force orders six, 38
CAREERS: Are EEs over 40 facing age discrimination? 40
CONSUMER: Electronic TV tuner uses MNOS memory, 40
NEWS BRIEFS: 43

57 Electronics International

WEST GERMANY: Bonding process uses tinned nickel spider, 57
AROUND THE WORLD: 57

63 Probing the News

MANAGEMENT: The great trade-secret rip-offs, 63
ELECTRONICS ABROAD: Europeans exploit microprocessors, 66
COMMUNICATIONS: Bell Labs faces future, 70
MICROPROCESSORS: Second-sourcing gets tricky, 74

77 Technical Articles

SPECIAL REPORT: C-MOS enlarges its territory, 77
Performance is enhanced, chip complexity increased, 80
Communications subsystems need just one chip apiece, 83
Logic, memory, I/O chips build computer systems, 85
COMPONENTS: V-f converters: versatility at low cost, 91
DESIGNER'S CASEBOOK: Optical couplers stabilize circuit, 98
How to prevent spurious tripping of protection circuits, 99
555 as switching regulator supplies negative voltage, 101
INSTRUMENTS: Logic analyzers help troubleshoot digital gear, 103
ENGINEER'S NOTEBOOK: DIP switch isolates faults in system, 112
Op amp converts DVM to fluxmeter, 112
Seven-segment indicator shows Roman I through V, 113
Ringer enables telephone to play simple tune, 115

121 New Products

IN THE SPOTLIGHT: Fiber-optic cable is multichannel, 121
Prices of thin-film resistor networks tumble, 123
INSTRUMENTS: Calculating processor simplifies data-logging, 125
DATA HANDLING: Wand reads printed numbers, 129
SUBASSEMBLIES: Line converter designed for IBM 370s, 135
PACKAGING & PRODUCTION: Tester checks analog/digital boards, 139
COMMUNICATIONS: Noise loader cuts cost of system tests, 143
MATERIALS: 149

Departments

Publishers letter, 4
Readers comment, 6
News update, 8
Editorial, 10
People, 14
Meetings, 22
Electronics newsletter, 29
Washington newsletter, 53
International newsletter, 59
Engineer's newsletter, 116

Highlights

The cover: C-MOS extends its range, 77

Complementary MOS has not only become dense enough to pack an entire communications subsystem or microprocessor on one chip—it has also acquired new protective circuitry that improves its performance in its original industrial applications. Cover is by Art Director Fred Sklenar.

How firms try to counter trade-secret theft, 63

An expanding technology and a mobile workforce between them create a lot of valuable know-how that's hard to keep secret. But electronics and computer companies do their best, using everything from paper shredders to lawsuits.

V-f converters find new applications, 91

A low-cost instrument or system can at last afford the good linearity and temperature stability of a voltage-to-frequency converter, which by now is priced at less than \$50 in modular form.

Fiber-optic cable can handle six channels, 121

The six individually jacketed glass fibers, one per channel, have a transmission loss of only 20 dB/km. Yet the flexible cable is economical enough for industrial use.

And in the next issue . . .

Electronics' expanding role in industry: start of a series . . . a smart way to design microprocessor-based systems . . . component screening with a sequential circuit analyzer.

EDITOR-IN-CHIEF: Kemp Anderson

EXECUTIVE EDITOR: Samuel Weber

MANAGING EDITORS: Lawrence Curran, *News*;
Arthur Erikson, *International*

SENIOR EDITORS: John Johnsrud,
H. Thomas Maguire, Laurence Altman,
Ray Connolly, Stephen E. Scrupski

ART DIRECTOR: Fred Sklenar

ASSOCIATE EDITORS: Howard Wolff,
Gerald M. Walker, Alfred Rosenblatt

DEPARTMENT EDITORS
Aerospace/Military: Ray Connolly
Circuit Design: Don Blattner
Components: Lucinda Mattera
Computers: Stephen E. Scrupski
Consumer: Gerald M. Walker
Industrial: Margaret A. Maas
Instrumentation: Andy Santoni
New Products: H. Thomas Maguire,
Michael J. Riezenman
Packaging & Production: Jerry Lyman
Solid State: Laurence Altman

COPY EDITORS: Margaret Eastman,
Everett C. Terry, Bill Dunne

ART: Charles D. Ciatto, *Associate Director*
Patricia Cybulski, *Assistant Director*

PRODUCTION EDITOR: Arthur C. Miller

EDITORIAL SECRETARIES: Janet Noto,
Julie Gorgoglione, Penny Roberts

FIELD EDITORS

Boston: Gail Farrell (Mgr.), Pamela Leven
Los Angeles: Paul Franson (Mgr.)
Judy Phelps

Midwest: Larry Armstrong (Mgr.)
New York: Ron Schneiderman (Mgr.)
San Francisco: Bernard Cole (Mgr.)

Judith Curtis
Washington: Ray Connolly (Mgr.)
Larry Marion

Frankfurt: John Gosch
London: William F. Arnold
Paris: Arthur Erikson
Tokyo: Charles Cohen

McGraw-Hill WORLD NEWS

Director: Ralph R. Schulz
Bonn: Robert Ingersoll
Brussels: James Smith
London: James Trotter
Madrid: Dom Curcio
Milan: Andrew Heath
Moscow: Peter Gall
Paris: Michael Johnson, Richard Shepherd
Stockholm: Robert Skole
Tokyo: Mike Mealey

PUBLISHER: Dan McMillan

DIRECTOR OF MARKETING: Pierre J. Braudé

ADVERTISING SALES SERVICE MANAGER:
Wallis Clarke

BUSINESS MANAGER: Stephen R. Weiss

CIRCULATION MANAGER: Nancy L. Merritt

MARKETING SERVICES MANAGER:
Tomlinson Howland

RESEARCH MANAGER: Margery D. Sholes

Publisher's letter

Complementary MOS is certainly a technology that has come of age. New devices from a dozen semiconductor houses are expanding C-MOS applications into communications and instrumentation from the base of industrial timing and control. What's more, the emergence of C-MOS microprocessors and memories is having its impact on the design of computer systems.

With so much activity going on in C-MOS development, we decided the time was ripe to put together a detailed special report on the subject. You'll find the 12-page report, authored by our senior editor, Larry Altman, starting on page 77.

Significantly, one of the big forces behind C-MOS's recent spurt forward is price. As Larry says in his introduction to the report: "All this new interest in complementary MOS's capabilities has been stimulated not just by technological progress but by sharply reduced prices." And, he quotes a marketing manager for a major semiconductor maker as saying: "We no longer need to sell C-MOS's low-power, easy-to-use features and apologize for its price—we can now sell C-MOS's low price and boast about its low-power, easy-to-use features into the bargain."

Yet his conclusion is a sobering one. "High volumes at low prices could spell disaster for the inefficient supplier, since every manufacturer, to remain competitive, will have to follow his pricing down the industry learning curve. This is what happened with TTL, and this is the year that will determine how many of a dozen suppliers can hack it in a newly competitive price-performance C-MOS world."

Don't look now, but the chances are there is an industrial spy behind you—or at least somewhere in your company. Trade secrets have always been a valuable property, and today's volatile electronics business is strongly based on specialized knowledge. To be sure, the bulk of attempts to grab hold of a competitor's secrets are fully aboveboard, ranging from hiring away key personnel to painstakingly dissecting one of his products. Yet cases of questionable ethics and of outright theft keep surfacing. For a look at what companies are doing to hold on to their hard-won secrets see the Probing the News story on page 63.

Bell Labs has a well-earned reputation for basic and applied research. There's the phone system as we know it to its credit, of course. But there's also the transistor, the traveling-wave tube, and the semiconductor laser on its roster of achievements.

But now Bell Labs is being buffeted by some unfriendly winds of change—from tight budgets to Washington's antitrust action against parent AT&T—and the question of where it goes from here has to be asked. We did just that in interviewing William O. Baker, president of Bell Labs. You'll find some valuable insights into Bell Labs' changing relationships with technology, the economy, and the rest of the Bell System in the questions and answers that start on page 70.



May 15, 1975 Volume 48, Number 10
94,726 copies of this issue printed

Published every other Thursday by McGraw-Hill, Inc. Founder: James H. McGraw 1860-1948. Publication office 1221 Avenue of the Americas, N.Y., N.Y. 10020; second class postage paid at New York, N.Y. and additional mailing offices.

Executive, editorial, circulation and advertising addresses: Electronics, McGraw-Hill Building, 1221 Avenue of the Americas, New York, N.Y. 10020. Telephone (212) 997-1221. Teletype TWX N.Y. 710-581-5234. Cable address: MCGRAW HILL N.Y.

Subscriptions limited to persons with active, professional, functional responsibility in electronics technology. Publisher reserves the right to reject non-qualified requests. No subscriptions accepted without complete identification of subscriber name, title, or job function, company or organization, including product manufactured or services performed. Subscription rates: qualified subscribers in the United States and possessions, Canada, and Mexico \$12.00 one year, \$24.00 three years; all other countries \$25.00 per year, except Japan and Israel \$50.00 per year, Brazil \$40.00 per year, Australia and New Zealand \$60.00 per year, including air freight. Limited quota of subscriptions available at higher-than-basic rate for persons outside of field served, as follows: U.S. and possessions and Canada, \$25.00 one year; all other countries \$50.00. Single copies: \$4.00.

Officers of the McGraw-Hill Publications Company: John R. Emery, President; J. Elton Tuohig, Executive Vice President-Administration; Gene W. Simpson, Group Publisher-Vice President; Senior Vice Presidents: Ralph Blackburn, Circulation; Walter A. Starbury, Editorial; John D. Hoglund, Controller; David G. Jensen, Manufacturing; Gordon L. Jones, Marketing; Jerome D. Lutz, Planning & Development.

Officers of the Corporation: Shelton Fisher, Chairman of the Board and Chief Executive Officer; Harold W. McGraw, Jr., President and Chief Operating Officer; Wallace F. Traudny, Group President, McGraw-Hill Publications Company and McGraw-Hill Information Systems Company; Robert N. Landes, Senior Vice President and Secretary; Ralph J. Webb, Treasurer.

Title registered in U.S. Patent Office; Copyright ©1975 by McGraw-Hill, Inc. All rights reserved. The contents of this publication may not be reproduced in whole or in part without the consent of copyright owner.

Subscribers: The publisher, upon written request to our New York office from any subscriber, agrees to refund that part of the subscription price applying to copies not yet mailed. Please send change of address notices or complaints to Fulfillment Manager; subscription orders to Circulation Manager, Electronics, at address below. Change of address notices should provide old as well as new address, including postal zip code number. If possible, attach address label from recent issue. Allow one month for change to become effective.

Postmaster: Please send form 3579 to Fulfillment Manager, Electronics, P.O. Box 430, Hightstown, N.J. 08520.

theKEPCO **PTR**

is an **OEM** modular power supply *with a difference!*

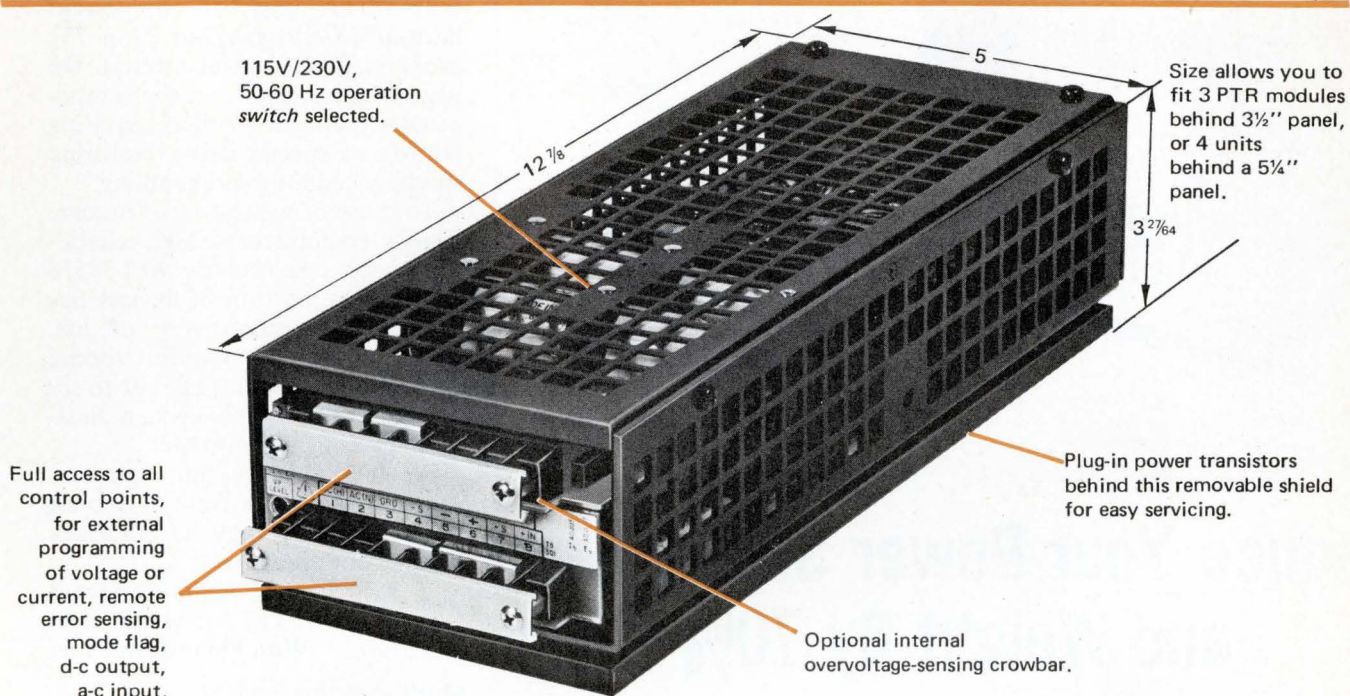

The Kepco PTR is an OEM modular power supply . . . with a difference.

The difference is that for \$273.00 you **don't** get a stripped-down, open-frame module with external heat sink fins, skimpy capacitors and a tricky derating chart versus ambient temperature—nor do you get a limited-range voltage stabilizer with fold back over-current protection.

For \$273.00, you get a Kepco PTR . . . a fully-programmable, automatic crossover voltage and current stabilizer that functions with its self-contained, convection-cooled heat sink to produce *full output* to +71°C with *no derating*.

PTR's produce from 0–7 volts at 5.5 amperes to 0–100 volts at 0.6 amperes in six different models. All units have two control channels with plug-in I-C control amplifiers for excellent stabilization (0.005%) and temperature immunity (0.01%/°C).

For an extra \$25.00, you can get a built-in overvoltage-sensing crowbar.

The PTR is a truly remarkable value—the features and performance of lab and systems-type power supplies in an inexpensive, value packed OEM module. Write for Catalog 146-1278 for the full details.



KEPCO®

For complete specifications,
write Dept. EL-14

*with KEPCO
you're in control!*

KEPCO, INC. • 131-38 SANFORD AVENUE • FLUSHING, N.Y. 11352 • (212) 461-7000 • TWX #710-582-2631 • Cable: KEPCOPOWER NEWYORK

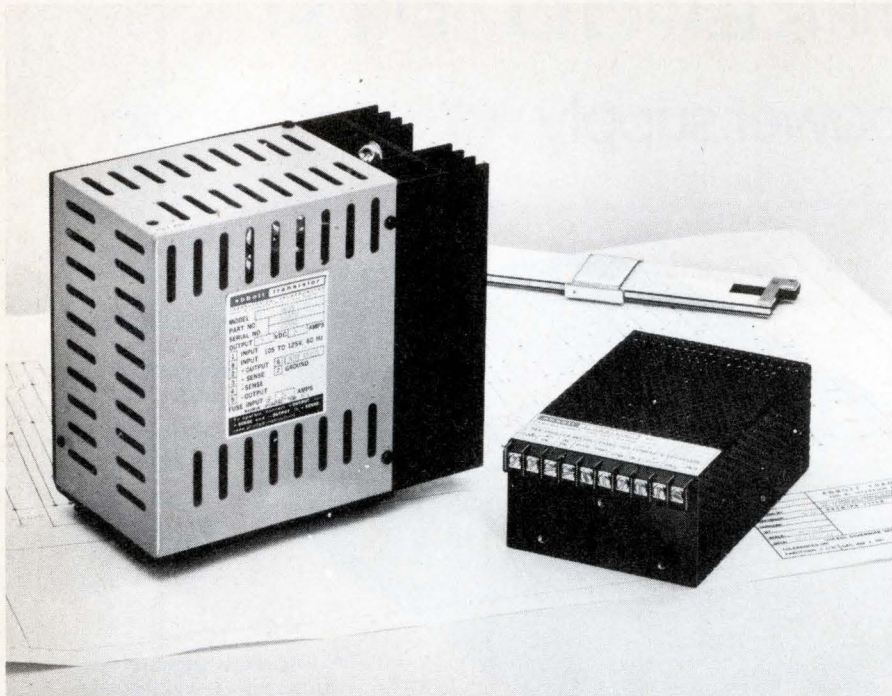

Reduce Your Power Supply Size and Weight By 70%

A new way has been found to substantially reduce power supply size and weight. Consider the large power supply shown at left in the above photo — it uses an input transformer, into a bridge rectifier, to convert 60 Hz to 5 volts DC at 5 amperes. This unit measures 6½" x 4" x 7½" and weighs 13 pounds. Abbott's new model Z5T10, shown at right, provides the same performance with 70% less weight and volume. It measures only 2¼" x 4" x 6" and weighs just 3 pounds.

This size reduction in the Model Z5T10 is primarily accomplished by eliminating the large input transformer and instead using high voltage, high efficiency, DC to DC conversion circuits. Abbott engineers have been able to control the output ripple to less than 0.02% RMS or 50 millivolts peak-to-peak

maximum. This design approach also allows the unit to operate from 100 to 132 Volts RMS and 47 to 440 Hertz. Close regulation of 0.15% and a typical temperature coefficient of 0.01% per degree Celsius are some of its many outstanding features. This new Model "Z" series is available in output voltages of 2.7 to 31 VDC in 12 days from receipt of order.

Abbott also manufactures 3,000 other models of power supplies with output voltages from 5 to 740 VDC and with output currents from 2 milliamps to 20 amps. They are all listed with prices in the new Abbott catalog with various inputs:

60 A to DC
 400 A to DC
 28 VDC to DC
 28 VDC to 400 A
 12-28 VDC to 60 A

Please see pages 307-317 Volume 1 of your 1974-75 EEM (ELECTRONIC ENGINEERS MASTER Catalog) or pages 853-860 Volume 3 of your 1974-75 GOLD BOOK for complete information on Abbott Modules.

Send for our new 60 page FREE catalog.

abbott transistor

LABORATORIES, INCORPORATED
 general offices eastern office

5200 W. Jefferson Blvd./Los Angeles 90016
 (213) 936-8185 Telex: 69-1398

1224 Anderson Ave./Fort Lee, N.J. 07024
 (201) 224-6900 Telex: 13-5332

Readers comment

'Special' is routine

To the Editor: J.A. Loranger Jr.'s article, "The case for component burn-in" [*Electronics*, Jan. 23, p. 73], evokes a good deal of interest. On page 74, he states, "... the components house regards orders requiring burn-in as special items, requiring special scheduling and handling."

To those of us who have become heavily committed to high-reliability devices, particularly Mil-38510 JAN circuits, burn-in of devices has become a standard way of life. These orders do require special scheduling and handling, but to try *any* order without it leads to a disaster in pleasing the customer.

We like to think that customer contentment, both from a service and a reliability angle, is still a key focus of our operation.

Thomas E. Magill
 ITT Semiconductors
 West Palm Beach, Fla.

Modifying the modifier

To the Editor: Basically we concur in the criticism of our phase-locked loop lock indicator offered by Gunther Kuerbitz, which appeared in your Readers comment section of Feb. 6. [The subject originally appeared in the Designer's casebook section, Sept. 5, 1974, p. 112]. However, we recommend the following modifications, which require fewer changes: First, interchange input signal connections to the HA-2825 (pins 1 and 2). Second, interchange the input pins to the waveshaper (HA-2311) to place the comparator in the inverting configuration.

Reversing the waveshaper inputs will put the 50-ohm resistor in the inverting lead, causing the slightly positive potential across this resistor to hold the output at zero volts (which is the desired output of the waveshaper with no input signal applied). This 180-degree phase inversion is compensated for by the interchanging of the signal input pins to the phase-locked loop.

J.A. Connelly
 Glenn Prescott
 Georgia Institute
 of Technology
 Atlanta, Ga.

Still fighting snap, crackle and pop?

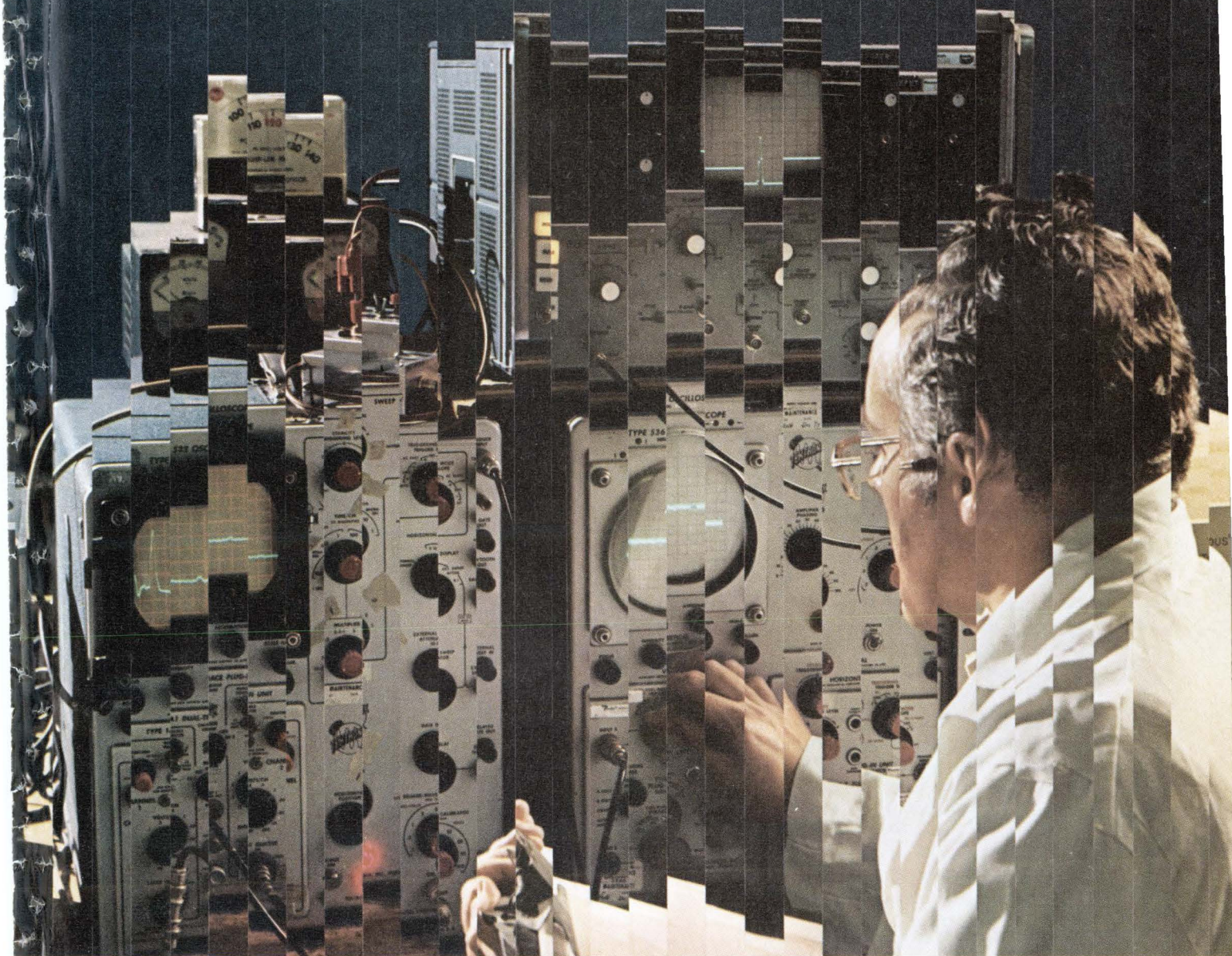

Noise has a way of showing up in circuits. Bendix has a way of preventing it. Filter connectors. Boasting some of the best attenuation curves available, Bendix filter connectors solve a wide range of low-pass filter problems. Small wonder Bendix is first choice in the fight against snap, crackle and pop.

These versatile connectors, production tooled, are available in a wide range of cylindrical and rectangular configurations designed to meet most any industrial, commercial and military application.



Configurations that can be intermateable with most MIL-Spec and popular commercial connectors and special designs for advanced state-of-the-art equipment. There's sure to be one that meets your attenuation and frequency requirements. You'll like what you hear when it comes to the price, too. And that goes for delivery as well.

Write for our new catalog. It's yours for the asking. The Bendix Corporation, Electrical Components Division, Sidney, New York 13838.

Bendix

Circle 7 on reader service card

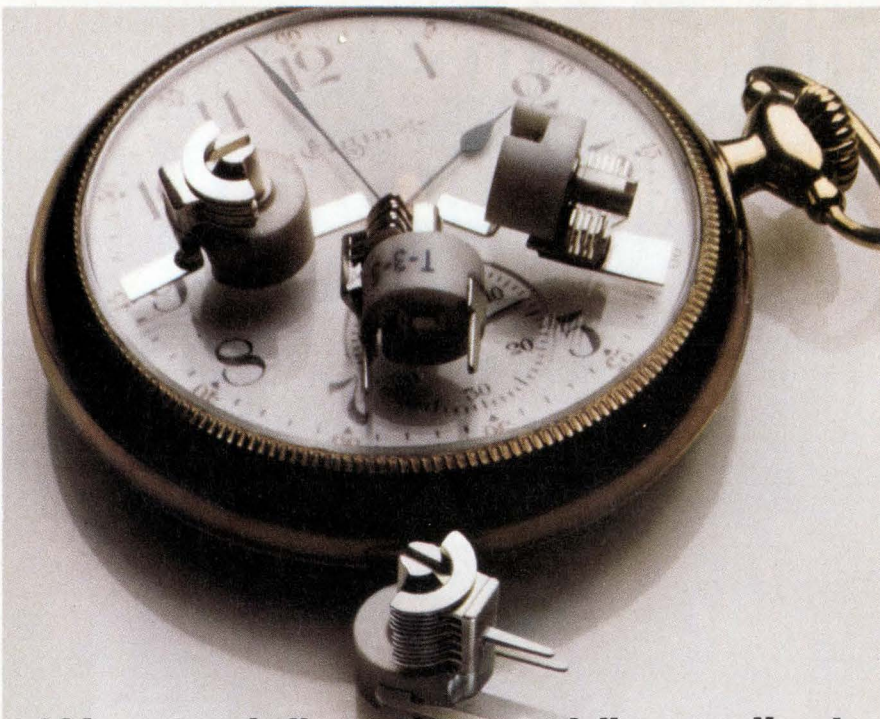

We can deliver the world's smallest 180° air variable capacitors. On time.

And since we're nice people, we don't even charge much for them. So if you have an application that calls for a sub-miniature capacitor that you can "tweak" to a specific frequency, these Johnson trimmers are ideal.

You can choose from either PC or stripline mount, either vertical or horizontal tuning. These Type "T" capacitors are about one-third the size of the familiar type "U" capacitors, so you can save space, cut costs and insure improved performance in the most compact electronic equipment.

Rotors and stators are precision-machined from solid brass extrusions, resulting in exceptional stability and uniformity. High Q—typically 2000 at 150 MHz. Temperature coefficient is a low plus 30 ± 15 ppm/°C. High torque ($1\frac{1}{2}$ to 8 oz./inches) holds rotor securely under vibration. They're designed to meet or exceed EIA-RS 204 and MIL Standard 202C Methods 204A and 201A.

In short, these capacitors may be just what you've been looking for. It'll only cost you a stamp to get more information. And if you give us your phone number, we'll call you and send free samples after we have clarified your application.

E. F. JOHNSON COMPANY
3005 Tenth Ave. S.W. / Waseca, MN. 56093

- Please send me technical information on the type T.
 Also, include information on your entire line of variable capacitors.
 I want test samples. Please call me at _____

NAME _____

TITLE _____

FIRM _____

ADDRESS _____

CITY _____ STATE _____ ZIP _____



E. F. JOHNSON COMPANY

News update

■ Princeton Material Sciences Corp., recently acquired by Fairchild Camera & Instrument Corp. [*Electronics*, May 1, p. 25], may have been the first company in the digital watch field to price itself out of the market. Originally a liquid-crystal materials and display supplier, the Princeton, N. J., firm and former Sprague Electric Co. affiliate began selling a liquid-crystal model last spring through Alexander's department stores in New York City, priced at \$99 retail. The price surprised many of the new and traditional watchmakers that were racing to develop a digital model for the under-\$100 market. But it didn't last long. Apparently realizing it couldn't make much profit at that price and that it couldn't compete with other major suppliers without a large marketing force, Princeton backed out of the watch business. Fairchild spokesmen haven't disclosed its plans for the company.

■ What ever became of the Naval Research Lab's highly sensitive but inexpensive "expendable hydrophone" developed a year ago for antisubmarine warfare? "It's in limbo, at least temporarily," says Robert W. Timme, head of the lab's Underwater Sound Reference division team at Orlando, Fla., that developed the air-droppable sub sensor under a feasibility study. Even though Timme and his colleagues figured the small sonar for use in arrays "would probably cost less than \$20 each" in production quantities of 10,000, the program seemed to fall between a crack.

Nevertheless, Timme and his colleagues are still refining the unit, reducing its length from 3.5 inches to 0.75 in. by using an IC in the preamplifier "without any sacrifice to our low noise figures." The hydrophone's 1-in. diameter, dictated by the size of the ceramic acoustic element, is unchanged. The two Type III radially-poled ceramic cylinders, combined with the high-gain, low-noise preamp, give a noise figure of -90 decibels reference to volt at 10 hertz, and -120 dB at 10 kilohertz.

SIEMENS

Where thick-film hybrid circuits meet your design challenge

From design to breadboard . . . layout to maskmaking . . . prototype to finished product . . . Siemens Custom and Standard Hybrids can meet the challenge of your toughest design problems. Whatever your thick film requirements, Siemens will focus its strong engineering resources on your circuit to achieve the most creative yet practical solution.

Siemens designs and manufactures its hybrid circuits for industrial and military applications in Scottsdale, Arizona. We began developing our microelectronics technology in the early 1960's, and the Scottsdale facility has been turning out hybrids for satisfied customers since 1967.

Siemens circuits have been used in such critical military systems as SRAM, Minuteman, TOW missiles and the AWACS military aircraft programs. Also, we're investing confidently for the future in product and process development, capital equipment and a leadership engineering and production team.

At Siemens, we believe a quality hybrid circuit is as important to the vendor as it is to the customer. A century-long tradition of enduring quality verifies this commitment.

For a closer look at Siemens' thick film capabilities, write us today for our new brochure, "Siemens . . . Microelectronics To Meet The Challenge of Tomorrow's Design" And remember . . .

Siemens: Where Quality And Resources Make The Difference.



Siemens Corporation
Components Group

P.O. Box 1390, Scottsdale, Arizona 85252
(602) 947-2231 TWX 910-950-1292 Telex 667-406

WEMA sets some benchmarks

Although the new semiconductor forecast by WEMA may come in for criticism as too bullish, any forecaster has to be very nervy, not to say nervous, in making predictions at this particular time. Although most indexes are still down, businessmen and economists are predicting a worldwide economic recovery for the second half.

The WEMA semiconductor group agrees with this optimism. Its forecast that semiconductor sales volume will be down 17% for the year is based on indications that the first half operating rate will be down even more than that. Foreseeing 1976 as a boom year for semiconductors, it expects world consumption to rise 25% to \$4.8 billion, with another 18% increase to \$5.7 billion due the following year.

WEMA's scenario for economic recovery includes lowered interest rates, increased money supply, and stepped-up business investment, as well as lowered inventory levels and an increase in new orders. The ambitious report—it reaches out to 1977, which takes a highly polished crystal ball—includes estimates of dollar volume for linear, digital bipolar, MOS and discrete devices.

Of course, there's room for argument in many of the figures. Forecasting product trends in an area like electronics, where technological developments can change the picture overnight, is a highly hazardous occupation.

For instance, MOS is shown outpacing bipolar technology. The report predicts that digital bipolars will grow from \$950 million in 1974 to \$1.14 billion in 1977, while MOS will jump from \$725 million in 1974 to \$1.249 billion in 1977. However, these figures are open to question because of new work being done in bipolar LSI. That work may produce low-cost and high-performing circuits that would have an explosive impact on the computer and high-speed controller markets.

But despite such obvious reservations, the WEMA report provides needed benchmarks for

the industry. The WEMA semiconductor group is to be congratulated and deserves the support of companies in the industry.

The risks of standing still

Once again the semiconductor industry is in a period of reduced sales, and once again it will be the smart company that will risk scarce capital to develop new technology. Nor is there a better example of how taking risks pays off than the story of complementary MOS.

The standard 4000 family of C-MOS circuits was a technology pioneered by RCA when almost all the industry was busy developing p-channel MOS for calculators and memory applications. For RCA, having missed its opportunity in TTL and ECL, C-MOS was almost a last-ditch effort to become a major supplier of digital ICs.

Even as the total semiconductor market was falling in 1970-1971, the corporation committed millions of development dollars to back up its conviction that C-MOS would become a mainstream digital technology. Moreover, the decision was made in the face of other big IC makers' opinion that C-MOS was basically a specialty technology.

Now the gamble has paid off. In a market that is approaching \$115 million, RCA has three times the share of its nearest competitor. With the introduction of data-processing circuits, the C-MOS market could grow to well over \$300 million in the next three years. And the rest of the industry has done an about-face, as a dozen latecomers the world over are scrambling to catch up.

When sales are depressed it may seem prudent to postpone the huge development costs of launching a major new technology—the risks simply appear too high for the times. But nothing is more dangerous to a company in the semiconductor industry, where standing still is the only sure route to failure.

Do you want speed or low-power? Would you settle for both?

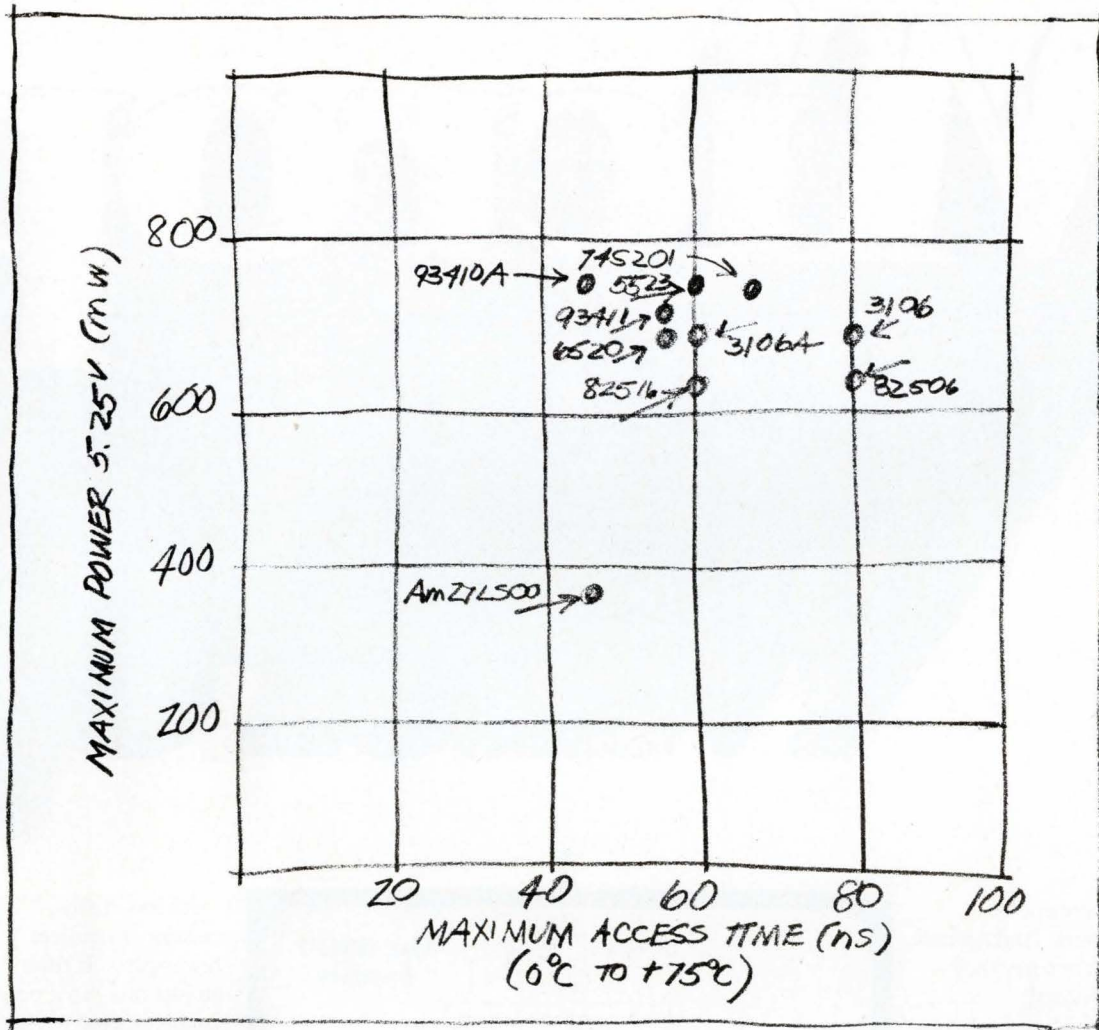

Advanced Micro Devices' 256-bit, low-power Schottky RAM: The Am27LS00. There's not another part that comes near it. Watch:

It runs on 70mA maximum. The next best part takes 115mA.

It has a 45ns access time over the commercial temperature range. (The only other part with that speed has a non-standard pin-out and burns enough power to make a designer cry real tears.)

It comes in plastic, hermetic DIP, or flat pack, open collector or three-state.

It works over the full military range with a 55ns access time and the same low 70mA. (That's 15ns faster than Fairchild or Intersil at half the power.)

And it's MIL-STD-883 for free.

Come and get it. Off the shelf at Hamilton/Avnet, Schweber or Cramer Electronics. The Am27LS00. Your fondest memory.

Advanced Bipolar Memory



Advanced Micro Devices, Inc. • 901 Thompson Place, Sunnyvale, California 94086 • Telephone (408) 732-2400 • Distributed nationally by Hamilton/Avnet, Cramer and Schweber Electronics.

Circle 258 on reader service card

“The 6800 has just left the starting gate, and it has made a most impressive get away... A darn good CPU chip.”

EDN

“To date... the most complete MOS LSI microprocessing system.”

Computer Design

Microprocessor

It's a whole new era for microprocessors. And a whole lot of people are sorry they started without us!

The S6800 Microprocessor family is getting rave reviews from designers, magazines and engineers—even those already committed to the 8080.

Small wonder. The powerful 8-bit N-Channel S6800 is the fastest, leanest, cheapest microprocessor system ever created.

To put it simply, it's already the industry standard that all other microprocessors will have to follow.

It's all in the family.

It's already a full-fledged family of six, and still growing. Each member was designed to interface directly with the MPU—or to stand alone. So you don't get tied up in bundling.

That can save you a bundle. Because the 6800 gives you standard LSI building blocks to put together a system without any restrictions on peripherals.

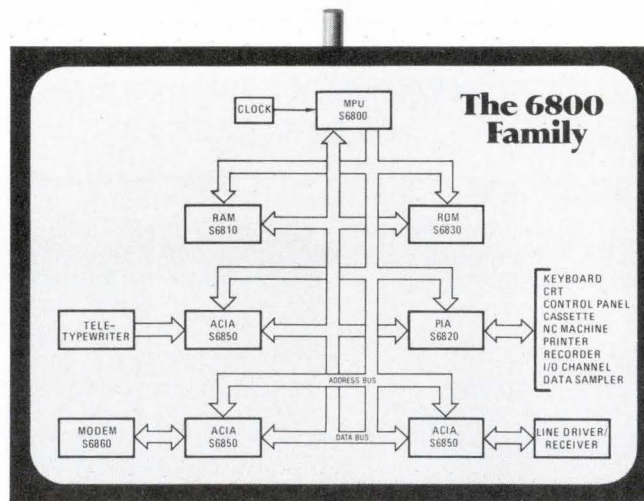

It's less costly because it requires fewer parts. It runs on just one +5V power supply instead of three. It has a more efficient instruction set, which reduces the number of locations needed in memory because of six memory addressing modes. And it needs no TTL to bring it together.

Better design gets better results.

Although the 5 volt clock operates at only 1 MHz, it still

executes instructions in a minimum of 2 microseconds. This speed is maintained with up to ten devices on the bus and no TTL buffering.

With the ALU's ability to hold data, it need not be first loaded into an accumulator. The result is fewer instructions and faster program execution.

Six memory addressing modes (including direct, extended and indexed) make list processing, and the use of external memory as working registers, very fast and efficient.

“...high speed, ease of use, and flexible control capability for many new applications.”

Electronics

“...the most sophisticated of these new single-chip devices.”

IEEE Spectrum

68000 processor

975

Meet the rest of the family.

The other five that make the 6800 function so smoothly include:

The S6810 static RAM, handily organized to 128 X 8, with access time of 575 ns.

The S6820 Peripheral Interface Adapter provides two programmable 8-bit I/O channels, with full interrupt control. Each data line can be programmed to be either an input or an output. The PIA is totally bus compatible with the MPU.

The S6830 static ROM, with its 1024 x 8 organization, is the densest, fastest (575 ns access max.) read/only memory with a single power supply.

The S6850 Asynchronous Communications Interface Adapter provides data formatting and control to interface serial asynchronous communications to bus organized systems like our MPU.

The S6860 MODEM supplies modulation, demodulation and supervisory control functions for data rates up to 600 bps, using frequency shift keying.

The S6800 MPU gives you these features:

8-bit parallel processing Decimal and binary arithmetic
Two accumulators

65K bytes memory addressing Variable length instructions
Maskable and non-maskable TTL compatibility
interrupts Three state outputs
External variable length stack 40-pin package
72 basic instructions 1MHz clock
Six addressing modes Single +5 volt power

The S6800 is not only the most cost-effective microprocessor system, it's also the only one that's second sourced. Motorola developed it, and we'll produce it in the kind of quantities a product this good demands.

So don't commit yourself to any microprocessor until you see the S6800. And that's as easy as calling your nearest AMI sales office. After all, who wants to follow the leader when you can be one?

England • Swindon, Wiltshire • 31345

France • Vincennes • 328-0336

Italy • Milan • 29 37 45

Japan • Tokyo • (501) 2241

West Germany • Munich • 48 30 81

it's
standard
at AMI[®]

AMERICAN MICROSYSTEMS, INC.

AMI
3800 Homestead Road
Santa Clara
CA 95051
Phone:
(408) 246-0330

From **RCL**,
The World's
Largest
Manufacturer
Of
Precision/Power
Wire-Wound
Resistors

FREE
ENGINEERING
HANDBOOK,
1975
EDITION

- △ Military style cross-reference chart
- △ Heat distribution curves
- △ Special T.C.'s
- △ Typical circuitry
- △ Resistance temperature characteristics
- △ Networks - (DIPs)
- △ Established reliability resistors
- △ Low cost commercial styles
- △ Computer and fast rise time applications
- △ Vitreous enamel resistors
- ...and much more

Call our hotline for prompt
service and delivery.
(603) 627-3831

AMF

RCL Electronics

General Sales Office:
700 So. 21st Street
Irvington, N. J. 07111

People

Sinclair's Searle buckles in for expansion in the U.S.

Taking over as president of the U.S. subsidiary of British-based Sinclair Radionics Ltd., Nigel Searle is determined not only to sell more of his company's calculators but to introduce other consumer products as



On-site. U.S. manager Nigel Searle is getting things ready for a flow of products.

well. "We're going to at least double our U. S. sales over the next year," declares the 28-year-old Searle who, however, declines to break out the present figure. He's pinning his hopes on high-end desktop and scientific calculators that complement the much smaller items that have so far been the mainstay of Sinclair's marketing effort in the U.S. [*Electronics*, Jan. 9, p. 76].

The British parent, located in St. Ives near Huntingdon, 60 miles north of London, had more than \$17 million income last year. Part of it came from sales in Europe of a line of audio hi-fi equipment and a digital multimeter.

But the U.S. subsidiary in New York, Sinclair Radionics Inc., had been managed from abroad by company president Clive Sinclair and lacked the service and repair network that would have allowed it to market products other than calculators, Searle points out. So his top priority is to set up repair facilities to support Sinclair' products.

Once this is done, the products should begin to flow, especially as

Searle will be concentrating on high-volume ones. First will come the items already sold in Europe, and next the ones "still on the drawing boards." These will include, says Searle, digital watches and small-screen personal TV sets. Also, having already entered the instrumentation market with its multimeter, Sinclair may design a small oscilloscope as an outgrowth of its small-TV project, he says.

Searle joined Sinclair about two years ago with a doctorate in mathematics from the University of Edinburgh. He's a multifaceted individual—a published author on subjects that range from biology to investing. At Sinclair, his first assignments were in developing algorithms and partitioning for the company's calculator chips. Last year, he moved to the West Coast to serve as liaison with Sinclair's semiconductor suppliers.

Having someone like himself, with technical knowledge of the products, as the on-site manager in the U.S. will be an advantage, Searle points out. Not only will the company continue to have close links to suppliers, but "we'll be in touch with the output end as well as the input end of our business."

Mueller wants to turn research into product lines

With three research laboratories reporting to him, William M. Mueller expects to be guiding some exotic developments to the practical realm of new products. He's been named

Director. William M. Mueller is out to speed the payoff in research at Hughes Aircraft.



Avoid that drawn-out feeling.

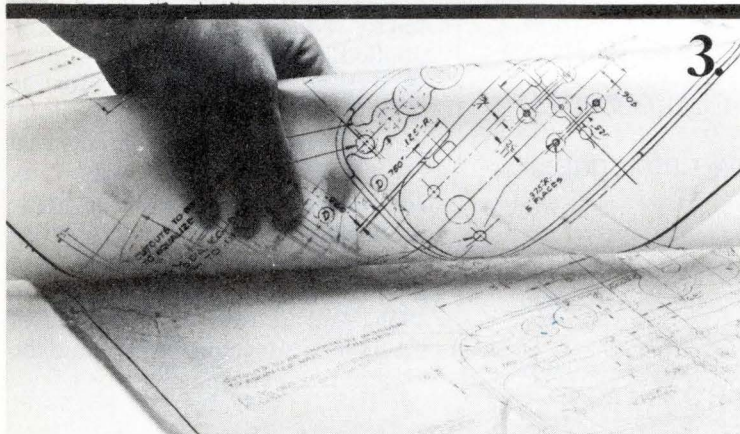
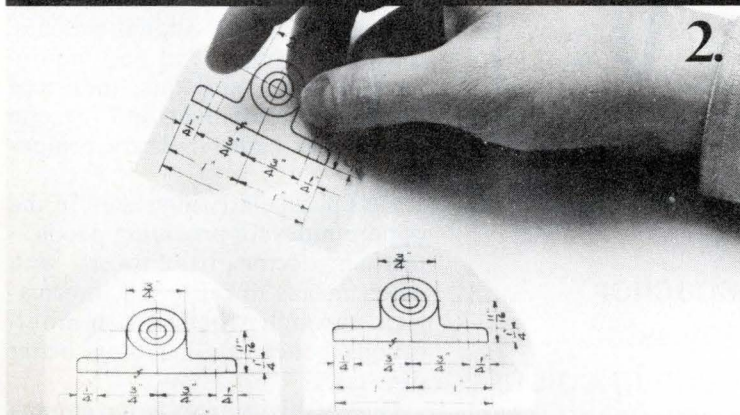
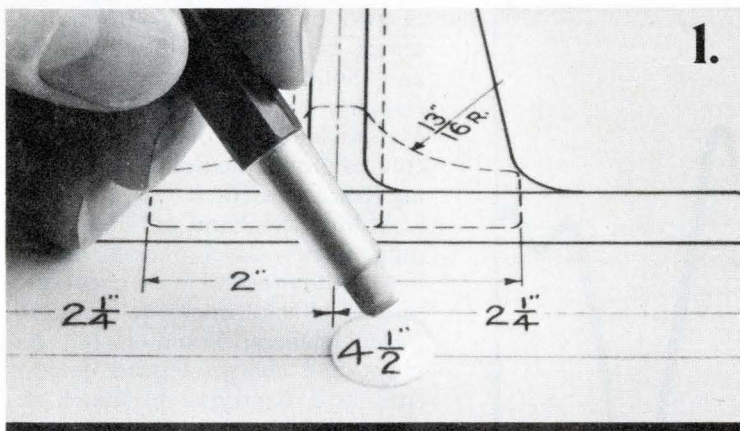

Shortcuts with Kodagraph materials can save hours of drafting time, job after job. **1.** Revising a drawing? Don't retrace the whole drawing. Make a second original on Kodagraph wash-off film. Wet-erase unwanted details. Then draw in the revision. **2.** Need to repeat the same design element a number of times? Don't draw it over and over again. Draw it once. Then make as many Kodagraph film or paper copies as you need. **3.** Restoring an old drawing? Don't redraw. You'll strengthen lines and drop out stains by making photographic reproductions on Kodagraph film. For more information on photoreproduction techniques, write Eastman Kodak Company, Graphics Markets Division, Dept. R5769, Rochester, N.Y. 14650.

**Kodak products
for drawing reproduction.**



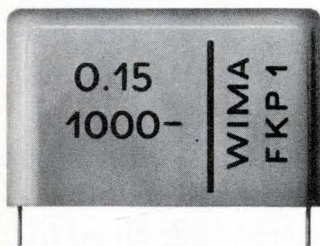
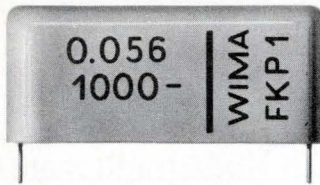
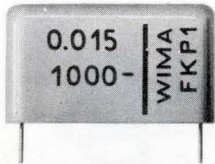
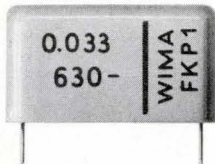
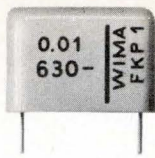

WIMA FKP 1

Self healing polypropylene capacitors with the lowest losses for high current duties

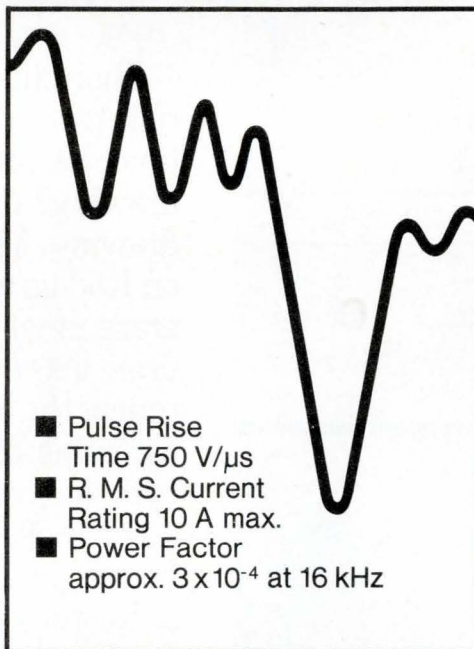

The unique capacitor designed for thyristor deflection circuits in colour television sets. Proven in leading TV models and in solid state equipment.

Write for our new catalogue!

WILHELM WESTERMANN

Spezialvertrieb elektronischer Bauelemente D-68 Mannheim · Fed. Rep. of Germany Augusta-Anlage 56 · P.O. Box 2345 Tel.: (06 21) 40 80 12.

People

to the newly created post of technology director for the Industrial Electronics group of Hughes Aircraft Co. And his goal is to push research devices into production faster than Hughes's corporate research laboratory in Malibu, Calif., which is not product-oriented, had been able to do.

"We want to form a bridge between Malibu and the Industrial Electronics divisions so that products may move more easily from pure research into manufacturing," says the 46-year-old electrical-engineering Ph. D. He'll have plenty to move over that bridge as supervisor of two of Hughes' California research centers—Solid State Devices and Solid State Microwave—that formerly had been supervised by Malibu. He'll also oversee a recently created group, the Solid State Imaging Research Center.

At Mueller's hand will be a broad range of new developments, including gallium-arsenide semiconductors, solid-state microwave and infrared devices, liquid-crystal displays, and charge-coupled devices. And he'll be trying to match research results to products that include MOS devices, digital watches, microwave tubes and test equipment, lasers, connectors, industrial production equipment, and—despite the group's name—military components.

He's particularly interested in the opportunities for providing people—teachers, doctors, bank tellers—with better means of retrieving information through "better communications, better data-handling, better displays."

One of his centers is developing microprocessors that could well be applied to those objectives. Another product he hopes to develop for the same purpose is a flat liquid-crystal display "with as many elements as a TV screen" [*Electronics*, May 1, p. 36]. Mueller also has a strong interest in microwave devices as a result of having worked extensively with them since he joined Hughes in 1956. And he expects that some of the Hughes developments could be used in radar equipment.



Aluminum is out.
Gold is in.
To bring you a
hermetic/plastic LHC.

RCA announces Hermeticity at

**Gold metalization plus
Chip Hermeticity In
Plastic (CHIP) means
corrosion-free,
extended life.**

Up to now, standard plastic LICs may have caused you some worries. Maybe a gnawing concern about field

failures, actual or potential. But you didn't want to pay the price of ceramic or frit seal. Or, maybe you've been using expensive hermetic packages, but they've been getting damaged during insertion into equipment.

Now, the solution. RCA "Gold CHIP" linear ICs. For the assurance that comes from hermeticity, *plus* the economy and ruggedness of plastic.

Gold CHIP LICs have non-corroding gold metalization and leads. No aluminum with its potential problems.

The chip itself is hermetic. And protected in our advanced plastic package that has proven outstanding reliability. The result of all this is a truly cost-effective hermetic linear IC. Priced at standard plastic LIC prices. How do we do it?

We make the junctions hermetic with a protective layer of silicon nitride.

We complete the chip hermeticity with gold runs and interconnects. Under the gold is a layer of platinum which acts as a barrier to the titanium layer, used to obtain maximum adherence.

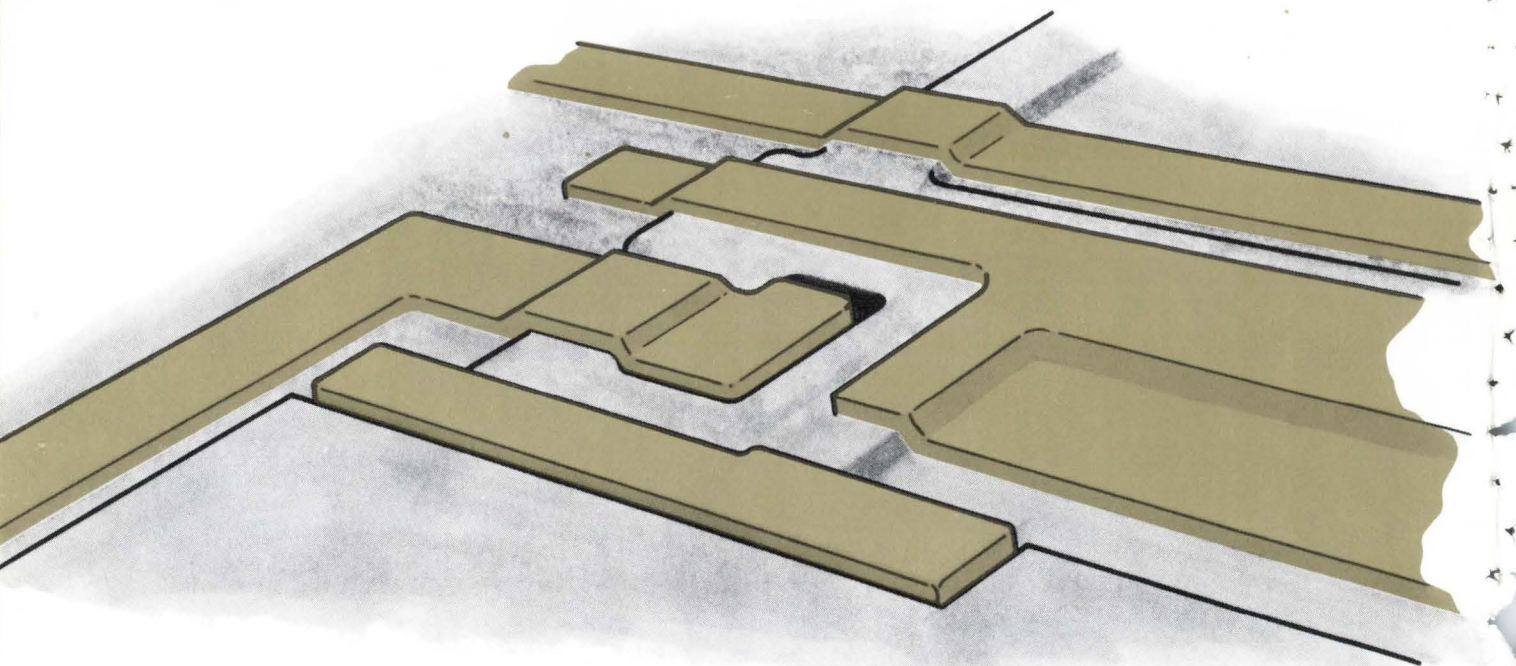
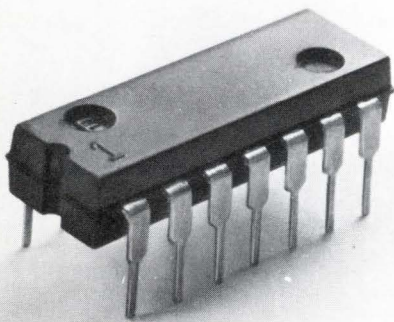

Gold runs and interconnects eliminate corrosion failure mechanisms.

"Gold CHIP" LICs. plastic prices.

Gold-to-gold-to-gold, from chip to external world.

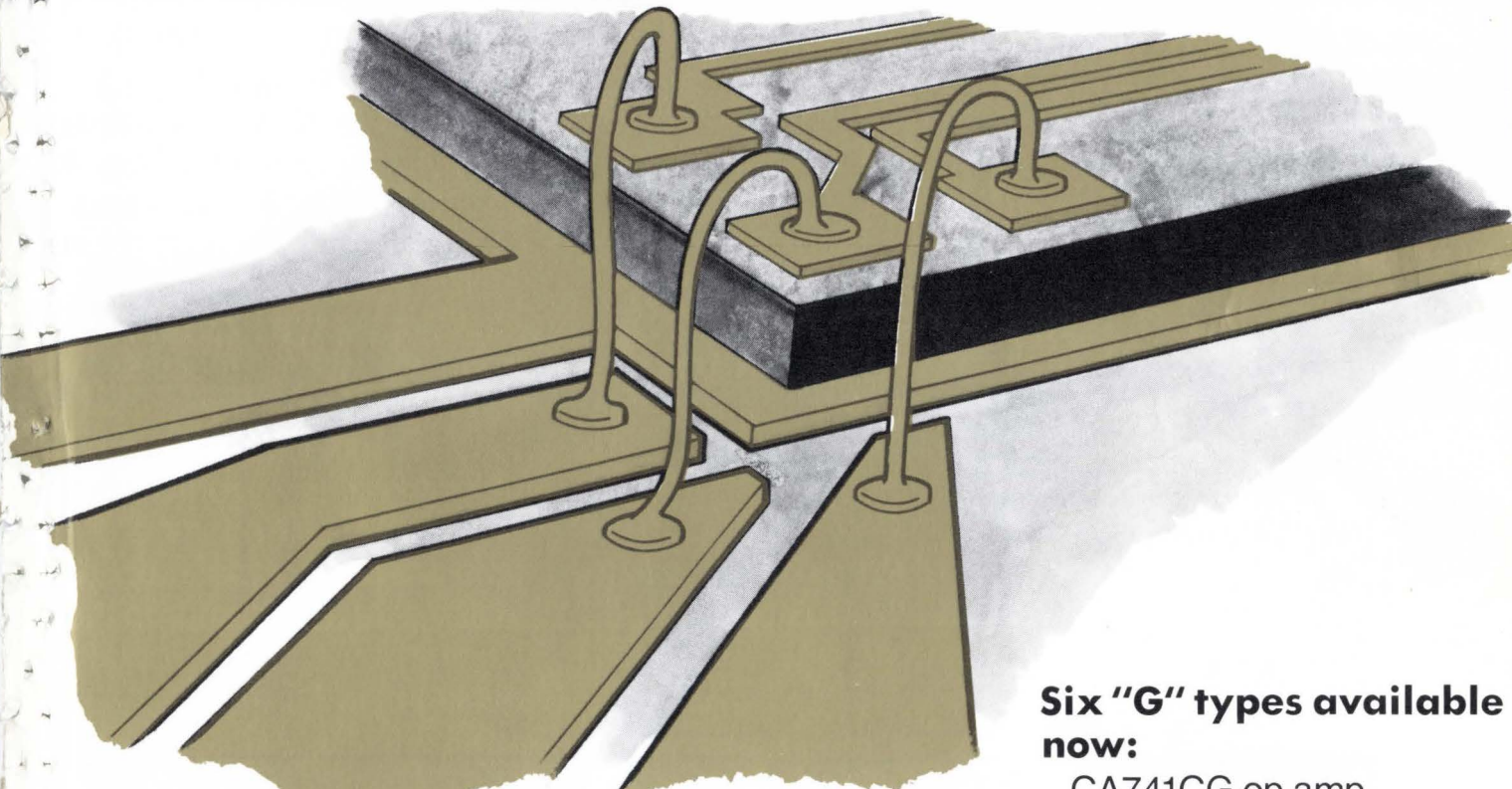

Here are some of the tests we have run:

| Test | Conditions | Sample Size | Duration | Unit-hours | Fail-ures |
|-------------------------------|-------------|-------------|----------|------------|-----------|
| Temperature/ Humidity/Bias | 85°C, | 200 | 5000 | 1,000,000 | 0 |
| | 85% R.H. | 35 | 3000 | 105,000 | 0 |
| | 15V reverse | 60 | 2000 | 120,000 | 0 |
| | bias | 19 | 1000 | 19,000 | 0 |

We have also had zero failures on the following tests: Operating Life; Thermal Fatigue; Pressure Cooker;

Thermal Shock; Temperature Cycle. All of the data is available to you.

Six "G" types available now:

CA741CG op amp
CA747G dual op amp
CA324G quad op amp
CA339G quad voltage

comparator
CA3724G high voltage transistor array
CA3725G high voltage transistor array

These types are available off the shelf from RCA Solid State distributors. They're also available processed in accordance with MIL-M-38510, Class B (RCA in-house program "/3").

FOR A FREE SAMPLE, MAIL COUPON →

Our challenge: evaluate Gold CHIP LICs yourself.

Compare them to any equivalent ceramic, frit-seal or plastic packages subjected to (1) Pressure cooker: 15 psi above atmosphere; (2) Temperature-humidity: 85°C, 85% RH, devices under rated bias conditions; (3) Operating life: operated under rated conditions.

Now you have no reason to take chances with non-hermetic plastic LICs. To find out more, contact your local RCA Solid State distributor. Or RCA.

Write: RCA Solid State, Box 3200, Somerville, N.J. 08876; Ste. Anne de Bellevue, 810, Canada; Sunbury-on-Thames, U.K.; Fuji Building, Tokyo, Japan.

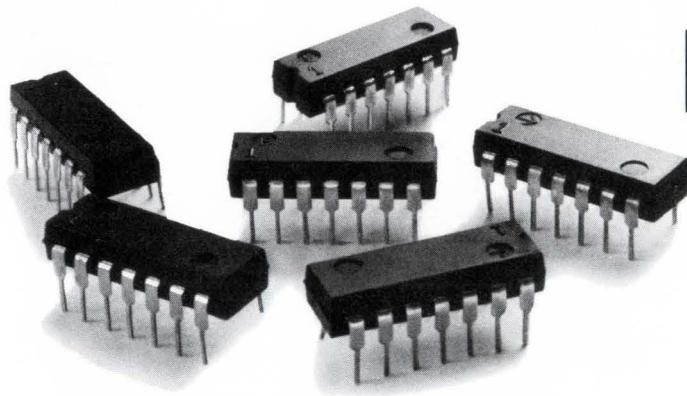

RCA

FOR A FREE SAMPLE, MAIL THIS COUPON.

Offer expires August 15, 1975

Mail to RCA Solid State, Box 3200, Somerville, N.J. 08876

Please send me, free, one Gold CHIP linear IC (check one, below):

_____ CA741CG op amp; _____ CA747G dual op amp; _____ CA324G quad op amp;
_____ CA339G quad voltage comparator; _____ CA3724G high voltage transistor array;
_____ CA3725G high voltage transistor array.

Estimated annual requirements _____

My firm buys ICs: Through distributor Direct from RCA

Distributor name _____

Address _____

My name _____

Title _____

Company _____

Address _____

City, State, Zip _____

E5-15

RCA. Full house in Linear ICs.

Design with the complete flat cable/connector system.

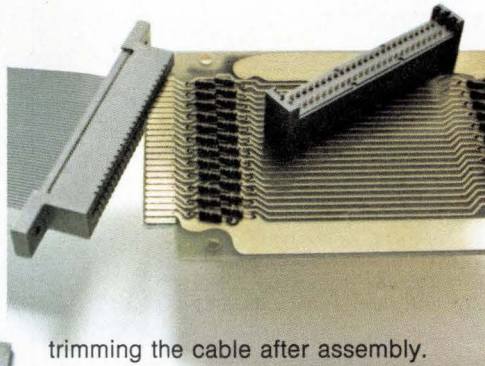

trimming the cable after assembly.

Connector units provide positive alignment with precisely spaced conductors in 3M's flat, flexible PVC cable. The connector contacts strip through the insulation, capture the conductor, and provide a gas-tight pressure connection.

With cable, connectors and assembly tools from one design and manufacturing source, you have added assurance the connection will be made surely, with no shorts or "opens."

And "Scotchflex" now offers you more design freedom than ever. From stock you can choose shielded and non-shielded 24-30 AWG cable with 10 to 50 conductors, and an ever-increasing variety of more than

The 3M DELTA pin and socket connector.



Assembly-cost savings are built in when you design a package with "Scotchflex" flat cable and connectors. But more important, 3M Company offers you the full reliability of a one-source system: cable *plus* connectors *plus* the inexpensive assembly aids that crimp the connections quickly and securely (with no special operator training required).

The fast, simple "Scotchflex" assembly sequence makes as many as 50 simultaneous multiple connections in seconds, without stripping, soldering or

100 connectors to interface with standard DIP sockets, wrap posts on standard grid patterns, printed circuit boards, or headers for de-pluggable applications. 3M's DELTA "D" type pin and socket connectors are now also available. For full information, write Dept. EAH-1, 3M Center, St. Paul, MN 55101.



3M
COMPANY

3M's "Scotchflex" line.

"Scotchflex" is a registered trademark of 3M Co.

Dialight sees a need:

(Need: The widest choice for your every application.)

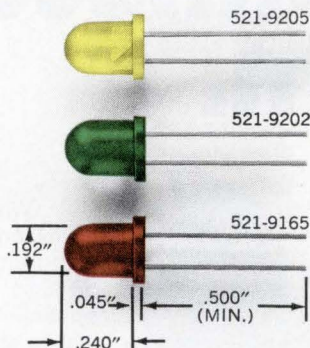

Now available in green, yellow and red. Mini-sized for maximum front panel density and easy panel mounting. High luminous intensity, low cost. Vibration/shock resistant. Solid state for long life. Wide viewing angles. Ideal for applications like panel lighting, film, annotation and alpha-numeric displays.

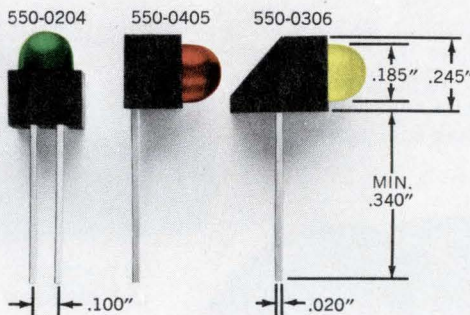

Mix 'em or match 'em. LED logic state fault indicators are available in red, yellow and green, in a variety of shapes, some with a built-in integral resistor. Can be driven from DTL and TTL logic. Designed for easy alignment on PC boards so that multiple functions can be displayed.



Dialight, the company with the widest choice in switches, LEDs, indicator lights and readouts, looks for needs . . . your needs . . . and then they develop solutions for your every application. No other company offers you one-stop shopping in all these product areas. And no other company has more experience in the visual display field. Dialight helps you do more

with these products than any other company in the business, because we are specialists that have done more with them. Talk to the specialists at Dialight first. You won't have to talk to anyone else. Send for your free new copy of Dialight's current catalog.

DIALIGHT

Dialight, A North American Philips Company
203 Harrison Place, Brooklyn, N. Y. 11237
(212) 497-7600

See Dialight.

Meetings

National Computer Conference, IEEE, AFIPS, Convention Center, Anaheim, Calif., May 19-22.

Semicon/West '75, SEMI Inc. (Mountain View, Calif.), San Mateo County Fairgrounds, San Mateo, Calif., May 20-22.

29th Annual Frequency Control Symposium, U.S. Army Electronics Command, (Fort Monmouth, N. J.), Howard Johnson Motor Inn, Atlantic City, N.J., May 28-30.

Laser Engineering & Applications Conference, IEEE, OSA, Washington Hilton Hotel, Washington, D.C., May 28-30.

Summer Consumer Electronics Show, EIA, McCormick Place, Chicago, June 1-4.

29th Annual Convention of the Armed Forces Communications and Electronics Association (AFCEA), Sheraton Park Hotel, Washington, D.C., June 3-5.

Chicago Spring Conference on Broadcast and Television Receivers, IEEE, Marriott Motor Hotel, Chicago, June 9-10.

Symposium on Applications on Ferroelectrics, IEEE, Albuquerque Hilton Inn, Albuquerque, N. Mex., June 9-11.

Second Annual Automotive Electronics Conference and Exposition, Electronic Representatives Association (Chicago), Cobo Hall, Detroit, June 10-11.

NAECON—Aerospace Electronics Conference, IEEE, Convention Center, Dayton, Ohio, June 10-12.

International Conference on Communications, IEEE, Fairmont Hotel, San Francisco, June 16-18.

Nepcon East and International Microelectronics Conference, ISCM Inc. (Chicago), New York Coliseum, New York, June 17-19.

Total cost effectiveness. TO-5 relays from Teledyne.

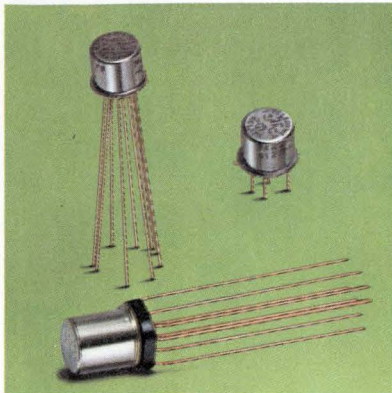

Whether you design commercial aircraft equipment, or MIL avionics, control and communications devices—the tough parameters are the same. High packing density, low power consumption and heat dissipation, utter reliability and always—cost effectiveness.

TO-5 relays from Teledyne are the unqualified answer. High density, PC board pinout, **half** the size and coil power of comparable multi-pole

switching devices. And they are **more reliable** and **less expensive** than semiconductor arrays for multi-switching functions.

Teledyne has the greatest choice of TO-5 relays available to you—ultra-sensitive types, maglatches, internal suppression diodes, internal drive transistors and many contact arrangements. All—welded and hermetically sealed; all fully qualified to MIL-R 39016 B, level “L” and “M” reliability. Specify them for your most exacting designs. Teledyne TO-5 relays—the totally cost effective switching solution. There’s an economical Commercial/Industrial line, too—and they’re in stock near you. Call your nearest Teledyne Relays office for location of your local representative or distributor.

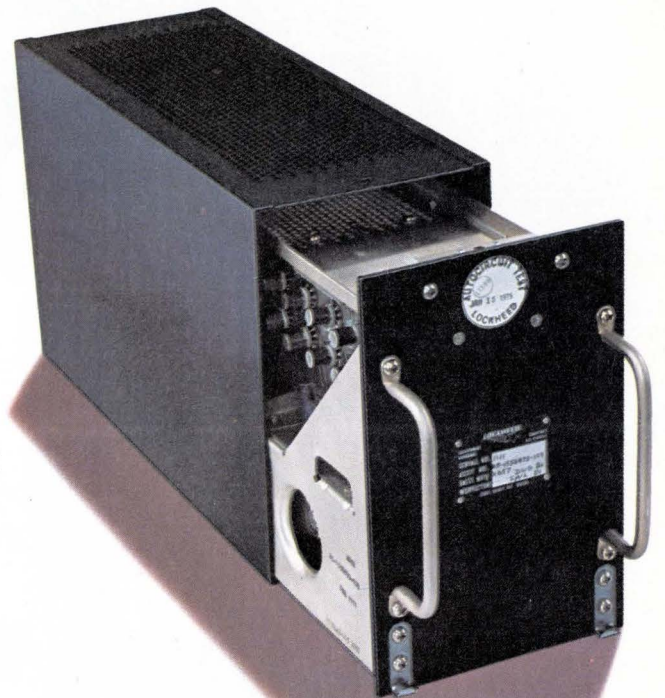
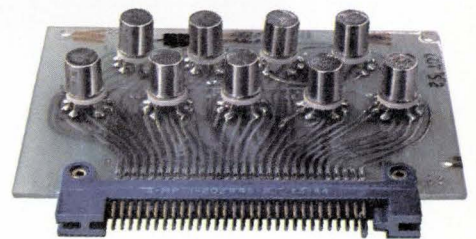

L-1011 VHF NAV Accessory Unit.
Courtesy Lockheed-California Co.

TELEDYNE RELAYS

3155 West El Segundo Boulevard, Hawthorne, California 90250
Telephone (213) 973-4545

Burgstrasse 6-8, 62 Wiesbaden, West Germany
Telephone: 06121-302031/2 Telex: 04-186851 (Trel-D)

Heathrow House, Bath Road, Cranford, Hounslow, Middlesex, U.K.
Telephone: 01-8972501 Telex: 935008

Hewlett-Packard introduces another uncompromising calculator,



the new HP-55 Programmable Scientific.

\$395.00*

Now \$395.00 buys:

All the pre-programmed functions and operations of our HP-45 plus 38 new ones.

Many of the user-programmable functions of our HP-65.

A built-in digital timer.

Here are the details:

49-Step User Memory. You can program the HP-55 to solve automatically repetitive problems you now step through manually—over and over.

Easy to program. Just switch to PRGM and enter your formula. You don't need software or a "computer" language. To solve a problem, switch to RUN, enter the variables and press the R/S (Run/Stop) key. Seconds later, the HP-55 gives you an answer accurate to 10 digits. To solve other problems using the same program, just enter the new variables and press R/S.

Full editing capability. The SST (Single Step) key lets you run through the program in the Memory a step at a time, so you can easily add, delete or change any program step anytime.

Branching and conditional test capability. You can program the HP-55 to perform direct branches or conditional tests based on logic comparisons.

86 pre-programmed functions and operations. They let you make all sorts of slide rule calculations very rapidly, and they save all kinds of steps when you incorporate them into your programs.

Expanded trig functions. You can perform vector and angle arithmetic; you can calculate in degrees, radians or grads; you can convert directly from degrees to radians and from decimal degrees to degrees/minutes/seconds—and vice versa.

Expanded stat capabilities. You can quickly calculate linear regressions, curve fits, summations and mean and standard deviations.

True metric conversion capability. Not just constants, true two-way conversions between U.S. and metric units.

20 Addressable Memory Registers. They'll save you minutes and errors when you're faced with problems that require multiple data manipulations; e.g., matrix inversions. Again, you can do register arithmetic on the first 10.

Digital Timer. A 100-hour timer, accurate to $\pm 0.01\%$, measures time in hours, minutes, seconds, tenths and hundredths and lets you store up to 10 "splits" in the first 10 Addressable Memory Registers.

HP's RPN logic system with 4-Memory Stack. It shortens all complex calculations and simplifies all calculations. You solve problems the way you think, the way you would if you were using pencil and paper. You can see all intermediate data anytime; you rarely have to re-enter data; and you can easily recover from errors because you can recall earlier entries.

"Keystroke" vs. "full" programmability. The HP-55 is for people who either run their programs directly after they write them or don't mind re-entering previously written programs when they want to re-use them. So it doesn't offer the program recording capability you'll find on our fully programmable HP-65. Nor does it accept pre-recorded programs. HP-55 software currently consists of two optional handbooks detailing Math and Stat programs.

800-538-7922, Ext. 700 (in Calif. 800-662-9862, Ext. 700). The numbers to call for a "hands-on" demonstration. We'll give you the name of a dealer near you, and we'll send you detailed specifications of our new HP-55. Challenge it with your repetitive problems. See for yourself what short work it makes of them.

HEWLETT  PACKARD

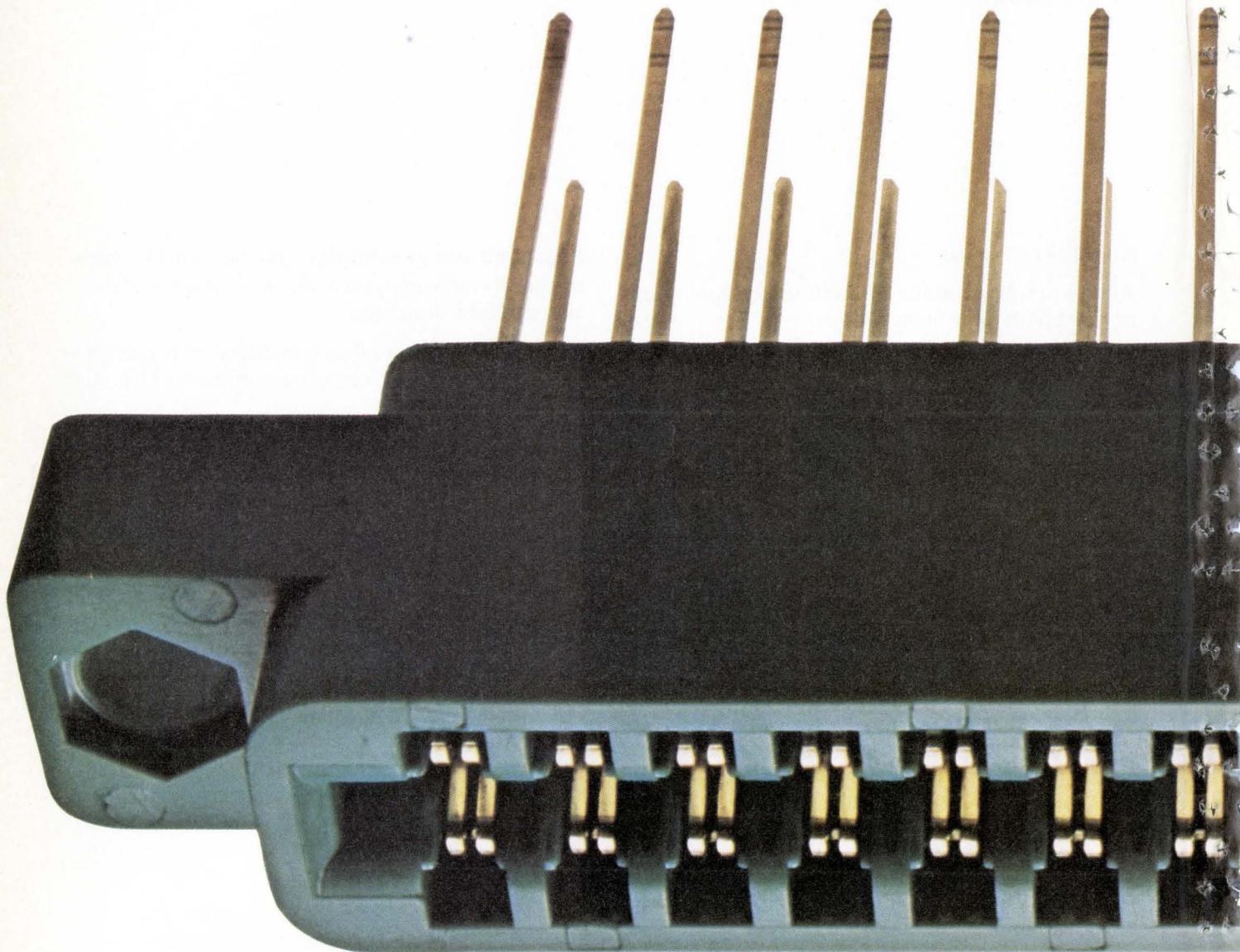

Sylvania connects

Our printed-circuit edge board connectors make contact with the outside world in almost any way you want. You can get gold-dot or gold-plated contacts in bellows or bifurcated styles, designed for crimp or point-to-point wiring, and in a choice of plastic bodies.

In manufacture, we control the complete operation from stamping and plating, through plastic molding and assembly.

Right up to the finished product.

When it comes to custom work, our engineers and designers bring this same high quality control to your own specific design.

Control of materials, production and quality inspection is one of the key features of our connector program.

(It's that ability to control quality all the way that helped us develop the most reliable gold-dot

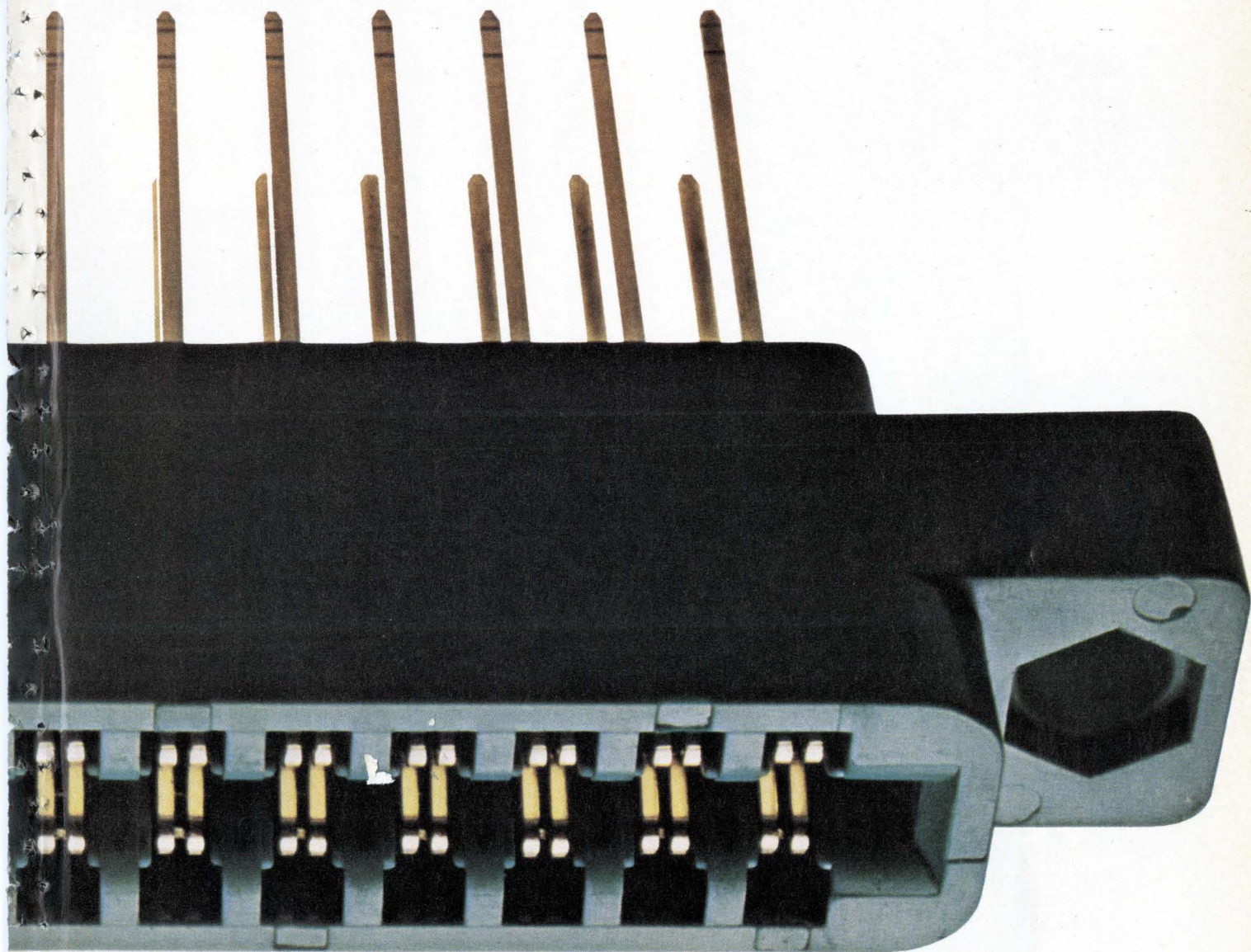

with the outside world.

contact on the market.)

We maintain this quality control and precision manufacture in high-volume production. We have to, since we supply the largest users of circuit connectors in the country.

What we've done for them, we can do for you.

When you need circuit board connectors that have to talk to the outside world, talk to somebody who's wise in the ways of the outside world

—Sylvania.

For more information, get in touch with: GTE Sylvania, Parts Division, 816 Lexington Ave., Warren, Pa. 16365.

We're helping you make it.

GTE SYLVANIA

47A-9

Repeatability in
thin film networks
is a matter of
experience.

If you're really
serious about cost,
be serious about quality.

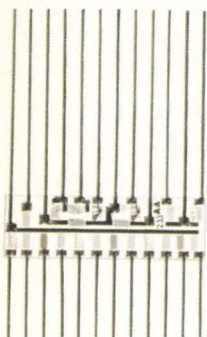
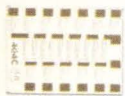

Our chrome-cobalt technology, for example, has been proven in dozens of applications ranging from D/A and A/D conversion, voltage division in digital multimeters and telemetry equipment, to communications paging devices.

In seventeen years of film resistor production, we've solved many problems that others are yet to encounter. This hard earned experience allows us to respond quickly to your custom needs. We regularly duplicate prototype performance in virtually any quantity. You get excellent delivery along with greater assurance of part-to-part consistency and quality.

Profit from the practiced teamwork of our application, quality control and production engineers. Standard items are available through your appointed Allen-Bradley Electronic Distributor. Write for Publication 5801. Allen-Bradley Electronics Div., 1201 South 2nd St., Milwaukee, WI 53204.

Performance specifications

TCR: 10 to 25 ppm/°C
Absolute tolerance: as low as .01%
Interconnections: metal film (no soldered or welded joints)
Stability: 50 ppm/year
Packaging: chip, conformal coated, encapsulated.



ALLEN-BRADLEY

Milwaukee, Wisconsin 53204

Circle 28 on reader service card

EC 65C

Motorola to offer ECL processors

Motorola Semiconductor Products division will expand its processor products from MOS and emitter-follower logic into fast, high-performance emitter-coupled logic with a new modular-processor family it will introduce at the National Computer Conference next week in Anaheim, Calif. The M10800 chip set is suitable for small but fast controllers through high-end minicomputers and even larger mainframes. **It will be up to 10 times faster than MOS models.**

The first entry will be the MC10800 4-bit processor slice, with samples to be available in the first quarter of 1976. Other family members for control and interface will follow. With compatible MECL 10K logic, it can form a powerful 10-chip 16-bit minicomputer with "hundreds" of instructions. Motorola says it's at least twice as fast as any other processor, with 55-nanosecond microinstruction time possible.

Intel to unveil automated system for digital design

A system that takes designers of digital systems a step closer to the ideal—beginning work with a complete prototype system so that hardware can be exercised, diagnosed, and debugged with software—will be introduced by Intel Corp. at the National Computer Conference. Dubbed the Intellec MDS (microcomputer development system), the new equipment **provides a common hardware-software setting for the engineer and programmer to develop their respective parts of the system.**

The MDS consists of two processors: one to control many bus-organized resources, such as memories, printers, a CRT terminal, and other peripherals, and the other to personalize the system to a particular microprocessor, emulating the prototype's master circuitry.

Sewing machine goes electronic

The Singer Co. is introducing the first electronic home sewing machine, the Athena 2000. John Rydz, vice-president for research and development at Singer's U.S. Consumer Products division, says more than 350 mechanical parts have been **replaced by a custom p-channel MOS read-only memory chip** supplied by American Microsystems Inc. of Santa Clara, Calif. Such factors as optimum stitch width, length, and density are automatically programmed. The machine retails for \$799.95.

System keeps eye on airline flights

Continental Airlines will soon begin operation of a complex flight-management system that **automatically monitors and plots the status of all its flights in real time.** The system, developed by E-Systems Inc. of Garland, Texas, is called SAFE (System for Automated Flight Efficiency).

SAFE determines approximate passenger loads before flights, accesses weather data to determine fuel reserves, monitors aircraft assignments, and determines runway conditions to calculate aircraft weight. The system includes a central processor and terminals in each office of Continental, which is based in Los Angeles.

Ion-implanted fast devices due

Solid State Devices Inc., Los Angeles area manufacturer of super-fast ion-implanted rectifiers, and diodes, has acquired the high-voltage, high-speed Westinghouse epitaxial power-transistor line, and expects

to be offering high-performance ion-implanted power transistors in three to six months. The new parts, with **switching times two to three times faster than the 200 to 300 nanoseconds of the present transistors rated at 375 volts and 90 amperes**, will use only ion-implantation and no diffusion. However, the firm will continue to make devices equivalent to the Westinghouse parts.

Sony promises faster devices with poly process

Researchers at Sony Corp. have developed a semi-insulating polysilicon technique for passivating semiconductors. The approach promises **denser, faster, and more reliable devices than those passivated with conventional thermally grown silicon dioxide**. Sony says the technique is inexpensive, versatile, and easily mass-produced. What's more, it can be applied to any silicon device. Also, the technique permits extremely high-voltage operation—Sony reports operating npn and pnp transistors at 10,000 volts.

Sony's C-MOS devices built with the technique are 50% denser than standard C-MOS because space-wasting guard rings are eliminated. Sony has already operated its devices at high temperature, high humidity, and high electrical fields with exceptionally high reliability.

Study pegs 1978 calculator sales at 22 million units

Domestic U.S. sales of calculators will reach 22 million units in 1978, almost double the 1974 figure of 12.2 million. That's the conclusion of a group of MBA candidates at New York University, who, after studying the market, predict that **85% of it will be shared by Texas Instruments Inc., Rockwell International Corp., Hewlett-Packard Co., and National Semiconductor Corp.** But, says the study, because of lower prices, sales volume in 1978 will amount to only \$900 million, compared to last year's \$658.3 million.

TI reveals automatic-bonding throughput totals

Affording outsiders a rare glimpse at semiconductor production rates, Texas Instruments has quietly disclosed just how high those rates can climb when automatic bonding is used. TI reports that throughput of **300 to 500 circuits per hour is achieved routinely with its Abacus bonding machines**. With its Mini-DIP film-strip line, formerly GE's Minimod, over 2,000 circuits can be assembled in an hour. And TI is preparing a Mini-DIP facility that promises to handle 4,000 circuits.

C-MOS suppliers vow to meet TI's price cuts

The price war is on in complementary MOS. Reacting to Texas Instruments' recent across-the-board price cuts in its commercial line, Ben A. Jacoby, Solid State division marketing vice president at RCA, the leading supplier of C-MOS, says: **"We intend to remain the industry leader. We will meet competitive pricing through any channel of distribution."** However, RCA made clear that it plans no across-the-board cuts at this time. Motorola's MOS marketing manager, Colin Crook, who predicted the price cuts, says, "We are positioned to match any bona fide competition."

THE FIRST PRACTICAL DATA-ACQUISITION MODULE:

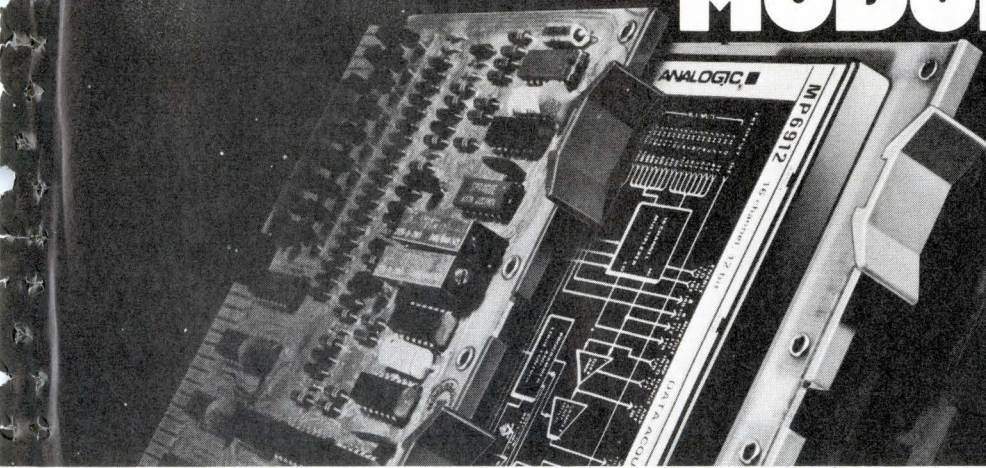

**Complete 12-bit,
16-channel
system fits 0.5"
card spacing--
anywhere.**

**Better
performance,
at lower cost,
than individual
module
combinations.**



0.375"
THIN

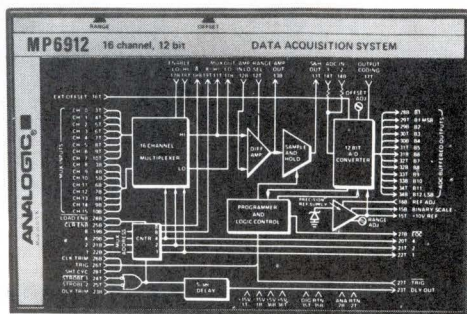

On a minicomputer motherboard, medical instrument or process control system . . . mounted on a single small card . . . plugged directly into a card-cage connector—there's always room for the 0.375"H x 4.6"W x 3.0"L Model MP6912. With space at a premium, this remarkable plug in, easily serviceable high-performance / low-cost system is your first really practical alternative to either in-house design or larger more costly systems. Particularly since you'd actually pay *more* to get comparable performance from individual modules that need 3-5 times the "real estate."

You get a 16-channel multiplexer (expandable to 512 channels), fast sample and hold, and a 12-bit A/D converter (accuracy $\pm 0.025\%$ at a 100kHz throughput rate), integrated with complete programming, control, and timing logic. (That's what we call the first *practical* data acquisition module.)

What you don't get is equally important: error accumulation; module interconnection costs and headache; redesign challenges every time the application changes; and testing, documenting, and quality-controlling at the module level.

The MP6912 is an optimized design: 100% shielding on all six sides to minimize interference; minimum parts count for inherently high reli-

ability; an exceptional 100kHz basic throughput rate that can be "short cycled" up to 450kHz; buffered outputs for trouble-free digital interconnection.

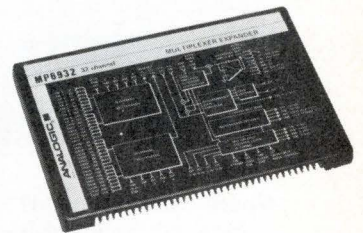

A companion module, the MP6932 Multiplexer Expander, can be used in conjunction with the MP6912 to provide 32 additional channels of single-ended or 16 channels of differential multiplexing with all associated addressing and logic. Up to 16 of these modules can be sub-multiplexed into one MP6912 system, providing 512 single-ended or 256 differential channels.

Prices for the MP6912 and accessories are remarkably low for such a compact, high performance system. Quantity discounts are substantial and if your application doesn't require 100KC throughput, lower speed 60KC and 30KC modules are available at much lower unit prices.

Write for our 16 page designer's guide to the MP6912 to Analogic Corp., Audubon Rd., Wakefield, Mass. 01880; Tel. (617) 246-0300.

ANALOGIC
... The Digitizers

For measurement, control and data processing

Microprocessor modules cut design time, production costs by up to 80%

Pro-Log's microprocessor modules are the hottest item around for use in dedicated control and data processing applications.

What is a microprocessor module?

By using large scale integration, a number of semiconductor manufacturers have made chips containing the central processor units used in small computers. These chips are called microprocessors.

Pro-Log has taken these microprocessors and coupled them with memory, a clock, and flexible input/output circuitry to produce a unique device called a microprocessor module.

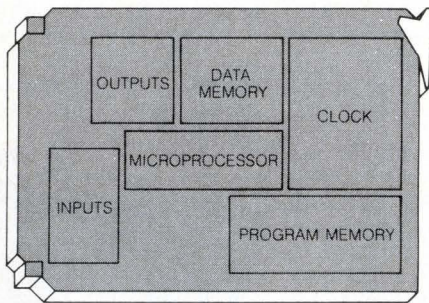

Where can it be used?

Microprocessor modules can be used in two general areas, dedicated control and data processing.

The dedicated control function is now being largely performed by hard-wired logic. Examples include calculators, pinball and slot machines, electronic cash registers and scales, test equipment, stoplights, medical monitoring systems, machine and process controllers . . . in fact almost any situation in which a man interfaces with a machine.

Data Processing applications are now most often handled by computers. Examples include record handling, accounting, inventory control, scientific analysis . . . wherever large volumes of varying data have to be manipulated and evaluated.

How it saves time and money

A microprocessor and a programmed PROM working in unison can replace large numbers of logic gates and timing elements. This also eliminates the sockets, power supplies, packaging, connectors, and wiring associated with hardwired logic. By decreasing the number of parts and interconnections in your product, you lower assembly and rework costs, improve reliability and cut inventory, making microprocessor modules a real cost-effective method of performing dedicated control and data processing. As a rule of thumb, if your circuit design calls for the use of more than 50 chips, a microprocessor module can probably do the job for less money.

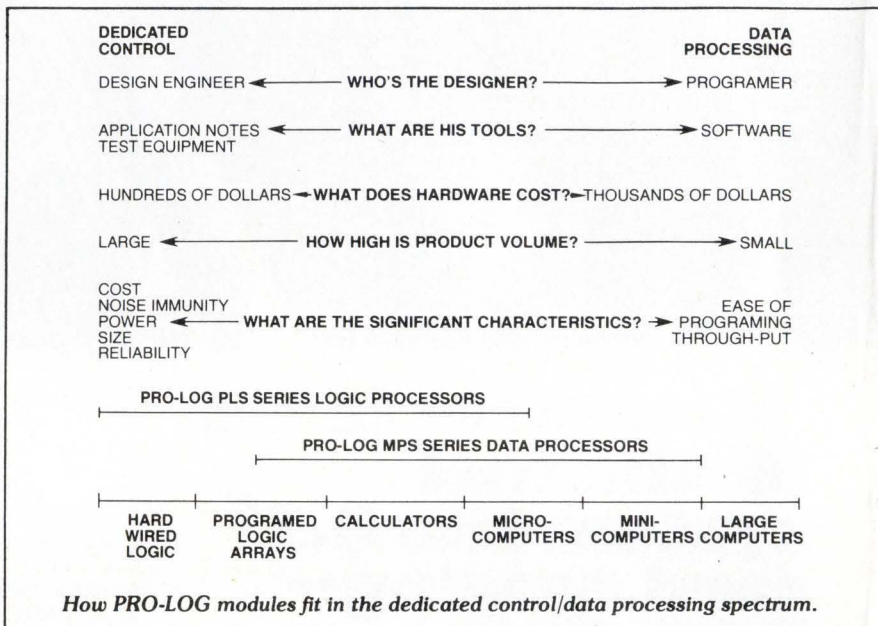

Since microprocessor modules are relatively simple, service calls become less expensive. And you spend less money and time in educating service engineers in system repair.

With our microprocessor modules, and test equipment, there's no need for design engineers to learn traditional programming techniques. It's not necessary to use assemblers, simulators, or compilers to arrive at working hardware.

Through the use of microprocessor modules, most companies realize savings of 60% to 80% over old-style designs.

Only Pro-Log offers a complete package

- **Hardware**—logic processor cards, microcomputer cards, interface cards, peripherals, boards, card racks, connectors, sockets, power supplies, and memory modules.

- **Instruments and test equipment**—PROM programmers and systems analyzers for engineering and field service.

- **Education**—Pro-Log offers microprocessor courses nationwide: a one day applications course tells how to evaluate microprocessor modules; a three-day hands-on course teaches how to design, program and use microprocessor modules.

- **Application notes.**

- **Designer manuals.**

For product information, circle number 210.

For information on applications courses circle number 211.

For information on design courses circle number 212.

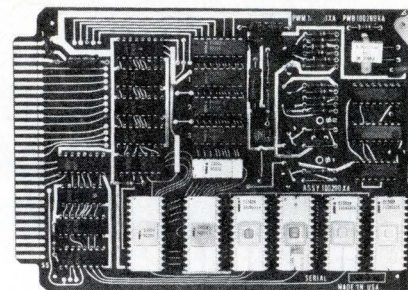

Shown above: Pro-Log's PLS-401 microprocessor module for dedicated control. Price \$355.

Shown below: Pro-Log's MPS-803-1 microprocessor modules for data processing. Price \$810.

OEM and volume discounts available on both.

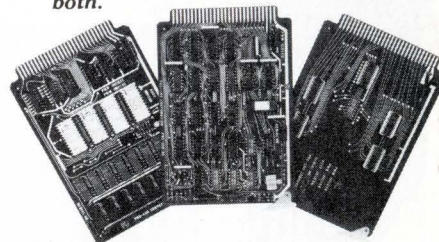

PRO-LOG CORPORATION



852 Airport Road
Monterey, CA 93940
Telephone (408) 372-4593
Bedford, Mass.,
(617) 275-1220

Fiber-optic field attracting new cable, connectors

Availability of components is making things easier for designers of communications systems using light pipes

Hardware developments for fiber-optic communications are beginning to snowball. The Telecommunications Products Department of Corning Glass Works, Corning, N.Y., is going to market with a multichannel fiber-optic cable (see p. 121), and at least two leading connector manufacturers—the Amphenol RF division in Danbury, Conn., and ITT Cannon Electric division in Santa Ana, Calif.—are now officially entering the market for fiber-optic connectors.

Fiber-optic communications offers unique advantages over conventional twisted-pair or coaxial transmission systems. Because an

optical network is inherently non-conductive and noninductive, it is naturally protected against electromagnetic and radio-frequency interference. Additionally, the wide bandwidth of light permits about 100 times more data to be transmitted through any given channel, and the crosstalk between channels can be held to a minimum.

Low loss. The new Corning fiber-optic cable, called Corguide, is the first multichannel low-loss, low-cost optical waveguide to be made available commercially. Corguide can handle six separate light channels at once, and its price is comparable to premium-grade coaxial cable. Maximum attenuation for each single-fiber channel is only 20 decibels per kilometer. According to David Stout, market development specialist, the price is now under 70 cents per foot, but that will come down to less than 10 cents per foot when Corning swings into full production.

Corguide is currently being made at a pilot production facility.

Fiber-optic connectors are needed to terminate the cable, or to join it to another cable if the transmission system is to be operated over long distances. At this time, no easy-to-install low-loss splice in mid-cable is available, but terminating connectors are. With a splice, alignment is critical (see following story) because a small-area fiber in one cable must mate accurately with a small-area fiber in another cable. As a result, a slight misalignment can mean heavy losses. With a terminating connector, on the other hand, the optical waveguide is being mated with either an emitter or a sensor. The area of each of these devices is so large that alignment is relatively easy.

Amphenol RF, which for the past year has been supplying fiber-optic versions of its subminiature series SMA coaxial connectors for the cable made by Galileo Electro-Op-

Connections. Amphenol's Allen Kasiewicz, holding an SMA connector, says he can supply a connector-pair for any fiber-optic cable. Rack-and-panel connector, below, is made by ITT Cannon.

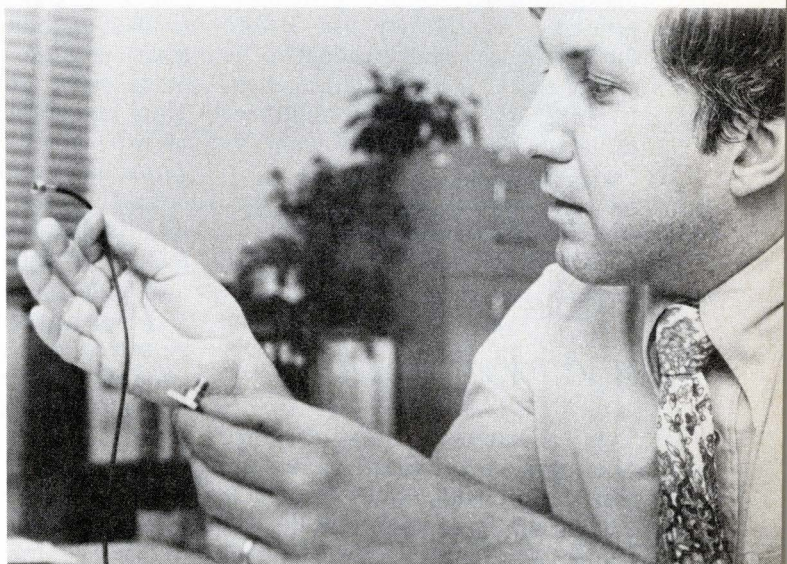
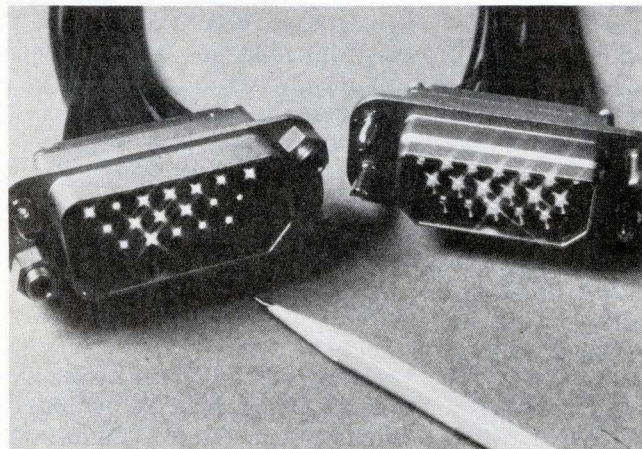

tics Corp. of Sturbridge, Mass., now says it can deliver a fiber-optic connector to satisfy any cable requirements. Marketing manager Allen Kasiewicz claims that turnaround time will be only four to six weeks for prototype quantities. The company is selling modified SMA-type units for approximately \$6 per mated pair in quantity. With these connectors, the user still has to mount the sensor and emitter devices himself, but at least he is spared the ordeal of taking a conventional connector and physically reaming out the hard plastic material that's usually there.

Glass or plastic. ITT Cannon is also now selling connectors for use with either glass or plastic optical fibers. The company is modifying some of its existing connector products, as well as supplying tailor-made custom devices, for both military and industrial/commercial customers.

According to Gerald Selvin, vice president of engineering, production quantities of either a modified or custom connector can be delivered within four months at most. Moreover, he claims that loss figures are very good—typically less than 3 decibels for coupling to a glass multifiber cable.

Selvin's Santa Ana group is working closely with the ITT Electro-Optical Products division in Roanoke, Va., which has been producing high-performance fiber-optic cables primarily for military use. Before the year is out, Selvin hopes to be selling a plastic subminiature circular connector for plastic multifiber cable at a volume price of under \$1 per mated pair. □

Fiber-optics

Cable gets coupler and multiplexer

Two obstacles to long-distance fiber-optic communications are the high transmission losses characteristic of light-pipe joints and the difficulty of multiplexing channels

down the same fiber. Now, researchers at University College in London think they've broken through these barriers. To connect cable lengths optically, they use holographic plates, and for multiplexing, they use pressure transducers to introduce new channels along a fiber-optic pipe by phase-modulating the light beam.

Both projects are still laboratory demonstrations, but the researchers believe the experiments point the way toward practical devices. Although sophisticated and complex equipment would be needed in the factory to assemble the holographic couplers to the cables, joining operations in the field by repairmen could be kept very simple, claims Professor Eric A. Ash of the electronic and electrical engineering department.

Also, the one-way telemetry system is flexible and even simple to retrofit for avionics or industrial monitoring systems because inputs could be literally clipped on anywhere along a fiber-optic cable, says Professor D. E. N. Davies. The two government-funded projects are the only ones of their kind, the researchers believe.

Connections. Fiber-optic bundles are generally connected either by painstaking microscopic alignment techniques or by fusing the cables, which causes high losses. "The hologram acts as a very special lens," Ash points out, and individual fiber-to-fiber alignment becomes unnecessary because, to a hologram, "one plane wave looks like another." Thus, holographic plates at the ends of two cables can be brought together and separated by a very thin optical spacer. But Ash cautions that the plates must not be tilted in relation to each other because this distorts the planar waves.

Several other problems remain to be solved. The thin spacer of polyethylene or metallic foil would have to be "very accurately defined" within 1-mil engineering tolerances, which should be possible to achieve, Ash says.

Most difficult of all, the efficiency of the hologram needs improving.

The laser beam that must be used passes through two holograms at each junction and, although it's possible sometimes to get 90% transmission efficiency, there's a 2-decibel insertion loss. If a system is designed for only 4 dB of loss per kilometer (an exceptionally low figure for present systems), then 2 dB is too much, Ash notes. His group is now obtaining a fiber-to-fiber crosstalk of 10 dB, but for digital traffic, a system needs 20 dB. For analog traffic, "a tough problem," 40 dB to 50 dB is needed, he says.

Transducers. Data channels are fed into the system by using piezoelectric transducers wrapped around single-mode or multimode optical fibers. Each encircling transducer, which mechanically pulses its message through the fibers, phase-modulates the optical carrier. The phase shifts add linearly without cross-modulation effects, Davies says.

The piezoelectric transducers are two semicylindrical shells that can be clipped to a fiber cable without damage to the protective plastic coating. Mechanical flexing of the cable modulates the light signal. At the far end of the fiber, the signals are converted to an intermediate frequency by a photodetector acting as a heterodyne mixer. The local oscillator here may be a second laser or a frequency-shifted version of the original laser. At the intermediate frequency, the signals can be demodulated by a discriminator and the data separated by means of frequency or tone demultiplexing.

Modulation frequencies above 100 MHz have been used, and video signals have been transmitted, as well. And although a gas laser operates the test rig, Davies thinks a solid-state laser would work, too. □

Industrial electronics

Mines to get new communications

The U.S. Bureau of Mines has developed a new kind of communications system for coal mines—one

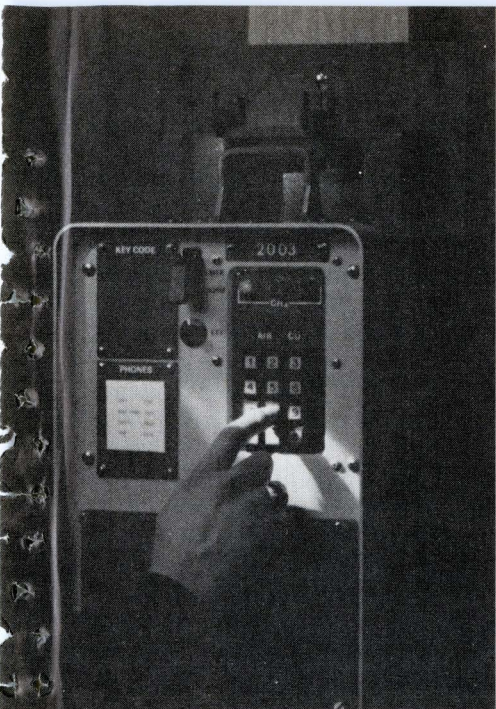

Assist. Collins Radio's console handles monitoring as well as communications.

that combines wireless and telephone communications with the monitoring of mine conditions critical to safety.

Installation of the first prototype system will be completed in September in a mine operated by U.S. Steel Corp. near Uniontown, Pa., says John Murphy, principal investigator for the U.S. Bureau of Mines' Mining and Safety Research Center in Pittsburgh. The new system—"the climax of three years of mine research," according to Murphy [*Electronics*, March 27, 1972, p. 32]—will replace simple loudspeakers and eliminate separate safety sensors.

Modules. The prototype is being built by Collins Radio Group, Cedar Rapids, Iowa, as a model for a new product line for all types of mines. It consists of a number of push-button telephone/console combinations linked by coaxial cables. Optional modules that can be plugged into the console include a personal pager that operates with a 3,000-hertz paging signal and an ultra-high-frequency module for interfacing a console to walkie-talkies within 300 feet. Solid-state sensors on the console will also monitor carbon monoxide and methane gas.

The console can also monitor the performance of electrical equipment in the mine, such as ventilating fans and electric motors driving coal conveyors and pumps. When preset

Match-box transmitter may save miners' lives

This summer, the Bureau of Mines will begin field-testing an emergency transmitter-receiver system built by Collins Radio Co. for locating trapped miners. The 4.2-volt battery pack used for the miner's helmet lamp powers the small transmitter that measures 0.3 inch thick, 1 in. wide and 2 in. long. When triggered, it emits a 10-watt signal at 2,000 to 3,000 hertz on a 10% duty cycle while attached to a miner's belt.

The waveform generator is actually a power audio oscillator. John Murphy of the Bureau of Mines, says it will send signals through 1,500 feet of earth, even though most mines are no more than 750 feet deep. A receiver on the surface can locate the signal source to within 25 feet, he adds.

Although the preproduction models have discrete components, Collins' Martin Bruns says that future units will be made of thin-film integrated circuits. Each transmitter will have a coded frequency within the 2,000-Hz to 3,000-Hz bandwidth for miner identification. "We're trying to make it as inexpensive as possible and are preparing cost estimates now for production units," Bruns says. The system will be marketed as part of Collins' mine-communications product line.

limits are exceeded, the system will trigger aural and visual alarms built into the consoles, and pass on the information to a minicomputer-controlled base station on the surface.

Up to 500 telephone/console combinations can be linked to the base station, reports Martin Bruns, Collins engineering chief for the project. Collins received \$109,000 for the hardware and installation, but Murphy estimates that \$2.5 million for 75 separate contracts were needed to integrate and modify such off-the-shelf components as telephone handsets, portable radios, and multiplexing equipment. The modifications were meant to ensure that the equipment would withstand an extremely dusty environment and rough handling.

"It is mainly a good job of systems engineering rather than developing a new art," says Murphy. Designing a flexible system that could accept additional modules for monitoring and paging, yet be simple enough to eliminate maintenance problems, was the big challenge, he says.

Flexible. Frequency-division-multiplexed telephone channels provided the desired flexibility, Murphy explains. "The existing [twisted-wire-pair] system wasn't flexible enough for use in monitoring as well as communications."

Collins planners hope the system

will serve as its entry into the mine communications business. "Several hundred mines" is the estimated size of the market. Minimum price is \$100,000 per system, which includes 250 telephone/consoles, the minicomputer-based central station, and a private branch exchange so calls can be made from within the mine over the common-carrier phone network.

Coal mine operators will save "15% to 25%" of the cost of buying separate monitoring systems if they buy the integrated Collins package, claims Bruns. Mining industry sources say that at least one mining company has already purchased a system. □

Communications

Mobile-radio nets get digital boost

Many two-way mobile radio systems such as those used by city police departments already use a technique called total area coverage to extend the effective range of communications. But now, in preparation for the day when these systems will be converted to digital transmission, the Motorola Communications division has introduced the Spectratrac, a digital receiver system

that enables networks to cope with digital speeds.

The key to total area coverage is the selection at a central station of the strongest signal from among several receivers that are dispersed at various points throughout the area. The receivers are connected by common carrier to the central station. A sort of analog voting system has been used to select the receiver with the strongest signal.

Spectratrac uses digital techniques to speed up by a factor of 25 the selection of the receiver to be monitored. This speed-up is highly significant because high-speed digital data can be lost if too much time is spent switching receivers.

Fast response. Jim P. Combs, base-station product manager at the Schaumburg, Ill., division, says, "we can acquire a signal in 40 milliseconds, and by using sample and hold, we can change receivers in less than 40 more." Earlier voting systems, including Motorola's, required 50 ms to acquire a signal and as long as 2 seconds to change receivers.

Digital sample-and-hold techniques, now common in test and measuring instruments, quickly determine the signal-to-noise ratios of the receivers. This approach gives the system extremely fast response time—desirable even in voice systems, but mandatory for data communications. Spectratrac discriminates differences in s/n ratios between receivers in 2-decibel steps. Competing systems, Combs points out, vote in 3-dB steps, and Motorola's present total-area-coverage system in 10-dB steps.

Motorola has also loaded Spectratrac, which sells for about the same as its 10-year-old predecessor, with features to facilitate servicing and maintenance. One convenience in the new equipment is telephone-line equalization, which had been available only by means of a separate rack of equipment—and the customer had to provide his own interface. "We've built in the ability for the system to compensate for loss of fidelity in the common carrier," Combs says.

Much like treble and bass con-

trols on a hi-fi player, Spectratrac's equalization allows the customer to boost both high- and low-frequency segments of the spectrum up to 9 dB in 3-dB jumps, tailoring the system for each receiver site.

Intelligibility. "This puts intelligibility into the system," Combs adds. "Phone lines tend to roll off both ends of the spectrum." Low frequencies are important for voice identification and high frequencies for articulation.

Motorola achieves equalization by including constant-amplitude tone generators at each receiver. Besides a 1,500-hertz signal that's continuously transmitted when the receiver doesn't have a signal worth sending, 400-Hz and 2,500-Hz tones are also sent out. To measure the tones' amplitudes, voltmeters are built in at the comparator. Built-in handsets at the receiver and comparator ends of the system also allow servicemen to talk back and forth on lines they're working on.

With Spectratrac, Motorola also introduced a line of solid-state base stations and repeaters for the 450-to-512 megahertz band. They're available with a 75-watt continuous-duty transmitter, or in 45-, 25-, and 12-watt versions. □

Avionics

Will F-16 avionics fit Navy's F-18?

Specialists in the aerospace industry are busy these days trying to figure out how much of the avionics developed for the Air Force F-16 (prime contractor: General Dynamics Corp.) can feasibly be adapted to the F-18 (McDonnell Douglas and Northrop). The answer could figure importantly in any Navy effort to keep down costs and placate Congress and the Secretary of Defense after its rejection of the single-engine Air Force plane in favor of its own twin-engine F-18.

The Navy's disclosure of its decision early this month immediately set off charges in the capital that it

was violating last year's congressional directive to use the Air Force air-combat-fighter technology. Under that directive, the Navy would limit its funds to development of a derivative of the USAF plane suitable for aircraft-carrier deployment.

Instead the F-18 is a derivative of the Northrop Corp.'s YF-17, which lost in the competition for the Air Force award [*Electronics*, Jan. 23, p. 30]. It will be heavier, will carry more avionics than the F-16 or the YF-17, and will have an all-weather radar. With McDonnell Douglas Co. leading on the Navy version, Northrop would get 30% of development work and 40% of production awards. (General Dynamics, in its run for the contract, had been teamed with LTV Aerospace Co.)

With the Navy's choice of the F-18, say Pentagon officials, Northrop now has new support for its efforts to market its fighter overseas. In such sales, Northrop will be prime contractor for the lighter and cheaper YF-17 under the teaming agreement with McDonnell. "The political economics of these choices have become as important as the technology," observes one Navy official.

Approval. If the Defense Secretary and Congress can be brought around to the Navy view—as Rep. George Mahon, chairman of the House Appropriations Committee and its defense subcommittee, thinks they can—then the Navy wants 800 of the F-18s. At a unit price of \$7.8 million, that would add up to \$6.24 billion. Unit price for the F-16 has been placed at \$6.7 million, but that eventually could go to \$8 million [*Electronics*, April 17, p. 36].

Meanwhile, there is the question of common avionics, and avionics is now worth an estimated \$750,000 per plane in the case of the F-16. Both planes will use digital fly-by-wire controls, but these have been developed independently, and a common system in this particular area is believed unlikely. However, as one Navy program specialist observes, "many of the subsystems can be made common. Things like ra-

Why You Should Buy Telequipment

Telequipment products are designed to meet the needs of the cost-conscious buyer without sacrificing reliability or general utility.

The Telequipment line of Tektronix oscilloscopes combines low price with a number of features not usually found in other oscilloscopes of the same price range. Features such as calibrated sweep rate and vertical step attenuators, variable controls, triggered sweep, probe-calibrated outputs, illuminated graticule and TV-field or line triggering, make these instruments versatile and easy to use.

The 10 MHz, dual trace, D61 is exceptionally easy to operate and low priced at only \$545. Its stable triggering characteristics, front panel simplicity, and versatility make it an excellent choice for industrial and educational applications. X-y analysis vector capability and TV line or frame triggering also make it especially well suited for communications equipment.

The Telequipment line, in addition, includes the S51B, a single-trace, 3 MHz oscilloscope with either automatic or normal trigger modes—at \$325, the lowest priced oscilloscope offered by Tektronix—and is excellent for use in audio to medium frequency applications. In addition, there's the DM 64, a 10 MHz dual-channel, bistable storage oscilloscope for \$1195, and more . . .

. . . The D67 oscilloscope at \$1125 combines dual trace, the 25-MHz bandwidth at 10 mV/div, FET inputs, regulated power supplies, and all solid-state circuits with delayed-sweep capability—a combination of features seldom found in a low-priced oscilloscope. The D66 offers all of these features except delayed sweep at an even lower price, \$875. Both feature a SUM mode with normal/invert capability that improves display of small signals in the presence of common mode noise. The easy-to-operate CT71 curve tracer enhances the line providing a dynamic semiconductor measurement capability by displaying characteristic curves of transistors, FETs, and diodes.

Available at only \$895, it is well suited for industrial application in production areas and research labs.

For more information about Telequipment instruments, contact your local Tektronix Field Office, or write Tektronix, Inc., Beaverton, Oregon 97077. In Europe, write Tektronix Limited, P.O. Box 36, St. Peter Port, Guernsey, Channel Islands. In Canada, write Tektronix Canada Ltd., 900 Selkirk St., Pointe Claire, Quebec H9R 3S3, Canada.



TEKTRONIX®

committed to
technical excellence

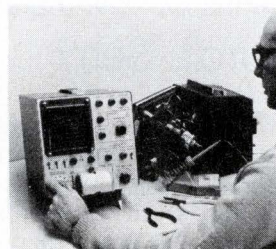
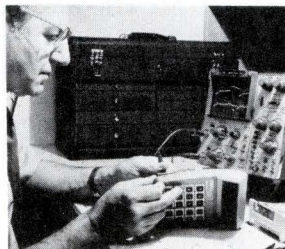
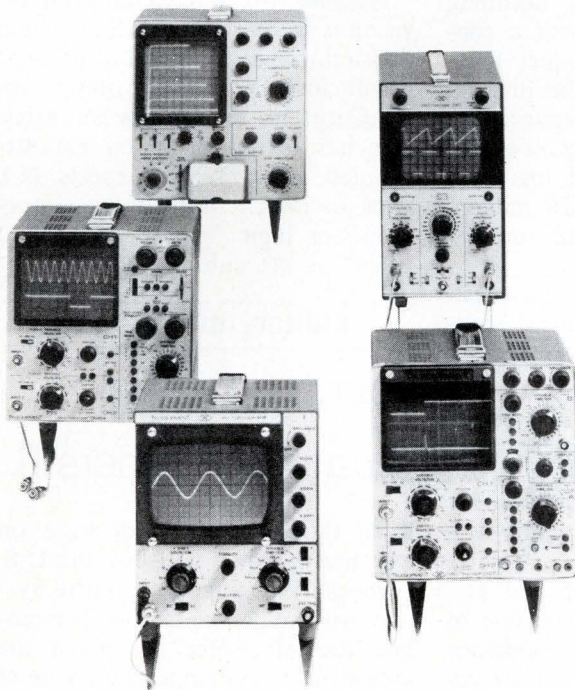

For Demonstration circle 36 on reader service card.

For Information circle 37 on reader service card.



Choice. The U.S. Navy wants the air combat fighter developed originally by Northrop Corp. As the YF-17, it had been passed up by the Air Force in favor of General Dynamics' F-16.

dios and other communications are no problem, of course. It's not much harder with the computers, and maybe even the radars. Beyond that," he suggests, "you get into problems" generated by the configuration and performance characteristics peculiar to each plane.

The Navy's controversial selection is said to have been heavily influenced by engine characteristics. One factor was the F-18's two General Electric YJ-101 engines; the Navy doesn't like single-engine fighters operating over water. The other was the Navy's judgment that the F-16, with its single high-performance Pratt & Whitney engine (the same one used in the USAF F-15 Eagle being built by McDonnell Douglas) was "just too hot" to meet the low-and-slow requirements of repeated carrier landings. The Navy also reportedly preferred the F-18's structural qualities as more adaptable to the tail-hook-landing needs of an aircraft carrier. □

Management

Welty plans changes at Motorola Semi

The departure of general manager Thomas J. Connors and general manager for U.S. operations Patrick B. Lynch from Motorola's Semiconductor Products division are only the first moves in a major reorganization of the division's top echelons. New general manager John R. Welty promises "appro-

priate revisions within a month."

Connors left late last month to become president of Mirco Inc., a small maker of games and circuit-board test systems in Phoenix, headquarters of the Motorola division. Lynch moved to an as-yet undefined assignment at corporate headquarters in Chicago.

The changes come only months after Motorola elevated John F. Mitchell to corporate assistant chief operating officer. Since then, the semiconductor division has occupied much of Mitchell's time. The reasons: at least two successive quarters without profits, declining market share coupled with a concentration on older product lines, and a realization that the division was top-heavy with management. Business Week, a McGraw-Hill magazine, estimates the loss over the last six months at \$20 million, but a Motorola spokesman wouldn't comment on that figure.

The 52-year-old Welty, an assistant to the last three general managers, feels that a top priority is to reinstate a responsiveness to customer needs that eroded during the fast growth of the division—approaching the \$500 million mark last year—in the past decade. He therefore intends to simplify the management structure. Admits Welty, "A big customer told me, sadly, that we had become one of the most difficult semiconductor companies to deal with"—a far cry from Motorola's customer-oriented reputation in the mid and late 1960s.

Welty will not discuss the planned

trimming in detail, but indications at the division point to a renewed emphasis on the responsibility of the product-line manager, the elimination of many line positions, and a major shakeup of the marketing group. He isn't unhappy with the division's big business in discrete semiconductors, although he's looking to newer IC lines for the more dramatic growth he and Mitchell obviously seek. He points out that discrete devices, other than small-signal transistors, are expected to continue to grow at a healthy 10% to 15% rate.

MOS, however, is a special concern of Welty's. The division started late in that business and still doesn't have a broad product line, although shipments of two key parts—the M6800 microprocessor and a 4,096-bit n-channel memory—have begun. And, after a six-month hiatus in the move of all MOS operations from Phoenix to Austin, Texas, caused by the business climate, that move is rolling again. A C-MOS module is already up and running in Austin, with n-channel memory and the microprocessor family due next.

Number two. Welty claims his division is second to RCA's Solid-State division in C-MOS sales and predicts it will close 1975 second only to Intel Corp. in microprocessor sales. Nor has he given up on emitter-coupled logic. Welty expects ECL sales to match those of transistor-transistor logic "within five to 10 years" as TTL subsides. □

Military electronics

NATO weighing Awacs; AF orders 6

Even though a NATO decision on whether or not it will buy the U.S. Airborne Warning and Control System will not come before November, the Air Force has given the long-delayed system a strong vote of confidence by ordering the first six production models. The value of the contract to the Boeing Co., Seattle, is \$247.6 million, which breaks

We make a logic tester for every purpose...

A family of testing solutions.

Fluke Trendar knows that your logic testing problems come in all sizes. From factory testing thousands of complex boards each month, to nailing one suspect IC in the field. That's why we've developed a family of testers with a model that's sized right for any volume. And with a range of prices to fit any budget.

High volume production.

Two Trendar testers cover the spectrum of factory needs. The Trendar 2000A, the patriarch of the family, is for big, tough boards. You will find it in a hundred customer installations, where millions of boards have been accurately tested, diagnosed and passed. It provides both single board testing/fault isolation and comparative board diagnostics for maximum speed. For smaller volume, the new Trendar 1010A console offers the same testing power and many of the diagnostic features of the 2000A for well under \$10,000*. It provides one pass, go/no-go testing. And, it offers level-programmable drivers

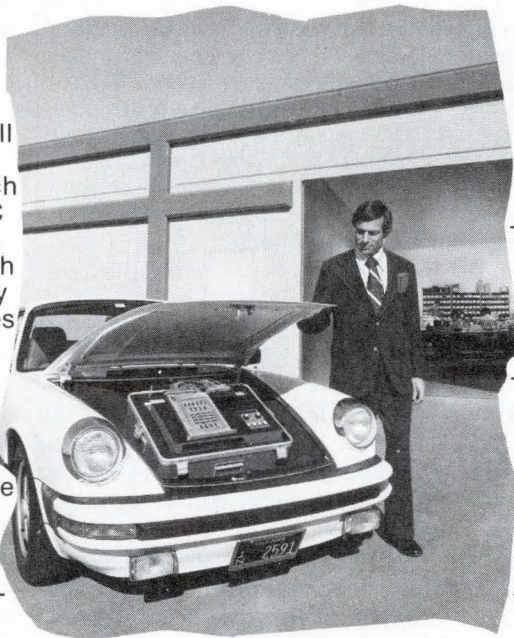

**your plant,
your pocket,
or your Porsche.**

and receivers for full CMOS and TTL capability. Faults are isolated by back-tracking logic errors with a built-in probe. The Trendar 1010A is program compatible with the Trendar 2000A . . . an ideal match for low volume production testing or field service applications.

Portable, too.

The Trendar 1000A is a compatible portable version. Used worldwide in small production and field service facilities, it fits in your Porsche. These testers hold the record for simplest, fastest programming.

Hand-held testing of IC's in circuit

The smallest family member and one of the most versatile, slashes logic troubleshooting time. TESTCLIP comes in three models to accommodate logic families from 5V TTL/DTL to CMOS and HTL. It acts as a logic probe, logic clip and IC comparator. One of the largest computer companies reports that TESTCLIP cuts troubleshooting costs in half. Another user saves \$1000 per month per technician.

Whatever size you specify, boards passed by Trendars work in the end product. Their initial low cost and high-volume throughput save big dollars.

Call us. Collect. Fluke-Trendar.
(415) 965-0350.

*U.S. prices only.

FLUKE TRENDAR
a subsidiary of John Fluke Mfg. Co., Inc.

500 Clyde Avenue, Mountain View, California 94303 • 415/965-0350 TWX 910-379-6573.
Europe, Fluke (Nederland) B.V., P.O. Box 5053, Tilburg, Netherlands, Tel. 013-673973, Telex 52273.
U.K., Fluke International Corp., Garnett Close, Watford, WD2 4TT, Tel. Watford (0923) 33066, Telex 934583.
Fluke (Deutschland) GmbH, Imhofstrasse 3, 8 Munchen 40, Tel. 09-4989369086, Telex 5216087.
Fluke (Deutschland) GmbH, Meineckstrasse 53, 4-Dusseldorf, Tel. 09-49211450831, Telex 8585576.

Logic testers so sophisticated they don't need a computer

Circle 39 on reader service card

Are EEs over 40 facing age discrimination?

The electronics industries show "a substantial discriminatory bias against older engineers," says the Institute of Electrical and Electronics Engineers' recently released 1975 manpower report—"The E/E at Mid-Career—Prospects and Problems." In fact, the report states that it "appears suspiciously as though a quota system is operating" for EEs in their 40s. While acknowledging that different conclusions may be drawn from the survey data, the report says, "after all of the excuses, one can only conclude that the employment pattern of the electronic equipment industry exhibits massive age discrimination."

In contrast, the IEEE data indicates that the aerospace industry shows a bias in favor of older engineers, and among all types of engineers the relative employment distribution does not discriminate against age.

Although the data which led to these conclusions was compiled last year, a random survey in March and April of 2,600 IEEE members in the U.S. indicates that, of the "involuntarily unemployed" (1 in 40 of those surveyed), 70.9% were over 40 years old.

In what could turn out to be something of a test case in the industry, the New York State division of Human Relations is holding hearings into charges of age discrimination that were brought against Sperry Rand Corp.'s Sperry division, Great Neck, N.Y., by 64 of the 88 engineers laid off in January. Of the total, 66 were past 40, and the state agency expects to hear each of the 64 plaintiffs in hearings scheduled to run into the middle of next month. A Sperry spokesman admits that the division has been taking a closer look at its engineer personnel policies since the complaint was filed, but claims the average age of its engineers is now 40.9 years.

down to \$41.2 million per plane. But this price is likely to be increased. Brig. Gen. Lawrence A. Skantze, Awacs program chief for the Air Force, says "a firmly negotiated price" will not be developed until late summer or early autumn. However, he is confident the buy can be kept within the \$407.5 million procurement appropriation—equivalent to \$67.9 million per plane.

NATO's attitude. Disclosure of the award at the end of April coincided neatly with the return of one of the three Awacs prototypes to AF Systems Command headquarters outside of Washington after a month of European demonstrations to potential NATO customers. The Pentagon wants NATO to buy 20 of the modified 707-320Bs with their 30-foot-diameter mushroom-shaped radomes. Gen. Skantze says the NATO/Awacs International Project Office's decision will depend more on costs than the technology, which has favorably impressed NATO officials.

NATO's unit price for Awacs "will be on the order of \$50 to \$60 million," Gen. Skantze estimates, "depending on what parts they want in

the final configuration." The figure is well below the \$65 million per plane production estimate for USAF models. Gen. Skantze points out that some NATO/Awacs components would be produced in Europe under offset agreements still to be negotiated.

If NATO buys Awacs, it may also want to alter the system's electronics, Gen. Skantze says. Those possibilities include adding tracking capacity plus automating the track-initiation function.

If NATO turns thumbs down on Awacs, however, the Air Force will have increasing trouble with the program's critics in Congress. Counting prior R&D outlays, the U.S. program investment is up to \$111 million per plane if 34 can be ordered. However, if the USAF is limited to buying only 15 for itself, the price soars to "between \$180 and \$200 million each," says Malcolm R. Currie, the Department of Defense Research and Engineering chief, who is, however, convinced that the NATO sale will succeed.

Add-ons. Enhancing the electronics system to allow upgrading of future Awacs models and retrofit

those now on order will continue to push system costs up, however. In the fiscal 1976 budget now before Congress, the Air Force wants \$689.7 million, including \$490.5 million for six more planes plus \$199.2 million more in R&D money.

In fiscal 1977, the program calls for \$380.1 million for a third block of six planes and \$123.8 million for development. Although most of the R&D money to come will cover the time-division multiple-access digital-data link and radar modifications to improve surveillance, it does not cover the costs of the USAF Seek Bus TDMA terminal [*Electronics*, Nov. 28, 1974, p. 83] being developed by Hughes Aircraft Co. □

Consumer electronics

TV tuner uses MNOS memory

A nonvolatile semiconductor memory which has found wide application in point-of-sale terminals could be the answer to an affordable all-electronic tuner for television sets.

The memory, employing metal-nitride-oxide semiconductor technology, is part of a solid-state tuner developed by the F.W. Sickles division of General Instrument Corp., Chicopee, Mass. And although Sickles declines to set a price on the tuner, sources believe it might sell for \$40—considerably less than the \$60 to \$65 retail price of available electronic varactor/capacitor tuners. At \$60, they are four times as expensive as conventional electromechanical tuners and therefore have been slow to break into American TV sets.

Tuners using digital large-scale-integrated technology have also been introduced [*Electronics*, June 27, 1974, p. 34]. However, this approach—frequency synthesis of channels by using an oscillator to generate pulses and a counter to find the correct channel frequency—has proved to be even more costly than the simpler varactor and ca-

SIEMENS

New Zener Wall Chart from Siemens

When it comes to Zeners, Siemens has your number and then some. And, the standard types are all included on this handy wall chart-selection guide. An earlier offer, when our Zeners were sold under the Dickson name, proved so popular that we have up-dated the chart to include the new expanded Siemens line.

From low cost commercial to highly sophisticated, ultra-reliable applications, Siemens has the exact voltage regulating (Zener) and voltage reference (TC) diode you need. And, you have the assurance that each and every Siemens Zener has the quality that can only come from the leader in high-rel devices.

Siemens offers 49 popular JEDEC series plus custom and proprietary devices in one of the most extensive lines of commercial and military Zeners available. With this product versatility and with our specialized Zener production facilities in Arizona, it's no wonder Siemens is looked upon as the preferred Zener Source by a growing number of systems and equipment manufacturers.

When you need Zeners, consider the extra quality and fast service of "the Zener specialists." For your wall chart, just drop us a note.

Siemens: Where Quality And Resources Make The Difference.

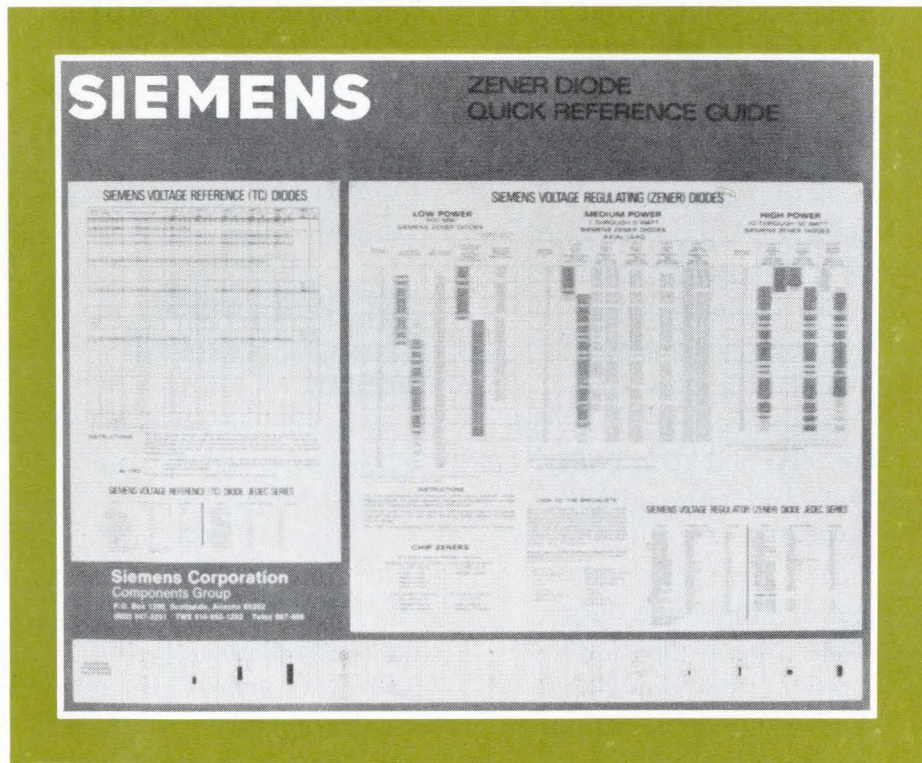

**Siemens Corporation
Components Group**

P.O. Box 1390, Scottsdale, Arizona 85252
(602) 947-2231 TWX 910-950-1292 Telex 667-406

Introducing 5 new LSI reasons to choose Isoplanar CMOS.

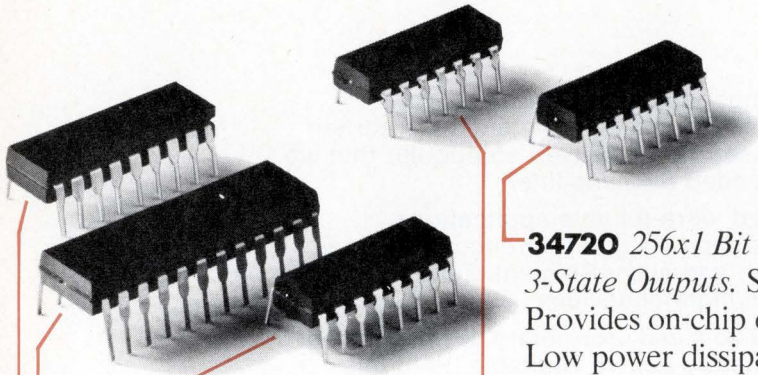

Now you can get five new LSI CMOS devices from Fairchild you just can't get from anyone else.

All five are the product of Fairchild's Isoplanar process.

And all five are available in quantity today:

34702 Programmable Bit Rate Generator. Controls up to 8 transmission channels. Provides all 13 popular bit rates. Conforms to EIA RS-404. With on-chip pull-up circuitry. And TTL compatibility.

34703 16x4 Parallel/Serial FIFO. Provides serial or parallel input and output. With 3-state fully-buffered outputs. New slim 24-pin DIP. Expandable without any external logic.

34710 16x4 Bit Clocked RAM with 3-State Output Register. Features full buffering. Edge-triggered. Optimized for register stack operation.

34720 256x1 Bit RAM with 3-State Outputs. Static. Provides on-chip decoding. Low power dissipation. High-speed. True and complementary outputs available. Fully-buffered.

34731 Quad 64-Bit Shift Register. Handles shift frequencies up to 4 MHz at VDD=10V. Serial-to-serial data transfer. 14-pin package. TTL compatible.

In addition, five other LSI CMOS circuits will be available soon.

LSI, MSI or SSI. The choice is all yours.

If you like our new LSI, of course, you'll love our whole CMOS family.

Fact. We've got what you want. Fairchild offers all of the CMOS devices most popular today. Altogether, 65 devices available now in quantity.

Fact. We've got it your way. Ceramic and plastic DIP, Flatpaks, Chips, Commercial or Mil Spec with 38510 or our special Matrix VI processing. Any way you want it, we're ready to deliver it.

Fact. We're more compatible. While other manufacturers are busy redesigning their lines to catch up with our Fairchild 34000 Series, we're compatible with *all* other CMOS—and we've got the high performance and standardization you want *now*.

The advantages of Isoplanar.

Here's another thing to remember.

LSI, MSI or even SSI—no matter what Fairchild CMOS you buy, you get the full advantages of our Isoplanar technology:

1. Highest guaranteed noise immunity.
2. Fully-standardized drive outputs for direct interface with low power TTL and low power Schottky TTL.
3. Propagation delay that's less dependent on loading—for increased system speeds.

And what makes it all extra nice, Fairchild's Isoplanar CMOS can replace any 4000 Series CMOS pin-for-pin.

Electronics review

pacitor type of tuner designs.

One problem has been the need for a digital-to-analog converter that translates digital output into analog signals at the channel frequencies. Another barrier has been the need for a low-cost memory that will provide an output equivalent to the desired channel frequency without a lot of peripheral tuning controls to be adjusted.

Omega. The result of a two-year-long R&D effort involving five GI divisions, the new tuner, called the Omega, contains 100 14-bit words of nitride-doped MOS memory capable of storing digital codes for at least 82 channels of very-high- and ultra-high-frequency signals. One 14-bit word is equal to one channel, which leaves 18 "lines" in the memory available for future "ancillary TV functions," Sickles explains. The MNOS memory is non-volatile, yet it functions much like a programmable read-only memory.

The basic Omega system contains four chips. Besides the MNOS memory, there are an n-channel control-logic chip to transfer channel selection to the memory, an n-channel display driver, and a complementary MOS digital-to-analog converter to transfer the memory output to the tuner.

Sickles is offering a two-digit gas-discharge Panaplex display licensed by Burroughs Corp. to GI's Signalite division and a 10-numeral keyboard from GI's C. P. Claire division. The chips will be built by GI's Microelectronics and Semiconductor Components divisions.

Licensed. The MNOS device is being used through a license from NCR Corp., which developed it for point-of-sale terminals. Channels could be programmed at the factory. The drawback of MNOS memory—slow access speed—is not significant in a TV tuner. Production of the tuner will begin by the year's end. □

Send for your free
CMOS Data Book
today.



If you drop us a note, we'll be happy to send you our new Fairchild CMOS Data Book with complete information on 98 devices—available now or coming soon.

Or just write or call your Fairchild Sales Office, Distributor or Representative today.

Semiconductor Components Group, Fairchild Camera & Instrument Corp., 464 Ellis St. Mountain View, CA 94040
Telephone (415) 962-5011
TWX: 910-379-6435

**MADE IN
FAIRCHILD**

No.1 for logic and memory.

Circle 43 on reader service card

News briefs

Capital spending in electronics heading down

Electronics companies will reduce their dollar outlays for new plant and equipment by 6% this year, according to the McGraw-Hill Publications Co.'s Department of Economics' spring survey on capital spending. However, since prices of capital goods are expected to increase 12% in 1975, this translates into a real decline of 15-18% in the acquisition by these companies of new plant and equipment. A further 2% reduction in capital spending is currently planned for 1976, followed by increases of 13% in 1977 and 6% in 1978, the survey indicates. The spending plans reflect the underutilization of capacity that prevails in the electronics industries.

Bowmar to sell semiconductor facility

Bowmar Instrument Corp. has won approval from the court having jurisdiction over its Chapter XI bankruptcy proceedings [*Electronics*, Feb. 20, p. 36] to sell its 50,000-square-foot Chandler, Ariz., production facility to General Instrument Corp. for \$3,330,000. GI plans to move its n-channel MOS process to Chandler and introduce its microprocessor and computer-memory-products activities there as well. Bowmar will sublease office space at the facility to carry on its engineering activities and light-emitting-diode marketing.

RCA experts move to Microwave Semiconductor

Microwave Semiconductor Corp. in Somerset, N.J., is picking up where RCA Solid State division left off when it phased out coaxial transistor products, used predominantly as oscillators in electronic warfare and telecommunications equipment. Three RCA engineers formerly associated with the line have joined Microwave Semiconductor which hopes to have prototype quantities of the gigahertz-range devices during the summer. The first two transistors will be the equivalent to the RCA TA8853 and TA8854, which have typical oscillating performances of 0.75 watt at 2.0 GHz and 1.5 watt at 2.0 GHz, respectively.

microprocessors

we've already delivered
over

2,500,000 *

and
you didn't even know it.

* (calculator arrays which
we programmed for you)

HEADQUARTERS—

MOS Technology, Inc., 950 Rittenhouse Rd.,
Norristown, Pa. 19401 (215) 666-7950



EASTERN REGION—

Mr. William Whitehead
MOS Technology, Inc., 410 Jericho Turnpike, Suite 312,
Jericho, N.Y. 11753 (516) 822-4240

WESTERN REGION—

MOS Technology, Inc., 2172 DuPont Dr., Suite 221,
Patio Bldg., Newport Beach, Calif., 92660 (714) 833-1600

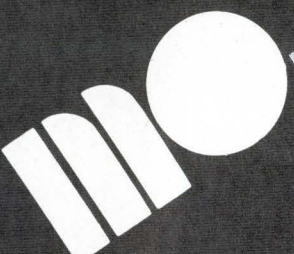
SO
NOW...
we're going to have
a  microprocessor**
and
you will know it!

AND IT WILL DO
re for less !

MOS TECHNOLOGY, INC.
VALLEY FORGE CORPORATE CENTER, NORRISTOWN, PA. 19401 (215) 666-7950

**
(which you program)

Why are other computer companies refusing to run benchmarks against the Eclipse?

Apparently, they've seen some of the results.

Eclipse has been running Fortran benchmarks faster than an IBM 370/155.

And more than twice as fast as the PDP-11/45.

It's even beaten out a Xerox Sigma 9.

And those benchmarks were not ones we designed to make Eclipse look good. We only ran programs that prospects asked us to run.

Not only that, the Eclipse they were run on was using core memory. If we had used semiconductor memory with cache, you can imagine what would have happened.

Eclipse may have caught the competition off guard, but that's just what we expected it to do.

That's why we built Eclipse around a new microprogrammed architecture and an instruction set designed for high level languages and real time operating systems.

And that's why we gave it the fastest Floating Point Processor in the industry.

But making a computer fast is one thing. Getting all that speed out of it is another.

So we also came up with a sophisticated new set of Eclipse software: A Fortran 5 package, and a new Mapped Real Time Disc Operating System with features like virtual overlays and window mapping. (Which you may not have heard about because we just invented them.)

Which means if you don't want to end up with a computer that's been eclipsed, you're going to have to do something about it.

Call (617) 485-5467.

DataGeneral

The computer company you can understand.

• Data General Corporation Southboro, Massachusetts 01772. (617) 485-9100.
Data Gen of Canada, Data General Europe, 116 Rue de la Tour, Paris 75016 France.
Data General Australia, Melbourne (03) 82-1361/Sydney (02) 908-1366.

A tough semiconductor in the hands of a wis

We put a lot of time and money into the development and production of reliable Delco Electronics semiconductor devices for a wide range of industrial, military and automotive applications.

So, understandably, we don't fool around when it comes to selecting our Delco semiconductor distributors.

We handpick

them for their excellence in customer service.

We insist that they give us—and you—their best distribution services.

Delco Electronics semiconductor distributors are strategically located across the country in locations that make fast service practical.

The people you'll find listed on the facing page are front-line members of our sales force. They handle our entire line of Delco Electronics semiconductor devices. They know how to get immediate assistance and advice from our factory personnel.

Next time you need a reliable power semiconductor, get it from a reliable semiconductor distributor.

Your Delco Electronics distributor.



ctor has no business hy-washy distributor.

ALABAMA, Birmingham
Forbes Distributing Co., Inc.
(205) 251-4104

ALABAMA, Huntsville
Powell Electronics
(205) 539-2731

ARIZONA, Phoenix
Sterling Electronics, Inc.
(602) 258-4531

CALIFORNIA, Goleta
R.P.S. Electronics, Inc.
(805) 964-6823

CALIFORNIA, Los Angeles
Kierulff Electronics, Inc.
(213) 685-5511

CALIFORNIA, Los Angeles
R.P.S. Electronics, Inc.
(213) 748-1271

CALIFORNIA, Palo Alto
Kierulff Electronics, Inc.
(415) 968-6292

CALIFORNIA, San Diego
Kierulff Electronics, Inc.
(714) 278-2112

CALIFORNIA, San Diego
R.P.S. Electronics, Inc.
(714) 292-5611

CALIFORNIA, Sunnyvale
Bell Industries
(408) 734-8570

COLORADO, Denver
Kierulff Electronics, Inc.
(303) 371-6500

CONNECTICUT, Norwalk
Harvey Electronics
(203) 853-1515

FLORIDA, Miami Springs
Powell Electronics/Florida
(305) 592-3260

ILLINOIS, Rosemont
Kierulff Electronics, Inc.
(312) 678-8560

ILLINOIS, Skokie
Bell Industries
Electronics Distributors Div.
(312) 282-5400

INDIANA, Indianapolis
Graham Electronics Supply, Inc.
(317) 634-8202

MARYLAND, Baltimore
Radio Electric Service Co.
(301) 823-0070

MASSACHUSETTS, Billerica
Kierulff Electronics, Inc.
(617) 935-5134
(617) 667-8331

MASSACHUSETTS, Newton
The Greene-Shaw Co., Inc.
(617) 969-8900

MICHIGAN, Livonia
Pioneer/Michigan
(313) 525-1800

MINNESOTA, Minneapolis
Stark Electronics Supply Co.
(612) 332-1325

MISSOURI, Kansas City
Walters Radio Supply, Inc.
(816) 531-7015

MISSOURI, St. Louis
LCOMP-St. Louis
(314) 647-5505

NEW JERSEY, Cinnaminson
Wilshire Electronics/Philadelphia
(609) 786-8990 (215) 627-1920

NEW JERSEY, Clifton
Wilshire Electronics/New Jersey
(201) 365-2600 (212) 244-8930

NEW MEXICO, Albuquerque
Sterling Electronics
(505) 345-6601

NEW YORK, Binghamton
Harvey Electronics
(607) 748-8211

NEW YORK, Buffalo
Summit Distributors, Inc.
(716) 884-3450

NEW YORK, Farmingdale
Wilshire Electronics/Long Island
(516) 293-5775

NEW YORK, Woodbury
Harvey Electronics
(516) 921-8700 (212) 895-9260

OHIO, Cincinnati
United Radio, Inc.
(513) 761-4030

TEXAS, Dallas
Sterling Electronics
(214) 357-9131

TEXAS, Houston
Harrison Equipment Co., Inc.
(713) 224-9131

WASHINGTON, Seattle
Kierulff Electronics, Inc.
(206) 763-1550

IN CANADA: ONTARIO, Scarborough
Lake Engineering Co., Ltd.
(416) 751-5980

ALL OVERSEAS INQUIRIES:
General Motors Overseas
Operations
Power and Industrial Products
Dept.,
767 Fifth Avenue, New York, N.Y.
10022
PHONE: (212) 486-3723



OHIO, Cleveland
Pattison Supply Co.
Industrial Electronics Division
(216) 441-3000

OHIO, Dayton
Pioneer/Dayton
(513) 236-9900

PENNSYLVANIA, Philadelphia
Almo Electronics
(215) 698-4000

PENNSYLVANIA, Pittsburgh
Cameradio Electronics
(412) 288-2600

SOUTH CAROLINA, Columbia
Dixie Radio Supply Co., Inc.
(803) 253-5333

Delco Electronics Regional Sales Offices
Union, New Jersey 07083
Box 1018 Chestnut Station
(201) 687-3770

Van Nuys, California 91404
Box 2968
(213) 988-7550

General Sales Office
700 E. Firmin, Kokomo, Ind. 46901
(317) 459-2175

Delco Electronics.
The Power Specialists.

As time goes by it becomes more and more difficult

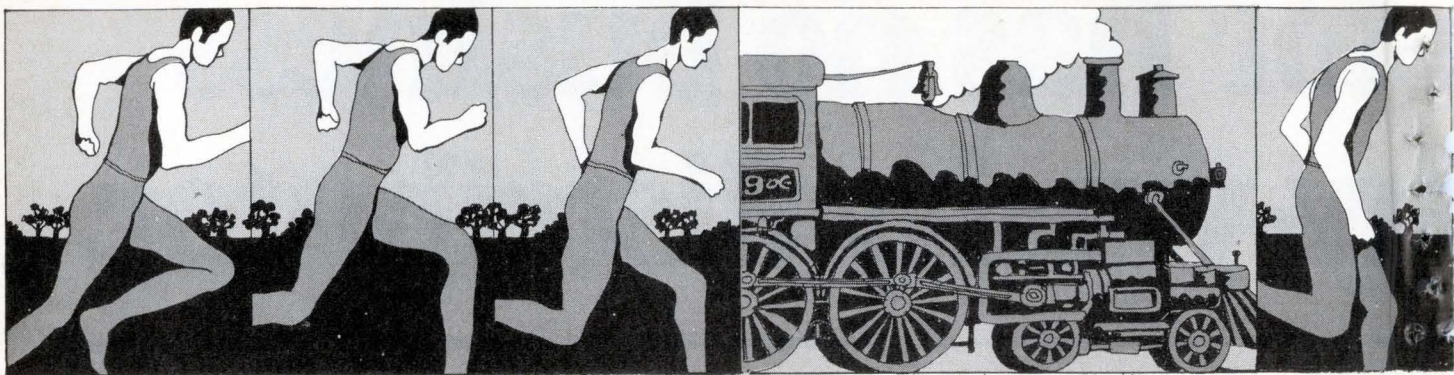

...with the accelerating advances in technology...

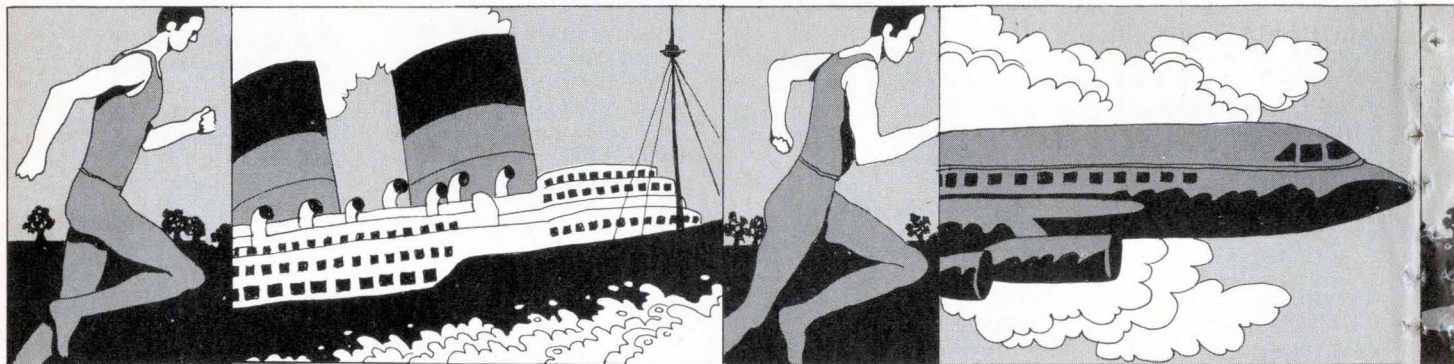

...but what is this on the horizon?

Caught up at last!

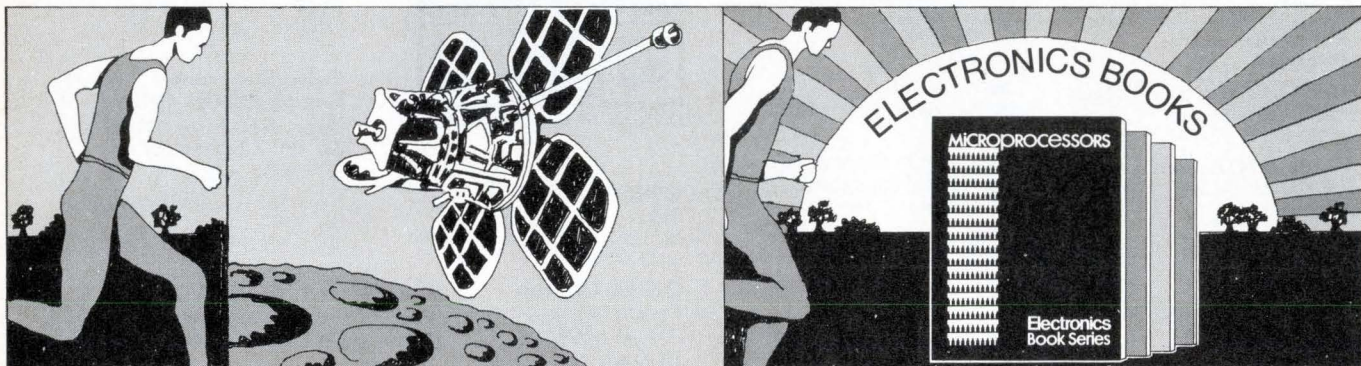

ELECTRONICS
INTRODUCES:

a Book Series

designed to keep you up-to-date on selected key technologies.

Each book will be a compendium of recent articles available from Electronics magazine on a particular technology. Each will be edited and produced by the staff of Electronics to form an invaluable reference work in one current volume.

to keep pace...

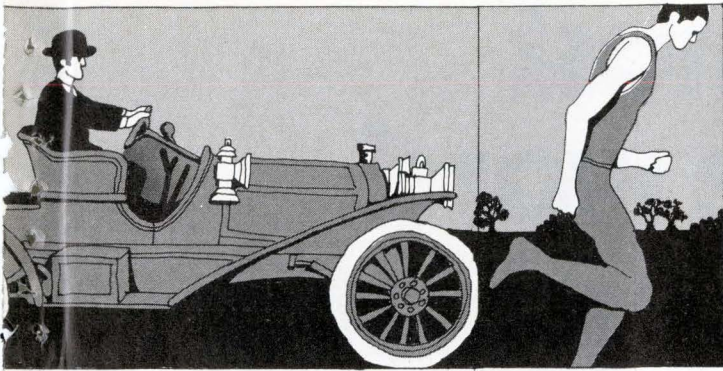

...it's really awfully difficult...

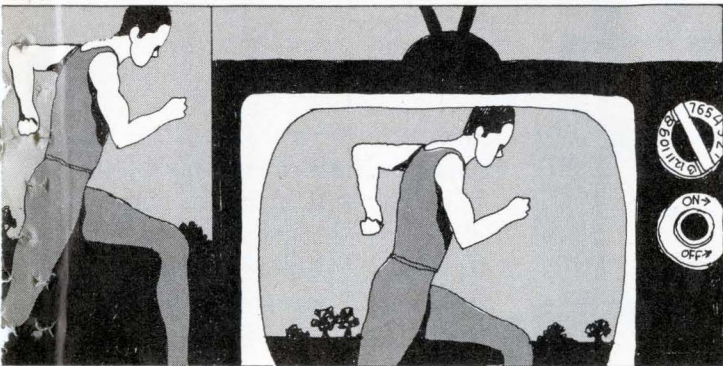

The first book will be published in May. The subject: *Microprocessors*.

The microprocessor has permanently changed the methods of designing and building electronic equipment—from process and industrial control to computer-based designs in instruments, communication and consumer/commercial equipment.

But, getting into microprocessors is no snap. As a fundamental departure from the old familiar hard-wired logic techniques, the microprocessor technology has already produced a host of devices competing for the designer's attention, each with its own software and hardware.

This book cuts through the confusion, presenting the design and application

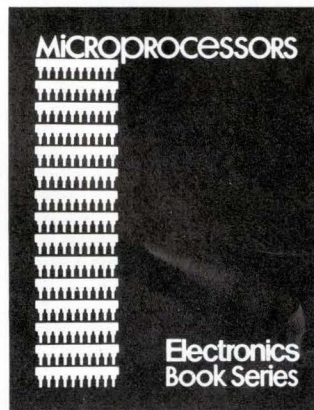

potential of this exciting technology in a manner that will appeal to the design engineer who needs to know how to use microprocessors as well as the system analyst who must assess the tradeoffs between microprocessors and other techniques to accomplish his system goals.

Using articles from the pages of *Electronics*, the book contains practical and up to date information on available microprocessor devices, technology and applications—ranging from the simplest 4-bit p-channel MOS system to the second-generation n-MOS 8-bit processor chips, and the new injection logic and Schottky TTL bipolar processor families needed for the toughest computer-based control applications.

UPCOMING VOLUMES

Others already planned for the Book series: *Thermal Design*, *Mini-computers in Action*, *Large Scale Integration*.

SAVE 22% BY ORDERING NOW

All orders for *Microprocessors* received by May 31 1975, will be accepted at the pre-publication price of \$6.95. Thereafter, the price will be \$8.95. For bulk order prices of ten or more copies, contact publisher.

ORDER NOW FOR
PRE-PUBLICATION DISCOUNT
(Discount available only if received by
May 31, 1975 and full payment must
accompany order)



Electronics Book Series
P.O. Box 669 Hightstown, N.J. 08520

Send me _____ copies of "Microprocessors".
Enclosed is payment at the pre-publication price
of \$6.95 per copy. I must be fully satisfied or you
will refund full payment if the book is returned after
10 days free trial examination.

Name _____ Title _____

Company _____

Street _____

City _____ State _____ Zip _____

Signed _____

Electronics
IS THE SOURCE
FOR BOOKS, TOO



The most accurate word in function generators is XCG.

When we introduced the first of the 180 Series last month, we said we hadn't told you everything. What we didn't tell you about is XCG.

Now it can be told [or XCG revealed]

XCG stands for xtal-controlled-generator — which stands for a degree of accuracy never before found in any function generator. In both the Models 181 and 183, generator output is locked to a crystal at up to 25 discrete points on the frequency dial. This means they will produce waveform frequencies with synthesizer accuracy of 0.01% of dial setting. When you dial a frequency, you know it's precise, and you don't need a counter to prove it.

The Model 181 XCG/Sweep Generator \$495

Besides being the most accurate function generator ever, the 181 is also a full sweeper — from 0.1 Hz to 2 MHz, with internal 1000 to 1 sweep. It provides sine, square, and triangle wave outputs (20V output p-p), as well as dc voltage, dc offset, and separate TTL output. And with full

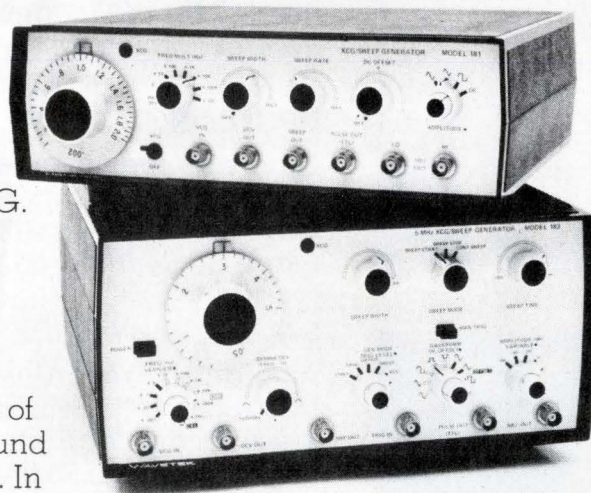

More 180s from Wavetek.

WAVETEK®

attenuation, you get ultra-clean signals down to -50dB . The only way you can come close to this performance is to buy the Model 180, which gives you everything but XCG for only \$275.

The Model 183 5 MHz XCG/Sweep Generator \$695

As you can see, the Model 183 is a couple of hundred bucks more than the 181. Here's what that buys you: The 183 has a top frequency of 5 MHz, and provides continuous, triggered, and gated operation. For precise adjustment of continuous sweep, there's a control to individually set start and stop points. There's also a variable symmetry control and another for amplitude — down to -60 dB . All of this, plus XCG, add up to the most versatile and accurate function generator ever produced.

Our Conclusion

Now that you know something about the Wavetek 180s, you'll want to know more. So for complete specs or demonstration, just contact Wavetek, P.O. Box 651, San Diego, CA 92112. Or call (714) 279-2200.

NASA sees promise in new thin-film GaAs solar cells

NASA has reported **development of thin-film gallium-arsenide solar cells that have longer lifetimes, higher efficiencies, and potentially lower fabrication costs than the silicon cells now in use.** Called AMOS, for antireflection coated metal-oxide semiconductor, scientists at NASA say the cell is economically promising because the GaAs layer is only five microns thick, which allows use of less material than in any competing technology. The AMOS cells are topped by a gold film 70 angstroms thick, with potential for space and terrestrial uses.

Samples of AMOS cells produced by NASA's Jet Propulsion Laboratory have shown efficiencies in terrestrial sunlight of up to 15%, compared to 8-to-9% for silicon, plus 30% less radiation degradation for a longer lifetime. JPL's Richard Stirn is leader of the development team, which **predicts that in three to four months, JPL will have a "fully reproducible cell with a 19% efficiency."** Details of the cell were reported by Stirn last week at an IEEE photovoltaic conference in Phoenix, and the cell itself was shown to the House subcommittee on space science and applications.

Avionics makers due for stricter FAA scrutiny . . .

Avionics manufacturers will find their products coming under **tougher scrutiny from the Federal Aviation Administration, and sooner than they might expect.** Transportation Secretary William T. Coleman Jr. has given the FAA until June 15 to produce detailed plans for improving its inspection procedures on aircraft equipment, only half the time customarily allowed for such DOT directives. Coleman's order followed an April report drawn up by a special DOT task force that made a study of the FAA's structure and operations, all of which was the outgrowth of mounting public criticism of FAA safety procedures.

One step the FAA is known to be taking is the hiring of additional inspectors, but the number has not been disclosed. **The beefed-up inspection force would review certificates of compliance with Federal specifications that must accompany aviation equipment.** However, these certificates will continue to be issued by FAA-approved corporate officials, as the DOT task force has conceded it would not be practical for the FAA to take on the certification process itself.

. . . as new in-flight aircraft monitors are proposed

The same special DOT task force has recommended evaluation of a new flight-data sensing and recording system that can monitor more than 240 different systems aboard a large commercial aircraft. The cost, says a spokesman for the FAA's Flight Standards Service, would be "at least \$100,000 per commercial aircraft." The Air Transport Association says it is awaiting comment from its members.

Direct broadcast satellite inquiry posted by FCC

A new inquiry to develop a U.S. position on direct-broadcast satellites operating in the 11.7-to-12.2 gigahertz band has been started by the Federal Communications Commission. The new FCC Docket 20468 is in preparation for the 1977 World Administrative Radio Conference (WARC) that will be convened **to plan for international use of those frequencies by satellites broadcasting for direct reception by the general**

Washington newsletter

public. The FCC set an Aug. 1 deadline for comments from industry and other interested parties, with a Sept. 2 deadline for replies. Since the 11.7-to-12.2 gigahertz band is also allocated under international regulations to fixed-satellite service (space-to-Earth) in North and South America, the Commission said the impact of direct-broadcast service on fixed satellites would be considered also.

DOT gets tough with Atlanta's transit project

The Department of Transportation, in an effort to avoid in Atlanta the interfacing problems that are troubling the BART system in San Francisco, has prodded the Metropolitan Atlanta Rapid Transit Authority (Marta) into hiring 45 extra in-house engineers. It is hoped that the additional technical monitoring will more effectively ward off problems in the mass transit project under construction there [*Electronics*, April 3, p. 43]. Transportation Secretary Coleman said in an interview, **"We agreed, based on the BART experience, that more in-house supervision of subcontractors was needed."** DOT's Urban Mass Transportation Administration is providing \$800 million for the Marta system.

Rifenburgh to succeed McGurk at computer group

Richard P. Rifenburgh, president and chief executive of Mohawk Data Sciences Corp., **is scheduled to take over from Dan McGurk as top industry member for the Computer Industry Association now that the group has moved its headquarters from Los Angeles to Washington, D. C.** Rifenburgh reportedly will take the title of CIA chairman, with McGurk's old title of president going to CIA's top staffer Jack Biddle, now executive director.

McGurk was reported as unwilling to make the move from California since he is considering a race for the House seat now held by Republican Barry M. Goldwater Jr., should Goldwater go after Democrat John V. Tunney's Senate seat next year.

ICAO grants delay in MLS proposals by member nations

The International Civil Aviation Organization **has agreed to a West German request for a six-month delay in the submittal of microwave landing system proposals by ICAO member countries.** [*Electronics*, Feb. 20, p. 78]. The delay pushes back the ICAO's schedule for reviewing the competing systems from July to December of this year. In the U.S., the FAA has opted in favor of the scanning-beam MLS system, while Britain is an outspoken proponent of a doppler MLS system. The Germans favor a scanning beam approach, but a more complex system than that advanced by the U.S. The All Weather Operation Panel of the ICAO will meet to debate the proposals in the summer of 1976, with a decision from ICAO expected in December, 1976.

Addenda

AT&T has told the FCC it will proceed with development of a high-capacity land-mobile communications network using the Bell Laboratories cellular approach [*Electronics*, Jan. 3, 1972, p. 100]. AT&T wants to begin testing a trial system in Chicago in 1978 . . . The FCC is wondering what to do with its authorization to Packet Communications Inc., for a "value-added" carrier service. PCI, first of the special carriers, ceased operations in April after running out of funds.

The only way to measure wet films is with light. And it's the safest way...wet or dry.

And the most economical.

The Zeiss Light-Section microscope uses a razor-edge beam of light to clearly profile the surface of thick-film hybrids, integrated circuits, or other semiconductor components. Then, by fine-tuning a reference line coupled to a micrometer, with $\frac{1}{2}$ micron divisions, you can easily obtain direct readings of heights and widths ranging from 1 micron to approximately 400 microns. Even an inexperienced technician can learn how in minutes.

Completely non-destructive.

Because there's no physical contact with the surface, there's no chance of damage or false readings. And the built-in camera gives you Polaroid® photo records, as shown below. These examples demonstrate the microscope's versatility. To find out about its economy, ease of use, and accuracy, write or call today.

Nationwide Service

Carl Zeiss, Inc., 444 5th Avenue, N.Y., N.Y. 10018 (212) 730-4400. Branches in: Atlanta, Boston, Chicago, Columbus, Houston, Los Angeles, San Francisco, Washington, D.C. In Canada: 45 Valleybrook Drive, Don Mills, Ont., M3B 2S6. Or call (416) 449-4660.

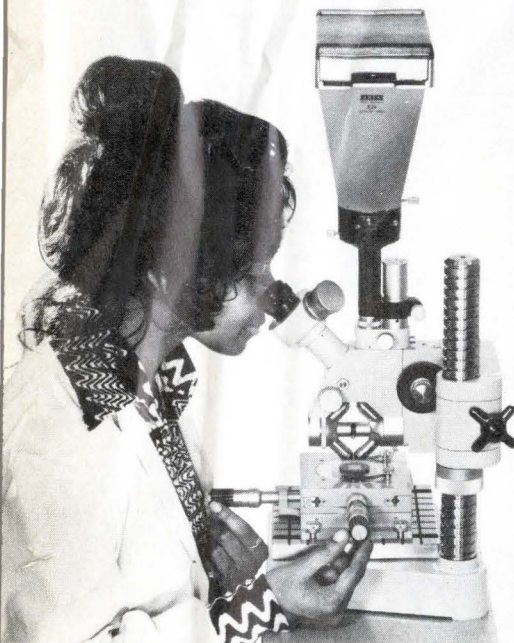

Learning to use the amazingly accurate Light-Section Microscope is a matter of minutes.

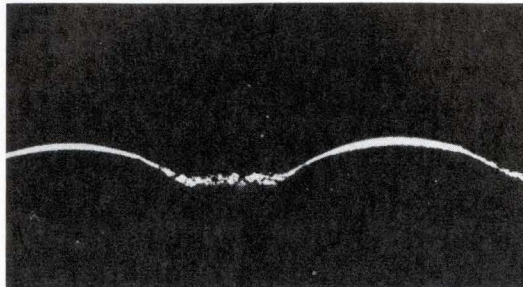

Measuring a thick-film conductor print in the wet state means no waste of substrates.

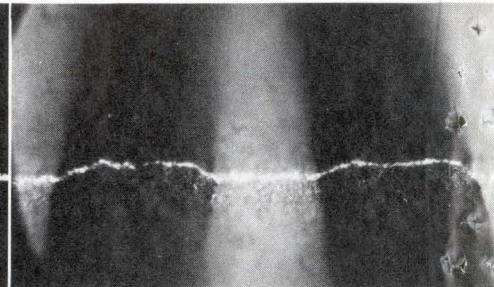

Measuring a dried print to determine if the deviation is within acceptable limits.

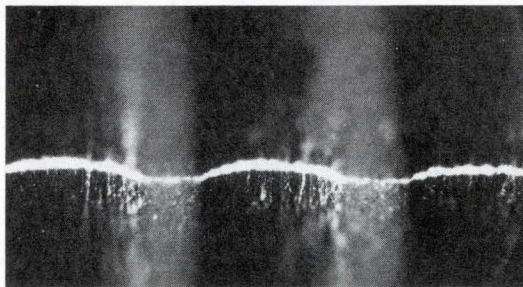

Checking the thickness of a fired print.

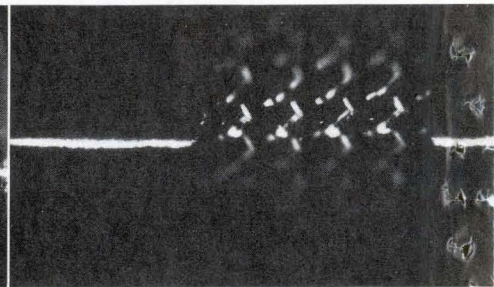

Measuring the emulsion thickness of a thick-film screen.

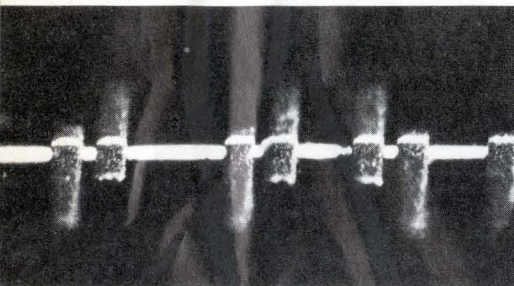

Beam leads on integrated circuits. Height and cross-section are measured.

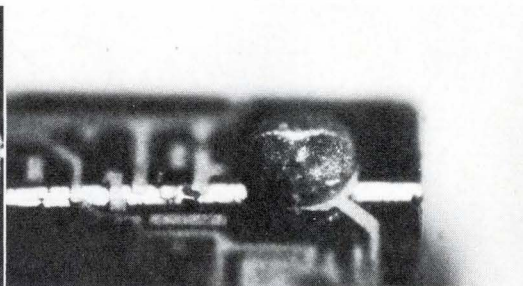

Flip-chip bumps. Measurement of height and cross-section.

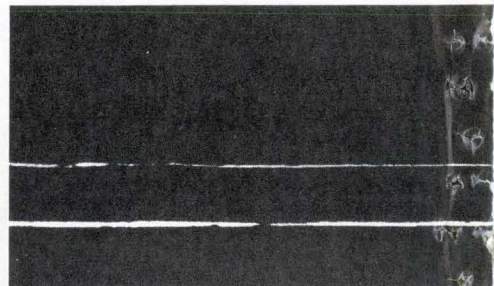

Transparent foil, 71 microns thick.

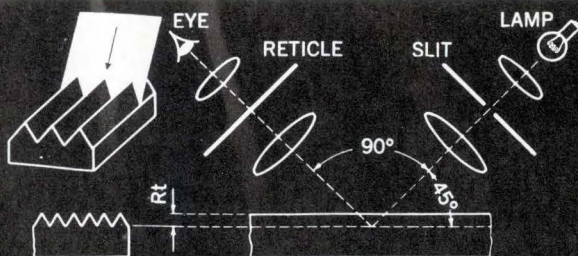

Principle of the Zeiss Light-Section Microscope.

Photomicrographs courtesy Mr. R. Atkinson, Affiliated Manufacturers, Inc.

ZEISS

THE GREAT NAME IN OPTICS



WEST GERMANY

AEG-Telefunken speeds up bonding of leads to ICs

Automating the bonding of leads to integrated circuits—and doing it economically—continues to be a goal of production engineers around the world. Now, workers at West Germany's AEG-Telefunken have come up with a process, called Sicon, to challenge beam-lead, flip-chip, and film-carrier methods.

Although the approach resembles the earlier spider-bonding, it features some notable variations on that technique. Among its innovations are galvanically grown gold balls at contact points, titanium-tungsten-gold metalization, a tinned nickel "spider" frame that serves to interconnect the chip and the pins of the final package, and an epoxy-based thermally conductive adhe-

sive to hold the chip to the package. The pull resistance of the contacts is about 50 pounds, about 10 times more than the value obtained in conventional wire-bonding with wires 25 micrometers in diameter.

Speed-up. Already, AEG-Telefunken has begun pilot production at its Heilbronn semiconductor plant of ICs for television applications. Output is 300 devices an hour, triple the wire-bonding rate. Current work on the process is aimed at upping hourly production to 1,000 units an hour. At that rate, costs would be only 11% of those of conventional wire bonding. Slashing costs per device to a mere 5% of the original is the next development goal, to be achieved by positioning

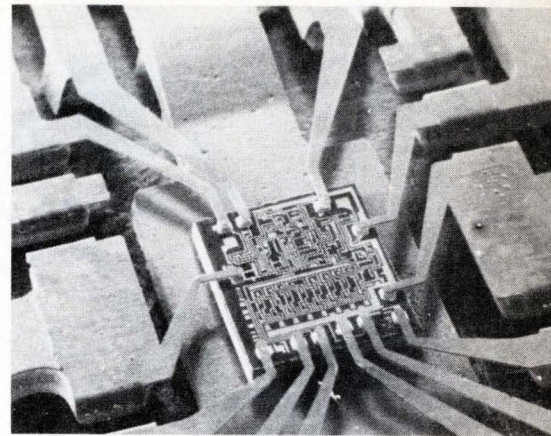

Connected. After frame legs have been soldered in place, the metal between the legs is cut and bent around leads.

the spider electronically on the chip.

The spider frames are arranged one after the other in an 8-millimeter-wide tinned nickel strip. These frames are held to the strip at four points. The strip is about 50 centimeters long, but later a longer strip, wound on a reel as in film-carrier techniques, will be used.

Steps. The process consists essentially of three steps: pasting the chip with the adhesive to a dual in-line strip's substrate carrier, contacting the spider, and punching apart the spider legs. First, the spider strip and the dual in-line strip are fed to the work station from different directions. A tiny drop of the adhesive is squirted onto the substrate carrier, and the chip is pushed onto it.

The frame is separated from its strip by cutting the four connecting bars and is held above the chip by suction. Looking through a microscope, the operator positions the spider with a manual manipulator. The spider legs are eutectically soldered simultaneously to the gold balls at one end and to the dual in-line strip's contact posts at the other.

The last step consists of punching loose the spider legs from the frame so that there are no short-circuits. In this step, the frame sections between individual legs are cut and the section ends bent around the post. Because of the relatively large area that the dual in-line strip presents to the frame, the chip can be positioned away from its ideal location as much as 150 micrometers in both X and Y directions without causing misplaced bonds. □

Around the world

Calculator experience spawns 2 consumer ICs

Having cut its teeth on volume production of MOS chips for various pocket-calculator manufacturers, General Instrument Microelectronics in the UK is now using its expertise to produce two products for the consumer market. This month, the company is introducing two devices it claims are the first MOS circuits of their kind designed and built in Europe—a TV channel-number display that can be modified to show time on the screen and a digital frequency display for high-fidelity audio tuners.

GIM says "straightforward" p-channel, nitride, aluminum-gate technology is used in fabricating the chips, which are being produced at the Glenrothes, Scotland, plant for undisclosed European customers. If North American sales grow enough, chips will be produced in the U.S.

The AY-5-8300 channel-display circuit enables viewer to see the channel number at the top right-hand corner of the screen in one of seven colors against a black background. The set maker determines whether the number appears for a few seconds or lasts until changed.

Access time of 1-k Siemens PROM is only 15 ns

A speed nearly twice that of previously announced 1,024-bit programable read-only memories is being claimed for the GXB10149 introduced by Siemens AG. Clever design is getting the credit for the access time of 15 nanoseconds. Siemens engineers used the same technology for the device, which is built around emitter-coupled logic, that they used in the high-speed 128-bit ECL random-access memory that was recently introduced.

The GXB10149 has the same designation and pinning as the Motorola ROM, which has an access time of about 25 ns. Although the basic concept is the same for the two devices, the Siemens circuit has an npn transistor in conjunction with the nickel-chromium programming element, and the Motorola part contains diodes. The new device is intended for use in fast logic arrays where PROMs of the TTL-Schottky variety are not fast enough.

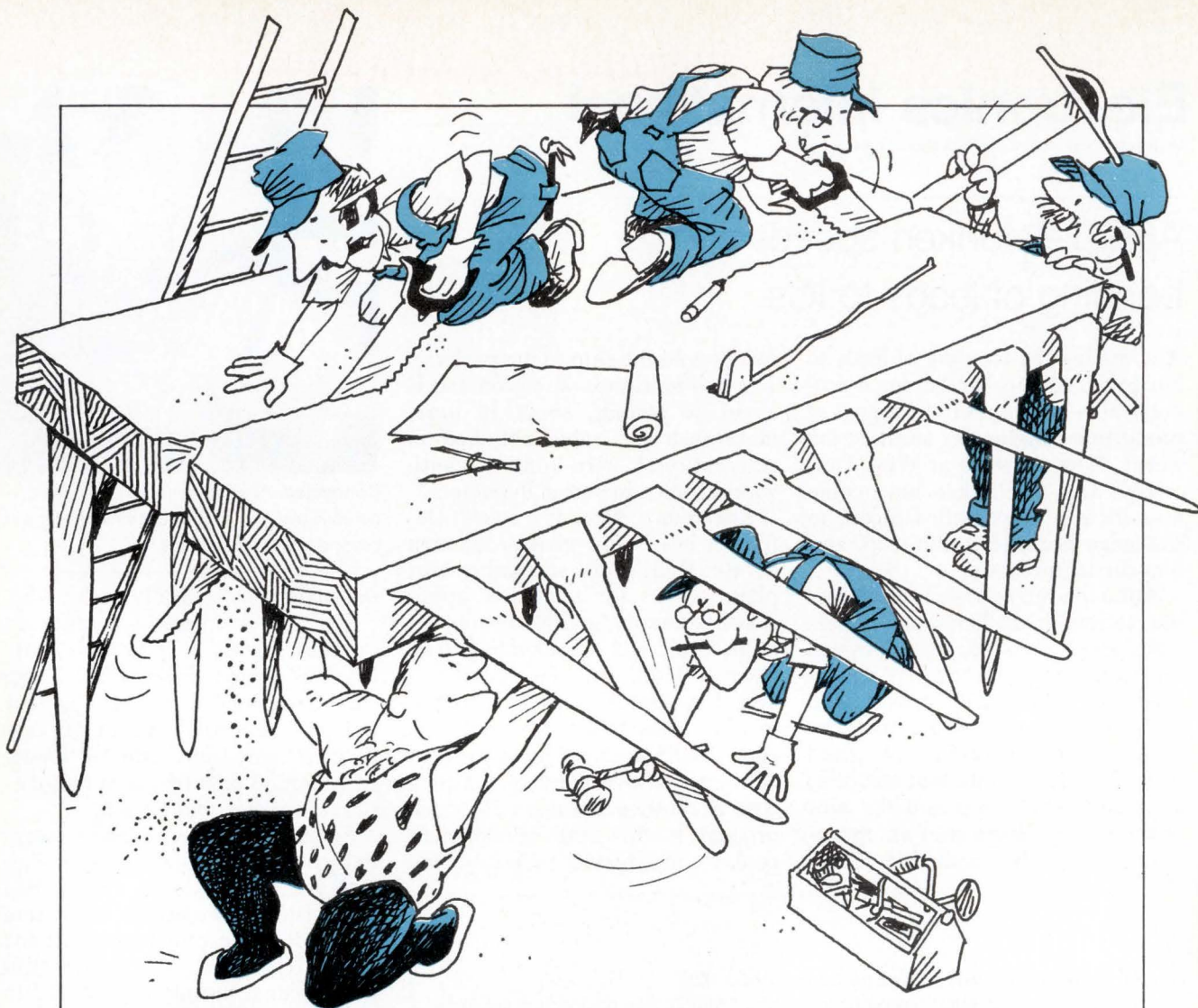

Our DIP crew makes great SIP resistor networks, too.

Leave it to our guys. They know you need a variety of space-stretchers to make your circuit-board packaging easier. And that's why these DIP experts also make Beckman RESNET™ standard SIP networks in 30 popular varieties.

These thick-film, cermet SIPs (.780" wide, .350" high, .090" thick) are standard 8-pin types, dimensionally uniform and ideal for automatic insertion techniques. Laser-tailoring assures precise resistance values, and every part is 100% tested.

Two convenient networks (see schematics)

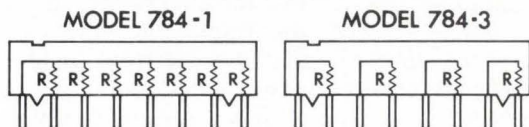

give you a 7-resistor model for applications like pull-up or pull-down networks, and a 4-resistor model for such typical uses as line termination and LED current limiting.

Resistance values available in both versions are 100, 150, 220, 330, 470, 680, 1K, 1.5K, 2.2K, 3.3K, 4.7K, 10K, 15K, and 22K.

And now for more good news. They're all stocked locally by your Beckman/Helipot distributor, ready for immediate delivery.

Cost? Truly competitive, actually giving you cermet quality at plastic prices.

Why wait? Let the new Beckman SIP line start making things a lot easier for you. For immediate literature or the phone number of your Beckman/Helipot representative, call toll-free (800) 437-4677. Right now.

Beckman®
HELIPOT DIVISION

TI module decodes text on television channels in UK

Anticipating a potentially large European consumer market, Texas Instruments' UK operation is first out of the gate with a low-priced module that enables television viewers to receive text and graphics on their receivers. The Tifax decoder, a pc-board module, enables a viewer to select pages of information broadcast over conventional TV channels. **First units, to be available in early 1976, will be priced at \$120 to the setmaker and at least double that amount to consumers—a price that makes competitors question the Tifax market potential.**

However, TI estimates that prices will fall to \$145 by 1978 after the first million units have been produced. The company has no firm orders, but it is talking with set makers. Experimental TV text is being shown regularly in the UK, and successful trials have been reported in Sweden and West Germany. Companies eying the market include Philips, Pye, Mullard, Decca, GEC, Plessey, and Jasmin Electronics.

Siemens silicon Impatt diodes put out 3 W at 7 GHz

Engineers at Siemens AG have developed laboratory versions of double-drift silicon Impatt diodes that produce more than 3 watts of power at 7 gigahertz with efficiency higher than 11%. Silicon Impatt diodes with these values, says Guenther Kesel, head of microwave device development at the Munich company, **"open the way for commercial applications of such diodes and could eventually sweep traveling-wave tubes operating below 10 w off the market."** Siemens later this year will begin marketing a double-drift silicon Impatt diode made with thin-film technology, but its output will be less than 3 w.

Other companies as well as Siemens have achieved frequencies higher than 7 GHz in labs with silicon Impatt devices [*Electronics*, June 21, 1973, p. 27], but Siemens says it will be one of the first to reproduce high performance values on the production line. The silicon Impatt diodes are smaller, weigh less, and cost less than low-power TWTs, but they have somewhat lower efficiency than gallium-arsenide devices. **However, they have higher thermal conductivity and can be processed with standard silicon techniques.**

Marconi-Elliott automates throttle control for 747s

An automatic throttle-control system for Boeing 747 jumbo jets will be introduced May 30 by Marconi-Elliott Avionic Systems Ltd. at the Paris Air Show. The company beat out U.S. competitors to win a Boeing contract to install the control in several hundred planes. **Now under advanced development, the analog system will become part of future production aircraft and may be retrofitted to existing planes.** Airlines will be able to choose such options as controlling flaps, compensating for engine differences, suppressing noise, and, later, handling advanced engines when they are installed. Marconi-Elliott also has built systems for the DC-10, the French-British Concorde, and the three-nation Multi-Role Combat Aircraft.

Nippon's IC sales augur enhanced watch competition

Look for a big upswing in contenders for the digital-watch market. Nippon Electric Co. says that it has **shipped samples of its standard digital watch circuits to more than two dozen companies since the end of last year.** These potential watch assemblers do not include the five Japanese companies—four watch companies and calculator manufac-

International newsletter

turer Casio—that now make electronic watches. Nippon Electric says that about half are manufacturers of electrical or electronic products, most of the rest are clock makers or trading companies, and two or three are camera makers. Although Nippon Electric doesn't expect all of them to go into digital-watch production, it thinks some will after they find that assembly of watches is not particularly difficult. Thus, **there is a good chance for an unstable situation similar to the one that is shaking out the weaker calculator makers.**

TV IC pact seeks market thrust for Italians, Germans

The intent of an agreement between Italy's SGS-Ates and West Germany's AEG-Telefunken for joint manufacture of integrated circuits to be built into television receivers is entirely technical, insists a spokesman for the Italian firm. Franco Stabillini, international marketing manager for linear ICs, **is seeking to dampen rumors that the German electronics giant has larger designs on his company.** He says the two companies will produce the components independently, and they will compete against each other. **Both hope to increase market penetration by enabling TV-set manufacturers to purchase modular kits and individual components from either of the two sources.**

The most important part of the agreement covers a three-chip kit for the chroma section of color-TV sets. **The three ICs in the kit are new, but they are based on the functions of previous SGS-Ates products, and additional circuits are either SGS-Ates or Telefunken originals.** The chroma kit consists of the TDA 2140 PAL reference-signal oscillator; TDA 2150 luminance and chroma amplifier; and the TDA 2160 chroma demodulator and RGB matrix.

Sweden develops two domestic missile systems

Two new missile systems that are intended as domestic alternatives to foreign missiles are being developed by SAAB-Scania of Sweden. **One system is for the fighter version of the Viggen aircraft, built by SAAB, and the other system is a land-based missile for sea targets.** If the Swedish government awards production contracts to SAAB for these systems, the total cost would amount to more than \$25 million.

Meanwhile, the Norwegian government has selected the Franco-German Roland-II missile to provide low-level ground-to-air defense for northern Norwegian airfields. The Roland-II, which was competing against the French Crotale missile system, is an American modification of the original Franco-German missile. Total cost of the purchase is \$115 million.

Air France doubles capacity for its reservation system

Air France is doubling the capacity of its computerized reservation system as part of a **diversification project to help offset declining revenues.** Airline officials are negotiating to rent the additional capacity to Middle East Airlines, Syrian Arab Airlines, Iraqi Airways, Egyptair, and Olympic Airways. The center, under construction near Valbonne in southern France, will operate three Univac 1110s.

Meanwhile, Air France is preparing to train about 25 Russians in the use of software for the Soviets' planned Aeroflot reservation system, which also will use Univac hardware if U.S. export officials approve the deal. Air France has adapted and translated its software to fit Soviet needs, also as part of its diversification effort.

It's here.



7 Digits, 100 MHz, Multifunction Counter Data Precision's Model 5740

The First 7 Digit, 5-Function Counter/Timer
Ever Offered For Under \$300
Measures: Frequency, Period, Period Average,
Total Events, Elapsed Time.

\$295.00



Name _____ Title _____

Company _____

Address _____

City _____ State _____ Zip _____

Send me Data Precision Model 5740 at \$295.00. I prefer the following purchase plan:

- Bill my company. Purchase Order enclosed.
- Check or money order enclosed.
- Send complete information and specifications.
- In addition, send complete information and specifications on the Digital Multimeters.

Model _____

DATA PRECISION
...years ahead

Data Precision Corporation, Audubon Road, Wakefield, MA 01880
(617) 246-1600

Every Dollar Counts

Designed to compete directly with counter/timers costing 2 to 3 times more, Model 5740 makes absolutely no compromises in the area of performance.

Every element — every component — has been "value-optimized" to keep its exceptional range, sensitivity, accuracy and resolution within your budget.

It's a remarkable instrument, made more remarkable by its price. \$295.00



Human Engineering

Simple and logically marked controls; a direct-reading display in the rated units; automatic decimal positioning and a bright easy-to-read .43" high LED display, with "overflow" and "gate-on" indicators.

SPECIFICATIONS: Sinewaves, Square Waves, Pulses, Pulse Pairs, Complex Waves

- **Frequency**
5 Hz to 100 MHz; 10 ms/100 ms/
½ sec./10 sec. gate times, resolution
to 0.1 Hz
- **Period**
1 microsecond to 0.2 sec.
- **Period Average**
10, 100, and 1000 periods

- **Total Events**
0 to 9,999,999 (unlimited with
"overflow" indicator)
- **Elapsed Time**
0 to 99,999.99 sec. (27.8 hrs.)

FEATURES:

- **Sensitivity**
10 mV from 5 Hz to 20 MHz rising
linearly to a high frequency sensi-
tivity of 50 mV RMS at 100 MHz
- **100 MHz Bandwidth**
- **250 Volts RMS Input Capability**

- **Low Component Count**
- **Wide Signal Tolerances**
- **Gate/Overflow Indicators**
- **Trigger Level**
Front Panel Adjustable
- **x1 and x20 Attenuator**

OPTIONS:

- **Remote Start/Stop**
- **50 OHM Input Termination**
- **External Clock Input**
- **BCD Interface and Logic Control**

The Data Precision DMM Family



Model 134 — the least expensive, full function DMM available; 3½ digits, 22 ranges. \$189.00



Model 1450 — 5 functions, 4½ digits, 21 ranges, with a DC accuracy of ±0.02% reading, ±0.01% f.s. \$325.00.



Model 245 — The only full function portable 4½ digit DMM available; 0.005% resolution; ±0.05% basic accuracy. \$295.00



Model 2440 — 4½ digits, basic accuracy ±0.007%, autorange, auto-zero, remote ranging and triggering, isolated BCD output. \$675.00



Model 3500 — more features for less money; the most accurate, reliable and versatile 5½ digit instrument in its class. \$995.00



Data Precision Corporation, Audubon Road, Wakefield, MA 01880
(617) 246-1600

Circle Reader Service #50

Business Reply Mail

No Postage Stamp Necessary If Mailed in the United States

Postage Will Be Paid By

DATA PRECISION
Audubon Road,
Wakefield, MA 01880

First Class
Permit No. 362
Wakefield, Mass.



The 'SOURCE'... for Digital Instrument Printers

Need a hard copy printer that is readable, reliable, flexible and maintainable?

With DigiTec's instrument printers you get a model to fulfill your exact specifications.

Want a printer that lasts with use and is easily repaired after abuse?

DigiTec's instrument printers have rugged, high-styled enclosures and state-of-the-art circuitry with plug-in components for serviceability.

Require integral clock for time recording, batch or event counting, up to 21 data columns, red or black print out, TTL or RTL interface, and integration into an existing product or system?

Selected DigiTec models offer these features in combination with many others.

Look first to the "SOURCE" for your digital instrument printers and ask about our generous OEM quantity discounts!

Contact your nearest United Systems representative for complete specifications on all DigiTec instrument printers.

6100 Series
digital printers for production, laboratory and OEM applications.

Starts at
\$549.

Model 6214
custom, modular printer adds hard copy capabilities to your product. Quantity prices starts at

\$350.

Model 691
systems printer for maximum flexibility in data acquisition systems.

Starts at
\$725.

DigiTec

UNITED SYSTEMS CORPORATION

a subsidiary of

Monsanto

918 Woodley Road • Dayton, Ohio 45403 • Ph: (513) 254-6251 • TWX: (810) 459-1728

"Information Only" circle 158 on reader service card.

"Demonstration Only" circle 61 on reader service card.

All 10-turn pots look alike

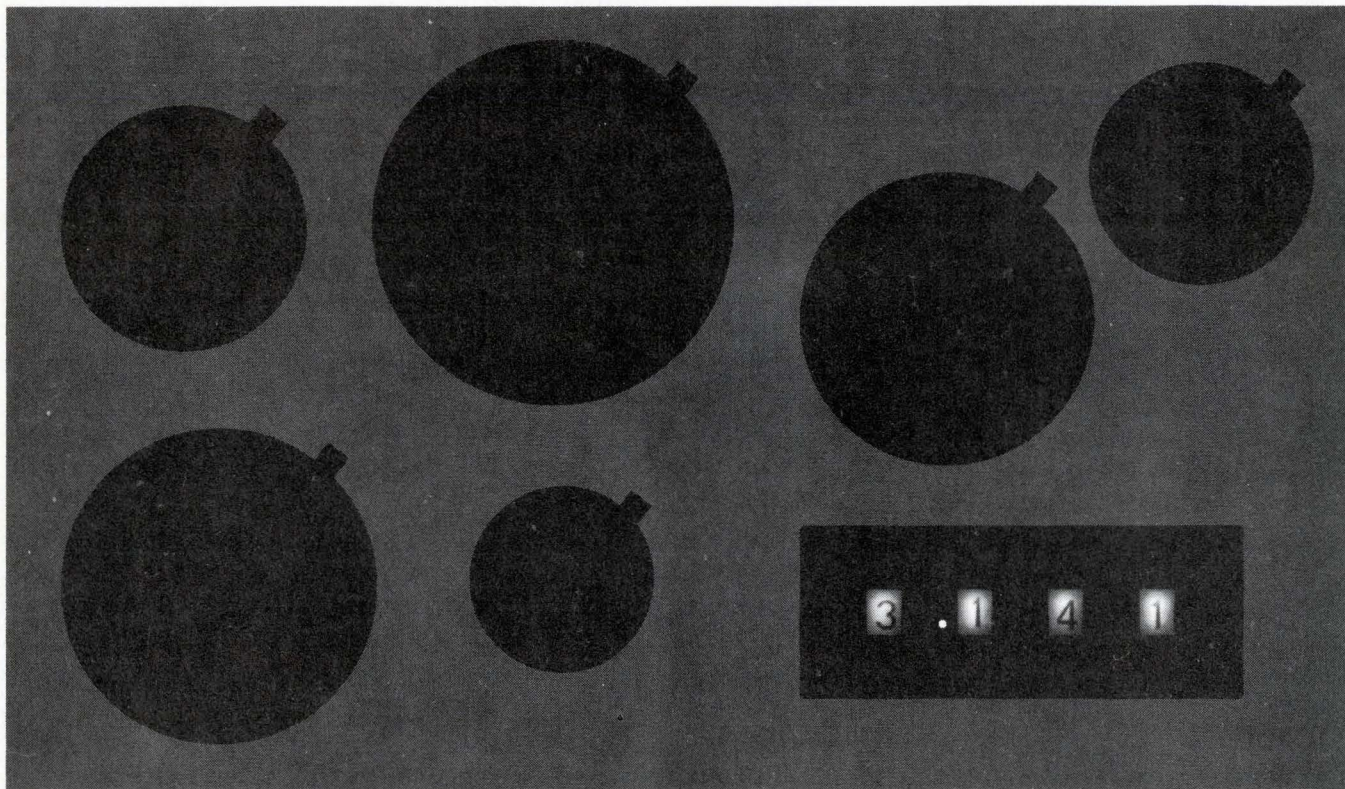

in the dark.

In the dark they're all unreadable. And if you're more than three feet away, you can't even read them in the light.

Ergo our new Thumbpot. It can be illuminated to read in the dark (above), and the numbers are large enough to read 10 feet away.

In addition you can set in those numbers rapidly with finger or thumb. And you can reset any number right on the button, exactly.

The reason for these superior features is that Thumbpot is not a pot. It is an incremental voltage divider. A switch. A switch specifically designed



to replace panel-mounted 10-turn pots.

Because Thumbpot is really a switch, it affords some other advantages. It is available in two sizes, with 1, 2, 3 or 4-digit readout, with or without a fixed or floating decimal point, in more than 400 standard versions. And its design is inherently more reliable and longer-lived than that of 10-turn pots.

There's much more to Thumbpot than we can cover here, however, so we urge you to request our brochure, by mail or telephone.

Thumbpot. No look-alike.

EECO

FOR SWITCHES

1441 East Chestnut Avenue, Santa Ana, California 92701
Phone 714/835-6000



Also available from Hall-Mark



G. S. Marshall



Schweber

Probing the news

Analysis of technology and business developments

Theft of secrets: headache continues

By a variety of methods and subterfuges, proprietary information gets to competitors, despite precautions and lawsuits

by Judith Curtis, San Francisco bureau

It doesn't appear on balance sheets, but trade-secret theft always has figured in electronics technology. However, in hard economic times, stiffer competition for profits makes such piracy more attractive. The result is a flurry of lawsuits aimed at transgressing engineers. In some recent ones:

■ In February 1974, American Microsystems Inc., Santa Clara, Calif., sued Synertek of Mountain View, Calif., for \$10 million. Other defendants included Victor Compotometer, Corp., Chicago, American Telecommunications Corp., El Monte, Calif., and General Automation Inc., Anaheim, Calif. AMI charged Synertek with breach of contract, unfair competition, and misappropriation of confidential and proprietary information. AMI alleged that its engineers had been talking to outsiders about forming a new company to produce p-channel silicon-gate devices and that those engineers took proprietary AMI information when they left for Synertek. The judge agreed and ordered Synertek to refrain from recruiting AMI employees for two years and from hiring any for one year.

■ Within the last month, officials at National Semiconductor Corp., Santa Clara, Calif., discovered that one of National's proprietary scientific-calculator chips had been stolen, copied, and sold below cost. The company is now investigating this incident and won't discuss it.

■ In June 1973, seven persons, including IBM Corp. employees, were arrested and charged with theft of plans and hardware for IBM's Merlin data storage device. Although the case now is near completion,

IBM officials are still reluctant to discuss it. But Capt. Larry Stuefloten of the San Jose, Calif., police department says that although IBM had known about the theft of the designs, company officials hesitated to bring charges because they "were reluctant to believe that people they treated so well would steal from the parent company. It was only when they were faced with the loss of the Winchester disc drive technology that they got [police] help."

■ Analogic Corp., Wakefield, Mass., claimed that officials of Data Translation Inc., Framingham, Mass.—two of whom were former Analogic executives—used trade secrets and marketing information for the Analogic subminiature high-speed data-acquisition module, the MP 6912, to

produce their own product [*Electronics*, April 17, p. 26].

A state superior court judge agreed with Analogic and ordered Data Translation to cease manufacturing, offering for sale, and selling three of its system modules; to cease making use of most of the circuitry; to cease soliciting customers who were known to have been customers of Analogic before the Data Translation officers left the company; and to pay Analogic nearly \$13,000 in damages from the sales of the products. The case is in appeal.

Those cases illustrate the popular ways to steal trade secrets: hiring away engineers who are privy to confidential matters, copying devices, starting a small company while working for a larger one, and

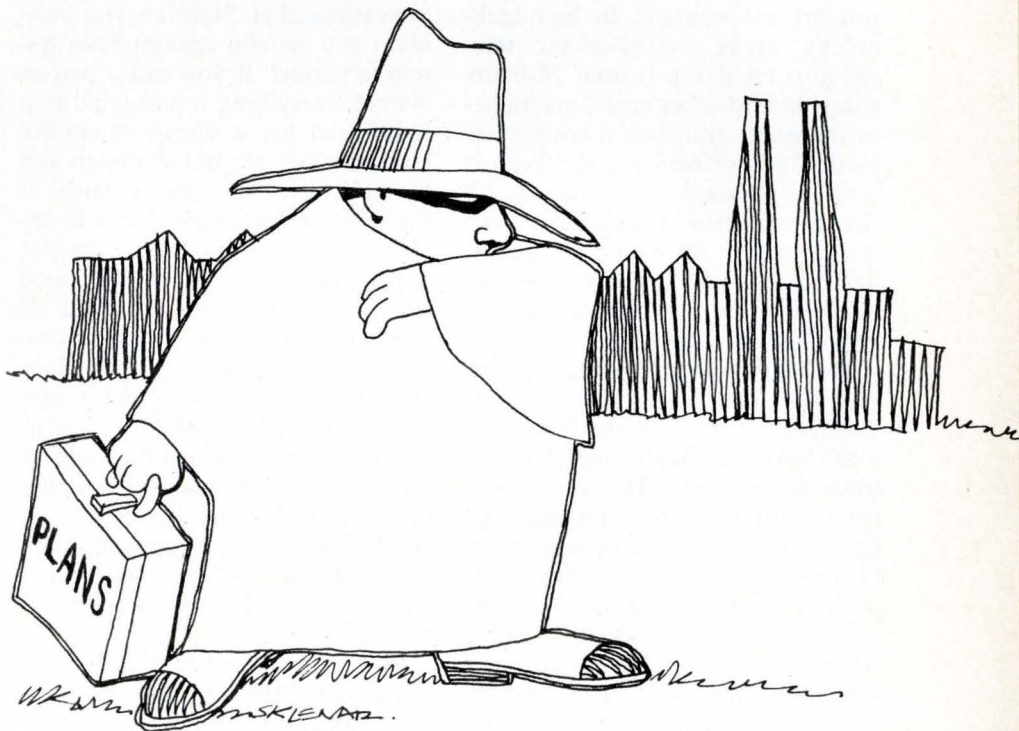

actually stealing masks or plans. And if there is one part of the country where all those art forms are pursued more passionately than in others, it's the so-called Silicon Valley in California. On the peninsula south of San Francisco are concentrated hundreds of high-technology electronics companies, including some of the giants of the semiconductor industry—and numerous cocktail lounges.

Bar talk. "There are more trade secrets passed on Friday nights at the local bars than during the week," says Roger A. Barney, director of personnel administration and security for Fairchild Semiconductor Components, Mountain View, Calif. "That's the nature of the business because it's still a relatively small community of people that have a common bond, not only in technology, but because many of them have worked for one of the other companies more than once."

Fairchild, like most other companies, requires an employee when he or she begins work to sign an agreement not to divulge to outsiders any Fairchild trade secrets. Employees do essentially the same thing on a project basis, so that they know they are working with proprietary information. In high-technology areas, closed-circuit television surveillance is used 24-hours a day, and in other areas, magnetic-card readers and special badges are used. Garbage cans are checked, as well as purses and briefcases. All these security measures, says Barney, might scare off a few potential thieves. "We try to provide many deterrents to increase the danger of getting caught."

Walking papers. Document theft, says Ray Vaden at Signetics Corp., Sunnyvale, Calif., "is the least popular, but most damaging" form of trade-secret theft. He says some form of theft goes on every day, and he blames it partly on management. "People in this industry lack discipline. They hate controls." Yet, Signetics uses "man traps," booths where a closed-circuit TV camera scrutinizes the badge and person trying to enter. If the guard on the

The Keronix-Data General case

On Jan. 3, 1973, the Santa Monica, Calif., plant of Keronix Inc. burned down. That fire—termed arson by authorities—has led to a bizarre chain of events climaxing in a suit by Keronix against Data General Corp. of Southboro, Mass., and a counter-suit by Data General.

Keronix has charged that Data General and some of its officers and directors had conspired to wiretap the company, set the plant afire, and obtain telephone records and use them to identify and harass customers in an attempt to drive Keronix out of business. The civil suit seeks \$5 million in compensatory damages and \$50 million in punitive damages. Last year, Edson de Castro, Data General's president, and some officers appeared before a Federal grand jury investigating the case.

Data General, which calls the charges "preposterous" and without substance, denies them. On March 10, Data General responded with a suit of its own. J.B. Stroup, director of financial relations, says the counter-claim charges unfair competition and misappropriation of Data General's trade secrets, specifically the trade theft of designs for Data General's computers.

The suit also charges a conspiracy by Keronix management, Herbert Itkin, and others unnamed, to damage Data General by disparagement and dissemination of injurious falsehoods. Data General claims Keronix fabricated evidence of the alleged incidents by Itkin and others who had been hired to do this. (Itkin himself, a lawyer, was involved in a scandal when he was an official in Mayor John V. Lindsay's administration in New York.) Data General is asking for damages, but the amount has not yet been specified. The suit is now in its discovery phase.

other end of the camera agrees that everything matches, he opens the door. Signetics also uses magnetic card readers and infrared sensors.

American Microsystems claims it has had one of the industry's most efficient security systems for years—in spite of the Synertek episode. Says Richard H. Skjerven, vice president and general counsel, "No system is perfect. If you had a perfect system, everything would grind to a halt." AMI has a document-control group that checks out all design and manufacturing process. Guards at the door perform spot checks to ensure that those documents are not leaving the company. At night, each AMI worker is required to put all private matter away. All such documents are printed on yellow paper so that if anything is left on top of a desk, says Skjerven, the maintenance people can spot it and put it away. AMI uses shredders for highly proprietary documents. And when employees leave the company, they are debriefed by their supervisors and also by the personnel department.

Bob Lloyd, former president of Advanced Memory Systems, who now works at National Semicon-

ductor Corp., contends, "There is not a company here who can keep a secret." He notes that a number of companies obtain a large part of their product line by hiring people away for that specific product. Lloyd adds an industry belief that the more transfers there are between companies, the more the technology moves."

But company wariness can frustrate job hunters. One well-known executive recruiter, Jon Harvey of Hicksville, N.Y., has trouble placing IBM people who have been working in sensitive areas, such as product planning or development. "Prospective employers are afraid that IBM might come after them if they ever come close to becoming competitors," he says.

How can thefts of trade secrets be prevented? They probably can't, but many officials contend that if the potential thief knows the company will take him to court if he's caught, that is as good a deterrent as there is. "As long as there is a company that will, in the interest of competition, hire away someone else's top people, then we can't stop trade-secret thefts," says one executive. "It's just seems to be built into the system." □

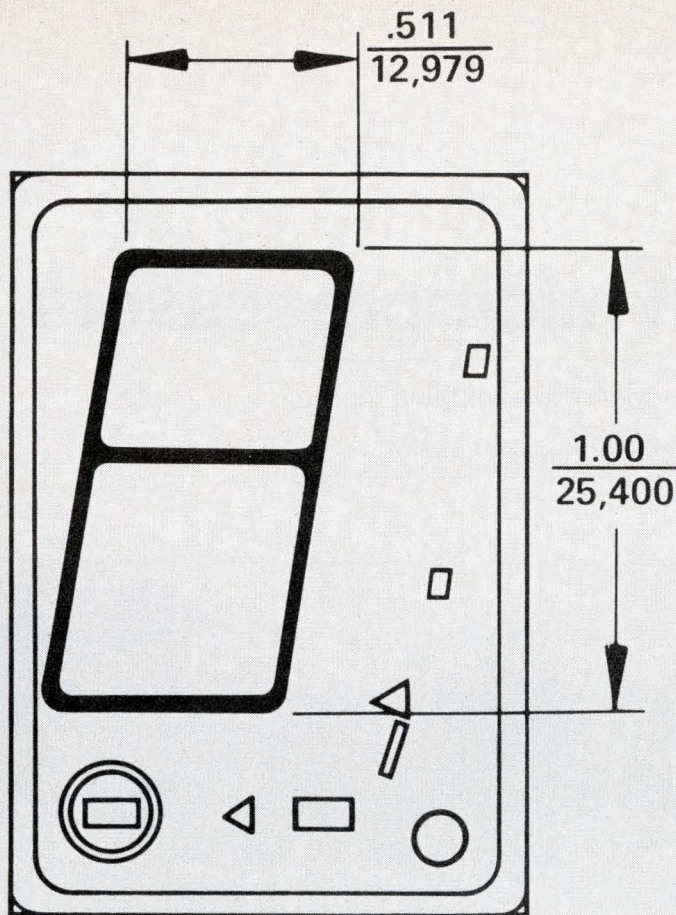

A bright, new display from Beckman



Here's the answer to your big display projects — a one-inch, seven-segment display from Beckman. Named the SP-101, it's ideal for any application requiring readability at extended distances or where styling dictates a large digit size.

- Easily read at distances up to 60 feet with 150° viewing angle...even in direct sunlight.
- Digit to digit spacing is flexible.

Minimum centerline spacing is 1.120".

- Brightness is rated between 100 and 500 footlamberts depending upon current.

- Beckman displays have crisp, clear, unbroken numerals that are easy to read; with a neon orange color (filterable to red) that's pleasing to the eye.
- Quality is assured through extensive in-process testing including 100% burn-in.
- Beckman will extend its minimum one-year warranty to match your product's warranty.
- Price is \$5.75 in 1000 unit quantity.

For additional information contact your Beckman sales office, or write, Beckman Instruments Inc., Information Displays Operations, P. O. Box 3579, Scottsdale, Arizona 85257.

Beckman®
INFORMATION DISPLAYS OPERATIONS

There's more eye appeal in Beckman Displays!

Circle 65 on reader service card

Electronics abroad

Europeans exploit microprocessors

Although American chip sets will continue to dominate exploding market, Continental customers are building them into products and systems

by Richard Shepherd, McGraw-Hill World News

While Europe's leading electronics manufacturers are moving fast to launch their own microprocessor-based products, it is already clear that U.S. semiconductor makers will remain dominant as chip-set suppliers. However, the Europeans are convinced they will win a major share in the bonanza by building these chips into a multitude of products and systems.

Few observers doubt that last year's trickle of orders for chips will explode into Europe-wide sales worth as much as \$200 million by 1980. But what is still far from settled is who will bridge the gap between the chips and the user's application. Manufacturers of minicomputers and microcomputers, systems houses with software expertise, and even some semiconductor makers themselves all think they can do the job. And no wonder. That market is worth many times the value of the chip sets alone.

It's too early to tell how much of the software and support the microprocessor makers will leave to the computer and systems houses. Right now, the largest semiconductor companies appear to be sticking to the business they know well. Texas Instruments, for one, is playing a closely guarded hand. Company officials in France say it will be a year to 18 months before they will decide how to make the most of the microprocessor's potential. Meantime, the company is test-sampling one chip for military applications, as well as completing a market survey of all potential customers.

Chips. Whatever TI decides to do, Intel Corp.'s European marketing director, Tom Lawrence, is con-

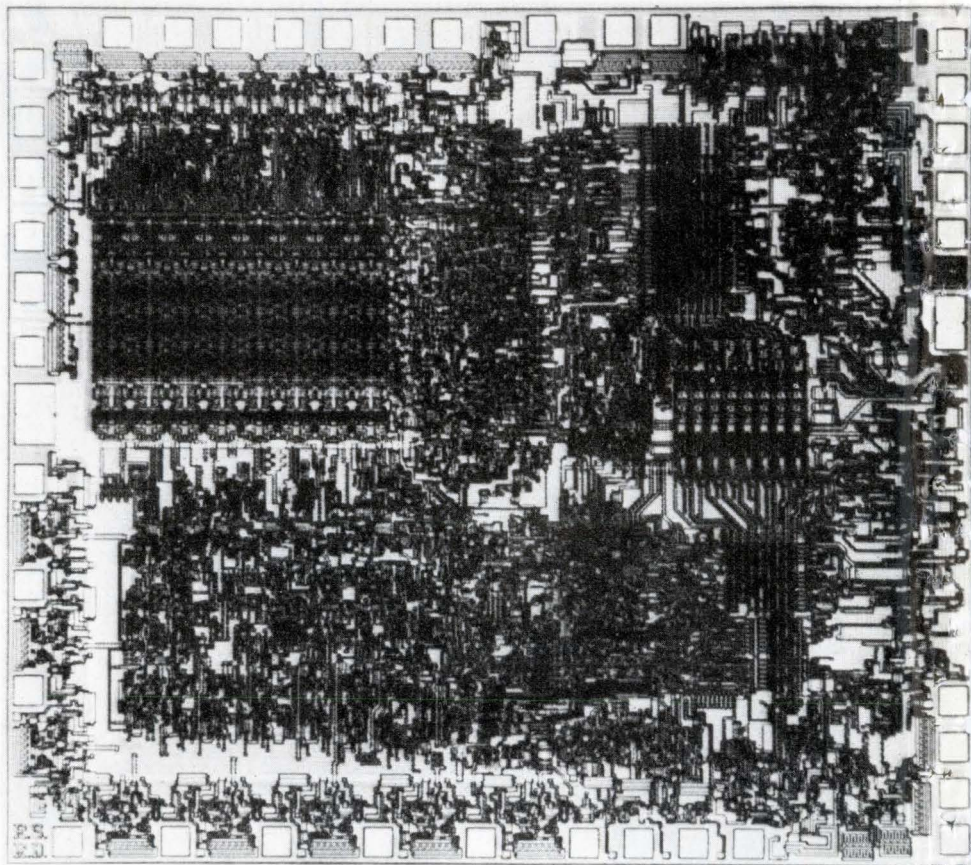

The leader. Intel's 8080 microprocessor has lion's share of European market.

vinced that the big U.S. companies will have to stick to selling chips alone, leaving the services and applications-design business open to European computer or systems houses.

Mike Bues, National Semiconductor Corp.'s marketing manager for Europe, and Intel's Lawrence agree that the main markets for the next couple of years will probably be for such industrial applications as process control, data-processing terminals, and telecommunications equipment. Lawrence predicts that

instrumentation and medical applications could also grow rapidly.

Consumer and entertainment markets are expected to follow within two to five years. But Lawrence is skeptical about prospects for a fast take-off for the automobile market. He argues that auto makers will have to design a complete electronics package to control all automobile systems, rather than only one function, such as fuel injection.

Growth prospects and market tar-

HERMES LOOP ANTENNA

THREE SAMPLE SITES
ON THE NORTH AMERICAN
CONTINENT —

DIFFERENT LATITUDES
DIFFERENT CLIMATE

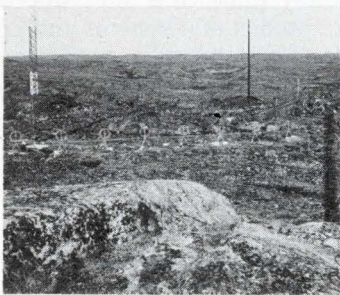

FROBISHER BAY, CANADA

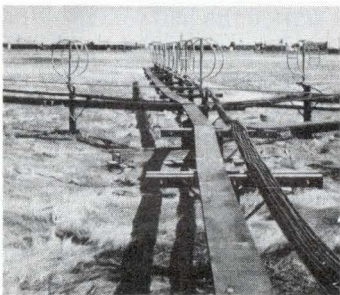

MARSHFIELD, MASS.

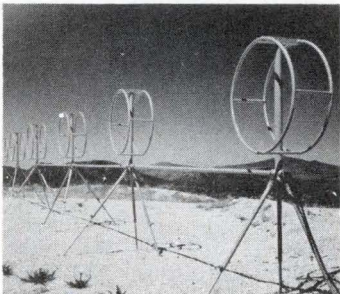

NEAR SAN DIEGO, CALIF.

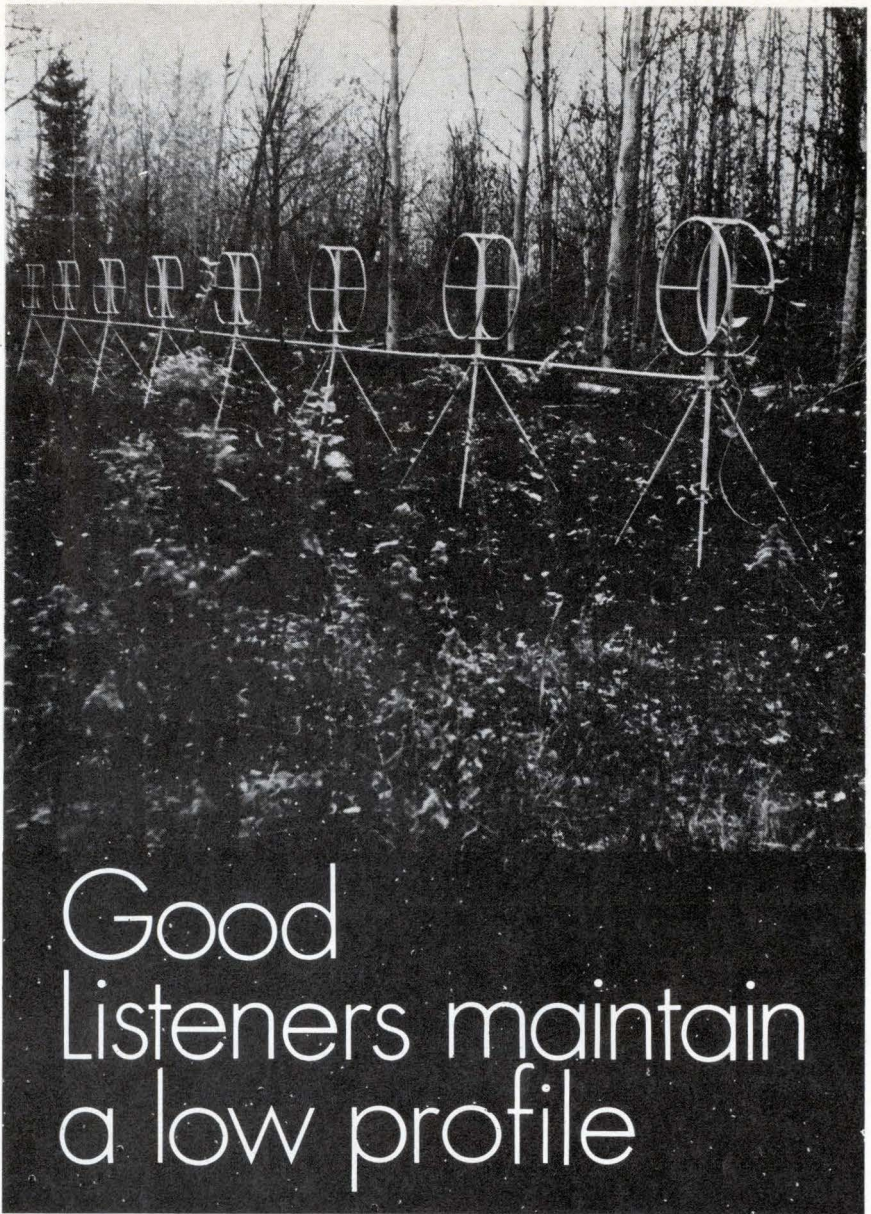

Good Listeners maintain a low profile

Even in the solitude of the forest depths, from rooftops, arctic tundra, swamps to sweltering tropics, 'neath snow, sand or ice, the Hermes Loop antenna keeps an ear to the sky. The amazing aperiodic antenna does away with vast log periodic and rhombic arrays - those towering antenna farms.

Excellent directional characteristics in rosette configuration, the Hermes loop antenna provides an omnidirectional broadband receiving array in space merely 1/100th that of the traditional antenna farm.

More than 53 government agencies around the world have pressed the loop antenna into service.

A new, even more compact version is available. Only Hermes Electronics makes it.

**2-32MHz
BROADBAND**



ASK US Send for our Brochure

Hermes Electronics Limited
Suite 315
2020 F Street NW
Washington, DC 20006 USA
202-296 2978
TWX 710 822 1106

Probing the news

gets seem clearly defined, but what about support, software, and systems-engineering services? At France's Réalisations et Etudes Electroniques, Europe's first home-grown microcomputer company, president Truong Trong Thi forecasts that the semiconductor leaders will dominate the bottom end of the

computer market. "We are convinced that it is only the big companies like Intel, Motorola, and National Semiconductor that will be our competitors in four to five years."

Some computer-industry pundits go further. At the European headquarters of International Data Corp., managing director Jim Bonnet foresees the microprocessor as a powerful influence on the rest of the

computer industry in Europe, as well as a key to new markets. "The micros are doing to the minicomputer market what the minis did to the mainframe people," he explains. "That will turn the whole bottom end of the industry upside down."

However, as Intel and National move within a hair's breadth of becoming members of the computer industry, giants like Motorola, TI, and Fairchild are keeping a respectful distance. "We are building semiconductors," says one Geneva-based marketing executive. "Any small company with half a dozen people can produce smart systems."

Many Europeans and Americans alike predict that systems and applications will be the way European electronics companies are going to share in the microprocessor boom. In France, for example, RTC-La Radiotechnique Compelec has built an integrated-injection-logic process to meet the specifications of avionics equipment designed by Electronique Marcel Dassault. A standard product may emerge later, but it was a custom-design OEM contract that started the ball rolling.

This year, the value of the European microprocessor market is expected to jump \$10 million to \$15 million as Motorola, National Semiconductor, and Fairchild begin to deliver in quantity. "We look for all companies to double business every year for the next few years," Intel's Lawrence notes.

The market for the \$100 to \$200 packages, each of which consists of a central-processing-unit chip with its associated memory and input/output circuits, should grow to at least \$60 million by 1977. Growth will slow after that to the \$200 million level by 1980, predict most of the main contenders. At National Semiconductor's European headquarters in Munich, the mood is even more optimistic. The target is 100% growth per year for five years, and National intends to lead the field. "We plan to be the major supplier in three or four years' time," Bues confidently asserts.

But for 1975, at least, Intel Corp. of Santa Clara, Calif., stands head and shoulders above its rivals in the European market. Réalisations et

Automatic 0.25% impedance measure- ment:



Our new Model 251 Digital Impedance Meter provides the most accurate measurements of inductance (L), resistance (R), capacitance (C), and conductance (G) available in any instrument up to five times the cost—plus it's fast and reliable.

Big, fat claims, right? But consider this: Accuracy of 0.25% + 1 digit, measurement speeds of a fraction of a second, high-intensity 3½-digit readout has overload blanking to prevent false readings, solid-state construction packed into a rugged 10-pound frame. And simple to operate.

You might consider this. Our reputation. We've led the building of precision impedance measur-

ing instruments for laboratory and quality control applications for 25 years.

Check us out, then call or write for the complete story. Ask about our discrete IC testers, too.

Electro Scientific Industries
13900 N. W. Science Park Drive
Portland, Oregon 97229
Phone: (503) 646-4141

\$1200.
(U.S.A.)

esi
ELECTRO
SCIENTIFIC

Etudes Electroniques claims to have moved even faster than its U.S. rivals in building a stand-alone computer around Intel's 8080 microprocessor. Since the Paris firm launched its Micral S last spring, numerous other European systems houses have rushed to devise systems around Intel's chips.

Users and competitors alike concede that Intel walked away last year with most of the \$3 million to \$5 million that the European market was worth. Lawrence has a simple explanation for that domination. "We can deliver products that work," he says. He might add that Intel also was able to deliver microprocessors in volume, while others were still sampling the market.

The U.S. semiconductor makers have all learned the vital importance of large-volume production. In its European microprocessor presentations last month, Fairchild drove home its message that it is selling cheap standard products with output aimed at volumes of hundreds of thousands. "What counts is a microprocessor's virtue of low cost, and not the fullness of its instruction set," explains one Fairchild engineer. The Fairchild representatives offered 20 sets for \$1,500 and predicted that individual chip prices would drop below \$15 by 1976 for large orders.

Motorola executives don't think Europeans can meet that kind of production challenge. They doubt that European companies can keep up with technological development that produces obsolescence within two to four months.

In Europe's biggest market, West Germany, AEG-Telefunken, Siemens, and Nixdorf Computer are all building microprocessors. Siemens is second-sourcing Intel's 8080 chip, AEG-Telefunken has designed its own, and Nixdorf's chip is being manufactured in the U.S. by Nitron, a division of McDonnell Douglas. None of the German firms is likely to make much impact on the U.S. market leaders' share in Europe, but that may matter little if they can win a slice of the market for microprocessor-based systems. AEG-Telefunken's chip is, in fact, being built into a table-top calculator built by its subsidiary, Olympia Werke. □

SLIM-MOX

**NOW VICTOREEN
QUALITY COSTS LESS
THAN A DOLLAR.**

Victoreen announces **SLIM-MOX**, our new, thick-film, flat substrate resistor.

Compact in design, it carries with it all the quality and dependable performance you have come to expect from Victoreen.

SLIM-MOX, right now, is available from stock in a wide range of standard resistance values. More important, **SLIM-MOX** will deliver the same proven performance in high-voltage applications that you find in more expensive resistors with more bulk.

Specify **SLIM-MOX** in any standard resistance value and your unit cost will be less than one dollar in OEM quantities. Truly a major cost breakthrough for resistors designed for miniaturized

electronic networks and equipment, or other critical applications that demand stability and reliability.

Standard tolerance is $\pm 15\%$ for all standard resistance values which include 1, 2,

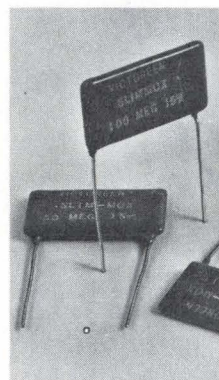

5, 10, 20, 50, 100, 200, 500, 1000, 2000, and 5000 megohm. All in stock. With a voltage coefficient of better than 5 ppm/volt, full-load drift typically less than 0.5% in 1000 hr at 70° C, and 250 ppm TCR or less to 5000 megohm, **SLIM-MOX** is a little, big performer. For less than a buck. From a name you know you can count on. Victoreen.

**Victoreen Instrument Division,
Sheller-Globe Corporation,**

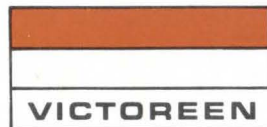

SHELLER-GLOBE CORPORATION

**10101
Woodland
Avenue,
Cleveland,
Ohio 44104**

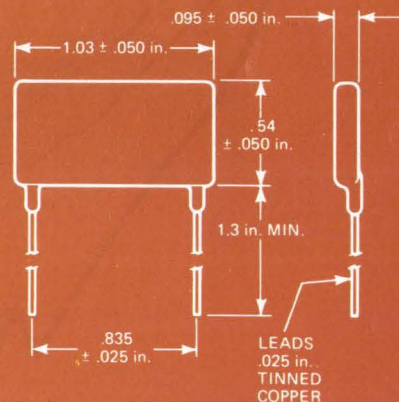
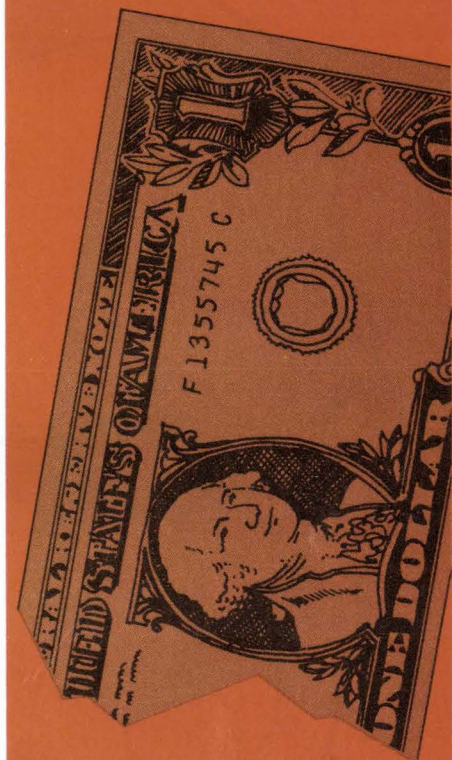

SLIM-MOX SPECIFICATIONS

| | |
|--|-----------|
| Resistance Range | 1M-5,000M |
| Power Rating @ 70°C | 2W |
| Maximum Operating Volts (Applicable above critical resistance) | 10,000V |
| Available Tolerance | 15% |
| Critical Resistance | 50M |
| Max. Service Temperature | 150°C |



Communications

Bell Labs girds for the future

Baker sees change in emphasis to software, warns that lab could not survive separately

Few industrial laboratories in the world can compare with Bell Laboratories in size, scope, or quality of work. It was there that the transistor, the traveling-wave tube, and the semiconductor laser were developed; it is there that pioneer work in telecommunications—and in many allied fields from astronomy to polymers—progresses daily.

But Bell Labs now is facing tightened economic strictures, changes in research emphasis, and Federal antitrust pressure. With its 16,177 employees and \$656.5 million budget for 1975, the institution for the first time finds itself almost in a defensive position.

Bell Labs has been criticized for lagging in developing new semiconductor technology and of not being responsive enough to change. Answering those critics, and giving his views on the labs' approach to technology, is William O. Baker, president of Bell Labs. He was questioned by the editors of *Electronics*.

Q. Bell Labs has been accused of being slow in developing and implementing new technology. Have you made any changes to get technology into the network faster?

A. Yes, we're doing it by much more detailed planning with operating companies. AT&T has taken a strong lead in organizing the operations so that operating companies can begin to talk and work with us at very early stages of operational innovation. Efficiency, cost of new connections, and other things like that are discussed in technological terms very much earlier. We're even involved in systems development. For example, we're automating the telephone system—not just a switching operation.

Q. Does this earlier contact with operating companies answer the complaint that you were aloof from user needs?

A. Yes. Formerly, we didn't have an opportunity, or take pains, to find out what the user would do—call it marketing deficiencies. We've changed that drastically now.

Q. What new systems are coming out of this new approach?

A. We are developing repertory dialing systems and have installed transaction telephone to give credit information directly.

Q. Is Picturephone an example of a development that didn't satisfy the market?

A. Yes. It was unsuccessful because of two things we didn't have: sufficient knowledge of the user's habits and price.

Q. How have you changed your approach to Picturephone?

A. We think that use for documentation, business operations, and the like would be much more appealing than the portrait use, and that will come within a couple of years. Transmission and, to some extent, switching capabilities for Picturephone are much improved.

Q. You've implied a change in emphasis. What new things are you concentrating on?

A. Well, very prominent among the other things is software technology. Software has been neglected in this country in spite of the fact that we have been the leaders in computers. The engineering of software is really one of the great challenges to the American engineering and scientific community in years to come.

Q. Along those lines, how do you envision using this new software capability in microcomputer-controlled phone equipment?

A. We think that's going to be a major factor—a very logical derivative of the minicomputers that we've got all over the place. Take the main distributing frame, a headache in our field for a hundred years. Well, we have the first minicomputer system, and the efficiency of main distributing frames has taken a jump of 20%. But we're at the next stage now—an automatic main distributing frame. There are microprocessors associated with various phases there.

Q. Are you working to get this small-computer ability into the terminal?

A. Very much so. We have had for several years a systems-research activity looking at what kind of telephone set could be created with microprocessors. Now that's been expanded.

Q. Critics say that AT&T monopolizes telecommunications technology. How do you answer them?

A. Quite the contrary. Technology developed here is in use everywhere—like the transistor. We see ourselves as a clearing house, relat-

ing opportunities and needs of telecommunications.

Q. How do you decide what to work on?

A. Economics is the major limiting factor. Those limits are very real, very practical. Our telecommunications share of the gross national product has risen much more rapidly than the gross national product—I think it's twice the rate. We believe that telecommunications spending helps the gross national product.

Q. You've pointed out how closely tied the whole AT&T-operating company-Bell Labs network is. What would happen if the Government succeeds in having Western and Bell Labs split off?

A. Because of the constant exchange between the R&D person and the field person, we see no way of serving telecommunications technology that way. People from the outside industries that are pressing for this say, "You just interpret the needs of telecommunications just as you do now. Then you put out a specification that says we need such and such equipment and we'll make it for you." It's all very systematic sounding.

The fact is that nothing could be less appropriate because the industries that suggest that—and I think they are sincere—would be the first to agree that they have maintained no continuing interest in what they've made. Maintenance is just not their business. Their warranties go for a year or two at most. When you talk to them, they say maybe they can work it out for five years, but they really don't know how. All the products they may have put in systems are not going to be made any more after five years. But the AT&T operating company is committed to a 40-year life.

Q. Don't you think independent manufacturers could work with operating companies?

A. Your manufacturers that come in from outside are just going to be frustrated at every turn, because the operating company will have to come back to them. They'll find that their field installations don't function, don't give the equipment the qualities that the manufacturer probably had fully intended to have

convert 3V logic to 15V logic

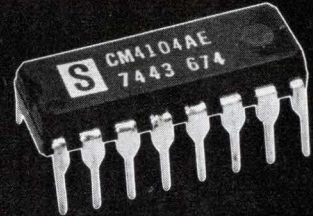

with this new Solitron CMOS chip

TTL TO CMOS LOGIC
LEVEL CONVERSION
CMOS TO CMOS INTERFACE
CMOS TO PMOS INTERFACE

Our new CM 4104A consists of 4 low-to-high voltage level translators, with an output enable control pin. All inputs are level translated, and any input may be driven more positive than V_{LO} , up to a level equal to V_{HI} . True and complement outputs are simultaneously available. When the Enable input is "low", all outputs become a high impedance. Price, \$3.62 (100 pieces).

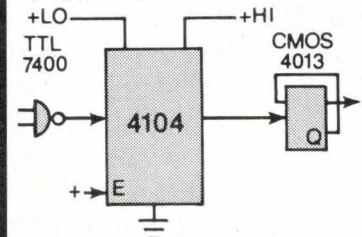

WATCH FOR NEW
DEVELOPMENTS IN OUR OVER
70 "4000 SERIES" DEVICES

Solitron

8808 BALBOA AVENUE
SAN DIEGO, CALIFORNIA 92123
TELEPHONE (714) 278-8780

You won't get a better DAC deal. Anywhere.

Because Teledyne Philbrick offers you the broadest line. The tightest specs. The best price/performance.

We're talking about our economy line DACs, for starters. The 4020 Series of 8, 10, and 12-bit DACs feature adjustment-free high performance at very low cost.

And our 4039QZ general purpose 12-bit DAC gives you a pin-for-pin, price-for-price edge in second sourcing the DAC-12QZ.

Our 4060 Series high speed current DACs have a guaranteed settling time of 60 nsec. to $\pm 0.1\%$ and give you a competitive and compatible option to Analog Devices and Datel.

Still not convinced? Our 4070 Series high speed multiplying DACs are unmatched in terms of specs and performance. Our 4072 is a 12-bit MDAC, the fastest in the industry with 500 nsec. at .01% accuracy.

In the high reliability, guaranteed performance area, we'll soon be announcing a 12-bit micro-circuit DAC which will be the fastest and most accurate for MIL-STD applications.

At Teledyne Philbrick you don't have to sacrifice spec for price. Or vice versa. We give you both.

For complete information, write for our Application Bulletins today. Or "DIAL" (our Direct Information Access Line) 617-329-1600. Teledyne Philbrick, Dedham, MA 02026. In Europe, Tel. 673.99.88, Telex: 25881. Or write, 181 Chaussee De La Hulpe, 1170 Brussels.



Probing the news

in it. Bell Labs is authorized by the Bell system and is obligated by the whole operation to apply the strict quality criteria to the installation, which Western Electric does.

Now, Western Electric gets in some tight binds sometimes because we say, "Look, your connections are not adequate, your techniques are faulty on this. We're not going to accept it. Send the whole thing back and start over again." You can imagine what an outside manufacturer would do.

Q. What would happen to Bell Labs if the Government is successful in its effort to split you away from AT&T?

A. We don't see any way to maintain the institution; it's just impossible. What these ideologists say is that there's design from Western Electric, and then we split up Western Electric, and the systems-engineering people stay with AT&T. It's absolute disaster. The operation depends on daily interaction.

Q. Couldn't you interact daily if Bell Labs became a commercial or Government lab?

A. No, because now we are working together on a single operating system, and then it would be to our interest to work separately, to work on operating systems that had somewhat different objectives. Western Electric—or any other producer—would be out to optimize production—optimize profit. That's a different set of objectives than to optimize performance—optimize reliability. It's just a head-on collision.

Q. Is there really a difference between performance and quality of the finished product on one hand and profit on the other?

A. Oh yes. The old traditional American industry—besides productivity—is economy, efficiency, a certain number of units being put out. Now lack of quality doesn't come back to bite these people, once they sell them. You sell your autos. It was very rarely, until recently, that they've come back. Drugs never come back; dishcloths never come back. In general, the productivity side—the production side—just doesn't have to live with the finished product. □

The Returnables

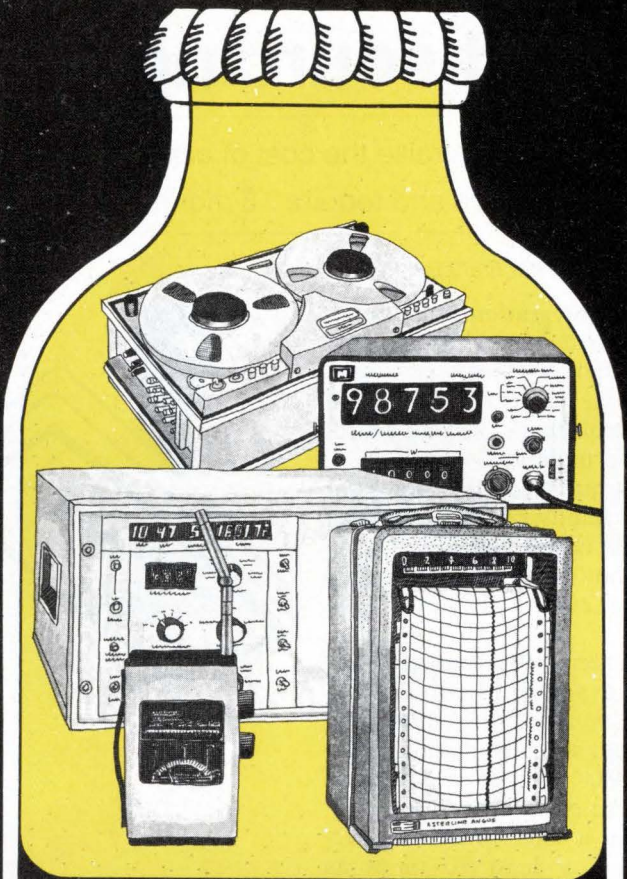

RENT-EM FROM GE

When you only need an instrument for a specific length of time, buying, maintaining and warehousing that equipment isn't economical.

Rent or lease one of our 5,000 returnables.

Call us, and we'll ship your instrument that day, calibrated to the manufacturer's specs.

Contact the GE Sales/Service Center nearest you—we have over 100 in major U.S. cities.

Better yet, call collect, and we'll send you a FREE Rental Catalog. (518) 372-9900.

Quick-rental*
instruments

*Trademark General Electric

GENERAL  ELECTRIC

Microprocessors

Second-sourcing gets tricky

Chip complexity can raise the cost of copying a microprocessor as high as \$2 million and require 18 months of development

by Bernard Cole, San Francisco bureau manager

Large-scale integration and microprocessor technology, plus the penetration of market areas where electronics has never been before, have made the problems of second-sourcing more formidable.

Second-sourcing a microprocessor or a whole family of microprocessor components is not as easy as copying, say, an 1103 random-access memory or even a 4,096-bit RAM version.

Ben Anixter, MOS market manager at Advanced Micro Devices Inc. in Sunnyvale, Calif., which happens to be second-sourcing Intel Corp.'s 8080 microprocessor, says one measure of the degree of difficulty lies in a microprocessor's circuitry being at least 10 times as complex as the circuitry making up an 1103.

Although it's true that some of the same problems are encountered in second-sourcing a 4-kilobit RAM and an 1103, Anixter points out that for memories, both the questions and answers are much simpler. "It's like the difference between talking in sentences and in paragraphs," says Anixter. "Inside a microprocessor, it's not only the words that are important, but also the way in which you ask the words." And a second source is constrained by all the things design innovations included by the first source.

Design changes. Bernard V. Vonderschmitt, vice president and general manager of RCA's Solid State division in Somerville, N.J., says that between the time the device is first made and maybe six months from production, some changes are often made by the original manufacturer. Then the second source



gets caught in the middle and has to go through several design iterations. Sometimes he must spend a lot of money even when he thinks he's copied something that had been totally debugged. "If he copies it too quickly, he sometimes gets trapped" between later changes Vonderschmitt says.

"It's not just a matter of cutting one of these things open, seeing how they did it, and then making one similar to it," says Anixter. "If you are going to second-source a microprocessor, you have to be willing to put a lot of effort into it." And this means at least a year to 18 months of work, plus a price tag that has been estimated at \$500,000 to \$2 million, depending on the approach that is taken.

How do companies that have developed original microprocessor designs, at costs ranging from \$5 million to \$10 million, react to second

sources? At National Semiconductor Corp. in Santa Clara, Calif., developer of the IMP and PACE microprocessors, officials are resigned.

"Irritating as the problem of second-sourcing is, there's not a lot that can be done about it," says Gene Carter, director of microprocessor marketing. "The best you can hope for is just enough lead time to recoup your development costs before the second-sources jump on behind, cut the prices, and split the market. What it comes down to is a matter of timing."

To ensure it a voice in the crucial matter of timing and second sources, the Motorola Inc. Semiconductor Products division in Phoenix, Ariz., has a formal second-source pact with American Microsystems, Inc. of Santa Clara, Calif., for the production of parts in Motorola's M6800 microprocessor family. And the company is also negotiating with other firms in the United States and internationally.

Going it alone. By contrast, Intel Corp. of Santa Clara, Calif., is going it alone in the marketplace. The result, predictably enough, is a crowd of second-sourcers hoping to grab a share of the market already developed by Intel. The company's 4004 p-channel MOS device, is being second-sourced by National. Making their versions of the n-channel MOS 8080 microprocessor are AMD, Texas Instruments, the now-defunct Microsystems International Ltd. of Canada, and Mitsubishi Electric Corp. and Oki Electric Co. of Japan. What's more, an adaptation of Intel's 3000 bipolar 4-bit slice series is being made by Signetics Corp. of Sunnyvale, Calif. □

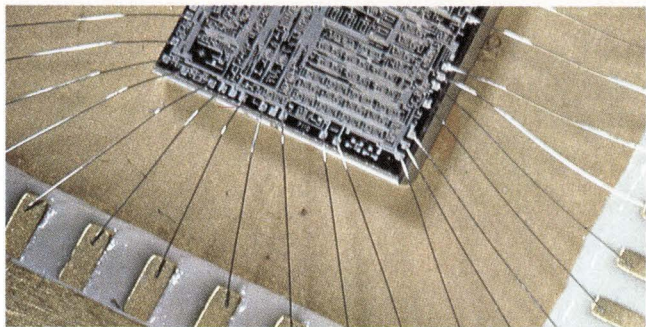

If you're planning a new product, you should know what we know about LSI.



During the past five years, we've helped our customers develop and produce numerous "dedicated" LSI subsystems in the fields of electronic timekeeping, instrumentation, medical and consumer electronics. These efforts have resulted in several outstanding product successes.

The advanced technologies of Large-Scale Integration, no matter how dramatic they may appear to be, aren't for every application.

Knowledge of the tradeoffs, pitfalls and limitations which can compromise LSI implementation is often just as important as projecting its potential benefits.

Knowing these things is our job. Things like cost/quantity tradeoffs, long-term profit analysis of the host product, how to choose the right processes to optimize performance and reliability.

If you're considering LSI, consider Micro Power first. Call us or write for some fact-filled literature on LSI—what it is, how it works, and how we can make it work for you.

We sell more than circuits. We sell solutions.

MICRO POWER SYSTEMS

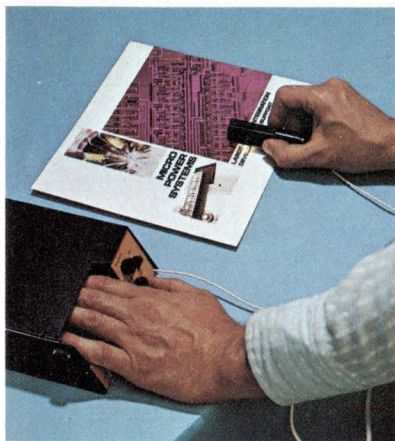
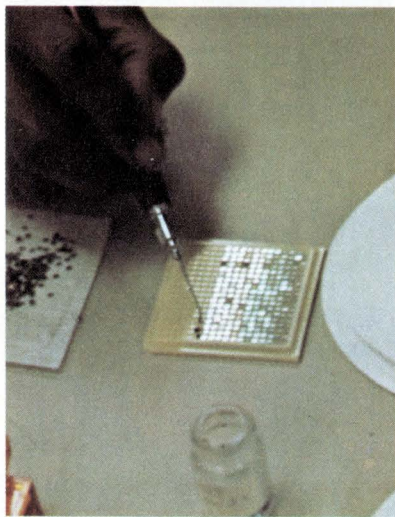

3100 Alfred Street
Santa Clara, CA 95050
Telephone (408) 247-5350
TWX 910-338-0154

MPS/Japan
21 Mori Bldg.
2-2-5 Roppongi
Minato-ku, Tokyo, Japan
Telephone 586-0371

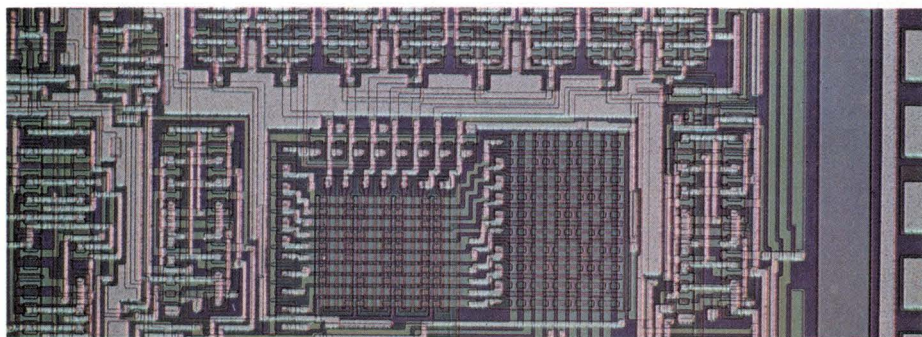

**Now! The readable
7/8-inch dial...
a fitting mate for our 7/8-inch pot!**

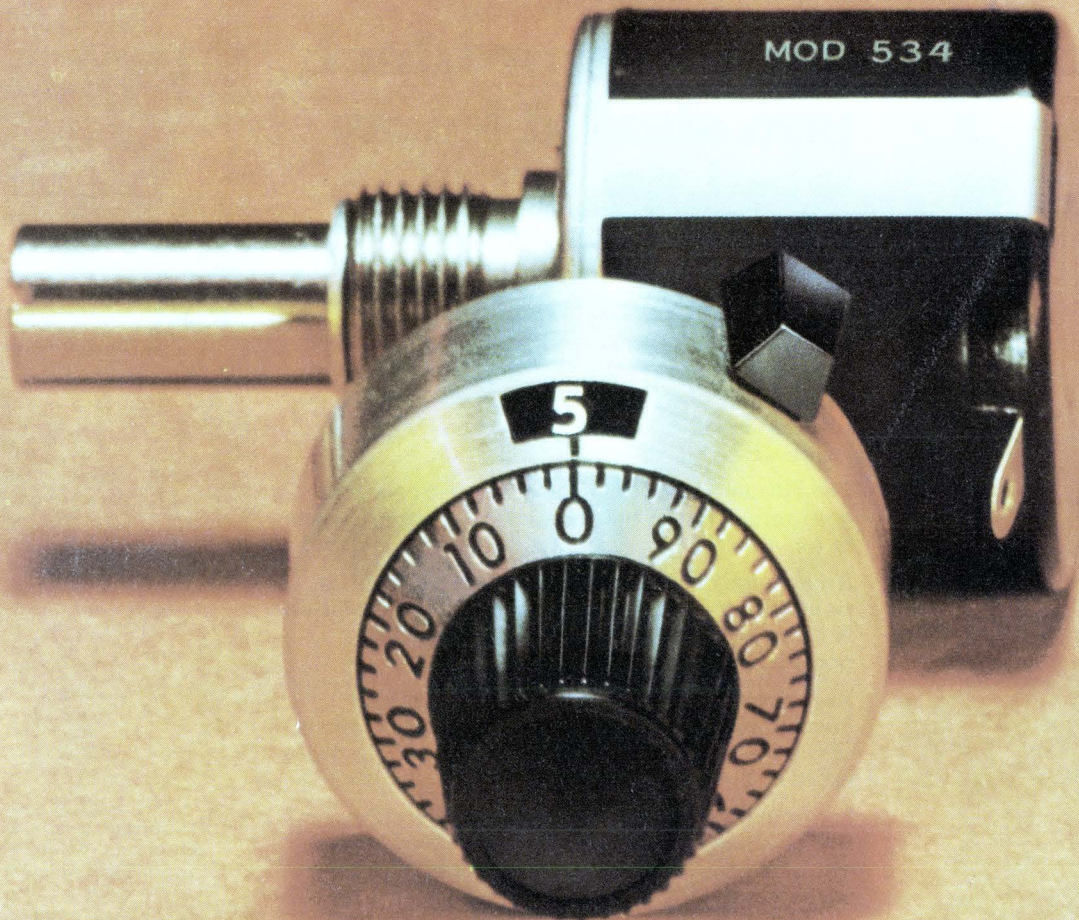

The New Spectrol Model 16 Dial

Interchangeable with competitive 7/8-inch dials — and much easier to read — it's a fitting mate for our Model 534, the industry's best low-cost multi-turn pot. Call or write for more information.



SPECTROL ELECTRONICS GROUP

UNITED STATES Spectrol Electronics Corporation 17070 E. Gale Avenue, City of Industry, Calif. 91745, U.S.A. • (213) 964-6565 • TWX (910) 584-1314

UNITED KINGDOM Spectrol Reliance Ltd. Drakes Way, Swindon, Wiltshire, England • Swindon 21351 • TELEX: 44692

ITALY SP Elettronica spa Via Carlo Pisacane 7, 20016 Pero (Milan) Italy • 35 30 241 • TELEX: 36091

Circle 76 on reader service card

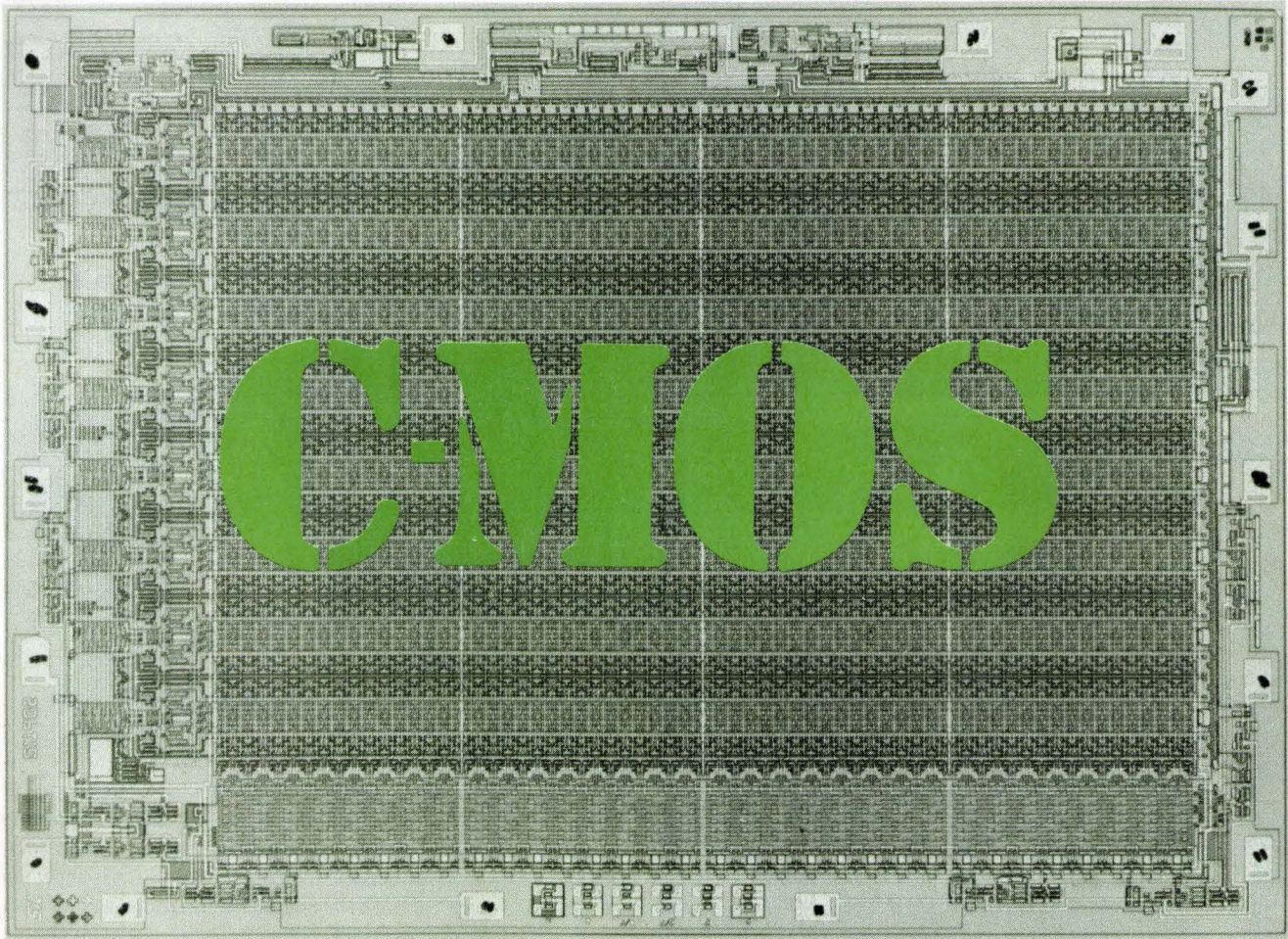

Special report: C-MOS enlarges its territory

Improved standard circuits have strengthened C-MOS's grip on process-control applications; greater chip complexity is opening up new jobs in communications, instruments, computers

by Laurence Altman, *Solid State Editor*

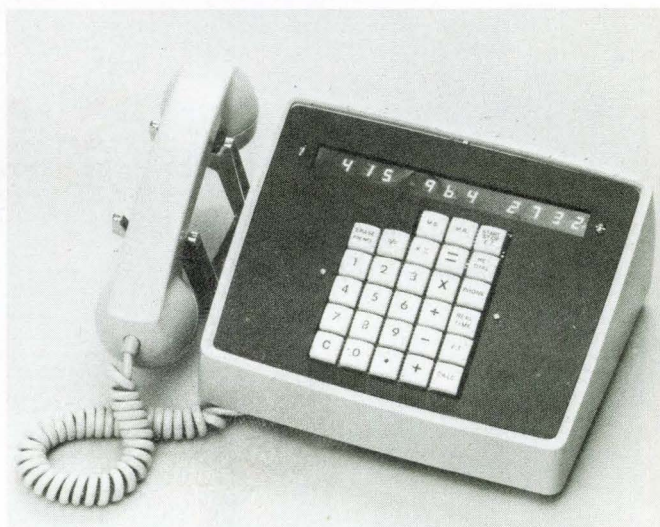
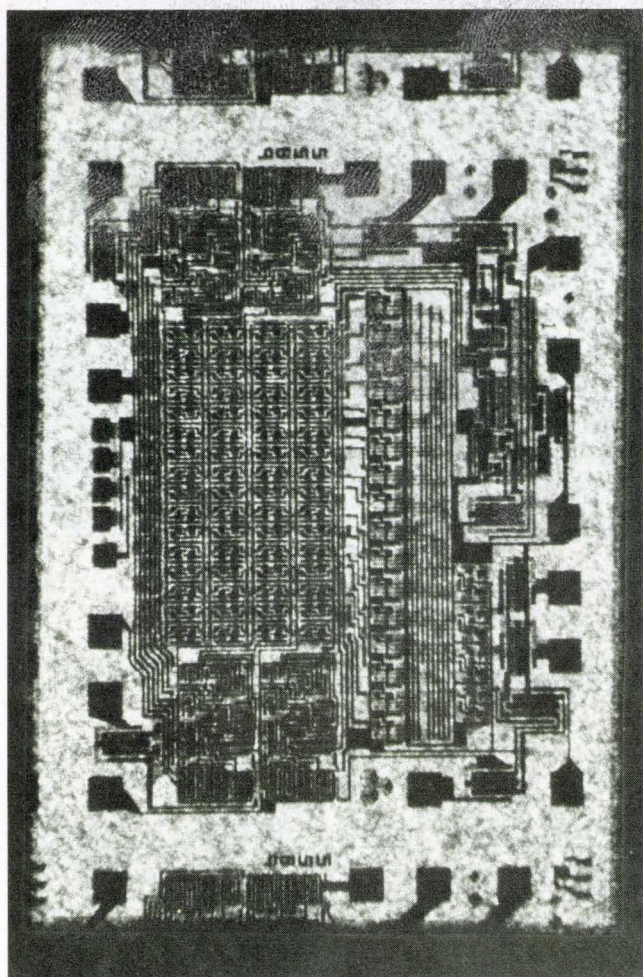
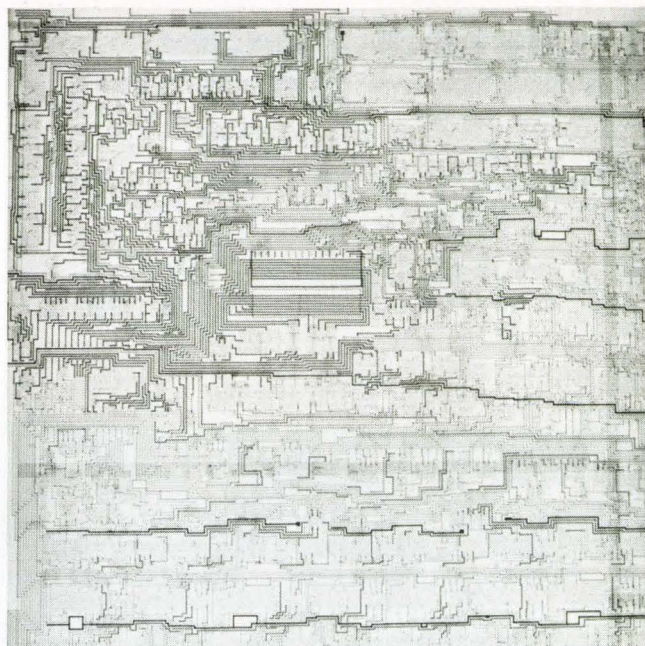
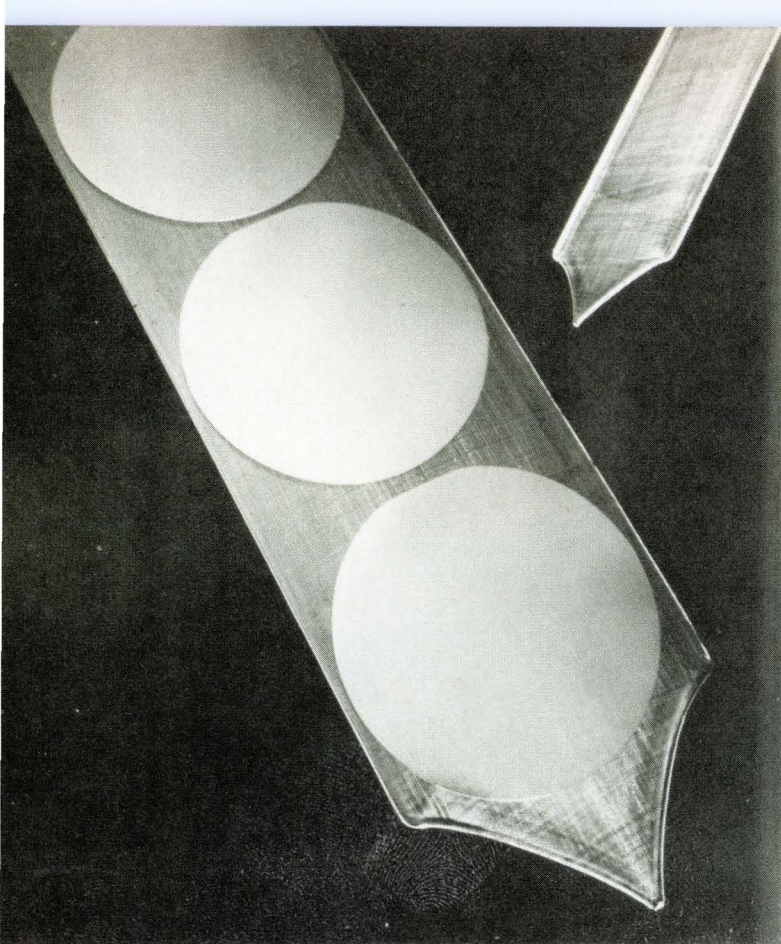

More competition from C-MOS. Long established in industrial timing and controls, complementary MOS devices are now meeting the performance requirements of telecommunications, instrumentation, and computers. An 8-bit microprocessor from RCA is shown in top right-hand corner, above a National Semiconductor dialing system built to show C-MOS shift-register capability. RCA's sapphire ribbon, in top left-hand corner, and Solid State Scientific's silicon-on-sapphire RAM demonstrate that sapphire substrates are one way to attain large-scale integration with C-MOS.

□ Complementary MOS is on the move. From being an industrial timing and control technology prized most for its low power needs and ease of use, C-MOS has developed into an efficient, general-purpose logic family.

The dozen or so manufacturers of standard digital C-MOS have refined and improved their methods until the chips are not only smaller, more complex, and cheaper, but also capable of operating in the megahertz range. By now, designers of communications and instrumentation can join the builders of computer systems in using the technology and in choosing from among a large assortment of medium- and even large-scale integrated C-MOS circuitry.

For communications, there are now C-MOS phase-locked-loop frequency control circuits, single-chip two-to-eight-tone encoders for telecommunications terminals, fast bit-rate generators, and binary-coded-decimal-rate multipliers. What's more, such interface circuits as IC modems, byte-sized bit and line drivers, and universal asynchronous receiver/transmitters (UARTs) are all becoming available.

For instruments and displays, there are BCD decoders, seven-segment latch decoder drivers, and three-digit counter-latch multiplexers. New hex contact-bounce eliminators also can replace dozens of TTL packages in phone terminals.

For interfacing with computers, there are 128-bit to 1,024-bit shift registers, full adders, and counters of all types—binary, BCD, up/down, and programable. Other C-MOS designs are bus registers, data selectors, complex decoders, multiport registers, and even 4- and 8-bit arithmetic logic units.

Finally, C-MOS technology has invaded the microprocessor and memory realm with new random-access and read-only memories, shift registers, and one- and two-chip microprocessors. RCA Solid State in Somerville, N.J., is well ahead with an 8-bit parallel processor that will ultimately use a silicon-on-sapphire substrate to achieve microsecond instruction time at micro-power operation. Solid-State Scientific Inc., Montgomeryville, Pa., is also banking on sapphire to boost C-MOS operation to the high speeds necessary for 8-bit microprocessor applications.

Other companies are taking the silicon-gate route to high-performance microprocessing. Intersil Inc., Cupertino, Calif., for one, is working on a 12-bit silicon-gate C-MOS processor chip that will take advantage of existing PDP-8A software for the emulation of 12-bit computer systems.

Complementing these microprocessor chips is a host of memories and input/output and interface circuits that promise complete families of C-MOS computing elements. Today's 1,024-bit C-MOS memories, built on both bulk and sapphire-film substrates, already are capable of 100- to 300-nanosecond access times at practically zero quiescent power dissipation—devices that virtually solve the volatile-memory problem. By the end of this year, 1,024-to 8,192-bit ROMs will be on hand to supply the storage needed in microcomputer-based designs.

All this new interest in complementary MOS's capabilities has been stimulated not just by technological progress but by sharply reduced prices. According to George

Riley, RCA's C-MOS market manager, while the average selling price of a C-MOS gate was well above 50 cents a year ago, today it is 20 cents and as low as 15 cents in large volume. For many applications, C-MOS costs less than equivalent TTL circuits and can be bought from more suppliers. Now, as Colin Crook, marketing manager of MOS at Motorola Semiconductor, Phoenix, says, "We no longer need to sell C-MOS's low-power, easy-to-use features and apologize for its price—we can now sell C-MOS's low price and boast about its low-power, easy-to-use features into the bargain."

The low prices, together with the availability of a full range of high-performance C-MOS parts from many high-quality semiconductor suppliers has been turning on the C-MOS market. In the U.S., it shot up to \$90 million in 1974, well above the previous year's sales.

But these high volumes at low prices could spell disaster for the inefficient supplier, since every manufacturer, to remain competitive, will have to follow his pricing down the industry learning curve. This is what happened with TTL, and this is the year that will determine how many of the dozen suppliers can hack it in a newly competitive price-performance C-MOS world.

What's so good about C-MOS?

C-MOS is virtually immune to noise, runs off almost any power supply, and is an extremely low-power circuit technique. In the off state, C-MOS draws zero power, and even when operating at moderate speeds, an entire 100-gate logic array will typically draw less than 0.1 milliwatt.

The low power of C-MOS follows from its basic inverter configuration, with n- and p-channel transistors connected in parallel. When one device is on, the other is off, and the net quiescent current is simply the leakage current of the off device—less than 1 nanoampere, in modern MOS processing. But even when operating, both transistors are only partially on for only a fraction of the operating interval, so that the current drawn is still in the microampere region. At moderate speeds in the 10-to-11 kilohertz range, power dissipation is less than a microwatt per gate. The power dissipation does, of course, rise at higher frequencies, so that at TTL speeds metal-gate C-MOS structures may dissipate as much as 20 milliamperes per gate.

Then, unlike every other logic family, C-MOS circuits don't need expensive close-tolerance power supplies or expensive on-card regulation. Because an inverter configuration is so insensitive to voltage variations, the circuits function happily off anything from 3 to 15 volts.

Perhaps most important, because C-MOS has a nearly ideal logic-transfer characteristic, it is extremely immune to noise. This immunity makes C-MOS a powerful logic technology for such environments as the automobile and factory. Its guaranteed noise margin is approximately 1.5 volts, compared to TTL systems with noise margins of only 0.4 V, so it's obvious why C-MOS logic circuits for seat belt interlocks, electronic ignition, and injection fuel systems are already being built. In manufacturing process-control equipment, too, standard C-MOS logic circuits are rapidly replacing TTL packages.

1. Advances in C-MOS technology

Performance is enhanced, chip complexity increases

Before C-MOS technology could invade communications and other new applications areas, ways had to be found to increase chip complexity to LSI levels. And standard C-MOS, too, has improved steadily over the last five years, as ways have been found to increase its output drive capabilities and decrease its sensitivity to input and output patterns.

As a supplement to the 4000 series, the upgraded B series of standard C-MOS chips is now available from most C-MOS manufacturers. Its superior input, output, and internal transfer characteristics all make it easier to use than the earlier series.

An example of an improved diode protection circuit (Fig. 1) shows a three-element structure built by Siltek, a new supplier of C-MOS circuits located in Bromont, Canada. Without such protection, C-MOS operation is affected by dc and transient input patterns, as evidenced by a shifting of the switching threshold with the selected input and a variation in output drive capability with the number of inputs selected.

In standard unbuffered C-MOS circuits, pattern sensitivity at the output was a problem. For example, in the unbuffered two-input NOR gate (Fig. 2a), either of the n-channel transistors connected to ground (V_{SS}) conducts when either input is high, causing the output to go low through the on resistance of the conducting device. If both inputs are high, both n-channel devices are on, and this has the effect of halving the on resistance by making the output impedance (and hence fall time) a function of input variables.

Similarly the p-channel devices are switched on by low signals; that is, when both inputs are low, conduction will occur from V_{DD} to the output. Since the

p-channel devices are in series, their on resistance must be decreased (by enlarging their chip area) if the output impedance is to be held within specification. As the number of gate inputs increases, even larger p-channel devices are required, and the output impedance to V_{SS} becomes even more pattern-sensitive.

A conventional unbuffered C-MOS two-input NAND gate interchanges the parallel and serial transistor gating (Fig. 2b). The changes in output resistance then move to the p-channel transistors connected to V_{DD} , while the n-channel devices must be increased in size, since they are now the ones connected in series.

The advantages of buffered gates

The solution to this pattern sensitivity is the buffered gates of Figs. 2c and 2d, which show fully buffered NOR and NAND gates, in this case supplied by Fairchild Semiconductor, Mountain View, Calif. Since there are two buffered inverters at the output of each gate, high gain is available to minimize switching threshold variations, and the output drive requirements are isolated from all input conditions.

In constructing the buffered gate, most companies use standard, small-geometry C-MOS transistors to generate the required logic function, which in turn is used to drive the low-impedance buffer stages. Consequently, process complexity is not much increased, and the layout size is kept minimal since only two large output transistors are required in any circuit configuration. Meanwhile, the rise and fall times at the output of the gate are independent of input pattern.

There's even a bonus or two. One is increased system speed, since the internal logic gates can be driven harder and the output buffer stages used to minimize the resulting increase in distortion. This means that the designer now has a means of making propagation delay less sensitive to output load capacitance.

Another advantage of the buffered gate is improved noise immunity. Nearly ideal transfer characteristics are realized (Fig. 3a) because of the increased voltage gain—greater than 10,000.

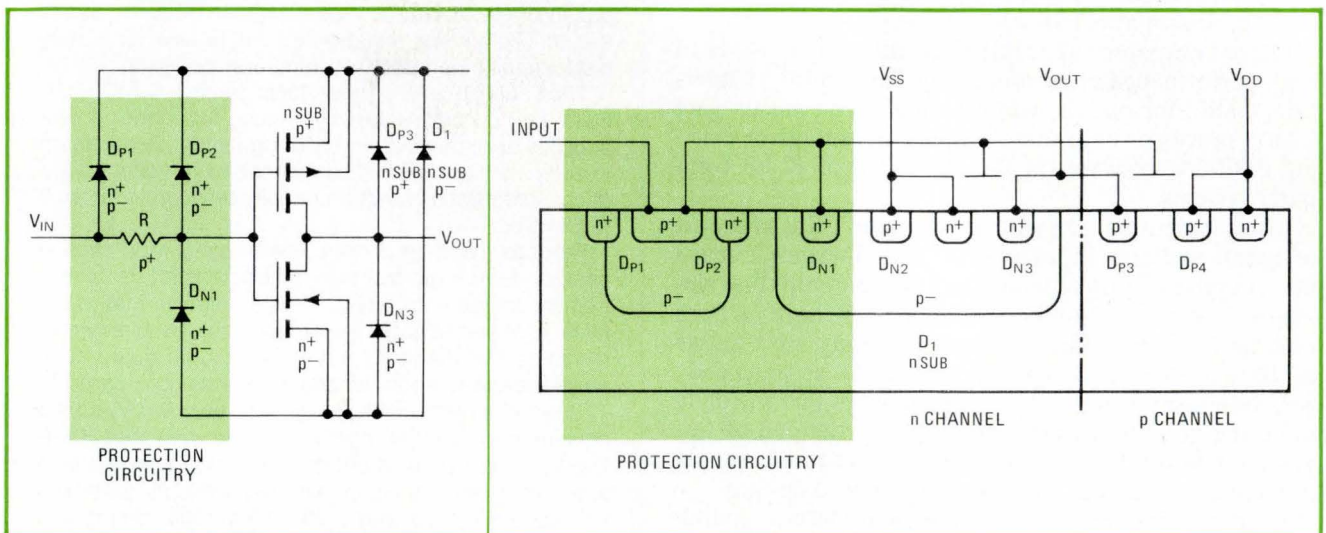

1. Well-protected. This three-diode input protection scheme from Siltek makes C-MOS circuits even easier to use by assuring smooth operation over a wide range of input levels. On silicon the circuit lays out on very little additional space.

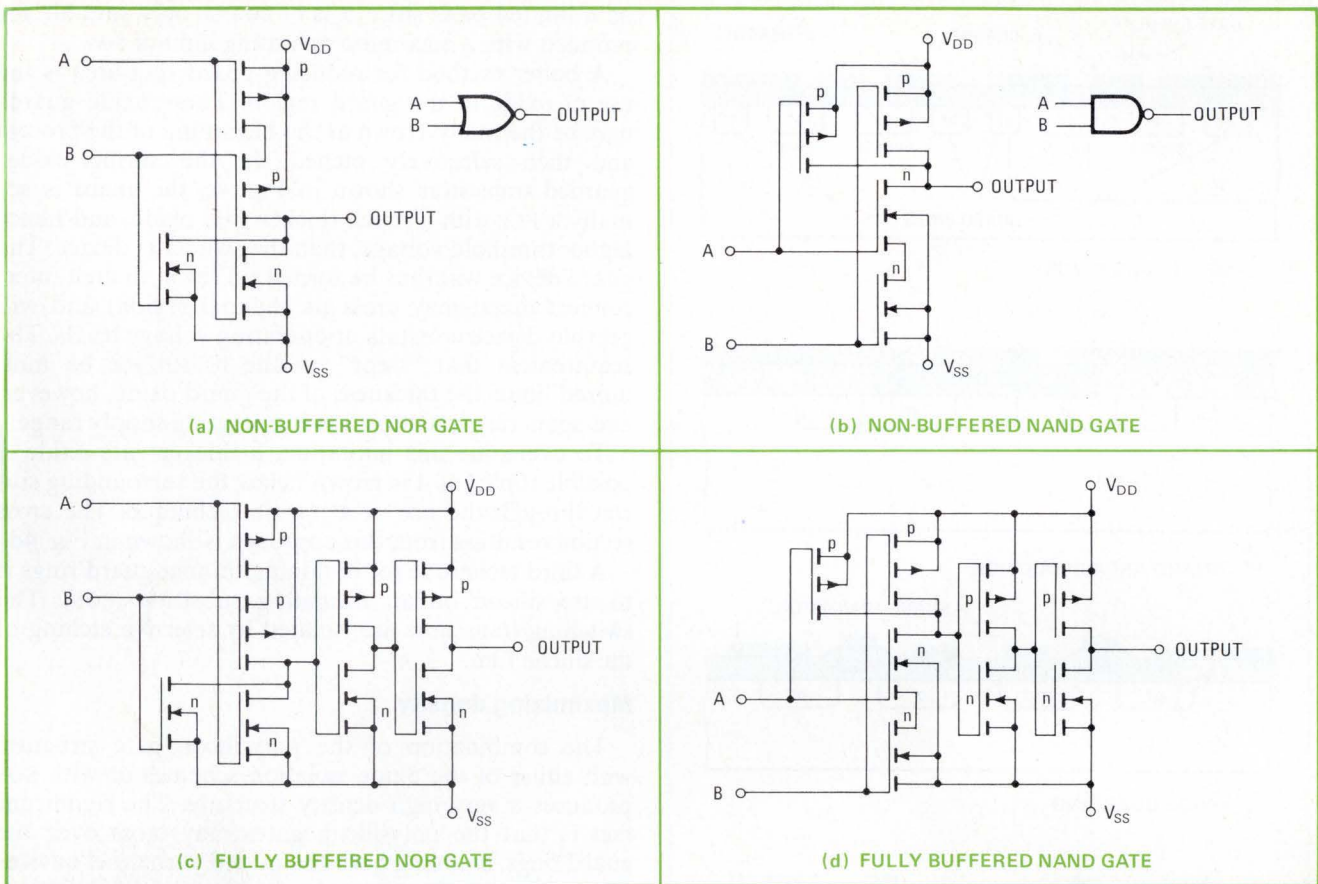

2. B for better. B-series C-MOS circuits containing buffered gates increase drive outputs and minimize the pattern sensitivity that could otherwise trouble them. B-series 4000 C-MOS circuits are now widely available, and those shown here are from Fairchild.

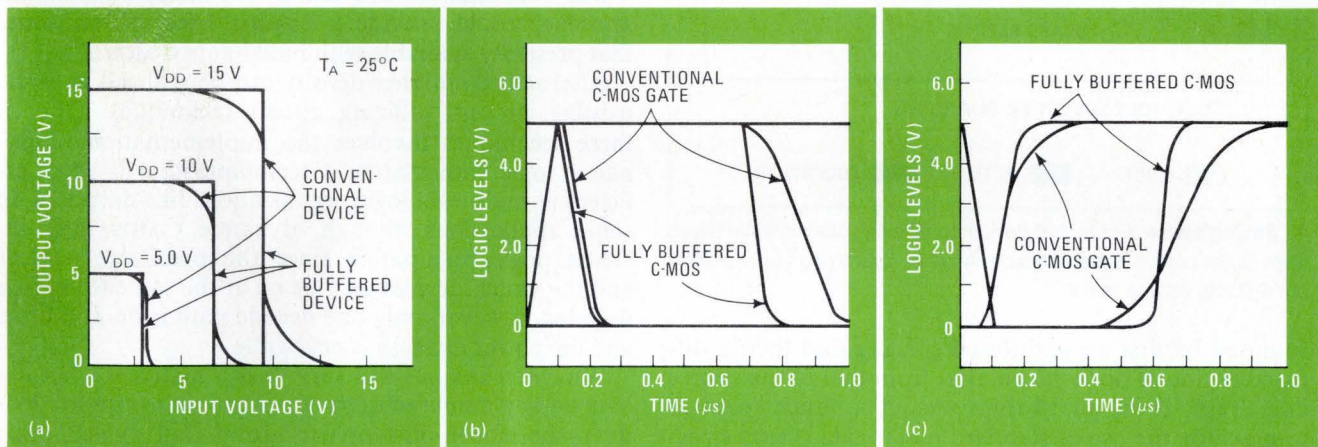

3. In good shape. Buffered outputs offer better noise immunity, as shown by transfer characteristics (a), and better gain resulting in cleaner pulse shapes, as shown in the output traces (b) and (c). Data is provided by Fairchild Semiconductor.

This high gain also provides significant pulse shaping (Figs. 3b and 3c). For input transition times of 100 nanoseconds or less, the output waveforms of both conventional and buffered C-MOS gates are similar. When the input transitions are stretched to 1 microsecond, the transition times of the conventional gate are increased while those of the buffered gate remain unchanged. This feature prevents the pulse characteristics in a system from progressively deteriorating.

C-MOS designers, when faced with the demand for

more complex MSI and LSI functions, had to overcome three design factors that limited C-MOS density: metal interconnections, gate alignments, and guarding structures that separated the n- and p-channel elements in the complementary configuration.

The problem was especially acute in standard metal-gate C-MOS structures (Fig. 4a) where each device, n-or p-channel, required a metal gate that had to overlap the source and drain regions. To eliminate conductive channels between devices, each transistor needed to be sur-

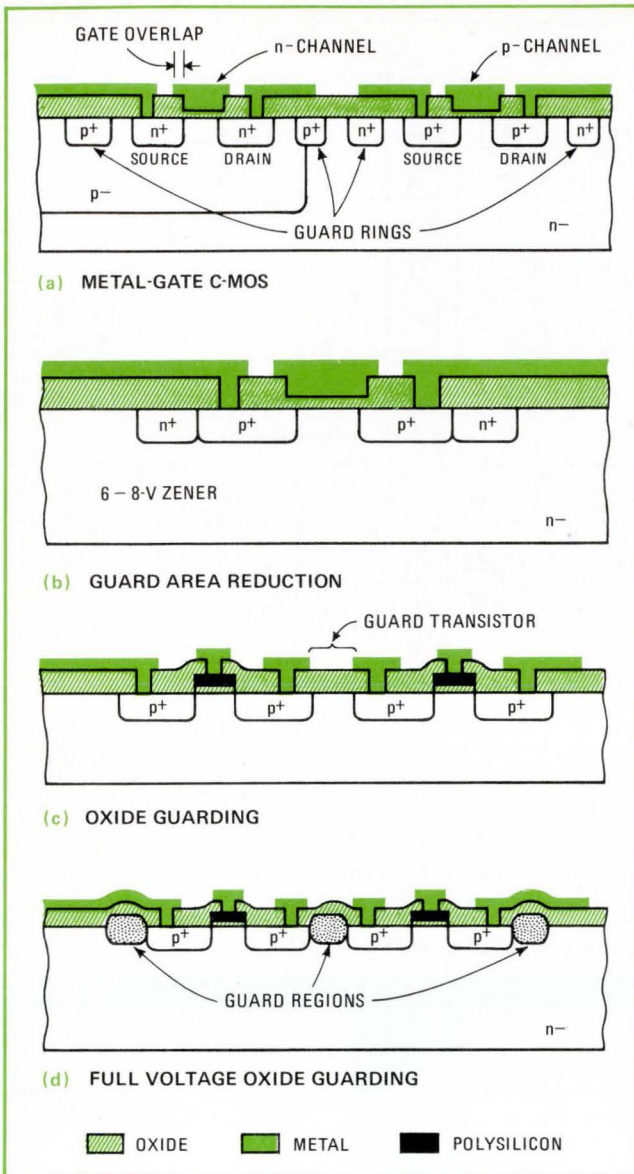

4. Saving space. For higher device complexity, conventional guard rings (a) occupy too much space. A zener guard ring (b) is smaller but restricts voltage to 8 V.

rounded by first an undiffused spacing and then a diffused region of opposite polarity from that of the source and drain. These guard rings wasted so much space as to preclude the use of standard metal-gate C-MOS structures in high-density circuit designs.

James W. Foltz, C-MOS design specialist at Motorola Semiconductor, outlines the various solutions being used for these problems. The interconnect limitation could be solved by the use of a two-layer metal system or with the use of polysilicon as the gate material. The polysilicon can be used as an interconnect crossunder and, being a self-aligning structure, eliminates the need for gate alignment tolerances as well.

A straightforward way of reducing the area required for guard rings is to eliminate the spacing between source/drain and guard diffusions (Fig. 4b). The result is the formation of n^+p^+ zener diodes with breakdown voltages of about 6-8 V. Such a technique could be used

on a limited basis since it is of course only suitable for products with a maximum operating limit of 5 v.

A better method for reducing guard ring area is the use of oxide in the guard region. These oxide guards may be thermally grown at the beginning of the process and then selectively etched. In the surface-oxide-guarded transistors shown in Fig. 4c, the guard is actually a FET with a much thicker gate oxide, and hence higher threshold voltage, than the switching device. The guard device will thus be turned off (even though interconnect metal may cross its channel region) and will prevent device crosstalk at operating voltage levels. The requirement that "steps" on the IC surface be minimized limits the thickness of the guard oxide, however, and again restricts it to a lower operating supply range.

To overcome this limitation, a thicker gate oxide is possible if part of it is grown below the surrounding silicon through the use of a nitride technique. The cross section resulting from this approach is shown in Fig. 4d.

A third technique for obtaining thinner guard rings is to use silicon on an insulating substrate (SOS). The switching transistors are isolated by selective etching of the silicon film.

Maximizing density

The combination of the polysilicon gate structure with either of the oxide isolation schemes or with SOS produces a very high-density structure. The significant fact is that the polysilicon gates may cross over the guard rings, enabling both the n- and p-channel devices of an inverter, for example, to be fabricated with a single run of polysilicon and with only one gate contact. When combined with a multilayer metal system, this approach could provide a density three to four times that presently available with metal-gate C-MOS.

Alternatively, higher density can be realized with the existing process utilizing circuit techniques. One of these techniques involves the implementation of dynamic logic with C-MOS, a technique that is most efficient in multilevel logic organizations like decoders. In some applications, though, dynamic C-MOS may increase power dissipation since the precharge devices and the switch devices may be on at the same time. In a decoder, however, only one decode path is on at a time, and the power increase is negligible.

Which techniques will survive is a matter for hot debate among manufacturers. Two distinct camps are evident—the silicon-on-sapphire group (led by RCA, the originator of C-MOS technology, as well as old-time C-MOS suppliers such as Solid State Scientific, Harris, and perhaps Motorola) and the newer C-MOS suppliers (National, Fairchild, TI, Signetics, AMI, Intel, and Intersil), all of whom have mature silicon-gate, n-MOS, and bipolar alternatives. These manufacturers feel that sapphire technology, although clearly better than bulk C-MOS for LSI applications, is too costly a program for them to pursue. For achieving higher-performing LSI circuits, they look to their other technologies, maybe n-MOS structures refitted with depletion loads or perhaps low-power integrated injection logic. On the other hand, RCA has long been working with sapphire and sees the material development as an evolutionary process.

2. Special functions in C-MOS

Communications subsystems need just one chip apiece

In the more demanding MSI and LSI C-MOS applications, a major trend is toward the complex circuit that fits on one chip yet provides a complete function in communications equipment or instrumentation. Perhaps the best example is Motorola's new 400 series, which, according to C-MOS product manager Bob Berner, "finds a middle ground between standard and custom implementation."

All chips in the 400 series are (or will be) medium- or large-scale circuits, each a subsystem in itself and some of them optimized toward a particular application, says Berner. And, he adds, "naturally they are completely compatible with the rest of the C-MOS family, which gives the system designer an enormous choice of peripheral logic functions to use in conjunction with the subsystem chips."

Already offered or about to be introduced in the 400 series are such functional blocks as a two-of-eight tone encoder, bit-rate generator and multiplier, quad-precision time/driver, and contact-bounce eliminator. All are monolithic implementations of complex functions that previously required tens of packages of transistor-transistor logic.

The two-of-eight tone encoder, for example, is typical of the C-MOS complexity now achievable with the standard bulk process. As the block diagram in Fig. 5a shows, the circuit is functionally designed to digitally synthesize the high- and low-band sine waves specified for telephone tone-dialing systems. The chip therefore contains an oscillator and multiple key disabling circuit, two divide-by-N control modules, two counter-registers, decoders, and two sine-wave generators, as well as on-chip pull-up resistors and full diode protection on all inputs.

In operation, a signal from a four-by-four-push-button keyboard connects one row and one column simultaneously to V_{SS} , turning on the chip's oscillator which provides the master clocking. The signal then goes through the counter and decoder logic to the sine-wave generator. Here, the high- and low-band signals are mixed in the resistor network to produce a signal specific to the particular keyboard button pushed.

It's worth noting that each generator output has an npn bipolar transistor that provides the low output impedance of 200 ohms and the high output drive currents of up to 0.75 ampere needed to drive conventional telecommunication lines. As a result, the tone encoder, designated MC-14410, can drop right into a standard telephone key-pad circuit with a minimum of interface circuitry. But the 410 will also be useful in mobile and radio telephones, process-control equipment, point-of-sale terminals, and credit card verification terminals. In fact, it has already been designed into alarm systems for generating set and opening codes and is being sampled by terminal-equipment manufacturers for use in por-

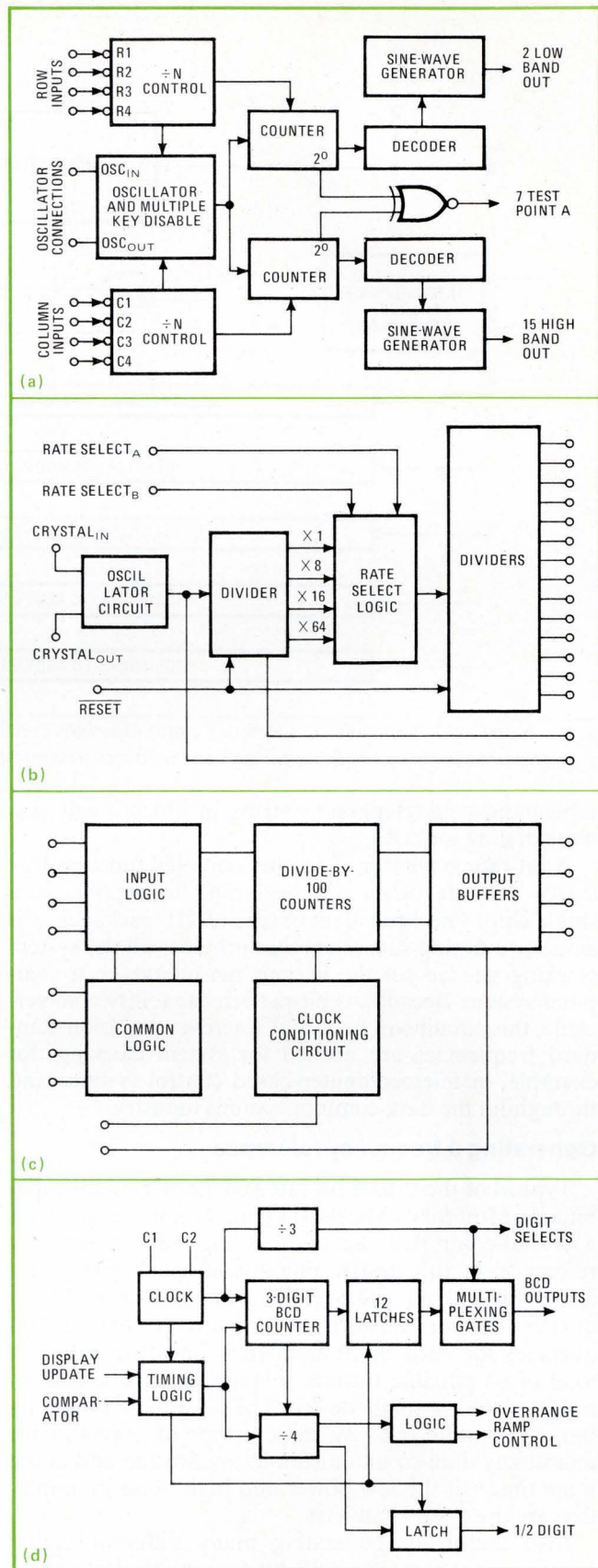

5. Better communication. Motorola puts complex functions on single chips. Tone generator (a) is for touch-tone dialing; bit-rate generator (b) provides wide range of frequencies, timer-driver (c) and converter logic (d) are aimed at printers and displays.

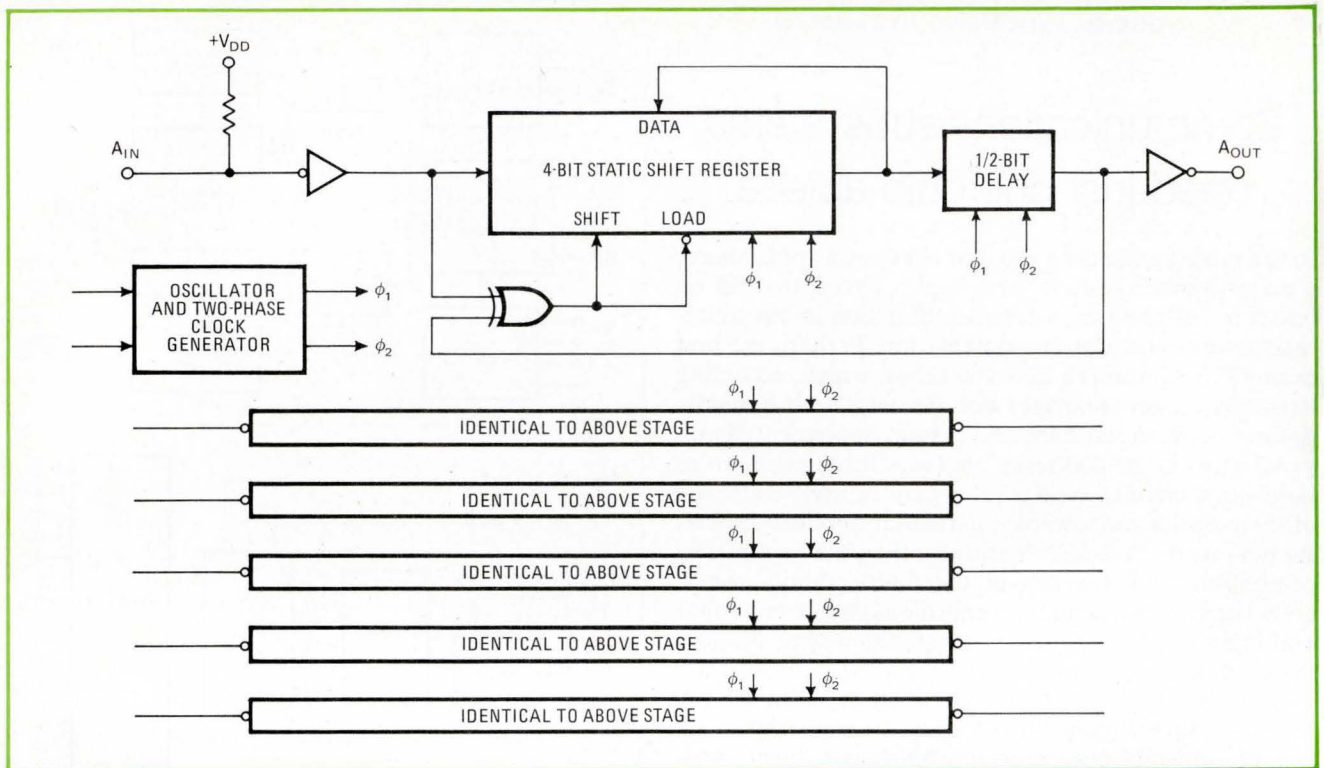

6. Bouncing made harmless. This Motorola circuit eliminates contact bounces that plague mechanical telephone switching. It takes an input signal from any of six bouncing contacts and produces a clean digital pulse after input has stabilized. No spurious signals are generated.

table hand-held telephone systems, in which it will generate dialing tones.

A bit-rate generator is another complex function that C-MOS manufacturers are beginning to supply on a single chip. The equivalent of tens of TTL packages, it is actually a timing subsystem that provides all the system clocking needed for the various peripherals in a computer system. Because its bit-pattern capability is so versatile, this circuit will be useful wherever precision standard frequencies are needed for system clocking, for example, in microcomputer-based control systems and throughout the data-communications industry.

Generating a frequency reference

Typical of the C-MOS bit-rate generator's circuit capability is Motorola's MC-14411 (Fig. 5b), which contains a crystal-controlled oscillator as the stable frequency reference. In this design, one of four clock rates is selected by a 2-bit address and passed through a frequency divider network to provide 16 output frequencies for each input frequency. In other words, a total of 64 possible bit-rate frequencies can be accommodated with a single device. The advantage to the designer is that he can buy just one type of generator for almost any data-communications application and at the same time get the low power and high noise immunity that are the C-MOS hallmark.

Also useful for generating many different digital functions is RCA's CD4089B bit-rate multiplier, an MSI implementation of a frequency synthesis circuit that usually requires many small-scale packages. The chip yields an output pulse train that is proportional to the product of two inputs. Since one input is just the clock

frequency and the other a pre-programmed multiplier number (binary or BCD) whose value is fixed at a given instant, the 4089B is a convenient way of obtaining a frequency of almost any multiple of a standard clock pulse.

Indeed, this rate multiplier is finding applications throughout the C-MOS spectrum, in numerical control, instrumentation, and digital filtering, as well as frequency synthesis. Moreover, when used with an up/down counter and control logic, it can multiply, add, subtract, generate algebraic equations, and even solve differential equations, integrate, or raise numbers to various powers.

Driving a fast line printer

A chip specifically designed for high-speed line printers is a quad-precision timer/driver, another Motorola 400 series part. Designated MC-14415, it can also be used wherever precision pulse widths are required. In a line printer, the timer/driver function (Fig. 5c) is realized as a hammer driver circuit supplying the critical timing pulses. The output pulse width of each digital timer is a function of the input clock frequency: once the proper input sequence is detected, the output buffer is set (turned on) and is reset (turned off) only after 100 input clock pulses are counted. Bipolar output buffers on the chip enable the 415 to drive directly the Darlington power transistors that can be found in most of today's printers.

C-MOS's low-power dissipation is a very evident advantage in the 415, which packs enough complex circuitry on the one chip to replace four analog one-shots and their assorted control logic. Until now, the analog

one-shot has been the most common means of implementing the hammer-driver function, but it consumes many tens of milliwatts of power and needs expensive precision-resistors and capacitors as well as several packages of digital logic for controlling the outputs. On the other hand, timer/drivers such as the 415, being composed of C-MOS all-digital elements, consume a tenth the power and are at least an order of magnitude more accurate than the older methods.

Handling high voltage breakdowns

Another growth opportunity for improved C-MOS circuits is in relay and line drivers. An early entry in this market is National Semiconductor's series of C-MOS drivers, which for the first time combine the low input current and power dissipation of C-MOS transistors on the same chip as the high output-drive capabilities of bipolar Darlington transistors. A modification to the C-MOS process also enables the devices to achieve the very high voltage breakdowns of 30 to 60 V that are necessary for telecommunications systems but that till now could only be handled by TTL drivers.

The first in this line from the Santa Clara, Calif., firm is a dual relay driver, 74C908/918. It is specified at 56 V breakdown and packaged in a 14-lead, 2.5-watt package. Two C-MOS NAND gates and an emitter-follower Darlington pair fit on a chip measuring only 72 by 83 mils, with the result that almost 0.5-ampere drive currents are available at the outputs.

According to Clark Davis, National's C-MOS design manager, the new parts are fabricated with standard C-MOS diffusion techniques, except that great care was taken in laying out the bipolar devices to prevent substrate currents. These, he says, "can kill you when high-current Darlington devices are contained on the same chip as low-current C-MOS devices."

Davis points out that the big advantage of these drivers over TTL equivalents is the almost zero quiescent-power dissipation of C-MOS circuits. "They'll be sitting out on a telephone line, drawing no more than a little leakage current when not operating. By contrast TTL relay drivers draw 10 to 20 milliamperes even on standby," he explains.

Countering contact bounce

Last in this group of C-MOS communications circuits is the contact-bounce eliminator circuit. It alleviates one of the biggest problems with mechanical switches—namely, that when activated, they actually bounce into and out of mechanical contact and provoke a period of extraneous level changing. To counter this bounce and prevent actuation on false signals, a delay must be built into the circuit, and for one switch, this is not hard. It becomes much harder in many more complex multiswitch systems, such as telephone switching networks, and indeed, the Bell System's mechanical-switch-bounce eliminator is a costly and cumbersome arrangement of filters, latches, and analog one-shots. What's more, the delay method eliminates bouncing only from the simple single-pole double-throw switch.

Enter the hex contact bounce eliminator (Fig. 6), which works on both make and break cycles. This cir-

cuit takes an input signal from any bouncing contact and generates a clean digital signal from it four clock periods after the input has stabilized.

In the Motorola MC-14490, each bounce eliminator is composed of a 4½-bit shift register plus some logic. During each clock edge the state of the input is shifted into the register and compared with the register's contents by the logic. When all the bits in the shift register are the same—four clock edges with input in the same logic state—the output signal goes to the level of the input signal. This inserts a delay of four clock pulses between the input and output signal change. The transition is sharp, and no false signals are generated.

Altogether, the 14490 debounces six switches, with the aid of one small external capacitor that adjusts it for the required operating frequency. The only other external components required are a pull-up resistor on each of the inputs, to switch ground input signals like those coming from relay contacts and push buttons. By switching ground, rather than a power supply lead, shorts and other faults won't cause excessive currents.

3. Data processing and C-MOS

Logic, memory, I/O chips build computer systems

C-MOS's biggest move of all is into the main-line data-processing area. Here, MSI and LSI circuits are performing many arithmetic and logic operations required in computer-control equipment, often at a more attractive speed-power performance than that of TTL circuits.

RCA's soon-to-be announced 4-bit ALU is a C-MOS implementation of the popular 74181 TTL part that's a basic building block of many of today's logical control systems. The CD40181B, like its TTL counterpart, can perform 16 arithmetic operations, including add, subtract, shift, and compare, as well as 16 logic functions of two Boolean variables, without needing any external circuitry. When used with a companion look-ahead carry logic chip, CD40182B, it can perform high-speed logic operations well into the megahertz range. But if high speed is not needed, ripple-carry inputs and outputs are available on the chip.

The 181 ALU plus a few standard C-MOS packages makes a 4-bit data slice for a micro-controller (Fig. 7). Less than a dozen parts are needed, among them a C-MOS shift register, a newly available multiport RAM (CD40108), and assorted latches, multiplexers, shift registers, and buffers, all in RCA's 4000 catalog.

Another approach to C-MOS data processing will be offered by Fairchild—a matched family of microprogrammable circuits that provides a wide range of data-processing capability. Called the Macrologic family, this 4-bit-slice system will come in both C-MOS and Schottky TTL versions. The C-MOS parts use Fairchild's buffered oxide-isolated technology and will of course be pin-to-pin compatible with the standard 4000 family.

Five of the chips will make a full 4-bit controller element. They include a 4-bit processor slice, a redundancy

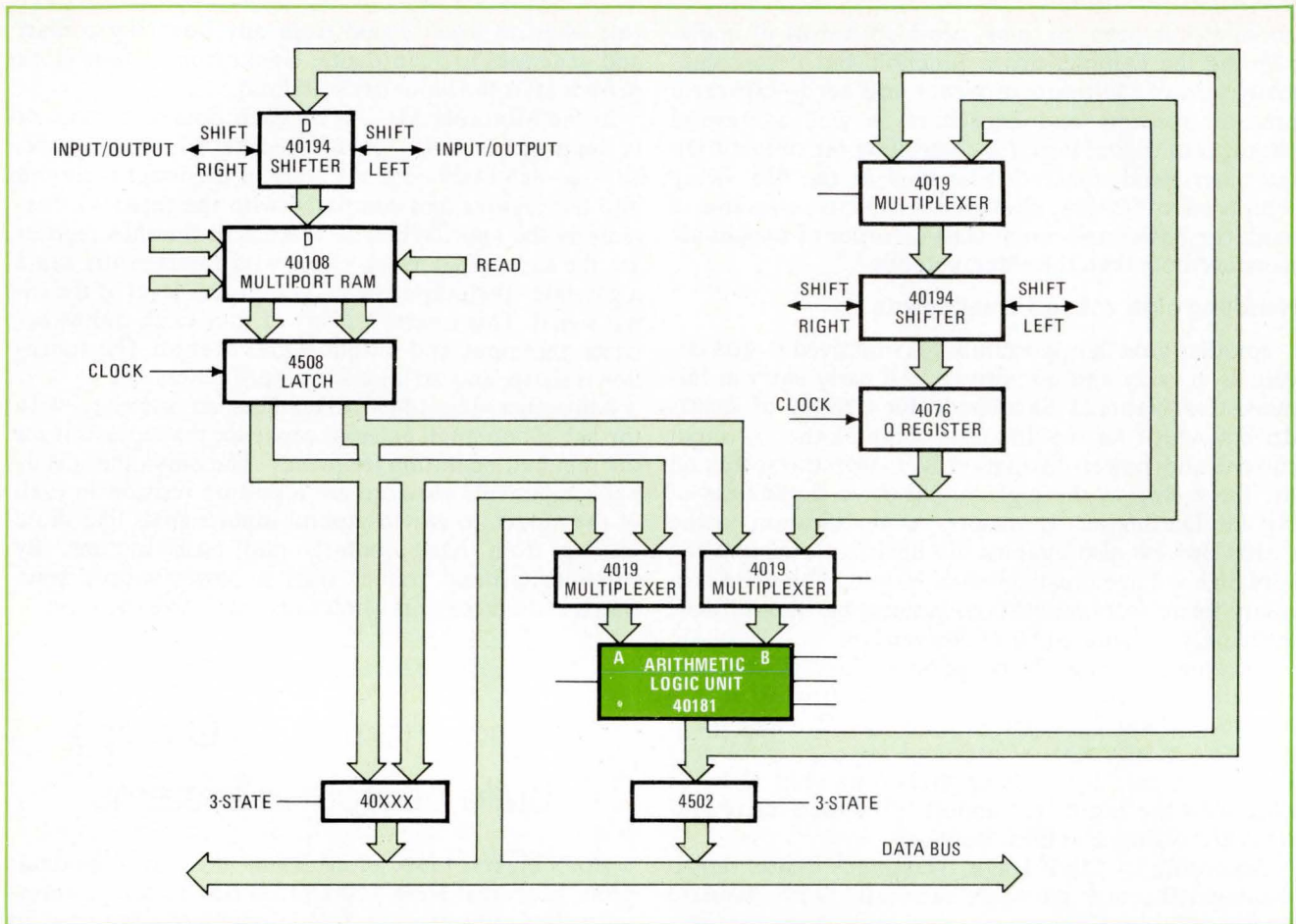

7. Expandable. By combining RCA's new 4-bit arithmetic logic unit, the 40181B, with standard 4000 parts, the designer can construct a 4-bit data-processing system that is expandable in 4-bit increments. The ALU chip is a C-MOS version of the popular 74181 TTL part.

check generator, a serial/parallel first-in first-out buffer memory, and 64-bit push-down/pop-up memory.

Microprocessors wait in the wings

If these general-purpose data-processing functions are already accelerating the trend to C-MOS computer-control designs, the arrival of C-MOS microprocessors will add an even larger impetus. Already at least three suppliers have made public their microprocessor development programs—RCA, Solid State Scientific, and Intersil—and several others, such as Motorola, Harris Semiconductor in Melbourne, Fla., American Microsystems Inc., Santa Clara, Calif. Siltek in Canada, and perhaps National Semiconductor and Intel Corp., both of Santa Clara, Calif., all may yet choose to build C-MOS processor chips.

RCA's microprocessor design, presently a two-chip version that uses standard metal-gate C-MOS technology, is soon to be followed by single-chip design using silicon-on-sapphire techniques. An 8-bit parallel processor, it has a small repertoire of instructions that fits a wide variety of input/output requirements—TV sets, keyboards, audio cassette players, typewriters, floppy disks, communication lines, and even a mini-computer can be interconnected to the system.

Called Cosmac, the system has at its heart a 16-by-16 scratch pad, and any reference to memory is made via

one of these 16 registers. Addressable memory is 65,536 8-bit bytes. An 8-bit two-way data bus interconnects the processor, any mixture of RAMs and ROMs, and the peripheral devices. The CPU presents to the system a 40-pin interface that handles, for example, the 8-bit data bus, eight lines for multiplexing out 16-bit addresses to the RAM or ROM, clock, reset, and load controls, and two signals to control memory read and write.

The flexibility of the Cosmac concept is evident in Fig. 8, since most standard microcomputer operations can be achieved with very few packages. Easily performed are such jobs as controlling I/O devices, transferring binary data between I/O and memory segments of the system, and moving memory bytes between different memory locations. Harder operations, such as interpreting or modifying bytes stored in the memory, need the aid of signals on flag buses from I/O circuits.

Unlike RCA's processor program, which is proceeding in two stages, Solid State Scientific, in a joint venture with General Electric, is going directly into silicon-on-sapphire C-MOS with an 8-bit microprocessor. Although the performance specifications are not as yet available, they are expected to exceed those of today's n-MOS chips—for instance, instruction times may be 1 to 2 microseconds or better.

Intersil, on the other hand, is developing an entirely independent but complete silicon-gate C-MOS micro-

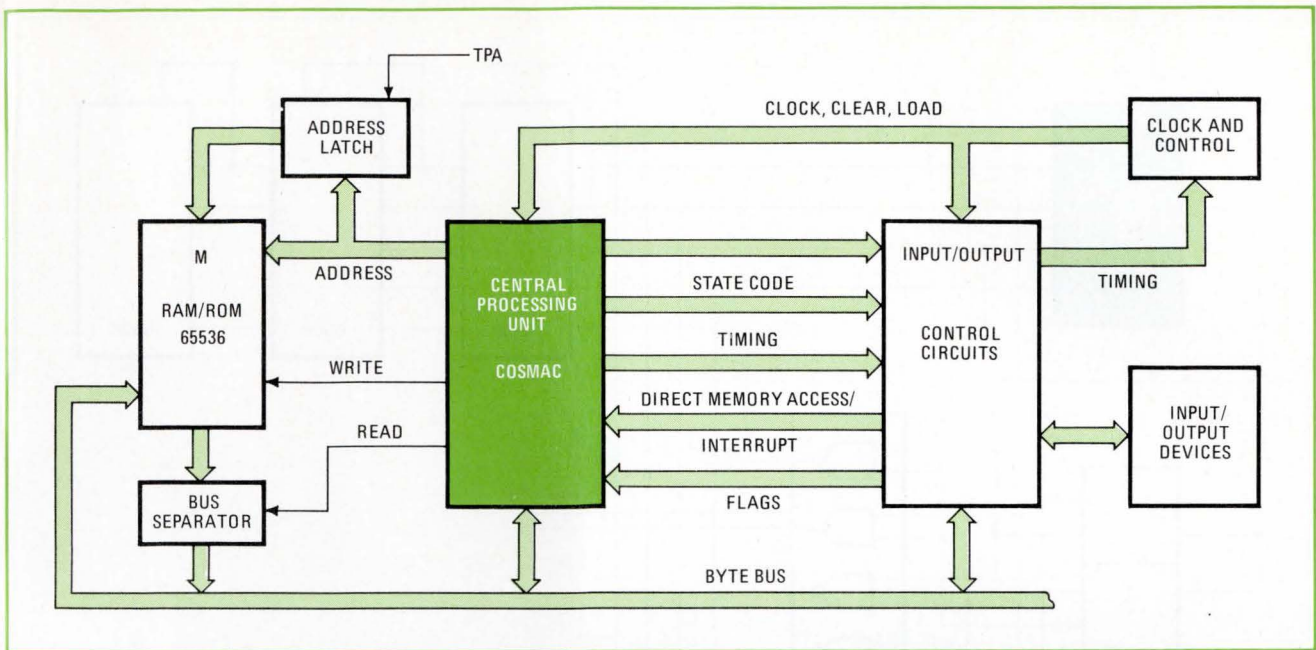

8. Low parts count. This C-MOS microprocessor system from RCA can perform host of computer-control functions with a minimum number of parts. Called Cosmac, the system can accommodate up to 65,536 bytes of memory. It can be built with standard C-MOS products.

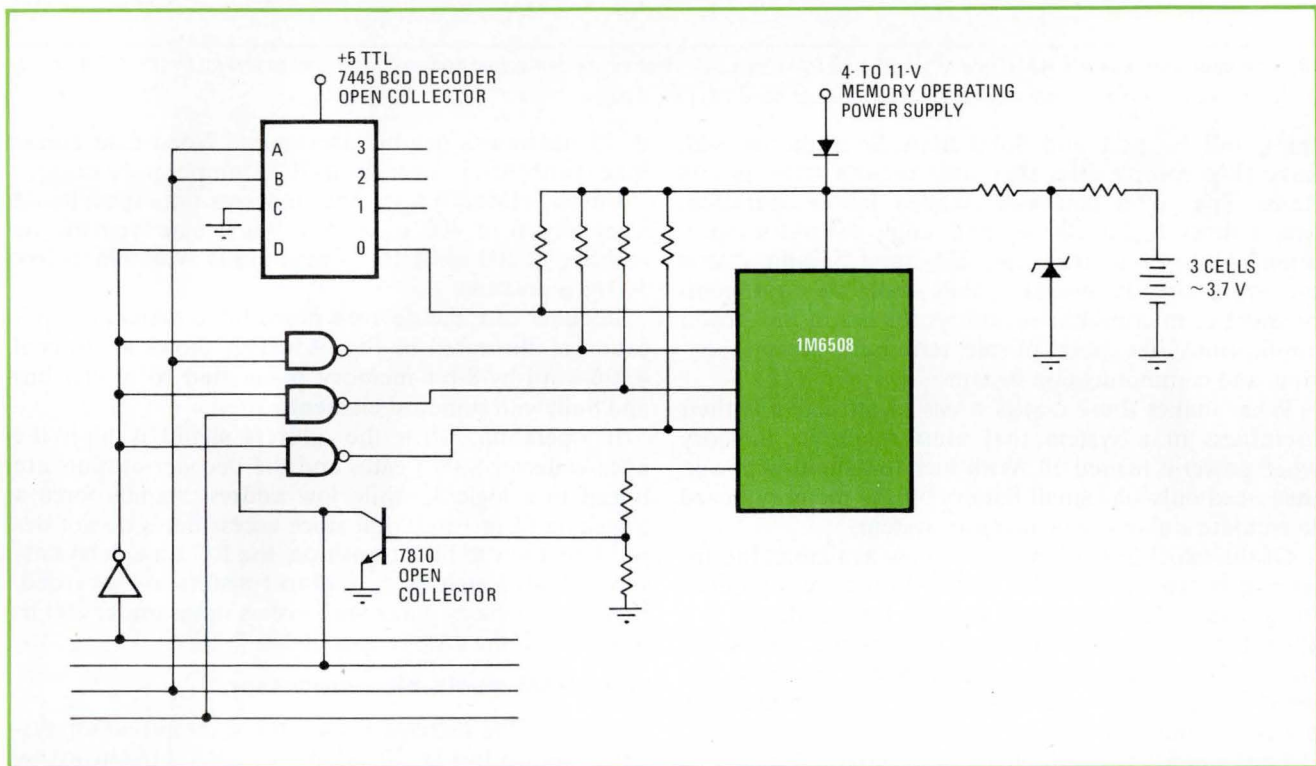

9. No forgetting. This C-MOS RAM system, built around Intersil's 1M6508 1,024-bit RAM, is a good approximation to a nonvolatile memory—it needs only a small battery to retain its data when system power goes off. The system, tied to a TTL bus, uses only off-the-shelf parts.

computer system that contains a group of newly designed C-MOS components—RAMs, ROMs, UARTs, and other specialized interface circuits. Instead of having the usual 8-bit format, the chip is a 12-bit device that allows a designer to take advantage of existing minicomputer software, like Digital Equipment Corp.'s PDP-8A system. This not only frees Intersil from supplying an expensive software package for its system but also means

that a designer can emulate existing systems in C-MOS and take advantage of the low-power features of that technology without a major investment in software.

C-MOS chip remembers 1 kilobit

Equally important is the thrust into the mainstream of the memory market, where 1,024-bit RAMs, built on bulk silicon using a silicon-gate process by Intersil and

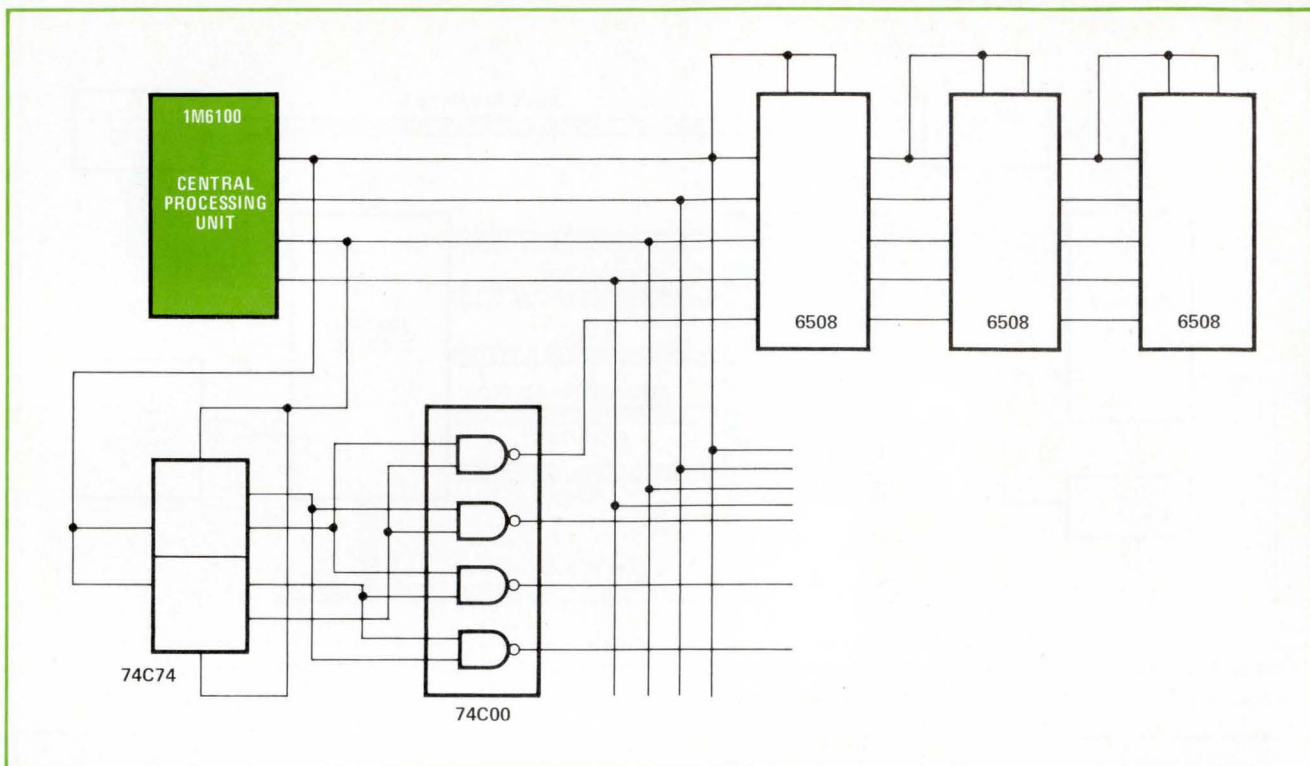

10. The microprocessor's RAM. Intersil's 1,024-bit RAM fits 12-bit-microprocessor-based applications nicely as shown by this 4,096-word-by-12-bit memory system. Address, data in, and data out need 12 lines; input/output control uses three lines.

Intel, and by RCA and Solid State Scientific on SOS, have chip complexities that rival today's static n-MOS RAMs. They offer nanowatt standby power operation, access times under 100 ns, and single 5-v static operation. Along with the 128-, 256-, and 512-bit C-MOS memories already available, they make up a full complement of micropower memories for use in low-power applications like point-of-sale terminals, remote sensing, and communication systems.

What makes these C-MOS RAMs so attractive is their usefulness in a system that must retain its memory when power is turned off. With such low standby power, they need only one small battery on the memory board to emulate a nonvolatile memory system.

Of the two 1,024-bit memories now available, the Intel part is organized in the 256-by-4-bit format popular for microprocessor systems, and the Intersil device is a 1,024-by-1-bit device. Both are silicon-gate C-MOS devices that, being static, eliminate clocks, interface circuits, and special power supplies while minimizing package count.

The Intel 5101 is contained in a standard 22-pin dual in-line package, which has four input data lines, four output data lines, output disable control, two chip-enable inputs, a read/write control input, and eight fully decoded address inputs, as well as power supply and ground pins. Outputs are three-state, and an output disable function is provided so that the data inputs and outputs may be easily OR-tied for use in common data I/O systems.

Even at high temperatures, the 5101 keeps battery drain extremely low. At 70°C, worst-case standby current is 15 nanoamperes per bit, limiting standby power

to 75 nanowatts per bit maximum. Worst-case access time is only 650 ns over the 0-70°C temperature range.

Intersil's IM6508 RAM has an access time specified at a maximum of 400 ns at 5 v but it can typically be accessed at 200 ns. If 10-v operation is available, below 100 ns is possible.

In either case the device's nonvolatile memory application is illustrated in Fig. 9, which shows an Intersil 4,096-word-by-8-bit memory plane tied to a TTL bus and built with standard elements.

In operation, when the address signal is high the open-collector NAND gates and the decoder outputs are forced to a logic 1, while low address signals force a transition from 1 to 0. But since access times do not depend on a low to high transition, the RC time delays associated with high-value pullup resistors are awarded. Indeed, a memory plane with access times under 200 ns is possible if the RAM is operated at 7-10 v.

When RAM meets microprocessor

The way the IM6508 works in a microprocessor system is shown in Fig. 10, where a C-MOS 4,096-word-by-12-bit memory system operates with a C-MOS microprocessor—in this case Intersil's soon-to-be-available IM6100 12-bit device. Here addresses, data in, and data out are multiplexed on 12 lines, while three additional lines provide the necessary memory and I/O control.

Access time for the memory system, which is largely limited by the propagation delays of the C-MOS dual flip-flops and NAND gates, is typically 175 ns for the flip-flop, 75 ns for the NAND gates, plus 80 ns for enabling the memory via the fast chip-select entry. Total system access time is a respectable 325 ns. □

Reduce Custom Power Electronics Time and Cost

With a handful of Powercube's Cirkitblock[®] modules and a few clip leads, you can quickly synthesize an infinite variety of power control circuits and power supplies.

Cirkitblock modules have demonstrated capability to meet most design needs and are packaged within a 1" x 1" x 2" basic building block so you can assemble power circuits and supplies of any complexity to any form factor you need in building block fashion.

Design time to operable prototype can be reduced by more than half because conventional breadboarding is eliminated. Your quickly assembled "breadboard" of Cirkitblock modules becomes your operable prototype.

Cirkitblock modules use space technology, but are specified and priced for industrial as well as military applications.

They can substantially reduce the "as installed" power electronics cost in instruments, navigational systems, computer peripherals, process control equipment, and communications gear.

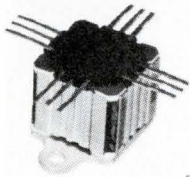

Original Powercube Module[®]

They can substantially reduce the "as installed" power electronics cost in

Three basic sizes

- 1" x 1" x 2"
- 1" x 2" x 2"
- 1" x 2" x 3"

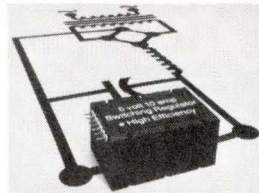

Cirkitblock functional modules not only save design time and money; they're also a lot of fun to work with. Circle reader service number to learn more about Powercube's Cirkitblock

functional modules.

Send for free catalog describing the entire Cirkitblock module family and packaging styles for complete power supplies.

Assemble Custom Power Supplies In Minutes

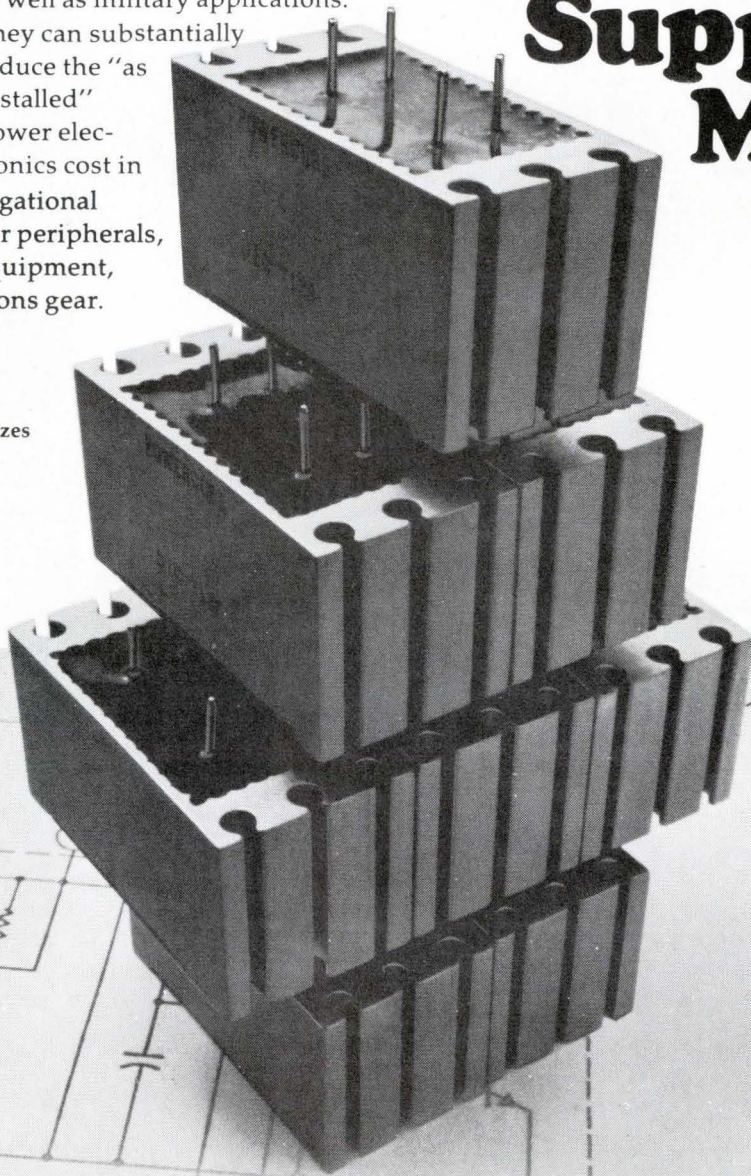

POWERCUBE CORPORATION

214 CALVARY STREET, WALTHAM, MASS. 02154 (617) 891-1830

SUBSIDIARY OF UNITRODE CORPORATION

Think Large. Think Small. Think Ise

Think our three jolly green giants for desk-top electronics. Our two pint-size pigmies for carry-in-the-pocket display designs. But don't stop there. Think low operating voltages, low power consumption, glass encapsulation all around, and wafer-thin thickness and dip clip pins for fast efficient mounting.

itron[®]

FG-159A2

ec = eb = 35Vp-p
ic = 4.5mA_{p-p}
ib = 3.5mA_{p-p}

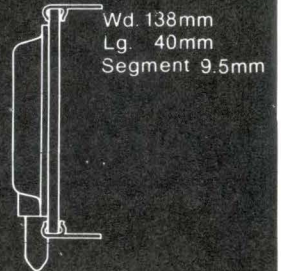

FG-139A2

ec = eb = 30Vp-p
ic = 3.6mA_{p-p}
ib = 2.8mA_{p-p}

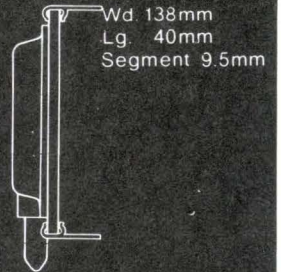

Our jolly green giants

FG-99A2

ec = eb = 24Vp-p
ic = 3.5mA_{p-p}
ib = 2.5mA_{p-p}

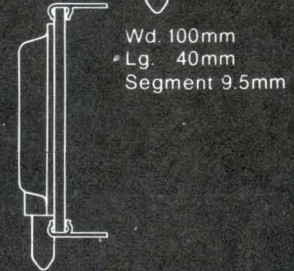

FG-125A2

ec = eb = 24Vp-p
ic = 2.0mA_{p-p}
ib = 2.0mA_{p-p}

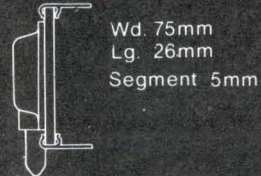

Our pint-size pigmies

FG-95A

ec = eb = 24Vp-p
ic = 2.0mA_{p-p}
ib = 1.5mA_{p-p}



Something else to think about

Think Ise for digital readouts for instruments, clocks and other products, too.

The Brighter Side of Electronics

ISE ELECTRONICS CORP.

Main Office:

P.O. Box 46, Ise City, Mie Pref., Japan
Tel: (05963) 5-2121 to 4. Telex: "4969523"

Tokyo Office:

2-7-7 Shigashi Shinbashi, Minato-ku, Tokyo, Japan
Tel: (03) 433-6616 to 9. Telex: "J26546"

Noritake Electronics Office:

22410 Hawthorne Blvd., Torrance California 90505, U.S.A.
Tel: (213) 373-6704. Telex: "230674910"

Voltage-to-frequency converters: versatility now at a low cost

Modular units that fit in your hand and go for less than \$50 are moving into low-cost instruments and systems, putting their excellent linearity and temperature stability to wider use

by Eugene L. Zuch, *Datel Systems Inc., Canton, Mass.*

□ Voltage-to-frequency converters can be purchased today for one tenth the price they were going for as rack mounted instruments less than three years ago. This, together with the v-f converter's long-prized linearity and temperature stability, accounts for the heightened interest they now enjoy among systems designers.

There are other reasons as well. The converter's recent evolution into a modular component package gives it a size advantage that widens the range of applications. One such application—not to be overlooked for certain data acquisition or control functions—involves the v-f converter's capability to interface between analog and digital circuits. By the same token, high common-mode voltage isolation, ratiometric measurements, and analog-signal integration also represent fertile areas for v-f applications. It has already been put to use in instruments that include low-cost 3½-digit multimeters, high-performance digital panel meters, and hand-held probe-type digital multimeters.

While the modular component v-f converter is relatively new, the basic technique of translating a given voltage level into a frequency signal is not. Until fairly recently, however, v-f converters have been available

only in the form of rather expensive instruments.

A v-f converter accepts an analog voltage or current input and generates an output train of digital pulses at a rate directly proportional to the amplitude of the input. In its most basic form [see Fig. (a) in the accompanying panel, "Converting v-to-f: three techniques"] conversion is accomplished by allowing the incoming voltage to charge a capacitor until it reaches a value equivalent to a reference voltage. At that point, a comparator triggers a monostable multivibrator which puts out a constant-width pulse. Other variations [panel figures (b), (c) and (d)] provide improved linearity and stability, or permit output pulses to be synchronized to a clock.

Datel Systems Inc. uses the charge-balancing technique in its v-f converters [see panel Fig. (c)]. And, by changing the connections at the external pins, the same module becomes a frequency-to-voltage converter. The f-v connections remove the logic buffer and permit an input pulse to be delivered to the timing circuit, and voltage to be taken from the output of the op amp.

The v-f converter has as its key characteristics good linearity—typically 0.002% to 0.05% over the input-output operating range—and excellent temperature stabil-

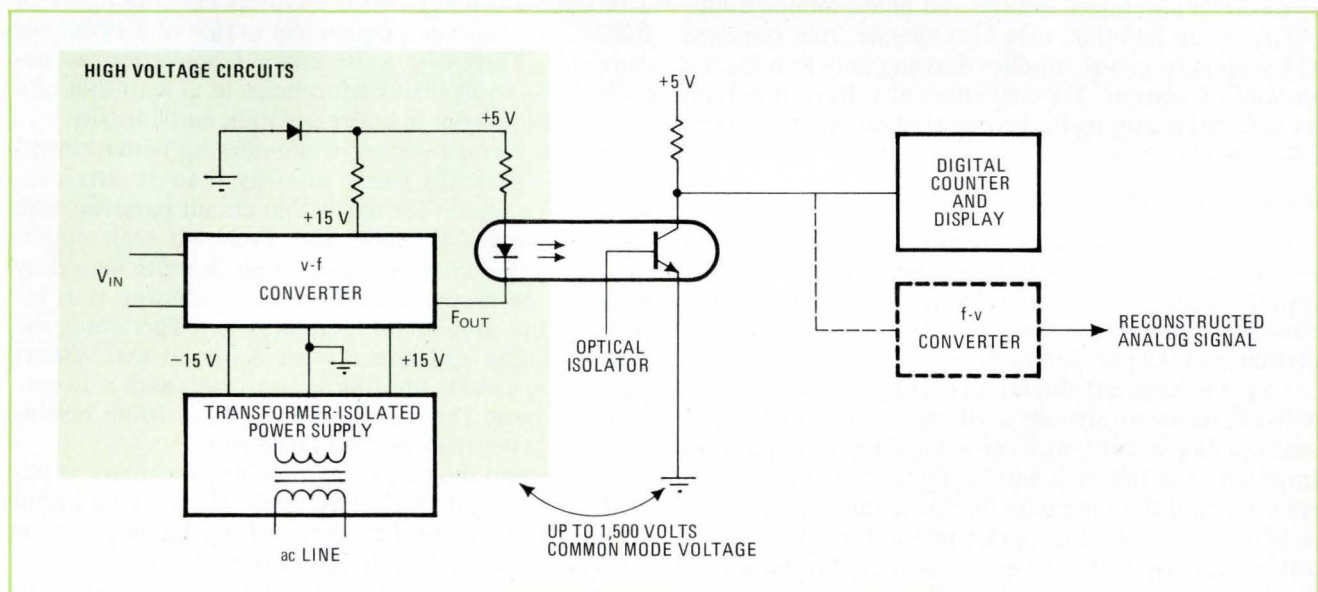

1. Isolation. Because the v-f converter has a serial output, the pulses can be transmitted through a single optical isolator. The v-f converter is floated at the high common-mode voltage at which the measurement is made. It is also powered by a floating and isolated supply.

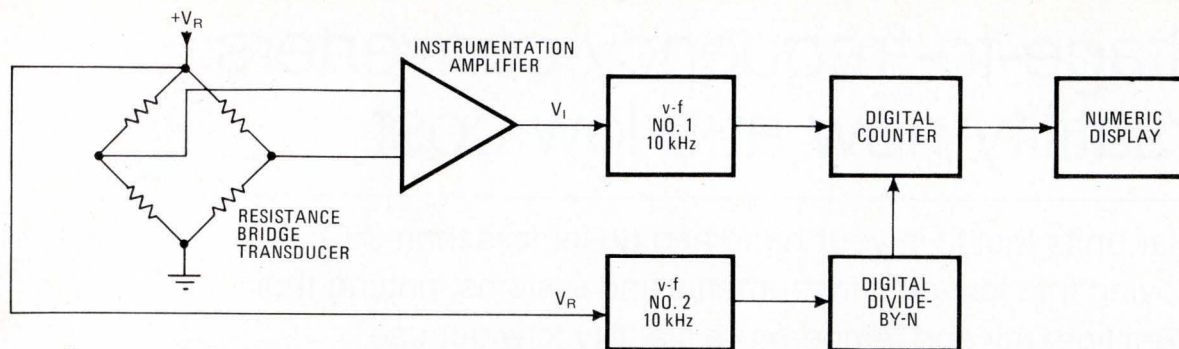

RATIO MEASUREMENTS USING N = 500

| V_I | V_R | TIME BASE (SEC) | OUTPUT RATIO | OUTPUT + DECIMAL |
|-------|-------|-----------------|--------------|------------------|
| 0.1 V | 10 V | 0.1 | 10 | 0.010 |
| 1 V | 10 V | 0.1 | 100 | 0.100 |
| 10 V | 10 V | 0.1 | 1,000 | 1.000 |
| 10 V | 1 V | 1 | 10,000 | 10.000 |
| 10 V | 0.1 V | 10 | 100,000 | 100.000 |

ity—typically 10 to 100 parts per million per °C over the operating temperature range. The analog input range is 0 to +10 v or 0 to -10 v for voltage inputs and 0 to +1 mA or 0 to -1 mA for current inputs; there is an input overrange of 10%. The most popular models today are units having output pulse rates of 0 to 10 kHz and 0 to 100 kHz. The outputs are usually constant-width pulses compatible with diode-transistor, transistor-transistor, or C-MOS logic levels, permitting a direct interface with digital circuits.

On the input side, v-f converter modules take analog inputs in the -10 v to +10 v range, making them directly compatible with analog modules and ICs such as operational amplifiers, sample and holds, analog multipliers, etc. In addition, they also operate from standard ±15 v op amp power supplies drawing only a moderate amount of current. V-f converters also have provision for external trimming for precise calibration of zero-and full-scale values.

Using v-f as a-d

While the v-f module is a relatively slow way to convert a-d, the cost is low and accuracy can be high. The digital output of the converter is in serial form, and must be counted over some period to give a final conversion value in parallel form.

To get a complete digital measuring instrument, it is only necessary to precede a v-f converter with a signal conditioning circuit, such as a high input impedance amplifier, and follow it with a digital counter and display. Then, if the time base for the counter is set to one second, the actual output pulse rate of the v-f converter will be displayed. If a 10 kHz converter is used, a full-scale value of 10,000 would be displayed with a one-second time base; with a 10-second time base a full scale value of 100,000 would be displayed, although the

2. Ratiometric measurements. One converter is used as the input v-f, a second converter is used as a reference and is followed by a divide-by-N digital circuit. The output of the divide-by-N is used as the time base for the digital counter.

counting time would be too long for many applications.

It is useful to discuss the characteristics of v-f converters in terms of well known a-d converter specifications. For a v-f converter, conversion time is determined by the time base, one second being a convenient time base for many applications. For faster conversion time, a 0.1 second time base could be used, giving a full-scale count of 1,000 for a 10 kHz converter. With a 100 kHz converter, the full-scale count is 10,000.

For an a-d converter, resolution is expressed in bits and is determined by the number of parts into which the full-scale range is divided. By comparison, a 10 kHz v-f converter has a resolution of 1 part in 10,000, assuming a one-second conversion time. This is equivalent to a resolution of greater than 13 bits (1 part in 8,192). A 100 kHz converter with a one-second time base gives greater than 16-bit resolution (1 part in 65,536).

Linearity is another important a-d converter specification. A good a-d converter has a linearity of $\pm\frac{1}{2}$ LSB (least significant bit) over its full-scale input range. For a 10 kHz v-f converter with a typical linearity figure of 0.002%, the linearity is equivalent to that of a 14-bit a-d converter. Therefore, a 10 kHz v-f converter, as described, has equivalent performance to at least that of a 13-bit a-d converter in both resolution and linearity.

The 100 kHz converters, while offering better resolution, have generally worse linearity than 10 kHz converters. The reason for this is that circuit parasitic time constants vary with pulse duty cycle. At high output pulse rates the small variations in pulse width with duty cycle will be proportionately more significant, thus increasing the amount of non-linearity. Therefore, the best resolution and linearity are achieved with slower pulse rates, namely the 10-kHz converters with a 10-second time base. These achieve better than 16-bit resolution with better than 14 bits of linearity.

A 10-second time base is prohibitive for many applications, but is obtainable by using a sample-and-hold circuit with a long holding time. A large holding capacitor is needed to make voltage decay negligible.

Another useful way of looking at v-f converters is in terms of dynamic range. This specification is critically dependent on linearity. Some v-f converters become

Converting v-to-f: three techniques

In its simplest form, Fig. (a), v-f conversion involves a current source driving a capacitor that charges linearly to a threshold voltage level determined by V_{REF} . At this voltage level, the comparator changes state and triggers a monostable multivibrator which puts out a constant-width pulse. At the same time a switch is used to discharge the capacitor and the cycle repeats itself. If the current source is designed to be proportional to input voltage, v-f conversion takes place.

A better implementation of the ramp-threshold method in Fig. (a) is the variation shown in Fig. (b). Here an operational integrator is used with a bipolar-transistor switch across the integrating capacitor. Starting with a negative input voltage, the circuit integrates in a positive direction until the reference voltage level is reached. The comparator then trips and triggers the monostable multivibrator, while at the same time resetting the integrator to zero by means of the saturating transistor switch. The disadvantage of this circuit is that it seldom offers better than a fraction of 1% linearity.

For higher linearity, the charge-balancing method is preferred, Fig (c). Here voltage or current is fed to an operational integrator. The output of the integrator goes to a

precision pulse-timing circuit whose output drives a pulsed current source that pulls current pulses out of the summing junction of the integrator. The current pulses occur at a rate that exactly balances the positive input current to the integrator.

This technique also can be used for frequency-to-voltage conversion by opening the feedback loop at the output of the integrator and connecting the input pulses directly to the timing reference circuit, Fig. (e). In this case, the input resistor of the integrator is also connected back to the output to form a single-pole low-pass filter which averages the train of input pulses.

Still another form, the "delta-sigma" converter, Fig. (d), is used when output pulses must be synchronized to a clock. Current pulses are generated by a D flip-flop when the integrator output is high and when a clock pulse is present. Note here the assumption that a negative input current or voltage is used, and that the pulsed current source is operating in a direction opposite that of (c). Output pulses are a result of ANDing the Q output of the D flip-flop with input clock pulses. As a result the output pulses are both proportional to the input voltage and synchronous with the clock.

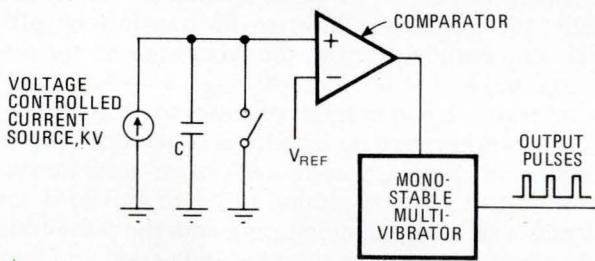

(a)

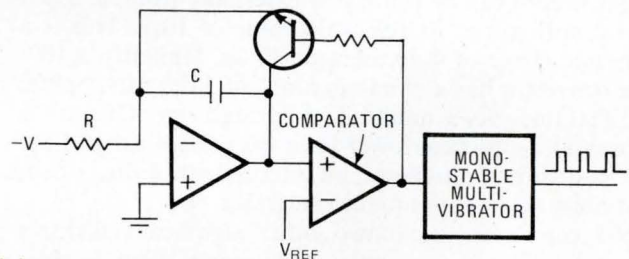

(b)

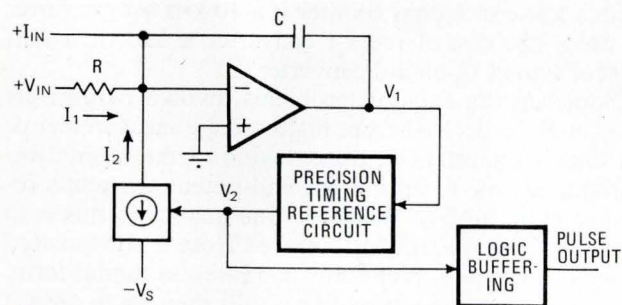

(c)

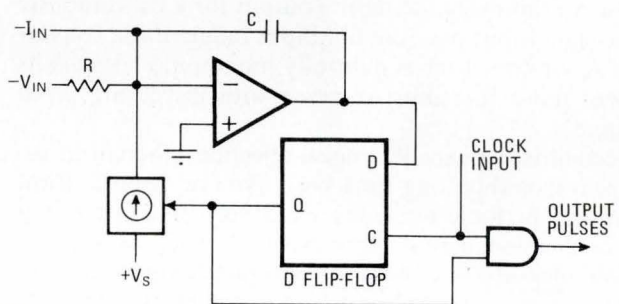

(d)

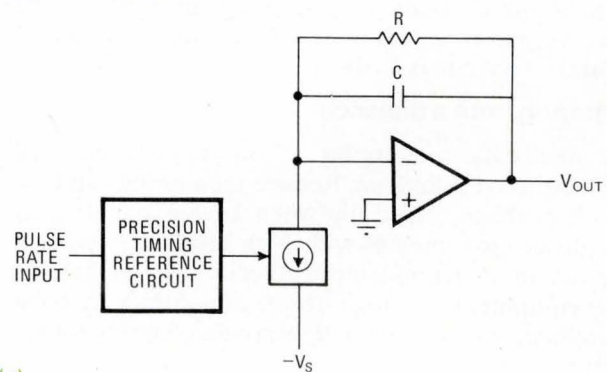

(e)

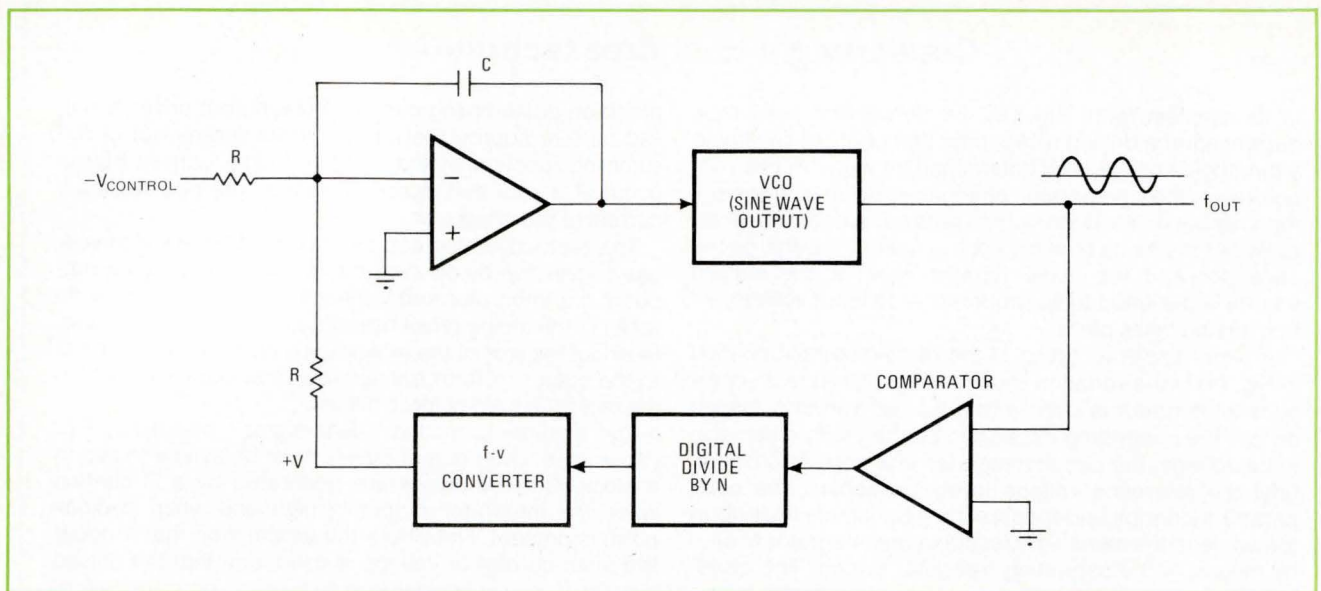

3. VCO improvement. A frequency-to-voltage converter is the key to a low-cost voltage-controlled oscillator. A special feedback control loop forces the VCO output to track the superior linearity and stability of the f-v converter.

nonlinear near zero and, therefore, the dynamic range is limited. A 10-kHz v-f converter that holds its linearity down to zero can be calibrated externally from an input of 1.0 millivolt to its full-scale value of 10 v. This is a dynamic range of 4 decades, or 80 dB. Similarly a 100-kHz converter has a dynamic range of 5 decades, or 100 dB, if its linearity is maintained through zero. One mV is chosen as a practical lower limit because of drift in the zero-adjust potentiometer, long-term drift of the circuit, and noise at the input to the integrator.

V-f converters have two other significant features when considered for analog conversion. First is their monotonicity. (A monotonic a-d converter is one that has a continuously increasing output for a continuously increasing input over the full input range of the converter.) A v-f converter is naturally monotonic because its output pulse rate must increase with increasing input voltage.

Second is the excellent noise rejection inherent in using a reasonably long time base like one second. Random and periodic noise are effectively integrated over the conversion period. Periodic noise, such as a 60 Hz power pick-up, is effectively integrated when the conversion period is long compared to the 60 Hz period of 16.66 ms. For a 60 Hz noise that is integrated over an unsynchronized 1-second measurement period, the noise rejection is approximately 46 dB; for a 0.1-second period the rejection is 26 dB.

Monitoring from a distance

Remote data monitoring is one application well suited to the v-f technique. Remote monitoring can be a difficult problem, especially when analog signals pass through an environment with high levels of electrical noise, as in a manufacturing facility where there is heavy equipment. If a high degree of accuracy must be maintained, analog signal transmission becomes prohibitive.

An obvious solution is to transmit the signals in dig-

ital form. This can be done by applying the analog signal to an a-d converter. The digital pulses can then be transmitted in parallel or serial format. If transmitted serially, the pulses will have to be transformed ultimately into parallel form at the receiving end for display or storage.

A superior solution in terms of cost is to use a v-f converter to transmit the data directly in serial form. This is a simple and effective way to achieve an accurate system of 10 to 13 bits resolution (0.1% to 0.01%) if the data rate is slow. At the monitoring end, the pulse train can be simply counted for a one-second period and then displayed to show the analog value. This can be done with a low-cost 4-digit counter if a 10 kHz v-f converter is used. The cost of the v-f converter is less than half that of a good 12-bit a-d converter.

Some instrumentation problems involve parameters that must be derived from high-voltage measurements. In these circumstances, transmission of the desired information back to normal ground-potential circuits requires some form of isolation. One answer to this is to use an isolation amplifier powered from a non-isolated supply. If the data eventually is desired in digital form, the output from the amplifier would then go to an a-d converter. The cost of an isolation amplifier and a good quality 12-bit a-d converter (0.024% accuracy) runs around \$200.

An effective alternative is to use a v-f converter with a floating power supply while optically coupling the digital data back to ground-level circuitry. The v-f converter output is a serial pulse train and, therefore, requires only one low-cost optical isolator for a total of roughly \$60. The isolated power-supply cost must also be factored in. This can be relatively low (around \$50) if the voltage is not too high (up to 1,500 v peak). For slow data rates this part of the system, shown in Fig. 1, is currently available for slightly over \$100.

An interesting variation that would reconstruct the original analog signal is shown dotted in Fig. 1. This

might be useful for a feedback control system. Another f-v converter hooked up to the isolator output reconstructs the signal into analog form.

Measuring the ratio

Ratiometric measurements are important for applications in which a transducer output might be affected by variations in the exciting power-supply voltage, as, for example, in a resistor bridge. This can be overcome by a measurement system that determines the ratio of transducer output to excitation voltage.

There are several ways of taking this measurement. One is simply to use a digital multimeter with ratiometric option. Such an option is usually obtainable on the more expensive models of digital multimeters, and sometimes on digital panel meters and a-d converters. But, in general, this capability is limited to high-priced models of a-d converters or digital panel meters, and the range is usually quite limited. Many models permit only a $\pm 10\%$ variation in the reference voltage to achieve ratiometric operation; some models go up to about $\pm 50\%$. This means that ratios with wide dynamic range cannot be measured at all by conventional means.

A simple and inexpensive way of using two v-f converters for accurate ratio measurements over a dynamic range of up to 1,000 to 1 is illustrated in Fig. 2. The resistance-bridge transducer is excited by reference voltage V_R which also goes to the input of v-f converter No. 2. The output of the bridge is amplified and goes to v-f converter No. 1. The resulting pulse rate is fed to a digital counter circuit. The output pulse rate of v-f No. 2 representing V_R is fed to a divide-by-N circuit, and the resulting pulse train is used as the time base for the counter. The parallel output of the counter drives a numerical display. Since the counting time is one half the output period of the divide-by-N circuit, the output count = $2N V_1/V_R$.

The value of N can be chosen so that the time base is one second or less. The table in Fig. 2 gives the results for different values of V_1 and based on the use of a 10 kHz v-f converter with N equal to 500. The ratio measurement can be made over a dynamic range of 1,000 to 1 while keeping the time base one second or less. If the time base is allowed to go to 10 seconds, the dynamic range can be increased to 10,000 to 1. The time base can also be shortened by a factor of 10 by using 100-kHz v-f converters.

Integrating analog

Accurate analog integration over a wide dynamic signal range is difficult, especially over an extended period like several minutes. The problem is drift error in the operational integrator. In the end a very expensive, low-input current amplifier with low drift must be used along with an expensive, stable capacitor that has low leakage and low dielectric absorption. Even with the best of components, the operational integrator cannot work well when the integration period exceeds 10 minutes. A simple alternative is an analog/digital integrator using a v-f converter. The analog signal is applied to the input of a v-f converter, and the output goes to a

counter operated in the totalizing mode to give a total count equal to the time integral of the signal.

$$\int V(t) dt = k \int f dt = k \int dN(t) dt/dt = kN$$

where N is the total count and k is a constant.

Because of the superior linearity, the integration is accurate for a signal dynamic range of 10,000 to 1. Since the output is an accumulated pulse count, there is no integrator drift as there would be with an operational integrator. Also, the counter can be stopped at any time for an indefinite period without affecting the integrated value. The limitation on the total integral is the total count capacity of the counter. Therefore, counter capacity must be based on the signal values and period of integration.

The actual integration time can be days if a counter has sufficient capacity. Assume, for example, a signal with an average value around 2 v but with occasional high peaks up to 10 v (full-scale input of the v-f converter). The output frequency of a 10 kHz converter is then 2 kHz, on average. If an 8-decade counter is used (99,999,999 full scale count), the integration period can be as long as 50,000 seconds, or 13.88 hours. The counter itself can be made from low cost ICs and be operated manually or by an external logic signal.

F-v useful, too

Applications using the counterpart to v-f converters, the f-v converter, can include frequency measurements in flowmeters and tachometer problems in motor speed controls. Output pulse rates from these devices are used to develop an analog voltage proportional to speed or flow. The voltage, in turn, is usually fed back to regulate the process or system. The f-v converter basically is an analog pulse counter as the output voltage is linearly proportional to input rate—with excellent temperature stability. Once the pulse rate is in analog form at the f-v converter output, other analog operations can be performed. Subtracting the output of two f-v converters gives an analog frequency difference, a quantity more difficult to obtain by other means.

Another application of the f-v converter is in stabilization and linearization of a voltage-controlled oscillator. VCOs with a high degree of linearity and low temperature coefficients are quite expensive, especially if a wide variation of output frequency is needed. Very high quality VCOs use an oven-controlled inductance-capacitance element (LC) to stabilize the frequency. On the other hand, low cost VCOs have only moderate linearity and temperature stability.

A low-cost VCO can be combined with a low-cost f-v converter to achieve a linearity of better than 0.005% and a temperature coefficient of 20 ppm/°C maximum. As shown in Fig. 3, the f-v converter is used in a feedback loop to control the VCO frequency. Of course, if a pulse output is satisfactory for a system, a v-f converter could be used directly. A large proportion of VCOs, however, are used with sinusoidal outputs and, in addition, at frequencies higher than those available in v-f converters. □

If you need fast Intel has the competi

We've just added five new three state 2K and 4K PROMs to our Schottky bipolar PROM family. Intel is now the first supplier with a complete family of 1K, 2K, & 4K bipolar PROMs, and 1K, 2K, & 4K interchangeable metal mask programmable ROMs. Intel PROMs give you the competitive edge in speed, power, and reliability, at competitive prices.

When you're looking for 4K PROMs, Intel offers open collector or three state outputs, silicon fuse reliability, and immediate delivery from distributor stock. You can select

the fast 4K (3604) with 70 ns guaranteed access time from 0° to +75°C or the low power 4K (3604L-6) that dissipates 60% less power when deselected and has 20% less operating power.

Intel's 16 pin, 1K PROMs have the edge in speed with 50 ns guaranteed access time from 0° to +75° C. For military applications you can get 90 ns access time from -55° to +125°C.

Our 2K PROMs give you twice the memory in a 16 pin package, 70 ns access time, and your choice of two low power parts with either open collector or three state outputs.

All Intel PROMs are easily programmed with high programming yields on any one of several commercially available programmers. With a programming time of 1 ms/bit any PROM can be programmed in a

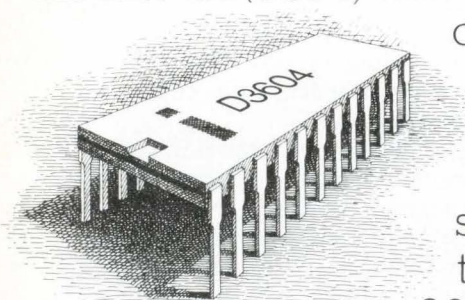
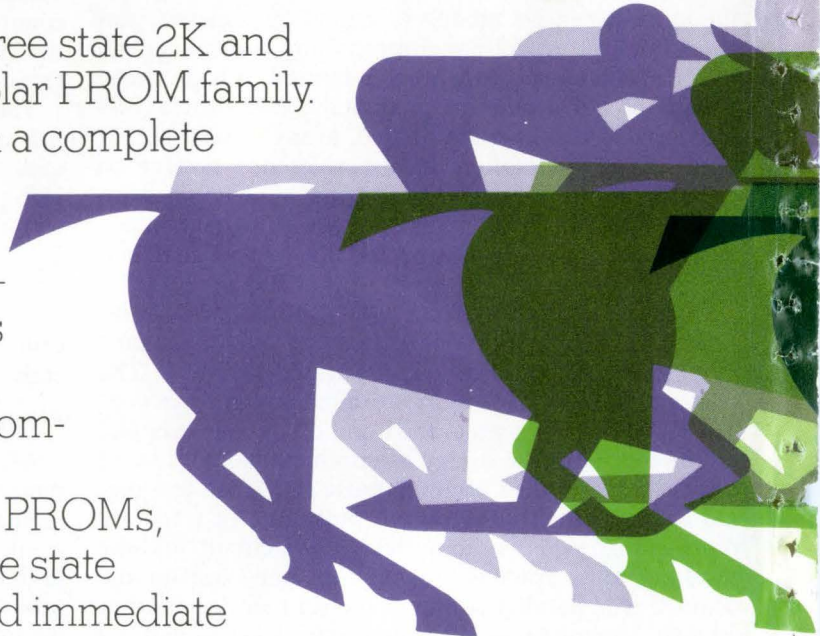

PROMs, you can bet tive edge.



few seconds. With an order of 10,000 or more Intel bipolar PROMs, we'll provide the programmer.

Intel PROMs are the most reliable bipolar PROMs made. Our polysilicon fuses show no regrowth or opening — not even after billions of fuse hours of high temperature reverse bias at 125°C. We have not had a single failure in over 1.2 billion hours of operating system life tests at 85°C. Intel's complete family of bipolar PROMs and EPROMs are available from distributor stock. Most Intel distributors also offer free

programming for prototype quantities. Contact: Almac/Stroum, Component Specialties, Inc., Cramer, Hamilton/Avnet, Industrial Components, Inc., Sheridan and L.A. Varah Ltd. For more information call any Intel regional office: West, (714) 835-9642; Mid-America, (214) 661-8829; Great Lakes, (513) 890-5350; East, (617) 861-1136; Mid-Atlantic, (215) 542-9444. For your copy of the new application note AP-6 "Designing with Intel PROMs & ROMs" write Intel Corporation, 3065 Bowers Avenue, Santa Clara, California 95051.

| INTEL BIPOLAR PROMS | | | | | | |
|---------------------|-------------|--------------|---------|--------------------------------------|--------------------------------------|---------------------------|
| SIZE | PART NUMBER | ORGANIZATION | PINS | WORST-CASE ACCESS TIME (0° TO +75°C) | OUTPUT OPEN COLLECTOR OR THREE STATE | INTEL INTERCHANGEABLE ROM |
| 1K | 3601-1 | 256x4 | 16 | 50 ns | OC | 3301A |
| | 3601 | | | 70 ns | OC | 3301A |
| | M3601 | | | 90 ns* | OC | M3301A |
| 2K | 3602 | 512x4 | 16 | 70 ns | OC | 3302 |
| | 3602-4 | | | 90 ns | OC | 3302-4 |
| | 3602L-6** | | | 120 ns | OC | 3302L-6 |
| | 3622 | | | 70 ns | TS | 3322 |
| | 3622-4 | | | 90 ns | TS | 3322-4 |
| 3622L-6** | 120 ns | TS | 3322L-6 | | | |
| 4K | 3604 | 512x8 | 24 | 70 ns | OC | 3304A |
| | 3604-4 | | | 90 ns | OC | 3304A-4 |
| | 3604L-6** | | | 120 ns | OC | 3304L-6 |
| | 3624 | | | 70 ns | TS | 3324A |
| | 3624-4 | | | 90 ns | TS | 3324A-4 |

*-55° to +125°C **Low Power

| INTEL EPROMS | | | | | | |
|--------------|-------------|--------------|------|--------------------------------------|--------------------------------------|---------------------------|
| SIZE | PART NUMBER | ORGANIZATION | PINS | WORST-CASE ACCESS TIME (0° TO +70°C) | OUTPUT OPEN COLLECTOR OR THREE STATE | INTEL INTERCHANGEABLE ROM |
| 2K | 1702A | 256x8 | 24 | 1.0 μs | TS | 1302 |
| | 1702A-6 | | | 1.5 μs | | 1302 |
| 4K | 2704 | 512x8 | 24 | 0.45 μs | TS | 2308 |
| 8K | 2708 | 1024x8 | 24 | 0.45 μs | TS | 2308 or 2316A |

intel® delivers.

Matched optical couplers stabilize isolation circuit

by Arnold Nielsen
Ford Motor Co., Dearborn, Mich.

Temperature independence in an isolation circuit can be achieved by using a matched pair of optical couplers. In any optocoupler, the transfer characteristic is a function of T , and therefore the gain of an isolator with a single coupler in a feedback arrangement can cancel out temperature effects if the thermal characteristics of the two couplers are alike.

As the diagram shows, the light-emitting diodes of the two couplers are connected in series so that an input signal causes the same current to flow through both of them. One LED couples the input section of the circuit to the output section, and the other LED provides the feedback path that stabilizes the circuit. Thus, any temperature effect that changes coupling to the output section also changes the amount of feedback so that over-all

circuit gain remains constant. The feedback also compensates for coupling nonlinearity.

A voltage from the LED bias potentiometer is fed to the noninverting-input terminal of operational amplifier A_1 . This voltage, amplified through A_1 , sets the LEDs in their most linear operating range. When an input signal is applied to the inverting terminal, operational amplifier A_1 drives the LEDs to a level at which collector current from Q_1 makes $I_{R2} = I_{R1}$, so that the inverting input is at virtual ground. (The 1N914 diode protects the LEDs against negative overvoltages; it is not part of the feedback circuit for A_1 .) Because the LEDs are in series and are matched, $I_{R3} = I_{R5}$.

In the output section, the collector-to-base capacitance of Q_2 tends to decrease the frequency response of the circuit. This tendency is overcome by operating op amp A_{2A} in the current-to-voltage-converter mode, which maintains the signal voltage at the inverting input of A_{2A} and across Q_2 at virtual ground. Amplifier A_{2B} provides buffering at the output. The output voltage, E_o , is given by

$$\begin{aligned} E_o &= I_{R5}R_G = I_{R3}R_G \\ &\approx (R_2 + R_3)I_{R2}R_G/R_3 \\ &\approx (R_2 + R_3)E_{IN}R_G/R_1R_3 \end{aligned}$$

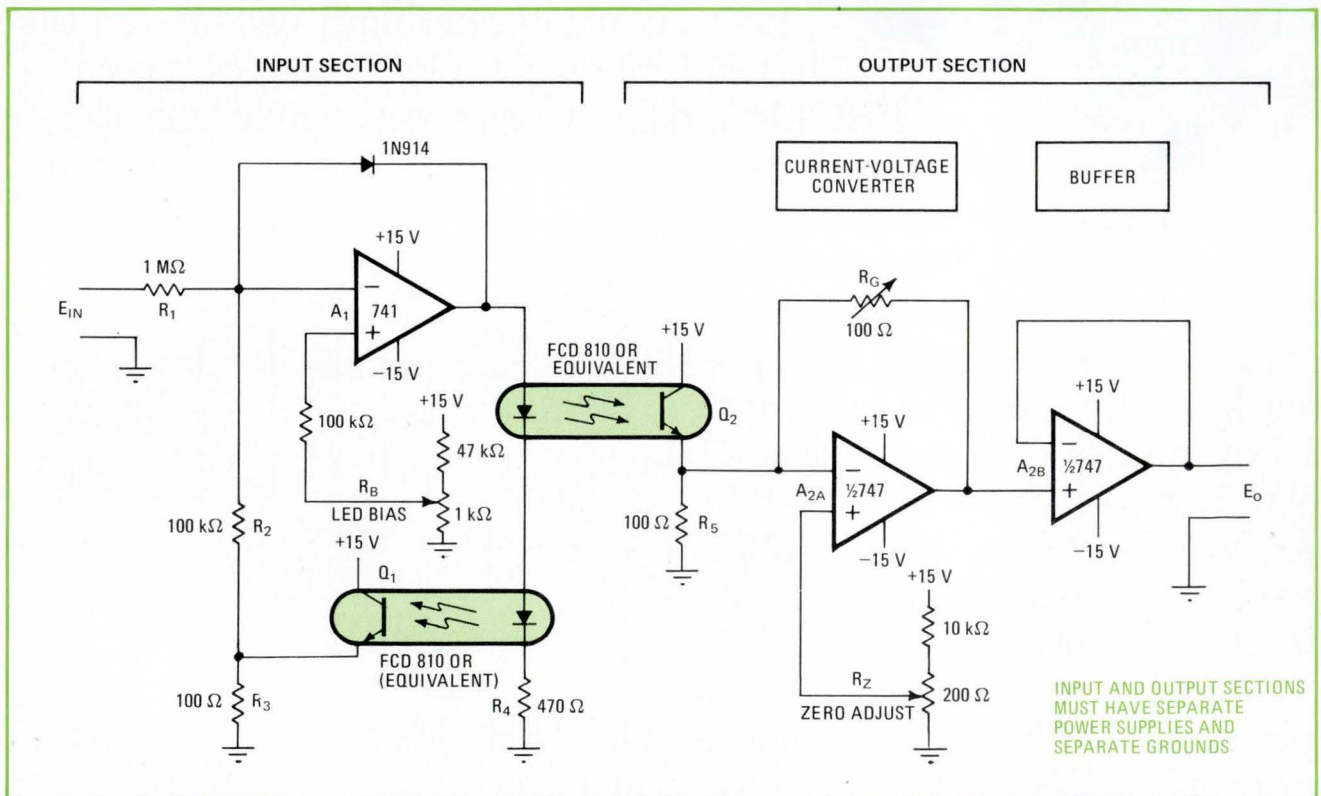

Stabilized by feedback. To avoid ground loop in instrumentation system, isolation between input and output is provided by optical coupling and by use of separate power supplies for each section. Temperature-sensitivity of optocoupler is compensated by second coupler in feedback loop of input op amp. The light-emitting-diodes are forward-biased for best linearity, and the feedback circuit further cancels nonlinear effects. Circuit operates with input signals of 0 to ± 3 V at frequencies from dc to 50 kHz. Gain is 0.1 for circuit shown.

Therefore the gain (or attenuation) of the circuit can be stated as

$$E_O/E_{IN} \approx (R_2 + R_3)R_G/R_1R_3$$

For the component values shown in the diagram, the gain is approximately 0.1.

When the circuit is turned on, a sine wave is fed into the input. The output is displayed on a scope, and R_B is adjusted for symmetrical clipping as the signal amplitude is raised to 3 v. Then the input terminals are short-circuited, and potentiometer R_Z is adjusted so that the output voltage is zero. Finally, a 1-v signal is applied to the input, and R_G is adjusted to give the desired output level (0.1 v in this example). The gain then remains constant to within $\pm 5\%$ for any operating temperature between 0°C and 80°C .

The input signal can have any value from 0 to ± 3 v, and the frequency response is determined mainly by the op amps used. The circuit shown here operates from dc to 50 kilohertz, where the signal is down 3 dB. The degree of isolation depends on the isolation resistance of the power supplies used for the input and output sections of the circuit. Therefore, power supplies that have high isolation resistance and electrostatic shielding are recommended, especially at low-millivolt signal levels. Isolation of at least 80 dB should be achieved without difficulty.

This circuit can be used as a single isolation amplifier or as part of a signal-distribution system. In the system application, one signal is common to all of the input sections, but the output sections are completely isolated from one another. \square

How to prevent spurious tripping of protection circuits

by Thomas E. Skopal
Acopian Corp., Easton, Pa.

Users of power supplies sometimes find that crowbar circuits for overvoltage protection trip unnecessarily. The spurious tripping is caused by transients that are not dangerous to the load circuit, but that have enough amplitude to momentarily raise the voltage seen by the circuit to a level greater than its trip voltage.

The protection circuit is susceptible to this unwanted tripping because the trip level is set close to the rated output voltage of the supply and because the circuit is designed for quick response. The tripping should be prevented by suppressing the transients, not by reduc-

ing the sensitivity of the protection circuit.

Transients can reach the crowbar circuit in three ways: by coupling through the power supply from the ac line, by conduction through the output wiring from transient-generating elements in the load, and by picking up radiated transients in the system wiring.

Bypassing the input and output terminals of the power supply usually reduces transients from all causes to insignificant levels. To be most effective, nonpolarized capacitors should have good high-frequency characteristics, as provided by Mylar, disk ceramic, and mica types; a value of 0.05 to 1.0 microfarad is most effective. (The output capacitor of a typical power supply is usually an electrolytic type, which is intended for stabilizing the regulator circuit and for filtering, but is not an effective bypass for high frequencies.)

If additional leads are used for remote sensing or for output-voltage programing, shielded wire should be used, with the shields grounded only at the power-supply end. Bypassing these leads would help to suppress

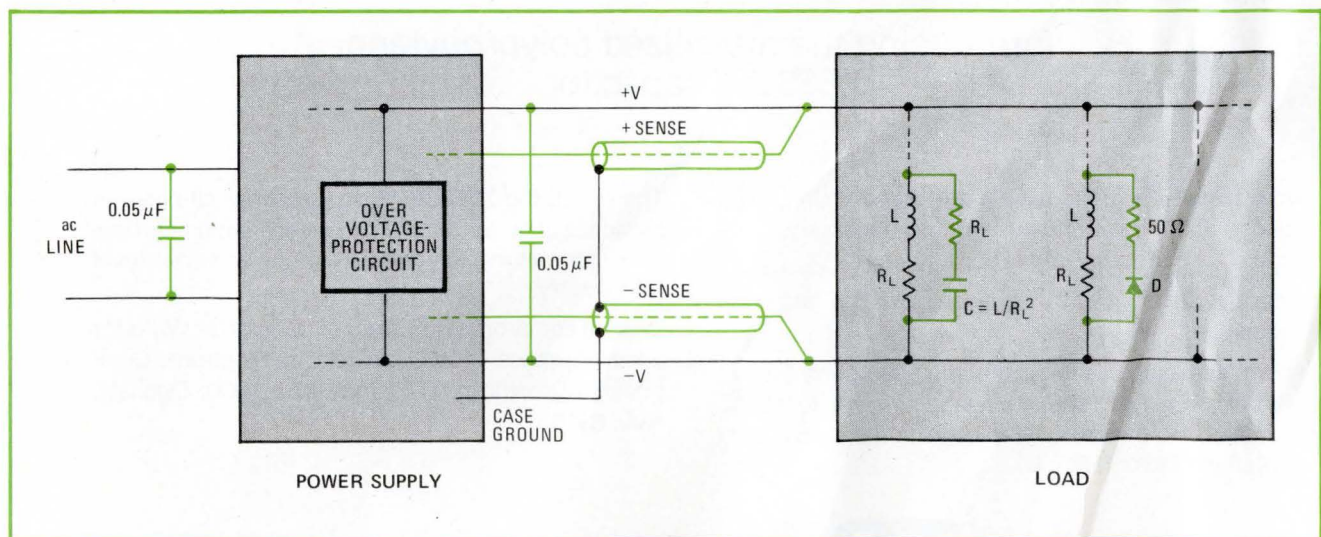

Transient suppression. Suppressing all transients generated within or induced into a system prevents unnecessary tripping of power-supply overvoltage protectors. Four techniques described in the text are illustrated in this circuit. Capacitors at input and output terminals of the supply normally reduce transients to insignificant levels. Leads for remote sensing use shielded wire, grounded only at the supply end. Transients from electromechanical load element are suppressed by RC shunt. Reverse emf from inductive load is shunted through diode.

Now freedom from compromise is no big thing.

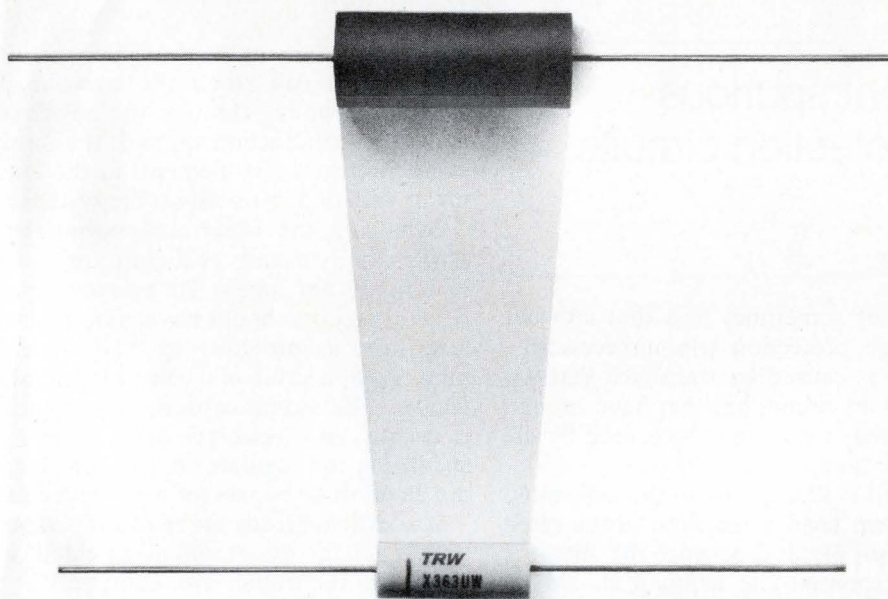

Introducing the metallized polypropylene X363UW capacitor.

Now, circuit designers have a new freedom in applications where trade-offs were always necessary.

And, our new capacitor is no big thing. It's small where it should be, in physical size. But large in capabilities.

Capabilities such as low dielectric absorption (even better than polystyrene). Outstanding stability. High insulation resistance equal to polystyrene. And a low dissipation factor (High Q).

The result: the X363UW is an excellent all-purpose capacitor ideal for many applications including time base generators, integrators, filters and low level RF circuitry.

Tired of compromising? Tired of trade-offs? Write for complete specs. TRW Capacitors, an Electronic Components Division of TRW Inc., Box 1000, Ogallala, Neb. 69153.

TRW® CAPACITORS

transients, but would also tend to slow the response of the supply, so shielded wire is used instead.

Crowbar operation is affected by electromechanical components in the load. Relays, counters, and solenoids tend to generate sizable transients that can damage a sensitive circuit; therefore, such transients must be suppressed at their source. They are most effectively suppressed by an RC network across the inductance. (Resistance in series with the bypass capacitor is necessary to prevent the high current surge that would otherwise flow into C when the load is energized. This current would burn switch contacts and cause noise.) The resistor value should equal the resistance of the load

component, R_L , and the capacitor value should be equal to L/R_L^2 , where L is the load inductance.

As an alternative, transients from an inductive component in a dc circuit may be suppressed simply by a diode connected across the component, back-biased relative to the supply voltage. The reverse voltage resulting from collapse of the magnetic field is shunted through the diode, and its amplitude is limited to the forward drop of the diode. However, this shunt diode tends to slow turnoff. The decay time-constant is given by $L/(R_L + R_{diode})$; if speed is critical, some suppression can be sacrificed for speed by adding a resistor (50 to 500 ohms) in series with the diode. □

555 as switching regulator supplies negative voltage

by S.L. Black
Western Electric Co., Columbus, Ohio

Latest addition to the 555 IC timer's seemingly endless bag of tricks is its use to generate a negative dc biasing voltage from a positive source. A current of well over 10 milliamperes can be delivered, and a form of switching regulation is employed to assure a constant output voltage. All of this is done with little more than an npn transistor and the 555 integrated circuit.

The 555 is operated in the astable mode, with the pulse width and frequency controlled by resistors R_1 and R_2 plus capacitor C_1 . These parameters can be selected for maximum regulation at the output voltage level desired. Terminal 3 of the IC is connected to a network consisting of C_2 , C_3 , and diodes D_1 and D_2 . Series capacitor C_2 causes the pulse train to lose its ground reference, so that D_1 and D_2 can rectify the signal and ca-

pacitor C_3 can filter it into a negative dc output voltage. The magnitude of this output voltage depends on the amplitude and repetition rate of the pulses coming from the IC.

To regulate the output voltage, the 2N2222 transistor varies the control voltage of the 555, increasing or decreasing the pulse repetition rate. Resistor R_3 acts as a collector load for the transistor; the base is driven from potentiometer R_4 , which compares the output voltage to the supply voltage. If the output voltage becomes less negative, the control voltage goes closer to ground, causing the repetition rate of the 555 to increase so that C_3 recharges more frequently. If the output voltage becomes more negative, the control voltage goes closer to the positive supply voltage, so the repetition rate decreases, and C_3 is recharged less often.

The output voltage can be set to any level from 0 to -10 volts by means of potentiometer R_4 . With the components shown in the figure, this circuit supplies -10 v from a 12-v source. Regulation is less than 5% at a current of 10 mA and less than 0.05% at 0.2 mA. □

Designer's casebook is a regular feature in Electronics. We invite readers to submit original and unpublished circuit ideas and solutions to design problems. Explain briefly but thoroughly the circuit's operating principle and purpose. We'll pay \$50 for each item published.

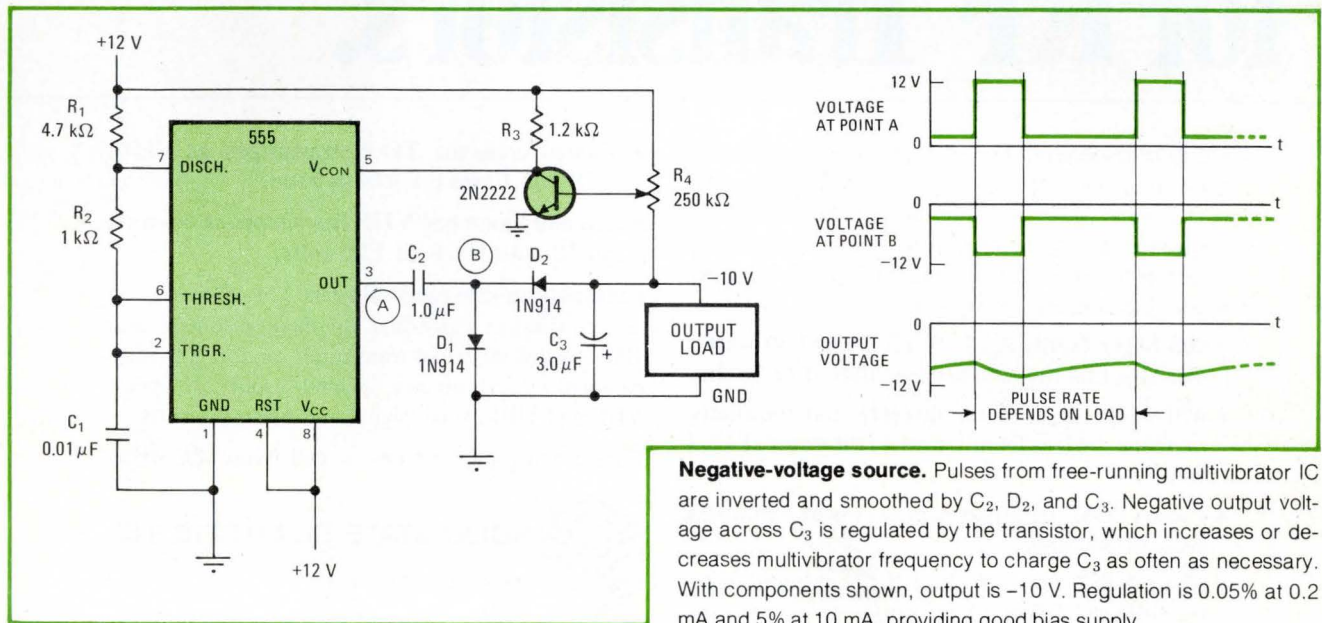

Call us S³

Call us Triple S.

Call us Solid State Scientific.

BUT CALL US.... for RF Transistors.

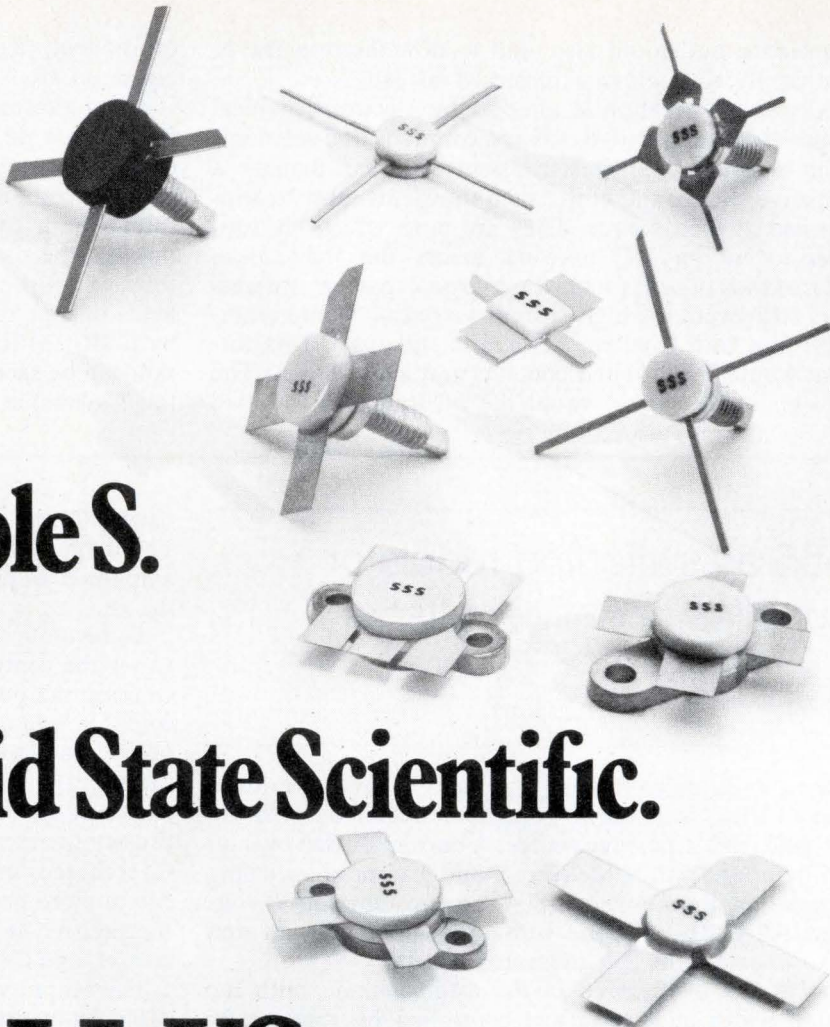

Call us for new designs. Tuned Q construction in the upper frequency bands, with wire bonds, geometries, package parasitics and internal matching networks controlled to tight tolerances. Many devices are available in our unique Miniature Chip Carrier package with extremely low parasitics.

- 900-MHz family . . . 1, 5, 15, 25 and 40 watts. The best that the industry can offer at 12.5 volts.
- 470-MHz transistors; discrete and internally matched devices from 1 watt to 40 watts at 12.5 volts.
- Pulsed DME transistors; in excess of 100 watts peak at 40 volts.
- 50-watt and 70-watt class B linear amplifiers, for sideband CB at 12.5 volts.

- Isolated collector TO39 transistors at VHF, UHF and Class E Citizens band.
- Internally matched VHF transistors at 40-watt and 70-watt levels at 12.5 volts.

Call us for better-than-equal transistors. Manufactured under stringent individual lot quality control and 100% tested in actual transmitter circuits to assure parametric performance beyond usual 2N specs. VHF and UHF, small signal and up to 90 watts.

For specifications and prices, call today. Or write.



SOLID STATE SCIENTIFIC INC.
Montgomeryville, Pa. 18936/(215) 855-8400/TWX 510-661-7299
The RF Power Specialists.

Troubleshooting in the data domain is simplified by logic analyzers

New instruments for checking out digital circuits pinpoint defects by monitoring bits in much the same way that oscilloscopes work in time and spectrum analyzers in frequency to find defects in analog circuits

by William Farnbach,
Hewlett-Packard Co., Colorado Springs, Colo.

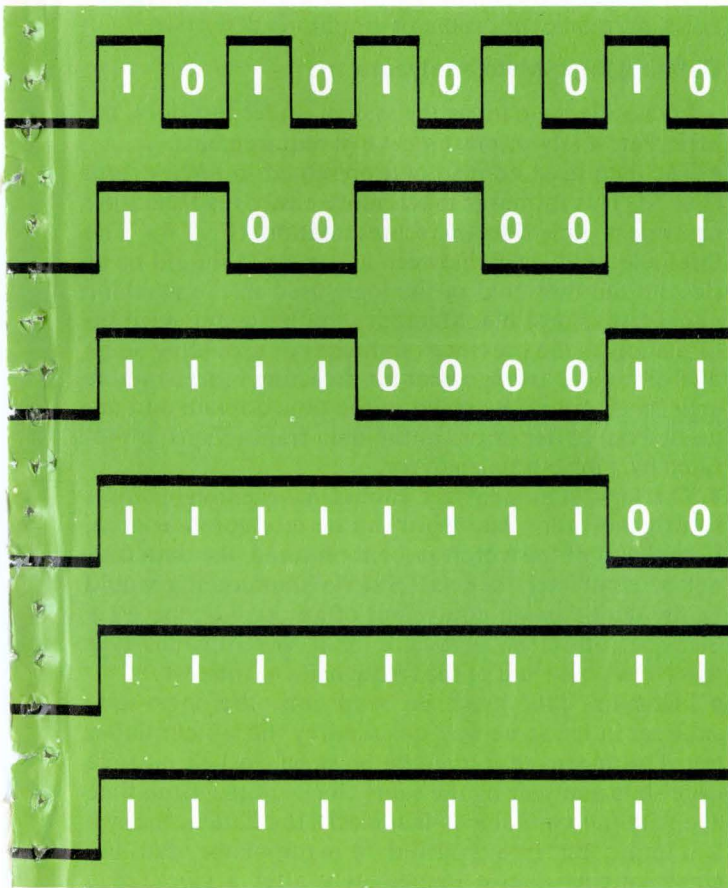

□ The increasing use of digital circuits in new products has created a concurrent need for new equipment to pinpoint and troubleshoot defects. Because more and more of these new products manipulate data, they operate in the data domain, rather than the time or frequency domains that are characteristic of analog circuitry. Instruments that analyze circuits in the time and frequency domains simply cannot cope with digital data manipulations.

Now, manufacturers are introducing instruments that operate in the data domain. Called logic analyzers, these instruments monitor bits, words, addresses, and instructions in the same way that oscilloscopes monitor time and spectrum analyzers monitor frequencies. Two examples of these logic analyzers are the Hewlett-Packard models 1600A and 1607A (Fig. 1).

These new instruments are ideal for many applications. One could be finding the defect in a processor-controlled cash register that won't do anything in its normal operating mode but initialize itself. Yet, when the machine is single-stepped, it always operates properly. Another malfunction that a data-domain instrument would easily pinpoint could be in a processor-based traffic-signal controller that causes all the lights at a six-way intersection to blink red about every two days at the beginning of the rush hour.

When a repair technician arrives, the program counter in the processor is pointing to, say, 37416—undefined territory. No random-access or read-only memory location in the controller corresponds to that address. After the technician takes the processor back to the shop for repair, it repeats the error every couple of days. The problem could be solved fairly simply if the point in the program from which the processor jumped could be determined.

Both of the machines described above can be classified as data manipulators. The processor sends some data—the program address—to a ROM or RAM and receives some data back—the next instruction to be executed. To define the operation of such machines, the repairman needs the data transactions, program addresses, instructions for the central processing unit, and input/output controls, as well as the sequence of program instructions.

Analysis of these data transactions is necessary for data manipulators to be tested, debugged, and repaired. This analysis requires working in the data domain, and

This article, which discusses the application of data-domain instruments to solving problems in digital circuits, is the second of a two-part series. The first installment, written by Charles House of Hewlett-Packard Co., defined the data domain and explained its importance in digital design and troubleshooting. That article appeared in the May 1 issue.

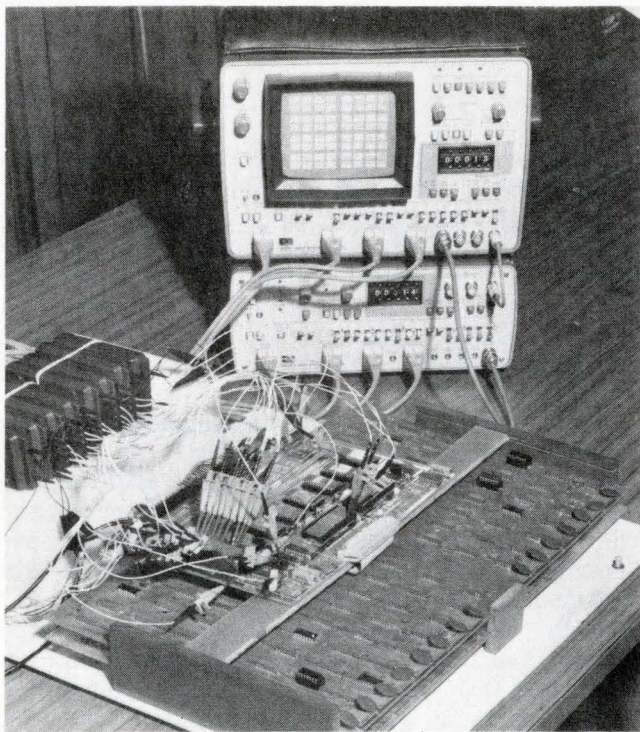

1. Analyzing the data domain. These two new logic-state analyzers are the Hewlett-Packard models 1600A (top) and 1607A (bottom).

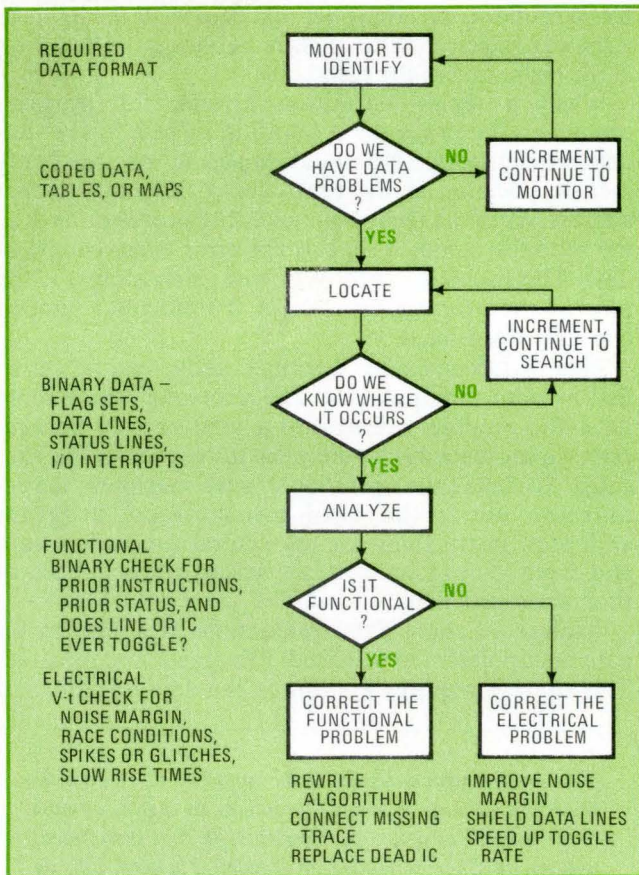

2. Troubleshooting pattern. The steps required to find and correct an error in a data-domain product is represented by this flow chart. Much of this analysis involves functional parameters, which can usually be displayed clearly on a logic-state analyzer.

it requires instrumentation especially designed for the task.

Data-domain instruments—generally classified as logic analyzers—are useful in analyzing data manipulators because they present in a readable format the information that is most important in understanding data manipulators: the sequence of program flow, and data transactions. The three basic classes of logic analyzers are logic-timing analyzers, logic-state analyzers, and logic-trigger generators.

Considering data-domain instruments

Most logic-timing analyzers display digital signals as replicas of voltage-versus-time functions and are most useful for analyzing parametric faults in digital systems. Logic-state analyzers are similar, but they display signals in binary form—either 1s or 0s—on a cathode-ray tube or on and off states of lamps. They are most suitable for functional checks. Logic-trigger generators are used to trigger displays on oscilloscopes upon receipt of specified data words.

Since, to a large extent, troubleshooting a digital system involves the examination of a system's functional behavior (Fig. 2), logic-state analyzers are the most commonly required instruments.

Logic-state analyzers must handle program flow and data transactions as nearly as possible the same way the device under test processes the data. This requirement is analogous to the way oscilloscopes must show time-domain signals with minimum nonlinearity, overshoot, or bandwidth degradation, and spectrum analyzers must show frequency-domain signals with a minimum of noise, harmonic distortion, or amplitude distortion.

Defining logic-state analyzers

To handle the data as the system under test does, the logic-state analyzer must meet five requirements:

- The data must be read and presented in binary form (Fig. 3). This format is much more easily read than the equivalent time-domain representation (Fig. 4). The threshold, or division between a 1 and a 0, should be as close to the threshold of the logic used in the machine under test as possible. Methods of pointing out such information as the presence of glitches or providing some dual-threshold arrangement for detecting indeterminate logic levels fall in the realm of the time domain and are needed only after errors in the data transactions are located by a logic-state analyzer.

- The logic-state analyzer should have enough inputs so that the entire data word can be monitored at once. If only part of the word can be monitored, the data cannot be completely defined. Such a shortcoming would be the data-domain equivalent of an oscilloscope trace that goes off-screen vertically, or a spectrum analyzer that covers only half of the frequencies of interest.

- Incoming data must be read into the logic-state analyzer in the same way it is read by the system under test. This means that the data must be clocked into the logic-state analyzer by the same clock—at the same time and with the same slope—that clocks the data in the system under test. In a typical data manipulator, data begins changing almost immediately after a clock edge

and becomes stable again shortly before the next clock edge. This requires that a logic-state analyzer have zero data-hold time (the period data must be held after the arrival of the clock-pulse edge) and the smallest possible data set-up time (the period data must be available before arrival of the clock pulse).

- The logic-state analyzer should change the system under test as little as possible. Test gear should not alter the performance of the system being tested, and the device should be tested in its normal operating mode. A processor won't run the same in a single-step mode as it does on a 5-megahertz clock. Likewise, it is a major alteration to a processor program if outputs, such as print or display commands, are added to trace the program. Such alterations are analogous to operating a high-speed linear amplifier at low speed so that it can be tested with an oscilloscope of limited bandwidth or operating a transmitter at 10% of full power so that a spectrum analyzer will not be damaged by the large input.

- Finally, the logic-state analyzer must be designed to connect to the system to be tested. It is impossible to connect 16 standard oscilloscope probes to one 24-pin dual in-line package. Even if a logic clip were used, the weight of the 16 probes would drag the clip off the integrated circuit. The probes must be far smaller than standard oscilloscope probes. In fact, probes should be small enough to connect to every lead in a row of DIP leads spaced on 0.1-inch centers, the standard spacing.

Generating usable displays

A logic-state analyzer must also be designed to make the display readable and useful. To present a useful data-sequence table, the logic-state analyzer must have some sort of trigger arrangement for selecting a particular segment of the data for viewing. Since the information displayed is in binary form, the obvious trigger would be some data pattern or data word. When that predetermined trigger matches a data word, the storage of data should be started or stopped. In tracing program flow, for example, the trigger word may be the address of a subroutine entry point. In troubleshooting a digitally controlled printer, the trigger word may be the code for a letter "A" that is always misprinted.

To make the data-sequence table easy to read, the logic-state analyzer should associate the maximum positive voltage with a 1 and the maximum negative level with a 0, or vice versa, so that the technician does not have to make this translation from voltage to data. In addition, the common way to write a sequence of data flow is with the most significant bit on the left and the least significant bit on the right with the first word at the top and each succeeding word under the word before it, as the table in Fig. 5 is written.

The data-sequence table can also be made easier to read by grouping the rows and columns of data into blocks with intervening spaces. The columns might be grouped into blocks of three if the data is to be read as octal or blocks of four if the data is to be read as hexadecimal or binary coded decimal. The rows should also be broken into groups by spaces to make it easier to follow one row across the screen.

The Hewlett-Packard 1600A and 1607A are two new

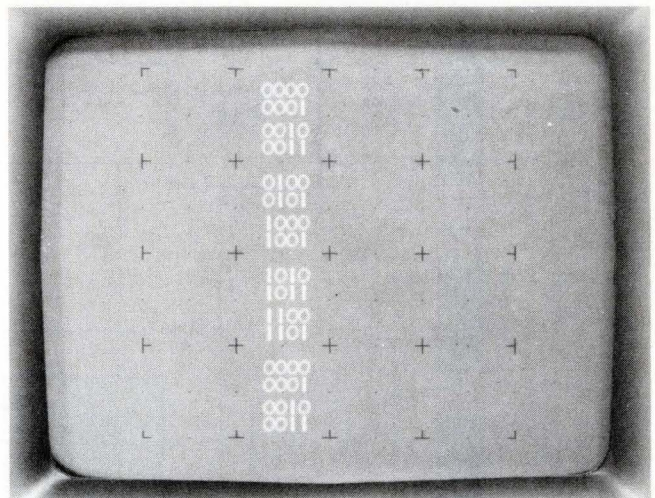

3. **Data-domain count.** The output of a counter can be examined easily if it is displayed as binary digits.

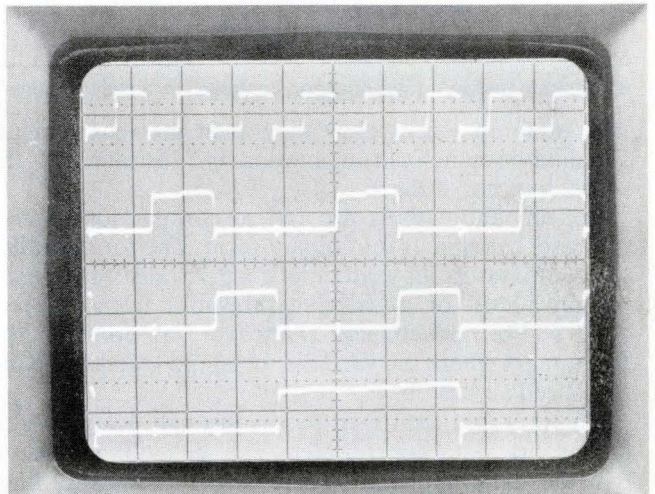

4. **Time domain.** The time-domain representation of a counter output yields more information about circuit operation than the equivalent data-domain pattern, but is more difficult to interpret if only logic-state information is required.

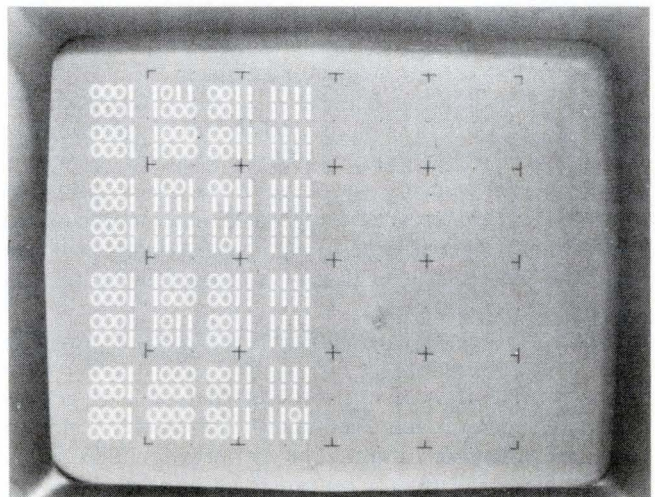

5. **Arranging the sequence.** To make a data-sequence table easier to read, a logic-state analyzer should display the information with the most significant bit on the left and the first word at the top.

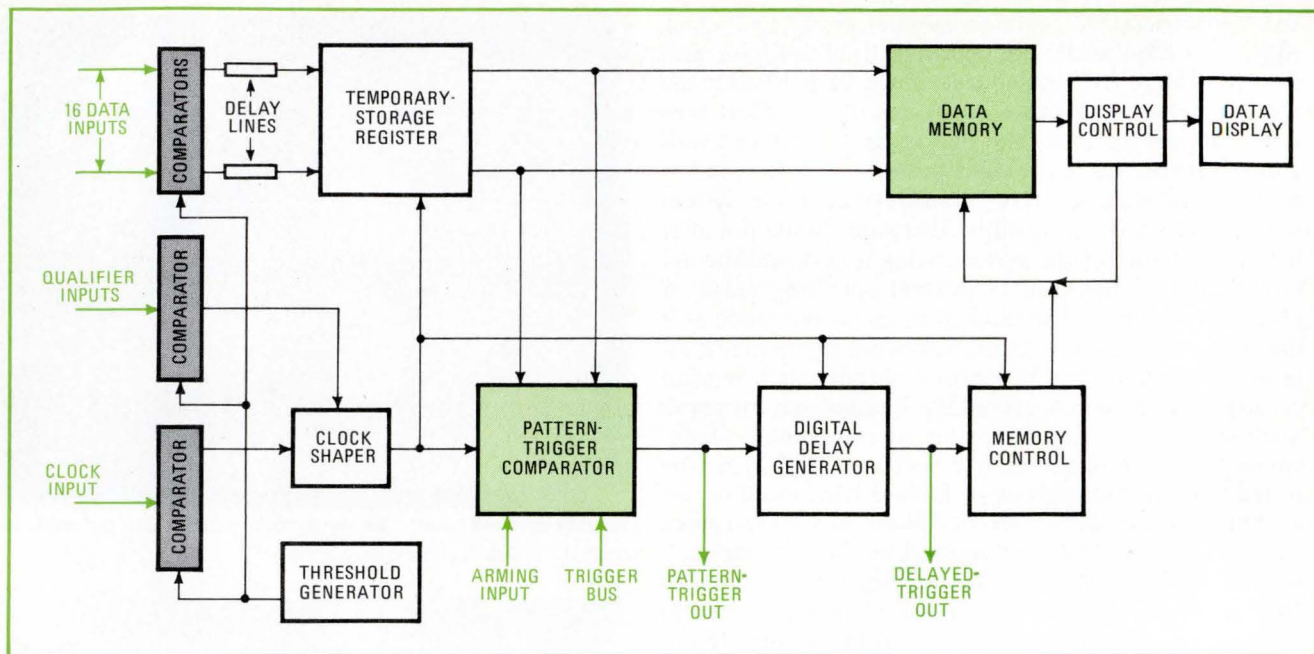

6. Looking inside. A logic analyzer, controlled by a pattern-trigger comparator, displays input data that has been held in a data memory.

logic-state analyzers. How they meet the requirements for data-domain instrumentation is illustrated by the block diagram of Fig. 6.

Sixteen data inputs are fed to comparators, which translate the signals into binary form. The threshold for the comparators may either be a 1.5-v transistor-transistor-logic level or a variable threshold from -10v to +10 v. For convenience, there is a test point on the front panel where the variable threshold voltage may be measured accurately.

The digitized data then passes through delay lines to a temporary-storage register. The delay lines ensure that the data hold time is zero. With these delay lines and the other delays in the data and clock paths, the data set-up time becomes 20 nanoseconds. The data is clocked into the temporary storage register by the system's clock. The clock shaper, which enables the active clock edge to be selected by a push button, inhibits the storage and display of data if the data on two qualifier inputs does not match the data pattern previously selected by two qualifier-selector switches.

After the data has been clocked into the temporary-storage registers, it is compared to the trigger word set on pattern-trigger switches. These switches, as well as the qualifier-selector switches, have three positions: high, off or "don't care," and low. When a match occurs, a pattern trigger is sent to the digital delay generator and the pattern-trigger output is also available for triggering an oscilloscope.

The arming input is normally disabled; however, if the arming function is active, then the arming input must receive a positive-going edge before a trigger can be generated and delivered to either the delay generator or pattern-trigger output. The arming signal usually is supplied by the trigger output from another 1600A or 1607A. In this mode, two data patterns must occur in sequence before a trigger can be generated. The trigger bus allows the pattern-trigger comparator of a 1600A to

be wire-ANDed with the trigger comparator of a 1607A to generate a 32-bit-wide pattern-trigger comparator.

Once the delay generator has received a pattern trigger, it counts off the number of qualified input clocks set by the delay thumbwheels on the front panel. When the preset number of clocks has passed, the delay generator provides a delayed trigger to the memory control and to the delayed trigger output.

When the trigger reaches the memory control, it either initiates or halts the storage of data in the data memory, according to the setting of the trigger-function controls. If the trigger initiates data storage, the next 16 words of data are stored for display.

If the trigger ends the data storage, the memory control rejects triggers until 16 data words are stored in memory so that the data in memory represents the 16 words preceding the receipt of a trigger. In this mode, the logic-state analyzer presents pretrigger information so that conditions leading up to an error can be displayed. After data storage has been completed, control of the data memory is transferred to the display control.

The display control arranges the data into an easily read format for display. This formatting includes dividing the rows of bits into 3- or 4-bit bytes, depending on the byte control, for easy grouping into octal, hex, or BCD characters. Another control allows unused bits to be blanked from the screen. In the repetitive mode, the data is displayed for some time, then control of the data memory is returned to the memory control so that new data may be stored. The length of the display may be set from the front panel for as long as about 5 seconds.

If a longer display is desired, the single-sample mode may be selected. In this mode, the stored data is displayed until a manual reset button is pushed. When the incoming clock rate is less than about 30 hertz, the display control and memory control can share the memory so that data can be displayed as it comes in. This sharing capability eliminates the need to have 16 clock

pulses before any data can be displayed.

The data inputs for the 1600A and 1607A come through a set of four probes (Fig. 7). Three of these probes contain the 16 data channels and two qualifiers. The fourth probe contains the clock input. The inputs may be connected directly to the input leads on a DIP with a grabber, or the grabber may be removed to expose a pin socket that can be connected to a logic clip or standard wire-wrap pin. This arrangement simplifies connection of a large number of leads in a small space.

The self-contained 1600A has a couple of more capabilities than the 1607A. When a 1607A is not connected to the 1600A, the 16 display channels reserved for the 1607A may be used to store data previously captured by the 1600A so that it can be compared to data taken later. In that mode, data may be transferred from the data memory to an auxiliary memory so that subsequent data captured in the data memory can be compared to the stored data. If desired, the data in the data memory can be held indefinitely whenever it does not match the data in the auxiliary memory.

Mapping data flow

Another advantage of the 1600A is the map display. In the map mode, the CRT displays an array of 2^{16} dots instead of a table of 1s and 0s. Each dot represents one possible combination of the 16 input lines so that any input word is represented by an illuminated dot. An input of all 0s is at the upper left corner of the CRT. An input of all 1s is at the lower right corner of the screen. The dots are interconnected so that the sequence of data transactions can be observed. The interconnecting line gets brighter as it moves toward a new point, thereby showing the direction of data flow.

The map display facilitates observance of the over-all operation of a machine in a repetitive loop. A properly functioning two-decade counter, for example, would be represented by the map of Fig. 8. If the counter were not functioning properly, its representation might be like the map of Fig. 9. In Fig. 9, the counter skips from state 59 (0101 1001) to state 70 (0111 0000) without passing through states 60 through 69. The map simplifies examination of the functional behavior of such circuits and pinpointing of errors.

To look at a data table of the counter shown in Fig. 9 or to trigger an oscilloscope where the improper state transition occurs, the 1600A can be switched into the table mode, or the pattern-trigger output of the analyzer can be connected to the external-trigger input of an oscilloscope.

The word that triggers the logic-state analyzer is represented in the map mode by a circle, as shown in Figs. 8 and 9. The position of this trigger-pattern cursor can be controlled through the trigger-pattern-selector switches on the front panel of the 1600A.

Figure 10 is a block diagram of the 1600A in the map mode. This diagram is similar to Fig. 6. The pattern-trigger comparator and delay generator are not used to control the storage of data in the data memory, but they do still generate pattern and delayed-trigger outputs. The other difference is the way the display is generated. The display controller connects bits 8 through 15 to a

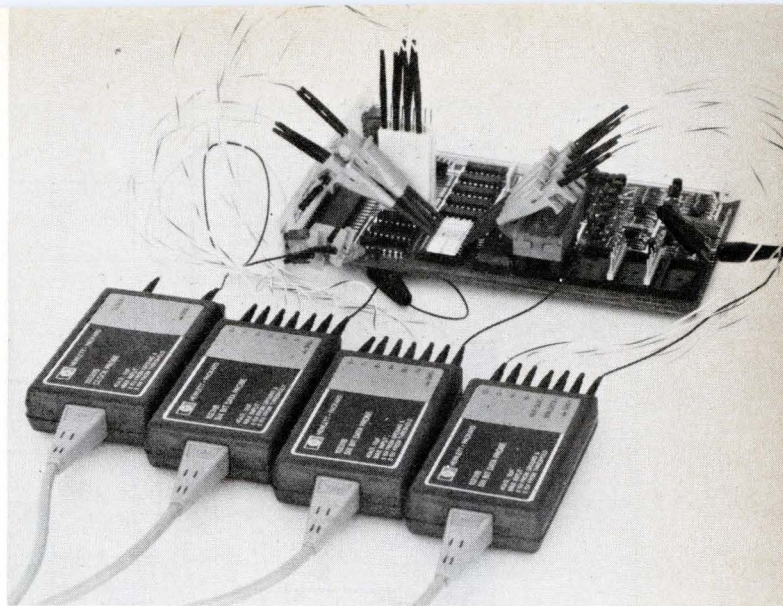

7. Probing for data. High-density multilines digital systems require the kind of compact probes shown here.

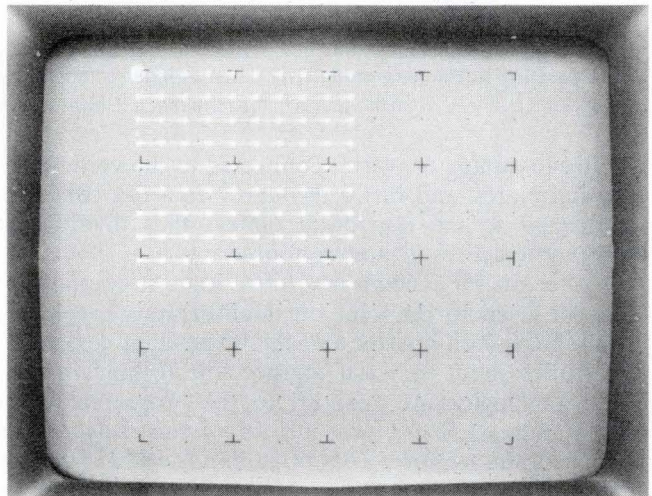

8. Mapping. A two-decade counter can be represented by a map of data states. Here, the counter sequence is from zero (upper left) through all intermediate steps to 99 (lower right), then back to zero.

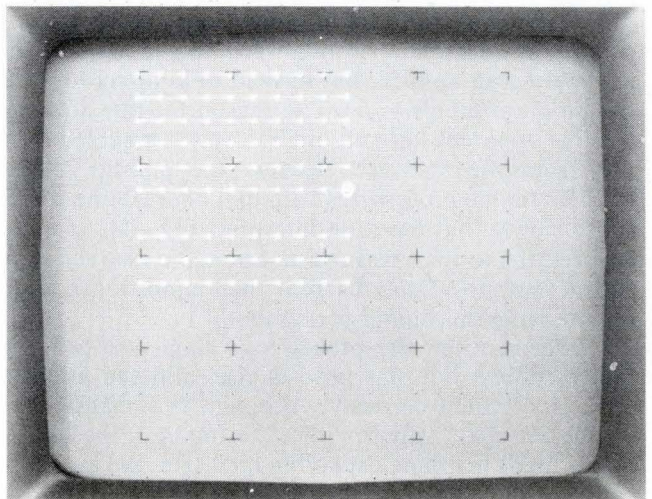

9. Pinpointing a malfunction. Functional faults in a counter show up clearly in a map display. The gap between the sixth and seventh lines displayed here means that the counter skips past 10 normally-required states—60 through 69. No other faults are evident.

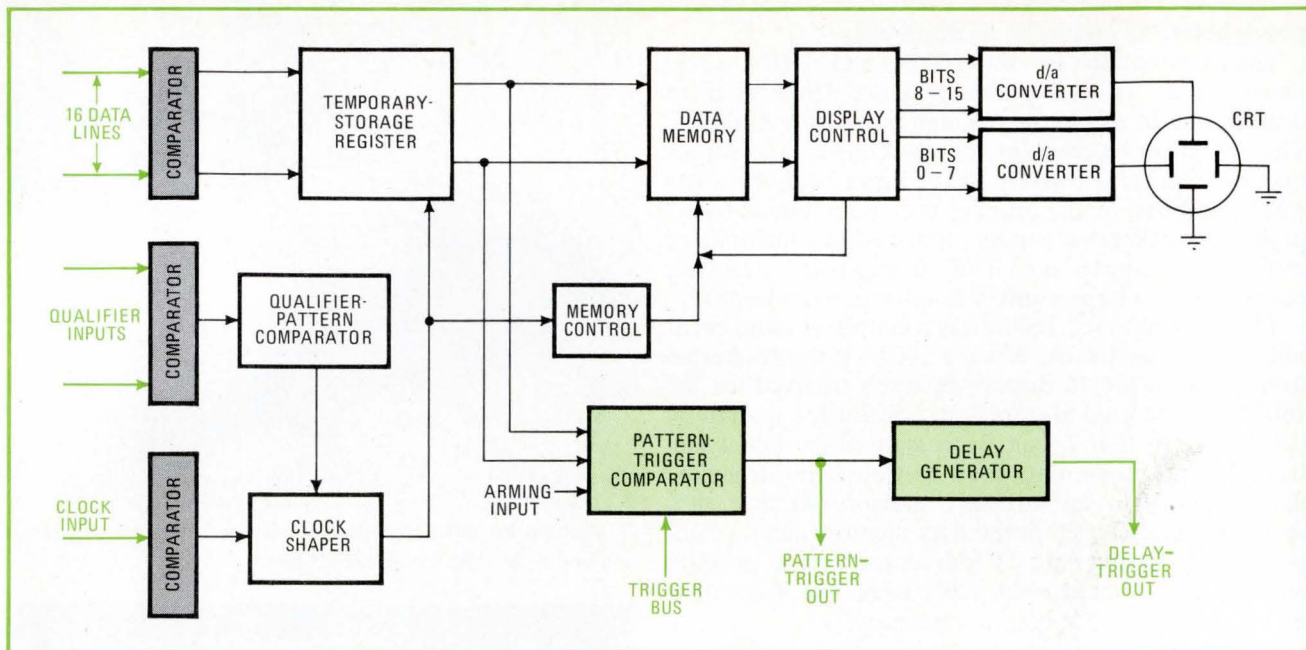

10. Operating in the map mode. The pattern-trigger comparator and delay generator are not used to control the storage or data in the 1600A data memory when the unit is in the map mode. However, they are still available for generating pattern and delayed-trigger outputs.

digital-to-analog converter connected to the vertical deflection plates, and bits 0 through 7 to a d-a converter connected to the horizontal plates. This divides the screen into a 2^8 by 2^8 matrix of dots.

Either an HP 1600A or 1607A logic-state analyzer may be used to pinpoint the malfunctions previously cited in the cash register and the traffic-light controller. To troubleshoot the cash register, the technician connects the logic-state analyzer to the program-counter (ROM-address) lines, turns off all of the trigger-word switches, and captures a set of data in the single-sample mode. This data indicates what the cash register is doing. The repairman chooses one of the words displayed as a trigger pattern; then returns the analyzer to the repetitive-sample mode and begins delaying through the loop until the program jumps back on itself.

The program calls for a jump from the initializing routine in locations 0 through 137 to the start of the keyboard scan at 4052. But instead of jumping to 4052, the program jumps to 52. The reason for this does not become apparent until an oscilloscope is triggered from the logic-state analyzer. Because the pull-up on the 4000 bit on the processor is bad, that address line comes up so slowly that the ROM interprets the address as 52 and returns to that instruction. Since the instruction at 52 is a jump to 57, the machine then jumps to 57, altering the program counter permanently.

However, when the processor is single-stepped, the faulty address line has time to rise, and the jump to 4052 is executed correctly. Although this malfunction can be detected easily by either the 1600A or the 1607A, the former's mapping capability facilitates the initial location of the defect. After the probes are connected, the service technician uses the map to examine the faulty loop, and uses the trigger-word locator to trigger the table mode a couple of states before the faulty jump. The analyzer can then be switched to the table mode,

and troubleshooting can proceed as before.

The trouble in the traffic-signal controller is even more easily diagnosed by a logic-state analyzer. The trigger word is set to address 37416 and the mode to end the data storage on the trigger word. The analyzer is then set to compile a single-sample table, connected to the program-counter bus, and left alone.

Whenever the traffic controller malfunctions, the logic-state analyzer will store and display the 15 words of program execution preceding the total jump to 37416. This information will remain on display until the technician gets back to see what is happening.

The traffic controller always jumps to 37416 from 2173. This instruction should be an AND instruction in a part of the program that changes the traffic light's timing cycles to accommodate the evening rush. In particular, 2173 is only called if one of the lights is yellow at exactly 4:40 p.m., when the rush hour timing is initiated. Since this occurs about every two days, the fault only shows up then.

A quick examination of the program instructions and the program counter shows that the instruction at 2173 is a JUMP instead of an AND because of a faulty bit in the program ROM. Once the processor encounters the JUMP, it interprets the next two instructions as a jump address and flies off to 37416. Since the processor interprets the unprogrammed or missing ROM, as a HALT, it promptly halts at 37416 until restarted.

Logic-state analyzers make quick work of troubleshooting data manipulators by pinpointing the errant data transactions. Even if additional time-domain analysis is required to find the glitch, race, or other malfunction, the logic-state analyzer shortens the search by putting out a trigger at or near the fault. The instrument also eliminates a large amount of probing by providing an exact record of the error so that only those nodes that could cause the error need to be probed. □

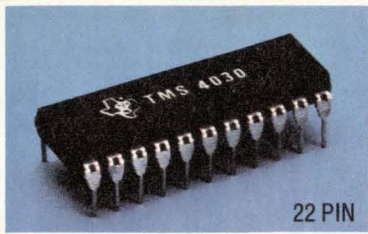
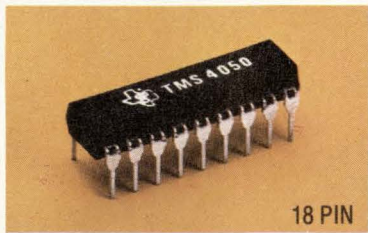
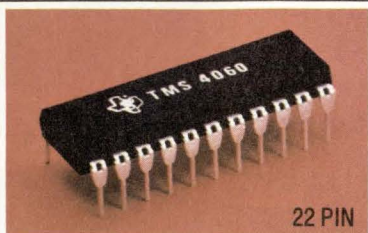
| DEVICE TYPE | PACKAGING | ACCESS TIME (NS) | POWER SUPPLIES |
|-------------|--|------------------|----------------|
| TMS 4030 |  22 PIN | 300 | -3V, +5V, +12V |
| TMS 4030-1 | | 250 | -3V, +5V, +12V |
| TMS 4030-2 | | 200 | -3V, +5V, +12V |
| TMS 4050 |  18 PIN | 300 | -5V, +12V |
| TMS 4050-1 | | 250 | -5V, +12V |
| TMS 4050-2 | | 200 | -5V, +12V |
| TMS 4060 |  22 PIN | 300 | \pm 5V, +12V |
| TMS 4060-1 | | 250 | \pm 5V, +12V |
| TMS 4060-2 | | 200 | \pm 5V, +12V |

MOS memories

Design Flexibility.

Texas Instruments 4K RAM family.
Helps you achieve optimum cost/performance designs.

When the design objective is to save space by increasing part density, the compact 18-pin TMS4050 may well be your best choice. You'll get 200ns performance and lower cost too—compared to 16-pin 4Ks, this is a 40% speed improvement and a 30% lower cost.

On the other hand, when separate data inputs and outputs are a design must, then the 22-pin TMS4030 or TMS4060 is the perfect choice.

Now with nine new 4K RAMs available, in plastic or ceramic, you can tailor the memory system performance to CPU needs. And you can design with

confidence. Because TI has more experience in building 4K RAMs than any other manufacturer. In

• First to combine the single transistor cell with the reliable N-channel silicon gate process.

- First to have an 18-pin 4K.
- First to offer a 200ns 18-pin 4K.

All TI 4K RAM types are in volume production. Availability is off-the-shelf through TI's authorized distributors in plastic (NL) or ceramic (JL).

For a Reliability Report or data sheets (indicate by type and number), write on your company letterhead to Texas Instru-

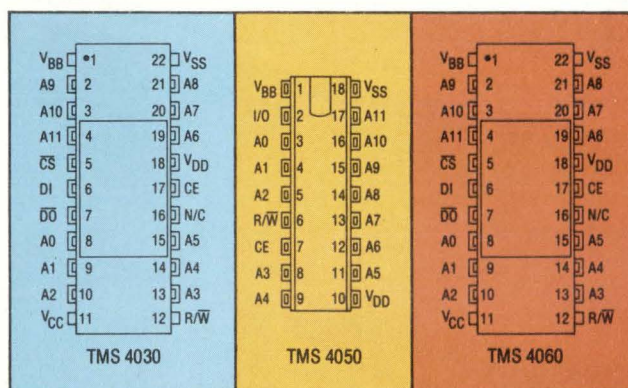

fact, TI can claim four big firsts in 4K technology:

- First to offer a 4K RAM.

ments Incorporated, P.O. Box 5012, M/S 308, Dallas, Texas 75222.



TEXAS INSTRUMENTS
INCORPORATED

"Smart"



FLUKE

6010A SYNTHESIZED SIGNAL GENERATOR

10.99999

MHz
kHz
Hz

REMOTE

REDUCE
OUTPUT LEVEL

FREQUENCY EDIT

DECADE

DIGIT

FM

AM

STORE
LOC 0-9

RECALL
LOC 0-9

CLEAR

OUTPUT LEVEL

POWER

ON
OFF

7

8

9

MHz

LEVEL

▲

▼

0

1

2

3

Hz

RANGE OVERRIDE

HI

10 Hz - 11 MHz

LO

10 Hz - 110 kHz

OUTPUT

50 Ω

10 Hz -

11 MHz

...but friendly!

INTRODUCING THE 6010A SYNTHESIZED SIGNAL GENERATOR

The first signal generator to incorporate a microprocessor.

The Fluke 6010A is a remarkable new instrument—a smart but friendly (easy to use) general purpose signal generator. It's a versatile 7 digit, 10 Hz to 11 MHz instrument with performance comparable to instruments costing twice our \$2,495.*

The key to the 6010A is... automation.

The Fluke 6010A features free-form entry of frequency in Hz, kHz, or MHz. Stores and recalls up to ten preset frequencies, modulation and attenuator settings by pushing a single button... a unique capability.



This feature is particularly important in any kind of repetitive testing, where tediously punching in a 7-digit number exposes the operator to error. It also radically shortens the time required by the testing sequence.

The microprocessor plays a part in several other operations, including *automatic range selection* and *automatic justification* (the unit automatically justifies the entry on the bright, 7-digit LED readout to give the greatest possible resolution).

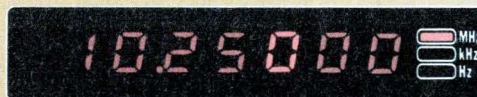

A sophisticated bench oscillator that's easy to use.

For all its sophistication, the 6010A works easier than any other instrument of its kind.

Continuous tuning is possible with Frequency Edit which consists of a large dual-concentric rotary knob.

The bright digit denotes the tuned decade. The bright digit can be decremented or incremented with complete wraparound and carryover.

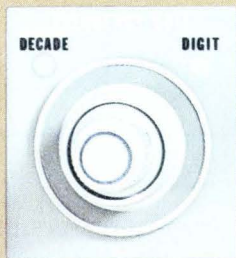

Spacewise, the unit measures only 5½" x 8½" x 19", so it takes up minimum space on the work bench.

Interfaces directly with ASCII systems.

The 6010A fits easily into an auto-testing system, because expensive interfacing is not needed. The unit "handshakes" directly with most ASCII (IEC) systems; the microprocessor handles the interfacing problems.

Here's price/performance without peer. And, it is backed by Fluke's second-to-none reputation for engineering, reliability and service.

For data out today, dial our toll-free hotline: 800-426-0361.

John Fluke Mfg. Co., Inc.
P.O. Box 43210
Mountlake Terrace, WA 98043



For a demo circle # 110. For literature only circle # 111.
For information on the rest of the Fluke line, see EEM or the Gold Book.

DIP switch isolates faults in system

by Robert A. Dougherty
RAD Technical Consulting, Dunedin, Fla.

A time-honored technique for isolating faults in a digital system is to bend up a pin of a dual in-line package, thus breaking the circuit by removing that pin from its socket. Sometimes, however, the circuit is not the only thing that breaks, because DIP pins are delicate.

The new in-line DIP switches offer a better way to disconnect one pin from the circuit. Two 16-pin DIP switches, each with eight spst slide switches, plus a 16-pin DIP socket and a 16-pin DIP component carrier, form a neat package that allows selective removal of any or all pins from the circuit at will. The DIP device is plugged into the socket on top of this package, and then the package is plugged into the circuit.

The accompanying sketch and photo show the simple assembly. (A 12-pin switch was used in the unit that was photographed.) □

Test assembly. DIP switches are mounted between socket and carrier to provide handy unit for isolating faults in a digital system. When a DIP IC is plugged into the socket and the whole assembly is plugged into the system, any pin or pins of the IC can be disconnected and reconnected quickly and safely.

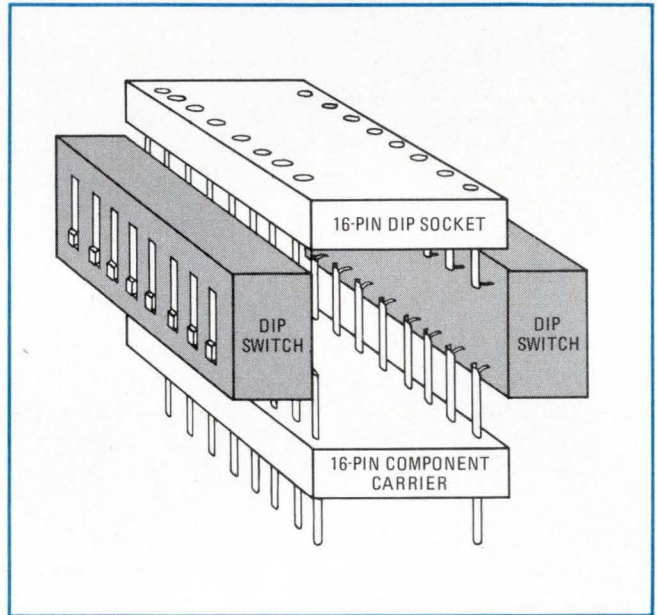
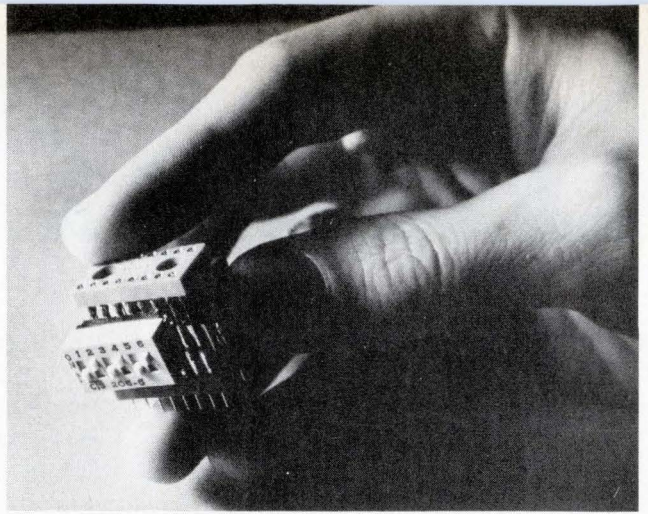

Op amp converts DVM to fluxmeter

by Lawrence F. Marinaccio
Mine Safety Appliances, Evans City, Pa.

The flux and flux density in a magnet usually are measured with a search coil and either a ballistic galvanometer or a galvanometer especially designed for use as a fluxmeter. Such fluxmeters are delicate, require special provisions for mounting and leveling, and must be calibrated from a mutual-inductance standard or a standard magnet.

A direct-reading fluxmeter that does not use a galvanometer and does not require calibration can be made with two operational amplifiers and a digital voltmeter, as shown in the circuit diagram. When the search coil moves through the magnetic field, a voltage is induced across its terminals. This voltage is amplified in the first op amp, and integrated in the second op amp. The inte-

grated output voltage is displayed on the digital voltmeter; the gain of the amplifier stage is adjusted so that the reading of the voltmeter directly represents the flux density in the magnetic field.

The voltage induced in an N-turn search coil cutting flux lines ϕ is given by Faraday's law:

$$e = N(d\phi/dt) \times 10^{-8} \text{ volts}$$

Therefore the number of flux lines cut in T seconds is

$$\phi = (10^8/N) \int_0^T e \, dt \text{ lines}$$

If the area of the loop is A square inches, the flux density B is ϕ/A lines per square inch. Flux density is commonly expressed in units of gauss (1 gauss = 6.44 lines/in.²), so

$$B = (1.55 \times 10^7/NA) \int_0^T e \, dt \text{ gauss}$$

In the fluxmeter circuit, which has a voltage gain of (R_2/R_1) in the amplifier stage, the output from the integrator is

$$E_o = (R_2/R_1)(1/RC) \int_0^T e \, dt \text{ volts}$$

Therefore, the flux density is given by

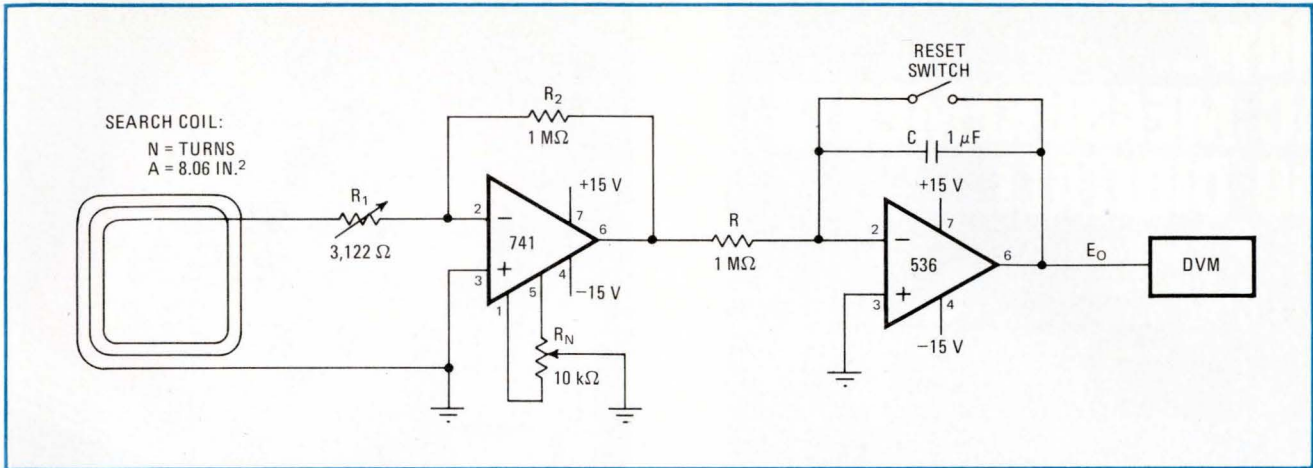

Fluxmeter. When search coil is flipped out of magnetic field, induced voltage pulse is amplified and integrated to produce output voltage that is displayed on digital voltmeter. Component values in circuit are chosen so that magnetic flux density in gauss is 100 times the DVM reading. This simple fluxmeter is more rugged than the galvanometers often used for magnetic field measurements, and it does not require calibration.

$$B = (1.55 \times 10^7 / NA)(R_1 R C E_0 / R_2) \text{ gauss}$$

The value of R_1 is set at 3122 ohms to make the DVM read directly; therefore, for the circuit as shown,

$$B = 100 E_0 \text{ gauss}$$

In the measuring circuit, the offset-null potentiometer R_N is adjusted to give a zero drift reading on the DVM. The search coil is then placed with its plane perpendicular to the flux in the magnetic field that is to be mea-

sured, and the reset switch is closed momentarily to ensure zero initial charge on capacitor C. Then the search coil is either rotated 90° or removed to a flux-free region. The resulting voltage pulse is amplified and integrated by the circuit to produce output voltage E_0 that is displayed on the digital voltmeter. If the flux density is 1,000 gauss, the DVM reads 10 volts.

An unselected 741 op amp was used in this circuit, but if lower fields are to be measured and greater sensitivity is required, a low-drift op amp should be used. □

Seven-segment indicator shows Roman I through V

by Yehia Hussein
Television Studios, Cairo, Egypt

To get away from ordinary numerals for indicating time modes (or any other five-level state), here is a quickly recognizable display that uses a standard 7-segment indicator. Roman numerals I, II, III, IV, and V are displayed by turning the 7-segment indicator on its side, as shown in Fig. 1. A decoder/driver, consisting of two exclusive-OR gates and one AND gate, operates directly from BCD inputs.

The display is implemented for a MAN-4 7-segment light-emitting diode, driven by transistor decoder/drivers from the BCD output of a divide-by-6 counter, as shown in Fig. 2. Transistors Q_1 , Q_2 , and Q_6 correspond to gate 1 in Fig. 1; Q_4 , Q_5 , and Q_7 correspond to gate 2; and Q_3 corresponds to gate 3.

When the BCD outputs A and C are low, Q_1 and Q_2 are off and therefore Q_6 is off, so the | segment receives no current and does not light. When A is high and C is low, Q_2 is off, but Q_1 is on; therefore, current from the A output flows through Q_1 to turn on driver Q_6 , which illuminates the | segment. The magnitude of the input

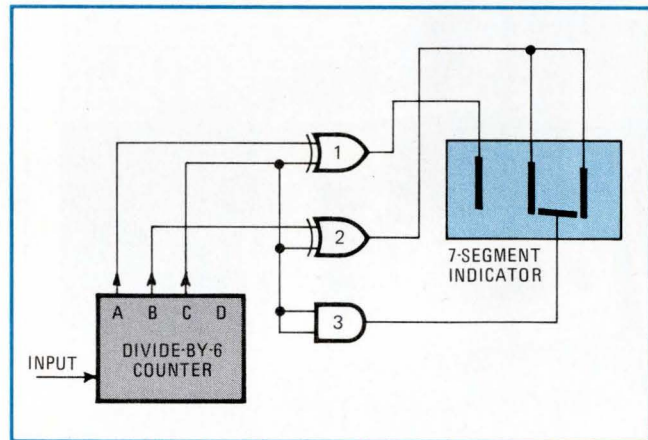

| STATE | A | B | C | EX-OR GATE 1 | EX-OR GATE 2 | AND GATE 3 | DISPLAY |
|-------|---|---|---|--------------|--------------|------------|---------|
| 0 | 0 | 0 | 0 | 0 | 0 | 0 | (NONE) |
| 1 | 1 | 0 | 0 | 1 | 0 | 0 | |
| 2 | 0 | 1 | 0 | 0 | 1 | 0 | |
| 3 | 1 | 1 | 0 | 1 | 1 | 0 | |
| 4 | 0 | 0 | 1 | 1 | 1 | 1 | _ |
| 5 | 1 | 0 | 1 | 0 | 1 | 1 | _ |

1. Roman numerals. Seven-segment display element, turned on its side, provides Roman numerals I through V. Indicator is driven by two exclusive-OR gates and one AND gate, which operate directly from BCD outputs of a digital counter.

Now... AC MEASUREMENTS GO DIGITAL!

- True RMS Volts
 - True RMS Current
 - AC Watts
- ... all in YEW's new 2504 AC DMM!

The new 2504 digital AC instrument offers unexcelled accuracy and versatility for the measurement of sinusoidal and non-sinusoidal waveforms and for measurements at low power factors. Flexible design allows optional purchase of just the measuring functions required while push-button controls provide ease of operation.

The YEW 2504 is the AC DMM. Its 0.25% accuracy and 0.01% resolution, standard analog output, and low cost (Prices start at \$1,590.) make it the ideal instrument for quality control, lab, field maintenance, and instrument calibration applications. Write for details.



Standard ranges (Multirange Model):
30V/60V/100V/150V/300V,
0.5A/1A/2A/5A/10A (15W to 3,000W)
Frequency range: 25 Hz to 1 kHz



Yokogawa Electric

YEWTEC CORPORATION

1995 Palmer Avenue
Larchmont, N.Y. 10538
Telephone: 914-834-3550

60 Years of Measuring and Recording Instrumentation

Circle 114 on reader service card

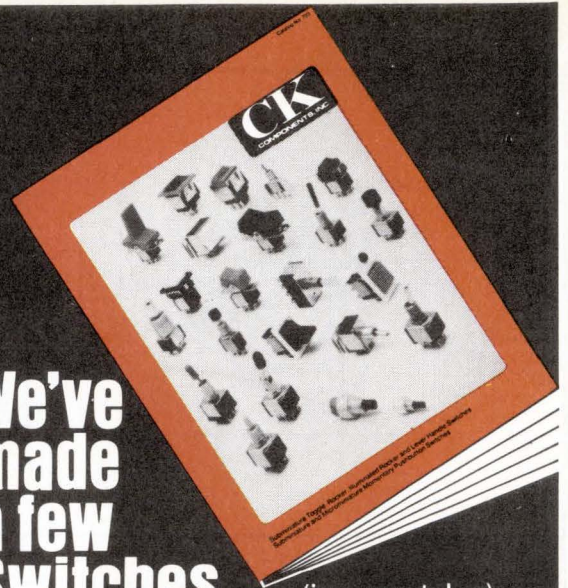

We've made a few Switches

(in our catalog).

Actually, as one of the world's leading manufacturers of electrical switching devices, we've made *millions* of switches: miniature, subminiature, and microminiature — with pushbutton, toggle, rocker, and paddle handles. But the switches we're referring to, here, are the switches in format and design of our catalog. We've simplified it. Made it easier to mix and match switch components and options. Easier to order. Easier to read. Get your 24-page C&K catalog now!

C&K COMPONENTS, INC.

103 Morse St., Watertown, MA 02172. (617) 926-0800
TWX: 710 327 0460 TELEX: 92 2546

Circle 160 on reader service card

BEST SPECS AT BETTER PRICES



MFE's 715A offers:

- | | |
|--|--|
| <input type="checkbox"/> Pad/load®, 8-1/2 x 11" recorder | <input type="checkbox"/> > 140 db CMR at line |
| <input type="checkbox"/> 5 ranges 1MV/in - 10V/in or .5MV/cm - 5V/cm | <input type="checkbox"/> Constant 1MΩ impedance |
| <input type="checkbox"/> Disposable fibre tip pen | <input type="checkbox"/> Slew speed 20 ips |
| <input type="checkbox"/> 50-400 hz, 115/230V switchable | <input type="checkbox"/> Plug-in timebase optional |
| <input type="checkbox"/> Electronic overdrive protection | <input type="checkbox"/> One week delivery |
| <input type="checkbox"/> Zero check pushbutton | |

Call or write Ron Gosk to discuss specific requirements.



MFE CORPORATION

Keewaydin Drive
Salem, N.H. 03079
Tel. 603-893-1921
TWX 710-366-1887



TELEX 94-7477

Circle 161 on reader service card

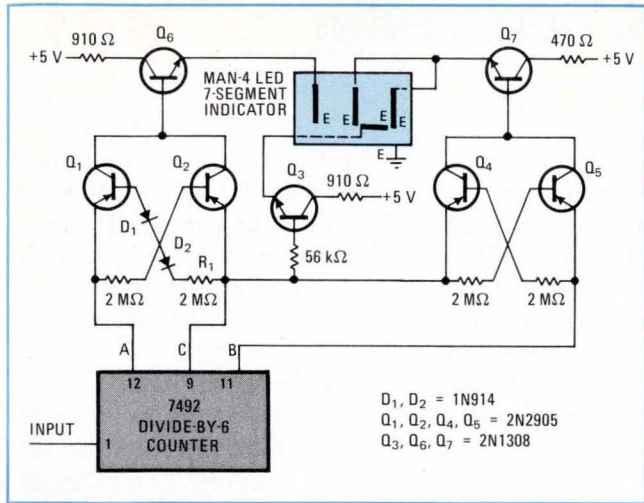

2. Circuit. Implementation of Roman-numeral indicator uses three transistors for each exclusive-OR gate and a single transistor for the AND gate. BCD data comes from divide-by-six IC. Display element is a 7-segment LED device. This novel display mode is useful for any system or situation with up to five levels or periods, such as gear positions, soccer quarters, elevator stops, and the like.

current to the driver is determined by resistor R_1 . If C is high and A is low, Q_2 conducts, and again the | segment glows. When both A and C are high, Q_1 and Q_2 are both off; diodes D_1 and D_2 ensure the performance of this exclusive-OR, even when the A and C highs are unequal because of current being drawn from C to the other transistors.

The exclusive-OR gate of Q_4 , Q_5 , and Q_7 operates in a similar manner to illuminate the || segments, but diodes are not needed because B and C are never high simultaneously (see truth table in Fig. 1).

The AND gate, transistor Q_3 , is a direct-drive circuit that lights up the horizontal bar to convert || to |_, which approximates Roman numeral V. □

Engineer's Notebook is a regular feature in Electronics. We invite readers to submit original design shortcuts, calculation aids, measurement and test techniques, and other ideas for saving engineering time or cost. We'll pay \$50 for each item published.

Ringer enables telephone to play simple tune

by Kenneth Dugan

General Telephone and Electronics, Clearwater, Fla.

By combining two simple circuits, you can make your telephone play a simple signature tune—perhaps “Smoke gets in your eyes” if you’re an electronic-circuit designer, while an educator might like “*Gaudeamus igitur*,” or a journalist might prefer “Somewhere over the rainbow.” The number of programable tunes is large.

The schematic for the interface circuit shows how to combine the two circuits, each of which has appeared in a past issue of *Electronics* (“Making music with IC timers,” April 18, 1974, p. 106, and “Optically coupled ringer doesn’t load phone line,” Feb. 20, 1975 p. 92). The 74121 Schmitt trigger input produces a sharp pulse

from the sinusoidal telephone-system ringing generator signal. The negative pulse output of the monostable turns the 555 timer on for about 10 seconds to allow the musical ringer to go through its cycle. This cycle will repeat until the telephone is answered or until the caller hangs up.

You may find your telephone company uses a ringing generator frequency that’s not 40 hertz. Frequencies of 20, 30, 42, 54, and 66 Hz are common, and a PABX installation in a building generally uses 30 Hz. The circuit can handle any of these frequencies.

If the idea of a musical telephone ringer sounds frivolous, that’s because it is. It was used with amusing effect on one of the old-time radio shows. But the circuitry can be adapted to control other devices besides a ringer.

One last thing—you should consult the telephone company before installation, even though the optical-coupling technique does not load the line severely. Incidentally, the company itself will supply you with a musical device, but it plays only three notes—nothing like a signature tune. □

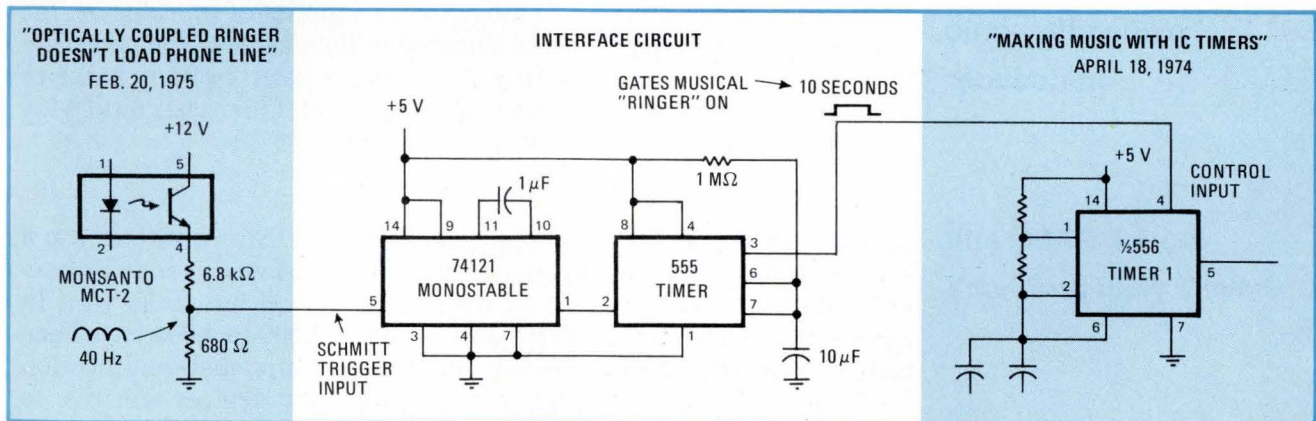

Musical signature. Interface circuit combines two circuits described in past issues of *Electronics*, as indicated. Optically coupled ringing detector triggers music synthesizer here; more generally, it allows control of other devices by dialing of a telephone number.

How to wire your own edge-triggered R-S flip-flop

Though an edge-triggered set-reset D-type flip-flop can be handy, especially for interfacing asynchronous signals, designers know they're hard to find in a catalog—and cost a fortune when they do appear. The answer: wire your own. Jay Chin of California State Polytechnic University in Pomona, Calif., points out that it's easy to wire a common dual D-type flip-flop to function like an R-S one—and it's also cheap, because you don't need any extra components.

To obtain an R-S flip-flop, **simply connect the clear input of one D-type flip-flop to the second flip-flop's \bar{Q} output.** Now, the D input of the first device serves as the set enable line, its clock input as the set line, and its Q and \bar{Q} pins as the complementary outputs. The D input of the second device is the reset enable line, and its clock input is the reset line. The preset inputs of the first and second devices can then be used as conventional set and reset lines, respectively.

IC inventory buildup is predicted by new market model

If your company got burned in the current IC inventory recession (and who didn't?), your management might take a look at Gnostic Concepts Inc.'s forthcoming multi-client IC forecast. Researchers there have developed **a model of market flow which takes into account IC production, shipments, manufacturers' and end-users' inventories, and equipment use.** In the model, distributors are classed as an end-user, and ICs returned by distributors reappear in the manufacturers' inventories.

It seems to work. When 1973 and 1974 data is plugged into the model, the answers jibe with experience, showing all too well how in the third quarter of last year soaring IC production was tracked by soaring user inventories and led to disaster. Looking ahead, the Gnostic study foresees heavy manufacturer inventory liquidation in the first three quarters of 1975 and **spots the fourth quarter as the start of new inventory buildups and increased IC demand**—a happy condition that should continue strongly throughout the first half of 1976.

But watch out. According to the Gnostic model, the last quarter of 1976 will see still another manufacturing inventory liquidation and, horrors, just at a time to coincide with another peak in IC production.

Trade in that dying ultrasonic transducer

Getting lousy results from your ultrasonic lead-bonding transducers? Well, according to Uthe Technology Inc., a supplier of transducers, the devices **should be replaced after about 40 million cycles.** The company is allowing users to trade old or worn-out transducers—of any make or condition—for new UTI devices at a 40% discount. Offer lasts until May 30. Call Uthe's Roland A. De Angelo at (408) 738-3301.

Do 4-k RAMs still have a yield problem?

If you're in the market for large quantities of 4,096-bit RAMs, you'll want to know the recent experience of a senior test engineer at Honeywell's Phoenix facility, where big buys of the devices are under way. In one batch of parts from a West Coast supplier, **3,000 to 4,000 have been tested so far and 30% have failed, 20% at the component-qualification level.** According to the source, not only were the devices sensitive to pingpong (or galloping) patterns, but the components failed when subjected to a voltage slew from 11.4 to 12.5 volts. —Laurence Altman

The counter system that stays on top of your needs and under your budget.

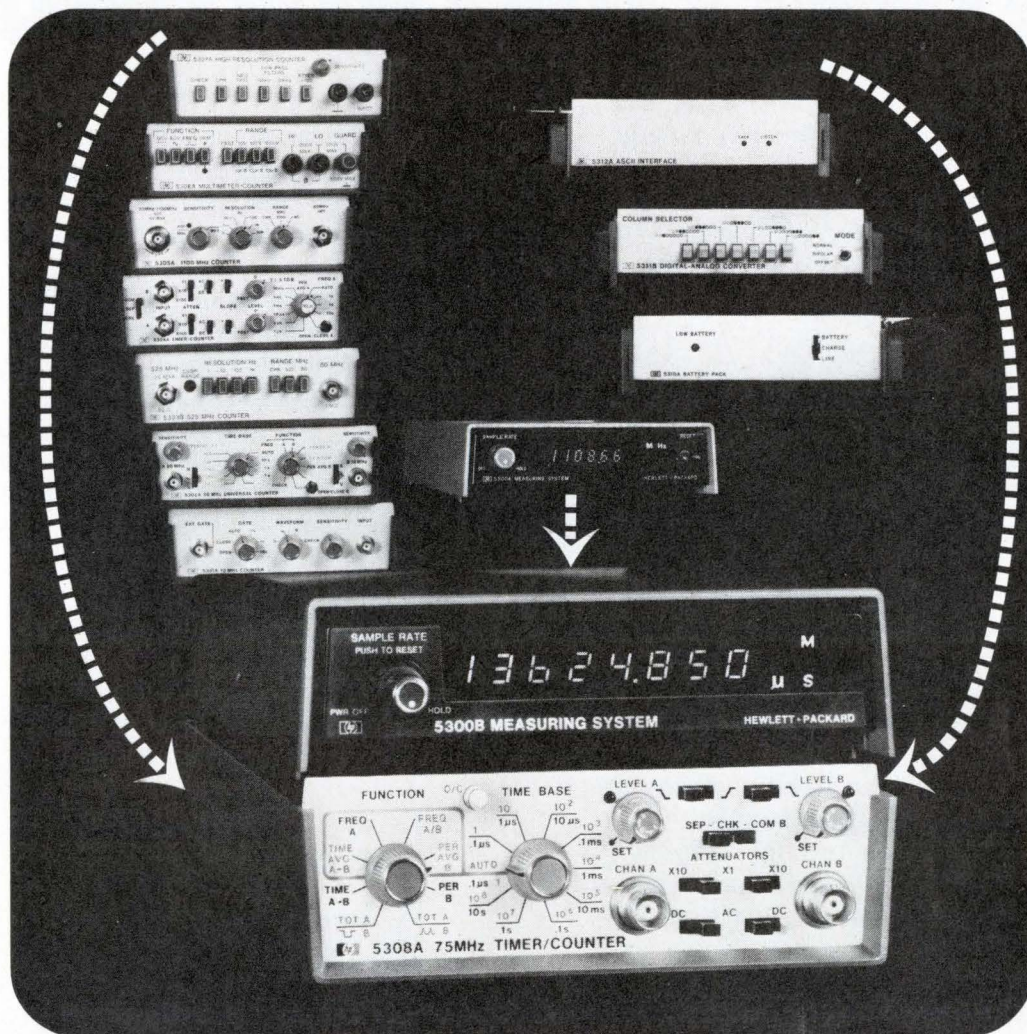

The heart of HP's versatile 5300 Measurement System is a sophisticated mainframe which contains counting circuitry and display. Snap it onto the bottom module you need and it instantly becomes one of eight feature-loaded instruments. The 5300 basic modules include:

- six and eight digit mainframes
- frequency counters to 1100 MHz
- universal counter/timers with

time interval averaging to 1 nsec.

- a high resolution counter that reads 60.0000 Hz in 1 sec.
- digital multimeter/counter for ac-dc volts, ohms and frequency
- snap-between capability can be added at any time, including:
 - battery pack for portable operation
 - D to A converter for analog outputs
 - HP-IB interface for flexible data acquisition systems.

Once you have the mainframe, it's the low cost way to build a complete workshop of first-line instruments, the one system that really does stay on top of your needs — and under your budget. Prices start at \$410* for a mainframe; \$175* for a module.

Send for a free detailed brochure on HP's 5300 Series Counters.

*Domestic USA prices only.

HEWLETT  PACKARD

Sales and service from 172 offices in 65 countries.
1501 Page Mill Road, Palo Alto, California 94304

When we introduce we don't just introduce

We introduce everything you might need to go with it.

A total support package that helps you get our new microprocessor on the job, working, with the least possible time, effort and money.

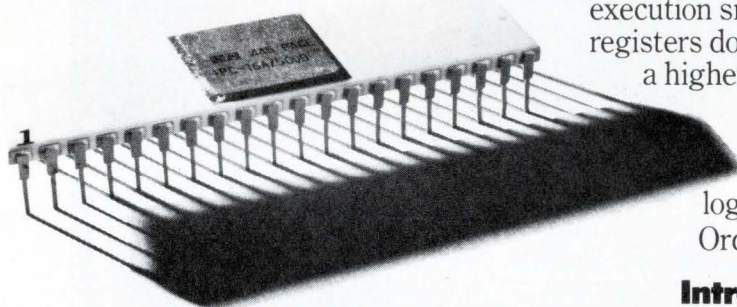

Introducing PACE.

The first 16-bit microprocessor on one chip.

PACE brings you 16-bit performance at an 8-bit price... and 8-bit simplicity.

By including on its single chip the functions that you typically had to add on yourself later, we can save you time and money.

PACE contains not just the bare bones CPU functions but a full-fledged processor with control logic, status register, four accumulators, a ten word stack and a six-level, vectored priority interrupt system.

16 bits has a lot to offer over 8 bits.

Higher efficiency, for one thing. You need a lot less memory, and in a microprocessor system memory is typically two or three times the cost of the CPU, so you're not talking about peanuts.

Lower programming costs, for another. A 16-bit's more powerful instruction set lets you do in one instruction fetch what an 8-bit machine would take 3 instruction fetches to perform.

And higher system throughput. On the execution side, 16-bit data paths and registers do so much more in one go, there's a higher net performance.

Getting 16 bits down onto a single chip is a pretty good example of National's technology leadership in microprocessing. Order your evaluation sample.

Introducing everything that goes with PACE.

To go with PACE we've developed optimized support and memory products that allow you to cut your development

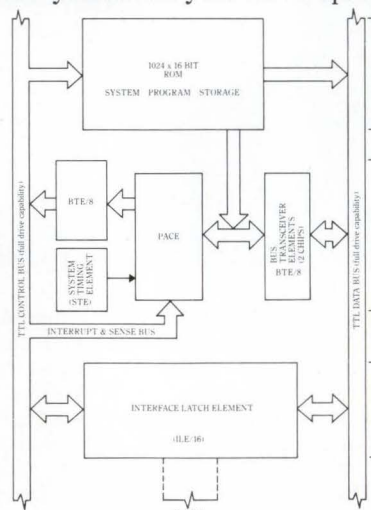

PACE Microprocessor Systems

a new microprocessor a new microprocessor.

costs and implement a complete PACE system inexpensively in seven packages.

Seven.

That's a complete, usable 16-bit system, with clocks, buffers, interrupts, handshake I/O control, sense inputs, control outputs, on-chip stack, and 16K bits of program storage.

Stack that up against 30 or so packages you need for some other microprocessors and you begin to get the picture of PACE's remarkable simplicity and economy.

But we know development effort comes before production hardware. That's why PACE is fully supported with development aids: a prototyping system, executing resident software including Edit, DEBUG, Conversational Assembler, and the best Relocating Macro-assembler in the industry. Coming soon, a Disk Operating System (D.O.S.) and our SM/PL resident high level language. This makes PACE the only fully supported one-chip microprocessor in the industry.

To complete our total customer support, we also provide application cards, training at our new Training Centers, field applications assistance, factory service, complete documentation, complete everything.

We can even provide all the other electronic parts you need in your microprocessor-based system. The displays, opto-isolators, transducers, A/D & D/A

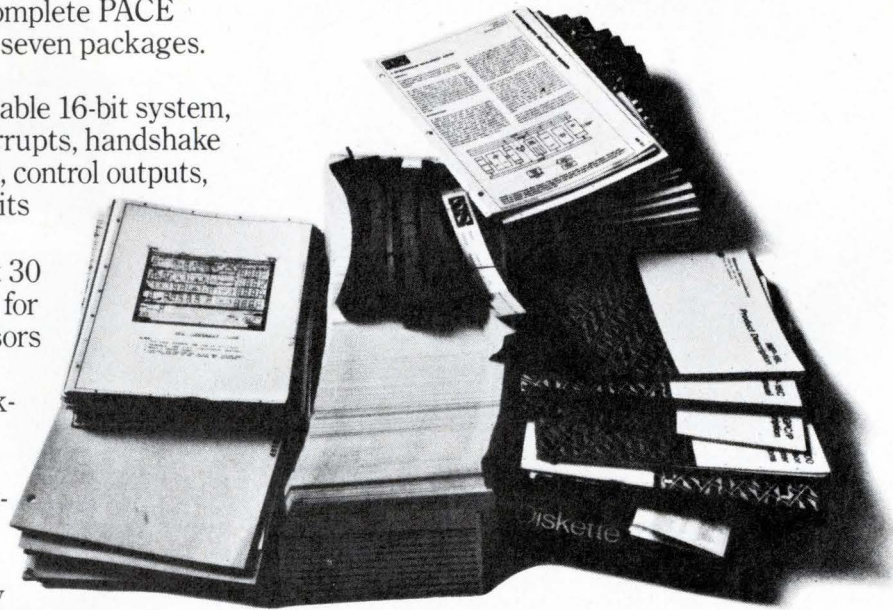

converters, analog & digital IC's, transistors, etc.

That's what we mean by our headline above, and our slogan below.

And that's what we can give you that nobody else can.

And that's our story.

Please send me a copy of your Microprocessor Brochures and complete details about PACE.

Name _____

Company _____

Address _____

City _____ State _____ Zip _____

Mail to: National Semiconductor, 2900 Semiconductor Drive, Santa Clara, California 95051

E515

National

There's more to microprocessing
than microprocessors.

If it's an IC, we make a tester that tests it.



The ALMA 550: Linear IC's

The 550's modular design provides comprehensive testing of linear IC's, utilizing convenient plug-in test modules and program limit cards. Even an inexperienced operator can test op amps, regulators, comparators, timers, and other types of linear IC's at a rate of twenty tests per second. The 550 both denotes and evaluates IC failures, displaying test results as well as the programmed limits. In addition to the broad range of standard linear IC test modules, custom modules are available for individual applications, as are blank circuit modules for customers wishing to develop their own test sequences.

Alma 550, circle No. 246



The ALMA Systems North 720: Watch IC's

A fully programmable MPU-controlled tester for quartz-crystal timing devices, the 720 tests both IC's and completed watch modules. Tests performed under control of the powerful software language include continuity, output breakdown voltages, input leakage, static and dynamic supply current, oscillator gain, functional checks, output drive parametric evaluations, and time intervals. The modular 720 architecture permits optimum configurations for different levels of circuit complexity, as well as differing process techniques.

Alma Systems North 720, circle No. 248



The ALMA 760: RAM IC's

The only moderately priced full capability RAM tester on the market. It completely tests MOS, TTL, and ECL RAM's without modification, and includes a powerful microprogrammable pattern generator for producing any complex pattern. The 760 features multiplexed addressing, I/O buss capability, 1V/ns drivers, sensitive comparators, and a versatile test deck for rapid interface to autohandlers and probers. Major options include a high-speed dc parametric test module, classification option for grading RAM's, a programming panel for convenient device evaluation, and raster scan display.

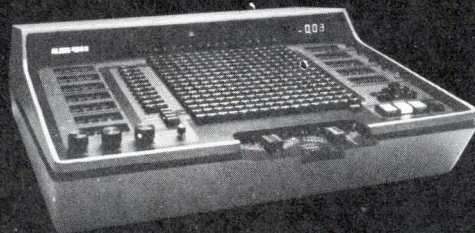

The ALMA 480B: Digital IC's

When you buy the ALMA 480B, you get over 800 test programs. FREE. Programs that allow you to test all of the popular DTL, TTL, ECL and bipolar compatible digital devices. Several powerful test patterns are accessed via push-button selection to provide thorough functional testing of the newer, more complex MSI and LSI devices. And the full front panel programmability of the 480B permits unsurpassed ability to evaluate and characterize digital IC's.

Alma 480 B, circle No. 249

ALMA offers you a complete family of digital and linear testers.

Write us . . . or call us, for complete information. If it's an IC, we make a tester that tests it.

ALMA Division of Develco, Inc., 530 Logue Avenue, Mountain View, CA. 94043 (415) 968-3903
Alma 760, circle No. 247

New products

Fiber-optic cable is multichannel

Flexible small-diameter waveguide provides six communications lines, yet holds transmission losses down to 20 decibels per kilometer

by Lucinda Mattera, Components Editor

Fiber-optic communications—transmitting data over optical waveguide by means of light—is fast becoming a practical reality because of recent developments in both fiber-optic connectors and cable. In the past, there was no low-loss multichannel cable available at all, much less at some reasonable cost. A cable was actually a jacketed bundle of optical fibers, and this limited its transmission capability to a single channel. Furthermore, expensive cables could hold transmission losses to tens of decibels per kilometer, but losses would climb to several hundred decibels per kilometer for low-cost cables.

Now, however, the Telecommunications Products department of Corning Glass Works is offering a low-loss multichannel cable, called Corguide, for industrial as well as military applications. Corguide, which sells for \$13.50 per meter, contains six individually jacketed glass optical fibers, making it capable of handling six channels of data at the same time. The maximum attenuation for each fiber is only 20 dB/km at a wavelength of 820 nanometers.

Vital uses. Industrial applications for the new cable include computer interconnections, process control, dedicated communications links, and electric-utility instrumentation. Military uses encompass telemetry links, internal communications links, weapons wiring, and secure data transmission.

Each of Corguide's six channels is first protected by a urethane coating. The buffered fibers, each having a core diameter of 85 micrometers, are then stranded around a

central member, which is also a urethane-coated glass fiber, for alignment purposes. Two parallel strands of a high-strength material are positioned 180° apart near the surface, along the cable's axis. The cable's outer insulation is also made of urethane.

Corguide is both flexible and completely dielectric, making it impervious even to high electromagnetic fields. The cable diameter is 0.5 centimeter, and weight is less than 25 kilograms/km. Tensile strength is 50 kg, and the minimum flexing radius is 2.5 cm. Optical crosstalk between the fibers is a maximum of -60 dB.

The cable can be terminated in a conventional manner—the insulation is stripped off, next the cable surface is cleaned, and then the ter-

minating connector is installed. Corning will supply the cable to a specified length with the terminating connectors already in place. At this time, standard cables can be as long as 500 meters.

Later this year, additional Corguide products will be available, including cables containing different numbers of fibers, cables having larger bandwidths, and cables offering lower attenuation characteristics. Hardware, like single-fiber sources, detectors, and connectors, will also be introduced before the end of 1975. Currently, prototype hardware already exists for operating six optical fibers as a group.

Delivery for all the Corguide products is from stock.

Corning Glass Works, Telecommunication Products Dept., Corning, N.Y. 14830 [338]

Inside look. Enlarged cross-section of fiber-optic cable shows how the six fibers used for data transmission are separated from each other. Center fiber is for alignment.

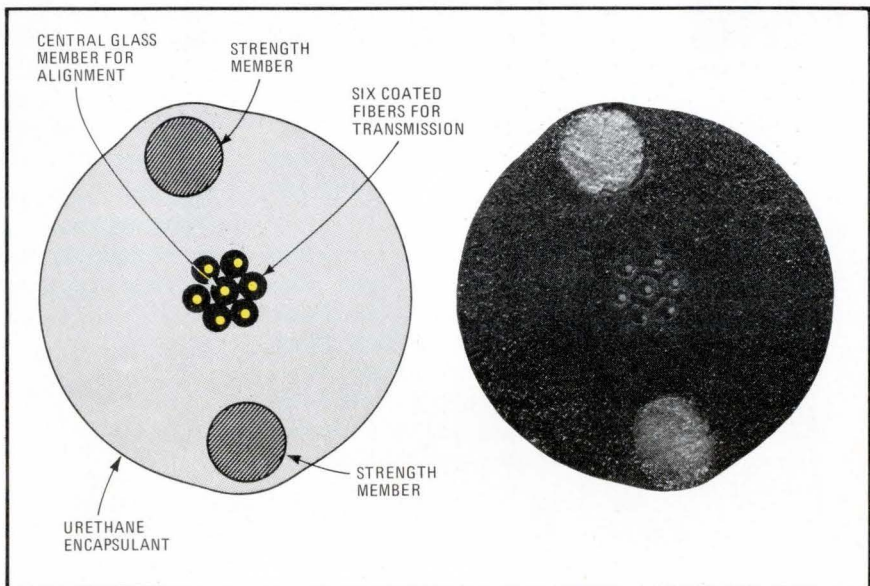

SIEMENS

Introducing the 203 Test System. Total semiconductor memory testing at true 20 MHz speed.



The 203 Semiconductor Memory Device Test System is a new, powerful tool for evaluating the performance of RAM's, ROM's and Shift Registers in production, engineering, and incoming inspection. The system satisfies all aspects of high-speed functional and DC-parametric testing requirements to provide total test flexibility and lowest cost-per-unit throughput.

The microprogrammable processor in the 203 generates address sequences and data patterns at true 20MHz test rates, enhancing its use for future high-speed devices. Multi-cycle timing is provided by 16 independently programmable channels. A high resolution 1ns clock permits meaningful time-related device tests, ensuring accurate, repeatable test results.

A minicomputer controller in the 203 provides system control and data retrieval. Flexible, task-oriented software using a macro-language simplifies programming. The 203 is available as a single station or may be used in a parallel or multiplex operation with up to four handlers or wafer probers.

The 203 Test System is totally unique in the semiconductor memory test field. It offers an unmatched test capability to the user at the least overall cost. Today and tomorrow.

Siemens Corporation
Computest Products

3 Computer Drive, Cherry Hill, N.J. 08002 (609) 424-2400

Thin-film resistor prices tumble

IC fabrication techniques yield low-cost precision networks, available in chip form, single in-line packages, and flatpacks

Historically, thin-film-resistor networks have been expensive, even though they lend themselves to the same high-volume automatic processing techniques that are used for integrated circuits. By taking advantage of such established IC-fabrication methods as large substrates and automatic wire-bonding, the Resistor Products division of Analog Devices is now offering several families of low-priced thin-film resistor networks that retain the precision characteristics of the earlier higher-priced devices. Standard networks are available in chip form or with beryllia substrates for increased power dissipation. And custom networks can be supplied in either a ceramic single in-line package or a ceramic flatpack.

The nichrome thin-film system used for all the networks provides temperature tracking as good as 0.5 ppm/°C and long-term ratio drift as low as 50 ppm/year at 25°C. Additionally, interlead capacitance, an important parameter for high-speed applications, can be as little as 1 picofarad. The voltage coefficient of the devices, which is negligible except for self-heating effects, can be held to 0.007 ppm/v.

The standard networks in chip form include 14 separate functions, as well as 250 resistance values and accuracy grades. The network configurations cover individual discrete resistors, summing networks, divider networks, and current ladders up to a complexity of 12 bits. Resistance accuracy can range from 0.01% to 10%, and the standard operating temperature is -55°C to +125°C. In quantities of 1,000, prices start at \$1.50 each for a discrete network

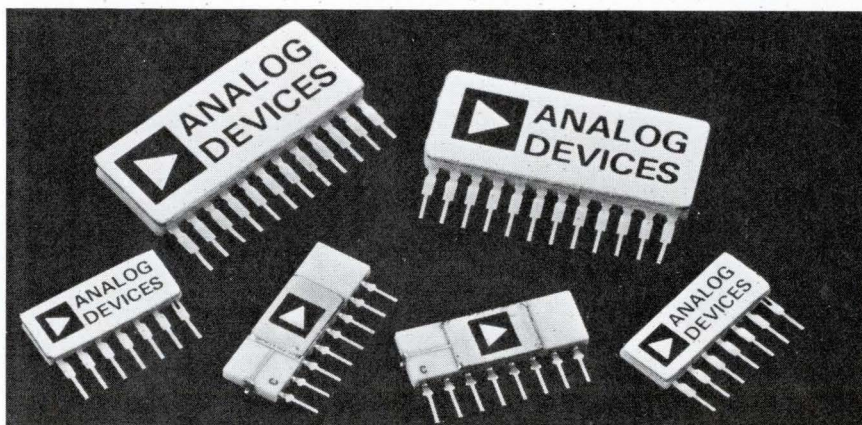

Wide choice. Selection of low-cost thin-film resistors includes both standard and custom networks in chip form, single in-line packages (shown here), and flatpacks.

having an accuracy within 0.1%, while a ladder network costs between \$8 and \$9. Delivery time is 10 weeks for the first 1,000 pieces, then 1,000 pieces per month.

The standard networks on beryllia substrates can dissipate seven times more power than those on alumina substrates. For example, with adequate heat-sinking, a seven-resistor discrete network can handle up to 0.5 watt. Prices for a 0.145-inch-square chip start at \$3 each in 1,000-lots. Delivery time is eight weeks for production quantities.

The new single in-line package for user-designed networks can have seven, eight, nine, or 12 pins. A seven-pin package can accommodate seven to 12 resistors, while a 12-pin one can have six to 14 resistors. The price of a seven-pin device, providing a ratio accuracy within 0.1% is as low as \$5 each in lots of 1,000. Production quantities can be delivered within 10 weeks.

User-designed networks can also be housed in 10-, 14-, 16-, or 24-pin ceramic flatpacks. These packages

are aimed at digital functions in avionics equipment or other applications requiring high reliability in pull-up, pull-down, terminating, or level-shifting resistors. In quantities of 500, price ranges from \$10 to \$30 for a network of 10 to 20 resistors with a drift of 50 ppm/°C, tracking between 1 and 5 ppm/°C, and screening to MIL-STD-883. Delivery time is eight weeks for the first 25 units, then decreases to 50 units per week.

As an additional standard product, Analog Devices is offering a 13-resistor summing network in either a 14-pin ceramic flatpack or a dual in-line package. Each resistor in the network can dissipate 50 milliwatts and is available in values from 0.05 to 250 kilohms. Prices start at \$4.30 each in quantities of 100 or more. Delivery is from stock.

Analog Devices Inc., Resistor Products Division, Rte. 1 Industrial Park, Norwood, Mass. 02062. For chips, circle reader service number 371; for beryllia substrates, 372; for single in-line packages, 373; and for flatpacks, 374.

For high-quality, low-cost MOS transmit-receive circuits,

We give communications and computer equipment manufacturers an alternate source for the best competitively priced synchronous/asynchronous terminal transmit/receive metal oxide semiconductor devices:

NC2257 terminal transmitter with internal clock and word complete. NC2260 terminal transmitter. NC2259 terminal receiver.

And they're all exact plug-in replacements for Motorola devices MC2257, MC2260, and MC2259 respectively.

Such complex data communications devices usually come in large, non-standard packages, but not these NITRON products. Our receivers and transmitters are separate units in standard 24 and 28-pin, dual-in-line packages.

Before you forget, fill out and mail the coupon below. We'll get right back to you with a data sheet, application report, and the full story of NITRON's transmit-receive circuits.

NITRON
A DIVISION OF
MCDONNELL DOUGLAS

don't forget NITRON.

NITRON
10420 Bubb Road, Cupertino, CA. 95014

NAME _____ COMPANY _____
TITLE _____ ADDRESS _____
CITY _____ STATE _____ ZIP _____

New products

Instruments

Simplifying data loggers

Low-priced calculating processor converts digital data to engineering units

A new type of instrument accessory developed by California Instruments provides an inexpensive alternative to conventional methods of putting together laboratory or industrial data-collection systems.

"The CP-70 calculating processor can eliminate the need for a mini-computer, programable calculator, or manual intervention in many small data-logging systems," says Richard H. Applin, president of California Instruments. The processor performs calculations and presents the results for data-logging, all without any programming. Price of the CP-70 is \$1,500. Programs, including complex calculations of such parameters as stress, are hard-wired into the processor and selected from the panel or remotely. Although other instruments use microprocessor chips for increased capability or for programability, the CP-70 has a calculator chip for its heart because the instrument is intended to simplify the operation of systems. It also accepts digital data from any source so it doesn't obsolete conventional instruments.

In a typical application, transducers measuring such values as rotational motion and pressure are used with digital voltmeters to give a BCD output. That value is sent to the calculating processor, which performs calculations on the data and constants entered through the front panel. Frequently eliminating the need for looking up data tables, the results, which are displayed on the front panel, as shown below, can simultaneously be printed.

The inputs to the processor are three six-digit variables, including decimal point and polarity. Normal format is 8-4-2-1 BCD in parallel, but serial characters can be handled as an option. The output is eight digits, including decimal point and polarity, displayed in light-emitting diodes on the front panel. The BCD equivalent in either parallel or serial form is provided for recording.

The calculating processor can store up to 16 programs, and 10 are supplied as standard. The programs are hard-wired by California Instruments, eliminating the need for any knowledge of software by the system designer or user. Available programs include equations involving up to three variables or two variables and a constant. The programs can be used for algebraic addition, multiplication, and division, plus calculations of deviation, creep, stress, elongation, temperature coefficient, velocity, distance, decibels, horsepower, flow, motor speed, and other measurements. Optional programs permit the linearization and conversion of the outputs of thermo-

couple types J, K, T, and E.

A switch array on the panel of the processor selects any of the stored programs, or this function can be performed remotely. LEDs indicate which program is in use.

The 10-key keyboard on the panel, plus switches, are used to enter constants, single-state alarms, or high/low limits. Up to nine constants and eight limit-pairs can be programmed. Constants and limits can be up to six digits each, and any one of the high/low limit pairs can be assigned to any of the 16 programs. Limit status is available at rear-panel connectors.

The processor's memory for constant and limit storage is a volatile semiconductor memory, so an optional built-in rechargeable battery is available. This source will maintain the memory a maximum of 100 hours if primary power fails.

The CP-70 calculating processor operates on 115 or 230 v ac, and is 17 inches wide, 3½ inches high, and 15¼ inches deep.

California Instruments Co., 5150 Convoy Street, San Diego, Calif. 92111 [351]

Scope fits in briefcase, sweeps dc to 5 megahertz

Miniature professional-quality oscilloscopes have greatly reduced the burden on field engineers, who once carried suitcase-size units for servicing equipment. Now the size has been reduced to briefcase dimensions by Vu-Data Corp., which is in-

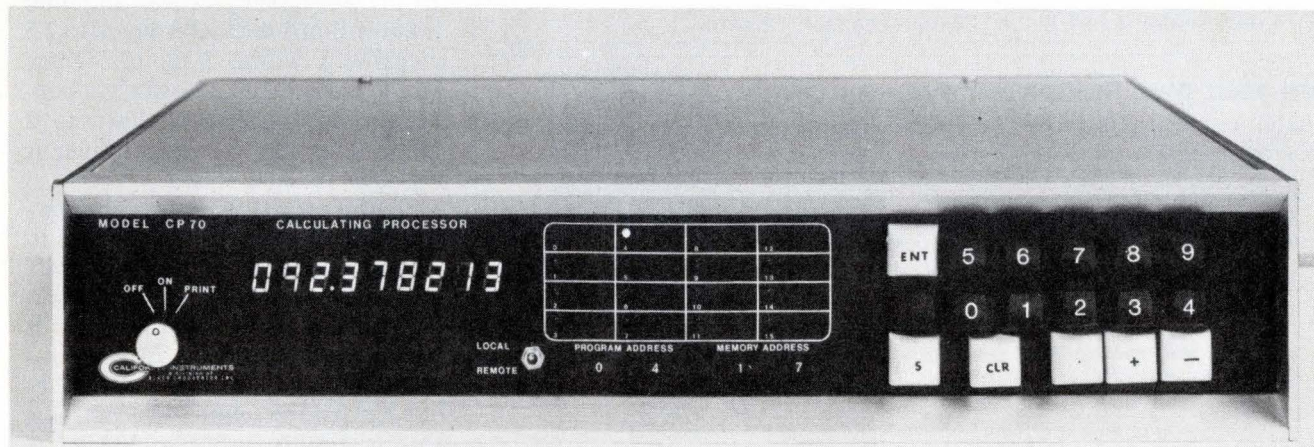

RC G M C 3 M
 B E B E N D I
 A P I O P K H E R M
 I C C P I N I L
 XEROX

If you want fluxless soldering with ultrasonics—call us! These Top 500 companies did.

Ultrasonic soldering system handles fluxless soldering of regular metals, exotics, glass and ceramics.

G-35 generator delivers 35 watts of ultrasonic heated power into soldering iron. Push button controlled power levels of heat and sound energy. All solid state circuitry. Auto-feedback, power tracking.

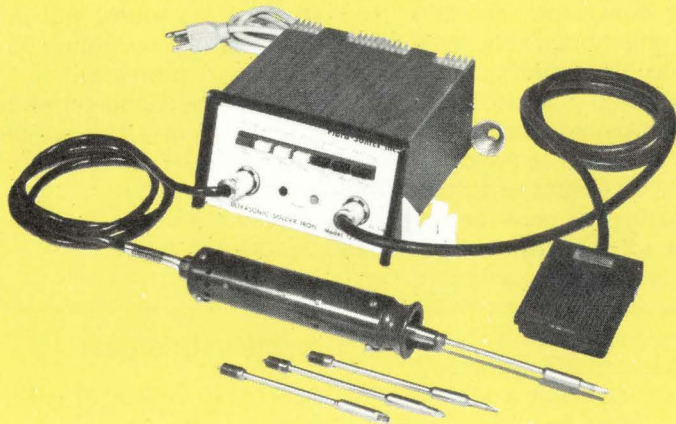

For a free confidential evaluation, send samples of your materials and description of your requirements to Fibra-Sonics. They will be returned at no cost or obligation.

FIBRA-SONICS®, INC.

4626 N. Lamon Avenue/Chicago, Illinois 60630/(312) 286-7377

For more information, circle 184 on reader service card.
 To have a representative call, circle 126 on reader service card.

Own your own holder to hold your own!

Hold your own copies of Electronics in specially designed slipcase holders. They'll keep your Electronics library neat and handy—a permanent information file, issue by issue.

Just complete the coupon and mail to Jesse Jones. He'll process your order upon receipt, postpaid.

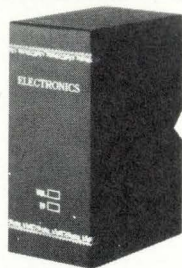

ELECTRONICS BOXER
 Jesse Jones Box Corporation
 2250 E. Butler St., Philadelphia, Pa. 19137

Please send me: boxes @ \$4.25 each; 3 boxes @ \$12.00; 6 boxes @ \$22.00.
 My check or money order is enclosed.

Name: _____

Address: _____

City: _____ State: _____ Zip: _____

New products

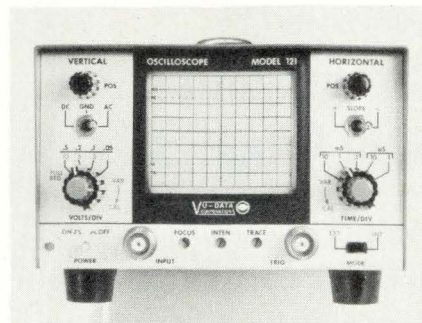

roducing the PS121A scope at a price that should make it attractive for many applications.

William Kraus, marketing vice president, plans sales for such applications as troubleshooting digital logic and telephone maintenance, as well as servicing marine-radio, industrial, audio, and medical-electronic equipment. He also predicts sales for home-electronics workshops. The PS121A, which was a full triggered sweep, dc to 5 megahertz, is only 12.26 inches deep, can fit in a tool box or briefcase, and it weighs 5 pounds.

All components in the new scope are solid state except for the cathode-ray tube, which Vu-Data has been supplying for its line of monitor scopes. The entire miniscope, in fact, is derived from these earlier instruments and has the same plug-in horizontal and vertical deflection boards. All components other than the CRT are standard off-the-shelf items; for ease of repair, it contains no special parts that are obtainable only from the manufacturer.

The viewing screen is 4 by 5 centimeters, and the graticule has 8 by 10 divisions. The vertical amplifier is flat within 1 decibel from dc to 2.5 megahertz, within 3 dB to 5 MHz, and it is usable to 10 MHz. Ac coupling is also selectable down to 2 hertz. Rise time of the amplifier is less than 70 nanoseconds.

Deflection sensitivity can be varied from 50 millivolts per division to 10 volts per division by the scope's calibrated attenuator, which is accurate within 3%. A vernier extends maximum deflection to 25 v per division. Input impedance is 1 megohm in parallel with 47 picofarads, and maximum input is 200 v. A

\$6.50 BUYS THE FASTEST MOST FLEXIBLE MONOLITHIC D/A CONVERTER MADE!

- Logic inputs directly interface CMOS, TTL, ECL, HTL, DTL, etc.

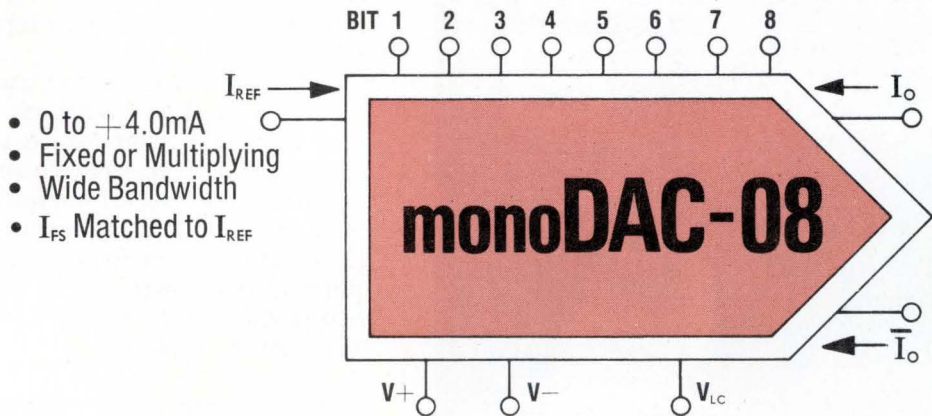

- 0 to +4.0mA
- Fixed or Multiplying
- Wide Bandwidth
- I_{FS} Matched to I_{REF}

- Dual Complementary Outputs
- 85nsec settling time
- -10 to +18V Compliance
- Balanced or Single-ended loads
- Short-circuit proof

- ± 4.5 to $\pm 18V$
- 33mW @ $\pm 5V$
- Small bypass caps

- Completely adjustable logic threshold

PHENOMENAL PERFORMANCE AT SUPER-LOW PRICES! Precision Monolithics' new monoDAC-08 is simply the fastest, most flexible monolithic D/A converter made! monoDAC-08 directly accommodates all popular logic families with its high swing, adjustable threshold logic inputs. The wide range multiplying reference input gives maximum performance in both fixed and wideband multiplying applications. And the tight reference-to-output current matching eliminates full scale trimming. Unique dual outputs provide true and complementary output currents. They can be used individually or to drive balanced or quasi-differential loads such as CRT deflections,

center-tapped transformers or coils and transmission lines, etc. And the -10 to +18V output compliance allows direct current-to-voltage conversion without output op amps. The ultra-fast 85nsec settling time makes possible 1 μ sec 8 bit A/D converters at very low cost—request AN-16 for details. monoDAC-08's not fussy about power supplies either—33 mW @ $\pm 5V$, ± 4.5 to $\pm 18V$ supply range, and tiny 0.1 μ F bypass capacitors. All monoDAC-08 models guarantee monotonicity and linearity over the entire temperature range, and at these low prices they're ideal for all 8 bit applications. Get 'em off your PMI distributor's shelf right now!

| MODEL | TEMP. RANGE | MONOTONICITY OVER TEMP. RANGE | LINEARITY OVER TEMP. RANGE | PRICE @ 100 PCS. |
|--------------|-------------|-------------------------------|----------------------------|------------------|
| monoDAC-08CZ | 0/70°C | 8 BITS | 0.39% | \$ 6.50 |
| monoDAC-08EZ | 0/70°C | 8 BITS | 0.19% | \$ 7.95 |
| monoDAC-08Z | -55/+125°C | 8 BITS | 0.19% | \$12.95 |
| monoDAC-08AZ | -55/+125°C | 8 BITS | 0.1% | \$20.00 |

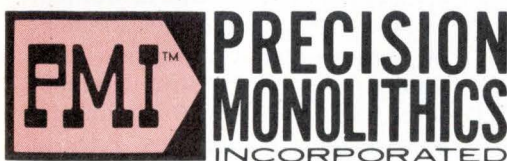

1500 SPACE PARK DRIVE, SANTA CLARA, CALIF. 95050
TEL. (408) 246-9222 • TWX 910-338-0528 • CABLE MONO

AUTHORIZED DISTRIBUTORS:

NEW YORK METROPOLITAN AREA Harvey Radio, Westbury, N.Y.: (516) 921-8700 • NEW ENGLAND AREA Gerber Electronics, Dedham, Mass.: (617) 329-2400 • UPSTATE NEW YORK Harvey Federal Electronics, Binghamton, N.Y.: (607) 748-8211 • NORTHEAST Newark Electronics, Woburn, Mass.: (617) 935-8350 • BALTIMORE-WASHINGTON Whitney Distributors, Baltimore, Md.: (301) 944-8080 • PENNSYLVANIA Hallmark Electronics, Huntingdon Valley, Pa.: (215) 355-7300 • Pioneer/Pittsburgh: (412) 391-4846 • MICHIGAN RS Electronics, Detroit, Mich.: (313) 491-1000 • SOUTHEAST Kirkman Electronics, Winston-Salem, N.C.: (919) 724-0541 • EAST CENTRAL Pioneer/Cleveland, Cleveland, Ohio: (216) 587-3600 • Pioneer/Indianapolis, Indianapolis, Indiana: (317) 849-7300 • Pioneer/Dayton, Dayton, Ohio: (513) 236-9900 • CENTRAL Hallmark Electronics, Elk Grove Village, Ill.: (312) 437-8800 • Minneapolis, Minn.: (612) 884-9056 • St. Louis, Mo.: (314) 291-5350 • TEXAS-OKLAHOMA Sterling Electronics, Houston, Texas: (713) 627-9800 • Dallas, Texas: (214) 357-9131 • SOUTHWEST Sterling Electronics, Albuquerque, N.M.: (505) 345-6601 • Phoenix, Ariz.: (602) 258-4531 • WEST Westates Electronics Corp., Chatsworth, Calif.: (213) 341-4411 • Sunnyvale, Calif.: (408) 733-8383 • Intermark Electronics, Sunnyvale, Calif.: (408) 738-1111 • Denver, Colo.: (303) 936-8284 • San Diego, Calif.: (714) 279-5200 • Santa Ana, Calif.: (714) 540-1322 • Almac-Stroum, Seattle, Wash.: (206) 763-2300 • Portland, Ore.: (503) 292-3534 • WEST CANADA Bowtek Electronics, Vancouver, B.C.: (604) 736-1141 • EAST CANADA Westburne-Haldane Electronics, Toronto, Ont.: (416) 789-4181 • Cesco Electronics, Montreal, Que.: (514) 735-5511 • INTERNATIONAL: Europe: Bourns AG, Baarerstrasse 8, Zug, Switzerland • India: Electronic Enterprises, 46 Karani Bldg., New Charni Road, Bombay 4 • Japan: Toyo Trading Co., Ltd., P.O. Box 5014, International, Tokyo • Australia: CEMA (Distributors) Pty. Ltd., 21 Chandos St., Crows Nest, N.S.W. 2065.

Profit from sameness.

Precise uniformity. That's what makes Kodak micro resist 747 a bargain.

With less variables to worry about, you'll no doubt find you'll waste less time, get fewer rejects, and improve your yield.

747 resist is negative-working, and it's available at a very positive price.

For details, write Eastman Kodak Company, Dept. 412L (48-B), Rochester, N.Y. 14650.

RESULTS COUNT

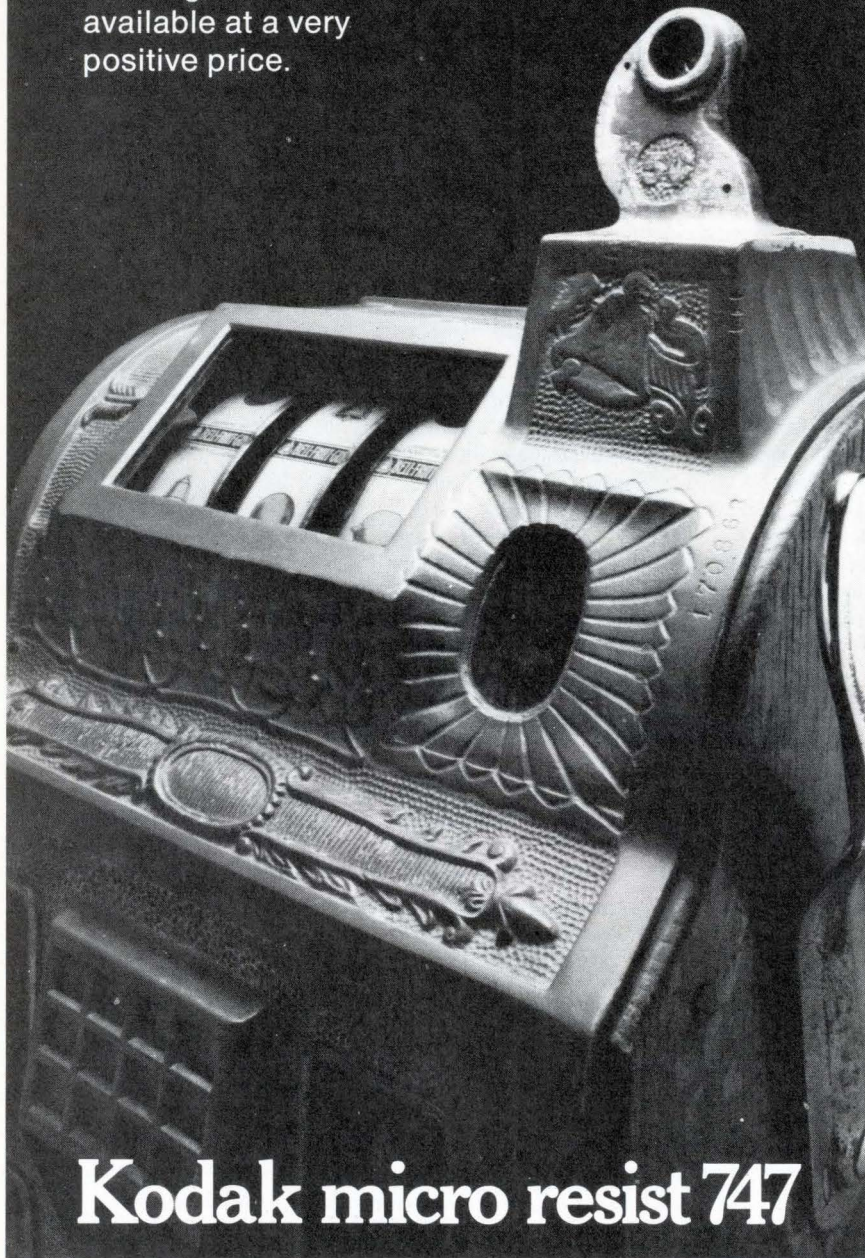

Kodak micro resist 747

New products

10:1 probe is available, and other standard probes can be used.

The horizontal deflection has five calibrated time-base ranges of 1 μ s per division to 10 milliseconds per division, accurate to within 3%. A vernier can be used to extend the sweep to 100 ns per division. Triggering is automatic, and no level-adjustment is required, except for very low frequencies. Positive or negative measurements are selectable, and an external trigger input is also provided.

As an option, the scope can be adapted to rack-mounting, as well as to rear-input connectors. A long-persistence P-7 phosphor can be substituted for the P-31 phosphor at extra cost. The PS121A operates on 115 or 230 v, 50 to 400 Hz, and requires 13 w of power.

Vu-Data Corp., 7170 Convoy Ct., San Diego, Calif., 92111 [352]

Sensitive milliohmeter spots source of short circuits

Designed principally to rapidly locate short circuits on electronic equipment, a low-priced milliohmeter called the ToneOhm 400 A does so without the need for disconnecting wiring or components. A short circuit can quickly be located between circuit lands, for example, to within 0.25 centimeter. High-gain integrated operational amplifiers assure accurate gain and permit use of a single calibration control. The instrument has a panel-meter readout with a specified accuracy to within 5% of full-scale deflection. Further, a variable-frequency resistance-dependent tone is emitted, which makes it unnecessary for the operator to read the meter in the process of locating the short circuit. Other uses of the instrument include detection and measurement of high-resistance joints and continuity-testing. The instrument measures 15.5 by 10 by 10 centimeters and weighs 1.1 kilograms. Price of the ToneOhm 400 A is \$96.60.

Polar Electronics, P.O. Box 97, Les Villets, Forest, Guernsey, Channel Islands [353]

New products

Data handling

Wand reads printed numbers

Aided by minicomputer analysis, hand-held scanner processes time, credit cards

A light, hand-held wand—the Miniscanner—developed by Pattern Analysis Corp. reads hand-printed numerals as well as printed or typed numerals in the OCR-A, E13B, 1403 and 7B fonts. For optical character recognition, the Miniscanner is moved by hand, line-by-line, scanning and processing numerals for analysis by a minicomputer supplied with special software. The system is priced at \$12,500 in single quantity, with the price dropping to \$5,000 in quantities of 100. The minicomputer is not included, but the system includes an interface with the General Automation SPC-16.

The PAC-64 system is intended for applications in processing of time cards, credit cards, laboratory requisitions, medical data, inventory, etc., where data can readily be printed in advance or by hand, with standard No. 2 pencil, carbon paper copy or India ink. The numeral is contained in a box 0.2 inch wide by 0.25 inch high; ideal separation between lines is 0.25 inch, with 0.15 inch usable, says Henry P. Kramer, president of the company.

The wand is 8 in. long and 1½ in. in diameter and weighs about a pound. It includes a light source that illuminates the paper. The image is focused with a mirror and lens of a self-scanning diode array. The output is amplified, digitized and processed by the external interface to the computer.

A novel feature is the wand's insensitivity to the speed at which it moves across the paper. An internal tachometer senses the speed for the scanner, permitting speeds of 1 to 20 in. per second.

Because the unit is insensitive to speed, it can be mounted in simple paper-handling devices, such as card readers, or in automatically indexed carriage-and-platen combinations.

The PAC-64 can be used with many computer-output devices, including tape and disk, printers and displays. An optional keyboard permits entry of material that the scanner cannot read.

Pattern Analysis is now working on interfaces to other computers, wand recognition of alphabetic characters, and use of a self-contained microprocessor.

Pattern Analysis Corp., 735 State St., Suite 309, Santa Barbara, Calif. 93101 [361]

Tape reader helps develop microcomputer systems

A high-speed paper-tape reader for Intel's Intellec 4/MOD 4 and 4/MOD 40 microcomputer-development systems shortens the time needed for developing microcomputer-based products by transferring data asynchronously at 200 characters per second. The high speed allows 4,096 bytes to be loaded in an Intellec 4 program memory in less than 30 seconds, minimizing the time used for repetitive program-loading, assembly and editing operations. The peripheral, designated the imm 4-90, has other features that expedite development work. It is fully compatible with new Intellec resident software. Hardware compatibility is provided by the reader's interface cabling and by the Intellec 4 imm 4-60 I/O module option. Price of the imm 4-90 is \$975, and delivery time is two weeks.

Intel Corp., 3065 Bowers Ave., Santa Clara, Calif. 95051 [362]

Small thermal printer weighs only 2.3 pounds

Measuring only 5.25 inches wide by 2.82 inches high, the model DPP-7 digital panel printer is a seven-col-

GAS SENSING SEMI-CONDUCTOR

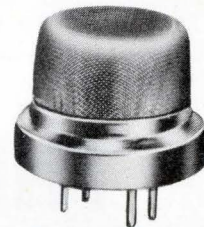

FIGARO GAS SENSOR

'75 New Models, some with highly sensitive CO sensor, now on the market.

Please contact the address below directly for catalogs and price/delivery information.

FIGARO ENGINEERING INC.

3-7-3, Higashitoyonaka, Toyonaka City, Osaka 560, Japan/Phone: (06) 849-2156
Cable: FIGARO TOYONAKA
Telex: 05286155 FIGARO J

Circle 129 on reader service card

Exclusive Economic and Industry Studies

For Financial Analysts, Corporate Planners, Business Economists, Marketing Executives

Geared directly to the future, our Department of Economics offers more than 40 forecasting tools to help project the general economy and industrial growth over the short and long run.

EXAMPLES: Do you know that the current operating rate for the chemical industry is 86%? For synthetic materials, the utilization rate is 93%? That construction and mining machinery new orders are expected to be 8% higher in 1974 than in '73? That steel expects a 3% decline in physical volume of sales in 1974? That consumer income after taxes will increase 8% in 1975?

At a modest cost, our various services covering most industrial segments of the economy are available to you.

For more information write for our booklet, "Exclusive Economic Studies," or phone Douglas Greenwald, Chief Economist, (212) 997-2216.

Department of Economics
McGraw-Hill Publications Company
1221 Avenue of the Americas
New York, N.Y. 10020



Visual images are fleeting—so, for the record, ... you need pictures. No telling when or how often they can prove invaluable.

THE CHAMP

...PICTURE TAKER



That's why so many of your peers are routinely snapping pictures while looking at specimens and samples with Bausch & Lomb's StereoZoom 7 visual-photographic system. The Champ's superb optical system which gives unbeatable visuals will put the images on film right while you're looking. And they will be available as often as you want to refresh your memory, make comparisons, prove points.

There's a choice of most camera formats with the new Integrated Cameras, Series II with optional exposure meter. They're integral, but do not interfere with the optical system and interchange to fit varying needs.

Be ready. Write for our new Stereomicroscope catalog 31-15 and our free demonstration offer.

BAUSCH & LOMB 
SCIENTIFIC OPTICAL
PRODUCTS DIVISION

62317 Bausch Street, Rochester, N.Y. 14602

StereoZoom, Reg. T.M.
Bausch & Lomb.

Circle 130 on reader service card

Cost Cutter

NEW Electronics Buyers' Guide ...
Easy-to-use, single volume
source for:

- Data on over 4,000 products
- Over 6,000 company listings and phone numbers.
- **EBG EXCLUSIVE:** quick access to over 1000 catalogs through a Direct Inquiry Service. The international world of electronics at your fingertips. Find suppliers ... fast ... accurately ... and locally! For your copy send \$20.00 (USA and Canada only; elsewhere send \$30.00) to address shown below.



Electronics Buyers' Guide

A McGraw-Hill Publication
1221 Ave. of the Americas, New York, N.Y. 10020

New products

umn machine with a maximum printing speed of three lines per second, a power consumption of only 20 watts, and a weight of 2.3 pounds. Designed for data-retrieval applications, the thermal printer is compatible with digital panel meters in size and data-handling procedures. It can share a clock and data

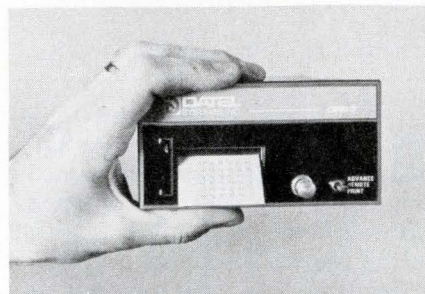

bus lines with a DPM, and it accepts six full-parallel four-line binary-coded decimal inputs and a sign input at TTL or DTL levels. Level-sensitive logic inputs permit error-free recording of noisy data with slow rise times such as that put out by mechanical encoders. In addition to the 5-volt direct-current unit, the DPP-7 is offered in a 115-v ac version. The latter printer weighs 4.2 pounds, consumes 40 watts, and extends 8.62 inches behind the panel as compared with 6 inches for the 5-v machine. The units are priced at \$475 each in single quantities. Delivery time for the printers is four to six weeks.

Datel Systems Inc., 1020 Turnpike St., Canton, Mass. 02021 [363]

Intelligent terminal stores
up to 20 megabytes on-line

Capable of providing up to 32 kilobytes of random-access memory and on-line storage of as much as 20 million bytes on disk, the model 1503 disk intelligent terminal system provides the user with a field-upgradeable computing system for a starting price of \$15,800 or a monthly rental of \$424. The 1503 includes a video display with options that allow it to handle up to 1,920 characters, two or four car-

tridge tape drives, and a console workstation. An unusual feature is an option which allows the system to operate continuously even when the ac power is momentarily interrupted. To add versatility, Singer provides a set of peripherals including printers, computer-compatible tape drives, a card reader, a paper-tape reader, and a modem. The 1503 will be on display at booths 2357 and 2359 at the NCC show in Anaheim next week.

Cogar Corp., a subsidiary of the Singer Co.,
Cosby Manor Rd., Utica, N.Y. 13502 [364]

5- and 10-megabyte units added to low-cost disk line

The 5-megabyte model 24 and the 10-megabyte model 28 fixed-disk drive units have been added to

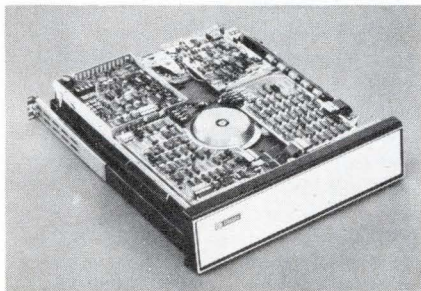

Diablo's Series 20 line of low-price drives. Both are designed to match the disk storage capacities of IBM's recently announced System 32. Deliveries of the model 24 are scheduled to begin in July, while shipments of the model 28 will start next January. Prices, in OEM quantities, will be below \$2,000.

Diablo Systems Inc., Hayward, Calif. [365]

Copier duplicates 2,400-foot computer tapes in 10 minutes

A computer tape copier (CTC) is designed to duplicate 1,600 character-per-inch phase-encoded tapes in tape libraries. The unit can copy and verify a 2,400-foot reel in less than 10 minutes. The CTC can also be used to write headers on new

There is the
bad guy!

I didn't
know that

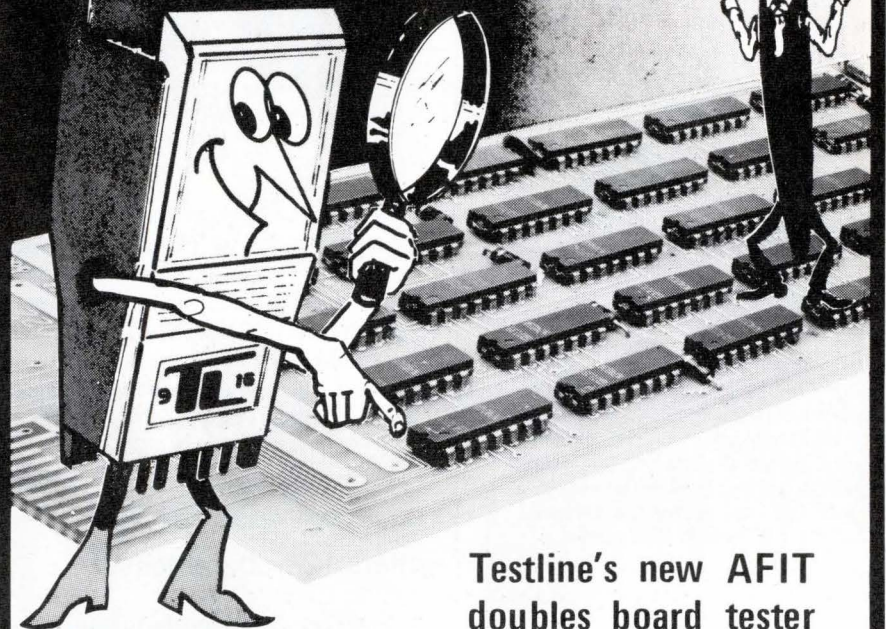

Super Sleuth

Testline's new AFIT
doubles board tester
throughput, cuts
equipment costs.

You can double the through-
put of your board tester with

Testline's high performance Automatic Fault Isolation Tester. Priced thousands of dollars less than software-directed probe equipment, the AFIT differentiates between a board problem and an IC problem, isolating in seconds the bad component. With the AFIT you find the problem not the problem area — quickly, efficiently and economically.

Testline's AFIT — it's the perfect complement to your existing board testing set-up.

I am interested in learning more about your Automatic Fault Isolation Tester.

Send technical data / / Have your representative call / /

Name _____ Title _____

Company _____ Phone _____

Address _____

City _____ State _____ Zip _____



TESTLINE

NORTH BREVARD INDUSTRIAL PARK
P. O. BOX 5686
TITUSVILLE, FLORIDA 32780
(305) 267-7212

Preston's A/D Conversion Systems have always delivered higher speed at lower cost with all the system flexibility you need-

and the new
lower cost **GMAD-4**
is ready for
delivery now!

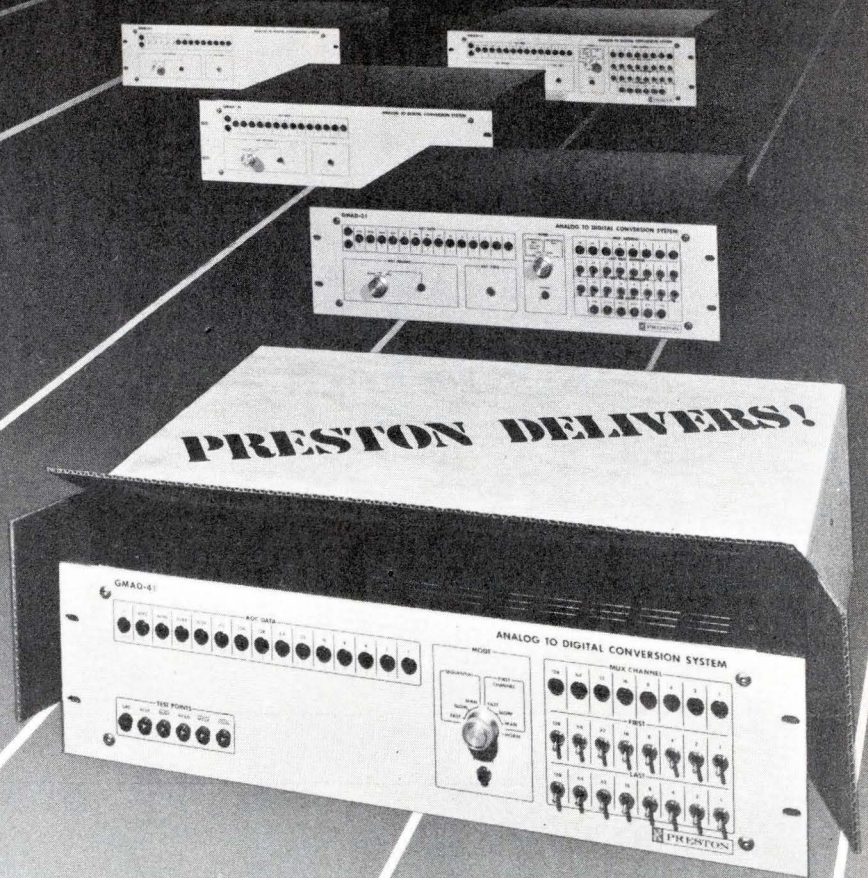

Here's the latest addition to Preston's famous GM Series of high speed, high reliability ADCs; the new, low cost GMAD-4 that gives you a choice of three resolutions — 9, 11 or 14 bits (plus sign, of course) — and a 'quick-step' conversion time of only 25 microseconds!

And like all of Preston's other GM Series ADCs, the GMAD-4 has all the front panel controls and back-panel system interfacing features that you and your data system need! Timing and address controls plus the ADC and central power supply are all built into the low-profile rack mounted chassis, and there's still room for as many as 256 analog input multiplexer channels and a system compatible Sample-and-Hold Amplifier that delivers 0.01% accuracy with 2 microsecond acquisition times!

Easy interfacing with your system helps to keep your installation costs low, too, and as your system requirements grow you can add analog multiplexer channels — up to 1000 or more — for less than \$20 per channel!

For complete specifications on the GMAD-4 A-D converters, Sample-and-Hold Amplifiers, Multiplexers and GMC Logic Control System, plus complete timing and interconnection data, ask for our new 12 page GMAD-4 brochure. And if you want to know more about the other GM Series ADCs that cover the range of conversion speeds from 10 microseconds to 100 nanoseconds, we'll see that you get that information, too!

Just write to Preston Scientific, Inc., 805 East Cerritos Ave., Anaheim, California 92805 — or call us at (714) 776-6400.

We'll put all our years of experience on the line!

Circle 133 on reader service card

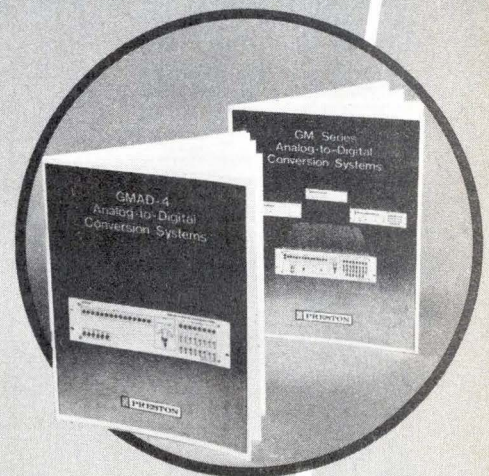

 **PRESTON**

Compare TI's NEW SR-51....

- Mean, variance and standard deviation.
- Automatic linear regression. ● 20 programmed conversions. ● Percent and percent difference.
- Random number generator.
- 3 accessible memories. And much more for only

\$179.⁹⁵

| FUNCTION | SR-51 | HP-45 |
|--------------------------------------|-------|-------|
| Log, ln | yes | yes |
| Trig (sin, cos, tan, Inv) | yes | yes |
| Hyperbolic (sinh, cosh, tanh, Inv) | yes | no |
| Degree-radian conversion | yes | yes |
| Deg/rad mode selection | yes | yes |
| Decimal degrees - deg-min-sec | yes | yes |
| Polar-rectangular conversion | yes | yes |
| y^x | yes | yes |
| ex | yes | yes |
| 10^x | yes | yes |
| x^2 | yes | yes |
| \sqrt{x} | yes | yes |
| $\sqrt[y]{x}$ | yes | no |
| $1/x$ | yes | yes |
| x! | yes | yes |
| Exchange x with y | yes | yes |
| Metric conversion constants | 13 | 3 |
| % and $\Delta\%$ | yes | yes |
| Mean and standard deviation | yes | yes |
| Linear regression | yes | no |
| Trend line analysis | yes | no |
| Slope and intercept | yes | no |
| Store and recall | yes | yes |
| Σ to memory | yes | yes |
| Product to memory | yes | yes |
| Random number generator | yes | no |
| Automatic permutation | yes | no |
| Preprogrammed conversions | 20 | 7 |
| Digits accuracy | 13 | 10 |
| Algebraic notation (sum of products) | yes | no |
| Memory (other than stack) | 3 | 9 |
| Fixed decimal option | yes | yes |
| Keys | 40 | 35 |
| Second function key | yes | yes |
| Constant mode operation | yes | no |

More math power for the money. More than log and trig and hyperbolics and functions of x... the SR-51 has these and also has statistical functions... like mean, variance and standard deviation, random numbers, factorials, permutations, slope and intercept, and trend line analysis. Check the chart above—compare it. With the HP-45 or any other quality calculator. Then try it—at no risk. We're sure you'll agree that the SR-51 offers extraordinary value.

Test the SR-51 at no risk. Full refund if not satisfied. Master Charge or Bank Americard accepted.

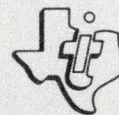

TO: Texas Instruments Incorporated
P.O. Box 22013, M/S 358, Dallas, Texas 75221

Try it 15 days. Return with all accessories if not satisfied.
Enclosed is my check, money order, company purchase order for \$ _____ for the purchase of _____ SR-51(s).
Please add state and local taxes where applicable.*

Please charge this order to my Master Charge. Or, BankAmericard
My Card Number is:

With the expiration date: _____

If Master Charge is used indicate 4-digit Bank Number appearing on card just above your name:

Name _____
Street _____
City _____ State _____ ZIP _____

Authorizing Signature (If billed to Credit Card Must be signed by card holder)

*AL, AZ, CA, CO, CT, FL, GA, IA, IL, IN, KY, MA, MD, MI, MN, MO, NC, NM, NJ, NY, PA, TN, TX, UT, VA, WA, WI. Offer good only in U.S.

TEXAS INSTRUMENTS
INCORPORATED

© 1975 Texas Instruments Incorporated
13500 North Central Expressway
Dallas, Texas

83016

New products

Subassemblies

Line converter built for 370s

System changes frequency
of power so it can drive
IBM memory systems

After Avtel Corp. of Los Angeles went bankrupt last year and the pioneering IBM-370-compatible solid-state 415-hertz frequency converter disappeared from the market, several companies began to look with

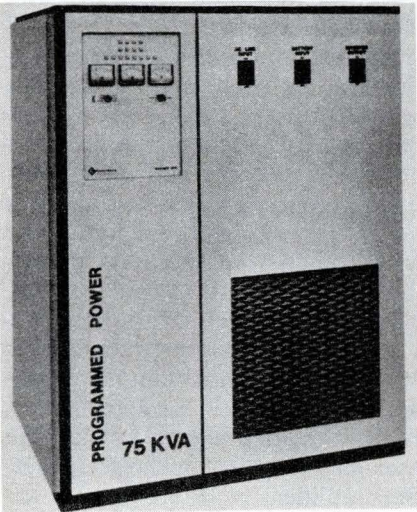

interest at filling the vacuum. And when IBM recently announced its decision to extend the lifetime of its 370 series another five to 10 years, the budding interest turned to a scramble to develop a solid-state frequency converter to power the memory system of IBM-370 computers.

One of the first into the market is Programmed Power Inc. of Menlo Park Calif., with its 75-kVA frequency converter. The 415-Hz-output model for the memory systems of the IBM 370/168, 370/195 and 360/85 computers will be introduced at the National Computer Conference, May 19 to 22.

Until now, the predominant technique for converting line power to the frequencies acceptable to 370

memory systems has been the use of motor generators. Because of the vibration, motor generators usually have to be bolted down to specially constructed concrete slabs. And because of high noise levels, they often have to be installed remotely from the computer installation and connected by cables several hundred to several thousand feet long.

J.L. Weatherman, product manager, says the 4,000-pound 75-kVA frequency converter, designated the system 475, is designed to be installed on computer floors. Measuring 54 by 72 by 36 inches, the system 475 is virtually silent in comparison to motor generators—its maximum noise level, measured five feet from the unit, is 70 db.

"The installation costs are reduced by shorter cable runs and by the absence of any requirement for special rooms," says Weatherman. "In addition, the operating costs of solid-state frequency converters are less than for motor generators because the efficiency is greater—about 85% for PPI's system 475, compared to about 70% for a motor generator."

At the inputs, the voltage specifications are 208 or 480 v line-to-line, $\pm 10\%$, three-phase, three-wire. Frequency input is 60 Hz $\pm 10\%$. Input power is 88.2 kilowatts for a 75-kw resistive load, and the power factor is 0.80 at nominal full-line load. Current distortion is 12% maximum at full load. Inrush current is less than 125% of normal full-load operating current.

The output frequency is 415 Hz $\pm 0.5\%$ and the voltage is 120/208 v, four-wire. Voltage adjustment range is from -1% to $+4\%$. Voltage regulation is $\pm 1\%$ for effects of line, load, and temperature. Automatic line-drop compensation is adjustable to 4%. Output-phase voltage unbalance is $\pm 0.5\%$ for any balanced load and $\pm 5\%$ for any combination of 50% phase-load unbalance. Voltage peak-to-peak amplitude modulation is 0.5%. Phase-angle unbalance is $\pm 6^\circ$ for any combination of 50% phase-load unbalance. Deviation factor is $\pm 5\%$ maximum, line-to-line at no load. Harmonic distortion is

3% maximum for linear loads (no one harmonic greater than 2%) and 5% maximum for standard nonlinear loads.

Weatherman says the System 475 requires only 50 milliseconds for the output voltage to recover to $\pm 1\%$ of the initial steady-state value after a $\pm 50\%$ load step or a $\pm 10\%$ line-voltage step. The transient amplitude deviation is $\pm 5\%$ for $\pm 50\%$ load step or a $\pm 10\%$ line-voltage step. Maximum overload capability is 125% for 10 minutes and 150% for 10 seconds. Overload protection is provided by an output breaker that is automatically tripped for output voltages exceeding a preset limit.

Although the unit can operate alone, PPI recommends a parallel redundant system: two or more converters with their outputs connected in parallel, which increases the system's reliability by a magnitude of 10, from a mean time between failure of 10,000 hours to one of 100,000 hours. This system can be retrofitted in the field to an uninterruptible power system. Price of the system 475 is about \$45,000. Delivery is from stock.

Programmed Power Inc., 141 Jefferson Dr., Menlo Park, Calif. 94025 [381]

Multiplying d-a converters are accurate, low-priced

Problems in processing have plagued the makers of monolithic converter products and have tended to keep yields comparatively low and prices relatively high.

But Hybrid Systems Corp. says it has eliminated both production and pricing headaches in a new family

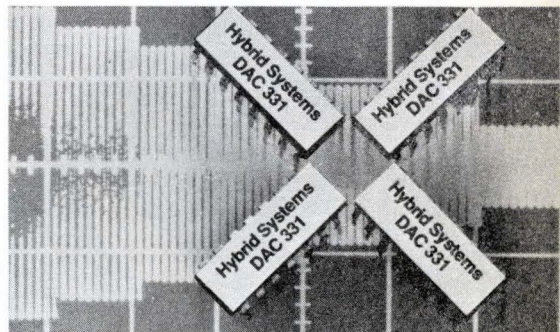



PRECISION

in manufacture of large parts
from conductive materials

YOURS FROM

**A-207.61 spark eroding machine with
A-745.17 program control console and
continuous wire electrode**

Star Features:

- three times quicker shaping with 5-th to 6-th Class surface finish
- industrial water used for interelectrode fluid instead of kerosene
- ability to cut large contours (250 x 250 mm) in work 1 mm to 120 mm thick
- considerably simplified chemical cleaning and polishing, with close to 100% yield of quality product, since only easily removable oxides are left on eroded surface

Main specifications:

- Max. capacity at cutting 30 mm to 40 mm thick work with 0.3 mm dia. copper wire electrode, mm/min:
copper - 70 · steel - 30 · hard alloy - 20
- Max. dimensions of work, mm:
length - 430 · width - 270 · height - 120

Main Program Console Data:

- Type - two-coordinate, position-wise, with feedback and successive coordinate positioning
- Program Carrier - standard eight-track paper tape
 - Minimum program-preset displacement - 0.01 mm
 - Maximum single frame-preset displacement - 0.99 mm
 - Reference System - absolute

The unique design, compact size & versatility make the A-207.61 Spark Eroding Machine what it is: the champion in shaping the internal and external surfaces of conductive work in Cartesian coordinates

Exporter:
V/O TECHMASHEXPORT
35, Mosfilmovskaya,
Moscow V-330, USSR
Telex: 7568

TECHMASHEXPORT



New products

of general-purpose multiplying digital-to-analog converters by using thin-film resistor networks in a hybrid package. Each resistor is laser-trimmed to meet accuracies required for specific converters. The price of the 8-bit DAC 331-8 is only \$9.90 each for one to nine. The 10-bit DAC 331-10 is \$19. Hybrid Systems claims its products are the lowest-cost multiplying d-a converters on the market. The 10-bit unit is pin-for-pin compatible with an Analog Devices Inc. converter, the 10-bit AD 7520.

The 0.75 by 0.25 by 0.20 inch devices are in 16-pin dual in-line packages. Temperature coefficient for each is 1 ppm/°C. The units have true 8-bit and 10-bit accuracies, and linearity is within 0.2% for the 331-8 and 0.05% for the 331-10. Power dissipation for each is 20 milliwatts, and the current output has a compliance of 0.1 volt maximum. The devices can accept both ac and dc signals, and signal feedthrough is better than 0.1% at 10 kilohertz. The output of the converters is compatible with both C-MOS and TTL devices. In dynamic performance, the small-signal settling time to 0.05% is 1 microsecond maximum; large-signal settling time is 3 microseconds. Both units are designed to allow the user flexibility in his choice of output amplifier.

Hybrid Systems says that the primary application of these products is in digital attenuation. Any signal-generating instrument or measuring instrument such as precision voltage sources, oscillators and waveform generators can exercise instant digital control when the d-a converter is added to its output. In applications with CRT displays, the converters can control the input signals to the X and Y axis of the display. Scaling of signals can then be controlled by computer or by manual control. The DAC 331 family can also be used in feedback control. By using the units in a feedback loop of a control system, the gain and stability of the loop can be set digitally.

Delivery is from stock.

Hybrid Systems Corp., 83 Second St., Burlington, Mass. 01803 [382]

Single resistor sets gain
of instrumentation amplifier

High accuracy and high input impedance make the instrumentation amplifier attractive to systems designers, but many times they can't take advantage of the device because of cost. Now, however, National Semiconductor Corp. has developed a low-cost unit. Called the LH0037, the new circuit is a classical instrumentation amplifier using three operational amplifiers and a precision laser-trimmed thin-film network. "It's intended for precision differential signal processing," says Dean Coleman, a marketing manager at National. "It offers extremely high accuracy, due to its 300-megohm input impedance, and an excellent common-mode-rejection ratio of 100 dB." Only a single resistor is needed to set the gain of the LH0037 from 1 to 1,000, and it operates from supply voltages ranging from ± 5 volts to ± 22 V. The LH0037 is available in a 12-pin TO-8 hermetic can for operation over the industrial temperature range from -25° to $+85^\circ\text{C}$ (type LH0037CG) and over the military range from -55° to $+125^\circ\text{C}$ (LH0037G). Price of the military version is \$12.10 each in quantities of 100. Delivery is from stock.

National Semiconductor Corp., 2000 Semiconductor Dr., Santa Clara, Calif. 95051 [383]

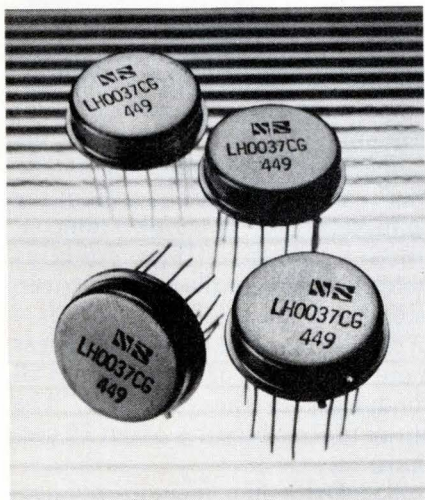

HEATSINK E-GREASERS

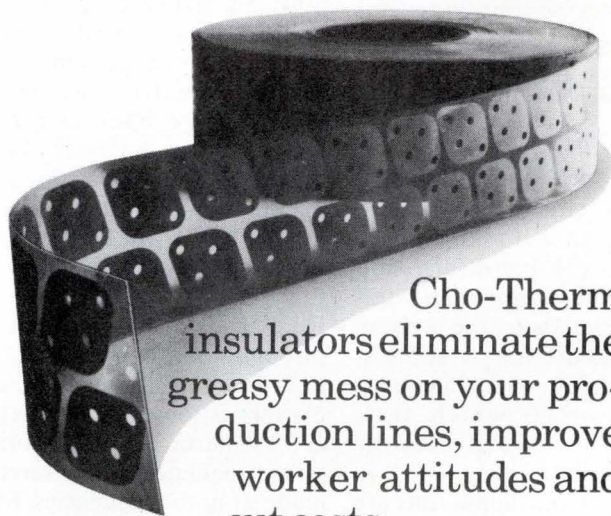

Cho-Therm insulators eliminate the greasy mess on your production lines, improve worker attitudes and cut costs.

Cho-Therm comes in convenient rolls for dispensing ease, pre-cut to fit your power packages. It's available adhesive coated for use when gravity's working against you. It eliminates grease handling costs and the soldering problems and costs resulting from sloppy application.

Grades are available to replace greased mica (circle Bingo number on right) and BeO (circle Bingo number on left).

End your heat transfer headaches with Cho-Therm. (It'll make your QA group smile too!)

CHOMERICS

77 Dragon Court
Woburn, Ma. 01801
(617) 935-4850

I'm
replacing
BeO
137

I'm
replacing
greased mica
185

Packaging & production

Board tests are analog/digital

Production system checks circuit paths, functional blocks to isolate faults

Production of circuit boards that contain analog as well as digital circuits is constantly increasing, and pc-board manufacturers must test both types of circuits on the production line. Teradyne Inc. is addressing this market with its L125 circuit-diagnostic system, which tests analog/digital boards automatically with a guided probe.

Combined analog/digital tests are made by dividing the board into primary paths and functional blocks. On primary paths, signals are unidirectional. Each logical element on the path lets the signal—digital dc, analog dc, or ac—go only one way. A fault on a primary path is traced backward with a guided probe; when the fault ceases to exist on the path, it has been found. The test plan defines how signals are to be measured at each node on the primary path; no circuit analysis is necessary.

In the digital mode, the probe measures high and low values; in the analog mode, it measures voltage; and in the ac mode, it measures peak to peak, rectified average value, and the dc-offset value. Tol-

erances are automatically programmed at 10% unless the user specifies otherwise.

Since faults in functional blocks are not unidirectional but radiate in several directions, the entire blocks must be analyzed. When a failing path leads to a block, the block is treated as a component, and its inputs are checked to determine if the fault is in the block or not. To isolate a fault in the block, the test sequencing is stopped, and the automatic fault locator takes over.

The probe checks power-supply buses, then power is turned off, and the board is grounded. A current from the probe is then forced through nodes in the block, and impedance to ground is measured. Current is forced through at 10 and 100 kilohertz, and an algorithm-directed sequence of measurements is made at both frequencies. Measurements have a tolerance of about 20% unless the operator specifies otherwise. After every part is probed, a printout tells which parts are bad and what the faults are.

To make this automatic diagnosis, the writer of the test plan must make a circuit file for the L125 that uses names or numbers to define the locations of components, their interconnections, and the functional blocks. Then a probe map is drawn to characterize the type of measurement—digital dc, analog dc, or ac—that must be made at each interconnection.

Once the test sequence and circuit characterizations are filed, an operator stores all circuit elements and interconnections in the L125's

memory. Then a known good board is plugged into the system, and the operator probes each node in succession, according to instructions that appear in sequence on a one-line display, and he records measurements. When a board is tested, the probe automatically goes into the proper mode, and the L125 compares results with results from the good board in its file.

Hardware for the L125 includes a teletypewriter, a cathode-ray-tube display with keyboard, a one-line display that shows instructions to guide the operator, analog-dc, and ac measurement functions, and traditional driver/comparator sets for digital inputs. The analog dc and ac functions are connected by a switching matrix to the connector pins on the board. Programs are stored in CartriFiles, and the computer-controlled system has a core memory of 20,480 18-bit words, expandable to 128,000 words.

The price of an L125, with 20-kiloword memory for testing only digital boards, is \$70,000, and an analog/digital system is \$90,000. Delivery time is 12 weeks.

Teradyne Inc., 183 Essex St., Boston, Mass. 02111 [391]

Flat-cable connector

cuts assembly time 85%

Offering assembly time savings of as much as 85% over other methods of attaching connectors to flat, flat-woven, or jacketed cable with up to 25 conductors, the Scotchflex Delta Connector System requires no stripping, soldering, positioning, or crimping of discrete wires in the connector body. Instead the assembler removes a paper liner from the connector cover, exposing a nonconductive adhesive. The adhesive holds the cable in place while cover, cable, and connector are placed in a press. One stroke of the press handle simultaneously assembles all conductors to the connector. The entire process requires about 30 seconds.

The Delta line includes connec-



How to drive a microprocessor.

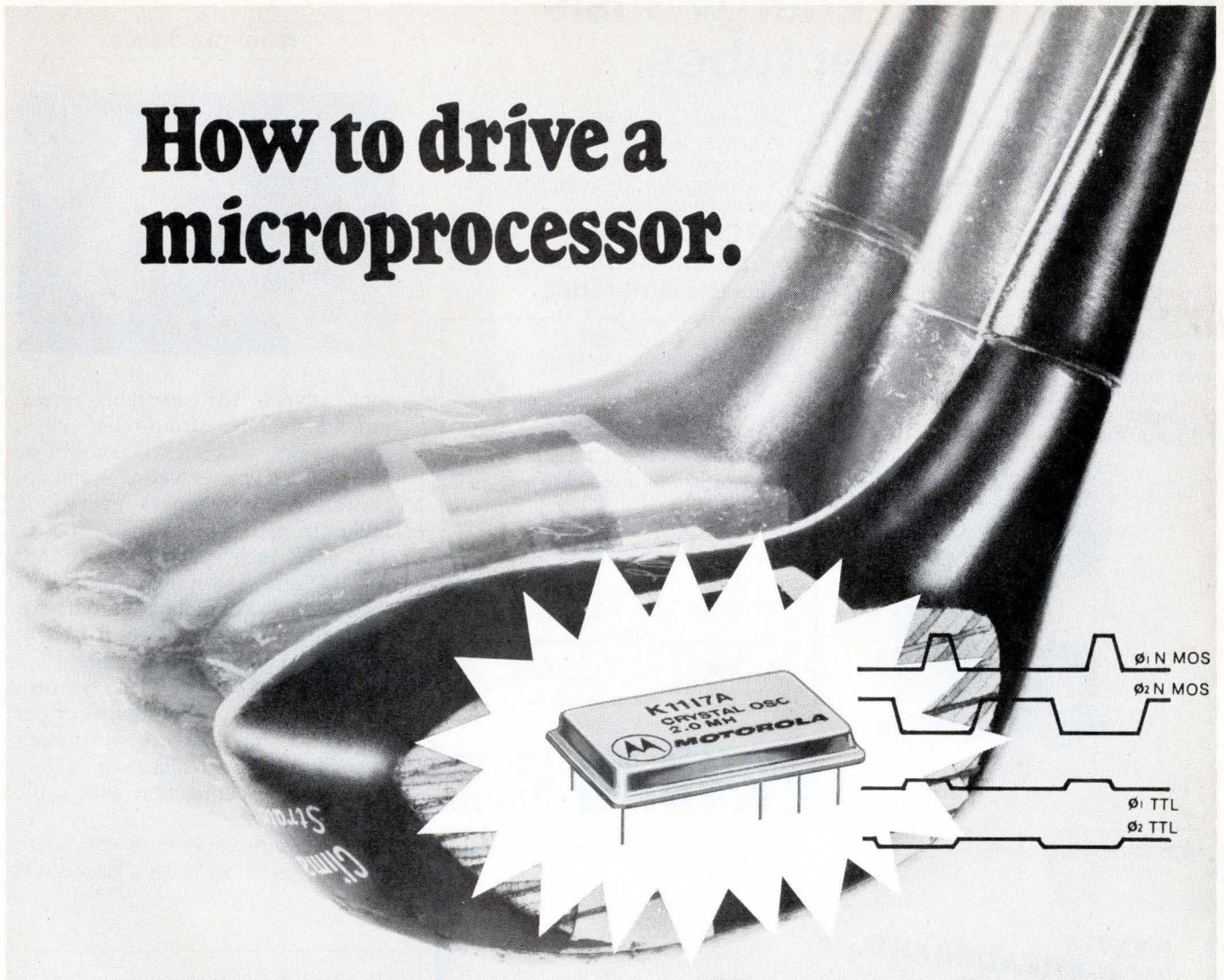

For the Intel 8080 CPU, use our K1117A.

For the Motorola MC6800 MPU, use our MC6871A.

Each is designed to provide the critical 2-phase nonoverlapping waveforms required by the specific microprocessor. Crystal, oscillator, TTL and NMOS drivers and necessary waveshaping circuitry are packaged by hybrid thick-film IC technology into one dual-in-line module that cuts your component count and board space.

Cut out this coupon. Cut down your design time.

Now you can divert valuable engineering time from oscillator/driver design to equipment or software design.

Send this coupon for information and prices to Motorola Inc., Component Products Department, 2553 North Edgington, Franklin Park, Illinois 60131. Or call (312) 451-1000 for immediate attention.

Name _____

Title _____

Company _____

Address _____

City/State/Zip _____

Send more information on _____ K1117A

_____ MC6871A _____ Both



MOTOROLA INC.

COMPONENT PRODUCTS DEPT.

There's no RF energy crisis with RCA power tubes.

RCA's combined families of regular and large power tubes not only comprise the broadest line of such tubes in the industry, but they range in power all the way up to 250 kW... and in frequency to 1450 MHz.

Covering almost every major power tube application area, the RCA line also includes a comprehensive array of cavities and circuits. These cavities and circuits are specifically designed to enhance the advantages of RCA's power tubes. Together they achieve a total power package unmatched for reliable high performance.

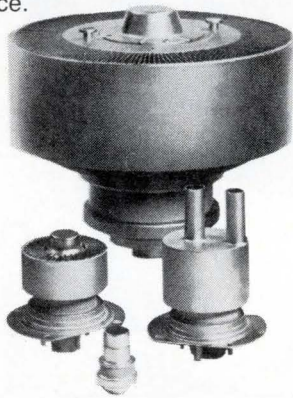

For more information on the entire RCA power tube line, call your RCA Representative or RCA Industrial Tube Distributor, or complete and return the coupon.

RCA Lancaster — where people and technology make the difference.

Manager, Power Tube Marketing
RCA, New Holland Avenue, Bldg. 100
Lancaster, Pa. 17604

____ Please send me the RCA Power, Frequency and Application Chart.
____ Please have an RCA Representative call me. Telephone _____

— This is your mailing label. Please print. —

Name _____

Company _____

Street _____

City _____

State _____

Zip _____

RCA Power Tubes

New products

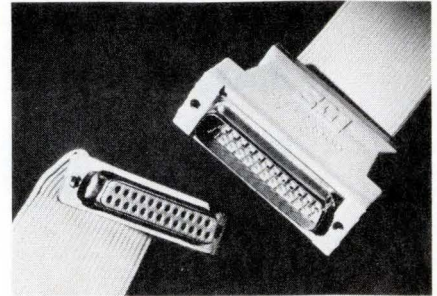

tors, covers, the assembly press, junction shells, strain-relief clips, jack screws, jack-socket assemblies, and a special cable whose center-to-center spacing tapers every 9.5 inches from 0.054 inch to 0.050 inch. The 0.054-inch spacing is standard for "D" series subminiature connectors, while 0.050-inch is standard for card-edge, printed-circuit-board, DIP, and Scotchflex connectors.

The contacts in the Delta connector are made of beryllium-copper with a 50-microinch gold plating over 50-microinch nickel for a gas-tight reliable connection with cable conductors.

3M Co., Electronic Products Div., Dept. EDP4-21, Box 33686, St. Paul, Minn. 55133 [393]

**NEW!
MINI-BREADBOARD
BUDGET KIT
FOR THE ECONOMY-MINDED
EXPERIMENTER...**

Proto 100 Board

Patent Pending
Made in USA

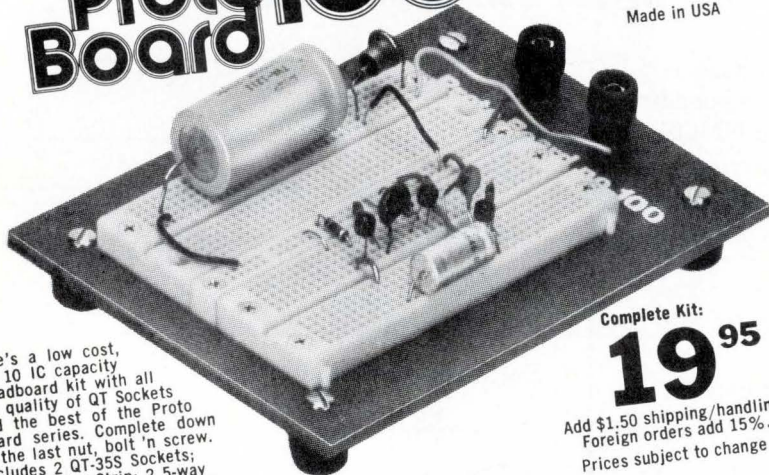

Here's a low cost, big 10 IC capacity breadboard kit with all the quality of QT Sockets and the best of the Proto Board series. Complete down to the last nut, bolt 'n screw. Includes 2 QT-35S Sockets; 1 QT-35B Bus Strip; 2 5-way binding posts; 4 rubber feet; screws, nuts, bolts and easy assembly instructions. Order off-the-shelf today from CSC or local distributor. Charge: BAC, MC, AX. Write for free catalog. Free English/Metric Slide Rule with each order. Dealer inquiries invited.

Complete Kit:
19⁹⁵

Add \$1.50 shipping/handling.
Foreign orders add 15%.
Prices subject to change

**CSC Continental
Specialties Corp.**

Box 1942, New Haven, CT 06509 • 203/624-3103

W. Coast Off.: Box 7809, S. Fran., CA 94119 415/383-4207
Canada: Available thru Len Finkler Ltd., Ontario

Continuity checker makes
20,000 tests per second

A microcomputer-controlled automatic continuity test system, ACT 1, performs continuity and anti-continuity tests at a rate of 20,000 tests per second. Available with from 1,280 to 10,000 points, the unit can check out backplanes, mother boards, multilayer boards, cables, and wrapped-wire panels. These ap-

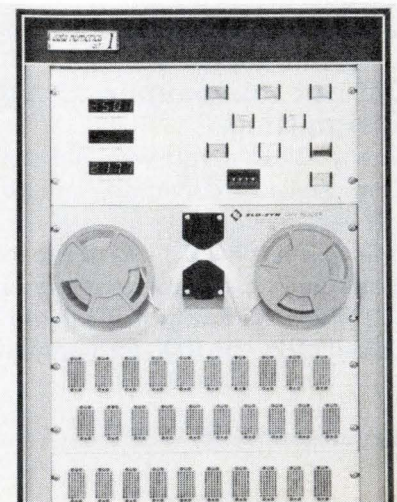

**ANTIMONY
ARSENIC
BISMUTH
CADMIUM
COPPER
GOLD
INDIUM
LEAD
SELENIUM
SILVER
SULPHUR
TELLURIUM
THALLIUM
ZINC**

Asarco
produces more
high purity
elements than
anyone in the U.S.

Asarco offers a wide selection of elements in both research quantities and commercial quantities for ready delivery.

All of the elements are available with a purity exceeding 99.999%. Many are also available in an intermediate purity grade exceeding 99.99% for use in less critical applications.

Whether you use high purity elements for electronics, metallurgy, research, or any other application, our specialists are anxious to assist you. For more information write our By-Products Department at 120 Broadway, New York, N.Y. 10005.

ASARCO

American Smelting and Refining Company

Circle 141 on reader service card

New products

Applications are possible because the system can detect high-impedance short circuits of up to 20 kilohms. The basic 1,280-point unit, consisting of a tape reader, a control panel, and an error display sells for \$10,900. It is expandable in increments of 128 points up to the 10,000-point maximum. A self-testing feature for the basic unit and its peripherals is standard, while a self-programming feature is optional.

Data Numerics Inc., 141-A Central Ave., Farmingdale, N. Y. 11735 [394]

Heat sink for TO-3/66 cans is only 0.375 inch high

Low-profile heat sinks for TO-3/66 devices are only 0.375 inch high, allowing them to be mounted on circuit boards with center-to-center spacings of only 0.5 inch. The model 6060 and 6061 are identical except for the length of their fins. Clear-

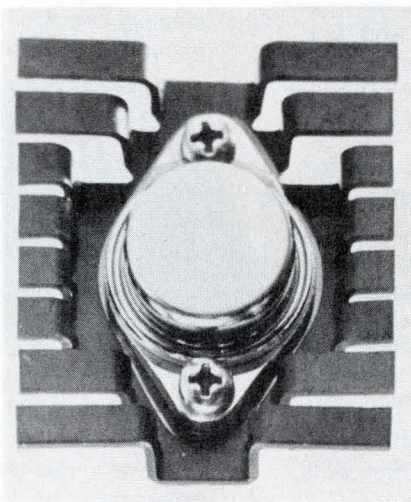

ance under the fins permits small components to be mounted to the board without sacrificing space. The 6060 has an over-all width of 1.7 inches and a resultant thermal resistance of 8°C per watt at 10 watts. The model 6061 measures 2.25 inches across and has a thermal resistance of 6°C/W at 10 W. The 6060B (black finish) sells for 19 cents each in lots of 1,000.

Dept. M, Thermalloy Inc., P. O. Box 34829, Dallas, Texas 75234 [395]

1%
AMERICAN MADE
Tolerance
SCHAUER
1-Watt
ZENERS

Immediate Shipment
Low Prices

ANY voltage from 2.0 to 16.0

| Quantity | Price each |
|-----------|------------|
| 1-99 | \$1.07 |
| 100-499 | .97 |
| 500-999 | .91 |
| 1000-4999 | .86 |
| 5000 up | .82 |



All welded and brazed assembly
No fragile nail heads

Write for complete rating data and other tolerance prices.



Buy the kit-
Save a lot

Kit contains a 51-piece assortment of SCHAUER 1% tolerance 1-watt zeners covering the voltage range of 2.7 to 16.0. Three diodes of each voltage packaged in reusable poly bags. Stored in a handy file box. Contact your distributor or order direct.

A \$54.57 value for
ONLY \$24.50

Semiconductor Division
SCHAUER
Manufacturing Corp.

4514 Alpine Ave. Cincinnati, Ohio 45242
Telephone: 513/791-3030

Circle 163 on reader service card 141

SHIFT INTO HIGH PERFORMANCE WITH A 4K STATIC RAM

FULLY STATIC: The SEMI 4402 is a fully static 4K RAM. That's important. For one thing, it means you can now design a 250 nsec MOS memory system around a 4K device without worrying about refresh or charge pump circuitry. For another, static RAMs are inherently less susceptible to soft bit error problems than comparable dynamic devices.

350 NANOSECOND CYCLE: The SEMI 4402 4K static RAM has a *complete cycle time* of just 350 nsec and 200 nsec maximum access time. That makes it the fastest 4K static RAM in production. Now you can design a truly high performance MOS memory around a static 4K device.

AVAILABLE NOW: The SEMI 4402 4K static RAM is here now. We're already delivering it to customers at the memory system level. And it is second sourced by a major supplier of MOS devices.

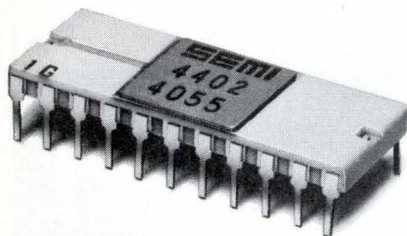

LOW POWER: The SEMI 4402 4K static RAM has similar power levels to

comparable dynamic devices. However, power conservation is achieved by the Chip Select Input, which causes the 4402 to enter a low power standby state whenever it is unselected. Normal V_{DD} is 12 Vdc, but V_{DD} can also be reduced to 5 volts without risking loss of stored data. And the 4402's differential output results in inherently high noise immunity memory systems.



PERFORMANCE TESTED: Like all SEMI NMOS components, the 4402 4K static RAM must meet our own tough test standards, since we use it in our memory systems — for example the MICRORAM 3400N. With our reputation riding on its performance, you may be sure the acceptance standards are high indeed. In fact we 100% ac and dc test our components twice — at wafer and again in the package.

MODEL SELECTION: In addition to the 4402, EMM SEMI offers you a complete line of static NMOS RAM and ROM components to meet your design needs. Make your selection from the adjacent chart.

| Part No. | Bit Org. | Access Time |
|-----------------|----------|-------------|
| RAMS | | |
| SEMI-1801 | 1024 x 1 | 90 nsec. |
| SEMI-1802 | 1024 x 1 | 70 nsec. |
| SEMI RA-3-4256 | 256 x 4 | 1 usec. |
| SEMI RA-3-4256B | 256 x 4 | 1 usec. |
| ROMS | | |
| SEMI RO-3-4096 | 512 x 8 | 500 nsec. |
| SEMI RO-3-5120 | 512 x 10 | 500 nsec. |
| SEMI RO-3-16384 | 4096 x 4 | 1.0 usec. |

More new products to come . . . additional 4K static RAMs, ROMs.

PROVEN TRACK RECORD: At EMM we've been making memory components and systems since 1961. Unlike memory suppliers who market components only, all EMM components are all performance proven in our own systems. When you buy from EMM, you get the benefit of the unusually high acceptance standards we

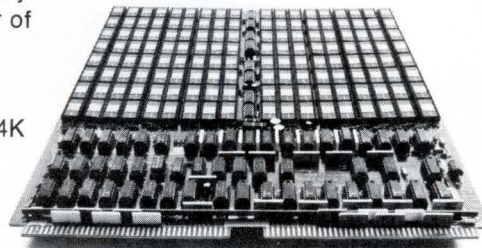

impose on ourselves, as well as our years of experience in meeting the needs of the memory marketplace. If you'd like further information about any of the products featured here, or any other EMM components or systems, contact your local EMM office today.

EMM SEMI

A division of Electronic Memories & Magnetics Corporation
3883 North 28th Avenue, Phoenix, Arizona 85017
Telephone (602) 263-0202

Circle 142 on reader service card

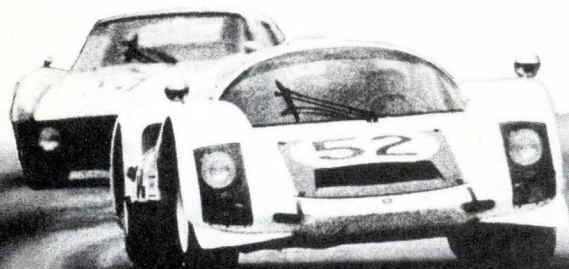

New products

Communications

Noise loader cuts costs

System tests microwave links without need for specialized noise receiver

The usefulness of noise-power-ratio (NPR) testing to check the over-all operation of multichannel communications links is well established. What seems to be equally well established in many people's minds is



the idea that such testing must be very expensive. The latest noise loader from W&G Instruments changes this cost picture—at least for microwave links.

Priced at \$2,290, the model AT-9003 noise loader saves the user money, not only because of its price but also because it does not require a specialized, expensive noise receiver to go with it. An ordinary high-quality selective-level meter, which most microwave operations almost certainly have on hand already, is nearly always all that is needed to form a complete system. The only additional piece of equipment that may be needed for some applications—such as short-haul systems in which NPRs in excess of 50 dB must be measured—is a preselector filter. The W&G AT-9004 at \$350 is designed for such work.

The AT-9003 puts out white noise

over the frequency range from 6 kilohertz to 12.5 megahertz. This wideband noise is limited to the bandwidth corresponding to the number of voice channels in the system by means of a pair of plug-in band-limiting filters. Thus, at the touch of a front-panel switch, one of two channel sizes can be selected. Presently available channel capacities are 600, 1,200, 1,500, 2,100, 2,400, and 2,700.

But if a user purchases a competitive 1,200/2,400-channel system and later wants to upgrade to one of larger capacity, he needs a whole new instrument. With the AT-9003, he merely purchases one or two additional filters at a price of \$100 or so. The band-stop filters, like the band-limiting filters, are plug-in units. A complete noise loader contains two band-limiting filters and three band-stop filters for its basic price of \$2,290.

Containing few controls, the noise loader can be operated by relatively unskilled personnel with a minimum of training. It automatically corrects for the loss in output power caused by the insertion of a band-stop filter, thus making it unnecessary for the operator to readjust the level every time a filter is switched in or out.

Key technical specifications of the AT-9003 are a maximum output power of 0 dBm (1 milliwatt) adjustable in 1-dB steps down to -39 dBm, a maximum power error of 0.5 dB, and a standard output impedance of 75 ohms through a coaxial connector. A balanced 124-ohm output together with a pre-emphasis network is available as an option.

W&G Instruments Inc., 119 Naylor Ave., Livingston, N. J. 07039 [401]

Modem runs at 4,800 bits/s, uses custom microprocessor

A new MOS LSI 4800-bit-per-second modem developed by Hycom uses a proprietary high-speed n-channel microprocessor to provide what company president T. Mitsutomi says is the lowest bit error rate avail-

There's an EMM office near you.

WESTERN REGION

Regional Office
SAN FRANCISCO
(408) 247-9711

LOS ANGELES AREA
(213) 644-9881

ORANGE COUNTY AREA
(714) 639-5811

MINNEAPOLIS AREA
(612) 941-2404

PHOENIX AREA
(602) 968-2492

DALLAS AREA
(214) 231-7207

EASTERN REGION

Regional Office
BOSTON
(617) 861-9650

CHICAGO AREA
(312) 297-7090

WASHINGTON, D.C. AREA
(703) 941-2100

NEW YORK AREA
(516) 423-5800

CLEVELAND AREA
(216) 842-8920

INTERNATIONAL OFFICES

European Headquarters
BELGIUM
(031) 76.69.75

UNITED KINGDOM
(01) 751-1213

WEST GERMANY
(089) 74.30.40

SALES REPRESENTATIVES

FLORIDA, ALABAMA,
GEORGIA, NORTH CAROLINA,
SOUTH CAROLINA, MISSISSIPPI,
TENNESSEE, LOUISIANA
Gentry Associates
(305) 894-4401
(205) 534-9771
(919) 227-3639

AUSTRALIA, NEW ZEALAND,
HONG KONG, SINGAPORE
Delairco Industries Pty. Ltd.
Sydney 29-2863

FINLAND
Digelius Electronics Finland OY
(90) 650-995

CANADA
Megatronix
(416) 742-8015
(514) 488-0404
(613) 729-4004
(604) 526-3312

INDIA
Southern Electronics
442-397, 445-983

ISRAEL
S.T.G. International Ltd.
(03) 53459

JAPAN
Nissho Electronics Corporation
(03) 542-2351

EMM ELECTRONIC MEMORIES &
MAGNETICS CORPORATION.

12621 Chadron Avenue
Hawthorne, Calif. 90250
(213) 644-9881

**IC
checker
champ**

**the
A P
test clip**

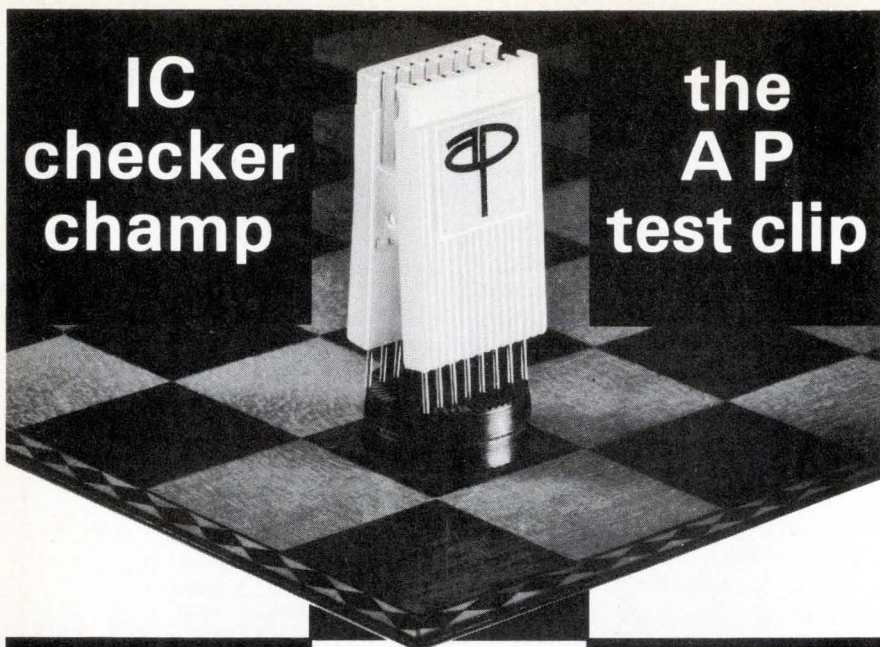

**new
lower pricing**

TC-14 \$ 5.25 ea.
TC-16 5.75 ea.
TC-24 13.85 ea.

All products are guaranteed
to meet or exceed
published specifications

A P TEST CLIPS
provide full access
to DIP leads

11 models
available to fit
all DIP sizes



A P PRODUCTS INCORPORATED
Box 110-E, Painesville, Ohio 44077
(216) 354-2101 • Twx 810-425-2250

Circle 144 on reader service card

Complete RF Network Analysis

- **0.4 to 500 MHz** in three overlapping bands; log, linear, CW, and $f_0 + \Delta f$ modes.
- **115-dB Dynamic Range** — 80 dB direct display.
- **0.005-dB Resolution** — 0.05 dB flatness per 10 MHz; 0.4 dB full-band flatness.
- **Absolute Level in dBm** — direct swept display 0 to -80 dBm.
- **Phase and Group-Delay Measurements** — direct-reading swept displays.
- **50 and 75 Ω** — interchangeable measuring circuits with complete selection of coaxial components for each impedance level.
- **Measure** filters, amplifiers, antennae, cables, delay networks, equalizers, components, transistors, etc.
- **Display Simultaneously** magnitude and phase, magnitude and absolute level, magnitude and group delay, transmission and reflection.
- **Synthesizer-Based Systems from 0.2 to 500 MHz** — for precision narrow-band measurements on devices such as crystal or surface-wave filters, consider the GR 2261 Synthesizer Network Analyzer.



GR's 1710 RF Network Analyzer is the instrument that provides the complete RF network analysis described above. Call or write for complete information, application assistance, or for a demonstration.

For High-Frequency Measurements



General Radio

300 BAKER AVENUE, CONCORD, MASSACHUSETTS 01742
GR COMPANIES • Grason-Stadler • Time/Data

NEW YORK (N.Y.) 212 964-2722, (N.J.) 201 791-8990
BOSTON 617 646-0550 • DAYTON 513 294-1500
CHICAGO 312 992-0800 • WASHINGTON, D. C. 301 948-7071
ATLANTA 404 394-5380 • DALLAS 214 234-3357
LOS ANGELES 714 540-9830 • SAN FRANCISCO 415 948-8233
TORONTO 416 252-3395 • ZURICH (01) 55 24 20

New products

able— 1×10^{-6} at 17 dBm. The modem uses digital techniques to a high degree, including digital filtering, automatic equalization, modulation and automatic-gain-control circuitry. These functions are generally handled with analog circuitry, even in high-speed modems.

Use of the digital approach, plus the custom microprocessor, also results in fewer parts for high reliability and long-term stability through the elimination of drift-prone analog parts such as inductors, operational amplifiers, and precision resistors, and capacitors. The digital method also eliminates the analog adjustments usually required.

The new model 505 modems are available in stand-alone versions or as card sets for use in data-communications terminals, facsimile sets and other equipment. In OEM quantities, the card versions are priced under \$1,000.

Mitsutomi says the custom microprocessor is suitable for other modem products. Hycom, an affiliate of Sharp Corp. of Japan, plans to use it for 9,600 bits/s and CCITT-compatible modems. The microprocessor consists of five n-channel chips; two are usable with all modems and three are customized for the specific variety. Standard general-purpose microprocessors were too slow for the 800,000 10-bit-by-10-bit multiplications required per second, says Mitsutomi.

An additional feature of the microprocessor capability is that it permits easy implementation of built-in test capability. An internal pattern generator, plus diagnostics and panel fault indicators, simplify maintenance.

The modem operates on the direct-dial network or on unconditioned 3002 private lines, in half- or full-duplex on four-wire lines and half-duplex on two-wire lines. Equalization is continuous and automatic and the modulation technique is Hycom's eight-vector complex amplitude modulation. Optional fast-learn requires only 37 milliseconds, and dynamic range is 0 dBm to -40 dBm. Dial backup, digital and audio loop-back, and er-

ror and signal quality indicators are standard. Interfaces available are TTL, EIA RS-232-C, CCITT-V.24 and MIL-188C. The unit operates from 115 v ac, 47 to 63 hertz. The 505 modem consists of five circuit cards, with an additional card containing the EIA interface for stand-alone operation.

Hycom, 16841 Armstrong Ave., Irvine, Calif. 92705 [402]

Front-end processor handles many transmission modes

The Xerox 3625 is said to be the first programable communications processor capable of interfacing multiple modes of data transmission with a single line-interface module. The 3650 dual-multimode line-interface module in the 3625 can handle synchronous, asynchronous, and isosynchronous transmissions. It is designed to permit increased control and utilization of equipment in dial-up communications installation, and to provide improved error detection. Intended to work with Xerox 560 and Sigma 9 computer systems using the Control Program-Five (CP-V) operating system, the 3625 is a special-purpose processor with a 350-nanosecond instruction cycle time and up to 32,000 words of memory. It can accommodate all standard character lengths from five to eight bits, and has 19 standard asynchronous line speeds ranging from 37.5 bits per second to 19,200 b/s. A typical 3625 system, which includes any mixture of 32 synchro-



With *Vector* Cards, It's Easy To

PICK A WINNER!

LIKE OUR

4112 SERIES LOGIC CARD

FROM OVER 100 "Off-the-Shelf" MODELS
Plus Matching Terminals

SPECIALS AVAILABLE

Model 4112-4, 4 1/2" x 6 1/2"
For Soldering or Wrapping
Holds Up to 25 DIPs

3682-2
3474
3662
3677-2
838A

Vector

ELECTRONIC COMPANY, INC.
12460 Gladstone Avenue, Sylmar CA 91342
(213) 365-9661 TWX 910-496-1539 37415

FOR MORE VECTOR EEM Vol. 3, pp. 722-726
GOLD BOOK Vol. 3, pp. 227, 269

Circle 145 on reader service card

Could you build a \$200 Rolls?



Send for this free brochure and find out.

The classic Rolls Royce Phantom II Sedan Coupe. 26-1/2" long. Reproduced in exact 1/8 scale in Pocher d'Italia's incredibly authentic car model kit. You build it with nuts and bolts and screws. No painting, no special tools needed. Doors, hood and trunk open. Steering, crankshaft, connecting rods, gears, fan, generator operate. Windows open. Headlights turn on. 2,199 separate parts of brass, stainless steel, copper, rubber, high-impact plastic. Complete details on this and three other classic car kits from \$100 in our free full-color brochure.

Deluxe Classics, Dept. WE9
5900 Wilshire Boulevard, Suite 2760
Los Angeles, California 90036

Please send me your free full-color brochure.

Name: _____

Address: _____

City: _____

State/Zip: _____

RF-PACKAGES—MICROWAVE SYSTEMS

WORLD'S LARGEST RADAR & MICROWAVE INVENTORY

AUTOTRACK ANTENNA SCR-584 RADAR SYSTEM

360 deg AZ 210 deg EL. 1 mil. accuracy. Missile vel. accel. and slew. rates. Amplidyne control. Handle up to 20 ft. dish. Compl. control chassis. ALSO in stock 10 cm. van mounted rad. system. Conical scan. PPI. 6 ft. dish. 300 pg. instr. bk. on radar \$25



RF SOURCES

CW: 300-535KHz **500W**; 2-30MHz **3KW**; 4-21MHz **40KW**; 24-350MHz **100W**; 385-585MHz **1KW**; 750-985MHz **10KW**; 95-8.8GHz **150W**; 1-1.5GHz **110W**; 1.7-2.4GHz **10KW**; 4.4-5GHz **1KW**; 8.8-11GHz **200W**. Many more.

UHF: 1 **Megawatt** 210-225MHz $5\mu\text{sec}$ 180 PPS; **14KW** 400-420MHz .0002DC; **1KW** 400-700MHz .002DC.
L BAND: **1KW** 1-1.5GHz .1DC; **500KW** 1.2-1.35GHz $2\mu\text{sec}$ 400PPS.

S BAND: **1KW** 2.4-2.6GHz $.75\mu\text{sec}$ 1200PPS; **250KW** 2.7-3.3GHz $.8\mu\text{sec}$ 1600PPS; **500KW** 2.7-3.1GHz $.8\mu\text{sec}$ 1600PPS; **1 Megawatt** 2.7-2.9GHz $1\mu\text{sec}$ 1200PPS; **5 Megawatts** 2.75-2.85GHz $2.5\mu\text{sec}$ 400PPS.
C BAND: **225KW** 6.275-6.575MHz $4\mu\text{sec}$ 680PPS; **250KW** 5.4-5.8GHz $.5\mu\text{sec}$ 680PPS; **1 Megawatt** 6GHz $1\mu\text{sec}$ 1000PPS.

X BAND: **100W** 9.2-9.5GHz $.5\mu\text{sec}$ 1000PPS; **1 KW** 8.9-9.4GHz .001DC; **65KW** 8.5-9.6GHz .001DC; **250KW** 8.5-9.6GHz .0013DC; **400KW** 9.1 GHz $1.8\mu\text{sec}$ 450PPS.

Ku-K BAND: **50KW** 16.4-16.6GHz .001DC; **135KW** 15.5-17.5GHz .0006DC; **40KW** 24GHz .0007DC; **40KW** 35GHz .0004DC.

PULSE MODULATORS + H.V.P.S.

245 KW LINE Output 16 KV 16 A. $.25\mu\text{s}$ 4000 PPS.
405 KW FLOATING DECK Output 20 KV 20 A $1\mu\text{s}$ to 10 millisecc pulse.

500 KW LINE Output 22 KV 28 A. $.4/1.75/2.25\mu\text{s}$ 2500/550/300 PPS.
1 MW HARDTUBE MIT MODEL 9 Output 25 KV at 40 A. $.25\mu\text{s}$.002 D.C.

2.0 MW LINE 30 KV 70 A. $1/2\mu\text{s}$ 600/300 PPS.
3 MW LINE Output 39 KV 75 A. $.25/1\mu\text{s}$ 500 PPS.
10 MW LINE 76 KV 135 A. $2.5\mu\text{s}$ 350 PPS.
17 MW LINE 17 KV 1000 A. $2.5\mu\text{s}$ 150-2000 PPS.

SEND FOR FREE 24 PG. CATALOG

MOD IV HI-RES MONOPULSE TRACKER

Instrumentation radar; freq. 8.5-9.6 GHz, Pwr: 250 KW. $.1\text{ mil}$ accu. Trk. Rng. 50 or 200 mi.

RADAR SYSTEMS

K BAND MONOPULSE 40KW E-34
KU BAND SEARCH 135KW B-58
X BAND MISSILE CONTROL NIKE AJAX/HERC
X BAND FIRE CONTROL 250KW M-33
X BAND WEATHER/SEARCH 250KW AN/CPS-9
X BAND AIRBORNE TRACKER 50KW B-47
X BAND MOBILE TRACKER 40KW AN/MPQ-29
X BAND WEATHER/SEARCH 40KW AN/SPN-5
X BAND TRANSPONDER 100W AN/DPN-62
C BAND HGT. FDR. 5MW FPS-26; 1MW TPS-37
C BAND SEARCH 285KW AN/SPS-5B/D
S BAND HEIGHT FINDER 5MW AN/FPS-6
S BAND SEARCH COHERENT 1MW AN/FPS-18
S BAND ACQUISITION 1MW NIKE AJAX/HERC
S BAND TRACKER 10' DISH 500KW AN/MPQ-18
S BAND MORTAR LOCATOR 250KW AN/MPQ-10A
S BAND TRACKER 250KW AN/MPS-9
L BAND SEARCH 40' ANTENNA 500KW AN/FPS-75
L BAND SEARCH 500KW AN/TPS-1D/GSS-1
UHF SEARCH 1MW TPS-28

DRONE CONTROL SYSTEMS

UHF COMMAND SYSTEM AN/URW-14
X BAND DATA LINK AN/UPW-1
X BAND TRACKER AN/MPQ-29
X BAND TRACKER AN/MSQ-51

SHORAN Type CPN-2A Freq 290-330 MHz
Pwr 30KW consists of trans., recv., monitor, etc.

SPARE PARTS IN STOCK

Nike Ajax, Nike Hercules, M-33, MPS-19, TPS-1D, TPS-10D, FPS-6, SPS8, SCR-584, HIPAR. Many more, write.



**Radio
Research
Instrument
Co., Inc.**

3 QUINCY ST., NORWALK, CONN. 06850
(203) 853-2600

Circle 146 on reader service card

**edi cuts corners
to cut costs and
improve performance**



**LOW COST
SILICON RECTIFIER
BRIDGES**

Only \$1.10 for this new, low cost, small size bridge rectifier. Rated at 10 Amp continuous duty, 20 A. Peak, 150 A. surge. 50 to 800. Peak Reverse Voltage. Unique round shape provides small size: .89" dia x .30" high.

FREE SAMPLES. Write on letterhead or call outlining your application for evaluation samples and catalog information. Use Reader Service Card for just catalogs.
buy from the specialist.

edi® electronic devices inc.

21 GRAY OAKS AVE., YONKERS, N.Y. 10710
(914) 965-4400, TWX (710) 560-0021

Manufacturer of high voltage and high current assemblies.

146 Circle 166 on reader service card

New products

nous and asynchronous lines, is priced at \$55,800. Leases can also be arranged. Deliveries are scheduled for the fourth quarter of 1975.

Xerox Corp., 701 South Aviation Blvd., El Segundo, Calif. 90245 [403]

Rugged digital unit locates telephone conductor faults

The fully autoranging model 4930A conductor-fault locator detects and pinpoints shorts and ground and battery crosses in paired-conductor telephone lines at distances up to 199,900 feet. Its digital display not only shows readings corrected for temperature, wire gauge and material (copper or aluminum), but also minimizes the effects of noise by

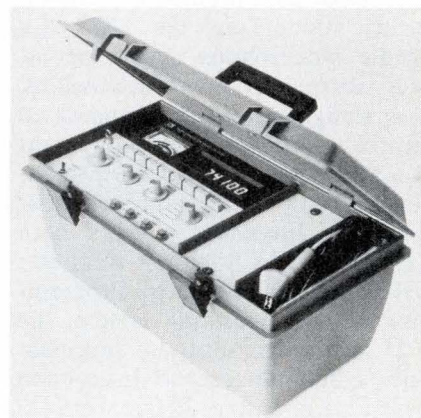

showing readings that are averages of several sample readings. Powered by a single 12-volt lantern battery, the portable tester is packaged in a rugged, water-resistant, foamed polycarbonate case with a rubber gasket to seal the electronics compartment. Price is \$1,095.

Inquiries Manager, Hewlett-Packard Co., 1501 Page Mill Rd., Palo Alto, Calif. 94304 [404]

Short-haul modems can run at 50 kilobits a second

A series of modems designed for limited-distance transmission of digital data over wire networks includes synchronous and asynchro-

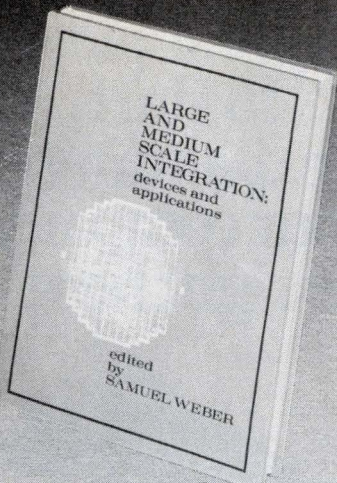

Large and medium scale integration: Keep up with this fast changing technology

Now, in one comprehensive volume, a complete working grasp at large and medium scale integration for electronics engineers engaged in the design of electronic systems, equipment and products.

A wealth of practical working data on large and medium scale integration has been culled from the most important articles in Electronics magazine by Samuel Weber, Executive Editor. Emphasis is on design problems at the system or subsystem level, as well as on the economics of today's design.

Whatever the design problem— from partitioning a digital system to working with a semiconductor company in producing the best LSI design, this book covers the full range of today's important technologies on a practical, rather than a theoretical, level.

It's yours for \$15.00. Keep up.

FREE 10-DAY EXAMINATION

McGraw-Hill Book Company
1221 Ave. of the Americas,
New York, N.Y. 10020



Send me a copy of Large and Medium Scale Integration (068815-X) for 10 days on approval. At the end of that time, I will either remit \$15.00, plus tax, postage, and handling, or return book without further obligation. (Remit in full with this coupon, plus any tax, and McGraw-Hill pays all postage and handling costs.)

Name _____

Address _____

City _____

State _____ Zip _____

Offer good only in the U.S. and subject to acceptance by McGraw-Hill. For prices outside U.S., contact McGraw-Hill Book Co.

23 K138-4018-3

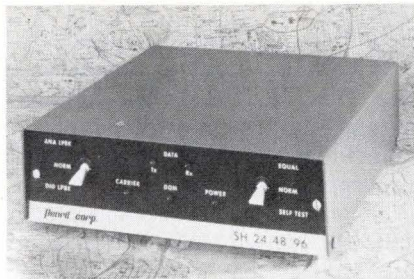

nous models with speeds as high as 50 kilobits per second. The asynchronous unit can handle data at any rate from 0 to 9,600 b/s, while various single-speed and multi-speed clocked models have standard speeds of 2,400, 4,800, 9,600, 19,200, and 50,000 b/s. Depending upon network wire gauge and transmission speed, the modems can work over distances as long as 35 miles. They all feature digital and analog loopback circuits, self-test capability, and line-equalization capability with no need for external test equipment. The modems' single-unit prices range from less than \$300 to \$710. Quantity discounts are offered, and leasing arrangements are available.

Penril Corp., 5520 Randolph Rd., Rockville, Md. 20852 [405]

Precise amplitude modulator tests navigation systems

Although suitable as a piece of general-purpose communications test equipment, the TK2181/1 amplitude modulator is intended primarily for precision measurements on VOR and ILS aircraft navigation systems, and its frequency range of 10 to 520 megahertz includes all carrier frequencies used by these two systems. Modulation frequency can be varied from 20 hertz to 50 kilohertz, and modulation depth is adjustable from 0 to 95%. Built-in output attenuators make the unit suitable for

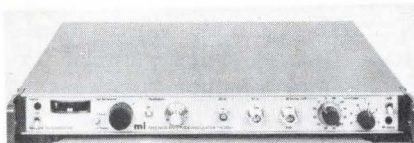

tems, and its frequency range of 10 to 520 megahertz includes all carrier frequencies used by these two systems. Modulation frequency can be varied from 20 hertz to 50 kilohertz, and modulation depth is adjustable from 0 to 95%. Built-in output attenuators make the unit suitable for

NEW

from ROTEK

AN AUTOMATIC METER CALIBRATION SYSTEM THAT PUTS AN END TO...

repetitious knob twisting

Voltage, current, frequency, resistance are automatically set

manual tolerance determination

A simple, automatic GO/NO-GO indication is given

logging of data

All data are automatically recorded as hard copy

questionable readings

Stored procedures and tolerance data provide consistency and reliability

The Rotek® Model 5500 Automatic Meter Calibration System does its work quickly, accurately and repeatably. It can be used to calibrate a wide variety of instruments, including DMM's, DVM's, and DPM's, as well as most analog types.

Programming is quick and easy, and little skill or training is required to operate the system effectively. A very modest initial cost, plus significant savings in calibration time, better records and increased accuracies, can provide a rapid return on your investment. Write or call today for complete details.

ROTEK INSTRUMENT CORP.

40 Guinan Street,
Waltham, Ma. 02154
Telephone: (617) 899-4611

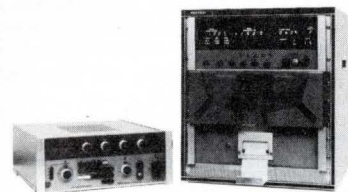

OPEN THE GATE TO DIGITAL KNOW- LEDGE

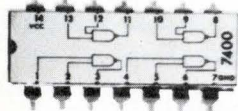

**WITH THE NEW
LR INNOVATOR
SERIES FROM
E&L INSTRUMENTS**

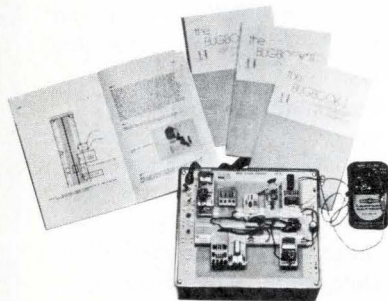

The LR Innovator Series introduces you to a radically new approach to the learning of digital electronics.

You encounter hardware on the very first day. The software (over seven hundred pages — over 90 experiments) is designed for both formal instruction or for self-programmed learning. You learn through the use of the actual integrated circuit chips. The hardware has been designed "open ended." As electronics industry changes and evolves, the Innovator system allows the user full access to new IC technology.

Write today for full details of this exciting new system.

**E&L
INSTRUMENTS,
INC.**

61 First Street, Derby, Conn. 06418
Phone (203) 735-8774

New products

use with signal generators in which the attenuator input is not accessible. The TK2181/1 can handle one-tone and two-tone audio inputs, and includes a monitoring voltmeter for setting modulation depth.

Marconi Instruments, 100 Stonehurst Ct., Northvale, N. J. 07647 [406]

Transformerless converter mates 75- and 124-ohm lines

The type TSF video impedance converter is an all-electronic device designed to provide an interface between 75-ohm unbalanced coaxial video-signal lines and 124-ohm balanced telephone lines. The first instrument to be manufactured in the U. S. by Rohde & Schwarz, the TSF provides separate input and output grounds, thus making it useful for the elimination of ground loops and hum even in applications where no impedance conversion is needed. Functionally, the TSF converter

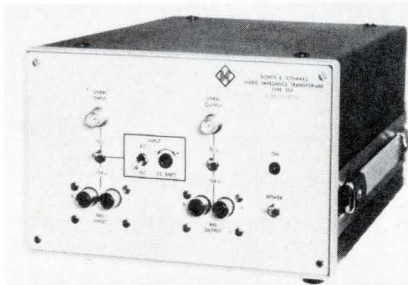

consists of a balanced differential amplifier with push-pull outputs, and it can handle high common-mode voltages at the input. The unit is intended for use in TV studios, transmitters, mobile vans, closed-circuit systems, links between TV stations and telephone equipment, and in development laboratories and production test facilities. Key specifications include flat gain to within 0.05 dB up to 5 megahertz, nominal gain of 0 dB \pm 0.1 dB, input/output isolation in excess of 40 dB, and differential phase shift of less than 0.1° at 1 V peak-to-peak. The unit sells for \$275.

Rohde & Schwarz, 14 Cloria Rd., Fairfield, N. J. 07006 [407]

A great place to start expanding your company is right here.

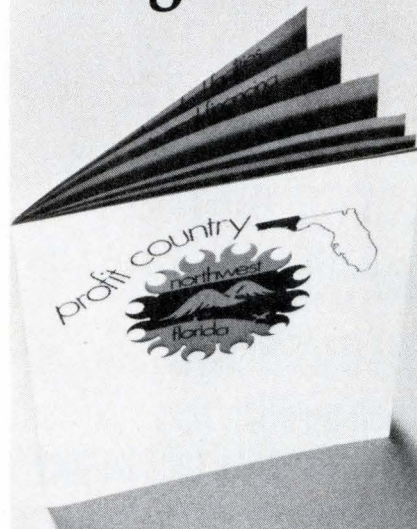

Our 16 page book talks about the labor force, about deep water ports, about utilities, temperatures, taxes. There's everything here from financing to flying times, from industries to schools — all the things that make Northwest Florida one of the most profitable, most livable business climates in the country. And it's free.

Gulf Power Company
Manager, Area Development
Department D-8
P.O. Box 1151
Pensacola, Florida 32520
Please send me your book.

Name _____

Title _____

Company _____

Address _____

City _____

State _____

Zip _____

MONOLITHIC CRYSTAL FILTERS

the
state
of the
Art

NEW FM DISCRIMINATORS . . .

One hang-up in designing a single-conversion NBFM receiver is demodulation. Until now you've had the option of making a second conversion, using phase-locked loop techniques, or designing your own discriminator. Now PTI has made demodulation simple with two new monolithic crystal discriminators offering low distortion — typically 1% — and high recovered audio — typically 800 mV — when used with the CA3089E IC quadrature detector or equivalent.

Detailed spec sheets are available. Ask for Models 2283F (10.7 MHz) and 2378F (21.4 MHz).

SOME THINGS NEVER CHANGE

Five years ago, when this ad series began, we offered some 20 low-priced standard monolithic crystal filters at 10.7 MHz. Since then the number has grown to 60 at 10.7 and 21.4 MHz (not to mention standards at other frequencies). Even though it's five years later, we still offer those original models — and at prices no higher now than in 1970. Times may be changing, but our quality and price aren't.

SOMETHING OLD, SOMETHING NEW

Our new discriminators and our original standard models are two good examples of PTI's leadership in monolithic crystal filters. If you have a problem calling for monolithics we may have the answer already on the shelf.

PTI

Piezo Technology Inc.

2400 Diversified Way Orlando, Fla. 32804
(305) 425-1574

The standard in monolithic
crystal filters.

New products/materials

Asbestos-free ceramic fiber gaskets intended for use as seals, spacers, and insulators in high-temperature applications have a melting point of 3,200°F, and are rated for continuous use above 2,300°F. The gaskets, which meet requirements of the Occupational Safety and Health Administration, are available in tape form, or they can be die-cut from ceramic-fiber paper, blanket, or board.

Cotronics Corp., 37 West 39 St., New York, N. Y. 10018 [476]

A one-part conductive epoxy coating material, Eccocoat 341, has electrical conductivity comparable to the best silver lacquers at a fraction of their cost. An 8-mil (0.2-millimeter) coating of the material has a surface resistivity of 0.3 ohm per square. Usable over the temperature range from -54°C to +177°C, Eccocoat 341 is suitable for such rf-shielding applications as the conductive element in an antenna, a coating for radar targets, and a pc-board conductor or ground plane. It can be applied by brush, spray, or dip to a variety of materials from wood and plastic to metals, ceramics, and concrete.

Emerson & Cuming Inc., Canton, Mass. 02021 [477]

A magnetic-fluid engineering kit, model K-102, contains two low-viscosity ferrofluids that perform well in such applications as damping, sealing, and lubrication levitation. The kit, which sells for \$25, includes 30 cubic centimeters of a diester-base 200-gauss ferrofluid and 7 cc of a hydrocarbon-base 400-gauss material along with magnets, accessories, and applications data.

Ferrofluidics Corp., 144 Middlesex Turnpike, Burlington, Mass. 01803 [478]

An electrical-contact cleaner that is nonflammable and will not stain may be applied to operating contact points of timers, relays, computer heads, and high-frequency equipment without causing any arcing.

A. W. Chesterton Co., Middlesex Industrial Park, Route 93, Stoneham, Mass. 02180 [479]

about
5¢/yr.*
buys a lot
of reliability
with
Angstrom's
new
SAR,
20 year
end-of-life
precision
metal film
resistors!

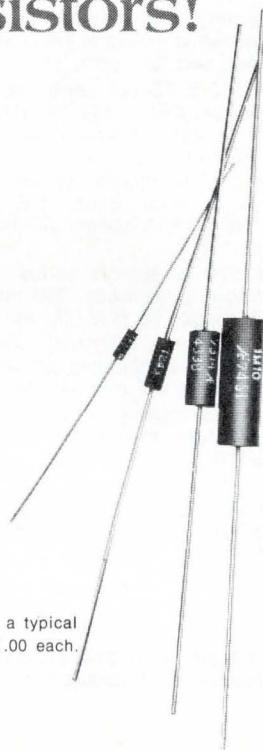

*Based on a typical
cost of \$1.00 each.

**angstrom
precision, inc.**

one precision place
hagerstown, maryland 21740
telephone: 301-739-8722
twx: 710-853-6834

Schottky Barrier Rectifiers

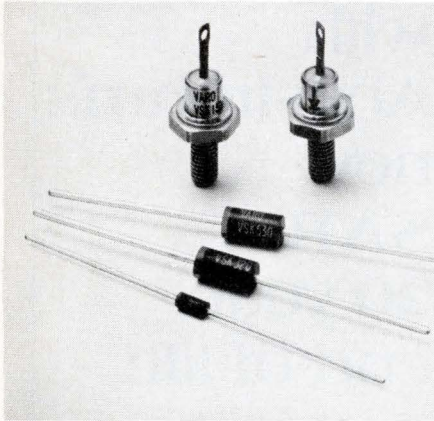

- Four series: 1A, 3A, 5A and 15A (I_o) with 20V and 30V (V_{RRM}).
- Extremely fast recovery (t_{rr}), very low forward voltages (VF), high reliability and low cost.
- VSK 120 & 130-1A series in DO-41 packages. 450 & 550 mV (VF). 40A peak $\frac{1}{2}$ cycle surge (I_{FSM}). 10 mA (iR) at 100°C.
- VSK 320 & 330-3A series. Epoxy package, axial leads. 475 & 500 mV (VF). 150A surge. 30 mA (iR) at 100°C.
- VSK 520 & 530-5A series. Epoxy package, axial leads. 380 mV (VF). 250A surge. 75 mA (iR) at 100°C.
- VSK 1520 & 1530-15A series in DO-4 metal stud cases. 550mV (VF). 300A surge. 75 mA (iR) at 100°C.
- All series have junction operating temperature range of -65°C to +125°C.
- Typical pricing, 1000 qntys, from \$1.38 ea. (VSK 120) to \$3.67 ea. (VSK 1530).

Call Charlie Merz 214/272-4551
for complete information



VARO

VARO SEMICONDUCTOR, INC.

P.O. BOX 676, 1000 NORTH SHILOH,
GARLAND, TEXAS 75040
(214) 272-4551 TWX 910-860-5178

Electronics advertisers

May 15, 1975

| | | | |
|---|-----------|---|-----------|
| ■ Abbott Transistor Labs, Inc. Technical Advertising Agency | 6 | ■ Fluke Manufacturing Company, John Bonfield Associates | 110-111 |
| * Adret Electronique Psycho Publicite | 19E, 24E | ■ Fluke Trendar Moorehead Marketing Agency | 39 |
| ■ Advanced Micro Devices Keye Donna Pearlstein | 11 | ■ General Electric-Instrument Rental Division R.T. Blass, Inc. | 73 |
| ‡ Allen Bradley Company Hoffman, York, Baker & Johnson, Inc. | 28 | ■ General Magnetics McCarthy, Scelba, DeBiasi Advertising Agency, Inc. | 3rd Cover |
| ■ Alma/Division of Develco Moorehead Marketing | 120 | ■ GENERAL RADIO Company Grad Associates | 144 |
| ■ American Microsystems, Inc. Wilton Coombs & Colnett Inc., Advertising | 12-13 | ■ Georgia Department of Community Development Gerald Rafshoon Advertising, Inc. | 151 |
| ■ American Smelting & Refining Company Clyne Maxon, Inc. | 141 | ■ Gould Inc./Instrument Systems Division Carr Liggett Advertising, Inc. | 152 |
| ■ Analogic Corporation Analogic Advertising | 31 | ■ GTE Sylvania-Parts Division Doyle, Dane, Bernbach, Inc. | 26-27 |
| ■ Angtrophm Precision Kenmart Advertising | 149 | ■ Gulf Power Company Ad/Com Advertising, Inc. | 148 |
| ■ AP Products Incorporated Marketing Communications Associates | 144 | ■ Hermes Electronics, Limited Public & Industrial Relations Limited | 67 |
| ■ Bausch & Lomb, Inc. Wolf Associates, Inc. | 130 | ■ Hewlett-Packard Richardson, Seigle, Rolfs & McCoy, Inc. | 2 |
| ‡ Beckman Instruments, Inc., Information Displays Operations N.A. Winter Advertising Agency | 65 | ■ Hewlett-Packard Dancer Fitzgerald Sample, Inc. | 24-25 |
| ‡ Beckman Instruments, Inc., Hallpot Division N.W. Ayer/Jorgensen/MacDonald, Inc. | 58 | ■ Hewlett-Packard Tallant/Yates Advertising, Inc. | 1 |
| ■ The Bendix Corporation, Electrical Components Division D'Arcy-MacManus-Masius | 7 | ■ Hewlett-Packard Tallant/Yates Advertising, Inc. | 2nd Cover |
| ■ Cambridge Thermionic Corporation Chirurg & Cairns, Inc. | 28 | ■ Hewlett-Packard Bozell & Jacobs/Pacific | 117 |
| ■ Chomerica, Inc. The Brightman Company, Inc. | 137 | ■ Intel Corporation Regis McKenna, Inc. | 96-97 |
| ■ C&K Components Van Christo, Inc. | 114 | ■ Ise Electronics Corporation Shinwa International, Inc. | 90 |
| * C.P. Clare International N.V. Markcom | 11E | ■ J. Johnson Company, E.F. Martin Williams Advertising | 8 |
| ■ Clairex Corporation Marquardt & Roche, Inc. | 4th Cover | ■ Kepeco, Inc. Weiss Advertising | 5 |
| ■ Continental Specialties Corporation Robert A. Paul | 140 | * Logabax | 20E |
| ■ Data General Corporation Scali, McCabe, Sloves, Inc. | 46-47 | ■ MFE Corporation Brightman Company, Inc. | 114 |
| ■ Data Precision Allied Advertising Agency, Inc. | 60A-60B | ■ Micro Power Systems Associated Ad Ventures, Inc. | 75 |
| ‡ Delco Electronics Division, General Motors Corporation Campbell-Ewald Company | 48-49 | ■ 3M Electronic Division Batten, Barton, Durstine & Osborn, Inc. | 21 |
| ■ Dialight Corporation Michel-Cather, Inc. | 22 | ■ MOS Technology, Inc. Henry S. Goodsett Advertising, Inc. | 44-45 |
| ‡ Eastman Kodak Co. Graphics Markets Division-Engineering Data System Micrographics J. Walter Thompson Company | 15 | ■ Motorola Inc.-Components Products Department Marsteller | 139 |
| ■ Eastman Kodak Co.- GMD GD Photofabrication- Microelectronic Rumill-Hoyt, Inc. | 128 | ■ National Semiconductor Corporation Chiat/Day, Inc. Advertising | 118-119 |
| ■ EECO The Greer Agency | 62 | ■ Neff Instruments Corporation Basso/Boatman, Inc. | 55 |
| ■ EL Instruments, Inc. Langeier-Stevens, Incorporated | 148 | ■ Nitron a division of McDonnell Douglas Corporation J. Walter Thompson Company | 124 |
| ■ Electro Scientific Industries Commack Group, Inc. | 68 | * Nortron Technik Marketing | 122 |
| ■ Electronics Book Series | 50-51 | * Oscilloquartz SA, Neuchatel Publicitas Service International | 22E |
| ■ Electronic Devices, Inc. McAndrew Advertising | 146 | * Philips N.V. PR/T&M Division Brookies Communications Systems SA | 14E-15E |
| ■ Electronics Components Conference | 132 | ■ Piezo Technology, Inc. Shattuck/Roether Advertising, Inc. | 149 |
| ■ Electronics/Deluxe Classics Grumpertz/Bentley/Fried/Scott | 145 | ■ Polymetalurgical Corporation Horton, Church & Goff, Inc. | 152 |
| ■ Electronic Memories and Magnetics Corporation S. Michelson Advertising | 142-143 | ■ Powercube Corporation, Division of Unifrode Advertising Assistance, Inc. | 89 |
| * English Electric Valve Co. Ltd. The London Advertising Partnership | 12E-13E | ‡ Precision Monolithics, Inc. Marlborough Associates, Inc. | 127 |
| ■ Fairchild Semiconductor, Inc. Carson/Roberts, Inc. Advertising Division of Ogilvy & Mather, Inc. | 42-43 | ■ Preston Scientific, Inc. James Bischof & Associates Advertising/Communications | 133 |
| ■ Fibra Sonics, Inc. Division of C.E. Niehoff The Griswold + Eshleham Company | 126 | ■ Pro-Log Corporation Tyce-Fultz | 32 |
| ■ Figaro Engineering Inc. Standard Advertising, Inc. | 129 | ■ Radio Research | 146 |
| | | ■ RCA-Solid State Division Marsteller, Inc. | 17-20 |

OUR ORGANIZATION HAS PLANS FOR YOUR ORGANIZATION.

Just give the word. And our industrial development experts will design a site selection plan for you.

In Georgia, we mean business. Our 16-man research staff will conduct tailor-made surveys for your company. While our departmental representative consults with you. Confidentially.

We'll work closely with

all state-wide developers, including banks, railroads and utilities. Then, using a computerized site selection system, we'll match your company's requirements with available plant sites and buildings.

Ready to take a good, hard look at Georgia? Contact our organization. The Georgia Department of Community Development.

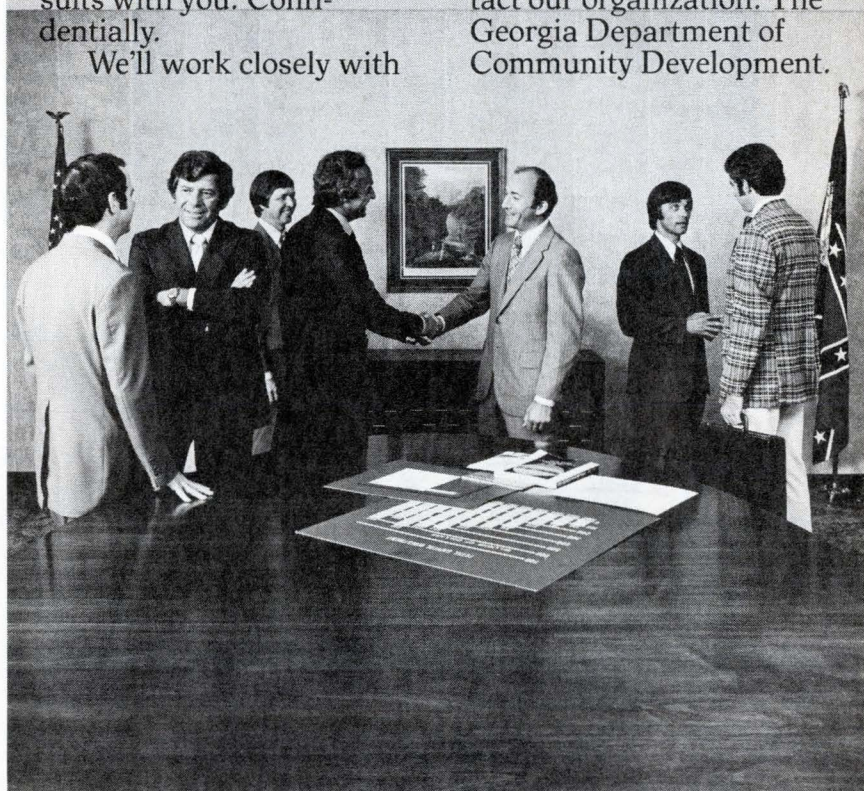

| | |
|---|----------|
| ■ RCA Industrial Tube Products Al Paul Lefton Company, Inc. | 140 |
| ■ RCL Electronics, Inc. Morvay Advertising Agency | 14 |
| • Rohde & Schwarz | 1E, 6E |
| • Rotek Instrument Corporation Buck Associates | 147 |
| • Schauer Manufacturing Corporation Nolan, Keelor & Stites | 141 |
| • Schiumberger Delpire Acvico | 2E-3E |
| • S.E. Labs. (EMI) Ltd. Graphic Publicity Ltd. | 4E-5E |
| • Sescosem Bazaine Publicite | 58 |
| • SGS Ates McCann-Erickson | 15 |
| • Siemens A.G. Munich Linder Presse Union GmbH | 56 |
| • Siemens Components Division N.A. Winter Advertising Agency | 9, 41 |
| ‡ Siemens Corp.—Electronic Systems Division, Computest Products JL Associates | 122 |
| • Solid State Scientific Inc. Atkin-Kynett | 102 |
| • Solitron Devices, Inc. Sol Advertising Agency | 71 |
| ■ Spectrol Electronics Corporation JMR, Inc. | 76 |
| • TEAC Corp. Dentsu Advertising Limited | 109 |
| ■ TEC, Inc. TEC-AD | 132 |
| • Tekelec Altronc S.P.F.D. | 21E, 23E |
| ■ Tektronix, Inc. Tektronix Advertising | 37 |
| • Teledyne Philbrick Ingalls Associates | 72 |
| ■ Teledyne Relays S. Michelson Advertising | 23 |
| • Testline Instruments W.L. Vergason Advertising | 131 |
| ‡ ■ Texas Instrument Incorporated, Components Group Tracy-Locke Advertising, Inc. | 109 |
| ■ Texas Instruments-Scientific Calculators Tracy-Locke | 134 |
| ■ TRW / Capacitors Gray & Rogers, Inc. | 100 |
| • Ultra Electronics Components Ltd. Dennis Dolling Limited | 16E |
| • United Systems Corp. A sub. of Monsanto Company Advertising & Merchandising, Inc. | 61 |
| • Varo Semiconductor, Inc. Warren-Guild | 150 |
| • Vector Electronic Company, Inc. Communications Management Company | 145 |
| • Victoreen Instrument Division Dix & Eaton, Inc. | 69 |
| • V/O Techmasheport Vneshtorgreklama | 136 |
| • Wavetek San Diego Chapman Michetti Advertising | 52 |
| • Wima, Westermann Oliver-Beckmann GmbH | 16 |
| • Yewtec Corporation Kenmarc Advertising, Inc. | 114 |
| • Yokogawa Electric Works Limited General Advertising Agency, Inc. | 49 |
| ‡ Carl Zeiss, Inc.-Micro Michel-Cather | 56 |

■ For more information on complete product line see advertisement in the latest Electronics Buyers' Guide
 * Advertisers in Electronics International
 ‡ Advertisers in Electronics domestic edition

Georgia Department of Community Development
 Industry & Trade Division, Dept. EL-57
 Box 38097
 Atlanta, Georgia 30334



Name _____

Title _____

Company _____

Street _____

City _____ State _____ Zip _____

GEORGIA.
WE MEAN BUSINESS.

Introducing the Brush 110 strip chart recorder—with a thermal writing pen guaranteed for life.

There isn't another strip chart recorder on the market today that can match the Brush 110's performance, ruggedness, versatility and writing dependability.

The new hot-tip thermal writing system produces clear, sharp, highly reproducible blue traces with no smudges, no smears, no skips and no puddles.

Before you buy, check out the remarkable Brush 110. Contact your nearest Gould sales engineer for a demonstration. Or write Gould Inc., Instrument Systems Division, 3631 Perkins Avenue, Cleveland, Ohio 44114.



Circle 152 on reader service card

COPPER/F-15

Copper clad ASTM F-15, in various ratios, is the basic material for cold welded packages. Semiconductors, Hybrids, and RF Crystals are a few of the items now using the cold weld closure technique. PMC stocks a wide variety of Copper Clad F-15. If your products use Copper Clad F-15, PMC can probably deliver "off the shelf" material. Why not call Mr. Harry Friedman at (617) 695-9312 or write, Polymetallurgical Corp., 262 Broadway, North Attleboro, MA 02761. 

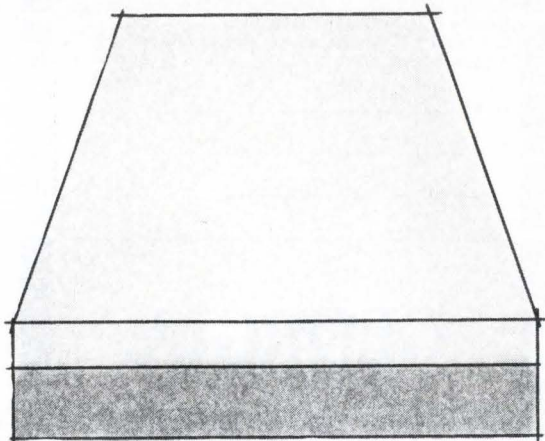

152 Circle 169 on reader service card

Advertising Sales Staff

Pierre J. Braudé New York [212] 997-3468
Paris Tel. 720-73-01
Director of Marketing

Atlanta, Ga. 30309: Warren H. Gardner
100 Colony Square, 1175 Peachtree St., N.E.
[212] 997-3617

Boston, Mass. 02116: James R. Pierce
607 Boylston St. [617] 262-1160

Chicago, Ill. 60611:
645 North Michigan Avenue
Robert W. Bartlett (312) 751-3739
Paul L. Reiss (312) 751-3738

Cleveland, Ohio 44113: William J. Boyle
[716] 586-5040

Dallas, Texas 75201: Charles G. Hubbard
2001 Bryant Tower, Suite 1070
[214] 742-1747

Denver, Colo. 80202: Harry B. Doyle, Jr.
Tower Bldg., 1700 Broadway
[303] 266-3863

Detroit, Michigan 48202: Robert W. Bartlett
1400 Fisher Bldg.
[313] 873-7410

Houston, Texas 77002: Charles G. Hubbard
375 Dresser Tower, 601 Jefferson St. [713] CA 4-8381

Los Angeles, Calif. 90010: Robert J. Rielly
Bradley K. Jones, 3200 Wilshire Blvd., South Tower
[213] 487-1160

New York, N.Y. 10020
1221 Avenue of the Americas
Warren H. Gardner [212] 997-3617
Michael J. Stoller [212] 997-3616

Philadelphia, Pa. 19102: Warren H. Gardner
Three Parkway,
[212] 997-3617

Pittsburgh, Pa. 15222: Warren H. Gardner
4 Gateway Center, [212] 997-3617

Rochester, N.Y. 14534: William J. Boyle
9 Greylock Ridge, Pittsford, N.Y.
[716] 586-5040

San Francisco, Calif. 94111: Don Farris
Robert J. Rielly, 425 Battery Street,
[415] 362-4600

Paris: Alain Offergeld
1 rue-Georges Bizet, 75 Paris 16, France
Tel: 720-73-01

Geneva: Alain Offergeld
1 rue du Temple, Geneva, Switzerland
Tel: 32-35-63

United Kingdom & Scandinavia: Keith Mantle
Tel: 01-493-1451, 34 Dover Street, London W1

Milan: Luigi Rancati
Robert Saidei (Middle East)
1 via Baracchini, Italy Phone 86-90-656

Brussels: Alain Offergeld
23 Chaussee de Wavre
Brussels 1040, Belgium
Tel: 13-73-95

Frankfurt/Main: Fritz Krusebecker
Dieter Rothenbach (East European Countries)
Liebigstrasse 27c, Germany
Phone 72 01 81

Tokyo: Tatsumi Katagiri, McGraw-Hill
Publications Overseas Corporation,
Kasumigaseki Building 2-5, 3-chome,
Kasumigaseki, Chiyoda-Ku, Tokyo, Japan
[581] 9811

Australasia: Warren E. Ball, IPO Box 5106,
Tokyo, Japan 100-31
Tel: (03) 667-7397

Business Department

Stephen R. Weiss, Manager
[212] 997-2044

Thomas M. Egan,
Assistant Business Manager [212] 997-3140

Carol Gallagher
Production Manager International [212] 997-2045

Dorothy Carter, Production Manager Domestic
[212] 997-2908

Frances Vallone, Reader Service Manager
[212] 997-6057

Lisa Hoenig, Secretary
[212] 997-6481

Electronics Buyers' Guide

George F. Werner, Associate Publisher
[212] 997-3139

Regina Hera, Directory Manager
[212] 997-2544