

MAY 29, 1975

**NEW SERIES: HOW INDUSTRY'S PROBLEMS CHALLENGE ELECTRONICS/110**

Can instrument makers live with UL safety standards?/75  
Sequential analyzer tests active and passive components/121

FOUR DOLLARS A MCGRAW-HILL PUBLICATION

# Electronics®



**Orchestrating  
microcomputer  
system design**

1420 TCH598 665A9 JUN75  
STATE TECH INST  
LIBRARY  
5983 MACON COVE  
MEMPHIS TN  
38134

# THE BEAUTY OF THE BRAND-REX CABLE YOU BUY IS THE HUNDREDS OF BRAND-REX CABLES YOU DIDN'T BUY.

Brand-Rex keys its business approach on the ability to give you advice. Objective, professional advice. It's an important difference. One we earned the hard way.

It stems from having a broad product line. With the range of materials we process and our broad manufacturing skills, we can offer completely objective solutions to your problems. No preconceived answers restricted by limited capability. The product we recommend results from the conscious elimination of those we don't.

Over the years we have learned to work with 14 different plastics, 7 different circuit identification methods. Ten varieties of metallic shields. Our products meet



applicable UL and CSA standards, and government and industry specifications. We have more UL listings for thermoplastic insulated wire and cable than any other manufacturer.

Our products include everything from simple hook-up and back panel wires, to the more sophisticated ribbon cables and TapeCable®, to highly sophisticated signal, interconnecting, control, data collection and point of sale cables.

What's more, we have an experienced engineering staff with a reassuring record for solving those difficult problems.

So don't think of your Brand-Rex representative as a salesman. Think of him as a problem solving partner with a lot more to offer than just a product. Call him. You'll see.

Brand-Rex Company,  
Electronic and Industrial  
Cable Division, Willimantic,  
CT. 06226, 203/423-7771.

## BRAND-REX

ELECTRONIC & INDUSTRIAL CABLE DIVISION

Other Brand-Rex Divisions:

Abbott & Co., wiring harnesses □ Nonotuck Manufacturing Co., copper wire  
Pyle-National Co., electrical connectors □ Telecommunications Cable Division  
Teltronics, Inc., telephone equipment and components □ Brand-Rex, Ltd. (Scotland), wire and cable.

BRAND-REX CO., A PART OF AKZONIA INCORPORATED

Signal has the answer...

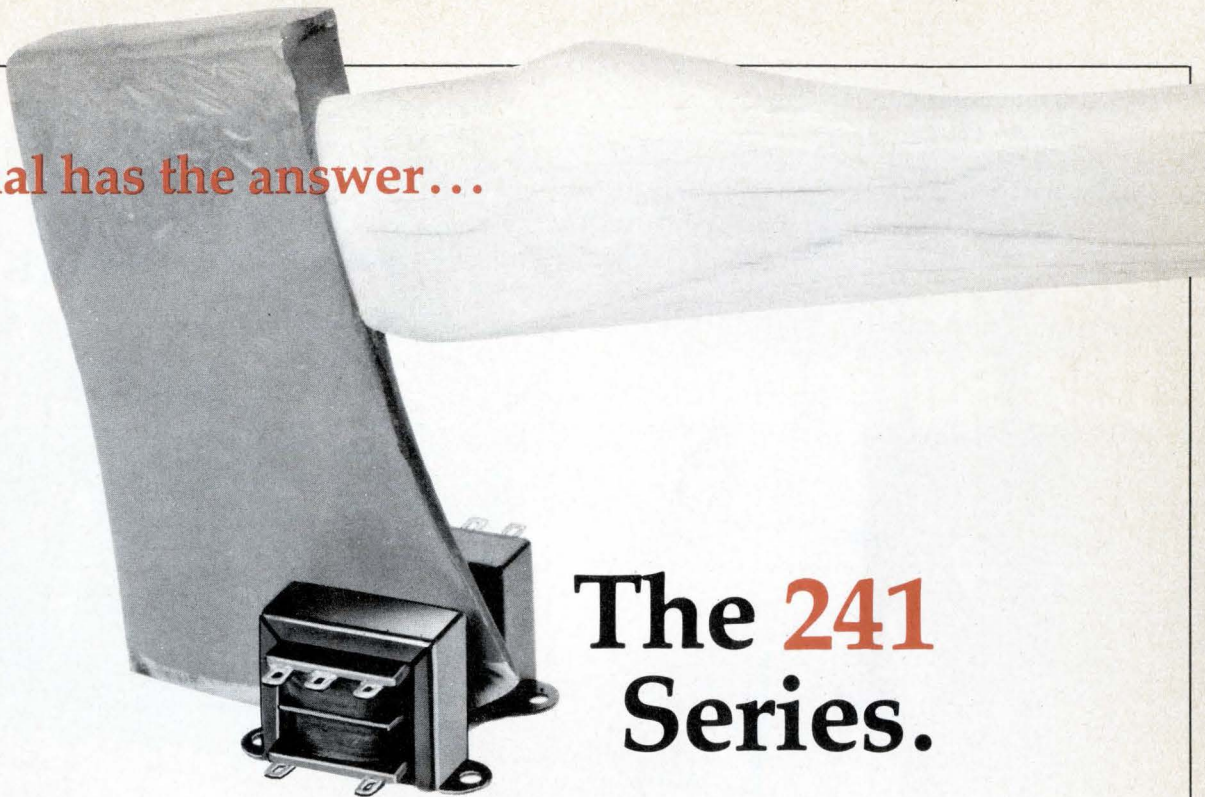

## The 241 Series.

**Cuts transformer weight, size and cost almost in half!**

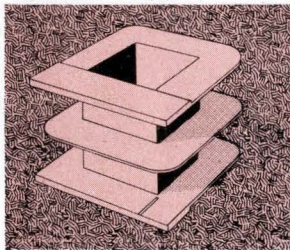

Special "split" bobbin (secondary wound alongside primary rather than over it) effectively isolates primary and secondary and reduces inter-winding capacitance. An electro-static shield

is not required in all but the most sensitive applications. Hipot rating of 2500V RMS is standard. Bobbin winding technique affords a 40-50% savings in winding space over conventional layer winding. "Split" bobbin eliminates the need for inter-winding insulation and cross-over of primary and secondary leads.

Grain-oriented steel core is used at higher saturation flux densities and results in about a 40% reduction in turns required. Although the cost per lb. of grain-oriented steel is higher than that

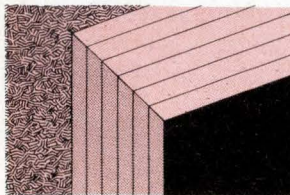

for ordinary silicon steels, the net cost is less, since less core weight is required and a significant reduction is made in copper weight.

Terminals, which are wedged into the bobbin wall, are designed so that they can be used as solder lugs or as 0.187" quick-connect types. Lead slots are incorporated in the bobbin wall leading to the terminals. It is not necessary to tape the start lead since it comes to the top of the coil through the slot and is thus separated from the winding. Separate lead wires or terminal boards and the extra assembly time to use them are eliminated.

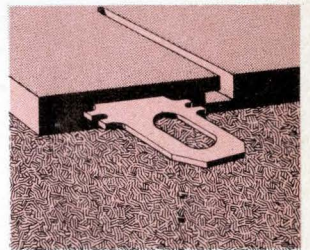

Fresh thinking in engineering design and material selection has reduced material and labor cost and results in a series of small power transformers which cut weight, size, and cost almost in half. Therefore, we named them the "2-for-1" series...



**signal transformer co., inc.**

1 Junius Street, Brooklyn, N.Y. 11212  
Tel: (212) 498-5111 • Telex 12-5709

**-and Signal has it in Stock!**

**narda...  
the source**

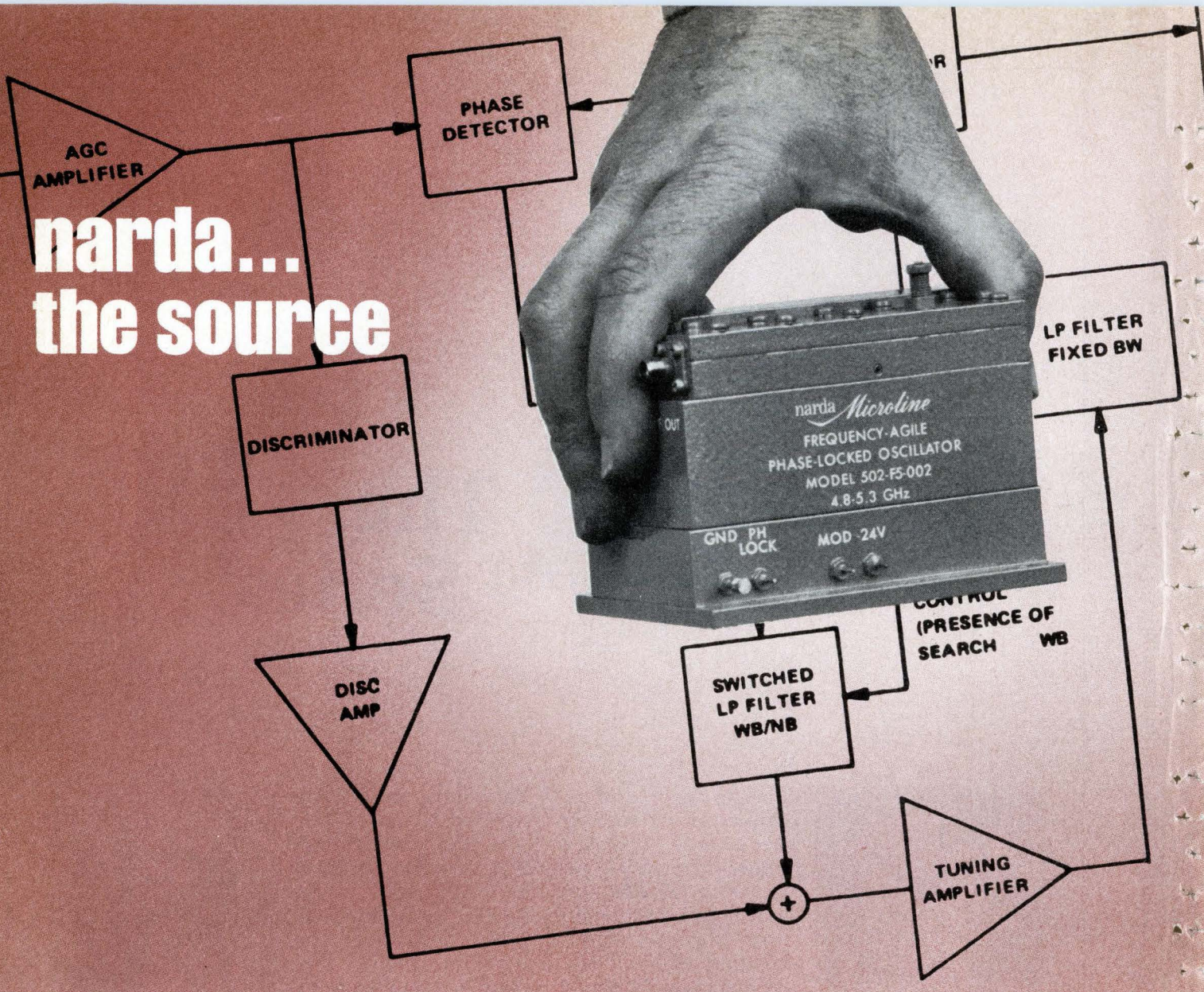

## Frequency Agile Phase-Locked Oscillators provide long-term stability and optimum system performance

### Benefits You Get With Narda Sources:

- Solid State, Fully Automatic
- Cannot Lock to Incorrect Harmonic
- Locks To Sequential Frequency Commands In Any Increment
- Wide Dynamic Range: Input Reference Signal Level -3dBm to +20dBm
- Wide Frequency Range (500 MHz)

Narda's Solid State Signal Sources automatically adjust to a changing input reference signal. The source will track a sweeping input signal, or if switched to a new input will lock to it within 0.1 second, in sequential frequency commands in any increment.

These devices are particularly well suited for applications which require exceptional operating stability and outstanding spectral purity such as: microwave radio transmitters, receivers in communications systems, transmitter exciters, receiver local oscillators, doppler radar frequency references and frequency reference standards for laboratory experiments.

**Write for complete information . . .** Model 461-F5-001 from 4.5 to 4.8 GHz, Model 502-F5-002 from 4.8 to 5.3 GHz.

Other models available covering the frequency range of 900 MHz to 8.0 GHz.

Circle 2 on reader service card

*wherever microwaves go...* **narda**

THE NARDA MICROWAVE CORPORATION • PLAINVIEW, L.I., NEW YORK 11803

516-433-9000 • TWX: 510-221-1867 • CABLE: NARDACORP PLAINVIEW NEWYORK

## 41 Electronics review

PHOTOVOLTAICS: Concentrator cell shows 21% efficiency, 41  
MILITARY: LTV protest clouds Navy's F-18 choice, 42  
GOVERNMENT: FAA's Dow pushing for new flight recorders, 43  
CONSUMER: National's Novus readies electronic games, 44  
MICROPROCESSORS: Intersil chooses 12-bit design, 44  
ECL processor line comes in blocks, 46  
SOLID STATE: IBM uses electron beams for dense memory, 46  
EMPLOYMENT: EE graduates facing tight job market, 48  
COMPUTERS: Honeywell-Bull absorbs CII in merger, 48  
U. S., IBM square off in landmark trial, 50  
NEWS BRIEFS: 52

## 63 Electronics International

FRANCE: Government triples electronic anesthesia budget, 63  
AROUND THE WORLD: 63

## 75 Probing the News

INSTRUMENTATION: Wary makers eye UL standard, 75  
MILITARY ELECTRONICS: Paris is a military market, 78  
COMMUNICATIONS: Europe set for first digital-TV setup, 82  
COMPANIES: Western Digital seeks new formula, 84  
COMMUNICATIONS: Cable TV looks to satellites, 88

## 91 Technical Articles

COMPUTERS: Integrating hardware and software in microcomputers, 91  
Microcomputer-development system achieves harmony, 95  
DESIGNER'S CASEBOOK: Logic gates and LED indicate phase lock, 106  
ECL IC oscillates from 10 to 50 MHz, 106  
Tri-level indicator monitors automobile's electrical system, 107  
INDUSTRIAL: Electronics can thrive by increasing profitability, 110  
Part 1: Automating the machine shop, 112  
INSTRUMENTS: Sequential analysis speeds up incoming testing, 121  
ENGINEER'S NOTEBOOK: DIP switches and diode form PROM, 126  
Jitter generator tests bit synchronizer, 127

## 135 New Products

IN THE SPOTLIGHT: Data converters—hybrid or modular? 135  
COMPONENTS: Beckman adds thick- and thin-film resistors, 139  
PACKAGING & PRODUCTION: IC probe station is versatile, 143  
SEMICONDUCTORS: Edge-triggered RAM speeds TTL systems, 147  
DATA HANDLING: Disk controller is microprogramed, 151

## Departments

Publishers letter, 4  
Readers comment, 6  
News update, 8  
Editorial, 10  
People, 14  
Meetings, 30  
Electronics newsletter, 37  
Washington newsletter, 59  
Washington commentary, 60  
International newsletter, 63  
Engineer's newsletter, 130

## Highlights

### Cover: How to conduct microcomputer design, 91

Now that they are being built around microcomputers, digital systems are compelling engineers to become heavily involved in programing and computer-aided design. For instance, an error-free prototype can be built with the help of a new system that simulates both hardware and software and the interactions between them (p. 95).

On the upbeat in the cover photograph by Art Director Fred Sklenar is Associate Editor Howard Wolff.

### UL standard will raise instrument costs, 75

Underwriters' Laboratories' revised standard for test and measuring instruments is under review by manufacturers, who, however, fear that its use will complicate and prolong the development of new models.

### The industrial electronic revolution, 110

New and better electronic equipment is needed by several industries which, even today, are prosperous and competitive enough to be planning large outlays on automation. Kicking off a series on this subject is an article on the demand for smarter machine tools.

### Modular data converters are still ahead, 135

High-performance converters cost less in modular form. But hybrid versions may yet break out of the military and avionics markets if manufacturing methods improve.

### And in the next issue . . .

Automation comes to the office . . . electronics in the steel industry, Part 2 of a series . . . the case for silicon on sapphire.

EDITOR-IN-CHIEF: Kemp Anderson

EXECUTIVE EDITOR: Samuel Weber

MANAGING EDITORS: Lawrence Curran, News;  
Arthur Erikson, International

SENIOR EDITORS: John Johnsrud,  
H. Thomas Maguire, Laurence Altman,  
Ray Connolly, Stephen E. Scrupski

ART DIRECTOR: Fred Sklenar

ASSOCIATE EDITORS: Howard Wolff,  
Gerald M. Walker, Alfred Rosenblatt

DEPARTMENT EDITORS  
*Aerospace/Military*: Ray Connolly  
*Circuit Design*: Don Blattner  
*Components*: Lucinda Mattera  
*Computers*: Stephen E. Scrupski  
*Consumer*: Gerald M. Walker  
*Industrial*: Margaret A. Maas  
*Instrumentation*: Andy Santoni  
*New Products*: H. Thomas Maguire,  
Michael J. Riezenman  
*Packaging & Production*: Jerry Lyman  
*Solid State*: Laurence Altman

COPY EDITORS: Margaret Eastman,  
Everett C. Terry, Bill Dunne

ART: Charles D. Ciatto, Associate Director  
Patricia Cybulski, Assistant Director

PRODUCTION EDITOR: Arthur C. Miller

EDITORIAL SECRETARIES: Janet Noto,  
Julie Gorgoglione, Penny Roberts

FIELD EDITORS

*Boston*: Gail Farrell (Mgr.), Pamela Leven  
*Los Angeles*: Paul Franson (Mgr.)  
Judy Phelps  
*Midwest*: Larry Armstrong (Mgr.)  
*New York*: Ron Schneiderman (Mgr.)  
*San Francisco*: Bernard Cole (Mgr.)  
Judith Curtis  
*Washington*: Ray Connolly (Mgr.)  
Larry Marion  
*Frankfurt*: John Gosch  
*London*: William F. Arnold  
*Paris*: Arthur Erikson  
*Tokyo*: Charles Cohen

McGRAW-HILL WORLD NEWS

*Director*: Ralph R. Schulz  
*Bonn*: Robert Ingersoll  
*Brussels*: James Smith  
*London*: James Trotter  
*Madrid*: Dom Curcio  
*Milan*: Andrew Heath  
*Moscow*: Peter Gall  
*Paris*: Michael Johnson, Richard Shepherd  
*Stockholm*: Robert Skole  
*Tokyo*: Mike Mealey

PUBLISHER: Dan McMillan

DIRECTOR OF MARKETING: Pierre J. Braudé

ADVERTISING SALES SERVICE MANAGER:  
Wallis Clarke

BUSINESS MANAGER: Stephen R. Weiss

CIRCULATION MANAGER: Nancy L. Merritt

MARKETING SERVICES MANAGER:  
Tomlinson Howland

RESEARCH MANAGER: Margery D. Sholes

## Publisher's letter

**P**roductivity can be looked at as one of the products that electronics companies can offer for sale. "Productivity," after all, is a much clearer way of saying "better control of a process," "more output per dollar of investment," "decreased need for system maintenance and, thus, downtime," and the host of similar phrases that are used to describe the benefits of electronic controls.

And nowhere does the potential of electronics appear greater than in the industrial field. More and more companies in the manufacturing industries—metal-working, steel, oil, paper, and the like—are seeking relief from their recession-induced economic troubles in productivity-improvement projects. And more and more of them are turning to electronic systems as the mechanism to meet the projects' goals.

This issue we are presenting the first article in a series on the application of electronics to industrial productivity. The article, which you'll find on page 110, details what's going on, largely due to electronics, machine tools are becoming smarter.

Our industrial editor, Peggy Maas, points out in the article: "In the last three years, machine tools have started tackling tasks that they never did—or could do—before. The change is not in the tools themselves, but in their controls, which, thanks to the falling prices of solid-state equipment, in particular the minicomputer, contain a larger-than-ever proportion of electronics."

No longer is the search for production innovations limited to the big companies that build their own controls. Now that a lot of the basic applications work has been done,

the smaller companies are following the leaders toward increased reliance on electronics. And that trend is evident in other industries as well. In upcoming issues, we will spotlight such industries as steel-making, petroleum and paper.

**I**t's show time again for our Paris news bureau. With the Paris Components Show hardly over, Art Erikson, our managing editor for international news, was hard at work arranging for the previews of the Paris Air Show and the biennial Montreux Television Symposium that appear in this issue.

And some interesting new developments are surfacing at the shows. As Michael Johnson, head of McGraw-Hill's World News operation in Paris, found in preparing the air show report, which appears on page 78, "commercial-aircraft builders, arms peddlers, and avionics makers are converging in Paris to size up the booming export markets in the Middle East and Latin America. And the stake for electronics, which accounts for 15% of the cost of military gear, is proportionately high."

Though far from the carnival atmosphere of the air show, the meeting at Montreux, on the placid shores of Lake Geneva, is the scene of a lot of activity. The big news from there is the massive move to the digital handling of TV program signals from the studio right up to the transmitter. You can read about that trend starting on page 82.

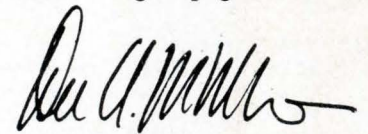

May 29, 1975 Volume 48, Number 11  
95,462 copies of this issue printed

Published every other Thursday by McGraw-Hill, Inc. Founder: James H. McGraw 1860-1948. Publication office 1221 Avenue of the Americas, N.Y., N.Y. 10020; second class postage paid at New York, N.Y. and additional mailing offices.

Executive, editorial, circulation and advertising addresses: Electronics, McGraw-Hill Building, 1221 Avenue of the Americas, New York, N.Y. 10020. Telephone (212) 967-1221. Teletype TWX N.Y. 710-581-5234. Cable address: MCGRAW HILL N.Y.

Subscriptions limited to persons with active, professional, functional responsibility in electronics technology. Publisher reserves the right to reject non-qualified requests. No subscriptions accepted without complete identification of subscriber name, title, or job function, company or organization, including product manufactured or services performed. Subscription rates: qualified subscribers in the United States and possessions, Canada, and Mexico \$12.00 one year, \$24.00 three years; all other countries \$25.00 per year, except Japan and Israel \$50.00 per year, Brazil \$40.00 per year, Australia and New Zealand \$60.00 per year, including air freight. Limited quota of subscriptions available at higher-than-basic rate for persons outside of field served, as follows: U.S. and possessions and Canada, \$25.00 one year; all other countries \$50.00. Single copies: \$4.00.

Officers of the McGraw-Hill Publications Company: John R. Emery, President; J. Elton Tuohig, Executive Vice President-Administration; Gene W. Simpson, Group Publisher-Vice President; Senior Vice Presidents: Ralph Blackburn, Circulation; Walter A. Starbury, Editorial; John D. Hoglund, Controller; David G. Jensen, Manufacturing; Gordon L. Jones, Marketing; Jerome D. Luntz, Planning & Development.

Officers of the Corporation: Shelton Fisher, Chairman of the Board and Chief Executive Officer; Harold W. McGraw, Jr., President and Chief Operating Officer; Wallace F. Traendly, Group President, McGraw-Hill Publications Company and McGraw-Hill Information Systems Company; Robert N. Landes, Senior Vice President and Secretary; Ralph J. Webb, Treasurer.

Title registered in U.S. Patent Office; Copyright ©1975 by McGraw-Hill, Inc. All rights reserved. The contents of this publication may not be reproduced in whole or in part without the consent of copyright owner.

Subscribers: The publisher, upon written request to our New York office from any subscriber, agrees to refund that part of the subscription price applying to copies not yet mailed. Please send change of address notices or complaints to Fulfillment Manager; subscription orders to Circulation Manager, Electronics, at address below. Change of address notices should provide old as well as new address, including postal zip code number. If possible, attach address label from recent issue. Allow one month for change to become effective.

Postmaster: Please send form 3579 to Fulfillment Manager, Electronics, P.O. Box 430, Hightstown, N.J. 08520.

# For \$495 how many functions should a Function Generator generate?

Fifteen. That's the number of waveforms you can get with Krohn-Hite's Model 5100A. How? A unique Symmetry Control that allows pulse rep rate to be set independently of pulse width and also provides independently adjustable triangle slopes. You can skew any of the basic sine, square, triangle and ramp waveforms by as much as 99% to produce 10 additional functions. Frequency range of 0.002 Hz to 3 MHz can be manually tuned or externally controlled for VC of 1000:1. When you compare the 5100A with the rest, there's quite a generation gap. For fast action, call The Wavemakers at (617) 491-3211, TWX 710-320-6583 Krohn-Hite Corporation, 580 Mass. Ave., Cambridge, Mass. 02139.



**KH KROHN-HITE**  
CORPORATION

SALES OFFICES: ALA, Huntsville (205) 534-9771; ARIZ., Scottsdale (602) 947-7841; CAL., San Jose (408) 292-3220, Inglewood (213) 674-6850; COLO., Denver (303) 750-1222; CONN., Glastonbury (203) 633-0777; FLA., Orlando (305) 894-4401; HAWAII, Honolulu (808) 941-1574; ILL., Des Plaines (312) 298-3600; IND., Indianapolis (317) 244-2456; MASS., Lexington (617) 861-8620; MICH., Detroit (313) 526-8800; MINN., Minneapolis (612) 884-4336; MO., St. Louis (314) 423-1234; N.C., Burlington (919) 227-3639; N.J., Haddonfield (609) 795-1700; N.M., Albuquerque (505) 299-7658; N.Y., E. Syracuse (315) 437-6666, Rochester (716) 328-2230, Vestal (607) 785-9947, Elmont (516) 488-2100; OHIO, Cleveland (216) 261-5440, Dayton (513) 426-5551; PA., Pittsburgh (412) 371-9449; TEX., Houston (713) 688-9971, Richardson (214) 231-2573; VA., Alexandria (703) 354-1222; WASH., Bellevue (206) 624-4035; CANADA, Montreal, Quebec (514) 636-0525, Toronto, Ontario (416) 499-5544, Stittsville, Ontario (613) 836-3990, Vancouver, British Columbia (604) 278-2009, Halifax, Nova Scotia (902) 434-3402.

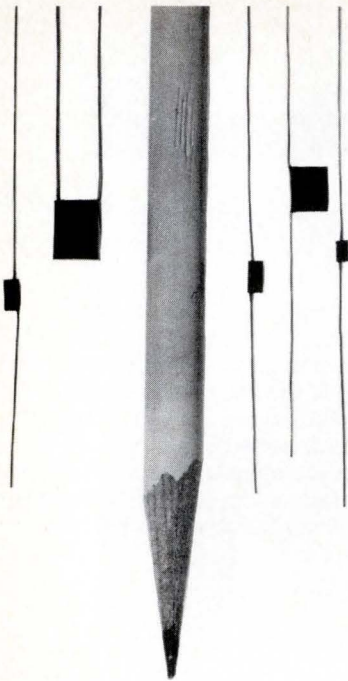

## Tansitor Miniature solids... designed to meet your tantalum capacitor needs... 3 ways.

**in performance.** These tantalum HA (cylindrical) and TC (rectangular) deliver a capacitance range from .01 to 68 uf and .01 to 470 uf. Both carry a 2-50VDC and an operating range of -55°F to 85°C with voltage derating to 125°C. Our polar and non-polar miniatures are encased in plastic with epoxy seals and offer a choice of radial or axial leads. With 24 case sizes one of our standards will meet your needs... perfectly.

**in price.** Ask for a quote. You'll find us extremely competitive. That's why we're a leading manufacturer of tantalum mini-solids.

**and in delivery.** At Tansitor, we're different. Our delivery schedule is tailored to your needs. Need we say more? For more information or spec sheets, call your Tansitor representative or write:

**Tansitor**  
ELECTRONICS  
DIVISION OF AEROTRON, INC

West Rd. • Bennington, VT 05201  
Phone: 802/442-5473 TWX: 710/360-1782

## Readers comment

### 'Supershow' knocked

**To the Editor:** The editorial in your April 3 issue suggests the need for an electronics "supershow" that would somehow present all that's new in consumer electronic products, industrial systems, packaging, automotive, communications, computing, components, instrumentation. You might be able to squeeze all of that into one hall—McCormick Place in Chicago—but that is the only possibility. There would be serious questions on travel costs from the East Coast and West Coast electronics centers. Such an event would have to attract about 100,000 persons, mostly engineers and mostly from the two coasts.

We wish to point out some of the statistical facts which impact on other comments in the editorial:

The "big [IEEE] shows of a decade ago" were in large part a function of government programs in electronics and the rapid evolution of new technology into products. Uncle Sam was paying for many exhibits and many exhibitors—and many pages of space advertising, as well. In the long run, he was also picking up the tab for visitors' travel.

The "supershow" would have the same potential merit as a "supermagazine," one that would cover all aspects of the "pervasiveness" of industry, from concept and design all the way to end-users of all systems. Neither is really feasible.

Even in the "good old days," the IEEE Show was regional, even though people didn't think of it that way. Up to 80% of 60,000-plus attendance was always from within 400 miles of New York City. The program may have been international (but wasn't, really). The exhibitors may have been international (some were), but the audience was always regional.

You can apply the same formula to the Paris components show or Electronica in Munich. Draw a circle with a 400-mile radius from either city and then check geographical attendance. (In either case, of course, your circle will include many countries.)

The editorial also mentioned

Tokyo and Osaka. The Japan Electronics Show alternates between the two cities, as Wescon does between San Francisco and Los Angeles, and as ELECTRO will between Boston and New York.

With the exception of the Japan show, none of the expositions mentioned has tried to be all things to all people, as the editorial implies. As frequently pointed out by *Electronics*, we are no longer dealing with a single industry but a whole family of electronics industries, several of whom have little in common except the technology. They have different markets, different distribution, different everything.

There is likely to be greater "regionalization" of conventions and shows, not less. The reason is that "nobody pays his own way"—that is, companies must send their engineering personnel and pay the way. Except in that period where the tab ultimately went to Washington, there has been no way in which management could afford to send any sizeable number of engineers across the nation for shows and conventions.

That is why you see regular regional shows each year (NEPCON-East, West, and Central; Semicon-East and West; Intercon (now ELECTRO) in the East and Wescon in the West. That is why you also see ISA changing locations each year and the National Computer Conference doing likewise. Attendance is always local and regional (in a viable market territory). It is the exhibitors who are national, and who, incidentally, demand a show that serves a particular market.

There should be no confusion with other industrial shows that are attended by single proprietors who pay their own way: The Consumer Electronics Show, attended by self-employed hi-fi retailers and distributors; the National Home Builders Show, attended by self-employed contractors, builders, and suppliers; and many others.

Donald E. Larson  
Electrical and Electronics  
Exhibitions Inc.  
Los Angeles, Calif.



## HiNIL Interface

# Keeping the bugs out of microprocessor systems with high noise immunity logic.

An MOS microprocessor system can be troubled by disastrous bugs unless it is protected against noise transients generated by switches, electromechanical peripherals and other nearby noise sources, such as lamps and machinery. But filters and shielding, the traditional cures, are often difficult to add to a microprocessor because of size and cost constraints.

These problems can be avoided by substituting HiNIL interface devices for conventional I/O logic. HiNIL—Teledyne's bipolar High Noise Immunity Logic—has a guaranteed DC noise immunity about 10 times that of TTL, for example (3.5 vs. 0.4V). Also, HiNIL blocks AC transients large enough to cause TTL malfunctions. Two additional advantages are superior output drive and, in low power systems, protection of CMOS memory and random logic inputs.

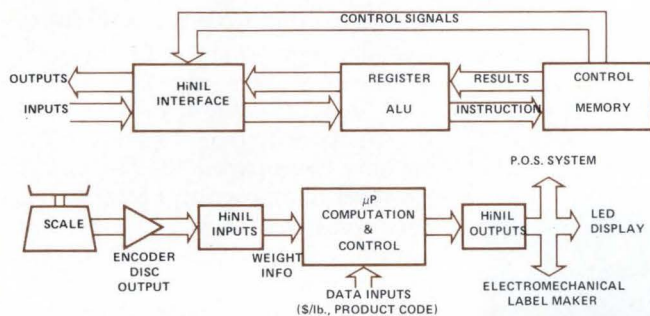

Figure 1. Use of HiNIL interfaces in POS systems with electronic scale. Top diagram shows basic microprocessor configuration.

One manufacturer of microprocessor-controlled electronic scales decided to use the configuration in Figure 1 because he was concerned about the consequences of incorrect weights and prices. The probability of errors resulting from noise transients was high because the scale would be used in a supermarket POS system, where the environment includes refrigerators, fluorescent lamps, meat grinders and electromechanical label makers.

In the system, the microprocessor receives weight codes from an encoder disc in the scale and operates a cash register interface, LED display, and relays of a receipt printer or label maker. The system designers put HiNIL interface logic on the microprocessor board to handle the I/O functions, suppress noise transients picked up along the transmission lines, and drive the peripheral devices. HiNIL output interfaces can drive long lines, relays, displays and lamps without additional components since they sink up to

65 mA and source up to 12 mA. (The new 390 buffer series will sink up to 250 mA.)

Manufacturers of systems requiring random logic are finding that HiNIL and CMOS are an ideal combination. They maximize system noise immunity and assure an excellent system function/power product. HiNIL and 54C/74C CMOS interface directly at  $V_{CC}$  voltages from 10 to 16 volts, the power supply range of HiNIL. Moreover, HiNIL protects CMOS inputs from destruction by static electricity and from harmful DC input levels that can exist before CMOS circuits are powered up.

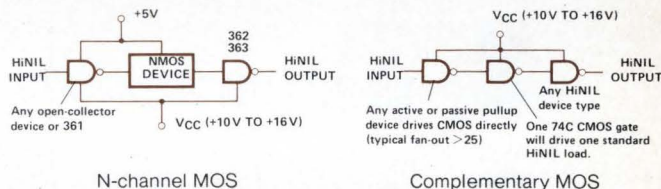

Figure 2. Typical HiNIL/MOS and HiNIL/CMOS interfaces

The rules for using HiNIL with MOS or with CMOS operating at lower voltages are simple. The pullup resistor of an open collector HiNIL device is connected to the desired high logic level voltage (see Figure 2). To use HiNIL with other bipolar logic, just plug in a Teledyne dual or quad interface circuit (see table). HiNIL is also compatible with most analog devices.

### Examples of HiNIL Interface Devices

301 Dual 5-Input Power Gate	65mA relay or lamp driver
302 Quad Power NAND Gate (OC)	
323 Quad NAND Gate (OC)	Input noise protection plus open-collector pullup to other logic levels
332 Hex Inverter (OC)	
334 Strobed Hex Inverter (OC)	
350 8-Bit Multiplexer	Drive longer lines than TTL with 10X noise immunity ( $I_{OH} = 12mA$ )
351 Dual 4-Bit Multiplexer	
361 Dual Input Interface	361 directly connects HiNIL to DTL/RTL/TTL
362 Dual Output Interface	362 and 363 connect DTL/RTL/TTL to HiNIL
363 Quad Output Interface	
367 Quad Schmitt Trigger	Suppress 100V/1 $\mu$ s spikes, protect CMOS, decode switches, etc.
368 Quad Schmitt Trigger (OC)	
380 BCD to Decade Decoder	
381 BCD to Decade Decoder (OC)	Provide decode/drive for lamps, LEDs, gas discharge displays, etc.
382 BCD to Decade Decoder	
383 BCD to 7-Segment Decoder	
390 Interface Buffer Series	250mA HiNIL driver series will be available soon.

If you need a simple, inexpensive solution to a difficult noise problem, write or call Teledyne Semiconductor for a copy of application notes and specifications on Teledyne's High Noise Immunity Logic family.

# TELEDYNE SEMICONDUCTOR

1300 Terra Bella Avenue, Mountain View, California 94043 Tel: (415) 968-9241 TWX: 910-379-6494 Telex: 34-8416

ENGLAND: Heathrow House, Cranford, Hounslow, Middlesex, Tel: (44) 01-897-2503 Telex: 851-935008

FRANCE: 90, Avenue Des Champs Elysees, 75008 Paris, Tel: 2563069 Telex: 842-29642

WEST GERMANY: Albert Gebhardtstrasse 32, 7897 Tiengen, Tel: 7741-5066 Telex: 841-792-1462

JAPAN: Nihon Seimei-Akasaka Bldg. (3F), 1-19, Akasaka 8-chome, Minato-ku, Tokyo 107, Tel: 03-405-5738 TWX: 781-2424241

Additional offices in West Germany, Hong Kong and the United States. Representatives and distributors worldwide.

# Only Sprague bantam 4-pin DIP capacitors can give you these advantages . . .



**guaranteed max. high frequency impedance**



**low inductance and low ESR . . .  
4-terminal connection mode option**



**preferred capacitance values to  
optimize performance when tantalum  
and ceramic capacitors are paralleled**



**automatic insertion capability**



**your choice of layer-built ceramic  
or solid-electrolyte tantalum**

## Type 935C MONOLYTHIC<sup>®</sup> CERAMIC CAPACITORS

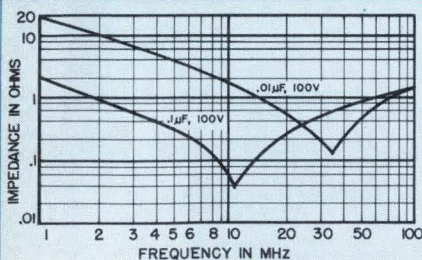

Proven multi-layer construction. C0G(NP0) and X7R temperature characteristics. Preferred ratings are .01, .047, and .1  $\mu\text{F}$  @ 100 WVDC. Operating temperature range,  $-55\text{C}$  to  $+85\text{C}$ .

Circle 8 on reader service card

## Type 935D TANTALEX<sup>™</sup> SOLID-TANTALUM CAPACITORS

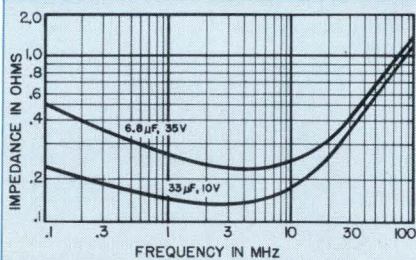

Dual in-line plastic package for mechanical protection and increased reliability. Preferred ratings are 6.8  $\mu\text{F}$  @ 35 V, 15  $\mu\text{F}$  @ 20 V, 22  $\mu\text{F}$  @ 15 V, and 33  $\mu\text{F}$  @ 10 V. Operating temperature range,  $-55\text{C}$  to  $+85\text{C}$ .

Circle 163 on reader service card

For complete technical data on Type 935C or 935D Capacitors, write for Engineering Bulletins 6242.3 or 3542.3, respectively, to: Technical Literature Service, Sprague Electric Company, 35 Marshall St., North Adams, Mass. 01247.

45-4124

# SPRAGUE

THE MARK OF RELIABILITY

THE BROAD-LINE PRODUCER OF ELECTRONIC PARTS

## News update

■ An experimental setup meant to automate testing of autos at state inspection stations has proved to be too expensive, says the National Highway Traffic Safety Administration. A test system has been in operation in Washington, D.C., since late last year. Funded by the Traffic Safety Administration [April 4, 1974, p. 59], the \$210,000 system, built by Avco Systems division, Wilmington, Mass., checks emission-control equipment and mechanical controls. Meanwhile, evaluation of a smaller, minicomputer-based optical-reader system, which analyzes mechanics' reviews of auto performance, is under way in Tennessee. The new system costs about 10% of the one tested in Washington.

■ Bell-Northern Research, Ottawa, Canada, says work is continuing on its experimental 1-megabit, 16-bit-word memory system using 128 of its proprietary 8,192-bit CCD memory chips [April 4, 1974, p. 35]. However, the program's priority has been somewhat reduced in the past several months. Bell-Northern expects to present a paper on its work at the CCD applications conference in San Francisco in October.

■ The first two high-rise security systems introduced last year [April 4, 1974, p. 42] by Westinghouse Security Systems Inc., Pittsburgh, are currently being installed at two new condominiums. They are the Representative, a 207-unit development in Arlington, Va., and the 237-unit Towson Center in Towson, Md. Westinghouse has several more orders for its security system, but says it must wait for the builders to complete their own financing arrangements before Westinghouse can complete the details of the sales.

The Westinghouse system is built around a custom p-MOS LSI chip that does all the processing for two-way communications, alarms, an identification panel, notification lights, and disarming codes.

# What Would You Call an Easy-to-Use, Low Cost, Portable, Flexible, Time-Saving, Four Channel Test Instrument?

Most people would call it unbelievable.

We call it the Bell & Howell® Datagraph Model 5-144, probably the most convenient test instrument you'll ever use.

With a frequency response of up to 10,000 Hz, the Model 5-144 records both analog and digital data with equal ease.

Four channels are available for viewing simultaneous events, such as timing sequences or multiple, inter-related functions.

The Model 5-144 contains all electronics needed to record information. There's no need to make special cables or calculate complicated damping networks. Just plug in your scope probes and record your data.

And after you've captured that data, the Model 5-144 provides a hard-copy for further examination.

In fact, think of it as a scope with a screen 200 feet wide.

Other user features include trace polarity reversal, ac or dc coupling, and three selectable timing reference line spacings.

Two choices of gridlines and ten recording speeds are also available.

Total weight for all of this capability is only 34 pounds.

For more information or a demonstration, circle the appropriate reader service number below or write the CEC Division of Bell & Howell.

The Datagraph Model 5-144 will make a believer out of you.

## CEC DIVISION

360 Sierra Madre Villa, Pasadena, California 91109

 **BELL & HOWELL**

(In Canada: 125 Norfinch Drive, Downsview, Ontario M3M 3B5)

CEC is a registered trademark of Bell & Howell.

© Bell & Howell 1975

Circle 9 on reader service card



## Productivity means education

*The current moves to upgrade productivity in the nation's industry represents a huge growth area for electronics. But how much and how fast electronics makes market inroads will depend, in large part, on how well manufacturers of electronic systems educate themselves. The drawing board and development laboratory are worlds apart from the heat, dust, and oil mist, the greasy-pawed operators and skeptical maintenance men, and the raw mechanical forces of the industries that hold so much for electronics' future.*

*To deal with an industrial user—whether he be in metals, machine tools, chemical, paper, or any other basic industry—the seller must understand him: how he functions, his attitudes, his economic viability, and—an often overlooked aspect—the mechanics of the machinery on which the electronics will be used.*

*For example, a 25-hp motor driving a cutting tool is literally bending a machine that may stand 20 feet high. A laser positioning system to control the machine's cutting motion may look attractive. However, such a system, since it measures in angstroms, has to be carefully compensated, although the old-time machinist made the adjustment instinctively. One machine-tool industry man laments: "The positioning systems I saw at the IEEE show looked like toys. They would never work in a shop environment."*

*Perhaps more important, though, is the job of educating the old-line industrial companies in the benefits of electronics. Industrial buyers have the reputation for being very cautious and certainly are not going to adopt new technology for technology's sake.*

*They shudder at talk of mean time between failure, because "failure" in all too many processes means costly, even catastrophic, stoppages. They fear electronic parts won't stand up to the wear and tear of the factory floor. They have viewed pneumatic and hydraulic controls as inherently safer than electronics, although intrinsically-safe electronic hardware is available and proven.*

*Even more significant is the fact that, in those segments of heavy industries where technological progress is measured in decades, the breathless pace of electronics is not only bewildering, but has led many a company to freeze current designs until the rate of technological change slows down.*

*But the fact is that electronics technology is not going to slow down to the point where heavy industry finds it comfortable to keep in step. Instead, electronics companies have their work cut out for them in convincing—call it educating, if you will—many of their potential industrial customers that electronics technology holds a vital key to dramatically increased productivity.*

# Finally. A cure for the common One-Shot.

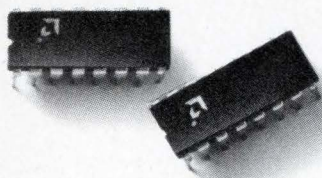

You know about one-shots. You just have to live with them, right?

You just have to put up with their unpredictability, instability and slowdowns, right?

Wrong.

Advanced Micro Devices announces the cure for the common one-shot: The Am26S02, a superb, Schottky part — the missing link in the all-Schottky system.

It has a minimum pulse width of 28 nanoseconds versus 45 nanoseconds for the slow kids. Its output pulse width stability over the commercial temperature range is .4%, compared to 4% for The Wobblers. It has a guarantee 5% unit-to-unit predictability. The guys down the street guarantee 10%. (We deliver a military version. Yes. Deliver.)

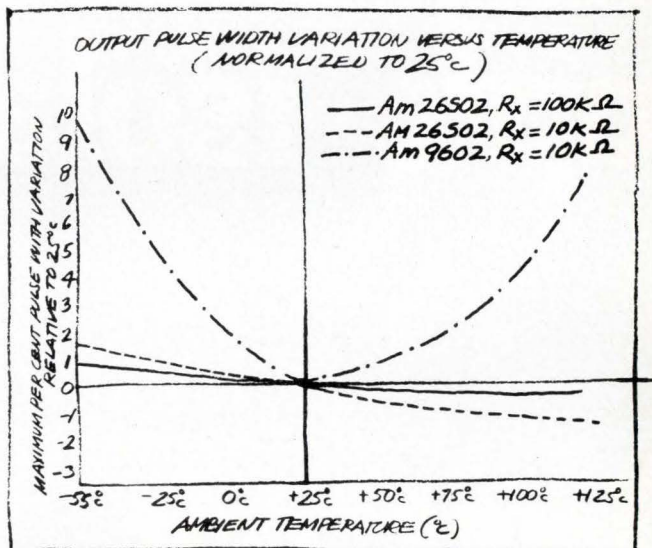

So say good-bye to potentiometers. Say good-bye to those semi-sort-of-Schottky systems.

From now on it's all Schottky, no heartache. Just ask for the Am26S02, the cure for the common one-shot.



## Advanced Interface

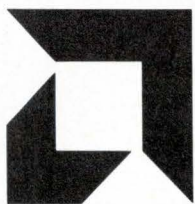

# Want a half million opto-isolators?

## Just ask.

single channel

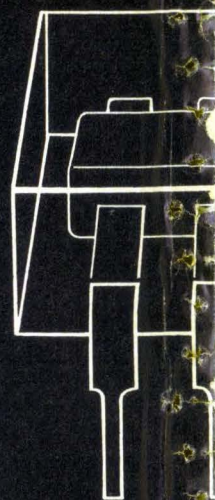

dual channel—  
two independently  
isolated channels

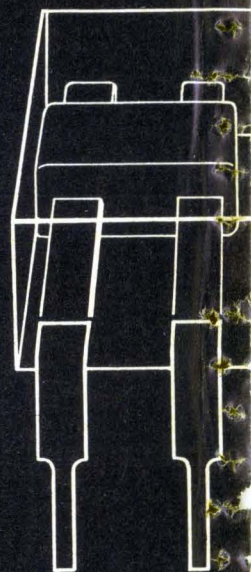

quad channel—  
four independently  
isolated channels

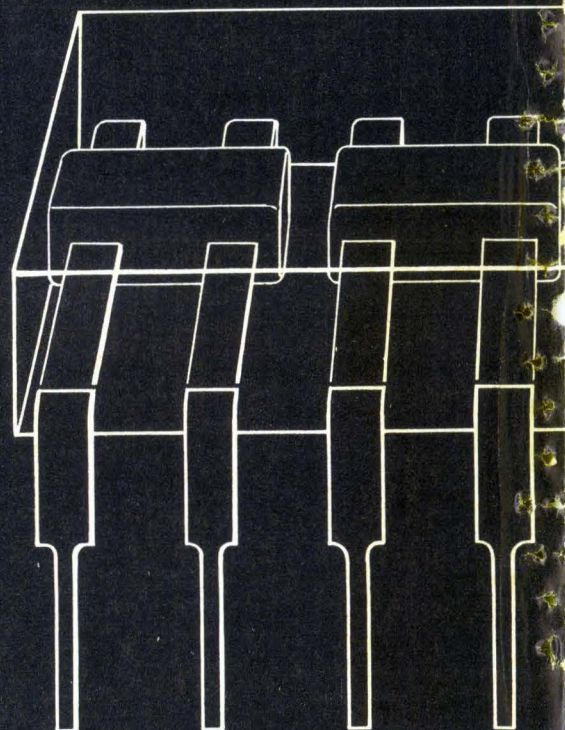

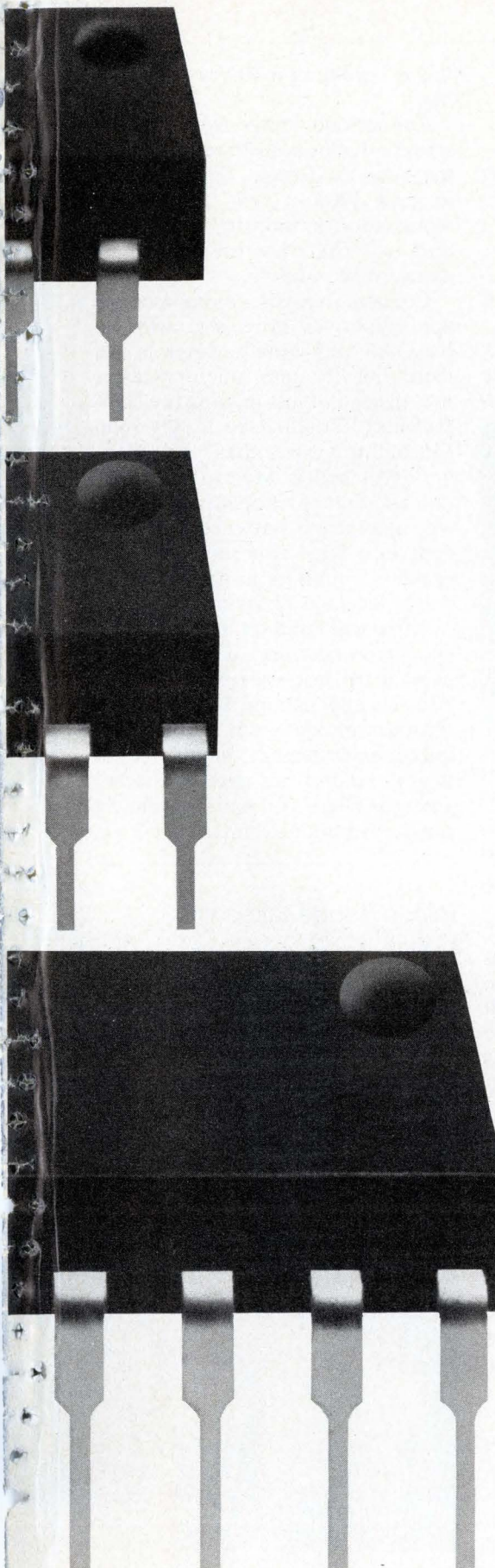

You can't see the LEDs in our opto-isolators...but they're there.

That's one reason why the No. 1 producer of LEDs has now become a high-volume producer of opto-isolators. Our opto-isolator production capacity has multiplied ten times in the past 12 months. And our line has become broad enough to satisfy nearly every application. For example:

**General purpose.** Litronix has a full line of phototransistor/LED opto-isolators in standard dual-in-line packages.

**Low cost.** If you're looking for opto-isolators at a really competitive price, we can offer units for less than 60¢ each in quantity orders of 1,000.

**High CTR.** If you need plenty of output current, we have models that match an IR LED with a photodarlington sensor to give you a current transfer ratio of 300%.

**High speed.** If you want ultra-fast response, we have an opto-isolator that uses a built-in IC to transmit data at rates up to 5 megabits per second.

Our innovative, solid-state line runs from the simplest to the most sophisticated.

We're a dependable source for opto-isolators because we're a vertically integrated company—a fancy phrase meaning that we make everything in-house. We don't buy any high technology parts outside. This gives us better quality control. Better price control. And better delivery.

So don't forget: our expertise in LEDs has made us a leader in opto-isolators, too. Solid-state reliability comes in many forms.

For details on Litronix opto-isolators write us at 19000 Homestead Road, Cupertino, California 95014. Phone (408) 257-7910. TWX 910-338-0022.

**No wonder  
we're No.1  
in LEDs**

**litronix**

## If you want to hurt the 240L RF Power Amplifier

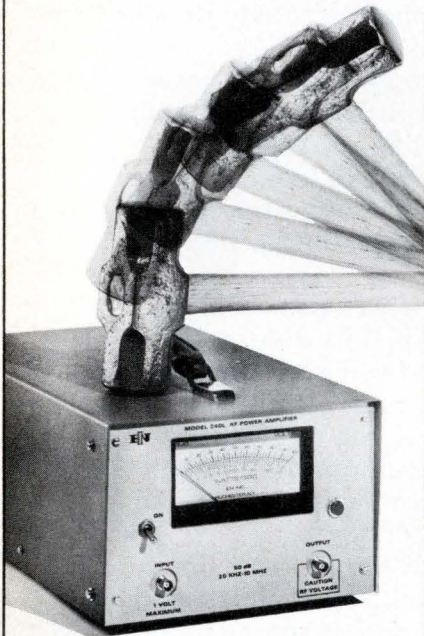

... you've got to do more  
than short circuit its output.

As a matter of fact, this *brand new* instrument will deliver more than 40 watts of Class A linear power and up to 150 watts of CW and pulse power to any load impedance (from an open to a short circuit). Immune to load damage and unconditionally stable the 240L covers the frequency range of 20 KHz to 10 MHz with a flat 50 db gain. Completely *solid state* the 240L will faithfully reproduce input waveforms from any signal or function generator in its range.

If you need a transducer drive source for ultrasonics, RFI/EMI, biological research, electro or acousto optics the 240L was designed for you.

Solid state reliability is here at \$1595.00.

For further information or a demonstration contact ENI, 3000 Winton Road South, Rochester, New York 14623 (716) 473-6900 or TELEX 97-8283

# ENI

The world's leader  
in solid-state power amplifiers.

## People

Connors: the thrill is back  
after move to Mirco

"This is the nuttiest thing I've ever done," says the 6-foot, 3-inch Irishman dressed in cowboy garb. "I guess I'm mad—crazy mad—but I've always had an itch to be an entrepreneur. I couldn't afford to do it before, but now I can."

And what could make Thomas J. Connors, 46, crazy enough to leave his job as general manager of Moto-

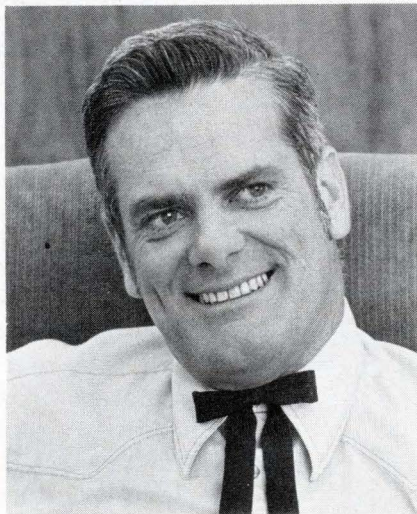

**Entrepreneur.** Mirco's Connors likes the excitement of a small company.

rola's nearly \$500 million Semiconductor Products division to become president of Mirco Inc., a small maker of test systems and electronic games [*Electronics*, May 15, p. 38]? Answer: the excitement of the challenge—and the potential of the microprocessor.

Mirco's founder and chairman of the board, John L. Walsh, has brought the Phoenix company from zero to 135 employees in four years. Sales this year are estimated at over \$10 million, mostly in logic-test systems and games.

**Whipping the world.** Connors says, "the thing I find exciting here is the people and the future. I remember the excitement at Texas Instruments when I joined it back in the middle '50s. We had that feeling we were going to whip the world. We had the same thing at Motorola when I went there in 1964. Maybe

this is becoming a 10-year cycle for me."

Connors obviously feels that the semiconductor industry doesn't hold the same excitement. "We're trying to grow 100% a year. I think the semiconductor industry is just settling in." That view isn't shared by many in the industry.

Connors regards microprocessor applications as Mirco's growth vehicle. So why didn't Motorola get more heavily into microprocessor uses instead of just making the components? "You'll have to get John Mitchell to answer that," says Connors. Mitchell is Motorola's corporate assistant chief operating officer, who may have hastened Connors' departure after two successive unprofitable quarters at the Semiconductor Products division.

Mirco will build on its present use of microprocessors, albeit custom ones, in its test systems and move into new applications. Games are an obvious candidate, but beyond that, the company remains mum. "I want to grab hold of this tiger by the tail and run. There's no limit to what we can do," Connors claims.

R&S's Rohde takes aim  
at U. S. instrument market

For most of its 20 years in the U.S., Rohde & Schwarz, the German instrument firm, has operated out of store-front quarters in Passaic, N.J. By selling German-made test and

**Cost conscious.** Rohde has an eye on tight American budgets.





# D-3 type telecommunications hybrid active filter

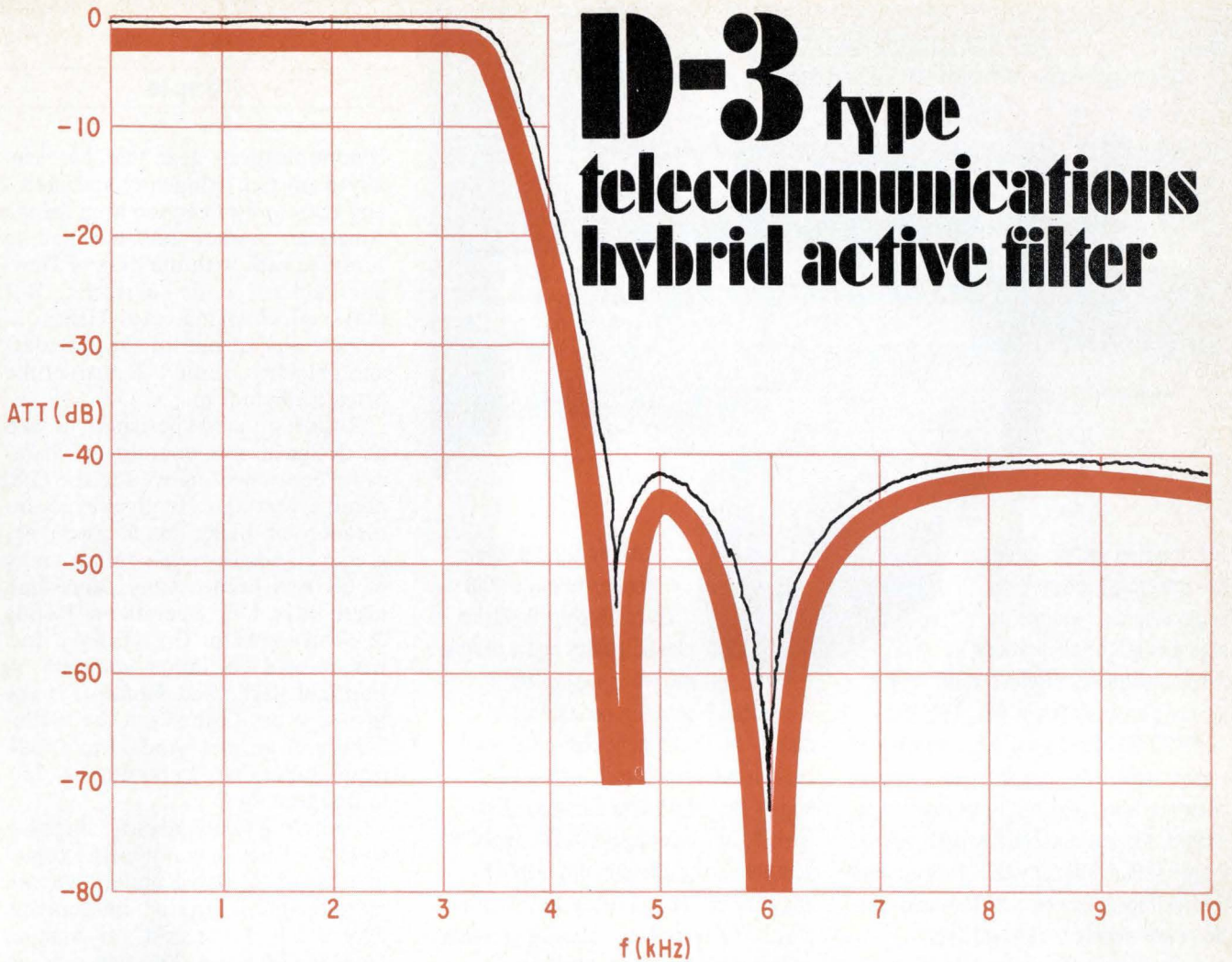

**New.** ACF 7170C, General Instrument's state-of-the-art D-3 type hybrid low-pass filter is designed for use in telephone and other sample-data systems.

With its combination of stable frequency components and advanced hybrid packaging techniques, the ACF 7170C is able to deliver big-size performance in a small-size, 1.9"x0.9"x0.25", sealed edgemount package.

The ACF 7170C is for use in both transmit and receive modes and features:

- ±0.15 dB pass-band ripple from 0°C to 70°C
- Better than 40 dB stop-band attenuation @ 4600Hz
- 3.4 kHz cut-off frequency\*
- 2.5 mW power dissipation

ACF 7170C D-3 type filters are available *now* in production quantities.

For complete information call (516) 733-3232, or write, General Instrument Corporation, Hybrid Division, 600 W. John St., Hicksville, N.Y. 11802.

\*Cut-off frequency can be tailored to meet your specifications

## GI'S GOT IT!

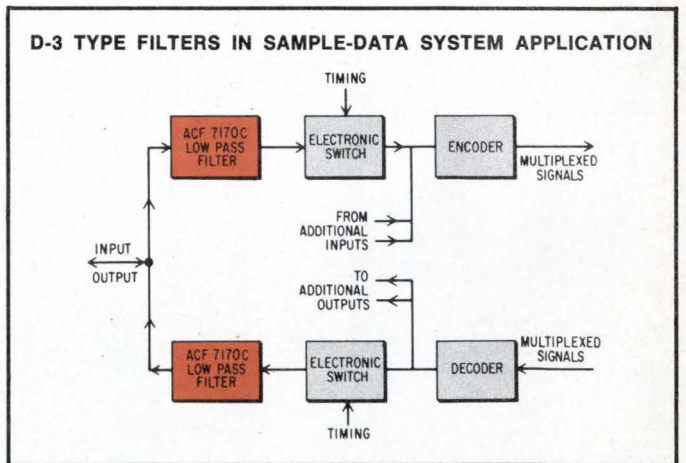
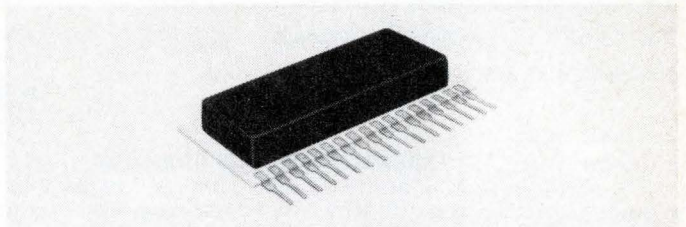

**GENERAL INSTRUMENT CORPORATION  
HYBRID DIVISION**



# NEW Continental Specialties Logic monitor

## FASTER THAN A SCOPE! SAFER THAN A VOLTMETER! BRINGS ICs TO LIFE!

Made in USA

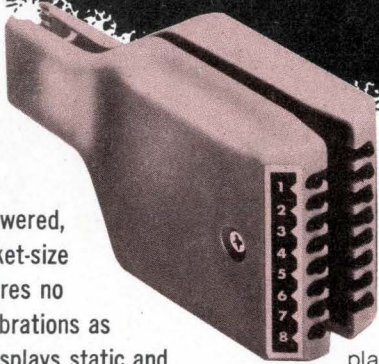

\* Patent Pending

The amazing self-powered, self-contained, pocket-size Logic Monitor requires no adjustments or calibrations as it simultaneously displays static and dynamic logic states of DTL, TTL, HTL or CMOS DIP ICs. Now you can watch your signals work their way through counters, shift registers, timers, adders, flip-flops, decoders, even entire systems! High intensity LEDs turn on when lead voltages exceed the threshold (2V). **No power supply is needed!** The power-seeking gate network locates DIP supply leads and feeds them into the Logic Monitor. Forget about grounds, pin counting or sync polarity.

Simply clip the Logic Monitor to any DIP IC up to 16 pins. Precision plastic guides and a flexible

plastic web\* insure positive connections between non-corrosive nickel/silver contacts and the IC leads. Logic levels appear instantly on 16 large (.125" dia.) high intensity LEDs. Logic "1" (high voltage)-LED ON. Logic "0" (low voltage or open circuit)-LED OFF. Yes, now you can see your designs come alive. Order your fast, versatile, accurate, indispensable Logic Monitor today!

"Deliveries starting March 15."

**ORDER TODAY! 84<sup>95</sup>**

Add \$2.50 postage/handling.  
Foreign orders add 15%.  
Prices subject to change.



**Continental Specialties Corporation**

Box 1942, New Haven, CT 06509 • 203/624-3103

W. Coast Off.: Box 7809, S. Fran., CA 94119 • 415/383-4207 Canada: Available thru Len Finkler Ltd., Ontario

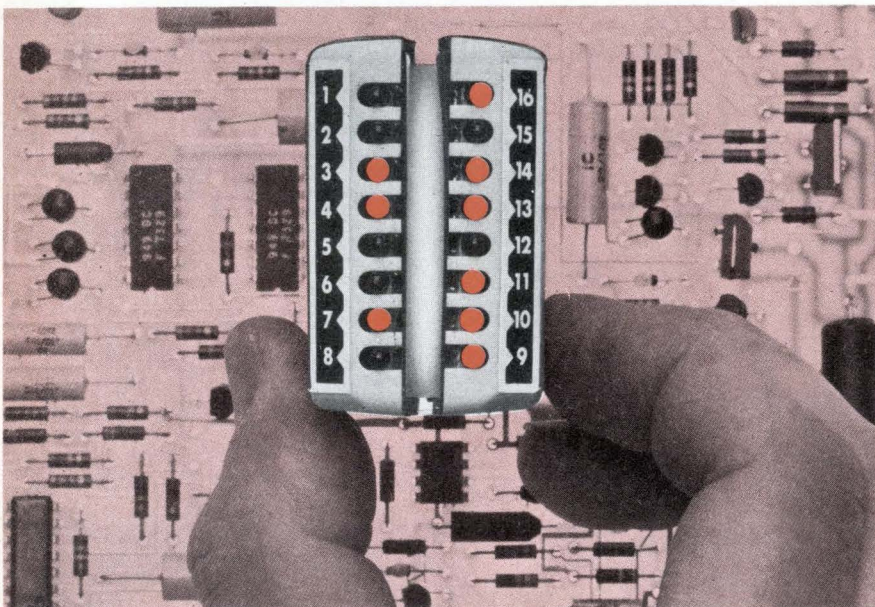

## People

communications gear that has usually been too stringently specified—and therefore priced too high for the American market—R&S has had to compete here with the likes of Hewlett-Packard and Tektronix. But that's all changing, says Ulrich L. Rohde, son of one of the founders and president of the U.S. arm of the privately held firm.

Rohde, an avid sportsman as well as designer and operator of ham-radio equipment, moved to the U.S. about a year ago. He gives every indication of being much more aggressive and progressive than many of his R&S predecessors. Since he's taken over U.S. operations, Rohde & Schwarz Sales Co. (U.S.A.) Inc. has moved to larger quarters in Fairfield, N.J., and Rohde for the first time has farmed out the manufacture of an R&S product to a U.S. firm—Ballantine Laboratories Inc. in Boonton, N.J.

"With the two-way duty, shipping costs, and lower components prices in the U.S.," says Rohde, "we can manufacture certain instruments here for half the cost" of making them in Germany. The first product to come off Ballantine Labs' production lines for R&S is a video impedance converter, which cost \$900. It's now priced at \$275. The German and the American models are electrically identical, says Rohde.

A directional rf-power meter, which has never sold in the U.S., probably because it was listed at \$2,000, will be made here and sold for \$900, initially to the Federal Aviation Administration, the first time the company has cracked the U.S. market.

"One of the reasons we can cut the price of this unit so much is that its development costs have already been paid for by our European customers," Rohde explains. But the U.S. specifications may not be the same. "American philosophy is, first, it has to meet the budget. Americans are so used to compromises to save money that it might not occur to them to look closely at the accuracy of the instrument or its life expectancy."



# MEASUREMENT COMPUTATION

innovations from Hewlett-Packard

# NEWS

JUNE, 1975

## in this issue

HP-46 desk-top electronic slide rule with printer output (page 5)

New phase modulation capability in 1-2600 MHz signal generator (page 2)

10,000 component measurements per hour with LCR meter (page 7)

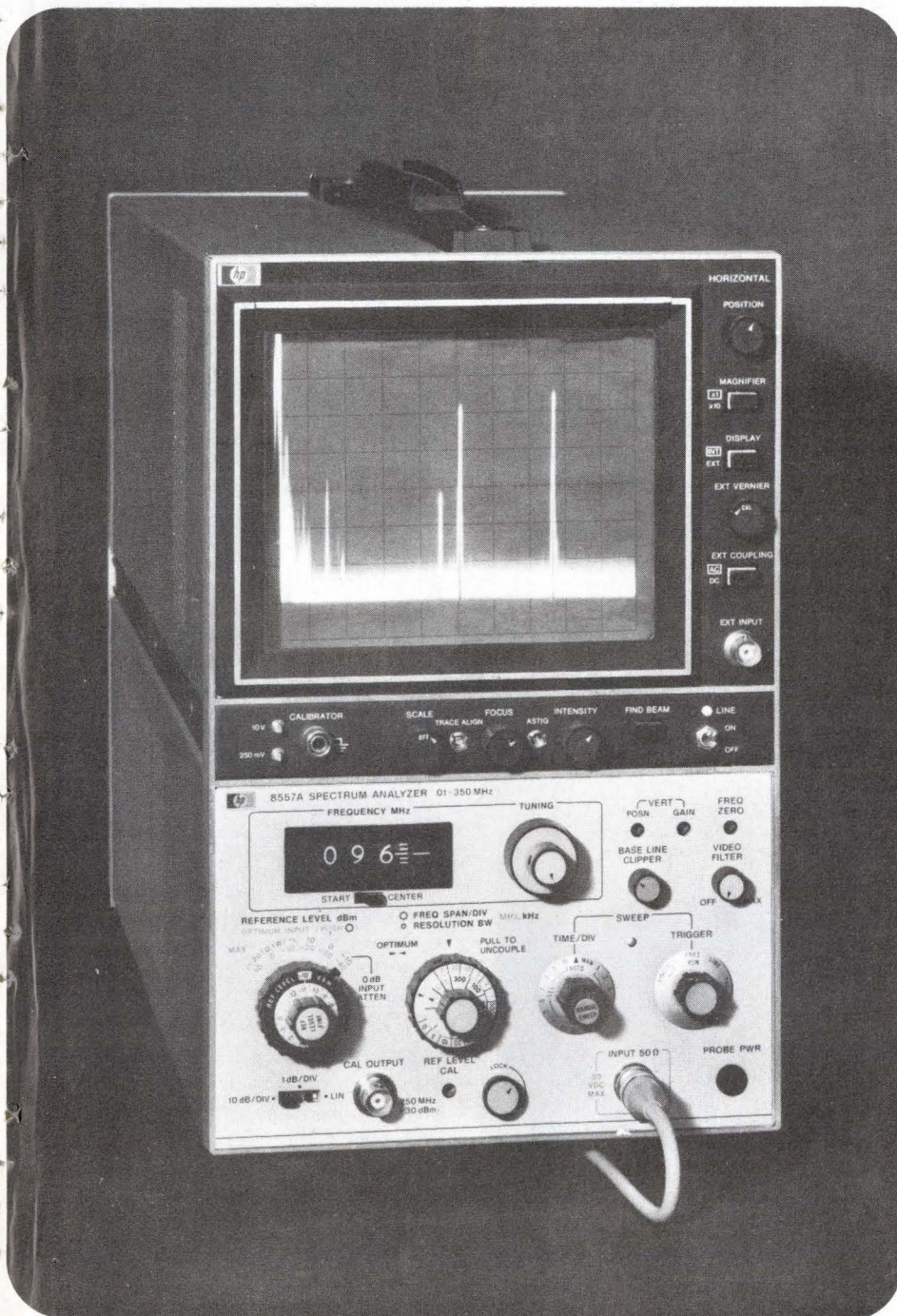

## New VHF Spectrum Analyzer Offers Lab-Grade Performance at a Low Price

New 350 MHz Spectrum Analyzer plug-in is accurate, easy to use, and economical.

In the past, engineers usually time-shared one expensive spectrum analyzer, even though most of their measurements did not require high resolution. Now comes an analyzer priced for every bench, so the expensive analyzer can be reserved for more demanding measurements.

The new HP 8557A Spectrum Analyzer, a plug-in for HP 180-series scopes, features performance and accuracy that qualify it for lab use. Yet its ease of operation and economy make it attractive for such cost sensitive applications as production test, service, maintenance, and education. With 10 kHz to 350 MHz range, it's well suited for CATV, telecommunications, mobile radio, broadcast systems, navigational aids and telemetry measurements.

(continued on third page)

**Direct counting up to 520 MHz with NEW low cost counter**

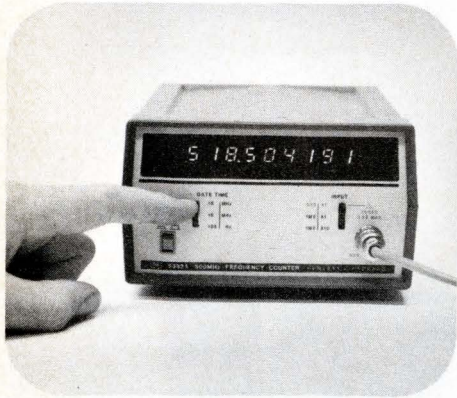

Simple, virtually error-free operation complements the 5383A's high accuracy.

Low cost counters generally use pre-scalers (input frequency dividers) to get up to 500 MHz. Unfortunately, pre-scalers impose a resolution or speed penalty—usually a decrease of 4 to 10 times. Now, however, by borrowing unique circuitry from our sophisticated higher priced counters, we're able to offer the HP 5383A, a new, laboratory quality, low cost model using the speedy, accurate, direct counting technique. This technique gives 1 Hz resolution up to 520 MHz using a 1 second gate time.

You're likely to find the 5383A close to ideal for production line testing, communication, navigation and telemetry equipment servicing and R&D since it offers a host of useful features such as:

- 10 Hz to 520 MHz, direct counting
- Nine digit readout
- Accuracy of  $\pm 1$  count  $\pm$  time-base error
- Time base aging rate  $< 0.3$  ppm/month
- Optional TCXO time base for high accuracy calibration needs
- 1 megohm, or fuse protected 50 $\Omega$  input
- 25 mv to 50 mv sensitivity
- Gate times of 0.1, 1.0, 10 seconds
- Rugged aluminum case.

Start on your way to speedier, more certain frequency measurements by looking into the 5383A today.

For a data sheet, check J on the HP Reply Card.

**New 4-Channel Recorder with Interchangeable Plug-ins offers greater versatility**

Now you can record one to four input signals against time with the new HP 7404A oscillograph recorder. You can adapt this new recorder to your varied applications including the capability to amplify and measure dc signals with a broad range of sensitivities, or record transducer outputs with ac or dc excitation supplied.

With the choice of plug-ins, you can measure parameters such as voltage, pressure, flow, force, displacement and temperature with respect to time.

The 7404A is a four-channel recorder but will also record on two 80 mm-wide channels.

Clear traces that dry immediately upon contact with the paper are produced by the pressurized ink system of these units. The pens are designed to last the life of the instrument, and will not be damaged by any input signal frequency.

Twelve chart speeds are front-panel selectable as standard on the 7404A. Remote operation is also possible by contact closure or TTL.

To help you choose the recorder for your needs, find out more by checking L on the HP Reply Card.



New 4-channel recorder with easy paper loading, rugged stainless steel pens, modular construction.

**New 1-2600 MHz signal generator features phase modulation, is HP Interface Bus compatible**

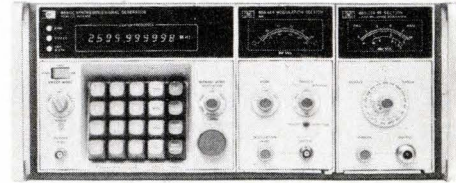

L-Band communications and telemetry applications now have a new precision signal source.

The new HP 8660C synthesized signal generator spans the range 1 MHz to 2600 MHz in steps as small as 2 Hz. Also being introduced are two new modulation plug-ins which offer HP's first calibrated phase modulation capability.

This added frequency range and phase modulation capability provides precision signals needed to test satellite and space telemetry receivers or communications links. Or, it can serve as a local oscillator in certain frequency-agile transmission systems. The phase modulation also permits comprehensive analysis of phase-lock loop circuits.

The new plug-in modules include an RF Section (86603A) which generates output from 1 MHz to 2600 MHz at levels from +7 dBm to -136 dBm. Model 86634A is a phase modulation plug-in which provides calibrated, linear phase modulation at rates to 10 MHz. Another new modulation plug-in (86635A) provides phase modulation plus frequency modulation.

The 20-key mainframe keyboard provides digital entry of center frequencies, steps, or sweeps. The synthesizer's digital sweep mode is particularly useful in testing extremely stable or sharply tuned components, such as crystal filters.

With the HP-IB (Interface Bus), the generator may be connected as a programmed signal source for a variety of user-assembled mini systems for lab and production uses. (Option 005)

To receive more information, check Q on the HP Reply Card.

## New Bench Supplies for MOS, CMOS and Linear IC Designs

Now there are two low-cost bench supplies designed specifically for industrial and educational labs working with MOS, CMOS and Linear integrated circuits. The HP 6237A delivers three outputs: 0 to 18V, up to 1A; and dual-tracking 0 to  $\pm 20V$ , 0 to 0.5A.

The Model 6237A, and the 6236A shown below, are compact, easy to use and incorporate the key performance and safety features needed in the lab environment.

The complimentary Model 6236A has outputs: 0 to 6V, up to 2.5A; and 0 to  $\pm 20V$ , 0 to 0.5A, and is intended primarily for use with TTL/Linear IC designs.

Each supply can be powered from a nominal 100V, 120V, 220V, or 240V, 47-63 Hz ac input. Both the single and dual-tracking outputs are protected from overloads by fixed current limiting circuits.

For more information, check K on the HP Reply Card.

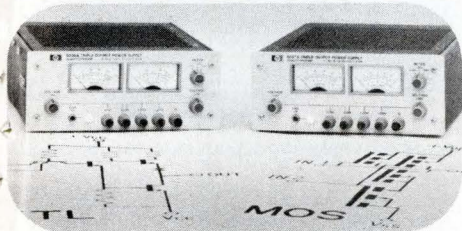

What every industrial and educational lab needs: convenient, low-cost dc power for TTL, MOS, CMOS and Linear IC test and development.

## New VHF Spectrum Analyzer

(continued from page one)

Signal amplitudes from +20 dBm to -117 dBm may be measured and viewed over sweep widths ranging from 350 MHz down to 50 kHz. Eight resolution bandwidths from 1 kHz to 3 MHz permit a wide variety of measurements, such as viewing modulation or analyzing pulsed RF spectra.

Impressive, also, is the 8557A's ease of operation. Most measurements are a simple three step process:

1) Tune the inverted marker to the signal to be measured and read its frequency on the digital readout.

## Why you should consider spectrum analysis

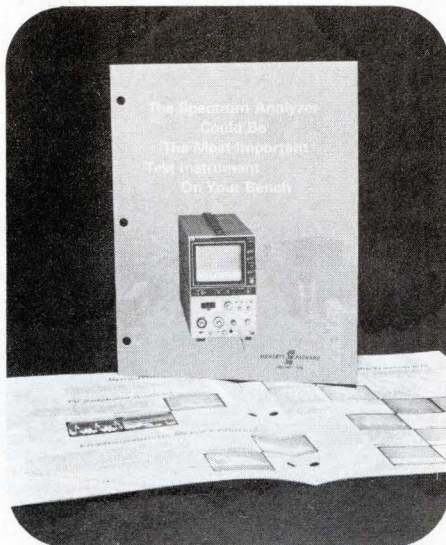

Our new spectrum analysis brochure shows the spectrum analyzer's versatility in making RF signal measurements such as field strength, power, noise, frequency, distortion and modulation. The brochure demonstrates these measurements as they may apply to your work: in powerful techniques for component evaluation, equipment testing and system performance verification.

In addition, the brochure is a guide to help you select the right analyzer for your application by defining critical spectrum analyzer specifications such as resolution bandwidth and amplitude measurement range.

For your copy of the brochure, check U on the HP Reply Card.

## New automatic receiver system for versatile communication uses

The HP ARS-400 is a fully automatic precision receiver for signal detection and analysis in the 100 kHz to 18 GHz frequency range. It has many useful applications including satellite system monitoring, spectrum management, site surveillance, electronic intelligence, and EMI testing.

The system consists of reliable, field-proven commercial equipment under program control. The high-speed precision receiver features IF bandwidth from 10 Hz to 3 MHz, multiple detectors for AM, FM and SSB detection.

Specially designed calls have been included to allow the receiver to tune and measure at very fast rates.

Application programs can be created by the user and stored on the disc unit for future use. Output data is written on the IBM-compatible, 9-track magnetic tape for later analysis on the ARS-400 or larger computer systems.

Critical signal parameters such as power, or modulation levels, signal bandwidth, carrier-to-noise ratio, etc. can be provided on-line.

The ARS-400 is capable of gathering significant amounts of usage information over several communications channels. This data can be analyzed on-line or stored on magnetic tape.

The ARS-400 is a totally integrated system, providing a fully characterized precision receiver, data processing capability, interactive graphics, and mass storage devices.

For details, circle P on the HP Reply Card.

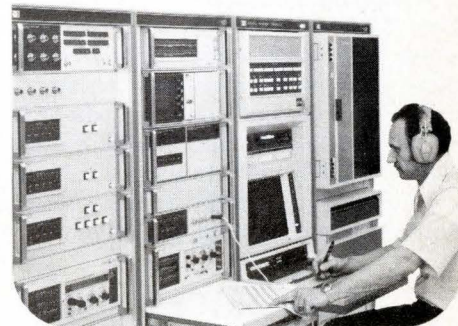

New fully automatic precision receiver for spectrum management, electromagnetic interference, site surveillance, or system monitoring.

For more information, check O on the HP Reply Card.

## New RTE-III Operating System manages up to 512K bytes of memory, up to 64 partitions

Hewlett-Packard's new RTE-III is a disc-based real-time operating system that manages up to 512K bytes of memory, organized in partitions, using the Dynamic Mapping System in 21MX M20 or M30 Computers. Up to 64 multi-user partitions can be defined for simultaneous use such as executing and developing programs, and managing data in a variety of high-level languages that can include FORTRAN IV, Multi-User Real-Time BASIC, and ALGOL. RTE-III supervises execution of many different user's programs in a multi-programming mode; programs may be scheduled by time, events, other programs, or operator command. Software includes a file manager for easy access to random or sequential files. Disc storage can start at 5M bytes, and can be expanded to 118M bytes.

With RTE-III, users at multiple terminals may be developing interactive programs while other user's terminals are engaged in data management. Multi-stream batch processing can be used to provide job control over program development and other background operations. Optional distributed multi-processing software provides for real-time program scheduling and file management functions from remote satellite computers. RTE-III can support a variety of peripherals, including mag tapes, line printers, card readers, plotters, and analog and digital I/O interfaces. System integrity is safeguarded; system software provides for power-fail restart with intact programs and data; a watchdog timer calls the user when I/O devices fail to respond. There are now two levels of memory protection, one by hardware fences and the other by the Dynamic Mapping System.

*For full details about this new operating system, check R on the HP Reply Card.*

## Two new OEM CRT displays feature high resolution with numerous options

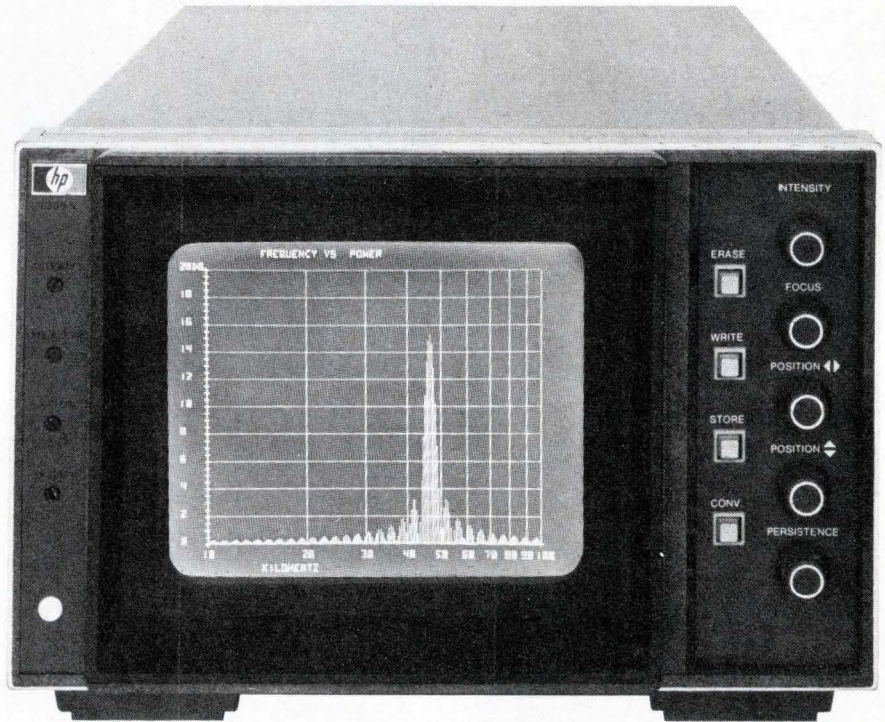

Fine image detail and a well-focused spot at all intensity levels make the 1335A ideal for use in analytical and automatic test system applications.

Two new HP CRT displays offer exceptional picture quality and resolution, uniform focus with wide changes of intensity, and X-Y amplifiers with 70 ns rise times. These displays are ideal for use in systems for Spectrum, Fourier, Network and Chemical analysis, as well as in automatic test systems.

Model 1335A, shown above, is a variable persistence, storage, and non-storage CRT display with excellent performance. Persistence is continuously variable from about 0.2 seconds to full storage. The totally new CRT design offers a high resolution image with excellent contrast and uniformity for many applications.

Model 1332A has a standard CRT with a spot of 0.305 mm (0.012 in.) diameter at high intensity levels which remains extremely well-focused over a wide range of intensity levels. The high resolution makes the display ideal for applications requiring sharp focusing

on multiple gray shades or varying writing speeds with frequent video drive level changes.

Numerous options are available to tailor the displays to fit a specific application. These factory-installed options include:

- (1) For the X-Y amplifiers: deflection factor, polarity, input impedance, and rise time;
- (2) Z-axis amplifier: blanking range, polarity input impedance, gain, and digital input;
- (3) for the CRT: graticule, phosphor (on the 1332A), and contrast filter; and
- (4) for the mechanical frame: covers, controls, line voltage, and tolerance, and special ac cords.

*For more information on these two new displays, check B on the HP Reply Card.*

## For improved lab productivity, HP Calculator family now interfaces with many instruments

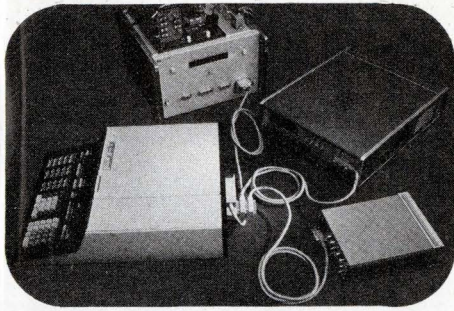

Instrumentation control from a desk-top programmable calculator.

Now, assembling a custom calculator-controlled instrumentation system is fast and easy because of interfacing cables that allow you to connect multiple instruments.

Digital voltmeters, electronic counters, waveform analyzers and synthesizers, scintillation counters, clocks, capacitance meters and other instruments can be interfaced directly to a 9800 series calculator which can then operate as both a controller or a data logger.

HP interface cards accommodate instruments using 8-4-2-1 BCD output, 8-bit parallel codes in any input and output formats, and bit-serial data.

The new Hewlett-Packard Interface Bus (HP-IB) provides a byte serial interface system that offers plug-to-plug compatibility between common instruments.

For more information on how to interface an HP 9800 series programmable calculator to your instrumentation, check S on the HP Reply Card.

## The HP-46 offers a built-in LED display and printer for only \$675

Since its introduction nearly two years ago, thousands of scientists, engineers, and educators have purchased the HP-46. Applications range from the various engineering disciplines through biology and chemistry, to math, stat, medical research, navigation, even surveying.

The desk-top HP-46 has 48 preprogrammed scientific functions and operations. If you choose, it also prints a functional notation for each operation so you know what was done and when it was done. Thus, you can achieve the most effective use of the nine storage registers, three angular modes, and metric conversions.

The HP-46 reduces intricate and extensive calculations to a series of quick key strokes. And, you can combine arithmetic operations. Serial calculations, chain calculations, and mixed chain calculations are uncomplicated without the need of reference tables.

Put the HP-46 on your desk simplifying calculations, eliminating tedious recalculations, and saving your valuable time.



Select either scientific or fixed point display to match your calculations with up to 10-digit accuracy.

For details, check A on the HP Reply Card.

## Retrofit kits boost accuracy, stability and reproducibility of Cesium Beam frequency standards

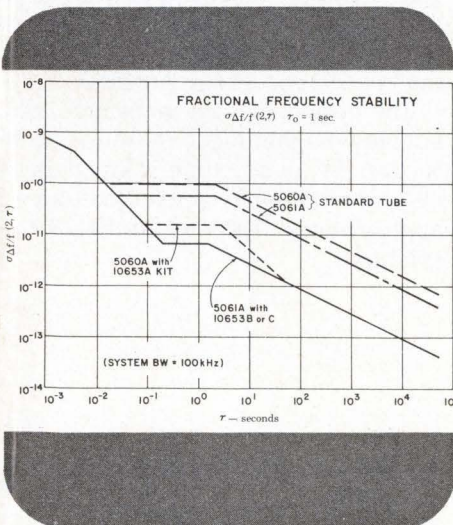

Newly available retrofit kits give present owners of HP's 5060A and 5061A Cesium Beam Frequency Standards an order of magnitude improvement in short term stability. This improvement was formerly only available in newly-ordered 5061As as Option 004. The state-of-the-art performance improvements were attained through major design changes in the cesium beam tube: increased length of the microwave cavity results in higher accuracy, which was achieved without increasing tube size; increased cesium beam flux and a unique HP design of multiple beams results in better short-term stability and greater immunity to shock and vibration; more effective

magnetic shielding reduces effects of external magnetic fields and improves settability.

See the graph to the left for performance characteristics. Other principal specifications of instruments upgraded by the kits are:

Accuracy	$\pm 7 \times 10^{-12}$
Reproducibility	$\pm 3 \times 10^{-12}$
Settability	$\pm 1 \times 10^{-13}$
Long Term Stability	$\pm 3 \times 10^{-12}$

To receive complete technical data, check T on the HP Reply Card.

## New 4.5 GHz Counter offers highest performance in its frequency class.

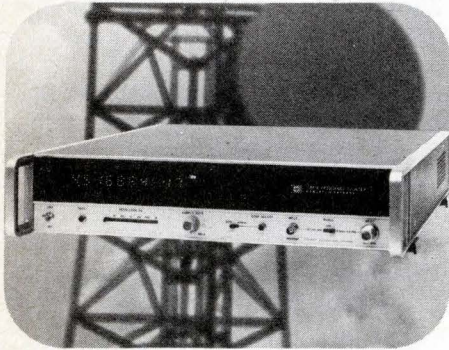

The 5341A Counter offers "best case" performance gems like 30 MHz peak-to-peak FM tolerance, -20 dBm sensitivity, 100  $\mu$ sec acquisition time and +30 dBm damage level on its microwave range.

For cost-effective UHF and microwave equipment production testing, as well as lab troubleshooting from 10 Hz to 4.5 GHz, the new HP 5341A Automatic Frequency Counter is close to ideal.

Compare its range, sensitivity, FM tolerance, speed, accuracy, resolution, overload tolerance, systems compatibility and built-in diagnostics—the new 5341A is unexcelled in the "up to 4 GHz" class of automatic counters today. Its unique "switchable filter" heterodyne technique allows a much faster signal acquisition than other methods. The 5341A can acquire and begin measurement of any frequency to 4.5 GHz within 600  $\mu$ seconds (100  $\mu$ sec in MANUAL mode). Operator convenience is a key feature of the 5341A, with a choice of automatic or manual operation and a unique self-troubleshooting technique.

The ten-digit LED display provides 1 Hz resolution all the way to 4.5 GHz. The 5341A may be purchased with frequency range limited to 1.5 GHz at a reduced price. If desired, you can later upgrade it to 4.5 GHz.

We welcome your comparison of the price-to-performance ratio with other microwave counters.

For more information, check I on the HP Reply Card.

## New capabilities added to bit-error-rate measurement system

Hewlett-Packard's 3760A Data Generator and 3761A Bit Error Rate (BER) Detector provides more flexibility and convenience for communication testing in such areas as fiber optics, digital radio, digital cable and millimeter wave transmission systems. The 3760A/3761A are also useful in applications such as digital multiplex and digital tape and disc recording.

HP's measurement system operates between 1 Kb/s and 150 Mb/s, providing a broader operating range than previously available. Both mean signal and dc triggering are available as a switch selectable option in the 3761A Error Detector. This allows the equipment to be used in either continuous or burst (e.g., time division multiple access transmission systems) signal modes. A second data output, delayed from the primary output by eight bits, is available on the 3760A Data Generator. This effectively provides two uncorrelated outputs for such test applications as four-phase, phase-shift-keyed transmission systems, and cross-talk interference tests. Fixed crystal clock speeds are available for the 3760A Data Generator. This provides the user added convenience where frequent testing at specific speeds is required.

The 3760A Data Generator is also very useful as a stand-alone instrument. It provides flexible pattern (i.e., PRBS, 1010 sequence) and word generation signals with pulse generation quality.

For technical information on the 3760A, 3761A and the new options, check C on the HP Reply Card.

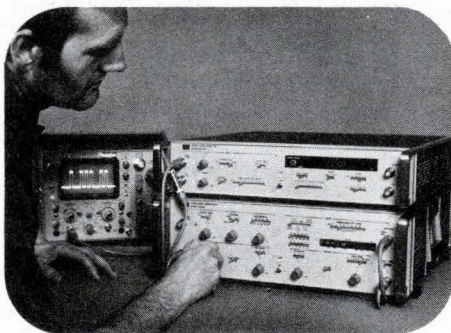

For design, development, commissioning and maintenance of pulse code modulation, PCM, systems, data generator and error detector provide a complete local or remote bit error rate measuring system.

## New detectors and step attenuators for microwave measurements

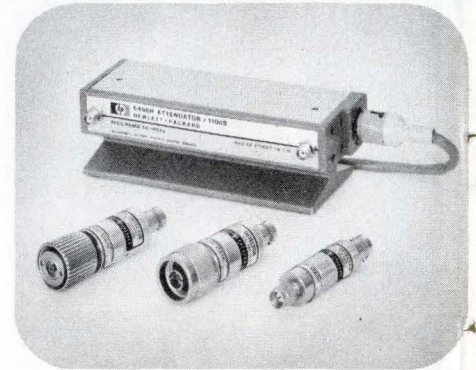

### Detectors

Low barrier hot carrier diode technology (LBHCD) has permitted a new family of microwave detectors covering the 10 MHz to 18 GHz range; HP 8470B (APC-7 or Type N), 8472B (SMA) and 423B (Type N, 12.4 GHz). These detectors have much flatter frequency response than previous point-contact types:  $\pm 0.2$  dB over any octave to 8 GHz;  $\pm 0.3$  dB, 10 MHz to 12.4 GHz;  $\pm 0.6$  dB, 12.4 to 18 GHz.

Microwave detectors are general purpose components, widely used for CW or pulsed power detection, leveling of sweepers, and frequency response testing of other microwave components. Thus, improved flatness and SWR are highly desirable and directly yield more accurate measurements.

### Programmable Attenuators

Models 8495 G/H and 8496 G/H programmable microwave attenuators offer 70 dB or 110 dB range in 10 dB steps from DC - 18 GHz. Models 8494G/H offer 11 dB range in 1 dB steps. Programmability makes the attenuators particularly well-suited for mini-system use under Interface Bus control, using the HP 59306A Relay Actuator.

The design uses an innovative self-latching magnet mechanism for each section. Switching time is less than 20 ms and momentary actuation current is approximately 100 mA for the 25V solenoids.

For detailed information on the detectors, check M; for the attenuators, check N on the HP Reply Card.



## High speed measurements of low-value components with digital meter

If you're testing diodes and capacitors or trimming IC capacitors and resistors, you need fast precise inductance, capacitance, resistance and loss measurements. Plug the HP 4271A Digital LCR meter into your system and you get 10,000 measurements or more per hour.

Using a four-pair measurement technique that reduces stray capacitance and residual inductance, this 1 MHz digital meter measures capacitance from 0.001 pF to 19,000 nF with an accuracy of 0.1%, and inductance from 0.1 nH to 1900.0  $\mu$ H. Capacitance loss components are measured as parallel conductance or as dissipation factor (as

low as 0.0001). Inductance loss components are measured as series resistance (10  $\Omega$  to 10 K $\Omega$ ) or dissipation factor (as low as 0.0001). And you can vary dc bias from 0 V to 39.9 V in 0.1 V increments.

The LCR meter has a four-digit LED display with 90% overrange, and it interfaces easily with HP computers, calculators, and digital recorders.



Typical uses for the 4271A LCR meter include: testing discrete components and varicap diodes, checking semiconductors, and L or C examinations of delay lines.

## Stripline Schottky Diode Quads for Double Balanced Mixers

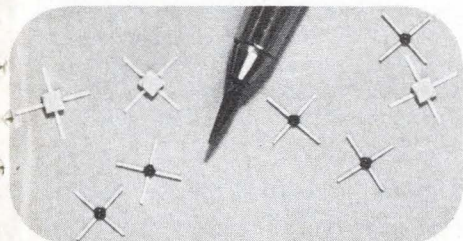

For the first time, Schottky diode quads designed for use in microwave integrated circuits, microstrip or stripline, from 1 to 8 GHz, are available in hermetically sealed packages.

The 2.54 mm (0.10 in) square package, 5082-2261/62/63, contains a monolithic array of Schottky diodes interconnected in ring configuration. Uniform electrical characteristics among the four diodes result in a tightly matched quad.

Broadband quads, 5082-2291/92/93/94, for applications to 18 GHz, are available in a sub-miniature 1.27 mm (0.05 in) square ceramic package whose leads are brazed to the substrate for maximum package ruggedness.

For details, check F on the HP Reply Card.

## Guaranteed ruggedness in new beam lead PIN diode

Each lead of these new beam lead PIN diodes will survive a two gram pull. This high lead strength is achieved by a new process enabling Hewlett-Packard to guarantee the ruggedness of this Model 5082-3900.

Breakdown voltage of the new diodes is a guaranteed minimum of 150 volts, and 200 volts is typical. Capacitance ( $C_0$ ) is a low 0.02 picofarads, resulting in isolation equal to or better than other presently available PIN diodes.

These diodes are for use in stripline or microstrip circuits using welding, thermocompression or ultrasonic bonding techniques. Applications include switching, attenuating, phase shifting, limiting and modulating at microwave frequencies.

For detailed specifications, check G on the HP Reply Card.

## New common cathode .43" display

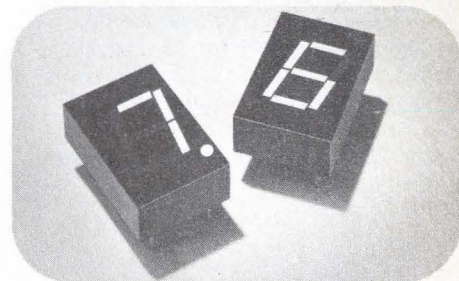

.43" display offers a bright, continuously uniform seven segment display in a 0.3" dual-in-line configuration.

A new, common cathode 0.43-inch (11 mm) high LED display is low cost and easy to interface. The new direct-drive MOS clock circuits interface directly with this new HP 5082-7760 indicator. It is expected to be widely used in many consumer applications, including clock radios, business machines, TV channel indicators and low-cost electronic instruments.

Designed for viewing distances of up to 20 feet, these single digit displays provide a high contrast ratio and a wide viewing angle.

For more details, check H on the HP Reply Card.

# The IC Troubleshooters show it like it is... at new reduced prices

Originated by HP, the Logic Probe, Logic Pulser, and Logic Clip have seen widespread use where digital circuits are designed, built or serviced. Their popularity stems from their rapid, simple, virtually error-free operation, coupled with ruggedness. Now, these new low prices will further enhance their popularity.

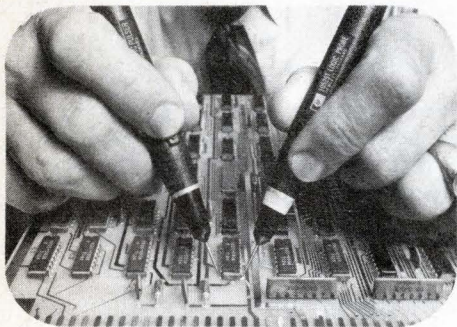
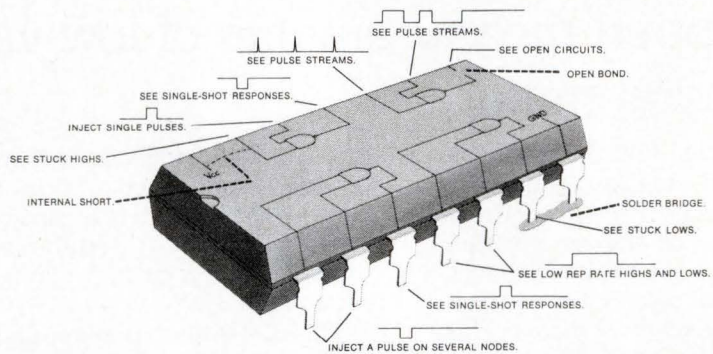

Using the 10526T Logic Pulser and 10525T Logic Probe you can inject pulses into TTL/DTL gates directly and see the results—without unsoldering or trace cutting. Simply press the Pulser's button to inject a pulse and the Probe quickly verifies gate operation—high, low or bad level. It'll read single pulses down to 10 ns and pulse trains up to 50 MHz.

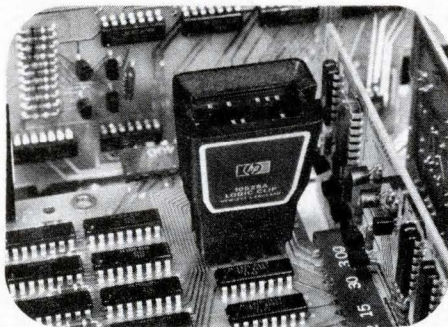

The 10528A is an easy-to-use tool for viewing all the pins of 14- or 16-pin IC's simultaneously. When used in conjunction with the 10526T Pulser, sequential logic circuits like shift registers come alive—each state change is immediately visible—and circuit analysis achieves new meaning.



The 5015T Mini-Kit puts it all together—for less. Order the Probe, Pulser, and Clip in this convenient kit with carrying case provided. Get all of the stimulus-response capability of our popular troubleshooters in this fully integrated kit for the lowest price we've ever offered.

*For more information on the latest techniques in digital troubleshooting, check E on the HP Reply Card.*



**East-4** Choke Cherry Road, Rockville, MD 20850  
Ph. (301) 948-6370.  
**South-**P.O. Box 28234, Atlanta, GA 30328,  
Ph. (404) 434-4000.  
**Midwest-**5500 Howard Street, Skokie, IL 60076,  
Ph. (312) 677-0400.  
**West-**3939 Lankershim Blvd, North Hollywood, CA  
91604, Ph. (213) 877-1282.  
**Europe-**P.O. Box 349, CH-1217 Meyrin 1, Geneva,  
Switzerland, Ph. (022) 41 54 00.  
**Canada-**6877 Goreway Drive, Mississauga, Ontario,  
L4V 1L9, Ph. (416) 678-9430.  
**Japan-**Yokogawa-Hewlett-Packard Ltd., Ohashi  
Bldg., 59-1 Yoyogi, 1-chome, Shibuya-ku,  
Tokyo 151, Ph. 03-370-2281/92.

# EMI FILTER CAPITAL OF THE WORLD

**FROM CERAMIC POWDER TO MIL-APPROVED TEST LAB...  
ERIE HAS IT ALL, UNDER ONE ROOF**

Only one company can deliver your total EMI Ceramic Filter needs . . . ERIE. We've been applying sophisticated ceramic and related technologies to developing superior filters for 35 years. Today ERIE has, by far, the broadest line of subminiature EMI Filters in the world. From tiny high frequency filters to broad band filters to custom filter assemblies, ERIE offers the ultimate in quality. And you get single-source responsibility too, for we build the complete filter in a plant devoted exclusively to the design and manufacture of EMI Filters. So come to ERIE for your filter needs. We'll put a team to work on your particular application. Aerospace. Communications. Avionics. Industrial Equipment. Whatever the market, we can help eliminate electromagnetic "noise" and emissions. In the meantime, write for our complete catalog . . . EMI Filters or call 613/392-2581.

**ERIE TECHNOLOGICAL PRODUCTS, INC.**  
Erie, Pennsylvania 16512  
Circle 27 on reader service card

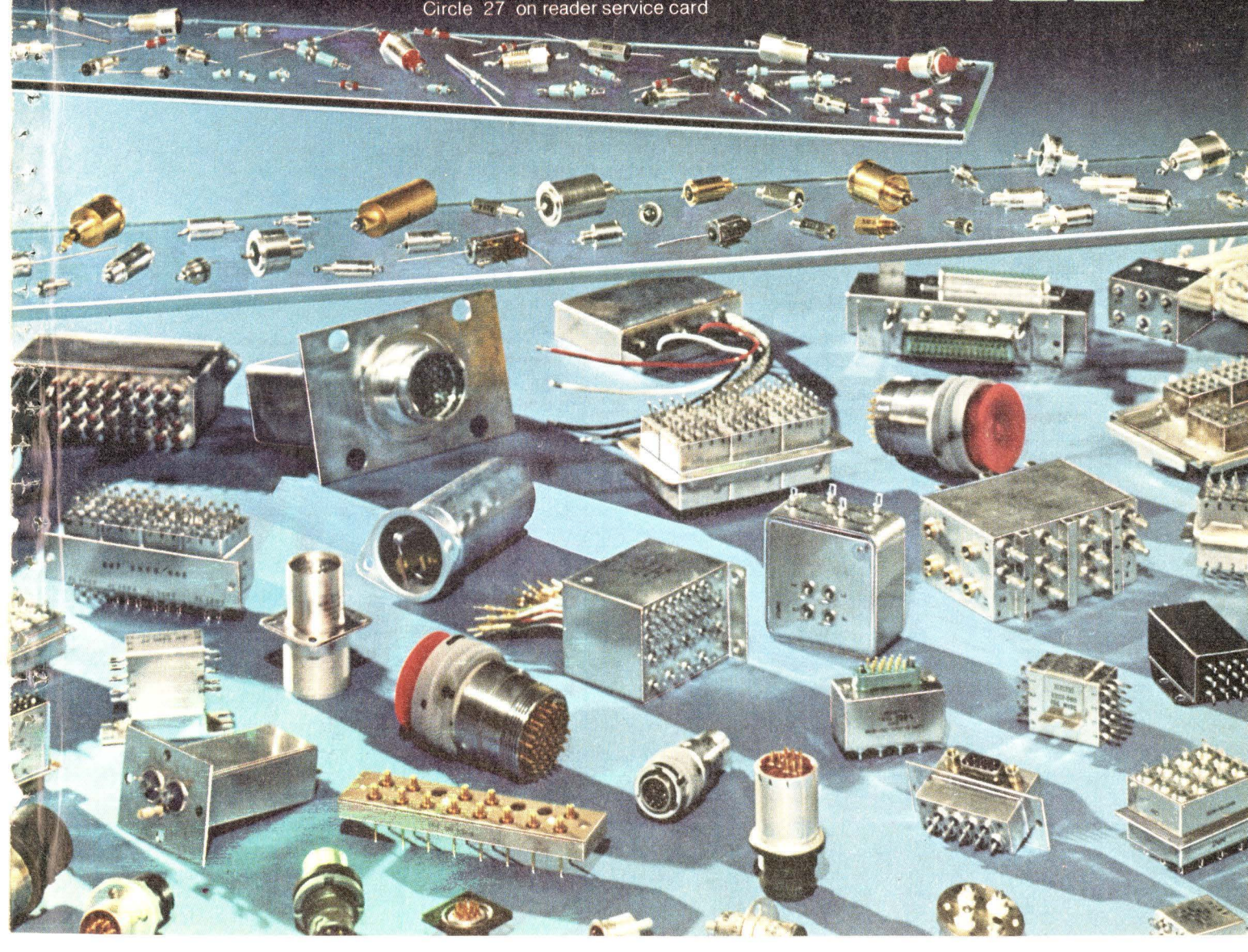
The logo for ERIE Technological Products, Inc. features the word "ERIE" in a bold, sans-serif font. The letter "I" is stylized as a vertical line with a small circle at the top, resembling a filter component or a signal. The letters are white with a slight shadow effect against the dark background.

# How to buy a m

Which comes first—the hardware or the software? You need both, of course, to create new products with microcomputers. The tougher question is: How do you assure product profitability? That gets you into questions of hardware availability, software support, design assistance and confidence in your supplier. When an electronics publication recently asked readers to rank their microcomputer buying criteria, it came as no surprise to Intel that availability, software support and supplier reputation topped the list.

Intel can supply you today with five general-purpose CPUs, supported by numerous peripheral, I/O and memory components, software packages and development manuals, and the industry's largest library of users' applications programs. Our five microcomputers span a 1000:1 performance range and include the lowest cost, highest performance and most popular designs available today. Their applications are

equally broad, from electronic games to high speed controllers and processors. We want to make sure that our customers don't begin designing with pieces of the hardware/software puzzle missing. To minimize development and assembly cost, each CPU is backed up by more than a score of performance-matched system components—advanced programmable I/O

INTEL MICROCOMPUTER SYSTEM FAMILIES					
MICROCOMPUTER SYSTEM	MCS™ <sup>4</sup>	MCS™ <sup>40</sup>	MCS™ <sup>8</sup>	MCS™ <sup>80</sup>	Series 3000
CENTRAL PROCESSOR	4004	4040	8008	8080	3001, 3002, 3003
Technology	PMOS	PMOS	PMOS	NMOS	Schottky Bipolar
Parallel Bits	4	4	8	8	2 per 3002 CPE
Instruction Cycle	10.8µS	10.8µS	12.5µS	2µS	100nS
SUPPORT COMPONENTS					
RAMS (including CMOS)	4	4	5	5	8
PROMS	3	3	3	4	7
ROMS	4	4	3	3	6
*Peripheral Interfaces	6	6	6	6	8
Interrupt Unit			1	1	1
Clock Generator	1	1	1	1	TTL
*I/O Units	5	5	3	3	3
Total Component Choices	23	23	22	23	33
SYSTEMS SUPPORT					
Software Packages					
Microassembler					1
Assemblers	2	2	2	2	
Compiler			1	1	
Monitor	1	1	1	1	
Simulator	1	1	1	1	
Text Editor			1	1	
Manuals	6	6	5	6	1
User's Library	Yes	Yes	Yes	Yes	Yes
Intellec® Development System	Yes	Yes	Yes	Yes	In development

\* Five additional I/O and peripheral devices will be available in 2nd half of 1975.

# microcomputer.

subsystems, peripheral interfaces, clock generators, priority interrupt and other control units, and the broadest selection of erasable and bipolar PROMs, compatible metal mask ROMs, CMOS and NMOS RAMs.

Moreover, Intel software packages include resident monitors, assemblers and text editors available on Intellec® microcomputer development systems. Assemblers, simulators and compilers

are also available as cross products on magnetic tape or on leading time share

networks. With these aids programs can be written and debugged in a fraction of the time required a few years ago.

You may need design assistance before the meter starts running in the research and development lab. Intel has the industry's most experienced microcomputer field applications engineering group. If your staff needs help to get started, we have regional training centers, workshops, seminars and on-site training courses available.

With Intel, there's no shell game about hardware or software delivery, no guessing whether the supplier can handle all your production commitments. Intel has been

delivering microcomputers in volume since 1971. Our reputation speaks for itself. We've already delivered more general-purpose microcomputers than the rest of the industry combined.

If you have tough questions about which microcomputer will make your new products most profitable, call or write Intel for our solutions. Intel Corporation, 3065 Bowers Avenue, Santa Clara, California 95051 (408) 246-7501.

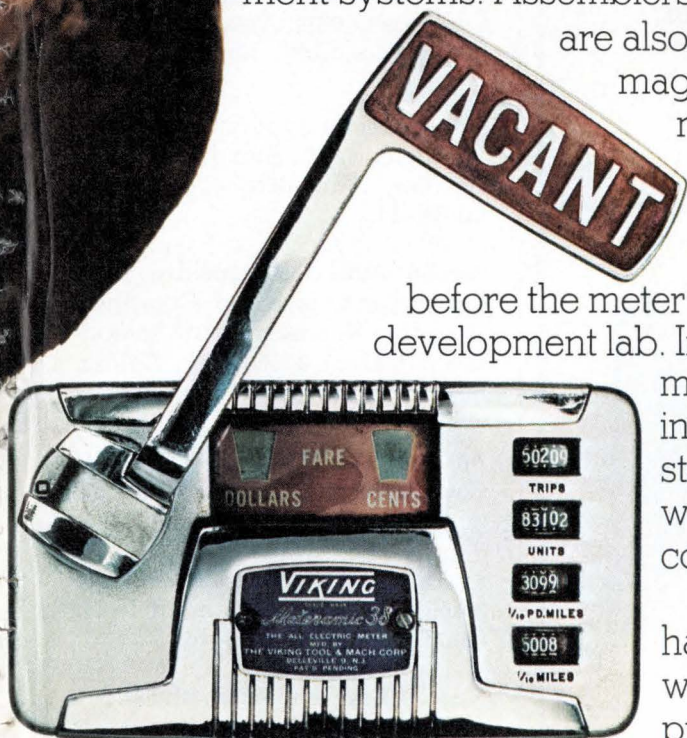
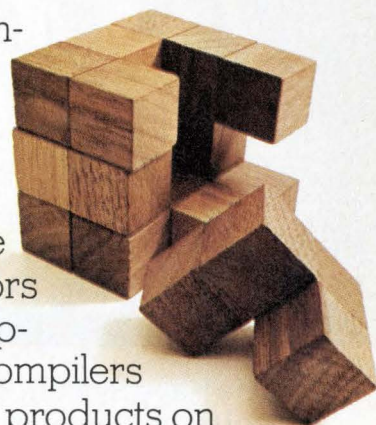

**intel**® Microcomputers. First from the beginning.

# Now You Have A Choice

## RENT OR BUY THE BEST DATA SYSTEM

The Kaye System 8000 is the most reliable and most versatile automatic data system for measuring, recording and alarming:

- temperature  pressure  strain  flow
- current  voltage



Features include complete input signal conditioning for all common transducers and serial output to all standard recorders and computers.

And now, economical weekly or monthly rentals of Kaye Systems are available through General Electric's Instrument Rental Program. When you need a data system in a hurry, or for specific projects, consider renting from General Electric. For application assistance and purchase information, contact Kaye Instruments.

**KAYE**  
INSTRUMENTS

15 De Angelo Drive, Bedford, Mass. 01730  
For application assistance, call  
Newell Tillman collect, 617-275-0300.

**Quick-rental<sup>\*</sup>**  
**instruments**

**GENERAL ELECTRIC**

1 River Road, Schenectady, N.Y. 12345  
For the rental office nearest you,  
call collect, 518-372-9900.

\*Trademark General Electric

## Meetings

**International Symposium of the Antenna Propagation Society**, IEEE and URSI, University of Illinois, Urbana-Champaign, Ill., June 2-5.

**29th Annual Convention of the Armed Forces Communications and Electronics Association (AFCEA)**, Sheraton Park Hotel, Washington, D.C., June 3-5.

**Chicago Spring Conference on Broadcast and Television Receivers**, IEEE, Marriott Motor Hotel, Chicago, June 9-10.

**1975 Power Electronics Specialists Conference**, IEEE, Americana Hotel, Los Angeles, Calif., June 9-11.

**Symposium on Applications on Ferroelectrics**, IEEE, Albuquerque Hilton Inn, Albuquerque, N. Mex., June 9-11.

**Second Annual Automotive Electronics Conference and Exposition**, Electronic Representatives Association (Chicago), Cobo Hall, Detroit, June 10-11.

**NAECON—Aerospace Electronics Conference**, IEEE, Convention Center, Dayton, Ohio, June 10-12.

**International Conference on Communications**, IEEE, Fairmont Hotel, San Francisco, June 16-18.

**Nepcon East and International Microelectronics Conference**, ISCM Inc. (Chicago), New York Coliseum, New York, June 17-19.

**Symposium on Computer Networks—Trends and Applications**, IEEE and NBS, Gaithersburg, Md., June 18.

**International Conference on Fault Tolerant Computing**, IEEE, Paris, France, June 18-20.

**Symposium on Computing in the Mid-70s: An Assessment**, ACM and NBS, Gaithersburg, Md., June 19.



# How do you connect round cable to flat?

Now it's easier than ever to connect round cable to flat. Or flat cable to flat. Or round to round.

Because now Hughes introduces the HAC-PAK Connectors—a whole new connector family offered in three types of contacts: crimp/removable rear-release (non-environmental, environmental or potted); RFI/EMI fixed filter contacts; and fixed solder-tail contacts.

HAC-PAK Connectors are intermateable and intermountable with one another—and with Hughes front-release subminiature rectangular connectors. (W and WSS Series.)

Our exclusive PolarHex™ center jackscrew coupling assures alignment, provides positive polarization with a choice of keying

## It's a snap.

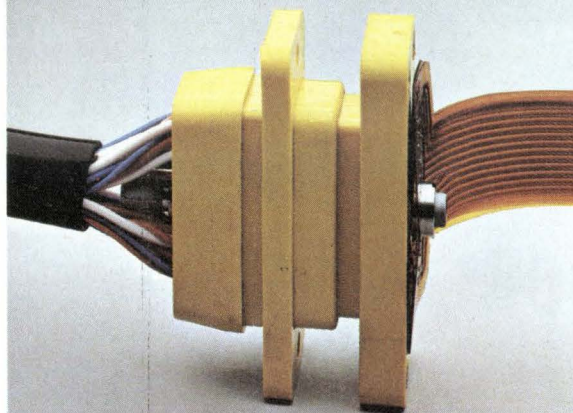

The new Hughes  
**HAC-PAK™ Connector.**  
(MIL-C-28804)

positions, and prevents mismatching

HAC-PAK subminiature connectors have the highest density of number 22 contacts in the industry (.085" centers.)

To get all the details, make connection with Ron Ross at (714) 549-5701, or write: Hughes Connecting Devices, 17150 Von Karman Avenue, Irvine, CA 92705

#### HUGHES MICROELECTRONICS LTD.:

UNITED KINGDOM—Clive House, 12-14 Queens Road, Weybridge, Surrey, England  
Telephone Weybridge 47262

EUROPE—Res Hera Apartment 64, Passage International 29, Brussels 1000, Belgium  
Telephone 17.91.72

### HUGHES

HUGHES AIRCRAFT COMPANY  
CONNECTING DEVICES DIV.

**We crack the tough ones**

# The EPC 2200.

## A hard copy recorder for spectrum analysis.

The new EPC Model 2200 is the first truly fine quality, low cost, hard copy recorder. When matched with a spectrum analyzer or processor, the Model 2200 prints spectral data on a continuous dry paper display 19.2" wide. This hard copy history-plot presents 2,048 clearly defined data points per scan, revealing spectrum lines buried as much as 6db below the noise level.

The Model 2200 interfaces with digital and analog equipment, accepts a variable dump rate and permits flexible expansion or contractions of scale. It sweeps at speeds between 1/10 second and 8 seconds, and is mechanically virtually jitter-free.

The EPC Model 2200 is currently built in four modified formats. Further customization is possible. Write for information and a quote.

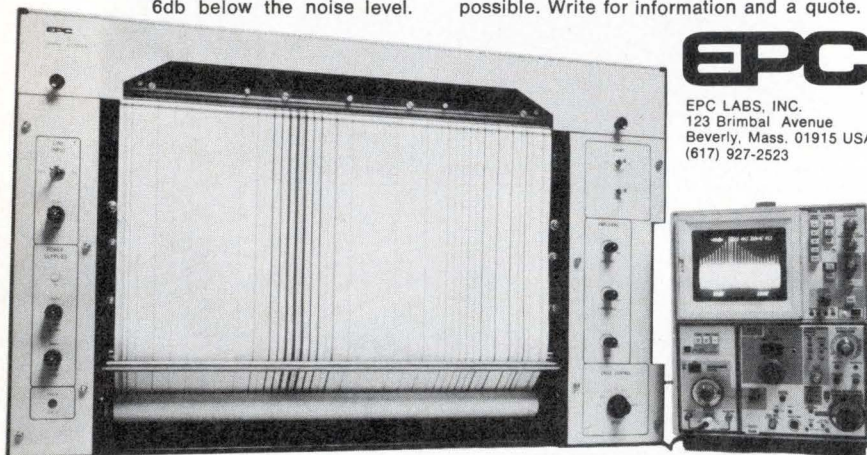

**EPC**

EPC LABS, INC.  
123 Brimbal Avenue  
Beverly, Mass. 01915 USA  
(617) 927-2523

Circle 32 on reader service card

# Hot Semis? Get relief fast!

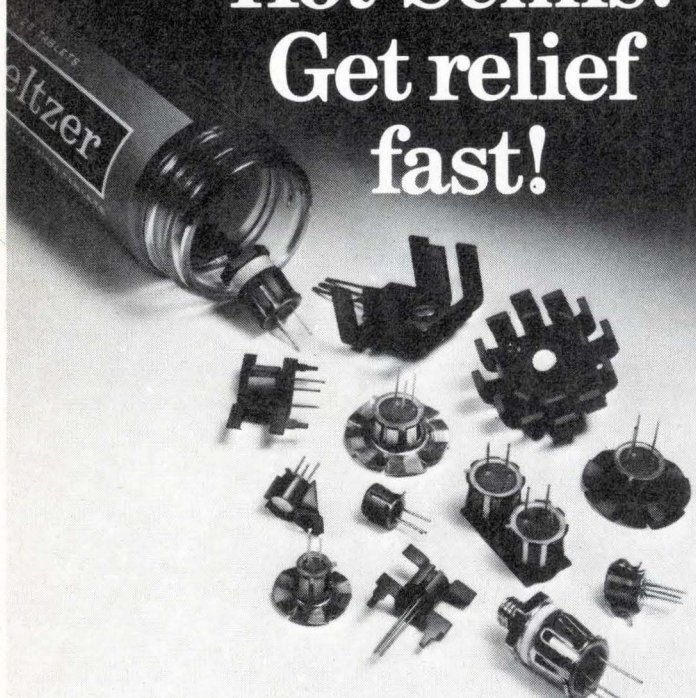

**IERC**



**Heat Sinks**

INTERNATIONAL ELECTRONIC RESEARCH CORPORATION / A SUBSIDIARY OF DYNAMICS CORPORATION OF AMERICA / 135 WEST MAGNOLIA AVENUE, BURBANK, CA. 91502

32 Circle 165 on reader service card

## Meetings

**Design Automation Conference**, IEEE and ACM, Statler Hilton Hotel, Boston, Mass., June 23-25.

**Siggraph '75, Second Annual Conference on Computer Graphics and Interactive Techniques**, ACM, Bowling Green State University, Bowling Green, Ohio, June 25-27.

**Tenth Intersociety Energy Conversion Engineering Conference**, IEEE, University of Delaware, Newark, Del., Aug. 17-22

**19th Annual SPIE Technical Symposium: Developments in Optical and Electro-Optical Engineering, Past and Future**, Society of Photo-optical Instrumentation Engineers, Town & Country Hotel, San Diego, Calif., Aug. 18-22.

**Active Semiconductor Devices for Microwave and Integrated Optics**, IEEE and Cornell University, Ithaca, N.Y., Aug. 19-21.

**IFAC/75: International Federation of Automatic Control Sixth Triennial World Congress**, IFAC, Massachusetts Institute of Technology, Cambridge, Mass., Aug. 24-30.

**Nuclear and Space Radiation Effects Conference**, IEEE, Humboldt State, Arcata, Calif., July 14-17.

**Summer Computer Simulation Conference**, ISA et al, St. Francis Hotel, San Francisco, Calif., July 21-23.

**Dielectric Materials, Measurements, and Applications**, IEEE, Churchill College, Cambridge, England, July 21-25.

**1975 Gordon Research Conference on Solid State Studies in Ceramics**, Brewster Academy, Wolfeboro, N.H., Aug. 4-8.

**Symposium on the Simulation of Computer Systems**, NBS and ACM, Boulder, Colo., Aug. 12-14.

**Optical Fiber Communication International Conference**, IEEE, London, England, Sept. 16-19.



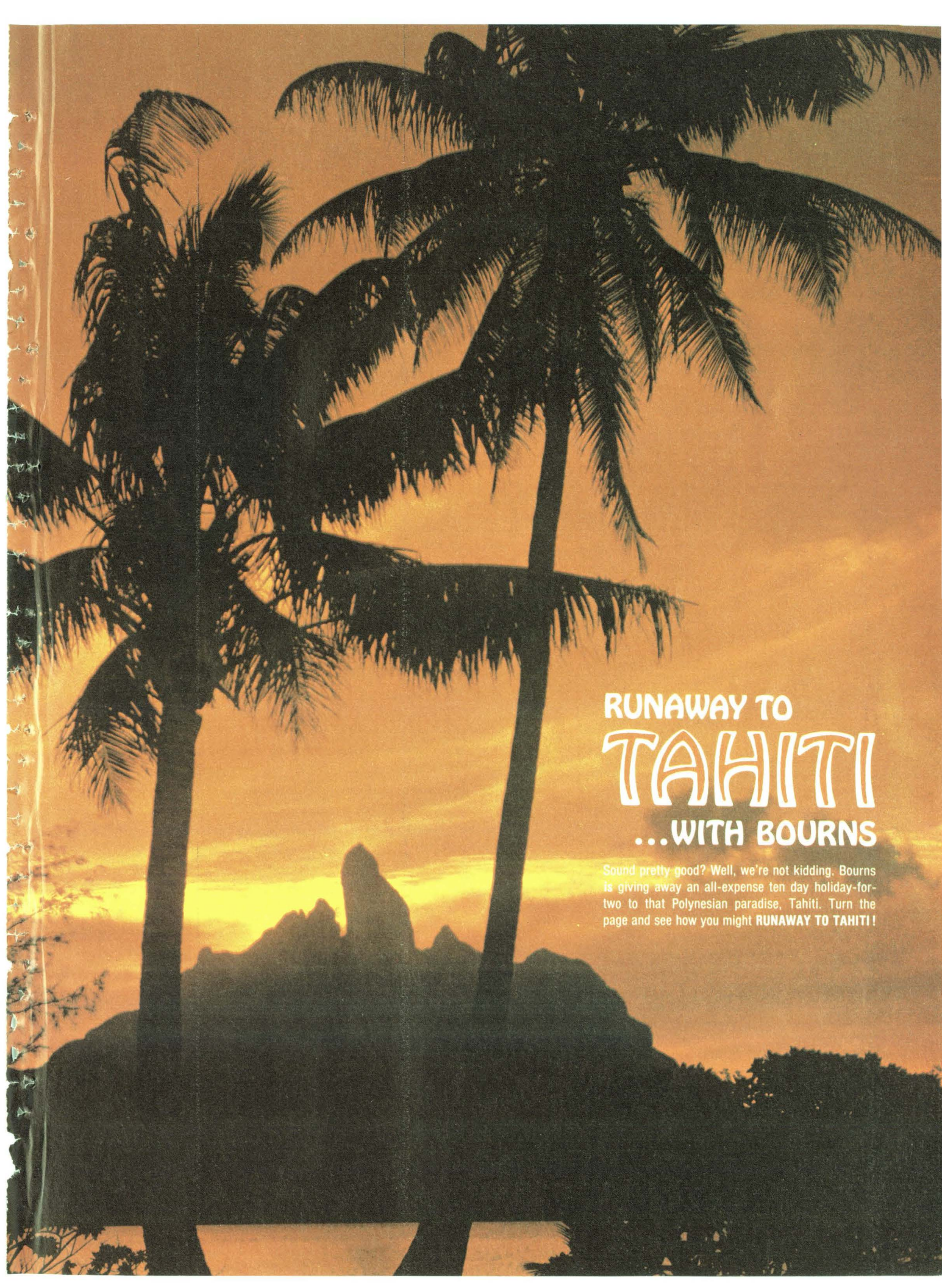

**RUNAWAY TO  
TAHITI  
...WITH BOURNS**

Sound pretty good? Well, we're not kidding. Bourns is giving away an all-expense ten day holiday-for-two to that Polynesian paradise, Tahiti. Turn the page and see how you might **RUNAWAY TO TAHITI!**

# RUNAWAY TO TAHITI ...WITH BOURNS

## THE PRIZE...

Runaway to the fabled Polynesian islands of Tahiti, Moorea and Bora Bora. Ten days of fun, adventure . . . and relaxation on the crown jewels of the Pacific. All expenses paid — deluxe hotels, air travel (from U.S.), inter-island travel, introductory island excursions, Tahitian feast, personal guide service . . . plus spending money. You can go marketing, paddle an out-rigger canoe, do your own bicycle or motor scooter exploring, go sailing, take a glass bottom boat ride, water ski, snorkeling . . . or, go deep sea fishing, if you like. Above all, soak up the sun and relax.

## OTHER PRIZES...



### LASER . . . INTERNATIONAL CLASS SAILBOATS

The next best thing to sailing to Tahiti . . . is sailing in your home waters. So . . . Bourns is

giving away two LASER sailboats to the next two winners (after 1st). The LASER — world's most successful new one-design — is 14-feet of cartoppable fun and speed. Class fleets everywhere.

### NEW HP-55 PROGRAMMABLE CALCULATORS

HP's new Model 55 scientific calculator does about everything but whistle for a cab. Besides all the mathematical stuff . . . the HP-55 also has 20 addressable storage registers, built-in digital timer (stopwatch) . . . and it stores and runs up to 49-step programs. Bourns is awarding two of these beauties.



### TEXAS INSTRUMENTS SR-50 ENGINEERING CALCULATORS

The ultimate engineering "slide rule" calculator . . . squares, roots and reciprocals, quadratic equations,  $n^{\text{th}}$  power and roots, sines, cosines, tangents, exponentials, logarithms. Ten-digit display, 2 digit exponent, plus 2 signs. We're giving away TEN.

### NEW POTENTIOMETER HANDBOOK

McGraw-Hill and Bourns have collaborated to produce THE comprehensive handbook on variable resistive components. Over 320 pages, extensively illustrated, covers everything from design, applications, explanations of performance specifications and test methods . . . and much, much more. McGraw-Hill will sell them for \$13.50. We're giving away ONE-HUNDRED.



NOTE: Delivery of above prizes free within continental U.S. only.

## CONTEST RULES

All you have to do to enter . . . is complete the questionnaire below. To answer the questions **correctly**, you must read and comprehend the information contained in the eight mini-ads on the next two pages. This questionnaire is no gimmick . . . if you want a chance to RUNAWAY TO TAHITI, you will **have** to answer every question . . . and answer each correctly. This gives **serious** contestants improved odds over those who are only casually interested. However . . . everyone has an equal **opportunity** to win. You may enter as many times as you wish . . . **BUT ONLY ON QUESTIONNAIRES CLIPPED FROM ACTUAL TRADE MAGAZINE ADS.** Winners will be drawn from all **correctly** answered questionnaires. All prizes will be awarded. Only one prize per entrant (one per family). If you wish to have a list of the actual winners, simply send a self-addressed, postage paid envelope with your entry. Bourns employees, and employees of Bourns advertising agency, authorized reps, distributors, and trade magazines are ineligible for this contest.

READ THE MINI-ADS ON THE NEXT TWO PAGES, THEN COMPLETE THIS QUESTIONNAIRE AND MAIL TO: RUNAWAY TO TAHITI, C/O BOURNS, INC., 1200 COLUMBIA, RIVERSIDE, CALIFORNIA 92507.

1. Bourns gives you a choice in low-cost  $\frac{3}{4}$ " rectangular trimmers. How many adjustment turns variations are offered? \_\_\_\_\_
2. What is the 1000-pc. price of the Model 3006 trimmer? \_\_\_\_\_
3. Did you know Bourns makes a  $\frac{3}{8}$ " square multi-turn trimmer that sells for only \$1.10 ea.? What is the Bourns Model No.? \_\_\_\_\_
4. Who offers the widest selection in square multi-turn trimmers? \_\_\_\_\_
5. The power rating of the 3352 single-turn trimmer is \_\_\_\_\_. The 1000 pc. price is \_\_\_\_\_.
6. What Bourns Division offers "Free Lunches For a Week . . . if"? \_\_\_\_\_
7. Did you know that Bourns can **now** deliver special thick-film networks (with chip capacitors, special circuits, etc.) in 5 to 8 Weeks? \_\_\_\_\_
8. Bourns Model 3540 \_\_\_\_\_-turn,  $\frac{3}{4}$ " x  $\frac{7}{8}$ " Diam. Precision Potentiometer sells for \_\_\_\_\_ in 1000 piece quantities, \_\_\_\_\_ section configurations are offered as standard option.
9. Bourns Magnetics Division manufactures audio, power and pulse transformers in sizes up to \_\_\_\_\_ pound(s).
10. How many **standard**, off-the-shelf resistor networks are available from Bourns? \_\_\_\_\_
11. Does Bourns Model 3680 Pushbutton potentiometer need adjustment or phasing before installation? \_\_\_\_\_
12. Bourns  $\frac{3}{4}$ " cermet panel controls have the most \_\_\_\_\_ - for-size.
13. Do you have an application for Bourns 3680 Pushbutton Potentiometer? \_\_\_\_\_  
If yes, what \_\_\_\_\_
14. Did you know Bourns new 3851 and 3858 conductive plastic panel controls are direct replacements for the Allen-Bradley Model J . . . but require only  $\frac{1}{2}$  as much behind-the-panel space? \_\_\_\_\_

Name \_\_\_\_\_

Address \_\_\_\_\_

City \_\_\_\_\_ State \_\_\_\_\_ Zip \_\_\_\_\_

Company \_\_\_\_\_ Phone \_\_\_\_\_



TRIMPOT PRODUCTS DIVISION  
1200 COLUMBIA AVENUE, RIVERSIDE, CALIFORNIA 92507  
PHONE 714 684-1700, TWX 910 332-1252 CABLE: BOURNSINC

# RUNAWAY TO TAHITI ... WITH BOURNS

SECRETS REVEALED

be choosy  
about  
trimmers  $\frac{3}{4}$ "

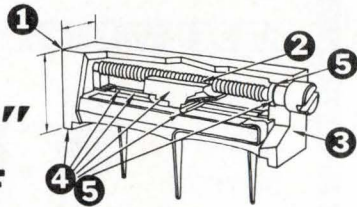

Bourns gives you a **choice** in high-quality, low-cost  $\frac{3}{4}$ " rectangular, multiturn trimmers . . . so you can tailor performance more closely to your specific application needs . . . and your budget. **1** If you need a **thin**  $\frac{3}{4}$ " trimmer, we have the 3005 wirewounds at .17" thin . . . if you need a **short** one, our 3006 cermet unit stands only  $\frac{1}{4}$ " high **2** For tailored adjustability choose 7½-, 10-, 15-, 20-, or 30-turn versions . . . in either solid or transparent cases **3** for panel mounting requirements, choose factory installed or flexible do-it-yourself options **4** Performance? How about 1% CRV • electrical adjustability of  $\pm 0.05\%$  VR • Mil-Grade environmental specs • power handling from .5 to 1 watt • TC of  $\pm 100$ PPM/°C for all resistance ranges. **5** Plus all the nice technological advances like: press-fit lead screws that eliminate o-ring windup and backlash . . . yet seal against humidity and board washing processes; multi-wire wipers for improved CRV; end-adjustment idling to prevent overtravel damage; swagebond termination for long-term stability, reliability; one-piece high temp thermoplastic cases; wide choice of pin configurations **6** Price? How about \$93 ea. (1000 pc. quantities, Model 3006) **7** Availability is off-the-shelf at 97 distributor locations . . . plus an extensive factory stock.



NOBODY KNOWS MORE ABOUT TRIMMERS THAN BOURNS

small  
size,  
low cost,  
BIG  
PERFORMANCE...



\$3.97\*

Bourns Model 3540 family of 3-, 5-, and 10-turn potentiometers incorporate all the precise electrical specs of larger military grade pots . . . in a compact  $\frac{7}{8}$ " Diam.-by- $\frac{3}{4}$ " long package. Dual-ganged and dual-concentric shaft units available as **standards**. Availability is OFF-THE-SHELF at over 97 distributor locations, and from our extensive factory stock.

If you're now using one of the following parts . . . switch to the BOURNS Model 3540 family . . . and be SURE.

AMPHENOL: 2131B, 2151B, 4101B, 4201B, 4301B, MF-78  
HELIPOT: 7216, 7246, 7266, 7276, 7366, 7466  
SPECTROL: 502, 510, 520, 530, 532, 533, 534, 535, 550  
TRW/IRC: 1000, 1005, 7500, 7505, 8400, 8403

Yes, we have custom options . . . like rear shaft extensions, hi-torque, special linearity and resistance tolerances, triple sections, centertap, etc. Our 3540's work great with a BOURNS turns-counting dial, too!!

### FREE SAMPLE

Tell us about your application. Call 714-684-1700 and ask for a PANEL POWER Engineer.

\*\$3.97 ea. (single unit, 10-turn style) in 1,000 pc. quantity.

SQUARE  
SHAPE,  
COOL  
PRICE!



Pick your package . . . pick your price . . . in square, WGAP multi-turn trimmers . . . and still get the **best** — BOURNS! Choose from 6 cermet and 5 wirewound models . . . at super competitive prices. Our  $\frac{3}{8}$ " square Model 3299 cermet unit has the lowest price we know of (\$1.10 in 1000 pc. quantity) and **still** outperforms comparable units. If you need wirewound element performance, you can get it from Bourns . . . from \$2.16 (Model 3255, 1000 pc. quantity). We've got QPL mil-spec models (RT-24, -26 and RJ-22, -24, -26) and sizes and pin styles to suit your requirements. Same superb construction features as our rectangular lead-screw trimmers.

COMPARE . . . you'll understand why Bourns is still No. 1

	Size	Res. Range	Res. Tol.	Power	CRV	Adj. Turns	Max. Temp.	Vib-ration	Price
BOURNS 3299	$\frac{3}{8}$ " sq.	10-1 Meg.	$\pm 10\%$	$\frac{1}{2}$ W 70°C	3%	25	125°C	20G	\$1.10/1000 pc.
BECKMAN 66	$\frac{3}{8}$ " sq.	10-2 Meg.	$\pm 20\%$	$\frac{1}{2}$ W 25°C	No Spec	20	105°C	10G	\$2.70/1000 pc.

Availability is off-the-shelf at 97 distributor locations . . . plus an extensive factory stock. For a free sample, contact your local authorized Bourns representative or distributor.

single-turns  
with  
singular  
performance

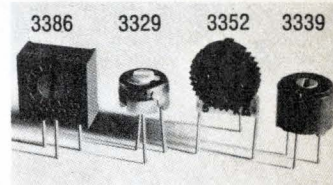

If you have a single-turn application, Bourns can cover you every-way from Sunday. You can choose wirewound or cermet element models with superlative performance and reliability . . . priced from 43¢ each (Model 3352, 1000 pc. quantity). You can have top adjust, side adjust, Mil-Spec units . . . in all kinds of pin styles. For example, our little  $\frac{3}{8}$ " square Model 3386 single-turn is available in 12 different terminal styles. If size is your prime concern . . . our little  $\frac{1}{4}$ " Diam. Model 3329 stands only .18" high. If you want just a little more adjustability . . . Bourns unique Model 3339 gives you four-turns in a single-turn package.

Compare Bourns performance and reliability . . . and you'll understand why Bourns trims more circuits than anyone else in the world!

Model Element	Power	CRV	Adjust-ability	Res. Range	Term. Styles	Shock Vibration	Size	Price 1000 pcs.
3352 Cermet $\frac{3}{4}$ W @ 40°C	1%	$\pm 0.05\%$ VR	10-5 Meg.	12	100/30G's $\frac{3}{8}$ " Dia.	.43		
3386 Cermet $\frac{1}{2}$ W @ 85°C	1%	$\pm 0.03\%$ VR	100-2 Meg.	8	100/30G's $\frac{3}{8}$ " Dia.	.49		
3329 Cermet $\frac{1}{2}$ W @ 85°C	3%	$\pm 0.1\%$	10-1 Meg.	3	100/30G's $\frac{1}{4}$ " Dia.	1.22		
3339 Cermet $\frac{1}{2}$ W @ 85°C	3%	$\pm 0.03\%$	10-1 Meg.	3	100/30G's .30" Dia.	1.46		

Available off-the-shelf at 97 distributor locations . . . plus an extensive factory stock.

# RUNAWAY TO TAHITI ...WITH BOURNS

## Update Your PANEL with the NEW BOURNS® PUSHBUTTON POTENTIOMETER

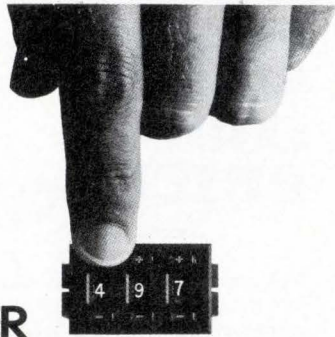

The new Model 3680 Pushbutton Potentiometer integrates a precision incremental decade potentiometer with an easy-to-read digital display. AND a speedy pushbutton control action. It is handsome, accurate, and a "snap" to install. Everything is INSIDE the Model 3680 . . . no resistors or mini-PC boards are required . . . nothing clutters the back of the unit to steal precious space. No pot-to-dial phasing required . . . it's ready to install when you open the box.

### FEATURES SUMMARY

- 0% to 100% capability by 0.1% steps
- In-Line Digital readout
- Accuracy (Dial Reading to Output Ratio)  $\pm 0.5\%$
- Convenient snap-in mounting with bezel
- Rear solder lug terminals fit AMP series 110 receptacles (dual purpose solderable)
- 100 PPM/ $^{\circ}$ C tempo
- 2 watts power rating
- Rectangular to match other panel components

For more information, call your local Bourns representative, distributor, field sales office . . . or call the factory direct and ask for a PANEL POWER engineer.



## Switch to BOURNS and get the most power-for-size in low-cost PANEL CONTROLS

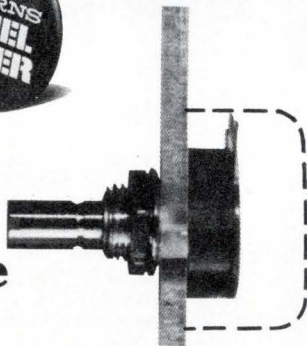

Save valuable "real estate" behind the panel . . . switch to BOURNS® unique SPACE SAVER controls design. Extends only  $\frac{1}{4}$ " behind your panel, yet handles as much power as bulkier alternatives.

Choose Bourns CERMET CONTROLS for maximum power-for-size and optimum stability.

Choose Bourns NEW CONDUCTIVE PLASTIC CONTROLS for low noise and long life. Ideal replacement for bulky carbon controls.

Bourns controls are available off-the-shelf at 97 distributor locations nationwide. Standards can be shipped direct from factory stock in 24 hours.

### FREE SAMPLE

Call "CONTROLS" at 714-684-1700 and tell us about your application. We'll send you the Bourns Control that best suits your needs. Pronto.

## NETWORKS...

### Off- The- Shelf

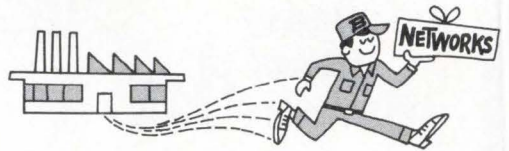

We've got over a quarter-of-a-million standard resistor networks on the shelf . . . in your favorite Beckman, CTS, Dale and Allen-Bradley part numbers . . . we can ship in 24 hours. Call your friendly Bourns rep or distributor today for a quote! Our pricing-pencil is super sharp these days!

### ... or Made- To- Order

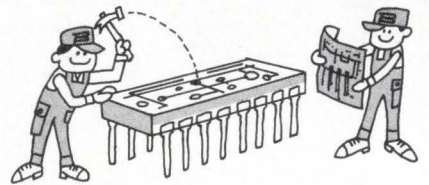

WE'LL BUILD TO YOUR PLANS — Last year was Bourns "start-up" year in networks . . . and our reputation for "quality, service and value" got us more custom networks opportunities than we could handle. Well . . . our operation is up-to-speed now. We are in production on many kinds of complex specials . . . including resistor/capacitor combinations. We can deliver special circuits to your requirements—prototype quantities in 5 weeks, production quantities in 8 weeks. Our price is right, and Bourns stands behind every part.

## Switch to BOURNS and get the most power-for-size in low-cost PANEL CONTROLS

Save valuable "real estate" behind the panel . . . switch to BOURNS® unique SPACE SAVER controls design. Extends only  $\frac{1}{4}$ " behind your panel, yet handles as much power as bulkier alternatives.

Choose Bourns CERMET CONTROLS for maximum power-for-size and optimum stability.

Choose Bourns NEW CONDUCTIVE PLASTIC CONTROLS for low noise and long life. Ideal replacement for bulky carbon controls.

Bourns controls are available off-the-shelf at 97 distributor locations nationwide. Standards can be shipped direct from factory stock in 24 hours.

### FREE SAMPLE

Call "CONTROLS" at 714-684-1700 and tell us about your application. We'll send you the Bourns Control that best suits your needs. Pronto.

## FREE LUNCH...

if our standard pricing  
can't beat the price  
you're now paying for  
Transformers,  
Inductors  
or Delay Lines\*



...we'll buy your lunch FOR A WEEK!

Try us. Simply send a letter telling us (1) what you're buying and how many (2) price you're paying (3) technical specifications. SEND ACTUAL SAMPLE OF WHAT NOW BUYING. We'll respond in one week . . . with a better price on a better product (our return rate is less than  $\frac{1}{2}\%$ ) . . . or a FREE LUNCH ticket!

\* specifically, audio or power transformers and inductors (20hz to 500 khz) and pulse transformers in quantities of 10,000 or more . . . and delay lines in quantities of 1000 or more. Sizes up to  $\frac{1}{2}$ -lb.

BOURNS INC., MAGNETICS DIVISION  
28151 HIGHWAY 74, ROMOLAND, CA 92380 PHONE: 714 657-5195 TELEX: 67-6446

## **Welty shuffles Motorola marketers**

The reorganization of Motorola Semiconductor Products division that had been promised by new vice president and general manager John Welty has begun in the marketing department. **And more changes are expected through June.** Charles E. Thompson, formerly director of material and information-management operations, has been named director of marketing, replacing Rod O'Connor, who will stay as a computer-marketing consultant. Thompson will be responsible for day-to-day tactical operations. Colin Crook, formerly MOS-marketing manager, has been named assistant marketing director responsible for the division's over-all technology-marketing strategy.

Crook, who has been with the Phoenix division for only two years, is generally credited with changing Motorola's sluggish MOS performance by installing aggressive microprocessor and memory programs. Although based in Phoenix, he will remain in close touch with Motorola's new Austin, Texas, MOS operation.

## **DEC developing own bipolar parts at new lab**

Digital Equipment Corp. has quietly started a laboratory in Worcester, Mass., **to develop custom bipolar semiconductor devices.** DEC is renting space from Sprague Electric Co., which is also providing the lab with semiconductor knowhow. The lab was set up to give DEC an understanding of advanced semiconductors, which it is using in ever-increasing numbers. Only a handful of people is there at the moment, though, and DEC will not say if they are working on logic, memories, or both.

## **Rockwell schedules 16-k n-MOS RAM**

Although late in developing an n-channel process for commercial products, Rockwell International's Microelectronic Device division is aiming to leapfrog the industry with a 16,000-bit random-access memory **built with a proprietary n-channel silicon-gate process.** According to Arthur H. Hammond, chief engineer, the 16-k RAM, which Rockwell plans to introduce in 1976, will likely have a one-transistor-cell design. Like Rockwell's 4-k part, the 16-k version will fit into the industry standard 16-pin package.

Rockwell's designers are aiming at a 200-nanosecond access time for its 16-k part, which will have the same multiplex-input structure as the 4-k, making the RAMs fully compatible. Rockwell also will be furnishing its 8-bit PPS-8 microprocessor, which is now built with p-channel technology, **in a faster n-channel version.** It will be available this year. At the same time, Rockwell is developing integrated-injection-logic designs for memories.

## **TI finally to show its own 5-function digital watch**

Making its long-awaited entrance into the digital watch market at the Consumer Electronics Show in Chicago June 1, Texas Instruments will preview its five-function model with a light-emitting-diode display. **The company plans to bypass normal watch-distribution channels** and, as with its calculators, let its Consumer Products division market directly to retail outlets.

The watch, built with TI's I<sup>2</sup>L timing and control chip, displays seconds, minutes, hours, days, and months. Prices of the four models start

## Electronics newsletter

at around \$100. All have a battery-saving feature—**circuitry that requires less power in dim light**. Observers estimate that the company will make 1.5 million watches in the first year of production.

### **Northrop wins \$33 million contract for Missile X**

Northrop Corp. has received the important \$33 million initial development contract for the Missile X inertial guidance platform from the Air Force. Northrop beat out Rockwell International's Autonetics Group, **which supplied the guidance platform for the current Minuteman ICBM, predecessor to Missile X**. However, both companies are developing guidance computers for the system, and the contract for a third component, electronics integration, has not yet been awarded. The award to Northrop will not mean any layoffs at Autonetics.

### **NCC attendance tops estimates**

Attendance at the National Computer Conference in Anaheim, Calif., last week greatly surpassed expectations, **with about 30,000 persons going through the doors**. Last year's attendance in Chicago was 26,000, while 1973 attendance in New York was 23,000. Only 25,000 were expected this year due to the show's location and the recession, but long lines at the gates continued through the third day of the four-day convention and heavy crowds surrounded the 795 booths.

### **Bell unveils CCD camera at Montreux**

Bell Laboratories is scheduled to disclose a new experimental charge-coupled device **and demonstrate its use in a TV camera** at the International Television Symposium at Montreux, Switzerland (see p.82). Michael F. Tompsett, supervisor of the CCD group in Bell Labs' MOS Development department, Murray Hill, N.J., who is a last-minute addition to the symposium program, says the new CCD chip measures 16 by 20 millimeters and contains 496 vertical and 475 horizontal picture elements. The device will be demonstrated in a camera measuring 2.5 by 2.5 by 6 inches.

### **AMI processor aims at low-end controller sector**

American Microsystems Inc. is quietly marketing a p-MOS processor chip **aimed at low-end controller applications that require only a little data processing and manipulation**. The stand-alone chip, called AMI 9209, is microprogramable and has a nominal instruction time of 15 microseconds.

Although designed primarily for single-chip display calculators of up to 12 digits, the part contains the essential elements of a microcomputer. As a microcomputer, each 9209 will cost \$6 to \$10.

### **Rolm expands into PBX arena**

Rolm Corp. of Cupertino, Calif., is making a significant departure from its traditional business as a major supplier of ruggedized minicomputers to the U.S. Government's civilian and military agencies. **Rolm is entering the \$250-million-a-year private-telephone system market** with its CBX Business Switch. The heart of the system is Rolm's Model 1603 minicomputer with 8,000 to 40,000 bits of memory and a four-card central processor that uses Nova software.

# Data General announces the one thing that may have kept you from communicating with us.

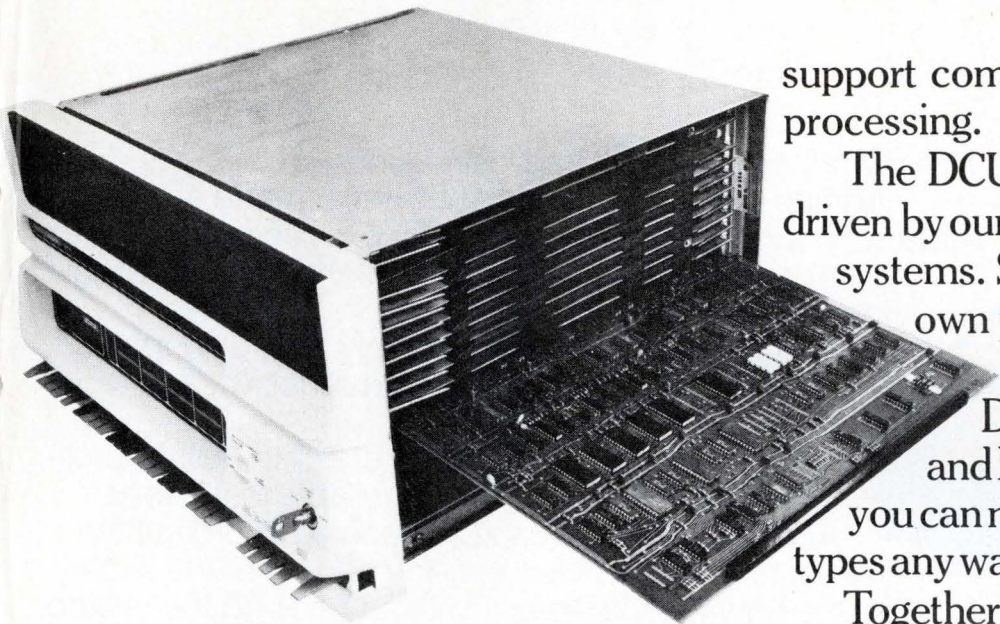

For years, Data General has been the company people have come to for basic communications networks. Because we've always made our computers, peripherals and software completely compatible with each other.

Now you can come to Data General if you want to build big, complex networks.

Because now we have the communications controller board you see here. The DCU/50 (Data Control Unit).

The DCU is designed to work in terminal, switcher, concentrator and front end systems. It takes care of line control and all the character processing. Which leaves the computer free to

support communications message processing.

The DCU is programmable and driven by our real-time operating systems. So you can define your own protocols.

Or you can use our Data General teletypewriter and BISYNC protocols. And you can mix your protocols and line types any way you want.

Together with our high density 16, 8, and 2 line synchronous and asynchronous multiplexers, the DCU gives you direct memory access for extremely high throughput, with minimal systems overhead.

And when you need more speed and more lines, you won't have to throw out anything. You can add on to what you already have.

For example, you can start off interfacing our multiplexers directly to the computer. And later on, plug in the DCU.

Which means no matter how big or small you want your network to end up, you can start off communicating with Data General.

## Data General

Data General, Route 9, Southboro, Mass. 01772 (617) 485-9100. Data General (Canada) Ltd., Ontario, Data General Europe, 15 Rue Le Sueur, Paris 75116, France. Data General Australia, Melbourne (03) 82-1361/Sydney (02) 908-1366.

# Some people will pay any price for a bad linear IC.



In rework, field service, and lost business.

Adding value to a bad part has never made sense. That's why our digital IC tester, the J133C, is so popular. And it's one reason why we're now offering a comparable linear IC test system.

The benchtop J149 thoroughly tests all popular op amps (including duals and quads), voltage regulators, and comparators.

The system includes features like built-in oscillation detection to prevent unreliable test results. And automatic continuity screening to protect the tester and IC from damage. You can insert the wrong IC, or the right one backward, without harming the device.

Like the J133C, our new linear tester requires no user programming. All programming is done by Teradyne. All you do is plug in the preprogrammed family and device cards appropriate to the devices being tested.

If IC inspection is what you want, the J149 will give you high throughput. If you want evaluation, the system comes equipped with all the digital readouts, operating modes, and test capacity you need to analyze a device thoroughly.

As you would expect, the J149 needs no calibration adjustments and is designed for hard industrial use. Naturally, its circuit boards are covered by Teradyne's unique 10-year warranty.

High yield is the difference between finding bad parts early and finding them late. The J149 could be spotting the no-goods for you right now. Boosting your yield and your profits.

Think yield.

For a closer look at the new J149 linear IC test system, write: Teradyne, Inc., 183 Essex Street, Boston, Massachusetts. In Europe: Teradyne Ltd., Clive House, Weybridge, Surrey, England.

## The **J149** Linear IC Test System

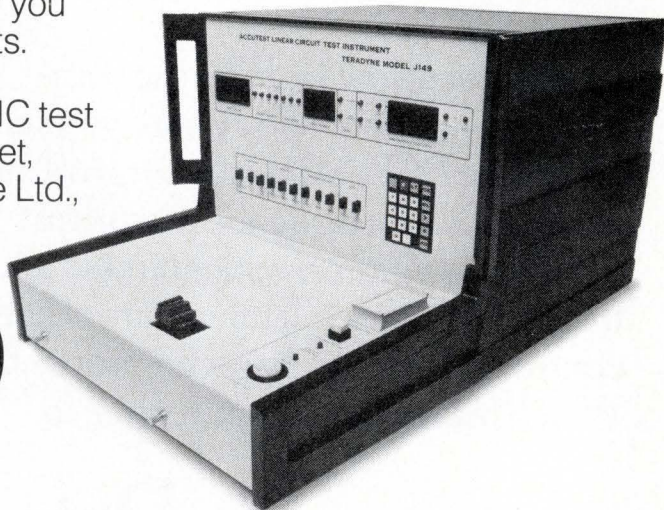

# TERADYNE

CHICAGO (312) 298-8610 / DALLAS (214) 231-5384 / NEW ENGLAND (617) 458-1256 / NEW YORK (201) 334-9770 / SUNNYVALE (408) 732-8770  
LONDON (0932) 51431 / PARIS 265 72 62 / ROME 59 47 62 / MUNICH (089) 33 50 61 / TOKYO (03) 406-4021



## Solar cell offers 21% efficiency with GaAs

Varian engineers promise even higher rating using concentrator principle; 1-kilowatt array planned

NASA scientists at the Jet Propulsion Laboratory hardly had time to savor their announcement of a thin-film gallium-arsenide solar cell promising a 19% efficiency, when engineers at Varian Associates began claiming efficiencies of 21% for what they call gallium-arsenide-concentrator solar cells. What's more, they say the cells can reach 23% efficiency in terrestrial use.

A JPL team in Pasadena, Calif., promised solar cells of 19% efficiency within four months when it reported earlier this month its achievement of 15% efficiency at an IEEE photovoltaic conference in Phoenix [*Electronics*, May 15, p. 53]. However, the Varian engineers maintain they're already getting 21% efficiency in laboratory devices. And Ronald L. Bell, director of Varian's solid-state laboratory in Palo Alto, Calif., says his group is building an array of 128 cells measuring 70 by 140 inches that will deliver 1 kilowatt after it's mounted atop the laboratory roof by mid-summer.

The Varian approach is different from NASA's anti-reflection-coated metal-oxide-semiconductor solar cell, which uses a gallium-arsenide layer only 5 micrometers thick, topped by a 70-angstrom gold film. Instead, Varian engineers are making a heterojunction cell of aluminum gallium arsenide and gallium

arsenide. The process is an outgrowth of work at the corporate laboratories on photocathodes for laser and power semiconductor devices.

**Processing.** The construction of the AlGaAs cell is similar to that of a normal cell, say L. W. James and R. L. Moon, the engineers working on the device. The starting material is a wafer of bulk n<sup>+</sup> type GaAs, on which a liquid epitaxial layer of n-type material is grown. "This material has a longer hole diffusion length than the bulk material, which gives it a higher efficiency," says James. "And the n<sup>+</sup>n junction gives some carrier confinement, again slightly increasing efficiency."

On top of this layer, an AlGaAs layer is grown and doped with a p-type source such as zinc, which diffuses a small distance into the n-type GaAs layer during the AlGaAs growth, producing the pn junction across which the photovoltage appears, and a p-GaAs layer. The p-GaAs, p-AlGaAs heterojunction, says Moon, confines the electrons generated in the p-GaAs layer. This restriction makes for a low velocity of surface recombination, which greatly increases the efficiency over what is possible with a straight GaAs cell, Bell notes. The layer is a window for photons that have energies below the

AlGaAs band gap.

**Concentration.** "Our approach differs from the flat-panel-array concept in that it is not limited to operating from incident available light from the sun," says Bell. "It is a concentrator cell that operates most efficiently when it is aimed directly at the sun using light that is concentrated as much as 1,000 times by mirrors or lenses."

The main factor that limits the amount of concentration at which a solar cell may usefully operate is the

**Concentrating.** Varian's gallium-arsenide cell employs sunlight-concentrating mirror.

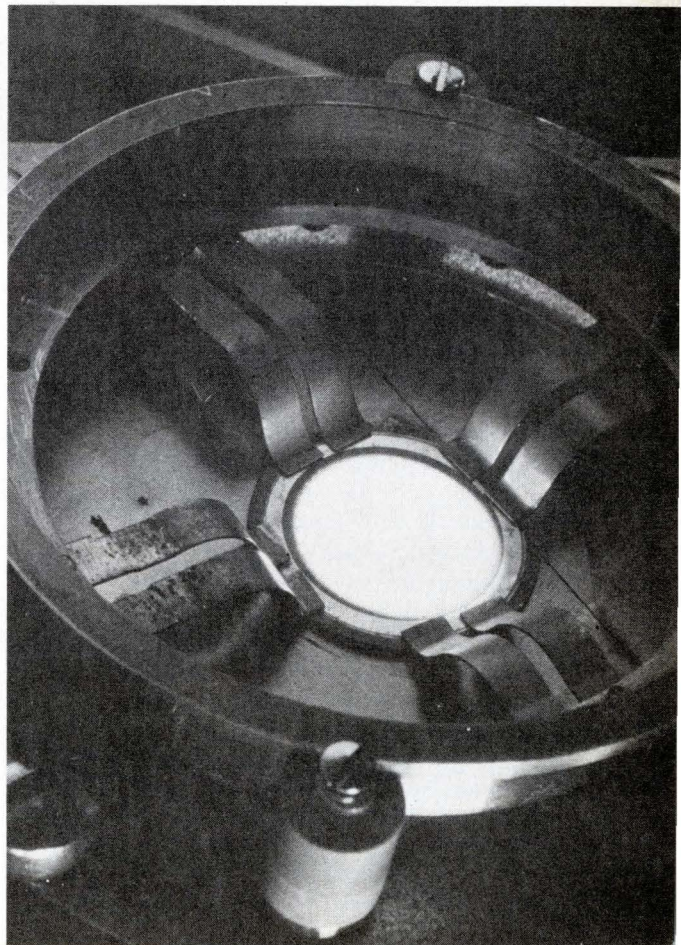

cell's series resistance. If one tries to reduce the series resistance of a normal silicon cell by producing a thicker top n-layer, efficiency drops rapidly. "However, in our cell the AlGaAs sheet resistance is in parallel with the p-GaAs sheet resistance, and the low recombination velocity at the interface allows the AlGaAs to be quite thick without reducing efficiency substantially," says James.

Without concentrator lenses or mirrors, Bell claims that Varian experimental cells have demonstrated efficiencies of 18.2% and 21%. In other tests, with a parabolic mirror

concentrating direct sunlight 896 times, experimental cells demonstrated efficiencies of about 17.2% at an output power density of 0.13 megawatt a square meter. However, efficiencies as great as 23% can be achieved by other simple concentrator schemes, Bell maintains.

A 10-megawatt peak-output electric-power plant constructed of these cells, says Bell, would require only 80 square meters of gallium arsenide; an equivalent system using silicon cells of 12% efficiency would require an array that would cover 2½ acres. □

McDonnell Douglas was free of such tradeoff constraints and was not evaluated on a comparable basis. Thus LTV asks that "the Navy Air Combat Fighter competition be reopened to the aerospace industry."

**Costs.** Beyond the legalities, LTV estimates that the Navy could save \$158 million in its 800-plane engineering development and procurement program if it had gone with the LTV/GD carrier version of the F-16 (see table). And the company also argues that the 15-year life cycle costs of the F-18 program will run to \$14.1 billion—between \$2 billion and \$2.4 billion more than if the Navy had opted for one of the two derivatives of the F-16.

While the GAO investigation and decision are not expected to be completed before the end of August, the Navy is saying as little as possible about its F-18 selection. But Navy officials argue that they picked the best plane for their needs.

They say that the Northrop YF-17, from which the F-18 is derived, is a product of the Air Force competition—if not the winner—and therefore meets the congressional requirement. They note also that

Military

LTV protest clouds Navy's F-18 choice as company seeks new competition

Did the Navy violate the law by choosing the F-18 as its next-generation air combat fighter? Yes, says loser LTV Aerospace Corp. in its mid-May protest to the General Accounting Office urging that the competition be reopened.

As a carrier-qualified contractor, LTV headed a team with General Dynamics Corp. to propose a modified version of the Air Force F-16 in the Navy competition. But the F-18, the McDonnell Douglas-Northrop entry selected by the Navy, is designed around Northrop's twin-engine YF-17, which was rejected by the Air Force [*Electronics*, Jan. 23, p. 30].

Not only does LTV claim the Navy broke the law, but it also charges that the Navy changed the ground rules in its evaluation in such a way that the McDonnell entry gained an advantage. The law in question is the fiscal 1975 defense appropriations act which spells out how the \$20 million in Navy funds for the air combat fighter must be spent: "Adaptation of the selected Air Force ACF to be capable of carrier operations is the prerequisite for use of the funds provided."

As to ground rules, LTV contends that the Navy proposal request called for "the highest degree of

commonality with, and . . . the maximum use of [ACF] technology and hardware." Because of that, LTV's proposals incorporated tradeoffs that may have lessened the likelihood of satisfying "each and every Navy need." Since the F-18 is not a derivative of the F-16, it has no commonality with it. LTV says

HOW LTV FIGURES F-16 COMMONALITY COULD SAVE THE NAVY \$187 MILLION

Savings on:	(in thousands of dollars)		
	Full-scale development program (Lot 1)	Production lots 2-12	Total program
<b>Total aircraft</b>	\$49,817	\$108,263	\$158,080
- airframe	15,396	31,732	47,127
- avionics/armament weapons delivery	31,172	60,793	91,965
- systems engineering (other than ILS)	3,249	59	3,308
<b>Total Instrument Landing System</b>	\$ 2,233	\$ 12,330	\$ 14,563
- systems engineering	548	720	1,268
- data	397	2,297	2,694
- Trainers/training	121	401	522
- GSE	885	2,739	3,624
- Spares	282	6,173	6,455
<b>Total test programs</b>	\$14,326	-	\$ 14,326
<b>TOTAL PROGRAM</b>	<b>\$66,376</b>	<b>\$120,593</b>	<b>\$186,969</b>

source: LTV Aerospace Corp.

Defense Secretary James R. Schlesinger said in February that the Navy was free to pick a derivative of either plane.

**Choices.** With its evident support of the Navy's controversial choice, the Pentagon clearly sees the long-term viability of the U.S. fighter plane industry as a larger issue overriding those of congressional mandates, aircraft commonality, and its short-term economies. Had the Navy bought the F-16, one Pentagon planner notes, "General Dynamics and LTV would have a lock on the market in five years."

When the existing contracts of Grumman Corp. for the Navy F-14, McDonnell Douglas for the USAF F-15, and Northrop Corp. for the F-5 international fighter all run their course some time after 1980, "we would have been left with General Dynamics," notes DOD's man. "That's not healthy."

Malcolm R. Currie, DOD's research and engineering chief, made the point somewhat more subtly in his first justification of the F-18 choice to the Congress. Of the "two other very significant points to be made in the development of the F-16 and F-18," he said, "one is the importance of having options in future defense planning." The second, Currie went on, is "that there is nothing so effective in holding cost down as the existence of on-going competition between manufacturers." Citing the pressure of the F-16 and F-18 programs on the producers of the F-14 and F-15, as well as the competitive pressures of the F-16 and F-18 on each other, Currie called the level of competition "a situation we have not had for over 20 years." As a result, he believes, "the payoff will be substantial." □

## Government

### FAA's Dow pushing new flight recorders

Despite strong opposition from U.S. airlines and their pilots, the Federal Aviation Administration's acting

chief, James E. Dow, is set to propose a new and costly flight-data recording system. The new system's concept would include computer analysis of recorded data to monitor pilot performance and to provide a preventive-maintenance program for aircraft by measuring component performance within predetermined parameters. The recorders were recently recommended by a Federal task force to upgrade airline safety [*Electronics*, May 15, p. 53].

Although Dow agrees with industry estimates of \$100,000 per plane to install the new recorders and the scores of new sensors that would interface with them, he wants adoption of the new system by 1978. "We'll have a new rule-making in three years" that would require the recorders, Dow predicted in a recent interview.

He has invited 10 representatives of the Air Transport Association, the Air Line Pilots Association, and the Allied Pilots Association to a June planning session to discuss proposed new sensor points for transports and a schedule for industry-operated flight tests.

**Opposition.** Air carriers, who oppose the system on economic grounds, are citing a two-year test, concluded in 1971, to support their position. Those test packages, with as many as 70 sensors per plane, were on board 30 American Airlines BAC-111s. Pilots charge that the system's monitoring of their performance "is a violation of basic constitutional rights and is totally unacceptable" because it would "inhibit the free communication and necessarily relaxed atmosphere in the cockpit, which is vital."

Avionics makers, who estimate the cost of the new recorders at \$10,000 each, say that another \$20,000 would be added for recorder-avionics interfaces and signal-sequence controllers, plus up to \$20,000 for sensors and wiring. Labor and other materials could account for another \$50,000 per plane. The system, with its capability of monitoring hundreds of aircraft parameters—a maximum of 240 have been mentioned—would replace



**Determined.** Dow wants new flight-data recorders adopted by 1978.

voice units and data recorders that monitor air speed, heading, altitude, and abrupt vertical forces. Among performance functions proposed to be monitored are aircraft pitch and roll while turning, trim, engine temperature, oil pressure, and such electromechanical subsystems as landing gear and flaps.

**Tape swamp.** If a pilot or other crew member deviates from safe operating procedures, ground-based computers envisioned by the FAA would detect the deviation while analyzing recorder tapes. However, avionics makers say the large number of computer tapes would swamp airline computers. They expect that an on-board processor would also be needed to filter nonessential inputs. "But the FAA doesn't like that. They want to have all the raw data to look at," says a senior marketing official of a major West Coast avionics company.

Dow says he can provide the economic incentive to offset high initial industry costs, though. "Flight data recorders will reduce costs to the airlines. They will save the cost of fuel for check flights," he says, as well as provide an automatic preventive-maintenance system. Pilots currently must fly two proficiency flight checks each year without passengers

---

## Electronics review

---

and under observation by FAA-designated examiners. Dow would reduce the number of check flights for airlines, substituting instead the flight-data recorder as a monitor of pilot performance. □

---

## Consumer electronics

---

### Novus readying electronic game

Officials at Novus, the consumer-products division of National Semiconductor Corp., are playing games again, this time with home-television sets. Novus, which had previously announced an electronic roulette game and a calculator for juveniles [*Electronics*, March 6, p.26], is now challenging Magnavox Co. and other makers of electronic games played on home-TV sets. The Novus entry will make its debut next week at the IEEE's Summer Consumer Electronics Show in Chicago.

The Novus briefcase-sized unit, which attaches to a TV set's antenna leads, will compete in price with the Magnavox "Odyssey" series, probably the best-known home TV-based game, first marketed in September, 1972. Odyssey 100, which retails at up to \$100, depending on the number of options in the package, employs a plastic sheet that diagrams the game and is placed over the TV screen.

In contrast, according to game and toy marketing manager Michael Luckman, the Novus game will have the playing pattern programmed into a plug-in module about the size of a stereo tape cassette. The plug-in fits into the portable video unit, which contains a TV transmitter that broadcasts on either channel 3 or 4.

But Magnavox isn't standing still. Last week, the company unveiled Odyssey 200, priced from \$79 to \$100, which also offers on-screen boundaries for three games, including tennis and hockey, and permits four tennis players. Odyssey 200, to be marketed in September, features

a Magnavox-designed integrated circuit used to control ball speed and placement. The IC also centers the game on any TV screen.

Odyssey 200 also offers optional on-screen scoring and sound effects to simulate those of hockey pucks or tennis balls. The third game in Odyssey 200 is a combination of handball and Jai Alai, which is called Smash.

**For starters.** "The first Novus units will use discrete components," says Stu Weiss, director of engineering at Novus, "and will, we hope, be in production at about \$100 retail with four of the simpler plug-in paddleboard games.

"A new system using LSI MOS rather than discrete circuitry will be available by mid- or late-1976 for about \$50 to \$75, and be made in four to eight game modules."

The strategy for capturing a market put at "millions of units" includes the introduction of eight to 10 plug-in modules with new options each year, Luckman says. "In terms of the kinds of games that can be programed onto these modules, the possibilities are endless," he says. "In the time we've worked on this project—about a year—we've looked at less than 1% of the games that could be played: not only paddleboard, racing and shooting games, but all sorts of strategy and mathematical games as well."

To avoid patent problems with other electronic game makers, Novus has developed its own proprietary circuitry and logic approach, says Weiss. A patent is also being considered on the low-cost, low-power broadcaster it has developed for the unit, he says.

Luckman says that for the consumer-home market, the portable video games will be distributed through the channels it has already developed for its calculators [*Electronics*, Aug. 30, 1973, p. 25], its digital watches [*Electronics*, Oct. 3, 1974, p. 52], and its other games.

Novus will also introduce a coin-operated version for the amusement arcade and game outlets that are now served by the \$800 to \$1,500 video games sold by such companies



**New game.** Magnavox's Odyssey 200 has tennis for four, automatic scoring.

as Atari Inc. and Midway Manufacturing Co. [*Electronics*, June 27, 1974, p. 69]. □

---

## Microprocessors

---

### Intersil chooses 12-bit design

Trying to break into the crowded microprocessor market, Intersil Inc. spotted a gap—12-bit devices—and is gambling that its newly developed complementary-MOS line will give it a viable market position [*Electronics*, Oct. 17, 1974, p. 26]. What's more, the Cupertino, Calif., company doesn't look at the 12-bit approach as much of a gamble. After all, the widely used PDP-8E is a 12-bit machine, and the Intersil devices can run on the same software.

After more than a year of development work, Intersil will begin introducing the various elements of its C-MOS 12-bit microcomputer systems as they become available in sample quantities over the next four or five months. First into production will be the IM6100, the system's 12-bit, 40-pin CPU, scheduled to be available by mid-June for \$395 each for up to 24 units and \$240 for 100-999 units.

It will be followed in short order, says Ronald Hammer, director of C-MOS product marketing, by the rest of the system parts: the IM6402,

# We don't just build lasers. We build OEM subsystems that put those lasers to work in your products.

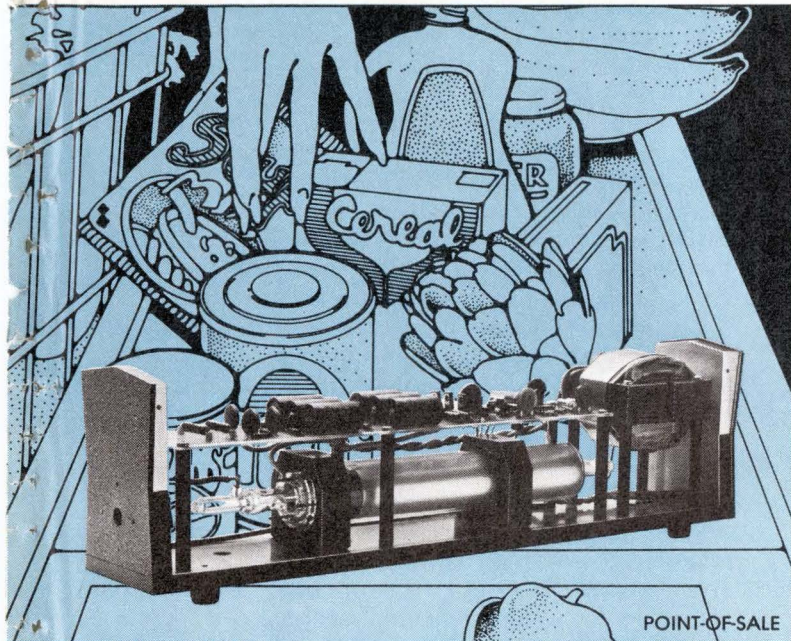

POINT-OF-SALE

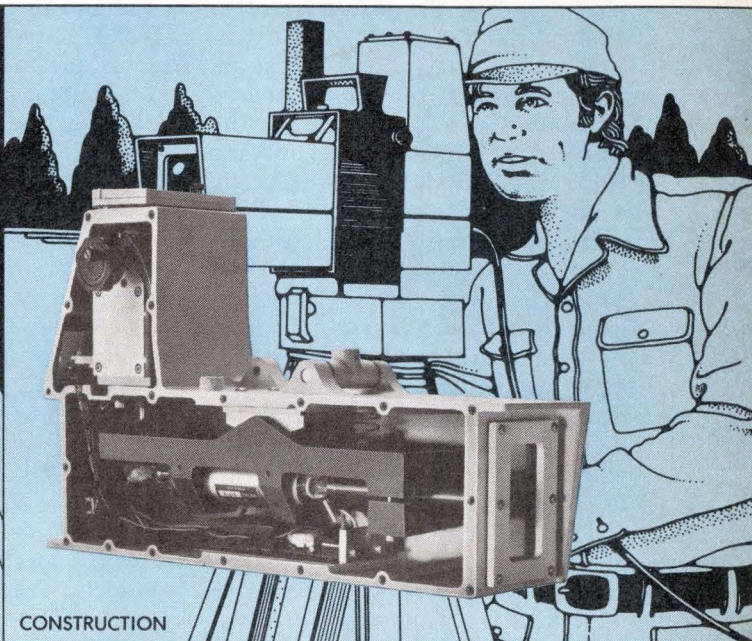

CONSTRUCTION

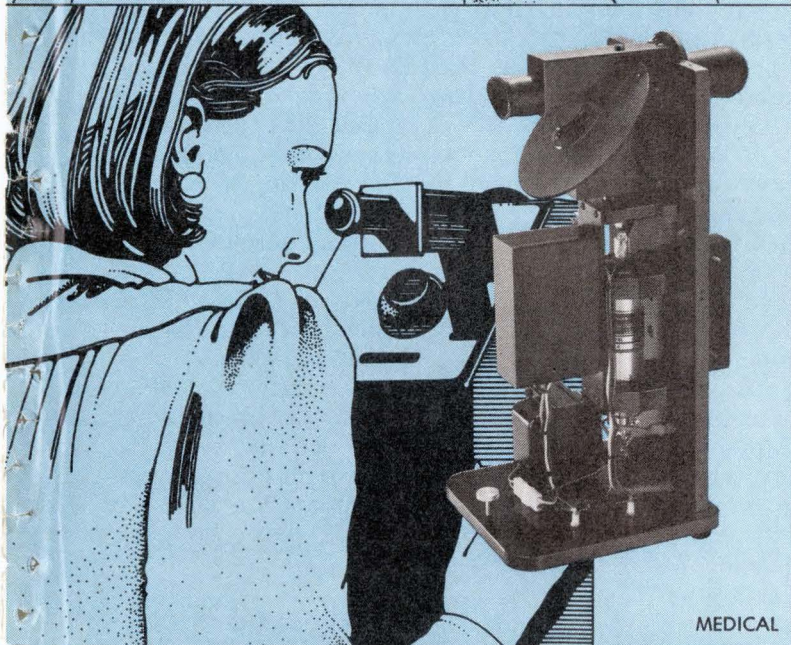

MEDICAL

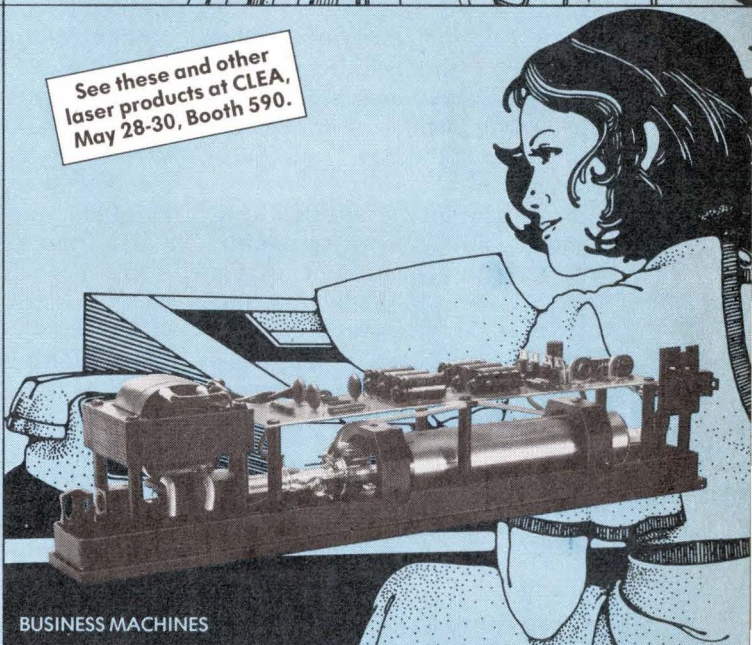

BUSINESS MACHINES

See these and other  
laser products at CLEA.  
May 28-30, Booth 590.

There are several companies who can sell you helium-neon lasers. Including us. But there aren't many who will roll up their sleeves and design and manufacture a complete laser subsystem for you. To your specifications.

And that's where we really shine. Look at what our laser subsystem offers you:

1. Simplified interface. Hughes integrates the laser, optics and electronic components for you.

2. Reliability through extensive testing. Products are tested over the environmental extremes during the design phase and prior to shipment.

3. Interchangeability. Our pre-aligned subsystems make field replacements easy.

4. Operation from either standard line voltage or battery voltage — all high voltages are inside package.

5. Options galore. Modulatable outputs, water-tight seals, ultra-rugged construction, beam-forming optics, output power stabilization, mechanical shutters.

If you have an OEM requirement for hundreds, or thousands, of subsystems, call us about your requirements: (213) 534-2121, extension 2446. Or write: Hughes Electron Dynamics Division, 3100 W. Lomita Blvd., Torrance, Calif. 90509.



Circle 45 on reader service card

a 256-bit universal asynchronous receiver-transmitter; the IM6312, a 1,024-by-12-bit read-only memory; the IM6400 family of parallel interface elements; the IM6551, a 256-by-4-bit random-access memory; as well as a C-MOS first-in, first-out memory/buffer for modem-based systems. Two other parts, the IM6508, a 1,024-bit RAM, and the IM6523, a 256-bit RAM, are already available.

**No guard rings.** Using a silicon-gate, rather than a metal-gate, C-MOS process, Intersil engineers have virtually eliminated the space-hogging guard ring structures normally needed to separate n- and p-channel elements. The resulting 1-k RAM chip measures 142 by 174 mils, about the size of a 256-bit RAM using guard rings.

The CPU chip is not much larger, about 163 by 178 mils. Yet it holds six 12-bit registers, a programmable logic array to generate control signals, an arithmetic-and-logic unit, and the timing circuitry. "The IM6100 is a single-address, fixed-word-length, parallel-transfer microprocessor using 12-bit, two's complement arithmetic," says Hammer.

There are many applications, Hammer points out, where double-precision arithmetic must be used in 8-bit machines. "A 12-bit machine provides straightforward memory referencing and sufficient numerical accuracy without the large memory overhead associated with 16-bit architectures," he says.

**Calculated move.** But what makes Intersil's 12-bit decision a carefully calculated marketing move is that the system will emulate the machine organization and instruction set of the TTL-based PDP-8E minicomputer built by Digital Equipment Corp.

Both the interrupt structure and the memory-handling capacity of the IM6100 are compatible with the PDP-8E. It can address up to 4 kilobits of basic memory directly, and the memory capacity can be expanded to 32 kilobits by external hardware. In addition, it has a one-cycle direct memory access similar

to other microprocessors. Where the PDP-8E takes 2.4 microseconds to add two 12-bit words, the IM6100 takes 5  $\mu$ s at 5 volts and 2  $\mu$ s at 10 v.

The advantages of C-MOS extend beyond 12-bit minicomputers, and Intersil does not plan to limit itself, says Hammer. "We've also been looking at the PDP-11," he points out. "Eighteen months ago we didn't see any way of putting a C-MOS version of the PDP-11 CPU on one chip. But what we've done with the 8E, and subsequent work, indicates it is a definite possibility in the near future." □

## ECL processor line comes in blocks

As its third entry into the hot chip-processor market, Motorola's Semiconductor Products division is reading a family of fast emitter-coupled-logic devices that can be configured to form many levels of computers. The new M10800 family is not competing with earlier Motorola units—the M6800 n-channel MOS family, now on the market, and the M5800 emitter-follower family for military applications, made with masks from TRW Systems.

The new devices, announced at the National Computer Conference in Anaheim [*Electronics*, May 15, p. 29], are for high-performance applications. Instead of a single-chip construction, the circuits are divided into functions Motorola hopes will give maximum versatility. Jack L. Burns, manager of bipolar strategic planning at the Phoenix, Ariz., division, says that defining the functions for wide applicability was a major problem.

**Standardizing.** "We need standard LSI functions. It didn't make sense to have faster gates because interconnections would have limited speed. A lot of the arrangement resulted from work with the mainframe industry, but we've made the functions as flexible as possible." He sees application in top-of-the-line minicomputers, scientific computers, high-speed test equipment, military

and communications systems.

The first member of the family will be the basic 4-bit processor slice, the MC10800, which can be stacked horizontally to make 8-, 16-, 32-bit or wider computers. Samples of the part will be available in early 1976. Other members of the family are the MC10801 control function, MC10802 timing function, MC10803 slice/memory interface, and MC10804 slice look-ahead.

This set of parts, plus compatible MECL 10,000 memory and logic circuits, forms a small processor. A minimum 16-bit system contains 10 packages plus memory. Instructions can be in the hundreds. Speed is dependent on configuration, but can be three to 10 times that of MOS microprocessors. The system delivers 55-nanosecond microinstructions.

The MC10800 arithmetic/logic unit has full binary and BCD arithmetic, with two bidirectional ports and one unidirectional port, permitting it to handle three variables. Other features are look-ahead carry, all logic functions for each port, right and left logic and arithmetic shifts, a master-slave accumulator for temporary storage, parity outputs, and full masking to a 1 or 0 bit.

The parts use an unusual low-cost 48-pin quad in-line package that fits in the same area as a standard 24-pin package, saving space and reducing propagation delay between chips. Half the pins on each side are extended beyond the others before bending. They are on 50-mil centers, but with 100 mils between each pin. Package dissipation is 1.3-watt typical, with -5.2- and -2-v power supplies. □

## Solid state

### IBM puts 8 kilobits on 1.76-mm<sup>2</sup> chip

It's still experimental, but an IBM effort that has produced a dense, fast 8,192-bit n-channel memory device could show the way to even tighter packing by combining electron-

the small camera  
with big potential -

## Fairchild MV-101 All Solid-State CCD TV Camera

### Laboratory to Marketplace...

Fairchild's MV-101 Television Camera has moved charge-coupled device (CCD) solid-state technology from the laboratory to the marketplace.

### Proven Performance...

Since its introduction in 1974, the MV-101 has proven its capability in a variety of applications in many diverse industries throughout the world. The camera's ultra small size, versatility, and high performance have demonstrated the advantages of solid-state imaging for a wide range of commercial, industrial and military uses.

### Advanced Features...

The MV-101 Television Camera uses a 100 x 100 element CCD array. It operates with standard closed-circuit TV receivers, suitably modified, and with video recorders. MV-101 key features include:

- **ULTRA SMALL SIZE**  
2-7/8" diameter, 1-7/8" deep,  
weight—11 oz. (less lens)
- **HIGH SENSITIVITY**  
0.2fc scene illumination (incand.)
- **IR SENSITIVITY**  
silicon response characteristics
- **LOW POWER**  
1.5 watts continuous at 15 VDC
- **SOLID-STATE RELIABILITY**  
low maintenance design

### Available NOW...

The MV-101 is priced at \$4000, including a monitor and power supply, and is available for immediate delivery.

### What is your application?

If solid-state imaging with advanced features and high performance is your requirement, consider the MV-101. For further details, contact Security and Surveillance Marketing (516) 931-4500, Ext 369.

MV-101  
(2-7/8" dia. x 1-7/8" deep)  
mounted on mini-tripod

**FAIRCHILD**  
CAMERA AND INSTRUMENT  
CORPORATION  
FEDERAL SYSTEMS GROUP

## SECURITY AND SURVEILLANCE SYSTEMS

300 ROBBINS LANE, SYOSSET, NEW YORK 11791  
TEL: 516 WE 1-4500 TWX: 510-221-1836

SELECTED AREAS ARE STILL AVAILABLE FOR U.S. DISTRIBUTION OF THE FAIRCHILD TV CAMERA LINE.

Circle 47 on reader service card

E-5-29-75

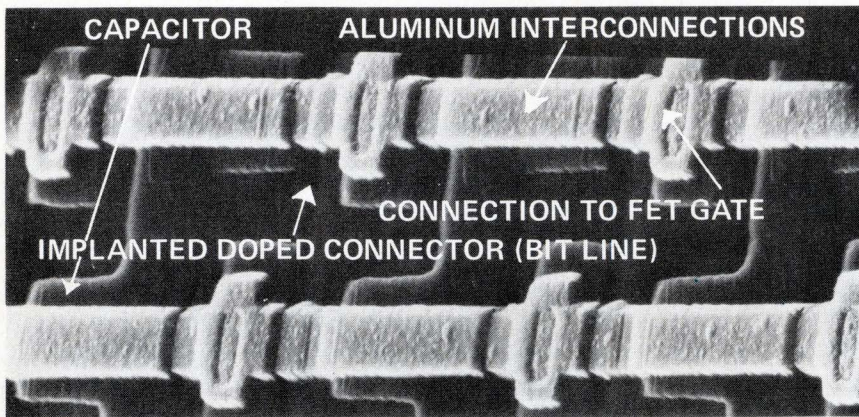

**Lay of the land.** The vertical light-color lines shown in this scanning electron micrograph are about 2.3 micrometers wide. Electron beam lithography gives fine geometry.

beam lithography with ion implantation. In fact, IBM scientists foresee no obstacle to early development of a 16,384-bit version because of the fine geometries they've achieved.

IBM now has in its lab an 8-kilobit chip measuring 1.1 by 1.6 millimeters. That's equivalent to 5 million bits per square inch, 10 times denser than existing memory arrays of similar size. Line widths are 1 to 1.5 micrometers; optical lithography typically can produce widths of 4 to 5  $\mu\text{m}$ .

Still, the researchers claim they can further reduce their widths to 0.5  $\mu\text{m}$ , which would assist in getting them to the 16-kilobit device density in essentially the same area required for the 8-k unit they have operating.

Sticking with the IBM-invented memory cell requiring one transistor per bit, the new design uses a field-effect transistor to charge a capacitor (actually a surface-inversion layer) to store one bit of information. And, although it wasn't operated as a memory in a system, the fully decoded chip had an access time of 90 nanoseconds when tested dynamically at 7 volts.

The FETs are n-channel devices with channel regions, source, and drain ion-implanted to increase control of the profile. No diffusion was used on the chip except for the polysilicon gates, which have a gate-oxide thickness of 350 angstroms. The silicon around the active devices is doped p-type by ion-implanted boron ions to achieve better isolation. □

## Employment

### EE graduates face tight job market

Graduating electrical engineers are having a tough time finding jobs this year, and it's going to get even tougher in the future. Surveys conducted by the Engineering Manpower Commission of the Engineers Joint Council indicate a steady deterioration of employment prospects for EEs. In fact, those job prospects have been declining since October, 1973, when the commission began taking surveys every six months.

Everett Teal, director of Lehigh University's placement office in Bethlehem, Pa., sees the EE job market as "very tight" this year. Of all the engineering disciplines at Lehigh, Teal says, "This is the first year that EEs came out on the short end of the stick in finding jobs." Specifically, he says some 30% of this year's crop of graduating EEs have yet to be placed.

At Massachusetts Institute of Technology, too, placement director Robert Weatherall agrees that EE job hunting is "patchy" at the moment: "there are many companies we talk with every year which haven't decided how many people they want or when. Several students have been into my office lamenting the fact that they haven't been able to make contact with any of the

companies they're interested in."

**Missing recruiters.** Two regular spring visitors to MIT have been recruiters from Bell Laboratories and Texas Instruments. But Bell Labs, which is laying off technical staff members for the first time since the Depression years, sent its regrets, and TI notified Weatherall only two weeks ago that it wouldn't pay MIT a visit until July.

Anne Marie Weiner-Sumner, placement director at the Cooper Union for the Advancement of Science and Art in New York City, called EE placements "the worst we've seen in 10 years. It took longer to place people and we had to do extra things, like contacting more alumni, to help."

And the road ahead is anything but smooth. The Engineering Manpower Commission's most recent survey of the demand for EEs was taken last fall and represents the situation as it appeared to employers in October and November. But the commission notes in its recent report that the national economy has worsened since then and says that employers have curtailed their hiring plans "even more than was apparent at that time."

**Where to look.** Although immediate hiring prospects are "rather poor" for EEs in most specialties, the commission indicates that prospects for the year ahead are above average in a few fields, such as instrumentation, communications, and computers. The outlook is "very poor" in microwave, solid-state, and management areas. The report does, however, identify communications, computers, and solid-state as fields in which advanced-degree holders enjoy a high concentration of employment. □

## Computers

### Honeywell-Bull merges with CII

Eleventh-hour rescues, bankruptcies, and merger schemes are nothing new for Europe's battered





# 15V CMOS specs are not for everyone

Just about everybody says their CMOS operates up to 15 V, or above. They don't say *how* their CMOS operates at that level. Only Motorola's McMOS\* is actually described with min and max specifications at 15 V, plus 5 V and 10 V, too.

These are specs you can design to for maximum speed and maximum noise immunity. And, the meaning of these 15 V specs extends beyond 15 V applications. McMOS can be used with full confidence at or anywhere in between maximum voltage ratings, because the designer knows exactly what to expect. Confidence like this is justified. We publish 15 V specs because that's the way we test McMOS.

No, 15 V CMOS specs are not for everyone, but they do benefit you. Only Motorola supplies them.

**Better noise immunity specs, too!  
Look for our footnote.**

Recent McMOS data sheets and

Sample 15 V Specifications

(From device data for the MC14022 Octal Counter/Divider) Switching Characteristics	Symbol	V <sub>DD</sub> Vdc	Min			Max		Unit
			AL Device	CL/CP Device	Typ All Types	AL Device	CL/CP Device	
Output Rise Time (C <sub>L</sub> = 15 pF)	t <sub>r</sub>	5.0	—	—	70	175	200	ns
t <sub>r</sub> = (3.0 ns/pF) C <sub>L</sub> + 25 ns		10	—	—	35	75	110	
t <sub>r</sub> = (1.5 ns/pF) C <sub>L</sub> + 12 ns		15	—	—	25	55	80	
t <sub>r</sub> = (1.1 ns/pF) C <sub>L</sub> + 8 ns								
Maximum Clock Frequency	PRF	5.0	2.5	2.0	5.0	—	—	MHz
		10	7.0	5.0	12	—	—	
		15	9.0	6.7	16	—	—	

the new McMOS Data Book have an important footnote to noise immunity specs. The message applies equally to all McMOS devices, and it says "Noise immunity specified for worst case conditions". Worst case conditions are, in this case, all inputs switching randomly and regardless of input conditions. The devices will have to work under those conditions in systems, so that's the way we test them.

Add superior specs to leadership in MSI, broadest functional coverage, leading-edge pricing (down with

the TTL it replaces so nicely), and formidable reliability. No wonder McMOS is the standard for new CMOS designs.

A batch of diverse useful information on McMOS has been collected into one 40-page brochure called the "McMOS Idea Book". Address your request to McMOS Idea Book, Motorola Semiconductor Products Inc., P.O. Box 20912, Phoenix, AZ 85036, or circle the reader service number.

\*Trademark of Motorola Inc.



**MOTOROLA McMOS**  
- complementary MOS for contemporary systems

# High-Q Tunable Filter



The EDMAC Hi-Q Tunable Filters are general purpose active filters which can be used in either a bandpass or a bandreject mode of operation.

## FEATURES

- Tunable bandwidths corresponding to circuit Q's to 1000.
- Tunable frequencies from 1 Hz. to 30,000 Hz.
- Dynamic range to 95 db.
- Residual noise; 100 microvolts RMS.
- Independent controls for bandwidth and center frequency.
- Simultaneous bandpass and bandreject filter functions.
- Controlled input-output phase relationship.
- Zero phase shift at center frequency.
- Selectable automatic tracking.
- Circuit overdrive indication.
- Selectable calibration mode.

G.S.A. Contract #GS-005-28766  
WRITE FOR COMPLETE SPECIFICATIONS

## EDMAC Associates Inc.

333 West Commercial Street,  
East Rochester, New York 14445  
(716) 385-1440

## Electronics review

computer industry, but this month's merger of the two mainframe manufacturers in France to compete with IBM Corp. is the biggest gamble yet for independent survival. With an elaborate exchange of shares designed to calm French nationalistic passions, French computer maker Compagnie Internationale pour l'Informatique is being absorbed by Honeywell-Bull, the main overseas subsidiary of Honeywell Information Systems. Together, they will form the largest European computer company and account for 10% of the world market.

In one swift stroke, the French government's approval of the merger has:

- Crowned with success two years of effort by Honeywell-Bull president Jean-Pierre Brulé to join his money-making company with CII.
- Automatically hiked Honeywell-Bull's share of the French computer market from 17% to 37%.
- Virtually sounded the death knell for Unidata, the struggling association that combined the computer marketing and R&D arms of CII, Germany's Siemens, and Holland's Philips.

**Separated.** Says Brulé, the ex-IBM World Trade executive, "It's a bizarre accident of history that France's computer potential has been separated in two distinct companies. I always thought it deplorable that the two could not be put together. Now we have achieved it."

What had always prevented CII's merger with Honeywell-Bull has been French determination to fight foreign control. But this merger skirts that objection by providing for Honeywell Information Systems to sell 19% of its 66% ownership in Honeywell-Bull, cutting its holdings in the firm to a minority.

Honeywell-Bull thus becomes a French company that absorbs another French company, CII. This tidy arrangement apparently has satisfied political critics.

**Phase 1.** For Brulé, whose strategy is aimed at creating a counterbalance to IBM's 53% domination of Europe's computer markets, the

French consolidation is only phase 1. The two-year-old Unidata is virtually certain to collapse within the next few months because of the French *fait accompli*. But Brulé hopes to pick up the pieces. "We have made overtures to Siemens," says Brulé. "We want them to join our partnership in some form. After Siemens, we will work on Philips."

Brulé feels his formula, which calls for a fully integrated pan-European company rather than a loose association, is the answer for the survival of the Europeans. □

## U. S., IBM square off in antitrust trial

Any way you look at it, the Justice Department's civil antitrust suit against IBM Corp. evokes a mass of superlatives: six years in the making, the largest antitrust action ever undertaken by the Justice Department, is bound to be a landmark. It finally went to trial last week in Federal Court in New York City.

There were few surprises as the trial began to unfold before Chief Judge David N. Edelman, who will be the sole arbiter. Justice Department attorneys, led by Raymond M. Carlson, say they will prove that IBM has monopolized what Carlson carefully calls the "general-purpose systems market," and which he defines as central processing computers, peripherals, software programs, and services.

**Barriers.** In his opening remarks, Carlson said he will show how IBM "presented its competitors with major barriers to growth" through various alleged means—from bundling its systems into single pricing packages to keep customers from buying competitive products and offering educational discounts to large, prestigious institutions to the use of so-called "fighting machines." These are computers—mainly System/360s—which Carlson claims IBM announced well ahead of their readiness for the market. He says this was done to forestall customer con-

Prices on the  
**'BRIGHT ONES'**  
 reduced 27%



**CHERRY**

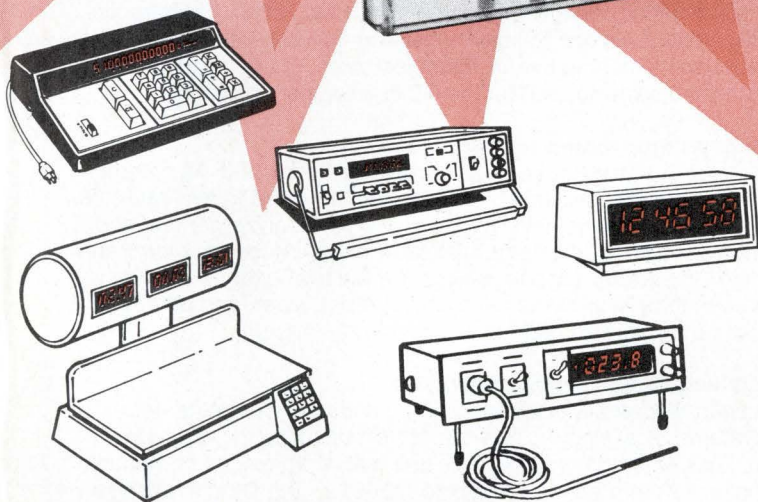

the newest Gas Discharge Digital Display Panels...with all the features you've been looking for . . . now cost even less!

- Lighted digital readouts with . . .
- Halo effect backlight gives a more continuous line for greater visibility and clarity
- Greater contrast
- Flicker-free uniform brightness
- Large, 0.40" high size digits are readable from distances of up to 25 feet
- Neon orange color that is easy on the eyes, readily filtered
- Low power ratio to character size (typically 7 mw. per segment)
- And, they're totally interchangeable with the panels you are now using
- Low cost per digit
- Also available: Custom designs in from 3 to 16 digit formats.

CALL OR WRITE FOR COMPLETE SPECS...AND NEW LOW PRICES.  
 TWX 910-235-1572...or PHONE 312-689-7700...or circle the reader service number.

**CHERRY**



CHERRY ELECTRICAL PRODUCTS CORP.

3608 Sunset Avenue, Waukegan, Illinois 60085  
 Circle 51 on reader service card



# SWITCHING POWER SUPPLY



HR0510

High Efficiency

Compact and Lightweight

Competitive Price



ELECTRICAL CHARACTERISTICS HR0510

Output	5V10A
Efficiency	74%
AC Input voltage	117V±10%, 220V±10%
Line Regulation	±0.2% or less
Load Regulation	±0.2% or less
Ripple & noise (max)	40mV (p-p)
Overload protection	Current Limit Type
Overload protection	Signal Inhibit Type
Output on/off control level	TTL
Withstand voltage	1.5KV AC for one minute
Isolation resistance	100MΩ or more at 500V DC
Temperature rise	30°C or less
Ambient temperature range (operating)	0-50°C
Temperature coefficient	0.02%/°C
Weight	1.7 Pounds
Size (WxHxD)	1.77"x4.72"x7.87"

HR0510 • HR0520 • HR0530 • HR0905  
5V 10A 5V 20A 5V 30A 9V 5A

HR1204 • HR1506 • HR2406  
12V 4A 15V 6A 24V 6A

Corporations interested in acquiring the right to manufacture our products introduced above, please contact:

**NEMIC**

**Nippon Electronic Memory Industry Co., Ltd.**

1-20-1, Sendagaya, Shibuya-ku, Tokyo  
151, Japan Tel: (03) 478-3935  
Telex: 3862-405 NEMIC J

## Electronics review

sideration of competitors' machines, even though IBM knew in advance that little or no profit would be made from the "fighting machines."

IBM attorney Thomas D. Barr from Cravath, Swaine & Moore of New York City, however, says he will prove IBM hasn't had monopoly power or ever intended to possess it. Barr says he intends to call up to 134 customers as witnesses who will

testify that "they weren't led down the garden path" by IBM.

Perhaps setting the tone for the trial, Justice Department lawyers declined an offer by the computer firm's counsel to share the cost of an IBM copier. When IBM attorneys chose not to pay the full cost of using the copier for trial documents, attorneys for both sides decided to lease their own machines. □

## News Briefs

### GE develops Electron-beam memory

General Electric Co. has developed a 32-million-bit, electron-beam-addressed MOS memory with an access time of 30 milliseconds and a transfer rate of 10 million bits per second. Key elements of the device are the semiconductor target and a matrix of electron "lenslets" that direct a cathode-ray beam to read, write, or erase at precise memory sites on four silicon chips, each 15-millimeters square, all housed in a vacuum module. Similar devices by Micro-Bit Corp. of Lexington, Mass., are being tested by Control Data Corp.'s Advanced Design Laboratory, St. Paul, Minn. [Electronics, May 1, p. 36]. Also, Stanford Research Institute delivered its version of a beam-addressable memory to the Air Force last year. The Army Electronics Command provided some support for the GE development project.

### RCA studying 'no drop' bomb scoring

RCA's missile and Surface Radar division in Moorestown, N.J., is conducting a five-month study for the Naval Air Systems Command to evaluate "no drop" bomb-scoring systems. Initially, the study will analyze general scoring situations and include effects of multipath, changing beam width, and greater choice of tracking parameters for low-altitude exercises. Simulations will be used to determine the capability of radar, laser, and other position-measurement sensors to perform bomb-scoring missions.

### Modular data-acquisition system activity up

There have been few recent additions to the catalog of complete data-acquisition systems in a module. But almost simultaneously, Burr-Brown, Tucson, Ariz., has entered the field with a unit that is pin-for-pin compatible with the pioneer in the area, the Analogic MP6912, and Data Translation has announced a new DT5700 series that differs from its earlier DT1600 series in only one important respect; it has tri-state outputs, to make it easier to interface with microprocessors.

### National Semiconductor readies converters

Look for National Semiconductor Corp. of Santa Clara, Calif., to begin making digital-to-analog and analog-to-digital converters in large numbers. From a virtually zero product position, it will, by the end of this year, have 14 families of converter devices covering 85% of the existing market—at prices that it says are 20% to 60% below present ones. National's first product, available next month, will be an ion-implanted p-channel monolithic a-d converter. Key specifications are 8-bit resolution within half a least significant bit, 30-microsecond conversion time, and a clock range from 5 to 500 kilohertz.

### Bell to use bubble memory in repertory dialer

At a cost of 10 to 20 millicents a bit, the Bell System plans to use a magnetic bubble memory in a repertory dialer in the near future. Plans also include bubbles in voice-message recorders, mass storage in electronic switching systems, and as replacements for paper and magnetic tape, says John A. Hornbeck, vice president for electronics technology at Bell Labs.

# meet the all american carbon film resistors only from Piher!



... With performance to beat all at prices to beat all, too!

Resistance values locked on target. Minimum noise. Fine tolerances. Uniformity to guarantee high reliability. Toughness to preserve precision, beat heat and humidity extremes . . .

When you're absolute about quality, but resolute about lowest price, call for Piher. Because the all ahead price/performance ratio of Piher Carbon Film Resistors is fact — not talk. Whether you compare with carbon comps or competitive carbon film.

Only Piher All American Carbon Film Resistors are manufactured here. In the U.S.A. Using quality control, computerized mass production techniques producing nearly 1 billion resistors a year for domestic markets.

So there's no question. Availability is immediate. Off-the-shelf in quantity from Piher Distributors. Nationwide.

Choose values from 10 ohms to 10 meg, specify 1/4W, 1/2W, 1W and 2W wattage styles. Select tolerances to fit your design: 2%, 5% and 10%. And figure on the important built-in features to enhance your electronics. Get complete details on the All American Carbon Film Resistors from your Piher Distributors, now.

## All American Features

- Temperature Cycling: 5 cycles at -55°C to +125°C.  $\Delta R$  will not exceed 1%.
- Load Life: 1000 hours at 25°C at rated voltage.  $\Delta R$  is less than 2%.
- Temperature Coefficient: Begins at -200 ppm per degree C.  Minimum Noise: Less than .5 $\mu$ v/v at 10K ohms!  Shelf Life: 4 times longer than carbon composition!  Moisture Resistance: 6 times greater than carbon composition.  Tough, multilayer encapsulant maximizes environmental protection.  Advanced Precision Design. Homogenous carbon deposited on high quality ceramic cores, spiral cut for precise resistance values at tolerances of 2%, 5% and 10%.

Advanced quality for the least cost . . . by design.



## PIHER Corporation

Electronic Components

399 Washington St. (On Rte. 128), Woburn, Mass. 01801  
(617) 935-8750 Telex 94-9382

USA Corporate Headquarters and Manufacturing Facilities

### Distributors

Acacia Sales, Inc.  
384 San Aleso Avenue  
Sunnyvale, California 94086  
Telephone: (408) 735-0100  
TWX: (910) 339-9268

Acacia Sales, Inc.  
11111 West 8th Avenue  
Lakewood, Colorado 80215  
Telephone: (303) 232-2882  
TWX: (910) 937-0731

Arrow Electronics  
Pleasant Valley Avenue  
Noorstown, N. J. 08057  
Telephone: 215-928-1800  
609-235-1900

Baldwin Component Center  
2 E. Sawwood  
Deer Park, L.I., New York 11729  
Telephone: (516) 586-2230

Components Center, Inc.  
1240 "E" Logan Avenue  
Costa Mesa, California 92626  
Telephone: (714) 979-0433

Edmar Electronics  
1275 Rand Road  
Des Plaines, Illinois 60016  
Telephone: (312) 298-8580

Electra-Distributing Co.  
1914 West End Avenue  
Nashville, Tennessee 37203  
Telephone: (615) 329-3971

Future Electronics Corp.  
225 Worcester Road  
Frammingham, Mass. 01701  
Telephone: (617) 879-0860

Kirkman Electronics  
Drawer K - Salem Station  
901 West 2nd Street  
Winston-Salem, N. C. 27108  
Telephone: (919) 724-0541

Masline Electronics  
511 S. Clinton Avenue  
Rochester, New York 14607  
Telephone: (716) 546-5373

Newark  
P.O. Box 4217  
Inglewood, California 90307  
Telephone: (213) 678-0441

Norvell  
10210 Manor Drive  
Dallas, Texas 75220  
Telephone: (214) 350-6771

OHM Electronics  
649 Vermont Avenue  
Palatine, Illinois 60067  
Telephone: (312) 359-5500

Park Electronics  
2206 Edgewood Ave. South  
St. Louis Park, Minnesota 55426  
Telephone: (612) 925-3118

Powell Electronics  
411 Fairchild Drive  
Mountain View, California 94040  
Telephone: (415) 964-0820

QAR Industries  
621 S. Columbus Avenue  
Mt. Vernon, New York 10550  
Telephone: (914) 699-2224

Scott Electronic Supply Corp.  
P.O. Box 4467  
Lincoln, Nebraska 68504  
Telephone: (402) 464-8308

Sheridan Associates, Inc.  
P.O. Box 37826  
Cincinnati, Ohio 45222  
Telephone: (513) 761-5432

Slate Electronics  
36 Route 10  
Hanover, New Jersey 07936  
Telephone: (201) 887-2550

Taylor Electric Co.  
P.O. Drawer 11N  
Milwaukee, Wisconsin 53201  
Telephone: (414) 241-4321

Semad Electronics Ltd.  
1111 Finch Avenue, West  
Suite #102  
Downsview, Ontario  
Telephone: (416) 635-8980

Wilshire Electronics/Connecticut  
2554 State Street  
Hamden, Connecticut 06517  
Telephone: (203) 281-1166

Wilshire Electronics/New England  
One Wilshire Road  
Burlington, Massachusetts 01803  
Telephone: (617) 272-8200

Wilshire Electronics/New York  
617 Main Street (Westover Plaza)  
Johnston City, New York 13790  
Telephone: (607) 797-1236

Wilshire Electronics/Philadelphia  
855 Industrial Highway (Unit 5)  
Cinnaminson, New Jersey 08077  
Telephone: (215) 627-1920

(609) 786-8990  
Zepher Electronic Sales  
647 Industry Drive  
Seattle, Washington 98166  
Telephone: (206) 242-2517

### Piher Offices

Western Region  
143A Shaker Road  
East Longmeadow, Mass. 01028  
Telephone: (413) 525-4741

District Office  
1239 Rand Road  
Des Plaines, Illinois 60016  
Telephone: (312) 297-1560  
Telex: 28-2514

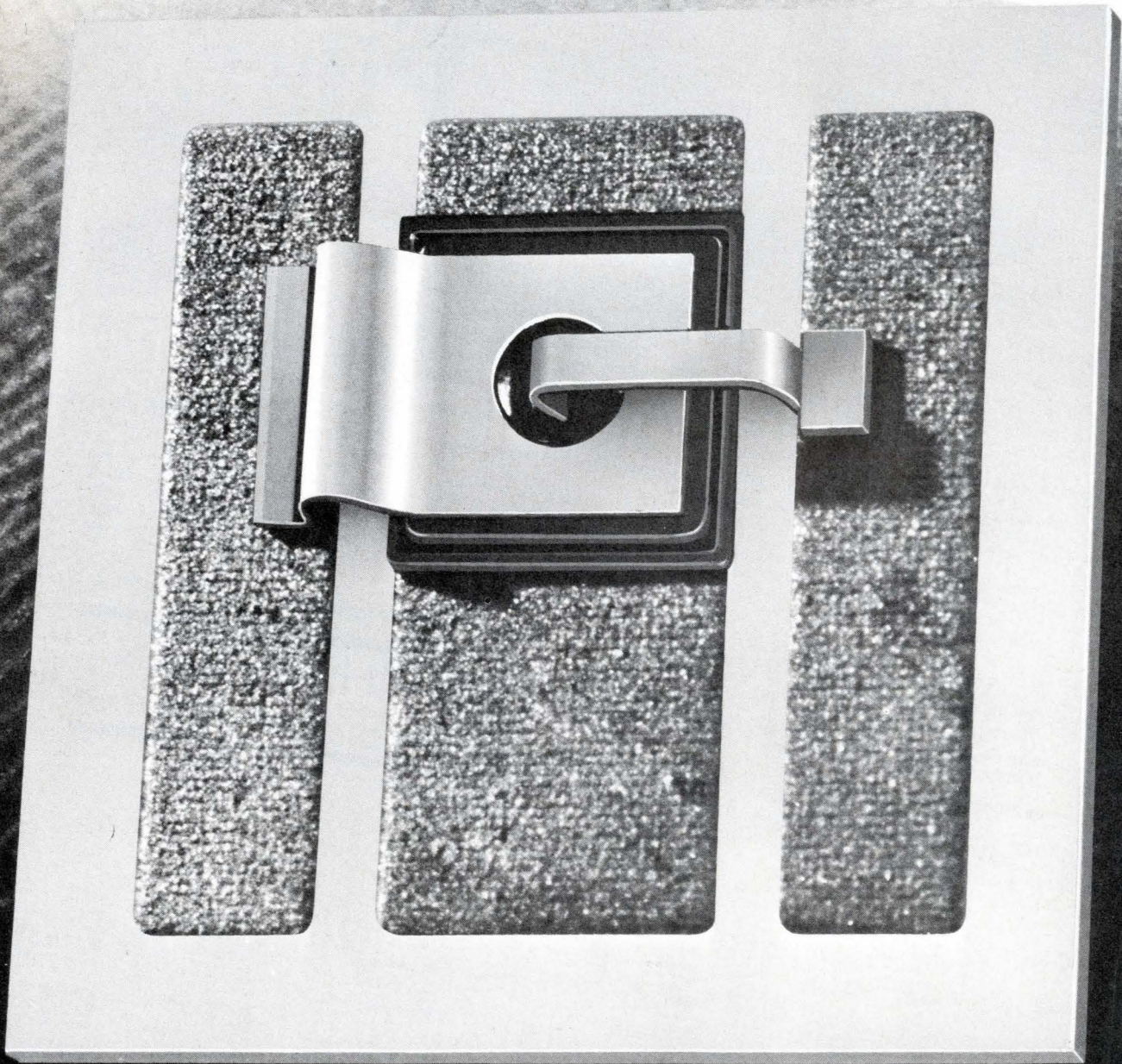

# Introducing ChipStrate™ power SCRs and triacs.

## The reliability of a package for the price of a chip.

We take a glass-passivated chip (a power SCR or triac), mount it on a solderable ceramic substrate, test it and specify it. That's a ChipStrate.

**Save a bundle over conventional components.** Because we've eliminated the expensive metal package, ChipStrates cost up to 40% less than packaged devices. And they take up a good deal less space on the board.

**Improve the reliability of your circuit.** ChipStrates come with the same guaranteed performance specifications as a packaged device. And due to their improved thermal design, they can handle more power, more reliably than either a packaged device or a chip.

**No special equipment, no risks.** ChipStrates are complete devices — attach

™ChipStrate is a trademark of Unitrode Corporation.

them to a heat sink or directly onto thick-film metalization. No need for a heavy investment in capital equipment, no worries about yield, none of the problems associated with unmounted chips.

### Send for our free brochure.

ChipStrate SCRs and triacs are available in currents from 1A to 55A and in voltages up to 600V. Our brochure tells the whole story. Just circle our number on the reader service card. Unitrode Corporation, 580 Pleasant Street, Watertown, Mass. 02172.

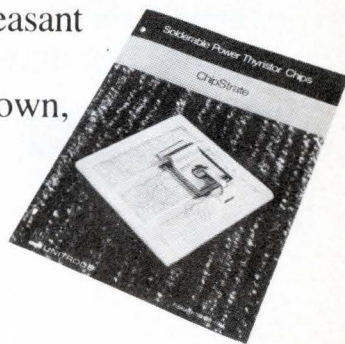

 UNITRODE

# Industry standards... Seven cermet trimmers that can.

## How?

- Through design versatility
- Fast delivery
- Excellent quality

## Necessary Decisions:

1. Single vs. multiturn
2. Sealed vs. not sealed
3. Size
4. Resistance
5. Pin spacing
6. All-important, PRICE

**Take a close look before you select your next trimmer. Call your local Beckman Helipot distributor for free evaluation samples, or immediate technical literature.**

**Beckman**  
HELIPOT DIVISION

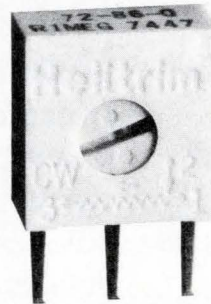
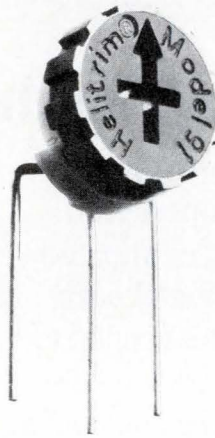

## Single-turn

### Model 91

- High quality — low price
- Unique brush contact
- Excellent setability
- 100% inspected
- Protective dust cover
- Top or side adjust
- Screwdriver or hand adjust
- Standoffs prevent rotor binding and permit board washing
- Small  $\frac{3}{8}$ " dia. size
- 12 pin configurations
- Wide resistance range: 10 $\Omega$  to 2 meg $\Omega$

**Price: \$0.42\***



### Model 72

- Sealed for board washing
- Available in VALOX 420-SEO housing
- Top or side adjust
- Brush contact
- Excellent setability
- Only 2 ohms of end resistance
- $\frac{3}{8}$ " square
- 100% inspected
- 7 pin configurations
- 19 resistance values

**Price: \$0.54\***



### Model 82

- Lowest profile trimmer in industry
- $\frac{1}{4}$ " dia. by 0.150" max. height
- Sealed for board washing
- Flame-retardant design
- 82P — top adjust
- 82PA — side adjust
- 100% inspected
- Brush contact provides excellent setability
- A cermet benefit that wirewound can't approach: resistance range 10 $\Omega$  to 1 meg $\Omega$

**Price: \$1.12\***



**★ Still waiting for delivery on trimmers from another manufacturer?**

**Call your local Beckman Helipot distributor for a convenient cross reference from stock.**



# handle 95% of your applications.

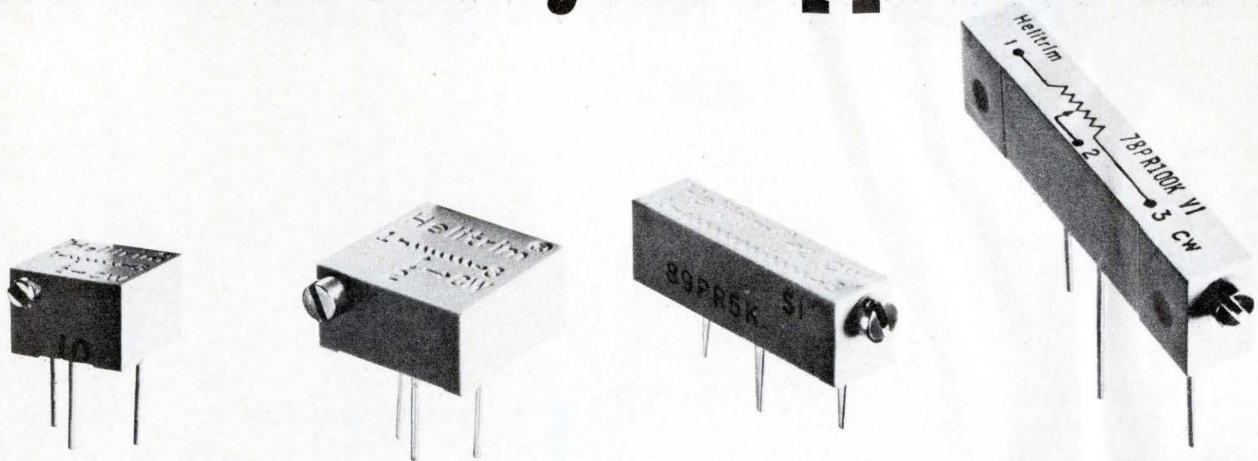

## Multiturn

### Model 64

- Miniature, sealed trimmer
- 22 turns of adjustment
- Operates with 0.25 watt at 85°C derating to zero watts at 150°C
- 100% inspected
- 18 resistance values: 10Ω to 1 megΩ
- ¼" square size is excellent for P.C. board packaging
- Uses Beckman's unique brush contact design
- Adjustability — voltage ratio within 0.01%

**Price: \$4.20\***



### Model 66

- Low-cost, multiturn with benefits of more costly trimmers
- Sealed for board washing
- 20 turns for adjustment accuracy
- Compact ⅜" square housing
- Brush contact
- 3 pin styles for efficient space utilization
- Broad resistance range: 10Ω to 2 megΩ
- Operates with ½ watt at 25°C
- 100% inspected

**Price: \$2.70\***



### Model 89

- Our lowest cost multiturn
- Sealed for board washing
- ¾" rectangular trimmer just 0.250" high
- Needs no O-ring because of our unique ultrasonic sealing technique
- Only 2 ohms of end resistance
- 15 turns for accurate and quick adjustment
- 3 pin styles for mounting versatility
- Panel mount available
- 100 ppm/°C tempco
- 19 resistance values available
- 100% inspected

**Price: \$1.05\***



### Model 78

- Military performance at industrial prices
- 1¼" rectangular only 0.195" wide
- Sealed
- 3 terminal styles: Flex leads, Printed circuit pins, Solder lugs
- Panel mount available
- Power rating 0.75 watt at 70°C
- 100% inspected
- 22 turns of adjustment
- Resistance range: 10Ω to 2 megΩ
- 100 ppm/°C tempco

**Price: \$2.28\***



\*1,000-piece price

# Do professional 1K n-channel static RAM buyers know something you don't?

At first, it looks like all 1K n-channel static RAM suppliers supply just about the same thing.

Not at all.

The more you buy, the more you come to appreciate the advantages of buying your 2102 (1024x1) and 3538 (256x4) devices from Fairchild.

## The 5 little known secrets of big-time static RAM-buying.

What kind of advantages? Well, for example:

### 1. Reliability.

Other suppliers may equal Fairchild in price and economy. But for the same price other suppliers deliver in plastic, *Fairchild delivers in hermetically sealed ceramic packages.*

### 2. Speed vs. power.

There are other suppliers who emphasize their fastest 2102 device. And in fact, some are actually faster than those we now offer at Fairchild. But if you look at our product matrix and find a device that is sufficiently fast to meet your requirements, you'll be gratified to discover that *Fairchild devices deliver the lowest speed-power product in the industry.*

### 3. Power down. And up.

Fairchild's power down spec meets the industry standard — 1.6V for 32mV dissipation. But no one else in the industry can power up as fast as Fairchild. On the 2102, *Fairchild delivers a slew rate*

*of 100v/ $\mu$ s,* followed by access in 100ns.

### 4. MIL spec.

If you're interested in MIL spec, of course, here's another little-known fact. *Fairchild can deliver any 2102 device (in flat pak, too) to full Mil/hi-rel standards — both processing and temperature range.*

And our 3538 is the only 256x4 RAM available at MIL temp specs —

as well as MIL 883 level B processing.

### 5. Delivery.

Last but not least, other suppliers may come and go. But Fairchild has eighteen 2102/3538 devices available today to meet your requirements — all processed with Fairchild's high-yield, high-density Isoplanar technology. Which means *Fairchild delivers what you want, when you want it.*

When you put all these reasons together, you can see why people who

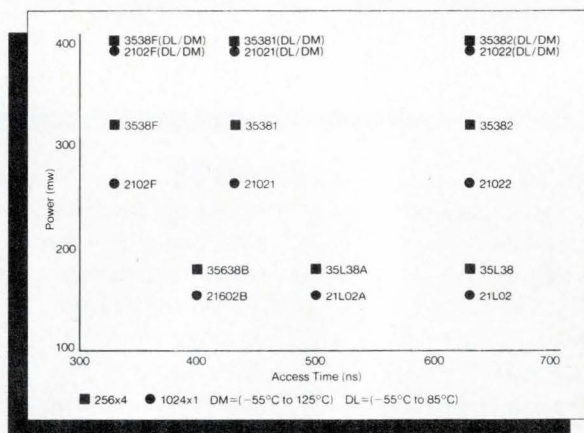

Speed vs power matrix of Fairchild 1K n-channel static RAMs

buy a lot of static RAMs, buy a lot from Fairchild. No. 1 for memory.

Write or call your Fairchild Sales Office, Distributor or Representative today. Would you want to buy from anyone else?

Semiconductor Components Group, Fairchild Camera & Instrument Corp., 464 Ellis St., Mountain View, CA 94040, Tel: (415) 962-5011 TWX: 910-379-6435

**MADE IN FAIRCHILD**  
**No. 1 for logic and memory.**

### **Pentagon slows avionics schedule for Air Force F-16**

The Pentagon, determined to hold down costs of the General Dynamics Corp.'s F-16 lightweight fighter for the Air Force, **has set a fly-away cost of \$4.5 million per plane and slowed the avionics development schedule by separating it from that of the aircraft.** "If the reliability goals for the full avionics system are not substantiated," warns Defense Research and Engineering Chief Malcolm R. Currie, "F-16s with an austere avionics package will be produced." The actions by the Pentagon's Defense Systems Acquisition Review Council (DSARC) came after the group was told by DOD analysts that F-16 unit production costs could climb to \$5.6 million. Internal Air Force estimates had put fly-away costs at \$4.7 million [*Electronics*, Apr. 17, p. 36].

The DSARC cost target, expressed in fiscal 1975 dollars, is **based on a buy of 650 planes at a maximum production rate of 10 a month to start, rising with a learning curve to 15 a month.** Air Force officials say the new fly-away cost goal may set back plans to make the F-16 an all-weather fighter from the start.

### **Brookings study says SCCs facing monopoly threat**

Specialized common-carriers like Datran and MCI "may be transitory," according to a new economic study by the Brookings Institution. "If the new technologies, lasers and waveguides, prove efficient, the minimum efficient scale in intercity communications will vastly increase," explains Leonard Waverman of the University of Toronto faculty in the report. As a result, **American Telephone & Telegraph Co.'s "natural monopoly may return"** since it will have the economic and technological advantage in a competition that "will center on how to innovate most rapidly."

Waverman's conclusions are contained in one chapter on intercity telecommunications in the 397-page Brookings volume titled, "Promoting competition in regulated markets." Ten other chapters researched and written by members of the academic community deal with regulation in banking, electric utilities, civil aviation, rail and truck transport, securities and insurance.

### **FAA to require X-ray checks at foreign airports**

Responding to congressional pressure, the Federal Aviation Administration is ready to require inspection of hand luggage and of passengers boarding aircraft overseas for flights to the U.S. **About 1,000 X-ray inspection systems will be required at busy international airports in Europe, Asia and elsewhere,** industry sources indicate. Many airports, from Australia to Austria, have already begun looking for suitable equipment, sources say.

Meanwhile, the State Department has been called in to calm foreign governments angered over U.S. infringement on foreign sovereignty, the FAA says. But the agency notes that airline self-interest alone would have prompted equipment buys to protect planes from hidden bombs and firearms. Smaller airports are expected to continue to mimic U.S. practice and conduct manual inspections by flight attendants.

## **Pacemaker deaths spur FDA summons to manufacturers**

Two deaths from faulty pacemaker systems and the recommended replacement of potentially faulty pacemakers have prompted the Food and Drug Administration to hastily call a Washington conference of pacemaker manufacturers this summer. Dates are not yet firm. Improved quality control, life-test methods, and manufacturing standards will be discussed, and officials from the National Bureau of Standards will be on hand to aid the FDA in upgrading manufacturing standards.

The FDA says "fractured" leads from the pacemakers, built by Pacesetter Systems, of Sylmar, Calif., caused the recent deaths of two children, and physicians have been advised to replace 47 other Pacesetter units implanted in heart patients. Leaking batteries in units made by Vitatron Medical Company, Dieren, Holland, have caused that company to advise physicians that 250 implanted units should be replaced.

## **Industry at odds with FAA list on buying plans**

Industry estimates are generally at wide variance with what the FAA expects to pay over the next 10 years for air-traffic-control equipment. One tentative big buy, for Discrete Address Beacon Systems (DABS) for digital communications between aircraft and controllers, is pegged by the FAA at more than \$100 million. This would buy 100 DABS for en-route ATC and 73 for terminal ATC. **There is near unanimity among industry sources that the actual DABS cost will be more than double the FAA estimate.**

The FAA also says it expects to spend more than \$600 million between 1976 and 1985 for new or improved electronic navigation and landing system hardware, including \$200 million for navigation aids, \$155 million for 380 microwave landing systems, and \$148 million for nationwide radar tracking. On these figures, industry estimates are both higher and lower. But observers agree that one FAA spending projection does seem to be in the ballpark—\$1 billion for all areas of aviation research and development by 1985, and 80% of that for hardware.

## **Westinghouse filling Iranian radar order**

Iran is beginning to take deliveries of Westinghouse Electric Corp's Air Route Surveillance Radar (ARSR), developed for the FAA but modified for use by the Royal Iranian Air Force. Meanwhile **the General Accounting Office is nearing a decision on the protest by Bendix Corp. against the FAA contract to Westinghouse for 30 ARSR systems.** Last year the low bid of just over \$41 million from Westinghouse won the competition against Bendix and Texas Instruments.

Westinghouse only acknowledges that it is making overseas deliveries of ARSR units. It is unwilling to say how many, how much, or even to identify the customer, although that is common FAA knowledge.

## **Addenda**

McDonnell Douglas will go to pilot production of the anti-ship missile Harpoon with \$21.6 million received from the Naval Air Systems Command . . . Navy has awarded \$9.6 million to Singer's Kearfott division for guidance system components for the Trident missile . . . The General Services Administration has named Theodore D. Puckorius to be government services manager for Lester B. Knight & Associates Inc. to head its automated data and telecommunications services, which oversees GSA's computer and communications procurement.

# State-of-the-Art AC Voltmeters Give You More "Measure Power" at Half the Price...



**Make us prove it...**

Send for the EVIDENCE today...  
and/or ask for a demonstration.

Buy any one of these Ballantine ac voltmeters (Model 3045A, 3046A or 3056A)\* and get even greater performance than from any two (2) of our competitor's units combined... and save more than \$400.

You'll get a rugged, line operated or portable, solid state, precision ac voltmeter that provides high accuracy, broadband (sub-audio through high frequency) ac measurements. And, it can also function as a precision-gain, wideband, ac amplifier and ac to dc converter.

Plus, Ballantine's exclusive "front panel selectable grounded or floating input" allows you to make measurements not possible with competitive, single ended units... only when floating can an ac meter be used between two off-ground ac points... only when floating can you use an ac meter as a null meter in a bridge circuit.

### Now just check these specifications:

Full scale ranges 100 $\mu$ V to 300V (3045A, 3046A); 100 $\mu$ V-1000V (3056A). ■ Bandwidth 5Hz-15MHz (useable 2Hz-20MHz); ■ Accuracy to  $\pm 1\%$  midband (3045A, 3046A);  $\pm 0.2$ dB (3056A); ■ Low pass filter; ■ Large, easy to read, long scale meter ■ Relative reference control for calibrated or variable dB reference ■ Rechargeable internal battery option.

\*3045A — linear voltage/log dB scale, 10dB step ranging; \$415  
3046A — log voltage/linear dB scale, 10dB step ranging; \$435  
3056A — log voltage/linear dB scale, 20dB step ranging; \$410



**Ballantine Laboratories, Inc.**

P.O. Box 97, Boonton, New Jersey 07005,  
Phone (201) 335-0900, TWX (710) 987-8380

*Four Decades of Innovation in Electronic Instrumentation*

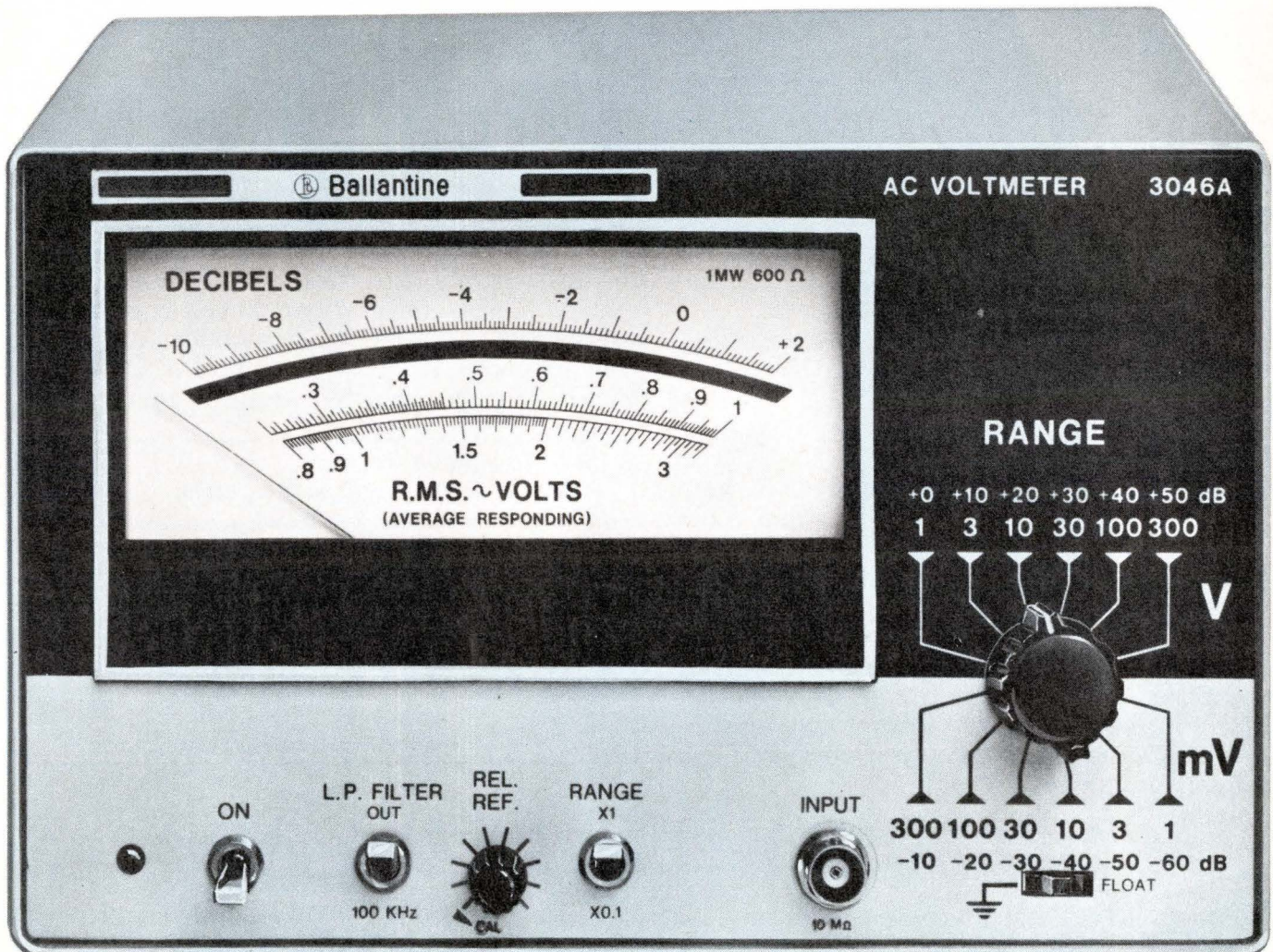

**You can buy  
this signal generator  
for a 3-month job,  
and then let it  
gather dust.**

**You can rent  
this signal generator  
for a 3-month job,  
and return it  
when you're done.**

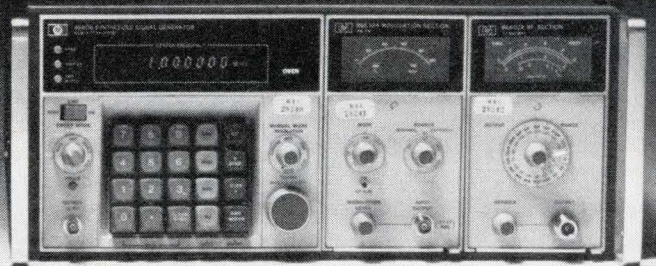
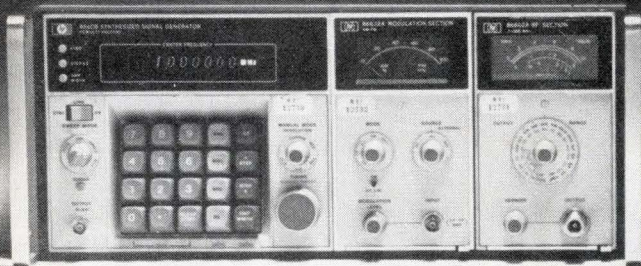

When you buy electronic test equipment for a short-term project, you're stuck with the equipment after the project is completed. Maybe it'll sit around gathering dust and costing you money. Or maybe you could sell it at a loss.

Or maybe, you should have rented it from REI.

When you rent equipment from us, you keep it only as long as you need it. When you're through with it, you send it back. Since you pay only for the time you have your instruments, you never have to spend your money on idle equipment. Short-term needs are just one reason for renting. Immediate delivery is another. Because we maintain over \$10 million in inventory in fully stocked instant inventory centers around the country, you can get delivery within hours.

REI stocks over 8,000 fully checked-out test instruments. And they're ready whenever you are. For the full story on renting as well as our low prices, send in the coupon for prompt delivery of our free illustrated catalog. Or call us now for your immediate requirements.

Rental Electronics, Inc.,  
99 Hartwell Avenue, Lexington, Mass. 02173.  
Please send me your free instrument rental catalog:

Name \_\_\_\_\_ Title \_\_\_\_\_

Company \_\_\_\_\_

Address \_\_\_\_\_

City \_\_\_\_\_ State \_\_\_\_\_ Zip \_\_\_\_\_

Tel. Number \_\_\_\_\_

**Rental Electronics, Inc.** 

A PEPSICO LEASING COMPANY

Burlington, MA (617) 273-2770 • Gaithersburg, MD (301) 948-0620 • Oakland, NJ (201) 337-3757 • Ft. Lauderdale, FL (305) 771-3500  
Des Plaines, IL (312) 827-6670 • Dallas, TX (214) 661-8082 • Mountain View, CA (415) 968-8845 • Anaheim, CA (714) 879-0561  
Rexdale, Ontario (PLC Leasing Ltd.) (416) 677-7513

# Electronics international

Significant developments in technology and business

## France triples funding of research in electronic anesthetic technique

A commitment to complete development of the world's first all-electronic anesthesia system has been made by the French Health Ministry and the country's largest electronics firm, Thomson-CSF. The system, which blocks out pain by a direct-current pulse train administered through electrodes affixed to the head, is going into all of France's 50 state-owned hospitals.

By the end of the year, they will begin using a version of the technique that calls for small doses of anesthetic drugs to be administered at the beginning of the operation. The French Health Ministry and Thomson have endorsed the once-controversial method and launched a research program to try to eliminate drugs altogether. The only funding, less than \$100,000 a year for the past four years, has come from the U.S. Army's Medical Research & Development Command.

The U.S. Army, which was interested in the method for use in field hospitals, funded the program at the Necker Hospital in Paris because it had the most advanced research program in the world. In the U.S., experiments on humans can not proceed until the Food & Drug Administration approves an application for such testing, and no one is saying if and when that approval will be sought.

The French government's tripling of the funding allows Thomson's electronics technicians to assist at Necker operations and work with new waveforms while surgery is in progress. Results are being charted by anesthesiologists and analyzed in Thomson's computer center.

**Product.** Earlier this year, Thomson started marketing Anesthelec, a \$6,000 signal generator based on the design of Dr. Aime Limoge, a dental surgeon who has been a leader in electronic anesthesia research in France for 20 years. Anesthelec is

### Around the world

#### Japanese cassette-TV system has 1-hour capacity

TV watchers in Japan can now set a timer to record their favorite television programs—color, as well as black and white—while they are away from home. Sony Corp. has added that feature and cut prices in a new videotape recorder and playback system, called Betamax, which uses ½-inch cassettes with capacities of 30 minutes and an hour. Costs were reduced by increasing the density of the recorded signals and using integrated circuits extensively. Eliminating the guard bands between the recording channels also helped to reduce the tape size to ½ in., and the tape base is only 20 micrometers thick, rather than the 27 or 30 μm used in previous systems.

Circuit costs were also reduced by using two recording heads so that processing is required only for alternate tracks. Resolution of the system is more than 240 lines for color and more than 280 lines for black-and-white pictures. The Betamax tape deck is selling in Japan for about \$785, and the tape deck plus a receiver monitor that has an 18-in. color-TV screen with 114° deflection is about \$1,540. Cassettes are \$10 and \$15 each.

#### UK's Plessey adapts IC process to I<sup>2</sup>L

Plessey Semiconductors in the UK has found that Process-3 technology, which it uses to make fast analog and emitter-coupled-logic circuits, can produce integrated injection logic circuits, as well. Due out this summer is the first fruit of that discovery, a 225-gate fully programable pseudorandom-sequence generator. Called the WM-1, the product will be the first of a series of I<sup>2</sup>L devices that Plessey predicts will push the technique into new applications. Two products, scheduled soon, are a quad decade counter and a 256-bit random-access memory for battery-powered portable equipment.

not used to put a patient to sleep, but it maintains the anesthetic effect after small doses of tranquilizers and analgesics are injected.

Surgeons say the device is most beneficial in operations that last more than three or four hours and would normally require prolonged administration of potentially dangerous drugs to keep the patient unconscious. The drugs weaken resistance to infection and cause some problems in abdominal operations.

**Waveform.** The French have achieved two basic breakthroughs. One is the finding that the current is most effective when the cathode is placed between the eyebrows and two anodes are placed behind the ears. And, after several years of experimentation on animals, they have learned that a rectangular-

pulse train that has an average intensity of 10 milliamperes gives the best results.

Dr. Limoge says the duration of the pulses seems to be the key to success. The pulses are 3 milliseconds long, spaced 10 ms apart. Experiments have shown that most patients were jolted awake when the pulses were shorter than 3 ms or longer than 5 ms.

The French three years ago hit upon the waveform, which humans can tolerate without going into convulsions or suffering variations in blood pressure. A team of anesthesiologists, headed by Dr. Christian Debras at the Necker Hospital, tried the method first, and more than 500 patients have been anesthetized with no harmful physical or mental effects. □

# Shrink big.

When designing MOS circuits, we can save you money by making them smaller—or bigger.

You see, we put more functions on a chip than any other MOS manufacturer. We make every chip as small as possible, because you pay for the size of the die. But we also design larger, more complex chips than anyone else. Because one bigger chip is cheaper and more efficient than two smaller ones.

Take Hewlett-Packard's new HP-21 calculator, for example. Through a series of cost-effective redesigns, we were able to put many more functions in and cut several chips out.

We worked closely with Hewlett-Packard, improving and refining designs. Even while introducing such innovations as direct interface to LEDs, we still helped get the HP-21 on line and on time.

As the world's largest custom MOS/LSI manufacturer, we can turn jobs out fast (as quick as 16 weeks for prototypes

in some cases). And in the past nine years, we've improved over a thousand products with MOS.

So get the jump on the competition by calling your nearest AMI sales office. You'll find out that shrinking big is a good way to grow.

Manhattan Beach CA, (213) 379-2452 • Mountain View CA, (415) 969-0610 • Altamonte Springs FL, (305) 830-8889 • Elk Grove Village IL, (312) 437-6496 • Norwood MA, (617) 762-0726 • Livonia MI, (313) 478-9339 • Minneapolis MN, (612) 546-3354 • Monsey NY, (914) 352-5333 • Ambler PA, (215) 643-0217 • Richardson TX, (214) 231-5721 • Head Office: 3800 Homestead Road, Santa Clara CA 95051  
Phone (408) 246-0330.

**AMI**<sup>®</sup>  
AMERICAN MICROSYSTEMS, INC.

**first in custom LSI**



### **Government takes control to rescue Ferranti projects**

Injection of \$36 million and consequent control of Ferranti Ltd. by the British government should enable the financially troubled aerospace company to go ahead with several new electronics projects held in limbo during its liquidity crisis [*Electronics*, Oct. 3, 1974, p. 69]. Although the company awaits appointment of a new managing director and chief financial officer, **developments likely to proceed include radio-frequency power transistors, a 1,000-gate uncommitted logic array, and a gas-discharge plasma-display panel with inherent memory.**

### **Toshiba to build 26-inch color-TV sets for Germans**

A production line at Japan's Toshiba will begin this autumn turning out 26-inch color-television picture tubes for an undisclosed German customer and others. Production rate for the tubes, which have a 110° deflection angle, will be 2,500 per month or more. **Toshiba will use the so-called RIS design with rectangular funnel, in-line guns, slotted mask, and black stripes between phosphor stripes for added contrast.**

The shadow mask uses a brick-wall arrangement of slots. The rectangular funnel permits use of a wide neck with large-diameter electron guns for good focus and freedom from blooming while keeping deflection power demand down to a level comparable to that of narrow-neck tubes [*Electronics*, Nov. 22, 1971]. **Toshiba won't use tube for the domestic market because demand at present for such large sets is insignificant.** The order from the German company is adequate to start up the production line, and Toshiba hopes that demand will develop in other European countries and Australia.

### **\$120 barrier falls as programable calculator bows**

A programable scientific calculator priced at less than \$120 is being introduced by Britain's aggressive Sinclair Radionics June 2 at the Chicago Consumer Electronics Show [*Electronics*, May 15, p. 14]. **The calculator will compete in a nearly new market already targeted by the National Semiconductor Corp.'s Novus line, as well as products from Texas Instruments and Hewlett-Packard Co.** The specially designed calculator upgrades the Oxford 300 advanced scientific calculator Sinclair introduced early this year.

However, Sinclair's long-awaited digital watch with light-emitting diodes and priced below \$100 [*Electronics*, Jan. 9, p. 76] is likely to be held past its scheduled July launching goal. **The company is said to need further development of the custom integrated-injection-logic chip being built by ITT Semiconductors.** The watch, cased in black plastic, was shown to selected distributors at the recent Hanover electronics show. And the 2-inch monochrome television set, awaited even longer, probably won't be started in quantity production until next year.

### **Test train rides electromagnets to travel 199 mph**

Magnetically suspended trains that may travel as fast as 300 miles per hour will be propelled closer to reality if tests in West Germany continue to be successful. In demonstrations near Munich earlier this month, **an 8.5-ton unmanned test vehicle controlled by telemetry reached a top speed of 199 miles per hour on its electromagnetic-suspension system.** The vehicle, a project of Messerschmitt-Bölkow-Blohm

## International newsletter

and Krauss-Maffei, checked out various components such as magnets, linear motors, energy-supply systems, antiskidding and braking apparatus, and related equipment. The MBB/KM test program calls for 240-mph runs later this year.

As part of the demonstrations this month, the two firms also tested their 171-ton manned Transrapid 04 vehicle, also electromagnetically suspended, which traveled at only about 100 miles per hour, although it had reached 120 mph in earlier tests. Aim of the Transrapid 04 tests is to obtain data on ride quality, noise level, and other operational parameters. **Meanwhile, a second group of companies consisting of AEG-Telefunken, BBC, and Siemens AG, is readying its electrodynamically suspended vehicle for levitation tests later this year.** Financially supporting the various German projects is the Ministry for Research and Technology. To maintain the country's lead in the vehicle-levitation field, it recently earmarked another \$50 million for the next two years.

### Interference filters aimed at auto use

Although complex electronic control systems are not getting into automobiles as fast as first thought, **the new generation of radio-frequency-interference filters** they will need to protect them from transients are on their way to the market. Laboratoire d'Electronique et d'Automatisme Dauphinois, a Grenoble-based research outfit, expects a modular rf filter it has developed will go into production this fall. Instead of the usual two-pole layout, the filters have a four-pole layout with a distributed series inductance designed into the capacitance module.

**Capacitance and inductance modules snap together** to build filters that have cutoff frequencies below 100 hertz. SIC-Safco will produce the capacitors, which will first be aimed at the radio-installers market. Radios are not generally OEM equipment on French-made autos. However, LEAD president Ferdy Mayer says that **a major French automaker is looking at the modular filters for OEM "noiseproofing" of its cars.**

### System compensates room lighting as outside light changes

After several years of testing, a small German company is now marketing an electronic system that automatically adjusts artificial room lights to compensate for changes in daylight. The system, from Altenburger KG steplessly brightens the room lighting as daylight diminishes, or is dimmed as the daylight increases in intensity. Altenburger's system employs closed-loop principles in which a small photo-resistor is the key element. The desired lux value of total ambient light is preselected on that element. **The system, the company says, not only cuts down energy requirements, but also increases the operating life of lamps.**

### Japanese combine develops large LCD display

An experimental model of a large-area liquid-crystal-display system that operates in the dynamic-scattering mode has been developed in Japan by Hitachi Ltd., Dai Nippon Toryo Co., and Asahi Glass Co. **The display panel, 400 by 500 centimeters, can selectively display 600 alphanumeric or Japanese kana characters.** Each character is formed from a 7-by-9-dot matrix. Rise and fall times are each about one second, and contrast ratio of display is about 20:1. Research has been carried on since 1972 by the three companies, which were subsidized by the Ministry of International Trade and Industry.

# CUTLER-HAMMER'S BIG LINE OF COMMERCIAL MINIATURES.

Toggles. Pushbuttons. Rockers. Rotaries. Available in a vast array of operator styles, colors, and shapes. Including illuminated pushbuttons and rockers. Many featuring snap-in mounting. And all in stock for fast delivery!

Now the same great quality, service and availability you've come to expect from Cutler-Hammer is available in miniature size—at a competitive price!

Make your selection. Standard or watertight. Single or multiple pole. A wide range of decorator caps, buttons, bezels that extend application flexibility. And for their size, hefty electrical/mechanical ratings.

Before you place that next order, check with your source for commercial miniature switches—your nearest Cutler-Hammer Sales Office or Authorized Stocking Distributor.



**CUTLER-HAMMER**  
SPECIALTY PRODUCTS DIVISION, Milwaukee, Wis. 53201

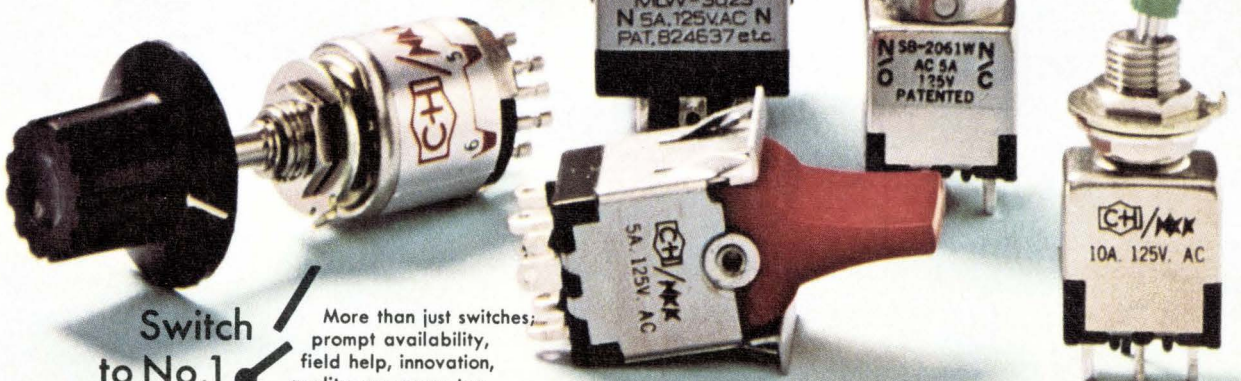

Switch  
to No.1

More than just switches;  
prompt availability,  
field help, innovation,  
quality assurance, too.

# Intersil's new FPLA.

## The first PLA that can be programmed electrically in the field.

### The PLA Unmasked!

Programed Logic Arrays make translation of Boolean logic into hardware much easier than ever before. They simplify design, reduce parts count, cut assembly time, use less power and are more reliable than discrete logic.

Until now programming a PLA required preparation of a mask, with delays and added cost. But no more.

The mask is eliminated in Intersil's IM5200. Electrically programmable in seconds, it's the first **Field Programmable Logic Array (FPLA)**.

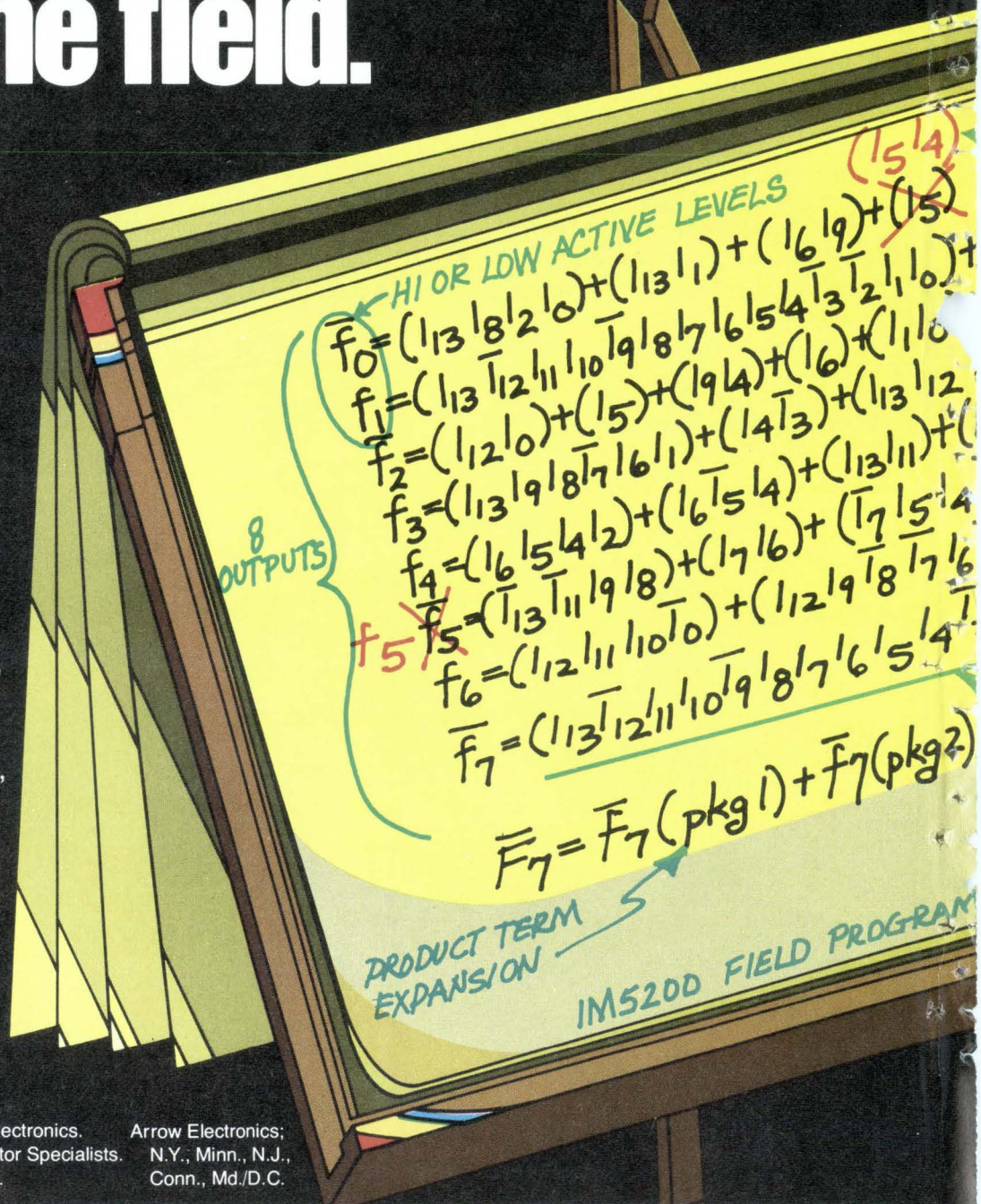

Intersil stocking distributors.  
Elmar/Liberty Electronics.  
Kierulff Electronics; Mass.

Schweber Electronics.  
Semiconductor Specialists.  
Weatherford.

Arrow Electronics;  
N.Y., Minn., N.J.,  
Conn., Md./D.C.

## FPLAs in production and available now.

The IM5200 is equivalent to a group of AND gates which may be ORed at any output. With 14 inputs, 8 outputs and 48 product terms, it provides the complexity of up to 500 4-input logic gates for applications such as random combinatorial logic, code conversion, microprogramming, sequential control and others.

A TTL device, the IM5200 comes in a 24 pin DIP, with typical propagation delay of 65 nanoseconds. Price in 100-999 quantities is \$25.00. Setup charge is \$25.00 per program, with nominal per-unit programming cost.

## And flexible? You bet.

For representing functions in true or complement form, the output level is programmable to high or low active levels. Passive pullup outputs are useful for product term expansion by wire-ORing the outputs of different IM5200s.

Even after programming, there are provisions for editing. Entire product terms may be added or deactivated, new input variables added, or outputs changed from low level to high.

## Proven AIM programming.

Programming is done with Intersil's Avalanche Induced Migration process, U.S. patent No. 3,742,592. AIM has created more than 3 billion memory bits in over 4 years' use with Intersil P/ROMs . . . without a single bit failure!

Reliability is outstanding because the entire process takes place beneath the surface of the silicon, hermetically sealing it from the environment. In addition, programming is much faster than with other methods.

Send for complete product data, including applications. From Intersil, 10900 North Tantau Ave., Cupertino, CA 95014.

**Intersil**



**Intersil area sales offices.**  
Boston (617) 273-2055.  
Chicago (312) 371-1440.  
Dallas (214) 387-0539.

Los Angeles (213) 532-3544.  
Minneapolis (612) 925-1844.  
San Francisco Bay Area.  
(408) 984-2170.

New York (201) 567-5585.  
Upstate New York/Canada.  
(315) 463-3368.

**Representatives in all major cities.**

Circle 69 on reader service card.

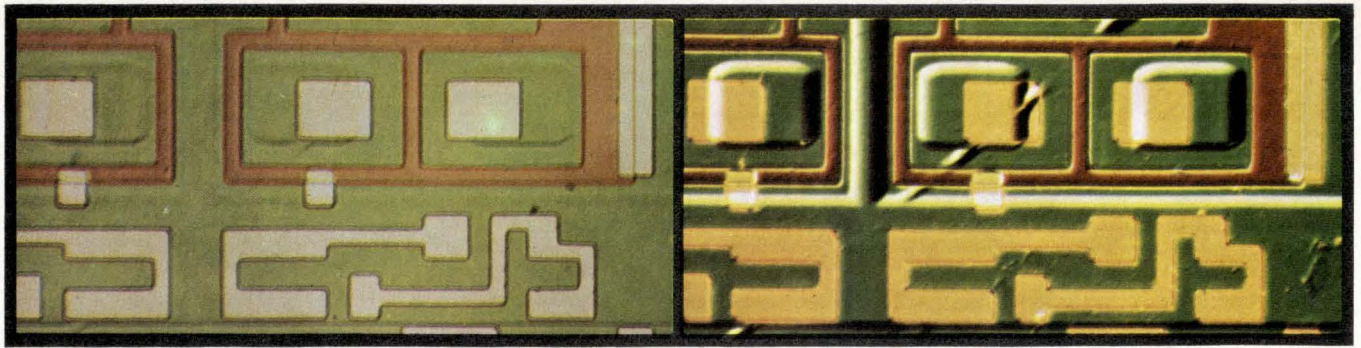

## If this is all you're seeing, this is what you're missing.

The AO DICV Series 10 Differential Interference Contrast Microscope can make a big difference. A standard brightfield microscope reveals only what is shown in the specimen on the left.

Now look at the specimen on the right. With this ability to reveal significant detail in outstanding relief in black and white or color, the AO DICV Series 10 can help you spot surface irregularities, inclusions and faults.

By using incident light, after Nomarski, it provides contrast enhancement of opaque



and semi-opaque materials. Helps you make critical quality control checks of semi-conductors, integrated circuits and metallurgical samples.

AO DICV Microscopes convert quickly from interference contrast to brightfield.

So if you can't afford to miss something, you can't afford to overlook the AO DICV Microscope. For details, write American Optical Corporation, Scientific Instrument Division, Buffalo, N.Y. 14215.



**AMERICAN OPTICAL CORPORATION**

SCIENTIFIC INSTRUMENT DIVISION • BUFFALO, N.Y. 14215

Circle 70 on reader service card

## Fluke's new portable telecommunications frequency counter I920A for only \$859\*

\*U.S. price F.O.B. Buffalo, N.Y. Options extra.

**Easy-to-Read**  
9-digit LED display  
Large 7-segment characters  
Full leading zero suppression  
Automatic annunciation and overflow

**High Frequency/High Sensitivity**  
520 MHz prescaler with better than 15 mV sensitivity and AGC standard  
Optional prescalers to 1 GHz and 1.25 GHz  
Low-level threshold - if input is below threshold display reads zero

**Resolution Multiplier (Optional)**  
Coherently multiplies audio tone signals by 1000, providing a resolution of 0.001 Hz in 1 sec

**Easy-to-Operate**  
Direct input and corresponding switches color-coded blue  
Prescaled input and corresponding switch color-coded yellow

**Burst Measurements**  
Measures frequency of RF bursts having 2 ms or greater duration. Display is automatically reset to zero if burst width is less than gate time selected

**Display Check**  
Pressing reset switch when counter is in self-check mode lights all digit segments

**Rapid-Access Gate**  
In the absence of signals, gate logic "free runs" to be in a position to open gate for selected gate time as soon as signal is sensed, thereby avoiding measurement delays

**Auto Reset**  
A new measurement sequence is started every time any front panel switch is activated

**FLUKE**  
COUNTER DIVISION

John Fluke Mfg. Co. Ltd. Counter Division, P.O. Box 1094 Station D, Buffalo, N.Y. 14210, Phone (716) 842-0311, TWX 610-492-3214

70 Circle 173 on reader service card

Circle 71 on reader service card →

# Reliability at 300° C is not the only reason Babcock Electronics uses Ekkcel™

Designing for reliability means considering the extremes. Relays designed for ambient temperatures of 125° C (256° F) see much higher internal temperatures when in operation at this extreme. So components like arc cages, bobbins, and shield insulators have to be able to take the higher temperatures.

Babcock Electronics found ceramic too fragile to withstand the vibration and shock. Other high temperature plastics tend to outgas at the operating temperatures which caused contact resistance problems.

Ekkcel injection molding resins were the perfect answer. Our high temperature reliability at a continuous 300° C (572° F) is unmatched. And our radiation resistance is 10<sup>10</sup> rads.

We'd like to work with you on similar high temperature applications. We can help you give your electronic components all the reliability you can get.  
Carborundum Plastics, Inc.  
Ekkcel Division  
5785 Peachtree Industrial Blvd.  
Atlanta, Georgia 30341  
(404) 455-6127

CARBORUNDUM

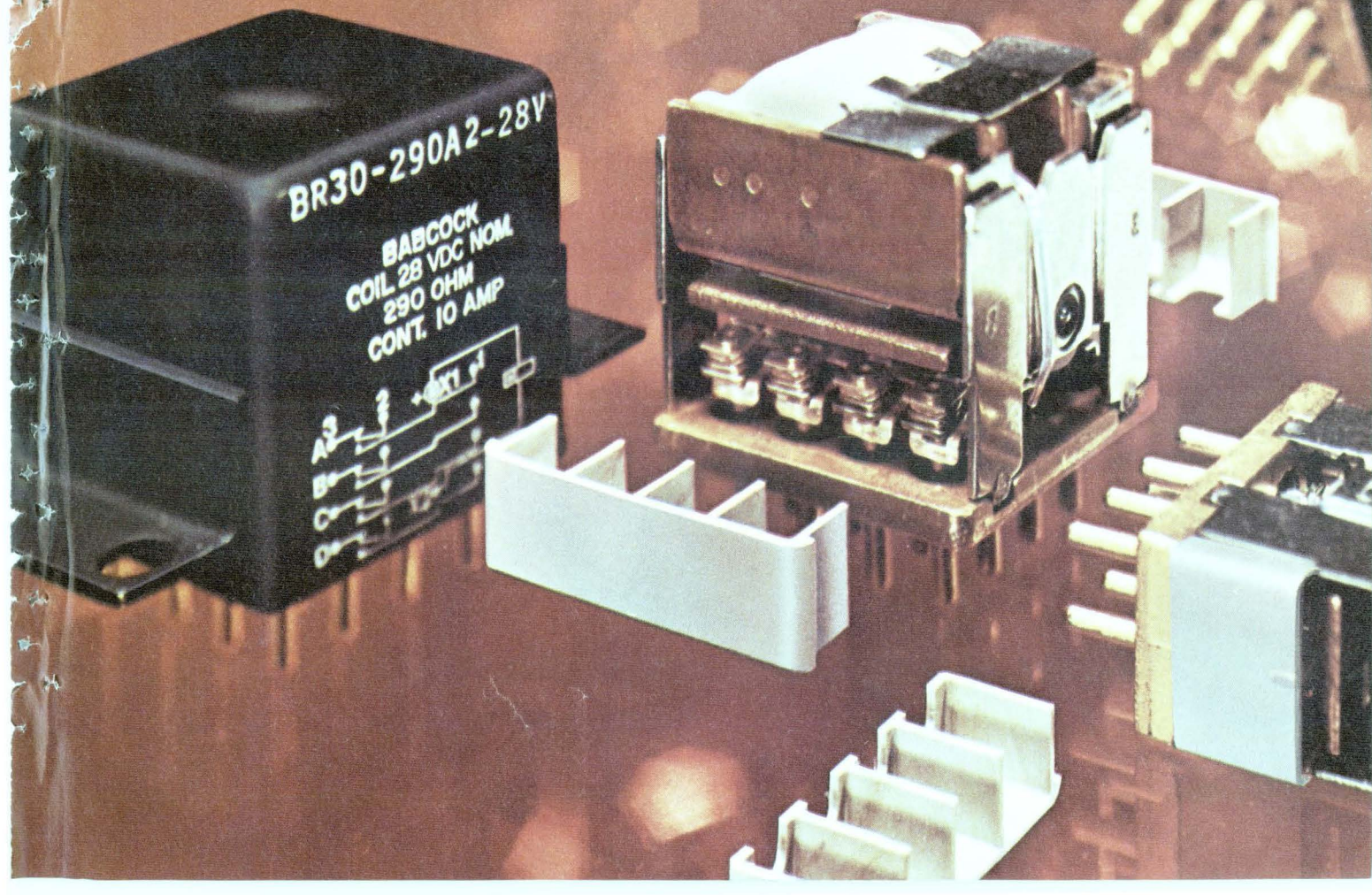

# “This is to think P talk price”

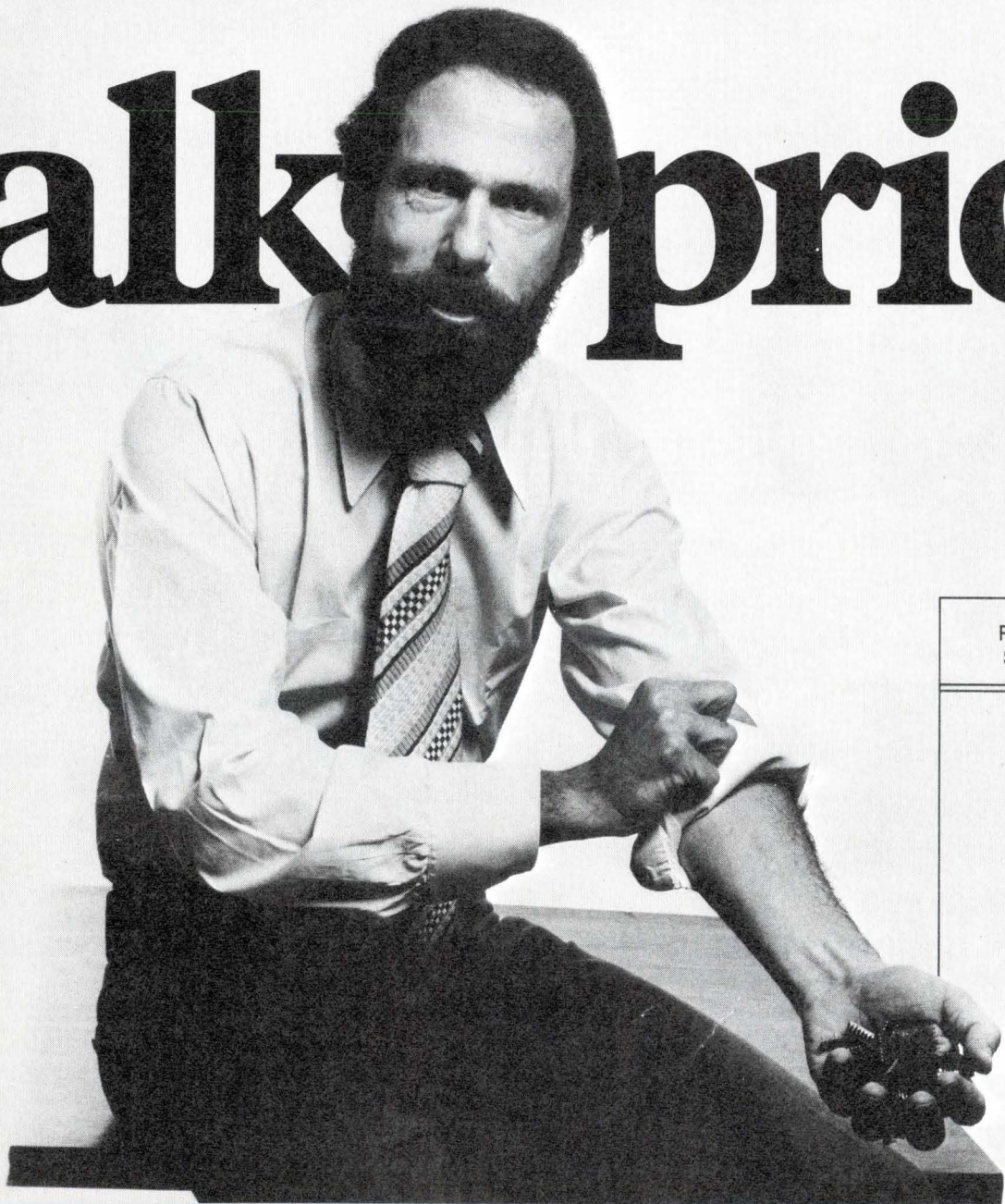

PROM SIZE	ORGANIZATION
1k	256 x 4
	256 x 4
	256 x 4
	256 x 4
2k	512 x 4
	512 x 4
	512 x 4
	512 x 4
4k	512 x 8
	512 x 8
	512 x 8
	512 x 8



# the year ROMs and

You have every right to look to MMI for price and performance leadership; we're the biggest bipolar memory company in the world.

Since we were the first to design and produce 1K, 2K and 4K PROMs (and compatible ROMs) you'll recognize our part numbers; but the price and power figures are happy news. (And this is a year we can all use some good news.)

We've completely redesigned our PROM line. The Schottky process we're using has already been proven on our 8K, 9K, and 10K bipolar ROMs. On our new *Dash One PROMs* it not only cuts power requirements by 30% **without any loss of speed**, but it also yields good parts in quantities that

allow **dramatic price reductions**. All major characteristics are improved. Fan-in is .25mA max. **Grow-back is virtually eliminated**. And we've added extra fuses to give you **superior programming yield**. **At least 95% of all units will program to completion** in 2 seconds or less. And we fully test every part for programmability before we ship it.

The results: MMI gives you better prices. Better performance. Better programmability. Better reliability. Looks like a better year all around.

Please compare the numbers on the OLD and NEW chart. Then get the product and prove it for yourself. The industry is getting moving again. And we can help in lots of ways. Try us.

Call, telex or write our Marketing Department. Monolithic Memories, Inc., 1165 East Arques Avenue, Sunnyvale, California 94086. Phone: (408) 739-3535. Telex: 910 339 9229. In Europe, contact Monolithic Memories, Inc., Amsterdam, Holland, Phone: 100727. Telex: (844) 16365.

**mmi**  
This is our year.

PROM PART NOS.		(100-999) PRICE		OUTPUT	MAX ICC		OPERATING TEMPERATURE	ROM INTERCHANGEABLE PART NUMBER
OLD	NEW	OLD	NEW		OLD	NEW		
6300	6300-1	\$ 17.00	<b>\$ 5.95</b>	Open Collector	120mA	105mA	0°C to 75°C	6200*
6301	6301-1	17.00	<b>5.95</b>	Tristate	120mA	105mA	0°C to 75°C	6201*
5300	5300-1	44.00	<b>11.95</b>	Open Collector	120mA	105mA	-55°C to 125°C	5200*
5301	5301-1	44.00	<b>11.95</b>	Tristate	120mA	105mA	-55°C to 125°C	5201*
6305	6305-1	45.00	<b>13.95</b>	Open Collector	130mA	105mA	0°C to 75°C	6205*
6306	6306-1	45.00	<b>13.95</b>	Tristate	130mA	105mA	0°C to 75°C	6206*
5305	5305-1	58.00	<b>24.95</b>	Open Collector	130mA	105mA	-55°C to 125°C	5205*
5306	5306-1	58.00	<b>24.95</b>	Tristate	130mA	105mA	-55°C to 125°C	5206*
6340	6340-1	70.00	<b>33.00</b>	Open Collector	140mA	140mA	0°C to 75°C	6240*
6341	6341-1	70.00	<b>33.00</b>	Tristate	140mA	140mA	0°C to 75°C	6241*
5340	5340-1	100.00	<b>54.00</b>	Open Collector	140mA	140mA	-55°C to 125°C	5240*
5341	5341-1	100.00	<b>54.00</b>	Tristate	140mA	140mA	-55°C to 125°C	5241*

\*Pin-compatible ROM-mates are available for all MMI PROMs. Electrical specs are identical. MMI ROMs always cost substantially less than our PROMs, and now our PROMs are the least expensive in the industry.

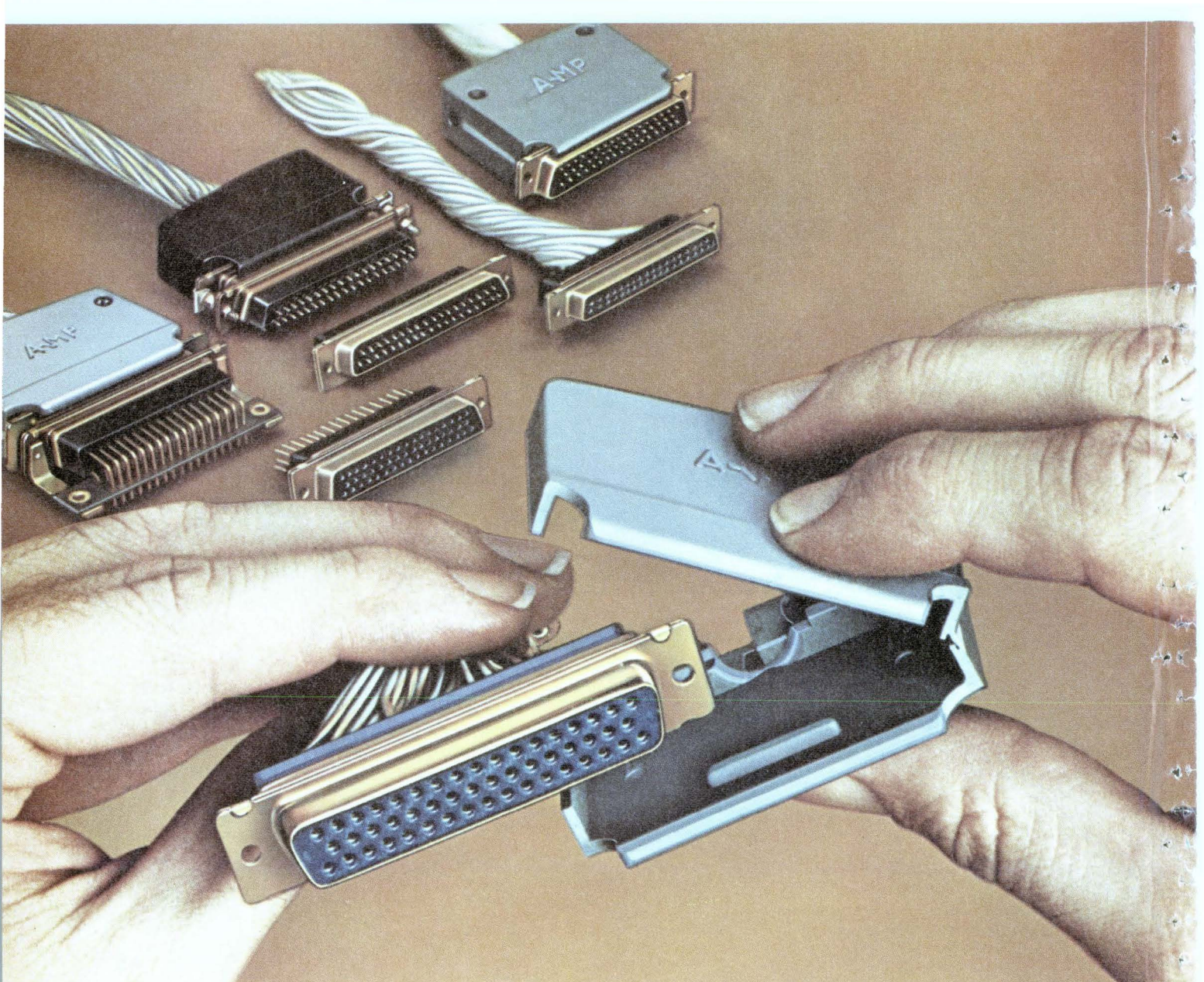

**Because  
you  
only have  
two hands.**

**AMPLIMITE high-density connectors**

come with our exclusive, one-piece plastic strain relief/shield. You can't get one that's easier or less complicated to put on.

Hold the joined "clam-shell" in one hand. Turn the screw with the other. It's that simple to cut into your handling costs.

In addition, you have a highly versatile line of reliable and economical AMP high-density connectors.

With rack and panel interconnections as well as posted configurations. Straight as well as right-angle post contacts. And a variety of contact styles including some with insulation support features. Sizes are 9, 15, 25, 26, 37, 44, 50, 62, 78 and 104 positions.

Of course AMPLIMITE connectors are intermateable with existing high-density types.

For immediate information, call (717) 564-0101. Or write AMP Incorporated, Harrisburg, Pa. 17105.

AMP and AMPLIMITE are trademarks of AMP Incorporated.

**AMP**  
INCORPORATED

# Probing the news

Analysis of technology and business developments

## UL instrument standard weighed

Wary manufacturers fear added costs, design time, as they study proposal containing revisions spurred by their earlier objections.

by Andy Santoni, Instrumentation editor, and Judith Curtis, San Francisco bureau

### Strong objections

from manufacturers about Underwriters' Laboratories' proposed safety standard for test and measurement instruments sent UL back to the drawing board last fall. The result, now being circulated for industry comment, is a heavily revised document. But even if the new version of UL 1244 is satisfactory in terms of what is tested and how it is tested, manufacturers are still worried about costs and time the testing procedure would add to the development cycle needed for new instruments.

Independent third-party safety testing of electrical and electronic apparatus is required by OSHA. So instrument makers had no objection more than two years ago when UL announced it would accept oscilloscopes, testers, recorders, and other metering and test equipment for investigation and listing. But there was a major snag—no single UL classification or safety standard covered such equipment. At a meeting early last year, instrument makers agreed with UL that it might as well be the third party and that an instrument-safety standard would simplify matters. By late summer, the first draft was ready. Industry reaction was immediate—the standard didn't come close to meeting its objectives, and instrument manufacturers sat down with UL again in

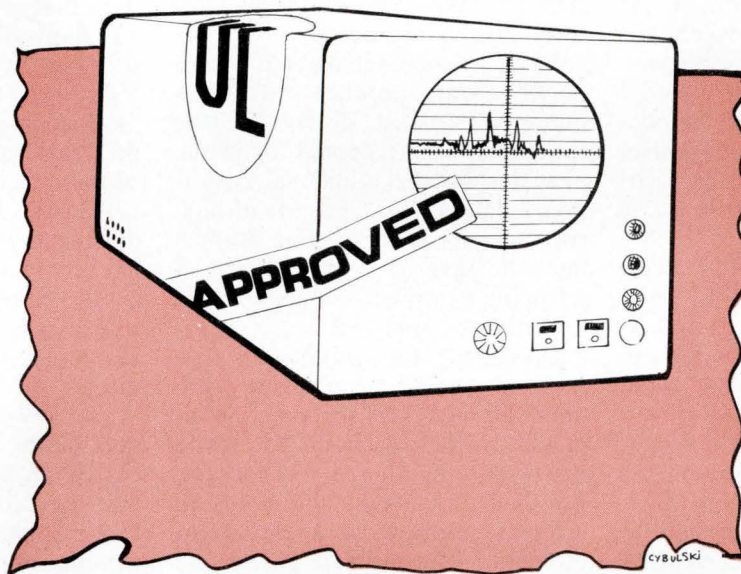

Chicago last fall to air their views and objections.

Says Robert Seelbach, managing engineer of the UL electrical department in Chicago, "What we learned in that meeting was that, frankly, we were a bit off target with respect to the proposals in that we had incorporated an awful lot of television-like philosophy into the standard. We'd adopted a lot of the requirements out of UL 492 for television-receiving devices on the basis that the circuitry was somewhat comparable." That assumption didn't work out. A lot of the specifics that may have been suggested as appropriate for a consumer product in the home just didn't apply in this case.

One reason instrument makers were upset by UL's first draft, says Steve Fischer, product safety man-

ager at Hewlett-Packard Co., Palo Alto, Calif., was that "people at UL have for years worked with our instruments. But in many cases, they don't understand what our products do." As a result, he says, they are "put in a strange position to assess our equipment."

To that charge, Seelbach replies that the lab has had extensive experience in testing high-technology commercial equipment, including computers and other data products and sys-

tems, office appliances, and business equipment. And he points out that UL understood instrument makers' objections to the first draft well enough to agree that a substantial revision was in order.

For example, the first draft not only required that transformers undergo testing procedures to guarantee against flammability under adverse conditions but also specified acceptable construction methods. After analyzing the types of transformers in use by instrument makers, UL eased these requirements.

In the second draft, expensive and time-consuming tests have been deleted, leaving only a few tests of secondary circuits' susceptibility to breakdown. In addition, transformer-construction details have been reduced to require only that

## Probing the news

they be impregnated for water-proofing and that they be enclosed in their own or the instrument's cabinet.

The first draft also required that secondary circuits undergo short-circuit, overload, and limited-power tests to uncover fire and shock hazards. These tests were based on similar requirements that UL enforces for certification of television and radio receivers.

Two factors have led to reducing the complexity of these tests on secondary circuits in the latest version of the document. Requirements for materials used in primary circuits have been made more stringent, thus leaving less flammable material inside the instrument, and the construction differences between instruments and TVs make secondary circuits of instruments less susceptible to failure.

**High cost of safety.** As for additional costs, meeting safety standards could cost instrument makers as much as \$50,000 for redesign of existing product lines and could take "hundreds to thousands of man hours," says Richard Nute, manager of product-safety engineering at Tektronix Inc., Beaverton, Ore. Nute points out that redesign to comply with UL standards "means a different kind of discipline. It's not that we've been wrong or that UL is right. It's just different. It's not necessarily unsafe, but it might not meet Underwriters' Laboratories' standards," he says.

HP's Fischer says that any decision to overhaul a product to meet UL 1244, "like any other standard, comes to a marketing concern." If 90 out of 100 companies elect to follow the standard, he says, "10 companies will be adversely affected" by their decision to avoid UL listing. He says standards that look simple on paper turn out to be a lot more complex when it comes to application. "You may have to change a power switch or make a power transformer bigger. This often entails changing the entire device." To move a switch, for example, "you may have to change the front panels" and scrap the old ones.

Fischer says there are two ways for instrument companies to approach the upcoming standards: "Wait until they are finalized," and then begin a redesign effort, or "get involved early." HP has decided to follow the latter course, he says.

HP is getting involved in meeting standards, says Fischer, "so we can be sure to sell in certain areas," where UL listing is required, such as Los Angeles and Chicago. The job, he says, won't be easy. All departments must be aware of the standards. Marketing, for instance, must know which products are listed and which are not, and advertising materials must be scrutinized to ensure that no unsafe procedures are pictured in advertisements.

Fischer believes that about a third of HP's 3,000 products will eventually be UL listed. He says, "If [the standards] are accounted for in the new design, the additional cost is pretty darned low." In spite of high costs of retrofitting existing product lines, he says, "I can't conceive of dropping a product as an alternative to getting UL approval."

One option for instrument manufacturers, says Tektronix' Nute, is to offer two models of the same instrument. Hewlett-Packard has done that with some models, Fischer says. But, Nute points out, "that's only an interim solution to a long-term problem." The ultimate answer, he says, is to have all products listed by UL.

And for the big companies, he says, that won't be too hard. "If you start the design from scratch, the cost to gain a UL listing is a very small percentage of the product development." But "if you're a small company," says Nute, "the costs will be very high."

**Ceiling on fees.** David Scott, president of Interstate Electronics Corp., Anaheim, Calif., agrees that earning a place on UL's approved listing can be costly and time-consuming. UL specifies a cost ceiling to test a particular device, then bills the maker for the actual expense of testing up to that ceiling.

UL's Seelbach adds, "The major portion of the charges [for getting a product listed] are a manufacturer's own charges, especially if he has to change anything. The direct, out-of-

pocket costs [paid] to Underwriters' Laboratories is completely overshadowed by any tooling changes that he might make on his own product."

Tektronix' Nute says, "if the changes are extensive, there may be a chain reaction in what needs to be changed. You may end up changing parts three or four times." He notes, for example, that spacing on printed-circuit boards might be a problem in primary circuits. "If the boards are designed without attention to spacing," he says, "They have to be relaid out. That may force other mechanical changes."

UL's intention is to write a standard that covers foreseeable hazards and limits design freedom as little as possible, says Seelbach. "Safety is really a relative thing. The most safe product in the world probably has no utility, couldn't be sold, couldn't be manufactured."

Adds Seelbach, "If we were to sit down and write a standard which no presently manufactured device could comply with, I'm just not so sure that we would really be doing much of a service to any manufacturer."

The key reason for the standard, says Nute, is that it will "give the customer independent assurance that the product is safe." But since UL disclaims responsibility for product-manufacturing defects, what good is a UL listing? "We can show we made an effort to make the product as safe as we know how. The only defense the manufacturer has is he did his best to anticipate" safety problems, says Nute, and a UL listing could help his cause.

But, says Fred Katzmann, president of Ballantine Laboratories, Boonton, N.J., "we want to minimize this legal-crutch aspect. Many of us would welcome safety standards that really protect the end user and apply equally to all manufacturers."

UL says the safety standard should be in final form by next year, and Seelbach adds, "We are in a cooperative effort with the industry to write a standard, looking down the road toward certification of their products. It's not a debate between the two of us. We're working closely together." □

# Wire wrapping with no ifs, ands, or buts.

Doing any job – big or small – better than anyone else. Fast. At low cost. And no excuses.

This is how dataCon (Datacon Inc. and Data Connections Inc.) got to be the largest independent wire wrapping company in the world.

No competitor can match our experience. Indeed, many of our people have been with wire wrapping since its inception.

And our equipment? The best. Computer-controlled semi-automatics. Gardner-Denver 14 FV automatics. No job is too complex or difficult for our machines, or our skilled people.

Today, we can produce over 70,000,000 wires annually. But tomorrow, we'll be able to wrap even more, because additional machines will be arriving as part of our continuing expansion program.

This is not our whole story, however. Our software capabilities and programming assistance are unmatched in the industry. We have the ability to constantly monitor pro-

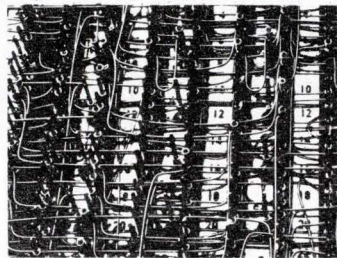

grams and to completely control input and output, thanks to our intelligent remote terminal system. Priority runs can be turned around in minutes – normal runs in a matter of hours.

All of these things – experienced management and supervisory staff, skilled technicians, machines that will handle any job, and sophisticated software – add up to a quality product at low cost as well as on-time deliveries for jobs no matter how big or small.

So contact the dataCon companies. We can beat any competitor or in-house operation for quality and economy. With no ifs, ands, or buts.

## The Challenge.

Yes, I want to learn more about how the dataCon companies can do my wire wrapping jobs better than anyone else.

Name \_\_\_\_\_

Address \_\_\_\_\_

City \_\_\_\_\_ State \_\_\_\_\_ Zip \_\_\_\_\_

Tel. \_\_\_\_\_ Ext. \_\_\_\_\_

# dataCon

## The Wire Wrappers.

The dataCon companies: Datacon /semi-automatic wrapping • Data Connections /automatic wrapping.  
40 Cummings Park, Woburn, Mass. 01801, Tel. (617) 935-7200.

SEE US AT  
BOOTH # 4729  
NEPCON  
'75 EAST.

Military electronics

## Paris is military carnival

U. S., French, British, Italian salesmen take orders at air show, and Arabs are the big spenders

by Michael Johnson, McGraw-Hill World News

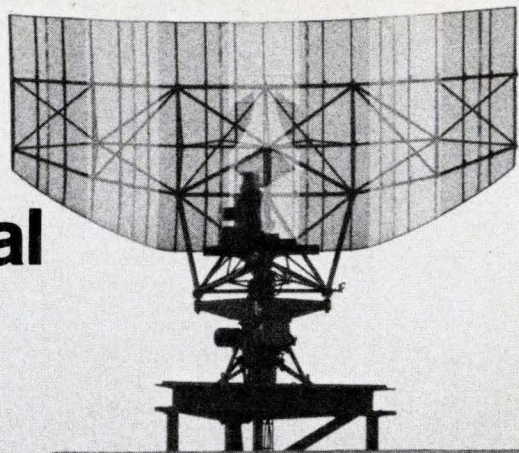

The atmosphere is highly charged with competition at the Paris Air Show, which opens May 29. Commercial-aircraft builders, arms peddlers, and avionics makers are converging in Paris to size up the booming export markets in the Middle East and Latin America. And the stake for electronics, which accounts for 15% of the cost of military gear, is proportionately high.

The Middle East oil states are on such a buying spree, in fact, that the Paris Air Show is virtually a military carnival this year. And although U.S. commercial-aircraft exports continue strong, European aerospace firms are rapidly shifting their manufacturing balance in favor of military planes, simply because of market forces.

While other industries struggle to keep their sales level in this recession year, arms makers in the United States, France, Britain, and Italy are reporting spectacular growth. U.S. arms exports in this fiscal year will total about \$8 billion, more than double the total for the previous year. And France last month revealed that total arms exports hit \$5 billion, also an increase of about 100% over the 1973 level.

The surge of military export orders has been something of a godsend for the aerospace and arms industries in the U.S., France, the UK, and Italy, as well as for individual

national economies. With civilian air traffic down and airline profits suffering, European civil programs have been especially disaster-prone. Only military orders are keeping several major companies afloat.

**Boom.** Heavy investment in commercial aircraft plant and technology during the past 10 years has been based on predictions of a boom market for such aircraft as the British-French supersonic Concorde and the Franco-German A300B Airbus in the 1970s. But the Concorde, hampered by environmentalists' concern and shrinking airline budgets, is still blocked at nine firm orders, despite advanced production of 16 units. And the jumbo Airbus, which faces tough competition from Lockheed's 1011, the McDonnell Douglas DC-10, and the Boeing 747, is struggling to hang on to its fewer than 50 orders—Spain and Germany have both recently threatened to cancel options. The break-even point for the Airbus program is more than 300 sales now, an increasingly elusive target as the program grows older.

France's largest aerospace firm, La Société Nationale des Industries Aérospatiales, builder of the supersonic Concorde, the Airbus, and the business-jet Corvette, derived about 70% of its income last year from military sales. This was the first year Snias, regarded as the country's

**Looking up.** This radar from France's Thomson-CSF was installed a few months ago at the Oslo airport in Norway.

prime commercial-aircraft company, tilted so heavily toward the arms business.

The French commitment to the arms business is the heaviest in Europe. About 80% of orders in the aerospace industry covering the next two and a half years are for military customers. Besides Snias, the industry is dominated by Mirage builder Dassault-Breguet, engine manufacturer Snecma, and missile-maker Engins Matra.

"France has been having a real drive in arms exports," says a weapons expert at Stockholm International Peace Research Institute, a private group that keeps track of arms traffic around the world. "French military attachés abroad are essentially arms salesmen, and that's unusual for Europe." The French "diplomatic" effort seems to be worth the trouble. Filling the void left by the United States in Greece, for example, France moved in swiftly and signed up the Greek air force for 40 Mirage F-1 jet fighters. The bill totaled about \$360 million, and about \$150 million of that amount is for electronic equipment.

**Electronics.** Airborne electronics exports from France totaled about \$105 million last year, estimates

Paul Assens, director of international affairs of the government's Délégation Ministerielle pour l'Armement, and orders are climbing in the first half of this year. Electronique Marcel Dassault, a subsidiary of the Mirage creator, accounted for about 40% of that total. At the air show, Marcel Dassault will display two microprogrammed modular minicomputers, the CP-8 and CP-16, designed to detect faults in aircraft electrical systems. Also from Marcel Dassault will be a new family of identification-friend-or-foe responders. Developed from the basic instrument aboard the Mirage F-1, it's designed for other craft.

The French have been selling 75% of their arms to the Middle East and Latin America, where petrodollars or military regimes, or both, make the market a fertile one. Indeed, the Peace Institute's Richard Booth says the current trend is for small military-minded or oil-rich countries to overarm.

Britain, which last year slipped to third place behind the U.S. and France among Western arms exporters, is placing high hopes on finding more markets for the Rapier low-altitude anti-aircraft-missile system manufactured by British Aircraft Corp. "A number of potential orders are in the pipeline," says a company official, to add to about \$500 million worth sold during the past two years. Iran and the Arab states are the biggest customers.

British Aircraft also is tapping its European neighbors for arms sales. The Belgian army recently ordered the Swingfire, a wire-guided anti-tank missile. And in the same family of missiles, the B-Swing infantry man-pack version is about to be peddled abroad, and a helicopter-mounted derivative called the Hawkswing is under development.

Hawker Siddeley Aviation is showing its new Hawk trainer and ground-attack aircraft at Paris, which will be its first appearance outside of Britain. Talks already are well advanced with Egypt for a licensing deal that would include building a plant in Egypt to produce Hawks for other Arab countries.

**Italy's arms.** Italy's trade-balance problems have nudged its arms exports to the fore to help keep the

country solvent. As a result, Italian arms makers managed to double their exports in 1974 to fourth place among Western countries. Exports last year totaled about \$2 billion, and the current pace of orders indicates a 30% increase this year.

Although Italy's Fiat produces the G-91 fighter aircraft, the Italian arms industry is probably at its best in missiles, military radar, and air-traffic-control systems. Rome-based

Selenia is showing its new Aspide multirole missile system at the Paris show.

Selenia also is showing its Albatross naval air-defense system that works off pulse and continuous-tracking waves. Selenia says the Italian navy has contracted for the system, and some export orders have been firmed up, but officials decline to specify in which markets they've been made. □

DO YOU NEED

**LARGE  
DIGITS?**

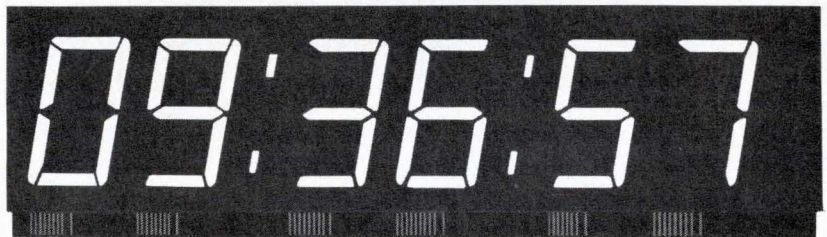

Look at PLASMAC™ Displays

- ★ 3" to 6" character height. ★ Low cost.
- ★ High brightness. ★ Variety of formats.

**NATIONAL ELECTRONICS**

a varian division

geneva, illinois 60134 (312) 232-4300



# INTRODUCING THE WORLD'S FIRST A/D CONVERTER SPECIFICALLY DESIGNED FOR MICROPROCESSORS. AD 7570

The AD7570 is both.

Making it *the* ADC for microprocessor applications.

As well as *the* ADC for any application where CMOS low power consumption, ratio-metric operation, and monolithic reliability are important.

The AD7570 is a monolithic CMOS successive approximation ADC, available with either 8- or 10-bit resolution in a

28-pin DIP, requiring only a 311 type external comparator, reference, and passive clocking components.

The parallel output data lines and BUSY line utilize three-state logic to permit busing with other AD7570 outputs and control lines, or with other three-state I/O interface circuitry. Two enables (one for the two MSBs, the second for

the remaining eight LSBs) provide the control interface for most 8-bit microprocessors. A serial data output line is also available, to be used in conjunction with the serial sync line.

The AD7570 can run as high

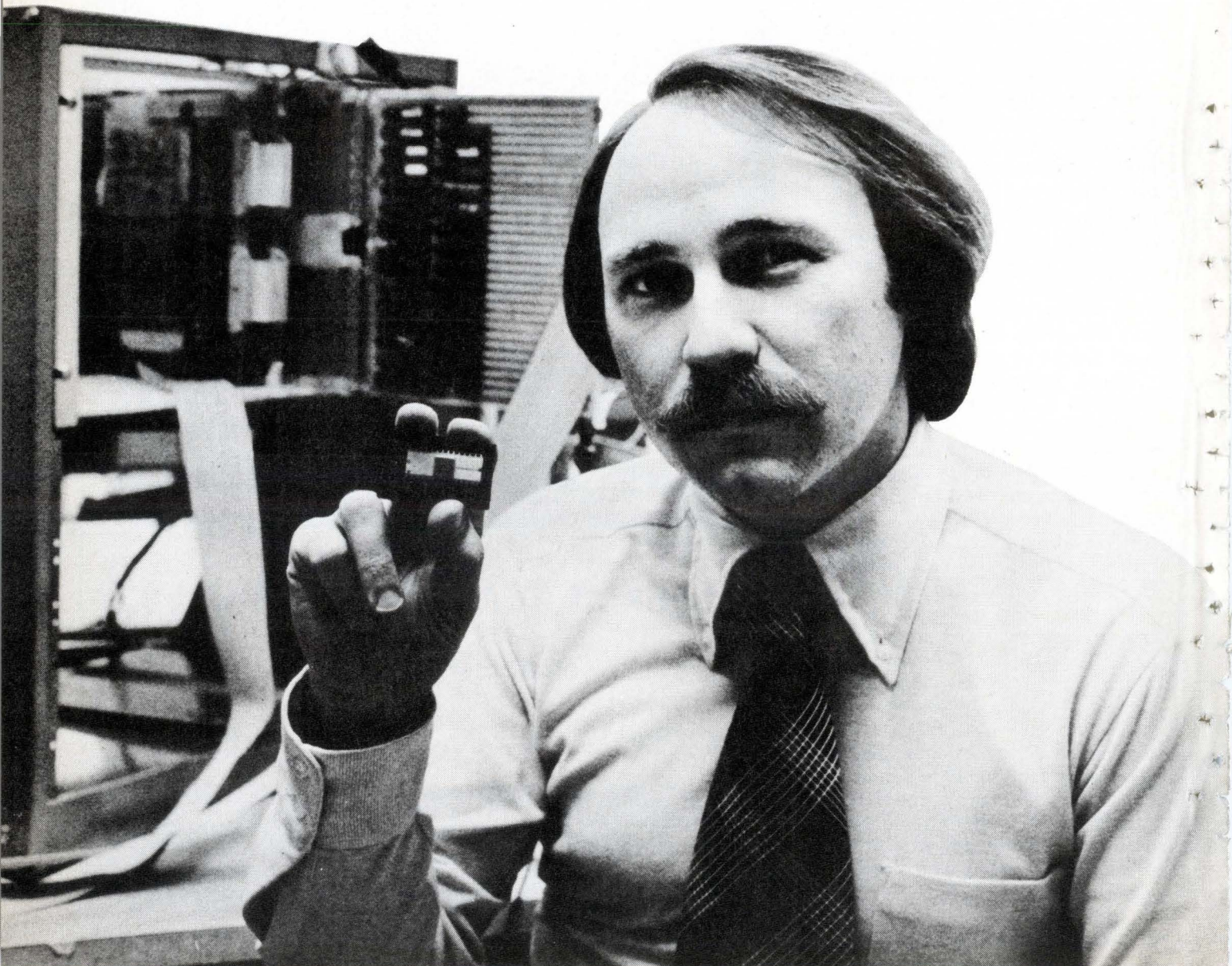
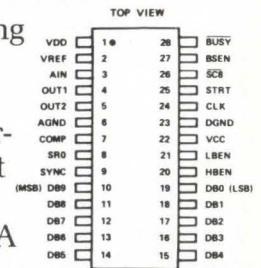



# INTRODUCING THE WORLD'S FIRST 10-BIT MONOLITHIC CMOS A/D CONVERTER. AD 7570

as 0.6MHz ( $20\mu\text{s}$  total conversion), either clocked internally or with external clock.

Two supplies are required, a +15V main supply (at 0.5mA), and a 5 to 15V (at 0.5mA) digital supply, depending upon whether you want TTL/DTL or CMOS compatibility.

And it's priced from \$37 in 100's.

Call for more information,

or to place your order.

For the one new product that deserves two introductions.

Analog Devices, Inc. Components for test and measurement instrumentation and control systems. Norwood, Mass. 02062.

East Coast: 617-329-4700

Midwest: 312-894-3300

West Coast: 213-595-1783

Texas: 214-231-5094

Circle 81 on reader service card

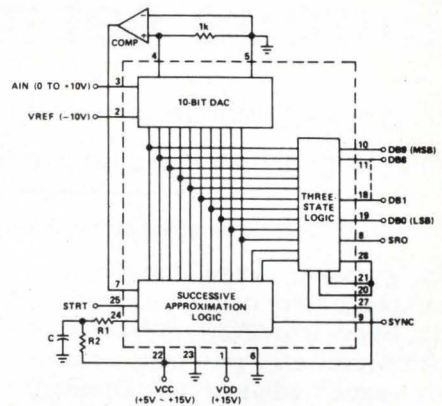

 **ANALOG  
DEVICES**

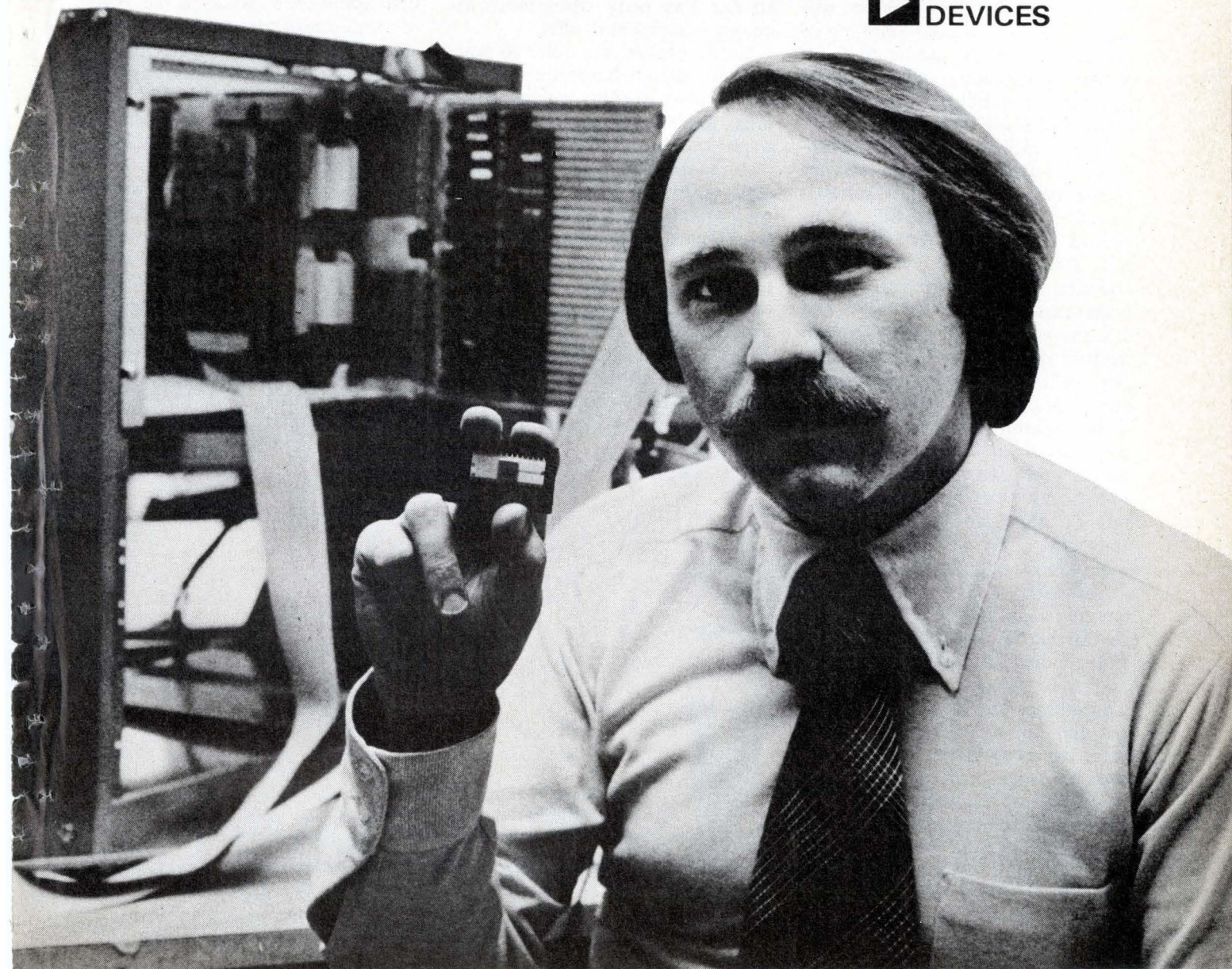

Communications

# Europe set for first digital-TV step

Engineers at Montreux meeting talk about equipment designed to get signal from the studio to the transmitter

by Arthur Erikson, Managing Editor, International

In guessing when broadcasters around the world will start beaming digitized television programs to home receivers, "even bold prophets are vague," admits Frank Davidoff, himself an advanced-technology prophet of sorts for the CBS television network. But in predicting when European broadcasters will turn *en masse* to digital handling of programs from the studio right up to the transmitter, even timorous prophets turn bold. It's bound to happen within the next few years.

Some impressive digital equipment has already gone into service. In the UK, a digital converter that transforms 525-line/60-field-per-second broadcasts from the U.S. into the 625-line/50-field standard common in Western Europe has been in use for some two years. And a scant year ago, the government-controlled French broadcast agency put a 625-line/819-line digital converter into service and has since added another. These are only the beginning. At the biennial Montreux television symposium this week, engineers from the U.S., Canada, Britain, France, Germany, and Italy told of development work for other kinds of digital hardware.

Montreux visitors also saw the commercial debut of the pioneering British hardware developed by the Independent Broadcast Authority and since taken over by Marconi Communication Systems. Marconi has tied an eye-opening \$500,000 price tag on its DICE (for digital intercontinental conversion equipment) hardware. The potential market at the moment looks like about 80 satellite ground stations around the world, but Marconi will have to

compete for the business with Japan's Oki Electric Industry Co., which has developed a digital system for the Japanese Government broadcast agency NHK. Fernseh GmbH, a unit in the Robert Bosch Group of West Germany, also has its corporate eyes on this market but so far has only optoelectronic analog equipment to offer.

DICE's backers are quick to point out that digital hardware does the job without needing alignment—as does analog optoelectronic hardware—and without degrading the picture quality. Essentially, DICE does three things to an incoming program. It changes the field rate (two fields, remember, are interlaced to get a complete picture frame) from 60 hertz to 50 Hz. It changes for number of raster-scanning lines from 525 to 625 and adjusts the line length accordingly. Finally, it switches the color coding from the NTSC standard used in the U.S. to the PAL or Secam system, the two used in Europe.

Much the same technique is used in the "transligneur 625/819" developed by Thomson-CSF for the CCETT (a research facility run jointly by the French posts and telecommunications ministry and the broadcast agency Télédiffusion de France.)

Digital line converters are just a first application. Because the costs of semiconductor memories and logic circuits are now so low, European broadcasters are getting excited about the possibility of digital signal handling from the camera head all the way out to the transmitter, where conversion to a conventional analog video signal would be made. Such a scheme could make it simple to exchange programs (the PAL or Secam encoding would be done at the transmitter). And because digital formats can be manipulated handily, broadcasters would be able to cram two, or perhaps even four, channels into the bandwidth now used to relay a single program by microwave.

To pack in two channels, the bit

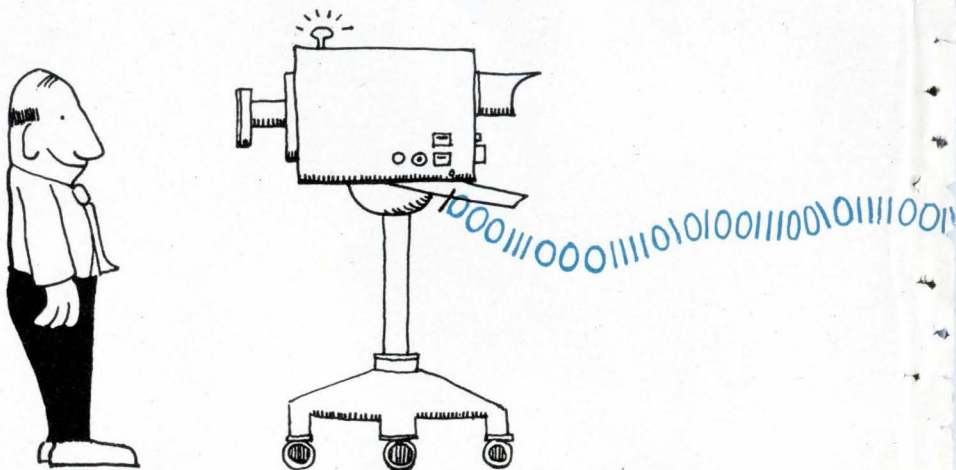

rate for the transmission would have to be around 30 megabits per second, a speed no one has yet achieved while maintaining broadcast-quality images. "I expect we will get down to about 35 megabits in a year or so," predicts Jacques Sabatier, who heads CCETT's coding-systems section. At Montreux, Sabatier described the "Occitan" system developed at CCETT. It uses differential pulse code modulation, with four bits to characterize the difference between the predicted value for a picture element and its actual value. Occitan currently achieves broadcast-quality at bit rates around 50 Mb/s.

Along with differential pulse code modulation, CCETT is also taking a look at orthogonal transforms to get a band compression as high as 10 times. The work, also on the schedule for discussion at Montreux, was done for the agency by Laboratories d'Electronique et de Physique Appliquée of the Philips group.

In Occitan, the luminance and chrominance components of the video signal, rather than the composite signal, are digitized and encoded for transmission via differential pulse code modulation. There's no general agreement, though, that that is the way to go. The British Broadcasting Corp. has developed hardware that encodes a composite PAL signal and transmits it at 47 Mb/s. And at Montreux, Norbert Mayer of the West German Institut für Rundfunktechnik described analog reduction of the video signal followed by straight pulse-code-modulation coding. □

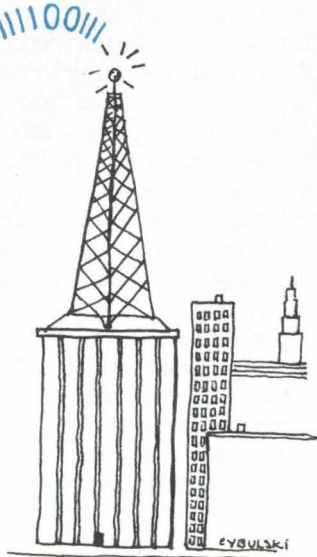

## MEMODYNE RECORDING STARS ON CENTER STAGE

WHAT A TEAM!

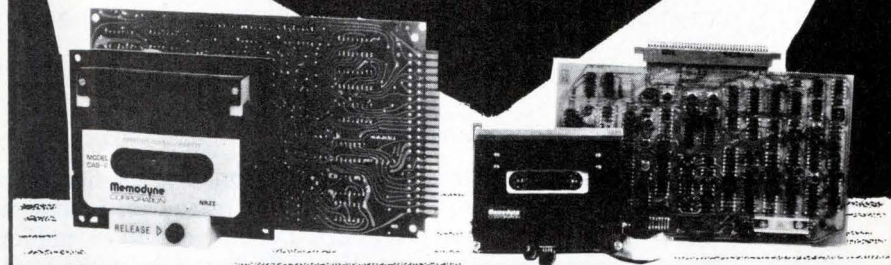

The MODEL 333 is an off line terminal-oriented digital cassette recording system to store and read alpha-numeric information. All data is written incrementally and is accepted in 7 or 8 bit parallel words. The 333 is CMOS and TTL compatible and has a storage capacity per cassette of up to 72,000 characters.

This star performer is ideal for keyboard applications such as calculators, microcomputers, point of sale machines and other off-line terminals. As well as data logging and a host of other recording tasks. TTY and RS232C interfaces are also available.

The MODEL 763 digital cassette recorder is in a class by itself! Consisting of transport, read/write and motor drive electronics, it is designed for computer or terminal peripheral storage. It stacks up as the very best cassette recorder for tape and bandwidth capabilities. The 763 moves tape at speeds up to 120 inches a second for searching and rewinding and records and reads at 20 inches a second (10 inches optional) bidirectionally. Speeds are fully servo controlled by a patented system that uses only two moving parts—the hub motors.

Without question the 763 is the simplest, gentlest and most reliable cassette recording system to ever hit the big time circuit. Write for complete data or better still call us to book either of these star performers in your town. We'll get them to you immediately!

**Memodyne**  
CORPORATION

375 Elliot Street  
Newton Upper Falls, Mass. 02164  
(617) 527-6600 Telex: 922537

Circle 83 on reader service card

## Cost Cutter

NEW Electronics Buyers' Guide...

Easy-to-use, single volume source for:

- Data on over 4,000 products
- Over 6,000 company listings and phone numbers.
- **EBG EXCLUSIVE:** quick access to over 1000 catalogs through a Direct Inquiry Service. The international world of electronics at your fingertips. Find suppliers... fast... accurately... and locally! For your copy send \$20.00 (USA and Canada only; elsewhere send \$30.00) to address shown below.

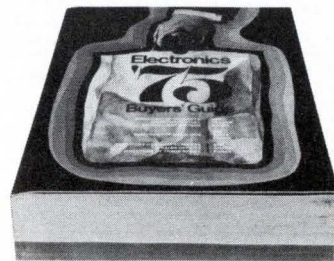

**Electronics Buyers' Guide**

A McGraw-Hill Publication  
1221 Ave. of the Americas, New York, N.Y. 10020

Companies

## Western Digital seeks new formula

Data communications, memory, processor products will end reliance on calculators; helping the firm through the transition is the DEC contract

by Paul Franson, Los Angeles bureau manager

**Your best customer** files a Chapter XI, prices for the product that accounts for three quarters of your business dive, and the recession roars into the neighborhood. Some exciting new products that will broaden your customer base are ready to go, but can you make it until they get a toehold in the market?

That's the situation at Western Digital Corp., Newport Beach, Calif. Its best customer for calculator chips was Bowmar Corp., which is now reorganizing under Chapter XI. What's more, the big, vertically integrated makers and marketers of complete calculators have stolen the thunder—and most of the sunshine—from the assemblers and their suppliers, among whom Western counts as a major factor.

The numbers tell the story, but also supply Alvin B. Phillips, presi-

dent and chairman of the five-year-old firm, with reason for optimism. Western Digital lost \$0.75 million on sales of \$2.92 million in the quarter that ended March 31. In the corresponding 1974 quarter, it earned \$0.23 million on sales of \$2.84 million, so that profits dropped about \$1 million in a year. But Phillips expects to break even in the current quarter and points out that the March 31 quarter saw sales rise 60% and losses drop 25% from the previous three-month period.

Another reason for his optimism is the slowly changing mix of products, some of which already are finding customers. The goal is to end Western Digital's near total reliance on calculator assemblers. Biggest new plum is a \$6.3 million contract with Digital Equipment Corp. to supply a high-performance four-chip processor for DEC's LSI-11 minicomputer. Add other new products in the data-communications field, some belt tightening, continued sales of calculator chips, and a newly established line of credit, and it becomes easier to understand Phillips' rosy view.

To turn the company around, Phillips has made substantial changes, but unlike in many semiconductor firms, where heavy layoffs hit production, he's started at the top—almost. The whole management team, other than Phillips himself and senior vice president of operations, Joseph Baia, has been replaced over the last few months. Phillips says bluntly, "The company has made a transition from a found-

ing-type team to an ongoing management team."

Among those out is former vice president of R&D William H. Roberts, whose work is acknowledged by Andrew Knowles, vice president for components at Digital Equipment, as the major reason that Western Digital got the LSI-11 contract. Now that the complex chips are in production, however, both Knowles and Phillips agree that the contract is not jeopardized. Phillips says that shipments next month, only the second month of production, will be in the thousands.

As for calculator sales, Phillips says they'll be down to 40% from 75% by July 1976, the end of the firm's next fiscal year, and its market will be broader.

New calculator chips are coming along, including scientific and direct digit drive versions. But most of the new product emphasis is in memories, microprocessors, and data communications.

In the last named, the firm is adding a universal asynchronous/synchronous transmitter/receiver chip (Astro) and is working to complete a chip, which will be out in early 1976, for the important IBM-compatible synchronous data line control. In cooperation with major drive makers, the firm is also developing a floppy-disk formatter, samples of which are scheduled for later in the year.

The related memory and microprocessor field will feel Western Digital's biggest push, however. In memories, the company is readying its first second-source products. It will go into production next month on a charge-pump 7001-type 1,024-

**Optimist.** President and chairman Alvin Phillips says company has found right track.



# A new champion—the clean-punching laminate from Norplex.

Score another technical knockout for Norplex, leading developer of championship-caliber laminates.

Now there's NP-424—a new *punchable* laminate for printed circuitry that gives you cleaner holes for reliable through-hole

plating. And NP-424 is less expensive than G-10 and G-10FR.

Because it's so cleanly punchable, this versatile laminate can lower your cost-per-board over drilled holes without sacrificing end-product quality. NP-424 is available in rigid, double and single-clad stock—all carrying a UL 94V-0 flammability rating.

This tough, machinable laminate will still be going strong under rigorous punching when its rivals are hanging on the ropes.

Let us send you our new brochure about this exciting new contender in the laminate ranks. Mail the coupon or phone 608/784-6070.

Norplex<sup>®</sup> laminates  
by UOP

© 1975 UOP

Norplex Division, UOP  
Norplex Drive,  
La Crosse, Wis. 54601.

Rush me more info about your new punchable laminate!

Name \_\_\_\_\_

Company \_\_\_\_\_

Address \_\_\_\_\_

City \_\_\_\_\_ State \_\_\_\_\_ Zip \_\_\_\_\_

Circle 85 on reader service card

# Precision Resistor Networks. We Make Them All. In Quantity.

Need tight temperature performance . . . close ratios . . . tolerances better than 0.006% . . . HyComp's unique thin-film resistor capability is ready.

Whether in chip form, flat pack, or DIP, HyComp can guarantee <math><1\text{ppm}/^\circ\text{C}</math> ratio tracking, TC's <math><25\text{ppm}/^\circ\text{C}</math>, laser trimmed accuracy to better than 0.006%, and full processing to Mil-Std 883.

Who knows . . . our library of standard networks may have your network . . . with 46 off-the-shelf standards to pick from. Call (617) 897-4578 for applications assistance . . . they'll know.

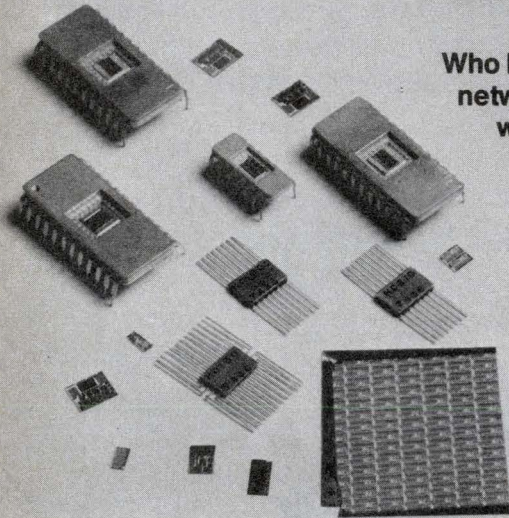

**HyComp**

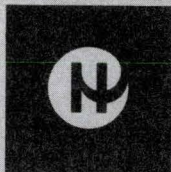

HyComp, Inc.  
146 Main Street  
Box 250  
Maynard, MA 01754  
(617) 897-4578

Circle 86 on reader service card

## Probing the news

bit random-access memory, the RA1721H. It is now producing two RAMs with a 256 four-bit layout—the 300-nanosecond SR1641D and slower 5-volt SR1793H.

The big effort now is in 4,096-bit RAMs. Phillips admits that its present Intel-compatible 22-pin RM1701H is slow at 300 nanoseconds: But Western Digital will have a 200-ns version in July. "There will be a continuing need for this fast part," he says. A 16-pin version, the RM1801J, compatible with the Mostek Standard and specified at 200 ns, also will be out in September.

Also in memories, the company is preparing a very fast (300-ns), 1,024-by-8-bit, n-MOS read-only memory for use with microprocessor sets and elsewhere. It's scheduled for July. With these devices, Phillips expects to increase memory business to 25% by the July 1976 target date.

He also expects sales of microprocessors to hit 25% by then and in fact saves his greatest enthusiasm for them. Now that Western Digital is delivering the LSI-11 chip set, it's working with DEC to find a viable second source and is preparing its own three-chip controller version for marketing separately, with demonstration boards, in September.

Phillips feels his company is on track now, but along the way there have been disappointments. The company was lined up to produce all the calculators—not just chips—for Gillette's big push into that business in 1975 until the consumer firm dropped the plans. It also stopped marketing its Spartan LSI test systems—its first saleable products—a year or more ago and is negotiating to sell the line. Western Digital has also put C-MOS watch efforts on the back burner.

In the eyes of one Wall Street analyst, Sal Accardo of William D. Witter Inc., "There always will be room for calculator assemblers, and as long as they can get low-cost, high-quality chips, there's an opportunity for suppliers like Western Digital. The company has good technology in its microprocessor and calculator chips, and a good manager. □

## Our attenuators can be

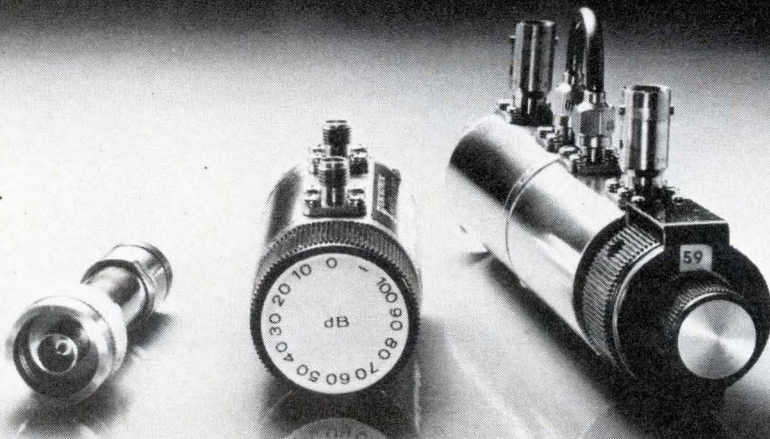

## Fixed Rotated Ganged

If your design calls for any type of attenuator in the DC to 4 GHz range, talk to Telonic first. We have 'em for handling .1 dB all the way to 140 dB. The solid-state, thick film resistors we use give longer service life, higher accuracies and power capabilities of 3 watts or better. Prices start at \$28.00, even lower in quantities. Our attenuator catalog is yours on request. Write or call.

**TelonicAltair**



2825 Laguna Canyon Rd. · Box 277  
Laguna Beach, California 92652  
Tel: 714 494-9401 · TWX: 910 596-1320 · Cable: TELENG

Telonic—the name for attenuators

86 Circle 174 on reader service card

Electronics/May 29, 1975

# The way our distributors stock Wood Electric Circuit Breakers, they're practically on the way to you right now.

Fast delivery, that's what it's all about. Circuit Breaker ratings from 0.5 to 60 amperes. Voltages from DC to 400 Hz. Trip times instantaneous to 75 seconds, at 200% of rated load. Many are UL Recognized and CSA Listed. Call your Wood distributor, or write Potter & Brumfield Division, AMF Incorporated, Princeton, Indiana 47671. Phone: 812-385-5251.

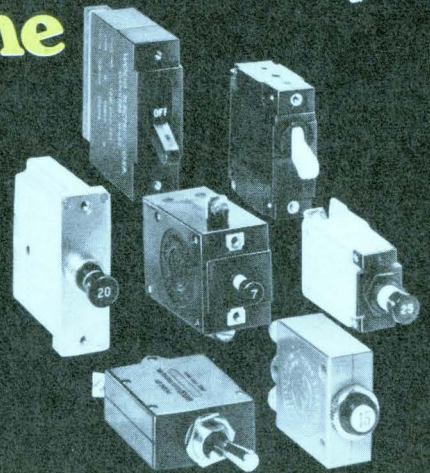
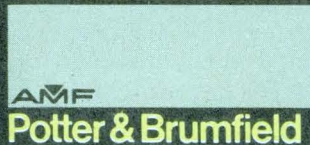

## P&B circuit breaker distributors

- ALABAMA**  
Birmingham  
M. G. Electronics & Equipment Co.  
205/328-4525
- ARKANSAS**  
Ft. Smith  
Wise Wholesale Electronics, Inc.  
501/783-8925
- CALIFORNIA**  
Culver City  
Avnet Electronics Corporation  
213/559-4111  
Hamilton Electro Sales  
213/871-7171  
El Segundo  
Liberty Electronics Division  
213/322-8100  
Garden Grove  
Allied Electronics Corporation  
714/894-7581  
Hawthorne  
Standard Sky Stores  
213/679-2561  
Inglewood  
Newark Electronics Corporation  
213/678-0441  
Irvine  
Cramer/Los Angeles Div.  
714/979-3000  
Los Angeles  
California Wholesale Electric Co.  
213/723-6711  
Mt. View  
Elmar Electronics  
415/961-3611  
Oakland  
Brill Electronics  
415/834-5888  
Riverside  
Electronic Supply  
714/683-8110  
South San Francisco  
Van Dusen Acft. Supplies  
415/589-3133
- COLORADO**  
Denver  
Cramer/Denver Div.  
303/758-2100
- CONNECTICUT**  
Fairfield  
U-Tronics, Inc.  
203/255-4521  
North Haven  
Cramer Electronics, Inc.  
203/239-5641
- FLORIDA**  
Miami  
Electronic Equipment Co., Inc.  
305/871-3500  
Oakland Park  
Peerless Radio Corporation of  
Florida Inc.  
305/566-5966  
Orlando  
Brownell Electro  
305/843-6770  
Cramer/EW-Orlando Div.  
305/894-1511  
Hammond Electronics  
305/241-6601  
Pensacola  
Grice Electronics, Inc.  
904/433-4616  
Tampa  
Hammond Electronics  
813/253-0104  
Winter Park  
Electronic Equipment Company  
305/644-4833
- GEORGIA**  
Atlanta  
Lykes Electronics Corporation  
404/355-2223  
Hapeville  
Brownell Electro, Inc.  
404/762-5181
- ILLINOIS**  
Broadview  
L-Comp—Chicago, Inc.  
312/865-7600
- Chicago**  
Electro Kinetics, Inc.  
312/286-4200  
Newark Electronics Corporation  
312/638-4411  
Elgin  
Allied Electronics  
312/697-8200  
Elk Grove Village  
Cooper Aviation  
312/439-3050  
Diplomat/Lakeland Electronics, Inc.  
312/595-1000  
Joliet  
Avionics Associates, Inc.  
815/792-0820  
Palatine  
OHM Electronics, Inc.  
312/359-5500  
Peoria  
Klaus Radio, Inc.  
309/691-4840
- INDIANA**  
Evansville  
Hutch & Son, Inc.  
812/425-7201  
Indianapolis  
RA-DIS-Co., Inc.  
317/357-5571
- KANSAS**  
Wichita  
Radio Supply Co., Inc.  
316/267-5216
- KENTUCKY**  
Lexington  
Radio Electronic Equipment Co.  
606/255-6661  
Louisville  
P. I. Burks Company  
502/583-2871
- LOUISIANA**  
Lafayette  
Ralph's of Lafayette  
813/234-4507
- MARYLAND**  
Kensington  
Marine Air Supply  
301/949-1353
- MASSACHUSETTS**  
Boston  
Sager Electrical Supply Co.  
617/542-2281  
Burlington  
Wilshire Electronics/New England  
617/272-8200  
Newton  
Cramer Electronics  
617/969-7700  
Springfield  
T. F. Cushing, Inc.  
413/788-7341  
Watertown  
Sterling Electronics  
617/926-9720
- MICHIGAN**  
Detroit  
R-S Electronics  
313/491-1000  
Wyoming  
Newark Industrial Electronics  
616/241-6681
- MINNESOTA**  
Minneapolis  
Northern Automotive Inc.  
612/726-5700  
St. Paul  
Gopher Electronics  
612/645-0889
- MISSOURI**  
Bridgeton  
Van Dusen Aircraft Supplies  
314/731-1700  
North Kansas City  
L-Comp Kansas City  
816/221-2400  
St. Louis  
L-Comp St. Louis  
314/647-5505
- MONTANA**  
Billings  
Glacier State Electric Supply Co.  
406/252-4663
- NEBRASKA**  
Omaha  
Omaha Airplane Supply Co.  
402/422-6566
- NEW JERSEY**  
Cherry Hill  
Cramer/Pennsylvania  
609/662-5061  
Clifton  
Wilshire Electronics/New Jersey  
201/365-2600  
Hanover  
State Electronics Parts Corp.  
201/887-2550  
Pennsauken  
RESCO  
609/662-4000
- NEW MEXICO**  
Albuquerque  
Walker Radio Co., Inc.  
505/247-2288
- NEW YORK**  
Binghamton  
Harvey Electronics of Binghamton  
607/748-8211  
Buffalo  
Summit Distributors, Inc.  
716/884-3450  
East Syracuse  
Cramer/Syracuse Div.  
315/437-6671  
Farmingdale  
Arrow Electronics  
516/694-6800  
Garden City  
Standard Aircraft Equipment, Inc.  
516/747-8787  
Hauppauge  
Cramer/Long Island Div.  
516/231-5600  
Long Island City  
H. L. Dalis, Inc.  
212/361-1100  
Lynbrook  
Peerless Radio Corporation  
516/593-2121  
Rochester  
Masline Electronics, Inc.  
716/546-5373
- NORTH CAROLINA**  
Charlotte  
Brownell Electro Inc.  
704/394-4341  
Greensboro  
Hammond Electronics of  
Carolina, Inc.  
919/275-6391  
Raleigh  
Southwestern Radio Supply  
Company  
919/828-2311  
Winston-Salem  
Kirkman Electronics, Inc.  
919/724-0541  
Piedmont Aviation  
919/767-5431
- OHIO**  
Akron  
Sun Radio Company  
216/434-2171  
Cincinnati  
Hughes-Peters, Inc.  
513/351-2000  
Schuster Electric  
513/221-6040  
Cleveland  
Pioneer-Cleveland  
216/587-3600  
Columbus  
Hughes-Peters, Inc.  
614/294-5351  
Dayton  
Esco, Inc.  
513/224-9192  
Lima  
Lima Radio Parts Company, Inc.  
419/228-1220 419/223-5075
- Solon**  
Repco Div.  
216/243-8900
- Warren**  
REM Electronics  
216/399-2777
- OKLAHOMA**  
Oklahoma City  
Electro Enterprises, Inc.  
405/239-7561  
Tulsa  
Oil Capitol Electronics Corporation  
918/836-2541
- OREGON**  
Eugene  
Vitus Electric Supply Company  
503/345-4377  
Portland  
Platt Electric Supply Company  
503/228-6121
- PENNSYLVANIA**  
Allentown  
A. A. Peters  
215/434-5237  
Braddock  
M. Left Radio Parts Co., Inc.  
412/271-2800  
McKeesport  
Barno Radio Company  
412/462-7574  
Montgomeryville  
Pytronic Industries, Inc.  
215/643-2511  
Reading  
Barbey Electronics  
215/376-7451  
Spring House  
Avionics Associates, Inc.  
215/643-6555  
York  
Rosen Electronics Company  
717/843-3875
- RHODE ISLAND**  
Providence  
Wm. Dandreta & Company  
401/861-2800
- TENNESSEE**  
Knoxville  
Industrial Electronics, Inc.  
615/573-7135  
Memphis  
Brownell Electro, Inc.  
901/332-9254  
Mid-America Avionics Distributors  
901/396-4400  
Nashville  
Electra Distributing Company  
615/255-8444
- TEXAS**  
Dallas  
Associated Aircraft Supply, Inc.  
214/331-4381  
Dallas Avionics, Inc.  
214/243-6391  
Hamilton/Avnet Electronics  
214/638-2850  
Ft. Worth  
Allied Electronics  
817/336-5401  
Garland  
Newark-Dallas Electronics Corp.  
214/271-2511  
Houston  
Harrison Equipment Company  
713/224-9131
- WASHINGTON**  
Bellingham  
Superior Electrical Supply, Inc.  
206/734-5500  
Seattle  
Platt Electric Supply, Inc.  
206/624-4083  
Radar Electric Company  
206/282-2511
- WISCONSIN**  
Cedarburg  
A-A Electric  
414/377-8000

Communications

## Cable TV looks to satellites

New York operator leases channels aboard Westar craft from RCA, as interest from other systems promises big terminal market

by Larry Marion, Washington bureau

A nationwide cable-television network that will undoubtedly spark considerable demand for receive-only ground terminals has moved nearer to reality. Home Box Office Inc., New York City, a major cable-program packager in the Northeast, last month subleased two domestic satellite channels from RCA Globcom Inc. aboard Western Union's Westar I and II domestic communications satellites. According to the agreement, Home Box Office will be able to transmit its sports and movie programming for five years, beginning this fall.

It's the first time a cable-program packager has gone beyond regional confines, and the step lends urgency to cable-system operators' evaluations of earth-station quotes from electronics companies.

The operators are also trying to determine how many terminals and microwave links they'll need to distribute programming to their subscribers after RCA's first domsat is launched in December. But there's some disagreement about how big the antennas should be, and this the FCC will apparently decide.

"To us, satellite distribution is the way to go," says Monroe Rifkin,

president of American Television and Communications Corp., Denver. His firm will file an application with the FCC in June for a permit to construct an earth station to link a number of its cable systems in Florida. It is more economical to transmit by satellite than rent AT&T lines, he claims, since satellite carriers RCA Globcom and Western Union Telegraph Co. will reduce their rates.

Proposed tariff for a coast-to-coast one hour link from RCA is \$1,300, while AT&T charges approximately \$1,900. A Western Union official pledges that his company will remain competitive and propose lower tariffs, too.

TelePrompTer, the largest cable-system operator, demonstrated satellite reception of national programming in 1973, but economic hard times precluded industry interest. Now Home Box Office's move has started other program packagers "thinking satellite" and of offering national programming soon, says Hubert Schlafly, currently a cable-industry consultant and founder of TelePrompTer. TelePrompTer is negotiating with Home Box Office to buy 20 terminals by the end of

the year, say industry sources. However, a TelePrompTer official will only acknowledge that negotiations are under way. Other packagers, now using video cassettes and the U.S. mail to deliver their films, are considering the satellite link as an alternative.

Ultimately, the size of the market for earth stations will be decided by the FCC. A 10-meter dish will receive almost automatic approval, say sources, while smaller—and less expensive—dish proposals would meet with close FCC scrutiny. "Anything smaller than 30 feet has to make a special showing that interference won't be unacceptable," says Ron Lepkowski of the FCC's Common Carrier Bureau.

Many say that a smaller dish is adequate. "There is no reason for a 10-meter dish. It [receive-only] could be done adequately with a 12-foot dish," claims Schlafly. If dishes smaller than 10 meters are authorized, the FCC is limited to 10 domestic communications satellites—at 5° satellite spacing—using the same frequency, an industry source estimates. But as many as 15 satellites with 10-meter dishes could be spaced at 3° or 4°.

Another technical question concerning cable operators is signal quality. Commercial TV networks broadcast at a video signal-to-noise ratio of about 54 decibels, but cable systems receive signals at 47 or 48 dB, notes an official of the National Cable Television Association. Cable operators say they can't compete with the commercial networks unless reception is improved to match the quality of network microwave feeds. □

### It costs less out there

Home Box Office Inc., which wants to broadcast cable-TV programs via satellite, is the offspring of Time Inc.'s Manhattan Cable Television. Its 61,000 subscribers on Manhattan Island make it the nation's third largest cable system in one location. Home Box Office was started late in 1972 to purchase recent movies and exclusive live coverage rights to sports events for distribution to Manhattan Cable and other systems in the Northeast. The company turned to satellites when it became apparent that the charges for a two-hop microwave link with its clients exceeded the cost of a receive-only terminal.



**Now! A 5V, 120-amp switcher  
with forced-air cooling, 80% efficiency,  
measures only 8" W x 10" L x 5" H,  
weighs less than 12 lbs. and costs only \$595**

The newest addition to the LH line of switching regulated power supplies is the super-compact forced-air cooled 120-amp series. With dimensions ideal for computer memory system installations, these switchers are available in single or multiple output models with extremely high efficiencies: 80% on primary output, an average of 75% on all others.



cable, interconnections have been reduced 90%, greatly enhancing reliability.

**Ask for full-line folder**

Our new 6-page folder fully describes the new 120 amp units and other standard LH switchers, and discusses options for specific requirements.

Write for a copy today.

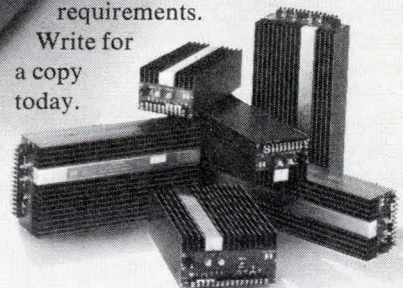

**Most comprehensive switcher line made**

LH Research makes several hundred standard switchers, with single and multiple outputs from 250 to 600 watts, and AC or DC inputs. All are extremely compact and lightweight, with six package shapes to suit your assembly. Efficiencies are 75-80%, and costs are as low as 75 cents a watt. Among the newest is the double dual model, which has two isolated 250-watt outputs plus two low power outputs, and weighs only 16 pounds.

**Up to three outputs**

Primary output is 5 VDC, 120 amps; second and third outputs are  $\pm 12$ , or  $\pm 15$  at 8 amps. Combined load on all outputs is limited to 600 watts. All outputs are fully regulated as a standard feature, and all are adjustable from the front panel.

**Outstanding features**

Over-temperature protection and RFI line filtering are standard features; over-voltage protection is standard on primary output, optional on secondaries. Other options include remote on-off, master-slave paralleling, and paralleling of up to

10 units. Mounting is by side or bottom in any direction. They operate in ambient temperatures of up to 50°C without de-rating.

**Selectable AC inputs**

AC inputs can be externally selected 115/230V, 47 to 63 Hz, simply by changing a jumper on the front terminal strip.

**Easy maintenance, high reliability**

In single-output models all components are mounted on just two circuit boards, multiple-output models use three, so the entire switcher can be disassembled in less than five minutes. Through the use of ribbon

*High power switchers exclusively  
(that's why we're No. 1)*



LH RESEARCH, INC., 2052 South Grand Avenue, Santa Ana, CA 92705 • (714) 546-5279

Prices and specifications subject to change without notice.

# Ceralam<sup>®</sup> Chips. When you're on the outside looking in.

If you're looking at ways to put more capacitance into a microcircuit, look into Ceralam chips. Because they're ceramic, they have the volumetric efficiency necessary for microcircuit applications. So you can package a lot of capacitance. Even when you're short on space.

Because they're made by the leader in multilayer technology, AVX chips deliver the performance needed in your

most demanding applications. They're tested for physical, electrical, environmental characteristics repeatedly during production. Qualified to AVX's demanding specifications. So you can adhere to yours.

Ceralam chips also make bonding easy. They're available in a variety of terminating materials, so you won't have to introduce changes into existing designs. And they

can be supplied with special terminations. Like AVX's exclusive alloy NiGuard<sup>®</sup>. A material that eliminates the need for preforms and wire bonding. And prevents base metal bleed through and silver migration.

If you've been looking around for the right kind of capacitors for your microcircuit designs, settle on Ceralam chips. They'll make an insider out of you.

## AVX: The Insiders

AVX Ceramics, P.O. Box 867, Myrtle Beach, SC 29577 (803) 448-3191 TWX: 810-661-2252  
Olean, NY (716) 372-6611 TWX: 510-245-2815

### *Specifications*

*12 physical sizes  
Capacitance Range:  
1pf to .58 mfd  
Voltages:  
200, 100, 50, 25  
Four temperature  
characteristics  
Seven available  
terminations*



AVX Distributors: Cramer Electronics, Inc. / Jaco Electronics, Inc.  
Liberty-Elmar Electronics / Newark Electronics / Texas Instrument Supply

# THE COMING MERGER OF HARDWARE AND SOFTWARE DESIGN



**In easy reach.** An engineer or programmer can control several peripherals through the Intellec microcomputer-development system.

---

Microcomputer technology is spawning design tools that can integrate hardware and software development; this article examines the background, and the following article describes the tools in detail

---

by William Davidow, *Intel Corp., Santa Clara, Calif.*

□ Trends in logic design make it clear that the digital-systems engineer will eventually become a high-level programmer. In order to solve most of his system-applications problems, he'll probably converse with his system in an English-like software design language, and the interaction will likely take place at the display of a design automation instrument that is also used to speed up hardware development.

The microcomputer development system described in the next article would seem to guarantee such a future. With it, an engineer can integrate software and hardware at the very start of system development. He can quickly compose and edit programs, try them out in prototypes operating in real time and in the real system environment. He can diagnose operations, do most of his debugging with program modifications, and document the changes—all with only occasional use of traditional diagnostic instruments and debugging tools. Therefore, this microcomputer-based instrument is serving notice on the engineering profession that design methods are still changing, but even more swiftly than in the past.

Already the industry at large is making a transition from hardware to software design, and, by integrating software and hardware development to an extent not seen in the past, the new approach is, for the average engineer, making an involvement in programming more imperative.

#### Economic dicta

Few companies in the past could enjoy the benefits of a computer-aided digital design center at the system level. Only large companies, working on large continuing projects could justify the cost. But now programmable large-scale integration shifts most of the preliminary design work to software, and software is readily automated.

Programmable LSI has also drastically simplified the phases of the design cycle that generally have defied automation because of the amount of manual engineering work traditionally demanded, namely, detailed development and laborious, time-consuming debugging. Even these phases can now be largely automated by a software design approach—an approach, moreover, that can be implemented with a microcomputer as the development tool. Thus the smallest companies can share in the benefits of design automation.

By the same token, automation for many companies will become mandatory, at least to the extent that the profitability of new designs depends on keeping development costs down and on penetrating new markets as soon as possible. More engineers will become involved in programming because the time has arrived when programmable LSI is high enough in performance for most digital systems. Compared to the earliest MOS microprocessors, the new microcomputer systems have 100 to 1,000 times the capabilities.

The use of design automation systems in the development of microcomputer applications is becoming increasingly practical for a number of reasons. As computer designers have long known, programmed logic techniques in general can rationalize system design.

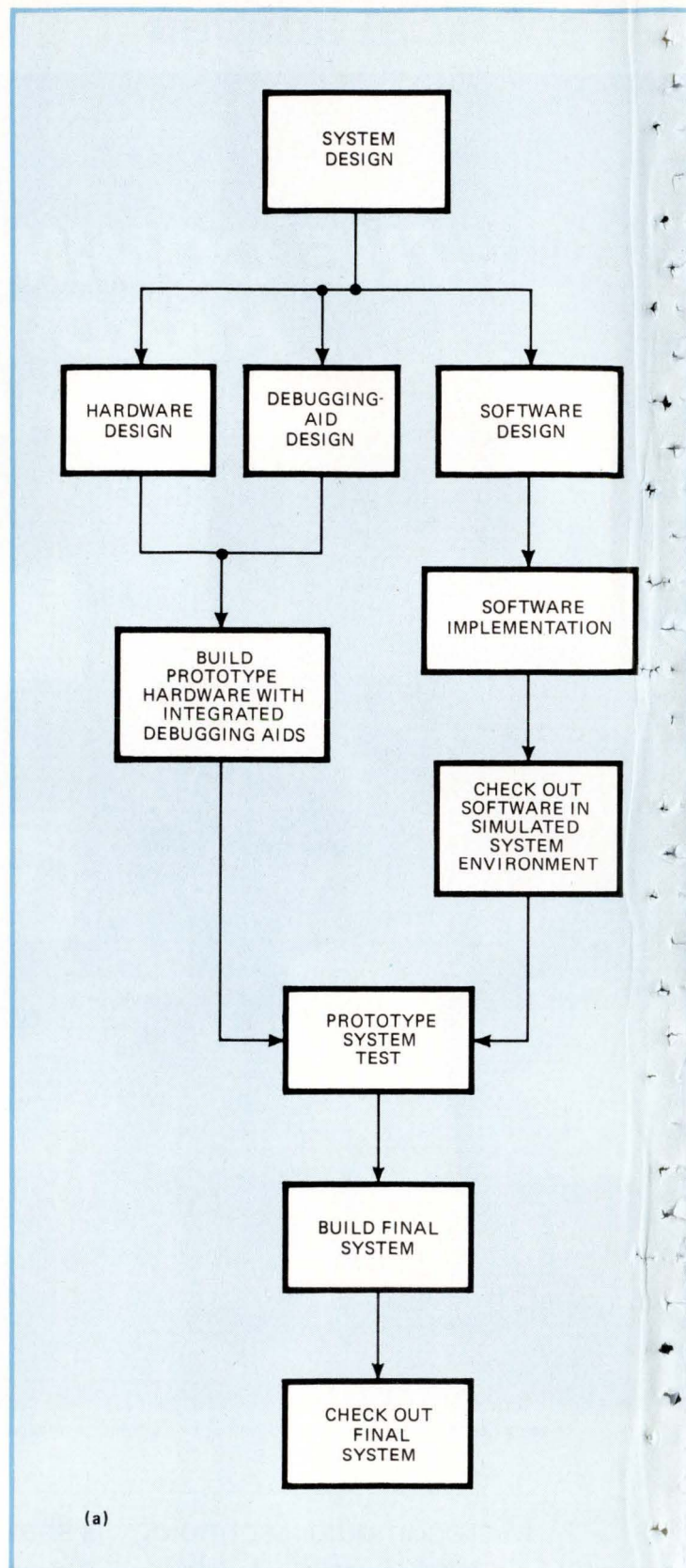

1. **The blender.** In microcomputer development (a), hardware and software are usually developed and debugged separately before being merged in the prototype. With the Intellec MDS (b), they can be developed and debugged simultaneously, avoiding subtle faults that can appear when the two are combined in the system.

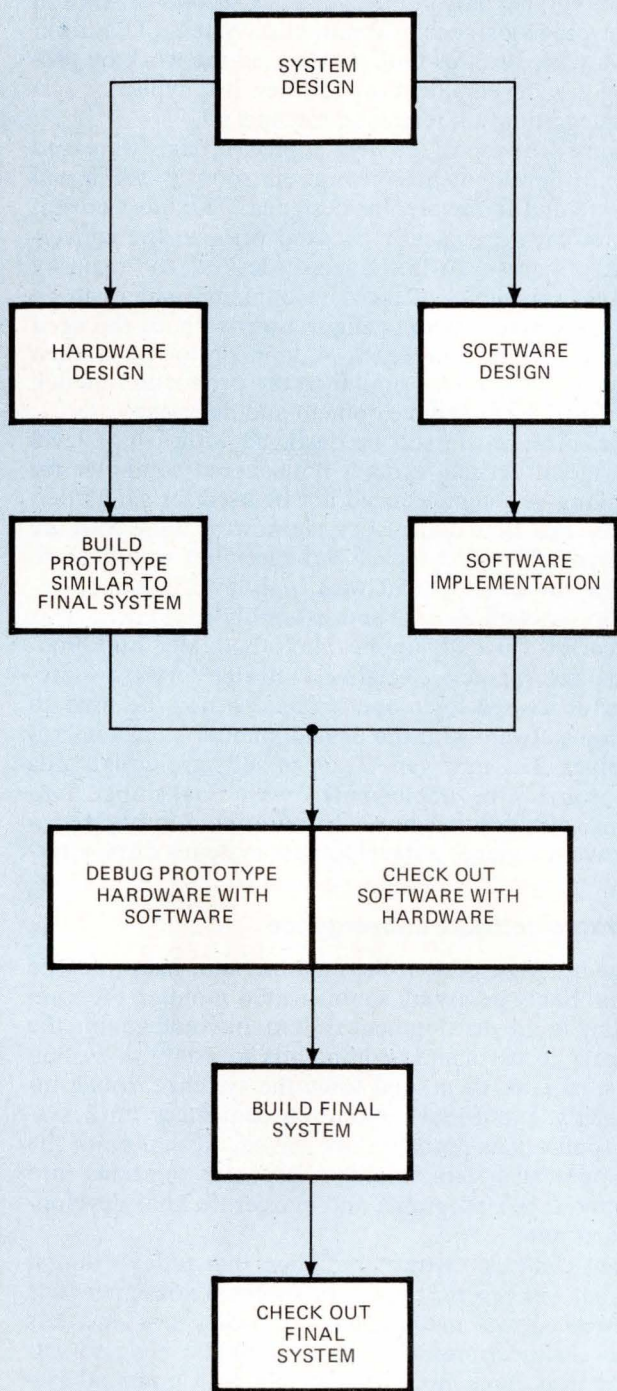

(b)

Also, LSI adds a high degree of hardware standardization, which facilitates shortcuts in development work. And because the semiconductor manufacturer produces programmable LSI in high-volume, standardized components, he has been able to underwrite the high cost of developing automation aids for the industry at large.

The cumulative effects of microprogramed logic standardization through LSI on the design process is often overlooked in the fascination with day-to-day developments in "computer on a chip" technology. But this standardization, probably more than any other trend to date, has changed system engineering techniques.

### Programed logic design

M.V. Wilkes, back in 1951, described the concept of programed logic design and argued that, if such logic were used, system design could be approached in a more organized fashion. Wilkes' concepts became popular with computer designers, and many of today's computers have microprogramed control subsystems rather than hardwired logic.

However, the great majority of other system designers continued to use hardwired logic, even though programed logic would probably have been more cost effective in the long run. At the time, most engineers either lacked a clear understanding of programed logic techniques or decided they could not justify the much greater effort required for initial development of a programed logic assembly.

These obstacles were removed almost overnight with the advent of microprocessors in 1971. Engineers could now implement new designs with programable LSI. They could utilize standard program instruction sets and standardized components instead of laboriously developing microprogrammable bipolar-logic assemblies. A few years later, microprogrammable bipolar LSI also became available.

In the relatively brief period since then, hundreds of companies, and lately thousands, have committed themselves to a software design approach. Semiconductor companies began to supply software design aids, such as assembler, simulators and high-level programming languages (the most powerful of which have reduced the manual work required for program development to only 1/25th to 1/50th of that required by early machine-language codes). These aids furthermore have become oriented toward design purposes because microcomputers are utilized to create new system designs, whereas in conventional computer programming, comparable aids are confined largely to the development of scientific and data-processing programs. For example, an extensible microassembler—one that can be adapted to different microinstruction sets for solving different problems—has been developed for use with microprogrammable bipolar LSI.

All this is not to say that hardware development techniques have lagged over the past 25 years. Indeed, they too have improved dramatically.

Throughout the 1950s, of course, logic designers spent much of their time doing traditional analog work; analog oscilloscopes, voltmeters, and other traditional tools were used to determine whether discrete-compo-

nent gates and flip-flops would work properly. Then in the 1960s, monolithic functions arrived and grew larger and larger, giving the engineer increasing confidence that his logic-circuit elements would work as specified. He could concentrate more of his time on logic organization.

Nevertheless, the engineer still spent a great deal of time on the prototype, devising test fixtures, installing indicator lamps and other extraneous hardware, and then gathering the information required to diagnose logic faults, and debug. While necessary, these chores detracted from the ultimate objective of getting a reliably working design into production as soon as possible.

### **Tedium of debugging**

Gathering debugging information is usually tedious and time-consuming. The engineer may have to set many flip-flops to initial states, and then, after going through a brief operating sequence, determine the states of the storage elements in the system. He also needs information on state sequences. An historical record of these sequences is very valuable for locating logic errors, which explains the instant popularity of digital instruments that record events and show present and previous states.

Still, because the prototype usually had extraneous hardware and was tested in a lab environment, the engineer could not be confident that the production model would not have serious faults. A breadboard might shrink down to a single card installed in a data terminal, where it would encounter a new electrical noise, thermal and mechanical environment. Or bits might drop out of the data stream because of control timing errors that were not discernible until the terminal was placed in its actual operating environment.

Such timing errors can require extensive redesign of hardwired logic (or of programmed logic software). Thus, some method of packaging and debugging prototypes in their final environment has always been high on the engineer's "wish list."

Programmable LSI goes a long way toward fulfilling the wish. A large portion of the circuitry is prefabricated and has known characteristics. Through software modifications, such major operating faults as timing errors can frequently be corrected. And, as often noted, the amount of extra circuitry added to the microcomputer is often trivial, making it relatively easy to design and debug and less subject to change than conventional assemblies.

Most ancillary circuitry is timed and controlled through the microcomputer. Consequently, the logic subsystem prototype can be packaged like the production system if the extraneous circuitry required for diagnostics and debugging is eliminated. The prototype itself can thus be used to check out software and hardware in real time and in the actual system environment. In other words, the prototype can become the vehicle for development and debugging of an integrated hardware/software design.

With early-generation microprocessor development aids, like simulator boards, the typical system went

through the development paths shown in Fig. 1(a), usually with iterations. Hardware and software could be fully integrated only at the end. Then second generation prototyping aids, such as the Inteltec systems, [*Electronics*, May 24, 1973, p. 130], accelerated the work by providing new development capabilities. But, typically, system integration still remained the final step.

Figure 1(b) shows the new approach. Hardware and software development converge as soon as the initial software and hardware are designed. The most critical parts of each are usually checked prior to the convergence, of course. At this stage, it desired, the memory and other resources of the development system can be used to explore system configurations without the need to build several prototypes. A lone prototype is then fabricated that is very similar to the production model, and is used for final development and debugging.

The software can still be designed with a high-level language, if desired, using a time-shared computer for compiling. A computer need not be used for simulation because real-time diagnostics can now be done with the prototype. The next logical enhancement would be to provide the development with high-level language capability, as well as edit and assembly capability. This approach is currently applicable to both MOS and bipolar microcomputers. Relatively straightforward statements of desired logic operations can now be used to develop software with the development system's microcomputer. The next generation of software-design aids will probably be implemented with English-like languages so that the engineer can use them in highly interactive manner at a development system's display terminal.

### **Hardware-software convergence**

The interface between the engineer and his prototype will probably be a very sophisticated monitor program residing in the development system. It would enable the engineer to use simple commands to establish system states, monitor them, and force the system through increasingly appropriate execution sequences until system-applications problems are solved. At that point the development system would incorporate solutions into the prototype's programs and accelerate final development, as now.

I am confident in my prediction that today's digital designer will become tomorrow's software designer. The experienced system designer will worry less and less about electrical problems, give up his probes and soldering iron, have more time to talk with potential systems users about their applications problems, and solve these problems through software engineering. Hardware design will become very simple, even for those unfamiliar with the fine points of Schottky gates, ECL, and transmission-line phenomena.

Even now, engineering labs at hundreds of companies are taking on the appearance of the software labs that once were found only at computer companies. Our industry is in a period of great change in technology. It faces an exciting prospect. But the immediate challenge to the engineers and educators in our industry is to utilize today's new technology today. □

# MICROCOMPUTER-DEVELOPMENT SYSTEM ACHIEVES HARDWARE-SOFTWARE HARMONY

Simultaneous debugging of microcomputer hardware and software from the beginning of the design cycle ensures engineers and programmers bug-free prototypes that can move smoothly to the production line

By Robert Garrow, Sterling Hou, James Lally, and Hap Walker, *Intel Corp., Santa Clara, Calif.*

□ To achieve optimum design of a microcomputer-based product at lowest cost, software and hardware should be considered simultaneously throughout the development cycle. If the give and take between engineers and programmers begins early enough, bugs can be avoided in the production model, where problems are usually most difficult to diagnose and correct. A bug-free prototype is not impossible, but developing one does require a common hardware/software environment, unencumbered by conventional laboratory-type diagnostic aids, as well as more sophisticated diagnostic techniques than such aids usually provide.

Ideally, the development team should begin its work with a complete prototype system so that all hardware

can be exercised, diagnosed, and debugged with the developmental software, and, conversely, the software can be exercised with the developmental hardware. That process is impossible, of course, since the engineer generally develops hardware subsystems in an orderly progression—firming up the central logic first, then working outward through the system to the memory, input/output, and peripheral subsystems. But it is possible to so completely emulate the missing subsystems at the beginning of the development cycle that, for all practical purposes, the actual system environment is duplicated for both engineer and programmer.

As a vehicle for integrating hardware, developing software, and debugging them both, the Intellec MDS

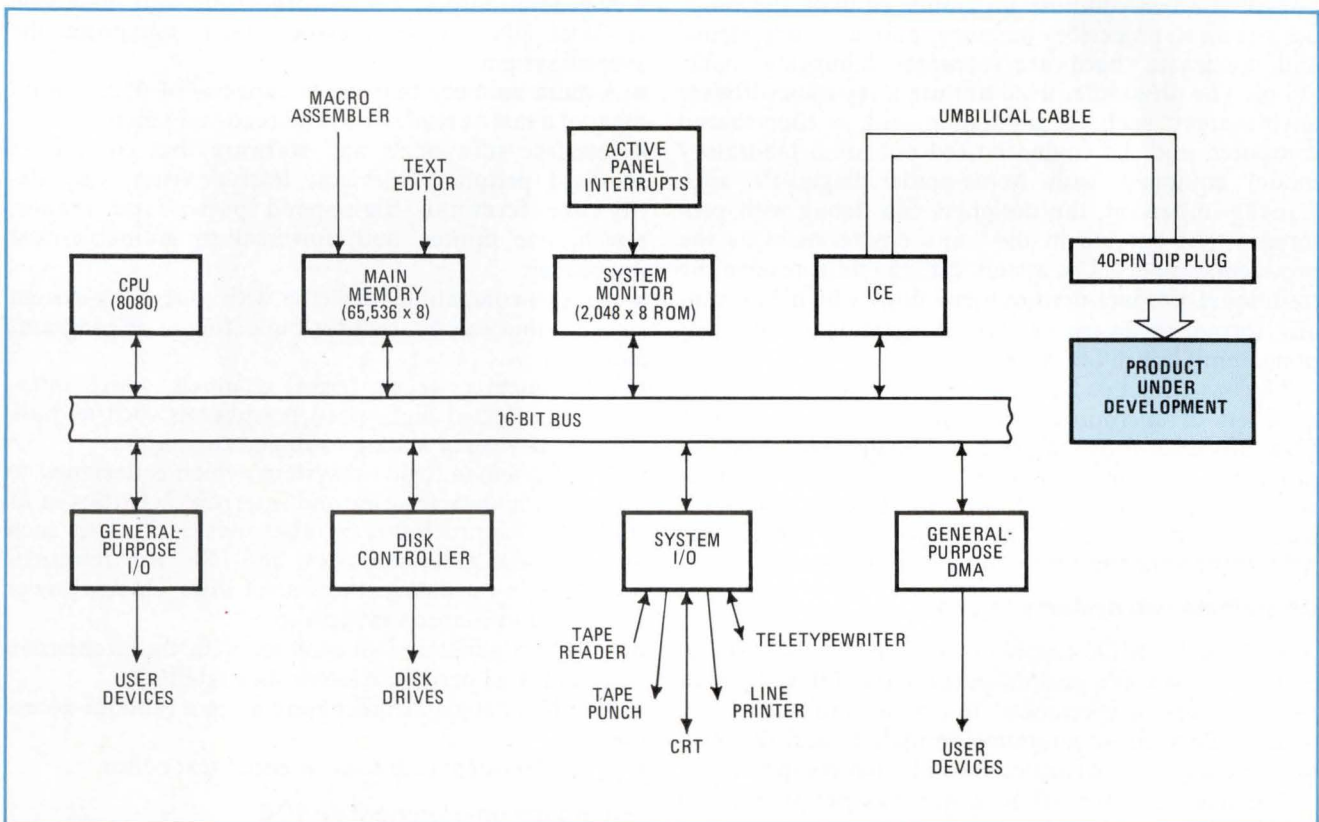

**1. Multi resources.** The Intellec MDS controls many peripherals through its 16-bit bus. The peripherals can emulate equipment that will be used in the product under development. The in-circuit emulator, ICE, replaces the master circuitry of the product under development.

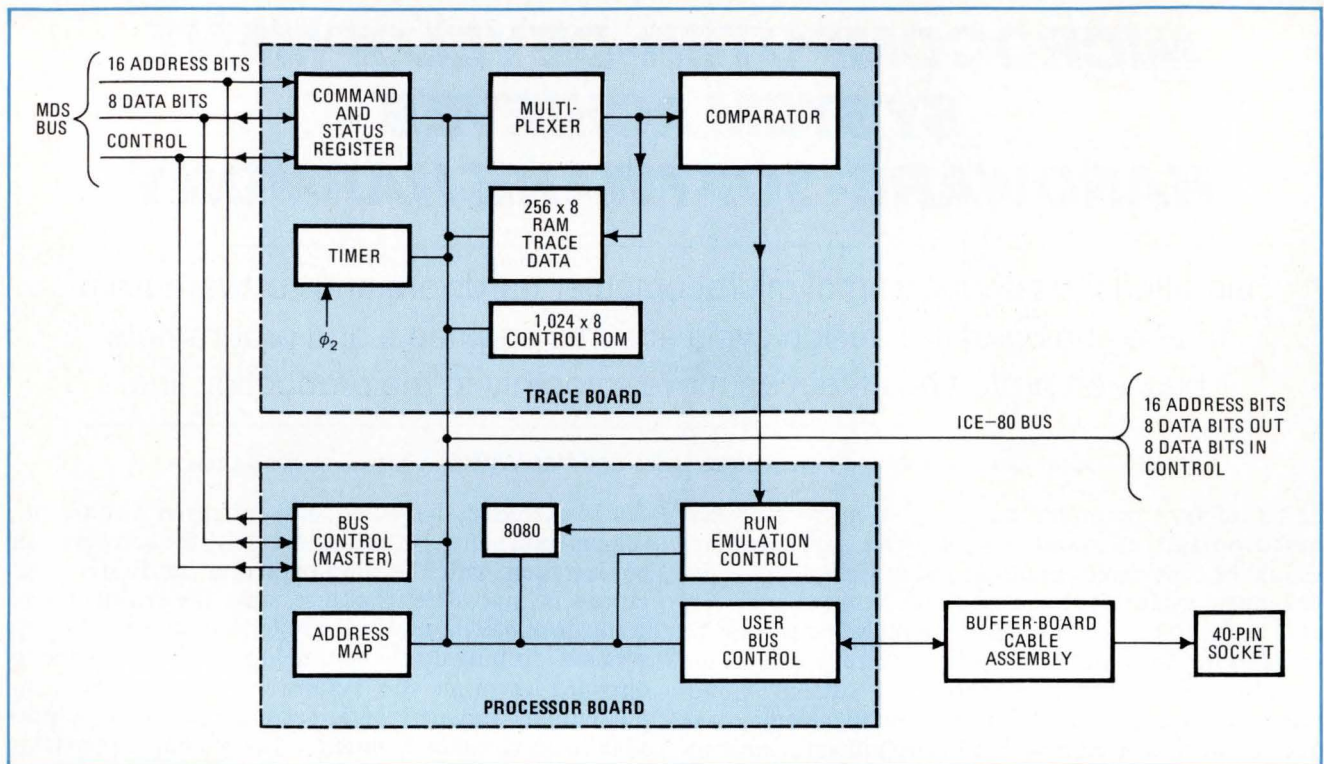

**1. MOS ICE.** The ICE-80 is an in-circuit emulator system using the MOS 8080 microprocessor. It is mounted on two circuit boards—one holds the central processor and the other holds circuitry that allows the user to trace the preceding 44 program steps.

(microcomputer development system) was developed to satisfy the combined needs of engineer and programmer. The system can compose programs, emulate the product's central processor, memory, and I/O subsystems, and automate hardware/software debugging operations. The programmer need not use a separate software environment, such as simulation with a time-shared computer, and the engineer need not use a laboratory model equipped with home-made diagnostic aids. Equally important, the designers can debug with prototypes that operate in the same environment as the production model. The system can, in effect, reverse the traditional product-development flow, which has usually forced hardware-software integration to be postponed until late in the cycle.

The basic Intellec MDS can be adapted to work with a variety of microprocessors, whether MOS or bipolar. This processor-independence eliminates the need for multiple development systems, which were designed for specific microprocessors. Now, only software and hardware enhancements are needed to adapt the Intellec MDS to present and future microcomputers.

### Combining two systems in one

The Intellec MDS consists of two systems: a basic facility that controls a general-purpose set of development resources and a specialized in-circuit emulator (ICE), which tailors the programming, emulation, and diagnostics functions to a particular class of microcomputers.

The basic Intellec MDS facility has peripheral and software resources that enable the programmer to use the system much like a large-scale computer for program development. It is a multiprocessor-oriented micro-

computer with a variety of bus-organized subsystems (Fig. 1). These are:

- A general-purpose central-processing unit, based on an Intel 8080 microprocessor, which supervises the over-all system.
- A main memory that has a capacity of 65,536 8-bit bytes of a mix of read/write and read-only memory.
- Interface subsystems and software that control six standard peripheral devices: teletypewriter, cathode-ray-tube terminal, high-speed paper-tape reader, punch, line printer, and universal programable-ROM programmer.
- An IBM-compatible diskette with operating-system software that can be used for bulk storage or programs and data.
- Direct-memory-access (DMA) channels, which interface user-selected high-speed peripherals such as bulk memory devices or analog-to-digital converters.
- A bus-oriented logic subsystem, which is designed to organize the data transfer and interrupt activities of as many as nine processors or other master modules such as the central processor, DMA, and ICE. Bus resources include a 16-bit data path, control lines, clocks, power supplies, and connection facilities.
- A ROM-resident system monitor with comprehensive diagnostic and peripheral-control capabilities.
- An 8080 macroassembler resident in a random-access memory.
- A RAM-resident character-oriented text editor.

### Putting the environment on ICE

The ICE module, which adapts the Intellec MDS to a particular class of microcomputers, contains the master



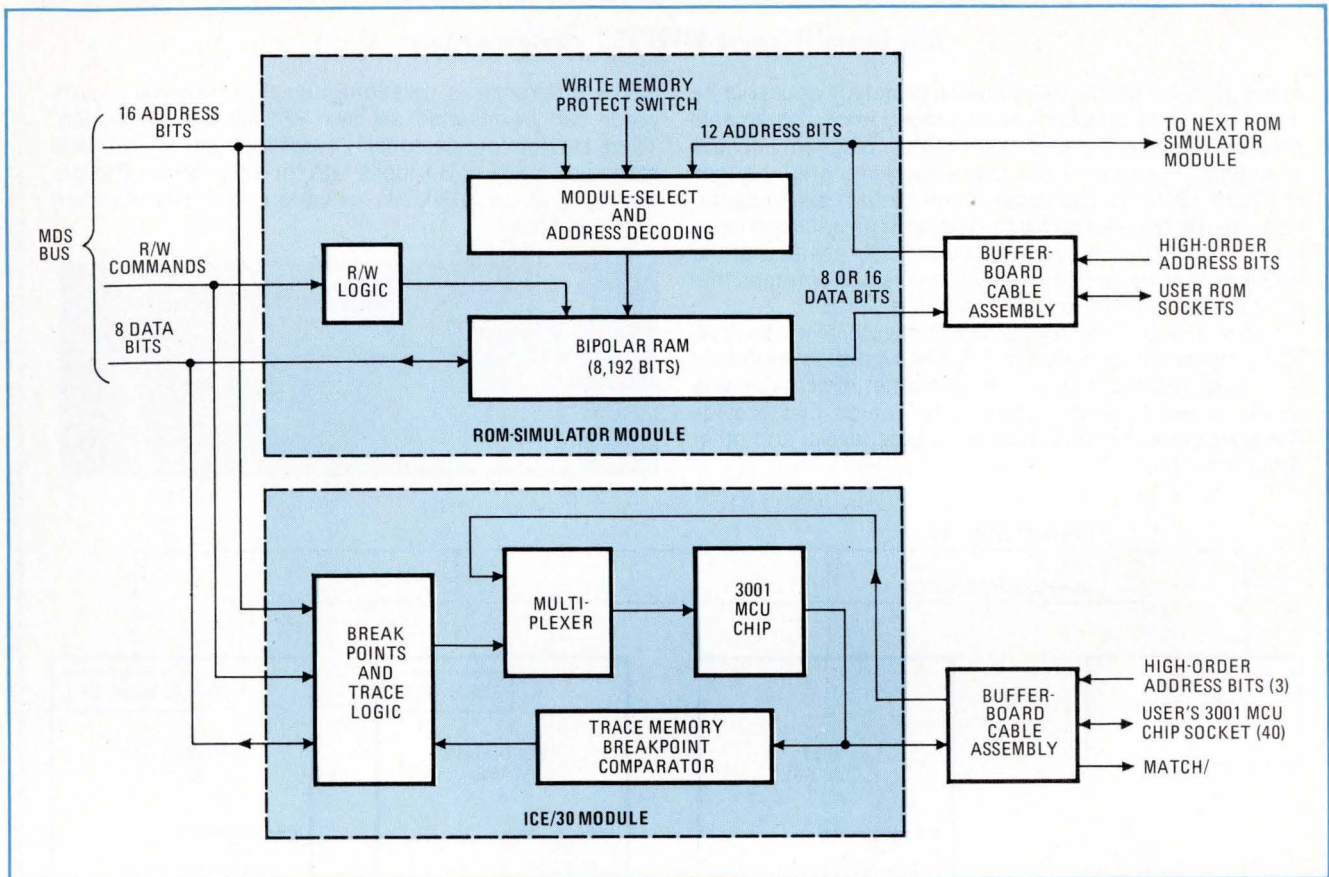

**3. Bipolar ICE.** The ICE-30 is an in-circuit emulator for systems using the bipolar series 3000 microprogram-control unit. It consists of the MCU chip itself plus a high-speed bipolar RAM that simulates the ROM usually used with the series 3000 circuits.

circuitry of the prototype being developed. This circuitry includes the CPU of an MOS microcomputer or the microprogram control unit of a bipolar system.

The ICE module, which also contains logic and memory for monitoring prototype behavior and interfacing it with the basic resources, can be driven by the prototype's clock circuitry for real-time emulation. The module has an umbilical cable (Fig. 1) that plugs into the prototype where the finished product's master circuitry will plug into the production model. The cable also picks up the user's bus structure at this point. The rest of the prototype can be identical to the production model, and no extraneous hardware is needed for diagnostic aids.

The ICE diagnostic modes replace the diagnostic aids and operating interfaces, such as light-emitting-diode display and switch panels, ordinarily assembled into laboratory models, as well as most of the manual acquisition of diagnostic information with instruments. (In fact, as the speed and complexity of microcomputer-based systems have increased, the utility of conventional diagnostic aids and instruments has waned.) Thus, the development team can use prototypes that are packaged the same as production models to check out hardware and software in the product's actual operating environment. In effect, the prototype is the production model.

The ICE module has three major functions. It allows the programmer to use the basic Intellec MDS resources

as though they were a part of the prototype system. But, since the ICE contains the master circuitry itself, and is not merely a simulation, the programmer can debug the software because he is exercising the software in its actual hardware environment.

The module also allows the programmer and engineer to diagnose and debug in a common hardware and software environment, using one to check out the other, as the prototype hardware is checked out and built up in an orderly progression. Typically, the engineer would first use the master circuitry to debug CPU auxiliary logic, which is usually the most critical portion of his design.

In this phase, memory, I/O, and peripheral subsystems can be emulated by the MDS basic resources. Then, as the engineer adds such functions as the memory, I/O logic, and peripheral subsystems, the emulated resources can be "disconnected" and replaced by the actual production-packaged hardware of the final system.

Finally, the ICE module is the development team's "window" for observing prototype operation with convenient, highly automated designer/machine interfaces, such as an interactive CRT display-keyboard console. Through this window, the ICE module takes "snapshots" of system states, including the transitory states that occur during an instruction cycle. The team can also stop the prototype at any desired point in real-time operation, freeze the system state for detailed inspection.

## An intelligent PROM programmer

In the past, the hardware/software prototype could not be integrated until programs were loaded into programmable read-only memories and the PROMs plugged into the prototype. Then came the final debugging and changes in PROM patterns. But today, such pattern experimentation, can be handled along the way with an in-circuit emulator. The PROM then can be loaded near the end of the development cycle with a new universal programmer that operates as a peripheral of the Intellec MDS.

Inside the programmer, a microcomputer with an Intel 4040 tailors the program to the PROM the development team has decided to use. The programmer directs the data to be stored through "personality" cards that provide the appropriate timing patterns, voltage levels, and other requirements.

The programmer is partitioned so that new personality cards can be inserted as new PROMs are developed. There are now four personality cards for Intel MOS PROMs storing as many as 8 kilobits and for Intel bipolar PROMs storing 1, 2, or 4 kilobits in various industry-standard configurations.

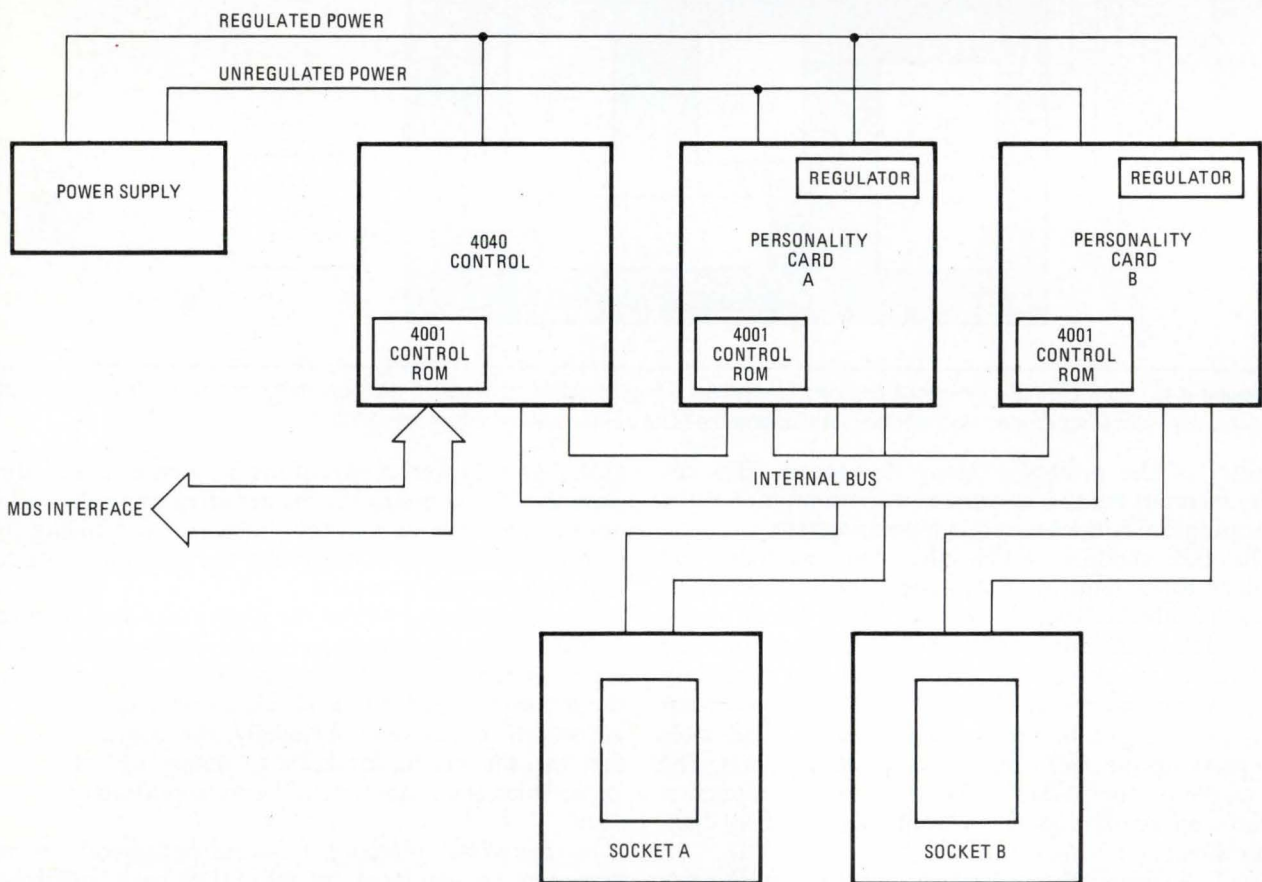

tion, force selected changes in system states, and observe the results.

Two ICE modules have been developed—the ICE-80, for systems based on the MCS-80 microcomputer family, which uses the 8080 silicon-gate n-channel MOS 8-bit CPU [*Electronics*, April 18, 1974, p. 95], and ICE-30, for systems built with series 3000 Schottky bipolar LSI microprogrammable computing elements [*Electronics*, Sept. 5, 1974, p. 89].

The ICE-80 module (Fig. 2) is a complete microcomputer system on two cards. In addition to the 8080 CPU, its master circuitry contains control-request regis-

ters, scratchpad RAM, control ROM, and the interfaces required to emulate the 8080 CPU in the user's prototype equipment.

The ICE-30 module (Fig. 3) contains all the circuitry required to emulate the Intel 3001 MCU. It operates in conjunction with a bipolar ROM simulator, which is a high-speed 135-ns bipolar read/write memory that contains the actual microcode to be executed. The MCU and the control ROM constitute the heart of all series 3000 systems. The MCU selects from ROM storage the microinstruction sequences required to reconfigure the system logic to execute a macroinstruction from the over-all

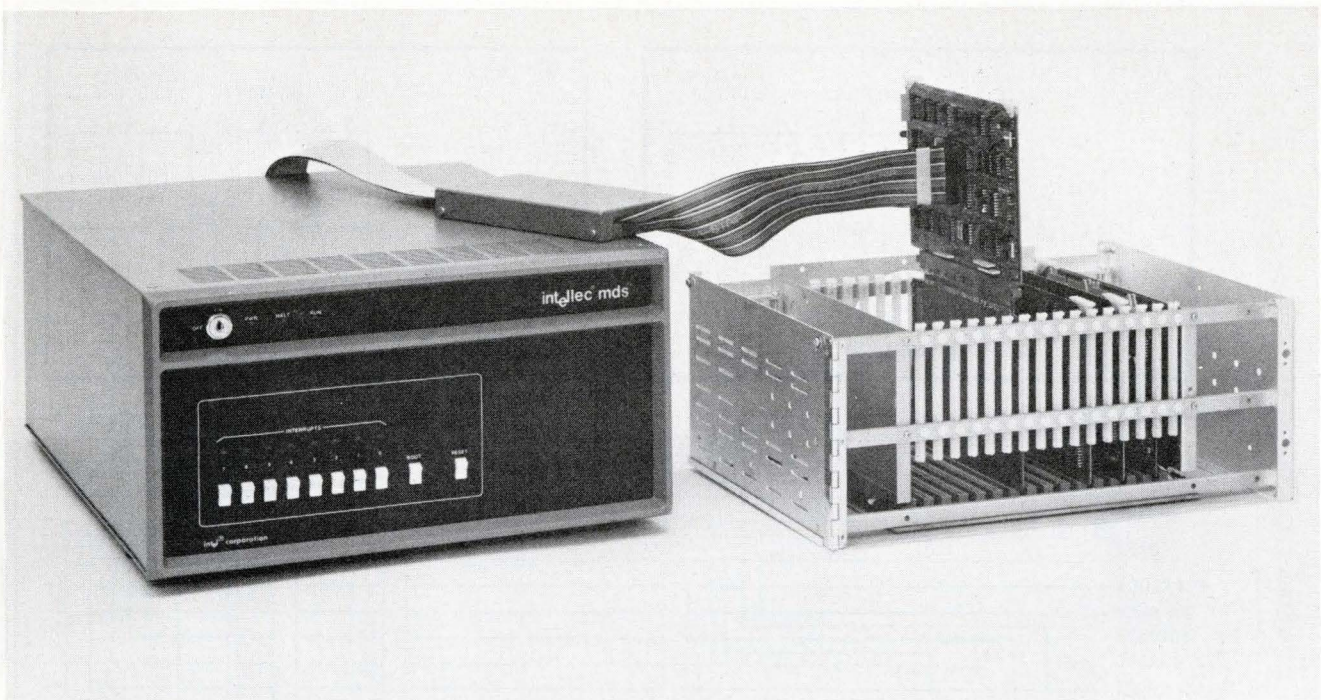

**Uncut cord.** An umbilical cable connects the Intellec MDS to the prototype equipment through a 40-pin dual-in line plug. The plug is inserted in the socket where either an 8080 microprocessor or a series 3000 bipolar microprogram-control unit will later be placed.

system program. Backed up by new microprogram-generation software that runs on a medium-scale computer, this process makes microprogram development and debugging easy and efficient. This configuration allows for the extremely variable CPU and bus structures encountered in microprogrammable bipolar systems.

### Diagnosis and debugging

Conventional diagnostic aids and instruments may enable an engineer to see by means of LEDs the states of complex microcomputer-based systems at the end of an instruction cycle, but he cannot see the many changes in system states that occur at nanosecond speeds during each cycle—and the most stubborn bugs usually involve these transitions. To avoid endless hours of probing, engineers have had to add elaborate diagnostic aids and special interfaces to lab models in order to force, monitor, store, and interpret system-state sequences. Programmers have taken similar steps to help in debugging software.

To cope with these difficulties, development teams often work with much extraneous hardware and software. The aids not only are costly, but also force team members to work in arbitrary hardware and software environments, which often lead to trouble in debugging production models.

The ICE module greatly simplifies this diagnosis. The three most basic ICE diagnostic modes are interrogation, single-step, and multiple single-step operation. In the interrogation mode, the ICE can be used to examine and modify internal CPU registers and memory locations.

For example, ICE-80 enables the operator to reset the 8080's flag logic, stack pointer, program counter, or general-purpose registers and then see the results of the

modification on the next step. If the program-counter contents are modified, for example, the system jumps to the desired instruction and executes it. If the stack pointer is changed, information that had been saved in memory during some previous execution can be inspected directly.

In the single-step mode, one instruction is executed, and a "snapshot" is taken of system states, including memory address, data, and status, which are translated into readable images that can be displayed on the system console. The next instruction is then executed upon operator command.

In multiple single-step operation, the system appears to run continuously. It single-steps automatically, pausing only long enough between instruction cycles to display or log the data that has been collected. This mode is particularly useful when an engineer or programmer wants to look at system behavior throughout an operating sequence. He can note operations that appear to be troublesome, as well as retrieve the images from bulk memory for detailed off-line analysis.

These modes can be alternated or combined with a real-time emulation mode to thoroughly analyze hardware/software interaction in the user's environment.

### Emulating in real time

The real-time emulation mode exercises the user system at full speed, dynamically tracing program address, data, and status information in real time. In this mode, ICE breakpoint comparators are set to the appropriate memory or I/O addresses, and the system is run at full speed until a breakpoint address is encountered.

At the breakpoint, the system is automatically halted and the results of previously executed instructions can be recalled for analysis. ICE-80, for example, can recall

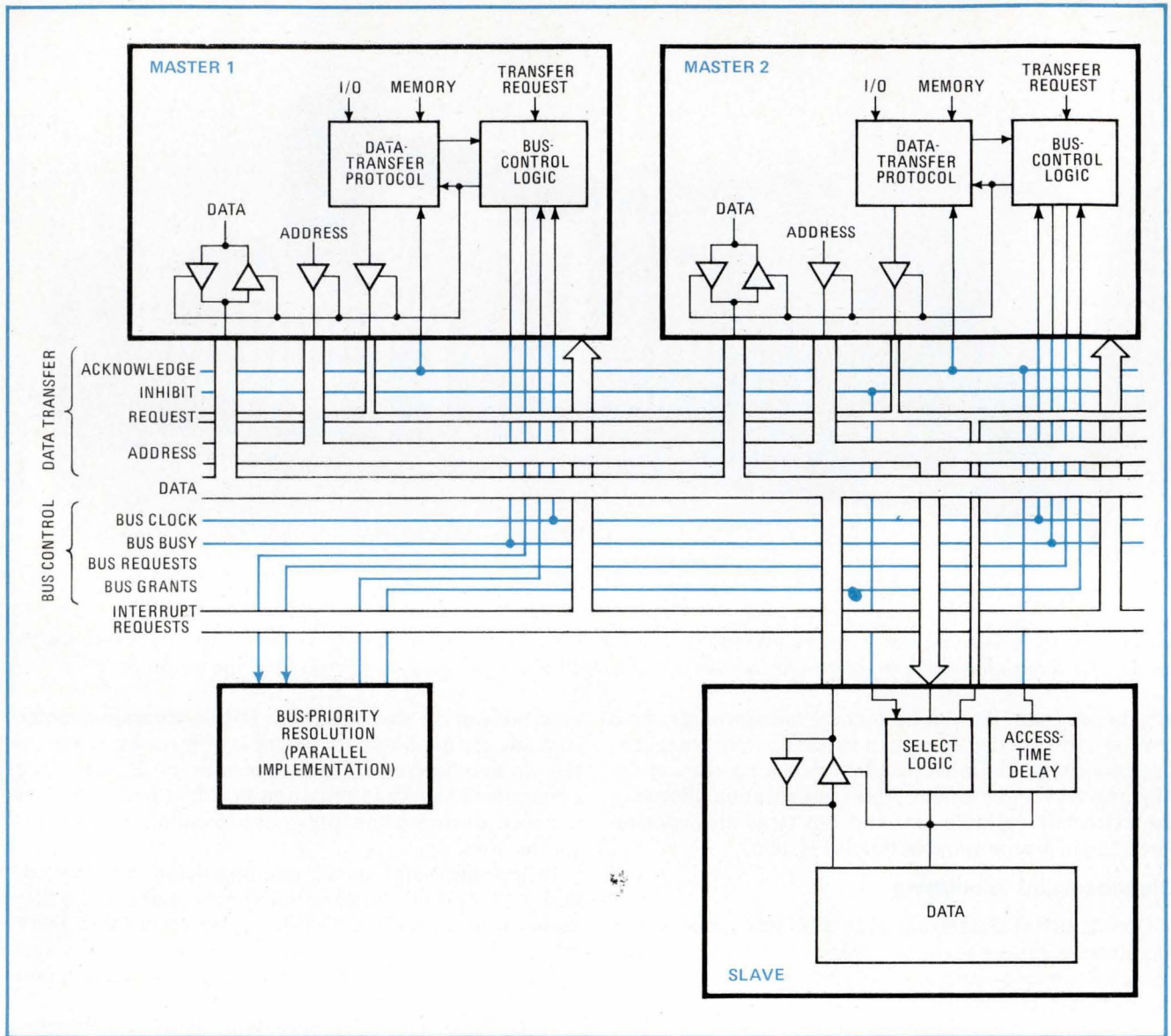

**4. Bus organization.** The bus, which carries data and addresses between the various resources of the Intellec MDS, can be controlled from master modules, such as the CPU, DMA, or ICE. Typical slave modules are ROMs and RAMs. Priority assignments can allow important modules to interrupt less important modules' control of the bus. Transfers are asynchronous at rates up to the 5-megahertz bus bandwidth.

the address, data, and status information of the previous 44 machine cycles.

A variety of breakpoint conditions can be specified to stop a program: memory read, memory write, I/O read, and I/O write. These conditions may even be further qualified by prototype logic operations, combined with such functions as stack operations or instruction-fetch. For example, the user could monitor a device such as flip-flop A in his prototype and specify a breakpoint halt when A is set and a specific stack address is being accessed. This enables the development team to make sure the flip-flop is set at the proper point in a control, data-processing, or interrupt-handling routine.

The MDS/ICE system can emulate as yet unbuilt hardware quite realistically. Even though the engineer may use a static RAM in his prototype, and the Intellec MDS uses a dynamic RAM, the effects of the two will be functionally indistinguishable. And, since he has pre-

sumably already chosen to use the 8080 microprocessor or 3001 microprogram-control unit, it is unlikely that the actual memory in the prototype will differ significantly from the Intellec MDS main memory or ROM simulator.

The growing standardization in I/O equipment should enable the Intellec MDS to support most desired mixes of I/O peripherals. A floppy-disk drive, paper-tape reader and punch, CRT terminal, teletypewriter, and line printer can be accommodated. Although hardware timing may be different in the actual prototype, the software can be used to adjust for these differences and make the peripherals operate as they will in the final prototype.

Nevertheless, some specialized hardware devices may have to be interfaced with the Intellec MDS, since it cannot simulate all possible types of input/output equipment. To meet these requirements, the MDS

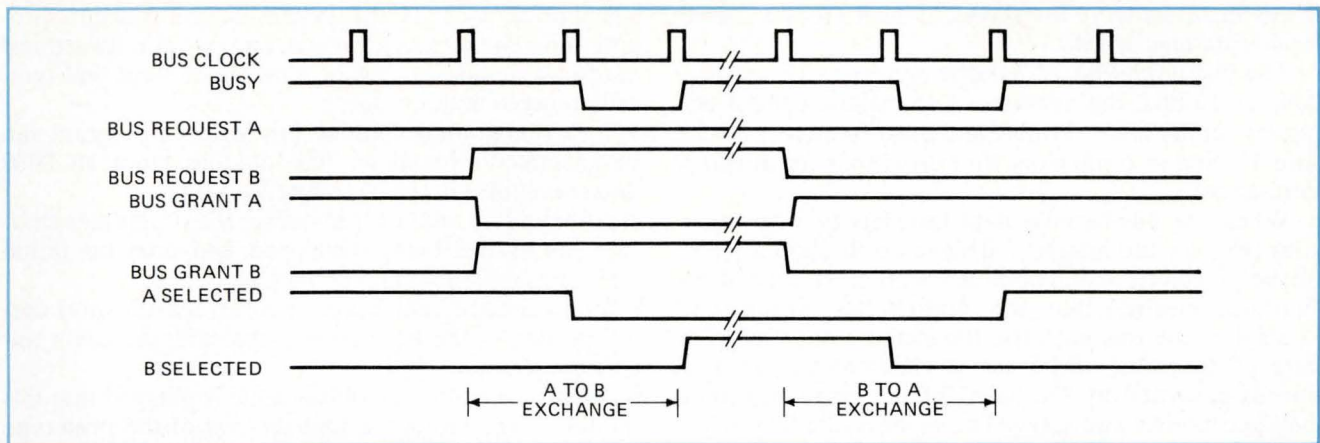

**5. Bus exchange.** Control of the bus is transferred within two clock periods. With A in control, module B requests the control. The A selected line goes low, and then the B selected line goes high, completing the transfer. During transfer, the busy line is low, blocking other requests.

offers general-purpose I/O and DMA modules that can be used to interface special-purpose peripherals, such as scanners, a-d converters, and similar control and data-collection devices.

### Using Intellec MDS software

Resident software provided with the basic MDS includes the system monitor, 8080 macroassembler, and text editor. Used together, these three programs simplify program preparation and speed the debugging task. The system monitor, written in 8080 assembly language in 2,048 bytes of ROM, completely controls operation of the basic MDS.

All necessary functions for loading programs and executing 8080 programs or series 3000 microprograms are provided. Additional commands include extensive debugging facilities and PROM-programming functions. System peripherals may be dynamically assigned, either via monitor commands or through calls to the system monitor's I/O subroutines.

The system monitor contains a powerful and easily expandable input/output system, which is built around four functional types of devices. These are the console device, reader device, punch device, and list device. Associated with each functional type of device may be any one of four physical devices. The user controls the assignment of each physical device to each logic device through a system command.

Drivers are provided in the system monitor for an ASR-33 Teletype unit, the universal PROM programmer, high-speed paper-tape reader, high speed paper-tape punch, line printer, and CRT. The user may write his own drivers for other peripheral devices and easily link them to the system monitor.

The resident 8080 macroassembler translates symbolic assembly-language instructions into the appropriate machine-operation codes. In addition to eliminating the errors of hand-translation, the ability to refer to program addresses with symbolic names makes it easy for the user to modify programs by adding or deleting instructions.

Full macro capability eliminates the need to rewrite similar sections of code repeatedly and greatly simplifies the problem of program documentation. Condi-

tional assembly permits the assembler to include or delete sections of code, which may vary from system to system, such as the code required to handle optional external devices.

Object code produced by the assembler is in hexadecimal format. It may be loaded directly into the Intellec MDS for execution and debugging, or it may be converted by the system monitor to the standard ROM-programming format, BNPF. (The B and F are start and stop characters, and the N and P indicate general strings of 0s and 1s, respectively.)

The assembler occupies 12 kilobytes of RAM, including space for more than 800 symbols. By adding RAM, a user may expand the table size to a maximum of 6,500 symbols.

The text editor is a comprehensive tool for the entry and correction of 8080 assembly-language programs and series 3000 microprograms. Its command set allows manipulation of either entire lines of text or individual characters within a line. The text editor occupies 8,192 bytes of RAM, including more than 4,500 bytes of work space. This space may be expanded to a maximum of 50 kilobytes by adding RAM.

Programs may be entered directly from the console keyboard or from the system-reader device. Text, which is stored internally in the editor's work space, may be edited quickly and efficiently by means of the commands, string insertion or deletion, string search, and string substitution.

The assembler and text editor are written in PL/M, Intel's high-level system-programming language [*Electronics*, June 27, 1974, p. 103]. All I/O in the assembler and editor is handled through the system monitor, enabling the assembler to take advantage of the monitor's I/O system. The assembler and editor, both of which are standard, are shipped in hexadecimal object format on paper tape or diskette.

### Take the bus

All subsystems, including the ICE modules, interact via the bus, which can be controlled from as many as nine "master" modules, which are any modules capable of requesting a data transfer (Fig. 4). The CPU, DMA, and ICE modules act as masters, and devices such as

RAMs or ROMs serve as "slaves," which are the sources or destinations of data.

The bus motherboard handles systems with words as long as 16 bits. Bus resources also include control and power-supply lines, variable and fixed-frequency clocks, and 18 plug-in connectors with provisions for auxiliary connectors.

When the bus handles data transfers between modules (Fig. 5), the master and slave go through a handshake procedure that, combined with other control operations, ensures that the master has unequivocal control of the bus until the transfer is completed. The rate of transfers, which are asynchronous, varies at speeds governed by the needs of the communications between master and slave. The highest rate is 5 megahertz, the maximum bus bandwidth.

The bus also communicates interrupt requests from one module to another. Interrupts, which may be generated by front-panel switches or by sources such as external request lines connected to general-purpose I/O or DMA modules, are processed by the system's CPU. The user needs only to define system responses to interrupts and assign priorities to ensure that contentions for interrupt service are handled unambiguously.

An inhibit is included in the bus-transfer functions to allow one slave to override another's ability to respond to a transfer request by disabling the other's address decoders and output drivers. This function allows RAMs and PROMs to be mixed in main memory.

### Expanding memory and I/O capacities

Memory capacity in a mix of read/write and read-only memory can be combined in the MDS's standard chassis for a total of 65,536 8-bit bytes. RAM cards are organized in 16-kilobyte blocks, but they can be paired by simple jumper wires to operate in 16-kiloword blocks. The standard PROM cards contain erasable and reprogrammable ROMs storing either 6 kilobytes or 4 kilowords per card. Only 2 kilobytes of address space are required for the basic Intellec MDS internal operations, leaving the remainder as prototyping or programing resources.

The system's I/O module and the resident monitor, which is firmware in a ROM array, operate six types of peripherals—interactive CRT display/keyboard console, teletypewriter, high-speed printer, high-speed paper-tape punch and reader, and a universal PROM programmer, which itself is a microcomputer system (see "An intelligent PROM programmer." p. 98).

The general-purpose I/O subsystem is modularly expandable to 44 input and 44 output ports. Each module provides four 8-bit input and four 8-bit output ports. Besides the usual latched outputs and multiplexed inputs, the prototyping resources include adjustable output strobes, latched inputs, selectable termination networks, open-collector interrupt drivers, high-current output drivers, and eight system-interrupt lines.

### Developing prototypes

The appropriate ICE module and software enable the engineer and programmer to work with automated hardware and diagnostic facilities in the actual system envi-

ronment as soon as the system-design concept, program-flow charts, specifications, and initial software and hardware designs are ready. The major steps will typically proceed in this order:

- Initial program generation (an MCS-80 program can be generated without an ICE module, since an 8080 CPU is available in the basic Intellec MDS).
- After an ICE module is installed, the programmer emulates the system being developed and does his initial real-time emulations and debugging.
- Simultaneously, the engineer constructs the most critical portion of the logic system, typically the CPU's ancillary logic.
- The ICE module's umbilical cable is plugged into this portion of the prototype, and the rest of the prototype system is emulated by the ICE module, together with the Intellec MDS memory and I/O resources.
- The prototype is exercised with the software, allowing the team to use Intellec MDS/ICE diagnostic facilities to thoroughly check out and debug the hardware and related software.
- The critical hardware portions—memory, I/O, other subsystems, and standard peripherals—are added successively in order of importance, to the prototype. As each is added, the corresponding Intellec MDS resources may be "disconnected" and each portion of the hardware/software system debugged.
- By this stage, the prototype should be identical to the production model when the ICE umbilical cable is replaced by the actual master circuitry.
- The prototype is released to production where the Intellec MDS/ICE configuration can be used for production-testing. What is important is that never does it become necessary for the user to install extraneous hardware in the prototype in order for the engineer to perform diagnostics.

### Humanizing the interface

In the past, programmers have had the lion's share of design automation and diagnostic aids. Both engineers and programmers have had good reason to grumble about this situation, since it hampered their ability to work together as a team. But now they can join to achieve the mutual goal—delivery of a bug-free design in production. This was Intel's primary objective in developing the Intellec MDS.

Other major objectives were to avoid the expense to supplier and customer alike of developing dead-end facilities appropriate for only one class of microcomputer and to minimize the number of options that had to be specified to arrive at a system with optimum configuration for a specific project. Now, as new microcomputers emerge, the development team can enhance the basic Intellec MDS system to personalize it to a particular class of microcomputer.

Best of all, the new prototyping and diagnostic techniques simplify and humanize the entire designer/machine interface. Previous debugging tools were designed for the machine's convenience—not the designer's. Now a programmer and engineer or a single software engineer seated at an interactive display has all the required design tools within arm's reach. □

**RELIABILITY:** When the highest capacitor reliability is required for critical filtering, bypass and coupling circuits in medical equipment, space vehicles and undersea communications equipment, KEMET GR500 Series Graded Reliability Capacitors are specified.

Each GR500 Series Capacitor is thoroughly tested and precisely performance-graded. Your order is shipped with the actual test data documenting the failure rate—as low as 0.001% per 1,000 hours. They are available now for prompt delivery in six hermetically sealed case sizes in a CV range of 0.0047 to 1,000  $\mu\text{F}$ , 6 to 100 VDC for operation at  $-65^{\circ}\text{C}$  to  $+125^{\circ}\text{C}$ .

The performance characteristics and specifications for these capacitors are described in a new series of product catalogs. Write today for this latest information.

Components Department, Union Carbide Corporation, P.O. Box 5928, Greenville, SC 29606; phone (803) 963-6300, TWX: 810-287-2536, or Telex: 57-0496.



# KEMET<sup>®</sup> OFFERS YOU MORE.



**UNION CARBIDE** COMPONENTS DEPARTMENT

KEMET is a registered trademark of Union Carbide Corporation

In Europe: Union Carbide Europe, S. A. 5, Rue Pedro-Meylan, Geneva 17, Switzerland. Phone: 022/47 4411 Telex: 845-22253

Circle 103 on reader service card

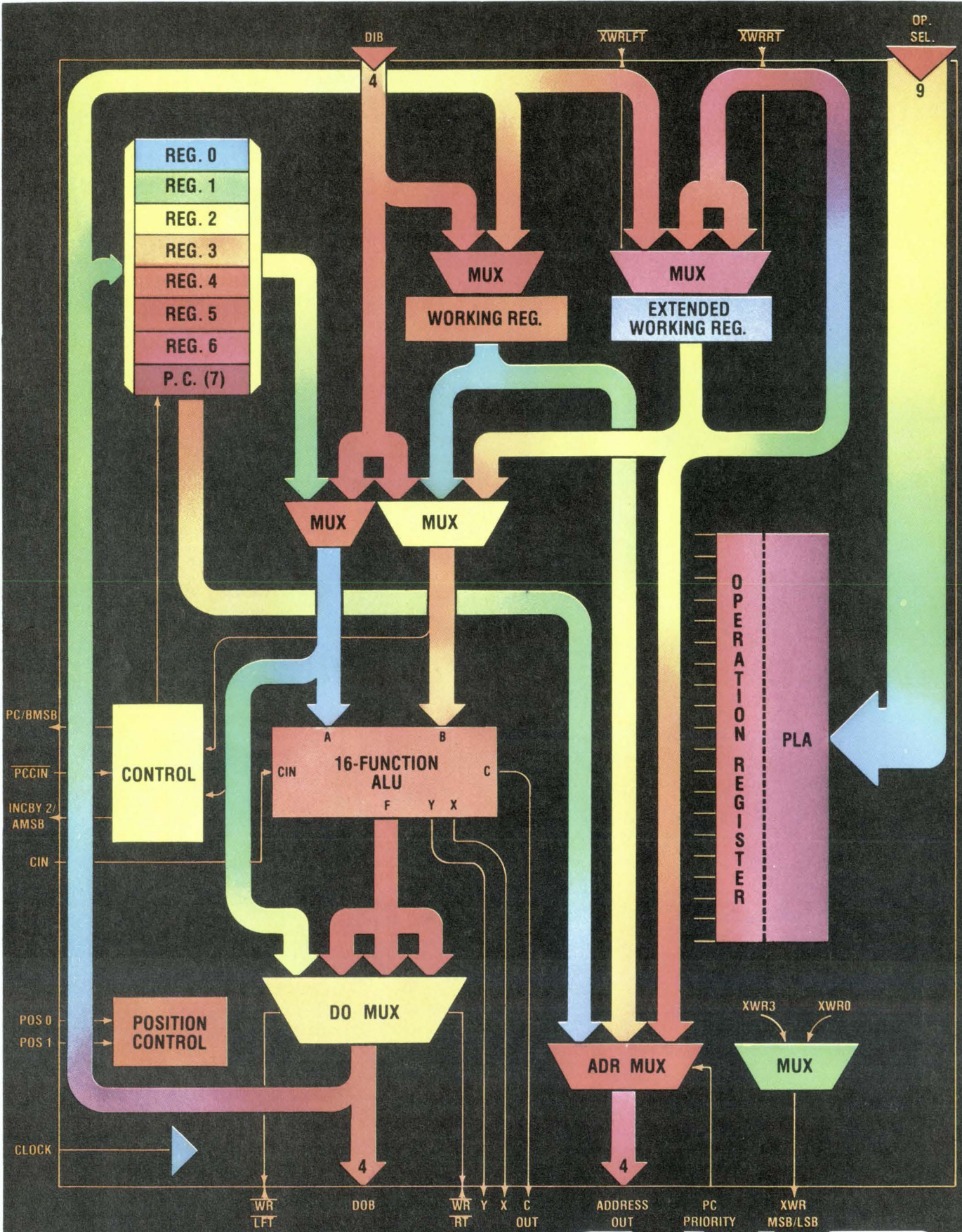

Combine the unique properties of integrated injection logic with microprogrammable bit-slice architecture. The result. A very powerful microprocessor element and the beginning of a revolutionary new technology. Texas Instruments has pioneered both.

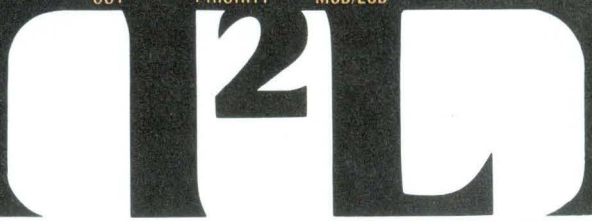



# SBP0400

## 4-bit slice microprogrammable microprocessor element. Integrated Injection Logic. ...from Texas Instruments.

The SBP0400 is a digital processor building block and the first of the standard Integrated Injection Logic (I<sup>2</sup>L) ICs from TI.

The 0400 combines the unique properties of I<sup>2</sup>L technology with an expandable 4-bit slice architecture to offer an unmatched level of performance and design flexibility.

It's microprogrammable. You build instructions by externally sequencing the 0400's factory-programmed micro-operations. Emulate existing designs, at either the micro or macro level, with software compatibility. Or create highly efficient new designs with tailored instructions.

With over 1,600 gates, monolithically integrated into a 40-pin package, the 0400 offers the basis for efficient, low cost design solutions to a host of applications in both industrial (0° to 70°C) and military (-55° to 125°C) environments.

The SBP0400 is also directly expandable to any word size which is a multiple of 4-bits.

Some examples: One SBP0400 can make a basic 4-bit intelligent controller. Two, in parallel, makes an 8-bit dedicated processor. Three makes a 12-bit controller. And, with four—the CPU of a general purpose 16-bit "mini".

SBP0400 is characterized by the ability to perform any one of its 512 preprogrammed micro-operations within a single clock cycle.

### Basic Architecture

- Microprogrammable, bit-slice design expandable in 4-bit multiples.
- Parallel access to all control, data and address functions.
- 16-function ALU with full-carry look ahead capability.
- 8-word general register file including independent program counter with incrementor.
- Dual 4-bit working registers with full shifting capability.
- On-chip factory programmable logic array (PLA) contains a repertoire of 512 micro-operations.

### Functional Power

- Static edge-triggered operation with full TTL compatibility.
- ALU operand modifications/combination via 8 arithmetic or 8 Boolean functions.
- Bidirectional logic/arithmetic shift/circulate of single/double signed, single/double precision binary words.
- Single clock ALU-shift combinations simplify implementation of iterative multiply and non-restore divide algorithms.
- Internal operation register and independent program counter provide pipelining capability.

**Performance:** The SBP0400 operates at a constant speed X power product over a 10<sup>5</sup> performance range. Virtually any single DC power source, voltage or current, can be used.

Speed is a direct function of supply current. As the graph shows: For typical microcycle times of one

microsecond, just over 100 milliamps of total supply current is required. Any point along the constant speed X power plot can be chosen. Down to one microamp of total supply current for corresponding microcycles of 100 milliseconds.

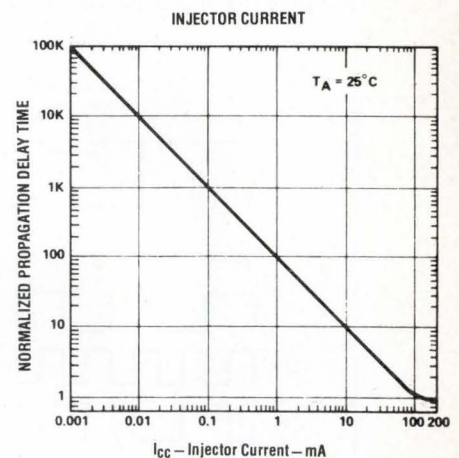

Design with the 0400 and the choice is yours: Word size. Instruction set. Power and speed. Use your imagination. The SBP0400 is just the beginning.

Engineering evaluation devices are available now. Designated X0400N, they are \$90.00 each (1-24). Order directly from your nearest TI Sales Office. A product manual accompanies purchase. For a "Mini-Spec" write Texas Instruments Incorporated, P.O. Box 5012 M/S 308, Dallas, Texas 75222.



TEXAS INSTRUMENTS  
INCORPORATED

# Designer's casebook

## Logic gates and LED indicate phase lock

by R. P. Leck  
Bell Laboratories, Crawford Hill, Holmdel, N.J.

Phase-locked loops are widely used for signal processing and digital applications such as fm demodulation, tone-decoding, and clock synchronization. If the error signal is accessible, signal acquisition and locking in the PLL can be observed from decrease of error voltage to zero. For integrated-circuit PLLs without an error-signal terminal, however, acquisition and lock can be indicated by two exclusive-OR gates and a light-emitting diode. The LED glows brightly when the input signal is first applied, then dims as the loop signal pulls into synchronism, and it goes out when the loop locks.

If the locked signal from the loop were in phase with the input to the loop, a single exclusive-OR gate would suffice for the indicator. In fact, however, the locked signal lags the input by  $90^\circ$ , so a second gate is needed to

introduce an extra quadrature shift on either the input or output signal. As shown in the figure, the phase is shifted by applying frequencies  $f$  and  $2f$  to an exclusive-OR gate. In the circuit shown here, the extra  $90^\circ$  is added to the locking signal before it goes into the loop; this procedure is convenient when  $f$  is generated by counting down from a master oscillator, because  $2f$  is readily available.

From the square waves at  $f$  and  $2f$ , gate 1 develops the  $90^\circ$ -shifted signal  $f'$  that is the input to the loop-phase detector. Gate 2 functions as an auxiliary phase detector, comparing the phase between the loop output,  $f_o$ , and the non-phase-shifted input  $f$ . The output from gate 2,  $f_D$ , drives the light-emitting diode that indicates acquisition and lock.

When the loop is locked and its natural frequency is close to  $f$ , the inputs to the detector coincide. The resulting pulse width of the signal present at its output is either tiny or nonexistent, so the LED is turned off. When the loop is out of lock and its natural frequency is far from  $f$ , maximum output pulse width is obtained and the LED is turned on at its maximum brightness. As the loop acquires lock, the output-pulse width decreases, decreasing the brightness of the LED. □

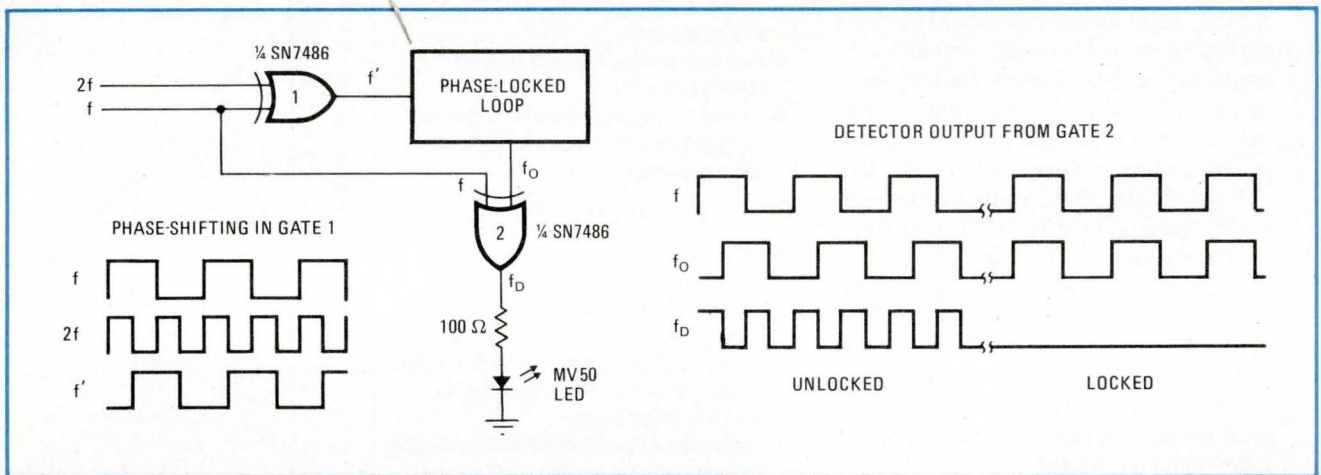

**Loop monitor.** Phase-locked loop has LED monitor that glows brightly when loop is unlocked, dims as loop nears sync, and is dark at lock. Output from loop lags input by  $90^\circ$ ; therefore, to permit comparison of output with locking signal, signal is shifted  $90^\circ$  before entering loop.

## ECL IC oscillates from 10 to 50 MHz

by William A. Palm  
Control Data Corp., Minneapolis, Minn.

One of the simplest of oscillators, the emitter-coupled-logic type outlined in Fig. 1, uses one third of the circuitry of an MC10116 ECL integrated circuit. Besides the IC, the only elements required for the oscillator are

resistor  $R$  and capacitor  $C$ . The frequency of oscillation equals  $1/3.4 RC$ .

Details of the oscillator are shown in Fig. 2. Transistor  $Q_1$  is a constant-current source for the differential amplifier made up of  $Q_4$  and  $Q_5$ . The output signal, taken from emitter-follower  $Q_2$  at pin 2, is fed back to  $Q_4$  as the oscillator reference voltage at pin 4. Thus, pins 2 and 4 are always at the same voltage, and they switch between the ECL levels shown in the waveforms.

Operation of the circuit is indicated by the waveforms of voltage at pins 2 and 4, and at pin 5. The capacitor charges and discharges through resistor  $R$  when pins 2 and 4 go higher or lower than pin 5. When pins 2 and 4

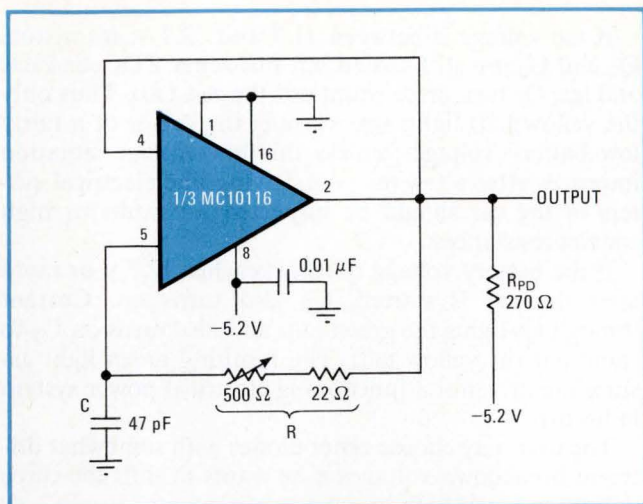

**1. Oscillator.** Extremely simple connections to emitter-coupled-logic IC result in an oscillator that provides square-wave output. Adjustment of R tunes frequency across a range of 10 to 50 MHz. Different R and C permit band-switching over a 10:1 range of frequencies.

are high,  $Q_4$  conducts and  $Q_5$  is off; the capacitor charges up until  $Q_5$  starts to conduct, whereupon  $Q_4$  cuts off and the voltage at pins 2 and 4 drops. The capacitor then discharges; when the capacitor voltage gets low enough,  $Q_4$  starts to conduct,  $Q_5$  cuts off, and the voltage at pins 2 and 4 jumps up. Thus, the capacitor voltage at pin 5 chases the voltage at pins 2 and 4, but never reaches their level because of the limited gain of the amplifier (approximately 8).

Values of R and C are not critical. The resistance of R can be as high as several kilohms or as low as 20 ohms. As R becomes smaller, pull-down resistor  $R_{PD}$  must also become smaller to keep emitter-follower  $Q_2$  in conduction. For maximum oscillation frequency, R can be 20 ohms and C a few picofarads. The adjustable oscillator in Fig. 1 oscillates at frequencies in the range from 10 to 50 megahertz. Other choices for C and R can produce oscillation at frequencies ranging from audio to vhf.

The frequency equation is inaccurate at the upper ranges because of propagation time, stray capacitance, and the difference between charge and discharge impedances presented at the output. It is desirable to buffer the oscillator through a second stage of the ECL IC.

Use of a varactor diode in place of capacitor C, as shown in Fig. 3, makes the circuit a voltage-controlled oscillator. A varactor with a capacitance range of 10:1,

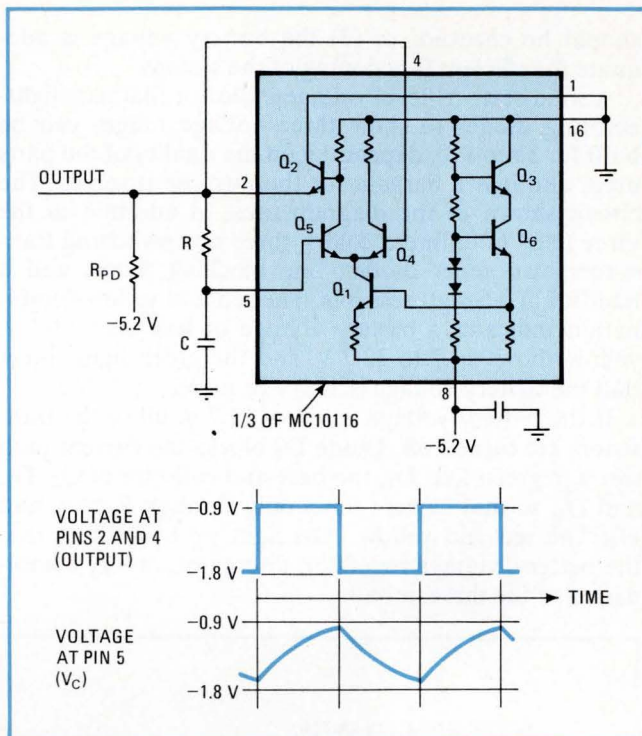

**2. Operation.** Circuit diagram shows how ECL oscillator operates. Output voltage is fed back to  $Q_4$ . Capacitor voltage at pin 5 tries to reach voltage at pin 4, causing output to switch between different ECL levels. Oscillator can never hang up.

such as the MV1401, works well. Coupling capacitance  $C_C$  can be much larger than the diode capacitance, or can be chosen to limit the range of deviation. The oscillator in Fig. 3 operates at  $(15 \pm 10)$  MHz for a voltage swing of 0 to -5.2 volts at the VCO input. □

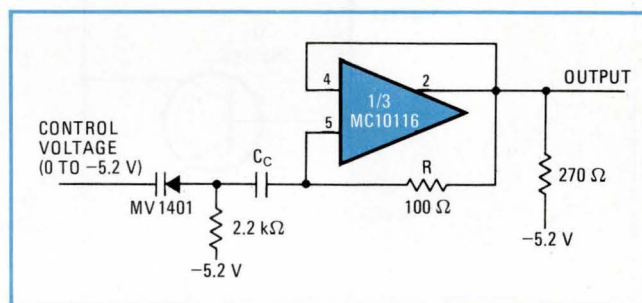

**3. Voltage tuning.** Varactor diode in place of C makes circuit a voltage-controlled oscillator. This VCO operates at  $(15 \pm 10)$  MHz.

## Tri-level indicator monitors automobile's electrical system

by S. K. Wong  
Torrance, California

The battery voltage of a car in operation indicates a great deal about the condition of the alternator, the voltage regulator, and the battery itself. Expensive

sports cars are routinely equipped with gages to monitor voltage. Sedans may be optionally equipped with these voltmeters, but a good gage usually costs more than \$30, and its size may make it difficult to install on the instrument panel.

Fortunately, exact voltage readings are not necessary to indicate the condition of the electrical system, even if a precise value could be read while the car is running. An instrument that shows three levels of voltage can give enough information to indicate that (1) a major component of the electrical system is faulty; (2) the battery voltage is fairly low, and the electrical system

should be checked; or (3) the battery voltage is adequate for efficient functioning of the system.

A solid-state tri-level voltage indicator that uses light-emitting diodes to show three voltage ranges can be built for \$5 to \$10, depending on the quality of the parts used, and it is a bargain for the purpose it serves. The circuit shown in the diagram uses, in addition to the three LEDs of different colors, three npn switching transistors, two zener diodes, one blocking diode, and a handful of 0.5-watt resistors. The red and yellow combination indicates a battery voltage of less than 11.7 v, yellow shows 11.7 to 12.7 v, and the green light shows that the battery voltage is 12.7 v or more.

If the battery voltage is below 11.7 v, all of the transistors are turned off. Diode  $D_4$  blocks the current path through green LED  $D_3$ , the base and collector of  $Q_2$ ,  $D_2$ , and  $D_1$ , so that current flows only through  $R_2$ ,  $D_2$ , and  $D_1$ . The red and yellow LEDs light up to indicate that the battery, voltage regulator, alternator, or any combination of the three, is bad.

If the voltage is between 11.7 and 12.7 v, transistors  $Q_2$  and  $Q_3$  are still turned off, but zener  $ZD_1$  conducts and lets  $Q_1$  turn on to shunt out the red LED. Thus only the yellow LED lights up, warning the driver of a fairly low battery voltage. Unless this low-voltage situation improves after a few miles of driving, the electrical system of the car should be inspected for faults or high contact resistances.

If the battery voltage quickly reaches 12.7 v or more after the car is started,  $Q_3$  also turns on. Current through  $Q_3$  lights the green LED and also turns on  $Q_2$  to shunt out the yellow LED. The resulting green light assures the driver of a functioning electrical power system in his car.

The user may choose zener diodes with somewhat different breakdown voltages if he wants to shift the three indication levels to fit his own requirements. □

Designer's casebook is a regular feature in Electronics. We invite readers to submit original and unpublished circuit ideas and solutions to design problems. Explain briefly but thoroughly the circuit's operating principle and purpose. We'll pay \$50 for each item published.

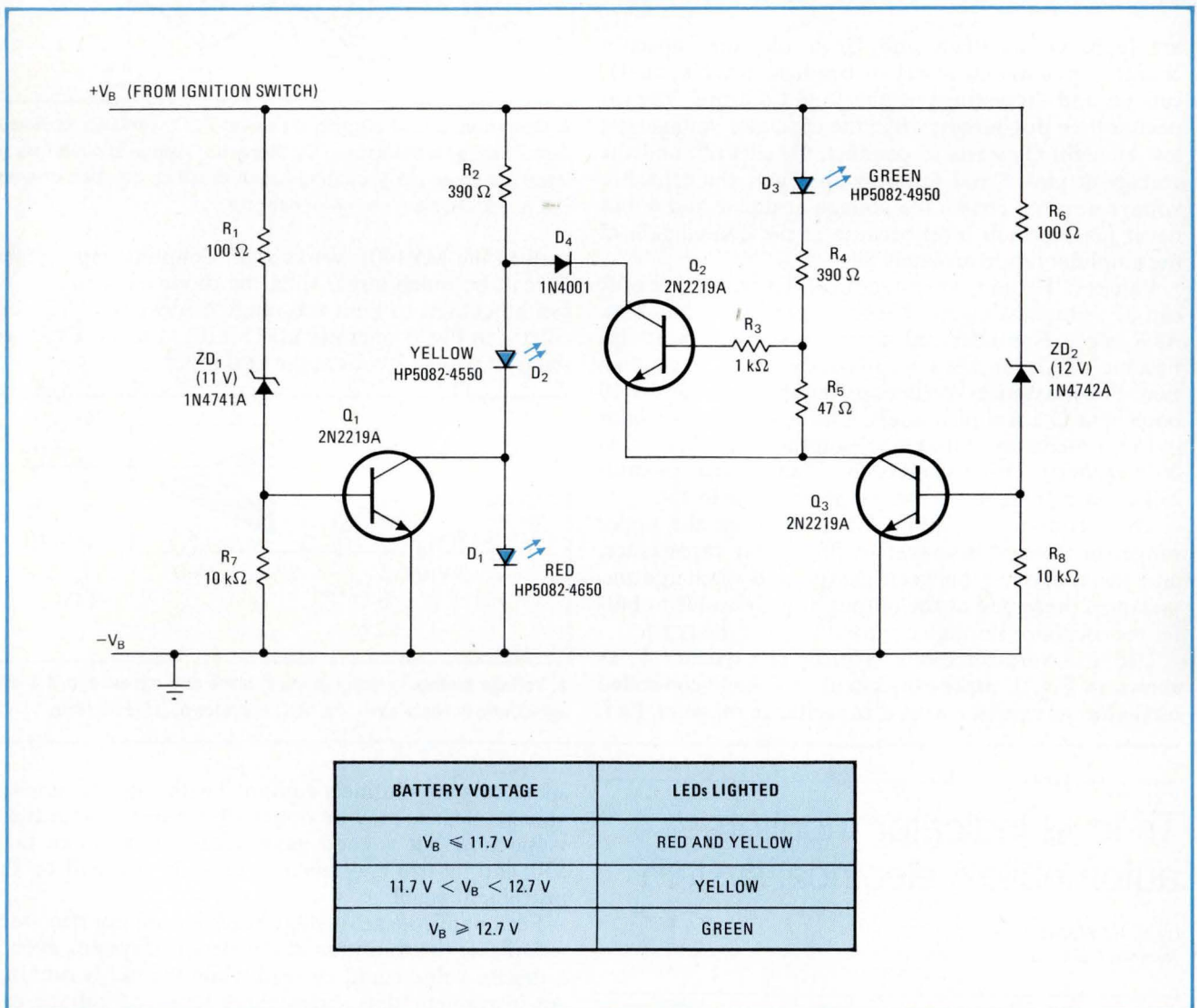

**Battery-voltage indicator.** Colored LEDs indicate three ranges of battery voltage in car. A weak battery turns on red and yellow, a stronger battery breaks down 11-V zener to light only yellow, and a strong battery turns on green as both zeners conduct. Resistors  $R_7$  and  $R_8$  provide high-temperature stability. This unit can warn of need for corrective maintenance of car's electrical system.

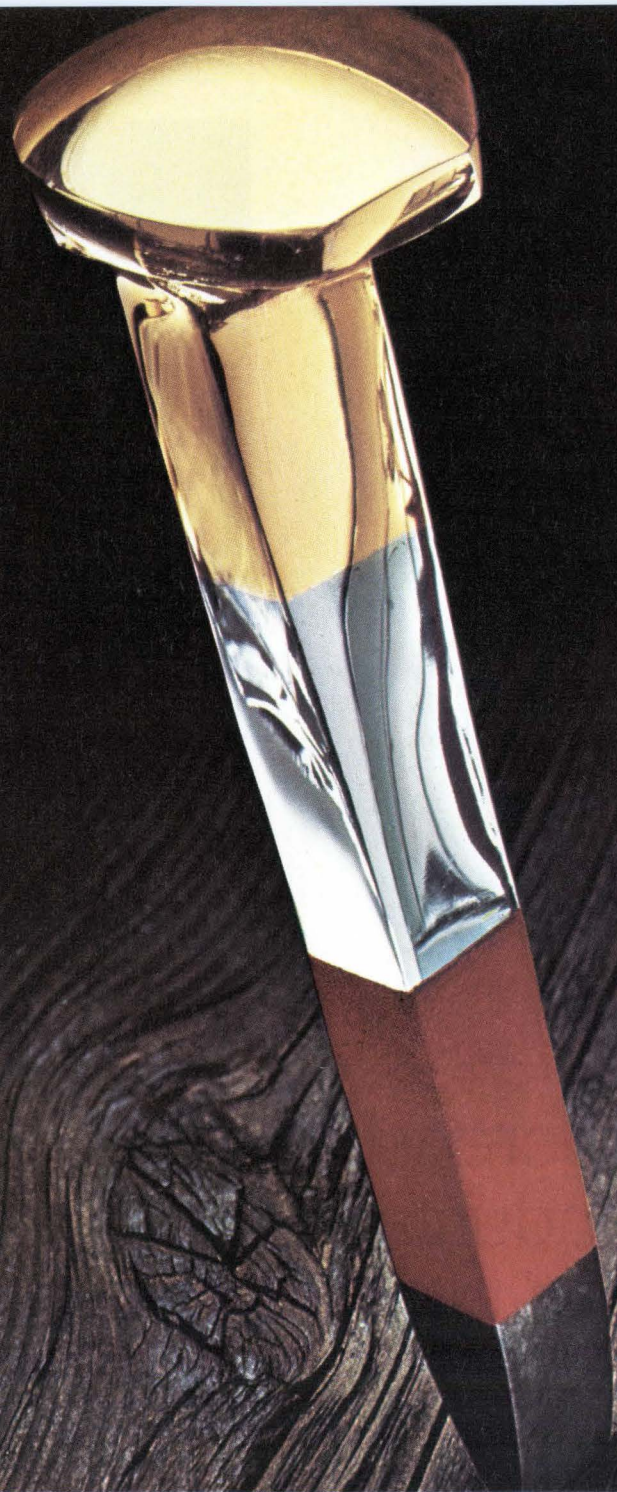

## OMI is where answers in metal finishing are nailed down.

Metal finishers have been bringing us their toughest ones for years. Fine. We've got the answers.

For example:

A manufacturer of hydraulic cylinders was producing precision parts faster than existing plating facilities could handle them. OMI's Udylite Division installed its Ultrachrome™ ACS process and production capability jumped 70% with no sacrifice in quality.

The world's largest coil-coating line must process more than a mile of strip at a speed of 600 fpm. Its designers looked to our Parker Division for the super line's complete wet section—cleaning and prepaint-treating chemicals and control equipment. They got it.

Dissatisfied with cost and production levels for critical gold plating processes, a maker of telecommunica-

tions devices switched to a new process from OMI's Sel-Rex Division. Plating time was cut in half...gold consumption was reduced by 15%. And the resulting boost in production allowed for a 50% saving in labor cost alone.

Need a better answer...a better way to increase the capability and profitability of your operation? Chances are OMI can help. Ask for our brochure "The World of OMI," write:

Oxy Metal Industries Corp., 21441 Hoover Rd., Warren, Michigan 48089.

# OMI

**OXY METAL INDUSTRIES CORPORATION**  
UDYLITE • SEL-REX • PARKER

Circle 109 on reader service card

## By increasing other industries' profitability, electronics can increase its own

Industries that were formerly the stronghold of mechanical and electromechanical controls are looking to electronic gear to an extent unheard of before these days of programable controls and low-cost LSI

by Margaret A. Maas, *Industrial Editor*

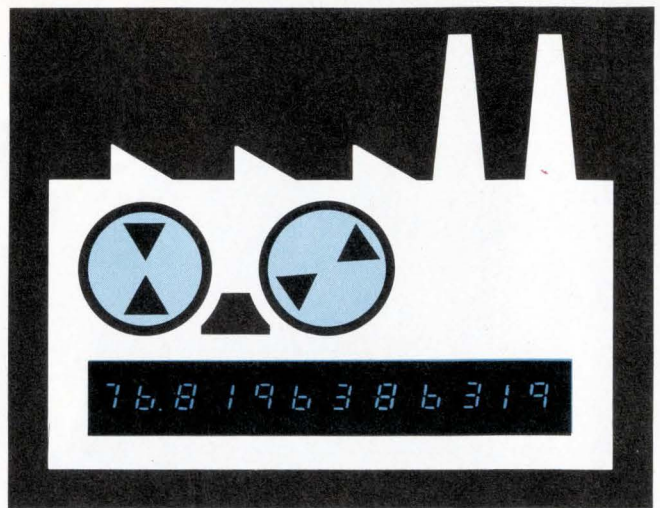

□ In spite of the doldrums gripping U.S. business, segments of industry still bask in a relative economic sunshine. Continuing demand or unprecedented backlogs are carrying machine tools, metals, petroleum, and a few other key industries past the economic storm to a long-term future that, according to market predictions, is also bright.

Together with their prosperity, however, these industries face the same need to boost productivity as everybody else, and this makes them a big, if not the biggest, potential growth area for electronics. Now productivity improvement refers to anything that increases throughput, reduces rejects, or decreases the number of employees or level of employee skills required—a list that sounds strangely like the benefits of automation. A look at plans for capital expenditure on automation, therefore, should hold the clue as to who needs the most help and has the money to pay for it.

The chart on the page opposite shows that one of the biggest spenders, as might be expected, is the petroleum industry. The push is on to find more oil, recover more, and transport more. So more electronics is needed for measuring and monitoring flow, pressures, and temperatures in pipelines, for control of offshore platforms, and in data acquisition at the refineries.

The activity in petroleum has, in turn, been responsible for the relatively good health of the steel industry, since much of the steel normally funneled into automotive fenders and axles has been diverted to petroleum pipes, wellhead structures, and offshore platforms. At present, steel companies are planning to add 19 million tons of new steel-making capacity. To get the most out of the added capacity, the new facilities will inevitably be computer-controlled. Existing plants, too, will be pushed to the limit by such equipment as more accurate electronic gage controls on rolling mills and temperature control on hot strip lines.

These are only two of the industries and a few of the applications to be discussed in a five-part series on industrial electronics. Starting in this issue, the series will analyze the areas where electronics is making inroads, why it is doing so, and where it can do more.

One of the factors that is either encouraging the use of electronics—or inhibiting it—is attitude. Most indus-

tries are quite conservative when it comes to adopting new technologies. Nevertheless, the competition to increase production and the need to improve the reliability of production equipment are pushing them steadily towards electronics.

The declining prices of solid-state equipment is bringing down the cost of machine control, and more companies will have to invest in it to stay competitive. Software and microprocessors also, by adding functions that it would have been impractical, if not impossible, to add with hardwired logic, are increasing the number of aspects of manufacturing that it's possible to automate.

As for reliability, lost production time can never be made up in plants that are running 24 hours a day, and just trying to locate a troublesome mechanical part or faulty relay will waste precious time. But electronics can keep downtime to a minimum through built-in diagnostic programs and easy-to-replace electronic modules.

The increasing reliability of solid-state devices is wooing engineers from their "tried and true" pneumatic and hydraulic controls to the world of integrated circuits. No longer is electronics gear avoided because of possible safety hazards. In chemical and petroleum plants, where an electrical spark could trigger an explosion, pneumatic and hydraulic controls till recently were considered the only kind of control to use. But with an intrinsically safe electronic system, this is no longer true [*Electronics*, p. 91-94, Feb. 6, 1975]. Such a system is incapable of releasing sufficient electrical or thermal energy to cause an explosion. Though the concept is not new, it took recent advances in solid-state electronics to make the approach both practical and economical.

Industry has never had to be sold on electronics when

it came to a need to perform complex calculations at high speeds. However, the ability to buy small inexpensive computing packages, namely microprocessors, is opening up a new world of distributed control. The so-called intelligent transducer, which can compute and control as well as sense, is not so far away.

Moreover, bigger computing power in smaller, lower-cost packages is making it possible to use intricate mathematical models for control of processes that before were only seat-of-the-pants operations. Carrying this concept a step further is the learning network.

Some processes are so complex that it is extremely difficult to develop mathematical models for them. But an electronic learning network can take any variables that are typical of the process—not just the standard parameters of temperature, pressure and flow, but even the sounds that the process makes—and figure out how they interrelate. From this interrelation, it can develop a way to predict the output. Its conclusions are then used to control the system, and as new output data is collected, it updates the relationships. Processes that might be impossible to model any other way can be modeled with a learning network. At present, one learning network is being used to control a rolling mill, and another is being developed to tell what surface finish is being produced on a part during machining without the part's having to be taken off the machine and measured.

Basically, then, what electronics has to sell to industry is an ever-increasing degree of control of both the speed and quality of the manufacturing process—at an increasingly affordable price. But success in actually making the sale will depend on how well electronics matches its skills to particular industry needs.

PLANS FOR CAPITAL SPENDING

Industry	Dollars Totals (in \$ billions)				Percent for Automation	
	1974	1975	1976	1977	1974	1976
Aerospace	\$ .80	\$ 1.01	\$ .82	\$ .76	35 %	29 %
Airlines	2.00	1.86	1.90	1.08	6	3
Autos, trucks, and parts	2.70	2.19	2.34	2.36	8	24
Chemicals	5.69	6.49	7.40	7.62	19	27
Communications	13.96	13.40	13.94	15.47	24	27
Electrical machinery	2.97	2.70	2.86	3.17	19	22
Electric utilities	17.63	17.63	20.63	24.55	53	56
Food and beverages	3.25	3.25	3.47	3.70	26	30
Gas utilities	2.92	3.39	4.20	4.45	10	11
Iron and steel	2.62	4.01	5.09	5.29	56	60
Machinery	4.42	4.46	4.90	5.18	36	38
Mining	3.18	3.97	4.18	4.03	6	5
Nonferrous metals	2.33	2.38	2.31	2.33	24	30
Paper and pulp	2.58	3.07	3.28	3.08	18	22
Petroleum	8.00	10.48	11.11	10.22	64	69
Railroads	2.54	3.35	3.92	3.92	27	25
Rubber	1.47	1.26	1.36	1.50	42	42
Stone, clay, and glass	1.44	1.48	1.46	1.49	31	25
Textiles	.84	.72	.72	.77	50	48

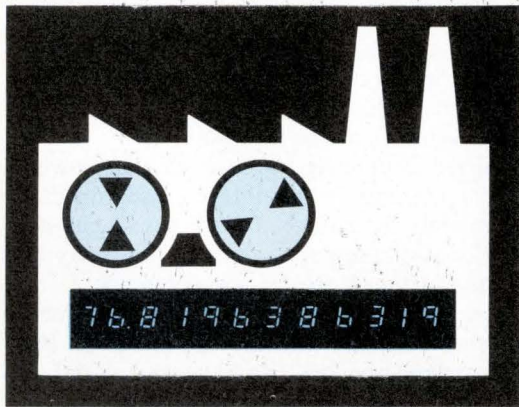

# Part 1: Automating the machine shop

Smarter machine tools reduce users' needs for skilled labor, increase makers' demand for sophisticated but rugged electronics

by Margaret A. Maas, *Industrial Editor*

□ In the last three years, machine tools have started tackling tasks that they never did—or could do—before. The change is not in the tools themselves, which have remained much the same for perhaps 50 years, but in their controls, which, thanks to the falling prices of solid-state equipment, in particular the minicomputer, contain a larger-than-ever proportion of electronics.

The machine-tool industry, despite its \$2.5 billion annual sales, is populated by relatively small companies with relatively limited development programs. So the search for new and improved applications of electronics has till now been pretty much left either to the more innovative firms that build their own controls (for instance, Cincinnati Milacron, Kearney & Trecker, and Sundstrand) or to the traditional control suppliers (General Electric, Sperry Vickers UMAC, Bendix, Allen-Bradley) and more recently to computer companies like General Automation.

But other machine-tool builders are starting to follow the leaders more closely, as users clamor for the advantages electronics can offer—basically, improved efficiency, and a reduced need for skilled manpower.

A machine tool may cost a quarter million dollars or more, which is much too expensive for inefficient use. So setup time, time spent flailing air instead of cutting metal, and down time is all lost time that needs to be reduced or eliminated. Here, electronics has made strides through automatic tool gaging, optimization of cutting speeds, and remote diagnostics.

Then there is the shortage of skilled machinists. Machine-shop owners are being forced to hire unskilled people, and the rising cost of labor is making even them expensive. So machines must become smarter—electronically—so they can do more for themselves without the operator's intervention.

Consequently, shop owners are turning to numerically controlled (NC) machines, where a quarter of the selling price goes into electronics. The numerical control receives digital data, usually from a tape, disk, core, or semiconductor memory, then performs some logical function on it, and finally outputs the result as a signal that controls the machine. The entire process is automatic. If the control, instead of being performed by a hardwired, special-purpose circuit, is performed by a general-purpose computer, it is referred to as computer numerical control (CNC). And the trend towards more

CNC is perhaps the most significant one for electronics (see "A market view of machine tools," p. 117)

For large machines with multiple tools, valuable time is spent just loading the tools. Not only must the correct one be selected and inserted into the tool drum, but its length must also be accurately determined, since otherwise there is no economical way to know what depth of cut will result from a fixed tool advance.

## More efficient setup

Cincinnati Milacron, Cincinnati, Ohio, has worked on this problem and has introduced a modular tool-management system for machining centers. A typical system might include a computer, a remote tool readout control panel (located near the tool storage matrix), and a portable electronic gage, which can be wheeled from machine to machine.

Initially, the tool room makes a punched tape that contains the basic tool information needed for that machining job. Each tool is identified by an 8-digit numeric code and may also be assigned several other pertinent pieces of data, such as a tool usage factor to indicate how many minutes the tool may be used before sharpening. In addition to storing this information in the computer, the tape also sets up a file in memory for the locations and lengths of the tools.

To use the system, an operator rolls his tool cart over to the machine and advances the tool matrix on the machine until an empty pocket is in the ready position. An encoder on the tool matrix indicates to the computer which pocket is in this position. From a table in memory, which has been established by the parts programmer, the number of the tool assigned to this pocket is determined and registered on the display.

Next, the operator removes the tool from the cart and inserts it into the electronic tool gage. The gage, which contains an optical encoder, measures the tool to within 0.001 inch and displays that measurement on its digital display. The operator pushes a button on the gage panel, and the 8-bit reading in the gage registers is transmitted serially to the computer memory and stored along with the tool pocket location. He then loads the tool into the pocket and repeats the procedure.

Cincinnati estimates that the automatic gaging operation alone saves close to two hours per day on a 15-tool machining center averaging four setups per day. Pre-





**1. Numerical control.** Operator adjusts jog speed on a Pratt & Whitney three-axis machining center, which is suitable for both small-lot and production jobs. Though inputs are normally entered on punched paper tape, data can be entered manually at the control panel.

viously, operators had to gage length with a feeler gage while the tool was mounted in the machine spindle.

Tape preparation, too, is part of an NC machine's setup time, and making a good tape can be a time-consuming task. Ted Smith, marketing manager, Sperry Vickers UMAC, Burlington, Vt., claims that a shop averages five or six tapes before it makes a good one—and not just because of tape errors. Until the operator runs a trial cut with the tape, he usually does not know whether his speeds are right or if he has allowed enough clearance to avoid cutting the workholders but not so much clearance that he is wasting time cutting air. Program editing on the floor speeds up this process.

For on-floor editing, Sperry offers an editable storage program (ESP) console that functions without a computer. There are two versions, one containing disk storage, the other semiconductor memory. Data may be inputted either manually or by a tape reader, Teletype or computer. Once the program is stored, any portion can be added to, modified or erased merely by pushing the proper buttons. After changes are made, the corrected program can be recalled over a tape punch, displayed on a cathode-ray tube or routed through the NC system for machine control.

Another approach to reducing tape-preparation time borrows from voice recognition. A voice input terminal

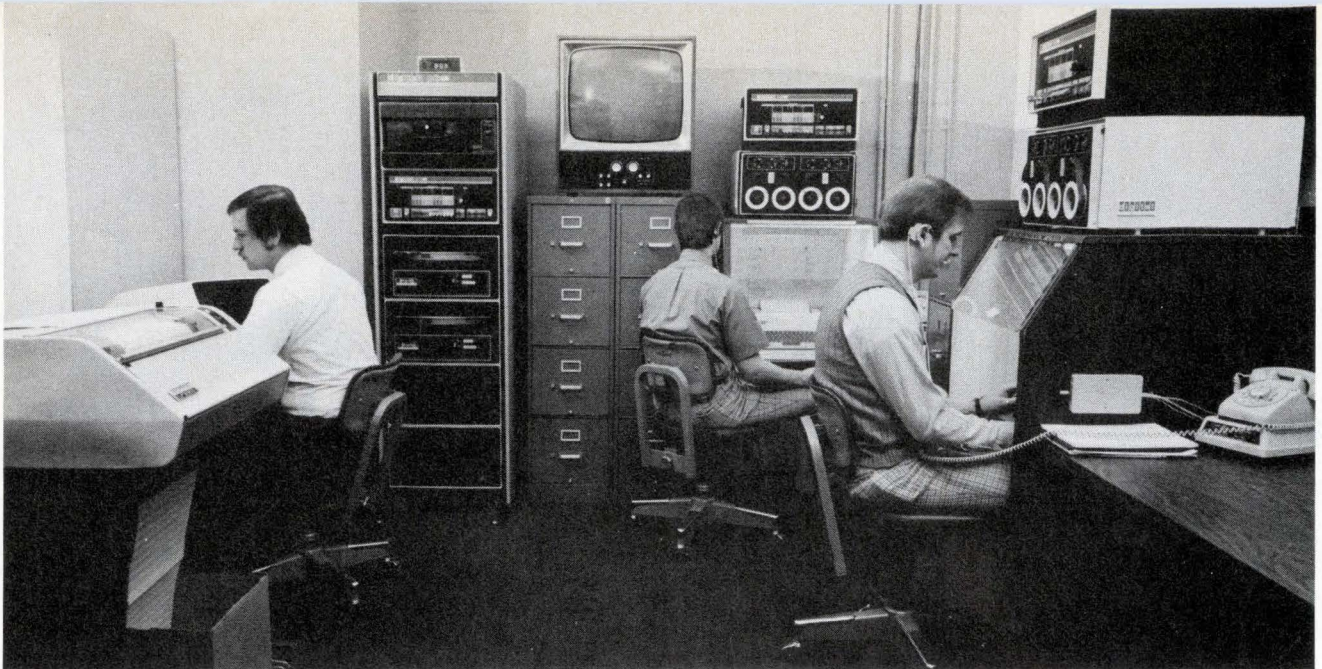

**2. Diagnosing problems.** When a Kearney & Trecker customer encounters a mechanical or electrical problem with his machine, he phones K & T's Diagnostic Center and connects his machine's CNC system to the Center's computer by means of a Data Phone modem. A diagnostic program is run on the machine, and the results are printed out and analyzed at the Center. Often the customer can do his own repairs.

offered by Threshold Technology, Cinnaminson, N.J., allows an operator to program his machine right on the floor by "telling" it what to do. Basically, the system accepts simple commands (like drill, cut, and the X and Y coordinates for these operations), formats them automatically into either ASCII or EIA codes, and outputs them on punched paper tape.

The system can be used by several operators, but must be trained for each. This is done by pushing the training-mode button on the speech-recognition system panel, and having each operator repeat, 10 times, every command in the computer's vocabulary. He can use English, Spanish, or mix languages, so long as he consistently uses the same sounds for the same command.

As he speaks, his words are processed by the speech-recognition system, which removes any dependency on the time taken to say a word and also averages the significant speech features in each word. This average word representation is stored either in computer memory or on magnetic tape for later processing into a numerical control tape.

When the operator is ready to use the system, he pushes a recognition key on the panel of the speech-recognition system and speaks into the system. The computer analyzes his words, compares them with the previously stored vocabulary, and selects the best fit. The selected word or dimension is then punched on paper tape in a machine-compatible format.

Cadds-3 is still a third way to reduce programming time and eliminate the trial-and-error approach to parts programming. Cadds-3 is a program developed by Computervision, Bedford, Mass., for its interactive graphic system. The system allows the user to create his design in three dimensions on a CRT screen. In addition he can define the path for each cutting tool required and check the path by watching a representation of the cutter action on the screen. When he is satisfied that the machining procedure is correct, the information is punched onto a paper tape that is used to run the NC machine.

General Electric Co., Lynn, Mass., is using the system to machine aircraft engine parts. Initially, the operator defines the cross-sectional geometry of his part either by drawing it with an electronic stylus or by defining points along the outline. If a similar part is already stored in the computer memory, it is displayed and modified through the CRT terminal.

Next the operator indicates each tool to be used and defines each cutter path by specifying critical points along the part outline. Once sufficient points have been defined, the system automatically develops a spline curve between these points. Simultaneously, a graphic representation of the cutter appears on the screen and, if the curve has been properly defined, the operator will see the cutter trace the outline of the part.

After all tools and cutting paths have been determined, the data is processed once more by the mini-computer to modify it for the particular machine that will be used, and a paper tape is punched out.

### Optimizing cutting speed

Surface finish and tool wear depend largely on machining speed and tool pressure. Excessive speed produces rough finishes, while excessive pressures accelerate tool wear—and some tools cost as much as \$1,500. On the other hand, too slow a speed wastes time.

On manual machines the operator watches the color and shape of chips or the sounds of the cutting tool and adjusts the machine feed rates and spindle speeds accordingly. But knowing exactly what to look for and how to correct for it takes years of experience, and even the most skilled operator cannot make adjustments fast enough if conditions change constantly.

Adaptive control is one answer. Theoretically, adaptive control monitors parameters such as cutter deflection and spindle torque and regulates the speed of the machine accordingly. The aim is for the tool to cut at the fastest rate consistent with the desired surface finish and low tool wear.

The principal users of adaptive control are aerospace firms, mainly because it is costly—typically \$25,000 per three-spindle machine. McDonnell Aircraft, for instance, has installed 32 units and has 34 more either ready for installation or on order. However, heavy equipment and automotive companies have also begun using the MAC I system.

MAC I, a unit manufactured by Macotech, Seattle, Wash., is a very simple system primarily suitable for end milling and face milling machines. The idea behind it is that optimum cutting conditions require a constant force against the edge of the cutting tool. Since tool deflection is directly related to cutting force, by measuring spindle deflection the hard-wired controller knows whether to increase or decrease machine feedrate.

MAC I's spindle-deflection sensor is a ring of four inductive transducers mounted 90° apart. They can detect spindle displacements as small as 0.00002 inch and are electronically balanced so that variations such as thermal expansion will not affect the readings.

The two probes on each axis form one-half of an impedance bridge, and the vector outputs of the two bridges are summed to give the resultant force on the spindle. This force is then compared to a reference value.

The reference value, which is stored on punched tape, is decoded by the controller which places the value in buffer storage until it is brought out through a digital-to-analog converter and compared to the voltage representing the actual force. The error signal that results is used to control the feed rate. What it actually does is to override the programmed feed rate, in proportion to the error.

The feed rate is also varied within the constraints of the maximum allowable spindle horsepower. To prevent overload, each ac spindle motor carries a simple current transformer to serve as a load sensor. For dc motors, the current draw is measured through a shunt.

"The heart of our system," says Bob Carlise, director of marketing, Macotech, "is our software, which fits right into the APT package." (APT is a high-level language developed specifically for numerical-control ap-

plications.) The machining program defines the hardness of the workpiece material; the type of cutter material; cutter geometry, including length, diameter, and number of flutes; and the maximum stock cross section. From that information, the software calculates the highest theoretical rate the machine can achieve without breaking the cutter, damaging the spindle, or unnecessarily dulling the cutter. That information is inserted on the punched tape in the form of a feed rate (up to six times the rate required at maximum stock cross section), spindle rpm, and a force code (force safe for the spindle, cutter, and optimum cutting conditions). Using this information and feedback data from the sensors, the MAC I varies the feed rate as stock conditions change to hold the machine at optimum productivity.

The system will also detect the absence of cutting forces. For instance, when the tool exits the workpiece, the MAC I temporarily accelerates the machine to the tape feed rate until it reenters the material.

Tool wear is automatically compensated for. As a tool dulls, the forces increase and therefore the feed rates are automatically reduced.

Time savings with the system are impressive. Alumi-



**3a. Voice-created tape.** Operator creates NC tape for Hillyer milling/drilling machine by speaking machining instructions into microphone. At left is the speech-recognition preprocessor-minicomputer unit, topped by an alphanumeric display that flashes each voice command for verification and also displays the next entry required.

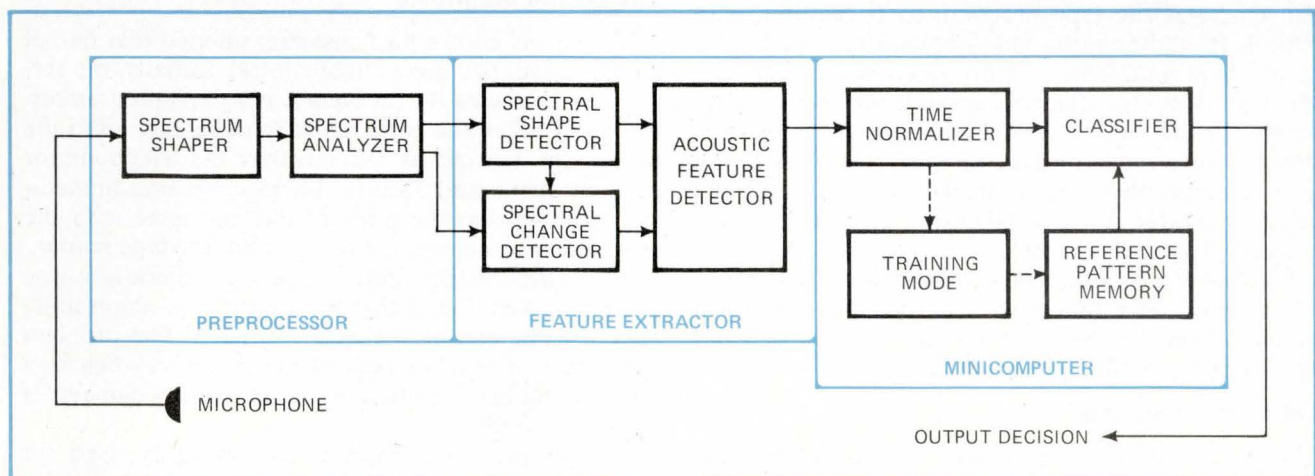

**3b. Voice processing.** Preprocessor removes speech irregularities and minimizes the effect of input amplitudes. The feature extractor processes the speech spectrum to produce 32 acoustical features and their time of occurrence. The pattern-matching logic compares the features of a spoken word with the previously stored vocabulary and determines which word, if any, matches up.

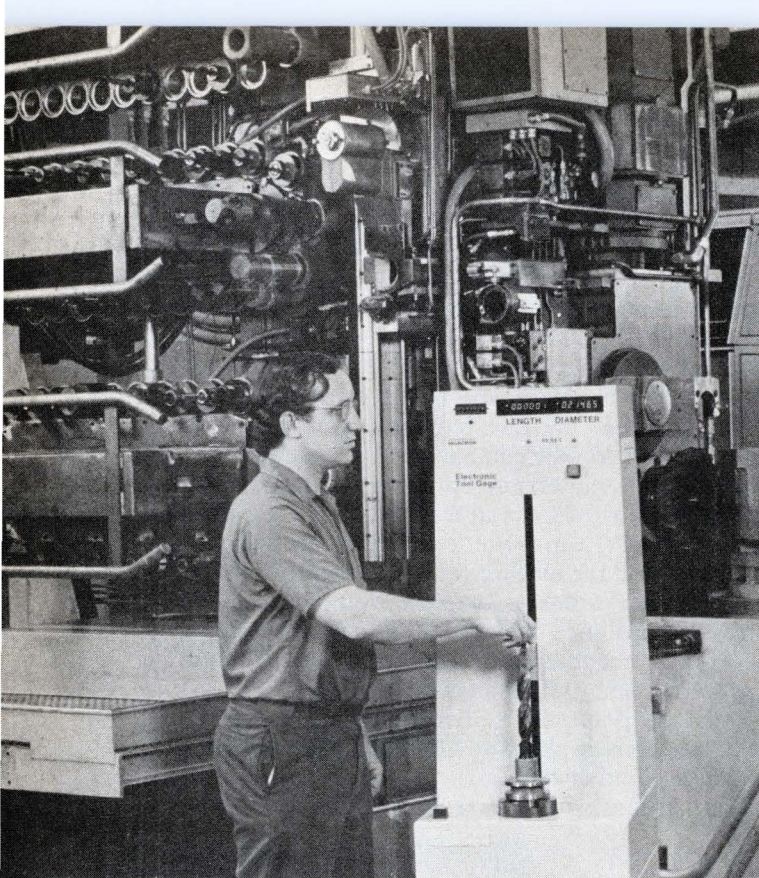

**4. Automatic tool gaging.** Operator electronically gages tool length for a 90-tool Cincinnati Milacron NC machining center. The length is registered on the LED display. After gaging, tool is inserted in whichever of the tool pockets, visible at the upper left, is appropriate.

num can be machined 30% faster, and steel and titanium 50% faster or more. "One customer working with titanium reduced cutting time from eight hours to two and a half hours," claims Carlise.

A second generation of the system, called MAC XX, is now undergoing field test. Available as a microprocessor—Intel's 8080 and 1,200 bytes of storage—or as a software program for a CNC minicomputer, MAC XX allows the same NC tape to be used on different size machines. This is because individual machine characteristics are resident in the memory of the MAC XX at the machine instead of being in the mainframe computer that generates the tape program, as is required with MAC I. In addition, the new system allows editing at the machine tool with a feature called React (Remote Editor for Adaptive Control Tapes). If the user wants to change the force code, feed rate or spindle rpm while cutting is in process, he can. In effect, he produces an updated tape without rerunning it on the computer; the system overrides the original instructions without actually modifying the integrity of the original tape.

"The microprocessor makes this flexibility possible at a low cost," says Macotech vice president, Richard Mathias. "And for the size program we have, we can't justify a minicomputer just for this purpose."

#### **Reducing down time**

Diagnostic software can reduce the task of troubleshooting a sick CNC machine to a minimum. For the most part, diagnostics track control malfunctions down to the board level so that the faulty unit can be quickly located and replaced. But Kearney & Trecker has ex-

tended this to include diagnosis of the machine itself.

K&T reports that 95% of the downtime recorded in CNC machining centers, the company's prime product, is spent just trying to locate the malfunction. A full day may be lost in just getting a serviceman out to a distant customer. Worse yet, very few service people understand both the machine and computer control.

K&T has therefore established a Diagnostic Communications System that connects the customer's machine and computer output via a Data Phone modem and telephone line to the K&T computer facility in Milwaukee. Before a machine leaves the K&T facility, it is "fingerprinted," so to speak. Tests are run under dynamic conditions on items such as axis drive torque and the time it takes for tool changes and index table positioning. Information is stored both as hard copy and on magnetic tape or disk, from which it can be retrieved by entering the machine's serial number.

When a customer calls in about a problem, the serviceman reviews the difficulty with him and also checks the "fingerprints" on file. Then he selects the proper diagnostic program stored on magnetic tape, and using this program, the K&T computer puts the remote machine through its paces. Inputs to the system can be made via teletype, CRT or magnetic tape.

The communication system operates in full duplex mode. An interface card inserted in the customer's computer converts incoming (10 bit) serial test signals into parallel inputs to the customer's computer and, conversely, converts outgoing signals back into serial form for transmission via the modem.

Tests, which are performed over WATS lines to keep phone bills down, typically take one to five minutes and detect such problems as ball screws out of alignment, malfunctioning position locks and limit switches out of adjustment. The customer's data, which can output onto a high-speed printer for diagnostic purposes, is also collected on magnetic tape as part of a data bank on component life and mean time between failures. This information is then used to design potential problems out of machines that are still on the drawing board.

#### **Successful diagnosis**

In a typical case, a K&T customer phoned that one of his axis drives had gone out of control. Initially, the serviceman suspected the problem was a parts program error. So he asked the customer to load his tape onto the reader and transmit its contents over the telephone for printout at the K&T facility. There it became immediately evident that the printout did not agree with the tape. The problem was not the tape but the tape reader.

In another instance, during a periodic check of a machine tool, K&T found that the torque was abnormally high near the end of one axis' excursion. The problem was traced to misalignment of the guide way bearings which would have resulted in serious bearing damage, if left uncorrected.

Cathode-ray-tube terminals are primarily used for maintenance diagnostics and also for on-the-floor editing of the parts program, as already noted. In addition, these terminals can be used to signal the operator that he must perform certain tasks, such as loading a tool

that is too big for the automatic tool changer.

Another CRT from Vega Servo-Control Inc., Troy, Mich., replaces all the selector switches and about half the push buttons normally found on a CRT control panel.

For example, a 10-position selector switch may indicate functions as automatic, manual, edit, punch and verify. In the Vega system, these functions are listed in a column on the CRT screen, and the operator selects one simply by positioning a cursor next to it. This saves Vega the bother of engraving different control panels for each kind of machine and making new panels when new modes are required. Instead it makes the changes in software.

Similarly, push-button functions such as EIA/ASCII, inch/mm, and on/off are also listed in a column, and the mode in which the system is presently operating is listed next to each. For example, ASCII displayed next to the listing EIA/ASCII means the system is converting all machine codes into ASCII format. To change modes, the operator positions the cursor next to EIA/ASCII and pushes the function-alternate button, making EIA appear instead.

### **Bigger brains for smaller machines**

As the foregoing examples indicate, software not only adds flexibility to an NC machine, it also adds expense. Computer control systems begin at about \$15,000, and at that price, demand usually at least a \$60,000 machine. But with the cost of integrated circuits and minicomputers coming down rapidly and with the advent of the microprocessor, much less costly machines will soon be using CNC.

"Considering what it costs to design and build relay panels," adds Tom Schifo, marketing manager, Sundstrand Machine Tools, Belvidere, Ill., "I see computer control even on the simplest machine eventually."

As machine tools evolve from NC to CNC, the number of new features per year will multiply. In the past any changes in logic design meant new boards and quite a design and production effort. But once it's merely a matter of adding some more software, the machine can have functions and features that previously might have taken a year to design and prove out.

For example, K&T has optimized lubrication of its tool ways, bearings and lead screws. A machine tool's lubrication needs, like a car's, depend on the usage and time between lubes, so Ed Kirkham, director of technology development, says, "We lubricate by the minute and by the mile."

To keep track of slide position, a pulse generator on each axis is fed to an electronic counter, which, in turn, is sampled by the computer. The computer also uses this system to accumulate data on the total slide travel. When the total distance reaches some predetermined limit, the computer signals the solenoid drivers to open the solenoid valves at the oil reservoir, allowing oil to flow to the proper lubrication points. The same thing happens when the time limit expires.

"Back in the hardwired days," says Kirkham, "it would have been unthinkable to use so much logic for something like lubrication, so lubrication was strictly a

## **A market view of machine tools**

While the economic downturn has brought layoffs to many industries, it hasn't to machine tools. Instead, it has brought backlogs down to a reasonable 12 to 18 months from last year's unmanageable two to two and one-half years. Even if business continues to slacken, the \$100 million controls market will continue to grow. The reason: an ever larger market share is falling to numerically controlled and computer numerically controlled machines, in which electronics contributes roughly 25% of the selling price.

At present, conventional machine tools outnumber NC machines by 100 to 1. But this ratio is changing. Sales of NC units have mushroomed, and during the last two years approximately one out of every five machines sold was numerically controlled.

There are more than three million lathes, machining centers, grinders, punch presses, drills, and so on in the U.S., of which roughly 60% are over 10 years old. While some tools spew out parts for 30, 40, and even 50 years, 15 years is the typical life. As competitive pressures mount on obsolete machine shops, more and more of this equipment will have to be replaced.

Russell A. Hedden, president, Kearney & Trecker Corp., predicts that the machine-tool industry will continue to grow at an annual rate of about 9% in constant dollars. And as demand will go on exceeding supply, long lead times will remain commonplace. According to Hedden, the dominant factor in the marketplace during the late 1970s will undoubtedly be innovations in computer numerical control.

function of time. Now regardless of whether a machine is standing idle or operating 24 hours a day, it still gets the right amount of oil, and it also gets a quick general lubrication during each startup."

The Wiedemann division of Warner & Swasey Co., King of Prussia, Pa., even uses software to define the function of limit switches. "In one case," says L. Earl Thomas, manager, production engineering, "a limit switch indicates the position of the workholder so that the machine won't cut through it. Another time the same switch limits the overtravel of the machine slide. Which function it serves at any one time depends on what the software tells it that it is."

### **Microprocessors versus minicomputers**

The level of computing power required in a given machine depends partly on the complexity of the task to be done and partly on the amount of time available for performing the task. Multiple-function machines in particular are pressed for time when doing elaborate calculations for such tasks as path generation.

"For us, microprocessors are still too slow to replace in quantity the DEC PDP-8 that we are using," says K&T's Kirkham. "We're pressed for time—the CPU has to check the slide position, the coolant, the temperature of this and the level of that, see if there is a tool change in process, read another character on the tape and get back in time to catch the slide before it moves more than a few microinches. If we had simpler machines that didn't require such a high data-processing rate,

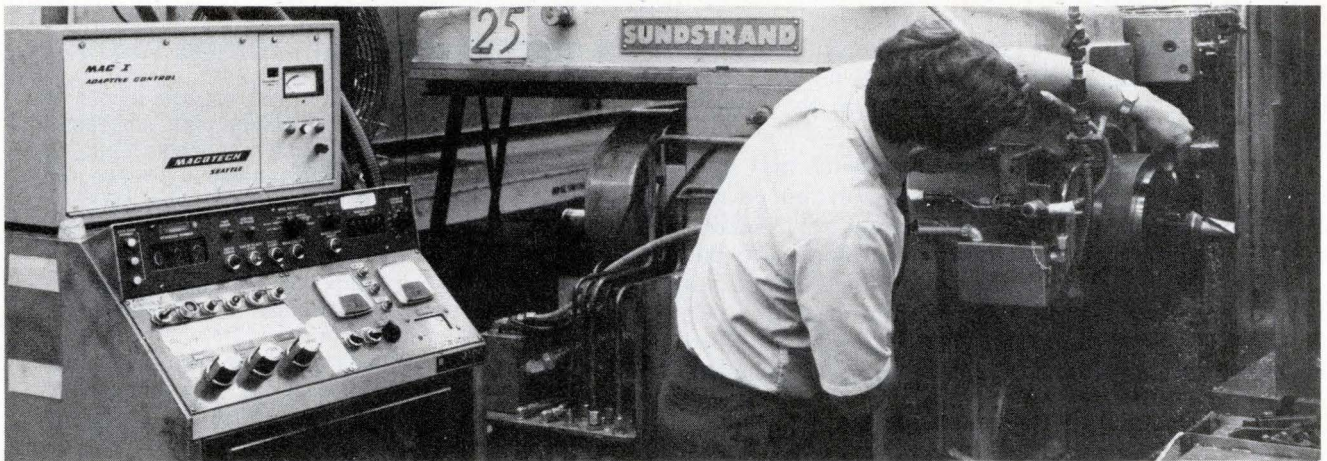

**5. Deflection sensor.** Sensor ring mounted on tool spindle detects spindle deflection, compares it with the maximum allowable value, and regulates machine speed accordingly. Adaptive control electronics are contained inside unit sitting on top of the NC controller.

perhaps we would use one of the microprocessors.”

Juris Vikmanis, director of engineering at Bendix Corp., Detroit, Mich., agrees and, in fact, wishes existing minicomputers could do more and do it faster. “Some micros have fast cycle times, but take many instructions to implement a math function,” he observes. “In NC operations some calculations result in very large numbers. A micro handling superprecision multiplications would need lots of instructions and memory.”

In some applications the limited computing power of the microprocessor is actually an advantage. “Being a hybrid between software and hardware, the micro seems to have a perfect niche in low-quantity specialized circuits, where only a few users want certain editing features or have loading and unloading fixtures that require special control,” claims Charles Dalzell, Jones & Lamson, division of Waterbury Farrel, Springfield, Vt.

“In that case,” continues Dalzell, “the trend will be to switch to micros because of the commonality of hardware, and leave the flexibility in the programs instead of having to design new circuit boards each time. With a micro you can get the hardware in a little lower common denominator than you can with a mini.”

This ability to tailor a system is why General Electric introduced a microprocessor in its NC system, the Mark Century 1050. Rather than use a general-purpose off-the-shelf minicomputer, the company feels that it was able to process data more efficiently by building some special hardwired arithmetic capability around a National Semiconductor 16-bit microprocessor chip set. The hardwired electronics performs the special functions required for NC at high speed, taking a relatively few steps compared to a general-purpose mini. The microprocessor, which would be too slow if it performed all the data processing, instead shuffles data, handles input/output functions, and is the system housekeeper.

Originally Bendix developed a microprocessor-based system but dropped it in favor of tailoring the control through a combination of a minicomputer and a programmable interface controller (PIC). PIC handles the sequential control plus much of the digital control. For instance, it solves Boolean equations for relay ladder diagrams, so that the minicomputer operating program,

need never be touched. The user needs only enough knowledge to program PIC and does not need to understand assembly language or learn computer programming. “In the past, every time a change was made, you had to reassemble or recompile the program,” comments Juris Vikmanis, “and when you patched the program, there was always the danger that you might change something you didn’t want to and suddenly the control wouldn’t work.”

In the Bendix control system, the breakpoint between what goes into the programmable controller and what goes into the CNC depends on the application. Generally what used to be in the relay panel is now in the PIC and what used to be in the NC—reading the tape, offset, cutter compensation, interpolation, formatting of the controller data input—is all in CNC. The computer reads all the inputs and hands them to the PIC, which solves the repetitive Boolean equations controlling tool sequencing and hands the output back to the computer which uses it for control.

#### **DNC: the ultimate**

Computer-controlled machine tools can be carried a step beyond the CNC concept to the hierarchical system of direct numerical control (DNC). Originally DNC meant one large computer handling all the control functions for several machines. But big computers are not necessarily an efficient way to control a bank of tools.

The DNC philosophy, introduced by Sundstrand Machine Tools in 1968, has since evolved from one master computer controlling several tools to a master computer supervising perhaps 10 minicomputers, with each mini, in turn, dedicated to a separate machine.

“Our new philosophy,” says Tom Schifo, “is to allocate to each level computer the task best done by it. When it comes to running a machine, that machine needs the constant attention of a mini. The DNC computer [master processor] stores the programs, edits them, and sends them to the local computers as needed. Since some companies have up to 20,000 programs, tape storage requires a lot of space, and every time a change is made, a new tape is needed. Master storage of programs can eliminate tapes.”

One of the important features of DNC is the accumulation of machine utilization data: how much time is a machine down? Is it down because of breakage or is it out of material? Is it being used below its capacity? While this log could be kept at each machine by the CNC computer, the DNC can tie the information for all the machines together. As a result, management can direct both the flow of material and job assignments much more effectively.

The problem with DNC systems is that they are expensive. One installed by K&T at the Allis Chalmers Corp.'s Agricultural Tractor division carried a \$9 million tab. This system machines eight different tractor power train parts, which enter the system randomly as rough castings and leave ready for assembly.

The system is a little different from DNC as just defined in that the two computers operate in parallel. Two Interdata Model 70 computers control the system; one supervises machining, the other material handling.

At the beginning of the day, the foreman informs the material-handling computer how many rough castings are available, the product mix desired, the machines required to make each part, and the sequence in which these machines must be used. Then the computer decides in what order the parts should be made to achieve the desired mix and signals the operator via a Burroughs Self-Scan display what the next part will be. The operator loads a casting onto a fixture/pallet combination in a cart, and he signals the material-handling computer that the part has entered the system.

The carts, drawn by a towline recessed in the shop floor, loop around a stand of machine tools. As a cart passes into a particular machine tool zone, it trips a limit switch that tells the materials-handling computer of its arrival. Only one cart is allowed in a zone at a time.

The material-handling computer searches for an available machine in the loop and raises stops to halt the cart when it reaches that tool. Then gripper fingers grasp the pallet, pull it onto a shuttle, and position it ready for machining. Meanwhile the empty cart is released to go on its way so that trailing carts can move around the loop. The machining computer selects the part program, directs and monitors machining, and controls delivery of the finished part to the unload station.

### The shape of future NC

Although electronics has achieved much in the area of machine-tool NC, it could achieve more. Some electronic equipment, like computer peripherals, is still often not rugged enough for the machine shop environment. Elements like the tape readers present problems, too. Finally, not enough is as yet known about the parameters of metal cutting.

Oil mist in the air, greasy-fingered operators punching keyboards, and half-inch-thick iron dust on housings prove particularly hostile to CRTs and limit their applications in this area. Some machine-tool builders use them, but K&T has made a switch to Burroughs Self-Scan displays.

Sundstrand circumvents the problem by repackaging a commercial CRT terminal inside a molded fiberglass



**6. Automated shop.** Tow carts (blurred by motion) deliver castings at the Allis-Chalmers plant to the appropriate tool. Castings are automatically loaded onto the tool, machined, and unloaded.

cover with a molded-in plastic face. The unit is heavily sealed, and a cover is provided for the keyboard. The result is an expensive \$5,200, but, says Tom Schifo, "If we didn't do this, we'd constantly be replacing them."

Tape readers are often considered the weakest link in an NC system. Indeed, some users opt for CNC just so that they can do away with the inherent problems of tape breakage and reader failure, as well as the time spent rewinding and re-reading programs that are executed repetitiously.

The mechanics of cutting metal must be studied further. While adaptive control has been used successfully, it is expensive. In addition, simple deflection and torque measurements are not always sufficient to control cutting. Increases in tool deflection or torque do not always mean that the machine feed rate should be decreased. The rules apply only in simple cases where the same material is used consistently.

A big boost for the future of machine tools may come, not from a tool builder, but from a tool user. General Motors is sponsoring a multi-million dollar R&D program to develop entirely new machine-tool concepts. If entirely new machining concepts do in fact emerge from this program, new controls will be needed. And the effects cannot help but spill over into the general machine-tool area. If GM finds a way to double or triple productivity, other customers are going to want to do the same. That means buying new tools, and of course, new controls.

The future of machine tools looks good right now, but if electronics can provide a giant leap forward, it will look even better. □

## New Super-Fast Silicon Rectifiers!

30 Nanosecond Recovery Time

A major breakthrough in junction technology makes Super-Fast silicon rectifiers possible. These new high speed silicon rectifiers feature low forward voltage drop at higher operating currents and reverse recovery time better than 30 nanoseconds.\* In addition, these devices have extremely low reverse leakage and high surge ratings.

Super-Fast rectifiers use Semtech's proven Metoxilite non-cavity monolithic high temperature construction. Super-Fast rectifiers are designed for high frequency

\*Typical readings are as low as 15 ns.

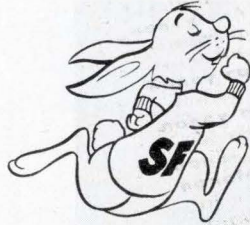

applications, such as high speed switching regulators and converter circuits. These rectifiers are radiation hardened for use in military applications, even though they

are priced for volume usage in industrial and commercial equipment.

Semtech's Super-Fast Silicon rectifiers are stocked for immediate delivery.

## SUPER-FAST METOXILITE RECTIFIERS



### TYPES: FF05, 10 & 15

Peak Inverse Voltage @ .25°C: 50, 100 and 150 V  
Reverse Current (Max): @ 25°C 1.0  $\mu$ A  
Instantaneous Forward Voltage @ 1.5 A (Typical): 0.97 V @ 100°C  
Capacitance @ 12 V DC (Max): 24 pF  
1 Cycle Surge Current (tp = 8.3 ms): 25 A  
Reverse Recovery Time, Trr (Max): 30 ns  
Dimensions (Max): Body; .070" D x .165" L Leads; .031" D x 1.25" L

### TYPES: 3FF05, 10 & 15

Peak Inverse Voltage @ .25°C: 50, 100 and 150 V  
Reverse Current (Max): @ 25°C 5  $\mu$ A  
Instantaneous Forward Voltage @ 3 A (Typical): 1.0 V @ 100°C  
Capacitance @ 12 V DC: 58 pF  
1 Cycle Surge Current (tp = 8.3 ms): 50 A  
Reverse Recovery Time, Trr (Max): 30 ns  
Dimensions (Max): Body; .110" D x .165" L Leads; .040" D x 1.10" L

### TYPES: 5FF05, 10 & 15

Peak Inverse Voltage @ 25°C: 50, 100 and 150 V  
Reverse Current (Max): @ 25°C 10  $\mu$ A  
Instantaneous Forward Voltage @ 5 A (Typical): 0.8 V @ 100°C  
Capacitance @ 12 V DC: 230 pF  
1 Cycle Surge Current (tp = 8.3 ms): 125 A  
Reverse Recovery Time, Trr (Max): 30 ns  
Dimensions (Max): Body; .165" D x .165" L Leads; .040" D x 1.10" L

## SUPER-FAST DO-5L STUD

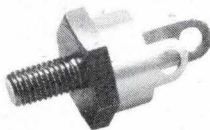

### TYPES: STFF05, 10 & 15

Add "R" to type number for reverse polarity  
Designed with the new Super-Fast Metoxilite silicon rectifiers in a DO-5L base. Especially suited for high frequency converter applications.

Peak Inverse Voltage @ 25°C: 50, 100 & 150 V  
IR (Max) @ PIV: @ 25°C .1 mA and @ 100°C 3 mA  
VF (Max): 10 Amps; @ 25°C .84 V, @ 100°C .70 V and 150°C .60 V.  
30 Amps; @ 25°C .96 V, @ 100°C .85 V and @ 150°C .78 V.  
50/Amps; @ 25°C 1.05 V, @ 100°C .93 V and @ 150°C .90 V.  
Recovery Time, Trr (Max): 30 ns.  
Dimensions (Max): Body .69" D x .45" H Stud ¼ 28 UNF x .43" L

"We're number 1 because we try harder"



**SEMTECH CORPORATION**

652 Mitchell Road, Newbury Park, California 91320  
(805) 498-2111, (213) 628-5392 / TWX: 910-336-1264

CHICAGO: (312) 352-3227  
DALLAS: (214) 387-3551  
FLORIDA: (305) 644-5404  
MARYLAND: (301) 424-6663  
NEW JERSEY: (201) 654-4884  
SAN FRANCISCO: (415) 494-0113  
EUROPEAN SALES HDQ: Bourns AG Zug, Switzerland (042) 232-242

NOTE: VF is measured @ pulse if duration = 8.0 millisecc. Maximum.



# Sequential analysis means fast, inexpensive testing

Multi-parameter assessments can be made at incoming inspection without sacrificing much of the speed normally associated with simple functional testing, thus resolving a not uncommon quandary

by George M. Ettinger, Plessey Co. Ltd., Poole, England

□ A production engineer may face a dilemma when trying to select the tests to be applied for acceptance of electronic components at incoming inspection. Go/no-go functional testing is quick, and it offers some useful screening information. But it gives no indication of how well the components are meeting their specifications—parametric trends. On the other hand, multi-parameter, quasilinear testing gives much more detailed information, but can be too slow for production purposes.

There is another consideration: functional testing, particularly truth-table testing, covers only one of several areas needed for full confidence that a device will work well in any application (see table). Faults in other areas can cause more severe problems during equipment checkout and operation than the obvious functional failures. But opting for the usual alternative—automatic testing to cover all or even the majority of the items listed in the table—can be expensive in terms of time as well as hardware.

An obvious middle ground would be found in a tech-

nique that combines some of the better attributes of each of the two traditional methods. At the Plessey Co. Ltd., Poole, England, such a technique has been adopted through the development and use of an instrument called the sequential circuit analyzer (and covered by British patents). Various methods of sequential circuit analysis are designed to cover most of the param-

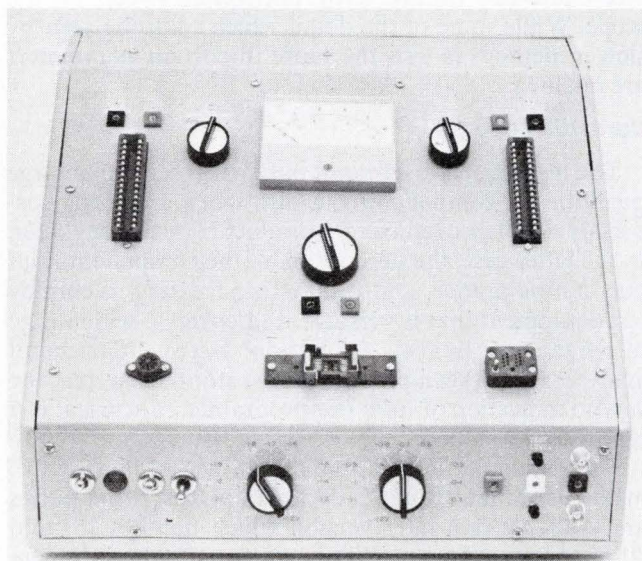

**1. Analyzer.** Most parameters of electronic components, and even functional modules and printed-circuit boards, can be checked with a sequential circuit analyzer. The two large sockets on the analyzer carry wired program cards for each device type. The device under test is connected via universal sockets on the sloping panel, and test conditions are set on the lower front panel.

TEST PARAMETERS FOR ELECTRICAL COMPONENTS		
GROUP	EXAMPLES	TYPICAL FAULTS
Mechanical	Dimensions Lead spacing Encapsulation Marking	Bent leads Short/long leads Molding residues Poor marking Wrong marking Bad plating
Thermal	Power consumption Temperature rise Thermal time constant Bonding	Excess $I_{CC}$ Excessive drift Local hot-spots
Noise and instability	Intermittent contacts Abnormal bandwidth Surface states	Rf instability in some test modes Long term drift
Output parameters	Saturation Power out Logic levels Linearity	High saturation voltage Low output Wrong/abnormal logic levels Visible non-linearities or discontinuities Breakdown voltage
Transfer parameters (functional)	Truth table Resistance Sensitivity, gain	Wrong device Mis-bonding Internal shorts Low gain
Others	Speed Cutoff	Material Processing Geometry Stray inductance or capacitance

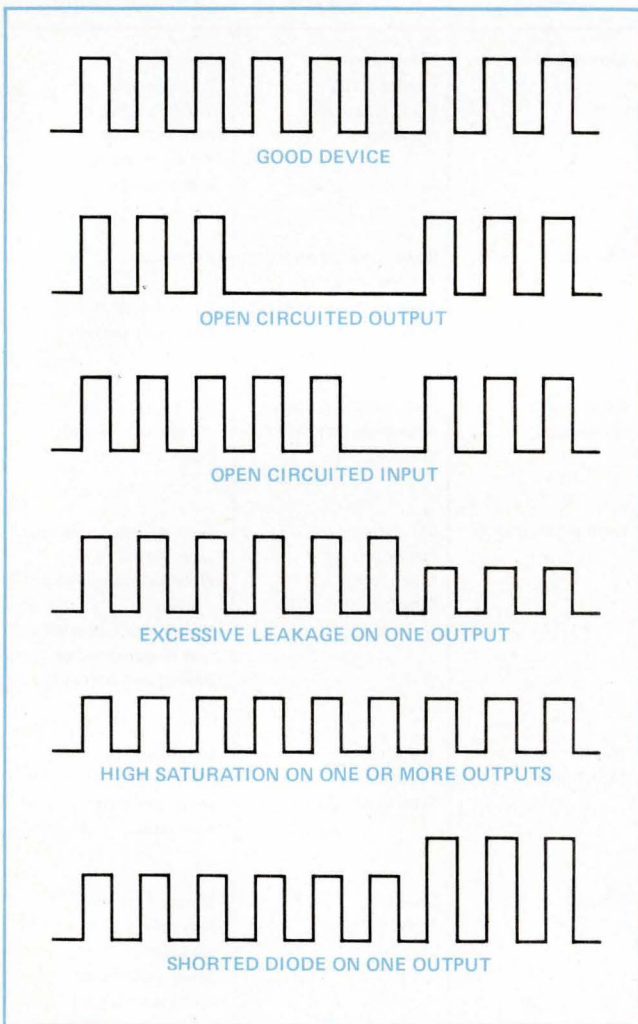
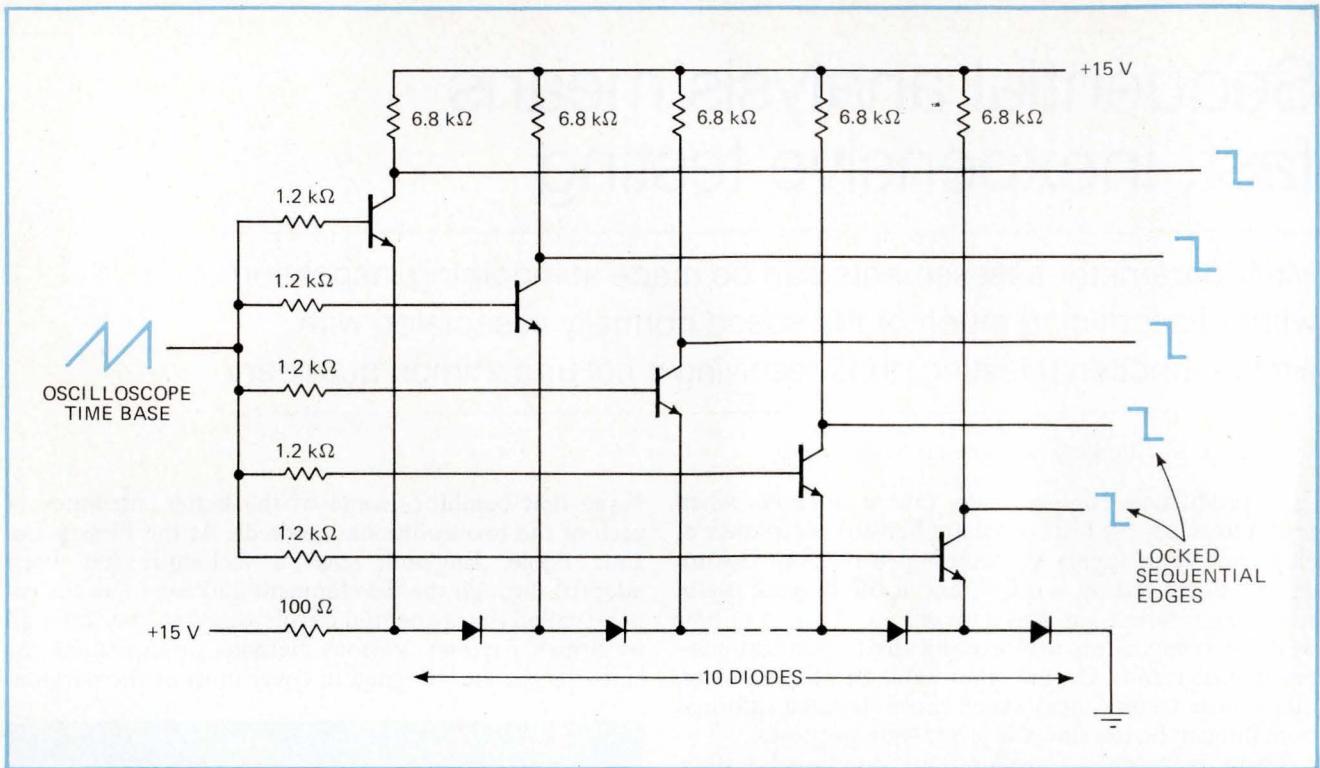

**2. Locked edges.** Sequential edges used for testing various devices are generated from an oscilloscope time base signal. By synchronizing the test pulses to the scope, the scope trigger circuit does not have to be adjusted for changes in sweep rate.

ters required for incoming inspection of a wide range of components, yet perform the tests about as quickly as simpler, go/no-go functional tests. In conjunction with an oscilloscope, a sequential circuit analyzer displays the transfer characteristics of an analog or digital device-under-test during each horizontal sweep of the scope. While some of the detail which could be seen by slower methods is lost, the more important parameters are retained.

### Versatility counts

The technique is useful not only when screening large quantities of components but also when analyzing suspect devices removed from a product by a test engineer. In the latter case, the description of the component fault may not be precise, and it may be necessary to employ test equipment that is versatile and covers a wide range of parameters. In such a situation, a sequential circuit analyzer (Fig. 1) can provide more information than the yes/no indication of fully pre-programmed functional test set-ups.

The sequential circuit analyzer in use at Plessey Co. makes use of ten sequentially-timed pulses. More pulses are available in a later version which handles 28- and 40-pin packaged devices. The sequential pulses are generated from the oscilloscope time base to avoid the need for synchronizing a scope to the analyzer output (Fig.

**3. Signatures.** The responses of all the gates within an integrated circuit can be viewed simultaneously with a sequential circuit analyzer. Each fault within the ic has a unique signature.

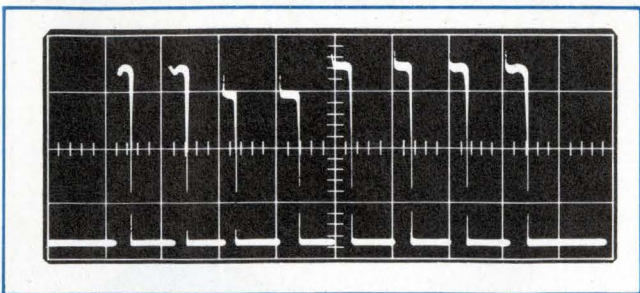

**4(a). NAND gate.** The transfer characteristic of a 7400 TTL quad 2-input NAND gate should show eight pulses of equal height. Here, the scope trace shows that one gate in the package has output leakage, so two pulses are shorter than others.

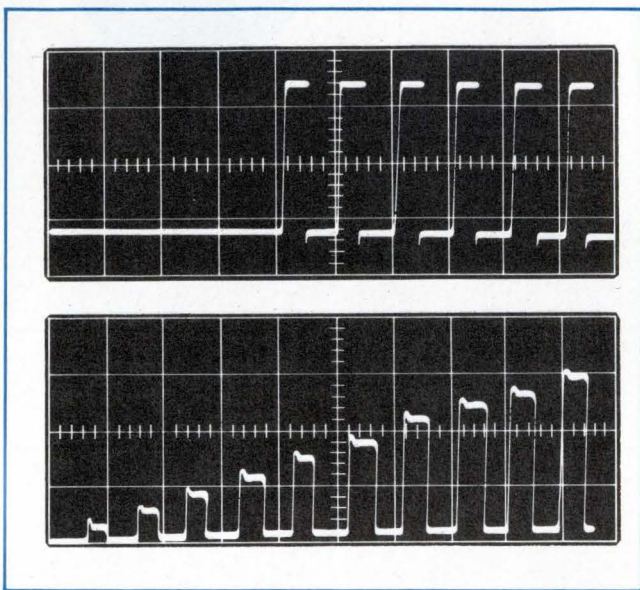

**4(b). Linear.** A 709 operational amplifier can act like a comparator. With sequential pulse inputs increasing in amplitude from  $-50$  to  $+50$  millivolts in  $10$ -mV steps, the output level of this amplifier switches from  $0$  to  $1$  at an input of  $-10$  mV.

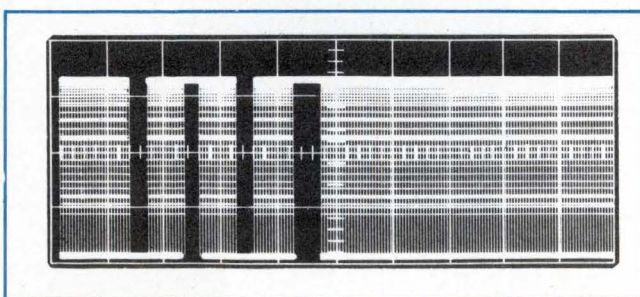

**4(c). Flip-flop.** A type 945 DTL flip-flop can be tested by applying pulses at its inputs while it is being clocked. Clear areas here represent inputs at the clear, preset, K and J terminals, and shaded areas represent toggling at  $500$  kHz.

2). With this arrangement, the test operator can vary the time base over a wide range and still have a steady picture containing complete testing information for the component or module under test.

The sequential-pulse generator is followed by pulse-forming and level-setting circuitry. The 1-level and 0-level voltages of the pulses are precisely set through

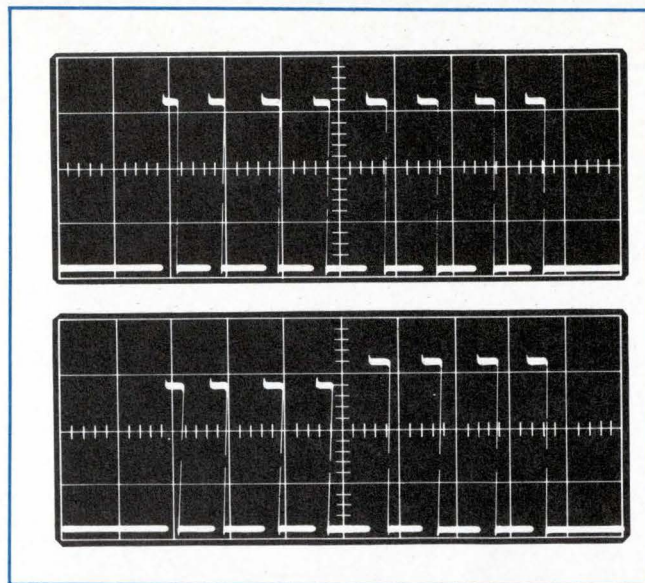

**4(d). Low power.** A 74LS153 low-power Schottky dual 4-line data selector should display eight equal-height pulses at its output. If one of the two selectors in the package cannot reach the minimum 1-level, half the pulses are too short.

front-panel controls. Power-supply voltages and monitoring facilities are sufficiently flexible for testing of a variety of device families and component types.

The analyzer can test devices ranging from passive components to complex circuits, whether implemented in the form of large-scale integration or as assemblies of components on printed circuit boards. The range is not limited by the sequential analysis technique, only by the design of the instrument used to implement it—that is, by the number of sequential stimuli provided, the number of buffers, inverters, loads, etc., placed in the plug-in program, and available drive power.

A program for testing each device type is housed in a plug-in which contains the necessary discretionary wiring needed to go from the ten standard sequential pulses available in the analyzer to a universal device socket, as well as appropriate output loads and a clock source, when necessary.

Programs numbering in the hundreds have been developed at Plessey. These programs are used to test such devices as 7400-series transistor-transistor logic (including high threshold and low-power Schottky devices), C-MOS, ECL, many linear circuits, and other components and printed-circuit board assemblies. Among the circuit types for which programs have been written are gate circuits, shift registers, counters, adders, digital comparators, display decoder/drivers, PROMs and ROMs, and linear amplifiers and comparators.

### Faults observed

Sequential circuit analyzers have been used in a number of Plessey factories, mainly for goods-received testing. They have also been applied for in-depth laboratory analysis of goods that have failed in the field. Test rates, when hand-feeding components, are on the order of  $400$  dual-in-line packages per hour. Apart from obvious faults, including short-circuits and broken bonds,

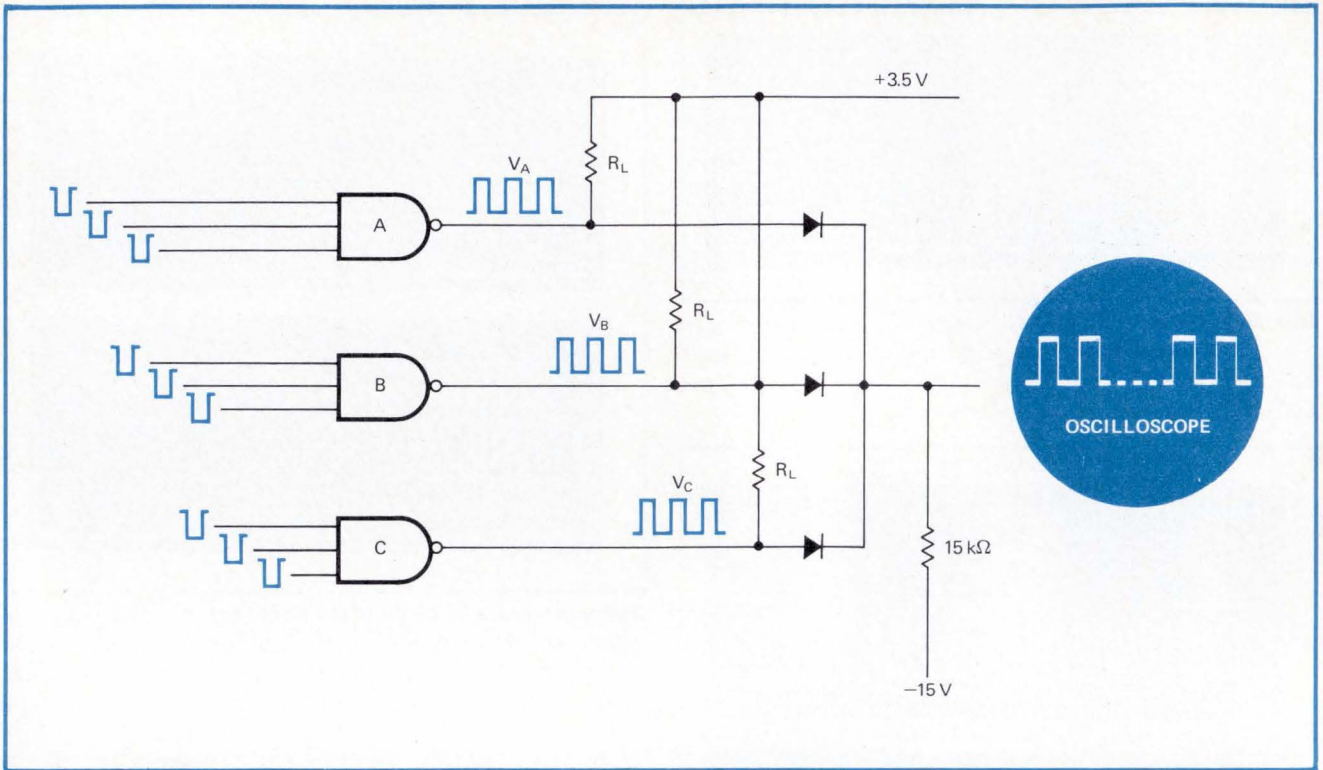

**5. NAND gate.** The nine inputs of a triple three-input NAND-gate IC, such as a TTL type 7410, are connected to the sequential pulse outputs of the analyzer and the three outputs of the IC are connected through a summing network for display on an oscilloscope. The oscilloscope then displays the operation of all inputs and outputs of all three gates in the package on each sweep.

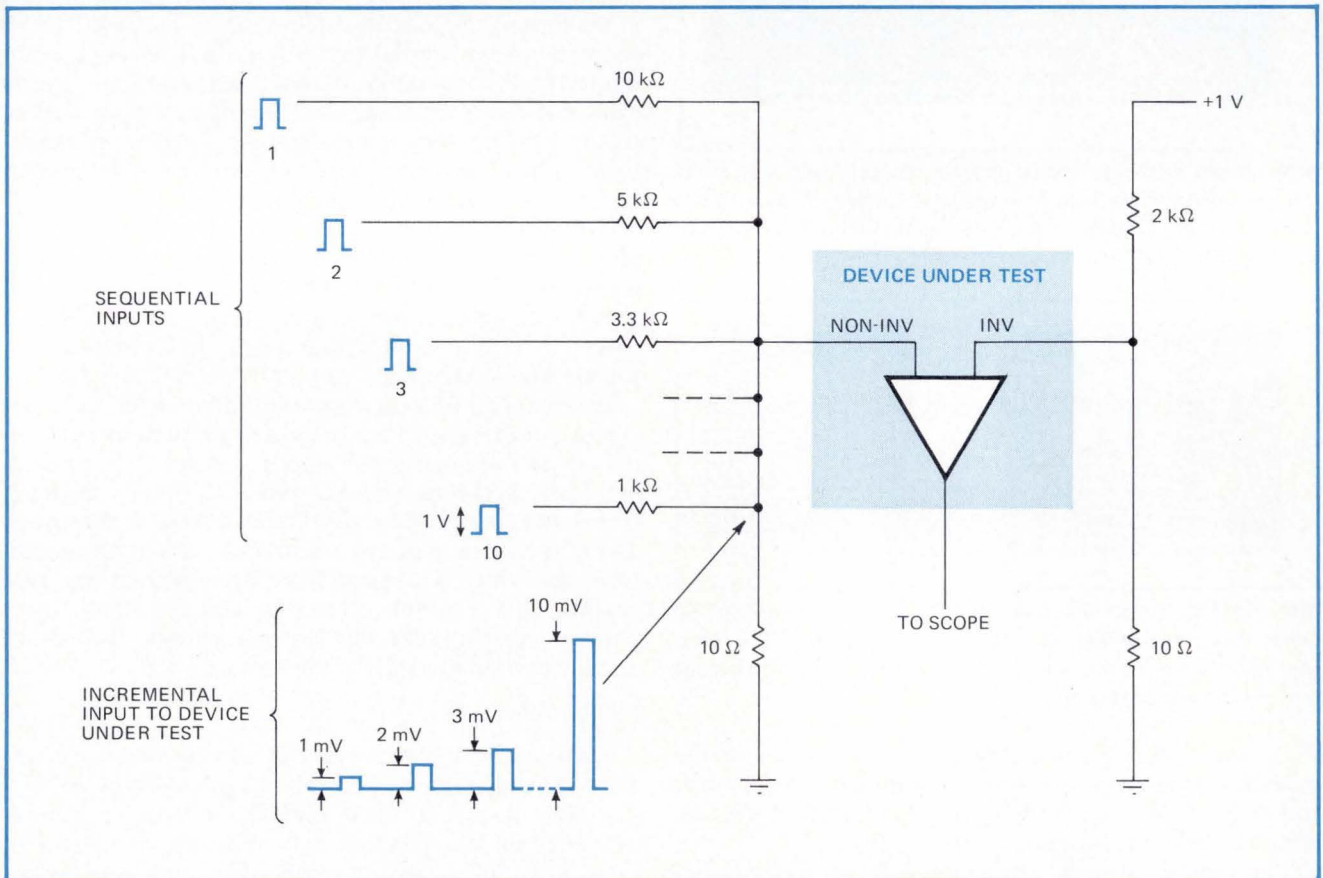

**6. Linear circuit.** The sequential outputs of the analyzer are set at incremental voltage levels and summed to provide an input for the device under test. The output of a good device, as displayed on an oscilloscope, will show the increasing-voltage pulses in each sweep.

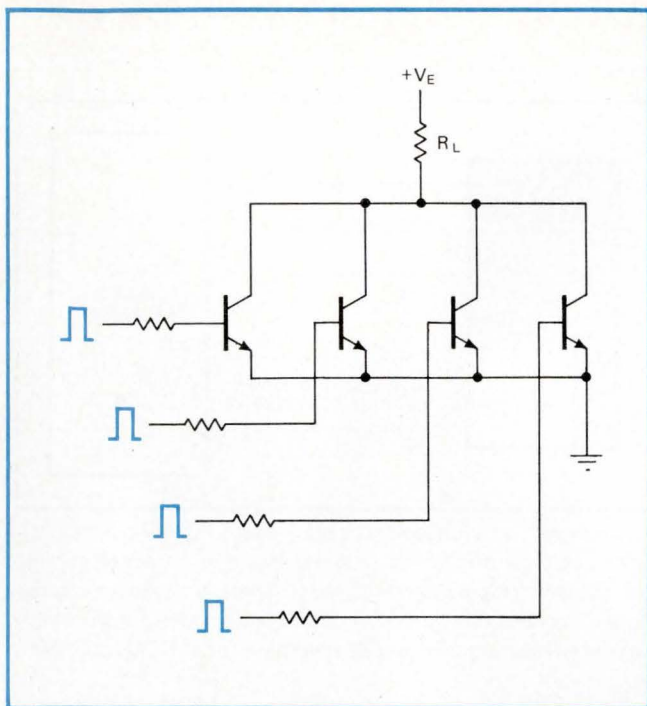

**7. Transistor arrays.** These can be tested with a sequential circuit analyzer by joining their collectors. Between pulses, the transistors are off; when a pulse is applied to any transistor the output falls to the saturation voltage of that device.

parametric trends such as incorrect saturation voltage or current, or excessive leakage can be readily observed.

Rapid diagnosis and remedial action is made possible by the ability to pinpoint problems in a particular part of the circuit in an IC. The instrument is also useful for testing small digital and hybrid printed circuits where the scope display allows rapid fault location.

The sequential circuit analyzer shows up processing irregularities and incipient failures such as marginal latch-up in master-slave flip-flops and secondary breakdown in TTL. The form which the output patterns take is indicated in Fig. 3 for a triple three-input NAND gate such as a 7410. Here, the existence and voltage level of each sequential output pulse clearly shows the quality of each of the input, gate, and output circuits within the IC. Various types of failures have distinct signatures easily read by an operator.

The characteristic curves for ICs with excessive leakage on one output, high saturation current on one or more outputs, and a shorted diode on one output represent processing faults not readily detectable with conventional digital testing. The devices would appear satisfactory in go/no-go tests, which merely ensure that the output-low voltage is low enough and the output-high voltage is high enough.

Since all the information is recreated during each oscilloscope sweep, device performance can easily be monitored during environmental testing, and even small parametric changes can be observed. For example, faulty chip bonding can show up as a thermal time-constant and apparent parameter drift when using the sequential circuit analyzer.

Oscilloscope traces for a number of different types of

circuits are shown in Fig. 4. With a minimum of training, an operator can easily detect that a device is faulty and classify the fault for later analysis.

As a routine procedure at Plessey, operators classify IC failures into eight groups. This is preferable to merely reporting "dead on arrival" and fosters remedial action.

### Motivation up

The availability of a scope display also helps to maintain operator motivation by keeping the operator involved in the testing process. In addition, operators can easily detect new classes of faults, whereas an automatic functional test program is unlikely to include statements relating to faults that have not previously occurred. Human operators can also detect dimensional, lead and marking errors, and, using the oscilloscope display, can find major parameter drifts, intermittencies, and discontinuities.

Consider, for example, a TTL gate with an amplifier-like transfer characteristic. Figure 5 shows a triple three-input NAND gate having nine unique transfer characteristics. The analyzer drives the nine gate inputs sequentially with identical stimuli. A combining circuit, also shown in Fig. 5, gives a composite output pattern which contains all the transfer information.

The following faults are readily detected as changes in the composite pattern:

- Truth table violations
- Broken bonds
- Output(s) fixed at 1
- Output(s) fixed at 0
- Output(s) at abnormal levels
- Input(s) fixed at 1
- Input(s) fixed at 0
- Inter-pin shorts
- Faulty supply voltage lines
- Faulty ground lines

To test linear amplifiers and comparators, the ten available stimuli are combined into a staircase, typically 1 millivolt per step (Fig. 6). Component values in the program are arranged so that the effective input for the device goes from  $-5$  mV to  $+5$  mV in distinct steps.

A transistor array can be tested by joining its collectors (Fig. 7). During the intervals between the sequential inputs, all transistors are off, and the voltage drop across the common load indicates the sum of the leakage currents. When a pulse is applied to any one transistor, the output falls to the saturation voltage of that transistor. Provision is made in the instrument for inverting the drive pulse polarity and supply voltage to cope with pnp devices.

As noted, many other device types can be accommodated. Using the sequential circuit analyzer, they can all be tested quickly and easily, assuring a high confidence level, with a minimum of testing cost. □

### BIBLIOGRAPHY

- M.J. Wainwright and M.J. Howell, "Production Testing with ATE," *Automatic Testing* 1974, Brighton, England, pp. 2-53.  
 D.G. Wagner, "Curve tracer tests logic IC quickly," *Electronics*, June 24, 1968, p. 98.  
 G.M. Ettinger, "Improvements in or Relating to the Testing of Apparatus," British Patent 1,322,182.

# Engineer's notebook

## DIP switches and diodes form programmable ROM

by Louis E. Frenzel  
Heath Co., Benton Harbor, Mich.

Microprocessor-based equipment depends more on software than on hardware for its operation, and therefore the design of such equipment consists largely of program development. If the memory in which a program is stored can be changed easily and quickly, program writing and debugging are simplified. The programmable read-only memory described here speeds up these program-development processes, and thus facilitates physical breadboarding with the microprocessor in the initial stages of design.

The PROM shown in Fig. 1 is a switchable diode matrix organized into 16 8-bit words. Each bit is implemented with a single-pole, single-throw switch and a diode. To simplify construction and minimize size, the PROM uses the new 8-switch/16-pin dual in-line packages. Each DIP unit thus represents one 8-bit word.

Instruction words and data words are loaded into the

**1. DIP-switch memory.** Microprocessor programs can be tested with read-only memory, consisting of eight-switch DIPs used as 8-bit binary words. This memory, which is simple to set or change, can be checked visually. Diodes in the ROM isolate words from one another. The decoder connects the DIPs to the data bus.

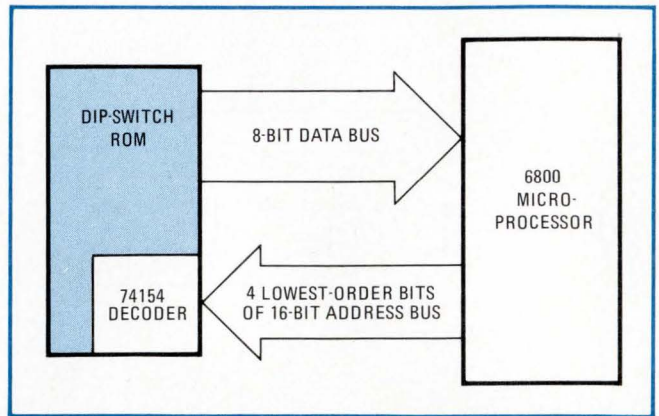
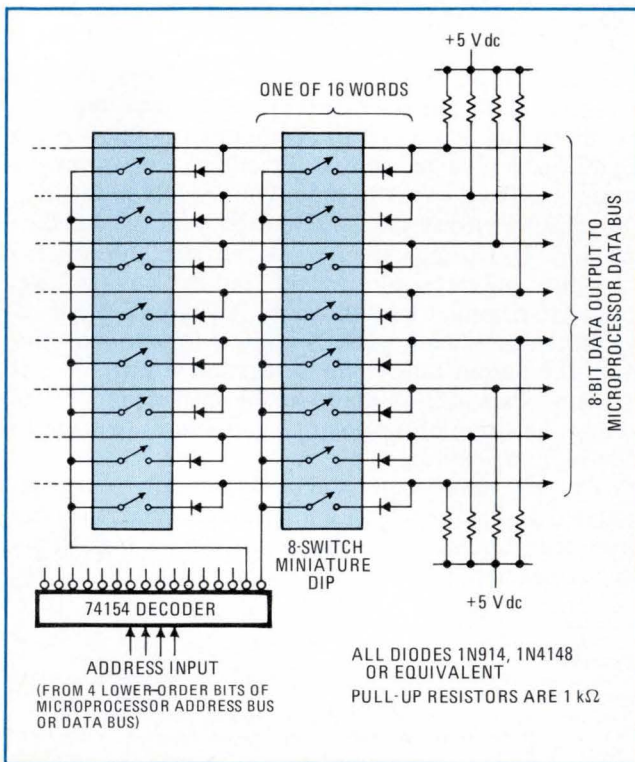

**2. Example.** This arrangement of a DIP-switch ROM with a 6800 microprocessor is used for the program shown in the accompanying box. (Other microprocessors may have different means for address input.) Programs can be set up, tested, and modified more simply with the switch memory than with integrated-circuit ROMs or RAMs.

memory by setting the switches; a closed switch produces a low (binary 0) output, while an open switch generates a high (binary 1) output.

Instruction words are loaded into sequential memory locations. Data words can be placed in any convenient memory location that is available. If the DIP switches are arranged in address sequence with the switch levers properly oriented (up = 1, down = 0), the memory contents can be determined at a glance. The ability to see the memory content and to change it in seconds will greatly expedite program development. It becomes possible to modify and debug a program in a fraction of the time that would be required if a conventional ROM or RAM were used.

The use of only 16 words may seem severely limiting in a ROM, but it is usually more than adequate to test and exercise a microprocessor. The memory is sufficient to try all instructions and to test short subroutines. The flexibility of being able to quickly and conveniently change a program and to actually see the program stored in memory makes it easy to design microprocessor systems and to learn programing.

A 74154 TTL 1-of-16 decoder is used to address the memory words. The decoder input lines are connected to the four lower-order bits of the microprocessor address bus or data bus.

The box (top, right) shows a sample program using DIP-switch ROM with a 6800 microprocessor, as in Fig. 2. For this application the 16 switches are numbered consecutively in hexadecimal notation: 00, 01, 02 . . . 09, 0A, 0B, . . . 0F. The program contains five instruction words and two data words. Three of the instructions (LDAA, ADAA, and STAA) occupy two sequential 8-bit locations. Instructions DAA and WAI each occupy a single 8-bit location. The instruction words are loaded into the first eight DIP switches because the microprocessor operates on instructions sequentially. The two data words can go into any of the eight remaining switches; here the data words are put into the last two

switches (0E and 0F). The data stored for this example are the numbers 48 and 37, which are set on the switches as 0011 0000 and 0010 0101, respectively.

The program tells the microprocessor to do the following: first, load its accumulator register A with the number stored at location 0F; next, add the number at location 0E to the number in the accumulator, and store the sum in A; finally, convert the binary number in A to its decimal (BCD) equivalent, and store the decimal number in location 1F. After it has completed all these operations, the microprocessor is to await an interrupt signal.

The instruction set provided by the manufacturer of the 6800 shows how to set the ROM switches to deliver these instructions to the microprocessor. The first instruction, designated LDAA, is set into switch 00 as hexadecimal 96, which is binary 1001 0110. The second half of this instruction is stored in switch 01, and gives the location of the data to be loaded; that location is hexadecimal 0F, or 0000 1111. The next instruction, ADDA, is found from the 6800 instruction set to be hexadecimal 9B, or binary 1001 1011. The remaining steps are similarly set into the DIP switches by use of the 6800 instruction set.

The result of adding 37 to 48 could be displayed by an output device that showed the content of location 1F. It would show 85, because decimal notation was specified. □

SAMPLE PROGRAM				
ROM address	Instruction or Data	Operation performed	Hex	Binary
00	LDAA	Load accumulator A with the contents of	96	1001 0110
01	F	memory location 0F.	0F	0000 1111
02	ADDA	Add contents of memory location 0E to the	9B	1001 1011
03	E	number in accumulator A and store the sum in A.	0E	0000 1110
04	DAA	Convert the binary number in A into BCD.	19	0001 1001
05	STAA	Store contents of accumulator A in memory location	97	1001 0111
06	1F	1F.	1F	0001 1111
07	WAI	Wait for interrupt.	3E	0011 1110
08				
09				
0A				
0B				
0C				
0D				
0E	48	Data	30	0011 0000
0F	37	Data	25	0010 0101

## Jitter generator tests bit synchronizer

by M. Harikumar and N. Gopalan Nair  
Vikram Sarabhai Space Center, Trivandrum, India

To test bit-synchronizer performance in the presence of frequency jitter, it is often necessary to produce random variations in the frequency of a square-wave oscillator. A sinusoidal voltage can be used to vary the oscillator frequency within a specified range, but the sinusoidal variation is a poor approximation of discrete frequency changes. However, a circuit can be built to shift the output frequency among four levels in a noise-like jitter in such a way that the known and repetitive properties of the jitter help in a realistic evaluation of the system performance.

In this circuit, the outputs from all four stages of a four-stage shift register are summed and applied to a voltage-tunable oscillator. Each shift-register stage can have a logic level of either 0 or 1, but the all-zero state is suppressed. The summed output can range from 1 to 4, which would result in voltages of 5, 10, 15, and 20 volts for 5-v logic. The input to the register consists of the outputs from the third and fourth stages, fed back through an exclusive-OR arrangement to generate a pseudorandom sequence of 15 states. The 4-input NOR gate suppresses the all-zero state after turn-on.

TABLE 1. SEQUENCE OF SHIFT-REGISTER STATES AND THEIR SUMMED VALUES

Shift-register state	Sum of outputs from register stages
.	.
.	.
.	.
1111	4
0111	3
0011	2
0001	1
1000	1
0100	1
0010	1
1001	2
1100	2
0110	2
1011	3
0101	2
1010	2
1101	3
1110	3
.	.
.	.

The successive shift register states and their sum outputs are given in Table 1. It can be seen that the summed output has a binomial distribution, which is an approximation of a gaussian distribution. The summed value 1 occurs four times, which is just the number of possible combinations of four things taken one at a time

# What makes Gallium from Arkansas so special?

It's available . . . in quantity . . . now!  
Availability you can depend on for a  
long time . . . from stock, and as close as your  
nearest airport.

The reason: Alcoa has just completed a  
new plant in Bauxite, Arkansas. The plant is in  
full operation . . . processing large quantities of  
gallium from our own gallium-rich reserves of  
Arkansas bauxite.

All of it pure. And the known consistency  
of our domestic source promises no unexpected  
trace elements.

That kind of gallium will be coming out  
of Arkansas for a long time.

Alcoa<sup>®</sup> gallium.

So there's now an ample supply of gal-  
lium for optocouplers, LEDS, injection lasers,  
magnetic bubble memories or anything else.  
So don't hesitate in designing with, specifying  
and purchasing devices utilizing gallium.

Alcoa can now supply the gallium needs  
for today and tomorrow . . . in million-gram  
quantities if required.

Send us your questions about gallium.  
Just write Aluminum Company of America,  
850D Alcoa Building, Pittsburgh, PA 15219.

Change for the better with  
Alcoa Gallium





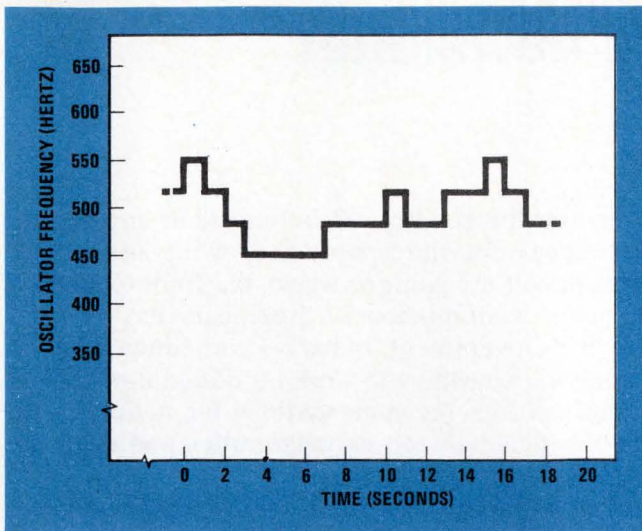

**1. Frequency jitter.** Pseudorandom jitter of frequency from voltage-controlled oscillator is generated by using the sum of the outputs from individual stages of a four-stage shift register to tune VCO. Oscillator's output frequency has more possible values, with more noise-like distribution, when more shift-register stages are used.

( $C_1^4$ ). The value 2 occurs six times, which is  $C_2^4$ , the value 3 occurs four times ( $C_3^4$ ), and value 4 occurs only once ( $C_4^4$ ). The shift register is activated by clock pulses that have a repetition frequency of only 1 hertz or whatever jitter rate is desired.

The outputs from the individual stages of the shift register are summed in an adder circuit, producing a stepped sequence of voltages that is used to tune the voltage-controlled oscillator. If the synchronizer bit rate is 500 Hz and a variation of  $\pm 10\%$  is required, the VCO is adjusted to oscillate at 450 Hz for the lowest voltage

Number of stages in shift register	Feedback stages
4	3, 4
5	2, 5
6	5, 6
7	6, 7
8	4, 5, 6, 8
9	4, 9
10	7, 10

from the adder, and to oscillate at 550 Hz when the summed voltage is a maximum.

In this example, with a 4-stage shift register, the output-frequency variation is limited to four steps. But a longer shift register can provide more voltage levels for a better approximation of noise-like properties in the jitter introduced. Table 2 shows what stages should be fed back to the input of longer registers. □

Engineer's Notebook is a regular feature in Electronics. We invite readers to submit original design shortcuts, calculation aids, measurement and test techniques, and other ideas for saving engineering time or cost. We'll pay \$50 for each item published.

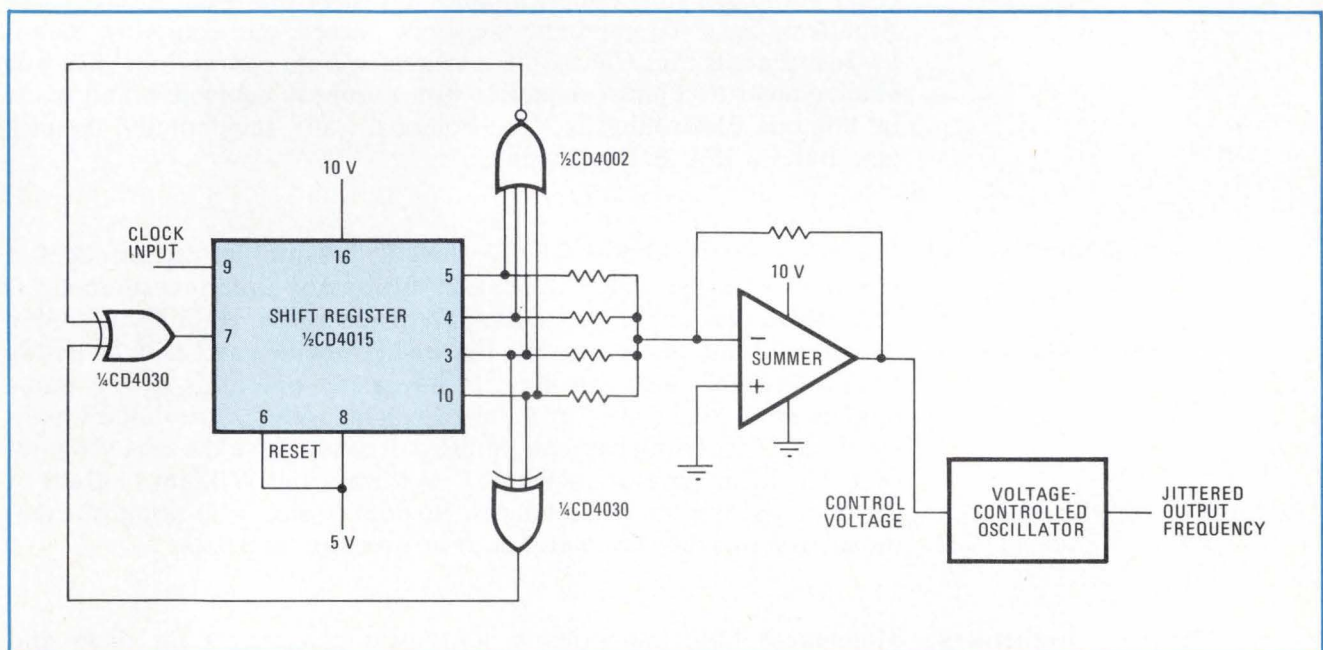

**2. Random oscillator.** Output voltages from individual stages of shift register are summed and used to determine output frequency from VCO. Feedback arrangement in shift register makes summed voltages vary among four levels in pseudorandom, repeating 15-step sequence. Four-input NOR gate suppresses all-zero condition in register after turn-on, so that exclusive-OR gates can generate sequence of voltage levels. Longer registers produce more levels, longer sequences, and a more nearly gaussian distribution.

## Conference to discuss engineering manpower problems

If you have any ideas on how this country can better use its engineering talent, now's the time to speak out. In response to growing anxiety that this nation's engineering talents are going to waste, the Joint Council of the Engineering Manpower Commission of Engineers has called a meeting to discuss how the Government, industry, and educational institutions can put engineering knowhow to work on national problems. The objective is to come up with **recommendations for action by the Government in solving conflicts between national policy and engineering manpower resources.**

The week-long meeting will be held at the Engineering Foundation conference facilities in Henniker, N.H., July 13-18. Representatives of the IEEE and 20 other engineering societies will participate. Send them your views and get the details: 345 E. 47th St., New York, N.Y.

## Pc-board systems for Germany must meet the DIN spec

In any equipment aimed at the German market, you should make sure the pc-board packaging system meets the German electronics industry's specification DIN 41494. Basically 41494 requires **plug-in cards specified at 100 by 160 millimeters (3.94 by 6.30 inches) and 233.4 by 160 mm (9.2 by 6.2 in.),** plus card files (frames) to accommodate the cards. U.S. suppliers of hardware for this system are hard to find, but one is Vero Electronics, 171 Bridge Rd., Hauppauge, N.Y. 11787

## Banana plugs are bigger in Europe

If you're designing instruments and prototype equipment aimed at the European market, obviously you've got more on your mind than banana plugs. But you should know that standard European banana plugs are longer than American ones and stick out when inserted into American jacks. To eliminate the shock hazard, one company, Keithley Instruments Inc., Cleveland, is **switching from conventional five-way binding posts to a jack compatible with European equipment** and made by Pomona Electronics Co. Inc., Pomona, Calif. Incidentally, the jack also mates with U.S. banana plugs.

## A simple way to calibrate a sampling scope

For those of you who've fallen in love with sampling oscilloscopes, a reminder—the instrument's precision during any time measurement is critically dependent on the accuracy of its timebase. Happily it's no big deal to calibrate the scope. **The required reference can easily be gotten from a snap-off diode and a cavity wavemeter** operating in the transmission mode and driven by a pulsed voltage source. The diode's high-amplitude, fast-rising baseband pulse will easily drive the cavity's input port. The idea comes from James R. Andrews and William L. Gans of the National Bureau of Standards, Boulder, Colo., who point out that the accuracy of the wavemeter need be no more than 0.2%.

## Memory designers, take note

Magnetic-bubble memories as low-cost replacements for disks and drums (100,000 bits and up) are very much alive. Texas Instruments, which has quietly been **operating a 16-chip 256-bit bubble memory module** at its minicomputer facility in Houston, will begin pilot production this year.

—Laurence Altman

# Be serene in your logic.



## Attain flexibility with TRW/Cinch logic boards.

You can be master of logic changes. Total flexibility in the interconnection of integrated circuits is the soul of I.C. logic boards from TRW/Cinch Connectors.

For prototyping and short production runs, TRW/Cinch has assembled a line that gives you these features and options:

- High density DIP boards in 14 and 16-pin patterns (in 30-pattern multiples up to 180) or universal boards that accept 8 to 40-lead IC's.
- Socket terminals accept rectangular or round pins. Have two or three-level wire wrap\* terminals.
- FR-4 epoxy glass  $\frac{1}{8}$ " boards, with power and ground planes on opposite sides.
- Complete line of interconnection accessories.

Since we believe in flexibility, our application engineers are available to assist in the development of custom board designs.

Fast, off-the-shelf delivery is available through these distributors and their branches in all major market areas:

• Pioneer-Standard Electronics • Rampart Components • RESCO Electronics • Sterling Electronics • Wilshire Electronics

Write or call your local TRW/Cinch logic board distributor or your local TRW/Cinch sales office or TRW/Cinch Connectors, an Electronic Components Division of TRW Inc., 1501 Morse Avenue, Elk Grove Village, Illinois 60007, phone (312) 439-8800.

*As time goes by it becomes more and more difficult*

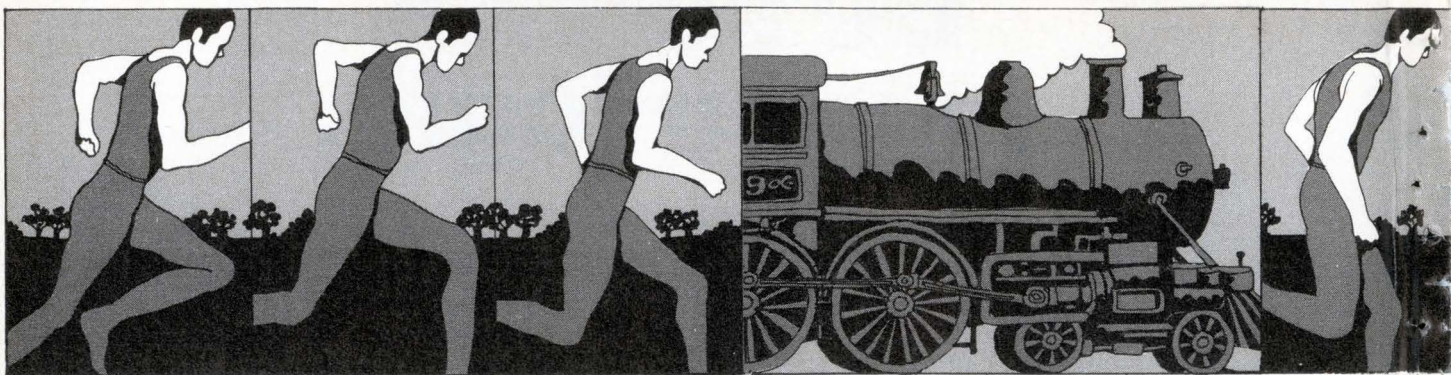

*...with the accelerating advances in technology...*

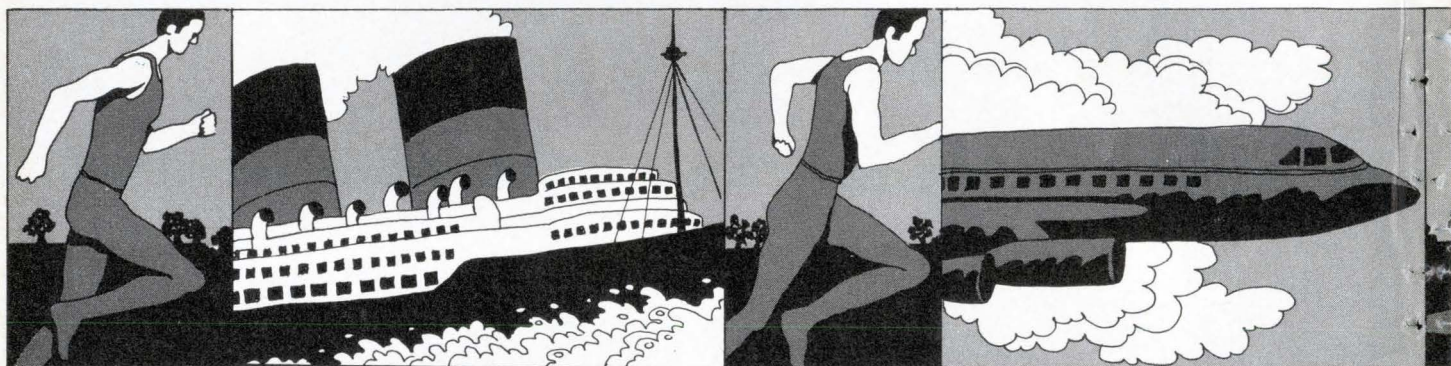

*...but what is this on the horizon?*

*Caught up at last!*

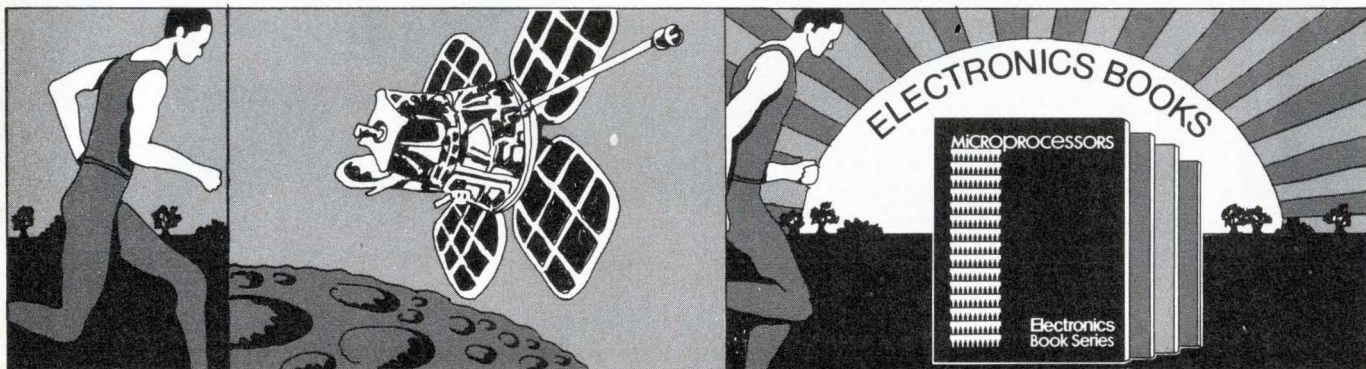

**ELECTRONICS  
INTRODUCES:**

# a Book Series

designed to keep you up-to-date on selected key technologies.

Each book will be a compendium of recent articles available from Electronics magazine on a particular technology. Each will be edited and produced by the staff of Electronics to form an invaluable reference work in one current volume.

to keep pace...

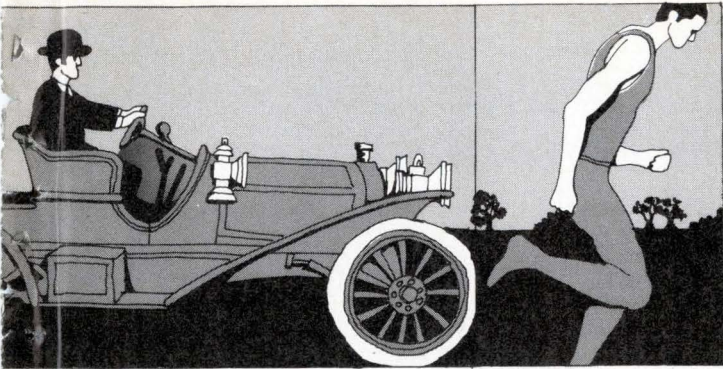

...it's really awfully difficult...

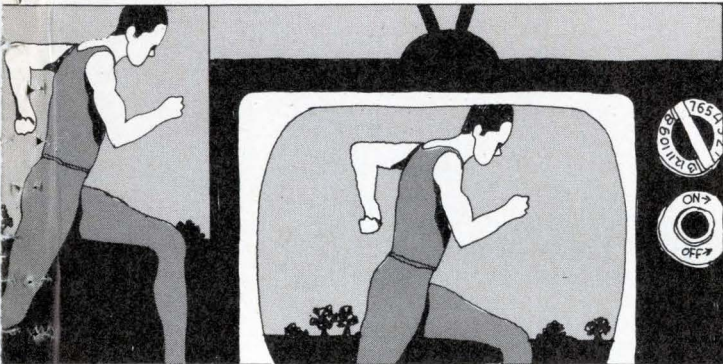

The first book will be published in May. The subject: *Microprocessors*.

The microprocessor has permanently changed the methods of designing and building electronic equipment—from process and industrial control to computer-based designs in instruments, communication and consumer/commercial equipment.

But, getting into microprocessors is no snap. As a fundamental departure from the old familiar hard-wired logic techniques, the microprocessor technology has already produced a host of devices competing for the designer's attention, each with its own software and hardware.

This book cuts through the confusion, presenting the design and application

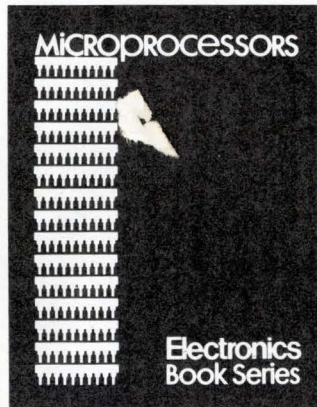

potential of this exciting technology in a manner that will appeal to the design engineer who needs to know how to use microprocessors as well as the system analyst who must assess the tradeoffs between microprocessors and other techniques to accomplish his system goals.

Using articles from the pages of *Electronics*, the book contains practical and up to date information on available microprocessor devices, technology and applications—ranging from the simplest 4-bit p-channel MOS system to the second-generation n-MOS 8-bit processor chips, and the new injection logic and Schottky TTL bipolar processor families needed for the toughest computer-based control applications.

#### UPCOMING VOLUMES

Others already planned for the Book series: *Thermal Design*, *Mini-computers in Action*, *Large Scale Integration*.

#### SAVE 22% BY ORDERING NOW

All orders for *Microprocessors* mailed by June 15, 1975, will be accepted at the pre-publication price of \$6.95. Thereafter, the price will be \$8.95. For bulk order prices of ten or more copies, contact publisher.

ORDER NOW FOR  
PRE-PUBLICATION DISCOUNT  
(Discount available only if mailed by  
June 15, 1975 and full payment must  
accompany order)

Electronics Book Series  
P.O. Box 669 Hightstown, N.J. 08520

Send me \_\_\_\_\_ copies of "Microprocessors".  
Enclosed is payment at the pre-publication price  
of \$6.95 per copy. I must be fully satisfied or you  
will refund full payment if the book is returned after  
10 days free trial examination.

Name \_\_\_\_\_ Title \_\_\_\_\_

Company \_\_\_\_\_

Street \_\_\_\_\_

City \_\_\_\_\_ State \_\_\_\_\_ Zip \_\_\_\_\_

Signed \_\_\_\_\_



**Electronics**  
**IS THE SOURCE**  
**FOR BOOKS, TOO**



# Now ready!

A new line of VHF tetrodes with PYROBLOC® grids...  
for super-reliable FM-radio transmitters

- 3 kW to 30 kW of output power.
- Only one power tetrode needed.
- Direct solid-state drive for the output stage.

Whith a big extra plus: THOMSON-CSF's own RF line-circuit designs for optimum overall amplifier performance and reliability!

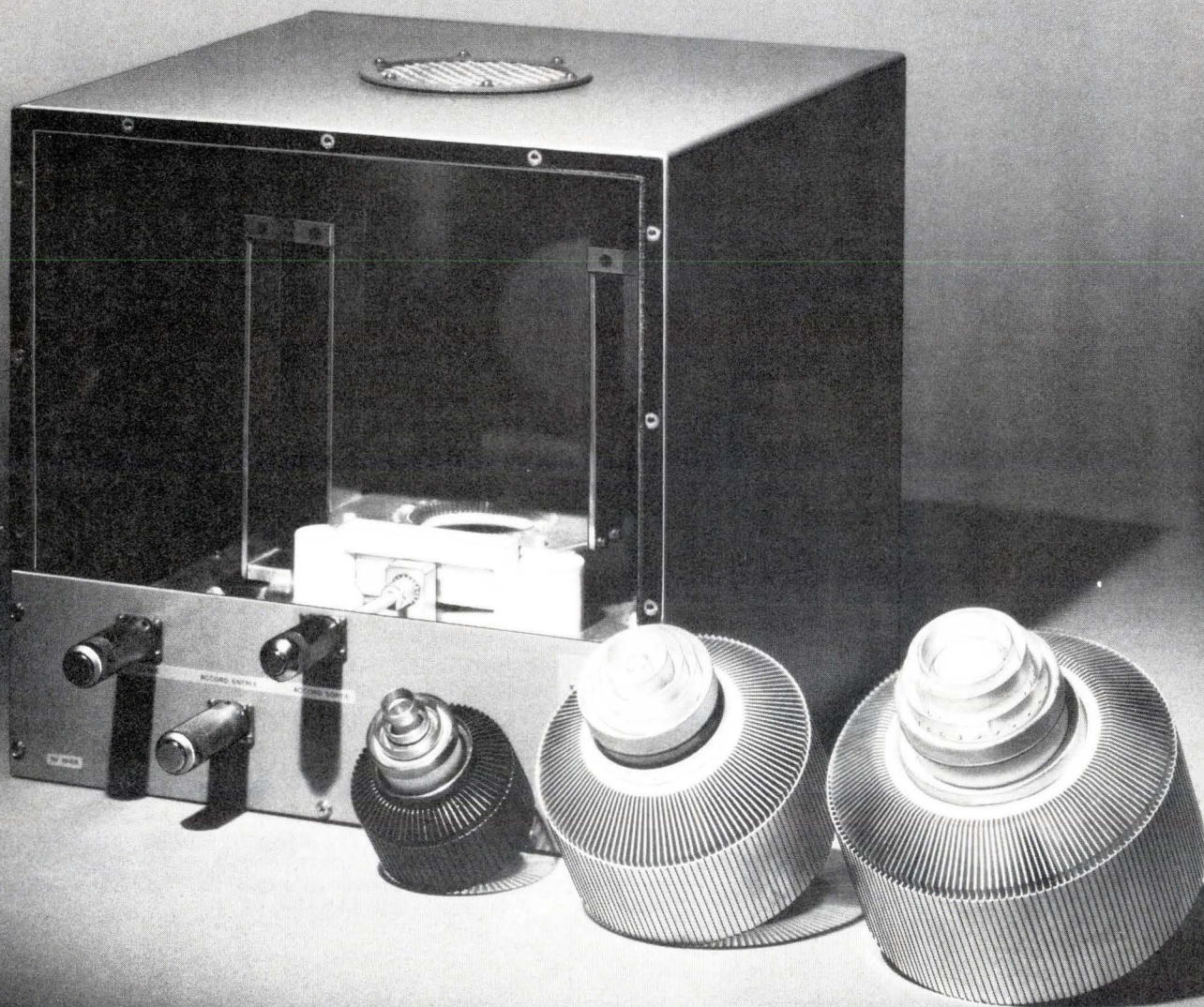

**THOMSON-CSF**

THOMSON-CSF ELECTRON TUBES, INC / 750 Bloomfield Avenue / CLIFTON NJ 07015 / Tel. (201) 779 1004 / TWX: 710 989 7149

France - THOMSON-CSF Groupement Tubes Electroniques / 8, rue Chasseloup-Laubat / 75737 PARIS CEDEX 15 / Tel. (1) 566 70 04

Germany - THOMSON-CSF Elektronenröhren GmbH / Am Leonhardsbrunn 10 / 6 FRANKFURT / MAIN / Tel. (0611) 70 20 99

Italy - THOMSON-CSF Tubi Elettronici SRL / Viale degli Ammiragli 71 / ROMA / Tel. (6) 38 14 58

Japan - THOMSON-CSF Japan K.K. / Kyosho Building / 1.9.3. Hirakawa-cho / Chiyoda-ku / TOKYO 〒102 / Tel. (03) 264 6341

Spain - THOMSON-CSF Tubos Electronicos SA / Alcala 87 / 7° Dcha / MADRID 9 / Tel. (1) 226 76 09

Sweden - THOMSON-CSF Elektronrör AB / Box 27080 / S 10251 STOCKHOLM 27 / Tel. (08) 22 58 15

United Kingdom - THOMSON-CSF Electronic Tubes Ltd / Ringway House / Bell Road / Daneshill / BASINGSTOKE RG24 0QG / Tel. (0256) 29155

Circle 134 on reader service card

## New products

# Data converters—hybrid or modular?

Debate rages over components for data-acquisition systems; modules still outperform hybrids, which are smaller and more rugged

by Michael J. Riezenman, New Products Editor

To go hybrid or not to go hybrid—that is the question facing the makers and users of high-performance modules for data-acquisition systems. Monolithic integrated circuits have been clearly established as the way to go for low- and medium-performance analog-to-digital converters, digital-to-analog converters, sample-and-hold amplifiers, analog multiplexers, and similar devices. However, the choice between modules and hybrid integrated circuits is debatable for high-performance gear.

Modules are assemblies of cased components, including integrated circuits, all mounted on a circuit board, assembled in a single wave- or flow-soldering operation, and encapsulated in a rectangular package—many are 0.4 inch high. Hybrids are assemblies of uncased active and passive chips mounted on a ceramic substrate, wire-bonded together, and housed in a hermetic IC-type package.

The point at which the “high-performance” border begins is a bit fuzzy, but the category may be said to encompass d-a converters with better than 10-bit resolution and a-d converters with resolutions finer than 8 bits. It thus definitely includes the 12-bit converters that are widely used in a variety of industrial applications.

Everyone seems to agree that hybrids are the only choice when one needs a small, rugged, reliable device for an avionics application. The debate begins over the question of whether hybrids are or are not too expensive when size, weight, and hermeticity are not of the utmost importance. Many recently intro-

duced general-purpose data-conversion products, such as Burr-Brown's ADC-85—a \$195 12-bit a-d converter—and Hybrid Systems' DAC 331-10—a \$19 10-bit d-a converter—are hybrids. This fact demonstrates that some manufacturers, at least, believe in them. Further, Datel, a major manufacturer of modular data-

Teledyne Philbrick, puts it, “somebody invents a way of mass-producing hybrids where you could automatically drop the chip down and somehow wire-bond to it.” Barring that development or some equivalent production breakthrough, Lukas contends that hybrids have no advantages whatever, except

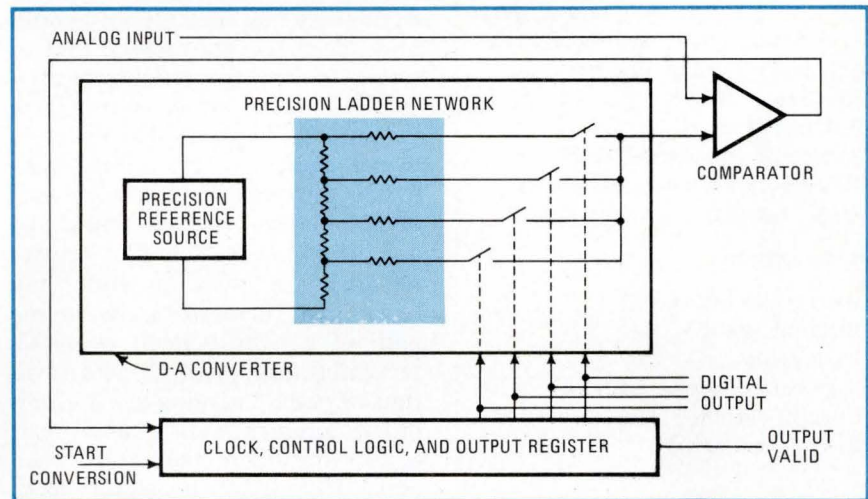

**Widely used.** About 75% of all a-d converters are successive-approximation types in which an internal d-a converter generates a voltage that is compared with the input signal.

conversion devices, has invested a large amount of money in a new hybrid facility that is expected to produce its first product this summer.

Other makers, including Teledyne Philbrick and Analogic, however, maintain that hybrid converters have no legitimate place outside of the high-priced miniaturized world of military and aviation electronics. These manufacturers claim that, at any given performance level, they can build a cheaper unit in modular form than can be built as a hybrid. That point of view is solid, unless, as Alan Lukas, a product specialist at

their small size and hermeticity.

Bernard M. Gordon, founder and chairman of Analogic, who built the first a-d converter back in 1956, goes further. “What do you do,” he asks, “when your 12-bit (or better) converter drifts out of spec, as inevitably it must?” If it’s a hybrid, the only alternative is to throw it away. But in a module, he points out, a faulty resistor can be replaced or an adjustment pot tweaked up.

Hybrid-circuit supporters muster two arguments in favor of their contention that hybrids are, or soon will become, economical. The first is that

# RELIABILITY PLUS! 5-YR WARRANTY



DIGITAL  
MULTIMETER

## LX-2



### \$595

#### Features Include:

- Full four digits with a 5th digit for 20% over-range
- Measures ac & dc volts in 4 ranges, resistance in 5 ranges and multi-function ratio in 5 ranges
- Accuracy:  $\pm 0.02\%$
- Automatic polarity
- Automatic and manual ranging
- Power: 115/230 vac, 50-400 Hz
- Size: 3-1/2"H x 8-1/2"W x 15"D

#### Options Include:

- Battery operation
- BCD outputs
- Input cable
- High voltage probe
- Current shunts
- Rack-mounting tabs

Call our distributor, the G. S. Marshall Co., for more information.

For immediate delivery, fill in below and mail direct to NLS.

**NON-LINEAR SYSTEMS, INC.**  
Box N, Del Mar CA 92014  
PH (714) 755-1139 - TWX 910-322-1132

Special offer of \$595 with your check and coupon.  Single unit price of \$645 C. O. D. or valid purchase order.

Name \_\_\_\_\_

Company \_\_\_\_\_

Address \_\_\_\_\_

City \_\_\_\_\_ State \_\_\_\_\_ Zip \_\_\_\_\_

California Residents Add 6% Sales Tax

Offer expires in 90 days

1234 6789101112 ★ 1 3456789101112

## New products

yields on thin-film-resistor networks are constantly improving as makers gain experience. The second is that advances in large-scale integrated circuitry are reducing the numbers of admittedly expensive wire bonds needed to fabricate a hybrid circuit. Eugene L. Zuch of Datel points out, for example, that the number of ICs used to perform the logic functions in one of his company's a-d converters has dropped from 13 to three to one over the years.

**Volume.** Believers in the validity of the hybrid approach liken it to the semiconductor business, but on a smaller scale. That is, they characterize the successful manufacture of hybrids as an undertaking that requires a substantial capital investment and a reasonably large volume to make it pay off.

Carl Kramer of Hybrid Systems—a company that makes both hybrids and modular converters, but is tilting toward the latter recently—emphasizes the importance of high volume. He explains that his company's success in the hybrid business is attributable to its high level of automation—both in fabricating and trimming its thin-film resistor networks. A possible stumbling block that therefore arises in the path of a hybrid-circuit manufacturer is getting involved with small runs of parts. Learning to avoid this pitfall, Kramer says, is simply part of growing up in the hybrid business. The desire to handle both small and large runs economically is one reason Kramer cites for maintaining both hybrid and module capabilities at the same company.

It is perhaps on the subject of volume that the debate over hybrids and modules gets down to brass tacks. Even such a confirmed skeptic as Gordon of Analogic agrees that hybrids would be the way to go if the volume were high enough. But where, he asks, is the volume supposed to come from? He concedes that there is a large market for low-performance converters, but that market already belongs to the big semiconductor houses. The automotive market, when it develops, will also use monolithic converters.

Equipment for chemical analysis? Oil-exploration gear? Nuclear-research instruments? All are real enough markets, but taken together, Gordon asserts, they don't require enough volume to justify the investment in a hybrid operation.

In fact, he claims, the size in dollars of the a-d converter market has actually decreased during the past decade. In 1963, his last year with Epsco, that company shipped more dollars worth of a-d converters than are shipped *in toto* today. And that's not counting inflation.

Although recognizing, of course, that unit sales have gone up as prices have plummeted, Gordon nevertheless maintains that the demand for high-performance data-conversion modules is not and will not be large enough in the foreseeable future to make hybrids a paying proposition.

**Speed.** Another argument that some critics raise against hybrids is that they are unsuitable for high-speed applications. Ron Gadway of Burr-Brown and Datel's Zuch—both of whose companies are heavily committed to hybrids—point out that high-speed converters consume large amounts of power, and hence would get very hot if housed in small hybrid packages. A fast converter, one that makes a 12-bit conversion in substantially less than 10 microseconds, can easily pull over 2 watts. This, they explain, could easily cause enough uneven heating to make a 12-bit converter drift at least one least-significant bit. Although Richard D. Tatro of Micro Networks, the company that built the first commercially successful hybrid converter in 1971, and Kramer of Hybrid Systems don't agree with this viewpoint, the fact remains that no commercially available hybrid a-d converter today is capable of running at a speed in excess of 100,000 conversions per second. By contrast, Datel's \$229 modular unit—the EH-12B—can do a 12-bit conversion in 4 microseconds. Tele-dyne Philbrick's model 4133 sells for \$485, but it can convert 12 bits in only 2.5  $\mu$ s.

Kramer explains that his com-



# MATSUSHITA'S ARROW-M INTRODUCES THE WORLD'S FINEST RELAYS.

Unique designs and superior manufacturing techniques produce relays of highest quality and reliability.

## DL relays

Mercury film contacts feature non-position sensitivity, no bounce and chatter, low and stable contact resistance, and long life.

Compact size and DIP terminals are ideal for high density pc board mounting.

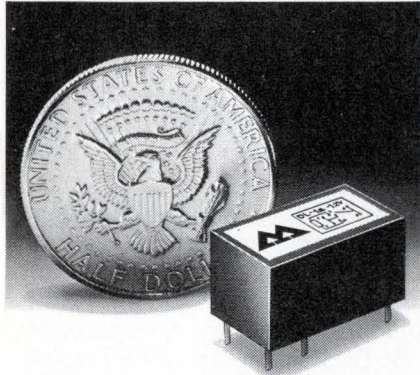

## R relays

Sub-miniature form C reed relays are an innovation.

No glass capsule is used.

Bifurcated contacts, high speed and sensitivity, low operating power, both latching and non-latching functions, and a large capacity of 1 Amp/20WDC prove their reputation.

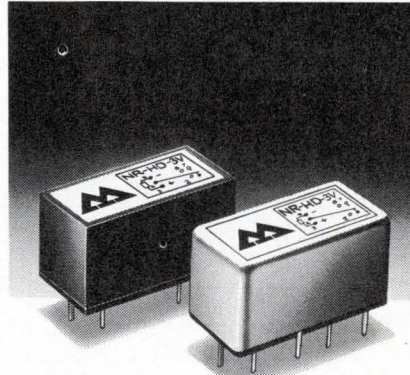

## NF relays

Low profile relays of .402 inch height meet high density packaging design requirements.

Unique molding technique, lift-off contact system, and twin contacts assure dependable application.

Patented design absorbs chatter and bounce.

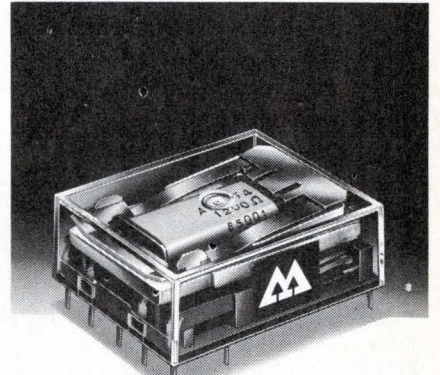

## K relays

Miniature cradle relays assure highly reliable operation.

Large magnetic force, lift-off contact mechanism plus screwless assembly and simultaneous molding techniques guarantee an excellent quality.

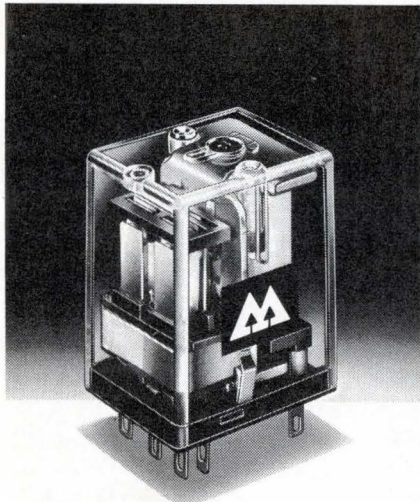

## HC relays

Miniature power relays are available in form 1C(10A), 2C and 3C(7A) and 4C(5A), each at 240VAC.

Arc barrier, contact debris well, gold-flashed AgCdO contacts, and one-piece molded contact blocks ensure long life and high reliability.

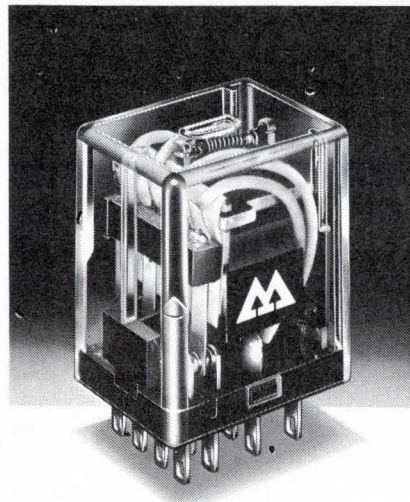

## More information

Short-form catalog is available to provide you with specifications of Arrow-M relays.

Call or write to Arrow-M or our nearest representative for catalogs and more information.

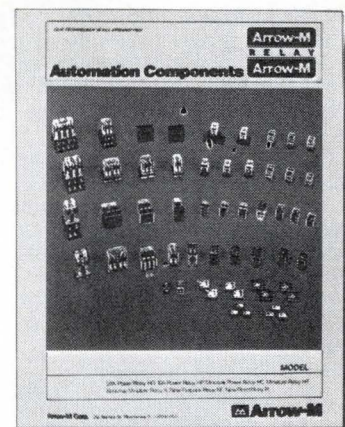

Arrow-M Corp. 250 Sheffield St.,  
Mountainside, N.J. 07092  
201-232-4260

Relays for advanced technology



# Arrow-M

Circle 137 on reader service card

# Could you build a \$200 Rolls?

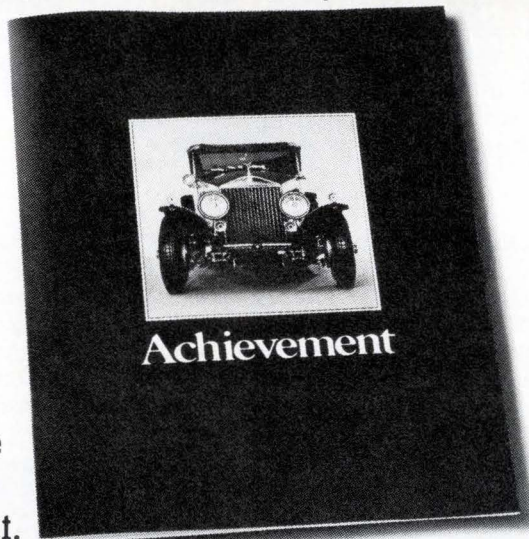

Send for this free brochure and find out.

The classic Rolls Royce Phantom II Sedan Coupe. 26-1/2" long. Reproduced in exact 1/8 scale in Pocher d'Italia's incredibly authentic car model kit. You build it with nuts and bolts and screws. No painting, no special tools needed. Doors, hood and trunk open. Steering, crankshaft, connecting rods, gears, fan, generator operate. Windows open. Headlights turn on. 2,199 separate parts of brass, stainless steel, copper, rubber, high-impact plastic. Complete details on this and three other classic car kits from \$100 in our free full-color brochure.

Circle 179 on reader service card

Deluxe Classics, Dept. WE9  
5900 Wilshire Boulevard, Suite 2760  
Los Angeles, California 90036

Please send me your free full-color brochure.

Name: \_\_\_\_\_

Address: \_\_\_\_\_

City: \_\_\_\_\_

State/Zip: \_\_\_\_\_

## There's no RF energy crisis with RCA power tubes.

RCA's combined families of regular and large power tubes not only comprise the broadest line of such tubes in the industry, but they range in power all the way up to 250 kW... and in frequency to 1450 MHz.

Covering almost every major power tube application area, the RCA line also includes a comprehensive array of cavities and circuits. These cavities and circuits are specifically designed to enhance the advantages of RCA's power tubes. Together they achieve a total power package unmatched for reliable high performance.

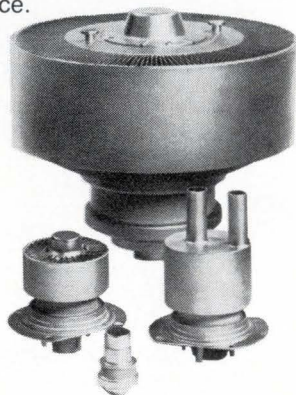

For more information on the entire RCA power tube line, call your RCA Representative or RCA Industrial Tube Distributor, or complete and return the coupon.

**RCA Lancaster — where people and technology make the difference.**

Manager, Power Tube Marketing  
RCA, New Holland Avenue, Bldg. 100  
Lancaster, Pa. 17604

\_\_\_\_\_ Please send me the RCA Power, Frequency and Application Chart.

\_\_\_\_\_ Please have an RCA Representative call me. Telephone \_\_\_\_\_

— This is your mailing label. Please print. —

\_\_\_\_\_ Name \_\_\_\_\_

\_\_\_\_\_ Company \_\_\_\_\_

\_\_\_\_\_ Street \_\_\_\_\_

\_\_\_\_\_ City \_\_\_\_\_

\_\_\_\_\_ State \_\_\_\_\_

\_\_\_\_\_ Zip \_\_\_\_\_

**RCA** Power Tubes

### New products

pany isn't producing any super-speed hybrid a-d converters simply because it hasn't had the time yet. The company only recently entered the hybrid-converter business, he points out, and is first trying to establish a position in the higher-volume general-purpose area. Hybrid Systems recently introduced the DAC 331-10 d-a converter which goes some way toward supporting his contention. This 10-bit hybrid has a maximum large-signal settling time of only 3  $\mu$ s. Since a fast d-a converter is at the heart of most fast a-d converters (see diagram, p. 135), this development suggests that Hybrid Systems is at least on the road toward higher speed.

Throughout all of the arguments over the viability of hybrids, what is Analog Devices, the biggest maker of modular converters, doing? It has avoided the usual hybrid approach of interconnecting several standard semiconductor chips and a separate thin-film resistor network in favor of something it calls compound monolithic integration. In this technique, a small number—possibly two—custom chips are interconnected, and the thin-film network is deposited over the circuitry on one of them. Analog Devices' latest product, the DAC 1132, is a modular unit that contains one of these compound monolithic circuits. This d-a converter within a d-a converter allows the company to make a complete converter—including input storage register, reference source, and a fast-output amplifier—in a half-size (2-by-2-inch) module that sells for only \$159.

Analog Devices Inc., Rte. 1 Industrial Park, Norwood, Mass. 02062 [351]

Analogic Corp., Audubon Rd., Wakefield, Mass. 01880 [352]

Burr-Brown, International Airport Industrial Park, Tucson, Ariz. 85734 [353]

Datel Systems Inc., 1020 Turnpike St., Canton, Mass. 02021 [355]

Hybrid Systems Corp., 87 Second Ave., Northwest Park, Burlington, Mass. 01803 [356]

Micro Networks Corp., 324 Clark St., Worcester, Mass. 01606 [357]

Teledyne Philbrick, Allied Drive at Rte. 128, Dedham, Mass. 02026 [358]

Components

## Beckman adds film resistors

Thin-film network put in plastic DIP; thick-film array in low-profile SIP

Packaged networks, both thin- and thick-film, are the fastest growing segment of the resistor market. Long a major supplier of thick-film networks, the Helipot division of Beckman Instruments is now enter-

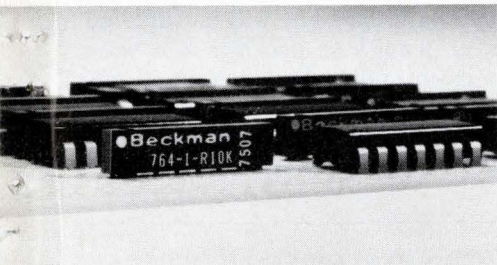

ing the thin-film resistor business with a network of seven individual resistors, packaged in a plastic 14-pin dual in-line housing. The company is also offering a new thick-film device whose low-profile, plastic, single in-line package has a seated height of only 0.2 inch maximum, no higher than a conventional DIP (see photo).

Resistance values for the series 699-3 thin-film network, which is intended for precision analog applications, can range from 100 ohms to 20 kilohms, at a tolerance of  $\pm 1\%$ . (Tighter tolerances, down to  $\pm 0.01\%$ , are available on a custom basis.) The nichrome resistors have an absolute-value temperature coefficient of  $+50 \text{ ppm}/^\circ\text{C}$  maximum, and a tracking temperature coefficient of  $\pm 5 \text{ ppm}/^\circ\text{C}$  maximum. Operating temperature range is  $-55^\circ\text{C}$  to  $+125^\circ\text{C}$ .

Since nichrome resistors are particularly sensitive to moisture, they are generally supplied in hermetic packages. However, Beckman has chosen the rugged epoxy-B type of

plastic for its new device and is not anticipating any moisture failures, says Lyle Pittroff, product marketing manager. As a matter of fact, the first model in the series 699-3 meets all the requirements of MIL-R-83401, which is the document covering resistor networks. Price is \$4.50 each in prototype quantities.

The new series 764 low-profile thick-film network is available in two eight-pin versions: the 764-1, containing seven individual resistors; and the 764-3, four resistors. Standard resistance values range from 100 ohms to 22 kilohms, and tolerances are within  $\pm 2\%$ . Temperature coefficient, which depends on the resistance value, varies between  $0 \pm 150 \text{ ppm}/^\circ\text{C}$  and  $-225 \pm 225 \text{ ppm}/^\circ\text{C}$ . The tracking temperature coefficient is  $\pm 50 \text{ ppm}/^\circ\text{C}$  maximum, operating temperature range is  $-55^\circ\text{C}$  to  $+125^\circ\text{C}$ , and resistance voltage coefficient is  $-0.01\%$  per volt.

In still air, at  $25^\circ\text{C}$ , the maximum power rating for the total package is 1.5 watts, while each resistor can handle either 0.175 w (the 764-1 device) or 0.2 w (the 764-3 device). For quantities of 100 to 499, price is 52 cents each for the 764-1, 48 cents each for the 764-3.

Both new product lines are available from stock.

Beckman Instruments Inc., Helipot Division, 2500 Harbor Blvd., Fullerton, Calif. 92634. For further information on the new thin-film resistor, circle 341 on reader service card; for inquiries on the thick-film devices, circle 342.

### Switches use Hall-effect, eddy-current techniques

As its first product in its new line of solid-state sensing switches, the Micro Switch division of Honeywell has applied its Hall-effect chip to a current sensor for the protection of electronic equipment.

The current sensor, called the series ES, is one of a family of devices that mark a major push by Micro Switch into the solid-state sensor market. All rely on either the

Hall-effect—which the company uses in its keyboards—or on an eddy-current-killed oscillator (ECKO).

Everett Vorthmann, director of solid-state engineering at Micro Switch, points out that advantages of solid-state sensing include small size, easy electronic interfacing, reliability, and high switch speed and repetition rate. "We're basically doing the same job as mechanical switches do, but we have a truly logic-compatible output," he adds.

In the series ES devices, instead of using a magnet to trigger the Hall-effect sensor, Micro Switch uses a coil that becomes an electromagnet when current reaches a factory-preset level. The over-current sensor is now available in 1-, 2-, 5-, 10-, and 30-ampere versions. Quantity price is about \$5 each, and delivery is from stock.

Micro Switch is applying both the Hall-effect and the ECKO technologies to proximity sensors, and it has plans to develop versions of the Hall-effect technique for use in devices such as pressure transducers.

When used as a proximity sensor, the Hall-effect chip is housed in a threaded bushing. It can detect magnets head on or as they slide by—in a limit-switch, for example—or act as a rotary-motion sensor, using a multipole magnetic ring.

The new line also includes a Hall-effect sensor configured as a vane, a U-shaped part with sensor and magnet facing each other across a slim channel. As a linear or rotary cam passes through the channel, ferrous teeth interrupt the flux path, shielding the chip from the magnet. Applications for the vane, which will sell for \$3 each in production quantities, include tachometers, shaft-position-encoding sensors, limit switches, cam-operated programming switches, and ignition triggers.

Unlike the Hall-effect sensors, the ECKO devices do not require magnets for actuation, and they can detect either ferrous or nonferrous metals. Micro Switch has integrated everything except the oscillator coil on a single chip. "As you bring any conductor near that coil," Vorth-

**Now! Accuracy  
Can Go Anywhere!**



**SS-3100 DC - 7MHz**

Here is a non-conventional, accurate and valuable NEW prolific DUAL TRACE Tri-power, lightweight Mini Portable IWATSU SS-3100, DC - 7MHz oscilloscope to use anywhere to accurately make those critical measurements. It has the X-Y functions and the vertical system extended bandwidth from DC to 10MHz of 4 div. and DC - 7MHz 8 div. display amplitude with a 10mV/div. sensitivity, each channel. You can measure AC-GROUND-DC input signals. The very bright, rectangular, parallax-free graticule CRT has an effective 8 div. vertical length by a 10 div. horizontal width view area. The completely synchronized horizontal system allows internal triggering from 50Hz to 10MHz and external triggering from DC to 10MHz. Wide sweep time is from 0.5 $\mu$ sec/div. to 0.2 $\mu$ sec/div. and the fastest sweep time of 100 ns/div. AC power: 100 through to 234 Volts, 50 to 400Hz. DC 9 to 14 Volts, either rechargeable Ni-Cd battery or external DC.

**Your Dual Trace  
Portable Oscilloscope!**



**SS-4121 DC - 100MHz**

This Dual-Trace X-Y operational non-conventional portable IWATSU SS-4121, DC - 100MHz oscilloscope, has the accuracies of many larger bench type similar scopes. Each channel offers an input sensitivity of 1mV/div. from DC to 20MHz. The post-deflection bright CRT display area is 8 x 10 div. with an accelerational voltage to 20kV. The linearity and pattern distortion are as critical as the IWATSU high quality 6,000 series oscilloscopes. It has a tri-sweep system - Triggered, Free-run, Single, and the fastest sweep time of 5 ns/div.  $\pm$ 2% horizontal sweep. The additional feature includes FULL AUTO trigger and delayed sweep time of 1 $\mu$ s to 5s.

USA: Dument Oscilloscope Lab.  
201-575-8666

W.Germany: NBN Elektronik 08151-13036

Sweden: Teleinstrument AB 08-380370

Finland: OY Honeywell 780311

Austria: Universal Elektronik 422358



**IWATSU ELECTRIC CO., LTD.**

(ASAHISEIMEI BUILDING)  
1-3, NIHONBASHI 2-CHOME, CHUO-KU  
TOKYO 103, JAPAN  
PHONE: TOKYO 272-0461  
TELEX: J24225 TELEIWA

**New products**

mann points out, "eddy currents induced in the conductor will load the coil enough to kill the oscillation."

Micro Switch Division of Honeywell Inc., 11 W. Spring St., Freeport, Ill. 61032 [403]

Push-button switches  
have changeable legends

Introduced at the Design Engineers' Electronic Components show in Washington, D. C., earlier this month, a modified version of Grayhill's series 82 modular push-button switch has a slotted cap that accepts slip-in legends for easy changing of

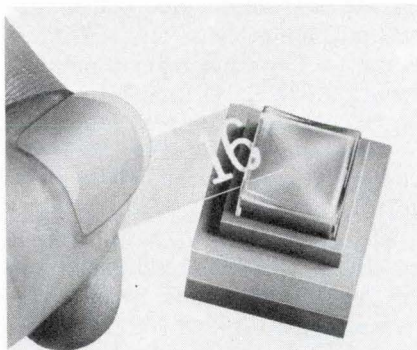

switch labels during prototype development. Series 82 units are available in one-, two-, three-, and six-button modules that can be stacked in any desired configuration. The standard contact arrangement for an individual switch can range from single-pole single-throw to four-pole single-throw. Special switch contact can be coded internally to provide up to a seven-wire or seven-bit code under each button.

Grayhill Inc., P. O. Box 373, La Grange, Ill. 60525 [343]

AVX offers glass-encased  
multilayer chip capacitors

Besides being rugged and stable, glass-encapsulated multilayer ceramic chip capacitors offer the advantages of hermeticity and easy automatic insertion. Last year [*Electronics*, July 11, 1974, p. 129], both USCC/Centralab of Burbank, Calif.

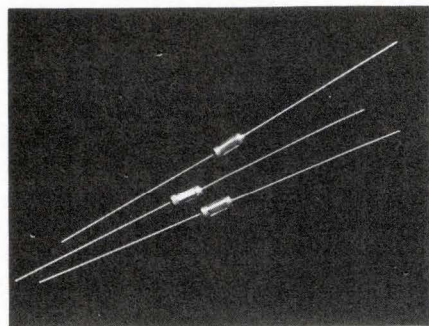

and the ITT Components Group Europe in Devon, England, introduced families of these devices. At the Design Engineers' Electronic Components show earlier this month, AVX Corp. announced its own line of glass-encased chips, called GlasGuard. Like its competitors, the GlasGuard line will be supplied in an axial-lead package in a wide range of physical sizes, voltage ratings, and capacitance values.

AVX Ceramics Corp., Box 867, Myrtle Beach, S. C. 29577 [344]

Small, low-tempco trimmer  
needs no padding resistors

A 0.25-inch trimmer resistor has a temperature coefficient of resistance of only 10 ppm/ $^{\circ}$ C, making the use of compensating (padding) resistors unnecessary. In addition to its low temperature coefficient, the model 1240 trimmer is noteworthy for its

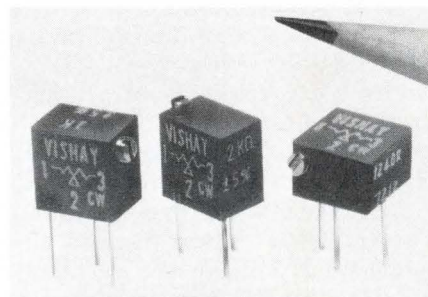

100-megahertz frequency response, 10-nanosecond rise time, and low parasitic inductance of only 0.08 microhenrys. The 1240 is available in resistance values from 5 ohms to 5 kilohms.

Vishay Resistive Systems Group, 63 Lincoln Highway, Malvern, Pa. 19355 [345]

RIGHT ON TARGET AGAIN



Bearing it well!

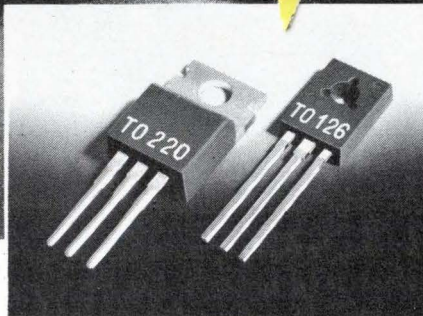

## Complementary power pairs in plastic

### Epibase-darlingtons

#### 4 Amperes - TO 126 pack

NPN	PNP
2N 6037	2N 6034
2N 6038	2N 6035
2N 6039	2N 6036
SJE 800	SJE 700
SJE 801	SJE 701
SJE 802	SJE 702
SJE 803	SJE 703

#### 8 Amperes - TO 220 pack

NPN	PNP
BDX 53/A/B/C	BDX 54/A/B/C

### Epibase-transistors

#### 2 Amperes - TO 126 pack

NPN	PNP
2N 4921/22/23	2N 4918/19/20
SJE 720/21/22	SJE 710/11/12

#### 4 Amperes - TO 126 pack

NPN	PNP
2N 5190/91/92	2N 5193/94/95
SJE 220/1/2/3/4/5	SJE 230/1/2/3/4/5

#### 4 Amperes - TO 220 pack

NPN	PNP
2N 6121/22/23	2N 6124/25/26
SIP 31/A/B	SIP 32/A/B

SGS - ATES Semiconductor Corporation - Newtonville, Mass. 02160 - 435 Newtonville Avenue - Tel: 617-9691610 - Telex: 922428.  
Stocking Distributors: Edmar Electronics Co., Des Plaines, ILL., (312) 298-8580 - Energy Electronic Products, Los Angeles, CA, (213) 641-9020 - Esco Inc., Dayton, OHIO, (513) 226-1133 - KA Electronic Sales, Dallas TX, (214) 634-7870 - Radar Electric Co., Seattle, WA, (206) 282-2511 - Rosyl Electronics, Bayshore, NY, (516) 586-1800 - Wilshire Electronics, Burlington, MASS, (617) 272-8200 - Prelco Electronics Ltd., Montreal 357, Quebec, (514) 389-8051.

Circle 141 on reader service card

# Digital's solution to the micro madness.

## THE \$634 LSI-11.

You can stop worrying about who's coming out with what next in microprocessors, chip sets, microcomputers, and all the rest.

You can stop worrying and start getting to work right now.

The LSI-11 is here.

The LSI-11 is an unbundled, honest-to-goodness PDP-11 that LSI technology has enabled us to put onto an 8½" x 10" board and sell for a mere \$634 in 100's.

This single board contains an n-channel MOS CPU which executes the instruction set for the PDP-11 family up through the 11/40, a 4K word MOS random access memory (RAM), a 16-bit

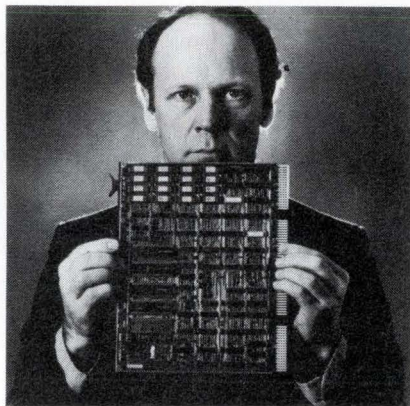

parallel buffered I/O bus, a real time clock input, power fail/auto re-start, and bootstrap.

And best of all, the LSI-11 is truly flexible. You can expand the system with a minimum of hardware.

Now that you have this kind of flexibility and performance, in this kind of size,

and at this kind of price — backed by Digital's experience with over 15,000 installed PDP-11's — you can put real processing intelligence into a whole lot of places it's never been before.

If you'd like to find out all the possibilities for the LSI-11, just give us a call: 1-800-225-9480, (Mass. 617-481-7400 Ext. 6653).

LSI-11. A \$634 stand-alone PDP-11 on an 8½" x 10" board.

Components Group, Digital Equipment Corp., One Iron Way, Marlborough, Mass. 01752.

In Canada: Digital Equipment of Canada, Ltd.

Europe: 81 Route de l'Aire, 1211 Geneva 26, tel. 42 79 50.

Prices apply to USA only

**digital**  
**COMPONENTS**  
**GROUP**

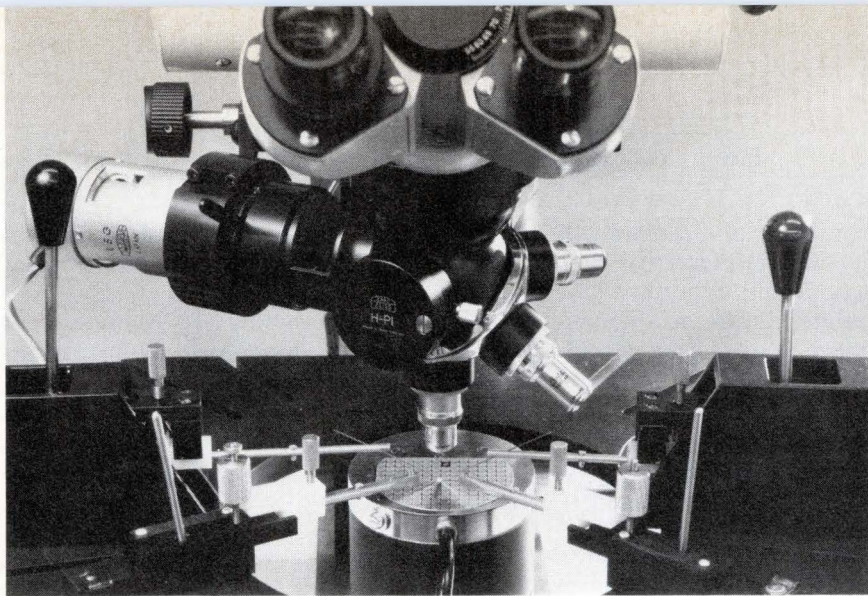

Packaging & production

## IC probe station is versatile

Positioning system permits static and dynamic tests on wafers, hybrids, LSI devices

Integrated-circuit probing stations are precise electromechanical/optical systems that position extremely fine-measurement probes on specific areas of thick/thin film hybrids, discrete semiconductors or IC wafers. These stations are also being used for research and development work on hybrid and monolithic ICs, for failure-mode analysis and for quality control.

In the past, no probe system could cover all these applications. However, an analytical probe station introduced by Lorlin Industries, thanks to a modular probe, is flexible enough to statically and dynamically test hybrid, discrete, and LSI/MSI devices. The P700 can accept four types of Lorlin-designed micropositioners or standard probe cards. The P-700 may be purchased as a low-cost system for manually probing large hybrid and thick-film semiconductor circuits and later expanded to a high-precision system for testing complex LSI circuits. It may also be expanded to semiautomatic operation for production probing of wafers. Priced from \$3,500 for a basic manual unit to \$20,000.

For work on hybrids or for simply

connecting to an IC pad, the MP-50 micropositioner can be used to probe 1-mil areas. For IC applications that require probing of 0.1-mil areas, two probes are available: the MP-150, which has joystick X-Y positioning and thumbscrew Z-axis adjustment, and the MP-300, with three-axis thumbscrew adjustment. Finally, for probing 1-micrometer areas of bipolar and MOS/LSI, the remotely controlled MP-450 is accurate within 0.1 micrometer. A swing-away 24-position platen supports the micropositioner types that are being used.

A cast aluminum base, which forms the foundation of the probe system, houses a 3-by-3-inch X-Y platform controlled by a variable-speed induction motor; a leveling stage is included for a precise flatness adjustment and a stage for Z-motion. Two options are available for step-and-repeat probing operations: type Q-101, which indexes in 0.001-inch increments; and Q-102, which indexes in 0.0001-in. increments.

For observation of the device under test, two types of stereozoom systems are offered, as well as two types of metallurgical research microscopes and a choice of four light sources. Closed-circuit television and various photographic systems are also offered.

Digital Equipment Corp. is using a Lorlin P700 (shown in photo at top of page) to measure the electrical characteristics and to check the failure modes of LSI wafers and packaged LSI devices.

Lorlin Industries Inc., Precision Rd., Danbury, Conn. 06810 [391]

## Tester spots short circuits caused by solder blobs

Most companies that wave-solder printed-circuit boards inspect them visually to remove blobs of solder that cause shorts, but often one or two shorts remain undetected, being either hidden under a component or too small to see. Teradyne Inc. estimates that about 60% of failures at board test are caused by soldering faults. To find these faults before they reach board test, the company is introducing the L427 shorts detector, which requires no programming.

A single electrical contact to each circuit stripe or pad is made through a "bed-of-nails" fixture containing spring-loaded pins, and continuity checks are made at a rate of 2,000 points a second between each pin and every other pin. This is done by forcing 100 millivolts to a current limit of 10 milliamperes; any measurement less than 10 ohms is considered a short. Detected shorts in all their possible combinations are printed out on a strip-printer. Fixtures to hold the pins can be drilled by using the numerical-control program, templates, or the board being tested.

As a secondary method for detecting shorts in low-volume situations, an edge-connector fixture can make contact at the connector fingers leading to the circuit stripes. Teradyne says this method will catch about 40% of shorts.

The L427 is a benchtop system



# Breadboard II

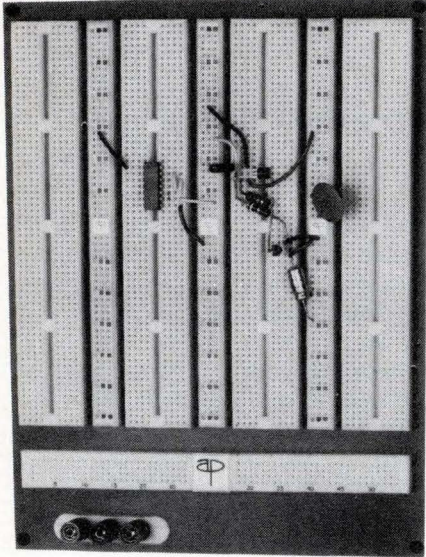

A P 923605

## Reuseable... Reliable... Remarkable!

- 2,696 solderless, plug-in tie-points – fully assembled – not a kit.
- Low impedance distribution system with integral ground plane.
- Minimizes unwanted voltage spikes due to low-inductance, high distributed capacitance design.
- Accommodates all DIP's, TO-5's, discretes and patch wires with leads up to .032-in. diameter.
- Ideal for checking out circuits requiring two supply voltages plus ground return.
- Invaluable for signal distribution as in transfer, reset shift and clock lines.

Call nearest Rep for details:

201-546-3660	414-421-2300	514-782-8835
206-322-6200	415-328-3232	602-946-4437
214-567-3399	416-743-4267	609-429-4013
216-333-4120	513-433-0966	612-922-7011
301-484-5400		617-272-8163
305-894-3351		713-691-3961
312-298-4830		714-565-9444
313-781-3900		714-833-1802
314-567-3399		816-765-2998



**A P PRODUCTS INCORPORATED**

Box 110 ■ 72 Corwin Drive, ■ Painesville, Ohio 44077  
Tel: 216/354-2101 ■ Twx: 810-425-2250

## New products

consisting of a chassis with continuity and printer-drive circuits using low-power Schottky TTL, a strip printer, and an operating panel. Since contact points can be arbitrarily assigned, programing is unnecessary, so there is no memory or data-processing capability.

A standard system that can test 160 nodes costs \$9,500. Increments of 200 nodes are offered at \$3,500, and the L427 can handle up to 760 nodes. Delivery time of the unit is 12 weeks.

Teradyne Inc., 183 Essex St., Boston, Mass. 02111 [392]

### Machine waxes board, cuts leads, solders components

After manual or automatic insertion of components on printed-circuit boards, leads are usually cut short and then clinched to the solder side of the card. This time-consuming and costly procedure ensures that parts are held in place for wave-soldering. And for extremely dense boards, parts are inserted and wave-soldered in place with their original long leads. Then, leads are cut short and the bare copper of the leads must be soldered again. This expensive method requires two soldering cycles and an extremely deep solder wave.

However, the procedure has been simplified by Hollis Engineering of Nashua N.H. which has developed two soldering systems, the Stabilizer 100 and 150. These systems lock long straight pc leads onto a board, trim the leads automatically, and then wave-solder the boards—all in one continuous flow. In the Stabilizer 100, boards with components that have long straight leads are sprayed with solder flux, preheated, and then passed over a standing bath of wax. The wax hardens quickly, locking the leads in place, and lead-cutting disks trim them to the desired shortness in one pass. Then the board moves onto a wave-soldering position where the wax is melted away and leads are soldered. The Stabilizer 100 is about 19 feet

long. It has been used by Digital Equipment Corp. to wave-solder 2,000 boards per day.

The Stabilizer 150 is similar but does not have a spray-fluxing attachment. Instead, this machine applies a combination of flux and wax at the same time. Boards may then be stored at this point for as long as six months before wave-soldering.

Hollis Engineering Inc. Charron Ave., Nashua, N.H. 03060 [401]

### Low-cost stitch-wirer challenges wire-wrapping

Priced at only \$995, the model LC8000 stitch-wire machine typically operates at 125 wires per hour, compared with 40 wires per hour for wire-wrapping by hand. This speed-cost combination is expected to thrust the unit into serious challenge with hand-operated wire-wrapping equipment in both breadboard and production applications. The stitch-wiring approach combines the ruggedness and low profile of printed-circuit boards with the low engineering cost and ease of making changes of wire wrapping.

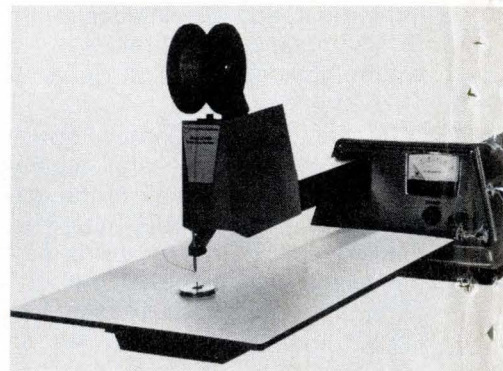

Planar circuit boards to work with the LC8000 stitch-wire machine are available, both with and without sockets. Capacities range from 20 to 195 integrated circuits. The boards sell for about \$1 per IC position without sockets, and \$2 per position with sockets. Delivery time is two weeks.

Apac division/Varian Data Machines, 17662 Armstrong Ave., Irvine, Calif. 92705 [393]



# Systems Supermarket



Photo above shows several systems in production at the Concord plant's Systems Center, one of three such centers.

If you are in the market for a computer-controlled automatic testing/troubleshooting system, GR is the place to do your shopping. Here you will find a wide selection of automatic systems for testing digital, analog, or hybrid (digital and analog) circuits. And the new CAPS-VII software package that is now available is the current state-of-the-art for testing/troubleshooting software.

For a guide to help you compile your shopping list, request a copy of our new Systems Brochure. It concisely describes and illustrates the several standard GR systems you'll find any day being assembled off the aisles of our systems supermarket.



**1792-D Logic-Circuit Test System**  
For high-speed, parametric digital and analog testing.

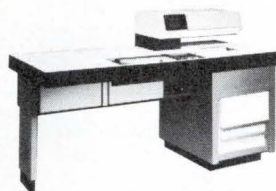

**1790 Logic-Circuit Analyzer**  
A basic functional and diagnostic test system for logic elements.

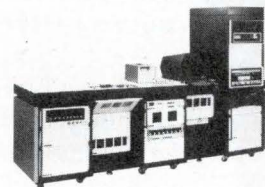

**2210-C Analog Test System**  
A general-purpose analog test system.



**2210-A Analog Test System**  
A low-cost dedicated analog test system.



**1793 Logic-Circuit Tester**  
A "starter system" — provides rapid digital testing of complex logic circuits at minimum initial cost.

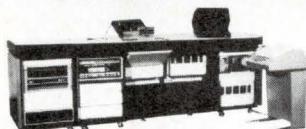

**1792-B Logic-Circuit Test System**  
Designed for the production environment, where low-cost testing and troubleshooting are mandatory.

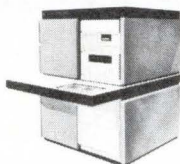

**2214 Analog Test System**  
A commercial-electronics analog test system.



**General Radio**  
**GR Test Systems Division**

300 BAKER AVENUE, CONCORD, MASSACHUSETTS 01742  
NEW YORK (N.Y.) 212 964-2722, (N.J.) 201 791-8990 • BOSTON 617 646-0550 • DAYTON 513 294-1500  
CHICAGO 312 992-0800 • WASHINGTON, D. C. 301 948-7071 • ATLANTA 404 394-5380  
DALLAS 214 234-3357 • LOS ANGELES 714 540-9830 • SAN FRANCISCO 415 948-8233  
TORONTO 416 252-3395 • ZURICH (01) 55 24 20

GR COMPANIES • Grason-Stadler • Time Data

# If your bench scope says your ECL logic looks like this...

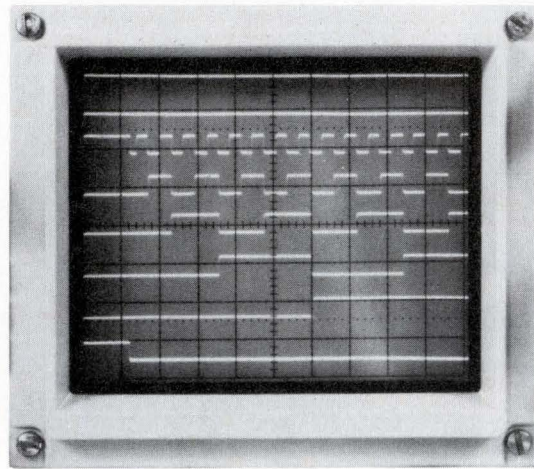

## ...you're using the new 100MHz 8100-D Digital Logic Recorder from Biomation.

**Introducing the new 100MHz Glitch Fixer: Biomation's 8100-D puts a faster fix on faster glitches.**

The original Glitch Fixer, Biomation's 810-D, has been helping a lot of engineers study timing relationships of 8-bit signals at speeds up to 10MHz.

But because the world's going faster—with MECL, ECL II, ECL III and Schottky-clamped I<sup>2</sup>L parts in your boards—we've built a new digital logic recorder, the 8100-D, with speeds up to 100MHz.

It's the new-and-faster way to turn your ordinary bench scope into a data stream display. It records 8 data channels at once and presents them in the same format you're used to seeing on data sheets.

The 8100-D features built-in combinatory logic setting to help you isolate your problem event *fast*. It has a big memory, too; can store up to 2,048 8-bit data words, including the often critical information that lies *just ahead* of the

triggering event. And it also provides digital output for computer analysis or mass storage.

The 8100-D is a piece of diagnostic instrumentation that circuit designers and troubleshooters have been asking us for. We will be glad to send you all the splendid details. Just use the reader service number or get in touch with us directly. Biomation, 10411 Bubb Road, Cupertino, CA 95014. (408) 255-9500. TWX 910 338 0226.

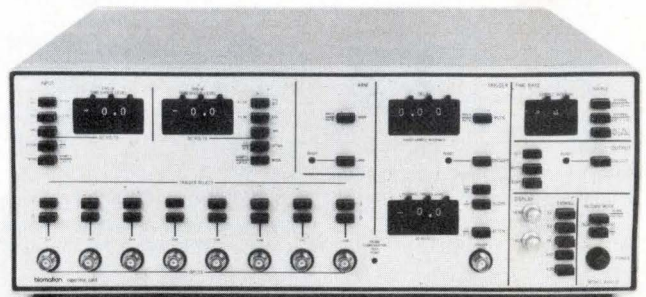

# biomation

Semiconductors

## Edge-triggered RAM speeds TTL

---

Schottky memory device permits system access in 65 nanoseconds

---

Using an edge-triggering technique originally developed for C-MOS memory devices, National Semiconductor Corp. has built the first of a family of Schottky bipolar random-access memories that should double the speed of TTL processor systems.

This is because the edge-triggered memory has the ability to write on a transition edge rather than on a level. It is in the active state for a shorter period of time, and this both increases its over-all speed and allows less time for logic oscillation to occur.

National's memory, the model MM75S68/85S68, is a fully decoded 64-bit edge-triggered bipolar RAM, which in function is roughly equivalent to an addressable "D" storage cell or flip-flop. When an input signal is applied to this kind of memory and clocked, says Dale A. Mrazek, National's manager of digital systems applications, the memory on the clock edge acquires the logic signal on the D2 terminal just prior to the clocking transition.

The 75S68/85S68 is organized as 16 four-bit words. The write cycle provides positive triggering; data is entered via the data inputs, and it may be changed prior to the positive edge of the write-clock. At any time except during the rise of the write clock edge, says Mrazek, the state of the write-disable becomes irrelevant, and the data is read as what is written into the memory. All data from the last addressed word will be held at outputs when the output-store is held high. When the output-disable goes from a logic 0 to a logic 1, all outputs will go to the high-impedance state.

Although the worst-case access

time for National's 75S68 is only a 5-nanosecond improvement over the 40 ns of a comparable level-sensitive bipolar TTL device, it is the system speed that is significantly enhanced. In a four-bit slice with zero delay in the arithmetic-logic unit, a level-triggered memory with buffering to prevent logic oscillation requires about 80 ns to make the loop, whereas National's edge-triggered device does it in 35 ns. With a 30-ns delay in the ALU, the system speeds are 110 ns and 65 ns, respectively. Configured into an 18-pin dual in-line package, the 75S68/85S/68 requires only one +5-volt power supply. Power dissipation is about 400 milliwatts. Sample quantities of the 64-bit edge-triggered RAM will be available in June. Pricing on the device has not been set.

In TTL computing systems, the usual approach has been to use what are called level-sensitive RAMs and shift registers in the register and arithmetic-logic-unit loop of the computing circuitry. In such level-sensitive devices, when the write control line is in an active state, the entire contents of the memory get applied to the ALU loop. But, under certain circumstances, because they are in the active state for a relatively long period, the RAMs cause the circuits to become logic oscillators in which 0s and 1s are bounced back and forth between the inputs and outputs of the registers in the system, with no work accomplished.

National Semiconductor Corp. 2900 Semiconductor Dr., Santa Clara, Calif. 95051 [411]

---

## 2,048-bit field-programable PROM has 70-ns access time

A high-speed 2,048-bit field-programable read-only memory is organized as 512 words by four bits, and is available in both open-collector (model HM-7620) and three-state (HM-7621) output configurations. Access time is guaranteed less than 70 nanoseconds over the full commercial temperature and voltage range, with 85 ns guaranteed for

military-temperature-range devices. Typical programing time is less than 2 seconds. The memory, which is the first of a series known as the "Generic" family, is TTL-compatible on both input and output. Future members of the family will have the same dc and programing parameters as the 7620/7621, bringing a measure of standardization to a confused product area. In lots of at least 100 pieces, the HM-7620 and HM-7621 sell for \$20.45 each in the commercial version, and \$51.25 in the military-temperature-range type.

Harris Semiconductor, P. O. Box 883, Melbourne, Fla. 32901 [413]

---

## Fast one-shot has pulsewidth stable to within 1.5%

Featuring a maximum output pulsewidth variation of 1.5% over the full military temperature range, the Am26S02 is a Schottky-clamped version of the Am2602 dual retriggerable one-shot. The new device has a maximum delay, from trigger to output, of 20 nanoseconds; and a maximum delay, from clear to output, of 9 ns. It sells, in 100-up quantities, for anywhere from \$3.80 to \$20.60 depending upon packaging and temperature range.

Advanced Micro Devices Inc., 901 Thompson Place, Sunnyvale, Calif. 94086 [414]

---

## Transistor puts out 10 watts from 450 to 512 megahertz

Using the company's tuned-Q technology, which employs automatic wire bonding to maintain tight control over internal inductances, the model SD1087 rf power transistor by Solid State Scientific is able to develop a minimum of 10 watts at 12.5 volts over the frequency range from 450 to 512 megahertz. Intended for uhf mobile applications, the device uses a MOS capacitor chip as an internal impedance converter. The transistor was designed to drive the internally matched

# YOU CAN DO IT YOURSELF...

## WITH UNIVERSAL'S MECHANIZED ELECTRONIC ASSEMBLY MACHINES

For over 15 years Universal has been supplying Mechanized Electronic Assembly Equipment to nearly all the leading computer, communications, aerospace, automotive and consumer electronics companies in the world, regardless of their size. We feel we have given them the "in-house" capability to build their products profitably. We can do the same for you with:

- Axial Lead Component Processing Equipment.
- Transistor, DIP and Axial Lead Prepping Equipment.
- Transistor, Disc Capacitor and Axial Lead Taping Equipment.
- Disc Capacitor, DIP, Transistor, SIP and Axial Lead Insertion Equipment.
- As well as Pin Insertion and Wire Termination Equipment.

Universal's Semi-Automatic and Computer Controlled Systems reduce cost, improve quality and give your company the "in-house" production capability to assemble all your electronics... you can do it yourself. For details on how to purchase or lease a Universal Electronic Assembly Machine, call or write today.

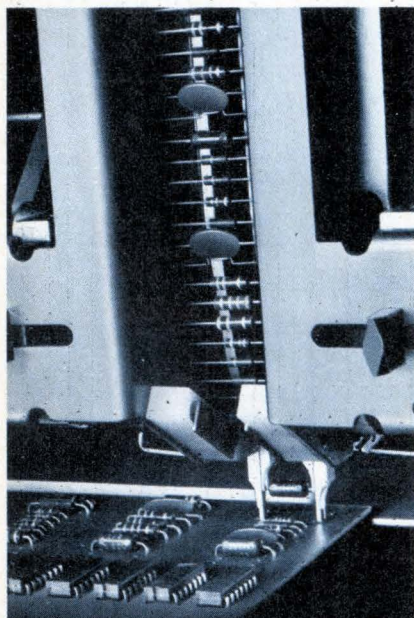

 **Universal**

Box 825 Binghamton, NY 13902  
607-772-7522 TWX: 510-252-1990

## New products

SD1089, which is rated at 40 w, 12.5 v, 450-512 MHz.

Solid State Scientific Inc., Montgomeryville, Pa. [417]

### 8-bit input/output port is bidirectional

In many otherwise sophisticated 8-bit minicomputers, microcomputers, and other bus-oriented digital systems, data flow is often constrained because they lack bidirectional bus or port controllers with latching capabilities. Such a latching function is important, particularly in microprocessors, because of timing considerations. Often the processor in a particular computing system operates within timing constraints that differ from both the input/output and the memory. It would be helpful to use a latch to store information at one end or the other of a bidirectional bus.

To add this flexibility, Signetics Corp. has developed the 8T31, an 8-bit bidirectional I/O port. Housed in a 24-pin package, the 8T31 consists of eight clocked latches with two sets of bidirectional I/Os.

Each bus has a write-control line and a read-control line.

The two buses operate independently, except when the user is attempting to write data in from each bus simultaneously. Then, the data on bus A will be written into the latches, while bus B will be forced into a high-impedance state. Data written into one bus will appear inverted at the other bus.

A master-enable is provided to enable or disable bus B, regardless of the other inputs. The 8T31 can be started up in a predetermined state. If the clock is maintained at a voltage of less than 0.8 v until the power supply reaches 3.5 v, bus A will always have all logic-1 levels, while bus B will have all logic-0 levels. In addition, bus A overrides if a write conflict occurs.

The 8T31 is priced at \$7.20 each in quantities of 100.

Signetics Corp., 811 East Arques Ave., Sunnyvale, Calif. 94086 [402]

# ...OR WE CAN DO IT FOR YOU

## WITH UNIVERSAL'S MECHANIZED ELECTRONIC ASSEMBLY SERVICES

When you don't have the capacity to do all your own component preparation, assembly or wire wrapping—or when it doesn't pay you to do it yourself—let us do it for you, with no capital investment on your part. Working for you are the industry's most automated facilities including:

- Axial Lead Component Taping, Sequencing and Insertion.
- Transistor Prepping, Taping and Insertion.
- DIP Insertion.
- Pin Insertion.
- SIP Insertion.
- Computer-Aided Design Accessibilities.
- Wire Termination.
- Complete Systems Assembly.
- And, of course, complete testing for all services.

Universal's Mechanized Electronic Assembly (MEA) Division services provide close-tolerance production, on-time delivery and substantial savings in direct labor cost from two locations: Binghamton, New York, and Palatine, Illinois. Write or phone today for full details on what Universal's MEA can do for you.



 **Universal**  
MEA

Box 825 Binghamton, NY 13902  
607-772-7522 TWX: 510-252-1990



# Introducing 1200 feet of Step-Mate.

This is an ad about an unusual tape reader: Step-Mate. And about what makes it even more unusual than it already is: our new spooler.

With the spooler, Step-Mate can handle up to 1200 feet of tape at a time, on 7½-inch spools. The whole unit, only 8¾ inches high, fits in any RETMA rack. And, with a choice of three different connector types (edge card, ribbon, or subminiature 25-pin), it's exceptionally easy to interface.

Step-Mate, if you don't mind our reminding you, is our reader which reads one character per command pulse. And it does this at speeds up to 150 characters per second. In addition



tion it has a life expectancy greater (probably) than yours, with LEDs for never-fail light sources, error-free phototransistor read sensors, a gentle-on-the-tape barrel sprocket, a genuine step-motor drive, and a self-cleaning read head. Finally, it reads virtually all 5, 6, 7, and 8-level tapes without adjustment.

So there you are, a new tape reader without equal, at a price also without equal, \$905 with power supply, \$795 without.

Our brochure will tell you more. Write for it. Or, for instant action, call collect.

## EECO

FOR READERS

1441 East Chestnut Avenue, Santa Ana, California 92701  
Phone 714/835-6000

Noise at the front-end of an otherwise tight low frequency design is terribly frustrating. And we don't blame you for sounding off if you want to specify for lower noise and can't come up with an FET to suit your purpose.



Crystalonics new 2N6550 is a silicon, N-Channel, junction FET designed for low frequency amplifier applications, with an ultra low noise figure of  $2nV/\sqrt{Hz}$  at 1 KHz. You won't find one quieter! This device is designed to produce the cleanest signal possible at the front-end, for pure follow-through and ultimate signal clarity, so critical to military field communications. It's as silent as current technology allows, and with Crystalonics' 2N6550, you'll note a marked improvement in your prototype.

Crystalonics has been in the business of helping to solve designers' problems for over a decade. While other companies have abandoned military applications and opted for the production of commercial standards, we've stuck by our trade: high quality, innovative production with the designer in mind. Direct communication between the designer and our applications engineers is our mark.

**We're at your elbow to ease your design.**

Send for our new condensed catalog of Junction FETs, Fotofets, and Low Level Bipolars, including the 2N6550 at \$15, 1-99; \$10, 100-999.

Samples on request. Or for immediate design assistance, give us a call. Ask for Jack Senoski, Art Pauk or Richard Antalik, of our applications engineering squad.

Crystalonics. We listen.

**Give us  
a little of your noise**



**TELEDYNE  
CRYSTALONICS**

147 Sherman Street, Cambridge, Mass. 02140  
Tel: (617) 491-1670 • TWX: 710-320-1196

Circle 150 on reader service card

## New products

Data handling

### Disk control is microprogramed

Cartridge or pack plus fixed-head data can be controlled by one command

The physical characteristics of a disk memory—cartridge, disk pack, or fixed-head unit—are invisible to the user of a microprogramed Universal Disk Controller introduced last week by Prime Computer Inc. at the National Computer Conference. Prime also introduced a new version of its model 300 time-sharing computer system with virtual-memory capability. The new system's capacity has been nearly doubled to accommodate 31 time-sharing users. The MOS main memory contains 256,000 words.

The Universal Disk Controller can handle up to four cartridge or disk pack units with capacities of 3, 6, or 30 million words, in addition to one fixed-head disk. Using a control technique called channel-command program, the user issues only one instruction to the controller, which then determines whether the operation should be read or write, and what disk contains the information. All logic of the \$3,500 unit is mounted on one circuit board that can be plugged into any Prime computer.

The expanded Prime 300 has two 16-line asynchronous multiline controllers, instead of the previous one line, to bring the time-sharing capacity to 31 users (one line is for executive control). With the 256 kilowords of MOS memory, each user is provided with 64 kilowords of virtual-memory space. Users can write programs in Fortran and Basic, as well as macro- and micro-assembler languages. Along with the expanded hardware, Prime has added to its virtual-memory disk-operating software an automatic log-out to prevent inactive con-

nected terminals from holding systems resources beyond a predetermined time limit, a read/write lock system for file security, and a main memory scan that automatically tests the computer's main memory and can identify and bypass faulty locations.

The expanded Prime 300 has the same central processor with virtual-memory capability as previous models, hardware multiply/divide, a maximum data transfer rate of 1.25 million words per second, automatic program loaders for disk, magnetic tape and paper tape, and micro-verification routines. Double-precision floating-point arithmetic and writeable control store are available as options.

Price of the basic Universal Disk Controllers is \$3,500, but to handle disks of more than 15 million words, a \$1,500 option is necessary. Prices for the expanded Prime 300 range from less than \$50,000 for a four-user system to about \$160,000 for a 31-user system. Delivery time is 30 to 60 days.

Prime Computer Inc., 145 Pennsylvania Ave. Framingham, Mass. 01701 [361]

### Floppy disk plugs into Motorola's microcomputer

Recognizing that a lot of programming time will be needed to develop products with microprocessors, semiconductor firms are introducing complete microcomputers that are designed for development tasks. An example is Motorola's M6800 EXORCISER. Till now this unit could only plug in to a slow teletypewriter or silent terminal, so that the user had to endure long waits unless he



## GAS SENSING SEMI-CONDUCTOR

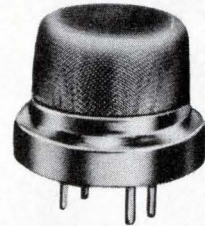

## FIGARO GAS SENSOR

'75 New Models, some with highly sensitive CO sensor, now on the market.

Please contact the address below directly for catalogs and price/delivery information.

## FIGARO ENGINEERING INC.

3-7-3, Higashitoyonaka, Toyonaka City, Osaka 560, Japan/Phone: (06) 849-2156  
Cable: FIGARO TOYONAKA  
Telex: 05286155 FIGARO J

Circle 151 on reader service card

CONNECTORS/  
P.C.

## JACKS & PINS

BERYLLIUM  
COPPER  
CAGES

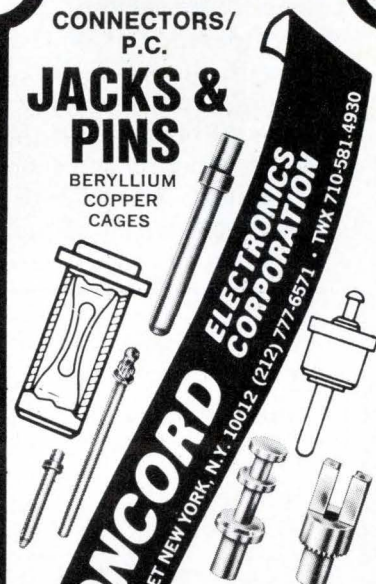

**CONCORD ELECTRONICS CORPORATION**  
37 GREAT JONES STREET NEW YORK, N.Y. 10012 (212) 777-6571 • TWX 710-581-4930

and  
**TEFLON\***  
AND SOLDER  
**TERMINALS**

\*DUPONT T.M.

SEND FOR CATALOG

There is the bad guy!

I didn't know that

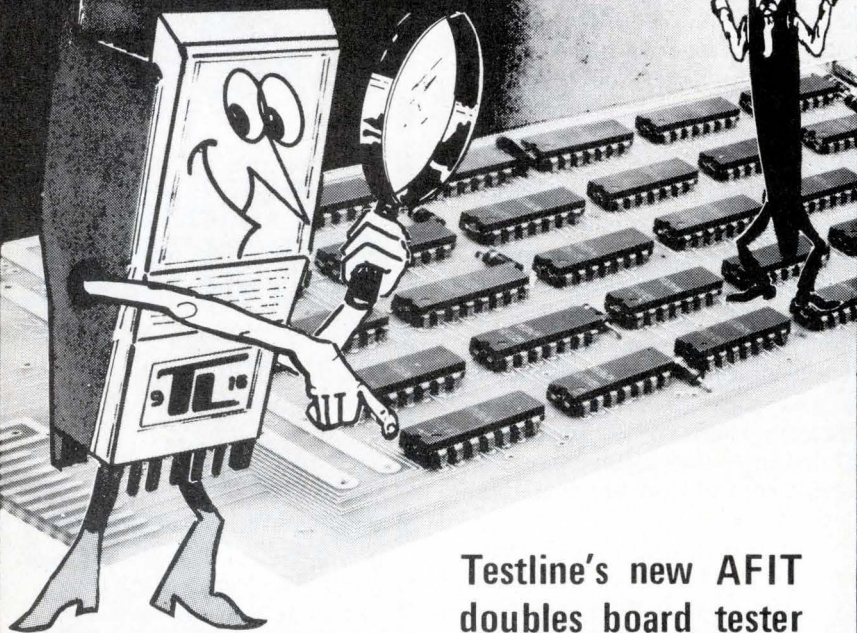

## Super Sleuth

Testline's new AFIT doubles board tester throughput, cuts equipment costs.

You can double the throughput of your board tester with

Testline's high performance Automatic Fault Isolation Tester. Priced thousands of dollars less than software-directed probe equipment, the AFIT differentiates between a board problem and an IC problem, isolating in seconds the bad component. With the AFIT you find the problem not the problem area — quickly, efficiently and economically.

Testline's AFIT — it's the perfect complement to your existing board testing set-up.

I am interested in learning more about your Automatic Fault Isolation Tester.

Send technical data / / Have your representative call / /

Name \_\_\_\_\_ Title \_\_\_\_\_

Company \_\_\_\_\_ Phone \_\_\_\_\_

Address \_\_\_\_\_

City \_\_\_\_\_ State \_\_\_\_\_ Zip \_\_\_\_\_

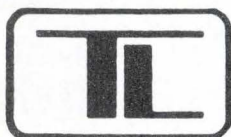

### TESTLINE

NORTH BREVARD INDUSTRIAL PARK  
P. O. BOX 5686  
TITUSVILLE, FLORIDA 32780  
(305) 267-7212

## New products

had access to a time-sharing system. A third option has therefore been developed by iCOM—a floppy-disk system that can provide complete local capability at a cost comparable to only a few months' time-sharing charges.

The FD-360-68 disk system plugs directly into the Motorola EXORciser, with all required hardware, firmware, and software to permit immediate operation. It reduces program development time by a factor of 10, says iCOM president David Callan, because the editor can be loaded from the disk in 3 seconds rather than the 25 minutes required for the teletypewriter paper reader, and the assembler takes 8 s rather than 45 min. He states that a typical edit/assembly sequence takes about 5 to 10 min. as opposed to three hours with the teletypewriter.

The system consists of a single or dual flexible-disk drive using Pertec D400 decks, a controller, plus all electronics and cable necessary to make it compatible with the Motorola microcomputer. The firm had earlier developed similar units for the Intel Intellec and National microcomputers. The dual unit is priced at \$3,300, the single at \$2,800. Included in these prices is \$300 for a required interface.

The disk drives are IBM-compatible and store 256,256 bytes per disk. Up to four drives can be controlled, with two others in a separate enclosure. The drive head retracts from the media when not reading or writing, to increase media life; and the system includes complete hardware track-seek, seek-verification, and cyclic redundancy check. The controller has two 128-byte input and output buffers to permit asynchronous byte transfer to and from the computer, plus operation with devices such as keyboards, paper tape, and communications and data-acquisition equipment.

The FD-360-68 measures 8¼ by 17 by 17 inches, and operates from 115 or 230 volts, 50 or 60 hertz. All cabling and connectors are included.

iCOM is also preparing a high-



# FEATURE ARTICLES FROM ELECTRONICS MAGAZINE ARE NOW AVAILABLE IN REPRINT FORM!

Valuable additions to your electronics library are now available thru this exclusive reprint service. Just check the articles you wish to order and enclose check or money order for prompt service.

No. of Copies Wanted		No. of Copies Wanted	
_____	R- 11 Computer-Aided Design .....	_____	R-310 Penetration Color Tubes are Enhancing Information Displays .....
_____	R- 15 Special Report on LSI Packaging .....	_____	Information Displays .....
_____	R-016 Special Report on The Transistor: Two Decades of Progress .....	_____	R-312 Leadless, Pluggable IC Packages Reduce Costs ..
_____	R- 18 Reshaping the EE for the Seventies .....	_____	R-316 Hybrid Circuit Technology Solves Tough Design Problems .....
_____	R-023 Special Report: Tomorrow's Communications.....	_____	R-318 Buckling Up for the Bumpy Road to Detroit.....
_____	R-027 Consumer Hazards: Why They Happen, How They Can Be Fixed .....	_____	R-320 Planar Interconnection Techniques (Designer Must Plan Early for Flat Cable) .....
_____	R-031 Circuit Designer's Casebook (U.S. Only) .....	_____	R-322 Special Report: The New Displays Complement the Old .....
_____	R-032 Active Filters .....	_____	R-324 Semiconductor Memories Are Taking Over Data-Storage Applications .....
_____	Infra-Red Detector Chart	_____	R-326 Optical Spectrum Report and Optical Spectrum Chart .....
_____	R-101 Special Report: The Right Numeric Readout, a Critical Choice for Designers .....	_____	R-328 Pervasiveness of Electronics Entire Issue of Electronics .....
_____	R-104 The New Concept for Memory and Imaging: Charge Coupling .....	_____	R-500 Japanese Forecast 1975 .....
_____	R-107 Wanted for the '70s: Easier-to-Program Computers .....	_____	R-502 European Forecast 1975 .....
_____	R-110 Automation for Survival and Profit .....	_____	R-504 U.S. Forecast 1975 .....
_____	R-113 Optoelectronics Makes It At Last (3 part series)...	_____	R-406 Logics New Design Tools .....
_____	R-203 East Europe Market Report .....	_____	R-408 Bringing Sight to the Blind .....
_____	R-205 Bridging the Analog & Digital Worlds with Linear ICs .....	_____	R-410 Passive Components .....
_____	R-207 Technology Gap Starts to Close for Computer Peripherals .....	_____	R-412 Liquid Cooling Semiconductors .....
_____	R-209 Semiconductor RAMs Land Computer Mainframe Jobs .....	_____	R-414 Simplified n-Channel Process .....
_____	R-211 Electromagnetic Spectrum Report and Foldout Chart .....	_____	R-416 Optical Waveguides Look Brighter .....
_____	R-213 Electromagnetic Spectrum Chart (rolled in mailing tube) .....	_____	R-418 Computer Analyses of RF Circuits .....
_____	R-306 Charge Coupling Improves Its Image, Challenging Video Camera .....	_____	R-420 Computerized Text-Editing and Typesetting .....
_____	R-308 Program for Transition from NonLinear to Linear Transistor Model .....	_____	R-422 A Microprogramable Minicomputer .....
		_____	R-424 Microprocessor Applications .....
		_____	R-426 Special Issue—Technology Update—1974 .....

## Payment must accompany your order...USE THIS PAGE AS YOUR ORDER FORM

Make check or money order payable to Electronics Reprints. All orders shipped prepaid via parcel post. Allow two to three weeks for delivery.

Back Issues Now Available. 1960 to 1969 \$5.00 each. 1970 to 1973 \$3.00 each.

Mail Your Order To  
Janice Austin  
**ELECTRONICS REPRINTS**  
P.O. Box 669  
Hightstown, N.J. 08520

Amount of Order	\$ _____
Plus 10% Handling Charge	\$ _____
<b>TOTAL AMOUNT ENCLOSED</b>	<b>\$ _____</b>

### SEND REPRINTS TO

Name \_\_\_\_\_  
Company \_\_\_\_\_ Dept. \_\_\_\_\_  
Street \_\_\_\_\_  
City \_\_\_\_\_ State \_\_\_\_\_ Zip \_\_\_\_\_

Model Number (1)	Impedance Ohms	Freq. Range	Unit Price (2)				
			BNC	TNC	N	SMA	PC
Coaxial Fixed Attenuator, Calibrated, 1 to 20 dB:							
AT-50	50	DC-1.5 GHz	10.50	10.50	13.50	18.50	—
Coaxial Fixed Attenuators, 1 to 20 dB:							
AT-51	50	DC-1.5 GHz	9.50	9.50	12.50	15.50	—
AT-75	75	DC-1.5 GHz	10.50	10.50	13.50	18.50	—
AT-90	90	DC-750MHz	10.50	10.50	13.50	18.50	—
Dual-In-Line Fixed Attenuator, 1 to 20 dB:							
AT-51PC	50	DC-500MHz	—	—	—	—	9.50
Trimmer Attenuator, Range 7 to 9 dB:							
TA-8-2	50	DC-500MHz	—	—	—	39.50	—
Resistive Impedance Transformers, Minimum Loss Pads:							
RT-50/75	50 to 75	DC-1.5 GHz	10.00	10.00	13.00	18.00	—
RT-50/93	50 to 93	DC-1.0 GHz	10.00	10.00	13.00	18.00	—
Coaxial Termination, Calibrated:							
CT-50	50 (1/2W)	DC-4.0 GHz	10.00	12.50	12.50	15.00	—
Coaxial Terminations:							
CT-51	50 (1/2W)	DC-4.0 GHz	8.75	9.50	9.50	11.50	—
CT-52	50 (1W)	DC-2.5 GHz	11.50	11.50	13.50	13.80	—
CT-53	50 (1/2W)	DC-4.0 GHz	5.00	—	—	5.00	(10 PC)
CT-54	50 (2W)	DC-2.0 GHz	—	—	—	15.50	—
CT-75	75 (1W)	DC-2.5 GHz	10.00	10.00	10.00	15.00	—
CT-93	93 (1/4W)	DC-2.5 GHz	10.00	10.00	—	—	—
Coaxial Feedthru Termination:							
FT-50	50 (1W)	DC-1.0 GHz	10.00	10.00	—	—	—
FT-75	75 (1W)	DC-500MHz	10.00	10.00	—	—	—
FT-90	90 (1W)	DC-150MHz	10.00	10.00	—	—	—
Coaxial Resistive Decoupler, Series Resistor:							
RD-1000	1000	DC-1.5 GHz	9.50	9.50	12.50	17.50	—
Coaxial Capacitive Coupler, Series Capacitor:							
CC-1000	1000 PF	DC-1.5 GHz	9.50	9.50	12.50	17.50	—
Coaxial Inductive Decoupler, Series Inductor:							
LD-R15	.17 uH	DC-500MHz	9.50	9.50	12.50	17.50	—
LD-6R8	6.8 uH	DC-55MHz	9.50	9.50	12.50	17.50	—
Coaxial Fixed Attenuator Sets, Calibrated, 3, 6, 10 & 20 dB:							
AT-50-SET	50	DC-1.5 GHz	40.00	40.00	52.00	72.00	—
Coaxial Fixed Attenuator Sets, 3, 6, 10 & 20 dB:							
AT-51-SET	50	DC-1.5 GHz	36.00	36.00	48.00	60.00	—
Multicoupler, 2 Output Ports:							
TC-125-2	50	1.5-125MHz	27.00	27.00	42.00	42.00	—
Multicoupler, 4 Output Ports:							
TC-125-4	50	1.5-125MHz	35.00	35.00	60.00	60.00	—
Dual-In-Line Multicoupler, 2 Output Ports:							
TC-125-2PC	50	1.5-125MHz	—	—	—	—	16.00
Dual-In-Line Multicoupler, 4 Output Ports:							
TC-125-4PC	50	1.5-125MHz	—	—	—	—	24.00

Note 1: See Catalog for complete Model Numbers. Specials Available.  
 2. Price is F.O.B. Deer Park, N.Y. Delivery is Stock to 30 Days ARO.  
 Price is subject to change without notice.

Send for Free Catalog on your Letterhead.

**Elcom SYSTEMS INC.** 516-667-5800

127F BROOK AVENUE, DEER PARK, N. Y. 11729

Circle 154 on reader service card

## New products

speed paper-tape system for use with the Motorola EXORCISER.

ICOM Inc., 6741 Variel Avenue, Canoga Park, Calif. 91303 [362]

Video-display system can handle five terminals

Capable of supporting five video terminals or system printers, the model IS/7801A general-purpose mini-cluster video display system is plug-to-plug compatible with IBM 3275 and 3270 systems. Selling for up to 39% less than the IBM 3270, the IS/7801A interfaces with IBM/Systems 360 and 370, and with System/3 model 10 or 15 over

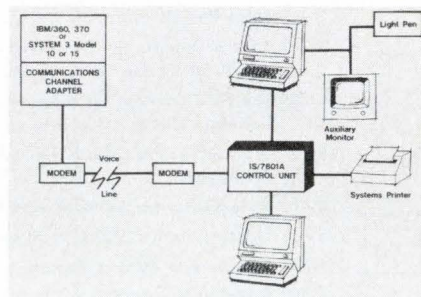

voice-grade, half-duplex binary synchronous lines. Bit rates of 1,200 to 9,600 bits per second can be accommodated. Each video terminal in the system can support a light pen and an auxiliary monitor. Screen size is 12 inches on the diagonal, and the standard repertoire includes 128 characters. Line drawings and bar-chart characters are optional. Display capacity ranges from 240 to 1,920 characters. System prices range from \$9,450 for a one-terminal or one-printer system, to \$20,850 for five terminals or five printers.

GTE Information Systems Inc., Four Corporate Park Dr., White Plains, N. Y. 10604 [363]

Cartridge-tape system can store 152 megabits

Noteworthy for both its capacity and speed, the model DI-112-03 is a digital cartridge-tape drive with a

# Everything in Fail-Proof Digital Printers.

Pick a Tape for Your Very Own For: Point-of-Sale; Test Equipment, Data Logging Tickets, Calculators, Fast Food Receipts, Tolls.

The No. 1 Printers serve the toughest leaders — many years of field-proven experience. Tell us your need — we'll recommend the printer perfect for you —

or custom-design it. FAST. Phone Hans Weck, Sales Manager.

**CI** C. ITOH ELECTRONICS, INC.

Systems & Components Division  
 280 Park Avenue, New York, N.Y. 10017  
 (212) 573-9467. Telex: WUD 12-5059

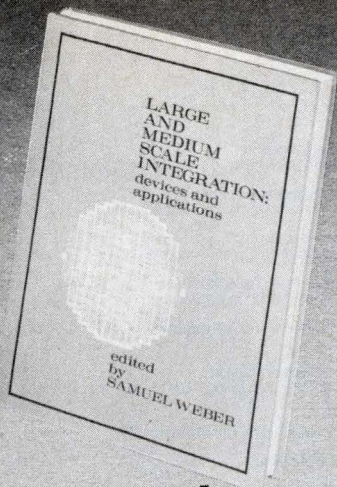

## Large and medium scale integration: Keep up with this fast changing technology

Now, in one comprehensive volume, a complete working grasp at large and medium scale integration for electronics engineers engaged in the design of electronic systems, equipment and products.

A wealth of practical working data on large and medium scale integration has been culled from the most important articles in Electronics magazine by Samuel Weber, Executive Editor. Emphasis is on design problems at the system or subsystem level, as well as on the economics of today's design.

Whatever the design problem — from partitioning a digital system to working with a semiconductor company in producing the best LSI design, this book covers the full range of today's important technologies on a practical, rather than a theoretical, level.

It's yours for \$15.00. Keep up.

### FREE 10-DAY EXAMINATION

McGraw-Hill Book Company  
1221 Ave. of the Americas,  
New York, N.Y. 10020



Send me a copy of Large and Medium Scale Integration (068815-X) for 10 days on approval. At the end of that time, I will either remit \$15.00, plus tax, postage, and handling, or return book without further obligation. (Remit in full with this coupon, plus any tax, and McGraw-Hill pays all postage and handling costs.)

Name \_\_\_\_\_

Address \_\_\_\_\_

City \_\_\_\_\_

State \_\_\_\_\_ Zip \_\_\_\_\_

Offer good only in the U.S. and subject to acceptance by McGraw-Hill. For prices outside U.S., contact McGraw-Hill Book Co.

23 K138-4018-3

## New products

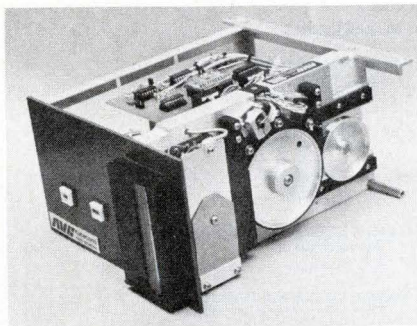

maximum unformatted capacity of 152 million bits (19 million bytes) and a maximum read-transfer rate of 768 kilobits per second. When formatted as a typical 256-kilobyte floppy disk, the DI-112-03 has a random-access time that is approximately 50% faster than that of a disk system. And since the tape system has such a large capacity, it is practical to store the equivalent of more than 50 floppy disks on a single tape. Programs control movement from "disk" to "disk" on the tape. In this mode of operation, the DI-112-03 can move from one disk to the adjacent one in less than 400 milliseconds and can move 10 disks in less than 3.5 seconds. The price of the DI-112-03, in lots of 100 units, is less than \$1,000 for the drive only, and less than \$1,200 for the drive plus basic read/write and control electronics.

American Videonetics Corp., 795 Kifer Rd., Sunnyvale, Calif. 94086 [364]

## Controller interfaces computer with typewriter

Occupying a single printed-circuit board, a low-cost computer-interface controller allows an IBM Selectric typewriter to be used as an input/output terminal for a Digital Equipment Corp. PDP-8/E or PDP-8/I minicomputer. Four of the controllers can be used with a single computer to interface with four typewriters. The Totalert Interface Controller sells for \$800 in quantities of five or more. Delivery time is six weeks.

Totalert Systems Inc., 2001 K. Karbach, Houston, Texas 77018 [366]

## MEASURE RPM IN 1 SECOND!

handheld digital tachometer  
NEW — MADE IN U.S.A.

Power Instruments, leader in portable Tachometer equipment brings you the first high precision digital tachometer made in U.S.A.



Model 1704

**POWER INSTRUMENTS, INC.**

7352 N. Lawndale Ave.,  
Skokie, IL 60076 • (312) 676-2300

Circle 155 on reader service card

- Easy push button operation
- Accuracy to 0.01%, ± 1 RPM
- 100% solid state, built-in memory
- No gears, springs or magnets
- Range — 10 to 9,999 RPM
- Compact, 1½" x 2¼" x 8", under 1 lb.
- Up to 50,000 readings per battery set
- Easy to read, red luminescent digits
- Carrying case, tips, batteries included
- Only \$175.00 FOB our plant
- Distributor inquiries invited

## Exclusive Economic and Industry Studies

**For Financial Analysts,  
Corporate Planners,  
Business Economists,  
Marketing Executives**

Geared directly to the future, our Department of Economics offers more than 40 forecasting tools to help project the general economy and industrial growth over the short and long run.

EXAMPLES: Do you know that the current operating rate for the chemical industry is 86%? For synthetic materials, the utilization rate is 93%? That construction and mining machinery new orders are expected to be 8% higher in 1974 than in '73? That steel expects a 3% decline in physical volume of sales in 1974? That consumer income after taxes will increase 8% in 1975?

At a modest cost, our various services covering most industrial segments of the economy are available to you.

For more information write for our booklet, "Exclusive Economic Studies," or phone Douglas Greenwald, Chief Economist, (212) 997-2216.

**Department of Economics**  
McGraw-Hill Publications Company  
1221 Avenue of the Americas  
New York, N.Y. 10020



# Electronics advertisers

May 29, 1975

<b>ADAC</b> Allied Advertising Agency, Inc.	157	<b>Fairchild Camera</b>	47	<b>Piher Corporation</b> Renaccio Advertising & Marketing Inc.	53
<b>Adelsy</b> Studio CPM	18E	<b>Fairchild Semiconductor, Inc.</b> Carson/Roberts, Inc. Advertising Division of Ogilvy & Mather Inc.	58	<b>Power Instruments, Inc.</b> Tri-State Advertising Company, Inc.	155
<b>Advanced Micro Devices</b> Keye Donna Pearlstein	11	<b>Figaro Engineering Inc.</b> Standard Advertising, Inc.	151	<b>* Procone S.p.A.</b> Quadrangolo Comunicazione	19E
<b>Aluminum Company of America-Chemicals</b> Ketchum, MacLeod & Grove, Inc.	128	<b>John Fluke Mfg. Co., Ltd.</b> Lennox Marketing Limited	70	<b>RCA Industrial Tube Products</b> Al Paul Lefton Company, Inc.	138
<b>‡ American Microsystems, Inc.</b> Wilton, Coombs & Colnett Inc. Advertising	64	<b>General Electric—Instrument Rental Division</b> R.T. Blass, Inc.	30	<b>* RCA Industrial Tube Products</b> Al Paul Lefton Company, Inc.	67
<b>American Optical, Scientific Instrument Division</b> Wilson, Haight, & Welch, Inc.	70	<b>General Instrument Corporation, Microelectronics Division</b> Norman Allen Associates, Inc.	15	<b>‡ Rental Electronics, Inc.</b> Humphrey Browning MacDougall, Inc.	62
<b>AMF/Potter &amp; Brumfield Division</b> Fuller & Smith & Ross, Inc.	87	<b>■ General Radio Company</b> Grad Associates	145	<b>* Rifa</b> MK Marknadskommunikation AB	14E
<b>■ AMP, Incorporated</b> Altikin-Kynnett, Inc.	74	<b>* Golden Gate Enterprises</b> Associated Ad Ventures, Incorporated	137	<b>* Rohde &amp; Schwarz</b>	1E,11E
<b>■ Analog Devices, Inc.</b> Schneider Parker, Inc.	80-81	<b>■ Gould Inc./Instrument Systems Division</b> Carr Liggett Advertising, Inc.	158	<b>* S.A.F.T.</b> U.N.C.C.	5E
<b>* Anritsu Electric Company, Ltd.</b> Diamond Advertising Agency Company Limited	33	<b>■ Hewlett-Packard</b> Corporate Marketing Communications	17-26	<b>* Seimart</b> CPM Studio	36
<b>■ AP Products Incorporated</b> Marketing Communications Associates	144	<b>Hughes Aircraft Company</b> Foote, Cone & Belding/Honig	31,45	<b>Semtech Corporation</b> Adgraphix Corporation	120
<b>‡ Arrow-M Corporation</b> Halloff & Caine Associates	137	<b>HyComp, Inc.</b> Fred Molinari Associates	86	<b>* Sescosem</b> Bazaine Publicite	62
<b>AVX Ceramics</b> TCI Advertising, Inc.	90	<b>Intel Corporation</b> Regis McKenna, Inc.	28-29	<b>* Sfernice</b> Jean Haechler Publicite	20E
<b>■ Ballantine Laboratories, Inc.</b> McCarthy, Scelba, DeBiasi	61	<b>International Electronic Research Corporation</b> McCarron, Kane Inc.	32	<b>SGS-ATES International</b> McCann-Erickson	141
<b>‡ Beckman Instrument, Inc., Helipot Division</b> N.W. Ayer/Jorgensen/MacDonald, Inc.	56-57	<b>Intersil, Inc.</b> Tyser-Fultz	68-69	<b>Signal Transformer</b> Russell Technical Services, Inc.	1
<b>‡ Bell &amp; Howell—Electronics &amp; Instruments Group</b> CEC/Instruments Division	9	<b>■ Interstate Electronics Corporation</b> Chris Art Studio, Inc.	158	<b>* Spectrol Reliance Limited</b> JMR Advertising	6E-7E
<b>Blomation</b> Paul Pease Advertising	146	<b>■ C. Itoh &amp; Co. (AMERICA) Inc.</b> Zam & Kirshner, Inc.	154	<b>Sprague Electric Company</b> Harry P. Bridge Company	8
<b>‡ Bourns, Inc.</b> Marlborough Associates, Inc.	33-36	<b>* ITT Cannon</b>	8E	<b>■ Tansitor Electronics</b> Devey, Thompson & Vignola Advertising, Inc.	6
<b>Brand-Rex</b> Creamer, Trowbridge, Case & Basford, Inc.	2nd Cover	<b>Iwasaki Taushinki Company Limited</b> Universal Ad Co., Ltd.	140	<b>Teledyne Crystalonics</b> Impact Advertising Agency, Inc.	150
<b>■ Cambridge Thermionic Corporation</b> Chirurg & Cairns, Inc.	158	<b>Krohn-Hite Corporation</b> Impact Advertising, Inc.	5	<b>Teledyne Semiconductor</b> Regis McKenna, Inc.	7
<b>Carborundum Company, The</b> Stahlka/Faller, Inc.	71	<b>LH Research, Inc.</b> McCarron, Kane Inc./Advertising	89	<b>Telonic Altair</b> Jansen Associates Inc. Marketing Services	86
<b>■ Cherry Electrical Products Corporation</b> Kolb/Tookey & Associates, Inc.	51	<b>Litronix, Inc.</b> Bonfield Associates	12-13	<b>Teradyne Inc.</b> Quinn & Johnson, Inc.	40
<b>■ Concord Electronics Corporation</b> Sound Advertising	151	<b>* Logabex</b>	16E	<b>Testline Instruments</b> W.L. Vergason Advertising	152
<b>■ Continental Specialties Corporation</b> Robert A. Paul	16	<b>Magnecraft Electric Company</b> Marketronics, Inc.	3rd Cover	<b>Texas Instruments Incorporated, Components Group</b> Tracy-Locke Advertising, Inc.	104-105
<b>‡ Cutler-Hammer, Inc.</b> Campbell-Mithun, Inc.	67	<b>* Magnetti Marelli</b> CPM Studio	35	<b>Thomson CSF</b> Bazaine Publicite	134
<b>■ Dale Electronics Inc. A Sub of the Lionel Corporation</b> Swanson, Sinkey, Ellis, Inc. Advertising	4th Cover	<b>* Marconi Instruments Limited</b> Russell Powell Advertising Limited	17E	<b>■ TRW, Cinch Connectors</b> Stral Advertising Company, Inc.	131
<b>Datacon, Inc.</b> Henry Sherlock Company	77	<b>Memodyne Corporation</b> Ikon Communications Consultants, Inc.	83	<b>■ Union Carbide Corporation— Components Department</b> McConnell-Downs	103
<b>Data General Corporation</b> Scali, McCabe, Sloves, Inc.	39	<b>MMI</b> Paul Pease Advertising, Inc.	72-73	<b>■ Unilrode Corporation</b> Schneider Parker, Inc.	54-55
<b>Digital Equipment Corp.— Components Group</b> Schneider Parker, Inc.	142	<b>Motorola Semiconductor Products, Inc.</b> E.B. Lane & Associates, Inc.	49	<b>Universal Instrument Corporation</b> Commercial Art Service Graphics	148
<b>EDMAC Associates</b> J.L. Newman & Associates, Inc.	50	<b>■ Narda Microwave</b> McCarthy, Scelba, DeBiasi Advertising Agency, Inc.	2	<b>Universal Oil Products, Norplex Division</b> Campbell-Mithun, Inc.	85
<b>EECO</b> The Greer Agency	149	<b>National Electronics</b> Lea Advertising	79	<b>V/O Technabexpport</b> Vneshtorgreklama	157
<b>Eicom Systems, Inc.</b>	154	<b>Nippon Electronic Memory Ind. Co., Ltd.</b> Nihon Keizaisha Advertising Ltd.	52	<b>* Wavetek, San Diego, Inc.</b>	109
<b>Electronics Book Series</b>	132-133	<b>* Oscilloquartz SA, Neuchatel</b> Publicitas Service International	2E	<b>* La Zincocelere S.p.a.</b> Studio Dr. Giuliano Blei	34
<b>Electronics/Deluxe Classics</b> Gumpert/Bentley/Fried/Scott	138	<b>‡ Oxy-Metal Industries Corporation</b> Poppe Tyson, Inc. Division of deGarmo, Inc.	109		
<b>Electronics Navigation Industries</b> Hart/Conway Advertising— Public Relations	14	<b>* Phillips Elcoma</b> Brookies Communications Systems	64		
<b>■ EPC Labs, Inc.</b> Superfine Productions	32	<b>* Phillips Industries</b> Vaz Dias	56-57		
<b>■ Erie Technological Products, Co., Inc.</b> Altman Hall Associates Advertising	27	<b>* Phillips N.V. PIT/T&amp;M Division</b> Brookies Communications Systems SA	12E-13E		

■ For more information on complete product line see advertisement in the latest Electronics Buyers' Guide  
\* Advertisers in Electronics International  
‡ Advertisers in Electronics domestic edition

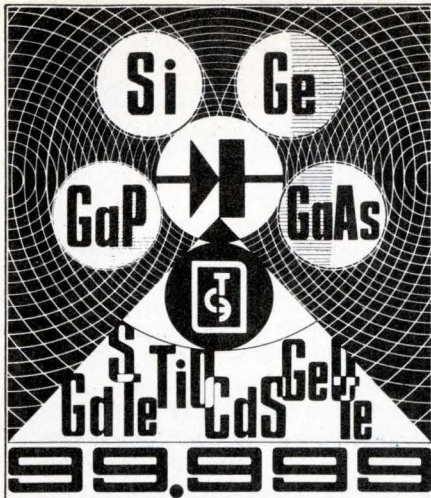

## MATERIALS FOR ELECTRONICS

Epitaxial structures of silicon and  
semiconductor structures

### Germanium:

monocrystalline & polycrystalline  
germanium dioxide 99.99% & 99.9999%  
germanium monoxide

### Silicon:

monocrystalline & polycrystalline

### Gallium:

arsenide

### Indium:

arsenide

### Gallium

phosphide

Monocrystals of semiconductor  
compounds

Extra-pure materials, diffusing agents,  
quartz crucibles

Exporter:

## V/O TECHSNABEXPORT

Moscow G-200, USSR  
Tel. 244-32-85 · Telex 7628

Agent:

**KOLON TRADING CO., INC.,**  
540 Madison Avenue, New York, N. Y. 10022

 **Technabexport**

### Advertising Sales Staff

**Pierre J. Braudé** New York [212] 997-3468,  
Paris Tel. 720-73-01  
Director of Marketing

**Atlanta, Ga. 30309:** Warren H. Gardner  
100 Colony Square, 1175 Peachtree St., N.E.  
[212] 997-3617

**Boston, Mass. 02116:** James R. Pierce  
607 Boylston St. [617] 262-1160

**Chicago, Ill. 60611:**  
645 North Michigan Avenue  
Robert W. Bartlett (312) 751-3739  
Paul L. Reiss (312) 751-3738

**Cleveland, Ohio 44113:** William J. Boyle  
[716] 586-5040

**Dallas, Texas 75201:** Charles G. Hubbard  
2001 Bryant Tower, Suite 1070  
[214] 742-1747

**Denver, Colo. 80202:** Harry B. Doyle, Jr.  
Tower Bldg., 1700 Broadway  
[303] 266-3863

**Detroit, Michigan 48202:** Robert W. Bartlett  
1400 Fisher Bldg.  
[313] 873-7410

**Houston, Texas 77002:** Charles G. Hubbard  
375 Dresser Tower, 601 Jefferson St. [713] CA 4-8381

**Los Angeles, Calif. 90010:** Robert J. Rielly  
Bradley K. Jones, 3200 Wilshire Blvd., South Tower  
[213] 487-1160

**New York, N.Y. 10020**  
1221 Avenue of the Americas  
Warren H. Gardner [212] 997-3617  
Michael J. Stoller [212] 997-3616

**Philadelphia, Pa. 19102:** Warren H. Gardner  
Three Parkway,  
[212] 997-3617

**Pittsburgh, Pa. 15222:** Warren H. Gardner  
4 Gateway Center, [212] 997-3617

**Rochester, N.Y. 14534:** William J. Boyle  
9 Greylock Ridge, Pittsford, N.Y.  
[716] 586-5040

**San Francisco, Calif. 94111:** Don Farris  
Robert J. Rielly, 425 Battery Street,  
[415] 362-4600

**Paris:** Alain Offergeld  
17 Rue-Georges Bizet, 75 Paris 16, France  
Tel: 720-73-01

**Geneva:** Alain Offergeld  
1 rue du Temple, Geneva, Switzerland  
Tel: 32-35-63

**United Kingdom & Scandinavia:** Keith Mantle  
Tel: 01-493-1451, 34 Dover Street, London W1

**Milan:** Luigi Rancati  
Robert Saidel (Middle East)  
1 via Baracchini, Italy Phone 86-90-656

**Brussels:** Alain Offergeld  
23 Chaussee de Wavre  
Brussels 1040, Belgium  
Tel: 13-73-95

**Frankfurt/Main:** Fritz Krusebecker  
Dieter Rothenbach (East European Countries)  
Liebigstrasse 27c, Germany  
Phone 72 01 81

**Tokyo:** Tatsumi Katagiri, McGraw-Hill  
Publications Overseas Corporation,  
Kasumigaseki Building 2-5, 3-chome,  
Kasumigaseki, Chiyoda-Ku, Tokyo, Japan  
[581] 9811

**Australasia:** Warren E. Ball, IPO Box 5106,  
Tokyo, Japan 100-31  
Tel: (03) 667-7397

### Business Department

**Stephen R. Weiss, Manager**  
[212] 997-2044

**Thomas M. Egan,**  
Assistant Business Manager [212] 997-3140

**Carol Gallagher**  
Production Manager International [212] 997-2045

**Dorothy Carter,** Production Manager Domestic  
[212] 997-2908

**Frances Vallone,** Reader Service Manager  
[212] 997-6057

**Lisa Hoenig,** Secretary  
[212] 997-6481

### Electronics Buyers' Guide

**George F. Werner,** Associate Publisher  
[212] 997-3139

**Regina Hera,** Directory Manager  
[212] 997-2544

# mini- computer data acquisition family

Adac Data Acquisition Systems give the user a superior alternative to expensive external systems and the time-consuming task of assembling a system.

Adac systems are available for most popular minicomputers. They offer superior performance at savings up to \$4000 over other approaches.

### Advantages:

- Lowest cost
- Up to 64 channel multiplexer
- Direct interface to bus
- Software control programmable gain
- High speed 12 bit A/D converter (100 KHz)
- Up to 4 DAC's
- Plugs directly into computer mainframe

Compatible with the following computers

PDP-8E, F, M, N

PDP-11 series

Nova, Eclipse, 800 and 1200 series

Consult factory for other minicomputers not listed.

### GET THE FACTS.

A critique comparing the price and performance of our systems against alternate approaches is available for the asking.

For additional information contact our representatives or Adac Corporation, 118 Cummings Park, Woburn, MA 01801. Phone (617) 935-6668.

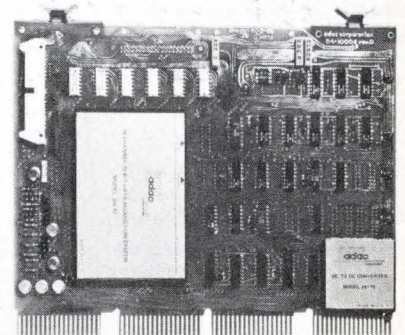

**adac**  
corporation

A CAMBION® Double "QQ" Product Line

# Socketing IC's?

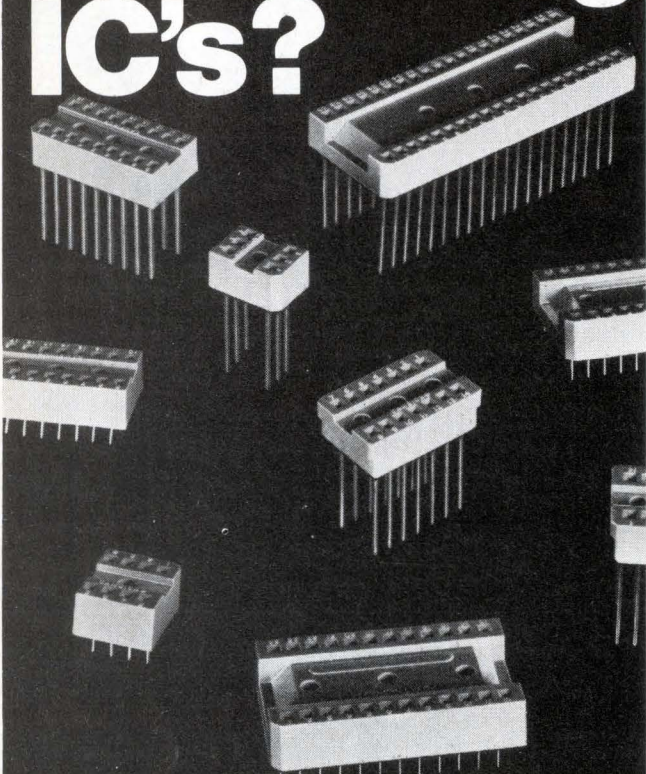

## Trust CAMBION for three good reasons.

Engineers more and more are putting IC's in separate sockets. What's the reason? There are three.

**First, reliability.** True pin positioning and precisely formed contacts are required for hand or automatic wire-wrapping.

**Second, serviceability.** Replacement and servicing of IC's is quick. Equipment downtime is minimal.

**Third, protection.** A DIP should not be subjected to the elevated temperatures of pin soldering. Or, if wrapped, needs a positive, long-life connection.

Those are the reasons for socketing. The reasons for trusting CAMBION?

**First, quality.** Each CAMBION socket has controlled body design and materials, finest contact plating, excellent retention, true durability.

**Second, quantity.** In either wrappable or solderable types, in variety and body design, CAMBION has 6, 8, 14, 16, 18, 22, 24, 28, 36 and 40 pin sockets available in whatever quantity you require. We sell millions annually.

**Third, reliability.** So far, customer rejects have been less than .1 of 1% (our QC man says that's infinitesimal).

So take CAMBION Double "QQ" approach to socketing and order the quality you want - in any quantity. We've a catalog full of them so you can make your own selection. Cambridge Thermionic Corporation, 445 E Concord Avenue, Cambridge, Massachusetts 02138. Phone: 617-491-5400. In Los Angeles, 8703 La Tijera Blvd. 90045. Phone: 213-776-0472.

Standardize on

## CAMBION®

The Guaranteed Electronic Components

158 Circle 158 on reader service card

## Introducing the Brush 110 strip chart recorder—with a thermal writing pen guaranteed for life.

There isn't another strip chart recorder on the market today that can match the Brush 110's performance, ruggedness, versatility and writing dependability.

The new hot-tip thermal writing system produces clear, sharp, highly reproducible blue traces **with no smudges, no smears, no skips and no puddles.**

Before you buy, check out the remarkable Brush 110. Contact your nearest Gould sales engineer for a demonstration. Or write Gould Inc., Instrument Systems Division, 3631 Perkins Avenue, Cleveland, Ohio 44114.

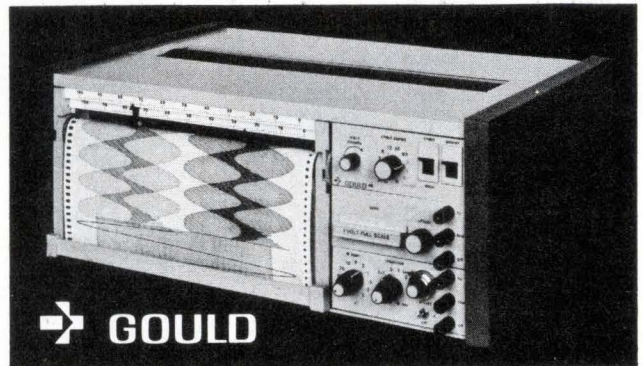

Circle 185 on reader service card

## Countdown Free!

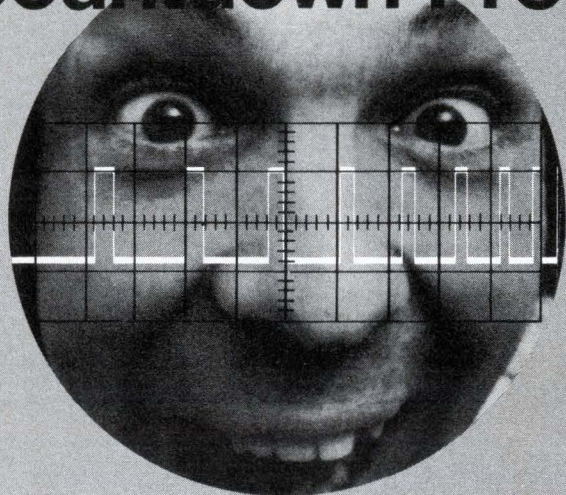

### Interstate Pulse Generators have Constant Duty Cycle

Interstate's exclusive Constant Duty Cycle mode automatically controls pulse width as a percentage of the period, so when you're varying the rep rate, the generator can't possibly skip a pulse or two and give you an invalid output.

Constant Duty Cycle is only one of many innovative Series 20 features you've never seen in a pulse generator before. Call John Norburg collect and he'll send you the new Interstate Series 20 Pulse Generator catalog — it's free, too!

Phone (714) 772-2811

 **INTERSTATE ELECTRONICS CORPORATION**  
Subsidiary of A-T-O Inc.

Dept. 7000, Box 3117, Anaheim, California 92803  
TWX U.S.A. 910-591-1197 TELEX U.S.A. 655443 & 655419.

Circle 186 on reader service card

# Compute Power



167 Nanosecond  
MULTIPLY-ADD . . .  
in normalized,  
convergently-rounded,  
8 decimal digit  
**FLOATING POINT.**

Designed for heavy computational applications, the AP-120B is capable of 12 million floating-point calculations per second. It contains very powerful pipelined floating-point arithmetic elements which are supported by extensive address manipulation capability, all controlled by a flexible microprocessor with writable control store.

Power. Power you can use. In a package you can understand. Software to solve your problems. Transparent Hardware Format Conversion. Interfaced to the computer of **your** choice.

The AP-120B. The latest in a long history of excellence. We supply computational solutions ranging from simple floating-point hardware to the Array Transform Processor. Call or Write for the facts.

## SOPHISTICATED SIMPLICITY

**floating  
point  
systems**  
incorporated

10520 S.W. Cascade Blvd., Portland, Oregon 97223  
Phone (503) 620-1980 Telex: 360470 FLOATPOINT PTL

Circle 231 on reader service card

## Where can you find a remote controlled cassette tape transport for under \$100?

### For Applications In:

1. Micro Processors
2. Data recording/logging/storage
3. Programming
4. Instrumentation
5. Industrial Controls
6. Data duplicating
7. Security/automatic warning systems
8. Test applications
9. Audio Visual/Education
10. Others

### With Features Of:

- 4 motor reliability
- Quick head engage
- Completely programmable-Logic
- No tape coasting
- Low power—AC or battery

**HERE!**

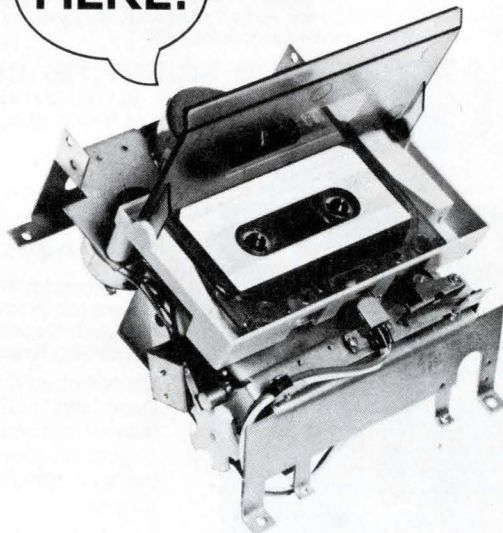

## PHI-DECK

*The Economy Co., III Division  
Oklahoma City, Oklahoma 73125*

The Phi-Deck is the first American-made tape transport with remote control capabilities and features including standard and nonstandard functions — selling for under \$100 in quantities of one.

The Economy Co., III Division  
1901 North Walnut  
Oklahoma City, Oklahoma 73105  
(405) 528-8444 Ext. 71 or 79

- I am interested in application no. \_\_\_\_\_  
 Have Representative call  
 Send application notes

Name \_\_\_\_\_ Title \_\_\_\_\_

Company Name \_\_\_\_\_

Address \_\_\_\_\_

City \_\_\_\_\_ State \_\_\_\_\_ Zip \_\_\_\_\_

Phone Number \_\_\_\_\_

Circle 191 on reader service card 191

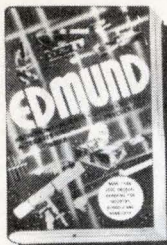

# FREE GIANT CATALOG

180 PAGES  
MORE THAN **4500 UNUSUAL BARGAINS**  
OPTICS • SCIENCE • ELECTRONICS

## 1,000's OF HARD-TO-FIND BUYS FOR INDUSTRY

Brand new 180-page easy-to-read edition packed with new products, charts, diagrams, illustrations. On-the-job helps; quality control aids, unique, exclusive items to speed your work, improve quality, cut development and production costs! Loaded with optical, scientific and electronic equipment available from stock for industry, research labs, design engineers, experimenters, hobbyists.

### ONE SOURCE FOR ALL YOUR NEEDS

Tremendous variety. Terrific savings. Countless hard-to-get surplus bargains. Many "one-of-a-kinds" nowhere else. Ingenious scientific tools. Thousands of components: lenses, prisms, wedges, mirrors, mounts, all types of accessories. Hundreds of instruments: pollution testing equipment, lasers, comparators, magnifiers, microscopes, projectors, telescopes, binoculars, photo attachments, ecological items, black light equipment and America's largest collection of alternate energy sources: solar, wind, methane.

### BUY DIRECT WITH MONEY-BACK GUARANTEE

Edmund ships over 5,000 orders monthly to America's largest industrials — every item guaranteed! You must be satisfied, or return your purchase in 30 days for your money back. Shop the catalog of America's largest Science-Optics-Electronics Mart with confidence! Get your FREE copy without obligation. No salesman will call. Write now for free catalog. "EX"



**EDMUND SCIENTIFIC CO.**  
300 EDSCORP BUILDING  
BARRINGTON, NEW JERSEY 08007  
TELEPHONE: 609-547-3488

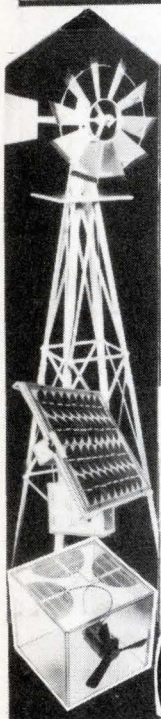
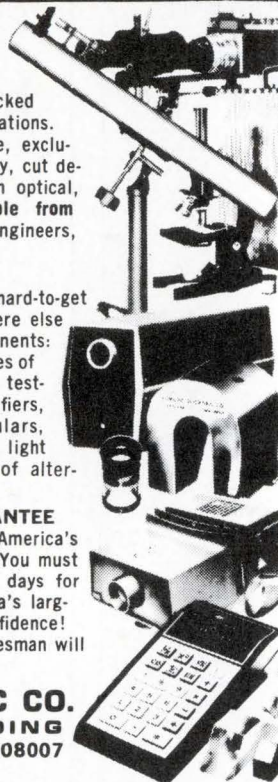

Circle 192 on reader service card

### Advertising Sales Staff

**Pierre J. Braudé** New York [212] 997-3468  
Paris Tel. 720-73-01  
Director of Marketing

**Atlanta, Ga. 30309:** Warren H. Gardner  
100 Colony Square, 1175 Peachtree St., N.E.  
[212] 997-3617

**Boston, Mass. 02116:** James R. Pierce  
607 Boylston St. [617] 262-1160

**Chicago, Ill. 60611:**  
645 North Michigan Avenue  
Robert W. Bartlett (312) 751-3739  
Paul L. Reiss (312) 751-3738

**Cleveland, Ohio 44113:** William J. Boyle  
[716] 586-5040

**Dallas, Texas 75201:** Charles G. Hubbard  
2001 Bryant Tower, Suite 1070  
[214] 742-1747

**Denver, Colo. 80202:** Harry B. Doyle, Jr.  
123 Speer Blvd., # 400  
Denver, Colorado 80203  
(303) 893-3863

**Detroit, Michigan 48202:** Robert W. Bartlett  
1400 Fisher Bldg.  
[313] 873-7410

**Houston, Texas 77002:** Charles G. Hubbard  
375 Dresser Tower, 601 Jefferson St. [713] CA 4-8381

**Los Angeles, Calif. 90010:** Robert J. Rielly  
Bradley K. Jones, 3200 Wilshire Blvd., South Tower  
[213] 487-1160

**New York, N.Y. 10020**  
1221 Avenue of the Americas  
Warren H. Gardner [212] 997-3617  
Michael J. Stoller [212] 997-3616

**Philadelphia, Pa. 19102:** Warren H. Gardner  
Three Parkway,  
[212] 997-3617

**Pittsburgh, Pa. 15222:** Warren H. Gardner  
2 Gateway Center [412] 391-1314

**Rochester, N.Y. 14534:** William J. Boyle  
9 Greylock Ridge, Pittsford, N.Y.  
[716] 586-5040

**San Francisco, Calif. 94111:** Don Farris  
Robert J. Rielly, 425 Battery Street,  
[415] 362-4600

**Paris:** Alain Offergeld  
17 Rue-Georges Bizet, 75 Paris 16, France  
Tel: 720-73-01

**Geneva:** Alain Offergeld  
1 rue du Temple, Geneva, Switzerland  
Tel: 32-35-63

**United Kingdom & Scandinavia:** Keith Mantle  
Tel: 01-493-1451, 34 Dover Street, London W1

**Milan:** Luigi Rancati  
Robert Saidel (Middle East)  
1 via Baracchini, Italy Phone 86-90-656

**Brussels:** Alain Offergeld  
23 Chaussee de Wavre  
Brussels 1040, Belgium  
Tel: 13-73-95

**Frankfurt/Main:** Fritz Krusebecker  
Dieter Rothenbach (East European Countries)  
Liebigstrasse 27c, Germany  
Phone 72 01 81

**Tokyo:** Tatsumi Katagiri, McGraw-Hill  
Publications Overseas Corporation,  
Kasumigaseki Building 2-5, 3-chome,  
Kasumigaseki, Chiyoda-Ku, Tokyo, Japan  
[581] 9811

**Australasia:** Warren E. Ball, IPO Box 5106,  
Tokyo, Japan 100-31  
Tel: (03) 667-7397

### Business Department

**Stephen R. Weiss, Manager**  
[212] 997-2044

**Thomas M. Egan,**  
Assistant Business Manager [212] 997-3140

**Carol Gallagher**  
Production Manager International [212] 997-2045

**Dorothy Carter,** Production Manager Domestic  
[212] 997-2908

**Frances Vallone,** Reader Service Manager  
[212] 997-6057

**Lisa Hoinig,** Secretary  
[212] 997-6481

### Electronics Buyers' Guide

**George F. Werner,** Associate Publisher  
[212] 997-3139

**Regina Hera,** Directory Manager  
[212] 997-2544

# Primo



## UD-876M Uni-directional Dynamic Microphone

The UD-876M microphone is a unidirectional cardioid dynamic microphone intended for the most demanding needs of professional musicians. The dynamic cartridge used in this microphone has been designed with the needs of the performer on stage in mind.

The wind screen provides exceptional rejection of both breath blast and wind sounds.

• For catalog, write to:

### PRIMO MICROPHONE INC.

2468 DELTA LANE, ELK GROVE VILLAGE  
ILLINOIS 60007, U.S.A. TEL: 312-595-1022  
TELEX: 28-3474 PRIMO MUS ELGR

### PRIMO COMPANY LIMITED

6-25-1 MURE, MITAKA-SHI, TOKYO, JAPAN  
TEL: 0422-43-3121~9  
TELEX: 2822-326 PRIMO J

Circle 232 on reader service card

## Exclusive Economic and Industry Studies

### For Financial Analysts, Corporate Planners, Business Economists, Marketing Executives

Geared directly to the future, our Department of Economics offers more than 40 forecasting tools to help project the general economy and industrial growth over the short and long run.

EXAMPLES: Do you know that the current operating rate for the chemical industry is 86%? For synthetic materials, the utilization rate is 93%? That construction and mining machinery new orders are expected to be 8% higher in 1974 than in '73? That steel expects a 3% decline in physical volume of sales in 1974? That consumer income after taxes will increase 8% in 1975?

At a modest cost, our various services covering most industrial segments of the economy are available to you.

For more information write for our booklet, "Exclusive Economic Studies," or phone Douglas Greenwald, Chief Economist, (212) 997-2216.

**Department of Economics**  
McGraw-Hill Publications Company  
1221 Avenue of the Americas  
New York, N.Y. 10020

