

SEPTEMBER 2, 1976

WESCON: MICROPROCESSORS DOMINATE THE BIG SHOW/114

Designing low-cost fiber-optic data-transmission systems/94

How to use the new 4,096-bit RAMs effectively/103

FOUR DOLLARS A McGRAW-HILL PUBLICATION

Electronics

1420 TCH598 MCSA9 SEP76
STATE TECHNICAL INST
FREEMAN LIBRARY 017823
5983 MACON COVE
MEMPHIS TN

38134

STATE TECHNICAL INSTITUTE
AT MEMPHIS
LIBRARY

LIBRARY
STATE TECHNICAL INSTITUTE
MEMPHIS

18

183

1835

18352

**MAKING CONVERSIONS
TEN TIMES
FASTER**

183526

THE SOLUTION TO YOUR NEXT EDP POWER DISTRIBUTION PROBLEM IS RIGHT BEFORE YOUR EYES

You're looking at six products that can solve a lot of problems.

When space is limited, our flat cables are just what you need. Installed in layers, they can follow the contours of almost any enclosure. Break-outs and terminations are easily and quickly made by mechanical means. And they're available in copper or aluminum strip with PVC or Tefzel insulation or as polyester laminated Brand-Rex TAPE CABLE®

A lot of other problems can be solved with our standard round wires and cables — many having dual UL/CSA ratings. They're available with conventional plastics, or irradiated PVC and polyethylene insulations. Brand-Rex has sold millions of feet of these products to leading CPU and peripheral equipment manufacturers around the world. We probably already make an EDP power distribution wire or cable that's just what you need. If we don't, we can design one for you. Just talk to your local Brand-Rex sales-engineer, or write or call Brand-Rex Company, Electronic and Industrial Cable Division, Willimantic, CT 06226. 203/423-7771.

BRAND-REX

ELECTRONIC & INDUSTRIAL CABLE DIVISION

Other Brand-Rex Divisions:
Abbott & Co., wiring harnesses
Nonotuck Manufacturing Co., copper wire
Pyle-National Co., electrical connectors
Telecommunications Cable Division
Teltronics, Inc., telephone equipment and components
Brand-Rex, Ltd. (Scotland), wire and cable

BRAND-REX CO., A PART OF Akzo® INCORPORATED

TAPE CABLE® — FLAT CONDUCTOR CABLE — 3 conductors — 12 AWG, polyester insulation. Available in other gauge sizes and number of conductors

PVCC® CABLE — TEFLON INSULATED SPLIT COPPER BUS. Also available with one insulated copper strip

PVCA® CABLE — PVC INSULATED ALUMINUM STRIP. Available in #16 to 2/0 AWG equivalent sizes

3 CONDUCTOR CABLE. Components: 12 AWG stranded, PVC insulated conductors

IRRADIATED PVC INSULATED #14 STRANDED CONDUCTOR

PVC INSULATED #10 AWG STRANDED CONDUCTOR

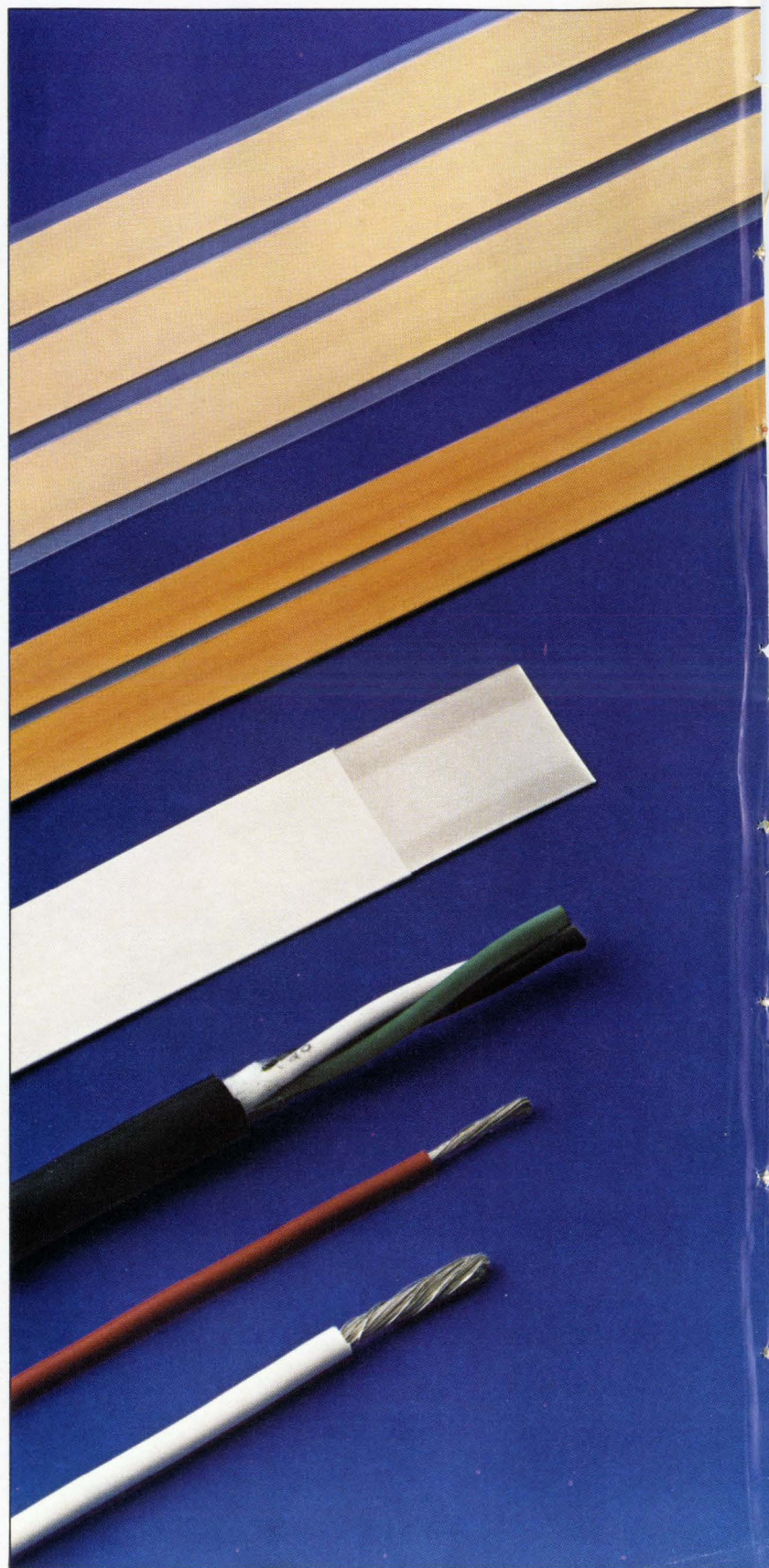

Circle 900 on reader service card

Let's talk about a way for you to save hours in microprocessor SOFTWARE DEBUGGING

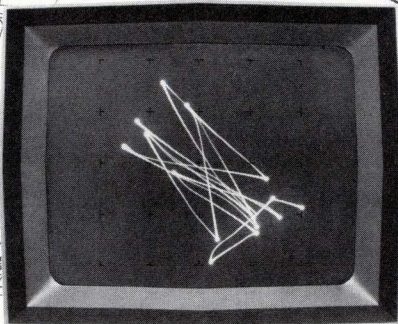
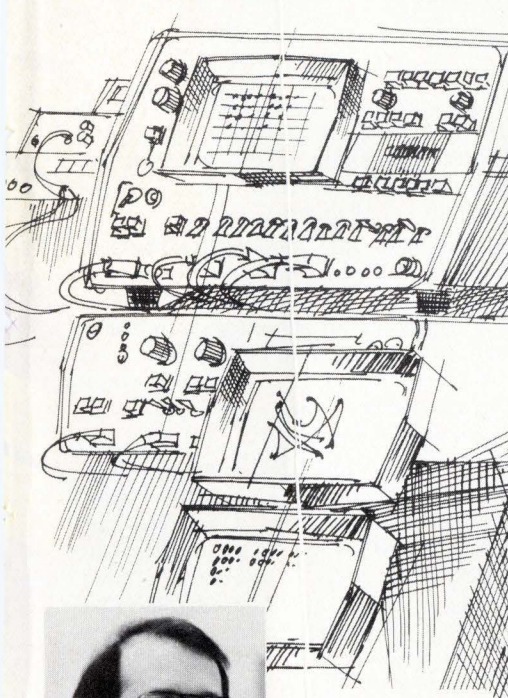

HP's 1600S Logic State Analyzer, in the MAP mode, lets you examine the unique "fingerprint" of every logic system.

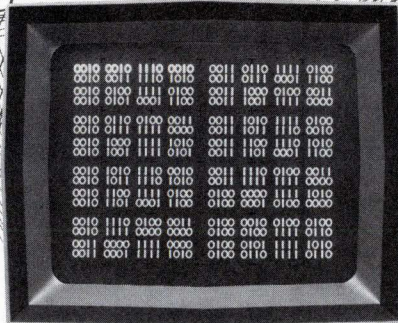

In the TABLE mode, the 1600S displays up to 16 lines of code, with their sequential relationships in familiar logic notation.



I mean many hours of savings if you've ever had this problem: You've just finished

your prototype microprocessor-based system, made the preliminary checks on the hardware, and loaded the program in RAM. You hit the start button. Everything's running smoothly, then wham! You're out of business. Things are out of sequence and the system is doing things you never intended. Now you could be in for hours—or even days—of troubleshooting.

But let me tell you about a much faster way to spot software problems... with HP's 1600S Logic State Analyzer. This instrument lets you look inside your operating circuit—right on the buses and qualifier lines—and see program implementation. That's the fastest way I know to locate software problems in operating circuits. Actually, the 1600S gives you two ways to view program flow:

Mapping. This is a dynamic view of your system's operation... a pattern of dots and lines that are unique for each program. Each dot is a specific data word. It's location indicates binary magnitude, and its brightness indicates relative frequency of occurrence.

You might call the map a personal fingerprint. It's different for every program. With a little practice, you can easily spot a suspicious pattern and locate the word or group of words that could be the trouble

source. Then you simply position a cursor over the word in question and push a front-panel switch to go to the Table display mode.

Table. The CRT now gives you a display of word flow using the word you selected as the trigger point. It displays up to sixteen 32-bit words at one time... in familiar One's and Zero's. You can look at events leading up to, surrounding, or following the trigger word. And even delay up to 99,999 clock cycles beyond the trigger point to view events anywhere in your program.

Suppose your problem is an erroneous data word that causes an unwanted jump. Mapping helps you spot the jump, and the Table mode lets you quickly compare each data word leading up to the jump with your written program.

That's just a simple example. HP's 1600S Logic State Analyzer, priced at \$7100*, can speed more complex software debugging problems too. We'd like to tell you more. And HP has arranged a number of seminars to make that possible. Find out how to attend one in your area by calling your local HP field engineer. He can also supply you with complete spec sheets and application notes detailing the use of mapping

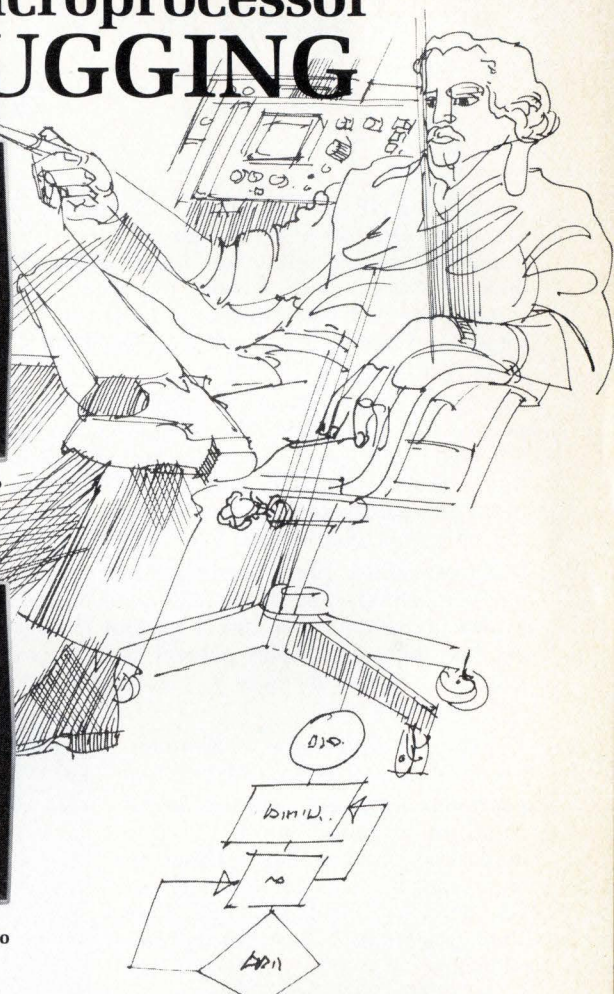

for troubleshooting minicomputer and microprocessor systems. You'll discover an exciting new concept in digital troubleshooting.
*Domestic U.S.A. price only.



086/7

HEWLETT  PACKARD

Sales and service from 172 offices in 65 countries.
1507 Page Mill Road, Palo Alto, California 94304

The right DVM Decision means >1 ppm resolution, HP-IB, and math... all for \$3200*.

Introducing HP's 3455A DVM—a microprocessor controlled DVM with high resolution and computational capability for the lab plus high speed and good noise rejection for systems use... complete with true r.m.s. ac to 1MHz, dc and ohms for \$3,200*. HP's new high-speed microprocessor gives the lab user:

5½ or 6½ digit resolution. Choose from the normal 5½ digit mode or the High Resolution 6½ digit mode for >1 part per million resolution... ideal for trimming, matching and balancing in the Standards lab. Wide bandwidth ac readings are always displayed with 5½ digit resolution.

Math capability. Enter constants into memory and you can offset readings, take ratios or scale a measurement to give direct readout in engineering units. Or, display percent error from a standard value in memory to speed calibration and inspection tasks.

But the microprocessor is also control oriented to give the systems user:

Fast reading. Read at rates up to 24/sec on dc ranges, up to 12/sec in the fast ac mode and up to 12/sec on ohms ranges. You get this high dc speed with >60 db normal mode noise rejection at line related frequencies.

Easy programming. Program by pushing front-panel buttons. That's right, program-code knowledge is not required. In the Binary Program Mode, the HP-IB (HP's implementation of IEEE's 488-75) compatible 3455A

automatically monitors front-panel control settings and reports their status to the controller, speeding and simplifying instrument programming. Front-panel indicators give complete instrument status at all times.

Removable reference and automatic calibration. Calibrate your 3455A on the spot. Now your DVM needn't go to the lab for dc and ohms calibration. Simply keep an extra reference on hand. Then, to calibrate, just pull one out... slip another in... and with HP's Auto Cal you're ready to go again in seconds.

And for both lab and systems:

Microvolt sensitivity and high accuracy. Read directly from thermocouples and other low-level sources... with >140 dB CMR. On dc you have 1 µV sensitivity, 10 µV on ac, and HP's Auto Cal provides dc accuracy of ±0.005% of reading + 1 digit) for 90 days by automatically measuring reference constants and digitally correcting readings. A test function signals out of tolerance constants and identifies the constant for rapid repair.

Plus convenient features and options. Choose either 2-wire k Ω or 4-wire k Ω measurements. Switch select 50 or 60Hz operation... front or rear panel inputs. And for \$200 less (\$3,000) you can substitute an average ac converter for the r.m.s. converter. Once you see the 3455A, you'll know it's the right system or lab DVM decision. Ask your local HP field engineer for all the details.

* Domestic U.S.A. price only.

**HP DVM's—
the right decision**



HEWLETT *hp* PACKARD

Sales and service from 172 offices in 65 countries.

1507 Page Mill Road, Palo Alto, California 94304

For assistance call: Washington (301) 948-6370, Chicago (312) 677-0400, Atlanta (404) 434-4000, Los Angeles (213) 877-1282, Toronto (416) 678-9430

Circle 2 on reader service card

29 Electronics Review

MILITARY: Two-way data link teams up the E-2C and F-14, 29
HYBRIDS: Standard circuits meet promise of high volume, 30
CONSUMER: Heath adds game kit for TV receivers, 31
COMPANIES: Costs, financing problems are too much for Datran, 32
MICROWAVES: Fine geometry improves transistors, 32
MICROPROCESSORS: Intel eases use of high-level language, 34
NEWS BRIEFS: 36
AIR-TRAFFIC CONTROL: System detects dangerous aircraft wakes, 36
CITIZENS' BAND: Problems accompany move to 40 channels, 38
COMPANIES: Rockwell shifts product emphasis, 40

61 Electronics International

JAPAN: Toshiba markets country's first 8-bit microcomputer chip, 61
AROUND THE WORLD: 61

67 Probing the News

IEEE: Professional program wins few cheers, 67
AUTOMOTIVE: Big Three take different roads to microprocessor, 70
MEMORIES: Conferees close in on 16-k standards, 76
MINICOMPUTERS: Shortage of field technicians looms, 79

89 Technical Articles

INSTRUMENTS: Error correction speeds a-d conversion tenfold, 89
COMMUNICATIONS: Fiber-optic data transmission is practical, 94
DESIGNER'S CASEBOOK: Tunable notch filter suppresses hum, 100
PROM decoder replaces chip-enabling logic, 100
MEMORIES: Check list for 4,096-bit RAMs flags likely problems, 103
ENGINEER'S NOTEBOOK: Programable calculator finds spurs 108
Log-ratio module measures high resistances, 109
WESCON: Microprocessors dominate scene at sold-out show, 114
Computers, 116
Instruments, 117
Communications, 118
Production, 119
Components, 119
New-product preview, 131

151 New Products

IN THE SPOTLIGHT: Character generator fits on chip, 151
INSTRUMENTS: True-rms-meter prices drop, 152
DATA HANDLING: Mini offers 600-ns cycle time, 165
SEMICONDUCTORS: Chip controls two motors, 177
SUBASSEMBLIES: Camera uses CCD array, 190
MATERIALS, 202

Departments

Publisher's letter, 4
Readers' comments, 6
News update, 10
Editorial, 12
People, 14
Meetings, 20
Electronics newsletter, 25
Washington newsletter, 51
Washington commentary, 52
International newsletter, 64
Engineer's newsletter, 112
New literature, 206

Highlights

Cover: Making a-d conversions faster, 89

High-resolution analog-to-digital conversion no longer needs to slow the work of digital multimeters and voltmeters. A new error-correcting technique permits the subtraction, as well as addition, of correction values to successive results in the conversion process. The result is conversion in as little as a tenth of the time of previous instruments.

Cover is by Art Director Fred Sklenar.

Professional-activities plan draws boos, 67

Reaction to the revised professional-activities plan of the Institute of Electrical and Electronics Engineers is not overwhelmingly enthusiastic. The focus of the complaints is the apparent lack of action in the plan's five goals.

Standard hardware is key to optical systems, 94

Off-the-shelf cables and components make fiber-optic transmission systems a practical reality. An experimental system demonstrates the low cost and high performance possible, while pointing to cost-effective improvements for large operating systems of the future.

Wescon may be standing room only, 114

It could look like the 1960s at the Sept. 14-17 Wescon in Los Angeles, where the show will be the biggest in at least six years. The ubiquitous microprocessor will dominate both technical program and exhibits. Our Wescon overview and program guide is followed by a sampling of new products at the show.

And in the next issue . . .

A master-slave arrangement of processors forms a universal microcomputer-development system . . . more about the 8500A microprocessor-based test system . . . how to analyze the performance of fiber-optic transmission links.

EDITOR-IN-CHIEF: Kemp Anderson

EXECUTIVE EDITOR: Samuel Weber

MANAGING EDITOR: Arthur Erikson,
International

SENIOR EDITORS: Laurence Altman,
Ray Connolly, Lawrence Curran,
John Johnsrud, H. Thomas Maguire,
Stephen E. Scrupski

ART DIRECTOR: Fred Sklenar

ASSOCIATE EDITORS: Howard Wolff,
Gerald M. Walker, Alfred Rosenblatt

DEPARTMENT EDITORS
Aerospace/Military: Ray Connolly
Circuit Design: Don Blattner
Communications & Microwave:
Richard Gundlach
Components: Lucinda Mattered
Computers: Stephen E. Scrupski
Consumer: Gerald M. Walker
Instrumentation: Andy Santoni
New Products: H. Thomas Maguire,
Michael J. Riezenman
Packaging & Production: Jerry Lyman
Solid State: Laurence Altman

CHIEF COPY EDITOR: Margaret Eastman

COPY EDITORS: Everett C. Terry, Ben Mason

ART: Charles D. Ciatto, *Associate Director*
Paula Piazza, *Assistant Director*

EDITORIAL SECRETARIES: Janet Noto,
Penny Roberts, Marilyn B. Rosoff

FIELD EDITORS

Boston: Lawrence Curran (Mgr.), Pamela Leven
Los Angeles: Larry Waller (Mgr.)
Midwest: Larry Armstrong (Mgr.)
New York: Bruce LeBoss (Mgr.)
San Francisco: Bernard Cole (Mgr.)
Judith Curtis
Washington: Ray Connolly (Mgr.)
Frankfurt: John Gosch
London: William F. Arnold
Paris: Arthur Erikson
Tokyo: Charles Cohen

McGraw-Hill World News

Editor: Michael Johnson
Brussels: James Smith
Madrid: Dom Curcio
Milan: Andrew Heath
Moscow: Peter Gall
Paris: Joel Stratte-McClure
Stockholm: Robert Skole
Tokyo: Colin Gibson

PUBLISHER: Dan McMillan

DIRECTOR OF MARKETING: Pierre J. Braudé

MARKETING ADMINISTRATION MANAGER:
Wallis Clarke

CIRCULATION MANAGER: Nancy L. Merritt

MARKETING SERVICES MANAGER:
Tomlinson Howland

RESEARCH MANAGER: Margery D. Sholes

"An engineer can always make a circuit work," says Joe Reedholm, "but it takes time to make it work consistently well in products coming off the assembly line." The circuit for the high-speed analog-to-digital converter, described by Reedholm and Riekus Koeman of John Fluke Manufacturing Co. in the article on page 89, is no exception.

Reedholm, who has just moved to Keithley Instruments, discussed the idea of incorporating bidirectional error correction to the a-d converter in a digital multimeter with his engineering group at Fluke early in 1972. "It looked like we could gain conversion speed with no increase in sensitivity to noise," he says. After some initial talks, Koeman began a feasibility study, and by mid-1973 he had proven that the circuit worked, that it could be built—but that it was costly to implement.

These early circuit designs, however, did not include microprocessor control, and when low-cost one-chip devices became available, the bidi-

rectional error-correcting technique became economically feasible. Two more Fluke engineers then became involved in the project. Dean Ballard, who now is a consultant to Fluke, designed the microprocessor-controlled version of the circuit. Bob Hatch, whose article on the flexible module-and-bus structure of the 8500A multimeter will appear in the next issue, developed the intelligent instrument itself.

By the middle of 1975, they had proved out the unit's basic design, but some bugs remained. For example, stray capacitances were causing nonlinearities, and Ray Kletke, project manager for power sources and calibrators, was called in. Kletke's experience with precision circuits helped in making such corrections as keeping leads short to minimize the effects of dielectric absorption.

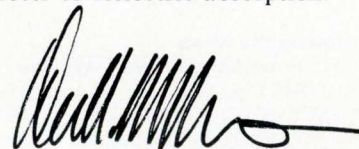

We're looking for editors

We can provide an exciting and rewarding career opportunity for two enterprising engineers with writing skills. There are currently two openings on the New York editorial staff of *Electronics*:

- **Industrial electronics editor.** Will travel extensively, interview the people who are applying electronic technology to industrial controls and processes, and will write and edit technical articles and news stories on the expanding technology of industrial electronics.
- **Circuit design editor.** Must be adept at modern analog and digital circuit design and analysis, and be able to evaluate circuits for accuracy and innovativeness.

Candidates should have at least a BSEE and substantial engineering experience. If you're interested, send résumé and salary requirements to: Executive Editor, *Electronics*, 1221 Avenue of the Americas, New York, N.Y. 10020.

September 2, 1976 Volume 49, Number 18
100,240 copies of this issue printed

Published every other Thursday by McGraw-Hill, Inc. Founder: James H. McGraw 1860-1948. Publication office 1221 Avenue of the Americas, N.Y., N.Y. 10020; second-class postage paid at New York, N.Y., and additional mailing offices.

Executive, editorial, circulation and advertising addresses: *Electronics*, McGraw-Hill Building, 1221 Avenue of the Americas, New York, N.Y. 10020. Telephone (212) 997-1221. Teletype 12-7950 TWX 710-581-4879. Cable address: MCGRAWHILLNEWYORK.

Subscriptions limited to professional persons with active responsibility in electronics technology. Publisher reserves the right to reject non-qualified requests. No subscriptions accepted without complete identification of subscriber name, title, or job function, company or organization, and product manufactured or services performed. Subscription rates: in the United States and possessions \$12.00 one year, \$30.00 three years; Canada and Mexico \$14.00 one year, \$32.00 three years; Europe \$35.00 one year, \$87.50 three years; Japan, Israel and Brazil \$60 per year; Australia and New Zealand \$80.00 per year, including air freight; all other countries \$40.00 per year. Limited quota of subscriptions available at higher than basic rate for persons outside of field served, as follows: U.S. and possessions and Canada \$25.00 per year; Europe \$40.00; Japan, Israel and Brazil \$85.00; all other countries \$50.00. Single copies: \$4.00. Please allow four to eight weeks for shipment.

Officers of McGraw-Hill Publications Company: Gordon L. Jones, President; Paul F. McPherson, Executive Vice President; Gene W. Simpson, Group Vice President; Senior Vice Presidents: Ralph Blackburn, Circulation; John B. Hoglund, Controller; Ralph R. Schulz, Editorial; David G. Jensen, Manufacturing; Vice Presidents: James E. Boddorf, Planning & Development; Edward E. Schirmer, Marketing Administration.

Officers of the Corporation: Harold W. McGraw, Jr., President, Chief Executive Officer, and Chairman of the Board; Robert N. Landes, Senior Vice President and Secretary; Ralph J. Webb, Treasurer.

Title registered in U.S. Patent Office; Copyright © 1976 by McGraw-Hill, Inc. All rights reserved. The contents of this publication may not be reproduced in whole or in part without the consent of copyright owner.

Subscribers: The publisher, upon written request to our New York office from any subscriber, agrees to refund that part of the subscription price applying to copies not yet mailed. Please send change-of-address notices or complaints to Fulfillment Manager; subscription orders to Circulation Manager, *Electronics*, at address below. Change-of-address notices should provide old as well as new address, including postal zip code number. If possible, attach address label from recent issue. Allow one month for change to become effective.

Postmaster: Please send form 3579 to Fulfillment Manager, *Electronics*, P.O. Box 430, Hightstown, N.J. 08520.

from **KEPCO** by **TDK**

the series

RMK

25 KHz SWITCH-MODE POWER SUPPLIES

- 75% efficiency
- 90-130V a-c input (brownout protection)
- d-c input
- ±10% output adjustment
- adjustable current limit
- adjustable overvoltage
- logic level on-off
- 1 millisecond recovery
- < 2% envelope, (load, line and temperature)
- 50°C rating (uprating for lower temperature)

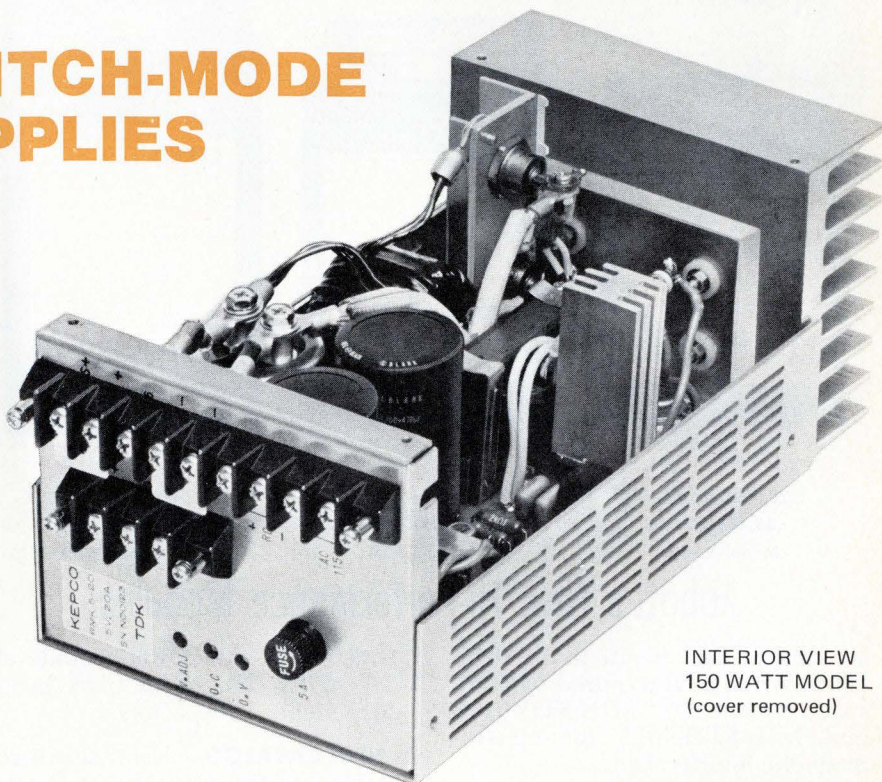

INTERIOR VIEW
150 WATT MODEL
(cover removed)

BLOCK DIAGRAM OF
THE RMK SWITCH-MODE
POWER SUPPLY

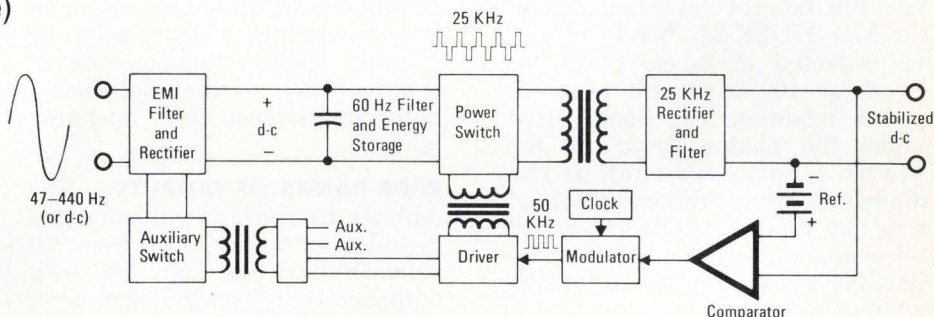

AVAILABLE OUTPUT
RATINGS FOR THE
KEPCO RMK MODELS

Volts	5V	9V	12V	15V	24V	SIZE	WGT.	PRICE
Amps	10A	6A	5A	4A	2A	2 3/16" x 5 1/8" x 7 1/2"	3.0 lbs.	\$210.00
Amps	20A	10A	8A	8A	4A	3 9/32" x 5 1/8" x 8 3/4"	4.75 lbs.	299.00
Amps	30A	16A	12A	12A	6A	4 1/16" x 5 1/8" x 8 3/4"	5.25 lbs.	399.00

CALL YOUR KEPCO REP FOR AN IMMEDIATE DEMONSTRATION ask him to show you the clean layout, the cool operation, the silent performance. Put an RMK to your test, check the excellent stability, the low noise, the rapid response. Compare Kepco's 5-year warranty.

Call or write Department FL-14
for a 4-page Specification Folder.

KEPCO®

When You Buy a Power Supply, Why Not Get the Best?



28 VDC to DC
(55,463 Hrs.)
Model C95D

28 VDC to 400 A
(61,387 Hrs.)
Model S3D

400 A to DC
(56,148 Hrs.)
Model W5D

Abbott's New Hi-Performance Modules

are designed to operate in the stringent environment required by aerospace systems — MIL-STD-810B and MIL-STD-461A for electromagnetic interference.

RELIABILITY — MTBF (mean time between failures) as calculated in the MIL-HDBK-217 handbook can be expected in excess of 50,000 hours at 100°C for all of these power modules. The hours listed under the photos above are the MTBF figures for each of the models shown. Additional information on typical MTBF's for our other models can be obtained by phoning or writing to us at the address below.

QUALITY CONTROL — High reliability can only be obtained through high quality control. Only the highest quality components are used in the construction of the Abbott power module. Each unit is tested no less than **41 times** as it passes through our factory during fabrication — tests which include the scru-

tinizing of the power module and all of its component parts by our experienced inspectors.

NEW CATALOG—Useful data is contained in the new Abbott Catalog. It includes a discussion of thermal considerations using heat sinks and air convection, a description of optional features, a discussion of environmental testing, electromagnetic interference and operating hints.

WIDE RANGE OF OUTPUTS — The Abbott line of power modules includes output voltages from 5.0 volts DC to 740 volts DC with output currents from 2 milliamperes to 20 amperes. Over 3000 models are listed **with prices** in the new Abbott Catalog with various inputs:

- 60A to DC
- 400A to DC
- 28 VDC to DC
- 28 VDC to 400A
- 12-28 VDC to 60 A

Please see pages 1037-1056 Volume 1 of your 1975-76 EEM (ELECTRONIC ENGINEERS MASTER Catalog) or pages 612-620 Volume 2 of your 1975-76 GOLD BOOK for complete information on Abbott Modules.

Send for our new 60 page FREE catalog.

abbott transistor

LABORATORIES, INCORPORATED
general offices eastern office

5200 W. Jefferson Blvd./Los Angeles 90016
(213) 936-8185 Telex: 69-1398

1224 Anderson Ave./Fort Lee, N.J. 07024
(201) 224-6900 Telex: 13-5332

SEE US AT WESCON/76 SHOW IN LOS ANGELES, Booth NO. 1057

Readers' comments

Feerst can't lead

To the Editor: I disagree with the premise in your July 22 article "Who will lead the IEEE into change?" [p. 78] that the presidential election is a contest among three candidates of equal leadership ability but with differences in platform and style. I have serious questions about Irwin Feerst's ability to lead or responsibly represent the Institute of Electrical and Electronics Engineers.

Past leadership in the IEEE is the only meaningful measure I know to predict future performance. The board-nominated candidates, Robert Saunders and Robert Briskman, and the petition candidates, Robert Rivers and Carleton Bayless, each have an impressive record of leadership within the IEEE. But Feerst's record only includes a short-lived membership on the professional-activities committee of Long Island. His complete alienation from all levels of IEEE leadership will make it impossible for him to achieve any substantial progress toward professional goals within the organization.

Although you may be accurate in your reporting, readers may derive the over-simplified impression of abrasive Feerst, idealistic Rivers, and affable Saunders. You describe Feerst as abrasive, but he is also abusive. His scapegoat tactics, confrontation politics, and flamboyant actions make good copy, but poor presidential material.

You describe Rivers as given to "elaborate analysis and lists of ideal goals," but he is an activist on behalf of professional activities. You do not mention his positive record of achievements in promoting professionalism within the IEEE. In 1971 he advocated the changes in the constitution which paved the way for the U.S. activities board, where he plays a strong role in addition to his activities as a technical director.

You describe Saunders as an "affable educator," but he is also an eminent consultant for industry and government. His leadership ability in bringing together diverse elements for constructive action has been demonstrated in his activities on

PMI's Universal DAC.

**The stuff
dreams are
made of.**

The DAC-08 is more than the world's fastest monolithic DAC (settling in 85 nsec. typ.); it is a true current output device . . . a *digitally controlled current source*. And it features true 8-bit accuracy: **1/2LSB max. over temp.**

It can deliver wide output voltage swings without loss of linearity, since its impedance approaches infinity.

The DAC-08 is universal in its applications because its logic threshold is universal. It accepts TTL, CMOS, P- and N-MOS—any digital input. It's right at home in μ P designs. And if you're interested in 4-quadrant multiplication, you'll want to know that you can do it with only two DAC-08's.

Free Sample

If you just want the data sheet, circle the number below. But if you would like to run some tests on a DAC-08, write us on your letterhead and tell us what your application is. We'll get a sample to you fast, along with appropriate Application Notes.



Precision Monolithics, Inc.

1500 Space Park Drive,
Santa Clara, CA 95050
(408) 246-9222, TWX: 910-338-0528
Cable MONO.
Circle 7 on reader service card

UNIVERSAL LOGIC INTERFACE
DIGITAL FILTERS
FOUR QUADRANT ALGEBRAIC FUNCTIONS
PROGRAMMABLE SUPPLIES
VIDEO DECODING
DIGITAL MULTIPLICATION
Line Driving
4-quadrant multiplication
Digital Gain Control
DIFFERENTIAL INPUT A/D CONVERTER
DIGITAL DIVISION



Break your analyzer bottleneck

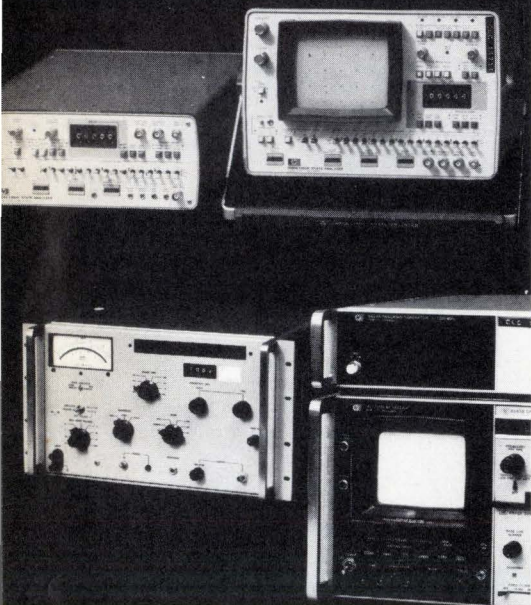

Today's best may be second-best tomorrow! If you're pushing the state-of-the-art and need the latest in speed, range and accuracy call the "Instrument Professionals". We can deliver the best available and replace it immediately when a better one comes along.

Write or call for data on our other specialties: Instrument Leasing • Computer Peripherals • Equipment Sales • Instrument Service.

Call Continental Rentals

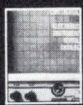

Get our FREE Catalog

Div. Continental Leasing Co., Inc.
175 Middlesex Turnpike, Bedford, MA, 01730 (617) 275-0850

Metuchen, NJ (201) 549-8500;
Gaithersburg, MD (301) 948-4310; TX (214) 357-1779; Elk Grove, IL (312) 439-4700; Costa Mesa, CA (714) 540-6566; Santa Clara, CA (408) 735-8300; Los Angeles, CA (213) 477-7521

Circle 8 on reader service card

Readers' comments

behalf of the educational-activities board and as vice president for regional activities.

Thelma Estrin
president-elect, IEEE engineering in medicine and biology group
■ *The IEEE ballots are scheduled to be mailed by Sept. 1 and must be returned by Nov. 1.*

Competition must be limited

To the Editor: Your editorial "Legislating competition out of telecommunications" [June 10, p. 10], although based on reported facts, concluded with the hope "that Congress will reject limitations on telecommunications competition." This hope is unreasonable in its comprehensive nature.

Much experience and other evidence has shown that unlimited competition is bad—not good—in the public-service field, which includes telecommunications. The problem for Congress will be to establish, in the public interest, the specific limitations on competition, rather than whether there will be competition. Certainly there will be competition among telecommunications companies in the future at least to the degree it has existed in the past.

The primary goal of Congress while establishing the future limitations on competition will be to enable full realization in the U.S. of the best attainable telecommunications services at the least cost consistent with fair treatment of the employees, stockholders, and customers of the telecommunications companies. Limited competition will be only one of many factors involved in realizing this goal.

Henry H. Abbott
retired director,
customer telephone
systems laboratory
Bell Telephone Laboratories

Correction

In the Designer's Casebook "One-op-amp oscillator keeps sine-wave amplitude constant" [June 24, p. 107], the thermistor is model 32A3 from Victory Engineering Corp.

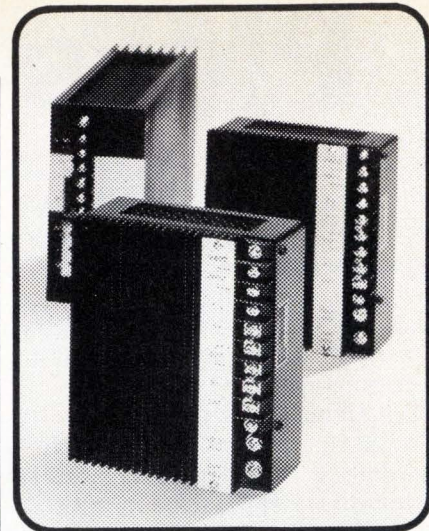

SWITCHING POWER SUPPLIES

- **COMPACT AND LIGHT-WEIGHT!**
- **LOWER PRICE WITH HIGHER RELIABILITY!**
- **SIMPLER CIRCUITS BUT HIGHER EFFICIENCY!**

MODEL NO.	OUTPUT VOLTAGE (V)	OUTPUT CURRENT (A)
YP-0510A	5	10
YP-0525A		25
YP-0550A		50
YP-1204A	12	4
YP-1210A		10
YP-1220A		20
YP-1504A	15	4
YP-1510A		10
YP-1520A		20
YP-2402A	24	2
YP-2405A		5
YP-2410A		10
YP-3002A	30	2
YP-3005A		5
YP-3010A		10

Sole Distributor:
WAMCO Technical Sales, Inc.
705 W. 16th St. Costa Mesa
Calif. 92627, U. S. A.
Tel. No. (714)-833-9361 or
(714)-642-5100
TELEX No. 678-459.

YUTAKA ELECTRIC MFG. CO., LTD.
No. 228 KARIYADO NAKAHARA-KU, KAWASAKI
CITY KANAGAWA PREF-211 JAPAN
TELEX: J22890 CABLE: TLX-J22890 YUTACO

Circle 224 on reader service card

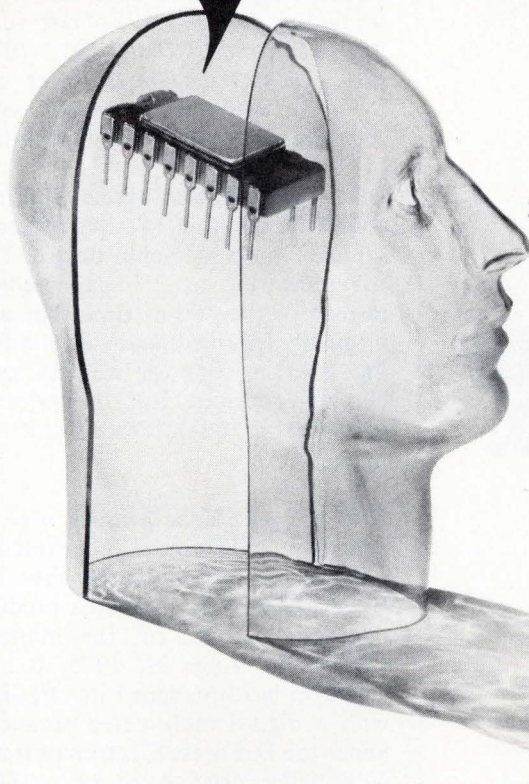
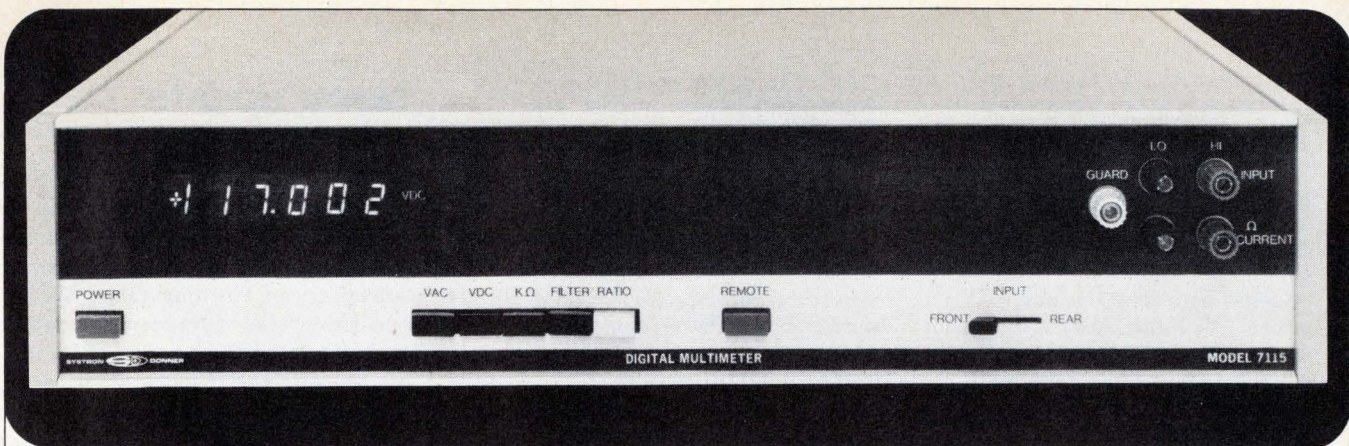

Go SDVM*

*Systron-Donner "smart" DVM

Meet Model 7115, the industry's first **microprocessor**-based digital multimeter. It does what no conventional DVM could hope to do:

Automatic zero/self calibration. Using its computing power and built-in memory, Model 7115 continually calibrates itself against drift and component aging. Similarly,

it detects and corrects for zero drift and offset error. Result: accurate readings all the time!

Self-diagnosis. Microprocessor power again. Out-of-limit conditions or failures are signalled

on the front panel; internal LED's direct the operator to their location inside.

High-speed autoranging. A rapid new S-D autoranging technique finds the correct range, goes there immediately and reads. It's not only a big improvement for bench use, but systems users can now use autoranging.

Command performances. An optional keyboard for programming the Model 7115 allows it to linearize and normalize, run comparison programs for checking out-of-tolerance conditions, multiply by a constant, average readings... and much more.

These features, too. Up to 100 readings/sec. • DC accuracy of $\pm 0.002\%$ rdg. • Parallel programming or ASCII option • True RMS AC volts option • High accuracy resistance measuring option.

Get the full story on the first SDVM from Scientific Devices, or contact us at 10 Systron Drive, Concord, California 94518. Phone (415) 676-5000. Overseas, contact Systron-Donner in Munich; Leamington Spa, U.K.; Paris (Le Port Marly); Melbourne.

SYSTRON  DONNER

Disc has made it easy for the OEM using optical encoders in small quantities to realize costs in the same low range as the big users—like under \$100.00.

We've maintained the same high order of resolution, accuracy, and reliability found in our more expensive units for this new EC series. "EC," obviously, is our economy model, but it could also stand for exceptional capabilities. Here's what you get for your \$99 (much less in quantity):

- LED source
- 20 to 1024 pulses / revolution
- Differential electronics
- Square wave output
- ± 2.5 minutes accuracy
- Solar cell light sensors
- Instrument bearings
- 1/4" shaft for interfacing

THE PRICE OF OPTICAL ENCODERS JUST PLUMMETED.



Translated into benefits, these features mean the Disc EC ROTASWITCH® Encoder gives you superior performance, a long service life, and a unit cost you just can't touch.

That's the model EC 81. It has a single channel output. If you need dual channel, we also offer the EC 82 at \$125.00 in single quantities. It too plummets to well under \$100.00 in quantity.

A new spec sheet is just off the press—write or call for your copy. Immediate questions can be answered by calling 714/979-5300.

Disc Instruments, Inc., 102 East Baker Street, Costa Mesa, CA 92626.



News update

■ Scientific Micro Systems of Sunnysvale, Calif., wanted to get into the single-chip microprocessor business. The designers at the company, a subsidiary of Corning Glass Works, considered the alternatives open to them and decided to take the shortest route to the market: they simply "unbundled" their MicroController system. The bipolar unit has been offered as part of a controller on a printed-circuit board. So last summer [*Electronics*, Aug. 21, 1975, p. 26], SMS began to offer the Schottky TTL microprocessor as a separate part in a 48-pin dual in-line package.

The move was a success, says the company, pointing to sales of thousands of the single-chip device. The part now runs at 250 nanoseconds instead of the 300-ns time that was originally specified, and SMS is offering asynchronous as well as synchronous devices. But the price is still \$90 in quantities of 100 or more.

■ In the year since he took over as president of Dumont Oscilloscope Laboratories, John Carter has led the firm away from its sole product line, oscilloscopes for the military [*Electronics*, Aug. 21, 1975, p. 14]. The firm has broadened its offerings with a digital multimeter produced under the DeForest Electronics trade name [*Electronics*, April 29, p. 160], as well as the year-old line of commercial scopes.

"The best mover we have right now is the 100-megahertz-bandwidth commercial scope [model 1100P]," says Carter, "and we're trying to come up with a line of low-cost test equipment to complement the DMM." Soon to be introduced is a 10-megahertz scope with a 3-inch screen, and a frequency counter is on the drawing boards.

Progress on the new lines has been steady, but not as fast as expected because, admits Carter, "we don't have the biggest engineering department in town." But encouraging sales of the DMM—8,000 in the first three months—have convinced Carter that the firm can be successful in the commercial market.

Problem:

You need more than a card frame.

Solution:

See Bud's new system. It not only provides card carrying capacity, but also affords modular packaging.

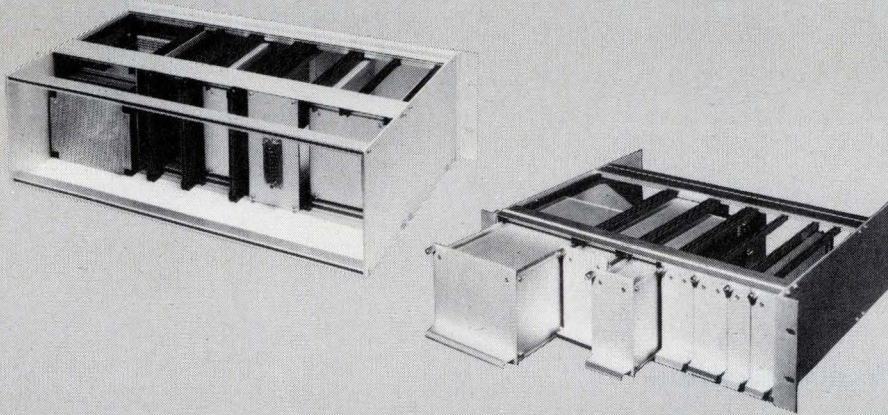

Our new modular packaging system is the most versatile on the market. We know you'll agree when you see it. Eight sizes take 44 different size modules. Yet, the design is simple. Components are easily assembled, easily modified. Your Bud representative will demonstrate it anytime. **YOUR PROBLEM IS SOLVED!**

Call toll free:

(800) 321-1764 for more facts. In Ohio, (800) 362-2265.

BUD

BUD RADIO, INC.
Willoughby, Ohio 44094

Now in stock at your Bud distributor.

Call for a demonstration today!

ALABAMA

Birmingham -
James W. Clary Co.
205-322-2486

ARKANSAS

Little Rock -
Carlton Bates Co.
501-562-9100

CALIFORNIA

Chatsworth -
Westates Electronics Corp.
213-341-4411
Los Angeles -
Radio Product Sales, Inc.
213-748-1271
Mountainview -
Elmar Electronics, Inc.
415-961-3611
Riverside -
Electronic Supply
714-787-9220

COLORADO

Denver -
Electronic Parts Co.
303-744-1992
Newark Electronics
303-757-3351

FLORIDA

Orlando -
Hammond Electronics, Inc.
305-849-6060

GEORGIA

Atlanta -
Lykes Electronics
404-355-2223

ILLINOIS

Chicago -
Newark Electronics
312-638-4411

Palatine -
Ohm Electronics
312-359-5500
Peoria -
Klaus Radio, Inc.
309-691-4840

INDIANA

Indianapolis -
Graham Electronics
Supply, Inc.
317-634-8486
Ra-Dis-Co., Inc.
317-637-5571

KANSAS

Wichita -
Radio Supply Co., Inc.
316-267-5213

LOUISIANA

Lafayette -
Ralphs of Lafayette, Inc.
318-234-4507

MARYLAND

Gaithersburg -
Pioneer/Washington
Electronics, Inc.
301-948-0710
Rockville -
Capitol Radio
Wholesalers, Inc.
301-881-2270

MASSACHUSETTS

Dedham -
Gerber Electronics, Inc.
617-329-2400
West Newton -
A. W. Mayer Co.
617-277-3577

MICHIGAN

Ann Arbor -
Wedemeyer
Electronic Supply
313-665-8611
Detroit -
RS Electronics
313-491-1000
Livonia -
Pioneer/Michigan
313-525-1800

MINNESOTA

St. Paul -
Gopher Electronics Co.
612-645-0241

MISSOURI

Kansas City -
Walters Radio Supply, Inc.
816-531-7015

NEW MEXICO

Albuquerque -
Walker Radio Co.
505-247-2288

NEW YORK

Binghamton -
Harvey Federal
Electronics
607-748-8211
E. Farmingdale -
Harrison Electronics
516-293-7990
Lynbrook, L.I. -
Peerless Radio Corp.
516-593-2121

NORTH CAROLINA

Winston-Salem -
Kirkman Electronics, Inc.
919-722-9131

OHIO

Cleveland -
Pioneer/Cleveland
216-587-3600
Cincinnati -
Hughes-Peters, Inc.
513-351-2000
Columbus -
Hughes-Peters, Inc.
614-294-5351
Dayton -
Pioneer/Dayton
513-236-9900
Solon -
Radio & Electronic
Parts Corp.
216-248-8900

OKLAHOMA

Tulsa -
Oil Capitol
Electronics Corp.
918-836-2541

PENNSYLVANIA

Allentown -
A. A. Peters, Inc.
215-434-5237
Montgomeryville -
Pytttronic Industries, Inc.
301-792-7000
Philadelphia -
Almo Electronics Corp.
215-698-4000
Pittsburgh -
Cam/RPC Electronics
412-782-3770
Pioneer/Pittsburgh
412-782-2300

SOUTH CAROLINA

Columbia -
Dixie Radio
Supply Co., Inc.
803-779-5332

TENNESSEE

Memphis -
Bluff City Electronics
901-725-9500
Nashville -
Electra Distributing Co.
615-329-3971

TEXAS

Dallas -
Wholesale
Electronic Supply
214-824-3001
Ft. Worth -
Swieco, Inc.
817-335-6521
Houston -
Harrison Equipment Co.
713-652-4750
San Antonio -
Sherman Electronics
Supply, Inc.
512-224-1001
UTAH
Salt Lake City -
Standard Supply Co., Inc.
801-466-3371

VIRGINIA

Charlottesville -
Virginia Radio
Supply Co., Inc.
804-296-4184

WASHINGTON

Seattle -
Almac/Stroum
Electronics, Inc.
206-763-2300

A slow start for IEEE's professional activities

The Institute of Electrical and Electronics Engineers is still struggling to get an effective, generally acceptable professional activities program off the ground. The members at large, to judge by their initial reaction, are still far from satisfied with the five-goal 1976 program plan developed by the institute's 16-member U.S. activities board. In fact, their generally critical reception of the plan is yet another illustration of the basic problem: the poor communications that exist between the membership and its current leadership.

Although it was a good—if quite obvious—idea to circulate the details of the plan to the general membership, and to publish them in the institute's magazine, *Spectrum*, we have to agree with many members who are wondering why more of them weren't given a chance to participate in forming the plan in the first place.

One critic, more harshly, feels that the U.S. activities board has effectively shut out members till now. "The board went into a secret laboratory to invent a new profession—engineering—and upon emerging is surprised the results have no resemblance to the real world," he says.

His assessment may be too severe, but it's still a reading of the grass-roots sentiment

on how the IEEE operates. Its perception is that communications between those at the top is excellent, but somewhere between membership and leadership there's an open circuit.

The board, chaired by James H. Mulligan Jr., a professor at University of California, admittedly includes six appointed members at large, as well as six regional directors, three technical-division directors, and some assistants from IEEE's headquarters staff. But despite Mulligan's efforts, the feeling seems to be widespread that the board is still really not representative of the average engineer, who is, after all, the one with the most at stake in the planned professional-activities program.

Part of the problem may be that comments on the plan were solicited only from section chairmen and chairmen of local professional-activities committees, which vary enormously in quality and interest. But if the IEEE is to overcome the disenchantment and, even worse, the apathy of many of its members, a way must be found to give those members who will be most affected by projected programs greater participation in planning them. There needs to be much more input to headquarters "establishment" from the membership at large.

our high density rack & panel connectors do it with one contact.

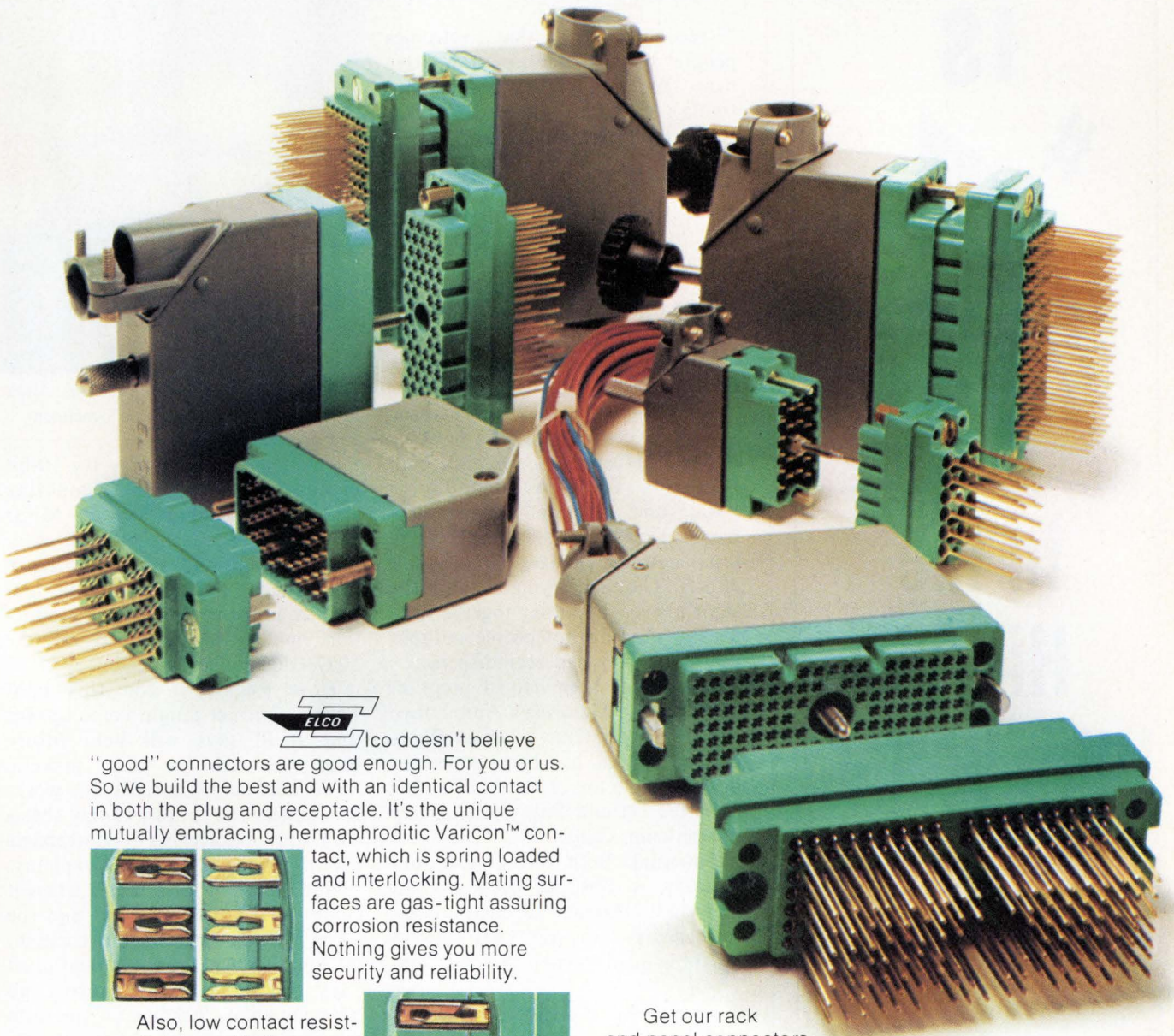

Elco doesn't believe "good" connectors are good enough. For you or us. So we build the best and with an identical contact in both the plug and receptacle. It's the unique mutually embracing, hermaphroditic Varicon™ contact, which is spring loaded and interlocking. Mating surfaces are gas-tight assuring corrosion resistance. Nothing gives you more security and reliability.

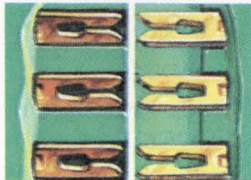

Also, low contact resistance is inherent in the Varicon contacts spring action. Tests show that in some applications, contact resistance even decreases after a number of mating and unmating cycles. All this contributes to a high current capacity. And Varicons' large mating surfaces exert positive pressure to assure resistance to shock and vibration.

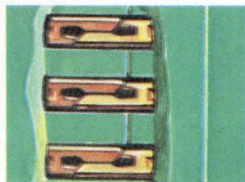

It's an important list of advantages — all yours in a wide range of connector configurations, no matter what your needs.

Get our rack and panel connectors with a variety of grid patterns, in sizes ranging from 20 to 165 contacts, with steel, aluminum and molded covers.

Elco can match the right high density rack and panel connector to do the job you want done at a competitive price and with fast delivery. And thanks to Varicon, we'll do it with one contact.

"GREAT CONNECTIONS . . . WORLDWIDE"

Elco Corporation
2250 Park Place, El Segundo, Ca. 90245
213-675-3311 / TWX 910-325-6602



Elco Corporation

A GULF + WESTERN MANUFACTURING COMPANY

RCL

is

#1

in the Hi Rel Wire-Wound Resistor Field!

RCL has more military approvals on power and precision fixed wire-wound resistors than any other manufacturer.

AMF

RCL Electronics

195 McGregor St.
Manchester, N.H. 03102
(603) 627-3831

People

Rockwell, Motorola organize for auto-electronics business

"I recognize clearly that electronics people cannot define automotive firms' functional needs," says Motorola's Willard E. Hauth Jr. And at Rockwell International, H.A. Beall observes, "It's more difficult for us to understand how an auto company works than for them to understand our microprocessors." These two statements, made by officials in new posts at semiconductor houses seeking to expand sales of "under-the-hood" electronics to auto firms, sum up the principal problems facing them.

To bridge what they say has been a gap in communications between the two industries in the past, both Motorola Inc.'s Semiconductor group and Rockwell's Microelectronic Device division have made organizational changes to focus their efforts. They are trying roughly the same approach, pulling together into a single organization people and jobs that previously had been dispersed.

Hauth has been named program manager for Motorola's Automotive Electronics Systems group in Phoenix, and Beall has been appointed business director of Rockwell's Automotive LSI and Subsystems group in Anaheim, Calif.

Potential. Both predict the auto industry is close to becoming an important customer for microprocessor-based systems. But Beall's group has a big head start on Motorola and

In close touch. Offering Detroit an alternative is Hauth's way at Motorola.

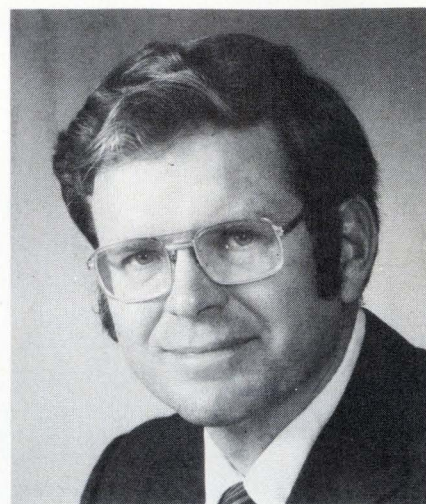

Future payoff. Rockwell's Andy Beall looks to the long run for a return on investment.

the rest of the industry. Its 10-bit processor will be the computing element for General Motor's Misar (microprocessed sensing and automatic regulation) system [*Electronics*, Aug. 9, p. 43]. Misar, the first such equipment planned for production models, is scheduled for the 1977 Oldsmobile Toronado.

How Rockwell won this bellwether contract taught some lessons that Beall says will help future programs with the auto makers. "You need a dedicated team working closely on a day-to-day basis with its engineering counterparts over a period of years," he explains.

But the going gets tough when it comes to contractual terms and the stringent qualification, environmental, and life tests the equipment must pass, he says. And there's no hurrying things because of the auto industry's product-development philosophy that "a step at a time cuts risks on very large dollar investments."

Motorola's Hauth is aware of this too, and of the close working relationship that's required. "You have to understand their problems so well you can offer alternative ways of solving them."

To the top. Hauth and Beall came to their present posts by opposite paths. Hauth, from the auto industry, joined Motorola as operations manager for sensors late last year

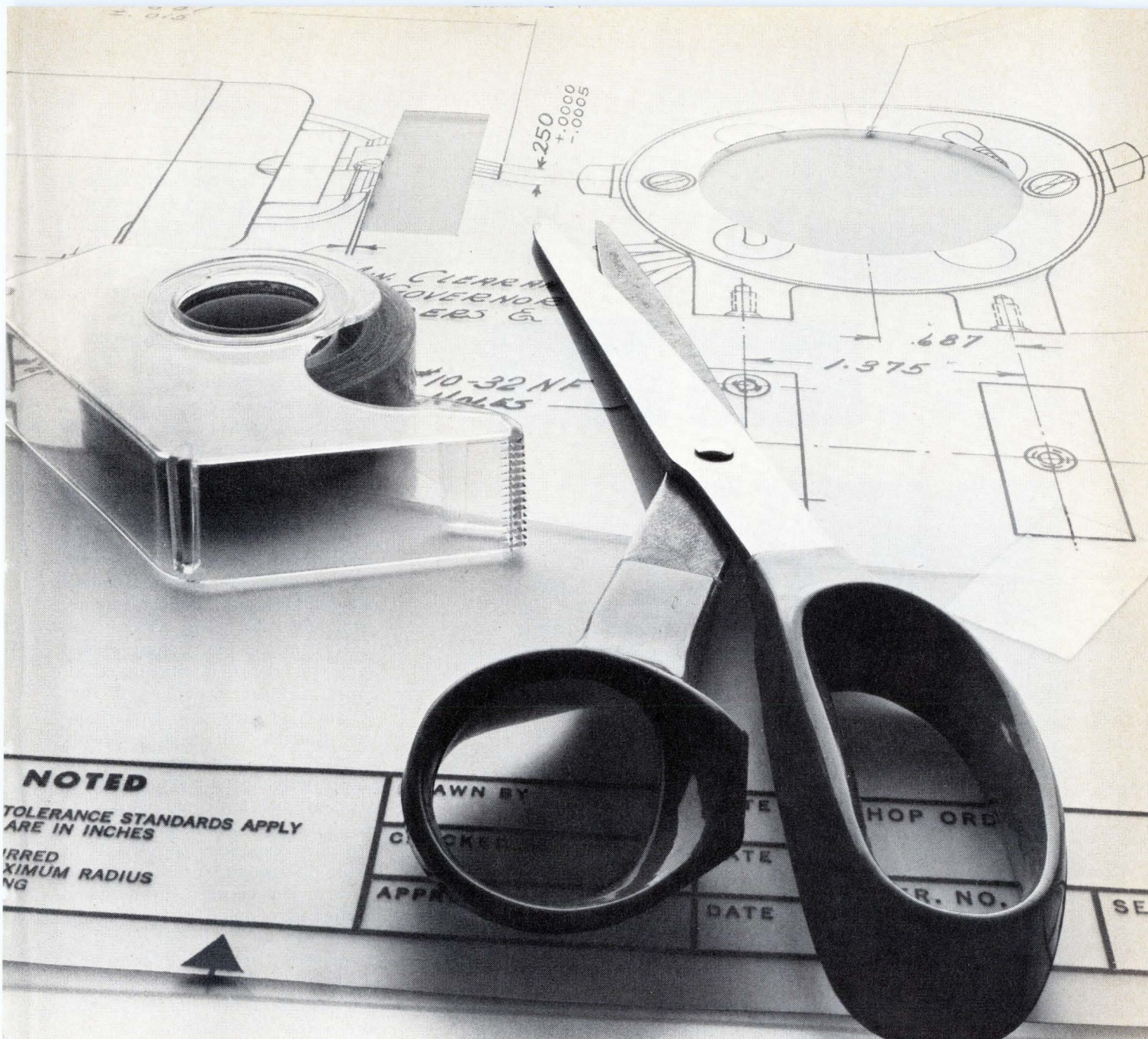

Cut out the old. And cut costs.

You can make drafting revisions a lot quicker with photography and a pair of scissors. Just make a photoreproduction of the original on clear Kodagraph film and scissor out the unwanted detail. Tape the elements you want to a new drawing form and make a reproduction of this composite on Kodagraph matte film. Then simply draft in the new detail.

For more information on how this and other reprographic shortcuts can save you money, write: Eastman Kodak Company, Graphics Markets Division, Dept. R 6850, Rochester, New York 14650.

Kodagraph films and papers
Versatility in reprographics



Pulse withstand capacitors for colour T.V.

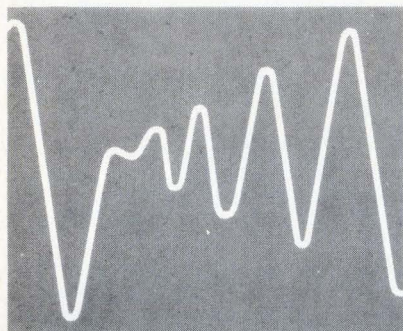
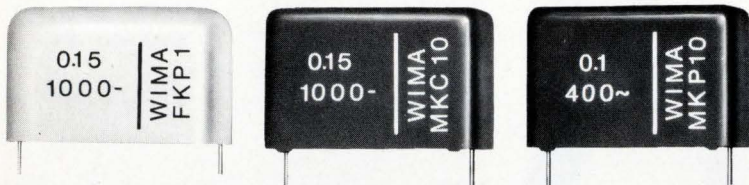

WIMA FKP 1

Polypropylene film and extended foil electrode capacitors encapsulated in cast resin. Self-healing properties. Suitable for sharp-edged or short rise time pulses in thyristor deflection circuits.

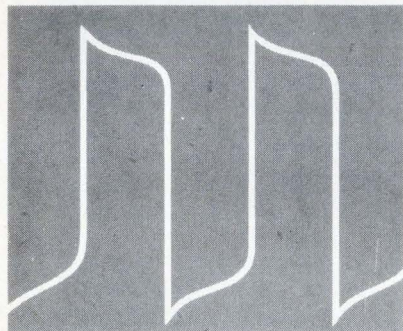

WIMA MKC 10

Metallized polycarbonate capacitors. Particularly suitable for stringent pulse and surge conditions. Low power factor at high frequencies. Self-healing properties. Plastic case design.

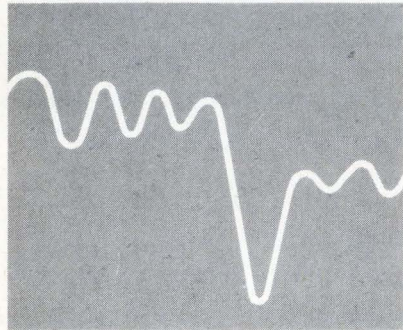

WIMA MKP 10

Metallized polypropylene capacitors in plastic cases. Self-healing properties. Suitable for both high current and pulse circuits owing to low dielectric losses.

- Other special capacitors in metal cases.
- One year successful field experience in equipment by leading manufacturers.
- Suitable for advanced solid-state equipment.
- For professional electronics.



WILHELM WESTERMANN

Spezialvertrieb Elektronischer Bauelemente
D-68 Mannheim 1
Fed. Rep. of Germany
Augusta-Anlage 56
P. O. Box 2345
Tel.: (621) 40 80 12

Write for our new catalogue.

People

after a long career with General Motors, most recently as director of research and development for the AC Spark Plug division. There, he was involved in microprocessor-oriented programs, in the development of digital instruments, and the electronic antiskid system for trucks.

Beall has been rising through corporate ranks at Rockwell ever since he came there 20 years ago out of college. He was in aerospace work until 1970, and in 1974, he became director of industrial electronics.

Although the auto industry's need for the efficiency of electronic systems is spurred by what Hauth calls the "combined crunch of Federal standards for emission control and gas mileage," developments are being held back by the Government, the two men claim. Congress must agree on the final standards for emissions and mileage so that designers of electronic engine-control systems will have a steady target. "Until our customers, the auto firms, find out what the standards will be, they can't tell us what to build," Beall points out.

Beall's operation has a staff of about 25 people, primarily engineers, divided between advanced and product development. In Phoenix, Hauth has an 11-person effort, an "engineering group that serves as a technical interface with our automotive customers, drawing on all Motorola areas of expertise."

Economics is it. In looking at the market, Beall terms "economics the driving force" for electronic systems. "Computational capacity of the chip is no problem," he says. "And we are working on ways to use it to take more of the load off the sensors." Sensors still need the biggest improvements, he says, since they are still mostly analog and more expensive than the auto companies like.

Both officials say they have a number of programs going with various auto firms but decline to discuss them specifically. At any rate, "since only a few of them eventually hit, you have to be prepared to make an investment for the long run," Beall says.

SSR UPDATE

We've got 87 answers to your AC solid state relay needs.

Teledyne Relays can handle virtually any AC solid state relay switching application. The reason? A family of AC SSRs with 87 models — and more on the way. We offer a broad range of voltage ratings up to 600V peak, with current ratings from 0.5 to 40 Amps. Add to that a variety of packages for pc board, chassis, or heat sink mounting and you have the industry's most complete line of AC SSRs.

But hardware isn't the only answer. You need assurance of the best available applications engineering support.

And we've got it — backed by seven years as a pioneer and leader in SSR technology to enable you to use our SSRs to their maximum advantage.

That know-how, for example, is reflected in Teledyne's new 970 Series MOV transient suppressors designed specifically to protect our AC solid state relays against high voltage transients.

Contact your local Teledyne Relays people. You'll find we have the experience, technical support and products to meet your SSR needs.



- A. **601 Series***
5 and 10A (to 600V peak). Optically isolated, zero voltage turn-on. Screw terminals, quick disconnects, and pcb pin options.
- B. **611 Series***
10, 15, 25 and 40A (to 600V peak). Optically isolated, zero voltage turn-on. Dual purpose screw/quick disconnect terminals.
- C. **675 Series***
Low profile (0.5" max.) pc board SSRs. Output rating 3A, up to 600V peak. Optically isolated, zero voltage turn-on.
- D. **671 Series**
I/O Converter Modules. Special purpose SSRs for use in programmable controllers, machine tool controls, etc. Mounting panel available.
- E. **SerenDIP® Series***
TO-116 DIP package. Output rating 1A/280VRMS. Logic compatible 3.8 to 10VDC input.
- F. **970 Series MOVs**
High voltage transient suppressors designed specifically for use with all Teledyne AC SSRs.

*UL recognized/CSA certified.

TELEDYNE RELAYS

3155 West El Segundo Boulevard, Hawthorne, California 90250
Telephone (213) 973-4545

Designers ... Have It Your Way!

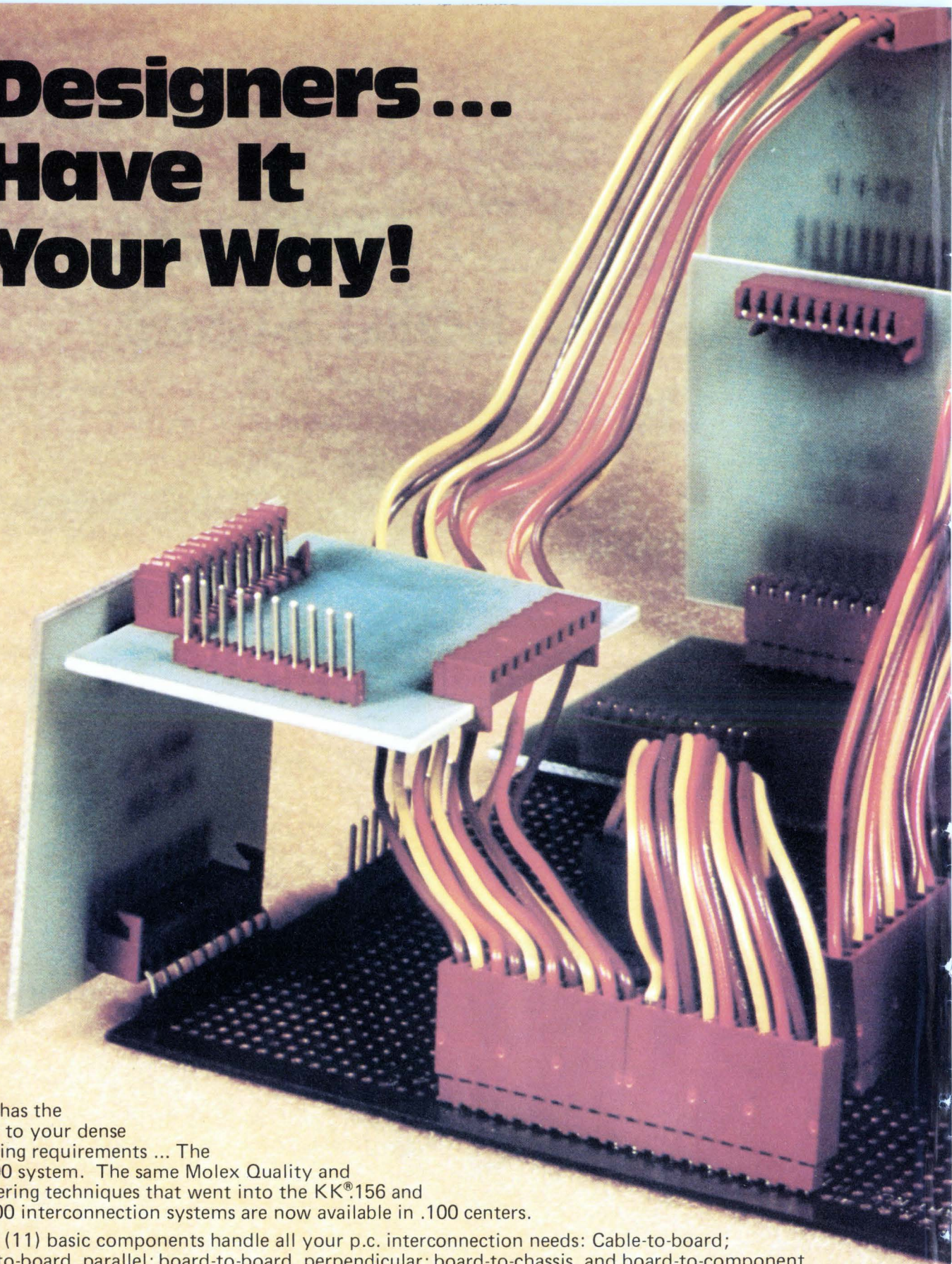

Molex has the answer to your dense packaging requirements ... The KK[®].100 system. The same Molex Quality and engineering techniques that went into the KK[®].156 and KK[®].200 interconnection systems are now available in .100 centers.

Eleven (11) basic components handle all your p.c. interconnection needs: Cable-to-board; board-to-board, parallel; board-to-board, perpendicular; board-to-chassis, and board-to-component.

The photo illustrates examples of typical applications, configurations and components. The KK[®].100 system consists of .025 pins; right angle, straight and polarized wafers; female connector housings, both crimp type and p. board mount; polarizing keys; and crimp or solder tail terminals, featuring the Molex patented dual cantilever term system. Non-flammable 94V-O material is used in all KK[®].100 connector housings and wafer bases.

To compliment this system, Molex has developed the most economical and fastest pinsetting equipment in the industry. The patented equipment can offer single or multiple pinsetting capabilities and the unique Molex honeycomb vibratory can set 12,000 pins in 3 minutes! **Now you can really have it your way!!!**

The New Molex KK[®] 100 Interconnection System

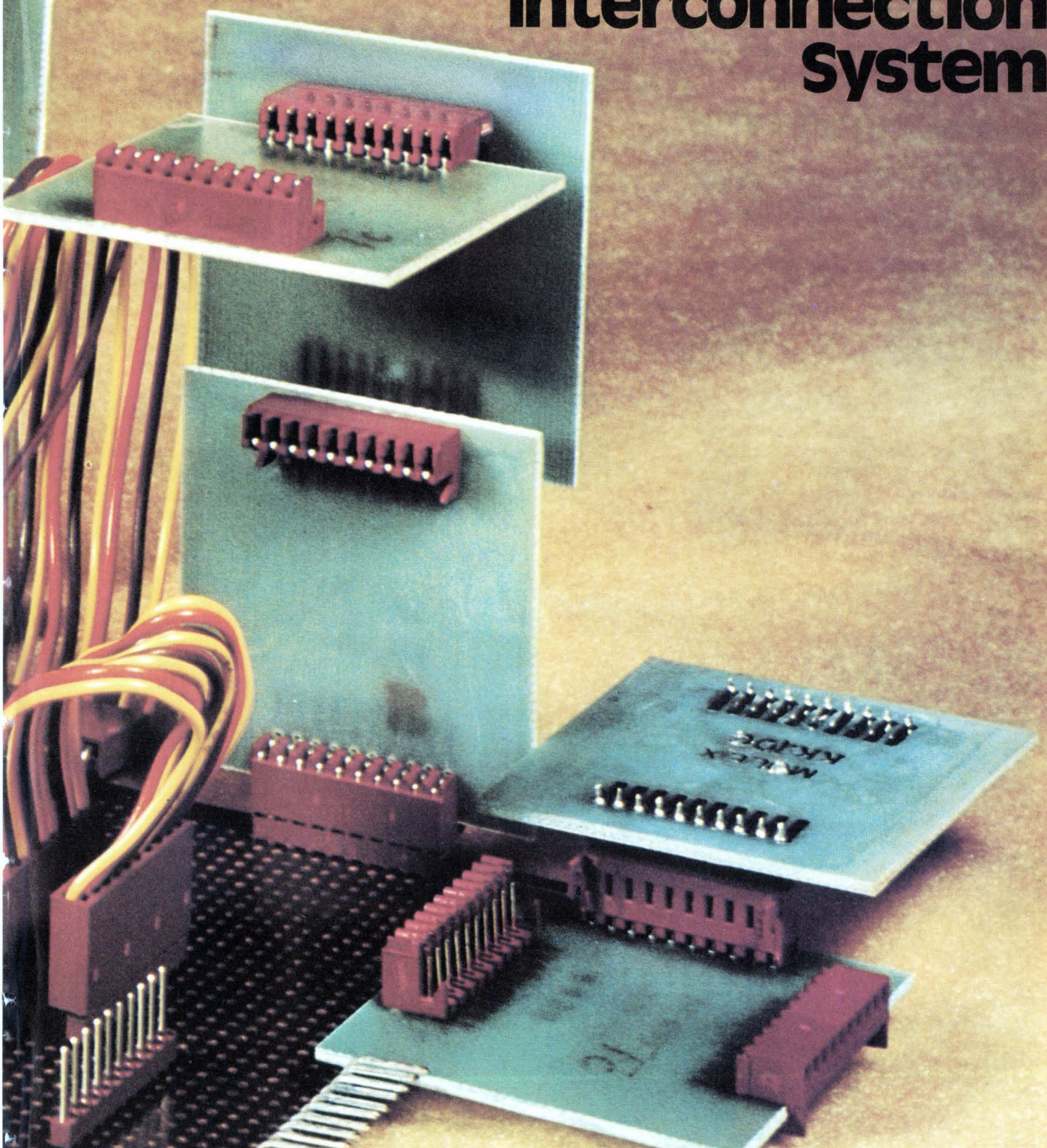

molex ... Affordable Technology

For complete information on the Molex KK[®] 100, KK[®] 156 and
KK[®] 200 Interconnection Systems, call or write:
Molex Incorporated, 2222 Wellington Court, Lisle, Illinois 60532
(312) 969-4550

Circle 19 on reader service card

. Our
em which

if you really need
**the smallest 10-bit
 synchro-to-digital
 converter...**

...then you really need
 DDC's model
 HSDC-10.

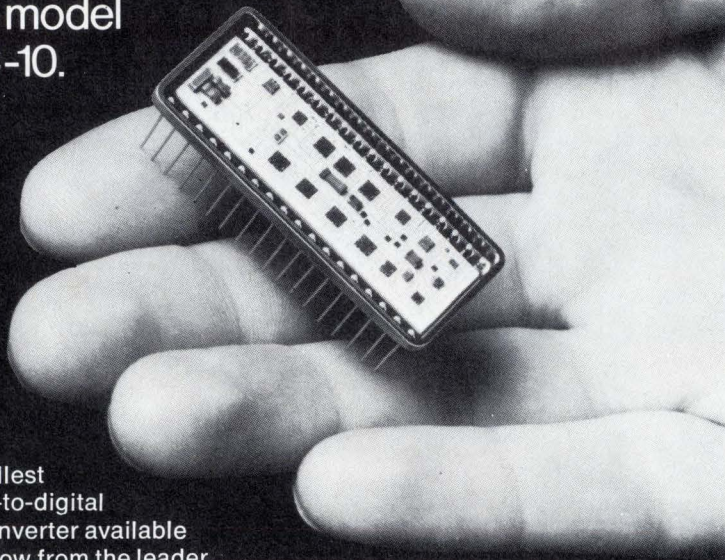

The smallest synchro-to-digital 10-bit converter available is here now from the leader in data conversion devices. It's the Model HSDC-10 offering you a 36-pin double D.I.P. hermetically sealed can measuring only 0.78 by 1.9 by 0.21 inches.

Besides small size, the HSDC-10 offers you a whole range of outstanding features:

- Excellent dynamics — true type II servo tracking ($K_a=200,000$)
- Low power — 200 ma
- High reliability — MIL-STD-883 level C processing (Level B optional)
- Low cost

If you really need a converter whose ratiometric conversion technique makes it insensitive to voltage and frequency variations... then you really need the HSDC-10. Also... its unique circuit design eliminates the need for the usual —15VDC supply. With the all-new HSDC-10 only +15 volts and a logic supply (+4.5V to +15VDC) are required.

The unit is fully transient-protected and is available with or without transformer isolation.

The HSDC-10 accepts all standard inputs, synchro or resolver, and can be easily provided in a Navy Standard Electronic Module (SEM) Configuration.

Let us send you full details and technical specifications.

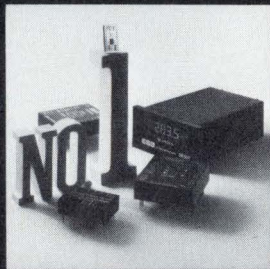

We're Number One in High Performance Data Conversions



ILC DATA DEVICE CORPORATION

A Wholly Owned Subsidiary of ILC Industries, Inc.

AIRPORT INTERNATIONAL PLAZA BOHEMIA, LONG ISLAND, N.Y. 11716 (516) 567-5600

APPLICATIONS AND SERVICE CENTERS

CALIFORNIA: 7337 Greenbush Ave.,
 No. Hollywood 91605 (213) 982-6454

EUROPE: England: The Sanctuary,
 Oakhill Grove, Surbiton, Surrey, Tel.: 01-399-7262

Interested engineers, write or call Harry Lewis or send for our 164-page product line catalog.

Meetings

Electro Optics/Laser '76 Conference and Exposition, Industrial & Scientific Conference Management Inc. (Chicago, Ill.), New York Hilton Hotel, New York, Sept. 14-16.

WESCON—Western Electronic Show and Convention, IEEE, Los Angeles Convention Center, Los Angeles, Sept. 14-17.

6th European Microwave Conference, Microwave Exhibitions & Publishers Ltd. (Sevenoaks, Kent, England), Palazzo dei Congressi, Rome, Italy, Sept. 14-17.

Convergence 76—International Symposium on Automotive Electronics and Electric Vehicles, IEEE and SAE, Hyatt Regency Hotel, Dearborn, Mich., Sept. 20-22.

International Broadcasting Conference, IEEE *et al.*, Grosvenor House, London, U.K., Sept. 20-24.

22nd Annual Holm Seminar on Electrical Contacts, Illinois Institute of Technology and IIT Research Institute, Pick-Congress Hotel, Chicago, Sept. 21-23.

Semicon/East 76, Semiconductor Equipment and Materials Institute (Golden Gate Enterprises, Santa Clara, Calif.), Nassau Veterans' Memorial Coliseum, Uniondale, N.Y., Sept. 21-23.

Broadcast Symposium, IEEE, Washington Hilton Hotel, Washington, D.C., Sept. 22-24.

EASCON—Electronic and Aerospace Systems Convention, IEEE, Stouffer's Inn, Washington, D.C., Sept. 26-29.

MICRO-9—Ninth Annual Workshop on Microprogramming, IEEE and ACM, Delta Towers Hotel, New Orleans, Sept. 27-29.

Quality Testing Show, American Society for Nondestructive Testing (Columbus, Ohio), Shamrock Hilton Hotel, Houston, Tex., Sept. 28-30.

MICROMINIATURES FLEXIBLE INTERCONNECTIONS SYSTEMS CAPABILITY

We put it all together for you! Your single source for complete systems capability in flexible interconnections and microminiature connectors is Cannon. We offer you a complete system, 100% electrically and mechanically checked out, ready to plug into your assembly.

The best feature of this total capability? **It lowers your total installed cost.** And that's your real cost!

We can custom manufacture your flexible circuitry and assemble your complete interconnection system. Shielded wire, coaxial cable can be assembled with the

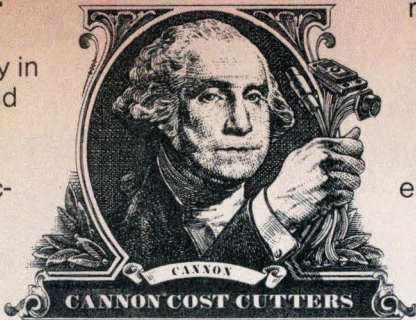

most reliable microminiature connectors available. Other pluses to think about: You can cut system costs as much as 50%, reduce weight and space up to 80% and eliminate point-to-point wiring, bundling and lacing. Solve those difficult density problems.

Cannon microminiature custom cable terminations can help you trim the costs inherent in your in-house hard wiring or harnessing—expensive engineering time, assembler training, quality assurance setup, inventorying, materials scrap and wastage.

There's much, much more you should know about Cannon's interconnection innovations and how they can lower your installed costs.

Send for our "Cannon Cost Cutters" brochure. ITT Cannon Electric, 666 East Dyer Road, Santa Ana, CA 92702. Toll-free, 24-hr. 800-854-3573; in California, 800-432-7063.

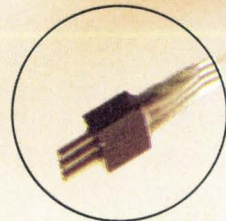
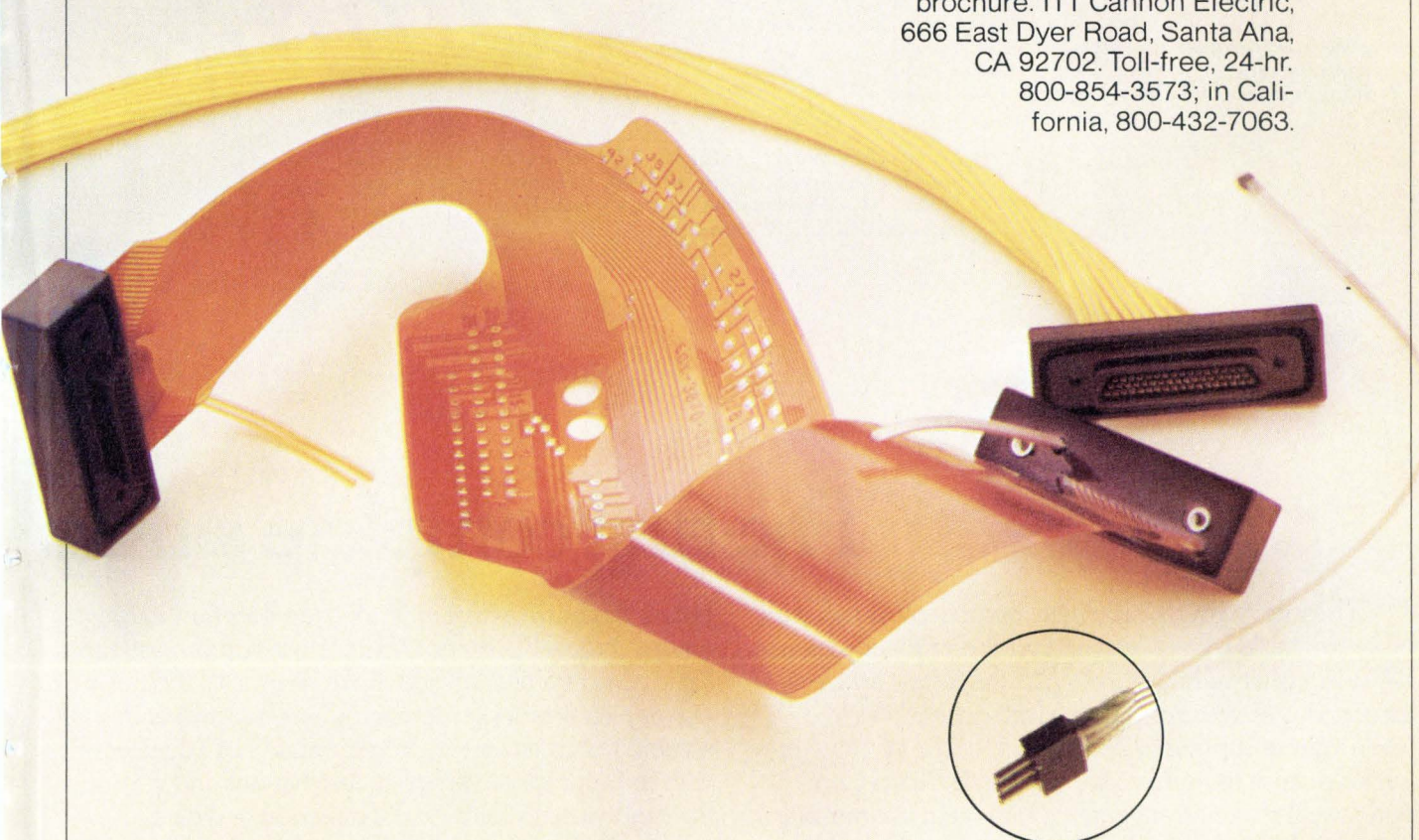

Six decades on the leading edge of interconnect technology.

CANNON ITT

Programmable, parallel I/O lets you define the direction and data transfer characteristics of six 8 bit I/O ports. Reconfigure the interface or entirely alter the I/O structure by changing no more than four program instructions.

Plug-in standard TTL drivers or line terminators to easily tailor the I/O interface to meet your system requirements.

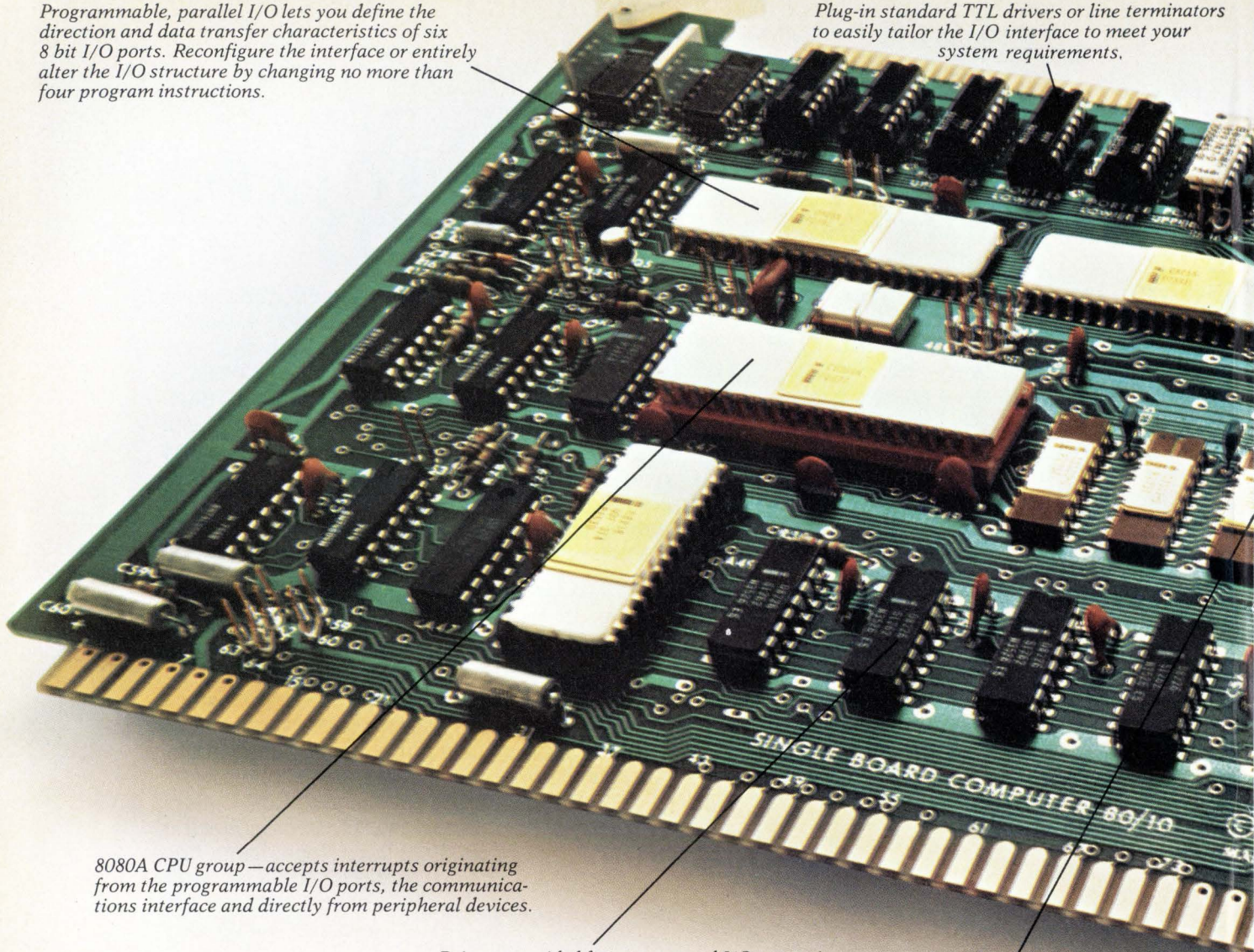

8080A CPU group—accepts interrupts originating from the programmable I/O ports, the communications interface and directly from peripheral devices.

Drivers provided for memory and I/O expansion. Simply plug any of the SBC 80 RAM, EPROM/ROM, I/O or Combination expansion boards into the standard SBC 80 card cage.

1K bytes of high speed, low power static RAM.

The first complete single

The Intel® SBC 80/10 Single Board Computer, with programmable I/O, is designed for the profit conscious OEM in a hurry. The SBC 80/10 is the fastest and lowest cost way of getting your products to market. And when your equipment sales increase to the point where it makes sense to build your own Single Board Computer, we'll make arrangements for you to use our bill of material, fab and assembly drawings, and artwork.

Now it's possible to standardize on one computer board for all your products. Everything you need—CPU, ROM, RAM and I/O is on a single 6.75" x 12"

board. And since we've extended the programmable nature of the CPU to the I/O interface you can use the same board even when you make an interface change or completely redesign your product's input/output section. Just initialize the programmable I/O devices with the appropriate program instructions and you have individually defined the direction and data transfer characteristics of the six on-board ports. Programmable I/O makes your products more versatile and cuts parts cost and development time.

Cut development costs even more with the Intellec

Programmable serial interface lets you choose virtually any asynchronous or synchronous communications technique. Data format, control character format, parity, and asynchronous serial transmission rates are all under program control.

Both teletype and RS 232C interfaces are included, choose the one you need.

Selectable baud rate generator—pick the communications frequency you want.

Capacity for 4K bytes of erasable and reprogrammable EPROMs or ROMs for user's program storage. Plug-in any mix in 1K byte increments.

board computer for \$295.*

MDS™ Microcomputer Development System with optional Diskette Operating System and unique ICE-80 In-Circuit-Emulator. Develop and debug your system software directly on the SBC 80/10 using the symbolic debugging capability of ICE-80.

The 80/10 is supported by macroassemblers, text editor, Intel's PL/M™ compiler, a user's library with over 150 programs, and comprehensive documentation.

Training is available at training centers or scheduled at your plant. For additional technical assistance contact your Intel Field Applications Engineer.

The Intel® SBC 80/10 is available from distributor stock. To order contact: Almac/Stroum, Component Specialties, Components Plus, Cramer, Elmar, Hamilton/Avnet, Industrial Components, Liberty, Pioneer, Sheridan, or L.A. Varah.

For your copy of the SBC 80/10 brochure, use the bingo card or write: Intel Corporation, 3065 Bowers Avenue, Santa Clara, California 95051.

intel® delivers.

Circle 22 on reader service card

Licon® non-lighted PB switches offer you the greatest possible value with good-as-gold quality and reliability at terrific prices!

Know something?

Our Licon lighted PB's have been glowing so brightly that they've cast our *non*-lighted PB's into undeserved shadow.

And therein lies an opportunity you may have been missing. Because, quite frankly, Licon non-lighted PB's are a terrific deal in every way!

You'll find that there's one for just about every .25 to 10 Amp switching application you can dream up. Plenty of sizes to choose from, even down to our Series 78, which is possibly the smallest non-lighted PB made. Variety of key tops, lens cap colors and bezel mountings. Momentary and alternate types of action. Choice of terminal configurations in single or double pole. U.L. listed and C.S.A. approved.

Most non-lighted PB models feature Licon's exclusive, ultra-reliable Butterfly® switching mechanism.

Best of all, though, is the pleasant surprise you get when you check Licon pricing on 1,000-piece and larger orders. Look into it. You'll be pleased.

Contact your local Licon distributor or call or write for our Switch Catalog: Licon, 6615 West Irving Park Road, Chicago, Illinois 60634. Phone (312) 282-4040. TWX 910-221-0275.



LICON

A DIVISION OF ILLINOIS TOOL WORKS INC.

Circle 24 on reader service card

Golden Opportunity Pushbutton Switches!



GI to introduce 8-k electrically alterable ROM . . .

General Instrument is about to introduce **the most ambitious electrically alterable read-only memory yet**—an 8,192-bit chip-erasable device. (GI and McDonnell Douglas' Nitron division are the only U.S. suppliers of commercial Earoms.) The Hicksville, N.Y., company expects to supply samples of the nonvolatile part in September and put it into production by year's end. Manufactured with GI's metal-nitride-oxide-semiconductor process, the ER 2800 is erased by applying a voltage to the package pins. It should not be confused with the Intel's 2708 avalanche-injection type of erasable memory, which is erased with ultraviolet light.

Brian Cayton, ROM marketing manager, says specifications of the ER 2800 will be similar to those of GI's ER 2401 4,096-bit part. Reading takes 2 microseconds at p-channel voltage levels; writing and erasing take a respective 10–20 milliseconds and 100 ms at 28 volts. These figures qualify the new Earom for use in small memory systems in point-of-sales equipment or automatic dialers, say, and as core-replacements for the military—all applications where the ER 2800's **erasability and nonvolatility matter a lot and its slowness matters less**. For faster applications, GI will begin selling samples of a 650-ns 4-kilobit part, the ER 3400, by the end of the year.

. . . as Nippon plans 500-ns 8-k Earom

At the same time, Japan's Nippon Electric Co. will add an 8-kilobit Earom to its line of programable ROMs that includes 1- and 2-k Earom devices. Unlike GI's nitride process, the avalanche-injection technique used by Nippon **is based on standard polysilicon MOS technology**, and unlike Intel's uv-erasable device, this one is electrically erasable. The new part, designated μ PD 458D, has a minimum read access time of less than 500 nanoseconds, making it the fastest commercially available anywhere. The device, to be introduced in sample quantities in November, will be priced at \$100 in small quantities.

Mini floppy disks prepare for debut

In a move that could double or triple the present market for floppy-disk systems, several companies plan to introduce **miniaturized versions for the many applications now dominated by cassette tape units**. First will be Shugart Associates of Sunnyvale, Calif., which later this month will begin shipping its SA400 "Minifloppy," SA104 "Mini-diskette," and SA440 "Ministreaker" controller. With about one third the capacity of a standard system, the Minifloppy is, more importantly, about half the size and half the cost—about \$200 to \$250 in volume. Applications for such miniaturized system will include word processing, minicomputer and microcomputer program storage, power typing systems, intelligent desktop calculators, and the emerging microcomputer hobby market.

McDonnell divisions to offer 3-chip 16-bit processor set

Two commercial semiconductor divisions of McDonnell Douglas Corp. are pushing into the microprocessor-control business. A three-chip, 16-bit processor serves as the computing element for an advanced numerical-control system. **These three chips are the first large-scale MOS devices** to come from the Actron division in Monrovia, Calif., which designed them as part of a \$1 million-plus research program, and the Nitron division in Cupertino, Calif., which manufactures them.

Consisting of a 16-bit controller and two 8-bit slices serving as arithmetic units, each processor can handle up to 200,000 instructions per second,

claims G.C.C. Chang, vice president of engineering at Actron. Since three processors are used in the basic n/c system, called Actrion III, the total of 600,000 instructions per second gives it enough computing power to perform the most complex machining functions. Chang says the speed of the 8-bit slices varies from 2 microseconds to 500 nanoseconds in order to accommodate different types of memory. Less than 16 kilobits of memory is used in the n/c system, he notes.

E-H dropping out of data systems, gets new president

E-H Research Laboratories Inc. in Oakland, Calif., is getting out of the data-logger/acquisition-systems business—which it entered last year through acquisition of Data Graphics Inc. of San Antonio, Texas. The move follows the appointment of Richard Kirk by the board of directors to replace E-H president Jack Hubbs. The new management, which plans to concentrate E-H's activities on programable instruments and digital logic recorders, decided that **the return on investment from data-acquisition systems didn't justify the expense required to develop a viable product line** to compete with companies like Doric Scientific, John Fluke, and Esterline.

“We decided we couldn't handle that many different markets,” says E-H marketing vice president Domenic Norcia. “Data systems fragment our markets and product line too much, and it would have been too expensive to support all of them.”

Being dropped are the recently introduced model 7000, a remotely controllable data logger, base-priced at \$5,200 for a 100-channel system that is expandable to 1,000 channels, as well as a microprocessor based data logger that was in development. Former Data Graphics president John Peddie, who had been named to head a new Data Systems division of E-H, has resigned. Also leaving E-H are about a dozen former Data Graphics employees who teamed with more than 20 E-H employees to man the now-defunct division.

Development system for 2650 processor to go universal

Millenium Information Systems, Inc. of Santa Clara, Calif., which designed the Twin development system for the Signetics 2650 microprocessor, **has gone out on its own and extended the concept.** In the future, it will build the UDS (universal development system), which by interchanging a few internal boards, will adapt to any microcomputer system. However, in the immediate future, Millenium will introduce a UDS that will work with Intel Corp.'s 8080 microprocessor. The company is also building up a marketing organization.

Biomation offers logic analyzer

In addition to being one of the many firms that will take the wraps off new microprocessor analyzers at the Wescon exhibition in Los Angeles later this month [*Electronics*, Aug. 19, p. 31], Biomation Corp. of Cupertino, Calif., also will unveil a new logic analyzer and an associated word formatter. A 16-channel, 50-megahertz analyzer, the model 1650D, **stores 512 bits per channel and costs \$5,000.** Like the new DF1 display formatter (see p. 132) from Tektronix Inc. in Beaverton, Ore., Biomation's new model 116 formatter enables users to troubleshoot hardware and software in the timing-diagram and state-table (1s and 0s) modes.



If you want to do business abroad, fly Data General.

If you want to use your systems somewhere outside of the country, you don't have to go it alone.

Put Data General equipment in your systems and we can be there to take care of it.

Chances are, we already have support people wherever you want to go. So we're in a good position to stand behind every piece of Data General equipment you buy.

If you ever happen to need service, someone can be right over. Chances are, trained people are already there. And if your systems need replacement parts, we won't have to send across the ocean and go through foreign customs offices to get them. Because we've placed Data General parts all over the world.

You won't have to send your customers (or employees) to the USA for training. Because we can do that right on the spot.

And if you need software support, we can have systems engineers wherever you need them.

Our equipment will also be right at home wherever you take it. Because we've designed it to work just about anywhere in the world.

For example, all you have to do to make our microNOVA computer meet different power requirements is change the power cord. (As opposed to other manufacturers who make you rewire the power supply.)

If you want to know more about the above, clip your business card below.

It's a lot easier to do business abroad when you know the right people to fly with.

Clip your business card here
and send it to Data General, Department J-3,
Southboro, Mass. 01772.
We'll send you a copy of our support brochure.

Data General

• Data General, Route 9, Southboro, Mass. 01772 (617) 485-9100. Data General (Canada) Ltd., Ontario.
Data General Europe, 15 Rue Le Sueur, Paris 75116, France. Data General Australia, Melbourne (03) 82-1361



Now one Programmer handles 80 different PROMs. With more on the way.

New personality modules make Series 90 PROM Programmer more versatile than ever.

The Series 90—a simple, straightforward method of programming, duplicating or verifying MOS or bipolar PROMs. Plug-in personality modules are currently available for all the PROMs shown below.

Gives engineers design flexibility. Makes prototyping a snap.

You program from a hexadecimal keyboard. Addresses and data appear on a hexadecimal display which you can use to verify your entry prior to programming.

Wide range of interface options available for use with the Series 90

Teletype Control
Paper Tape Reader
Parallel Input/Output
RS232

Field-proven reliability.

We've been producing PROM programmers since 1973. We have more than 1,000 currently in the field.

Rugged and fully portable for field use.

It weighs less than 18 pounds and comes in an attache case. An optional bench-top model is available.

Low-priced.

The M-900 Master Control Unit costs \$1,800. Personality modules range from \$360 to \$550.

New Series 92 Peripheral Programmer and Duplicator comes with teletype interface standard.

It gives you low cost peripheral programming and off-line duplicating capability. The Series 92 uses the same personality modules as the Series 90. An RS232 interface is optional. The M-920 Master Control Unit costs only \$995.

We have other instruments, microprocessor subsystems, and education, too.

4- and 8-bit microprocessor system analyzers; 4- and 8-bit microprocessor subsystems; a half-day economics seminar for decision makers; and a three-day hands-on design course for engineers.

Call or write for data sheets, a free copy of the PROM User's Guide, or course and seminar schedules.

AMD	Fairchild	Harris	Intel	Intersil	MMI	NSC	SIG	TI
1702A	93416/	1024	1702A	5600/	5300/5301	1702A	82S114	74S188/
1702/	93426	7602/	1702	5610	5305/5306	4204	82S115	74S288
9702	93417/	7603	2704	5603A/	5330/5331	5202/	8223	74S287/
	93427	7610/	2708	5623A	5335	5203	82S23/	74S387
	93436/	7611	3601/	5604/	5340	5203A	82S123	74S470/
	93446	7620/	3621	5624	6335/6301	5204	82S126/	74S471
	93438/	7621	3602/	5605/	6305/6306		82S129	74S472/
	93448	7640/	3622	5625	6330/6331		82S130/	74S473
		7641	3604/		6335		82S131	74S474/
			3624		6340			74S473
								74188A

If you don't see the PROM you want here, give us a call. We're probably working on it right now.

Circle 28 on reader service card



PRO-LOG CORPORATION
2411 Garden Road
Monterey, CA 93940
Telephone (408) 372-4593
TWX 910-360-7082

Two-way link teams up the E-2C and F-14

Digital data exchanged automatically includes radar inputs from fighters and orders from commanders

Using an early-warning aircraft as a flying headquarters to command fighter interceptors has been difficult in the past because voice communications could be jammed or misunderstood, says Capt. Frank Roth, program manager at the U.S. Navy's E-2C Project Office in Washington. "But with the new two-way data link" between the E-2C AEW Hawkeye and the F-14A Tomcat fighter, "that's a problem that hardly exists any more," he asserts.

Moreover, the new digital link augments the "eyes and ears" of the E-2C with its ability to communicate with more than 30 F-14s. Both aircraft are built by Grumman Aerospace Corp., Bethpage, N.Y.

Uhf link. The fighter's radar automatically feeds such data as range and azimuth of potential enemies to one of several on-board computers. The data is encoded and transmitted via a time-division-multiplexed ultra-high-frequency data link to the E-2C. Also included automatically is data on the state of the fighter itself—for example, its remaining fuel and ammunition stores.

Once received aboard the E-2C, target information is processed, correlated, and presented on cathode-ray-tube screens to battle-control officers who decide how the threat is to be met. Their orders to the fighter pilots are transmitted back to the fighters via the data links. And by

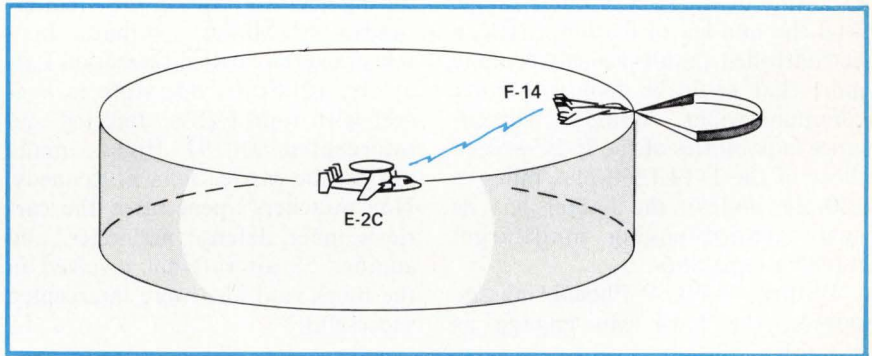

In command. Digital data link allows an E-2C airborne early-warning aircraft, hovering with its circular radome over the battle area, to issue attack orders to F-14 fighters.

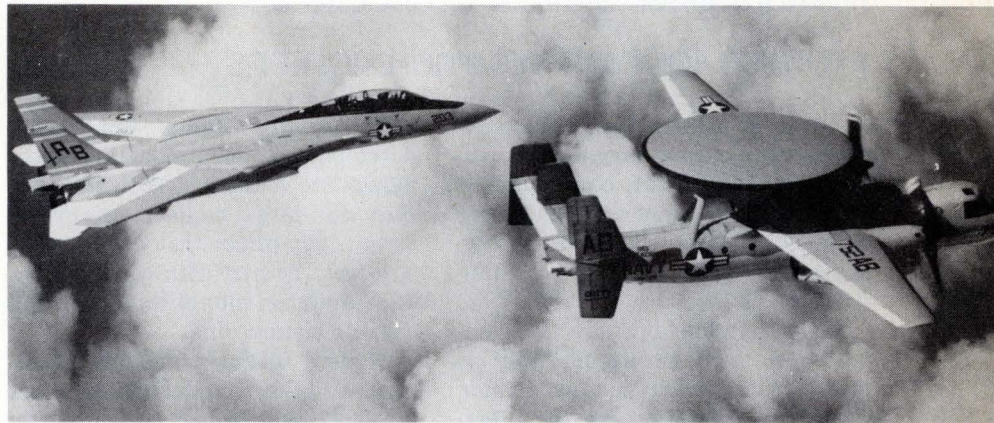

including information processed by the E-2C, the combat pilot can get a full 360° representation of the battle area—never before possible. Additionally, the data can be sent to shipboard Navy and Marine tactical data systems, for integration into still higher levels of command.

The two-way link for the E-2C/F-14A team represents the first time that AEW aircraft could command and control the fighters as well as receive target and other information from sensors aboard the fighters. Previously, there had been a one-

way data link only to transmit command data from the E-2A, an earlier version of the E-2C, to the McDonnell-Douglas Corp. F-4 Phantom fighter.

The heart of the two-way link is the AN/ARC-158 uhf communications system supplied by Collins Radio Co., Cedar Rapids, Iowa. Typically, officers aboard the E-2C select the most appropriate of the F-14s (in terms of such things as position relative to target, fuel state, weapons complement) and vector the fighters to their targets by means of

Electronics review

coded data messages. Once in contact with the enemy, the F-14 takes control, and the fighter presses the attack, relying on its own system inputs. Upon completion of the attack, the E-2C resumes control, vectoring the F-14 to rendezvous with a tanker aircraft for refueling, if necessary, or to a landing site.

Extended range. "Equally important," as a result of using the two-way link," Roth continues, "is the extension of the E-2C's radar range. And the number of fighters that can be controlled simultaneously is many more than could be done with voice communications." While the surveillance capabilities of the E-2C exceed those of the F-14 (250-plus miles vs 100-plus miles), the fighter has its own forward-looking multitarget tracking capability.

With its AWG-9 Phoenix missile system, the F-14 can engage as

many as six targets simultaneously with guided missiles. Thus, with the E2C's ability to control upwards of 30 F-14s via two-way link, "the maximum number of simultaneous target engagements possible has been increased an order of magnitude," says James McManus, AEW future-systems program manager at Grumman.

The E-2C/F-14A team has already stacked up an enviable record during fleet exercises in the Mediterranean, McManus continues. In a recent exercise called Operation Lafayette, 12 F-14s, operating in concert with four E-2Cs, detected and intercepted all 91 flights made against the carrier John F. Kennedy. No "attackers" penetrated the carrier's inner defense perimeter, and another 58 aircraft not involved in the mock raid also were intercepted successfully. □

Instrument Corp.'s Hybrid division in Hicksville, N.Y., is joining companies like National Semiconductor Corp. and Beckman Instrument Inc.'s Helipot division to make hybrids as standard products.

Cheaper. These devices are being turned out at prices much lower than custom hybrids, and they are competitive with discrete designs. "We have many commercial and industrial firms coming to us for hybrids because they want to put 16 times the functions in the same-size or smaller-size equipment," says Allan C. Bahr, GI's director of telecommunications products.

National, in Santa Clara, Calif., entered the standard active-filter market last fall with basic building-block filter circuits—a universal active filter and a generalized impedance converter [*Electronics*, Dec. 11, 1975, p. 124]. It has since developed 14 hybrid active filters for tone-receiver systems, and these modules are available as individual modules or on assembled cards for telephone central-office equipment.

In Fullerton, Calif., Beckman followed suit with a family of 13 hybrid tone-receiver modules and card assemblies [*Electronics*, April 1, p. 123] which, like the General Instrument and National units, are compatible with Bell-System equipment.

Return. The payoff could be huge indeed. "The standard hybrid business will be \$50 million to \$100 million within the next three to five years," estimates Beckman's hybrid-microcircuits manager, Richard Snyder.

General Instrument's Bahr is equally sanguine. He predicts, "In the very near future, our standard hybrid business will surpass that of our custom business," which was slightly less than \$10 million this year. "We'll easily do a \$15-million-plus business within three years, just for standard telecommunications products, even if we don't crack Western Electric," which has its own hybrid-assembly operation for Bell.

Trimmer. Resistor on hybrid circuit is trimmed on General Instrument's production line by YAG laser from Korad Corp.

Hybrids

Makers offer standard circuits as promise for high-volume brightens

A surge in demand from manufacturers of telecommunications, medical, and industrial equipment is changing the emphasis in hybrid technology from short-run custom designs to high-volume lines of standard products.

Hybrid technology has traditionally been used mostly for military applications because the armed forces are willing to pay the premium for special functions in rela-

tively small volume. But recent developments in production techniques are making it economical to turn out large numbers of hybrid circuits for prices that could otherwise only be met with combinations of standard monolithic ICs and discrete components.

Modern methods. Taking advantage of newer production methods involving such things as automatic laser trimming and testing, General

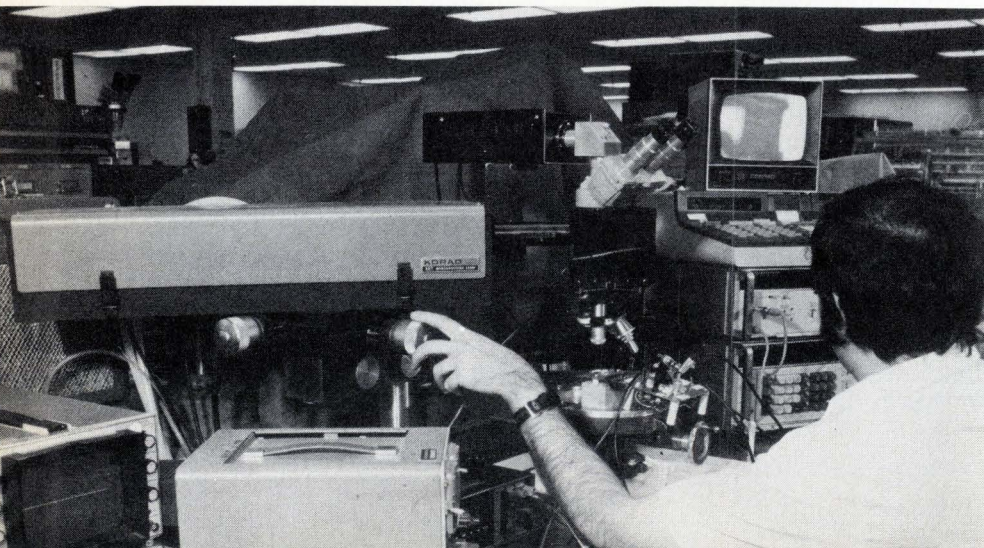

National probably has the most experience with the market by virtue of its earlier entry. "Most of the activity for our universal filters and generalized impedance converters is coming from the telecommunications industry," says Dennis Dauenhauer, National's hybrid-product marketing engineer. "But there's a lot of interest from many other areas." These include security systems and medical electronics.

Dauenhauer says orders are coming in quantities of 10,000 to 30,000 pieces, primarily from independent telephone-equipment manufacturers who don't have their own assembly operations. Such orders are considered prototype quantities, and orders for hundreds of thousands devices are in the offing, Bahr claims.

Filters. General Instruments' new standard line includes more than 60 hybrid active filters for switching and multiplexing systems, tone receivers, and modems—three segments of the telecommunications industry that it's targeting as its primary market. Penetration into a fourth segment—voice transmission over radio—will begin in late September when the firm is to sample a hybrid tone-squelch system that will replace electromechanical and discrete-component subsystems used in transceivers. □

Consumer

Heath adds game for TV receivers

After watching scores of games makers scurry to the Federal Communications Commission for type approval of new video games, Heath Co. sat back and developed a game not subject to any such regulations.

The Benton Harbor, Mich., manufacturer of do-it-yourself electronics kits designed its game to bypass entirely the television set's antenna terminals, the interface that is regulated by the FCC because it can be a source of radio-frequency interference. Instead, Sportscreen, as it's called, is designed to be hooked

directly into the TV circuitry, and it can be played with any solid-state television receiver Heath has ever had on the market.

Customer knowhow. "We're able to do it because our customers have built their own sets, so they know where everything is," points out vice president William E. Johnson. Once the back of the set is off, it takes only about three minutes to hook up the game with five alligator clips, he says.

However, it takes five or six hours to assemble the game kit, built around a chip from General Instrument's Microelectronics division. Savings for labor and parts—the game uses the TV set's power supply, for example—will allow Heath to tag the four-game Sportscreen at \$54.95 (by mail, \$49.95) when it's available in October in the company's retail stores.

Besides GI's n-channel, metal-oxide-semiconductor chip, the kit's single printed-circuit board holds a reference crystal and a second integrated circuit that works as an oscillator, and associated discretes. "We use a pass transistor and a series resistor as a regulator to accommodate the different voltages the game will see from our 15 different solid-state TV models," says Roger Brockway, chief engineer for Heath's consumer products.

Five wires to different points in

Do-it-yourself. Heath Co.'s game kit, which will sell for about \$50, plays four games on a black-and-white TV display.

the receiver hook up the video and sound inputs, power supply and ground. The game also includes an intermediate-frequency "defeat" circuit that turns off the broadcast video and sound signals.

All the connections except those for sound are made by clipping the wires to the i-f board connector. And all five are terminated in a connector on the back of the set so that the game's control box can be moved easily from set to set.

Remote control. The black-and-white Sportscreen, which has its own sound and on-screen scoring, will play ping pong, squash, hockey, and a one-person practice game. It uses two remote-player control boxes wired to a central control unit that sits atop the set. "The GI chip could also provide a pair of target games that we're not presently using," Brockway says. Paddle size, ball speed and rebound angle, and volume are chosen by the players. The ball may be served manually or automatically.

Johnson doesn't rule out making future game kits that would use TV-antenna hook-ups and require FCC approval.

"We can't become involved in modifying other manufacturers' TV



sets, so there would be no other way to do it," he says. Some parts of those kits would have to be preassembled for type approval. □

Companies

Costs, financing too much for Datran

Last week's demise of specialized common carrier Data Transmission Co. (Datran) in Vienna, Va., seemingly is a case of either too much too soon or not enough too late.

Post-mortems by data-communications industry observers and Datran officials indicate the firm invested much more in its digital switching system and microwave transmission network than its market share justified. Moreover, financing did not arrive in time to complete the system's original concept of totally digital communications lines owned outright by Datran. Also late were Government rulings that might have prevented American Telephone & Telegraph Co. from offering certain digital data transmission rates that the FCC's law judges found in June to be unlawful, unreasonably low, anti-competitive, predatory, and designed specifically to eliminate Datran.

Facilities. Founded originally as a University Computing Co. subsidiary in 1968, Datran was to provide the Dallas-based data-processing-

services firm (now Wyly Corp.) with transmission facilities. It was then expanded to offer the same services to a data-communications marketplace. However, that market—Datran attracted 150 to 200 customers—never came even close to generating revenues to cover Datran's front-end costs that totaled upwards of \$100 million. In 1975, for example, when Datran's revenues reached about \$1 million, it posted a \$14 million loss.

The big losers, in addition to Wyly Corp. (\$45 million), are Haefner Holding AG of Switzerland (about \$50 million), Bechtel Co. (about \$4 million), which constructed the system's microwave towers, and Nippon Electric Co., which supplied the microwave radios, time-division multiplexers, and other equipment.

"Datran was a very different kind of common carrier," says telecommunications consultant Harry Newton of New York City. "It stressed state-of-the-art technology and took numerous gambles in building an all-digital data communications network," as opposed to other specialized carriers which concentrated on voice communications. For instance, Datran installed the first-ever electronic data switch [*Electronics*, Dec. 12, 1974, p. 91].

As originally conceived, Datran's network was entirely digital, an alternative to the Bell System's analog telephone net. It was also to have cost less while providing higher transmission rates and lower average setup times. "But many potential users, wondering if Datran would stick around, opted to play it safe and stay with Bell," says Newton.

Expensive. Unfortunately for Datran, the tremendous cost of installing dedicated digital loops forced it to lease some analog lines from other carriers. The mix of lines meant Datran needed a lot of modems—typically four per connection, instead of the two required by other specialized carriers.

John Guttenberg, a former Datran vice president, says about \$30 million more was needed for such things as remote switching units to eliminate some of the leased channels.

But money, as well as customers, was always hard to come by. Says Guttenberg, "AT&T could cause a wait-and-see attitude to take place up and down the market spectrum, whether it was the market for customers, capital, or regulatory decisions."

Just how AT&T's posture affected Datran may be answered in the \$285 million law suit Wyly has filed against AT&T, charging it with violation of Federal antitrust laws.

Terminations. Datran, which inaugurated services in early 1974, grew to have about 1,000 data links in 22 cities. By late last week it expected to discontinue all services and had terminated all but a handful of about 250 employees, down from a peak of 300 at the year's start. And it was meeting with other carriers that could serve its customers.

Datran leaves an estimated \$1.1 billion market to be shared by survivors such as MCI Communications, Southern Pacific Communications—and AT&T. William G. McGowan, chairman of MCI, doesn't expect Datran's departure to affect his operations significantly since only about 7% of its 14,000 circuits is used for data communications. A spokesman for AT&T in New York says the firm has no plans to take over any of Datran's transmission facilities or routes "and neither do we intend to solicit any of Datran's customers." Ironically, Datran was the largest customer for AT&T's digital data system, outside of the company's own organization. □

Microwaves

Fine geometry improves transistors

In their drive toward higher frequencies with even higher gains, while keeping noise low, makers of silicon bipolar microwave transistors have worked themselves into a double bind. Geometries of microwave transistors must be tiny because of the frequencies at which they operate—the higher the frequency, the finer



Have we got Ceramic Capacitors for you!

How about a ceramic capacitor that when used with your automatic insertion equipment, puts the in-place cost lower than other capacitors.

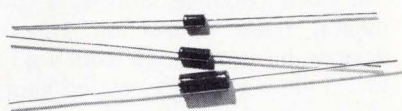

This axial leaded glass encapsulated beauty, called the Green Goddess, offers a wide range of capacitances (10pF to .56mFd) in three dielectric formulations (COG, X7R & Z5U).

O.K. so you don't have automatic insertion equipment, you've got to look into our Clover Cap line of radial leaded capacitors with capacitances from 5.6pF to 4.7mFd. The series is epoxy coated for durability and available in a variety of dielectrics.



Speaking of radials...I'll bet you didn't know that we make MIL-C-11015 qualified CKO5's and CKO6's?...That's right, we make them for those special applications where military qualified components are required.

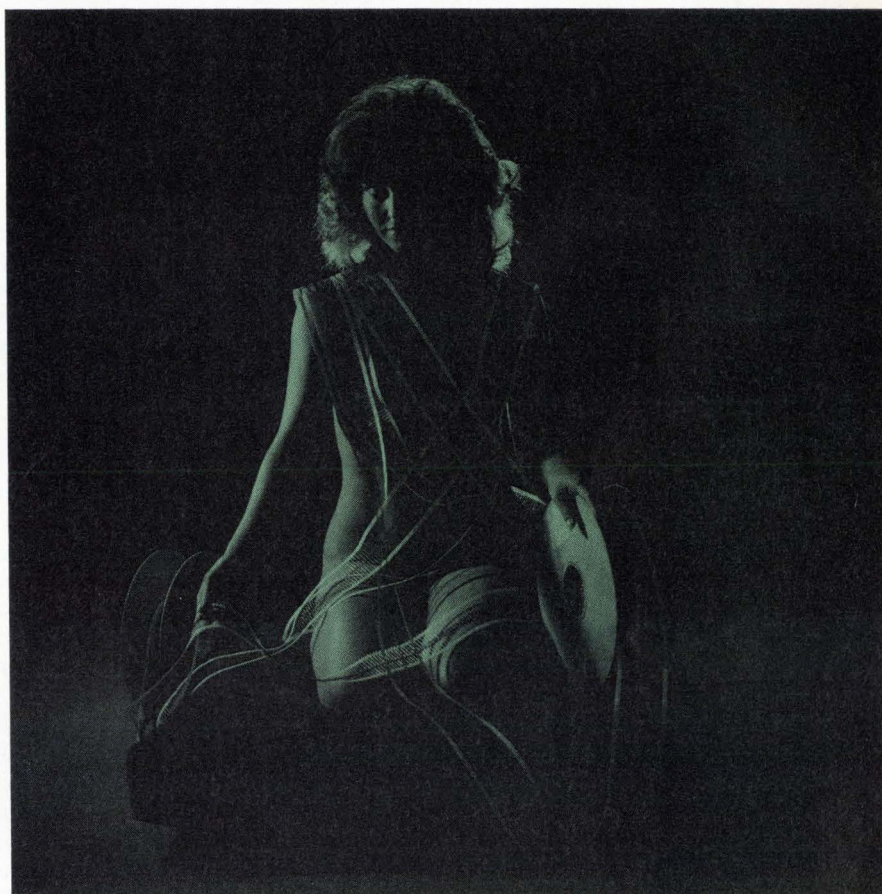

With your automatic insertion equipment, the in-place cost of the Varadyne Green Goddess capacitor can be lower than other capacitors.

You don't need leaded devices?



How about ceramic capacitor chips, with capacitances from 1pF to 2.2mFd, for those thick film hybrid circuits? We've sold millions of them for commercial, industrial and military qualified applications.

When it comes to quality ceramic capacitors...we have your capacitor. Drop us a line and get the literature you need. And remember, if you have a special request or technical question, our Applications Engineering department is here to help.

Varadyne

Varadyne Industries, Inc. 1520 Cloverfield Blvd. Santa Monica, California 90404
(213) 829-2984 — TWX (910) 343-6856

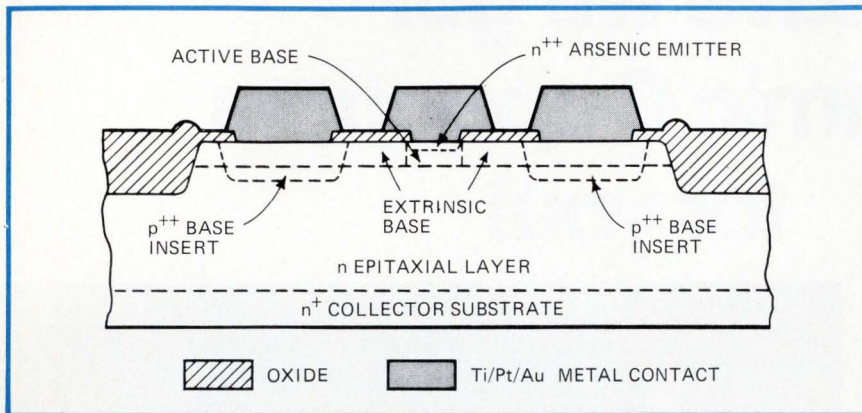

Process. New HP transistors use ion implantation and self alignment to define n⁺⁺ arsenic emitter and p⁺⁺ base insert. Metals insure low contact resistance, reliability.

the geometry of the emitter "fingers." But, as the devices get smaller, the current density becomes enormous, and capacitive effects grow, decreasing gain. What's more, as thermal and injection-current effects increase, noise increases.

However, engineers at Hewlett-Packard Co.'s Microwave Semiconductor division appear to have found a way out of this bind. They have developed a technique that enables them to make submicrometer emitter fingers without sacrificing device gain or yield, and yet minimize the noise figure. Without pushing the limits of their process, engineers at the Palo Alto, Calif., division have built, and are producing in volume a 4-gigahertz device—the HXTR-6101—that has an associated gain of about 9.0 to 9.5 decibels and a typical noise figure in the 2.3- to 2.7-dB range.

In contrast, competitors like Avantek Inc., TRW Semiconductor, Microwave Semiconductor Corp., Texas Instruments, Nippon Electric Co. and Fujitsu Ltd. are getting for comparable 4-GHZ silicon transistors under development associated gains ranging from about 7.5 to 8 dB and typical noise anywhere from 2.7 to 3.5 dB.

Complex. The HP technique, involving a combination of ion implantation, local oxidation, computer-aided design and a proprietary self-aligning process, is complex but effective. Craig Snapp, section manager for bipolar transistors at HP, says highly reproducible emitter-to-

emitter spacings of 5 micrometers and emitter widths of about 0.7 μm can be achieved by using conventional contact lithography and hard-surface oxidized chrome photo-masks.

"Transistors with this fine a geometry have previously been fabricated," says Snapp, "but usually with processes requiring projection-mask aligners, electron-beam lithography, or lateral-diffusion techniques, none of which are associated with high-volume production."

Keys to the fine geometries are the use of ion implantation and a self-alignment technique that simultaneously defines the emitter and base-contact windows in a silicon-dioxide layer, he says. In conventional devices, by contrast, a combination of diffusion and ion implantation is used in the fabrication of the emitter and base fingers.

Combined with the self-alignment technique, this eliminates one of the most critical alignments and, thus, two major sources of noise in silicon bipolar transistors: thermal noise arising in the base-spreading resistances and shot noise in the injection of current across the emitter-base junction.

Increasing gain. To improve the gain of their devices, Snapp found he had to minimize the effects of the collector-base junction capacitance and the collector-base bonding-pad capacitance. "The first was achieved partly as a side product of improving the noise characteristics," he says. Another factor was the closer place-

ment of the interdigitated fingers of the emitter.

To reduce the collector-base bonding-pad capacitance, a relatively thick oxide is formed by a local-oxidation/ion-implantation combination that uses a silicon-nitride cap to prevent the formation of oxide in the base region during a thermal-oxidation cycle.

Family. The HXTR-6101, says Snapp, is the first in a family of linear microwave power-amplifier elements extending from as low as 0.4 GHz to as high as 8 GHz. Experimental noise figures on 1.5 GHz devices, he says, range from 1.45 dB to 1.5 dB, with an associated gain of 15 dB. At the high end, around 6 GHz, devices have been fabricated with 3.9-dB noise figures and 7.5-dB associated gain. □

Microprocessors

Intel eases use of high-level language

"For the first time, microcomputer designers have access to the more powerful software techniques developed in the past 10 years," says Intel Corp.'s Paul Rosenfeld, software product manager for microcomputer systems. "And they do not add appreciable extra complexity to the [software] development process."

Enhancements. Rosenfeld is talking about the modular approach to programing and the use of a high-level language, both of which are groundbreaking features of an enhanced software package for Intel's Intellec microcomputer-development system [*Electronics*, May 25, 1975, p. 95]. Called the ISIS-II, the package will be introduced at the Wescon meeting in Los Angeles later this month.

Until now, any designer who wished to modularize his microcomputer's software has been able to use high-level languages for the job only with difficulty. To link the program modules and assign them correctly to memory addresses, the designer has been forced to conform to very

Looking at price? Then look to the future... With glass TAX capacitors from ITT Components Group

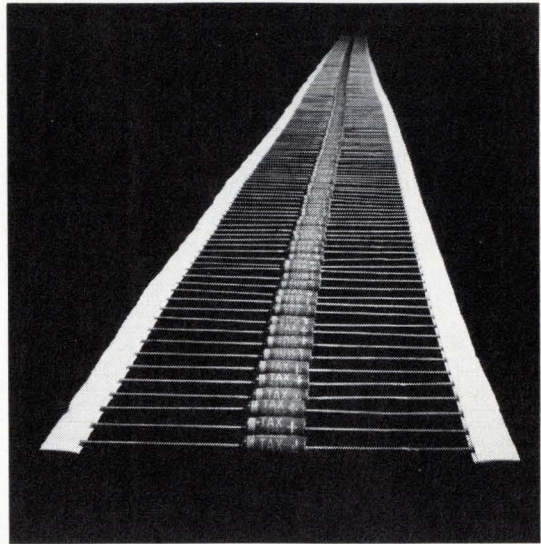

Today is the time to replace the Sprague 150D or the Kemet T110 you're using now with a compatible solid tantalum axial leaded capacitor available at a competitive price. Look into glass encapsulated, hermetically sealed TAX capacitors from ITT Components Group.

Glass . . . it's the look of the future. Your better buy because glass tantalums can be produced by super automation processes and require no insulating sleeves. The simple manufacturing process will make glass — as time goes by — the increasingly economical alternative to metal-canned, axial leaded tantalum capacitors. And with future assurance of good delivery levels.

The TAX series is packaged to run

right off its reel and into your operation. Automatically. And if you are using Kemet's T310 you will want to compare the reliability of epoxy against our **better priced better option — glass**. Each unit is 100% tested for hermeticity and to all data sheet parameters because sample testing just isn't good enough for ITT Components.

Look to the future today by checking out glass tantalum capacitors. For technical specifications and free samples of the TAX, write to George Kase at ITT Components Group, 1551 Osgood St., No. Andover, MA 01845. Or call him at (617) 688-1881. Tell him you want to look into our better alternative!

Ratings

Capacitance:	0.1 to 47 μ F
Tolerance Range:	$\pm 20\% \pm 10\%$
Voltage:	6.0 to 35 volts DC (50 volts on request)
Temperature Range:	-80° C to $+125^{\circ}$ C.

We're listed in sections 1500 and 4500 in your 1976-7 EEM catalog.

Components **ITT**

When you need capacitors, our better alternative will be your first choice.

detailed cross-reference specifications. ISIS-II, however, which has a disk-based operating system, includes both linker programs and locator programs that work with a resident compiler for the high-level PL/M language. A new macro-instruction assembler and a library manager complete the package.

Intel's original Intellec system has become a model for in-circuit emulation systems, which stand in for the microprocessor during the design and development of associated hardware and software.

The approach gives the engineer a lot of freedom in prototyping a microcomputer system, and the addition of a high-level language and modularization is a step that will undoubtedly be followed by other major suppliers of microprocessors.

PL/M was originally developed by Intel for its earlier 8008 microprocessor. But before ISIS-II the language could be compiled for the 8080 chip only on a large 32-bit computer. The new PL/M compiler is compatible with the earlier PL/M cross-compiler but was rewritten from scratch, according to Rosenfeld. It makes multiple passes through the Intellec system and requires 65 kilobytes of memory.

Modular programming has the same advantages for the design of microcomputer-based systems as for computer- and minicomputer-system design. It enables the programmer to write separate subroutines for common tasks, debug them separately, and then—in the case of ISIS-II—use linker and locator software aids to stitch them together into a larger program. And, with the ISIS-II library manager, the routines can be stored on disk and easily withdrawn when needed.

New bus. The key to linking these new elements together according to Rosenfeld, is to establish language specifications for a "software bus." These work like the standard specifications that allow a hardware bus to be connected to all hardware modules meeting the standards. Similarly, standard specifications for a software bus permit its interconnection to program modules.

News briefs

Fairchild takes on Mostek 4-k RAM

Mostek Corp., the acknowledged leader in sub-200-nanosecond 4,096-bit random-access-memory chips, has chosen Fairchild Semiconductor as its second source for its 16-pin MK 4027. Mask and process exchanges between the two manufacturers should insure close conformity of specifications between the hard-to-build depletion-mode polysilicon devices. The deal continues the two companies' already close association—Mostek, in turn is Fairchild's only second source in the U.S. for the popular F-8 microprocessor system.

Add-on memory maker recalls employees

Cambridge Memories Inc. has been able to recall 80 of 350 laid-off workers by selling its leasing operations to pay off \$13 million of its \$16 million debt [*Electronics*, Aug 5, p.38]. Yet to come is its decision whether to sell all or part of its Poughkeepsie, N.Y., plant for making n-channel metal-oxide-semiconductor memories. The Bedford, Mass., company had sales of \$11.6 million for the six months ending Feb. 28, while during the same period it lost \$604,000.

Peterson resigns to make way for Penisten . . .

Valentine E. Peterson, who was serving as interim president of American Microsystems Inc., Santa Clara, Calif., succeeding Bernard T. Marren, has resigned. He makes way for Glenn E. Penisten, former head of Datran (see p. 32), who had been elected president and chief executive earlier.

. . . as Signetics names Sharp to head Logic division

U.S. Philips Corp.'s Signetics subsidiary in Sunnyvale, Calif., has named Steven J. Sharp general manager of its Logic division. Formerly the division's advanced technology manager, Sharp replaces Norman J. Miller, who becomes president of U.S. operations for ITT Semiconductor, based in Woburn, Mass.

The locator program then takes over and adjusts the memory addresses of the linked programs so that each resides in nonconflicting sections of memory. The program can then be executed. With the linker and locator, a software library can be built up of basic routines and

drawn upon whenever it's needed.

Users who have the Intellec system now will be sent the ISIS-II package, which includes linker, locator, library manager, and macro assembler and requires 32-k memory. But the PL/M compiler will be sold separately. □

Air-traffic control

System under test at O'Hare Airport detects dangerous aircraft wakes

Aircraft attempting to land in the turbulent wake of planes touching down ahead of them can encounter dangerous buffeting. To warn air-traffic controllers of the presence of these wake vortexes, as they're called, the Department of Transportation's Systems Center has installed a wake advisory system at Chicago's O'Hare International Airport and is

now in the process of testing it. The hope is also to increase the number of landings (and take-offs) by safely shortening the separation between landing aircraft.

Wake vortexes are the tube-shaped trails of turbulent air churned up by the plane's wings and flaps. They can remain in the approach corridors so long after a

When a new and unknown company gets to be No. 1 in bipolar PROM

It isn't because of their reputation

It takes innovative, quality products and the ability to produce and deliver them on time. It takes the breadth of product line, including a full mil. temp.

version of every part, that gives the customer the choices he needs.

And last, but not least, it takes competitive pricing that helps the customer hold down the cost of his product.

But don't take our word for it.

Look over our product line and our prices. You'll see why we've become No. 1.

For more information call, TWX or write:

United States
Monolithic Memories, Inc.
1165 East Arques Avenue
Sunnyvale, CA 94086
Tel: (408) 739-3535
TWX: 910-339-9229

Europe
Monolithic Memories, GmbH
8000 Munich 80
Mauerkircherstr. 4
West Germany
Tel: (089) 982601, 02, 03, 04
Telex: (841) 524385

Far East
MMI Japan, K.K.
2-2, Sendagaya 4-chome,
Shibuya-ku,
Tokyo 151, Japan
Tel: (03) 403-9061
Telex: J26364

MONOLITHIC MEMORIES PROMS

MEMORY SIZE	ORGANIZATION	DEVICE	OUTPUTS	PINS	OPERATING RANGE	MAX* ACCESS TIME (ns)	100-999 PRICE
256	32 x 8	6330/1-1	OC/TS	16	com	50	\$ 2.55
		5330/1-1	OC/TS	16	mil	60	5.00
1024	256 x 4	10149	OE	16	com	30	17.50
1024	256 x 4	6300/1-1	OC/TS	16	com	55	3.25
		5300/1-1	OC/TS	16	mil	75	7.90
2048	256 x 8	**6308/9-1	OC/TS	20	com	65	15.95
		**5308/9-1	OC/TS	20	mil	85	33.50
2048	512 x 4	6305/6-1	OC/TS	16	com	60	7.00
		5305/6-1	OC/TS	16	mil	75	15.95
4096	512 x 8	**6348/9-1	OC/TS	20	com	65	15.95
		**5348/9-1	OC/TS	20	mil	85	33.50
4096	512 x 8	6340/1-1	OC/TS	24	com	90	15.95
		5340/1-1	OC/TS	24	mil	120	33.50
4096	1024 x 4	6350/1-1	OC/TS	18	com	60	15.95
		5350/1-1	OC/TS	18	mil	75	33.50
4096	1024 x 4	6352/3-1	OC/TS	18	com	60	15.95
		5352/3-1	OC/TS	18	mil	75	33.50
8192	1024 x 8	**6386/7-1	OC/TS	22	com	90	Consult
		**5386/7-1	OC/TS	22	mil	125	Factory
8192	1024 x 8	**6380/1-1	OC/TS	24	com	90	Consult
		**5380/1-1	OC/TS	24	mil	125	Factory

*max access time is guaranteed over the complete voltage and temperature variation.
**available October 1976.

Monolithic Memories

RF power

We've made the most of it...
You can, too!!

All wrapped up in a neat little package, our Model 510L is an ultra-wideband RF power amplifier whose wide range of frequency coverage and power output provide the user with the ultimate in flexibility and versatility in a laboratory instrument. Easily mated with any signal generator, this completely solid state unit amplifies AM, FM, SSB, TV, pulse and other complex modulations with a minimum of distortion.

Constant forward power is continuously available regardless of the output load impedance match making the 510L ideal for driving highly reactive loads.

Unconditional stability and instantaneous fail-safe provisions in the unit provide absolute protection from damage due to transients and overloads.

This outstanding unit covers the frequency range of 1.7 to 500 MHz with a linear power output of more than 9.5 watts and there is no tuning.

For further information or a demonstration, contact ENI, 3000 Winton Road South, Rochester, New York 14623. Call 716-473-6900 or TELEX 97-8283 E N I ROC

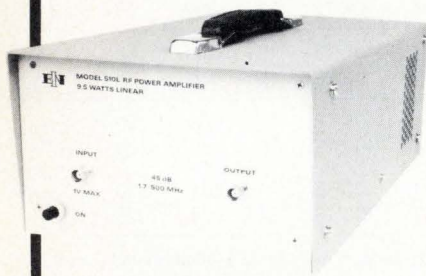

ENI

The world's leader
in solid state power amplifiers

Electronics review

large jet like a Boeing 707 has landed that a single-engine plane may have to keep a 6-mile distance from the 707 when coming in behind. And until now, air-traffic controllers have had no way to detect the air disturbance. Instead, they simply used extremely conservative aircraft-separation rules.

Earlier data. James Hallock, a member of the technical staff of the transportation center's safety and operations branch, says the advisory system is the outgrowth of data collected from more than 33,000 landings at New York's John F. Kennedy, Denver's Stapleton, and London's Heathrow airports.

According to that data, a corridor in which wake vortexes are no longer a problem can be consistently detected. It has an elliptical shape, and once the wake vortexes have been swept outside the ellipse by head and crosswinds, "there is no reason controllers can't maintain the minimum 3-nautical-mile separation" between aircraft landing under instrument flight rules.

The TSC system uses cup anemometers and weathervanes on six 50-foot-high towers in the O'Hare approach zones to indicate wind magnitude and direction.

A multiplexer samples the sensor outputs and converts them to a parallel digital word that's transmitted to a central facility. There, receivers reconvert the data for input to an Intel 8080-based microcomputer. Data derived from two samples per second from each sensor is averaged over 2 minutes from each runway corridor and compared to an algorithm that defines the vortex-free elliptical patterns.

Central display. The microcomputer data drives a digital display at which traffic controllers can select the runway corridor they want to check via thumbwheel switches, and the display will show them how widely separated incoming planes should be to avoid the turbulence.

Hallock says that if the O'Hare tests show the system can squeeze even four or five extra landings and takeoffs into an hour, runway capacity will be significantly increased. □

Citizens' band

Problems accompany move to 40 channels

Afraid of being stuck with unsold citizens' band receivers, several U.S. manufacturers are offering to update their units to operate over the 40 channels that will go into service on Jan. 1. But the modification may not be easy and may even be impossible at an acceptable price.

Much depends on how the channel frequencies, in the 27-megahertz range, are generated and whether or not the sets meet Federal Communications Commission requirements. The few transceivers that generate their carriers with phased-locked loops and synthesizers will be easy to modify. Inserting a new read-only-memory integrated circuit that generates the digital code to program the synthesizer will do the trick.

Crystal sets. But most of the sets imported from Japan and other offshore suppliers that are sold by a large number of U.S. firms generate frequencies with crystal synthesizers—as many as 14 crystals are required for the present 23 channels. To convert these sets, manufacturers would either have to switch to phased-locked loops or add more crystals, both relatively expensive modifications.

Still other problems will remain, however, even after the number of frequencies is increased. The FCC, in ruling for the 40-channel class D service [*Electronics*, Aug. 19, p. 34], wants all modified sets to meet new and more demanding specifications that put a tighter lid on spurious radiations from the CB transmitters and receivers.

The circuit boards in most offshore sets have no shielding, and it may be difficult to add to prevent radiation from the chassis. Also, a front-end filter may be needed to prevent local-oscillator radiation from leaking out the antenna.

The U.S. set makers now offering to modify their 23-channel sets

SORENSEN IS THE SOURCE.

FOR A COMPLETE LINE OF HIGH QUALITY POWER SUPPLIES

... that are priced right, immediately available, conservatively designed and rated, and covered by Sorensen's full warranties.

Sorensen. For a complete line of modules, lab supplies, assemblies, AC regulators, open frame, encapsulated and D/A programmers.

Sorensen Company,
676 Island Pond Rd.,
Manchester, N.H.
03103.
(603) 668-4500.

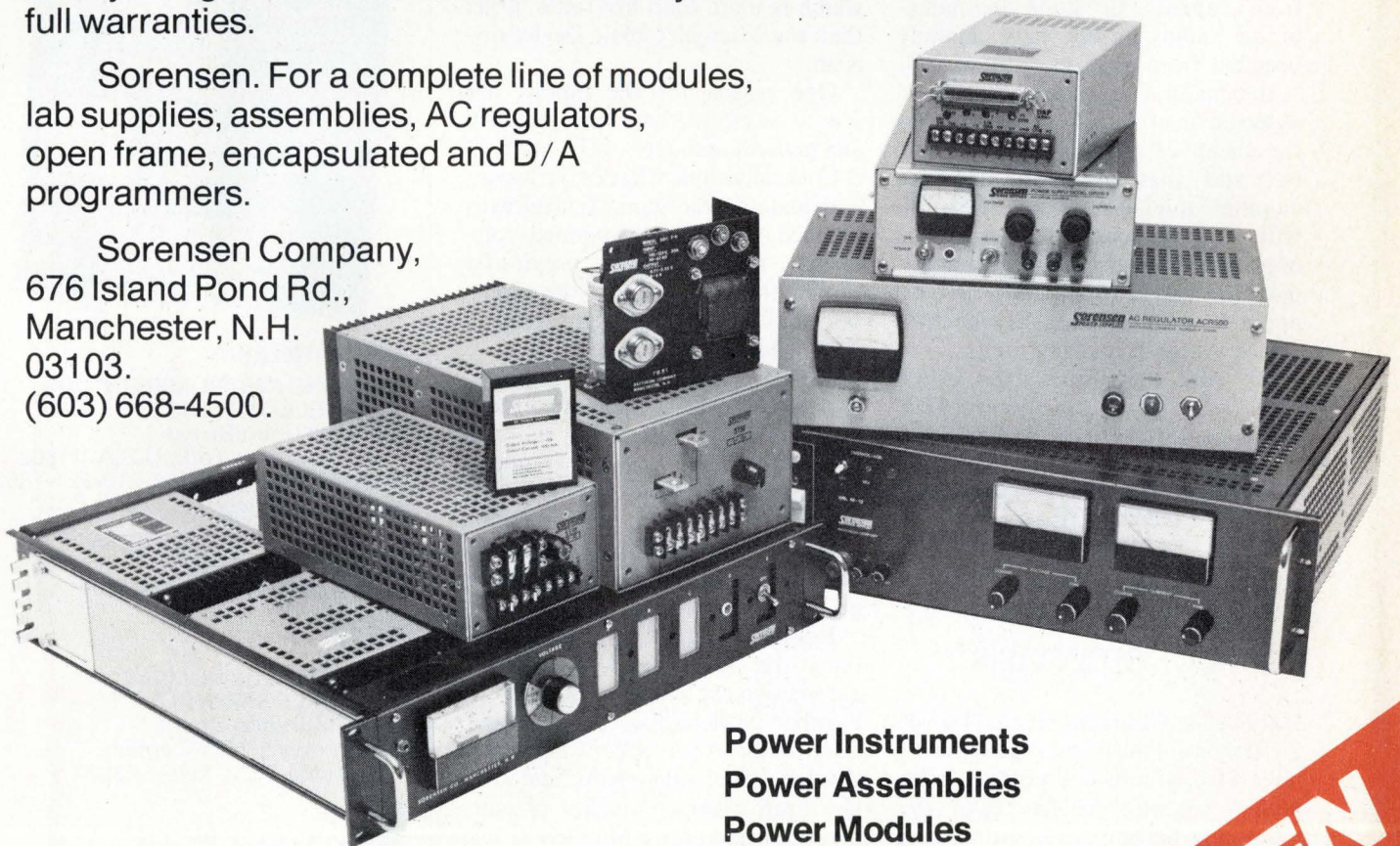

Power Instruments
Power Assemblies
Power Modules

See us at Booth
#765-767
Wescon '76
Los Angeles, Sept. 14-17

SORENSEN
POWER SUPPLIES

A Raytheon Company

Circle 39 on reader service card

include Hy-Gain Electronics Corp., Lincoln, Neb. and the California firms of SBE Inc., Watsonville, Communications Power Inc., Mountain View, and Pathcom Inc.'s Pace Communications division, Harbor City. They'll modify already owned or yet to be purchased sets at fees that range from \$25 to \$95. But not all the companies are, in general, offering to modify all their models—probably only the ones that are easiest to update.

Lower prices. For the consumer, however, prices are dropping. Some manufacturers forecast that, by Christmas, 23-channel sets will be priced at only \$49.95, as the scramble goes on to get rid of crystal-synthesized sets already in inventory and others committed to be shipped from Japan. For some big-name-brand radios prices have already been cut from \$159 to a low of \$99.

But major U.S. manufacturers do agree on one thing. They predict that the cheap 23-channel sets will fade out and that top-of-the-line 40-channel models, many operating with single-sideband transmissions of generally longer range, will dominate the marketplace until the FCC opens a so-called class E service in the very-high-frequency range about 1979. And they think sales of CB radio will remain at the current level of about 750,000 sets a month for two or three more years. □

Companies

Rockwell shifts product emphasis

Rockwell's Microelectronic Device division is emphasizing production of integrated circuits and products with higher potential profits than the minuscule margins of the division's former mainstay, calculators.

That is the immediate result of the first big change made by Donald R. Beall, who took over as president of Rockwell Electronics Operations in Anaheim, Calif., late this spring from Donn L. Williams [*Electronics*, May 13, p. 36]

Even though production of calculators and consumer-electronic products remains the largest operation in the division, managers have also been assigned responsibility for large-scale-integrated circuits applied to microprocessors, modems, and automotive products. This assignment of accountability comes as no surprise, since Beall had favored clear definition of responsibilities for product-line managers when he headed Rockwell's Collins Radio group, which he turned around to profitability.

Timing. Although Beall had been expected to make structural changes in the billion-dollar Electronics Operations, which includes Collins, some sources had thought he would give priority to the Autonetics group, which is more than five times larger than the Microelectronic Device division.

One reason for the timing, one source says, is that vice president and general manager of the Microelectronic division, Charles V. Kovac, had had the reorganization already planned when Beall assumed command. Williams had previously turned thumbs down on the proposal, wanting to keep tight central-management control.

Although the four new organizations will not be separate profit centers, each will have its own product-planning, design engineering, marketing, and financial sections. All will share such common functions as production, engineering, quality assurance, sales, and personnel.

Leaders. Heading the organizations are: H.A. Beall (see p. 14), automotive LSI and subsystems; D.R. Barnhart, calculator and consumer electronics; Alan Secor, microprocessor LSI and subsystems; and D.P. Del Frate (former director of marketing for the entire Microelectronic Device division), modem LSI and subsystems.

In a statement, Kovac said the move "culminates a three-year diversification plan, during which substantial business" was generated in the non-calculator and consumer areas. □

Tear out the new GI MOS Product Guide or contact any of the offices below for another copy or for more information.

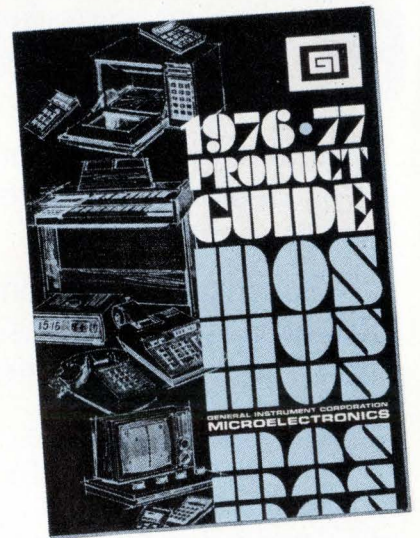

NORTH AMERICA

GENERAL INSTRUMENT CORP.
MICROELECTRONICS
600 West John Street
Hicksville, New York, U.S.A. 11802
Tel: 516-733-3107, TWX: 510-221-1866

SOUTH AMERICA

GENERAL INSTRUMENT IeC Ltda
Av. Faria Lima 1794,
Sao Paulo CEP 01452, Brazil
Tel: 2105508

EUROPE

GENERAL INSTRUMENT
MICROELECTRONICS LTD.
57/61 Mortimer Street,
London W1N 7TD, England
Tel: 01-636-2022, Telex: 23272

ASIA

GENERAL INSTRUMENT
HONG KONG LTD.
Room 704 Star House
3 Salisbury Road,
Kowloon, Hong Kong
Tel: 3-675528, Telex: 84606

GENERAL INSTRUMENT
MICROELECTRONICS 

See us at WESCON
Booths 1086-1088

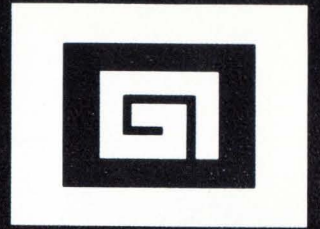

1976·77 PRODUCT GUIDE

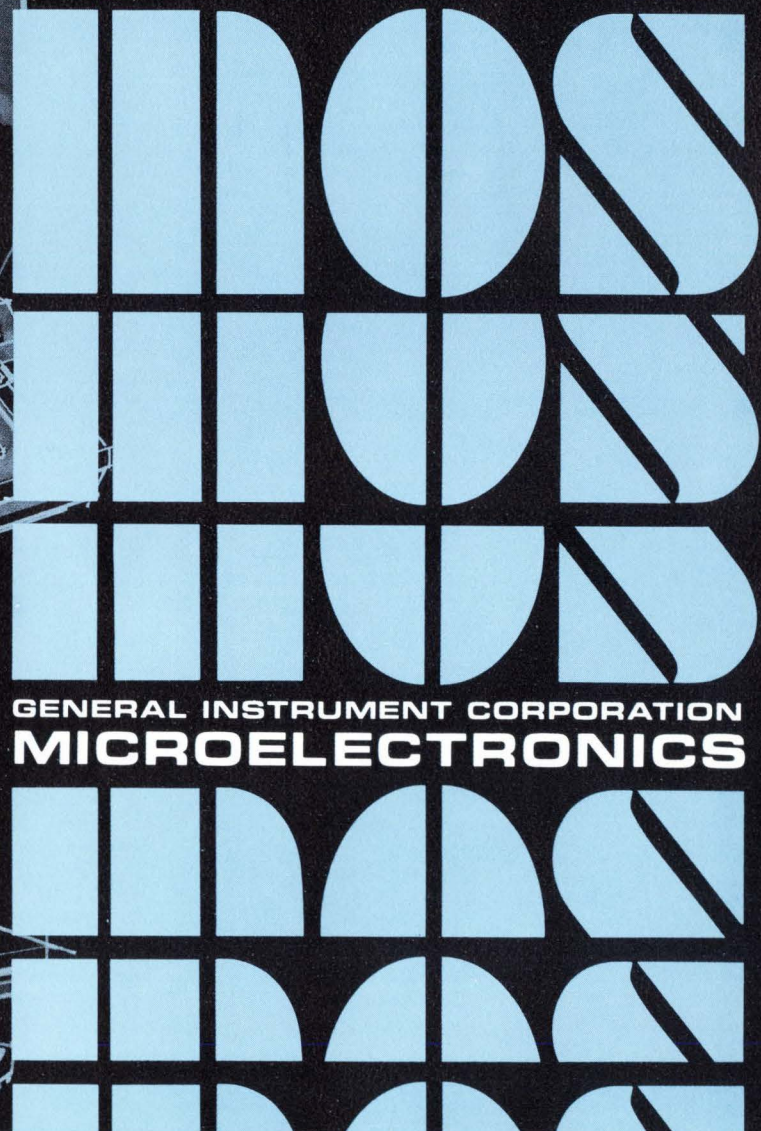

GENERAL INSTRUMENT CORPORATION
MICROELECTRONICS

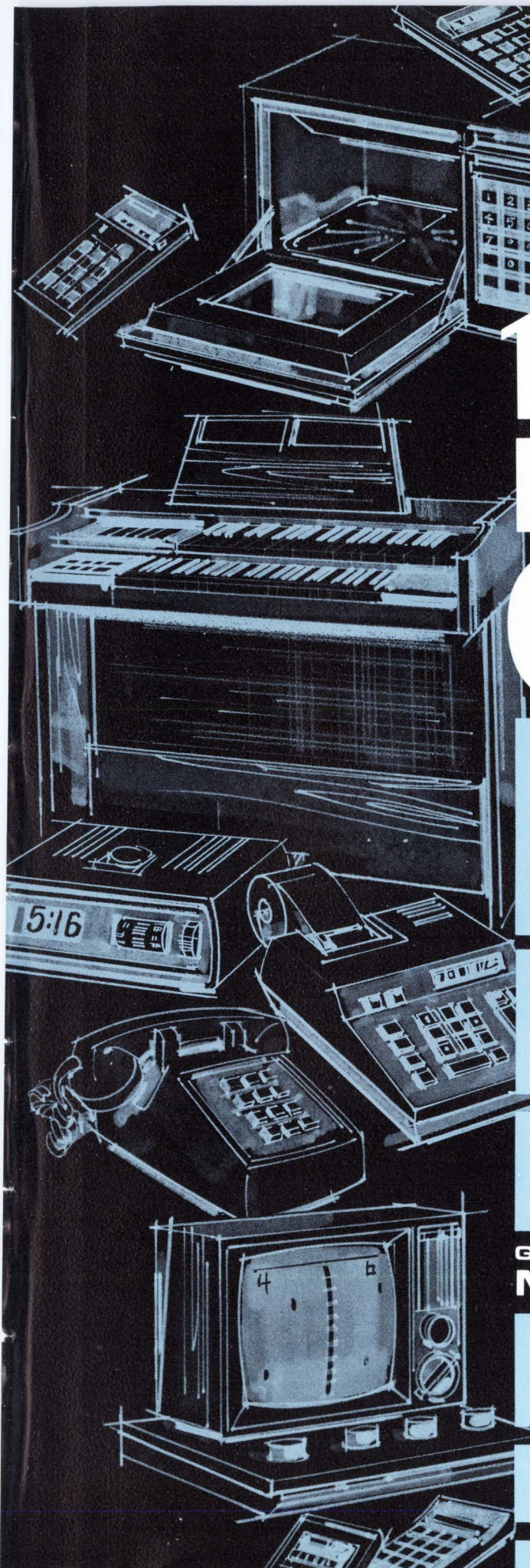



ELECTRONIC ORGANS / FREQUENCY DIVIDERS

DESCRIPTION	FUNCTION	PART NUMBER	MAXIMUM FREQUENCY	POWER SUPPLIES	PACKAGE	FEATURES
MASTER FREQUENCY GENERATOR	Generates a complete octave of musical frequencies	AY-1-0212	1.5 MHz	+12, GND	16 DIP	250 kHz minimum frequency
		AY-1-0212A	2.5 MHz			
TOP OCTAVE GENERATOR	Generates top octave scale	AY-3-0214	4.5 MHz	+10 to +16, GND	16 DIP	12 outputs, 50% duty cycle
		AY-3-0215				13 outputs, 50% duty cycle
		AY-3-0216				13 outputs, 30% duty cycle
PRIORITY LATCHING NETWORK	Establishes priority level of 13 latch inputs/outputs	AY-1-1313	20 kHz	GND, -12, -27	40 DIP	Stackable for expanded latching/priority function.
RHYTHM GENERATOR	Generates 6 rhythms, drives 8 instruments	AY-5-1315	10 kHz	GND, -15	18 DIP	Resets for coupling chords to rhythm. 32 beat pattern. Mask programmable.
CHORD GENERATOR	Produces major, minor, 7th chords, walking bass	AY-5-1317A	50 kHz	GND, -15	40 DIP	Mixed outputs, sustain, top key priority
PIANO KEYBOARD	Electronically simulates piano operation and sound	*AY-5-1350	—	GND, -10, -27	40 DIP	12 keys per unit, loudness proportional to key press velocity.
FREQUENCY DIVIDERS	4 stage	AY-1-5051	1 MHz	GND, -13, -27	10 TO	Arranged 2+1+1
	5 stage	AY-1-6721/5	1 MHz	GND, -13, -27	10 TO	Arranged 3+2
	6 stage	AY-1-6721/6	1 MHz	GND, -13, -27	12 TO	Arranged 3+2+1
		AY-1-1006	50 kHz	GND, -12, -27	14 DIP	Arranged 3+2+1
	7 stage	AY-1-2006	50 kHz	GND, -12, -27	14 DIP	Arranged 2+2+1+1
		AY-1-5050	1 MHz	GND, -13, -27	14 DIP	Arranged 3+2+1+1
		AY-1-1007B	50kHz	GND, -12, -27	14 DIP	Arranged 3+2+1+1, power-on reset
2 ¹⁶ ÷ 2 Counter/Divider	AY-9-1000	Operation is a function of current through a resistor from V _{CC} to Injection input.		8 TO, 16 DIP	Crystal/RC oscillator input; divide by 2 ¹⁶ , 2 ¹⁵ , 2 ¹² , 2 ¹¹ , 2 ¹⁰ , or 2 ⁷ .	

*For future release.

TELECOMMUNICATIONS

DESCRIPTION	FUNCTION	PART NUMBER	POWER SUPPLIES	PACKAGE	FEATURES
PUSH BUTTON TELEPHONE DIALLER CIRCUIT	Converts push button input to rotary dial pulses	AY-5-9100	SEE DATA SHEET	18 DIP	Programmable timing, one-call memory, optional re-dial and access pause capability.
REPERTORY DIALLER	Stores ten telephone numbers	AY-5-9200	SEE DATA SHEET	16 DIP	Complements AY-5-9100 to enable storage of up to ten 22-digit telephone numbers. Stackable.
COINBOX CIRCUIT	Controls the operation of a standard pay telephone	AY-5-9300	SEE DATA SHEET	24 DIP	Up to 3 coin denominations recognized. 16 selectable coin value ratios.
DUAL TONE MULTI-FREQUENCY GENERATOR	Generates MF/telephone frequencies	AY-3-9400	+5, GND	14 DIP	With a low cost ceramic resonator, generates 12 tone pairs.
		AY-3-9410	+5, GND	16 DIP	Same as AY-3-9400 but generates 16 tone pairs for data transmission.
C-MOS CLOCK GENERATOR	Generates 2-phase clocks from a single power supply	AY-5-9500	SEE DATA SHEET	14 DIP	Generates 2-phase clocks for AY-5-9100 & AY-5-9200.
MULTI-FREQUENCY RECEIVER	Detects and converts MF/Tone telephone frequencies.	AY-5-9800	SEE DATA SHEET	28 DIP or 40 DIP	Many programmable features provide wide applications.

DATA COMMUNICATIONS

DESCRIPTION	FUNCTION	PART NUMBER	REPLACES (PIN-FOR-PIN)	BAUD RANGE	MAX. FREQ.	TEMP. RANGE	POWER SUPPLIES	PACKAGE	FEATURES
UAR/T*	Complete 5-8 bit serial/parallel, parallel/serial interface	AY-3-1015	AMI S1757 SIG 2536 SMC COM2505 TI TMS6011 WD TR1402A WD TR1602A	0 to 30 kb	480 kHz	0 to 70	+5, GND, -12	40 DIP	1, 1.5, or 2 stop bits
		†AY-6-1013		0 to 20 kb	320 kHz	-55 to +125			
		AY-5-1013		0 to 30 kb	480 kHz	0 to 70	+5 to +14, GND	40 DIP	1, 1.5, or 2 stop bits
		AY-5-1013A		0 to 40 kb	640 kHz	0 to 70			
		AY-3-1014A		0 to 30 kb	480 kHz	0 to 70			
RANDOM/SEQUENTIAL ACCESS MULTIPLEXER	Multiplexes 16 analog channels, current, voltage, or differential mode	AY-5-1016	—	—	2 MHz	0 to 70	+5, GND, -12	40 DIP	
		†AY-6-4016				-55 to +125			

*Also available with MIL STD 883 screening (add suffix TX to part number).

*UAR/T is a trademark of General Instrument Corporation.

MICROELECTRONICS

COUNTERS / DIGITAL METERS

DESCRIPTION	FUNCTION	PART NUMBER	MAX. COUNT FREQUENCY	DISPLAY CURRENT	POWER SUPPLIES	PACKAGE	FEATURES
1 DIGIT COUNTER	Counts & decodes one decade to BCD outputs.	MEM 1056BCD	1.0 MHz	—	GND, -13, -27	24 DIP	BCD outputs.
1 DIGIT COUNTER/DISPLAY DRIVER	Counts & decodes one decade to 7-segment outputs.	MEM 1056	1.0 MHz	1.0 mA	GND, -13, -27	24 DIP	7-segment outputs
4 DIGIT COUNTER	Counts, stores & decodes four decades to BCD outputs.	AY-5-4057	500 kHz	—	+5, GND, -12	16 DIP	BCD outputs
4 DIGIT COUNTER/DISPLAY DRIVER	Counts (up or down), stores & decodes four decades to 7-segment outputs.	AY-5-4007	600 kHz	25 mA/V	+5, GND, -12	24 DIP	BCD outputs, true/complement control
		AY-5-4007A				40 DIP	Includes features of AY-5-4007 & 4007D.
		AY-5-4007D				24 DIP	Serial count output, three carry outputs
3½ DIGIT DVM CIRCUIT	DVM logic incorporating dual ramp integration	AY-5-3507	40 kHz	6 mA	GND, -15	18 DIP	Range to 1999, 7-segment outputs
		AY-5-3510		—		16 DIP	Range to 1999, BCD outputs
3¾ DIGIT DVM CIRCUIT	DVM logic incorporating single ramp integration	AY-5-3500	200 kHz	6 mA	GND, -7.5, -15	28 DIP	3 ranges: 999, 1999, 2999. Dual polarity, BCD & 7-seg. outputs
4¾ DIGIT DVM CIRCUIT	DVM logic incorporating dual ramp integration	AY-3-3550	400 KHz	2.5mA	+5, GND	40 DIP	Auto-range, auto-zero, auto-polarity, 7 segment/BCD outputs, counter mode.
10 BIT D/A CONVERTOR	Ladderless D/A converter	AY-5-5053	SEE DATA SHEET	—	+5, GND, -12	24 DIP	Employs stochastic techniques.
A/D CONVERTOR CONTROL	With AY-5-5053, performs A/D with transmitter facility.	AY-5-5054	SEE DATA SHEET	—	+5, GND, -12	24 DIP	For use in remote sensing applications.

NEW

MICROPROCESSORS

DESCRIPTION	PART NUMBER	INTERNAL REGISTER ADD	CLOCKS/FREQUENCY/MICROCYCLE	INTER-FACE	POWER SUPPLIES	PACKAGE
16 BIT — High performance, N-Channel, single-chip with 3rd generation minicomputer architecture, 87 basic instructions, 8 general purpose 16 bit registers, last-in/first-out stack of unlimited depth, 65K memory address capability, dual level priority interrupt system, and Direct Memory Access capability.	CP1600	3.6 μ s	2/3.3 MHz/ 600 ns.	TTL	+12, +5, GND, -3	40 DIP
	*CP1600A	2.4 μ s	2/5 MHz/ 400 ns.			
8 BIT — PIC 1640: A single-chip byte oriented micro-programmable interface controller for low cost microprocessor/peripheral device interfacing. An internal ROM microprogram defines the overall functional characteristics and operational waveforms on each of the general purpose I/O lines. PIC 1650: A single-chip byte oriented micro-programmable controller, with 32 bidirectional I/O lines, designed to satisfy the requirements for a low-cost, stand-alone 8-bit microcomputer. Full software support and a hardware emulator are available for both units. Both products emphasize control and interface functions. PIC 1650 design/instruction set also supports computing functions. Full software support and a Hardware Emulator are available.	PIC1640	1 μ s	1/4 MHz/1 μ s	TTL	+5, GND	40 DIP
	PIC1650					40 DIP
8 BIT — ALPS: Advanced Logic Processing System. A kit of 5P-Channel arrays consisting of microprocessor, ROM, I/O, memory interface (to standard, RAM, ROM, PROM), and a clock/reset generator circuit. The microprocessor contains an 8-bit accumulator, 48-internal registers, binary and decimal capability, and an input/output port allowing simple systems to be configured with as few as two chips.	LP8000	5.5 μ s	1/720 kHz/694 ns.	TTL or high level (open drain)	+5, GND, -12	40 DIP
	LP6000					40 DIP
	LP1010					40 DIP
	LP1000					40 DIP
	LP1030					8 DIP
INPUT/OUTPUT BUFFER — A byte-oriented programmable input-output buffer that can interface a 16-bit I/O port to any 8-bit or 16-bit data bus. A real-time presetable counter, three levels of priority interrupt logic, three interrupt vectors, control and status registers, parity check logic and all handshaking logic are included.	IOB1680	—	—	TTL	+5, +12, GND	40 DIP
DUAL D/A CONVERTER — Provides 2 digital-to-analog converter outputs using a 10-bit pulse width modulation technique. There are 4 registers that can be set or read via an I/O port: 2 D/A registers and 2 auxiliary registers which can be used for switch inputs, light driver outputs and mode control.	DAC1600	—	—	TTL	+5, +12, GND	40 DIP

NEW

NEW

General Instrument offers a "total product family" approach to microprocessor circuits including the circuits described here plus a full complement of semiconductor circuits, PC modules, prototype development hardware, extensive software support and comprehensive documentation.

*For future release.

RANDOM ACCESS MEMORIES

BITS/MODE	MEMORY ORGANIZATION	PART NUMBER	REPLACES (PIN-FOR-PIN)	ACCESS TIME/CYCLE TIME	POWER SUPPLIES	PACKAGE	FEATURES
1024 / STATIC	256 x 4	RA-3-4256	—	500ns/500 ns	+5, GND	24 DIP	Power down mode
		RA-3-4256A	—	650ns/650ns	+5, GND	24 DIP	Power down mode
		RA-3-4256B	—	650ns/650ns	+5, GND	22 DIP	
4096 / STATIC	4096 x 1	RA-3-4200	SEMI 4200	215ns/400ns	+12, +5, GND, -5	22 DIP	TTL output
		RA-3-4402	SEMI 4402	200ns/350ns	+12, GND, -5	22 DIP	Differential outputs

GENERAL INSTRUMENT MICROELECTRONICS

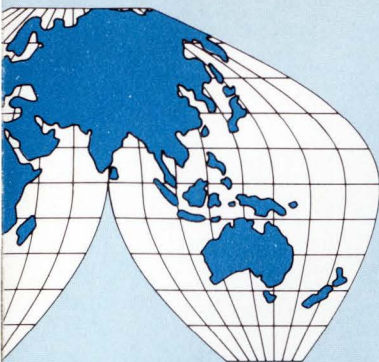

EUROPE

EUROPEAN SALES HEADQUARTERS: GENERAL INSTRUMENT MICROELECTRONICS LTD.

57/61 Mortimer Street, London W1N 7TD
Tel: 01-636-2022, Telex: 23272

CENTRAL EUROPEAN SALES OFFICE: GENERAL INSTRUMENT DEUTSCHLAND GmbH

(MOS Produktgruppe)
Nordendstrasse 1A, 8000 Munchen 40
Tel: (089)28.40.31, Telex: 528054

SOUTHERN EUROPEAN SALES OFFICE GENERAL INSTRUMENT EUROPE

Via Lorenzetti 6, 20100 Milano
Tel: 02/4084101, Telex: 39423

ASIA

JAPAN: GENERAL INSTRUMENT INTERNATIONAL CORP.

Fukide Building
17 Shiba-Fukide-cho, Minato-ku, Tokyo 105
Tel: (03) 437-0281-5, Telex: 26579

HONG KONG: GENERAL INSTRUMENT HONG KONG LTD.

Room 704 Star House
3 Salisbury Road, Kowloon, Hong Kong
Tel: 3-675528, Telex: 84606

MANUFACTURING FACILITIES

Hicksville, New York; Chandler, Arizona;
Glenrothes, Scotland; Kaohsiung, Taiwan

Farmingdale
Arrow (516) 694-6800

Fishkill
Arrow (914) 896-7530

Hauppauge
Semiconductor Concepts
(516) 273-1234

Johnson City
Wilshire (609) 797-1236

Woodbury
Diplomat (516) 921-9373

OHIO
Cleveland
Arrow (216) 464-2000

Dayton
Arrow (513) 253-9176

Diplomat (513) 228-1080

Semiconductor Specialists
(513) 278-9455

OREGON
Portland
United Radio (503) 233-7151

PENNSYLVANIA
Horsham
Pioneer (215) 674-5710

Pittsburgh
Semiconductor Specialists
(412) 781-8120

Trevoise
Hall-Mark (215) 355-7300

TEXAS

Dallas
Component Specialties
(214) 357-6511
Semiconductor Specialists
(214) 358-5211

Houston
Component Specialties
(713) 771-7237
Lenert (713) 225-1465

UTAH

Salt Lake City
Century (801) 487-8551
Diplomat (801) 486-7227

WASHINGTON

Seattle
Intermark (206) RO 7-3160

WISCONSIN

Milwaukee
Semiconductor Specialists
(414) 257-1330

New Berlin
Arrow (414) 782-2801

CANADA DISTRIBUTORS

BRITISH COLUMBIA
RAE Industrial Electronics Ltd.
1629 Main St.
Vancouver, B.C.
Tel: (604) 687-2621
TWX: (610) 929-3065

MANITOBA
Cam Guard Supply & Service Ltd.
1777 Ellice Avenue
Winnipeg, Manitoba
Tel: (204) 786-8481
Telex: 07-57622

ONTARIO
Cesco Electronics Ltd.
24 Martin Ross Avenue
Downsview, Ontario
Tel: (416) 661-0220
Telex: 02-29697

Cesco Electronics Ltd.
1300 Carling Avenue
Ottawa, Ontario
Tel: (613) 729-5118
Telex: 053-3584

Future Electronics Corp.
44 Fasken Drive, Unit 24
Rexdale, Ontario
Tel: (416) 677-7820

Electro Sonic Inc.
1100 Gordon Baker Road
Willowdale, Ontario
Tel: (416) 494-1666
Telex: 06-22030

QUEBEC
Cesco Electronics Ltd.
4050 Jean Talon St. West
Montreal, Quebec
Tel: (514) 735-5511
Telex: 05-25590

Future Electronics Corp.
5647 Ferrier Street
Montreal, Quebec
Tel: (514) 735-5775
TWX: (610) 421-3251
Telex: 05-827789

EUROPE AGENCIES & DISTRIBUTORS

AUSTRIA
Elbatex GmbH
Gatterholzgasse 20
A 1120 Wien
Tel: 0222/83 02 16, Telex: 13060

BELGIUM
C.P. Clare International N.V.
102 Gen. Gratry
Bruxelles 4.
Tel: 02-736.01.97., Telex: 24157

DENMARK

A/S Nordisk-Elektronik
Transformervej 17
DK-2730 Herlev
Tel: 84.20.00, Telex: 19219

FINLAND

Jorma Sarkkinen Ky.
Heikintori, P.O. Box 19,
SF-02100 Tapiola
Tel: 46.10.88, Telex: 122028

FRANCE

P.E.P.
4 Rue Barthelemy
92120 Montrouge,
Tel: 735.33.20, Telex: 204534

GERMANY

Frankfurt/Main
Berger Elektronik GmbH
Am Tiergarten 14
Tel: 0611/490311, Telex: 04-12649

Heilbronn
Elbatex GmbH
Caecilienstr. 24
Tel: 07131/89001, Telex: 728362

Lehrte

Altron
A.E. Thronicke KG
3160 Lehrte
Postfach 1280
Tel: 05132/53024, Telex: 922383

Munchen

Electronic 2000 Vertriebs-GmbH
Neumarkter Str. 75
8000 Munchen 80,
Tel: 0 89/43 40 61, Telex: 02-2561

GREECE

Elfon Ltd.
46 Asklipiou Str.
Athens
Tel: (021) 629-385, Telex: 214150

HOLLAND

Curijn Hasselaar
V Limburg Stirumstraat 31
P.O. Box 37, Geldermalsen
Tel: (0) 3455-3150, Telex: 40259

ITALY

Calderara Di Reno
I.C.C. S.r.l.
Localita Lippo
Via Crocetta, 38
40012 Calderara Di Reno (BO)
Tel: 051/726186

Genova

Adelsy S.p.A.
P.zza della Vittoria, 15/25
16121 Genova
Tel: (010)/589674

Milano

Adelsy S.p.A.
Via Domenichino, 12
20100 Milano
Tel: 4985051-2-3-4-5, Telex: 39423

Roma

Adelsy S.p.A.
P.le Flaminio, 19
00196 Roma
Tel: 06/3606580/3605769

Torino

Adelsy S.p.A.
C. so Matteotti, 32/A
10121 Torino
Tel: 011/53914

Udine

Adelsy S.p.A.
Via Marangoni, 45/48
33100 Udine
Tel: 0432/26996

NORWAY

J.M. Feiring A/S
Box 101, Bryn, Oslo 6
Tel: (02) 68.63.60, Telex: 16435

SPAIN

Julio Gazcon Hontecillas Electronica
Caspe 26
Barcelona-10
Tel: 231834/2227457, Telex: 52764

SWEDEN

Ajgers Elektronik AB
Box 7052
S-172-07 Sundbyberg
Tel: 08-985475, Telex: 10526

SWITZERLAND

Elbatex AG
Albert Zwysigstr. 28
CH 5430 Wettingen
Tel: 056/265641

UNITED KINGDOM

Keighley
Semicomps Northern Ltd.
Ingrow Lane
Keighley, W. Yorks
Tel: Keighley 65191, Telex: 517343

Kelso

Semicomps Northern Ltd.
East Bowmont Street
Kelso, Roxburghshire
Tel: Kelso 2366, Telex: 72692

Portsmouth

SDS Components Ltd.
Hilsea Industrial Estate
Portsmouth, Hants PO3 5JW
Tel: 0705 65311

St. Albans

Semicomps Ltd.
Wellington Road
London Colney
St. Albans, Herts
Tel: Bowmans Green 24522

West Drayton

Semiconductor Specialists Ltd.
Premier House, Fairfield Road
Yiewsley, West Drayton, Middlesex.
Tel: West Drayton 46415

MIDDLE EAST

IRAN

A. Ardehali
138 Vozara Ave., Tehran
Tel: 622896

ISRAEL

Alexander Schneider Ltd.
44 Petach Tikva Road
Tel-Aviv
Tel: 320.89-346.07, Telex: 033/613
Cable: DANYGAL, Tel-Aviv

ASIA

HONG KONG

Astec Components Ltd.
6 Hankow Road—2nd Floor
Keystone House, Kowloon
Tel: 3-687760 Kowloon
Telex: 780-74899 +

INDIA

SDM and Associates
Greater Kailash—1
New Delhi—110048
Tel: 611513

AUSTRALIA

New South Wales

G.E.S. (PTY) Ltd.
99 Alexander Street
Crows Nest, N.S.W.
Tel: 439-2488, Telex: 25486

Victoria

R and D Electronics (PTY) Ltd.
23 Burwood Road
Burwood, Victoria
Tel: 288-8232, Telex: 33288

SOUTH AFRICA

Metlronics (PTY) Ltd.
P.O. Box 39690
Bramley 2018
Tel: 40-7746, Telex: 43-4852

ELECTRICALLY ALTERABLE READ ONLY MEMORIES

BITS	MEMORY ORGANIZATION	PART NUMBER	READ ACCESS TIME	ERASE TIME	ERASE MODE	WRITE TIME	POWER SUPPLIES	PACKAGE	FEATURES
512	32 x 16	ER2050	4 μ s	100 ms	WORD (16 BIT)	100ms/ 16 BIT WORD	+5, -29	28 DIP	10 year data storage @ 70°C
1024	256 x 4	ER1105	2 μ s	100 ms	BLOCK (32 x 1)	10 ms/ 4 BIT WORD	+12, -12	24 DIP	
1400	100 x 14	ER1400	3.4 ms	20 ms	WORD (14 BIT)	20ms/ 14 BIT WORD	-35	8 TO	
4096	1024 x 4	ER2401	2 μ s	100 ms	BLOCK (1024 x 4)	10 ms/ 4 BIT WORD	+5, -5 -14, -24	24 DIP	
		*ER3400	600ns	1ms	WORD (4 BIT)	100 μ s/ 4 BIT WORD	+5,-12, -30	22 DIP	
8192	2048 x 4	ER2800	2 μ s	100 ms	BLOCK (2048 x 4)	20ms/ 4 BIT WORD	+5, -5 -14, -24	24 DIP	

*For future release.

READ ONLY MEMORIES

DESCRIPTION	BITS	MEMORY ORGANIZATION	PART NUMBER	REPLACES (PIN-FOR-PIN)	ACCESS TIME	CLOCKS/VOLTAGE	POWER SUPPLIES	PACKAGE	FEATURES
GENERAL PURPOSE	1024	256 x 4	RO-7-1024/4	—	1 μ s (typ.)	STATIC	+5, GND, -12	16 DIP	RO-6 versions avail. for -55° to +125°
		128 x 8	RO-7-1024/8	—	1 μ s (typ.)	STATIC	+5, GND, -12	24 DIP	
	2048	512 x 4	RO-7-2048/4	—	1.5 μ s (typ.)	STATIC	+5, GND, -12	24 DIP	
		256 x 8	RO-7-2048/8	—	1.5 μ s (typ.)	STATIC	+5, GND, -12	24 DIP	
			RO-5-1302	INTEL 1302	1.5 μ s (typ.)	STATIC	+5, GND, -12	24 DIP	Mask programmable version of 1702
	2560	512 x 5	RO-3-2560	—	450 ns.	STATIC	+5, GND	18 DIP	
	4096	512 x 8	RO-3-4096	—	500 ns.	STATIC	+5, GND	22 DIP	
	5120	512 x 10	RO-3-5120	EA 4000	500 ns.	STATIC	+5, GND	24 DIP	
	8192	2048 x 4	RO-5-8192	AMI S8865 T1TMS4000	1.2 μ s (typ.)	2/TTL	+5, -12	24 DIP	
	16384	4096 x 4	RO-3-16384	AMI S8996	1 μ s	STATIC	+5, GND	24 DIP	Address/CS latch
			RO-3-8316A	INTEL 8316A	850 ns.	STATIC	+5, GND	24 DIP	Replaces two 2708 or 8708 PROMs.
RO-3-8316B		AMI S6831A	450 ns.						
2048 x 8		RO-3-9316A	INTEL 8316E	850 ns.	STATIC	+5, GND	24 DIP		
		RO-3-9316B	AMI S6831B MOT 68317	450 ns.					
32768	4096 x 8	*RO-3-9332	—	850 ns.	STATIC	+5, GND	24 DIP		

NEW

*For future release.

Note: All Read Only Memories are mask-programmable.

KEYBOARD ENCODERS / CHARACTER GENERATORS

DESCRIPTION	BITS	MEMORY ORGANIZATION	PART NUMBER	REPLACES (PIN-FOR-PIN)	ACCESS TIME	CLOCKS/VOLTAGE	POWER SUPPLIES	PACKAGE	FEATURES
KEYBOARD ENCODER	2376	88 x 3 x 9	AY-5-2376	SMC KR2376	10-100 KHz Scan Rate	1/TTL OR INT. OSC.	+5, GND, -12	40 DIP	2 key rollover, 88 keys, 3 modes
	3600	90 x 4 x 10	AY-5-3600	SMC KR3600	10-100 KHz Scan Rate	1/TTL OR INT. OSC.	+5, GND, -12	40 DIP	2/N key rollover, 90 keys, 4 modes
CHARACTER GENERATOR	2240	64 x 5 x 7	RO-5-2240S	MK 2302 FSC 3257	1 μ s (typ.)	1/TTL FOR SCANNING	+5, GND, -12	24 DIP	5x7 char. col. out. on-chip scanning
	2560	64 x 8 x 5	RO-3-2513	SIG 2513	450 ns.	STATIC	+5, GND	24 DIP	5 x 7 characters, row output
	5184	64 x 9 x 9	RO-5-5184	—	5 μ s (typ.)	1/TTL FOR SCANNING	+5, GND, -12	24 DIP	9x9 char. on-chip left/right scanning

Note: All Keyboard Encoders and Character Generators are mask-programmable.

STATIC SHIFT REGISTERS

BITS	ORGANIZATION	0° to 70° PART NO.	-55° to +125° PART NO.	OPERATING FREQ. RANGE	INPUT/OUTPUT	CLOCKS/VOLTAGE	POWER SUPPLIES	PACKAGES	FEATURES
32	VARIABLE	SS-5-1032	SS-6-1032	DC-1 MHz	TTL	1/TTL	+5, GND, -12	16 DIP	6 S/R's arranged 1-1-2-4-8-16
	DUAL 16	†SS-5-8211	SS-6-8211	DC-2 MHz	TTL	1/TTL	+5, GND, -12	16 DIP	Set control dual input selector
		†SS-5-8212	SS-6-8212	DC-2 MHz				8/14 DIP, 8 TO	
64	QUAD 16	†SL-5-4016	—	DC-2 MHz	TTL	1/TTL	+5, GND, -12	14 DIP	
100	DUAL 50	†SL-5-2050	SL-6-2050	DC-1 MHz	TTL	1/TTL	+5, GND, -12	8/14 DIP, 8 TO	
	QUAD 25	†SL-5-4025	SL-6-4025	DC-1 MHz				14 DIP	
128	DUAL 64	†SL-5-2064	SL-6-2064	DC-1 MHz	TTL	1/TTL	+5, GND, -12	8/14 DIP, 8 TO	
	QUAD 32	†SL-5-4032	SL-6-4032	DC-1 MHz				14 DIP	
200	DUAL 100	†SL-5-C2100	—	DC-2 MHz	TTL	1/TTL	+5, GND, -12	14 DIP, 8 TO	
256	DUAL 128	†SL-5-2128	—	DC-1 MHz	TTL	1/TTL	+5, GND, -12	8/14 DIP, 8 TO	
		SL-5-C2128	—	DC-2 MHz					

† Available in Europe as part number SS-7-2016 (16 lead plastic DIP only)

† Available in Europe as part number SS-7/SL-7 (14 lead plastic DIP only)



GENERAL INSTRUMENT MICROELECTRONICS

UNITED STATES SALES REPRESENTATIVES

ALABAMA

20th Century Marketing
P.O. Box 6127—Hertz Sky Ctr.
Huntsville, AL 35806
Tel: (205) 772-9237
TWX: 910-726-2194

ARIZONA

Piper Goyne
P.O. Box 1648
Scottsdale, AZ 85252
Tel: (602) 946-4437
TWX: 910-950-0083

CALIFORNIA

Varigon Assoc.
931 S. Douglas
El Segundo, CA 90245
Tel: (213) 679-0621
TWX: 910-325-6610

PM Sales

475 So. San Antonio Road
Los Altos, CA 94022
Tel: (415) 941-4444
TWX: 910-370-7463

Varigon Assoc.

2423 Camino Del Rio S.
Suite 207
San Diego, CA 92108
Tel: (714) 299-5413

COLORADO

Piper Goyne
8041 W. 170
N. Frontage Rd.
Arvada, CO 80003
Tel: (303) 420-4646
TWX: 910-938-0755

CONNECTICUT

Gerald Rosen Co.
Colonial Square
2420 Main St.
Stratford, CT 06497
Tel: (203) 375-5456

FLORIDA

Hutto, Hawkins & Peregoy
139 Candace Dr.
Maitland, FL 32751
Tel: (305) 831-2474
TWX: 810-853-0256

Hutto, Hawkins & Peregoy

2159 S.E. 9th St.
Pompano Beach, FL 33061
Tel: (305) 943-9593
TWX: 910-956-9402

GEORGIA

20th Century Marketing
6176 Ridgeway
Douglasville, GA 30134
Tel: (404) 942-6483

ILLINOIS

Metcom Assoc.
2 Talcott Rd.
Park Ridge, IL 60068
Tel: (312) 696-1490
TWX: 910-253-5941

INDIANA

V.S. & Assoc.
1000 N. Madison Ave.
Greenwood, IN 46142
Tel: (317) 888-2260
TWX: 810-260-2231

V.S. & Assoc.

2122A Miami St.
South Bend, IN 46613
Tel: (219) 291-6258
TWX: 810-299-2535

IOWA

P M A
P.O. Box 1090
Cedar Rapids, IA 52401
Tel: (319) 362-9177

KANSAS

P M A
P.O. Box 6264
Overland Park, KS 66206
Tel: (913) 381-0004
TWX: 910-749-6473

P M A

P.O. Box 11252
Wichita, KS 67202
Tel: (316) 264-2662
TWX: 910-741-6851

MARYLAND

Component Sales
Hilton Plaza Inn—Suite 206
1726 Reisterstown Rd.
Baltimore, MD 21208
Tel: (301) 484-3647
TWX: 710-862-0852

MASSACHUSETTS

Gerald Rosen
271 Worcester Rd.
Framingham, MA 01701
Tel: (617) 879-5505
TWX: 710-380-0466

MICHIGAN

V.S. & Assoc.
29551 Greenfield Rd.
Suite 219
Southfield, MI 48076
Tel: (313) 559-3680
TWX: 810-299-2535

MINNESOTA

Nortec Sales
4530 W. 77th St.
Minneapolis, MN 55435
Tel: (612) 835-7414
TWX: 910-576-2842

MISSOURI

P M A
P.O. Box 1539
Maryland Heights, MO 63043
Tel: (314) 569-1220

NEW JERSEY

R.T. Reid Assoc.
705 Cedar Lane
Teaneck, NJ 07666
Tel: (201) 692-0200
TWX: 710-990-5086

NEW YORK

Quality Components
2095 Kensington Ave.
Buffalo, NY 14226
Tel: (716) 839-4170

Quality Components
116 E. Fayette St.
Manlius, NY 13104
Tel: (315) 682-8885
TWX: 710-545-0663

Quality Components

45 Solmar Dr.
Rochester, NY 14624
Tel: (716) 889-1919

NORTH CAROLINA

Component Sales
P.O. Box 18821
Raleigh, NC 27609
Tel: (919) 782-8433
TWX: 510-928-0513

OHIO

Bear Marketing
3623 Brecksville Rd.
Richfield, OH 44286
Tel: (216) 659-3131
TWX: 810-427-9100

OREGON

Jas. J. Backer Co.
2035 S.W. 58th St.—Room 207
Portland, OR 97221
Tel: (503) 297-3776

Jas. J. Backer Co.
353 Reese Hill Rd. S.E.
Salem, OR 97302
Tel: (503) 362-0717

PENNSYLVANIA

Foster-McClinton
2867 Washington Rd.
Bridgeville, PA 15017
Tel: (412) 941-4800
Telex: 866477

Foster-McClinton

2131 W. 8th St.
Erie, PA 16505
Tel: (814) 455-9111
Telex: 914462

ABC Electronic Sales

1 Fairway Plaza, Suite 310
Huntingdon Valley, PA 19006
Tel: (215) 947-6960
TWX: 510-665-5303

TEXAS

Oeler & Menelaides
P.O. Box 35428
Houston, TX 77035
Tel: (713) 772-0730
TWX: 910-867-4745

Oeler & Menelaides

777 S. Central—Suite 2C
Richardson, TX 75080
Tel: (214) 234-6334

WASHINGTON

Jas. J. Backer Co.
221 West Galer St.
Seattle, WA 98119
Tel: (206) 285-1300
TWX: 910-444-1646

WEST VIRGINIA

Foster-McClinton
17 Pembroke Lane
Huntington, W. VA 25705
Tel: (304) 763-5161

DISTRIBUTORS

ARIZONA

Phoenix
Mirco (602) 944-2281

CALIFORNIA

Newport Beach
Semi Comp (714) 833-3070

San Diego

Intermark (714) 279-5200
Semi Comp (714) 560-0373

Santa Ana

Intermark (714) 540-1322

Sunnyvale

Diplomat (408) 734-1900
Intermark (408) 738-1111
Semi Comp (408) 736-2330

Woodland Hills

Semiconductor Concepts
(213) 884-4560

COLORADO

Wheatridge
Century (303) 424-1985

CONNECTICUT

Hamden
Arrow (203) 248-3801

FLORIDA

Clearwater
Diplomat (813) 443-4514

Ft. Lauderdale

Arrow (305) 776-7790

ILLINOIS

Eik Grove
Diplomat (312) 595-1000

Elmhurst

Semiconductor Specialists
(312) 279-1000

Rosemont

Advent (312) 298-4210

INDIANA

Ft. Wayne
Ft. Wayne Electronics
(219) 423-3422

Indianapolis

Semiconductor Specialists
(317) 243-8271

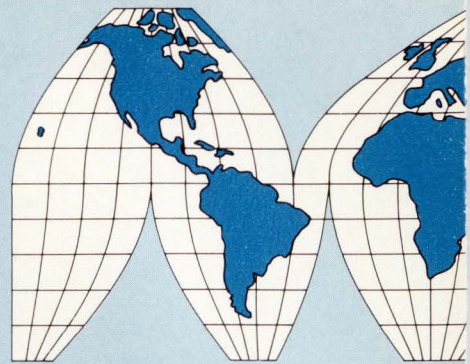

NORTH AMERICA

UNITED STATES: GENERAL INSTRUMENT CORPORATION MICROELECTRONICS

HEADQUARTERS—600 West John Street
Hicksville, New York 11802
Tel: 516-733-3107, TWX: 510-221-1866

NORTHEAST—Riverside Office Park, Suite 103,
Riverside Road, Weston, Massachusetts 02193
Tel: 617-899-8800, TWX: 710-324-0767

SOUTHEAST—271 Schilling Circle,
Hunt Valley, Maryland 21030
Tel: 301-628-2120, TWX: 710-862-9064

CENTRAL—3101 West Pratt Boulevard,
Chicago, Illinois 60645
Tel: 312-338-9200, TWX: 910-221-1416

SOUTHWEST—2355 West Williams Field Road,
Chandler, Arizona 85224
Tel: 602-963-7373, TWX: 910-950-1963

WESTERN—1100 Quail Street, Suite 114,
Newport Beach, California 92660
Tel: 714-833-9400, TWX: 910-595-1730

CANADA:

GENERAL INSTRUMENT OF CANADA LTD.
61 Industry Street, Toronto M6M 4L5
Tel: 416-763-4133, TWX: 610-491-1217
2359 43rd Avenue, Lachine, Quebec
Tel: 514-636-9454, Telex: 21721

SOUTH AMERICA

BRAZIL:

GENERAL INSTRUMENT IeC Ltda
Av. Faria Lima 1794, Sao Paulo CEP 01452
Tel: 2105508

IOWA

Cedar Rapids
Deeco (319) 365-7551

KANSAS

Kansas City
Semi-Conductor Specialists
(816) 452-3900

Lenexa

Hall-Mark (612) 884-9056

MARYLAND

Baltimore
Arrow (301) 247-5200

Rockville

Pioneer (301) 424-3300

MASSACHUSETTS

Chicopee Falls
Diplomat (413) 592-9441

Holliston

Diplomat (617) 429-4120

Newton

Greene/Shaw (617) 969-8900

Woburn

Arrow (617) 933-8130

MICHIGAN

Farmington
Diplomat (313) 477-3200
Semiconductor Specialists
(313) 478-2700

MINNESOTA

Bloomington
Arrow (612) 888-55-

Minneapolis

Diplomat (612) 788-
Hall-Mark (612) 884-
Semiconductor Sp
(612) 854-8841

MISSOURI

Hazelwood
Semiconductor Sp
(314) 731-2400

St. Louis

Diplomat (314) 645

NEW JERSEY

Little Falls
Diplomat (201) 785-

Mt. Laurel

Diplomat (609) 234-

Moorestown

Arrow (609) 235-19

Saddlebrook

Arrow (201) 797-58

NEW MEXICO

Albuquerque
Century (505) 292-;

NEW YORK

Buffalo
Summit (716) 884-C

CALCULATORS

DESCRIPTION	FUNCTION	9V LED	9V FLUOR.	9V LED (DIRECT)	15V FLUOR.	15V LED
8 DIGIT BASIC	4 functions and percent key.	C-683	CF-683	C-683D	CF-583	C-583
	4 functions, percent key, one-key or multi-key memory.	C-685	CF-685	C-685D	CF-585	C-585
8 DIGIT ALGEBRA	4 functions, percent key, x^2 , \sqrt{x} , $1/x$, $+/-$, one-key or multi-key memory, choice of 20 to 29 keys.		—	—	CF-589	C-589
8 DIGIT ALGEBRA II	4 functions, percent key, x^2 , \sqrt{x} , $1/x$, $+/-$, one-key or multi-key memory, brackets, inch-centimeter conversion, choice of 24 to 30 keys.		CF-689	C-689D	—	—
9 DIGIT BASIC	4 functions and percent key.				CF-593	C-593
	4 functions, percent key, one-key memory.				CF-594	C-594
	4 functions, percent key, multi-key memory.				CF-595	C-595
9 DIGIT SCIENTIFIC	Basic 4 functions, scientific notation, sin, cos, tan, arc sin, arc cos, arc tan, memory, square root, pi, natural logs, $1/x$, e^x , memory exchange, degrees and radians, exponent range ± 99 , choice of 19 to 35 keys.				CF-596	C-596
	All the above plus: 0 to 10^{99} degree trig range, \log_{10} , 10^x , y^x , extended digit accuracy of transcendentals, choice of 21 to 38 keys.				CF-598	C-598
	All the above plus: two levels of parenthesis, X^2 , %, $+/-$, choice of 24 to 41 keys.				CF-599	C-599

The C-500/C-600 series are pin-for-pin compatible chips designed to fit in the same basic PC board. All have automatic constant in 4 functions, floating decimal, on-board oscillator, single power supply, and drive LED segments or fluorescent displays directly. All are in a 28 lead DIP.

DESCRIPTION	FUNCTION	PART NUMBER	PACKAGE	FEATURES
8 DIGIT PRINTING	Basic 4 functions and percent.	*C-716	40 DIP	Accumulator and 4 key memory
12 DIGIT PRINTING	Basic 4 functions and percent, automatic constant in multiply and divide, repeat add/subtract, decimal select mode, memory-in-use indicator, rounding options, non-add(=)/date key, and other features. Interfaces with the Shinshu Seiki Model 310 impact printer.	C-717 C-717X	40 DIP	Accumulator and Grand Total Memories.
		C-718		Accumulator, item counter, and four-key independent memory.
PRINTER-DISPLAY INTERFACE	Adds display capability to the C-717X and C-718 printing calculator circuits.	C-719	28 DIP	For both LED and fluorescent displays.

*For future release.

CLOCKS / CLOCK RADIOS

DESCRIPTION	FUNCTION	PART NUMBER	DISPLAY TYPE	FLASHING SECONDS	ZERO BLANKING	50/60 Hz OPERATION	PACKAGE	FEATURES
4 DIGIT	12/24 hour clock	AY-5-1200A	7-SEGMENT FLUORESCENT		✓	✓	24 DIP	Direct fluorescent display drive.
		AY-5-1202A	7-SEGMENT FLUORESCENT	✓	✓	✓	24 DIP	Direct fluorescent display drive.
		AY-5-1203A	BCD OUTPUTS	✓		✓	24 DIP	See AY-5-8320 TV circuit.
		AY-5-1204A	7-SEGMENT FLUORESCENT	✓		✓	24 DIP	Direct fluorescent display drive.
		AY-5-1224A	BCD OR 7-SEGMENT LED		✓	✓	16 DIP	Zero blanking in 12 hour mode only.
4 DIGIT WITH ALARM AND DIRECT DISPLAY DRIVE	12 hour clock, 24 hour alarm	CK3000	7-SEGMENT PLASMA	✓	✓	✓	40 DIP	Snooze alarm, individual digit drive.
		CK3100	7-SEGMENT LED	✓	✓	✓	40 DIP	Snooze alarm, individual digit drive.
	12/24 hour clock, 24 hour alarm	CK3200	7-SEGMENT PLASMA	✓	✓	✓	28 DIP	Snooze alarm, duplexed digits.
		CK3400	7-SEGMENT LED	✓	✓	✓	28 DIP	Snooze alarm, duplexed digits.
4 DIGIT AUTOMOBILE CLOCK	12 hour clock	*CK3500	7-SEGMENT LED	✓	✓	✓	28 DIP	Snooze alarm, duplexed digits, sleep-timer, timeswitch, battery standby capability
	12 hour clock			✓	✓	CRYSTAL INPUT	28 DIP	Operates directly from a 3.58 MHz crystal.

*For future release.

CALCULATOR / CLOCK MODULES

DESCRIPTION	FUNCTION (SEE ABOVE)	PART NUMBER	FEATURES
8 DIGIT CALCULATOR	Same as C-683D	M-683	Self-contained module which requires only the addition of a keyboard and battery to produce a working calculator.
	Same as C-685D	M-685	
	Same as C-689D	M-689	
4 DIGIT CLOCK RADIO	Same as CK3300	M-3300	Self-contained module which requires only the addition of switches and a power source, to produce a working clock.

RADIO / TELEVISION

DESCRIPTION	FUNCTION	PART NUMBER	POWER SUPPLIES	PACKAGE	FEATURES
RADIO RECEIVER FREQUENCY COUNTER/DISPLAY	Counts & displays MW, SW, and VHF frequencies	AY-5-8100	GND, -17	28 DIP	4½ digit display; MW 2999 KHz, SW 29.995 MHz, VHF 299.95 MHz, 0 to 99 FM channel indication (European standard), 7-segment outputs.
		AY-5-8101	GND, -12		
RADIO RECEIVER FREQUENCY COUNTER/DISPLAY WITH 4 DIGIT CLOCK	Counts & displays AM/FM frequencies with a 12 hour clock	AY-3-8110	+5 to +12, GND	28 DIP	Easy time set controls, low power consumption, on-chip intensity control.
TV CHANNEL/TIME DISPLAY SERIES	Various circuits in series to display channel numbers on TV screen with some additionally featuring either separate or simultaneous time display.	AY-5-8300 SERIES	+18, GND	14 DIP or 24 DIP	Selection of display position on screen, automatic display recall, BCD time inputs (see AY-5-1203A clock circuit)
TV REMOTE CONTROL I	Transmitter	SAA 1024	9V BATTERY	16 DIP	30 ultrasonic control channels, 34-44 kHz. Utilizes a 4.4 MHz TV crystal for accuracy.
	Receiver	SAA 1025	SEE DATA SHEET	16 DIP	Power on/off output, 16 TV channel selection (& 5 spares), 3 analog outputs.
TV REMOTE CONTROL II	Transmitter	*AY-5-8410	GND, -15	—	23 channels, either local control at receiver or remote control.
		*AY-5-8411	9V BATTERY	—	
	Receiver	*AY-5-8420	GND, -15	—	63 channels with error-detection.
TV REMOVE CONTROL III	Transmitter	*AY-5-8450	9V BATTERY	16 DIP	18 ultrasonic control frequencies, interfaces directly with a 5×6 matrix keyboard.
	Receiver	*AY-5-8460	GND, -18	18 DIP 24 DIP	Interfaces directly with OMEGA 10 digit keyboard inputs plus 1 analog control, fine tune up/down, and recall function.
2 CHIP TV DIGITAL TUNING SYSTEM	AY-5-8200 control circuit: accepts direct or remote inputs to control and program system.	ECONOMEGA®	+12, GND	40 DIP	16 programs, 14 bit accuracy with coarse and fine tune.
	Memory circuit: see ER1400 EAROM description on Pg. 6		+12, -24	8TO	100×14 bit memory
4 OR 5 CHIP TV DIGITAL TUNING SYSTEM	Control circuit: accepts keyboard or remote inputs to control and program system.	OMEGA®	+12, GND	40 DIP	Scan mode or search mode may also be selected.
	Display circuit: displays selected channel number.		+12, GND	40 DIP	Decodes and drives BCD or LED displays.
	D/A convertor circuit: converts output to coarse and fine tune outputs.		V _{REF} , +12, GND	14 DIP	14 bit accuracy for precise varactor tuning.
	Memory circuit: see ER1400 EAROM description on Pg. 6		+12, -24	8TO	100×14 bit memory
	Optional channel selector interface circuit: permits pre-set favorite channel selection.		+12, GND, -24	40 DIP	Up to 20 channels; pre-set and/or customer selection.

*For future release.

® OMEGA and ECONOMEGA are trademarks of General Instrument Corporation.

TV GAMES

DESCRIPTION	FUNCTION	PART NUMBER	POWER SUPPLIES	PACKAGE	FEATURES
BALL & PADDLE I	Add-on for TV sets, 6 games tennis, squash, hockey (soccer), pelota, rifle shooting 1 & 2	AY-3-8500	9V BATTERY	28 DIP	4 two-person and 2 one-person games. Automatic scoring (displayed on TV screen), realistic sounds, visually defined playing area, 525 and 625 line standards.
		AY-3-8500-1			
BALL & PADDLE II	Add-on for TV sets, 5 advanced games of tennis, squash, soccer, hockey and practice	*AY-3-8600	9V BATTERY	40 DIP	2 or 4 player, on-screen scoring, color or black & white, 2-axis player motion.
BATTLE	Add-on for TV sets, 2 games: tank fight, tank battle with strategy	*AY-3-8710 *AY-3-8720	9V BATTERY	40 DIP	2 player tank battle games with limited ammunition and destructible barriers, on-screen scoring and realistic battle sounds
PROGRAMMABLE GAMES	Add-on for TV sets, multiple games to be announced	*AY-3-8800 SERIES	+12, +5, GND, -3	40 DIP	Single person and 2 person interactive games using programmable microcomputer

*For future release.

APPLIANCE TIMERS

DESCRIPTION	FUNCTION	PART NUMBER	POWER SUPPLIES	PACKAGE	FEATURES
CLOCK TIMER	24 hour programmable repeatable on/off time switch with 24 hour clock.	AY-5-1230	GND, -17	28 DIP	50 Hz input (60 Hz option on request), BCD or 7-segment direct fluorescent display drive outputs, zero blanking, 24 hour display (12 hour option on request).
COUNT-DOWN TIMER	Keyboard programmable count-down timer with 99 min/99 sec capability.	*CT 7000	GND, -15	40 DIP	60 Hz input, drives 4 digit display, end-of-count audio output.

*For future release.

FEATURE ARTICLES FROM *ELECTRONICS* AVAILABLE IN REPRINT FORM

No. of
copies
wanted

New reprints

- ___ R-606 Special issue—microprocessors \$4.00
- ___ R-600 World market report 1976 24 pp \$5.00
- ___ R-526 How reliable are today's components 16 pp \$3.00
- ___ R-524 Special report on bipolar large-scale integration 12 pp \$3.00
- ___ R-522 Special report on power semiconductors 12 pp \$3.00
- ___ R-514 Eight ways to better radio receiver design 6 pp \$3.00
- ___ R-512 Design of circuits for dangerous environments 4 pp \$3.00
- ___ R-510 Bipolar integration advances with I^2L microprocessor 8 pp \$2.00
- ___ R-508 Designing microprocessors with standard-logic devices 12 pp \$3.00

Charts

- ___ R-516 Electronic symbols (chart) \$2.00
- ___ R-211 Electromagnetic spectrum (16-page report and chart) \$4.00
- ___ R-213 Electromagnetic spectrum (chart) \$2.00
- ___ R-326 Optical spectrum (6-page report and chart) \$3.00
- ___ R-327 Optical spectrum (chart) \$2.00

Books

- ___ R-520 Microprocessors—Electronics Book Series \$8.95
- ___ R-11 Computer-aided Design 135 pp \$4.00
- ___ R-032 Active Filters 88 pp \$4.00
- ___ R-031 Circuit Designer's Casebook 182 pp (U.S. only) \$5.50 (foreign) \$12.00

Other Reprints

- ___ R-518 Special issue—productivity \$4.00
- ___ R-506 The case for component burn-in 7 pp \$2.00
- ___ R-434 Designing automated systems with the new standard interface 12 pp \$3.00
- ___ R-432 An update on communications satellites 8 pp \$2.00
- ___ R-430 Choosing the right bipolar transistor model for computer-aided design 20 pp \$3.00
- ___ R-428 Designing with low-cost lasers 6 pp \$2.00
- ___ R-504 U.S. forecast 1975 20 pp \$3.00
- ___ R-502 European forecast 1975 20 pp \$3.00
- ___ R-500 Japanese forecast 1975 16 pp \$3.00
- ___ All three forecasts \$7.50
- ___ R-426 Special issue—technology update 1974 \$4.00
- ___ R-424 Microprocessor applications 28 pp \$3.00
- ___ R-422 A microprogrammable mini-computer 8 pp \$2.00
- ___ R-420 Computerized text-editing and typesetting 8 pp \$2.00
- ___ R-418 Computer analyses of rf circuits 8 pp \$2.00
- ___ R-416 Optical waveguides look brighter 8 pp \$2.00
- ___ R-414 The ion-implanted n-channel process 6 pp \$2.00
- ___ R-412 Liquid cooling of power semiconductors 6 pp \$2.00
- ___ R-410 Special report on passive components 16 pp \$3.00
- ___ R-408 Bringing sight to the blind 8 pp \$2.00
- ___ R-406 Designing with the new logic, C-MOS and bipolar 16 pp \$3.00
- ___ R-328 Special issue—pervasiveness of electronics \$2.00
- ___ R-324 Semiconductor memories are taking over data-storage applications 16 pp \$3.00
- ___ R-322 Special report: new displays complement old 10 pp \$2.00
- ___ R-320 Special report on designing with flat cable 14 pp \$3.00
- ___ R-318 Special report on auto electronics 16 pp \$3.00
- ___ R-316 Hybrid circuits solve tough design problems 16 pp \$3.00
- ___ R-312 Leadless, pluggable IC packages reduce costs 7 pp \$2.00
- ___ R-310 Penetration color tubes are enhancing information displays 6 pp \$2.00
- ___ R-308 Program for transition from nonlinear to linear transistor model 6 pp \$2.00
- ___ R-306 Charge-coupling improves its image, challenging video camera tubes 8 pp \$2.00
- ___ R-209 Semiconductor RAMs land computer mainframe jobs 15 pp \$2.00
- ___ R-207 Technology gap starts to close for computer peripherals 16 pp \$3.00
- ___ R-205 Bridging the analog and digital worlds with linear ICs 16 pp \$3.00
- ___ R-203 East Europe market report 16 pp \$2.00
- ___ R-113 Optoelectronics makes it at last 34 pp \$4.00
- ___ R-107 Wanted for the '70s: easier-to-program computers 24 pp \$3.00
- ___ R-104 The new concept for memory and imaging: charge-coupling 12 pp \$2.00
- ___ R-023 Special report on tomorrow's communications 32 pp \$3.50

Payment must accompany your order

Make check or money order payable to Electronics Reprints. All orders are shipped prepaid by parcel post. Allow two to three weeks for delivery.

Back issues now available:
1960 to 1969, \$5.00 each
1970 to 1973, \$3.00 each
1974 to 1975, \$4.00 each

USE THIS PAGE AS YOUR ORDER FORM

Cost of orders \$ _____
Plus 10% handling charge \$ _____
TOTAL AMOUNT ENCLOSED \$ _____

Mail your order to:
Janice Austin
ELECTRONICS REPRINTS
P.O. Box 669
Hightstown, N.J. 08520

SEND REPRINTS TO

Name _____
Company _____ Dept. _____
Street _____
City _____ State _____ Zip _____

We thumbs prefer **Cherry** thumbwheel switches

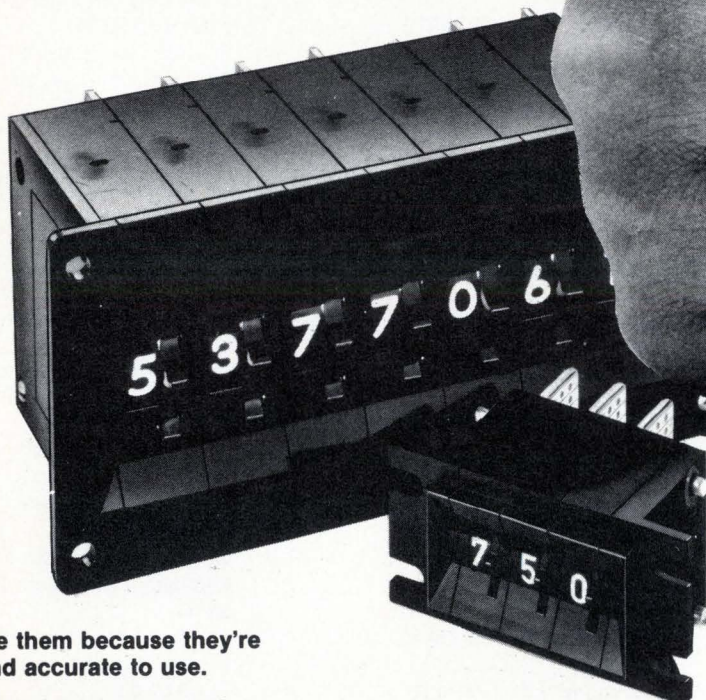

NEW! The smallest thumbwheel switch of them all.

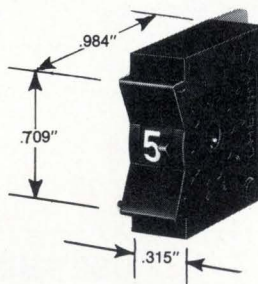

The new T-50 sub-miniature thumbwheel that takes only 8mm x 18mm front panel space . . . just 32mm depth back of panel.

"We like them because they're easy and accurate to use.

You'll like them because of selection, features and price."

You'll also like Cherry quality. The kind of quality you always hope for . . . but that is only realized when a company (like Cherry) has total in-house manufacturing capabilities. To make sure the thumbwheel or leverwheel switch you order is the finest available. Anywhere. Combine this dedication to quality with the broadest line and lowest prices, and you'll understand why our customers say "thumbs up" to Cherry thumbwheels.

See us at
WESCON
'76

Los Angeles
Convention
Center
SEPT.
14-17
CHERRY
BOOTHS
526-530

For complete data and specs: TWX 910-235-1572 . . . or PHONE 312-689-7700 . . . or circle reader service number.

CHERRY

CHERRY ELECTRICAL PRODUCTS CORP.
3608 Sunset Avenue, Waukegan, Illinois 60085

SWITCHES • KEYBOARDS • DISPLAYS—Available locally from authorized distributors.

Washington newsletter

Bill would protect engineers from wage-busting

A bill introduced in the House promises to protect engineers **against the wage-busting tactics** that most commonly affect those working for large contractors at Huntsville, Cape Kennedy, and similar places. The measure, HR 15228, was drafted by the IEEE and introduced by Frank Thompson (D., N.J.) and James Corman (D., Calif.) as an amendment to the Service Contract Act of 1965. It has been referred to committee.

The bill is aimed at situations where a company wins a contract by underbidding the company that holds it. When engineers and other professionals already on the project seek jobs with the new contractor, they are forced to accept pay or benefits cuts.

Grumman working on attack version of F-14 fighter

Grumman Aerospace Corp. in Bethpage, N.Y., is working on an all-weather attack version of its basic F-14 Tomcat air-superiority fighter, called the A-14. If procured by the U.S. Navy, the new craft would replace aging A-6 aircraft in the fleet inventory. **Approximately \$9 million worth of electronics goes into each F-14**, so additions to the Tomcat production line in the form of A-14s would create a windfall for subcontractors.

United Technologies' Norden division in Norwalk, Conn., has, under contract to Grumman, developed a flyable brassboard of a synthetic-aperture radar to be flown on the F-14 to prove an attack capability. The experimental radar is expected to increase the stand-off distance and accuracy of radar-guided weapons systems employed on the F-14.

Foreign TV sales in U.S. up 151% during first half

While America's television manufacturers await resolution of a jurisdictional dispute over which Federal agency gets to hear charges of dumping against Japanese color-television manufacturers [*Electronics*, July 22, p. 42], **new figures attest to the scope of the foreign inroads** into the U.S. market. Electronics Industries Association computations show that imports of color receivers in the first half of the year skyrocketed 151% higher than a year earlier.

Photocell prices drop 50%, ERDA claims . . .

The last 18 months have seen a 50% drop in the average price of photovoltaic cells intended for use as sources of electrical current in rural areas. That's the report of officials at the Energy Research and Administration Development, **elated over a fall to \$15 per watt from \$30 or more.** The lower figures are quoted in bids responding to a recent 130-kilowatt procurement request; the higher came in an earlier 46-kW purchase. ERDA will soon announce that it has signed contracts worth \$2.3 million.

The biggest winner is Spectrolab Inc., with a \$718,000 contract for 40 kW. ERDA will pay less to Sensor Technology of Chatsworth, Calif.—\$512,000 for 40 kW—because the Sensor cells are more efficient and therefore can produce more electricity with less surface area. Other winners: 30 kW from Solarex Corp., Rockville, Md., \$519,000; 15 kW from Solar Power Corp., Wakefield, Mass., \$349,000; and 5 kW from M4 International Inc., Arlington Heights, Ill., \$139,000

. . . while CdS cells and optics are next

The success of the silicon solar-cell program has led ERDA to gear up its next effort—**improving the efficiency of advanced compounds in other technologies** that can generate electricity directly from the sun. Next year,

Washington newsletter

ERDA will release requests for proposals for three cadmium-sulfide projects and seven other projects to improve solar-array concepts. And ERDA's Sandia Laboratory in Albuquerque, N.M., soon will release requests for proposals for photocell systems using optical concentrators to increase the intensity of ultraviolet sunlight [*Electronics*, Aug. 19, p. 69].

'Science Court' debate set

Two Government agencies have agreed to review the proposal of an electronics-company executive to organize a "science court" that would **take debates over nuclear power and environmental quality away from lawyers and nontechnical judges.** Arthur Kantrowitz, chairman of the Avco-Everett Research Laboratory, persuaded the National Science Foundation and the Commerce Department to consider the proposal at a debate scheduled Sept. 19 to 21.

FCC refuses bid to speed action on satellite review

The Federal Communications Commission will not drop a request for an evidentiary hearing, as requested by Satellite Business Systems to hasten review of its domestic-satellite system proposal. The proposed system, **which would pit SBS' partner, IBM Corp., against AT&T, Western Union, and RCA,** includes use of small dish antennas for point-to-point communications and would have the system bypass local telephone companies. SBS is worried that a prolonged FCC review—which could take four more years—would give its competitors additional time to become entrenched in the embryonic field.

Five bidders await Coast Guard's word on 41-plane deal

The off-again, on-again, procurement of 41 patrol planes for the U.S. Coast Guard is on again, and it is expected to result in at least a **\$200 million contract to one of five bidders.** Falcon Jet, Grumman, Lockheed, Rockwell, and VFW Fokker submitted acceptable bids, says the Coast Guard, which is promising a decision by the end of the year. More than \$20 million worth of special sensor hardware also will be purchased. An earlier procurement was challenged in Congress because competitors claimed that the specifications favored the Rockwell plane.

GE to build 4-k RAMs for cockpit display

The Air Force Systems Command has given General Electric a contract **to develop a production capability for a militarized version of its 4-kilobit static MOS random-access memory,** for use in a new aircraft cockpit display. The new hardware would replace the 1-kilobit static RAM used in the virtual-image display being flight-tested on the F-111 and F-4. Delivery of prototype hardware is expected by January 1978.

Addenda

NASA, anxious to add to the list of hundreds of innovations that have been transferred from the space program to private industry, has scheduled a **conference on biomedical instrumentation.** It will be held at the University of Connecticut in Storrs on September 21. . . . A Commerce Department study of the effect of increased telephone installation charges on requests for new installations and disconnections shows, not surprisingly, **that those requests decrease.**

And start talking about Cryo-Torr® High Vacuum Pumps for fast, clean, trouble-free, oil-free pumping of all gases in high vacuum systems. Cryo-Torr Vacuum Pumps eliminate process chamber contamination problems of conventional oil diffusion or turbo-molecular pumps.

Operating costs are lower too, because Cryo-Torr pumps totally eliminate the need for any liquid nitrogen, helium or cooling water. The Cryo-Torr 7 Model, a direct replacement of

conventional 6" pumps, achieves high pumping speeds — 1,000 lps for air, 3,000 lps for water vapor — in a small compact package.

Cryo-Torr Vacuum Pumps keep it clean in such applications as ion implanters, deposition systems, including sputtering. And at new low prices. Get all the facts on the Cryo-Torr High Vacuum Pumps. Write or call: CTI-Cryogenics, Kelvin Park, Waltham, Massachusetts 02154. Telephone: (617) 890-9400.

CTI-CRYOGENICS

STOP THE DIRTY TALK ABOUT HIGH VACUUM PUMPING.



Circle 53 on reader service card

HELIX
A Helix Company

Introducing SpinGuard[®]

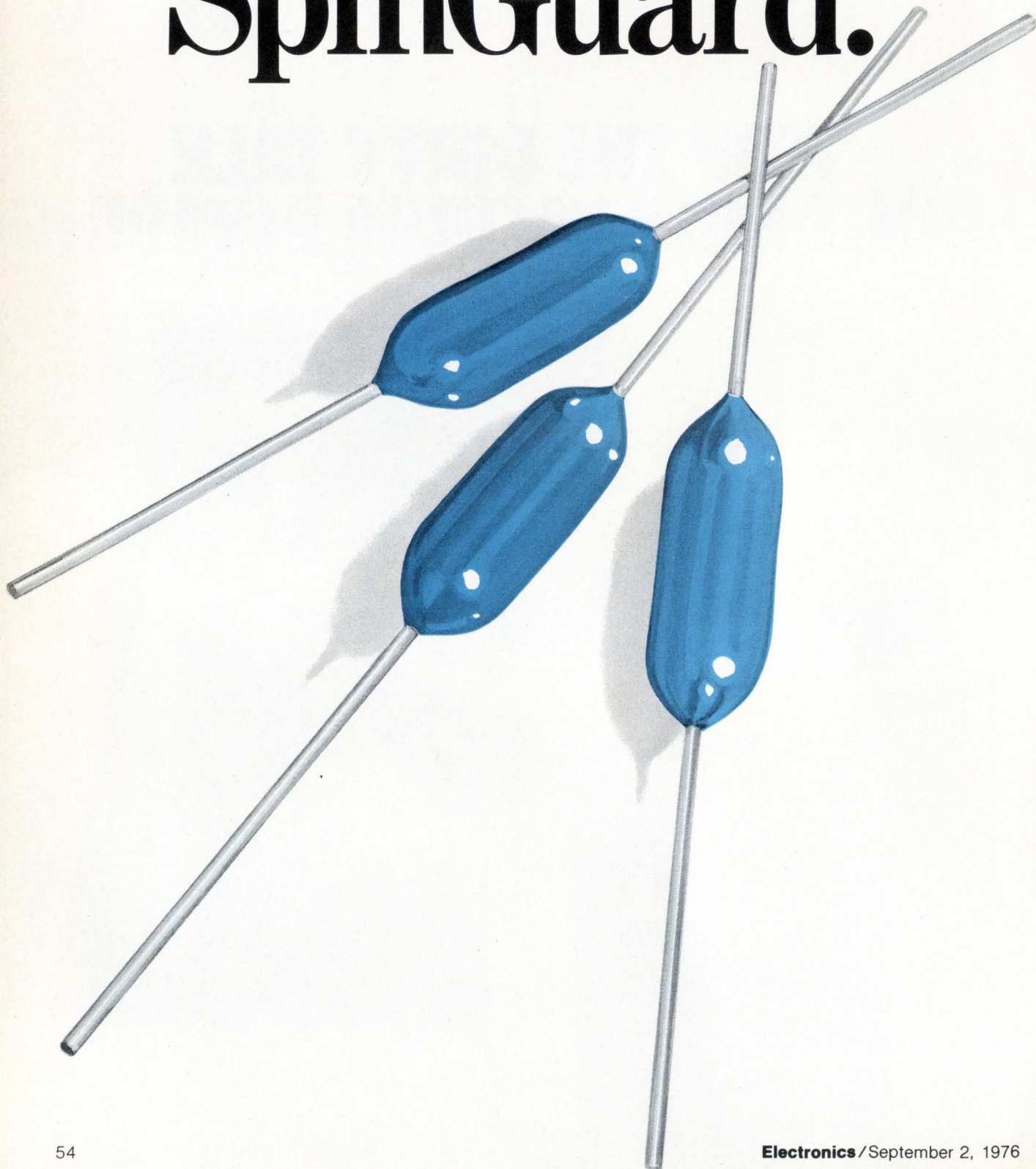

A new case for AVX quality.

SpinGuard is AVX's new multi-layer ceramic capacitor in an economical epoxy case. Axial leded to make it perfect for automatic insertion.

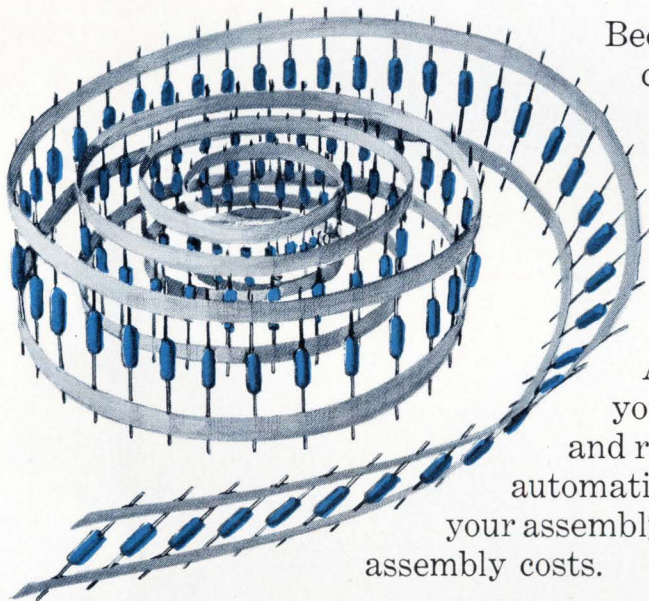

Because it comes from AVX, you can be sure of its quality. Quality designed in, built in and demonstrated by exhaustive testing. To guarantee you greater reliability, exact adherence to temperature and tolerance specifications.

And because it's axial leded, you can order SpinGuards taped and reeled to run trouble free on your automatic insertion equipment. Cutting your assembly time. Reducing your assembly costs.

AVX quality in a low cost component, designed for low-cost assembly. That's quite a case for switching to SpinGuard.

Free sample

Mail this coupon today. We'll send you a SpinGuard sample, plus information on how to get more samples in your specific applications ratings. Mail coupon to AVX Ceramics, P.O. Box 867, Myrtle Beach, SC 29577

Name _____

Title _____

Company _____

Address _____

Tel. _____ Zip _____

AVX: The Insiders

AVX Ceramics, P.O. Box 867, Myrtle Beach, SC 29577 (803) 448-3191 TWX: 810-661-2252
Olean, NY (716) 372-6611 TWX: 510-245-2815

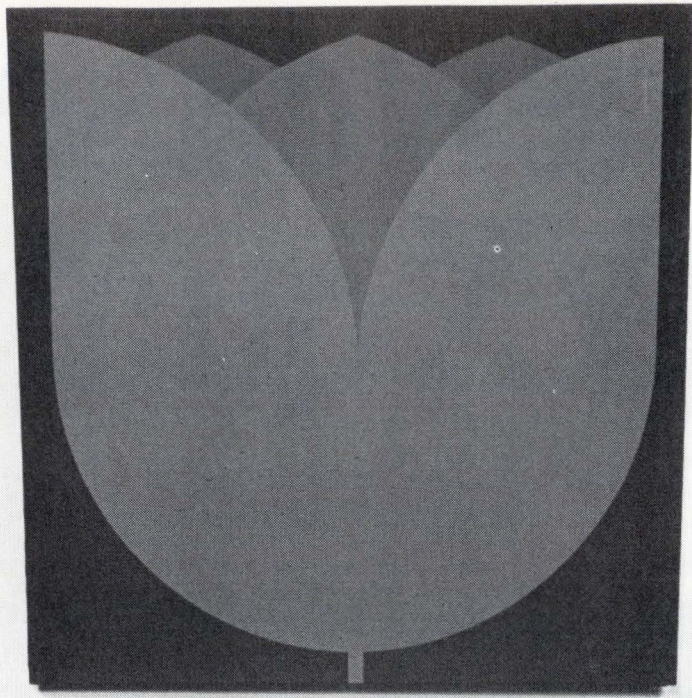

Five tough questions to ask our 8080A competitors.

1. Do you have an 8K Electrically Erasable PROM? You know, like NEC Microcomputer's μ PD458 that's compatible with 2708's but can be erased in 1 minute, programmed in 80 seconds, only needs two voltages for reading and programming, has conventional packaging, a guaranteed data retention time of 10 years, and an access time of 450/650ns, making it the first practical non-volatile RAM storage.

2. Do you have a Universal Synchronous Receiver/Transmitter Data Communications Controller? You know, like NEC's μ PD379 with SDLC capacity up to 50K baud.

3. Do you have a 450ns 16K ROM? You know, like NEC's μ PD2316A that's pin compatible with other 2316As but has the speed to match the 8080A.

4. Do you have a Floppy Disk

Controller? You know, like NEC's μ PD372 that can control up to four IBM 3740-compatible drives.

5. Do you have a Tape Cassette Controller? You know, like NEC's μ PD371 that can control up to two cassette drives with International Standard Data Format.

Go ahead, ask any competitor you like. What you'll find is that if you want these super 8080A peripherals, you'll simply have to come to NEC.

And when you do, you'll also be dealing with an 8080A supplier with complete applications support — plus the full range of 8080A products listed.

Any more tough questions?

Your NEC rep or distributor is waiting to put you at ease.

NEC Microcomputers, Inc.,
Five Militia Drive, Lexington, MA
02173. 617-862-6410.

μ PD8080A	2.0 MHz MPU
μ PD8080A-E	1.25 MHz MPU
μ PD8080A-2	2.5 MHz MPU
μ PD8080A-1	3.0 MHz MPU
μ PD411	4K DYN-RAM
μ PD5101-E	1K STATIC RAM
μ PD2101AL	1K STATIC RAM
μ PD2102AL	1K STATIC RAM
μ PD454	2K EE PROM
μ PD2308	8K Mask ROM
μ PD369	UART
μ PD758	Sieko Printer Controller
	I/O Port
μ PB8212	Priority Interrupt Controller
μ PB8214	Bus Driver
	Clock
μ PB8216	Generator/Driver
μ PB8224	System Controller
	Prog. Comm. Interface
μ PB8228	
μ PB8251	
	Peripheral Interface
μ PD8255	

NEC microcomputers, inc.

REPS: East — C & D Sales 301-296-4306, Contact Sales 617-273-1520, Trionic Assoc. 516-466-2300; South — Merino Sales 214-233-6002, Perrott Assoc. 305-275-1132, 305-792-2211, 813-585-3327, Wolffs Sales Serv. 919-781-0164; Midwest — Electronic Innovators 612-884-7471, K-MAR Eng. & Sales 314-567-1829, 816-763-5385, McFadden Sales 614-221-3363, R. C. Nordstrom 313-559-7373, 616-429-8560, R. F. Specialists 312-698-2044; West — Mike Duffy Assoc. 303-934-7392, Electronic Component Mktg. 213-340-1745, 714-295-6122, 714-524-9899, Summit Sales 602-994-4587, Trident Assoc. 408-734-5900, Tri-Tronix 505-265-8409; Canada — R. F. Q. Ltd. 416-626-1445, 514-626-8324

DISTRIBUTORS: Century Electronics (Albuquerque, Denver, Salt Lake City) Diplomat (Chicago, Chicopee Falls, Clearwater, Dayton, Detroit, Little Falls, Minneapolis, Mount Laurel, Newport Beach, St. Louis, Salt Lake City, Sunnyvale, Woodbury) Harvey Electronics (Boston, Fairfield, Norwalk, Woodbury) Intermark Electronics (San Diego, Santa Ana, Seattle, Sunnyvale) Lionex Corp. (Boston) G. S. Marshall (Sunnyvale) Mirco Electronics (Phoenix) R-M Electronic (Detroit) Semiconductor Specialists (Boston, Chicago, Dallas, Dayton, Detroit, Indianapolis, Kansas City, Los Angeles, Milwaukee, Minneapolis, Pittsburgh, St. Louis; Malton, Canada) Technico, Inc. (Baltimore)

TDA

We h
They say



There's a saying in Italy, where we come from, that goes something like this: "between saying and doing there's a sea in the middle". OK, may be it doesn't sound too great in English, but in Italian it does and it rhymes as well!

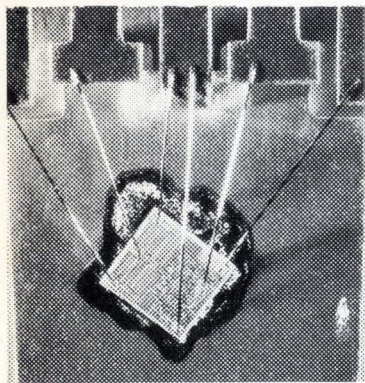

The TDA 2002 chip on its Pentawatt® frame.

Now, the particular "sea" in our case is just this: TDA 2002 was invented and patented by SGS-ATES; we were the first to

produce it and we're already delivering it - in fact, we've been mass-producing the TDA 2002 since the beginning of 1976. Now we hear that somebody else is going to launch a similar product on the market... in 1977. That's good, but for the moment let's talk about

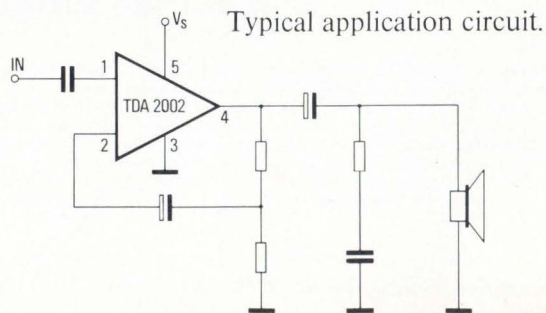

2002

ave it.
they do.

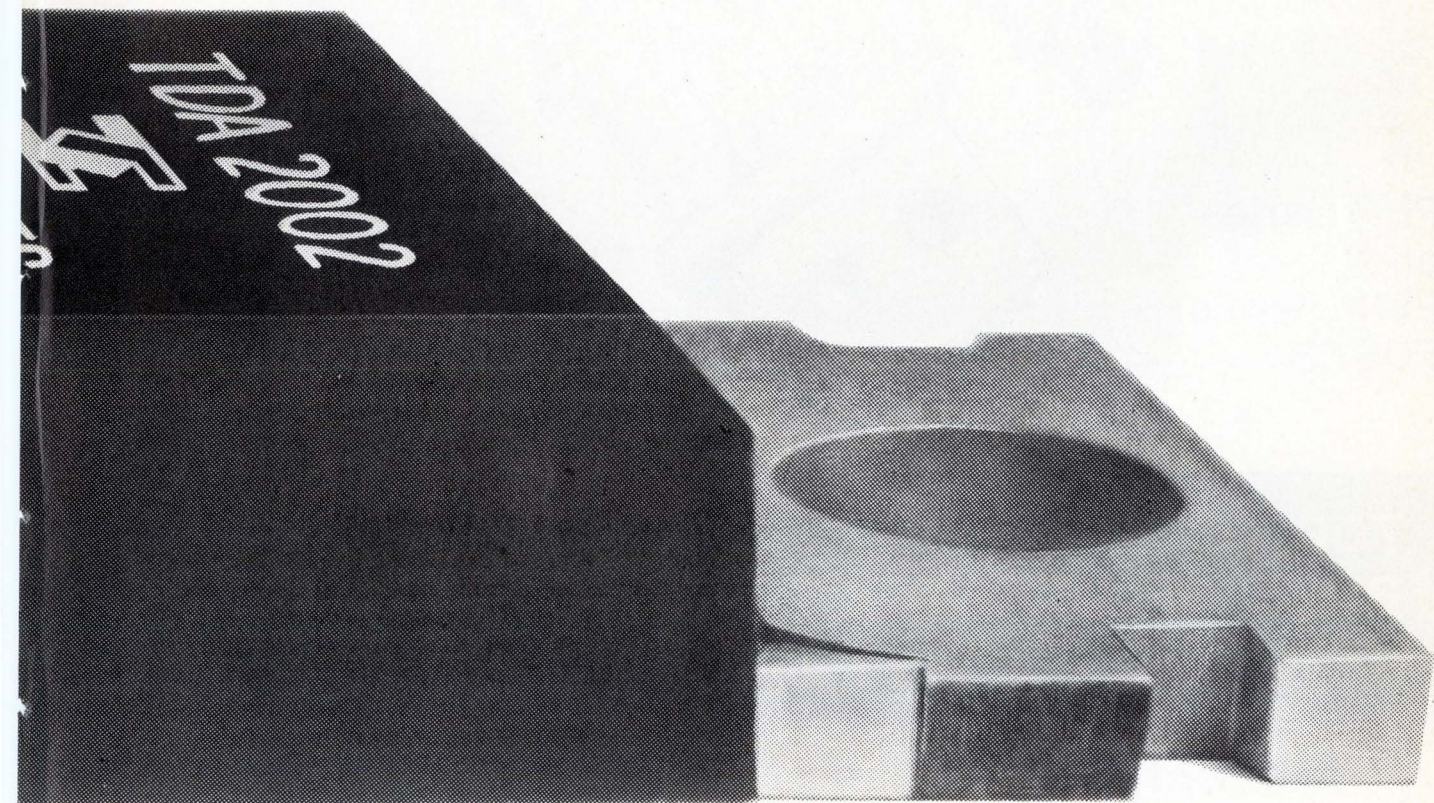

TDA 2002: 8W integrated audio amplifier.

our TDA 2002, since it's the only one...

Worldwide patents for both the circuit and the package have been granted, or have been applied for. All of SGS-ATES' years of experience in the design and production of power linears are behind this product.

The package (Pentawatt®) and type of assembly guarantee more than 10,000 cycles of thermal fatigue with $\Delta T_c = 100^\circ$, and that means long life. What's more, it's highly protected against short circuits; thermal over-range; supply overvoltages, including spikes; open ground; polarity inversion - which ensure the same trouble free, long life, even under exceptional conditions.

With a 14.4 V supply it gives 8 W on 2Ω . It is ideal for car radios and CB transceivers: it saves 50% on external components and even more on space.

And that's why

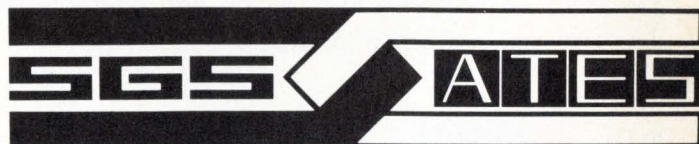

SGS-ATES SEMICONDUCTOR CORPORATION
Newtonville Avenue, Newtonville, Mass.
tel.: 617-9691610

Circle 58 on reader service card

NEW

IN SEMICONDUCTOR PROTECTION!

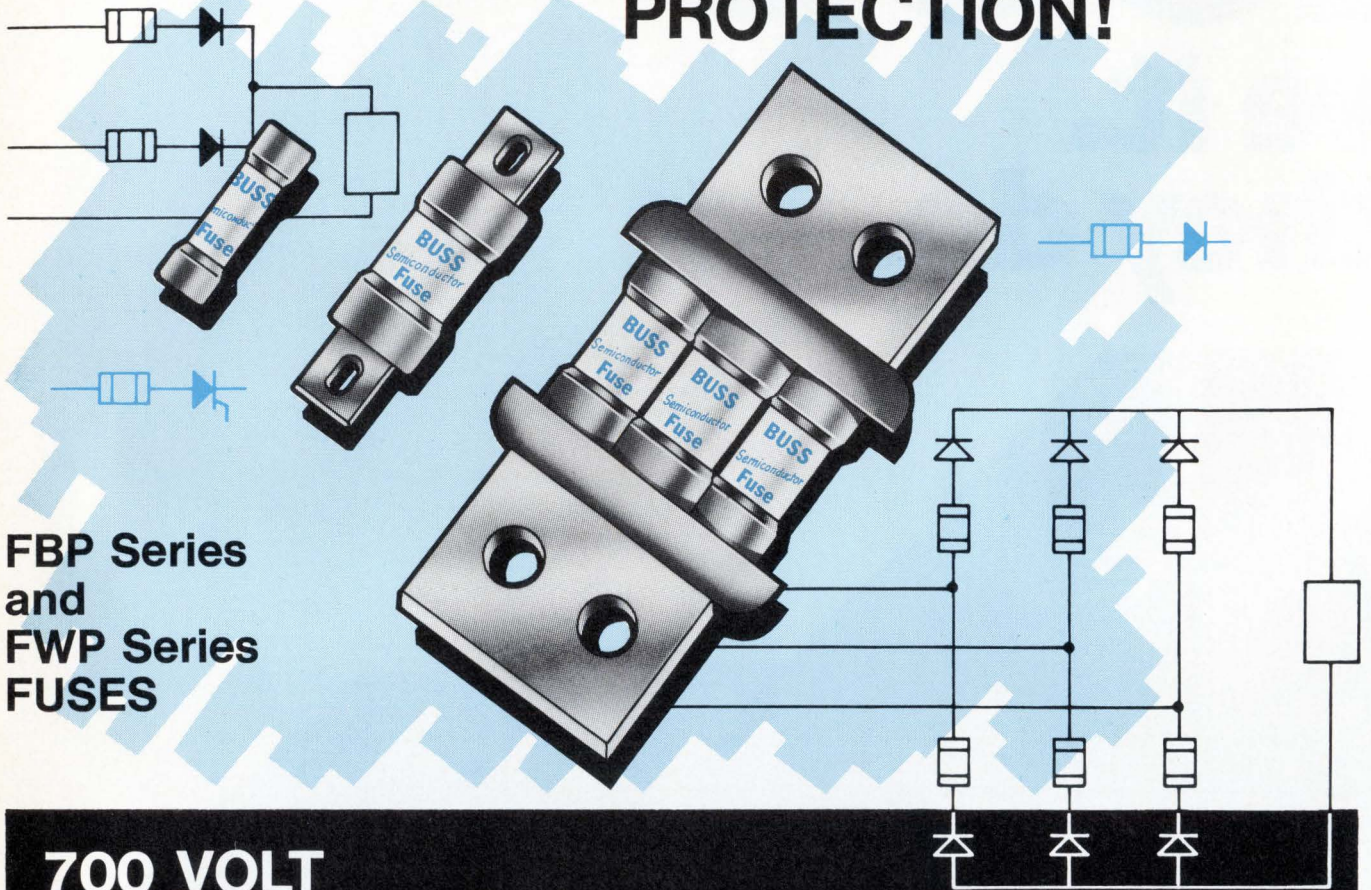

**FBP Series
and
FWP Series
FUSES**

**700 VOLT
BUSS® SEMICONDUCTOR FUSES
EXTREMELY LOW I^2t and I_p LET-THRU VALUES**

AMP RATINGS

15 to 1000

VOLTAGE RATINGS

700 V. a-c 700 V. d-c

BUSS Semiconductor Fuses provide a very high degree of current-limitation so necessary for the protection of Diodes, SCR's and other Semiconductors.

For detailed information and characteristic curves, write for **BUSS Bulletin SCFP**.

AVAILABLE IN TWO SIZES



FWP Series

dimensions made to fit mountings for 700 volt fuses that have been used in the past.



FBP Series

compact dimensions — shorter than FWP fuses — save equipment space.



BUSSMANN MANUFACTURING
a McGraw-Edison Company Division
St. Louis, Missouri 63107



Toshiba scores first in Japan with 8-bit microcomputer chip

Toshiba scored points against its Japanese semiconductor-maker competitors last month when it went to market with the country's first 8-bit microcomputer on a chip. Although the chip—the T3444—will turn up first in controllers for data-processing hardware like floppy disks, data cassettes, and intelligent terminals, Toshiba foresees a wide spread of applications.

The price for the chip in quantity is a low \$24, so Toshiba expects to sell it to producers of hardware like data loggers, heating controls, microwave cookers, and even video games, as well as to makers of data-processing equipment.

For their money, buyers will get in a 42-pin ceramic package a chip with an arithmetic/logic unit, a random-access memory, a read-only memory, and input/output ports. The ROM, mask-programed for each specific application, can hold up to 256 24-bit words. The RAM capacity is a modest 16 words by 8 bits. The clock and transistor-transistor-logic I/O drivers are not on the chip. Although the T3444 has less capability than the Intel 8080A, it is much faster.

Long instructions. Modest, too, at first glance, is the ALU's set of 14 instructions, far fewer than the 50 or more instructions used in popular 8-bit general-purpose microprocessor chips. But this drawback is offset by high speed; clock cycles as fast as 1.25 microseconds are possible because of its n-channel silicon-gate-MOS technology with enhancement driver and depletion load.

What's more, the 24-bit instruction words in the microprogram increase the apparent speed because execution of the first instruction in the ROM is followed by branching to execute the instruction in the register. In effect, the equivalent of two instructions is executed during one clock cycle.

The instructions, designed for effi-

cient processing, include a cyclic code. As a controller, the T3444, operating at a maximum clock rate of 800 kilohertz, can control a floppy disk with data speeds up to 800 kilobits per second.

Microprogramming. To make microprogramming and system debugging easier for T3444 users, Toshiba has developed a simulation board built with some 120 TTL packages (the chip is completely TTL-compatible), including two 4-bit-slice ALUS

from Texas Instruments. There are enough sockets for field-programmable ROMs so that designers can try out alternative microprograms. The TTL packages on the board duplicate the chip functions internally as well as externally. For that reason, Toshiba has included on the board a 42-pin socket with the logic levels of the chip. As with the chip itself, the board has neither a clock nor the four TTL I/O drivers that have to be outboarded. □

Around the world

British associative processor to work with disks

A design group at Brunel University in Uxbridge, Middlesex, England, has designed an associative processor around an array of large-scale-integrated memory and supporting LSI transistor-transistor control logic. The processor combines the potential cheapness of LSI with the speed of associative processing to yield a flexible terminal base for text processing.

The so-called Micro-App, patented by the government's National Research Development Corp., could be used in local editing terminals for such applications as quick retrieval of documentary information stored in disk files. Only dedicated associative memories like the Micro-App could load and unload information at disk speeds. Even with buffering, general-purpose microprocessors can't handle the common transmission rate of 5.5 microseconds per byte.

Brunel has designed two Micro-App memories, one a 16-word-by-16-bit version on a chip of 169 by 118 mils. That version has minimum read-cycle and write-cycle times of 40 and 120 nanoseconds, respectively, and power dissipation is 307 milliwatts. Estimated cost after development is about \$1 each in quantity.

Hitachi simplifies video-disk laser pickup

The Hitachi Central Research Laboratory has miniaturized and simplified the laser pickup for an experimental video-disk system developed by Philips of the Netherlands. Hitachi claims its experimental pickup, which is only a twentieth as large and requires only a fraction of the power, is interchangeable with the Philips assembly for disks built to the same specifications. Instead of employing the usual helium-neon-gas laser, Hitachi turned to a buried-heterojunction injection laser. The pickup, together with its mount, occupies a cube only about 1 centimeter on a side; in contrast, typical low-power gas lasers, which also require large high-voltage power supplies, are about 25 cm on a side.

Simplicity is achieved by transmitting a single beam through mirrors and lenses for automatic focusing, tracking, and video-signal pickup with the aid of servo motors. Experimental laser pickups developed by Philips put out about 1 milliwatt—twice as much as the Hitachi product. The buried heterojunction laser has an active region about 1 micrometer square. This tiny radiant area simplifies focusing the beam as a spot 1.6 μm in diameter on the video disk and reduces the input current required to achieve lasing. In the experimental unit, the laser provides the 0.5-mW output with an input current of only 10 milliamperes.

Tiny jumpers and connector versatility.

Your imagination is the key to the range of uses you can find for Cambion connector products. Take the tiny jumpers that mate with spring-loaded receptacles. These are being used extensively as low-cost, trouble free circuit switches because engineers recognize the advantages they provide. And, they got a bonus in terms of long-life – the jumper switches have been tested for more than 50,000 cycles (insertions/ extractions).

Color coding and positive position indication are two more features of this one product group that demonstrate connector versatility. And that's only a *part* of the Cambion connector line.

To become better connected, ask for the Cambion connector catalog by writing: Cambridge Thermionic Corporation, 445 Concord Avenue, Cambridge, Ma. 02138. In Los Angeles, 8703 La Tijera Blvd., 90045.

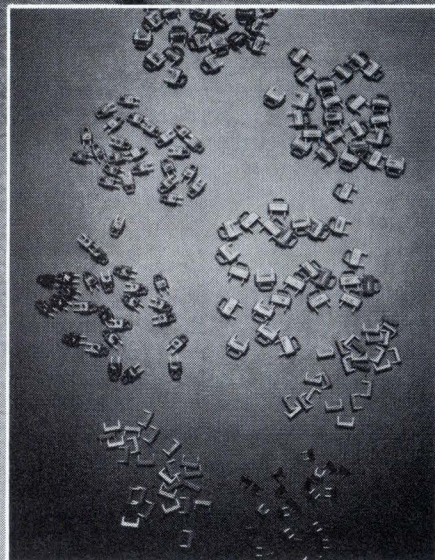

Standardize on

CAMBION[®]
The Guaranteed Electronic Components

Circle 162 on reader service card

Send
for
newest
catalog
747A

Electronic gear controls cleansing of Amsterdam water

Amsterdam, which has always lacked enough clean ground water, is turning to electronic equipment to control purification of water from the highly polluted Rhine River for drinking. A new purification and supply system, which can handle Amsterdam's drinking water demand for some 90 million cubic meters a year, is being officially opened Sept. 2 by Prince Claus, a member of the Dutch royal family. In the system, **nearly \$3 million worth of electronic gear from Philips Gloeilampenfabrieken continuously monitors and measures water quality during filtration.** Several Philips P800 minicomputer systems scan hundreds of measuring points, perform the necessary calculations, and determine any alarm conditions.

U. S. Navy tests British display for aircraft pilots

A helmet-mounted head-up symbolic display for aircraft pilots has been delivered by Marconi-Elliott Avionic Systems Ltd. to the U.S. Navy for testing, and the company says other military services are also considering it. Symbols are generated for the pilot by a tiny matrix of light-emitting diodes mounted inside a standard flying helmet with a modified sighting visor. He views the symbols either through the visor or an eyepiece. The helmet also contains a prismatic optical system, energizing electronics, and an umbilical cord that connects the array to data and power sources in the cockpit.

The low-power LED matrix, made by GEC Hirst Research Centre, is claimed to be the first that is bright enough and has enough resolution for helmet displays. Consisting of 20 by 23 LED elements on a 0.3-millimeter pitch, it puts out 10,000 foot-lamberts.

Stereo attachment measures profiles of semiconductors

The tiny dimensions of semiconductor chips can be measured precisely by an experimental stereoscopic attachment for scanning electron microscopes. The device, developed at the Hitachi Central Research Laboratory, enables a Hitachi electron microscope to provide a vertical resolution of 300 angstroms, along with the microscope's horizontal resolution of 30 angstroms—adequate for measuring the thicknesses of metal patterns, field oxide, and most other vertical deposits on semiconductors except the thin gate oxide.

The three-dimensional effect is achieved by making two black-and-white images of the chip, differing about 10° in rotation about a single axis, and by storing the two in memory tubes. These images are reproduced alternately at a field rate on a television monitor. Two optically active crystal shutters, synchronized with the field rate, alternately open and close to show different images to the left and right eyes.

French firm aims at U. S. market for fiber optics

A French fiber-optics company hopes to enter the United States market later this year to cash in on the growing demand for optical communications systems, optoelectronic proximity detectors, and endoscopes. The Fort Group of Paris, which has already sold endoscopes to three North American airlines to inspect the interiors of jet engines, is looking for an American distributor or licensee. The company manufactures fiber-optic systems, as well as the fibers. **It makes more than 2,000 types of endoscopes and controls more than 90% of the French endoscope market.**

International newsletter_____

SAW oscillators become synthesizers for mobile radios

Problems with temperature and reliability that have prevented surface-acoustic-wave (SAW) oscillators from penetrating the market for hand-held and mobile radiotelephones apparently have been solved by Edinburgh University's department of electrical engineering. **The group employs phase-control techniques on delay-stabilized SAW oscillators so that the more rugged modules consume less power than conventional crystal oscillators that use frequency multiplication.**

The basic module, consisting of a SAW delay line, an electrically variable phase-shift circuit, and a feedback amplifier, produces a stable oscillation at a single frequency that can be modulated to obtain a desired frequency. By adding digital dividers to the modules, the group can synthesize many frequencies for multichannel operation at very-high and ultrahigh frequencies. Because the basic module can be added to a conventional reference oscillator, the group predicts a large retrofit market. The project, funded by the British Science Research Council and Hewlett-Packard Ltd., is being closely watched by British manufacturers.

Germans install independent net to fight crime

West German police are installing their own communications network to enhance cooperation between police precincts and intensify the fight against crime. The hierarchical network, which transmits both speech and video signals at voice frequencies, uses a Siemens automatic main exchange system at Wiesbaden, headquarters of West Germany's Federal Criminal Offices. Subordinate exchange systems, located in the country's various provinces, are supplied by other communications-equipment companies. **Besides speech, the network transmits telephotos, fingerprints, and documents in support of crime evidence, as well as pictures of wanted criminals and the scenes of crimes.**

Toshiba offers 1-k nonvolatile RAM at core price

A refinement of an earlier design has enabled Toshiba in Japan to offer a 1,024-bit nonvolatile static random-access memory with four times the capacity of one it introduced last year. The RAM, which can also be used as an electrically alterable read-only memory, is priced at \$13. The price per bit is competitive with small magnetic-core memories used to prevent loss of memory contents during power failure because **of the relatively high production volume of 20,000 units a month and a projected volume of twice as many next year.**

Toshiba's device is a conventional p-channel silicon-gate MOS RAM backed up by electrically alterable metal-nitride-oxide-semiconductor transistors in each cell. It can retain memory contents with the power off for a minimum of a year. The memory, arranged as 256 words by 4 bits, comes in an 18-pin ceramic package. Compatible with transistor-transistor logic, it has a maximum read-access time of 1,500 nanoseconds, typical read-access time of 800 ns, maximum power drain of 600 milliwatts, typical power drain of 400 mW, and maximum write-cycle time of 1,000 ns.

Addendum Philips of the Netherlands plans to begin construction in December of a \$50 million plant in Taiwan to make color-television picture tubes. The company is to supply \$22 million. The plant will employ 800 people when construction is completed in two years near a Philips factory in Chupei that is already manufacturing parts for black-and-white TV sets.

The era of personal programming is here.

And TI's new low prices prove it.

SR-56

Key programmable

\$109⁹⁵*

SR-52

Card programmable

\$299⁹⁵*



*U.S. suggested retail price, may vary elsewhere.

Long calculations. Analytical math. Time-consuming and error-prone to do by hand. Costly on a computer. An SR-52 is a better way.

If you're a professional—or studying to be one—then chances are you're deeply involved with: Optimization. Mathematical modeling. Iteration. Data reduction. Projections. What-if matrices. Risk analysis. Forecasts. Worst case analysis. Probability.

If you have the time, you work them out. Or, you get in line for computer time, then wait. So, more often than you'd like to admit, you rely on your intuition. Make an educated guess. Or do some ball-park figuring.

But you can change all this. You don't need to guess. You can *know*. Because personal programmables help you cope with more data, explore with more insight, far more successfully than ever before. You make better decisions, chosen from more options—better decisions founded on a broader data base. More decisions. Faster. On the spot.

**A card programmable
that offers outstanding
capability at an extremely
attractive price.**

Without compromising quality.

TI's advanced technology and manufacturing know-how are the keys to the SR-52's exceptional value.

You can process data or perform complex calculations automatically. Load the card and put its contents into program memory. Key variables directly into the program — or into the 20 data memory registers (up to 60 in certain cases). Run a program as often as needed. Change values of variables as often as you desire.

Program memory and data registers in abundance. Data recording, too. The SR-52's 224-step program memory uses merged prefixes, so each step can hold two keystrokes. With this capability the SR-52 can handle programs you may have thought required a computer. Although the basic 20 data registers are usually more than adequate, you can use up to 40 additional registers. (28 in program memory, the 10 pending operations registers, and 2 more.) And you can record up to 28 data registers onto blank magnetic cards. Read them back in later.

Computer-like branching. The SR-52 offers seven types of unconditional branching. And 10 conditional branches each with three ways to address: absolute, label, or indirect. That's 37 different branch-

© 1976 Texas Instruments Incorporated



At a new low price:

Circle reader service number 200 **\$299⁹⁵***

Due to the difficulty of photographing calculator readouts, displays represented in this brochure are simulated.

Develop, write and record your own programs.

ing instructions. Five flags can be set, cleared, or tested from the keyboard or within a program. You also get 10 user-defined keys.

Direct or indirect access to all data memories. Store numbers directly in any memory register. Or, store a number in a data memory specified by any other register (indirect addressing). Add, subtract, multiply, divide directly within all registers. Exchange display with memory.

Edit and debug. Move through a program a step at a time. Forward or backward. Insert. Delete. Or write over steps. List and trace your programs on the PC-100 printer.

Basic Library of 22 programs included. Put them to work right away: math, statistics, finance, electrical engineering, and others. You also get a 96-page Basic Library manual. Each prerecorded program card is supported with sample problems, user instructions and program listings.

Programming is just logical thinking. You can do it. Using the programming manual with the handy coding form and user instruction tablet, you'll be writing programs in just a few hours. More than likely you won't be able to write optimum programs straight-off. Programs which run the fastest and use the fewest steps. However, you can begin writing programs that work. Press LRN to store each keystroke. Press it again and the SR-52 has learned your program. It's ready to RUN. Record your program on a blank magnetic card, and make it part of your personal library to use again and again. As your programming knowledge develops, you'll discover how this skill magnifies your professional capability. Better decisions will be as near as your SR-52.

Share programs with your colleagues through PPX-52.

There may be times when you need a complex specialty program. But you'd like the convenience of having a ready-made program that's not a bother to obtain. This is where TI's Professional Program Exchange (PPX) can be of enormous help. Here's how it works:

As a member you'll be able to turn to the section of your PPX-52 Catalog that serves your discipline. With hundreds of user-submitted programs available, there's a good chance the one you need is there. Order it, and put it to work on receipt.

What you get is a program developed, tested and submitted by one of your professional peers. Likewise, when you develop programs you may submit them for possible inclusion in the Exchange for others to use.

PPX-52 is for SR-52 owners who want to increase their professional contribution and efficiency. The annual membership fee of \$15 entitles you to a Catalog, updates, and a subscription to the PPX-52 newsletter. Plus, your choice of three programs. Order more programs as you need them — \$3.00 each.

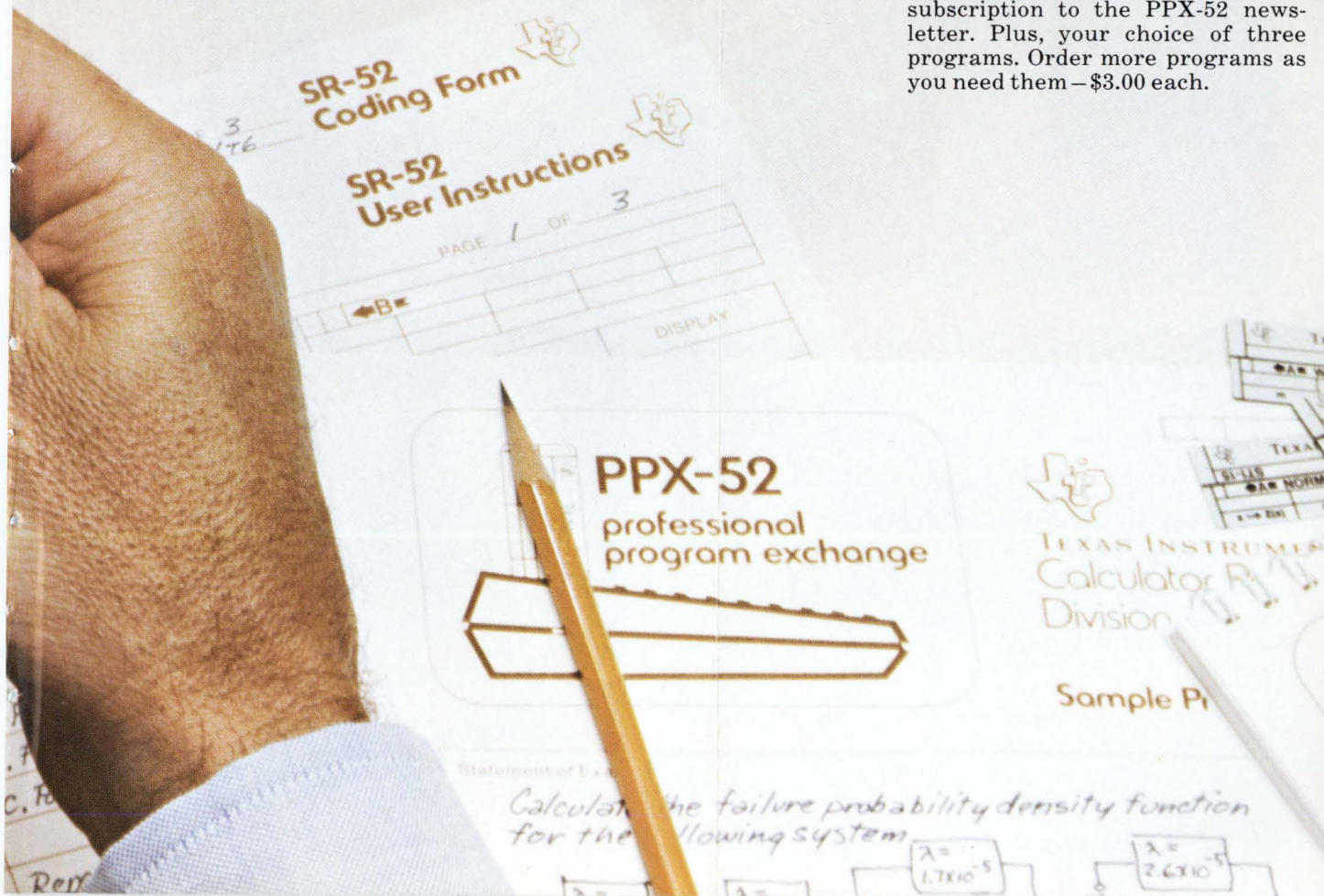

TI's unique Algebraic Operating System makes the calculator part of the solution. Not part of the problem.

With the introduction of the SR-50 slide rule calculator a few years ago, Texas Instruments had a choice: algebraic entry or Reverse Polish Notation (RPN). TI chose algebraic entry because it's the most natural and easiest to use. Now, with the new programmable calculators, TI takes another major step forward in power and ease of use—the unique Algebraic Operating System.

AOS is more than just algebraic entry. It's a full algebraic hierarchy coupled with multiple levels of parentheses. This means more pending operations, as well as easy left-to-right entry of expressions—both numbers and functions.

Pending operations let you compute complex equations directly. For example, a seemingly simple calculation like this:

$$1 + 3 \times \left[4 + \frac{5}{\left(7 - \frac{2}{9} \right)} \right] = ?$$

contains six pending operations as it's written. A TI calculator with full AOS easily handles it just as it's stated, left-to-right. You don't have to rearrange the equation, or remember what's in the stack as with RPN.

Here's how AOS stacks up.

AOS remembers both numbers and operations, so you key-in your equation left-to-right. RPN only remembers numbers, you have to remember operations and the order.

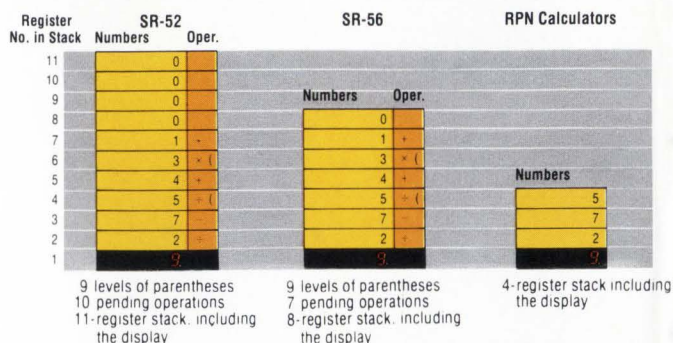

A calculator with full AOS remembers both the numbers and functions in its register stack. And performs them according to algebraic hierarchy. As more operations become pending, the stack fills up (see diagram). Finally, when the equals key is pressed, the operations in the register stack are performed to give you the correct answer (15.21311475). Automatically.

Compare the SR-52 & SR-56 with other programmables in their class.

Operating characteristics	SR-56	SR-52	Calculating characteristics	SR-56	SR-52	Programming capability	SR-56	SR-52
Logic System	AOS	AOS	Log, ln x	●	●	Program steps	100	224
Maximum number of pending operations	7	10	10 ^x , e ^x	●	●	Merged prefixes	●	●
Parentheses levels	9	9	X ² , √X	●	●	Program read/write on mag. cards	—	●
Memories	10	22	1/X, π	●	●	Data read/write on mag. cards	—	●*
Store & recall	●	●	Y ^x	●	●	User defined keys	—	10
Clear memory	●	●	√y	●	●	Possible labels	—	72
Sum/Subt to Memory	●	●	X!	●*	●	Absolute addressing	●	●
Multi/Div to Memory	●	●	Int X (integer part)	●	●*	Subroutine levels	4	2
Exchange display with memory	●	●	Fractional part	●	●*	Program flags	—	5
Additional special memories	1	38	Trig functions & inverses	●	●	Decrement & skip on zero (loop)	●	●
Indirect memory addressing	—	●	Hyperbolic functions & inverses	●*	●*	Conditional branching instructions	6	30
Exchange x with t	●	—	Deg/min/sec to decimal deg & inverse	●*	●	Unconditional branching	3	7
Fixed decimal option	●	●	Deg to Rad conversion & inverse	●*	●	Indirect branching	—	●
Calculating digits	12	12	Polar to rectangular conversion & inverse	●	●	Editing: Step, Backstep	●	●
Angular mode Deg/Rad	●	●	Mean, variance & standard deviation	●	●*	Insert, delete	—	●
Grad angular mode	●	—		●	●*	NOP	—	—
Digits displayed (mantissa + exponent)	10 + 2	10 + 2				Single step execution	●	●
						Pause	●	—

*Programmable functions

PC-100 printer. Turns an SR-52 or SR-56 into a quiet, high-speed printing calculator. \$295*

Imagine the convenience of getting a hard copy print-out of: Data. Intermediate results. Answers. Imagine the efficiency of listing an entire program at the push of a key. Or, printing the calculator's entire data memory contents with a simple program. And now imagine seeing every step of your program as it's executed—both the number and the function. Imagine no more. TI's exclusive PC-100 printer is here.

*U.S. suggested retail price, may vary elsewhere.



Be sure and send coupon to get your 16 page brochure and free preprogrammed magnetic card. Circle reader service number 200

TEXAS INSTRUMENTS
INCORPORATED

Printed in U.S.A.
65543

Or, run prerecorded programs from TI's Libraries.

Optional libraries for the SR-52 go further and do more. Because of the 10 user-defined keys, 20 data memories and 224 program steps. So more steps and functions can be put on a card.

Math. Hyperbolic functions. Quadratic and cubic equations. Simultaneous equations. Interpolation. Numerical integration. Differential equations. Matrix operations. Base conversions. Triangle solutions. Complex functions. 34 program cards. \$29.95*

Electrical Engineering. Active filters. Resonant circuits. T- π networks and transformations. Transmission lines. Phase-locked loops. Transistor amplifiers. Fourier series. Coils. Power transformers. Controlled rectifier and power supply circuits. 25 programs. \$29.95*

Statistics. Means, moments, standard deviations. Random numbers. Permutations and combinations. t-statistics. Analysis of variance. Regression analysis (linear, power curve, exponential, logarithmic, quadratic). Multiple regression. Histograms. 12 distributions (normal, chi-squared, Poisson, Weibull, hypergeometric, etc.) 29 programs. \$29.95*

Finance. Ordinary annuities. Compound interest. Accrued interest. Sinking fund. Annuity due. Bond yield and value. Days between dates. Annuities with balloon payments. Interest rate conversions. Add-on rate installment loans. Loan amortization. Interest rebate. Depreciation (SL, DB, and SOYD) and crossover. Variable cash flows. Internal rate of return. Capital budgeting. 32 programs. \$29.95*

Now available. Three new applications for the SR-52: Aviation. Surveying. Navigation. Check the new system that interests you, and we'll send you detailed information.

SR-56 new low price: \$109.95*

74-preprogrammed operations. Incredible calculating power, 10 memories and computer-like programmability in 100 steps.

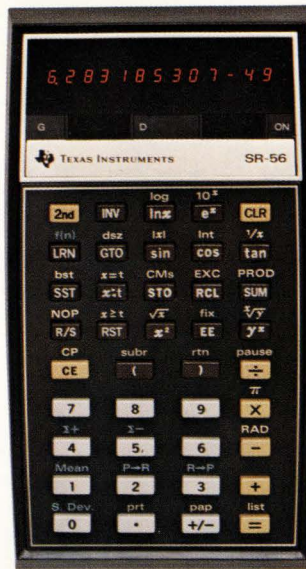

A powerful slide rule calculator that also does double-duty as an economical, powerful key-programmable with: 100 programming steps. Eight-register stack (handles up to seven pending operations). Nine levels of parentheses. And 10 data memories.

Branches like a computer. Capable of direct addressing, which includes: Go to. Reset. Subroutine (4 levels). Plus six conditional branches.

Unique independent test register. Compare the value in the display with a value in the t-register—without interfering with calculations in progress. Or, use it as an extra memory.

10 memories for your tough problems. Store and recall data. Add, subtract, multiply, or divide within a memory register without affecting the calculation in progress.

Unique pause key works two ways. Using this key in a program displays any step you designate for a 1/2-second. Hold the key down and you'll see the result of every step in the program for 1/2-second.

Easy editing. Single-step and back-step keys let you sequence through program memory to examine what you've done. If you pressed a key incorrectly, you can go back and write over it.

An applications library, too. A 192-page collection of programs. All pre-written. Select a program. Follow the listing (putting in your own data, of course). And you'll immediately begin using your SR-56's computing power to solve your own problems. • Math (10 programs) • Statistics (12 programs) • Finance (11 programs) • Electrical Engineering (11 programs) • Navigation (7 programs) • Miscellaneous and games (5 programs).

Circle reader service number 200



Texas Instruments Incorporated
P.O. Box 5012 M/S98
Dallas, Texas 75222

Check one. Send me free:
 EE program card
 Statistics program card
 Finance program card

Send me more information:
 Navigation System
 Aviation System
 Surveying System
 PPX-52

Name _____

Title _____

Company _____

Address _____

City _____ State _____ Zip _____

T I M D I R D N E

*U.S. suggested retail price, may vary elsewhere.

When professionals need decisions, programmables deliver. Anywhere. Anytime.

"The SR-52 saves me time in designing attenuators—pi pads, T-pads, H-pads, etc. I key in the impedance and amount of loss and, in seconds, the SR-52 tells me what resistors to use. Without a calculator, it might take hours to optimize these values. The SR-52 is very easy to program—it works very naturally. It's cheaper, of course, than using a time shared system. It's also quicker and more convenient—not having to go to a terminal and access the big computer. And many things—formula translations, for example—are just easier to do on the SR-52."

M. H. Kindermann
Engineering Staff
Supervisor
AT&T Long Lines
Kansas City

"I'm using the SR-52 to handle long calculations in determining optimum locations in a warehousing system. I need lots of data storage—plus I can copy the magnetic cards and send them to our clients for use on their SR-52. We're also working on an energy model—a huge computer program with thousands of calculations. Here, I'm using the SR-52 for pre-processing and post-processing data to get it in a more usable form—to get my data out faster. The SR-52 is very powerful—and convenient. It's always available. I can take it anywhere."

Marleen Mandt
Operations Researcher
Stanford Research
Institute
Menlo Park

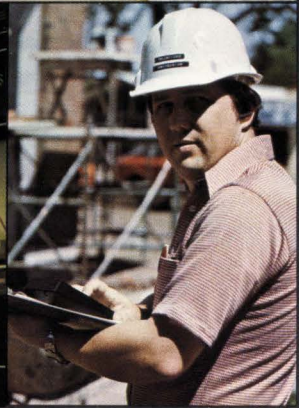
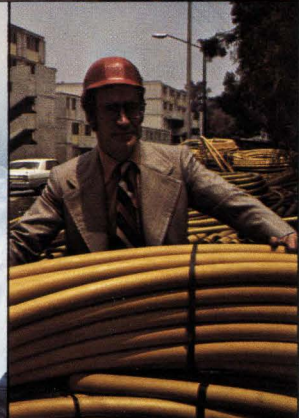
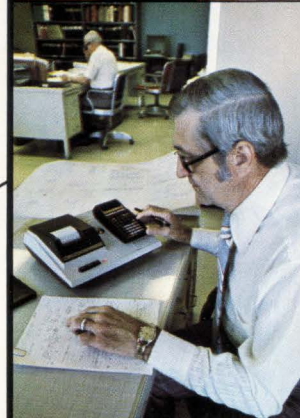

"Inserting a lens in the eye, usually at the time of a cataract extraction, has become an important surgical technique. The lens must be precise. This is where my SR-52 has proven invaluable. First the length of the eye is measured by ultrasound. Then I incorporate this and other data into formulas which I've developed and programmed on the SR-52. Of course, I share my programs with my colleagues. And, my approach is an integral part of my lectures."

Richard D. Binkhorst, M.D.
Ophthalmic Surgeon
New York City

"Calculating a gas pipeline network for 200 homes under construction takes hours of tedious work. I developed a program for my SR-52. It makes all the necessary iterations—and gives me pressures and flow rates. Now I do in less than two hours the same work that used to take 10."

Carlos de León
Consulting Engineer
Diseño Ingeniería y
Técnica en Gas, S.A.
Mexico City

"I wrote a program which I use in designing overhead bridge cranes. It calculates the moment and the maximum deflection on the beams that carry the trolley. I plug in the section's modulus and moment of inertia. Then the bending stresses and deflection are calculated for me. I wrote another program that I use in designing column footings. A programmable gives me the capability to analyze several set-ups very rapidly and come up with a good solution."

Joel Waldbieser
Civil Engineer
Waldbieser Engineering
Terra Haute

"We had a program we ran twice a week on time shared computer. It involved entering stock prices, option exercise prices—60 option prices. We had chronic difficulty getting a clean, accurate run because wrong quotations crept in. We'd lose time locating each error. I got the idea we could do it faster with an SR-52 and a PC-

100 printer—screening each entry. I wrote the program myself. It worked beautifully. It's a big dollar savings. My secretary usually runs the program now."

Biddle W. Worthington, Jr.
Securities Account
Executive
Wertheim & Co., Inc.
New York City

The Answer Book. It makes your job easier. \$25.

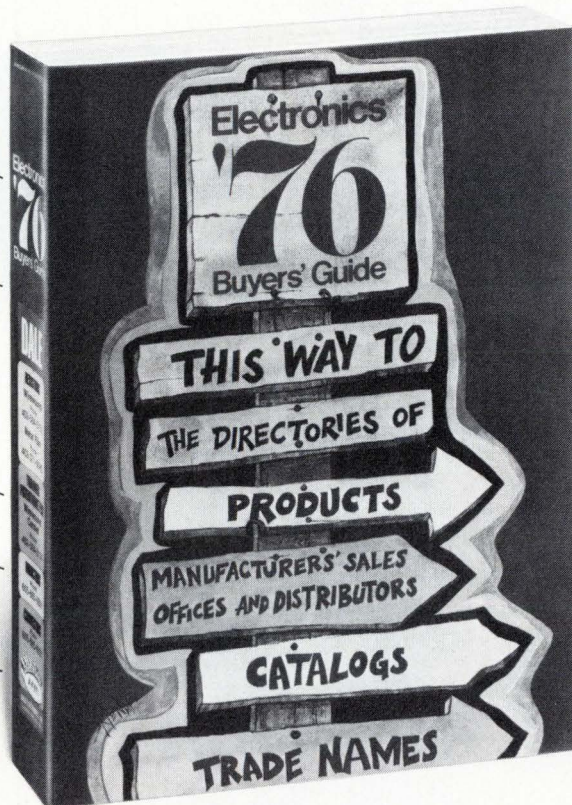

"WHO MAKES WHAT?"

"WHAT COMPANIES MAKE THE PRODUCTS I NEED?"

(See alphabetical directory of 4000 products)

"WHERE ARE THEIR NEAREST SALES OFFICES?"

"WHO ARE THEIR DISTRIBUTORS?"

"WHAT ARE THEIR LOCAL PHONE NUMBERS?"

(See alphabetical directory of 6000 manufacturers)

"HOW CAN I GET THEIR CURRENT CATALOGS FAST?"

(See directory of catalogs by product and by company, including catalog inquiry card for 5-second ordering, page 901)

"WHO MANUFACTURES THIS TRADE NAME?"

(See directory of trade names, page 1276)

Special no-risk offer. If The Answer Book is not everything we say it is and more, return the book to us within ten days and we will refund your \$25.

Electronics Buyers' Guide (EBG) is as easy to use as your telephone directory. The whole international world of electronics is at your fingertips. Great emphasis is put on *localizing* the information you need. You won't have to call half-way across the country to company headquarters because we list local sales offices and distributors.

To order from our Directory of Catalogs, simply circle the corresponding number on the Inquiry ("bingo") Card and mail. This way you get *current* catalogs. Also, semi-annually we mail out an updated list of current catalogs plus a "bingo card." The Answer Book's objective: Make your job easier.

Electronics Buyers' Guide

1221 Avenue of the Americas
New York, N.Y. 10020

Yes, send me a copy of The Answer Book.

I've enclosed \$25 (USA and Canada only, elsewhere send \$35). Full money back guarantee if returned within 10 days.

Name _____

Company _____

Street _____

City _____

State _____

Zip _____



**Now! The readable
7/8-inch dial...
a fitting mate for our 7/8-inch pot!**

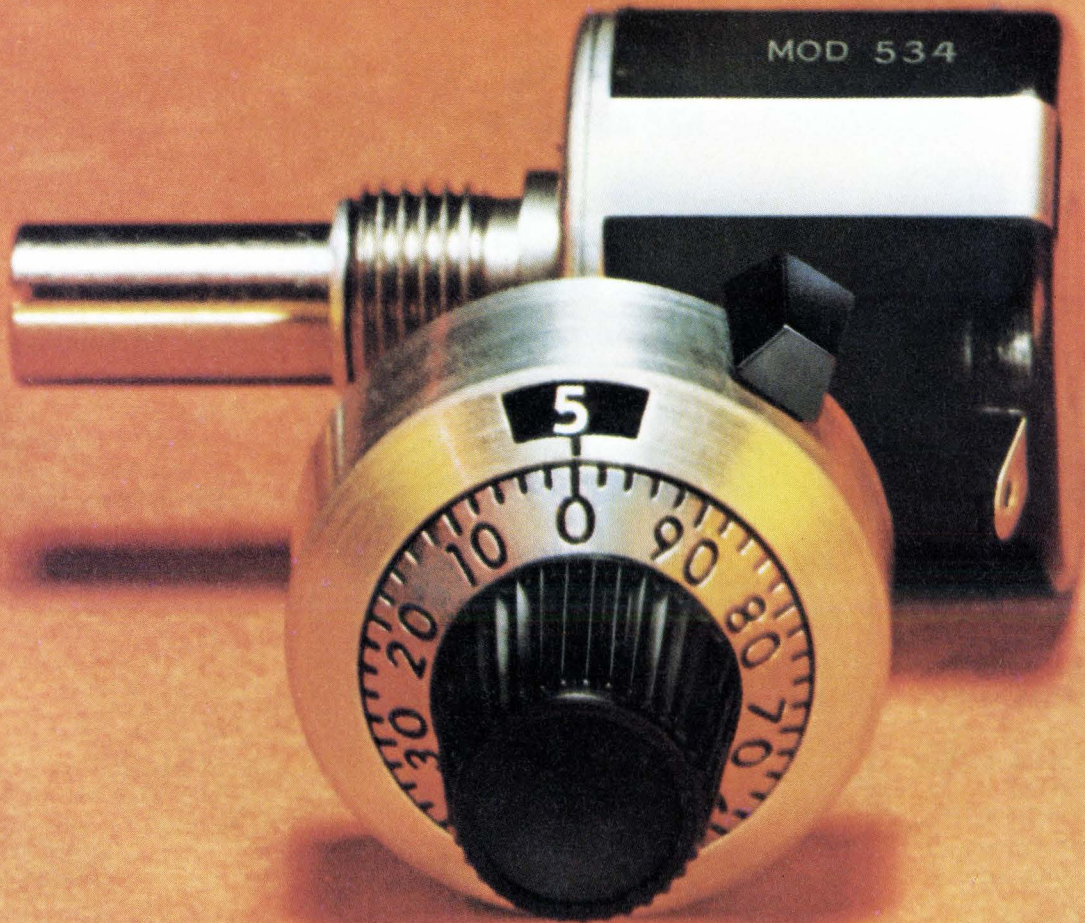

The New Spectrol Model 16 Dial

Interchangeable with competitive 7/8-inch dials — and much easier to read — it's a fitting mate for our Model 534, the industry's best low-cost multi-turn pot. Call or write for more information.

Spectrol

SPECTROL ELECTRONICS GROUP

UNITED STATES Spectrol Electronics Corporation 17070 E. Gale Avenue, City of Industry, Calif. 91745, U.S.A. • (213) 964-6565 • TWX (910) 584-1314

UNITED KINGDOM Spectrol Reliance Ltd. Drakes Way, Swindon, Wiltshire, England • Swindon 21351 • TELEX: 44692

ITALY SP Elettronica spa Via Carlo Pisacane 7, 20016 Pero (Milan) Italy • 35 30 241 • TELEX: 36091

Circle 66 on reader service card

Professional program gets few cheers

Grass-roots reaction to the IEEE U.S. activities board's 1976 program plan ranges from lukewarm approval to disappointment

by Gerald M. Walker, Associate Editor

If the IEEE is having second thoughts about asking members to comment on its proposed professional-activities plan, it could be forgiven. For the plan, drawn up in January and revised in July, is being greeted with less than wild enthusiasm.

A sampling of those who have read the plan [*Electronics*, Aug. 5, p. 32] shows a typically unfavorable reaction. The prime complaint, even among members who praise the plan's five general goals, is that there is an apparent lack of action in those goals, which are subdivided into individual tasks (see "The plan in brief," p. 68).

The reactions were generated by what is for the IEEE an unusual step. When the revised plan was ready, James H. Mulligan Jr., the society's vice president of professional activities and chairman of its U.S. activities board, decided to circulate it among section and professional-activities committee chairmen. In a covering letter, he asked for written suggestions by Aug. 31. Those comments will be placed before the 16-member U.S. board at its Sept. 10-11 meeting for consideration in formulating the 1977 plan.

Most of those section leaders who have studied the program want a closer meeting of the minds. "Why," typically complains a Midwest member, "do they wait until after the program is completed to ask the 'grass roots' for its opinions? Why didn't they ask us before?"

More specifically, "the program does not meet the needs of West Coast members," declares J. G. Hoagland, chairman of the Orange County section of the Los Angeles Council. There is a "big discrep-



any" between what members want and expect and what the program talks about, he adds. He blames this on the makeup of the U.S. activities board. "Too many academics and pseudo-academics. It's another series of studies on top of studies, which is the academic approach," he says.

Response. In contrast, Myron Ross, acting professional activities chairman of the Boston-area IEEE, observes, "The activities board seems to be trying to respond to the members' needs, at least to some of the expressed desires of Boston-area members." Section chairman Allan Schell points out that he is more concerned with local professional activities than with the national plan. "I'm convinced that if the sections don't generate programs on the local level that are somewhat analogous to the national program, then they are remiss."

Meanwhile, an official's view was expressed by Joel B. Snyder, Region 1 PAC chairman and a member of the activities board's steering committee

and its controller, who claims that the board has tried to modify existing programs and develop new programs to address each of seven previously stated "needs of engineers" adopted by the executive committee.

Estimating his views on the overall program as falling between that of "rabid fanatics and rabid conservatives," Snyder says, "To my thinking, the program is a very ambitious one. But, considering our limited financial position, the program is, perhaps, too ambitious."

Snyder considers the bulk of the 24 tasks previously adopted to be responsive to the needs of engineers. "In general, the tasks under the five goals are needed by engineers; in some cases, immediately; in others, it's more of a long-range thing. Unfortunately, some of those things needing immediate attention can't be accomplished overnight."

Criticism. One of the most outspoken critics of the plan, Robert Bruce, PAC chairman for the Long

Now there's a
universal computer-based
in-circuit/functional
test system with extensive
digital test capability.



FAULTFINDER[®] FF303

The new FF303 provides two separate in-circuit test approaches. Analog testing procedures use guarding techniques for straightforward component fault isolation. Pulse techniques are used for digital testing of all combinatorial and sequential logic independent of the surrounding circuitry. The FF303 can be configured with up to 928 analog test points and 1216 digital test points.

In-circuit test programming is done with a Faultfinder extension of BASIC which permits on-line editing and simplified, high-level language programming with user nomenclature.

The FF303 is a complete, flexible in-circuit test system for your production floor with low-cost software generation and unique capabilities for testing hybrid boards. We'd like to show you what it can do for you. Write or call for complete information.

Circle 68 on reader service card

FF FAULTFINDERS Inc.
15 AVIS DRIVE, LATHAM, NY 12110 (518) 783-7786

Irvine, CA
Sunnyvale,
Park Ridge, IL
Faultfinders GmbH, Eschborn, Germany

Cicero, IN
Waltham, MA

Probing the news

Island section, complains, "I don't think the board deliberately set out to squander over \$1 million of our dues, but this plan accomplishes the same thing."

Bruce lists these criticisms:

- Employer cooperation in career maintenance (task I-e) does not cope with the core of the EE's problem—oversupply. There is no mention in the plan about controlling the quantity and quality of engineers directly.
- Affirmative action for senior engineers (task II-b) also misses the mark by failing to put teeth in the proposal, such as maintaining a black list of undesirable employers, as do other professional organizations. This comment also applies to the employment guidelines (task II-d)—no teeth, no blacklist.
- Standard occupational titles (task II-g) could work against the engineer by "pinning him to a board like a butterfly." These titles could narrow an EE's chances of finding employment and may not reflect his true talents either.

Suggestions. Somewhat disappointed by the final plan, James Nawrocki, chairman of the Santa

Clara, Calif., professional-activities committee, notes, "The program looks more like a program goal than a program plan." He has submitted several suggestions to the board. In one, Nawrocki says, "They ought to work on task IV-a (communications). The board has been active in 'upward communication,' but has been short on 'downward communication' to members."

He recommends that the IEEE inaugurate an employer-evaluation survey, such as the Santa Clara chapter plans to initiate, and rate local firms as good, poor, and bad for engineers. Nawrocki, who believes that the USAB will heed the will of the members, is also concerned about what the institute is doing and not doing about describing the drawbacks of the EE career to students, women, and minorities.

George F. Kujawski, PAC chairman for the Metropolitan Los Angeles Council, is lukewarm on the plan. "While the program addresses all the proper areas and identifies the problems, it is not as specific as it could be," he says. Most of all, it lacks a sense of urgency in accomplishing certain tasks. □

The plan in brief

The U.S. Activities Board's revised 1976 program plan is a well-organized document done in outline format. Here are the contents, with the amounts budgeted for each goal:

- Goal I (\$201,300): Improvement in financial and economic benefits for members. Tasks are pension coverage, portable benefits, employment rights under Government contracts, patents rights of employed inventors, and employer cooperation in career maintenance and development.
- Goal II (\$158,900): Improvement in career conditions and opportunities. Tasks include employment assistance, affirmative action for senior engineers, career centers, extension of work on employment guidelines, manpower reports, forecasting engineering-manpower requirements, standard occupational titles, and a data base for manpower planning.
- Goal III (\$31,900): Improvement in professional status. Tasks are professional identification, professional qualification, and matters of ethical concern.
- Goal IV (\$225,800): Improvements in Government relations and other interfaces. Tasks cover contributions to Government decision-making, participation in technical projects related to professional activities in the United States, continuation of congressional fellowships, and the U.S. intersociety legislative advisory project.
- Goal V (\$114,100): Improvement in communicating USAB aims, activities, and accomplishments. Tasks are communication among IEEE members, with employers of IEEE members, with other societies and professions, and with Government bodies.

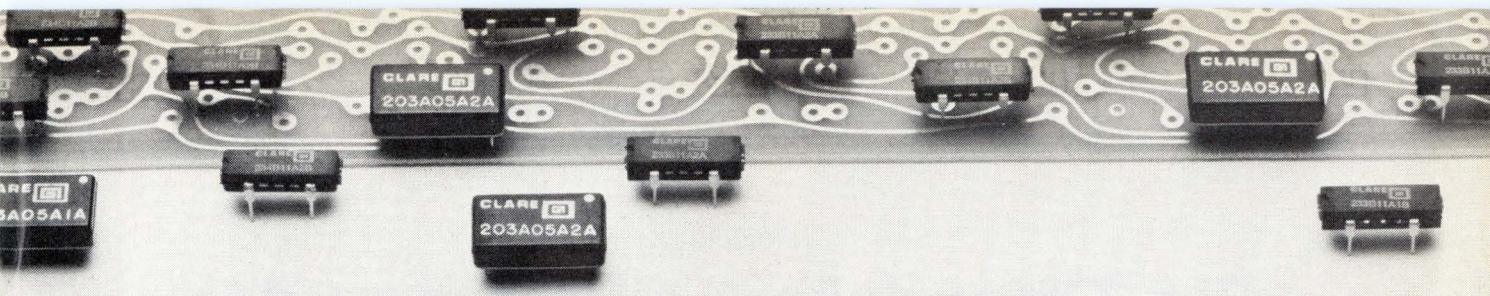

Use CLARE Solid State relays across the board...

There's a CLARE SOLID STATE RELAY
for every PCB application.

For heavy duty AC applications—computer peripheral, process control, inductive load. For DC control applications—motor and servo controllers for process control and machine tools.

From popular modules to DIP for 0.5" PCB mounting centers. Or from wire wrap to quick disconnect for non-PCB use. If you need the speed and reliability of solid state, Clare has the right relay for you.

All Clare solid state relays offer complete input-output isolation, zero-crossing synchronous switching, and a

productive life of over 10 billion operations.

For solid answers on solid state relays, contact your Clare Representative, or C. P. Clare & Company, 3101 W. Pratt Avenue, Chicago, Illinois 60645. Phone (312) 262-7700.

QUALITY, SERVICE, RELIABILITY

**C. P. CLARE & COMPANY
GENERAL INSTRUMENT CORPORATION**



and then some.

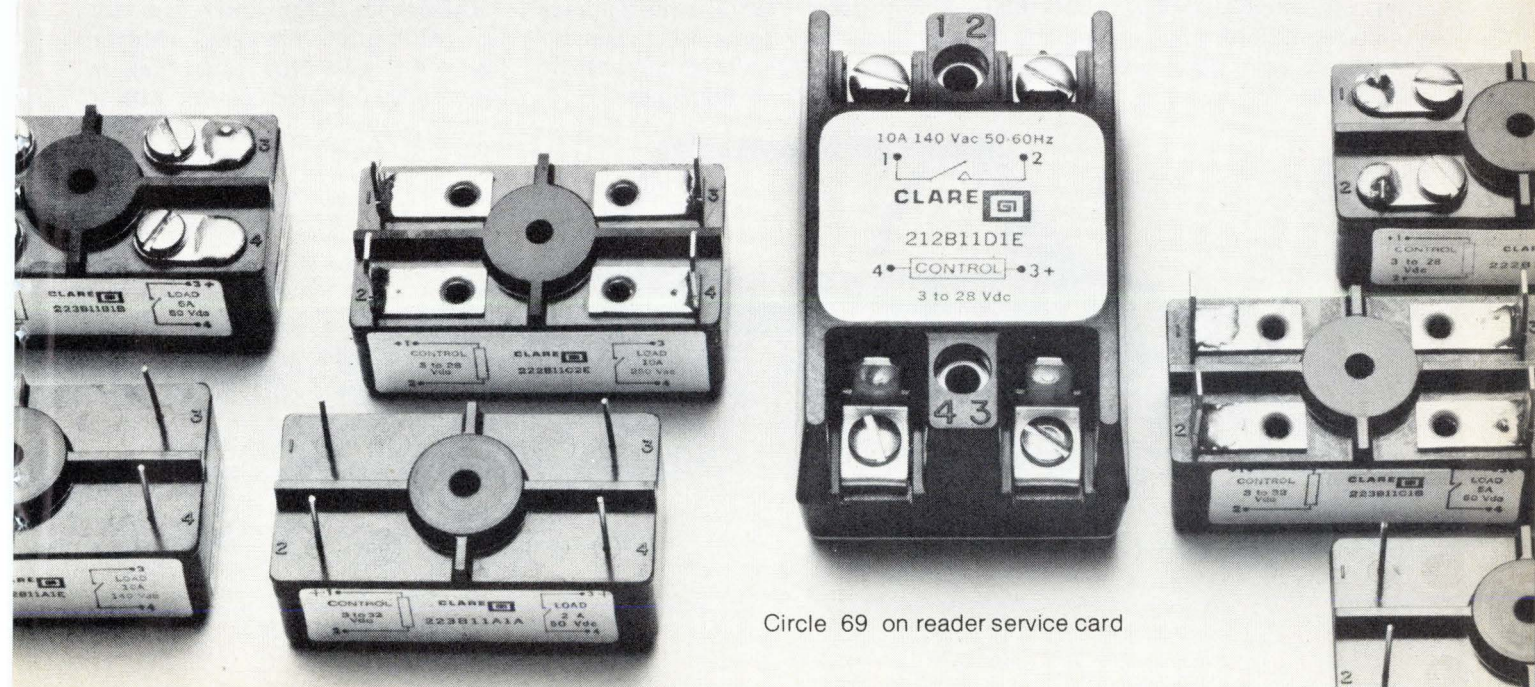

Circle 69 on reader service card

Automotive

Big Three follow different routes

Now that microprocessor has made debut in GM car, Chrysler plans to expand linear applications, but Ford will wait

by Larry Armstrong, Midwest bureau manager

The microprocessor has made its long-awaited debut in autos, and Detroit's Big Three all expect microprocessors to be widely used for engine control by 1980. However, Chrysler and Ford are taking different paths toward that goal, while GM has started with its announcement that some 35,000 Oldsmobile Torados will be equipped with a microcomputer from Rockwell International to handle ignition timing and spark regulation [*Electronics*, Aug. 19, p. 43].

Electronic ignition systems have been installed on cars by all manufacturers for several years now, and spark advance has become the function that's ripe for the switch to electronics. General Motors came down heavily in favor of digital microprocessors in its first attempt to handle spark advance with electronics. Chrysler plans to expand its linear sparking system, first shipped in January, to nearly all eight-cylinder engines in its 1977 models, an estimated 400,000 to 500,000 units. And Ford, while not lagging in microprocessor development, has decided that relying on electromechan-

ical devices, at least this year, is a better idea.

GM's Delco-Remy, working on a system in competition with Delco Electronics, a sister division, opted for PAC—for programable automotive controllers—from Rockwell's Microelectronic Device division to use in the Toronado. First shown a year and a half ago [*Electronics*, March 6, 1975, p. 36], PAC is a 10-bit p-channel MOS central processor, coupled with a 1,024-by-10-bit read-only memory programed to the customer's specifications. Besides preprogramed instructions, the ROM chip also holds data curves for table look-up, and the CPU chip interpolates between points on the curves.

Chrysler has elected to stand by its successful discrete electronic-spark computer, which is used with a "lean-burn" engine [*Electronics*, April 3, 1975, p. 38]. About 100,000 copies of the analog system have been sold as options on 400-cubic-inch engines this year. Chrysler was able to meet Federal emission-level requirements without using catalytic converters or so-called EGR (exhaust-gas-recirculation) techniques.

This year, however, as emission limits have been pushed another step downward, Chrysler has had to return the catalyst. It is standard equipment on 360-, 400-, 440-, and will be optional later this year on the 318-cubic-inch 1977 engines. However, these cars operate without the additional drag of EGR.

Chrysler engineers are at work to eliminate the catalytic converter with a version of the spark computer that will meet the mandated lower nitrogen-oxide levels. "As the environmental limits get more severe, this is still somewhat speculative," points out Earl W. Meyer Jr., assistant chief engineer for engine electrical engineering at Chrysler in Detroit. But the firm has completed 50,000-mile durability tests on a 400-in.³ engine equipped with the advanced system; after the data is submitted to the U.S. Environmental Protection Agency, the system without the converter will probably be offered as an option.

Differences. "The differences are just calibration changes," Meyer says. "We run a little leaner fuel-air ratio and try to overcome it with a

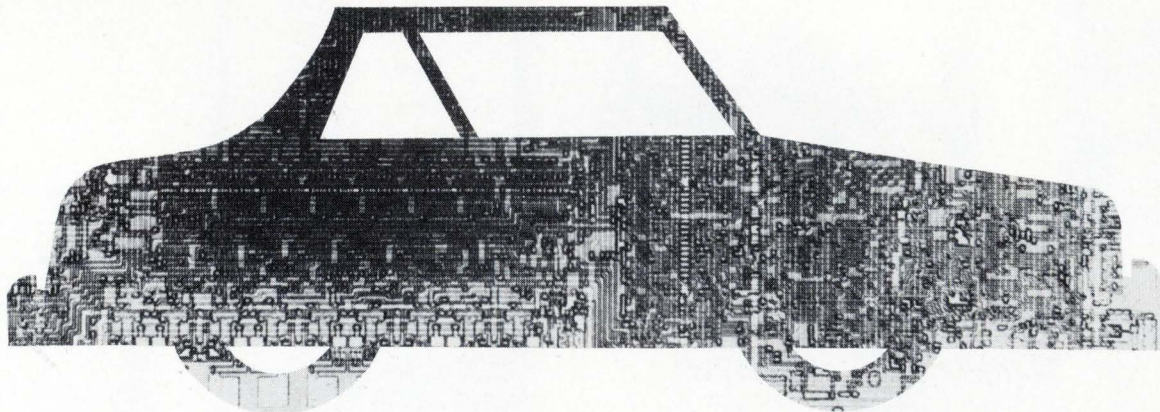





Dumb Terminal

NOW FORTIFIED WITH DCA!

A single Dumb Terminal currently provides all of the following key ingredients:

- DIRECT CURSOR ADDRESSING
- 12" Diagonal Screen
- 960 Upper Case Character Display
- 59 Data Entry Keys
- 32 Positive Action Switches
- 11 Selectable Baud Rates† (from 75 to 19,200)
- 1 RS232S Interface
- 1 20mA Current-loop
- 1 Hatchback Bonnet

†No official minimum requirements have yet been established

NET WEIGHT: 25 lbs
The Dumb Terminal (ADM 3A)
is a product of
Lear Siegler Inc
Anaheim California

NOW FORTIFIED WITH DCA*!

*DCA means Direct Cursor Addressing. And that's exactly what you'll find added to each and every ADM-3A Dumb Terminal from Lear Siegler. As a basic, standard ingredient.

Now our Dumb Terminal's even more of a snap to use. Because direct addressing lets the operator tell the cursor—quite literally—where to go. Up. Down. Right. Left. Any X and Y location you choose. Even where to home.

Your operators will tell you it's "GRRRRREAT!" Not to mention fast and simple. For tracking down typos. Typing in additions. Even for retyping entire passages. Because if the problem's still on the screen, it's open to instant improvement.

What's more, the Dumb Terminal still provides a balanced diet of your favorite standard features. Like a bright 12" diagonal screen. Fifty-nine data entry keys. A 960 character display. Plus 32 positive action switches that let you activate goodies like 1 of 11 different baud rates, an RS232S interface, or a 20mA current-loop. And more. All handsomely packaged in a handy hatchback bonnet

And if you want to sweeten up the deal by adding switch-selectable options, you've got your pick of plenty. Like a complete upper and lower case USASCII character set, a 1920 character display, or even an "answer-back" capability.

So forget the flaky imitations with their puffed-up, premium prices. (And join the thousands who already start their day, in an LSI kind of way.)

Because what the Dumb Terminal—now fortified with DCA—really delivers, you won't find anywhere else.

Not even in Battle Creek.



DUMB TERMINAL. SMARTER BUY.

Forget the box tops, for more information contact:
Lear Siegler, Inc./E.I.D., Data Products

714 N. Brookhurst St., Anaheim, CA 92803
Tel. (714) 774-1010



COIL-LER

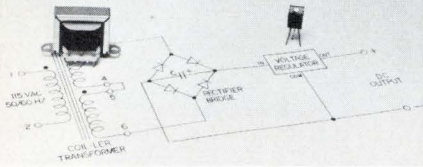

STOCK P.C. POWER TRANSFORMERS

- For use with 3-terminal IC voltage regulators
- Printed circuit mounting
- For power supplies for most integrated circuit families
TTL LOGIC ECL LOGIC
CMOS LINEAR—OP AMPS
- 36 models in stock

Write or phone for complete data sheet.

CUSTOM TRANSFORMERS, COILS, TOROIDS

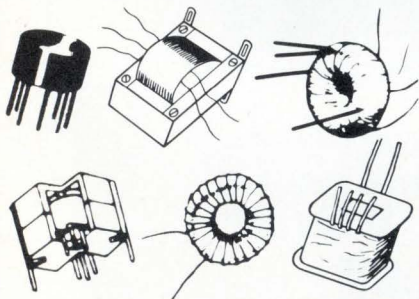

Our precision manufacturing facility produces a full range of medium, miniature or ultra-miniature size transformers and coils — bobbin or toroidal wound. We can meet both your specs and your delivery dates whether for prototype, small or large production runs. Our experienced engineers are at your service.

Write or phone for information or quotes.



COIL-LER MANUFACTURING, INC.

2-E Town Line Circle Rochester, N.Y. 14623
716/442-6630
Representatives in Principal Cities

Probing the news

more dynamic spark-advance schedule." Also, later this year, Chrysler will replace more than half the components in the system with three custom integrated circuits; National, RCA, and Texas Instruments are building two each.

Chrysler is in the process of switching from analog to digital electronics, and the firm has long said that its first use of microprocessors will be for electronic fuel metering. "It's a natural step that will be used in combination with the lean-burn engine," Meyer says. "An electronic fuel system simply operates leaner than a carburetor can." He predicts that microprocessors will be installed in Chrysler 1979 or 1980 models, although there's talk around Detroit that the firm's first microprocessor-based fuel system might show up during the 1978 model year.

Less cost. "We could do it in custom linear ICs every bit as reliably, but the microprocessor gives us a certain flexibility from model year to model year as calibrations and features change," he says. "More important, we can do it at a reduced cost."

Chrysler defined equations for its linear designs and handed the package to RCA and Texas Instruments. "The products that both companies are proposing are evolutions of their standard microprocessors," Meyer says. "But it became clear, for economy and reliability reasons, that the devices had to have some custom concepts in them, so they will be automotive microprocessors."

RCA's is an 8-bit C-MOS device; TI's is part of its 16-bit 9900 family. "We need at least 8 bits, and we have enough computing capability with 8 bits," Meyer says. "But bit length also entails tradeoff with the input/output circuits. Some would argue that it's better to have more powerful processors and memories so that custom inputs and outputs could be simpler and more general."

Ford, in a splashy introduction last fall, unveiled an electronic spark advance of its own, called computer-controlled timing (CCT). CCT, built primarily of complementary MOS by

Aeronutronic Ford and Motorola's Automotive Products division, was later postponed and then quietly sacrificed for a more conventional electromechanical sparking system. "It met our performance and reliability requirements, but alternate means were giving us better fuel economy," comments Robert S. Oswald, manager of electronic subsystem and component design at Ford in Dearborn, Mich. Ford claims that the system is still in the development stages, but an insider contends that it's a less capable system than those from GM and Chrysler.

Ford first. But Ford was one of the first to design a microprocessor, a custom 12-bit chip built by Toshiba in 1972. "Even though we've worked with ours longer, and have more confidence in it, and more experience with it," Oswald says, "we're not committed to it. It's 1972 architecture, and we're not going to be casting our lot in with what would be classed today as obsolete." Even so, the industry expects to see Ford introduce limited numbers of the Toshiba system in cars at the top of its line, simply to get on-the-road experience with electronics.

Ford is expected to go out this month with a set of specs for its next generation CCT, this one microprocessor-based. And Ford's criteria for the Toshiba design still apply. "It has to be a single chip and give us sufficient accuracy to do calculations for engine control without going to double precision," Oswald says. "And it can't be a word processor; it should be oriented to the control task, with hardware multiply-and-divide and bit-manipulation capability."

Ford is considering the use of microprocessors for total engine control: ignition, spark, EGR, fuel metering, and several associated on/off functions for switches and solenoids. The company set up a task force a little over a year ago to formalize the application of electronic engine controls. "We picked the R&D systems and put them into a production program," says Melvin F. Sterner, who heads the task force. "We thought it was an aggressive program then, and it's even more so now. We've moved the timetable up within the past year." □

57* La 138.90		64 Gd 157.25		70 Yb 173.04
	59 Pr 140.90		68 Er 167.26	
58 Ce 140.12		65 Tb 158.92		71 Lu 174.97
	60 Nd 144.24		69 Tm 168.93	
	62 Sm 150.4	66 Dy 162.50		90 Th 232.03
39 Y 88.90		67 Ho 164.93		
	63 Eu 151.96			

rare earths Rhône-Poulenc

all grades ranging
from 95% to 99,9999% purity

rhodia inc. Chemicals Division, P.O. Box 125 - Monmouth Junction - NEW JERSEY. 08852 (USA) - Telex 844.527 - Tel. 846.77.00
rhône-poulenc (CF/PSP), 21 rue J.-Goujon - F. 75360 PARIS - Cedex 08 - Tel. (1) 256.40.00



Name _____
 Address _____

 Tél. _____



Please send me information on rare earths.
 CF.G1.6/12 - Electronics

Announcing a BiMOS breakthrough...

The RCA 3140: most useful op amp since the 741.

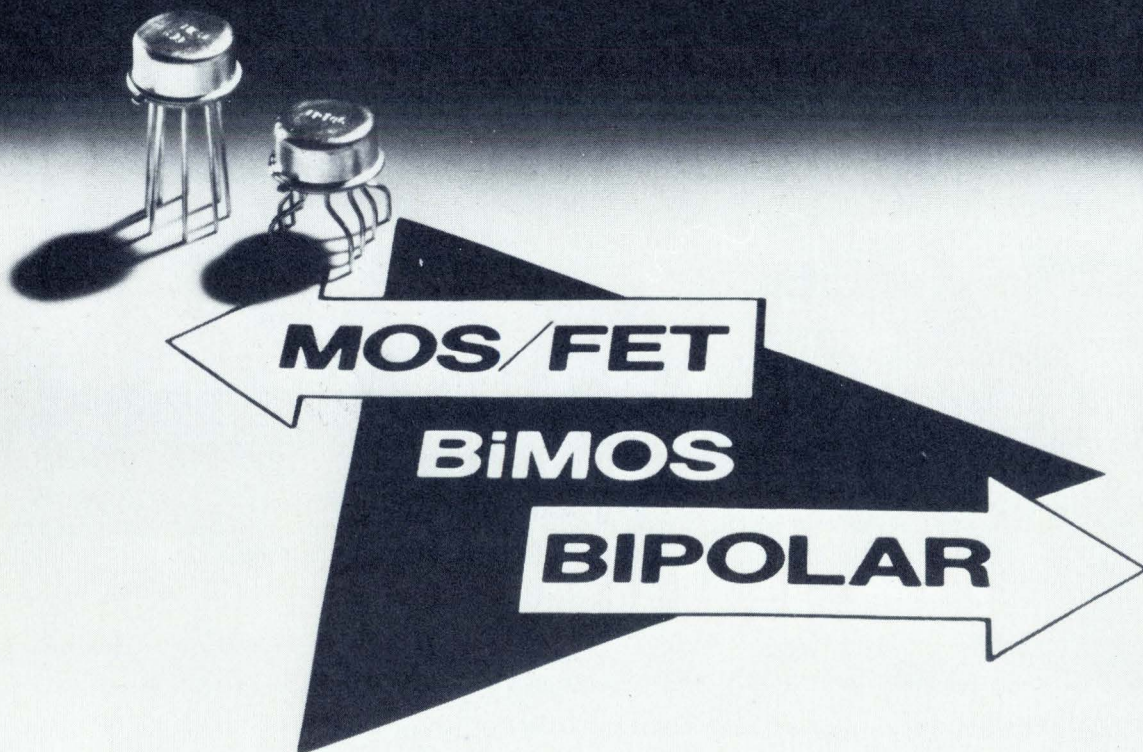

For the price of a 741 you get
a lot more op amp.
MOS/FET input makes the difference.

Every so often a new advance greatly expands op amp versatility. In 1965 there was the general-purpose 702. Followed in 1966 by the 709, with higher voltage, gain and input impedance. Along came the 101 with still higher voltage and gain. Then in 1968 the remarkable 741 gave you the added benefits of on-chip compensation and low cost.

Now, RCA announces a new giant step toward the ideal op amp. The CA3140 Series of BiMOS op amps.

It gives you the big advantages of MOS/FET input...plus bipolar speed and high supply voltage operating capability: 4 to 44 V, dual or single supply. That means very high input impedance: 1.5 TΩ typ. Very low input current: 10 pA typ. at ±15 V. Low input offset voltage: as low as 2 mV max. Wide common-mode input voltage range—can be swung 0.5 V below negative rail. In addition, output swing complements input common-mode range, permitting full utilization of low supply voltages (down to 4 V). And PMOS input devices are protected by rugged bipolar diodes.

BiMOS vs. 741

You get all of those features for the price of a 741. 69 cents at the 100 unit level for the CA3140T, S. Plus big circuit savings. BiMOS minimizes bias circuitry. Allows single supplies in portable, automotive and instrumentation equipment.

BiMOS vs. BI-FET

Compared to recently announced higher-priced BI-FET types, the CA3140 offers lower input currents, higher input resistance, improved offset current and comparable offset voltage—all with high slew rate and bandwidth. So chances are, you don't have to pay the higher prices.

In fact, in most existing circuits using premium op amps, the CA3140 permits cost reductions and/or improved performance with minimum circuit redesign. And if you have an application where you ruled out op amps altogether because of cost...reconsider. The CA3140 is cost effective in many places where other op amps are not.

Low circuit cost

The CA3140 needs no external compensating circuitry. It is characterized for low-cost TTL systems requiring operation at 5 V and maintains operation down to 4 V. Its wide bandwidth—4.5 MHz unity gain—makes possible low-cost video and audio circuits. For low-cost sample and hold and other data acquisition systems, it offers fast settling time: 1.4 μs typ. to 10 mV. When it's driving power transistors, the output swings to within 0.2 V of the negative supply, eliminating the need for level-shifting circuitry.

CA3140 vs. 741 at a glance

Characteristics	Limits						Units
	CA 3140T, S			CA 741CT, S			
at Supply Volts: V+ = 15, V- = -15 @ 25°C	MIN	TYP	MAX	MIN	TYP	MAX	
Input Resistance, R _i	300,000	1,500,000	—	0.3	2	—	MΩ
Input Current, I _i	—	10	50	—	80,000	500,000	pA
Input Offset Current, I _{IO}	—	0.5	30	—	20,000	200,000	pA
Input Offset Voltage V _{IO}	—	5	15	—	2	6	mV
Slew Rate, SR (Closed Loop)	—	9	—	—	0.5	—	V/μs
Gain-Bandwidth Product f _T	—	4.5	—	—	1.0	—	MHz
Common-Mode Input Range, V _{ICR}	-15	-15.5 to +12.5	+11	-12	±13	+12	V
Output Swing R _L = 2KΩ	-14	-14.4 to +13.0	+12	-10	±13	+10	V
Large Signal Voltage Gain A _{OL} R _L = 2KΩ	—	20,000	—	—	20,000	—	

Versatile building block

Beyond standard op amp uses, the CA3140 can perform in many other applications. Such as ground-referenced single-supply amplifiers. Sample and hold amplifiers. Long-duration timers/multivibrators. Photocurrent instrumentation. Peak detectors. Active filters. Comparators. Tone control circuits. Function generators. Power supplies. Portable instruments. Intrusion alarm systems.

Six commercial versions are available: in the TO-5, the standard CA3140T and the premium types CA3140AT and CA3140BT; the CA3140S, CA3140AS and CA3140BS are the DIL-CAN versions of the TO-5. Also available is the chip version—CA3140H. The CA3140 series is available processed to all levels of MIL-M-38510/883.

Send for 13 useful circuits.

To show you how useful the CA3140 is, we've designed it into 13 typical circuits. To get these circuits plus other information, contact your RCA Solid State distributor. Or RCA.

Write: RCA Solid State, Box 3200, Somerville, N.J. 08876; Ste Anne de Bellevue H9X 3L3, Canada; Sunbury-on-Thames, U.K.; Fuji Bldg., Tokyo, Japan.

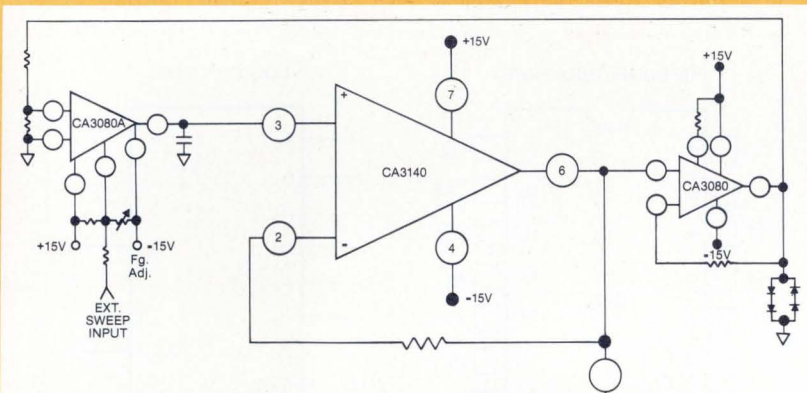

Basic Function Generator

The CA3140 gives 1,000,000:1 range, single control when used as a buffer readout for the integrating capacitor in this basic function generator. The RCA data sheet (File No. 957) tells you how to build this circuit.

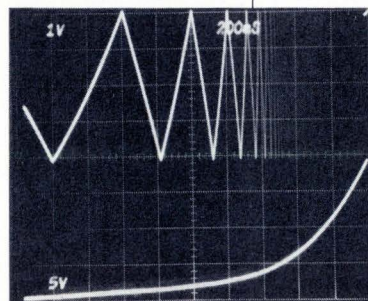

RCA. Full house in Linear ICs.

Memories

Conferees close in on 16-k standards

But Jedec committee may be beaten to the punch by whichever RAM that can be supplied in volume demanded by users

by Bernard Cole, San Francisco bureau manager

Take heart: the great battle over latches in 16-kilobit RAMs—and other less important, but related, skirmishes—may soon be resolved.

In a series of meetings to be sponsored by the Joint Electron Device Engineering Council over the next few months, vendors and users will attempt to extend the agreement on 16-k RAM pinouts that was completed about a year ago [*Electronics*, June 12, 1975, p. 80] to cover at least two additional levels of standardization: latched or unlatched outputs, plus timing and control—64- or 128-cycle refresh and other related functions. The first discussion on those points took place on Aug. 10.

But, even if the attempts fail, a number of forces already set in motion in the 16-k marketplace may force the issue. Depending on how fast most vendors get to market with their 16-k RAMs, the standards may be set by supply and demand—what's available in volume. Right now, Intel Corp. and its latched 2116 part are in front. But if a number of other vendors arrive in the marketplace with unlatched 16-k parts reasonably quickly, the standards may be set by them.

Latched or unlatched. So far, the only available latched device is Intel's 2116, which appeared in sample quantities in December. But such major suppliers as Texas Instruments, which began showing samples of its unlatched 4070 in April, and Mostek Corp. with its 4116, as well as Motorola Semiconductor, Fairchild Semiconductor, and National Semiconductor, all have opted for unlatched versions. Others, including Advanced Micro

Devices Inc., Advanced Memory Systems Inc., and American Microsystems Inc., are investigating both options, and they could go either way, although the momentum at this point is building toward the unlatched approach.

David House, Intel's memory-applications manager, says his company chose the latched output for the 16-k RAM on the basis of compatibility with existing 4-k RAMs. "Our surveys show that a majority of our customers—as many as 60% or 70%—want the output latch," he says. "Besides, if a user doesn't want it, he can just use the column-address strobe to disable it."

But, says Jeffrey Kalb, National's

director of memory-components operations, "the 16-k is basically a new part, and we shouldn't be constrained by its predecessor." More important, he says, an on-board latch simply slows down the part. He points out that Mostek, for one, hasn't seen anything slower than 200 nanoseconds so far, compared to the 2116's access time of 250 to 350 ns.

House, however, counters with the observation, "Again, the majority of the market, we feel, is not in the high-speed area." Moreover, in a systems environment, he says, much of the speed differential between a latched and nonlatched part disappears.

In a nonlatched output device,

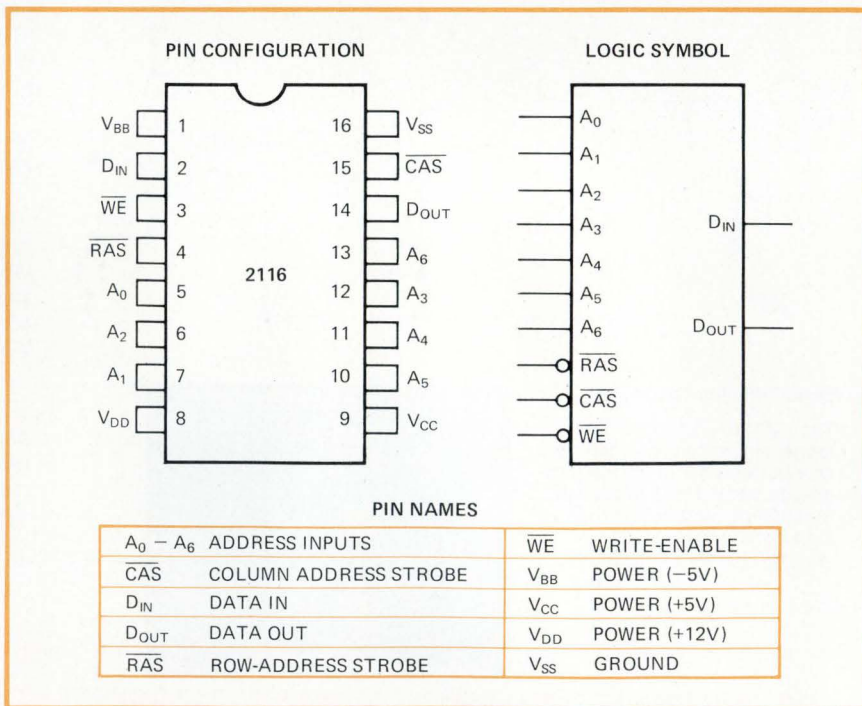

Pinned down. As 16-k chip makers and their customers meet to iron out differences in devices, the only thing parts have in common is pinout. Shown is Intel's 2116.

data output is valid only during the time both the column address and row address clocks are active and each memory cycle can be maintained as a separate entity. Latched outputs, on the other hand, hold the data output valid into the succeeding memory cycle and need an extra cycle to clear the latch, thus adding to the cycle time of the memory system.

Refresh. Besides having latched outputs, Intel's part is the only one that can be refreshed in either the 64- or 128-cycle, 2-microsecond modes. All other current designs require a 128-cycle refresh only, a limitation chosen because in the 64-cycle refresh mode the user must strobe both row and column addresses—in other words, he must change the on-cycle timing in the system to take advantage of the shorter refresh time. And that causes higher power dissipation.

House's response to this criticism is that 64-cycle refresh is an advantage to users because it provides greater utilization of memory than the 128-cycle approach. "Most customers I've talked to don't want the memory tied up for too long in refresh, where it can't be accessed," he says. The cost in power for the 64-cycle option, says House, has been overstated. "The increase is only 10% to 20% during the refresh cycle," he says, "and only 1% to 2% added average power."

Derrell Coker, applications engineer at Mostek, is one who believes the marketplace may decide the standard before any committee does, and he has his own view of what that will be. "The winner will be the source that can supply a 16-k RAM that will be able to fit into everyone else's socket and also has the most device margin," he says. "In other words, the guy with the fastest part with the lowest power, good power-supply tolerances, and input and output levels."

Intel, however, has one powerful counter-argument left—availability. Although some users aren't entirely happy with the approach the Santa Clara, Calif., company has taken, they are buying it because the 2116 is the only device being shipped in volume—perhaps as many as 2,000 parts per month. □

Now, a single integrated circuit, our TAD-32 (Tapped Analog Delay), can provide filtering with passband-to-stopband ratios of 40 DB or more per device. Simple variation of the clock sampling rates over 5 decades will accordingly shift a given filter characteristic. Transversal or recursive filters can be constructed with over 60DB dynamic range and linear phase. Tapped delays up to several hundred milliseconds are possible.

Discrete time analog signal processing using charge transfer devices is a reality at RETICON.

The TAD-32 is just one device in this growing family.

We don't just talk about them, we make them.

THIS DIP DOES IT ALL.

TAPPED DELAYS
MATCHED FILTERS
CORRELATION
CONVOLUTION

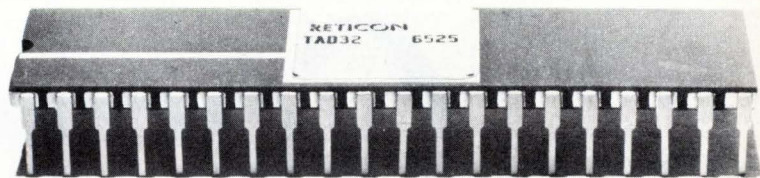

RETICON®

910 Benicia Avenue, Sunnyvale, California 94086
PHONE: (408) 738-4266 TWX: 910-339-9343

The Great



SEND FOR THE NEW CELCO YOKE GUIDE LISTING OVER 175 TYPES. SELECT THE ONE YOKE FOR YOUR SPECIAL DISPLAY APPLICATION.

American YOKE Company

CONSTANTINE ENGINEERING LABORATORIES COMPANY

1150 E. Eighth Street, Upland, CA 91786

70 Constantine Drive, Mahwah, N J 07430



78 Circle 78 on reader service card

Electronics / September 2, 1976

Minicomputers

Shortage of field technicians looms

DEC is working with two-year colleges on minicomputer technology programs as other makers also push recruiting

by Pamela Leven, Boston bureau

Minicomputer makers are beginning to worry about a growing shortage of field-service technicians as the industry expands and a traditional source of such personnel—the military—shrinks. Most of the manufacturers are intensifying talent hunts and training programs, none perhaps as much as Digital Equipment Corp., the industry's sales leader.

DEC expects its sales to top \$1 billion a year by 1980, compared with \$736.3 million in the fiscal year that ended July 3. To service that growing product base, DEC figures it will need an additional 2,000 junior technicians. In what the company hopes will eventually be an industry-wide effort, it is helping public and private two-year colleges establish programs that will result in associate degrees in minicomputer-service technology. Donald Palko, coordinator of minicomputer technology for DEC's educational services, says that graduates of the program who are hired and receive further training from DEC should fill about 30% of the jobs. The rest will come from other schools, other companies, and DEC's own training program at its Maynard, Mass., headquarters.

The college courses, built with curriculum advice and materials from DEC, as well as discounted equipment in the laboratories, will cover the "principles, fundamentals, and concepts of computers; they will not go into specifics on product lines," says Palko.

Ron Lund, assistant coordinator for the program, adds, "The idea behind the program is to bring the students into the industry at a predetermined level of competence in state-of-the-art training. Now, they

come to us with very high and very low states of preparedness."

DEC is relying on its service managers in the field to point out candidate schools in areas where potential DEC sales increase and customer-service needs are expected to be greatest. So far, three schools are offering mini-tech programs: Bucks County Community College in Pennsylvania, Daniel Hale University in Chicago, and Franklin Institute in Boston. Lund says another 10 to 15 schools have programs in the developmental stages.

As the giant in the minicomputer industry, DEC has the resources to create a successful college-level-degree program—and is using them. DEC offers participating schools much of the material the company uses in its in-house training program, DEC Tech. This support includes state-of-the-art equipment at discount prices for students' hands-on experience, documented curriculum materials, and audiovisual instruction aids.

Teaching teachers. Faculty members get as much attention from DEC as the students. Lund says that two instructors per school are offered tuition-free courses at the DEC educational-services program in Maynard. In two intensive summer sessions, instructors take four weeks of software courses and six weeks of hardware. Lund estimates that, with tuition fees at \$500 per course, each school receives \$10,000 worth of training. "If we were to market the entire mini-tech program, we'd set the price for each school at between \$500,000 and \$750,000," says Lund.

DEC expects to benefit financially



in the long run from its program. The company figures that each graduate is ready to enter the final product-specific phase at DEC Tech, or approximately the last three weeks of the 13-week course. Lund estimates that the elimination of about 10 weeks of training saves DEC \$7,500 to \$10,000 in student technicians' salaries, travel, and housing. If the mini-tech program produces the expected 600 junior technicians by 1980, DEC will have saved \$4.5 million to \$6 million a year.

By 1980, DEC plans for about 60 schools to have established mini-tech programs, with about 48 producing graduates for final product training.

What other companies are now doing depends on how they view future demand. At Data General Corp., Joanna Flint, field-personnel representative, considers the technician shortage a problem of quality rather than quantity. "There's going to be a lot of competition for the same top people," she comments. But she agrees with DEC's approach, saying, "It is inevitable that companies are going to have to tell

When Clear Displays Count

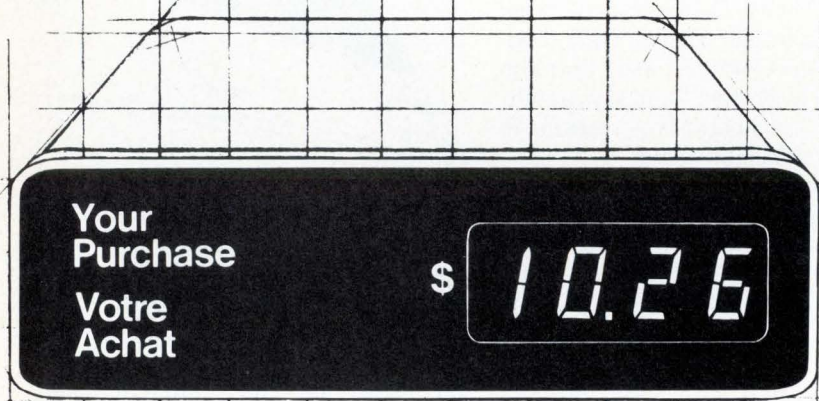
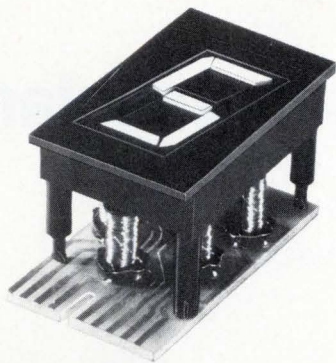

You can count on Ferranti-Packard's electromagnetic 7-Bar display module to give you the electronic compatibility you need plus the reliability and visibility your customers demand.

Only 7 moving parts to each display module — no complex mechanical linkages to wear out, or incandescent lamps and neon tubes to burn out.

Performance-proven for over 5 years, the simple design and construction, backed by Ferranti-Packard research and engineering, gives you the combination of reliability, visibility and flexibility that no other read-out component can match.

When you design an electronic read-out system, Ferranti-Packard display modules will help you do it better. It's clearly the display module you should consider. See the difference for yourself, write or call us and we'll prove it.

When clear displays count — Specify Ferranti-Packard.



Ferranti-Packard Limited

Electronics Division,
121 Industry Street,
Toronto, Ontario, M6M 4M3, Canada
Telephone: (416) 762-3661
Telex: 06-22007

Probing the news

schools what they want the schools to produce, so it's logical that they have input into the curriculum of the schools."

The minicomputer maker, in Southboro, Mass., has intensified its search for qualified candidates by recruiting at two-year colleges and technical institutes in a manner similar to its college-level head-hunting for engineers. Data General then sends such technical-school graduates through an additional year to 18 months of intensive training at its regional facilities to teach them electronics and minicomputer theory and give them hands-on experience with products.

Joseph Rechner, customer service vice president at Interdata Inc. in Oceanport, N.J., agrees with Flint.

"There aren't as many ideal candidates today to fill customer engineering positions as there were five years ago," he says. "Businesses like ours must take less trained and less qualified candidates and supplement their knowledge with additional training."

For several years, Interdata, a subsidiary of Perkin-Elmer Corp., has been cultivating relationships with technical schools around the country. The firm offers "generous discounts" on equipment and provides teaching aids and curriculum consulting to the selected schools.

Coastal calm. West Coast minicomputer firms say they're not worried about an impending technician shortage, although firms around Los Angeles agree that DEC is probably correct in its assessment of a shortage somewhere down the line. They note, however, that DEC has the resources to provide technical assistance to schools that smaller computer makers can not hope to match.

At Hewlett-Packard Co.'s Computer Services division, Will Houde says he expects no problems attracting technicians and does not plan to participate in any outside training programs. "We'll leave the business of education up to the colleges," he says. "We tell them what they need to do and what kind of people are marketable." □

Whatever the application



We help keep your world turned on.

Capacitors for the Automotive, Computer, Home Entertainment and Industrial Electronic Industries.

REPRESENTATIVES

ALABAMA
Interrep Assoc., Inc.
(205) 881-3677

ARIZONA
Chaparral-Dorton
(602) 263-0414

CALIFORNIA (Northern)
Caltrom/Pyle, Inc.
(415) 964-3244

CALIFORNIA (Southern)
J. J. Riley Associates
(213) 374-3468

COLORADO
Electrodyne
(303) 757-7679

CONNECTICUT
Impact Sales Co., Inc.
(203) 281-1331

FLORIDA (Southern)
Reptronics, Inc.
(305) 251-5478

FLORIDA (Northern)
Reptronics, Inc.
(813) 522-8220

GEORGIA
Interrep Assoc., Inc.
(404) 394-7756

ILLINOIS
Midwest Electronic Inds.
(312) 777-9700

INDIANA
Midwest Electronics Inds.
(317) 253-0590

MARYLAND
Component Sales, Inc.
(301) 484-3647

MASSACHUSETTS
Impact Sales Co., Inc.
(617) 893-2850

MICHIGAN
Greiner Assoc., Inc.
(313) 499-0188

MINNESOTA
Robert W. Marshall Co.
(612) 929-0457

NEW JERSEY (Northern)
Dolan Associates
(201) 382-2797

NEW JERSEY (Southern)
BGR Associates
(215) 643-4111

NEW YORK (Metro)
Nichicon (America) Corp.
(516) 567-2994

NEW YORK (State)
Leonard D. Allen, Inc.
(315) 458-7470

NORTH CAROLINA
Component Sales
(919) 782-8433

OHIO (Cleveland)
KW Electronic Sales, Inc.
(216) 831-8292

OHIO (Dayton)
KW Electronic Sales, Inc.
(513) 890-2150

PENNSYLVANIA (Eastern)
BGR Associates
(215) 643-4111

PENNSYLVANIA (Western)
KW Electronic Sales, Inc.
(412) 487-4300

TEXAS
William Reese Assoc.
(214) 638-6575

WASHINGTON
Ray Over Sales
(206) 454-4551

DISTRIBUTORS WEST COAST

LOS ANGELES
JACO Electronics
(213) 887-6400

SEATTLE, WASH.
Bell Industries
(206) 747-1515

MIDWEST

BEACHWOOD, OHIO
Sheridan Sales Co.
(216) 831-0130

CHICAGO, ILL.
Hall Mark Electronics
(312) 437-8800

CHICAGO, ILL.
Midwest Electronic Inds.
(312) 777-9700

DALLAS, TEX.
Hall Mark Electronics
(214) 231-6111

DAYTON, OHIO
Sheridan Sales Co.
(513) 277-8911

FARMINGTON, MICH.
Sheridan Sales Co.
(313) 477-3800

FLORISSANT, MO.
Sheridan Sales Co.
(314) 837-5200

INDIANAPOLIS, IND.
Sheridan Sales Co.
(317) 547-7777

MINNEAPOLIS, MINN.
Hall Mark Electronics
(612) 925-2944

OVERLAND PARK, KA.
Sheridan Sales Co.
(913) 383-1636

READING, OHIO
Sheridan Sales Co.
(513) 761-5432

EAST COAST

HUNTSVILLE, ALA.
Hall Mark Electronics
(205) 539-0691

ORLANDO, FLA.
Hall Mark Electronics
(305) 855-4020

PHILADELPHIA, PA.
Hall Mark Electronics
(215) 355-7300

PITTSBURGH, PA.
Sheridan Sales Co.
(412) 244-1640

CANADA

MONTREAL, QUEBEC
Audio Electronics, Inc.
(514) 735-6197

TORONTO, ONTARIO
Audio Electronics, Inc.
(416) 495-0720



Nichicon (America) Corporation: 6435 N. Proesel, Chicago, Ill. 60645 (312) 679-6530
New York Branch: 40 Orville Dr., Bohemia, N.Y. 11716 (516) 567-2994
Division NICHICON CAPACITOR LTD., Kyoto, Japan

Allen-Bradley Trimmers:

**We have what
you need.**

**Our distributors have
them when your
need is now.**



CERMET TRIMMERS

Type A: 1/4" diameter, single turn, 10 ohms to 2 megs $\pm 10\%$, 0.5W at 85°C, immersion sealed, 3 terminal options, Publication 5238. **1000 piece price \$1.12 to 1.68.**

Type S: 3/8" dia., single turn, 50 ohms to 1 meg $\pm 10\%$, 0.5W at 85°C, immersion sealed, top or side adjust, Publication 5208. **1000 piece price \$1.15 or 1.40.**

Type E: 3/8" square, single turn, 10 ohms to 2 megs $\pm 10\%$, 0.5W at 70°C, immersion sealed, 13 terminal options, Publication 5219. **1000 piece price \$0.49.**

Type D: 3/8" diameter, single turn, 10 ohms to 2 megs $\pm 20\%$, 0.5W at 70°C, dust cover, 6 terminal options, Publication 5240. **1000 piece price \$0.42.**

Type 90: Approx. 7/16" square, single turn, 100 ohms to 2 megs $\pm 20\%$, 0.5W at 70°C, open frame, 2 terminal options, Publication 5242. **1000 piece price \$0.55.**

Type MT: 3/8" square, 20 turn, 10 ohms to 2 megs $\pm 10\%$, 0.5W at 70°C, immersion sealed, 3 terminal options, Publication 5241. **1000 piece price \$1.18.**

Type RT: 3/4" long, 20 turn, 10 ohms to 2 megs $\pm 10\%$, 0.75W at 70°C, immersion sealed, 3 terminal options, Publication 5237. **1000 piece price \$0.65 or 0.93.**

CARBON COMPOSITION TRIMMERS

Type Y: 1/2" dia., single turn, 100 ohms to 5 megs $\pm 10\%$ or 20%, 0.25W at 50°C, dust/splash resistant, 5 styles, non-linear tapers, Pub. 5209. **1000 piece price \$0.90 to 1.59.**

Type F: 1/2" dia., single turn, 100 ohms to 5 megs $\pm 10\%$ or 20%, 0.25W at 70°C, immersion sealed, 6 styles, non-linear tapers, Pub. 5234. **1000 piece price \$1.00 to 1.62.**

Type O: 1/2" dia., single turn, 100 ohms to 5 megs $\pm 10\%$ or 20%, 0.40W at 70°C, immersion sealed, 4 styles, non-linear tapers, Pub. 5235. **1000 piece price \$1.20 to 1.58.**

Type FD: 1/2" dia., 2 sec., 1 turn, 100 ohms to 5 megs $\pm 10\%$ or 20%, 0.25W at 70°C, immersion sealed, 4 styles, 5 tapers, 2 atten. Pub. 5231. **1000 piece price \$2.65 to 4.10.**

Type BT: 1/2" dia., 2 section, 1 turn, for 75 ohm Bridged-T pad applications, dust/splash resistant, side and top adjust versions. Pub. 5236. **1000 piece price \$2.49.**

Type N: 1 1/4" long, 25 turn, 100 ohms to 2.5 megs $\pm 10\%$ or 20%, 0.33W at 50°C, immersion sealed, Publication 5206. **1000 piece price \$2.50 or 2.65.**

Type R: 1 1/4" long, 25 turn, 100 ohms to 2.5 megs $\pm 10\%$ or 20%, 0.25W at 70°C, immersion sealed, bushing mount option, Pub. 5205. **1000 piece price \$2.87 to 3.73.**

Quality in the best tradition.



ALLEN-BRADLEY
Milwaukee, Wisconsin 53204

EC120

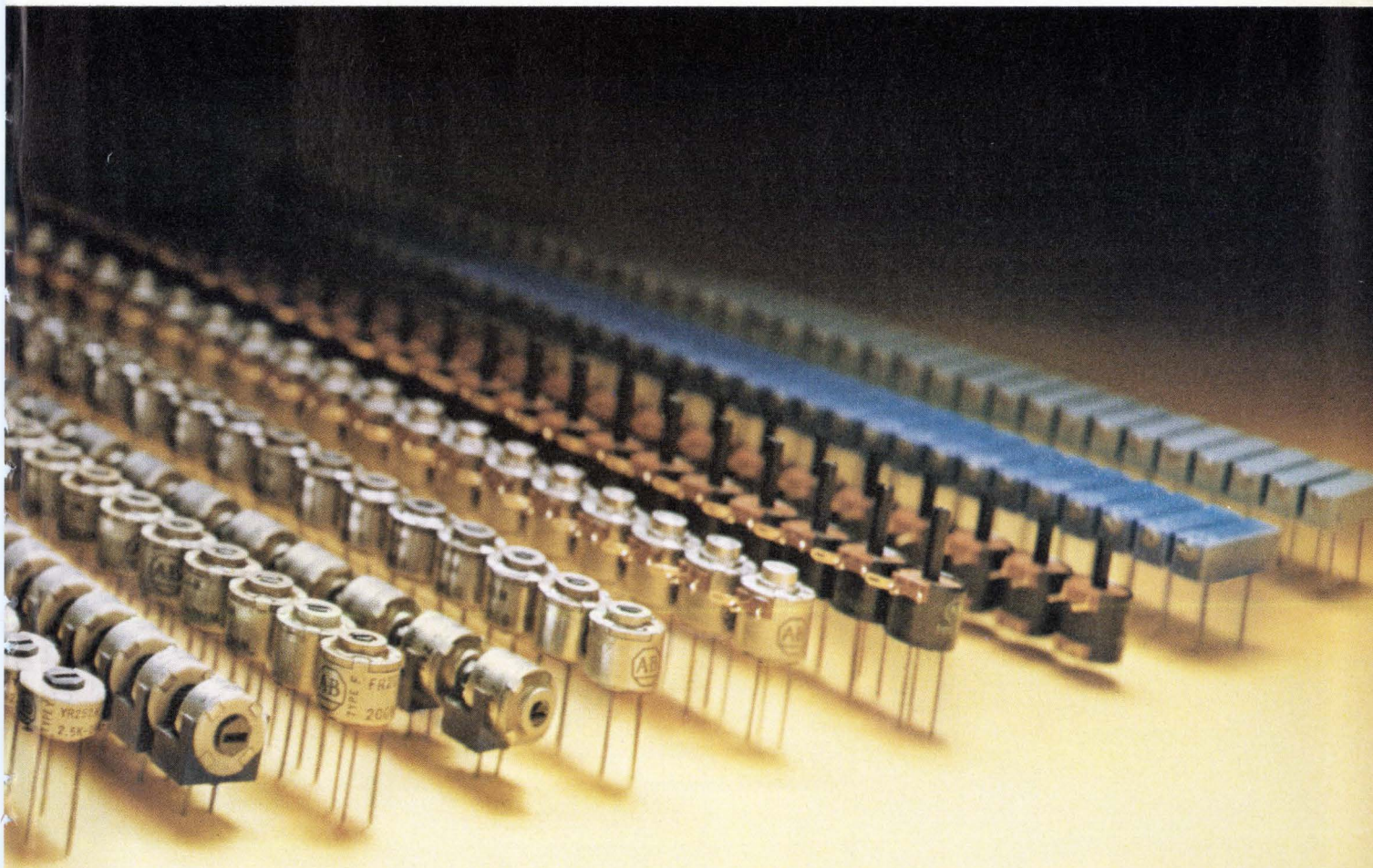

Good reasons to go CMOS/LSI with your microprocessor design.

Use the CMOS microprocessor with a second source on-stream.

Here's a way to simplify design problems while gaining the system advantages of silicon gate Complementary MOS (CMOS) circuitry ... all by using Intersil's IM6100 12-bit CMOS microprocessor and its all-CMOS family of associated devices, now also available from Harris Semiconductor.

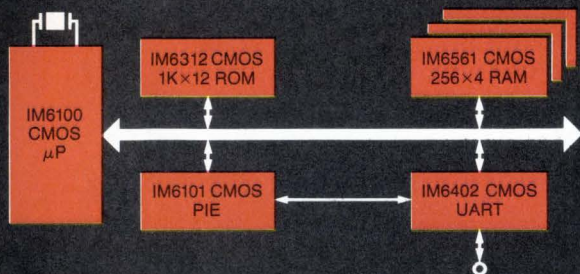

Simple power supplies.

By their very nature, CMOS circuits operate from uncomplicated, inexpensive supplies; all devices in the 6100 CMOS family use only one unregulated +4 to +11 volt supply. At 4MHz and 5V, the IM6100 dissipates only 10mW, with similar power levels for all the other members of the CMOS family. Because there's little heat, cooling problems disappear.

Superb noise immunity.

CMOS is famous for its noise immunity, allowing trouble-free operation in troublesome environments.

Military temperature range.

The IM6100 and all other members of its compatible CMOS family offer you a choice of industrial (-40 to +85°C) or full military (-55 to +125°C) temperature ranges.

Inexpensive crystal clock.

Timing for the IM6100 system operation is supplied by an on-chip clock, driven by an external crystal. No clock generators or level translators needed.

Standard interfacing.

The entire IM6100 CMOS family operates well with other technologies such as NMOS, PMOS and TTL. These Intersil devices interface directly with industry-standard RAMs, P/Roms and LSI peripheral interfaces such as UARTs, FIFOs, keyboard encoders, analog converters, modems, etc.

Uses standard, available software.

The IM6100 executes the instruction set of the most popular minicomputer, DEC's PDP-8/E®.

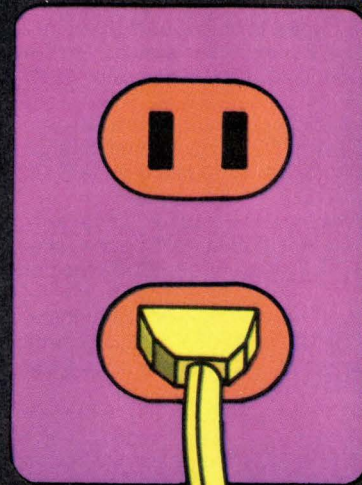

Getting started's easy as ABC.

Intersil has simplified your getting into microprocessor design with three easy alternatives.

A. IM6100 CMOS Family Sampler. A fully documented, complete pre-packaged kit of components for an all-CMOS IM6100 Microprocessor system. Seven-part kit includes IM6100, IM6101 PIE, IM6312 1024 x 12 ROM, IM6402 UART and three IM6561 256 x 4 RAMs. Ideal for low-cost prototyping and evaluation. Single-piece prices total \$125.30. Special offer price (valid only until Oct. 31, 1976) is \$55.00.

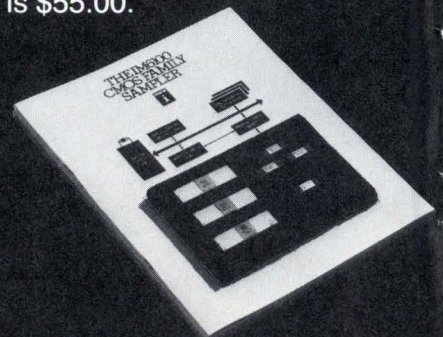

INTERSIL
CMOS/LSI

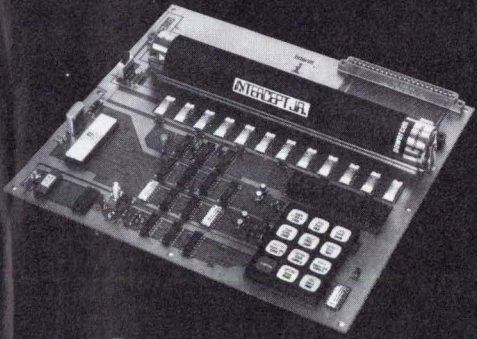
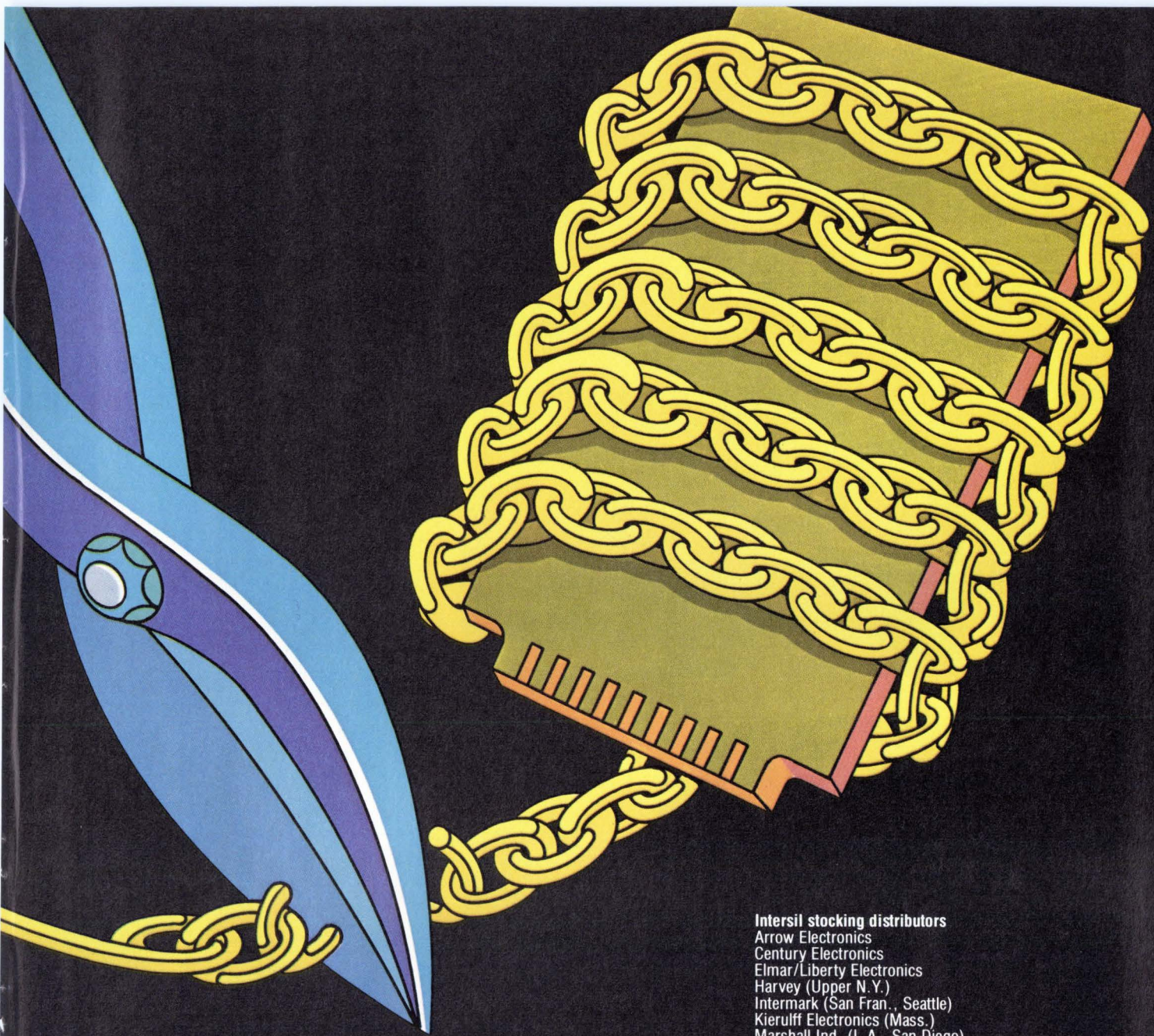

B. Intercept Jr. Tutorial System. A complete one-card battery-powered operating system, including multi-function keyboard, 8-digit LED display, 256 x 12 RAM, resident microinterpreter, provisions for modular expansion and detailed instruction manual for \$281.00.

C. Intercept Prototyping System. Provides an easy economical means of prototyping user systems and evaluating the IM6100 family of devices in typical configurations. Price \$2,850.00.

All from Intersil. 10900 North Tantau Ave., Cupertino, CA 95014.



Intersil stocking distributors
 Arrow Electronics
 Century Electronics
 Elmar/Liberty Electronics
 Harvey (Upper N.Y.)
 Intermark (San Fran., Seattle)
 Kierulff Electronics (Mass.)
 Marshall Ind. (L.A., San Diego)
 R.A.E. Ind. Elect. Ltd. (Van. B.C.)
 Schweber Electronics
 Sheridan Assoc.
 Diplomat (Fla.)
 Weatherford
 Zentronics (Canada)

Intersil area sales offices
 Boston (617)273-2055
 Chicago (312)986-5303
 Dallas (214)387-0539
 Los Angeles (213)532-3544
 Ft. Lauderdale (305)772-4122
 Minneapolis (612)925-1844
 New York (201)567-5585
 San Francisco Bay Area (408)984-2170
 Upstate New York/Canada
 (607)754-7406

Representatives in all major cities.



HIGH RELIABILITY



Get the **high reliability** that eliminates trouble. RNDIP sockets make contact with the wide, flat sides of your IC leads. This provides **100% greater surface contact** for positive electrical connection.

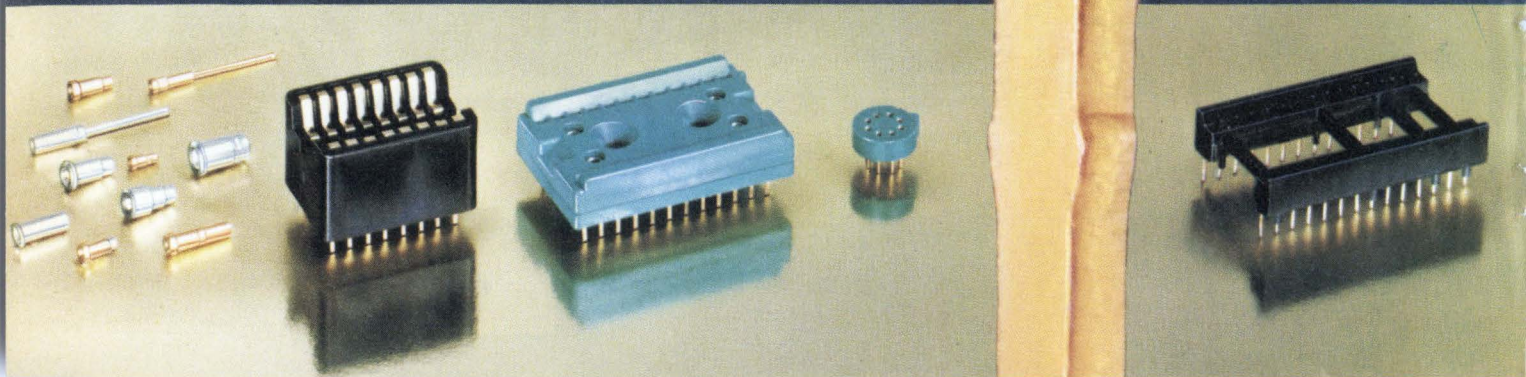

DIP SOCKETS **for the price you're paying for junk!**

Robinson Nugent "side-wipe" DIP sockets make 100% greater contact than any edge-bearing socket on the market.

This 100% greater contact with the wide, flat surface of your IC leads is your guarantee of unmatched reliability. This RN "side-wipe" contact provides constant low contact resistance. No edge-bearing contact can possibly deliver this long term dependability. This designed-in reliability of RN DIP sockets is your assurance of trouble-free IC interconnects—yet they cost no more than ordinary sockets.

Put an end to troublesome junk sockets! Write today for catalog and informative book "What to Look for in IC Interconnects." It's free from RN—the people who make more kinds of high reliability IC sockets than anyone.

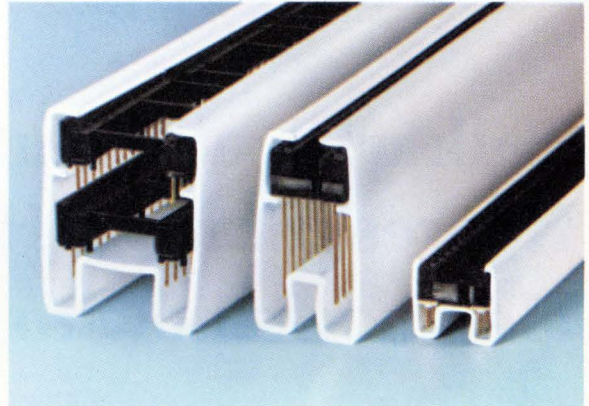

They're even packaged for high reliability.

"Protecto-pak"® packaging delivers consistently perfect RN sockets to your production line—for automated or manual assembly.

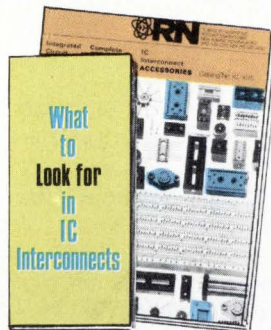

RN ROBINSON NUGENT, INC.

800 East Eighth Street • New Albany, Indiana 47150 • Phone: (812) 945-0211

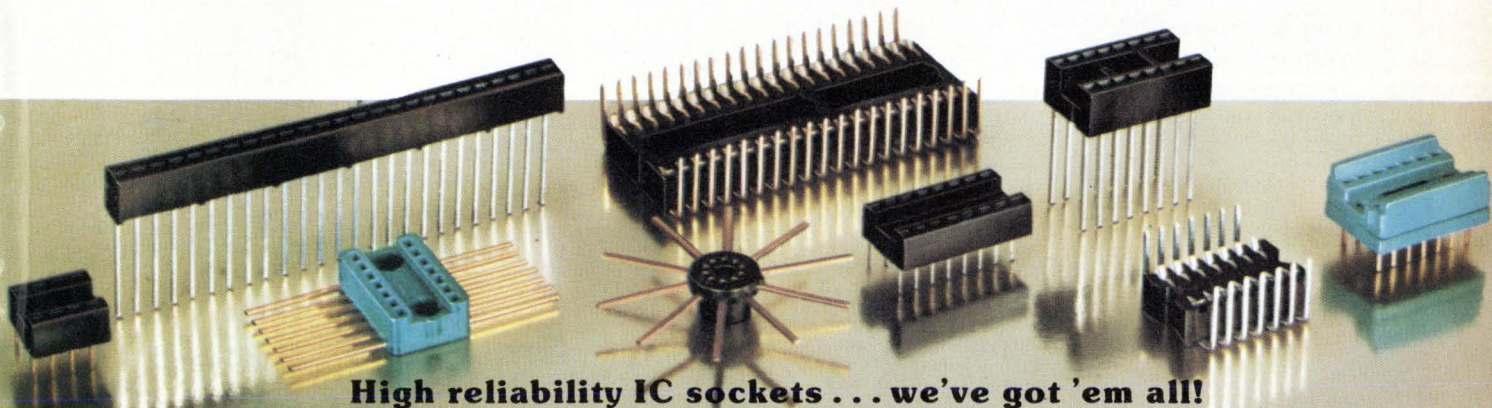

High reliability IC sockets . . . we've got 'em all!

Circle 86 on reader service card

You don't go to an amateur for product design, or corporate financing, then why use amateurs to try to sell your products.

Talk with a Manufacturer's Representative. He is a professional—He knows how to get results.

A manufacturer's representative has a broad base of product and market knowledge because of multiple-line selling. Each call for each product helps uncover new applications, new market opportunities.

His objective—his **only** objective—is to develop his **chosen** territory into the best marketplace possible.

The manufacturer's representative is more than a commissioned salesman. He's a territory manager . . . A personnel manager . . . A customer service manager . . . A sales manager . . . A product manager . . . A merchandising manager. **And an independent business man!**

For more information on how a manufacturer's representative can help you market **your** products, write or call the Electronic Representatives Association. We can help you set up the finest representatives in the world!

**See You
at
WESCON,
Booths
1173 to 1177**

Electronic Representatives Association
233 E. Erie Street, Suite 1002
Chicago, Illinois 60611
(312) 649-1333



—Manufacturers' Representatives make good business sense, at a time when we really need it most—

Yes, send me information on how I can use representatives.

Name _____

Company _____

Address _____

City _____

State _____

Clip out and send to
Electronic Representatives Association
233 E. Erie Street, Suite 1002
Chicago, Illinois 60611

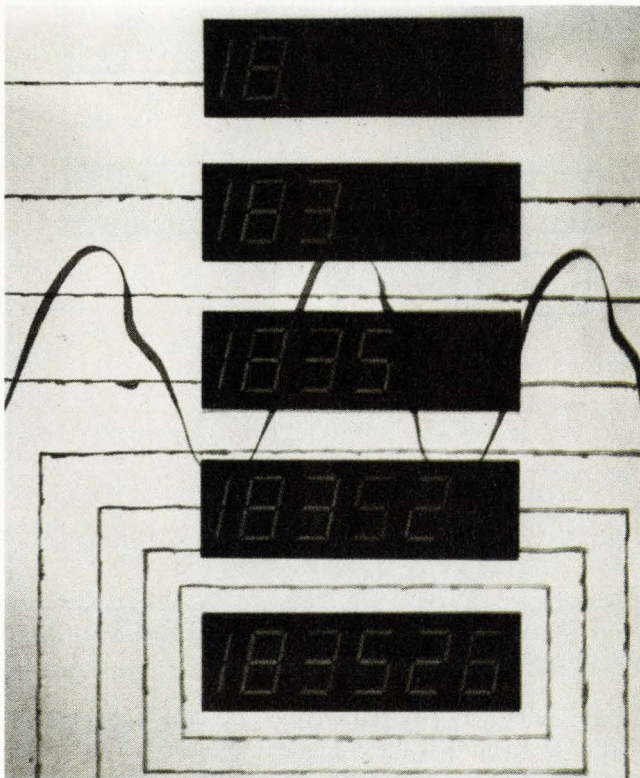

Error correction speeds up a-d conversion tenfold

Subtracting and adding correction values to successive results overcomes limitations in conversion rate

by Riekus Koeman and Joe Reedholm,
John Fluke Manufacturing Co. Inc., Mountlake Terrace, Wash.

□ A novel technique for analog-to-digital conversion increases conversion speed in digital multimeters and voltmeters by an order of magnitude over conventional methods. Taking advantage of the capability to subtract error-correction values from digitized results, as well as adding corrections as do conventional a-d converters, the innovation enables errors made during each step of the conversion process to be corrected during succeeding conversion steps.

Use of this bidirectional error-correcting technique increases the speed at each stage of the conversion because the measurement at any stage does not have to be very precise. An imprecise reading is being corrected during the succeeding step of the conversion, while higher-resolution readings are being processed.

The speed with which an analog signal can be converted to digital form is the most important factor that limits the operating speed of measurement instruments such as DVMS and DMMS. Especially in instruments designed for use in systems, as opposed to bench instruments, a prime requirement is to combine a short measurement period with high resolution.

Indeed, the first commercial application of the bidirectional error-correcting technique is a 5½-digit multimeter, model 8500A [*Electronics*, Aug. 19, p. 117]. In this instrument, a microprocessor controls the timing, parallel a-d conversion, and accumulation of error-correction results. The microprocessor directs the sequence of steps taken by the converter, such as setting the polarity of its voltage reference.

Although the success of the technique does not depend on the microprocessor, inclusion of the device within the instrument makes possible a great deal of flexibility in configuring the instrument, as well as the addition of functions such as calculating ratio values, correcting for offset and calibration errors, and averaging readings. By averaging readings, for example, the microprocessor improves the instrument's performance, since it can combine the vastly reduced response to line-related noise of dual-slope integrating conversion with the high speed and resolution of cyclic conversion.

Converting cyclically

Cyclic a-d converters provide a direct conversion of a dc voltage to a digital value by successively:

1. approximating and digitally storing the approximation of an unknown voltage,
2. setting a d-a converter's output to this value,
3. amplifying the difference between the d-a output and the unknown dc voltage,
4. storing the amplified difference (remainder) on a capacitor,
5. disconnecting the unknown voltage and the capacitor from the converter,
6. reconnecting the capacitor to the converter so as to treat its voltage as an unknown voltage, and
7. repeating all the previous steps (using another capacitor as a storage element) until enough d-a conversions have been made to achieve the desired resolution.

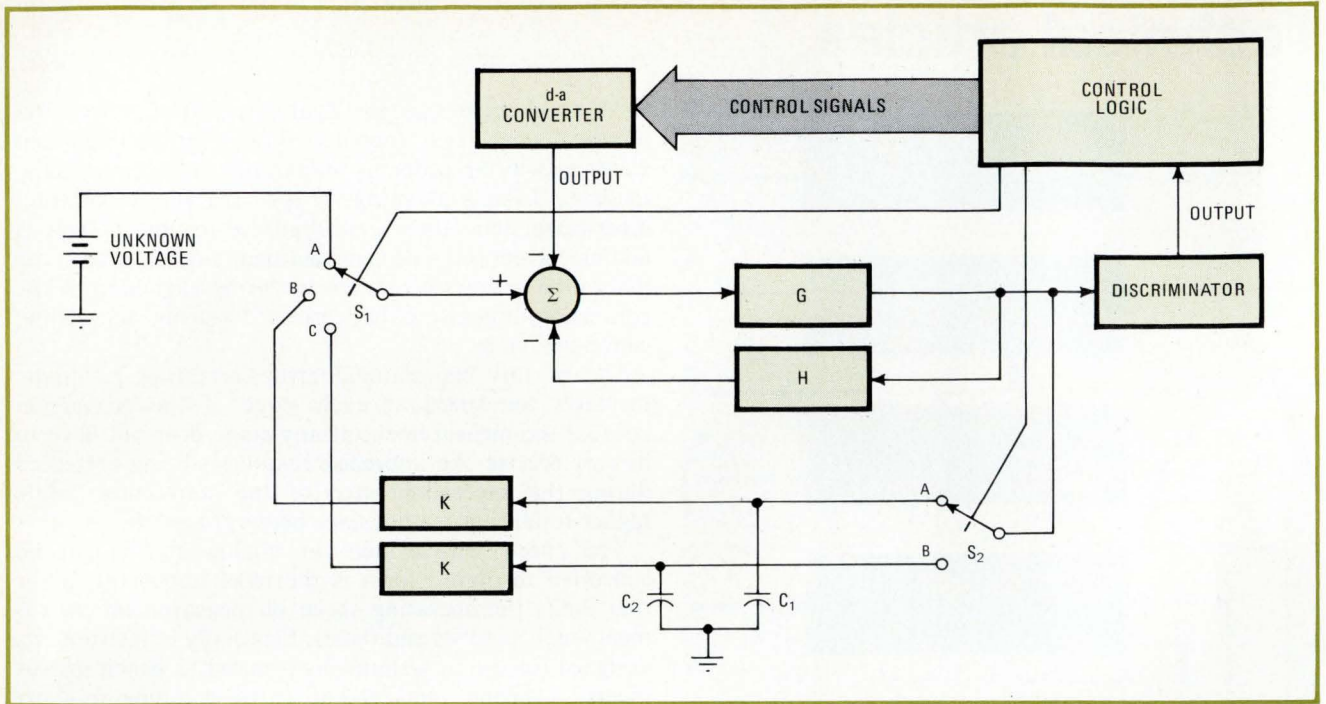

1. Cyclic conversion. In converting an analog signal to digital form, as much resolution as desired can be obtained by repeatedly cycling ever-smaller error voltages, stored on capacitors C_1 and C_2 and scaled by K , through the a-d conversion process.

A cyclic converter can perform steps 1 through 4 virtually simultaneously (Fig. 1). Blocks G and H form a classic control loop that amplifies the difference between the unknown voltage and the output from the d-a converter.

The control logic, in conjunction with the discriminator, controls the output of the d-a converter so that the voltage to be stored on capacitors C_1 and C_2 and scaled by K is within the subtracting range of the d-a circuit. Steps 5 and 6 would be accomplished by rotating both S_1 and S_2 from position A to position B and repeating steps 1 through 4. The voltage stored on C_1 and scaled by K would be treated in the same fashion as the unknown voltage was treated. Capacitor C_2 would then store the amplified difference, or remainder.

Repeating steps 5 and 6 to generate more resolution would require switching S_1 from B to C, switching S_2 from B to A, and repeating steps 1 through 4. As much resolution as desired can be generated with the cyclic process by continually repeating steps 5, 6, and 1 through 4. While there are no limits as to achievable resolution, practical limitations are set by errors caused by such factors as thermal noise, imperfect d-a converter linearity, dielectric absorption, and leakage. The practical limits of resolution are quite high: the 8500A has achieved repeatable measurements with a resolution of 1 part in 4×10^6 .

Without concern for the means of implementing the various functions that would be required, consider the example of a four-decade cyclic a-d converter that has a full-scale dynamic range of +16 v. Assume that an input of +11.045 v must be measured.

Within the converter, assume that G approaches infinity and $H = 1/10$, so that a signal at S_2 is equal to exactly 10 times the difference between the unknown

voltage and the d-a output voltage. It is further assumed that $K = 1$ and that the d-a can output, in 1-v intervals, all voltages in the band between 0 v and +15 v.

To further simplify the example, it is assumed that the amplifier G has an infinite output-voltage range and that the discriminator is itself an a-d device whose least significant bit is equivalent to +10 v and whose most significant bit is equivalent to +80 v.

During the first cycle, the initial conditions include a d-a converter output of 0 v, S_1 and S_2 are set to A, and therefore $V_1 = 11.045$ v. This would produce a V_o of 110.45 v, and the a-d would digitize this value and present it to the control logic as 110 v. The control logic would then act on that 110 v by dividing it by 10, setting the d-a output to be equal to the resultant 11 v, and storing the 11 v number in memory. As a result of the d-a converter's output going to 11 v, V_o would then be equal to $10(11.045 \text{ v} - 11.000 \text{ v}) = 0.45 \text{ v}$. Capacitor C_1 would be charged to 0.45 v.

Continuing the process

During the second cycle, the initial conditions include a d-a converter output of 0 v, S_1 and S_2 are set to B, and therefore, $V_1 = 0.45$ v. Under these conditions, $V_o = 4.5$ v, which would be digitized as 0 v. The d-a converter's output would be set to 0 v, and a value of 0.0 v would be stored. V_o would be uncharged, and capacitor C_2 would be charged to 4.5 v.

During the third cycle, the initial conditions include a d-a output of 0 v, S_1 is set to C, and S_2 is set to A; therefore, $V_1 = 4.5$ v. Then, $V_o = 45$ v, which would be digitized as 40 v. The d-a converter would be set to 4 v, and a value of 0.04 v would be stored. V_o would equal $10(4.5 \text{ v} - 4 \text{ v}) = 5 \text{ v}$, and C_1 would be charged from 0.45 v to 5 v.

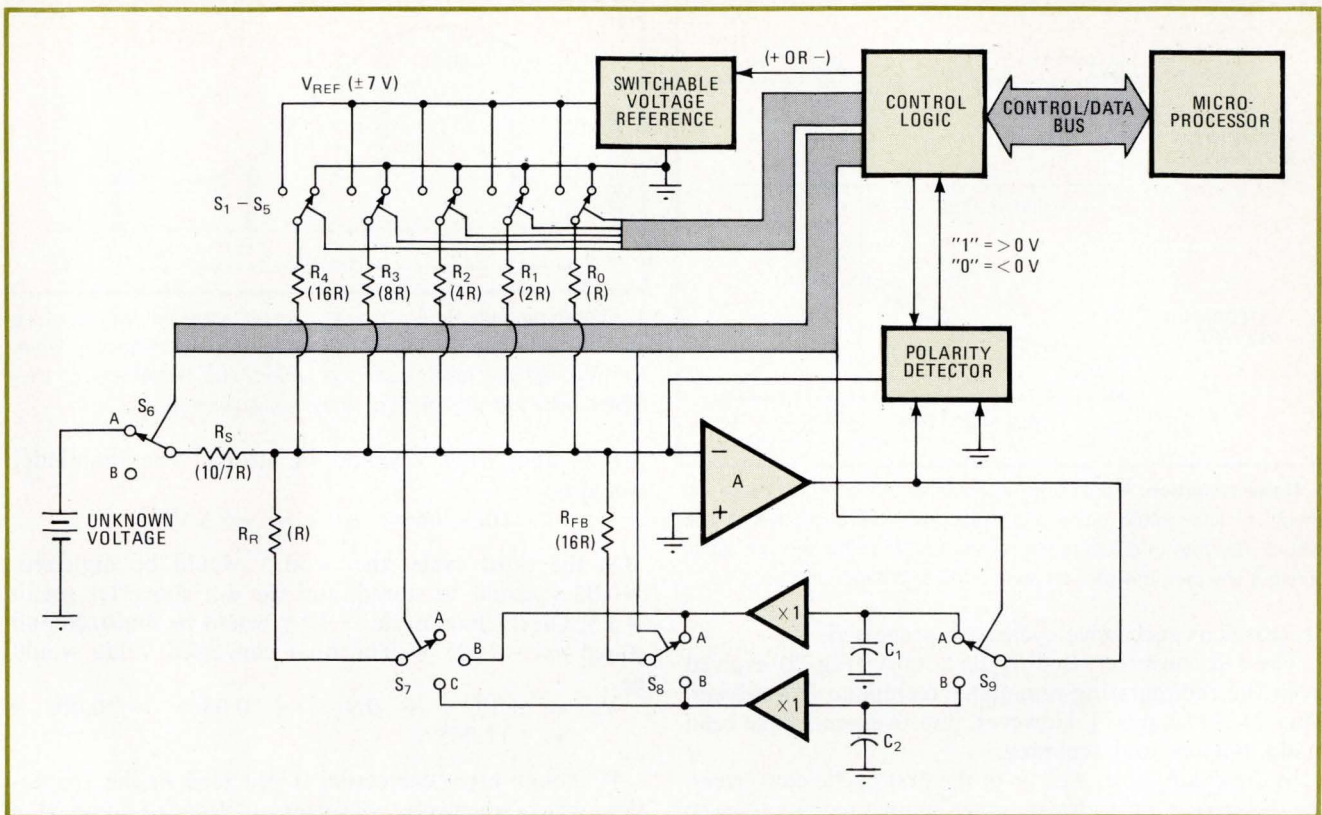

2. Faster loop. A digital-to-analog converter that is made up of a 5-bit voltage ladder and a switchable voltage reference allows error corrections to be subtracted from, as well as added to, the results of each cycle.

During the last cycle, the initial conditions include a d-a converter output of 0 v, S_1 and S_2 are set to B, and, therefore, $V_1 = 5$ v. The value of V_o is then 50 v, which would be digitized as 50 v, and a value of 0.005 v would then be complete, and the converter would be ready to begin another conversion. The final converted value would be the sum of the values stored during each cycle, or

$$V_{in} = 11 \text{ v} + 0.0 \text{ v} + 0.04 \text{ v} + 0.005 \text{ v} = 11.045 \text{ v}$$

Limiting speed

A novel approach to increasing the speed of cyclic converters relies on digital logic to perform arithmetic operations. A microprocessor provides this capability at very low cost.

What are some of the speed limitations of cyclic converters? To get at that answer, it helps to break up the time required for each cycle into two main components—decision time and settling time.

Decision time is the time required for a converter to decode and act on the value at which the d-a converter's output must be set, reducing the amplified difference between this output and the input voltage to a level within the dynamic range of the d-a converter. Settling time is the time required for the converter to store, within the error limits as implied by the converter's resolution, the amplified difference between the d-a converter's output and the input voltage.

At the end of each decision time, a d-a converter output is subtracted from the unknown voltage, and the

remainder is less than the converter's full-scale output. Such a process is in itself an a-d conversion whose resolution is equal to the maximum difference that the process allows.

That sequence illustrates how a cyclic converter sequentially processes, first, the input voltage, and then, the remainder voltage from each previous cycle, through the same a-d converter process.

Making decisions

The cycle-decision time is the time required for the single-cycle a-d conversion process. For the simplistic example illustrating how a cyclic converter works, the discriminator functions as the entire single-cycle a-d process. (It is practical to use a separate limited-resolution a-d converter for the approximation process, but it is easier to have the cyclic converter itself operate directly on the input voltage.) In order to achieve the minimum decision time, the a-d converter would be implemented as a parallel converter whose output could directly drive the d-a conversion circuit. If minimum decision times were not necessary, a slower successive-approximation a-d converter might be used.

Precision cyclic converters are not limited in speed by the decision times, but are, instead, limited by settling times. For the 22-bit converter used in the 8500A, such limitations as those caused by printed-circuit-board materials, frequency compensation, and storage capacitors prevent first-cycle settling times of less than 150 microseconds. Subsequent cycles have shorter settling times because the required accuracy of the remainder

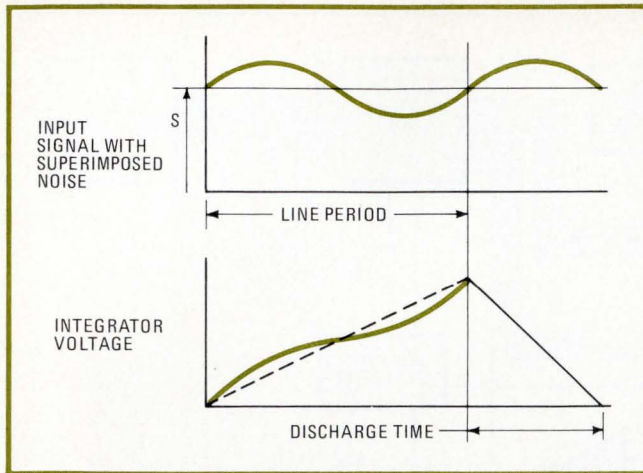

3. Noise rejection. A dual-slope integrating converter minimizes the effects of line-related noise and ripple by integrating over a line period. The rate of discharge is constant so that the average signal during a line period is proportional to the discharge time.

decreases as successive cycles are processed.

The a-d converter used in the 8500A (Fig. 2) evolved from the recirculating-remainder technique [*Electronics*, May 25, 1970, p. 97]. However, improvements have been made in speed and accuracy.

In the example, as well as in the first cyclic converters, the d-a device must always be set below the voltage to be digitized during each cycle so that logic circuitry can accumulate the final value by summing the results of each cycle. This is easy to accomplish unless the unknown voltage is only slightly lower than the value that would require a step in the d-a converter's output voltage. Elaborate precautions ensure that interference from such sources as noise, overshoot, and transients won't be great enough to falsely step the d-a converter.

Speeding the conversion

However, there is no need to go to great lengths to inhibit such influences from setting the d-a converter too high in value. Conceptually, the cyclic device can produce an accurate remainder, regardless of whether or not the d-a converter's output is greater than the input voltage. Proper operation would be maintained if it were possible to digitize the positive or negative remainder that resulted from too small or too large a d-a converter output (compared to the input voltage). A bipolar d-a converter would allow precision analog subtraction and addition, and it would be necessary only that the accumulating logic be capable of subtracting, as well as adding, the digitized remainders to the accumulator.

The capability to subtract from, as well as add, remainders to the accumulator is referred to as bidirectional error correction. The concept of bidirectional error correction can be illustrated by the example given earlier with the further assumption that the control logic sets the d-a converter's output to +12 during the first cycle. The remainder would then be

$$10(11.045 \text{ v} - 12 \text{ v}) = -9.55 \text{ v}.$$

On the second cycle, the a-d converter would digitize -95.5 v to be -90 v , the d-a converter would be set to

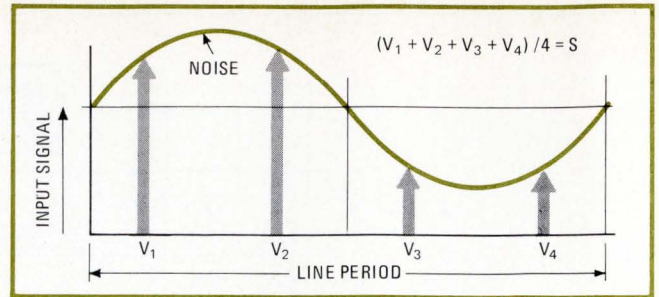

4. Averaging out. Similar results can be obtained with a cyclic converter if the process is synchronized with the line frequency. Here, four readings are taken each line period, and the effects of line-related noise are averaged out of the measurement.

-9 v , and -0.9 v would be stored. The remainder would be

$$10(-9.55 \text{ v} - 9 \text{ v}) = -5.5 \text{ v}.$$

On the third cycle, the -50 v would be digitized, -0.05 v would be stored, and the d-a converter set to -5 v . On the final cycle, -50 v would be digitized and stored as -0.005 v . The final converted value would be

$$V_{in} = +12 \text{ v} - 0.9 \text{ v} - 0.05 \text{ v} - 0.005 \text{ v} = +11.045 \text{ v}.$$

If enough error correction is provided in the conversion process, the cyclic converter functions as a precision sample-and-hold with a very small aperture time. Thus, a cyclic a-d converter can be used as a sampling converter and can provide information on higher-frequency signal components than implied by its maximum conversion rate.

Successive approximation

Settling times are the predominant factors in fast recirculating-remainder a-d conversion times. A successive-approximation approach, which does not drastically affect the conversion rate, is therefore used during the decision times. The successive-approximation a-d device makes use of the precision elements in the cyclic converter and employs a polarity detector as a discriminator.

As shown in Fig. 2, the precision d-a converter is made up of a switchable voltage reference and a 5-bit voltage ladder consisting of switches S_1 through S_5 and resistors R_0 through R_4 . Reference voltages of $\pm 7 \text{ v}$ ensure that the reference voltages depend only on the reference amplifier and not the ancillary circuitry in the reference supply. A voltage ladder is used instead of a current ladder so that the loop gain around amplifier A will stay constant, regardless of the setting of the digital-to-analog converter.

The polarity-detector output is used by the control logic to determine whether or not the d-a converter has been set to a value that causes the remainder to change polarity. The standard successive-approximation sequence is followed by the control logic; the logic increases the d-a converter's output each time the polarity doesn't change, and it attempts a lower d-a-converter output when the polarity does change.

Summing resistor R_5 determines the dynamic range of

the fast recirculating-remainder a-d converter. In the 8500A, R_S was selected to be 10/7 of the value of R_0 , the most-significant-bit resistor in the d-a conversion circuit, so that 10 v at the input would exactly correspond to the nulling current that could flow through the most-significant-bit resistor. The result is that the a-d device produces a binary output whose MSB is equivalent to 10 v. As 21 magnitude bits are created by the fast recirculating-remainder converter, the least significant bit is equivalent to $20 \times 2^{-21} \mu\text{v}$.

Feedback resistor R_{FB} and remainder-summing resistor R_R are connected so that the voltage-drift characteristics of the two illustrated voltage followers are reduced by the loop gain around A.

The feedback resistor has a value of 16R, and, together with amplifier A, provides a remainder that is 16 times the difference between the d-a converter's output and the unknown. Thus, even though the resolution is 5 bits, the digitized remainders are added to or subtracted from the accumulator after having been divided by 16. The a-d conversion process, in going through its five cycles, generates a total of 25 bits; however, since the remainder gain is 24 instead of 2^5 , the conversion word length is not 25 bits, but is, instead, 21 bits.

The logic that is part of the a-d converter and physically removed from the 8500A's microprocessor consists of control latches whose outputs directly drive the field-effect-transistor switching equivalents of S_6 through S_9 , a 5-bit bipolar successive-approximation-logic circuit whose outputs drive the d-a converter, and interface circuitry for communicating directly with the microprocessor via a control/data bus.

The control latches are loaded directly from the control/data bus, thus providing the microprocessor with means to directly control switches S_6 through S_9 . An attempt was made to design all of the a-d logic functions into the microprocessor, thereby reducing the control-logic cost even further, but the speed limitations encountered were not deemed worth the cost reductions.

Averaging the readings

In addition to high conversion rates, digital multimeters for system applications must have high rejection of line-related noise and ripple. Dual-slope integrating a-d conversion is often employed specifically for its noise rejection. In such converters, the input signal is integrated during the line period, and the result is discharged at a constant rate. The discharge time is then proportional to the input signal (Fig. 3).

If the integrated period is reduced below the line period in order to increase conversion speed, the advantage of line-frequency-noise rejection is reduced. The decision circuit that determines the end of a discharge period also tends to cause inaccuracies at higher discharge rates.

An alternate approach was taken in the model 8500A. The microprocessor contains a phase-locked loop so that the conversion can be synchronized to the line frequency, whether it is 50 or 60 Hz, and a reading may be started every $1/4$ of a clock period. By averaging readings that are taken over the line period, the effects of line-related noise and harmonics do not appear in the result (Fig. 4).

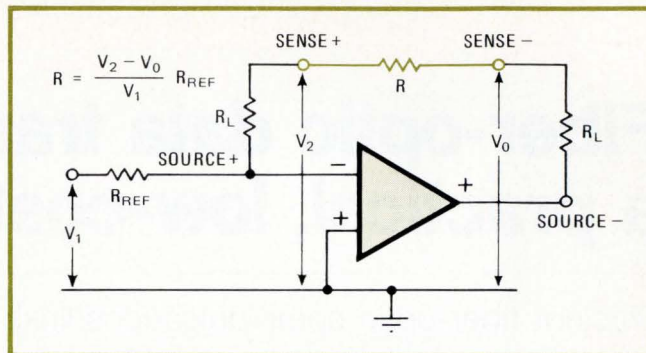

5. Resistance check. The availability of a microprocessor within a multimeter makes possible new measurement techniques. Here, three voltages are checked and the resistance calculated, eliminating variations in reference voltage as a source of error.

In the averaging mode, the noise behavior of the 8500A is similar to that of a dual-slope integrating meter, while attaining twice the conversion rate.

The availability of a microprocessor within the instrument makes it possible to add many other functions. The ratio of two input signals can be measured, for example, by processing each signal independently, then dividing the results. In contrast, conventional voltmeters make ratio measurements by replacing the internal a-d converter reference with the external input signal. Since the operation of the a-d converter is optimized at the internal reference voltage, the accuracy is considerably less in the ratio mode. By computing ratios and not changing the internal reference, full performance is maintained in the ratio mode.

The ohms-measurement circuitry is similarly affected by microprocessor control. In conventional digital voltmeters, the ohms function is achieved by driving a highly regulated current through the unknown resistor, and the voltage across that resistor is measured. In the 8500A, ohms values are calculated from three voltage measurements (Fig. 5). But, since the value of the internal reference voltage does not influence the result, any contribution to inaccuracy by this source is eliminated.

The microprocessor also eliminates the need for a zero-adjusting trimming potentiometer, and readings may be made at any preselected offset from zero by storing a reference voltage and subtracting it from the reading. Setting zero, which compensates for external thermal EMFs as well as internal zero drift, requires only that the measuring leads be shorted outside of the instrument, and the zero button be pushed. This function operates only in the most sensitive range. Offsets may be any value within scale, in any range, and in any function.

The microprocessor also makes corrections within the instrument to compensate for drift away from calibration or for scaling. Gain-correction values may be determined for every range and stored in an optional non-volatile memory, and the microprocessor can correct readings by applying the appropriate gain-correction factors. This compensation greatly reduces the time the instrument—and the system in which it operates—would otherwise be unavailable for use because it is undergoing calibration. □

Fiber-optic data transmission: a practical, low-cost technology

Efficient fiber-optic communications links are put together with standard off-the-shelf optical and electronic components

by Hermann Schmid, *General Electric Co., Binghamton, N. Y.*

□ Designers have long been intrigued by the practically gigahertz bandwidth and the immunity to electromagnetic interference that lightweight optical fibers offer for reliable transmission of all kinds of data. But the question foremost in their minds has always been, "Is it practical?" Next comes, "Are enough low-cost, high-performance components available to make such systems technologically feasible?"

The answer to both questions is an unqualified "Yes." For most applications, the technology exists, and for many applications, off-the-shelf fiber-optic cables and components are available from several manufacturers at reasonable cost. And, obviously, as optical-fiber hardware is developed further and more systems begin using it, costs will drop even more.

Consider this fact: right now, the cost per channel for a 10-meter link in a relatively simple multichannel system with a bandwidth from direct-current to 10 megahertz is \$30, including the cable (see Table 1). However, a design that uses a maximum of off-the-shelf components could drop per-channel costs to a couple of dollars.

How can anyone be so positive? It has been proven. To determine the feasibility of a basic fiber-optic system, General Electric engineers last year set up an experi-

mental system. They replaced an 11-channel shielded twisted-pair cable with a fiber-optic link, including electro-optic interfaces to carry digital data between two flight-control computers. The system, though large and expensive, was workable and showed great promise of efficiency and economy. And, as usual in such experimental setups, numerous deficiencies in the technology and the components became readily apparent.

Eliminating all possible shortcomings in the experimental system, the engineers designed a 16-channel system. However, for the sake of economy, only three channels of the system were prototyped. In comprehensive tests, the performance proved to be better than had been expected, and it is economical.

Experience in building and testing the systems is pointing up the desirable criteria, as well as pitfalls, in fiber-optic design. What's more, test results suggest additional improvements that should be cost-effective in large operating systems of the future.

Getting started

Figure 1 shows the most basic fiber-optic link—it needs only three key components. The transmitter can use either a light-emitting or laser diode, which is modulated by a digital waveform. The modulated light travels

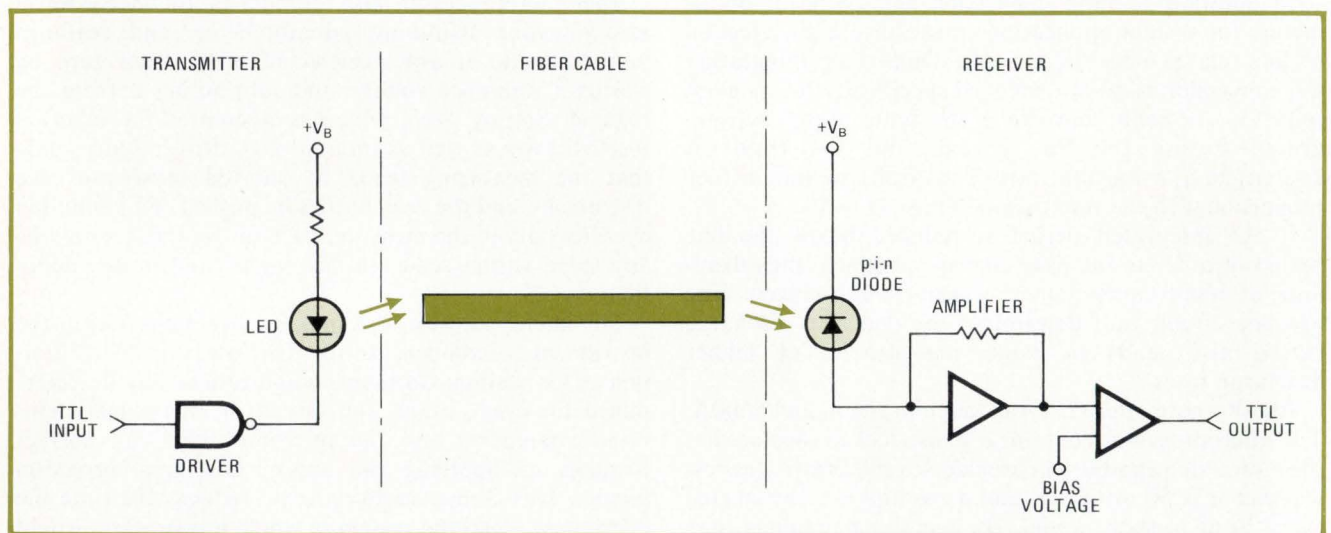

1. Basic fiber-optic system. The transmitter portion uses a light-emitting diode modulated by a TTL driver. The modulated light travels over the fiber cable to the receiver, where a p-i-n photodetector converts the light signals back into the original digital waveform.

beam is then coupled into the optical-fiber cable to carry that information to the receiver portion of the system. In the receiver, an inexpensive p-i-n photodetector converts the modulated light signals into photocurrents that reproduce the original digital waveform. The amplifier converts the current into a voltage needed to drive transistor-transistor logic.

However, in any practical system, these basic components must be configured to meet the individual system's requirements. To do this, several questions, although seemingly straightforward, must be dealt with. Here are some that should be resolved early:

- What type of system is needed? Will the link be used only point-to-point, or to supply multiple locations?
- Will it be used for short- or long-distance communications?
- Will the link be used for one-way or two-way communications?
- Will data be multiplexed over a single channel or carried over parallel channels?
- What bandwidth is needed?
- Should the system be dc- or ac-coupled?

Another important consideration is whether or not the fiber system will replace existing electrical cabling or be used in a completely new application. This choice sets the constraints on the system and determines the amount of freedom the designer has. A replacement system, for example, must use the power-supply voltages and space available in the existing system.

An important initial consideration is the environment in which the system must operate. Temperature, humidity, dust, shock, and vibration—these are only a few of

TABLE 1: COST-PERFORMANCE FIGURES

System performance	
Quantity of 16-channel fiber-optic links	1,000
Bandwidth	dc to 10 MHz
Cable length	10 meters
Temperature range	-55°C to +70°C
Cost per channel	
Connector/transducer assembly ($\$80 \div 16$)	\$ 5.00
Spectronics SPX 2231 LED	6.00
Spectronics SPX 2232 photodiode	6.00
Quad MECL line receiver ($\$3 \div 4$)	0.75
Quad high-speed comparator ($\$3 \div 4$)	0.75
Quad Schottky NAND gate ($\$3 \div 4$)	0.75
Miscellaneous discrete components	0.75
	\$ 20.00

Note: Costs were based on price lists of April 1976
Cost of 10 meters of cable is about \$10.

the factors that should ultimately determine which integrated circuits are selected, how the connectors and housings are sealed, and whether plastic or hermetically sealed components should be used.

Finally, the mechanical arrangement of the system must be chosen. Such items as how the cables are terminated, where connectors are located, and where the electronic and optical components are placed in relation to the connectors must be firmed up.

For instance, putting the connections at the natural interface between cable end and the transducer in the

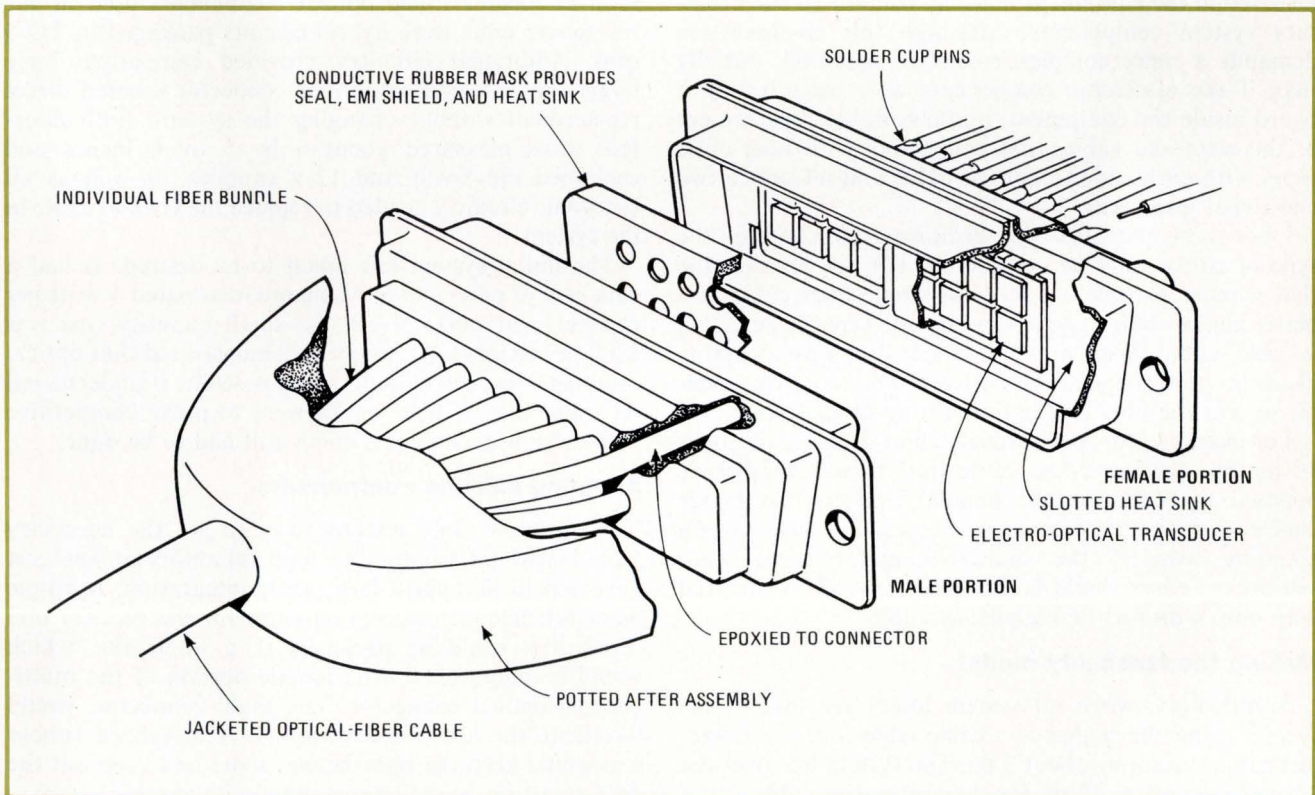

2. High-density packaging. All sources and photodetectors are mounted side by side, along with the electronic interface circuits, on a common substrate in the female half of the connector. The male half of the connector terminates the fiber-optic cable.

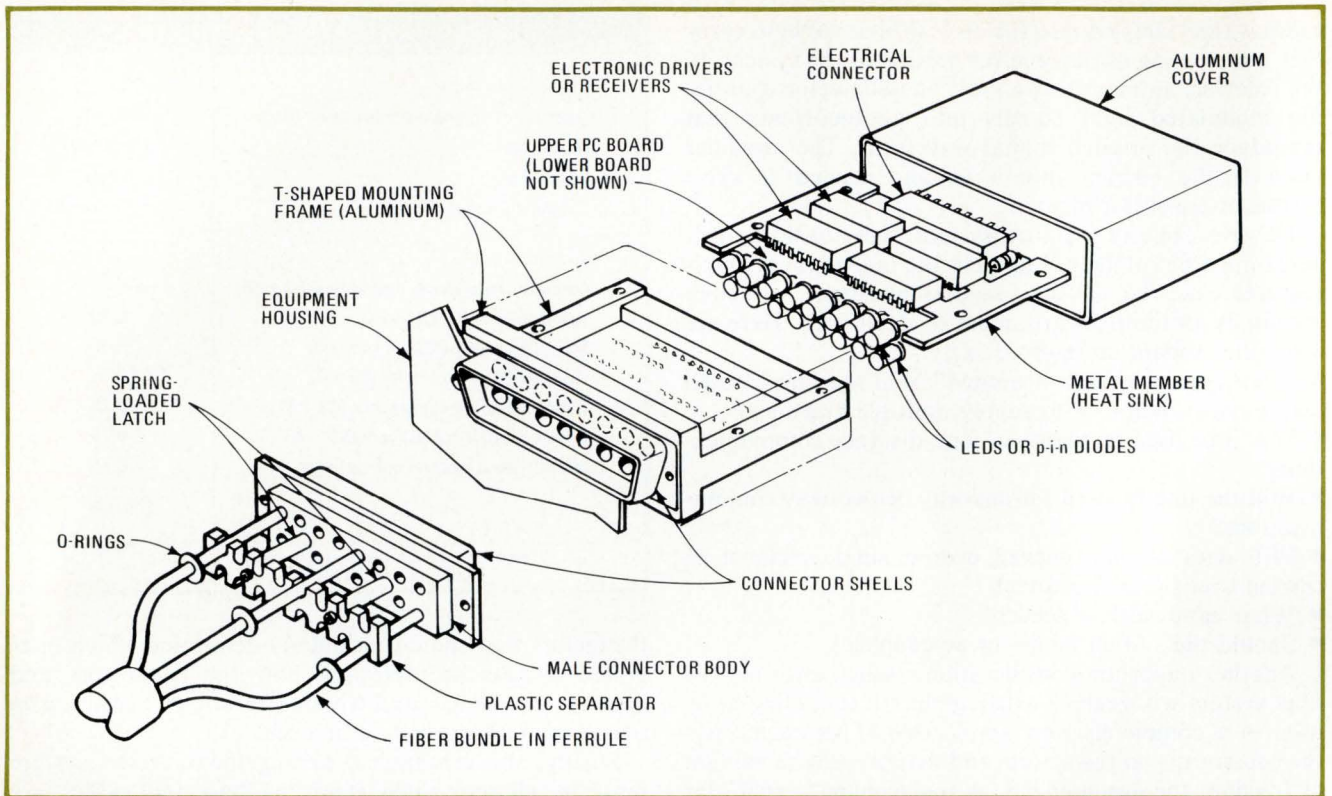

3. Design concept. All off-the-shelf components were designed into a modified connector. The female half is drilled out to accept the LEDs or photodiodes, mounted along with the electronic circuitry on a printed-circuit board, and the male half terminates the fiber bundles.

system requires that the male optical-fiber connector terminate the fiber cable and that the female connector, fastened to the equipment housing, contain all the necessary system components. Although this configuration demands a more complex connector assembly initially than if the electronic components were mounted on a board inside the equipment, it allows direct replacement of the electrical cables and connectors with fiber-optic types without having to cut the cable and introduce two additional interfaces.

Once these questions have been resolved, choosing the type of cable must be considered. It's not always true that a more expensive lower-loss single-fiber cable is a better choice than a higher-loss bundle type. In selecting a cable, cable losses must be weighed against coupling losses in the connections between fiber and photodetector and the fiber and light-emitting-diode source.

For example, for the relatively short distance of about 10 meters, the lower-loss cable (less than 1 decibel, as opposed to 5 dB for the bundle) appears the better choice. But what isn't obvious at first is the difference in coupling loss. If the smaller-diameter cable were selected, the loss would be far greater—7 dB, compared with only 4 dB for the higher-loss cable.

Making the feasibility model

Surprisingly, when all system losses are tallied, the system using the higher-loss cable edges out the lower-loss cable system by about 3 dB. The system loss over the 10-meter length is 13 dB for the higher-loss cable.

In the feasibility model, the fiber cable was terminated at both ends by the male half of a modified

connector. The female half, mounted on the transducer-interface units, contained the actual transmitter and receiver modules. The optical components used in the transducer units were hybrid circuits packaged in TO-5 cans. Additional circuitry provided compatible logic levels and an electrical-output connector assured direct replacement without changing the system. Both interface units measured about 4 by 5 by 6 inches and contained the 5-volt and 12-v supplies, as well as all electronic circuitry needed to replace the coaxial cable in the system.

The initial system left much to be desired. It had a data rate of only 5 MHz, was large, dissipated 1 watt per channel, and worst of all, the small quantity cost was \$300 per channel. Although it demonstrated that optical coupling between computers was possible, it underscored the point that, if fiber optics were to prove competitive with existing techniques, much still had to be done.

Adapting existing components

At first, the only possible way to get the necessary high-density packaging and high reliability at low cost appeared to be hybrid large-scale integration. Multiple optoelectronic transducers on chips for the receiver and transmitter could be packaged in a single DIP, which would be plugged into the female portion of the multi-channel optical connector. The male connector, would terminate the fiber cable (Fig. 2). A metalized rubber seal would keep the light beams apart and keep out the dust, moisture, and electromagnetic interference.

The idea was workable, but the cost of developing all the necessary custom hybrid circuits was too high. An

alternate, more practical, solution was found: off-the-shelf ICs and a modified electrical connector.

That design goal for the 16-channel connector/transducer assembly was accomplished with the system shown in Fig. 3, in which all off-the-shelf components would be standard ICs with medium-scale ICs, LED light sources, and photodiodes. An ITT Cannon type DRA-50R miniature electrical connector was modified so that the male half of the connector would terminate the cable, and the female half would house the transducer assemblies. Only the front shells of the connector would be used, and everything else would be altered.

The plastic spacer separates the bundles and aids in alignment. A spring-loaded latching mechanism holds the ferrules containing the fibers in place, while pushing them forward to ensure longitudinal alignment between the sources and photodiodes when the connector halves are mated. A pliable O-ring on each ferrule keeps humidity and dust away from the fiber ends. When all the fiber bundles had been inserted into the connector body, a modified cover was pushed over the terminated cable and attached to a mechanical support on the back of the male connector body to protect the fibers.

In this 16-channel design, the female half of the connector would house two pc boards containing the LEDs, photodiodes and IC drivers or amplifiers. Standard ICs packaged in DIPs, together with a few discrete components of the transmitter and receiver circuits, would occupy the rest of the board space. Also, an electrical connector would interface with existing link equipment.

When the boards were in place, all 16 diodes would protrude through the front holes in the connector shell and, when mated, would be properly positioned with the terminated optical-fiber bundles. Alignment of the

diodes and the fiber bundles would be assured by the closely machined tolerance of connector assemblies.

The 16-channel transmitter board would use 16 LEDs along with the same number of 68-ohm current-limiting resistors to ensure safe operation and long LED life. Two quad two-input Schottky NAND gates would switch the current of all eight LED sources.

Figure 4 shows the drive circuit for one channel. The rather large beam of light from the gallium-arsenide edge-emitting LED is focused by an internal lens into a much narrower beam of 30° to hold the total coupling loss to about 7 dB in coupling the 1 milliwatt of infrared light output into the 0.045-inch fiber bundle. The power dissipation per channel, consumed almost entirely by the LEDs, is normally 250 mW.

The switching time, which includes the propagation delay of the drive circuit and the turn-on time of the LED, is typically 12 nanoseconds. This is more than adequate to handle a rate of 10 MHz.

The eight-channel receiver board would contain eight photodiodes, two Motorola emitter-coupled-logic line receivers, two high-speed quad comparators that would function as amplifiers, and several resistors and capacitors. In addition, to keep dissipation low, the 8-v negative supply voltage needed for the MECL circuits would be generated by the series regulator mounted on the pc board. The receiver then would need only the same two voltages as the transmitter.

In each receiver (Fig. 5 shows a single channel) the p-i-n photodiodes would convert 10 microwatts of light power at the end of the 10-meter length of fiber bundle (approximately 1% of what would be emitted from the LED) into a 50-microampere photocurrent. The MECL line receiver (actually a quarter of a MC 10115) would be connected as a transimpedance amplifier. Also,

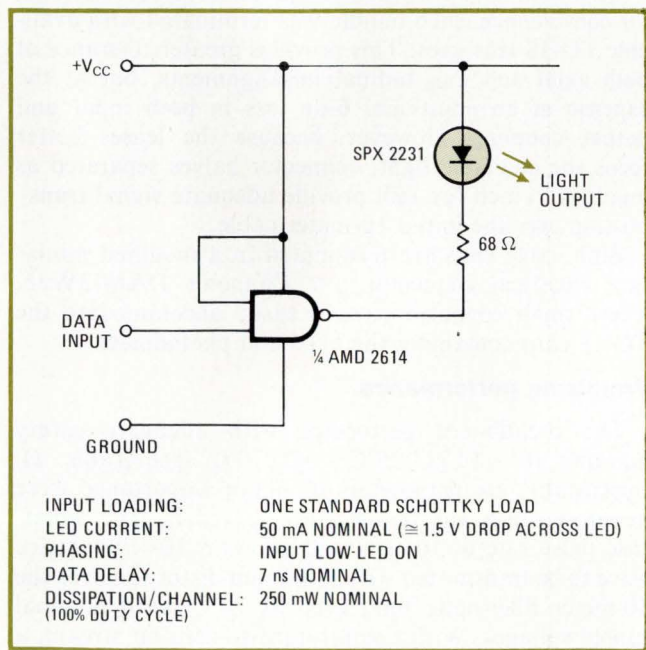

4. Light modulator. A two-input Schottky NAND gate switches the current through the LED according to the input-data waveform. The LED current is limited to 50 milliamperes by a 68-ohm resistor, and the power dissipation is 250 milliwatts per channel.

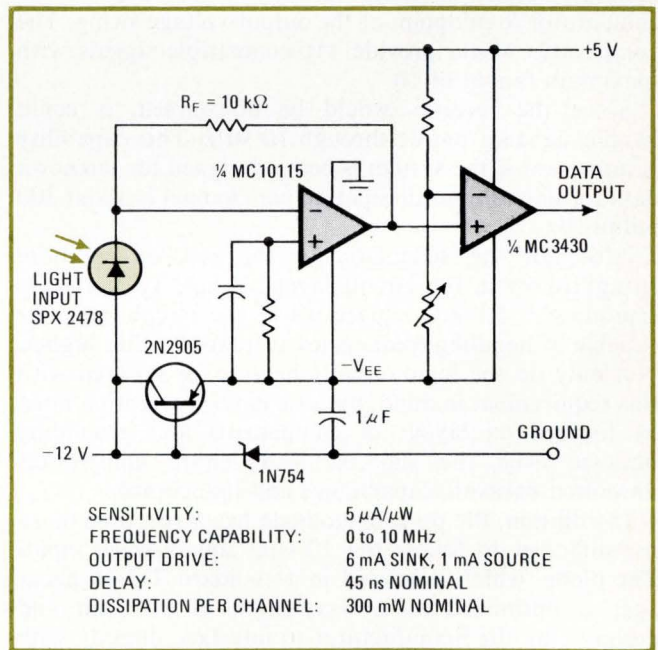

5. Fiber-optic receiver. An emitter-coupled-logic line receiver and a high-speed comparator amplify the converted light power. The MECL line receiver is connected as a transimpedance amplifier that provides a 50-millivolt peak-to-peak output.

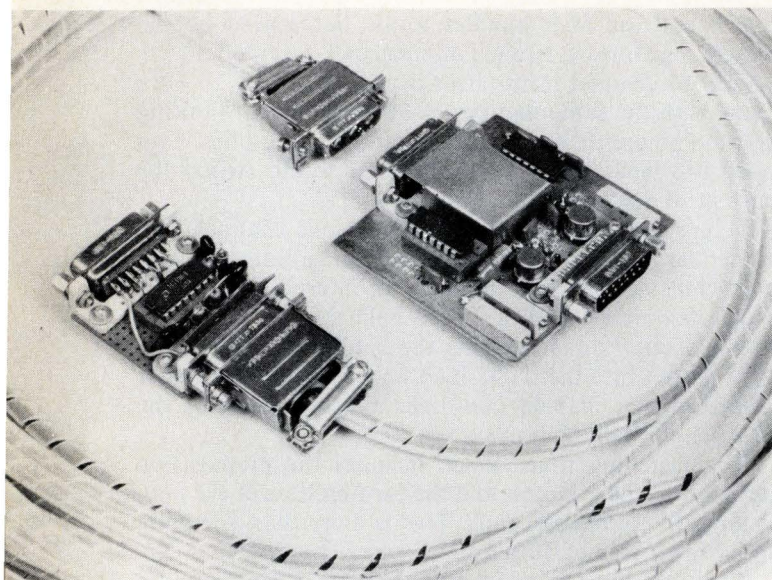

6. Breadboard proves concept. A three-channel system proves the feasibility of the 16-channel link design. The transmitter assembly (left) uses only one IC, and the receiver uses three. Both are linked by a fiber optic-cable and terminated in the modified connector.

with a feedback resistance of 10 kilohms, the input of the MECL line driver would be sufficiently low to provide the needed current-to-voltage conversion and still maintain sufficient gain.

The output of the amplifier would produce a 50-millivolt peak-to-peak swing with 10 μ W of input power. The output is directly coupled into the positive input terminal of one of the comparators (four channels are served by a single MC 3430). The negative input of the comparator would be biased to the dc level of the line-receiver output in order to set the dc level of the comparator to midpoint of the output-voltage swing. The comparator would provide TTL-compatible signals with maximum fanout of 10.

Since the receiver would be dc-coupled, it could handle signals from dc through 10 MHz. This capability is important if the system is being designed for unknown data formats. Power dissipation per channel is about 300 milliwatts.

Although the schematic of the receiver is quite straightforward, the circuit layout is not. To faithfully reproduce a 10-MHz square wave, the circuit must be capable of handling frequencies at least 10 times higher. Not only do the logic circuits have to be selected with this requirement in mind, but also careful attention must be focused on layout of components and grounding because even the shortest lead length contributes unwanted parasitic capacitance and inductance.

In addition, the p-i-n photodiode has a rise time of 15 ns, sufficient to follow the 10-MHz square-wave input. The diode, which is housed in a standard TO-46 package, is optimized at a wavelength of 900 nm and designed by the manufacturer to interface directly with the 0.045-inch diameter of the fiber bundles.

The receiver could operate at significantly lower light-input levels and over greater temperature extremes (from -55°C to $+125^{\circ}\text{C}$) if ac coupling were used

between the transimpedance amplifier and the comparator. However, this type of coupling would limit the minimum data rate to about 10 kHz with a capacitor of reasonable size.

To demonstrate the practicality of the 16-channel concept, the three-channel breadboard developed by General Electric and built by Spectronics Inc. (Fig. 6) was tested. The smaller unit on the left with only one IC is the transmitter and the larger unit with three ICs is the receiver. They are connected by a medium-loss (less than 0.5 db per meter) optical-fiber cable containing three bundles of 285 fibers each.

Putting together a prototype

To assure minimum parasitics and maximum operating speeds, rf techniques were used to build both the transmitter and receiver. Instead of using the standard type of pc board, from which most of the metalization has been removed, leaving only the narrow interconnecting lines and small component mounting pads, most of the metalization is left on the board to form a large ground plane. And rather wide metal interconnect lines are tailored for minimum length to reduce lead inductance between the transmitter NAND gate and the LEDs and between the receiver amplifier and the photodiodes. Moreover, parasitic capacitances and inductances are kept to a minimum by soldering the discrete components directly to the line receiver.

It is also important to properly ground the transducer assembly to the connector case when the pc board and frame are screwed directly to the connector housing. The three-bundle, 10-meter fiber cable is contained in a flexible convoluted Teflon duct to limit the minimum bend radius of the cable to protect the individual fibers of the bundle against breakage.

Both ends of the cable were prepared as before, and, for convenience, each bundle was terminated with available TO-18 lens caps. This provides greater tolerance of both axial and longitudinal misalignments, but at the expense of an additional 6-db loss in both input and output coupling. However, because the lenses better focus the available light, connector halves separated as much as $\frac{1}{4}$ inch can still provide adequate signal transmission over the initial 10-meter cable.

Both cable ends are terminated in a modified miniature electrical connector, ITT Cannon's DAM-3W35. These small connectors could easily accommodate the TO-18 cans containing the LEDs and photodiodes.

Promising performance

The breadboard performed with adequate safety margins at -55°C , 25°C , and 70°C (see Table 2). Specifically, six parameters of major importance were monitored over the temperature extremes. The worst-case pulse rate of 10 MHz still allows a 10-MHz square wave to be transmitted with minimum distortion over the 10-meter fiber-optic link, even at 70°C , with nominal supply voltages. With a non-return-to-zero bit stream, a 20-MHz bit rate would be possible.

The most critical of the power-supply voltages is the 5-v transmitter supply. The LED is least efficient at high temperatures, but even at 70°C , transmitter output is

TABLE 2: 3-CHANNEL BREADBOARD TESTS

TEST PARAMETERS	-55°C			25°C			70°C			
	Channel			Channel			Channel			
	1	2	3	1	2	3	1	2	3	
Maximum pulse rate (MHz)	20	16	16	14	13	14	10	10	12	
Power supply tolerances (V)	+5 V _T	3.5	3.3	3.3	3.3	3.3	3.95	4.9	4.8	4.8
	+5 V _R	3.45	3.6	3.7	3.12	3.91	3.72	5.00	5.00	4.57
	-12 V _R	7.2	7.7	6.9	7.9	8.2	7.6	11.9	11.5	9.7
Power drain (mA)	+5 V _T	41	41	40	48	48	47	51	52	51
	+5 V _R	51	53	54	53	53	54	50	50	50
	-12 V	88	88	88	89	89	89	88	88	89
Analog output swing (mV pk-pk)				50	50	50				
Delay time (ns)	110	110	115	120	125	120	130	125	125	
Cross modulation analog (mV pk-pk)				20	20	20				

V_T = Transmitter supply voltage V_R = Receiver supply voltage

sufficient to maintain proper waveforms. The total delay time between the TTL input at the transmitter end is typically 120 ns, and the TTL output at the receiver varies little over the temperature range. Half this delay is the propagation delay in the fiber cable.

Measuring the analog swing of the MECL line driver and the resulting crosstalk in the temperature chamber would have been difficult because any leads hooked to it would have changed the results. But in testing the entire system, including the cable, in a temperature chamber, data rates remained equal or better than 10 MHz.

The breadboard, when dc coupled, cannot operate over the full temperature range of -55°C to 125°C because of the drift of both amplifier and comparator circuits. However, an ac-coupled version using a 50% duty cycle, as provided by a Manchester code, should easily handle that temperature range, because, in this type of operation, the effect of transimpedance-amplifier drift is eliminated.

The most difficult problem with a dc-coupled system is to keep the drift over temperature small, compared to the amplitude of the pulse signal. To minimize the drift, the MECL bias voltage was connected to the noninverting input of the comparator, thus forcing the comparator to track the dc component of the MECL amplifier over its temperature range.

Looking ahead

The proposed 16-channel fiber-optic transmission link is only a start. Several possible improvements should increase performance and efficiency in smaller, lower-cost versions. These improvements could be made in most parts of the system, but the key is to combine as many of the functions as possible in future systems.

In the receiver section, for instance, the separate ICs could be integrated in a single IC so that only two are necessary for the entire 16-channel setup. These circuits would include both quad amplifier and quad comparator, as well as the series regulator needed for the MECL bias voltage. What's more, including an automatic-gain-

control circuit on the same chip would minimize the effects of using different cable lengths.

The size of the connector could be reduced or its form factor could be changed by arranging the photodiodes in one of two ways. By mounting four or eight photodiodes in a single package with 0.1-inch channel spacing, all 16 channels could be set in a single 1.6-in. row or two rows 0.8 in. long.

And, of course, mass-fabrication techniques such as casting or molding plastic materials for ferrules and covers would drastically cut costs. Metal housings, however, might be needed to shield the electronic portion in environments with severe electromagnetic interference. Also minimizing the need for precision dimensioning is important. Using guide pins, as well as self-aligning and heat-shrinkable plastic ferrules will further lessen costs and simplify assembly.

The transmitter assembly could be similarly reconfigured. Mounting two quad drivers into a single IC package and placing four or eight LEDs into a single package with 0.1-in. channel spacing would reduce overall size. But perhaps the biggest improvement needed is to minimize the dependence of the LED output on temperature and power-supply variations. One approach would be simply to replace the current-limiting resistors with thermistors or by driving the LEDs from constant-current sources. In more demanding applications, the LED output could be sensed by an inexpensive p-i-n photodetector and the drive circuit adjusted accordingly to maintain constant output, despite temperature and power-supply changes.

Finally, using fewer fibers with larger numerical apertures and lower loss will allow longer transmission lengths without changing the components. And as costs of low-loss fiber cable come down, longer links will become as cost-effective as the shorter ones are today. □

For more information on the status of the technology of fiber optics and fiber-optic components today, see the special report in Electronics, Aug. 5, pp. 81-104.

Tunable notch filter suppresses hum

by Peter Lefferson
Milton Roy Co., St. Petersburg, Fla.

Close-tolerance components are not necessary in a hum filter if its rejection frequency can be adjusted to the frequency of the line-current hum. Such a filter is cheap and easy to build.

Notch filters are often designed into audio and instrumentation systems to eliminate unwanted signals or pickup such as 60-hertz line-frequency hum. For a given rejection frequency, close-tolerance components are usually required to guarantee repeatable design. An inexpensive, reproducible, narrow-stop-band circuit that can be built with wide-tolerance parts and can be tuned from 50 Hz to 60 Hz with 30-decibel minimum notch depth satisfies most hum-rejection requirements.

The illustrated circuit employs a bridge-differentiator RC network with active feedback. The notch frequency in hertz is given by:

$$f_o = 1/2\pi C(3R_1R_2)^{0.5}$$

where C is the farad value of the capacitors in the circuit; R_1 is the sum of the 4,700-ohm fixed resistor and the left-hand portion of the potentiometer, expressed in ohms, and R_2 is the sum of the right-hand portion of the pot and the fixed 75,000-ohm resistor. Although the operational amplifier can be of almost any sort, the 741 shown is typical. The notch bandwidth is set by the feedback gain of the noninverting amplifier, so replacing the 68-ohm resistor with a lower value narrows the rejection band.

With the given component values, this circuit can be tuned to reject the U. S. 60-Hz or the European 50-Hz power-line frequency. With 10%-tolerance capacitors, the minimum notch depth is 30 dB and the total 3-dB bandwidth is 14 Hz for 50 Hz and 18 Hz for 60-Hz center frequency. The insertion loss outside of the stopband is a negligible fraction of a decibel. □

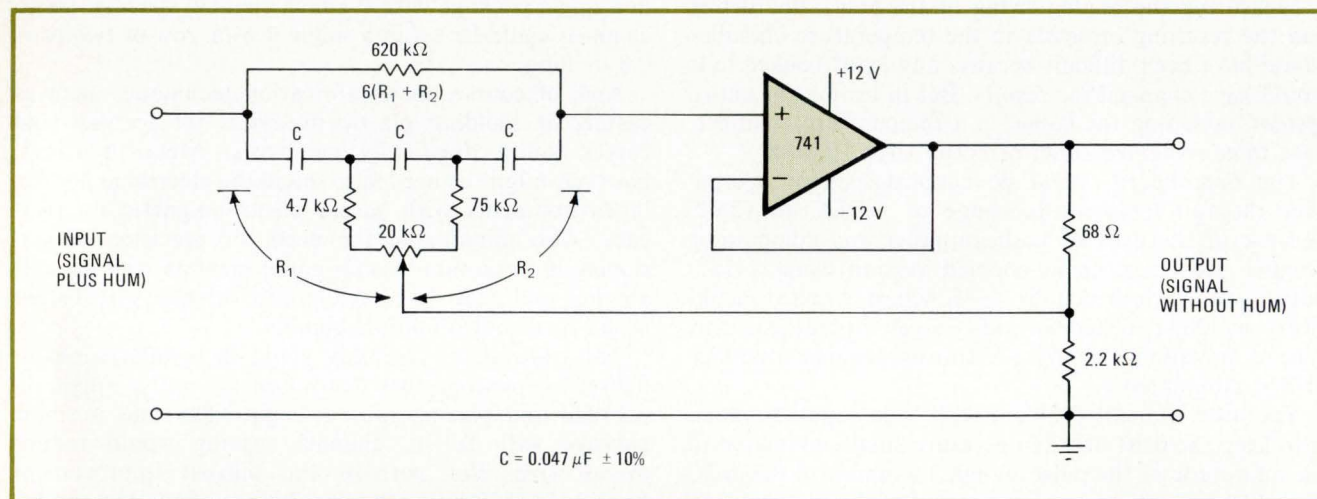

Tuning a hum. This narrow-stop-band filter can be tuned by the pot to place the notch at any frequency from 45 to 90 Hz. It attenuates power-line hum or other unwanted signals by at least 30 dB. Because the circuit uses wide-tolerance parts, it is inexpensive to build.

PROM decoder replaces chip-enabling logic

by Roy Blacksher
Signetics, Sunnyvale, Calif.

A microprocessor-based system with up to 6 kilobytes of memory and two input/output ports can be easily configured by using a single 32-word-by-8-bit programmable

read-only memory as the decoding element. In this application, the PROM generates all the chip-enable signals for the memory and also provides the clock pulses for the I/O ports so that it replaces a lot of random logic. And because the 6 kilobytes of memory are ample for most microprocessor applications, this arrangement is practical as well as simple.

The circuit diagram shows the implementation of the system, the heart of which is a Signetics 2650 microprocessor. The memory, which is segmented into 1-kilobyte banks, can be all ROM, all random-access memory, or any combination of both. The diagram shows 3 kilobytes

of ROM and 3 kilobytes of RAM. Each RAM bank consists of eight 2108 1-k-by-1-bit static RAMs, while a ROM bank consists of a single 2608 1-kilobyte ROM. Each of the I/O ports is an 8T31 8-bit bidirectional I/O interface element.

Ten of the address lines, A₀ through A₉, run from the microprocessor to all the six memory banks. The PROM enables just one of these ROMs or RAMs to read or write at a memory location indicated by the 10-line memory bus. The bus can have 2¹⁰ or 1,024 different address descriptions, and the enable signals from the PROM can apply these to any one of the six memory banks, so the total number of unique memory locations for data from the 8-bit data bus is 6 kilobytes.

The 2650 microprocessor multiplexes address and I/O information on two of its lines—i.e., lines A13-E/ \overline{NE} and A14-D/ \overline{C} . In memory operation, these serve as the two highest-order address lines and thus determine which 8-kilobyte page of memory is addressed. In I/O operations, if line A13-E/ \overline{NE} is low, then either port D or port C is enabled, depending on whether line A14-D/ \overline{C} is high or low. The M/ \overline{IO} line of the microprocessor indicates whether the A13-E/ \overline{NE} and A14-D/ \overline{C} lines are in memory or I/O operation; the M/ \overline{IO} line is high for memory operation and is low for I/O.

As the schematic shows, input terminal A₄ of the PROM is driven by the M/ \overline{IO} line from the processor. Therefore A₄ must be high in any PROM input that

enables one of the six memory banks, and it must be low to enable, or clock, either I/O port.

The WRP (for write-pulse) line from the processor is connected to input terminal A₃ of the PROM. This line must be high to enable any RAM for either reading or writing. The state of the WRP line does not matter for ROM or I/O operation.

PROM input terminal A₂ is driven by microprocessor address line A₁₀. This line must be high to enable a ROM and low to enable a RAM.

Input terminals A₁ and A₀ of the PROM are driven by the multiplexed lines already discussed; they determine page number in memory, or choose between ports in I/O operation.

The one other input to the PROM is the operation-request (OPREQ) line from the processor, which enables the PROM. This line must be high to enable any RAM, ROM, or port.

The ROMs and RAMs are enabled by low signals; hence the notation ($\overline{RAM A}$) indicates that RAM A is enabled, ($\overline{ROM B}$) means that ROM B is enabled, etc. However, the I/O ports are clocked, or enabled, by high signals, so (PORT C) means that port C is enabled.

The PROM transfers the microprocessor's control and address lines into appropriate control signals to enable the memory and I/O according to the relationships shown in Table 1. In program form, the coding of the PROM is as shown in Table 2. Notice that input words 0 through

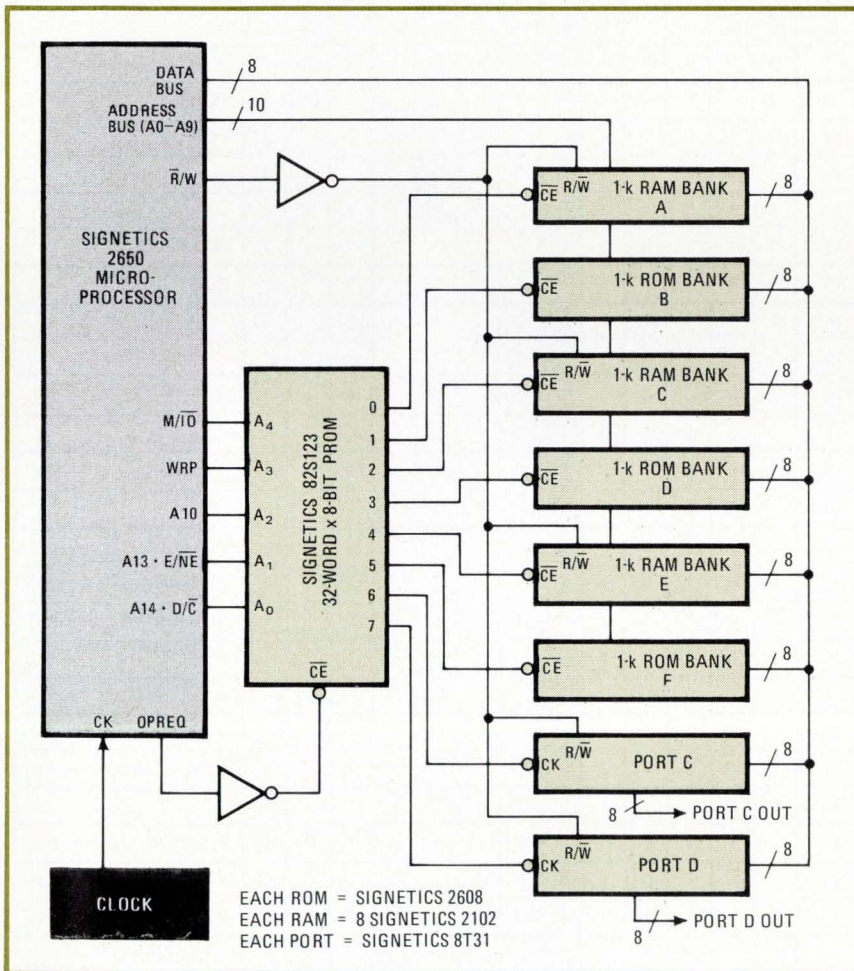

PROM in aid. Control and address lines from microprocessor are decoded by PROM to enable any one of the memory banks or I/O ports. This arrangement provides 6 kilobytes of memory, which is enough for most microprocessor applications, and requires fewer parts and less space and money than random logic for decoding.

TABLE 1.
ENABLING CONDITIONS FOR ROMs, RAMs, OR I/O PORTS

$(\overline{\text{RAM A}}) = (\text{OPREQ}) (\overline{\text{M}/\overline{\text{IO}}}) (\text{WRP}) (\overline{\text{A13} \cdot \text{E}/\overline{\text{NE}}}) (\overline{\text{A14} \cdot \text{D}/\overline{\text{C}}}) (\overline{\text{A10}})$
$(\overline{\text{ROM B}}) = (\text{OPREQ}) (\overline{\text{M}/\overline{\text{IO}}}) (\overline{\text{A13} \cdot \text{E}/\overline{\text{NE}}}) (\overline{\text{A14} \cdot \text{D}/\overline{\text{C}}}) (\text{A10})$
$(\overline{\text{RAM C}}) = (\text{OPREQ}) (\overline{\text{M}/\overline{\text{IO}}}) (\text{WRP}) (\overline{\text{A13} \cdot \text{E}/\overline{\text{NE}}}) (\overline{\text{A14} \cdot \text{D}/\overline{\text{C}}}) (\overline{\text{A10}})$
$(\overline{\text{ROM D}}) = (\text{OPREQ}) (\overline{\text{M}/\overline{\text{IO}}}) (\overline{\text{A13} \cdot \text{E}/\overline{\text{NE}}}) (\overline{\text{A14} \cdot \text{D}/\overline{\text{C}}}) (\text{A10})$
$(\overline{\text{RAM E}}) = (\text{OPREQ}) (\overline{\text{M}/\overline{\text{IO}}}) (\text{WRP}) (\overline{\text{A13} \cdot \text{E}/\overline{\text{NE}}}) (\overline{\text{A14} \cdot \text{D}/\overline{\text{C}}}) (\overline{\text{A10}})$
$(\overline{\text{ROM F}}) = (\text{OPREQ}) (\overline{\text{M}/\overline{\text{IO}}}) (\overline{\text{A13} \cdot \text{E}/\overline{\text{NE}}}) (\overline{\text{A14} \cdot \text{D}/\overline{\text{C}}}) (\text{A10})$
$(\text{PORT C}) = (\text{OPREQ}) (\overline{\text{M}/\overline{\text{IO}}}) (\overline{\text{A13} \cdot \text{E}/\overline{\text{NE}}}) (\overline{\text{A14} \cdot \text{D}/\overline{\text{C}}})$
$(\text{PORT D}) = (\text{OPREQ}) (\overline{\text{M}/\overline{\text{IO}}}) (\overline{\text{A13} \cdot \text{E}/\overline{\text{NE}}}) (\overline{\text{A14} \cdot \text{D}/\overline{\text{C}}})$

Table settings. Six output lines from the microprocessor go to the PROM, as shown in the circuit diagram. Table 1 indicates the states these lines must have to enable any one of the memory banks or I/O ports. (A read/write signal, $\overline{\text{R}/\text{W}}$, from the microprocessor directly to the RAMs determines whether a byte is read into or out of a RAM; if the PROM enables one of the I/O ports instead of a memory bank, the $\overline{\text{R}/\text{W}}$ signal determines whether the port reads data on to the data bus or off it.) Table 2 contains redundancy because many of the input lines are "don't care" lines for memory banks or for I/O ports.

15 all have A_4 low, producing I/O operation, and words 16 through 31 have A_4 high for memory operation.

The arrangement described here decodes only the first 10 address lines ($\text{A}_0 - \text{A}_9$) of the microprocessor, along with the two page-address lines $\text{A13-E}/\overline{\text{NE}}$ and $\text{A14-D}/\overline{\text{C}}$. Lines A_{11} and A_{12} are not decoded and are therefore "don't care" lines, so the same 1 kilobyte of information can appear four places on one page. Only the first three pages are used in this system, although the ROM and RAM position on each page can be reversed by simply recoding the PROM. Recoding also allows the use of page 3. □

Designer's casebook is a regular feature in Electronics. We invite readers to submit original and unpublished circuit ideas and solutions to design problems. Explain briefly but thoroughly the circuit's operating principle and purpose. We'll pay \$50 for each item published.

TABLE 2. CODING OF 82S123 PROM

WORD	INPUTS					OUTPUTS								COMPONENT ENABLED
	A_4	A_3	A_2	A_1	A_0	7	6	5	4	3	2	1	0	
0	0	0	0	0	0	0	1	1	1	1	1	1	1	PORT C
1	0	0	0	0	1	1	0	1	1	1	1	1	1	PORT D
2	0	0	0	1	0	0	0	1	1	1	1	1	1	—
3	0	0	0	1	1	0	0	1	1	1	1	1	1	—
4	0	0	1	0	0	0	1	1	1	1	1	1	1	PORT C
5	0	0	1	0	1	1	0	1	1	1	1	1	1	PORT D
6	0	0	1	1	0	0	0	1	1	1	1	1	1	—
7	0	0	1	1	1	0	0	1	1	1	1	1	1	—
8	0	1	0	0	0	0	1	1	1	1	1	1	1	PORT C
9	0	1	0	0	1	1	0	1	1	1	1	1	1	PORT D
10	0	1	0	1	0	0	0	1	1	1	1	1	1	—
11	0	1	0	1	1	0	0	1	1	1	1	1	1	—
12	0	1	1	0	0	0	1	1	1	1	1	1	1	PORT C
13	0	1	1	0	1	1	0	1	1	1	1	1	1	PORT D
14	0	1	1	1	0	0	0	1	1	1	1	1	1	—
15	0	1	1	1	1	0	0	1	1	1	1	1	1	—
16	1	0	0	0	0	0	0	1	1	1	1	1	1	—
17	1	0	0	0	1	0	0	1	1	1	1	1	1	—
18	1	0	0	1	0	0	0	1	1	1	1	1	1	—
19	1	0	0	1	1	0	0	1	1	1	1	1	1	—
20	1	0	1	0	0	0	0	1	1	1	1	0	1	ROM BANK B (PAGE 0)
21	1	0	1	0	1	0	0	0	1	1	1	1	1	ROM BANK F (PAGE 2)
22	1	0	1	1	0	0	0	1	1	0	1	1	1	ROM BANK D (PAGE 1)
23	1	0	1	1	1	0	0	1	1	1	1	1	1	—
24	1	1	0	0	0	0	0	1	1	1	1	1	0	RAM BANK A (PAGE 0)
25	1	1	0	0	1	0	0	1	0	1	1	1	1	RAM BANK E (PAGE 2)
26	1	1	0	1	0	0	0	1	1	1	0	1	1	RAM BANK C (PAGE 1)
27	1	1	0	1	1	0	0	1	1	1	1	1	1	—
28	1	1	1	0	0	0	0	1	1	1	1	0	1	ROM BANK B (PAGE 0)
29	1	1	1	0	1	0	0	0	1	1	1	1	1	ROM BANK F (PAGE 2)
30	1	1	1	1	0	0	0	1	1	0	1	1	1	ROM BANK D (PAGE 1)
31	1	1	1	1	1	0	0	1	1	1	1	1	1	—

Check list for 4,096-bit RAMs flags potential problems in memory design

Startup, noise, and other aspects of random-access-memory operation still vary enough, even in 4-k devices, to need careful checking out

by R.C. Foss and R. Harland, *Mosaid Inc., Ottawa, Canada*, and J.A. Roberts, *Computing Devices Co., Ottawa, Canada*

□ After all their timing and applications problems with 1103-type 1,024-bit random-access-memory chips, memory-system designers have been looking forward to presumably easier-to-use 4,096-bit devices. However, a 4-k-device user must still grapple with many subtleties of operation before he can confidently pass a design on to production. One of the best ways he can review his design is with a detailed check list.

Such a check list, first of all, offers a structured method for evaluating designs. If it is really good, it will show a deeper insight into design than simply asking such mundane questions as "Have all tolerances been examined?" or "Have the manufacturer's design rules been adhered to?" But also note that a well-constructed check list can allow an objective, dispassionate critique of a design and thus avoid conflicts arising from simple personal preferences. The check list should command the same respect as a company's design standard.

The check list on page 106 is not comprehensive, but it does represent a good starting point. It covers such trouble areas in memory-system design as startup, refresh modes, temperature effects, noise, latches on address and data buses, and clock circuitry.

Cold startup

The first point to check is what happens when power is applied. A memory chip usually is not required to successfully write valid data in its first active cycle after the supply voltage, V_{DD} , is turned on. Most memory chips, in fact, require one or more active cycles before attempting a valid operation. However, this point could easily be overlooked in planning an incoming inspection test sequence, where each part is to be briefly checked before actual usage.

The precharge clock generator shown in Fig. 1, for example, is used by several makers. On initial switch-on, a poor logic-1 level occurs at the output, and the circuit nodes, which are driven by the precharge clock or inverse of the chip-enable signal, \overline{CE} will not be correctly set. At least one active cycle is needed to charge the bootstrap capacitor fully so that an output level can be set solidly at the supply voltage, V_{DD} . Here, Intel often uses either a resistance load or a bootstrapped load, paralleled by a resistor to overcome low levels in cold starts. Some other manufacturers, however, have memory chips requiring clocks bootstrap-driven above V_{DD} . When this is the case,

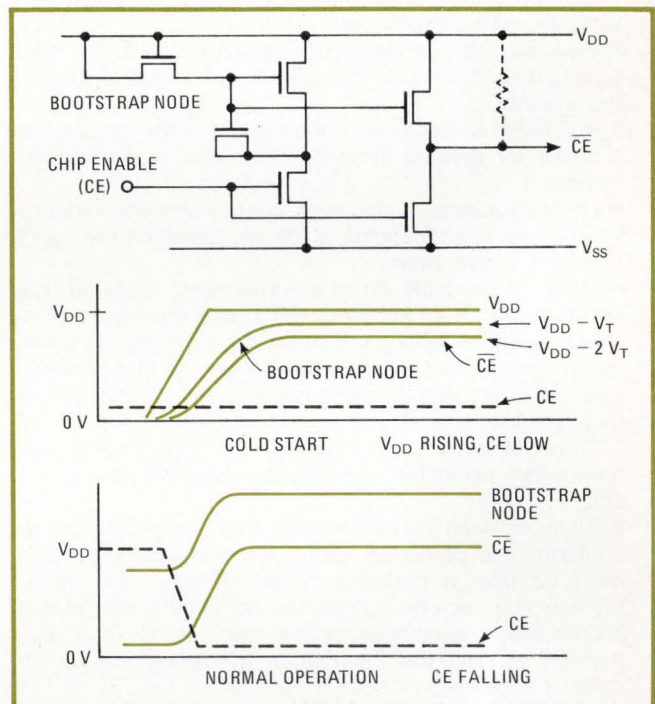

1. Startup. This precharge clock generator requires at least one cycle to charge the bootstrap capacitor (the MOS transistor with drain and source shorted) before the output reaches V_{DD} . The resistor shown dashed is sometimes used to help raise the output.

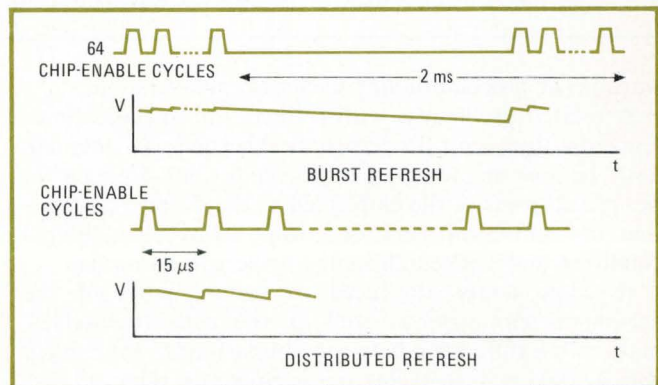

2. Refreshing. With burst refresh, in which all 64 cycles are grouped together, precharge levels can deteriorate more than when the 64 cycles are distributed over this 1-ms refresh time. Distributed refresh also smooths the load on the power supply.

How to gain clout with a RAM supplier

The most satisfied users of 4-k RAMs appear to be at two extremes—large-computer manufacturers who maintain their own extensive qualification and incoming inspection department, and small-volume users who can get by with data sheets and manufacturer's application notes. Medium-scale users, such as many of the smaller mini-computer manufacturers, face the biggest problems because they cannot afford large evaluation centers and yet must come up with optimum designs for their memory systems.

Most large-volume users have become more aggressive in gathering technical information and now take a number of steps at their own expense. They:

- Directly monitor the component through the design and vendor-qualification stages.
- Evaluate early engineering samples (probably after signing a nondisclosure agreement) and feed back data to the vendor.
- Purchase a significant quantity of early production samples for detailed in-house parametric and sensitivity testing.
- Demand access to and even control over the vendor's internal test specifications, which are based on the user's purchase specifications.

Often, in the early life of a component, the large user knows more about its deficiencies than the vendor. The user's extensive testing will show the component's weaknesses, and in fact many of the design changes made to new RAMs are directly attributable to the feedback from large-volume users.

The small-volume user of RAMs, on the other hand, also has certain protection mechanisms available to him. He can:

- State on each purchase order that the product must conform to a particular, dated, vendor data sheet and must be from a particular mask revision. (The mask-revision number can sometimes be determined from a microscopic examination of the chip; usually it is also possible to gain this information by calling the vendor product engineer.)
- Design the memory cards as closely as possible to the published application notes.
- Use vendors who have adequate applications service—preferably those who also employ field-applications engineers.

The medium-sized user of RAMs is in an extremely

vulnerable position. Whereas the small user usually is not pushing the state of the art and can design in larger safety margins, the medium user typically deals with larger memories and wants to get as much as possible from the components. Without the weight to monitor the design phase, to engage in qualification or early product testing and to influence the design changes, he is open to serious application problems. But there are several alternate possibilities for regaining control and for the generation of component design knowledge.

Above all, since vendor staff engineers are not anxious to reveal information that could be considered derogatory to their own components, it is vital to display a disarming degree of knowledge about their components early in any communications. This is where the help of third-party design authorities, who are engaged in evaluating RAM designs, can prove invaluable. They will not only supply insight into possible application problems but will help the RAM user gain the vendor's respect. All pretense will collapse at such a juncture, and it is in everyone's long-term interest that it should do so.

In addition, the user of a moderate volume of RAMs should:

- Use a purchase specification to define simple parametric and sensitivity testing and not simply to read back the vendor data sheet.
- Also, quote the mask-set revision number and require the marking of the component with the user specification number. Since manufacturers make frequent mask changes to eliminate bugs, improve performance, or enhance yield, it cannot be assumed that the work to prove in and accept a part necessarily remains valid, particularly in the case of unwritten parts of specifications. The supplier may not appreciate that such second-order characteristics are important in a system or even that the characteristics have changed as a consequence of a "fix" put in for other reasons.
- Monitor the design position, the design status, and the vendor-personnel responsibilities with a questionnaire such as is shown here.

The above procedure makes it possible to reject components which have undergone unnotified design changes, to communicate usefully with the appropriate vendor staff members, to develop simple incoming-test procedures, and to generate adequate design criteria for system engineers.

warmup or preconditioning cycles are unavoidable.

A related problem is with refresh-time specifications. Once the time limit for refresh is exceeded, not only can data be lost in active memory cells, but voltages in peripheral parts of the chip, such as the decoder and bit-line and address drivers, can droop away to an illegal condition and a preconditioning cycle will be needed.

In some RAMs, the need to restore parts of the peripheral circuitry, as well as the cells themselves, makes for a difference between "burst-mode" refresh (in which all 64 refresh cycles are grouped together, say, 0.5 microsecond apart) and "distributed-mode" refresh (in which the 64 cycles are spread over the entire 1-ms refresh time, say, 15 μ s apart—see Fig. 2).

Distributed refresh can give a valuable bonus if, for

example, any major line in the memory floats while the RAM is quiescent. It will restandardize the level of that line more often. Distributed refresh also smooths the load on the power supply and is, therefore, generally preferred. In systems using battery backup, however, burst mode may have to be used, to make the most economical use of power by allowing shutdown of associated logic elements between refresh cycles.

V_{DD} noise susceptibility

Most designs that use balanced sensing also generate an on-chip reference potential, V_R , which is a level intermediate between a stored 1 and a stored 0. The exceptions use geometric scaling between a dummy cell and the storage cell. In debugging a new design, varying

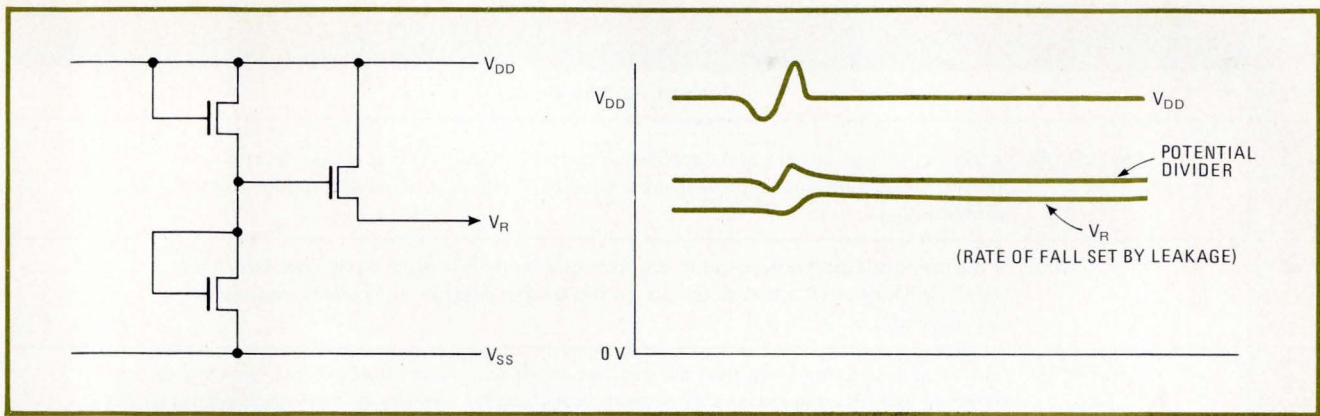

3. Reference generator. The chip reference voltage is commonly developed with a divider circuit and a source follower. While negative transients on the supply line are masked by the charge on the load capacitance, positive transients are stretched into variations in V_R .

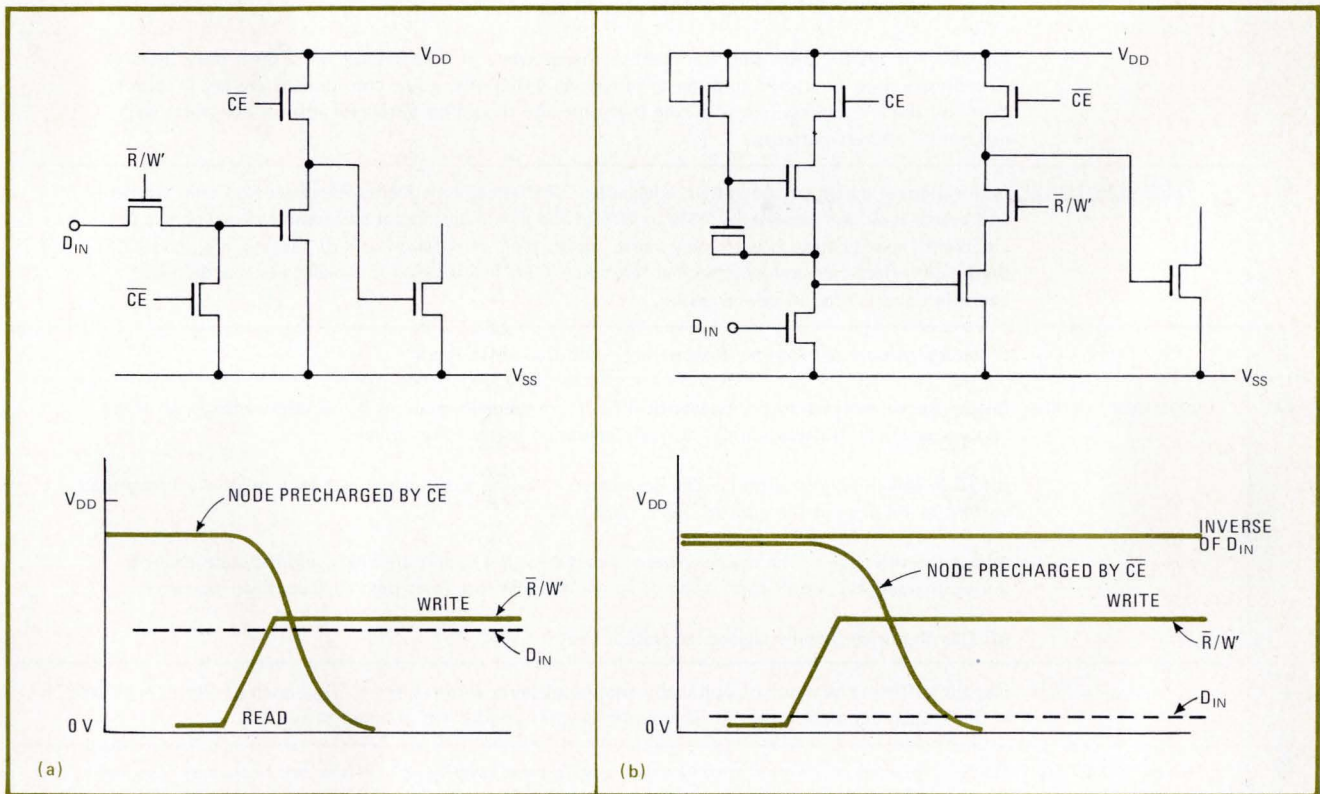

4. Latches. Data-input lines may be latched in one of two ways—as 1's latch (a) or as 0's latch (b). After a write transition, the D_{IN} line can change positively in the 1's latch, negatively in the 0's latch. Internal signal \bar{R}/\bar{W} is the inverse of external input R/\bar{W} .

V_R can be a valuable technique for exploring the safety margins of the part. However, in actual operation, such variations, if excessive, can give read errors. Variation of V_R as a function of the stored data pattern is particularly undesirable, while variation of V_R with V_{DD} makes the part sensitive to noise on the power bus.

A typical reference-generator circuit used by several major manufacturers is simply a potential divider and source follower (Fig. 3). Since there is no dc current drawn from V_R , there is less sensitivity to negative-going transients—such as those that occur when a heavy load is suddenly placed on the V_{DD} bus. That's because the circuit acts as a peak rectifier. If V_{DD} suddenly dips, the level of V_R is maintained for a while by the charge on its load capacitance even though the source follower is cut

off. However, if a positive transient—a noise spike—occurs on the V_{DD} line, V_R will rise a proportionate amount of this transient and hold the new higher level until the extra charge can leak away.

A positive transient may also occur after heavy spike loads on V_{DD} . When enabled, a chip may go from near zero current to over 100 milliamperes. While V_R will not fall in sympathy with the fall in V_{DD} , inadequate local decoupling may cause overswing as the current spike combines with the printed-circuit track inductance.

A second source of V_{DD} noise injection is in the storage cell itself. Most one-transistor-cell memories actually have two transistor structures per bit—one as the access device, and the other with the gate element connected to V_{DD} as a storage capacitor. Any variation in V_{DD} between

CHECK LIST FOR 4-k RAM SYSTEMS

ITEM	REQUIREMENT
1	SWITCH ON Is the sequence of power supply application correct? (Substrate bias should never go into forward conduction and, to prevent the possibility of high I_{DD} , should be applied together, with, or before V_{DD} .)
2	COLD START Is the memory expected to write in data correctly on its first active cycle after switch-on? (This is unlikely in an actual system, but could be demanded in an incoming inspection test sequence.)
3	REFRESH (a) If a chip is left for more than the specified refresh time-limit (usually 2 ms), does the system expect to lose only the stored data without recognizing the need for a "cold start" resetting cycle? (b) Does the system use burst-mode refresh or refresh cycles distributed through the refresh period? (The latter is preferable with most chip designs and highly desirable where, in a memory array, the internal design allows major lines to float while the memory is quiescent.) (c) Does the system allow the Y address to change while it's refreshing? (Although only the six X addresses must be cycled through to refresh all 4,096 bits, a few chip designs are NOT "don't care" on their Y address inputs during that time and should be tested for refresh operation with differing Y-address patterns.)
4	TEMPERATURE Is the thermal design of the system adequate? (Refresh time is highly dependent on chip temperature, and access time can increase by 15% to 20% at the maximum operating temperature. The usual "ambient" specification is extremely vague. Board type, orientation, use of sockets, etc., can all drastically affect case-ambient thermal resistance. Case temperature is usually a better defined condition and is used in device testing.)
5	NOISE Is the board noise environment compatible with the device used?
6	ADDRESS BUSES (a) Do the drivers guarantee the pseudo-TTL levels generally required? (A safety margin on these levels is generally highly desirable for safe operation of the parts driven.) (b) Have spike loading currents been considered? (Some memory chips draw a relatively heavy load current at the instant the address bus is sampled.) (c) Has the behavior of the memory been checked for the condition where address state changes during the address "don't care" time of an active cycle (e.g. reset high to save driver power)? (d) Can the driver handle charge fed back into it?
7	D_{IN} LATCH Has the different behavior of nominally equivalent parts with respect to D_{IN} latching been considered? Is the system compatible in this regard with all the vendors it is planned to use?
8	D_O LOADING Does D_O loading correspond to data-sheet specification conditions? (These are not always the same as the maximum load driving capability.)
9	D_O LATCH In 16-pin parts with a D_O latch, have all the conditions for latch deselection been considered? In particular, if RAS only refresh is planned, what provision is made to deselect this latch?
10	CLOCK DRIVERS Do the clock drivers provide the required clock levels at all part location on the memory boards? (With high-level drivers, soft failures can occur if the CE level falls too far below V_{DD} even on a noise spike. Compatibility of drivers and memories is particularly difficult if a common V_{DD} feeds both.)

writing and reading is thus impressed on the stored level. The use of dummy-cell structures, as in TI's 4-k RAMs, will compensate partially for this effect. Parts that do not use the reference level stored on a dummy cell are inherently more noise-sensitive. Thus, the permissible data-sheet variation in V_{DD} should not be interpreted as a change allowable while the part is in operation.

There is no really good design of address buffers to be found in any of the presently available parts. None meets

all of the ideal criteria and, in fact, many fall far short. Ideal address buffers would:

- Operate with true TTL levels of 0.8 v and 2.0 v (none achieves this).
- Latch the address and have a true "don't care" state after address hold time. Not only should the output level not change if the inputs are subsequently changed, but there should be no other second-order changes resulting in, for example, input current drawn, power-supply

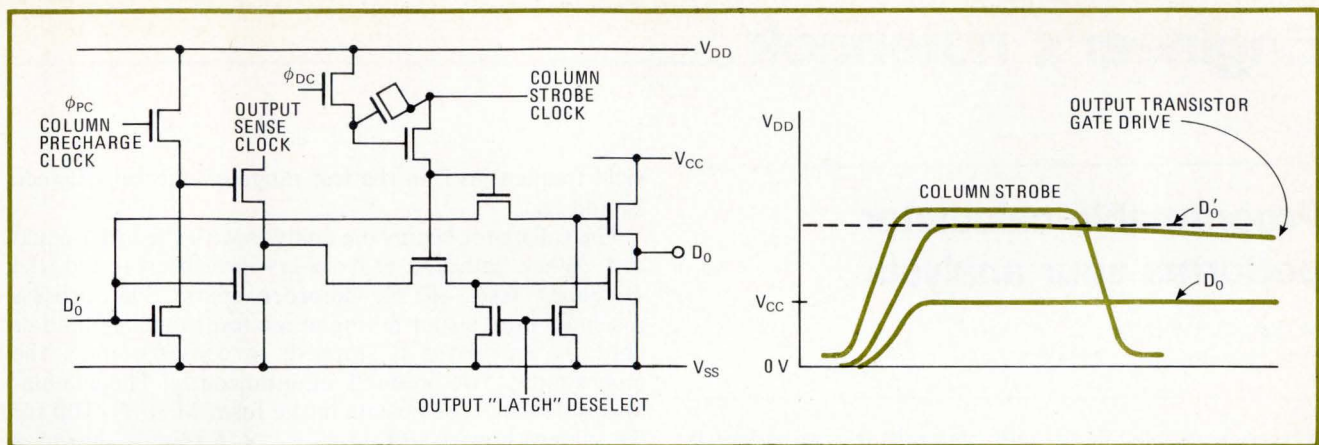

5. Output latch. After the disappearance of the column strobe pulse, output level can be latched simply by the charge on the gate of the output transistor. However, charge may leak, and variations in output voltage could couple back into the gate and turn it off.

current drawn, or drive conditions to decoders.

- Present only a moderate capacitance loading and neither draw spike current at the critical instant when address state is being read off the address bus nor pump charge back into the address driver.
- Fail in a "digital" way as input levels degrade. If output levels or internal time delays change significantly with input levels, then marginal parts will show pattern sensitivity as decoders are fed poor signals.
- Operate independently of other address buffers on the chip to eliminate any potential interaction.

Differences in data-in latches

Inputs are latched in 4-k RAM addressing as the chip-enable signal (CE) rises—or in 16-pin RAMs as row-address-select signals (\overline{RAS}) fall. Much less well-defined, however, is the behavior of the data-in line (D_{IN}). For the most part, specifications imply D_{IN} should be stable as R/\overline{W} goes to the write condition. In 16-pin designs, and in some 18- and 22-pin parts as well, D_{IN} is latched at that time.

But the user cannot assume that this is always the case. The D_{IN} circuitry of TI's memory chip, for example, is a "1's latch" (Fig. 4a). This allows D_{IN} to change after the transition to write—but only in a positive-going sense. Then a latch action is created by the discharge of a node that has been precharged during \overline{CE} time. The ease of use of the TI 18-pin 4050, with its common I/O pin, depends on this feature.

Conversely, the Intel 2107B is a "0's latch" (Fig. 4b), which latches only as input data goes from 1 to 0 again by the discharge of a precharged node. As yet another variant, the AMD 9060 does not latch data at all. This is simpler in some respects, because D_{IN} timing can vary relative to R/\overline{W} and still allow correct data to be written in. This increases susceptibility to noise at a time when other memories are in a "don't care" state.

Freeing the output latch

In 16-pin-RAMs, an output latch holds data into the next cycle. The combinations of conditions necessary to free that latch and restore a high-impedance output state are complex and differ from part to part.

Most specifications cover the case where the latch will

be maintained. For example, it may be stated that the occurrence of a \overline{CAS} rising edge no later than 50 nanoseconds after the \overline{RAS} rising edge will not deselect the latch. But they do not explain and specify all the ways in which deselection is achieved.

The term "output latch" is itself liable to mislead the user. In practice, the latch storage function will most likely be dynamic and may even consist only of the charge left on the output transistor gates. This arrangement (Fig. 5) requires that the user understand several MOS circuit subtleties.

First, it is very undesirable to apply any load disturbances to the output pin. Any variation in output voltage couples back into the gate and can help bootstrap it off. More important, an unusual refresh problem occurs at high temperatures as the refresh time limit of the memory is approached. The stored charge may have leaked enough to bring output-current drive parameters outside specification limits.

A further consequence of the dynamic nature of an output latch is indeterminate operation if \overline{RAS} -only refresh cycles are attempted. Since only the X-address bits are needed for refresh, there is no need to supply the column address strobe at all (or there shouldn't be). Depending on both the chip and the system design the \overline{CAS} clock may have to be used, if only to clear down this output latch.

To help explain several of these points, sketches of various circuits have been used, but their suppliers are not always identified. The omission is deliberate because it is by no means sure that the circuit given represents the latest parts. A circuit configuration a year or so old, which is known to have caused problems, can reasonably be expected to have been changed by the manufacturer.

Finally, one bit of advice on "unwritten" portions of specifications. These are areas in which the relatively chaotic second-source situation on 4-k memories hurts most. Not only can the guaranteed limits and specified timing conditions vary in supposedly interchangeable parts, but when a follow-on producer aims his skills at a device specification, the result is often a part whose second-order characteristics differ drastically. Thus, it is not advisable to mix parts from different suppliers on one board. □

Programmable calculator performs spur analysis

by John R. Coleman
Harris Electronic Systems, Melbourne, Fla.

A programmable hand-held calculator can identify spurious frequencies generated in the mixing of two signals. For instance, an HP-25 calculator can be used in place of a spur chart or a digital computer to calculate these values both accurately and quickly. The same HP-25 program is used for both up-conversion and down-conversion, and in contrast to many graphical methods, the maximum order of spur product need not be limited.

If frequencies f_1 and f_2 are mixed, some of the resulting frequencies are:

$$f_s = \pm Mf_1 \mp Nf_2$$

The arrangement of signs eliminates the trivial situations in which both terms are positive, and the meaningless cases where both are negative. M and N , which are positive integers, are called the coefficients of a spur, and the order of the spur is the sum ($M+N$). The HP-25 program analyzes the situation sketched in Fig. 1. The lower input frequency, f_1 , lies in the range from f_{11} to f_{12} ; the higher input frequency, f_2 , lies in the range from f_{21} to f_{22} , and the calculator finds all values of M and N that

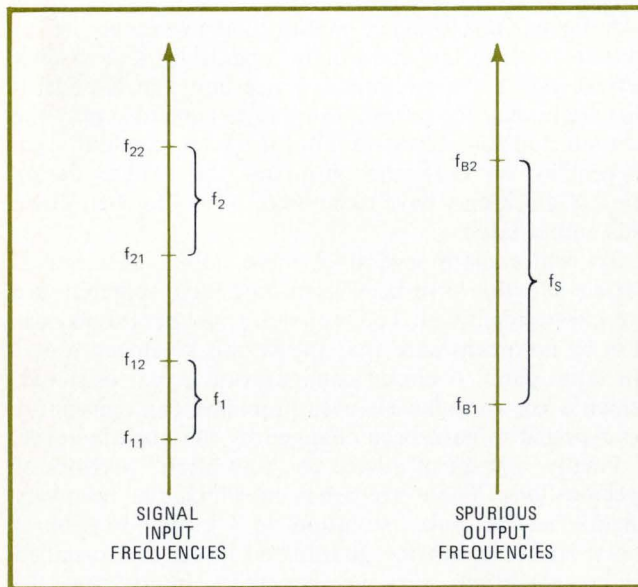

1. The ins and outs of spur analysis. In the program for finding spurious outputs from mixing of two input signals, the two input frequencies can lie anywhere within the ranges from f_{11} to f_{12} and from f_{21} to f_{22} , respectively. The program finds coefficients of any spurious frequencies that lie in the range from f_{B1} to f_{B2} .

yield frequencies f_s in the test range of interest between f_{B1} and f_{B2} .

The calculator begins the analysis with the order equal to 1. When both first-order spurs have been tested, the calculator tests all second-order spurs. The process continues until a spur falling in the test range is found or until the calculator is stopped; to conserve time, the program tests two products simultaneously. The calculator displays the coefficients in the form $M + N/100$ for the sake of brevity so that a -2×5 spur is shown as 2.05, as is a 2×-5 spur. The user decides, if he wishes, which coefficient is negative.

The calculator selects one set of positive values for M and N . Each set defines two mixer products, either or both of which may be spurs—i.e., in the output pass-band. The potential spurious product P_1 results when the term Mf_1 is positive and the term Nf_2 is negative. P_2 is the mirror image of P_1 , in which the term Mf_1 is negative and Nf_2 is positive. Either or both products may be spurs, and if the calculator finds that P_1 does not fall in the output test range, it tests P_2 . If P_1 does fall in the test range, the calculator displays the values of M and N . If P_1 and P_2 are not in the test band, the calculator proceeds to the next set of values. The program is shown in the table.

The program is run by following these steps:

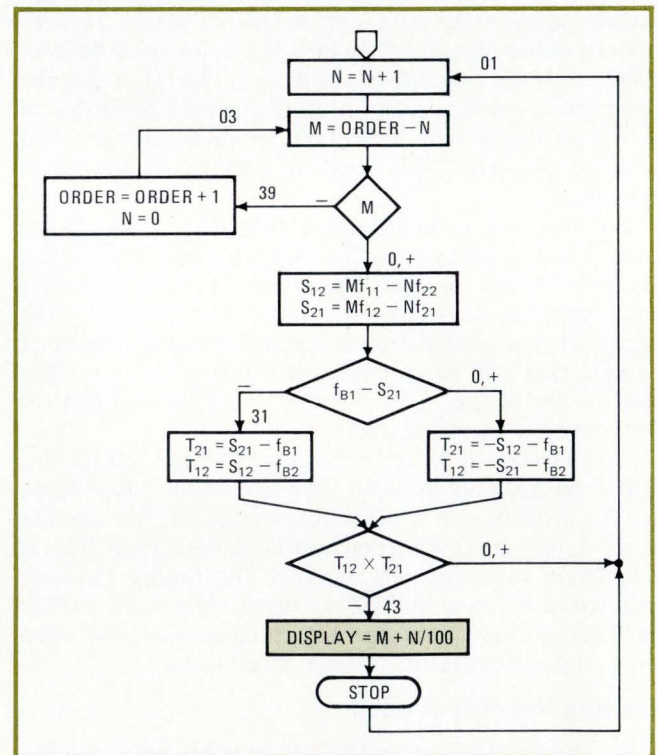

2. The light at the end of the program. Flow diagram for spur-analysis program shows that the calculator displays the coefficients for spurious outputs. Program then stops, but can be restarted with R/S button. The complete program is listed in the table.

HP-25 PROGRAM FOR SPUR ANALYSIS WITH
ARBITRARY TEST RANGE

LINE	CODE	KEY
00	-	-
01	01	1
02	23 51 07	STO+7
03	24 00	RCL 0
04	24 07	RCL 7
05	41	-
06	15 41	g x < 0
07	13 39	GTO 39
08	24 01	RCL 1
09	61	X
10	24 07	RCL 7
11	24 05	RCL 5
12	61	X
13	41	-
14	24 00	RCL 0
15	24 07	RCL 7
16	41	-
17	24 04	RCL 4
18	61	X
19	24 07	RCL 7
20	24 02	RCL 2
21	61	X
22	41	-
23	24 03	RCL 3
24	14 41	f x < y

LINE	CODE	KEY
25	13 31	GT031
26	22	↓
27	32	CHS
28	21	xoy
29	32	CHS
30	24 03	RCL 3
31	41	-
32	21	xoy
33	24 06	RCL 6
34	41	-
35	61	X
36	15 41	g x < 0
37	13 43	GTO 43
38	13 01	GTO 01
39	23 41 00	STO-0
40	34	CLR x
41	23 07	STO 7
42	13 03	GTO 03
43	24 07	RCL 7
44	01	1
45	15 21	g %
46	24 00	RCL 0
47	24 07	RCL 7
48	41	-
49	51	+

REGISTER ASSIGNMENTS

7	N (init = 0)				
4	f ₁₂	5	f ₂₂	6	f _{B2}
1	f ₁₁	2	f ₂₁	3	f _{B1}
0	Order (= 0)				

- Load program into the calculator.
- Store the initial value of the order, 0, in register R₀; store the lower limits for each range, f₁₁ in R₁, f₂₁ in R₂, and f_{B1} in R₃, and store the upper limits for each range, f₁₂ in R₄, f₂₂ in R₅, and f_{B2} in R₆. Store 0 (the initial value of N) in register R₇.
- Press f, PRGM, and R/S.

The flow diagram in Fig. 2 shows what the program does. The first step is to increment N by 1. M is then calculated and tested, and the test is used to increment the order of the spur when required. After values are found for M and N, the end points of the frequency range of product P₁ are calculated. The highest possible frequency for P₁ is the value S₂₁. This value is compared with the lower limit of the output test range.

If the highest frequency of the mixer product P₁ is still less than the low end of the test range, then P₁ cannot be a spur and the calculator prepares P₂ for test. In both cases, the end points of the range of possible frequencies of the selected product are then compared with the output test range limits.

The test values T₁₂ and T₂₁ in the next step must have the same sign for the range of the selected product to be safely outside the output test range. If not, a spur exists and the calculator jumps to the display routine. The display routine retrieves the value for N and divides it by 100. This result is added to M to produce the displayed number.

The program stops when a number is displayed, but a push on the R/S button starts it again.

Example:

- Low input range: 11 to 12 MHz
- High input range: 21 to 22 MHz
- Test range: 31 to 35 MHz

Procedure:

Load registers; initialize R₀ and R₇ to 0

Results:

- 3.00 (± 3f₁ ∓ 0f₂)
- 1.02 (± f₁ ∓ 2f₂)
- 5.01 (± 5f₁ ∓ f₂)

□

Log-ratio module measures high resistances

by Bucky Crowley
Butler Automatic Inc., Newton, Mass.

It doesn't take a voltmeter with a range switch to provide full-range measurement of low-level currents or high resistances. All it takes is a log-ratio module coupled with a voltmeter.

The module compares an unknown current to a reference current, producing an output voltage proportional to the ratio of the logarithm of the two currents. This proportionality allows accurate measurements over large ranges of input current. The inexpensive log-ratio module is a standard product from such firms as Analog

Devices, Teledyne Philbrick, Intronic, and others.

The current-input terminals of the module are internally connected to inverting terminals of operational amplifiers, so they are at virtual ground. Therefore the driving voltage is applied to just one end of the device under test, as shown in the circuit diagram.

Reference currents of either 10⁻⁶ ampere or 10⁻⁸ A are provided. The output voltage is equal to k × log(I_{SIG}/I_{REF}), but here the module has been connected so that k is 1 volt per decade. The bias current into the op amps is less than 10⁻¹¹ A, so resistance measurements can be accurate within 1% to 10¹⁰ ohms (10 v and 1 nanoampere) and have resolution of 10¹² ohms (10 v and 10 picoampere).

The table shows how this measurement technique is used for the production testing of different components. For example, to test the leakage in diodes, the reference input is set to a current that represents an acceptable level; screening for leakage current greater than 10 nA



More Super-Fast Silicon Rectifiers

Featuring 30 nanoseconds Reverse Recovery Time

A breakthrough in junction technology makes Super-Fast silicon rectifiers possible. These new high speed silicon rectifiers feature low forward voltage drop at higher operating currents and reverse recovery time better than 30 nanoseconds. In addition, these devices have extremely low reverse leakage and high surge ratings. Super-Fast rectifiers use Semtech's proven Metoxilite non-cavity monolithic high temperature construction. Designed for high frequency applications, such as high speed switching regulators and converter circuits. Semtech's Super-Fast silicon rectifiers are stocked for immediate delivery.

LO-V_F Metoxilite

Available as JAN, JAN TX & JAN TXV
to MIL-S-19500/503 (EL)

Types: 1N6073, 74 & 75 (Trr 30ns)

PIV: 50, 100 & 150V
Reverse Current (Max.): 1 μ A DC @ 25°C
Instantaneous Forward Voltage @ 1.5A:
1.0V @ 100°C

Capacitance @ 12V DC (Max.): 24 pF
Single Cycle Surge Current: 35A
Dimensions (Max.): Body .070" D x .165" L
Leads .031" D x 1.25" L

Types: 1N6076, 77 & 78 (Trr 30ns)

PIV: 50, 100 & 150V
Reverse Current (Max.): 5 μ A DC @ 25°C
Instantaneous Forward Voltage @ 3.0A:
1.0V @ 100°C

Capacitance @ 12V DC (Max.): 58 pF
Single Cycle Surge Current: 75A
Dimensions (Max.): Body .110" D x .165" L
Leads .040" D x 1.10" L

Types: 1N6079, 80 & 81 (Trr 30ns)

PIV: 50, 100 & 150V
Reverse Current (Max.): @ 25°C 10 μ A DC
Instantaneous Forward Voltage @ 5.0A:
.8V @ 100°C

Capacitance @ 12V DC (Max.): 230 pF
Single Cycle Surge Current: 175A
Dimensions (Max.): Body .165" D x .165" L
Leads .040" D x 1.10" L

"State-of-the-art"

Types: FF30, FF40 & FF50 (Trr 30ns)

PIV: 300, 400 & 500V
Reverse Current (Max.): 1 μ A @ 25°C
Instantaneous Forward Voltage @ .5A:
1.5V @ 25°C
Capacitance @ 12V DC (Max.): 15 pF
Single Cycle Surge Current: 10A
Dimensions (Max.): Body .070" D x .165" L
Leads .031" D x 1.25" L

Types: 3FF30, 3FF40 & 3FF50 (Trr 30ns)

PIV: 300, 400 & 500V
Reverse Current (Max.): 5 μ A @ 25°C
Instantaneous Forward Voltage @ 1A:
1.5V @ 25°C
Capacitance @ 12V DC: 20 pF
Single Cycle Surge Current: 25A
Dimensions (Max.): Body .154" D x .165" L
Leads .040" D x 1.10" L

LO-V_F DO-4 Stud

**Types: SFF05, 10 & 15 and
*2SFF05, 10 & 15 (Trr 30ns)**

PIV: 50, 100 & 150V
Reverse Current (Max.): IR:
10 & *20 μ A DC @ 25°C
Instantaneous Forward Voltage:
VF @ 10A DC: 1.1V @ 25°C
*VF @ 20A DC: 1.2V @ 25°C
Single Cycle Surge Current: 125 & *250A
Dimensions (Max.): Body .424" D x .405" H

DO-4 Doublers & Center Taps

**Types: SDF05, 10 & 15;
SNFF05, 10 & 15,
& SPFF05, 10 & 15
(Trr 30ns)**

PIV: 50, 100 & 150V
Reverse Current (Max.): IR @ PIV:
10 μ A DC @ 25°C
Instantaneous Forward Voltage VF @ 10A:
1.1V @ 25°C
Single Cycle Surge Current: 125A
Dimensions (Max.): Body .424" D x .405" H

LO-V_F DO-5L Stud

Types: STFF05, 10 & 15 (Trr 40ns)

Add "R" to type number
for reverse polarity
PIV: 50, 100 & 150V
IR (Max.) @ PIV:
@ 25°C 0.1mA &
@ 100°C 3mA
VF (Max.) 10A:
@ 25°C .84V; @ 100°C .70V; @ 150°C .63V
VF (Max.) 30A:
@ 25°C .96V; @ 100°C .85V; @ 150°C .78V
VF (Max.) 50A:
@ 25°C 1.05V; @ 100°C .93V; @ 150°C .90V
Dimensions (Max.): Body .64" D x .50" H
Stud 1/4 28 UNF x .43" L

NEW

LO-V_F DO-5DL Isolated Stud

**Types: STFF05DL,
10DL & 15 DL
(Trr 30ns)**

PIV: 50, 100 & 150V
Reverse Current (Max.): IR 20 μ A @ 25°C
Instantaneous Forward Voltage @ 10A:
1.2V @ 25°C
Single Cycle Surge Current: 250A
Dimensions (Max.): Body .64" D x .50" H
Stud 1/4 28 UNF x .43" L

★ ★ ★ ★

1975 NATIONAL SBA SUBCONTRACTOR OF THE YEAR

**SEMTECH
CORPORATION**

652 Mitchell Road, Newbury Park, California 91320
(805) 498-2111 • (213) 628-5392 • TWX: 910-336-1264

CHICAGO: (312) 352-3227 • DALLAS: (214) 387-3551
FLORIDA: (305) 644-5404 • MARYLAND: (301) 424-6663
NEW JERSEY: (201) 654-4884 • SAN FRANCISCO: (415) 494-0113
EUROPEAN SALES: Bourns AG Zug, Switzerland (042) 232-242

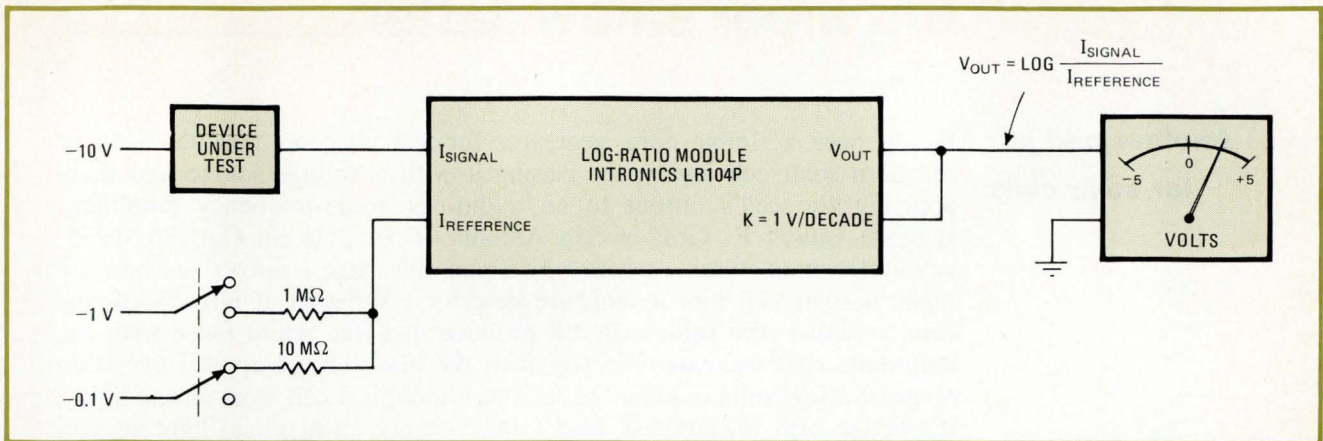

Covering many ranges. A log-ratio module produces an output voltage proportional to the logarithm of the ratio of currents at inputs, so currents or resistance values can be measured without need for a range switch. Connections shown here give 1 V per decade of current ratio, and a reference current of 10^{-8} A. Hence, signal currents of 10^{-3} to 10^{-8} A (or test resistors of $10^4 \Omega$ to $10^9 \Omega$) yield outputs of 0 to +5 V.

TYPICAL LOW-CURRENT MEASUREMENTS

INPUT TO DEVICE UNDER TEST	DEVICE UNDER TEST (CONNECT TO I_{SIGNAL} INPUT)	MEASUREMENT
-1 V		Incoming sorting of resistors without range switching, over 6 decades ($1 \text{ k}\Omega$ to $1 \times 10^9 \Omega$).
-10 V		Switch leakage.
-10 V		Connector leakage.
-10 V		Printed-circuit board process leakage.
Voltage per specification		Diode leakage.
Voltage per specification		Capacitor leakage.
-10 V		Potting materials, insulating oils, etc.

requires a reference current of 10 nA (0.1 V and 10 megohms). Acceptable diodes will produce negative output voltages, and rejects will yield positive numbers, the exact values on the voltmeter being expressed in logarithms. For instance, if the meter reads +2.00 V, the device fails (because the sign is positive), and the leakage current is 100 times worse than specification because the antilog of 2 is 10^2 or 100.

In measuring the leakage current of a capacitor, a few extra components are used, as shown in the test arrange-

ment in the table. The capacitor is charged to the desired voltage through the 10-kilohm resistor, and the switch is opened to take the reading of leakage. The other resistor, R_{Large} , prevents noise from being coupled from the supply into the input. This resistor should be as large as possible, but not large enough to cause a significant dc drop at the expected leakage current. □

Engineer's notebook is a regular feature in Electronics. We invite readers to submit original design shortcuts, calculation aids, measurement and test techniques, and other ideas for saving engineering time or cost. We'll pay \$50 for each item published.

Another odd job for solar cells

If you need a simple noise generator for test purposes and you have a selenium solar cell handy, try biasing it with a voltage source and then applying the cell's output to an audio- or radio-frequency amplifier, suggests Calvin R. Graf of San Antonio, Texas. (In an Oct. 30, 1975 newsletter item, Graf—a heavy hitter on this page—showed us how to make a solar cell into a moisture detector.) Whether it is forward- or reverse-biased, **the solar cell will produce hiss-like white noise with an amplitude that increases directly with the bias voltage** applied over the range of a few volts to about 15 v. And although it can work in the light, it's better kept in darkness, says Graf, because an artificial light source, like an incandescent or fluorescent lamp, causes 60-hertz power-line hum that overrides the cell's white-noise output, especially when the cell is forward-biased. Fluorescent lamps, he notes darkly, are worse than incandescent.

PROMs make it easy to change frequencies

Designers of phase-locked-loop frequency-control circuits can take a cue from some manufacturers of citizens' band radios, who have discovered how to change a circuit's operating frequency without redesigning it. They use a programable read-only memory to control the programable counter that locks the phase-locked loop to a particular frequency. **A simple code change in the field then results in a new frequency.**

A see-through pc board

Looking for a fancy circuit board? Try Rogers Corp., supplier of die-stamped printed-circuit boards. Its Electro Components division in Rogers, Conn., (203) 774-9605, will accept special orders for fiber-glass boards with conductive patterns of copper, stainless steel, brass—you name it. The division's latest is **a see-through board made of Lexan, a popular material for storm doors and windows.** The plastic was chosen, say Rogers engineers, because it lends itself to die stamping. In fact, die stamping is the key to making pc boards out of offbeat materials that take poorly to the normal board laminating and etching processes.

How to cash in on scrap disk heads

Before throwing away any crashed heads—worn-out magnetic-disk heads to those of you in other businesses—check with Trans-Data Corp., 170 Glenn Way, Belmont, Calif. 94002. The company repairs and refurbishes disk equipment for third-party maintenance companies, OEM manufacturers, and disk users, and it is **looking for disk heads that are compatible with the IBM 2314 or 3330 models.** Call Trans-Data's Don Collier at (415) 593-8545.

It's simple, we're told, to make sample-and-hold more precise than of old

You can, of course, build a sample-and-hold circuit by using an analog-to-digital converter to drive a digital-to-analog converter that controls a programable power supply [*Electronics*, July 22, p. 120]—but there's an easier way, says Henry E. Schaffer, professor of genetics at North Carolina State University in Raleigh. Just replace the two converters with a single tracking a-d converter.

Better still, it's a more accurate method. Included in a tracking a-d converter is an up/down counter that drives a d-a converter, and when disabled stops the converter's output at its most recent value. **Since this internal d-a converter operates inside a feedback loop, its accuracy is improved to the limits of its resolution,** says Schaffer. Like all precision sample-and-hold methods, this one's slow—but that's not a drawback in many applications.

—Laurence Altman

SERIES 40's Frequency Marker ends frequency-chasing and control-twiddling.

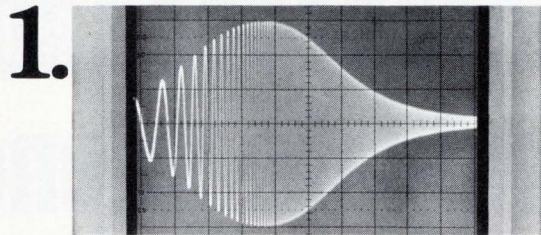

Sweep the Unit Under Test. Here, for example, is the output of a filter being swept from 600 Hz to 60 KHz on channel 1 of the scope.

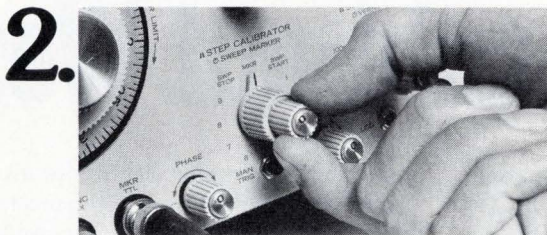

Select Sweep Marker. On Interstate's new F47 function generator, you select "Marker" and set its TTL output on the scope's channel 2.

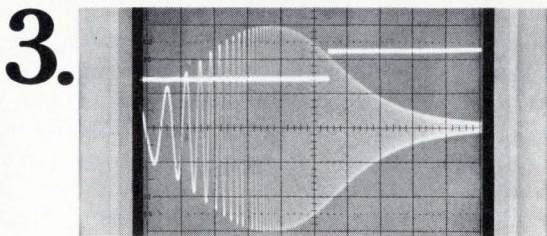

Adjust the vernier. Then you fine-tune the marker vernier to pinpoint the TTL step at the exact position on the waveform for which you want to know the frequency. On the scope shown, the marker is positioned at the 70% roll-off point... the -3 db level.

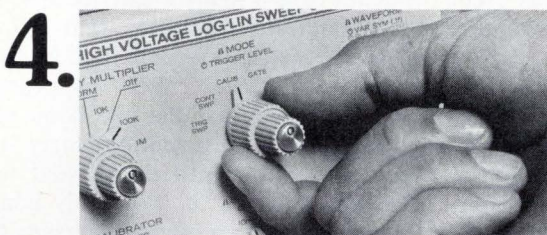

Select Calibrate Mode. Next, you switch from the Continuous Sweep Mode to the Calibrate Mode.



Get the exact frequency. A counter at the F47's output will then display the precise frequency at which the filter's -3 db point occurs.

SERIES 40 Function Generators - New from INTERSTATE



SERIES 40 is the only function generator line with marker, 10-step frequency calibrator, state-of-the-art high output voltage to 40 v p-p open circuit, and Interstate's exclusive direct-reading sweep width control. The best function generators money can buy from \$475 to \$695. Write for

INTERSTATE
ELECTRONICS CORPORATION

Subsidiary of A-T-O Inc.

the new SERIES 40 catalog for complete specifications and prices.

P.O. Box 3117, Anaheim, California 92803 • (714) 549-8282 • TWX U.S.A. 910-591-1197 • TELEX 655443 & 655419



Microprocessors dominate scene at sold-out Wescon

□ For its silver anniversary, the Western Electronic Show and Convention, which is being held in Los Angeles September 14 through 17, may be celebrating one of its most successful shows. Unquestionably the stimulus comes from the booming electronics industries, a welcome condition that Wescon organizers are hoping will renew buyers' interest in big trade gatherings.

In terms of numbers of exhibitors and projected attendance, the 1976 show should not only be the largest since 1970, but could approach the halcyon days of the 1960s, when Wescon, together with the East Coast spring convention of the Institute of Electrical and Electronics Engineers, dominated the electronic industries new-product introductions.

Sold out since early summer, Wescon/76 has attracted nearly 400 companies, who will occupy more than 740 exhibition units in 170,000 square feet of the Los Angeles Convention Center. (Last year's show in San Francisco's Brooks Hall had 530 booths.) Moreover, Wescon officials are expecting from 30,000 to 35,000 visitors at some three dozen technical sessions.

Prospects for big trade shows began picking up at last year's gathering, when more than 31,000 visitors turned out, marking an upswing from several lackluster earlier shows. Next came this spring's Electro/76, the IEEE's successful Boston event. It drew 22,000 attendees at the technical sessions and saw some brisk exhibitor action on the convention floor. Thus, two good U.S. trade shows in succession have set the stage for big things at Wescon/76.

Microprocessors aplenty

While good business provides the backdrop, the colorful icing on Wescon's 25th birthday cake is the glamour aura of microprocessors that promises to permeate the show. Along with more than one third of the technical sessions devoted to some aspect of the devices, a complete array of processor product lines will be there. Two suppliers, Intel and Mostek, will show their own devices, which also will appear with other lines

at the booths of major electronics distributors.

The excitement of having the most advanced semiconductor products at a show is considered an important event, lacking since the big semi houses pulled out in the mid-1960s. Cramer Electronics, occupying 15 booths, and Hamilton-Avnet Electronics, with 14 booths, as well as Semiconductor Specialists and Wyle Distribution Group, are four major distribution firms showing complete microprocessor lines and related design and simulation systems. In addition, Avnet will display microprocessor software from Ryan-McFarland Co., which it calls a first for distributors.

An interesting question that will be raised by the attention distributors will undoubtedly get with their processor hoopla is: "What happens at future shows?" One view holds that the big manufacturers will remain content to let distributors carry their selling load, supporting them with money and technical personnel. Others familiar with the highly competitive nature of semiconductor marketing speculate that swelling Wescon crowds at distributor booths might well cause the makers to jump right back into the shows.

Avnet president Tony Hamilton agrees with the latter view. "My feeling is this trend will retrigger the interest of chip manufacturers to come back in, in a big way, and with their full lines," he says.

While resolution of this question will play a big role in determining the shape of future Wescons, the product composite of the show is already changing. Past Wescons maintained a rough balance between the components/packaging and instrument categories, with each having about 40% of the exhibits. This year finds the former category up to about 55-60% of the exhibits. Instruments, with the same number of companies as in the past, is down to about 35% of a larger show.

Moreover, new product activity at Wescon appears to be somewhat stronger than in 1975 (see p. 131). But it is below Electro/76, where companies rushed new model introductions to take early advantage of the upturn in the national economy.



Wescon in the beginning

Wescon can trace its origins to 1944, when a group of West Coast electronics pioneers decided that a trade show would be a good way to sell products in the post-world-war period. Spearheaded by the late Les Hoffman, a prominent manufacturer of electronic equipment, the show made its debut at the Los Angeles Elks Club. It featured mostly radio equipment laid out on card tables. A few hundred local engineers attended.

So it remained through the late '40s—a small regional event sponsored by the West Coast Electronics Manufacturers' Association (now called WEMA), which put on the trade exhibits, and the Institute of Radio Engineers (the IEEE now), which organized the technical program. But, in

1949, the institute pulled out and held its technical sessions separately (goaded by purists who saw the trade portion of the convention as a distraction). The trade show almost died.

In 1952, the manufacturers convinced local institute officials to come back. Wescon as it's presently conceived got started—this time in the Long Beach Municipal Auditorium where 25 companies displayed their wares. A few years later, the show began alternating between Los Angeles and San Francisco. Since then, participation has built steadily, with the peak years coming in the aerospace boom of the mid-1960s, when nearly 50,000 were attracted to the shows at the Los Angeles Sports Arena.

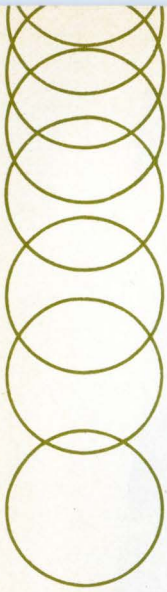

Like the exhibition, the technical program is tilted toward microprocessor system design—with the emphasis, appropriately, on software and system development. Attendees should be warned, however, that the organizers oriented the sessions toward high-performing, rather than low-cost, designs, perhaps influenced by the many aerospace and military-system designers from firms in the area that are always attracted to Wescon when it's held in Los Angeles.

The instrumentation sessions will be good companions to the ones on microprocessors, presenting digital-measurement techniques, several new instruments for analyzing the digital domain, and devices for testing digital, large-scale integrated circuits. The communication sessions are less focused, covering a wide-ranging assortment of topics from satellite-borne radar equipment to new techniques in surface acoustic waves. Also included is an excellent calculator-user session, a good one on component reliability, and a rather specialized session on high-performance digital-circuit techniques. Finally, there are two sessions on jobs, careers, and unions.



computers

□ Anyone doubting that microprocessors are already out of their adolescence need only look at the Wescon/76 program. Of the host of papers devoted to microprocessors, none introduces a new device. Rather, they are devoted to design problems associated with presently available devices and to their impact on computer systems, as well as to formulating guidelines for the standardization of microprocessors for military programs.

Particular attention is being given to bipolar bit-slice microprocessors in Session 26, which comprises four papers, one from each of the major makers of bit-slice devices—Fairchild, Advanced Micro Devices, Intel, and Monolithic Memories. First, Peter Alfke, of Fairchild Microsystems, San Jose, Calif., distinguishes between presently available families of devices: Intel's 3000 series; Monolithic Memories' 5700/6700 family; Advanced Micro Devices' 2900 family; Fairchild's Macrologic, and Motorola's M10800 family.

The session then turns to three aspects of bit-slice devices: microprogramming, present and future applications, and the impact on computer systems.

Monolithic Memories' John Birkner, in "The Bipolar Microprocessor Revolution of 1976," makes the point that the rapid pace of development of bipolar large-scale integration is beginning to outrun the ability to use it. The next generation of bipolar microprocessors, he says, "will face the challenge of making everything—programmable ROMs, RAMs, field-programable logic arrays, and interface circuits—play together with maximum speed in minimum real estate."

One way is through distributed processing, in which each block performs a few specialized functions with maximum efficiency. A task processor, for example, could direct the system by interpreting the stored program, responding to interrupts, and controlling other processors, while a multiply-divide processor could perform those specialized tasks, and a special-function processor could perform such operations as floating

point, square roots, or transcendental functions.

Also included in session 26 is a good tutorial review on microprogramming techniques. John Mick, Advanced Micro Devices Inc., Sunnyvale, Calif., suggests that an engineer beginning his first microprogramming job temporarily ignore the width of the microprogram words and concentrate on the machine architecture. Later, he can study the format of the words to see if any bits may be saved in the width of the microprogram memory. (This is one of the few papers that must be read carefully to get its full import, since Mick is teaching a technique.)

Finally, Rob Walker of Intel Corp., Santa Clara, Calif., will present survey results on applications of bit-slice microprocessors. Walker asked engineers working on 30 different projects for their comments on data word length, emulation of instruction sets, speed program preparation, sizes of microprogram stores, and so on.

One of his major conclusions is that most users have been attracted to the bipolar bit-slice devices because of their higher speed compared with MOS devices, rather than the flexibility inherent in microprogramming. This leads him to believe that many of the present applications will eventually fall prey to higher-speed MOS devices with fixed instruction sets.

The Navy standardizes

Session 11 contains the papers on military standardization of microprocessors and microcomputers with Ralph Martinez, Naval Electronics Laboratory Center, San Diego, Calif., covering the Navy's program. He says the program is aimed at selecting a commercially available 8-bit central processing unit, since "the 8-bit technology has matured sufficiently to be well-sourced and price-competitive." Moreover, the development time (estimated at two to four years) and cost (estimated between \$2 and \$10 million) "is simply not favorable for a custom 8-bit CPU development," he adds.

On higher-performing devices, Martinez reports that the technology is not adequately developed to specify a standard for 16-bit or slice CPUs. But the Navy's work will move forward in this area during the next year.

In session 28, John Stidd, Four Phase Systems, Cupertino, Calif., shows the effect of LSI circuit technology on traditional computer design. Its impact has been restricted primarily to the central processing unit itself.

While the CPU never accounted for more than 10% of the total system cost, one built with large-scale integrated circuits offers more capability at a lower price. For \$2,500, Stidd says, LSI techniques may soon provide a 32-bit CPU with 32,000 words of memory and many features that cost \$25,000 to \$30,000 today.

Also in this session is Robert F. Wickham's overview of the next generation of LSI computer systems. Wickham, president of Vantage Research Services, Los Altos, Calif., notes that "we are already into the stage where the chip design must also take into account the system architecture and system software." He goes on to make the point that the cost of software and system overhead required for the extensive operating systems will move more of the software into hardware and result in the increased use of high-level language for applications programs. Thus, the present high start-up costs for high-level language programs will be offset by reduced memory costs and processors compiling and translating the language directly into machine language.

Charles Bass, Zilog Inc., Los Altos, Calif., takes off on this point in "Microprocessor Architecture versus High-level Language Execution." Although microprocessors will undoubtedly be built to execute high-level language programs directly, he concludes this approach will be secondary to processor designs that simplify the translation and execute the code more efficiently.

Viewing development

Development systems are the meat of session 16. Bruce Gladstone, Microkit Inc., Santa Monica, Calif., points out that there are two basic approaches in development systems—using one or two microprocessors. The two-processor approach allows one to act as a host to run the system, while the target, or user's microprocessor, executes the program under development. Only a minimum of new software is needed for each new target processor added. But the technique does require extra processor or hardware and could create problems in matching new processors to the timing of the memory bus. On the other hand, the single-processor approach requires new software each time a new device is added; yet it's cheaper, needing less hardware.

In-circuit emulation is the subject of a paper by Roger Doering, Digital Electronics Corp., Berkeley, Calif. He introduces a new control scheme, called bus intercept. It involves a two-processor system in which the master processor intervenes during emulation and takes control of the user system by substituting a set of instructions stored in a stack. For example, the master would take over upon sensing a certain breakpoint address on the address bus. The scheme, however, is not in use on any commercial system.

In session 32, "Single-Board Computers: The Emerging Micro vs. Mini Battle," two minicomputer engineers, Duane Dickhut of Digital Equipment Corp., Maynard, Mass., and Ed Zanders of Data General Corp., Southboro, Mass., will present the minicomputer side of the controversy. Dickhut looks at the software available for development, while Zanders gives an overview.

Each author, rather than being strictly mini-oriented, has one foot in the minicomputer camp, since each

company offers a computer on a board—DEC's LSI-11 and Data General's microNova. Each points out the minimaker's main strength—software compatibility with larger computers—but Dickhut notes that it's not easy to quantify such aspects as flexibility, ease of use, and price/performance. He recommends that a potential user study the available operating system for a comparison of the usefulness of such basic design tools as an editor, an assembler, and a debugger.

George Adams, Intel, will present the semiconductor maker's viewpoint on microcomputers, using his company's SBC 80/10 as an example [*Electronics*, Feb. 5, p. 79.] Such devices, he says, allow a manufacturer to add computer control to a product without incurring the costs and long development time of designing a controller from scratch.



instruments

□ While automatic test equipment gets plenty of attention in the instrumentation sessions, the chief emphasis is an analysis of microprocessor design. "The wave of new microprocessor applications has brought with it a wave of new measurement problems not easily solvable by traditional time-domain analysis," say Thomas A. Saponas and Jeffrey H. Smith of Hewlett-Packard's Colorado Springs division.

Their paper on logic-state analysis describes the features and applications of HP's new model 1611A microprocessor analyzer. It is one of four in session 17 devoted to testing in the data domain.

Saponas and Smith point out that time-domain measurements aren't very important in most microprocessor systems, since there is no specific test to be performed on the 24 signal lines that make up the primary signal path. "The important measurement is the flow of information on those 24 lines," say the authors.

Looking at analyzers

Along with HP's model 11611A, other new circuit analyzers aimed at the needs of the microprocessor user are Motorola's MPA-1, Scanoptik's Logicorder 32, and Systron-Donner's model 50. In session 16, Zoltan Tarczy-Hornock, director of research for Systron-Donner Corp., Concord, Calif., shows how the analysis of the complex random logic of microprocessor designs can be simplified by allowing direct connection to the processor sockets instead of the myriad of separate leads needed in older analyzers. Moreover, these newer instruments may offer octal, hexadecimal, or (as in the case of HP's instrument) alphanumeric mnemonics. All of them are compatible with a microprocessor's operating codes.

Differentiating between the classes of analyzers is the subject of a session 17 paper from Edward S. Jacklitch of Biomation Corp., Cupertino, Calif. He explains that timing analyzers display a timing diagram for the digital circuit under test so that the user can examine timing relationships among several digital signals. On the other

hand, state analyzers display signals in 1s and 0s so that the user can examine the information on the display from the software point of view. Timing analysis is especially useful in catching hardware problems, while state analysis is best for uncovering software bugs.

A hybrid class of logic analyzers, capable of both timing and state analysis, has recently become available. Carver Hill of E-H Research, Oakland, Calif., describes his firm's entry into this class, the model 1330 Digiscope. His paper shows how the instrument can display the data during each bit-time as a column of three octal digits below the timing-diagram curves. Thus the user can obtain logic-state information directly from the screen without translating it from waveforms.

Plugging in

Tektronix Inc.'s digital-analyzer approach is embodied in the 7D01 logic analyzer plug-in unit [*Electronics*, April 29., p.121] and a new DF1 companion digital formatter. These instruments are the subject of a paper by Murlan Kaufman, project manager for the series for the Beaverton, Ore., firm. The beauty of the Tektronix units is that, taken together, they permit selection with a front-panel switch of timing diagrams, state diagrams, or map-like displays of digital data. The state table can then be coded in binary, octal, or hexadecimal notation—again, a feature intended to appeal to designers of microprocessor-based circuits.

Two sessions deal with automatic test equipment. Both functional and in-circuit testing will be explored, with a description of the costs of hardware and software associated with each method. The emphasis on ATE hardware/software tradeoffs was built into the session, says GenRad Inc.'s Robert Szpila, organizer and chairman of session 8, "because even after an appropriate automatic tester has been chosen, you can spend a fair amount in software and additional hardware just to get going. And there's a different formula for functional or in-circuit methods.

Another hidden cost in ATE systems is preparing test programs, and that's the subject of a paper by Pat Harding and Wade Williams from GenRad, Concord, Mass. "As board complexity increases", they say, "cost for test-program preparation can become the dominant cost item, while the cost for the test system and its operator becomes less significant."

Monitoring test sequences

GenRad's approach to cutting ATE programing costs, called interactive test-generation, involves an interactive simulation system to monitor the effects of test sequences as they are added to the test program. Thus, test programs can be developed in stages, sequence by sequence, and the results obtained quickly.

A different scheme aimed at similar ends applies pseudorandom patterns to the unit under test. The technique, explains Noel Lyons, Fluke Trendar Corp., Mountain View, Calif., boils down to the fact that if enough patterns are used and analysed in any one measurement, any fault present will be uncovered. He says this vastly reduces the time take in selecting a set of test programing, since all patterns are used.



communications

□ This year's communications sessions concentrate on three areas: satellite transmission (three sessions) and fiber-optic and surface-acoustic-wave technologies for secure communications and commercial television systems (one session each). Perhaps most interesting of the satellite papers is the entry in session 20 from NASA's Goddard Space Flight Center, Greenbelt, Md., on improvements in search and rescue programs using satellites. It deals with a relatively cheap, low-altitude satellite method for finding downed aircraft equipped with emergency locator transmitters.

"The old way of searching with volunteer aircraft is inadequate because all areas of the U.S. can't be covered," says coauthor D. L. Brandel. "In contrast, our satellite system not only detects the radio signals from low-power beacons aboard downed aircraft, but, using doppler-frequency measurement from a single satellite pass, the downed aircraft can be positioned to within 10 kilometers." Moreover, he expects a tenfold improvement in resolution. With multiple satellites, North America and the bordering Maritime regions could be covered in considerably less than 12 hours.

Satellite-borne radar systems get a good airing in session 4. Chairman Frederick C. Williams, Hughes Aircraft Co., Culver City, Calif., set up the session to concentrate on applications demanding high resolution.

Mapping Venus

Best of the lot is Williams' own paper, coauthored with two other Hughes workers, in which a synthetic-aperture radar technique for mapping Venus is described. The technique, which will be used on the upcoming Pioneer Venus spacecraft, is a good example of high-resolution systems that could also be used to map weather patterns, storms, and even predict crop yields.

"Synthetic-aperture radar increases resolution," Williams says, "because it lets you synthesize a very long antenna—kilometers long—on a very small satellite, making it possible to distinguish 5 feet at 20 miles. With conventional methods, that resolution would require an antenna several kilometers long."

To get around the complex processing required with synthetic-aperture systems, Hughes is using fast Fourier transforms in the data reduction. The FFT analysis can cut 1,000 calculations to 10—"it's what makes high-quality synthetic-aperture radar possible," he says.

The paper also describes the radar package earmarked for the Pioneer spacecraft. Operating about 200 km above Venus, the on-board system will map the surface with resolutions of less than 30 km and an altitude accuracy of 600 meters. The biggest problem was power—"we were allowed only 25 watts," Williams says, "and, rather than just using most of it to boost transmitter power, we put the major portion into signal processing except for 1 w for the transmitter and 2 w for the receiver."

In the optical-communication and surface-wave technology sessions, the emphasis is on the effect of these technologies, emerging from research-and-development laboratories, on military and commercial communications. Good general reviews on fiber technology are offered in session 14 by Don N. Williams, program manager for fiber optics at the San Diego Naval Electronics Research Laboratory, and Larry U. Dworkin and Louis Coryell of the Army Electronics Command, Ft. Monmouth, N. J. They give an overview of fiber-optic transmission applications, backing it up with data from actual systems running at their laboratories.

The session has three papers from industry. Jim E. Goell and Tom A. Eppes, ITT Electro-optical Products division, Roanoke, Va., and Gerald Aaronson and John Fulenwider of GTE Sylvania give separate updates on analog and digital fiber systems. Eric N. Randle, Valtec Corp., a W. Boylston, Mass., manufacturer of fiber cables, surveys the commercially available fiber types, giving data on bandwidth capability, attenuation, etc.

Most interesting of the surface-wave papers in session 24 is one showing how this technology is getting into commercial applications, such as TV sets, to replace costly, hard-to-tune LC filters. Surface-acoustic-wave bandpass filters, for example, are already displacing lumped-constant LC devices in intermediate-frequency filters—the subject of a paper by A. J. DeVries and R. L. Miller of Zenith Radio Corp., Oak Grove, Ill., the first U.S. TV maker to install these devices.



production

□ The weight of the evidence in session 25, which deals with wiring high-speed logic, suggests that the popular multilayer pc-board wiring methods are being superseded by Multiwire, stitch welding, Solder-Wrap, and Wire Wrap. These alternatives can lead to lower production costs, while maintaining low-loss transmission essential for fast logic. Indeed, this session should of great interest to designers of emitter-coupled-logic systems, since all the papers deal with that logic form.

R. J. Clark of General Electric Co., Syracuse, N. Y., discloses his firm's successful applications of Multiwire in a series of ECL prototype boards. He shows that Multiwire boards designed with computer aid provide a controlled impedance environment for mass production.

Comparing stitch welding

A paper by Don Moore, Moore Systems, Chatsworth, Calif., briefly reviews the advantages of the stitch-weld process and compares test results obtained for an ECL ring oscillator with a three-layer stitch-welded board and a specially balanced laboratory fixture used as a standard. The stitch-welded oscillator operated at frequencies up to 540 megahertz compared to 544 MHz for the standard, while maintaining practically constant performance over the operating range. According to Moore, this is proof enough of the worth of the process.

Robert Whitehead of the United Wiring and Manufacturing Co., Garland, Texas, describes Solder-Wrap, a new wiring process that is beginning to emerge on automatic assembly lines. It is based on machinery that can lay down, test, and solder as many as 1,800 insulated wires per hour (a faster rate than a fully automatic wire wrapper). The wire used for Solder-Wrap is a special type whose plastic insulation melts from the heat of soldering, eliminating the need for wire stripping. For high-speed logic, this system puts down twisted pairs between circuit nodes to reduce transmission losses. For transistor-transistor-logic digital integrated circuits, single wires are adequate.

Working with Wire Wrap

Len Doucet of Augat Inc., Attleboro, Mass., describes the construction details of a wire-wrappable, multi-layered IC socket panel usable with ECL packaged in dual in-line packages. In addition to providing higher speed and lower power losses, this technique allows the ECL terminating resistor lines to accept single in-line packages—which makes system layout easier and less expensive. This method eliminates the expense of wiring in many discrete resistors.

Session 3 is the latest in a continuing series of Wescon microelectronic clinics. Led by Stanley M. Stuhlborg of Hughes Aircraft Co., Fullerton, Calif., and Ralph Redemske of Teledyne Microelectronics, Los Angeles, this clinic serves as a technology-exchange program between panelists and the audience. The session will examine such topics as the application to hybrid substrates of chips on tape carriers, automatic wirebonding, and beam-leaded or flip chips.



components

□ Component reliability has long been a staple at Wescon meetings, and this year is no exception. The chairman, James E. Bridgers, a reliability specialist for Hoffman Electronics Corp., El Monte, Calif., says session 10 "will compare the manufacturing processes of military and commercial devices, with the aim of identifying those components in the lower-price commercial sector that satisfy military specifications."

The reason for this is simple. Standard military parts come in several levels of reliability, all easily identified by a military numbering system, Bridgers explains. Although popular commercial parts can also be purchased in several levels of reliability, there is no industry-standard numbering system for identifying them. "Many designers simply don't know where to get their hands on the information," he says, adding that the session should go a long way toward doing the job of providing the information.

The three papers in this session examine the manufacturing processes that determine the various reliability levels of standard commercial and military parts. Each speaker will also give some cost-effective procurement

tips for specifying commercial devices as substitutes.

Steve Stephens, a reliability engineering manager at Motorola Semiconductor Products Group, Phoenix, Ariz., will concentrate on transistors. Jerry Myers, manager of material-process engineering at Siemens Corp. in Scottsdale, Ariz., will cover diodes. And Robert Marlow, product marketing manager for tantalum capacitors at Sprague Electric Co., North Adams, Mass., will discuss solid-tantalum capacitors.

Panel follows

Bridgers will wind up the session with a panel discussion, in which the audience is encouraged to participate. Joining the three speakers will be two industry representatives for commercial-equipment manufacturers: Lincoln White, a project engineer for automotive braking systems at Rockwell International Corp. in Anaheim, Calif., and Robert Hunn, director of quality assurance at King Radio Corp., Olathe, Kan.

Reliability of power supplies in minicomputers, as well as other characteristics essential for successful design with them, will be taken up in session 2, "Minicomputer Power Supplies." It includes useful but hard-to-locate information on power-line characteristics, safety hazards, certification standards, environments, and so on.

Perhaps most useful is the paper of Rudolf Severn, a designer for The Magnavox Co., Torrance, Calif., "User Performance Characteristics for Minicomputer Power Supplies." He tabulates the wide variations of line-voltage requirements, frequency ranges, transient standards, and so on, that power-supply manufacturers must satisfy for various computer manufacturers.

This paper is followed by one from Robert Harris, an applications engineer from Underwriters Laboratories,

Santa Clara, Calif. He discloses the thinking behind UL standards on shock and fire hazards for minicomputer supplies. Finally, Kenneth Check of Hewlett-Packard's Data Systems division, Cupertino, Calif., puts it all together in "Power Supply Design for Today's Minicomputer Needs," which summarizes all the power requirements for minicomputer system design—safety, radio-frequency interference, EMI standards, and so on.

Also at this year's Wescon is a pocket-calculator update. Building on the lively response to his calculator session at Boston's Electro/76, Rudolph Panholzer of the Naval Postgraduate School, Monterey, Calif., is throwing the proceedings at session 7 open to the floor, after four experts warm up the gathering.

Here's a preview of what some of the experts will say. The founder of the HP-52 users' club, Richard J. Nelson of Statek Corp., Orange, Calif., promises to show how capabilities of existing programmable calculators far outpace the software available for them.

Users find capabilities

"Sure the user has a powerful tool, but he lacks vendor information necessary to fully apply it," he says. Nelson has many examples of how users discover capabilities not disclosed by the makers, such as extra memory and programs to call in a card with another program.

Edward Lybrand of Texas Instruments Inc., Dallas, Texas, will tell what to look for in choosing a hand-held programmable unit, giving the pros and cons of algebraic and reverse-Polish notation, etc. George McCarty of the University of California, Irvine, and Robert B. Johnson, National Semiconductor Corp., Santa Clara, Calif., will offer pointers on calculator calculus and calculator decision-making in business, technology, and government. □

Fireworks expected at career sessions

As was the case at the Electro/76 technical sessions, career-related topics will get serious attention at this year's Wescon. Indeed, the two sessions slated promise to be hot ones.

Harold S. Goldberg, president of Data Precision Co., Wakefield, Mass., will hold a West Coast repeat of a panel on the engineer past 40, which proved to be a good draw at Electro/76 in Boston in May. Expected to be provocative, session 5 will feature almost the same panel members debating topics such as: continuing education is useless; the engineer after 40 is on borrowed time, and others. As before, about a third of the time will be devoted to statements by panelists, a third to interchange among the panelists, and a third to fielding questions from the audience.

"The big fact is that it's the engineer's career, and the engineer shouldn't be deluded by others into believing that he has no control over his own career," Goldberg says. "We intend to present the facts as we see them; for facts, not demigods to hang onto, are what engineers need."

Even more likely to produce fireworks is session 30 on forming professional unions. Headed by a lawyer, Thomas A. Skornia of Skornia and Rosenblum, San Francisco, the panel will have a union representative, a successful union

stopper from industry, and a lawyer who advises both companies and individual engineers on contract negotiations.

Knowing that Southern California is a hotbed of pro-union thinking among engineers, Skornia expects that engineers in the audience will put management representatives on the spot. "The main question, it seems to me, is that, even with employment agreements in which engineers can get good salaries, fringe benefits, and even stock options, how is the engineer to be protected or avoid layoffs," he says. "The unions have an answer: organize, join a union, and be protected. But it will be interesting to hear management's answer."

Skornia intends to devote about an hour to questions from attendees to the three panelists: Jerald E. Rosenblum, also of Skornia and Rosenblum; Jerry Whipple, United Auto Workers, Bell, Calif., and Carl Peacock, ITT—Rayonier, New York.

If similar discussions held elsewhere are any indication, the audience will no doubt have a number of union organizers on hand to try to sway the engineers. And, although sessions 5 and 30 are separated by two days, they are closely related. Many engineers feel that, to help solve the plight of engineers past 40, they must organize a strong union to bargain on job security.

THE BUCK STOPS HERE!

WHEN YOUR PROBLEMS MUST BE SOLVED



360

AILTECH 360 DIRECT FREQUENCY SYNTHESIZER delivers crystal controlled signals with:

- Clean signals — spurious 100 dB below the output
- Quiet signals, phase noise floor typically 138 dB/Hz below the output
- Resolution — 0.1 Hz available
- Fast switching — 20 μ sec
- Modular — for maximum versatility
- Frequency — 10 KHz to 180 MHz (other ranges to become available)

ALL AT NEW, LOW COSTS!

AILTECH Noise Figure measuring instruments, the standard of the industry. Noise Figure Indicators, Hot/Cold Generators, Coaxial, Waveguide and Solid-State Noise Generators, Precision IF Attenuators and Test Receivers . . . A complete solution to your Noise Measurement needs. The 75 Precision Automatic Noise Figure Indicator measures Noise Figure with accuracy and resolution . . . Automatically. The 7009 Hot/Cold Standard Noise Generator — the instrument that put accuracy into Noise Figure measurements.

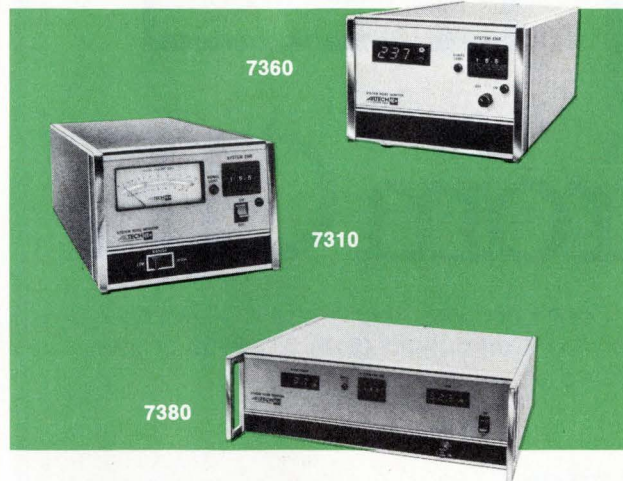

7360

7310

7380

AILTECH Spectrum Analyzers provide 100 dB display range and 10 GHz scan widths . . . higher and wider than comparable analyzers available today.

AILTECH Spectrum Analyzers feature:

- Internal Preselection
- Spurious responses 80 dB down
- Ease of use
- Automatic phase lock
- Digital Frequency Readout
- Variable Persistence and Storage Displays available
- IF filter selectivity 5:1 (60 dB to 3 dB ratio)
- Frequency :
 - 727 — 1 MHz to 20 GHz
 - 707 — 1 MHz to 12.4 GHz



727



75



7009

The AILTECH 7300 Series of System Noise Monitors are designed to satisfy those field, production and on-line system monitoring applications that demand **Simplicity, Economy and Accuracy** in their instrumentation. The System Noise Monitor Series offer half rack and full rack models, analog and digital models and an assortment of options. The 7380 digital unit provides both Noise Figure and Gain monitoring simultaneously. This single instrument converts your complex test stations into one single operation.



125

126A

445

446

473

AILTECH RF Power Signal Sources provide a broad range of High RF Power Generation. A wide variety of standard product offerings are available, spanning 10 KHz to 8000 MHz in frequency and 50 microwatts to 100 watts CW up to 1000 watts peak, power output. AILTECH's line of RF Power Signal Sources includes octave, double-octave, and decade frequency bands, plus the extraordinary versatility of plug-in frequency bands.

EAST COAST OPERATION • 815 BROADHOLLOW ROAD • FARMINGDALE, NEW YORK 11735
Telephone (516) 595-6471 • TELEX 510-224-6558

WEST COAST OPERATION • 19535 EAST WALNUT DRIVE • CITY OF INDUSTRY, CA 91748
Telephone (213) 965-4911 • TELEX 910-584-1811

INTERNATIONAL OFFICES

FRANCE—La Garenne-Colombes • Telephone (01) 780-73-73 • Telex 62821

GERMANY—Munich • Telephone (089) 5233023 • Telex 529420

UNITED KINGDOM—Crowthorne • Telephone 5777 • Telex 847238

JAPAN—Tokyo • Telephone (404) 8701 • Telex 781-02423320 (Nippon Automatic)

REMEMBER . . . THE BUCK STOPS HERE!

. . . We can help you satisfy your most difficult applications . . . call AILTECH for free engineering consultation service.

AILTECH 
A CUTLER-HAMMER COMPANY **CONTROL**

Circle 129 for Product Information
Circle 228 for Demonstration

You Don't Have To Beg, Borrow Or Buy...

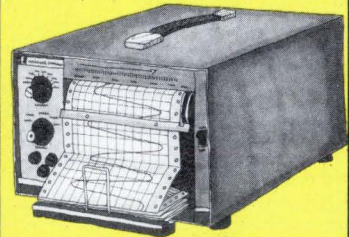
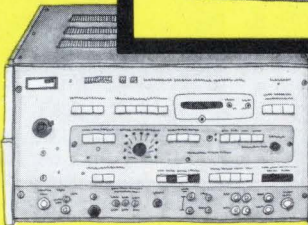
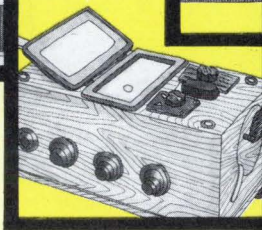
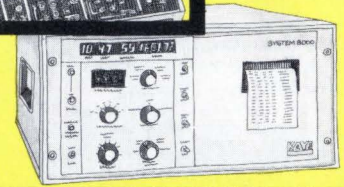
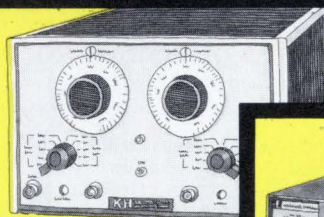
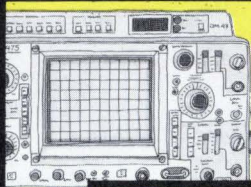
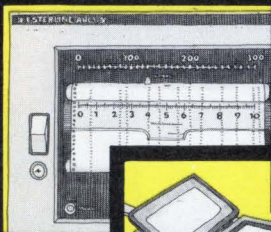
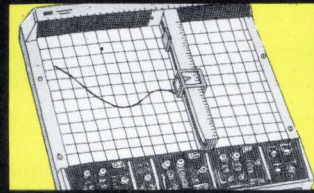

Rent 'em From GE

Short or long-term instrument rentals give you flexibility and economy.

GE has over 9,000 instruments available for immediate shipment: □ Tek Scopes □ Biddle Megger Insulation Testers □ H-P Signal Generators □ Honeywell Oscillographs □ Complete Data Systems □ Esterline Angus Recorders □ GE Chart Recorders □ Modems □ Communication Terminals . . . all calibrated to the manufacturer's specs.

We have over 100 Sales/Service Centers, and one of them is near you. In addition to maintaining our Rental Inventory, they can also repair and calibrate your own equipment.

Don't borrow someone else's GE Rental Catalog. **Call collect (518) 372-9900** or your nearest Sales/Service Center.

Quick·rental^{*}
instruments

*Trademark General Electric

GENERAL  ELECTRIC

ALA. BIRMINGHAM (205) 925-3101 • **ARIZ.** PHOENIX (602) 278-8515 or 8516, TUSCON (602) 294-3139 • **CAL.** LOS ANGELES (213) 674-7900, SAN FRANCISCO (415) 436-9260 • **COL.** DENVER (303) 371-1260 • **CONN.** SOUTHWINGTON (203) 261-4059 • **FLA.** JACKSONVILLE (904) 751-0610 • **GA.** ATLANTA (404) 458-2231 • **ILL.** CHICAGO (219) 933-4500 • **IND.** INDIANAPOLIS (317) 639-1565 • **KY.** LOUISVILLE (502) 452-3311 • **LA.** NEW ORLEANS (504) 367-6528 • **MD.** BALTIMORE (301) 837-4500 • **MASS.** BOSTON (617) 396-9600 Ext. 160, SPRINGFIELD (413) 781-1111 • **MICH.** DETROIT (313) 285-6700 Ext. 212 or 209 • **MINN.** MINNEAPOLIS (612) 522-4396 • **MO.** KANSAS CITY (816) 231-4377, ST. LOUIS (314) 342-7835 • **N.J.** CLIFTON (201) 471-6556 • **N.Y.** BUFFALO (716) 876-1200, SCHENECTADY (518) 385-2195 • **N.Y.C.** CLIFTON, N.J. (201) 471-6556 • **N.C.** CHARLOTTE (704) 525-0311 • **OH.** CINCINNATI (513) 874-8512, CLEVELAND (216) 523-6382, TOLEDO (419) 691-3501 • **OR.** PORTLAND (503) 221-5101 • **PA.** PHILADELPHIA (609) 424-4450, PITTSBURGH (412) 462-7400 • **TEX.** DALLAS (214) 357-7341, HOUSTON (713) 672-3569 • **VA.** RICHMOND (804) 232-6733 • **WASH.** SEATTLE (206) 854-0211 • **W.V.** CHARLESTON (304) 346-9421 • **WISC.** MILWAUKEE (414) 744-0110 • **PUERTO RICO** PONCE (809) 843-4225.

New products



A buyers' mood will prevail at Wescon/76

A buying atmosphere is anticipated when the 25th anniversary Wescon show convenes Sept. 14-17 in Los Angeles. Sponsors and exhibitors say their optimism springs from the gradual economic upswing plus the emergence of exciting products to be introduced.

Data-acquisition system takes 5,000 readings a second

Where high-speed testing and on-line computational capabilities are required, computer control is usually necessary. These tasks include parametric testing of electronic parts, process-monitoring and control, stimulus-and-response testing, and signal-analysis systems. To reduce costs of performing similar functions, Hewlett-Packard's 3052A automatic data-acquisition system is controlled by a calculator instead of a computer. What's more, it uses the standard instrumentation-interface bus (IEEE-488) to allow simple and low-cost restructuring of the system when the user needs change.

A basic 3052A system, priced at \$16,500, consists of a model 3455A high-resolution digital voltmeter, a model 3437A high-speed digital voltmeter, a model 3495A calculator with 6,844 bytes of memory, and accessories. The system can make dc measurements at rates up to 18 channels per second with 1-microvolt resolution on a 100-millivolt full-scale range, so that, for example, thermocouple measurements with resolutions of less than 0.5°C can be obtained.

True-rms measurements can be made up to 1 megahertz with the standard true-rms converter, and a programable fast-ac mode provides an ac measurement rate of up to 10 channels per second for inputs above 300 Hz.

Repetitive waveforms up to 1 MHz or transients below 1 kHz can be digitized by the 3437A sampling DVM. Combined with the 9825A calculator, up to 5,000 readings a second on a single high-speed chan-

nel may be stored for analysis.

By multiplexing the 3437A's input with a scanner, up to 100 channels a second can be measured with a resolution of 100 μV and 3½ digits. In addition, the 3455A DVM can make two- or four-wire resistance measurements.

The 9825A calculator can be programmed to perform such calculations as transducer linearization and statistical analysis. Multidimensional arrays allow logical data organi-

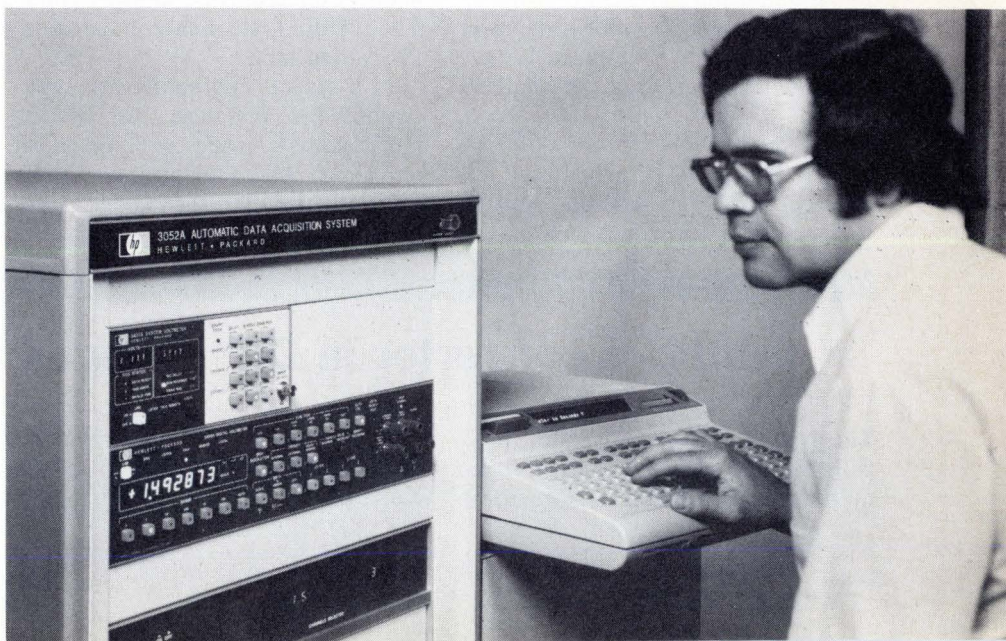

New products

zation and storage for complex testing, and a high-speed bidirectional data cartridge provides bulk data storage.

From 10 to 40 fully guarded channels are available in each 3495A scanner, and the 3052A system is expandable to 480 channels by means of the standard interface bus. A total of 14 bus-compatible instru-

ments can be connected to the system, and more channels can be obtained by the addition of one or two bus-interface cards in the calculator's input/output slots. Each such card can interface up to 14 other bus-compatible instruments.

Supplied with the 3052A is a complete system library, consisting of three volumes of documentation

to aid the user in system startup, operation, programing, and problem diagnosis. One volume contains pre-recorded program cartridges with verification checks, system-programing routines, and example programs ready to be loaded and used.

Inquiries Manager, Hewlett-Packard Co., 1501 Page Mill Road., Palo Alto, California 94304 [341]

Logic-analyzer formatter offers five display modes

As the electronics world becomes more and more digitally oriented, the demand increases for troubleshooting instruments that provide quick, direct readout—in such configurations as hexadecimal, octal, or timing diagrams; as well as binary.

Few instruments have that versatility, despite a market projected to reach \$50 million by 1980. Dave McCullough, marketing program supervisor for logic analyzers at Tektronix, says, "If you look at the 6800-type and 8080-type microprocessors, they all relate to the hex numbering system."

At the Wescon/76 show, Tektronix will introduce its DF1 display formatter, a microprocessor-controlled plug-in option to its 7000 series oscilloscopes. The formatter allows designers of microprocessors and mainframes, as well as engineers working with digital circuitry, to get the desired display state and timing mode by pushing a button.

The DF1 module, shown at lower left in the photo, is designed for use with Tektronix' 7D01 logic analyzer only. It is aimed, says McCullough, at anyone involved with digital-system design work, including microprocessor transmission systems for telephone companies, computers,

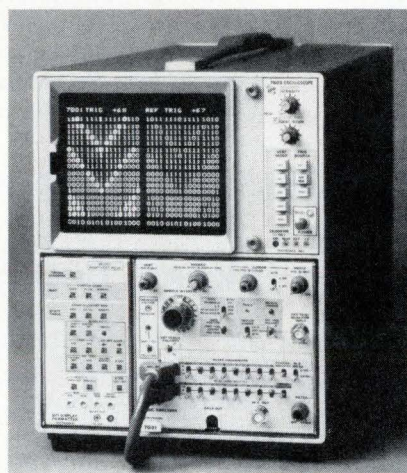

video games, and digitally controlled brake systems and similar automotive accessories—"anything that has output in terms of a high and a low that will swing from -12 to $+12$ volts," he adds. The \$1,195 DF1 displays test results in the state mode, offering binary, hexadecimal, octal, exclusive OR, and mapping. The 7D01 logic analyzer provides the timing mode.

In a typical microprocessor application, for instance, use of the hexadecimal mode will be most prevalent, McCullough says, while octal will be more useful for large-mainframe designers. To get a

"quick thumbprint" of a situation in which, for example, the operator wants to check data in a random-access memory, he would turn to the map mode. Then, if he saw a particular dot that was out of place in the map display, he could switch to hexadecimal to pin down its location even further.

The DF1 is controlled by a 6800 microprocessor in the 7D01. That 4,096-bit formattable memory plus the hex display allow the user to "page through and glance at the 4-k bits stored in the 7D01 in the form that it is in the spec sheet or whatever you happen to be checking against," McCullough says. Previously, digital troubleshooters could get that information in binary form only and had to convert it.

The DF1, says McCullough, automatically converts those configurations and, as a result, "is a tremendous time-saver to many of the software designers."

The DF1 is priced at \$1,195, but users with a 7603 scope would save \$400 since they would not need the cathode-ray-tube readout capability of the 7000 series mainframe. Delivery time is 12 weeks.

Tektronix Inc., P.O. Box 500, Beaverton, Oregon 97077 [342]

8-bit d-a converter in DIP includes storage register

The growth of microprocessor applications has stiffened industry requirements for smaller, more com-

plex digital-to-analog converters at low cost. Micro Networks Corp. has met this requirement with a multi-

range 8-bit d-a converter that includes a storage register. Priced at \$39 each in small quantities, the

DATA AT YOUR © FINGERTIPS



TOUCH INPUT SYSTEM

Mate CARROLL'S TOUCH INPUT SYSTEM with your terminal. View a display and select points of interest by simply touching them. Truly DATA AT YOUR FINGERTIPS, in an ideal intelligent interface.

This is now possible with CARROLL'S TOUCH INPUT SYSTEM. An array of infrared light beams is projected directly above the display surface. When interrupted by your finger, they signal digital logic to generate the co-ordinates of the touch-point as binary data. Simple and error-free.

Let CARROLL design your TOUCH INPUT SYSTEM with off-the-shelf technology, and have YOUR data at YOUR fingertips.

For additional information, call or write:



1212 HAGAN STREET • CHAMPAIGN, IL 61820 • 217/352-5438

New products

model MN3020 is the only d-a unit with a register in a dual in-line package. It measures .925 by .52 by .15 inch, approximately $\frac{1}{20}$ the size of comparable d-a converters in modular form.

Housed in an 18-pin hermetic DIP designed to withstand hostile environments, the MN3020 also includes an internal reference and an output amplifier. The Worcester, Mass. company has laser-trimmed the thin-film resistor networks so that no external components or adjustments are required by the user to reach initial specifications. The trimmed unit guarantees linearity within $\pm \frac{1}{2}$ LSB, zero offset and range.

The MN3020 provides user-selectable output ranges of 0 to +10, +5 to -5, +10 to -10, and 0 to -10 v. The input circuitry is TTL-compatible, and the output voltage is linear within $\pm \frac{1}{2}$ LSB. A Mil Spec

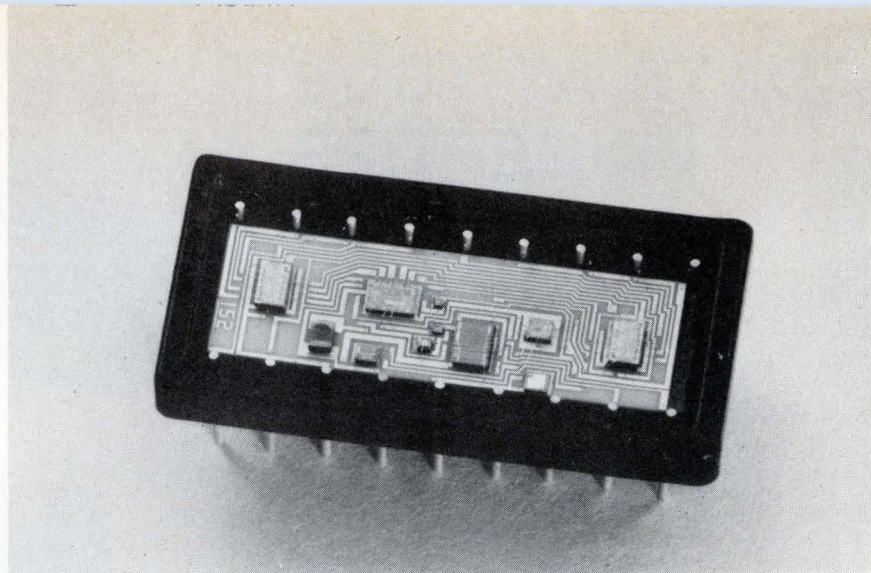

version, the MN3020H, guarantees linearity within $\pm \frac{1}{2}$ LSB from -55°C to $+125^{\circ}\text{C}$. Worst-case settling time is 3 microseconds.

Micro Networks notes that with the converter clock input high, digital words are converted to analog voltages and will follow all changes in the inputs; with the clock low, the information present at the inputs is

retained and the analog output will not change with input changes.

In quantities of 1 to 24, the MN3020 is priced at \$30 each; the military-type MN3020H is priced at \$69 each. Both are available from stock.

Micro Networks Corp., 324 Clark Street, Worcester, Massachusetts 01606. Phone (617) 852-5400 [343]

Simulator cuts cost of writing logic-test programs

Since becoming commercially available in the early 1970s, automatic logic testers have been indispensable to manufacturers designing equipment that uses an ever-growing number of complex circuit boards. With a succession of improved testers and lower prices, the test field has grown into one of the most competitive. In particular, logic simulation of equipment, needed to generate the software required by the automatic tester, has been a focus of differing design and marketing approaches.

One of the latest developments, being introduced by Computer Automation's Industrial Products division, is an add-on logic simulation system configured as a package that may be attached to most of the firm's 4000-series testers. Priced at \$21,900, the model 4850 add-on simulator is intended to offer substantial savings, both against the company's two stand-alone units, selling at \$78,900 and \$57,900, and against competitive models combining the testing and software-simula-

tion functions.

"The 4850 really should be regarded as a memory expansion of our testers to supply simulation software," says David Smith, director of product development and manufacturing. "It is a simple aid to help users solve production testing problems."

Key to the new add-on unit lies in its sharing and moving-head flexible-disk system and alphanumeric cathode-ray-tube peripherals that are part of the top tester models in the Computer Automation line, he says. This is possible because of the modular nature of the entire line and accounts for the short time—less than three months—that was required to take the 4850 off the drawing board and into finished hardware.

"In effect, what the 4850 package does is just add the extra core memory required to run the simulation software," he explains. In operation the 65,536-word-by-16-bit memory of the add-on simulator is divided as needed between the

central processing unit in the tester and by the simulator. Dimensions of the simulator are 10 by 21 by 26 inches; it has its own dc power supply or operates from commercial current.

Smith says that development of the simulator is an important aid in helping the customer cut the costs of writing logic-testing programs: "After we had the tester perfected, it was apparent that the software was still a problem, with engineers needing weeks to work out the programs." With the new add-on simulator, programs for even the most complex logic boards may be written in two or three days, he says, and the testers then run these programs in minutes.

A customer now can have a complete Computer Automation testing and simulation package, using the 4850 add-on, for less than \$70,000, says a marketing official at the firm's plant in Irvine, Calif. Smith says he believes that add-on simulators will attract many smaller manufacturers who previously could

Follow the leader.

Turn to the Cube.

For more than a quarter of a century, Ferroxcube has been the leading supplier and innovator of ferrite materials. There's good reason for that.

We sell reliable products of consistent quality.

We offer the largest selection of ferrite components and accessories.

We provide application assistance. And we can deliver.

We're reliable. Ask the competition.

We think Ferroxcube is the industry leader, but don't take our word for it.

Ask around. Talk to our competition . . . and yours.

Write for your free copy of the new Ferroxcube Linear Ferrite Catalog. Write to:

Ferroxcube Corporation
Dept. E-976 Saugerties, New York 12477 Tel: (914) 246-2811

FERROXCUBE
A North American Philips' Company



O.E.M.

TWO MORE *STANDARDS* from the Leader in the Memory Industry...

NOW . . . from **STANDARD MEMORIES** . . . the new single board ECOM® H 16K and the ECOM® R 32K Core Memory Systems with specifications that meet or beat any others in the industry! And you get a total upward compatibility to 32K.

The basic ECOM® Memory System was introduced in 1968 and has established a time-proven record for reliability at a competitive price. Today, for low-cost, off-the-shelf and custom memory systems, there is only one **STANDARD** THROUGHOUT THE WORLD!

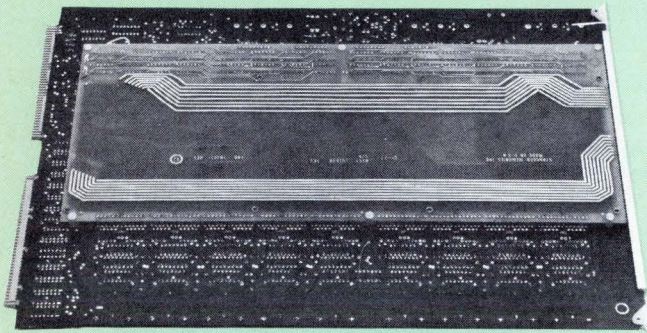

ECOM® H MEMORY MODULE H16K18MM

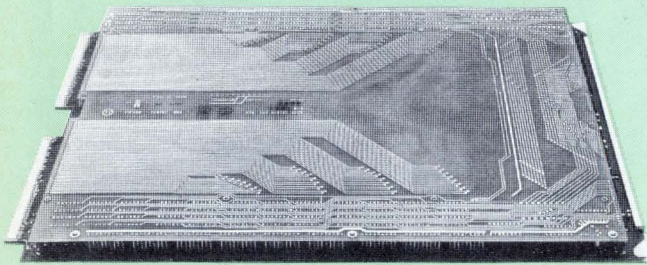

ECOM® R MEMORY MODULE R32K18MM

SPECIFICATIONS

MODEL	SERIES H	SERIES R
MEMORY SIZE	16K	32K
CYCLE TIME	650	750
ACCESS TIME	250	300
PHYSICAL SIZE	11.5 x 16 x .75	11.5 x 16 x .75
COMPATIBILITY	YES	YES
	16K to 32K	

STANDARD MEMORIES

 AN APPLIED MAGNETICS COMPANY

4120 Birch Street, Suite 105
Newport Beach, CA 92660
Phone: 714-752-8455
TWX: 910-595-2533

New products

not afford to buy automatic testing equipment.

Along with the 64-k memory, the 4850 comes with simulation software and documentation. Delivery time

for the simulator is two weeks. Computer Automation Inc., Industrial Products Division, 18651 Von Karman, Irvine, Calif. 92713. Phone (714) 833-8830 [344]

Six digital panel instruments bow

Six digital panel instruments will be brought out this fall by Newport Laboratories Inc., in response to "an economy that has people ready to buy," according to Charles N. Hasley, national sales manager of the California firm.

Singled out by Hasley as "offering the best price on the market" is the 850 series of multipoint selectors, for applications where temperature measurements must be displayed or recorded by a printer. At \$350 these multipoint data units have scanning rates of from 30 channels per second to 1 channel every 10 seconds. Ten channel boards, at \$115 each, may be added to the basic unit for a maximum of 100 channels.

Key specification for the 850 series, Halsey says, is a thermal emf of 0.1 microvolt per degree celsius maximum. The units can multiplex low-level thermocouples, resistance temperature detectors, and isolated floating input signals to a single digital panel meter. An adjustable time delay allows system transients to settle.

The 850 is designed for flexibility,

the Newport sales official says. In the manual mode with a printer, for example, the system prints the selected channel continuously or once only, through front panel switching. It can be manually advanced to any channel. In the automatic mode, the model 850 can be programmed to scan continuously or for just one complete cycle. An external input initiates the single cycle scan mode, he says, while an clock input permits a user to decrease the system scanning rate.

The design philosophy underlying the 850 and other Newport instruments is to obtain reliability by keeping down the parts count, which in turn minimizes the internal temperature rise. This is accomplished through extensive use of low-power LSI C-MOS circuitry.

One result is seen in the new model 213 2,000-count and model 216 6,000-count edgewise voltmeters, which have calculated MTBFs exceeding 40,000 hours. Features of the two models include a differential input circuit with less than 1 nanoampere bias current, which



NEW!

REVOLUTIONARY INSTRUMENT

IN AC & DC CURRENT MEASUREMENT

No longer is it necessary to break the circuit to make an ac and dc current measurement! This time-saving feature is extremely useful in troubleshooting, maintenance, design and other fields. Now it is possible to obtain current measurements more easily and safely than voltage measurements by use of clamp-on probes.

Model 1776 features include digital readout, peak read and hold capability, resolution 10 mA on lowest range, wide dynamic range, portability with built-in recharging circuitry, three clamp-on probes, extremely low insertion impedance.

The 1776 is the only current meter of its type in the world!



MODEL 1776 DIGITAL CURRENT METER

Current Ranges	10, 100, 1,000 amperes, FS.
Accuracy	
D.C.	±0.5%, FS.
A.C. (Sinusoidal)	±2.0%, FS.
Peak Detection (D.C. Accuracy)	±0.2%, FS.
Frequency Response	D.C. to 10kHz
Readout	Digital (3½ digit)

The Gaussmeter People

F. W. Bell, Inc.
4949 Freeway Drive East
Columbus, Ohio 43229
614 888 7501
TWX: 810-337-2851

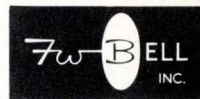

SEE US AT WESCON!

A subsidiary of The Amold Engineering Company

At least it seems like everybody wants a sample. And it's easy to understand why. These miniature low cost, quick disconnect, high-contact-density Thorkom connectors will go just about anywhere.

And they have.

From computers and medical instrumentation, where the compactness and reliability are essential – to marine and automotive use, where the ruggedness, corrosion resistance and low cost are critical.

Get Your Own Free Sample

Get a Thorkom in your hands and we think you'll get all kinds of ideas as to how you can use them.

Here are a few of the specifics you'll notice:

- high contact density (there are 7, 12 and 24 contact models)

- positive lock, yet with quick, easy disconnect; just squeeze and pull
- crimp removable contacts (all types) with MIL-T-22520 crimp tool
- positive polarization – they cannot be mated incorrectly

Plus – they're tough, shock-proof, light weight, can be mounted quickly and they are available with or without cable assembly – and more good things than we can cover with one ad.

So use the coupon and get your own free Thorkom. Or, if you don't want to wait, call us. The number: (213) 341-4330.

Everybody wants a sample.



7 pin plug and receptacle shown life size

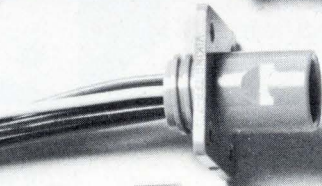

12 pin, square flange receptacle



24 pin receptacle, shown with dip solder contacts

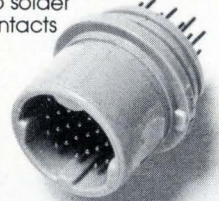

Send me one. I'm thinking of using a Thorkom connector in:

- Computer equipment Medical instrumentation
- Automotive Communications Marine Aviation
- Process control Other (Please indicate) _____

NAME: _____

TITLE: _____

COMPANY: _____

CITY: _____

STATE: _____

ZIP: _____



Viking

CONNECTORS

Viking Industries, Inc., 21001 Nordhoff Street
Chatsworth, CA 91311 U.S.A.



And we can add the cable.

What kind of cable? Any kind. Our cable assembly service is custom tailored to your exact specifications.

Expensive?

No, just the opposite. The fact that we're in the connector business usually makes it possible for us to bring connectors, cable and labor together on a project — turn out a higher quality assembly than you can (each pre-tested for hi pot, IR and continuity) — and cut your cost and time in the process.

When the time comes, make sure you ask us about it.



Circle 139 on reader service card

New products

allows accurate measurement of high-impedance signals up to 1 volt from digital ground. Supply voltage is 4.75 to 5.25 v dc. A dual-slope measurement technique is used for good rejection of line-frequency normal-mode noise. Priced from \$65 in 100 and up quantities, the voltmeters have 30-day deliveries.

A product that employs Newport's patented Polylog linearization technique to achieve better than 0.25% accuracy is the model 268 digital pyrometer. Measuring thermocouples and platinum RTDs, it offers celsius, fahrenheit, and Kelvin temperature scales, plus automatic zero and polarity. Options include a one- or two-setpoint controller, linearized analog output and 5 v dc input power capability. The model 268 sells for \$165 in 1-4 quantities, with

delivery taking four to six weeks.

Two Newport instruments that primarily feature versatility of programming are the model 204 digital process monitor and the model 6130 universal panel counter. The 6130, with an input sensitivity of 20 millivolts over the range of dc to 20 kHz and 40 mv to 100 kHz, may be programmed for each mode of operation from the rear connector, Hasley says. The model 204 counter may be scaled to virtually any engineering unit, he claims, with a number of available options, including a 350-v optoisolator and a true-rms converter. The model 6130 is priced at \$250, and the model 204 sells for \$150.

Newport Laboratories Inc., 630 East Young St., Santa Ana, Calif., 92705. Phone (714) 540-4914 [345]

10-MHz counter sells for \$295

Low cost and high performance don't often go together in counters. Add low frequency, say the product development engineers at Systron-Donner, and they think they have achieved the combination.

At Wescon, the company's Instrument division will introduce the model 6202B, a 10-megahertz frequency counter for \$295. According to Gail Dishong, product sales manager, it combines features that make it usable in industrial plants, on

production lines, in school laboratories, telephone service units, field use and in systems.

Unlike most low-cost counters, says Dishong, the input of the 6202B was designed to accommodate the type of signals most frequently encountered in low-frequency applications and will accept nonsinusoidal as well as sinusoidal waveforms. In addition, an input attenuator control provides the operator with a choice of three attenuation factors: 1, 10, or

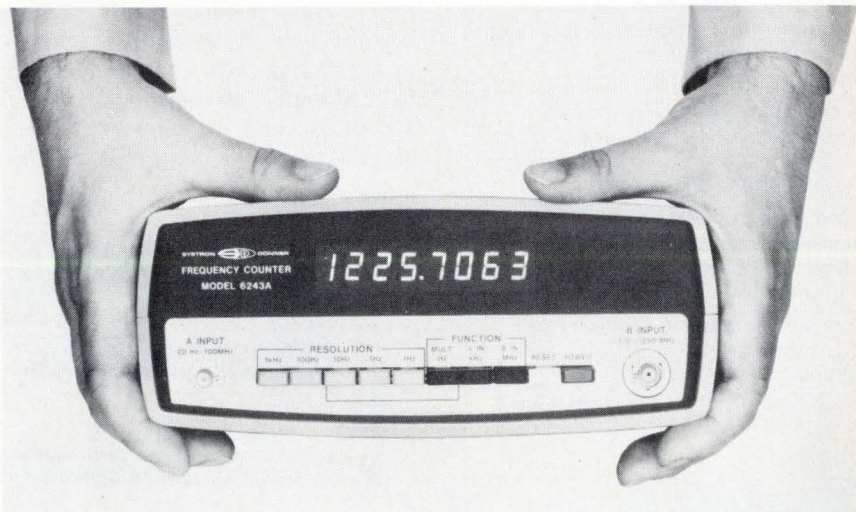

Compare Grayhill lighted switches!



**Outstanding
performance
from logic levels to
1/4 amp**

- **Compare design**... Grayhill's self-cleaning wiping contacts outperform butt contact or snap action types.
- **Compare selection**... Grayhill has both momentary or alternate action; SPST, SPDT, and DPDT circuitry; front-panel bezel or sub-panel mounting; square or round button shapes in wide choice of colors.
- **Compare panel appearance**... Grayhill provides a compact, attractive panel... and a unique design-coordinated line of matching unlighted switches and indicator lights.
- **Compare service**... Grayhill's expert technical assistance, prompt quotations, and speedy deliveries save you time and money.
- **Compare price**... Grayhill lighted switches cost no more than other brands with equivalent ratings.

Start the comparison process NOW, by asking Grayhill for Lighted Switch Catalog #252 and information on our free sample offer.



561 Hillgrove Avenue
La Grange, Illinois 60525
(312) 354-1040

New products

100. This insures that the applied input signal does not overdrive the input amplifier, says Dishong, and thus cause false counting.

Furthermore, the 6202B counter has a control that provides a plus or minus offset of about 0.8 volt times the attenuator setting. What this means is that the operator can vary the input trigger point and set it to the best amplitude level where triggering occurs. For input signals not requiring adjustments in offset, the 6202B can be operated in a fixed trigger-control position.

Since input signals may vary greatly in waveshape, it is important, Dishong points out, to have a counter with adjustable input controls that accommodate all types of inputs. "The 6202B is this type of counter," he adds. "Its measurement capability is not limited to sinusoidal waveforms."

Measurements on the 6202B are displayed by a parallax-free 7-digit light-emitting-diode display that includes an automatically positioned decimal point. Not all measurements require the same resolution, so the 6202B provides four different gate times to allow the operator to measure the input frequency to the most convenient resolution. These gate times are 10 seconds, 1 s, 100

milliseconds and 10 ms, with corresponding resolutions of 0.1, 1, 10 and 100 hertz.

The 6202B also has a rear-panel dc power connector that can be used to operate the counter where ac power is not available. And in applications that require a temperature-controlled crystal oscillator in place of the standard oscillator, this can be satisfied with the option 08 high-stability oscillator, which adds \$100 to the price.

Also being introduced at Wescon is a new series of communications counters in the range from 20 hz to 1.25 gigahertz. The \$595 model 6241A measures frequencies from 20 megahertz to 100 MHz; the \$795 model 6242A from 20 Hz to 512 MHz, and the \$995 model 6243A (shown in photo on page 139) from 20 Hz to 1.25 GHz. Features common to all three units include 10-millivolt sensitivity, ability to withstand exceptionally high input-signal levels, an overload-fuse-protected rf input, full 8-digit LED display, selectable resolution in decade steps from 10 kHz to 0.1Hz and a high-stability time-base oscillator offering ± 2 parts in 1 million per year.

Systron-Donner Corp., Concord Instrument Division, 10 Systron Dr., Concord, Calif. 94518 [346]

Unit resolves single events to 100 ps

Single-event measurements should become a practical reality in automatic testing with the introduction by Eldorado Instruments Co. of a 100-picosecond time-interval meter—the model 797—at Wescon. Un-

til recently, says Hank Beech, vice president for marketing at the Pleasant Hill, Calif. company, the lowest resolution available on single-event meters has been about 1 nanosecond, ruling out its use in large automatic



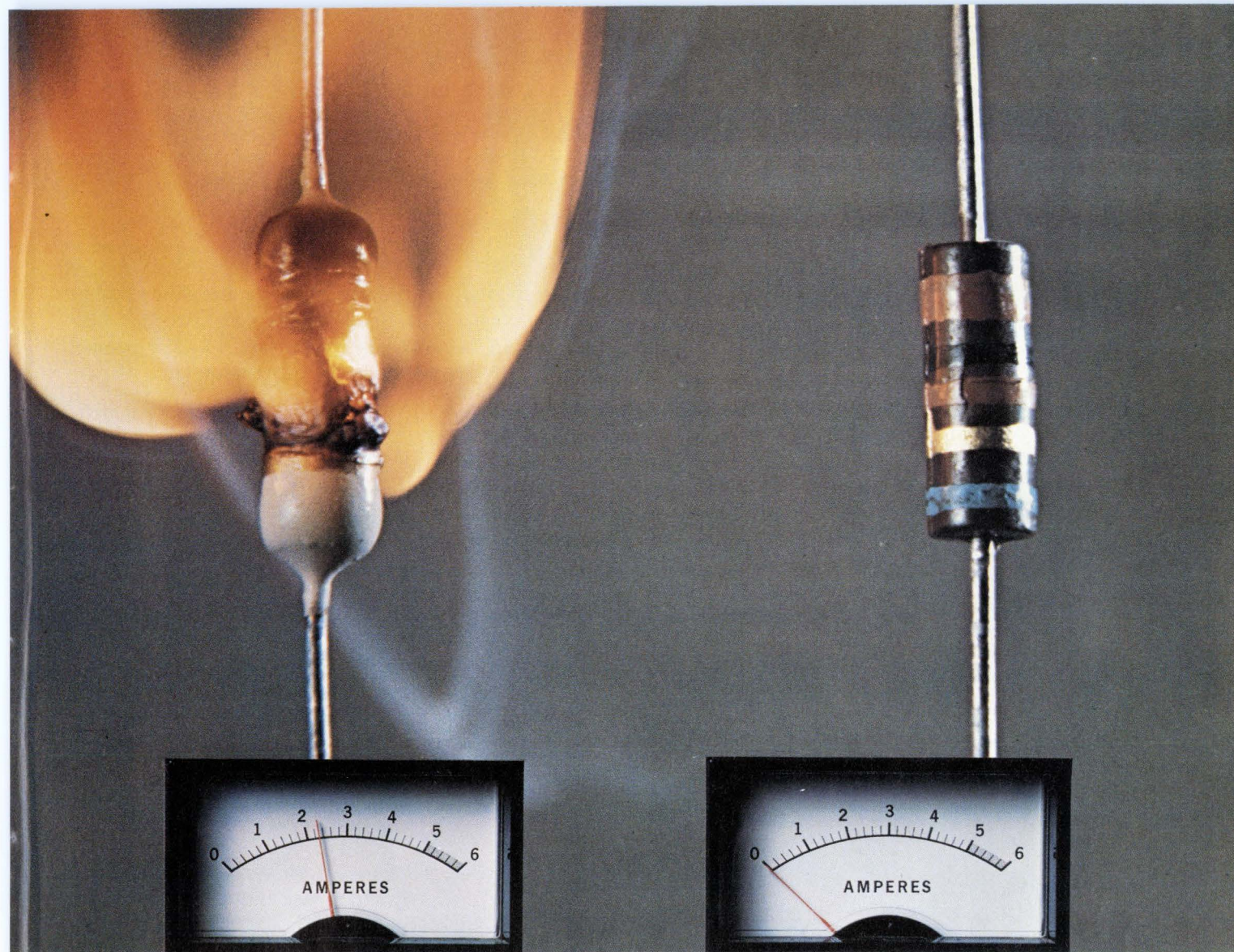

The failure. A 16 W overload causes this 1/2 W carbon film resistor to burst into flame. The initial failure mode is a short circuit, causing even more current to be drawn as shown on the meter.

The successful failure. The TRW 1 W rated BW-20F (1/2 W size) stays cool and fuses quickly and safely under identical power surge conditions. The failure mode, as shown, is an open circuit.

A failure your circuit can live with.

Failsafe, Fusible, Wirewounds Offer Built-In Circuit Protection.

Cool wirewounds like our BW failsafe series have a dual personality.

They provide stable resistance to normal operating current. But at specific overloads, they open the circuit like a good fuse. So, as shown above, they'll protect your circuit from excess heat and fire in places where severe fault conditions are encountered.

The BW failsafe series, UL listed per Document 492.2, can save cost by eliminating the need for both resistor

and fuse. Save space, too, because they're about half the size of standard 1 and 2 W devices.

Depending on your specific circuit parameters, other TRW film and wirewound resistors can be engineered to meet your requirements.

For more information on resistors your circuit can live with, contact TRW/IRC Resistors, an Electronic Components Division of TRW, Inc., 401 N. Broad St., Phila., Pa. 19108. Tel. 215-922-8900. Telex: 710-670-2286.

TRW IRC RESISTORS
ANOTHER PRODUCT OF A COMPANY CALLED TRW

AMP has high powered solutions to high current problems.

When you specify AMP high current connectors you get the problem-solving support a professional engineer deserves. On the production line, in quality control, in sampling for prototyping and by working with you on future improvements.

Product solutions too—like the Power Lock Connectors which feature hermaphroditic contacts rated at 30A or 75A, and snap together housing designs that reduce inventory and provide unlimited variations. Our economical *rectangular* High Current Commercial Connectors incorporate a positive locking feature. With silo construction housings, they are suitable for both free hanging and panel mounted applications. And are recognized under the U.L. component program for 35A, 125 V circuit breaking.

Widely accepted in many industries, the *Circular Plastic Connector* series features two designs rated up to 35A, and includes the recently introduced, sealed 7-way version for highway equipment.

Need a solution for a p.c. board power problem? The *Hi-current Edge Connector* is an economical one, available in 2 through 12 positions and rated to 30A.

Write today for information on AMP High Current Connectors. Learn why we have an international reputation for innovation. AMP Incorporated, Harrisburg, PA 17105. (717) 564-0100.

AMP is a trademark of AMP Incorporated.

SEE US AT
LJUBLJANA ELECTRONICS
SHOW

AMP
INCORPORATED

Circle 142 on reader service card

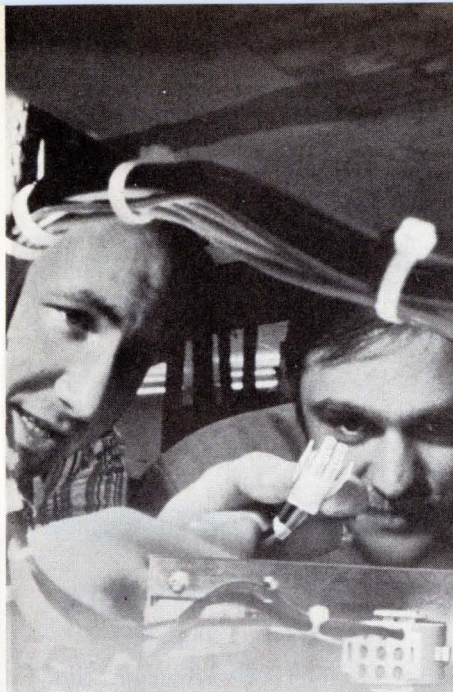

New products

test and measuring systems.

Using an enhanced version of the vernier digital interpolation technique pioneered by Eldorado in its 1-ns model 796, the model 797 provides single-event absolute resolution of 100 ps with no ± 1 count ambiguity (equivalent to ± 50 -ps resolution) as well as an accuracy of ± 100 ps.

"The instrument is specifically designed for single-event measurement," Beech says, "and all of the internal circuits are optimized for this purpose." The single event may be the time interval between two separate pulses, the width of a single pulse, or one period of a repetitive signal. The start and stop points may be independently selected for positive or negative slope and for positive or negative polarity on any input waveform.

For either single-event or continuous signals, a period mode is available, which measures the time interval between two successive start-channel input transitions at the same trigger point and slope, Beech says. In the period mode, the stop measurement occurs at exactly the same point on the input waveform as the start to assure accurate determination of the time of one input cycle.

A width mode is available in which the time interval between two successive start-channel input transitions is measured at the same trigger amplitude level but with opposite slope.

With the start and stop channels externally connected to a single input, the start threshold may be set at 10% of the maximum input level and the stop threshold at 90%, in this way providing a single-event rise-time measurement with 100-ps resolution. When used in a programmable system, the model 797, may be readily sequenced to measure rise time, pulse width, fall time, and period.

Aging rate on the oscillator is ± 1 ppm per year after 30 days, but higher-stability options are available. The 3.5-by-17-by-18-inch model 797 has a 10-decade seven-segment planar display and is priced at \$4,850. The model 797 may be ordered with options that include binary-coded-data output for \$250 (option PL), or a general-purpose interface bus for \$490 (option P4). Remote programming of all functions is available for \$450 (option J).

Eldorado Instruments Co., 2495 Estand Way, Pleasant Hill, California 94523 [347]

AMP EUROPE

Austria — AMP Austria. Branch of AMP Deutschland GmbH. Markgraf-Ruediger Str. 6-8, 1150 Vienna. Phone: 924191/92

Belgium — AMP Belgium. Branch of AMP-Holland B.V., Rue de Brabant 62-66, Brussels. Phone: 322.17.55.17

France — AMP de France. 29 Chaussée Jules-César. Boîte Postale No. 39. 95301 Pontoise France. Phone: 030 82 20, 030 92 30

Germany — AMP Deutschland GmbH. Ampèrestrasse 7-11, 607 Langen, B. FFM., West Germany. Phone: (06103) 7091

Great Britain — AMP of Great Britain Limited, Terminal House, Stanmore, Middlesex, England. Phone: 01-954-2356

Holland — AMP Holland B.V., Papierstraat 2-4 's-Hertogenbosch, Holland. Phone: (04100) 25221

Italy — AMP Italia S.p.A., Via Fratelli Cervi 15, 10093 Collegno (Torino), Italy. Phone: 785-656

Spain — AMP Española, S.A., Apartado 5294. Pedro IV, 491, 495, Barcelona 5, Spain. Phone: 307-75-50

Sweden — AMP Scandinavia AB, Datavägen 5, 17500 Jakobsberg, Sweden, Mailing Address: Fack S-175 20 JARFALLA 1, Sweden. Phone: 0758/10400

Switzerland — AMP AG, Haldenstrasse 11, 6006 Luzern, Switzerland. Phone: (414) 235421, 235422, 235423

AMP NORTH AMERICA

Canada — AMP OF CANADA LTD., 20 Esna Park Drive, Markham, Ontario, Ph: 416-499-1251

Mexico — AMP de Mexico, S.A., Apartado Postal 179, Naucalpan de Juarez, Edo, de Mexico, Phone: Mexico City 576-41-55

Puerto Rico — AMP OF CANADA LTD., 677 Calé de Diego, Rio Piedras, Puerto Rico 00924, Phone: (809) 766-2346

United States — AMP Incorporated, Harrisburg, Pa. 17105, Phone: 717-564-0100

AMP SOUTH AMERICA

Argentina — AMP S.A. Argentina 4 de Febrero, 76 Villa Zagla — SAN MARTIN, Buenos Aires, Argentina, Phone: 752-4612

Brazil — AMP do Brasil Ltda., AV Comendador Martinelli 185, Lapa, Sao Paulo, Phone: 262-4353

AMP PACIFIC

Australia — Australian AMP Pty. Limited, 155 Briens Road, Northmead, N.S.W. 2152 Australia, Mailing Address: P.O. Box 194, Baulkham Hills, N.S.W. 2153 Aus. Ph: 630-7377

Japan — AMP (Japan), Ltd., No. 15-14, 7-Chome, Roppongi Minato-Ku, Tokyo, Japan, Ph: 404-7171

Products and services for many specialized industries are provided by the AMPLIVERSAL Division. In the United States, this division is known as AMP Special Industries.

For AMP products and services in other countries, write: AMP International Division, Harrisburg, PA 17105, USA.

Thermal printer gives DPM readouts

Designed to provide numeric printouts from groups of digital panel meters, a thermal printer from Gulton Industries can be rack-mounted in hospital intensive-care units, laboratories, and other noise-sensitive areas.

Virtually silent, the model NP-7 produces seven columns of digits, or six digits with a sign, as fast as four lines a second. The packaged unit is supplied with interface electronics for most digital panel meters. It accepts binary-coded-decimal data and is compatible with diode-transistor and transistor-transistor logic.

The company points out that the model NP-7 is designed and built to standard rack width. Thus, it can be



NATIONAL BEWARE!

**We've got
the bite
on you!**



MSK IS ON THE PROWL!

We're proud to announce the MSK032 . . . the new competition for the LH0032. Its "pin compatible" and competitive in both cost and specifications. Check these specs!

NATIONAL

Gain: 70 dB Typ.
Slew: 500 V/uSec Typ.
1% Settling: 100 nSec Typ.
Bandwidth: 70 MHz Typ.

MSK

Gain: 70 dB Min.!
Slew: 500 V/uSec Min.!
1% Settling: 100 nSec Min.!
Bandwidth: 70 MHz Min.!

*And there are No Funny Harmonic Distortions Around 3 MHz Either!!

Having any difficulty getting delivery on your LH0063 Buffers? Try an MSK 330. It's pin compatible and delivery is from stock!



M.S. Kennedy Corp. Pickard Drive,
Syracuse, New York 13211
Tel. 315-455-7077

New products

incorporated into a rack containing a wide variety of measuring instruments in order to provide hard copy of their outputs.

The printout is on thermally sensitive paper, and the only moving part in the paper-advance mechanism is a permanent-magnet motor. A front-panel switch provides for selection of manual or continuous operation.

Paper can be loaded in 5 to 10 seconds by swinging out the front panel, sliding the roll onto a spindle, and inserting the paper through the drive rollers. Unit price of the NP-7 is \$459. Delivery time is 30 days.

Gulton Industries Inc., Measurement and Control Systems Division, East Greenwich, Rhode Island 02818. Phone (401) 884-6800 [348]

Standard calibrates ac and dc meters

Most users who buy panel meters and multimeters must make both ac and dc measurements. To accommodate them, RFL Industries has developed a precision voltage and current standard to be used for the incoming inspection and calibration of analog and digital meters. Designated the model 82, the new instrument is accurate within 0.01% for dc measurements and 0.05% for ac over its range of 100 millivolts to 10 volts (ac and dc) and 100 microamperes to 100 milliamperes (ac and dc). The standard, which has a percent deviation dial and fractional scale division, also has a frequency range to 1 kilohertz internal and 25 kHz external.

Robert Schmehl, sales manager for RFL's Instrumentation division, says other precision voltage and current standards on the market may have comparable accuracies for

either ac or dc measurements. But, he claims, most other standards of this type, if not all of them, don't have the versatility of the model 82 in that they measure either ac or dc only.

The model 82 does not yet cover as broad a voltage and current range as RFL's earlier 829 series of standards, but it uses solid-state zener references, resistors matched within 0.005% and an internal calibration point to improve the earlier series' accuracy, which was within 0.05% dc and 0.08% ac. Ken Jacobson, product manager, notes the 829 series had an optional internal calibration point, and used 0.03-0.04% wire-wound resistors and electrochemical cells "which really weren't in the heart of the system, but were used more or less as a self-check reference."

Traceable to the National Bureau

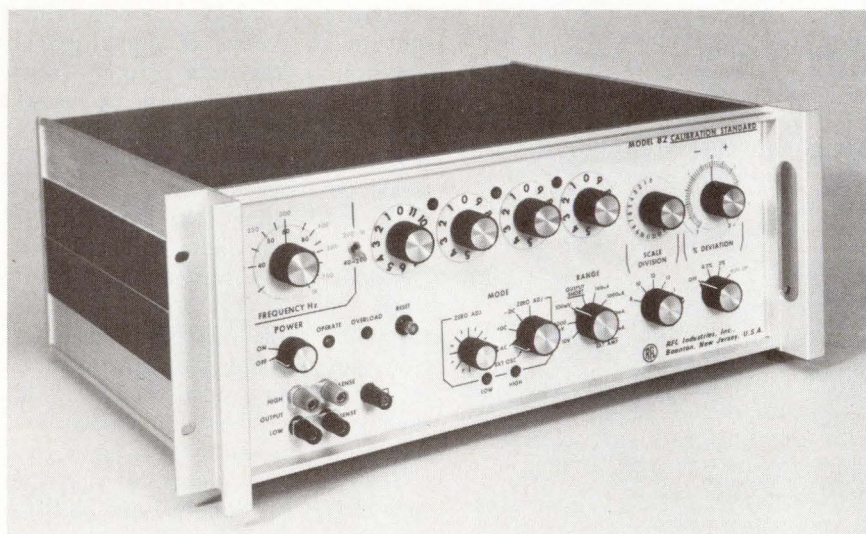

Now 1% time measurements are this easy...

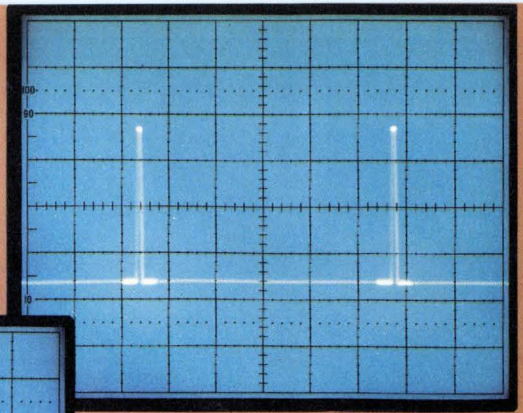
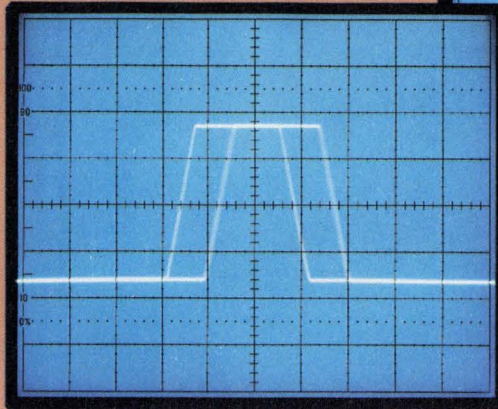

1 Position intensified spots at beginning and end of time interval.

2 Switch to delayed sweep mode and use Δ Time dial to superimpose beginning and end of interval.

1.132



3 Read time interval directly.

Faster Timing Measurement

Differential time measurements are made faster when the new DM 44 with *Delta Delayed Sweep** and direct numerical readout is included on a TEKTRONIX Portable Oscilloscope. At the same time, measurement repeatability is improved, the chance for computational errors is eliminated, and 1% accuracy is consistently achieved. Frequency measurement (on periodic waveforms) with 2% accuracy is obtained by simply pushing the 1/Time button.

Built-in DMM as a Bonus

There's no need to carry a separate multimeter. DM 44-equipped TEKTRONIX Portables also measure dc voltage with 0.1% accuracy and temperature from -55°C to $+150^{\circ}\text{C}$ simultaneously with oscilloscope display of related waveforms. And you get ohms measurement with 0.25% accuracy as well.

Your Choice of Oscilloscope Performance

The DM 44 is available on five high-performance portable oscilloscopes to best match your performance and price needs. Choose bandwidth of 100, 200, or 250 MHz. Or select from two fast storage models. One actually stores single-shot signals at its full 100 MHz bandwidth.

Due to highly cost-effective design, the outstanding DM 44 option adds only \$410 to the price of the basic portable oscilloscope chosen. All DM 44-equipped TEKTRONIX Portable Oscilloscopes, and seven more models as well, perform analysis on up to 16 channels in the digital domain by simply adding the

LA 501W Logic Analyzer. Capabilities of the DM 44 are also available in the TEKTRONIX 7000 Series of plug-in oscilloscopes.

Let Us Show You

To see how the DM 44 makes faster, more accurate measurements in your application, contact your Tektronix Field Engineer. Or write to Tektronix, Inc., P.O. Box 500, Beaverton, Oregon 97077 for complete information. In Europe, write to Tektronix, Limited, P.O. Box 36, St. Peter Port, Guernsey, Channel Islands.

*Two independently adjustable delayed sweeps.

U.S. Sales Price FOB Beaverton, Oregon



TEKTRONIX®

committed to technical excellence

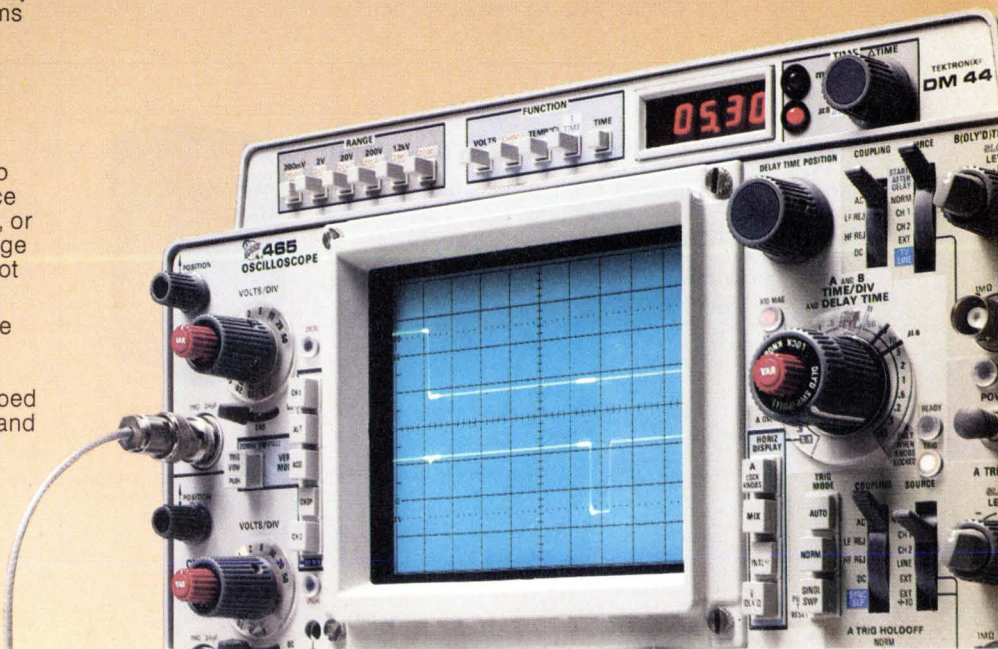

Reliable AC line filters

Advanced engineering of inductors combined with the unique ceramic capacitor technology acquired from Allen-Bradley offers the reliability your equipment demands. Spectrum power line filters are designed for:

125/240VAC @ 125°C 0-400 HERTZ

Proven Reliability

Controlled thermal characteristics

Limited AC voltage rise

Volumetric efficiency

Available in C, Pi, L, T

Mil-F-15733

TYPICAL PARTS	I Amps	Volts AC	Insertion Loss—Db		
			150KHz	10MHz	1GHz
54-367-006	15	125	12	53	65
51-353-112	3	125	13	70	70
51-320-023	1	240	24	70	70

For other ratings—see EEM 1-576 to 1-583

AVAILABLE from stocking distributors

HALL-Mark ELECTRONICS 215-355-7300 MOLTRONICS 213-773-6521
METUCHEN CAPACITOR 201-442-0500 ROSE ELECTRONICS 415-697-0224

ELECTRO 76 Boston Booths 2624/2626
IEEE EMC Symposium Wash. D.C. Booths 31/32



SPECTRUM CONTROL INC.
152 EAST MAIN ST · FAIRVIEW, PENNSYLVANIA 16415



SPECIALISTS IN ELECTRO-MAGNETIC COMPATIBILITY

For a complete EMC solution let us test and analyze your equipment.

Circle 146 on reader service card

Own your own holder to hold your own!

Hold your own copies of Electronics in specially designed slipcase holders. They'll keep your Electronics library neat and handy—a permanent information file, issue by issue.

Just complete the coupon and mail to Jesse Jones. He'll process your order upon receipt, postpaid.

ELECTRONICS BOXER
Jesse Jones Box Corporation
2250 E. Butler St., Philadelphia, Pa. 19137

Please send me: boxes @ \$4.25 each; 3 boxes @ \$12.00; 6 boxes @ \$22.00.
My check or money order is enclosed.

Name: _____

Address: _____

City: _____ State: _____ Zip: _____

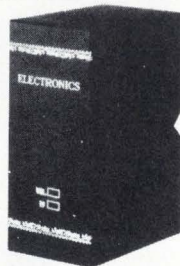

New products

of Standards, the model 82 is priced at \$2,250. Initial deliveries are scheduled for November, 1976.

RFL Industries Inc., Boonton, N.J. 07005.
Phone (201) 334-3100 [349]

Faster assembly

The proliferation of microprocessor applications has led suppliers of hardware/software development systems to upgrade performance, particularly in the operating speed of the programs.

Initial development systems used teletypewriters as data inputs, followed by plug-in cassette tapes, and then resident semiconductor memories. Now a floppy-disk operating system is being offered by Microkit as an external, augmented memory. It edits and assembles large programs up to 16 times faster than a combination of resident random-access memory and cassette tape, the company says.

This system, called Microdisk, has dual Pertec disk drives and a controller and provides a half-million bytes of on-line storage. In assembling a 4,000-line program, the Microdisk requires about 2.5 minutes, compared to 42 minutes using tape, or 7 hours with a teletypewriter input, according to the company. A 200-line program takes 10 seconds, compared with 2 min and 20 min.

Microkit is marketing the Microdisk primarily as an addition to its stand-alone A model 8/16 development system that accommodates either the Intel 8080 or Motorola 6800 microprocessor. The Microkit 8/16, including 20,000-character-per-second cathode-ray-tube display, keyboard peripherals and software, is priced at \$3,850. The microdisk, with interface and software, sells for \$3,650. As a development package, the two systems are said to be cheaper than comparable equipment without floppy-disk capability and limited to only one type of chip.

Microkit Inc., 2180 Colorado Ave., Santa Monica, Calif. 90404. Phone (213) 828-8539 [350]



From those wonderful folks who brought you the best high-priced testers.

The best low-priced tester.

Introducing the GR 1795 logic circuit tester. The first tester to give you the full diagnostic capability of our GR 1792 series of testers. For about one-third the cost.

This means that for the price of a pretty ordinary tester, you can now get one that will run our powerful CAPS Computer-Aided Programming Software.

So you get all the trouble-shooting speed and accuracy of our big systems.

You get our latest look-ahead probe with pulse-catching capability and automatic programming for different logic families.

And you get a diagnostic clip, fast floppy disc storage, and the same device adapter we use on our big machines.

So what don't you get with the 1795?

Simple. You don't get CAPS simulation and programming capability.

For set-up, you have to program on either an existing 1792 or a separate GR 1797 Programming Station, or use our Programming Service.

Or, you can buy our alternate model GR 1795-LTM.

Instead of CAPS, the LTM uses our new Learner/Tester Mode for set-up and trouble-shooting. It's far more accurate than other schematic/operator-guided probing techniques since it stores full data per node instead of making transition counts. And, it allows you to move up to full CAPS diagnostics at any time.

Now that this kind of performance is available in a low-cost system, big-time testing capability can come to a lot of places it's never been before. Like service depots, to reduce board float. Or small companies on small budgets. Or large companies with multi-station applications.

The new GR 1795 and GR 1795-LTM.

The first low-cost testers that are as good as a GR tester.

GenRad, Inc. (formerly General Radio), Test Systems Division, 300 Baker Avenue, Concord, Mass. 01742, 617-369-8770.



GenRad

The difference in software is the difference in testers.

Circle 147 on reader service card



HP-97 \$750*



Hewlett-Packard announces two powerful breakthroughs in fully programmable portable calculators.

Two important breakthroughs distinguish Hewlett-Packard's newest personal-sized calculators.

Breakthrough Number One: Power.

The HP-67 and HP-97 are the most powerful personal calculators Hewlett-Packard's ever built. Both can handle programs up to 224 steps. But there's a lot more to program capacity than just the number of steps available.

Example: All prefix functions and operations are merged—conserving steps—allowing you to store two or three keystrokes as a single program instruction.

Also, for the first time ever in a battery-powered calculator, you can directly record the contents of all 26 data storage registers on a separate magnetic card for easy reloading later. The result: Another substantial saving in program steps since constants and other numerical data don't have to be incorporated in your program.

And while we're still on the subject of power, here are a few more of the programming features built into the remarkable HP-67 and HP-97:

- 3 Levels of Subroutines
- 10 User Definable Functions
- 10 Conditional/Decision Functions
- 4 Flags
- 3 Types of Addressing
 - Label Addressing
 - Relative Addressing
 - Indirect Addressing

But there's more to the HP-67 and HP-97 than raw power. There's ease of use.

Breakthrough Number Two: Ease of Use.

With the HP-67 and HP-97, a "smart" card reader automatically records the display mode, angular mode setting and flag status separately from your program so you never have to waste program steps for these "house-keeping" chores. What's more, it also prompts you—via a "Crd" display—when there's additional information on the card that must be loaded into the machine. Moreover, it's virtually impossible to improperly load programs or data from the cards.

In addition, the "smart" card reader enables you to automatically expand the capacity of either calculator beyond 224 steps. Here's how: At the appropriate point in your program—and under program control—the card

More than three times the program capacity of the HP-65.

Hewlett-Packard analyzed 34 comparable Application Pac programs for both the new HP-67/97 and the industry's classic programmable, the HP-65.† These programs included a broad spectrum of disciplines: Electrical engineering, mathematics, statistics, and finance.

The results of this analysis indicate that the HP-67/97 offer over three times the program capacity (actually 3.4 times) and yet they have only twice as many program steps (224 vs 100). This is because the HP-67/97 are more efficient—in every case the HP-67/97 required fewer program steps to accomplish the same task (the overall ratio was 1:1.5).

As you can see, you can't judge a calculator's programming power solely by the number of program steps available—you must also evaluate program efficiency, that is, how many program steps it takes to solve a problem.

†Complete details available upon request.

reader can automatically turn on and read another card. This new card can be used to load either selected portions of program memory or selected data registers.

For ease of editing, the line number and all keycodes of every instruction are displayed. You can insert, delete or change functions at any point in your program. And, you can check or execute your programs step-by-step in order to locate programming errors.

Still another reason the HP-67 and HP-97 are so easy to use: RPN logic and four-register automatic-memory-stack. This means you can forget about parenthesis keys and tackle complicated programs with confidence.

Your Choice of Models. Pick the One That Suits You Best.

The HP-67 and HP-97 are identical in both versatility and capability. All programs written and recorded on the HP-67 can be loaded and run on the HP-97 (and vice-versa).

The HP-67 gives you shirt-pocket portability. The battery-powered HP-97 gives you attaché-case compactness plus a quiet, built-in thermal printer.

Programming, debugging and editing are so much faster and easier with a printer, you'll wonder how you

ever got along without one. The printer provides hard copy not only of routine calculations but also of programs, listed by stepnumber, key mnemonic and key-code. Or you can TRACE a running program and have the stepnumber, function, and result printed for each step as it is executed. And you can also list the contents of the automatic memory stack or the contents of the data storage registers. With a clear record of your programs or data, you don't have to remember what you've done and what remains to be done.

An Unparalleled Program of Product/Owner Support.

With either the \$450* HP-67 or the \$750* HP-97 you get all of the following: A detailed Owner's Handbook and Programming Guide, Standard Application Pac (with 15 programs of broad appeal), and a free one-year subscription to a Newsletter that provides programming assistance and keeps you informed about new Application Pacs.

Optional Application Pacs of up to 24 prerecorded programs are available in a variety of disciplines such as statistics, mathematics, finance, electrical engineering, surveying, mechanical engineering, and medicine. In addition, Hewlett-Packard maintains a User's Library** of programs contributed by owners.

If you would like additional information about the HP-67 or HP-97—including the name of a nearby dealer, simply call 800-538-7922 (in Calif. 800-662-9862) toll-free, or send in the coupon.

HEWLETT  PACKARD

Sales and service from 172 offices in 65 countries.
Dept. 214G, 19310 Pruneridge Avenue, Cupertino, CA. 95014

Hewlett-Packard
Dept. 214G
19310 Pruneridge Avenue
Cupertino, CA. 95014

Please send me complete details on the HP-67 and HP-97, and the HP product catalog.

Name _____
Firm _____
Address _____
City _____
State _____ Zip _____

*Suggested retail price, excluding applicable state and local taxes—Continental U.S., Alaska and Hawaii.

**Available in U.S. and selected other countries. 616/26

WANTED: GOOD PROGRAM PROPOSALS FOR ELECTRO/77 IN NEW YORK

If you've got a good idea for a solid, half-day professional session, we'd like to hear from you!

This is a Call for Sessions for Electro77, the international electronics convention in New York, April 19-21, 1977.

The Professional Program Committee will present a program of about 35 half-day sessions at the Hotel Americana, concurrent with the Electro77 product exposition at the New York Coliseum. They will be selected competitively from submitted proposals and sessions originated by the committee.

This is a Call for Sessions, *not* for individual papers. Proposals should be for sessions of no more than four individual speakers, each covering a part of the main subject.

The committee is interested in sessions that are timely and relevant, and of direct near-term benefit to electronics engineers.

The program will also be weighted in favor of disciplines and interests prominent in the eastern United States. The majority of Electro77 program participants will come from that area.

How to Propose a Session

The Electro77 program selections will be made in a two-step process.

The first step is for the proposer to submit a letter of intent to propose. This is a simple statement, in letter format, that includes the following:

1. The subject and topic of the proposed session.
2. The scope and range of the material to be presented. How general or specialized will the session be? Will it be an "update" on the subject; applications-oriented; or describing a trend?

3. What is the significance of the subject? Why is it important and to whom is it important?

4. The names and affiliations of up to four speakers or panelists. (No more than two from one organization.)

The deadline for letters of intent is October 5, 1976.

Address your letter to:

John J. Golembeski, Chairman
Electro77 Professional Program Committee
c/o IEEE
345 East 47th Street, New York, N. Y. 10017

If your letter is accepted:

You will be asked to prepare a second, more detailed proposal. (Session title, speakers' names and topics, and short abstracts or summaries.)

The deadline for the second proposal is December 1, 1976.

For further information, write to Electro77 Professional Program Committee, attention Joseph Antonaccio, Convention Manager, c/o IEEE, 345 East 47th Street, New York, N. Y. 10017.

Some Guidelines to Proposing

The Electro77 Professional Program Committee will pursue its programming task according to a plan that assumes the following:

1. That the "session unit" approach (rather than solicitation of individual papers) results in sessions in which individual papers are related and will be complementary to each other.
2. That Electro audiences are primarily regional, with a small percentage of participants from distant geographical areas. The committee will emphasize those technologies, kinds of manufacture, and electronics applications that are most prominent in the eastern United States.
3. That the committee will plan a program which is timely and relevant to the

electronics engineering, manufacturing, and marketing of today. It will include major trends in technology; applications of hardware and software to important new tasks; needs for new devices and systems; trends in management and marketing; and new tools and techniques for design engineers.

4. All sessions will be presented in carpeted and air-conditioned rooms of the Americana, with professional audio and visual services, rehearsal facilities, and full-time program supervision.

5. In making your proposal and selecting speakers, please keep in mind that Electro77 plans to pre-publish manuscripts in full, and will tape all sessions, to be available at the convention. Manuscript deadline is February 1, 1977.



Electro77

April 19-21, New York Coliseum and Hotel Americana

Character generator fits on one chip

Bipolar LSI device provides 64 alphanumericics for CRT displays and matrix printers

by Bernard Cole, San Francisco bureau manager

Now that microprocessors have reduced the number of packages in computing systems, designers are turning to peripherals with the same idea in mind.

A good example is National Semiconductor Corp.'s introduction of the industry's first one-chip character generator for cathode-ray-tube displays and matrix printers. The move could be the beginning of the end for the use of standard medium-scale-integrated circuitry in these applications.

The bipolar large-scale-integrated device, the DM8678, is a 64-character unit housed in a 16-pin standard dual in-line package. It performs the system functions of parallel-to-serial shifting, character-address latching, character spacing, and character-line spacing without the addition of other packages.

To do the same job in present systems, a character-generating ROM usually requires two to four additional chips. And, compared to a systems component cost of about \$15 to \$30 using present devices, the DM8678, says Larry Jordan, bipolar memory product manager, does the same job for a 100-piece price of \$14.95 each. In larger volumes, he says, the price is below \$10 each.

National chose to go the bipolar route on the DM8678, says Jordan, because the requirements of the marketplace—in CRTs, 80 characters per line and 24 lines per screen—meant the device needed a serial output clock rate of 20 megahertz. "And nothing but bipolar would give us that," he says. "While MOS should have given us greater density, we would have had to add external circuits to make a similar MOS device

operate in a system going at 20 megahertz."

The 124-by-161-mil chip consists basically of a 6-bit series of fall-through latches for the character address; a 4,032-bit ROM; a 4-bit line counter; a 7-bit parallel-in, serial-out shift register; a data-output buffer with a tri-state control; a multiplexer, and in addition an edge-trigger generator.

The DM8678 is particularly unusual, says Jordan, in that the on-board ROM, depending on the customer's choice of mask program, can have either of the two standard printer/CRT fonts, 7-by-9 or 5-by-7. In addition, it can be programmed to scan horizontally across the page in CRT fashion, or vertically, down the page, in matrix-printer fashion.

The line counter consists of a 4-bit

ripple counter with an asynchronous clear input, plus an input clock that is shaped by the edge-triggered clock generator. The output can sink 16 milliamperes at 0.45 volt for a low signal out and will source 2 mA at 2.4 v for a high signal out.

Total power required for the MM8678 is 725 milliwatts, about 30% less than conventional character-generation systems incorporating MOS ROMs and 50% less than those with bipolar ROMs. The combination of low cost, low power, and low components count, says Jordan, makes the bipolar device applicable in several high-volume markets such as home video games and standard television sets.

National Semiconductor Corp., 2900 Semiconductor Dr., Santa Clara, Calif. 95051 [339]

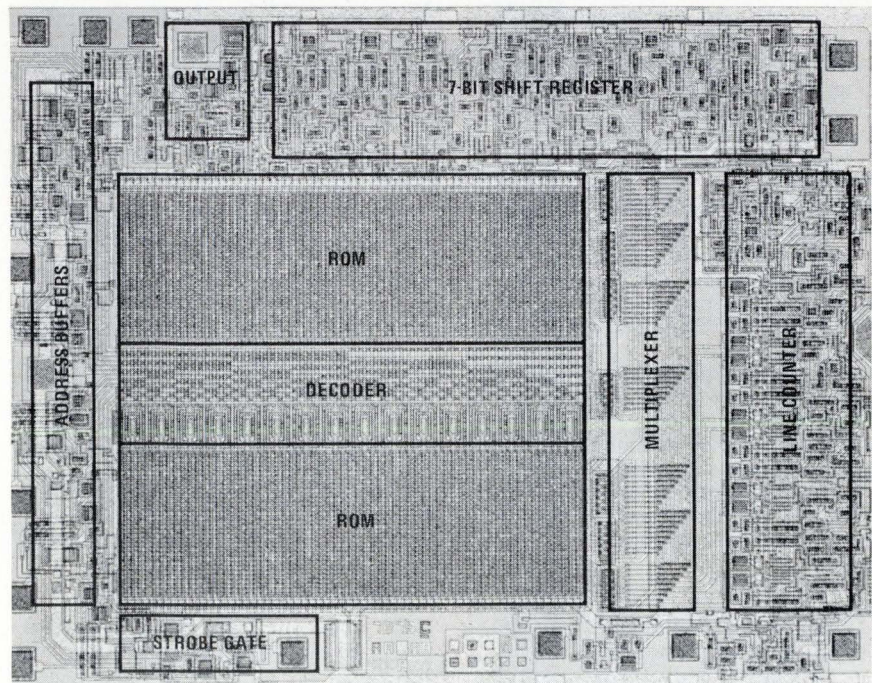

TIME & FREQUENCY....

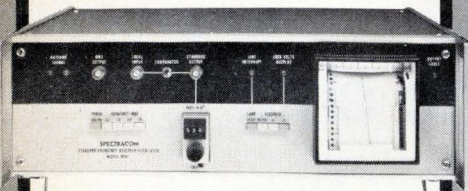

If these words are important to you then you should know more about Spectracom Corporation. We specialize in **TIME and FREQUENCY**, and produce test equipment that leads the industry.

For instance, our **WWVB RECEIVERS** are the finest available. Priced from about \$700 to \$2500, they all have features and performance found only in competitive equipment costing \$5,000 to \$10,000. And some of these features, such as positive go/no-go front panel phase lock indication, are available only from Spectracom. For the first time, you can install a receiver and immediately know beyond doubt that it is working, receiving a strong enough signal, and giving correct frequency calibration and time code information! The green "go" light will be on steadily, because our receivers work well under poor signal-to-noise conditions where other won't!

Another example is our **FREQUENCY DISTRIBUTION SYSTEM**, also the finest on the market. You don't need a separate cable for each remote station. You install our system by running one coaxial cable past each remote station in turn, similar to a cable TV system. Buffered line taps at each station give you the standard frequency you need there. If you want to add a station somewhere along the line, just cut the cable and insert another line tap for the desired frequency! Up to 25 stations can be driven from one base station that costs about \$650, and the cost is even less if you buy the system built into one of our VLF Receivers!

Our **FREQUENCY STANDARDS** can also be furnished with the Distribution Amplifier built in. We also have a Frequency Standard that is furnished as part of a WWVB Receiver, tracked continuously against the NBS standard frequency.

So you see, we have good reasons to be proud of our products. And the people who buy them and use them are proud of them too. For the highest quality and performance you can buy in Time and Frequency test equipment, or for special communications test equipment, call your Spectracom sales engineer.

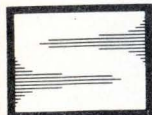

SPECTRACOM CORP.
87 WEDGEWOOD DR
PENFIELD, NY 14526
PHONE 716-381-4827

New products

Instruments

True-rms-meter prices drop

3½-digit DMM at \$235 and 4½-digit unit at \$425 are suitable for field service

Accurate measurement of a waveform any more complex than a pure sine wave can only be achieved with an instrument that responds to the signal's root-mean-square value. But most rms-responding meters are expensive. While within the reach of the laboratory budget, they have been too costly for large-scale use in field service, or on the production line, for example.

Two new digital multimeters from Fluke offer true-rms response in low-cost instruments whose small size and light weight are designed for field service as well as bench use. The 3½-digit (1,999-count) model 8030A is priced at \$235, and the 4½-digit (19,999-count) autoranging model 8040A (shown in photo) is priced at \$425.

Each of the two instruments has 26 ranges and five major functions (ac and dc voltage, ac and dc current, and resistance). In addition to five ranges for each function, the 8040A has an additional resistance range and the 8030A has a diode-test position.

The diode-test function allows measurement of diode and transistor forward-voltage drops. A 1-milliamperere bias current is forced through the junction, and the resultant voltage drop, in millivolts, is measured and displayed.

In the ac-measurement modes, ac coupling rejects dc bias during voltage measurements, and dc coupling in the current ranges provides the ac + dc capability necessary for measuring power supply and SCR regulating circuitry.

In either instrument, a standard set of four alkaline C cells typically provides 10 hours of operation.

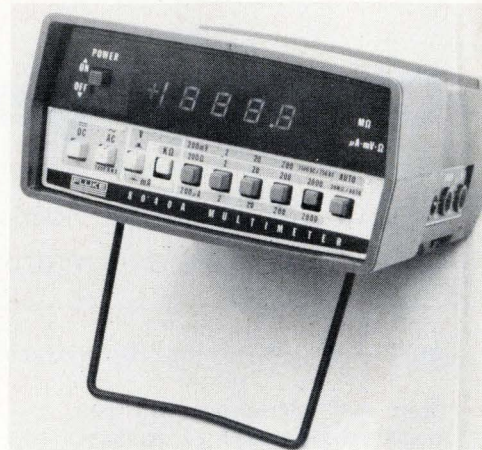

Optional nickel-cadmium battery packs provide eight hours of operation from full charge, and typical recharge time is 14 hours.

In dc voltage ranges, the 8030A is typically accurate within $\pm(0.1\%$ of reading + 1 digit) and the 8040A is typically accurate within $\pm(0.05\%$ of reading + 2 digits). In ac voltage ranges, the 8030A is accurate within $\pm(0.5\%$ of reading + 2 digits) from 45 hertz to 1 kilohertz, and the 8040A is accurate within $\pm(0.5\%$ of reading + 10 digits) from 45 Hz to 10 kHz.

John Fluke Mfg. Co. Inc., P. O. Box 43210, Mountlake Terrace, Wash. 98043. Telephone (206)774-2211 [351]

A-m/fm signal generator covers 125 kHz to 175 MHz

A phase-locked signal generator that covers the frequency range from 125 kilohertz to 175 megahertz in 11 bands can be amplitude-modulated over its entire range and frequency-modulated on its top five bands (8 MHz and above). A built-in six-digit frequency counter can be used to read the generator's frequency or the frequency of any externally applied signal. In addition to acting as a standard signal generator, the model 103B can be used as a sweeper. Five sweep modes are standard: a swept range of 60 kHz centered at 262 kHz, a range of 60 kHz centered at 455 kHz, a range of 200 kHz centered at 1.2 MHz, 2 MHz centered at 10.7 MHz, and 40 MHz centered at 100 MHz. Other sweep ranges may be

Ask CONTROL DATA about a new line of OEM terminals— backed with a 1-year warranty!



We have it!

Control Data has a new line of OEM terminals so reliable, we warranty them for twice or even four times as long as other terminal manufacturers!

What's more, we've given them unique modular construction — with plug-in printed circuit boards — for easier configuring and maintenance. For low mean time to repair. For greater ease in adding or deleting options later... and longer life.

Best of all, we've built them with freedom-from-maintenance in mind. For example, we offer convection cooling, that practically reduces special preventive maintenance to zero! No noisy fans that can fail on you. No filters that can clog...require cleaning.

Right now, we're ready to produce — as many as 1000 terminals a month — so you'll have no problems with fast delivery. Here's what we have — and more is on the way:

- **Model 92451 Stand-Alone Display.** Microprocessor-based, general purpose. Has unique built-in, self-test diagnostics feature.

Shown here:
the new Model 92451
microprocessor-based Stand-Alone Display.
Also available: the Model 92452 Conversational Display.

Capacity: 960 characters, expandable to 1920. Edit feature. Optional Bulk Storage, Hardcopy, Polling, and Current Loop. Cursor Position and Read.

- **Model 92452 Conversational Display.** A neat console device for a computer. Scroll or page mode. Cursor Position. Optional Hardcopy and Numeric Pad Keyboard.

Both models offer asynchronous communications at 110 to 9600 Baud and detachable keyboards. And both are backed by 15 years of CDC experience in the terminals business.

Call (612) 482-4259 or return coupon to: Mike Arman, OEM Marketing, Dept. E-926
Control Data Corporation, 2401 N. Fairview Ave., Roseville, MN 55113
Please tell me more about your new OEM Terminals Line.

NAME _____ TITLE _____
COMPANY _____ ADDRESS _____
CITY _____ STATE _____ ZIP _____ AREA CODE _____ PHONE _____

Ask the CDC OEM people

**GD CONTROL DATA
CORPORATION**

New products

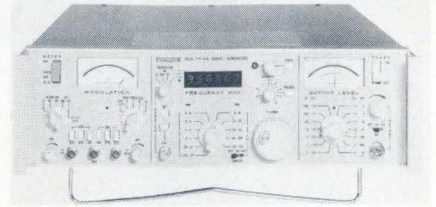

substituted on special order. The sweep center frequency as well as the frequency of a variable marker can be read on the digital display.

The rf output of the model 103B is leveled, monitored by a panel meter, and adjustable from -130 dBm to 13 dBm by a 13-position step attenuator and a 13-dB continuously variable control. The model 103B sells for \$4,295. It is offered without phase lock, as the model 103A, at \$3,575. Delivery time for both units is eight weeks. The model 103B will be on display at Wescon.

Boonton Electronics Corp., Route 287 at Smith Rd., Parsippany, N.J. 07054. Phone Wallace F. White at (201) 887-5110 [353]

Inexpensive unit locates pc-board short circuits

Short-Trak is an instrument designed to pinpoint the exact location of an etch or solder short on a fully loaded printed-circuit board without damaging land areas or components. Unlike other short-circuit locators, Short-Trak does not sense the magnetic field associated with a current; hence, it cannot be confused by very dense wiring patterns.

The instrument consists of a box that injects current pulses into the board under test and a two-tip probe that detects the current by sensing its induced voltage drop. Two col-

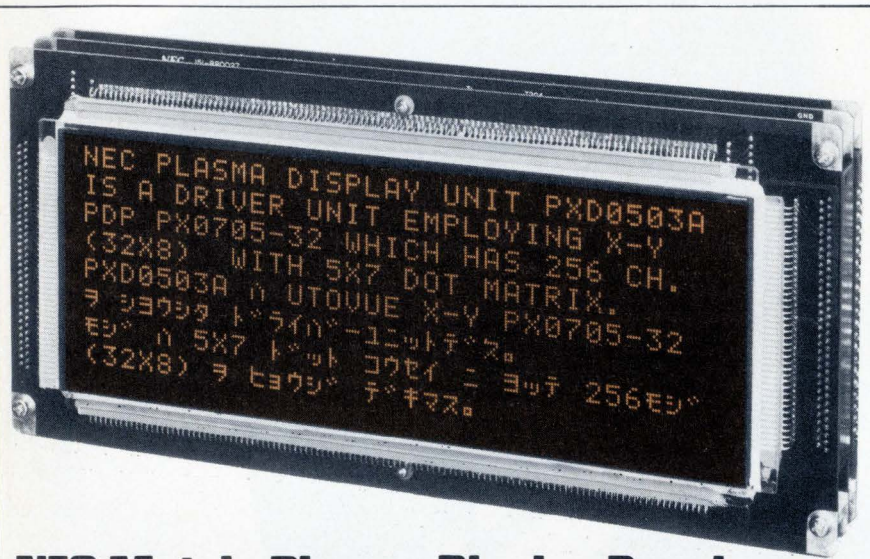
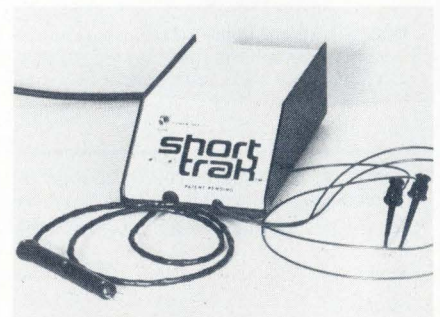

NEC Matrix Plasma Display Panel — compact, complete with driver circuits. TTL compatible.

Type PXD0503A displays 256 characters (32 x 8 lines) in 5 x 7 dot matrix form. The 0.26-inch high characters are high contrast neon orange. No glare, distortion, flicker or fuzziness. NEC's unique transparent electrodes enhance inherent high readability. TTL level interface. Measures 5.5 x 12.6 x 2.1 inches including connectors. Ideal for terminal display applications.

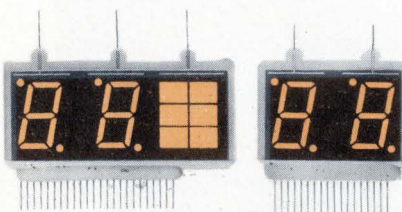

Type PO2504T-02 Type PH2524T-02

AC-coupled Plasma Display Panels

- Inch-high or up to 4 inches.
- Static/dynamic drive.
- Usable up side down.
- Noble display appearance.

U.S.A. Sole Agent: World Products, Inc.
7625 Bush Lake Road, P.O. Box 35263, Minneapolis, Minn. 55435
Tel: (612) 835-2117 Telex: 29-0181 WORLD PROD EDNA

Europe NEC Electronics (Europe) GmbH
4000 Düsseldorf, Immermannstrasse 22, F.R. Germany
Tel: Düsseldorf 357088, 357089, 357080 Telex: NECD 8587419

NEC
Nippon Electric Co. Ltd.
P.O. Box 1, Takanawa, Tokyo, Japan

The fastest microcomputer known to man

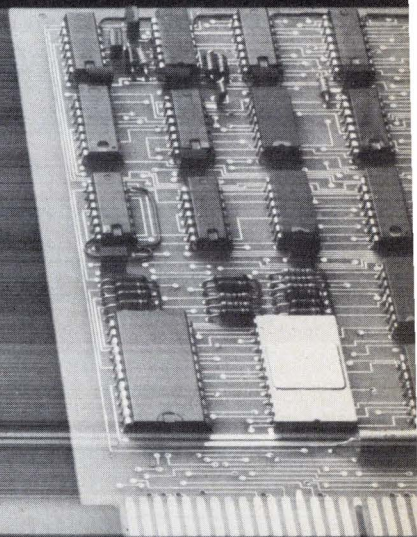

Want to see it again?

Just call Plessey and ask about the 16-bit MIPROC 16, the first microcomputer fast enough for your real-time systems.

It has faster hardware (350 ns full cycle time).

Faster software (most instructions take only a single cycle at a throughput rate of 2.8 megahertz).

And it's months faster to get on line (no microprogramming, no hardware design and development).

For just \$760 (100-qty), you get a complete high-speed computer-on-a-card that's ready to go the day you get it.

For starters, the Plessey MIPROC 16 has 82 powerful 16-bit instructions, a versatile prototype development kit and a FORTRAN IV cross-assembler/simulator for use on the

Tymshare and GE Mark III networks.

Options include 75 more instructions, a DEC and Data General cross-assembler, a 1.4 μ s hardware multiplier, serial and parallel I/O ports, priority interrupts, an extended temperature range (-55° to $+125^{\circ}$ C), and a ruggedized version for military applications.

So if you're still paying the price of hardwired logic just to get speed, ask for details and a demonstration of the Plessey MIPROC 16.

We've just brought microcomputing up to speed.



Plessey Microsystems

United States, Irvine, CA (714) 540-9945
United Kingdom, Towcester (0327) 50312

**CHECK OUT THE MIPROC 16 IN OUR HOSPITALITY SUITE AT THE HOLIDAY INN
ACROSS FROM THE CONVENTION CENTER DURING WESCON**

Circle 155 on reader service card

sealed high density miniature switching

for 12 PDT to 108 PDT with MIL-R-5757 protection against
humidity ... sand ... dust ... moisture ... corrosion ...
splash ... explosion ... built to withstand shock/vibration!

T-bar ENVIRONMENTALLY
SEAL® SEALED
SERIES
831/931
RELAYS

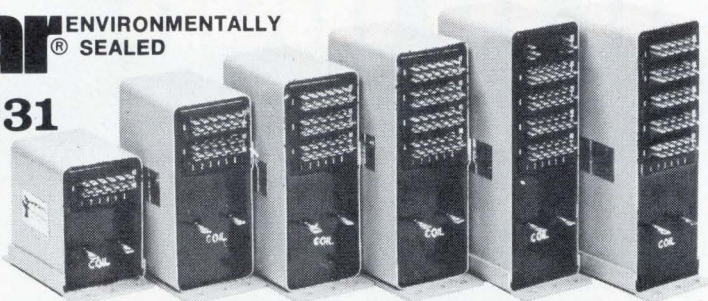

12P, ST or DT 24P, ST or DT 36P, ST or DT 48P, ST or DT 52P, ST or DT 60PST

All contacts epoxy sealed in backfilled metal enclosure for ground support or shipboard applications and other hostile environments. Pulse operated magnetic latching available. Simple crimp snap-in contacts fit into single block connectors for easy wiring. 60 circuits switched in a space as small as 2¾" x 1½" x 4½".

Interested? Write or
phone T-Bar today for
complete facts, prices,
quantity discounts.

T-bar INCORPORATED
SWITCHING COMPONENTS DIVISION

141 Danbury Road, Wilton, CT 06897 • Telephone: 203/762-8351 • TWX: 710/479-3216
Circle 156 on reader service card

The book that turns businessmen into best sellers.



Many who've read it are now reaping the rewards. Because they've found that U.S. exports are a \$95 billion a year business, that exporting creates both company profits and company growth, that U.S. goods have never been more competitive in international markets. Above all, they've found that, with the help available from the U.S. Commerce Department, selling overseas is no more difficult than selling at home. And this fact-filled book can prove the same to you. Write Charles W. Hostler, Deputy Assistant Secretary for International Commerce, U.S. Department of Commerce, BIC 8C, Washington, D.C. 20230.

U.S. Department of Commerce



A Public Service of This Magazine
& The Advertising Council

New products

ored light-emitting diodes in the probe tell the operator when he has found the short. As the operator slides the probe from one current-injection point to the other, a green LED stays lit indicating that the probe is on the right track. When it changes to red, the probe is at the short location.

Short-Trak sells for \$287.50. A version for operation from 220 v ac is priced \$10 higher. Delivery is from stock to three weeks.

Digital Facilities Inc., P.O. Box 34834, Dallas, Texas 75234. Phone (214) 241-7600 [354]

3½-digit multimeter
also has analog display

By adding option 20 to the model 3028A digital multimeter, one obtains both the meter's 3½-digit display and an analog indication of the same quantity. The edge-type analog panel meter option, which



adds \$65 to the price of the \$279 DMM, should prove very useful in those applications where a trend indication is required. Examples are the adjustment of a bridge circuit for a null indication and the tuning of various resonant circuits for maximum (or minimum) output. The panel meter is marked with 10 linear divisions—0 to 2—and is accurate to within 5% of full scale. A decibel scale that extends from -20 to +6 dB is also provided. 0 dB corresponds to 1 mw into 1 kilohm. The 3028A, which will be shown at Wescon, measures ac and dc voltage and current and resistance. It is an rms-responding instrument with a bandwidth that extends from 15 hertz to

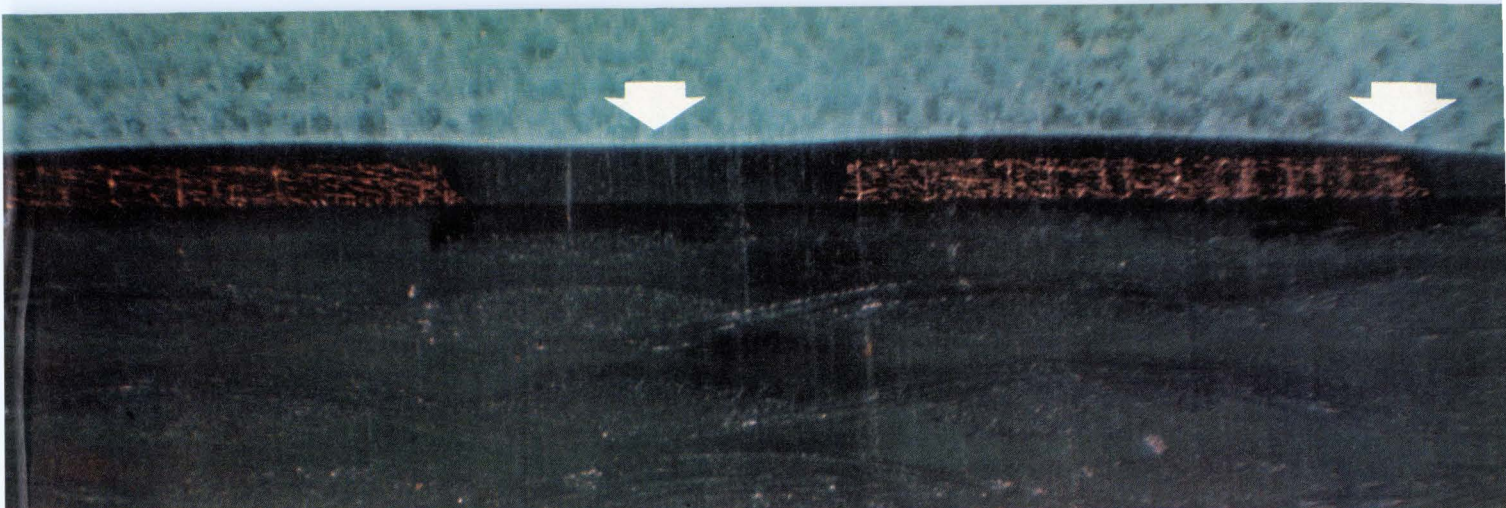

When spray or dip coatings fail...

Parylene works.

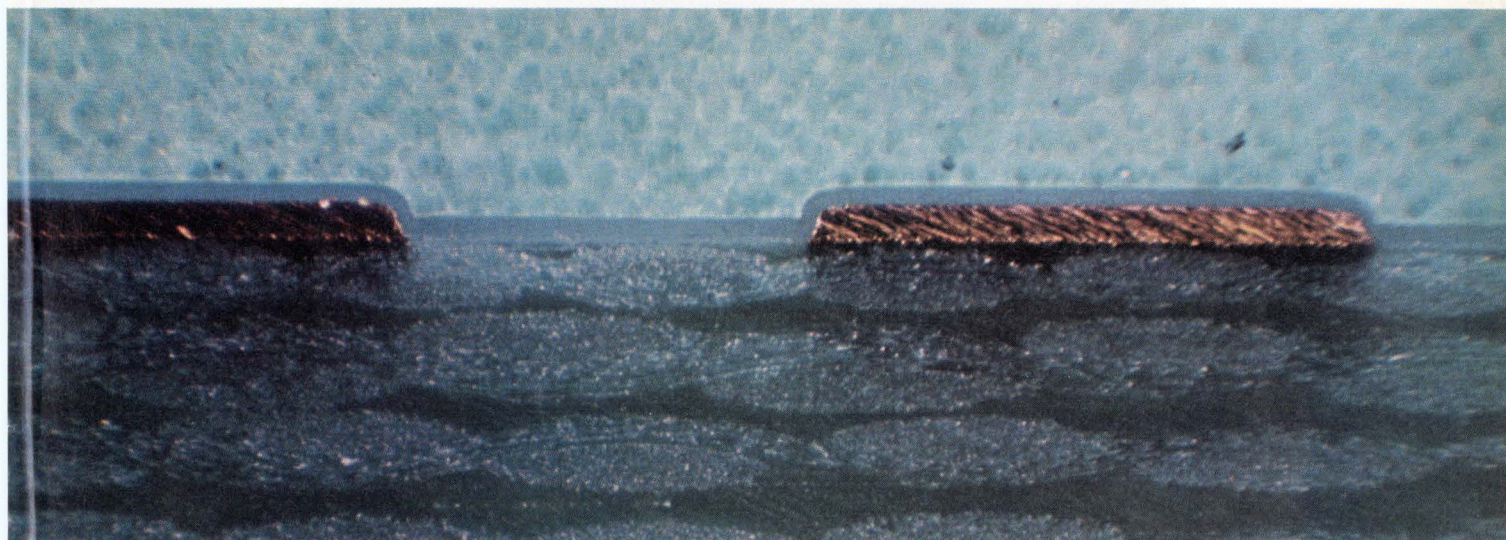

You are looking at magnified cross-sectional views of copper conductors on a circuit board . . . and why parylene protection brings the highest reliability to electronic circuitry.

The spray-applied urethane coating (top photo) bridges the channel between conductors, and offers scant protection at the edges. Urethane, silicone, epoxy . . . liquid coatings are uneven, and can produce potential failure points.

Parylene forms a thin and even coating, whatever the configuration, however complicated or delicate or densely populated. Without bridging. Without pinholes, voids, bubbles. We call it a conformal coating. From conformality comes reliability.

Parylene conformal coatings can be applied in precisely controlled thicknesses from 0.002 to 3 mils. *In one step.*

Parylene is applied at *room temperature*. No heat, no melting, no cure. No coating shrinkage. In other words, no discomfort for delicate components.

Parylene provides better barrier protection than urethanes, silicones or epoxies. It is extremely resistant to chemical attack,

exceptionally low in trace metal contamination, and compatible with all electronic solvents. Dielectrics are excellent.

Parylene has qualified under the stringent requirements of MIL-I-46058C; it does so with a 0.6 mil coating—parylene excels in the micro-electronic virtue of thinness.

Parylene conformal coatings have shown excellent cost effectiveness in many applications. On delicate, sophisticated and complex circuitry, in hybrid circuits and components, they may be the most cost effective answer for long term reliability.

Union Carbide invented the parylene system. The method is gas phase deposition, which is the only route to the reliability of conformal protection. Various patents apply; commercial use of the patented technology is licensed.

You can get complete information on parylene by writing for our 16-page brochure: Union Carbide Corp., 270 Park Ave., Dept. RB36, New York, N.Y. 10017. Further investigation will no doubt indicate a trial run, which we can perform at reasonable cost. If you would like to discuss that or any other related matters, please call Bill Loeb at (212) 551-6071.

In Europe: Mr. Peter Crook, Bakelite Xylonite Limited, Redfern Road, Tyseley, Birmingham, England.
In Japan: Mr. N. Fusada, Tomoe Engineering Co. Ltd., Shin Shin Kai Bldg., 14-1 Nihonbashi 3-Chome, Chuo-Ku, Tokyo.



Circle 157 on reader service card

EFFICIENCY EXPERT.

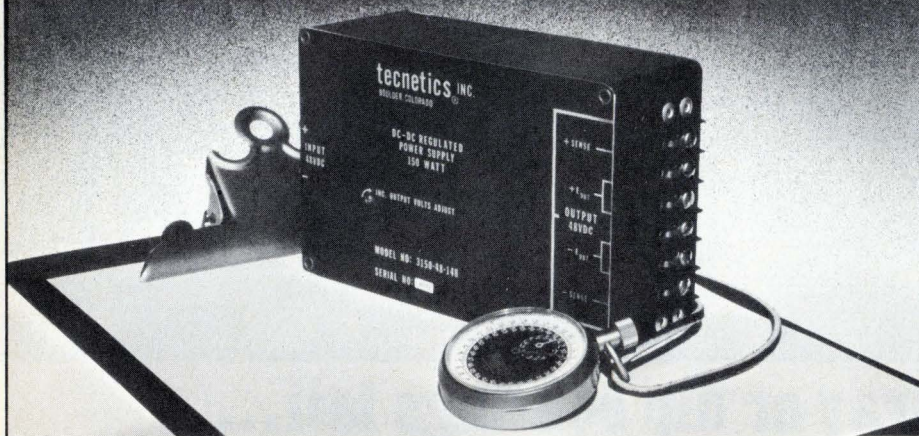

Up to 86% efficiency in Tecnetics DC to DC regulated converters.

When your design calls for a highly efficient regulated converter in a compact package, Tecnetics' 3000 series fits the bill. Efficiencies range from 66% to 86% with packing densities up to 2.78 watts per cubic inch. Our broad product line gives you a choice of models with 25, 50, 100 and 150 watts of power and outputs from 5 to 48 volts.

Standard features of the 3000 series include input-output isolation, overload and short circuit protection, input filters to reduce conducted EMI, and remote error

sensing to insure that the proper voltage is maintained at the point of load. All units are fully encapsulated and designed to meet the vibration, shock, humidity and altitude specs of MIL-E-5400.

So, when you are looking for state-of-the-art power converters, look to Tecnetics, the company with proven expertise. For more information and prices on the 3000 series, or three-hundred other power supplies, write for our 26 page catalog.

3000 SERIES HIGH EFFICIENCY REGULATED CONVERTERS

Output Power	150, 100, 50, & 25 watt models
Output Voltages	13 standard outputs from 5 to 48 V
Input Voltages	28VDC or 48VDC (48 VDC only on 150 w units)

Price range: \$395-\$525.

Dimensions (excluding terminals):

25 & 50 watt:	4x4x2 inches 36 oz. Fully encapsulated
100 & 150 watt:	6x4x2¼ inches 60 oz. Fully encapsulated

Regulation:

Line (LL to HL)	0.3%
Load (½ to FL)	0.1%
Load (NL to FL)	0.4%
Temp	0.01% / °C

tecnetics® The Power Conversion Specialists P.O. Box 910,
1625 Range Street, Boulder, Colorado 80302 (303) 442-3837 TWX 910-940-3246

Circle 158 on reader service card

The Answer Book. It makes your job easier. \$25.

Who makes what? Over 4000 products, 6000 manufacturers with their local contacts, directory of trade names and catalogs, inquiry "bingo" card for 5-second ordering of current catalogs.



Electronics Buyers' Guide
1221 Ave. of the Americas
New York, N.Y. 10020

Yes, send me a copy of The Answer Book. I've enclosed \$25 (USA and Canada only, elsewhere send \$35). Full money back guarantee if returned within 10 days.

Name _____

Company _____

Street _____

City _____

State _____

Zip _____

New products

110 kilohertz, plus dc, of course.

Ballantine Laboratories Inc., P.O. Box 97, Boonton, N.J. 07005. Phone (201) 335-0900 [355]

Wide-scale panel meter

is accurate to within 0.5%

An easy-to-read wide-scale analog panel meter, the model 612 is available with full-scale sensitivities from 5 microamperes dc to 30 A dc, 10 millivolts dc to 500 V dc, 100 μA ac to 50 mA ac, and 250 mV ac to 500 V

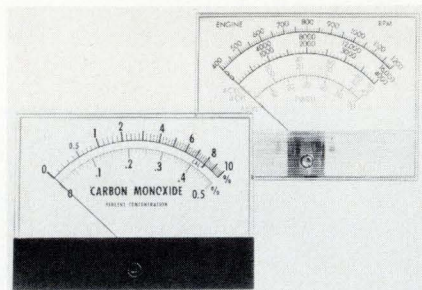

ac. Higher ranges are available with external shunts or transformers. Standard accuracy of the model 612 is to within 2% of full scale, but accuracy to within 0.5% is offered. Prices on the meters range from \$32 to \$64 each in small quantities. Delivery is from stock.

Advertising Dept., LFE Corp., 1601 Trapelo Rd., Waltham, Mass. 02154. Phone (617) 890-2000 [356]

200-watt dc power supply
is bus-programable

Programable by means of the HP Interface Bus, which conforms to IEEE Standard 488-1975, the model 6002A dc power supply is a 200-watt instrument that operates both as a constant-voltage source and as a constant-current source. Front-panel indicator lights continuously show the supply's operating status. Voltage output is adjustable from 0 to 50 V, current output from 0 to 10 A. While one of the variables is being held constant, the other is free to vary with the load subject to the

is there a truly REVOLUTIONARY INDICATOR?

Yes. We call it the ULTRALITE.

These high-efficiency solid state indicator lights easily rival current conventional models for brightness and efficiency. Plus, they offer solid state longevity, durability, and low-power drain. Consider the advantages in applications where life, shock, vibration, and heat/power consumption are crucial factors.

The key is a unique package we designed from the ground up . . . from chip to functional chrome housing. The result takes real advantage of the LED light. In fact, our larger lamp puts out up to 13 mcd! And along with brightness comes an incredible field of indication up to 160°.

Three sizes are available: standard LED, .30-inch spot diameter, and .40 spot diameter. Order with or without resistors. Colors are red, amber and green. Options include voltage, current, lenses, and more.

ULTRALITE! You really have to see it to believe it. Contact us at Chicago Miniature Lamp Works, 4433 N. Ravenswood Avenue, Chicago, Illinois 60640. Phone (312) 784-1020.



CHICAGO MINIATURE HAS THE ANSWER!

CHICAGO MINIATURE LAMP WORKS

GENERAL INSTRUMENT CORPORATION 

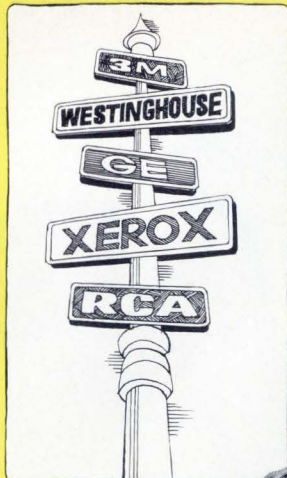

Follow the leaders...

To Fibra-Sonics.

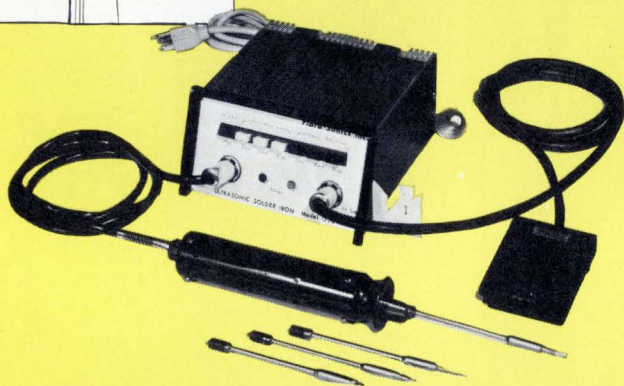

These Top 500 companies are now using our ultrasonic fluxless soldering system. Here's why.

The ultrasonic soldering system handles fluxless soldering of metals, exotics, glass and ceramics.

The G-35 generator shown here delivers 35 watts of ultrasonic heated power into the soldering iron, and features push button controlled power levels of heat and sound energy.

Solid state circuitry assures you of worry-free durable performance. And auto-feedback and power tracking leads to perfect production every time.

To find out how we can help you, send samples of your materials and a description of your requirements to Fibra-Sonics. We'll return them to you without cost or obligation.

FIBRA-SONICS®, INC.

4626 N. Lamon Avenue • Chicago, Illinois 60630 / (312) 286-7377

Circle 160 on reader service card

HOPE

in a word is what we are.

Project HOPE exists because there are people with hope—people who have given 3.5 million men, women, and children on four continents the chance for happier, more productive lives through improved health care.

Give to
**PROJECT
HOPE**

Department A
Washington, D. C. 20007

New products



200-watt power limitation. The unit is regulated to within 0.01% with ripple and noise of 1 millivolt rms, 10 mV peak to peak. Without the interface-bus capability, the 6002A sells for \$800. Programability adds \$350 to the base price.

Hewlett-Packard Co., 1501 Page Mill Rd., Palo Alto, Calif. 94304 [357]

Data-acquisition controller has analog and digital I/Os

A microcomputer-based data collection and control system called the Tychon Data Acquisition Controller has both analog and digital inputs and outputs. Consisting of a variety of standard hardware and software modules integrated to fit a specific need, the Controller is easily adapted to fit a user's changing demands. Typical applications are in auto-

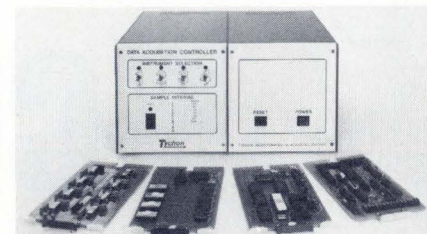

matic testing, data logging from a variety of instruments, remote data acquisition and data reduction, test sequencing and monitoring, and as a sequential programmable controller. Prices for basic systems start at \$2,500; delivery time is 60 to 90 days.

Tychon Inc., P.O. Box 242, Blacksburg, Va. 24060. Phone Jonathan Titus at (703) 951-9030 [358]

HOW THE LEADER IN DIGITAL VOLTMETERS PLANS TO STAY THERE.

A while back, we got a head start on everybody else in DVM's. People bought more of our instruments than they did the competition's.

Nothing has changed.

We still have the lead because we discovered a few things about the test and measurement field. We learned some things about developing new DVM's for the changing electronics industry.

Above all, we learned, don't offer a DVM unless it truly has value for the guy on the bench.

That means value across the board.

Five-range AC/DC volts to 1200V	only Fluke
Six-month calibration cycle	only Fluke
10,000-Hour demonstrated MTBF	only Fluke
Environmental capability specified and defined	only Fluke
Full line of accessories offering HI volts to 40 KV, RF to 500 MHz, current to 600A	only Fluke

There's not much competition.

Not just one feature that's unique or one lock-out spec, but an entire package that makes complete sense and offers you total value all the way around. Take specs, for example. We publish very conservative specifications. No one else does, but we think it's important that the instrument gives all the specs we've guaranteed. And then a little more. We feel that you ought to get better performance than you expected when you buy a Fluke instrument.

So what should you expect in a DVM?

First, an initial low cost. But also a low cost of ownership.

The Fluke 8600A sells for \$549.*

But, even more important, the 8600A has a demonstrated 10,000 hours MTBF. We've fully defined and specified environmental capabilities. And the calibration cycle is 6 months.

That's going to save you a bundle in cost of operation.

Without any sacrifice in specs.

Guaranteed six-month accuracy specs at 15°C to 35°C with an extremely low

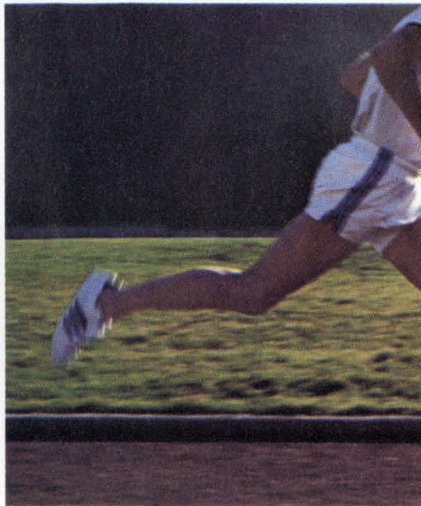

A running start helps.

temperature coefficient. Five ranges each of ac and dc volts to 1200V with 0.02% dc and 0.2% ac accuracy. Five ranges each of ac and dc current to 2A with 0.1% dc and 0.3% ac accuracy. Six ranges of resistance to 20 megohms with 0.1% accuracy. AC bandwidth to 100 kHz.

Autorangeing through all ranges plus individual range selection. Continuous

overload specified for all ranges/functions with overload indication.

Features for flexible operation.

Environmental capability specified and defined. Automatic zeroing. Low 7-watt power consumption for reliability. And a full line of accessories including 40 KV high voltage probe, 500 MHz RF probe and 600 A ac current probe. A self-contained rechargeable battery option.

And remember, those are conservative specs for the 8600A. At \$549.

A genuine value from Fluke.

Which suggests we plan on being the leader in DVM's for a long time coming.

No matter how much it upsets our competitors.

For data out today, dial our toll-free hotline, 800-426-0361.

John Fluke Mfg. Co., Inc., P.O. Box 43210, Mountlake Terrace, WA 98043

Fluke (Nederland) B.V., P.O. Box 5053, Zevenheuvelenweg 53, Tilburg, Netherlands.

Phone: (013) 673-973 Telex: 52237

**Domestic price only.*



THE INDUSTRY STANDARD. 8600A DVM. **FLUKE**

AN INVITATION TO LEARN WHY THE FLUKE 8500A IS CALLED THE WORLD'S FINEST DVM.

We'd like to introduce you to a new concept in digital voltmeters.

The Fluke 8500A.

It's a measurement system—not a dedicated instrument, but a bus-oriented, microprocessor-controlled measurement device. Modules which convert parameters, such as ac voltage, resistance or current, are simply plugged into any available slot in the bus structure. The microprocessor then talks to the module and displays the new value in the desired parameter.

That's the heart of the 8500A—unlimited measurement architecture. At any time, different measurement, control or servicing modules can be plugged in the bus.

And the 8500A is a different measuring device.

All for a basic system price of \$2,695*:

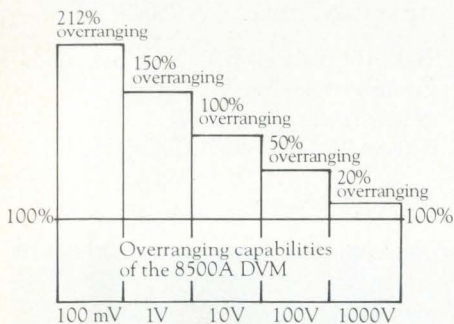

Most other DVM's offer only 20%-60% overranging.

The 8500A is a high-speed 5½-digit DVM capable of 500 readings per second at full resolution and accuracy. Fluke's patented Recirculating Remainder (R²) A/D Conversion technique is used for high, long-term accuracy and linearity. There's a calibration memory that allows for automatic correction of calibration error. And it's the only systems DVM that measures ac and dc current.

DC voltage measurement and dc ratio are standard features. DC voltages are measured over five ranges, with resolution between 1 μ V and 10 mV and a basic accuracy of $\pm 0.001\%$ (10 ppm) for 24 hours, 20°C $\pm 1^\circ$ C. Starting with the lowest range, a maximum display of

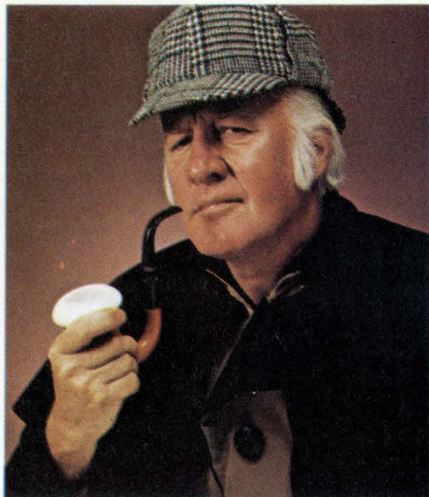

"It's not difficult to understand why it's called the finest. After all, it is a Fluke DVM, isn't it?"

312.5 mV is possible with a resolution of 1 μ V. Displays on the lower ranges are in volts, followed by an exponent display of -3.

Two types of ac measurement options are available for the 8500A. While only one can be installed in the instrument at a time, removing one option and installing the other requires a minimum of time and/or operator training. At power up or after reset, the front panel displays whether the averaging converter, true rms converter or neither is installed in the instrument.

The Averaging Converter (Option -01) measures up to 1000V ac on four ranges with a bandwidth from 30 Hz to 100 kHz and accuracies up to $\pm 0.05\%$ + 5 digits. The True RMS Converter (Option -09) measures up to 1000V ac on four ranges with a bandwidth from 10 Hz to 300 kHz and accuracies up to $\pm 0.1\%$ + 15 digits.

Resistance measurements can be made on eight ranges from 10 Ω full scale to 100 M Ω full scale with the Ohms Converter (Option -02). Basic accuracy from 100 Ω to 1 M Ω is $\pm 0.003\%$ + 1 digit, with resolutions up to 100 $\mu\Omega$ obtainable.

Both ac and dc current can be

measured with the Current Module (Option -03) provided one of the ac options is installed in addition to the basic dc. Current measurements to 1A can be made with sensitivity to 1 nA. Accuracies to $\pm 0.03\%$ + 10 digits, for dc readings and to $\pm 0.06\%$ + 8 digits for ac readings. Bandwidth of the 100 μ A through Amp ranges is 30 Hz to 10 kHz. For the 1A range only, the bandwidth is 30 Hz to 3 kHz.

Guaranteed accuracies for the 8500A measurement options are based on 90 days, 18°C to 23°C.

Three Remote Interface options are available with the system. Only one of the three may be installed at a time; however, one can be easily exchanged for another when the top cover is removed. This allows the instrument to be used with more than one interface system, requiring only that additional modules for the desired interfaces be obtained.

The IEEE Standard 488-1975 Bus Module (Option -05) provides an eight-bit (one byte) parallel interface. The Bit Serial Asynchronous Interface Module

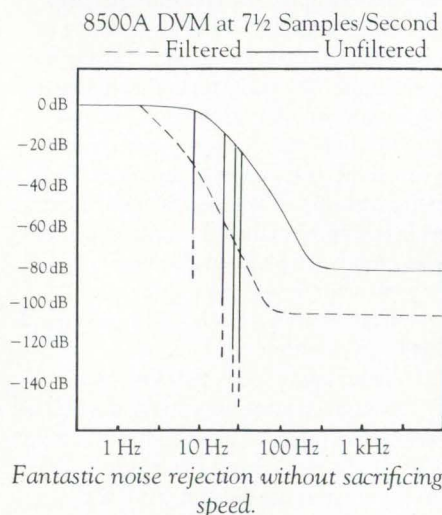

(Option -06) interfaces the 8500A to systems using either RS232B, RS232C, or Current Loop interface. Selection of type and Baud rate is made with bit switches accessible through an entry

Automatic correction for zero, offset, calibration and drift with microprocessor controlled memory storage.



Extra digit of resolution.

As an extra bonus, the range digit can be converted to a 6th measurement digit—for 6½ digits of resolution.

port on the rear panel. And the Parallel Interface Module (Option -07) provides a 16-bit duplex register interface compatible with mini-computer and microprocessor systems.

A non-volatile calibration memory module stores correction factors desired from a standard input during CAL mode operations. It can also be used to compensate for long-term drift, eliminating the need for manual adjustments or trips to the calibration laboratory. This al-

IEEE-488 interface bus	Fluke
ASC11 interface	Fluke
Parallel interface (16 bit)	Fluke

Only one system DVM offers all the interfaces you need.

18 different sample rates	Fluke
5 different filter modes	Fluke
Programmable scaling factor	Fluke
Store and test for limits	Fluke
Local and remote lockout	Fluke
Front panel display on/off	Fluke
Line and non-line synchronized readings	Fluke
Store and display of highest and lowest values found	Fluke
Recall and display status	Fluke
6½ digits of resolution	Fluke

And with any interface there are expanded remote features.

lows the operator to remove power from the instrument or the system to suffer a power failure without loss of automatic calibration factors. The battery permanently installed on the module will keep power on the memory to retain the stored data in excess of 90 days after removal of power.

Service capability is one of the strong points in the 8500A program. Of course, extensive overload protection has been designed into the instrument. But should problems develop, most of them can be handled in the field by using the available service aids. An extender card, a bus monitor, a test module, and a static controller, together with diagnostic programs and the microprocessor control should handle 60%-80% of most troubleshooting problems.

If you've read this far, you know

why the 8500A is called the world's finest DVM. Microprocessor control, modular design, complete measurement and systems interface capability and ease of service are all combined in one instrument. And the best thing about it is that it's made by Fluke. So you know you can count on quality and service throughout the world.

The 8500A. One more reason why Fluke is the leader in digital voltmeters.

For data out today, dial our toll-free hotline, 800-426-0361.

John Fluke Mfg. Co., Inc., P.O. Box 43210, Mountlake Terrace, WA 98043
 Fluke (Nederland) B. V., P.O. Box 5053, Tilburg, The Netherlands.
 Phone: (013) 673-973 Telex: 52237
 *U.S. price only.



NOTHING COMPARES. 8500A DVM. **FLUKE**®

Your Single Bored Computer can be the life of the party.

Just introduce it to these swinging **iCOM Microperipherals.**TM

Intel's SBC80/10 Single Board
Computer and Card Cage

iCOM PP80 SBC/MDS
PROM Programmer/Memory
Expander—Programs 2704 and
2708 EPROMs. Has sockets for up
to 8K additional PROM.
Occupies one slot in SBC card
cage. Works with Intellec
MDS-800 too.

iCOM 360-56 SBC80/10 Interface
card—Interfaces iCOM Frugal
FloppyTM to the Intel SBC80/10.
Includes software driver PROM
and iCOM's famous FDOS-II
software with macro assembler
and string oriented text editor.
Occupies one slot in SBC card
cage.

iCOM FF36-1 Frugal FloppyTM—
Includes disk drive with daisy
chain capability, proven IBM
compatible controller, all cables
and connectors. Also available as
a completely packaged system.
MDS version available, too.

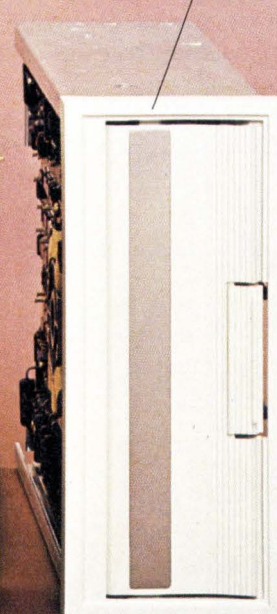
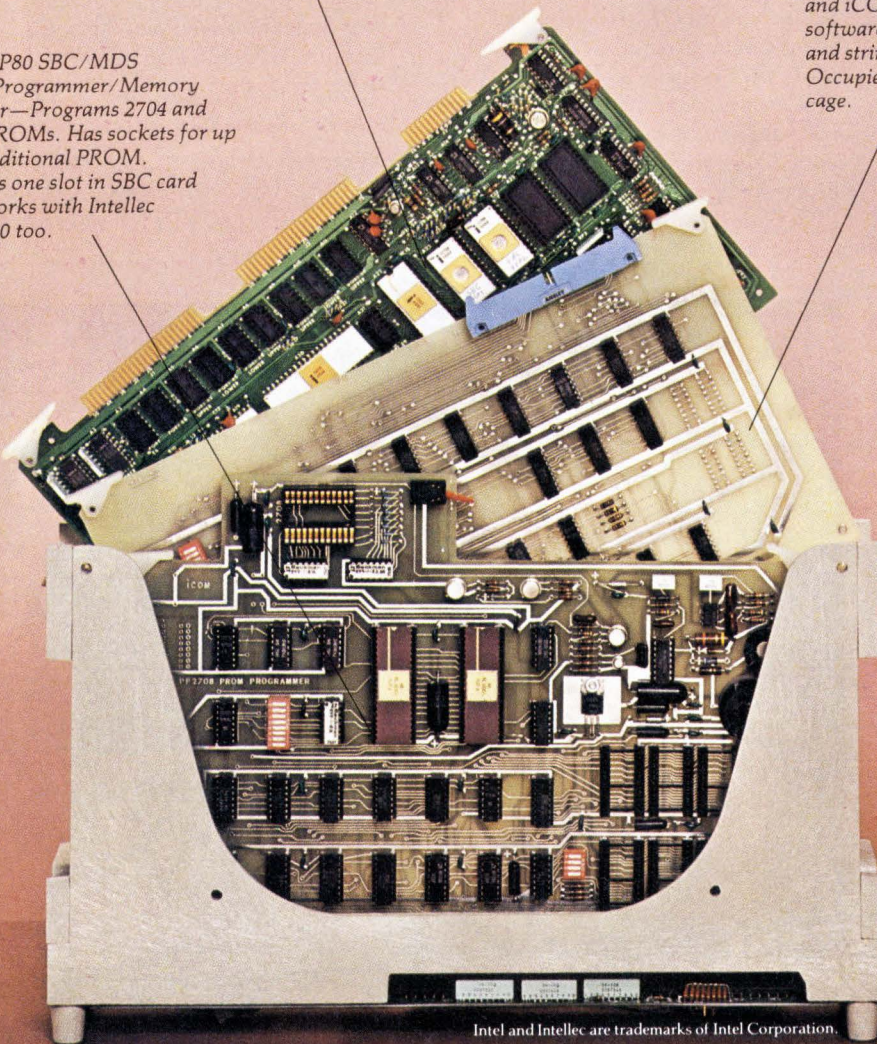

Intel and Intellec are trademarks of Intel Corporation.

So you have a computer on a board.
Now what? iCOM has the answers with
two essential Microperipherals.

First, our Frugal FloppyTM with disk
drive, controller and SBC80/10 interface,
for just \$1495 complete. Includes our
famous FDOS-II software with super
features, such as named variable length

files, autofile create open and close,
multiple merge and delete—and more.

Second, our PROM Programmer/
Memory Expander for 2704 and 2708
EPROMs. Just \$395 including 1K ROM
resident programming firmware.
Room for 8K of additional PROM, too.
So call iCOM today.

MICROPERIPHERALSTM
iCOM

iCOM Inc, 6741 Variel Avenue
Canoga Park, CA 91303 • (213) 348-1391
Circle 164 on reader service card

New products

Data handling

Mini offers 600-ns cycle

Wang machine uses 4,096-bit RAM for microinstruction storage and user memory

Since the 1970 introduction of its 2200A minicomputer, Wang Laboratories has incrementally improved the central processor in at least four evolutionary steps. Now the company has thoroughly redesigned the CPU as part of the 2200VP, which will be introduced at Wescon/76. The minicomputer allows instruction executions six to eight times faster than its immediate predecessor, the 2200T. However, both software and peripherals are compatible with earlier 2200 models.

A redesigned microprocessor, to accommodate the operating system and systems interpretive language, and a new random-access memory combine to deliver a cycle time of 600 nanoseconds compared with 1.6 microseconds for the earlier 2200T. A 4,096-bit RAM is used for both microinstruction storage and user memory, which also contributes to system speed; in earlier 2200-series minicomputers, system microcode was stored in slower read-only memory.

Everett Sheppard, Wang's product manager for large systems, points out that the increased speed means that an instruction such as FIND A NEW FILE requires 0.28 second per record in the 2200VP. The same instruction in the 2200T took 1.72 seconds per record, which translates into more than a 6:1 improvement for the VP. Sheppard says further that if the 2200T software were recorded to optimize it for the VP, the throughput increase could average as much as 10:1. But he emphasizes the importance of maintaining software compatibility with the earlier systems to protect the customer's investment.

Sheppard says that the increased performance of the VP, plus the capability to address up to 64,000 bytes of memory vs 32,000 for earlier 2200 models, will enable Wang to compete more favorably against certain minicomputers offered by Digital Equipment Corp., Data General Corp., and IBM Corp. "We're starting to compete more and more with those companies," Sheppard says. "We've always been able to compete with them in price, but the 2200VP will make us competitive in both price and performance."

The system is intended for both engineering and commercial applications. It can be used as a stand-alone unit by a small business, in a department of a larger company, or in a multiterminal distributed-processing system. It can communicate with larger mainframes because it accommodates most asynchronous and bisynchronous telecommunications protocols.

The 2200VP will be priced between \$12,000 and \$15,000. Deliveries will begin in late October.

Wang Laboratories Inc., 836 North St., Tewksbury, Mass. 01876. Phone (617) 851-4111 [361]

Thermal-printer option annotates analog charts

An internally mounted alphanumeric thermal printer that requires no user adjustment is now available as an option on Astro-Med analog chart recorders. The printer, which

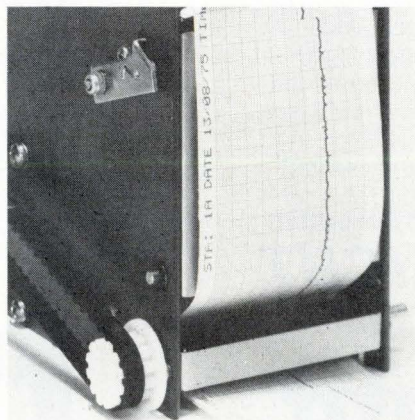

A great place to start expanding your company is right here.

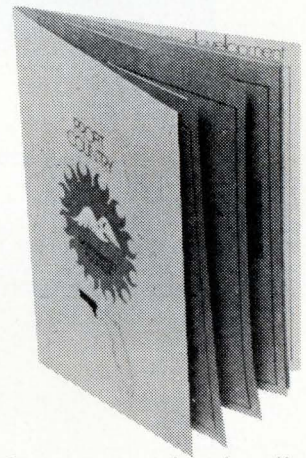

Our 16 page book talks about the labor force, about deep water ports, about utilities, temperatures, taxes. There's everything here from financing to flying times, from industries to schools—all the things that make Northwest Florida one of the most profitable, most livable business climates in the country. And it's free.

Gulf Power Company
Manager, Area Development
Department D-8
P. O. Box 1151
Pensacola, Florida 32520
Please send me your book.

Name

Title

Company

Address

City

State

Zip

Dialight LED Displays

The widest choice for your every application.

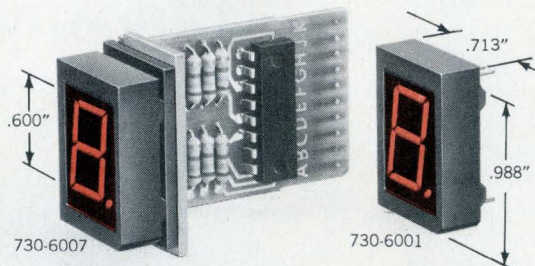

730 SERIES A new 0.600" LED character in super bright red, seven-segmented readout . . . low power . . . draws 10mA/segment or less . . . operates with standard IC power supply levels. Very high contrast ratio . . . visible from 40°. Available with or without on-board decoder/driver, plus or minus bar, and with bezel mounting. In 1000-lot quantities each LED **730-6007 . . . \$6.05. 730-6001 . . . \$2.55.**

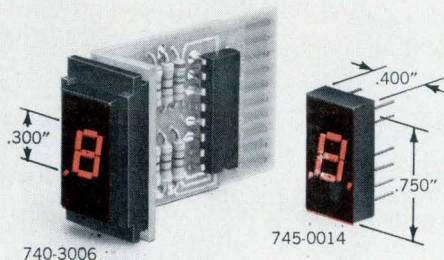

745 SERIES A new 0.300" LED character in a very bright red, seven-segmented readout . . . low power requirements. Standard 14-pin DIP . . . available with left and right decimal with ± 1 , and with and without on-board decoder/driver. Compatible with most TTL and DTL circuits. In 1000-lot quantities each **740-3006 . . . \$6.43. 745-0014 . . . \$2.10.**



Dialight, the company with the widest choice in switches, LEDs, indicator lights and readouts, looks for needs . . . your needs . . . and then they develop solutions for your every application. No other company offers you one-stop shopping in all these product areas. And no other company has more experience in the visual display field. Dialight helps you do more

with these products than any other company in the business, because we are specialists that have done more with them. Talk to the specialists at Dialight first. You won't have to talk to anyone else. Send for your free new copy of Dialight's current catalog.

DIALIGHT

Dialight, A North American Philips Company
203 Harrison Place, Brooklyn, N. Y. 11237
(212) 497-7600

See Dialight.

New products

automatically responds to programmed commands, can be useful in the interpretation of analog data from medical and seismic monitors, for example. Typically, the printer would be used to record such data as station number or location, date, and time along the margin of the chart paper.

The printer contains a character generator, a clock, and a 5-by-7-dot matrix of integrated resistive elements that do the actual thermal printing. It is fast enough to print at least 10 characters per second on chart paper moving at speeds up to 50 millimeters per second. All of the characters, which are 0.1-inch high, belong to the standard 64-symbol ASCII code. Priced at \$150, the printer is available from stock.

Astro-Med, Atlan-Tol Industrial Park, West Warwick, R.I. 02893. Phone (401) 828-4000 [363]

Data General introduces new Nova and a printer family

Data General Corp. will show at Wescon its top-of-the-line Nova 3/D computer—a system-level machine with memory mapping and protection, and a main memory capacity of 131,072 words. In addition, the company will introduce four terminal printers, the 6040 series, which are the first to be designed and manufactured by Data General.

The 16-bit, 12-slot Nova 3/D uses 32,768-word MOS-memory modules

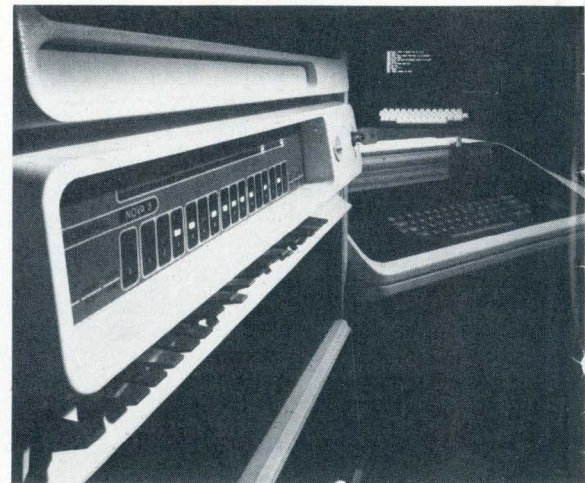

How to tell the good guys from the bad guys.

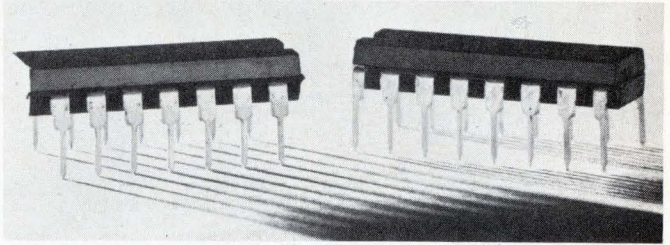

First, the real villains aren't the ICs that come to you *dead-on-arrival*.

You can spot those quickly with a modestly-priced tester and send them packing.

No, the worst guys are the ICs that sneak into your plant looking fine—then steal you blind by breaking down after you've invested time and labor into installing them.

It's weeding out these ICs in the *infant mortality* group that's important. And it's what we spend our lives solving here at Datatron.

Preconditioning is the key. It amounts to subjecting an IC to the rigors of a year's worth of living—compressed into a few days. We do it with burn-ins, thermal-shock, temperature cycling, stabilization bakes—anything required to appropriately test your parts for your application.

Everything from the early, simple ICs through some of the latest, most complex have passed through our labs... over 40,000,000 of them last year. Our test analyst engineers have the experience and are the best in the business at determining

exactly what kind and how much preconditioning and testing your parts need.

How much will it cost you? How much can you save? How long does it take?

Our engineers are right at the other end of your phone, ready to discuss your needs and give you the best possible recommendations.

And it's the best first step you can take to getting to your bad ICs—before they get to you.

Free. Basic Handbook of Preconditioning and Testing Semiconductors

Here's your quick guide to some of the important ins and outs. It won't replace your need for experts—but it will certainly help you get the most out of them. Included: "Testing—how much, how little?" "The cost of testing vs. not testing." "How to test the test labs." And more.

Just call or write for your free copy.

datatron, inc.

MICROELECTRONIC TESTING LABORATORIES DIVISION

1562 Reynolds Avenue • Irvine, California 92714 • (714) 540-9330 • TWX 910-595-1589

11 Esquire Rd. • No. Billerica, Mass. 01862 • (617) 667-2191 • TWX 710-390-1447

178 Warren Allen Dr. • Wood Dale, Ill. 60191 • (312) 595-0440 • TWX 910-256-4845

Semiconductor Testing

RAIN! RAIN! RAIN!

IT'S A DIRTY WORLD!

BUT NOT WET OR DIRTY ENOUGH TO CONTAMINATE OUR SEALED DIGITAL SWITCHES.

We make five different lines of environmentally sealed DIGITAL SWITCHES.

- Series 200 MINISWITCH®
- Series 700 MINISWITCH®
- Series 9000 DIGISWITCH®
- Series 12000 MINIBUTTON
- Series 24000 DIGILEVER

and they are all QPL Approved to MIL-S-22710.

Send for Data Sheets describing these switches.

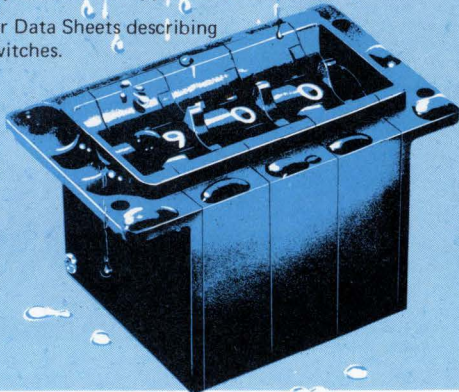

DIGITRAN®

Pasadena, California 91105 • Phone (213) 449-3110

For more information use the Inquiry Form provided on this page.

INQUIRY FORM

1. DO YOU WANT MORE INFORMATION? Yes, send data about:
- KL MINIKEY Keyboard
 - Series 8000 MINISWITCH
 - Series 23000 SNAP-IN SLIMSWITCH
 - Series 29000 ECONOMY MINISWITCH
 - Series 12000 MINIBUTTON
 - Series 24000 DIGILEVER
 - Series 28000 MINILEVER
 - QPL Approved DIGITAL SWITCHES
 - DIGITAL VOLTAGE DIVIDER and RESISTANCE DECADE Catalog
 - Send me your complete "DIGITAL SWITCH" Catalog.
 - Send a

Sales Engineer to see me. My phone is: (_____) _____

2. Is the purchase of this type product anticipated? Yes No. If "Yes", what is your application? _____
3. Is your requirement: Current 1-3 months 3-6 months longer?
4. How many assemblies per year? under 100 100-500 500-1000 or more.
5. Are you responsible for: Design Specification Purchasing?
6. Have you specified or purchased products of the type made by Digitran in the past? Yes No. If yes, whose? Digitran
- Other _____
7. Have you ever been contacted by a Digitran Sales Representative? Yes No. If "Yes", When? Recently 3-6 months ago 6-12 months ago 12 months or more.

Name _____ Title _____

Company _____

Address _____

City _____ State _____ Zip _____

For detailed information about Digitran's products, please complete this INQUIRY FORM, clip and send it to:

THE DIGITRAN® COMPANY

A Division of Becton Dickinson Company B-D E 976
855 South Arroyo Parkway • Pasadena, California 91105

New products

with a cycle time of 700 nanoseconds. Built with the same architecture as the family of Nova-3 computers introduced 10 months ago, the new machine is compatible with Nova-line software and peripherals.

For its printer-terminal debut, the company is offering units capable of printing at 30 characters per second and at 60 c/s. For each speed, there is a receive-only model and a keyboard version that can be used off line as a typewriter. All models print full 132-column lines on paper widths from 4 to 15 inches. They interface with all Eclipse and Nova computers and are compatible with standard ASCII input devices. Prices range from \$2,200 for a 30-c/s receive-only terminal to \$2,650 for a 60-c/s KSR unit.

Prices on the Nova 3/D start in the vicinity of \$10,000 for a machine with 32,768 words of memory and reach about \$100,000 for the largest system with such accessories as expanded memory, disk drives, tape drives, CRT displays, a real-time clock, and a printer. Both the printers and the computers have a delivery time of 90 days.

Data General Corp., Southboro, Mass. 01772. Phone (617) 485-9100 [364]

Rugged tape recorder has head sealed in tape module

For maximum protection against severe environments, the four-track head of a rugged quarter-inch tape recorder is not mounted on the tape transport itself, but is sealed into each of the unit's removable tape modules. Each sealed module, which contains 300 feet of quarter-inch tape, can either store 16.8 megabits with industry-standard block-recording or twice that amount with a high-density technique. The tape drive has a bidirectional read/write capability at a preset speed of up to 30 inches per second. Search and rewind speeds are four times the preset read/write speed.

Among the unit's high-performance specifications are an operating

THE LOGICAL CHOICE—First in a series

Logic Probe 1 is a compact, enormously versatile design, test and troubleshooting tool for all types of digital applications. By simply connecting the clip leads to the circuit's power supply, setting a switch to the proper logic family and touching the probe tip to the node under test, you get an instant picture of circuit conditions.

LP-1's unique circuitry—which combines the functions of level detector, pulse detector, pulse stretcher and memory—makes one-shot, low-rep-rate, narrow pulses—nearly impossible to see, even with a fast scope—easily detectable and visible. HI LED indicates logic "1", LO LED, logic "0", and all pulse transitions—positive and negative—are stretched as narrow as 50 nanoseconds—are stretched to 1/3 second and displayed on the PULSE LED.

By setting the PULSE/MEMORY switch to MEMORY, single-shot events as well as low-rep-rate events can be stored indefinitely.

While high-frequency (5-10MHz) signals cause the "pulse" LED to blink at a 3Hz rate, there is an additional indication with unsymmetrical pulses: with duty cycles of less than 30%, the LO LED will light, while duty cycles over 70% will light the HI LED.

In all modes, high input impedance (100K) virtually eliminates loading problems, and impedance is constant for all states. LP-1 also features over-voltage and reverse-polarity protection. Housed in a rugged, high-impact plastic case with strain-relieved power cables, it's built to provide reliable day-in, day-out service for years to come.

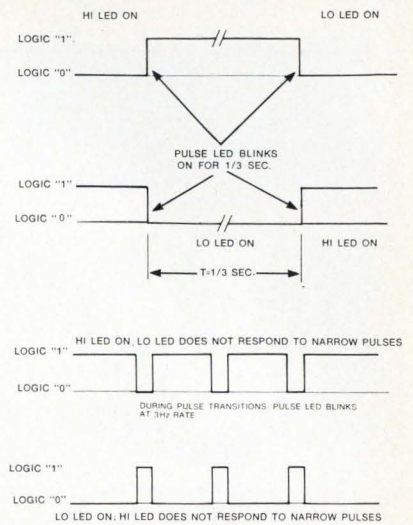

CSC'S MULTI-FAMILY LOGIC PROBE 1. AT \$44.95, IT DIGS UP A LOT OF INFORMATION WITHOUT BURYING YOUR BUDGET.

HI/LO LED's—Display level (HI-logic "1", LO-logic "0") of signal activity at node under test

PULSE LED—Lets you know what's going on—and off. Indicates positive and negative pulse and level transitions. LP-1 stretches pulses as narrow as 50 nanoseconds to full 1/3 sec. (3Hz pulse rate)

PULSE/MEMORY Switch—PULSE position detects and stretches pulses as narrow as 50 nanoseconds to 1/3 sec. Switch to MEMORY and it stores single shot and low-rep-rate events indefinitely; HI/LO LED's remain active

Logic Family Switch—TTL/DTL or CMOS matches Logic "1" and "0" levels, for greater versatility. High Input Impedance—100K virtually eliminates circuit loading problems and is constant in both "0" and "1" states. CMOS position also compatible with HTL, HiNIL and MOS logic

Non-corrosive nickel-plated probe tip and clip leads—For reliable contacts and maximum life

Rugged high impact plastic case—Built to take it... in the lab or in the field

Protected—Features built-in reverse polarity and over-voltage protection; strain-relieved power cable

\$44.95 Price tag—Costs so little it can be your personal property

CONTINENTAL SPECIALTIES CORPORATION

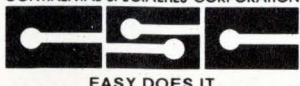

For more information, see your distributor or write for our catalog and distributor list.

44 Kendall St., Box 1942 New Haven, CT 06509 • 203-624-3103 TWX: 710-465-1227 West Coast office: Box 7809, San Francisco, CA 94119 • 415-421-8872 TWX: 910-372-7992 Canada: Len Finkler Ltd., Ontario

"COME SEE US AT WESCON BOOTH #7813"

Circle 169 on reader service card 169

New from Standard Grigsby



P/rel T.M.

the programmable rotary encoded logic switch everyone will be talking about...

...because no other rotary switch has as much versatility with as low a cost as Standard Grigsby's P/rel switch!

The economy is twofold. This switch not only lends itself to full automation, but installed costs are lower by the use of our printed circuit terminals (solder terminals are also available).

A specially processed printed circuit disc is fully

programmable to the truth table of any code. We provide 100% program disc inspection to customer specifications. Up to 60 detent positions are available with our new double ball Dual Flex™ detent. And, the use of concentric shafts allows up to 120 detent positions from a single switch!

Everyone will be talking about P/rel . . . so will you!

Send for your free "Yes" button and literature.



standard grigsby, inc.

920 Rathbone Avenue, Aurora, Illinois 60507, Phone (312) 897-8417

Circle 170 on reader service card

**The Answer Book.
It makes your job
easier. \$25.**

Who makes what? Over 4000 products, 6000 manufacturers with their local contacts, directory of trade names and catalogs, inquiry "bingo" card for 5-second ordering of current catalogs.



Electronics Buyers' Guide
1221 Ave. of the Americas
New York, N.Y. 10020

Yes, send me a copy of The Answer Book. I've enclosed \$25 (USA and Canada only, elsewhere send \$35). Full money back guarantee if returned within 10 days.

Name _____
Company _____
Street _____
City _____ State _____ Zip _____

New products

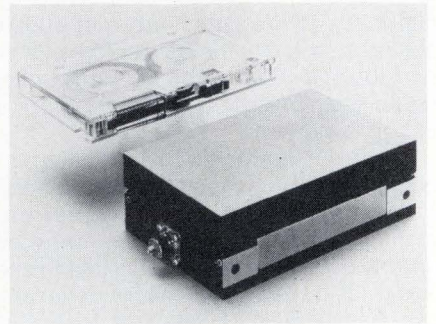

temperature range of -54°C to 95°C for MIL-E-5400 Class 2 applications. Operation consumes less than 30 watts, and the standby-power requirement is only 5 w.

The BDSU (for bulk data storage unit) transport sells for \$5,000, and each tape module is priced at \$595. Electronic Memories & Magnetics, Severe Environment Products Division, 20630 Plummer St., Chatsworth, Calif. 91311 [365]

Modules cut cost of fast Fourier transform processing

A series of fast Fourier transform modules is claimed to provide spectrum-analyzer systems with performance matching that of minicomputer-based FFT systems at much lower cost. The first two modules in the series are the SPM-01 at \$5,000, and the SPM-02 at \$6,000. The former has a transform characteristic of 1,024 complex points in 600 milliseconds, while the latter requires only 250 ms. Data input for



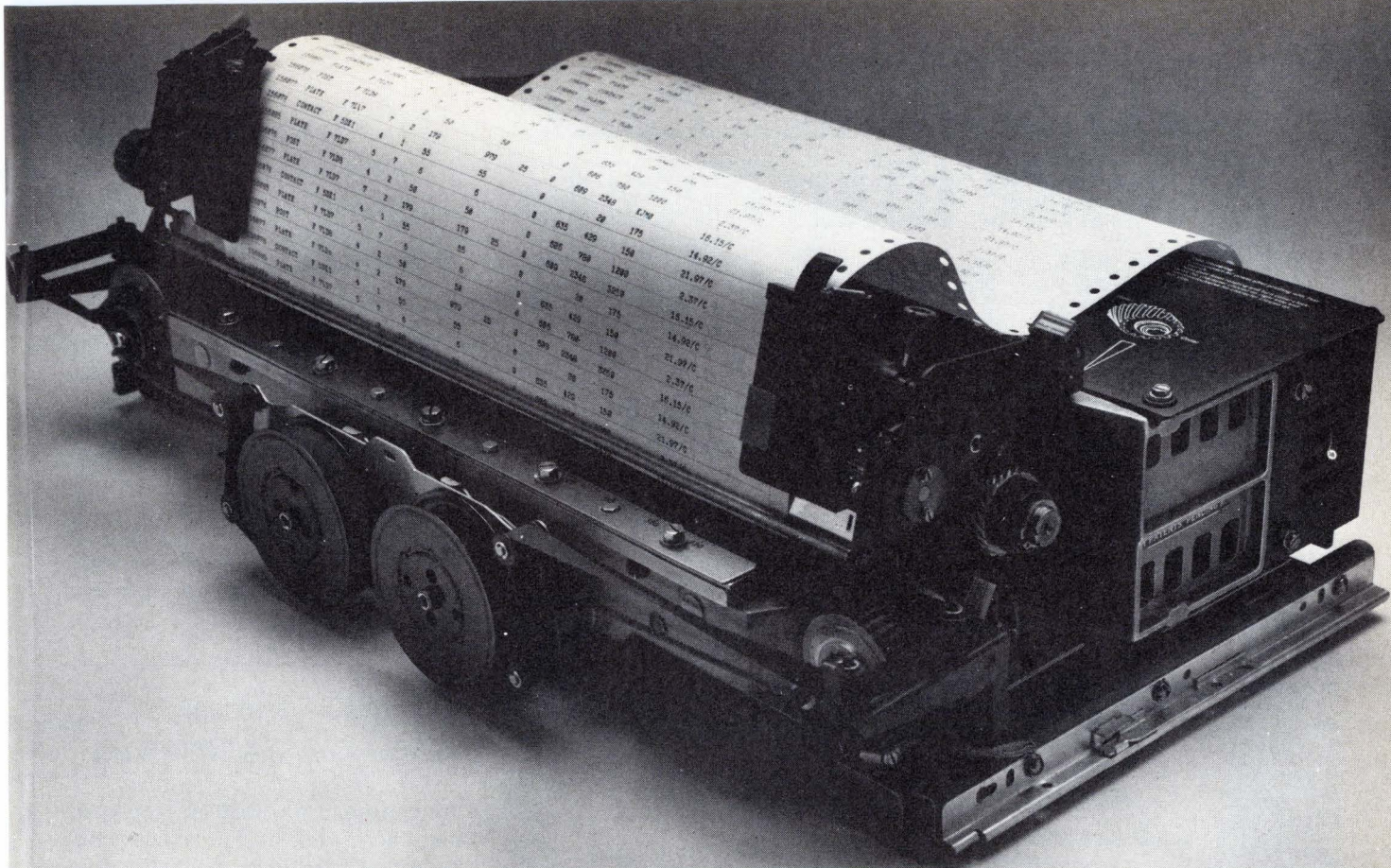

132 columns. Over 300 lines per minute. Under \$2000*.

In printers, it's not just a question of how much they cost, but one of how much you get for your money. And on a price/performance basis, nothing even comes close to the Teletype® model 40 OEM printer.

Besides getting a 132-column, heavy-duty impact printer that delivers over 300 lpm for less than \$2000, you also get a printer with outstanding flexibility and reliability.

The big reason behind the model 40's price/performance advantage over the competition is our unique design. Even though it operates at speeds over 300 lpm, wear and tear is less than you'd find in a conventional printer operating at a much slower speed. Fewer moving parts and solid-state components add up to increased reliability and reduced maintenance.

We'd be ahead if we just stopped there, but the model 40 also offers you a number of other features. Like a choice of character sets, operator-adjustable form width and form length, parity error indication, and a built-in self-test feature, just to name a few.

For complete information, please contact our Sales Headquarters at: 5555 Touhy Ave., Skokie, Ill. 60076. Or call Terminal Central at: (312) 982-2000.



**The Teletype model 40 OEM printer.
Nothing even comes close.**

Teletype is a trademark and service mark registered in the United States Patent and Trademark Office.
*80-column-version available for under \$1400.

Circle 171 on reader service card

Today, it makes more sense than ever to test the big 3 against it.

MATSUO DIPPED TANTALUM CAPACITORS

1. ✓ **Matsuo builds them better & pretests longer** Matsuo builds on lead frames — the quality mode of construction. Then pretests for 48 hours at full voltage.
2. ✓ **Matsuo has lowest failure rate** Our standard failure rate is only 2% per 1,000 hours — 60% confidence level. Selected units at 1% per 1,000 hours. What we deliver, delivers!
3. ✓ **Matsuo provides better leakage control** Our standard units are .01XCV. Selected capacitors are .001XCV. Ten times better when you need it.
4. ✓ **Matsuo saves costly assembly time** Matsuo lead spacing is fixed — always the same to fit assembly board quickly, easily. Positive leads are longer — touch tells assembler, eliminates examining. Leads are square — “bite” corners so Dip stands upright even during soldering. Each feature saves you costly assembly minutes.
5. ✓ **Matsuo prices are competitive and then some** All the features, all the quality are yours at unbeatable prices. Test us here, too!

Other Matsuo Capacitors:
Type 242 Molded Tantalum, Type 262 Chip Tantalum.

These days with Dipped Tantalum Capacitors readily available, shouldn't you be sure you're getting the most for your money. All we ask is that you test Matsuo Dips against the one you're using. And that, we think, says more about the way we build our Dips than anything else!

For engineering samples, literature, prices, write or call

MATSUO

ELECTRONICS

831 SO. DOUGLAS ST., EL SEGUNDO, CA 90245 / (213) 679-0379

New products

the two modules may be in either analog or digital format at speeds up to 50 kilohertz.

Based on the high-speed Plessey Microc-16 microcomputer, the modules perform both forward and inverse transforms and can present the output data either in analog or digital form in a variety of formats: real part, imaginary part, alternating real and imaginary parts, or as a computed power spectrum.

Plessey Microsystems, Microcomputer Products, 1674 McGaw Ave., Irvine, Calif. 92714. Phone Jay Jhu at (714) 540-9945 [366]

'Smart' CRT terminal

operates up to 9,600 bauds

Built around an 8080 microprocessor, the model 8030 is a firmware-programmed cathode-ray-tube terminal that communicates at speeds to 9,600 bauds. Unlike most firmware-programmed terminals, the 8030 permits users to program communications functions from the terminal keyboard. A two-page refresh memory with a total of 3,840 characters



allows the user to scroll through both pages of stored data and to edit it as necessary before transmitting it to the computer. Time-saving features are provided in the \$2,750 unit for applications employing the protected-field mode.

The 8030 uses a 15-inch CRT, on which it displays 1,920 characters. Omron Corp. of America, Information Products Division, 432 Toyama Dr., Sunnyvale, Calif. 94086 [368]

whatever
your need...
we have
your

Videobrite LCDs

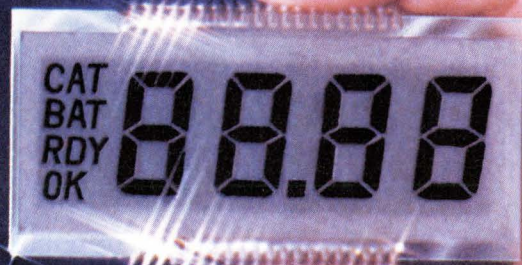

custom design

Off-the-shelf LCDs by LXD are the finest on the market. Readable, economical, pluggable, durable, and reliable. LXD also offers unparalleled versatility. The most experienced staff in the industry can design displays to fill your needs, or build displays to fit your design. Virtually any display — digits, letters, or symbols — is possible.

LXD for your LCDs.



Liquid Xtal Displays INC.

SUBSIDIARY OF DICKEY-john CORPORATION

24500 HIGHPOINT ROAD • CLEVELAND, OHIO 44122

TELEPHONE: 216/831-8100

Circle 173 on reader service card

SEE US AT THE WESCON SHOW BOOTH 1012 AND 1014



“Nervous Nellie” Nelson choosing his

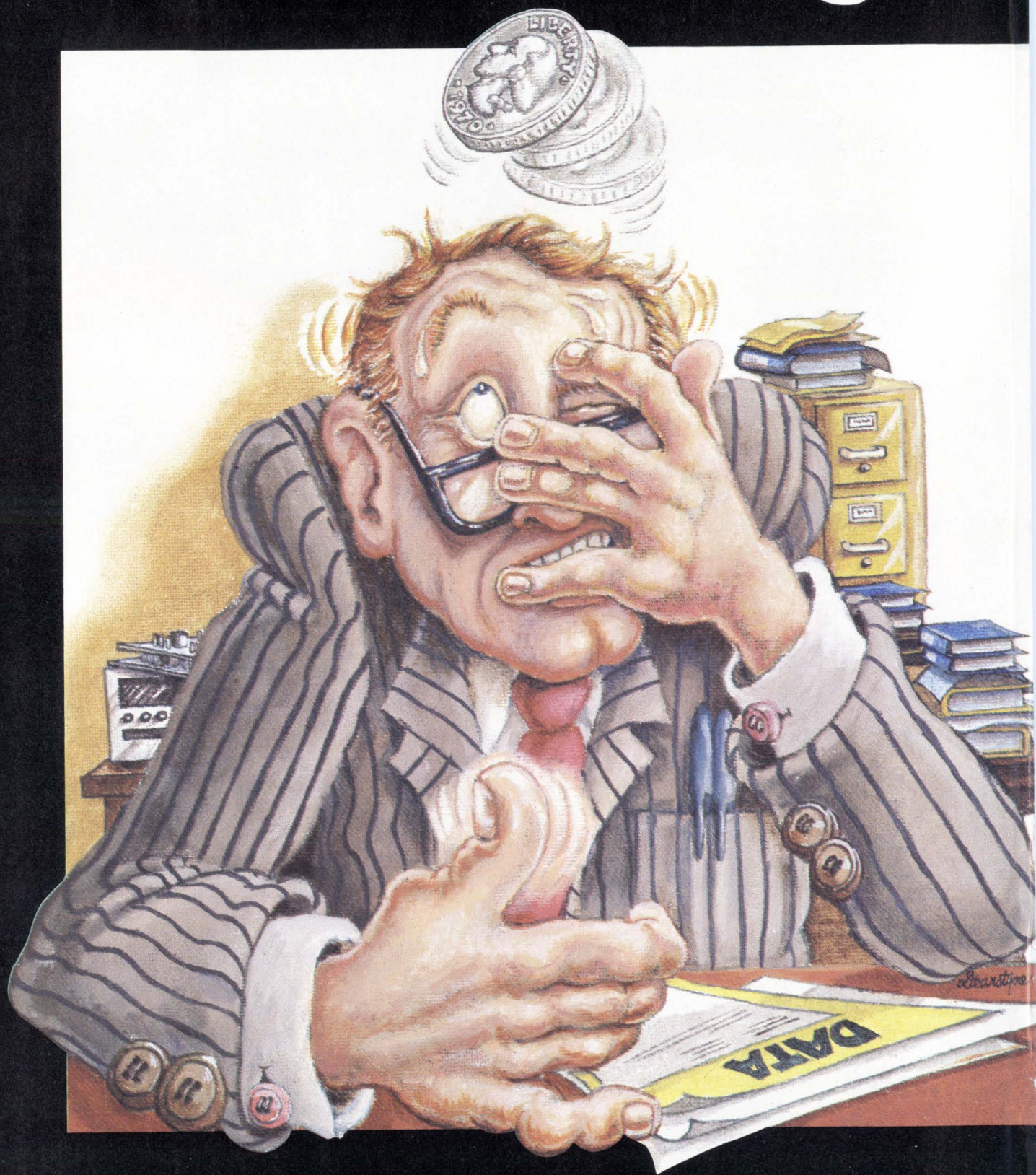

used to sweat bullets mini memories

Nelson "Nervous Nellie" Nelson.

To avoid undue confusion, had the same first and last names.

Always wore a belt and suspenders at the same time.

Owned several shares of Amalgamated Safety Pin.

Hated to make decisions. Especially when choosing minicomputer memories.

"Nervous" was *sure* he didn't like the high prices of the mini manufacturers.

Yet he was afraid to buy from a lower-priced independent because he wasn't sure what he would be getting.

One day, while shopping for a security blanket, "Nervous Nellie" spotted the following message monogrammed on the label:

"Plessey Microsystems is the largest independent supplier of minicomputer add-on memories there is, and they are part of an international billion dollar corporation. Plessey's low prices are complemented by the high quality and reliability of their products and the comprehensiveness of their support services.

"Plessey Microsystems.

"P.S.: Do not remove this Plessey pitch under penalty of law."

"Hmmm," noticed Nervous. "Billion dollar corporation. Largest independent mini memory supplier. Low prices. Reliable products."

He was certain he sort of liked that.

With a newfound surge of self-confidence, he placed a person-to-Plessey call and reassured himself that Plessey Microsystems was everything the label said they were. And more.

From then on, Nelson Nelson bought all his mini peripherals from Plessey.

And threw away his suspenders.

You, too, can find out how add-on core memories, single and dual disc drives and punched tape readers from Plessey Microsystems can expand your mini at low prices without your having to sweat about the results.

Just call and we'll be glad to tell you more about our products.

The Pacifiers

Plessey disc drive systems store up to four times the data in one quarter of the space at a much lower cost than drives from the mini manufacturers.

They are software, hardware, and media compatible with DEC and Data General minicomputers and they are available in a variety of types and sizes for doing your job your way.

To expand your mini systems even further, just plug the compatible Plessey disc controller into your mini mainframe. It will control up to eight Plessey disc drives, or any mix of Plessey and mini manufacturer drives with total capacities of 10, 20 and even 327 megabytes (depending on your mini model).

It all adds up to a great deal more capacity, performance and reliability for a great deal less than equivalent competitive drives.

You can count on it.

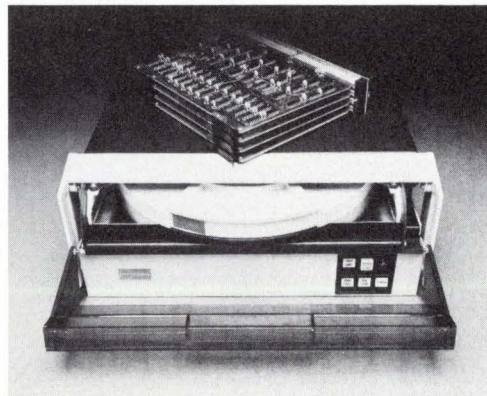

Plessey Microsystems

(714) 540-9945

Circle 175 on reader service card

The Ansley "D" Connector...

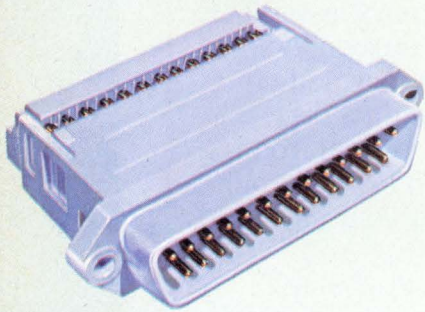

Our new series of male and female "D" connectors offer you a cost effective external mass termination cable and connector system second to none. Its uniqueness begins with a one-piece "D" connector package that meets industry standards for size, pin spacing, and contact reliability. With no loose parts to match up, positive cable-to-contact alignment is assured. Conductors are mass terminated in seconds with our standard BLUE MACS™ hand or bench tools. The results? Faster installation, higher reliability.

Contact pins are spaced on .054" centers — a perfect fit for any standard inter-cabinet "D" type connector application. Our new "D" connectors are designed to mate with standard 50 mil pitch flat cable as well as our new, improved jacketed cable — the only flexible flat cable engineered specifically for out-of-cabinet use.

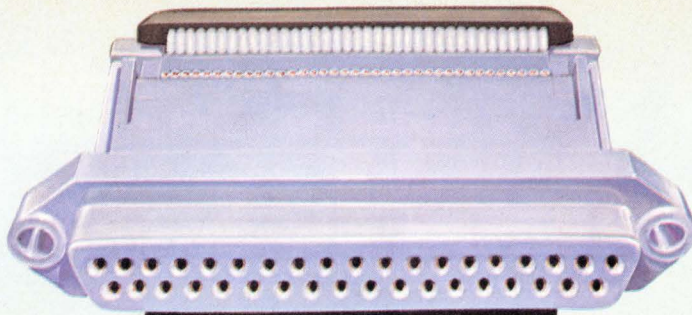

a new meaning to cost effectiveness.



The Ansley BLUE MACS™ jacketed cable is U.L. listed for external interconnection of electronic equipment. Electrically, it outperforms standard jacketed twisted pairs in typical I/O applications. And there's no special zipper lock tubing required — reducing the need for an extra cable accessory. Installation is faster, easier. And like all Ansley connectors, you can daisy chain our "D" types anywhere in the cable — along with our DIP socket, card edge, or pc board connectors.

Cable alignment and high contact reliability is assured — because both cable and connector are grooved for absolute alignment. Our patented TULIP™ 4-point insulation-displacing contacts are permanently fixed and sealed-in to provide a reliable, gas-tight, corrosion-free mass termination.

For the full reliability/cost effectiveness story and technical data, call or write:

T&B / Ansley

The mass termination company.

T&B/Ansley Corporation • Subsidiary
of Thomas & Betts Corporation
3208 Humboldt St. • Los Angeles, CA
90031 • Tel. (213) 223-2331 •
TWX 910-321-3938

Available through authorized
Ansley distributors

In Canada: T&B/Ansley, Ltd.
700 Thomas Ave.,
Industrial Park
Iverville, P.Q.

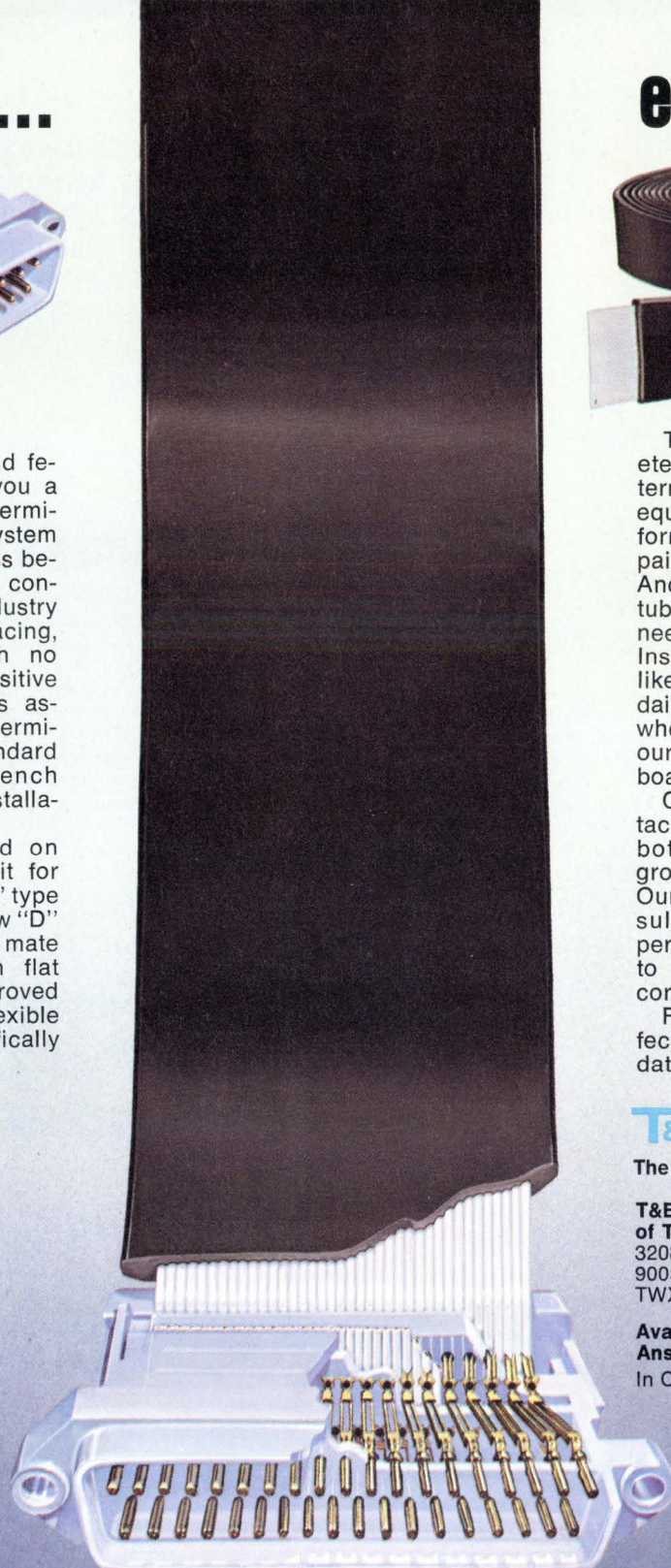

New products

Semiconductors

Chip controls two motors

With an external transistor, IC provides speed regulation that is within $\pm 0.1\%$

To prevent sound distortion in cassette recorders or lack of synchronization in the motors that control the sound and film functions in a movie camera, accurate control of motor speeds is important. That's why engineers at Micro Components Corp. feel that their integrated circuit for dual motor-speed control is going to find its way into such consumer equipment.

The MCC 140, when used with an external output transistor, provides typical motor-speed regulation to within $\pm 0.1\%$. Indeed, the company guarantees regulation to within 1% maximum over a supply range of 7 to 12 volts and over a temperature range from -20° to $+70^\circ\text{C}$. George Fowler, an MCC design engineer, says the tight accuracy is achieved in

the device by using a closed-loop feedback system employing an optical or sinewave-tachometer technique—the more conventional back-electromotive-force technique typically has only 1% to 2% accuracies.

The 16-pin plastic dual in-line package contains two identical motor-speed-control units on a single monolithic chip. Each unit contains a high-gain input amplifier and comparator, a phase comparator, a one-shot multivibrator, a phase comparator, output amplifier, and short-circuit protection. "The big advantage of this circuit is that we use a closed-loop technique to detect the frequency of the motor under control," Fowler says.

He adds that the accuracy is generated by the one-shot multivibrator. The tachometer's zero-cross-over voltage is compared to the pulse width of the one-shot multivibrator, "and from this we detect an error voltage and correct the speed of the motor," Fowler adds.

The optionally programable delay offers the capability to delay the start of a second motor for some predetermined time after the first motor starts.

The MCC 140 is available from stock, with a price of \$2.60 each in quantities of 100, or \$2.35 in thou-

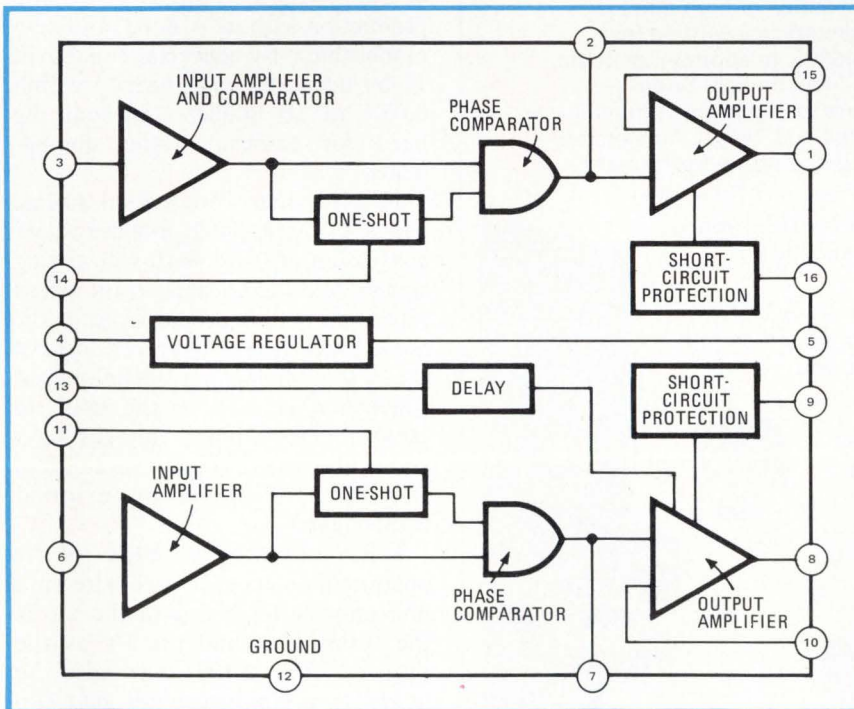

**ONE-UP
MICROPROCESSORS
WITH A SINGLE-CHIP
MICRO-SYSTEM**

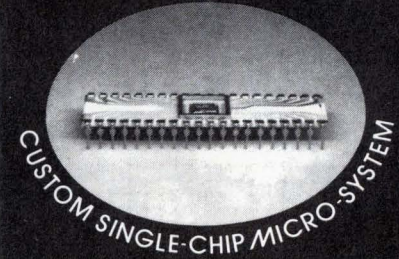
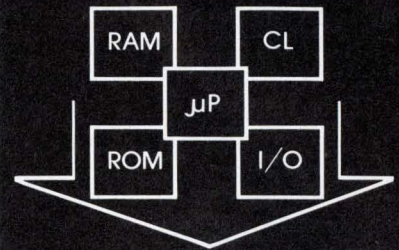

Microprocessor, Memory, I/O and Clock on the same chip optimized to your needs including special instruction set.

Non-Microprocessor functions such as special Counters, Timing, Multiplexers, UARTS, FIFOs, A/D, etc. can be included on same chip.

Performance proven by breadboard simulator.

Proprietary to you—you own the tooling.

PMOS, NMOS, or CMOS.

Guaranteed prototype development—with or without production commitment.

Guaranteed multiple manufacturing sources.

Contact us today for full details.

ALPHATRON, INC.

10340 BUBB ROAD
CUPERTINO, CALIFORNIA 95014
TEL. (408) 446-1494

We torture them today...

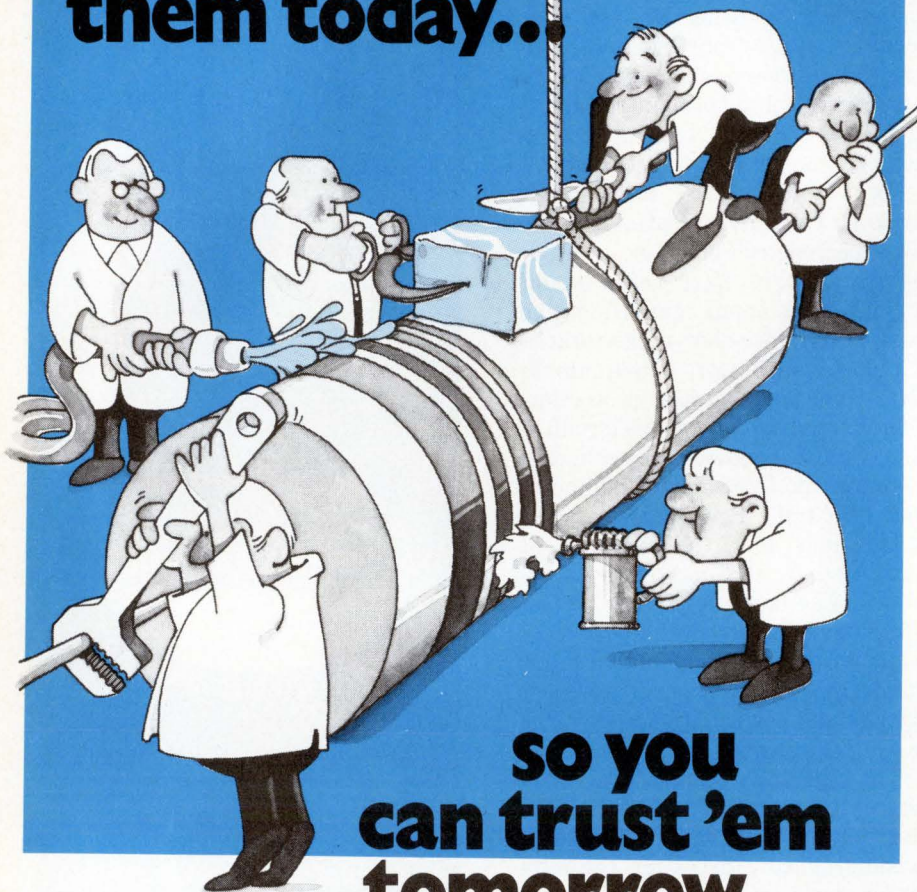

so you can trust 'em tomorrow

Rugged environment? Routine trips through torture test prove out the reliability of typical inductive components selected at random from production runs. This sample is subjected to a series of high and low temperature extremes with performance characteristics verified for conformance to Military Specification MIL-C-15305. In addition, periodic samples are subjected to other torture tests: Mechanical Shock — 18 shocks at 100g force Vibration — 12 hours to 20g force Humidity — 10 days to 98% R.H. Terminal Strength — Pull and Twist Immersion — Cyclic Load Life — 2000 hours at elevated temperature. Performance characteristics hold the line.

We are proud that we can't make 'em fail. Our failure is your assurance of reliability. Any better reason for specifying Delevan inductors?

Our Environmental Test Laboratory is sanctioned by DESC with electronic/mechanical equipment calibrated and certified under MIL-C-45662. This service is available to you. Ask us about our repair and calibration service of Boonton Q Meters, Model 260.

INDUCTIVE COMPONENTS — CLUTCH AND BRAKES FOR ELECTRONIC AND AEROSPACE INDUSTRIES

Delevan
Division



**AMERICAN
PRECISION
INDUSTRIES INC.**

270 QUAKER RD. / EAST AURORA, N. Y. 14052
TELEPHONE 716/652-3600 TELEX 091-293

Other Divisions

Basco • Dustex • A.P.I. of Tennessee • A.P.I. (U.K.) Ltd.



New products

sands. A \$1 version for single-motor control is planned.

Micro Components Corp., 99 Bald Hill Rd., Cranston, R.I. 02920. Phone (401) 463-6000 [411]

Voltage-frequency-voltage units give 11-bit accuracy

In the year since bipolar monolithic voltage-to-frequency-to-voltage converters first made their appearance [*Electronics*, May 15, 1975, p. 91], use of them to replace modular and discrete configurations has been slight. Apparently, this is because one of the main areas of application for v-f-v converters is in data-acquisition systems where analog information is transmitted digitally from remote locations. Such systems typically require at least 8- to 11-bit accuracy and linearity to within 0.4 to 0.5% or better to avoid signal degradation. But present monolithic converters, while low-priced at \$3 to \$6, usually require the addition of several external active components to achieve greater than 7-bit accuracy.

Hoping to overcome these limitations, Intech/Function Modules Inc. of Santa Clara, Calif. is going into production with its A-8402, an \$8.95 monolithic v-f-v converter capable of 11-bit accuracy and linearity within 0.05% at 10 kilohertz without the need for external active components.

Housed in a 15-pin dual in-line package, the A-8402 provides linear conversion of 0- to +10-volt analog signals to a digital pulse train whose repetition rate is proportional to the analog voltage. An improved form of the charge-balancing technique of conversion is used in the 8402 to convert analog input voltages to a stable linear output pulse rate of 0 to 100 kHz, selectable by external components.

When linked to an 8402 for f-v operation, an accurate two-wire data link may be formed with the v-f as the transmitter and the f-v as the receiver. The 8402 may also be linked to a binary counter that can



nce upon a time, in a place known as Testingland, there was a big company. Fairchild, as the company was called, was a veritable giant in the field of semiconductor testing. But a kind and benevolent giant. And so, when Fairchild stumbled upon an old and dusty tome hidden deep within the walls of a wise old engineer's office, it decided to share it with the world. And so our story begins...

Free.

Please send me your easy-to-read, 32 page booklet on IC testing "Logic in Testingland" written by Martin Marshall of E.D.N.... I like a good story.

Name _____

Company _____

Address _____

City _____ State _____ Zip _____

FAIRCHILD

Fairchild Systems Technology, A Division of Fairchild Camera and Instrument Corporation,
1725 Technology Drive, San Jose, CA 95110.
(408) 998-0123 TWX: 910-338-0558

from Electronic Measurements . . .

SCR 1 ϕ & 3 ϕ DC Power Supplies

We are pleased to report that we now produce the industry's largest selection of SCR phase-controlled power supplies.

How did we do it?

Slowly.

We didn't acquire the largest selection without selling a lot of power supplies along the way. Our way, for 35 years, has been giving the user what he wants; and in a watts/dollar ratio that gives him no choice but E/M.



Type	SINGLE PHASE				THREE PHASE			
Watts	500	800	1600	2400	2500	5000	10 KW	To 60 KW
Volts	0 to 7.5 V up to 600 V DC							
Amperes	0 to 0.75 A up to 3000 A DC							
Height (in.)	3.50	3.50	5.25	7.00	7.00	8.75	12.25	To 4'
Price (\$)	450 to 500	575 to 650	800 to 895	1000 to 1100	1200 to 1600	1500 to 2300	2300 to 2900	To 9500

Over 100 standard models. Thousands of optional combinations.

To order, or for any technical information, call

TOLL FREE (800) 631-4298



ELECTRONIC MEASUREMENTS INC.

405 Essex Road, Neptune, N.J. 07753

Phone (New Jersey) 201-922-9300 (Toll free) 800-631-4298

Specialists in Power Conversion Equipment

New products

perform about 390 8-bit digital conversions a second. By just adding a minimum of external components, other full-scale inputs and outputs can be obtained. Other potential applications are in isolation amplifier systems and in the automotive aftermarket in tachometers, cruise control and temperature-sensing devices.

Scale-factor temperature stability at 10 kHz is ± 100 parts per million per degree centigrade. At a 15-volt supply level, typical power required is 250 milliwatts. And, though present monolithic v-f-v converters can only run off voltages down to about +8 v, the 8402 will operate off a +4-v supply, which makes it compatible with +5-v transistor-transistor-logic systems. Delivery of the converter is from stock.

Intech/Function Modules Inc., 282 Browkaw Rd., Santa Clara, Calif. 95050 [412]

6.9-volt IC zener has

1-ohm dynamic impedance

A two-terminal integrated circuit consisting of a zener diode and circuitry to buffer it against current changes behaves like a zener diode with a dynamic impedance of less than 1 ohm. The 6.9-volt voltage-reference diode operates over the current range from 0.5 milliampere to 15 mA. At the center of the monolithic device is a new sub-surface-breakdown zener that exhibits lower noise and more stable breakdown than conventional zeners. Noise is typically 7 microvolts rms from 10 hertz to 10 kilohertz, with a guaranteed maximum of 20 μ v rms. Long-term stability, at constant temperature, is within 20 ppm.

The model LM 129 IC zener is offered with selected temperature coefficients from 0.001%/°C to 0.01%/°C and a temperature range of either 0°C to 70°C or -55°C to 125°C. In addition, it is available in either a TO-46 hermetic transistor package or a plastic TO-92 package. Depending upon packaging, specifications, and temperature range, the IC zener is priced from 75 cents to

**Monolithic capacitors have been
our business for nearly three decades.**

We build them better.

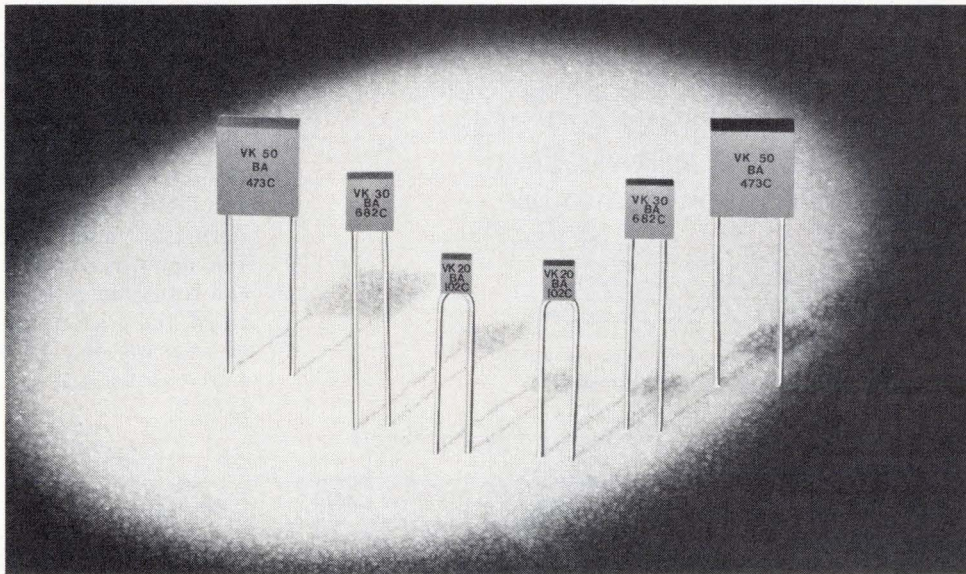

Our $\pm 0.25\%$ tolerance is low for any capacitor.

In short, our cased-radial NPO Ceramic Capacitors are unique.

They feature capacitance tolerances as low as $\pm 0.25\%$ — the tightest we've seen advertised — in all values from 10 pF to .051 μF .

Our other commercial and military ceramic capacitors are unique, too. They all bear the stamp of 'Vitramon' — a mark of high-quality capacitors and contemporary technology since we introduced the first 'VK' part (forerunner to all radial CK capaci-

tors), at WESCON in 1959.

Looking for high-quality CK and CKR military capacitors . . . a variety of commercial cased-radial components . . . dipped-radial parts in NPO, BX, X7R and Z5U dielectrics . . . values from 1.0 pF to 4.7 μF ?

We offer them all — as well as 29 styles of 'VY' Porcelain Capacitors that put the word monolithic into capacitor technology nearly three decades ago.

As important, we deliver what we offer. Call us at (203) 268-6261.



Vitramon®

**Vitramon North America
Division of Vitramon, Incorporated
Box 544, Bridgeport, Conn. 06601**

Subsidiaries: Vitramon Limited (London) • Vitramon GmbH (Stuttgart) • Vitramon France S.A.R.L. (Paris) • Vitramon Pty. Limited (Sydney) • Vitramon Japan Limited (Tokyo)

A SLIDE WITH PRIDE.

C&K's new Model 1101 subminiature SPDT slide switch has a *proven* internal mechanism be-

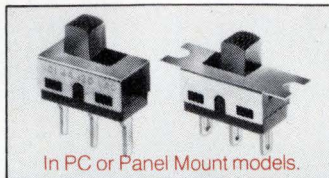

In PC or Panel Mount models.

cause it's the same one we've been using for years to build our famous toggle switches. We've retained all the toggle terminal and sealing options and added a spring-loaded teflon actuator. It's a powerful 6 amp (at 120 VAC) slide switch offering 40,000 actuations at full load. Because the actuator is only .200" high, the 1101 slide switch maintains a low profile but deep down it's a proud little son-of-a-toggle.

C&K Components, Inc. 103 Morse St., Watertown, Mass. 02172, U.S.A.
Tel: (617) 926-0800 Telex: 92-2546
TWX: 710-327-0460.

Free Engineering Sample on request.

Circle 182 on reader service card

New products

\$15 each in lots of 100. Delivery is from stock.

National Semiconductor Corp., 2900 Semiconductor Dr., Santa Clara, Calif. 95051. Phone Brent Welling at (408) 737-5884 [413]

Bipolar transistor has 2.5-dB noise figure at 4GHz

A microwave bipolar transistor with a gain of 9 decibels has a typical noise figure of 2.5 dB at 4 gigahertz. Guaranteed maximum noise figure is only 2.7 dB. The ion-implanted device, designated the model HXTR-6102, is housed in a rugged hermetic metal/ceramic package. For quantities of one to nine units, the transistor sells for \$150. For 10 to 24, the price drops to \$130.

Inquiries Manager, Hewlett-Packard Co., 1501 Page Mill Rd., Palo Alto, Calif. 94304 [414]

Divide-by-eight count extender uses only 40 mW

A divide-by-eight count extender that operates at frequencies from dc to at least 120 megahertz dissipates only 40 milliwatts of power. The extender is used to increase the division ratio of modulus-2 counters while retaining their ratio differences. It converts a divide-by-10 or -11 counter into a divide-by-80 or -81 counter, or it can change a divide-by-5 or -6 counter into a divide-by-40 or -41 unit.

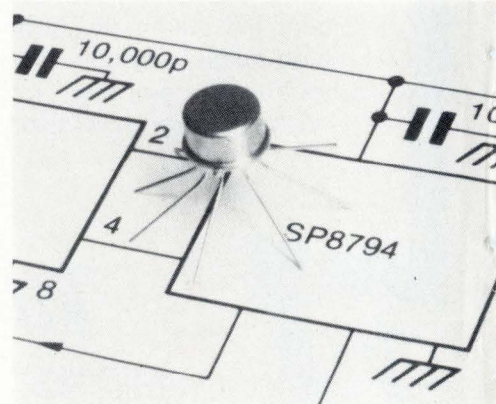

Everything in Fail-Proof Digital Printers.

Used by the world's leaders including Anadex, Digitec, Doric, Esterline, etc.

Whatever your hard-copy need—alpha-numeric/digital printout; multi-copy; multi-color; ordinary calculator paper/pressure-sensitive tape; card, label, fan-folded forms, sales slip,—one of our 12 basic field-proven impact printers will suit you perfectly.

Products of Shinshu-Seiki, world-famous for a decade of reliability. Choose up to 21 columns, up to 42 characters/column, 3.4 lines/sec printing speed. Lowest sample prices. Phone Floyd Makstein, VP/Marketing or write . . .

C. Itoh Electronics, inc.
SYSTEMS & COMPONENTS DIVISION
280 Park Avenue, New York, NY 10017
(212) 573-9466. Telex: WUD 12-5059

See us at WESCON Booth 704, 706, 803, 805.

182 Circle 232 on reader service card

Now!

from
FUJITSU

A comprehensive lineup of high-reliability reed switches

Quality materials and advanced manufacturing techniques make a world of difference when it comes to today's reed switches. And Fujitsu FDR-series reed switches are tops in both. You get Rhodium-plated contacts for the highest cold-weld immunity. You get state-of-the-art infrared sealing techniques via fully automatic carousel assemblers for the finest contamination-free packaging. And, of course, you get Fujitsu's dedication to excellence that ensures the highest reliability and longest service life for trouble-free operation for millions of operations to come. Our FDR-series is comprehensive, too, offering models to meet almost every switching requirement. Whether it be for general-purpose, high electrical load, telecommunications, telephone exchange or latching applications, there's an FDR-series reed switch to cover the job. So, get smart. Choose the maker known the world over for the finest in reliability. Get Fujitsu! Availability is NOW. Write or call for more information. You'll be glad you did.

Class	Model	Contact Gap	Glass Length (max.)
General Purpose	FDR-3	Center	0.846"
	FDR-4	Center	0.669"
	FDR-7	Offset	0.59"
High Electrical Load	FDR-2K	Center	0.846"
	FDR-3K	Center	0.846"
Telecomm. Switching	FDR-2W	Center	1.10"
Cross-point Telephone Exchange	FDR-2B	Center	1.12"
Latching	FDR-8	Center	1.142"

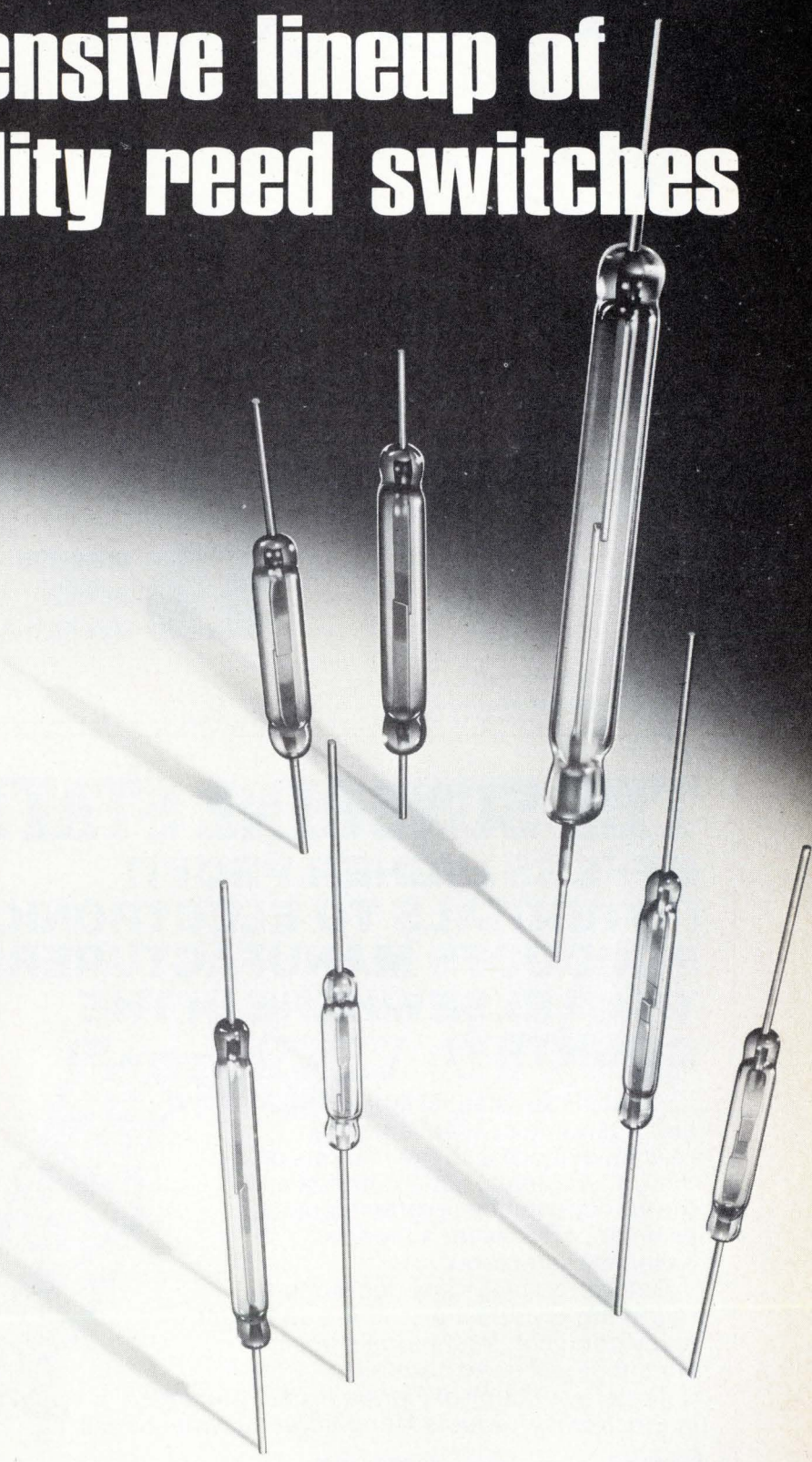

FUJITSU LIMITED
Communications and Electronics
Tokyo, Japan

For further information please contact:
■ **Components Division (Head Office):** Syuwa Onarimon Bldg., 1-1, Shinbashi 6-chome, Minato-ku, Tokyo 105, Japan Phone: Tokyo (03) 437-2111 Cable: FUJITSULIMITED TOKYO Telex: 2424511 FT SIN J ■ **New York Office:** 680 Fifth Avenue, New York, N.Y. 10019, U. S. A. Phone: (212) 265-5360 Telex: 23 234969 ■ **Fujitsu California, Inc.:** 1135 East Janis Street, Carson, California 90746, U. S. A. Phone: (213) 636-0858, 537-8930 Telex: 230 673387 ■ **London Office:** Norman House, 105/109 Strand, London, W. C. 2, England Phone: 240-0461/0462 Telex: 51 22305

Circle 183 on reader service card

Spectrum Analyzer Checklist

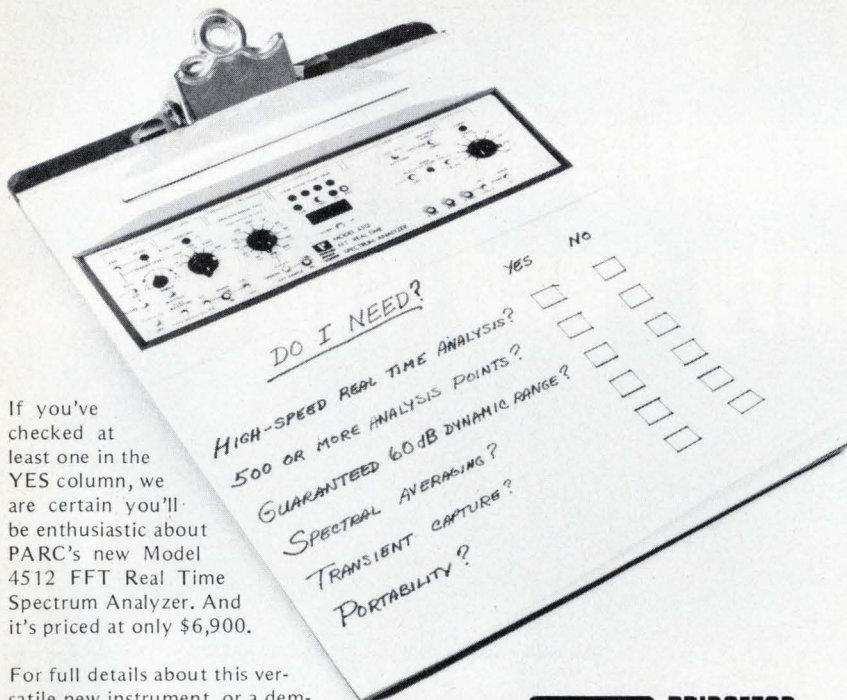

If you've checked at least one in the YES column, we are certain you'll be enthusiastic about PARC's new Model 4512 FFT Real Time Spectrum Analyzer. And it's priced at only \$6,900.

For full details about this versatile new instrument, or a demonstration in your lab, contact Princeton Applied Research Corporation, P. O. Box 2565, Princeton, New Jersey 08540, (609) 452-2111.



356

See Us at Wescon Booth #470
Circle 184 for Additional Information Only

THE SUNSHINE STATE OFFERS HIGHER PROFIT POTENTIALS TO ELECTRONIC PRODUCTS MANUFACTURERS THAN ELSEWHERE IN THE COUNTRY!

Florida's substantial labor and operating cost advantages, plus ready access to the markets of the United States, Latin America and the world, combine to offer a unique profit opportunity for a Florida-based manufacturer.

Before you make any decisions regarding your business, this new industry study documenting Florida's position should be reviewed carefully.

To get your copy of *Florida Profit Potentials in Electronic Products Manufacturing*, write or call:

FLORIDA
WE'RE MORE THAN SUNSHINE

Joe Hennessy, Director
Division of Economic Development
Florida Department of Commerce
107 W. Gaines Street, Room 103E
Tallahassee, Florida 32304
(904) 488-5507

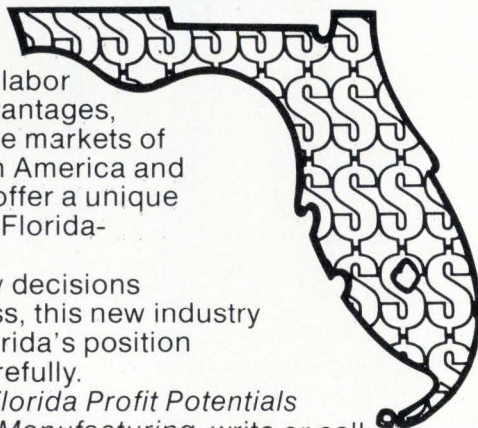

New products

The model SP8794 offers considerable power savings for low-power synthesizers because it can bring the combined output frequency down to the range where C-MOS or low-power TTL can be used to control the divider. It is offered in three temperature ranges: 0°C to 70°C, -40°C to 85°C, and -55°C to 125°C. The first of these sells for \$7.10 each in hundreds.

Plessey Semiconductors, 1674 McGaw Ave., Irvine, Calif. 92714. Phone Dennis Chant at (714) 540-9979 [417]

Serial/parallel register completes processing trio

An 8-bit serial/parallel register, the model Am25LS22, is the third member of a triad of integrated circuits designed for digital-filtering and signal-processing applications to 30 megahertz. The other devices are a multiplier and an adder/subtractor. The low-power Schottky register is available in a variety of packaged and uncased forms, in both commercial and military temperature ranges, at prices that range from \$4.25 each to \$9.20 each in hundreds. The IC, which is available from distributors, will be second-sourced by other manufacturers as the 54/74LS322.

Advanced Micro Devices Inc., 901 Thompson Pl., Sunnyvale, Calif. 94086. Phone (408) 732-2400 [415]

GaAs FET chip has 10-dB gain at 10 GHz

The model AFT2000 is a gallium-arsenide FET chip with a maximum available gain at 10 GHz of 10 to 12 decibels. Typical noise figure at 10 GHz is 3.5 dB. The device, which has a 1-micrometer gate, may be used in low-noise applications up to about 15 GHz. Similar in physical configuration and S-parameter characteristics to devices now in use, the AFT2000 can be employed in existing designs with little or no redesign. Available from stock, the transistor sells for

All aerosols are not alike.

The constant progression of sophistication in electronics has demanded a parallel progression in standards of purity. Industrial cleaning is one very vital link in maintaining component and system purity and reliability.

Let's look at eight important criteria and compare Miller-Stephenson products to the general aerosol industrial cleaner industry.

SOLVENTS:

Miller-Stephenson — Most of our aerosols contain 80% Active Ingredient, 20% Propellant.

Other Aerosol Cleaners — Active Ingredient averages 70-75%.

Miller-Stephenson — Uses only Certified Virgin Solvent.

Other Aerosol Cleaners — Some utilize reclaimed solvents. Though lower in cost, reclaimed solvents usually contain foreign substances.

PROPELLANTS:

Miller-Stephenson — Uses only the highest purity, safest propellants. They are nonflammable - TWA 1000 ppm.

Other Aerosol Cleaners — Many use cheap, sometimes flammable, sometimes higher order of toxicity propellants.



FILTERING:

Miller-Stephenson — We double filter "Freon" solvent and propellant — first with a 0.5 micron filter, then with a Millipore 0.2 absolute filter.

Other Aerosol Cleaners — Some use no filters; others only a 0.5 micron filter.

LOADING LINES:

Miller-Stephenson — All loading lines are dedicated to the individual ingredients used.

Other Aerosol Cleaners — Loading lines are often used for multiple products and if not thoroughly flushed, contamination will occur.

LOADING ENVIRONMENT:

Miller-Stephenson — Class 100 Clean Room conditions.
Other Aerosol Cleaners — Normally uncontrolled — environmental contamination can occur.

VOLUME PRODUCTION:

Miller-Stephenson — Our principal raw materials come direct from Du Pont tankers into our 5500 gallon storage tanks through a closed system direct to container.
Other Aerosol Cleaners — Low volume suppliers often load from open 55-gallon drums thereby introducing possibility of contamination.

CONTAINER:

Miller-Stephenson — Our new seamless cans further reduce the possibility of contamination.
Other Aerosol Cleaners — Cans with soldered seams may introduce residual contaminants.

SAFETY IN SHIPPING:

Miller-Stephenson — Most of our "Freon" aerosol solvents are non-regulated items, exempt from all Federal Regulations "Restricted Articles". May be Shipped Air Transport.

Other Aerosol Cleaners — Do not meet Air Transport Regulations.

MS aerosol solvents have the lowest residual contamination in the industry — some approaching 5-7 ppm. The general range for the industry is 50-130 ppm.

*Freon™ is Du Pont's registered trademark for its fluorocarbon compounds.

miller-stephenson

E-9U

Danbury, Connecticut 06810 (203) 743-4447

- Enclosed is \$2.00, please send my "Trial Unit" of MS-180.
 Enclosed is \$5.00, please send my "Trial Units" of MS-180 & Cobra Brush.
 Please send FREE literature and prices.

Intended Use _____

Name _____ Dept./Title _____

Company _____

Address _____

LOS ANGELES • CHICAGO • DANBURY, CT. • TORONTO
 Circle 185 on reader service card



MS-226 "COBRA"®
Solvent Spray
Brush

Scrubbing action dislodges hard-to-remove residue. Fits all Miller-Stephenson aerosol solvents and cleaners.

The time you save may be your own.

Used to be you'd get a circuit idea, lay out a pc board, print it, solder everything together, troubleshoot, change your layout, try a new board, and spend absolutely too much time breadboarding. Now A P ACE All Circuit Evaluators let you breadboard in a fraction of the time. Make your changes immediately. Keep full leads on your components. Avoid the heat damage possible with repeated soldering and desoldering. And have a pattern for your board—if you need a board—sitting in front of you. In about as long as it takes to sketch a schematic. Get cooking with ACE. ACE. The All Circuit Evaluator from A P Products.

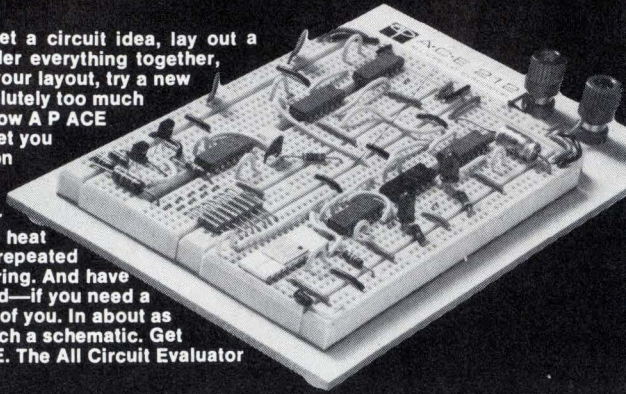

Part No.	ACE Model No.	Tie Points	DIP Capacity	No. Buses.	No. Posts	Board Size (inches)	Price Each
923333	200-K (kit)	728	8 (16's)	2	2	4-9/16x5-9/16	\$18.95
923332	208 (assem.)	872	8 (16's)	8	2	4-9/16x5-9/16	28.95
923334	201-K (kit)	1032	12 (14's)	2	2	4-9/16x7	24.95
923331	212 (assem.)	1224	12 (14's)	8	2	4-9/16x7	34.95
923326	218 (assem.)	1760	18 (14's)	10	2	6-1/2x7-1/8	46.95
923325	227 (assem.)	2712	27 (14's)	28	4	8x9-1/4	59.95
923324	236 (assem.)	3648	36 (14's)	36	4	10-1/4x9-1/4	79.95

Ohio and California Residents Add Sales Tax
All orders subject to acceptance at factory.

For quick phone service, call
the A P distributor nearest you:

Write us for the full line A P Products catalog.



A P PRODUCTS INCORPORATED
Box 110-E Painesville, OH 44077 (216) 354-2101
TWX: 810-425-2250

(201) 224-8032	(314) 863-7800	(617) 237-6340
(206) 682-5025	(412) 782-2300	(617) 273-1860
(213) 768-3800	(415) 326-5432	(617) 879-0860
(213) 875-2862	(415) 969-9240	(713) 350-6771
(215) 698-4000	(513) 236-9900	(713) 777-1666
(216) 587-3600	(516) 483-9200	(714) 549-8611
(312) 298-8580	(516) 883-0999	(803) 779-5332
(313) 525-1800	(612) 488-0201	(914) 664-0088

(If no distributors in your area, call factory)

Circle 186 on reader service card

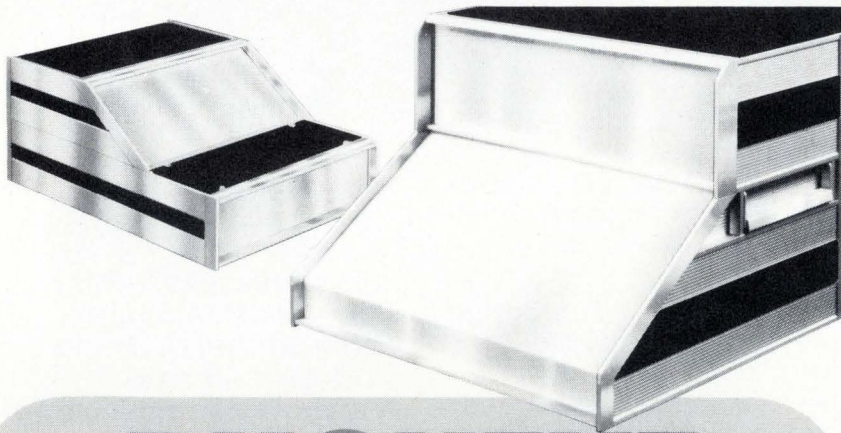

BUCKEYE slant-front CASES

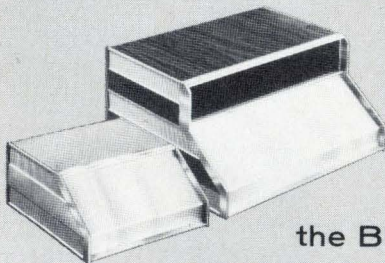

New, sloped-front aluminum cases have the modern, crisp lines of custom design at off-the-shelf costs. Stocked in a range of widths, heights and depths. Write today for detailed literature.

the BUCKEYE stamping co.

555 Marion Rd., Columbus OH 43207 Phone: 614/445-8433



New products

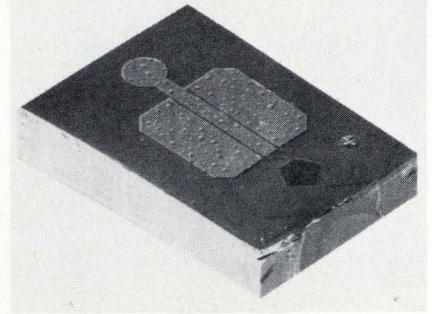

\$95 per chip in lots of 10 to 49 pieces.

Aertech Industries, 825 Stewart Dr., Sunnyvale, Calif. 94086. Phone Van Price at (408) 732-0880 Ext. 471 [416]

TOPICS

Semiconductors

Motorola Semiconductor Products Inc., Phoenix, Ariz., is

second-sourcing the popular 3N201, -02, and -03 series of n-channel dual-gate MOSFETs. Designed for vhf television and communications applications, the 3N201 and -02 sell for \$1 each in small quantities, while the 3N203 is priced at 85 cents. . . **Electronic Devices Inc., Yonkers, N.Y.**, has modified its 12-ampere bridge rectifiers to handle 15 A and increased the surge rating from 150 A to 200 A. At the same time, the price has been dropped to \$2.40 each in thousands.

. . . **Texas Instruments Inc., Dallas, Texas**, is second-sourcing the Fairchild 7800 and 7900 series of three-terminal voltage regulators. Price is \$1.38 each in hundreds. . . **SMC Microsystems Corp., Hauppauge, N.Y.**, is expanding its baud-rate generator series with the addition of the model COM 5026 single-baud-rate generator. Priced at \$11 for singles and \$6 for hundreds, the COM 5026 is compatible with the COM 5016 dual-baud rate generator. . . **Teledyne Semiconductor, Mountain View, Calif.**, has announced the availability of its 8-bit monolithic analog-to-digital converter in a 24-pin plastic dual in-line package. The price in hundreds is \$9.95 each.



Big technology for Mini-computers.

The mini-computer market has grown to the point where it demands "3330" disk technology in a package that fits.

**Introducing:
The Trident Disk Drives.**

Greater track density helped get us down to size. The new Trident Series brings you 370 tracks-per-inch. And up to 6,060 bits-per-inch. Storage capacities range from 27-82 megabytes.

Designed for the OEM.

The Tridents are each compact, self-contained and rack-mountable.

Their start or stop time is only 20 seconds. Pack changes take less than one minute. Rotational speed is 3600 r.p.m. Track access time is 6 milliseconds.

The Trident Series has one of the lowest cost-per-byte ratios in the industry.

These features make the Tridents easy to buy and easier to sell. Call or write California Computer Products, Inc., EN-M-9-76, 2411 West La Palma Avenue, Anaheim, California 92801. (714) 821-2011.



CALCOMP

The Electronics Book Series offers you:

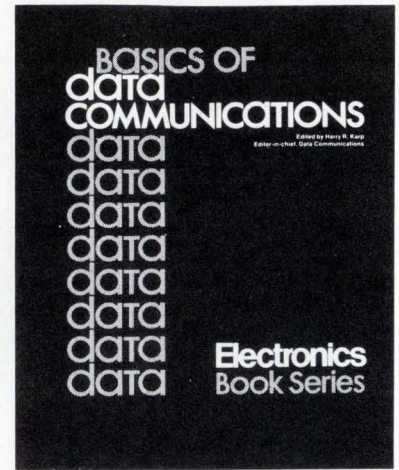
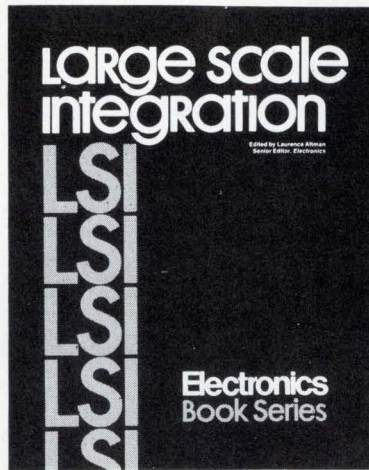
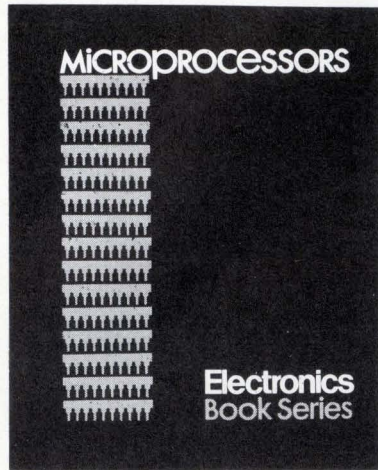

1 MICROPROCESSORS

The microprocessor has permanently changed the methods of designing and building electronic equipment—from process and industrial control to computer-based designs in instruments communication and consumer/commercial equipment.

This book cuts through the confusion, presenting the design and application potential of this exciting technology in a manner that will appeal to the design engineer who needs to know how to use microprocessors as well as the system analyst who must assess the tradeoffs between microprocessors and other techniques to accomplish his system goals.

Using articles from the pages of Electronics, this book contains practical and up-to-date information on available microprocessor devices, technology and applications.

2 LARGE SCALE INTEGRATION

The Electronics Book Series offers you a handbook on the current and revolutionary impact of LSI on digital design. This 220-page book presents a unique opportunity for circuit designers, systems designers, and engineering managers and supervisors to bring their expertise into line with today's LSI design requirements.

"Large Scale Integration" is a compendium of recent articles published in Electronics. Although in some ways it is a companion piece to "Microprocessors" because it explains the new circuits that play in mp systems, it is much more. "Large Scale Integration" deals with the entire range of design applications: main memory systems, peripheral memories, memory controllers, on-line industrial controllers, data acquisition boards, communication systems, calculators, watches, etc.

3 BASICS OF DATA COMMUNICATIONS

Data communications is one of the fastest-growing electronic equipment markets in the U.S.—during the decade of the '70's, better than 15-20% per year, compounded!

Chances are you are going to be a part of the data communications market. There's no better place to start than getting a copy of "Basics of Data Communications"—a 316-page compilation of essential articles which have appeared in Data Communications magazine. From the basic, tutorial, still state-of-the-art information published in the 1972 and 1973 Deskbook issues (now out of print), on through information on the practice of present-day data communications, this book includes forty-seven articles covering more than eleven key areas.

Electronics Book Series • PO Box 669, Hightstown, N.J. 08520



- 1 Send me _____ copies of "Microprocessors" at \$8.95 per copy.
- 2 Send me _____ copies of "LSI" at \$9.95 per copy.
- 3 Send me _____ copies of "Basics of Data Communications" at \$12.50 per copy.

Discounts of 40% on orders of ten or more copies of each book.

I must be fully satisfied or you will refund full payment if the books are returned after ten day trial examination.

Payment enclosed Bill firm Bill me

Credit Cards Charge My Book To

American Express Master Charge
 Diners Club BankAmericard

Name _____
 Title _____
 Company _____
 Street _____
 City _____
 State _____ Zip _____
 Signature _____

Acct. No. _____

Date Card Expires _____

Interbank No. _____

(1st No's. above name on Mastercharge only.)

HERMES LOOP ANTENNA

THREE SAMPLE SITES
ON THE NORTH AMERICAN
CONTINENT —

DIFFERENT LATITUDES
DIFFERENT CLIMATE

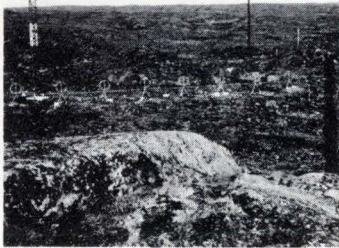

64°N

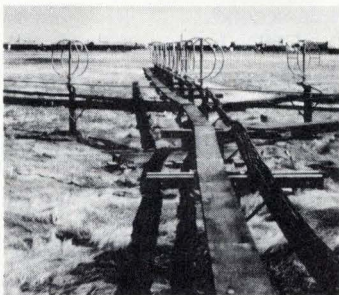

42.5°N

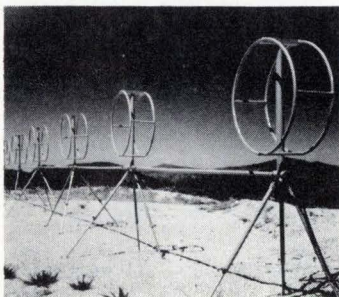

32.5°N

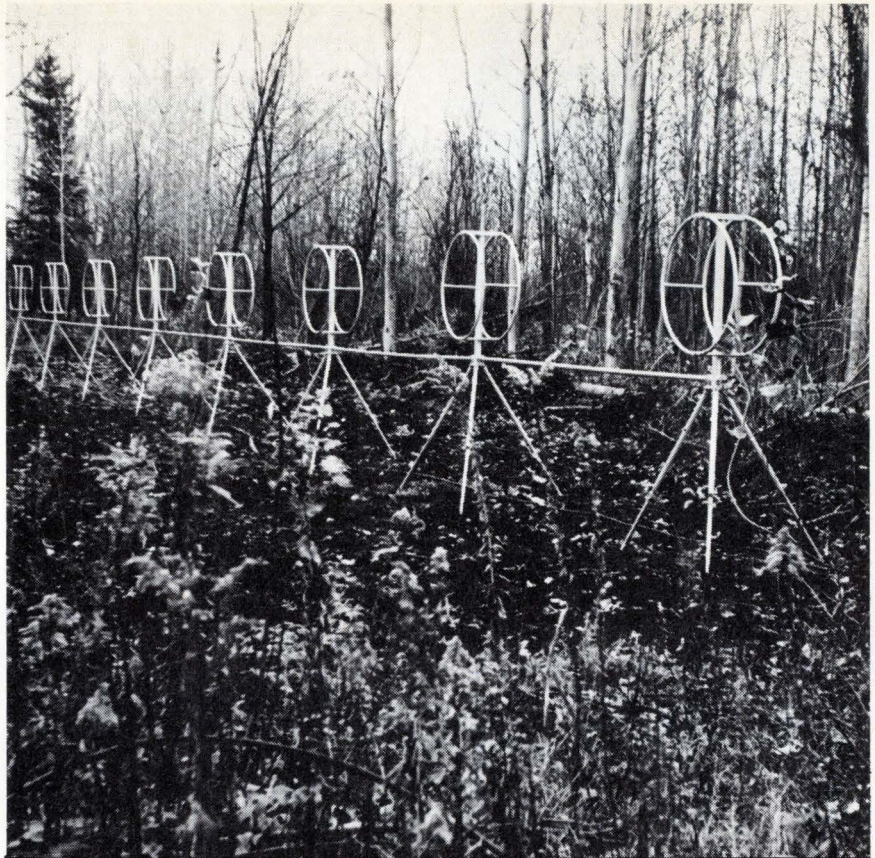

Good Listeners maintain a low profile

Even in the solitude of the forest depths, from rooftops, arctic tundra, swamps to sweltering tropics, 'neath snow, sand or ice, the Hermes Loop antenna keeps an ear to the sky. The amazing aperiodic antenna does away with vast log periodic and rhombic arrays - those towering antenna farms.

In rosette configuration, the Hermes loop antenna provides an omnidirectional broadband receiving array in space merely 1/100th that of the traditional antenna farm.

More than 53 government agencies around the world have pressed the loop antenna into service.

A new, even more compact version is available. Only Hermes Electronics makes it.

**2-32MHz
BROADBAND**

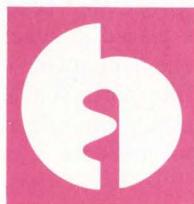

ASK US Send for our Brochure

Hermes Electronics Limited
Suite 315
2020 F Street NW
Washington, DC 20006 USA

202-296 2978
TWX 710 822 1106

**PROFESSIONAL
DISCOUNT
PRICES
AVAILABLE ON**

**Texas
Instruments
Engineering
Calculators**

**PHONE TOLL-FREE
800-638-8906**
FOR THE CURRENT LOW DISCOUNT PRICE
OF THE LATEST MODEL TEXAS
INSTRUMENTS CALCULATOR OF
YOUR CHOICE

Texas Instruments SR-52



Programming power from Texas Instruments. Easy hand held programming for scientists, engineers, students — anyone who works with advanced mathematics. Check these features: 224 program locations, 20 addressable memory registers, 23 pre-programmed key functions, indirect addressing, permanent program storage on magnetic cards.

Texas Instruments SR-56



More power from Texas Instruments. Hand held key programmable calculator. 100 program steps, 5 program levels (up to 4 levels of subroutine may be defined). Easy single step editing. Main features include 26 preprogrammed key functions, 10 addressable memory registers, algebraic logic and 9 levels of parentheses.

PC-100 Lock down printer; for a hard copy of your results; step by step listing of programs, or "debugging" programs. The PC-100 printer may be used with the SR-56 or SR-52.

OTHER MODELS AVAILABLE
SR-50A, SR-51A, TI 255011, TI 250011, TI 5100

**ALL THE FAMOUS
TEXAS INSTRUMENTS
ELECTRONIC CALCULATORS
ARE AVAILABLE AT DISCOUNT PRICES**

Mail and phone orders accepted. Master Charge and BankAmericard accepted. Add \$2.50 per unit for shipping and handling. Maryland residents add 4% sales tax.

Use our toll free phone: **800-638-8906** (Maryland residents phone: **(301) 340-7200**) to order or for current discount quotations on the leading brands of electronic calculators: Texas Instruments, Hewlett-Packard, Rockwell, Ricoh, Kingspoint, Corvus, Novus, and many more.

THE GUARANTEE

10 day money back trial. If you are not completely satisfied you may return the Texas Instruments calculator you order within 10 days for a cash refund or charge cancellation. In addition Texas Instruments Inc. and Capital Calculator Co. Inc. warrant each calculator for a period of one year against defective parts and workmanship.

Capital Calculator Company

**701 East Gude Drive
Rockville, Maryland 20850**

New products

Subassemblies

**Camera uses
CCD array**

System with 1,024 sensors is aimed at measurement, control, document work

Making use of its charge-coupled-device technology, Fairchild Camera and Instrument Corp. will soon begin production of a line-scan camera subsystem, the CCD1300. Frank Bower, marketing manager for CCDs, says the system, consisting of two basic units—a remotely positionable computer-compatible camera (the CCD1310) and a camera-control unit (the CCD1320)—is aimed at such applications as measurement, process control, document scanning and object recognition.

Heart of the subsystem is the CCD131, a monolithic self-scanned 1,024-element image sensor, which in addition to the row of sensing elements contains two charge-transfer gates, a pair of two-phase analog shift registers and two gated charge integrators that provide a 1-volt swing at the output. This 1,024-element array in the camera senses a line of optical information and produces an analog waveform proportional to the brightness of the image. When motion is being sensed, a complete picture or series of line scans can be generated.

When used with a microprocessor or a computer, says Dennis Stoscher, manager of CCD-systems applications, the CCD1300 is a powerful scanning and recognition tool. For example, he says, to bin or store rear-lighted documents being sensed by the line-scan camera, a digital representation of one or more desired objects to be binned is stored in the microprocessor read-only memory and is placed in synchronization with the unknown object located on a transport. When both the camera output and the microprocessor output indicate a match,



the proper binning control is activated to receive the document.

The CCD1310 camera contains the sensor elements, a timing module, a signal-processing module, and one of five standard lenses. The camera measures 2.6 by 5.5 by 6 inches. Its spectral range covers the visible to infrared, and dynamic ranges go from 200:1 up to 500:1. Saturation exposure is 0.06 foot-candela-second.

The CCD1320 control unit, which measures 12 by 4 by 8 inches and contains the power supply, provides three basic control functions: video output controls for both analog and binary mode, with selectable automatic gain control; a video data rate that is variable from 100 kilohertz to 10 megahertz; and either synchronous or asynchronous exposure control. Available from stock, price of the subsystem is \$3,250 with one lens.

MOS/CCD Products Division, Fairchild Camera and Instrument Corp., 4001 Miranda Ave., Palo Alto, Calif. 94304 [381]

**Hybrid op amp delivers
±75 mA at ±140 volts**

Housed in a standard eight-pin TO-3 package, the model 3583 operational amplifier provides output-voltage swings as wide as ±140 volts with currents as high as ±75 milliamperes. The op amp has a monolithic FET input stage which provides an input impedance of 10¹¹

MURPHY'S OVENS

Turn on the heat, set up the program, and give 10,000 4K RAMs a chance to fail.

At Microtest we succeed when your parts fail—whether you make IC's or buy them.

We do testing, you see. And build life-test systems.

Our biggest Murphy's Oven, System 10,000, will put 10,000 16-pin 4K RAMs through a complete dynamic life-test regimen. It will do lots of other devices, too. But RAMs are what people need to test most this year. And system 10,000 has programs and capabilities for all 4K RAMs:

- ANY VOLTAGE
- ANY TIMING
- ANY PINOUT

So if your job involves large quantities of 4K RAMs that *must not fail* in a system, please give them a fighting chance to fail in Murphy's Oven. And when you're ready for 16K RAMs, so are we. If you need to life-test smaller quantities of digital

and linear devices, ask about Murphy's Oven System 1,000, which starts at \$15K. Use the reader card or write/phone/TWX Microtest Systems, Inc., 743 N. Pastoria Ave., Sunnyvale, CA 94086. (408) 739-8001. TWX: 910-339-9325.

IF THEY
CAN FAIL,
THEY WILL
FAIL HERE



Microtest

When you Need it NOW call National

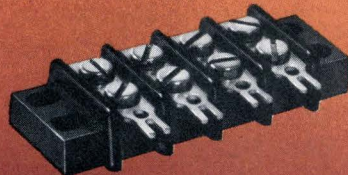

Take barrier blocks. We can deliver up to 400 standard variations right off the shelf. High quality, double row blocks in $3/8$ " or $7/16$ " pitch and ten different terminal styles. Custom designs are no problem either. So whenever you need terminals or connectors of any kind, call National.

Write for our free barrier blocks brochure.

State Road Hill
Meadville, PA 16335
614/724-6440

ntt
NATIONAL
TEL • TRONICS

Circle 192 on reader service card

New products

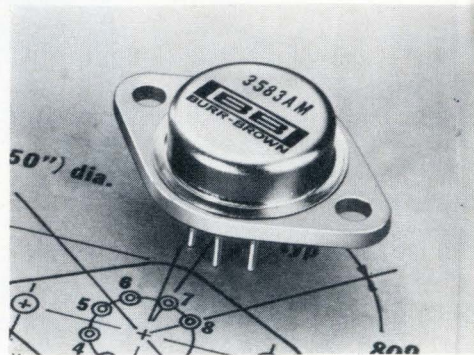

ohms and a bias current of 20 picoamperes at 25°C. Laser trimming results in an input offset voltage of less than 3 millivolts at 25°C; if necessary, the offset can be trimmed to zero with an external pot. Supply voltages for the 3583 can range from ± 50 v to ± 150 v dc. The open-loop dc gain at rated load is typically 105 dB, and full power is maintained out to 60 kilohertz. The unity-gain small-signal bandwidth is 5 megahertz. Slew rate is 30 v per microsecond. Two versions of the 3583 are offered; both can be operated over the military temperature range from -55°C to 125°C . But the 3583J is only guaranteed to meet all of its specifications from 0°C to 70°C , while the 3583A meets all specifications from -25°C to 85°C . In hundreds, the units sell for \$56 and \$57.50, respectively. Delivery is from stock to four weeks.

Burr-Brown, International Airport Industrial Park, Tucson, Ariz. 85734. Phone Dennis Haynes at (602) 294-1431 [383]

Low-cost f-v converters
are linear to within 80 ppm

Two low-cost frequency-to-voltage converters, the 10-kilohertz model 451 and the 100-kHz model 453, are offered in versions with maximum nonlinearities of 80 ppm. Their frequency input ports will accept TTL, HNIL, C-MOS, sine-wave, square-wave, pulse, and triangle-wave signals. The converters are offered with three performance levels. The 451J and 453J have a maximum nonlinearity of 0.03%, a maximum gain



New MCL power generators feature flexibility, high output, minimum distortion.

Main frames for 115 VAC and for 208/220/240 VAC operation. Six standard front panel plug-ins provide frequency range from 10 MHz to 2500 MHz with a minimum output of 65 watts. Two optional plug-in modules are available which produce 100 watts narrow-banded.

Single knob tuning for each plug-in provides exact frequency selection. Front panel, direct frequency readout is accurate to ± 1 percent.

Solid-state mainframe designed for minimum components, optimum reliability. Residual AM held to .1 percent, eliminating nearly all AM distortion in output waveform. Generates continuous or 1 KHz square wave pulsed output. External AM signal generator can be added with single plug-in connection. External pulse circuit is TTL compatible. Automatic VSWR protection.

Write or call for your 4-page power generator brochure: Tom Rys, MCL, Inc., 10 N. Beach, LaGrange, IL 60525. (312) 354-4350.

MCL
INC

192 Circle 236 on reader service card

Electronics / September 2, 1976

VACTEC brings you BLUE

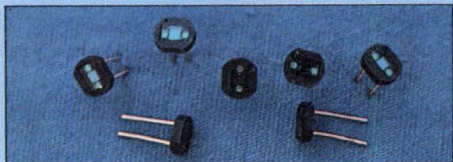

Unlike our little Japanese friend, photodetectors have always been insensitive to blue. Until now.

Vactec's latest development is a new Blue Enhanced Silicon (BES) photodiode with exceptionally low dark current for efficient response in the blue region (200 - 400 nm). Made in Missouri, U.S.A., it performs equally well in an expensive Japanese SLR camera or in an American-made colorimetric analyzer as well. And you'll like the price, which could be as big a breakthrough as blue sensitivity.

Vactec also introduces a new line of PIN photodiodes that operate at high voltages, low noise levels, and fast rise times, with about half the blue sensitivity of the BES photodiode. For larger areas, Vactec offers a complete range of Blue Enhanced Silicon photovoltaic cells up to 1 1/8" diameter.

Vactec now supplies the broadest line of photodetectors in the industry, including:

- silicon solar cells
- hi-speed/low-leakage silicon cells
- NPN phototransistors
- NPN photodarlington
- CdS & CdSe photoconductors
- CMOS & bi-polar custom ICs
- opto-couplers
 - a) LED/photoconductor
 - b) LED/phototransistor or darlington
 - c) lamp/photoconductor
- selenium photovoltaic cells

Call or write today:

Vactec, Inc.

**2423 Northline Industrial Blvd.
Maryland Heights, Mo. 63043
(314) 872-8300**

Circle 193 on reader service card



New from Displaytek...

ANNOUNCING
L84
 CONTINUOUS
 LINE OF 84 DOTS
 THERMAL
 PRINT HEAD

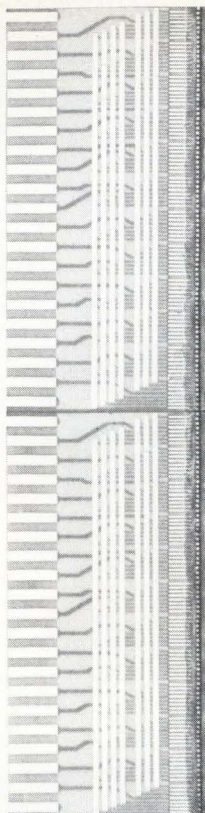

Call or write Cliff Ensminger,
 VP/Engineering, at 4441 Sigma
 Road, Dallas, Texas 75240,
 (214) 239-9193.
 Circle Reader Service No. 249



4441 Sigma Road, Dallas, Texas 75240

ANNOUNCING

PS40 PS40 PS40 PS40 PS40 PS40

40 COLUMN..THERMAL..HALF PAGE
 ALPHA NUMERIC..SERIAL PRINTER
 TOTAL CAPACITY..48 COLUMNS
 SIZE.. 8.6 W.. 3.1 H.. 7.7 D INCHES
 WEIGHT.. 3 POUNDS

12345678901234567890123456789012345678901234
 ABCDEFGHIJKLMNOPQRSTUVWXYZABCDEFGHIJKLMNOR

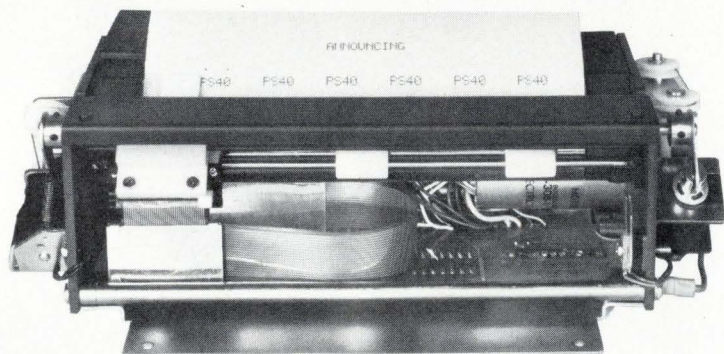

For more information contact
 Dick Hanschen, 4441 Sigma
 Road, Dallas, Texas 75240,
 (214) 233-6631.
 Circle Reader Service No. 250

telpar, inc.

4441 Sigma Road, Dallas, Texas 75240

New products



drift of 100 ppm/°C, and respective small-quantity prices of \$39 and \$41. The "K" versions have a nonlinearity specification of 0.015%, a gain drift spec of 50 ppm/°C, and prices of \$45 and \$47, respectively. Finally, the 451L and 453L guarantee a maximum nonlinearity of 0.008%, a maximum gain drift of 50 ppm/°C, and prices of \$51 and \$55 for small quantities. All versions operate from 0°C to 70°C, are housed in compact 1.5-by-1.5-by-0.4-inch modules, and are available from stock.

Analog Devices Inc., P.O. Box 280, Norwood, Mass. 02062. Phone Lowell Wickersham at (617) 329-4700 [384]

Unity-gain buffer amplifier
 has 100-MHz bandwidth

The MSK model 350 is a closed-loop unity-gain buffer amplifier with a small-signal bandwidth of 100 megahertz. Optimized for linear applications as a noninverting device, the 350 has a full-power bandwidth of 20 MHz and a slew rate of 1,300 volts per microsecond. The amplifier has a settling time to within 1% of the final value of 15 ns, a minimum

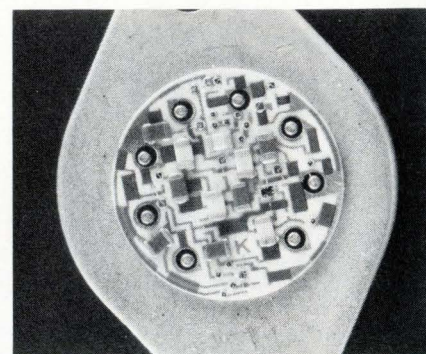

Design with the complete flat cable/connector system.

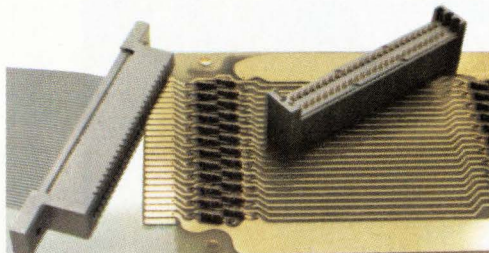

trimming the cable after assembly.

Connector units provide positive alignment with precisely spaced conductors in 3M's flat, flexible PVC cable. The connector contacts strip through the insulation, capture the conductor, and provide a gas-tight pressure connection.

With cable, connectors and assembly tools from one design and manufacturing source, you have added assurance the connection will be made surely, with no shorts or "opens."

And "Scotchflex" now offers you more design freedom than ever. From stock you can choose shielded and non-shielded 24-30 AWG cable with 10 to 50 conductors, and an ever-increasing variety of more than

The 3M DELTA pin and socket connector.

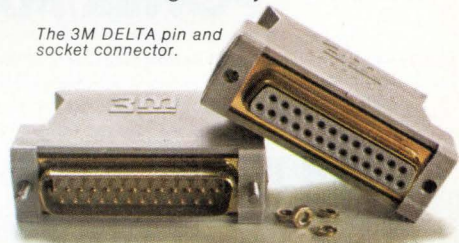

Assembly-cost savings are built in when you design a package with "Scotchflex" flat cable and connectors. But more important, 3M Company offers you the full reliability of a one-source system: cable *plus* connectors *plus* the inexpensive assembly aids that crimp the connections quickly and securely (with no special operator training required).

The fast, simple "Scotchflex" assembly sequence makes as many as 50 simultaneous multiple connections in seconds, without stripping, soldering or

100 connectors to interface with standard DIP sockets, wrap posts on standard grid patterns, printed circuit boards, or headers for de-pluggable applications. 3M's DELTA "D" type pin and socket connectors are now also available. For full information, write Dept. EAH-1, 3M Center, St. Paul, MN 55101.



3M
COMPANY

Don't miss
THE PUZZLE CHILDREN
October 19 on PBS.

3M's "Scotchflex" line.

See our catalog in EEM—Page 1056.

"Scotchflex" is a registered trademark of 3M Co.

33% more power to the people.

Power/Mate presents Econo/Mate II.

The open frame power supply.

Now Power/Mate brings you 33% more power in the same package size with the second generation of our Econo/Mate series.

The size is the same, the basic components are the same for easy interchangeability. But that's where the similarity ends.

Econo/Mate II adds features like dual AC primary and a plug-in IC regulator for improved regulation.

And Econo/Mate II is tough. Computer design, quality control, and Power/Mate's experience helps insure 100,000 hr. MTBF even at this higher power output.

But for all its features, Econo/Mate II is still, most of all, economical.

We wouldn't call it Econo/Mate if it wasn't.

Econo/Mate II is in stock, ready for delivery. Send for our free brochure.

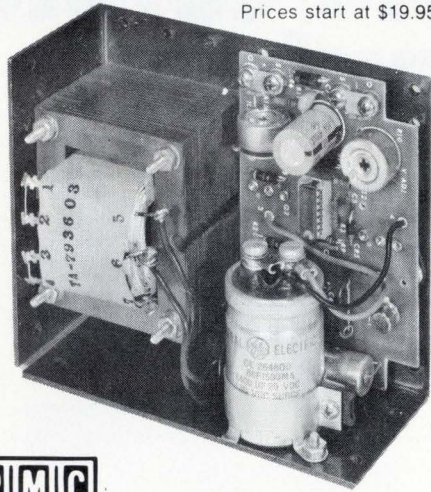

Prices start at \$19.95.



POWER/MATE CORP.

World's largest manufacturer of quality power supplies.

514 South River Street/Hackensack, N.J. 07601/Phone (201) 343-6294 TWX 710-990-5023

Circle 196 on reader service card

New products

voltage gain of 0.9990, a maximum input bias current of 3 microamperes, and an output voltage range of ± 10 v. In hundreds, the 350 sells for \$55 each.

M.S. Kennedy Corp., Pickard Dr., Syracuse, N.Y. 13211. Phone Byron Lesjack at (315) 455-7077 [385]

Dc-to-dc converter packs

5 watts into 2 cubic inches

Housed in a 1-by-1-by-2-inch module and weighing only 3 ounces, a dc-to-dc converter will deliver up to 5 watts at 5 volts from input voltages in the range of 42 to 56 v dc. Under

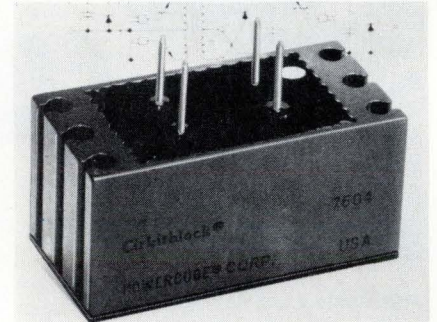

full load and with an input voltage of 42 v dc, the converter will put out a minimum voltage of 5.0 v dc. With no load and with an input voltage of 56 v dc, the unit will put out no more than 5.3 v dc. Its maximum temperature coefficient is 0.02%/°C. Maximum peak-to-peak ripple is 50 millivolts, while typical ripple is half of that.

Powercube Corp., 214 Calvary St., Waltham, Mass. 02154. Phone John C. Prestidge at (617) 891-1830 [386]

1,500-volt optoisolator has output rating of 300 V

A compact optically coupled isolator, the model OPI 6000, has an input-to-output isolation rating of 1,500 volts dc with an output breakdown rating of 300 v dc. The unit, which is housed in a six-pin plastic dual in-line package, consists of a gallium-arsenide infrared emitter

RF-PACKAGES — MICROWAVE SYSTEMS

AUTOTRACK ANTENNA SCR-584 RADAR SYSTEM

360 deg Az 210 deg EL. 1 mil. accuracy. Missile vel. accel. and slew rates. Amplidyne control. Handle up to 20 ft. dish. Compl. control chassis. ALSO in stock 10 cm. van mounted rad. system. Conical scan. PPI. 6 ft. dish. 300 pg. instr. bk. on radar \$25



RF SOURCES

CW: 300-535KHz **500W**; 2-30MHz **3KW**; 4-21MHz **40KW**; 24-350MHz. **100W**; 385-585MHz **1KW**; 750-985MHz **10KW**; 95-8.8GHz **150W**; 1-1.5GHz **110W**; 1.7-2.4GHz **10KW**; 4.4-5GHz **1KW**; 8.8-11GHz **200W**. Many more.

UHF: **1 Megawatt** 210-225MHz **5μsec** 180 PPS; **14KW** 400-420MHz. **0.002DC**; **1KW** 400-700MHz. **0.02DC**.

L BAND: **1KW** 1-1.5GHz **1DC**; **500KW** 1.2-1.35GHz **2μsec** 400PPS. Many more. Phone or write.

S BAND: **1KW** 2.4-2.6GHz **.75μsec** 1200PPS; **250KW** 2.7-3.1GHz **.8μsec** 1600PPS; **1 Megawatt** 2.7-2.9GHz **1μsec** 1200PPS; **5 Megawatts** 2.75-2.85GHz **2.5μsec** 400PPS.

C BAND: **225KW** 6.275-6.575MHz **4μsec** 680PPS; **250KW** 5.4-5.8GHz **.5μsec** 680PPS; **1 Megawatt** 6GHz **1μsec** 1000PPS; **10 Megawatt** 5.4-5.8GHz **5-10 μs** 400 PPS.

X BAND: **100W** 9.2-9.5GHz **.5μsec** 1000PPS; **1 KW** 8.9-9.4GHz **.001DC**; **65KW** 8.5-9.6GHz **.001DC**; **250KW** 8.5-9.6GHz **.0013DC**; **400KW** 9.1 GHz **1.8μsec** 450PPS. Many more. Phone or write.

Ku-K BAND: **50KW** 16.4-16.6GHz **.001DC**; **135KW** 15.5-17.5GHz **0.006DC**; **40KW** 24GHz **.0007DC**; **40KW** 35GHz **0.004DC**. Many more. Phone or write.

PULSE MODULATORS + H.V.P.S.

245 KW LINE Output 16 KV 16 A. **.25 μs** 4000 PPS.

405 KW FLOATING DECK Output 20 KV 20 A **1 μs** to 10 millisecc pulse.

500 KW LINE Output 22 KV 28 A. **.4/1.75/2.25 μs** 2500/550/300 PPS.

1 MW HARDTUBE MIT MODEL 9 Output 25 KV at 40 A. **.25 2 μs .002 DC**.

2.0 MW LINE 30 KV 70 A. **1/2 μs** 600/300 PPS.

3 MW LINE Output 39 KV 75 A. **.25/1 μs** 500 PPS.

10 MW LINE 76 KV 135 A. **2.5 μs** 350 PPS.

17 MW LINE 17 KV 1000 A. **2-5 μs** 150-2000 PPS.

66MW LINE 160 KV 400 A. **5-10 μs** 400 PPS.

SEND FOR FREE 20 PG. CATALOG

AN/MPS-19 5 Band Tracker

Pwr: 500 KW. Range: 100 miles. Display: PPI and "A" scopes. 8' dish. Heilhut mounted.

RADAR SYSTEMS

K BAND MONOPULSE 40KW E-34
KU BAND SEARCH 135KW B-58
X BAND MISSILE CONTROL NIKE AJAX/HERC
X BAND HI-RES. MONOPULSE TRACKER
X BAND FIRE CONTROL 250KW M-33
X BAND WEATHER/SEARCH 250KW AN/CPS-9
X BAND AIRBORNE TRACKER 50KW B-47
X BAND MOBILE TRACKER 40KW AN/MPQ-29
X BAND WEATHER/SEARCH 40KW AN/SPN-5
X BAND ANTI-INTRUSION 7 KW AN/TPS-21
X BAND ANTI-INTRUSION CW DOPPLER AN/PPS-9/12
X BAND TRANSPONDER 100W AN/DPN-62
C BAND HGT. FDR. 5MW FPS-26; 1MW TPS-37
C BAND SEARCH 285KW AN/SPS-5B/D
S BAND HEIGHT FINDER 5MW AN/FPS-6
S BAND SEARCH COHERENT 1MW AN/FPS-18
S BAND ACQUISITION 1MW NIKE AJAX/HERC
S BAND TRACKER 10' DISH 500KW AN/MPQ-18
S BAND MORTAR LOCATOR 250KW AN/MPQ-10A
S BAND TRACKER 250KW AN/MPS-9
L BAND SEARCH 40' ANTENNA 500KW AN/FPS-75
L BAND SEARCH 500KW AN/TPS-1D/GSS-1
UHF SEARCH 1MW TPS-28

DRONE CONTROL SYSTEMS

UHF COMMAND SYSTEM AN/URW-14
X BAND DATA LINK AN/UPW-1
X BAND TRACKER AN/MPQ-29
X BAND TRACKER AN/MSQ-51

60 FT. DISH

Complete with Az-El pedestal, ready for installation. Immed. delivery. Write or call.

SPARE PARTS IN STOCK

Nike Ajax, Nike Hercules, M-33, MPS-19, TPS-1D, TPS-10D, FPS-6, SPS, SCR-584, HIPAR. Many more. write



Radio Research Instrument Co., Inc.

3 QUINCY ST., NORWALK, CONN. 06850
 (203) 853-2600

npe PLASTICS SHOW '76

What's up in electronics?

“Plastics...that's what!”

Plastics' use in electrical/electronic applications could easily quadruple by the end of the century — reaching 6.8 billion lbs. Reason? A rapidly growing technology is leaning away from metal to plastics and plastic-enclosed devices. Stay on top of the dramatically advancing world of plastics at NPE/76, December 6-10, McCormick Place, Chicago.

NPE/76 will be the most comprehensive U.S. plastics exposition in the history of this vital industry. More than 400 participating companies with more of everything...nearly 300,000 square feet of exhibits...new products...and equipment...design consultation services...educational seminars on plastics technology and applications...a cornucopia of new ideas and techniques to spark your company's profits...all available in one place, at one time, under one roof!

New convenience and economy too.

For the first time, a single economical registration fee entitles you to explore your special interests at the exhibits of the National Plastics Exposition as well as attend the eleven seminars of the concurrent National Plastics Conference. The low fee also includes unlimited free bus service between major hotels and McCormick Place.

Advance registration kit available.

Now you can register in advance for even greater economy and convenience. Your advance registration kit includes everything you need to pre-register at a price of \$7.50 (vs. \$10.00 at the door) as well as reserve your hotel room. To obtain your advance registration kit, write, or use the Reader Service Coupon. At NPE/76 you will have five, full, information-packed days. Plan to make the most of every minute.

Your competitive edge!

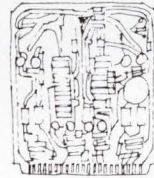

Electronics and plastics are inseparably linked. So there will be a lot of NPE/76 devoted to your specific interests.

- New materials
- New processes
- New applications

...and seminars on management, marketing, processing technology that will enable you to cut costs, increase sales, innovate, and plan for the future.

In the three years since the last Plastics Show, a lot has happened. The plastics industry moves fast. So catch up at NPE/76. Save time and money by registering in advance. Write The Society of the Plastics Industry, Inc., 355 Lexington Avenue, New York, N.Y. 10017, or...CIRCLE READER SERVICE NO. 197.

National Plastics Exposition 

Sponsored by The Society of the Plastics Industry, Inc.

Electronics / September 2, 1976

DANA INTRODUCES THE SMART COUNTER.

Series 9000: World's First Microprocessing Timer/Counter.

The Dana Series 9000 is smart enough to make your work a lot easier. Microprocessing controls provide all the features of a premium timer/counter, a reciprocating counter and a calculator. Plus interfacing options and operating capabilities never before available in one instrument.

The Dana Series 9000 Microprocessing Timer/Counter goes so far beyond all other counters it takes a whole brochure just to explain its capabilities. Ask for it. It's the smart thing to do.

Dana Laboratories, Inc., 2401 Campus Drive, Irvine, California 92664, 714/833-1234.



Circle 198 on Readers Service Card for Product Demonstration
Circle 268 on Readers Service Card for Literature Only

New products

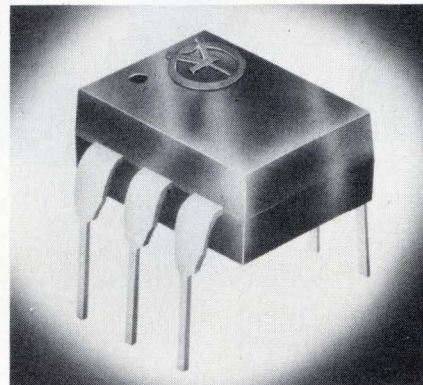

and a high-voltage npn phototransistor. Guaranteed maximum output leakage current is 100 nanoamperes at a collector-emitter voltage of 200 V.

Saturation voltage for the output transistor is 0.4 V maximum with an input current of 10 milliamperes and an output of 0.5 mA. Current transfer from input to output is a minimum of 20% with a 10-mA input current and 5 V on the output transistor. In thousands, the OPI 6000 sells for \$1.25 each.

Optron Inc., 1201 Tappan Circle, Carrollton, Texas 75006. Phone (214) 242-6571 [387]

Sample-and-hold unit has
200-ns acquisition time

An ultra-fast sample-and-hold module can acquire a signal to within 0.1% in 200 nanoseconds or to within 0.01% in 350 ns. Designed to work with fast 10- and 12-bit analog-to-

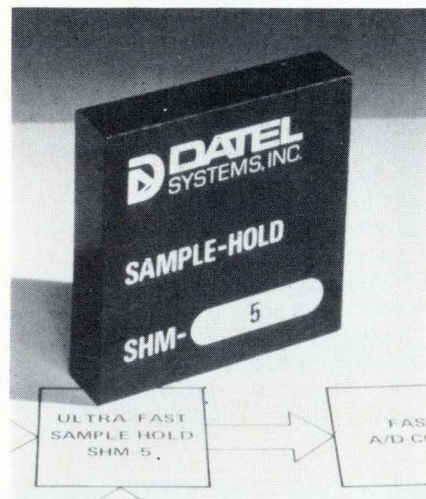

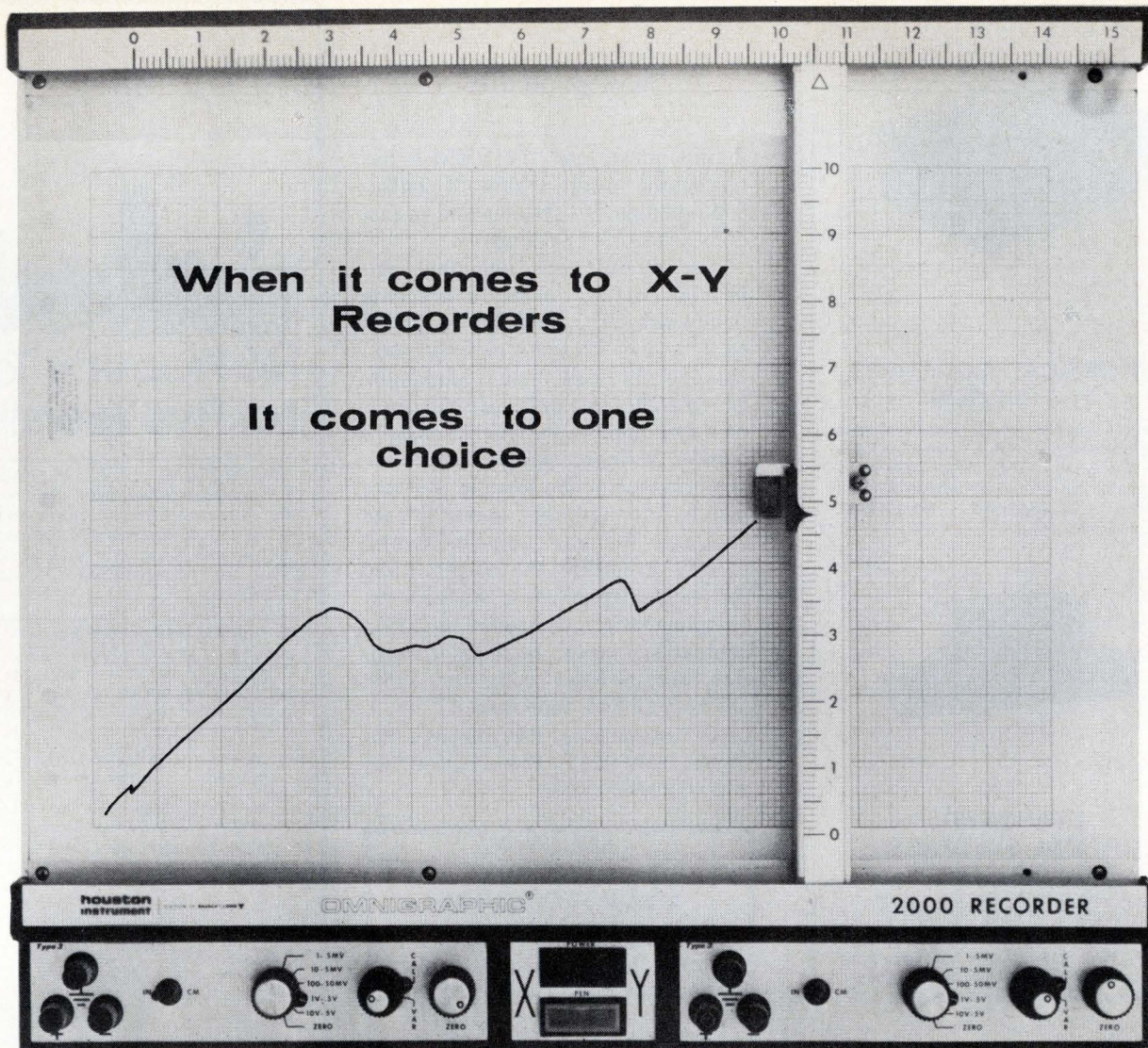

When it comes to X-Y
Recorders

It comes to one
choice

BEST VALUE - MOST FLEXIBILITY

This versatile 11" x 17" recorder is adaptable for laboratory or field, production or process, OEM (with or without modules) or dedicated applications in either bench or rack mounted. Inch/centimeter scaling by front panel switch.

Differential input is potentiometric with no less than 2 megohms slewing resistance. High common mode rejection. Acceleration, slewing speed, phasing and damping of X and Y axes drives are matched for

minimum error under dynamic conditions. Amplifiers are interchangeable as are input modules.

Overall accuracy $\pm 0.2\%$. Linearity $\pm 0.1\%$ full scale. Repeatability $\pm 0.1\%$ full scale. Resetability $\pm 0.05\%$ full scale. Overshoot is less than 1%. Basic sensitivity 1 mv/inch (0.5 mv/cm). Zero is fixed or can be remotely controlled. Local or remote control electric pen lift. Dozens of selections for input modules.

OEM discounts available.

Need more information? Call or write:

**houston
instrument**

DIVISION OF **BAUSCH & LOMB** 

ONE HOUSTON SQUARE (at 8500 Cameron Road) AUSTIN, TEXAS 78753
(512) 837-2820 TWX 910-874-2022 cable HOINCO

TELECOPIER

EUROPEAN OFFICE

Rochesterlaan 6 8240 Gistel Belgium

Phone 059/277445 Telex Bausch 81399

"the recorder company"

® A registered trademark of Houston Instrument.

NOW AVAILABLE!

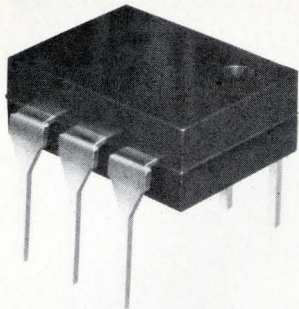

5KV OPTICAL ISOLATORS IN 6-PIN DIPS

Industry's first 5KV isolators to be offered in the popular 6-pin dual in-line package are available now! They are directly interchangeable with standard industrial 6-pin isolators . . . **UL approved . . . No. E58979.** Circle R.S. NO. 219

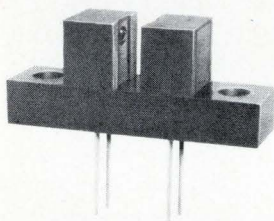

STANDARD OPTICAL SWITCHES

Six, low-cost off-the-shelf optical switches are available as direct replacements for such popular devices as the H13A1, A2; H13B1, B2; MCA 8, 81 and MCT 8, 81. Both phototransistor and photodarlington versions are available from factory stocks. Circle R.S. NO. 221

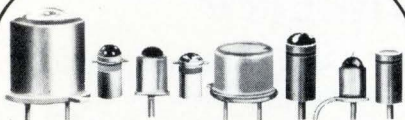

LOW-COST PHOTODETECTORS & LEDs

Spectronics provides industry's largest selection of standard off-the-shelf detectors and LEDs. Direct replacements for such popular industrial types as: LED55CF, BF, B, C; SSL315, 15, 35; TIL31, 81, 23, 24; and TIL601-616 Series. Call today for prices and deliveries. Circle R.S. NO. 222

Call Spectronics for everything you need in opto. We make optoelectronics work . . . for you!



Spectronics
INCORPORATED

830 E. Arapaho, Rd.
Richardson, Texas 75080
(214) 234-4271

WESCON BOOTH No.1055

New products

digital converters, the SHM-5 has important applications in pulse-code-modulation systems and in fast data-acquisition systems.

The module has an input impedance of 10^8 ohms, a tracking bandwidth of 5 megahertz, and a slew rate of 25 volts per microsecond. In the hold mode, maximum droop is 20 microvolts per microsecond and maximum feedthrough is 0.005% of input signal. Key to the performance of the module is a very fast hybrid amplifier manufactured at Datel Systems' thin-film hybrid facility. Preceding the amplifier and the hold capacitor is a fast FET sampling switch controlled by a TTL-compatible input. In small quantities, the SHM-5 sells for \$189. Delivery time is four weeks.

Datel Systems Inc., 1020 Turnpike St., Canton, Mass. 02021. Phone Eugene Zuch at (617) 828-8000 [388]

TOPICS

Subassemblies

Motorola Semiconductor Products Inc., Phoenix, Ariz., has announced that its MDA-3500 series of full-wave 35-ampere rectifier bridges has received recognition of suitability by Underwriters' Laboratories for use in UL-approved power supplies. The rectifier-bridge series includes assemblies with voltage ratings from 50 V to 1,000 V. . . . **Semiconductor Circuits Inc., Haverhill, Mass.**, has introduced its RA series of dc-to-dc converters. The 24 members of the family are second sources for equivalent units made by Analog Devices, Datel Systems, and Stevens-Arnold. . . . **Powertec Inc., Chatsworth, Calif.**, has made several important improvements in its Super Switcher series of power supplies without increasing their cost. Among the improvements: dual 115/230 V ac inputs for all output voltages, an input-voltage tolerance of +10% and -20% for better operation during brownouts, and front-panel output studs rather than bus bars.



No Property Tax For Five Years!!

Why consider locating or expanding in Rochester, New York? Because that move could mean money in the bank for growth-oriented companies that qualify under the New York State Job Incentive Board Program (JIBP).

By helping this economically-diversified Upstate New York Community increase urban job opportunities for its residents, your firm could enjoy the benefits of JIBP, including:

- Tax credits deducted from your company's State Business Tax Bill.
- Total local property tax exemption for five years with abatements decreasing annually for five more years.

Plus all the other benefits offered by the Rochester, New York area:

- A labor force of skilled professionals, technicians, and tradesmen.
- Corporate neighbors such as Eastman Kodak, Xerox, IBM, Sybron, Bausch & Lomb, General Motors, and Gannett Newspapers.
- Superb educational and cultural facilities, including Rochester Institute of Technology, the University of Rochester, Eastman School of Music, Rochester Philharmonic Orchestra, George Eastman Museum of Photography, and the Strasenburgh Planetarium, among others.

We will be glad to help interested firms apply for the JIBP, or to explore other real estate tax aid possibilities with companies that could provide jobs, improve older existing structures, or even construct new facilities.

Any manufacturing firm interested in further information may contact:

**John Stockton, Director
Bureau of Economic Development
City of Rochester
150 State Street
Rochester, New York 14614
(716) 428-6966**

City of Rochester

If high start-up costs have delayed your expansion, contact Georgia.

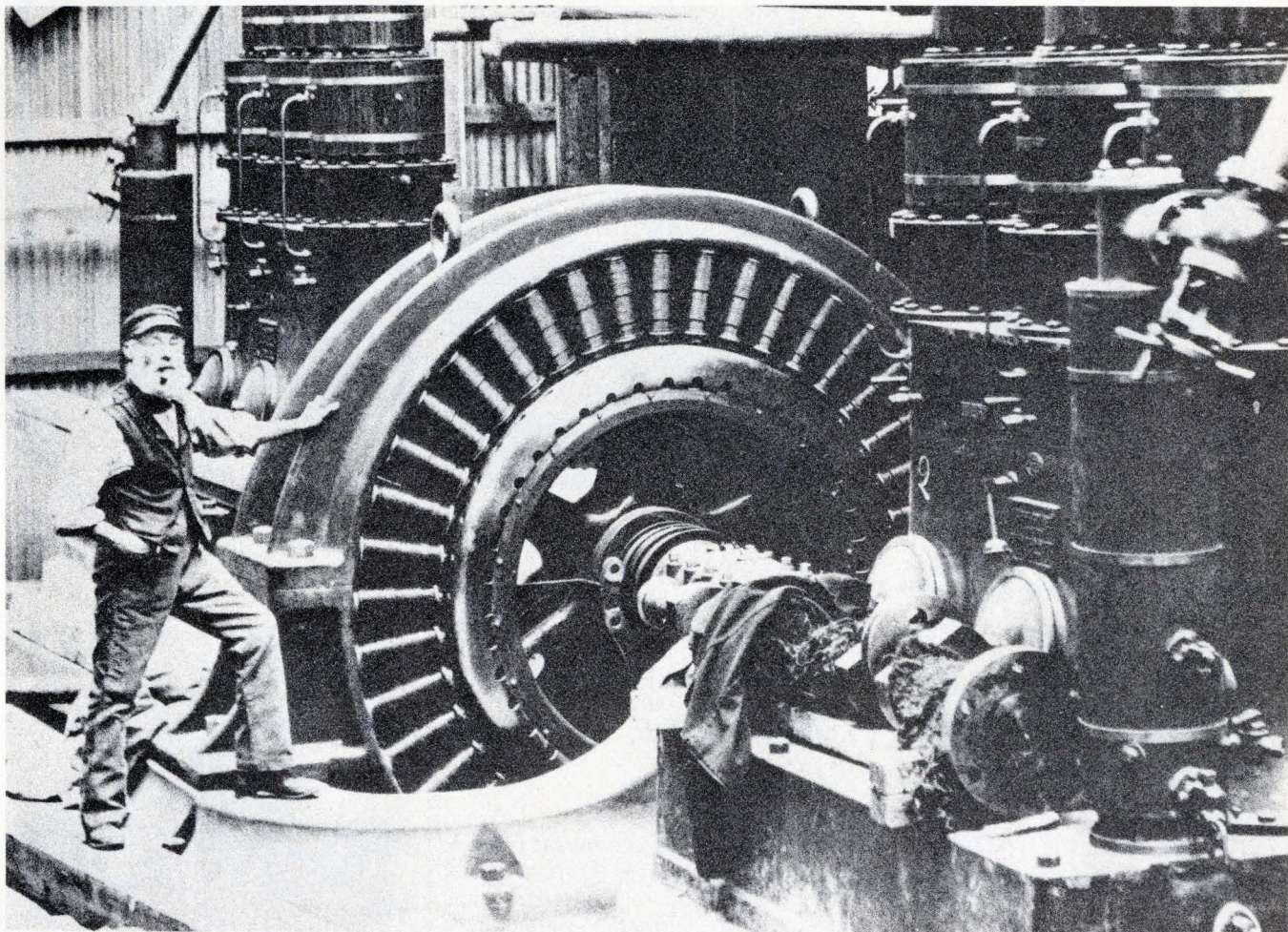

The Bettmann Archive, Inc.

We're wired into the needs of the electronics industry. And we'll come to you with profit incentives you can appreciate.

Like available buildings and low-cost construction. A skilled and stable work force that

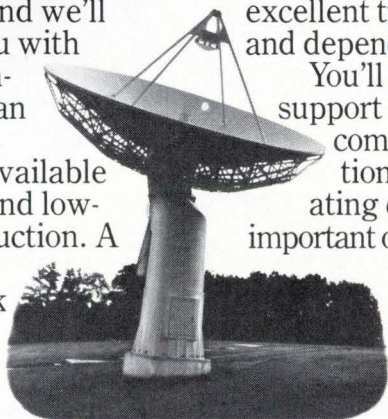

we'll train free. Fiscally-responsible government, excellent transportation and dependable utilities.

You'll also find good support from allied companies. In addition to lower operating costs, we offer important opportunities for higher education. Including the country's

second largest electrical engineering school at Georgia Tech. And the cultural amenities that help provide a pleasing lifestyle.

For more information contact Milt Folds, Commissioner, Georgia Bureau of Industry & Trade, P.O. Box 1776, Atlanta, Georgia 30301, Dept. EL-732.



Georgia

THE PREMIER 50MHz PORTABLE OSCILLOSCOPE



The new IWATSU SS-4511 portable DC-50MHz oscilloscope provides a variety of functions and precision $\pm 2\%$ accuracy comparable to that of sophisticated bench type oscilloscopes, yet weighs only 7.8kg (17.2 lbs.). The new scope not only features a brighter, clearer CRT, but also provides excellent linearity. AC power: 100, 117, 217, 234 volts $\pm 10\%$, 50 to 400Hz.

Main Features

- CRT designed for 100MHz scope under 20kV accelerating voltage
- $\pm 2\%$ accuracy at 5mV/div. and 0.1 μ s/div.
- 1mV/div., both channels
- Delayed and mixed sweep
- Composite trigger

For further details, please contact to the following distributors.

USA: Dumont Oscilloscope Lab.
201-575-8666

W.Germany: NBN Elektronik 08151-13036

Sweden: Teleinstrument AB 08-380370

Finland: OY Honeywell 780311

Austria: Universal Elektronik 422358



IWATSU ELECTRIC CO., LTD.

(ASAHISEIMEI BUILDING)
1-3, NIHONBASHI 2-CHOME, CHUO-KU
TOKYO 103, JAPAN
PHONE: TOKYO 272-0461
TELEX: J24225 TEIWIWA

New products/materials

High-conductivity ceramic potting compound Ceramacast 510 is a high-alumina formulation with a thermal conductivity of 25 BTU-inches per ft²-hr-°F. Neither acid nor alkaline, the material will not attack electrical windings. It has a compressive strength of 7,500 psi and a modulus of rupture of 1,500 psi. Dielectric strength is 50 volts per

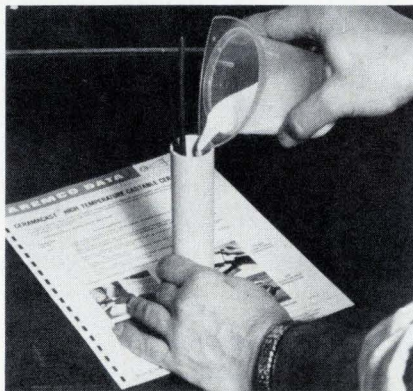

mil. Supplied as a powder to which water is added, Ceramacast 510 sets up chemically and then requires a bakeout at 200°F to complete the cure. It sells for \$27.50 a quart, \$50 a gallon, and as little as \$15 per gallon in 50-gallon lots. Delivery is usually from stock.

Aremco Products Inc., P.O. Box 429, Ossining, N.Y. 10562 [476]

Platinum-silver conductor ESL 9501A is a glass-free formulation for use in hybrid microcircuits. Priced at 55 cents a gram, the conductor is said to have better solder-leach resistance than similar low-cost platinum-silver materials. ESL 9501A can be fired at peak temperatures from 850°C to 940°C with little variation in its electrical and mechanical properties. It is compatible with Electro-Science Laboratories' 2800 series thick-film resistors, and can be bonded by either ultrasonic or thermo-compression techniques. Sample quantities sell for \$1.25 per gram.

Electro-Science Laboratories Inc., 1601 Sherman Ave., Pennsauken, N.J. 08110. Phone (609) 663-7777 [477]

Conductive coatings for the rf shielding of plastic enclosures are included in a \$25 kit from Electro-Kinetic

"The manufacturer's
manufacturer of
CONNECTORS/P.C.

JACKS & PINS

BERYLLIUM
COPPER
CAGES

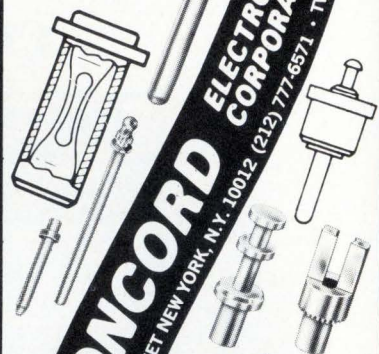

CONCORD ELECTRONICS CORPORATION
37 GREAT JONES STREET NEW YORK, N.Y. 10012 (212) 777-6571 TWX 710-381-4930

and
TEFLON*
AND SOLDER
TERMINALS

*DUPONT T.M.

SEND FOR CATALOG

Circle 239 on reader service card

Gas Sensing Semiconductor

FIGARO GAS SENSOR

TGS quickly senses
even small
amount
of gas.

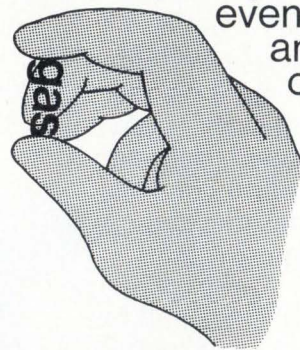

New Models,
some with highly sensitive
CO sensor, now on the market.

Please contact the address below directly for
catalogs and price/delivery information.

FIGARO ENGINEERING INC.

3-7-3, Higashitoyonaka, Toyonaka City, Osaka 560,
Japan/Tel: (06) 849-2156

Cable: FIGARO TOYONAKA/ Telex: 05286155 FIGARO J

Finally. A low-cost predictable filter.

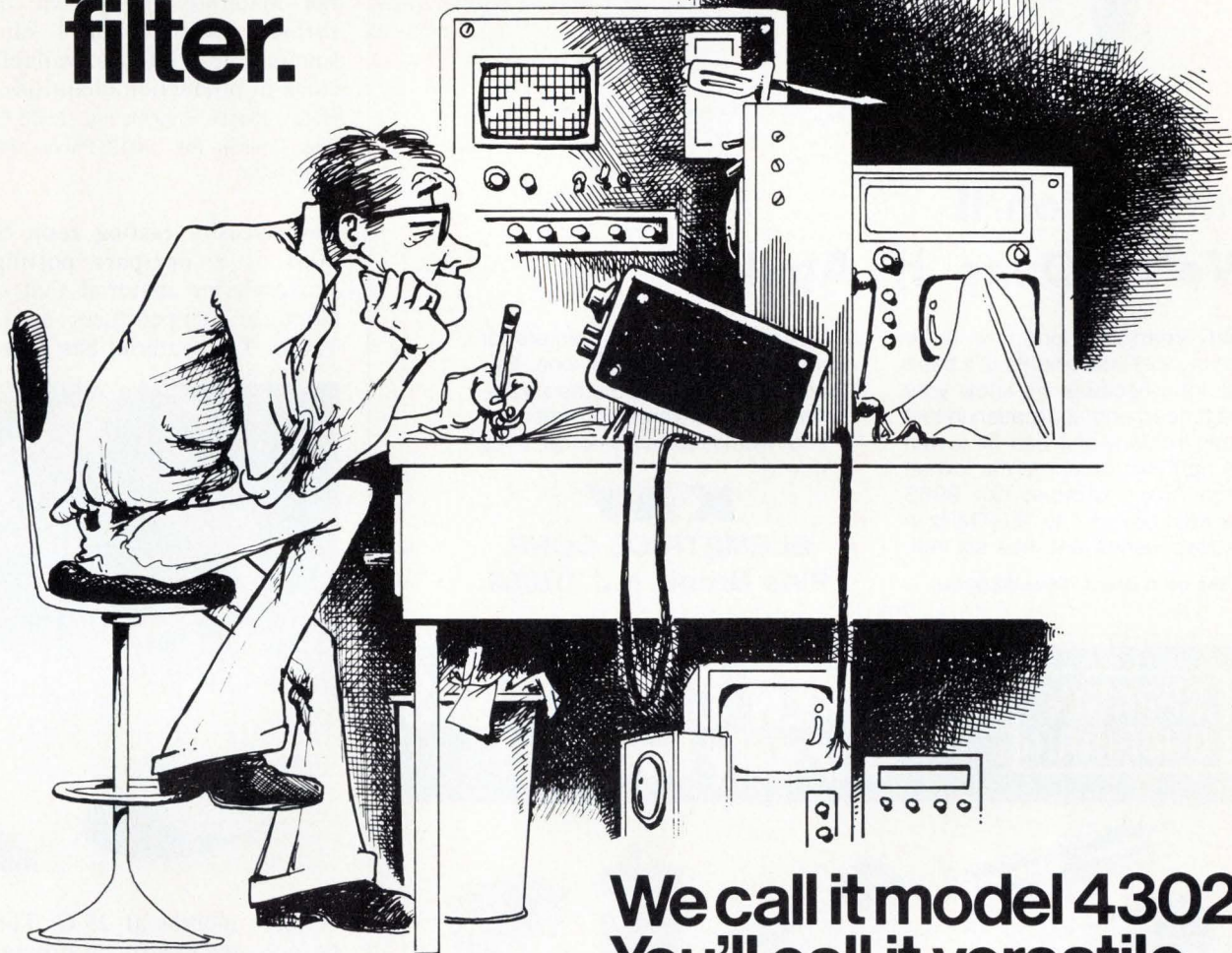

You probably have equipment in your lab or data acquisition system that you don't really trust, or that you have to calibrate whenever you use it. So we thought you'd appreciate a high performance, low-priced dual filter that's predictable.

It takes unusual performance to make a predictable filter.

Like .005% distortion at 20 volts peak to peak output. 25 μ volts self noise. 100dB outband rejection. And 100dB crosstalk attenuation. All better than any competitive filter, even higher priced ones. And switch selectable frequency

We call it model 4302. You'll call it versatile.

settings (10 Hz to 1MHz), let you repeat settings over and over again. With predictable results.

Versatility is written all over its face.

Each 24dB/octave filter can be used as high pass or low pass with selectable gain of 1 or 10. Or connect them in series for bandpass, 48dB/octave high pass, or 48dB/octave low pass, with selectable gain of 1, 10, or 100. Select normal (Butterworth) and pulse (Bessel) by the push of a button. All of this is standard.

Send for our data sheet.

It'll tell you all you need to know about our newest filter. And when you need a filter that does just what you expect, you'll know where to find it. The predictable filter.™ \$655. Ithaco. Box 818, Ithaca, New York 14850. Call (607) 272-7640.

ITHACO

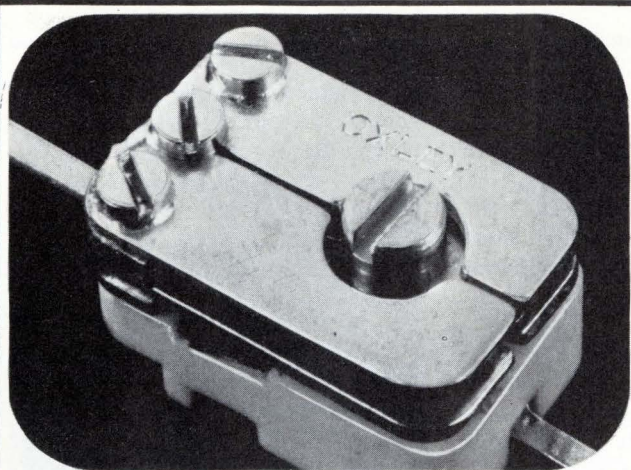

take a close look at the **OXLEY** Thermotrimmer[®]

Designed to correct thermally induced drift in electronic circuits, the OXLEY THERMOTRIMMER[®] provides controlled adjustment of capacitance/temperature characteristic for compensating tuned circuits. Nominal capacitance at room temperature is 2.5pF. Range of temperature coefficient plus or minus 1000ppm/°C. Other types also available. Send for full details.

Visit us at WESCON stand 1007

OXLEY Oxley Developments Co. Ltd.

ULVERSTON · CUMBRIA · LA12 9QG · ENGLAND
CABLES OXLEY ULVERSTON · TELEX 65141 · TELEPHONE: 0229 52621

Circle 205 on reader service card

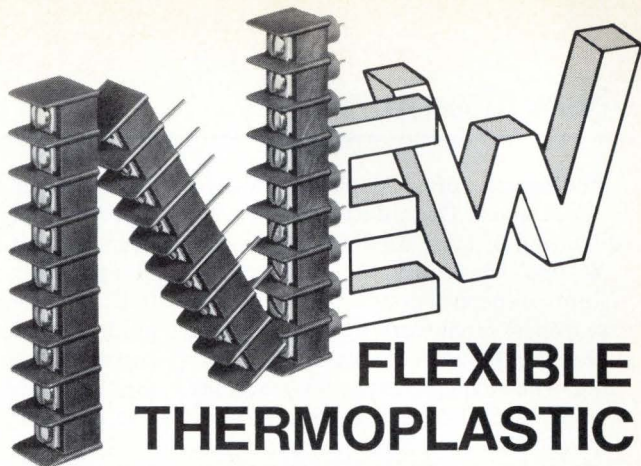

FLEXIBLE THERMOPLASTIC

Flat mounts, PC mounts or insulated feed-thru turrets – we've got them in our new high-barrier thermoplastic terminal board line. Available in a wide variety of bottom terminations and surface hardware configurations. Whatever your requirements, Kulka can deliver. Complete specs shown in our new catalog. Send for it today.

Kulka

A NORTH AMERICAN PHILIPS COMPANY

Kulka Electric Corp., 520 S. Fulton Ave., Mt. Vernon, NY 10551

See Them at Booth #737 WESCON/76

Circle 242 on reader service card

WE'RE NUMBER ONE FOR CUSTOM MOS

NUMBER ONE for experience. Our MOS experience dates back to 1964 and our company has been producing Custom Mos since its' founding in 1969.

NUMBER ONE for making the economics of Custom MOS right for you, whether your production quantities are 1,000 or 1,000,000. (We have no production minimum or maximum.)

NUMBER ONE for quality. Reliability is built into every MOS/LSI circuit we manufacture, whether packaged in plastic or ceramic.

NUMBER ONE for protecting the proprietary nature of your product. Your competition will not know about your product design and we will not become your competition.

NUMBER ONE for flexibility. We offer you PMOS, CMOS, and NMOS (we help select the right process for your requirement) and the assurance that multisourcing is available when needed.

LSI computer systems, inc.

22 Cain Drive, Plainview, NY 11803 (516) 293-3850

New literature

Photomask life. A paper entitled "Photomask Degradation in Contact Printing of LSI Circuits Onto Silicon Wafers" describes the results of a joint experimental effort by researchers from Corning Glass Works and the Hewlett-Packard Co. During the experiments, comparisons were made between soda-lime, alumina-soda-lime, and alumina borosilicate glasses. Also studied were chrome films, dc-sputtered iron-oxide films, and rf-sputtered iron-oxide films. A major result of the study was that alumina borosilicate glass can double mask life. Perhaps more importantly, it can also increase yields in critical multilayer fabrication. Copies of the paper may be obtained from the Materials Dept., Corning Glass Works, Corning, N.Y. 14830. Circle reader service No. 421.

Triac and SCR guide. A 32-page

cross-reference guide that covers more than 2,100 triacs and SCRs has been put out by the RCA Solid State division, Box 3200, Somerville, N.J. 08876. Designated CRG-421, the guide includes an easy-access short listing of the more popular thyristors, in addition to the comprehensive directory. [422]

Microscopes. A line of 13 microscopes and their accessories is described in a 10-page catalog entitled "From Slice to Circuit." Among the covered inspection and measuring microscopes are units for checking the flatness and surface characteristics of wafers, units for measuring the thickness of junctions and thin films, and microscopes for detecting pinholes, stacking faults, voids, and other flaws. Copies of the catalog are available from Carl Zeiss Inc., 444 Fifth Ave., New York, N.Y. 10018. [424]

Semiconductors. A 52-page catalog from Semitronics Corp., 64 Commercial St., Freeport, N.Y. 11520,

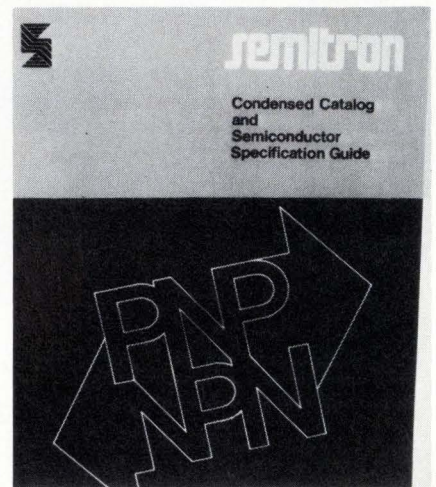

lists more than 5,000 semiconductor devices, including transistors, rectifiers, thyristors, and signal diodes. [426]

Phase Lock like you've

Separate modulation meter

100 Hz resolution with phase-lock

Wide deviation at all carrier frequencies

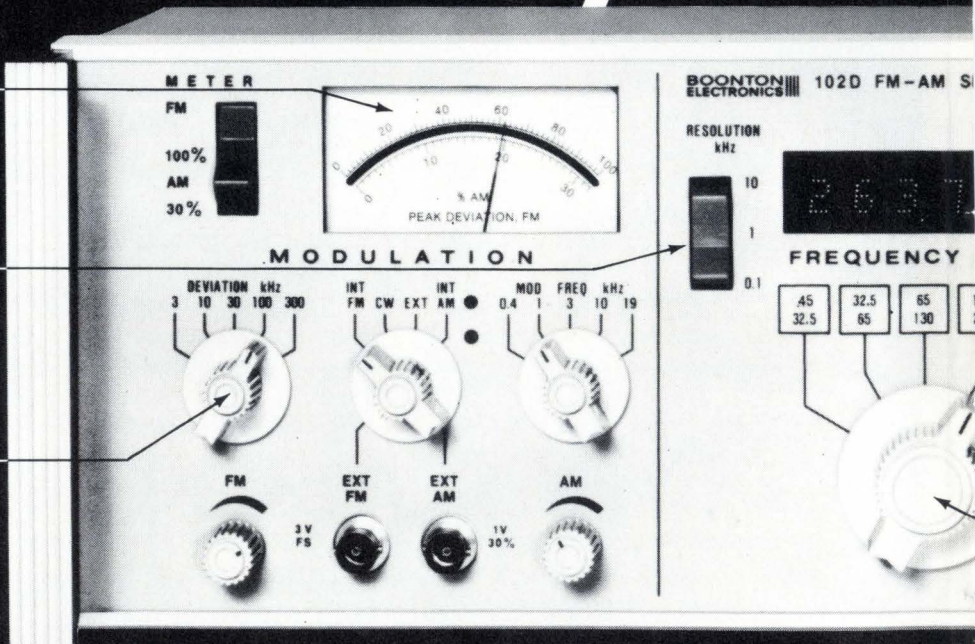

How do you make a great signal generator like our 102A better?

Simple—you not only extend the frequency range to cover 450 kHz to 520 MHz, but you make sure that the frequency you see is the frequency you get... exactly. (And virtually indefinitely.)

With the unprecedented phase-lock stability of this new model 102D, you can be as specific as you like. Simply lock-in the desired frequency with pushbutton ease to get a 6-digit display of the true locked output frequency with full 100 Hz resolution—even when the

vernier is used to tune between lock points. Phase-lock operates with either the stable internal TCXO or an external reference from your frequency standard or other generator.

No one else makes it that easy, even in generators selling for \$2100 more. But

Flat-cable connectors. Catalog 73-177 from AMP Inc. covers nearly 100 latch connectors for the mass termination of flat cables. The cable conductors, which can be 28-gauge stranded or 30-gauge solid, should be on standard 0.050-inch centers. The connectors can be applied at the end of a cable or anywhere along its length. Also described in the catalog are new card-edge connectors in sizes that accommodate from 20 to 60 positions. Copies are available from AMP Inc., Harrisburg, Pa. 17105. [429]

Magnetic shielding. One of the features of the new Ad-Vance Magnetics magnetic-shielding catalog/manual is a 28-page engineering section that includes technical articles, graphs, and tables for aid in the solution of shielding problems. An important part of this section is an article entitled "Why You May

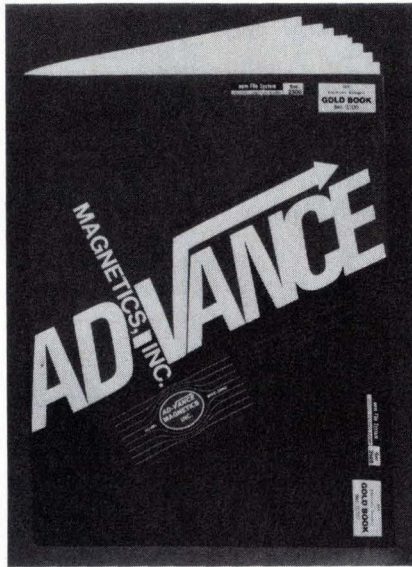

Need More Than Figures to Design Magnetic Shields." For a copy of 48-page manual No 76, write to Richard D. Vance, president, Ad-Vance Magnetics Inc., 226 East

Seventh St., Rochester, Ind. 46975 [430]

Zener Diodes. A 146-page catalog put out by Siemens Corp., Components Group, 186 Wood Ave., South, Iselin, N.J. 08830, covers the company's full line of zener diodes. Included are cross-reference lists, diode specifications, and application notes. [431]

4-k RAMs. A 16-page commentary on the reliability of 4,096-bit random-access memories manufactured by Texas Instruments covers the company's popular series TMS 4030, 4050, and 4060. Reliability figures from five customer locations are reported. Copies of the report may be obtained from Texas Instruments Inc., Inquiry Answering Service, P.O. Box 5012, M/S 308 (Attn: Bulletin CR-112), Dallas, Texas 75222. [432]

never seen before.

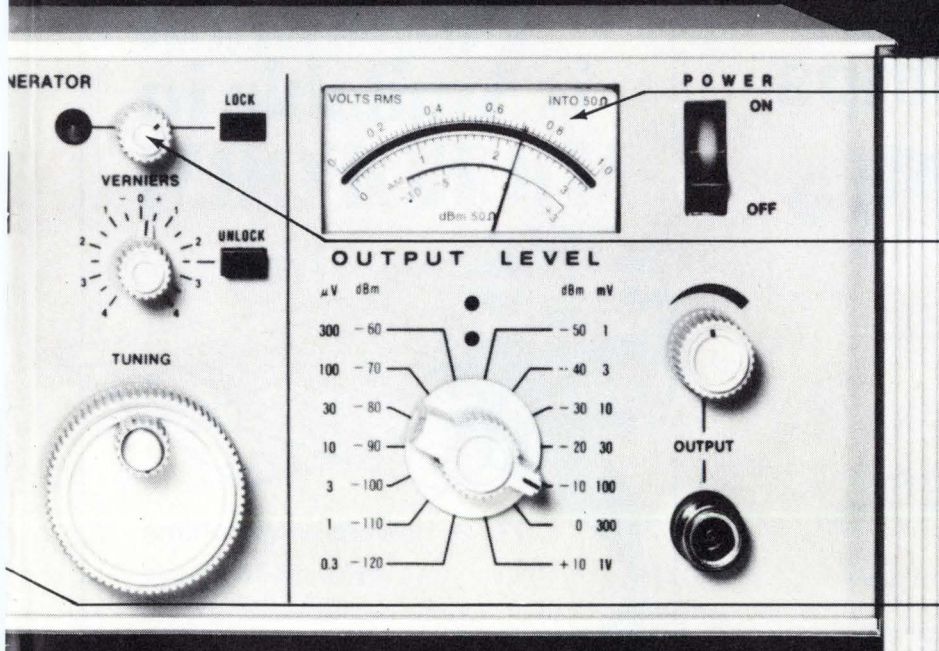

Separate output meter

Phase-lock with unique fine-tuning capabilities

Extended frequency range of 450 kHz to 520 MHz

if you think that's the only reason the 102D is right on the money, look again: At a panel control layout unmatched for easy-to-understand-and-use convenience; at the separate modulation and output meters; at the wide FM deviation unrestricted at low carrier fre-

quencies...and at all the other specs. Compare them against the competition's \$6400 unit, and see for yourself why our \$4295 domestic price-tag (\$3575 for the comparable 102C without phase-lock) is generating all the excitement today.

For complete data or a demonstration, write or call Boonton Electronics Corp., Rt. 287 at Smith Rd., Parsippany, N.J. 07054; tel. (201) 887-5110.

BOONTON

Circle 207 on reader service card

We'll make your face light up.



Terminal pins and "Snappers" are designed for the calculator industry as standard interconnects. These connectors may be used to join displays with P. C. boards, attaching keyboards to a component board or the permanent joining of two substrates. Our tooling is flexible, assorted sizes and combinations are available. Send for an Application Data Sheet today or call us directly for complete technical specifications.

Precision Concepts, Inc.

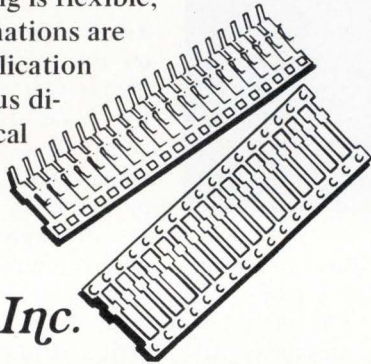

1595B OCEAN AVENUE □ BOHEMIA, NEW YORK 11716 (516) 567-0995

Circle 208 on reader service card

by popular demand . . .

Thumbwheel Switches-in-Strips

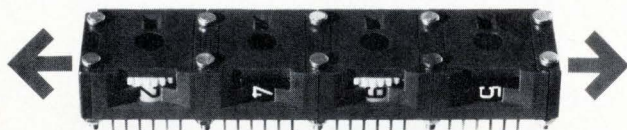

Any Length!

- QUALITY CONSTRUCTION
 - MODULAR DESIGN- MIX OR MATCH OUT PUT CODES
 - CHOICE OF 10 OR 16 POSITIONS, 2 WHEEL COLORS, 6 OUT PUT CODES
 - OFF-THE-SHELF DELIVERY
- CALL US FOR DETAILED INFORMATION



ONE OF THE PURDY GROUP OF COMPANIES
770 Airport Blvd., Burlingame, CA 94010
Phone (415) 347-8217 TWX 910-374-2353 TELEX 34-9373

208 Circle 245 on reader service card

ZEBRA®

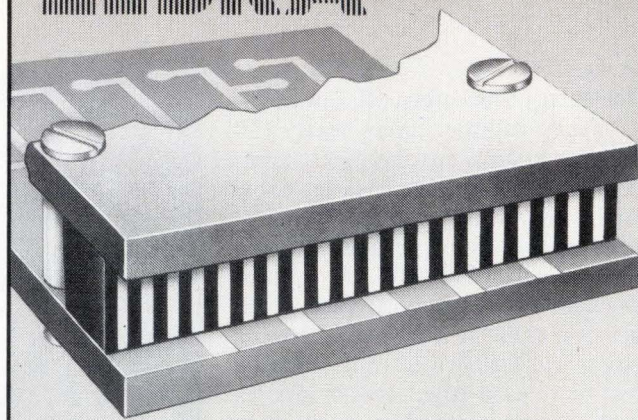

ELECTRICAL CONNECTOR LAYERED ELASTOMERIC STRIP

- A new concept for solderless inter-connection of printed circuit boards, hybrids and displays
- Provides vibration isolation
- Low profile packaging
- Close spacing: up to 30 contacts per inch
- Provides a gas-tight seal
- Cost effective: standard configuration available from stock.



Send for Connector Catalog.

Eastern Division • 129 Dermody St., Cranford, NJ 07016, (201) 272-5500
Western Division • 427 Olive St., Santa Barbara CA 93101, (805) 903-1867

Circle 244 on reader service card

This Publication is Available in MICROFORM

from...

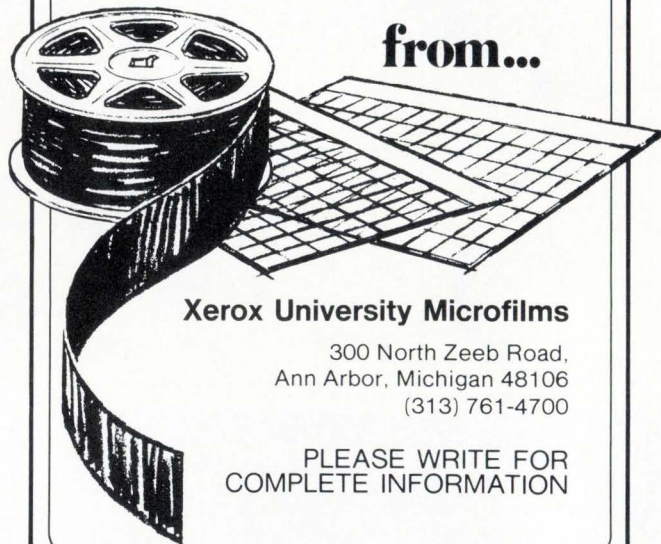

Xerox University Microfilms

300 North Zeeb Road,
Ann Arbor, Michigan 48106
(313) 761-4700

PLEASE WRITE FOR COMPLETE INFORMATION

Classified section FOR ENGINEERING/TECHNICAL EMPLOYMENT OPPORTUNITIES

CLASSIFIED SALES REPRESENTATIVES

Atlanta Joe Lane 404/892-2868
 Boston Holt Buchanan 617/262-1160
 Chicago Bill Higgins 312/751-3733

Cleveland Connie Byers 216/781-7000
 Dallas Rick Ofstie 214/742-1747
 Denver Jay Johnson 303/266-3863
 Detroit Mac Huestis 313/873-7410

Houston Rick Ofstie 713/659-8381
 Los Angeles Stan Kassir 213/487-1160
 New York Holt Buchanan 203/359/2860
 Dave Hawksby 212/997/3594

Philadelphia Dan Ferro 215/568-6161
 Pittsburgh Pam Petika 412/391-1314
 San Francisco Mary Kenny 415/362-4600
 XEROX 400 TELECOPIER 212/997-6800

POSITION VACANT

The Colorado School of Mines is seeking applications to fill a faculty position at the Assistant or Associate Professor level in the area of industrial electronics, control, and instrumentation for the Mineral Industry. Although a Ph.D. degree is desirable, experience in the area is more important. Research in the problems of the Mineral Industry is encouraged. Rank and salary depend upon qualifications. Send a letter of application and resume to Professor Henry A. Babcock, Basic Engineering Department, Colorado School of Mines, Golden, Colorado 80401. An Equal Opportunity Employer.

EMPLOYMENT SERVICE

If you are willing to relocate we have excellent opportunities in Electronics Industry. Executives, Engineers, Sales, others, U.S. abroad. Fee paid 15 to 50K. Send resume. Nationwide Executive Search, Suite 616 Fox Pavilion, Jenkintown, Pa. 19046.

Biomedical Professionals: Our clients have numerous openings for qualified and experienced individuals in Technical, Marketing and Managerial positions nationwide. Send resume in confidence to: Health Industry Consultants, P.O. Box 2634, Evergreen, Colorado 80439 or call (303) 674-4696.

Electronics' Industry Newsletter tells you which firms have current employment opportunities, in the field of Electronics, for all types of Engineers, Sales Representatives, Technicians, Executives, Computer Personnel and others. Latest product information is also reported. For information write: Electronics' Industry Newsletter, Dept. 304A, 23573 Prospect Avenue, Farmington, MI 48024.

DON'T forget the Box Number when answering the replies.

CHECK for Accuracy.

INCORRECT Box Numbers may result in a delay in re-forwarding your reply.

PLASMA PHYSICS LABORATORY

A directed research arm of Princeton University funded by the United States Energy Research and Development Administration, is engaged in CONTROLLED THERMONUCLEAR RESEARCH. You will work with foremost scientists and be exposed to a broad interdisciplinary spectrum. Our sophisticated facility is exceptionally equipped. Our continuous growth has created the following opportunities...

DIGITAL ELECTRONIC ENGINEER

An exceptional digital designer is needed in our Instrumentation Section to work with other engineers and programmers on a variety of projects involving mini-computer interface, micro-computers, memory systems, transient recorders, and data acquisition. Desire experience with MSI design techniques. **PROJECT I-22.**

ELECTRONIC INSTRUMENTATION ENGINEER

Our Electronic Instrumentation Group is involved in a number of varied projects involving analog and digital circuit design, computer interface, radiation detection, signal conditioning, and signal transmissions problems which provide support for diagnostics and data acquisition from large fusion research devices. We seek a Design Engineer who is experienced in most of the above areas. This person must be able to work independently or as a member of a team, as may be required. **PROJECT I-20.**

We offer excellent salaries fully commensurate with your experience, exceptionally comprehensive benefits, and a stimulating and sophisticated environment.

For prompt consideration, please send detailed resume and salary requirements in confidence. Please indicate in your response which position you are interested in by using **PROJECT NUMBER.**

Director of Personnel

Plasma Physics Laboratory

Princeton University



POST OFFICE BOX 451
 PRINCETON, NEW JERSEY 08540

An Equal Opportunity /
 Affirmative Action Employer M/F

We have been placing graduate **ENGINEERS** in **FEE-PAID** positions THROUGHOUT THE U.S. since '59. Over 1,000 client companies. We are graduate engineers working full-time for you. Send resume & salary history today or request confidential application.

ATOMIC PERSONNEL, INC.
 Box L. 1518 Walnut St., Phila., Pa. 19102
 An Employment Agency
 For All Technical Fields*

POSITION VACANT

Graduate Assistantships in Physics can begin during any quarter. Write: Dr. R. Madey, Kent State University, Kent, OH 44242.

Engineering

ELECTRICAL ENGINEERS R&D

Aggressive, growing manufacturer of data communication terminals has choice opportunities for experienced Electrical Engineers with a minimum of a BSEE degree to handle expanding Research and Development programs.

Strong background in computer software development or digital logic design required.

We offer attractive starting salaries plus participation in a liberal benefit program.

TELETYPE CORPORATION
 5555 Touhy Ave.
 Skokie, Ill. 60076

An Equal Opportunity Employer M/F

Not just a recruitment ad.

It's a challenge. And a very unique one at that. As you probably already know, Memorex is back on track... and like never before. We've just completed a succession of record quarters in both sales and earnings. And the demand for Memorex products is at an all-time high. So what's the challenge? Memorex Project '76... an ambitious product development program designed to transform Memorex's turn-around momentum into unquestioned technological and market leadership. The people who will turn this challenge into achievement are not people who answer recruitment ads. They are people who respond to challenge... people who want more out of a job than a paycheck. If you've read this far, that might be you. If you would like more information about joining the Memorex Project '76 Team, there are three things you can do. Send us the coupon, call our information hotline (408) 987-3800, or send us your resume. We are an equal opportunity employer M/F.

MEMOREX TEAM76

Project '76 Team Positions Include:

Senior Logic Design Engineers Mechanical Engineers Microprogrammers
Add-on Memory Engineers Datacommunications Engineers Magnetic Head Engineers Systems Programmers
Display Terminal Engineers Magnetic Recording Circuit Engineers Ceramic Process Engineers Peripheral Interface Specialists Mechanism Designers

EL Memorex Project '76 Team
Memorex Corporation
San Tomas at Central Expressway
Santa Clara, CA 95052

Name _____

Address _____

City, State, Zip _____

Phone _____ Occupation _____

Employer _____ Years Experience _____

COMMUNICATIONS

Do you respond to challenge?

If you're one of those rare professionals that respond well to challenge, then perhaps its time you investigated these excellent opportunities now available with Lockheed. We're looking for dedicated professionals ready to advance the state-of-the-art in their field, and who require plenty of variety and rewards to equal the challenges. If you're such an individual, then see if you qualify now.

Washington D.C. Area

Excellent opportunities for Sr. Communications Engineers to develop and design Advanced Communications and Signal Processing System concepts. Requires advanced degrees in Electronic Engineering, with 12 or more years' related experience and knowledge of theoretical, analytical and practical techniques. Must also have experience in Communications Program Management; interpretation and derivation of requirements; generation of specifications; test plans; definition of interfaces; technical trade studies; recommendation of design-to-cost and design-to-performance approaches; monitoring of sub-contractors and vendors; and installation and test of subsystems and systems.

San Francisco Peninsula

Specific areas of expertise required are:

1. Advanced Satellite Payloads and Communication Conceptual Design and Development.
2. Conventional and SAR Radar Analysis and Synthesis.
3. Spread Spectrum Communications and High Data Rate Coding Conceptual Design & Development.
4. Signal Processing System Conceptual Design & Development.
5. Advanced Analog and Digital System Design & Development.
6. RF/IF Hardware System Design and Development.

Advanced degree in Electronic Engineering with 12 or more years' applicable experience plus knowledge of theoretical, analytical and practical techniques required. Ability to provide leadership for staff-level development projects expected.

If you are interested and qualified, and a U.S. citizen, then take charge of your future today and advance the state-of-the-art with other dynamic professionals who enjoy challenge and responsibility. You can expect an excellent salary, wide range of benefits and the excitement of using your talents and ideas to the fullest.

For immediate consideration, please send your resume with salary history in confidence to Professional Employment, Dept. M-4, P.O. Box 504, Sunnyvale, California 94088. We are proud to be an equal opportunity affirmative action employer.

LOCKHEED
MISSILES & SPACE COMPANY

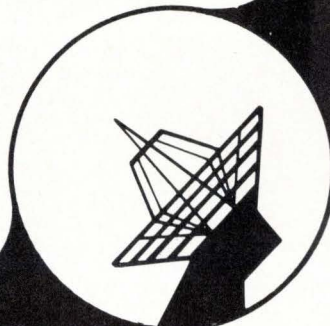

electronics

electronics engineer

Professional opportunity for Electronic Design Engineer, BSEE, with minimum five years' related experience.

Responsibilities will include design and development of micro-processor based electromechanical products, primarily in hardware and software interfaces, real time processor systems, software reliability and performance evaluation.

This position will require supervision of test technicians and customer applications support.

Please send your resume in confidence to Tally Corporation, 8301 South 180th, Kent, WA 98031.

An Equal Opportunity Employer M/F

TALLY

MANUFACTURERS' REPRESENTATIVES

Major U.S. manufacturer of matrix print heads, mechanisms and data terminals needs qualified manufacturers' representatives for France, Spain, Italy, Switzerland/Austria, Belgium, Scandinavia, Eastern Bloc Countries and Canada.

Applicants should currently represent computer or peripheral companies, be technically competent and able to service our products. Send resume including current lines and sales volume to:

MRW-1223

Electronics, Class. Adv. Dept., P.O. Box 900
New York, N.Y. 10020

THIS SPACE AVAILABLE. ONLY \$138.

Your recruitment advertising in this three inch space will cost you only \$46 per inch, or \$138.

You'll reach over 68,000 domestic engineers and technical people, as they're reading to combat job obsolescence, while they're thinking about their future and bettering themselves.

There's no charge for typesetting and free layout service is provided. For more information, call or write:

Electronics

Post Office Box 900
New York, N.Y. 10020
Phone: 212/997-2556

“I’ve had offers from other companies, but I’m staying right here. I believe in Fairchild because Fairchild believes in me. If you work hard and take advantage of the training they offer, there’s no limit to your advancement opportunities here. I did and I’ve advanced rapidly in 4½ years. Sure my salary has increased significantly, but even more important is the challenge and job satisfaction I’ve received. I can’t think of anything another company could offer me that I’m not already getting at Fairchild.”

Hank Miranda
Manufacturing Manager
Bipolar Memory Water Fab

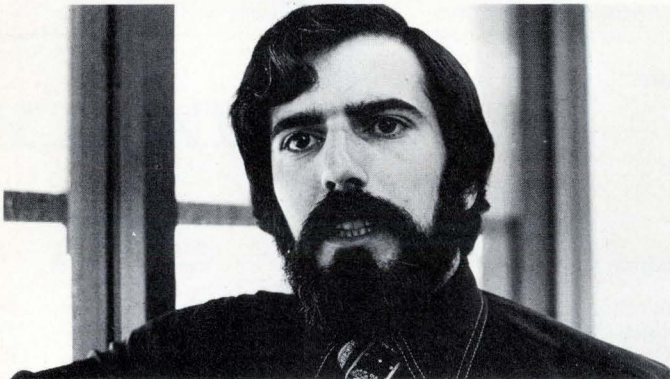

Fairchild offers more of what you work for.

Our immediate openings include:
LIC Product Engineers
Product Manager/Optoelectronics
Sr. Process Development Engineer/R&D
Supervisor, MOS Product Engineering
Sr. Product Engineers/Bipolar/Memory/ECL
Sr. Process Dev. Engineers/Bipolar & ECL
MOS Process Development Engineers
Product Engineer/Transistors
CMOS Design & Product Engineers
Hybrid Design & Appl. Engineers

Send your resumé to: Director of Professional Staffing, 464 Ellis Street, MS 22-0100, Mountain View, CA 94042. An Equal Opportunity Employer M/F.

FAIRCHILD
CAMERA AND INSTRUMENT
CORPORATION

MOS ENGINEERS

Extraordinary avenues to professional advancement begin at AMI . . .

As we begin our second decade of growth . . . with new leadership . . . exceptional growth opportunities exist as never before!

DESIGN ENGINEERS

Assume complete responsibilities from customer specs through first silicon. Work on a variety of consumer and telecommunications products, as well as memories and State-of-the-Art techniques. Minimum 3 yrs. MOS experience and a strong background in device physics plus a BS degree required.

PRODUCT ENGINEERS

You must have in-depth knowledge of MOS technology combined with minimum of 2 years experience in Product Engineering. Our Product Engineers are a vital link in both customer interface and AMI's Circuit Design and Applications Engineering BS preferred.

Send your resume, including salary history, to Terri Johnson, Employment Manager, AMI, 3800 Homestead Road, Santa Clara, CA 95051. We are an equal opportunity employer M/F.

AMI

FREE Your dream job.

We hope you're happy in your current position, but there's always that ideal job you'd prefer if you knew about it.

That's why it makes sense to have your resume on file in the Electronics Manpower Register, a computerized data bank containing the qualifications of career-conscious ELECTRONICS readers just like yourself.

You'll benefit from nation-wide exposure to industry firms privileged to search the system, and since the computer never forgets, if you match up with their job requirements you'll be brought together in confidence.

To take advantage of this free service, mail your resume to the address below.

ELECTRONICS MANPOWER REGISTER
Post Office Box 900/New York, N.Y. 10020

Plug-in protection for μ P's and minicomputers



Sola's Minicomputer Regulator provides a dedicated power line plus crucial line-voltage protection.

A small investment can give your equipment both a dedicated line and protection against malfunction and damage due to brownouts and other line voltage irregularities.

The portable Sola Minicomputer Regulator accepts line voltage variations from 95 to 130 volts . . . then stabilizes output within $\pm 3\%$ variation. Output remains within $\pm 5\%$ operational range even when power line voltages drop to 65% of nominal. The unit responds to all line or load variations in less than 25 milliseconds, and provides complete isolation from electronic noise. All by simply plugging it in—no need for an electrician.

The Minicomputer Regulator. Part of Sola's complete selection of line voltage regulation devices—CVS constant voltage transformers . . . computer line Solatrons for large-frame computers . . . UPS and standby power systems.

SOLA ELECTRIC **SE**
SOLA BASIC

They are all in stock at your Sola distributor. Or contact Sola Electric, 1717 Busse Road, Elk Grove Village, Illinois 60007. Phone (312) 439-2800.

Think of us as your DEDICATED LINE.

Circle 213 on reader service card

PINPOINT HEAT

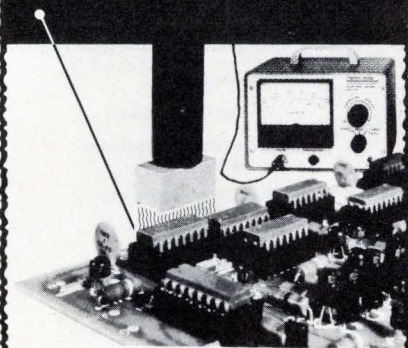

Heat any I. C. or semiconductor component to its rated temperature with a heat probe. Accuracy $\pm 1/2^\circ\text{C}$. Or check the component's temperature with a thermocouple probe. Accuracy $\pm 1^\circ\text{C}$. Model 810 Thermo-Probe does both. Reads out directly in $^\circ\text{C}$ and $^\circ\text{F}$ on a large $4\frac{1}{2}$ -inch meter.

PRICE \$299.50 F.O.B. South Laguna

Models with other temperature ranges available. For details write to:

MTI MICRO-TECHNICAL INDUSTRIES

P.O. Box 287 South Laguna, CA 92677

(714) 545-3734 • TWX 910-587-3425 MICRO OHM ELM

FOR HOME AND INDUSTRY **EDSYN** PRODUCTS

WORLD'S MOST PRACTICAL SOLDER HANDLING TOOLS

**SOLDERING +
DESOLDERING +
RESOLDERING =**

SOLDER Ability ELEMENTARY TO ELITE

ATMOSCOPE™ VACUUM PUMP
VP171

100% Pneumatic Automatic Closed Loop, Self-Regulating, Variable Pulse Width Modulation Vacuum Control System

HIGH VACUUM
without **MOTORS**
or **ELECTRICAL PARTS**

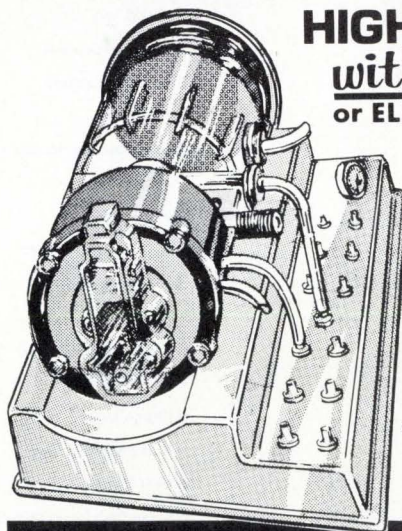

Vacuum to 22" mercury from shop air supply of 90 to 120 PSI. Operates on demand, compact, whisper quiet. Twelve manifold outlets allow operation of several vacuum tools from one pump.

contact your local **DISTRIBUTOR** inquiries invited

Covered by U.S. and Foreign Patents and Pending Applications

EDSYN **INC.**
15858 ARMINITA ST., VAN NUYS, CALIF. 91406
24 HR. PHONES Local (213) 989-2324 L.A. (213) 873-5115
CABLE: EDSYNEX VAN TELEX 65-1469

144 PAGE TRAINING MANUAL
NEW! OVER 1,000 ILLUSTRATIONS



Electronics advertisers

September 2, 1976

■ Abbott Transistor Labs Inc.	6	‡ Eastman Kodak Company Graphics Division	15	LXD Liquid Crystals	173
° AGFA Gevaert NV	62	Edsyn, Inc	213	■ Matsuo Electronics of America	172
Alltech	129	ELCO	13	■ MCL Inc.	192
Allen Bradley Company	82,83	‡ Electro/77	150	° Membrain Limited	15E
Alphatron, Inc	177	° Electrol	81	° M.E.S.L. Microwave Div	2E,3E
■ AMP Incorporated	142,143	■ Electronic Measurements Inc.	180	■ MFE Corporation	219
Ansley Electronics Corp.	176	Electronic Navigation Industries	38	■ Micro Technical Industries	213
■ AP Products Incorporated	186	Electronic Products Assoc Inc	218	Microtest Systems, Inc	191
■ AVX Ceramics	54,55	‡ Electronic Representatives Association	88	■ Miller Stephenson Chemical Inc.	185
■ Bell, F.W.	137	Fairchild Systems Technology	179	3M Electronics Division	195
Boonton Electronics	206,207	Faultfinders Inc.	68	Molex (International) Incorporated	18,19
■ Bourns Inc.	3rd C	■ Ferranti Packard	80	Monolithic Memories Inc.	37
Brand Rex Corporation	2nd C	‡ Ferroxcube Corp.	135	Motorola Data Products	217
■ Buckeye Stamping Company, The	186	■ Fibra Sonics Inc. Division of C.E. Niehoff	160	National Tel Tronics	192
■ Bud Radio, Inc	11	Figaro Engineering Inc.	202	‡ Nec Microcomputer Inc.	56,57
‡ Bussman Mfg. Division of McGraw Edison Co.	60	Florida Dept. of Commerce	184	‡ Nichicon Corporation	81
California Computer Products	187	■ John Fluke Mfg. Co., Ltd.	161-163	‡ Nikkei Electronics	215
‡ Cambridge Thermionic Corporation	62	° Fort Electronique	81	‡ Nippon Electric Co. Ltd	154
° Capital Calculator Co.	156,190	Fujitsu Ltd.	183	° Nuovo Pignone Divisione "Sistemi di Automazione"	88
Carroll Mfg	133	General Electric Instrument Rental Division	130	OK Machine & Tool Company	217
■ CELCO (Constantine Engineering Labs. Co.)	78	General Instrument Corporation, Microelectronics Division	40-48	° Oscilloquartz	24
■ Cherry Electrical Products Inc.	50	General Magnetics	220	Oxley Developments Ltd.	205
Chicago Miniature Lampworks	159	■ GenRad	147	° Philips Elcoma	60
■ C. Itoh	182	Georgia Department of Community Development	201	Plessey Microsystems	155,174-175
■ C&K Components	182	■ Grayhill Inc.	140	■ Powermate	196
■ Clairex Corporation	4th C	Gulf Power Company	165	Precision Concepts	208
■ Coil-ler Mfg Inc	72	Hermes Electronics, Ltd.	189	■ Precision Monolithic Inc.	7
Committee of 100, Ch of Com, Ocala, Fla	218	■ Hewlett-Packard	1,2nd C, 148,149	■ Princeton Applied Research Corp.	184
° Communication Associates Inc.	15	Houston Instruments	199	° Procond S.p.A.	21
Computer Automation	121-128	Hutson Industries	219	Pro-Log Corporation	28
■ Concord Electronics Corp.	202	ICOM, Inc.	164	■ Radio Research Instrument Corporation	196
■ Continental Rentals	8	■ ILC Data Devices	20	° RCA Electro-optics and Devices	35
■ Continental Specialties Corporation	169	Intel Corporation	22,23	RCA Solid State Division	74,75
Control Data Corp.	153	Intersil Inc.	84,85	■ RCL Electronics Inc.	14
‡ C. P. Clare International N.V.	69	■ Interstate Electronics Corp.	113	Reticon Corporation	77
‡ CTI Cryogenics	53	Interswitch	208	Rhone Poulenc	73
° Dale Electronics Inc. A Subsidiary of Lionel Corporation	10E,11E	■ Ithaco, Inc.	203	■ T.L. Robinson Co. Inc	218
■ Dana Laboratories	198	‡ ITT Cannon Electric	21	Robinson Nugent Inc.	86,87
Data General Corporation	27	‡ ITT Components Group	35	City of Rochester	200
Datatron/MTL	167	Iwatsu Electric Co., Inc.	202	° Rohde & Schwarz	1E
■ Delevan Division American Precision Industries, Inc.	178	■ Kay Elemetrics Corp.	204	° Schlumberger Somv	69
■ Dialight Corporation	166	■ M. S. Kennedy	144	° SECME	16E
■ The Digitran Co.	168	■ Kepco Inc.	5	Semtech Corporation	110
Disc Instruments, Inc.	10	■ Kulka Electric Corp.	205	° Sfernice	13E
Display Tek Corp	194	■ Lear Siegler	71	SGS Ates	58,59
Dynamics, Div. Waugh Controls	216	‡ Licon Division of Illinois Tool Works Inc.	24	Society of the Plastics Industry	197
		■ LSI Computer Systems	205	Sola Electric	213
				Solartron Schlumberger	4E,7E,9E
				° Sonimag	14E

Every other week we talk to the 32,329 decision-makers in Japan's electronics industry.

The way they talk back is astonishing.

us more about the readers who send in the Information Service Card. Here is what we learned:

57.4% of the readers who returned the card for additional product information acknowledged that they participate in or influence the purchasing decision of their companies.

Of this group, 31% said they were *solely* responsible for decision making, and 67.4% said they were partially responsible.

After learning more about the product or service offered, 25% of our readers wanted to buy it or wanted to think more about it.

And, in the long run, more than 50% of the respondents decided either to buy the product or are still debating whether or not to buy it.

Seven magazines in Japan communicate with management and professional engineers. But only one influences the influentials. That's us, Nikkei Electronics, the *Electronics* of Japan.

If you're thinking about selling the electronics decision-makers in Japan, talk to them in our pages. Contact Mr. H.T. Howland, Marketing Services Manager, Electronics, McGraw-Hill Publications Company, 1221 Avenue of the Americas, New York, N.Y. 10020. Telephone: (212) 997-6642. Or talk to any member of McGraw-Hill's sales staff in the U.S. or Europe. Or contact us directly in Japan.

We communicate.



Each bi-weekly issue of Japan's most influential electronics magazine contains a Reader Information Service Card (exactly like the one in the magazine you're reading now, except in a different language).

One important way we're able to tell how our influence works with management and professional engineers in the Japanese electronics industry is the way they respond to our advertising by returning the card.

In a word, the response is phenomenal.

Recently we asked the Marketing Information Center of Tokyo, an independent research organization, to tell



Nikkei Electronics: Ask anybody who can read us.

WE MANUFACTURE
THERMISTORS
AND PUT THEM IN
HOUSINGS
TO SUIT YOUR NEEDS

ASSEMBLIES **SENSORS**

PROBES

SEND FOR BULLETIN A900

THERMOMETRICS INC.
15 JEAN PLACE EDISON, N.J. 08817
(201) 548-2299

Circle 216 on reader service card

Throw away your Electromechanical Counters.



Model 428
Minicounter II
Actual Size

\$49.
one piece

We've done it again!

We introduced the electronic Minicounter I in 1973 and now, the Minicounter II, at a price so low it must be considered for every counting application.

Just look at these features:

Physically interchangeable with Electromechanical Counters.

Eight digit LED display.

Remote reset with optional front panel reset.

Count rate to 12,000 counts/min.

Small size 24 x 48 mm.

Silent operation.

List price \$49., no ups.

Quantity discounts available.



Waugh Controls

9001 Fullbright Avenue, Chatsworth, CA.91311 • (213) 998-8281

Sorensen, Div. of Raytheon	39
Spectracom Corp.	152
■ Spectrol Electronics Corp.	66
Spectronics, Inc	200
Spectrum	146
■ Sprague Goodman Electronics	204
Standard Grigsby	170
Standard Memories	136
Systron Donner Concord Instrument	9
‡ T-Bar, Inc	156
Technit	208
Tecnetics	158
■ Tektronix Inc.	145
■ Teledyne Relays	17
Teletype	171
Texas Instruments Incorporated Components Div.	64A,64F
■ Thermometrics	216
■ TRW/IRC Resistors	141
■ Union Carbide Corporation	157
■ Vactec Inc.	193
Varadyne Industries	33
Viking Industries	138,139
Vitramon, Inc	181
° Wandel und Goltermann	69
° Wavetek San Diego	53
Wide Range Electronic	219
Wilhelm Westermann	16
Yutaka Electric Co. Inc	8

Classified and employment advertising

F. J. Eberle, manager 212-997-2557

■ For more information of complete product line see advertisement in the latest Electronics Buyers Guide
° Advertiser in Electronics International
‡ Advertiser in Electronics domestic edition

Your best design deserves it.

A Motorola CRT module offers the extra quality and performance a good terminal design deserves.

It's the quality you expect from a name like Motorola. The finest materials. Creative and sensible engineering. All the ingredients that make up reliability—and produce the performance that can make your system look good.

Whether your terminal is intelligent, passive, interactive, or remote. Whether it's used for order entry, inventory control, point-of-sale, situation display, text editing or video games—there's a Motorola CRT module to fit right in.

Whether you need a 5, 9, 12, 15, 20 or 23 inch screen. Whether it's for U.S. or European operation. Your design deserves a Motorola CRT module.

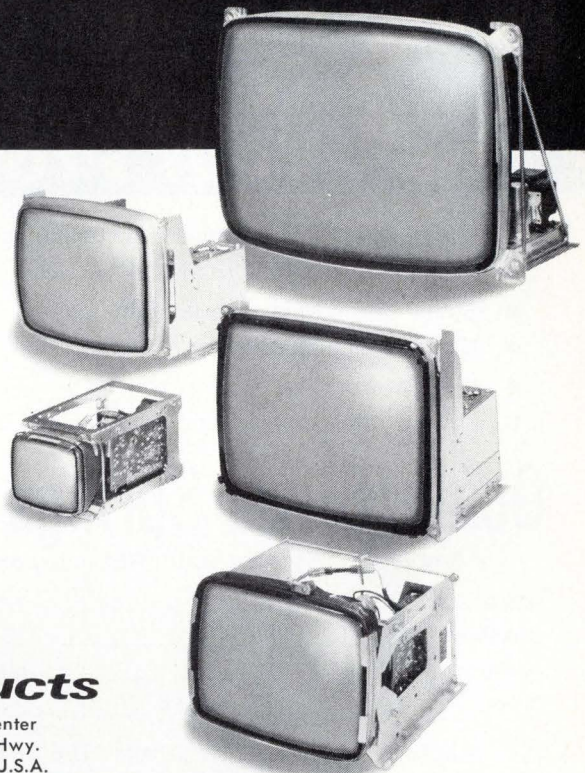

MOTOROLA Data Products

Domestic 455 East North Avenue
Carol Stream, Illinois 60187
312-690-1400 TWX: 910-252-4404
(NY and New England, for your convenience contact Int'l. office)

International Airport Center
4250 Veterans Memorial Hwy.
Holbrook, L.I., NY 11741 U.S.A.
516-588-4700 TWX: 510-228-1096

Circle 217 on reader service card

IN WIRE-WRAPPING HAS THE LINE.....



OK MACHINE & TOOL CORPORATION

3455 Conner St., Bronx, N.Y. 10475 (212) 994-6600 / Telex 125091

6

Proven Ways To Better Your Profits*

- Manufacturer's wage rates: \$2.50-4.50 per hour
- Property cost \$4,000 to \$20,000 an acre
- State corporate income tax only 5%
- No state income tax
- Right to work law - yes
- Low tax rates; building and property; city, 3.38; county 11.99 mills

Ocala/Silver Springs FLORIDA

(*And More - Write for your FREE copy of "Profit Facts")

NAME _____ TITLE _____
 COMPANY _____
 ADDRESS _____ PHONE _____
 CITY _____ STATE _____ ZIP _____

Industrial Development Div. COMMITTEE OF ONE HUNDRED
 P. O. Box 459-B, Ocala, Florida 32670

In cooperation with the Florida Department of Commerce

Circle 218 on reader service card

MICRO68 Microprocessor

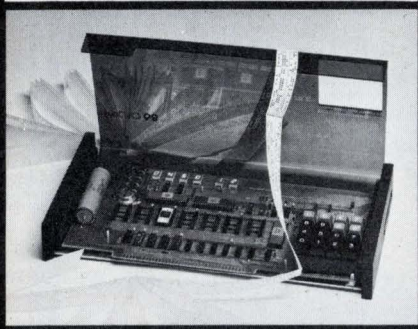

The MICRO-68 is a completely assembled computer, for only \$430. Built around the Motorola/AMI/Hitachi 6800 microprocessor, MICRO-68 has its own integral power supply, 16 button keyboard, six digit LED display, and 128 words of RAM. The 512 word MON-1 PROM contains the service routines necessary to load programs, inspect and edit, insert break points for debugging, and execute. Memory expansion to 64K and full I/O can be obtained with convenient edge connectors.

The MICRO-68 can be expanded with a complete line of EPA peripherals, resulting in the power to accomplish the most demanding applications.

EPA Electronic Product Associates, Inc.
 1157 Vega St., San Diego, CA 92110
 (714) 276-8911

Circle 264 on reader service card

INTRODUCING A NEW REVOLUTIONARY MULTI-DIGIT SOLID STATE READOUT BELOW \$1. PER DIGIT

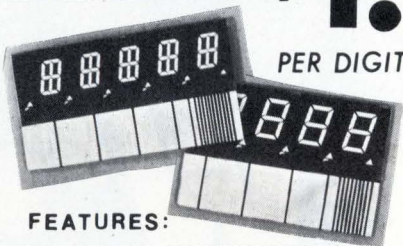

FEATURES:

- Non-fatiguing ELECTROLUMINESCENT light
- Space saving thin profile
- Wired for multiplexing
- Low a.c. power consumption
- Compatible with IC logic decoders and segment drivers
- Rugged, pluggable laminated plastic construction

SPECIAL TRIAL OFFER

ORDER FROM STOCK at 97¢ per digit, any of the following multi-digit readouts having 2 to 5 digits:

- 1/2" high with 9-segments
- 0.6" high with 7-segments (minimum order--\$10.)

T.R.

T.L. ROBINSON CO., INC.
 P.O. BOX D, EAST AURORA, N.Y. 14052
 TEL. (716) 652-2111 TELEX: 91566

Circle 265 on reader service card

Advertising Sales Staff

Pierre J. Braudé New York [212] 997-3468
 Paris Tel: 720-73-01
 Director of Marketing

Atlanta, Ga. 30309
 100 Colony Square, 1175 Peachtree St., N.E.
 [404] 892-2868

Boston, Mass. 02116: Frank Mitchell
 607 Boylston St. [617] 262-1160

Chicago, Ill. 60611:
 645 North Michigan Avenue
 Robert W. Bartlett (312) 751-3739
 Robert M. Denmead (312) 751-3738

Cleveland, Ohio 44113: William J. Boyle
 [716] 586-5040

Dallas, Texas 75201:
 2001 Bryant Tower, Suite 1070
 [214] 742-1747

Denver, Colo. 80203: Harry B. Doyle, Jr.
 123 Speer Blvd. #400
 [303] 837-1010

Detroit, Michigan 48202: Robert W. Bartlett
 1400 Fisher Bldg.
 [313] 873-7410

Houston, Texas 77002: Paul Reiss
 601 Jefferson Street, Dresser Tower [713] CA 4-8381

Los Angeles, Calif. 90010: Robert J. Reilly
 Bradley K. Jones, 3200 Wilshire Blvd., South Tower
 [213] 487-1160

New York, N.Y. 10020
 1221 Avenue of the Americas
 Warren H. Gardner [212] 997-3617
 Michael J. Stoller [212] 997-3616

Philadelphia, Pa. 19102: Warren H. Gardner
 Three Parkway,
 [212] 997-3617

Pittsburgh, Pa. 15222: Warren H. Gardner
 4 Gateway Center, [212] 997-3617

Rochester, N.Y. 14534: William J. Boyle
 9 Greylock Ridge, Pittsford, N.Y.
 [716] 586-5040

San Francisco, Calif. 94111: Don Farris
 Robert J. Reilly, 425 Battery Street,
 [415] 362-4600

Paris: Alain Offergeld
 17 Rue-Georges Bizet, 75 Paris 16, France
 Tel: 720-73-01

Geneva: Alain Offergeld
 1 rue du Temple, Geneva, Switzerland
 Tel: 32-35-63

United Kingdom & Scandinavia: Robert Ghey
 Tel: 01-493-1451, 34 Dover Street, London W1

Scandinavia: Andrew Karnig and Assoc.
 Kungsholmsgatan 10
 112 27 Stockholm, Sweden
 Tel: 08 51 68 70 Telex: 179 51

Milan: Luigi Rancati
 1 via Baracchini, Italy Phone 86-90-656

Brussels: Alain Offergeld
 23 Chaussee de Wavre
 Brussels 1040, Belgium
 Tel: 13-73-95

Frankfurt/Main: Fritz Krusebecker
 Liebigstrasse 27c, Germany
 Phone 72 01 81

Tokyo: Tatsumi Katagiri, McGraw-Hill
 Publications Overseas Corporation,
 Kasumigaseki Building 2-5, 3-chome,
 Kasumigaseki, Chiyoda-Ku, Tokyo, Japan
 [581] 9811

Australasia: Warren E. Ball, IPO Box 5106,
 Tokyo, Japan

Business Department

Thomas M. Egan,
 Production Manager [212] 997-3140

Carol Gallagher
 Production Manager International
 [212] 997-2045

Dorothy Carter, Production Manager
 Domestic
 [212] 997-2908

Frances Vallone, Reader Service Manager
 [212] 997-6057

Electronics Buyers' Guide

George F. Werner, Associate Publisher
 [212] 997-3139

Regina Hera, Directory Manager
 [212] 997-2544

Classified and Employment Advertising

Frank Eberle, Manager
 [212] 997-2557

Look To The Leader For Thyristors ... Get Hutson Quality, Reliability

At Hutson, we emphasize quality and reliability. And we keep on improving our devices to make them better . . . and to reduce their cost to you.

Hutson is a leader in thyristor applications technology and one of the largest manufacturers of thyristors. Since 1965, Hutson's advanced state-of-the-art technology has produced high quality, low cost semiconductors for the industrial user.

Call a Hutson representative . . . and try our quality and reliability when you need thyristors.

ALABAMA Huntsville: K&E Associates (205) 883-9720.
ARIZONA Tempe: Gassner & Clark (602) 968-9037. **CALIFORNIA** Glendale: Orion Sales (213) 240-3151; Redwood City: Parks & Pruitt (415) 364-1640; Tustin: Orion Sales (714) 832-9687. **COLORADO** Denver: Electrodyne, Inc. (303) 757-7679. **CONNECTICUT** Newton: Gerber Sales (203) 426-3440. **FLORIDA** Lighthouse Point: R. C. Simon (305) 941-2757. **GEORGIA** Hartwell: K & E Associates (404) 376-5438. **ILLINOIS** Chicago: L-Tec, Inc. (312) 286-1500. **INDIANA** Greenwood: Valentine/Schillinger (317) 888-2260; South Bend: Valentine/Schillinger (219) 291-6258. **KANSAS** Wichita: Dytronix, Inc. (316) 943-6221. **MARYLAND** Baltimore: Stemler Associates (301) 944-8262; Pasadena: Stemler Associates (703) 548-7818. **MASSACHUSETTS** E. Longmeadow: Gerber Sales (413) 525-3059; Waltham: Gerber Sales (617) 890-8040. **MICHIGAN** Grosse Point Park: Greiner Assoc. (313) 499-0188. **MINNESOTA** Minneapolis: Bitronics Sales Co. (612) 835-7744. **MISSISSIPPI** Corinth: K & E Associates (601) 287-5369. **MISSOURI** Hazelwood: Dytronix, Inc. (314) 731-5799; Kansas City: Dytronix, Inc. (816) 761-6543. **NEW JERSEY** Haddonfield: Sunday-O'Brien (609) 429-4013; Irvington: Murray Gallagher, Inc. (201) 399-4350. **NEW YORK** N. Syracuse: Precision Sales (315) 458-2223 (NYC, Gallagher — see New Jersey). **OHIO** Chagrin Falls: Midwest Marketing Association (216) 247-6655; Cleveland: Midwest Marketing Assoc. (216) 249-2816; Dayton: Midwest Marketing Assoc. (513) 433-2511. **OREGON** Beaverton: N. R. Schultz (503) 643-1644. **TEXAS** Plano: Precision Devices (214) 423-7618. **WASHINGTON** Bellevue: N. R. Schultz (206) 454-0300. **WISCONSIN** Greenfield: L-Tec, Inc. (414) 545-8900. **UTAH** Salt Lake City: Electrodyne, Inc. (801) 277-8392.

HUTSON INDUSTRIES

P.O. Box 34235 (214) 241-3511
2019 West Valley TWX 910-860-5537
View Lane
Dallas, Texas 75234

Circle 219 on reader service card

decades

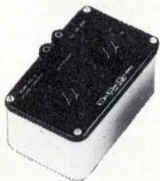

**performance
and endurance
at half the price**

For instance, the ARD-41 resistance decade has a range of 0 to 1.1 meg. ohm in 1 ohm steps and an accuracy of 1% for only \$65.82

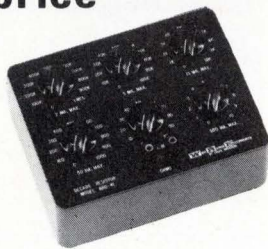

Why pay more when you don't have to?

Other models of resistance, capacitance, and inductance decade boxes also available at comparable savings. Send for complete details today. Dealer inquiries invited.

WIDE **R**ANGE **E**LECTRONICS CORPORATION

2119 Schuetz Road • St. Louis, MO. 63141 U.S.A. • 314 567-5366

Circle 266 on reader service card

THE BEST IS NOW #1*

MFE's 250B Digital Tape Transport
Offers a 32000BPS Data Transfer Rate

ANSI/ECMA
COMPATIBLE

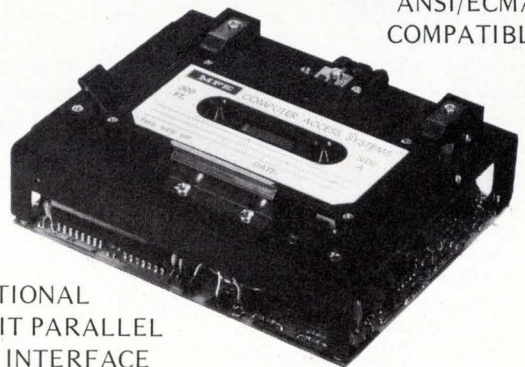

OPTIONAL
8 BIT PARALLEL
I/O INTERFACE

- 15,000 Hr. MTBF • 1 Year warranty • Two moving parts
- Reel to reel • Constant tape tension and constant tape speed — servo controlled • ± 5 VDC operation • Guaranteed cassette interchangeability • Up to 800 BPI • Read after write heads • Bi-directional read/write operation • Size: 4.39" x 5.46" x 2.42" • A few \$525, a hundred \$325 • Call or write Jim Saret

*Recent survey among leading buyers named MFE number 1. Source on request. Over 15,000 in the field.

MFE

MFE CORPORATION

Keewaydin Drive
Salem, N.H. 03079
Tel. 603-893-1921

TWX 710-366-1887
TELEX 94-7477

See us at WESCON Booth # 875-877 219
Circle 167 on reader service card

Solid State Sine-Cosine Synchro Converter

This new encapsulated circuit converts a 3-wire synchro input to a pair of d-c outputs proportional to the sine and cosine of the synchro angle.

- Complete solid state construction.
- Operates over a wide temperature range.

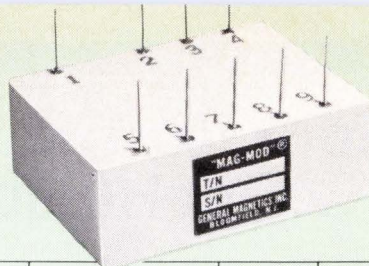

UNIT	DMD 1436-1	DMD 1430-1	DMD 1403-2	DMD 1361-6	DMD 1361-4	DMD 1193-4	DMD 1361-8	DMD 1446-1	DMD 1193-5	DMD 1193-6	DMD 1361-10	DMD 1472-2
L-L SYNCHRO INPUT (VRMS)	11.8	90	95	90	11.8	11.8	11.8	11.8	11.8	11.8	11.8	90
FREQUENCY (Hz)	400	400	60	400	400	400	400	400	400	400	400	60
FULL SCALE OUTPUT (VDC)	±10	±10	±3	±3	±3	±10	±10	±10	±10	±10	±10	±10
OUTPUT IMPEDANCE	<1Ω	<1Ω	<1Ω	<1Ω	<1Ω	<1Ω	<1Ω	<10Ω	<1Ω	<1Ω	<1Ω	<1Ω
L-L INPUT IMPEDANCE	>10K	>30K	>5K	>30K	>5K	>5K	>5K	>5K	>5K	>5K	>5K	>5K
REFERENCE VOLTAGE (VRMS)	26	115	115	115	26	115	26	115	115	115	26	115
ACCURACY SIN/COS (+25°C)	±6MIN	±6MIN	±6MIN	±6MIN	±6MIN	±6MIN	±6MIN	±0.5%	±6MIN	±6MIN	±6MIN	±6MIN
FULL TEMPERATURE RANGE ACCURACY SIN/COS	±15MIN	±15MIN	±15MIN	±15MIN	±15MIN	±15MIN	±15MIN	±0.5%	±15MIN	±15MIN	±15MIN	±15MIN
D.C. SUPPLY (VDC)	±15	±15	±15	±15	±15	±15	±15	±15	±15	±15	±15	±15
D.C. SUPPLY CURRENT	<30MA	<30MA	<30MA	<30MA	<30MA	<30MA	<30MA	<30MA	<30MA	<30MA	<30MA	<30MA
BANDWIDTH	>10Hz	>10Hz	external set	>20Hz	>5Hz	>10Hz	>10Hz	>10Hz	>2Hz	>40Hz	>5Hz	external set
SIZE	1.1x3.0 x1.1	2.0x2.25 x1.4	1.1x3.0 x1.1	1.5x1.5 x0.6	1.85x0.85 x0.5	2.01x2.25 x1.4	0.85x1.85 x0.5	2x2.25 x1.4	2x2.25 x1.4	2x2.25 x1.4	2.15x1.25 x0.5	1.1x3.0 x1.1
NOTES	-	dual channel unit	-	-	-	dual channel unit	-	dual sine output unit	dual channel unit	dual channel unit	-	-
TEMPERATURE RANGE	-40°C to +100°C	-40°C to +100°C	-40°C to +100°C	-40°C to +100°C	-40°C to +100°C	-40°C to +100°C	-40°C to +100°C	-40°C to +100°C	-40°C to +100°C	-40°C to +100°C	-40°C to +100°C	-40°C to +100°C

High Precision Analog Multipliers

PRODUCT ACCURACY (MCM 1519-1) ± ½% OF ALL THEORETICAL OUTPUT VALUES OVER FULL MILITARY TEMPERATURE RANGE OF -55°C TO +125°C. ZERO POINT ERROR FOR ANY INPUT COMBINATION IS ± 2MVRMS



Features:

- No external trims required
- Distortion free AC output over entire dynamic range
- Linearity, product accuracy and zero point virtually unaffected by temperature

- All units are hermetically sealed and are not affected by external fields
- High analog product accuracy and wave quality allows dual multiplier assemblies to be matched with 1% of point over the specified temperature range
- Full four quadrant operation
- Package size, power supply requirements and other specs. may be altered to your exact requirements at no extra cost.

Specifications:

- Transfer equation: $E_o = XY/10$
- X & Y input signal ranges: 0 to ±10V PK
- Maximum zero point error (X=0; Y=0 or X=±10; Y=0 or X=0; Y=±10): 2MVRMS
- Input impedance: Both inputs 20K min.
- Full scale output: ±10V peak
- Minimum load resistance for full scale output: 2KΩ
- Output impedance: 1Ω
- Short circuit duration: 5 sec.
- Frequency response characteristics (both inputs) 1% amplitude error: DC to 1200 Hz (min.) 0.5 DB Amplitude error: DC to 3500 Hz min. 3 DB point: Approx. 10K hz Roll off rate: 18 DB/octave
- Noise Level: 5MV PK-PK @ 100K Hz approx.
- Operating temp. range: See chart
- Storage temperature range: -55°C to +125°C
- DC Power: ±15V ±1% @ 30MA
- Dimensions: 2" x 1.5" x .6"

Type No.	Product Accuracy	Operating Temperature Range
MCM 1519-1	± 0.5%	-55°C - +125°C
MCM 1519-2	± 0.5%	-25°C - +85°C
MCM 1519-3	± 0.5%	0°C - +70°C
MCM 1520-1	± 1.0%	-55°C - +125°C
MCM 1520-2	± 1.0%	-25°C - +85°C
MCM 1520-3	± 1.0%	0°C - +70°C

Precision AC Line Regulator

Total Regulation 0.15% Max.

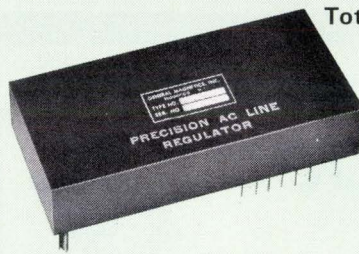

Features:

- Low distortion sinusoidal output
- Regulation control better than ten times superior to commercial AC voltage regulators transformer product lines
- No active filters or tuned resonant circuits employed resulting in immunity to line frequency changes
- 6.5 watt output level
- Small size
- Output set to ±1% accuracy — this includes initial set point plus line, load, frequency and temperature changes
- Foldback short circuit protection provided resulting in protection against overloads and short circuits of any duration
- Low profile package with straight pins makes the unit suitable for PC board mount (unit is hermetically sealed)
- Transformer isolation between all power inputs and the outputs.

*Other units available at different power levels. Information will be supplied upon request.

Specifications Model MLR 1476-2:

- AC input line voltage: 115V RMS ±20% @ 400 Hz ±20%
- Output: 26V RMS ±1% (for any condition)
- Load: 0 to 250 MA, RMS
- Total regulation: ±0.15% maximum (any combination of line, load or frequency)
- Distortion: 2% maximum
- AC input line current: 100 MA. max. at full load
- DC power: ±15 V DC ±5% @ 15 MA. max.
- Phase angle: 1° max.
- Temp. Range: -40°C to +85°C
- Case Material: High permeability nickel alloy
- Terminals: Glass to metal hermetic seal pins

GENERAL MAGNETICS • INC

135 Bloomfield Ave., Bloomfield, New Jersey 07003 - Tel. (201) 743-2700

Circle 220 on reader service card