

OCTOBER 14, 1976

AUTOMATIC TEST SYSTEMS: NAVY'S COSTLY HEADACHE/65

Choosing optical-fiber components from system specifications/95

The crucial make-or-buy decision in power supplies/107

FOUR DOLLARS A MCGRAW-HILL PUBLICATION

Electronics

Property
LIBRARY
INSTITUTE
TECHNOLOGY

**COMPUTERIZED
SCANNING**

**X-RAY
-X-RAY
-X-RAY**

**DIAGNOSIS
IN DEPTH**

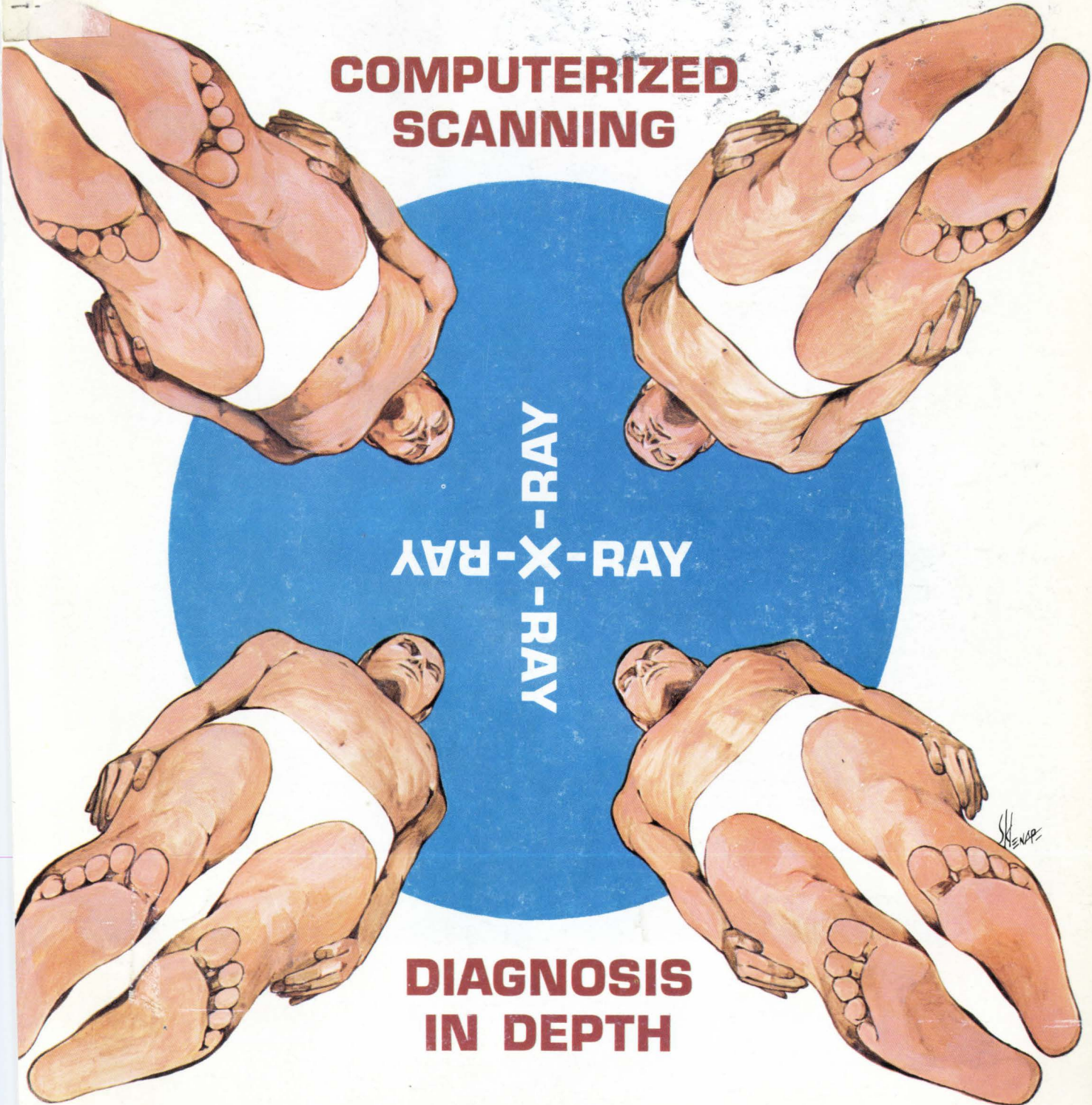

1420 TCH21, TNLAB NOV77
AMPENGE TECH INSTITUTE

Introducing HP's \$335* DMM.

The right DMM Decision means added performance:

Hewlett-Packard's new 3435A 3½ digit, five function digital multimeter, with full one-year accuracy specifications, is the right decision for your general purpose bench or field needs because it has . . .

Autoranging and manual modes: AC voltage, DC voltage and resistance can be measured either on autorange or manually selected ranges. Select autorange to speed readings and minimize reading error . . . the LED readout always displays appropriate units. For repetitive readings, or AC and DC current measurements, use the manual mode, selecting from at least five ranges for each function . . . again the appropriate units will be automatically displayed.

Wide AC bandwidth, low-range ohmmeter: Eliminate the need for both a high frequency AC voltmeter and a low-range ohmmeter. The 3435A operates over a bandwidth five times greater than most comparably priced DMM's . . . measure AC voltages from 30 Hz up to 100 kHz, with midband accuracy of 0.3% of reading plus three digits. Or, test resistance from a new low range of 20Ω up to 20MΩ. DC voltages up to 1200V are measured with a full-year best accuracy figure of 0.1% of reading plus one digit. AC and DC current ranges extend from 200 μA to 2A. All inputs are protected, polarity is automatically sensed and displayed, and autozero occurs before each reading.

Autoranging and manual modes,

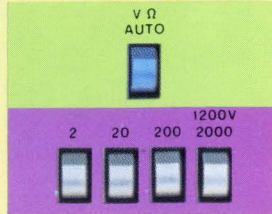

Wide measurement ranges,

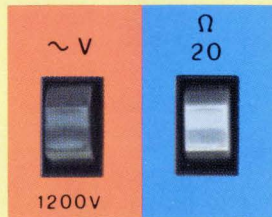

And touch-hold probe accessory.



Special application accessories: For accurate measurements in hard-to-reach spots, use the new 34112A touch-hold probe for only \$40.* You can concentrate on your circuit, conveniently hold the measurement and read the display after removing the probe. You're confident of measuring at the right point without accidentally shorting the circuit. The full line of 3435A accessories also includes probes for measuring AC voltage at frequencies as high as 700MHz and DC voltage up to 40 kV.

Low cost: The standard 3435A priced at \$400* is AC line or battery operated and includes batteries and recharging circuitry. If you don't need battery operation, option 001 gives you line operation only for just \$335.*

Functional design: Low power consumption means fully charged batteries last up to ten hours. And a four-hour charge prepares them for a full eight hours of portable operation. With the modern, rugged case and handle, the 3435A is perfectly suited to demanding field conditions. LSI technology and only three circuit chips mean less down time, greater reliability. A rack mounting model is also available. Of course, the 3435A is backed by HP's service organization. For more information, contact your local HP field sales engineer.

*Domestic U.S.A. price only.

**HP DMM's—
the right decision**

096/45



HEWLETT  PACKARD

Circle 900 on reader service card

Sales and service from 172 offices in 65 countries.

1507 Page Mill Road, Palo Alto, California 94304
For assistance call: Washington (301) 948-6370, Chicago (312) 677-0400,
Atlanta (404) 434-4000, Los Angeles (213) 877-1282, Toronto (416) 678-9430

Let's talk about solving I/O PROBLEMS between your microprocessor and your system.

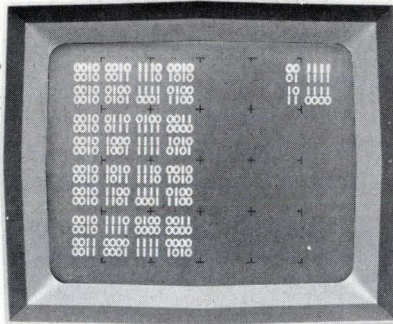
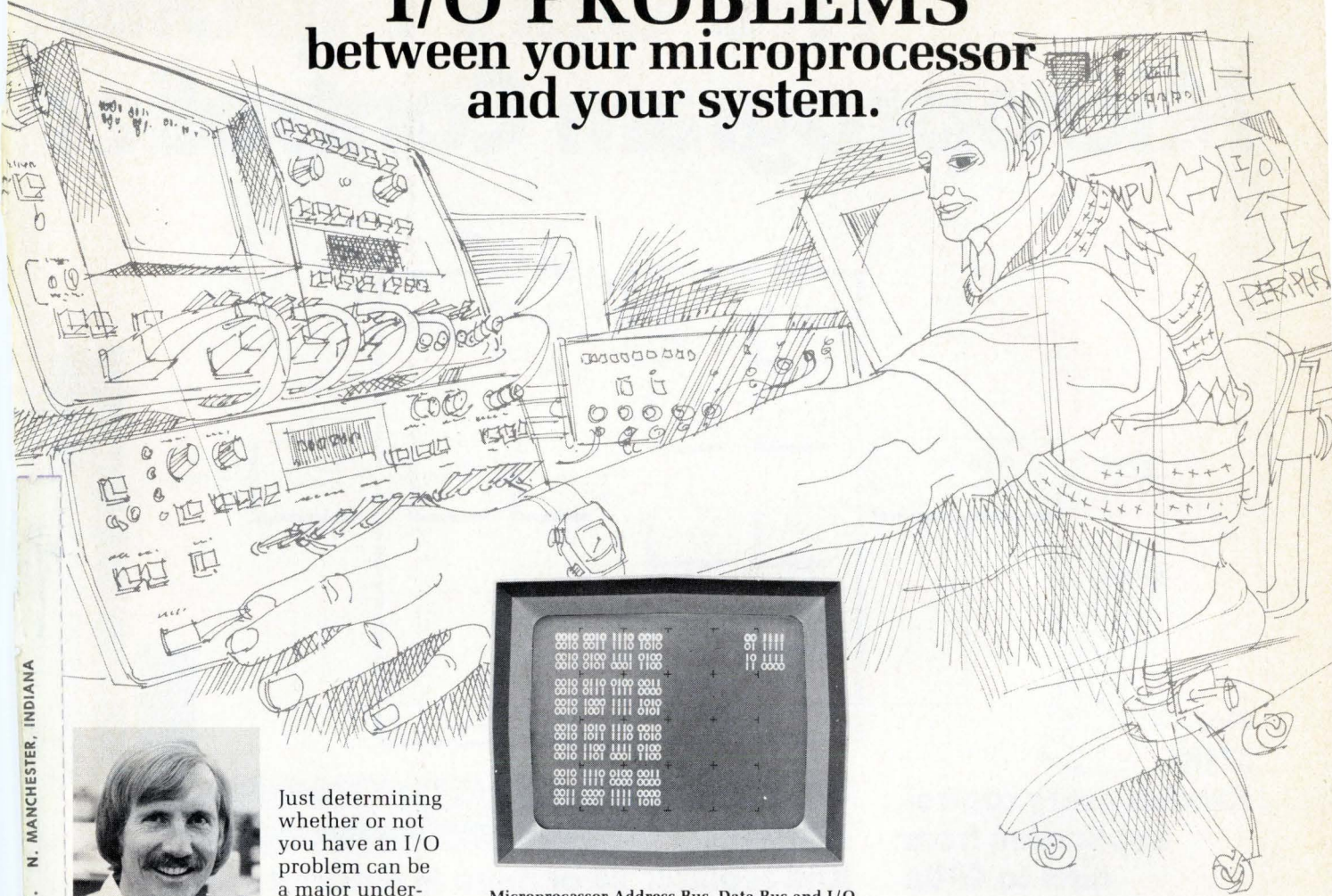

Microprocessor Address Bus, Data Bus and I/O input and output data are displayed simultaneously on the HP 1600S screen.

mapping for troubleshooting minicomputer and microprocessor systems. You'll discover an exciting new concept in digital troubleshooting. *Domestic U.S.A. price only.

THE HECKMAN BINDERY, INC. N. MANCHESTER, INDIANA



Just determining whether or not you have an I/O problem can be a major undertaking... I know, I've been there too. We call communication

with the microprocessor "handshaking," but sometimes information transfer, especially across an I/O port, reminds me more of "armwrestling."

Analysis of data transfer across an I/O port can be very tricky. The microprocessor and the peripheral may have independent system clocks, or the peripheral may be asynchronous. There may be a parallel-to-serial data transformation, or vice-versa. The systems may require a common trigger to interact properly. How do you verify all that? And how do you determine that the instructions are being received and executed properly?

About the only way I know that you can really be sure everything is working right (without spending an excessive amount of time) is to look at it on an HP 1600S Logic State Analyzer. Then it doesn't matter whether you have independent system clocks going. Or whether part of the system is asynchronous.

The HP 1600S lets you display two separate tables of data on one

screen, so you can look at program flow right alongside the input and output states of the I/O port. That way there's no question about correct sequencing—or about data flow in either direction.

Confidence in your system design and operation will be high. I mean, when you can actually look at all those data buses, read their information flow, and see that it's all perfect—that's confidence!

What's more, if you do find a problem, the HP 1600S will help you pinpoint it more quickly than any other way I know. It can help you put an end to armwrestling within your microprocessor systems.

The HP 1600S, at \$7100*, is one of the biggest timesavers you'll ever find. You should learn more about it. HP has arranged a number of seminars around the country to make that possible. Find out how you can attend the one in your area by calling your local HP field engineer. He can also supply you with complete spec sheets and application notes detailing the use of

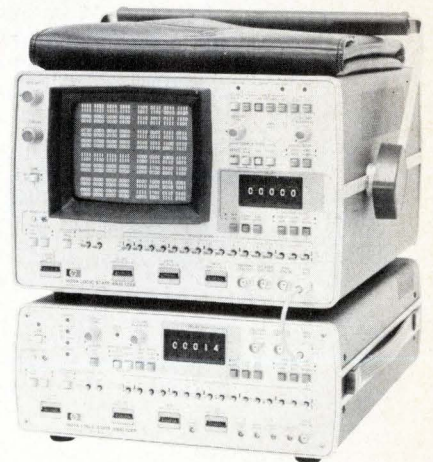

086/6

HEWLETT  PACKARD

Sales and service from 172 offices in 65 countries.
1507 Page Mill Road, Palo Alto, California 94304

The Only Bipolar Microprogram Controller

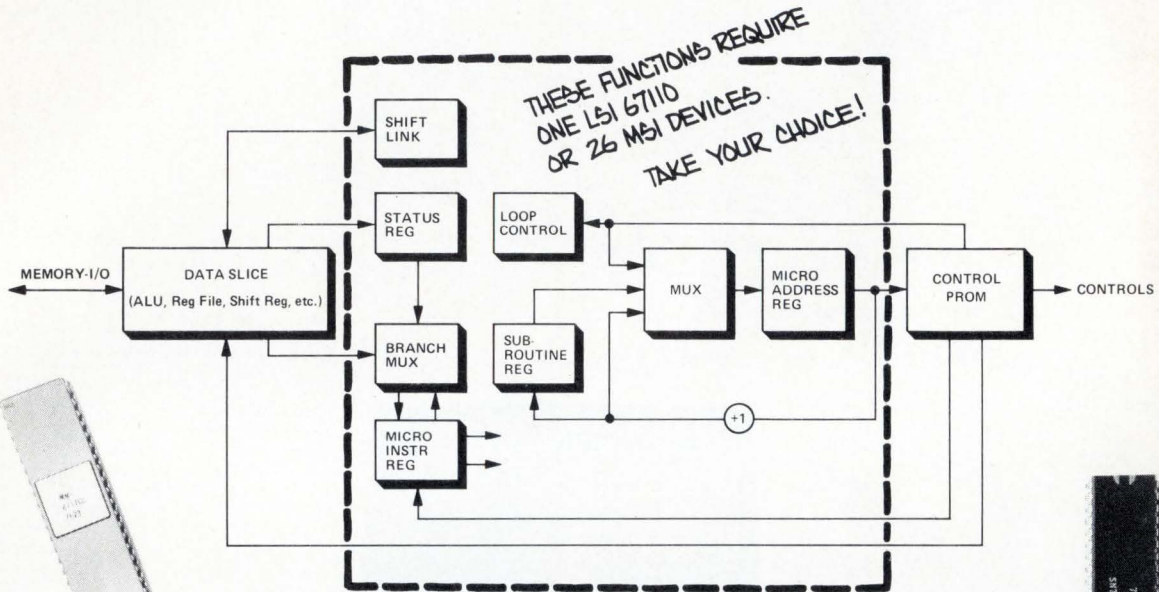

The 67110
Handles every control application from discs to CPUs.

And replaces 26 or more MSI devices.

Applications

CPU
 Process Control
 Disc Control
 High Speed Printer Control
 CRT Controller
 Signal Processing Control

DEVICE	TEMPERATURE	100 QUANTITY PRICE
67110J	Commerical	\$25.00
57110D	Military	\$55.00

Features

- Works with any bit slice microprocessor such as MMI 6701, 2901, 3002.
- Works as a stand alone non-arithmetic controller
- Directly addresses 512 words of microprogram storage
- On-chip five bit loop counter for program looping routines
- Data shift linkage for arithmetic and logic shifting with 4 bit slices
- Microsubroutine and four way branch capabilities
- Very High Speed — 33 MHz

Information

For more information about this revolutionary microprogram controller and about other members of our growing family of LSI logic devices that will eventually replace all MSI logic, call, TWX or write:

In the United States,
 Ed Barnett or John Birkner.
 In Europe, Bernd Kruse

United States
 Monolithic Memories, Inc.
 1165 East Arques Avenue
 Sunnyvale, CA 94086
 Tel: (408) 739-3535
 TWX: 910-339-9229

Europe
 Monolithic Memories, GmbH
 8000 Munich 80
 Mauerkircherstr. 4
 West Germany
 Tel: (089) 982601, 02, 03, 04
 Telex: (841) 524385

Far East
 MMI Japan KK
 Parkside-Flat Bldg
 4-2-2, Sendagaya Shibuya-Ku
 Tokyo 151, Japan
 Tel: (3) 403-9061
 Telex: (781) 26364

Monolithic Memories

29 Electronics Review

COMPUTERS: New computer to compete against IBM 370/158, 29
COMMERCIAL: Tests set for next year of anti-hijack system, 29
CONSUMER: Small solar-cell power pack powers electronics, 30
Audio infrared headsets do well in Germany, 31
COMMUNICATIONS: Single monolithic chip has a-m transceiver, 32
INSTRUMENTS: I²L creates \$39 digital panel meter, 34
CAREERS: Engineering Commission to continue demand forecasts, 36
NEWS BRIEFS: 39
SOLID STATE: C-MOS circuit voltages range to 150–200 V, 40
COMPUTERS: Small HP system woos volume users, 42

53 Electronics International

GREAT BRITAIN: Digital module decodes dialing tones, 53
JAPAN: It's Tokyo's turn for Electronics Show, 53

65 Probing the News

MILITARY ELECTRONICS: VAST causes headache for Navy, 65
CONSUMER ELECTRONICS: Japanese in home-VTR race, 68
ELECTRONICS ABROAD: Polish plant ready to roll, 74
MILITARY: PDP-11 to be base of tactical computers, 77
COMPUTERS: Britain's ICL is on upward curve, 78

89 Technical Articles

MEDICAL: Computerized multiple X rays view body's interior, 89
FIBER OPTICS: System needs dictate component parameters, 95
DESIGNER'S CASEBOOK: Simple phase shifter is adjustable, 100
Chopper mode improves multiple-trace display, 101
MICROPROCESSORS: Data-acquisition system built around 8080, 104
SUBSYSTEMS: Power-supply decisions in sophisticated designs, 107
ENGINEER'S NOTEBOOK: Clip-on monitor displays count in IC, 117
Power supply's VC product sets interrupt capability, 117
Program provides card-storage of SR-52 data-memory contents, 118

123 New Products

IN THE SPOTLIGHT: Multiplexer expands scope uses, 123
COMPONENTS: LED display cuts parts count, 124
INSTRUMENTS: True-rms meter sells for \$345, 135
SEMICONDUCTORS: Detector chip 'sees' smoke, 144
PACKAGING & PRODUCTION: Laser trimmer saves time, 150
SUBASSEMBLIES: Hybrid op amps minimize drift, 159
MATERIALS: 167

Departments

Publisher's letter, 4
Readers' comments, 6
News update, 8
Editorial, 12
People, 14
Meetings, 20
Electronics newsletter, 25
Washington newsletter, 49
Washington commentary, 50
International newsletter, 55
Engineer's newsletter, 120
New literature, 172

Services

Employment opportunities, 174
Reprints available, 146
Reader service card, 183

Highlights

Cover: Computer provides better X-ray image, 89

Medical diagnosticians are hailing computerized axial tomography, a new X-ray imaging technique that provides a high-resolution display of a horizontal "slice" of the body. Organs obscured in the single plane of conventional X rays stand out clearly with CAT scanners.

Cover is by Art Director Fred Sklenar.

Naval test system draws flak, 65

A general-purpose automatic test system for Naval avionics has drawn fire from the fleet as a defective concept. VAST, intended as a total support system, has serious operational and maintenance problems, an official report charges.

Microprocessor monitors chemical data, 104

A microprocessor-based data-acquisition controller that monitors chemical instrumentation uses a modular approach to hardware and software design for a simple, flexible system. This article is another in the series, "Microprocessors in action."

Power-supply choice is crucial, 107

Sophisticated electronics equipment makes greater demands on the power supply. In selecting this increasingly important component, equipment manufacturers choose between three types of supply and decide whether to make or buy.

And in the next issue . . .

The annual technology update . . . *Electronics'* 1976 achievement award.

EDITOR-IN-CHIEF: Kemp Anderson

EXECUTIVE EDITOR: Samuel Weber

MANAGING EDITOR: Arthur Erikson,
International

SENIOR EDITORS: Laurence Altman,
Ray Connolly, Lawrence Curran,
John Johnsrud, H. Thomas Maguire,
Stephen E. Scrupski

ART DIRECTOR: Fred Sklenar

ASSOCIATE EDITORS: Howard Wolff,
Gerald M. Walker, Alfred Rosenblatt

DEPARTMENT EDITORS

Aerospace/Military: Ray Connolly

Circuit Design: Don Blattner

Communications & Microwave:

Richard Gundlach

Components: Lucinda Mattered

Computers: Stephen E. Scrupski

Consumer: Gerald M. Walker

Instrumentation: Andy Santoni

New Products: H. Thomas Maguire,

Michael J. Riezenman

Packaging & Production: Jerry Lyman

Solid State: Laurence Altman

CHIEF COPY EDITOR: Margaret Eastman

COPY EDITORS: Everett C. Terry, Ben Mason

ART: Charles D. Giatto, *Associate Director*
Paula Piazza, *Assistant Director*

EDITORIAL SECRETARIES: Janet Noto,
Penny Roberts, Marilyn B. Rosoff

FIELD EDITORS

Boston: Lawrence Curran (Mgr.), Pamela Leven

Los Angeles: Larry Waller (Mgr.)

Midwest: Larry Armstrong (Mgr.)

New York: Bruce LeBoss (Mgr.)

San Francisco: Bernard Cole (Mgr.)

Judith Curtis

Washington: Ray Connolly (Mgr.)

Frankfurt: John Gosch

London: William F. Arnold

Paris: Arthur Erikson

Tokyo: Charles Cohen

McGRAW-HILL WORLD NEWS

Editor: Michael Johnson

Brussels: James Smith

Milan: Andrew Heath

Moscow: Peter Gall

Paris: Joel Stratte-McClure

Stockholm: Robert Skole

Tokyo: Colin Gibson

PUBLISHER: Dan McMillan

MARKETING ADMINISTRATION MANAGER:
Wallis Clarke

CIRCULATION MANAGER: Nancy L. Merritt

MARKETING SERVICES MANAGER:
Tomlinson Howland

RESEARCH MANAGER: Margery D. Sholes

One of the hottest buzzwords in medical circles these days is CAT—which stands for computerized axial tomography. And with a name like that, it's a good thing that the technique has a catchy acronym. What's more, to an increasing number of patients, it's a good thing that there even is a technique to go with the name. Says Haim Zaklad, who wrote the article that starts on page 89, "it can probably be said that CAT, the reconstruction of a transaxial section of the human body by means of X-rays, represents one of the major feats of technology in medicine."

Zaklad, of Israel's Elscint Ltd., adds: "CAT promises to revolutionize diagnostic medicine, the essence of which is a considerable enhancement in the quality of health care delivered to society. Further, the increasing tendency of government to become financially involved in national health-care expenditure is bound to induce the physician to practice more conservative medicine, primarily based on better diagnostic procedures.

"The present inefficiencies of health-care delivery stem from hospitalization and crisis medicine with ensuing high expenditures. Consequently, the need for high-quality diagnostic inspection, delivered on an out-patient basis, is expected to open the market for new sophisticated diagnostic instruments."

As is fairly common among technological advances, CAT took off rather slowly, but once it was proven out, the race was on to cash in on the technique. Again in the words of Zaklad:

"Towards the end of 1973, the

medical community, particularly the neurologists, were astonished to see the structural details in man available from the first CAT head-scanner from Britain's EMI Ltd. However, the basic idea of X-ray transaxial tomography was proposed as early as 1963 through a patent granted to W. H. Olendorf. The story is told that Olendorf arranged the tracks of his son's toy train in a circle, placed an object in the circle and mounted a radiation source and a detector on the train in such a manner that the source and detector were diametrically opposite each other. By letting the train run while taking the signal from the detector, sufficient data were generated to allow for a crude reconstruction of the object."

"In the same year, A. M. Cormak showed a mathematical technique suitable for the 'determination of a variable gamma-ray absorption coefficient in a two-dimensional region from observations made outside the region.' The first CAT scanner was designed by G. N. Hounsfield of EMI. With the publication, a decade after Olendorf's patent, of its performance in diagnosing brain tumor and lesions the machine became an instant success. This development was the start of a new era in which some 20 companies, producing both head and whole-body machines, are competing. The cost of a scanner may reach \$600,000. The market size is estimated to have the potential of \$1 billion in the next decade."



October 14, 1976 Volume 49, Number 21
95,401 copies of this issue printed

Published every other Thursday by McGraw-Hill, Inc. Founder: James H. McGraw 1860-1948. Publication office 1221 Avenue of the Americas, N.Y., N.Y. 10020; second class postage paid at New York, N.Y. and additional mailing offices.

Executive, editorial, circulation and advertising addresses: Electronics, McGraw-Hill Building, 1221 Avenue of the Americas, New York, N.Y. 10020. Telephone (212) 997-1221. Teletype 12-7960 TWX 710-581-4879. Cable address: MCGRAW HILL NEW YORK.

Subscriptions limited to professional persons with active responsibility in electronics technology. Publisher reserves the right to reject non-qualified requests. No subscriptions accepted without complete identification of subscriber name, title, or job function, company or organization, and product manufactured or services performed. Subscription rates: in the United States and possessions \$12.00 one year, \$30.00 three years; Canada and Mexico \$14.00 one year, \$32.00 three years; Europe \$35.00 one year, \$87.50 three years; Japan, Israel and Brazil \$60 per year; Australia and New Zealand \$80.00 per year, including air freight; all other countries \$40.00 per year. Limited quota of subscriptions available at higher-than-basic rate for persons outside of field served, as follows: U.S. and possessions and Canada \$25.00 per year; Europe \$40.00; Japan, Israel and Brazil \$85.00; all other countries \$50.00. Single copies: \$4.00. Please allow four to eight weeks for shipment.

Officers of McGraw-Hill Publications Company: Gordon L. Jones, President; Paul F. McPherson, Executive Vice President; Gene W. Simpson, Group Vice President; Senior Vice Presidents: Ralph Blackburn, Circulation; John B. Hoglund, Controller; Ralph R. Schulz, Editorial; David G. Jensen, Manufacturing; Vice Presidents: James E. Boddorf, Planning & Development; Edward E. Schirmer, Marketing Administration.

Officers of the Corporation: Harold W. McGraw, Jr., President, Chief Executive Officer, and Chairman of the Board; Robert N. Landes, Senior Vice President and Secretary; Ralph J. Webb, Treasurer.

Title registered in U.S. Patent Office. Copyright © 1976 by McGraw-Hill, Inc. All rights reserved. The contents of this publication may not be reproduced in whole or in part without the consent of copyright owner.

Subscribers: The publisher, upon written request to our New York office from any subscriber, agrees to refund that part of the subscription price applying to copies not yet mailed. Please send change-of-address notices or complaints to Fulfillment Manager, subscription orders to Circulation Manager, Electronics, at address below. Change-of-address notices should provide old as well as new address, including postal zip code number. If possible, attach address label from recent issue. Allow one month for change to become effective.

Postmaster: Please send form 3579 to Fulfillment Manager, Electronics, P.O. Box 430, Hightstown, N.J. 08520.

Angle accuracy to .02 degrees

Our Model 6500 digital phasemeter measures typically to .02° accuracy. The broad bandwidth extending from 3 Hz to 5 MHz coupled with the wide voltage range from 10 mV to 120 V makes it ideal for numerous applications. Here's a 0-360° continuous non-ambiguous display with resolution to .01°. This unit requires no "extras" and is priced for only \$1995. Going through a phase? Contact The WAVEMAKERS at (617) 580-1660, or any of the offices listed.

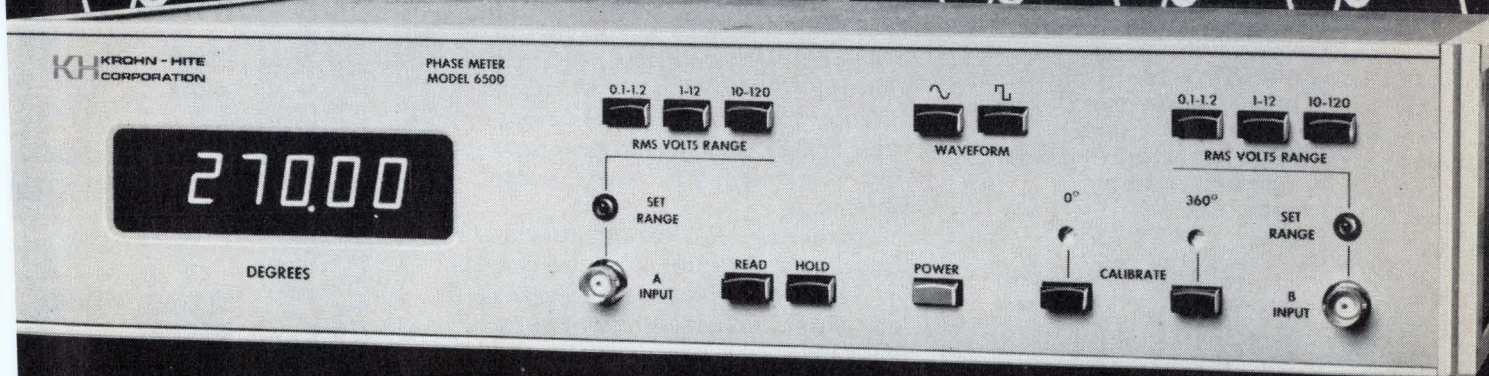
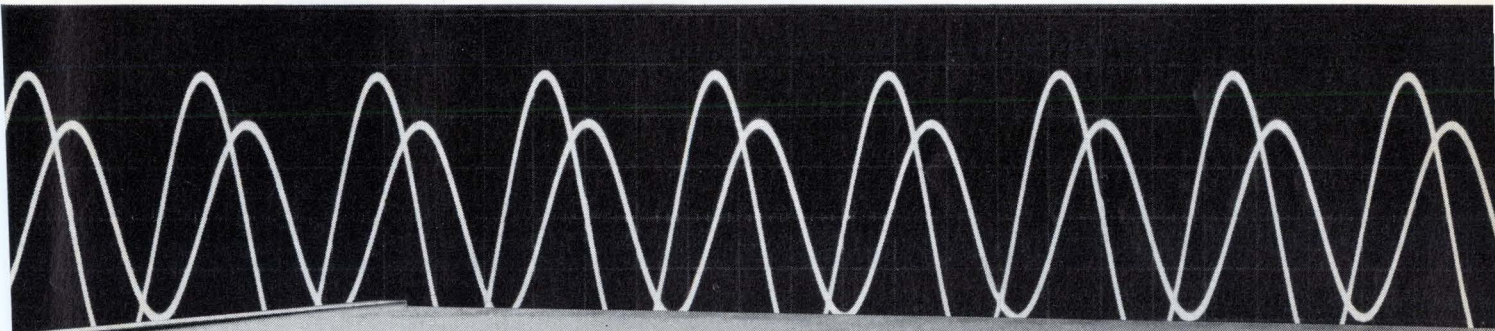

**KH KROHN-HITE
CORPORATION**

Avon Industrial Park, Avon, Mass. 02322 • (617) 580-1660, TWX 710-345-0831

SALES OFFICES: **ALA.**, Huntsville (205) 534-9771; **ARIZ.**, Scottsdale (602) 957-9110; **CAL.**, San Jose (408) 292-3220, Inglewood (213) 674-6850; **COL.**, Denver (303) 773-1218; **CONN.**, Glastonbury (203) 633-0777; **FLA.**, Orlando (305) 894-4401; **GA.**, Atlanta (404) 237-7272; **HAWAII**, Honolulu (808) 941-1574; **ILL.**, Arlington Hts. (312) 394-3380; **MD.**, Baltimore (301) 321-1411; **MASS.**, Lexington (617) 861-8620; **MINN.**, St. Paul (612) 645-5816; **MO.**, St. Louis (314) 423-1234; **N.M.**, Albuquerque (505) 255-2330; **N.J.**, Cherry Hill (609) 482-0059; **N.Y.**, Elmont (516) 488-2100, Rochester (716) 328-2230, Syracuse (315) 437-6666, Vestal (607) 785-9947; **N.C.**, Burlington (919) 227-3639; **OHIO**, Chesterland (216) 729-2222, Dayton (513) 434-8993; **OKLA.**, Tulsa (918) 299-2636; **ORE.**, Portland (503) 297-2248; **TEX.**, Dallas (214) 661-0400, Houston (713) 688-1431; **VA.**, Falls Church (703) 573-8787; **WA.**, Bellevue (206) 454-3400; **CANADA**, Montreal, Quebec (514) 341-7630, Ottawa, Ontario (613) 235-5121, Toronto, Ontario (416) 445-9900, Vancouver, British Columbia (604) 253-5555, Halifax, Nova Scotia (902) 454-8321, St. John's, Newfoundland (709) 726-2422.



**New PuriTan™
all-tantalum capacitor
from Tansitor.**

Qualified to MIL-C-39006/22A (CLR79)

Developed for the most stringent conditions in aerospace applications, the PuriTan all-tantalum capacitor is a major advance in capacitor capability.

The new PuriTan capacitor solves your problems with:

- Superior AC ripple characteristics
- Reverse voltage capability
- Excellent capacitance stability
- True glass-to-tantalum hermetic seal
- Low ESR
- Low DC leakage

For complete information on the PuriTan all-tantalum capacitor and/or other Tansitor capacitors, call your local Tansitor representative, or contact:

Tansitor
ELECTRONICS
DIVISION OF AEROTRON, INC.

West Road, Bennington, Vermont 05201
Phone: (802) 442-5473
TWX: (710) 360-1782

Specialists in Tantalum Capacitors

TM Trademark of Tansitor Electronics

Readers' comments

Feerst boosted, Schulke panned

To the Editor: The letter in the Sept. 2 issue by Thelma Estrin regarding the leadership, experience, and abilities of the various candidates for the presidency of the Institute of Electrical and Electronics Engineers was very interesting.

Giving Robert Rivers credit for his work on professional activities was aptly contrasted by the editorial on p. 12 ("A slow start for IEEE's professional activities") and the article on p. 67 ("Professional program gets few cheers"). If the professional-activities program is to be credited to Rivers' leadership, we do not need him.

With one exception, the other candidates, all of whom are on the board of directors, are then responsible for the present financial situation of the IEEE and for the engagement of Maj. Gen. Herbert Schulke (ret.) as the inept manager. The IEEE is where it is now because of this type of "leadership."

As a working engineer, my motto must be: Elect Feerst; can Schulke!

Gordon Edwards
Phoenix, Ariz.

Correction

Bell Laboratories manufactured the cables used in Bell's experimental fiber-optic telephone link [July 22, p. 43], not Western Electric Inc. and Corning Glass Works. Western Electric made all the fibers in one cable and 75% of those in the other. The remaining 25% came from Corning.

The average loss of all fibers in the primary test cable was 6 decibels per kilometer, which was 2 dB/km less than the design goal specified by Bell Labs.

Using special low-loss splices and selected low-loss fibers from one of the cables, Bell achieved an average loss of 4.5 dB/km over a 10.9-km line; with a total acceptable loss for the system set at 50 db, no regeneration was required under a distance of 10.9 km.

We thank M. I. Schwartz of Bell Laboratories, Norcross, Ga., for providing us with the information to correct our article.

Need LSI-11 microcomputer components? Call the "FIRST"!
(312) 920-1050
no magic—just performance
FIRST COMPUTER CORPORATION
764 BURR OAK DRIVE, WESTMONT, ILLINOIS 60559
® Registered trade mark of Digital Equip. Corp.

What's new in solid state ...

RCA BiMOS op amps. They mix technologies to match circuit needs.

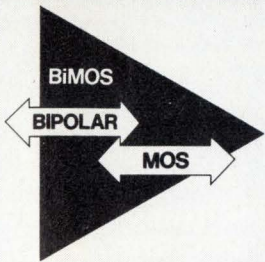

BiMOS was born with our CA3100. On a single chip we combined Bipolar with PMOS—for a more cost-effective wide-bandwidth op amp.

Next, the versatile 3130. With FET, Bipolar and CMOS, it can do a tremendous variety of jobs well.

Latest arrival: our 3140. The most useful op amp since the 741. Able to fill the great mass of op amp sockets, thanks to MOS/FET input and Bipolar output.

Low-cost, no-compromise circuits

BiMOS gives you the best from each technology without the drawbacks. So you can select op amps with exactly the characteristics you need. A single op amp can often do jobs that ordinarily require many more parts. And that ability opens up new cost-saving ways to meet circuit needs.

Why pay more than you have to for your circuit? Check into BiMOS. Contact your RCA Solid State distributor. Or RCA.

Write: RCA Solid State, Box 3200, Somerville, N.J. 08876; Sunbury-on-Thames, Middlesex TW16 7HW, England; Ste. Anne de Bellevue H9X 3L3, Canada; Fuji Bldg., Tokyo, Japan.

Op amp category	What BiMOS contributes	RCA device
General Purpose	Wide applicability. Low cost.	CA3140 CA3130
FET Input	Lower device cost. Reduced circuit cost. Large input voltage range: capability of swinging to 0.5 V below rail.	CA3140 CA3130
Wideband 4.5 to 70 MHz	High slew rate with low ringing.	CA3140 CA3130 CA3100
Micropower down to 1.5 mW	Strobability.	CA3130
High Current up to 22mA	Eliminates driver stage. Low device cost. Rail-to-rail output swing.	CA3130

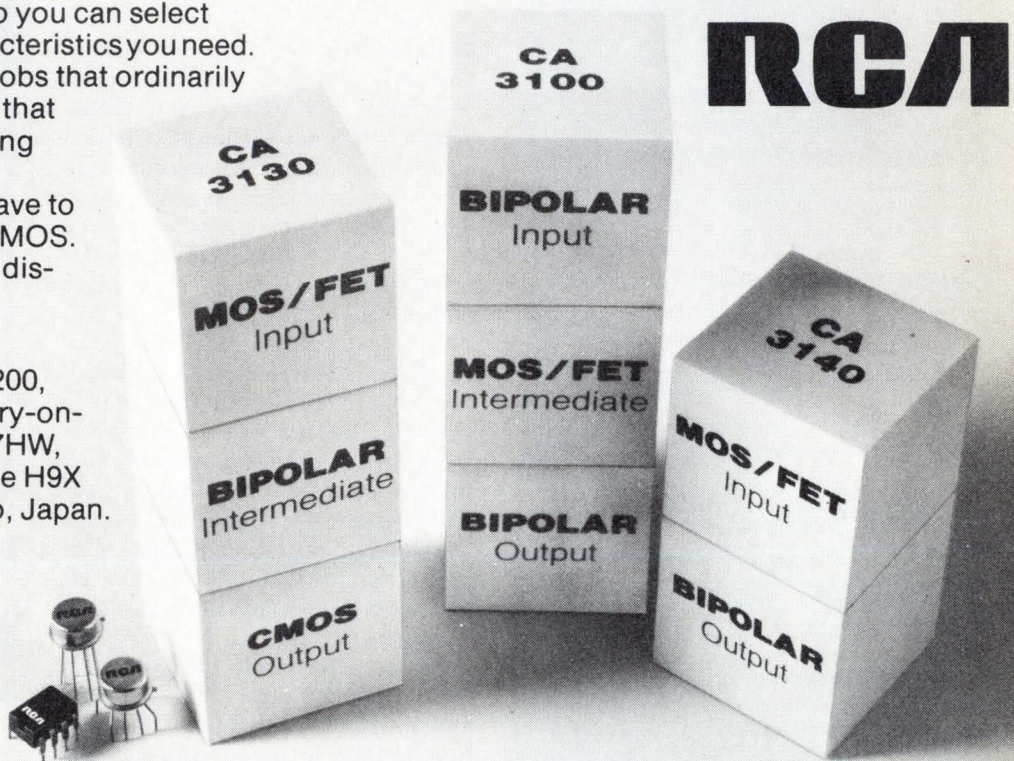

RCA

RCA. Full house in Linear ICs.

Circle 7 on reader service card

Get the scope you need-Now!

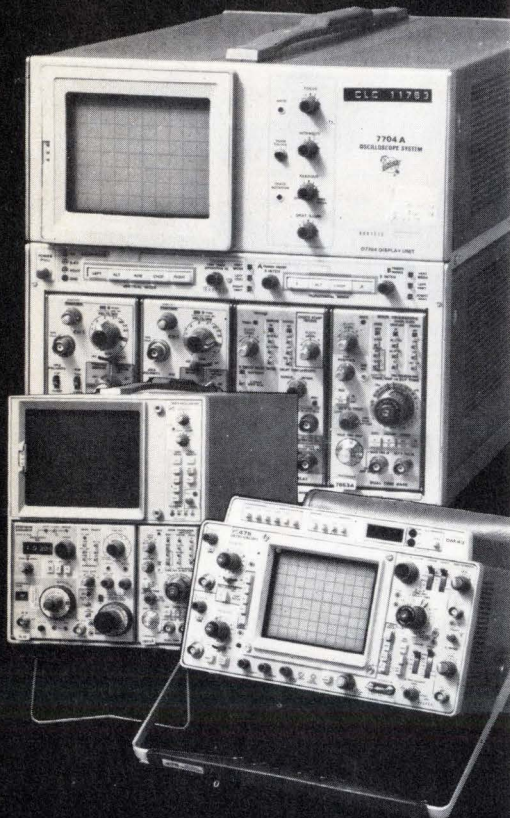

Our "Instrument Professionals" will tell you which scope will do the job best, at the lowest cost, make immediate delivery and guarantee performance.

Write or call for data on our other specialties: Instrument Leasing • Computer Peripherals • Equipment Sales • Instrument Service.

Circle 8 on reader service card

Call Continental Rentals



Get our FREE Catalog

Div. Continental Leasing Co., Inc.
175 Middlesex Turnpike, Bedford, MA, 01730 (617) 275-0850

Metuchen, NJ (201) 549-8500;
Gaithersburg, MD (301) 948-4310; TX (214) 357-1779; Elk Grove, IL (312) 439-4700; Costa Mesa, CA (714) 540-6566; Santa Clara, CA (408) 735-8300; Los Angeles, CA (213) 477-7521

News update

■ Since its first installation in a dog-food factory [*Electronics*, Oct. 16, 1975, p. 26], American Laser Systems Inc.'s infrared closed-circuit TV transmission system has found plenty of other uses. Not only is the industrial market for the product "so large it's hard to address it," boasts Duncan B. Campbell, president of the Goleta, Calif., firm, but another development has turned up.

A national news-gathering agency, which he won't name, has paid to bring American Laser's system, which is based on an IR optical carrier, up to broadcast industry standards. Improvements include tighter differential phase and gain, flat frequency response, and better transient response. The company is selling the system to television stations as short-range transmission links for the new electronic news-gathering minicamera and recording equipment. Stations are buying "a number of units" which are cheaper than comparable microwave transmission equipment, Campbell says. His firm should sell about \$500,000 worth of both versions this year, he estimates. They cost \$4,000 to \$6,000 per copy.

■ Rome Air Development Center, the Air Force's semiconductor watchdog, will soon request proposals for reliability studies of large-scale integration and microprocessors and associated support chips. The center, which last year suffered a temporary cutback in funds for outside reliability studies [*Electronics*, Oct. 16, 1975, p. 25], "is in really great shape for fiscal 1977," says David F. Barber, head of the Reliability Branch. The branch was able to reacquire most of its fiscal 1976 money, about \$1.3 million, out of RADC's existing funds and reinstate five threatened outside study programs. Among them were programable read-only memories, and complementary-MOS semiconductors on sapphire. "Funding appears to be stable through fiscal 1980," Barber says. "We don't see any problems with funds stabilization. In fact, there probably will be a slow increase."

IMP-1 Bi-directional Line Printer-\$450 (6800 & 8080 Compatible)



The IMP-1 was designed to satisfy low priced peripheral needs for the rapidly growing microprocessor field. It is a 5 x 7 dot matrix impact printer with a 40 column multicopy output. The printer, complete with drive electronics, internal power supply, character decoding and software driver prompts interfaces directly with the 6800 and 8080 microprocessors. The printer is capable of bursts up to 80 characters per second bi-directionally.

IMP-1, another outstanding product from EPA-First in Microprocessor Systems.

EPA Electronic Product Associates, Inc.

1157 Vega St., San Diego, CA 92110
(714) 276-8911

First in Microprocessor Systems

Circle 184 on reader service card

PROFESSIONAL DISCOUNT PRICES AVAILABLE ON

HEWLETT  PACKARD

Engineering Calculators

PHONE TOLL FREE
800-638-8906

FOR THE CURRENT LOW DISCOUNT PRICE OF THE LATEST MODEL CALCULATOR OF YOUR CHOICE

THE GUARANTEE

10 day money back trial. If you are not completely satisfied you may return the Hewlett-Packard calculator you order within 10 days for a cash refund or charge cancellation. In addition Hewlett-Packard and Capital Calculator Co. Inc. warrant each calculator for a period of one year against defective parts and workmanship.

Capital Calculator Company



Maryland residents phone:
(301) 340-7200

701 East Gude Drive
Rockville, Maryland 20850

Circle 185 on reader service card

Program it or modulate it ...

RCA presents the variable op amp. As easy to use as a transistor.

The CA3080 variable op amp is the first differential-voltage input, current output op amp. Like a transistor it has a control input—one that lets you vary not just voltage but also power, bandwidth, slew rate, input current and output current. It can be programmed and/or signal modulated to select the optimum gain, speed, bandwidth and power. And the output can sink or source current.

It puts the designer in complete charge.

This wide range of operation gives you unusual design flexibility. You can create simplified versions of present designs ... or take unique approaches to new designs. You have linear gain over a 6-decade range to work with. A 50V/ μ s slew rate. Power levels adjustable from below 1 μ W up to 30 mW. And if you need more than 1 mA output, the CA3094 has integral Darlington's to provide 300 mA peak output.

In short, you can "shape" the variable op amp to fit the job—and create big circuit savings.

How much does all this flexibility cost? Amazingly little: 55¢ for the 3080E and 65¢ for the 3094E, at the 1K level.

For data sheets and application notes on these op amps, contact your local RCA representative. Or RCA.

Write: RCA Solid State, Box 3200, Somerville, N.J. 08876; Sunbury-on-Thames, Middlesex TW16 7HW, England; Ste. Anne de Bellevue H9X 3L3, Canada; Fuji Building, Tokyo, Japan.

RCA

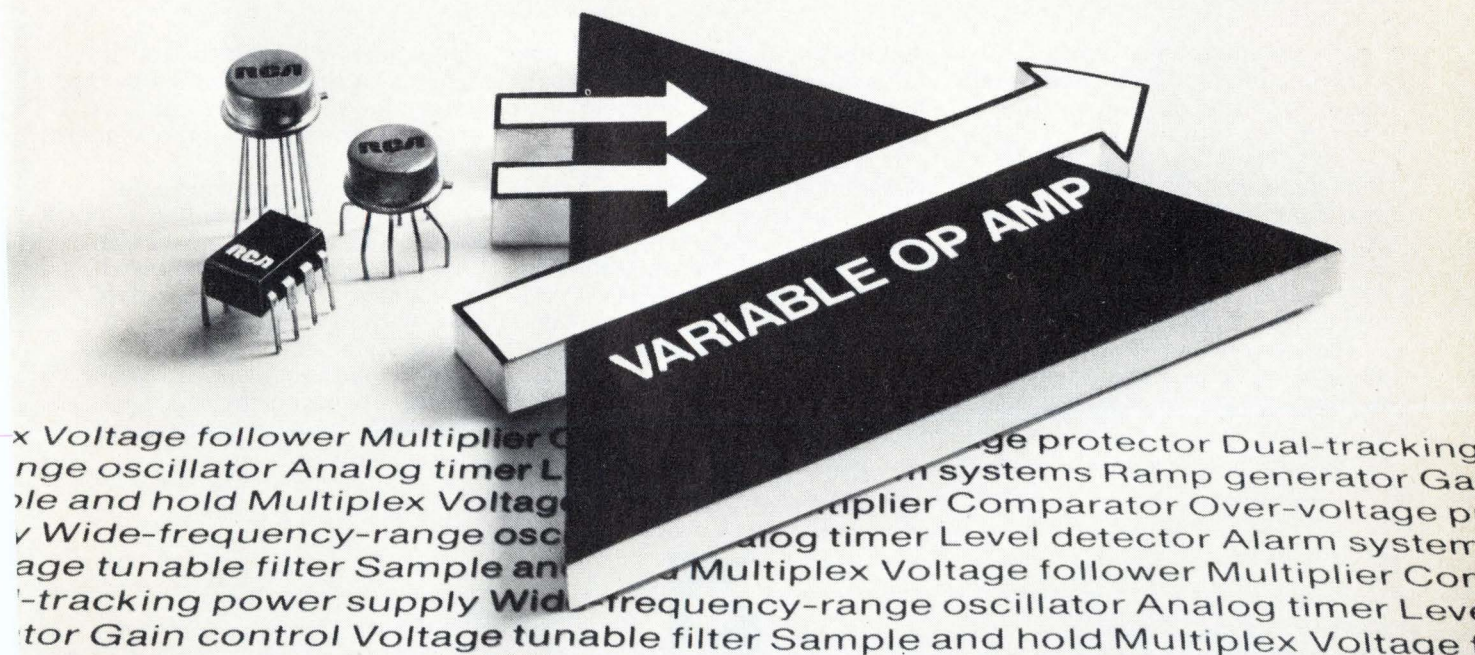

RCA. Full house in Linear ICs.

Circle 9 on reader service card

Draw one of these:

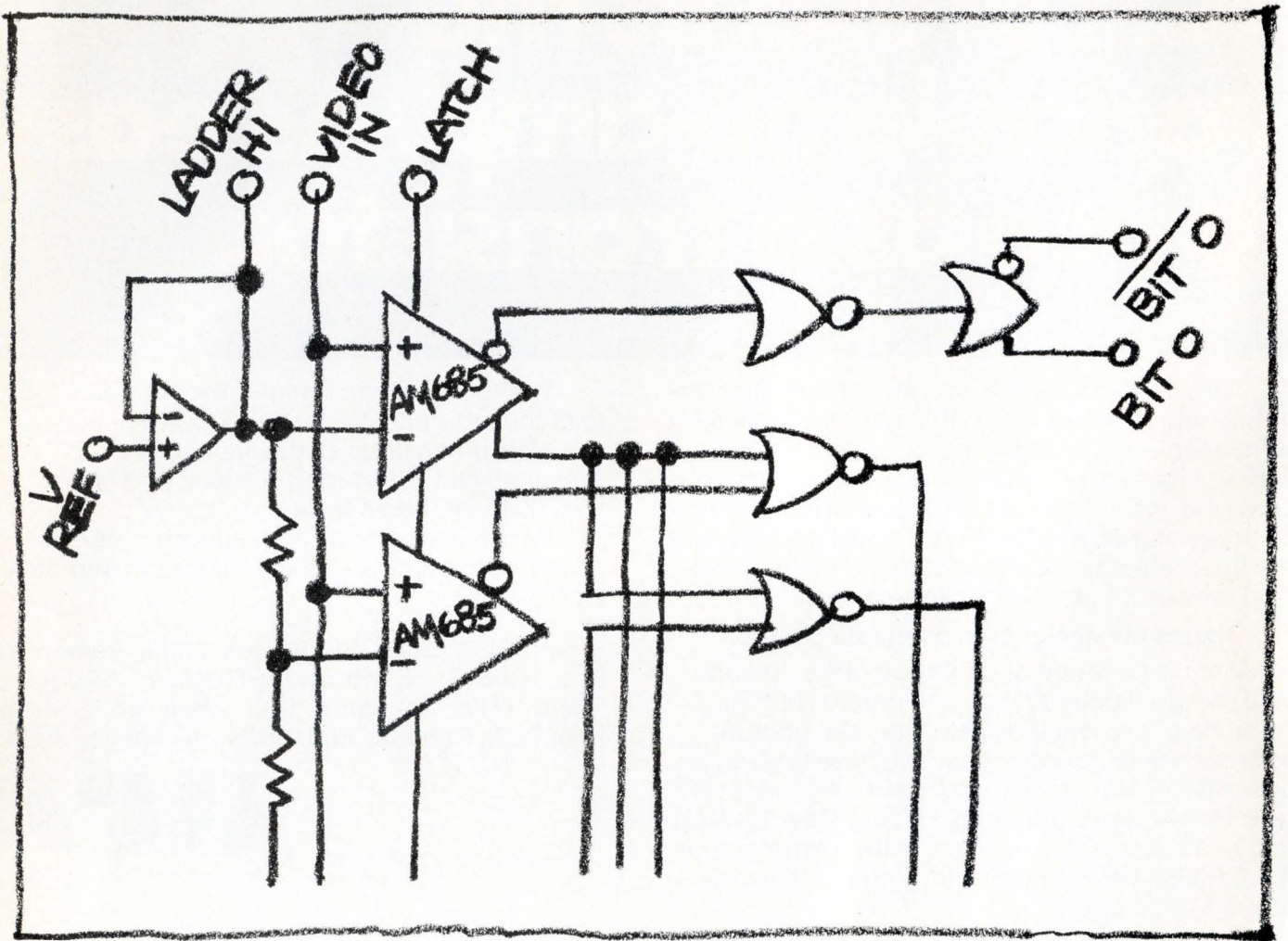

Never thought you'd own a Porsche, did you? Well, there's only one way to find out: fill out the coupon.

Advanced Micro Devices will send you a contest kit that includes two samples of your choice of three terrific high-speed comparators — the Am685, Am686 or Am687 — applications materials, data sheets and contest entry form.

Then you design an original application using the high-speed comparator you've chosen. That

shouldn't be too hard to do because Advanced Micro Devices' comparators are the fastest, most accurate parts you can get. Anywhere.

If you're the winner, you'll own a brand new, shiny, speedy Porsche 924. Which is one of the fastest, most accurate cars you can get. If your design comes in second or third you'll win a Porsche Chronometer. The next six winners win Porsche Racing Team Jackets.

You must have your entries in by January 15th. A panel of impar-

tial experts will pick the top 10 designs. A drawing will be held to determine the winners. And we'll announce the names of the winners by March 1, 1977.

In the meantime, you've got some very important things to think about. Like what color you want. Do you want a silver body with black interior? Red with saddle? Blue with tan? How about a gold racing stripe along the side?

And you thought linear comparators were boring.

Advanced Linear



Advanced Micro Devices • 901 Thompson Place, Sunnyvale, California 94086 • Telephone (408) 732-2400 •
Distributed nationally by Hamilton/Avnet, Cramer and Schweber Electronics.

Drive one of these:



First, the kit. Then, the car.

Don't wait around! Only the first 3,000 entries will be eligible. Send us the coupon, attached to your company's letterhead. No letterhead, no kit.

Advanced Micro Devices, 901 Thompson Place
Sunnyvale, California 94086

I'm a player. Here's my coupon and letterhead. Send me the kit and the parts.

NAME _____

COMPANY _____

ADDRESS _____

PART TYPE Am685 Am686 Am687

(Check Box)

Several Electronics editorials have raised questions about what role the educator should play in influencing the supply of engineers. The following comments, which form a rebuttal to points made in some of those editorials, are by David J. Comer, professor of electrical/electronic engineering, California State University, Chico, Calif.

In defense of the educator

Over the last six years, I have read with interest and concern about the plight of the electrical engineering profession. We have seen cutbacks and recessions lead to thousands of unemployed engineers with particularly serious effects on the over-40-year-old engineer.

This is a complete turnaround for a profession that in the last few decades has been on the right side of the supply-demand curves for manpower. Since 1970, the supply and demand curves have drawn uncomfortably close together, allowing even minor economic fluctuations to move the demand curve either above or below the supply curve.

In the concern to solve this problem, many proposals have been made. These range from limiting enrollment of engineering schools and establishing a viable professional association, such as the American Medical Association, to unionization of the engineer with strikes or militant tactics as the *modus operandi*.

The engineering educator is now becoming accustomed to hearing complaints that he is self-serving because he does not represent the true career situation to the prospective engineer, presumably causing many changes in major to other fields. However, some points pertaining to these criticisms have not been emphasized in the past.

When a student elects to major in electrical engineering, he is generally rather serious about preparing for a specific career. This is not true in many other cases, especially in the liberal arts, where students tend to have a very ill-defined career objective in mind as they begin their college work.

When a freshman student seeks career advice, most engineering teachers are conscientious enough to review the employment situation over the last few years. I generally start by relating the story of an ex-student, one who graduated in 1965. This academically average student had interviews with 17 firms, receiving 13 job offers. Then I point out that this situation has changed considerably and that our best students now have to hustle to get a handful of job offers. I mention that our poorer students have been able to get jobs, but in recent bad years have often had no more than a single offer, and this after several interviews at the campus placement center. Some have had to go in person to various firms before securing a job. I then quote the average starting salary of the electrical engineer, as indicated by the College Placement Council.

I usually discuss the need for an engineer to study on his own throughout his career to avoid

obsolescence and discuss the topping out of salaries for those who shun management. If the student is interested, I discuss the broadness of the field and the possible areas of his employment, drawing on my own full-time industrial work, my consulting, and my summer employment experiences.

Now let us assume that after this discussion which can last an hour, the student decides to change majors. His next questions logically relate to other four-year programs.

What are the starting salaries and demand for these areas?

A truthful answer is that the only other four-year program that approaches the engineer's starting salary is business administration, and the demand is also comparatively high in this field. But beyond that single field, no other area even approaches the demand and starting salary of the engineer. Neither the liberal arts major, the school teacher, the mathematician, nor the physicist can expect to receive the number or dollar amount of offers that the engineer expects. The psychology student, the history major, the English major, the agriculture student and others often end up changing fields upon graduation. In good times or bad, the engineer has been at the top.

What other four-year program should the faculty member recommend?

The possibility of medicine or dentistry is often brought up along with the monetary advantages of these professional fields. Self-employment in fields not requiring a college education, such as home building, are sometimes suggested, but ultimately the student makes his own decision.

Why should engineering be one of the few fields that experiences an undersupply of talent?

All other fields with the exception of those such as law or medicine have fewer jobs than people trained in these areas. Is engineering sacred to the extent that there should be no competition for jobs? Perhaps this is why we have so few engineers in public office, in government service, or in nontechnical administrative jobs. There have always been enough technical jobs to absorb all graduates. Competition for jobs may upgrade the profession and nudge some capable people into other worthy professions.

As an educator, I cannot apologize because many mathematically minded students choose engineering—at least not until someone can demonstrate a better choice. Is it the educator who is self-serving or is it those that would divert capable students into less opportune fields to preserve their own job security?



From the originators of the photo-isolated solid-state power relays that have become the industry standard . . .

8 AMP SERIES 2 FOR HEATSINK OR PANEL MOUNT
Two models, S218 (120 Vac) and S228 (240 Vac), feature standard 0.187" terminals for push-on connectors or bare-wire solder connection, positioned to provide maximum isolation between signal and power circuits. Offset positioning of the terminals permits side-by-side gang mounting for high packaging density. Occupying less than 1.0 cubic inch, they provide a full 3 ampere (rms) current rating and a high surge current capacity suitable for control of the toughest loads. The S218 units are \$5.90 in 1,000-piece lots.

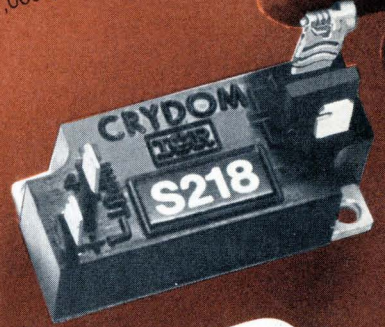

A QUANTUM STEP IN SIZE AND PRICE REDUCTION!

TWO NEW CRYDOM CHALLENGER SOLID-STATE RELAYS!

The new Crydom Series 2 and 3 SSRs combine small size and low price, challenging all comparably rated SSRs, hybrid relays, and in-house designs on a size/cost/performance basis. They provide photo isolation, zero voltage switching, high current rating and rugged packaging — first established by the original Crydom Series 1, now the world's leading SSR design. Designed for UL/CSA approval, they offer the advantages of long life, RFI-free switching, logic level control, and excellent electrical and mechanical isolation of signal and power circuits.

The application of SSRs is no longer limited by size and cost. Crydom Challengers have knocked down these barriers. SSR control of motors, heaters, lamps, transformers, solenoids, valves and contactors now becomes practical in many new applications.

Think about it for your product . . . and join the Challengers!

INTERNATIONAL RECTIFIER
IOR CRYDOM
DIVISION

1521 Grand Avenue, El Segundo, CA 90245 (213) 322-4987

...the pacesetters!

Circle 13 on reader service card

2 AMP SERIES 3 FOR PC BOARD MOUNT

Two models, S312 (120 Vac) and S322 (240 Vac), provide a higher power handling capability than any SSR of equal size. Occupying less than 0.4 cubic inch, Series 3 SSRs achieve a full 2 ampere free-air rating in a 40° ambient. A low 3/8" profile allows 1/2" spacing of rack mounted printed-circuit boards. The S312 units are \$4.90 in 1000-piece lots.



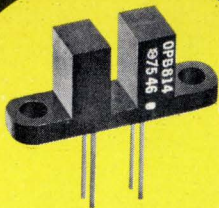

NON-CONTACT SWITCHING!

OPTICALLY COUPLED INTERRUPTER MODULES

OPTRON OFFERS IMMEDIATE DELIVERY OF NEW, LOW COST SERIES

OPTRON's new, low cost optically coupled interrupter module series combines non-contact switching and solid state reliability for applications requiring sensing of position or motion of an opaque object such as motion limit, paper edge or shaft encoding.

The new OPB 813, OPB 814 and OPB 815 consist of a gallium arsenide infrared LED coupled with a silicon phototransistor in an economical molded plastic housing. With a LED input of 20 mA, the OPB 813 and OPB 815 have typical unblocked current outputs of 2.0 mA and 3.0 mA, respectively. Typical output of the OPB 814 is 3.0 mA with a 10 mA input. The entire series is available from stock.

Background illumination noise is eliminated by a built-in infrared transmitting filter and dust cover in each device type. The OPB 813 also is available with a 0.010 inch aperture for high resolution applications.

New OPTRON optically coupled interrupter modules are interchangeable with similar products as follows:

OPTRON	GE
OPB 813	H13A1
OPB 813	H13A2
OPB 814	H13B1
OPB 814	H13B2

Detailed technical information on these and other OPTRON standard interrupter and reflective modules, as well as versions for specific applications is available on request.



OPTRON, INC.

1201 Tappan Circle
Carrollton, Texas 75006, U.S.A.
TWX-910-860-5958
214/242-6571

People

Quick growth, is Sinnott's plan for Data Systems group

"Perkin-Elmer wants to achieve a significant position in the information-processing industry in a relatively short period of time," says Daniel Sinnott, vice president and general manager of the newly formed Data Systems group of Perkin-Elmer Corp. of Norwalk, Conn. To this end, Sinnott has the resources of minicomputer maker Interdata Inc. of Oceanport, N.J., tape and disk-drive producer Wangco Inc. of Los Angeles, and printer-terminal maker Terminal Products of Randolph, N.J. These are the three subsidiaries of Sinnott's new group, a consolidation of the computer-related companies acquired in the last two years by Perkin-Elmer.

Total supplier. "To be one of the surviving companies in the early 1980s, we need to be a total supplier of products to the information-processing market. This we'll do by adding other products to what we presently have, either by building them ourselves, by acquisition, or by both," asserts the 42-year-old executive who had helped guide Interdata, which he founded in 1966, to sales of \$23.5 million a year.

The Data Systems group kicked off a new fiscal year in August after its units posted combined revenues of more than \$70 million in the previous year. "We have some exciting growth plans for the next three fiscal years," says Sinnott, who doesn't argue with industry estimates that the group will more than double its revenues by the end of fiscal 1979. "Most of the growth will come out of Interdata," he adds, "but we're also looking for growth rates above industry standards in other fairly select areas."

Plans. To meet this objective, Sinnott is considering both internal growth and acquisitions. "We have excellent tape- and disk-drive capabilities, so there's no need for us to buy them. But line printers—there's a talent we don't have and one we might go out and buy."

A software house is being consid-



Climber. Daniel Sinnott should double his \$70 million sales in fiscal 1979.

ered for acquisition, as well as a semiconductor manufacturer. However, the group may develop a facility to build its own semiconductor memories for use in its products.

And don't be surprised if the semiconductor project grows beyond supplying memories in-house. Sinnott says, "If we get into that business, we may serve the semiconductor-memory market through its own marketing channels. Right now, it's just one of the areas where we're doing our homework to be one of the survivors."

Persuasion part of Wolff's art at MIT's electronic lab

"Find good people, give them money and support; then pray." That's the broad philosophy of research embraced by Peter Wolff, the new director of the Research Laboratory of Electronics at the Massachusetts Institute of Technology. He considers his principal role is that of persuader, and that researchers must be encouraged to communicate with each other—hardware and software people most of all.

Wolff's laboratory in Cambridge, Mass., provides an umbrella under which faculty members, a research staff, and students from 10 academic departments at MIT conduct research in three broad disciplines—quantum physics, astrophysics and plasma

New unique design OAK rotary switch

Accurate.
Dependable.
Long life.
Up to 60 positions.
Logic programmable.
Low cost.

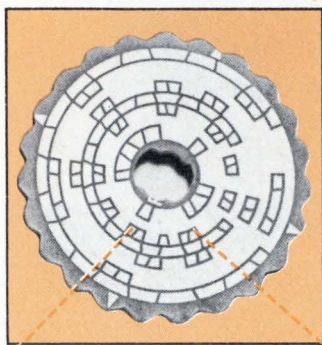
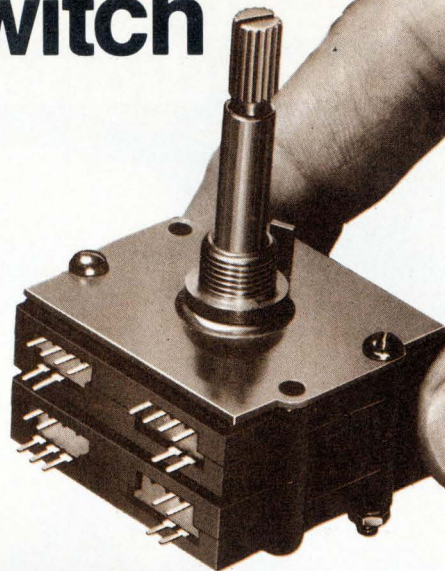

OAK ROTOR DESIGN

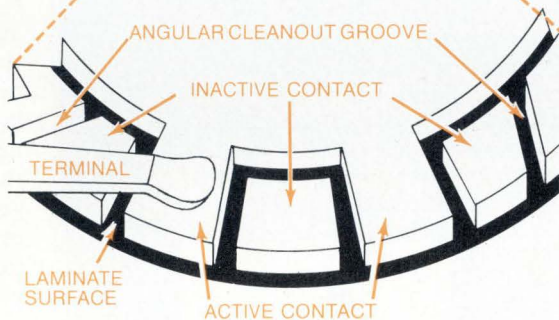

CONVENTIONAL ROTOR DESIGN

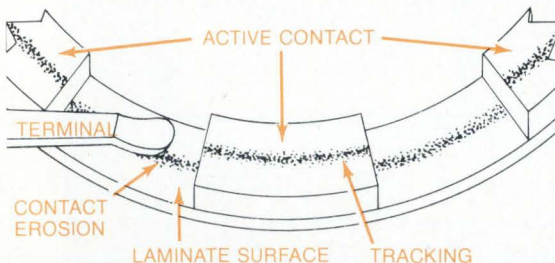

The Oak Communicator Series switch features a patent-applied-for rotor design for long term contact registry and integrity. Programming is accomplished on a metal-clad, laminated rotor of exclusive construction.

High dependability is assured because the stationary wiping contacts never touch the insulation surface. Instead, they move from electrically live to electrically inactive metal surfaces. Tracking is eliminated due to Oak's exclusive clean-out grooves and rotor circuit design. In addition erosion or the formation of particles between contact and insulation surface is drastically reduced.

Intermittent opens or shorts are almost impossible.

Complex wiring problems are eliminated, because all switching logic, wiring and contact arrangements are programmed within the factory-assembled switch.

Small size (1.665 x 1.5 x 0.4), simple construction, accurate registration and low cost permit the Oak Communicator Series to be adapted to almost any application.

For additional information and specifications, contact your nearest Oak sales office or call 815-459-5000.

OAK Industries Inc.

SWITCH DIVISION / CRYSTAL LAKE, ILLINOIS 60014
TELEPHONE: 815 • 459 • 5000 ■ TWX: 910 • 634 • 3353 ■ TELEX: 72 • 2447

if you really need
**the smallest 10-bit
synchro-to-digital
converter...**

...then you really need
DDC's model
HSDC-10.

The smallest
synchro-to-digital
10-bit converter available
is here now from the leader
in data conversion devices. It's the
Model HSDC-10 offering you a 36-pin double D.I.P. hermetically
sealed can measuring only 0.78 by 1.9 by 0.21 inches.

Besides small size, the HSDC-10 offers you a whole range of
outstanding features:

- Excellent dynamics — true type II servo tracking ($K_a=200,000$)
- Low power — 200 ma
- High reliability — MIL-STD-883 level C processing (Level B optional)
- Low cost

If you really need a converter whose ratiometric conversion
technique makes it insensitive to voltage and frequency
variations . . . then you really need the HSDC-10. Also . . . its
unique circuit design eliminates the need for the usual
—15VDC supply. With the all-new HSDC-10 only +15 volts and a
logic supply (+4.5V to +15VDC) are required.

The unit is fully transient-
protected and is available with or with-
out transformer isolation.

The HSDC-10 accepts all standard
inputs, synchro or resolver, and
can be easily provided in a
Navy Standard Electronic Module
(SEM) Configuration.

Let us send you full details
and technical specifications.

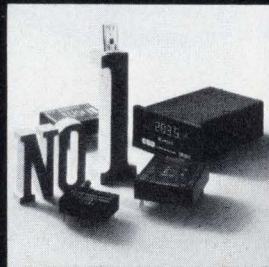

We're Number One in High Performance Data Conversions

DDC

ILC DATA DEVICE CORPORATION

A Wholly Owned Subsidiary of ILC Industries, Inc.

AIRPORT INTERNATIONAL PLAZA BOHEMIA, LONG ISLAND, N.Y. 11716 (516) 567-5600

APPLICATIONS AND SERVICE CENTERS

CALIFORNIA: 7337 Greenbush Ave.,
No. Hollywood 91605 (213) 982-6454

EUROPE: England: The Sanctuary,
Oakhill Grove, Surbiton, Surrey, Tel.: 01-399-7262

Interested engineers, write or call Harry Lewis or send for our 164-page product line catalog.

People

dynamics, as well as communica-
tions and engineering sciences.
Wolff was most recently director of
the MIT Center for Materials Science
and Engineering and head of the
solid-state and atomic physics divi-
sion of the physics department.

He points out that even though
electrical engineering "is the heart of
the [research laboratory], the elec-
trical engineering faculty is split into
hardware and software people, and
it's not easy to get researchers in
these different disciplines to talk to
each other. I've got no authority over
them, but I can be a catalyst. I can
persuade them to bring together
things that should be together."

Close cooperation is needed, for
example, in a project involving a
\$10,000 microprocessor-based ma-
chine that converts text into speech
to aid the blind. One of the chal-
lenges, putting the proper accents
and emphasis in the audio, involves
developing software algorithms
based on linguistics knowledge and
building hardware that functions
according to these algorithms.

In quantum electronics, Wolff
again considers that his task is to
foster good communications. MIT has
a good reputation in optics, he says,
and it's his job to bring together "the
theoretical people with the optical-
device people, and to form ties
between the physicists and the engi-
neers who use optics as a device. All
the pieces are here to be put to-
gether—probably the best and
broadest academic program in op-
tics, which touches a lot of national
problems, including communications
and weapons."

Another responsibility he accepts
is to ensure that his laboratory
attracts and encourages young re-
searchers. In this endeavor, Wolff
feels he has a little more leverage
than simply being a persuader. He
can influence who is chosen for the
research staff by accepting the
research proposals he feels are
important. "A younger person has
all-out devotion to his early proj-
ects," Wolff maintains, "so one of
the most valuable things an organi-
zation like ours can do is to get good
young people started."

ERIE RESPONDS. that's why WE'RE NO. 1 WORLDWIDE in Ceramic Capacitors



Forty years ago, ERIE foresaw a need and introduced the first ceramic capacitor to U.S. markets. Today, ERIE is still dedicated to fulfilling customer needs. Our state-of-the-art ceramic technology continues to lead the way in the development of smaller, more efficient ceramic capacitors, both fixed and variable. And ERIE's line of high quality components is as broad as the markets we serve. So when knowledgeable people think ceramic capacitors, increasingly, they think ERIE. To remain number one in our competitive industry, we have to be responsive to your needs. We think we are. Try us.

ERIE TECHNOLOGICAL PRODUCTS, INC.
Erie, Pennsylvania 16512

Circle 17 on reader service card

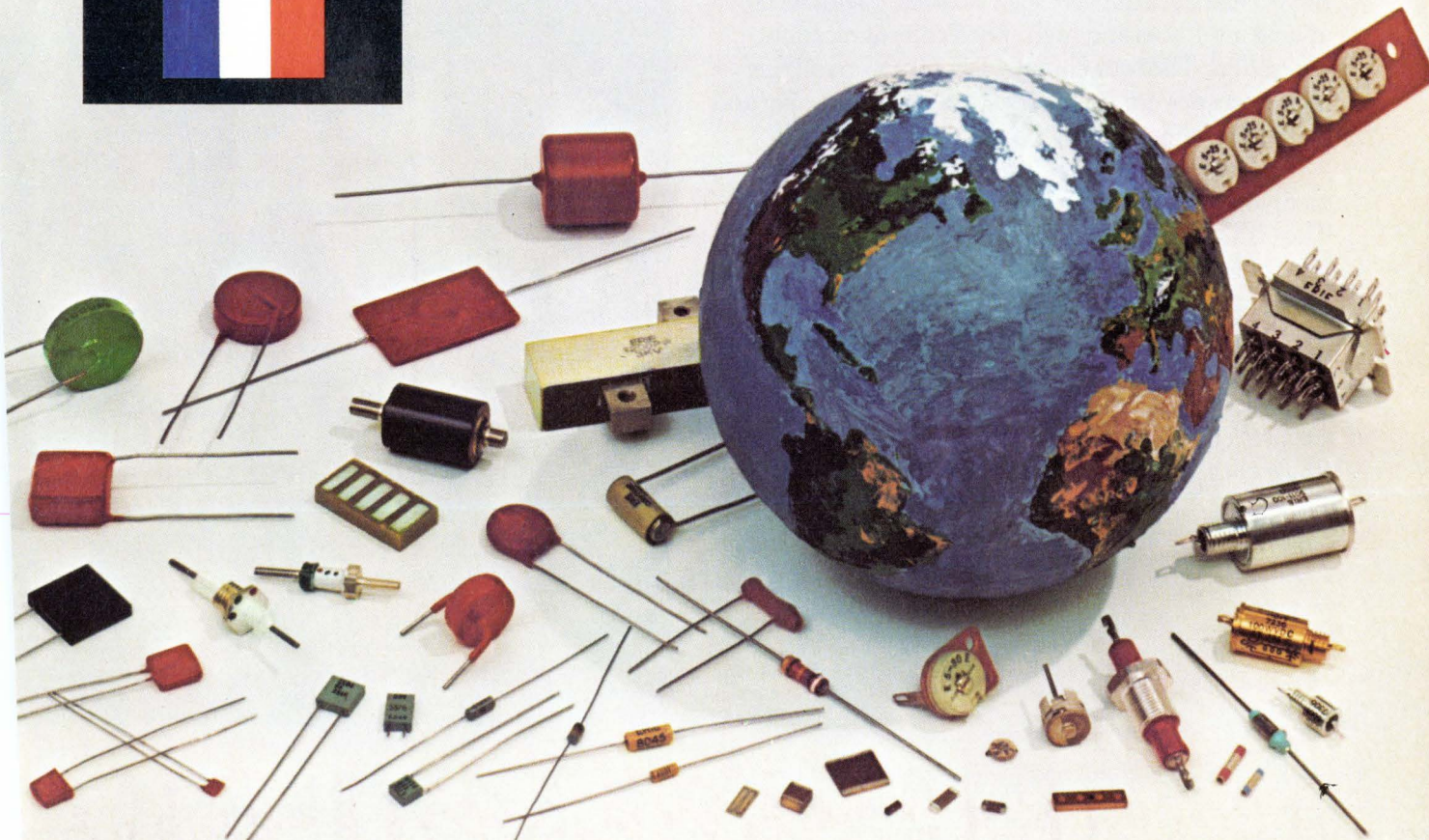

Intel 8080 peripherals

Now you can get microcomputer based products out of the lab and into production faster than ever before. Intel® 8080 programmable LSI peripherals give you the competitive advantage by helping you reduce design time, component count and manufacturing and inventory costs. Most of all they'll help you get to market first.

Intel 8080 programmable peripherals are software controlled LSI replacements for hardwired SSI/MSI logic assemblies. You simply attach the appropriate peripherals to the system bus and the +5V supply. Then, with system software, you personalize device operating configurations to suit your applications. Reconfiguration and design changes are made with software. No expensive and time consuming hardware redesigns are necessary.

One peripheral, the 8253 Programmable Interval Timer, is the first LSI solution to system timing problems. It counts out I/O servicing delays, eliminating software timing loops and increasing CPU throughput. It also saves hardware when you need event counters, rate generators or real-time clocks. Each 8253 contains three 16-bit timer/counters.

Our 8257 Programmable DMA Controller is the lowest cost way to handle applications that require high speed data transfer such as disks, magnetic tape, analog interfaces and high speed communication controllers. The four channel 8257 contains all the logic necessary for bus acquisition, cycle counting and priority resolving of the channel requests.

The 8259 Priority Interrupt Controller replaces complex TTL arrays and minimizes component costs. The CPU can change interrupt structure "on the fly" to suit changes in the operating environment, such as time of day or process control parameters. The 8259 handles up to eight vectored priority interrupts. Multiple 8259's can control up to 64 interrupt levels.

Use the 8251 Programmable Communication Controller for "serial I/O." The first true USART in a single chip, the 8251 implements all popular com-

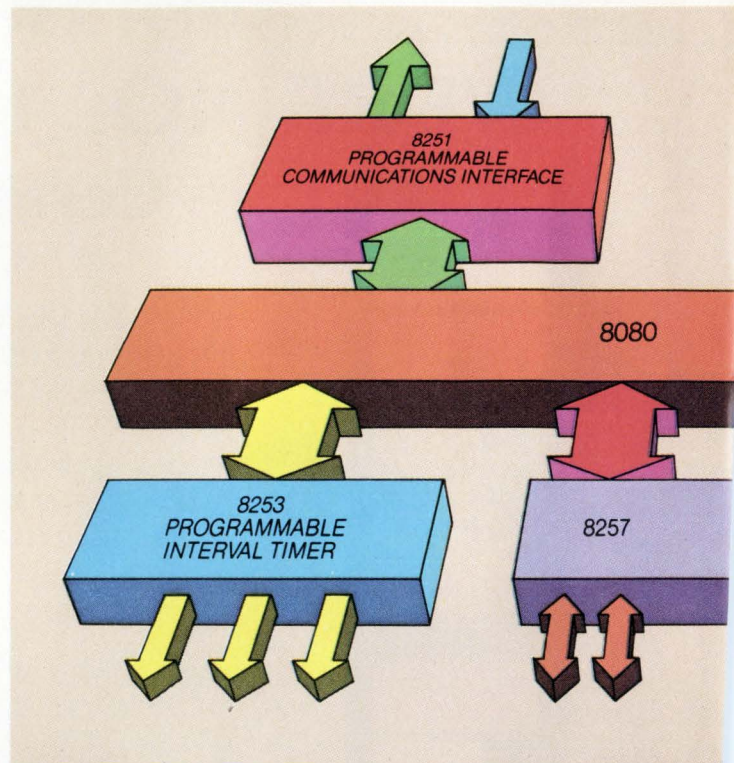

get you to market first.

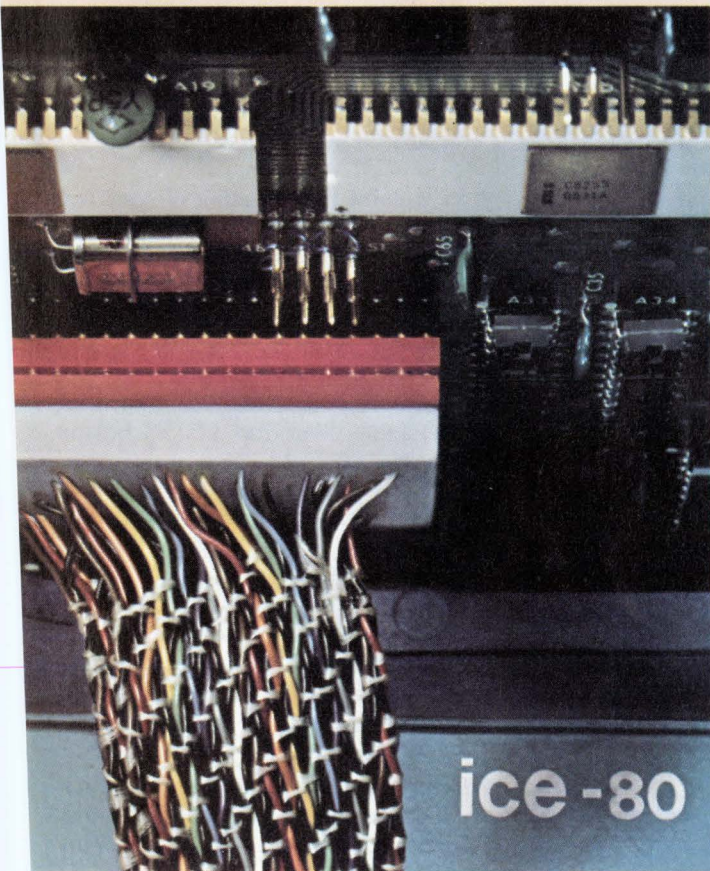
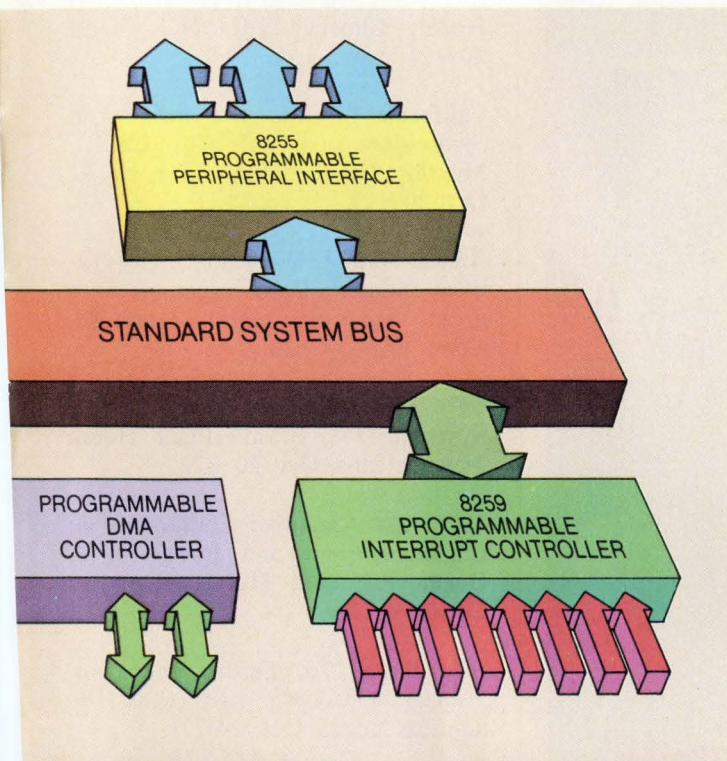

munication protocols, including IBM Bi-Sync. For "parallel I/O," each 8255 Programmable Peripheral Interface gives you 24 versatile I/O lines to interface relays, motor drives, printers, keyboard/display and other parallel equipment.

Once you've selected the peripherals to fit your application, use the Intel[®] Microcomputer Development System for both software and hardware development. Using the Intel[®] CRT terminal, call up the resident text editor. Write the source program to initialize the peripheral and the subroutines for peripheral/system operation. Then you assemble or compile the source programs into an object file using resident macroassembler or resident PL/M compiler—and store the object file on the Intel[®] diskette. With the relocation and linkage capability of the Intel[®] ISIS II diskette operating system, these routines can be added to a system library and called from user programs as needed. Once the main system program is written, the new peripheral device routines are easily linked in. The entire program is now ready to be run on your prototype via the Intel[®] ICE-80™ in-circuit emulation module. ICE-80 lets you debug your software and hardware in your actual prototype environment. Move from system integration and debugging to production in a fraction of the time previously required.

Intel also provides applications assistance, training programs, the largest user's program library, and volume production support. Intel's 8080 programmable peripherals give you the competitive advantage from start to finish. Be first to market.

To order the new peripherals, contact our franchised distributors: Almac/Stroum, Components Specialties, Components Plus, Cramer, Elmar, Hamilton/Avnet, Industrial Components, Liberty, Pioneer, Sheridan or L.A. Varah. For your copy of our 8080 System brochure write: Intel Corporation, 3065 Bowers Avenue, Santa Clara, California 95051.

intel[®]
Microcomputers. First from the beginning.

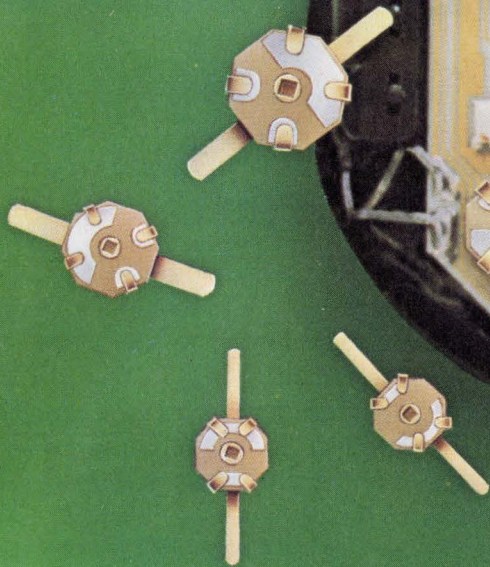

Thin-Trim[®] capacitors

Tucked in the corner of this Pulsar Watch is a miniature capacitor which is used to trim the crystal. This Thin-Trim capacitor is one of our 9410 series, has an adjustable range of 7 to 45 pf., and is .200" x .200" x .050" thick.

The Thin-Trim concept provides a variable device to replace fixed tuning techniques and cut-and-try methods of adjustment. Thin-Trim capacitors are available in a variety of lead configurations making them easy to mount.

A smaller version of the 9410 is the 9402 series with a maximum capacitance value of 25 pf. These are perfect for applications in sub-miniature circuits such as ladies' electronic wrist watches and phased array MIC's.

Johanson Manufacturing Corporation
Rockaway Valley Road
Boonton, New Jersey 07005
(201) 334-2676 TWX 710-987-8367

Meetings

9th Annual Connector Symposium, Electronic Connector Study Group Inc. (Camden, N.J.), Hyatt House Hotel, Cherry Hill, N.J., Oct. 20-21.

California Circuits Association Fall Symposium, CCA (Palo Alto, Calif.), Marriott Hotel, Santa Clara, Calif., Oct. 20-21.

Annual GIDEP Workshop, Government-Industry Data Exchange Program, Sheraton Hotel, Hartford, Conn. Oct. 20-22.

1976 Symposium on Nuclear Power Systems, IEEE, Braniff Place Hotel, New Orleans, Oct. 20-22.

1976 IEEE Canadian Conference on Communications and Power, IEEE, Queen Elizabeth Hotel, Montreal, Oct. 21-22.

Info/Expo '76, Data Processing Management Ass'n., Las Vegas Hilton, Las Vegas, Oct. 24-27.

Second International Congress On Technology Assessment, International Society for Technology Assessment, University of Michigan, Ann Arbor, Oct. 24-28.

1976 Joint Fall Meeting of American Ceramic Society's Electronics, Basic Science, and Nuclear Divisions, American Ceramic Society (Columbus, Ohio), Hotel St. Francis, San Francisco, Oct. 31-Nov. 3.

Engineering in Medicine and Biology, IEEE, Sheraton Hotel, Boston, Nov. 6-10.

Joint Conference on Pattern Recognition, IEEE et al., Del Coronado Hotel, Coronado, Calif., Nov. 8-11.

Photovoltaic Specialists Conference, IEEE, Hilton-Corporate Square, Baton Rouge, La., Nov. 15-18.

Computer Networks: Trends and Applications, IEEE, National Bureau of Standards, Gaithersburg, Md., Nov. 17.

The Ansley "D" Connector...

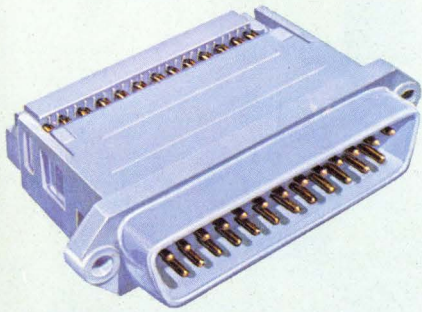

Our new series of male and female "D" connectors offer you a cost effective external mass termination cable and connector system second to none. Its uniqueness begins with a one-piece "D" connector package that meets industry standards for size, pin spacing, and contact reliability. With no loose parts to match up, positive cable-to-contact alignment is assured. Conductors are mass terminated in seconds with our standard BLUE MACS™ hand or bench tools. The results? Faster installation, higher reliability.

Contact pins are spaced on .0545" centers — a perfect fit for any standard inter-cabinet "D" type connector application. Our new "D" connectors are designed to mate with standard .050" pitch flat cable as well as our new, improved jacketed cable — the only flexible flat cable engineered specifically for out-of-cabinet use.

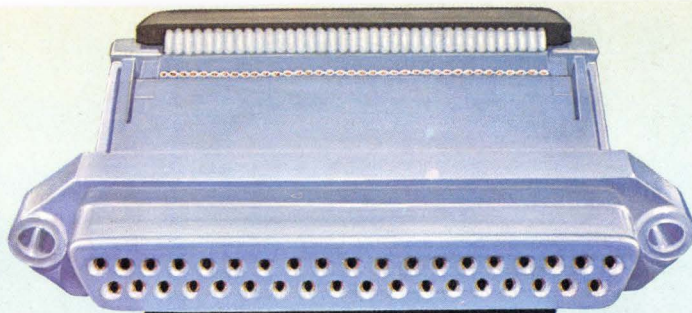

a new meaning to cost effectiveness.



The Ansley BLUE MACS™ jacketed cable is U.L. listed for external interconnection of electronic equipment. Electrically, it outperforms standard jacketed twisted pairs in typical I/O applications. And there's no special zipper lock tubing required — reducing the need for an extra cable accessory. Installation is faster, easier. And like all Ansley connectors, you can daisy chain our "D" types anywhere in the cable — along with our DIP socket, card edge, or pc board connectors.

Cable alignment and high contact reliability is assured — because both cable and connector are grooved for absolute alignment. Our patented TULIP™ 4-point insulation-displacing contacts are permanently fixed and sealed-in to provide a reliable, gas-tight, corrosion-free mass termination.

For the full reliability/cost effectiveness story and technical data, call or write:

T&B/Ansley

The mass termination company.

**T&B/Ansley Corporation • Subsidiary
of Thomas & Betts Corporation**
3208 Humboldt St. • Los Angeles, CA
90031 • Tel. (213) 223-2331 •
TWX 910-321-3938

**Available through authorized
Ansley distributors**

In Canada: T&B/Ansley, Ltd.
700 Thomas Ave.,
Industrial Park
Iberville, P.Q.

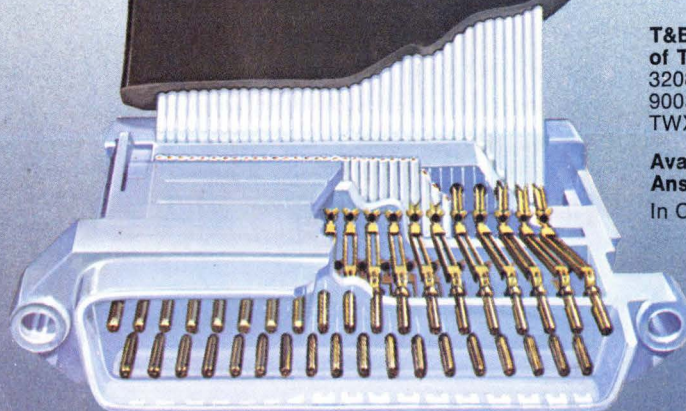

25-bit words:

Biomation's 16+8+1 answer to μ Processor analysis.

The first microprocessor analyzer that really analyzes.

Biomation has developed a new instrument to solve a new problem: How to get inside the mind of your microprocessor. The instrument is our 168-D. The Mind Reader.

In the process, we've invented a new word. 25 bits long. Contains 16 bits of address, 8 bits of data, and one bit that tells you whether your machine is reading or writing. All in hex characters, just like your program listing.

The Mind Reader starts by capturing up to 256 of those 25-bit words at synchronous rates as fast as 10MHz. That's fast enough for anybody. You can dial in a hardware breakpoint and step your system through its program. Or you can monitor your system as it runs free. But that's just the beginning. Now watch:



... the Big Picture

The Mind Reader takes a first bite out of the territory you're investigating. 256 big words. In Memory Mode you can see the areas of memory where the action occurred. (You're writing into ROM, or heaven's sake!?)

When zoom in!

The 168-D gives you a movable cursor that locks onto a location and stays with it through the analysis modes. Once you spot the action you've been looking for, stake it out with the cursor and switch to Page Mode. That gives you the address, data, and read/write information.

Now: A whole new perspective . . .

You've found the program, now switch to Sequential Mode and find out **how it got there**. Where were you coming from, and where did you go from there? Study all time relationships. A powerful new way to analyze the problem!

By switching to the List Mode you display the twenty words surrounding the cursor location you selected in the Page Mode. Address and data are presented in hex along with the R/W bit to let you compare the sequence to your program listing.

In summary: The 168-D lets you record with respect to time and analyze with respect to location.

It's the first microprocessor analyzer that really analyzes. You can put it to work today on **8080A** and **6800** problems. Personality modules for other μP 's are currently under development.

So if you're working with microprocessors and want to know whether your software or hardware is giving you problems, Biomation's 168-D Mind Reader will tell all: What happened . . . where . . . and when. You've got to get the data sheet. Circle the number below. Better yet, call Biomation for a demo. Biomation, 10411 Bubb Road, Cupertino, CA 95014, (408) 255-9500. TWX: 910-338-0226.

biomation
Creating tools for technology



A resistor for all reasons

Here's a way to cut the daylights out of your fixed resistor inventory. Standardize on our Type CC cermet. It's sized like a ¼-watt but you get performance that ranges from ½-watt at 125°C to ½-watt at 70°C (250 volt max.) Tolerance is 1% over the complete resistance range of 10 ohms to 22.1 megs or 0.5% from 10 ohms to 499K. TCR is as low as ± 50 ppm/°C. The one resistor for all reasons: industrial, RN55C, RN55D and RLR07 needs to 1% and 2% tolerance. We have what you need; our distributors have it when your need is now. Ask for Publication EC33.

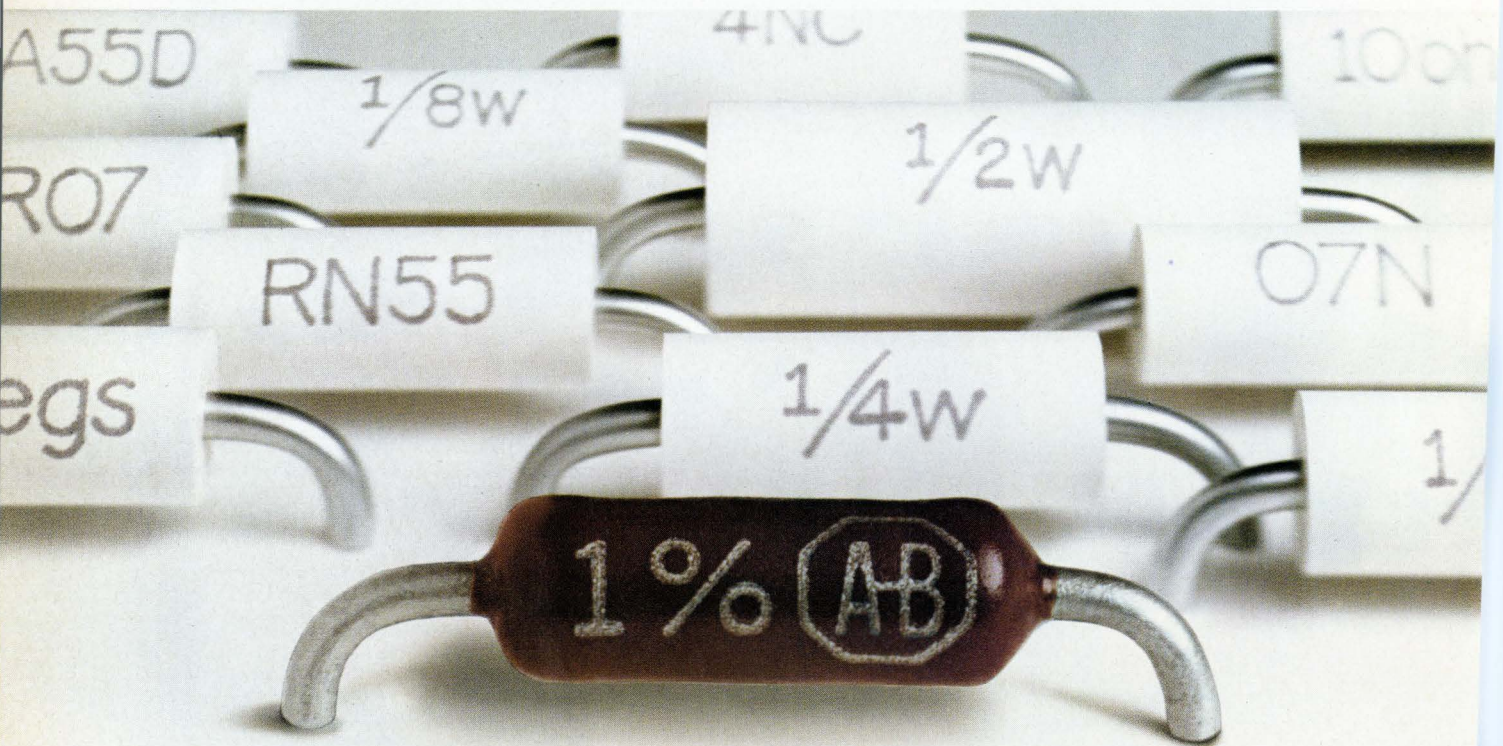
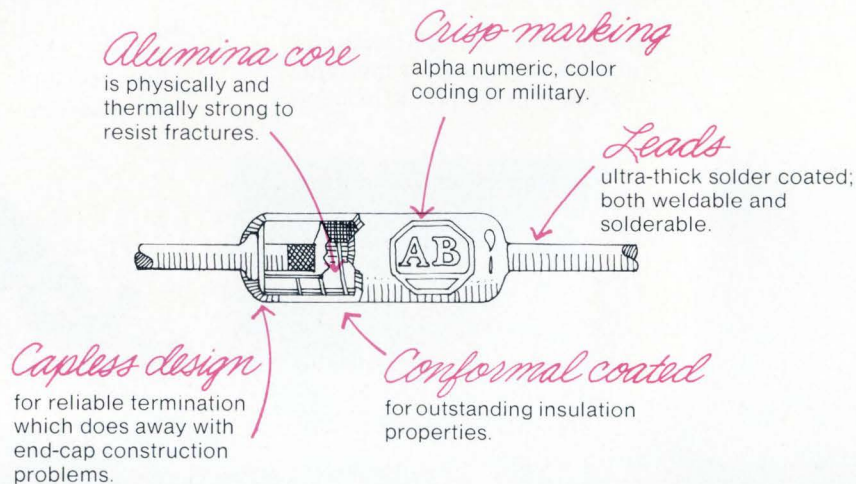

Quality in the best tradition.



ALLEN-BRADLEY
Milwaukee, Wisconsin 53204

EC129

Signetics readies first circuits using multi-level logic

Expect a major announcement from Signetics Corp. by the end of the year concerning the first practical implementation of multi-value, or multi-level logic, until recently considered only a theoretical possibility. Rather than binary logic based on the absence or presence of a signal, **multi-level logic can discriminate between any number of levels.** Thus, a logic system based on multi-levels can be fabricated, increasing information density per given area 4, 8, or 10 times without any substantial changes in present processing. The company's first effort will be a four-value "quad-logic" family (0, 1, 2, 3) compatible with binary logic (0, 1) circuits. Circuits based on octal (8) and decimal (10) logic are being evaluated. Multi-value devices would potentially cost less per gate, but, more important, would provide logic flexibility unattainable with binary systems.

The Signetics development is based on two years of investigation into threshold logic using bipolar techniques like emitter-coupled logic and integrated-injection logic. Similar work is reported being pursued by Texas Instruments, Fairchild Camera & Instrument Corp., and Philips.

TI, N.Y. firm to swap licenses on semiconductors

A small Long Island firm, Standard Microsystems Corp. of Hauppauge, whose president holds a basic MOS patent, is reaping the first fruits of its campaign to benefit. It now has access to the arsenal of semiconductor processes used by Texas Instruments Inc. as a result of its worldwide cross-licensing agreement with TI. The agreement covers each firm's semiconductor technology patents and patent applications **on file or applied for over the next five years.** Principal patents included in the exchange are the basic IC patents issued to Jack Kilby of TI and those dealing with high-density, high-speed n-channel MOS structures, for use in 4-k and 16-k random-access memories and microprocessors, issued to Standard Microsystems president Paul Richman.

The pact with TI, which includes an undisclosed amount of cash to be paid by TI over a four-year period, is part of an overall patent-licensing program under way at Standard Microsystems, says Richman. He declines to identify the other firms with which discussions are being held; however, both Fairchild Camera & Instrument Corp. and Intel Corp. are believed to be vulnerable since both firms have strong n-MOS RAM and microprocessor programs that use the isolated MOS process.

Color CRT display aims at S-3A

Loral Corp.'s Electronic Systems division in Yonkers, N.Y., and Lockheed-California Co. of Burbank, Calif., have developed a color tactical display they are proposing for use in the U.S. Navy's S-3A antisubmarine warfare aircraft. The system is the **first airborne color display to be developed for an antisub plane.** It consists of a beam-penetration cathode-ray tube that uses a multilayer phosphor to produce three colors—red, green, and yellow—with two tones for each, so as to provide six codes for establishing target identification and priorities. Scheduled for flight tests in late 1977, the display also uses a Loral-built 16-bit microprocessor.

Intel to offer digital compandor

Intel Corp. is pushing into a market outside its traditional computer and timepiece sectors: telecommunications. It will soon begin shipping samples of a single-channel companding pulse-code-modulated coder/decoder (codec) system. Where competitors such as Signetics Corp., National

Semiconductor Corp., and American Microsystems Inc. [*Electronics*, April 1, p. 65] prefer a two-chip approach using a mixed bag of digital and analog techniques, a three-man design group under Ted Hoff (credited with early microprocessor concepts), **is pursuing a single-chip, all-digital approach.** The technology will be n-channel MOS versus I^2L at Signetics, bipolar/C-MOS at National, and all-C-MOS at AMI.

TI getting into panel meter market with I^2L chip

Texas Instruments Inc. is preparing an entry into the 3-digit panel meter business with an integrated-injection-logic LSI chip set for market introduction by the end of the year. TI is going in two directions with the basic chip, using it as an a-d converter either for digital panel meter or for microprocessors, depending upon the associated interface circuitry, says H. Dean Toombs, vice president and director of engineering.

Like a proprietary I^2L chip for DPMS developed by Analog Devices Inc. of Norwood, Mass., in conjunction with RCA Corp.'s Solid State division in Somerville, N.J. (see p. 34), the TI chip needs few external parts—a light-emitting-diode display, some transistor digit drivers, and a few capacitors and resistors—to implement a DPM.

Although TI won't comment, it's not difficult to imagine the big semiconductor supplier selling the finished DPM, the way Fairchild Camera & Instrument does, or supplying uncased modules as is National Semiconductor. TI now makes the IC, the displays, and all the rest of the DPM parts as well.

Tests begin on displays for B-1 bomber

The Boeing Co. has begun tests of airborne displays that will show Air Force B-1 bomber crews **computerized images of hostile aircraft** and missile sites, radar sites, or other threat information so that the crew-member operating the defensive subsystem can initiate countermeasures. The 16 displays were developed and delivered to Boeing, the avionics integrator for the Rockwell B-1, by Sanders Associates, Nashua, N.H., under terms of a \$1.2-million contract. There are two types of CRT displays: a unit that graphs threats within a radius of 25 to 200 miles of the bomber and an alphanumeric display that depicts dialogue between the defensive-subsystem operator and the aircraft's computer.

Micros shrink graphic display to desktop size

A programable graphic-display terminal incorporating dual microprocessors to substantially shrink it was unveiled this week by the Computer Graphics division of Sanders Associates, Nashua, N.H. Use of the bipolar microprocessors—one a graphics controller and the other replacing a minicomputer used in earlier Sanders systems—**allows the Graphic 7 to fit on a desk top.** It has all the graphics capabilities of larger Sanders units, however, and will sell for some 25% less than its predecessor, the SA 500. A typical system will consist of the single-box terminal controller, 21-inch CRT display and keyboard, and 8,192 words of 16-bit semiconductor memory. Price is \$32,800.

Sanders engineers chose the bipolar microprocessor for its speed and because the unit, Monolithic Memories Inc.'s 6701 4-bit slice, allows them to use their own instruction set. The Graphic 7 is aimed at a variety of commercial and military applications ranging from computer-aided design to flight simulation and training. It can be connected to any local or remote standard host computer.



Announcing a giant increase in the NOVA line.

Towering above is the new top of the NOVA® line. The NOVA 3/D.

It features a new Memory Management and Protection Unit that lets you do both on-line multitasking and batch operations. Concurrently. For instance, applications that need real-time multi-terminal software and on-going program development.

Plus, the NOVA 3/D features a new, economical, 32K-word MOS memory module. Which is something no other major minimaker has.

All of which makes the NOVA 3/D more NOVA computer, at a lower price, than you've ever seen before.

What's more, the NOVA 3/D also has all the things that have made NOVA the most popular name in minicomputers.

Things like extended NOVA line instructions. Reliable high-speed MOS and economical 16K-word core memory modules.

The single-board CPU design concept Data General pioneered. The same concept that led to our removeable single-board power supply module.

Plus all the other things you've come to expect from a company like Data General.

Things like field-proven, real-time operating systems: our mapped Real-time Disc Operating System, diskette-based Disc Operating System, and our Real-Time Operating System. They're compatible with the entire NOVA line of computers.

Things like high-level FORTRAN IV and FORTRAN 5, as well as easy-to-work-with extended BASIC. Also fully NOVA-line compatible.

Things like the complete and completely-compatible line of Data General peripherals. All you could ever need to put together any system you could ever need. Including 10 to 90 megabyte discs, diskettes, and our new 30 and 60 cps terminal printers.

And when you do business with Data General, you get the kind of total systems support you can only get from a major computer manufacturer. Everything from sales and systems engineering to field service, training, and special systems design.

Write for information on the new NOVA 3/D. Or call your local sales office.

And see what the NOVA line is up to now.

NOVA 3/D

Data General

• Data General, Route 9, Southboro, Mass. 01772, (617) 485-9100. Data General (Canada) Ltd., Ontario. Data General Europe, 15 Rue Le Sueur, Paris 75116, France. Data General Australia, Melbourne (03) 82-1361

NOVA is a registered trademark of Data General Corp.

Circle 27 on reader service card

The 150 volt rectifier that performs like a low voltage Schottky.

If you want to design an efficient higher voltage switching power supply with the low forward voltage drop and fast recovery time you get with Schottky's in 5V supplies, you ought to take a look at our line of 50-100-150V industrial rectifiers.

Unlike the so-called fast-switching (250ns) rectifiers, Unitrode's rectifiers deliver real Schottky-like features:

1. Low forward voltage drop — typically .7V under maximum operation conditions.

2. Fast recovery times — reverse, typically 30ns;

forward, typically 15ns.

3. Low thermal resistance — less than 1.2°C per watt for our DO-4, .8°C for the TO-3, and .6°C for the DO-5.

4. High junction temperature of 175°C maximum.

5. Highest ratings — 25A for the DO-4, 30A

for the TO-3 and 70A for the DO-5.

Best of all, Unitrode's high voltage rectifiers are priced competitively with the less efficient high voltage types.

For complete specs plus an application note on the benefits of speed and low voltage drop for high voltage applications, just call or write: Unitrode Corporation, 580 Pleasant St., Watertown, MA 02172, 617-926-0404.

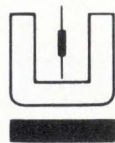
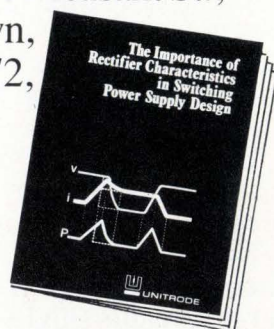

UNITRODE

New computer to compete against IBM's 370/158

Emulation unit built by National Semiconductor will be marketed by Itel Corp and sell for half IBM's price

The IBM 370/158 has acquired a twin and a rival—a large-scale digital computer built by National Semiconductor Corp. The challenger is not only a direct emulation of the 370/158 but runs on IBM's own software.

The machine is being marketed by Itel Corp., San Francisco, which has been leasing to end users IBM central processor units as well as IBM and non-IBM add-on memories and plug-compatible peripherals.

Heretofore, only Amdahl Corp. has cashed in on the existing 370-series software with its System 470 V/6 computing system, a higher-performance replacement for the top-of-the line 370/168 [*Electronics*, Nov. 28, 1974, p. 39]. National/Itel's 158 also achieves higher performance—a minimum of 25% improvement in throughput, according to a source at Itel. But it is priced 50% below IBM's 370/158 price, which can range upward from \$2 million. Targets for Itel, are about 1,000 370/158s already in place and the others to come.

Microprogramed. The 158 emulation uses a microprogramming technique developed originally by Digital Scientific Corp. of San Diego, Calif. In 1970, Digital introduced the Meta 4, a microprogramed 16-bit processor emulating IBM's 1130 and 1800 system. Since then it has been developing several computers to re-

place more advanced IBM systems. For example, it had a working prototype of a 370/145 central processing unit, which never reached the production stage.

Work on the 370/158 emulation began as an in-house development at Digital Scientific about two years ago. National bought rights to the machine in December 1975. It funded a development group in San Diego under the name Exsysco, which now has been absorbed as a subsidiary.

The first full operational prototype system was qualified about a month ago. It is reported that Itel has ordered at least 25 of the machines, which rely in part on high-speed Schottky transistor-transistor logic. National expects to deliver the first machine by January.

A large part of Itel's business is in package leasing, in which it leases an entire system to an end user. It is believed that Itel will offer the National machine on the same basis. The firm already markets several of National's add-on memory systems to IBM end users, as well as disk and tape products manufactured by inde-

pendent plug-compatible suppliers.

Thus, this move by Itel appears to be a logical step for a company with an existing end-user marketing organization already selling IBM replacement products. It might be easier for Itel than for others to convince potential users to relinquish the "security blanket" of buying IBM. Of course, it will have to convince the user that its service and maintenance organization will be as responsive as IBM's.

Reorganization. In a parallel move, National is re-organizing its Memory Systems and Microcomputer Systems groups to reflect this new venture. Memory Systems' general manager Dave Martin, will head a new Computer Systems group, which includes add-on and original-equipment memory systems, the Exsysco effort, and small computer systems. The last of these incorporate the microcomputer-card-and-systems effort previously under William Baker, general manager of the Microcomputer Systems' group, which will now concentrate on development and production of microcomputer components. □

Commercial

California tests set for next year of Aerospace Corp. anti-hijack system

The Law Enforcement Assistance Administration believes it has an electronic deterrent to truck hijackers and cargo thieves. The effectiveness of the package will be determined next year when its developer, Aerospace Corp., begins an

\$800,000 year-long field study in metropolitan Los Angeles using 40 trucks travelling over a 400-square mile area. The company put together the security system over 3½ years under an \$815,000 contract.

According to LEAA estimates,

cargo thefts run at an annual rate of \$1.5 billion, most of it in trucking. An Aerospace survey shows that, on the average, the loss per truck engaged in urban pickup and delivery runs to \$1,950 a year. Thus, for it to be economically attractive, Aerospace concludes its system should not cost more than \$1,000 per truck each year.

"Two separate technologies will be tested in the upcoming program," explains Robert Kennel of Aerospace's Washington office which is managing the program for LEAA. One system employs an amplitude-modulated phase-lock technique that measures changes in position. The other is an "electronic signpost" system that provides absolute position. According to Kennel, one system can be employed to backstop the other. But the user's choice will depend upon the geography of the area where it is used.

Radio stations. The phase-lock technique relies on three commercial a-m radio stations whose normal broadcasting frequencies have been synchronized via high-precision frequency-control units. Thus, signals from the three stations in Los Angeles, KFI, KNX and KPOL, "create a stable hyperbolic electronic navigational grid across the city," says Lester Shubin, development program manager for LEAA's National Institute for Law Enforcement and Criminal Justice in Washington. This is much like the master-slave stations of a Loran system. "As a vehicle moves across the city, its transceiver picks up the a-m signals from the three stations, compares phase differences and relays the comparison back to a base-station computer. The computer, in turn, matches the information to the pre-stored (hyperbolic) grid for an accurate determination of the truck's location."

However, because the phase-lock system does not measure absolute position, and radio contact may be lost from time to time as a vehicle passes through a tunnel or under high-tension wires, the signpost system is added to update position. It consists of small transmitters

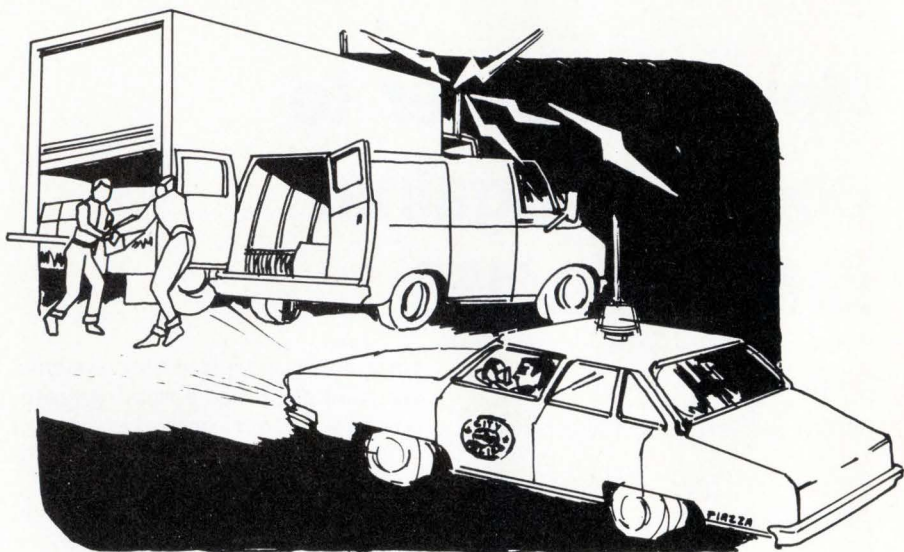

mounted, like signposts, on utility poles along the truck routes. Each transmitter, which Kennel says costs \$150-\$200, radiates a unique identification code over a limited area. As a truck passes, its receiver picks up the coded transmission and retransmits it to a base station.

"The (base station) monitor can tell that the truck just passed the intersection of, say, Fifth and Jones streets," Shubin explains. "If the truck were to be hijacked and go off-route, the monitor would soon pick it up."

Sensors. A computer at the base station processes the data and interprets truck location, displaying information on a cathode-ray-tube terminal. It also monitors sensors built into the truck for determining such things as whether the driver's seat is occupied, when a door is opened, or whether someone is in the cargo compartment. There's also a

foot-operated alarm that can be covertly operated, and a magnetic movement sensor to signal if the vehicle moves.

Somewhere between 300 and 600 signpost transmitters will be used in the upcoming tests, Kennel says. The exact number has yet to be worked out. In an earlier pilot test completed in Los Angeles in June involving six trucks and 25 square miles, 331 transmitters were used, placed about 1,000 ft. apart. But it was found the area could be covered with transmitters much further apart.

Aerospace's Kennel believes that the a-m phase-lock approach will probably be preferable "because it is cheaper" than the signpost alternative. Phase lock "is accurate within 600 ft. and works 95% of the time," he says, which is good enough. He expects contract awards for the hardware and upcoming tests will be made in two months. □

Consumer

Small \$39.95 solar-cell power package provides current for consumer electronics

So far, the public has met solar cells mainly in novelty items—executive toys and expensive digital watches. But the cells could turn up in portable radios and calculators, too,

now that a small Chicago-area firm is marketing a low-cost photovoltaic power system that not only converts solar energy to electricity but stores it as well.

"It can be used to power anything that runs on three or four dry-cell batteries," says Ronald W. Ignatius, president of M7 International Inc., Arlington Heights, Ill. The unit, called the Sun Tap 1 and priced at \$39.95, consists of a 3 1/4-inch-square panel of silicon solar cells, four rechargeable nickel-cadmium batteries from Gould Inc.'s Burgess division, and a power cord with a multiple-jack adapter for plugging into the battery or dc power jacks on small portable electronic gear. In full sun, it will produce 6 volts at 50 to 60 milliamperes—more than enough power to charge the battery pack, which requires at least 1.4 v and slightly over 10 mA per cell to charge.

When used simply as a charger, the system will easily pay for itself in batteries, Ignatius claims, pointing out that the ni-cads can take 500 charges each, the equivalent of 2,000 1.5-v AAA batteries. Moreover, the shirt-pocket-sized solar panel—it's only 3/8-inches thick—can be disconnected from the battery pack and used to drive consumer electronics gear directly. "At open circuit [minimum current conditions], the solar array will put out 10.25 v," Ignatius says, "and most high-quality 12-v radios will operate on 9 1/2 v."

Portable equipment that requires higher current levels, such as calculators with light-emitting-diode or gas-discharge displays, tape recorders, and camera flash equipment, need the 2 ampere-hours that a fully charged battery pack is able to provide.

ERDA cells. M7 builds the panel from the same 2 1/4-inch silicon wafers that it processes into solar cells for the Federal Government's Energy Research and Development Administration. Each is scribed and broken into tenths, and each tenth delivers more than 50 mA at 0.4 v. Eighteen of the segments are wired in series: 15 are needed to get the output up to 6 v, another is used to compensate for the 0.3 v drop across the blocking diode that keeps the batteries from discharging through the panel when there is no light, and

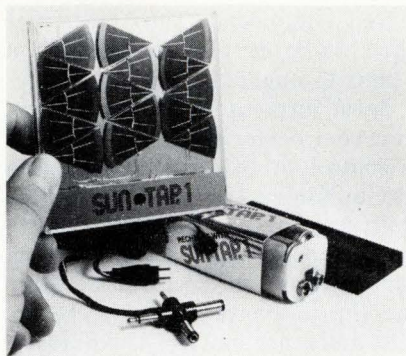

Solar power. Multiple-jack adapter plugs M-7's solar cell power pack into variety of gear. Two-pronged plug in middle of power cord is used to reverse polarity of output.

two are added for margin.

"It's that margin that takes care of the solar cell's temperature problem (output decreases as temperature rises) as well as days that we don't see full sun," Ignatius says. It also gives the panel the extra power to run 12-v radios. □

Audio IR headsets do well in Germany

Ever since infrared systems for transmitting sound beams from a television receiver to a headset were first demonstrated two years ago, there's been much speculation in

West Germany over other applications for this wireless sound-transmission technique. Now that more than 100,000 infrared headsets have been sold in West Germany since they went to market last summer, new consumer applications are already coming to the fore—sooner than most observers had expected.

Of this trend, there was plenty of evidence at the Photokina 1976 photographic-equipment show in Cologne and at the Hifi 76 audio-equipment exhibition in Dusseldorf held earlier this month. At Hifi 76, headsets for picking up stereo sound-modulated IR signals from audio equipment were introduced by several German producers, including AKG GmbH, Munich, and Eugen Beyer, Heilbronn. These headsets are expected to sell as well as did the monophonic types for reception of TV sounds after their market debut last year.

Private sound. Behind such optimism are, first of all, the advantages that wireless sound reception provides. Without any cables to bother them, listeners may walk freely about a large room without missing a sound because the IR rays reflect from every surface and spread throughout the room. Further, the headset wearer can listen to a program without disturbing other people in the room.

Besides such selling points, a big

Infrared audio a lead balloon in U.S.

Television and audio equipment makers in the United States have been thoroughly unenthusiastic about using infrared devices for wireless sound transmission. To date, no producer has given IR a tumble, although there has been some laboratory work.

In May 1973, Zenith Radio Corp. demonstrated Concept 4X, which was a futuristic four-channel stereo unit that featured infrared wireless transmission. The two front speakers were wired to the audio amplifier and in turn transmitted IR signals that drove the two rear speakers. The firm has since put Concept 4X on the back burner.

Looking to sell infrared diodes for consumer products, Texas Instruments this spring showed a possible IR earphone design that could be adapted by an original-equipment manufacturer. But it has not attracted much real interest. In addition, U.S. television makers have just about ignored IR for remote-control tuning, preferring to go along with ultrasonic transmission.

The main reason for this lack of interest is the cost. Price is much more of a factor in the U.S. market than in West Germany, and manufacturers here have tended to stay with the well-accepted and lower-cost wired audio headphones and ultrasound TV remote controllers.

The new Airpax process monitor combines digital readout with analog setpoints.

Only from Airpax

Choosing the type of instrument you need is as simple as a flick of the pen. The Airpax '78 Digital Process Monitor can be ordered as a Tachometer, an accumulator, a timer, or a ratio monitor.

Large, bright display

Clearer, brighter, and half again as large as the LED's used in our other instruments. You choose the number of digits and decimal point locations.

Fast analog setpoints

for the overspeed/underspeed protection of speed-sensitive machinery. Or, select precise digital setpoints. Or, a combination of analog and digital setpoints. The choice is yours.

More versatile

than anything else on the market today. You choose the signal inputs, the number and type of setpoints, output, and power. Installation is as simple as slide-in-and-hook-up.

Price?

Depends on the options you choose, but for a four digit tachometer with fixed gate time, plan on about \$335, OEM quantity one. Want all the guns? A five digit tachometer with adjustable gate time, two analog out-puts and two adjustable digital setpoints, about \$790.

Circle our number on the Reader Service Card and we'll send you the full story, along with a model map that makes it easy to choose the specs that make the '78 right for your application. Whatever you choose, we can ship it in three to four weeks.

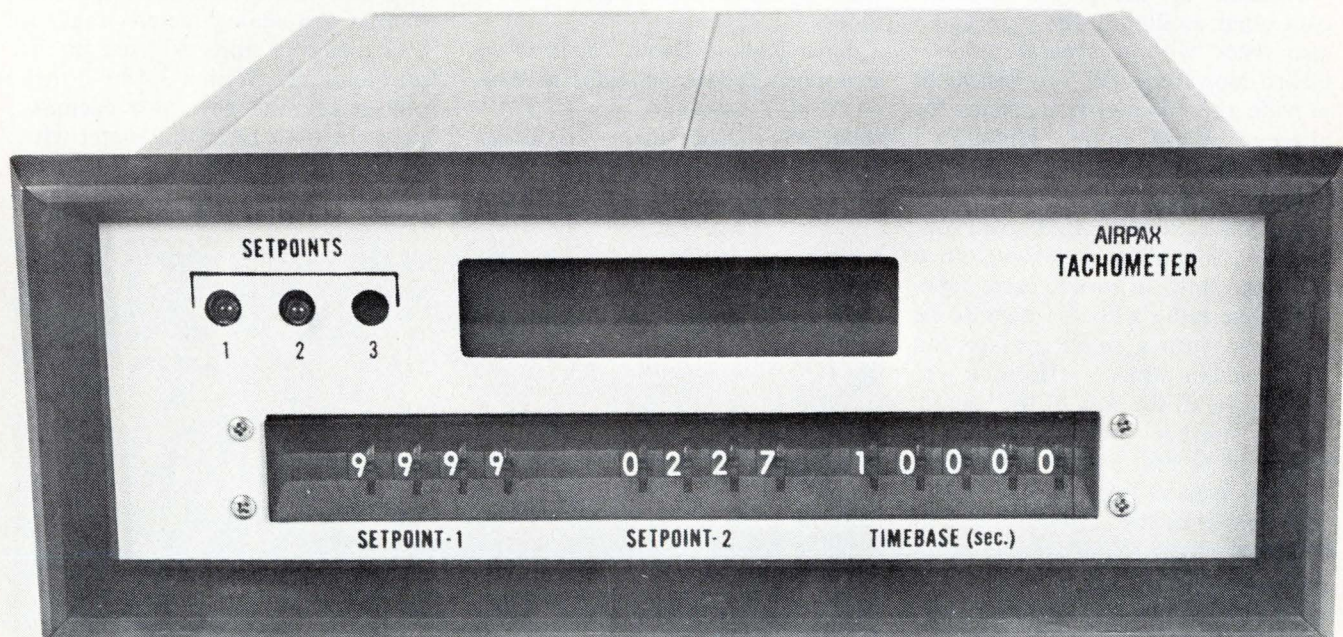

AIRPAX

Controls Division 6801 W. Sunrise Boulevard, Fort Lauderdale, Florida 33313 (305) 587-1100

watches has more than enough empty space to include our chip plus the needed tuned elements that can be put into hybrid form," he asserts. The transmitter draws about 40 milliamperes of current and provides upwards of 60 milliwatts of radio-frequency power. In the squelched mode, the receiver draws only 1.5 mA.

The transceiver chip, the LP 2700, contains separate transmitter and receiver circuitry as well as the transmit/receive logic circuits. It also has the circuitry for the two crystal-controlled oscillators. Standard bipolar technology is used for all circuits. However, the receiver design incorporates a unique automatic-gain-control amplifier that puts a lot of gain in a small space yet assures a wide dynamic range.

Op amp. The AGC is built around an operational amplifier in which the dynamic range of the AGC is equal to the open-loop gain of the amplifier—about 100 decibels. The closed-loop feedback of the circuit drops the gain to unity to prevent distortion on strong received signals—often a problem with conventional AGC.

Instead of using the crystal-controlled oscillator, the chip could also work with a separate phase-locked-loop frequency synthesizer to provide the channel frequencies for citizens' band radio, Hirschfeld points out.

Producing a practical wrist transceiver will take more than just dropping the chip, along with some tuned elements, into a watch case, however. The radio will also have to be fitted out with a small speaker and an antenna that's efficient yet doesn't get in the way of the user.

The speaker problem could be solved in several ways. "We could use the plastic front of the watch case as part of the transducer mechanism or let the sound radiate out of the side edges of the case using an electromagnetic transducer," says Hirschfeld. "Or we could build the transducer into the wristband."

A suitable antenna is more difficult. One approach that seems promising, says Hirschfeld, embeds an antenna wire in a plastic wristband.

But the wrist radio is not just around the corner. Hirschfeld has no plans for Lithic to engineer such a radio itself. But if anyone else wants to try to put it together . . . □

Instruments

I^2L creates \$39 digital panel meter

Is there finally a low-cost digital alternative to instrument-grade analog panel meters? Maybe so, with the new 3-digit, low-power digital panel meter being put on the market for \$39 (in 100-piece quantities) by the Instruments and Systems group of Analog Devices Inc. in Norwood, Mass.

Designated the AD2026, the DPM is built around a single custom integrated-injection-logic chip developed in conjunction with RCA Corp.'s Solid State division in Somerville, N.J. All told, the large-scale-integrated chip helps reduce the electrical parts count to 14. The display uses half-inch-high light-emitting diodes.

Says Robert Boole, modular instruments product director at Ana-

Meter chip. Using I^2L with conventional linear processing packs an entire three-digit digital voltmeter into a single silicon chip.

log Devices, "[The DPM] was designed from the outset to achieve two specific goals: a price that would convert analog-meter users to digital meters for precision measurement instruments, and reliability consistent with the experience of analog-meter users."

Original equipment. Analog Devices is targeting the AD2026 for use in original equipment such as medical and analytical instruments and those used to measure process variables such as temperature, flow, pressure and strain. These markets use about 2 million analog units annually and "\$65 DPMs don't make sense," Boole says. He believes the new digital panel meter could "quickly attract upwards of 10% of the estimated \$50 million market" for instrument-grade \$10–30 analog meters "because of other advantages of the digital meter"—for instance, its 0.1% accuracy, compared with the 2% of its analog competitors, its equal or better resolution, and its direct-reading display and smaller size.

Further, the DPM can be scaled with a simple resistive divider to read out in any engineering units, whereas the analog meter's readout in engineering units is fixed on its front template. With a 3.4-by-2-inch front panel, the new DPM occupies less space than an analog meter with a typical 3.5-inch scale. And the DPM's depth—only 0.7 inch—is

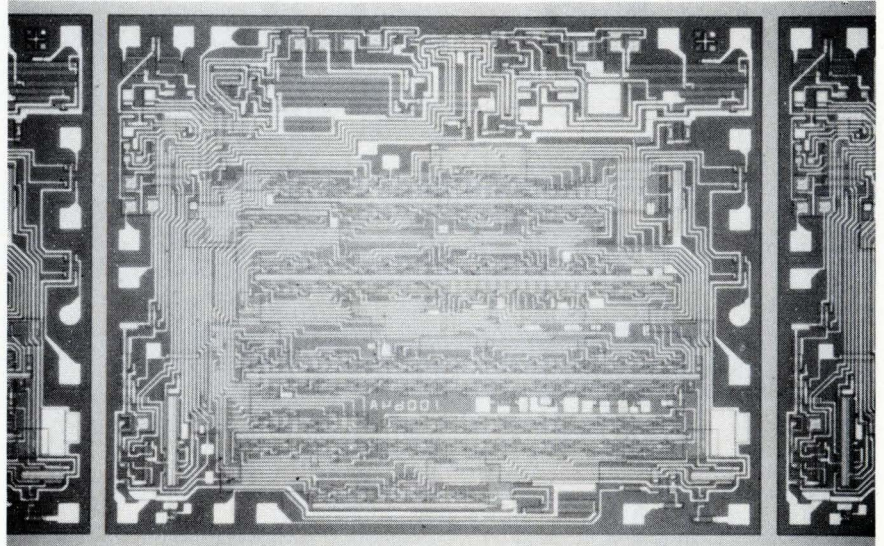

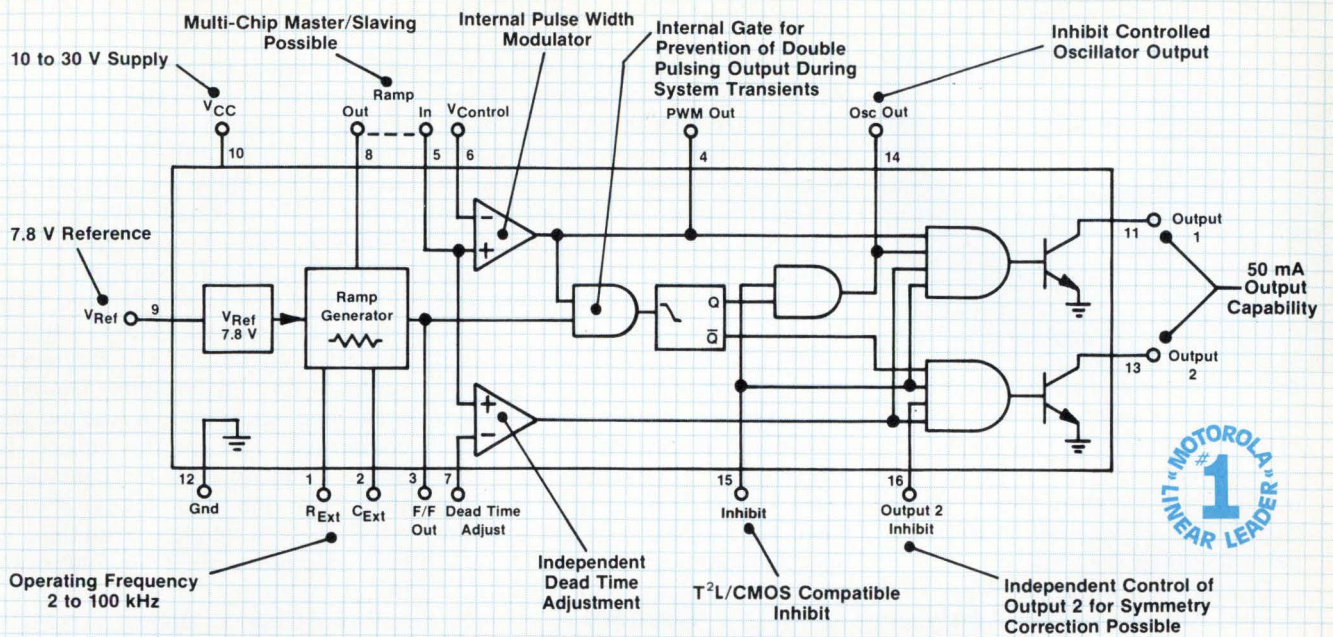

If switching regulator control is all work and no play, boy, do we have news for you.

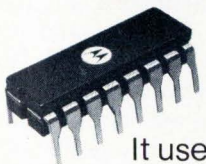

MC3420 Switchmode* Regulator Control

It used to be a dull, tedious job putting together reference, oscillator, PWM, phase-splitter and dual alternating outputs from numerous components to form a regulator control circuit. Not to mention hours of design time.

The MC3420 Switchmode regulator control circuit has changed all that.

Now all you do is plug it in and you've got all the functions needed to regulate the simplest to the most complex constant frequency

switching power supply.

It's virtually all things to all designs.

- It has a power supply voltage range of 10V to 30V.
- It's capable of 2 to 100 kHz operation and can be slaved to others like itself for synchronization.
- Its 0 to 100% dead-time comparator is unique.
- Its outputs are open-collector type with a saturation voltage of 0.5V @ 40mA and can block 40V.
- It features an inhibit input and has options for

independent control of one output for implementing a symmetry correction control loop.

Best of all, it's priced at just \$5.75 (100 up), a pittance compared to what it cost in parts and time before.

Now it's so easy and simple to control single and double-ended supplies, transformer-coupled dc-to-dc converters, transformerless voltage doublers and polarity converters et al you'll wonder what happened to all the hard work. We did it for you.



*Trademark Motorola Inc.

Motorola Semiconductor Products Inc., Box 20912, Phoenix, Arizona 85036

MOTOROLA Semiconductors

—and you thought we were just a production house

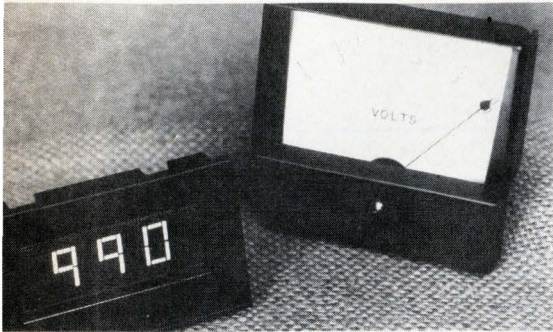

DPM. At \$39 in quantity, three-digit panel meter from Analog Devices is going after the instrument-grade analog meter market.

much less. It weighs under 2 ounces, works from a 5-volt source and dissipates less than 0.75 watt.

Density advantage. Why i^2L ? While Analog Devices' designers could surely have used standard complementary metal-oxide-semiconductor technology for the digital side of the chip's converter, they turned to the more speculative i^2L approach because it offers three times the density of C-MOS (total chip size is slightly over 10,000 mil^2). It also offers the opportunity to use the same linear bipolar process in the digital as in the analog portion which includes the voltage current converter, current source, and comparator, explains Lew Smith, the senior engineer responsible for the project.

Injection logic also has the lowest speed-power product of any circuit technique—three times lower than standard C-MOS—so that, for the same speed, it's possible to operate the converter portion of the chip at a third of the power dissipation.

Analog Devices is not alone in choosing i^2L for its DPMS. Texas Instruments, Fairchild Semiconductor, Motorola, National Semiconductor, Signetics and RCA are all evaluating it for DPMS, sometimes in competition with a C-MOS effort. Siliconix, on the other hand, has chosen the C-MOS route for its new 3-digit panel meter chip.

Mass-produced. Because of its small parts count, the Analog Devices meter can be mass-produced from start to finish. Production flow starts when 15 separate printed-circuit patterns are plated onto a 12-

by-12-inch glass-epoxy circuit board called a pallet. Components for all 15 DPMS are then inserted automatically on a high-speed assembly line. After wave soldering, the pallet of DPM boards move to a testing station where each DPM is subjected to 32 in-circuit and 50 functional tests. The same test station also runs 216 tests on the i^2L chip.

After testing, the 15 DPMS on the pallet undergo a 168-hour burn-in. Then the pc boards are removed individually from the pallet board and snapped into mounts in a special case. Analog Devices calculates the mean time between failure at more than 250,000 hours. □

Careers

EMC to continue demand forecasts

Despite criticism that its studies of manpower demand actually contribute to an oversupply of engineers, the Engineering Manpower Commission seems determined to disseminate data that, by its own admission, have limited validity. The EMC, the research arm of the Engineers Joint Council that is supported by 36 professional societies, at its latest meeting turned back all proposals to discontinue its demand projections or to modify its method of making them public.

About two-thirds of EMC's 41 members had met to hear an interim report assessing various demand surveys from its *ad hoc* committee on supply and demand. The committee was formed initially to investigate charges by the National Society of Professional Engineers that the studies endanger engineering careers [*Electronics*, March 4, p. 67]. The report was to have been an informal response to the charges and to serve as a guide in determining the limitations of demand surveys [*Electronics*, Sept. 16, p. 75].

Delay. However, not only did the EMC overwhelmingly turn down motions calling for it to stop making supply and demand forecasts, but it

also declined to postpone making projections until a valid model was developed. And it put off making a formal report until next month's meeting. The delay was attributed to illness and workload of committee members, but it was viewed by critics as further foot-dragging.

"EMC is still in the demand business," says David Reyes-Guerra, executive director of the Engineers' Council for Professional Development and chairman of the *ad hoc* committee. The interim report, he notes, came up with the conclusion that "no one can really project demand. The models available, at best, provide a 1-2 year accurate predictive value."

Reyes-Guerra, taking a middle ground in the controversy, says the problem with demand studies is that "people who know little about their caveats are using them as guides. Publishing demand data whose rationale is not known is something we just don't want to do."

Grumman Aerospace Corp.'s Art Gilmore, EMC's chairman, says: "Although there are lots of models around, all of them are highly controversial. We aren't confident that any validated model could be developed in a reasonable time. But that doesn't mean we can't print what people from a couple of hundred manufacturers indicate as to how many they intend to hire over a period of time."

However, the group has decided to review its policy on demand studies. But for now, Gilmore adds, "EMC is still free to do studies of demand information that is completely qualified." That qualifier, he says, is being worked on and will be in a policy statement due at a Nov. 16 meeting.

Criticism. Robert A. Rivers, president of Aircom Inc. of Union, N.H., and an IEEE representative to the EMC, criticizes the rejection of his proposals to get out of the forecasting business. "This indicates a complete disregard on their part for the need to stop promoting engineering enrollments and the tremendous opportunities in engineering."

EMC's interim report indicates that

For the record.

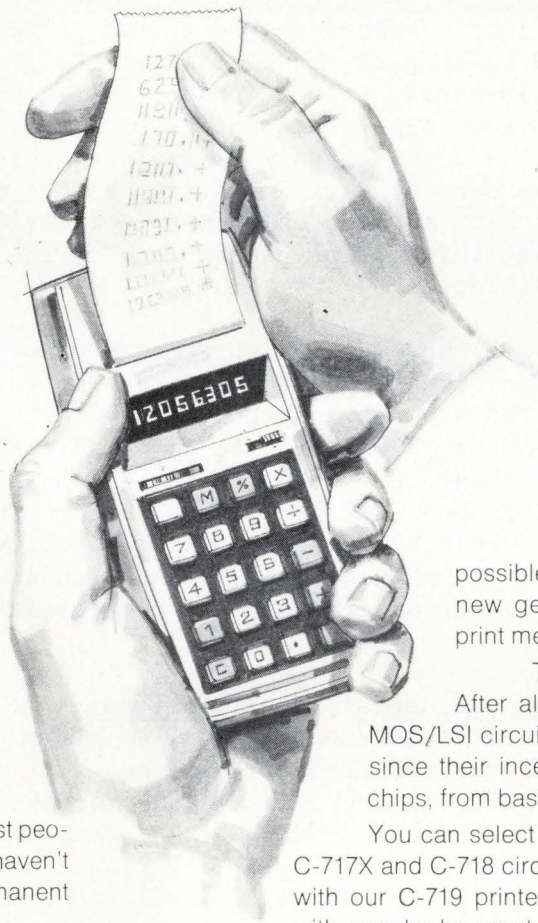

Hand-held calculators have become standard tools for the busy businessman, investor, accountant, engineer, shopper—for everyone. No wonder they're so popular.

But there's one limitation. The "display only" machines provide no record of your entries and the results. Try adding up a column of figures. Most people have to do it twice to be sure they haven't hit a wrong key. And—there is no permanent record for the files.

Not so with a hand-held printing calculator. It prints figures as you calculate. For the record. Yet these new calculators—complete with printout—can fit in the palm of your hand.

For the record, too, General Instrument microelectronic circuits are making the printing calculator revolution

possible. Our chips are compatible with the new generation of low-cost miniaturized print mechanisms.

This shouldn't come as a surprise. After all, GI has been a major supplier of MOS/LSI circuits for hand-held display calculators since their inception. We make a whole range of chips, from basic to scientific. In depth.

You can select the 8-digit C-716, or 12-digit C-717, C-717X and C-718 circuits. Or you can even add a display with our C-719 printer-display interface circuit. All work with popular low cost print mechanisms.

Any way you figure it, General Instrument Microelectronics is the place to come for all kinds of calculator chips. Especially, the kind that help people figure for the record. Write or call General Instrument Microelectronics, 600 West John Street, Hicksville, New York 11802, Tel: (516) 733-3107.

We help you compete.

**GENERAL INSTRUMENT CORPORATION
MICROELECTRONICS**



SCIENCE/SCOPE

U.S. Air Force F-15 Eagle fighters recently downed two simulated MIG-25 Foxbats in tests at Eglin AFB, Fla. Equipped with Hughes APG-63 radar, the McDonnell-Douglas-built Eagles took on jet drones simulating the high-performance MIGs. The first Eagle launched a Sparrow missile with a dummy warhead at a drone moving at Mach 2.7 at 71,000 feet. The missile passed within lethal range of the target. The second Eagle, with live missiles, found and destroyed the mock MIG-25 at 68,000 feet and Mach 2.7.

A precision Ground Laser Locator Designator, for guiding laser-homing missiles like Maverick and Hellfire or cannon-launched guided projectiles to their targets, is undergoing field testing at the U.S. Army's Redstone Arsenal. GLLD (pronounced "glid") is a 50-pound, tripod-mounted device built by Hughes for use by ground troops. It combines high-power optics with a viscous-fluid-damped tracking unit, providing the accuracy to work against rapidly moving distant targets. GLLD emits a narrow beam of invisible light to the target. The guided missile senses the reflected beam and thereby homes unerringly on the target for a direct hit. Range and beam information can be sent to the artillery battery for use with conventional artillery.

For the first time, NASA will have direct correlated measurements of Venus's atmosphere as a result of the Pioneer-Venus twin missions in 1978. The program will use two spacecraft, the Orbiter and the Multiprobe. Data from the Multiprobe, to be launched in August 1978, will be compared with measurements taken remotely from instruments aboard the Orbiter, to be launched in May or June 1978. One large and three small probes will be launched before the Multiprobe spacecraft enters Venus's hot, dense atmosphere. Major objective of the mission is a detailed investigation of Venus's atmosphere and clouds. Hughes is designing and building the two spacecraft and integrating the scientific payload for NASA's Ames Research Center.

Hughes needs systems-level engineers: Sonar Systems -- to develop PM/FL at systems and hardware level; to develop/conduct test of advanced sonar systems..... Torpedo systems -- develop overall advanced systems..... Programmers -- design experience in real-time graphic display, sonar data processing, and/or hardware simulations. AN/UYK-20 computers and CMS-2 highly desirable. Requirements: BS or higher degree, U.S. citizenship. Please send resume to: Engineering Employment, Hughes Aircraft Company, P.O. Box 3310, Fullerton, CA 92634. An equal opportunity employer.

New products from Hughes include a traveling-wave tube designed for use in satellite earth terminal transmitters and capable of more than 400 watts of CW RF output power over the frequency range of 5.925 to 6.425 GHz; design and construction of the PPM-focused, metal-ceramic tube is based on Hughes' high-power CW and space-qualified communication tubes..... a new series of mechanically-tuned Gunn-effect oscillators designed to meet requirements as parametric amplifier pumps, local oscillators, and transmitter sources; the new units feature inherently low AM noise characteristics, compactness, and ease of operation; they are factory adjusted to one of eight specific center frequencies in the 18- to 60-GHz range.

Creating a new world with electronics

HUGHES

HUGHES AIRCRAFT COMPANY

News briefs

Crystal growing process tailors materials

Scientists at Bell Telephone Laboratories in Murray Hill, N.J., have successfully used a new crystal-growing process, called molecular beam epitaxy. They believe the process could permit tailor-making materials with specific, built-in electronics, optical and mechanical properties. A new crystalline material—a monolayer crystal—was assembled atomic layer by atomic layer by the process, which allows the chemical composition of each layer to be individually controlled. The synthetic crystal, not found in nature and never before prepared in the laboratory, has the same average composition as crystals used in fabricating light-emitting diodes and tiny lasers now under investigation for future Bell telecommunications systems.

Interactive fiber-optic cable TV to begin tests in Japan

An interactive fiber-optic cable television network will begin two-way tests on November 15 with 300 subscribers near Osaka, Japan. The Optical Video Information System will do such things as answer requests for TV programs and data, send facsimile transmissions, provide computer-assisted instruction, allow for cashless transactions, TV shopping and reservations, and read utility meters automatically. Three Japanese companies involved in the project are Fujitsu Ltd. (control center and digital data interfaces), Sumitomo Electric Industries Ltd. (optical fiber transmission system), and Matsushita Electric Industries Co. (studio equipment and subscriber terminals).

The system comprises three fiber-optic trunk cables, each containing 36 fibers and connecting the head-end facility to a subcenter. The subcenters have a video switch and control equipment and up to 14 distribution cables, each containing 24 optical fibers that will fan out to serve 12 subscribers. The final subscriber drop thus allows for two-way transmission between user and head-end. In addition to homes, fiber-optic cables will be connected to schools, hospitals, and town halls to allow programs that originate at those sites to be transmitted to the head end for further distribution to the subscribers.

CDC wins F-18 standard computer award

Control Data Corp.'s 480 computer has been chosen by the Naval Air Systems command for its standard airborne computer—Stacom—to be known as the AN/AYK-14(V) [*Electronics*, April 1, p. 40]. A \$6.5 million Stacom contract calls for 150 pre-production models, with an option for 350 more, for use as the central computer on the Navy's new F-18 fighter. The selection of a winner from competitors IBM Federal Systems division, Lear Siegler, and initial favorite Sperry Univac was postponed for two months when the office of H. Tyler Marcy, assistant Navy secretary for research and development, ordered Stacom competitors to benchmark their systems against Univac's AN/UYK-20 already in inventory. As winner of the first Stacom competition, CDC stands to have its system picked for use in the antisubmarine helicopter program known as Lamps—for light-airborne multi-purpose system. In addition, Navair could acquire as many as 800 F-18 fighters over the next several years, pushing AN/AYK-14 procurements for that program alone up to 1,600 systems on the basis of two per plane.

long-term models for determining demand shouldn't be used publicly since the future is determined by policy decisions that haven't been made yet. However, Rivers adds, "the majority of the commission seems to want to generate this baloney. The predominant attitude of the group is that they don't want to stop these projections."

One of the supporters of Rivers' proposals, Hans C. Cherney, a personnel administrator at International Business Machines Corp. in Poughkeepsie, N.Y., and vice chairman of the IEEE's U.S. Activities Board, asserts that the vote "highlights exactly what the problem is with EMC and the EJC. They do not represent the interests of the

CABLES, CIRCUITS, CONNECTORS— HUGHES PUTS IT ALL TOGETHER.

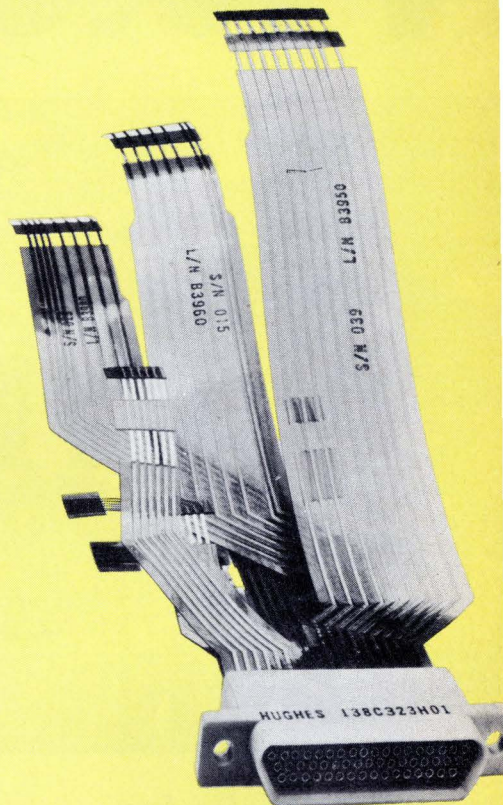

We're the company that has total interconnection capability—in flat cable, flex circuits and connectors. And we've had more experience designing them for high technology applications.

But we do more than design them to work together—we also put them together for you in special assemblies.

So call the people you can count on. Call us. (714) 549-5701. Or write: 17150 Von Karman Avenue, Irvine, CA 92714.

HUGHES
HUGHES AIRCRAFT COMPANY
CONNECTING DEVICES DIV.

FF101A FF101B FF101C



Building blocks for the in-circuit/functional test system you need.

The system you use to test printed-circuit assemblies should be tailored to your specific needs and readily expandable to handle your future requirements. When you specify **FAULTFINDER® FF101** test systems, you have the building blocks you need to do the job.

Think of Faultfinders first for test hardware, software and experience.

WRITE FOR COMPLETE COLOR BROCHURE

Circle 40 on reader service card

FF FAULTFINDERS Inc.
15 AVIS DRIVE, LATHAM, NY 12110 (518) 783-7786

Irvine, CA
Sunnyvale, CA
Park Ridge, IL
Faultfinders GmbH, Eschborn, Germany

Cicero, IN
Waltham, MA

Electronics review

engineering profession. When they voted, it was for the good of the company, educational institution or employment office they work for. They admitted that the information they have is bad, but that they'd rather have bad information than no information at all." □

Solid state

C-MOS voltages range to 150-200 v

Complementary metal-oxide-semiconductor technology, with a number of high-volume applications beckoning, is breaking through its traditional small-signal barrier and entering the high-voltage domain.

Researchers at Stanford University's Electronics Laboratory in Palo Alto, Calif., have developed two separate transistor fabrication techniques that allow construction of high-voltage C-MOS driver and switching circuits with source-to-drain breakdown voltages in the 150-to-200-volt range. Threshold voltages of 5 to 15 v make them compatible with standard low-voltage, low-power C-MOS logic.

What this makes possible, say the researchers James D. Plummer and Gerald A. May, are linear and digital C-MOS circuits that can operate off a rectified 120-v ac line.

The circuits were developed at Stanford for specific biomedical instrumentation applications. But they would be useful in many consumer/industrial time-keeping applications because it would be possible to put on one chip instead of two control functions and driving circuitry for such uses as high-voltage gas-discharge, neon, and fluorescent displays.

In telecommunications applications such as line receivers, transceivers, and digital switching networks, the 150-to-200-v source-to-drain breakdown makes it easier to protect against spurious signals and noise on the line.

By contrast, virtually all commercial C-MOS integrated circuits have source-to-drain breakdowns of about 25 to 30 v, and maximum operating voltage is limited to little more than 20 v. The limit can be pushed to about 40 v by increasing the doping level across the source-drain diffusion or increasing the base width to eliminate parasitics. Threshold voltages increase undesirably with increased doping, and chip area increases with base width.

Bootstrap. To get around these limits, May uses high-voltage p-channel transistors on the same die as 15-v standard C-MOS transistors. In the high-voltage portion, three transistors are fabricated in a totem-pole push-pull configuration. The gate of one device has a large boot-

New realm. Switch in the high-voltage C-MOS structure designed by Stanford's James D. Plummer consists of double-diffused n-channel and one or two p-channel transistors. A quad analog switch array has been built to handle 300 milliamperes at 200 volts.

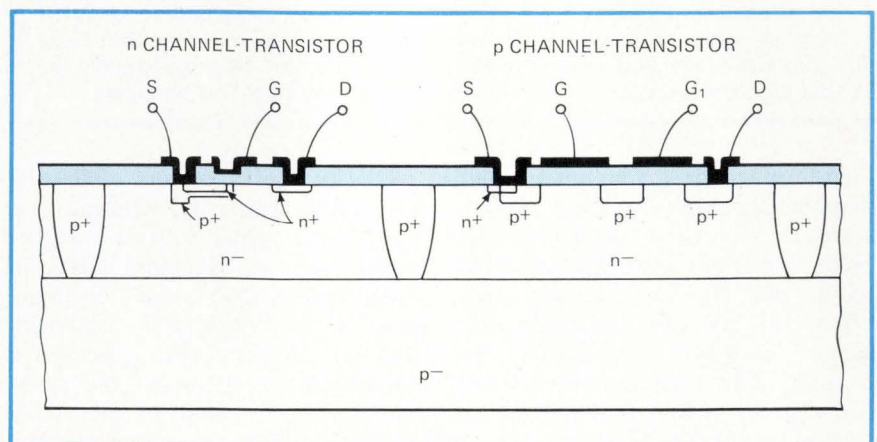

How to get a lot more into a lot less.

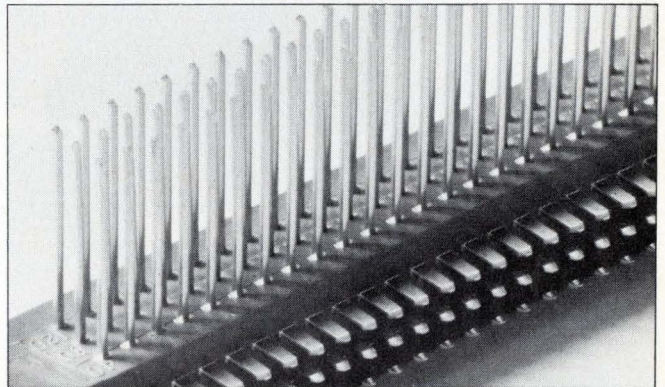
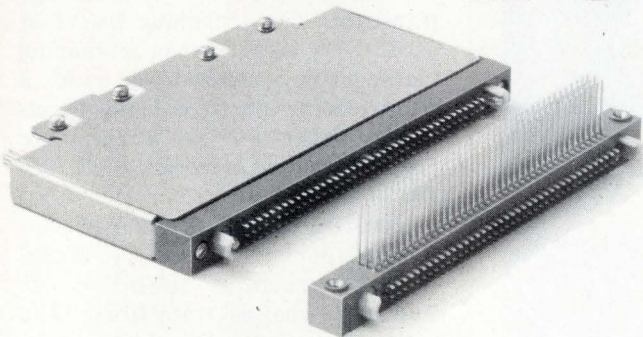
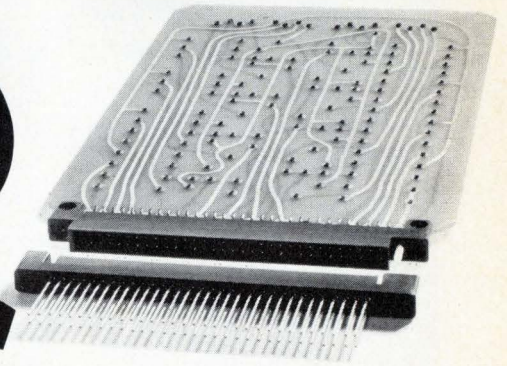

First, with 3 rows of contacts on .100 centers, Viking's unique Nordic 2-piece P/C board connectors and I/O I.C. panel plugs get a lot more contacts into a lot less space.

Second, our unusual polarizing system lets you key each mating pair to prevent cross mating with adjacent connectors of the same type. You can stack a series of Nordic connectors next to one another in cramped space and not worry that they might be cross mated.

Our full line includes 64 and 82 contact models as well as the 120. Contacts on I/O connectors are crimp, snap-in, removable, gold plated and use MIL-T- 22520 tools.

Diallyl Phthalate is the insulator in most models. And all connectors are designed to meet conditions of MIL-C-55302.

If you need them right now, our distributors have most models in stock. For details, use the coupon and get our latest catalog.

O.K. Send me: Your latest catalog with details on the two-piece PC connectors...and your nearest rep. I have some questions for him.

Name: _____

Position: _____

Company: _____

Address: _____

City: _____ State: _____ Zip: _____



Viking

CONNECTORS

Viking Industries, Inc., 21001 Nordhoff Street, Chatsworth, CA 91311

Profit from sameness.

Precise uniformity. That's what makes Kodak micro resist 747 a bargain.

With less variables to worry about, you'll no doubt find you'll waste less time, get fewer rejects, and improve your yield.

747 resist is negative-working, and it's available at a very positive price.

For details, write Eastman Kodak Company, Dept. 412L (48-E), Rochester, N.Y. 14650.

RESULTS COUNT

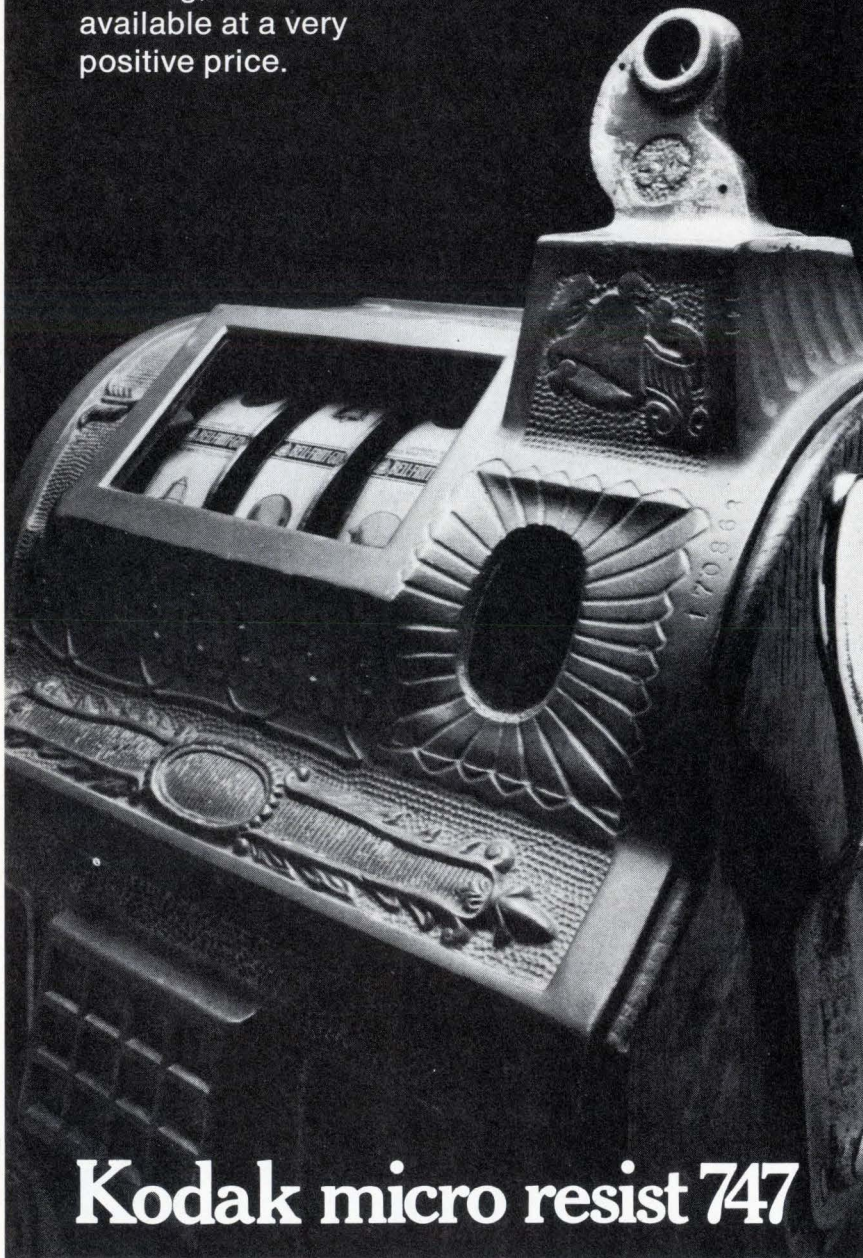

Kodak micro resist 747

Electronics review

strap MOS capacitor connected back to its source for positive feedback, enabling the control logic to drive the high-voltage output devices.

The maximum voltage the circuit can switch, May says, is limited by the breakdown of the pre-charge transistor in the trio. So in the fabrication process, the low-doped, deep p-well diffusions on the C-MOS chip are used as the source-drain junctions of the high voltage structure to obtain breakdowns of about 75 to 80 v. To increase the breakdown to 200 v, a negatively-biased field plate [Electronics, Dec. 11, 1975, p. 30] surrounds the drain junction of the p-channel precharge transistor. The technique was first used, May says, in an 8-channel tactile-display-screen driver IC for a blind reading-aid. It is being developed further for an implantable artificial ear [Electronics, Feb. 20, 1975, p. 38].

Double-diffused. In Plummer's approach, double-diffused n-channel (D-MOS) structures substitute for standard n-channel transistors. "The high-voltage capability of the device is a result of the n-minus drift region between the p-channel and the n-plus drain contact diffusion," he says. "The gate extends over this region as a field plate to reduce surface fields and increase the breakdown voltage."

The high-voltage p-channel structures that result consist essentially of two p-channel transistors in series, which effectively divide the applied voltage making possible breakdowns ranging from 150 v to above 200 v. Threshold voltages are 5 and 12 v respectively. Plummer's technique is currently being implemented in a quad analog switch for a medical ultrasonic imaging system. □

Computers

HP's small system woos volume users

Hewlett-Packard, in a move to garner more business from software-oriented systems houses, is changing

New from Texas Instruments: An authoritative guide to understanding microprocessor software...from the beginning. Only \$12.95.

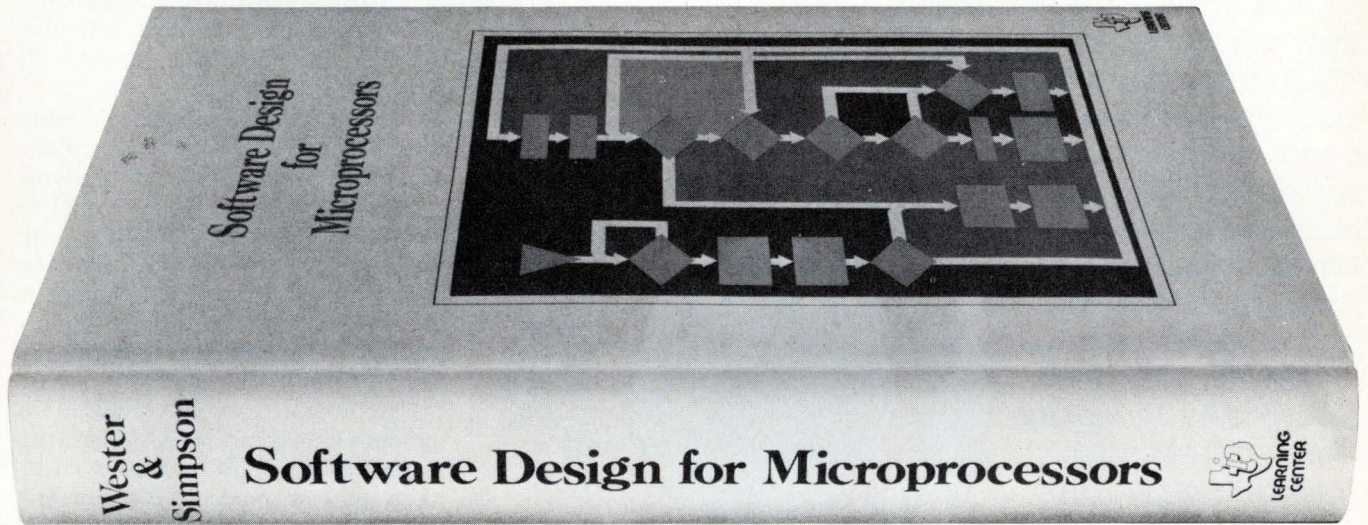

A working knowledge of microprocessor software is essential to mastery of microprocessors. And acquiring such knowledge is now simplified with TI's new text, *Software Design for Microprocessors*.

This new book is designed to help you to fully understand the basics of microprocessor machine code and assembly language. It is equally suitable for the non-technical professional as for the technically trained.

Complete, stand-alone guide: Having more than 500 pages, the book contains the information you need to learn the language, special terms, and underlying concepts of microprocessors that lead to an understanding of the complex facets of software. Here are clear, readable discussions as well as references, graphs, tables, data sheets, examples and appendices. It's a convenient, single source to show you how to pro-

gram microprocessors to do what you want.

Comprehensive text: In the first chapter, you learn basic terms, study basic machine architecture and look in detail at instructions as well as addressing. In succeeding chapters, you progress on to investigating the process of generating software...defining the support and documentation required...designing a simple machine to demonstrate how to program a problem. In conclusion, you gain experience by examining four sample problems.

This book is an ideal companion to TI's series of μ P Learning Modules—learning systems to help you become familiar with fundamental hardware/software relationships. *Software Design for Microprocessors* is economically priced at only \$12.95. Use the coupon to order your copy today.



TI Learning Center P.O. Box 5012, M/S 54 Dallas, Texas 75222			E10
Please send me _____ copies of (LCB 1891) <i>Software Design for Microprocessors</i> at \$12.95* per copy.			
I enclose <input type="checkbox"/> check <input type="checkbox"/> money order for \$ _____			
<input type="checkbox"/> I would also like a brochure on TI's Microprocessor Learning Modules.			
Mail checks and money orders to: P.O. Box 3640, M/S 84, Dallas, Texas 75285. Postage paid. Add state and local taxes where applicable.†			
Mail company purchase orders to: P.O. Box 5012, M/S 84, Dallas, Texas 75222. Postage and taxes will be added to your invoice.			
NAME _____			
TITLE _____			
FIRM _____			
ADDRESS _____			
CITY _____		STATE _____	ZIP _____
*Subject to change without notice			
† AL, AZ, CA, CO, CT, FL, GA, IA, IL, IN, KY, MA, MD, MI, MN, MO, NC, NJ, NM, NY, OH, PA, TN, TX, UT, VA, WA, WI.			

TEXAS INSTRUMENTS
INCORPORATED

Our carry-in recorder/reproducer will carry on for 32.8 hours!

The 70-lb. Sabre VI: It's a giant leap beyond any other small, high performance IRIG analog tape recorder/reproducer. Records at 8 electrically selectable speeds: 120 ips through 15/16 ips; reproduces at any 3 electrically selectable speeds; records from 15.3 minutes at the highest speed to 32.8 hours at the slowest on 14" reels. Remote speed selection and LED footage counter. LED bar data monitor. Let us give you full details.



SANGAMO DATA RECORDER DIVISION
P.O. BOX 3347 • SPRINGFIELD, ILLINOIS 62714

SANGAMO WESTON
Schlumberger

670A

44 Circle 44 on reader service card

Electronics review

some of its marketing ways. For starters, it has priced its latest small system, the HP 1000, at about \$33,500, saying it is lower in cost but faster than its own comparable models. That starting price, which is a 9% cut, covers a processor with 64 kilobytes of semiconductor memory, a 5-megabyte disk, and a 9,600-baud cathode-ray-tube terminal with two built-in mini-cartridge drives, all mounted in a cabinet.

Then, HP says, it will not only ship the complete system directly to the end user on behalf of the systems house, but also use HP personnel to install it. Quantity discounts, HP says, range up to 30%, and the company says this is the first time it is discounting complete original-equipment-manufacturer systems rather than individual boxes.

Microcycle timing. According to product manager Fred Gibbons, the higher speed—60% to 100% faster than present models—for the HP 1000 was achieved not only with faster components, but also with a concept called dynamic microcycle timing. Instead of allowing the same amount of time for all functions so that the slowest function sets the pace, the control processor adjusts the microcycle to match the time needed to complete each function. Thus, the control processor allots 280 nanoseconds for slow functions but 175 ns for most others.

The system also offers users the ability to do extensive microprogramming, since it has a control processor address space of 8,500 24-bit words for the microprocessor subroutines. To back up this capability, HP says it is offering an extensive set of software tools for microprogramming, including a micro-assembler, micro-editor, loader, and debugging aids. The system also can load routines directly from a peripheral storage medium, such as magnetic disk, to the control store.

Experience needed. With such features, the system clearly is not aimed at the first-time user, but rather at experienced users writing software in such areas as scientific computation, instrumentation, and manufacturing data-base management. □

Electronics/October 14, 1976

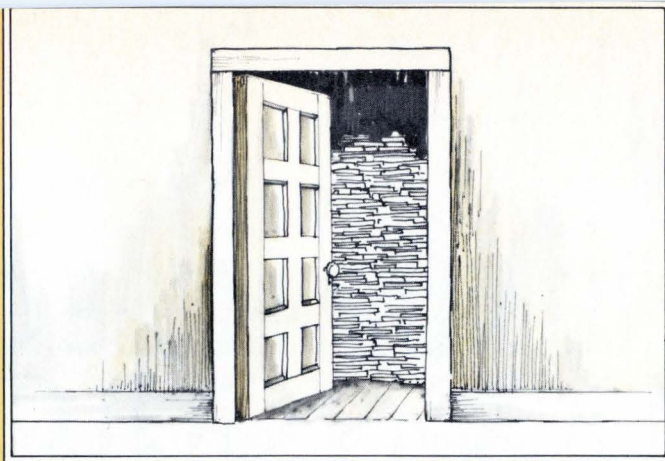

A roomful of boards.

How a leading manufacturer of electronic products repaired over 10,000 defective boards in 30 days using Zehntel's in-circuit tester.

What to do when you've accumulated over 10,000 defective circuit boards?

A major manufacturer of consumer products faced this problem recently.

The boards had piled up because it took technicians an average of over an hour to locate problems and repair a board.

This company got out of the dilemma with a Zehntel TROUBLESHOOTER test system.

Incredible but true, over 10,000 defective boards were diagnosed and repaired in 30 days, using Zehntel's in-circuit inspector.

The roomful of boards evaporated!

Test time per board was reduced to a few seconds with Zehntel's in-circuit measuring techniques which isolate and measure each component and node.

And since TROUBLESHOOTER prints out all of the defects on a board that failed, a technician could repair a bad one in just a few minutes.

Zehntel's in-circuit test system paid for itself on this cleanup job alone — and during the 30 day period also did regular production testing.

This is not an isolated case . . .

Zehntel in-circuit test systems are reducing test/repair time for many of the country's largest companies who build TV sets, AM-FM radios, CB's, automotive

electronics, medical equipment, computer peripheral instruments — literally all kinds of industrial and consumer products. In fact, our customer list reads like "Who's who in electronics".

Easy to use

Using our tester, non-technical operators can inspect hundreds of boards daily. The operator merely puts the board on our test fixture and pushes the start button. If the board is good, that's it. If the board fails, precise rework instructions are automatically printed. Typical test time: 5 to 30 seconds!

Summing up the advantages — TROUBLESHOOTER:

- Tests a wide variety of products
- Detects and pin points single or multiple defects on an entire assembly in seconds

- Eliminates need for technically-oriented operator
- Prints specific rework instructions for defective assemblies
- Is easy to program since each step deals with a single component
- Adapts to any flat assembly regardless of its complexity
- Can generate statistical data on component failures



Zehntel,® Inc.

2440 Stanwell Drive, Concord, CA 94520
Tel: (415) 676-4200 • TWX: 910-481-9471



Circle 45 on reader service card

THE MIRACLE OF SILICON GULCH

In the beginning there was the Op Amp. And it was good. Unfortunately, it had high bias current and was slow.

So, we created the LM108, with Super Beta. Super Beta reduced the high bias current. But it was still slow. So we developed the LM118. A beautiful thing, with feed-forward, large BW and slew. Well, that made it faster. But it left us with the bias current problem all over again.

Then a long silence enveloped the Op Amp world. Everyone waited. There was even some talk that linear was dead.

Months passed. Then, a wondrous event.

National succeeded in putting Bipolar and JFET together on a single chip.

Hallelujah!

The result is called BI-FET.

BI-FET is the first major new linear process in a decade. Easily the biggest thing to hit linear since the original Op Amp.

BI-FET has ion-implanted, ultra-matched, super fast, low noise and high voltage JFETS plus Bipolar, on the same chip. The best low input current, high speed, low noise, low drift combination ever.

And BI-FET features low offset voltage and offset voltage drift. Both coupled with offset adjust that doesn't degrade drift or common mode rejection.

The LF156 was designed for high slew rate, wide bandwidth and an incredibly fast setting time.

2mV maximum offset, 5 μ V/C maximum drift.

10 pA maximum offset current and 50 pA maximum bias current.

100 Hz noise of .01 pA/ $\sqrt{\text{Hz}}$ and 15 nV/ $\sqrt{\text{Hz}}$.

12V/ μ sec. slew rate.

5 MHz bandwidth.

The LF156 is the most accurate, high speed amplifier in the industry: 1.5 μ sec. settling time to 0.01%.

And, if that's not fast enough for you, why don't you try our LF157 Series.

Or for very low current drain there's nothing better than our LF155 Series.

Whichever one you choose BI-FET Op Amps pack a lot of performance in a small package, at low cost. Only \$2.50 in quantities of 100 and up for commercial TO-99.

BI-FET. Bipolar and JFET together, forever. Amen.

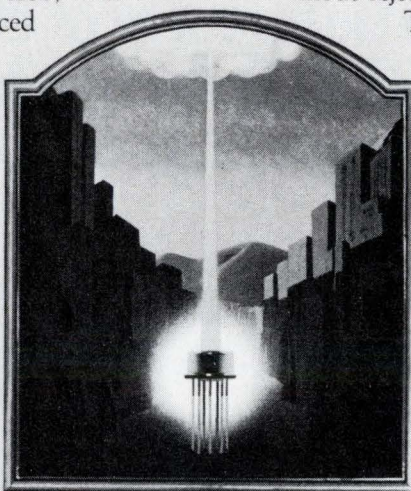

BI-FET

NATIONAL SEMICONDUCTOR 

National Semiconductor Corp., 2900 Semiconductor Drive, Santa Clara, Calif. 95051; Scottsdale, Ari. (602) 945-8473; Mountain View, Calif. (415) 961-4740; Sherman Oaks, Calif. (213) 783-8272; Tustin, Calif. (714) 832-8113; Miami, Fla. (305) 446-8309; Chicago, Ill. (312) 693-2660; Indianapolis, Ind. (317) 255-5822; Lenexa, Kan. (816) 358-8102; Glen Burnie, Md. (301) 760-5220; Burlington, Mass. (617) 273-1350; Farmington, Mich. (313) 477-0400; Minneapolis, Minn. (612) 888-4666; Englewood Cliffs, N.J. (201) 871-4410; Syracuse, N.Y. (315) 455-5858; Dayton, Ohio (513) 434-0097; Dallas, Tex. (214) 233-6801

A miracle is a tough act to follow.

Matter of fact, with a thing as heavenly as our Bi-FET, it's almost impossible.

But not quite.

Now we've topped our old story a bit by coming up with some *new* Bi-FET products, to extend the range of Bi-FET's applications.

For one, the wondrous LF 13741 op amp. It replaces the 741 op amp when you need extremely low input current.

And other terrifically good stuff like the LF 13331 family of analog switches (with no latch-up or static blow out problems) and the LF 352 instrumentation amplifier (combining low input current and excellent linearity), and the LF 398 sample and hold amplifier (a delightfully pleasant combination of noise, acquisition time and price numbers).

And what they all have in common is that they're the least

expensive way to get the kind of performance they offer.

So, to our original Amen we can only add, Amen.

National Semiconductor E1014
2900 Semiconductor Drive, Santa Clara, CA 95051

Gentlemen:
Please send me info on your new Bi-FET's.

NAME _____ TITLE _____

COMPANY _____

ADDRESS _____

CITY _____ STATE _____ ZIP _____

 **National Semiconductor**

NEW

IN SEMICONDUCTOR PROTECTION!

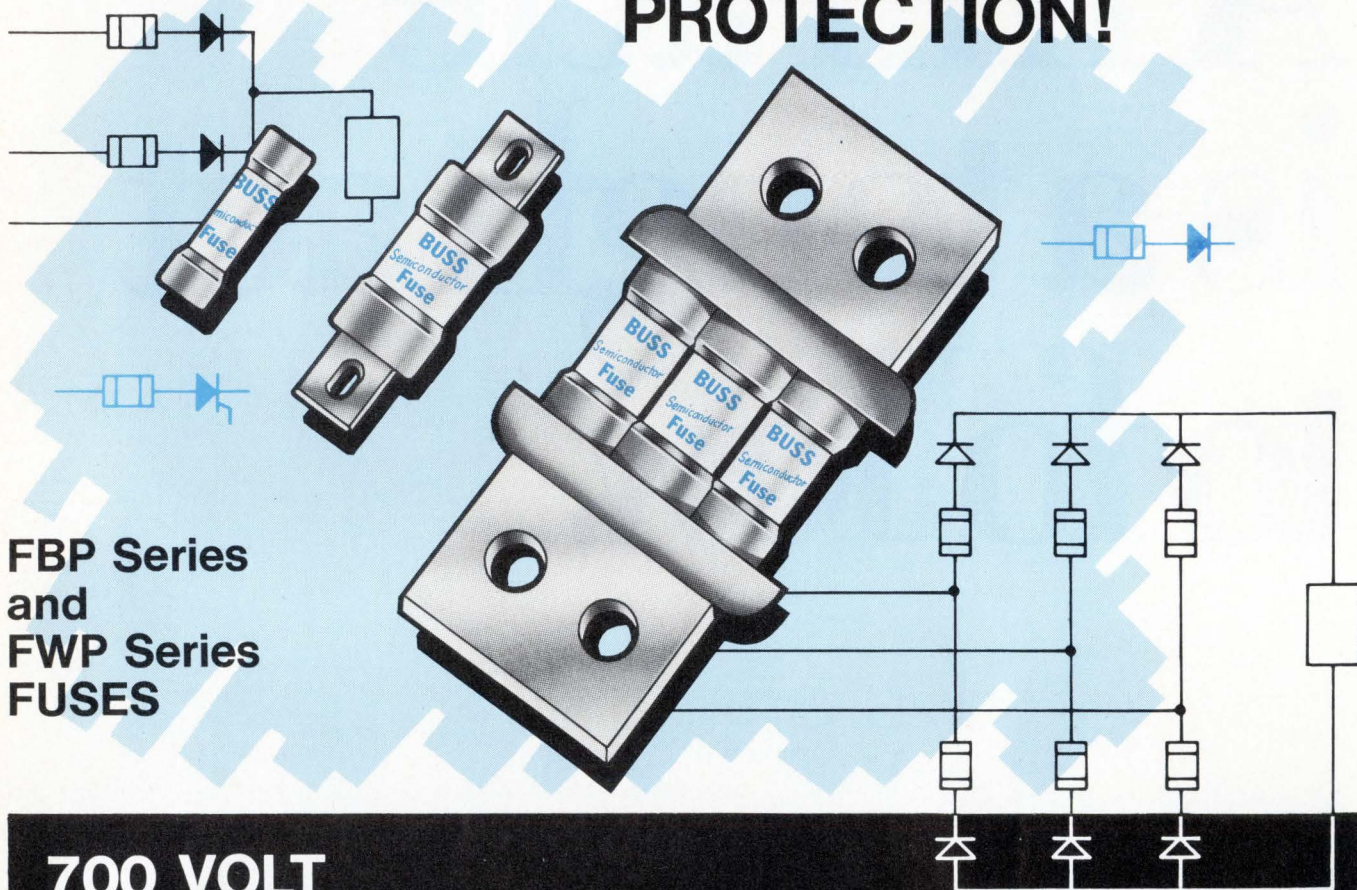

**FBP Series
and
FWP Series
FUSES**

700 VOLT BUSS® SEMICONDUCTOR FUSES EXTREMELY LOW I^2t and I_p LET-THRU VALUES

AMP RATINGS

15 to 1000

VOLTAGE RATINGS

700 V. a-c 700 V. d-c

BUSS Semiconductor Fuses provide a very high degree of current-limitation so necessary for the protection of Diodes, SCR's and other Semiconductors.

For detailed information and characteristic curves, write for **BUSS Bulletin SCFP**.

AVAILABLE IN TWO SIZES



FWP Series

dimensions made to fit mountings for 700 volt fuses that have been used in the past.



FBP Series

compact dimensions — shorter than FWP fuses — save equipment space.



BUSSMANN MANUFACTURING
a McGraw-Edison Company Division
St. Louis, Missouri 63107



Carter critics claim turnabout on AT&T issue

Democratic presidential nominee Jimmy Carter has dismayed supporters and gladdened critics in the telecommunications industry by **apparently changing his views on an issue** to meet the needs of an immediate audience. The contrast came in Carter's replies to questions on the currently hot topic of competition in telecommunications before two different groups. Appearing before a meeting of consumer activist organizations sponsored by Ralph Nader in Washington, Carter was asked about the American Telephone & Telegraph Co. antitrust suit by the Justice Department and the AT&T-backed consumer communications reform legislation that would restrict U.S. telecommunications competition. Carter at first confessed unfamiliarity with the subject, but then went on to call the suit "a good move in the right direction," adding that he sees no current need for "any corrective legislation."

In a later letter responding to an inquiry from Glenn E. Watts, president of the Communications Workers of America, which supports the Bell bill, Carter said he has "not precluded all possible legislation in this field," and labeled the preliminary hearings on the legislation as "the first step toward a comprehensive review of the direction of our telecommunications policies for the long term." Again, he prefaced his comments with the observation that he had not yet "been briefed on this problem."

EIA forecasts 125% rise in communications outlays by 1982

Defense outlays for command, control, and communications will soar by 125% in the six fiscal years between 1976 and 1982, according to a new Electronic Industries Association market forecast. Spending on research, development, and procurement **will jump to \$2.7 billion annually by 1982 from the present level of \$1.2 billion.** At the same time, the EIA estimates that operating and support costs will remain virtually static, permitting R&D and procurement spending to rise to 54% from the present level of 36% of the Defense Department's total annual investment in command, control, and communications.

The EIA forecast, by Will Gray of Honeywell's Aerospace and Defense group and Jim Lee of Hughes Aircraft Co., identifies interoperability between tactical command and control system as an urgent first priority within the Defense Department, with emphasis on increased standardization and consolidation of data links, greater use of standard electronic modules, and standard computers [*Electronics*, Dec. 25, 1975, p. 52].

37 companies seek FCC approval of 40-channel CBs

Applications for type-acceptance and certification of new 40-channel citizens' band transceivers **are drowning the Federal Communications Commission laboratory** in the rush by manufacturers to make the January market. Thirty-seven companies had submitted applications for one or more models by October, the FCC says. Familiar names include: Channel Master, E. F. Johnson Co., General Electric, Hy-Gain of Puerto Rico, Pace Communications, Pioneer Electronics, and RCA, as well as such offshore producers as Kyodo Communications, Matsushita Communications Industrial Co., Matsushita Electric, Sharp Electronics, and Toyota Motor Sales. Among the merchandisers filing were: Lafayette Radio & Electronics, Montgomery Ward, Radio Shack, Sears Roebuck & Co., and Western Auto Supply.

Plunging EFT into the political pit

The promised revolution of the nation's banking system by electronic funds transfer was relegated to the status of creeping evolution by the U.S. Supreme Court on Oct. 4. By refusing to review two Federal appeals court rulings that computerized customer banking communications terminals in shopping centers, supermarkets, and other sites off bank premises constitute "branch banks," the Supreme Court let the earlier judgments stand. Thus point-of-sale bank terminals are subject to Federal regulations limiting the number of branches that may be established by a national bank.

At stake initially, from the electronics viewpoint, is an average outlay of \$25-35,000 per national bank on terminals alone. Overall, for all types of banks and including communications, switching, automated bank clearinghouses, and retail point-of-sale tie-ins, the potential hardware market is enormous—one preliminary estimate puts it at more than half a billion dollars within the decade.

What now? Bankers agree they must now turn to the 95th Congress that convenes next January as their court of last resort. "It is now clear that a legislative remedy will be required," sighed J. Rex Dewey, president of the American Bankers Association. The ABA is "disappointed with the decision which will allow discrimination to continue in the implementation of EFT services for bank customers," Dewey declared, and "will develop new strategies" to counter the challenge.

ABA's dismay

With the U.S. Comptroller of the Currency on their side, bankers had anticipated a Supreme Court review and hoped for a favorable judgment. Thus they were dismayed when the refusal came down on the third day of the ABA annual meeting in Washington.

After the initial shock had subsided, most of the ABA members and some of the EFT technologists among them began expressing concern about the prospects of getting a favorable judgment from the new Congress. National bankers recognize that the financial community is divided on the issue of off-premises terminals and that they face some powerful opposition in the political arena from state-chartered commercial banks and the state banking commissions that generally support them. State banks, fearful of being overwhelmed by the bigger national banks with multiple remote EFT terminals, are determined to maintain the economic *status quo* if they can.

Savings and loan associations present another and perhaps more powerful lobbying threat to national banks anxious to exploit EFT systems. "The S&Ls like to cast themselves in the role of the good little guys against us big greedy bad guys," mused one national banker from New England at the ABA meeting, "and they can be very effective in pulling it off." The fact that S&Ls are unaffected by the court ruling against remote terminals, he added, "is doubling their determination. They are expanding like crazy."

Two more years?

If the division within the banking community prolongs a legislative remedy for the EFT problem by a year, the National Commission on Electronic Funds Transfer threatens to make it two. Though the big 32-member body now shows signs of beginning to function effectively—particularly in its survey of EFT equipment makers on the issue of national standards—it is still handicapped by its slow start, thanks to President Gerald Ford's failure to appoint any commission members for almost a year following its creation [*Electronics*, Aug. 21, 1975, p. 10]. Congress is unlikely to take any action whatsoever on EFT before getting the commission's report, so bankers and the computer companies anxious to serve them seem to have no choice but to sit and wait until next year for a report that was first mandated for delivery no later than next month.

This sad state of affairs could easily permit Donald I. Baker to become smug, if he wished. For it was Baker, the knowledgeable and perceptive U.S. assistant attorney general for antitrust who warned the EFT community of just such a turn of events more than a year ago [*Electronics*, March 20, 1975, p. 50]. On that occasion, he likened tomorrow's promise of electronic funds transfer to that of cable television yesterday.

"About five years ago," he recalled, "everyone looked on cable the way we now look at EFT—as the wave of the future. Unfortunately, cable ran into the broadcasters and their regulators. The same thing can happen to EFT. It can be loaded down with legal restrictions to protect existing interests and with expensive obligations to serve the dreams of social engineers. If this happens, it is likely to lose the cost-effective advantages it now has and to become a relatively minor factor in the muddled future."

Baker's words are more chilling today than when delivered 20 months ago. Now they are closer to becoming true.

Ray Connolly

WHO MAKES THESE CUSTOM ICs?

We don't make commodity ICs. Our 15 years of intensive experience in ICs is devoted to the development and manufacture of **innovative** circuits . . . circuits making special contribution to industry technology . . . circuits manufactured under the most exacting QAR program ever implemented . . . **creative** circuits such as the types shown here. **If you can't quite do the job with standard products, we can design integrated circuits tailored to your needs.**

- Printer Controllers
- Ground Fault Interrupters
- Smoke Detectors
- Voltage Regulators
- Photographic Shutter Controls
- Camera Flash Controls
- Stroboscopic Controls
- Auto Ignition Circuits
- Hall-Effect Switches
- Anti-Theft Controls
- Lamp Monitors
- Low Coolant Monitors
- Brake Fluid Monitors
- Seat Belt Interlocks
- Clock Circuits
- Photo Diodes
- Quad FM Decoders
- Electronic Timers
- Electronic Games
- AM/FM/TV Circuits
- Communications Circuits
- CB/Scanner Circuits
- MOS Custom Circuits

For the full story on digital bipolar and MOS circuits, write or call George Tully; for consumer entertainment and other linear circuits, write or call Bob Milewski; for automotive and photographic circuits, write or call Brad Marshall.

*Sprague Electric Company, 115 Northeast Cutoff,
Worcester, Mass. 01606 (Tel. 617/853-5000).*

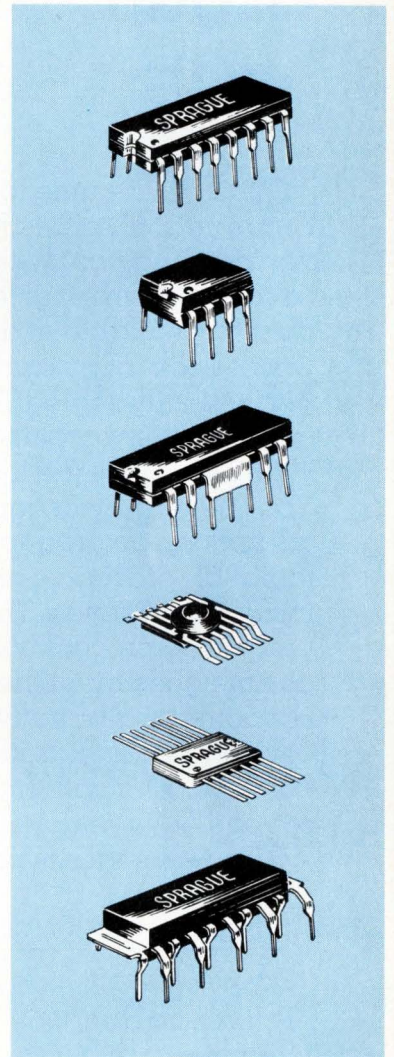

ICs for IMAGINATIVE DESIGNERS

SPRAGUE[®]
THE MARK OF RELIABILITY

*... and you thought we
only make great capacitors.*

Looking at price? Then look to the future... With glass TAX capacitors from ITT Components Group

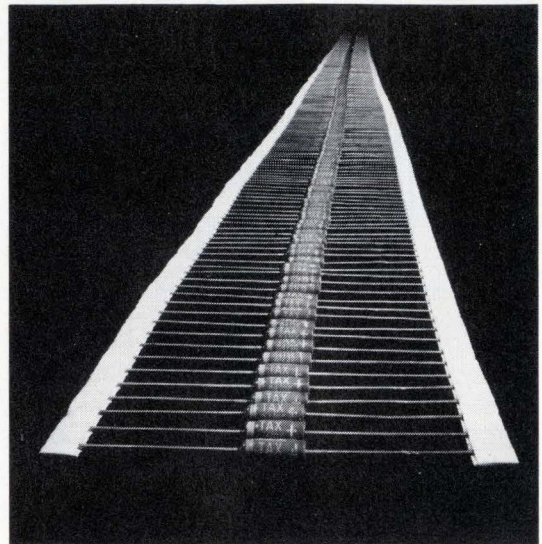

Today is the time to replace the Sprague 150D or the Kemet T110 you're using now with a compatible solid tantalum axial leaded capacitor available at a competitive price. Look into glass encapsulated, hermetically sealed TAX capacitors from ITT Components Group.

Glass . . . it's the look of the future. Your better buy because glass tantalums can be produced by super automation processes and require no insulating sleeves. The simple manufacturing process will make glass — as time goes by — the increasingly economical alternative to metal-canned, axial leaded tantalum capacitors. And with future assurance of good delivery levels.

The TAX series is packaged to run

right off its reel and into your operation. Automatically. And if you are using Kemet's T310 you will want to compare the reliability of epoxy against our **better priced better option — glass**. Each unit is 100% tested for hermeticity and to all data sheet parameters because sample testing just isn't good enough for ITT Components.

Look to the future today by checking out glass tantalum capacitors. For technical specifications and free samples of the TAX, write to George Kase at ITT Components Group, 1551 Osgood St., No. Andover, MA 01845. Or call him at (617) 688-1881. Tell him you want to look into our better alternative!

Ratings

Capacitance:	0.1 to 47 μ F
Tolerance Range:	$\pm 20\% \pm 10\%$
Voltage:	6.0 to 35 volts DC (50 volts on request)
Temperature Range:	-80° C to $+125^{\circ}$ C.

We're listed in sections 1500 and 4500 in your 1976-7 EEM catalog.

Components **ITT**

When you need capacitors, our better alternative will be your first choice.

Digital module decodes dialing tones for older phone exchanges

The spread of push-button telephones has been limited by the basic inability of electromechanical exchanges to convert the multi-tone frequencies into the series of pulses required to complete a call. Conversion circuitry has, of course, been installed in some exchanges, but it has been a patchwork of discrete components, inductors and filters that are mounted on a printed-circuit board.

Now, General Instrument Microelectronics is introducing a metal-oxide-semiconductor chip that does away with inducting coils and much of the discrete supporting cast. The AY-5-9800, employing a speedy digital tone-acquisition technique, can detect and decode digits as fast as they can be keyed in by a push-button phone, a considerable improvement over existing analog hybrid modules, according to Peter Rush, product manager, microprocessors and memories. In fact, it does its job as quickly as 15 milliseconds, well within the new international standard of 40 milliseconds.

Advantages. The chip also offers the expected benefits over hybrid modules of smaller size, lower current drain, cheaper assembly and final price. What's more, the circuit module needs no factory adjustments. It gets all its timing signals from a single external 1-megahertz clock. Then, too, to meet various markets, the AY-5-9800 has seven mask-programable options of center frequencies, tone accuracies, tone-acquire and tone-release criteria, one-tone or two-tone signaling, output-pulse length, and choice of bit-output code for computer applications or 16-bit fully decoded output for telephone-exchange applications.

The company, now sampling the chip, targets a big potential market in North America and Europe. One exchange could absorb thousands because each incoming line requires

a tone detector-decoder. But the chip-based module costs only \$50, half that of the competing analog hybrid modules, according to James P. Smillie, telecommunications product manager. Moreover, GIM, which supplies 45% of Europe's MOS phone circuits, sees a market in private exchanges where multi-frequency dialing is used internally. This intended market also would need the company's AY-5-9100, which converts the keypad output into pulsed line output for the slower exchange switches.

In multifrequency phone-signaling systems, each digit is represented by a simultaneous burst of one high and one low tone, four of each being required. These can be paired in 16 high-low combinations to yield 10 digits plus six control functions needed by data applications. A problem with the analog modules is that they need eight narrow-bandpass filters to separate the tones. Besides the high component count, these filters, to achieve adequate tone discrimination, must have high

filter delay, which means that tone bursts of less than 60 milliseconds can remain undetected.

GIM's digital tone-detection technique, developed at its Glenrothes, Scotland, plant, simplifies things so that the incoming tone burst need only be separated into high-tone and low-tone groups. Thus, fast wide-bandpass filters can be used. The high and low tones then are processed by frequency-recognition logic. Each frequency is squared by a Schmitt trigger, then frequency-divided to produce a uniform mark-to-space-ratio pulse, which can be handled by conventional logic circuitry.

Each tone period is counted by a timer clocked by the external 1-megahertz clock, which can drive several modules. If the period fits any of the four tones, the tone is indicated by an appropriate register. Further circuitry, including a programmable logic array and a mask-programable timer, ensure a proper signal, one that is undisturbed by noise. □

It's Tokyo's turn this year

Nearly 330 companies, including about 70 foreign firms, will exhibit their products at Japan Electronics Show '76, which will be held Oct. 22 through 27 in two exhibition halls at the Tokyo International Trade Center (Harumi Fairgrounds) alongside Tokyo Bay. This year, show officials say, more companies will occupy more exhibit space than last year in Osaka, where about 210 companies were represented.

Sponsored by the Electronic Industries Association of Japan, the annual show is held alternately in Tokyo and Osaka. The Tokyo show is usually slightly larger than the Osaka version, but improvement in the general economy is also one of the factors behind the pronounced upswing in exhibitor interest this year. Nevertheless, the total number of participants is not expected to bounce back to the level of the 1974 Tokyo show, where 280 Japanese companies and 152 foreign exhibitors signed up.

The components and parts section will be specially strong this year, occupying about half of the total space. In the industrial-products section, microprocessor applications will be featured. Stereo products, usually exhibited in the consumer-products section, will be seen this year at the International Audio Fair, scheduled for the same period in an adjacent exhibition hall. Other consumer products, including television sets, will be displayed in the consumer section as usual.

**You can buy
this Spectrum Analyzer
and take a big chunk
out of your budget.**

**You can rent
this Spectrum Analyzer
and get more
equipment out of
your budget.**

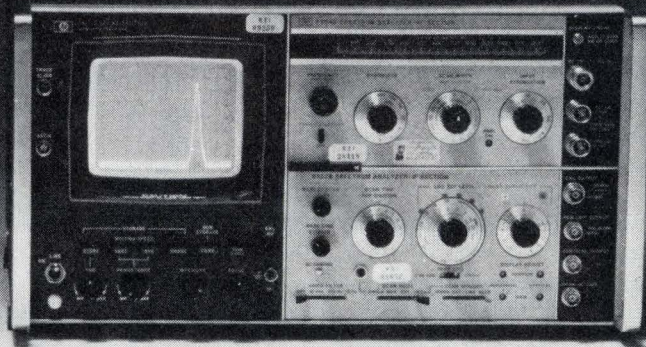
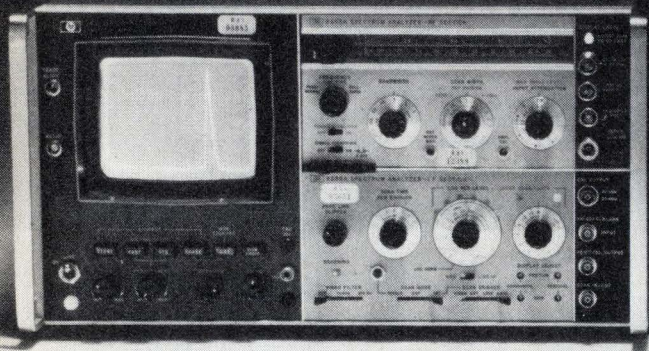

Even the best equipment budget can only go so far. And at the price you pay for electronic test equipment nowadays, that's not very far at all.

Unless you rent your equipment from REI.

When you rent from us, there's no large cash outlay. You pay only for the time you have your instruments, and you return them when you're through. So you never have to spend your money on idle equipment.

Getting more for your money is just one reason for renting from REI. Immediate delivery is another. We have over \$10 million in inventory in fully stocked centers around the country. And, when you have short-term needs, you can rent equipment for just as long as you need it, and make it pay for itself.

REI stocks over 8,000 fully checked-out test instruments, and they're ready whenever you are. For the full story on renting, as well as our low prices, send in the coupon for prompt delivery of our free illustrated catalog... or call us now for your immediate requirements.

Rental Electronics, Inc.
99 Hartwell Avenue, Lexington, Mass. 02173
Please send me your free instrument rental catalog:

Name _____ Title _____

Company _____

Address _____

City _____ State _____ Zip _____

Tel. Number _____

Rental Electronics, Inc. 

A PEPSICO LEASING COMPANY

Burlington, MA (617) 273-2770 • Gaithersburg, MD (301) 948-0620 • Oakland, NJ (201) 337-3757 • Ft. Lauderdale, FL (305) 771-3500
• Des Plaines, IL (312) 827-6670 • Dallas, TX (214) 661-8082 • Mountain View, CA (415) 968-8845 • Anaheim, CA (714) 879-0561
• Rexdale, Ontario (PLC Leasing Ltd.) (416) 677-7513

Circle 54 on reader service card

Electronic 'watermarking' protects bank cards

Applying an electronic "watermark" to conventional magnetic tape, EMI Ltd. has developed a tamper-proof security system for the growing market in credit and bank cards. Applicable, too, to transportation tickets, currency, and passports, EMI's proprietary process **encodes a magnetic stripe by changing the direction of transverse areas of the magnetic fields on the tape. The special trick, which took 10 years to develop, is to do this while the plastic film containing the iron oxide particles is still hot and fluid.** Once the plastic is cooled, the encoded data, which has a density of 50 bits per inch of track, is so embedded in the tape that no surface electromagnetic tampering can alter it. Having already sold a 350,000-card security system to the British Government, EMI is talking with British Airways and the International Air Transport Association, as well as eyeing a vast U.S. market for its tape and recording-head readers.

Flying-spot scanner compares cells in mask-defect inspector

An automatic unit for checking defects in LSI masks has been developed by Nippon Jido Seigyo Ltd. Despite an operating speed called 10 times faster than with optical comparators, it can pick up defects that are skipped by optical systems. The key to the unit's operation is a flying-spot scanner, which works with two microscope-type optical systems spaced to view identical features in adjacent unit cells on same photomask. **Any differences in the two cells is picked up and their locations stored. Comparison of one of the two cells with a third then give an indication of which cell is bad.** What's more, an operator can indicate the locations of defects, and the unit automatically shows an enlarged image of each defect area on a 9-inch cathode-ray-tube monitor. The price tag of the defect inspection system is about \$120,000 in Japan. Delivery is said to be about 6 months after an order. The system, for use with masks based on transmission of light, is not designed for working with reflected light from semiconductor wafers.

Chinese deal to buy Control Data computer falters

A management team representing Control Data France will visit the People's Republic of China this month in an attempt to further interest the Chinese Government in the purchase of a computer network to process oil-exploration information. Control Data, in collaboration with France's Compagnie Générale de Géophysique, has been negotiating the sale of a Cyber 172 computer, which is intended to be installed in Peking to enable the Chinese to better estimate the extent of their reputedly substantial oil reserves. **However, the Paris-based international coordinating committee for exportation to Eastern countries has not yet approved the sale, and industry sources speculate Peking may soon look elsewhere for a similar system.** The main objector to the sale, according to observers, is the U.S. Department of Defense, which feels the Chinese might employ the Cyber 172 for other purposes.

Solar cells built of polycrystalline silicon reach 10% efficiency

AEG-Telefunken has reported success in building terrestrial solar generators consisting of large-area polycrystalline silicon solar cells. Using a proprietary silicon material supplied by West Germany's Wacker-Chemitronic, **the 10-by-10-centimeter cells exhibit an efficiency of better than 10%.** While it won't put a price on these prototypes, AEG-Telefunken says

it has reached an important milestone towards the goal of generating electrical energy from sunlight for less than \$1 per watt.

Sanyo launches lithium battery line

A series of lithium energy cells will be placed on the market soon by Sanyo Electric Co. Designed to match requirements of a variety of miniature electronic equipment, their main selling point is their **high energy density—typically four times that of silver oxide cells, five to six times that of alkali cells, and 10 times that of standard dry cells.** What's more, the nominal terminal voltage of 3 volts reduces number of cells required when voltages higher than the 1.5 v of most other cells are needed.

The first in the series, the LF-1/2W has a diameter of 24.5 millimeters and a length of 2.8 mm—half as long as standard W-size cells. But 200 milliampere-hours are packed into its 4-gram weight. Two of these will power a new Sanyo 6-mm-thick calculator with a liquid-crystal display to go on sale next month. Price per cell in Japan is \$1.75. Applications for other cells in the series, which use a lithium negative electrode and manganese dioxide positive electrode, include electronic watches, electronic cameras, hearing aids, tape recorders, communications equipment, and other cordless equipment.

West Germany's Grundig plans hi-fi expansion

After a relatively slow startup period, West Germany's high-fidelity equipment market is now entering a phase of strong expansion. That's the assessment of industry observers at the HiFi 76 exhibition held in Düsseldorf last month. As officials at Grundig AG see it, **the 1976 and 1977 West German hi-fi market will rise by 8% to 10% a year, and not before the mid-1980s do they expect that market to reach a saturation level of 80%.** To cash in on this market potential, Grundig is considerably expanding its hi-fi equipment production capacity. The Nuremberg-based company already is West Germany's biggest TV producer.

Interference suppression cables pushed by France's LEAD

At least three U.S. companies, including one major automobile manufacturer, will be vying for American licensing rights to French-developed ignition cables that suppress interference. The companies anticipate that the Federal Communications Commission will introduce legislation that will impose lower noise emission levels and require a new type of ignition cable. The Grenoble-based research and development firm Laboratoire de'Electronique et d'Automatique Dauphinois in a joint venture with its French licensee Electricfil Bougicord **will display the cable, based on frequency selective absorptive wires and capable of attenuating signals up to 1 gigahertz, in Detroit later this month.**

Long-life lithium cell powers Siemens pacemaker

West Germany's giant Siemens AG has joined the small number of companies that are offering pacemakers powered by a lithium-iodide battery, a type of battery with a useful life of up to 10 years. **Delivering pulses that are 5.2 volts in amplitude and only 0.5 millisecond in duration, the company's new lithium pacemakers consume very little current, so that the batteries last longer.** The titanium-housed units are produced at Siemens-Elema, the West German firm's subsidiary in Sweden, and come in various sizes—from small units weighing only 25 grams and intended for babies to regular-size versions for grownups.



**COMING ATTRACTIONS
4K STATIC RAMS
DOWN TO 100NS.**

They're gonna make you a star.

In just a very short while, we'll be giving static RAM users the same thing we've already given dynamic RAM users.

The fastest MOS device on the market.

Using the same super technology that gave you the world's first 150ns 4K dynamic RAM, we'll soon be giving you the μ PD410 series of 4K static RAMs with speeds down to 100ns.

So right now you can start

designing products where that kind of speed at that kind of density can really help make you a star.

For your present applications, we'll also have slower versions you'll want to use right away.

In addition to access times down to 100ns, our n-channel silicon gate 4K x 1 static RAMs will also feature cycle times down to 200ns, 12 μ W/bit maximum standby power, three-state output, proven cross-coupled Flip-

Flop storage cell structure to eliminate soft errors and the need for refresh circuitry.

And they'll be pin compatible with the industry standard 22-pin dynamic part.

The μ PD410 series of 4K static RAMS.

For people into terminals, add-on memories, mainframes, and minis, it's quite a coming attraction.

NEC Microcomputers, Inc.,
Five Militia Drive, Lexington,
MA 02173. 617-862-6410.

NEC microcomputers, inc.

(Data sheets now at reps and distributors.)

REPS: East—C & D Sales 301-296-4306, Contact Sales 617-273-1520, Trionic Assoc. 516-466-2300; South—Merino Sales 214-233-6002, Perrott Assoc. 305-792-2211, 305-275-1132, 813-585-3327, Wolff's Sales Serv. 919-781-0164; Midwest—K-MAR Eng. & Sales 816-763-5385, McFadden Sales 614-221-3363, R.C. Nordstrom 313-559-7373, 616-429-8560, R.F. Specialists 312-698-2044; West—Mike Duffy Assoc. 303-934-7392, Electronic Component Marketing 714-524-9899, 714-295-6122, 213-340-1745, Summit Sales 602-994-4587, Trident Assoc. 408-734-5900, Tri-Tronix 505-265-8409, 206-454-0940; Canada—R.F.Q. Ltd. 416-626-1445, 514-626-8324 DISTRIBUTORS: Century Electronics, Diplomat (Chicopee Falls, Woodbury, Mount Laurel, Little Falls, Newport Beach, Clearwater, Dayton, Elk Grove Village, Farmington, Minneapolis, St. Louis, Salt Lake City, Sunnyvale), G.S. Marshall (Sunnyvale), Harvey Electronics (Lexington, Norwalk, Woodbury, Fairfield), Intermark (Santa Ana, San Diego, Sunnyvale, Seattle), Lionex Corporation, Mirco Electronics, R-M Electronics, Semiconductor Specialists, Technico.

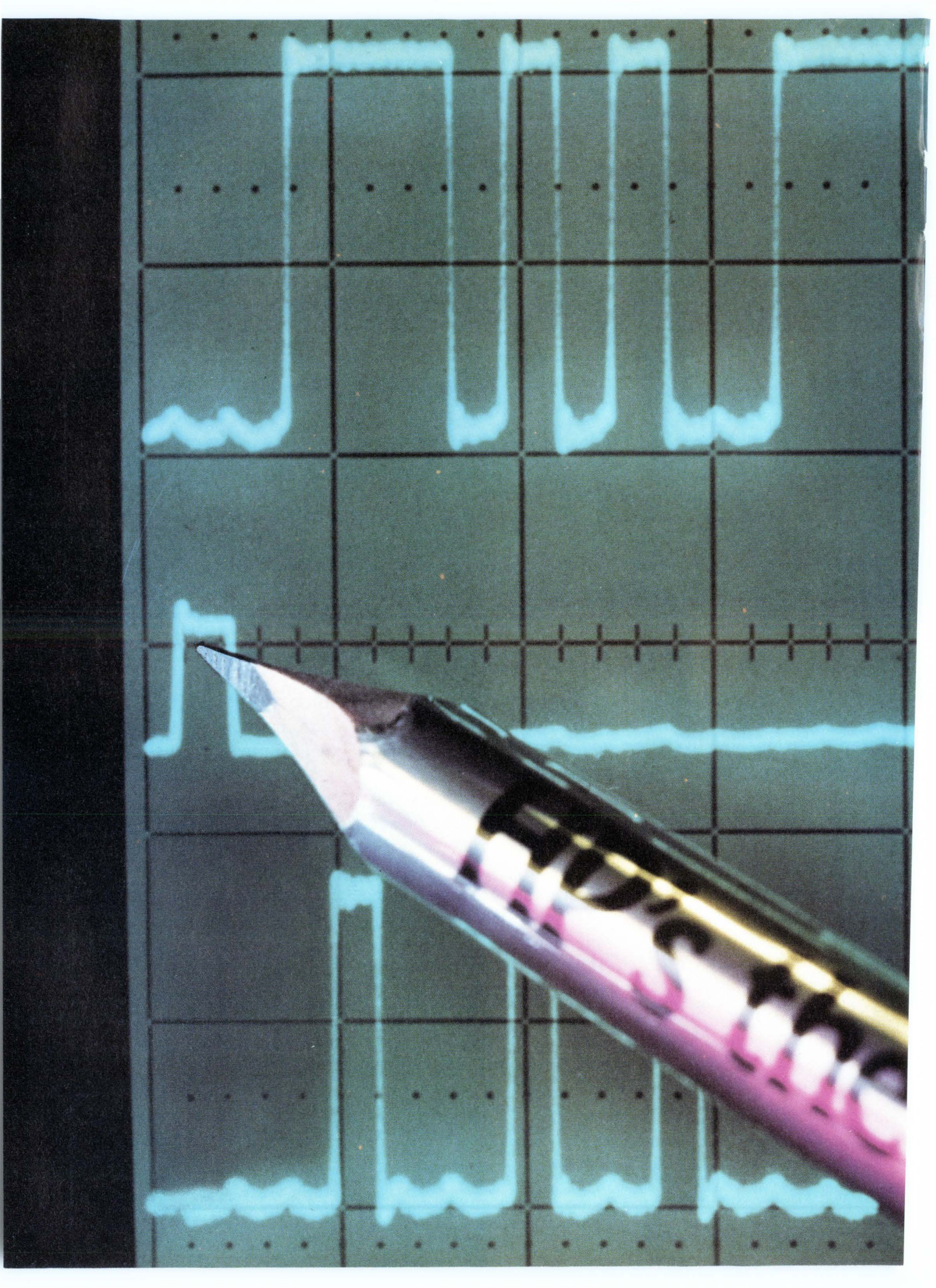

When logic demands variable persistence, storage plus third channel trigger view...

HP's the Answer.

HP's new **1741A** variable persistence/storage scope, with 100 cm/ μ s writing speed, gives you the combination of features you need in a 100 MHz scope. Storage for studying single-shot events; variable persistence for clear viewing of glitches and low-duty-cycle traces; and third-channel trigger view for accurate trigger-to-event timing.

Excellent variable persistence means a bright, sharp trace you'd expect only on a non-storage scope. The result is a bright display of fast, low-duty-cycle repetitive signals.

Auto erase/Auto store. In Auto erase you adjust the number of displays per second up to 10 seconds. After that, it's all automatic, which means you simplify your set-up time and you eliminate smeared displays of digital data. It's a powerful tool for capturing those elusive glitches in data streams.

In Auto store, your 1741A is armed,

ready to trigger and store those random, single-shot events when they occur.

Third-channel trigger view lets you observe an external trigger signal simultaneously with Channel A and B traces. This gives you a simple way to make accurate timing measurements from the trigger signal to events on either or both channels. In most applications you can consider this to be a third channel. (The center horizontal graticule line is the internal and external trigger level point.)

For measurement convenience, the 1741A has a selectable 50 Ω input in addition to the standard 1 M Ω input. A 5X magnifier permits two channel measurements as low as 1 mV/div. to 30 MHz, without cascading. The 1741A is priced at \$3,950*.

Call your local HP field engineer today for all the details.

*Domestic U.S.A. price only.



HEWLETT  PACKARD

Sales and service from 172 offices in 65 countries.
1507 Page Mill Road, Palo Alto, California 94304

For assistance call: Washington (301) 948-6370, Chicago (312) 677-0400,
Atlanta (404) 434-4000, Los Angeles (213) 877-1282

086 11

**You're looking at less
than 5 percent of Omron's
control components line.**

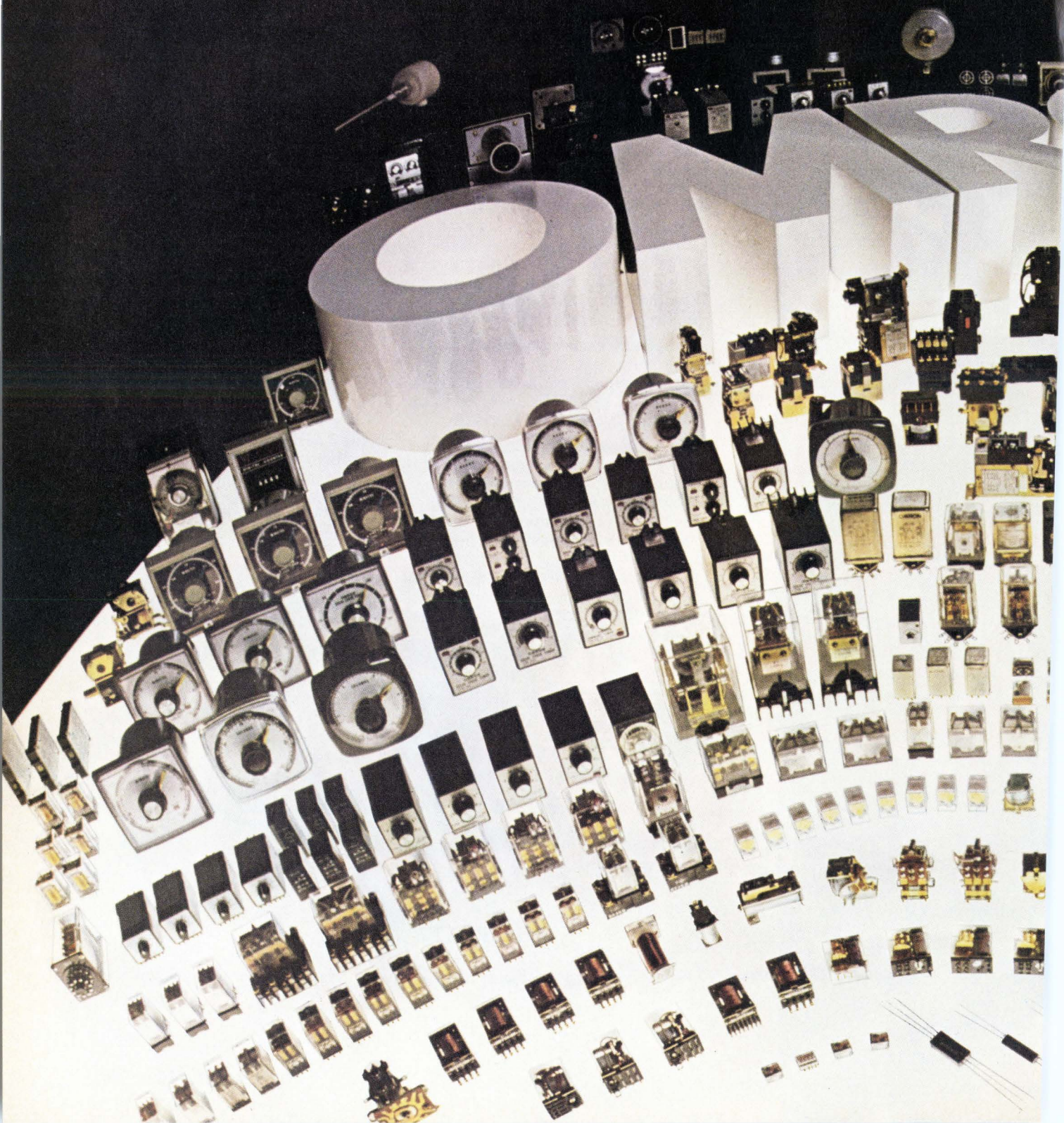

If you don't see the control component you need, maybe it's because we didn't have room for it in the photograph. Omron manufactures what is probably the largest selection of relays, switches, and timers in the world, and to show them all we'd need a 40-page ad.

What does this mean to you? It simply means that we may already have the "unique" component you need in stock. If we

do, you'll get it fast, thanks to our expanded distributor network. You'll also know you're getting a quality product: Omron has been a world leader in control components for 43 years, and our growth over the decades has been based on excellence in engineering, manufacturing, marketing, and—above all—in serving you, the Omron customer.

To find out what Omron can do for you, contact your nearest Omron distributor. Or give us a call at (312) 885-9500.



*a world leader
in electronics
since 1933*

Omron Corporation of America
Corporate Headquarters
Sears Tower, Chicago, Illinois

Sales and Service
1051 State Parkway
Schaumburg, Illinois 60172
Phone: (312) 885-9500

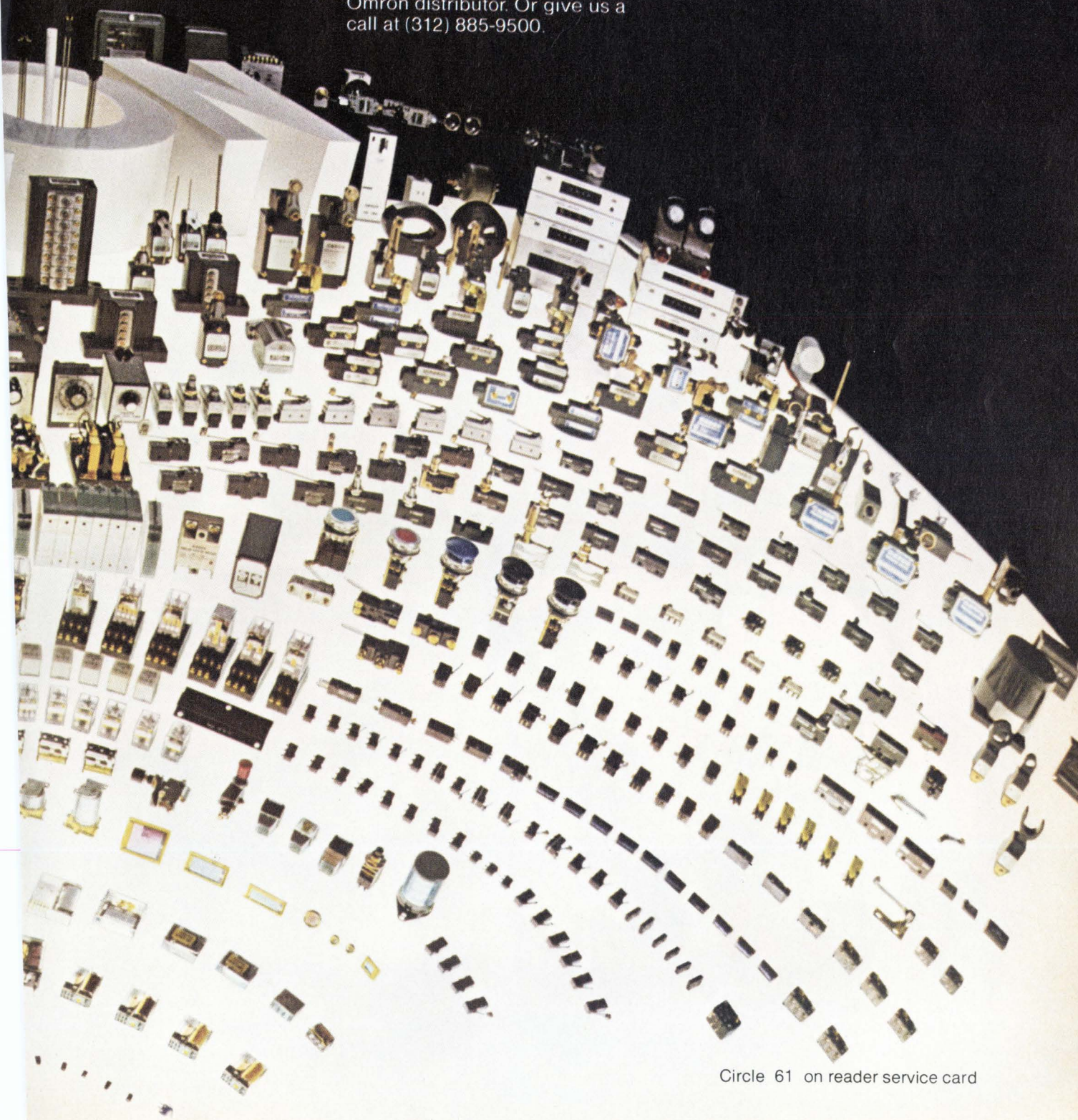

Circle 61 on reader service card

If you can find any other logic board tester on the market that has all these features, we'll buy it for you.

Power-fail protection to safeguard software system.

Automatic loader provides one-step bootstrap procedure for system initialization.

Most complete service program available. One-year on-site warranty on entire system.

Simulator generated test program on diskette for convenience of program distribution.

LSI-II mini-computer with 16K words of memory and direct memory access.

Console with built-in digital voltmeter for operator convenience.

Simulation capability can be added to test station or provided as stand-alone for fast, efficient test generation.

Both hardware (TAPS) and software (Simulator) modeling available for fault verification of the test program.

16K Core Memory, expandable to 64K.

Alphanumeric CRT for faster and quieter operation.

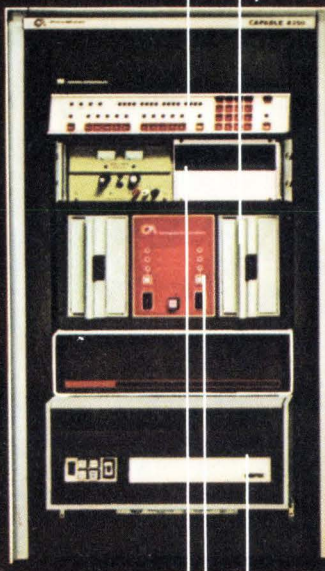

Wide range of UUT power supplies available.

Single or dual 256K byte floppy disk drive for low-cost mass storage.

Optional 5M byte dual moving head disk drive provides increased capacity for even the most complex boards.

Analog capability for testing hybrid boards.



UUT interface pins available in 3 types and expandable to 767 pins.

Guided Fault Isolation for fast troubleshooting by a low-skilled operator using a guided probe.

Added GFI capability using our new Clever Clip which can handle IC's up to 24 pins.

Our family of CAPABLE logic board testers are in a class by themselves. That's why we can make an offer like this and not worry for a minute that it'll be put to the test.

Because the only way to match our features is to custom-build or custom-order. And even then you can't match our pricing (starting under \$22,000).

To begin with, all CAPABLE testers have our own powerful, ComputerAutomation LSI-II 16-bit computer with 16K words of memory and direct memory access for quick execution of the test program.

Next, there's Guided Fault

Isolation (GFI) with both a single point probe and our new Clever Clip,TM which can handle IC's up to 24 pins. This not only makes testing faster, but also minimizes the chance for error because the operator has less to do. There's even a special readout that tells you if the clip isn't making proper contact with the pins.

Both our probe and Clever Clip have individually-programmed threshold settings, which allow them to adjust automatically as different logic levels are probed.

CAPABLE testers are available with three types of pin electronics — TTL, CMOS, and programmable. So we can tailor a test system to your specific needs and minimize fixturing and adaptation costs when your needs change.



And since our entire system is modular, you can add pin electronics up to 767 pins as your boards become larger and more complex. You can add additional memory as your test routines become larger. You can add new logic families. Or you can convert your CAPABLE into a complete analog test system. All as you need it.

Here's even more flexibility. An add-on simulation capability

with a unique offer attached: We'll buy it back at full price anytime your needs require that you upgrade to one of our larger simulators.

The list of CAPABLE features goes on: Automatic Test Generation (ATG). Fault Detect Verification (FDV). Analog testing capability. A ticket printer for producing hard copy failure reports. Even an alphanumeric CRT input/output terminal with standard office typewriter keyboard.

And CAPABLE testers carry the most complete support program available. Starting with a one-year, on-site warranty on the entire system — no exceptions. And including one week of technical training at start-up and on-going engineering assistance as you need it.

We're uniquely able to help you solve your testing problems because we've gone to school on our own testing problems. Our sister division produces over 35,000 boards a year, as the industry's second largest shipper of OEM mini-computers. And, using CAPABLE testers, they experience the industry's lowest percentage rate of field failure.

So before you buy a logic board tester, compare CAPABLE's features against the others. And if you find one (custom-builds don't count) that out-features and out-performs us for the same price, we'll buy it for you. For details, write or call us. In the U.S.A., 18651 Von Karman, Irvine, CA 92713, Tel. (714) 833-8830 or in Europe, CAI Ltd., Hertford House, Denham Way, Maple Cross, Rickmansworth, WD3 2XD Hertfordshire, England, Tel. Rickmansworth 71211, Telex 922654.

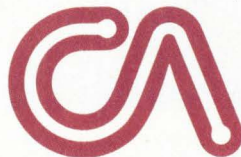
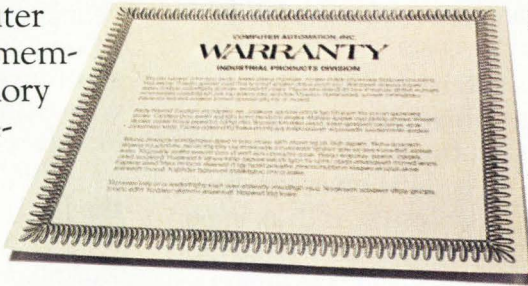

ComputerAutomation
Industrial Products Division

TERADYNE'S J401: THE FULL CAPABILITY IC TEST SYSTEM EVERY ENGINEER CAN USE.

Until now, the complexities of test programming have kept all but a few specialists from using IC test systems. Everyone else had to queue up at the programmer's desk or do without the kind of information that was really needed.

Now there's a J401. A fully programmable test system for T²L ICs with up to 24 pins, complete with built-in CRT, printer, and mag tape unit, that any engineer can learn to use in minutes.

For IC producers this means immediate access to vital process control information. For IC users it means the data necessary to choose components and vendors intelligently. And the ability to extract from field returns the information needed to improve product quality and yield.

The performance and flexibility of a large, computer-operated test system.

The J401 delivers the flexibility ordinarily associated only with larger, more expensive systems. It can datalog any forced or measured function and it can generate an x-y plot of any two parameters. The system also operates as a high throughput go/no-go tester for the production line or incoming inspection.

Product data fast. Higher product yield.

For the semiconductor manufacturer, the easy-to-use J401 allows errors to be spotted before they can begin to multiply. QC engineers can use it to evaluate devices, determine test margins, and check device lots.

The electronic equipment manufacturer will find the J401 useful in monitoring vendor-to-vendor and lot-to-lot variations.

It enables him to spot device characteristics that could be contributing to problems. And QC personnel can use the system to analyze failures and reduce service costs.

A system for meeting the real objectives of incoming inspection.

The J401 gives you fast go/no-go testing with an important difference. It gives control over the way devices are tested. By pushing a few keys you can change test conditions, bin out top-quality ICs, or have datalogging to support returns. All in seconds. This is incoming inspection as it should be.

It's a Teradyne.

Each J401 is built for hard use on the factory floor. Each is supported by Teradyne's ten-year circuit module warranty, a 24-hour telephone troubleshooting service, and a world-wide field service backed up by local parts stocking centers.

For complete information on the J401, write: Teradyne, 183 Essex Street, Boston, Massachusetts. In Europe: Teradyne, Ltd., Clive House, Weybridge, Surrey, England.

WE SELL PRODUCTIVITY.

TERADYNE



CHICAGO (312) 298-8610/DALLAS (214) 231-5384/NEW ENGLAND (617) 458-1256/NEW YORK (201) 334-9770
SUNNYVALE (408) 732-8770/LONDON (0932) 51431/PARIS 073 16 98/ROME 59 47 62/MUNICH (089) 33 50 61/TOKYO (03) 406-4021

VAST causing headache for Navy

\$750 million, 15-year program to deploy general-purpose avionic test station 'has proven defective,' says report

by Bruce LeBoss, New York bureau manager

For three quarters of a billion dollars, should a government agency get what it ordered? The U.S. Navy is beginning to think so. It has spent upwards of \$750 million and 15 years to develop, build, and implement a general-purpose automatic-test-equipment (ATE) system that was billed as the solution to its pressing problems of avionics testing. But now the fleet seemingly finds itself sinking in an ocean of problems surrounding the operation and maintenance of its primary equipment, the versatile avionics shop test (VAST) system developed by Harris Corp.'s PRD Electronic division in Syosset, N.Y.

VAST is intended as a total maintenance-support system aboard aircraft carriers and at shore installations. The concept for the system, designated AN/USM-247, was a general-purpose test station that is programable and controlled by a computer. Such a system, it was reasoned, should be able to supplant the many kinds of support equipment used in the fleet. It was also to improve avionics turn-around time and reduce the space, manpower, and training required to operate support equipment.

But despite the fact that VAST has been operating for 1.1 million hours, the concept "has proven to be defective," says the recent "Report on Navy Issues concerning Automatic Test, Monitoring and Diagnostic Systems and Equipment," prepared at the request of the Assistant Secretary of the Navy for R&D.

Test at sea. A Navy technician aboard the aircraft carrier USS Kennedy uses VAST to check main display units of an E-2C.

Users in the fleet are frustrated, the report says. "Despite promises, they do not see the situation improving. From their vantage point, the opposite appears to be happening. Increasingly complex testers and software, still failing to do the job, are being furnished to them."

Frustrations. While the serious problems in the operation and maintenance of the Navy's support equipment involves virtually all aspects of ATE, the report calls VAST the "primary air-Navy tester" and says it "exemplifies the promise and the problems of ATE utilization." Typical of the problems cited are: ATE that doesn't perform as intended; is not reliable and causes a maintenance problem itself, and cannot be, or is not, properly used. Also, the report says the equipment has not fulfilled its mission: improving fleet readiness at reduced cost and manpower.

Explains Art Morrow, PRD's vice

president, programs, "The problem is one mainly of management: management of the test-program tapes, of the carrier shops, and of the avionics configuration. Prime-weapons contractors wrote the test programs wrong, or there were changes in the avionics and the guy writing the test-program tapes was behind the group coming up with the changes, so the test programs were behind in diagnostics." Also, Morrow says that the failure rate of some of the avionics was "much higher than expected" and, as a result, VAST was so overworked that it couldn't be used for testing everything it was supposed to.

Morrow's view is shared to a large degree by Michael Myles, ATE section head at the Naval Air Systems Command in Washington. Says Myles, "The report reflects problems related more to the management of the VAST system than to

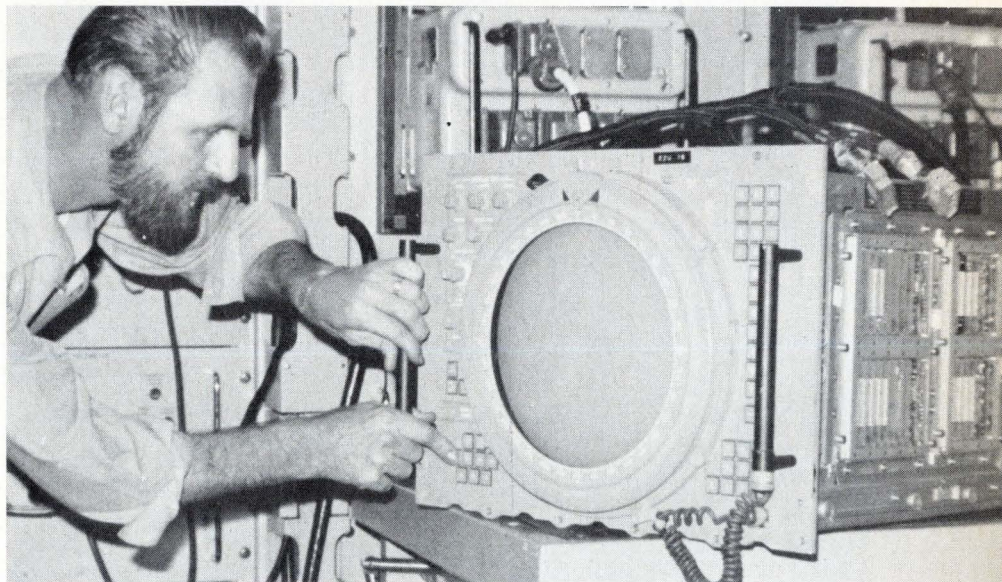

Probing the news

problems with VAST system hardware." When the Navy first began tracking the reliability of the hardware, the average mean time between failures was 24 hours. "It's now better than 160 hours as the result of corrective action that is still going on, primarily in the form of improvements to the test program," says Myles.

A dramatic example of the ATE problem is the support of the F-14 fleet-defense fighter, S-3A antisubmarine-warfare plane, the E-2C early-warning and control aircraft, and certain government-furnished equipment, notes the report. Because of limited workload capacity and the cost and time required for generating test software, many test requirements are being shifted from VAST to other equipment already in the inventory or being procured.

For example, Grumman Aerospace Corp. in Bethpage, N.Y., builder of the F-14 and E-2C, has contracted to supply the Navy with 25 computer-automated testers, designated CAT IIID. They will be used for upwards of 200 F-14 and E-2C shop-repairable assemblies. Similarly, the Navy has ordered from Lockheed-California Co. of Burbank, builders of the S-3A antisubmarine plane, some 22 hybrid automatic test systems (HATS) to test modules.

Grumman also has an order to

deliver a CAT IIID system to PRD to develop test-program sets for select assemblies on PRD's own VAST system. Says Ed Stroud, F-14 support equipment manager at Grumman, "We're building support equipment for the support equipment. VAST does work, but it has some disappointments."

The Navy now plans to put weapon-replaceable assemblies and very complex ship-repairable assemblies on VAST. "This leaves us with putting moderate and simple shop-repairable and some weapon-replaceable assemblies on other module testers such as HATS and CAT IIID," says Myles. "This represents a change in the basic philosophy of using one system, VAST, for testing both. We found the workload is so great on VAST that it is practical to devote it primarily to weapon-replaceable assemblies."

Thus far, the Navy has ordered 88 VAST stations, of which approximately 75 have been delivered. The latest purchase is an initial \$3.2 million contract for three systems to support new avionics on the A-7E trainer aircraft. In addition, the Iranian Air Force has purchased and received seven VAST stations to support its F-14 aircraft.

The problems with VAST today are that the weapons systems being supported have extremely complex electronics, says Jim Zing, an engineer at Lockheed's Automatic Test System division and developer of S-3A test-systems software for both

HATS and VAST. "The avionics is super-complicated and difficult to understand," he claims. "VAST itself is a tough system for the operator to learn. People underestimated the training required for the Navy whitehats [service technicians] to learn how to run complex electronics on a complex support system."

Navair's Myles agrees that VAST requires highly trained maintenance technicians who must be more skilled than technicians from the previous manual ground-support equipment. However, the operator of VAST "can't just be a button-pusher. It requires additional training in trouble-shooting the system when it isn't working properly. Operator training on VAST is greater than anticipated, but we're using less people to do the equivalent job."

Training. The training related to VAST "is the overwhelming shortcoming" of the system, asserts Kamill R. Hilberth, a former PRD employee on the VAST program and now, as president of GT&T Industries Inc. of Panorama City, Calif., an ATE consultant to three VAST users. But Hilberth also points to deficiencies in test-program sets. "If VAST or the test setup is not acceptable, or if the unit under test has been tampered with, the test result will often become misleading."

The fact that VAST has met many of its objectives, although not to the degree intended, leads PRD vice-president and general manager Thomas H. O'Brien to assert that the program "is still pretty viable. We don't see its level of business going down for the foreseeable future."

The fact that the Navy would specify VAST for the new F-18 is, says O'Brien, "an indication that it really achieved what the Navy started out to do—have a system that could take on new aircraft without going to a completely new support system." He asserts that the capability to switch from one aircraft to another without a big initial investment for special support equipment, has saved the Navy hundreds of millions of dollars. □

Control check. Navigation control unit from an S-3A antisub plane is tested by a technician using the USS Kennedy's VAST.



A reducing plan for microprocessors.

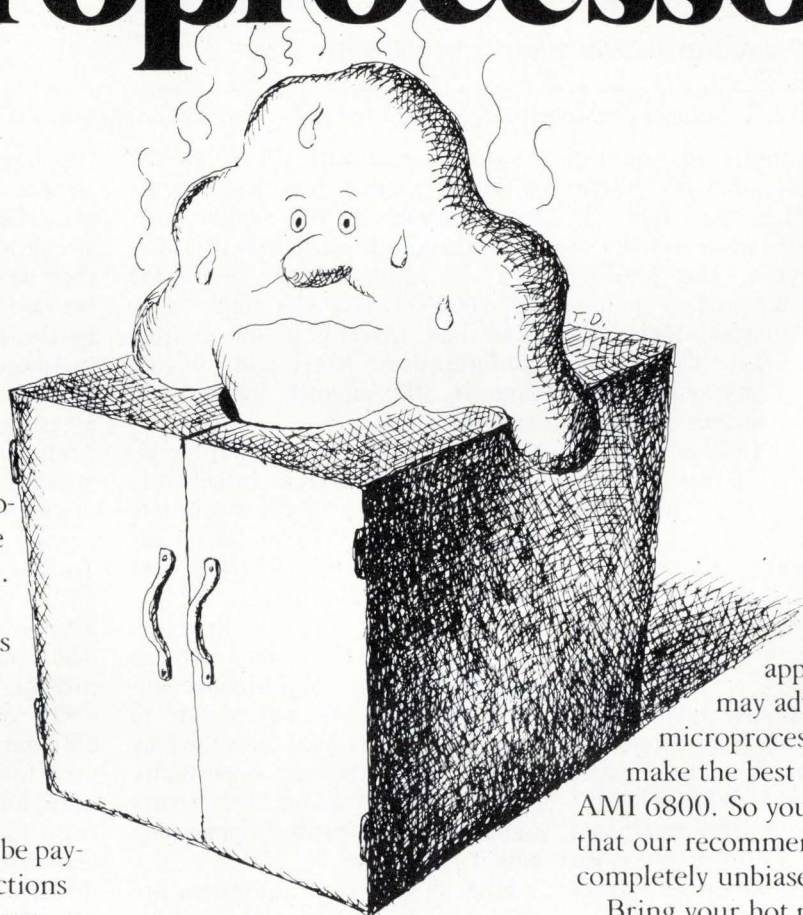

Here's a way to get a micro-computer that's *exactly* the right size for your product.

It's a custom microprocessor. We've made millions of them since 1966. And we're selling more of them today than ever.

The reason is simple. When you buy a standard microprocessor, you could be paying for a lot of built-in functions that you don't need. And, even though the standard part is cheaper going in, you can tell by the chart that custom comes out ahead in high volume runs.

If you're not sure which way to

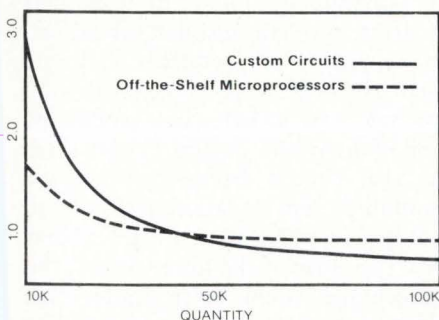

go, come to us. Nobody can match our experience in custom MOS, with our full-time staff of engineers, technicians and marketing specialists. We've recently developed a totally new method of design that cuts about 25 percent off the development cycle time. And our production lines in Santa Clara and Pocatello are geared to produce all the CMOS, N-Channel or P-Channel circuits you want.

After we've assessed your

application, we may advise a standard microprocessor—ours! We make the best one going, the AMI 6800. So you can be sure that our recommendation will be completely unbiased.

Bring your hot new idea to your nearest AMI sales office. Or write for our brochure on Custom MOS to: AMI, 3800 Homestead Road, Santa Clara CA 95051. One way or another, we'll help you cut out the fat.

Long Beach CA (213) 595-4768 • San Jose CA (408) 249-4550 • Altamonte Springs FL (305) 830-8889 • Elk Grove Village IL (312) 437-6496 • Norwood MA (617) 762-0726 • Livonia MI (313) 478-9339 • Minneapolis MN (612) 559-9004 • Monsey NY (914) 352-5333 • Cleveland OH (216) 292-6850 • Ampler PA (215) 643-0217 • Richardson TX (214) 231-5721

tailor-made MOS
from AMI
AMERICAN MICROSYSTEMS, INC.

Consumer electronics

Japanese tangle in home-VTR contest

Videotape players from Victor and Matsushita blunt Sony lead as battle lines are drawn over price and cassette time

by Gerald M. Walker, Consumer Electronics Editor, and Charles L. Cohen, Tokyo bureau manager

Competing strenuously to establish the first beachhead with home-video-tape-records, an area deserted by U.S. companies in favor of video-disk players, the leading Japanese consumer-product manufacturers have launched their new models in the market. The sudden rash of announcements, so typical of these companies, indicates that their products are getting closer together in prices, but not in designs that could lead eventually to some degree of compatibility.

Before the leader or leaders are clearly established, there will be more in-fighting and specification juggling. There are four entries now:

- Sony Corp. late last month came out with a stripped-down version of its BetaMax, priced at about \$800, compared to about \$1,000 for its SL-7300 video-cassette deck introduced last July. Sony has also cut the price of its one-hour tape cassette from about \$16 to about \$13.

- Victor Co. of Japan (JVC) earlier in September introduced its new VHS videotape recorder, priced at \$890.

Its two-hour cassette will sell for \$20 when the product hits the domestic market some time this month.

- Matsushita Electric Industrial Co. Ltd. this summer began selling the VX-2000 for \$730. Its single video head and cassette is an unusual configuration. Maximum playing time is 100 minutes for its \$26 cassette.

- Toshiba and Sanyo, joint developers of a fourth system, came out in June with a new model V-Cord II capable of playing two-hour cassettes and priced at \$1,150 and \$1,220. The cassette sells for \$24.

- Hitachi Ltd., which is strong in video-tape-recorder technology, has indicated it will not introduce another home system, but prefers to cooperate with "whatever of the four systems offers the best opportunity to reduce the selling price substantially," a company spokesman puts it.

Hitachi says that its dealers are clamoring for a VTR, and there's a good chance that the company could get a unit built on an OEM basis by Victor—in the same way JVC now

supplies its U-Matic players—on the shelves in time for the year-end sales. Other companies without such strength also want to offer VTRS to their dealers, so there is intense pressure on the competitors to show up best early in the race.

Advantages. According to initial reactions in Japan, JVC and Sony appear to have the best chance, but Matsushita has the largest dealer network in the nation and enough marketing clout to put its VX-2000 across. Prospects for Sanyo and Toshiba now appear to be fading. In part, that's because their two-hour playing time is achieved by a skip-field technique that diminishes picture quality.

Of course, it's possible that two different systems could coexist, to use a favorite Japanese term. Matsushita, for instance, is likely to market both its own recorder and the VHS designed by JVC. In addition, Sony, through its prompt response to the JVC announcement, has served notice that it will fight hard to make BetaMax, the first home VTR on the market, a winner.

What market do these firms expect? This year, it's not very spectacular—about 200,000 units could be produced, most in the last quarter, and half destined for export. Next year, the producers estimate that 200,000 to 400,000 units may be sold, so a safe bet would be 300,000. At the outset, export sales to the United States represented around 60% of Japanese production, but today it's closer to 50%. Next year, because of the lower prices, the percentage could shift again, this time in favor of domestic sales. The next surge in sales probably won't

COMPARING VIDEO-TAPE RECORDERS

	JVC VHS	Sony BetaMax	Sanyo/Toshiba V-cord	Matsushita VX-2000
Tape speed (mm/s)	33.35	40	73.87	52.1
Relative speed (m/s)	5.8	6.9	7.73	9.09
Weight (kg)	13.5	20.5	17	20
Dimensions of cassette (mm)	188 x 104 x 125	156 x 96 x 25	156 x 108 x 25	213 x 146 x 44
Max. recording time (min)	120	60	120	100

CAN THE LEADER IN DIGITAL VOLTMETERS TAKE OVER IN COUNTERS?

Well...

We've seen some surprising changes.

Last time we checked, for instance, we were sitting in the number two spot.* Not too bad for a company that didn't begin building counters until 1973.

But, then again, we had an advantage. We knew what to do. We knew what it would take to be a leader in counters.

Give the guy on the bench, or building a system, a top-performing, Fluke-quality counter at a price a few hundred bucks less than he expected to pay. An honest bargain is always a big seller.

Frequency Extension Options

520 MHz Prescaler

Covers frequency range of 50 to 520 MHz, using a scaling ratio of 4. Sensitivity is 15 mV rms (AGC). Maximum allowable input is 5 V rms (fuse protected). VSWR less than 2:1 into 50 ohms for levels less than 1 V rms.

1000 MHz Prescaler

Covers 50 to 1000 MHz using a scaling ratio of 8. Sensitivity is 15 mV rms, and maximum allowable input is 5 V rms (fuse protected). VSWR less than 2.5:1 50 ohms for levels less than 1 V rms.

1250 MHz Prescaler

Covers 50 to 1250 MHz using a scaling ratio of 8. Sensitivity is 20 mV to 1000 MHz, increasing to 40 mV rms at 1250 MHz. Maximum input 5 V rms (fuse protected), and VSWR less than 2.5:1 for levels less than 1 V rms.

We know frequency.

For example, a bench/systems box at \$995** with the same programming potential of counters selling \$130 to \$305 and even \$640 more.

That \$995 bargain is our 1953A Programmable Universal Counter/Timer. What does \$995 buy? Here's a good example of how we're changing the counter market. The 1953A is designed for both bench and systems use in frequency, ratio, period(s), time interval and gateable totals measurement. The basic box has a frequency range from DC to 125 MHz at sensitivities to 30 mV. Nine-digit LED display. Full triggering control.



Counters!

But you can see. Take a look at the unit pictured in this ad—you're going to see a lot more on the front panel.

And there are options. Time base options. Frequency extension options. System interface options. We're going to have to send you information for you to get a complete idea of what this counter can do.

But it all starts with the \$995 unit.

An honest bargain from Fluke.

And, meanwhile, when someone asks

if we're going to take over in counters, we just smile, shrug and keep on building those great Fluke counters.

After all, we've only been at it 3 years.

	Time Base Options	
	TCXO	Oven-Stabilized
Frequency:	10.00 MHz	10.00 MHz
Aging Rate: (constant temperature)	$<\pm 3 \times 10^{-7}/\text{mo.}$	$<\pm 1 \times 10^{-7}/\text{mo.}$
Temperature Stability:		
20°C-30°C	$\pm 2 \times 10^{-7}$ typ.	$\pm 3 \times 10^{-9}$ typ.
0°C-50°C	$<\pm 5 \times 10^{-7}$	$<\pm 1 \times 10^{-8}$
Line Voltage: ($\pm 10\%$ change)	$<\pm 5 \times 10^{-8}$	$<\pm 3 \times 10^{-9}$

We know time.

For data out today, dial our toll-free hotline, 800-426-0361.

John Fluke Mfg. Co., Inc., P.O. Box 43210, Mountlake Terrace, WA 98043

Fluke (Nederland) B.V., P.O. Box 5053, Zevenheuvelenweg 53, Tilburg, Netherlands.

Phone: (013) 673-973 Telex: 52237

*Source available upon request.

**U.S. price only.

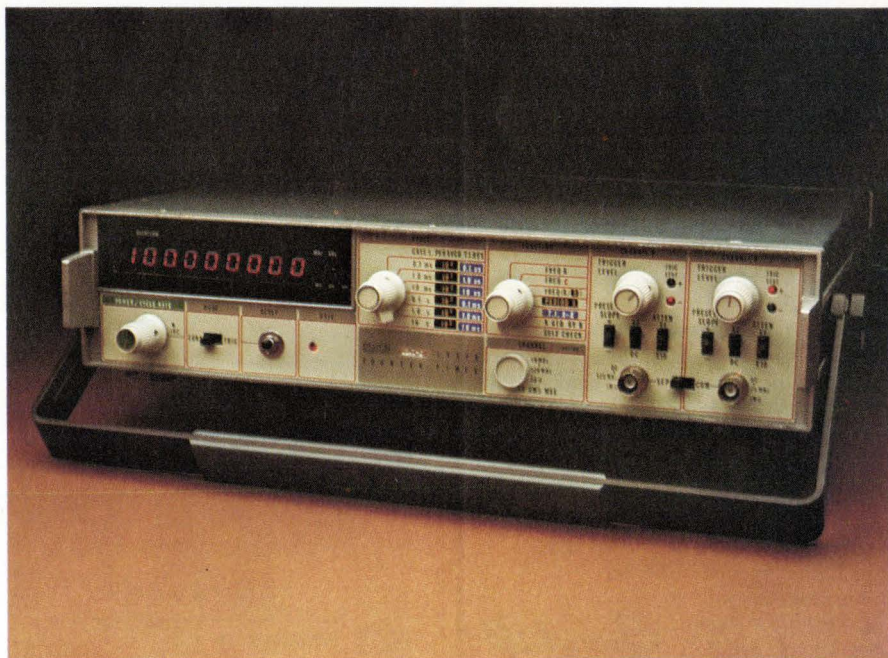

THE SURPRISING NEWCOMER. 1953A COUNTER. 

Circle 68 for demonstration, circle 69 for literature.

Now, more applicability for our most popular 1" switch

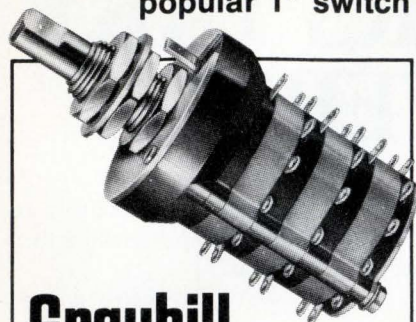

Grayhill U.L. listed 1 inch 1 amp rotary

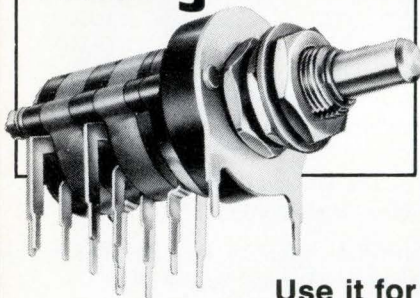

Use it for test equipment, medical electronics, instrumentation and other line voltage switching

- U.L. listed at 1 amp, 125 VAC, to accommodate most "power switching" requirements
- Switches measure approximately 1" diameter, 1" behind panel for a 1 deck switch, 5" behind panel for a 12 deck switch.
- Wide variety of circuit choices and features

The U.L. listed Grayhill series 42 and 44 Rotary Switches offer a wide variety of circuit choices including 30°, 36°, 45°, 60°, and 90° angle of throw, 1 thru 12 decks, 1 thru 6 poles per deck, and non-shorting or shorting contacts. Optional features include concentric shaft or "add-a-pot" types, shaft and panel seals, adjustable stops, and PC mount versions.

U.L. Card E35289 with complete listing data, and New Product Bulletin #251 containing Series 42 and 44 specifications, may be obtained free from Grayhill, Inc., 561 Hillgrove Avenue, La Grange, IL 60525 (312) 354-1040.



Probing the news

come until the makers reduce the price below \$700, to about the price in Japan of an 18-inch color-TV receiver, which now starts at \$480.

Prospects. That point is some years away. In the meantime, a fairly substantial market is expected to develop at present prices. As for a standard VTR compatible with decks from other manufacturers, that's a long way off, and it will depend largely on how dealers and consumers react to the present line-up.

Nevertheless, all the contenders fear harm may result from confusing potential customers. "Perhaps," Yutaka Ikeda, general manager of Toshiba's TV-receiver division suggests, "none of the present helical-scan systems will be the best. There may be a better chance for a different approach, such as a fixed-head player."

Besides the electronics in a VTR, there are also mechanical considerations. The dimensions of the cassette are also a factor because people will expect to keep libraries of recorded television broadcasts. JVC's entry has a cassette measuring 188 by 104 by 25 millimeters to provide two hours of playing time. Victor's slow tape speed of 33.35 millimeters per

second and small drum diameter of 62 mm help conserve tape. But they combine to give a tape speed relative to video head of only 5.8 meters per second, which makes it necessary to use sophisticated circuit techniques to get good reproduction.

Although Sony has a one-hour tape now, it claims that technology for a two-hour version is well in hand, although no product is imminent. Matsushita promises by the end of the year a two-hour tape that will play on VX-2000s.

Sony attributes the lower price for the single-touch BetaMax SL-7100 in part to production savings resulting from increased output of the BetaMax 7300 and in part from the removal of a couple of frills from the original. Essentially, the new videocassette player is the same, except audio-dubbing and pause features have been removed.

The firm expects to increase manufacturing from the present 10,000 units a month to 15,000 units a month in April when additional production facilities go on line. Sony asserts that even though it is losing market share, there is an increase in total sales. □

Playback. Victor's new video-tape-recorder handles a two-hour cassette. Machine will sell for \$890, cassette for \$20.



FLUKE PROVES AN INEXPENSIVE, HANDHELD DMM CAN BE BUILT WITHOUT LEAVING EVERYTHING OUT.

Let's face it.

Before now, if you bought an inexpensive, handheld digital multimeter you didn't get much—they just left most everything out.

We knew that was no answer.

So we built the 8030A 3½-digit DMM. It's a small, portable, inexpensive, handheld DMM, but it performs like our benchtop units.

With one basic difference. The 8030A was designed, built and tested to a size and shape proven best for field service and laboratory technicians. There's a built-in hood that can be slipped forward to shade the readout in sunshine. It has rms capability. The best overload protection. Diode test. It weighs 2.2 pounds, and will take a beating without failing. Finally, we guarantee accuracy specifications for one year.

And it only costs \$235*.

True rms.	Fluke
1-year accuracy specs.	Fluke
High voltage protection.	Fluke
Diode test.	Fluke

A full line of accessories offering rf voltage, high current ac, high voltage dc, and temperature measurement probes. Fluke

There's only one place to go for all the performance you need in a handheld DMM.

There are measurement functions in five selectable ranges for dc volts, ac volts (true rms), dc current, ac current (true rms), and resistance. DC voltage measurement is from 100 μ V to 1100V with basic accuracy of $\pm 0.1\%$, ac measurement is from 100 μ V to 750V rms with basic accuracy of $\pm 0.5\%$. DC and ac current is from 100 nanoamps to 1.999 amps with basic dc accuracy of $\pm 0.35\%$ and basic ac accuracy of $\pm 1\%$. Resistance measurement is from 100 milliohms to 2 megohms with a basic accuracy of $\pm 0.4\%$.

We added true rms response for ac measurements. Specified accuracy is still attainable when the measured waveform is distorted.

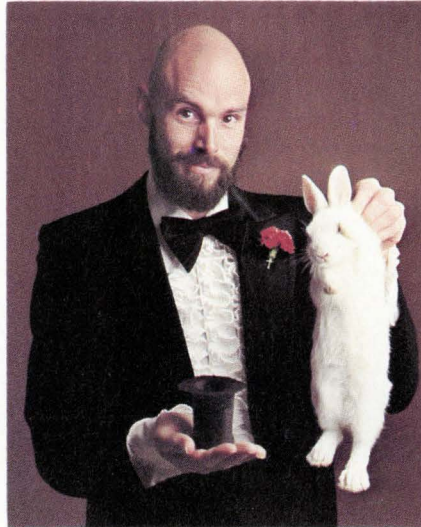

"Fluke does the impossible again."

There is extensive overload protection. It has been tested with transients up to 6000V peak across the input terminals.

Options include two battery operations: a rechargeable NiCad for 8 hours operation and throw-away alkaline cells. Accessories include probes for measure-

ment of rf voltages, high current ac, high voltage dc and temperature.

80T-150 Temperature Probe	
Sensitivity:	1 mV/°C or 1 mV/°F
Accuracy:	
+15°C to +35°C ambient:	$\pm 2^\circ\text{C}$ (3.6°F) - 25°C to +125°C $\pm 3^\circ\text{C}$ (5.8°F)
-50°C to -25°C and +125°C to +150°C ambient:	Add 1°C (1.8°F) to above

You can also get temperature measuring capabilities with the 8030A.

And because the 8030A gives you so much in performance, let us remind you once more of the price.

Only \$235*.

For the first handheld DMM that's small in size, small in price, but huge in performance.

For data out today, dial our toll-free hotline, 800-426-0361.

John Fluke Mfg. Co., Inc., P.O. Box 43210, Mountlake Terrace, WA 98043
Fluke (Nederland) B.V., P.O. Box 5053, Tilburg, The Netherlands.
Phone: (013) 673-973 Telex: 52237

*U.S. price only.

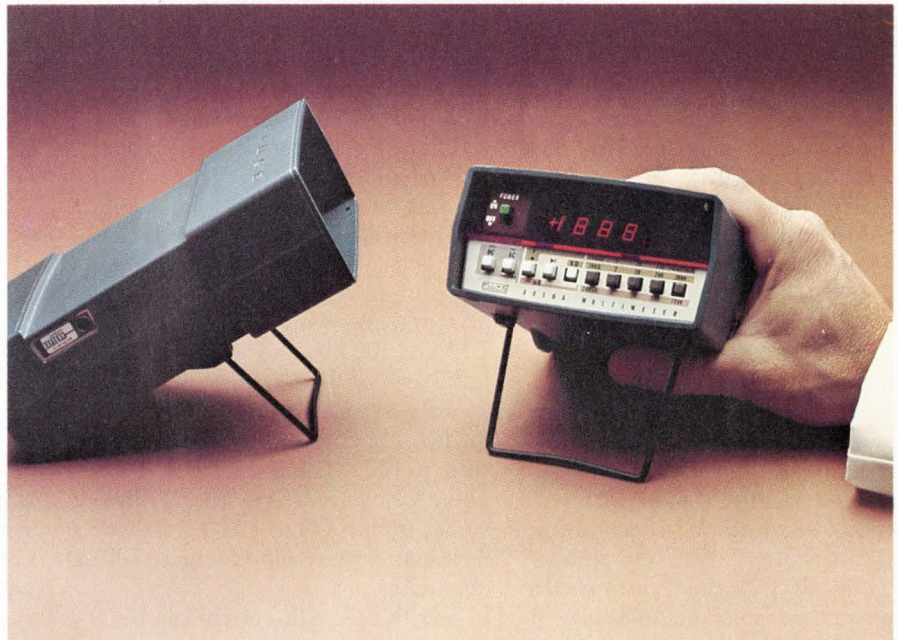

A NEW ADVANCE. 8030A DMM. 

AN INVITATION TO LEARN WHY THE FLUKE 8500A IS CALLED THE WORLD'S FINEST DVM.

We'd like to introduce you to a new concept in digital voltmeters.

The Fluke 8500A.

It's a measurement system—not a dedicated instrument, but a bus-oriented, microprocessor-controlled measurement device. Modules which convert parameters, such as ac voltage, resistance or current, are simply plugged into any available slot in the bus structure. The microprocessor then talks to the module and displays the new value in the desired parameter.

That's the heart of the 8500A—unlimited measurement architecture. At any time, different measurement, control or servicing modules can be plugged in the bus.

And the 8500A is a different measuring device.

All for a basic system price of \$2,695*.

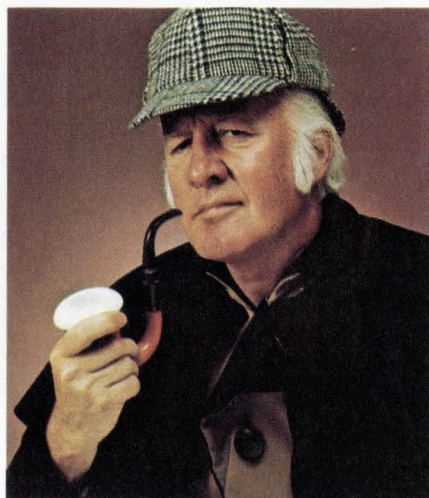

"It's not difficult to understand why it's called the finest. After all, it is a Fluke DVM, isn't it?"

312.5 mV is possible with a resolution of 1 μ V. Displays on the lower ranges are in volts, followed by an exponent display of -3.

Two types of ac measurement options are available for the 8500A. While only one can be installed in the instrument at a time, removing one option and installing the other requires a minimum of time and/or operator training. At power up or after reset, the front panel displays whether the averaging converter, true rms converter or neither is installed in the instrument.

The Averaging Converter (Option -01) measures up to 1000V ac on four ranges with a bandwidth from 30 Hz to 100 kHz and accuracies up to $\pm 0.05\%$ + 5 digits. The True RMS Converter (Option -09) measures up to 1000V ac on four ranges with a bandwidth from 10 Hz to 300 kHz and accuracies up to $\pm 0.1\%$ + 15 digits.

Resistance measurements can be made on eight ranges from 10 Ω full scale to 100 M Ω full scale with the Ohms Converter (Option -02). Basic accuracy from 100 Ω to 1 M Ω is $\pm 0.003\%$ + 1 digit, with resolutions up to 100 $\mu\Omega$ obtainable.

Both ac and dc current can be

measured with the Current Module (Option -03) provided one of the ac options is installed in addition to the basic dc. Current measurements to 1A can be made with sensitivity to 1 nA. Accuracies to $\pm 0.03\%$ + 10 digits, for dc readings and to $\pm 0.06\%$ + 8 digits for ac readings. Bandwidth of the 100 μ A through Amp ranges is 30 Hz to 10 kHz. For the 1A range only, the bandwidth is 30 Hz to 3 kHz.

Guaranteed accuracies for the 8500A measurement options are based on 90 days, 18°C to 23°C.

Three Remote Interface options are available with the system. Only one of the three may be installed at a time; however, one can be easily exchanged for another when the top cover is removed. This allows the instrument to be used with more than one interface system, requiring only that additional modules for the desired interfaces be obtained.

The IEEE Standard 488-1975 Bus Module (Option -05) provides an eight-bit (one byte) parallel interface. The Bit Serial Asynchronous Interface Module

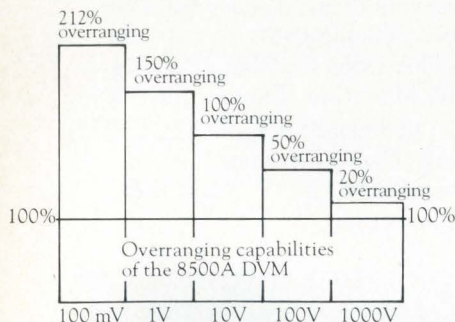

Most other DVM's offer only 20%-60% overranging.

The 8500A is a high-speed 5½-digit DVM capable of 500 readings per second at full resolution and accuracy. Fluke's patented Recirculating Remainder (R²) A/D Conversion technique is used for high, long-term accuracy and linearity. There's a calibration memory that allows for automatic correction of calibration error. And it's the only systems DVM that measures ac and dc current.

DC voltage measurement and dc ratio are standard features. DC voltages are measured over five ranges, with resolution between 1 μ V and 10 mV and a basic accuracy of $\pm 0.001\%$ (10 ppm) for 24 hours, 20°C $\pm 1^\circ$ C. Starting with the lowest range, a maximum display of

8500A DVM at 7½ Samples/Second
--- Filtered — Unfiltered

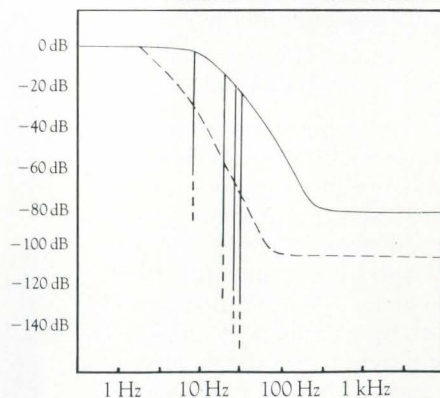

Fantastic noise rejection without sacrificing speed.

(Option -06) interfaces the 8500A to systems using either RS232B, RS232C, or Current Loop interface. Selection of type and Baud rate is made with bit switches accessible through an entry

Automatic correction for zero, offset, calibration and drift with microprocessor controlled memory storage.



Extra digit of resolution.

As an extra bonus, the range digit can be converted to a 6th measurement digit—for 6½ digits of resolution.

port on the rear panel. And the Parallel Interface Module (Option -07) provides a 16-bit duplex register interface compatible with mini-computer and microprocessor systems.

A non-volatile calibration memory module stores correction factors desired from a standard input during CAL mode operations. It can also be used to compensate for long-term drift, eliminating the need for manual adjustments or trips to the calibration laboratory. This al-

IEEE-488 interface bus	Fluke
ASC11 interface	Fluke
Parallel interface (16 bit)	Fluke

Only one system DVM offers all the interfaces you need.

18 different sample rates	Fluke
5 different filter modes	Fluke
Programmable scaling factor	Fluke
Store and test for limits	Fluke
Local and remote lockout	Fluke
Front panel display on/off	Fluke
Line and non-line synchronized readings	Fluke
Store and display of highest and lowest values found	Fluke
Recall and display status	Fluke
6½ digits of resolution	Fluke

And with any interface there are expanded remote features.

lows the operator to remove power from the instrument or the system to suffer a power failure without loss of automatic calibration factors. The battery permanently installed on the module will keep power on the memory to retain the stored data in excess of 90 days after removal of power.

Service capability is one of the strong points in the 8500A program. Of course, extensive overload protection has been designed into the instrument. But should problems develop, most of them can be handled in the field by using the available service aids. An extender card, a bus monitor, a test module, and a static controller, together with diagnostic programs and the microprocessor control should handle 60%-80% of most troubleshooting problems. If you've read this far, you know

why the 8500A is called the world's finest DVM. Microprocessor control, modular design, complete measurement and systems interface capability and ease of service are all combined in one instrument. And the best thing about it is that it's made by Fluke. So you know you can count on quality and service throughout the world.

The 8500A. One more reason why Fluke is the leader in digital voltmeters.

For data out today, dial our toll-free hotline, 800-426-0361.

John Fluke Mfg. Co., Inc., P.O. Box 43210, Mountlake Terrace, WA 98043

Fluke (Nederland) B. V., P.O. Box 5053, Tilburg, The Netherlands.

Phone: (013) 673-973 Telex: 52237

*U.S. price only.



NOTHING COMPARES. 8500A DVM. 

Electronics abroad

Polish plant ready to roll

Power semiconductor facility, set up in \$9.7 million deal by Westinghouse, starts production in November

by Howard Wolff, Associate Editor

Late next month, the first production thyristors will roll out of a plant 20 miles south of Warsaw in Poland—and Donald A. Walczak of New Alexandria, Pa., will sit back, take a deep breath, and begin thinking about a vacation.

Walczak has been a virtual Pennsylvania-to-Poland commuter since the spring of 1974. That's when the Westinghouse Electric Corp. team he heads as project manager began fulfilling its \$9.7 million contract with the Polish government to design, equip, and put into operation a power-semiconductor plant. And before that there were two years of negotiations.

The deal, the first sale of technology by an American semiconductor maker to Poland, is the largest technology sale ever made by Westinghouse. The company is so pleased with results that its repre-

sentatives are shuttling among Eastern European capitals looking for similar business. Nothing is yet in hand, but the governments of Bulgaria, Rumania, and Czechoslovakia have been sounded out. As Walczak explains: "It takes so long to determine what they want; everything is tied in to five-year plans."

The Rumanians already have a plant equipped by an American company—a tuning-diode facility that started manufacturing devices last summer. It was outfitted by ITT and has licenses and knowhow from Intermetall GmbH, the German member of the ITT Semiconductor group. And in Bulgaria, a selenium-rectifier manufacturing facility has been set up by ITT's Components group in Europe.

Warsaw is eager. But Poland, of all the Eastern bloc nations, appears to be making the strongest effort to import Western electronics technology. While their eyes are on a wide range of technology available from the West, officials of the big Unitra Electronic Industry Union were eager to land a contract with Westinghouse. Jerzy Bilip, Unitra's technical director, says that the company was selected as a partner because of its "very strong knowhow." The next big technology sale, in a contract that was signed last summer, provides for RCA Corp. and Corning Glass Works to put up a color-television-tube plant.

The Poles, unlike counterparts elsewhere in the Eastern Bloc, are frank about their need for Western technology. The figures back them up. Of Unitra's total production, about 28% is based on foreign licenses. And in semiconductor products alone, the figure is much higher—around 65%. As for integrated circuits, Japanese technology is used by the big Polish combine mainly in linear circuits, and French knowhow—from Thomson CSF—primarily in digital types.

The Unitra numbers are a good indication of Poland's drive away from agriculture and toward industrialization, because electronics is leading that drive and Unitra, with 1975 volume of about \$1.1 billion, is the largest single electronics producer in Poland, accounting for half the output. Unitra executives expect the tempo to pick up and forecast an

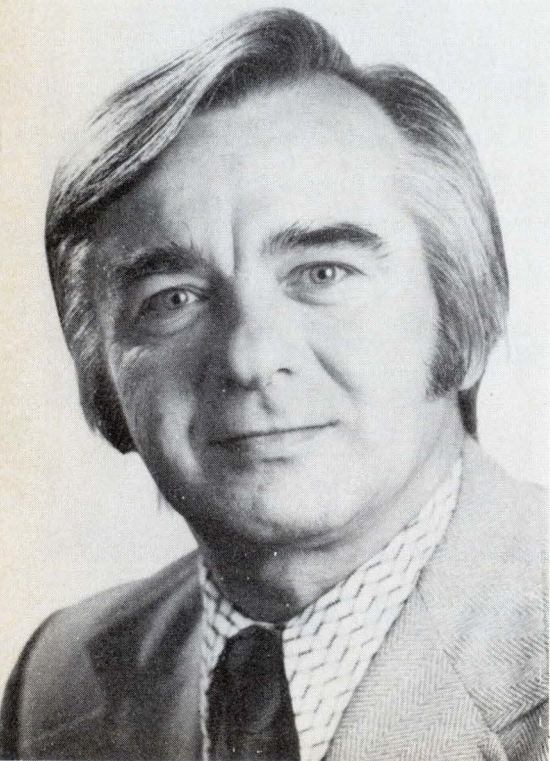

Builders. Donald Walczak, left, was project manager as Westinghouse designed and built a power semiconductor plant for Poland. Maurice C. Sardi, right, is general manager of Westinghouse's Semiconductor division. Poland paid \$9.7 million.



annual growth of 15% to 20% for some years to come [*Electronics*, July 10, 1975, p. 68].

Westinghouse officials are careful to note that their success in making the sale and delivering the product to the Poles is not necessarily transferable to other electronics industries. The power semiconductor industry, they point out, is unique. It's a difficult business in which to make money, they say, because it requires a heavy investment in research and development and equipment. But from a manufacturing standpoint, the market is a relatively low-volume one, so that to recover the investment a company like Westinghouse must either price its products high or sell its technology. And since the competition for that relatively small market is stiff, costs can't be covered through sales alone. The result is, in the words of one official, "If you can do better by selling technology than product, then you do it." Still, even the Westinghouse officials agree that it's not a good business decision to sell technology if you can sell product.

Competition. Their experience brings up two big questions: one for the company in particular, and one for American electronics firms in general. The first is the question of putting a potential competitor in business, specifically, in Poland's case, one whose government can marshal national resources of money, time, and labor almost to any lengths.

No problem, says Maurice C. Sardi, Semiconductor division general manager. "The benefits of selling technology are sufficient to offset the disadvantage of setting up competitors," he says. The way Sardi explains it, "when negotiating the contract, it was necessary to freeze the technology at a particular point four years ago. But since then, Westinghouse has been continuing its own R&D; we are now four years smarter. I can sell technology through, let's say, phase one. But it would take the same resources to get to phase two as it took to get from zero to one, and there are no option clauses in the contract under which we would provide the next phase to Poland. Moreover, the Poles want to advance themselves. They now have the core,

but how they perpetuate it is their problem."

The division's operations manager, Mickey Turner, adds, "It takes a long time to learn the semiconductor business, and it will take many years for the Poles to get good yields. We just showed them how."

But perhaps the larger question is one of exporting a precious American resource—technology—to a nation that's part of a bloc that could one day face the U.S. in a hot, as well as an economic war.

Sardi concedes that there has been some concern that Westinghouse's sales might lift the Poles to the level of Western power-semiconductor makers. However, he says, "Either we believe that we in the U.S. have the resources, talent, and systems to apply technology better than anyone else or we don't. That's what's important: the ability to apply the technology. After all, I can give you a Rolls Royce, but if you can't drive it, you can't enjoy it. We, as Americans, simply can't live under a bushel basket."

The Westinghouse team agrees that one of the pleasant surprises it encountered while building and setting up the plant was the cooperation it got from the Polish government. "They assigned talented people to us," says Sardi, "and the work proceeded in an atmosphere of mutual confidence and trust. There was never any feeling that anyone was trying to put something over on anyone else. The Polish people are hard negotiators, and they held the line hard at getting what they paid for, but there was no attempt to go beyond that." The result is that the project was completed right on time, says Walczak, and Westinghouse's profit from the fixed-price contract met its projections.

The major difficulty was the unavailability of certain materials, particularly metals. Two years were spent seeking local materials that would meet Westinghouse's specifications because the Poles were loath to use hard currency to purchase material outside the country. But the biggest lesson that the Westinghouse officials learned from the project, they agree, is to have one man in charge of the project from the first day. That man was Walczak. □

a little A-300 goes a long way.



In high frequency transmission. RF power generation for industrial and research processes. RF/EMI and general laboratory applications, too.

The Model A-300 is a totally solid state power amplifier, covering the frequency range of 0.3 to 35MHz with a gain of 55dB. Capable of delivering 300 watts of linear Class A power and up to 500 watts in the CW and pulse mode, the A-300 is the ultimate in reliability.

Although the unit is perfectly matched to a 50 ohm load, it will deliver its full output power to any load (from an open to a short circuit) without oscillation or damage.

Complete with power supply, RF output meter and rack mount, the A-300 weighs a mere 89 pounds and operates from ordinary single phase power.

High power portability goes a long way for \$5350.

For further information or a demonstration, contact ENI, 3000 Winton Road South, Rochester, New York 14623. Call 716-473-6900 or TELEX 97-8283 ENIROC

ENI

The World's Leader
in Solid State
Power Amplifiers

Whatever you need in an IC socket... **RN has 'em all!**

—and with “side wipe” reliability

PRODUCTION SOCKETS

NEW! ICL Series

26% lower profile—.150"
Ideal for high density, high volume configurations, provides maximum vibration resistance. Solder type, single leaf “side-wipe” contacts. 8 to 40 contacts.

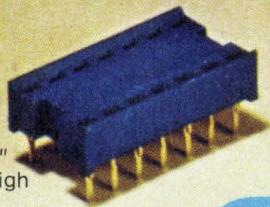

ICN Series high reliability general-purpose sockets. Low insertion force allows automatic IC insertion. In solder or wire-wrap. 6 to 64 contacts. Dual leaf “side-wipe” contacts.

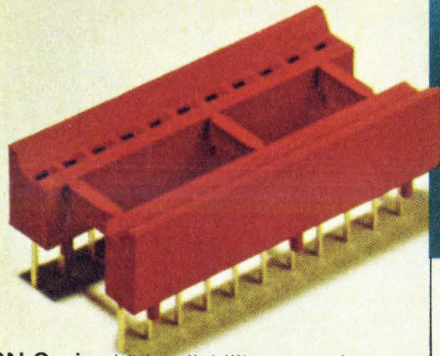

ICA Series

high reliability pin socket contacts. Low profile in solder or wire-wrap. 8 to 40 contacts.

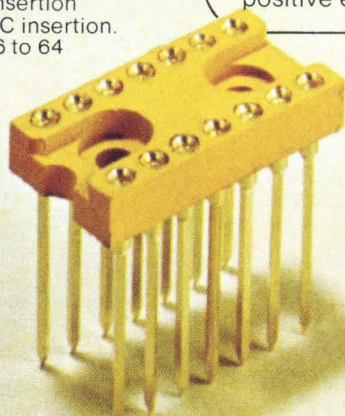

WRITE TODAY
for New RN “Product Selection Guide”...

BURN-IN, TEST SOCKETS

TS Series

very long contact life. Very low insertion force. Ideal for incoming inspection. With 14 to 40 contacts. Also strip sockets up to 21 positions.

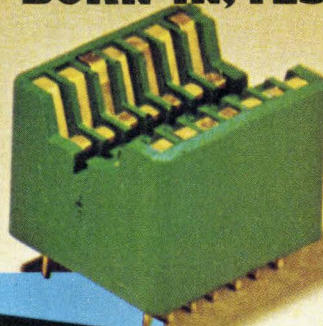

IC Series

moderate cost, long life. Designed for general test and burn-in up to 350°C. With 14 to 40 contacts.

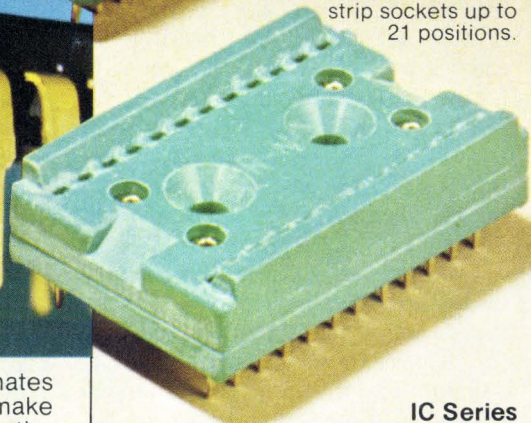

ICN/S2 Series

lowest cost burn-in socket available. Designed to accept IC extraction tool. With 8 to 40 contacts, with strip sockets up to 25 positions.

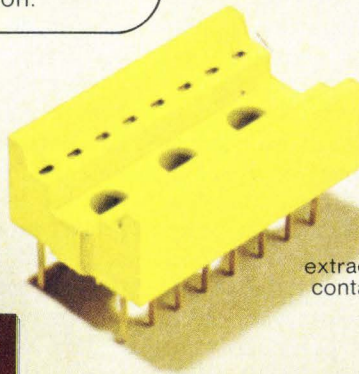

RN HIGH RELIABILITY eliminates trouble. “Side-wipe” contacts make 100% greater surface contact with the wide, flat sides of your IC leads for positive electrical connection.

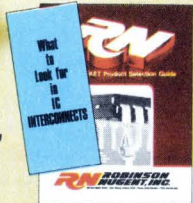

... and informative book “What to Look for in IC Interconnects.” Free from RN—the people who make more kinds of high reliability sockets than anyone.

RN ROBINSON NUGENT, INC.

ROBINSON-NUGENT, INC. • 800 East Eighth Street • New Albany, Indiana 47150 • Phone: (812) 945-0211

Call me, I'm interested Circle 76

Send product information Circle 187

Military electronics

PDP-11 chosen as tactical base

DEC's commercial architecture to be used for new military computer family in competition with IBM, Interdata

by Ray Connolly, *Military Electronics* editor

The search is over. After a year's examination and deliberation, the Army and Navy have agreed on Digital Equipment Corp.'s PDP-11 architecture as the base on which they will attempt to build a new family of software-compatible military computers for the 1980s. Known as MCF—for military computer family—the program is a joint effort led by the Army Electronics Command at Fort Monmouth, N.J., with support from the Naval Air Systems Command in Washington and Naval Research Laboratory.

Selection of the PDP-11 architecture over IBM's System/370 and Interdata Inc.'s 8/32 provides a significant boost in the military computer market for the Maynard, Mass., manufacturer of commercial machines. The selection came only days before ECOM selected United Technologies Corp.'s Norden division to develop an artillery system using PDP-11 technology (see "Norden's new artillery: PDP-11").

The selection of DEC's commercial architecture by a committee of representatives from more than 25 Army and Navy organizations "demonstrates that Alexandre Dumas was right," observed one Defense Department monitor of the program: "Nothing succeeds like success." But more than that, it confirmed earlier military concessions that tactical computer systems—with their expensive and incompatible software packages—have failed to keep pace with commercial developments.

More surprising was the choice of Itek Corp.'s Applied Technology division in Sunnyvale, Calif., to carry out a year-long system-imple-

mentation study. "Itek's computer expertise is not well known outside of 'spook' circles," says one official, referring to the company's classified work for government security agencies. The Itek award is only for \$600,000, and reflects elimination of fiscal 1977 Navy funds for the MCF program. The Navy is struggling to hang in, however, with uncommitted prior-year money, but at a lower level. As it stands now, the bulk of MCF's funds—and direction—is from the Army. And part of MCF is the Navy's former all-applications digital computer (AADC) program.

Processor due. With the selection of the PDP-11 computer family architecture, the program expects to have an instruction-set processor, or ISP, available by year's end. By that time also, Army and Navy staffers will have selected prior-generation military computers that may be backfitted with MCF software, and

processor specs for older computers will be prepared and validated. The specs of the PDP-11 family, plus those for the earlier military machines, Coleman explains, "will be basic input data for subsequent MCF implementation planning."

Along with the plan for system implementation, a parallel plan for support software will be procured from at least two contractors to permit a military choice for an integrated support software system. Initially, that system will consist of PDP-11 support software, of course, but it will be gradually augmented through efforts of the Pentagon and its contractors. The software plan will define the system and its major components; estimate their relative cost-effectiveness; consider alternative acquisition methods; estimate return-on-investment for each, and recommend a preferred method. □

Norden's new artillery: PDP-11

Digital Equipment Corp. has won another victory with September's \$6.2 million award by the Army's Electronics Command to United Technologies Corp.'s Norden division in Norwalk, Conn. The contract is for engineering development models of a new artillery computer for use by individual gun batteries. Norden's new battery computer system (BCS) will be a militarized version of DEC's PDP-11 system. DEC licensed Norden to militarize its small, highly successful commercial machine about a year ago.

Of the eight bids received by ECOM for the new system, Norden's entry became a finalist along with those of Litton Data Systems, Van Nuys, Calif., and Teledyne Brown Engineering, Huntsville, Ala. Should Norden's version prove successful in field tests, it could spell bad news for Litton's Tacfire program now used by the Army for artillery automatic fire control. Adoption of the Norden system for computation of artillery-fire trajectories and rates at the battery level by individual units would free them of dependence on the larger, division-level Tacfire system and presumably reduce requirements for Tacfire hardware and interconnection. The battery is the artillery's counterpart of the infantry company.

Computers

Curve is upward for Britain's ICL

by William F. Arnold, London bureau manager

On Oct. 1, International Computers Limited began its new fiscal year in a buoyant mood. Once a stodgy amalgamation of various computer entities, the British company over the last several years has transformed itself by some bold strokes, big government aid, and a few key managers imported from Sperry-Univac into an aggressive company whose new emphasis befits the first word of its name and not the last.

Now among the two or three largest computer companies outside the U.S., the firm plans to pull more than half of its annual sales in the new year from exports—up from less than half this past year. Executives foresee growing continental markets, especially in West Germany, France, Sweden, and the Netherlands. And they wouldn't be surprised if the new fiscal year's performance approximates the rise of the one now closed. When all the sums are finally totted up for the period just ended, ICL is expected to show profits on total sales of around \$500 million—up comfortably from the approximately \$432 million a year ago.

The buoyancy seems justified. The firm's New Range of large main-frame machines launched two years ago is now selling better than expected after some initial software teething problems, although sales remain mostly in Britain. Despite French opposition, the company is confident that it will grab an \$8 million deal to supply its largest computer, the 2980, to the European Economic Community, with possible later add-ons. The small-computer 2903 series is attracting customers in Europe and the U.S. And the first products from Computer Peripherals

Inc., the joint venture with NCR Corp. and Control Data Corp., are beginning to emerge.

But the company's new international thrust is best shown by the bold stroke earlier this year when it grabbed the Singer Business Machines division's profitable international business at almost distress-sale terms [*Electronics*, April 12, p. 55]. With a speed uncommon to large companies, especially British concerns, ICL plucked off for a mere \$2 million down payment Singer's overseas customer base and the option to market and manufacture as much of the firm's equipment overseas as it wanted. Even if it takes all of the estimated \$70 million international assets, ICL will have four years to pay it off.

What the deal gave was a crack at Singer's range of hardware—the point-of-sale equipment, the 1500 intelligent terminal, and the System 10 small computer system. Though there's some overlap between the System 10 and the 2903, the new gear fills gaps in ICL's lineup. More importantly, the deal enlarges the company's customer base by a third to about 5,000 users and increases its

overseas business by 50%.

Under terms of the deal, ICL begins the new fiscal year having chosen what it wants. According to Peter V. Ellis, director of the worldwide marketing group, beginning in February, the company will begin making Singer's System 10 in Britain, as well as continuing production in Singer's former factory in Utica, N.Y. The 1500 will be made in Utica, probably not in Britain, but will be sold abroad by ICL. The point-of-sales series "we'll continue with either in the U.S. or the UK," he says. The firm also plans a follow-up terminal to the Singer 920 in 1977.

How important is the Singer deal to ICL? "We have a 15-million-pound business in France," says Ellis. "With Singer it becomes a 25-million-pound business." With Singer, the companies will be able to set up trading operations in new territories, such as Italy, Spain, Norway, Finland, Portugal, and Latin America. Holding on to Singer's customer base, especially getting the customers to trade up into ICL equipment, might be difficult, but Ellis concedes no problems.

But ICL isn't relying on Singer

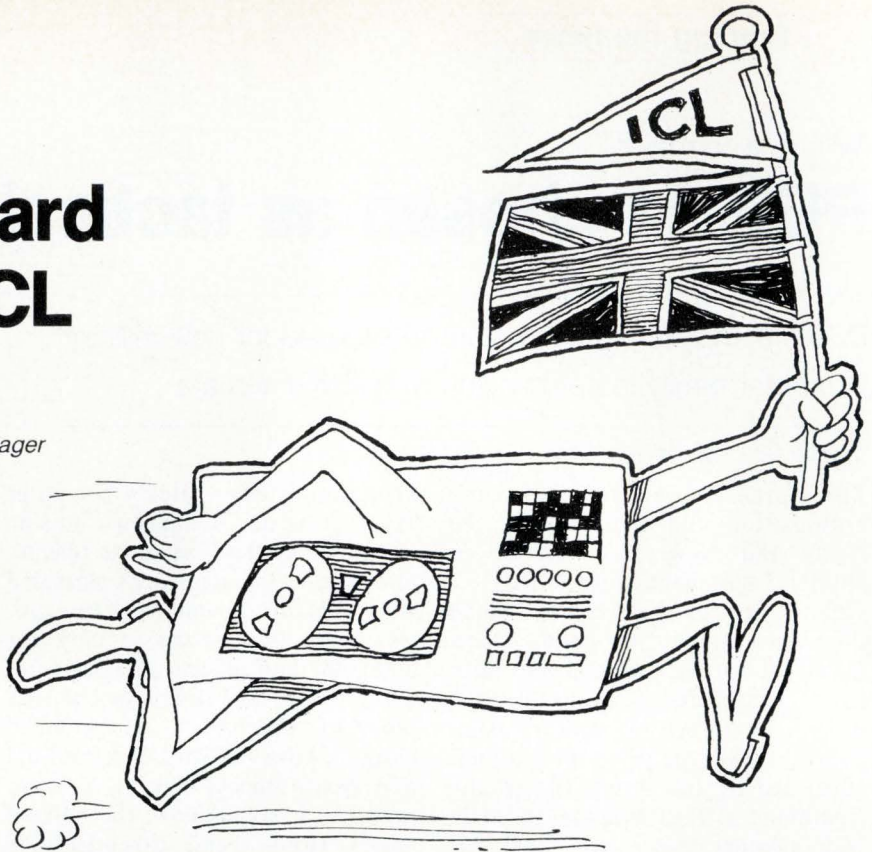

THE SWITCHING SUPPLY HAS TANTALIZED YOU LONG ENOUGH!

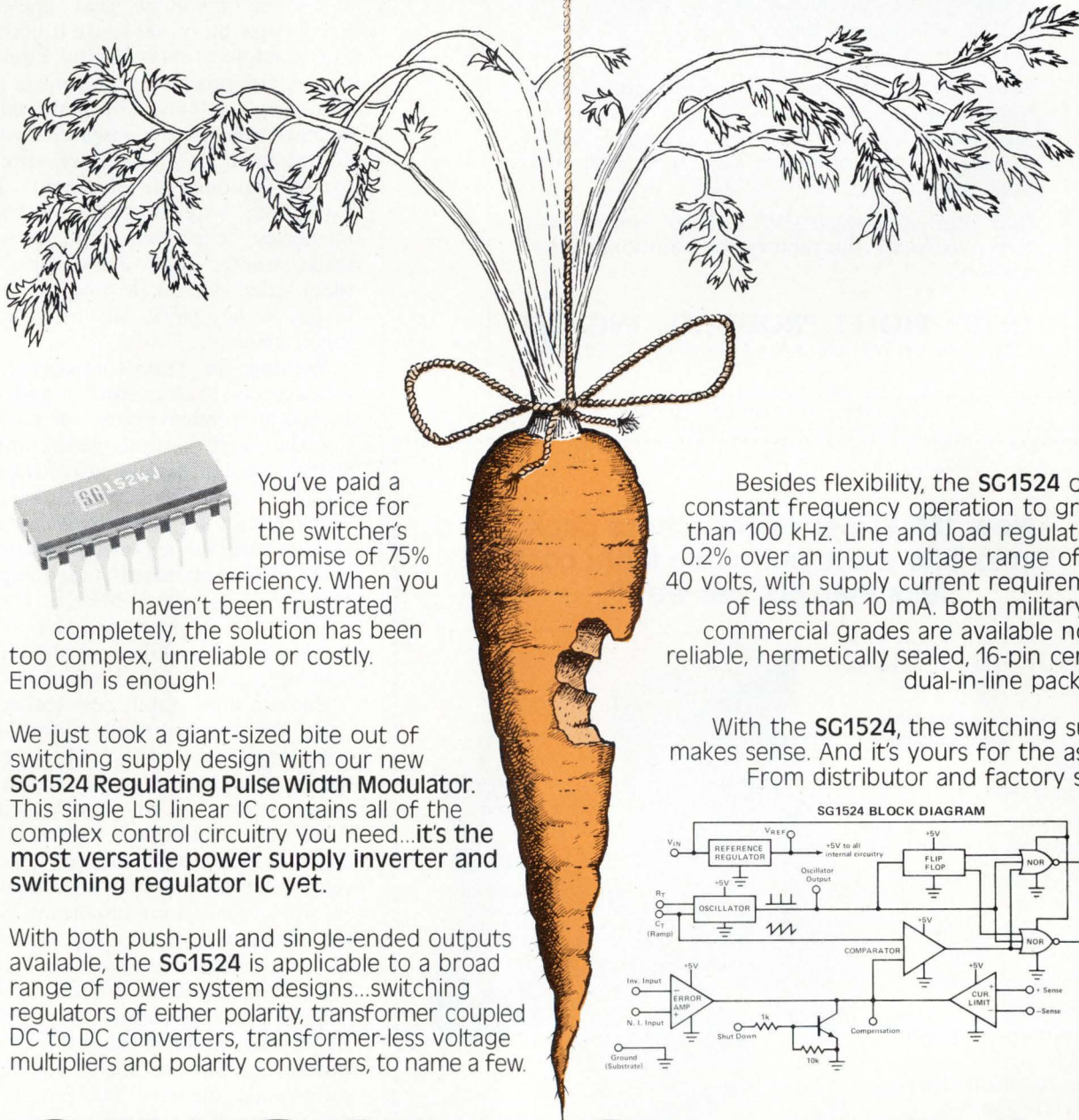

You've paid a high price for the switcher's promise of 75% efficiency. When you haven't been frustrated completely, the solution has been too complex, unreliable or costly. Enough is enough!

We just took a giant-sized bite out of switching supply design with our new **SG1524 Regulating Pulse Width Modulator**. This single LSI linear IC contains all of the complex control circuitry you need...it's the most versatile power supply inverter and switching regulator IC yet.

With both push-pull and single-ended outputs available, the **SG1524** is applicable to a broad range of power system designs...switching regulators of either polarity, transformer coupled DC to DC converters, transformer-less voltage multipliers and polarity converters, to name a few.

Besides flexibility, the **SG1524** offers constant frequency operation to greater than 100 kHz. Line and load regulation is 0.2% over an input voltage range of 8 to 40 volts, with supply current requirements of less than 10 mA. Both military and commercial grades are available now in reliable, hermetically sealed, 16-pin ceramic dual-in-line packages.

With the **SG1524**, the switching supply makes sense. And it's yours for the asking. From distributor and factory stock.

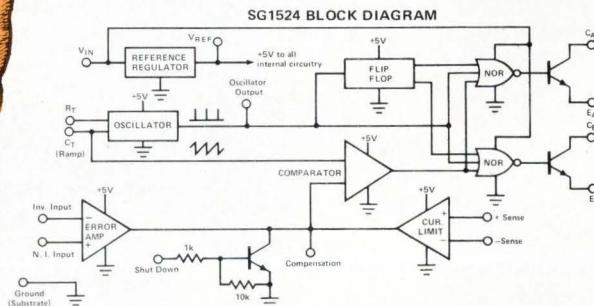

SILICON GENERAL

THE IC REGULATOR LEADER

7382 Bolsa Avenue • Westminster, CA 92683 • (714) 892-5531 TWX: 910-596-1804

ERASE EPROMS IN MINUTES . . .

Why Wait?

Completely erase your EPROMS fast and efficiently . . . in minutes! Two high intensity systems provide powerful ultraviolet energy. Designed especially for EPROM erasing, they're the UV sources recommended by EPROM manufacturers and users.

The S-52T is the fastest, most powerful UV erasing system. The UVS-54T is a versatile, economical system. Both are equipped with a stand and timer, or can be hand held for on-the-spot erasing.

Call your authorized UVP EPROM lamp dealer today, or write the factory for additional information.

ULTRA-VIOLET PRODUCTS, INC. 
5100 Walnut Grove Ave. • San Gabriel, CA 91778



Circle 92 on reader service card

New "MM" Series Switchers pack up to 2.26 watts per cubic inch; cost less than 60¢ per watt!

- 21 models — one, two, three, four, five and six outputs.
- Most watts/in.³ — more than 2 times denser than competitive switchers.
- Up to 80% efficient.
- Smallest sizes — 750 watt model measures only 5" x 5" x 12.75".
- Lightest weight — up to 62 watts/lb.
- Most reliable — all models carry 2-year guarantee.
- All models designed to meet UL 478.
- DC inputs and other options available.
- Almost 20,000 LH high power switchers now in use.

Write for 8-page catalog.

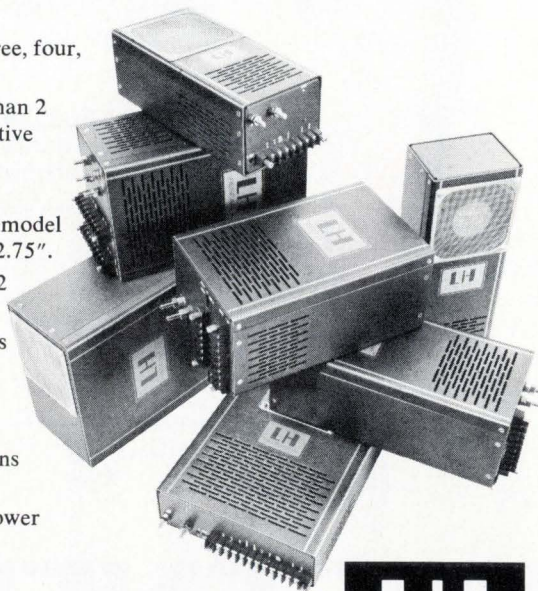

LH Research, Inc. • 1821 Langley Avenue, Irvine, CA 92714 • 714/546-5279

80 Circle 93 on reader service card

Probing the news

alone. In 1977 it plans to extend the New Range downward by introducing the 2950 for applications in retail distribution and data-base systems in manufacturing. The new mainframe will have 20% lower prices and 25% less throughput than the 2960 introduced this year. New software products and elaborations on the 2903 series are planned, too.

Basically, as Ellis points out, ICL is a systems company that doesn't make every bit of hardware it needs. For example, it buys Digital Equipment Corp. processors for some of its data-entry systems. The philosophy extends even to the research level, according to Edwin S. Mack, director of product development. In explaining why magnetic bubble memories "can't win," he quotes three essential rules: don't invest in them, other devices or processes are faster; if they work, buy in; if not, forget about it.

Waiting for CCD. Consequently, ICL expects to stay with standard 16,384-bit random-access memories for the next several years until charge-coupled devices prove themselves in performance and price. Mack admits however, to tinkering with a nonrevolving drum memory made from standard CCD chips. Motorola's standard MECL 10-K logic will remain in the big machines, for a while, too, although new logic can be added modularly.

But ICL does watch new technology. "What really turns me on are holographic memories," Mack enthuses, though he says they're years away. Also, "we're playing with thick film, of course." Part of the firm's thinking says that in a few years' time special-purpose computers will become more important. So, the company is developing associative processing and associative memory techniques, built around a distributed-array processor for three-dimensional problem-solving such as weather prediction, and a content-addressable memory for fast text retrieval, such as for telephone directory inquiries. And, it's working on marrying that to a computer-voice system for possible use by airline reservation networks. □

ANNOUNCING FAIRCHILD'S 30 PICOAMP FET INPUT OP AMPS IN METAL CAN AND **PLASTIC!**

**The μ AF156 Family.
The second source you've
been waiting for.**

Fairchild's entry on the scene makes FET Input Op Amps totally viable — with two major manufacturers now providing pin-for-pin alternate sources. Now you can confidently design-in the most advanced operational amplifiers in the world.

The Fairchild μ AF156 Family:

Typical Specifications

- I_B 30 pA
- I_{OS} 3 pA
- V_{OS} 2 mV
- V_{OS} Drift 5 μ V/ $^{\circ}$ C
- Slew Rate 15 V/ μ s
- Settling Time 1.5 μ s (to 0.1%)
- Noise 15 nV/ \sqrt{Hz}
- Bandwidth 5 MHz



There is no doubt that these new linears represent the next major generation in Op Amps technology.

And there is no doubt about Fairchild's linear reliability.

**Plus the logical next step.
Your first source
for plastic mini dip.**

Plastic Mini DIP:

This is the next development and —

Fairchild is first.

Low Cost. Low profile. Easier handling. And not just any plastic —

Fairchild's unique DM-6.

We're already in plastic Mini DIP production. Samples are available immediately.

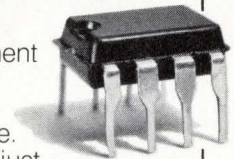

AVAILABLE IN METAL CAN

μ AF155/155A, μ AF355/355A
 μ AF156/156A, μ AF356/356A
 μ AF157/157A, μ AF357/357A

AVAILABLE IN PLASTIC MINI DIP

μ AF355, μ AF356, μ AF357

For complete information, contact your Fairchild Distributor, Rep or local Sales Office.

FAIRCHILD

WHO ELSE?

Tektronix TM 500

designed for configurability.

Collections of monolithic instruments assembled for a particular application often present a mind-boggling hodge-podge of interconnecting cables, instrument sizes and shapes, front panel nomenclatures, and questions of compatibility. Imagine, trying to get four or five separate units into the confines of a control console for troubleshooting.

Tektronix TM 500 is the one full line of test and measurement instrumentation on the market today that is designed with plug-in modular instruments, mainframes, and accessories so you can configure your instruments mechanically and electrically to best fulfill your needs.

While you can select TM 500 instruments as independent units, to work individually on the merits of their performance alone (just as you might a separate function generator, pulse generator, universal counter, or digital multimeter), **you gain unequalled capabilities when you select TM 500 for its unique design:** Bench-top mainframes for research and design labs. Rackmounting for production and quality control, or built-in test sets. Scope cart packages for time share or mobility through fixed equipment. And the Travel Lab mainframe lets you put the same instruments you use in the lab conveniently into field service. This is what we mean by mechanical configurability.

Plus . . . **TM 500 instruments can work together as powerful systems.**

As TM 500 plug-in modular instruments share a common power supply and main-frame enclosure, **they also share a common interface circuit board.** Inputs and outputs can be routed internally. Front-panel cable clutter can be reduced. Since compatibility is assured, instrument capabilities can be combined. For example, a trigger level from a universal counter can be displayed on a digital multimeter at the touch of an INT pushbutton. Or (what is most exciting) **signal parameters within the instruments, such as sweeps, ramps, or gate pulses, can be routed through the rear interfacing, so otherwise conventional TM 500 instruments can work together in ways as limitless as the vision of your imagination!** And this is what we mean by electrical configurability.

Next time you evaluate instrumentation, include configurability.

Tektronix, Inc. will introduce you to TM 500 instrumentation with a free catalog, application notes, and Field Engineer consultation. For further information circle the reader service number, write or call Tektronix, Inc., P.O. Box 500, Beaverton, Oregon 97077, (503) 644-0161 ext. 5283. In Europe write: Tektronix Limited, P.O. Box 36, St. Peter Port, Guernsey, Channel Islands.



TEKTRONIX®

committed to
technical excellence

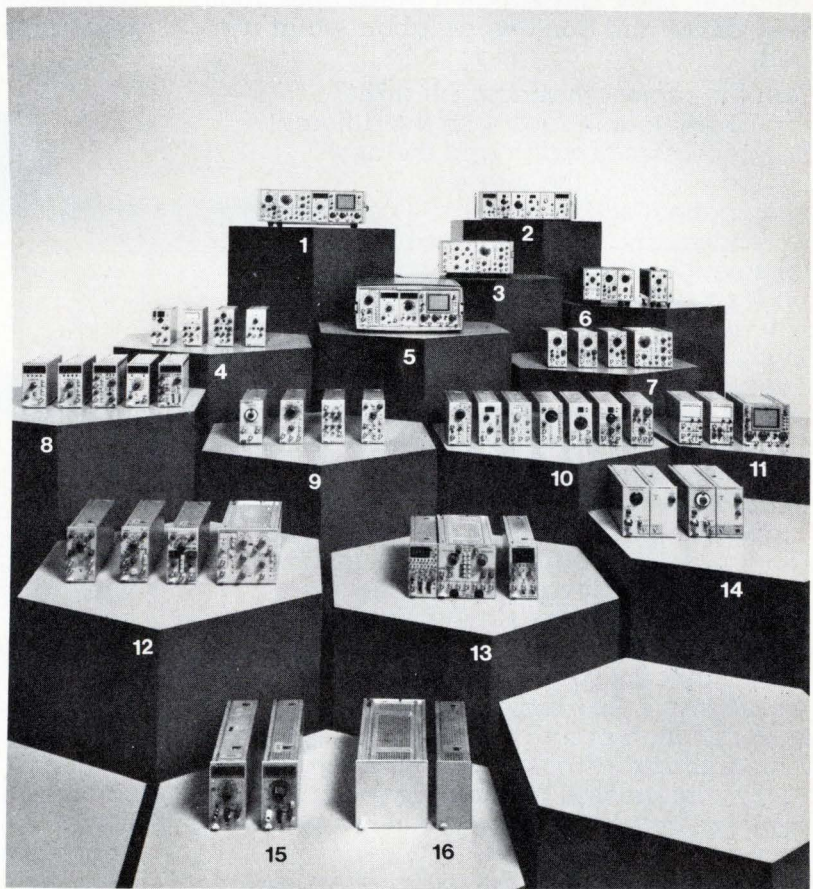
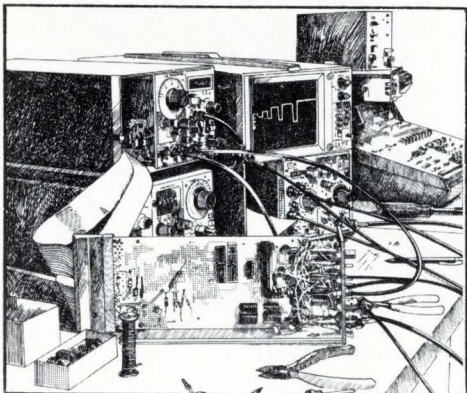
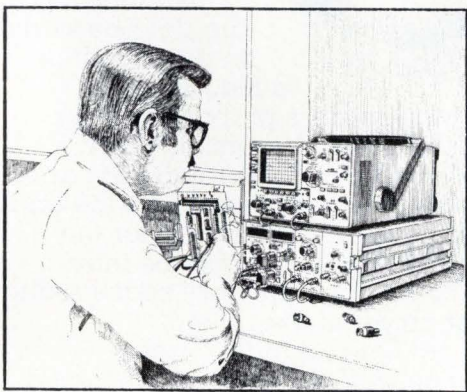
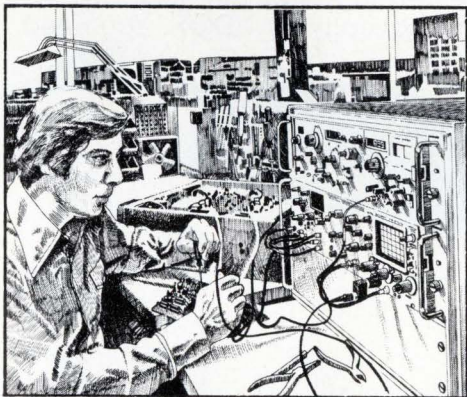
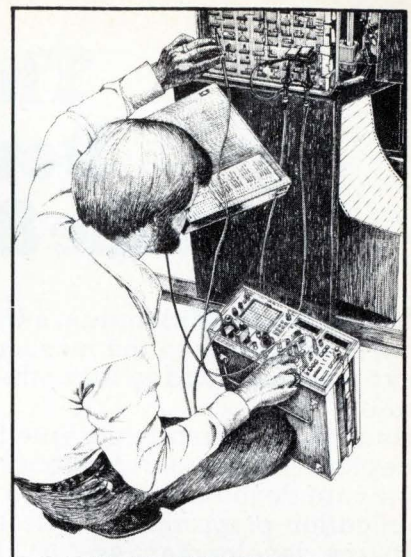
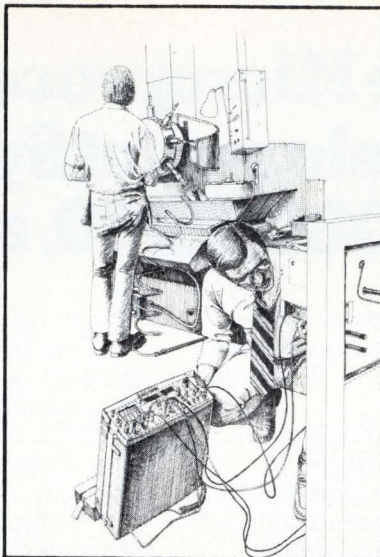
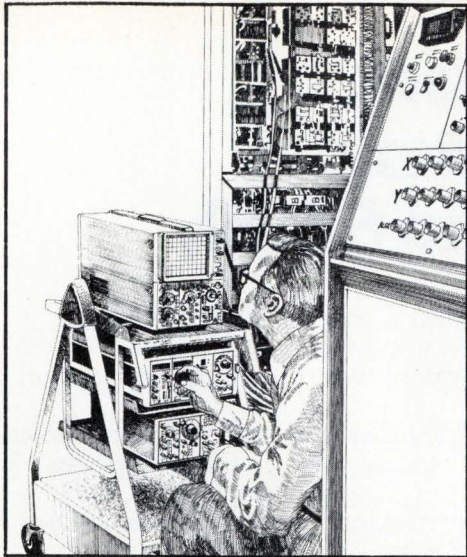

The TM 500 Family of Instrumentation

1. Bench-top mainframe holds up to 6 modular instruments.
2. Rackmounting mainframe for up to 6 modular instruments.
3. Bench-top mainframe (also mounts in TEK LAB CART MODEL 3) holds up to 4 modular instruments.
4. Plug-in modular power supplies.
5. Traveler mainframe — an "attache case" that powers up to 5 modular instruments.
6. Bench-top mainframes with 1 and 3 compartments.
7. Function generators.
8. Counters.
9. Amplifiers.
10. Sweep, calibration, and signal generators.
11. Oscilloscopes.
12. Pulse generators.
13. Logic analyzer and digital delay.
14. Tracking generators.
15. DMM's.
16. Blank plug-in kits.

Universal One

The Microprocessor Development System for the 8080, 2650, and 6800.

It's universal. Millennium's Universal One System interfaces to the most commonly used microprocessors today and others in the near future.

And, it's universally accepted. It's so well accepted that design engineers call it a hardware development aid. It's so powerful, application programmers call it a complete software development system. And project managers? They know it as a great time and money saver and don't worry about what it's called.

Can the project manager be right?

The ability to interface with the different microprocessors of today and the new microprocessors of the future is the key benefit of Universal One. Universal One will never be obsolete and therefore provides the greatest *Return On Investment* of any microprocessor development system available today.

The universality of the system is based on Universal One's innovative multiple CPU architecture. One CPU, the Master CPU, is the controlling element of the system and executes all application *independent* functions; file management, text editing, system utilities, system I/O and software debugging.

The second CPU, the slave, which is controlled by the master, executes those functions that are application *dependent*; the microprocessor Assembler, in-circuit testing, user application programs, and user I/O. Additional microprocessor slaves are readily added by interfacing the new slave to the system bus and integrating it into the system software.

By meeting all the staff's needs, Universal One cuts costs. It's not necessary to have special test fixtures for design engineers and software development systems for programmers. Universal One saves on personnel training expenses since only one system interface need be learned.

Can the programmer be right?

Universal One's software capabilities rival those found on many powerful minicomputer systems. Universal Disk Operating System (UDOS) was developed specifically for and tailored to the multiple CPU architecture. The

operating system is executed by the Master CPU in its own totally protected Master memory to prevent disruptions by application programs.

UDOS is floppy disk file oriented. The system was designed specifically for the characteristics and peculiarities of a floppy disk and as such makes maximum use of its benefits. Many file management functions, normally required to be performed by the user, are performed automatically by UDOS. You need

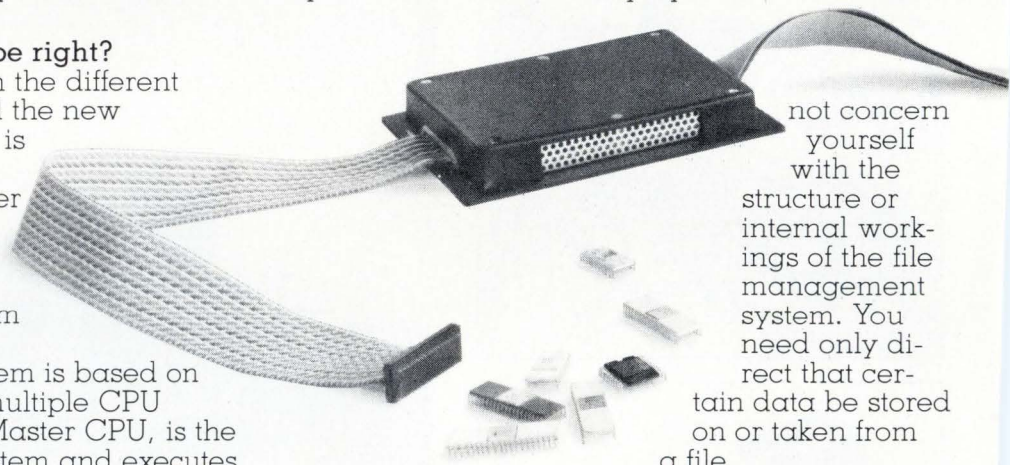

not concern yourself with the structure or internal workings of the file management system. You need only direct that certain data be stored on or taken from a file.

μ BASIC™, Millennium's proprietary high level compiler, is a flexible version of BASIC tailored for microprocessor development applications. Unlike interpretive systems the final output of μ BASIC is the object code for the microprocessor. μ BASIC can also be intermixed with Assembly for memory space reduction and faster program execution.

With Universal One's dynamic trace capability, the activity of a program is traced, instruction by instruction. For break-point analysis two hardware registers provide a break and display of the breakpoint address and contents on memory fetch only, memory write only or on memory read/write access.

Universal One contains a powerful text editor which is file oriented and has macro and iteration capabilities for combining commands.

Millennium provides comprehensive diagnostics which not only test the system's processors, memory & I/O but also check peripheral devices and interrupt logic.

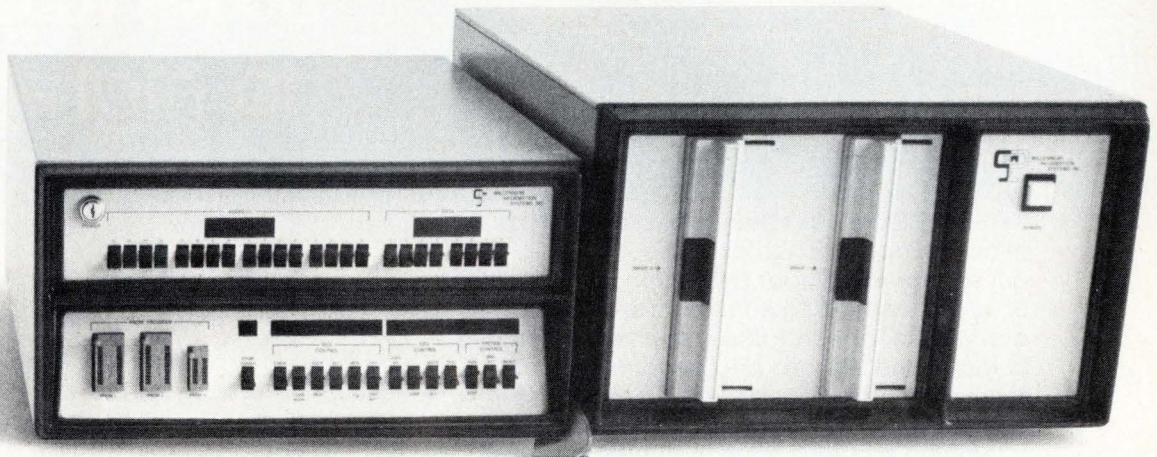

Can the design engineer be right?

Universal One provides two modes of development system emulation for saving time during initial hardware debug and during hardware/software integration. In the first mode, Universal One emulates the prototype's microprocessor and its memory, while I/O functions are controlled by the user hardware. In the second mode, the prototype uses its own memory and I/O. Universal One's two-stage emulation eases the transition from initial test to full prototype implementation.

The front panel PROM sockets accommodate the most commonly used PROMs, the *2708, the 1702A MOS erasable and 82S115 family of bipolar PROMs. Others will be added in the future.

Can they all be right?

Obviously yes! Universal One has the capabilities to get development projects completed on time and within budget. And, Universal One will be just as valuable in the future as it is today. The universal architecture assures the product will never be obsolete.

Universal One's powerful operating system is easy to use so personnel get the most out of it whether they are inexperienced or advanced programmers. μ BASIC saves vast amounts of software development and maintenance time.

Last but not least, development system emulation simplifies hardware and software integration. Put it all together, it's the Universal One for 8080s, 2650s, *6800s, application programmers and design engineers.

* Available January, 1977

A better hardware solution

If you already have good techniques for assembling and debugging your programs but need hardware and PROM programming capabilities, Millennium has a solution. It's Universal Emulator, an advanced product that provides all the hardware emulation and PROM programming capabilities of Universal One at a lower price. And, it can be upgraded to the Universal One in the field at any time.

You can be right, too!

Universal One and Universal Emulator are available for immediate delivery. A complete Universal One System with a single slave and dual flexible disc is \$8,900. Additional slaves are \$1,250. A single slave Universal Emulator is \$4,500. For a prompt direct reply, return the coupon.

I'm tired of doing it the hard way. Show me a better way. My need is Immediate Within the next six months for information only.

Name

Title

Company

Address

City/State/Zip

Application

Phone

MILLENNIUM

420 Mathew Street
Santa Clara, CA 95050
(408) 243-6652

Stretch your test instrument budget

Does a scope always have to be expensive to meet your needs? At B&K-PRECISION we don't think so. B&K-PRECISION offers a full line of scopes that give you the performance and features you need, at substantial cost savings... plus the advantage of immediate delivery and 10-day free trial through local distributors.

B&K-PRECISION to high-priced

B&K-PRECISION has taken a no nonsense, cost-effective, approach to oscilloscope design. All our scopes will trigger at frequencies typically 50 to 100% beyond their rated band-width. They are rugged, dependable instruments, designed to match the features and performance of far more expensive scopes, without matching their high price. An important part of our approach is that you shouldn't have to buy more scope than you need to get the features you want. Before making your next purchase, compare the features and performance you require with what we have to offer. You'll discover that your budget is a lot bigger than you first thought!

30MHz Dual-Trace 5" Triggered Scope with Signal Delay

For the engineer who requires a full-feature 30MHz scope

- Built-in signal delay line permits viewing of high-frequency pulse risetimes
- Triggers on signals up to 50MHz
- Rise time 11.7nS
- 20 calibrated sweeps—0.2 μ S/cm-0.5S/cm
- Built-in high and low-pass filters
- 5mV/cm vertical sensitivity
- Illuminated graticule
- TTL compatible intensity modulation
- X-Y capability using matched DC amplifiers
- P31 blue phosphor
- Internal .5Vp-p \pm 1% calibration source
- 5mV/cm horizontal sensitivity.

Model 1474 \$820 (not including probes)

15MHz Dual-Trace 5" Triggered Scope

Premium features and performance in a 15MHz dual-trace scope

- Ultra—flat in-band response with smooth rolloff past 15MHz
- Triggers beyond 27MHz
- 24nS risetime
- 19 calibrated sweeps—0.5 μ S/cm-0.5S/cm
- 10mV/cm vertical sensitivity
- Algebraic addition and subtraction
- Illuminated graticule
- X-Y capability using matched DC amplifiers
- P31 blue phosphor
- Internal calibration source
- Built-in TV sync separator
- For fast setup, mode automatically shifts between CHOP and ALTERNATE as you change sweep times.

Model 1472C \$630 (not including probes)

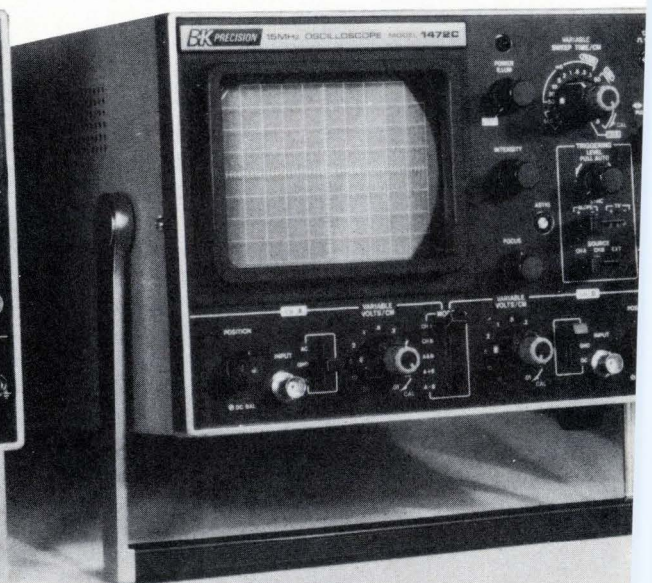
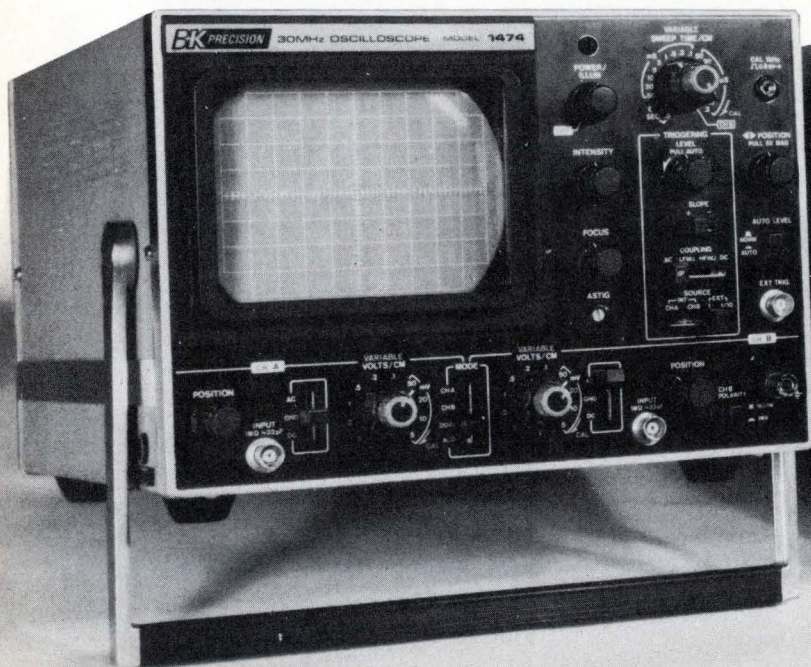

without stretching your standards... has an alternative oscilloscopes

10MHz Dual-Trace 5" Triggered Scope

Our lowest-cost dual-trace scope more than fills the need in applications where extended bandwidth isn't required

- Triggers to 15MHz
- Mode automatically shifts between CHOP and ALTERNATE as sweep time is changed
- 18 calibrated sweeps— $1 \mu\text{S}/\text{cm}$ - $0.5\text{S}/\text{cm}$
- 35nS risetime
- P31 phosphor
- X-Y capability using matched DC amplifiers
- Internal calibration source
- TTL compatible intensity modulation
- 10mV/cm vertical sensitivity

Model 1471B \$495
(not including probes)

10MHz 5" Triggered-Sweep Scope

A 5" triggered scope with TTL compatible Z-axis

- 10mV/cm vertical sensitivity
- 35nS risetime
- 18 calibrated sweep ranges— $1 \mu\text{S}/\text{cm}$ - $0.5\text{S}/\text{cm}$
- 5x magnification sweeps to $.2 \mu\text{S}/\text{cm}$
- Vectorscope capability
- Internal calibration source
- Internal TV sync separator
- P31 phosphor
- 11-position vertical attenuator, calibrated in convenient 1/2/5 step sequence
- Built-in calibration source.

Model 1461 \$428
(not including probe)

10MHz 3" Triggered-Sweep Scope

Meets the demands for an uncompromising ultra-compact triggered-sweep scope

- 19 accurate sweep ranges
- Accurate 11-position vertical attenuator
- 10MV/div vertical sensitivity
- Front panel vectorscope capability
- Internal calibration source
- Only 5.75 x 7.9 x 12.9 • Weighs only 13 lbs
- Capable of writing speeds up to $0.1 \mu\text{S}/\text{div}$ with 5x magnification.

Model 1431 \$399
(not including probe)

5MHz 3" Compact Scope

Ideal for many dedicated applications, freeing more expensive scopes from monitoring tasks

- 10mV/div vertical sensitivity
- Direct deflection terminals for waveform display to 450MHz
- Only 6 x 7.5 x 12" • Weighs just 8.5 lbs
- 600 Vp-p maximum input voltage
- Can be externally synced.

Model 1403A \$209
(not including probe)



Save up to 50% on probes!

B&K-PRECISION has engineered a full line of cost-effective probes to meet your needs. Our probes are designed for complete interchangeability with those of leading "ultra-sophisticated" brands, giving you compatible performance at about half the price.

FOR IMMEDIATE DELIVERY,
or 10-day free trial, contact your local B&K-PRECISION distributor. Ask him for Catalog BK-77 with complete information on B&K-PRECISION oscilloscopes, probes and more than thirty other fine instruments, or contact us directly.

B&K PRECISION
PRODUCTS OF DYNASCAN

6460 W. Cortland Avenue, Chicago, IL 60635 312/889-9087

Circle 87 on reader service card

WATCH THIS SPACE FOR DETAILS

WAVETEK MODEL 172
PROGRAMMABLE SIGNAL SOURCE

UNIT RCL AMPL SPEC LOAD



This is the face of our new Model 172 programmable signal source.

It gives you 7 function generator waveforms over a frequency range of 0.0001 Hz to 13 MHz. It's GPIB compatible, has a microprocessor-controlled interface, plus a 5½ -digit synthesizer option.

We'll give you more details in the next installment. Meanwhile, circle the inquiry card or contact us direct. Wavetek, P.O. Box 651, San Diego, CA 92112. Phone (714) 279-2200. Or TWX 910-335-2007.

WAVETEK®

Technical articles

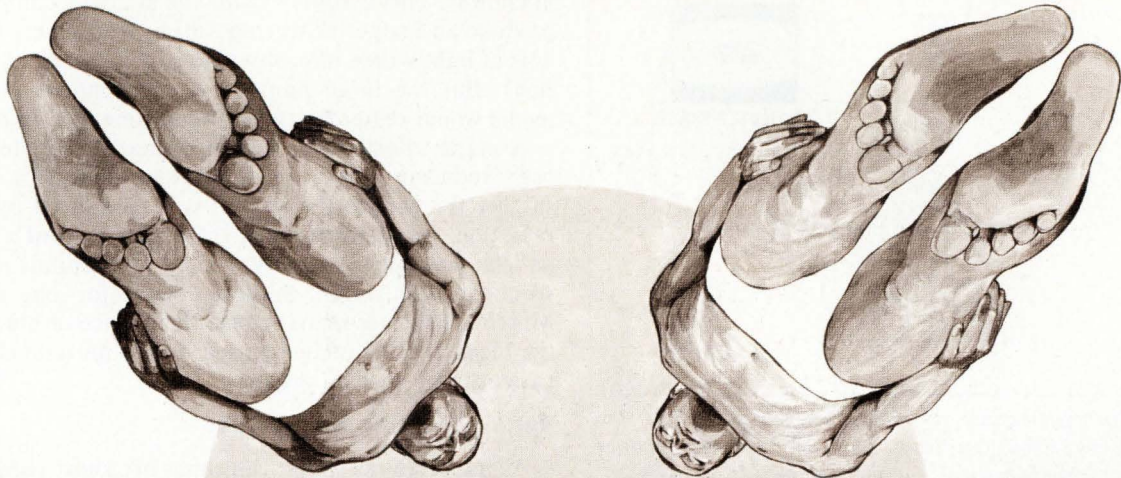

Computerized multiple X rays give a new view of the body's interior

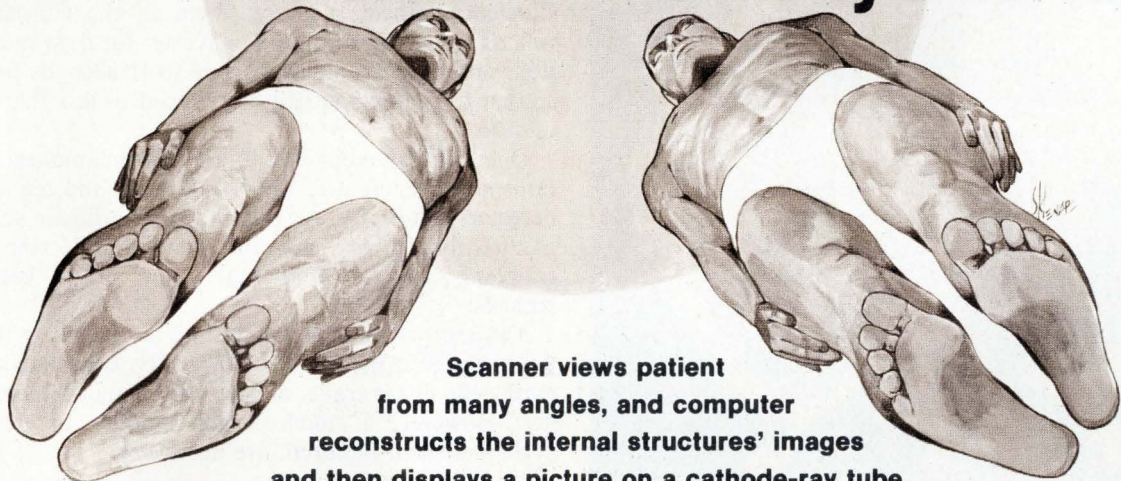

**Scanner views patient
from many angles, and computer
reconstructs the internal structures' images
and then displays a picture on a cathode-ray tube**

by Haim Zaklad, *Elscint Ltd., Haifa, Israel*

□ Imagine viewing a horizontal slice of a living human body without harming the subject. A detailed reconstruction of just such a view is possible with computerized axial tomography, a marriage of computer and X-ray tube that gives physicians a revolutionary diagnostic tool.

While conventional X-ray procedures are better than such invasive techniques for diagnosis as surgery, they are far from perfect in their ability to locate an abnormality precisely or, for that matter, even to determine that an abnormality exists. In conventional radiology, pictures are obtained by subjecting the patient to radiation from an X-ray tube acting as a point source and recording the attenuation of the rays through the thickness of the patient's body on a single film (Fig. 1).

This may result in overlapping of anatomical features so that some information may be hidden from view. What's more, the film detects less than 1% of the

projected X-rays, which limits the resolution of differences among soft tissues. Sometimes a gas or liquid is injected to increase contrast within the body. But these techniques can be painful and are not without danger to the patient's life.

Computerized axial tomography replaces many of these invasive procedures and provides a reconstructed three-dimensional image of the inspected organs with a resolution greater than has ever been possible without surgery (Fig. 2). This is achieved by viewing the patient via X-ray imaging from numerous angles, mathematically reconstructing the detailed structures, and displaying the reconstruction on a cathode-ray tube (Fig. 3).

The first CAT scanner, which was designed for brain examination, was introduced by the United Kingdom's EMI Ltd. in 1973 (see "How it works," p. 92). The whole-body scanner (Fig. 4), a rather new entry into the field, is intended for the examination of the chest cavity

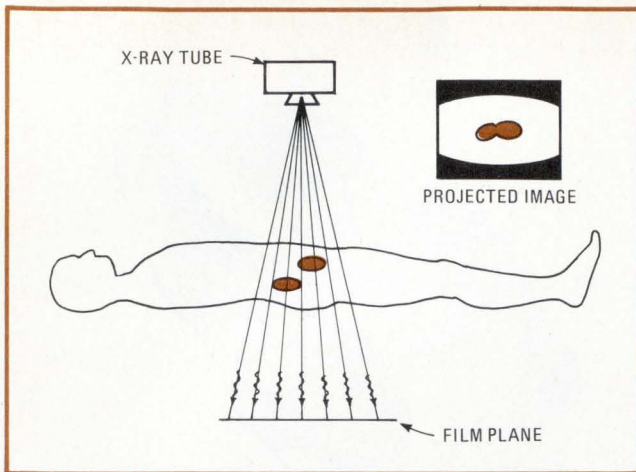

1. Overlap. In conventional X-ray imaging, like that used in common chest X-rays, two internal organs in the same transaxial plane are projected to the same place on the film. Their images will overlap.

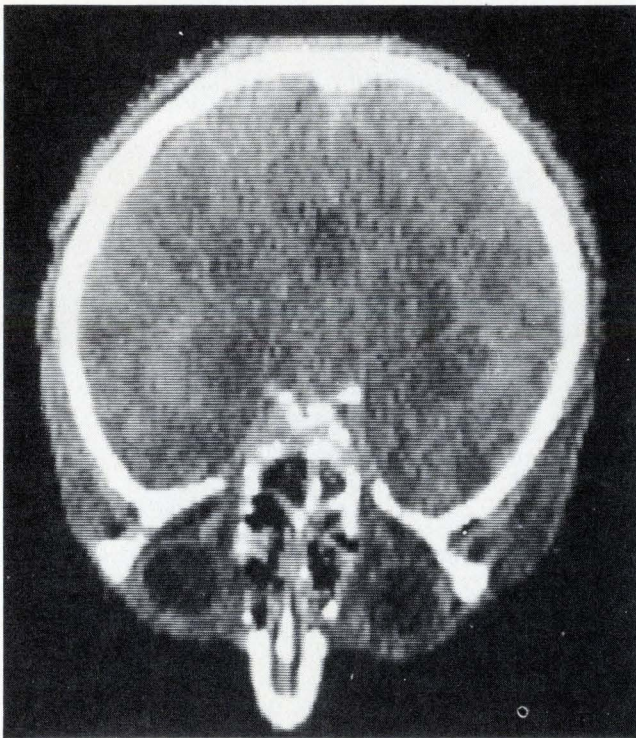

2. Cross section. By applying computerized tomography to the head, a cross-sectional view of the brain and sinus cavities can be obtained. The dark areas show where air is trapped in nasal cavities, and the white areas correspond to the skull bone.

and limbs, and is particularly useful for viewing the abdomen.

Scanning the body

In the basic scanning process (Fig 5a), a collimated X-ray beam passes through the body, and its attenuation is detected by a sensor that moves on a gantry along with the X-ray tube. The tube and detector move in a straight line, sampling the data 180 times. At the end of the travel, an 1° tilt is made, and a new linear scan begins. The assembly travels 180° around the patient's couch.

This procedure results in 32,400 independent mea-

surements of attenuation. The data generated can satisfy the solution of equations containing that number of unknowns. This is sufficient for the system's computer to produce an image measuring 180 by 180 pixels (square dots of light whose intensity varies to reflect the attenuation). But the large number of independent measurements would require a typical scan time of 5 minutes.

A major effort in the design of new CAT systems has been reducing this scan time. The shorter it is, the smaller the chance the patient will be injured by the X radiation. In addition, short scan times permit a higher patient throughput, greatly desired by hospitals that are spending over a half-million dollars for one system. Moreover, shorter scans reduce the chance of blurring in the reconstructed image caused by the movement of the patient or of internal organs.

Putting the picture together

As important as short scan times are short reconstruction times. It is the total of these two imaging periods that truly limits throughput, for the patient remains on the couch throughout the entire imaging procedure. With the 5-minute scan time of the earliest scanners, patient throughput amounted to two per hour, at best. Efficient mathematical treatment in the computer, as well as an analog-to-digital converter for data manipulation, can reduce calculation time to 10 seconds per scan, so that total imaging can be reduced to less than half a minute.

One technique reducing total scan time makes use of a fan-shaped segment of the X-ray beam and ten or more detectors (Fig. 5b). At the end of the linear scan, the gantry tilts 10° or more, instead of the 1° step of the simpler scanner. Total scan time drops below 10 seconds.

Yet another method for cutting scan time is to use a beam covering the width of the body, completely eliminating the linear travel of X-ray tube and detector (Fig. 5c). However, a much larger number of detectors, perhaps several hundred, are necessary.

Sensing the signal

Generally, CAT scanners use high-atomic-weight scintillators, such as those containing efficient radiation detectors like sodium iodide or calcium fluoride. All scanners use photomultipliers as noiseless gain stages to convert the scintillation light into a direct current. A problem with the detection material is their production of after-glow components in the scintillator and the photomultipliers.

Another problem is the high cost of the detectors. At present, a scintillator coupled to a photomultiplier tube, plus the associated peripheral circuitry, may cost more than \$200. If faster scans require the number of the detectors to be increased to several hundred, their price becomes a major part of the system's cost. An array of 300 detectors, for example, may cost \$60,000, or more than 10% of the total selling price of the most expensive CAT scanners.

Before reconstructing an image, the linear X-ray attenuation coefficient, μ , must be determined at each pixel. This coefficient is a measure of the stopping power

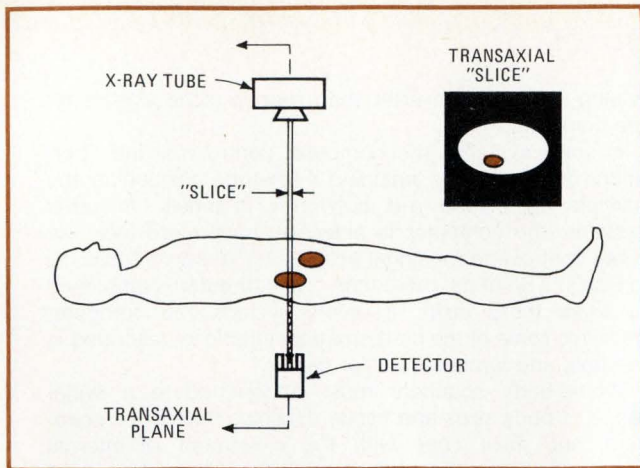

3. Taking a slice. A computer can reconstruct a sectional view, or transaxial slice, from X-ray projections via a detector that takes the place of X-ray film. Internal-organ projections don't overlap.

of tissues for an X-ray exposure. The quality of the reconstructed image is a matter of the differentiation between μ at different points and of the size of each pixel. Both of these factors warrant some discussion.

The differences in μ of the various body tissues are slight (see the table). Typically, the CAT scanner can measure differences in μ of less than 1%. An important factor in the measurement is the spectrum emitted by the X-ray tube. It is determined by the maximum accelerating voltage applied between its anode and cathode. For a peak voltage of 130,000 electronvolts, the weighted center of the spectrum is in the vicinity of 70 kiloelectronvolts. Although μ is highly sensitive to changes in the energy of the incident beam, the average energy of 70 keV yields meaningful results.

It turns out that typical tissue contains mostly elements of low atomic weight. At the photon energies used in CAT scanners, the dominant effect controlling interaction of these photons in tissue is the Compton effect, in which the impact of an X-ray photon with an electron is accompanied by a transfer of energy and a drop in the X ray's frequency.

The loss in energy is proportional to the density of electrons, which results in linear relationship between tissue density and alterations. So the differential attenuation coefficient ($\Delta\mu$) is well correlated with the increase in specific gravity above that of water (see the table). Hence, the image presented as a result of computerized tomography can be regarded as the mapping of densities.

For a given element of tissue of thickness ΔX , the radiation leaving this thickness is related to the input radiation I_0 ,

$$I = I_0 e^{-\mu \Delta X}$$

For a tubular segment of tissue of length L , the X ray leaving the tissue, I , is expressed as a line integral of the absorption of I_0 :

$$I = I_0 \exp \left(- \int_0^L \mu(x,y) dy \right)$$

The profile of the line resulting from a straight-line scan of the patient is called the shadow function. It is

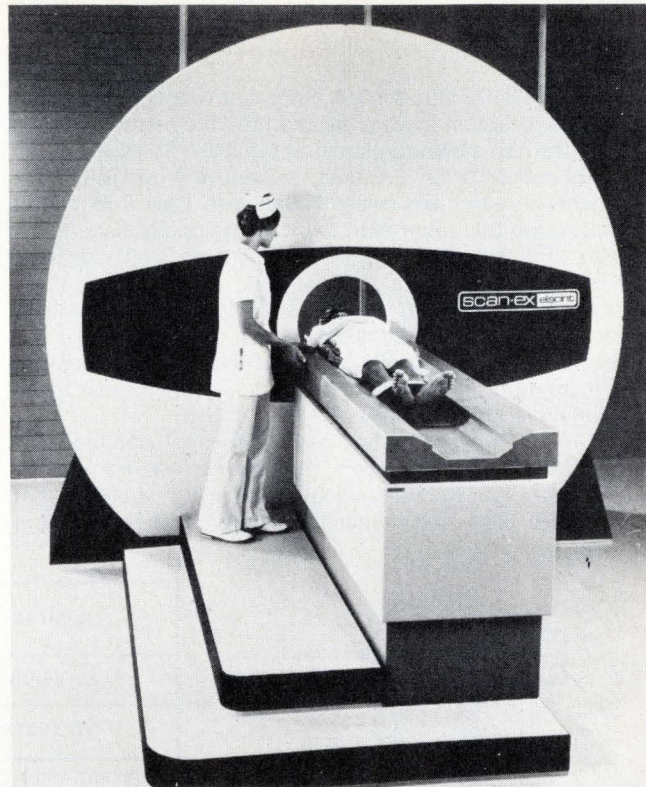

4. Diagnostic donut. The latest CAT scanners are large and fast enough to make images of cross sections of the torso. The computer and other electronics are usually housed in an adjacent room.

proportional to the total attenuation of the ray. As defined in Fig. 6,

$$g_0(x_1) = -\ln I/I_0 = \int_0^L \mu(x_1, y_1) dy_1$$

As the detector measures I , an electronic log circuit or a reference table stored in the computer files takes a logarithm. The problem is reduced to reconstructing the function of the attenuation coefficients $\mu(x,y)$ from the measured projections.

The distribution of frequencies in the X-ray beam traveling different lengths (the center of the body versus the edge) shifts because the low-energy components of the beam are stopped more easily. Since the energy of the detected photons is not measured, information about the changes is lost.

Adding errors

But the computation of μ assumes some mean energy that in reality is not constant, so errors are introduced in the form of image artifacts. Earlier solutions involved surrounding the head with a water bag so that the beam always travels the same distance. This is not suitable for the thorax and abdomen, and, at present, this effect is corrected mathematically, as discussed below.

The importance of pixel size in determining the quality of the image can be made clear with an example. To reconstruct an image of 256 by 256 pixels requires sampling each projection at 512 intervals. For a scan traverse of 25 centimeters as with a large adult abdomen, the resulting pixel size is 1.0 millimeter. This is about ten times worse than the resolution on conven-

How it works

Since the 1972 introduction of the first scanner for computerized axial tomography by EMI Ltd., the market for such devices has grown to almost \$80 million. Sales will reach \$100 million by 1979, estimates Creative Strategies Inc., a market-research firm based in San Jose, Calif. The market is so large that more than a dozen companies have taken aim at it by designing and introducing CAT scanners [*Electronics*, Dec. 25, 1975, p. 33].

There are two basic types: head scanners and whole-body scanners. Machines of both types resemble the block diagram of the EMI CT1010 head scanner below, although body scanners differ in some aspects because of their more complicated task.

On both types, the X-ray beam passes through the body for detection by scanners. Analog outputs from these detectors go through signal-conditioning circuitry that amplifies, clips, and shapes the signals. A relatively simple

analog-to-digital converter then prepares the signals for the computer.

In some systems, the computer controls all the operations of the scanner, including X-ray-tube positioning and multiplexing of the a-d converter channels. In other systems, the computer is aided by hard-wired logic for X-ray control and for signal processing. In some cases, as in Elscint's Scan-ex, more than one computer is employed to share these tasks. In every system, the computer performs some of the mathematical functions described in the text, and formats data for display.

Whole-body scanners must accommodate a wider range of body sizes and tissue densities than brain scanners, and must cope with the movement of internal organs, as when the patient breathes. Thus, they must have much lower scan times and higher resolution, as well as being larger to accommodate the entire body.

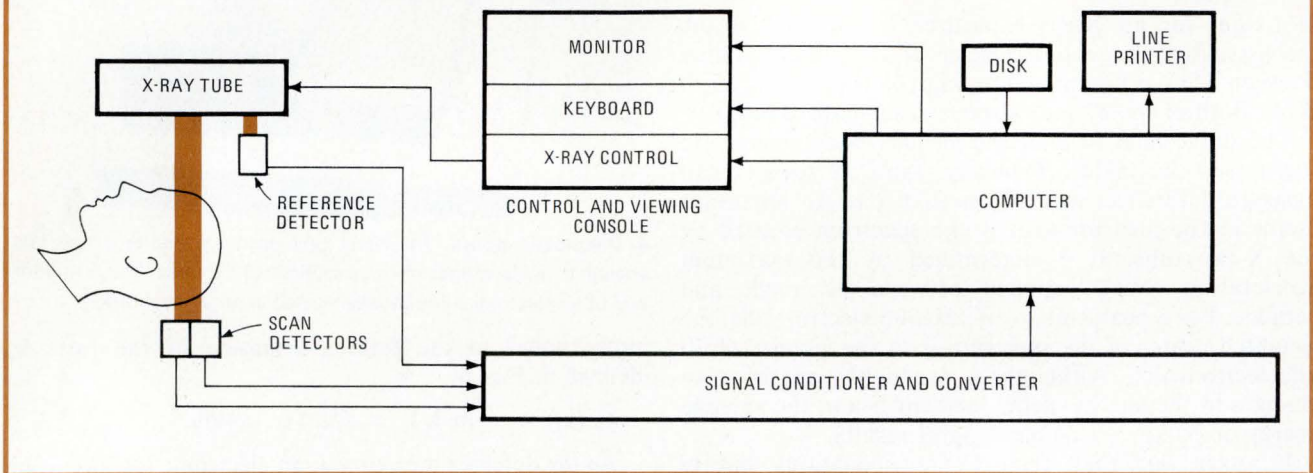

tional X-ray films. On the other hand, "larger" pixels are less sensitive to incidental variations in attenuation because more photons will strike a given pixel, and the larger sample more nearly approaches a statistical average.

A tenfold increase in pixel linear dimensions corresponds to a hundred-fold increase in the number of photons detected per pixel. The degree of resolution of the body density is ultimately determined by the number of detected photons. This number is affected by three factors: the power available from an X-ray tube, typically 70 watts per mm² of cathode area and 4 kilowatts output; maximum dose to the patient, which does not exceed 3 rads in standard procedures, and "thickness" of the patient.

Reconstructing a slice

The basic equations for reconstruction from projections were treated as early as 1917 by Johann Radon, an Austrian mathematician. They have been elaborated since then for applications in microwave astronomy, for mapping microwave solar activities; electron microscopy, for an understanding of the three-dimensional structure of a body, and nuclear medicine, in which the distribution of isotopes within a body is desired. The reconstruc-

tion methods can be classified into three major techniques:

- Back projection, which is analogous to a graphical reconstruction.
- Iterative methods, which implement some form of algebraic solution.
- Analytical methods, where an exact formula is used. Two of these are filtered back projection, which incorporates the convolution of the data and Fourier filtering of the image, and two-dimensional Fourier reconstruction, a more direct technique.

The method of back projection without any further processing is simple and direct, but it suffers from image artifacts. The subject (Fig. 7a) consists of a point of finite size. The three projected rays generate profiles on the projection planes. To reconstruct the point, these profiles are back-projected in the form of rays perpendicular to the image planes, and the three resulting patterns are added algebraically. The intersection of these rays reconstruct the point, but the rays are also retained in the image as artifacts in the form of dim lines, and the point itself is transformed into the shape of a star (Fig. 7b).

Although iterative methods have been used in reconstruction tomography, they tend to require long compu-

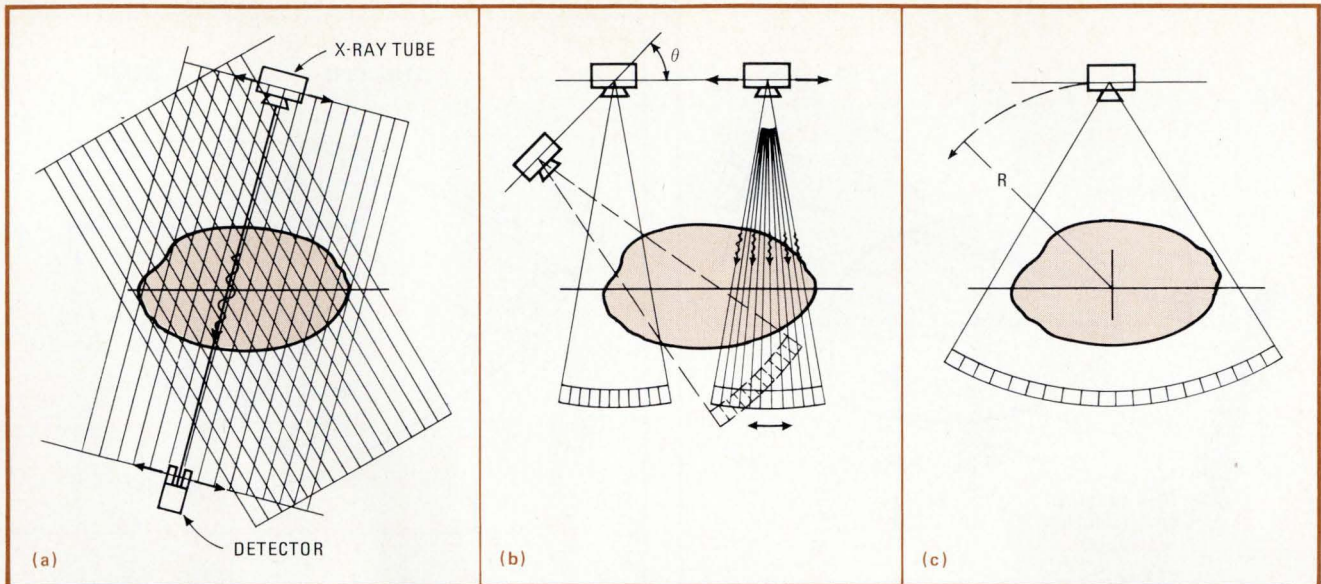

5. Scanning. The earliest CAT machines made a linear traverse before taking a 1° rotation (a). Using a fan-shaped beam and an array of detectors (b), larger steps can be taken and the process speeded up. If the fan is large enough, (c), no transverse motion is needed.

tation time. They have been mostly displaced by the analytical methods.

A spatial filter would be able to remove the blurring artifacts. This is accomplished by convolving the shadow function with a filter so that each point in the projection has a negative value, instead of 0, at every point other than its proper place in the projection. The resulting profiles are then back-projected and added (Fig. 8).

The net effect is such that the data of each pixel has a contribution near 0 in areas beyond the pixel, and the pixel itself receives positive contributions from the projections. The negative portion of each shadow function cancels out image artifacts that otherwise would be caused by other functions.

Mathematically, this can be presented by writing the Fourier inversion formula of $M(u,v)$ which is the two-dimensional Fourier transform of $\mu(x,y)$ in polar coordinates:

$$\mu(x,y) = \int_0^\pi d\theta \int_{-\infty}^{+\infty} \exp[2\pi i(x \cos\theta + y \sin\theta)r] M(r,\theta) |r| dr \quad (1)$$

Substituting

$$t = x \cos\theta + y \sin\theta \quad (2)$$

$$\mu(x,y) = \int_0^\pi d\theta \left[\int_{-\infty}^{+\infty} \exp(2\pi i t r) M(r,\theta) |r| dr \right] \quad (3)$$

The integral inside the square bracket in (3) can be recognized as the inverse Fourier transform of the function $M|r|$ at the point (t,θ) . By the convolution theorem, it is equal to the convolution of $g_\theta(x)$ with a filter $\Phi(\tau)$ such that $F[\Phi(\tau)] = |r|$, where F denotes the Fourier transform. Thus,

$$\mu(x,y) = \int_0^\pi Q(t,\theta) d\theta \quad (4)$$

$$Q(t,\theta) = \int_{-\infty}^{+\infty} g_\theta(t-\tau,\theta) \Phi(\tau) d\tau = g_\theta(t) * \Phi(t) \quad (5)$$

$Q(t,\theta)$ is the filtered projection and equations (2) and (4) define the back-projection process.

A more direct method, Fourier reconstruction, was first introduced by Ronald N. Bracewell in 1956. The advent of the fast Fourier transform in the middle 1960s

made this method a powerful tool, because it reduces the number of repetitive calculations. Special-purpose, high-speed computers for performing the fast Fourier transform are now available.

The two-dimensional (u,v) Fourier transform of the attenuation-coefficient map, $\mu(x,y)$ is:

$$M(u,v) = \int_{-\infty}^{+\infty} \int_{-\infty}^{+\infty} \mu(x,y) \exp[-2\pi i(ux + vy)] dx dy$$

At $v = 0$, a line in the Fourier plane is

$$M(u,0) = \int_{-\infty}^{+\infty} \exp(-2\pi i u x) \left[\int_{-\infty}^{+\infty} \mu(x,y) dy \right] dx = \int_{-\infty}^{+\infty} g_\theta(x) \exp[-2\pi i u x] dx$$

where $g_\theta(x) = \int_{-\infty}^{+\infty} \mu(x,y) dy$ is the shadow projected at $\theta = 0$.

The Fourier transform of any projection g_θ is equal to the function $M(u,v)$ on the line in the (u,v) plane which passes through the origin in direction θ .

In the direct method, many projections in angles such

MEASURED LINEAR ATTENUATION COEFFICIENT (μ) AND SPECIFIC GRAVITY OF HUMAN TISSUE AT 60 KeV

	μ (cm ⁻¹)	$\Delta\mu$ above water (%)	Specific gravity
Water	0.205	—	1.00
Whole blood	0.214–0.322	~ 4.3	1.034
Red cells	0.222	8.7	1.09
Spleen	0.216	5.3	1.06
Fat	0.190	- 7.8	0.93
Liver	0.221	7.8	1.05
Heart muscle	0.212	3.4	1.04
Breast	0.189	- 8.4	0.97
Brain:			
white matter	0.215	4.8	
gray matter	0.213	3.9	
Meningioma	0.214	4.3	1.05

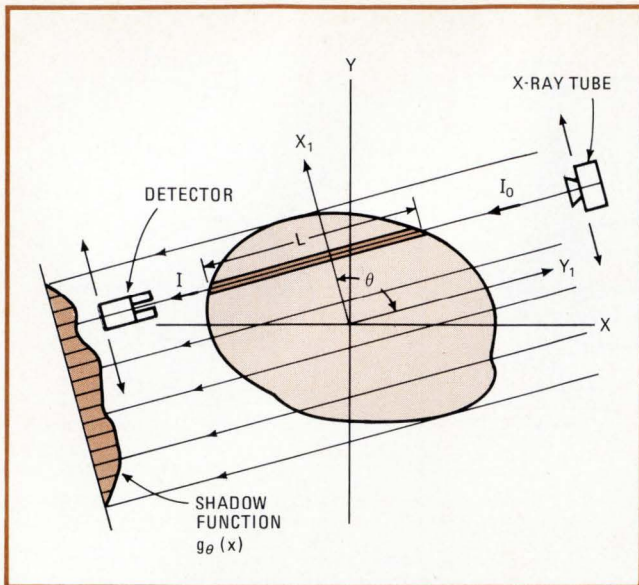

6. The shadow knows. The output from the detector produces a shadow function that is proportional to the attenuation caused by varying depths and densities of tissue.

as θ° , $\Delta\theta^\circ$, and $2\Delta\theta^\circ$ are measured as the scanner rotates, and their Fourier transforms are computed. The values of $M(u,v)$ on a set of rays crossing the origin, where $u = v = 0$, are thus determined.

By interpolation, the values of $M(u,v)$ at the Cartesian grid points of the (u,v) plane can be found. The inverse Fourier transform of M can be taken by a fast-Fourier algorithm and the desired function obtained.

Coming improvements

Although X-ray tubes have been around for many years, their design essentially has not changed. New demands by CAT technology have just started to make a dent in the conservative designs of the X-ray-tube manufacturers. There is a lot of work needed on higher power, power density, and controlling the output-energy spectrum.

With the present price of over half a million dollars each, only major hospitals can justify acquisition. Since prices reflect performance, it is likely that, as the CAT scanner gains acceptance, new markets will be opened to "slow" and lower-priced machines.

Major cost reductions are likely to occur with the advent of new detectors, high-voltage power supplies, and special computing hardware performing on-line reconstruction and display while reducing memory requirements. Some researchers have already presented results promising to reduce much of the computational load by means of reconstruction techniques based on analog or optical methods.

There is considerable research in progress on direct calculation of the effective atomic weight of tissue based on the measurement of attenuation coefficients at different accelerating voltages of the X-ray tube. This, in conjunction with scanning in planes that are not perpendicular to the body's vertical axis, promises to provide additional information on the structure of tissue in man. □

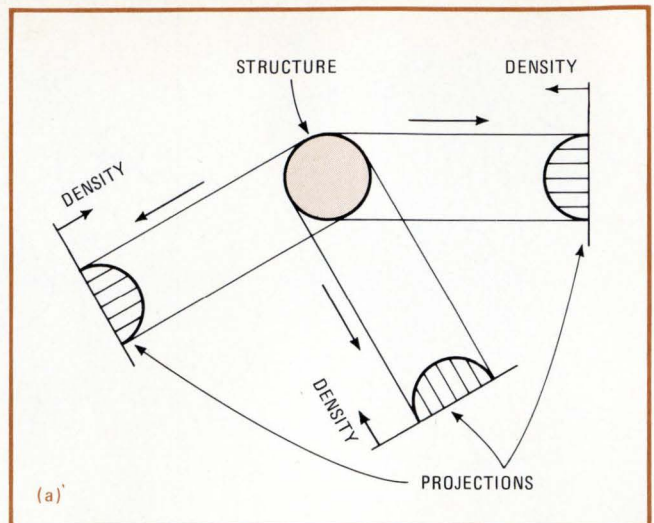

(a)

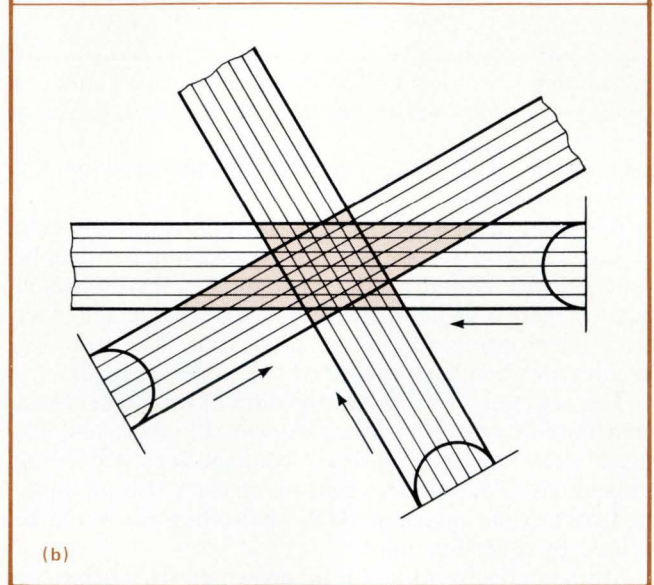

(b)

7. Artifacts. In reconstruction by adding the back projections produced by the shadow functions, the back-projected rays are added to the reconstructed image as artifacts, or unwanted points. The original circular structure is transformed into a star.

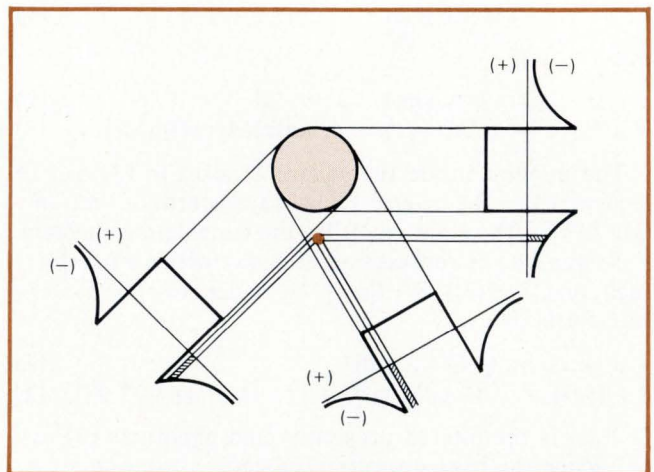

8. Clean-up. By filtering the signals from the detectors so that the contribution just beyond each image point is negative, unwanted images, like the color dot, are eliminated from the reconstruction.

System requirements dictate fiber-optic component parameters

When working with a new technology like optical fibers, it is desirable to treat a communications link as a subsystem and design in what is actually needed, rather than tailoring it to existing components

by Ray McDevitt, *Harris Corp., Electronic Systems Division, Melbourne, Fla.*

□ The most satisfactory way of designing a fiber-optic link, in terms of its overall cost, performance, and reliability, is to let system requirements determine the component specifications. However, as in most new technologies, initial component developments usually determine what system configurations emerge first. But, basing the system configuration on such standard components, which usually reflect what has been done, rather than what can be done or what is actually needed, is not the optimum approach.

Figure 1 details the steps involved in moving from user needs to actual specifications for the optical-fiber cable, transmitters, receivers, and other link hardware. In this scheme, "existing or planned device capability" has the lowest priority and, while important, it should only serve as the initial interaction between the user's needs and existing component capability.

The top priority usually is given to deciding whether to allot one channel to each optical fiber in an all-parallel approach, to multiplex several channels onto each fiber, or to combine the two approaches. If any multiplexing is involved, the next questions to ask are: which type would be more cost-effective, and what degree of multiplexing would be most economical? (Above a certain limit, the more channels squeezed into a fiber, the more stringent become the fiber-optic component specifications and the higher go their prices.) The answers to these questions determine component requirements, which last of all, are traded off against available device capabilities.

In favor of multiplexing

As it turns out, some degree of multiplexing is often desirable in fiber-optic communications links because most users want the freedom it gives them to add extra data channels to a system with relatively little difficulty. In many ground-based systems, for example, the most effective link consists of a combination of parallel data transmission and some sort of multiplexing—usually frequency-division multiplexing in the case of an asynchronous, multi-channel digital-data interconnection.

In fact, FDM is the type of multiplexing generally preferable for fiber-optic links. Time-division multiplexing, although it can be used, could require horrendously complex hardware to handle the variety of data rates commonly met with in these applications. FDM, on the other hand, much more readily accommodates asynchro-

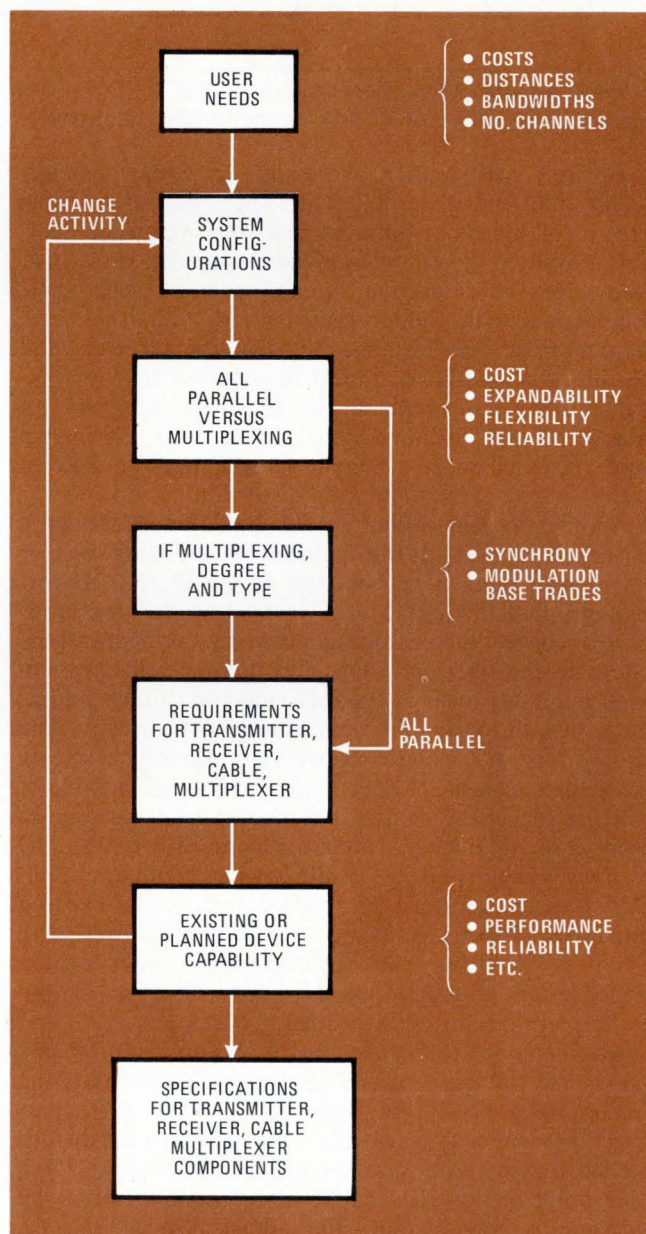

1. Interactive process. Specifying components for a fiber-optic-cable link requires several steps. Starting with user needs, each of the steps focuses on different, but essential, considerations of cost, expandability, flexibility, performance, and reliability.

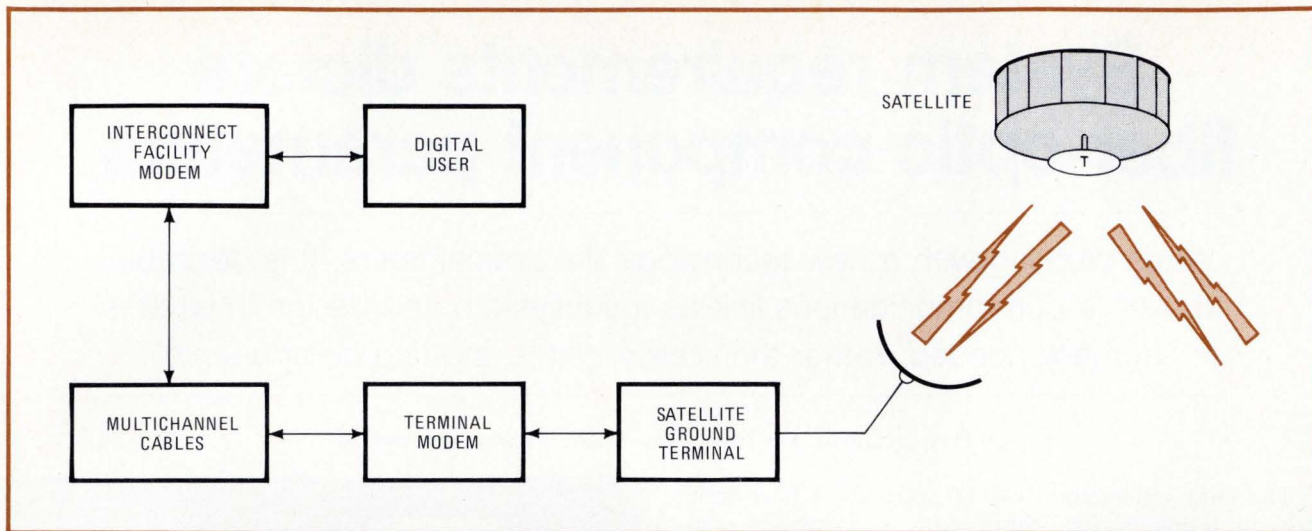

2. Satellite-terminal link. Fiber-optic cables that need no protection from electromagnetic interference and have large bandwidths can drastically reduce the cost of linking ground terminals with control facilities as far as two kilometers away.

nous rates, with either phase-shift or frequency-shift keying, and therefore makes it easier to send multiple streams of signals at different rates over the same fiber. This simplicity gives FDM an economic edge over TDM, even after consideration of its need for fiber-optic components with tighter specifications and, therefore, higher prices. For instance, in FDM, the receivers and transmitters may have to meet the equivalent of analog-transmission requirements in their handling of an increased bandwidth and signal fidelity. The fiber cable may also need more stringent specifications to prevent harmonic and intermodulation distortion.

Another consideration is the link's interface with existing equipment. If this includes such analog voice or video equipment, a key decision is whether to convert analog signals to digital form. Instead of inserting hardware to convert the analog signals to digital for transmission over the fiber-optic link and then converting them back to analog form at the receiving end, it may be less costly overall to use fiber-optic components directly. The savings from not using converters are partially offset by the greater expense of fiber-optic components capable of meeting the heavy demands of analog transmission. In terms of signal fidelity, a signal-to-noise ratio of 40 to 50 decibels is usually needed, while harmonic and intermodulation distortion must be 55 dB down to meet existing standards. For transmitting analog signals over long distances requiring multiple repeaters, direct analog transmission is much less attractive because of the buildup of noise in repeater lines.

Alternatively, to reduce the distortion requirements and hence the price of the fiber-optic components, the analog signals could be frequency-modulated. Technically, this approach is feasible—the increased bandwidth needed by fm formats would fall well within the large fiber-optic bandwidth capability. Economically, the outcome is less certain—the added cost of the fm equipment could outweigh the reduced cost of fiber-optic components.

The new signal formats that have been developed for fiber-optic systems could also prove worthwhile. They

differ from conventional wire-transmission techniques in that they exploit the large bandwidth of a fiber-optic link and its freedom from electromagnetic interference. As an example of the possibilities, it is easy in a noise-immune optical system both to send and receive a high-amplitude pulse and to include it in a signal format for synchronization purposes.

Perhaps the best way to illustrate the top-down approach to fiber-optic component specification is with an example. The purpose is to demonstrate that, by starting with user needs, the design will call for a different set of components than would be required if there are no tradeoffs at the subsystem level. For brevity, only one cycle of the design evolution shown in Fig. 1 will be assumed, and the major cost tradeoffs for each approach will serve as the primary evaluation criteria.

Defining user requirements

Satellite terminals are often located some 0.5 to 2 kilometers from a control facility containing the multiple digital and analog data sources. For the one shown in Fig. 2, a broad mix of data rates is required. But of the 20 receive channels, only seven require a data rate faster than 1 megabit per second, and of these seven, the fastest needs a rate of only 6 Mb/s. The remaining 13 channel rates vary from 12 kilobits/s to 960 kb/s. Of the 20 transmit channels, half have data rates faster than 1 Mb/s, the fastest being 4.2 Mb/s, and the other half have

TABLE 1: COST OF COMPONENTS OF OPTICAL-CABLE LINK

Item	1976	1977	1978 - 1979
Optical cable (10 fiber channels)	\$ 27/meter	\$ 13.50/meter	\$ 6.25/meter
Transmit/receive component sets	\$ 2,000	\$ 1,500	\$ 1,000
Connector sets (installed)	\$ 200	\$ 100	\$ 75

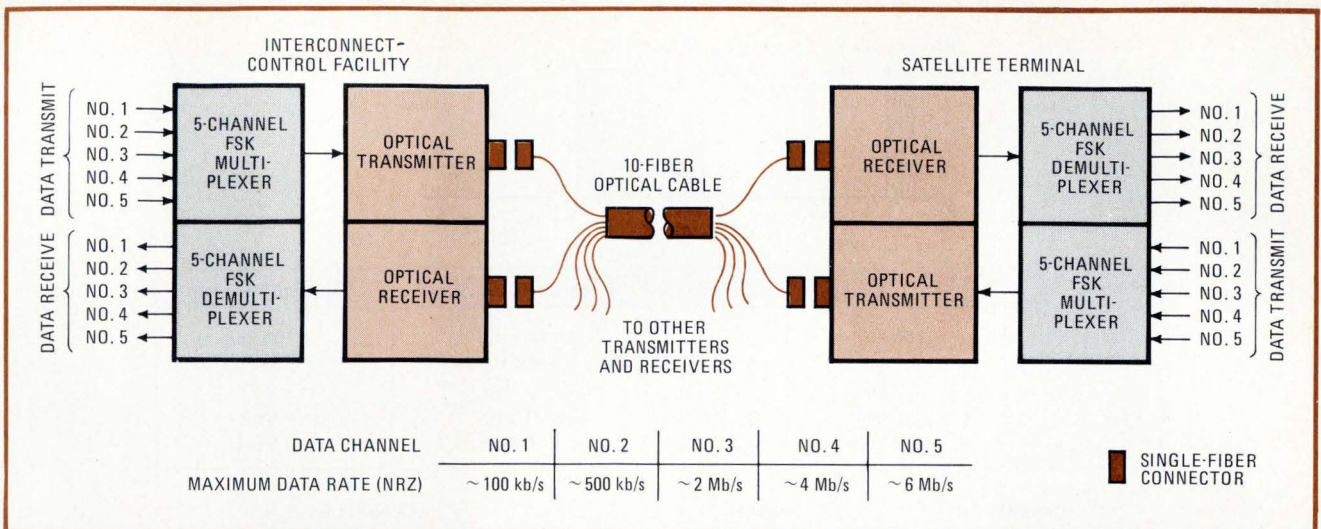

3. Optical-cable link. Multiplexing channels over a single 10-fiber optical cable provides both flexibility and room for expansion. The link can transmit 25 data channels in each direction. The composite FSK/FDM signal covers 100 kilohertz to 28 megahertz.

data-rate requirements of 12 kb/s to 960 kb/s.

The cost of supplying each of these simplex channels is the primary criterion for deciding between different link configurations. To this must be added the cost of any terminal equipment.

First, the cost of an all-parallel system is established. Second, multiplexing plans are introduced to determine whether their use of fewer optical transmitters, receivers, and cables would produce a net cost saving after the costs of the multiplexing hardware have been included. (In terms of performance, of course, more data can be transmitted with a single-fiber-per-channel approach, but even with individual channel rates of less than 6 Mb/s the wideband capacity of available optical fibers and components makes multiplexing attractive.)

Cost of the all-parallel approach

For comparison, the cost of a set of transmit/receive modules is set at \$2,000. This figure, which applies to quantities of 50 or more, assumes that each of these modules is ready for production without additional work. A full-duplex interconnect requires two fiber-optic channels and two sets of fiber-optic transmitters and receivers. Table 1 shows the price trend assumed for fiber-optic components over the next three years. Using the figures for today, the cost of 20 full-duplex channels for an all-parallel two-km interconnect link is:

- Four 10-fiber cables, with a 10-db/km loss, at

\$27/meter = \$216,000

- Forty connector sets at \$200 each when installed = \$8,000
- Forty transmit/receive sets at \$2,000 each = \$80,000
- Two racks at \$1,000 each = \$2,000
- Six power supplies (± 15 volts, 5 v) at \$200 each = \$1,200

The total recurring cost of such a system, therefore, works out to be \$307,200, and the average cost of a simplex channel is therefore \$7,600.

However, in planning for a system that is scheduled for production in a year or two, today's component costs may not be realistic. Actual system tradeoffs must be made partly on the basis of the cost of subsystems at the time of production. Accurate prediction of future prices is difficult, but it's safe to assume that they will drop as fiber-optic components mature and more systems are designed.

On the optimistic assumption that cable costs will drop to half of the present \$27/m next year and transmit/receive units will price out at \$1,500 a set, the cost per simplex channel would fall to \$4,380 (\$174,200/40). Further in the future, cable costs could again drop by a factor of 2 to \$6.25/m and transmit/receive sets could cost only \$1,000 a set, and the cost per simplex channel would then be \$2,405 (\$96,200/40). These figures apply to components having enough capability to close a two-km link at 30 Mb/s per channel with over 6 db of margin with a bit-error rate of 10^{-6} .

Multiplexing approaches

The next step is to calculate the cost of a system using multiplexed data channels with the same components and to select a specific multiplexing technique to start the comparisons. In this case, time-division multiplexing is discounted because lack of time synchronization among the interconnect's data channels would make this approach overly complex and costly.

Several frequency-division-multiplexing designs, using various electro-optical components and several subcar-

TABLE 2: COMPARISON COSTS PER SIMPLEX CHANNEL

	All parallel	FSK/FDM	
		Electro-optics portion	Left for FSK
This year	\$ 7,680	\$ 1,980	\$ 5,700
Next year	\$ 4,300	\$ 1,155	\$ 3,145
Future	\$ 2,400	\$ 661	\$ 1,739

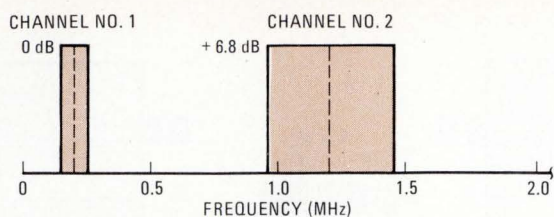

Channel No.	Center frequency	Deviation	Predetection bandwidth	Maximum NRZ rate
1	200 kHz	± 35 kHz	100 kHz	~ 100 kb/s
2	1.2 MHz	± 175 kHz	500 kHz	~ 500 kb/s
3	5.2 MHz	± 700 kHz	2 MHz	~ 2 Mb/s
4	13.2 MHz	± 1.4 MHz	4 MHz	~ 4 Mb/s
5	25.2 MHz	± 2.1 MHz	6 MHz	~ 6 Mb/s

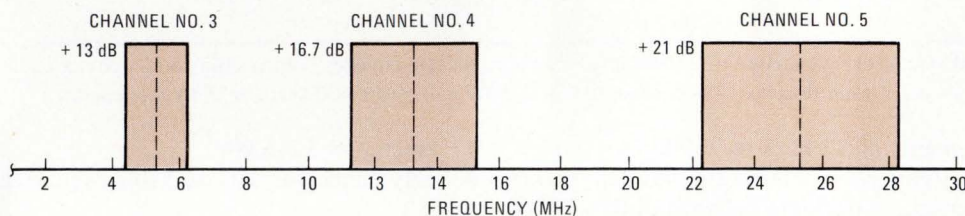

4. Frequency plan. The FSK/FDM approach is flexible, since any of the channels can be used to transmit at the maximum data rate. Each of the subcarrier levels must be weighted (as shown) to produce the same energy in the particular bandwidth.

rier-modulation types are possible. The best initial choice is frequency-shift keying (FSK), using noncoherent detection, rather than either phase-shift keying or quadrature PSK. This is because, when properly implemented, noncoherent FSK conserves bandwidth and provides a bit-error-rate performance that approaches that of PSK. Moreover, FSK has been around for some time, with two results: it is very cost-competitive, and practical filters providing over 30 dB of crosstalk rejection are available. It is therefore reasonable to assume that an FSK approach can easily handle the varying data rates needed.

To sum up, the FSK/FDM format allows a number of channels, multiplexed together, to occupy a 30-megahertz electro-optical channel. The bandwidth of such a fiber is normally sufficient for five channels to be multiplexed onto it with enough guard space to make extremely sharp cutoff filters unnecessary. On the other hand, as the channel data rate goes up, fewer channels can be multiplexed. This limit on bit-rate growth is less with the all-parallel approach, since its transmit/receive hardware can handle up to the maximum 30-Mb/s rate on each channel. To get around the problem, FSK systems generally include a few spare parallel channels. In the following analysis, therefore, a 10-fiber cable is used, even though with five channels multiplexed on each fiber, only eight fibers are necessary for a 40-channel system.

The hardware costs of the noncoherent FSK/FDM approach with five channels per fiber, excluding the FSK hardware, breaks down as follows:

- One 10-fiber cable at \$27/m (2 km needed) = \$54,000
- Ten connector sets at \$200/set installed = \$2,000

- Ten transmit/receive sets at \$2,000 each = \$20,000
 - Two racks at \$1,000 each = 2,000
 - Two power supplies at \$600 each = \$1,200
- The total per-simplex-channel costs without FSK is \$1,980 (\$79,200/40).

Table 2 compares the present and future costs of this and the all-parallel approach. The \$1,980 subtracted from the \$7,680 cost of each all-parallel channel leaves \$5,700 for the FSK/FDM hardware. Since such hardware in 1976 comes to about \$2,000 a channel, a saving of more than \$3,500 per channel results. If 1977's projected costs (Table 1) for the optical cable, transmit/receive sets, and connectors are used, then each simplex channel's cost drops to \$1,155. This amount, plus the FSK/FDM-multiplex cost/channel, still compares favorably with the \$4,300/channel cost for the all-parallel system. Three years from now, the cost/channel, not including the FSK/FDM hardware, is estimated at \$661. These comparisons point out that if the per-channel FSK/FDM hardware costs \$1,700 or less, then even in 1979, the FSK/FDM approach would be preferable, assuming that an all-parallel approach offers the user no needed extra capacity. This is often true, since the capacity of a 30-MHz channel greatly exceeds anticipated bit-rate increases over the next five years.

Obviously, the bandwidth and number of channels that can be multiplexed, the distance covered, and all assumed costs have a big impact when considering system tradeoffs. For example, if a maximum data rate of 6 MB/s per channel were specified, then the multiplexed approach would use more fiber-optic components making the all-parallel approach more attractive. With an FDM approach, the transmitter circuit would have to be capable of handling the more demanding analog

TABLE 3: DATA-CHANNEL ASSIGNMENT FOR INTERCONNECT FACILITY

	Fiber	Channel No. 1 100 kb/s	Channel No. 2 500 kb/s	Channel No. 3 2 Mb/s	Channel No. 4 4 Mb/s	Channel No. 5 6 Mb/s
Control facility to satellite terminal	1	100 kb/s	450 kb/s	1.0 Mb/s	3.0 Mb/s	4.2 Mb/s
	2	50 kb/s	Spare	1.0 Mb/s	3.0 Mb/s	4.2 Mb/s
	3	50 kb/s	Spare	900 kb/s	3.0 Mb/s	4.2 Mb/s
	4	12 kb/s	Spare	Spare	3.0 Mb/s	4.2 Mb/s
	5	12 kb/s	Spare	Spare	4.2 Mb/s	4.2 Mb/s
Satellite terminal to control facility	1	100 kb/s	550 kb/s	1.0 Mb/s	2.5 Mb/s	6.1 Mb/s
	2	50 kb/s	550 kb/s	1.0 Mb/s	1.8 Mb/s	Spare
	3	50 kb/s	450 kb/s	1.0 Mb/s	1.8 Mb/s	Spare
	4	12 kb/s	400 kb/s	960 kb/s	900 kb/s	Spare
	5	12 kb/s	300 kb/s	935 kb/s	Spare	Spare

requirements and would be more complex and costly than the simple on/off transmission techniques needed with the all-parallel approach.

The point to be made, however, is that unless system configuration tradeoffs are made, optimum components cannot be developed, and specifications for the transmitter/receiver bandwidths, intermodulation and harmonic distortion, and the capability to control bias currents for the different modulation indices would be quite different.

The frequency plan

Once the data rates of all channels are finalized, it is essential to consider the bandwidth requirements of each subcarrier before allocating channel-frequency slots. In determining such a frequency plan, several factors must be considered:

- The lowest-frequency channel should not approach dc; otherwise, large and rather expensive components, such as capacitors and inductors, would be needed.
- The actual position of each subcarrier on the frequency spectrum depends primarily on data bandwidth; the subcarrier frequency must be considerably greater than the data bandwidth.
- In spacing subcarrier frequencies, the harmonic content of adjacent channels must not overlap, and the crosstalk between channels must be held to an acceptable level.

The spacing depends on the characteristics of the filter used to separate channels multiplexed onto the link. In practice, available relatively low-cost four-pole Bessel-type filters are usually adequate. Should it be necessary to pack more channels into the allowable frequency allocation, a sharper cutoff filter could be used.

However, these filters are more costly and usually less stable, and, as more poles are added, in-band amplitude and phase response become much more difficult to control.

Final system configuration

Figure 4 shows the frequency plan for the FSK/FDM approach to the design of the optical-fiber-cable link between a satellite terminal and its control facility (Fig. 3). This frequency plan is flexible, and its flexibility provides for growth. Table 3 shows the exact data-channel assignment for the example problem.

The five data channels can handle a wide range of data rates that are multiplexed over a single optical fiber by FSK/FDM. Thus, if one 10-fiber cable is used, the system has the fiber capacity of 25 data channels in each direction—five more than the system needs at present—to allow for future expansion. Identical FSK multiplex-demultiplex hardware is used for each of the single fiber-optic channels. The composite FSK/FDM signal covers from 100 kilohertz to about 28 MHz, as shown in Fig. 4. Channel-to-channel isolation of more than 30 dB is provided by standard filters, and, besides supplying adequate transmission-channel bandwidth, each optical transmitter and receiver has intermodulation and harmonic distortion down more than 30 dB.

Note, finally, the capacity of the link. Any subchannel can accommodate a digital data rate with bit-error rates of less than 10^{-9} up to the nominal non-return-to-zero (NRZ) rate of that channel. □

For more information on fiber-optic technology, components, and systems see Electronics, Aug. 5, pp. 81–104, Sept. 2, pp. 94–99, and Sept. 16, pp. 113–116.

Frequency doubler and flip-flop make adjustable phase shifter

by Vladimir Brunstein
Nova Electric Mfg. Co., Nutley, N.J.

A frequency doubler for operation at the voltage levels of either complementary-MOS or transistor-transistor logic can be built with an inverter and a comparator. And if the doubled signal is then fed into a flip-flop, the output has the original input frequency, shifted in phase by an amount that depends on the reference voltage applied to the comparator. This shifter has been used to adjust the phase of the output from a phase-locked-loop device.

In the doubler circuit (a), the rectangular input signal and its inverted form are applied to capacitors C_1 and C_2 . Their triangular ramps, which are 180° out of phase, are

added through diodes to produce a sawtooth wave at twice the input frequency. This sawtooth is applied to the noninverting input of the comparator, producing an output at $2f_{in}$ with a duty factor that depends on the setting of the reference voltage at the inverting input.

Adding an edge-triggered D-type flip-flop to the circuit (b) yields an output signal of frequency f_{in} , phase-shifted with respect to the input signal. Varying the reference voltage V_{ref} , the phase shift between the output and the input signal can be set at any value between 0° and 180° . However, the duty factor of the output is always 50%. The frequency limit is set by the frequency band of the comparator used.

The component values shown were used for 60-hertz operation in a circuit that phase-locks the output of an uninterruptable power supply to the ac line. Connecting the output of the power supply back into the line provides a load that is inductive or capacitive, depending on the phase shift that is set by the reference-voltage potentiometer. □

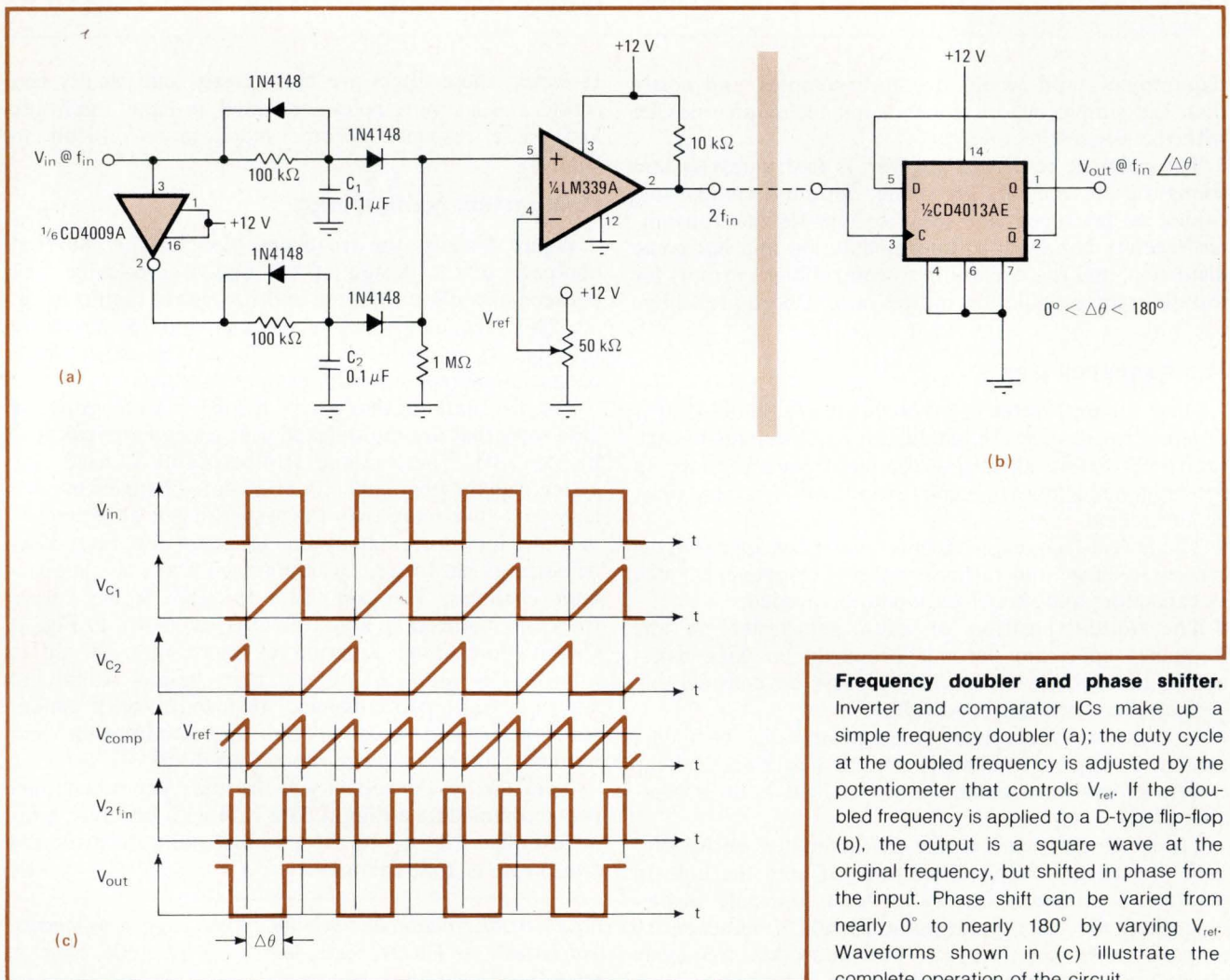

Frequency doubler and phase shifter. Inverter and comparator ICs make up a simple frequency doubler (a); the duty cycle at the doubled frequency is adjusted by the potentiometer that controls V_{ref} . If the doubled frequency is applied to a D-type flip-flop (b), the output is a square wave at the original frequency, but shifted in phase from the input. Phase shift can be varied from nearly 0° to nearly 180° by varying V_{ref} . Waveforms shown in (c) illustrate the complete operation of the circuit.

Chopping mode improves multiple-trace display

by C. S. Pepper
IRT Corp., San Diego, Calif.

A chopped mode of signal sampling extends the usefulness and versatility of an oscilloscope display that shows several signals simultaneously. The eight-trace oscilloscope switch described in [*Electronics* Dec. 25, 1975, p. 75] operates in an alternating mode that uses both beams of a dual-beam scope. One beam repeats as usual, and the second steps through a repeating pattern of eight

vertical levels. Each level displays one line of digital data; the result is a nine-channel trace-sequential display.

The sequential mode of sampling is satisfactory for data that is repeated at a sufficiently high rate. But, if data repeats slowly or occurs only once, all of the signals must be sampled at high speed and displayed during a single sweep. The circuit shown in Fig. 1 provides for both the chopped and alternate-sweep modes of signal sampling and display.

In this circuit, the 74S151 is an 8-line digital multiplexer. Inputs A, B, and C pick one of the eight digital signals for connection to the output at pin 5. A 74151 may be used if the faster Schottky device is not required.

The CD4051 analog multiplexer takes its inputs from

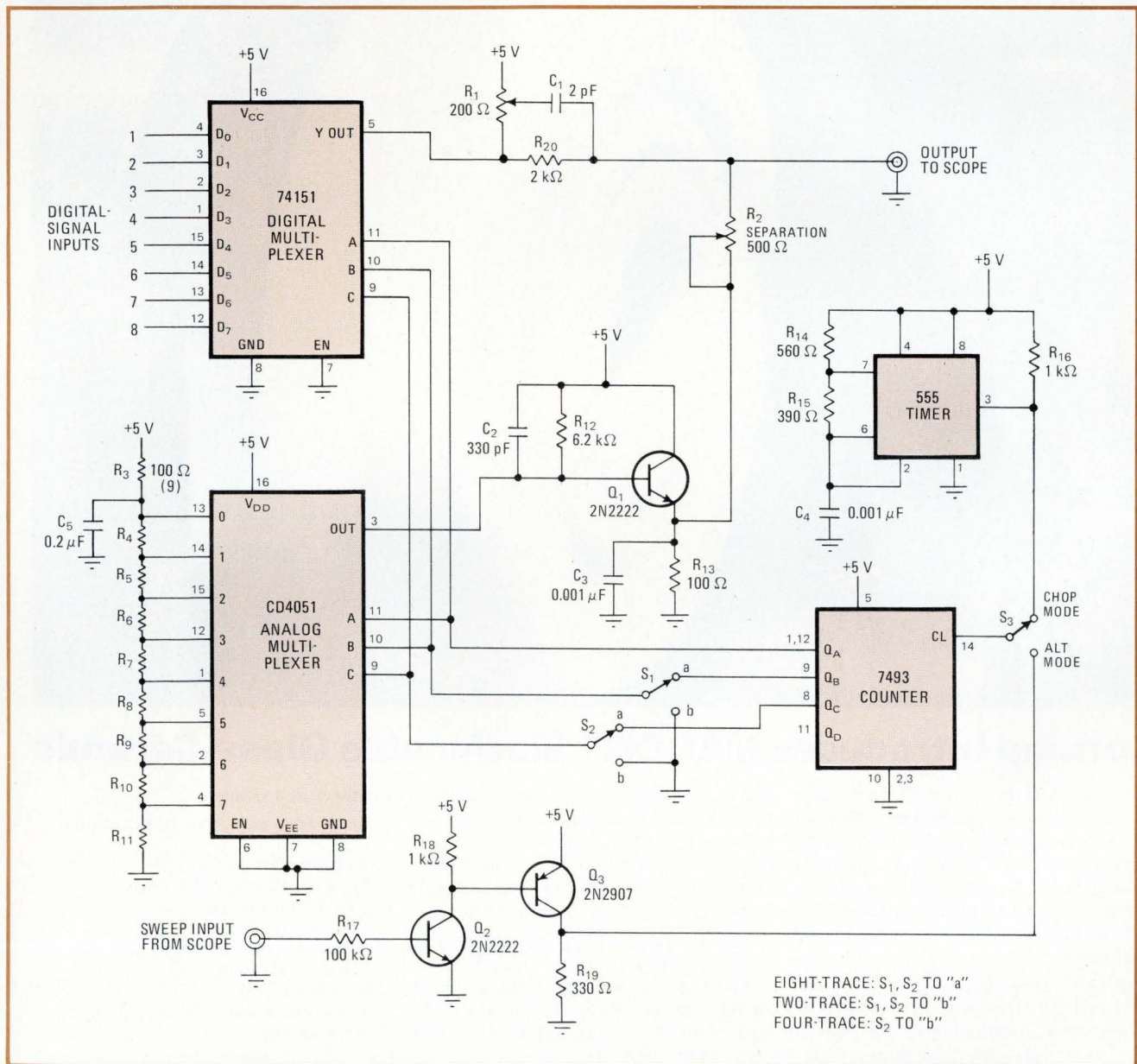

1. Signal traces. Scope displays two, four, or eight digital input signals, timeshared on either a chopped or sequential basis. The digital multiplexer selects individual inputs in cyclic succession, and the analog multiplexer separates their traces vertically. Both multiplexers are driven by a counter that counts pulses from a 555 timer for the chopped mode or sweeps from the scope for the alternate-sweep mode.

machinable glass? you've got to be kidding!

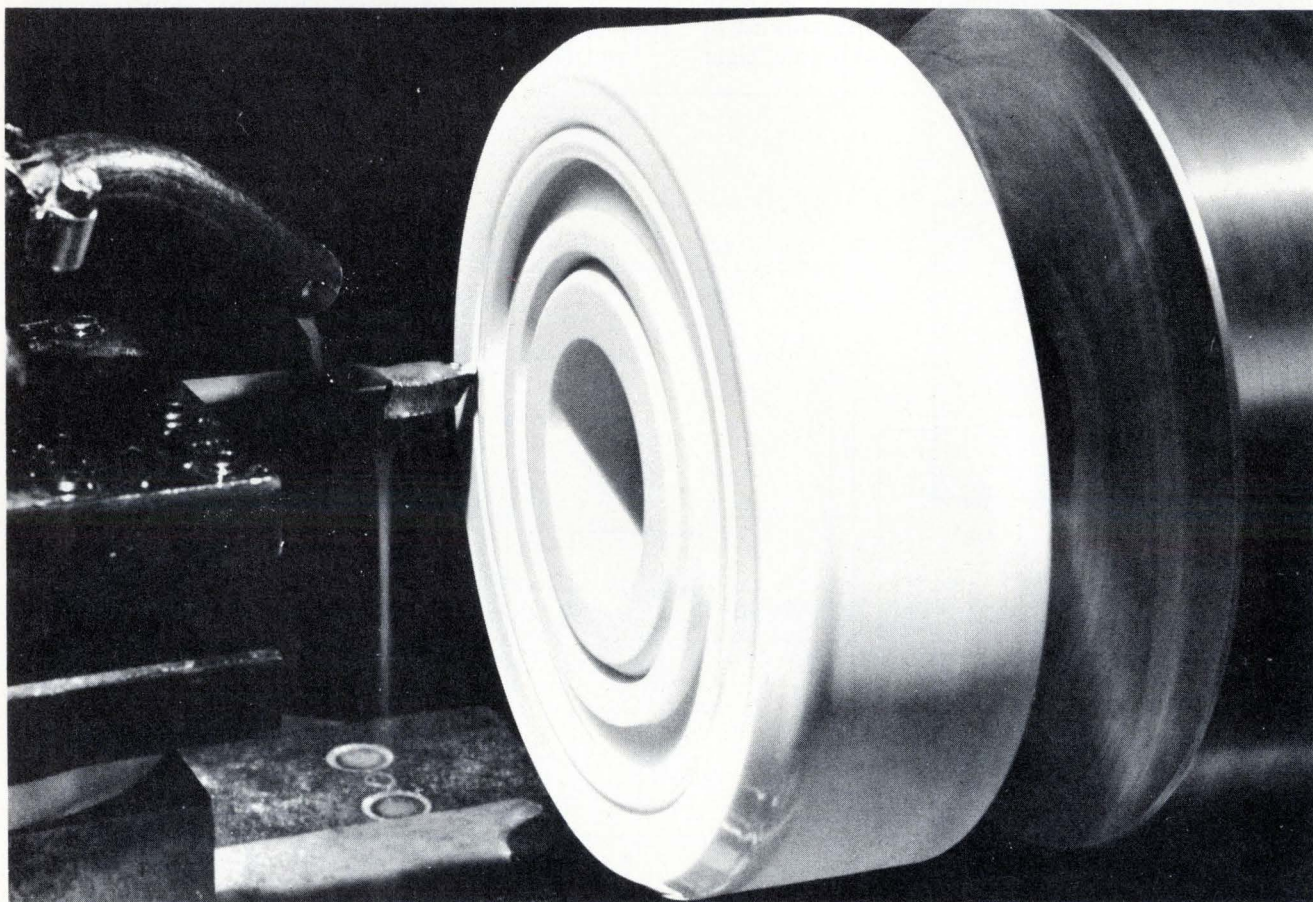

Corning Introduces MACOR™ Machinable Glass-Ceramic

Normally, glasses, ceramics, and glass-ceramics are not machinable without using diamond tooling. But MACOR™ glass-ceramic has a unique, partially crystalline structure which enables it to be machined to precision tolerances with ordinary metalworking tools and equipment.

MACOR™ glass-ceramic does not sacrifice strength, hardness or porosity to achieve this machinability, nor does it have to be fired after machining. Now, for the first time, there is a truly machinable, insulating material with physical properties that equal or exceed those of the best technical ceramics and glasses.

MACOR™ glass-ceramic can be hermetically sealed to metal, glass or ceramic utilizing a simple, glass-frit process that does not require brazing. It can also be metallized with thick-film inks and can be polished to excellent surface finishes.

MACOR™ glass-ceramic has outstanding dielectric properties and is completely nonporous; in fact its electrical and vacuum properties are as good as the best alumina or glass materials. However, MACOR™ glass-ceramic is available in standard sizes from stock and can be conveniently fabricated in your own shop saving you time and money while increasing your control over results.

Features at a Glance

- machinable with ordinary metalworking tools
- no firing after machining
- excellent dimensional stability
- good thermal shock resistance
- ultra high dielectric strength
- compatible thermal expansion coefficient
- low thermal conductivity
- low loss tangent
- zero porosity and zero water absorption
- non-magnetic

For technical specifications and a stock/price list, write:

MACOR™ Glass-Ceramic Dept., E-1076
Corning Glass Works, Corning, N.Y. 14830

CORNING

Electronics/October 14, 1976

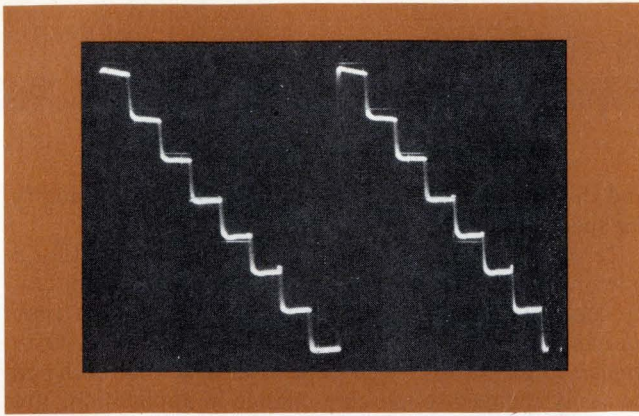

2. Fast steps. Staircase waveform positions scope trace in the chopped mode. Each step is 5 microseconds wide.

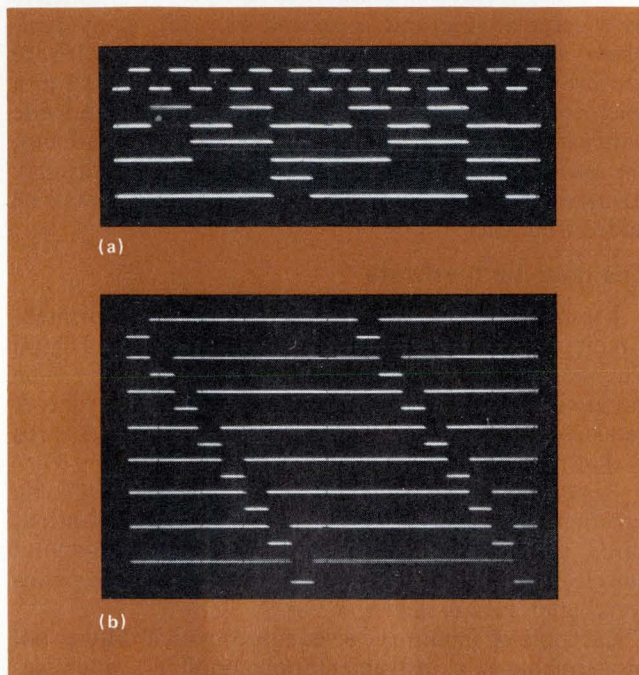

3. Outputs displayed. the chopped mode produced these waveforms of (a) the four outputs from a 7490 decade counter, and (b) the first eight outputs from a 7442 decimal decoder driven by the 7490. Input pulse rate was 1 kHz.

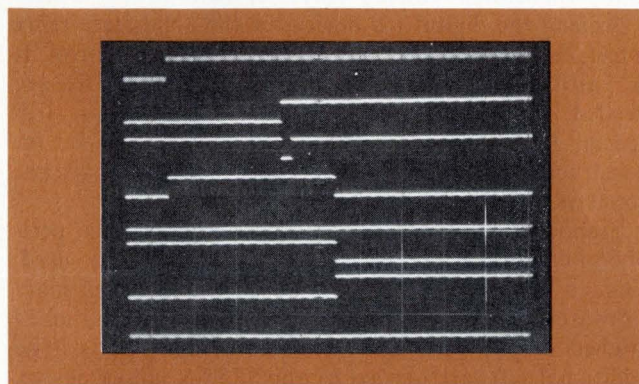

4. Slow process. Timing diagram of a slow speed controller with total trace length of 0.5 second was photographed by use of chopped mode. Display was triggered from the negative transition of the upper trace.

a resistance-chain divider that establishes a set of eight equally divided voltage levels. These levels appear at the output in the same sequence as the digital signals from the 74S151 because the two multiplexers have common addressing. A 2N2222 transistor, Q_1 , provides drive power for the analog output, and the digital and analog signals are summed at the output to the oscilloscope.

Addressing is obtained from the 7493 counter. The circuit utilizes a single channel of the oscilloscope, with external triggering from one of the signals or a related source. The Q_A , Q_B , and Q_C outputs provide fast chopping of the data. If a slower chop signal can be used, dropping back to Q_B , Q_C and Q_D will double the ON time for the same chop frequency.

Switches S_1 and S_2 provide options of eight, four, or two traces. For eight traces, both switches are in position (a), and for a two-trace display, both switches must be in the grounded (b) position. If only switch S_1 is in the (b) position a four-trace pattern, composed of traces 1, 2, 5, and 6, will appear. This can be a useful option because, at times, eight traces are too many, and the switches provide a means of momentarily reducing the clutter. Note that only addressing is changed; a two-trace display spaces the traces the same as the original eight.

A simple 555 timer circuit provides the counter input when switch S_3 is set for the chop mode. The values shown will provide a trace-bit time of about 5 microseconds, or a staircase time of 40 μs . The chop waveform is shown in Fig. 2. Each step is 5 μs —fast enough to cover the line breaks in the traces. Since the chop is not in synchronism with the data, surprisingly fast data can be viewed in the chop mode. The trace of Fig. 3a shows the four outputs from a 7490 decade counter with a 1-kilohertz input. Figure 3b shows the first eight outputs from a 7442 decimal decoder tracking the 7490.

The waveforms in Fig. 4 are those of a very slow control system, with a total sweep time of 0.5 second. The sequences shown are all for one single event. The only way to identify these scope traces is by photography—the single sweep goes by much too fast to begin to track the events taking place on the eight traces. The eight-channel switch and Polaroid film make the photography simple.

For operation in the alternate-sweep mode, the scope sawtooth provides the clock input to the 7490 counter. Because the signal level from some scopes is much too high for the 5-volt transistor-transistor-logic counter, the drive circuit with Q_2 and Q_3 is included. This circuit works well with a 30-v sweep in, but for other voltages, a revision of R_{17} may be needed.

Three compensation elements are included in the circuit. The first of these is C_5 , which may require some tweaking to best flatten the top step of the staircase shown in Fig. 2. The second is C_2 , which eliminates overshoot at the end of each step. The effect of overshoot is to draw a thick trace; the 330-picofarad value shown may require trimming to produce the narrowest trace and to eliminate ringing. Finally, R_1 and C_1 should be trimmed to produce the narrowest trace. \square

Designer's casebook is a regular feature in Electronics. We invite readers to submit original and unpublished circuit ideas and solutions to design problems. Explain briefly but thoroughly the circuit's operating principle and purpose. We'll pay \$50 for each item published.

Data-acquisition system built modularly around Intel 8080

by Jonathan A. Titus
Tychon Inc., Blacksburg, Va.

□ Early this year, engineers at Tychon were asked by a U.S. Government agency for an appraisal of what was available to monitor transducer outputs from chemical instrumentation. But when no commercial data-acquisition system could be found to meet the agency's requirements, Tychon proposed a design for a suitable microprocessor-based data-acquisition controller and won a contract to build it.

The agency wanted the monitoring system to have:

- A flexible and easy-to-change configuration.
- A mix of analog and digital inputs and outputs.
- A serial input/output port with both an RS-232-C interface for modems and a 20-milliampere current loop for teletypewriters and printers.
- A minimum number of controls.
- Complete software.

In addition, an acceptable system had to be simple enough for use by people who were not hardware or software experts. Yet all the information necessary for making software and hardware changes had to be available to guide those expert enough to do so.

Tychon's survey of data-acquisition systems turned up none that met all these specifications. Some units would have required extra interfaces and software, while others required data to be in a preset format or within decade voltage ranges. Still others were far too complex or lacked flexibility, though, otherwise, they were well-engineered instrumentation. Even those that were microprocessor-based were not flexible enough because they did not come with fully documented control programs,

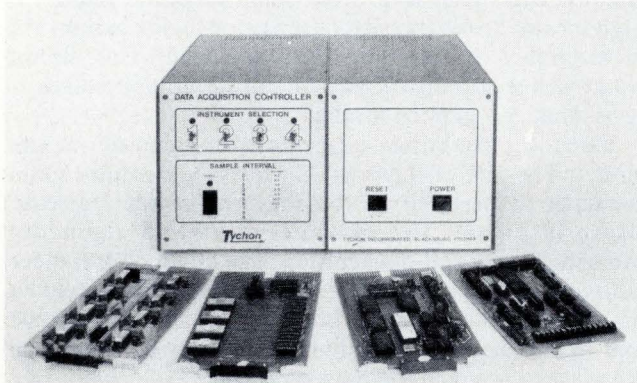

1. Modular. The Tychon data-acquisition controller is a microprocessor-based system with a variety of analog and digital inputs and outputs. Both the hardware and software are modular.

and this lack would have made them difficult to modify for specific needs.

To obtain the necessary flexibility, Tychon opted for a microprocessor-based modular design. Use of the microprocessor, instead of hard-wired logic, cut design time and kept system cost down to \$2,500. The modularity applies to software, as well as hardware, so that both can be easily changed to match a change in application. Yet nontechnical people can easily program and operate the system.

The microprocessor chosen was an Intel 8080, which is in widespread use and is second-sourced. Many peripheral and control chips and a wide variety of software are available for use with it. Around it was built a microcomputer with a bus signal structure to provide hardware flexibility. Thanks to the parallel-wired bus, the microprocessor module and other function cards may be moved from slot to slot, and more memory may be added if needed.

The modular hardware

For the function cards or modules, standard printed-circuit cards were adopted. The dual-width Digital Equipment Corp. size was picked because of the wide variety of function modules being made the same size. A version of the controller using a selection of these cards is shown in Fig. 1.

Besides the central-processing-unit card, available function cards include standard analog input and output cards, standard digital I/O cards, an analog-to-digital converter, a front-panel controller, and an asynchronous serial interface, as shown in Fig. 2.

Each analog input may be equipped with a differential programmable-gain instrumentation amplifier, when necessary, to provide for a wide range of analog-signal levels. The a-d converter is a prepackaged unit, complete with internal analog multiplexers, amplifier, and sample-and-hold circuitry; its resolution is 12 bits, even though many applications call for only 8 or 10 bits.

Among the digital I/O devices is the solid-state-relay interface card with four relays for 110-volt ac control. It is particularly valuable where external controls are needed. A dual I/O-interface circuit card helps with special digital I/O, since an area of the card is open for construction of special circuits, such as flags, registers, counters, and controllers.

Standard I/O proved preferable to programable peripheral chips such as Intel's 8255, which were not used. Though very flexible, they are expensive and need more software than do the logic chips used with standard latched output ports and three-state input ports. The additional software needed by the 8255 is not extensive, but it might be difficult for a user to understand—an unwanted complication.

The front-panel controls posed a problem. The panel could hardly contain all the special hardware needed for

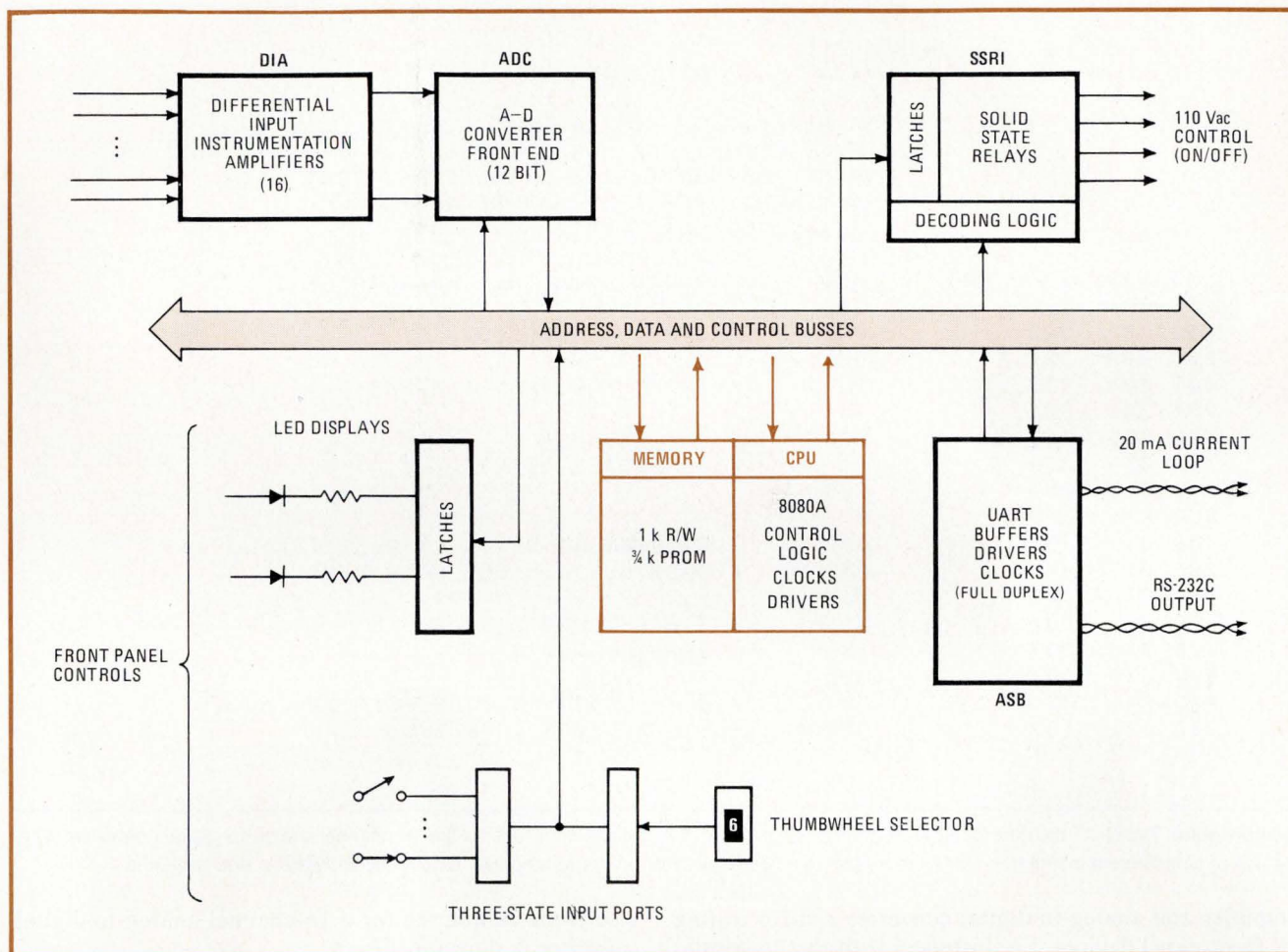

2. By bus. The microprocessor module communicates with the other modules over a parallel-wired bus. There may be up to 16 analog input channels, and the digital outputs can control ac-powered devices and interface with terminals or a remote computer.

all possible functions. Instead, all front-panel controls and displays are treated as I/O devices under software control. The controls and displays supply information to the 8080 and display information from it. What's more, because their decision-making and control functions are in software, they can easily be added or subtracted from the system as its needs to be changed. Even the functions can be changed. Still, in some applications only an on/off and a reset switch may be needed.

The hardware for the front-panel controller card had, consequently, to be very general in purpose. The card contains both input ports (for switches, keyboards, and push buttons) and output ports (for seven-segment displays, light-emitting diodes, and an audio alarm). It also contains a real-time clock with the time base derived from the 8080's crystal clock.

A hardware clock was preferable to a software-timer subroutine because the former allows for subsequent addition of interrupts. Interrupt-control signals are available, but are not used in most systems. The clock

control, like the front-panel controls, is handled by software subroutines that are available to the user.

The standard asynchronous serial-interface module makes it possible to use a teletypewriter or terminal with the data-acquisition controller. This full-duplex, four-wire interface is one of the easiest methods of interfacing to a computer, and it can transfer data as fast as 9,600 bits per second. Its presence means that a similar port could be used on a remote computer to accept data from the data-acquisition controller and return processed data or instructions to it.

In one application, the serial I/O port was used to send data to a computer 1,000 feet away and also to run diagnostic software with a nearby terminal. A software-sensed jumper in the serial-interface plug told the 8080 whether it was supposed to transmit (jumper in) data or run (jumper out) the diagnostic programs. This convenience enables even nontechnical people to test special functions easily.

The diagnostics are used for adjustments to the

```

/ SUBROUTINE ADC SELECTS A PARTICULAR ANALOG
/ CHANNEL, STARTS THE CONVERSION , WAITS FOR THE
/ END OF CONVERSION , AND INPUTS THE DATA.
/ INPUT: REG A = CHANNEL ADDRESS
/ OUTPUT: H&L = DATA

000 000 323  ADC,   OUT    / OUTPUT MULTIPLEXER ADDRESS
000 001 300          300
000 002 323          OUT    / START CONVERSION
000 003 301          301
000 004 333  EOC,   IN     / INPUT EOC FLAG & MSB'S
000 005 301          301
000 006 267          ORAA   / SET THE FLAGS
000 007 372          JM     / JUMP BACK IF EOC = 1
000 010 004          EOC
000 011 000          0
000 012 057          CMA    / COMPLEMENT MSB'S TO POSITIVE LOGIC
000 013 346          ANI    / MASK OUT ALL BUT DATA BITS
000 014 017          017
000 015 147          MOVHA  / STORE 4 MSB'S IN REG H
000 016 333          IN     / INPUT 8 LSB'S
000 017 300          300
000 020 057          CMA    / COMP. DATA TO FORM POSITIVE LOGIC
000 021 157          MOVLA  / STORE LSB'S IN REG L
000 022 311          RET

```

3. Subroutine. Typical of the data-acquisition controller's software subroutines is this one for the 16-channel analog-to-digital converter. Note the use of complement instruction (CMA) to replace hardware inverters on the a-d module. Diagnostic software is also available.

amplifier and analog-to-digital converter and for testing all front-panel devices. For instance, with the diagnostic program, a dc voltage reference is fed into the amplifiers so that gain settings and offset adjustments can be made. A similar procedure is used to calibrate the a-d converter. Users of microprocessor-based systems should insist upon diagnostic software, since check-out and repair become very expensive without it.

The modular software

The 8080 software may at first seem complex because it controls so many parameters, including analog and digital I/O, the asynchronous I/O port, the front panel, and diagnostics. However, it is written in easily understandable and usable subroutines, or "modules," like the logical and electronic functions. Even though each data-acquisition controller may be used for a different task, the software is very similar for all.

Usually, standard "off-the-shelf" software subroutines are linked in the correct sequence within the main controller program, but, on occasion, some software may be customized for special applications. This modularity decreases the time and cost of software development. It also means that new modules may be added and languages like Basic or APL may be used. An example of

a software subroutine for a 16-channel analog-to-digital converter is shown in Fig. 3.

In a typical application, 16 analog channels are scanned, and the data is formatted and serialized on a user-selected time interval. Only 768 bits of programmable read-only memory and 1,024 bits of random-access memory are used. Very little of the RAM is actually used—merely a few locations for a stack and some temporary data storage.

Memory within the data-acquisition controller may be expanded in increments of 256 or 1,024 bytes of PROM and 1,024 bytes of RAM to make up the maximum of 65,376 bytes that can be supported by an 8080 system. Data may also be logged locally on paper or magnetic tape, printed on a teletypewriter, or displayed on a terminal.

Although the original intent was not to design a general-purpose microcomputer system around the 8080 microprocessor chip, additional memory would enable editors and assembler programs also to be run in the data-acquisition controller. A D-BUG software package also available for the 8080 system allows a programmer to modify the random-access memory for a set point in a chemical process-control system, look in the stack, and examine the register. □

Power-supply choice looms large in sophisticated designs

Complex electronics demands more from supply; cost and size become more crucial as other components shrink

by D.J. Blattner, *Circuit Design Editor*

□ The power supply is the unsung hero of electronic equipment with its behind-the-scenes contribution. It's often the last part to be specified, almost as an afterthought. But with today's complicated equipment, that may be a mistake. As the electronics grows more sophisticated, it makes greater demands on the supply. And the shrinking of component costs and sizes makes the power supply loom larger in the overall system.

Surveying equipment manufacturers in a variety of fields discloses a growing concern with the type of supply specified. The familiar make-or-buy decision is still important, although specialized demands of some equipment virtually preclude off-the-shelf-supplies.

The growth in electronics applications translates into a wide range of circuit and operational demands. For example, logic circuitry is satisfied with 1% regulation and is immune to noise below the switching level. But analog circuitry requires regulation on the order of 0.04%, and it processes noise pickup along with the signal. Another factor is operating efficiency, which involves more than saving power. The greater the efficiency, the smaller the supply and the less the heatsinking. And, of course, regulation and efficiency are only a few of the considerations in choosing the type of power supply.

There are three basic technologies for regulated power-supply design: ferroresonant, linear, and switching. All three types of supply accept an ac line voltage and deliver one or more regulated dc output voltages, but they differ in the ways that they set and regulate the dc levels (see "How they do what they do," p. 109). The relative advantages and disadvantages of the three types of supply are summarized in the table.

Having decided upon the power-supply type and performance that he wants, the equipment manufacturer is faced with a make-or-buy decision, even with special requirements that could be built outside to the company's specifications by a custom supplier. In some cases the custom product can be less expensive than an off-the-shelf unit, because it delivers only the performance required.

The standard product, designed to meet broader needs, may have capabilities, unnecessary in the particular application, that add to the price tag. For the most part, however, the skill, efficiency, and manufacturing volume of the standard houses allow them to provide a wide range of supplies at unbeatable prices.

An increasingly popular middle ground in the make-or-buy decision on ferroresonant and linear supplies are the submodules sold by power-supply and component

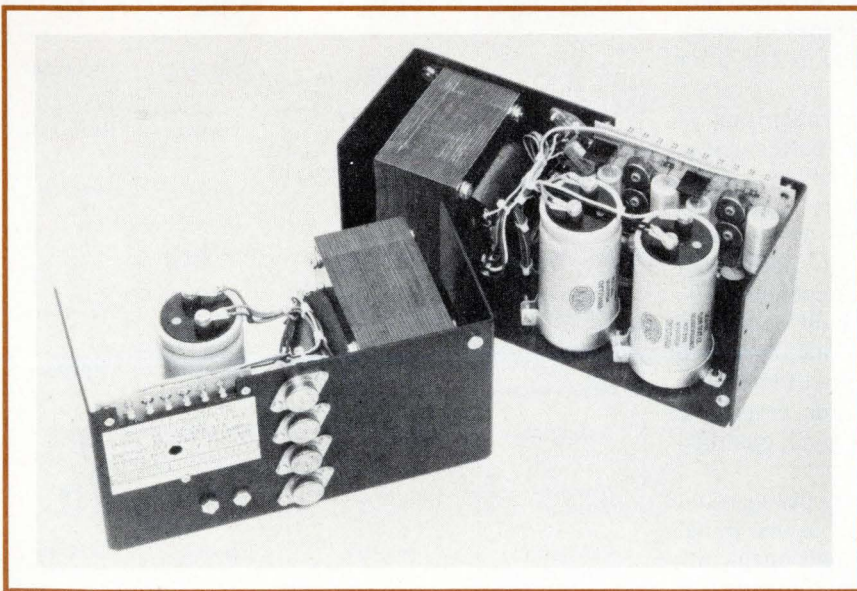

No frills, low bills. Open-frame linear power supplies, manufactured in large quantities, are favored by many OEMs because of their availability and low price. Several of these supplies can be used in one item of equipment—perhaps at different locations. They should be protected from dust, humidity, and high temperatures. Units shown are a single 12-V, 10-A supply and a dual 12-V, 5-A supply from Abbott Transistor Laboratories Inc.

makers. The equipment manufacturer needs only to couple a transformer with a submodule that includes rectifier, regulator, and filter (Fig. 1). Several submodules can be used to provide various voltages, perhaps at different locations for point-of-load regulation. With ferroresonant transformers, the regulating transistor can operate near saturation, and the submodules provide good efficiency, regulation, and economy.

A similar semi-custom procedure applies to switching supplies. Hybrid and monolithic integrated circuits are available for regulating and controlling the dc-to-dc conversion (Fig. 2). The equipment manufacturer selects only the switching power transistors and the magnetic components.

About 80% of all power supplies are manufactured in-house, mostly by large firms. "Generally, a company can think about designing its own power supplies when its volume gets high enough, it has the in-house expertise to keep out of trouble technically, and the return on the money invested is as attractive as from alternative investments," says Chuck Acken, product manager at the power-supply facility of Hewlett-Packard in Rockaway, N.J.

Making the decisions

However, a survey of manufacturers of different kinds of equipment discloses that some large firms have good reason to farm out some or all of the power-supply manufacturing. While some kinds of equipment generally may rely on just one of the three types of supply, there are special cases to which another type is better suited. Computers are a case in point. Their makers show strong reliance on switching power supplies, which they usually manufacture themselves. But there are some interesting exceptions.

Five years ago, Digital Equipment Corp., Maynard, Mass., used linear and ferroresonant supplies almost without exception. Now, says Philip Tays, manager of power and packaging systems, DEC is shifting more and more to switching supplies because they're low in cost and light in weight. And he predicts that, over the long term, they will deliver better mean times between failures. Nonetheless, the company has designed compact ferroresonant supplies, too, such as the one in Fig. 3 for the PDP-8/A minicomputer.

The make-or-buy decision includes consideration of cost, system schedule, reliability, and performance, according to Tays. The vendor's ability to respond to design changes during development is a substantial consideration too. "We'd like to find off-the-shelf conservative power-supply designs to do advanced functions," he says. "But it doesn't happen often enough."

The company sometimes has supplies built outside to its designs. "Power supplies are heavy and costly to ship," Tays says, "and we may have them built locally to our design for the savings in transportation costs. We don't want to build in-house if we can get good, qualified vendors."

However, for a variety of reasons, DEC designs and builds most of its own switching supplies. For one thing, the specifications of a system often change during its development, so that the power-supply requirements can

also change drastically and cannot be frozen from the conceptual stage. For another, the system may require a single supply with multiple outputs to serve, say, the central processing unit and memory. "The optimum route in such a case is to design one supply rather than buy a cluster of several," Tays says.

At Data General Corp., Southboro, Mass., staff engineer Dan Clemson says the company has been specifying mostly switching supplies because they offer the compactness and the variety of voltage levels needed. In addition, he says, battery backup is becoming an important consideration for minicomputers, and switching supplies are well suited to battery inputs.

In the Nova 3 minicomputer, introduced about a year ago, Data General wanted the power supply to fit on a single plug-in board (Fig. 4). A linear supply would have dissipated too much power, and the need for close regulation ruled out a ferroresonant supply.

A recent exception to the trend is the Eclipse line, the company's high-end minicomputer. The ferroresonant type is used because the system needs a simple supply of the highest reliability. Of all the systems that Data General has shipped to date, Clemson's guess is that half have switching supplies, with the rest split evenly between linear and ferroresonant.

The firm makes most of its own supplies, he says, because it can make the power supply an integral part of the system and save money. Then too, he adds, "we have a pretty strong buying arm and can buy parts in large quantities to save money. And, by being our own manufacturer, we have only ourselves to blame if we don't have the parts when we need them."

Hitachi Ltd. in Japan builds switching power supplies for its Control Computer 80. Engineer Yasuji Kamata of

COMPARISON OF CHARACTERISTICS OF REGULATED POWER SUPPLIES

	Linear	Switching	Ferroresonant
Initial cost	Moderate	Moderate to expensive	Economical
Operating cost	Higher	Low	Low
Size	Largest	Smallest	Intermediate
Weight	Heaviest	Lightest	Intermediate
Efficiency	Fair	Excellent	Excellent
Regulation	Excellent	Very good	Good
Noise	No problem	Needs filtering	No problem
Mean time between failures	~50,000-100,000 hrs	~50,000 hrs	~100,000 hrs
Repairability	Straightforward	Complex	Simple
Brown-out protection	No	Yes	Yes
Line-frequency sensitivity	Insensitive	Insensitive	Extremely sensitive

How they do what they do

In the linear or series-pass supply (a), the ac line voltage is stepped down through a transformer. The low-voltage alternating current is rectified to give an unregulated direct-current voltage about 5 volts higher than the desired output. The extra voltage is dropped in a variable dissipating element (the series-pass element).

This dissipating element is shown in the sketch as a variable resistor, but it actually is one or more power transistors operating in the linear mode; hence the term linear power supply. A control circuit continuously senses the output voltage and adjusts the transistors to maintain the desired level.

The linear supply provides excellent regulation, is reliable, and does not generate electrical noise. But the line-voltage transformer makes it large and heavy, and the heat sink for the pass transistor adds to the bulk. Also, the dissipative mode of regulation makes the linear supply inefficient—about 60% of the input power is wasted in low-voltage supplies—and requires cooling provisions.

If the ac line-voltage goes too high, the output voltage is unaffected. The series transistor merely dissipates extra power. If the input ac line voltage drops below the design value even momentarily, the output voltage drops too, because the low-voltage capacitor that holds the unregulated dc cannot store enough energy to maintain the output against a momentary line-voltage dip.

The switching power supply (b) rectifies the ac line voltage directly, storing energy in a high-voltage capacitor. The high dc voltage is switched at high frequency (around 20 kilohertz) across a transformer and then is rectified to provide the regulated dc output voltage desired. The switches used in the dc-to-dc conversion are actually power transistors, operating in the highly efficient

switching mode; hence the term switching power supply.

A control circuit senses the output voltage and provides regulation by adjusting the duty cycle of the transistors—the length of time that the switches are closed to charge the output capacitor. Because this charging is done in pulses and correction for a voltage change may require several pulses, the regulation response is not as fast as in the linear supply—resulting in reduced regulation.

The on-off switching in these supplies can generate electrical noise that may be radiated and conducted to other parts of the system unless special precautions are taken. The operation at high voltage and the greater number of components required make the switching supply more susceptible to failure than a linear supply. But it is lighter, smaller, and cooler, as well as less expensive to operate because of its greater efficiency. Also, the energy storage at high voltage provides some protection against brief drop-off of line power.

The ferroresonant supply (c) is the simplest and most reliable of the three types of regulated power supply. The input ac line voltage is applied to the primary of a transformer, exciting flux in the iron. A resonant secondary circuit causes part of the iron to saturate. A magnetic shunt provides a flux path for the secondary so that the primary flux remains unsaturated. The output secondary coil is across the saturated core, so the output voltage has a square waveform. Therefore the rectified output is fairly well regulated without the need for any external control circuitry. Inherently a current-limiting device, the supply automatically protects against overload.

The resonant circuit also provides protection against dips in line voltage, but is very sensitive to line frequency. So line-frequency stability must be assured.

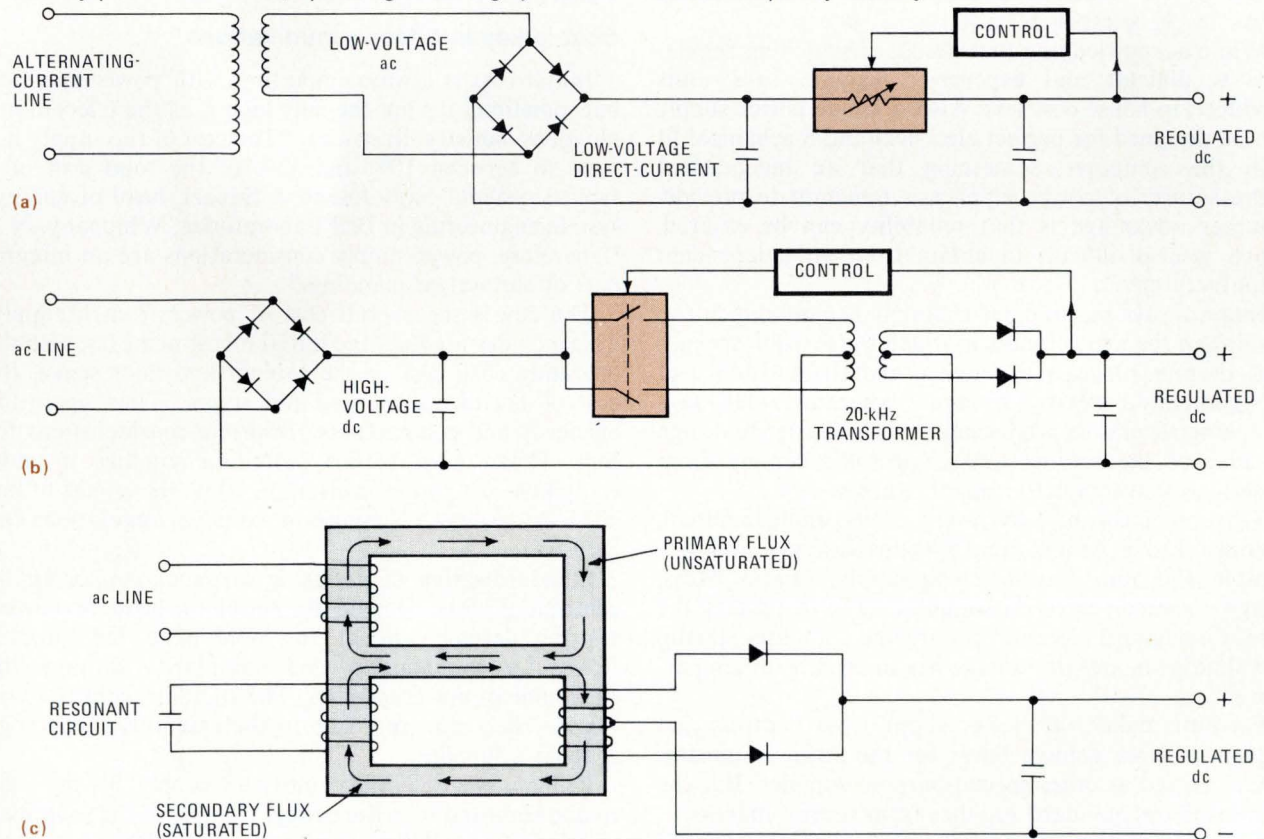

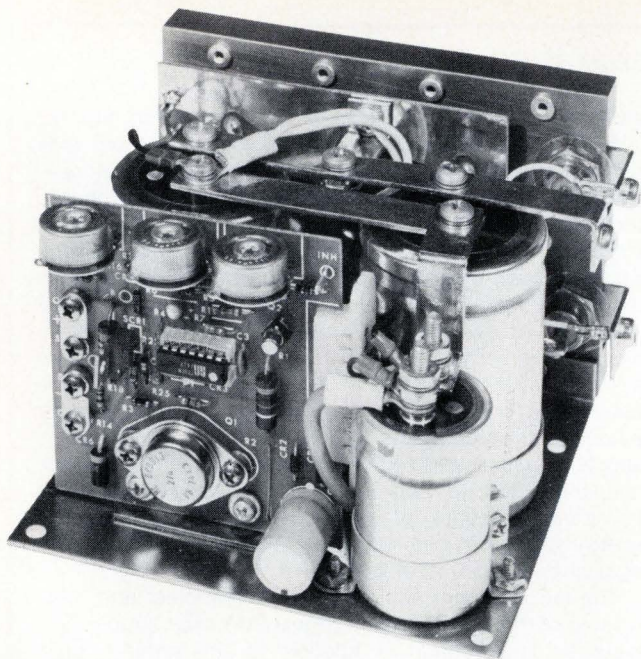

Hitachi's Omika works says that the vendor-produced series regulators previously used were sometimes larger than the control processor itself. And the linear supply weighed about 150 pounds to about 25 lb for the switching supply. Although the linear's initial cost was somewhat less, the power wasted over a 10-year life by its 30% efficiency would make it more expensive than a 70%-efficient switching supply. Kamata says that series regulators are now being mostly relegated to applications requiring 1 w or less, because efficiency at these feeble power levels is less important.

While acknowledging that design of switching regulators is difficult and expensive, Kamata says units produced in-house cost less. Also, a single power supply can be designed for perfect electrical and mechanical fit with the computer, something that an independent manufacturer of power supplies is reluctant to provide. Another advantage is that reliability can be assured, which is also difficult to obtain from an independent manufacturer.

Kamata says that the power supply is more difficult to build than the logic circuits in which the division specializes, despite 10 years experience and the assistance of the company's nearby research laboratory. He says switching regulators are becoming much easier to design because of the sensing and control ICs coming from American semiconductor manufacturers.

To protect the memory store of its minicomputers, Ferranti Ltd.'s Automation Systems division in Manchester, England, uses switching supplies. Frank Moss, design manager, says the supplies have to protect the core store against electrical failure and computer startup and shutdown, and the voltage has to track with temperature.

Ferranti makes the power supply that controls and sequences three voltage buses for the Argus minicomputer, as well as other special-purpose supplies. But the firm also buys standard supplies from several makers.

In Paris, CII-Honeywell-Bull technical director Henri

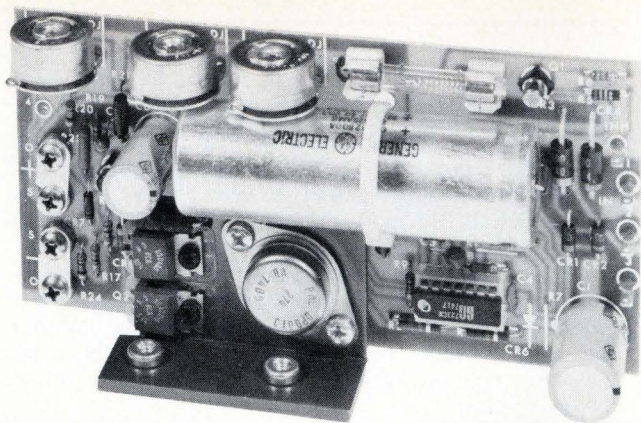

1. Subsupplies. Submodules, which are complete power supplies except for input transformers and heat sinks, are increasingly popular, because they allow freedom in the physical layout of an equipment design. Adjustable floating-output units from Power/Mate Corp., such as those shown here, cover the ranges from 1.2 to 30 V and 0.16 to 36 A. Potentiometer adjustments set voltage, over-voltage protection level, and current limiting. Both the pass transistor and the regulator IC are plug-ins for easy replacement.

Feissel notes a tendency among most European mini-computer makers toward specifying switching supplies. However, the higher cost of such units sometimes is a factor.

His firm paid particular attention to the power supply on the design of the series 60 computer line. One has a 10-kHz switching thyristor, while the other uses a single-phase transistor. The rule of thumb is to use transistors for the first hundred watts and switching thyristors for higher power, he reports.

Cost is key in telecommunications

Initial cost is always important with power supplies, but sometimes it's not the only factor, as the telecommunications industry illustrates. "The cost of the supply has risen to between 10% and 15% of the total cost of a typical system," says Joseph J. Suzzo, head of energy-system engineering at Bell Laboratories, Whippany, N.J. "Therefore, power-supply considerations are an integral part of our system planning."

The key is the overall cost of power from a supply. This includes not only the initial investment, but also the operating cost, cost of the cabinet and floor space, the cost of borrowing money, and so on. Thus operating efficiency and compactness are prime considerations for Bell. That's why it uses switching supplies in most equipment. At power levels up to 10 w, the effects of low efficiency are not as important, so linear regulations can be used.

Standardization of design is extremely important in controlling costs. Donald R. Anselmo, head of power-systems development at the Whippany laboratories, strives for commonality and modularity through the whole line of power supplies. The standard converters in Fig. 5 reflect this approach to the assembly technology of today's supplies.

Bell designs reliability into the supply by derating components and by redundancy. Control of the switching speed, low-inductance wiring, and filtering that dissi-

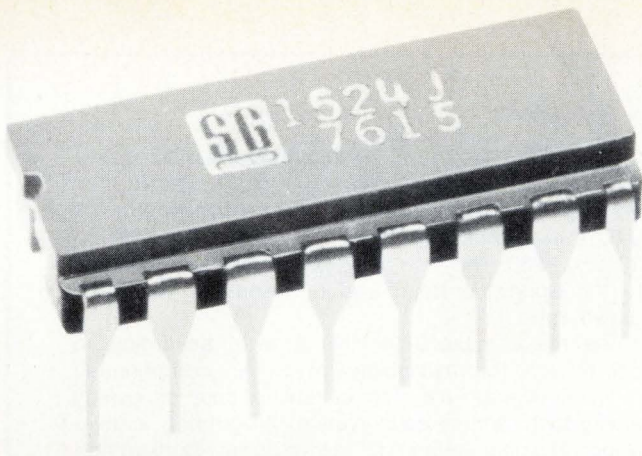

2. Control for switching supply. This Silicon General Corp. 1524 integrated circuit contains all the control circuitry needed for a push-pull switching-regulated power supply. Replacing 20 or more discrete components, it brings the parts count of the switching-regulated supply down to that of a series-regulated supply and almost reduces design of the switching supply to selection of appropriate power transistors and magnetic circuitry. Plessey Ltd. makes a similar IC, and Texas Instruments Inc. has a device for single-ended operation.

pates the noise energy all prevent electromagnetic interference.

In England, Marconi Communication Systems Ltd., Chelmsford, designs the power supply as part of the electronic circuit, according to Ian Alexander, technical director. Generally the firm uses conventional linear approaches, except when switching techniques are necessary to reduce heat dissipation and gain greater efficiency. "But you have to watch the economics of things all the way through the design because high-voltage switching transistors are expensive," Alexander cautions.

Marconi has "certain inhibitions about buying outside, because after all we're in the business of manufacturing electronic equipment," he declares. "We buy only if there is a specific requirement or only if using a subcontractor's module."

Linear supplies have proved to be the answer to the special demands of test equipment. Its manufacturers

prefer to buy outside whenever possible, but rigorous operating conditions sometimes force them to build their own.

GenRad's test-system division in Concord, Mass., produces equipment that performs both analog and digital testing. Analog work includes measurements down to the millivolt level and precision instruments in the system that don't tolerate noise well. Linear supplies are used to keep radiated and conducted noise to a minimum, says development engineer Karl Karash, because there is so much analog instrumentation in the systems. For example, the 2230 component test system (Fig. 6) has to test capacitance down to the picofarad level and voltages down to microvolts, "and you can't measure microvolts of signal if you have millivolts of noise," he says.

Another advantage of linear supplies is that they more readily accommodate the inevitable changes that take place during development. In a GenRad test system, changes may occur in the voltage levels to be measured, the current outputs, and the options available in the system. "It's much more difficult to design a switching supply to accommodate these kinds of changes than it is to use a linear supply," Karash maintains.

"It seemed like it took us a long time to get the 2230 out the door, but I'm convinced it would have been a lot longer in development if we had used switching supplies. The parts changes were minimal compared to what would have been required for a switching supply. If a voltage changes slightly, only a capacitor or transformer winding might have to be changed."

The company makes power supplies, but the policy is to buy wherever possible, Karash explains. He says the pattern has changed to buy for large systems in the last few years because of the availability of standard power supplies from vendors.

He likes the proliferation of vendors of the open-frame linear supply because it makes for price competition. "The price doesn't vary much more than 10% among possibly five different manufacturers."

The company has developed a set of rules for buying its linear supplies. They must be available of the

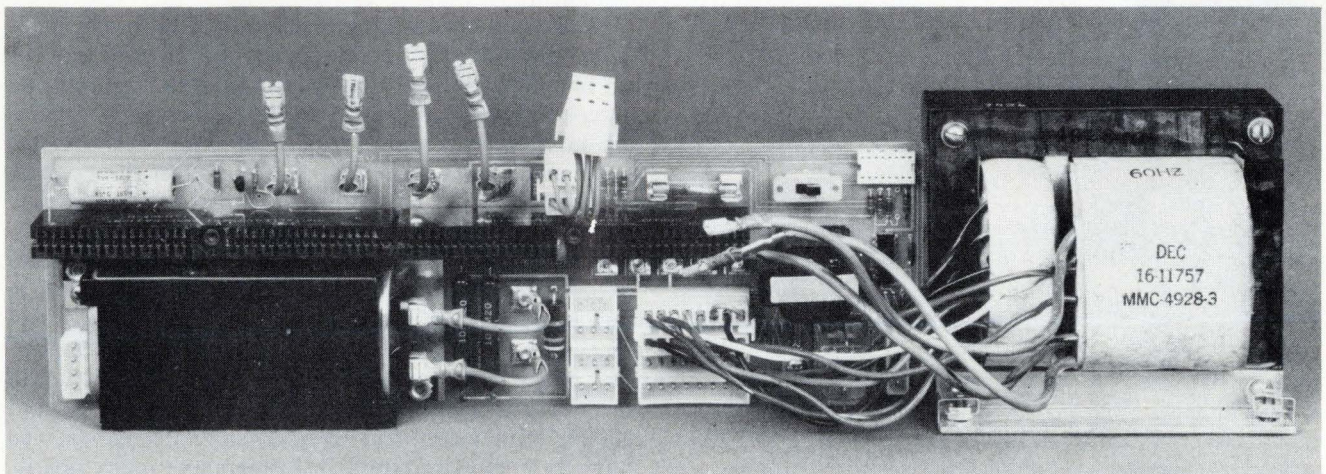

3. Minicomputer supply. Digital Equipment Corp. built this power supply to fit into the 3½-inch-high cabinet housing a complete minicomputer. Smaller coil on ferroresonant transformer is primary; larger windings are secondary and tank coils. The rectified output goes to a regulator board (not shown) to provide 5 V for TTL and for dc-to-dc conversion to +15 V for a teletypewriter or an EIA line driver.

What of the future?

An expanding electronics market means an expanding power-supply market, and Venture Development Corp., Wellesley, Mass., predicts the 1975 power-supply shipments of \$2 billion will approach \$3 billion by 1978. In-house manufacture will decline slightly from its present 80% share of the total.

Gnostic Concepts Inc., of Menlo Park, Calif., also foresees this strong growth in the power-supply market. It will be generated by the steady overall growth of the electronics industry, by the increasing use of electronics in place of electromechanical controls, and by the greater cost of power conversion compared to such functions as logic and memory.

Manufacturers of electronics equipment are showing an increasing tendency to use switching supplies, says

Dr. John M. Salzer, a consultant and an executive associate of Darling, Paterson, and Salzer in Los Angeles. The penetration of switching supplies in the U.S. power-supply market will grow from 8% in 1975 to 19% by 1980. This increasing penetration corresponds to the worldwide trend and represents a very high growth rate.

The major reasons for this growth, according to Salzer, are the availability of better components, reduced overall cost, the increased cost of energy (stimulating energy-conservation programs), convenience of higher-voltage dc bus for battery backup and line-fluctuation protection, and the advent of smaller products (such as microcomputers) that make smaller power units desirable.

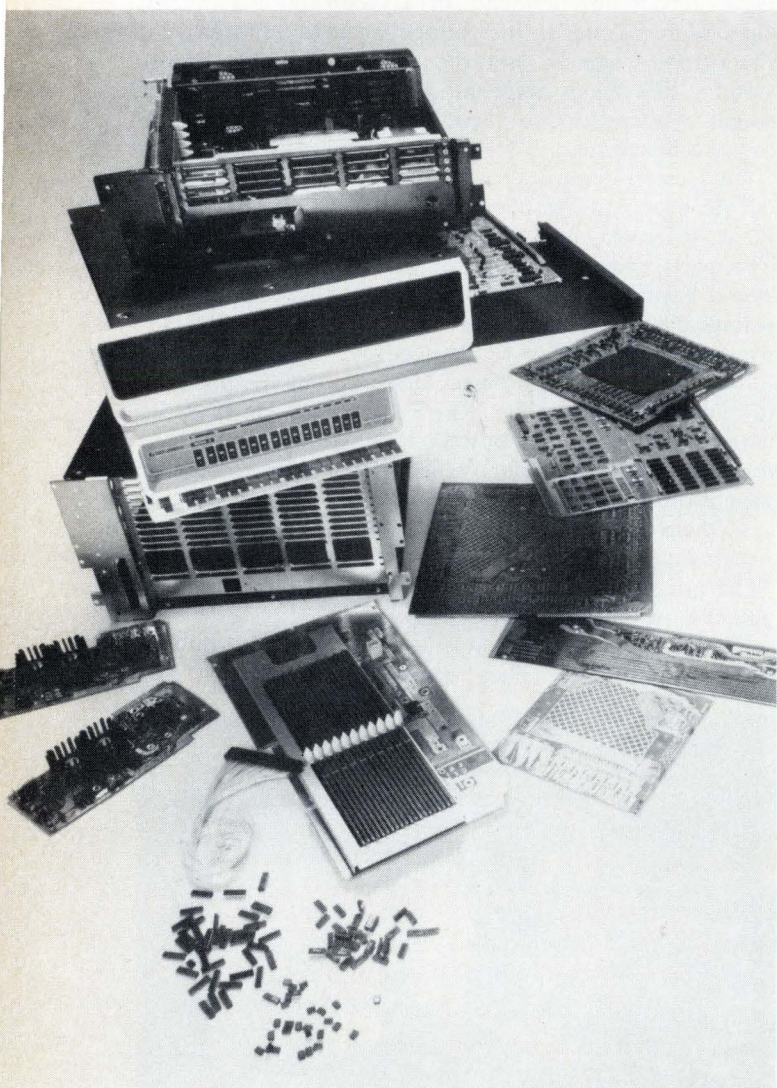

4. Tops for logic. Switching power supply for Data General Corp.'s Nova 3 computer is shown as top element in pile of chassis. Logic makers like switching supplies because they save space and run cool. They also can sustain the dc voltage during a dip in ac line voltage or while a battery backup comes on line during a power failure, thus preventing loss of data stored in volatile memories.

shelf, with a second source, and with short lead times (generally a week) because GenRad doesn't want to keep a big inventory of supplies. Karash wants a well-known manufacturer whose supplies have good technical performance and who is reasonable in helping solve the problems that invariably arise in using supplies from any vendor.

Portable instruments, which the company makes as well, often require specially designed supplies, and GenRad will probably continue to make more than 95% of them, Karash says. These include programable supplies, and he says the company knows it can make these for less than it could buy them.

Another part of the make-or-buy decision in a system that uses several supplies is the design engineering time. "The development time is greatly shortened if we buy the supplies," Karash observes.

RCA's Automated Systems division, Burlington, Mass. uses linear supplies in the Equate automatic test system, according to Bruce Wamsley, manager of design development. The company builds this van-mounted equipment for military depot use in automatic testing of circuit boards for a variety of military electronic equipment.

The Equate system uses internal supplies for the basic system power and programable supplies to generate the test functions performed on circuit boards. The internal power-supply choice is dictated by the degree of regulation required, Wamsley says, as well as current, package shape, and cooling requirements. These last three requirements also apply to the programable supplies needed for the various test stimuli.

Wamsley says his division doesn't build power supplies for test equipment these days. Earlier equipment to support the Lance, Tow, and Shillelagh missiles had company-built supplies, both fixed and programable. They had to withstand more humidity and vibration than then-available commercial supplies. This simply meant that all components had to be "firmly tied down," as Wamsley puts it, and all transformers and many boards got a potting compound to protect against moisture and vibration.

Another reason RCA built its own supplies, he says, is

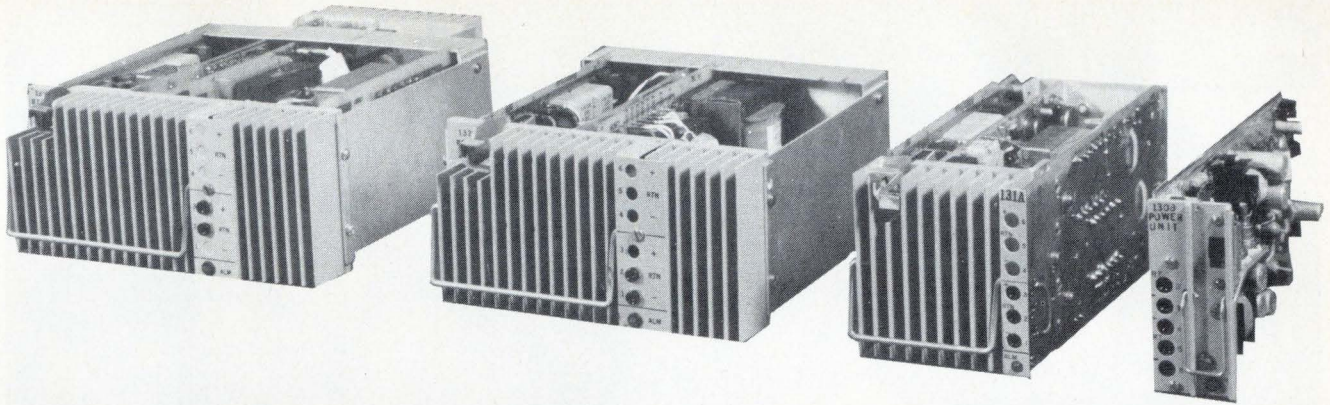

5. Standard converters. These dc-to-dc converters provide low-voltage power in Bell System telecommunications equipment. Their input power levels are (from left) 250, 150, 80, and 35 watts, respectively. To minimize cost, all units use the same structures, circuit boards, components, hardware, and cases. The transformer windings are chosen to provide a fixed output voltage (5.0 or 5.2 V or whatever is required) with a fixed input of 24, 48, or 140 V. Regulation is by pulse-width control. The conversion efficiency is 75 to 90 per cent.

that "people tended to think they could build their own cheaper than they could buy them. That turned out to be fallacy, so we've tended to buy lately."

At the Environmental Engineering division of Interstate Electronics, Anaheim, Calif., reliability and prompt delivery remain the principal consideration of project designer John Kracik. "We want something that's not going to give us trouble," he says. Reliability is particularly important for the division's adaptive data-reporting systems for marine oil-drilling rigs. Since variations in wind, waves, and current are critical for the rig's operations, the reporting system must perform flawlessly around the clock.

The system uses two linear supplies, a 15-v unit for driving low-pass filters and a 28-v model for powering the sensors. Kracik has found a serviceable off-the-shelf supply from a dependable nearby manufacturer and is not inclined to change. "As long as the supplies work and we have zero problems, we'll stick with them."

Interstate's own reliability testing requires a full-load 24-hour burn-in of each power supply, then random turning off and on about a half-dozen times as the system is kept running until delivery time. By this time, any problems would have shown up, he says.

Operating conditions created a make-or-else situation when the Eastman Whipstock division of Petrolane Inc., in Houston, Texas, needed a power supply for a down-hole oil-well surveying instrument. The supply had to fit inside a 1½-inch diameter pipe, to provide 9 w at 28 v from inputs varying between 6 and 18 v, and to operate at any temperature from -20° C to 175° C. High reliability was a must, because down-time on an oil rig costs \$3,000 per hour.

"We couldn't buy such a supply anywhere," says chief engineer Gordon Richardson, "so we built one ourselves. For compactness and low heat generation we used a switching-supply dc-to-dc converter, with the transistors operating at a small percentage of their rated dissipation. Our brassboard prototype for environmental testing survived the temperature tests and an impact of 2,000 g, and one hundred production units have been operating successfully in the field for over a year."

Sometimes systems will have a mix of power-supply

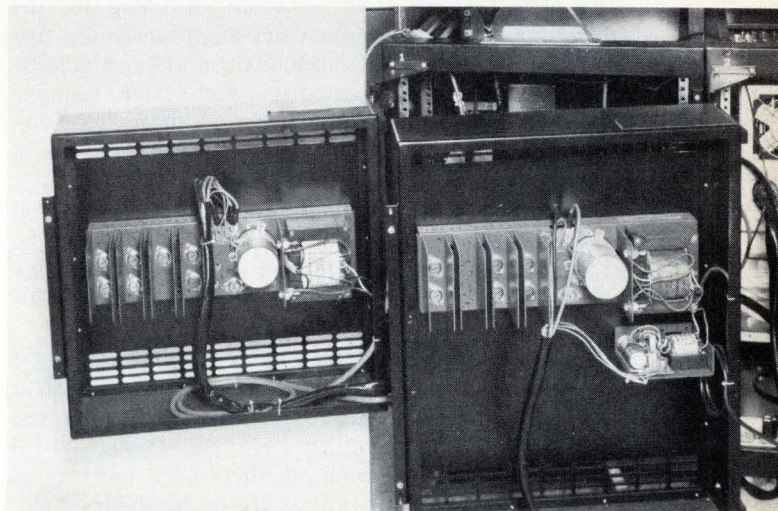
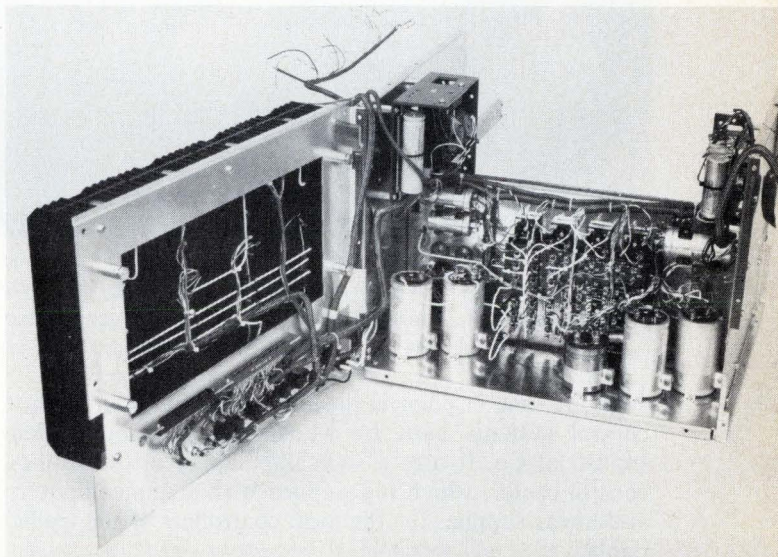

6. Make some, buy some. GenRad makes the linear power supplies used in its 2230 component test system (top). The hinged door of the supply subassembly contains heat sinks and provides access for service. For the 1795 logic-circuit test system (bottom), open-frame supplies are bought from outside. They are mounted on the doors so that exhaust air removes heat from the cabinets.

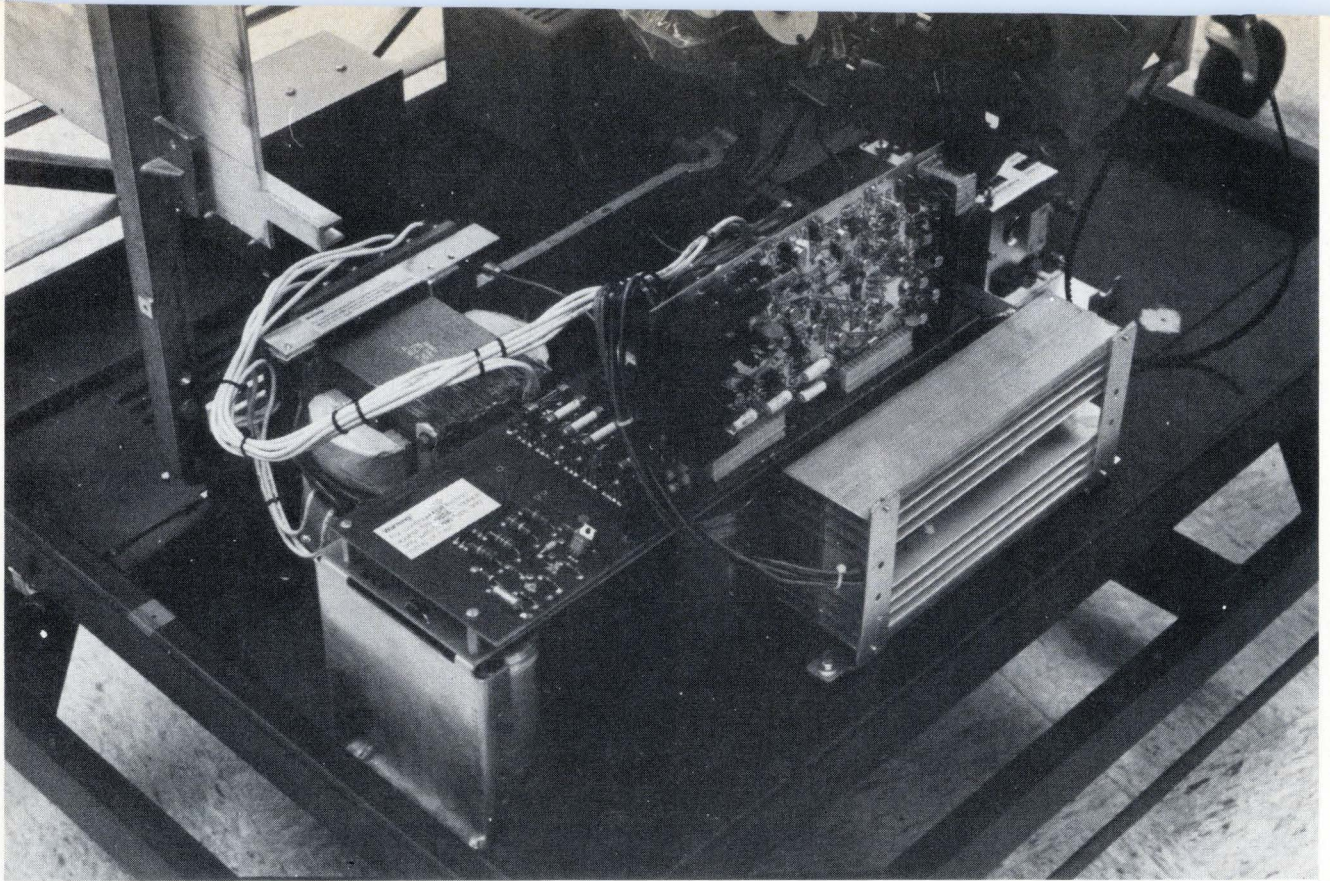

7. Looking into the power supply. The supply for IBM's new 46/40 Document Printer uses a ferroresonant transformer to produce six different dc voltages, four of which are further regulated by series-pass transistors. Printed-circuit boards eliminate point-to-point wiring, thus simplifying assembly. The lower horizontal board holds rectifiers and filter capacitors. The higher horizontal board has connections to series regulators, fuses, and output connectors. The vertical circuit board holds the control circuitry for the regulators.

types. A case in point is the Japanese wide-area traffic-control systems built by Matsushita Communication Industrial Co. It uses a switching supply in the traffic-control center, which is equipped with a minicomputer, and linear supplies for the local controllers of the traffic lights.

The firm changed from linear to switching for the central supply in 1975, says chief engineer Koji Kurimoto of the data-equipment and control-systems department. The linear supplies used just met system requirements, but they were large and ran at more than 60°, even with fan cooling. So there was a good chance of power-supply failure if the fan failed.

The smaller switching supplies are more efficient and run at about 40° when the fan is operating. They can be over-specified without undue cost in size or operating expense, so they are generally run derated to about 80% of capacity for improved reliability.

The linear supplies for the local traffic-light controllers are made by the firm, and parent company Matsushita Electric Industrial Co. makes the general-purpose switching supplies adopted for use in the traffic-control center. In-house production of the linear supplies is attractive because the quantities are in the thousands.

The buyers of office equipment almost never care what supplies power to their machines, so long as they work efficiently and reliably and don't take up a lot of space. "After the electrical requirements, cost and reliability determine which technology is used," says Jay Kinnard, power-systems project engineer at IBM's devel-

opment laboratories in Austin, Texas. But these requirements can be translated into different specifications for different machines.

"For office machines, such as magnetic-card typewriters or copiers, we use ferroresonant supplies if possible," Kinnard says. "There high reliability is particularly important in products that are to be used by the general public, and their cost is low."

The newly announced 46/40 Document Printer, for example, derives its dc power from a ferroresonant supply (Fig. 7). A couple of voltages require better regulation than the ferroresonant type provides, so linear regulation is added to those lines. But the rest of the sources are just rectified transformer outputs.

Where size or weight limitations rule out ferroresonant units, IBM may go to the switching supply. The electronic Selectric Composer is a good example. Because it is housed in a typewriter-like cover, the size of the power supply and the heat dissipation had to be minimized. Therefore a small, efficient switching supply was used.

The Memory Typewriter is the same size as the Composer, but has less stringent power requirements. It uses a lower-cost linear supply that is more compact than a ferroresonant unit.

IBM is an in-house producer of power supplies, not so surprising considering the size of the company. "We build our own power supplies for reasons of cost, reliability of components, integration of the supply into the system design, and time saving," Kinnard says. □

How to get through a bandwidth in ten easy steps.

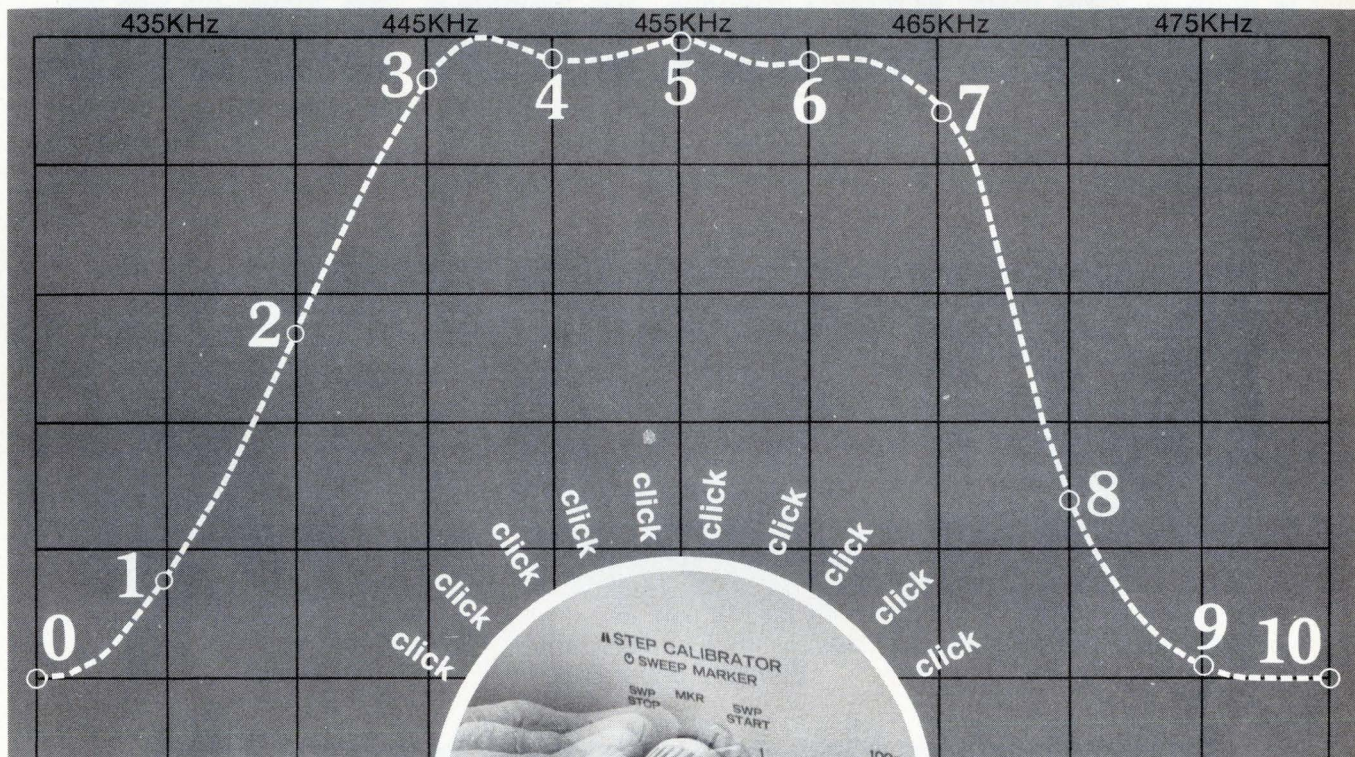

SERIES 40's Step Calibrator measures frequency response with the click of a switch.

Set SERIES 40's main dial *once*, and you'll get eleven precise frequencies in ten equal steps by simply clicking the Step Calibrator switch from zero to ten. With 1000:1 frequency change in the log mode, each step is equivalent to approximately one octave, which is particularly useful in audio testing. And unlike other function generators, SERIES 40 allows you to step up or down without having to cycle through the entire ten steps.

So — when you're testing frequency response, just set up the band edges and click through the ten steps, measuring amplitude at each step... it's that easy.

SERIES 40 Function Generators — New from INTERSTATE

SERIES 40 gives you plenty of amplitude — 40 V peak-to-peak (open circuit) — and takes the guesswork out of pinpointing response with its continuously variable Frequency Marker. SERIES 40 also offers you INTERSTATE's exclusive direct-reading sweep limit control and full spectrum of function generator capabilities in five models from \$475 to \$695. For additional SERIES 40 specifications, call Product Marketing at (714) 549-8282, or write Interstate Electronics, Dept. 7000, Box 3117, Anaheim, CA 92803.



INTERSTATE
ELECTRONICS CORPORATION
Subsidiary of A-T-O Inc.

WE'LL TAKE YOU PLACES YOU'VE NEVER BEEN BEFORE.

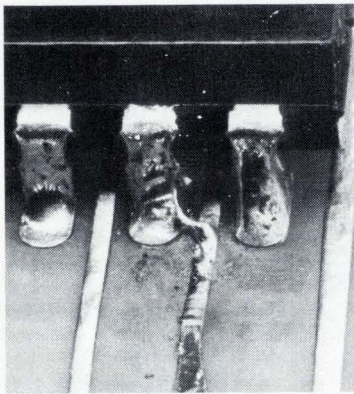

Shorts.

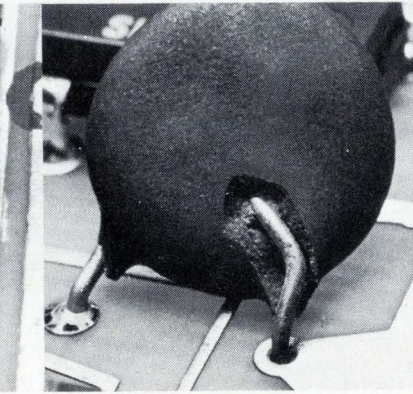

Faulty Components.

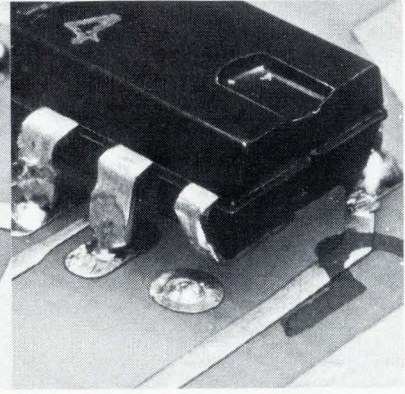

Opens.

Introducing the only board testers that pinpoint the actual fault.

Now, thanks to our new CAPS VIII software, our GR board testers can take you beyond identifying the faulty node to pinpointing random shorted tracks, opens, and faulty components. And they get there at least twice as fast as other testers that only get you to the node. So they save you both troubleshooting time and repair time and require fewer rework support people.

But that's not all. CAPS VIII software also gives you faster

setup, to reduce testing costs even more. This is accomplished through our new Automated Program Generation (APG) Software which includes an incremental simulator, event tracking capability, equation generation, and test-generation language. It will give you a test program that detects a greater percentage of faults in less time than any other setup method on the market.

To make CAPS VIII even more attractive, we're also

offering a new logic probe for detecting pulses, a diagnostic IC clip, an IEC buss interface, and data logging capability.

Of course, to get CAPS VIII's big improvement in resolution and troubleshooting and setup speed and cost, you first need a GR digital or hybrid circuit board tester. But that's no problem either. The number to call is 617-369-8770 ext. 273.

Gen Rad, Inc., Test Systems Division, 300 Baker Avenue, Concord, Massachusetts 01742.

Available in Europe 1977.



GenRad

The difference in software is the difference in testers.

See a CAPS VIII demonstration at WESCON and NEPCON/CENTRAL.

Clip-on monitor unit displays count in IC

by John Okolowicz
Honeywell Inc., Fort Washington, Pa.

An integrated decoder/display, mounted on a standard test clip that fits onto a dual in-line package provides a quick means for monitoring the state of an integrated-circuit counter. This monitor is brighter than the LED-chip monitors now on the market, and can be custom-made to suit any purpose.

In the setup, the pins that correspond to the outputs of the counter to be monitored are wired to the inputs of the on-chip driver. The enable line (pin 5) is then tied to ground so that the chip always displays the latest state of the counter.

For each different type of counter or latch to be monitored, a new assembly must be made. However, by

mounting a socket on the DIP clip, instead of soldering a display directly to the clip, a variety of monitor clips can be made without requiring a large number of display ICs.

The figure shows a Hewlett-Packard 5082-7340 hexadecimal decoder/light-emitting-diode-display IC mounted on a DIP clip; H-P 5082-7300 or 5082-7302 numeric displays may also be used.

This concept works best when the monitored counter can be single-stepped so that successive intermediate states are displayed. However, as long as the states are displayed for a sufficient time to be observed, any clocking arrangement is adequate.

This display technique provides a quick visual check of counters or latches with important outputs that need to be constantly monitored. The concept may be extended to monitoring of bus addresses or data-bus lines by using more than one display wired to a DIP clip with 24 or more pins and wiring only the first three inputs of each display so that an octal output format is displayed. Alternatively, all four inputs of each display may be used for a hexadecimal display. □

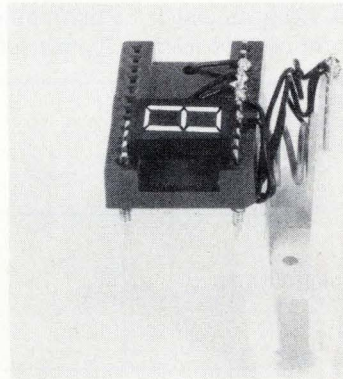
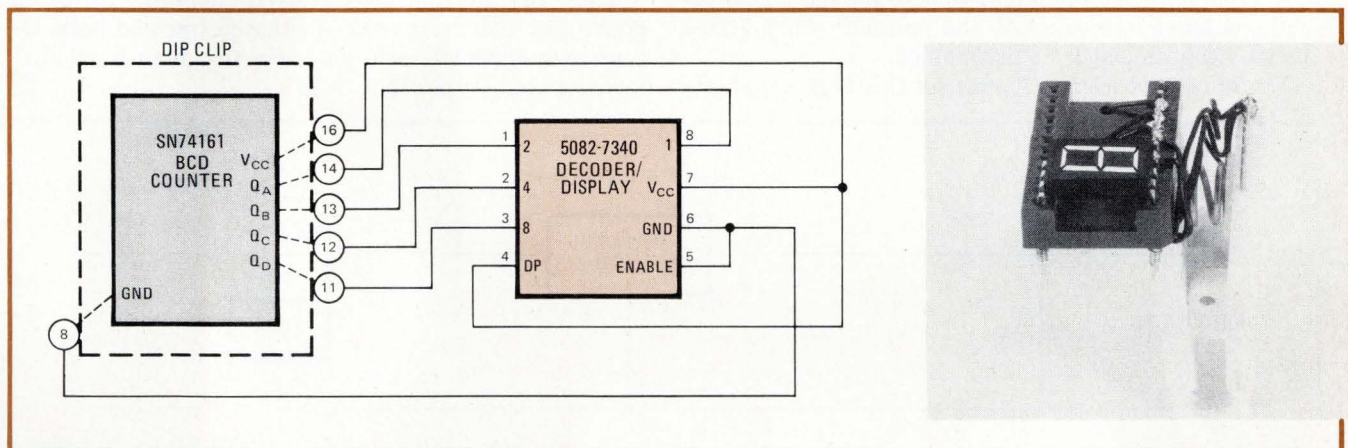

State monitor. LED decoder/display unit mounted on DIP clip is easily clipped to IC package to show the count on a counter such as the SN74161, the state of a latch, or the data on a bus. The unit draws power from the V_{CC} and ground pins of the package it is clipped to.

Power supply's VC product sets interrupt capability

by C.A. Watson Jr.
E-Systems Inc., Greenville, Texas

It's easy to calculate how long a power supply can continue to provide its regulated output voltage during interruption of the primary power source. The voltages and the storage capacitance in the supply determine this. Interrupt capability (also called holdover, holdup, or

carryover time) is important for preserving data in volatile memories during momentary power interruptions or while standby power goes on line during an outage.

The holdup time is estimated and tradeoffs in its optimization are evaluated by the expressions given here for the capacitive-storage supply shown in the figure. The capacitor may be only large enough to reduce ripple to within the range of the voltage regulator, or it may be larger.

The input voltage must be equal to or greater than the sum of the desired regulated load voltage plus the minimum drop in the regulator, and the input current to the regulator is the sum of the regulator current plus the

load current. For most efficient regulators and normal loads, the current drawn off by the regulator is small compared to the current to the load, so I_{in} is nearly equal to I_{load} .

To estimate the interrupt capability of a typical 5-volt, 1-ampere supply in which the minimum dropout voltage of the regulator is also 5 v, let

$$\begin{aligned} I_{in} &= I_{load} = 1 \text{ A} \\ V_{load} &= 5 \text{ v} \\ V_{reg} &= \text{minimum drop across regulator} = 5 \text{ v} \\ V_{in} &= 15 \text{ v} \\ C &= 1,000 \text{ microfarads} \end{aligned}$$

If the primary power source fails, the capacitor discharges through the regulator into the load until its voltage drops to $(V_{reg} + V_{load})$. The load current remains constant, and therefore I_{in} remains constant, so the discharge is linear with time. The interrupt capability in seconds is therefore given by

$$t = [(V_{in} - V_{reg} - V_{load})C]/I_{in}$$

where the units are volts, amperes, and farads. For this example,

$$\begin{aligned} t &= (15 - 5 - 5) \times (1 \times 10^{-3})/1 \\ &= 5 \times 10^{-3} = 5 \text{ milliseconds} \end{aligned}$$

In other words, the storage capacitor is drained at a rate of 1 v/ms until the minimum voltage for the regulator-load combination is reached and normal voltage across the load can no longer be maintained.

The price paid in input power for this 5-ms capability

is the product of the load current and the excess voltage, V_{ex} , above the minimum required for the regulator and load. In this case, $V_{ex} = 15 - 10 = 5 \text{ v}$, so the extra power required for the 5-ms capability is $5 \text{ v} \times 1 \text{ A}$, or 5 watts.

The energy stored in the capacitor is

$$\begin{aligned} E_C &= \frac{1}{2} V_{in}^2 C = (15^2 \times 1 \times 10^{-3})/2 \\ &= 0.1125 \text{ joule} \end{aligned}$$

If it is necessary to have 50 ms of interrupt capability, rather than 5 ms, the $V_{ex}C$ product must be multiplied by 10 (if the load current and voltage-regulator requirements are not changed). The two extreme solutions are to multiply V_{ex} by 10, so that V_{in} is 60 v, or to increase C to 10,000 μF .

If V_{in} is raised to 60 v, the energy stored in the capacitor is

$$E_C = (60^2 \times 1 \times 10^{-3})/2 = 1.8 \text{ J}$$

The power price of the 50-ms capability is $V_{ex}I_{in} = 50 \text{ v} \times 1 \text{ A} = 50 \text{ w}$.

If the voltage is unchanged, but capacitance is multiplied by 10,

$$E_C = (15^2 \times 1 \times 10^{-2})/2 = 1.125 \text{ J}$$

and the power price = $5 \text{ v} \times 1 \text{ A} = 5 \text{ w}$, which is the same as for 5 ms with 1,000 μF .

Thus the tradeoffs are clearly defined: increased power cost and stress versus increased size and bulk. Of course, intermediate solutions in which both V_{in} and C increase are also possible. □

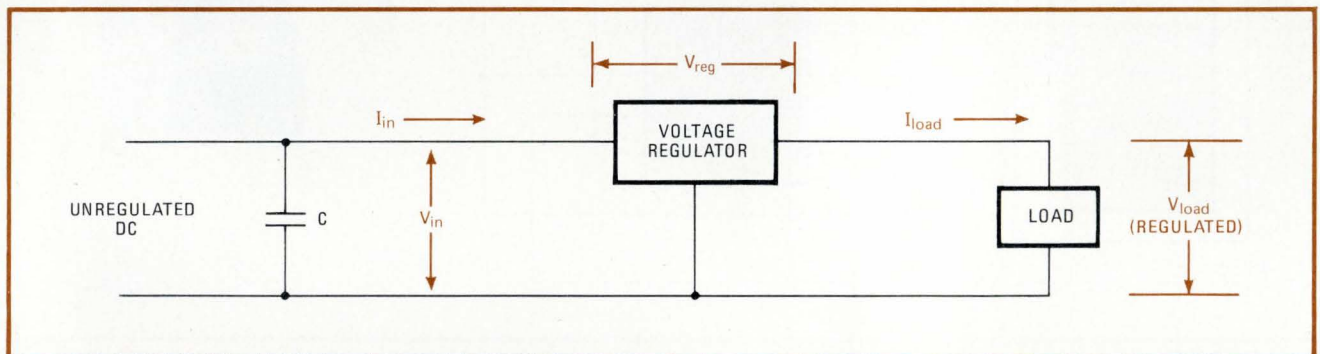

Sustaining the output. In the case of failure of the unregulated dc power to this power supply, the regulated output voltage and load current are maintained as long as the capacitor voltage is greater than the load voltage plus the minimum drop across the regulator. The capacitor discharges at a fixed rate, so the duration of interrupt capability depends linearly on capacitance and excess voltage.

Calculator notes

Program provides card storage of SR-52 data-memory contents

by David T. Phillips
Glendon Co., Goleta, Calif.

Data tables and computation results can be stored on the magnetic cards normally used by the Texas Instruments SR-52 calculator for program storage. The stored data

has the full 13-place accuracy used internally by the calculator, rather than the 10-place accuracy of the light-emitting-diode display.

The SR-52 card-programmable calculator stores its program in the 28 registers R70–R97. Each register holds eight program steps. The contents of registers R70–R83 can be stored or read from side 1 of a program card, and the other 14 registers are read in or out from side 2 of the card.

The SR-52 stores computational data and results in registers R00–R19. There is no direct provision for card storage of the data that is in these 20 data-memory

registers. However, the short program shown below exchanges the contents of registers R00–R19 with the contents of registers R70–R89, thus allowing storage of the data-register contents on a program card and also reloading of the data from the card.

The contents of up to 14 of these registers can be stored on half of the card, and the remaining six data registers share the second half of the card with the SWAP program. The program takes about 15 seconds to exchange the contents of two sets of 20 registers.

Under the program shown in the table, buttons are pushed in the following order: in the calculate mode, 19 STO 90 GTO 168 LRN; then in the learn mode, LBL A (RCL 90 STO 98 + 70) STO 99 IND RCL 98 IND EXC 99 IND STO 98 I +/- SUM 99 SUM 98 RCL 98 IFPOS 184 LBL B RCL 90 HLT LBL C STO 90 HLT.

The instruction IFPOS 184, which the coding form shows at program-storage locations 207–210, loops the program back to IND RCL 98 at location 184. Program A

exchanges the register contents, B shows the highest register exchanged, and C allows the user to alter the number of registers to be exchanged.

To store data, first enter or compute data in registers R00–R19. Next load the SWAP program from side 2 of the card. Then swap the register contents, by pressing key A. Finally, write the new card by pressing INV 2nd READ once for each side of the card. To see the number of the highest register to be swapped, press key B. To change the highest register, enter the number of the new highest register and then press key C.

To recall data, first read in both sides of the SWAP card, by pressing 2nd READ. Then move the data to registers R00–R19 by pressing key A. After that, proceed with computations, loading of program, and the like. □

Engineer's notebook is a regular feature in Electronics. We invite readers to submit original design shortcuts, calculation aids, measurement and test techniques, and other ideas for saving engineering time or cost. We'll pay \$50 for each item published.

SR-52 Coding Form

Program Title: SWAP

LOC	CODE	KEY	COMMENTS
000			Program storage locations 000 – 159 are registers R70 – R89 used for data storage.
159			
160	10		Register 90
	00		
	00		
	00		"19 STO 90"
	00		Highest register
165	00		to be
	19		exchanged
168	46	LBL	Main program
	11	A	
170	53	(
	43	RCL	
	09	9	
	00	0	
	42	STO	Set
175	09	9	lower
	08	8	index

LOC	CODE	KEY	COMMENTS
	85	+	
	07	7	
	00	0	
180	54)	
	42	STO	Set
	09	9	upper
	09	9	index
184	36	IND	Start loop
185	43	RCL	fetch lower
	09	9	register
	08	8	contents
	36	IND	Store lower
	48	EXC	in upper and
190	09	9	fetch upper
	09	9	contents
	36	IND	Store
	42	STO	upper
	09	9	contents
195	08	8	in lower
	01	1	
	94	+/-	
	44	SUM	
	09	9	Decrement

LOC	CODE	KEY	COMMENTS
200	09	9	indices
	44	SUM	
	09	9	
	08	8	
	43	RCL	
205	09	9	
	08	8	Test low
207	80	IFPOS	index
	01	1	(0 is positive)
	08	8	close loop
210	04	4	
	46	LBL	
	12	B	Display
	43	RCL	highest
	09	9	register
215	00	0	from 90
	81	HLT	
	46	LBL	
	13	C	Enter
	42	STO	new
220	09	9	highest
	00	0	register
	81	HLT	in 90

LABELS	
A	SWAP
B	Last register
C	Ent last register

REGISTERS	
00	↔ 70
01	↔ 71
02	↔ 72
03	
⋮	
18	↔ 88
19	↔ 89
90	Highest reg. – normally 19
98	Index 00 – 19
99	Index 70 – 89

SR-52 calculator: the final word on that extra memory

You've noticed the heavy coverage on this page devoted to the memory capability hidden in the SR-52 calculator. We'll cap it with a wrap-up of the situation by Bill Peterman, project engineer at AMF Tuboscope Inc., Houston, Texas. He notes that although memory locations 60 through 69 of the TI device are indeed available for memory usage as stated [Aug. 19, p. 114 and Sept. 15, p. 122], they are not particularly useful for data storage, since they're erased whenever you press the clear key.

On the other hand, says Peterman, they're perfect as pointer registers for the indirect mode, or as storage registers for intermediate calculated values that are repeatedly used in a program but not needed after the program is run. But, he cautions, "You must not let the parenthesis depth in a program overlap the algebraic registers used." **That means as you use each memory register, starting at location 69 and working downward, you should reduce by one the algebraic stack depth available for nested parenthesis calculations.**

Peterman also points out that it's not necessary to skip program steps 070 through 099 when you're using the program-memory registers as data registers unless the program steps themselves are serving as data registers in the program to be run. For example, if you want to use registers 90 through 97, all program steps from 000 to 160 should be available for program use.

Linear ICS upgrade power supplies and voltage references. . .

In recent months, a whole rash of sophisticated linear integrated circuits have come on the market for building power supplies and voltage references. **With these new devices, you can drastically reduce parts count, cut down design time, and save money to boot.**

Large-scale integration in power linears is bringing about complete switching regulators on a chip—devices are available for either single-ended or push-pull operation. Three-terminal IC voltage regulators, which used to be strictly fixed-output devices, are now available in adjustable versions. Moreover, output voltage can be varied over a substantial range—on the order of 35 volts in some—and output current for these regulators has been boosted to several amperes.

Monolithic voltage references are also being improved; some devices are now offering an adjustment range of several percent from nominal. Even discrete-like zeners now available in IC form permit you to achieve temperature coefficients of less than 1 part per million per degree celsius in free-air environment.

. . . yet linear experts are becoming an endangered species

It's ironic that engineers grounded in linear-circuit and analog-system design are a vanishing breed—an alarming situation caused by the glamor and high rewards associated with digital-product design. Today's best new engineers want to be digital designers, and for good reason: **they get to work on the high-visibility microprocessor, memory, and consumer LSI projects** that often develop into major product areas and new million-dollar markets. The situation is already so bad that, complains John R. Walker, senior vice president of operations at Datapoint Corp., San Antonio, Texas, "It's really getting tough finding competent power-supply and analog-circuit designers—men who understand and know how to deal with a superbeta or a gain-bandwidth product."

Laurence Altman

SORENSEN IS THE SOURCE: FOR RELIABLE OPEN- FRAME POWER SUPPLIES.

SOC, our new line of open-frame power supplies:

- Standard voltage and package sizes
- 115/208/230 Vac input standard
- Made in U.S.A. with quality components
- No overshoot with turn-on, turn-off or power failure
- Stocked for immediate delivery
- Conservatively designed and rated
- Low heat dissipation, high temperature stability
- One-year warranty, worldwide service organization
- UL recognized

Model No.	Series	Voltage**	Output Current (A dc)*			Price
			@ 40°C	@ 50°C	@ 60°C	
SOC 2-3	A	2V	3.0	2.4	1.8	\$32
SOC 2-6	B	2V	6.0	4.9	3.8	54
SOC 2-10	C	2V	10.0	8.0	6.5	67
SOC 5-3	A	5V	3.0	2.4	1.8	32
SOC 5-6	B	5V	6.0	4.9	3.8	54
SOC 5-10	C	5V	10.0	8.0	6.5	67
SOC 12-1.6	A	12V	1.6	1.3	1.0	32
SOC 12-4.0	B	12V	4.0	3.0	2.5	54
SOC 12-6.0	C	12V	6.0	5.0	4.2	67
SOC 15-1.5	A	15V	1.5	1.2	1.0	32
SOC 15-3.0	B	15V	3.0	2.6	2.2	54
SOC 15-5.0	C	15V	5.0	4.2	3.5	67
SOC 24-1.0	A	24V	1.0	.75	.55	32
SOC 24-2.2	B	24V	2.2	1.9	1.6	54
SOC 24-3.5	C	24V	3.5	2.9	2.4	67
SOC 28-0.8	A	28V	0.8	.64	.45	32
SOC 28-2.0	B	28V	2.0	1.7	1.4	54
SOC 28-3.1	C	28V	3.1	2.6	2.0	67

* Free-air rating — no external heatsink.

** ±5% adjustable.

Common Specifications:

AC Input Power: Vac 105-125, 190-226, 210 to 250 available by using taps on transformer.

Frequency 50 to 63Hz. (Derate 10% at 50Hz.)

Voltage Regulation (comb. line and load): ±0.15% + 6mV for 105 to 125 Vac and 100% load change.

Voltage Ripple and Noise: 1.5mVrms, 5mVpp.

Temperature Coefficient: 0.03%/°C.

Drift (24 hours): 0.2% after 1-hour warm-up.

Remote Sensing: 100mV maximum drop in each leg.

Operating Temperature: 0°C to 60°C.

Storage Temperature: -20°C to +85°C.

Overvoltage Protection: Available on all models except 2 volt. Specify by adding "VP" suffix to model number and add \$8 to unit price.

Current Foldback: Automatic, factory-set to 140% of rated (40°C) output current.

Cooling: Convection.

Finish: Black anodize.

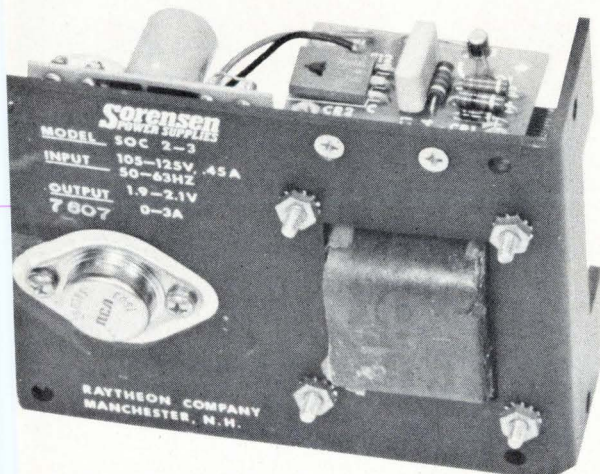

Call us for OEM discounts:

(603) 668-4500.

Sorensen

676 Island Pond Rd.,

Manchester, N.H. 03103.

SORENSEN
POWER SUPPLIES

A Raytheon Company

Circle 121 on reader service card

Erased any PROMS lately?

Nitron's MNOS non-volatile memories can be erased and reprogrammed in or out of your circuit. Electrically. No U.V. light source or programming hardware to mess with.

Loss of power doesn't bother data stored in Nitron's NVMs, either. The data is safe even if the power stays off for several years. Without backup batteries.

They're single word alterable and interface with either TTL or CMOS. And because they're fully decoded and bus compatible, using them is just like using more conventional memories.

What more can you ask for?

Nitron's new generation of NVMs: First the 64X4 NCM7040, and now the 256X4 NCM7050. Available off-the-shelf. So don't lose any more valuable time. Or data.

Write or call

NITRON

10420 Bubb Rd., Cupertino, Calif. 95014
(408) 255-7550

NITRON

A division of **MCDONNELL DOUGLAS**

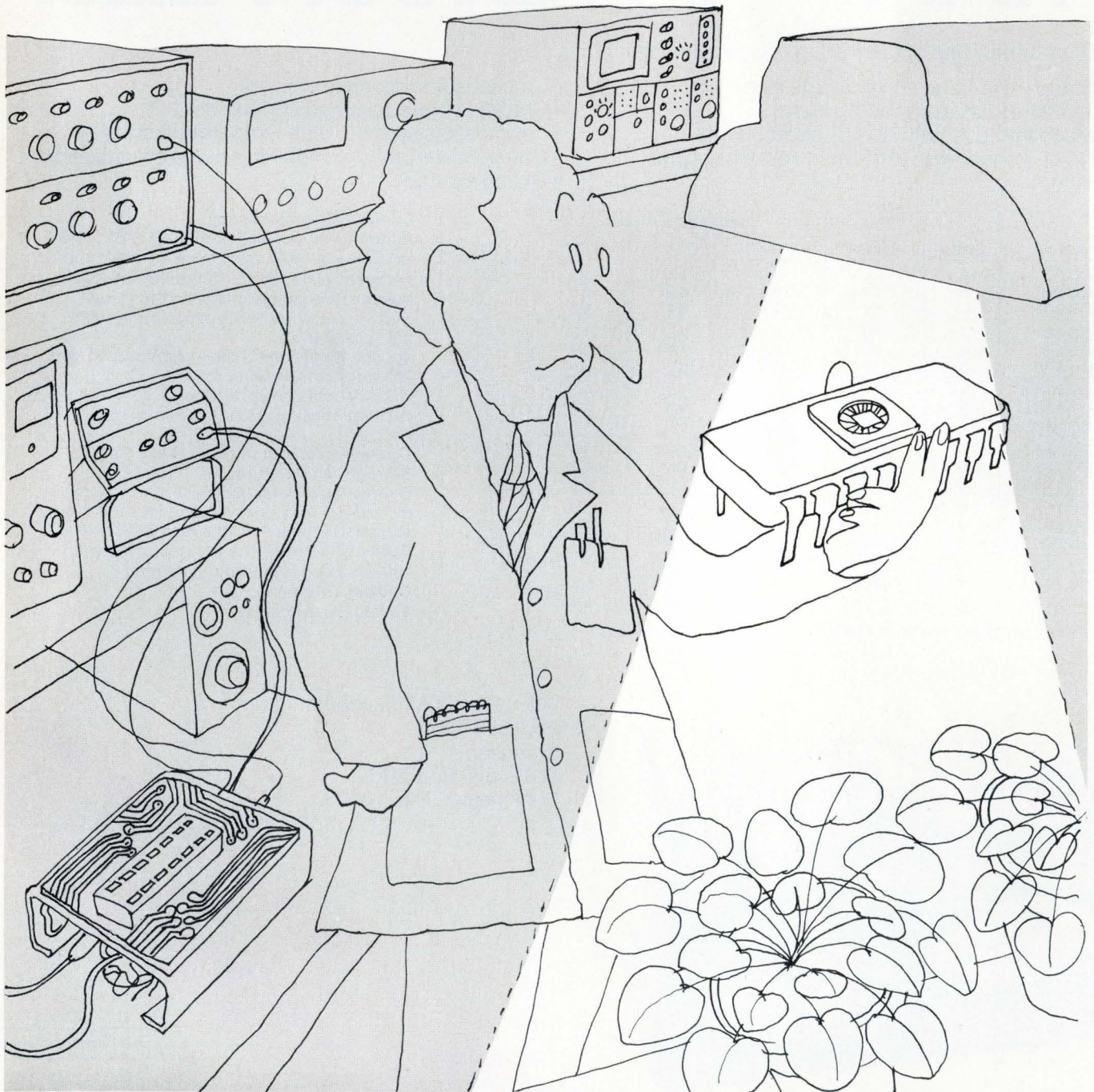

Multiplexer expands scope uses

Special triggering, variable threshold control added to one-channel scope yield a four-channel display for troubleshooting logic systems

by John Gosch, Frankfurt bureau manager

Combinatorial triggering and a continuously variable threshold voltage are the prime features of a multiplexer designed to expand any general-purpose single-channel oscilloscope into a parallel four-channel display for digital signals.

Developed by the small German firm, Dolch Logic Instruments GmbH (DLI) in Heusenstamm near Frankfurt, the SM40 scope multiplexer will be marketed in the U.S. by Glass Gorham Co. of Skokie, Ill. Deliveries in the U.S. of the \$395 unit will start before the end of this year, says Volker Dolch, president of DLI and designer of the instrument.

The new multiplexer has a frequency response from dc to 50 megahertz and allows the synchronous display of the four logic signals in either the alternate or chopped mode. And since several SM40s can be cascaded—by connecting the “sync out” terminal of one unit to the “ext trigger in” terminal of the next—an oscilloscope can be made to show not only four digital signals, but also multiples thereof, such as eight, 12, or even 16 signals.

The prime application of the SM40 is in troubleshooting logic systems, both in the laboratory and in the field, Dolch says. Simple to operate, the cigar-box-size, two-and-a-half pound instrument should “prove a powerful tool in evaluating information blocks and data words such as memory addresses and instruction sets,” he points out. Its multichannel display and analysis capability make the unit particularly useful in troubleshooting microprocessor systems.

In these and similar jobs, the multiplexer’s variable threshold-level

control should come in handy. The threshold can be continuously set by a calibrated high-resolution 10-turn potentiometer incorporating a digital dial. Variable from -10 to $+10$ volts, the threshold has a range large enough to serve MOS, transistor-transistor, emitter-coupled, and other logic types that are operated within a power supply range from -20 to $+20$ v, assuming a 50% threshold point.

By varying the threshold during the measurement, it is possible to define absolute logic levels as well as evaluate pulse shape and rise time. Since the multiplexer has an input characteristic (1 megohm in parallel with 20 picofarads) equivalent to regular oscilloscopes, any 10:1 scope probe can be used to expand the voltage range by a factor of 10, the company points out.

The multiplexer’s other principal feature—combinatorial triggering—is also helpful, Dolch stresses, as it allows users to evaluate complex sequential digital signals that cannot

be adequately analyzed with conventionally triggered scopes. Implementing combinatorial triggering in the SM40 is a trigger-generator consisting essentially of a 5-bit AND gate that, via four toggle switches, ties together the four data channels and an external trigger input. Each switch has two logic positions—1 and 0—and with the four switches a certain bit pattern can be selected ahead of time.

Only when the signals to be displayed correspond with the preselected bit pattern is a trigger pulse fed to the scope. This type of triggering is useful particularly in troubleshooting complex digital systems because only that portion of, say, a 4-bit data word is displayed on the scope that follows the preselected bit combination.

Glass Gorham Co., 7700 North Austin Ave., Skokie, Ill. 60076. Phone (312) 966-0300. [338]

Dolch Logic Instruments GmbH, 6056 Heusenstamm, Industriestr. 48, West Germany [339]

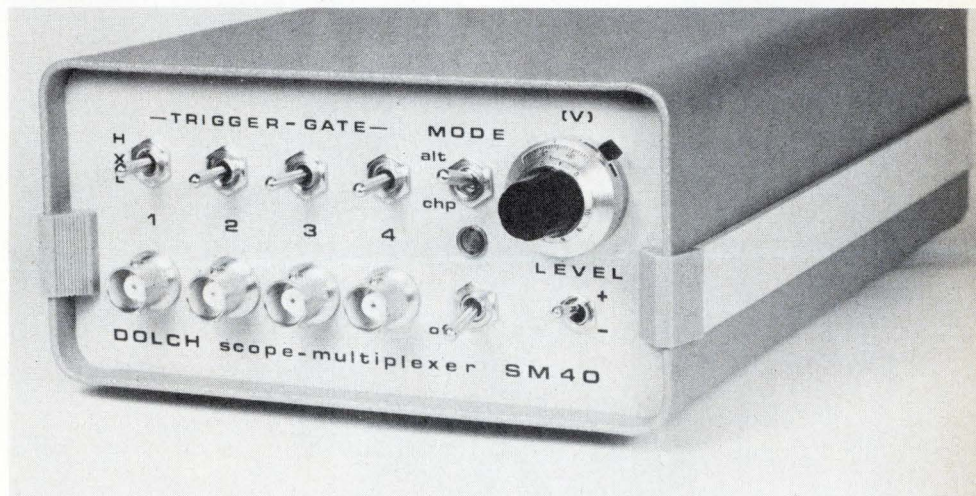

Components

**LED display
cuts parts total**

Four-character alphanumeric unit includes control and driver circuitry

Light-emitting-diode displays are gaining in sophistication these days. And now, from the Optoelectronics division of Hewlett-Packard Components comes a compact four-character alphanumeric unit that contains a significant portion of the display system inside its 12-pin dual in-line package. Because the shift registers and the LED drivers are internal, the associated circuitry needed for the display is considerably simplified. For example, for a typical 32-character system, the parts count is reduced by a factor of 36, says HP.

Each of the four characters of the new HDSP-2000 display is formed

by a 5-by-7-dot matrix capable of displaying the full ASCII font, including lower- and upper-case letters, punctuation marks, mathematical and other symbols, as well as numerals. Character height is 0.15 inch.

The serial-in/parallel-out 7-bit shift register associated with each character controls constant-current LED row drivers. Full characters are generated by external column strobing. The constant-current LED drivers, which are typically capable of sinking 13.5 milliamperes per diode, are externally programmable.

Because of the small size and high degree of integral circuitry of the HDSP-2000, HP expects the unit to open up many new markets. Anticipated applications include interactive point-of-sale equipment, portable business terminals, medical instrumentation, word-processing systems, and microprocessor-based instruments or control mechanisms.

The HDSP-2000, which operates from a nominal supply voltage of 5 V, is directly compatible with transistor-transistor logic and readily lends itself to microprocessor control. Maximum current consumption

is 15 mA per row. With 15 dots lighted, power consumption is 150 milliwatts per character, increasing to 225 mw when 20 dots are lighted. However, the HDSP-2000 has an intensity-control pin, permitting its brightness to be varied via duty-cycle modulation to reduce power consumption.

The sandwich-like construction of the unit's package is made up of a ceramic substrate, a Kovar spacer, and a glass lid. The glass, which is thermally matched to the Kovar and the ceramic, is a red contrast filter for crisp display appearance. Packages can be stacked end-to-end to form a string of characters, without affecting the 175-mil center-to-center spacing between characters. Operating temperature range for the HDSP-2000 is -20°C to $+70^{\circ}\text{C}$.

Price is \$47 per four-character cluster for orders of 125 clusters. Small quantities are available from stock.

Inquiries Manager, Hewlett-Packard Co., 1501 Page Mill Rd., Palo Alto, Calif. 94304 [341]

Power relays

sell for \$1.99

Priced as low as \$1.99 each in quantities of 1,000, a family of power relays, designated the HL-series, is noteworthy for its high reliability and small size. Processes that contribute to the unit's reliability include spot-welding all connections, arc barriers between contacts, and debris wells, along with simultaneous molding and heat-riveting. The single-pole, single-throw version can carry 15 amperes at 125 volts ac; the dpdt unit is rated 10 A at 250 V ac.

Arrow-M Corp., 250 Sheffield St., Mountainside, N.J. 07092 [347]

**Ceramic-encased resistors
range down to 0.001 ohm**

A commercial series of ceramic-encased wirewound resistors from RCD Corp. ranges from 30 kilohms in

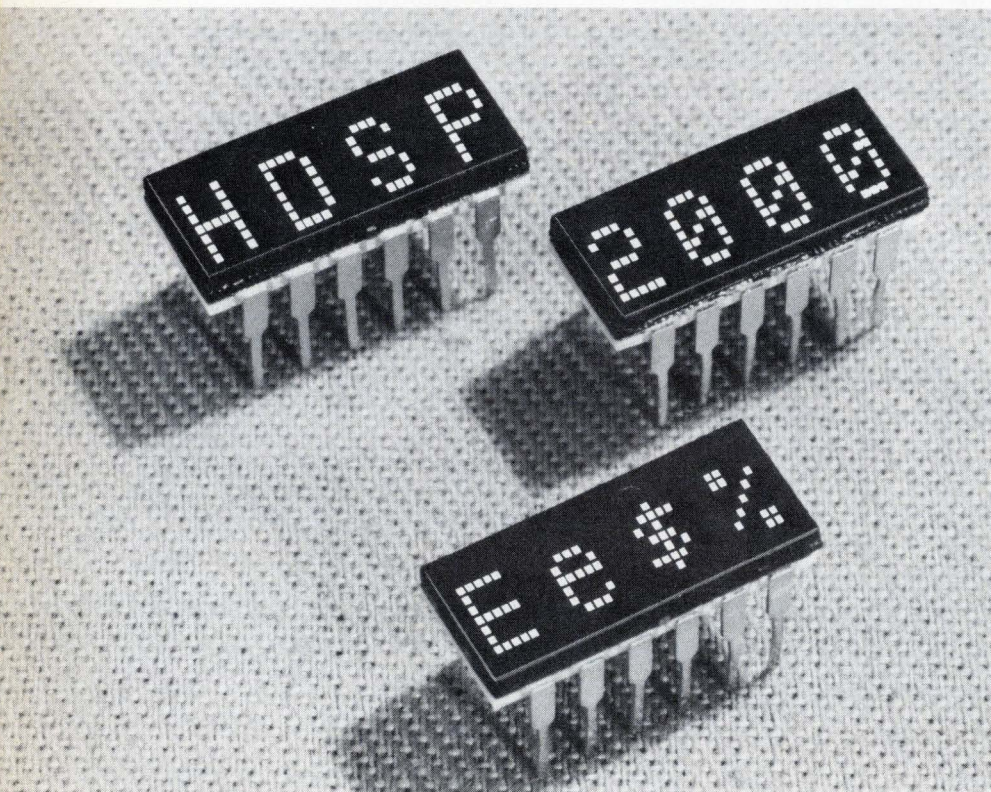



The keyboard switch with a heart of gold

...keeps your product WORKING year after year...after year.

In your keyboard or ours, Cherry key switches just don't fail. The knife-edge contact area is so small (9 millionths of a square inch) ... the contact pressure so great (about 5,000 psi) ... the gold alloy so pure and film-free ... that you are assured of positive contact every time. For 50 million operations and beyond. (Which is probably beyond the life expectancy of your product!)

Cherry "heart of gold" keyboard switches are available individually or with two-shot molded keycaps. Hopefully, you want keycaps. Because, *we have keycaps* ... in more legends, sizes, type faces than you're likely to find anywhere else. Sculptured keycaps? We've got 'em. Gloss or matte finish? We've got *both*. Colors? Lighted? Specials? Sure! Some "off the shelf" ... all at prices that make it obvious why the *Cherry way* is the *economical way* to put a heart of gold in any keyboard.

See Us At
Mini-Micro
Computer Conference
& Exposition
October 19-21
Booth #103-104

For free test sample switch
and catalog, just
TWX 910-235-1572 ...
or PHONE 312-689-7700.



CHERRY ELECTRICAL PRODUCTS CORP., 3608 Sunset Avenue, Waukegan, IL 60085

Cherry switches now
available locally from distributors.

Circle 125 on reader service card

POWER SUPPLY MAGIC



There's no trick! Get a full house everytime with Deltron's dual and triple power supplies.

U.L. recognized.
One year warranty.

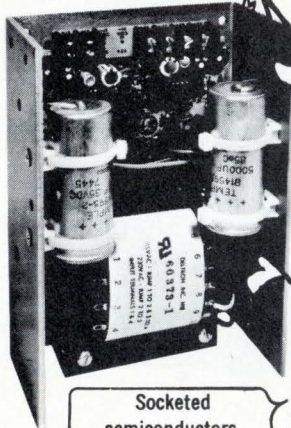

Socketed semiconductors.
Barrier block interface.

MODEL	RATINGS volts/amps	PRICE		
		1	100	250
QD12/15-0.6	±12 to ±15/0.6	\$42	\$36	\$35
QD12/15-1.7	±12 to ±15/1.7	\$62	\$54	\$49
QD12/15-3.0	±12 to ±15/3.0	\$79	\$67	\$64
QT-1	5/3.0 ±12 to ±15/0.5	\$69	\$66	\$65
QT-2	5/6.0 ±12 to ±15/1.0	\$89	\$82	\$79

Deltron inc.

Wissahickon Avenue
North Wales, PA 19454

Tel: 215/699-9261 Twx: 510/661-8061

AC-12

New products

value down to 0.001 ohm. And the PW-series devices, in sizes from 2 to 50 watts, include noninductive designs for high-frequency applications and printed-circuit styles with either

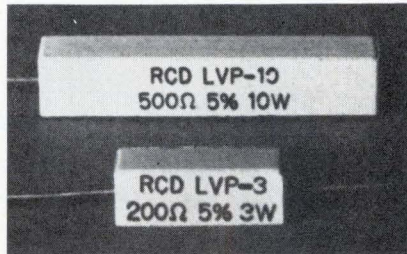

radial wire leads or lugs. A high-power mounting plate is available for increased dissipation. Delivery is from stock, and special orders require a lead time of four weeks. Price in 1,000-piece quantities ranges from 7 cents each to 19 cents each.

RCD Corp., 8 Blueberry Lane, Bedford, N.H. 03102. Call Ken Puleo at (603) 669-0054 [345]

Snap-action switch plugs into pc board

Cherry Electrical has added to its line of snap-action switches an open switch for insertion on printed-circuit boards. A front-mounting peg on the new S38-20H switch is flexible so that the switch is simply plugged in; no extra mounting hardware is needed. The switch is also fairly small: 0.658 inch high by 0.768 in. long by 0.228 in. wide. It extends about 1/2-in. above the pc-board surface and is rated at 2 amperes, 250 volts, ac. List price is \$1.05, with a net of 48 cents in

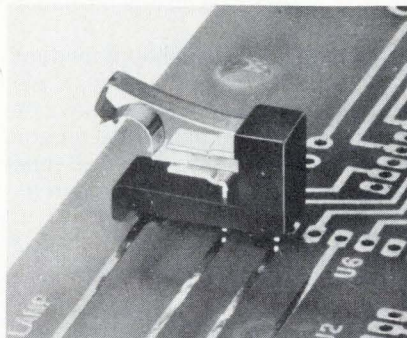

2,000-piece quantities and 36 cents for 10,000 pieces. Prototype samples are available from stock, and production-lead time is 10 to 12 weeks. Cherry Electrical Products Corp., 3600 Sunset Ave., Waukegan, Ill. 60085. Call Frank Amendola, (312) 689-7702 [344]

Printed-circuit-board relay multiplexes to common line

From three to seven isolated circuits can be connected to a single common line with a series of printed-circuit-board relays that come in nonlatching or magnetic-latching versions with up to four blades. Coils are for direct-current operation only with nominal voltages of 5, 6, 12, and 24 volts dc. Power consumption is 0.5 watt for the nonlatching version and 1.0 w per coil for the latching.

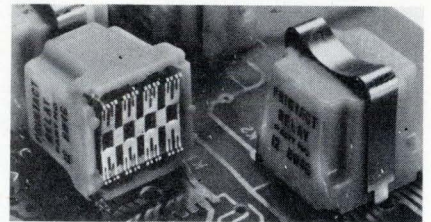

Contact rating is up to 1 ampere resistive at 24 v dc or 24 v ac maximum. Size is 0.9 inch by 0.95 in. by 1.032 in. high. Prices start at \$4.26, with quantity discounts available. Delivery of production quantities takes four to six weeks.

Printact Relay Division, Executone Inc., 29-10 Thomson Ave., Long Island City, N.Y. 11101. Call R.D. Burn at (212) EX-2-4800 [346]

Four-terminal resistors are current sensors

Four-terminal current-sensing resistors come in resistances from 0.01 to 1.0 ohm with tolerances including 1%, 3%, 5%, and 10%. And the series CS 4LPW units have ratings of 3, 5, 7, 10, and 15 watts. The four-terminal configuration offers a couple of advantages over a two-

For your pulse and digital timing measurements

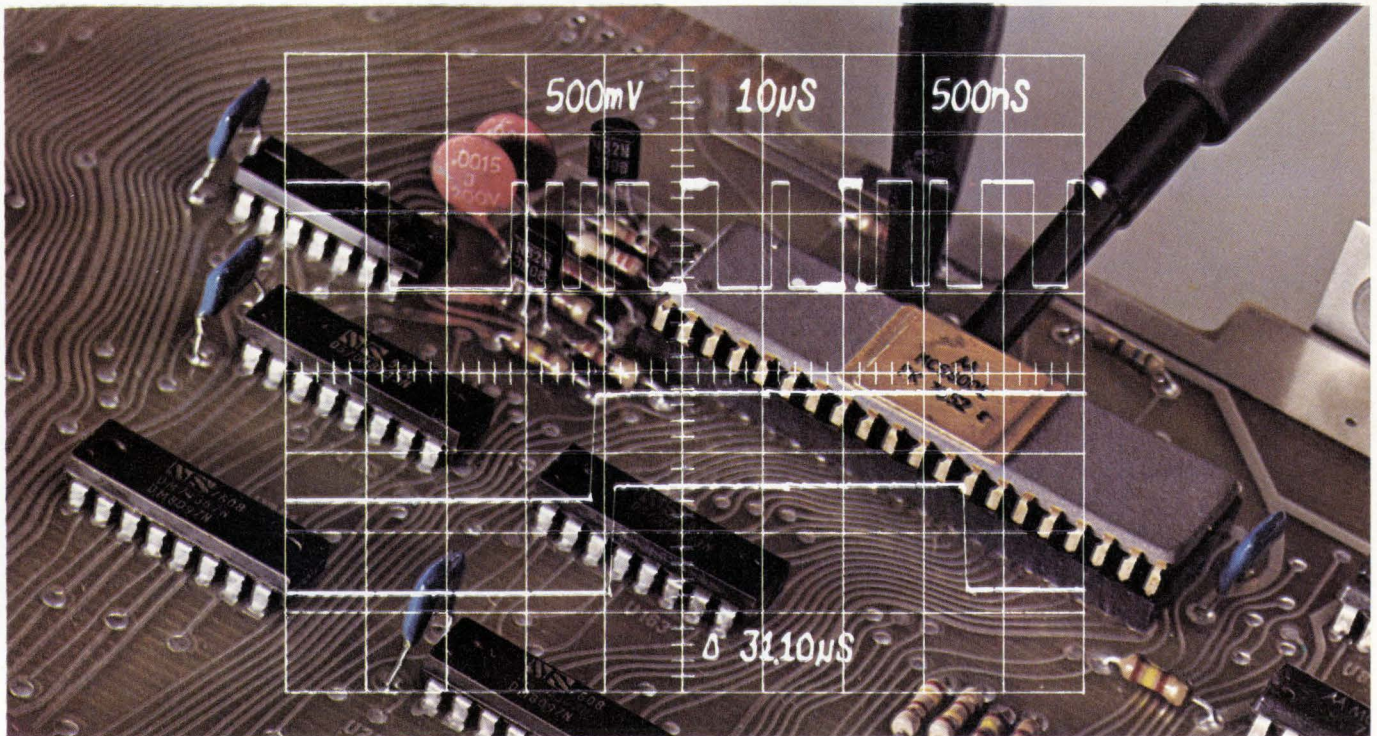

The instrument shown includes a 7904 mainframe configured for pulse and digital measurements. Our Δ time plug-ins, the 7B80 and 7B85 time bases, give you differential time measurements with sweep rates to 1 ns/div. The 7A19 provides one vertical channel with a rise time of 0.8 ns and the 7A26 provides dual channels with rise times of 1.8 ns.

It's easy to use. Your pulse train is displayed on a main sweep with two intensified zones that easily identify the time interval of interest.

And our package digitally displays your time interval on the crt in the correct units of measure. A Δ symbol precedes the time interval readout to indicate it is a differential time measurement. To make sure your answer is precise, you expand and adjust each intensified zone on separate delayed sweeps so each is positioned exactly where you want it on the pulse train.

Turn a switch and you are in the delay time mode; this mode lets you make propagation delay measurements using the beginning of the main sweep as a reference.

It gives you confidence in your answer. The Δ time you see displayed digitally on the crt is accurate to within 1%, even when you're measuring fast pulses.

And there is almost no chance of operator error. You view all three sweeps at the same time; that is, you observe the two intensified zones on the main sweeps while you expand those portions on two separate delayed sweeps.

It's convenient. Your pulse and digital timing measurements are easy to document photographi-

cally. The Δ time is displayed along with the main and delayed sweep speeds and amplifier sensitivities—all in the appropriate units of measure. This gives you the information you need in one complete crt display.

pick this plug-in scope

It's a flexible package. This 7904 configuration gives you Δ time capability—an easy and accurate way to make pulse and digital measurements. Because it's a plug-in scope, you can include other digital measurement capabilities—logic analysis, and digital and differential amplitude capability, to name a few.

To order the plug-in scope described here, call your local Tektronix Field Office.* For immediate assistance, call your Tektronix Field Engineer or circle 219 on your reader service card and we'll have him call you. For a copy of our new application note on pulse and digital timing measurements, circle 218 or write us at Tektronix, Inc., P.O. Box 500, Beaverton, OR 97077. In Europe, write Tektronix Limited, P.O. Box 36, St. Peter Port, Guernsey, Channel Islands.

The 7000-Series . . . more than an oscilloscope

*Ordering information:

7904 Oscilloscope\$4300
7A26 Amplifier\$1200
Recommended probe; P6063A, 1X, 10X\$ 100
7A19 Amplifier\$ 950
Recommended Probe; P6056, 10X\$ 85
7B80 Time Base\$ 745
7B85 Delaying Time Base\$ 895

U. S. Sales Prices FOB Beaverton, Oregon

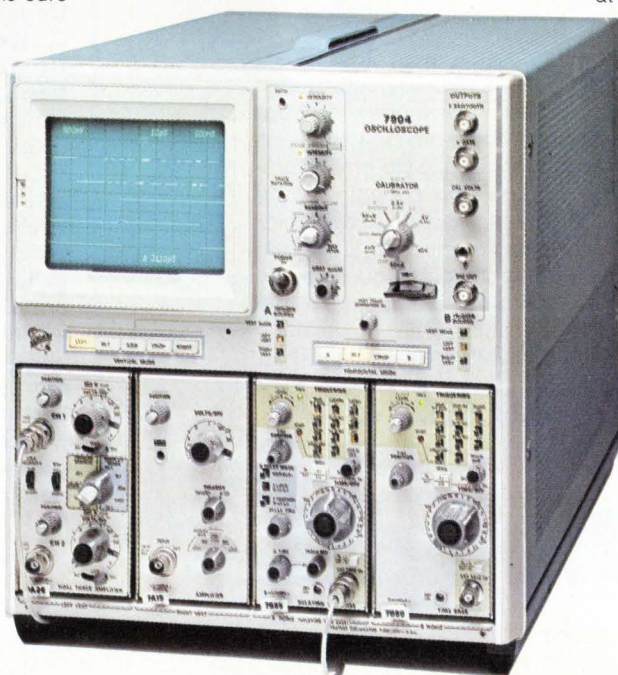

TEKTRONIX®

committed to
technical excellence

Dialight LEDs

The widest choice for your every application.

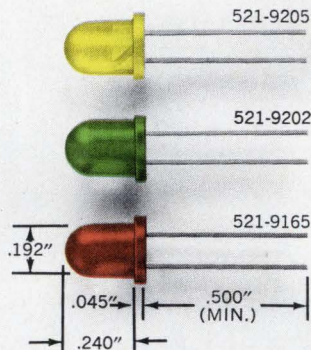

Now available in green, yellow and red. Mini-sized for maximum front panel density and easy panel mounting. High luminous intensity, low cost. Vibration/shock resistant. Solid state for long life. Wide viewing angles. Ideal for applications like panel lighting, film annotation and alpha-numeric displays.

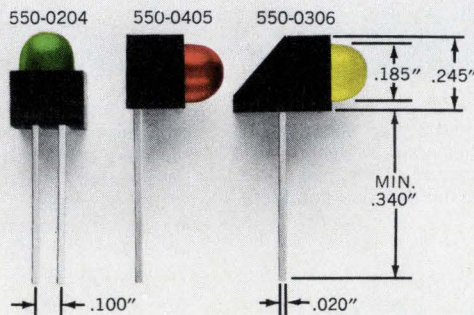

Mix 'em or match 'em. LED logic state fault indicators are available in red, yellow and green, in a variety of shapes, some with a built-in integral resistor. Can be driven from DTL and TTL logic. Designed for easy alignment on PC boards so that multiple functions can be displayed.



Dialight, the company with the widest choice in switches, LEDs, indicator lights and readouts, looks for needs . . . your needs . . . and then they develop solutions for your every application. No other company offers you one-stop shopping in all these product areas. And no other company has more experience in the visual display field. Dialight helps you do more with these products than any other company in the business, because we are specialists that have done more with them. Talk to the specialists at Dialight first. You won't have to talk to anyone else. Send for your free new copy of Dialight's current catalog.

DIALIGHT

Dialight, A North American Philips Company
203 Harrison Place, Brooklyn, N. Y. 11237
(212) 497-7600

See Dialight.

terminal design. Voltage developed across the sense leads, for example, is independent of the temperature coefficient of the leads so that the temperature coefficient of the developed sense voltage can be held to less than ± 30 ppm. In addition, lead length does not affect sense-voltage reading in a high-impedance circuit. Leads are oxygen-free copper or copperweld, depending on resistance, and they're electro-solder plated and are at least an inch long. Dimensions

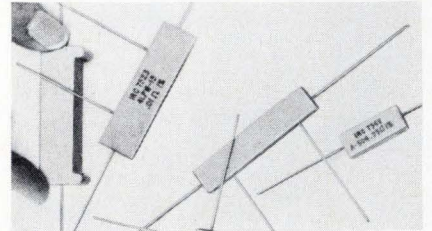

range from 0.88 in. long by 0.31 in. square for the 3-w size, to 1.88-in. long by 0.50-in. square for the 15-w size. The resistors are also available with standoff feet. Insulation resistance is 1,000 megohms dry; dielectric strength is specified at 500 volts ac.

TRW/IRC Resistors, P.O. Box 393, Boone, N.C. 28607. Call Art Brown at (704) 264-8861 [343]

TOPICS

Components

Dialight, Brooklyn, N.Y., announces that its 249 series of subminiature indicator lamps is now covered by listing with Underwriters' Laboratories. . . . **General Electric's Data Communication Products Dept., Waynesboro, Va.**, has announced qualification of its 3SBC (150-grid) series relay to MIL-R-39016/36 and 37 with established reliability failure-rate levels L and M. . . . **Cherry Electrical Products Corp., Waukegan, Ill.**, is now providing its popular subminiature thumb-wheel switch with 0.5-inch J-shape pin terminations. The new switch is designated the T50J-01M. . . . **Corning Glass Works, Corning, N.Y.**, has expanded its line of Spinseal axial-lead ceramic capacitors to include ultra-stable (COG) units.

HP's new thermal printer just keeps purring along.

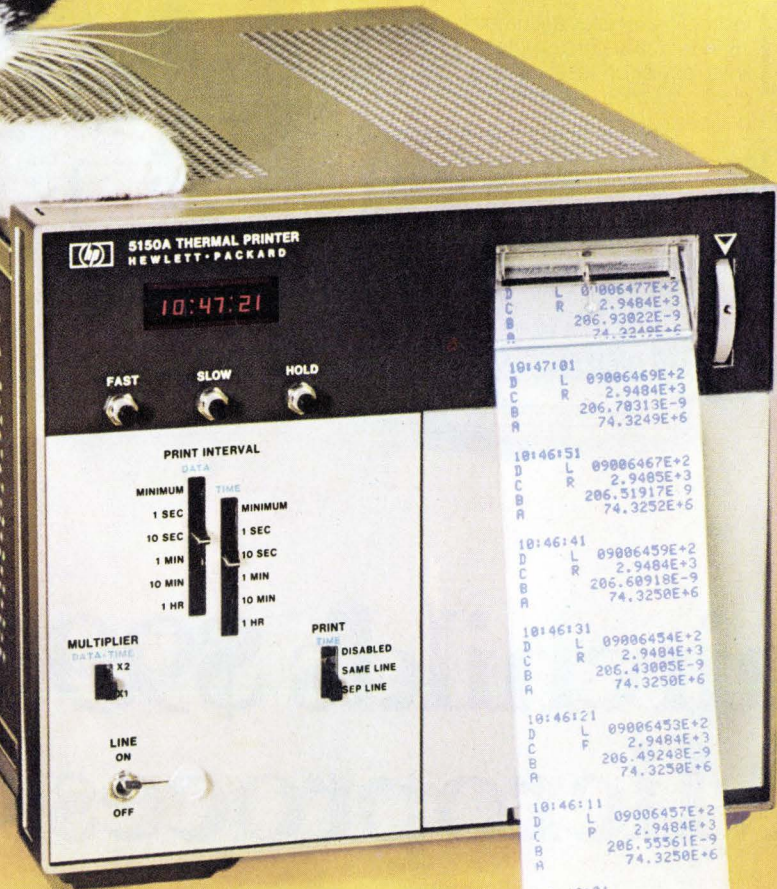

Say goodbye to the clank and rattle of mechanical printers and say hello to quiet, reliable operation. With its thermal printing technique, the new HP 5150A Thermal Printer needs only two moving parts — those that transport the tape.

That's just a beginning. Built-in flexibility and plug-in options mean that, at last, there is a printer that you can custom-tailor to your data printout needs without delay or compromise.

Alphanumeric printout. A full 64-character upper case ASCII printing set, with figures and symbols that read and reproduce clearly. Print speed is three lines per second.

ASCII Interface option. Interfaces to most ASCII coded sources or HP Interface Bus. Full 64-character, 20-column printout.

BCD Interface option. Interfaces with BCD \pm 8421 sources. Prints standard 16-character set, but can draw on the full 64-character complement of the 5150A. Ten or 20 columns.

Scanner option. The 5150A can function as a system controller for up to 13 instruments on the HP Interface Bus, providing automatic data-acquisition capability.

Clock option. With it, an entirely new order of convenience, flexibility and control becomes possible. Simple, front-panel controls let you record the time of day and select the time interval between samples.

Special BCD printouts. Special formats or re-interpretation of BCD inputs can be provided at minimum cost.

The price is right. Only \$875* for the 5150A mainframe. Plug-in options range from \$125* to 350*. At the price, no other printer matches its

flexibility, quietness and reliability. Write, or call your nearby HP field engineer, for complete technical specifications or a demonstration.

*Domestic USA prices only.

5150A THERMAL PRINTER
HEWLETT-PACKARD

10:47:21

FAST SLOW HOLD

PRINT INTERVAL

MINIMUM TIME
1 SEC 1 SEC
10 SEC 10 SEC
1 MIN 1 MIN
10 MIN 10 MIN
1 HR 1 HR

MULTIPLIER
DATA TIME
X2
X1

PRINT
TIME
DISABLED
SAME LINE
SEP LINE

LINE ON OFF

```

10:47:01
D L 09006477E+2
C R 2.9484E+3
B 206.93022E-9
A 74.3249E+6
    
```

```

10:46:51
D L 09006469E+2
C R 2.9484E+3
B 206.51917E-9
A 74.3252E+6
    
```

```

10:46:41
D L 09006459E+2
C R 2.9484E+3
B 206.60918E-9
A 74.3250E+6
    
```

```

10:46:31
D L 09006454E+2
C R 2.9484E+3
B 206.43005E-9
A 74.3250E+6
    
```

```

10:46:21
D L 09006453E+2
C R 2.9484E+3
B 206.49240E-9
A 74.3250E+6
    
```

```

10:46:11
D L 09006457E+2
C R 2.9484E+3
B 206.55561E-9
A 74.3250E+6
    
```

```

10:45:01
D L 09006455E+2
C R 2.9484E+3
B 206.62194E-9
A 74.3250E+6
    
```

```

10:45:51
D L 09006455E+2
C R 2.9484E+3
B 206.64314E-9
A 74.3251E+6
    
```

```

10:45:41
D L 09006453E+2
C R 2.9485E+3
B 206.56900E-9
A 74.3249E+6
    
```

```

10:43:11
D L 09006473E+2
C R 2.94805E+3
B 206.73760E-9
A 74.3252E+6

10:43:01
D L 09006476E+2
C R 2.9484E+3
B 206.63879E-9
A 74.3252E+6

10:42:51
D L 09006474E+2
C R 2.9483E+3
B 206.46013E-9
A 74.3252E+6
    
```

HEWLETT  PACKARD

Sales and service from 172 offices in 65 countries.
1501 Page Mill Road, Palo Alto, California 94304

Circle 129 on reader service card

Our \$995* CPU is actually less than half the price of the 8080 or 6800 CPU.

And it's just the beginning of your saving. On-chip RAM, ROM and timers make an even bigger difference. Difference in cost. Difference in reliability and difference in manufacturing time. The following is the whole price/performance story of our F8 system, from minimum configurations to expanded systems.

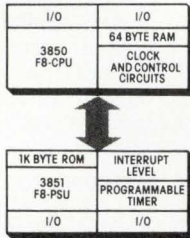

Lowest cost configuration

Our minimum configuration F8 is perfect for controlling home appliances, braking systems, vending machines, ignition systems and other uses with modest memory and I/O requirements.

Two chips do it all – a \$9.95 PSU (Program Storage Unit) and F8 CPU (Central Processing Unit) for \$9.95. The CPU is an 8-bit device, with a cycle time of 2 microseconds. It's the heart of all F8 microprocessors. It includes 70 instructions, 64-byte RAM (Random Access Memory), instruction register, accumulator, 16 individually controllable I/O lines, power-on reset, on-chip clock and control lines to other devices.

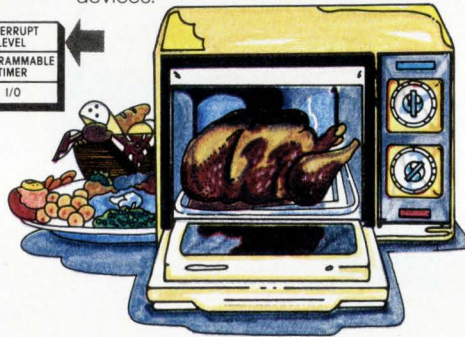

The PSU features a 1K byte ROM (Read Only Memory), program counter, 16 individually controllable I/O lines, 8-bit data port, stack register, incrementer/adder, and programmable timer and interrupt.

We're the only manufacturer in the world to offer this 2-chip performance. The 8080 requires 7 chips (9 chips with timer) to do the same thing.

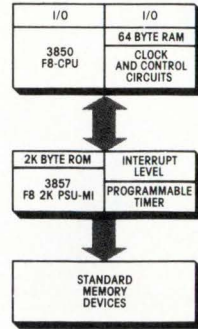

Double the program storage

If you need more program space, just substitute PSU's. Our new 2K byte PSU offers twice the ROM for only \$14.95.

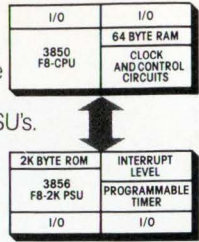

Built-in interface to external memory

But suppose you need a couple of RAM's added to your CPU and 2K/PSU. Again, substitute PSU's for one with a built in memory interface. Avoid paying for extra chips. Order our new 2K/PSU-MI for \$14.95.

This is super microprocessor power on 4 chips.

The 8080 takes 10 chips (12 with timer) to do the same thing.

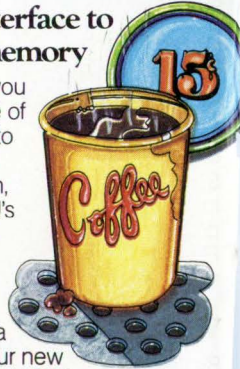

Fairchild's \$9.95 F8 Microprocessor

Half the Cost Twice the Versatility

A system that needs no ROM

If you don't want to commit to ROM, consider interfacing RAM and/or PROM (Programmable Read Only Memory) directly into the CPU. This approach is ideal when your production run is under 1,000 units, and for development prior to long production runs.

This F8 configuration uses only four chips: a CPU, a \$7.45 SMI (Static Memory Interface with interrupt and programmable timer) and two 2K PROMs. Competitors take twice as many chips to do the same thing.

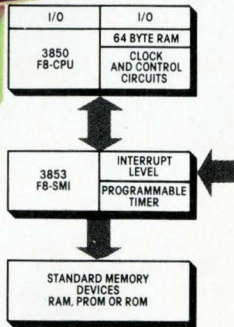
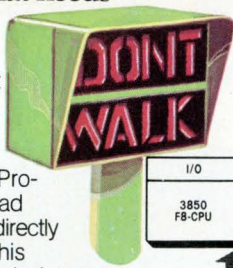

Where more I/O is needed

By adding our \$6.45 PIO (Parallel I/O) to this aforementioned configuration, you gain 16 I/O ports, another level of interrupt and a programmable timer. Now you have the perfect 5-chip microprocessor system for electronic scales, paper tape and cassette tape handlers, electronic games, traffic light control, cash register and similar applications.

Competitors take 10 chips to do the same thing.

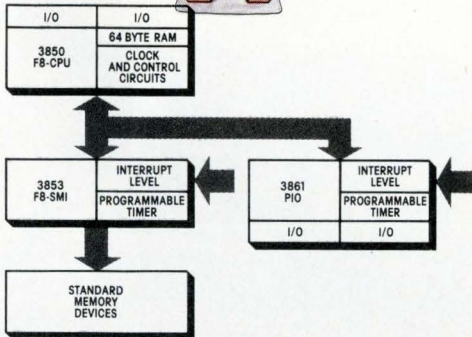
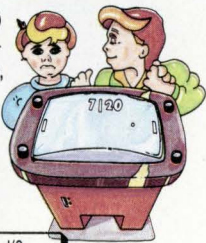

Memory intensive systems

In memory intensive applications like message concentrators, floppy disc controllers, and store-and-forward message switching you'll enjoy big benefits with the F8's DMI (Dynamic Memory Interface).



This \$7.45 device fits between your CPU and dynamic (or static) memory WITHOUT A MEMORY REFRESH CHIP.

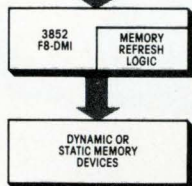
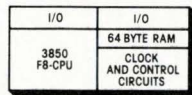

Memory refresh logic is built into the DMI, and operates in sync with the CPU. Your CPU never stops. There's no cycle stealing. No performance degradation. We are the only manufacturer in the world to offer this advantage.

A supercharger for this memory intensive configuration is DMA (Direct Memory Access).

This \$5.95 option comes in one chip. It creates a direct link between your memory and external data. All functional and internal system timing

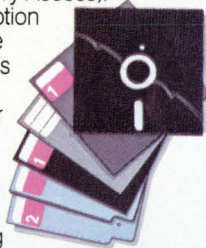

is built in. The DMA can run at 500K bytes/sec and never slows down the rest of the system.

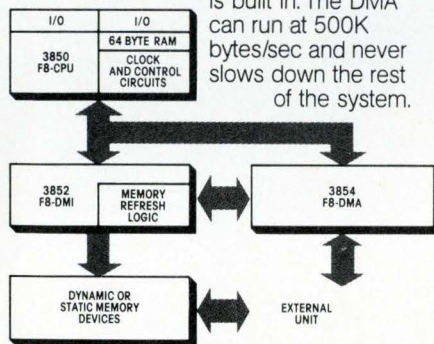

Expand your system

Interchangeability and compatibility are maximized for you. All inter-component timing is built in. Gang PSU's. Add PIO's. Daisy-chain multiprocessor systems.

To cut design time even more, you'll enjoy our Formulator.™ Think of it as an instant breadboard – a system developer, tester, debugger, and more. Of all hardware/software development aids on the market, this one is easiest to operate. Easiest to understand.

Discover how easy it is to assemble your own microprocessor. We provide a spectrum of hardware and software development aids. Everything you need including kits, hardware simulators and full program development support.

And then we will show you how to do it all, step by step in our brand new brochure, "THE PATHS OF LEAST RESISTANCE – Four Optimum Ways To Bring Your Microprocessor Product To Market." Write us now, your competitors probably will. We know ours will. Fairchild Micro Systems 1725 Technology Dr. San Jose, CA 95119 (408) 998-0123

FAIRCHILD

*All prices quoted are for 100 to 999 plastic packaged parts, effective Sept. 1, 1976.

NEW FROM KEITHLEY: TWO "BEST BUY" DMMs.



Model 173



Model 172

**4½ DIGITS. 30000 COUNTS.
UNDER \$500.**

Advanced features are found in both these general-purpose DMMs:

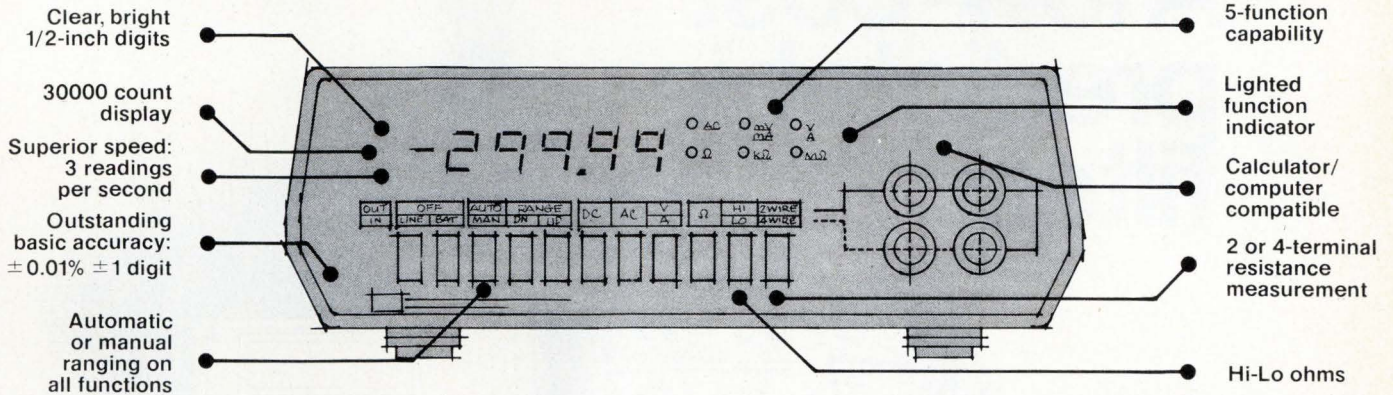

Take a look at the remarkable features of the new Keithley Digital Multimeters. They're unmatched in the industry.

Now consider price. At \$499 we think you'll agree the Keithley 172 is the best buy in a general purpose 4½-digit DMM.

There isn't another 4½ that matches the price-performance value of the 172. Except for its higher-rated companion, the Keithley 173.

For \$499: the exceptional 172.

To begin with, you get a dependable, durable, portable, easy-to-use, autoranging instrument with five functions. Designed for research, engineering or production applications.

Measure from 10 microvolts to 1200 volts dc, 10 microvolts to 1000 volts ac, 10 milliohms to 300 megohms, 10 microamps to 2 amps, ac or dc. DC accuracy is 0.01% ± 1 digit.

There's more: 3 month recal cycle. No-nonsense, full-year guarantee on parts, workmanship, and specs. 30000-count display yields maximum accuracy for 15, 18, 24 and 28-volt measurements.

For \$625: the even more exceptional 173.

The Keithley 173 is our top-rated 4½-digit DMM. It gives you all the performance and accuracy of the 172 plus superior autoranging current measurements from 10 nanoamps to 3 amps. This makes the 173 the most complete and versatile general purpose 4½-digit DMM in the world—at any price.

More versatility. Now or later.

Options and accessories expand the 172 or 173 to your specific needs: Rechargeable battery pack you can buy now or add later. Digital output/control. RF probe. 50-amp shunt. Clamp-

on ammeter. High-voltage probe. Rack mount kits. Test lead sets. Carrying case. IEEE 488 interface.

Make this easy decision.

For most 4½-digit DMM applications, the new Keithley 172 is your best buy. When you require more current measuring capability, the 173 is.

For convincing proof, send for detailed specs or request a demonstration. Or if you're already convinced, send your order to: Keithley Instruments, 28775 Aurora Road, Cleveland, Ohio 44139. (216) 248-0400. Europe: Heighhofstrasse 5, D-8000 München 70, West Germany. (089) 7144065.

DMMs for all your needs.

We know you have a variety of measurement requirements. So we offer a growing family of DMMs to meet your application and price objectives. Send for details.

3½ digits	4½ digits	5½ & 6½ digits
Model 168 General purpose. Low cost. Model 160B 1 µV and 10 pA sensitivity. Model 616 Super-sensitive. 0.1 pA full-scale.	Models 172 and 173 Two "Best-Buys!" Model 171 1 µV sensitivity. 5-functions. Model 174 0.1 µV sensitivity. (coming soon) Model 180 30 nV sensitivity.	Model 190 Multi-function. Low cost. Model 5900 0.001% accuracy. High stability. Model 6900 Accuracy, stability and sensitivity measured in ppm.

KEITHLEY

The measurement engineers.

Finally. A low-cost predictable filter.

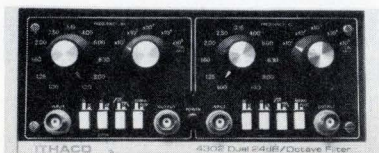
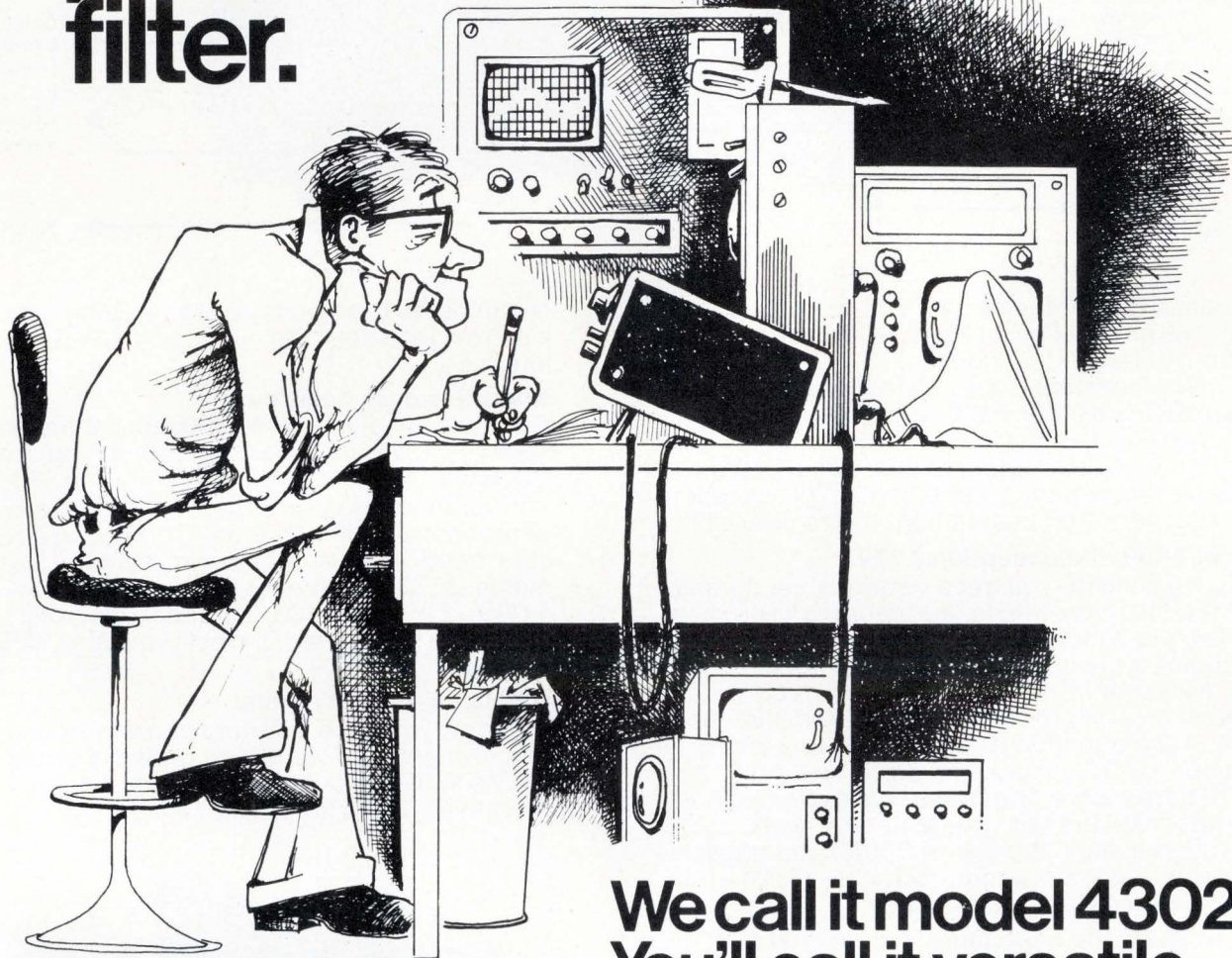

You probably have equipment in your lab or data acquisition system that you don't really trust, or that you have to calibrate whenever you use it. So we thought you'd appreciate a high performance, low-priced dual filter that's predictable.

It takes unusual performance to make a predictable filter.

Like .005% distortion at 20 volts peak to peak output. 25 μ volts self noise. 100dB outband rejection. And 100dB crosstalk attenuation. All better than any competitive filter, even higher priced ones. And switch selectable frequency

We call it model 4302. You'll call it versatile.

settings (10 Hz to 1MHz), let you repeat settings over and over again. With predictable results.

Versatility is written all over its face.

Each 24dB/octave filter can be used as high pass or low pass with selectable gain of 1 or 10. Or connect them in series for bandpass, 48dB/octave high pass, or 48dB/octave low pass, with selectable gain of 1, 10, or 100. Select normal (Butterworth) and pulse (Bessel) by the push of a button. All of this is standard.

Send for our data sheet.

It'll tell you all you need to know about our newest filter. And when you need a filter that does just what you expect, you'll know where to find it. The predictable filter.™ \$655. Ithaco. Box 818, Ithaca, New York 14850. Call (607) 272-7640.

ITHACO

© Ithaco, Inc., 1975. The predictable filter™ is a trademark of Ithaco, Inc.

New products

Instruments

True-rms meter sells for \$345

4¹/₂-digit portable unit
measures ac and dc voltage
and current plus resistance

Deriving the true root-mean-square measurement of a waveform with bench or portable instruments has been an expensive proposition. But engineers at Data Precision Corp. have changed that. Their \$345 model 248, a portable digital multimeter, gives a direct reading of true rms in ac volts with a one-year accuracy at 50 hertz within 0.4% of input +0.2% of full scale.

The unit also provides a true-rms readout of ac current and can measure dc voltage and current, plus resistance, in five ranges each. The 4¹/₂-digit meter features a 10-microvolt sensitivity in dc and ac, and a

basic accuracy within 0.05% for a year. The battery-operated instrument sells for some \$50 more than Data Precision's average-responding model 245 introduced about four years ago, but it offers a lower scale—100 millivolts full scale for all measurements—in addition to those provided by its predecessor.

Harold Goldberg, Data Precision president, points out that the model 248 uses a light-emitting diode rather than a gas-discharge display like the 245, making for lower-voltage operation. He looks for the new instrument to find widespread use where portability is important, and already has an order from the Bell System, whose telephone installers will use it for test purposes.

The rms-to-dc conversion is done principally in a linear bipolar IC developed by Analog Devices Inc. [*Electronics*, Sept. 16, p. 35]. The model 248 measures dc volts from ± 10 microvolts to $\pm 1,000$ v and dc current from ± 10 nanoamperes to ± 2 A. Ac voltages from 10 microvolts to 500 v are measured with true-rms response from 30 hertz to

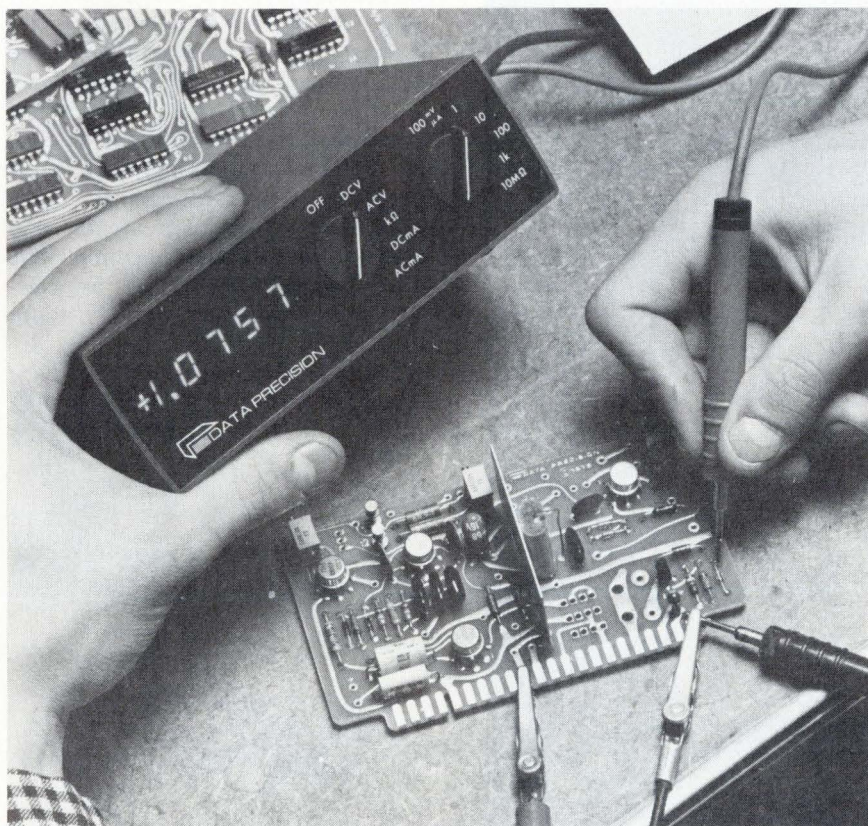

TEKTRONIX 4051 USERS

NOW THERE IS A
SECOND SOURCE
FOR 4051 PERIPHERALS



MAX 2000 WORKSPACE

- **Upgrades** your 4051 to its maximum 32K bytes.
- **High Quality** full spec components plus extensive testing guarantee reliable performance.
- **Warranty:** 1 year parts and labor
- **Price:** \$2,500.00 plus \$200.00 installation fee in continental U.S.A.

JOY STICK Model 2005

Optimizes rapid and accurate cursor positioning with high precision potentiometers, dual mode resolution, and absolute mapping electronics.

PRINTED CIRCUIT BOARD LAYOUT SOFTWARE

Advanced interactive graphics technique reduces layout effort by an order of magnitude. Software provides camera ready art digital storage, menu of standard components, plus definables.

GPIB/HPIB

MAG TAPE Series 3100

Operates as 2-11 megabyte mass/storage and stand alone data logging device. GPIB/HPIB based unit is IBM/ASCII compatible.

FLOPPY DISC Series 5000

Dual or single disc, GPIB/HPIB based random access memory features off line processing option with stand alone BASIC.

For immediate product line details, write or phone:



SECOND SOURCE INDUSTRIES



906 TREAT AVENUE
SAN FRANCISCO, CA. 94110
Telephone: (415) 282-1171

REAL TIME Analog I/O for Intel SBC 80/10 or MDS-800

A single board Analog I/O system for Intel's new single board computer. For laboratory or industrial measurements our DT1751 system can process 16 analog input channels and has 2 analog output channels with power amplifier for driving industrial loads. Drive CRT's directly as well...using the built-in point plot controller.

Real Time measurements are easily done with standard features such as external A/D trigger plus convenient interrupt operation. Optional switch gain amplifier extends dynamic range to 14-bits. CALL US at (617) 879-3595 for a complete set of applications data.

DATA TRANSLATION

INC

109 CONCORD ST., FRAMINGHAM, MA 01701 (617) 879-3595
TELEX 94-8474

...the analog I/O company

Circle 136 on reader service card

Two-Tone SSB RF Test Set

Model 315 combines two Model 925 RF Signal Generators having "Signallock" with a Model 210 Signal Combiner, resulting in a two-tone test set with unsurpassed stability from 50 kHz to 80 MHz. Signal level of each tone or combined tones is adjustable from 0.1 μ v to 2 volts with ± 10 Hz stability. Signal spacing is from 100 Hz to almost 80 MHz. Intermodulation distortion is 60 dB down at full output; better at lower outputs. Write or call today for complete specifications and pricing.

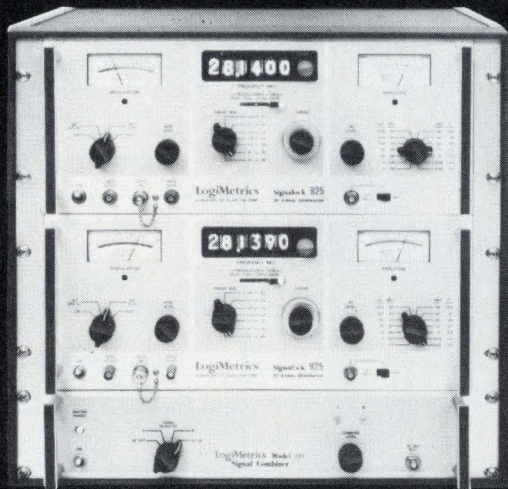

LogiMetrics

121-03 Dupont Street, Plainview, New York, 11803, (516) 681-4700/TWX: 510-221-1833
RF Signal Generators, Frequency Synthesizers, Traveling Wave Tube Amplifiers

136 Circle 188 on reader service card

New products

20 kilohertz. Ac current is also a true rms reading from 10 nA to 2 A. Resistance measurements range from 100 milliohms to 20 megohms, with a maximum open-circuit excitation of 3.5 v.

The instrument can be line-connected or run off the rechargeable nickel-cadmium battery pack included in the price. Also included are the charger, test leads, carrying case and one-year warranty for the instrument, which measures 1 3/4 in. high, 5 1/2 in. wide, and 3 1/2 in. deep.

When connected to an ac line, the battery pack is always recharging, whether or not the instrument is on. A blinking decimal point indicates that five minutes of in-spec operation remain before recharging is necessary. Delivery is from stock.

Data Precision Corp., Audubon Road, Wakefield, Mass. 01880. Phone Robert Scheinfein at (617) 246-1600 [351]

Laser power meter spans 200 to 1,100 nanometers

Direct readings of average power for cw or repetitively pulsed lasers with wavelengths from 200 nanometers to 1,100 nm are provided by the model 460 laser power meter. Extra-cost accessories are available for extending the 460's capability to include peak-power measurements, integrated energy measurements, and pulse-shape determinations. The meter has full-scale ranges, for average-power measurements, from

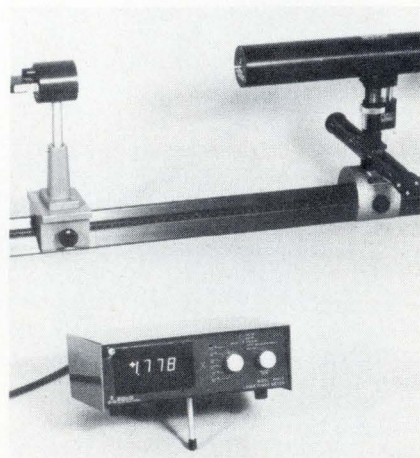

Electronics/October 14, 1976

Transient Voltage Suppressors! Zeners - Voltage Regulators!



**LOWEST
DYNAMIC
IMPEDANCE**

**Maximum Power
in a Mini Package!**

Semtech technology once again sets the standard for semiconductors! Now, a new generation of Voltage Regulators and Transient Suppressors for protection of delicate logic circuits and sophisticated power supplies, providing protection against voltage transients in airborne equipment as well as suppression of relay coil and contact noise.

The smallest package in the industry and with power ratings up to 1500 watts is available now thanks to a breakthrough in junction technology, combined with the proven metoxilite (metal-oxide) coating and superior non-cavity monolithic high temperature bonded construction!

LOW DYNAMIC IMPEDANCE VOLTAGE REGULATORS "ZENERS"

These new devices offer significantly lower dynamic impedance. Lower impedance means improvement in regulation, ripple reduction and transient protection.

1 watt

1N5559A,B thru 1N5589A,B.
Nominal Voltage: 6.8 to 120 V ($\pm 5\%$)
Low Reverse Leakage
Dimensions (max.): Body .070"D x .165"L
Leads .031"D x 1.25"L

5 watt

1N4954 thru 1N4984
Nominal Voltage: 6.8 to 120 V ($\pm 5\%$)
Low Reverse Leakage
Dimensions (max.): Body .140"D x .165"L
Lead .038"D x 1.10"L

3 & 5 watt

SX6.8 thru 120
Nominal Voltage: 6.8 to 120 V ($\pm 5\%$)
Low Reverse Leakage
Dimensions (max.): Body .140"D x .165"L
Lead .040"D x 1.10"L

10 watt

SY6.8 thru 120
Nominal Voltage: 6.8 to 120 V ($\pm 5\%$)
Low Reverse Leakage
Dimensions (max.): Body .165"D x .165"L
Lead .040"D x 1.10"L

BI-POLARITY TRANSIENT SUPPRESSORS

At last, a single chip device providing symmetrical transient voltage protection. Voltage matching to 5% in either direction. Protection for A.C. and D.C. circuits.

500 watt Peak Pulse Power

L 10A, 20A, 30A, 39A, 51A, 60A, 82A, 100A and 110A.
Nominal Voltage: 10 to 110 V
Dynamic Impedance (max.): 1.5 to 70 Ohms
Dimensions (max.): Body .140"D x .165"L
Lead .031"D x 1.25"L

1500 watt Peak Pulse Power

TS 10A, 20A, 30A, 39A, 57A, 60A, 82A, 100A and 110A.
Nominal Voltage: 10 to 110 V
Dynamic Impedance (max.): 0.7 to 35 Ohms
Dimensions (max.): Body .165"D x .165"L
Lead .040"D x 1.10"L

1975 NATIONAL SBA SUBCONTRACTOR OF THE YEAR



652 Mitchell Road, Newbury Park, California 91320
(805) 498-2111, (213) 628-5392 / TWX: 910-336-1264
CHICAGO: (312) 352-3227
DALLAS: (214) 387-3551
FLORIDA: (305) 644-5404
MARYLAND: (301) 424-6663
NEW JERSEY: (201) 654-4884
SAN FRANCISCO: (415) 494-0113
EUROPEAN SALES HDQ: Bourns AG Zug, Switzerland (042) 232-242

Contact factory for complete specifications.

General Electric wedge base lamps can save time, space, money.

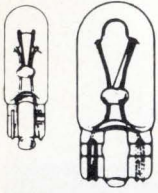

These lamps are ideal for applications such as indicators, markers and general illumination where space is at a premium. Their wedge-based construction makes them easy to insert and remove. They don't require bulky, complicated sockets. And because the filament is always positioned the same in relation to the base, you get consistent illumination from lamp to lamp.

You can choose from over 25 types of GE wedge base lamps. Voltages range from 6.3 V to 28 V. Candlepower from 0.03 to 12 cd. Bulb sizes range from subminiature at 6mm to a heavy-duty bulb at 15mm.

To send for updated wedge base lamp technical information, circle number below or write GE for Bulletin #3-5259.

Check these 6 halogen cycle lamps GE has added to its low-voltage line.

General Electric now offers over 27 halogen cycle lamps that pack high light output in small packages. (In addition, GE offers 8 sealed beam halogen lamps primarily for aircraft applications.) Bulb diameters range from $\frac{3}{16}$ " to $\frac{1}{2}$ ". Lengths from .520" to 2.25". Voltages from 3.5 to 28.0 V. And candlepower from 2.15 cd up to 250 cd.

They're ideal for you if you're designing applications such as optical systems, instrumentation, illuminators, fiber optics, card readers, displays and aircraft navigation. A variety of terminals are offered.

For updated technical information circle the number below or write GE for Bulletin #3-5357.

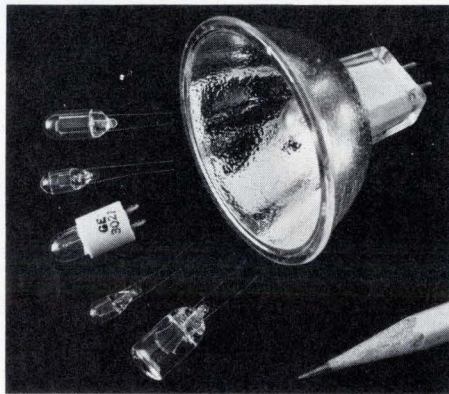

These three free GE catalogs include important data changes that could affect your present design. Send for yours today.

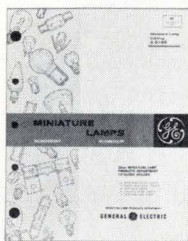

#3-5169

June '75 Miniature lamp catalog features 40 pages and 500 data changes for complete 500-lamp line.

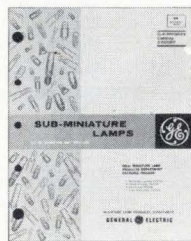

#3-6252R1

Feb. '75 Sub-miniature lamp catalog features 24 pages and 91 changes for more than 210 lamps.

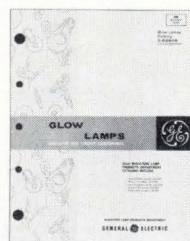

#3-6254R

Dec. '74 Glow Lamp catalog features 8 pages and 50 changes for 83 Glow Lamp Indicator and Circuit Component lamps.

For up-to-date technical information on any of these items write: General Electric Company, Miniature Lamp Products Department #3382-M, Nela Park, Cleveland, Ohio 44112.

GENERAL  ELECTRIC

New products

19.99 nanowatts to 199.9 watts. The energy range is from 1.999 nanojoules to 1.999 joules.

A silicon photovoltaic detector gives the instrument good long-term stability, uniform response over the detector surface, and low noise. No window is used over the detector, thus eliminating measurement errors caused by multiple reflections in parallel optics.

The model 460 laser power meter sells for \$995 and has a delivery time of two weeks.

EG&G Inc., Electro-Optics Division, 35 Congress St., Salem, Mass. 01970. Phone (617) 745-3200 [353]

Programable meter calibrator covers dc plus ac to 20 kHz

Fully programable by means of direct parallel interfacing or by means of the IEEE Standard 488-1975 interface bus, the series 600 precision calibrator provides both dc signals and ac up to 20 kilohertz. Accurate enough to calibrate 4 $\frac{1}{2}$ - and 5-digit multimeters, the series

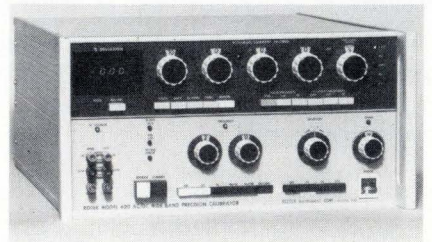

600 also provides for four-wire resistance measurements from 1 ohm to 10 megohms. Features include automatic percent-of-full-scale error computation.

Rotek Instrument Corp., 220 Grove St., Waltham, Mass. 02154. Phone Elliot Warner at (617) 899-4611 [355]

Unit supplies both +5 V dc and TTL-level signals

The Logiklab model 151 is a design, training, and test instrument that combines the functions of a power supply and a simple pulse and

57* La 138.90	59 Pr 140.90	64 Gd 157.25	68 Er 167.26	70 Yb 173.04
58 Ce 140.12	60 Nd 144.24	65 Tb 158.92	69 Tm 168.93	71 Lu 174.97
39 Y 88.90	62 Sm 150.4	66 Dy 162.50	90 Th 232.03	
	63 Eu 151.96	67 Ho 164.93		

rare earths Rhône-poulenc

all grades ranging
from 95% to 99,9999% purity

rhodia inc. Chemicals Division, P.O. Box 125 - Monmouth Junction - NEW JERSEY. 08852 (USA) - Telex 844.527 - Tel. 846.77.00
rhône-poulenc (CF/PSP), 21 rue J.-Goujon - F. 75360 PARIS - Cedex 08 - Tel. (1) 256.40.00



Name _____

Address _____

Tél. _____

Please send me information on rare earths.

CF.G1.6/12 - Electronics

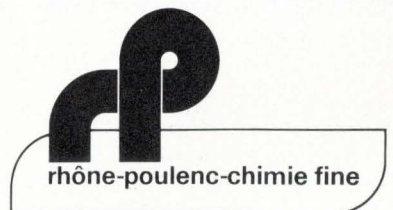

FIELD GUIDE TO BUGS

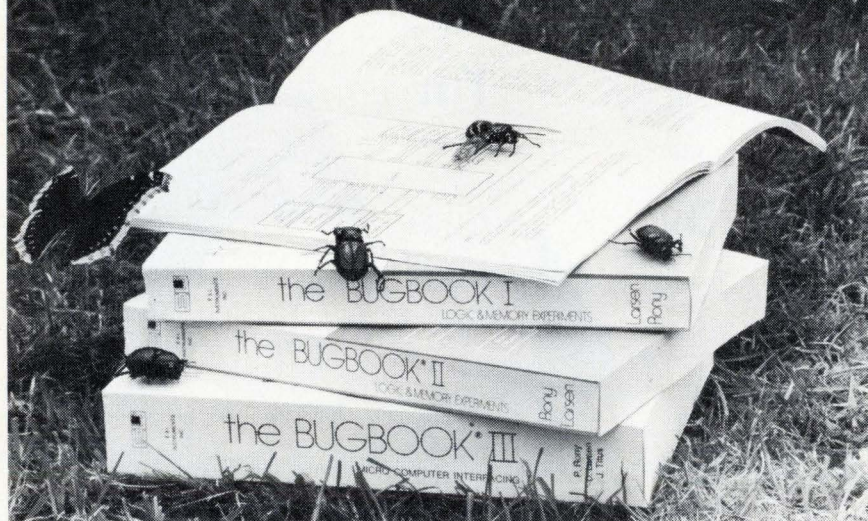

SPECIAL PRICE

The Bugbook library — Bugbooks I, II, IIA and III — are available together at the factory direct price of \$37.00 . . . save postage and handling . . . order today.

Prices applicable only in the U.S. and its possessions.

In a world crawling with bugs, it's good to have the Bugbooks by your side. Good to have just four books dedicated solely to teaching you digital electronics . . . from ground zero on up. From fundamental logic and memory experiments to interfacing with microprocessors. The Bugbooks are E&L Instruments' pioneering approach to mastering today's pulse-quick world of micro-electronics. With an approach that's simple and straightforward. Clear. Complete. Well-illustrated. And as fresh as tomorrow's circuit design. In all, some 1350 pages. They're the Bugbooks. Don't ven-

ture a step farther into the world of digital electronics without them. Because the place is crawling with bugs.

E&L INSTRUMENTS, INC.
Circuit Design Aids
61 First Street, Derby, Ct. 06418
(203) 735-8774

Order directly from one of our stocking representatives.

Los Angeles, CA (213) 377-0975
San Francisco, CA (415) 961-2828
Woodbridge, CT (203) 397-1461
Denver, CO (303) 744-2501
Orlando, FL (305) 351-1841
Chicago, IL (312) 956-8090
Kansas City, KS (913) 649-8952
New York, NY (201) 467-8585
Syracuse, NY (315) 699-2651
Dayton, OH (513) 222-0011
Philadelphia, PA (215) 723-8733
Dallas, TX (214) 690-4004
Fairfax, VA (703) 273-1803
Seattle, WA (206) 938-4166

New products



square-wave generator. The short-circuit-proof supply delivers up to 1 ampere at 5 v dc, while the pulser puts out both true and complementary TTL-compatible square waves and pulses over the frequency range from 10 hertz to 100 kilohertz. Single-quantity price of the model 151 is \$79.50; delivery time is stock to 30 days.

Integral Electronics Corp., P.O. Box 286, Commack, N.Y. 11725. Phone Marcy Talbot at (516) 269-9207 [354]

Fm/a-m signal generator spans 1.5 to 520 megahertz

Featuring continuous, single-knob tuning and an eight-digit LED display, the model 760 fm/a-m signal generator covers the frequency range from 1.5 megahertz to 520 MHz. Phase locking allows the instrument

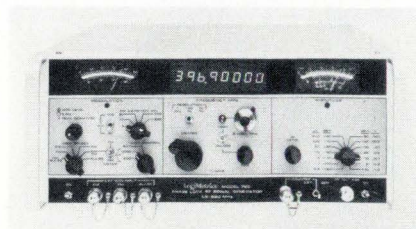

to maintain a resolution of 10 Hz.

The generator's fm capability, which may be used independently of, or in conjunction with, its a-m and pulse-modulation capabilities, has calibrated deviations of 3, 10, 30, 100, and 300 kilohertz.

The generator sells for \$4,675.

Logimetrics Inc., 121-03 Dupont St., Plainview, N.Y. 11803. Phone Murray Feigenbaum at (516) 681-4700 [357]

LINEAR INNOVATIONS
FROM TI

BIFET

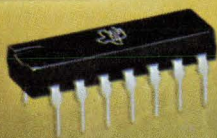

LINEAR IC'S

First quad BIFET op amp. Super Beta performance at low cost.

An innovation from Texas Instruments. The new TL084. The industry's first four-in-one BIFET operational amplifier.

Joining Bipolar and JFET technologies on the same TL084 chip gives you the outstanding qualities of Super Beta plus excellent AC characteristics: Extremely low input current, high speed, and less noise.

All at down-to-earth economy. Only \$4.35 (\$1.09 per function) in 100-piece quantities. Available in plastic or ceramic 14-pin dual-in-line packages. Same pin-outs as the LM124/2902.

	# of Op Amps per Package	Input Bias Current (pA)	Input Offset Voltage (mV)	Unity Gain Bandwidth V/μs	Slew Rate V/μs
μA741C (Single General Purpose)	1	80,000	2	1.0	0.5
LM324 (Quad General Purpose)	4	45,000	2	0.7	0.5
LM308 (Super Beta)	1	1,500	2	1.0	0.2
LF355 (Single BIFET)	1	30	3	2.5	5
LF356 (Single BIFET)	1	30	3	5.0	12
TL084C (Quad BIFET)	4	30	4	2.5	7

Typical data at 25°C

New source for LF155 op amps.

If your LF155 op amps are coming too slow or costing too much, check out TI. Immediate delivery from TI

distributors. In a choice of packages: 8-pin plastic or ceramic DIP, TO-99 metal can. Electrically and mechanically equivalent to their counterparts. Only \$1.60 for LF355P (100 pieces).

Also consider subbing TI's LF155 for certain Super Betas. Same pin-out. And you'll get 'em faster at a savings.

For more details on TI's innovative TL084 quad or the LF155 op amps, call your TI Distributor for data sheets. Or, write Texas Instruments, P.O. Box 5012, M/S 308, Dallas, Texas 75222.



TEXAS INSTRUMENTS
INCORPORATED

**Now AMP's most versatile
interconnection system
is even more so.**

**We've added a
whole family
of pin
headers.**



Top performance in a tiny space. AMPMODU posts, receptacles and headers make your packaging designs as tight as necessary.

We've also made it easier to place pins on a board. Forget about positioning pins one at a time. Forget costly front-end insertion equipment. Because AMP engineering ability shows up in our recently introduced AMPMODU pin headers.

Pins are fully protected. Headers are polarized and have self-retention locking latches. Headers fit everywhere on a board, including board center.

Ten basic header styles offer several thousand possible variations. You can approach mass termination with AMPMODU headers. Up to 80 positions.

These headers now complement the AMPMODU interconnection system, which features dual cantilever spring beams in the receptacle, five basic contact types and board to board or board to wire versatility. The forgiving nature of the receptacle design also ensures a uniform, positive electrical contact with the mating posts, everytime.

At AMP our application, service and sales engineers are located throughout the world, and are ready to help you with prototyping as well as providing a complete after-sale service.

For more facts about AMPMODU headers, write or call Customer Service. (717) 564-0100. AMP Incorporated, Harrisburg, PA 17105.

AMP

INCORPORATED

SEE US AT
MILAN BIAS SHOW

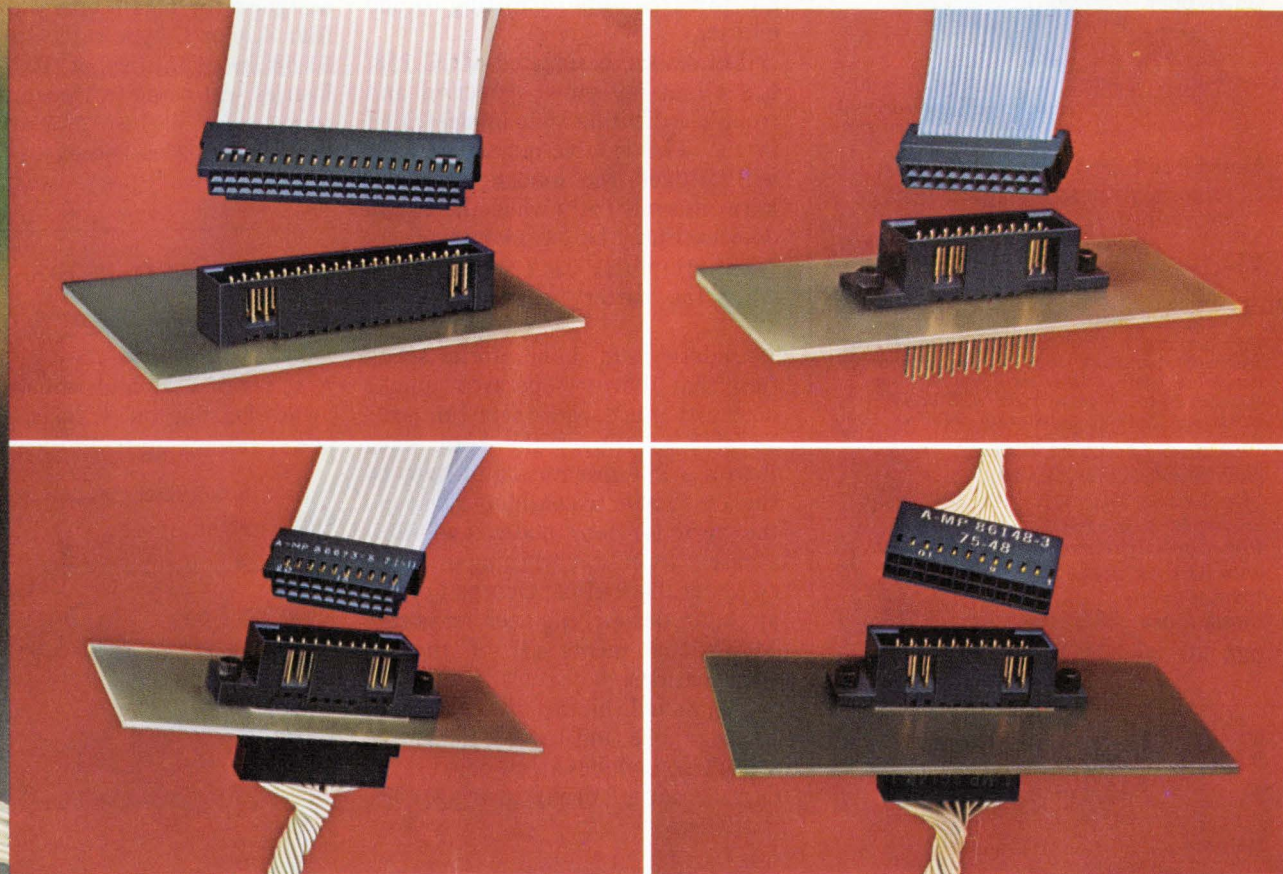

Circle 143 on reader service card

AMP and AMPMODU are trademarks of AMP Incorporated

Vector Wrap-N-Strap Wire Wrapping Tools Are More Versatile- Cost Less Than Most Others

Dual-purpose manual tools that fit power wrappers for faster action

Wrap-N-Strap right or left hand or unwrap right or left with same unwrap tool

Daisy-chain bare wire bussing or conventional wrapping from just a single tool



**P160-4R
POWER
WRAPPER**
\$45.68
Rechargeable

SHOWN WITH P160-2A INSTALLED

NEW! 110V. power tool also available

Single combination tool P160-9
wraps AND unwraps
26 - 30 ga. wire

\$17.45

Use manually
or in all Vector
power wrappers

Unwrap right or left hand wraps with
same tool. Dual-way P160-1A
Unwrapper - \$9.50

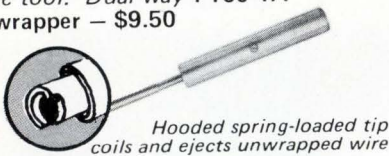

Hooded spring-loaded tip
coils and ejects unwrapped wire

Model P160-2A-1

Wraps right or left
hand rotation.

\$12.45

Wraps standard
insulated wire, or
spooled bare wire with
equal reliability and ease

Buy and stock only half the parts because
Vector's exclusive tool design eliminates
wrapping shells. Only two bits required
to wrap 26 to 30 ga. wire on .025"/.028"
posts, and 22 to 26 ga. wire on .045" sq.
or .031" x .062" size posts.

New revolutionary P180
Slit-N-Wrap tool now
available to wrap thin
but tough insulated
wire 3 times faster
than conven-
tional tools.

\$24.50



Vector

ELECTRONIC COMPANY, INC.
Dept. WS, 12460 Gladstone Avenue
Sylmar CA 91342
(213) 365-9661 - TWX (910) 496-153C

48876

New products

Semiconductors

Detector chip "sees" smoke

I²L device works with a
GaAs infrared emitter to
detect light obscuration

Battery-operated industrial and home smoke detectors usually touch off their alarm in one of three ways: a resistance change triggered by smoke striking a gas sensor, a current change initiated when smoke slows the travel of an alpha particle in an ionization chamber, or optical techniques that detect the obscuration or scattering of light caused by the presence of smoke. Designers at Micro Components Corp. maintain that optical techniques are less expensive than gas sensors and more sensitive to smoke than ionization chambers. So they have come up with a smoke-detecting chip that uses integrated-injection logic with an infrared light-emitting diode emitter.

The device, designated MCC 158, has all of its smoke-detection and trouble-indicating logic implemented in I²L. The trouble-indicating logic will trigger the smoke detector's horn intermittently when the circuit detects that the IR photodiode or input amplifier isn't working, or when the battery power is getting low.

Underwriters' Laboratories specifies that battery-operated smoke detectors must work for a full year, be able to trigger the horn when there's a 2% obscuration of light by smoke, be able to continuously sound the horn for four hours, and must assure a seven-day warning of battery power dissipation. George Fowler, an MCC design engineer, says the MCC 158 meets all of the UL specifications.

The monolithic circuit, in addition to the smoke and trouble-indicating logic, also includes an on-chip direct-current output driver to trigger the

horn, and an on-chip pulsing driver for the LED. That LED plus the silicon photodiode detector will be external devices in the overall smoke-detection circuit.

In operation, the MCC 158 drives the LED in a pulsed mode so that the smoke logic looks for smoke during a 50-microsecond window every 5 seconds. Any signal outside that window will be ignored, minimizing the possibility of false alarms. This is achieved by the synchronous nature of the detection circuitry: if the smoke logic receives pulses from the receiver (photodiode) detector and pulser at the same time, the smoke logic begins a timing cycle. If the cycle is longer than the pulser repetition rate, the MCC 158 will not trigger an alarm unless successive signals from the smoke chain indicate the presence of smoke. Further, Fowler says, the addition of an external capacitor to the smoke logic can set the device to trigger on any desired smoke-detecting pulse, further cutting down the chance of a false alarm.

The MCC 158 is in a 16-pin plastic dual in-line package and is designed for 6-volt operation, using four AA or C-type cells. Its price is \$1.58 in quantities of 10,000. Deliveries will begin in December.

Micro Components Corp. 99 Bald Hill Road, Cranston, R.I. 02920. Phone (401) 463-6000 [411]

High-voltage Darlington are rated up to 125 watts

A series of very high-voltage monolithic Darlington transistors with power ratings up to 125 watts offers

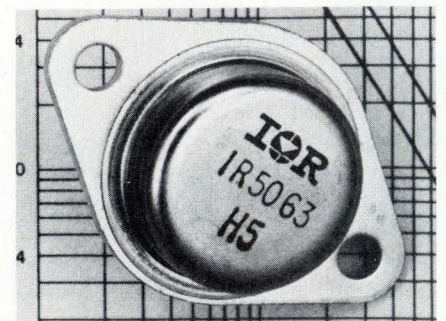

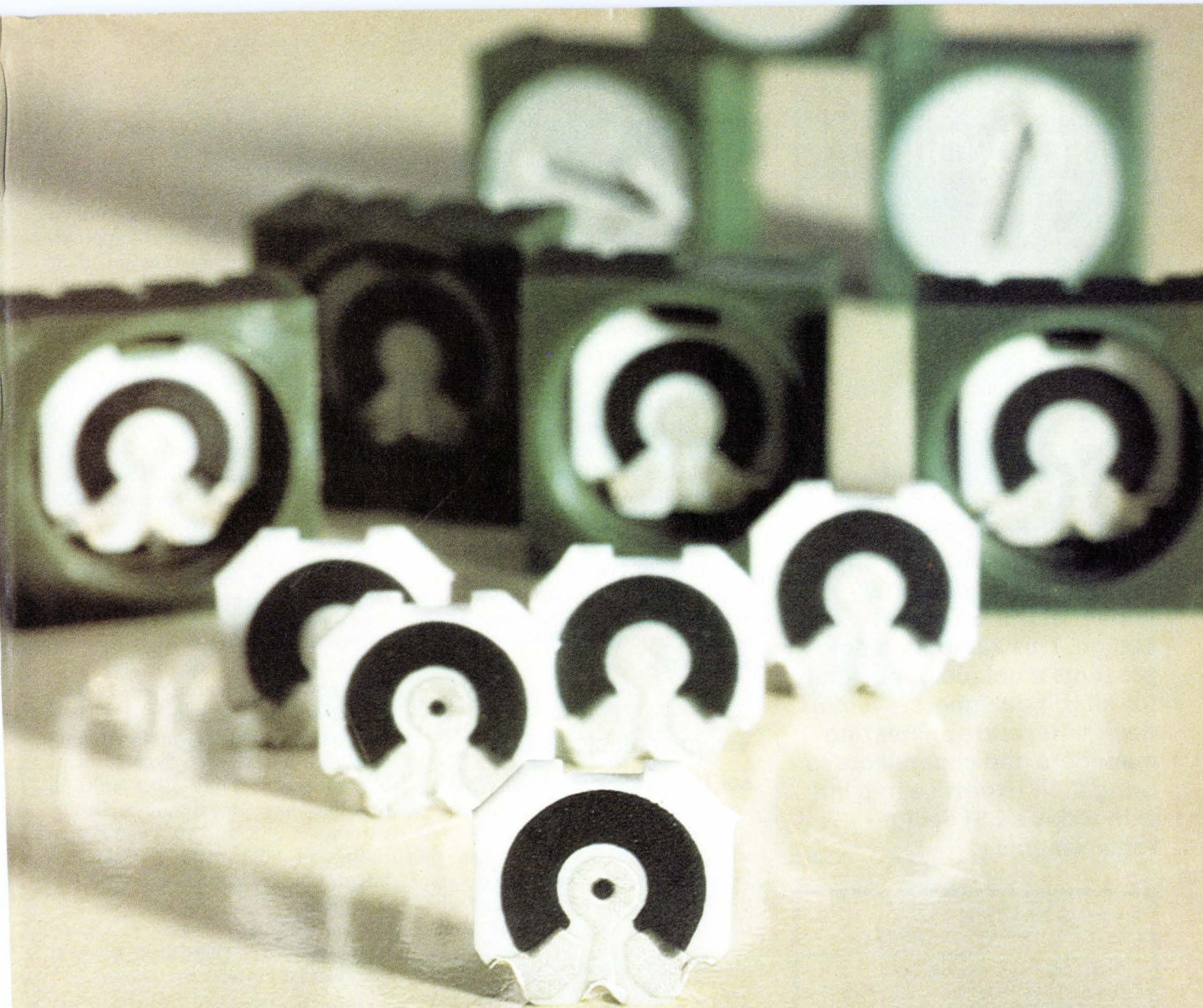

Cermet trimmers and potentiometers do more when they're made with thick film materials systems from DuPont.

With TCR's of less than 50 ppm/°C and CRV's as low as 0.1%, BIROX[®] 1500-Series Resistors are finding new uses in precision applications.

All resistivities, from 10 ohms/square to 1 megohm/square, give you excellent surface properties without polishing or etching.

Careful attention to quality control and built-in processing tolerance make high performance properties easily reproducible in volume production.

Developing unique products like the BIROX 1500-Series is where Du Pont's research and development capabilities

pay off. An experienced staff brings together the chemistry, metallurgy, ceramics, engineering and applications know-how necessary to create products with this level of performance.

And only Du Pont offers you as wide a range of thick film materials systems for cermet trimmers and potentiometers—BIROX 1500-Series for precision applications, the 4500-Series for low cost, and the 9400-Series for high-voltage applications.

All these resistor compositions are compatible with Du Pont conductor compositions—including low-cost Palladium/

Silver 9308 and Platinum/Silver 9770.

Du Pont is committed to developing and manufacturing the finest thick film materials to enable you to compete with semiprecision wirewound trimmers or low-cost carbon potentiometers and helping you find new applications.

Whether you manufacture cermet trimmers, potentiometers, resistor networks or hybrid circuits, Du Pont has a cost-effective system of thick film materials for your application. Call—toll free—800-441-9475. Or write: Du Pont Company, Room 25188, Wilmington, DE 19898.

Electronic Materials Division



Electronics

Circle 145 on reader service card

Large scale integration

LSI
LSI
LSI
LSI
LSI

Edited by Lawrence Altman
Senior Editor, Electronics
**Electronics
Book Series**

The Electronics Book Series offers you a handbook on the current and revolutionary impact of LSI on digital design. This 220-page book presents a unique opportunity for circuit designers, systems designers, and engineering managers and supervisors to bring their expertise into line with today's LSI design requirements.

Electronics Book Series

PO Box 669, Hightstown, N.J. 08520

Send me _____ copies of "Large Scale Integration" at \$9.95 per copy.

I must be fully satisfied or you will refund full payment if the books are returned after ten day trial examination.

Payment enclosed Bill firm Bill me

Credit Cards Charge My Book To

American Express Master Charge
 Diners Club BankAmericard

Acct. No. _____

Date Card Expires _____

Interbank No. _____

1st No.'s. above name on Mastercharge only.

Name _____

Title _____

Company _____

Street _____

City _____

State _____ Zip _____

Signature _____

New products

collector-to-base voltage ratings to 1,000 volts and collector-to-emitter ratings to 900 v. The devices, which carry designations from IR5063 through IR5066, all have a peak current rating of 20 amperes. Because hard-glass passivation makes the Darlington's stable at high temperatures, they are suitable for applications such as motor-drive circuits, high-voltage inverters, and high-voltage switching power supplies. They are packaged in the standard Jedec TO-3 case.

Examples of prices are \$11.75 for the 600-v IR5063 and \$18 for the 1,000-v IR5066. Both prices are for quantities of 100 to 999.

Sales Manager, Semiconductor Division, International Rectifier, 233 Kansas St., El Segundo, Calif. 90245. Phone (213) 322-3331 [414]

Voltage detectors can be set between 2 and 30 volts

Two voltage-sensing circuits—one whose output turns on when the input level falls below a preset value, the other whose output goes on when the input exceeds a desired level—

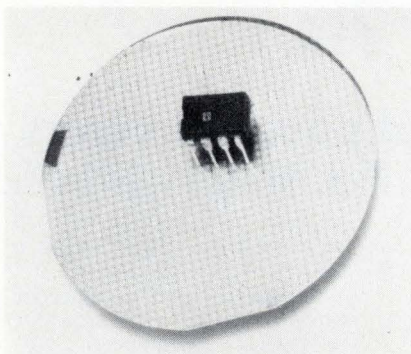

can be set to respond to potentials in the range from 2.0 to 30 volts. A pair of external resistors is used to set the desired voltage for both circuits.

Because the output of the ICL8211, which responds to voltages that fall below a set point, is current-limited to 7 milliamperes, it can drive a light-emitting-diode lamp with no need for a current-limiting resistor. The output of the ICL8212 is not fixed, making it suitable for

applications that demand a variable output or higher current.

Both voltage detectors pull a virtually constant current of approximately 20 microamperes in their sensing modes. This is low enough for them to be useful in battery-operated equipment, particularly as low-battery indicators. When packaged in an eight-pin miniDIP, the devices sell for \$1.50 each in hundreds. They are also offered in TO-99 packages.

Intersil Inc., 10900 North Tantau Ave., Cupertino, Calif. 95014. Phone (408) 996-5000 [413]

Plastic Darlington's are rated up to 300 V at 5 A

Four power-Darlington pairs in TO-202 plastic packages include what is believed to be the only fast-switching unit with a rating of 5 amperes at 300 volts. The three other units in the line have maximum collector currents of 3, 5, and 10 A and BV_{CEO} ratings of 60 to 100 v. Each has integral bias resistance and a protective diode.

Unitrode Corp., 580 Pleasant St., Watertown, Mass. 02172. Phone Vinnie Savoie at (617) 926-0404 [416]

Fast 8-bit d-a converter is linear to within 0.2%

A monolithic 8-bit digital-to-analog converter that comes with an internal reference has a maximum non-linearity of half a least-significant bit (0.2%). The DAC90 also has a settling time within 0.2% of only 200 nanoseconds. Gain drift is typically ± 50 ppm/ $^{\circ}$ C. The converter, which is offered in both military and



**Electronics
IS THE SOURCE
FOR BOOKS, TOO**



Why Parylene works where other microelectronic protection fails:

Controlled conformality

There's a uniform coating of parylene all the way around the half-mil tip of this phonograph needle. That's true conformality, and only parylene gives it, in precisely controlled thicknesses from .002 to 3 mils, in one step. Unlike spray or dip coatings, parylene won't bridge or puddle, or thin out at sharp edges, creating potential failure points. The parylene coating is completely uniform, no matter how dense or intricate the module. And because it's applied at room temperature, there's no component discomfort.

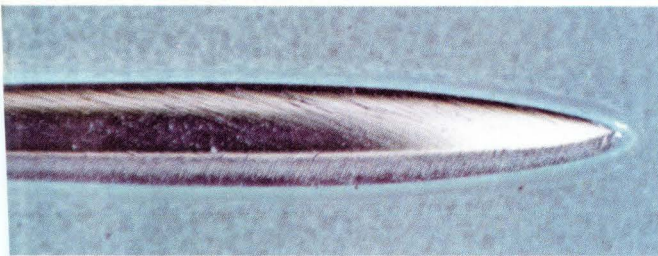

Crevice penetration in hybrids

This beam lead has a 0.3 mil parylene coating all the way to the weld. Parylene penetrates deep within small crevices, maintaining clearance while putting a coherent coating under beam leaded chips and air bridges. No area is left unprotected, preventing shorts and allowing the designer great latitude in component spacing and sizing. And parylene secures loose debris while preventing breakoff of pigtailed during shock and vibration loadings.

Lead Strengthening

It took up to 75 grams pull to break these 1 mil wires. Bare 1 mil aluminum wires, for instance, exhibit bond strengths of 3-5.5 grams; coated with 1 mil of parylene, pull strength increases by 60-70 grams.

So wire and bond are stronger, and sideward shorts and loop collapse during extreme g-loads are prevented. Parylene coatings will penetrate the less than 1 mil clearance between beam lead bonded chips and the substrate, giving such strong coating coverage that the chip cannot be lifted without destroying it.

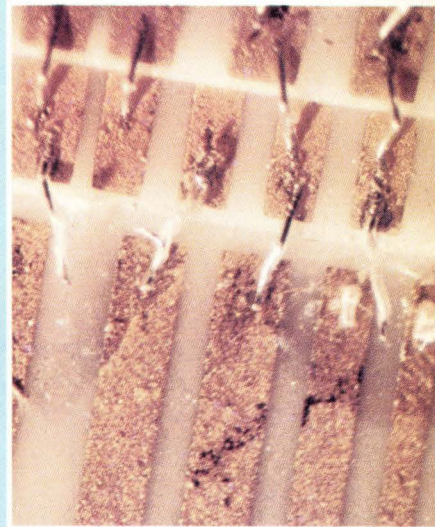

△200°C thermal shock protection

This hybrid microelectronics relay has undergone 200 45-minute cycles from -120 to 80°C, simulating earth-orbiting conditions. This X-ray shows all leads remain intact. Parylene protection was at work, on the transformer core and then the whole assembly before packaging (TO-116). There was no appearance of corona up to 5000 V_{dc}; leakage was reduced from 10 μA to <.001 μA at 1000V. RTV encapsulation suffered dimensional mismatch, straining and snapping leads, with 500 V/mil bulk breakdown.

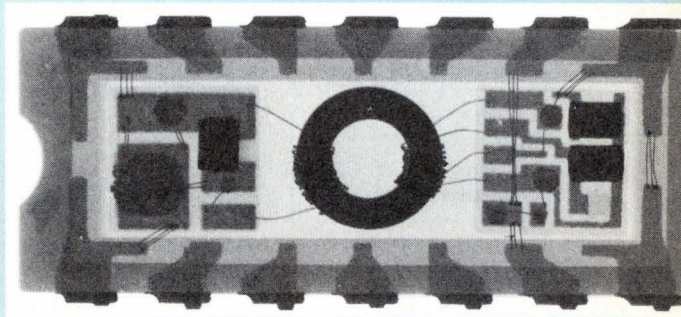

X-ray courtesy NASA Lewis Research Center and Sterer Eng. & Mfg. Co.

Broad cost effectiveness

These are some of the circuit modules now being protected with a conformal coating of parylene. Because nothing else offers parylene's combined protection against thermal cycling, shock, vibration, humidity, solvents, radiation, ionic contamination. Better barrier protection than liquid coatings like silicones, epoxies, and urethanes. On hybrids you can combine parylene with a hermetic seal for optimum environmental protection . . . and parylene alone will often do the job, and at less cost than hermetic seals. Parylene is compatible with active devices, and meets the tough requirements of MIL-I-46058C.

For long term reliability, parylene provides a cost-effective solution.

Union Carbide invented the parylene system. Various patents apply; commercial use of the patented technology is licensed. Write for our 16-page brochure: Union Carbide Corp., 270 Park Avenue, Dept. RFB-65, New York, N.Y. 10017. For instant communication, and information about a trial run at reasonable cost, call Bill Loeb at (212) 551-6071.



In Europe: Mr. Peter Crook, Bakelite Xylonite Limited, Redfern Road, Tyseley, Birmingham, England.
In Japan: Mr. N. Fusada, Tomoe Engineering Co. Ltd., Shin Shin Kai Bldg., 14-1 Nihonbashi 3-Chome, Chuo-Ku, Tokyo.

Circle 147 on reader service card

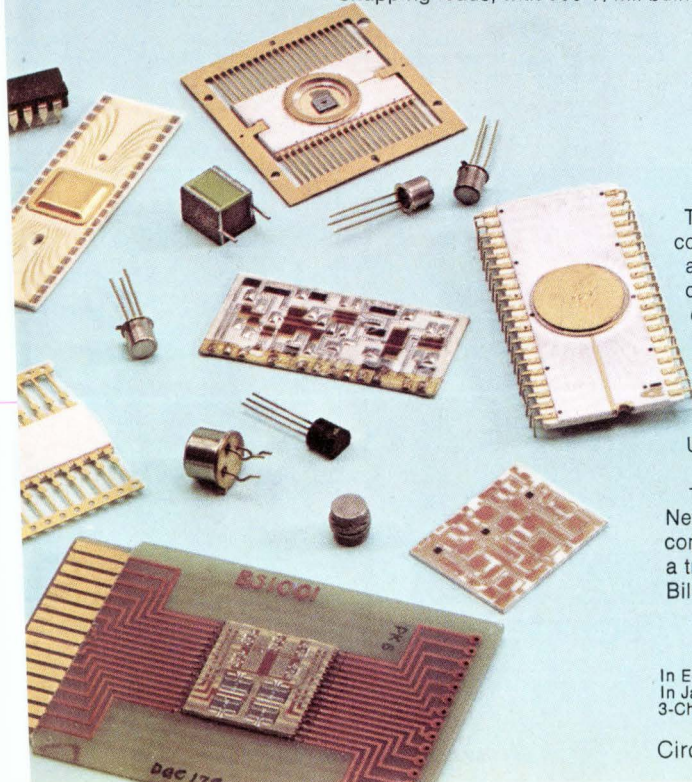

VACTEC Photodetectors

The Industry's Broadest Line Provides More Semiconductor Detectors for More Design Applications

Vactec serves manufacturers of a wide range of modern electronic products. Pictured are a few examples. All these devices are both made and sold by Vactec, including complete lines of LDR's (photoconductive cells, CdS and CdSe); silicon solar cells, as well as silicon high speed and blue enhanced cells; NPN phototransistors and darlington's; opto-couplers (LED/LDR, lamp/LDR and neon/LDR); selenium photovoltaic cells; silicon photodiodes, blue enhanced and PIN; and custom C-MOS and bi-polar IC's. Write for technical bulletins on the types that suit your requirements. Or send your application, and Vactec will recommend the right cell for the job.

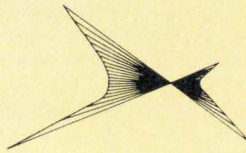

Vactec, Inc.

2423 Northline Industrial Blvd.
Maryland Heights, Mo. 63043
(314) 872-8300

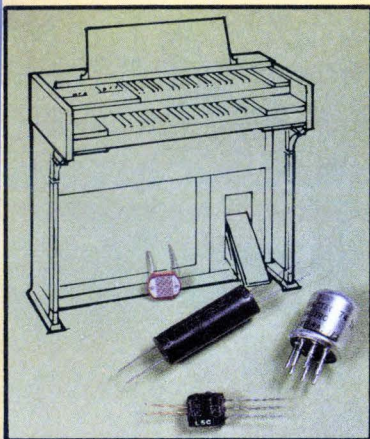

Electronic Organs

LED or lamp/LDR Vactrols for audio, and CdS cells for swell pedal controls.

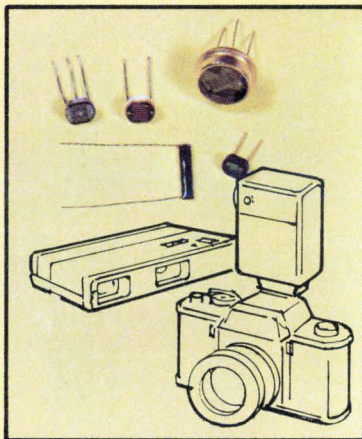

Cameras and Projectors

CdS or blue enhanced silicon photodiodes for automatic shutter timing; aperture servo systems for automatic projector focus; and slave flash controls.

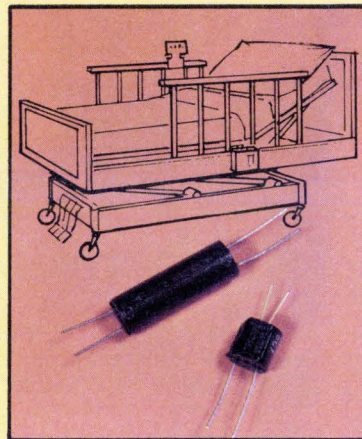

Triac Motor Controls

A special Vactrol gates a triac for forward and reverse motor operation as in hospital beds.

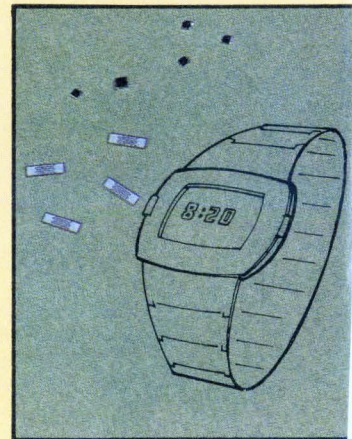

LED Watches

Photoconductive or phototransistor chip controls LED brightness.

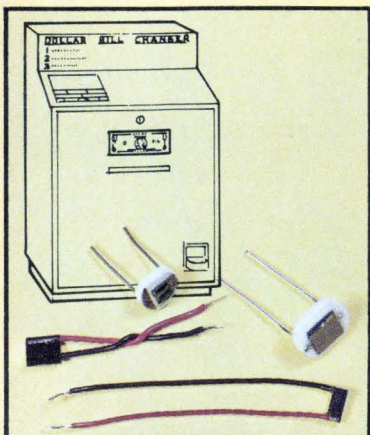

Dollar Bill Changers

Silicon photovoltaic cells analyze optical characteristics.

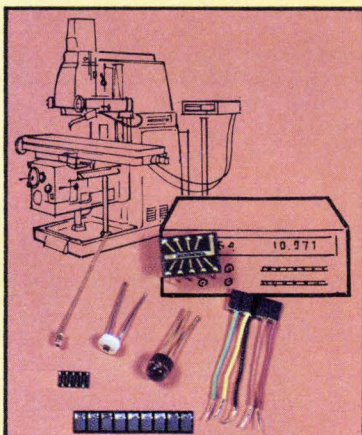

Machine Tool Controls

High-speed photovoltaic cells or transistor arrays help computer control repetitive operations, non-contact sensing, and counting and weighing.

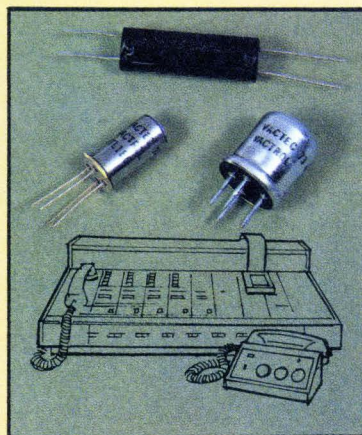

Telephone Equipment

Neon/LDR Vactrols sense ringing. Direct a-c coupling, slow LDR response isolates electronics from noise.

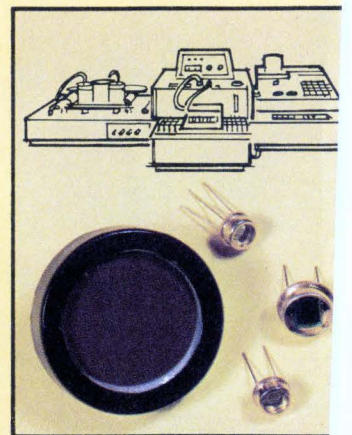

Scientific Instruments

Blue enhanced silicon or selenium photovoltaic cells detect solution densitometrically for precise blood chemistry and other analyses.

New products

commercial versions, is housed in a 16-pin ceramic DIP. In hundreds, the price for the commercial units is \$8.50 each while the military versions sell for \$12.50.

Burr-Brown, International Airport Industrial Park, Tucson, Ariz. 85734. Phone Joe Santen at (602) 294-1431 [418]

Quad op amp spans 8 MHz,
pulls only 35 mW/amplifier

The high-performance HA-4602/4605 quad operational amplifier is a dielectrically isolated device that combines bipolar and complementary-MOS circuitry. Typical specifications include a small-signal bandwidth of 8 megahertz, an input offset voltage of 0.3 millivolt, and a power consumption of 35 milliwatts per amplifier. Other important characteristics are a typical slew rate of 4 volts per microsecond and a typical settling time (within 0.01% of final value) of 4.2 μ s. The 4602, which is rated for operation from -55°C to 125°C , sells for \$9.90 in hundreds, while the 4605, which operates from 0°C to 75°C is priced at \$4.95 in similar quantities.

Harris Semiconductor, P.O. Box 883, Melbourne, Fla. 32901. Phone (305) 724-7412 [417]

PLL circuit includes counter,
divider, and phase detector

A complementary-MOS integrated circuit for phase-locked loops includes a phase comparator, a programmable reference divider that can divide by four, 16, 64, or 100, and a presettable 4-bit counter that can divide by integers from one to 15. Designated the MC14568B, the circuit, like others in Motorola's B-series line, can operate from 3 to 18 volts, and parameters are specified at 5, 10, and 15 volts. It can also drive a low-power Schottky load. The MC14568B is offered in ceramic and plastic 16-pin DIPs in two temperature ranges: -55°C to 125°C and -40°C to 85°C . Prices,

for 100 to 999, range from \$2.61 to \$3.90, depending upon temperature range and packaging. The part is also available as tested dice.

Motorola Inc., Integrated Circuit Division, Technical Communications Group, 3501 Ed Bluestein Ave., Austin, Texas 78721 [415]

Plastic-packaged SCRs
switch 25 A at up to 800 V

A series of plastic-packaged thyristors with designations from 2N6504 through 2N6509 are SCRs with current ratings of 25 amperes and peak reverse blocking voltages ranging from 50 volts to 800 v. All the devices have a peak nonrepetitive surge-current rating of 300 A.

Housed in TO-220 packages, the devices all have glass-passivated junctions and a center-gate-fire design for maximum parameter uniformity and stability. Designed for half-wave ac applications, such as motor and heating controls, the SCRs are claimed to sell for as little as two-thirds of the price of metal-cased equivalents. Two representative prices, for quantities of 100 to 999, are \$1.43 for the 50-v 2N6504 and \$4.95 for the 800-v 2N6509.

Technical Information Center, Motorola Semiconductor Products Inc., P.O. Box 20294, Phoenix, Ariz. 85036. Phone Thyristor Marketing at (602) 244-4426 [419]

Fairchild adds circuits to
Isoplanar C-MOS family

Fairchild has added two products to its Isoplanar family of C-MOS circuits. The 4528 is a dual retriggerable, resettable one-shot whose propagation delay is independent of the value of the timing capacitor. The 4511 is a BCD-to-seven-segment latch/decoder/driver. Pricing, in hundreds, varies from \$1.28 to \$2.22 for the 4528, and from \$1.64 to \$3.12 for the 4511.

Fairchild Camera and Instrument Corp., Digital Products Div., 464 Ellis St., Mountain View, Calif. 94042. Phone Bill Callahan at (415) 962-3816 [420]

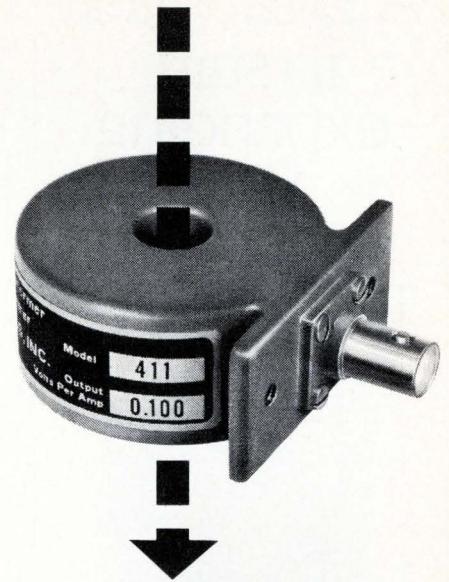

Wide Band, Precision CURRENT MONITOR

With a Pearson current monitor and an oscilloscope, you can measure pulse or ac currents from milliamperes to kiloamperes, in any conductor or beam of charged particles, at any voltage level up to a million volts, at frequencies up to 35 MHz or down to 1 Hz.

The monitor is physically isolated from the circuit. It is a current transformer capable of highly precise measurement of pulse amplitude and waveshape. The one shown above, for example, offers pulse-amplitude accuracy of $+1\%$, -0% (typical of all Pearson current monitors), 10 nanosecond rise time, and droop of only 0.5% per millisecond. Three db bandwidth is 1 Hz to 35 MHz.

Whether you wish to measure current in a conductor, a klystron, or a particle accelerator, it's likely that one of our off-the-shelf models (ranging from $1/2$ " to $10\ 3/4$ " ID) will do the job. Contact us and we will send you engineering data.

PEARSON ELECTRONICS, INC.

4007 Transport St., Palo Alto, CA 94303, U.S.A.
Telephone (415) 494-6444

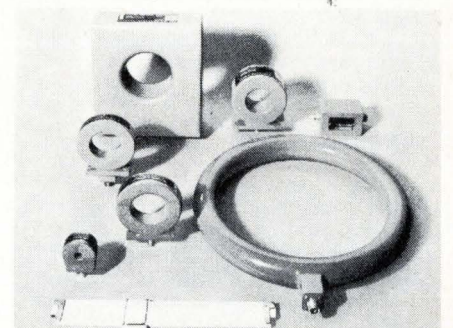

A great place
to start
expanding
your
company
is right here.

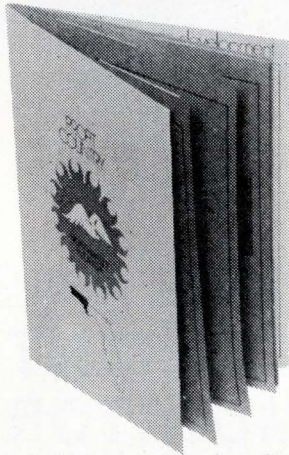

Our 16 page book talks about the labor force, about deep water ports, about utilities, temperatures, taxes. There's everything here from financing to flying times, from industries to schools—all the things that make Northwest Florida one of the most profitable, most livable business climates in the country. And it's free.

Gulf Power Company
Manager, Area Development
Department D-8
P. O. Box 1151
Pensacola, Florida 32520
Please send me your book.

Name

Title

Company

Address

City

State

Zip

New products

Packaging & production

Trimmer saves time and money

Automatic laser system
uses 8080 microprocessor
with extensive software

High-throughput laser trimming at low cost is the principal advantage of Quantrad Corp.'s model 1080 automatic trim system. Priced at about \$80,000, the system is designed around an 8080-based microcomputer and comes complete with a general-purpose Basic compiler permitting extensive computation. Software is provided in duplicate floppy-disk form. Some of the standard programs include a highly flexible data entry allowing joystick or keyboard positioning, editing for user-development of specific applications, display and alarm functions, and accumulation of deviation data for quality-control purposes.

The 1080 design features, in addition to complete program control, the latest technology in trim hardware. The pulsed neodymium yttrium-aluminum garnet laser is employed in what Quantrad calls a synchronous-trimming system: when the beam is accelerating or decelerating, the pulse-rate increases or decreases accordingly to assure a clean, uniform cut. The beam positioner is controlled by a closed-loop galvanometer system that eliminates the hysteresis inherent in most posi-

tioner designs, making it possible to approach a location from two different directions and attain a reproducibility of position of 0.0005 inch at slewing speeds up to 50 inches per second.

A TV viewing system that provides full coverage of the 2-by-2-in. trim area is standard equipment with the 1080. The television monitor also serves as the display screen for the output of programs, showing system status, alarm functions, and all statistical data.

Minimal set-up time is afforded by the ease and flexibility of programing. The trimming instructions may be entered via the keyboard in the form of coordinates taken from a drawing, or by what Quantrad refers to as adaptive programing—positioning the non-destructive blinking cursor displayed on the monitor using the joystick control. The probe network, which is capable of measuring more than 32 resistors per circuit with 64 Kelvin probes, may be made to order for large production runs or set up by the user for small runs with a probe-card-making system or a magnetically-indexed system. In performing resistor measurements, probe selection is matrixed and connections are directed by an eight-bit word which contains the probe-number and -destination information. Resistor measurement is interfaced to the microcomputer by precise digital-to-analog conversion, and the reference and measured voltages enter a comparator which controls the laser for trimming to tolerances as low as 0.05%. Because many manufacturers

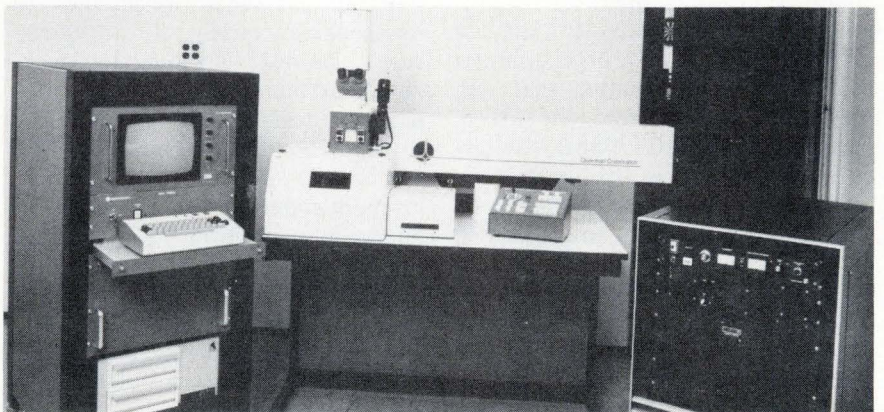

Reliability test results:

Matrix Reliability Test:
"TRW's 2,000 VDC - 16,000 VDC
metallized polyester capacitors
indicate MTBF (90% confidence limit)
greater than 260,000 hours at
rated voltage."

TRW's X675HV series is designed to meet the requirements of voltage multipliers and high voltage filters in high density, high voltage power supplies, instrumentation, data displays, pulse modulators and copiers.

They're smaller, lighter, self-healing and eliminate wet components which can bleed, crack and wreck a board.

The standard design is metallized polyester with axial leads, tape wrap and epoxy endfill case. Insulation resistance is 30,000 megohms x MFD and the dissipation factor is less than 1% at 1000 Hz.

The X675HV series can replace traditional dielectrics in many applications with substantial savings in size at comparable lower costs. *On quantity orders, modifications can be made to your specifications.*

Want to know more? Use the coupon for complete specs on the X675HV series — or information on any dielectric you require.

TRW Capacitors

An Electronic Components Division of TRW, Inc.
301 West "O" Street,
Ogallala, Nebraska 69153.

- Please send me specs on your new X675HV capacitors.
 I'd also like a copy of the matrix test results.
 Please have someone contact me.

Name _____

Firm Name _____

Address _____

City _____

State _____

Zip _____

TRW CAPACITORS

ANOTHER PRODUCT OF A COMPANY CALLED TRW

YOU WERE HIRED FOR YOUR BRAINS, NOT YOUR BODY.

It's not as silly as it sounds. Because many bright engineers and technicians are still spending their time soldering, desoldering and resoldering. Instead of designing.

Which is pretty silly, considering the waste of talent. Especially when there's a better alternative.

With CSC Proto-Board[®] solderless breadboards, assembling a circuit is practically as fast as designing one. No special jumpers or patch cords required—all types of components—from complex microprocessors to resistors, capacitors and LED's—connect and interconnect as simply as pushing in a lead... or short lengths of #22-30 solid hookup wire. And circuit changes are done with the same

*Manufacturer's suggested list
Prices and specifications subject
to change without notice

MODEL	NO. OF TIE-POINTS	14-PIN DIP CAPACITY	MFR'S SUGGEST LIST *	OTHER FEATURES
PB-6	630	6	\$15.95	Kit—10-minute assembly
PB-100	760	10	19.95	Kit—with larger capacity
PB-101	940	10	29.95	8 distribution buses, higher capacity
PB-102	1240	12	39.95	Large capacity, moderate price
PB-103	2250	24	59.95	Even larger capacity, only 2.7¢ per tie-point
PB-104	3060	32	79.95	Largest capacity, lowest price per tie-point
PB-203	2250	24	75.00	Built-in 1%-regulated 5V, 1A low-ripple power supply
PB-203A	2250	24	120.00	As above plus separate 1/2-amp +15V and -15V internally adjustable regulated outputs

plug-out, plug-in ease. All thanks to rugged, nickel-silver contacts and CSC's superior use-tested design.

Proto-Board breadboards are available in a variety of sizes, from 630 to 3060 solderless tie-points (six to thirty-two 14-pin DIP capacity), at prices from \$15.95* (kit) to \$79.95. And if you'd like built-in regulated supplies, they're available too, in models priced at \$75 and \$120.

Before you start your next project, put down your soldering iron and call 203-624-3103 (East Coast) or 415-421-8872 (West Coast) for full specifications and ordering information. Once you do, you'll find yourself soldering less... and more than likely, earning more.

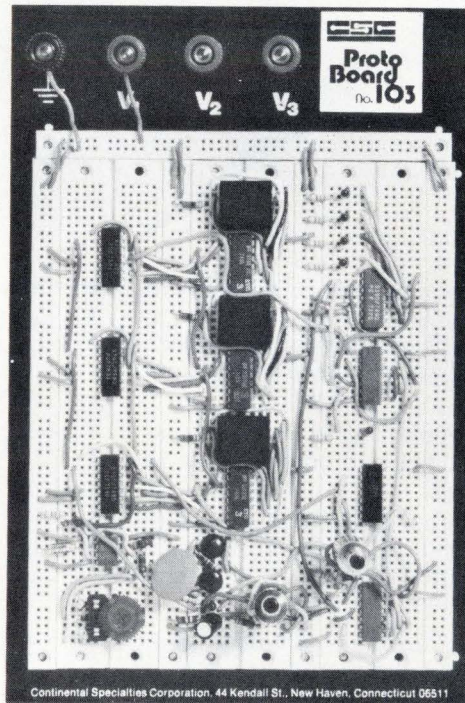

Continental Specialties Corporation, 44 Kendall St., New Haven, Connecticut 06511

CONTINENTAL SPECIALTIES CORPORATION

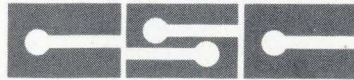

44 Kendall Street
Box 1942 New Haven CT 06509
203-624-3103 TWX 710-465-1227
West Coast office Box 7809, San Francisco CA
94119 • 415-421-8872 TWX 910-372-7992

© 1976, Continental Specialties Corporation

Circle 152 on reader service card

New products

have developed their own chip-handling equipment, Quantrad offers interfacing systems and hardware for low-cost updating of a company's laser-trimming system to automatic control.

Quantrad Corp., 139 Illinois St., El Segundo, Calif. 90245. Phone Wayne Stevenson at (213) 322-1452 [391]

Ultra-violet lamps speed EPROM erasing

Offering powerful short-wave capability, two new ultra-violet lamps reduce erasing time of erasable programable read-only memories to minutes. The model S-52T erases up to 16 chips in about seven minutes, while the UVS-54T handles up to

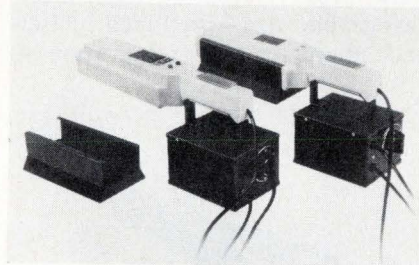

eight chips in about 14 minutes. Available in 115- and 220-volt versions, both include timer assembly and holding tray and are housed in a rugged case made of tough Cylolac plastic. Both versions are available from stock.

Ultra-Violet Products Inc., 5100 Walnut Grove Ave., San Gabriel, Calif. 91778. Phone Skip Spoden at (213) 285-3123 [393]

40-pin DIP clip costs only \$13.75

Selling for \$13.75, the PC-40 test clip is the lowest priced 40-pin DIP clip presently available, claims the manufacturer. Compatible with 0.6-inch-center ICs of as many as 40 pins, the clip features noncorrosive nickel-silver contacts for low-resistance connections and a narrow throat suitable for high-density circuit boards. The test terminals have gripping contacts to hold instrument

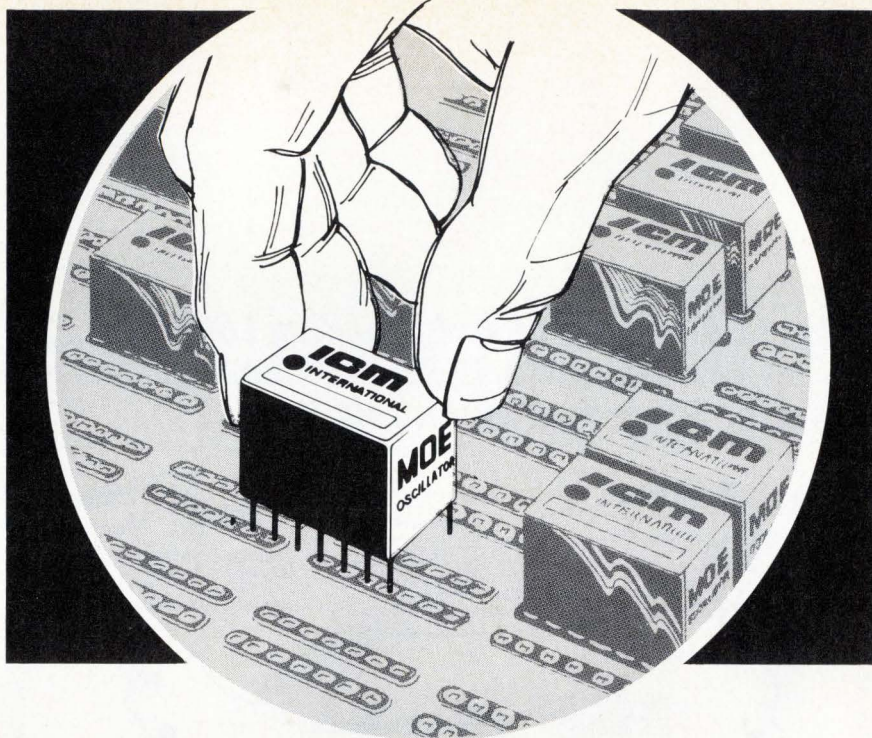

INTERNATIONAL'S moe CRYSTAL OSCILLATOR ELEMENTS

A Complete Controlled Signal Source from 6000 KHz to 60 MHz

The MOE series is designed for direct plug-in to a standard dip socket. The miniature oscillator element is a complete source, crystal controlled, in an integrated circuit 14 pin dual-in-line package with a height of 1/2 inch.

Oscillators are grouped by frequency and temperature stability thus giving the user a selection of the overall accuracy desired. Operating voltage 6 vdc. Output wave shape — non sine.

TYPE	CRYSTAL RANGE	OVERALL ACCURACY	25°C TOLERANCE	PRICE
MOE-5	6000KHz to 60MHz	+ .002% -10° to +60°C	Zero Trimmer	\$35.00
MOE-10	6000KHz to 60MHz	+ .0005% -10° to +60°C	Zero Trimmer	\$50.00

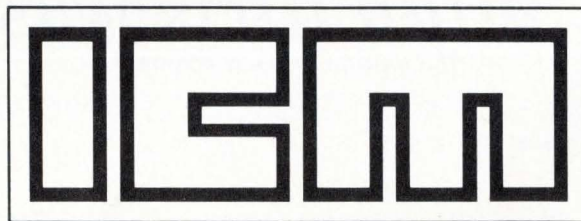

International Crystal Manufacturing Company, Inc.

10 North Lee, Oklahoma City, Oklahoma 73102

**Every Allied Office Is A Stocking Location . . .
And Now There Are THREE NEW Locations to
Better Serve Your Electronic Needs . . .**

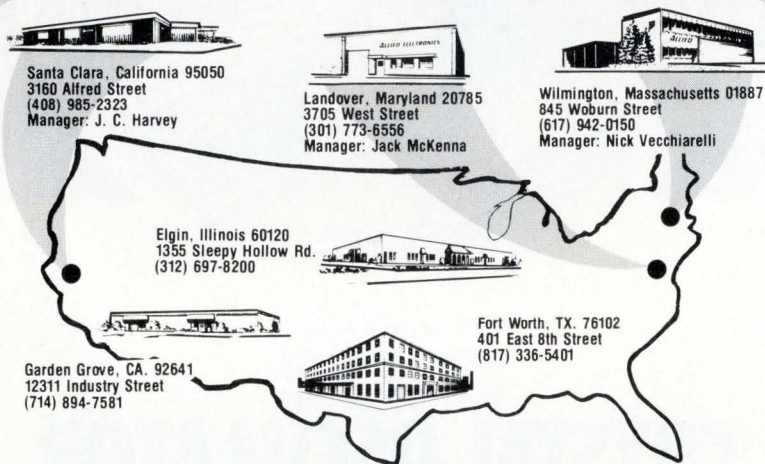

**Allied Shipped Complete FROM STOCK 88.9%
of All Line Items Written During April,
May and June of 1976**

Also, on Over 50% of the Balance, Partial Were Shipped!

Need parts instead of promises? Put Allied's staff of trained sales personnel to work for you! Get the parts you need when you need them — our six coast-to-coast stocking locations are ready and eager to help you. While others have less than a 75% fill from stock, we are continuing to improve on our higher (88.9) percent fill. And, we put our money where our mouth is! Any catalogued line item that Allied does not ship within one week, Allied will pay the shipping charges. This applies to all orders with the exception of Export, Pack and Hold, Ship Complete and Drop Ships.

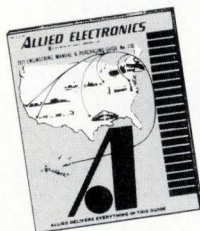

**NEW 1977 ALLIED ELECTRONICS ENGINEERING MANUAL AND
PURCHASING GUIDE NOW AVAILABLE FOR YOU . . .**

Our 1977 Guide fully describes thousands of electronic parts, components and replacement devices for Design Engineers, maintenance people, planners, estimators, buyers — anyone who specifies and uses electronic products. FREE to readers of this publication. Circle Reply Number below ad or send your request on company letterhead to:

**Allied Electronics, Dept. E-9, 401 East 8th Street,
Fort Worth, Texas 76102.**

"Number One Parts Place"

ALLIED ELECTRONICS

A DIVISION OF TANDY CORPORATION

Circle 154 on reader service card

New products

probes securely, and the over-all plastic construction of the test clip eliminates springs and pivots, assuring thousands of trouble-free operations.

Continental Specialties Corp., P. O. Box 1942, New Haven, Conn. 06509. Phone (203) 624-3103.

P. O. Box 7809, San Francisco, Calif. 94119. Phone (415) 421-8872 [394]

Cordless soldering iron charges fast

Equipped with a quick-charge nickel-cadmium battery that can completely recharge in four hours, the #200 cordless soldering station features a lightweight pencil iron with built-in lamp for illuminating the work area. Accepting two interchangeable tips—pretinned chisel and micro-spade configurations—



the iron offers touch-operation trigger control with an interlock switch. The UL-listed charging holder includes a tip-cleaning sponge tray and has a rated output of 3.2 volts dc at a charging current of 285 milliamperes, the maker reports.

Unger, Div. of Eldon Industries Inc., 233 East Manville St., Compton, Calif. 90220. Phone (213) 774-5950. [397]

Mini-lab temperature-tests components and wafers

Offering price savings of 30% over the cost of two independent systems, the TP22/34 allows the user to test components and wafers using a single controller. The tester has a temperature control range of

npe PLASTICS SHOW '76

What's up in electronics?

“Plastics...that's what!”

Plastics' use in electrical/electronic applications could easily quadruple by the end of the century — reaching 6.8 billion lbs. Reason? A rapidly growing technology is leaning away from metal to plastics and plastic-enclosed devices. Stay on top of the dramatically advancing world of plastics at NPE/76, December 6-10, McCormick Place, Chicago.

NPE/76 will be the most comprehensive U.S. plastics exposition in the history of this vital industry. More than 400 participating companies with more of everything... nearly 300,000 square feet of exhibits... new products... and equipment... design consultation services... educational seminars on plastics technology and applications... a cornucopia of new ideas and techniques to spark your company's profits... all available in one place, at one time, under one roof!

New convenience and economy too.

For the first time, a single economical registration fee entitles you to explore your special interests at the exhibits of the National Plastics Exposition as well as attend the eleven seminars of the concurrent National Plastics Conference. The low fee also includes unlimited free bus service between major hotels and McCormick Place.

Advance registration kit available.

Now you can register in advance for even greater economy and convenience. Your advance registration kit includes everything you need to pre-register at a price of \$7.50 (vs. \$10.00 at the door) as well as reserve your hotel room. To obtain your advance registration kit, write, or use the Reader Service Coupon. At NPE/76 you will have five, full, information-packed days. Plan to make the most of every minute.

Your competitive edge!

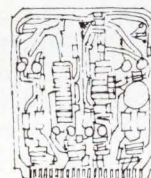

Electronics and plastics are inseparably linked. So there will be a lot of NPE/76 devoted to your specific interests.

- New materials
- New processes
- New applications

...and seminars on management, marketing, processing technology that will enable you to cut costs, increase sales, innovate, and plan for the future.

In the three years since the last Plastics Show, a lot has happened. The plastics industry moves fast. So catch up at NPE/76. Save time and money by registering in advance. Write The Society of the Plastics Industry, Inc., 355 Lexington Avenue, New York, N.Y. 10017, or... CIRCLE READER SERVICE NO. 155.

National Plastics Exposition 

Sponsored by The Society of the Plastics Industry, Inc.

Analogic's single chip DPI performs!



...And is low cost.

Yes, indeed, for over two years thousands of Analogic's AN2538's have been proving themselves as the premier "single-chip", bipolar, 3½ digit DPI. Imagine an MTBF of 60,000 hours. That's something you can really put *on the line!* And the AN2538s are made by Analogic, the World's Largest Manufacturer of DPIs.

- LOW POWER; LOW PARTS COUNT; LOW BIAS CURRENT; (50 Pa) LOW ZERO DRIFT ($2\mu V/^\circ C$) and of course at a low cost of \$69.00.
- HIGH RELIABILITY; HIGH INPUT IMPEDANCE; HIGH ACCURACY (0.05% reading ± 1 count)
- PLUS Off-the-Shelf Delivery; Auto-zeroing; Bi-polar; LED display; Meets specs immediately (No warm-up drift); cool running; DIN/NEMA standard plastic case (metal optional); Universal Line Power (100, 117, 220, 240V, all $\pm 10\%$, 47-63Hz).

For complete data on the AN2538 and short-form catalog showing our complete line of 16 types of DPIs, contact Bob Shipione at (617) 246-0300 or for your local Analogic sales office or stocking distributor, write today: Analogic Corp., Audubon Road, Wakefield, Mass. 01880.

ANALOGIC ■

...The Digitizers

Circle 156 on reader service card

New products



30–200°C. It controls both a heating head for the on-board testing of various components and a heating chuck designed to replace existing chucks on wafer probers with no electrical or mechanical interference of probing performance. Temperature gradient across the chuck surface is less than 1°C.

Temptronics Corp., 40 Glen Ave., Newton, Mass. 02159. Phone (617) 965-3420 [395]

Wire-Wrap panels offer high-density packaging

Capable of handling up to 200 ICs of any mix of 14- to 42-pin dual in-line packages, the 326 series of Wire-Wrap panels combines high density with flexibility of design. Input/output provisions of as many as 540 pins permit subdivision of logic with no sacrifice in electrical or mechanical integrity. Together with the multiple voltage-supply planes the I/O suits

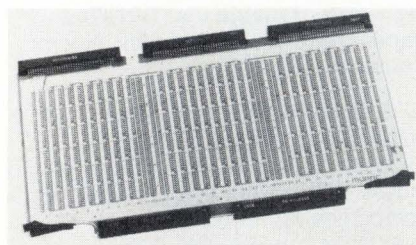

the panels for prototyping of micro-processor and other MSI/LSI circuit designs.

The panels may be mounted in conventional modular rack assemblies with multiple voltage-connector power planes or on planar frames with ribbon-cable I/O provisions.

Mupac Corp., 646 Summer St., Brockton, Mass. 02420. Phone (617) 588-6110 [396]

All aerosols are not alike.

The constant progression of sophistication in electronics has demanded a parallel progression in standards of purity. Industrial cleaning is one very vital link in maintaining component and system purity and reliability.

Let's look at eight important criteria and compare Miller-Stephenson products to the general aerosol industrial cleaner industry.

SOLVENTS:

Miller-Stephenson — Most of our aerosols contain 80% Active Ingredient, 20% Propellant.

Other Aerosol Cleaners — Active Ingredient averages 70-75%.

Miller-Stephenson — Uses only Certified Virgin Solvent.

Other Aerosol Cleaners — Some utilize reclaimed solvents. Though lower in cost, reclaimed solvents usually contain foreign substances.

PROPELLANTS:

Miller-Stephenson — Uses only the highest purity, safest propellants. They are nonflammable - TWA 1000 ppm.

Other Aerosol Cleaners — Many use cheap, sometimes flammable, sometimes higher order of toxicity propellants.



FILTERING:

Miller-Stephenson — We double filter "Freon" solvent and propellant — first with a 0.5 micron filter, then with a Millipore 0.2 absolute filter.

Other Aerosol Cleaners — Some use no filters; others only a 0.5 micron filter.

LOADING LINES:

Miller-Stephenson — All loading lines are dedicated to the individual ingredients used.

Other Aerosol Cleaners — Loading lines are often used for multiple products and if not thoroughly flushed, contamination will occur.

LOADING ENVIRONMENT:

Miller-Stephenson — Class 100 Clean Room conditions.
Other Aerosol Cleaners — Normally uncontrolled — environmental contamination can occur.

VOLUME PRODUCTION:

Miller-Stephenson — Our principal raw materials come direct from Du Pont tankers into our 5500 gallon storage tanks through a closed system direct to container.
Other Aerosol Cleaners — Low volume suppliers often load from open 55-gallon drums thereby introducing possibility of contamination.

CONTAINER:

Miller-Stephenson — Our new seamless cans further reduce the possibility of contamination.
Other Aerosol Cleaners — Cans with soldered seams may introduce residual contaminants.

SAFETY IN SHIPPING:

Miller-Stephenson — Most of our "Freon" aerosol solvents are non-regulated items, exempt from all Federal Regulations "Restricted Articles". May be Shipped Air Transport.

Other Aerosol Cleaners — Do not meet Air Transport Regulations.

MS aerosol solvents have the lowest residual contamination in the industry — some approaching 5-7 ppm. The general range for the industry is 50-130 ppm.

"Freon" is Du Pont's registered trademark for its fluorocarbon compounds.

miller-stephenson

E-10U

Danbury, Connecticut 06810 (203) 743-4447

- Enclosed is \$2.00, please send my "Trial Unit" of MS-180.
 Enclosed is \$5.00, please send my "Trial Units" of MS-180 & Cobra Brush.
 Please send FREE literature and prices.

Intended Use _____

Name _____ Dept./Title _____

Company _____

Address _____

LOS ANGELES • CHICAGO • DANBURY, CT. • TORONTO

Circle 157 on reader service card



MS-226 "COBRA"
Solvent Spray
Brush

Scrubbing action dislodges hard-to-remove residue. Fits all Miller-Stephenson aerosol solvents and cleaners.

welcome addition to the family



TRW/Cinch low cost Series 90 PC edge connectors

These TRW/Cinch Edge Connectors were created to beat rising material costs while maintaining product performance. Designed with 20 microinches of gold—at the contact areas only, over 30 microinches of nickel underplate—with high capability, glass-filled polyester insulators, they cost about 20% less than our standard commercial units, 50% less than our military types. The use of nickel, an effective barrier to base metal migration, rather than copper underplate, provides a longer wearing, more stable gold layer.

As with other members of TRW/Cinch Edge Con-

necter family, you have a choice of seven sizes from 6 to 25 positions, in both dip solder and solder tab terminations—and delivery is when you expect it, from TRW/Cinch Connectors or its distributors.

For more information call your nearest sales office or distributor (listed in EEM)—or contact TRW/Cinch Connectors, An Electronic Components Division of TRW, Inc., 1501 Morse Avenue, Elk Grove Village, Illinois 60007, (312) 439-8800. CC-7603

TRW CINCH CONNECTORS

ANOTHER PRODUCT OF A COMPANY CALLED TRW

Circle 158 on reader service card

New products

Subassemblies

Hybrid op amps minimize drift

Units for inverter uses have feed-forward amplifier for fast slew and low drift

Operational amplifiers in module form for inverting applications are bulky and expensive. Currently available space-saving hybrid counterparts use a field-effect-transistor input stage, which makes them subject to drift. Engineers at Datel Systems Inc. have overcome the drift problem in their AM-500 series of 14-pin DIP-housed hybrids for fast-settling inverting usage in high-frequency drivers, fast integrators, or the output stages of fast digital-to-analog converters and sample-and-hold circuits.

Datel has incorporated a feed-forward amplifier design that pro-

vides a settling time of 200 nanoseconds to an accuracy of 0.01%, a slew rate of 1,000 volts per microsecond and a drift of just 1 microvolt/°C. Those specifications are accomplished in combination with a minimum gain bandwidth of 100 megahertz.

Eugene Zuch, product marketing manager, says that Datel uses an AM-500 in its own recently introduced SHM-5 ultra-fast sample-and-hold module, which has a signal-acquisition time of 200 ns and is accurate to within 0.1% (*Electronics*, Sept. 2, p. 198). Its usage in that module has given Zuch confidence that the AM-500 specifications are accurate because "hundreds" of the circuits have been successfully produced, he says.

The specifications also include these dc characteristics: open-loop gain of 10^6 , 30-megohm input impedance, and a 1-nanoampere bias current. Input offset voltage is ± 0.05 millivolt, and input-voltage drift is $1 \mu\text{V}/^\circ\text{C}$. Three versions are being offered: the model AM-500GC, which covers the tempera-

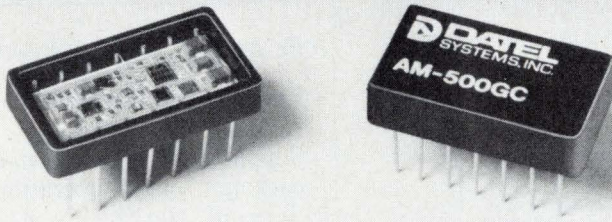
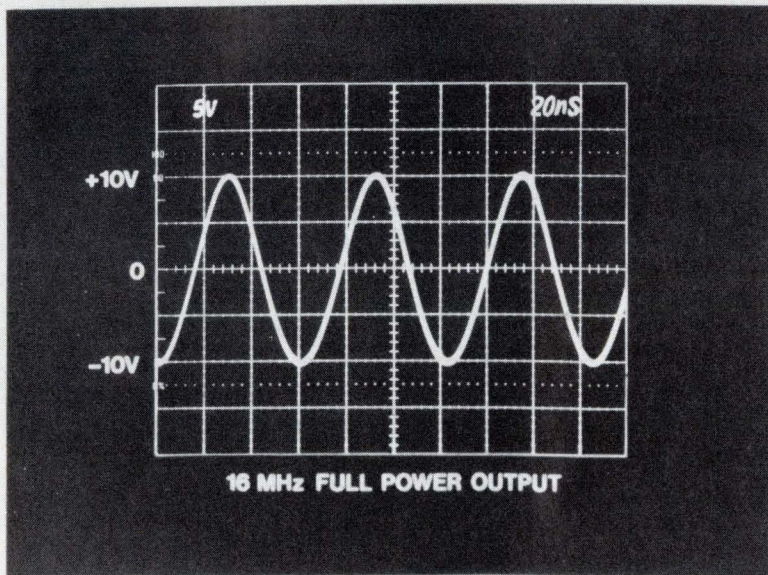

Economy Mini- computer Data Acquisition Systems

The ADAC Economy Series of software and mechanically compatible mini-computer data acquisition systems are for use with the DEC PDP-11, PDP-8E, F, M, A, and Data General computers.

* The basic system features include a 12 bit A/D converter, high speed sample and hold, 16 channels of mux, DC/DC power converter, bus interfacing, cable and complete documentation. A/D system throughput rate is 35 KHz.

Capability of expansion to 64 mux inputs, D/As, S & H, programmable gain amplifier with auto zero circuit, and DMA are optionally available.

Send for full technical data on the Economy Series and other ADAC minicomputer/microcomputer data acquisition and control systems and modules.

ADAC Corporation,
15 Cummings Park, Woburn,
MA 01801 Tel.: 617/935-6668

GSA Contract Group 66

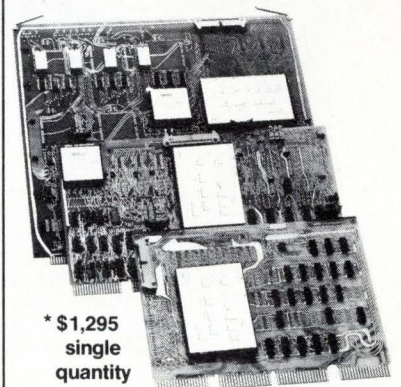

adac
corporation

PORTABLE

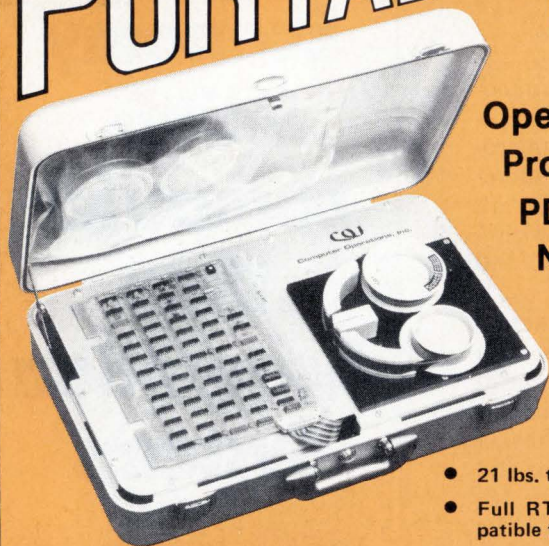

Operating System/ Program Loader for PDP[®]-11/LSI-11, NOVA[®] and Micro-Computers The Linear Disc- LINC TAPE

**\$2295 (unit qty)
w/controller**

Computer Operations, Inc.

9700-B GEORGE PALMER HWY.
LANHAM, MARYLAND 20801
(301) 459-2100 • TELEX 89-8327

- 21 lbs. total weight
- Full RT-11 support on DECTape[®] compatible tapes for PDP-11/LSI-11
- Full SOS with named files support for NOVA computers
- Edit, Assemble, Compile programs in the field
- Fill 16K word, 16 bit memory in 4 sec.
- Load diagnostics quickly and reliably
- Fits under airline seat or check as baggage
- XXDP support for PDP-11

Circle 160 on reader service card

TOUCH-TONE^{*}

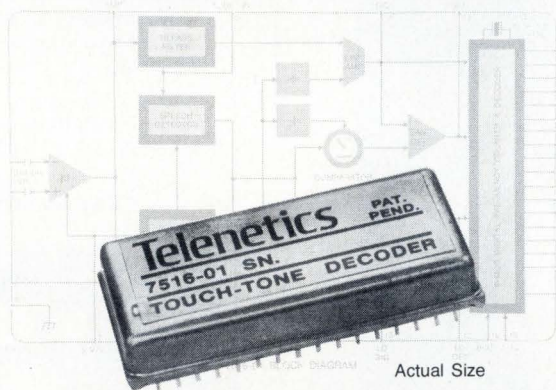

Telenetics' 7516-01 is a complete Touch-Tone Decoder in a 1/2 cubic inch, 32 pin DIP. Telephone Standard 2-of-8 tones are received, processed and decoded into discrete 1-of-16 or BCD (plus strobe) outputs. Input signal ranges -22 to +4 dBm with a balanced, capacitively coupled, 50 K Ω impedance. Operating voltage range is 8 to 28V dc (single supply); temperature range -30 to 70°C.

Telenetics 7516-01 gives you one-tenth the size at one-third the cost of comparable Touch-Tone Receivers. Telenetics also offers these other devices:

- 7603 Touch-Tone Encoders
- 7511 Address Selector
- 7507 A complete line of Multiplexers and Analog Switches
- 7635 Touch-Tone Keyboards

Write or call today for a catalog—and pricing information:

Telenetics

Telenetics, Inc., 4120 Birch Street,
Newport Beach, California 92660
Phone: (714) 752-6363

*R-Registered trademark of AT&T

New products/materials

ture range from 0°C to 70°C, with a price of \$85 in quantities of one to nine and a hermetically sealed glass case; AM-500MR for -25 to +85°C, which sells for \$95, and the AM-500MM for the -55 to +125°C range, which carries a \$135 price tag. The latter two units are in metal cases, and delivery time is six weeks; the AM-500 GC is available from stock.

Datel Systems Inc., 1020 Turnpike St., Canton, Mass. 02121. Phone (617) 828-8000 [381]

Data-acquisition system handles low and high levels

Designed to handle full-scale inputs as low as ± 10 millivolts and as high as ± 10 volts, the model SDM853 data-acquisition system is a 12-bit unit with 8 differential or 16 single-ended input channels. The system is extremely flexible because its input analog multiplexer, its gain-setting instrumentation amplifier, its sample-and-hold amplifier, and its analog-to-digital converter are not internally connected. The C-MOS analog multiplexer eliminates the need for stocking two comparable units for single-ended and differential inputs. The instrumentation amplifier can be programmed to have gains from 1 to 1,000, with an offset voltage drift of 2 microvolts/°C at a gain of 1,000. Minimum throughput sampling rates as high as 30 kilohertz are possible with full 12-bit performance; if 8 bits are adequate, throughputs up to 43 kHz can be achieved.

In quantities of 100, the SDM853 sells for \$170 each. Delivery is from stock to two weeks.

Burr-Brown, Box 11400, Tucson, Ariz. 85734. Phone C.R. Teeple at (602) 274-1431 [384]

Power op amp delivers more than 1 ampere

Supplied in 8-pin, hermetic TO-3 packages, power operational amplifiers of the series 833-21 can

If you don't have time to read 2000 magazines for technology innovations, have we got something for you.

Next month you can get reports on technology innovations in categories you specify, in this magazine and 2000 others.

And we'll do the reading.

We're TINA (Technology Innovation Alert), the INSPEC organization combined with the worldwide computerized network of Control Data Technotec. We'll give you access to the top ten thousand technology innovations from more than two thousand journals we study every year.

And because it's Technotec, your reports can be instantaneously available,

worldwide. We can send them to you through your in-house timesharing computer terminals. Or we can supply them by Telex, or mail.

To learn more, call 612-853-3575, or write to Technotec (TINA), Control Data Corporation, Box O, Minneapolis, Minnesota 55440.

TECHNOTEC

 a technology exchange service of
CONTROL DATA CORPORATION

High Voltage Diffused Silicon Rectifiers

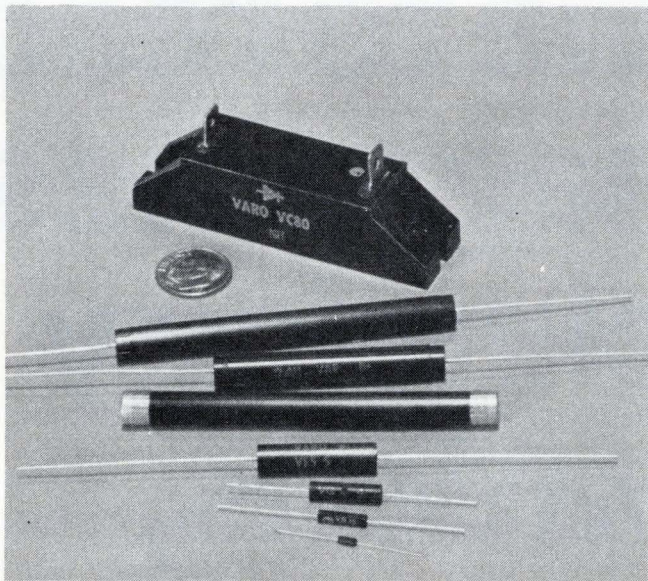

Varo Semiconductor, Inc. offers you the industry's most complete line of high voltage rectifiers for commercial and industrial applications that require high reliability at an economical cost.

Choose from one of these series:

VA, VB SERIES

- 1kV to 6kV (V_{RRM})
- 20 to 100 mA (I_o)
- 3A 1/2 cycle surge
- Fast recovery series (250ns, t_{rr})
- Minimum size

VG SERIES

- 1kV to 20kV (V_{RRM})
- 5 to 100 mA (I_o)
- 3A 1/2 cycle surge
- Fast recovery series (250ns, t_{rr})

VC SERIES

- 2kV to 8kV (V_{RRM})
- 1A to 2A (I_o)
- 50A 1/2 cycle surge
- Fast recovery series (300ns, t_{rr})

VF SERIES

- 5kV to 40kV (V_{RRM})
- 5 to 25 mA (I_o)
- 3A 1/2 cycle surge
- Fast recovery series (250ns, t_{rr})
- Axial lead or ferrule end caps

For more information
call Ms. Pat Brisendine
214/272-4551



Design us in . . . we'll stay there
VARO SEMICONDUCTOR, INC.

P.O. BOX 676, 1000 N. SHILOH, GARLAND, TEX. 75040
(214) 272-4551 TWX 910-860-5178

EUROPEAN OFFICE: UK: VARO SEMICONDUCTOR INTERNATIONAL, INC.
Deepdene House, Bellegrave Road, Welling, Kent, England DA163PY, 01-304-6519/0

New products

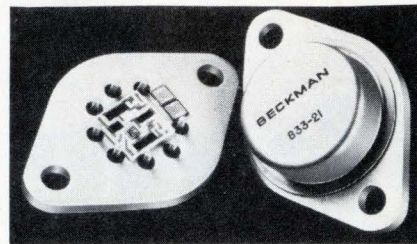

produce output currents in excess of 1 ampere. With an adequate heat sink, the units can dissipate 22 watts at 25°C. The units have a full-power bandwidth of 15 kilohertz (40 kHz, typical), a quiescent power requirement of only 200 milliwatts, and an input offset voltage of 1 millivolt. Typical applications of the amplifiers include cathode-ray-tube deflection, servo driving, audio amplification, and use in automatic test equipment.

The model 833-21 operates from -55°C to 125°C and sells for \$26.15 each in hundreds. It is a pin-for-pin replacement for National's LH0021, and its specifications are similar. The model 833-21C covers -25°C to 85°C, and the device carries a 100-piece price tag of \$13. It competes with National's LH0021C.

Beckman Instruments Inc., Technical Information Section, Helipot Division, 2500 Harbor Blvd., Fullerton, Calif. 92634 [383]

Synchro-to-digital converter takes up little room

Housed in a module that measures 2.12-by-2.56-by-0.82 inches, the series LSI/90 synchro-to-digital converter is believed to be the smallest such single-module unit available. Modules that provide 10- and 14-bit

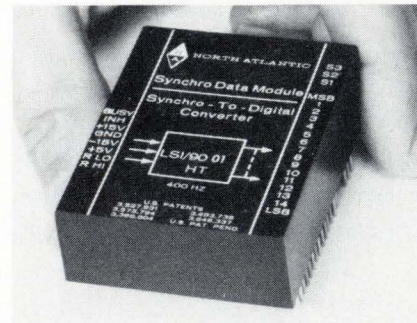

Model
AI-400

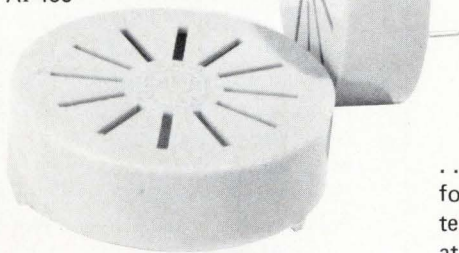

Actual Size

WE'RE WARNING YOU...SM

... this is a lot of buzzer in a little package! Designed with two pins... for PC board mounting and wave soldering. Easy to use for computer terminals, medical equipment, point-of-sale terminals. Rated to 90 dbA at 2.9 kHz; 5 to 30 vdc; draws just 10 mA maximum current. Sturdy yellow plastic case; 1.625" (41.3mm) overall diameter. Ask for free catalog and a demonstration.

Where to buy an audio indicator for every need:



projects[®]
unlimited

3680 Wyse Road, Dayton, Ohio 45414
Tel. (513) 890-1918, TWX 810-450-2523

Distributors throughout the world.

CALIFORNIA, COSTA MESA
MarVac Electronics

COLORADO, DENVER
Waco Electronics Inc.

MASSACHUSETTS, SHARON
Adcour

MICHIGAN, FARMINGTON
CMP Distributor Co.

MISSOURI, ST. LOUIS
Olive Industrial Elec.

NEW YORK, ROCHESTER
Osmann Component Sales

OHIO, CLEVELAND
CMP Distributor Co.

OHIO, CINCINNATI
COLUMBUS
Hughes Peters, Inc.

TEXAS, DALLAS
K. A. Electronic Sales

UTAH, SALT LAKE
Newark Electronics

WASHINGTON, SEATTLE
Frank Jackson & Associates

WISCONSIN, MILWAUKEE
Taylor Electric Co.

B. C., VANCOUVER
Deskin Sales Corp.

ONTARIO, TORONTO
Deskin Sales Corp.

ONTARIO, WILLOWDALE
Electro Sonic, Inc.

QUEBEC, MONTREAL
Deskin Sales Corp.

Circle 163 on reader service card

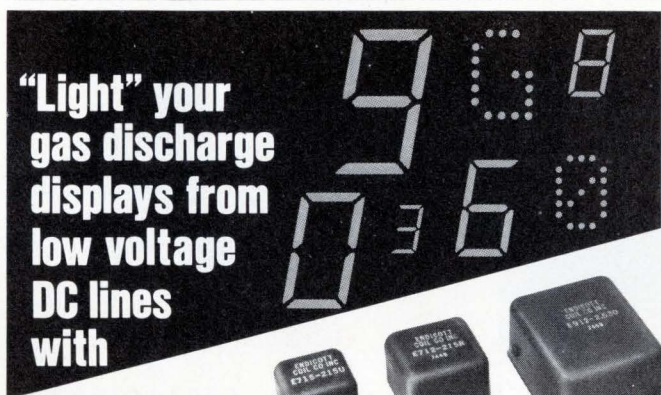

"Light" your
gas discharge
displays from
low voltage
DC lines
with

DC-to-DC Power Supplies

When you must convert low DC line voltages to nominal 200 or 250 V DC levels in order to activate gas discharge displays, ask us to recommend the DC-to-DC power supply that's right for your application.

Various models available:

- Standard inputs—5, 9, 12, 15 V DC; others under 5 V DC and up to 48 V DC.
- For seven-segment and matrix-type displays.

- Regulated and unregulated.
- Single and dual output, capable of up to 12 W total.
- Outputs from 5 V to 1500 V DC.

Compact size and light weight help give easy portability to equipment in which they are used!

Need custom designed power supplies for your gas discharge displays? Ask about our custom engineering and production capabilities.

Write for
free
literature:



ENDICOTT COIL

32 Charlotte St., Binghamton, N.Y.
13905 (607) 797-1263



NEW!

CHASSIS MOUNT MODULAR POWER SUPPLIES

The new CM series from Calex brings you the ultimate convenience in packaging. Prices start at \$39., for ±15V @ 50mA. Units are available with ±15V @ 200mA outputs, 5V @ 1 Amp and triple outputs also! For that next instrument design or bench supply, buy the best—buy Calex! Call or write for your complete brochure today.

CALEX

**CALEX MFG. CO., INC. 3305 Vincent Rd.,
Pleasant Hill, CA 94523
(415) 932-3911**

Circle 195 on reader service card

Circle 196 on reader service card 163

THE SUNSHINE STATE OFFERS HIGHER PROFIT POTENTIALS TO ELECTRONIC PRODUCTS MANUFACTURERS THAN ELSEWHERE IN THE COUNTRY!

Florida's substantial labor and operating cost advantages, plus ready access to the markets of the United States, Latin America and the world, combine to offer a unique profit opportunity for a Florida-based manufacturer.

Before you make any decisions regarding your business, this new industry study documenting Florida's position should be reviewed carefully.

To get your copy of *Florida Profit Potentials in Electronic Products Manufacturing*, write or call:

FLORIDA
WE'RE MORE THAN SUNSHINE

Joe Hennessy, Director
Division of Economic Development
Florida Department of Commerce
107 W. Gaines Street, Room 103E
Tallahassee, Florida 32304
(904) 488-5507

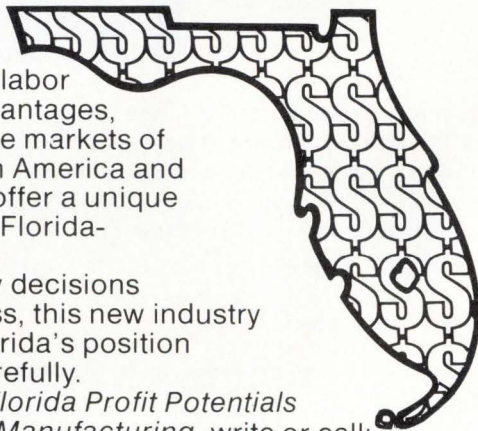

Circle 164 on reader service card

STOP TRANSIENT NOISE

ELIMINATE ERRORS IN YOUR COMPUTER OR INSTRUMENT SYSTEM

DELTEC DT series isolation transformers are designed for data loggers and process control systems. These isolators drastically reduce memory and transmission errors caused by transient noise on commercial power lines generated by industrial electrical equipment.

Common Mode Rejection is 140dB and interwinding capacitance is less than 1 femtofarad (0.001 pf).



Models are available from stock from 250 VA to 5 KVA. 3 Phase and special models available. For detailed specifications write or call:

DELTEC

CORPORATION

980 Buenos Ave., San Diego, CA 92110
Telephone (714) 275-1331

164 Circle 197 on reader service card

New products

resolution are offered. Standard operating temperature range is 0°C to 70°C although a special HT version is rated for operation from -55°C to 105°C. Accuracy is within 3 minutes up to 1,440° per second.

Electrically identical to North Atlantic's standard-size LSI/85 series, the LSI/90 series is slightly more expensive.

North Atlantic Industries Inc., Terminal Dr., Plainview, N.Y. 11803. Phone Ken Salz at (516) 681-8600 [387]

D-a converter offers 15-bit four-quadrant multiplying

A high-speed multiplying digital-to-analog converter, the model DAC-M, offers four-quadrant operation with a resolution of 15 bits. The thick-film hybrid device, which is housed in a 2.625-by-3.125-by-0.42-inch module, is intended for use in X-Y plotters, character generators, programed pulse generators, and

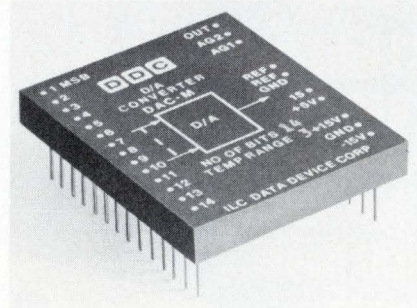

meter drive circuits. Offered in several accuracy grades with maximum errors from 0.024% down to 0.0031%, the DAC-M sells for \$270 and up. Output slew rate is 5 volts per microsecond minimum.

ILC Data Device Corp., Airport International Plaza, Bohemia, Long Island, N.Y. 11716. Phone (516) 567-5600 [386]

Logarithmic amplifier is extremely versatile

The model 4356 logarithmic amplifier is a bipolar device whose transfer function is linear for small

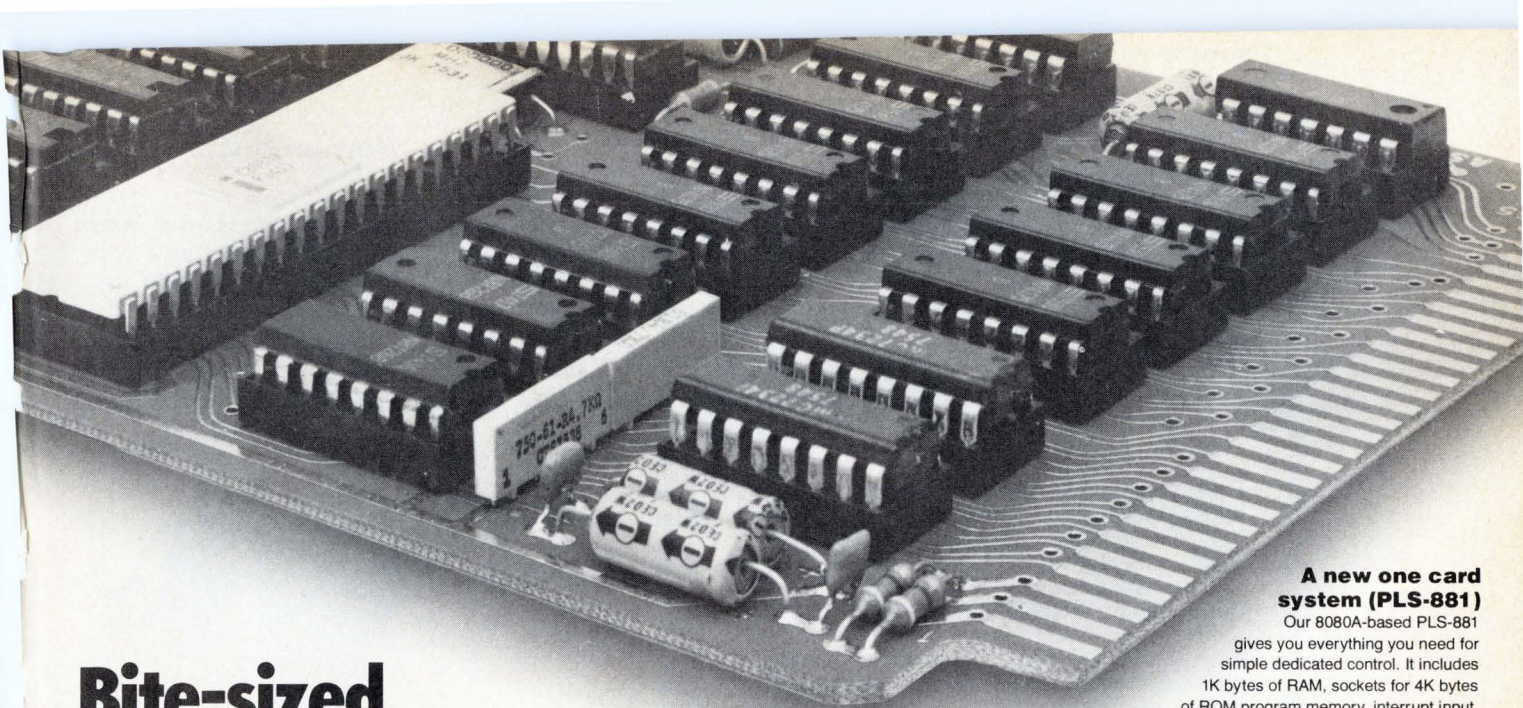

Bite-sized 8080A systems make big boards hard to swallow.

A new one card system (PLS-881)

Our 8080A-based PLS-881 gives you everything you need for simple dedicated control. It includes 1K bytes of RAM, sockets for 4K bytes of ROM program memory, interrupt input, crystal clock, power-on and external reset, three 8-bit output ports, and two 8-bit input ports. It costs only \$195 in 100 piece quantities.

Simple, flexible, standardized Pro-Log 8-bit microprocessor systems a best buy for OEM's.

We sell 8080A, 6800 and 9002 microprocessor cards two ways; as complete single or multicard systems, or as individual CPU and support cards so you can build a system of your own.

Our cards are all standard 4.5" by 6.5" with 56 pin edge connectors. They fit into standard card racks. To keep you from being tied to a specific semiconductor manufacturer for parts, delivery and pricing, our 8080A and 6800-based systems use only second-sourced parts.

Buy 250 of any particular card and we throw in free its manufacturing and assembly plans and non-exclusive rights to manufacture it, allowing you to build your own hardware, relying on us as an established and dependable second source.

We've got 4-bit systems, instruments, education and literature, too.

4-bit 4040 and 4004 systems; 4- and 8-bit microprocessor system analyzers; PROM programers; a half-day economics seminar for decision makers; a three-day hands on design course for engineers; manuals and support documentation.

Call or write for data sheets or a free copy of The Microprocessor User's Guide.



PRO-LOG CORPORATION
2411 Garden Road
Monterey, CA 93940
Telephone (408) 372-4593
TWX 910-360-7082

A new, expandable plug-in CPU card (8821)

Our "buffered bus" 8821 processor card implements the 8080A as a fully TTL buffered microprocessor. Add one I/O card and it becomes a complete two-card system. Or expand it to use full 8080A memory and I/O capability—it's compatible with all the Pro-Log ROM, RAM and I/O modules shown here plus many more. The 8821 costs only \$190 in 100-piece quantities. We also have equivalent cards implementing the 6800 and 9002 microprocessors.

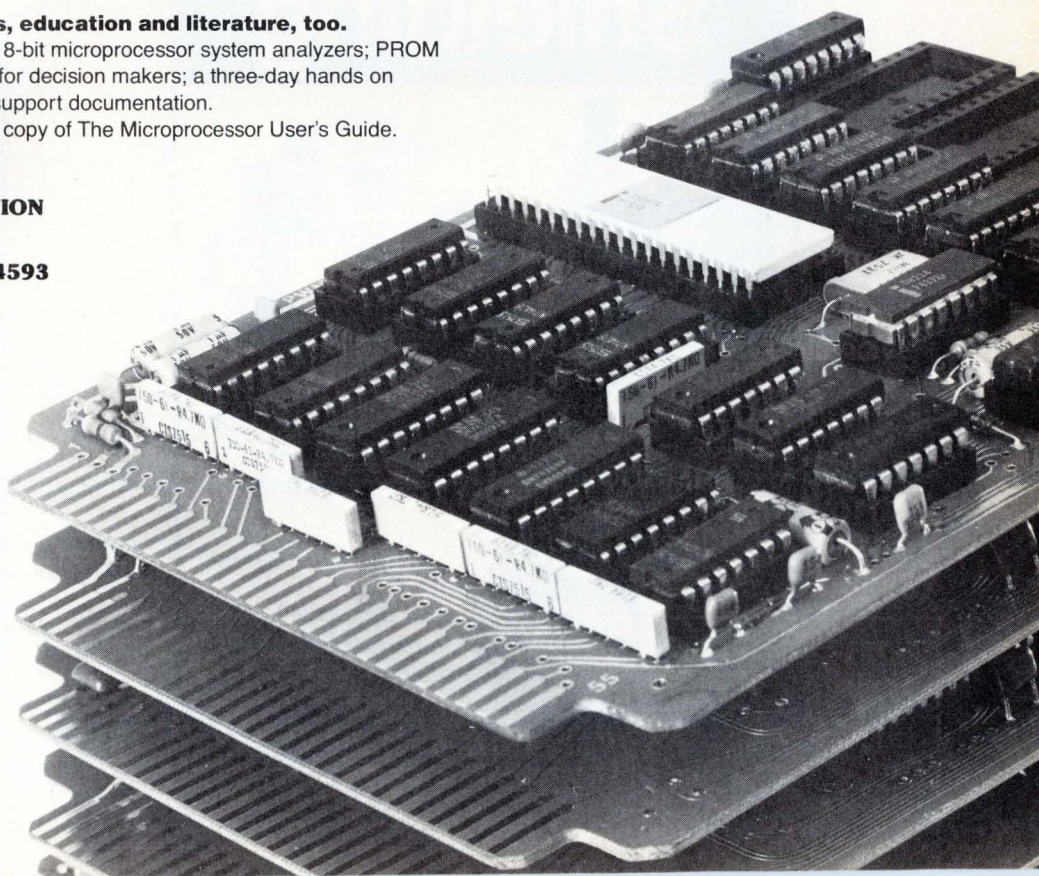

New Press Top Coolers are today's best buy for a nickel.

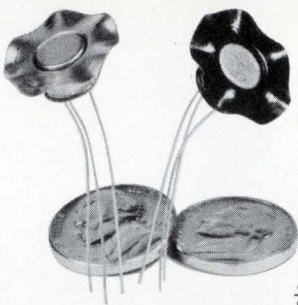

Here's how to really cut cooling costs for TO-5 packages. Wakefield's new 298 Press Top Coolers cost only 5¢ each in 5,000 quantity. This is less than 1/2 the price of comparable IERC Fan Tops or Thermalloy devices . . . and at no sacrifice in performance. With ΔT_{C-A} less than 70°C/W.

The unique wave design of the cooler is responsible for the high cooling efficiency while new automatic tooling allows the low price.

Try one free:

298 Coolers need no board space. See for yourself how they can solve heat problems and improve transistor performance. Send for a free sample.

Cut out and mail for a free sample.



WAKEFIELD ENGINEERING INC.

77 AUDUBON ROAD, WAKEFIELD, MA 01880 (617) 245-5900
TWX 710-348-6713 AN EG&G COMPANY

Circle 166 on reader service card

Magnetic Shielding



Custom & Standard Shields • Sheet & Foil
Design • Engineering • Fabrication
Heat Treating • Finishing • Testing



Catalog on request

P.O. Box 24283
Indianapolis, IN 46224
Phone (317) 297-1030

New products

signals but logarithmic for large ones. Thus it can be used as a non-saturating amplifier for audio systems that often have transients at their inputs (a machine-shop intercom, for example), as a dynamic speech compressor or expander, as



an open-loop automatic gain-control circuit, or as an inverse hyperbolic-sine generator.

The amplifier has a full-power bandwidth that extends from dc to 20 kilohertz. It will provide three-decade (1,000:1) logging action from dc to 10 kHz and 60 decibels of dynamic compression or expansion of data or speech from dc to 3 kHz. Priced at \$60 for small quantities, the model 4356 is available from stock.

Teledyne Philbrick, Allied Drive at Route 128, Dedham, Mass. 02026. Phone (617) 329-1600 [385]

TOPICS

Subassemblies

Analogue Corp., Wakefield, Mass., has announced a price reduction of about 15% on its model MP6912 16-channel, 12-bit data-acquisition modules. For small quantities, the 100-kilohertz model is reduced from \$695 to \$595, and the 60-kHz model from \$595 to \$495. . . Emphasizing this trend in the competitive data-acquisition field, **Data Translation Inc., Framingham, Mass.**, has reduced the price on its 12-bit, 16-channel DT5701 by 25% from \$350 to \$275. . . **Burr-Brown Research Corp., Tucson, Ariz.**, has announced price cuts of more than 15% for its model 3660 low-drift instrumentation amplifiers.

New products/materials

Solder that melts at 293°F has many applications in electronics. Among them are the soldering of heat-sensitive components, flexible printed circuits, gold-plated circuits, and situations in which a solder joint must be made close to, or on top of, another solder joint. In this last case, the first joint should be made with standard tin/lead solder, and the



second with low-temperature TLC alloy. TLC, which gets its name from the tin, lead, and cadmium that compose it, has an ultimate tensile strength of 4 tons per square inch. Unlike cadmium-bearing alloys for high-temperature brazing, TLC is considered completely nontoxic in use. It is furnished in wire form with five cores of activated rosin flux. Prices range from \$5 to \$7 per pound depending upon gauge and quantity.

Multicore Solders, Westbury, N.Y. 11590
[476]

A general-purpose detergent for lab use, Deconex is an alcohol-containing alkaline formulation that removes dirt, grease, oil, insoluble organic salts, baked-on glue, coal-tar products, and many other contaminants from laboratory glassware, plastic, rubber, and nonoxidizing metals. Useful on many electronic parts and safe for hand washing in recommended dilutions, the detergent has a pronounced germicidal effect. Special non-foaming varieties of Deconex are available for washing-machine use, including one acidic formulation, which is particularly effective against alkaline sub-

Thermal Imaging TV
is still in its infancy—
so is the Pyroelectric
Vidicon...

but when
you're ready

for Pyroelectric Vidicons— Come to Amperex

Thermal imaging TV (8-14 μ) is becoming a reality, and Amperex state-of-the-art pyroelectric vidicon (PEV) tubes figure to be the key factor. Amperex is America's leader in PEV technology; anyone with a stake in this field owes it to himself to keep up with what we are doing.

To help you get going in thermal imaging TV, our prototype PEV tubes and applications assistance are available for your evaluation.

For more information, contact: Amperex Electronic Corporation, PEV Marketing, Slatersville, Rhode Island 02876.
Tel.: 401-762-3800.

Amperex

TOMORROW'S THINKING IN TODAY'S PRODUCTS
A NORTH AMERICAN PHILIPS COMPANY

Circle 167 on reader service card

NEW LOOK BATON TOGGLE



CST
SERIES

A new generation of toggle switches with the look of tomorrow. A full line offering a choice of 2 or 4 poles, and 2 or 3 positions in a compact case style for PC board mounting. Its cylindrical aluminum baton actuator is attractive and offers excellent tactile feel. Long life expectancy in excess of 10,000 operations at 300 ma rating.

Circle 207 on reader service card

1/2" ROTARY SWITCH



MRB
SERIES

Rugged, compact and dependable describes this new rotary switch series. Features adjustable stops and molded-in terminals. Available in 1, 2, 3 and 4 poles and up to 10 positions. Choice of wired or PC terminals. 1/8" dia. shaft; with or without knob. Write or call (617) 685-4371 for additional information, samples and pricing.

ALCO ELECTRONIC PRODUCTS, INC.
1551 OSGOOD STREET, NORTH ANDOVER, MA 01845 U.S.A.

TEL: (617) 685-4371 FAX: (617) 342-0532

A SUBSIDIARY OF **AUGAT** INC.

MaX-Y line-up

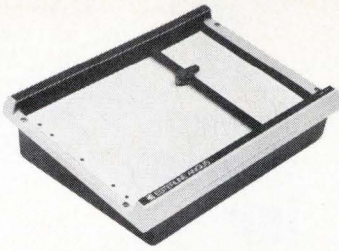
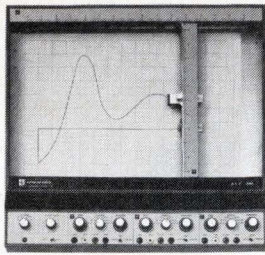

Esterline Angus has the newest and best in X-Y recorders, many models from high speed 2 pen to new stripped down OEM. Maximize your choices: rugged 'XXX' Model 540 zips along at up to 30 ips on each axis. Plots 2 independent variables against time or 3rd variable. Multirange with vernier on all axes. One millivolt/in. sensitivity.

OEM Model 575 contains a unique Y-axis pen shuttle with throwaway fiber-tip pen and pen lift in a single assembly. Slew speeds of 50 ips! Single ranges from 1 mV to 10 V/in. Add-on multirange module available for lab use. Full X-Y catalog: Esterline Angus Instrument Corporation, Box 24000, Indianapolis, Indiana 46224. Telephone 317/244-7611.



Circle 208 on reader service card

New products/materials

stances and certain synthetic resins. The detergent sells for \$12.50 per kilogram or \$60 for 6 kg. Minimum order is \$25; delivery is from stock.

Atomerger Chemetals Corp., 100 Fairchild Ave., Plainview, N.Y. 11803 [478]

Stick-on temperature indicators that irreversibly change color when a pre-determined temperature is reached can be used on power transistors, heat sinks, rechargeable batteries, transformers, etc., for design evalua-

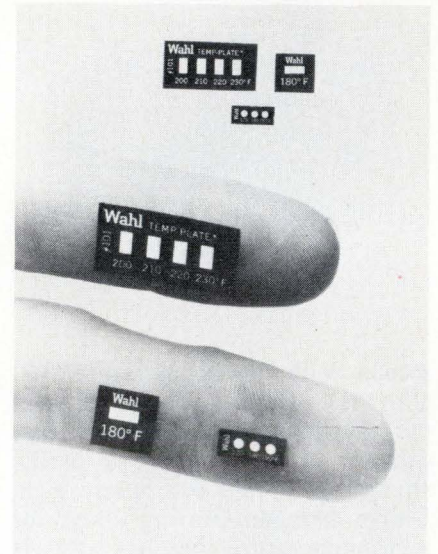

tion, preventive-maintenance indication, and warning of warranty abuse. Standard models have from one to eight indicators in the range from 100°F to 1,000°F. Temp-Plate recorders are available with both celsius and fahrenheit scales.

Temp-Plate Division, William Wahl Corp., 12908 Panama St., Los Angeles, Calif. 90066 [477]

An ultra-pure silicone resin for the protection and passivation of all semiconductor devices is offered as a one-part coating system. The resin, which contains less than 1 ppm of n, has a dielectric strength of 2,500 volts per mil, a dielectric constant at 1 megahertz of 3.12, and a volume resistivity of 3×10^{16} ohm-centimeters. It sells for \$10 an ounce, \$100 a pint, and \$700 per gallon.

Transene Co., Inc., Route 1, Rowley, Mass. 01969 [479]

33% more power to the people. Power/Mate presents Econo/Mate II. The open frame power supply.

Now Power/Mate brings you 33% more power in the same package size with the second generation of our Econo/Mate series.

The size is the same, the basic components are the same for easy interchangeability. But that's where the similarity ends.

Econo/Mate II adds features like dual AC primary and a plug-in IC regulator for improved regulation

And Econo/Mate II is tough. Computer design, quality control, and Power/Mate's experience helps insure 100,000 hr. MTBF even at this higher power output.

But for all its features, Econo/Mate II is still, most of all, economical. We wouldn't call it Econo/Mate if it wasn't.

Econo/Mate II is in stock, ready for delivery. Send for our free brochure.

Prices start at \$19.95.

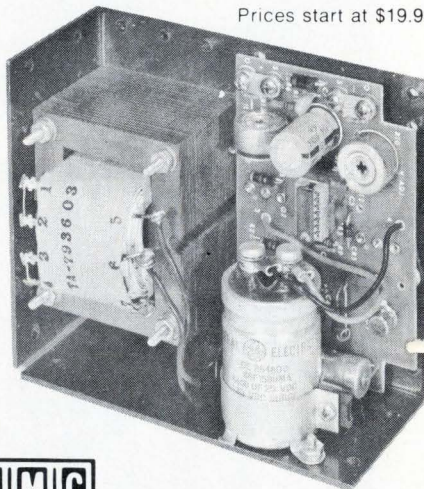

POWER/MATE CORP.

World's largest manufacturer of quality power supplies

514 South River Street/Hackensack, N.J. 07601/Phone (201) 343-6294 TWX 710-990-5023

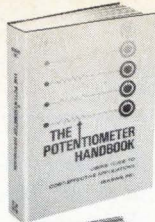

066/906
THE POTENTIOMETER HANDBOOK
by Bourns, Inc.
Pub. price, \$14.50
Club price, \$10.95

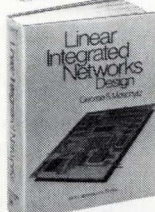

771/758
LINEAR INTEGRATED NETWORKS: Design
by G. S. Moschytz
Pub. price, \$29.95
Club price, \$21.95

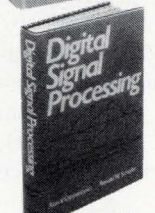

767/009
DIGITAL SIGNAL PROCESSING
by A. V. Oppenheim & R. W. Schaffer
Pub. price, \$22.95
Club price, \$17.95



766/746
MANUAL OF LINEAR INTEGRATED CIRCUITS
by S. D. Prenskey
Pub. price, \$16.95
Club price, \$13.50

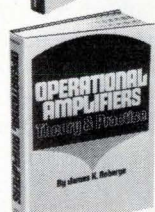

772/371
OPERATIONAL AMPLIFIERS: Theory & Practice
by J. K. Roberge
Pub. price, \$18.95
Club price, \$14.95

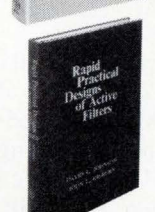

767/556
RAPID PRACTICAL DESIGNS OF ACTIVE FILTERS
by D. E. Johnson & J. L. Hilburn
Pub. price, \$15.00
Club price, \$11.50

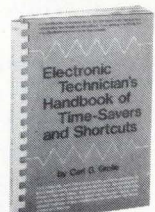

766/274
ELECTRONIC TECHNICIAN'S HANDBOOK OF TIME-SAVERS AND SHORTCUTS
by C. G. Grolle
Pub. price, \$12.95
Club price, \$7.95

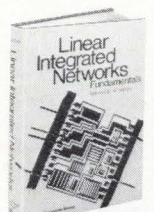

771/731
LINEAR INTEGRATED NETWORKS: Fundamentals
by G. S. Moschytz
Pub. price, \$29.95
Club price, \$21.95

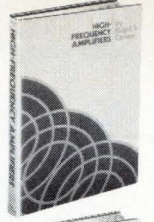

766/789
HIGH FREQUENCY AMPLIFIERS
by R. S. Carson
Pub. price, \$14.95
Club price, \$11.50

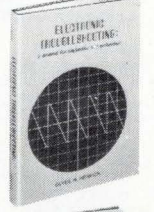

771/189
ELECTRONIC TROUBLESHOOTING
by C. N. Herrick
Pub. price, \$13.95
Club price, \$10.95

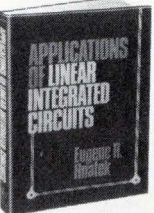

771/332
APPLICATIONS OF LINEAR INTEGRATED CIRCUITS
by E. R. Hnatek
Pub. price, \$26.95
Club price, \$19.50

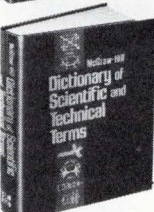

452/571
DICTIONARY OF SCIENTIFIC & TECHNICAL TERMS
by McGraw-Hill
Pub. price, \$39.50
Club price, \$29.50

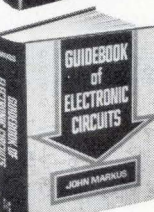

404/453
GUIDEBOOK OF ELECTRONIC CIRCUITS
by J. Markus
Pub. price, \$26.95
Club price, \$21.50

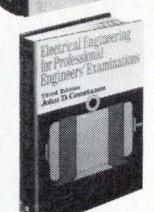

124/485
ELECTRICAL ENGINEERING FOR PROFESSIONAL ENGINEERS' EXAMINATIONS, 3/e
by J. D. Constance
Pub. price, \$17.00
Club price, \$12.50

Introductory offer to new members of the ELECTRONICS AND CONTROL ENGINEERS' BOOK CLUB

any one
of these great
professional books
for only **\$1.00**
values up
to **\$39.50**

Special \$1.00 bonus book comes to you
with your first club selection

save time and money by joining the ELECTRONICS AND CONTROL ENGINEERS' BOOK CLUB



Here is a professional book club designed to meet your on-the-job engineering needs by providing practical books in your field on a regular basis at below publisher prices. If you're missing out on important technical literature—if today's high cost of reading curbs the growth of your library—here's the solution to your problem.

The *Electronics and Control Engineers' Book Club* was organized for you, to provide an economical reading program that cannot fail to be of value. Administered by the McGraw-Hill Book Club Company, all books are chosen by qualified editors and consultants. Their understanding of the standards and values of the literature in your field guarantees the appropriateness of the selections.

How the club operates: Every month you receive free of charge *The Electronics and Control Engineers' Book Club Bulletin*. This announces and describes the Club's featured book of the month as well as alternate selections available at special members' prices. If you want to examine the Club's feature of the month, you do nothing. If you prefer one of the alternate selections—or if you want no book at all—you notify the Club by returning the card enclosed with each Bulletin.

As a Club member, you agree only to the purchase of four books (including your first selection) over a two-year period. Considering the many books published annually, there will surely be at least four you would want to own anyway. By joining the Club, you save both money and the trouble of searching for the best books.

MAIL THIS COUPON TODAY

ELECTRONICS AND CONTROL ENGINEERS' BOOK CLUB
P.O. Box 582, Princeton Road, Hightstown, New Jersey 08520

Please enroll me as a member of the Electronics & Control Engineers' Book Club and send me the two books indicated below. I am to receive the bonus book for just \$1, and my first selection at the special Club price. Actual postage, plus 25¢ handling charge will be added (sales tax, also, if applicable). These books are to be shipped on approval, and I may return them both without cost or further obligation. If I decide to keep the books, I agree to purchase as few as four additional books (including this first selection) during the next two years at special Club prices (guaranteed 15% discount often more). This order subject to acceptance by McGraw-Hill. Orders from outside the continental U.S. must be prepaid. All prices subject to change without notice. Offer good for new members only.

Write Code # of \$1.00
bonus book
selection here

Write Code # of
first
selection here

NAME _____

ADDRESS _____

CITY _____

STATE _____ ZIP _____

E33305

RF PACKAGES — MICROWAVE SYSTEMS

AUTOTRACK ANTENNA SCR-584 RADAR SYSTEM

360 deg AZ 210 deg EL. 1 mil. accuracy. Missile vel. accel. and slew. rates. Amplidyne control. Handle up to 20 ft. dish. Compl. control chassis. ALSO in stock 10 cm. van mounted rad. system. Conical scan. PPI. 6 ft. dish. 300 pg. instr. bk. on radar \$25



RF SOURCES

CW: 300-535KHz **500W**; 2-30MHz **3KW**; 4-21MHz **40KW**; 24-350MHz, **100W**; 385-585MHz **1KW**; 750-985MHz **10KW**; 95-8.8GHz **150W**; 1-1.5GHz **110W**; 1.7-2.4GHz **10KW**; 4.4-5GHz **1KW**; 8.8-11GHz **200W**. Many more.

UHF: 1 Megawatt 210-225MHz 5µsec 180 PPS; 14KW 400-420MHz .002DC; 1KW 400-700MHz .002DC.

L BAND: 1KW 1-1.5GHz .1DC; 500KW 1.2-1.35GHz 2µsec 400PPS. Many more. Phone or write.

S BAND: 1KW 2.4-2.6GHz .75µsec 1200PPS; 250KW 2.7-3.3GHz .8µsec 1600PPS; 500KW 2.7-3.1GHz .8µsec 1600PPS; 1 Megawatt 2.7-2.9GHz 1µsec 1200PPS; 5 Megawatts 2.75-2.85GHz 2.5µsec 400PPS.

C BAND: 225KW 6275-6575MHz .4µsec 680PPS; 250KW 5.4-5.8GHz .5µsec 680PPS; 1 Megawatt 6GHz 1µsec 1000PPS; 10 Megawatt 5.4-5.8GHz 5-10 µs 400 PPS.

X BAND: 100W 9.2-9.5GHz .5µsec 1000PPS; 1 KW 8.9-9.4GHz .001DC; 65KW 8.5-9.6GHz .001DC; 250KW 8.5-9.6GHz .0013DC; 400KW 9.1 GHz 1.8µsec 450PPS. Many more. Phone or write.

Ku-K BAND: 50KW 16.4-16.6GHz .001DC; 135KW 15.5-17.5GHz .0006DC; 40KW 24GHz .0007DC; 40KW 35GHz .0004DC. Many more. Phone or write.

PULSE MODULATORS + H.V.P.S.

245 KW LINE Output 16 KV 16 A. .25 µs 4000 PPS.

405 KW FLOATING DECK Output 20 KV 20 A 1 µs to 10 millisecc pulse.

500 KW LINE Output 22 KV 28 A. 4/1.75/2.25 µs 2500/550/300 PPS.

1 MW HARDTUBE MIT MODEL 9 Output 25 KV at 40 A. .25 µs .002 D.C.

2.0 MW LINE 30 KV 70 A. 1/2 µs 600/300 PPS.

3 MW LINE Output 39 KV 75 A. .25/1 µs 500 PPS.

10 MW LINE 76 KV 135 A. 2.5 µs 350 PPS.

17 MW LINE 17 KV 1000 A. 2-5 µs 150-2000 PPS.

66MW LINE 160 KV 400 A. 5-10 µs 400 PPS.

SEND FOR FREE 20 PG. CATALOG

AN/MPS-19 S Band Tracker

Pwr: 500 KW. Range: 100 miles. Display: PPI and "A" scopes. 8' dish. Heilhut mounted.

RADAR SYSTEMS

K BAND MONOPULSE 40KW E-34
KU BAND SEARCH 135KW B-58
X BAND MISSILE CONTROL NIKE AJAX/HERC
X BAND HI-RES. MONOPULSE TRACKER
X BAND FIRE CONTROL 250KW M-33
X BAND WEATHER/SEARCH 250KW AN/CPS-9
X BAND AIRBORNE TRACKER 50KW B-47
X BAND MOBILE TRACKER 40KW AN/MPQ-29
X BAND WEATHER/SEARCH 40KW AN/SPN-5
X BAND ANTI-INTRUSION 7 KW AN/TPS-21
X BAND ANTI-INTRUSION CW DOPPLER AN/PPS-9/12
X BAND TRANSPONDER 100W AN/DPN-62
C BAND HGT. FDR. 5MW FPS-26; 1MW TPS-37
C BAND SEARCH 285KW AN/SPS-5B/D
S BAND HEIGHT FINDER 5MW AN/FPS-6
S BAND SEARCH COHERENT 1MW AN/FPS-18
S BAND ACQUISITION 1MW NIKE AJAX/HERC
S BAND TRACKER 10' DISH 500KW AN/MPQ-18
S BAND MORTAR LOCATOR 250KW AN/MPQ-10A
S BAND TRACKER 250KW AN/MP-9
L BAND SEARCH 40' ANTENNA 500KW AN/FPS-75
L BAND SEARCH 500KW AN/TPS-1D/GSS-1
UHF SEARCH 1MW TPS-28

DRONE CONTROL SYSTEMS

UHF COMMAND SYSTEM AN/URW-14
X BAND DATA LINK AN/UPW-1
X BAND TRACKER AN/MPQ-29
X BAND TRACKER AN/MSQ-51

60 FT. DISH

Complete with Az-El pedestal, ready for installation. Immed. delivery. Write or call.

SPARE PARTS IN STOCK

Nike Ajax, Nike Hercules, M-33, MPS-19, TPS-1D, TPS-10D, FPS-6, SPS8, SCR-584, HIPAR. Many more, write



**Radio
Research
Instrument
Co., Inc.**

3 QUINCY ST., NORWALK, CONN. 06850
(203) 853-2600

Circle 210 on reader service card

New literature

Selecting a 4-k RAM. A report entitled "The 4-k RAM dilemma: 16-, 18- or 22-pin?" tries to help designers select the best devices for their particular applications. It describes the five basic types of dynamic 4,096-bit random-access memory now offered, and compares them on the basis of addressing, multiplexing, clocking, input/output, price, board area, availability, and reliability. Copies are offered by Texas Instruments Inc., Inquiry Answering Service, P.O. Box 5012, M/S 308 (Attn: "4-k RAM dilemma" Literature), Dallas, Texas. Circle reader service number 421.

Designing microprocessor-based systems. A six-page application note (AN 167-13) discusses the role of logic-state analyzers in the design of microprocessor-based systems. The note includes a few case histories of problems that were solved easily with these analyzers but would have been difficult with traditional methods. A brief bibliography is included. The report can be obtained from the Inquiries Manager, Hewlett-Packard Co., 1501 Page Mill Rd., Palo Alto, Calif. 94304 [422]

Terminal blocks. Catalog 201 describes the newly expanded line of barrier terminal blocks for printed-circuit boards and panel mounting offered by RDI/Reed Devices Inc., 21W183 Hill Ave., Glen Ellyn, Ill. 60137. The 16-page catalog gives prices and lists more than 110 distributors. [423]

Digital instruments. A broad range of portable, bench-type, and systems-oriented digital multimeters as well as a 100-megahertz counter/timer are covered in a 12-page catalog put out by Data Precision Corp., Audubon Rd., Wakefield, Mass. 01880 [424]

Safe cables. A line of communications and control cables that is UL-listed, CSA-certified, and OSHA-acceptable is presented in a 28-page catalog released by Alpha Wire Corp., 711 Lidgerwood Ave., Elizabeth, N.J. 07207 [425]



AO Fiber Optics

THE COMPLETE LINE FROM AMERICAN OPTICAL AND FEATURING THE NEW FIBERSCOPE DESIGN

FREE Fiber Optics Catalog

Features the complete AO line of fiber optics products—from Inspection Fiberscopes and Light Guides to Illuminators, Image Conduits, Faceplates and Custom Components. Includes the four newest remote inspection fiberscopes now available.

Describes the principle, technology and techniques used to make flexible light and image transmissions a proven, practical fact. Write today for your FREE copy of the AO Fiber Optics catalog to American Optical Corporation, Fiber Optics Division, Southbridge, Mass. 01550.

**AO
American
Optical**

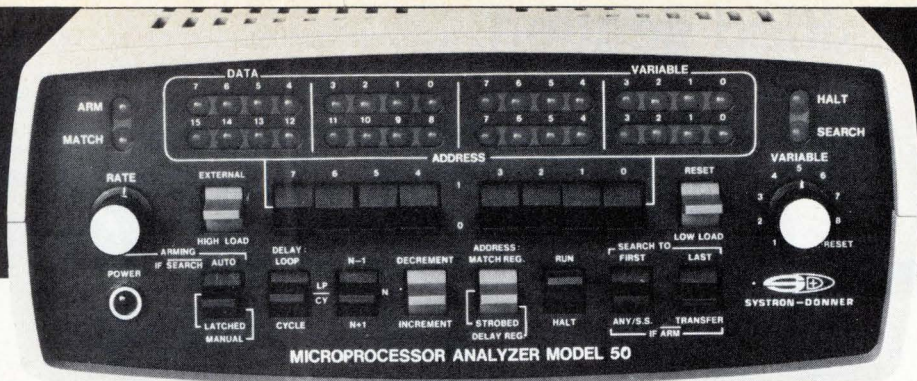

THE HOT NEW S-D MICROPROCESSOR ANALYZER

ONLY \$865 but Model 50 does more than a 32-channel logic analyzer costing 3 times as much.

First Universal Analyzer: Useable with **all** microprocessor families that have accessible bus structure.

Display: 16 bits of data and 16 bits of address.

Unique Search Modes: Identify the first and last instruction in a program loop, then step forward or backward through programs.

Passive or Interactive: Use as a passive real time monitor.

Find out more about the time-saving (to put it mildly) Model 50 features such as delay by loops, single step, dual clock, N - 1/N + 1 strobe, multiple unit capability, etc. Contact:



10 Systron Drive • Concord, CA 94518 • Phone (415) 676-5000

Circle 191 on reader service card

your exhibit in Moscow...

Participate in the worlds largest international specialized exhibition of communication equipment and technology.

SVJAZ-77

Moscow, U.S.S. R., April 5-15, 1977

For information contact:



OK MACHINE & TOOL CORPORATION

3455 Conner St., Bronx, N.Y. 10475 / (212) 994-6600 / Telex 125091

"On a map of Florida, draw a 100 mile radius around Bartow. Then watch what you catch in terms of oceans, civic centers, international airports, and the like. Then make a list of the ideal qualities you're looking for . . . if Bartow doesn't meet each one, it's just simply an oversight."

*D. E. Black, President
Florida First National Bank in Bartow.*



This short message is being brought to you by a select group of some of the Nation's top executives. Each has contributed his time and expertise on a portfolio of pertinent facts about the advantages of site location in and around Bartow.

The portfolio is yours free for the asking. Write for one today and let the Committee show you a side of the Florida sun you've never seen.

*Director of Economic Development
Committee of '76 Greater Bartow Chamber of Commerce
P. O. Box 956AD Bartow, Florida, 33830 Phone: 813-533-7125*

CLASSIFIED SALES REPRESENTATIVES

Atlanta . . . Joe Lane . . . 404/892-2868
 Boston . . . Holt Buchanan . . . 617/262-1160
 Chicago . . . Bill Higgins . . . 312/751-3733

Cleveland . . . Mac Huestis . . . 216/781-7000
 Dallas . . . Rick Ofstie . . . 214/742-1747
 Denver . . . Shirley Kotz . . . 303/837-1010
 Detroit . . . Mac Huestis . . . 313/873-7410

Houston . . . Rick Ofstie . . . 713/659-8381
 Los Angeles . . . Stan Kassir . . . 213/487-1160
 New York . . . Dave Hawksby . . . 212/997-3594
 Philadelphia . . . Dan Ferro . . . 215/568-6161

Pittsburgh . . . Dan Ferro . . . 412/391-1314
 San Francisco . . . Mary Kenny . . . 415/362-4600
 Stamford . . . Holt Buchanan . . . 203/359-2860
 XEROX 100 TELECOPIER . . . 212/997-6800

Break Away To Colorado Now.

Superior candidates are needed for permanent assignments working on desk top computers and peripherals.

If you want to associate with a people-oriented company in Colorado, then consider Hewlett-Packard's Loveland Division. With us you'll enjoy the advantage of small community living within an hour's drive of metropolitan Denver and the Rocky Mountain National Park.

Design Engineers working in:

- . **Softwares**
- . **Logic**
- . **Circuits**
- . **LSI**
- . **MOS/Thin Film Processes**
- . **Mechanical**

Hewlett-Packard is looking for design engineers who have state-of-the arts skills in one or more of the above areas, and have the aptitude and the desire to expand themselves into the other disciplines.

A strong broad academic background will be necessary to pass our technical screening. Successful candidates will be part of a team doing "hands-on design" of desk top computers and peripherals.

Qualified? Interested in a dynamic secure career with a respected company? Respond in confidence to Kathleen Kline, Professional Recruiting, Hewlett-Packard Company, Calculator Division, P.O. Box 301, Loveland, Colorado 80537. We are an equal opportunity employer dedicated to affirmative action.

HEWLETT  PACKARD

SENIOR PROJECT ENGINEER

If you are a BSEE looking for a dynamic organization in which you will be challenged in designing and developing miniature (under ¼ HP) AC and DC motors for highly sophisticated industrial applications, then you will certainly want to explore this opportunity with us.

You should have experience in motor systems for computer printers, tape drives, banking terminals, typewriters, etc. Knowledge of motor controls that are used in these systems including digital and analog feedback. Stepper motor experience is desirable. 10 or more years experience should qualify you for this senior position.

We offer excellent salary and fringe benefits package. Send resume to:

EMPLOYMENT MANAGER

**TRW
GLOBE
MOTORS**

2275 Stanley Avenue,
Dayton, Ohio 45404

An equal opportunity employer. m/1

POSITION VACANT

The Colorado School of Mines is seeking applications to fill a faculty position at the Assistant or Associate Professor level in the area of industrial electronics, control, and instrumentation for the Mineral Industry. Although a Ph.D. degree is desirable, experience in the area is more important. Research in the problems of the Mineral Industry is encouraged. Rank and salary depend upon qualifications. Send a letter of application and resume to Professor Henry A. Babcock, Basic Engineering Department, Colorado School of Mines, Golden, Colorado 80401. An Equal Opportunity Employer.

EMPLOYMENT SERVICE

Electronics' Industry Newsletter tells you which firms have current employment opportunities, in the field of Electronics, for all types of Engineers, Sales Representatives, Technicians, Executives, Computer Personnel and others. Latest product information is also reported. For information write: Electronics' Industry Newsletter, Dept. 304A, 23573 Prospect Avenue, Farmington, MI 48024.

Why your resume should be in the Electronics Manpower Register

Every engineer covets the job where he can contribute the most to his profession—and his family.

The Electronics Manpower Register, a computerized data bank containing the qualifications of career-conscious ELECTRONICS readers just like yourself, is our contribution to solving this problem of fitting the right engineer to the right job.

Here's how you'll benefit from having your resume on file:

- **It's absolutely free.** No charges or fees to you at any time.
- **The computer never forgets.** When your type of job comes up, it remembers you're qualified.
- **Service is nationwide.** You'll be considered for openings across the U.S.
- **Your identity is protected.** Your resume is carefully screened to be sure it will not be sent to your company or parent organization.

That's why it makes sense for you to take advantage of the Electronics Manpower Register. To do so, just mail your resume to:

ELECTRONICS MANPOWER REGISTER

P.O. Box 900
New York, N.Y. 10020

Avionics Professionals

As a leader in the advanced computer oriented avionics systems field, we are in a position to offer interesting and challenging career employment to professionals with specialized experience and training. Current requirements include:



SYSTEMS SOFTWARE PROGRAMMERS: To design and implement systems support software including assemblers, compilers, simulators, and linkage editors for a family of airborne minicomputers. FORTRAN and Assembly language programming background on System 370 or equivalent large scale computers required. Experienced personnel as well as new graduates are encouraged to apply.

CONFIGURATION MANAGEMENT SPECIALISTS: Requires specialized practical experience in configuration management as applied to major systems (hardware & software) for DOD inventory. Thorough familiarity with DOD specifications and standards for configuration management is essential, as is a background in data management. A college degree is preferred.

MAINTAINABILITY & TEST EQUIPMENT ENGINEERS: To provide project management and technical direction for maintainability analysis, test equipment and design, digital/analog system BITE, test point definition, software specifications and analysis, management and planning of maintainability demonstration. Requirements call for a BS in engineering as well as knowledge of digital and analog circuits, FORTRAN and statistical analysis. Ability to interface with AGE and test equipment design and ILS LCC/RIW analysis is essential. Field test experience desirable.

STANDARDS ENGINEER: Requires 2 years minimum standards and/or specification writing as well as electro-mechanical design experience. Knowledge of military standards desirable.

Located in the desirable Western Michigan area, the heart of Michigan Lake Country, these opportunities provide an environment for professional and family growth in an environment offering many educational and recreational opportunities.

LSI/INSTRUMENT.

Tomorrow's technology in yesterday's world.



LEAR SIEGLER, INC. INSTRUMENT DIVISION
4141 EASTERN AVENUE, S.E. GRAND RAPIDS, MICHIGAN 49508
An Equal Opportunity Employer M/F

Send your resume and salary history in confidence to
Mr. W. G. Mellinger, Dept E.

ELECTRONIC DESIGN ENGINEERS

Challenging work on state-of-the-art television and related equipment, including color, black and white, low light level, and video processing. Strong analog and math required.

Circuit Design—BS/MS - EE/Physics 2-5 years experience.

Senior Design—BS/MS
3-10 years experience.

Send resume to

D. O'Connell, Personnel Manager

Cohu, Inc.

Electronics Division

P.O. Box 623, San Diego, CA 92112

Equal Opportunity Employer (M/F)

MICROPROCESSOR ENGINEERS

Hardware Design & Development
Software Design & Development

Our Microprocessor Department has been set up due to the overwhelming increase in demand for engineers and scientists in this field. To explore those opportunities with our clients throughout the U.S., send your resume stating geographic preference and present salary—or request confidential application:

Search Director
Microprocessor Department
REGIONAL CONSULTANTS, INC.
213 W. 9th Street, Cincinnati, Oh. 45202
(513) 579-1513

POSITION WANTED

Communications Specialist: System integration, installation & test. HF, VHF, Microwave & Tropo. Satellite, telemetry, data & OTH radar systems. Experienced at field, project & site manager level. Write: Communications, Box 326, Calypso, N.C. 28325.

We have been placing graduate ENGINEERS

in FEE-PAID positions THROUGHOUT THE U.S. since '59. Over 1,000 client companies. We are graduate engineers working full-time for you. Send resume & salary history today or request confidential application.

ATOMIC PERSONNEL, INC.
Suite L. 1518 Walnut St., Phila., Pa. 19102
An Employment Agency
For All Technical Fields

Communication Engineers

**Make an impact in the design and development of advanced new products
in Long and Short Range Radio Communications.**

Harris Corporation, RF Communications Division has immediate career opportunities to support a corporate commitment to expand in the domestic and international communication markets. To meet this challenge we are seeking experienced communication engineers who are ready for increased responsibility and the chance to be recognized and rewarded for their professional accomplishments. Our headquarters are located in scenic upstate New York, where we enjoy year round recreational activities, numerous cultural events and one of the nation's best educational systems. Immediate opportunities exist for the following professionals and managers:

- Telephone System Engineers
- Sales Engineers
- International Area Managers
- Digital Engineers
- Mechanical Engineers
- Project Managers

Beyond the challenge and exposure you will receive, we offer an outstanding compensation and benefits program along with liberal relocation assistance.

- Systems Engineers and Managers
- Microprocessor Application Engineers
- RF Circuit Designers

For immediate consideration, please forward resume and salary history to: Personnel Dept. E.



1680 University Avenue
Rochester, New York
14610 U.S.A.

An Equal Opportunity Employer M/F

RF COMMUNICATION ENGINEERS

This is an opportunity for you to join a group of engineers who are producing communication equipment, primarily in the area of amateur radio, that has earned a top position in the industry. We are a growing company that can provide the right individuals the opportunity to be creative and to advance.

The successful candidates will be given total project responsibility from conceptual design to completion. We seek engineers with a BSEE or MSEE and a minimum of 3 years of proven capabilities in the design of communication equipment. A strong background in HF-SSB, BHF-FM receiver and transmitters is required. A familiarity with synthesizers is desirable.

We offer competitive starting salary, a comprehensive benefit package, stable employment and a pleasant life style in a small community on the shore of Lake Michigan. Send your resume and salary history in confidence to:

HEATH COMPANY
Personnel Dept.
Benton Harbor, Mich. 49022



An Equal Opportunity Employer M/F

Job-seekers... be the first to know with McGraw-Hill's Advance Job Listings

By having our weekly ADVANCE JOB LISTINGS sent to your home every Monday you can be the first to know about openings both in and out of your field. AJL will enable you to contact anxious recruitment managers BEFORE their ads appear in upcoming issues of 21 McGraw-Hill publications. To receive a free sample copy, plus information about our low subscription rates, fill out and return the coupon below.

ADVANCE JOB LISTINGS / P.O. BOX 900 / NY 10020

PLEASE SEND A SAMPLE COPY
OF ADVANCE JOB LISTINGS TO

NAME _____ ADDRESS _____

CITY _____ STATE/ZIP _____

CONNECTORS/
P.C.
JACKS & PINS
BERYLLIUM
COPPER
CAGES

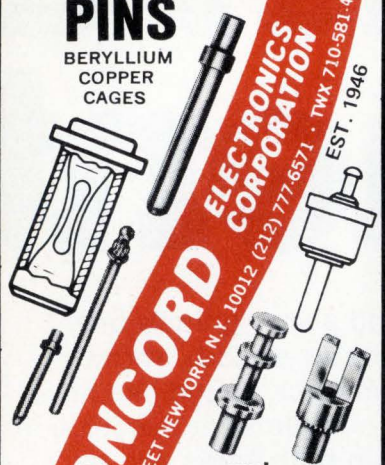

CONCORD ELECTRONICS CORPORATION
EST. 1946
37 GREAT JONES STREET NEW YORK, N.Y. 10012 (212) 777-5571 • TWX 710-581-4930

and
**TEFLON*
AND SOLDER
TERMINALS**
*DUPONT T.M.

SEND FOR CATALOG

Circle 178 on reader service card

Gas Sensing Semiconductor

FIGARO GAS SENSOR

TGS quickly senses
even small
amount
of gas.

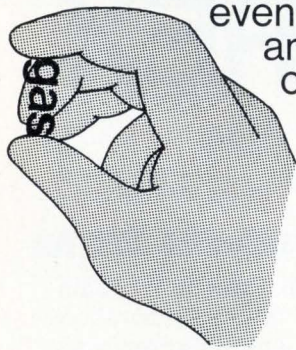

New Models,
some with highly sensitive
CO sensor, now on the market.

Please contact the address below directly for
catalogs and price/delivery information.

FIGARO ENGINEERING INC.

3-7-3, Higashitoyonaka, Toyonaka City, Osaka 560,
Japan/Tel: (06) 849-2156

Cable: FIGARO TOYONAKA/Telex: 05286155 FIGARO J

178 Circle 209 on reader service card

Electronics advertisers

ADAC	159	Fairchild Systems Technology	130,131
* Adret Electronique	16E	Faultfinders Inc.	40
‡ Advanced Micro Devices	10,11	Figaro Engineering Inc.	178
AEG Telefunken	31E	First Computer Corporation	6
■ Airpax Electronics	33	Florida Department of Commerce	164
Alco Electronics Products Inc.	167	■ John Fluke Mfg. Co., Ltd.	69,71,72,73
Allen Bradley Company	24	* Ganz Measuring Instruments	57
Allied Electronics	154	General Electric Co. Miniature Lamp Division	138
American Microsystems Inc.	67	General Instrument Corporation, Microelectronics Division	37
American Optical Corp. Fiber Optics & Industrial Products Division	172	GenRad	116
■ AMP Incorporated	142,143	Grayhill Inc.	70
Amperex Electronics Corporation	167	Gulf Power Company	150
* Amphenol Tichel	29E	■ Hewlett-Packard	2nd C,58,59,129
Analogic Corporation	156	* Hi G D'Italia	24E
Anslay Electronics Corp.	21	■ Hughes Aircraft Company	38,39
Bartow Chamber of Commerce	173	ILC Data Devices	16
* Bayer AG	27E	Intel Corporation	18,19
Biomation	22,23	International Crystal Manufacturing Company	153
B & K Precision Division Dynascan Corporation	86,87	■ International Rectifier Corp., Semi. Div.	13
* Bolt Beranek & Newman Inc.	28E	Interstate Electronics Corp.	115
■ Bourns Inc.	4th C	* Italtel/SIT	13E,19E
‡ Bussman Mfg. Division of McGraw Edison Co.	48	■ Ithaco, Inc.	134
Byte Publications Inc.	179	* ITT Cannon	48
Calex Mfg., Inc.	163	‡ ITT Components Group	52
* Capital Calculator Co.	8,26E	■ Johanson Manufacturing Corporation	20
■ Cherry Electrical Products Inc.	125	Keithley Instruments	132,133
Communication Associates Inc.	11	Krohn Hite Corporation	5
Computer Automation	62,63	LH Research Inc.	80
Computer Operations, Inc.	160	■ Logimetrics	136
Concord Electronics Corp.	178	McDonnell Douglas Co.	122
Continental Rentals	8	MDB Systems	181
Continental Specialties Corporation	152	Miller Stephenson Chemical Inc.	157
Corning Glass Works Fluidic Products Department	102	Millennium Information Systems, Inc.	84,85
* Dale Electronics Inc. A Subsidiary of Lionel Corporation	6E,7E	Monolithic Memories Inc.	2
Data General Corporation	27	‡ Monsanto Commercial Products Co.	52
Data Translation Inc.	136	■ Motorola Semiconductor Products Inc.	35
Deltec	164	* Munchener Messe und Ausstellungsgesellschaft GmbH	56
Deltron	126	‡ National Semi	46,47
■ Dialight Corporation	128	‡ Nec Microcomputer Inc.	57
Eagle Magnetic Co.	166	Neff Instruments Corp.	3rd C
■ Eastman Kodak Company GMD GD Photofabrication-Microelectronics	42	‡ Nikkei Electronics	182
E. I. DuPont De Nemours & Co. Inc.	145	OAK Industries Inc. Switch Division	15
■ E&L Instruments Inc.	140	OK Machine & Tool Company	173
Electronic Navigation Industries	75	‡ Omron Corporation of America	60,61
Electronic Product Associates	8	Optron, Inc.	14
Electronics & Control Engineers Book Club	169-170,171	* Oscilloquartz	43
Endicott Coil Co. Inc.	163	■ Pearson Electronics	149
■ Erie Technological Products Co. Inc.	17	* Philips Elcoma	2E
Esterline Angus Instrument Corporation	168	* Philips Electrologica	54
Fairchild Semiconductor Inc.	81	* Philips Industries	46,47
		■ Powermate	168
		Programmed Power Inc.	181

Projects Unlimited Inc.	163
Pro-Log Corporation	165
* Racal Thermionic Ltd.	11E
Radio Research Instrument Corporation	172
RCA Solid State Division	7.9
‡ Rental Electronics Inc.	54
* Rhone Poulenc	139
Robinson Nugent Inc.	76
* Rohde & Schwarz	1E
Sangamo Data Recorder	44
* Secme	30E
Second Source Industries	135
* Sefram	28E
* Seimart	23E
Semtech Corporation	137
* Sescosme	5E,25E
Sfernice	32E
* Shell Intern'l Chemical Co. Ltd.	21E
Silicon General	79
Society of the Plastics Industry, Inc.	155
* Solartron/Schlumberger	9E,15E
Sorensen	121
Sprague Electric Company	51
■ Sprague Goodman Electronics Inc.	179
Syston Donner Concord Instrument	173
Tansitor Electronics	6
* TEAC Corp.	61
Technotec, Div. of Control Data	161
■ Tektronix Inc.	82,83,127
Telenetics, Inc.	160
Teradyne Inc.	64
‡ Texas Instruments, Inc., Learning Center	43
Texas Instruments Incorporated Components Div.	141
TRW Capacitors	151
■ TRW Cinch Connectors	158
Ultra-Violet Products, Inc.	80
Unitrode Corporation	28
■ Union Carbide Corp., Parylene	147
Vactec Inc.	148
Varo Semiconductor Inc.	162
Vector Electronics Company Inc.	144
Viking Industries	141
Wakefield Engineering Inc.	166
* Wavetek San Diego	88
* Yokogawa Corporation of America	10
Zehntel	45

Classified and employment advertising

F. J. Eberle, Manager 212-997-2557

Atomic Personnel Inc.	175
Camera Systems and Equipment	175
Harris Communications	176
Heath Co.	176
Hewlett Packard	174
Lear Siegler	175
Memorex	177
Regional Consultants Inc.	175
TRW Globe	174

■ For more information of complete product line see advertisement in the latest Electronics Buyers Guide

* Advertisers in Electronics International

‡ Advertisers in Electronics domestic edition

**SPRAGUE
GOODMAN**

TRIMMER CAPACITORS

Our only business!

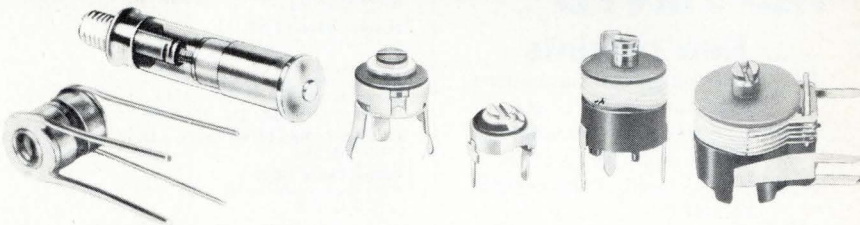

PISTONCAP® Multi-Turn Tubular

- Low-Loss, Glass or Quartz
- High Stability/High Reliability
- Simple, Long-Life Adjust Mechanism
- Professional / Military Applications, MIL Approved

CERAMIC Single-Turn

- Compact, Conserves Board Space
- Variety of Mounting Configurations
- Low Cost for Commercial/Industrial Applications

FILMTRIM* Single-Turn Film

- PTFE, Polypropylene, Polycarbonate
- Most Stable Trimmer for Size
- Very Wide Capacitance Ranges
- Low Cost for Commercial/Industrial Applications

*Trade Mark

Tired of broken delivery promises and poor quality? Deal with the trimmer capacitor specialist, for quality products delivered on schedule! Call on us for custom designs too, we deliver!

TRIMMER CAPACITORS — OUR ONLY BUSINESS!

Sprague-Goodman Electronics, Inc.

(An Affiliate of the Sprague Electric Company)

134 FULTON AVE., GARDEN CITY PARK, N.Y. 11040 • 516-746-1385 • TLX: 14-4533

Circle 179 on reader service card

THINKING ABOUT YOUR OWN COMPUTER?

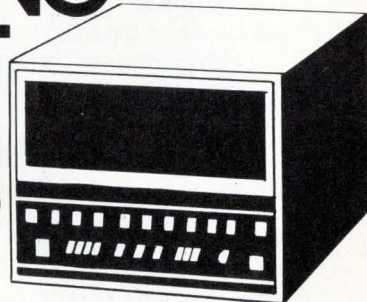

Join over 50,000 avid readers of BYTE, the magazine with rich, professionally edited articles on micro-computers . . . for building, expanding and having downright fun with your own system. You'll reread super articles on . . .

- detailed hardware/software designs by successful experimenters and hobbyists
- editorials on the fun of computers . . . electronic music, video games, hobbyist control systems, ideas for ham radio, model railroading and lots more
- reviews of upcoming general purpose systems
- tutorial background and sources full of ideas for home computers and computer science
- ads by firms with computer products you want
- club information and social activities

SUBSCRIBE TO BYTE NOW! IT'S FUN . . . AND GLITCH-PROOF!

Send this coupon for a trial subscription to BYTE. Get your first issue by return mail. Read it from cover-to-cover. If it isn't everything you want, just write "CANCEL" on the bill and return it to us. The first copy is yours to keep.

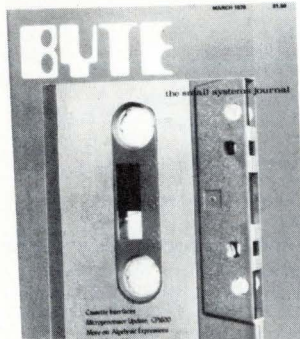

BYTE PETERBOROUGH, NH 03458

Please enter my trial subscription to BYTE . . .
 \$12 One Year \$22 Two Years \$30 Three Years
 I understand you will send the first issue by return mail and bill me later. If I don't like BYTE, I just write "CANCEL" across the invoice and return it. I will not be charged.

Name (Please Print) _____
 Address _____
 City _____ State _____ Zip _____

ELECTRONICS REPRINTS

No. of
copies
wanted

New reprints

- _____ R-612 Fiber-optic communications special report 24 pp \$3.00
- _____ R-610 Hybrid-circuit technology special report 19 pp \$3.00
- _____ R-606 Special issue—microprocessors \$4.00
- _____ R-600 World market report 1976 24 pp \$5.00
- _____ R-526 How reliable are today's components 16 pp \$3.00
- _____ R-524 Bipolar large-scale integration special report 12 pp \$3.00
- _____ R-522 Special report on power semiconductors 12 pp \$3.00
- _____ R-512 Design of circuits for dangerous environments 4 pp \$3.00
- _____ R-510 Bipolar integration advances with μ L microprocessor 8 pp \$2.00

Charts

- _____ R-516 Electronic symbols \$2.00
- _____ R-326 Optical spectrum (6-page report and chart) \$3.00
- _____ R-213 Electromagnetic spectrum (chart) \$2.00
- _____ R-211 Electromagnetic spectrum (16-page report and chart) \$4.00

Books

- _____ R-608 Basics of Data Communications—Electronics Book Series \$12.50
- _____ R-602 Large-Scale Integration—Electronics Book Series \$9.95
- _____ R-520 Microprocessors—Electronics Book Series \$8.95
- _____ R-011 Computer-aided Design 135 pp \$4.00
- _____ R-032 Active Filters 88 pp \$4.00
- _____ R-031 Circuit Designer's Casebook 182 pp (U.S. only) \$5.50 (rest of world) \$12.00

Payment must accompany your order

Make check or money order payable to Electronics Reprints. All orders are shipped prepaid by parcel post. Allow two to three weeks for delivery.

Mail your order to:

Janice Austin, ELECTRONICS REPRINTS
P.O. Box 669 Hightstown, N.J. 08520

Back issues now available:

1960 to 1969, \$5.00 each
1970 to 1973, \$3.00 each
1974 to 1975, \$4.00 each

Advertising Sales Staff

Atlanta, Ga. 30309: Glen N. Dougherty
100 Colony Square, 1175 Peachtree St., N.E.
[404] 892-2868

Boston, Mass. 02116: Frank Mitchell
607 Boylston St. [617] 262-1160

Chicago, Ill. 60611
645 North Michigan Avenue
Robert W. Bartlett (312) 751-3739
Robert M. Denmead (312) 751-3738

Cleveland, Ohio 44113: William J. Boyle
[716] 586-5040

Dallas, Texas 75201
2001 Bryant Tower, Suite 1070
[214] 742-1747

Denver, Colo. 80203: Harry B. Doyle, Jr.
123 Speer Blvd. #400
[303] 837-1010

Detroit, Michigan 48202: Robert W. Bartlett
1400 Fisher Bldg.
[313] 873-7410

Houston, Texas 77002: Paul Reiss
601 Jefferson Street, Dresser Tower [713] CA 4-8388

Los Angeles, Calif. 90010: Robert J. Rielly
Bradley K. Jones, 3200 Wilshire Blvd., South Tower
[213] 487-1160

New York, N.Y. 10020
1221 Avenue of the Americas
Warren H. Gardner [212] 997-3617
Michael J. Stoller [212] 997-3616

Philadelphia, Pa. 19102: Warren H. Gardner
Three Parkway,
[215] 997-3617

Pittsburgh, Pa. 15222: Warren H. Gardner
4 Gateway Center, [212] 997-3617

Rochester, N.Y. 14534: William J. Boyle
9 Greylock Ridge, Pittsford, N.Y.
[716] 586-5040

San Francisco, Calif. 94111: Don Farris
Robert J. Rielly, 425 Battery Street,
[415] 362-4600

Paris: Alain Offergeld
17 Rue-Georges Bizet, 75116 Paris, France
Tel: 720-73-01

Geneva: Alain Offergeld
1 rue du Temple, Geneva, Switzerland
Tel: 32-35-63

United Kingdom & Scandinavia: Robert Ghey
Tel: 01-493-1451, 34 Dover Street, London W1

Scandinavia: Andrew Karnig and Assoc.
Kungsholmsgatan 10
112 27 Stockholm, Sweden
Tel: 08 51 68 70 Telex: 179 51

Milan: Luigi Rancati
1 via Baracchini, Italy Phone 86-90-656

Brussels: Alain Offergeld
23 Chaussee de Wavre
Brussels 1040, Belgium
Tel: 13-73-95

Frankfurt/Main: Fritz Krusebecker
Liebigstrasse 27c, Germany
Phone 72 01 81

Tokyo: Tatsumi Katagiri, McGraw-Hill
Publications Overseas Corporation,
Kasumigaseki Building 2-5, 3-chome,
Kasumigaseki, Chiyoda-Ku, Tokyo, Japan
[581] 9811

Australia: Warren E. Ball
IPO Box 5106, Tokyo, Japan

Business Department

Thomas M. Egan,
Production Manager [212] 997-3140

Gayla Black
Production Manager [212] 997-2044

Carol Gallagher
Production Manager International
[212] 997-2045

Dorothy Carter
Production Manager Domestic
[212] 997-2908

Frances Vallone
Reader Service Manager
[212] 997-6057

Electronics Buyers' Guide

H.T. Howland, General Manager
[212] 997-6642

Regina Hera, Directory Manager
[212] 997-2544

Gayla Black, Production Manager
[212] 997-2044

Classified and Employment Advertising

Frank Eberle, Manager
[212] 997-2557

What you must know about Microprocessors

Using articles from the pages of Electronics, this book contains practical and up-to-date information on available microprocessor devices, technology and applications—ranging from the simplest 4-bit p-channel MOS system to the second-generation n-MOS 8-bit processor chips, and the new injection logic and Schottky TTL bipolar processor families needed for the toughest computer-based control applications.

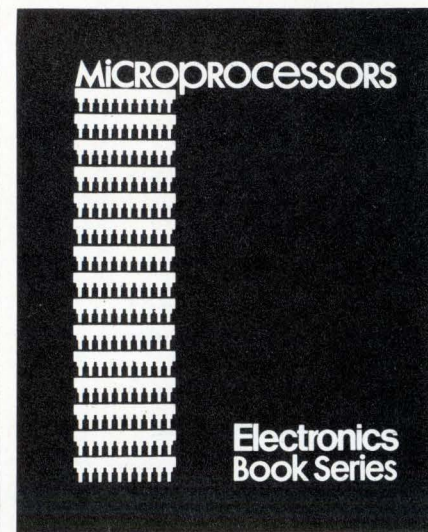

Electronics Book Series

P.O. Box 669
Hightstown, N.J. 08520



Send me _____ copies of
"Microprocessors" at \$8.95 per copy.

I must be fully satisfied or you will
refund full payment if the book is
returned after 10 days free
trial examination.

Payment enclosed Bill firm
 Bill me

Credit Cards Charge My Book To:
 American Express Master Charge
 Diners Club BankAmericard

Acct. No. _____

Date Card Expires _____

Interbank No. _____

(1st No's. above name
on Master Charge only.)

Name _____

Title _____

Company _____

Street _____

City _____

State _____ Zip _____

Signature _____

PROGRAMMED POWER...



75 KVA frequency converter/UPS

Beginning with sensitive Power Line Disturbance Monitors, then high-efficiency power frequency converters, UPS, and power conversion systems, PPI offers a broad capability in power problem detection and power problem solving.

PPI was first to offer Power Line Disturbance Monitors to characterize your problems on DC, 50, 60, 400, 415 and 441 Hz mains. PPI was first again with Transient Direction Detection to determine the source of your transients—and first once more with an 89%-efficient 400 Hz, 75 KVA frequency converter/UPS. Now, PPI offers advanced designs in 50-150 KVA UPS. For the future—an even broader capability in Disturbance Monitors and power conversion systems.

- 50 - 441 Hz Power Line Disturbance Monitors
- 75 KVA Frequency Converters/UPS
- 50 KVA UPS
- 75 KVA UPS
- 100 KVA UPS
- 125 KVA UPS
- 150 KVA UPS



Power Line Disturbance Monitor



Franklin Electric

Programmed Power Div., 995 Benicia Ave., Sunnyvale, CA., 94086 (408) 245-8900

Circle 181 on reader service card

MDB SYSTEMS presents... The LSI-11 Connection

GP Logic Modules · Peripheral Controllers · Communications · Interfaces · Special Purpose Modules · Accessory Hardware

Plus: DEC's own LSI-11 Microprocessor Module. MDB Systems products always equal and usually exceed the host manufacturer's specifications and performance for a similar interface. MDB interfaces are software and diagnostic transparent to the host computer. MDB products are competitively priced; delivery is usually within 14 days ARO or sooner.

Here are some MDB Systems connections to LSI-11 microprocessors:

- General Purpose Controllers:
 - Serial for TTY, displays, communications
 - Parallel for programmed I/O and DMA
 - Do-it-yourself dual and quad wirewrap for any

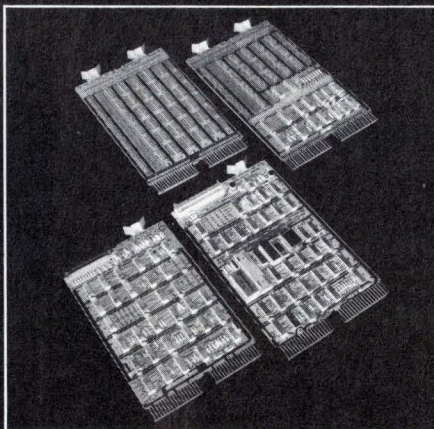

- DIP design
- Device Controllers for most major manufacturer's
 - Printers
 - Card equipment
 - Paper tape equipment
 - Plotters
- Communications/Terminal Modules
 - Asynchronous Serial Line Interface
 - Synchronous Serial Line Interface

- MDB Backplane/Card Guide Assembly
 - MDB's is a *real* chassis, accepts eight quad modules
 - Special Purpose Modules and Accessories
 - System monitoring unit provides front panel Switch addressing
 - Power on/off sequencing
 - Bus extenders/terminators
 - E-PROM and PROM modules
 - Bus connectors for backplane assemblies
- Check first with MDB Systems for your LSI-11 interface requirements.

MDB also supplies interface modules for DEC PCP-11, Data General NOVA, and Interdata minicomputers.

MDB
MDB SYSTEMS, INC.

1995 N. Batavia St., Orange, California 92665
714/998-6900 TWX: 910-593-1339

Every other week we talk to the 32,329 decision-makers in Japan's electronics industry.



The way they talk back is astonishing.

us more about the readers who send in the Information Service Card. Here is what we learned:

57.4% of the readers who returned the card for additional product information acknowledged that they participate in or influence the purchasing decision of their companies.

Of this group, 31% said they were solely responsible for decision making, and 67.4% said they were partially responsible.

After learning more about the product or service offered, 25% of our readers wanted to buy it or wanted to think more about it.

And, in the long run, more than 50% of the respondents decided either to buy the product or are still debating whether or not to buy it.

Seven magazines in Japan communicate with management and professional engineers. But only one influences the influentials. That's us, Nikkei Electronics, the *Electronics* of Japan.

If you're thinking about selling the electronics decision-makers in Japan, talk to them in our pages. Contact Mr. H.T. Howland, Marketing Services Manager, Electronics, McGraw-Hill Publications Company, 1221 Avenue of the Americas, New York, N.Y. 10020. Telephone: (212) 997-6642. Or talk to any member of McGraw-Hill's sales staff in the U.S. or Europe. Or contact us directly in Japan.

We communicate.

Each bi-weekly issue of Japan's most influential electronics magazine contains a Reader Information Service Card (exactly like the one in the magazine you're reading now, except in a different language).

One important way we're able to tell how our influence works with management and professional engineers in the Japanese electronics industry is the way they respond to our advertising by returning the card.

In a word, the response is phenomenal.

Recently we asked the Marketing Information Center of Tokyo, an independent research organization, to tell



Nikkei Electronics: Ask anybody who can read us.

Nikkei-McGraw-Hill Inc.: Nikkei Annex Building, 2-1-2, Uchikanda, Chiyoda-ku, Tokyo, Japan

TURNKEY 620 SYSTEMS FROM NEFF USING THE HP 9825 CALCULATOR.. the logical next step in data acquisition.

You're involved in a scientific, engineering, or industrial project that could use a high performance, low cost data acquisition system. But you know that system integration and software costs of most systems actually exceed the hardware. And your need is now, so you want a system that will take data immediately with minimum user training.

Our turnkey 620S was designed for you.

620S is a sophisticated data acquisition system with amplifier-per-channel or differential multiplexer analog signal processing and using the H.P. 9825 computing calculator for system control, data analysis and recording.

Neff systems are known for high performance and the 620S is no exception. Consider 0.1% accuracy with 50kHz channel scanning rate, fullscale input sensitivities from 5 millivolts to 10 volts, up to 256 channels or 2048 channels fully expanded, and 120dB rejection of common mode voltages up to 300 volts. Selectable data filters, simultaneous sample and hold and input signal conditioning are but a few of the many available features.

The Hewlett-Packard 9825 calculator provides the 620S computer performance with the operating convenience of a calculator. Programming is simple with HPL, an easy to learn, high level language designed for scientists and engineers. Standard features include a live-keyboard, alpha numeric printer and cassette recorder. Up to 24K memory is available. Plug-in peripherals include floppy disk, line printer, x-y plotter, and tape punch. It also attaches to H.P. Interface Buss.

A complete, integrated data acquisition system that's easy to use — that's our turnkey 620S.

Like to know more? Call us today at 213-357-2281 or write for our free brochure.

NEFF
INSTRUMENT CORPORATION

1088 E. Hamilton Rd., Duarte, Calif. 91010
Tel. (213) 357-2281 TWX 910-585-1833





FEEL
the pot . . .



CLICK
the switch . . .



GANG
the modules . . .

and add "quality-touch" appeal
to your product.

FEEL THE POT . . . a smooth, quality feel, only from Bourns® 81/82 Model Potentiometers. Rotational torque range, only .3 to 2.0 oz. inch, is consistent for one, two, three or four cup assemblies.

Independent linearity of $\pm 5\%$ and low 1% CRV provide exceptional setability in both cermet and conductive plastic element types.

CLICK THE SWITCH* . . . one that really clicks, with positive action detent at either CW or CCW end. The Bourns Model 85/86 potentiometer/switch combination is rated at 2 amps in DPST style and 1 amp in DPDT. Contacts are constructed of fine silver with gold overlay. This provides exceptionally low contact resistance, for reliable operation at low level analog or logic signal levels — or any application requiring an "on-off" function.

GANG THE MODULES . . . potentiometers and switches. Up to 4 modules can be ganged on the same single or dual concentric shaft, without sacrifice to the satin-smooth feel or the sure-fire click. Other options include a wide choice of bushing and shaft styles, P.C. pins or solder lugs. Think of the possibilities! Now you can specify custom pots and switches assembled from "off-the-shelf" modules — at standard cost and leadtime.

Add "quality-touch" appeal to your equipment with BOURNS Model 80 Family of Modular Potentiometer/Switches. Write or call today for complete technical information, direct or through your Bourns distributor.

FEEL, CLICK, GANG . . . BEAUTIFUL!

TRIMPOT PRODUCTS DIVISION, BOURNS, INC., 1200 Columbia Avenue, Riverside, California 92507, Telephone (714) 781-5122 — TWX 910 332-1252.

*Patent pending



Int'l Sales Offices: European Hdqtrs. — Switzerland, 042/23 22 42 • Belgium 02/218 2005 • France 01/2739633 • Germany 0711/24 29 36
• Italy 02/32 56 88 • Netherlands 070/88 93 18 • United Kingdom 01/572 6531 • Japan 075 92 1121 • Australia 83 9410 • Brazil 257-3535

Circle 902 on reader service card