

NOVEMBER 25, 1976

CAN YOU TRUST YOUR HANDHELD CALCULATOR?/77

Pinpointing logic faults by current tracing/106

How to predict the cost of a semiconductor memory system/117

FOUR DOLLARS A MCGRAW-HILL PUBLICATION

Electronics®

1420 TCH98 MCSA9 SEP76
STATE TECHNICAL INST
FREEMAN LIBRARY 017823
5983 MACON COVE
MEMPHIS TN
98134

PIAZZA



PROCOMPULSER

**ON-CHIP
EPROM
EXTENDS
PROCESSOR
CAPABILITY**

NEW SOLUTIONS FOR YOUR NEXT EDP SIGNAL TRANSMISSION CABLE PROBLEM

WOVEN RIBBON CABLE. Components: PVC insulated twisted pairs

TWISTED PAIR. Components: PVC insulated conductors

JACKETED BONDED RIBBON CABLE. Components: 95Ω air-spaced miniature coaxial cable

DUAL LAYER, JACKETED WOVEN RIBBON CABLE. Components: PVC insulated twisted pairs

BONDED RIBBON CABLE. Components: PVC insulated single conductors

TRI-LEAD. 2 conductors polyimide insulated, center conductor silver coated, Teflon FEP insulation overall

MULTI-CONDUCTOR 95Ω AIR-SPACED COAXIAL CABLE. (White / Green twisted pair for power)

50Ω COAXIAL CABLE — RG-174/U

95Ω MINIATURE AIR-SPACED COAXIAL CABLE — Braided shield

95Ω MINIATURE AIR-SPACED COAXIAL CABLE — Foil shield

100Ω TAPE CABLE — 28 AWG stranded conductors, PVC insulation

80Ω TAPE CABLE — 32 AWG conductors, polyester insulation

85Ω TAPE CABLE — 29 AWG conductors, Teflon FEP insulation

Limited space, cost, mechanical properties and operating environment are just a few of the considerations when specifying signal transmission cable.

Millions of feet sold

That's why Brand-Rex makes over a dozen different kinds of transmission cables . . . for leading computer and peripheral equipment manufacturers throughout the world. Options include twisted pairs, round or miniaturized air-spaced coax in round or flat configurations, or in flat forms such as Brand-Rex TAPE CABLE® or bonded and woven ribbon. They're available with a broad range of shielding options.

Our Engineers can help

Ask Brand-Rex engineers to recommend the best cost/performance cable to meet your signal transmission circuit needs. If we don't already make it, we'll design it for you. Call or write your local Brand-Rex sales engineer or Brand-Rex Company, Electronic and Industrial Cable Division, Willimantic, CT 06226, 203/423-7771.

BRAND-REX

ELECTRONIC & INDUSTRIAL CABLE DIVISION

Other Brand-Rex Divisions:
Abbott & Co., wiring
Nonferrous
Polyethylene

The SMC SAMPLER

**\$99 assortment of MOS/LSI for the
computer peripheral designer.**

- COM 2017 UART—pin for pin compatible with WD 1602A.
- COM 2017H UART—high speed, up to 60K baud available.
- COM 2502 UART—WD1402A and AY-5-1013 compatible.
- COM 2601A USRT—synchronous receiver-transmitter, bi-sync compatible.
- COM 5016/5036 Dual Baud Rate Generator—programmable up to 32 different standard or non-standard baud rates. (XTAL or TTL inputs)
- COM 5026/5046 Single Baud Rate Generator—low cost, programmable up to 16 different standard or non-standard baud rates. (XTAL or TTL inputs)
- KR 2376-XX Keyboard Encoder—Tri-mode, 88 key, 2-key rollover.
- KR 3600-XX Keyboard Encoder—Quad-mode, 90 key, N-key rollover.
- UPC 6001 General Interface Controller—universal peripheral interface controller for use with 8080 or 8080A MPU.
- CG 5004 CRT Character Generator—128 x 7 x 11 dot matrix.
- CG 4103 Character Generator—64 x 5 x 7 dot matrix.
- SR 5015 Quad Programmable Static Shift Register—80 through 133 bits programmable.
- SR 5017 or 5018 Quad Programmable Bi-Directional Static Shift Register—80 through 133 bits programmable.

Now you can get the complete selection of SMC's standard LSI peripheral interface circuits for only \$99. The same circuits that are currently being used by major computer manufacturers and data communications companies worldwide.

New Products:

In addition, SMC will soon be sampling sophisticated MOS interface controllers for **HDLC, SDLC, CRT Timing, Floppy Disc, Universal Asynchronous/Synchronous Receiver-Transmitters and ROM-less Keyboard Encoders.**

Custom MOS/LSI:

For applications requiring custom circuits, SMC's N-channel COPLAMOS[®] and P-channel technology is second to none. We are supplying custom circuits for virtually every digital

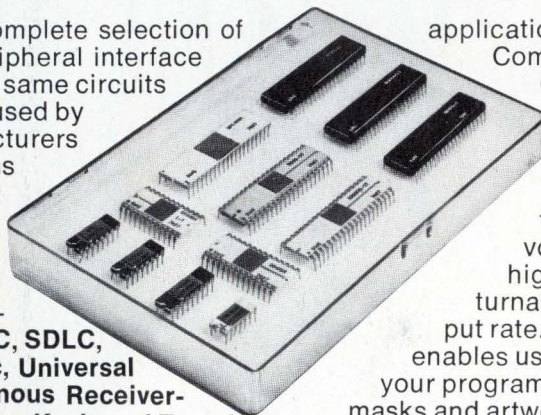

application: Computers, Data Communications, Voice Compression, Entertainment Systems, and Computer Terminals. SMC has structured its custom circuit and supporting departments to service the low and medium volume user as well as high volume customers, with fast turnaround time and high throughput rate. Our engineering expertise enables us to interface at any level of your program—from system design—to masks and artwork. Complete information is available from our Applications Engineering Department.

To order your peripheral interface circuit sampler, contact our sales office.

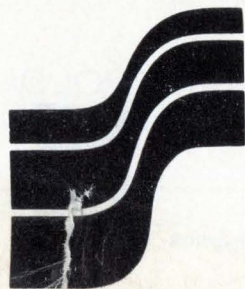

SMC Microsystems Corporation

Division of
Standard Microsystems Corporation

35 Marcus Boulevard, Hauppauge, N.Y. 11787
(516) 273-3100 TWX-510-227-8898

Ask CONTROL DATA for the OEM industry standard: 40, 80, 150 and 300 MByte Storage Module Drives you can interchange without changing your design.



We have it.

Ask who makes and ships the storage module drives that have become the industry standard and you'll get just one answer. Control Data. We've already delivered close to 3000 SMD's—all with removable media—to more than 100 customers. And all models are in production.

What's more, we offer easy system integration through common interface software and firmware. That means you can select the best drive for any given proposal without spending big dollars to modify your basic system design. And that's a big benefit for you in any price-competitive situation!

Now—with the introduction of the "Mini-module" drive—get an even more complete family of compatible drives.

Capacity	Type	TPI	Model	Media	Interface
12 MB	MMD	300	9730-12	Fixed, Sealed	Industry std. SMD I/O format and interface common to all models.
24 MB	MMD	300	9730-24		
48 MB	MMD	600	9730-48		
40 MB	SMD	200	9760	Removable	
80 MB	SMD	400	9762		
150 MB	SMD	200	9764		
300 MB	SMD	400	9766		

For more information call (612) 830-5741 or return coupon to: Ray Crowder, OEM Product Sales Manager, Control Data Corporation, 7801 Computer Avenue South, Minneapolis, MN 55435, Dept. E-11256.

Please send information on your Storage Module Drives.

NAME _____ TITLE _____
 COMPANY _____ ADDRESS _____
 CITY _____ STATE _____ ZIP _____ AREA CODE _____ PHONE _____

Ask the CDC OEM people

GD CONTROL DATA CORPORATION

41 Electronics Review

COMPUTERS: IBM lands squarely in minicomputer marketplace, 41
MEMORIES: Faster static RAMs coming on strong, 42
IBM stores data in no-transistor memory cell, 42
AVIONICS: FAA to test computerized voice system to brief pilots, 43
SPACE: NASA looks to transmitting power from space, 44
MICROPROCESSORS: Mostek readies one-chip F-8 . . . 46
. . . as Fairchild moves ahead on its F-8 line, 48
NEWS BRIEFS: 48
MILITARY: Norden hardens its first DEC computer, 50
IEEE: Split-ticket votes scramble top positions, 52
PHOTOVOLTAICS: Thick films ease solar-cell contact attachments, 53

63 Electronics International

LUXEMBOURG: Small company to market first video-disk recorder, 63
AROUND THE WORLD: 63

77 Probing the News

CALCULATORS: Can you count on your calculator? 77
COMPANIES: RCA's Griffiths plans to be No. 1, 80
COMPUTERS: Japanese come smiling through, 84
ELECTRONICS ABROAD: Color TV booms in Spain, 89

99 Technical Articles

SOLID STATE: One-chip microcomputer fills middle-range gap, 99
INSTRUMENTS: Inductive-current pickup tracks logic faults, 106
DESIGNER'S CASEBOOK: Telephone-ring detector needs no relay, 112
Timer extends life of teletypewriter, 113
Two inverters and a crystal assure oscillator start, 115
COMPUTERS: Predicting the costs of semiconductor memories, 117
COMPONENTS: Broadband transformers can handle kilowatts, 123
ENGINEER'S NOTEBOOK: Logic probe displays four modes, 130
IC timer drives electric fuel pump, 131
Programable calculator analyzes filter designs, 131

141 New Products

IN THE SPOTLIGHT: Analog I/O card plugs into microcomputer, 141
SEMICONDUCTORS: Linear-IC breakdown voltages zoom, 145
COMPONENTS: Citizens' band switch cuts parts count, 150
INSTRUMENTS: Modified spectrum analyzer tests CB sets, 160
DATA HANDLING: Computer kit sells for \$995, 169
SUBASSEMBLIES: Photodetector arrays include filters, 176
MATERIALS: Protective chokes for thyristors made smaller, 186

Departments

Publisher's letter, 4
Readers' comments, 6
News update, 8
Editorial, 12
People, 14
Meetings, 30
Electronics newsletter, 35
Washington newsletter, 59
Washington commentary, 60
International newsletter, 65
Engineer's newsletter, 134

Services

Employment opportunities, 188
Reprints available, 191
Reader service card, 199

Highlights

Cover: 8-bit microcomputer fits onto one chip, 99

An 8-bit microcomputer with erasable or nonerasable memory fits all elements needed for stand-alone computing onto a single chip. Through expansion with peripheral memory chips, it can also be used in many high-powered data-processing systems.

Theme of the cover illustration, by Assistant Art Director Paula Piazza, is the ultra-violet-erasable PROM of one version of the new Intel device.

Consumer electronics to boom in Spain, 89

Color-television sets will lead the expansion in Spain's consumer electronics next year, but other market sectors will show no real growth. This is the first in a series examining the electronics markets in various European countries.

Inductive pickup is key to fault tracing, 106

A handheld, self-contained probe traces current distributions by inductive pickup to determine exactly which integrated circuit has failed or, for an interconnection problem, the location of the short or open circuit. Since the probe responds only to current, it is compatible with all logic families

Semiconductor-memory costs loom larger, 117

Even though unit costs of semiconductor memories are dropping, their share of total system costs is rising as designers opt for more storage. Careful prediction of lifetime memory costs is essential—and possible with attention to a few parameters.

And in the next issue . . .

Converters meet microprocessors . . . an electrically alterable Famos ROM . . . microcomputer control comes to microwave ovens.



EDITOR-IN-CHIEF: Kemp Anderson

EXECUTIVE EDITOR: Samuel Weber

MANAGING EDITOR: Arthur Erikson,
International

SENIOR EDITORS: Laurence Altman,
Ray Connolly, Lawrence Curran,
John Johnsrud, H. Thomas Maguire,
Stephen E. Scrupski

ART DIRECTOR: Fred Sklenar

ASSOCIATE EDITORS: Howard Wolff,
Gerald M. Walker, Alfred Rosenblatt

DEPARTMENT EDITORS

Aerospace/Military: Ray Connolly
Circuit Design: Raymond P. Capece
Communications & Microwave:
Richard Gundlach
Components: Lucinda Mattera
Computers: Stephen E. Scrupski
Consumer: Gerald M. Walker
Industrial: Raymond P. Capece
Instrumentation: Andy Santoni
New Products: H. Thomas Maguire,
Michael J. Riezenman
Packaging & Production: Jerry Lyman
Solid State: Laurence Altman

CHIEF COPY EDITOR: Margaret Eastman

COPY EDITORS: Everett C. Terry, Ben Mason

ART: Charles D. Ciatto, *Associate Director*
Paula Piazza, *Assistant Director*

EDITORIAL SECRETARIES: Janet Noto,
Penny Roberts, Marilyn B. Rosoff

FIELD EDITORS

Boston: Lawrence Curran (Mgr.), Pamela Leven
Los Angeles: Larry Waller (Mgr.)
Midwest: Larry Armstrong (Mgr.)
New York: Bruce LeBoss (Mgr.)
San Francisco: Bernard Cole (Mgr.)
Judith Curtis
Washington: Ray Connolly (Mgr.)
Frankfurt: John Gosch
London: William F. Arnold
Paris: Arthur Erikson
Tokyo: Charles Cohen

McGraw-Hill World News

Editor: Michael Johnson
Brussels: James Smith
Milan: Andrew Heath
Moscow: Peter Gall
Paris: Joel Stratte-McClure
Stockholm: Robert Skole
Tokyo: Colin Gibson

PUBLISHER: Dan McMillan

MARKETING ADMINISTRATION MANAGER:
Wallis Clarke

CIRCULATION MANAGER: Karl Peterson

MARKETING SERVICES MANAGER:
Tomlinson Howland

RESEARCH MANAGER: Margery D. Sholes

It was Jerry Sevick's interest in amateur radio that launched him into experiments with transmission-line transformers, the subject of his article on page 123. Sevick, known in ham-radio circles as W2FMI, calls his transformer developments an extension of the work begun by one of his colleagues at Bell Labs, C.L. Ruthroff.

"I always knew they were capable of broad bandwidths," says Sevick. But after really looking hard at them, he notes, "I don't think anyone realized just how very efficient they were. Transformers wound on only 1/2-inch-diameter cores can handle 800 watts without even blushing."

Sevick's career has been a varied one. With Bell Labs for 20 years, he spent the first 15 in semiconductor development work and the past five as director of technical relations at Murray Hill. While in the semiconductor group, he was involved in development of the diffused-base transistor, which broke a crucial frequency barrier. The resulting high-frequency transistors could be batch-processed, and the road was open to, first, simple integrated circuits and, later, large-scale integration.

With a Ph.D. from Harvard in applied physics, Sevick started his career at Detroit's Wayne State College where he taught physics. While there, he spent two years as a weatherman on ABC's Channel 7. "I made more in the 2 1/2 minutes talking about the weather than I did in a whole day of teaching physics," he says.

His strong background in physics and his many years in device and

systems work serves him well in his present post of technical-relations director. "All that previous training helps me to interface with all the various people and projects under way at Bell Labs," he says. Still, he missed working in the lab and so he set up one of his own at home. That's where his transmission-line transformer developments were made.

As you may have heard, the United Parcel Service strike has caused an overload at the U.S. Postal Service. This, in turn, has caused delivery problems for *Electronics*. And, for reasons unknown, some of our subscribers are also receiving damaged copies.

If your copies of *Electronics* are arriving after the date on the cover or in a damaged condition, we'd like to hear from you. This will help us to figure out where the most serious problems are and perhaps help to improve our service. Please write me, Dan McMillan, at 1221 Avenue of the Americas, New York, N.Y., 10020, enclosing the address label from your copy.

November 25, 1976 Volume 49, Number 24
95,564 copies of this issue printed

Published every other Thursday by McGraw-Hill, Inc. Founder: James H. McGraw 1860-1948. Publication office 1221 Avenue of the Americas, N.Y., N.Y. 10020; second class postage paid at New York, N.Y. and additional mailing offices.

Executive, editorial, circulation and advertising addresses: Electronics, McGraw-Hill Building, 1221 Avenue of the Americas, New York, N.Y. 10020. Telephone (212) 997-1221. Teletype 12-7950 TWX 710-581-4879. Cable address: MCGRAWHILLNEWYORK.

Subscriptions limited to professional persons with active responsibility in electronics technology. No subscriptions accepted without complete identification of subscriber name, title, or job function, company or organization, and product manufactured or services performed. Based on information supplied, the publisher reserves the right to reject non-qualified requests. Subscription rates: in the United States and possessions \$12.00 one year, \$30.00 three years; company addressed and company libraries \$18.50 one year, \$46.00 three years; APO/FPO addressed \$35.00 one year only; Canada and Mexico \$14.00 one year, \$32.00 three years; Europe \$35.00 one year, \$87.50 three years; Japan, Israel and Brazil \$60.00 per year; Australia and New Zealand \$80.00 per year, including air freight; All other countries \$40.00 per year. Limited quota of subscriptions available at higher-than-basic rate for persons allied to field served. Check with publisher for these rates. Single copies: \$4.00. Please allow four to eight weeks for shipment.

Officers of McGraw-Hill Publications Company: Gordon L. Jones, President; Paul F. McPherson, Executive Vice President; Gene W. Simpson, Group Vice President; Senior Vice Presidents: Ralph Blackburn, Circulation; John B. Hoglund, Controller; Ralph R. Schultz, Editorial; David G. Jensen, Manufacturing; Vice Presidents: James E. Boddorf, Planning & Development; Edward E. Schirmer, Marketing Administration.

Officers of the Corporation: Harold W. McGraw, Jr., President, Chief Executive Officer, and Chairman of the Board; Robert N. Landes, Senior Vice President and Secretary; Ralph J. Webb, Treasurer.

Title registered in U.S. Patent Office. Copyright © 1976 by McGraw-Hill, Inc. All rights reserved. The contents of this publication may not be reproduced in whole or in part without the consent of copyright owner.

Subscribers: The publisher, upon written request to our New York office from any subscriber, agrees to refund that part of the subscription price applying to copies not yet mailed. Please send change-of-address notices or complaints to Fulfillment Manager; subscription orders to Circulation Manager, Electronics, at address below. Change-of-address notices should provide old as well as new address, including postal zip code number. If possible, attach address label from recent issue. Allow one month for change to become effective.

Postmaster: Please send form 3579 to Fulfillment Manager, Electronics, P.O. Box 430, Hightstown, N.J. 08520.

four important reasons to specify the **KEPCO OPS** power supply

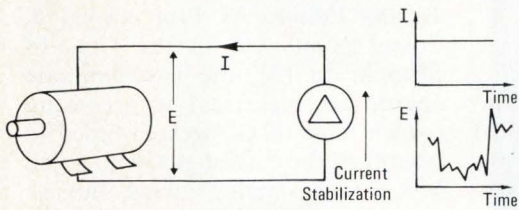

1 YOU'VE GOT THIS MOTOR that wants to be driven by constant current. Trouble is, its impedance varies wildly, and your conventionally-filtered current regulator can't hardly keep up. **YOU NEED A KEPCO OPS**—whose lack of output capacitance allows a stabilized current to be stable—even though the compliance voltage is doing nip-ups.

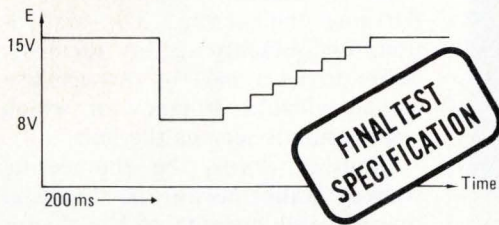

2 YOUR SYSTEM DESIGNER SPECIFIED THIS TEST SEQUENCE: . . . "15V for 200 milliseconds, shift to 8V (1 ms settling time) then stair step back to 15V @ 20 ms/step in 1V steps." Your conventionally-filtered power supply has a shunt capacitor that takes a half-second just to make it down to 8V . . . **YOU NEED A KEPCO OPS**, whose capacitorless output circuit can be programmed rapidly (up to $1V/\mu\text{sec}$) and yet suppress ripple and noise some 60–80 dB below peak output.

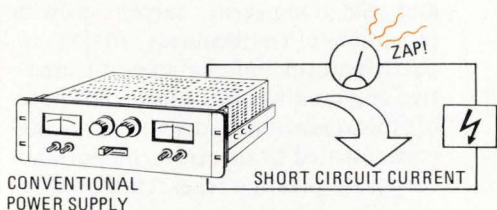

3 YOU'VE POWERED UP THIS SENSITIVE LOAD that suddenly shorts — zapping the delicate series ammeter . . . But the specs on your conventional power supply said "current limited." Problem is, the output capacitor isn't included! **YOU NEED A KEPCO OPS:** No output capacitor, no surge current, even when shorted!

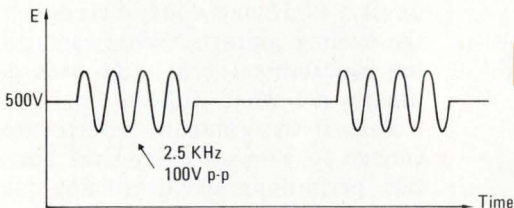

4 YOU NEED TO SUPERIMPOSE THIS 2.5 KHz MODULATION on top of a d-c level. You can either buy a modulator/amplifier and put it in series with your conventionally-filtered power supply, or **USE A KEPCO OPS**, which is a "modulatable power supply" and which for $1V/\mu\text{sec}$ slewing, will allow you up to 100V p-p modulation at 2.5 KHz.

Whenever your application requires a dynamically programmable voltage, a stable current into a dynamic load, or you just plain can't tolerate the energy stored in an output filter, you really do need a Kepco OPS. There are 61 models ranging from 20 W to 1000 W and offering outputs from 0–6 volts up to 0–5000 volts.

Of course, OPS are not for *every* application. Sometimes a big shunt filter is a good friend. Kepco makes a comparable line of capacitor-filtered models for these applications too. Our Catalog/Handbook contains extensive discussion about the dynamics of power supplies. Send for your copy today!



OPS III
(Modular
Style)

OPS IV
Bench/System
Style

OPS

are premium quality,
wide-band amplifiers
for dynamic applications

Write Dept. FD-14

KEPCO®

KEPCO, INC. • 131-38 SANFORD AVENUE • FLUSHING, N.Y. 11352 U.S.A.
(212) 461-7000 • TWX #710-582-2631 • Cable: KEPCOPOWER NEWYORK

These custom IC's are not for sale!



But the technology that created them is...

along with all the other capabilities you'll need for custom LSI from design through production.

Silicon Systems specializes in custom LSI . . . it's not a sideline. We're interested when others aren't because we've lowered the volume at which custom IC's become cost effective.

Over the years we have developed the world's most advanced IC design capability. A proprietary system, created in our own computer lab, helps us solve design problems in any technology—TTL, SCHOTTKY, ECL, I²L, LINEAR, PMOS, NMOS, CMOS, whatever is best for you.

Our custom IC's are used in talking calculators, traffic controllers, code generators, garage door openers, automotive instrumentation, etc.

Are your products ready for state-of-the-art custom LSI?

For more information, phone or write Jim Meyer,
(714) 979-0941 at 16692 Hale Ave., Irvine, California 92714.



Silicon Systems
incorporated

Readers' comments

The right job is elusive

To the Editor: As Prof. David J. Comer points out in the Oct. 14 editorial [p. 12], the baccalaureate degree in electrical engineering (which most of us sweated blood to secure) is the fastest ticket to a job with a high starting salary. But, as mentioned, salaries do top out. Why, then, are students still interested in pursuing engineering? The motivation, undoubtedly, is an idealistic desire to be a part of the creative technological aristocracy of which engineering is seen as the hub.

In other words, the engineering student trades away the financial rewards and prestige of the doctor and the long-term career growth potential of a business major to participate in the challenge of creative engineering. But more and more of this creative endeavor is being concentrated in the Government and corporate prestige research laboratories. The only ticket into these facilities is a Ph.D. and a list of credits in the leading journals. What remains for baccalaureates to fight over is usually not what students envision.

Even if the graduate is fortunate enough to gain an entry-level position performing work utilizing his academic background, in many cases this position dead-ends into a technical-support function when the project is completed. This places the engineer on the familiar track to obsolescence. All the study in the world will be in vain if one cannot practice the discipline.

So uncontrolled is the title of engineer that companies freely bestow it on math majors, computer-science majors, physicists, and even non-degree personnel, if this will enhance the chances of landing major contracts. Such practices are not conducive to the idea of professionalism.

Comer carefully asks what other four-year program to recommend. This question begs the real one. What course of study must be pursued to ensure that the student can successfully market himself so he may practice engineering as an applied science/art in a creative environment?

Stanley Katz
Bellerose, N.Y.

“When he says it’s 5 volts, it’s 5 volts.”

Son of Ref-01! The instant success of our Instant-On 10V monolithic Ref-01 made it only logical that we’d do a 5V version to serve designers who are working with 5V systems. Instantly-on, the Ref-02 replaces all those noisy, dirty, power guzzling zener references, with *essentially zero warm-up time*.

And like the 10V Ref-01, it is referenced to the bandgap energy of the silicon substrate itself.

So if you need low drift reference circuits for your low TC instruments (like 3ppm/°C), the Ref-02 will provide a stable 5V reference, *adjustable by 6%* with minimal effect on temperature stability. Price? \$1.90 (100’s). Delivery? From stock. Application notes? You bet. Circle the reader number or write SON OF REF at address below.



YOU NOISY
POWER GUZZLING
ZENER REFERENCES
ARE OUT
OF THE
GAME!



Precision Monolithics, Inc.
1500 Space Park Drive
Santa Clara, CA 95050
(408) 246-9222
TWX: 910 338 0528
Cable MONO.

Circle 7 on reader service card

Want to make waves?

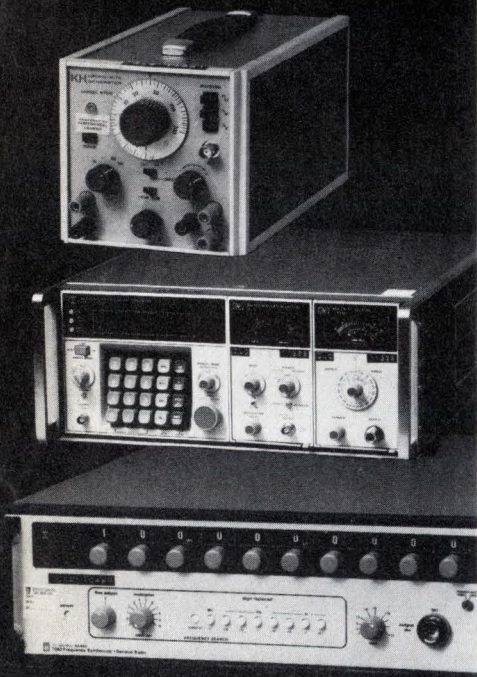

Call the "Instrument Professionals". They can tell you which generator, oscillator or synthesizer best fits your needs. They'll have it on your dock tomorrow — guaranteed to make all the waves you need. Renting the right gear will keep your head above water!

Write or call for data on our other specialties: Instrument Leasing • Computer Peripherals • Equipment Sales • Instrument Service.
Circle 8 on reader service card

Call Continental Rentals

Get our FREE Catalog

Div. Continental Leasing Co., Inc.
175 Middlesex Turnpike, Bedford, MA, 01730 (617) 275-0850
Metuchen, NJ (201) 549-8500;
Gaithersburg, MD (301) 948-4310; TX (214) 357-1779; Elk Grove, IL (312) 439-4700; Costa Mesa, CA (714) 540-6566; Santa Clara, CA (408) 735-8300; Los Angeles, CA (213) 477-7521

News update

■ The multilayer film carrier designed to handle complete watch modules, except batteries, is winning adherents around the world. Tom Angelucci, president of International Micro Industries of Cherry Hill, N.J., which developed the carrier [*Electronics*, April 15, p. 29], is negotiating contracts with Japanese, German, and Swiss firms that would act as licensing agents.

The process, says Angelucci, could save \$1 to \$3 worth of material in each watch module. Not only that, but labor costs would be cut by as much as 75%, he estimates. He figures that a line of 10 to 15 machines working with the new process, capable of producing 500 modules per hour, would occupy 5,000 square feet and be operated by 10 persons. He contrasts this with wire bonding and manual assembly that requires 40 persons to turn out the same number of modules.

■ The Army Electronics Command at Fort Monmouth, N.J., has finally received Defense Department approval to replace all its aging single-channel AN/VRC-12 vehicular, AN/PRC-77 manpack, and AN/ARC-114 airborne vhf-fm radios during the next several years. "The program is essentially where it was a year ago," says Col. James E. Wyatt, project manager, who's leading the Army's search for more than 175,000 radios to be deployed in the 1980s. They are to use the latest electronic technologies for communications security and electronic counter-countermeasures [*Electronics*, Nov. 13, p. 25].

"We got involved with negotiations concerning participation in the program by NATO countries, and this delayed the program," Wyatt explains. The Pentagon last month decided to allow British companies to bid also. "Our plan now is to go out to industry with requests for proposals for competitive advanced development in January 1977, a year later than we had hoped to," says Wyatt. The solicitation, he adds, will cover both technological and cost aspects of the new radios.

INTRODUCING A NEW
REVOLUTIONARY
MULTI-DIGIT
SOLID STATE READOUT
BELOW \$1.

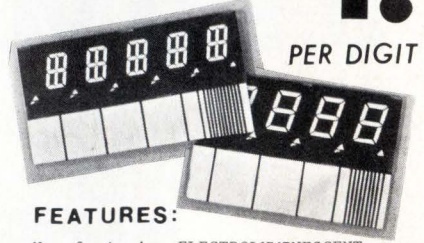

FEATURES:

- Non-fatiguing ELECTROLUMINESCENT light
- Space saving thin profile
- Wired for multiplexing
- Low a.c. power consumption
- Compatible with IC logic decoders and segment drivers
- Rugged, pluggable laminated plastic construction

SPECIAL TRIAL OFFER

ORDER FROM STOCK at 97¢ per digit, any of the following multi-digit readouts having 2 to 5 digits:
1/2" high with 9-segments
0.6" high with 7-segments
(minimum order--\$10.)

T.R. T.L. ROBINSON CO., INC.
P.O. BOX D, EAST AURORA, N.Y. 14052
TEL. (716) 652-2111 TELEX: 91566

Circle 3 on reader service card

High-Accuracy Phase Meters

0.5 Hz to 2 MHz
Digital or meter readouts
As low as \$1150



WILTRON COMPANY
for better electronics measurements

930 E. Meadow Dr. • Palo Alto, CA 94303
(415) 494-6666

Circle 4 on reader service card

How to get through a bandwidth in ten easy steps.

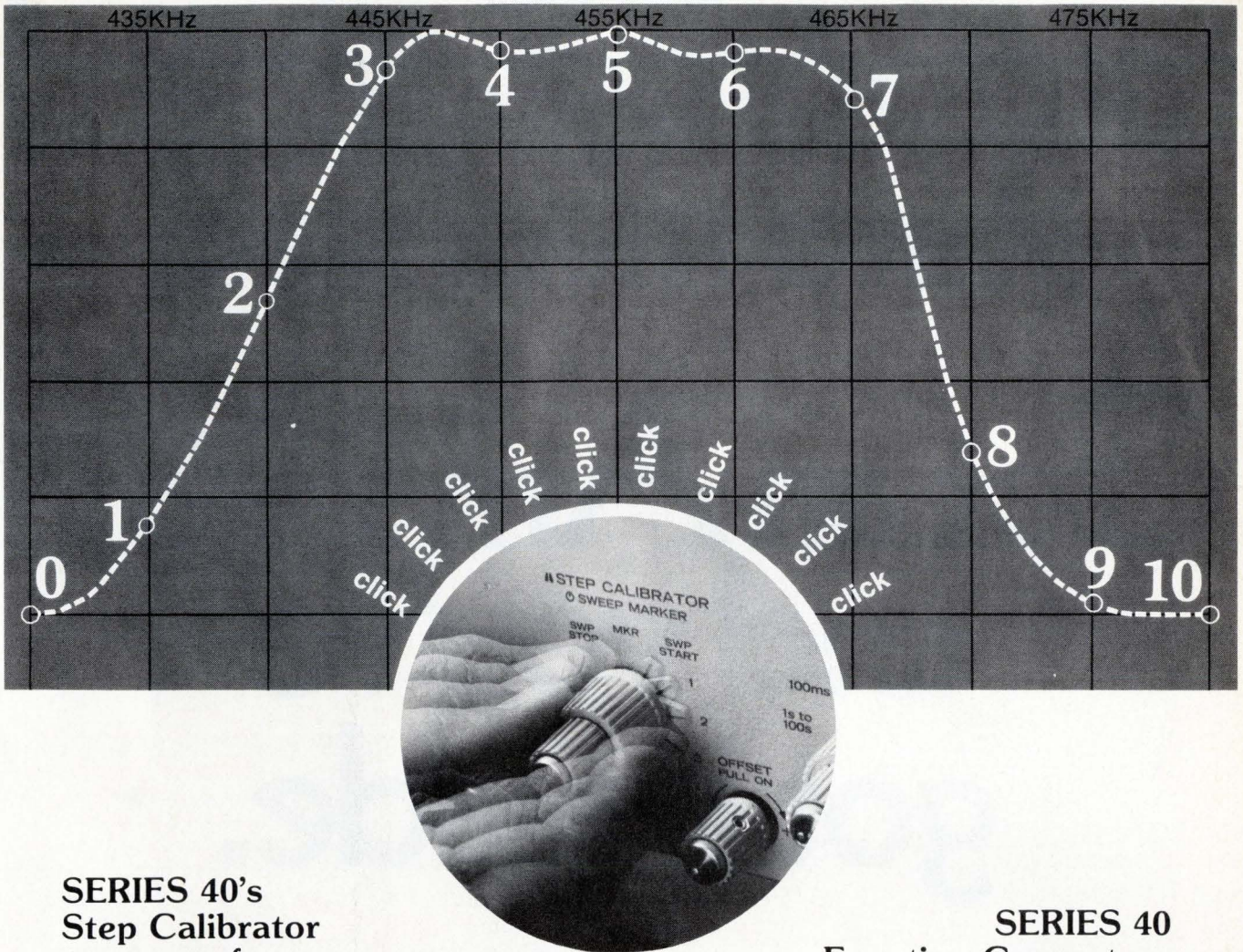

SERIES 40's Step Calibrator measures frequency response with the click of a switch.

Set SERIES 40's main dial *once*, and you'll get eleven precise frequencies in ten equal steps by simply clicking the Step Calibrator switch from zero to ten. With 1000:1 frequency change in the log mode, each step is equivalent to approximately one octave, which is particularly useful in audio testing. And unlike other function generators, SERIES 40 allows you to step up or down without having to cycle through the entire ten steps.

So — when you're testing frequency response, just set up the band edges and click through the ten steps, measuring amplitude at each step... it's that easy.

SERIES 40 Function Generators — New from INTERSTATE

SERIES 40 gives you plenty of amplitude — 40 V peak-to-peak (open circuit) — and takes the guesswork out of pinpointing response with its continuously variable Frequency Marker. SERIES 40 also offers you INTERSTATE's exclusive direct-reading sweep limit control and full spectrum of function generator capabilities in five models from \$475 to \$695. For additional SERIES 40 specifications, call Product Marketing at (714) 549-8282, or write Interstate Electronics, Dept. 7000, Box 3117, Anaheim, CA 92803.

INTERSTATE
ELECTRONICS CORPORATION
Subsidiary of A-T-O Inc.



**The
microprogrammed
state machine:**

**Get an Am 29811
and you've
got it made.**

If you make state machines — and you're tired of gates and flops and hassles and headaches — we've just made your life a lot easier.

Get an Am29811, add some Am2911's and you get an amazingly powerful, efficient microprogram controller. Throw in a couple other 16- and 20-pin packages, and throw away your state machine problems. For good.

Look:

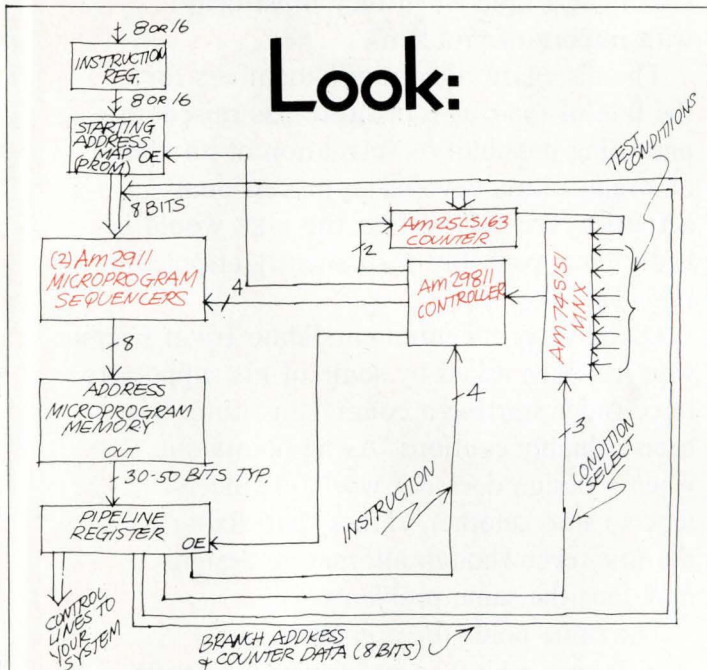

The Am2911 provides logic for sequential addressing, branching to any address, four levels of subroutines and looping.

The Am29811 is used to control the Am2911, as well as a loop counter and several branch address sources. The resulting system executes sixteen sequence control functions, most of which can be conditional. (With a 60ns microprogram memory, a typical system can run at 5MHz clock rate—even faster with some minor logic modifications. Wow!)

Two Am2911's can control up to 256 words of microprogram, enough for many state machines. (With three Am2911's, up to 4K words of microcode can be controlled.)

Look again:

Sequence Control Instructions

- Jump to Zero
- *Jump to Branch Address
- Load Counter
- *Repeat Jump if Counter \neq 0
- *Push PC or Push PC and Load Counter
- Jump to Map Address
- *Loop
- *Repeat Loop if Counter \neq 0
- *Jump to Subroutine
- *Return
- *Jump to One-of-Two Subroutines
- *Jump and Pop Stack
- Jump to External Address
- Jump to Branch Address
- *Jump to One-of-Two Branch Addresses
- Continue

*Conditional Instructions

Terrific. But how much?
Am2911, \$2.95 in volume.
Am29811, \$2.60 in volume.
 The entire controller shown, including 8-bits of loop counter and 8-input multiplexer is only \$11.64. That's right. \$11.64 total price.

If you want to know more about the Am2911 or the Am29811, just wire, write or phone. We'll send you a whole book about microprogrammed controllers. For free, of course.

Boy. Some guys really have it made.

Advanced Microprocessors



IEEE election: heeding the majority

A year ago we wrote that the Institute of Electrical and Electronics Engineers should listen to what the minority of voters in the presidential election was trying to tell them. This year, the results of the recent election reveal, the IEEE leadership had better acknowledge the wishes recorded by the majority of voters.

In our view, the results of the election are not a cause for complacency on the part of the institute leadership. The two petition presidential candidates, who ran against the nominee of the board of directors, won 56% of all the votes cast. What's more, the petition candidate for executive vice president took the election, setting up a rather awkward administration composed of a minority president and a dissident vice president. All three propositions initiated by member petition gained the approval of the majority, but none won the necessary two thirds for acceptance.

Clearly the members are telling the IEEE that they want reforms, especially through the professional-activities arm of the institute. Yet there's a certain ambivalence in the results. The most surprising—indeed, shocking—aspect of the vote was that only 36% of those eligible exerted the effort to return their ballots. Fewer voted this year than last, though the percentage was the same, owing to a decline in total membership.

Does it mean that 64% of the members are satisfied with whatever the institute's leaders may do? Or does it mean that this big majority of dues-paying members does not

care what IEEE does? This apparent apathy is disturbing because it might encourage inaction on the part of the institute's leaders at a time when they must deal with important problems.

The disregard of so many members for the fate of their own institute has raised an unsettling possibility—formation of another EE organization devoted to professional activities. We believe that the IEEE would be badly hurt, probably permanently crippled, if this idea takes shape.

Dissident presidential candidate Irwin Feerst, who has been asked by some of his supporters to consider starting a counter institute, has been laudably cautious. As he points out, when a design does not work, engineers tend to start another, rather than fixing the first, even though alternative designs may face the same problems.

The same holds for organizations. As a lever—a bluff in poker-playing terms—the spectre of a rival organization has possibilities and may shake some of the timid into action. However, we hope that all means for reform are thoroughly tried before such a radical course is actually pursued.

Maybe, like the original 13 colonies, the IEEE will be strongest when it appears weakest. This might just turn out to be the time when the leaders will work to win the confidence of the members, when the activities and voting records of the various boards will be opened to all, and when the bickering will stop long enough to allow reasonable progress toward the IEEE of the 1980s.

MOS for the new generation of organs (easy!)

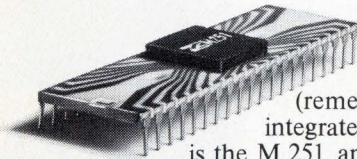

A new first from SGS-ATES (remember their integrated rhythm generator?) is the M 251, an automatic accompaniment generator integrated on a single MOS-LSI chip.

You've already selected your rhythm, and now you can correctly key-in the automatic accompaniment (chords, walking bass and arpeggio) for your melody, by pressing, that's it, just one key. A memory ensures that you can then proceed with your favorite "hands-off" operation.

All this thanks to SGS-ATES' MOS experience and many years of collaboration with major organ producers. Apart from the M 251, SGS-ATES manufactures a complete range of MOS integrated circuits for electronic musical instruments:

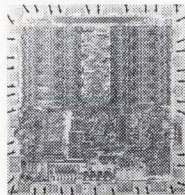

- M 087 top octave synthesizer
- M 147 pedal sustain (13 bit latch, left priority)
- M 251 chords, bass and arpeggio generator
- M 252 rhythm generator (15 rhythms, 8 instruments)
- M 253 rhythm generator (12 rhythms, 8 instruments)
- M 254 rhythm generator (8 rhythms, 12 instruments)
- M 255 rhythm generator (6 rhythms, 5 instruments)
- HBF 4727 7-stage frequency divider (2+2+1+1+1)
- HBF 4737 7-stage frequency divider (3+2+1+1)
- and in bipolar technology
- H 629 1x12 multiplexer
- H 632 2x6 multiplexer

And that's why



SGS-ATES SEMICONDUCTOR CORPORATION
Newtonville, Mass., tel: 617-9691610



RCL

is

#

1

in the Hi Rel Wire-Wound Resistor Field!

RCL has more military approvals on power and precision fixed wire-wound resistors than any other manufacturer.

AMF

RCL Electronics

195 McGregor St.
Manchester, N.H. 03102
(603) 627-3831

People

Tektronix' Fischer opts
for low-cost, flexible tests

Because it's getting tougher and more expensive to stay in the automatic-test-equipment marketplace, many companies are turning to a new breed of manager—one who grew up in both semiconductor and test industries.

One of this new breed is James Fischer, the new general manager of Tektronix Inc.'s Semiconductor Test System Group. At 39 he is already a veteran of almost 20 years standing. A graduate of the State University of New York, he received a thorough grounding in the essentials of semiconductors, computers, and test equipment design during five years at IBM, Endicott, N.Y. Then came an early 4-year stint at Tektronix as a field engineer for test equipment beginning in 1962, followed by work with automated test equipment at E-H Research Laboratories, Oakland, Calif., and Siemens Computest, Cherry Hill, N.J., before he returned to Tektronix in 1973.

Such a varied background will serve in good stead in view of the increasing demands he sees being placed on ATE manufacturers. "On the one side is a fast moving semiconductor technology, in which the size and complexity of memories and LSI logic devices, such as microprocessors, is increasing almost monthly," he says. "On the other side is the demand by semiconductor makers and users for lower-cost testers."

Looked at simplistically, the two demands, he says, seem mutually exclusive. "To keep current with the technology means developing a general-purpose test system that can be adapted to device changes easily," he says. "But the cost of such a system—at least its up-front price—is not inexpensive, at least \$100,000 and up." A user can reduce this price by buying systems dedicated to specific device types, he points out, but in the long run this could be more expensive as the technology forces a choice between being left behind or buying a new system.

The Tektronix approach, says Fis-

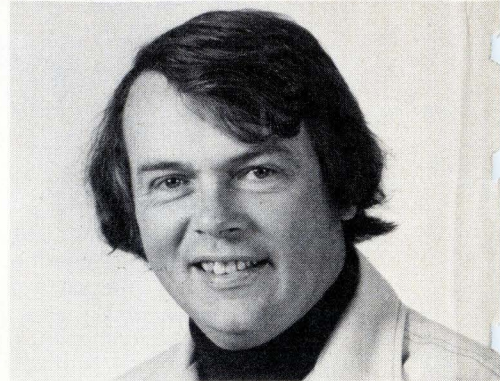

Way to go. James Fischer's approach is to lower the cost of using his test systems.

cher, will be to lower the cost of use of general-purpose test systems by making them easier to program, increasing the system reliability, reducing the time it takes to repair a system through modular design, and increasing test flexibility through better software and the use of intelligent terminal stations.

Steps are already being taken in these directions through the use of a parallel testing concept implemented in Tektronix' family of LSI memory and linear device testers. It's the only way to go, says Fischer, if Tektronix is going to be a major factor in an ATE market that he estimates will grow by at least 20% a year through the rest of the decade.

IE's Ward looks to
broader line, profitability

"All of the ingredients have come together to paint a very rosy picture for the future," claims Robert E. Ward, new president of Instrumentation Engineering Inc. in Franklin Lakes, N.J. But next month, as the manufacturer of automatic test equipment closes out the first profitable year of its seven-year existence, it will be counting on some new ingredients.

"We're no longer going after just the large manufacturers offering the potential of sizable repeat custom business," Ward says. "Rather, we hope to sell to a lower level of customer because we have converted our systems and diagnostic software

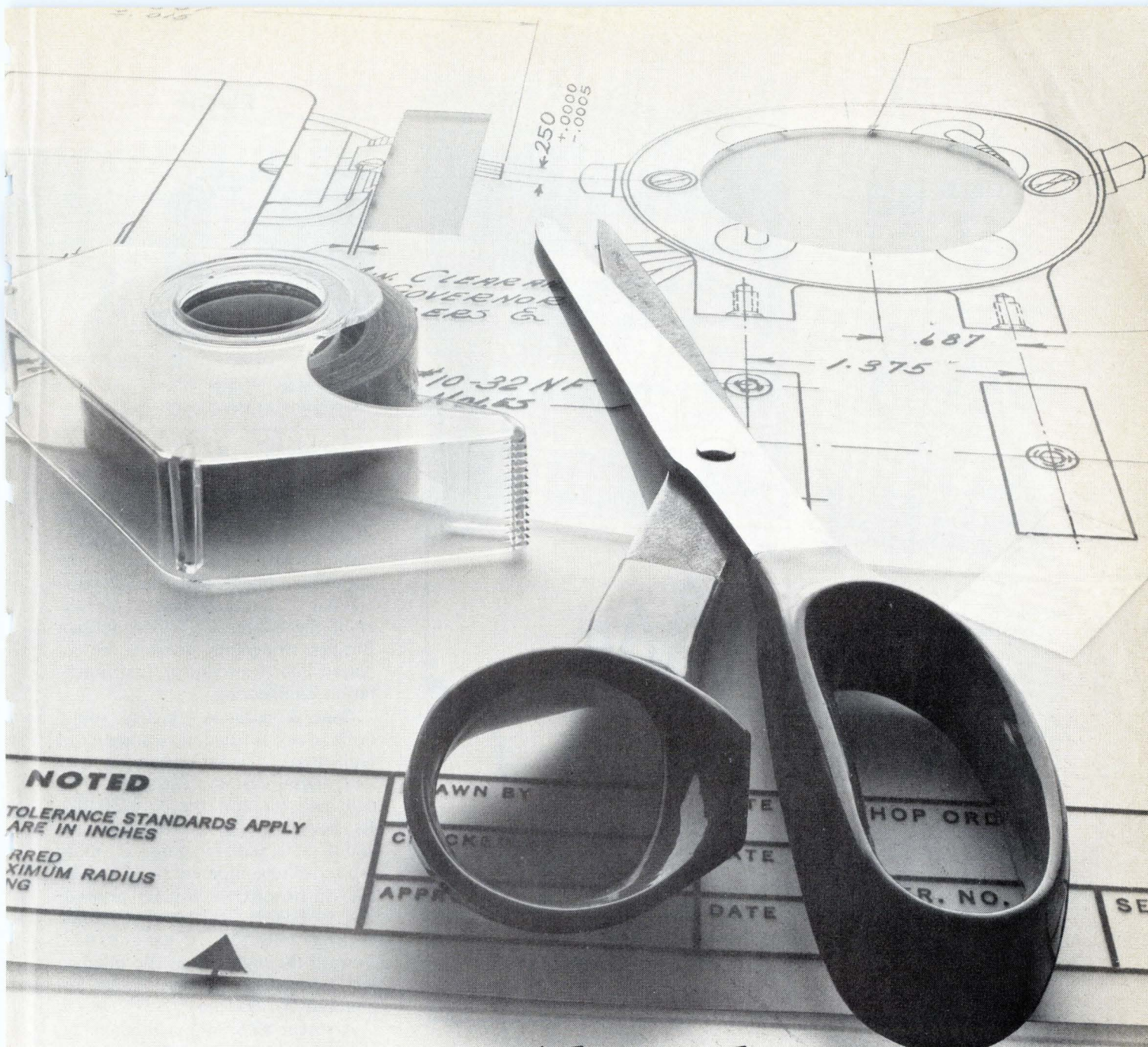

Cut out the old. And cut costs.

You can make drafting revisions a lot quicker with photography and a pair of scissors. Just make a photoreproduction of the original on clear Kodagraph film and scissor out the unwanted detail. Tape the elements you want to a new drawing form and make a reproduction of this composite on Kodagraph matte film. Then simply draft in the new detail.

For more information on how this and other reprographic shortcuts can save you money, write: Eastman Kodak Company, Graphics Markets Division, Dept. R 6850, Rochester, New York 14650.

Kodagraph films and papers
Versatility in reprographics



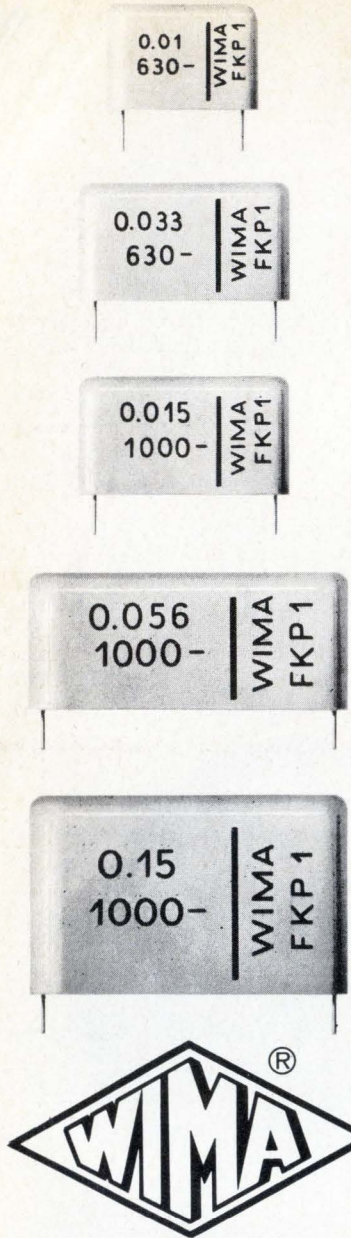

WIMA FKP 1

Self healing
polypropylene
capacitors
with the
lowest losses
for high
current duties

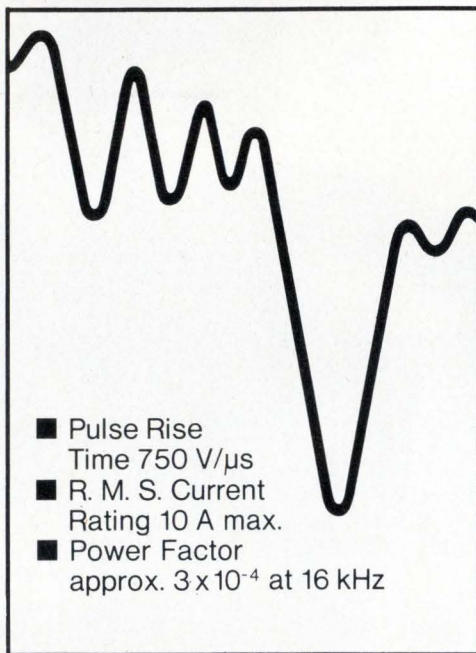

The unique capacitor designed for thyristor deflection circuits in colour television sets. Proven in leading TV models and in solid state equipment.

Write for our new catalogue!

WILHELM WESTERMANN

Spezialvertrieb
elektronischer Bauelemente
D-68 Mannheim · Fed. Rep. of Germany
Augusta-Anlage 56 · P.O. Box 2345
Tel.: (06 21) 40 80 12

People



Modification. Modular systems that users can upgrade are trumps for Robert Ward.

to a modular format."

A user can now start with a simple, slow-speed digital system and expand it later with additional analog or slow- or high-speed digital stations, without losing any of the initial investment, adds the 60-year-old Ward. Formerly general manager of the Singer Co.'s now-defunct Business Machines division, he replaced Paul Giordano at Instrumentation Engineering.

General purpose. IE has found fame, if not fortune, as a supplier of high-speed, general-purpose analog and digital test systems that typically sell for upwards of \$250,000. Its new low-end offering lists for about \$100,000, making it more attractive to equipment builders who use sufficiently complex printed-circuit boards and need dynamic testing with fault diagnostics. Toward the high end of the line is a test system for microprocessors announced last spring.

A recent \$2.5 million refinancing, Ward points out, improved IE's cash-flow position, weakened by heavy development costs associated with the microprocessor tester. "We feel most of the future growth will be related to microprocessor testing and where high-speed digital testing will be used with greater diagnostics and fault isolation."

Ward expects IE to post modest increases in sales volume for the next few years. "Sales this year will be the highest in IE's history," says Ward, acknowledging that industry estimates of about \$8 million for the privately held firm "are in the ballpark." He continues, "We're in the right posture to bring some of our developments to refined final form."

hp MEASUREMENT COMPUTATION **NEWS**

product advances from Hewlett-Packard

NOVEMBER 1976

in this issue

Full ASCII code in new matrix LED display

Recorders and CRT displays for the OEM

14.9 Mbytes of memory for HP 9825A



A new data acquisition system can measure parameters in the form of ac, dc and resistance, analyze the information and make decisions, process the information, present results in graphic or printed format, interact with a process and provide alarm and switching functions.

NEW data acquisition system reads up to 19 channels/sec with 1 μ V resolution

With capabilities found in many larger computer-based systems, the HP 3052A Automatic Data Acquisition system is a lower cost alternative for fast process monitoring and control, component and product test, environmental and energy use monitoring, stimulus/response testing and signal analysis.

Under control of the HP 9825A desktop computing controller, the HP 3052A uses two digital voltmeters to cover its wide measurement range and speed—the HP 3455A, a high resolution, high accuracy digital voltmeter and the HP 3437A, a high speed dc systems voltmeter. Inputs to both DVM's may be switched by the HP 3495A scanner. The 9825A takes over system control interfacing and data processing.

Dc measurements up to 19 channels/sec are possible with 1 μ V resolution on the 100 mV range.

Excellent noise rejection and low thermal uncertainty make the 3052A suited for accurate, repeatable, low-level measurements even in the presence of noise. The > 120 dB effective common-mode rejection of the 3455A/3495A effectively cancels out unwanted offsets or super-imposed signals.

Consider the wide range of problem solutions offered in the 3052A System:

- Signal digitizing
- High-speed scanning
- System timing
- Two-level interrupt system
- High-speed data access and storage
- Alphanumeric display for easy interaction with the operator.

For more information on data collection, processing and control solutions, check D on the HP Reply Card.

The HP 1000 for computing, instrumentation control and operations management



An HP 1000 can be dedicated to a specific application, or be part of a computer network linking "islands of automation" within a plant. Several users performing different tasks simultaneously will all think that *only they* are using the computer.

Hewlett-Packard introduces its new series HP 1000 computer systems—powerful, flexible tools that can be applied in a multitude of ways to help you optimize the use of your always limited resources.

Dynamic microcycle timing. A singular HP technical concept, allows the processor to execute most instructions in 175 ns while taking 280 ns for the occasional slower functions.

Processor growth power. A new microprogramming package including a symbolic microassembler and debug-editor allows you to increase the speed of time-critical tasks. New, fast, low cost, semi-conductor, main memory capacity of up to 608K bytes is twice that of comparable systems.

HP-pioneered mini-cartridges. The standard console is the fast new 9600 baud, high-resolution HP 2645 CRT terminal. Programmers on multiple terminals now can plug-in, modify, and then walk away with their own programs stored on pocket-size mini-cartridges. The 2645's "Soft-keys" can be programmed to automatically enter multiple keystroke sequences. With a single stroke of a user-defined "Soft-key", you can load or compile a program, query a data base, or monitor the status of multiple tasks.

HP software. The RTE operating system orchestrates interactive program development from multiple terminals concurrently with batch processing. Multi-lingual programming—in FORTRAN, ALGOL, HP Assembly and multi-user BASIC—allows users to communicate with the system in the most suitable language.

Rapid access disc. The fastest disc cartridge on the market, the HP 7905, employs the latest track-follower disc technology and a micro-processor based control unit. Disc storage capacity of up to 120M bytes allows the construction of a data base for most small to medium-sized organizations.

Hewlett-Packard Interface Bus. With an HP-IB kit, the HP 1000 can control multiple clusters of instruments in a very broad range of automated electronic or electrical testing measurement and control applications.

IMAGE/1000. Hewlett-Packard's data base management can define, build, and maintain a data base that can be used by many of your people for a wide variety of purposes. Non-programmers can access the data base with QUERY, an easy-to-use inquiry language in order to quickly retrieve meaningful information. IMAGE automatically links together related in-

formation and reduces redundant data. Users can have multi-terminal access to the data base for concurrent and interactive retrieval and reporting of information.

Computer networks. If you use more than one computer within your organization, HP's networking software will provide cost benefits that include sharing peripheral devices such as line printers, magnetic tape and disc memory systems. In addition to placing HP 1000 "power centers" where they are most needed, you can disperse terminals throughout your organization to feed timely data into the data base.

Choice of cabinet enclosures. The Models 30 and 80 are offered as attractive "deskcomputer" work centers; Models 31 and 81 are traditional cabinet-mounted versions.

This well-balanced combination of HP 1000 computer system power and IMAGE/1000 information handling usefulness makes dynamic, user-oriented information handling a reality at an exceptionally low cost.

If you would like more information on how the HP 1000 can be dedicated to a demanding application or distributed throughout an entire network, check A on the HP Reply Card.



Put the HP 1000 to work anywhere you need to combine computers and electronic instruments for faster and easier measurement and testing.

Memory of 9825A desktop system can be expanded in multiples of 468,480 bytes



With its live keyboard, vectored priority interrupt, direct memory access, and built-in tape storage, the 9825A can control and acquire data from several instruments while it performs calculations, prints or plots results, and reviews programs—all through simple keyboard commands and with apparent simultaneity.

Two fast, low-cost flexible disk drives expand the usefulness of the HP 9825A programmable desktop computing system.

The new disk drives, the 9885M (master) and 9885S (slave), have a memory capacity of up to 468,480 bytes per disk.

The master, in addition to containing the built-in power supply, contains the controller for managing the operations of the slave units. Up to eight 9885M master drives can be connected to a 9825A, and up to three slave drives can be connected to each master—a total of 32 separate disks with 14,991,360 bytes of user available memory. The flexible disks provide virtually unlimited economical off-line storage for both programs and data.

Fast transfer rates are achieved through the direct memory access (DMA) feature. Instantaneous transfer rate of information between the disk drive and the calculator is 62,500 bytes/sec; continuous throughput rate is 23,000 bytes/sec. Average access time to any place on the disk is 260 msec.

Double density read/write on the disk enhances the access rate in addition to increasing the total storage

capacity. The 9885M is controlled by a high-level command system that organizes the data into named files on the disk. A directory keeps track of the names of the files, where they are located, and the size and type of the files.

Write-verify automatically ensures that the information recorded on the disk is identical to the source information in the memory. Additional features include the ability to sort and print the directory or catalog information, recover data after a check sum error, and copy files, portions of files, or complete disks to other disks. Data can be organized serially or randomly for optimum data access.

The new 9878A Expander increases the usable I/O channels from three to nine. The addition of two expanders to the 9825A, in combination with the HP Interface Bus, makes it possible for the 9825A to interface with as many as 210 instruments and/or peripherals.

For more information on this computing and controlling capability, check K on the HP Reply Card.



The HP Interface Bus (HP-IB) is Hewlett-Packard's implementation of IEEE Standard 488-1975 and identical ANSI Standard MC1.1, "Digital interface for programmable instrumentation."

Presenting...computer product solutions from HP

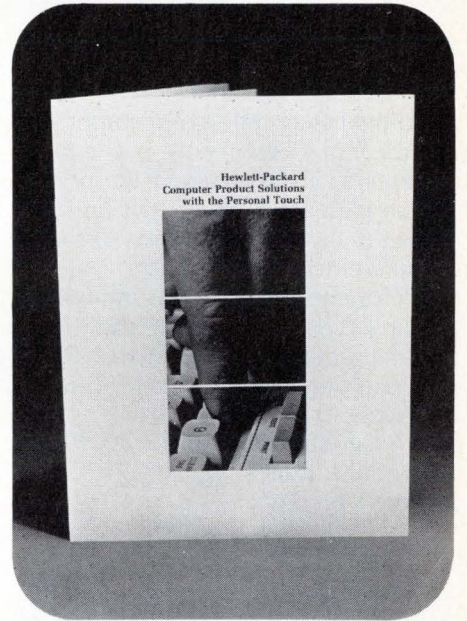

Hewlett-Packard can meet information processing needs at many levels. A free 12-page brochure describes our product range from hand-held units to full-scale computer systems.

Illustrated are examples of how such diverse organizations as Eastman Kodak, General Motors, The Travelers Insurance, Yale University, Walter Reed Hospital and Bell Labs are using our computer products.

Check Q on the HP Reply Card.

New telephone line analyzer simplifies high-speed data line measurements

The new HP 3770B analyzer is designed for audio data line characterization to CCITT M.1020 and M.1060 standards. In a single, portable unit, it provides all the routine maintenance measurements recommended by CCITT for high-speed data lines.

It measures group delay, attenuation distortion, and absolute level in the frequency range 200 Hz to 20 kHz. The 3770B also measures weighted noise, noise-with-tone, and impulse noise. An optional slave facility for group delay and attenuation distortion measurements allows the results, for both directions of transmission on a 4-wire circuit, to be displayed and recorded at one end of the circuit.

The sender and receiver are combined in a single, rugged unit. With automatic ranging, zeroing, synchronization and simultaneous LED readout of measurement result and frequency, the 3770B is an easy-to-use, portable test set.

Linked to an HP X-Y recorder, a permanent swept record of the measurement can be obtained. Pre-printed graph paper showing CCITT limits for group delay and attenuation distortion measurements is available.

Pertinent specifications include:

- Group delay (0 to ± 10 ms)
- Attenuation distortion (0 to ± 40 dB)
- Absolute level (+10 to -50 dBm)
- Noise (0 to -85 dBm)
- Noise-with-tone (0 to -80 dBm)
- Impulse noise
- Slave facility

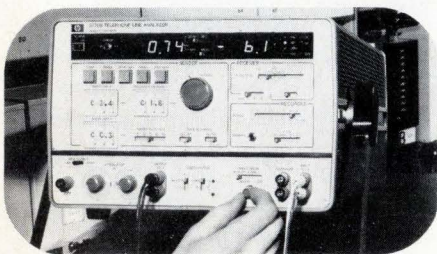

Select the capabilities you need from a wide range of options available for this new rugged, portable line analyzer.

For more information on solving your data line problems, check E on the HP Reply Card.

Now, HP's new digital IC troubleshooting probe, pulser, current tracer and clip are in kits

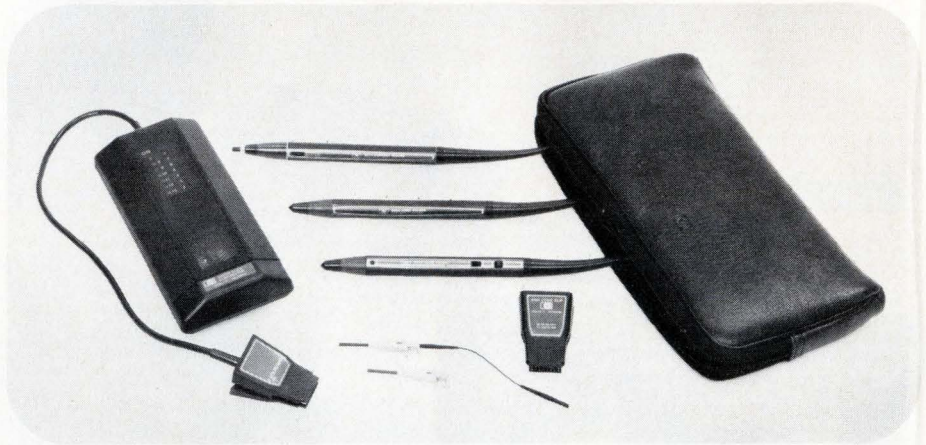

The HP 5023A shown here contains all five new IC troubleshooters from Hewlett Packard. Three kits are now available, each packaged in a convenient zippered vinyl case.

Recently, HP introduced four new multi-family IC troubleshooters: the HP 545A logic probe, 546A logic pulser, 548A logic clip, and the revolutionary 547A current tracer.

Now, these troubleshooting tools are available in three convenient kits. You'll save time and money when you purchase them, and again, when you use them in your circuits. That's because the kits cost less than our stand-alones, and also because they provide great troubleshooting benefits—packaged as easy-to-use, hand-held instruments.

Instruments	Kits		
	5021A	5022A	5023A
545A Logic Probe	X	X	X
546A Logic Pulser	X	X	X
547A Current Tracer		X	X
548A Logic Clip	X	X	X
10529A Logic Comparator			X

The new **5022A** kit provides all the capability you're likely to require for nodal and gate troubleshooting. It contains the probe, pulser, current tracer and clip plus handy vinyl carrying case and most of the connectors you'll need to connect up to any TTL, DTL, HTL, or CMOS circuit.

The addition of the 10529A logic comparator in the **5023A** kit provides the ability to do multi-pin static and dynamic testing.

The economically-priced **5021A** kit contains probe, pulser and clip, essential tools for most gate-to-gate troubleshooting problems.

For a data sheet on all kits, check G on the HP Reply Card.

Comprehensive new Application Note on precise time interval measurements

Just published is a new application note, AN 191, a thorough presentation of precision time interval measure-

ments using an electronic counter. Among the topics discussed are resolution, time interval averaging, trigger circuit operation, and error evaluation. Applications presented include phase measurements, ATC ranging, and remote operation via the Hewlett-Packard Interface Bus.

For your copy, check P on the HP Reply Card.

A wide range of DC power supplies are now HP-IB programmable



HP-IB

Utilizing the new 59501A programmer, you now may select from more than 80 HP power supply models for use in HP-IB test systems.

A new isolated D/A converter / power supply programmer, the HP 59501A, provides a convenient interface between the Hewlett-Packard Interface Bus and over 80 models of HP power supplies. Output voltage (or current) control of remotely programmable power supplies is accomplished by voltage programming from the 59501A, with gain provided by the power supply control circuits.

Isolation is rated at 600 Vdc between the input HP-IB data lines and output terminals to keep all power supply circuits separated from the controller and bus-connected instruments.

Output from the programmer is from 0 to 9.99 volts in 10 mV steps. Accu-

racy is 0.1% plus 5 mV. Increased resolution and accuracy are available over the lower 10% of output using the HP-IB programmable 0.1 X range. A network in the 59501A programmer may be adjusted to match the various power supply programming coefficients and full scale output ratings. In addition, the programmer output may be manually switched to a bipolar mode required for controlling power supply/amplifiers.

The 59501A may also be used as a low level DC voltage source with a conversion time of $< 150 \mu\text{s}$ and output current up to 10 mA.

For additional details, check H on the HP Reply Card.

New application note for testing active RF devices

Measuring the gain characteristics of active microwave devices—primarily amplifiers and transistors—has traditionally been a time consuming procedure because many tests had to be performed at discrete (i.e., CW) frequencies. Now a new HP Application Note (AN 155-1) describes how to make swept-frequency measurements of such important parameters as:

1. Gain and Power Output
2. Gain Compression
3. Harmonic Content

(CW Gain vs. Power Output is also described; a more convenient test than the traditional Gain vs. Power Input).

These applications are keyed to the HP 8755 Frequency Response Test Set, a versatile dual-channel detection and display system with ratio-ing capability and 60 dB dynamic range. Frequency coverage of the 8755 is from 15 MHz to 18 GHz. Operating instructions and accuracy considerations are included in this eight-page note.

Send for your copy today. Check O on the HP Reply Card.

New RF test sets offer convenience and precision

Two precision RF test sets, designed for use with the HP 8505A Network Analyzer (500 kHz to 1.3 GHz), are available separately so they can be used with such other RF instrumentation as the popular HP 8405A vector voltmeter (1-1000 MHz), HP 8407A 110 MHz network analyzer system, and HP 8755 frequency response test set (two-channel, magnitude-only detection and display system).

Model 8502 transmission reflection test set contains both a precision power splitter and a high directivity directional bridge permitting simultaneous measurement of transmission and reflection coefficients of the device under test. Also included in the test signal channel is an RF attenuator with 70 dB range in 10 dB steps, which means sensitive devices can be tested at very low test signal levels. The test device can be biased through a dc bias network incorporated within the set. This test set is available with test port impedance of either 50 ohms (8502A) or 75 ohms (8502B). The 75 ohm version is configured to allow measurements in 75 ohm systems using 50-ohm instrumentation.

The HP 11850 three-way power splitter is an extremely flat, well-matched signal divider useful for such transmission measurements as gain or loss, matched pair gain or loss, and comparison tests. The three output ports can be either 50 ohms (11850A) or 75 ohms (11850B).

For more details, check J on the HP Reply Card.

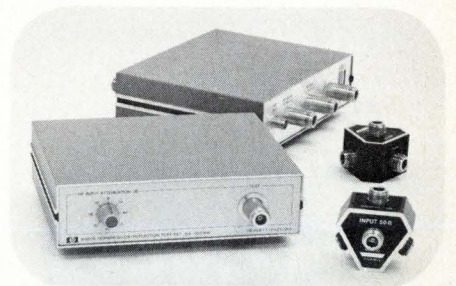

Precision test sets for measuring 50 and 75 ohm networks in the 500 kHz to 1.3 GHz frequency range: (left) HP 8502A/B transmission/reflection tests sets with built-in 70 dB attenuator, and (right) HP 11850 A/B three-way power splitters.

New low-cost Schottky diode for general purpose switching

With a low forward voltage of 410 mV, the HSCH-1001 (IN6263) is a functional replacement for many germanium diodes. It also offers 15 mA forward current and a 60V breakdown voltage for efficient switching in the picosecond range. With an operating range of -65°C to $+200^{\circ}\text{C}$, it is suitable for harsh environments.

The HSCH-1001 is ideal for waveform clipping, clamping and sampling, transistor speed-up, and rf signal detection and power monitoring.

For details, check M on the HP Reply Card.

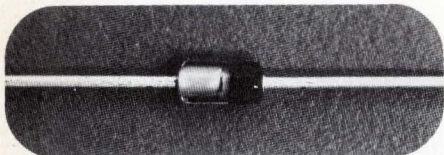

The HSCH-1001 is offered in the low-cost DO-35 hermetic package. It is rugged enough for automatic insertion equipment and can be supplied in tape or reel.

New low noise transistor

A new microwave bipolar transistor, the HXTR-6102, has a guaranteed noise figure of only 2.7 dB maximum at 4 GHz, with 2.5 dB typical. Associated gain is 9 dB.

The HXTR-6101, with a guaranteed noise figure of 3.0 dB, has been reduced in price up to 33%.

Check N on the HP Reply Card for further specifications.

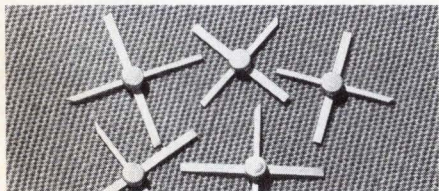

The HXTR-6102 is supplied in the HPAC-70GT, a rugged metal/ceramic hermetic package capable of meeting tough environmental and test requirements.

New compact alphanumeric display with on-board IC's reduces system complexity

Compared with the external circuitry required for earlier and more expensive alphanumeric LED displays, the HDSP-2000 reduces the parts count for a typical display system by a factor of 36:1.

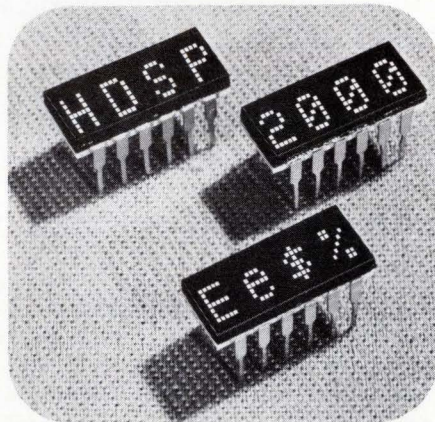

HP introduces a compact LED alphanumeric display, complete with on-board electronics. The HDSP-2000 is a 3.8mm (.150") high alphanumeric available in a standard DIP package. Packages are end-stackable to any message length. On board are shift registers and constant current drivers, reducing the parts count for a typical 32-character system by a factor of 36:1. These low voltage LED displays are directly TTL or CMOS compatible and are readily microprocessor controlled.

The internal circuitry accepts decoded 5×7 matrix data in a serial format. In operation, one column of data for each character in the display string is first clocked into the on-board shift registers from an external character generator and parallel-to-serial converter. The appropriate column of the HDSP-2000 is then strobed using an external column drive transistor.

Because of their small package size and on-board circuitry, HDSP-2000 alphanumeric displays are expected to open new application possibilities in-

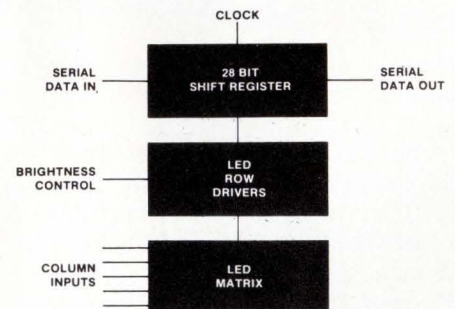

Only 12 pins are needed to address each 4-character set. On-board electronics includes shift registers and externally programmable constant-current drivers.

cluding interactive point-of-sale devices, compact mobile communications sets, 'smart' microprocessor-based instruments or control systems, medical instruments, and portable business terminals. The miniature package makes many hand-held applications feasible. Rugged solid state construction and ability to operate at temperatures from -20°C to $+70^{\circ}\text{C}$ allows these displays to be used in harsh industrial environments and many military designs.

Each HDSP-2000 character is formed with a 5×7 dot matrix capable of displaying the full ASCII character set, upper and lower-case letters, punctuation marks, mathematical symbols as well as numerals. The 35-dot matrix allows flexibility of character font design. Character height is optimized for hand-held, desk-top, or viewing distances of 1 to 3 meters.

For detailed specifications, check L on the HP Reply Card.

OEM NEWS

At Hewlett-Packard, your OEM dollar buys more than just hardware

When you purchase OEM equipment from Hewlett-Packard, you are assured of product performance, service and applications assistance from a company that recognizes your reputation and success depend partly on the support you receive from your OEM supplier.

Confidence can be yours with the knowledge that HP is ready to respond to your needs with over 3,000 sales, service and technical personnel located in 172 offices in 65 countries.

A highly competitive OEM discount structure is offered across a wide selection of instruments. In addition, many instruments can be custom tailored to meet your specific needs.

Confidence is yours when an HP recorder is part of your OEM system



HP-IB

HP instrumentation tape recorders, including the eight-channel shown above, are designed and packaged for versatility, portability and durability.

With the addition to the OEM recorder line of eight and four-channel instrumentation tape recorders, the HP 3968A and 3964A respectively, high performance data collection is realizable for the systems you manufacture.

Both recorders use economical 1/4-inch tape. A combination of FM and direct electronics permits recording from DC to 64 kHz. These compact, rugged recorders provide laboratory quality performance even in tough field environments. Standard features include TTL remote control, a push button built-in calibration source, tape servo, flutter compensation and voice annotation. Six tape speeds from 15/32 ips to 15 ips give you a 32:1 tape base compression or expansion for flexibil-

ity and easy data analysis.

Designed to serve the broadest possible range of OEM applications, HP also offers an extensive line of analog and graphic recorders including:

- **X-Y** Available in two basic configurations: 11×17" (DIN A3) and 8½×11" (DIN A4).

- **Strip Chart** Choose from four categories: single span, compact desk-top unit, "slim line" models, and a battery powered portable.

- **Graphic Plotters** Paper up to 11×17" (DIN A3) can be used in three models for use with communications terminals and computers.

An OEM catalog describing all these models is available. For your copy, check F on the HP Reply Card.

An HP display will enhance your system's image

End users of your system will judge capability by the information displayed. HP's CRT Displays are excellent choices for many applications.

The 1332A, 1333A and 1335A displays all have a very small spot size that focuses uniformly over the complete viewing area, regardless of writing speeds or intensity level. Fine image detail with excellent contrast and uniformity make them particularly well suited for applications involving complex graphics, especially when combined with alphanumeric data.

If you need a larger viewing area, and a brighter image at fast scan rates,

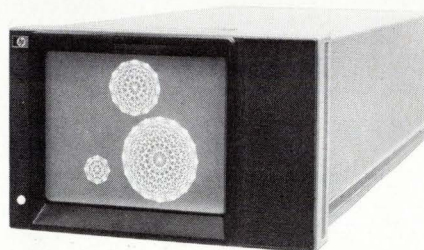

consider the **1332A** with a 9.6×11.9 cm viewing area.

For photographic recording of displayed data over the 8×10 cm area, the **1333A** offers an extremely small spot size (.20 mm).

The **1335A**, a variable-persistence, storage and non-storage display has a totally new CRT design. For maximum flexibility, any operating mode—erase, store, write, conventional or variable persistence—can be selected with manual front panel controls, re-

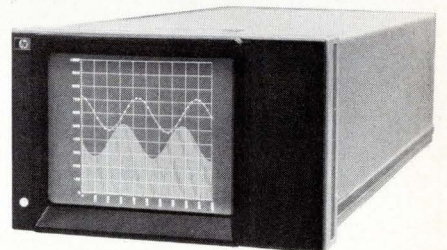

note program inputs, or both.

HP also offers five large screen graphic displays for OEM computer graphic and instrumentation applications. These large displays have linear writing speed of 25.5 cm/μs and X/Y settling times of ≤500 ns.

For details on large displays, check B on the HP Reply Card. For smaller displays, check C on the HP Reply Card.

New 1 GHz pulse generator for testing your fastest circuits

With transition times down to 300 ps and repetition rates to 1 GHz, the HP 8080 pulse/word generator system provides powerful new stimulus capabilities for testing the fastest of pulse circuits. Giving you a choice of high performance modules from 300 MHz and 1 GHz families, a system can be configured as either a pulse generator or a word generator whose features you can tailor to exactly match your testing requirements.

The 1 GHz repetition rate generator, delay generator/frequency divider, and output amplifier modules form a versatile dual channel pulse generator. With 300 ps transition times, 1.2V pulse amplitude, and precise 100 ps delay increments, the system tests the fastest available IC logic families. Frequency division and inter-channel delay are designed into the system so you can economically, and simply, generate the dual channel waveforms necessary for flip-flop and dual input device testing. Previously requiring 2 pulsers, these signals are produced using only a single system.

The 300 MHz module family consisting of a repetition rate generator, word generator, and output amplifier forms a serial 64-bit data source extremely useful in fiber optics and telecommunications applications. The system features 800 ps transition times, 2V amplitudes, and word lengths variable to 16, 32, or 64 bits. RZ and NRZ data formats and complementary out-

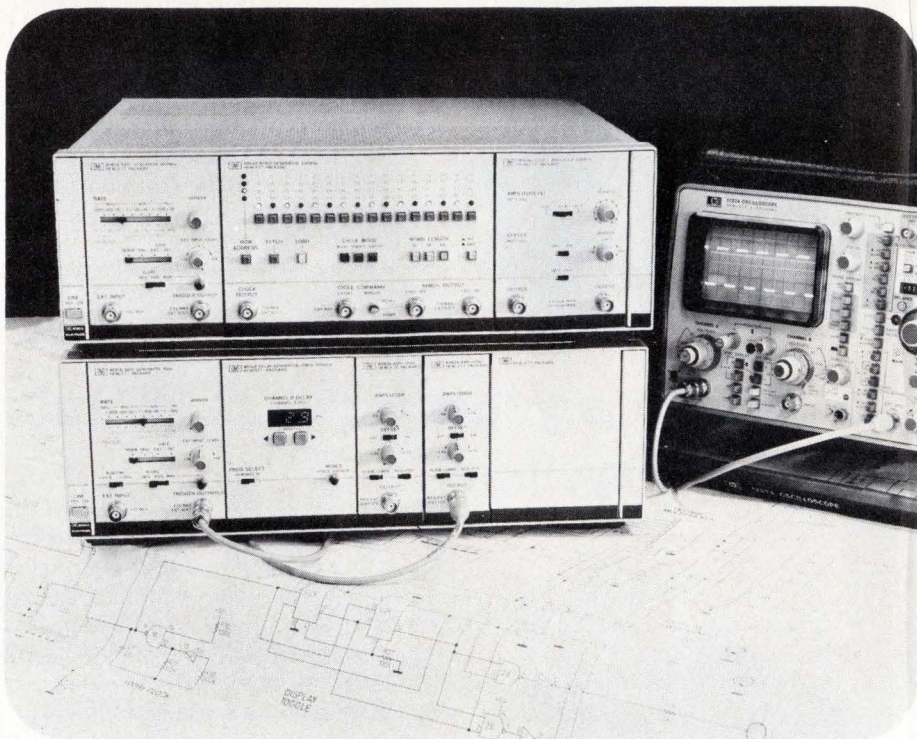

The 8080 series is a powerful new pulse and word generator system for subnanosecond risetime applications. The modular construction of the series enables you to configure pulse stimulus systems to exactly match your high frequency testing requirements, either at 300 MHz or 1 GHz operation.

puts provide flexibility for applications requiring fast serial data streams.

Other combinations of these fully compatible modules provide still further testing capabilities. Modularity protects your investment, letting you easily reconfigure or expand your system to meet changing requirements.

For more information on choosing the modules for assembling your system, check 1 on the HP Reply Card.

East-4 Choke Cherry Road, Rockville, MD 20850
Ph. (301) 948-6370.
South-P.O. Box 10505, Atlanta, GA 30348
Ph. (404) 434-4000.
Midwest-5500 Howard Street, Skokie, IL 60076,
Ph. (312) 677-0400.
West-3939 Lankershim Blvd, North Hollywood, CA
91604, Ph. (213) 877-1282.
Europe-7, rue du Bois-du-lan, P.O. Box, CH-1217, Meyrin-2,
Geneva, Switzerland, Ph. (022) 41 54 00.
Canada-6877 Goreway Drive, Mississauga, Ontario,
L4V 1M8, Ph. (416) 678-9430.
Japan-Yokogawa-Hewlett-Packard Ltd., Ohashi
Bldg., 1-59-1 Yoyogi, Shibuya-ku,
Tokyo 151, Ph. 03-370-2281/92.

HEWLETT  **PACKARD**

Sales and service from 172 offices in 65 countries.

hp MEASUREMENT news
COMPUTATION
product advances from Hewlett-Packard

November/December 1976

New product information from
HEWLETT-PACKARD

Editor: Iona M. Smith

Editorial Offices:
1507 Page Mill Road
Palo Alto, California, 94304 U.S.A.

TO-5 RELAY UPDATE

Maglatch TO-5: the relay with a mind of its own.

Whenever critical switching circuits call for non-destructible memory, choose Teledyne's magnetic latching TO-5 — the relay that remembers. Once set with a short pulse of coil voltage, it will retain its state until reset or reprogrammed — even if system power fails or is shut off. And you get the added advantage of reduced system power demands, since conventional relay holding power is not required.

But memory capability and low power consumption are not the only advantages of our TO-5 maglatch relays. Their subminiature size makes them

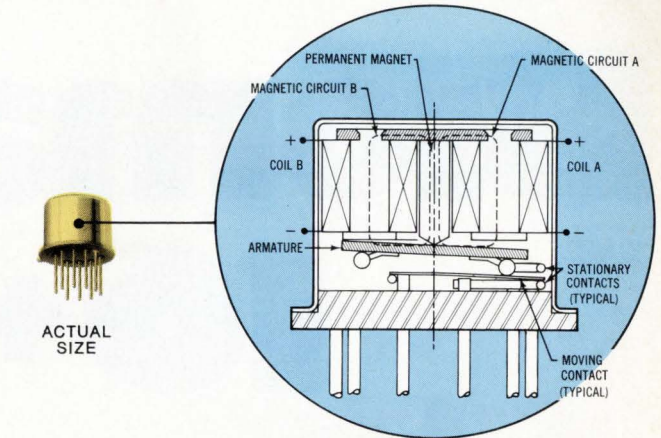

ideal for high density pc board packaging, and they're available in SPDT, DPDT and 4PST contact forms. And for RF switching, their low intercontact capacitance and contact circuit losses provide high isolation and low insertion loss up through UHF.

Our magnetic latching as well as our complete line of TO-5 relays includes military and commercial/industrial types with MIL versions qualified to "L" and "M" levels of established reliability specs. For complete data, contact Teledyne Relays — the people who originated the TO-5 relay.

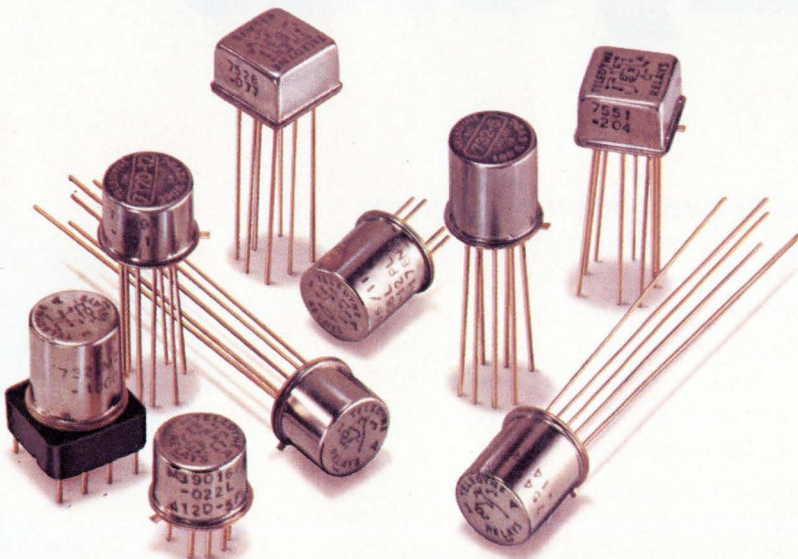

OTHER TELEDYNE TO-5 RELAYS

- **Hybrid "T" Series**
SPDT & DPDT types with internal transistor driver & suppression diode. Military and commercial/industrial versions.
- **"D" and "DD" Series**
With internal suppression and steering diodes. Military and commercial/industrial versions.
- **Centigrad® Series**
World's smallest relay—only .225" (5.72mm) high x .370" (9.40mm) square. DPDT, with optional internal suppression and steering diodes.
- **Hi-Rel Series**
Screened versions for space flight applications (NASA qualified).
- **High Environment Series**
Hi-temperature, Hi-shock, and Hi-vibration types.

 **TELEDYNE RELAYS**

3155 West El Segundo Boulevard, Hawthorne, California 90250
Telephone (213) 973-4545

25-bit words:

Biomation's 16+8+1 answer to μ Processor analysis.

The first microprocessor analyzer that really analyzes.

Biomation has developed a new instrument to solve a new problem: How to get inside the mind of your microprocessor. The instrument is our 168-D. The Mind Reader.

In the process, we've invented a new word. 25 bits long. Contains 16 bits of address, 8 bits of data, and one bit that tells you whether your machine is reading or writing. All in hex characters, just like your program listing.

The Mind Reader starts by capturing up to 256 of those 25-bit words at synchronous rates as fast as 10MHz. That's fast enough for anybody. You can dial in a hardware breakpoint and step your system through its program. Or you can monitor your system as it runs free. But that's just the beginning. Now watch:

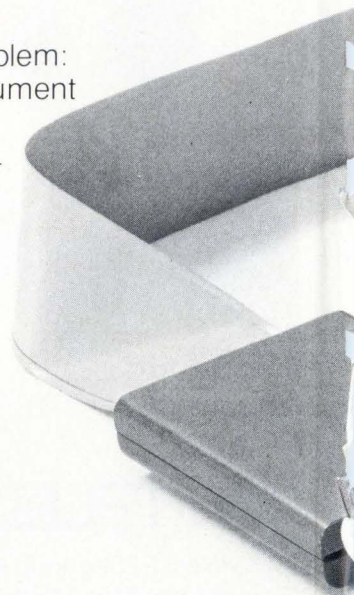

st, the Big Picture

The Mind Reader takes a first macro-bite out of the territory you're investigating. 256 big words. In memory Mode you can see the areas of memory where the action occurred. (You're writing into ROM, or heaven's sake!?)

Then zoom in!

The 168-D gives you a movable cursor that locks onto a location and stays with it through the analysis modes. Once you spot the action you've been looking for, stake it out with the cursor and switch to Page Mode. That gives you the address, data, and read/write information.

Now: A whole new perspective . . .

You've found the program, now switch to Sequential Mode and find out **how it got there**. Where were you coming from, and where did you go from there? Study all time relationships. A powerful new way to analyze the problem!

By switching to the List Mode you display the twenty words surrounding the cursor location you selected in the Page Mode. Address and data are presented in hex along with the R/W bit to let you compare the sequence to your program listing.

In summary: The 168-D lets you record with respect to time and analyze with respect to location.

It's the first microprocessor analyzer that really analyzes. You can put it to work today on **8080A** and **6800** problems. Personality modules for other μ P's are currently under development.

So if you're working with microprocessors and want to know whether your software or hardware is giving you problems, Biomation's 168-D Mind Reader will tell all: What happened . . . where . . . and when. You've got to get the data sheet. Circle the number below. Better yet, call Biomation for a demo. Biomation, 10411 Bubb Road, Cupertino, CA 95014, (408) 255-9500. TWX: 910-338-0226.

biomation
Creating tools for technology





TAKE THE GAMBLE OUT OF SPECIFYING POWER SUPPLIES

When you specify power supplies manufactured by Abbott Transistor Laboratories, you minimize your risks and maximize your return.

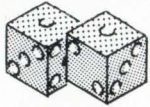

No "SNAKE EYES" with Abbott, only winning performance

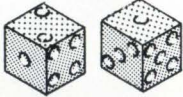

Abbott power supplies are reliable, they won't "CRAP OUT" on you

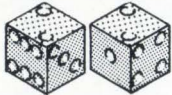

No "LITTLE JOE'S," Abbott units are big on performance

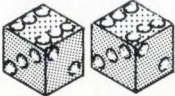

No "BOX CARS" either — Abbott units are compact

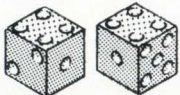

Don't go the "HARD WAY," specify Abbott, the easy way to solve your power supply requirements

Abbott makes a wide variety of industrial/commercial, OEM, military and aerospace power supplies. Each and every unit is subjected to rigorous quality control and electrical testing before shipment to insure that when you put it on the line, it will pass every time.

So when you want a reliable power supply, come to Abbott, the winner for price and performance.

Please see pages 1836-1848 of your 1976-77 EEM (ELECTRONIC ENGINEERS MASTER Catalog) or pages 672-682 Volume 2 of your 1976-77 GOLD BOOK for information on Abbott Modules.

Send for our new 60 page FREE catalog.

abbott transistor
LABORATORIES, INCORPORATED

GENERAL OFFICES
5200 W. Jefferson Blvd.
Los Angeles, CA 90016
(213) 936-8185
Telex 69-1398

EASTERN OFFICES
1224 Anderson Ave.
Fort Lee, NJ 07024
(201) 224-6900
Telex 13-5332

Meetings

Forum on Computer Technology, American Society of Mechanical Engineers, Statler Hilton Hotel, New York, Dec. 5-10.

Chicago Fall Conference on Consumer Electronics, Institute of Electrical and Electronics Engineers, Ramada Inn-O'Hare, Des Plaines, Ill., Dec. 6-7.

1976 International Electron Devices Meeting, IEEE, Washington Hilton Hotel, Washington, D. C., Dec. 6-8.

Bicentennial Winter Simulation Conference, IEEE, NBS, *et al.*, National Bureau of Standards, Gaithersburg, Md., Dec. 6-8.

1976 National Plastics Exposition and Conference, Society of the Plastics Industry Inc. (New York), McCormick Place, Chicago, Dec. 6-10.

Distributed Data Processing Conference, American Institute of Industrial Engineers (Santa Monica, Calif.), Ramada Inn-O'Hare, Des Plaines, Ill., Dec. 7-10.

Solar Cooling and Heating: A National Forum, Energy Research and Development Administration, Fontainebleau Hotel, Miami Beach, Fla., Dec. 13-15.

1977 Winter Consumer Electronics Show, EIA, Conrad Hilton Hotel, Chicago, Jan. 13-16, 1977.

Reliability and Maintainability Conference, IEEE, Marriott Hotel, Philadelphia, Jan. 18-20.

Power Engineering Society Winter Meeting, IEEE, Statler Hilton Hotel, New York, Jan. 30-Feb. 4.

Wincon—Aerospace and Electronic Systems Winter Convention, IEEE, Sheraton-Universal Hotel, N. Hollywood, Calif., Feb. 7-9.

ISSC—International Solid State Circuits Conference, IEEE, Sheraton Hotel, Philadelphia, Feb. 16-18.



FREON* **(BLACO-TRON**)**
**A rose by any other name
 will clean as well.**

Why shouldn't BLACO-TRON precision cleaning solvent clean the same as FREON: Their chemical formulas are identical. DuPont calls their trichlorotrifluoroethane "FREON" TF. We call ours "BLACO-TRON" TF. So now you have a choice.

If they're identical, why should you try BLACO-TRON? Service. The service you get only from Baron-Blakeslee—for 43 years the accepted

leader in advanced design precision cleaning equipment and the solvents to go in them.

Chances are good that the machine you are now using to clean with FREON was developed by Baron-Blakeslee!

BLACO-TRON
 FLUORINATED SOLVENTS—NOW THERE IS A CHOICE

NEW 6-page "PRECISION CLEANING SOLVENTS REFERENCE GUIDE" provides full technical data on all BLACO-TRON fluorinated solvents. WRITE FOR YOUR COPY TODAY.



Baron-Blakeslee

1620 South Laramie Ave., Chicago, Ill. 60650—Offices in All Principal Cities.

*FREON is DuPont's registered trademark for its fluorocarbon cleaning agents.

**BLACO-TRON is Baron-Blakeslee's registered trademark for its fluorocarbon cleaning agents.

Intel® 3000 the overtime out

There are two ways to get your bit slice design to market — on your own or with Intel Series 3000 support. The Intel way is faster. Much faster.

Intel Series 3000 components and total support help you save time right from the beginning — from concept through microprogram development to system integration and debug — right through to production.

Our Intel Series 3000 bipolar LSI microcomputer components are designed as a compatible family — eliminating the need for special drivers, bus multiplexers, address latches and other components. You can tailor the 3000 to fit your commercial or military application and do it with a minimum number of ancillary components. Your designs will cost less. Much less.

Cut your microprogram development, debug and documentation time with our Series 3000 CROMIS microassembler system. CROMIS is available in ANSI (standard) FORTRAN IV source form or on any of several time sharing networks.

Reduce your system integration and debug time with our Intellec Microcomputer Development System with ICE-30™ in-circuit emulation and ROM simulator (ROM-SIM). This Intellec ICE-30/ROM-SIM capability enables you to quickly isolate program faults and selectively debug portions of microcode. Store your microprogram in ROM-SIM's read/write memory. Then use ICE-30 to set program breakpoints and single step

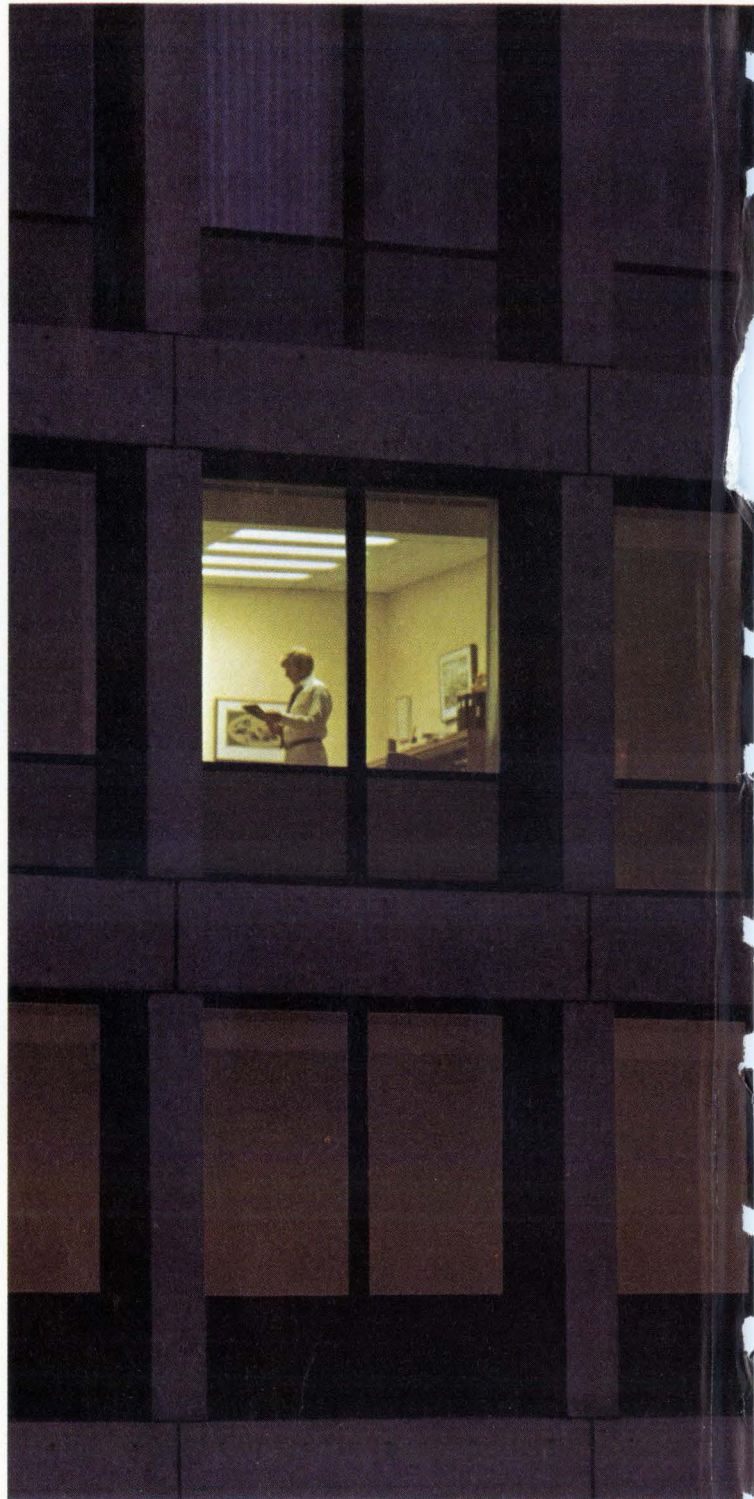

support takes of bit slice design.



the microprogram. ROM-SIM lets you examine or modify the program without blowing PROMs. Once the microprogram is debugged, you can program PROMs—transferring the microprogram stored in ROM-SIM to your PROM using the Intel Universal PROM Programmer.

Intel support doesn't end with CROMIS or the Intellec Microcomputer Development System. There's more. Field applications engineers are available to answer questions and give suggestions. Series 3000 application notes will give you helpful ideas on simplifying bit slice designs. And we offer customer workshops where you can get "hands on experience."

Whatever your bit slice application, you'll find the total support you get with the Intel Series 3000 cuts months off development time. Intel support makes the big difference. We take the overtime out of bit slice design.

For additional information use the reader service card. For quick response use the coupon below.

Intel Corporation
Attention: Series 3000 Mkg. Mgr.
3065 Bowers Avenue
Santa Clara, California 95051

E-1125

Send Information: Call me at _____

Name/Title _____

Company _____

Address _____

City _____

State/Zip _____

intel[®]

Microcomputers, first from the beginning.

Hot-molded resistors provide low temperature coefficient and unmatched reliability.

The Resistance Temperature Coefficient of Allen-Bradley hot-molded fixed resistors is typically less than 200 PPM over the entire resistor range shown in the normal equipment operating temperature of +15°C to +75°C. Excellent RTC ratings have always been an Allen-Bradley benefit. And consistency of Allen-Bradley resistors means repeatable results and tight performance patterns. Allen-Bradley resistors offer the **lowest cost—on the board**—where it counts!

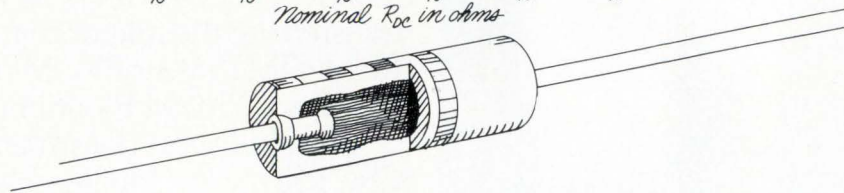
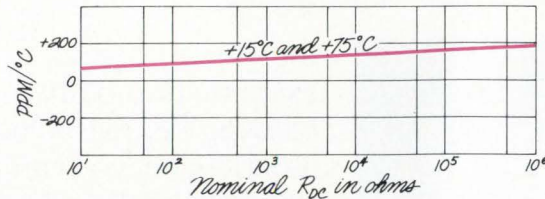

Reliability

is unsurpassed. Over 700 million unit test hours without a single failure.

No coatings

Insulation and resistance element integrally molded into one solid structure.

Pulse handling

characteristics offer outstanding protection against surges and transients.

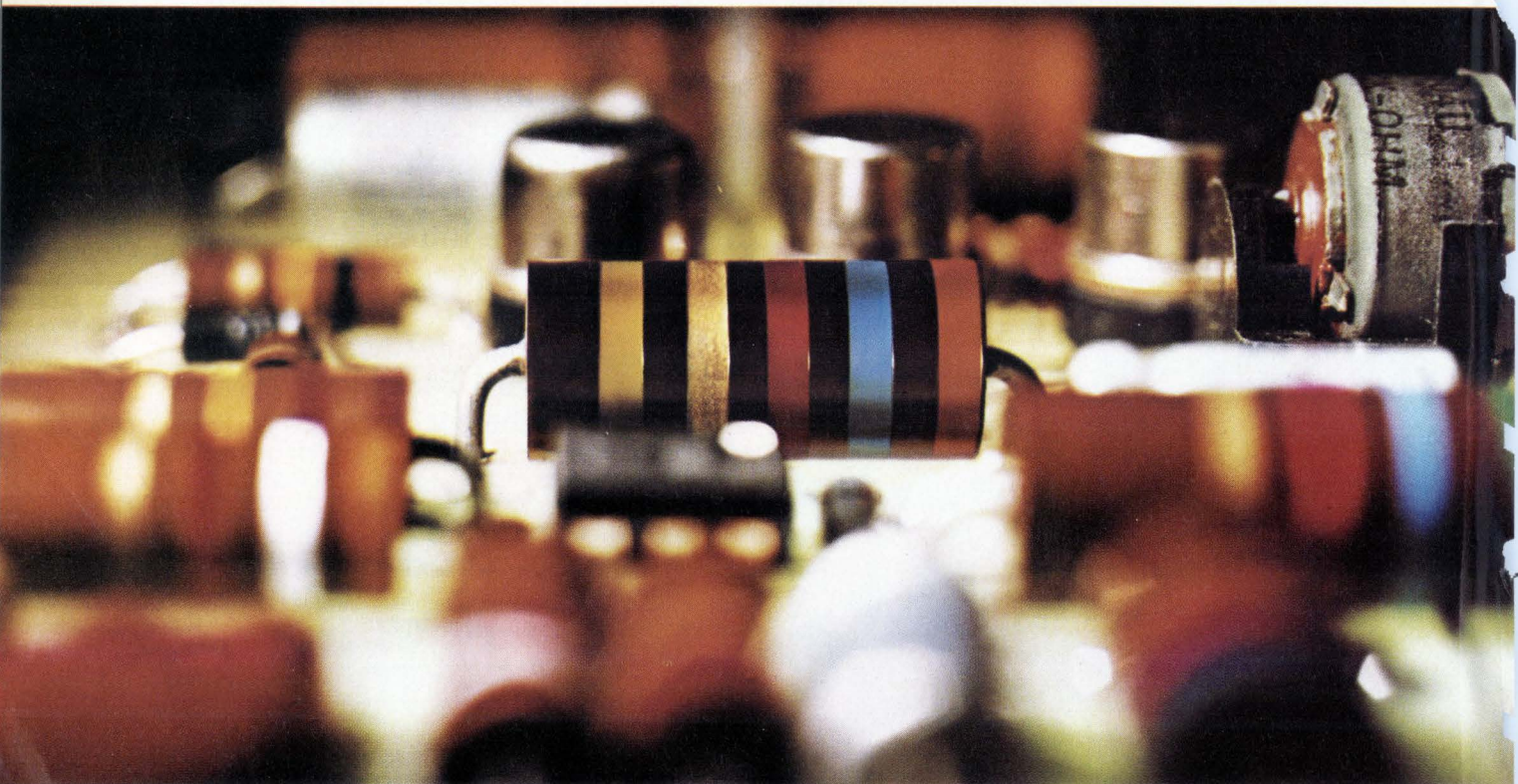

Quality in the best tradition.



ALLEN-BRADLEY

Electronics Division
Milwaukee, Wisconsin 53204

Motorola decides not to supply F-8 microprocessor . . .

Motorola will make a two-chip version of its own 6800 microprocessor and not supply the F-8 microprocessor as part of its recent technology and product exchange with Fairchild Semiconductor. Reports that Motorola would build the device were widely circulated recently. John Welty, vice president and general manager of the Motorola Semiconductor Products division, said at the company's annual security analysts' meeting that the company will not manufacture the two-chip part; instead, **it will introduce in the second quarter of 1977 the MC6801 two-chip version of its own 6800 family** aimed at the same low-end market as the F-8.

Welty indicates, however, that his mind is still open on the newer single-chip F-8 soon to be produced by Fairchild and Mostek Corp. "We'll do it if we see a need in the market," he says.

. . . and gets back into watch module business

Motorola's Inc.'s on-again, off-again flirtation with liquid-crystal-display watch modules—which last went off again in October 1974—has turned on again. This time, the firm's Communications division in suburban Chicago will produce LCD modules **"for major watch companies, but not for a Motorola brand-name watch,"** the company has revealed. Samples are circulating, and volume production will start the first quarter of next year. According to Motorola, LCD watches priced at around \$20 by its customers could be on the market early next year.

At present, the company makes all the watch components—complementary-MOS chip, display, and quartz crystal—except the batteries. However, Motorola expects to start production of its own batteries soon. The modules are said to be about half of the width of present LCD types, and the display is back-lit for visibility in darkness.

Research firm sees HP quitting low end of calculator market

Will Hewlett-Packard abandon the market for low-end scientific calculators? "No," says HP, but at least one institutional research firm, Paine, Webber, Jackson & Curtis Inc. in New York, predicts that HP's profit-pinch Advanced Products division **will elect to get out of that consumer-oriented sector.**

"Such a decision is inevitable," says Kent A. Logan, a Paine, Webber research vice president. "It should become increasingly obvious to international management that there is no way HP can compete with Texas Instruments on a cost, and therefore on a price, basis." HP's difficulties, adds Logan, stem from its lack of fully vertical integration and its production of a lower volume than TI. These factors probably result in higher per-unit overhead and marketing costs.

Proposals due for unit-level phone switch

Proposals for the U.S. military's next major tactical telephone-switching system, the unit-level switch, are due to be submitted to the Marine Corps in early January. The Marine Corps branch in the Naval Electronics Systems Command is handling the procurement, and the award for full-scale engineering development is probably worth \$20 million to \$30 million. The long-term production potential, however, **could be as much as \$200 million** to equip units of division size and smaller in the field. Bidders in the competition are expected to include GTE Sylvania Inc., International Telephone & Telegraph Corp., Martin Marietta Corp., North Electric Co., and RCA Corp.

1-MHz V-f converter due next month

Intech/Function Modules Inc., the Santa Clara, Calif., manufacturer of high-performance monolithic and modular converter products, will go into production next month with the **first monolithic 1-megahertz voltage-to-frequency (v-f) converter**. Designated the A-8404, it has a frequency range 10 to 100 times that of existing devices, and it will have 8-bit guaranteed accuracy. In a 14-pin ceramic dual in-line package, the A-8404 is priced at \$12. Potential applications are in high-speed process control, large-bandwidth isolation amplifiers, data acquisition, and fm data recording.

Data General adds software for Eclipse family

Data General Corp. continues to add to its software strength. The Southboro, Mass., minicomputer manufacturer last week unveiled its Advanced Operating System, a multiprogramming system for the Eclipse line of computers **that can control up to 64 concurrent timeshared, batch, or real-time operations**. In announcing AOS, president Edson de Castro also pointed out that the company doubled its software R&D expenditures in the past year, established a facility in North Carolina for advanced software development [*Electronics*, Oct. 28, p. 36], and hired William Foster from Hewlett-Packard Co. to head Data General's software development.

The company also announced two new 1,920-character CRT terminals for use with its Eclipse, Nova, and microNova computers.

I/O family for LSI-11 due on market

A complete family of analog input/output systems for the 16-bit Digital Equipment Corp. LSI-11 microcomputer will be introduced next month by Data Translation Inc. of Natick, Mass. The four modules **cover a range of input signals from 10 millivolts to 10 volts**. They're intended for LSI-11 users with laboratory and industrial applications, and encompass a price range of \$295 to \$1,095.

The \$295 unit price is for EOM quantities of 100 up for the lowest-resolution system, the DT1763, which will offer 16 input and 2 output channels with 8-bit data-conversion resolution. At the other end of the scale is the DT1762, with a single-unit price of \$1,095, which offers data acquisition on up to 64 channels, 12-bit data-conversion resolution, and options for a programable-gain amplifier and direct-memory access to the microcomputer. Two other models round out the family, with each of the four fitting on an 8½-by-10-inch printed-circuit board.

Addenda

Not only is Mostek Corp.'s 4027 MOS random-access memory setting the pace in the U.S. [*Electronics*, Nov. 11, p. 31], but its popularity seems to be spreading to Europe. There, ITT **Semiconductors in Britain will announce in January that it's second-sourcing** the part. . . . Venture Development Corp., the Wellesley, Mass., market analyst, says the hobby computer market will increase 250% in 1976, **from just under 7,500 units to 18,600**. Venture Development says there are more than 100 clubs, a dozen publications, and more than 50 retail outlets serving 20,000 fans. . . . ETEC Corp. of Hayward, Calif., plans to ship its first Manufacturing Electron Beam Exposure System in December. ETEC declines to identify the customer. The machine, priced in the \$500,000 range, is the **first commercial production system for electron-beam lithography** of ICs.

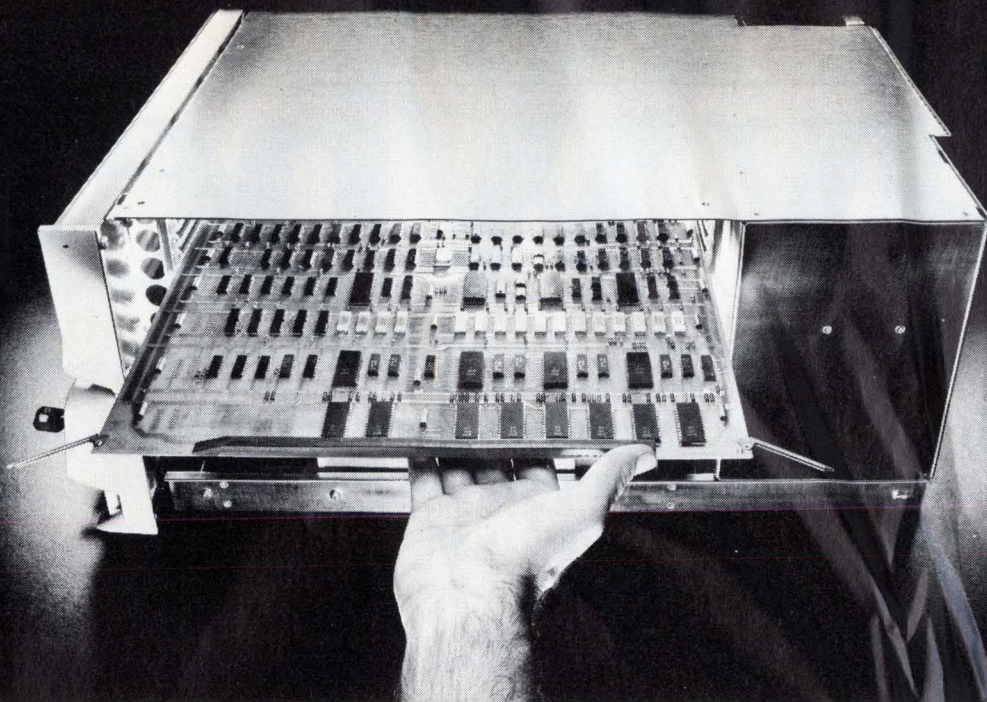

Give your data communications system a little goose and it'll put out ten times as much.

Open up the back of any Data General communications system, pop in our single-board DCU/50 Data Control Unit, run through a little step called COMGEN and stand back. Because that system can start pumping out ten times as much data. And possibly a good deal more.

What makes this all possible is a rather clever piece of engineering.

We've designed the DCU/50 as an intelligent programmable controller. So it takes over jobs the CPU used to do. Things like character handling and code conversion. Which frees up the CPU processing power and speeds up total systems throughput.

On the other hand, you may not need more throughput. Instead, you may need more lines or different types of lines. Both of which are just as easy to get. You just plug in some different boards.

We make modular synchronous and asynchronous multiplexors you can mix

in any proportion. They can handle anything from one to sixteen lines, are fully software supported and work equally well with or without the DCU/50.

Which brings up a rather significant point.

When you buy your communications equipment from Data General, you can get exactly what you need right now. And later, if you need more throughput, more lines or different types of lines, you won't have to throw out anything. All Data General communications hardware and software are completely compatible. So you can add on to what you already have.

Write for our free brochure, "The Sensible Way to Use Computers in Data Communications" and detailed information about the DCU/50 Data Control Unit.

And if that isn't enough information, we'll send a sales engineer who can also put out ten times as much.

DataGeneral

Data General, Route 9, Southboro, Mass. 01772 (617) 485-9100. Data General (Canada) Ltd., Ontario.
Data General Europe, 15 Rue Le Sueur, Paris 75116, France. Data General Australia, Melbourne (03) 82-1361

Say When.

Introducing the Consul 520. Now you can get exactly what you need in teletypewriter compatible equipment. Without paying for what you don't need. Check the features below and say when.

Let's say you need:

- Inquiry-response capabilities.
- Remote controls to X-Y address or position the cursor up, down, forward, backward and home.
- Audible alarm and keyboard lockout.
- 12" screen; 24 lines with 80 character positions per line.
- Dark lettering on light background for increased legibility.
- Bonded faceplate TV monitor.
- Five transmission rates, switch selectable.
- Scrolled or wraparound display.
- Automatic line feed button.
- EIA RS232 or 20 milliamper current loop.
- Video output.
- Full-duplex or half-duplex transmission.

It's the Consul 520. The meat-and-potatoes basic that's pure prime quality. It features as standard what most terminals call options. Single unit price, \$1595.



- Maybe you need all the above features, plus:
- Hard-copy capability with printer interface.
 - Cursor control keys.
 - Numeric pad.
 - Rack-mounting option.

It's the Consul 580. Like all our terminals, the 580 has an extended warranty option, and OEM/Educational discounts. Single unit price, \$1795.

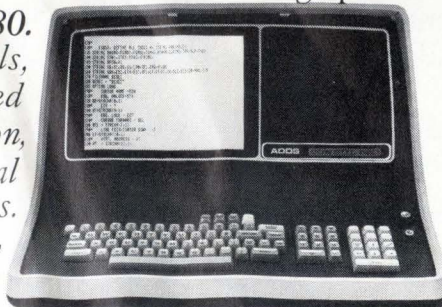

Moving right along, we drop the printer interface, and give you the above, plus:

- Protected formats.
- Block transmission to cut down on CPU functions and considerably reduce software needs.
- Selective transmission of only variable data.
- Upper and lower case ASCII display.
- Shift and lock keys.
- Transmission by page, partial page, line or character.
- Look-ahead cursor positioning to suppress trailing blanks.
- Automatic tabbing between fields.
- Half-intensity.
- Blinking at two rates.
- Remote recognition of cursor position.

It's the Consul 920. With its sophistication and flexibility, the 920 is a network designer's dream. Without a nightmare price. Single unit price, \$2200.



Still with us? Then you need the works:

- Graphics that show everything from bar charts to diagrams.
- Alphanumeric annotation of graphics.
- Line insert or delete; remote or local.
- Character insert or delete.
- Overwriting.
- Parallel and serial peripheral interfaces.
- Remote or local printing.

It's the Consul 980. Top of the line, and acts like it. You simply can't buy better. Single unit price, \$2800.

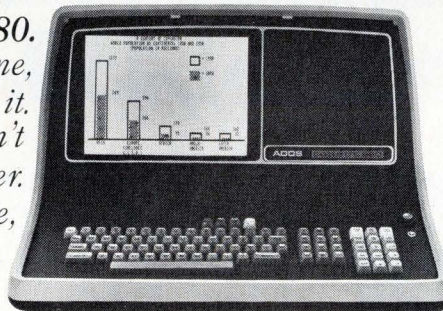

Now. If you've said when, we'll say where:
Applied Digital Data Systems Inc., 100 Marcus Blvd.,
Hauppauge, New York 11787 (516) 231-5400

ADDS



Plugs into any teletype, terminal, computer or microprocessor development system with a serial 20ma current loop interface. Programs, lists, duplicates and verifies. RS232 and other parallel interfaces optional.

Program or duplicate your PROMs for under \$1,450.

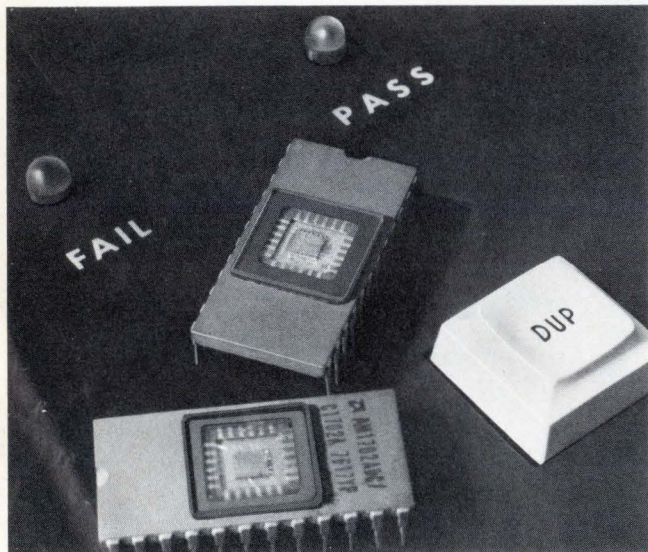

Duplicates PROMs automatically at the push of a single button. Has quick load, zero insertion force PROM sockets and pass/fail lights.

Circle 40 on reader service card

Use our new Series 92 two ways, as a peripheral PROM programmer, or as a stand-alone PROM duplicator.

It uses the same field-proven personality modules as our popular Series 90 PROM Programmer. We already have modules for more than 100 PROMs with more on the way, so your expansion capability is virtually unlimited.

The price—only \$995 for a master control unit, \$450 or less for a personality module.

And if you need a stand-alone programmer, don't forget our well-established Series 90.

It comes with a hexadecimal display and keyboard. Options include TTY, parallel and RS232 interfaces, and paper tape reader.

Write or call for data sheets, our Prom User's Guide, and our new price list which includes an up-to-date personality module listing.

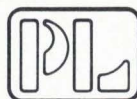

Pro-Log Corporation
2411 Garden Road
Monterey, CA 93940
(408) 372-4593

IBM throws hat in minicomputer ring with Series/1

New system goes after knowledgeable end user who needs a minimum of applications-software support

IBM Corp. has put itself squarely in the minicomputer marketplace by producing low-end hardware and selling it, in a sharp departure from form, with a minimum of applications software. For less than \$10,000, IBM will provide, with its new Series/1, a processor, input/output circuits, and one of several small peripherals.

In the same performance class as Digital Equipment Corp.'s middle-range PDP-11/34, the system will range in price from about \$10,000 to \$100,000 and is aimed at users—either end-users or original-equipment manufacturers—who need little support in applications programming. However, in contrast with other suppliers of minicomputers to OEMs, IBM says it will not offer quantity discounts on the system. "The price will be the same to all, large and small," says C. B. Rogers Jr., IBM vice president and president of the General Systems division, Atlanta, developer of the Series/1.

However, the lack of a discount schedule, apparently imposed by company policy, may present problems in competing in the price-sensitive market for machines used by OEM system houses. Here, IBM will have to rely on its reputation for service and support and "that nice warm feeling that dealing with IBM can give you," says one industry observer.

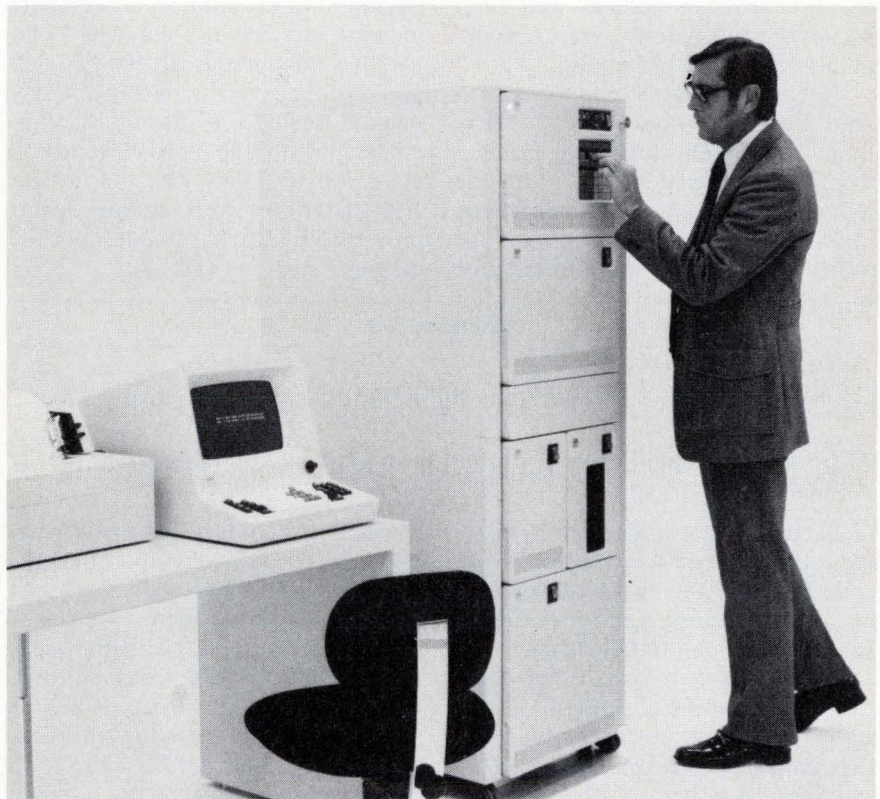

Complete series. IBM's Series/1 minicomputers include processor, fixed disk, and floppy disk in one 19-inch rack, plus a CRT display and serial printer as two separate units.

As for the minicomputer makers, they are adopting the expected wait-and-see attitude. The IBM announcement "has not tempered our expectations for continued growth and could possibly serve to expand markets for all suppliers," says a statement from Digital Equipment in Maynard, Mass.

Norman Zimbel, head of the distributed-systems unit at Arthur D. Little Inc., Cambridge, Mass., points out that IBM's earlier minicomputer product, the System/7, has been in need of replacement for a couple of years "and was never a

comprehensive minicomputer product. The Series/1 will undoubtedly be a comprehensive line. And it's clear they'll try to differentiate their product by the level of service they offer."

Two types of central processing units are offered, both based on IBM's large-scale-integrated TTL. Model 3 has a storage cycle time of 800 nanoseconds, and model 5 has a 500-ns cycle time. Memory comes in 16,384-byte increments, from 16 kilobytes to 65,536 bytes in model 3, and from 16 kilobytes to 131,072 bytes for model 5. Average instruc-

tion time for model 3 is 11.8 microseconds, and for model 5, 3.9 μ s. The circuitry seems fairly standard, although programmable processors relieve the central processor of some I/O control of the peripherals. Memories use n-channel 2,048-bit random-access-memory chips.

The system, described as general-purpose by Rogers, can be used in communications and sensor-based applications. It can communicate in an asynchronous mode as well as in bisynchronous and synchronous-data-link-control protocols.

Series/1, though not programmable by users, does have a fairly large instruction set—168 instructions for the model 3 and 177 for the model 5—and uses microcode stored in 48-kilobit read-only memories, the same devices as are used in the IBM

5100 portable computer. The software package, primarily aimed at program preparation, rather than applications programming, includes a text editor, macro assembler, and linkage editor.

The first units have been shipped to Citibank in New York and Quaker City Motor Parts, Middletown, Del.

The model 3 CPU alone with 16 kilobytes of memory is priced at \$4,400, and (\$1,800 per 16-kilobyte memory increment. The model 5 CPU with 16 kilobytes is \$6,200 (\$2,040 per 16-kilobyte increment). Peripherals include a fixed-disk, 9.3-megabyte storage unit (\$7,850); a 500-kilobyte floppy disk (\$3,140); a 120-character-per-second serial printer (\$3,720); a cathode-ray-tube display station (\$2,690). □

Memories

Faster static devices coming on strong; 4-k RAM will be quicker than 1-k design

In the market for high-density, bipolar, random-access memories, Fairchild Camera and Instrument Corp. has long been king—and it evidently has no intention of abdicating.

Some time next year, other companies will be introducing 1,024-bit static RAMs with better speeds than the Fairchild 93415, the industry standard. But before 1977 arrives, the Mountain View, Calif., company will be supplying samples of a 4,096-bit RAM that is faster than its 93415. In addition, the speeds of its entire bipolar RAM line will go up about 30%, a result of a more advanced process.

Extra tweak. Surprisingly, the new 4-kilobit 93470/71 uses neither integrated injection logic nor the new improved Isoplanar II isolation process employed in the company's 4-k dynamic bipolar RAM, the 93481 [*Electronics*, Aug. 19, p. 99]. It attains its maximum access time of 60 to 70 nanoseconds (40 to 50 ns typical) with Fairchild's standard Isoplanar I process.

However, says Lowell Turriff,

marketing manager for the Bipolar Memory Devices division, there is one extra tweak—the use of a walled-emitter technique, previously applied only to the company's subnanosecond emitter-coupled-logic circuits and the ¹L dynamic RAM.

The process reduces the transistor area by about 60%, and each memory cell occupies only 1 square mil. Chip size is 23,000 mil², only 13% larger than the 4-k dynamic RAM and only twice the size of the present 1-k 93415 chip, Turriff says. The only drawback to the 93470/71, he says, is its power requirement—about 900 milliwatts, compared with 500 mw for the 93415 and 400 mw for the 93481. “But we're sure we can get that down to a more reasonable level—600 to 750 mw—within the near future,” he says.

The present 1-k bipolar-RAM family also benefits from the walled-emitter/Isoplanar I combination, he says. Access times drop from 70 ns to 45 ns for the standard 93415 and from 90 ns to 60 ns for the low-power (250-mw) 93L415. What's

more, within a year, Fairchild plans to introduce a 93415A version with a maximum access time of 35 ns (25 ns typical) and a chip size that drops from the present 11,000 to 12,000 mil² down to 9,000 mil².

“And, even then, the process still hasn't run out of gas,” Turriff says. When combined with the newer Isoplanar II process, it is expected to reduce speeds in the company's ECL-memory line from 35 ns for the 1-k 10415 down to 20 ns maximum (15 to 17 ns typical) and from 30 ns to 10 ns for a 256-by-1-bit part, the 10410.

Elsewhere. Meanwhile, at Texas Instruments, work is continuing on a 4-k ¹L static RAM, specified in preliminary data sheets at a 75-ns read-write time and 500 mw. At Signetics Corp., redesign has been completed on its 82S10, a 1-k Schottky bipolar RAM, improving its speed from 45 ns to 35 ns and reducing its chip size from 25,000 to 14,000 mil². By June, the company expects to begin shipping samples of a 4-k Schottky static RAM with a 50–60-ns access time.

By next March, National Semiconductor Corp. expects to be sampling a 12,000 mil² oxide-isolated, 1-k, bipolar version of the 93415, with a 45–70-ns speed. Advanced Micro Devices Inc. is also working on its 93415.

On the MOS RAM side, new and faster metal-oxide-semiconductor static designs may soon intrude into the bipolar area. Intel Corp., for example, is designing faster versions of its 1-k 2115/2125, specified at about 45–60 ns. Similar fast 1-k efforts are under way also at National Semiconductor, Signetics, and American Microsystems, among others. □

IBM stores data in no-transistor cell

To build denser random-access memories, semiconductor makers are designing them around one-transistor cells—but researchers at IBM Corp. want to do away with the

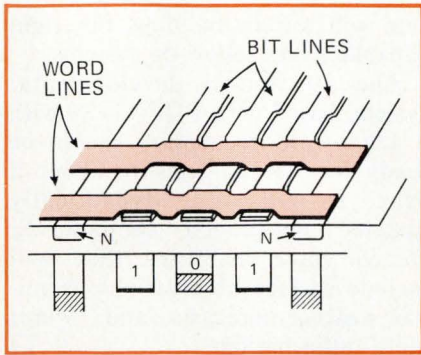

Memory. Diffused n region supplies charges to potential wells. Half-full wells are logic 0s, nearly empty wells are 1s.

transistor altogether. They are combining charge-coupled-device-like principles with standard n-channel metal-oxide-semiconductor processing to reduce the three principle elements of a RAM cell—word line, bit line, and storage electrode—to only two elements.

The result is a memory cell defined by the simplest of structures—the intersection of two conductors. One is the word line, and the other is a combined bit line and storage electrode. H. S. Lee and W. D. Pricer, engineers at IBM's Essex Junction, Vt., facility, will describe the development at the International Electron Devices Meeting in Washington, D.C., next month. At last year's meeting, Al Tasch of Texas Instruments Inc., Dallas, described a similar CCD-like structure that combined storage and switching elements under one CCD gate [*Electronics*, Dec. 25, 1975, p. 30] and that TI is still developing.

Potential well. In the IBM device, information is stored as minority carriers in a potential well beneath the cross-point of the word and bit lines. The wells are defined by regions of thin oxide between the bit line and the substrate; adjacent storage wells are separated by thick oxide regions in one direction and by the word lines in the other direction.

To write a 0 into the cell, the bit-storage-and-sense line is pulsed to a high voltage (about 10 volts), creating a well that collects electrons from a source of charge, a diffused n⁺ region. The potential well fills up

to about the halfway mark.

To write a 1, the same line is pulsed to half the previous voltage so that few charges are placed into the well. In reading, more charge flows into the wells. Those that were half filled receive less charge than those that were almost empty. Thus, the bit-sense line picks up higher voltages from the previously empty wells. The reading is destructive, since all wells will be about half filled after the operation.

Small array. So far, only an 8-by-8-bit array has actually been built, but Pricer says that "the chances of success of building a larger array are 100%." The real challenge, he says, is to build fast, high-gain sense amplifiers onto the same chips.

Generally, he says, the array will

take up about 30% to 50% of the chip area, while the sense amplifiers, connection pads, and the like will occupy the remaining space.

Although Pricer would not speculate on future devices, it is clear that, since today's photolithography can easily produce lines 5 micrometers wide, each cell in such an array need measure only about 0.16 square mil, and a typical 30,000-mil² chip should be able to hold 65,536 bits. (In contrast, a typical one-transistor memory cell measures about 1 square mil, and only 16,384 of them fit on the same size of chip.)

Of course, lines still narrower than 5 micrometers are a not unthinkable goal in the future, and then chip capacity could soar well above 65 kilobits. □

Avionics

FAA to test computerized voice response to queries from pilots

Next month the Federal Aviation Administration will begin testing a computer voice-response system to ascertain if it can be used to brief pilots of general-aviation aircraft. The agency intends to determine just how much information the pilots want in planning their flights.

The voice-response system, along

with other self-briefing terminals for pilots (see "Brief yourself by computer," p. 44), is being developed for the FAA by the Department of Transportation's Transportation Systems Center, Cambridge, Mass. Paul Abramson, chief of the automation branch in the center's Aeronautical Systems division, says the test



New voice. Weather data is entered into the voice-response briefing system being readied for pilots at the FAA's Transportation Systems Center in Cambridge, Mass.

system will allow one pilot at a time to request information from the data base. But the center is also developing a 10-channel system using a larger computer and magnetic disk that will be able to brief 10 pilots simultaneously.

Keyboard entry. The system is to be tested by a group of pilots at the FAA's National Aviation Facilities Experimental Center at Atlantic City, N.J. The pilots will use a telephone's Touch-Tone keyboard or a Touch-Tone pad for dial phones to gain access to a Digital Equipment Corp. PDP-11/20 minicomputer and disk memory in Cambridge. The disk stores 800 words and phrases recorded by a professional announcer. They range from "hello" to "ceiling" to "there are severe weather warnings along your route," or any combination for conveying the information that is now told to pilots by personnel called flight-service-station specialists.

After dialing the voice-response system, the pilot will be asked to enter a three-letter code for his location and a similar code for his destination. The recorded voice will then ask questions that require yes or no answers, which the pilot supplies by keying in "y" or "n."

The voice may also ask if a route-oriented briefing is desired with all available data on weather and winds. Requests for weather data are passed to a PDP-11/70 computer at

a Mitre Corp. facility in McLean, Va., to which the FAA's Weather Message-Switching Center feeds information.

The PDP-11/70 will fetch the requested information and transmit it back to the PDP-11/20 in the form of digital addresses corresponding to the words and phrases needed from the disk. They will have previously been stored in compressed form by means of an adaptive differential pulse-code-modulation technique that shrinks data from 10 to 4 bits per sample. The PDP-11/20 will take the compressed data from the disk and transfer it to an interface module built around an Intel 8080 microprocessor. The microprocessor will then expand the data back to 10 bits per sample, decode it, and convert it to the analog speech that the pilot hears.

Routine. In this manner, the pilot steps through a routine that includes other questions, such as "Do you want hourly surface observations?" or "Do you want a terminal forecast?" for weather at his destination. The extent of the briefing depends on the keyed-in responses.

The single-channel-system tests will mainly provide canned weather information but will also show pilots the kind of detailed briefing capability now under consideration by the FAA. Abramson believes that the data preferences demonstrated by pilots using the voice-response sys-

tem will aid in building the right capability into follow-on systems.

The 10-channel developmental system, based on a PDP-11/34 with a 4,000-word vocabulary should be ready for limited tests in about a year. It will offer dynamically updated—not canned—computer-directed voice briefings that will include surface observations, terminal weather forecasts, and "winds aloft" information. □

Space

NASA looks to power from space

Solar cells or solar furnaces? The choice between these technologies and their costs as space-based generators of electric power for microwave transmission to earth will be the subject of a year-long study by Boeing Aerospace Co., Kent, Wash., for the National Aeronautics and Space Administration.

The two-part study for NASA's Johnson Space Center in Houston is part of the space agency's investigation into the feasibility of solar-power satellites and the ground-antenna arrays needed to support them. Unlike fossil fuels and nuclear energy, the energy for such a system is nondepletable. The ultimate hope is that such systems would be cost competitive with more conventional energy sources.

The agency's effort, directed by Robert Piland, assistant director of program development in Johnson's Engineering and Development division, is soon to be supplemented by a request for proposals for a similar cost and technology study from NASA's Marshall Space Flight Center Huntsville, Alabama, according to industry sources.

Boeing, which won the \$970,000 award in competition with Grumman Corp. and Rockwell International Corp., says the first five months of the study will consider the various solar-energy conversion options, including how the huge solar-cell arrays or solar reflectors re-

Brief yourself by computer

The voice-response system is just one part of a major effort by the FAA to update its flight-service stations. Other pilot self-briefing terminals, also being developed by the Transportation Systems Center, will not only brief pilots but allow them to file flight plans. The pilots will use a computerized system to which they will gain access with personal calculator-like terminals or through television sets in their hotels or homes.

Still other, even more sophisticated terminals are in the offing, possibly for use in offices or airport facilities. These will use the same question-and-answer routine as the voice-response system, accepting queries through a keyboard and displaying their alphanumeric and graphic replies on a storage tube. Hard-copy printouts will be offered, including weather maps. This system should be ready for testing at selected sites in about a year.

The Transportation Systems Center is also working on a portable remote terminal built around an Intel 4040 microprocessor. It is essentially a keyboard, storage, and transmission unit that will tie into the voice-response system with an acoustic coupler.

To every OEM who needs a thin, easily set control meter.

Specify Airpax ER-35 meters. They're only $\frac{7}{8}$ " thin, and since they have no protruding barrel, you can stack them side-by-side or top-to-bottom.

Switching is 100% solid-state, for the utmost in accuracy. There are no physical contacts, mirrors, or prisms.

ER-35 meters are available with one or two setpoints. Setting is extremely easy because the levers move along the external face of the meter and can be adjusted over its full range.

What's more, the ER-35 can withstand extreme physical shock. The meter is shielded against outside magnetic influences, and it can be used under adverse environmental conditions.

By now you must be wondering about the price. Relax. In quantity, the ER-35 sells for less than \$75.

For more information, circle our number on the reader service card. If you're in a rush, give us a call. We're ready to assist you.

AIRPAXTM

Controls Division 6801 W. Sunrise Boulevard,
Fort Lauderdale, Florida 33313 (305) 587-1100

Other Divisions:

Circuit Breakers and Glass Seals, Cambridge Division, Cambridge, Md.
Broadcast T.V. Equipment, American Data Corp., Huntsville, Ala.



quired to heat gas-driven generator-furnaces could be assembled in space. Boeing project manager Gordon Woodcock says the study will attempt to determine whether the structures should be assembled in low-earth orbit for later transfer to geosynchronous orbit, or whether they should be assembled in geosynchronous orbit some 23,000 miles above the earth.

Costs. During the following seven months of the program, Woodcock says, Boeing will refine the cost estimates and seek means of reducing the satellite mass, now projected to cover many square miles.

Under NASA's concepts, solar-power satellites would each have the capacity to produce power on the order of that generated by Washington's Grand Coulee Dam, which has

a rated capacity of 2,161 megawatts. Woodcock estimates that technology would make such systems feasible "before the turn of the century." But he stresses that national policy choices on such programs still await more definitive economic studies in addition to technology and cost data.

Partners. Working under subcontracts to Boeing on the program, will be Hughes Research Laboratories and several elements of General Electric Co., Woodcock says. Hughes will investigate advanced gallium-arsenide solar-cell concepts, while GE's effort will be in a variety of areas, including studies on silicon thin-film solar cells, thermal engines, microwave antennas, radio-frequency generators, and high-power vacuum switches. □

the new chip will be found in the same controller market where the two-chip F-8 has found its niche, as well as in the lowest levels of control applications.

Ion implant. The part's density has been increased largely by programming the read-only memory with a new ion-implantation technique instead of conventional selective-diffusion or oxide-etching methods. Even with the large-capacity program store, chip size "will be well under 200 mils on a side," says Robert F. Schweitzer, marketing manager for the F-8. Each chip in the two-chip version measures about 175 mils on a side. (The family, which was oped by its prime supplier, Fairchild Camera and Instrument Corp., will also be supplied by Motorola Semiconductor under a recently concluded technology exchange agreement with Fairchild [*Electronics*, Nov. 11, p. 30].)

"Our primary goal was to be able to run the part with the same [program] codes as the multichip F-8s," says Robert Cook, microcomputer products manager for the Carrollton, Texas, firm. "And we can—the part is both hardware- and software-compatible with the existing F-8 family." Further, the ion-implantation of the ROM program comes late in the firm's standard n-channel process. This enables Mostek to stockpile partially processed wafers, cutting turnaround time to the customer.

Ceramic-packaged parts, are scheduled to be offered as samples in late February or early March. But Mostek plans production of plastic-packaged versions in the second quarter that will sell for \$10 each in lots of 1,000—about the cost of each chip of the two-chip type. Parts packaged in ceramic will probably sell for \$3 or \$4 more.

Mostek also plans to put development tools in customers' hands. In January it will start selling the Mini-Emulator, a printed-circuit card containing all the circuitry, including programable ROMs, for emulating the F-8/1. Also in February, Mostek will have a new application interface module to debug F-8 software. The

Microprocessors

Mostek readies one-chip F-8 . . .

In the race for the low-cost microprocessor dollar, Mostek Corp. has managed to put its two-chip version of the F-8 microprocessor onto a single chip. What's more the company has doubled the program capacity

to 2 kilobytes, as well. Users will also be thankful for the capability of the new MK3870, or F-8/1 as it's called, to operate from a single +5-volt supply, instead of the usual +5-v and +12-v levels. Major users for

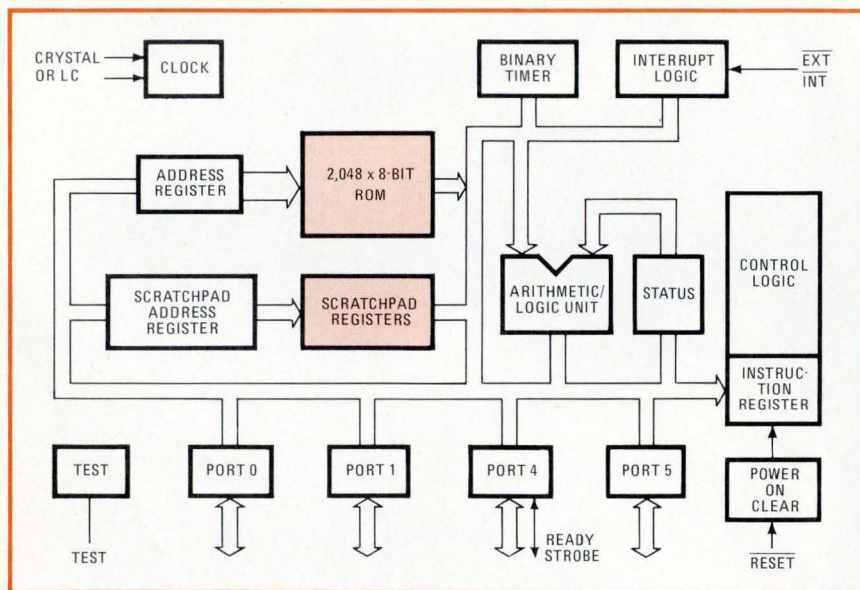

New chip in town. Mostek's one-chip F-8 has a 2-kilobyte ROM and extensive scratchpad facility to increase performance at about half the price of two-chip version.

13 ways to reduce waste from slice to circuit.

All with Zeiss optics.

Zeiss has a lucky 13 microscopes for the electronics industry, and a new brochure that describes them. Between its covers you'll find money-saving, waste-cutting applications described for every step from slice to circuit.

The microscopes range in size from the small, economical Standard T for the daily routine of the production line to the Novascan 30 Scanning Electron Microscope.

Along the way you'll find such unique instruments as the revolutionary Axiomat that sets new standards of stability and image quality for microscopes, and the Light-Section Microscope that cuts a profile, non-destructively.

Optics and versatility

Two invaluable characteristics distinguish all Zeiss microscopes, large and small:

1. superior performance of Zeiss optics for brightfield, dark-field, Nomarski differential interference contrast, polarized light, photography;

2. easy switching from one technique to another.

Send for this 10-page brochure with many striking photomicrographs and details on all 13 microscopes.

Nationwide service

Carl Zeiss, Inc., 444 5th Avenue, New York, N.Y. 10018 (212) 730-4400. Branches in: Atlanta, Boston, Chicago, Columbus, Houston, Los Angeles, San Francisco, Washington, D.C. In Canada: 45 Valleybrook Drive, Don Mills, Ont., M3B 2S6. Or call (416) 449-4660.



ZEISS
THE GREAT NAME IN OPTICS
CARL
ZEISS
WEST GERMANY

Circle 47 on reader service card

output of each will be a 40-pin connector designed to plug into MK3870 sockets. □

. . . Fairchild moves ahead on F-8 line

While Mostek concentrates on an ambitious one-chip F-8, Fairchild Camera and Instrument Corp., the microprocessor family's prime source, is planning upgraded versions of its original designs and a one-chipper as well. According to Van Lewing, microprocessor marketing manager at the Mountain View, Calif., semiconductor firm, Fairchild plans to introduce new F-8 one- and two-chip configurations to complement the existing 3850/51 chip by the middle of 1977.

Scheduled for January are two new versions of the 3851 program-storage unit, both containing a 2,048-by-8-bit read-only memory/programmable ROM on chip. The 3856 will have the same input/output capability as the 3851, while the 3857 will give up the I/O capability to bring out the bus, so external peripherals may be added to the F-8 system. Like the 3850/51, these will require +5- and -12-volt power supplies.

The cheaper one-chip version of the 3850/51 chip set is due in March, says Lewing. Designated the 3859, it will contain 1,024 bits of ROM or PROM and 32 bits of bidirectional TTL-compatible I/O. It will also require +5- and -12-v power supplies. Following this is a device comparable to Mostek's—a single-chip +5-v version, with 2 kilobits of ROM or PROM on chip, the 3860. It will be identical in virtually every way to Mostek's 3870.

Existing users. The 3859 one chipper, says Lewing, is aimed at existing users of the two-chip 3850/51. The 3859 will sell for about \$8 in volume, versus the \$12 for the 3850/51 chip set, he says. The 3860 (and the 3870, for that matter, Lewing says) is aimed at a sophisticated controller market requiring 2 kilobits of ROM or PROM on

News briefs

New products, systems from Sperry Univac

Sperry Univac, Blue Bell, Pa., has introduced several major products: the 1100/80, the largest of all its 1100 series of large-scale computers; Distributed Communications Architecture, which sets up the network interfaces and functions for distributed processing; Telcon, a new intelligent communications system for use under the rules of its DCA network architecture; and a new disk subsystem, which expands on-line storage for the 1100 and 90/80 systems. Of these, the DCA is perhaps the most significant product because it will, according to the company, influence the design of the company's data networks for the next 10 to 20 years.

1976 microwave-oven sales to reach record 1.6 million units.

The number of microwave ovens sold this year will reach a record-breaking total of 1.6 million, up 60% from 1975, according to a forecast by the largest U.S. manufacturer, Litton Industries Inc. William W. George, president of Litton Microwave Cooking Products, says the industry's estimated \$650 million in retail volume will exceed dollar sales of electric ranges for the first time, although the more costly microwave ovens still lag far behind unit sales of electric ranges, estimated at 2.48 million units this year with a value of \$610 million, up 19% from 1975. George attributes the microwave-oven sales to increased consumer acceptance, the availability of a variety of brands and features, and increased advertising outlays.

Automatic changer used with video disks

Insisting that the video-disk player system it put on the Market in 1975 is still alive, though not overwhelmed by sales, Teldec—Telefunken/Decca of Germany—has demonstrated a new video-disk changer for the first time in the United States.

Capable of holding 12 10-minute-play Teldec TED/disks at a time, the changer is tentatively priced at about \$813. However, no definite plans have been made to begin selling it until the company completes an evaluation of the software available for the longer playing time.

California gets new electronics association

With the goal of providing small companies with services that they might find expensive to provide on their own, the Electronics Association of California has been organized in the Silicon Valley area of northern California. President James J. Conway, a former vice president of industrial services at Wema, the trade association, says the aim is to "allow small and medium-size companies to leverage their dollars through collective purchases." He hopes to attract companies by providing such things as health and auto insurance, a credit union, and managerial courses. Annual dues will range between \$350 and \$2,000, depending on the company's size. Patrick Lynch, president of Norton Corp., Sunnyvale, is chairman of the 13-member board of directors.

Russians start their high-frequency interference again

After a week's silence earlier this month, the Soviet Union has resumed transmission of pulsed high-frequency signals that cause worldwide interference with a variety of communications, including ship-to-shore, air-to-ground, and overseas radio telephone. According to the Federal Communications Commission, the new signals fall in the 22-megahertz band but have a narrower bandwidth—about 50 kilohertz—than earlier transmissions. The earlier signals, which ranged between 6 and 28 MHz, were first picked up in late July and stopped Nov. 2. Thus far the Russians have not answered protest cables sent to its Ministry of Post and Telecommunications by the FCC.

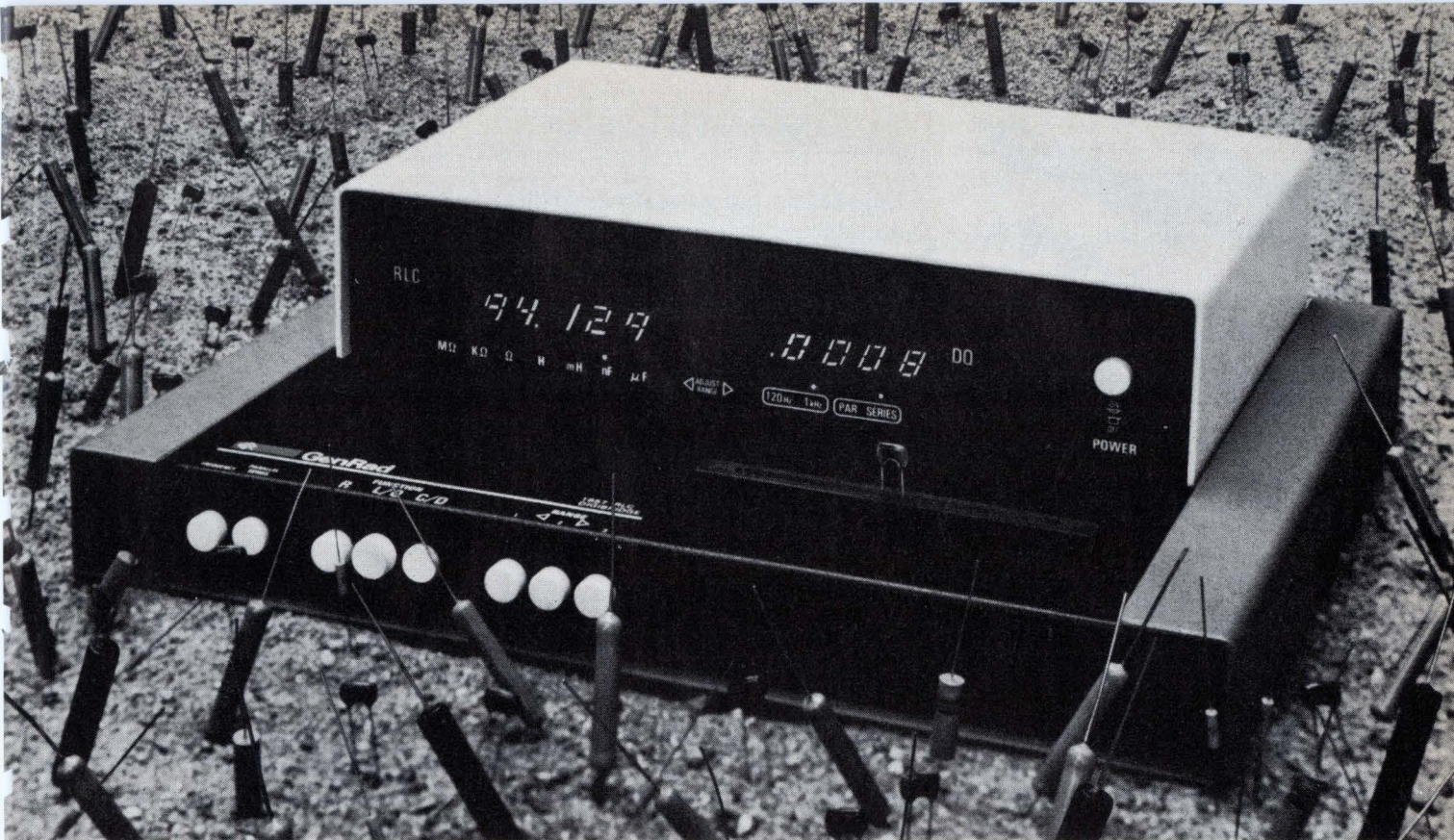

An automatic RLC tester for \$ 995? you've got to be kidding!

There's more to the new GR 1657 RLC Digibridge™ than its low \$995* price. It's designed with features to lower your R, L, and C component testing cost. That's what it's all about — isn't it?

Measures R, L, C, D and Q.

A **microprocessor** performs a combination of measurement and control functions in addition to lowering the GR 1657 unit cost.

Fast testing time of three measurements per second, unqualified.

0.2% Accuracy for R, L, and C.

Five full-digit LED display for R, L and C and four full digits are displayed for D and Q. All numbers go to 9.

Wide measurement ranges allow you to test a greater number of component values. Test R from 00.001 Ω to 99.999 M Ω , L from 0.0001 mH to 9999.9 H, C from 0.0001 nF to 99999. μ F, D from .0001 to 9.999, and Q from 00.01 to 999.9.

Microprocessor-directed ranging takes the guesswork out of setting the correct range. Lighted arrows on the front panel indicate which range

button is to be depressed and the correct range is identified automatically.

Three range positions provide measurements in multiples of 100, since each range has two full decades of measurement capability, a feature made possible by automatic decimal point positioning.

Automatic decimal point positioning causes the measurement to be made on the lowest possible range, so maximum resolution is always achieved.

Selectable test frequencies of 1 kHz or 120 Hz (100 Hz) are switched by the operator.

Selectable series or parallel measurement modes are operator specified across the full measurement range of every test parameter.

Hi-Rel Kelvin test fixture accommodates axial and radial lead components.

Now you know there's more to the GR 1657 RLC Digibridge than its low price. We're not kidding!

**U.S.A. domestic price only.*



GenRad

Circle 49 on reader service card

RF power

We've made the most of it...
You can, too!!

All wrapped up in a neat little package, our Model 510L is an ultra-wideband RF power amplifier whose wide range of frequency coverage and power output provide the user with the ultimate in flexibility and versatility in a laboratory instrument. Easily mated with any signal generator, this completely solid state unit amplifies AM, FM, SSB, TV, pulse and other complex modulations with a minimum of distortion.

Constant forward power is continuously available regardless of the output load impedance match making the 510L ideal for driving highly reactive loads.

Unconditional stability and instantaneous fail-safe provisions in the unit provide absolute protection from damage due to transients and overloads.

This outstanding unit covers the frequency range of 1.7 to 500 MHz with a linear power output of more than 9.5 watts and there is no tuning.

For further information or a demonstration, contact ENI, 3000 Winton Road South, Rochester, New York 14623. Call 716-473-6900 or TELEX 97-8283 E N I ROC

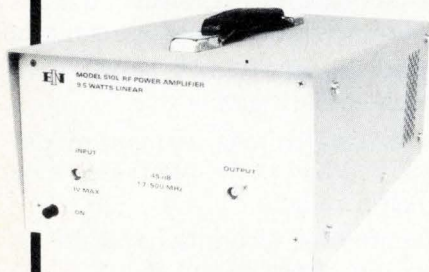

ENI

The world's leader
in solid state power amplifiers

Electronics review

chip but not extensive I/O capability. In volume they drop to about \$10.

The 3850/3856 and the 3850/3857 combinations are aimed at a more sophisticated controller market requiring, typically, twice as much ROM/PROM capability, as well as some system design flexibility. This is a three-chip solution where the user requires extensive I/O capability. For anywhere from \$15 to \$30 in volume, such a user would use the 3857 with the 3850 to give him external bus capability and then add either standard memories or 3856s.

Low end. "Basically we are trying to cover all the possible requirements of the low-end, high-volume controller market," Lewing says. "And you don't do this with a carved-in-concrete one-chip approach. What is needed is a family of chips flexible enough to meet a number of different cost and design constraints."

He points out that the F-8 uses a process identical to Mostek's Isoplanar n-channel depletion-load MOS. Depletion-load is what allowed designers to go from three power supplies to two power supplies. To get the +5-v supply, designers had to go to an on-chip substrate biasing technique similar to that used first in Intel's 2115 high-speed MOS RAM and later in Zilog's Z-80 microprocessor. He points out that though the Mostek chip is an essentially independent development, the 3860 and 3870 are almost the same. □

Military

Norden hardens its first DEC computer

The newest computer maker on the block hopes to do at least \$50 million in sales annually in just a few years. The firm is United Technologies Corp.'s Norden division in Norwalk, Conn., and its initial offering is a militarized version of the PDP-11/34 designed by Digital Equipment Corp. of Maynard, Mass.

Most other companies serving the Federal Government's needs with processors and memory systems sup-

ply little or no software. But Norden will offer DEC's extensive PDP-11 software library as well as a full set of militarized peripherals to support its systems, asserts Peter L. Scott, Norden's president. "The military user hasn't previously had such a complete package available in a hardened version," he claims.

A recent agreement by the Army and Navy should make for an even handsomer payoff, Scott points out. The two services settled on DEC's PDP-11 architecture as the base on which to build a new family of software-compatible military computers for the 1980s [*Electronics*, Oct. 14, p. 77].

Norden's first militarized, general-purpose digital minicomputer, the PDP-11/34M, made its debut last week. This was nine months after DEC had licensed Norden to militarize, manufacture, and market its small, but highly successful, commercial PDP-11 family.

PDP-11 spectrum. Norden eventually will offer militarized versions covering the full PDP-11 spectrum, even down to the LSI-11 single-board microcomputer [*Electronics*, Nov. 11, p. 14]. It chose to launch its thrust into the military computer field with the middle-of-the-line PDP-11/34 and expand from there.

"In time, we'll be offering all of the performance features and software that's available with the PDP-11 family," says Harold L. Ergott, vice president for computer products. The former manager of avionics and command control programs at IBM Corp.'s Federal Systems division is spearheading Norden's drive into the military computer field, where it will do battle with IBM, Sperry Univac, Hughes Aircraft Co. and Rolm Corp.

The PDP-11/34M, slated for initial deliveries by July 1977, is one of three computers in the family under development. Norden will have one lower- and one higher-performance computer "in the very near future" and then fill out its line "with a number of introductions in 1977," Ergott says.

Designed to meet the severe environmental requirements of airborne

The HSDC-14 is a thick-film MSI hybrid that opens up a whole new range of operating environments where conventional discrete converters can't stand the punishment. High resolution (14 bits) coupled with ratio-metric conversion and Type II tracking servo dynamics ($K_a = 58,000$), plus a power requirement of only 750 MW add up to superlative performance. The HSDC-14 features, in addition, a DC velocity output signal and requires only a +15V power supply in addition to logic voltage.

Reliability is built into this SEM-compatible unit with MIL-STD-883 Level C or B processing included, assuring the utmost in consistent high-level performance at an accuracy of $\pm 4'$, ± 0.9 LSB worst case error.

Separating the solid-state control transformer (SSCT) and error processor into two hybrid packages permits

great flexibility for other S/D functions such as ECDX and two-speed conversion. Its tiny size (two 0.8" by 1.9" by 0.21" modules) makes the HSDC-14 the ideal converter for remotely located, hard to access equipment where MTBF really counts — where rugged military, avionic and industrial demands can be met only by the finest product there is.



ILC DATA DEVICE CORPORATION

A Wholly Owned Subsidiary of ILC Industries, Inc.

AIRPORT INTERNATIONAL PLAZA
BOHEMIA, LONG ISLAND, N.Y. 11716 • (516) 567-5600

West Coast: 7337 Greenbush Ave., N. Hollywood, CA 91605 • (213) 982-6454
Interested engineers, write or call Harry Lewis or send for our 164-page product line catalog

DDC does it again

with the world's smallest 14 bit S/D converter!

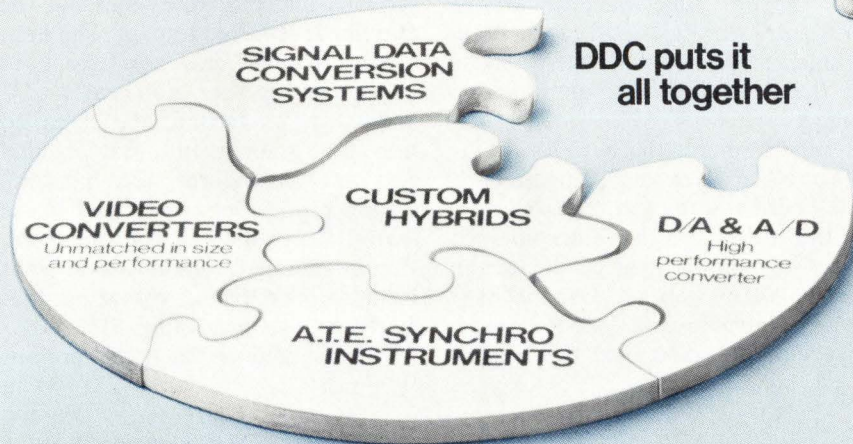
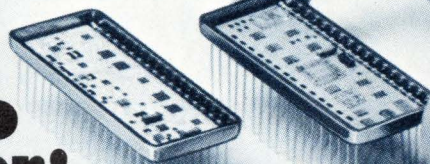

DDC puts it all together

VIDEO CONVERTERS
Unmatched in size and performance

SIGNAL DATA CONVERSION SYSTEMS

CUSTOM HYBRIDS

A.T.E. SYNCHRO INSTRUMENTS

D/A & A/D
High performance converter

Circle 51 on reader service card

DDC ILC DATA DEVICE CORPORATION
Airport International Plaza/Bohemia, Long Island, N. Y. 11716

Please send me technical data on the HSDC-14
 ... And on DDC's full product line

NAME: _____
TITLE: _____
FIRM: _____
ADDRESS: _____
CITY: _____ STATE: _____
ZIP: _____

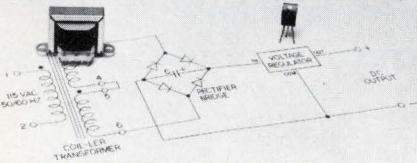

STOCK P.C. POWER TRANSFORMERS

- For use with 3-terminal IC voltage regulators
- Printed circuit mounting
- For power supplies for most integrated circuit families
TTL LOGIC ECL LOGIC
CMOS LINEAR-OP AMPS
- 36 models in stock

Write or phone for complete data sheet.

CUSTOM TRANSFORMERS, COILS, TOROIDS

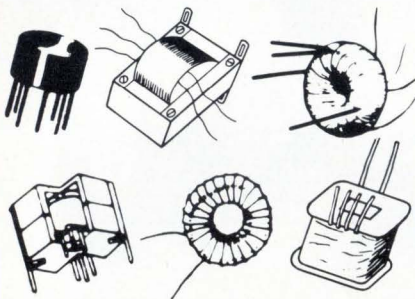

Our precision manufacturing facility produces a full range of medium, miniature or ultra-miniature size transformers and coils — bobbin or toroidal wound. We can meet both your specs and your delivery dates whether for prototype, small or large production runs. Our experienced engineers are at your service.

Write or phone for information or quotes.



2-E Town Line Circle Rochester, N.Y. 14623
716/442-6630
Representatives in Principal Cities

Electronics review

(MIL-E-5400), shipborne (MIL-E-16400) and land-based (MIL-E-4158) specifications, the 11/34M is available in a half-air-transport rack chassis with a 16,384- or 32,768-word core-memory module or, as an option, a full-ATR chassis with up to 131,072 words.

Price of a typical half-ATR is \$15,200 to \$20,000, while a typical full ATR sells for between \$18,500 and \$24,700, Ergott says. The PDP-11/34M comes with the extended PDP-11 instruction set (over 400 instructions) and has a 900-nanosecond cycle time with data-transfer rates of up to 2.5 million words per second.

Norden has made a one-for-one translation from commercial to military design, preserving the PDP-11's basic features, such as the use of late-vintage low- and high-powered Schottky transistor-transistor-logic and the high-speed, bi-directional Unibus that enables system elements to be easily interfaced. This was done so that the computers in Norden's militarized PDP-11 family will go beyond compatibility to identity with the commercial machines, says Ergott.

Above all, since software can be more expensive than hardware, he adds, "we feel that the DEC software will work unchanged on the military version is perhaps the most important aspect of our program." □

IEEE

Split-ticket votes scramble top posts

For the first time, members of the Institute of Electrical and Electronics Engineers split their tickets in the recent balloting for their top officers.

What's more, the new president-elect, Robert Saunders, a nominee of the board of directors, received 44% of the vote or less than the combined votes of the two other candidates on the ballot by petition. Carlton Bayless, a petition candidate for executive vice president beat the board's

nominee with 55% of the vote. However, only 36% of eligible voters actually cast their ballots, despite intense campaigning by all the candidates to get out the vote.

Coalition? The chief result may be a coalition board of directors. Saunders' defeated opponents, Irwin Feerst and Robert A. Rivers, favor this possibility. Feerst, a consulting engineer from Massapequa Park, N.Y., has already proposed three directors to the Nominations and Awards Committee. Rivers, president and owner of Aircomm Inc., Nashua, N.H., says that he would welcome participation on the board.

However, president-elect Saunders, a professor of electrical engineering at the University of California at Irvine, is not enthusiastic about the coalition prospect. He says this decision is up to the organization's nominating assembly and not to him. Saunders, who received 21,425 votes, muses that it was "a strange outcome, which I haven't quite decoded yet. He adds, "There will be soul-searching over why, in view of the strong campaign waged to get out the vote, there is apathy."

In winning second place, Feerst got 14,244 votes (29%) and Rivers received 13,145 votes (just under 27%). On the other hand, for the vice presidency, Bayless, division manager for Pacific Telephone & Telegraph Co., Sacramento, Calif., received 26,491 votes, or 55%, in defeating Robert D. Briskman, assistant vice president for fixed systems at Comsat Corp., Washington, D.C., and, like Saunders, a board-nominated candidate.

All three propositions on the ballot to amend the constitution received majority votes, but not the two thirds required to pass. The first, to put all future dues assessments to a membership vote, got nearly 61% in favor. The second, the so-called fair-play amendment that spelled out new procedures for handling future propositions, received more than 51% of the total. And the third, a more detailed version of amendment one concerning voting on dues increases, had just under 51%.

Both Saunders, the IEEE's present

vice president of regional activities, and Bayless, director of region VI, are Californians, and both have spent the major part of their IEEE service in regional affairs. Both agree that the situation created by the vote will cause problems, but say that they can work together.

No confidence. For Feerst, who was a petition candidate for president in last year's race, the results were "an overwhelming vote of no confidence in the IEEE board of directors. The board's presidential nominee won with only 44%, the board's vice president lost, and all three propositions, which the board opposed, got over 50%." As a result, Feerst proposed the three persons among the eight appointed to the board of directors: himself to become vice president for professional activities; Fred Schlereth, head of Inficon, East Syracuse, N.Y., for secretary-treasurer, and J. R. Smith of the department of Electrical Engineering, University of Florida, for vice president, educational activities.

In the meantime, Feerst says he's been asked by many of his supporters to consider forming a separate organization of electronics engineers dedicated to professional activities. "At present, all options are open," he says. "But in no way will I stop trying to improve the status of working engineers." □

Photovoltaics

Thick films ease contact attachment

By switching from vacuum evaporation to the use of thick-film conducting contacts on silicon solar cells, engineers for a solar-panel manufacturer say they will eventually cut costs by two thirds. "Putting on contacts cheaply is the name of the game in solar cells," says Bill Yerkes, general manager of Solar Technology International Inc., Chatsworth, Calif.

His company has developed a thick-film ink that can be put on at

A NEW GENERATION OF IMAGE SENSORS

SIMPLICITY OF USE

Requiring less than a dollars worth of circuitry to drive—and barely more than that for video processing—is just one of the key features of our new "G" series image sensors. Compare the non-critical single TTL clock needed for the "G" device to the complex multi-phase clocks prescribed by others.

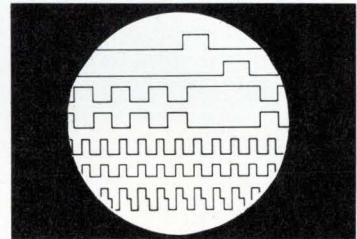
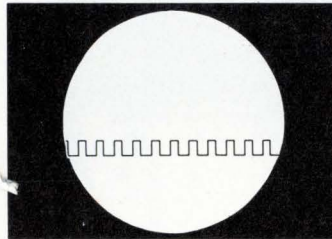

You need only this for Reticon



You need all these for others

HALF THE PRICE

Or even less will bring you 256, 512, 768, or 1024 sensor elements on 25 μ centers or up to 1728 elements on 15 μ centers in our "H" series.

SUPERIOR PERFORMANCE

Low dark current allowing low light level operation, on-chip noise cancellation, and smooth spectral response from visible through infrared makes this new generation the unquestionable choice.

APPLICATIONS

Page readers, facsimile, OCR, point of sale readers, non-contact measurements and inspection and many others.

RETICON®

910 Benicia Avenue, Sunnyvale, California 94086
PHONE: (408)-738-4266 TWX: 910-339-9343

The CROWN M-600 will drive shake tables, speaker coils, sonar transducers or servo motors.

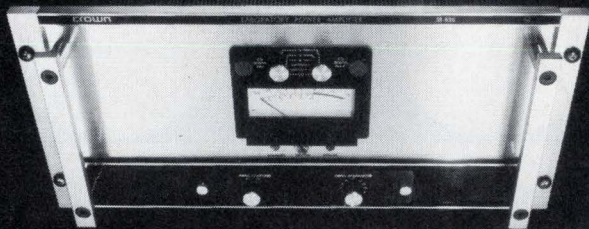

The Crown M-600 Amplifier is good at driving transducers, no matter what they're used for.

It's immune to damage from shorted, open or mismatched loads.

It operates continuously at full rated power.

It will give you up to 78 volts RMS. It will give you up to 1000 watts into 4 ohms, DC to 15 KHz. It works into any impedance. Compare the M-600 to any other amp in its frequency range, no matter what it's used for.

We're especially interested in helping you answer any application questions you might foresee for the M-600. Tell us your problem. We may already know a solution.



1718 W. Mishawaka Road, Elkhart, Indiana 46514

219 / 294-5571

Electronics review

temperatures low enough not to damage the shallow junctions of the silicon cell's photodiodes. There is a big saving, Yerkes points out, because the thick-film process is handled in a screen printer that costs a relatively low \$15,000 to \$20,000 and can accommodate about 1,000 wafers an hour.

Conventionally, solar-cell makers have been using thin-film titanium-silver contacts that are deposited in a vacuum-evaporation unit. Price of the evaporator ranges from \$50,000 to \$100,000, and throughput is limited to 100 wafers an hour.

"Modified" ink. Solar Technology International uses a standard thick-film printer to screen and then fire a "modified" silver ink on 3-inch wafers. Yerkes declines to comment on the ink's composition; he says only that it can be deposited at well below the 800°C temperature of the usual thick-film conducting inks. Widths of the contact lines are 12 to 13 mils, with Yerkes predicting 5-mil-wide lines in the future.

His company was organized about a year ago to manufacture solar panels for terrestrial power sources used at remote locations like navigation beacons and Forest-Service installations. A panel now costs \$15 per peak watt, says Yerkes, who was previously president of Spectrolab Inc., an old-line maker of solar cells. He predicts that as volume increases, wafers will be produced for \$10 per peak watt in 1978, and the cost will fall to \$5 in 1979.

Other metals. Looking ahead, Solar Technology International is experimenting with other non-noble-metal thick-film conductors such as copper, nickel, and aluminum in the hope of cutting costs even further. Other companies also looking into the application of screened-on conductors include Ferranti Ltd. in Great Britain and Matsushita in Japan.

In addition, Owens-Illinois Inc., Toledo, Ohio, and NASA's Lewis Research Center, Cleveland, are carrying on a joint investigation of the use of thick-film conductors on solar cells that are intended for space applications. □

NATIONAL ANTHEM



A Review of New Products and Literature from

National Semiconductor • No. 4

A drove of (peripheral) drivers

National's interface products include a variety of circuits to solve peripheral drive problems of all kinds. For example, if you need a high voltage (30 V), high current (300 mA), high speed (25 ns) driver with TTL inputs, then try our DS75450 series. These dual peripheral drivers have AND, NAND, OR, and NOR input configurations, and work nicely as power drivers, relay and lamp drivers, bus and memory drivers, etc.

Or, if you can sacrifice high speed for low cost, look into our DS75460 series of dual peripheral drivers. These circuits are functionally interchangeable with the DS75450 described above, but are rated at 65 ns, and are designed for



applications that require a higher breakdown voltage (35 V).

If you've had latch-up problems and would like to broaden your system's operating margins, then our DS3611 series is for you: 300-mA sink capability; 80-V breakdown; and no latch-up even at 55 V. The circuits are functionally interchangeable with the DS75451 through DS75454.

Low-Cost Development System for SC/MP Microprocessor

The SC/MP Low-Cost Development System (LCDS) is a simple-to-use controller that provides a maximum of flexibility at a minimum—and very affordable—cost. It has everything needed to develop and test SC/MP hardware and software designs for your applications.

LCDS features easy interfacing and expansion. Four prewired edge connectors, for example, provide a plug-in interface for SC/MP family cards, and also let you interconnect additional SC/MP applications hardware. (There's room for a fifth connector, too, if you wish to add it.) You can also add a flat cable connector for coupling the LCDS to an external card cage.

Built-in control and monitor functions permit transfer of control between the LCDS resident firmware—sub-routines that let you enter software debug commands via the control and

display panel, or an optional Teletype®—and your own application programs.

Expansion is easy, too, because of the cards offered for use with the LCDS. The 2K × 8 read/write memory and 4K × 8 ROM/PROM cards, for example, provide additional memory: just plug them into the card bus.

The minimum LCDS comprises a SC/MP CPU card, scratchpad memory, ROM-based firmware, and control logic. Also included are a 16-key dual-function hexadecimal keyboard, all necessary function keys and control switches, and a six-digit hexadecimal display.

With the basic LCDS configuration alone, you can examine and alter the SC/MP registers and memory locations, run SC/MP programs in continuous or single instruction mode, and even operate with an optional Teletype using SC/MP DEBUG. **Z**

N8080 family rounds out National's microprocessor line

National's line of microprocessors is now the broadest in the industry: to the ranks of our bit-slice IMP, 16-bit PACE, 8-bit SC/MP and 4-bit FIPS, we have added our new N8080 family. Well suited to the broad spectrum of general purpose microprocessor applications, the 8-bit INS8080A CPU fits neatly between our cost-effective 8-bit SC/MP and the versatile 16-bit PACE CPUs.

The INS8080A CPU, with its full line of support circuitry, offers you a family

approach to system design, multiple source availability, and total product support from National—RAMS, ROMS, PROMS, I/O components, and a wide variety of linear and digital interface circuits.

In addition, we are backing our N8080 family with a full range of development tools, both hardware and software, for quick and easy assembly of basic design kits and implementation of development systems. **Z**

How about driving power from CMOS? Our DS3631 family of dual peripheral drivers does it, sinking 300 mA and withstanding 56 V at the outputs. Other features include CMOS-compatible pnp inputs; low V_{CC} dissipation; output circuit protection against V_{CC} loss; and operation between 4.75 V and 15 V. Pin-outs are identical to those of the DS75451, DS75461, and DS3611 series.

Finally, there are our telephone relay drivers—the DS3686 and DS3687. Both are duals rated at 65 V and 300 mA. The DS3686 is a positive-voltage driver; the DS3687, negative. (See *National Anthem* No. 2, March 1976.)

You'll find complete information and specifications for these and many other products in our 464-page *Interface Data Book* (\$4.00). **Z**

A Review of New Products and Literature from National Semiconductor

A

Bi-FET™ 741 Op Amp:

low input-bias current,
low input-noise current,
high input impedance

The LF13741 op amp is a Bi-FET™ version of the popular 741 circuit. But the use of our Bi-FET technology lets us place JFET input followers ahead of the bipolar stages, which results in very low input bias and noise currents—50 pA and 0.01 pA/√Hz, respectively (typ.)—and a very high input impedance of $5 \times 10^{11} \Omega$. The slew rate is $0.5 \text{ V}/\mu\text{s}$, and GBW is 1 MHz.

This drop-in replacement for the 741 gives you that circuit's general operating characteristics, but you'll find that the LF13741 is easier to apply and will save you money if you've been using external, discrete JFETs with a 741 to get better input characteristics.

The LF13741 excels in those applications that require a low input-current moderate-speed amplifier or comparator such as transducer amplifiers, photocell circuitry, buffers in sample-and-hold systems, long-interval timers, and low-drift peak detectors. 

Durawatt™ RF line for CB rigs



Specifically designed for a citizens band transmitter line-up, these eight Durawatt™ and Durawatt 92-Plus™ power transistors offer a unique combination of special processing, power capability, and package types.

For example, the complete family of pre-drivers, drivers, and output types is interrelated through tuned roll-off processing, which rejects spurious responses and provides for optimum performance.

In addition, all family members have dissipation ratings that meet worst-

The accompanying tables present a summary of National's wide range of semiconductor memory products. They show at a glance whether or not we supply a given memory type, its organization(s), and its production status.

The letters in the tables represent memory organizations, as shown in the legend below the tables. Letters without asterisks show memories that are in volume production. The asterisks indicate products yet to enter production, although some of these are already in the sampling phase.

A letter with an asterisk preceded by the same letter without an asterisk indicates that another version of the same device is to be put into production. The second version may differ from the first in speed, pin-out, number of leads, etc. Keep in mind, too, that a single letter entry in the tables may represent a number of product types differing, again, in speed, pin-out, number of leads, etc.

In addition to the memory products shown in the tables, National supplies shift registers, PLAS, character generators, code converters, etc. Full information and specifications for our complete line of memory products will be found in our *Memory Data Book* (\$3.00); for information on asterisked products, contact your local National representative. 

case conditions: infinite v_{swr} at rated output power. Under worst-case conditions, when a 4-W a-m rig loses its antenna the output stage must withstand 30-W dissipation; the driver, 4 W; and the pre-driver, 0.8 W. Our transistors are designed to take such punishment and are rated at such levels; the output devices, in particular, are the strongest you can buy.

Finally, the family members are available in a variety of package types to meet your performance needs in an economic way. Our two pre-driver types, for instance, are a TO-92 NCBT13 and a Durawatt 92-Plus NCBX14; the three drivers include a TO-126 NCBJ14, a TO-39 NCBS14, and a TO-202 NCBV14; and the three output types are the TO-126 NCBJ35, the TO-39 NCBS35, and the TO-39 NCBW35. 

Memories ... at a glance

TOTAL BITS	RAMS			
	MOS (static)	MOS (dynamic)	CMOS	BIPOLAR
64			C	B,C
256	D		D,E	D
1024	G,I,I*		G,G*,I	G*
4096	P*,O*	O,O*		

TOTAL BITS	ROMS	
	MOS	BIPOLAR
256		F
1024	I,J	I
2048	M,N	M,N*
4096	P,P*,Q,Q*	Q
8192	R*,S	S
16,384	U*,V*	V,W

TOTAL BITS	PROMS/EPROMS	
	MOS	BIPOLAR
256		F
1024		I
2048	M,N	M,M*,N
4096	P,Q,Q*	P*,Q,Q*

Organization Codes

64 bits	2048 bits
A = 64 x 1	K = 2048 x 1
B = 32 x 2	L = 1024 x 2
C = 16 x 4	M = 512 x 4
	N = 256 x 8
256 bits	4096 bits
D = 256 x 1	O = 4096 x 1
E = 64 x 4	P = 1024 x 4
F = 32 x 8	Q = 512 x 8
1024 bits	8192 bits
G = 1024 x 1	R = 2048 x 4
H = 512 x 2	S = 1024 x 8
I = 256 x 4	
J = 128 x 8	
	16,384 bits
	T = 16,384 x 1
	U = 4096 x 4
	V = 2048 x 8
	W = 1024 x 16

Control Mode Entry Via Keyboard

Pushbutton entry of control mode is a popular feature of modern instrumentation because it is a convenience to the instrument user and its designer as well. In the application shown here, we use our MM74C922 keyboard encoder to scan and debounce the push-buttons for a mutually exclusive (one mode at a time) control group.

Keyboard encoders broaden CMOS line

Our MM54C922/MM74C922 (16 key) and MM54C923/MM74C923 (20 key) encoders provide all the logic you need to encode an array of SPST switches. An external capacitor or clock implements the scan, and diodes in the switch array are not needed to eliminate ghost switches.

Features of the new encoders include on-chip row pull-up devices, which allow the use of switches with up to 50-k Ω ON resistance; two-key rollover between any two switches; internal debounce circuitry that needs only a single external capacitor; on- or off-chip clocking; LPTTL-compatible Tri-State[®] outputs (for easy expansion and bus operation) with a last-key register; and +3 V to +15 V operation. 

One feature of the MM74C922 is that it permits the use of inexpensive, form-A contact (N.O. SPST), push-button switches. But in addition, the MM74C922 eliminates the need for a mode storage register because its output retains the last mode entered. If the instrument's mode controller uses a ROM or PLA sequencer, then the MM74C922's output is directly usable as a part of the ROM address, and points to the start address of the selected mode routine.

The MM74C922's data output strobe can reset or initialize the controller to enter the control mode from the top. And if a microprocessor controls the system, then the MM74C922 can scan,

debounce, and encode the mode keys, and also provide an interrupt to the processor to indicate a mode change.

If you wish to display the instrument's mode, connect the MM74C922's output directly to a 1-of-n decoder such as our MM74C42 or MM74C154, which can directly drive LED lamps. But if the mode is to be displayed in a seven-segment format, connect the MM74C922's output to some appropriate driver such as our MM74C48. (Remember to add current-limiting resistors between the MM74C48's output and the seven-segment display.) Both techniques are cost effective approaches to push-button mode entry. 

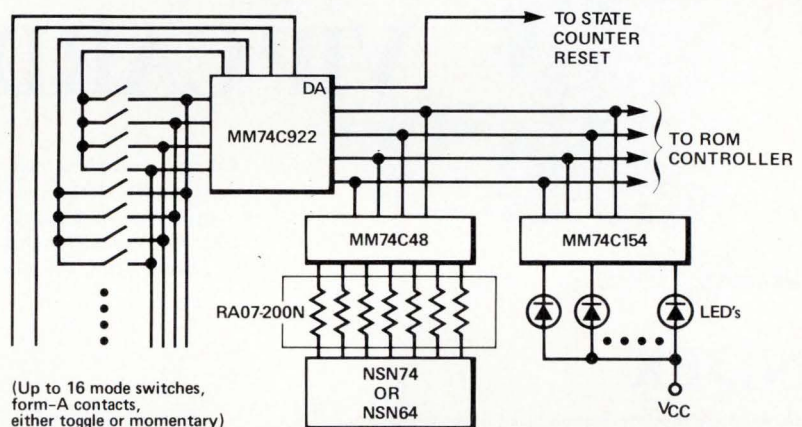

Dual and Quad Numeric Displays

National's new NSN (dual digit) and NSB (quad digit) series of displays are third-generation designs: the dice are mounted on a PC board and topped with a reflective cavity. Available in 0.3-, 0.5-, and 0.7-inch heights, each end-stackable module mounts the digits with their decimal points, and with or without polarity indication.

Four drive modes are available for the NSN series—common anode or common cathode, either multiplexed or direct. For the NSB series, the drive is common anode or cathode, multiplexed.

You will find the NSN and NSB multi-digit displays cost-effective in a wide variety of applications that includes CB and TV channel indicators, data terminal displays, and instrumentation in general. 

Termination networks for data lines

Our RA24 and RA28 thin-film resistor arrays are designed for use as digital transmission line terminators. The RA24 is a 24-resistor network in a 14-lead, molded Epoxy B DIP; the RA28 is a 28-resistor network in a 16-lead DIP. Other than the resistor count and the number of leads, the two types are identical.

Both feature low inductance (5-ns risetime, typical), excellent tracking (2 ppm/ $^{\circ}$ C typical, -55° to $+125^{\circ}$ C), and low cost. Resistor matching is to 0.2% typical, and package dissipation is 2 W at 25 $^{\circ}$ C.

Two versions—the RA24-3k/6.2kN and RA28-3k/6.2kN—are tailored for programmable instrumentation terminations per IEEE specification 488-1975 for bus-organized peripheral control. 

Single-chip quad analog switches

National's LF13331 and LF13201 series of SPST analog switches are the industry's first single-chip, quad, JFET switches. Our Bi-FET[™] technology makes them possible, and yields performance generally superior to that of CMOS (particularly the ON-resistance and leakage parameters) at lower-than-CMOS prices. In addition, these parts do not exhibit the latch-up problems common to CMOS switches.

Available in various combinations of normally closed and normally open configurations, the switches maintain a constant ON resistance (150 Ω) over their analog input range of ± 10 V, and to 100 kHz. The inputs operate from minimum TTL levels, and feature a break-before-make action. The LF13201 series is pin-compatible with DG201 types. 



New Pressure Transducer Housings are Second Generation Designs

Our new housings for the LX1700 series pressure transducers create small and lightweight, yet rugged, alternatives in pressure transducer packaging. Designated the PX7-1 (a zinc casting) and PX7N-1 (in nylon), these new packages, in combination with the LX1700 transducers, are well suited to applications such as air conditioning and refrigeration compressor control, compressed-air tank monitoring and control, gasoline and diesel

engine diagnostics, 3-15 psig pneumatic measurement and control, etc.

The housings are available in absolute, gauge, and differential (PX7D-1, nylon) configurations for pressure ranges from ± 5 psi to 0-300 psi. Mechanical features include an internal, captive O-ring seal, and a $\frac{1}{8}$ " NPT male pressure connector. A 13-inch cable for electrical connection makes testing

easy; the 5-pin connector at the cable end is keyed, locked, and strain relieved. 

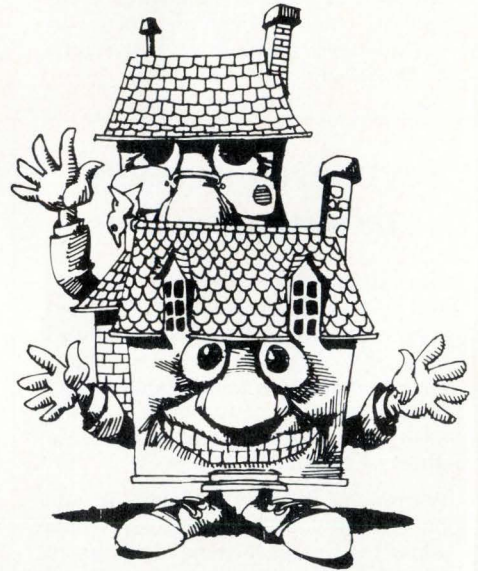

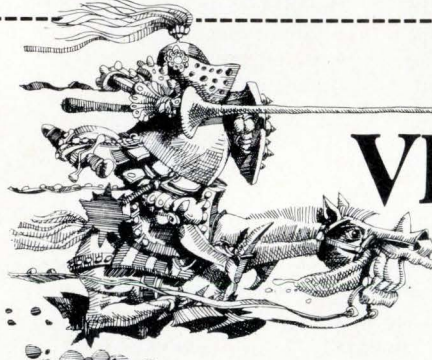

E1125

VIP CARD

Complete card and mail to
NATIONAL SEMICONDUCTOR
 Attn: Marketing Services
 2900 Semiconductor Drive
 Santa Clara, CA 95051

INDEX

Please send me the information that I have checked:

- | | |
|---|--|
| <input type="checkbox"/> SC/MP LCDS, Pg. A, Col. 2 | <input type="checkbox"/> Durawatt CBRF Line, Pg. B, Col. 1 |
| <input type="checkbox"/> N8080 MPU, Pg. A, Col. 2 | <input type="checkbox"/> MM74C922/923 Encoders, Pg. C, Col. 1 |
| <input type="checkbox"/> DS75450 Perph. Drvrs., Pg. A, Col. 1 | <input type="checkbox"/> Dual/Quad Displays, Pg. C, Col. 1 |
| <input type="checkbox"/> DS75460 Perph. Drvrs., Pg. A, Col. 1 | <input type="checkbox"/> RA24/28 Term. Nets., Pg. C, Col. 2 |
| <input type="checkbox"/> DS3611 Perph. Drvrs., Pg. A, Col. 1 | <input type="checkbox"/> LF13201/331 Switches, Pg. C, Col. 3 |
| <input type="checkbox"/> DS3631 Perph. Drvrs., Pg. A, Col. 1 | <input type="checkbox"/> LX1700/PX7 Transducers, Pg. D, Col. 1 |
| <input type="checkbox"/> DS3686/87 Rly. Drvrs., Pg. A, Col. 1 | <input type="checkbox"/> MM5382/83 Calen. Clks., Pg. D, Col. 3 |
| <input type="checkbox"/> LF13741 Op Amp, Pg. B, Col. 1 | |

Please send me the literature that I have checked:

- | | |
|--|--|
| <input type="checkbox"/> AN-146 FM Remote Speaker System | <input type="checkbox"/> AN-159 Data Acquisition System Interface to Computers |
| <input type="checkbox"/> AN-158 CMOS Line Drivers | <input type="checkbox"/> AN-160 Increasing Throughput for IMP-16 Serial Input/Output |

Your End Product or Application: _____

Have Salesman Call YES NO

Please print clearly; this information will be used for our mailing list.

NAME _____ TITLE _____

COMPANY _____

ADDRESS _____

CITY _____ STATE _____ ZIP _____

Digital calendar-clock circuits

The MM5382 and MM5383 digital calendar clock circuits provide the timing, control, and interface circuitry for a minimum-cost, solid state, digital clock radio.

The circuits have four display modes: time; alarm; date; and sleep—as well as a four-year calendar display. The timekeeping function operates in either a 12-hour or a 24-hour mode. The MM5382 is the 12-hour version, and has a month-date format; the MM5383 is the 24-hour version, and has a date-month format.

Outputs consist of a presettable 59-minute sleep timer (e.g., a timed radio turn-off) and an alarm tone. A power failure indication warns the user that the time displayed may be in error.

Other features include: alarm display; brightness control; 24-hour alarm set; PM indication; fast and slow set controls; and a nine-minute snooze alarm. (The MM5383 has an alarm on indicator.) Both circuits provide open drain outputs for the direct drive of LED displays to 15 mA. 

Washington newsletter

Litton asks FCC for 10.6 GHz for microwave ovens

A new line of microwave ovens heated by an "inexpensive magnetron" at 10.6 gigahertz is now in preliminary development by Litton Systems Inc. of Minneapolis. That disclosure is in a petition Litton has filed with the Federal Communications Commission requesting the 10.5–10.7-GHZ band for microwave ovens. Existing ovens operate at 2,450 megahertz, but Litton says a **shorter wavelength would cook food more uniformly** by reducing "overcooked spots adjacent to raw spots" in such foods as cakes and would also brown food surfaces better, since energy at 10.6 GHz does not penetrate as deeply into foods as it does at 2,450 MHz.

Cooking though, would take longer because of the shallower penetration. To overcome that drawback, Litton senior staff engineer Harold C. Anderson told the FCC, "An oven with a combination of 2,450 or 915 MHz [with 10.6 GHz] could be made." Anderson also said adherence to the rigid radiation limits for microwave ovens should preclude 10.6-GHZ ovens from interfering with other equipment at that frequency—including approximately 8,000 continuous-wave police radars operating at 10.525 GHz.

Radiation limits eased by FCC for CB rebuilds . . .

Manufacturers can upgrade their 23-channel citizens' band transceivers to 40 channels with less difficulty after Jan. 1, now that the Federal Communications Commission **has eased its chassis-radiation requirements for sets already in inventory by Nov. 1**. In so doing, the FCC has granted part of an Electronic Industries Association petition to reduce the chassis-radiation requirement from 5 microvolts per meter at 3 meters from the chassis to 50 $\mu\text{V}/\text{m}$, but the tougher 5- μV standard remains unchanged for new 40-channel CBs.

The FCC refused altogether to back off on its requirement that all remanufactured models must contain a phase-locked loop, just like the new 40-channel transceivers that go on sale Jan. 1. This means that only "about 50% of the 23-channel sets can qualify for upgrading," says the EIA's John Sodolski, Communications division vice president. Rebuilt sets marketed under the waiver must be labeled to that effect, the FCC says, and all such sales must end by Jan. 1, 1979.

. . . 1976 CB sales of 10–12 million seen as plateau

In the year-end sales countdown, 1976 citizens' band radio volume is expected to **double last year's record in both units and retail dollars**, rising to an estimated 10 million to 12 million transceivers worth approximately \$2 billion. That is the forecast of Electronic Industries Association vice president John Sodolski, who said in an interview that November and December sales of 23-channel class D sets will soar to "unprecedented levels," now that price-cutting "appears to have touched bottom" prior to January's introduction of new 40-channel units [*Electronics*, Aug. 5, p. 49].

The EIA executive's best guess on the ultimate size of the U.S. market is that 50 million units will be in operation within five years, and annual sales will stabilize near the 1976 level. About 70% of all CBs are now imported, mostly from Japan. And in the FCC's first approvals of 40-channel CBs for sale—25 models from 20 companies—all are made offshore. Radio Shack leads with three models, followed by Sears, Roebuck & Co., Teaberry Electronics Corp., and Kraco Enterprises with two each. Among the 16 other makers winning approval of single models is Toyota Motor Sales U.S.A. Inc., which will offer its CB as an option in new cars.

Will it be Carter versus Congress?

Watch the 95th Congress, particularly the House. In the wake of Jimmy Carter's narrow but nonetheless certain election to be President of the United States of America, that is the preliminary judgment of most of a score of the electronics industries' Washington lobbyists who, by the way, despise the label. "I like 'insider' best," smiles one major manufacturer's man. "It reads best at corporate" headquarters, "but 'observer' or 'analyst' will do, too." In fact, there are no true electronics industries insiders among the confidants of Jimmy Carter, although a number of officials are working hard to achieve that status.

Those persons not privy to Jimmy Carter's precise plans regarding Government and high technology suspect that many of those plans are still being formulated. Nevertheless, they have definite ideas about what a Carter Administration may be able to achieve—as distinct from actions it may take—and those achievements are seen as dependent on the 95th Congress.

Much of the action is expected to come in the 435-member House under the leadership of the new Speaker Thomas P. O'Neill (D., Mass.). While O'Neill is expected to demonstrate far greater effectiveness and party loyalty than his retired predecessor, Carl Albert of Oklahoma, the new Speaker may find a problem in controlling the votes of some of the younger new members in the Democratic majority, which now stands at 55%.

Youth movement

Indeed, a new influx of youth throughout the Federal Government is probably the biggest potential pitfall for the Carter White House as well as for congressional leaders like Tip O'Neill. None of the Carter appointees to his transition team is older than 35. This is not to say there will be no 40-plus appointees in a Carter Administration. The new "Policy and Supporting Positions" handbook of the Government Printing Office—the so-called "plum book" of presidential appointive offices—lists nearly 2,500 jobs, but Carter personally will become involved in no more than 200 or 220 selections, his transition office says.

Reports that one unspoken requirement for favorable job consideration in middle- and lower-level appointive posts of the new Administration is "no prior long-term Washington affiliation" are not denied by the Carter transition team, and this troubles experienced industry specialists. "I remember the Kennedy crowd in 1960," moans one company man, "and it scares

hell out of me. Kennedy got nowhere with the Congress, if you recall, and if Carter's people come on like that they'll get damn little done either."

Military spending options

But what about Carter's impact on spending programs, particularly defense? When it comes to military electronics hardware, another major Pentagon contractor's man is convinced that "there won't be a dime's worth of difference" in program funding levels for at least another year. If Carter moves quickly toward his promised \$5-7 billion cutback in the Pentagon budget—a request now forecast to rise to about \$126-128 billion from the last appropriation of \$104 billion—industry sources believe those cuts could come in only one area, operations and maintenance. One key cut in the O&M account could occur in the phased withdrawal of the remaining 40,000 American troops still stationed in South Korea. Another might come in the closing of domestic bases no longer considered to have important strategic value. That latter strategy has been tried twice before in the Nixon-Ford years and failed both times as congressmen and senators representing the affected districts mustered support to defeat the proposals. Similarly, a Korean pullout faces strong military opposition.

Another possibility for cutting defense costs would be to cancel the Air Force B-1 bomber program at Rockwell International, a move that most industry specialists believe is "politically unthinkable." A production decision will have to be made early next year after Carter's inauguration. "Don't forget that Carter's got a helluva debt to the AFL-CIO and George Meany, and they lobbied long and hard for the B-1 program. Canceling it would mean 7,000, maybe 9,000, jobs, most of them in California, and that would have an effect directly opposite to Carter's plan to get more people back to work," argues one Washington aircraft executive. Could Carter cut back the proposed B-1 buy from 240-odd planes by, say, 100? "The answer to that is no, too. A cut like that would push the price-per-plane right through the roof. Congress would never buy it." Some Washington specialists believe that might be a Carter ploy—to cut back the proposed buy and then let Congress cancel the program and take the rap. But that, too, is speculation among those industry outsiders still trying to get a look inside the tightly knit organization of the man from Plains.

Ray Connolly



**To be a social success
in Wabash, Indiana it helps to be
good at playing basketball and designing coils.
Some of us are still working on the basketball.**

If you're from these parts, people expect you to be good at one or the other. Our engineers are 'bout the best there is when it comes to designing coils. In fact, that's the reason why Wabash coils are famous and why Wabash makes the most molded coils in the United States, including epoxy, nylon, and engineered thermoplastic and thermoset materials.

But their basketball game... is awful. So on Saturday afternoons you can expect to find them over at Don Fisher's trying to pick up a few pointers from the kids. But it really doesn't bother them as much as they'd let you think. As Dick Kosiarek, our Coil Engineering Vice President put it, "George McGinnis never designed a coil in his life".



Shown: custom engineered thermoplastic and thermoset molded coils for automotive applications.

Coils, Relays & Transformers

wabash
of
Wabash, Indiana
and Huntington, Indiana; Farmington, Missouri;
Tipton, Iowa and South Boston, Virginia

For information and quotes write or call:
Wabash, Inc., Dept. CA-3, 810 N. Cass St., Wabash, Ind. 46992 Tel: 219/563-3111 TWX 810-290-2724
Circle 61 on reader service card

And start talking about Cryo-Torr® High Vacuum Pumps for fast, clean, trouble-free, oil-free pumping of all gases in high vacuum systems. Cryo-Torr Vacuum Pumps eliminate process chamber contamination problems of conventional oil diffusion or turbo-molecular pumps.

Operating costs are lower too, because Cryo-Torr pumps totally eliminate the need for any liquid nitrogen, helium or cooling water. The Cryo-Torr 7 Model, a direct replacement of

conventional 6" pumps, achieves high pumping speeds — 1,000 lps for air, 3,000 lps for water vapor — in a small compact package.

Cryo-Torr Vacuum Pumps keep it clean in such applications as ion implanters, deposition systems, including sputtering. And at new low prices. Get all the facts on the Cryo-Torr High Vacuum Pumps. Write or call: CTI-Cryogenics, Kelvin Park, Waltham, Massachusetts 02154. Telephone: (617) 890-9400.

CTI-CRYOGENICS

STOP THE DIRTY TALK ABOUT HIGH VACUUM PUMPING.



Circle 62 on reader service card

HELIX
A Helix Company

Small Luxembourg firm plans to market VDR before its giant competitors do

While consumers and producers await the battle between optical and capacitive long-playing video-disk recorders, one small manufacturer in Europe is betting it has the key to outselling the industry giants. Magnetic Disc Recording, a holding company based in Luxembourg, plans to get to market first next July with its MDR L 522, a video-in, video-out magnetic-disk system that will retail at \$700.

The system includes a video recorder and receiver, a 20-watt-per-channel stereo amplifier, and a radio tuner. The disks, which can record two hours of video on each side, will sell for only \$11, a price competitive with audio disks in the European market.

Industry observers agree on one thing: whoever reaches the consumer first with a long-playing, reasonably priced system has a good chance of scoring substantial market penetration. MDR, which has main offices in Paris, Zurich, and Nürnberg, claims that 200,000 L 522 recorders have already been ordered by one European distributor and that other international firms have also expressed interest.

Experience. Even though larger competitors like RCA, Philips/MCA, and Thomson-Brandt will not get their systems to market as soon, they have already had considerable experience in constructing and distributing audio/visual sets. In contrast, five-year-old MDR is relatively inexperienced.

"The one stumbling block to our success could be the ability to manufacture and distribute in sufficient quantity," admits MDR president Louis-Philippe Rebboah. The firm is still looking for someone to manufacture and distribute the L 522 in the United States.

Rebboah predicts that disks will hit the consumer with an impact similar to the advent of television.

"But, so far, we're the only company to manufacture a system that both records and plays on disks that are reasonably priced. The competition still plans to concentrate on pressed disks."

Versatility. The MDR unit, which can receive video input by cable directly from either a TV set or a video camera, is designed to work with PAL, Secam, or NTSC television standards. The video bandwidth is 2.5 megahertz, frequency response is 80 hertz to 13 kilohertz, and the audio range is 20 Hz to 29 kHz.

The key to the recorder's capabili-

ties is the disk itself. A magnetic head, which MDR claims has a playing time of 300 hours, rotates at 150 revolutions per minute on a disk covered with a magnetic film 8 micrometers thick. A sapphire stylus running on grooves on the inner half of the disk maintains a steady recording or playing pattern between the magnetic head and disk film on the outer half of the disk. Rebboah declines to reveal the exact composition of the magnetic head and film, but he does say that they are based on chrome dioxide "with many special alterations." □

Around the world

Toshiba puts register/ALU on sapphire chip

A combination register and arithmetic/logic unit (RALU) containing 2,400 gates has been fabricated with enhancement/depletion n-channel MOS technology on a substrate of silicon on sapphire. The engineers who developed the experimental RALU at the Toshiba Research and Development Center in Japan believe they can eventually build superior commercial SOS microcomputers. Their next step is to build a 5,000-gate device that is effectively a 16-bit minicomputer on a chip.

Begun in 1973, this R&D project is one of many in a large-scale program to develop a system for pattern-information processing that is being funded by Japan's Ministry of International Trade and Industry. A general-purpose commercial product probably will not be forthcoming for as long as a year after the scheduled completion of the contract in March 1978.

Local storage consists of 16 16-bit registers, two 4-bit address-stack pointers, and an increment/decrement circuit of addresses. The ALU can load, store, add, subtract, reverse subtract, AND, OR, shift left or right, branch and halt.

British firm bets on optical fibers

Europe's first factory to work solely on the design, manufacture, and marketing of optical fiber and cable has been opened in England by Standard Telephones and Cables. STC's initial goal is to get the technology designed into industrial and military applications while the company waits for the British and other European post offices to begin ordering fiber-optic networks in the 1980s. The first step is to acquaint potentially large customers such as utility companies with the advantages of the technology.

STC, an ITT subsidiary, is offering two types of systems. For transmission of data or pulse-code-modulated voice traffic, one configuration provides pulsed laser or light-emitting-diode transmission at 8 and 34 megabits per second. For television or data, an analog pulsed-laser setup operates at 10 megahertz. Exact prices depend on the type of system, but STC estimates that all the hardware in a 10-kilometer leg could cost less than \$85,000. The annual output—50 km of cable—will be made by the chemical-vapor-deposition process.

QUICKER than a WINK

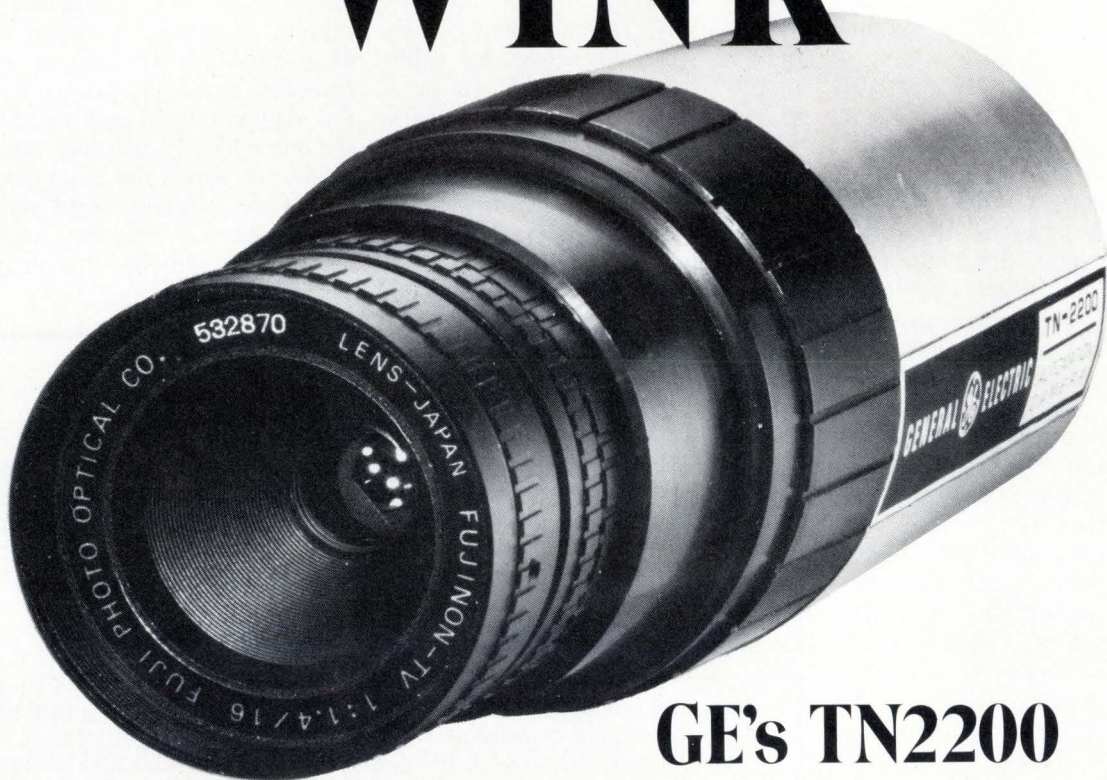

GE's TN2200 Electronic snapshots at 40 per second

Interface GE's latest automation camera to micro and mini computers for new sensor applications. Each exposure provides discrete data from 16,384 picture elements for inspecting parts, measuring hole diameters, handling materials, and controlling manufacturing processes. As the eyes of industrial robots or other automated equipment, TN2200's can exactly locate and identify an object on an assembly line.

For quality control the TN2200 can also view x-ray displays of packaged materials. Other applications include tracking airplanes, viewing callers on picture phones, and recording research observations as they occur.

GE's advanced design ensures long life and lack of drift. And being solid state it's small, rugged, and low on power consumption. For resolution and reliability at only \$840, call us about the TN2200.

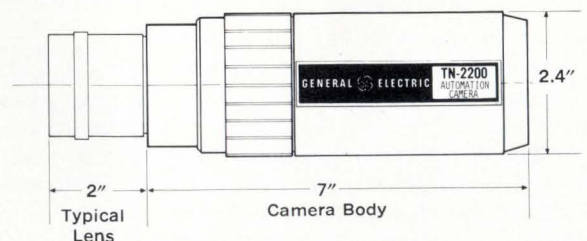

Optoelectronic Systems Operation
General Electric Company
Electronics Park 3-201
Syracuse, New York 13201
(315) 456-2832 or 2808

GENERAL  ELECTRIC

International newsletter

France pressures ITT firm to export more phone switches

Trouble is brewing between France's minister of Postes et Télécommunications, Norbert Ségard, and ITT subsidiary Compagnie Générale de Constructions Téléphoniques. The French minister is demanding that CGCT step up its exports to 50% of its total production of electronic switches in order to increase France's share of international telecommunications sales. The company, which exported more than \$60 million worth of switching equipment last year, **claims the PTT is being unfair in that it is not requesting France's other telephone-equipment manufacturers to meet the same requirements.** CGCT, which says Ségard is making the demands for political rather than economic reasons, contends that it already accounts for 70% of the country's switching exports.

Ségard is also asking ITT to separate its French operations from its main European headquarters in Brussels in an apparent attempt to further Frenchify CGCT. The French government recently forced ITT to sell its other French subsidiary, Le Matériel Téléphonique, and there is speculation that Ségard is trying to gain increasing control over CGCT.

Telephone, rail rate boosts augur business in Japan

Long-awaited passage of bills to increase the rates for Nippon Telegraph and Telephone Public Corp. and fares for Japanese National Railways should boost business for communications-equipment manufacturers. **In addition, the nation's Council of Economic Ministers has decided to revive some construction projects deferred by NTT and JNR.**

The delay in the rate increase from June 1 to Nov. 17 had caused NTT to defer \$1.55 billion worth of construction, most of the \$1.69 billion in income it figures it lost by the delay. Included in the deferment were 750,000 of the 2,600,000 phones to be added this year. The government plan will allow NTT to revive about \$1 billion worth of construction, including all 750,000 phones deferred. About \$570 to \$610 million of this will come from subscribers, obligatory debentures, and installation fees. The remainder will be a government loan that must be approved by the Diet, which will meet late in December. **The new NTT rates include a 150% increase in basic monthly charges, a 43% jump in message-unit fee, a 200% boost in the telegraph rates, and a 60% increase in the installation fee.** On April 1, the basic monthly charges will be boosted 200% above the original rate.

German auto radar has microprocessor to warn driver

Standard Elektrik Lorenz AG, a German ITT affiliate, is testing a microprocessor-based anticollision radar system for cars. A 2° beam from a radar mounted at the front of the car detects objects in its path. At the heart of the system is an 8080 microprocessor programmed to distinguish moving objects like people from stationary ones like traffic signs. Only potentially dangerous objects trigger the alarm, which warns the driver and indicates the direction of the threat. **The program ensures that only relevant echoes are processed and that "meaningless" echoes are prevented from triggering the alarm to warn the driver.**

UK firm announces monolithic 2.45-V reference source

A low-cost precision 2.45-volt reference source that has been made into a two-pin monolithic package is being announced by Ferranti's Electronic Components division at this month's Electronica exhibition in Munich. Aimed primarily at the expanding linear-mode power-supply market, the ZN458T has a temperature coefficient from 30 to 100 parts per million

International newsletter

per degree centigrade, a low slope resistance of typically 0.1 ohm, very good long-term stability and low noise—at price of only 82 U.S. cents each in quantities of 1,000.

Claiming that there are no monolithic competitors in its price and performance range, the British company says **it replaced the usual zener-diode-based discretecircuitry the classic band-gap reference or Widlar diode of three transistors, plus two on-chip amplifiers to keep the current through the diode constant.** Ferranti is also seeking sales of the ZN458T as a companion component for digital-to-analog converter and for high-quality light-measuring equipment. For these applications, only an external resistor is necessary. The firm claims performance is many times better than other approaches. Evaluation samples already have been shipped to several UK power-supply makers.

Siemens integrates radio, TV circuits on a single chip

Siemens AG has announced a linear integrated-circuit chip containing an eight-stage intermediate-frequency amplifier, a demodulator, and a complete low-frequency output stage on a single chip. The TDA2850, described at this month's Electronica show in Munich, is intended mainly for radio and television applications. The chips are to become available early next year. Previously, Siemens says, two chips—one for i-f amplification and demodulation and the other for final amplification—were necessary to integrate the three functions without appreciable loss of signal quality.

Single-chip integration of the TDA2850 is possible because of the IC's low internal losses, which results from improved diffusion techniques that lower the resistance of the silicon. The input sensitivity is 30 microvolts, and typical a-m suppression is 60 decibels at an operating voltage of 15 volts and a load impedance of 4 ohms. The output delivers 4 watts.

Microprocessor logs viewed TV programs for monitor in UK

A monitor that automatically logs which television programs are sampled as viewers watch is being developed by Britain's RCA Ltd. for network markets in Europe and the United States. Built around RCA's Cosmac CDP1800 8-bit complementary-metal-oxide-semiconductor microprocessor, the unit uses about 5 kilobits of silicon-on-sapphire memory and a 1,700-instruction program to keep track of what each viewer in the survey likes. Results are automatically reported daily over telephone lines to central processor.

Currently, viewers would have to key in their ages and sexes through a keyboard, but the RCA division and RCA Solid State-Europe are working jointly on **sensors that viewers would wear to flash their identities to the set-mounted loggers.** The monitor, being developed under an outside contract, would cost an estimated \$170 in production.

Addenda

West Germany's Lufthansa says it will be the first airline to use Sperry Univac's recently announced 1100/80 large-computer system. The system, to go on-stream early in 1979, **will handle not only seat reservations in planes but also hotel bookings and messages routing, as well as computer-aided instruction of more than 2,000 Lufthansa employees.** French prime minister Raymond Barre recently committed new credits to Egypt, **which will be spent, in part, on expanding the Egyptian color-television network, which uses Secam technology.**

The LSI-11. Anything less isn't really enough.

Almost everyone knows Digital's LSI-11 is the highest performance, most software-supported micro device on the market.

Which is why some people think that the LSI-11 may be just a bit too much.

In fact, for lots of applications, anything less than the LSI-11 isn't really enough.

Start designing your new product with anything less than the LSI-11's performance and you start with all kinds of limitations on your good thinking. Not enough speed. Not enough arithmetic capability. Not enough instruction set versatility. Not enough power in the software.

So anything less than the LSI-11 may not give you enough computer to get the job done. Or to make your product everything it could be.

Start designing with anything less than the LSI-11's proven hardware configuration — a ready-made 8½" x 10" card —

and fully-developed PDP-11 software, and you may miss the market.

Put your product on the market with anything less than the LSI-11's expandability, and you wind up starting from scratch as soon as the competition forces a re-design.

On the other hand, start with the LSI-11 and you may at first get more than you want.

But you'll certainly get everything you need.

Raw compute speed — 400ns micro cycle time.

Real arithmetic power — multiply-divide, integer and floating point arithmetic. Floating point multiply, typically 64 μ sec.

The most versatile instruction set in the micro market — all the instructions of the PDP-11/34.

Powerful software, proven on over 25,000 PDP-11's. For engineering, diagnostics and resident de-bugging. Three operating systems — RT-11,

RSX-11S, and PTS-11. Three high level languages — FORTRAN, BASIC and FOCAL. And a whole library of applications.

You also get 16-bit architecture, a bi-directional asynchronous, 33-line I/O bus that's far simpler than any 8-bit design, the only non-volatile core memory option in the micro marketplace, the ability to expand up into the rest of our famous PDP-11 family, plus the kind of reliability that's made us the number one company in bigger OEM machines.

The LSI-11. It may put you so far ahead at the start, the competition will never catch up.

For 600 pages of solid technical information, plus our new brochure of micro-computer case histories, "Why Anything Less than the LSI-11 Wasn't Enough for Me," just call toll free 800-225-9480 (in Mass. 617-481-7400, ext. 6819), or write Digital Equipment Corp., One Iron Way, Marlborough, MA. 01752.

digital
COMPONENTS
GROUP

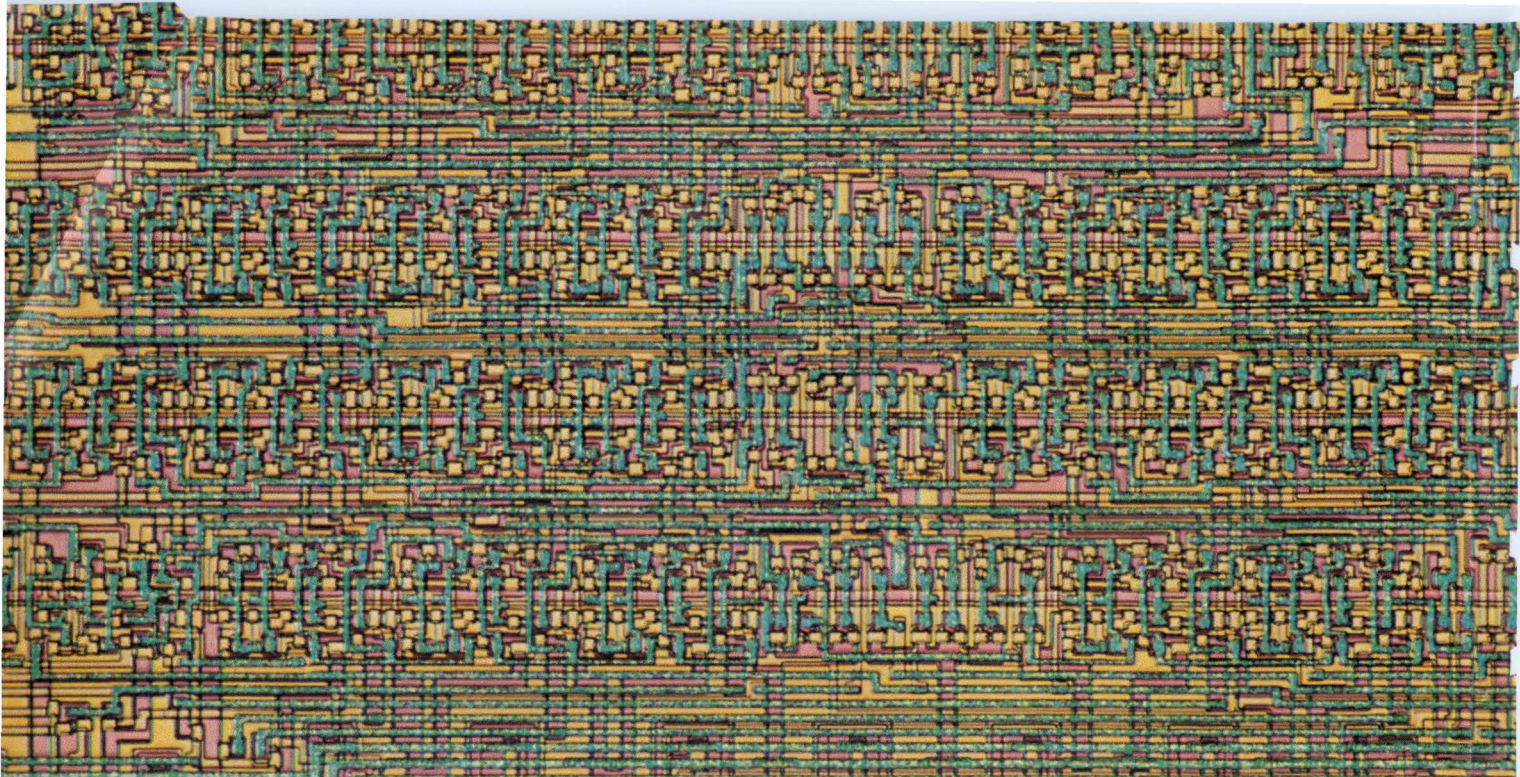

LAST YEAR THIS PROPRIETARY LSI CIRCUIT WAS ONLY AN IDEA. This year it made a good idea into an outstanding product.

Our business is helping original equipment manufacturers exploit the advanced semiconductor technologies to improve performance and reduce costs. We do it by developing proprietary LSI circuits for our customers' exclusive use. Maybe we should be doing it for you.



If you're trying to stay competitive with a new product—or by improving an existing product—now is the time to consider a custom development program. We can help you fully understand the very significant benefits of custom LSI.

Performance Bonuses That Cost You Nothing! The real beauty of LSI is the way it gives you product design options. Once you've made the decision to develop a custom circuit,

there's usually plenty of silicon real estate to use in new and different ways. You can add performance features to the product at virtually no incremental cost. In short, your product can be much better than a competitor's non-LSI equivalent.

High Yields Mean Lower Costs. Our LSI processes are production-proven. We get high yields. Which means you get lower chip costs. Plus, LSI reduces product assembly costs. Your product should have a competitive edge in price.

Low Power Consumption. LSI circuits conserve power. Their low current requirements often permit portability which would otherwise not be possible. Energy conservation in itself is a product advantage these days.

Small Size is Only Part of the Story. Product miniaturization is the most obvious advantage of LSI. Even if small size seems unnecessary for your application, don't overlook the numerous other benefits that we've been talking about.



Our knowledge of the custom LSI approach can help you to evaluate these potential benefits in your own terms. LSI may be exactly what you need. If it isn't, we'll be the first to tell you. Contact us today for some of the answers.



We sell more than circuits.
We sell solutions.

3100 Alfred Street, Santa Clara, CA 95050
Telephone: (408) 247-5350
Cable: Micropower
Telex: 910-338-0154 MICROPWR SNTA

Can you count on your calculator?

Error analyst finds wrong answers turn up consistently in machines costing from \$70 to \$500

by Bernard Cole, San Francisco bureau manager

You can't trust your handheld calculator entirely, says William Kahan, professor of mathematics and computer science at the University of California at Berkeley and a specialist in error analysis as it relates to large computers and their software. In recent years, he has also applied his expertise to handheld calculators because he found that most of the so-called professional models "couldn't be trusted to do a few basic mathematical and engineering functions accurately."

For simple arithmetic functions, those encountered in day-to-day accounting and checkbook calculations, almost any machine—from the \$5-to-\$10 "cheapie" to the \$400-to-\$500 high-end programables—can perform adequately. But for the more complex mathematical, engineering, scientific, and financial functions—the ones the so-called high-end professional calculators were designed to handle—the situation is laughable, says Kahan.

Widely available sophisticated calculators produce surprisingly wrong answers, he says, surprisingly often in the process of performing such basic calculations as:

- Elementary transcendental functions, such as sine, log, and so on.
- Means and standard deviations.
- Solutions of two linear equations with two unknowns.
- Solutions of quadratic equations.

Even in an operation as simple as calculating numbers carried to various powers, most sophisticated machines, from the \$70-to-\$100 nonprogramables (such as National Semiconductor Corp.'s Mathematician PR) to the \$400-to-\$500 machines (such as the SR-51 and 52

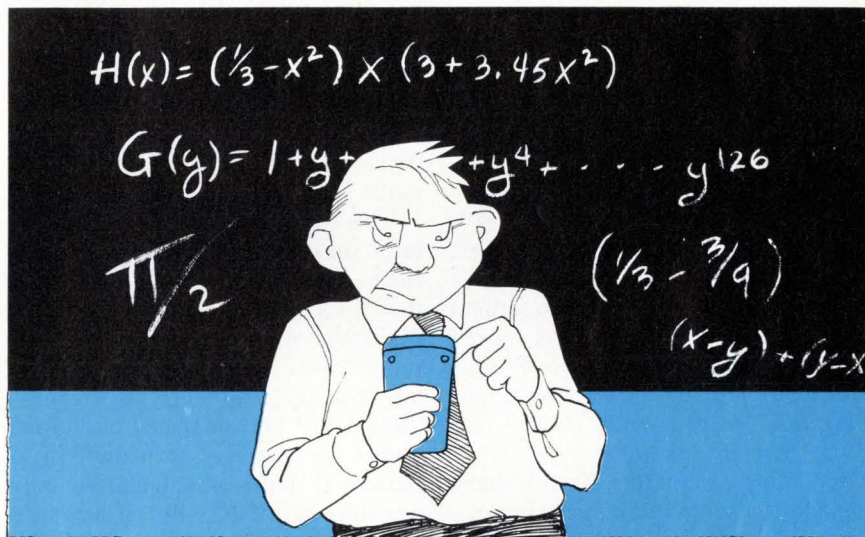

from Texas Instruments) are inaccurate, says Kahan. For example, 2^3 is 7.999994 on a middle-range professional machine (National Mathematician PR), and 8.00000002 on others. One high-end 13-digit machine displays 8.000000000 as the answer. But when the number is subtracted from itself, three non-zero numbers appear—the other three "hidden" digits.

Such errors, say many calculator makers, are trivial and are eliminated by simple rounding or chopping off. Kahan agrees that in and of itself such a simple calculation error is trivial. "But the important thing to note is that engineers seldom calculate the power of a number for that alone," he says. "In most cases that function is just part of a larger mathematical formula. What's worse, the calculations usually involve large numbers of repetitions."

In more complex calculations of, say, means and standard deviations, the errors are more grievous and less

predictable. The standard deviation of 10 numbers starting with 9,999,999,990, from a mean value of 9,999,999,999.5, is 3.02765034. But on the Hewlett-Packard machine he tested, Kahan says, the standard deviation displayed is 105,409.2553. On others, (such as the SR-51), the answer displayed is 0.

Bent slope. The microcoded algorithms that lead to such errors in standard-deviation calculations also mess up other more practical calculations in which the standard deviation is used, such as finding the slope and constant for the best straight line fit through colinear points. "For 1- or 2-digit numbers, sometimes even 3- or 4-, most high-end calculators can perform this calculation with no trouble at all," says Kahan. But in many of those cases, the solution is so obvious it is unnecessary to use a calculator at all. In this example, finding the equation of a line fitting three colinear points: 665,999 and -1 ;

Probing the news

666,000 and zero; and 666,001 and 1, the answer should be a slope equal to 1 and a constant value of 666,000, or $y = 1 (x - 666,000)$. Where there are a large number of points and numbers of five and six digits, most calculators are unable to perform—they blink or indicate error.

Although certain calculators carry only 10 significant figures and others 12 or 13, there is a polynomial of interest in financial calculations— $f(x) = (y)$ where $y = h(x)$ —that can be calculated to at least five significant figures on some 10-digit machines, only by trickery on some 13-digit machines, and not at all on others. For example, if $h(x) = (1/3 - x^2) \times (3 + 3.45 x^2)$ and $g(y) = 1 + y + y^2 + y^3 \dots y^{126}$, when $x = 0$, the answer should be 127. However, one 13-digit machine (Monroe 326) gives an answer of 12; two others (SR-50, SR-51) answer 14; a fourth (SR-52) displays 128. An 8-digit middle-range machine (National PR) answers 120. Only the HP line gives the right answer.

On some calculators (in this case, the SR-52) some fundamental mathematical identities are violated. For certain values, x does not equal x ; that is, when a particular value is subtracted from itself the result is not zero. For example, $\pi/2 - \pi/2$ equals -0.0000000000005 . In some cases $(x - y) + (y - x)$ does not

equal 0. (Using $1/3$ and $3/9$ the answer is -0.0000000000006).

Some of the sources of error in many calculators are simply the result of rounding or chopping off the last digit, Kahan says. "This is a perfectly acceptable procedure if it is done consistently," he says. "But on many calculators it isn't." On some, only rounding is done, on others, just chopping. At least one manufacturer, Monroe, uses both, rounding on multiply and divide, but chopping on add and subtract. A more serious source of error is the lack of guard digits. "On a 10-digit machine, for example, an extra guard digit is added internally to carry the function being performed, be it add, subtract, or whatever," says Kahan. "When a calculator lacks guard digits, the last digit is lopped off to make space for the function."

The argument used by most calculator makers is that the approximations used in the design of their machines do not affect the large majority of users, nor the large majority of calculations. "That is only true up to a point," says Kahan. "Say, only one engineer out of 10 needs particular accuracy in a particular kind of calculation only one time out of 10." But, if he gets a wrong answer for that one calculation because of some anomaly internal to the calculator, that in turn affects his certainty about the accuracy the other nine times.

Kahan emphasizes that he isn't criticizing particular models, but

using them because they're typical of high-end machines in general. His advice to the prospective user of a professional calculator: "Find a calculator that costs the least to use, not one that costs the least to buy."

Improving. However, the makers of the calculators cited by Kahan are unwilling to meekly don the mantle of guilt. David Cochrane, laboratory manager at HP's Advanced Products division and project manager on the first of the handheld models—the HP-35—admits that some of the earlier calculators had drawbacks like the ones Kahan decries. But, he adds, many have been eliminated from models just introduced, and more will be gone from newer ones to come.

"To do everything that he suggests would mean building a calculator with double-precision and 20-digit accuracy," says Cochrane. "That in turn would mean we couldn't build a handheld calculator at all. We are still relatively early in the learning curve."

National's Robert Johnson, director of advanced calculator development, agrees that the technology is young. But his feeling about Kahan's work is, "Thanks, we needed that." Johnson says, "It's the kind of response from the educational community we've been waiting for. I wish there were more people with his kind of expertise available."

He goes on to explain that many of the errors pinpointed by Kahan are boundary condition anomalies, and that one of the trade-offs most programmers have made is to assume that they occur in few calculations. But it turns out that some financial calculations often approach boundaries.

TI's Stavro E. Podromou, applications manager in the U.S. Calculator Products division, wonders just what is absolute accuracy. "There are limits to accuracy of any device," he says, "and they're stated in the manuals. Beyond that, it's only of academic interest. For engineering calculations, we now have a good 10 digits of accuracy, which you couldn't get with a slide rule or Fortran, single-precision calculations on an IBM 360. If there were a need in the marketplace, we could do better." □

What is accuracy?

William Kahan's peers tend to agree with him while differing about how much actually can be done. Typical is Fred N. Ris, a researcher at IBM's Thomas J. Watson Research Center in Yorktown Heights, N.Y. "I think that Kahan is actually getting something done," says Ris, "but the problem is as much philosophical as practical. What sells calculators is price-performance, not architecture. Errors bother me esthetically, but they're part of life. While I agree that things should be better, I'm not sure what the plausible instrument of change is. One should judge a calculator not by what it could do, but by whether there exists a program of equivalent cost that does the same thing."

At the Argonne National Laboratory near Chicago, mathematician W. J. Cody says he agrees completely with Kahan's standards of accuracy. But he points out that accuracy can be defined largely by what one expects. "I, as a numerical analyst, want one thing, but what about the physicist or engineer?" Cody isn't too optimistic about the future: "Why put in more than the public demands? I predict calculators with larger memories, more programming features, and better printers rather than more accuracy."

Trace quality. GOULD/Brush Recorders have it.

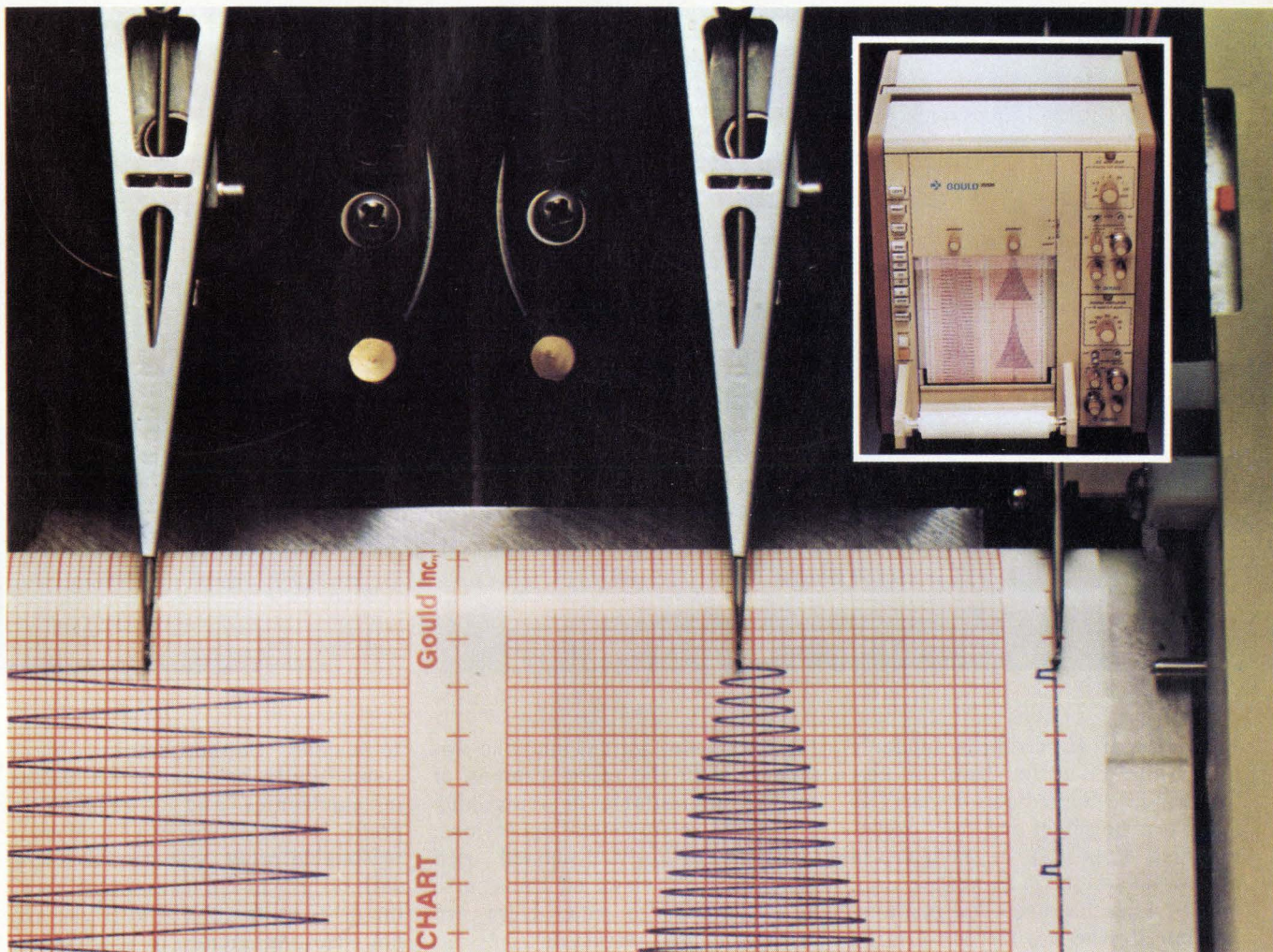

Regardless of pen velocity.

The exclusive GOULD pressurized fluid writing system assures you constant width traces regardless of pen velocity. The ink is injected into the paper and is wiped dry instantly by the high pen pressure seal. In combination

with GOULD low cost chart paper, your traces are permanent. They won't fade or deteriorate as do other writing methods.

An event that may only occur once demands the highest trace quality you can buy . . . GOULD.

For more information write Gould Inc., Instrument Systems Division, 3631 Perkins Ave., Cleveland, Ohio 44114. Or Gould Allco S.A., 57 rue St. Sauveur, 91160 Ballainvilliers, France.

For brochure, call Gould toll-free at (800) 325-6400, Ext. 77.
In Missouri: (800) 342-6600

 **GOULD**
The product development company

Companies

RCA's Griffiths: Planning for electronics lead



When Edgar H. Griffiths suddenly found himself at the helm of RCA Corp. in mid-September, it wasn't as if the new president and chief executive had been left to navigate in unfamiliar waters. A 28-year veteran of RCA when he succeeded Anthony L. Conrad, who was forced to resign after notifying directors he had failed, until recently, to file personal income-tax returns for the last five years, Griffiths has more than served his apprenticeship at the \$5 billion conglomerate. Most recently, he has been executive vice president and president of RCA Electronics and Diversified Businesses, two of RCA's three major business groups.

But many inside and outside of RCA wonder what the 55-year-old Griffiths' appointment portends for that company's vast electronics empire, representing about half the firm's volume. Known as a man with

his eye on the bottom line who was influential in the recent pruning of several unprofitable or marginally profitable electronics operations, Griffiths recently discussed with *Electronics* his views on the course he's charted for RCA. Here are excerpts of that discussion:

Q. How will your being a bottom-line-oriented man affect technological direction?

A. There isn't any conflict. I think it should really mean that we are very mindful of the need to make a reasonable profit and of the steps it takes to do that. It means nothing more than that. I feel some people believe it means ruthless cost-cutting, living for today with no interest for tomorrow, and being cavalier with people. It doesn't mean that at all, but simply to use an old-fashioned phrase, "stick to your knitting and do the kind of job that has

to be done." So there's quite a bit of compatibility between RCA's future in electronics and a reasonable profit. In fact, if you can't achieve a reasonable profit, you have a worry with respect to the future. One abets the other quite ably. And if you are not investing money in electronics, you're not going to have anything with which to make money.

Q. Do you foresee any changes in the company's present technology programs?

A. I don't see any changes at the moment. I think that everything we will do in electronics will evolve. I see no fantastic breakthroughs—just a continuation of where we are today.

Q. Will there be any emphasis on new programs?

A. When you talk electronics, you really can't divorce communications from that, and you know of our

Accuracy. GOULD/Brush Recorders have it.

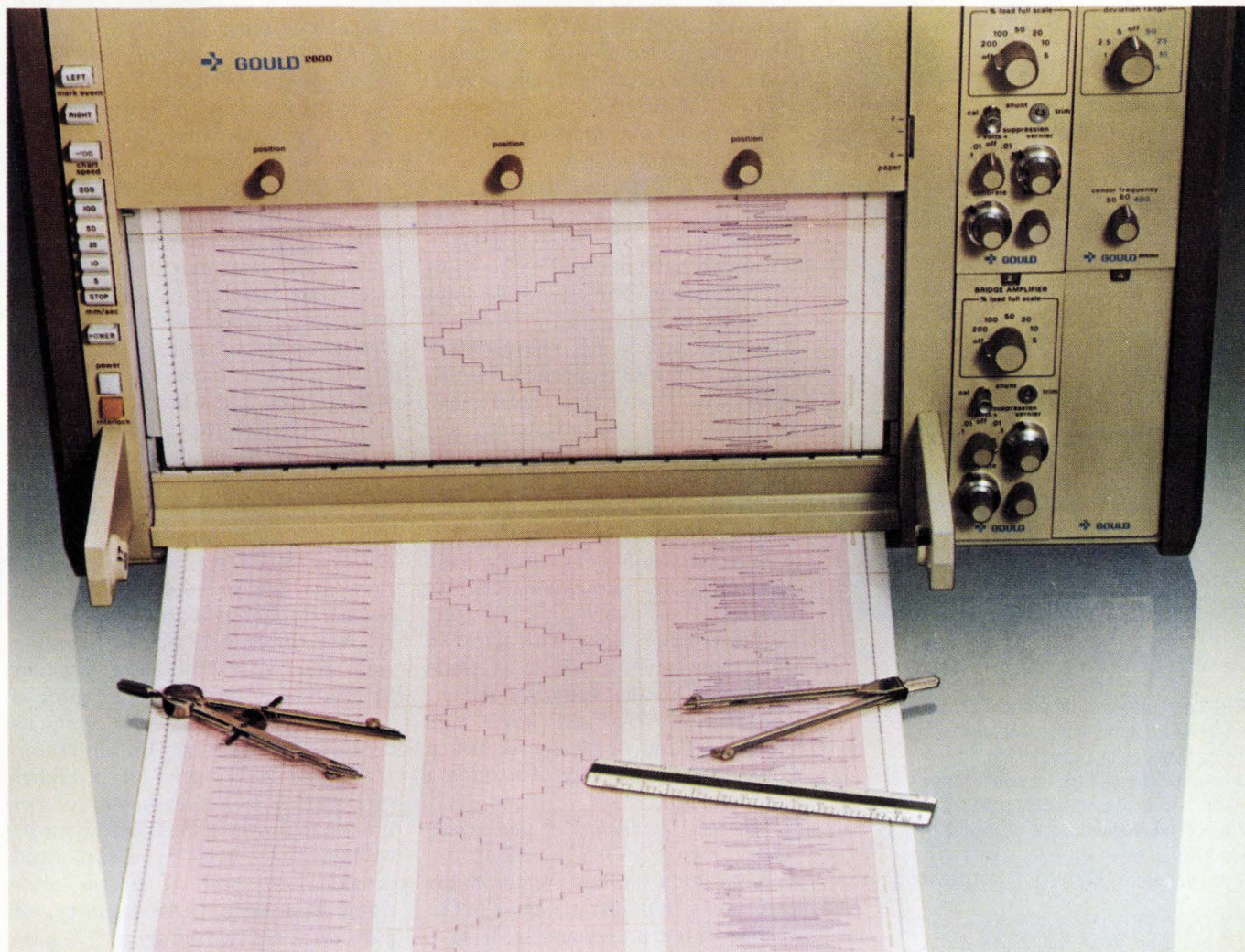

99.65% linearity.

Only GOULD Recorders offer you this exceptional accuracy because only GOULD Recorders give you a 100 gm/mm High Stiffness Pen Motor, a non contact METRISITE® position feedback

element having infinite resolution, and a unique servo drive system which anticipates changes in signal amplitude and velocity.

Accuracy is built into every GOULD direct writing recorder.

For more information on the best, write Gould Inc., 3631 Perkins Ave., Cleveland, Ohio 44114. Or Gould Allco S.A., 57 rue St. Sauveur, 91160 Ballainvilliers, France.

For brochure, call Gould toll-free at (800) 325-6400, Ext. 77.
In Missouri: (800) 342-6600

 **GOULD**
The product development company

low there's a
 niversal computer-based
 n-circuit/functional
 est system with extensive
 igital test capability.



FAULTFINDER[®] FF303

The new FF303 provides two separate in-circuit test approaches. Analog testing procedures use guarding techniques for straightforward component fault isolation. Pulse techniques are used for digital testing of all combinatorial and sequential logic independent of the surrounding circuitry. The FF303 can be configured with up to 928 analog test points and 1216 digital test points.

In-circuit test programming is done with a Faultfinder extension of BASIC which permits on-line editing and simplified, high-level language programming with user nomenclature.

The FF303 is a complete, flexible in-circuit test system for your production floor with low-cost software generation and unique capabilities for testing hybrid boards. We'd like to show you what it can do for you. Write or call for complete information.

Circle 82 on reader service card

FF FAULTFINDERS Inc.
 15 AVIS DRIVE, LATHAM, NY 12110 (518) 783-7786

Irvine, CA
 Sunnyvale,
 Park Ridge, IL
 Faultfinders GmbH, Eschborn, Germany

Cicero, IN
 Waltham, MA

Probing the news

massive efforts in satellite communications. We are making quite a heavy investment in that area and are in a start mode at the present time. That will lap into 1977 to some extent, but there will be nothing major. It's the business of the future—one we feel will begin to favorably impact earnings around the latter portion of 1977 or 1978. Also, the SelectaVision VideoDisc player system may be a new product area for the future.

Q. What is the timetable for the VideoDisc program?

A. In effect, we have never said when we were going to introduce SelectaVision, which is a way of saying we have not said we're going to introduce it. The closest we came to saying anything was a bit under duress at last year's shareholders' meeting when we responded, "within two years." I can't elaborate on that. We don't feel we are under any pressure to go by a particular date, and we will assess the business, its potentials, and hopefully have the intelligence to do everything right.

Q. What is the progress of the Solid State division's silicon-on-sapphire IC program?

A. It's coming along with a major effort between our people at Solid State and at the Princeton [N.J.] laboratories. We just have high hopes for it and we believe we have a reasonable chance here of making a breakthrough.

Q. Are any technological innovations planned for ColorTrak television?

A. No, I don't think so. We probably have taken that just about as far as we need take it. I guess we'll have some enhancements and modest improvements, but no particular breakthroughs or innovations.

Q. What are RCA's plans for recapturing the color-TV leadership held by Zenith Corp. the last four years?

A. There's a massive effort under way. ColorTrak is certainly an indication of that. We decided not to go the route of the new Zenith picture tube. We don't think it's a cost-saving approach, and we really don't see the styling enhancement that's available. Also—except for the tri-potential gun, which we'll have

reasonably soon, too—we don't see an improvement in the picture. I'm not accustomed to being second in anything, and in some of our non-electronic businesses we're first. I see no reason why we can't make a horse race out of color TV with Zenith. I can't give any precise road map or significant concoction that says how we're going to do it, but we certainly are dedicated to doing it. And we'll have to do it by all of the basics that make good sense.

Q. How do you define the role of the RCA Laboratories?

A. The role of the laboratories is to be the window that looks to our future with respect to where new products might come from. The second role that Princeton's playing, a relatively new departure for them as of a few years ago, is to assist our operating divisions in bringing new products or modifications onstream. We're trying to bridge the stream between when Princeton comes up with an idea and when it becomes a fully accomplished product in the market by tying them in more closely to the manufacturers. This role has accelerated, and I would expect it to continue.

Q. How much are you spending at Princeton, and are there any planned reductions in these expenditures?

A. Absolutely not. We're spending well over \$100 million a year at Princeton, and for that, we expect to see something that will give us continued leadership. With inflation, I imagine we'll spend at a higher rate. Part of RCA's leadership, if not the the major part, has to do with its willingness to invest in research and development. And, of all the electronics companies in this country, we have to be considered by any impartial person as being No. 1 in that area. Out of it have come black-and-white and color TV, communications satellites, and the VideoDisc.

Q. Are you aggressively in the marketplace looking to sell any electronic businesses, and are there any electronic product-lines that may be discontinued or wound down?

A. We took our big steps with respects to electronics late last year. There's no segment, major or minor, that we're attempting to sell. And all the major segments of our electronics business today are profitable. □

Versatility.

GOULD/Brush Recorders have it.

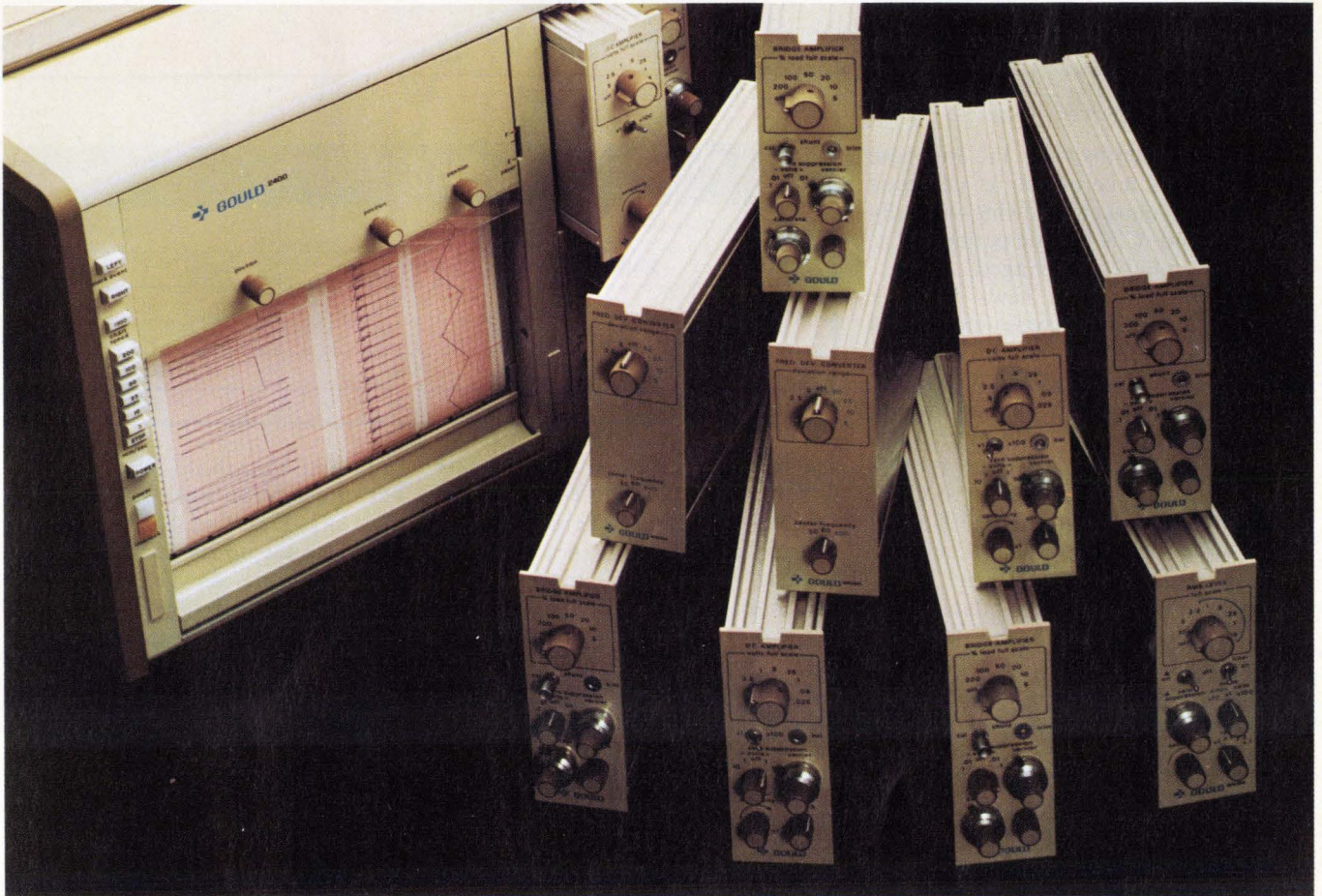

You can: amplify, convert, attenuate, suppress, reject, filter, expand, add, linearize, subtract, display, multiply, invert, square, divide, integrate, isolate, detect, alarm, control, demodulate...

Its modular design and interchangeable signal conditioners mean you get a recorder system "customized" to your needs with the ability to change input

parameters at will through the addition of appropriate plug-in conditioners. Let us tell you more. Write Gould Inc., Instrument Systems Division, 3631 Perkins

Ave., Cleveland, Ohio 44114. Or Gould Allco S.A., 57 rue St. Sauveur, 91160 Ballainvilliers, France.

For brochure, call Gould toll-free at (800) 325-6400, Ext. 77.
In Missouri: (800) 342-6600

 **GOULD**
The product development company

Computers

Japanese come smiling through

After year of liberalized competition, fears that domestic firms would slip in market turn into pleasure over 8% gain

by Gerald M. Walker, Associate Editor

In the 12 months since the Japanese government liberalized its domestic computer market, allowing virtually unfettered U.S. participation in it, nothing much has changed.

The non-event is news. The six domestic Japanese computer makers had feared that International Business Machines Corp. and other U.S. firms operating in Japan would rapidly grab a much larger share of the market. Instead, the foreign market share appears to have dropped by 8% in Japan's fiscal 1976 and is now estimated at about 43.6%.

What happened? For one thing, the computer market—with a couple of pleasing exceptions—has not been very charming, to use a favorite Japanese expression. Economic doldrums have continued to distress most industries. Banks, too, have been rather cautious in upgrading present systems. Nippon Telegraph and Telephone, a heavy computer user, has run into budget trouble and cut back on its orders. Overall, the computer market in Japan this year should grow by only 15%. That is not much of an opportunity for the competitors, foreign or domestic.

Another factor is that the Japanese computer industry was ready to do battle with IBM and the others. Aided considerably by government subsidies, the domestic companies set up three joint efforts to develop three computer series comparable to the IBM 370 machines, and these product lines put them in relatively safe positions before the complete liberalization took effect. Also, IBM insisted a year ago, and continues to insist, that it has no plan for dominating the Japanese computer market, which has the second largest

SALES OF JAPANESE SYSTEMS (980 installed as of June 1976)					
ACOS series		Cosmo series		M series	
NEC	Toshiba	Mitsubishi	Oki	Fujitsu	Hitachi
531	204	84	0	60	101
TOTAL		TOTAL		TOTAL	
735		84		161	

installed base in the world. But IBM is not exactly coasting either, so the competition has been fierce.

MITI helps. The Ministry of International Trade and Industry has continued to play an important role in the drama. The computer industry is slated to become a very important part in the economy because it will exploit the human resource of intelligence rather than material resources to create highly profitable exports.

"Never underestimate the intensity of Japan's hopes for its computer industry," comments an American observer in Tokyo. "On one side, they will do everything to protect their domestic market from the foreigners who they feel are equivalent to the arrival of Commodore Perry's black ships. On the other, there's strong feeling that no nation can be taken seriously technologically unless it has a computer industry competing internationally."

MITI's role once again takes the form of "administrative guidance" backed by financial aid. With a four-year budget of 30 billion yen (almost \$105 million), the ministry has organized five computer companies into two research groups under a central laboratory. One group, Computer Development Laboratory Ltd., is composed of Fujitsu Ltd., Hitachi

Ltd., and Mitsubishi Electric Corp. The other, Netis, links Nippon Electric Corp. and Toshiba Electric Co. Each has set up its own R&D effort to concentrate on very-large-scale integration (VLSI). The central laboratory is staffed by researchers from the five companies and the government, and its focus is basic research.

The objective of the present joint projects is to develop computers that will match what the Japanese suppose will be IBM's next line—its so-called Future System general-purpose series. The only one of the original Japan Six not involved is Oki Electric Co., which concentrated on industrial control systems and had little to contribute.

By the time the VLSI project has run its course, the Japanese very probably will start a strong push into computer export. So far Fujitsu, which has a licensing agreement with Amdahl Corp., has shown the most interest in moving overseas, mainly to Asian countries and Spain. Fujitsu's big gun in this campaign is the M 190, a system equivalent to IBM's 370/168. However, Hitachi is also selling the M Series, and because of its strong overall financial position is expected to be the second most aggressive computer exporter

Reliability. GOULD/Brush Recorders have it.

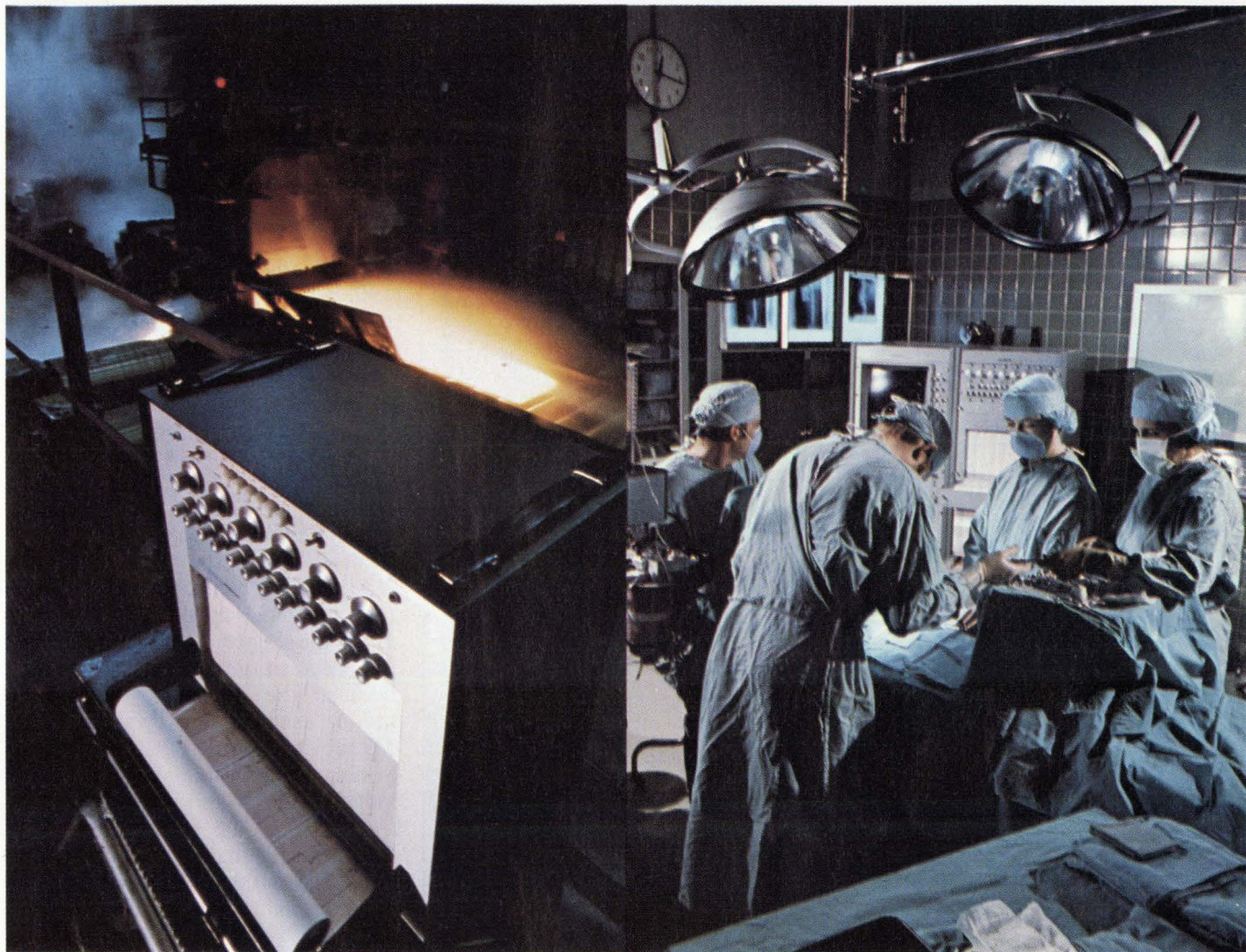

When you need it.

When there are no second chances, you need us — for a measurement you must have reliability. Gould gives it to you in every recorder. Rugged structural components and

proven design. Pressurized fluid writing for consistent trace quality. Very little maintenance required. It's what you'd expect from the leader.

Let us show you how we've

cut the element of risk. Write Gould Inc., Instrument Systems Division, 3631 Perkins Ave., Cleveland, Ohio 44114. Or Gould Allco S.A., 57 rue St. Sauveur, 91160 Ballainvilliers, France.

For brochure, call Gould toll-free at (800) 325-6400, Ext. 77.
In Missouri: (800) 342-6600

 **GOULD**
The product development company

in Japan. In addition, Hitachi has been successful in creating its own machine-rental credit operation, while the other Japanese companies have had to use a more restricting joint financing organization, originally set up by MITI.

Looking abroad. At the same time, Nippon Electric, an aggressive exporter in the semiconductor market, has picked up strength in Japan with its ACOS series and can also be expected to make a bid for overseas computer business. According to Masasuke Morita, executive vice president and director for NEC's computer operations, the ACOS series was the first all-LSI system in Japan. And whereas Fujitsu's M 190, which followed, has 100-gate LSI chips, ACOS has 200-gate chips mounted in a unique micropackage substrate that can be combined into a 16-layer printed-circuit board of 40,000 gates per board.

Toshiba, which also markets the ACOS series, has a natural opening into the U.S. computer market via Honeywell thanks to previous agreements between the two companies.

Mitsubishi, while its share in the total computer market is the smallest of the domestic companies, leads in process-control sales, in part because the industrial giant is a major user of its own systems. Mitsubishi is also putting together an export program, again using its industrial plant and equipment contracts as openings for its computers.

Continued financial support from MITI, price slashing on the domestic market, an aggressive buy-Japan program by the national government, and now the growing thrust of Japanese computers abroad—all this strikes Americans as irritating and unfair.

But the Japanese computer companies do not see it as unfair. They argue that U.S. companies had for years received Government contracts for systems that eventually became commercial products. "Government support of computer industries is not special to Japan," comments NEC's Morita. "Europeans have come to Japan to study our joint research project and may copy it."

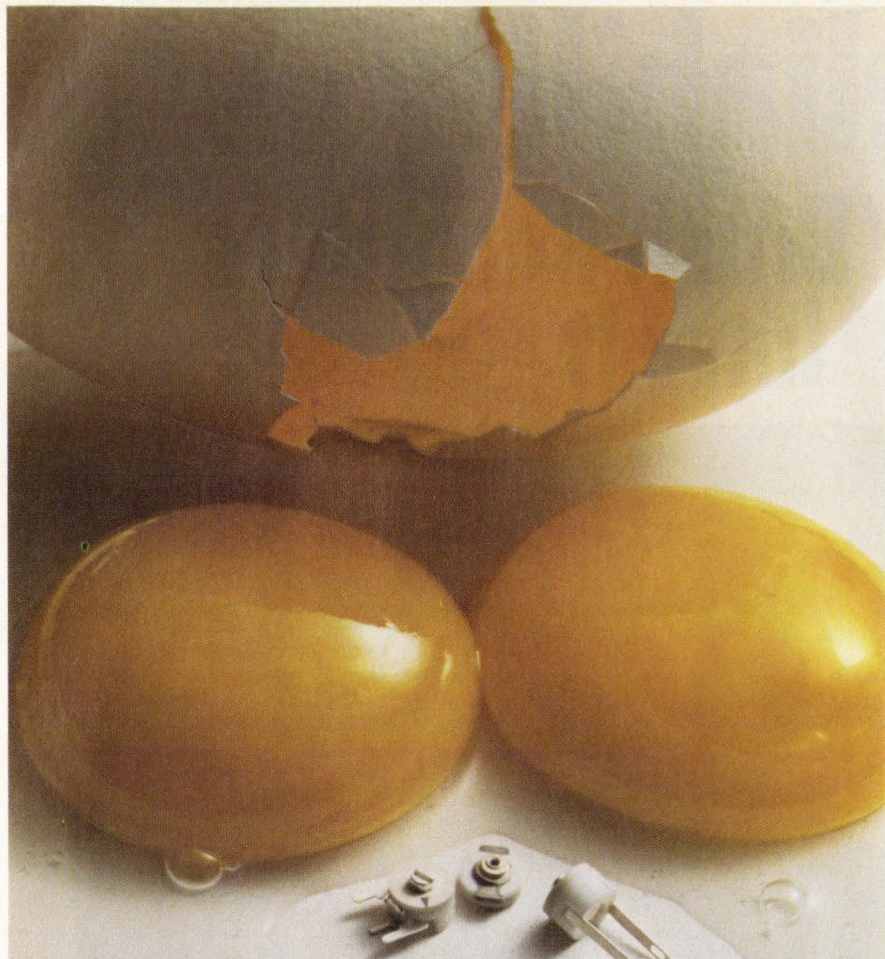

Our Micro-J[®] capacitors exceeded even our own expectations.

Not long after we introduced our sub-miniature ceramic disc trimmers, some customers began calling our attention to an error we made. It seems our Micro-J Capacitors actually perform better than we said they would.

The Quality Factor is typically greater than 1000 at 1 MHz. And the temperature coefficient of capacitance is typically better than ± 150 PPM/ $^{\circ}$ C over the entire

operating range from -55° to 125° C. This has prompted a number of people to call our Micro-J the best ceramic disc trimmer available at any price. And one customer even suggested that we could probably start charging more for it.

We must admit we were tempted. But we decided to continue selling Micro-J's at the original price.

We don't think you'll mind.

E. F. Johnson Company / Dept. EL, Waseca, MN 56093

I'd like more information about your Micro-J's.

Please send me your specifications.

I desire test samples. Please call me at _____

Name _____

Title _____

Firm _____

Address _____

City _____

State _____ Zip _____



JOHNSON

For fast service, contact your local Johnson Distributor.

Situation Wanted:

Name—Amphenol® 97 Series connector. For consumer, industrial, business equipment. And more. Here's the old pro of standard circular power connectors. It's for service from 250 to 4200 VDC (200 to 3000 VAC, RMS) and wire gauges from 4 to 16. So 97 Series connectors are ideal for all kinds of equipment—TV, computers, machine tools, communications, you-name-it.

And still more qualifications. Including MIL-C-5015. And our pre-aligned non-rotating contacts that mean quick, easy soldering. The 97 Series is also built strong to work hard. With diallyl phthalate insert material (it's highly stable at high temperatures). Molded barriers between contacts for higher voltage ratings. And a few more features you'll want to find out about.

Literally hundreds of configurations. Take your pick of inserts—for a number of wires, all of the same gauge. Or for lots of wire, all of different gauges. And choose the receptacle you want: wall, cable, or box. And the plug you want: straight, quick-disconnect, angle, or panel-mount.

Availability: Whenever you're ready. Amphenol 97 Series connectors are available now for off-the-shelf delivery from your Amphenol Industrial Distributor. Call him soon. Or to find out how Amphenol 97 Series connectors can be tailor-made to match your specific application, just write or call: Bob Ashley, Amphenol Connector Systems, Bunker Ramo Corporation, 900 Commerce Drive, Oak Brook, Illinois 60521. (312) 986-3763.



The right idea
at the
right time.

AMPHENOL Connector Systems **BUNKER RAMO**®

The snap action switch

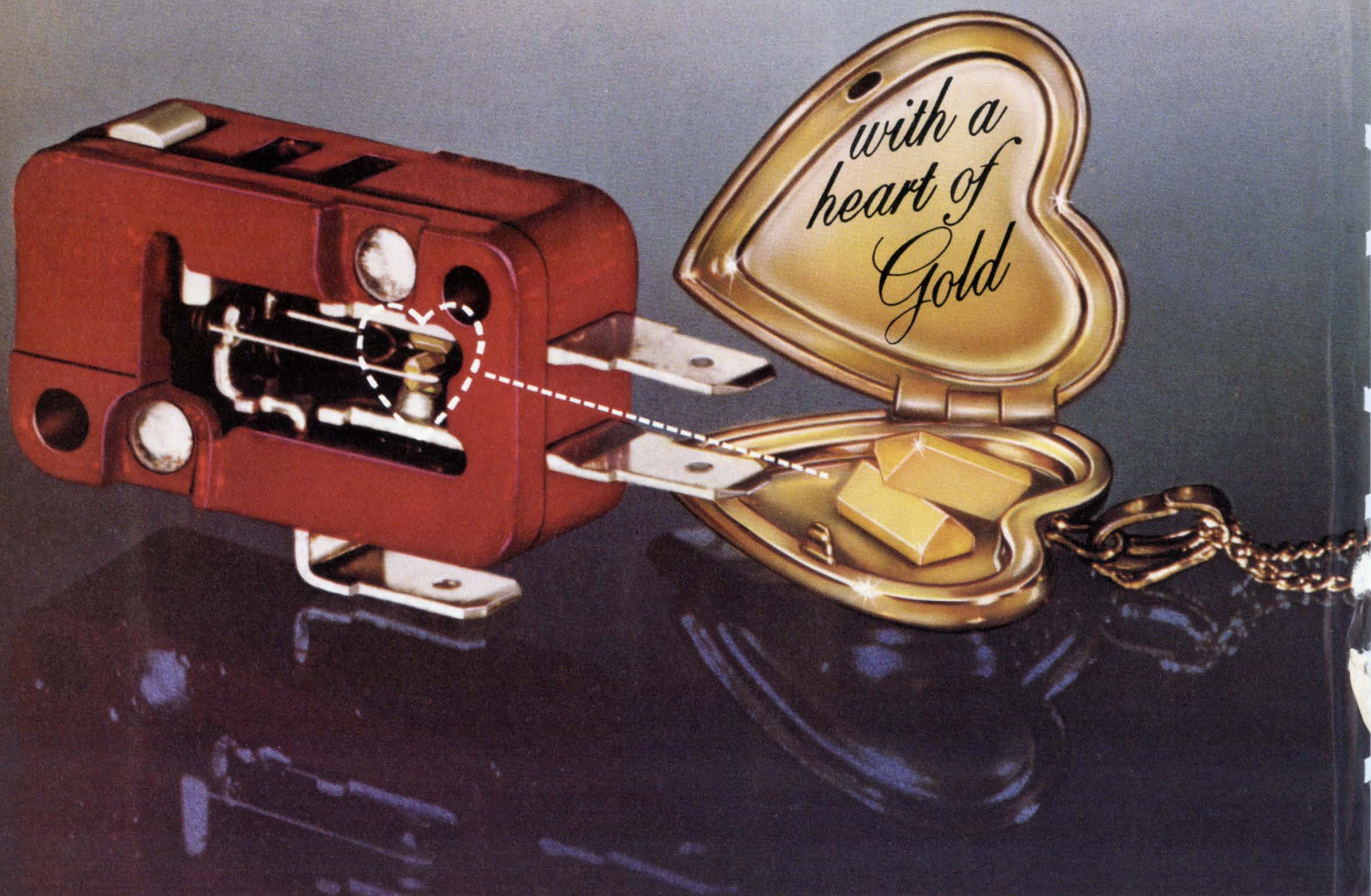

...for **POSITIVE** switching in low energy circuits

Now your 4 to 100 milliamperere, 4 to 30 volt circuits can have the same high reliability you've learned to love in Cherry snap action switches. Because, our "heart of gold" snap action switches have the same long life coil spring mechanism, the same large overtravel as all of our snap action switches.

They also have gold crosspoint contacts. A configuration with knife-edge contact area so small (9 millionths of a square inch)... with contact force so great (about 5,000 psi)... and gold alloy so pure and film-free... you are absolutely assured of positive contact every time. For 50 million operations and beyond.

Cherry Gold Crosspoint Contact Switches are available in virtually every snap action design in

Cherry's big catalog. And you *know* what a wide variety of switch types, sizes and mounts *that* is. Choose any switch design from a basic open or general purpose to a panel mount pushbutton, low torque, miniature, subminiature or subminiature module. Chances are 99 to 1 that the switch you have chosen is available with gold crosspoint contacts. Which will make designing low energy circuits a whole lot easier... and a whole lot *better*. (No love letters, please.)

For free test sample and complete catalog, just TWX 910-235-1572... or PHONE 312-689-7700.

CHERRY



Cherry switches now available locally from distributors.

CHERRY ELECTRICAL PRODUCTS CORP., 3608 Sunset Avenue, Waukegan, IL 60085

Circle 88 on reader service card

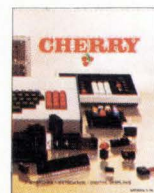
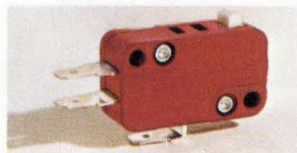

Electronics abroad

Color-TV sales boom in Spain

Sets provide bright spot as political unrest and 20% inflation will combine to make 1977 a flat year for electronics industries

by William F. Arnold, London bureau manager

For electronics suppliers, the gain in Spain lies mainly in the consumer sector. Spanish consumer executives, saying they were caught by surprise this year when sales of color-TV sets took off, expect the continuing boom to buoy consumer electronics.

But that's about the only sunshine in otherwise cloudy skies, say executives in other electronics sectors. "The best we hope for next year is 0% real growth," confides one data-processing-equipment manufacturer, a refrain expressed by other executives to *Electronics*.

Spain is holding its breath as it moves uncertainly to a more democratic form of government. Spending by the government for new programs is stalling, investment money is drying up, and businesses are tending to put off purchasing new equipment. Consequently the economy is going unattended, and the inflation rate is shooting up to 20% or more.

Overall, however, inflation and inertia combine to give the Spanish electronics market a slightly brighter hue than that which some observers see, according to initial estimates.

Electronics forecasts the total Spanish electronics market next year at \$1.1 billion, up 13.6% over 1976. All sectors show increases, with consumer products leading the way in terms of real, or noninflated, growth. Computers and communications, the next two biggest sectors, also show reasonable growth considering the uncertain times. *Electronics'* estimates of local consumption (68 pesetas to the dollar) are based on factory prices, not retail.

Component and TV-set suppliers expect next year's sales of color sets to soar to 300,000 to 400,000 sets, up from about 200,000 units this year. Black-and-white sales will fall to nearly the color level.

Color-TV sales are expected to rise to \$176 million in 1977, up substantially from the \$132 million this year. That will be almost half of the total estimated consumer market of \$394 million next year, up from this year's \$338 million. All in all, the boom should continue, says Rafael Salvador, marketing vice president for Piher, a leading components maker.

The sagging economy has reined in Spain's telephone company, the Compania Nacional Telefonica de España. Orders for telephone exchanges are down this year, and next year doesn't look much better, says José Coronado, assistant to the president of ITT subsidiary Standard Electrica, S.A., Madrid. *Electronics'* estimates show some increase in orders for public switching to \$23.5 million from \$19.1 million.

In sum, the communications sector will show a modest increase next year to \$256 million, with the microwave relay section rising to \$30.2 million and telephone and telegraph carrier equipment rising to \$89.7 million.

Computers and related equipment will slow their surging growth as the downturn hits this category, too. Projected sales are \$297 million, up from \$255 million this year. Minicomputers will jump to \$15.3 million; data terminals, which should reach \$13.2 million; data storage at \$45.6 million, and office equipment at \$53.7 million.

The microprocessor and minicomputer market could well explode as many small companies automate their accounting to help beat inflation, according to Carlos Mendez, marketing development and research manager at Sperry Univac.

Pocket calculators may suffer but desk calculators may be a little bit better says Luis Calvo, sales director, Instruments and Components division, Hewlett-Packard Española, Madrid. In planning a 10% increase in real terms for next year, HP may lead the general test and measuring category. □

This is the first in a series examining European markets.

SPANISH ELECTRONICS MARKETS FORECAST (IN MILLIONS OF DOLLARS)

	1975	1976	1977
Total assembled equipment	822	1,007	1,129
Consumer electronics	265	338	394
Communications equipment	203	228	256
Computers and related hardware	227	255	297
Industrial electronics	54	69	80
Medical electronics	39	44	51
Test and measuring equipment	28	32	39
Power supplies	6	7	8

Spanish look. Consensus estimates of consumption based on *Electronics'* survey in October and November. Domestic hardware is valued at factor prices, imports at landed costs.

MEMORY AT WORK

Process Control

Loss of power on

a computer-controlled processing system is real trouble. Get back on line fast—or risk losing an entire batch or run. EMM's reliable MICROMEMORY core memories take care of that. Just push your restart button and you're up and operating. No program reloading. No back-up batteries to worry about. We have designs for 4-bit, 8-bit and 16-bit microprocessors—even larger systems with capacities to 32K x 18. We make semiconductor memories, too. But for process control you need reliable MICROMEMORY core memory.

EMM

COMMERCIAL MEMORY PRODUCTS

A Division of

Electronic Memories & Magnetics Corp.

12621 Chadron Ave., Hawthorne, Calif. 90250

(213) 644-9881



MEMORY AT WORK

Diagnostics Memory for medical

diagnostic equipment must be reliable. Human lives are involved. It must be fast; dynamic imaging calls for high speed CRT refresh. Those are two reasons our MICRORAM static RAM memory systems are chosen so often. Cycle speeds are sufficient for CRT refresh. Our metal-gate technology is inherently reliable. And the support circuitry needed by static RAMS is very simple. That adds up to an overall system reliability you just can't beat.

You can't beat our 15-year experience in the memory business, either. Give us a call today and tell us what you need.

EMM

COMMERCIAL MEMORY PRODUCTS

A Division of Electronic Memories & Magnetics Corp.

12621 Chadron Ave., Hawthorne, Calif. 90250

(213) 644-9881

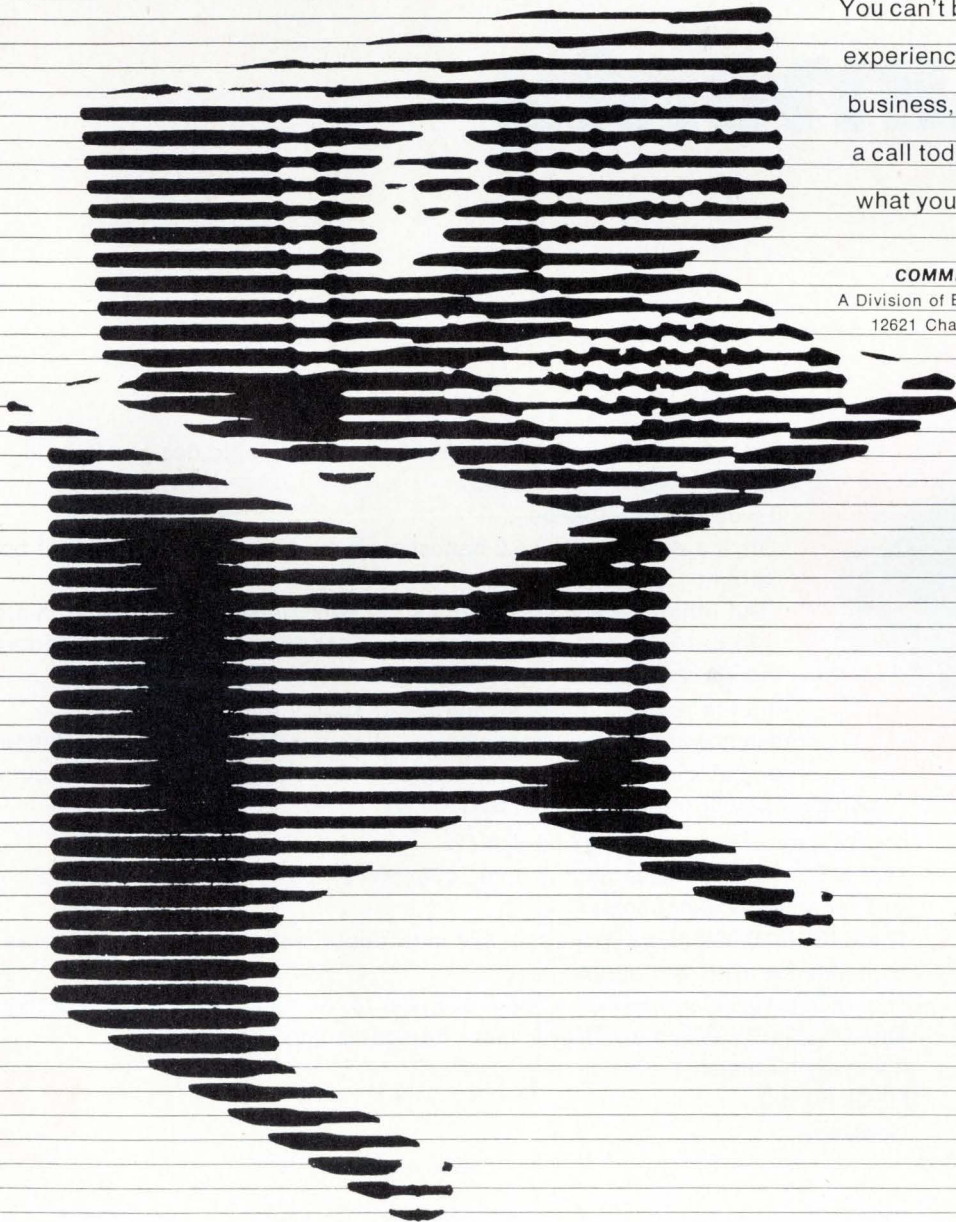

Everybody knows MECL 10,000 is more than mainframes and instruments

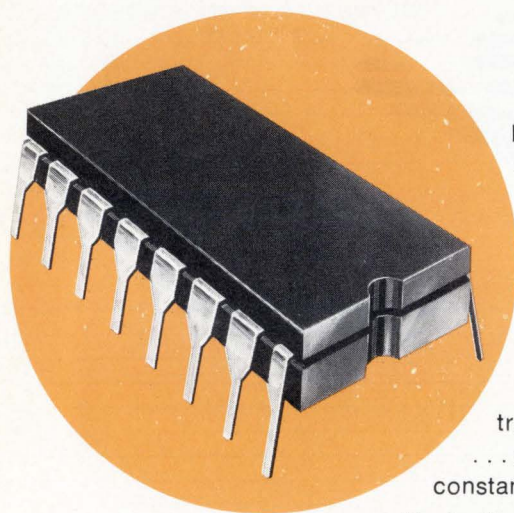

More people now use MECL 10,000 in general logic designs than in mainframes and instruments.

It was bound to happen.

Oh, it's still #1 with the 2 nanosecond mainframe and instrument boys alright.

But others have discovered it's the most versatile, functional, high-performance logic form around for a variety of high-speed commercial industrial designs.

And the reasons: insignificant power supply noise generation . . . transmission line drive capability . . . high input/low output impedance . . . compatibility with most other logic forms . . . complementary outputs . . . constant power dissipation with frequency . . . etc.

Maybe they know something you don't.

That MECL 10,000 raises performance, cuts power dissipation and package count and lowers equipment costs.

That MECL 10,000 offers more than 120 individual functions from simple gates to 1K RAMs for every throughput need.

That MECL 10,000 production costs are similar to, or even lower than, Schottky T²L.

That MECL 10,000 is more than number crunchers and counters.

It's everything else, too.

MECL 10,000.

Get smart.



Just ask 'em.

- **NATIONAL MEMORY** . . . uses MECL 10,000 in add-on memory
- **COLLINS**[†] . . . uses MECL 10,000 in peripheral controller
- **TRW** . . . uses MECL 10,000 in space shuttle
- **CINCINNATI MILACRON** . . . uses MECL 10,000 in small business systems
- **TERADYNE** . . . uses MECL 10,000 in IC test system
- **BURROUGHS** . . . uses MECL 10,000 in radar data processor
- **NETWORK SYSTEMS** . . . uses MECL 10,000 in data interface
- **AMS** . . . uses MECL 10,000 in add-on memory
- **KING RADIO** . . . uses MECL 10,000 in avionics
- **GENERAL DYNAMICS** . . . uses MECL 10,000 in missiles and F-16 support
- **RAYTHEON** . . . uses MECL 10,000 in ECM systems
- **DIGITAL COMMUNICATIONS** . . . uses MECL 10,000 in satellites
- **CDC** . . . uses MECL 10,000 in military magnetic disk drive
- **BUNKER-RAMO** . . . uses MECL 10,000 in Army systems
- **ELECTRONIC MEMORIES** . . . uses MECL 10,000 in add-on memory
- **STORAGE TECHNOLOGY** . . . uses MECL 10,000 in disk controller
- **CUBIC CORP** . . . uses MECL 10,000 in multi-band translator
- **DIGITAL EQUIPMENT CORP.** . . . uses MECL 10,000 in small computers

[†]DIVISION OF ROCKWELL INTERNATIONAL

MOTOROLA Semiconductors
—and you thought we were just a production house

Motorola Semiconductor Products, Inc., Box 20912, Phoenix, AZ 85036

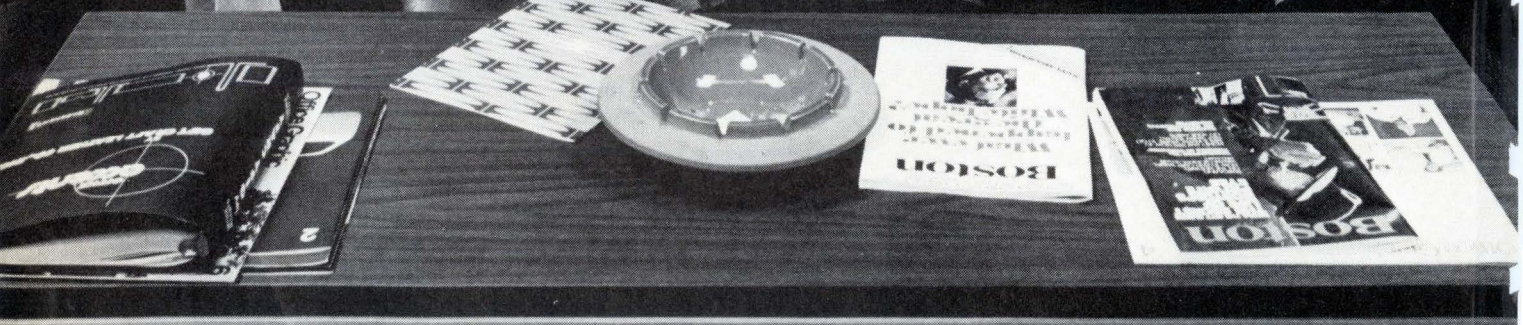
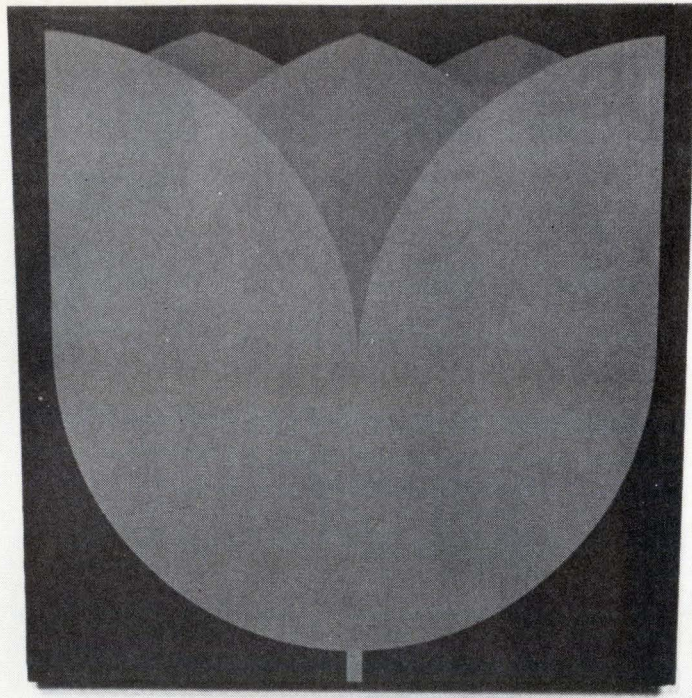

Five tough questions to ask our 8080A competitors.

1. Do you have an 8K Electrically Erasable PROM? You know, like NEC Microcomputer's μ PD458 that's compatible with 2708's but can be erased in 1 minute, programmed in 80 seconds, only needs two voltages for reading and programming, has conventional packaging, a guaranteed data retention time of 10 years, and an access time of 450/650ns, making it the first practical non-volatile RAM storage.

2. Do you have a Universal Synchronous Receiver/Transmitter Data Communications Controller? You know, like NEC's μ PD379 with SDLC capacity up to 50K baud.

3. Do you have a 450ns 16K ROM? You know, like NEC's μ PD2316A that's pin compatible with other 2316As but has the speed to match the 8080A.

4. Do you have a Floppy Disk

Controller? You know, like NEC's μ PD372 that can control up to four IBM 3740-compatible drives.

5. Do you have a Tape Cassette Controller? You know, like NEC's μ PD371 that can control up to two cassette drives with International Standard Data Format.

Go ahead, ask any competitor you like. What you'll find is that if you want these super 8080A peripherals, you'll simply have to come to NEC.

And when you do, you'll also be dealing with an 8080A supplier with complete applications support — plus the full range of 8080A products listed.

Any more tough questions?

Your NEC rep or distributor is waiting to put you at ease.

NEC Microcomputers, Inc.,
Five Militia Drive, Lexington, MA
02173. 617-862-6410.

μ PD8080A	2.0 MHz MPU
μ PD8080A-E	1.25 MHz MPU
μ PD8080A-2	2.5 MHz MPU
μ PD8080A-1	3.0 MHz MPU
μ PD411	4K DYN-RAM
μ PD5101-E	1K STATIC RAM
μ PD2101AL	1K STATIC RAM
μ PD2102AL	1K STATIC RAM
μ PD454	2K EE PROM
μ PD2308	8K Mask ROM
μ PD369	UART
μ PD758	Seiko Printer Controller
μ PB8212	I/O Port
μ PB8214	Priority Interrupt Controller
μ PB8216	Bus Driver
μ PB8224	Clock
μ PB8228	Generator/Driver
μ PD8251	System Controller
	Prog. Comm. Interface
μ PD8255	Peripheral Interface

NEC microcomputers, inc.

REPS: East — C & D Sales 301-296-4306, Contact Sales 617-273-1520, Trionic Assoc. 516-466-2300; South — Merino Sales 214-233-6002, Perrott Assoc. 305-275-1132, 305-792-2211, 813-585-3327, Wolffs Sales Serv. 919-781-0164; Midwest — Electronic Innovators 612-884-7471, K-MAR Eng. & Sales 314-567-1829, 816-763-5385, McFadden Sales 614-221-3363, R.C. Nordstrom 313-559-7373, 616-429-8560, R.F. Specialists 312-698-2044; West — Mike Duffy Assoc. 303-934-7392, Electronic Component Mktg. 213-340-1745, 714-295-6122, 714-524-9899, Summit Sales 602-994-4587, Trident Assoc. 408-734-5900, Tri-Tronix 505-265-8409; Canada — R.F.Q. Ltd. 416-626-1445, 514-626-8324

DISTRIBUTORS: Century Electronics (Albuquerque, Denver, Salt Lake City) Diplomat (Chicago, Chicopee Falls, Clearwater, Dayton, Detroit, Little Falls, Minneapolis, Mount Laurel, Newport Beach, St. Louis, Salt Lake City, Sunnyvale, Woodbury) Harvey Electronics (Boston, Fairfield, Norwalk, Woodbury) Intermark Electronics (San Diego, Santa Ana, Seattle, Sunnyvale) Lionex Corp. (Boston) G.S. Marshall (Sunnyvale) Mirco Electronics (Phoenix) R-M Electronic (Detroit) Semiconductor Specialists (Boston, Chicago, Dallas, Dayton, Detroit, Indianapolis, Kansas City, Los Angeles, Milwaukee, Minneapolis, Pittsburgh, St. Louis; Malton, Canada) Technico, Inc. (Baltimore)

The ITT Sem

Published by ITT Semiconductors, Commerce Way, Woburn, MA 01801

SECOI

NEW ITT 5W ZENERS MATCH PRICE, PERFORMANCE AND MOTOROLA

ITT Semiconductors new line of 5W zener diodes is competitively priced, but their performance is more than competitive. A unique patent-applied-for metal overlap contact system gives them excellent reliability.

An important advantage is the fact that these ITT 5Z type 5W zeners can be used in place of the Motorola 5M type and JEDEC 1N5338-1N5364 series zeners. And the cost efficiency of ITT's 5W zeners allows them to replace 2W and 3W zeners.

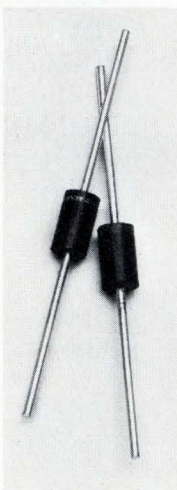

A larger than normal contact protects the junction area and gives the device a higher surge rating. The metallization prevents contamination from migrating into the junction as well. Low dynamic impedance and low leakage are also inherent in the design.

The 26 planar nitride passivated zeners cover the entire spectrum of applications up to 5W. They are available from 5.1 volts through 33 volts.

Applications for ITT's 5W zeners include both transient suppression and voltage regulation in automobiles, computers, telecommunications and power supplies. They will also replace some surge suppressors.

Part numbers for these plastic packaged zeners are 5Z5338 through 5Z5364. They are available with tolerances of 5%, 10% and 20%. ITT zeners with 5% tolerance are priced at 80¢ each in quantities of 100.

Write for 5W zener cross reference chart.

Circle #1 for more information.
(Or reader service #100)

ITT makes linear and digital consumer circuits for televisions, automobiles, clocks, and audio equipment.

Now – a complete line of low power rectifiers from ITT Semiconductors

ITT RECTIFIERS				
COMMON TYPES	PACKAGE	MAX. CURRENT	AVAILABLE THROUGH	SURGE RATING
1N645-1N649*†	GLASS	400mA	600V	10 amp
1N4001G-1N4006G	GLASS	1 amp	800V	30 amp
1N4001-1N4007	PLASTIC	1 amp	1000V	50 amp
1N5059-1N5062	GLASS	1 amp	800V	50 amp
ITT5059-ITT5062	GLASS	1 amp	800V	30 amp
1N4933-1N4937**	GLASS	1 amp	600V	30 amp
1N4383-1N4385*	GLASS	1 amp	600V	50 amp
1N4585-1N4586	GLASS	1 amp	1000V	50 amp
1N5391-1N5399	PLASTIC	1.5 amp	1000V	50 amp
1N4816-1N4822	PLASTIC	1.5 amp	600V	50 amp
1N5053-1N5054	PLASTIC	1.5 amp	1000V	50 amp
1N5400-1N5408	PLASTIC	3 amp	1000V	300 amp

*MIL APPROVED SERIES **Trr 200 nsec †APPROVED JAN. TX-1 VERSION

With the addition of 1.5 amp and 3 amp rectifiers, ITT Semiconductors now covers the complete range of low power rectifier needs from 400 mA to 3 amps, including 1 amp fast recovery rectifiers series 1N4933 through 1N4937.

The new series of 1.5 amp rectifiers, in plastic uses a lower thermosetting temperature, resulting in less strain to junctions and surfaces during the molding process. Moisture and humidity resistance are excellent. All devices have a 50 amp surge, Peak inverse voltage (PIV) of 1N5391-1N5399 is 50-1000V. PIV of the 1N4816-1N4822 series is 50-600V, and of the 1N5053-1N5054 series is 800-1000V.

The general purpose 3 amp series, 1N5400-1N5408, has a surge rating of 300 amps and a PIV of 50-1000V, available in a plastic package.

ITT's 1 amp series rectifiers replaces almost all commercial 1 amp rectifiers in the market. The 1N4001 series, in a plastic package, has a surge rating of 50 amps

and PIV of 50-1000V. It has good transient immunity. The DO41 glass packaged 1N4001G-1N4006G series has a 30 amp surge rating and PIV to 800V.

ITT has 2 types of 1 amp rectifiers designed for high reverse power surge ratings of up to 1000W. Both are in DO41 glass packages and have PIV of 200-800V. There are two chip sizes; the 1N5059-1N5062 series has a surge rating of 50 amps while the ITT5059-ITT5062 series for industrial applications has a surge rating of 30 amps.

The general purpose 1 amp series 1N4383-1N4385 and 1N4585-1N4586 has a DO29 glass package. Surge rating is 50 amps and PIV is 50-1000V. The former series is JAN and JAN TX approved.

The 400 mA 1N645-1N649 series, DO7 packaged in glass, has a surge rating of 10 amps and PIV of 100-600 V. This series also is JAN and JAN TX approved.

Also available is JAN TX 1N645-1 series in a DO7 case.

Circle #2 for more information.
(Or reader service #101)

FIT – FOR FAST DELIVERY OF TTL

For Fast Inventory Turnaround on TTL devices, call ITT Semiconductors. FIT service provides a better than 48-hour turnaround time on the off-the-shelf 7400 series.

The series is pin-to-pin compatible with competitive devices, and is available at competitive prices. They come in both

plastic and ceramic packages.

To see how fast ITT can turn around on these devices, call Chuck Gillies at 617-935-7910. Another "Second To None" service from ITT Semiconductors.

Circle #3 for more information.
(Or reader service #102)

Conductor News

NONES

Dial (617) 935-7910 for a quote instead of a quarrel

ITT introduces LS 24 functions in low power Schottky

Now there's a new source for low power Schottky — ITT Semiconductors. Starting in December, these 24 functions will be available from ITT. LS types and functions include:

Type	Function
74LS00N	quad 2-input Nand gate
74LS04N	hex inverter
74LS10N	triple 3-input Nand gate
74LS20N	dual 4-input Nand gate
74LS30N	8-input Nand gate
74LS74N	dual D-type positive edge triggered flip-flop w/reset and clear
74LS174N	hex D-type flip-flop w/clear
74LS08N	quad 2-input And gate
74LS11N	triple 3-input And gate
74LS51N	dual 2-wide 2/3-input And/or Invert gate
74LS151N	8-input mux, strobe, complementary output
74LS157N	quad 2-input mux, non-inverting
74LS191N	binary up/down counter, synchronous, preset input, mode control
74LS193N	binary up/down counter, synchronous, preset input
74LS253N	dual 4-input mux, three state
74LS257N	quad 2-input mux, non-inverting, three state
74LS258N	quad 2-input mux, inverting, three-state
74LS02N	quad 2-input Nor gate
74LS14N	hex Schmitt trigger inverting
74LS27N	triple 3-input Nor gate
74LS76N	dual J-K flip-flop with preset and clear
74LS90N	decade counter
74LS93N	4 bit binary counter
74LS170N	4x4 register file with open collector outputs

More LS devices will be added in January.

Circle #4 for more information. (Or reader service #103)

P.T.L., D.T.L., and MOS ICs are available from ITT Semiconductors.

ITT makes all sorts of diodes; thyristor, varactor tuner and zener, silicon, germanium.

ITT DROPS PRICE OF MEMORY DRIVERS ALL 88 INTERFACE ICs ARE LOW COST

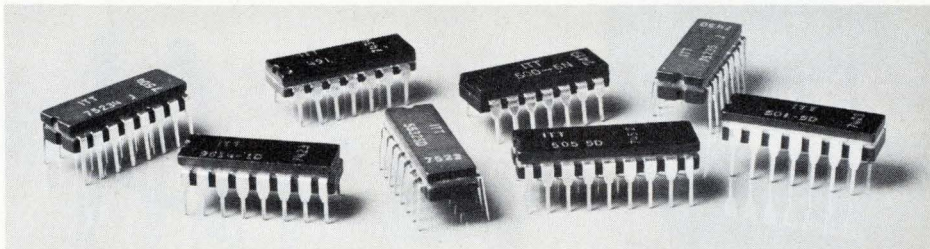

Now Intel-compatible memory drivers from ITT Semiconductors are even more price competitive. Price of the ITT 3207A bipolar-to-MOS level shifter and driver is now only \$2.75 for 100-999, while the price of the voltage version ITT 3207A-1 has dropped to \$3.80 for 100-999.

The rest of ITT's 88 hi-rel commercial interface circuits are also price competitive.

A new enlarged and updated pin-to-pin compatibility chart lists replacements for all competitive devices.

ITT's interface ICs include a line of 6 hammer drivers with high current capability and better power dissipation than competitive devices. With 26 devices, ITT's line of LED drivers is the broadest in the industry. The 10 external peripheral drivers

provide a high speed logic buffer interface in a variety of situations.

To order any of these devices, call ITT or one of its local franchised distributors.

In the United States:

A.C.I. Electronics
Calron Electronics
Cramer Electronics (all locations)
Diplomat/PC and/Southland
Edmar
Greene-Shaw Co., Inc.
Hamilton/Avent Electronics (all locations)
Intermark Electronics
J. V. Electronics
Milgray Electronics
Quality Components, Inc.
Resco of Raleigh
Semiconductor Concepts, Inc.
Semiconductor Specialists
Sheridan Sales Co.
Sterling Electronics

In Canada:

Cam Gard Supply, Ltd.
Cesco Electronics
Cramer
Hamilton/Avent
Westburne Enterprises

Circle #6 for more information.

(Or reader service #105)

ITT triacs cover popular 4-16 amp range

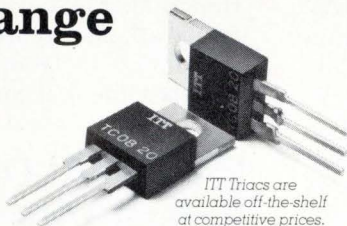

ITT Triacs are available off-the-shelf at competitive prices.

ITT's line of 24 silicon triacs come in the popular 4-16 amp range. Peak input voltage is from 50-600V. The high voltage junctions are protected and reliability increased with glass passivation.

Positive or negative gate triggering voltages switch the triacs from an off-state to an on-state. Both di/dt and turn on time are improved by use of center gate.

Prices for these gate controlled, full wave AC devices are competitive. They are designed for a wide variety of domestic, industrial and consumer applications.

Circle #5 for more information.

(Or reader service #104)

ITT Semiconductors

74 Commerce Way, Woburn, Massachusetts 01801

We'd be delighted to provide you with additional information on any of the stories or products appearing in the ITT Semiconductor News. Simply circle the appropriate number.

1 2 3 4 5 6

I have an immediate need. Please have your sales representative call me for an appointment.

My area of interest is _____

Name _____ Title _____

Company _____ Telephone _____

Address _____

City _____

State _____ Zip _____

E112576

ITT
SEMICONDUCTORS

Second To None.

The world's smallest complete Isolation Amplifier has



\$41 IN 100's

the world's smallest price.

We knew what you needed in isolation amplifiers. Smaller size, lower cost, better performance. So, we did it. We designed the Model 284J Isolation Amplifier to give you the kind of performance and versatility you need for a broad range of applications.

The 284J costs only \$41 in 100s, yet delivers all the key parameters in a small (1.5" x 1.5" x 0.62"), self-contained module. It even includes isolated power supply outputs for input pre-amplifiers or calibration signals. And because it requires no external DC/DC converter, the 284J is the smallest and least expensive isolation amplifier available today.

The 284J's total noise referred to input is a mere 8 μ V p-p in a 100 Hz bandwidth. Add an adjustable gain of 1 to 10V/V, a CMV of 5000V pulse or 2500V continuous and a minimum CMR of 110dB. And you've got all you need for a myriad of applications where optimum measurement accuracy and safety are concerned.

We didn't stop there with the product line. Consider our higher performance, Model 277 Instrument Grade Isolation Amplifier. Its uncommitted op amp front end gives you extreme versatility. Its CMR of 160dB and its gain nonlinearity of less than 0.025% for a full 20V swing plus a drift of less than 1 μ V/ $^{\circ}$ C give you exceptional performance. The 277's versa-

tility and performance at a price of \$114 (1-9) make it an excellent alternative in your most demanding instrumentation applications.

Then there's our Model 275 Industrial Grade Isolation Amplifier, \$79 (1-9), that is gain programmable over a range of 1 to 100 by a single resistor with nonlinearity to less than 0.05%. And our Model 285 is like the 275 but features a low impedance op amp output. And our Models 279, 282 and 283 for multichannel applications.

We could go on and on about this line. But our free Analog Devices Isolation Amplifier Handbook says it all. Ask for a copy along with the data sheets on our new Isolation Amplifiers. Write Analog Devices, the real company in isolation amplifiers.



The real company in isolation amplifiers

Analog Devices, Inc., Norwood, Massachusetts 02062

East Coast: (617) 329-4700, Midwest: (312) 894-3300, West Coast: (213) 595-1783, Texas: (214) 231-5094, Belgium: 03 38 27 07, Denmark: 97 95 99, England: 01/94 10 46 6, France: 686-77 60, Germany: 089/53 03 19, Japan: 03/26 36 82 6, Netherlands: 076-122555 and representatives around the world.



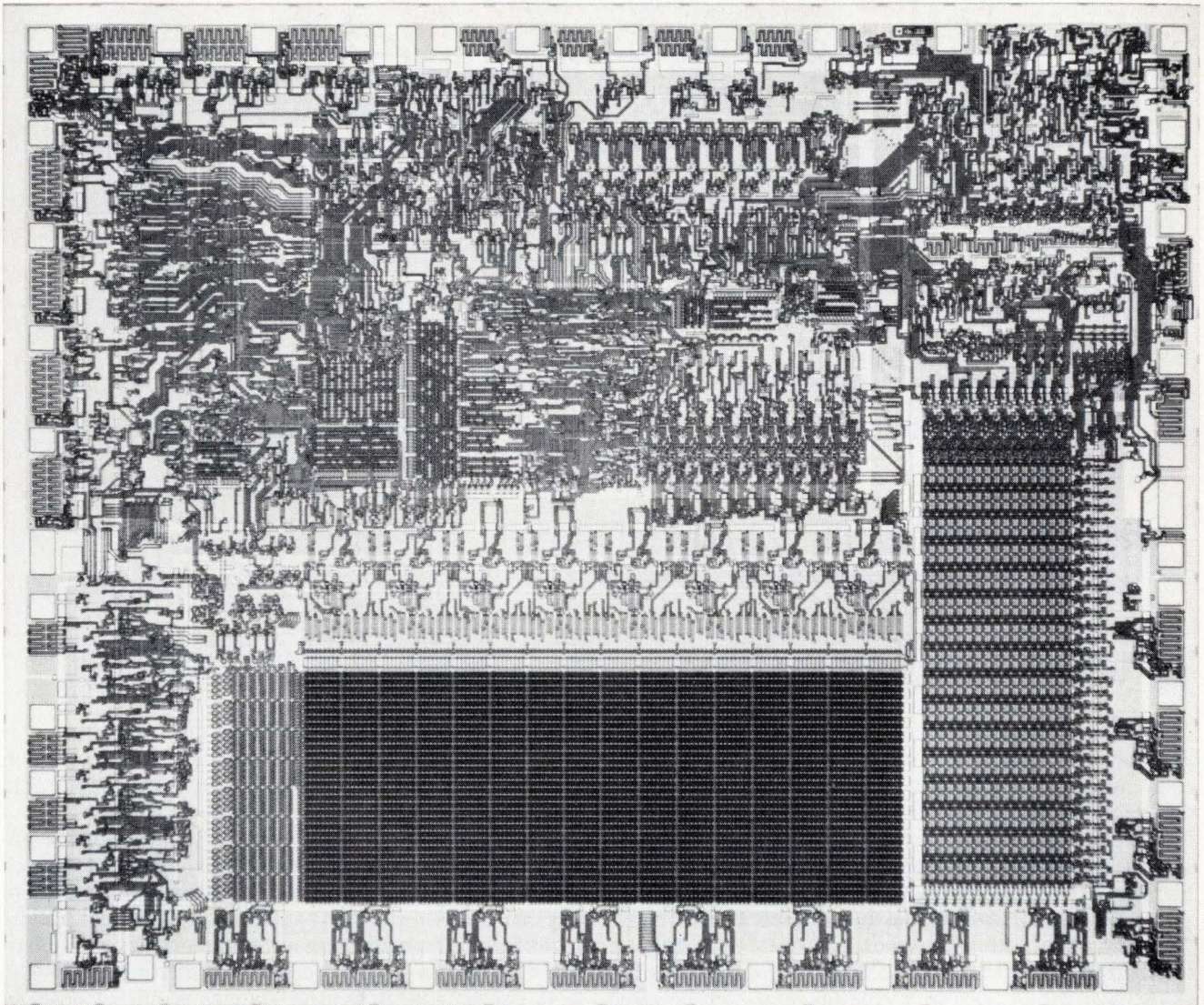

© Intel 1976

Single-chip 8-bit microcomputer fills gap between calculator types and powerful multichip processors

Capabilities range from stand-alone computing to high-power data processing; ultraviolet light erases programmable ROM of one version

by Henry Blume, David Budde, Howard Raphael, and David Stamm,
Intel Corp., Santa Clara, Calif.

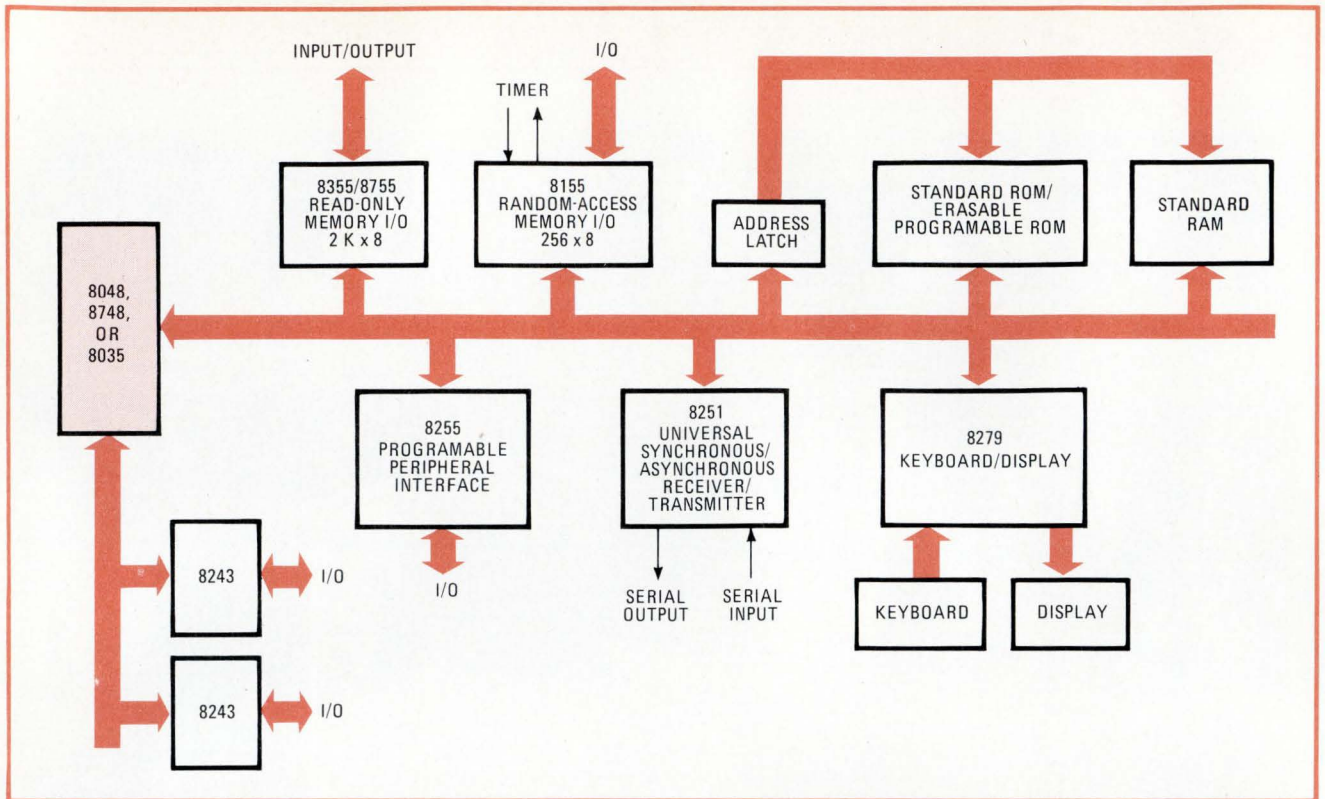

1. Expandable. Although well able to run a stand-alone controller by itself, the new processor can also work with other family members for larger control systems or with 8080 peripherals to handle complex data processing. This configuration typifies the MCS-48 capability.

□ Putting an 8-bit microcomputer onto a single chip is achievement enough, but realizing performance nearly equal to multiple-chip devices gives a bonus of added flexibility for the new family. The two devices that are the heart of the family are really high-performance, single-chip microcomputers that fill the gap between 4-bit calculator chips and the 8-bit multichip microprocessors. They can be used for the lowest levels of control, or, by being expanded with other ROM/RAM members of their family or with standard 8080 peripheral memory chips, they can be used in a wide range of high-powered data-processing systems.

The two versions of the microcomputer, the 8748 and the 8048, are like 4-bit calculator devices in that they each contain all the elements needed for stand-alone computing—central processing unit, program read-only memory, data random-access memory, input/output interface, plus clocks and timers. Yet they contain these elements in 8-bit configurations that vastly exceed the power of the calculator types and approach 8080 power.

Two ROM versions

The MCS-48 family is the first to offer a microprocessor with an erasable programable ROM, which will prove handy for low-volume applications and those in which periodic update of the program memory is required. The family also has a CPU-only chip, the 8035, which can be used with external memories.

The 8748 has a 2708-type, 8,192-bit EPROM with a program that can be changed by clearing with ultraviolet light and reprogramming electrically in the usual way. The

8048 has an 8-k mask-programable ROM. Together they give the user new flexibility: he can develop the program and build the prototypes with the reprogrammable chip and switch to mask ROMs for volume production.

The off-the-shelf 8748 also is perfect for quick-turnaround users who require small volumes only, since it can be programmed to meet any system specification in any quantity—in contrast to some single-chip controllers requiring mask programming at the factory, which is often available only in large quantities. Equally important, the 8748 can be used in control systems requiring periodic updating in the field, such as point-of-sale price-and-inventory controls. New program data can be fed into the system without a new ROM.

The free-standing operations of the 8048 and 8748 are made possible by the 1,024-by-8-bit ROM or EPROM for program memory, a 64-by-9-bit RAM for scratchpad functions, an 8-bit CPU consisting of an arithmetic/logic unit and accumulator for all the binary and decimal arithmetic functions, and an input/output facility that includes three 8-bit I/O ports plus three test/interrupt ports directly controlled by program instructions.

Memory and input/output of the processors can be expanded to handle large control applications (Fig. 1). There's an inexpensive expander chip, 8243, which allows the processor chips to handle an additional 16 I/O lines. Also included in the family are combination memory and I/O expanders, such as a 2,048-by-8-bit ROM with 16 I/O lines (8355), a 2-k-by-8-bit EPROM with 16 I/O lines (8755), and a 256-by-8-bit RAM with 22 I/O lines (8155).

The MCS-48 components also work directly with all

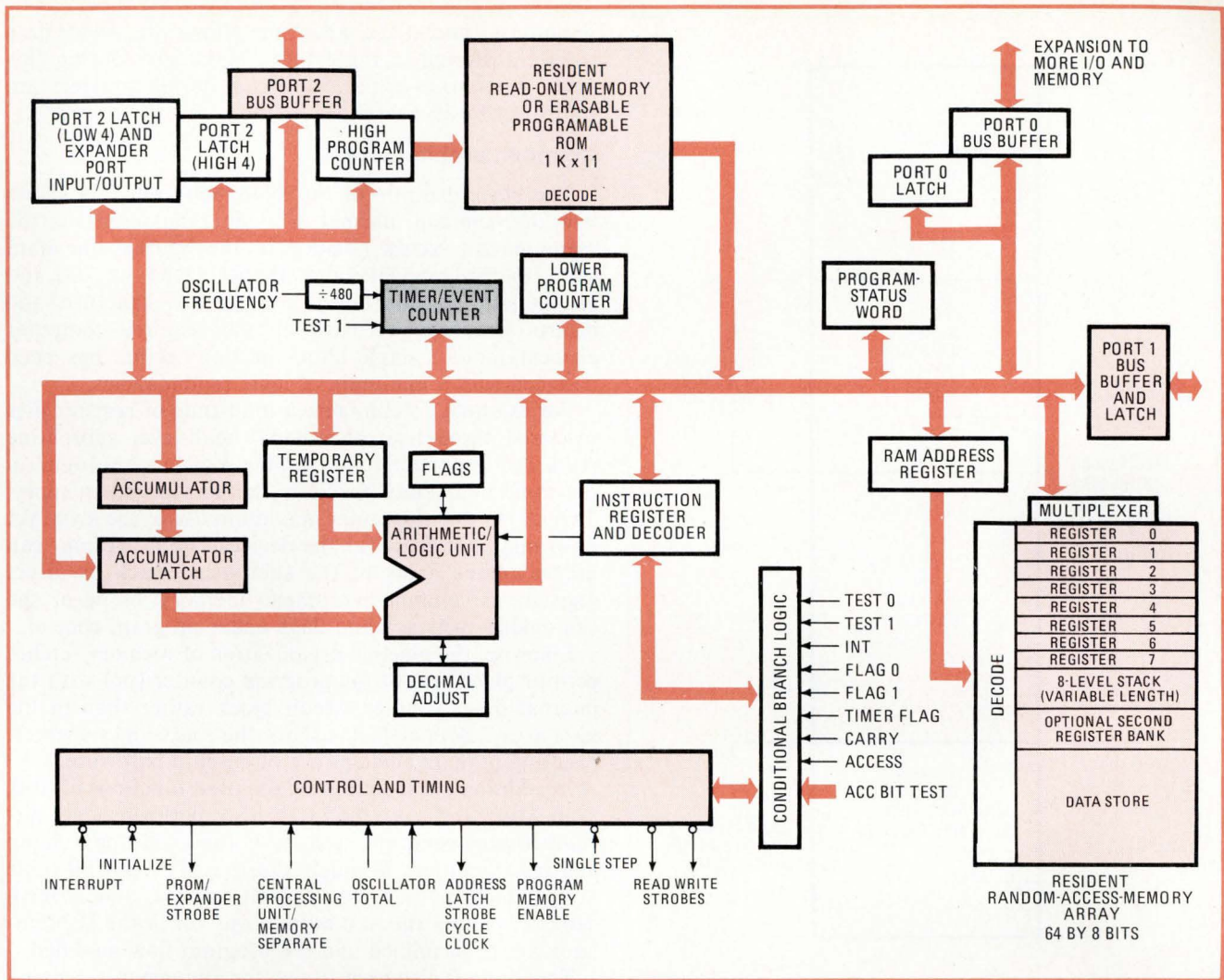

2. Stacked. The 8748 or 8048 processor chip supplies all the functions needed for a stand-alone microcomputer. It has a CPU complete with arithmetic/logic unit and accumulator, a 256-bit RAM, an 8,192-bit program ROM, a timer/event counter, and plenty of I/O capability.

the 8080 family of standard memory and peripheral parts, soon to number about 30 large-scale-integrated circuits. They include timers, programable I/O controllers, universal synchronous/asynchronous receiver/transmitters, decoders, and keyboard/display controllers.

One-chip advantages

The integration of all the basic blocks of a microcomputer system into one circuit brings about some architectural advantages. When the device is used as a stand-alone controller, it need interface only with its I/O peripherals. This means that the execution speed of the processing is limited only by the speed of the chip, because there is no slowdown from transferring data between memory and CPU, as in multiple-chip designs.

Moreover, technological upgrades can give enhanced performance without waiting for similar upgrades of external components, as is usually the case with multi-chip families. More immediately, the inclusion of data and program memories, which otherwise would have to be added separately to the system, simplifies the user's interface problems.

Having an active data store on the chip—the quasi-static 64-by-8-bit RAM—also simplifies system implementation, since all scratchpad operations simply become part of the CPU function. There is no need for refresh circuits operate the RAM; yet the device is dynamic in the sense that internal clocks are used for very fast, low-power access to the array.

The major objective was access to a RAM within a

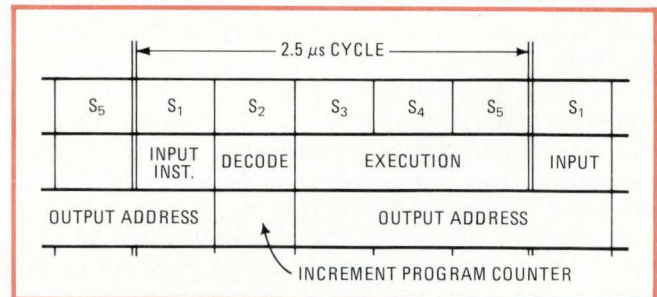

3. Simple. Operating the 8748/8048 is extremely straightforward, with each 2.5- μ s cycle consisting of five states. Instruction inputs are made in state 1, decoding and program incrementing in state 2. Program executions begin in state 3 and run through 4 and 5.

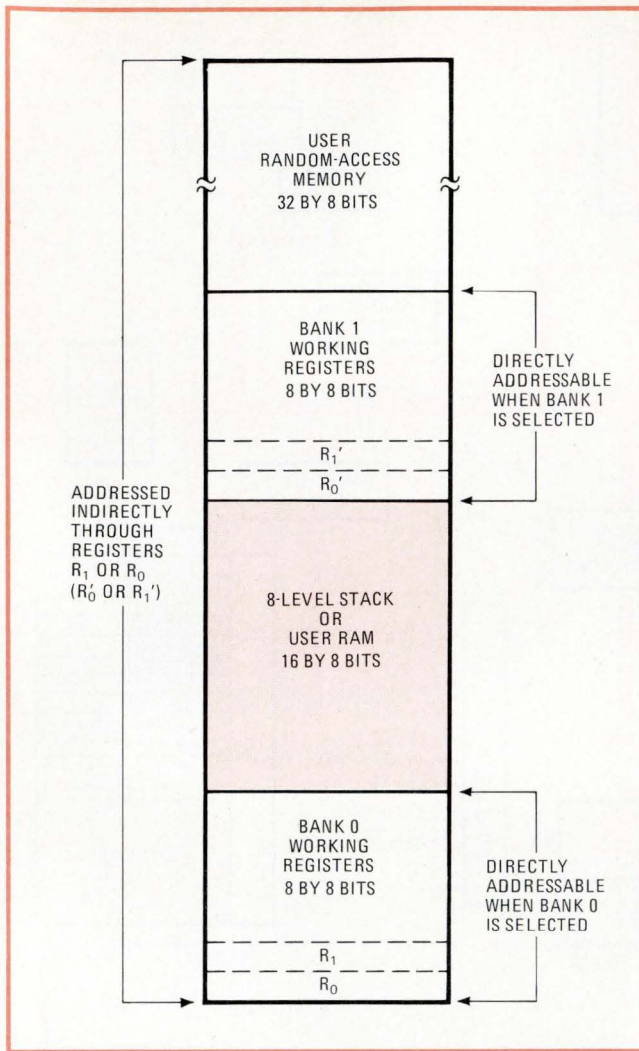

4. Powerful. The on-chip RAM, part of which is reserved for one or two banks of 8-bit working registers, also accommodates the stack of subroutine addresses, which can be eight levels deep. Each stack location can handle the program counter and status data.

fraction of an instruction cycle, so that those indirect internal instructions that require multiple addresses could still be executed in one instruction cycle. (Indirect RAM instructions require three separate accesses: one to fetch the address of the memory location to be operated on, one to fetch the contents of the addressed location, and one to store the results of the operation.) Since the RAM is dynamic, its power dissipation, including all decoding and sense circuits, is a mere 75 milliwatts.

Similarly, the EPROM of the 8748 relies on internal clocks for better access and lower power consumption. In this case, however, only one access per instruction cycle is required, since there are no indirect instructions to be processed in program memory.

Having the EPROM on the chip allows for an easy method of verifying a program. To accomplish this, the 8748 can be put into a special instruction cycle (called the third-state mode) for programing and verification of the EPROM. The CPU executes a special double-cycle instruction that allows the address and data information to be transferred to their respective registers during

programing and at the same time allows the EPROM data to be transferred to the external data bus. During this mode, the CPU essentially idles, while all transfers are controlled by asynchronous inputs.

Common architecture

The block diagram of the 8748/8048 (Fig. 2) shows how the common internal 8-bit data bus connects the major circuit blocks (shaded in the figure)—the data store, the program memory, the CPU with its ALU and accumulator, a timer/event counter, I/O structure, and control structure. To pack all the required computer elements onto a single chip, the CPU section has been designed with a minimum of logic redundancies.

For example, to eliminate a multitude of register files scattered throughout the chip, the 8-level subroutine stack and the directly addressable registers are found in the same addressing space as the scratchpad memory. This allows the programmer maximum use of the RAM, yet gives minimum logic for the device. The programmer can utilize unused areas of the subroutine stack or direct registers as common scratchpad memory, or he or she can modify the stack and flags under program control.

Likewise, the pipeline organization of memory fetches permits placement of the program counter (pc) with the internal timer/counter circuit block rather than in the RAM array. Both elements share the source incrementer, resulting in more efficient use of on-chip hardware.

In addition to executing the required functions of ADD, XOR, AND, and OR, the ALU also performs the bit-comparison operations necessary for conditional jump and test facilities. Through the use of a control-table ROM (which holds constant 8-bit values), and a zero-detect circuit on the ALU output, any bit in the accumulator can be examined and the program flow modified.

This setup is also used to test for any one of the many conditional jumps. Each of the conditional-jump flags and inputs is sent to the ALU as an 8-bit conditional word and tested with the same circuitry used to examine individual accumulator bits.

An internal oscillator also gives many system and device savings, such as the elimination of external components (except for a crystal or an RC network for setting the system's operating frequency). It also gives the chip designer maximum freedom in the structure of the internal clocking scheme, because there is no need for high-level, accurate clock inputs.

Through efficient use of internal bus transfers, most instructions can be executed in a single-cycle length. The exceptions are those instructions which require a second memory fetch or an external I/O transfer. In these cases, only a second cycle is required. Moreover, limiting instructions to two lengths reduces the complexity of the internal state generator. Since 70% of all instructions are executed in a single cycle, program-execution times and program-storage size are still minimized.

The multiplexed bus for address and data during external memory references maximizes the number of I/O pins available on a cost-effective 40-pin dual in-line package. For external program-memory references, bits of an additional I/O port are used for address lines, with the input/output data being restored after the memory

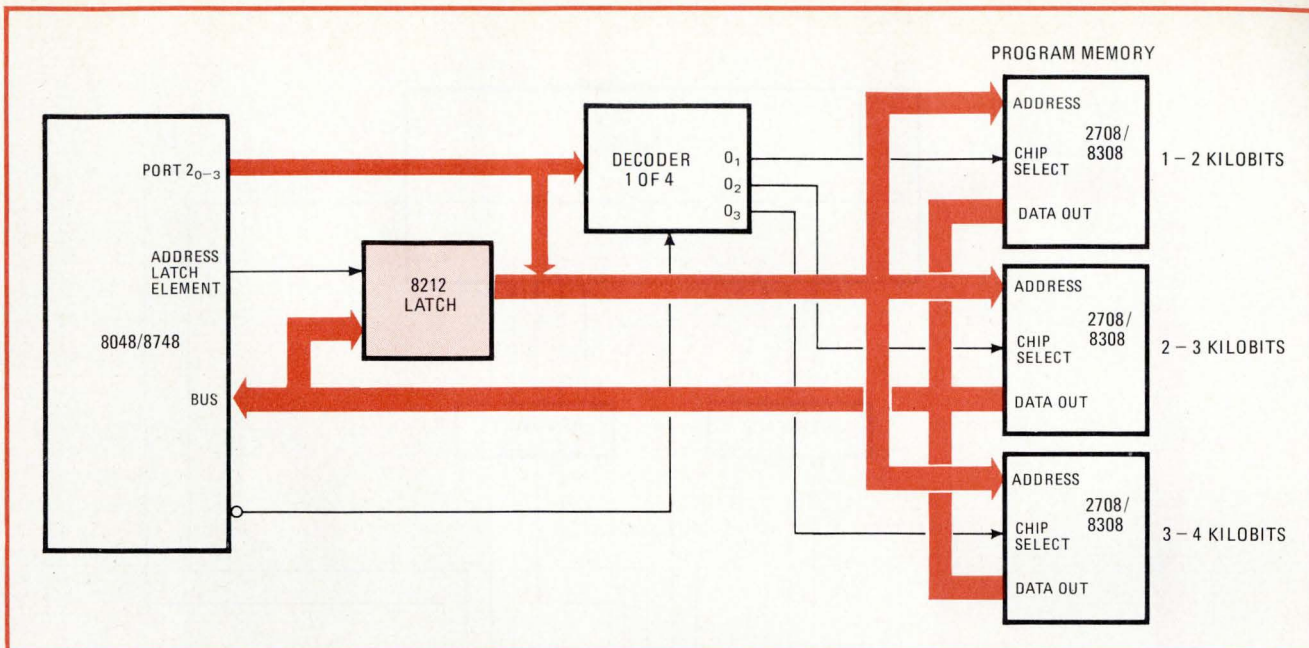

5. Latching on. Adding standard memories to the system is quickly done with external latch 8212, which allows standard memory parts to be hooked directly onto the 8748/8048 bus. Operation of the latch is under the control of signals from the processor.

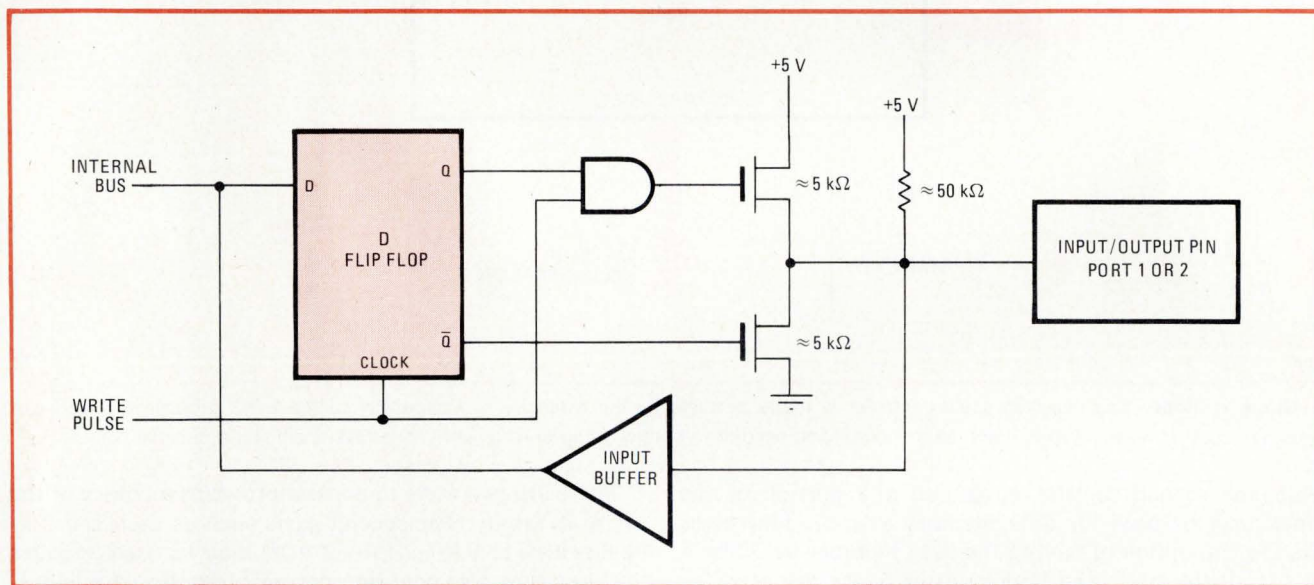

6. Mixing it up. Besides the main system port, 0, the processor chip has two others, 1 and 2, which allow inputs and outputs to be mixed on the same port. Here, writing a 0 causes the pull-down devices to sink the TTL load; writing a 1 calls on the 50-kilohm pull-up resistor.

reference is finished with the address.

One key to the simple operation of the 8748/8048 chip is the straightforward program sequences and timing needed for executing an instruction cycle (Fig. 3). Each cycle consists of five states. Instruction input is made in state 1, and decoding and pc incrementing is made in state 2. State 3 starts the beginning of the program execution, which can run through states 4 and 5. Simultaneously, the next cycle's program address is made in state 3, a pipelining (paralleling) of operations that increases device throughput significantly.

Because the chip is built with depletion-load silicon-gate n-channel technology, it operates off a single 5-volt supply with inputs and outputs that are compatible with

both transistor-transistor-logic and complementary metal-oxide-semiconductor devices. Instruction cycle time is a modest 2.5 microseconds and power consumption is a low 400 mW. Depletion-load techniques also pay off in practical chip sizes for volume production; the 8048 also is slightly over 200 mils on a side, while the 8748, with its big 8-k EPROM, is 221 by 261 mils.

Storing data in the scratchpad is simple, because part of the RAM can be reserved for one or two banks of 8-bit working registers—eight registers per bank (Fig. 4). The scratchpad also contains the subroutine address stack, which can be eight levels deep. Each location can accommodate the 12-bit pc and 4-bit status data.

Since all locations in the stack are indirectly address-

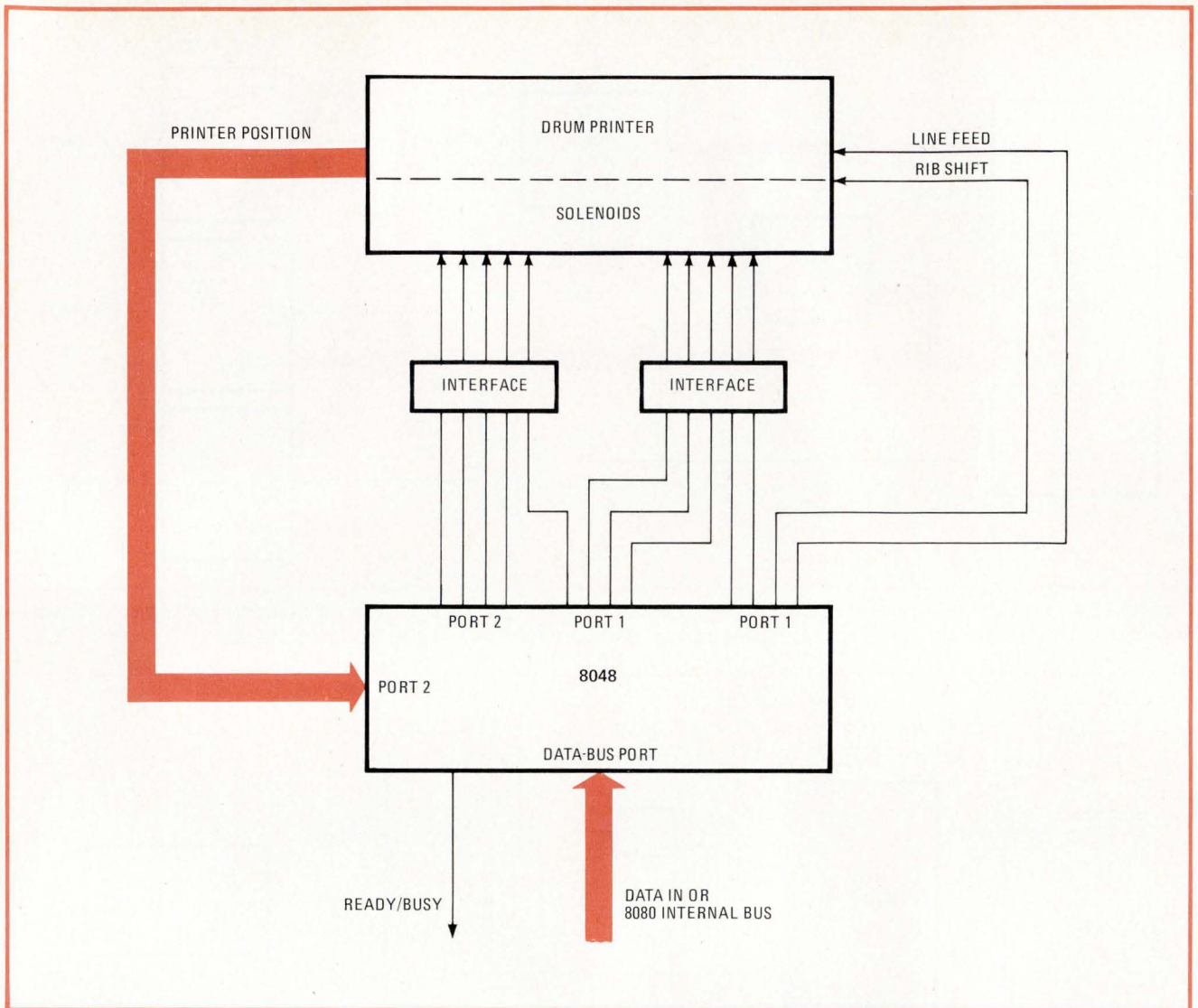

7. Going it alone. This one-chip scale controller is made possible by the extensive I/O capability of the 8748 processor, which can accommodate a 24-key keyboard and all the interfacing needed to control 14 seven-segment LED arrays, including a decimal point.

able, the second register bank and any portion of the stack may be used for data memory as well. This gives the user an option of having the data memory be 32 by 8 bits if all the stack and both register banks are used for program counting and status data, or 56 by 8 bits if only one register bank is used.

Program memory

The resident program memories on the 8048/8748 chips are handled so that they can be operated alone for programs of 1,024 bytes or less or combined with external ROM for expanded systems requiring larger programs. The program counter that feeds the memory is split into two parts. The low-order 8 bits can either address the resident 1-k ROM or be routed externally when addressing beyond 1,024 bits. (Since the 8035 contains no internal ROM, all address fetches are external.) The upper 4 bits of the program counter, located near port 2 (see Fig. 2), are gated out on that port for external reference. Two of these most significant 4 bits are then used for internal addressing requirements.

There are two ways to expand program memory of the MCS-48 family. The special parts such as the 8755 2-k-by-8 EPROM or 8355 2-k-by-8 ROM may be used. Besides I/O lines, they also contain appropriate buffers to demultiplex the 8-bit bus from the microcomputer chips to receive address and send back program-memory instructions. Alternately, standard memory parts, such as a 2708 EPROM or 8308 ROM may be used (Fig. 5). An external latch, such as the 8212, would latch up the address from the bus (via a signal from the 8048 or 8748) so that data could be returned on the bus. The high-order 4 bits of the address do not have to be latched, since they are not on the multiplexed bus.

The ALU, in conjunction with the accumulator, provides a full array of binary-and-decimal arithmetic, logic, shift, and increment/decrement functions. For example, the accumulator may be exchanged between registers, data memory, and program memory. Both the timer/counter and the program-status word are also accessible to the accumulator, through a latch that facilitates the accumulator source/destination instruc-

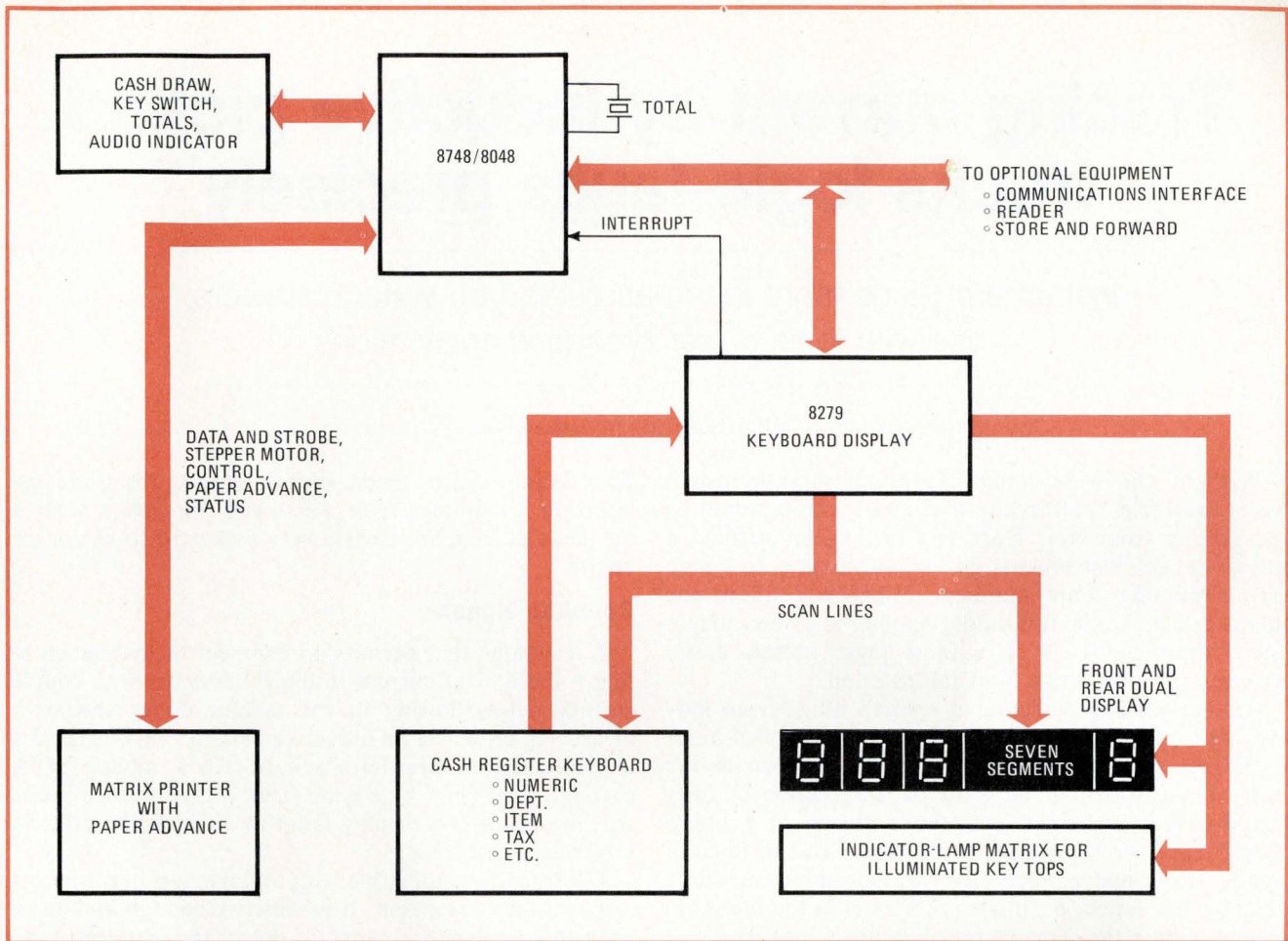

8. Working together. Proof of the MCS-48's ability to handle large systems is this gas-pump controller. The 8243 I/O expander chips allow the processor to interface with 47 lines and a USART communicating with a central control unit inside the service station.

tions. Here, the ALU generates a carry output fully accessible to the programmer under program control.

The timer/event counter is an 8-bit register that can operate in one of two modes, selectable under software control. As a timer, the device measures elapsed time. It is fed by the crystal frequency, divided by 280. At maximum frequency, the result is about 80 μ s per increment, or about 20 milliseconds over the counter range. As an event counter, a test line is designated to count 0 to 1 transitions of external events. As many as 256 transitions may be accommodated.

Both the timer and the counter indicate overflow by a maskable internal interrupt or by a testable flag bit. The internal interrupt may also be used to provide the system with a second external interrupt.

The input/output facilities of the 8048/8748 have been designed for maximum flexibility and expansion and are fully TTL-compatible. The basic facilities consist of three 8-bit I/O ports plus three test/interrupt inputs.

Port 0, called the bus, provides for system expansion. In essence, the port makes the bus completely compatible with an 8080 bus, so that all 8080 peripherals can be used with the MCS-48 family. In conjunction with four control and strobe lines, the port may be used for bidirectional interfacing to memories and I/O elements. For free-standing operations, it may be statically latched

or used as a general input port.

The remaining two I/O ports, 1 and 2, are termed "quasi-bidirectional" (Fig. 6). They allow inputs and outputs to be mixed on the same port. When writing a 0 (low value) to these ports, the pull-down device sinks the TTL load. When writing a 1, a large current is supplied through both pull-up devices to allow a fast transition. After a short time, they shut off and the pull-up of the 50-kilohm resistor sustains the 1 level.

Applying the 8748/8048

Two applications show the range of complexity that can be accommodated with this family. Figure 7 shows a typical minimum-chip MCS-48 system, in this case, a drum printer controller. The three output ports allow the one-chip 8048 to control the printer position, ribbon shift, and line feed. Two interface drivers operate the solenoids.

Figure 8 shows a far more complex system, in which the MCS-48 implements a low-cost point-of-sale terminal. The I/O capability of the 8748/8048 chip can be expanded to control and monitor many cash-register operations. These might include cash in the drawer, key switch, totals, audio indicator, as well as matrix printer, cash-register keyboard, seven-segment display, and a variety of optional equipment. □

Tracing current by inductive pickup tracks logic faults precisely

Instrument yields more information than do voltage sensors;
use with logic pulser broadens applications

by John Beckwith and Barry Bronson, *Hewlett-Packard Co., Santa Clara, Calif.*

□ Without the wide range of voltage-sensing instruments available, faultfinding in digital circuits would be like driving from New York to Los Angeles without a map. Yet such instruments give what amounts to a map that is missing route numbers. What will fill in the blanks and make the faultfinder happier is a new current tracer that, by itself or with a logic pulser, easily provides more complete fault information.

Voltage-sensing instruments—which range from low-cost logic probes and clips to computer-controlled automatic test systems—can localize failures down to the faulty node, tracking the fault to a collection of integrated-circuit terminals and the network of printed-circuit traces or wires connecting them. But to make a repair, it's usually necessary to determine precisely which IC has failed, or, if the problem is in the interconnection, where the short or open circuit is located.

Voltage measurements cannot provide this data, but variations in current provide exactly the information needed to pinpoint the faulty element. A map of current distributions will locate the precise point along a node at which an undesirable path, such as a short, exists.

Yet, despite this capability, little use has been made of the information provided by nodal current distributions simply because of the difficulty of measuring current

flow. Traditional methods, such as cutting the trace and inserting an ammeter, or encircling the trace with a magnetic pickup, are clearly very awkward to use on pc boards.

Coupling signals

A technique that permits an engineer or technician to follow the flow of current in digital systems is to couple current pulses flowing in the system under test to a measuring probe via an inductive pickup. This method is implemented in Hewlett-Packard Co.'s model 547A current tracer (Fig. 1), a hand-held, self-contained probe that incorporates a display lamp to indicate the relative level of current steps.

The tracer is compatible with all logic families, since it responds only to current. It is sensitive enough and has a wide enough dynamic range to detect currents resulting from faults in any of the presently available families. It can be powered from any dc source between 4.5 and 18 volts. Since this power source does not have to be referenced to the ground potential of the system under test, a floating power supply or battery may be used.

There are other physical phenomena and techniques for determining current distributions, but none is as convenient as inductive pickup. Liquid crystals could display the temperature rises resulting from power losses in the conductors because their reflectivity varies with temperature. However, this scheme has insufficient sensitivity and resolution to detect the smaller currents typically found on digital pc boards.

Another approach is to measure the voltage drops along the traces and thus uncover the directions of current flow. But the magnitudes of the drops along the typically short trace lengths found in digital systems are often on the same order as thermal emfs, and are therefore masked.

The faulty node could be stimulated by a sinusoidal signal and the current flow could be traced with an inductive pickup and a frequency-selective filter. But this method, which is often used by utility companies for locating cable faults, is awkward to use in practice. The injected stimulus must first be connected to the circuit, and it is not always obvious where the return connection should be made.

Another approach is to inject a pulse stimulus and then detect the resulting current flow with an inductive

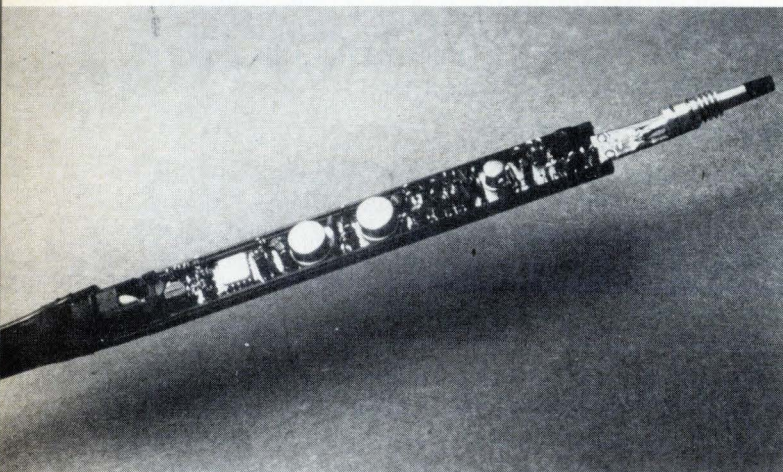

1. Fault tracker. By picking up current spikes via inductive coupling instead of checking voltage levels, a current tracer can uncover the precise location of a printed-circuit-board fault, such as a short or open circuit in the printed wiring or within an IC.

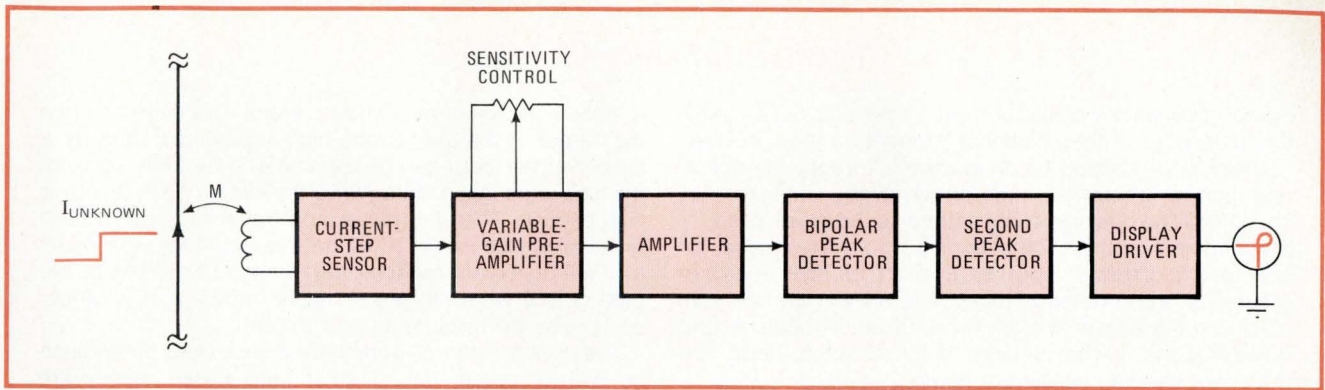

2. Gain stages. The voltage induced from an unknown current spike as small as 1 milliamperes requires multiple stages within the tracer to be amplified and stretched enough to drive an incandescent lamp to visible levels.

pickup coupled to a time-domain filter that rejects unwanted signals. This method can be quite effective, but requires a cable to synchronize the pulser with the pickup. This, along with the size of the instrument needed to perform the task, makes this system also somewhat awkward to use.

Simplifying the task

The HP current tracer is more compact than synchronized-signal tracers and is simpler to use. Since its dynamic range is large enough to respond to current changes present in most digital circuits, it typically does not require a stimulating signal. If a stimulus is required, as when testing an unpowered system, a signal can be provided by a logic pulser such as the HP 546A, or other models from HP and other logic-tester manufacturers. Even then, the tracer's shielding eliminates pickup from adjacent signal paths, so no synchronizing signal is needed.

The current tracer's tip is first placed near the driving point of the node, which is usually one of the IC terminals or the tip of the logic pulser. The tracer's sensitivity-control thumbwheel, which provides a range from 1 milliamperes to 1 ampere, is adjusted until the display lamp is between half and fully lit. The thumbwheel is designed so that its position yields some indication of the magnitude of the current flowing, which may be useful in determining the nature of the fault. For example, if it indicates an abnormally high current, the fault is due to a low impedance on the node.

The tip of the tracer is then moved along the conducting path, and the display remains at the same brightness as long as the same current is present. If the current is diverted to another path, then the increased separation between the tip and the current lowers the output of the current-step sensor, and the display becomes less bright. The operator gets enough information to track the actual path followed by the current as it flows toward the fault.

Since the current tracer is picking up current pulses by inductive coupling, its tip need not make physical contact with the conductive path. Thus, insulated wires and inner traces of multilayer pc boards can be tested.

The current tracer contains six stages of signal processing and amplifying circuitry within its cigar-size case (Fig. 2). A step change in current at the tracer's tip

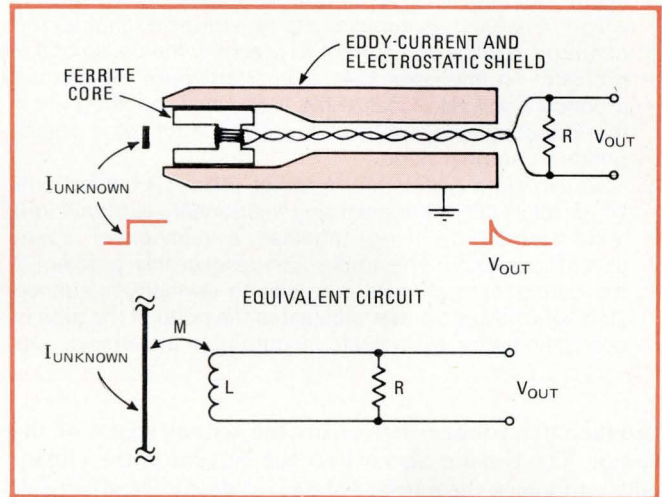

3. Current converter. Fine wires wrapped around a ferrite core act as a current transformer loaded by a small resistance that produces an output voltage. A conductive shield protects against unwanted magnetic and electrostatic fields.

is coupled, via mutual inductance, to the current-step sensor. This produces a voltage spike proportional in amplitude to the current step.

The spike is fed to a variable-gain preamplifier, which produces an output of about 1 millivolt when the sensitivity control is properly adjusted. This signal is further amplified, then stretched in time by two peak detectors in order to produce a pulse of sufficient height and width to light the incandescent lamp that serves as the tracer's display.

The current-step sensor (Fig. 3) operates like a current transformer. It provides information about current changes, not a quantitative display of the total value of the current, but this is sufficient for faultfinding in digital systems.

A step change in current near the tip of the tracer attempts to induce an emf in the windings on the coil within the sensor. But, because the coil is nearly shorted by a low-value resistor, a current is induced in the coil large enough to cancel the flux change caused by the unknown current step. The current step induced in the pickup coil has a magnitude that is proportional to that of the unknown current.

The induced current flows through the resistor,

Troubleshooters in action

Some applications of the current tracer and pulser show the usefulness of the additional information they provide.

Stuck node caused by dead driver. A frequently occurring fault symptom is a node on which the voltage is not changing. The question to be settled: is the driver dead, or is something on the node clamping it to a fixed value, for example, a shorted input or a short on the board to ground or some other voltage? The answer comes from placing the tracer at the driving terminal of the node and observing the current activity. If the driver is dead, the tracer will indicate no current flowing.

Stuck node caused by an input short. With exactly the same voltage symptoms as in the previous case, the tracer might indicate a large current flowing from the driver, which means it is functioning. It will also enable the operator to follow the current to precisely the cause of the problem—in this example, a shorted input. The same procedure will also localize the fault when the short is on the interconnecting path of the node, such as a solder bridge to another node.

Stuck wired-AND node. Another difficult troubleshooting problem for voltage-sensing instruments is a fault in a node formed by tying together a number of open-collector outputs. The tracer can resolve this problem if the output of each gate is forced to its high-impedance state while a logic pulser stimulates the node. If the gate is good, the tracer will indicate no current at its terminal, but

a stuck gate will draw a large current. The need to force the output of the gate to the high-impedance state by a jumper at the input can be eliminated if the duty cycle of the high-impedance state (while the circuitry is running) is high enough. Then the pulser and tracer may be used in the single-pulse mode. If the gate is not stuck, the operator will observe a random appearance of current at the gate output while single-pulsing the node. If it is stuck, each pulse will result in a large current.

Malfunctioning three-state data buses. Data buses such as microprocessor data and address buses usually are spread over large board areas and tie many integrated circuits together. Since voltage cannot provide sufficient resolution to locate the fault, the additional data provided by the current tracer is of maximum value. For example, if there is a "bus fight" between two drivers attempting to simultaneously control the bus, the current tracer will indicate abnormally large currents at the competing drivers. Other malfunctions can be localized in a manner similar to that used for wired-AND faults.

There are a number of other applications for the tracer and pulser. Whenever a low-impedance fault exists, the shorted node can be stimulated with a logic pulser and the current traced by the tracer. This combination has been effective in finding shorts in cables, motherboards, analog printed-circuit boards (including inner layers of multilayer boards), and voltage-distribution networks.

producing a voltage that forms the output signal of the sensor. The resistor also causes the current in the pickup coil, and hence the output voltage, to decay from its peak value at a rate determined by the time constant L/R . This constant is such that the sensor's output is a spike with a peak value proportional to the change in the unknown current. The peak value is independent of the rise time of the input current change for rise times of less than about 200 nanoseconds.

There are a number of conflicting design criteria that the sensor must meet. It must be able to reject magnetic flux from locations other than the tracer's tip; it must not respond to voltage changes, and it must provide a detectable output for the smallest current steps likely to be encountered in properly functioning systems. It also must be small so that currents in closely spaced traces can be distinguished from each other; it must be mechanically rugged, and it must have reasonable manufacturing costs.

To meet these demands, a ferrite core is enclosed within a relatively thick, highly conductive shield. Besides providing mechanical support and protection for the core, the shield protects it from time-changing magnetic fields by inducing eddy currents that oppose the changing flux. It is electrically grounded and thus protects the coil winding from electrostatic coupling with the voltages on the board. Electrical fields are attenuated by more than 110 decibels, so the tracer's tip will ignore voltage steps of 5 v but still react to current steps of 1 mA. For such a step, the sensor provides a 100-microvolt output spike, about 150 ns wide.

Considerable amplification is necessary to bring this

pulse up to a level that will drive a lamp and make the signal visible. Designing such an amplifier is difficult enough, but package constraints make it all the more difficult; for maximum convenience of operation, all the necessary electronics had to be housed within the body of the probe.

The shape and small size of the probe body make physical isolation of the amplifier stages impractical. The small volume within the probe also rules out effective high-frequency decoupling capacitors because of their large size. Yet another constraint is the requirement that the tracer operate from whatever power supplies are in digital circuits, typically 5 v or less.

Adding gain

Nevertheless, it was possible to package 80 db of stable linear amplification, with 20 megahertz of bandwidth, on a pc board about 0.5 inch wide and 4 in. long. This was accomplished by carefully locating components to minimize capacitive coupling and orienting them to cancel destabilizing parasitic mutual inductive coupling. Shielding of the sensitive amplifier from external electric and magnetic fields is provided by the tracer housing, which is aluminum and thus makes both an electrostatic and an eddy-current shield.

There were other problems to be solved in the design of the current tracer. For example, an incandescent lamp was chosen for the display and was placed at the tip of the probe immediately behind the current-step sensor. This is a convenient and clearly visible location. But it creates a difficult stability problem, since a pulse at the sensor is amplified and then returns to the display. The

energy content of the pulse that flashes the display can be greater than 10^{14} times that of the energy captured by the sensor.

With the shielding of the sensor, with the orientation of the amplifier components, and with careful pc board design, it is possible to electrically decouple the input from the output. In fact, the current pulse that drives the display lamp actually passes right through the amplifier area of the pc board.

Running the supply and return traces on the inner layers of the multilayer board, one above the other and separated by a very thin insulating layer, and covering them with an outer-layer ground plane confines the fields from the display pulse to a very small space. The ground plane also was designed so that the charging currents of the parasitic capacitance between the grounded eddy-current shield and the trace under investigation can pass through the amplifier area of the board without inductive coupling of unwanted signals.

Resolving problems

This still does not solve all the problems of designing a wideband, high-gain amplifier for the tracer. It is necessary to bring the fault currents in the various logic families and pulse stimulators to a common reference level so that the operator sees only the value of the current at the tracer's tip relative to that at the driving point of the node. The 60-dB (1,000:1) gain variation demanded by currents from 1 mA to 1A cannot be achieved with a potentiometric divider, since the parasitic inductances and capacitances at the extreme positions of the divider destroy the required high-frequency response. It is also necessary to insert the gain control at the initial stages of the amplifier chain because the requirement for operation from 5-v supplies severely restricts the linear operating range of the amplifiers.

To solve these problems, the entire 60 dB of gain control was placed in the first amplifier stage. The basic configuration of the stage is a single transistor with an emitter resistor that is approximately equal to the collector resistor and has no bypass capacitor. Current-controlled variable resistances, in the form of Schottky and silicon diodes, are ac-coupled to the collector and emitter resistors. When the sensitivity control on the tracer is in the 1-mA position, the emitter resistance is low and the collector resistance is high, forming a common-emitter amplifier of 20 dB gain. When the sensitivity control is in the 1-A position, the collector resistance becomes very small and the emitter resistance large, so the circuit becomes a 40-dB attenuator.

Stretching pulses

When the sensitivity control is set so that the display is at its reference level, the output of the current-step sensor emerges from the amplifier chain with an amplitude of about 500 mv and a width still of about 150 ns. The polarity of this output may be positive or negative, depending on the polarity of the current step and the randomly chosen orientation between the current path and the pickup coil in the tracer. Since the operator is interested only in the variation of this pulse as the tracer tip is moved from place to place, all that is required is a

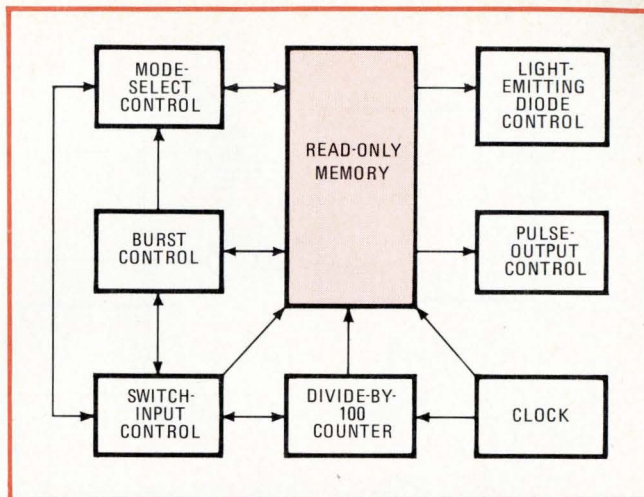

4. Pulse control. Almost all the circuitry of a logic pulser is contained on a custom integrated circuit, including the read-only memory that controls all the operations of the instrument. Even circuitry regulating the power-supply voltage is on the chip.

display-driving signal proportional to the amplitude of the output of the amplifier chain, but independent of its polarity and long enough to be visible.

This signal processing is accomplished in two peak detectors and a display driver. The first, or bipolar, peak detector produces an output pulse of the same amplitude as the input pulse, but always positive in polarity. It also stretches the peak of the 150-ns input pulse from about 20 ns to about 40 μ s. Since this is still not sufficient to produce a visible pulse, a second peak detector is employed to stretch the output of the bipolar peak detector to about 200 milliseconds, which is quite visible. The display driver then provides a signal of proper amplitude to drive the display lamp.

Driving nodes

Sometimes an external stimulus is required, or it may be more convenient than tracing the currents generated by the logic under test. A pulse generator or any of a number of logic pulsers can be used to perform this function.

One such logic pulser is the HP model 546A. It can overdrive logic nodes with narrow pulses of controlled voltage, polarity, width, rate, and count. A single, serially encoded switch selects continuous pulse streams at 1, 10, or 100 hertz, bursts of 10 or 100 pulses with 1-second pauses between bursts, or single pulses. To program a mode, the button is pushed a set number of times in rapid succession. Holding it down after the last push causes the selected function to be executed. Sliding it forward locks it down and keeps the pulser in the selected mode. Mode-select control circuitry determines whether the instrument is in the programing, executing, or standby mode.

The overall parts count, size, power consumption, and cost of the pulser are kept low by employing a single custom chip to perform most functions. The chip (Fig. 4) contains a 256-bit read-only memory, 14 flip-flops, 41 gates, and other devices, including an on-chip voltage regulator, for a total of about 1,000 transistors on a 108-

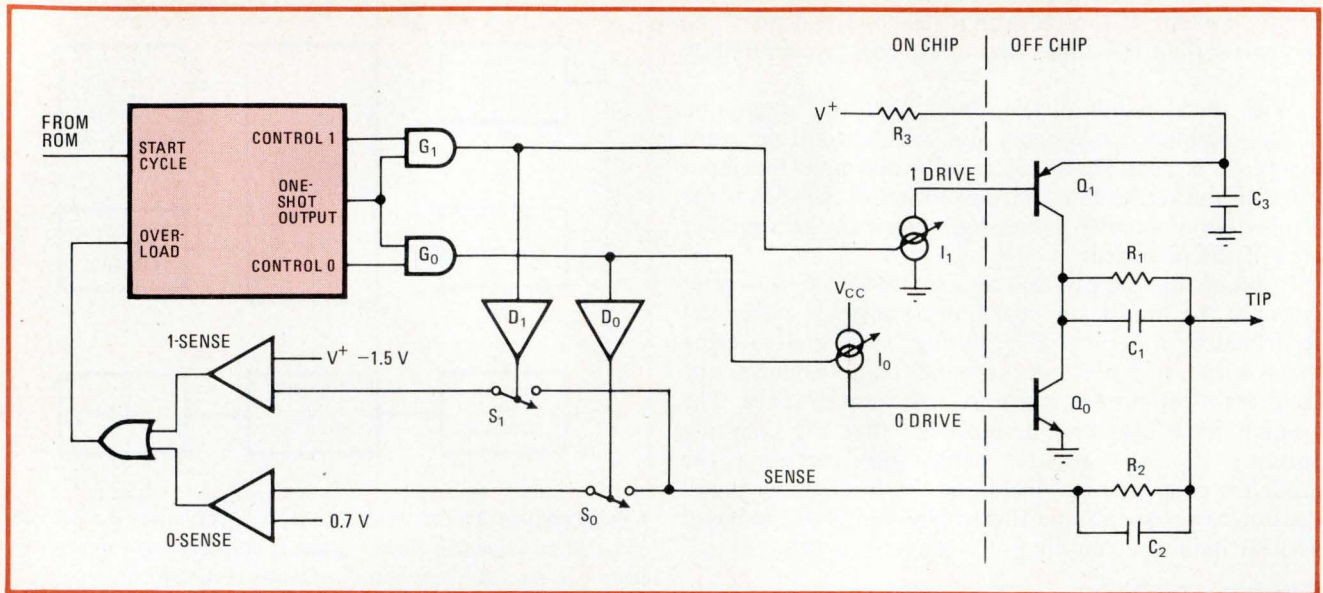

5. Power provider. By cutting off the one-shot output after 10 μ s or when C_1 is charged, the pulser output circuit compensates for different logic families. A low-current, wide pulse is fed to C-MOS devices, and a higher-current, shorter pulse drives TTL devices.

by-128 mil die. With micropower Schottky-transistor-logic cells, most of the IC operates at a low voltage, so two sets of layout rules were adopted to minimize total chip area. Using small cells for low-voltage and larger ones for higher-voltage circuits permits a standard, bipolar, single-level-metal manufacturing process.

Controlling the generator

The 256-bit ROM, which occupies less than 10% of the area on the chip, controls the operation of the logic pulser by decoding status information from other on-chip circuitry and translating this into binary commands. The ROM accepts inputs from switching, counting, and mode-selection circuitry, controls the pulse-tip output and light-emitting-diode indicator, and feeds status information back to timing and control circuits.

A free-running, 100-Hz clock circuit acts as a time base for the instrument. An external resistor and capacitor combination to control the 100-Hz rate makes accuracy better than 10% over a range of power-supply voltages and temperatures.

The divide-by-100 counter acts as a scaler for generating pulse and annunciator output rates, as a counter/controller for the bursts, and as a timer for mode detection and switch debounce. The switch-input control debounces the switch, presets the divide-by-100 counter and burst control, generates a single-shot output signal, and increments the mode-select control circuit.

The burst control governs the timing, count, and pause interval between burst outputs. The annunciator circuit is a constant-current sink that drives two high-efficiency LEDs mounted in the pulser's tip. The LEDs provide visual feedback of the pulser's mode and can be used to keep track of the number of pulses generated in the burst modes.

The pulse-output control delivers the pulse polarity, voltage, width, and rise time necessary to overdrive the logic node at the pulser's tip. The nature of the pulse depends on the logic family of the circuit under test. For

example, the pulser can deliver a 0–3-v, 10-mA, 10- μ s pulse to a 3-v complementary metal-oxide-semiconductor clock input, or a 0–5-v, 500-mA, 0.5- μ s pulse to a transistor-transistor-logic line-driver output.

In the pulse-output circuit (Fig. 5), transistors Q_0 and Q_1 are usually off, switches S_0 and S_1 are open, and the tip presents a high impedance to the logic node. Any residual charge on coupling capacitor C_1 is bled off by resistor R_1 . When a signal from the ROM initiates an output cycle, the one-shot is triggered, and transistor Q_0 turns on via a signal from the logic-0 control, which passes through G_0 and turns on a 100-mA current source, I_0 . When Q_0 saturates, S_0 is closed and the 0-sense comparator is turned on through delay element D_0 . The load on the pulser tip is pulled toward ground through C_1 . Current flowing through C_1 is reflected as a voltage, $dV = I dt/C_1$, on the sense line via input resistor R_2 and a speed-up capacitor, C_2 .

Forming an output

When the load current at the tip is low (less than 100 mA for C-MOS), C_1 charges slowly. Before it can reach 0.7 v, about 10 μ s goes by, causing the one-shot to shut off the 0-output circuit through G_0 . If the load is heavy, as when driving a TTL buffer, charge develops rapidly on C_1 . When the voltage reaches 0.7 v, the 0-sense comparator fires the overload line, causing the one-shot to retrigger and the 0-output circuit to turn off. The heavier the load, the shorter will be the output pulse.

At the conclusion of the 0-output pulse, the logic-1 output circuit goes into action. Its operation is much the same. The 1-sense circuit has a variable threshold setting to adjust to the 3–18-v operating range. The 1-output circuit includes charge-storage capacitor C_3 and charging resistor R_3 . Capacitor C_3 sets the 1-output-pulse amplitude and decouples potentially large current surges from the test circuit's supply line. Between output cycles, R_3 restores charge lost on C_3 during the preceding output. The output cycle ends when Q_1 turns off. \square

The Raytheon 2900 family gains five new members

Whereas: Raytheon is the established alternate source for the Am2901 and Am2909, (franchised distributors stocked), and,

Whereas: Raytheon brought you RAYASM, the powerful micro-assembler available on the NCSS computer network,

Now Therefore: Raytheon announces five additional 2900 family components, giving us a total of seven, To Wit:

2901 A 4-bit Microprocessor Slice—the fastest, most powerful LSTTL microprocessor in the world. With its cycle-saving two-address architecture, the 2901's speed can't be touched.

2905 A 4-bit Bus Transceiver— general purpose open collector bus interface device. Data to the 100 milliamper bus drivers is provided by a 4-bit register with a two-way multiplexer at its inputs. Data from the bus receiver may be held in the 4-bit receiver latch on its way to the three state receiver outputs.

2906 A 4-bit Bus Transceiver with parity —is equivalent to the 2905 but with the addition of an on-chip parity generator/checker.

2907 A 4-bit Bus Transceiver—similar to the 2906 with the two-way multiplexer at the input to the bus driver register elimi-

nated to allow the device to be packaged in the space saving 20-pin DIP.

2909 A Microprogram Sequencer—that can branch anywhere in memory, perform sub-routines, then return with up to four levels of sub-routine nesting. The device is a cascable 4-bit slice which allows addressing of up to 4K words of microprogram with three devices.

2918 A General Purpose 4-bit Register—with two sets of outputs: TTL and three state. This useful combination can reduce your package count for those status, command, and instruction registers which must drive both your control logic and a data bus.

93415 A 1024 × 1-bit Fully Decoded Random Access Memory—for your high-speed data and control stores.

Raytheon LSI is on the move. More 2900 family components soon to come include PROM's, sequencers, look-ahead carry generators, additional RAM's, and other goodies now in process.

For complete details, contact your local distributor or Raytheon Company, Semiconductor Division, Dept. 2900, 350 Ellis Street, Mountain View, CA 94042, (415) 968-9211.

Am 2900 SOLD & SUPPORTED HERE



SEMICONDUCTOR DIVISION

Telephone-ring detector eliminates relay

by Joe Gwinn
Baltimore, Md.

A dial-up telephone-line interface to a computer can detect telephone ringing signals with a circuit that includes a varistor, a programmable unijunction transistor, and a photon coupler. This circuit replaces the more conventional ring detector that consists of a capacitor-isolated full-wave bridge driving the coil of a small relay.

Like the relay, the arrangement described here isolates the phone line from the computer logic and is immune to noise interference. Nor does it suffer from the inherent mechanical disadvantages of relays. Indeed, this circuit has advantages of its own. It emits one and only one pulse per ring—it cannot be teased. Its line side is powered entirely by the ring, yet it loads neither the ring nor the line. By telephone-company standards, an ac impedance of 47 kilohms bridging a line is an open circuit; however, check your local phone company's rulings on connecting to the line.

As the circuit diagram in Fig. 1 shows, the incoming ac signal is rectified by bridge diodes $D_1 - D_4$, charging capacitor C_2 to about 10 volts during the ring. The time constant of R_2C_2 is chosen to smooth out the 20-hertz ripple, leaving a roughly rectangular pulse. Capacitor C_1 blocks the 48 v dc normally found on an idle phone line. Resistor R_1 limits the charging current to C_2 and with R_2 forms a divider that controls the voltage to which C_2

charges. Varistor VR_1 clamps transients.

The programmable unijunction transistor, Q_2 , fires when its anode voltage exceeds its gate voltage by about 600 millivolts. The anode voltage is controlled by C_3 and the divider formed by R_4 and R_5 . C_3 slowly charges to half the voltage across C_2 and reaches 4 v or so by the end of the ring. The gate voltage is controlled by R_3C_4 and follows the voltage on C_2 closely. When the ring ends, the anode voltage is 4 v and decaying slowly, while the gate voltage is 10 v and decaying quickly (Fig. 2). In about 100 milliseconds, the gate voltage catches up with

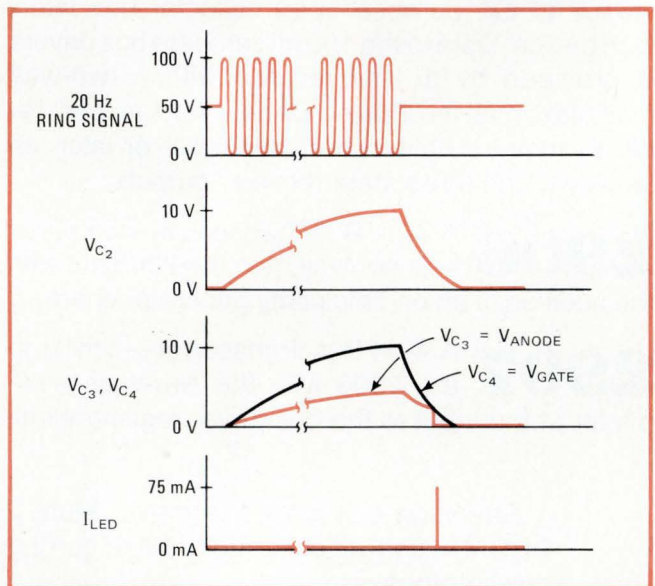

2. One pulse per ring. Waveforms of circuit in Fig. 1 show programmable unijunction transistor firing when gate voltage drops below anode voltage, dumping C_3 's charge into LED.

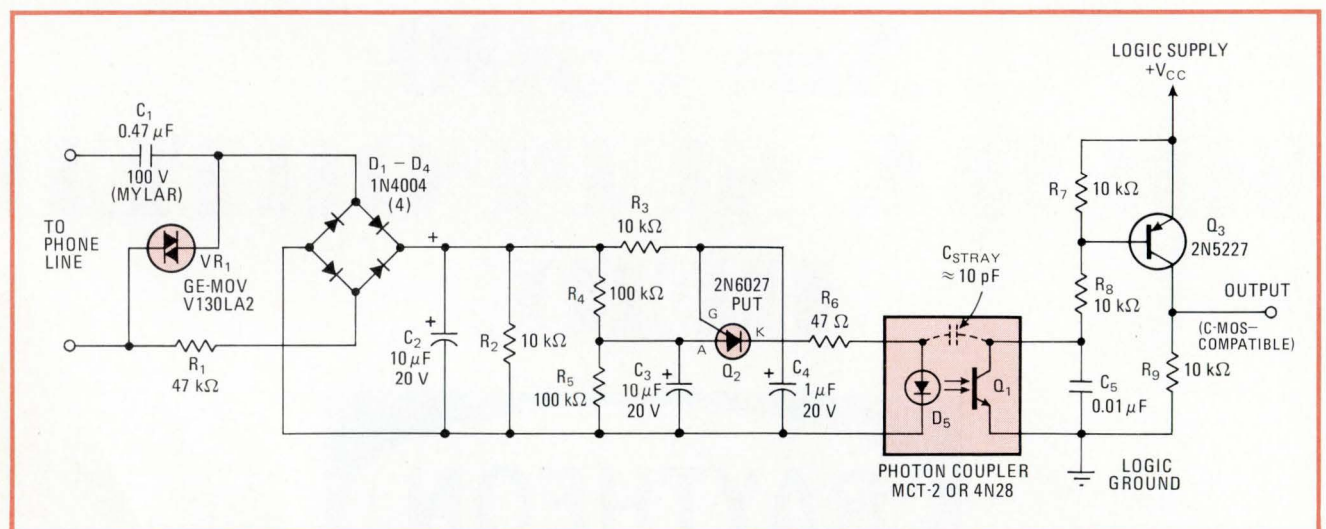

1. Relayless phone-ring detector. This circuit produces a single output pulse when a ringing signal comes in on the telephone line. It is useful in a computer-to-phone-line interface because it provides isolation, is immune to line noise, and is reliable. The programmable unijunction transistor, fired as capacitors discharge after ringing stops, pulses the photon coupler to produce output.

the anode voltage; Q_2 then fires, dumping C_3 's charge through current-limiting resistor R_6 and the light-emitting diode of the photon coupler.

When the LED conducts the current pulse from C_3 's discharge, it turns on transistor Q_1 in the photon coupler. Transistor Q_3 is then turned on, producing an output voltage pulse that is adequate to drive C-MOS circuitry. If transistor-transistor logic is to be driven, the pulse will

require some sharpening by a buffer transistor and a Schmitt trigger such as the 7413.

Capacitor C_5 is included to provide noise immunity. There is enough common-mode noise on telephone lines to falsely switch Q_3 even after it has passed through the stray capacitance of the coupler. C_5 forms a voltage divider with the stray capacitance, reducing the noise to insignificance. □

Timer extends life of teletypewriter

by Bob Piankian

Massachusetts General Hospital, Boston, Mass.

The mean time between failures of a teletypewriter terminal can be extended by a circuit that turns on the motor only when information is being received or transmitted. In that way, the mechanical wear and destructive temperatures are minimized in a motor that is continuously powered-up but seldom active. Moreover, the cost of power to the terminal is significantly reduced. A teletypewriter motor consumes about \$50 worth of electricity a year. If it is only active 10% of the time, this circuit could save \$45 each year for each machine.

A logic circuit for this application is shown in Fig. 1. When no characters are being transmitted over the current loop, the MCT2 opto-isolator keeps the trigger input of the 74121 monostable multivibrator at logic 0. If characters are sent to the teletypewriter, or if the teletypewriter BREAK key is depressed, the current loop is broken, and the 74121 is triggered. This triggering fires the 555 timer, activating relay K through Darlington pair Q_1 and Q_2 , thereby turning on the motor of the teletypewriter.

The time the motor remains energized, T , is given in seconds by $1.1(R_5 + R_6)C_4$, where C_4 is expressed in microfarads and R_5 and R_6 in megohms. Resistor R_6 adjusts the time period to between 2.5 seconds and 20 minutes.

If another character is received or the keyboard is used during the time span that the motor is energized, the monostable resets the timer and then retriggers it, keeping the teletypewriter on for another time period, T . To discharge C_4 completely during the reset process, R_4 should be greater than $2.4 C_4$, where R_4 is in kilohms and C_3 and C_4 in microfarads. D_3 , R_7 , and C_6 prevent the relay from turning off during the 0.3-second reset operation.

Standard current loops of 20 or 60 milliamperes can be used. Diode D_2 protects against accidental reversal of line polarity, and C_2 provides immunity from noise on the line. Defeat switch S permits normal use of the teletypewriter terminal.

Figure 2 shows the power supply for the circuit, which uses a standard transformer already in a KSR-33 Teletype. The entire circuit was built on a 3-by-3½-inch printed-circuit board and installed in many terminals. Total parts cost is about \$15 for each unit—and they pay for themselves in just a few months.

With this device installed, the power switch is left in the ON position. The system software should be changed to send a nonprinting character to the teletypewriter 1 second before actual information output so that the

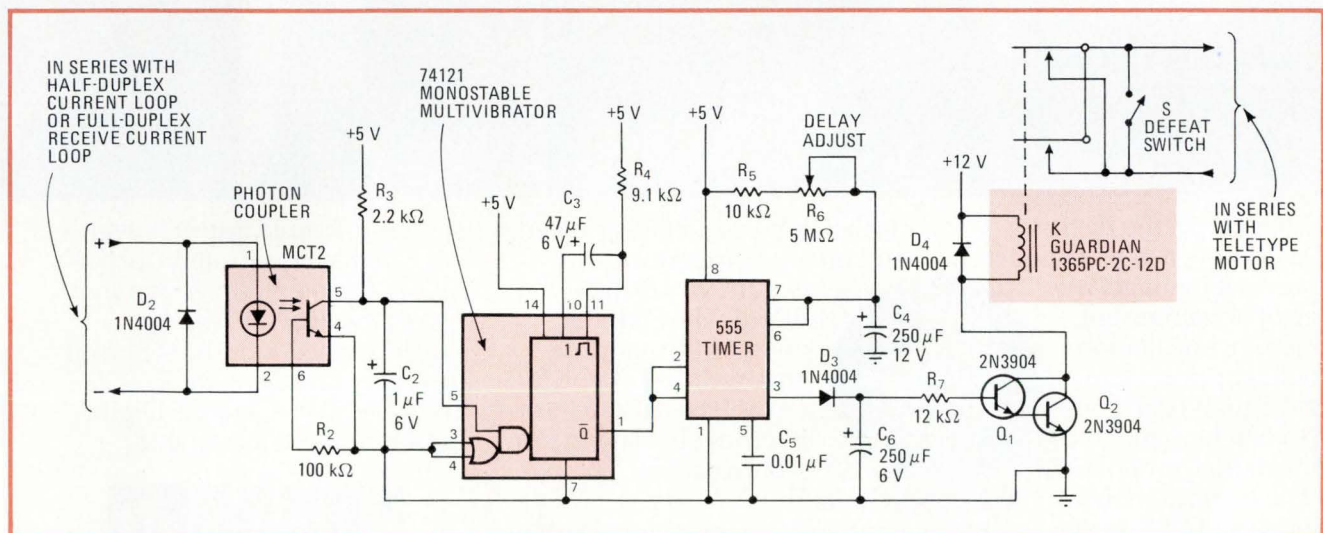

1. Turn-off circuit. Teletypewriter motor remains off unless information is being received or transmitted by terminal. When current loop is broken by transmission or reception of a character, the monostable fires and triggers the timer, which turns on the motor and keeps it on for a drop-out time of up to 20 minutes. Use of this \$15 circuit saves power and prolongs teletypewriter life.

"I'll tell you why this OEM picked PDP-8. It's good engineering and it's good business."

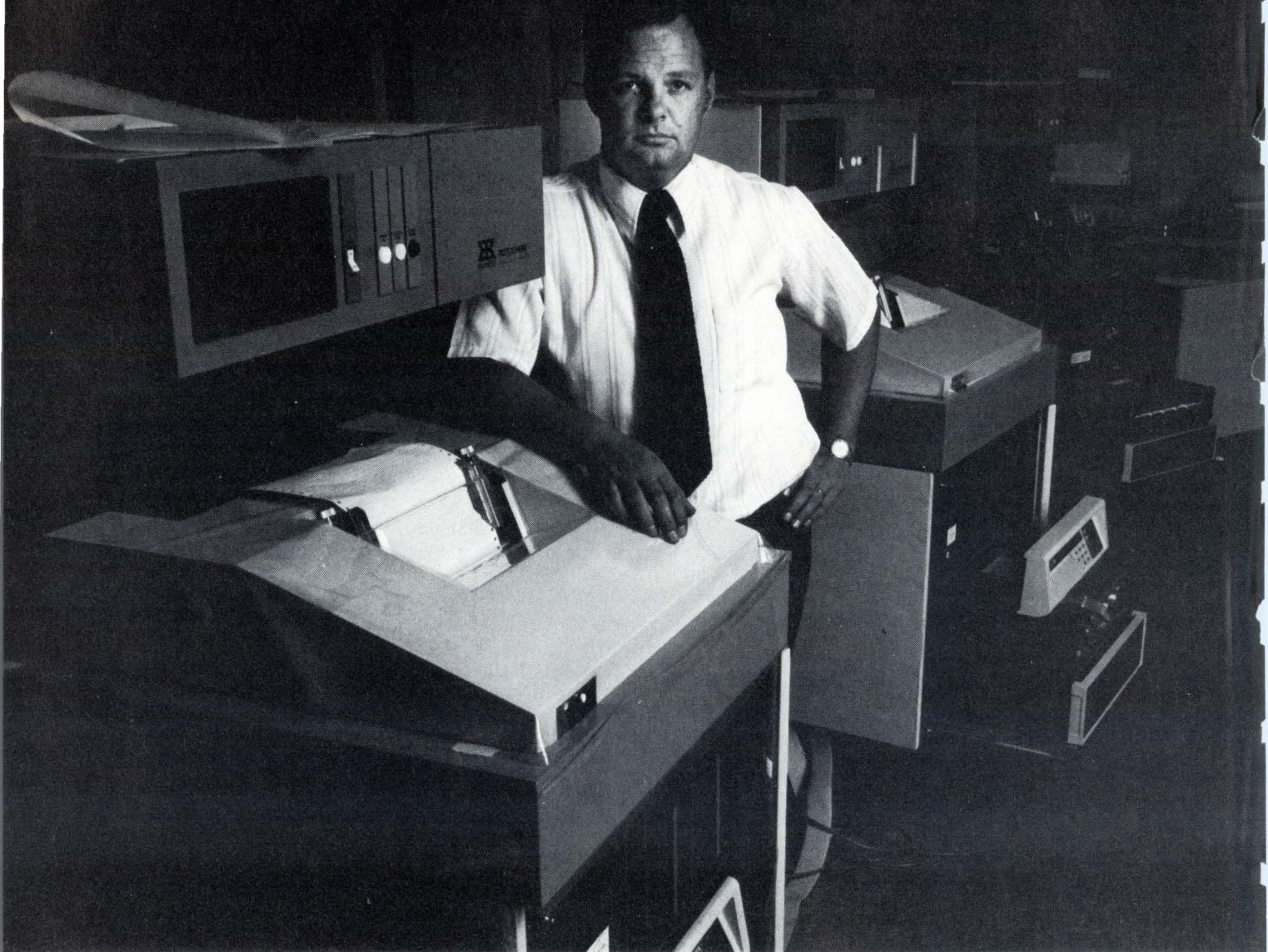

The man in the picture is Dr. David Kemper, biochemist and product manager in charge of development, production, installation and field support for an amazing analytical device called Rotochem IIa, from American Instrument Co.

The computer inside his product is a PDP-8A from Digital. Dr. Kemper is buying scores of them. Why?

"They're inexpensive in a market that's cost sensitive. They're incredibly reliable in a

market that's reliability oriented. And our customers can get service anywhere in the world. The PDP-8A gives us the performance we need at a price we can't beat. We can offer the capability to run 50 tests on each of 250 patients."

Sensitive but tough. High in performance, low in cost. "Good engineering. Good business." It's the same story you hear from OEMs around the world. And that's why PDP-8's the most

successful minicomputer ever.

Digital Equipment Corporation, Parker Street, Maynard, MA 01754. (617) 897-5111. European headquarters: 81 route de l'Aire, 1211 Geneva 26. Tel: 42 79 50. In Canada: Digital Equipment of Canada, Ltd.

**PDP-8
The Most
Successful
Minicomputer
Ever!**

digital

**50,000 computers saving
managers millions.**

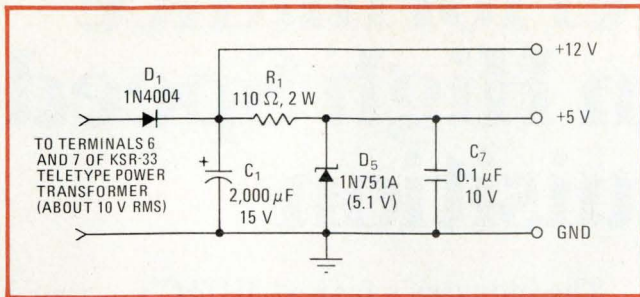

2. Power supply. By using a few additional parts, the 5-volt and 12-volt supplies required for the circuit of Fig. 1 can be obtained from a power transformer already present in the KSR-33 Teletype terminal.

motor can come up to speed. In a half-duplex system, hitting the BREAK key starts up the teletypewriter locally. For this feature to work in a full-duplex system, the software must echo the break to the machine. Turn-off time-delay T can be changed as desired to avoid needless turn-on/turn-off cycles. □

Two inverters and a crystal assure oscillator start

by Ronald H. Beerbaum
Southbury, Conn.

A crystal-stabilized, transistor-transistor-logic clock source with no start-up problems can be made with two TTL inverters in the arrangement described here. The circuit has two other advantages: it will operate with almost any crystal from any manufacturer, and its stability is dependent on the characteristics of only two components.

TTL circuitry has inherently low impedance at all nodes, necessitating a series-mode oscillator configuration to provide a reasonably high Q. This mode requires a low-impedance path through 360° of phase shift with sufficient gain to overcome the losses in the loop.

In the circuit below, I₁ and I₂ are TTL inverters (or NAND gates with the inputs tied together) that provide the necessary gain and phase inversion. RFC₁ and RFC₂ provide dc feedback at the inverters that forces them into a linear mode. These chokes are chosen to provide enough loop gain to drive a weak crystal, and should have a dc resistance on the order of 100 ohms or less. R₁

and R₂ are Q-swamping resistors inserted to eliminate oscillation of the circuit at the self-resonant frequency of the chokes. If low-Q chokes are used, these resistors may be eliminated, but it is wise to allow for them in the circuit-board layout to permit choke substitution.

Usually serial-mode crystals have three stable modes of oscillation—the one stamped on the can, one above that frequency, and one below that frequency. The higher- and lower-frequency modes are generally determined by both the crystal and distributed circuit parameters. Capacitors C₁ and C₂ are included in the circuit to eliminate these modes; by lowering the impedance of the loop they ensure that the specified frequency occurs. They have very little effect on the operating frequency, so high-quality capacitors are not required.

C₃ can be a trimmer or a fixed capacitor, depending on the exactness of frequency required. A tuning range of about 100 parts in 10⁶ can be obtained by varying C₃, but temperature stability and long-term stability are dependent on its characteristics.

This circuit with the values shown will operate in the frequency range of 2 to 5 megahertz. Below this range, the values of RFC₁, RFC₂, C₁, and C₂ should be increased. Above this range C₁ and C₂ should be reduced to 22 picofarads or less. □

Designer's casebook is a regular feature in *Electronics*. We invite readers to submit original and unpublished circuit ideas and solutions to design problems. Explain briefly but thoroughly the circuit's operating principle and purpose. We'll pay \$50 for each item published.

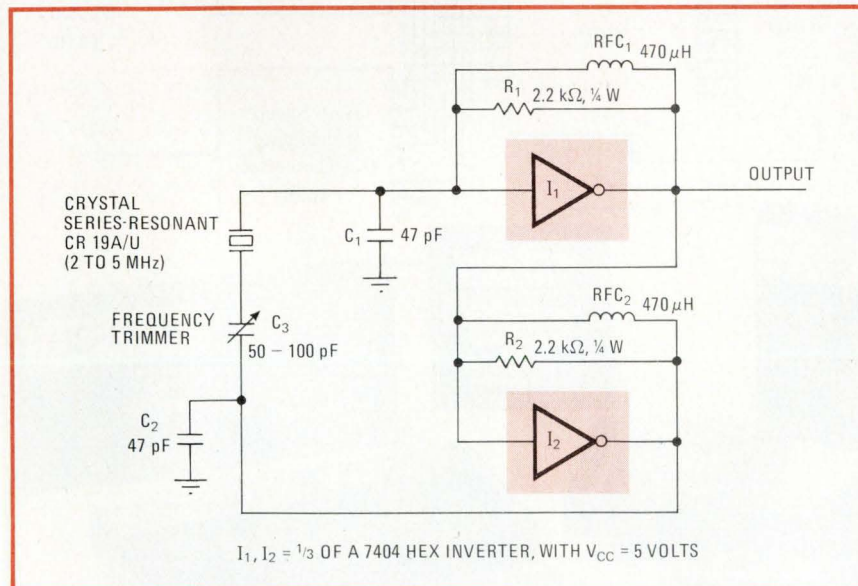

Reliable clock source. When power is applied to this series-mode TTL crystal oscillator, it always starts up at the right frequency. It will operate with most crystals; the components shown here are for crystals in the 2-to-5-MHz range.

Unmatched Performance and Selection in High Speed Data Acquisition

Ultra-high speed ADC's and DAC's, sample-holds, multiplexers, and super-fast op amps. Individually, they're outstanding — many without peer. Collectively, they are carefully matched to provide the fastest data acquisition systems available. Anywhere.

Ultra-High Speed ADC's	Resolution	Conv Time	Gtd Throughput Rate with 4855S/H*	Time per Channel	Add a 4550 Multiplexer Throughput
4130	8-bits	0.75 μ s	1.25 MHz	1.10 μ s	909 kHz
4131	10-bits	1.00 μ s	940 kHz	2.12 μ s	471 kHz
4133	12-bits	2.50 μ s	377 kHz	3.30 μ s	303 kHz

*Model 4855 features 250 nsec acquisition time to 0.01% and an aperture time of 2 nsec max.

For high speed MIL-applications, our 4058, a true 12-bit microcircuit DAC, features ultra-fast, ultra-stable operation from -55°C to $+125^{\circ}\text{C}$ with 100% screening available to MIL-STD-883.

Settling at 200 nsec to 0.01% max and providing 10 V @ 50mA output, our 1430 IC op amp is still the performance leader. Combine it with 4058: without question the fastest 12-bit hybrid voltage DAC. Anywhere.

The industry's fastest MDAC's — that's our 4070 series. 8, 10, or 12-bit resolution, 500 nsec settling to 0.1%, and inputs up to 7 MHz.

High Speed Current DAC's — our 4060 series give you a competitive and compatible selection, with a guaranteed settling of 85 nsec to $\pm 0.1\%$.

Radar pulse digitizing, video digitizing, FFT, simultaneous sample-hold systems, CRT displays, and waveform synthesis — applications where only Teledyne Philbrick can give you the complete high speed solution. And, a new series of Application Bulletins will facilitate your high speed design. Just write for them.

Teledyne Philbrick, Allied Drive, Dedham, MA 02026 — Telephone (617) 329-1600. In Europe, Telephone 673.99.88, Telex 25881, or write 181 Chaussee De La Hulpe, 1170 Brussels.

TELEDYNE PHILBRICK

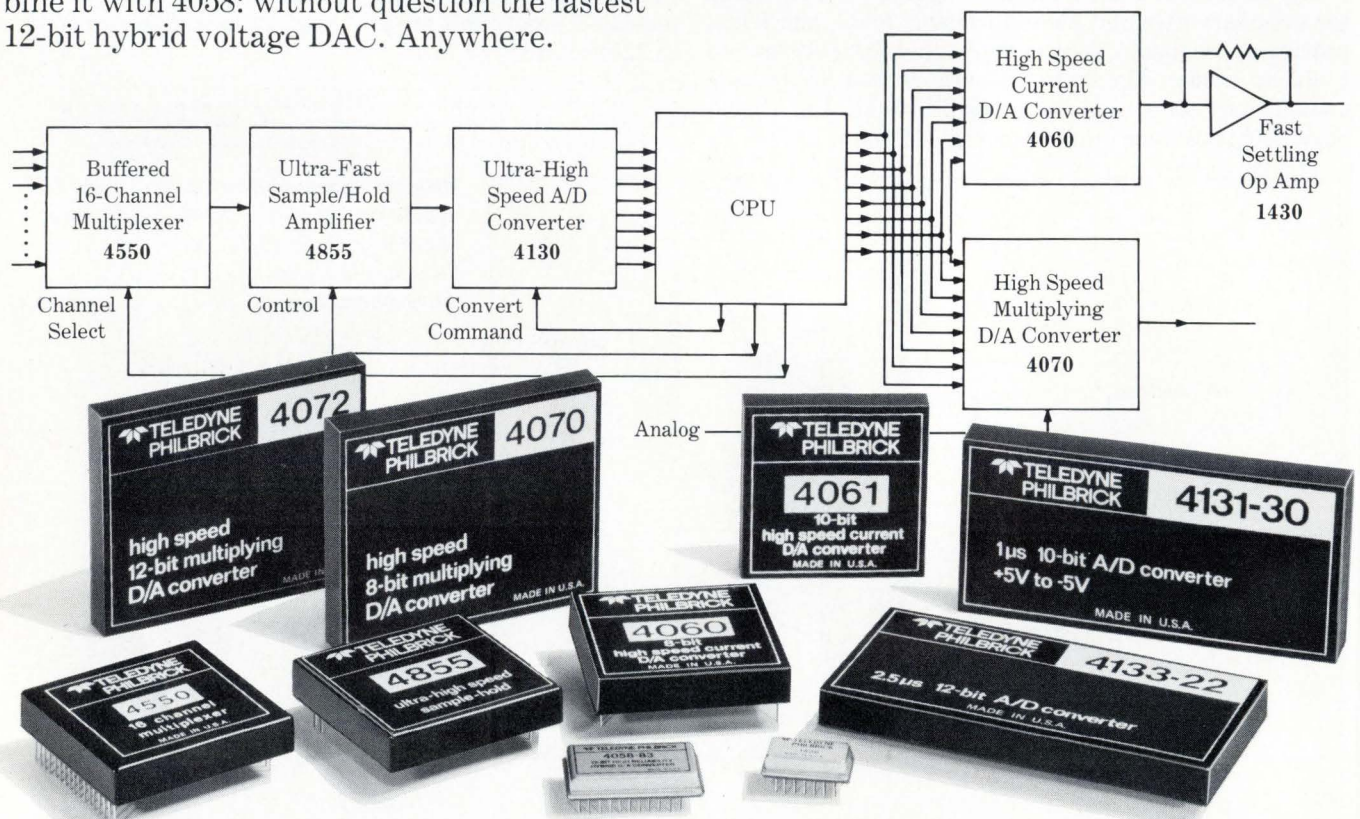

Predicting the real costs of semiconductor-memory systems

Storage costs are rising steadily in computer systems as large-scale integration continues to increase the capacity of RAM chips

by Robert J. Koppel and Irwin Maltz, *Intersil Inc., Sunnyvale, Calif.*

□ Designers and manufacturers of computer systems are finding that memory is increasing in importance in determining lifetime costs of an installation. On the one hand, unit prices are being steadily decreased by the declining price of semiconductor random-access memories as advances in technology are enabling designers to cram more and more capacity into smaller and smaller space.

But as the cost per bit is being driven downward, more storage is being used in most systems. The resulting memory cost as a percentage of the complete computer installation is continuing to climb.

The lifetime of a computer system can be extended and its life-cycle cost minimized if its memory is constructed in modules to allow for incremental upgrading. What's more, lifetimes can be extended and the costs of maintenance kept low by using the right testing procedures during manufacture and providing for adequate system cooling.

The subsystems of a typical memory are shown in Fig.

1. Production and maintenance expenses are determined primarily by:

- The need for device testing and the resulting effect on reliability.
- Error-correction techniques.
- The optimum size of memory modules to provide for the incremental growth of the system.
- The memory devices themselves and their supporting electrical and mechanical equipment.
- The power supply.

Evaluating reliability

Two of the major causes of memory-system failures are related to parameter instability in random-access memories and lack of initial testing of the devices. Standard test procedures in MOS manufacturing, such as the capacitance-voltage (C-V) plots and accelerated-temperature tests, have been optimized to weed out potentially unstable wafers or wafer lots. Since the source of instability is either contamination or disloca-

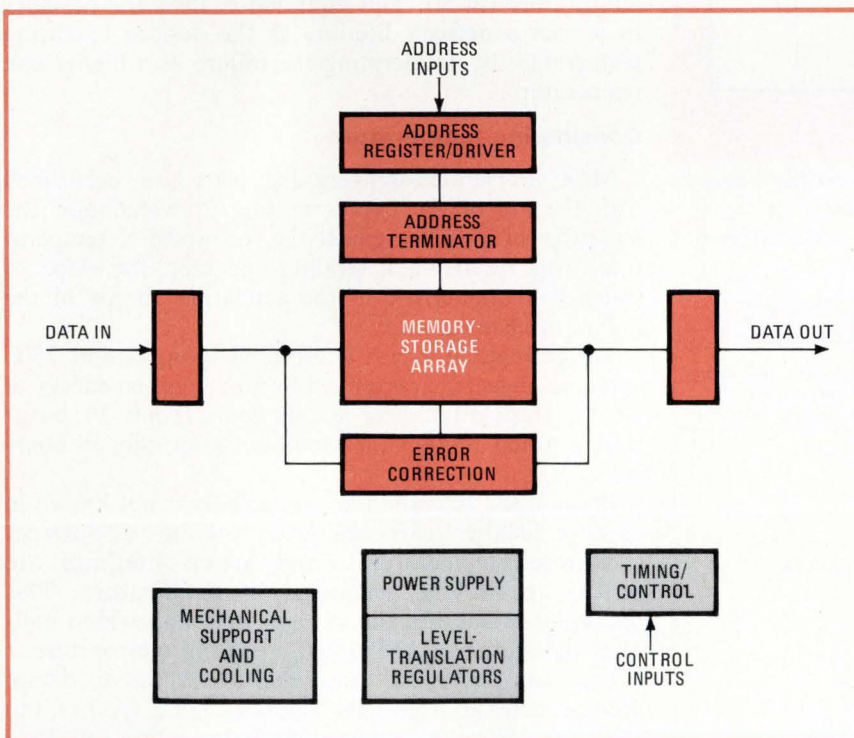

1. Memory system. A typical memory system is much more extensive than the storage array. When estimating the over-all system cost, support circuitry such as drivers, decoders, power supply, and cooling equipment must be considered. Often, error-correction circuitry is also included.

TABLE 1: TEST-PATTERN EFFECTIVENESS

Test pattern	Potential failure modes			
	Address	Multiple select	Address time	Write recovery
Marching 1s/0s	Fair	Good	Good	Good
Walking 1s/0s	Good	Poor	Poor	Poor
Galloping 1s/0s	Excellent	Excellent	Fair	Poor
Galloping write recovery	Excellent	Excellent	Fair	Excellent

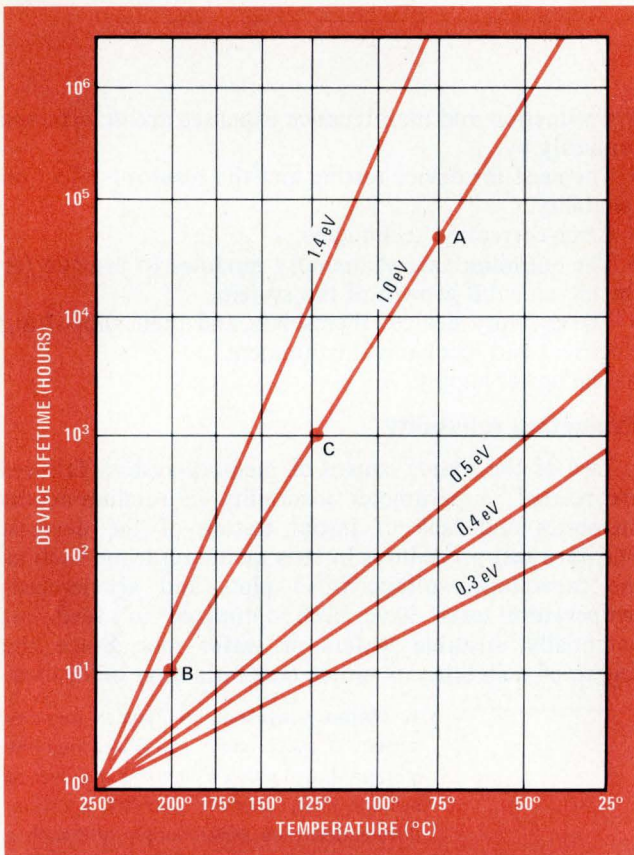

2. Temperature testing. An Arrhenius plot can predict a device's lifetime at a particular operating temperature after life-testing at a higher temperature. The same device that would last 40,000 hours at 75°C fails in only 10 hours at 200°C.

TABLE 2: EXTRA BITS FOR ERROR CORRECTION

Data bits per word	Single-error detection and correction	Single-error detection and correction double-error detection
1 to 4	3	4
5 to 11	4	5
12 to 26	5	6
27 to 57	6	7
58 to 120	7	8
121 to 247	8	9

tions, which can be localized occurrences, detection of these marginal cells or circuits is cumbersome. Very few of these defects will cause gross degradations. What's more, burn-in can escalate the gross defects to failures, and system margins can be set to allow for minor degradations.

Functional tests of memory devices should theoretically cover all possible combinations of three variables—test pattern, temperature, and timing. However, as a practical matter, some compromises must be made when testing actual devices.

A well-controlled production-device test has limits, or guard bands, set on supply voltages, refresh timing, and temperature, while functional tests are performed with a variety of test patterns chosen for the worst case of the device under test. For example, a thorough functional test would involve a four-corner voltage "shmoo" with ±10% excursions on supply voltage (although 5% is specified) and at 85°C (70°C specified). Refresh would also be tested at 85°C and 4 milliseconds (2 ms specified).

Many potential causes of MOS-device failures depend on the temperature at which the device is operated. Most failure mechanisms involve the movement of contaminants, metal migration, or some kind of chemical reaction that sooner or later will cause a critical parameter to go out of spec. Such reactions are described by the Arrhenius equation, which relates device lifetime to operating temperature:

$$\tau = \tau_0 e^{E/KT}$$

where τ is the MTBF (mean time between failures) at the desired temperature, τ_0 is the MTBF at the test temperature, E is the thermal activation energy of the chemical reaction causing the failure (in electronvolts), k is Boltzmann's constant (8.63×10^{-5} eV/K), and T is test temperature (in K). This equation enables the designer to predict a device's lifetime at the desired operating temperature by accelerating the failure at a higher test temperature.

Considering temperature

Most accelerated-temperature tests are performed with the aid of the curves in Fig. 2, which plot the logarithm of lifetime against the reciprocal of temperature. This results in a straight-line plot, the slope of which is characteristic of the activation energy of the failure mechanism.

For example, if a part is required to operate at 75°C and has a defect characterized by an activation energy of 1.0 eV, it would fail after 40,000 hours (point A), but if it were tested at 200°C, it would fail after only 10 hours (point B).

Because the activation energy usually is not known in advance, identical parts are tested to failure at different accelerated temperatures, and actual lifetimes are plotted against the reciprocal of temperature. This procedure establishes the straight-line plot, which indicates the lifetime at the actual operating temperature.

For example, again using the 1.0-eV curve, device lifetime increases from 1,000 hours at 125°C (point C) to 40,000 hours at the operating temperature of 75°C

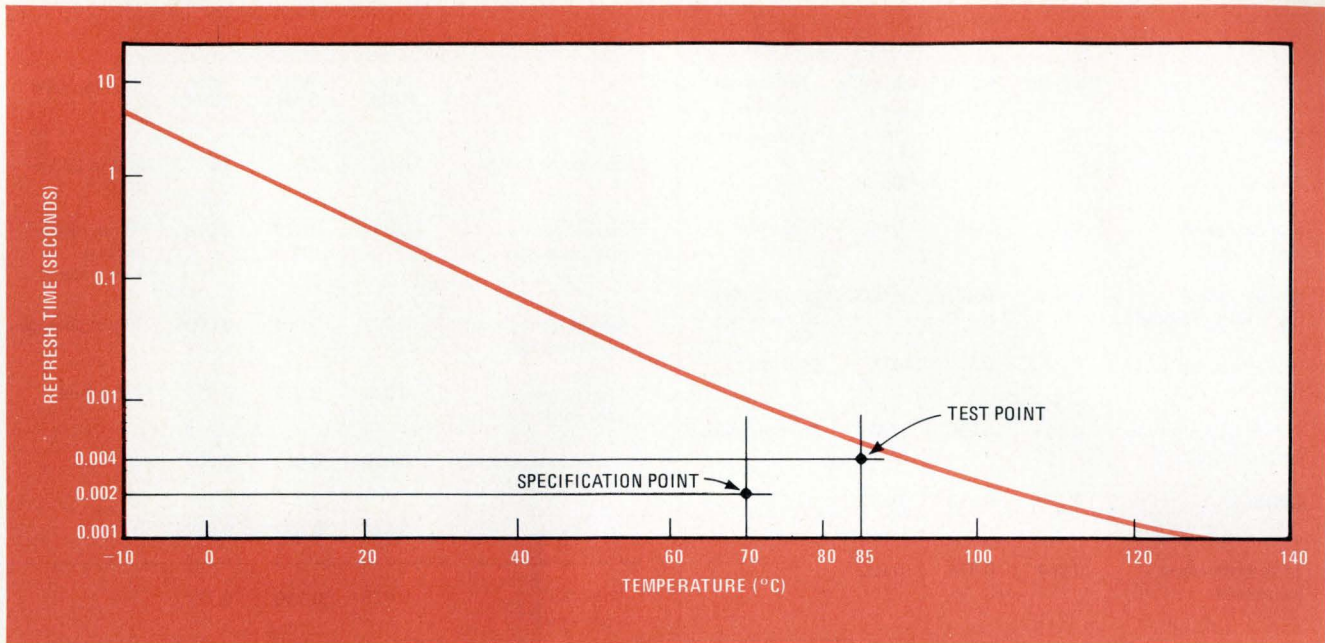

3. Refreshing. The refresh time interval for a typical 4-k RAM depends upon temperature. Devices should be tested at a higher temperature and longer refresh time than is specified. A device successfully tested at 85°C and 4 ms is reliable at the shorter operating interval.

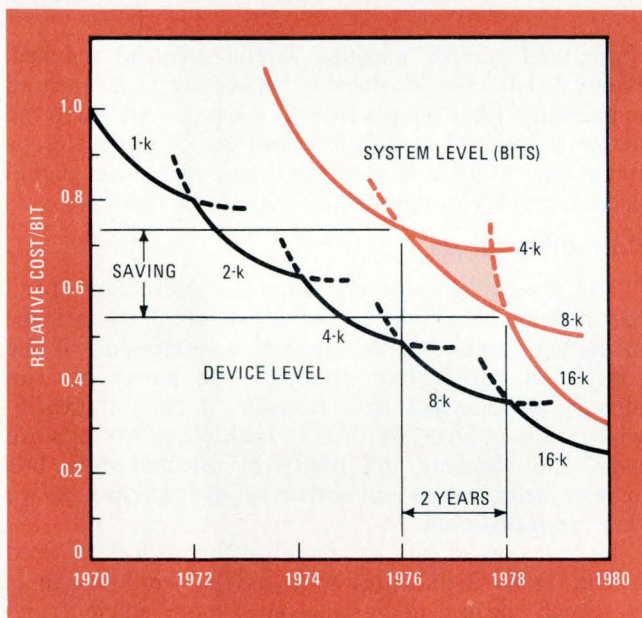

4. Price projections. Each generation of memory devices has reduced storage costs by an increasingly larger percentage. The 16-k RAM will be about 33% less costly than the 8-k chip, although the 4-k was only 25% less costly than the 2-k part.

(point A). For that reason, systems should be operated at the lowest ambient temperature permitted by the economics of cooling.

The effect of the proper testing on RAM devices can be quite dramatic. Parts received from some sources yield 1% fallout through component and system testing, while parts from other sources yield as much as 10% to 15% fallout for the same testing. If the user fails to test carefully, that 10% to 15% could fail in the field. A failure rate that high could be disastrous. This threat justifies burn-in of all finished memory cards before they

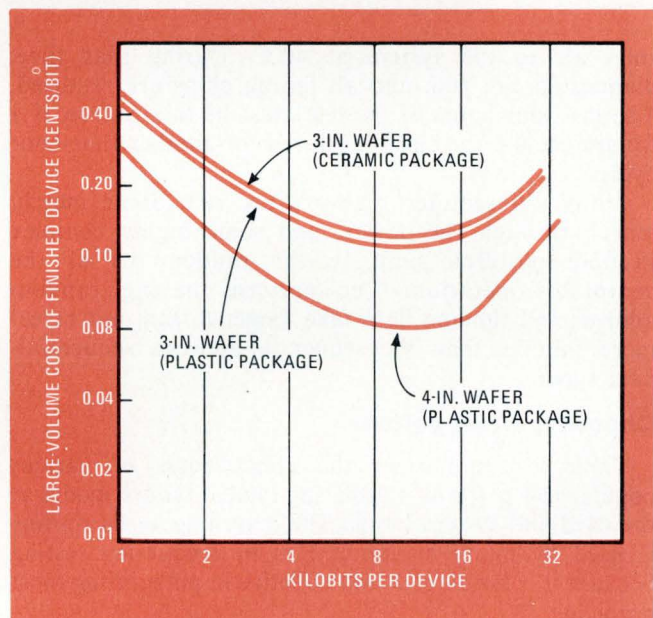

5. Cost and capacity. Estimated costs for devices of various capacities in 1977 show that minimum costs per bit will be reached for 8-k and 16-k devices. These curves are based upon such factors as mask quality, wafer size, and package type.

are shipped. Intersil cards are typically burned in for 24 hours at 50°C.

The company is also performing a thermal-shock test on all cards, which is particularly important for the peripheral devices. This test includes a 10-cycle thermal shock at -40°C to +70°C with one-hour stabilization at each end for all storage boards before the memory devices are inserted. This procedure is followed by functional card testing burn-in, final card test, and then system test.

Every system also is burned in for 24 hours, with the

TABLE 3: SMALL-CARD MEMORY-SYSTEM COST* (64-k BITS)

	1-k RAM	2-k RAM	4-k RAM	Assumptions
Number of RAMs	64	32	16	Dynamic RAMs
Package	P	P	C - P	
Storage device cost (cents/bit)	0.33	0.18	0.09	4-in. wafer
Storage-device board cost (cents/bit)	0.015	0.0075	0.0037	22-pin device 25 cents/in. ²
Non-storage cost (cents/bit)	0.22	0.13	0.06	64 k bits
System assembly/test cost (cents/bit)	0.10	0.050	0.075	Storage device
Overhead	0.199	0.110	0.054	
Total system cost (cents/bit)**	0.864	0.478	0.232	

*Performance level of 300-ns access, 500-ns read/write cycle, less power supplies. Typical application: buffer memory.

**Average cost over subsystem life to system assembler, assuming purchased components.

TABLE 4: LARGE-CARD MEMORY-SYSTEM COST* (256 k BITS) (1977 PRODUCTION)

	4-k RAM	8-k RAM	16-k RAM	Assumptions
Number of RAMs	64	32	16	200 to 250 ns access
Storage device cost (cents/bit)	0.09	0.075	0.079	16-pin plastic package 4-in. wafer
Storage-device board cost (cents/bit)	0.002	0.001	0.0005	16-pin package
Non-storage cost (cents/bit)	0.043	0.019	0.011	256 k bits
System assembly/test cost (cents/bit)	0.025	0.013	0.007	
Overhead	0.048	0.032	0.029	
Total cost (cents/bit)**	0.028	0.140	0.127	

*35-ns access, 550-ns cycle, less power supply. Typical application: add-on.

**Average cost over subsystem life to system assembler, assuming purchased components.

inlet air to the system at 40°C. During that time, diagnostics are run, and all failing chips are removed. The last four hours of the test must be failure-free; if a failure occurs, the clock is started for another four-hour cycle.

Many different test patterns are run. Some merely march through the device, and some highly complex random patterns simulate the randomness of the computer operation. The patterns having random address and random data take longer to run, but reveal more failures than the sequential-address, sequential-data types.

Choosing a test pattern

Table 1 summarizes the effectiveness of various popular test patterns in isolating typical failure modes at the card and system levels. The marching 1s/0s routine is used by many manufacturers in production testing because it is both quick and effective in pinpointing most problems.

During tests with both card and system patterns, supply-voltage margins are checked to examine operation under conditions causing both the slowest device operation and minimum noise margin. For example, a voltage "shmoo" plot, which reveals the combined effect of V_{DD} and V_{BB} displacement would show that if V_{DD} were low and V_{BB} were high, marginal timing would cause failure. But if V_{DD} were high and V_{BB} were low, system noise would be the primary cause of the system failure.

Broadly speaking, high-temperature system tests have two effects: timing margins are reduced by threshold-voltage shifts, and additional leakage increases refresh requirements. Guard-banding for these parameters is highly recommended. Timing margins should be reduced by 50% while testing at the maximum operating temper-

ature, and refresh margins should also be reduced. Figure 3 shows the relationship between refresh time and temperature for a typical Intersil 4-k RAM. Although the device is specified at 2 milliseconds at 70°C, the test is run at 4 ms at 85°C. Systems that pass these tests should operate reliably in the field after they are delivered.

Correcting errors

The process of error checking and correction (ECC) has contributed heavily to increased reliability in large memory systems. ECC is basically an extension of the concept of parity, but, although one parity bit can identify an incorrect data transfer, it cannot identify which bit is in error. With ECC, multiple parity bits are used, and checking the parity of selected data bits enables identification and correction of the errors before they are transferred.

However, extra bits are required for each data word stored. Table 2 indicates that, as the word length is increased, the use of ECC becomes more efficient and practical. For example, for an 8-bit data word, 4 ECC bits—50% of the data word—are required, but for a 72-bit word, 7 ECC bits—about 10%—are required. The ECC bits are treated exactly the same as data bits, in that a single bit failure in either category can be detected and corrected.

Without ECC, the industry typically experiences 10^{-7} failures per hour at the single-bit level. But when ECC is used, the failure rate drops to the order of 10^{-12} failures per hour, which is adequate in large memories. By making a reasonable set of assumptions on component-failure rates, one can calculate that ECC will increase system MTBF by a factor of 20 times for 64-kilobit cards to 50 times for 256-kb cards. Thus, with ECC, in spite of errors, a large machine may generally be serviced once every three months. And ECC reduces the servicing of a

Dynamic RAMs are superior

Even though dynamic random-access memories are cheaper and more reliable than static RAMs, designers appear to be reluctant to use them. A certain percentage of users won't consider the dynamic part because they don't trust its capability to retain data.

Admittedly, some computer designs do not allow for periods when the memory is unavailable because it is being refreshed. For instance, if a system is accepting data from a drum at high speed for storage, some data is lost during the refresh cycle because there is no place to put it. In this type of application, the static RAM is essential.

However, a system can be designed so that the refresh time of the dynamic RAM never interferes. In many systems, the lost time is well below 0.5% of the processing time, a period that is essentially unmeasurable. What's more, the dynamic RAM is generally more reliable than the static one. The dynamic device requires significantly less power, and keeping power dissipation low is the most important factor involved in ensuring device reliability. Smaller chip size is another factor that points in favor of dynamic devices.

The complexity and cost of dynamic-RAM systems can

Dynamic (7280)		Cost item	Static (7114)
\$256	(64 @ \$4)	RAMs	\$384 (64 @ \$6)
55	(42 ICs)	Support circuits	40 (36 ICs)
10.18	0.4 in. ² /RAM 0.36 in. ² /support ckt 0.25 cents/in. ²	Circuit board	9.64
150	+12 V @ 0.4 A + 5 V @ 0.4 A - 5 V @ 0.02 A	Power supply	100 +5 V @ 5 A
60	(2.7 hours)	System assembly/test	42 (2.0 hours)
\$531.18		Total direct cost	\$575.64
159.35	30%	Overhead	172.69 30%
\$690.53		Total cost to manufacture	\$748.33

be substantially reduced by using recently available single packages, each containing clock drivers and refresh circuits, along with the special medium-scale integrated circuits. Costs of static and dynamic RAMs, at 1977 prices, are compared in the table.

small machine to only once a year and virtually eliminates emergency repairs.

The addition of ECC for a 64-bit-word system typically requires about 15% more hardware for the extra storage and circuitry, while a 16-bit word requires 35% additional hardware. The designer should trade that off against the potential maintenance costs and customer satisfaction if the particular application permits the option.

Although there is typically also a speed penalty of 75 ns in read- and write-cycle times because of the extra logic levels accompanying ECC, the technique is becoming popular in memories with short words. As the price per bit continues its 25% to 30% decline per year, the extra bits and the associated logic required for ECC are becoming almost insignificant, compared with the cost of an emergency service call if the memory should fail.

Designing modules

A major problem arises in choosing the size of the smallest useful increment of card size in addition to the size of the BSM (basic storage module), which is a group of cards, and most BSMS contain 128 kilobytes or more. The BSM is frequently not large enough to fully utilize the capability of available drivers and sense circuits. If the module is too small, the designer is faced with the choice of placing these auxiliary circuits on a separate control board to supply several memory boards, or simply accepting the cost penalty of excess capability so that he can offer a single board type for memories of all sizes.

For most large systems, today's cards may contain 64 kilobytes, each organized as 32 kilowords by 18 bits. This capacity offers optimum combinations of RAMs and lowest non-storage costs. It also permits upgrading in the

field by the addition of cards to the largest capacity and performance demands likely to be required in this decade.

At this 64-kilobyte capacity, the card is large enough to fully utilize the peripheral driver and sense circuits that support the storage devices. In fact, by simple card redesign and back-panel changes, the same circuits can support either 8-k RAMs, which represent the next devices optimized for speed and density, or 16-k RAMs, the next higher level of devices optimized for cost and density.

For 32-k-by-18-bit cards, the storage array may be large enough to fully utilize the capability of available driver and sense circuits, but the timing and control circuits can effectively drive as many as four storage cards. For that reason, one control card for each four storage cards is usually specified, and the exact ratio is determined by the system-speed requirements for a particular application.

Small-card memories—4-k by 8 bits for microprocessor applications—have the entire system, including control circuitry, mounted on a single card. However, a gray area exists in moderate-size systems—16-kilobyte cards and higher. Some manufacturers offer separate control cards, and others mount the control circuits right on the storage cards.

Estimating system costs

In estimating the cost of a memory system, it is important to distinguish between storage costs—for the memory chips themselves—and non-storage costs, which represent the supporting electronics, for such purposes as data and address buffering, error correction, timing, control, and power, as well as mechanical support and cooling equipment (see Fig. 1). Storage costs are coming down much more rapidly than non-storage costs; in fact,

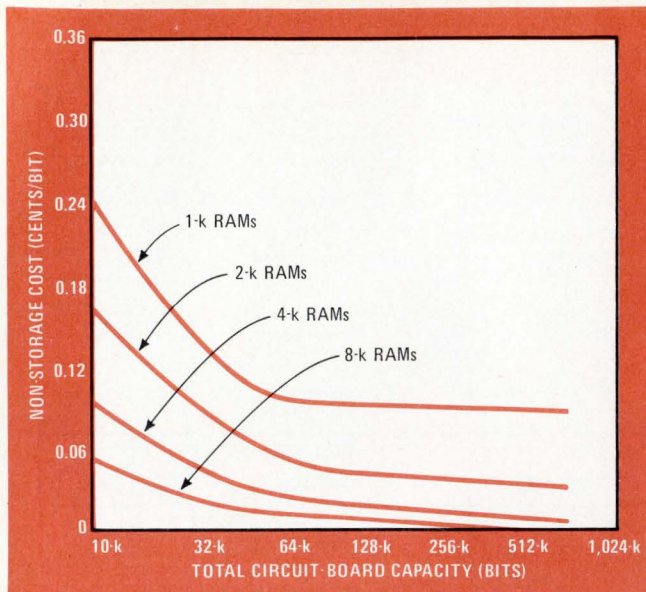

6. Non-storage. The memory cost per bit for non-storage hardware varies with device density, as well as the total bit capacity built onto one printed-circuit board. The curves tend to flatten out beyond the point of maximum capacity for typical pc boards.

each generation of memory devices has brought with it an increasingly larger percentage of reduction in storage cost (Fig. 4). At maturity, the price of a 16,384-bit RAM is predicted to be about 33% less per bit than the 8-k RAM, while the 4-k device is only 25% less costly than the 2-k chip.

The curves of Fig. 4 show another phenomenon: there continues to be need for doubling, rather than quadrupling, bit densities of chips for systems that have a useful lifetime beyond two years. The shaded area in Fig. 4, for example, shows that the 8-k device costs 0.15 cent less per bit than a 4-k chip. Thus, the 8-k chip can extend the life of the system, and only slight alterations are needed to accommodate it.

Figure 5, based on such cost factors as mask quality, wafer size, and package type, shows device costs as a function of bit density [see "Insight into RAM costs aids memory-system design," *Electronics*, Dec. 11, 1975, p. 101]. The curves show that 8-k and 16-k devices will cost about the same per bit in 1977.

Figure 6 shows non-storage costs as a function of total circuit-board capacity and RAM size. These curves tend to flatten out beyond the maximum capacity of a single board. The curves of Figs. 5 and 6 enable the designer to compute the overall costs of typical semiconductor memory systems.

Table 3 describes the costs of 65,536-bit memory systems using three different dynamic-RAM sizes—1-k, 2-k, and 4-k chips. The total system cost includes the storage devices, the circuit-board area dedicated to these chips, the non-storage devices, and finally, system assembly and test. (The storage-device costs are based on mature production parts made from 4-inch wafers—see Fig. 5.)

Table 4 presents a similar summary of typical costs for larger 256-kilobit boards constructed from 4-k, 8-k, and 16-k RAMs. Again, the same factors and assumptions are

TABLE 5: 1-MEGABYTE MEMORY-SYSTEM POWER DISSIPATION

Subsystem	Power dissipation	
	(Watts)	(Percentage)
Storage array	1,485	19
Registers (address, data, sense)	795	31
Timing/control	1,430	18
Power supply, regulators	980	32
Total	2,690	100

used, except that, in this guide, the devices are assumed to be packaged in plastic, and the application permits 250- to 300-nanosecond card-level access times for medium-size, high-density, semiconductor-memory systems.

The trend is clear. The large-board, dense-RAM systems cost substantially less than their smaller counterparts. Also, the costs of the storage devices and their circuit boards constitute approximately half of the cost of the small-card memory system, and roughly two thirds of the cost of the large memory card. Clearly, even greater cost efficiencies can be anticipated as larger RAMs, and larger card capacities can be accommodated at the system level. Larger RAMs, however, do not lower the cost of small cards and, in fact, do not even permit 1-k and 2-k word organization if RAMs are organized as 1-bit slices.

Selecting the power supply

Power-supply costs are coming down dramatically, and cooling costs are also falling because of increasing efficiency of the switching regulator supplies. Within the last two years, the reliability of high-power switching supplies has been increased, and several different vendors are supplying interchangeable supplies that can be widely used.

Power supplies should be modular to facilitate future incremental increases in the memory system. Most V_{DD} supplies can handle a large variety of memory sizes, but V_{EE} or V_{cc} supplies are built in 1-megabyte increments. In systems with emitter-coupled-logic interfaces, the -5-v supply powers the ECL circuitry. In a system with transistor-transistor-logic interface, the +5-v supply is the higher power. Both of these supplies should be selected to optimize future additions of memory increments.

A 1-megabyte memory system typically dissipates about 2.7 kw. The distribution of this power dissipation is shown in Table 5, which shows that the storage array consumes only a small portion—about 19%—of the system power.

Most semiconductor-memory systems are cooled by circulating ambient air through the cards by means of a high-volume fan or blower. For typical large systems, this approach limits the internal increase in air temperature to 15°C, thereby ensuring reliable operation and long life. □

Broadband matching transformers can handle many kilowatts

The discovery that transformers with transmission-line windings have 98% efficiencies opens up new uses for them in high-power applications

by Jerry Sevick, *Bell Laboratories, Murray Hill, N.J.*

□ The big news about broadband matching transmission-line transformers is their ability to deal with many kilowatts of power. On investigation, their efficiency turns out to be much higher than anyone had suspected—an astonishing 98% over most of a frequency range spanning several hundred kilohertz to 100 megahertz. Also news is the fact that they can be built with fractional impedance transformation ratios.

The small rugged devices, made of a short length of transmission line coiled around a single magnetic core,

are in wide use because of their inherently large bandwidth. Now their applications should be extended in particular to matching high-power amplifiers to an antenna, as well as matching small-signal amplifiers.

Experience long ago showed that other broadband matching devices—whether networks of capacitors and inductors or conventional transformers—had smaller bandwidths and lower efficiencies. High ohmic loss characterizes inductors of the size needed at low frequencies. High core loss in conventional transformers

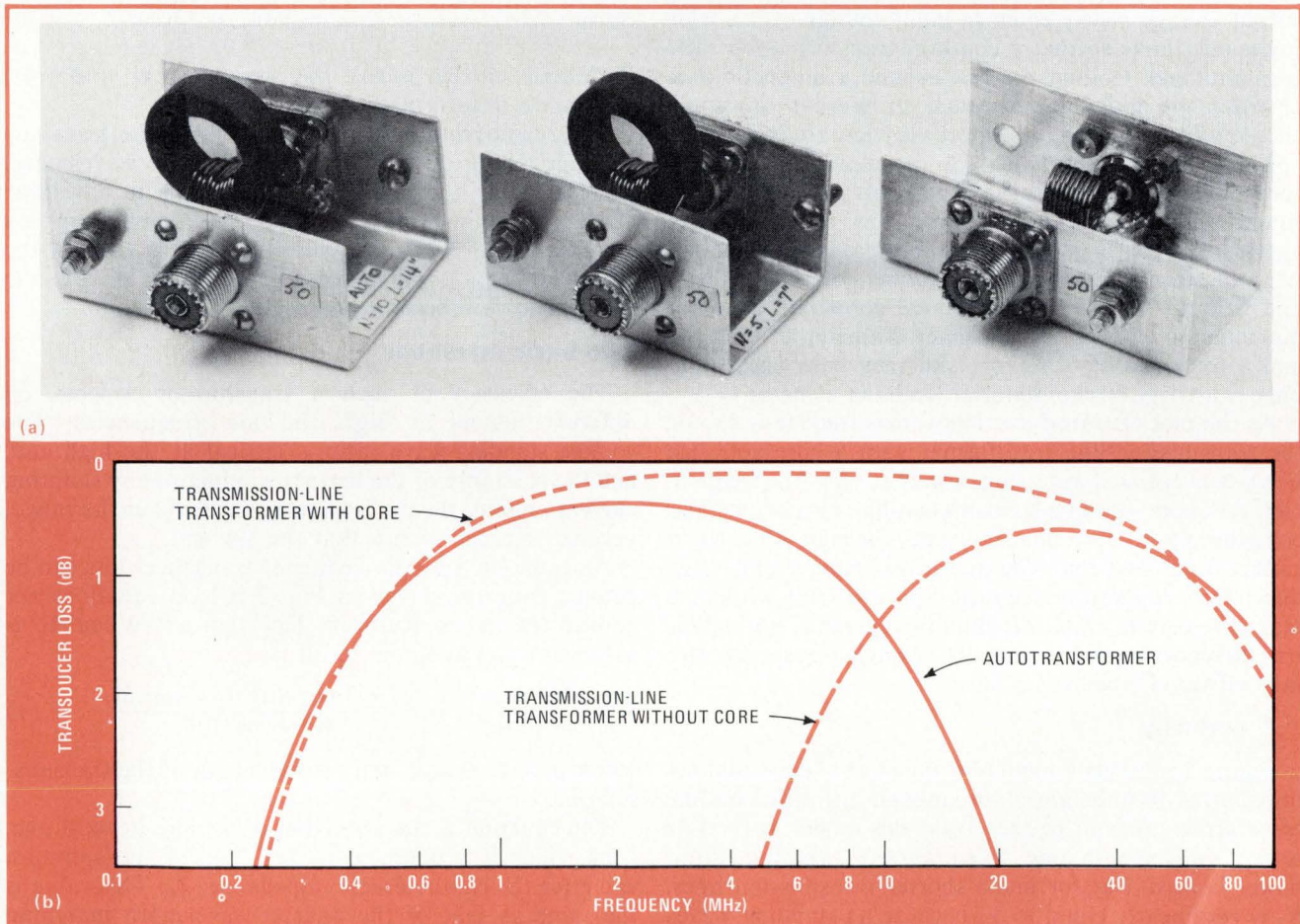

1. No magnetic coupling. The curves plotted for three types of transformers show that the transmission-line type with a toroidal core has good efficiency even at the very-low-frequency end, proving that there is considerable energy transferred by the transmission-line mode. At higher frequencies the core provides increased efficiency and bandwidth by preventing unwanted shunting currents.

drastically reduces their efficiency and with it their power-handling capability.

But only recently have careful experiments been done to determine just why a broadband transmission-line transformer is so superior. The new data explodes several assumptions about its mode of operation and about the function of the core.

In particular, the device was always thought to behave quite differently at the low and high ends of its frequency range. It was supposed to act like a conventional, three-terminal autotransformer at lower frequencies, coupling energy magnetically through the core, but like a transmission line at high frequencies, with the core having little effect.

What really happens . . .

Accurate measurements suggest another explanation. The transmission-line mode seems to be in effect throughout the frequency range, except at the very lowest end. The core's role is to prevent shunting currents at all frequencies and never to couple energy, except at the very lowest end of the range.

The equal and opposite currents that flow in the transmission-line windings essentially cancel core flux and so minimize core loss. The shortness of the transmission line (in relation to the wavelength of the highest operating frequency) minimizes ohmic losses, keeping output voltage nearly equal to input voltage over a wide frequency range so that a constant transformation ratio is maintained. Coiling the line around a magnetic core provides the inductance needed to prevent unwanted currents from flowing, except at very low frequencies.

Three transformers with 4:1 impedance ratios were constructed, and their performance was measured under similar conditions (Fig. 1). One was a conventional autotransformer of 10 turns on a toroidal core. The other two were transmission-line transformers of 10 turns with and without the core. The toroidal cores had an outer diameter of 1.25 inches, an inner diameter of 0.75 in., and a thickness of 0.375 in., and they both used high-bulk-resistivity ferrite material (Indiana General Q1).

As the plot of transducer loss versus frequency shows, the transmission-line transformer with a core acts just like a conventional autotransformer at very low frequencies. At about 400 kHz transmission-line operation starts contributing to its efficiency, and through 40 MHz it suffers much less than the autotransformer from transducer loss, suggesting reduced core loss. But without a magnetic core to choke off shunting currents, not only is its efficiency much less, but its frequency response also falls off rapidly below 1.5 MHz.

. . . and why

Figure 2 presents a model for the most widely used 4:1 unbalanced-to-unbalanced broadband transmission-line transformer. As can be seen from this model, if the line is half a wavelength long, V_2 equals $-V_1$, and the output power is zero. But for much shorter transmission lines, V_2 is very nearly equal to V_1 because no standing waves exist. Then—provided that nothing much more than transmission-line current is flowing through the bottom winding—the output voltage is twice the input voltage,

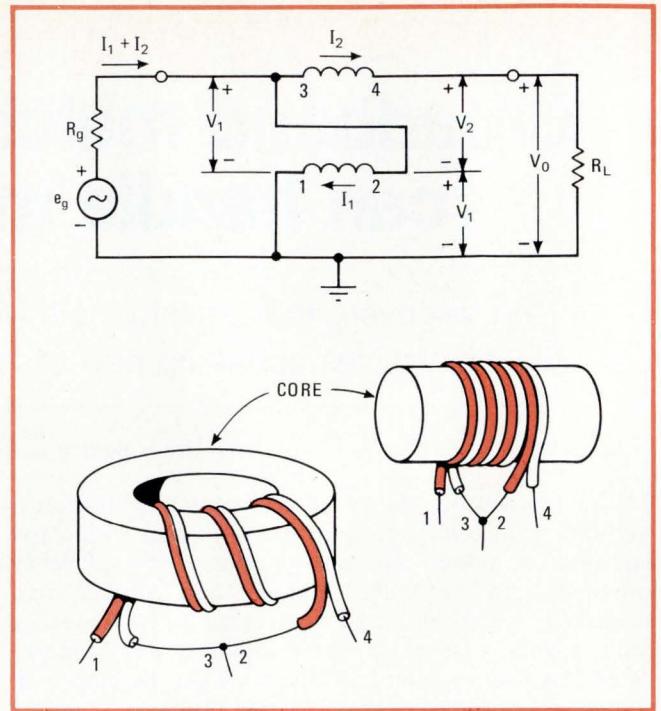

2. Transmission-line transformer. Both toroidal- and rod-type transformers provide broadband operation. Shown is the popular 4:1 unbalanced-to-unbalanced transformer that uses two wires of equal diameter closely wound around a magnetic core material.

the output current is half the input current, and a 4:1 impedance transformation exists.

The relationship holds up quite well if the transmission line is shorter than 0.2 of the effective wavelength. At this length the mismatch corresponds to a voltage standing-wave ratio of 2:1 where the transducer loss increases by 0.4 decibel. Any longer, and the VSWR of the particular length will increase or decrease V_2 , and the transformer will become less useful.

Two basic equations

The efficiency of such a transformer depends on different factors at high and low frequencies. The voltage standing-wave ratio is critical at the high end, and the reactance of the bottom winding to any shunting current present, though important throughout the range, becomes especially critical at the low end.

An equation for high-frequency transducer loss can be derived from the model in Fig. 2 if loop equations are applied to it, as Ruthroff has shown.¹ When I_1 is assumed equal to I_2 , the result is:

$$\frac{\text{available power}}{\text{output power}} = \frac{(1 + 3 \cos \beta l)^2 + 4 \sin^2 \beta l}{4(1 + \cos \beta l)^2} \quad (1)$$

where $\beta = 2\pi/\lambda_{\text{effective}}$ and l is the length of the transmission line.

The equation is the reduction of a more general one, from which it is obtained by insertion of the optimum value for the characteristic impedance, Z_0 . This value is the same as that of the quarter-wavelength matching transmission line, namely the geometric mean of the source and load resistance, $(R_g R_L)^{1/2}$.

Note that no reference to a core of magnetic material

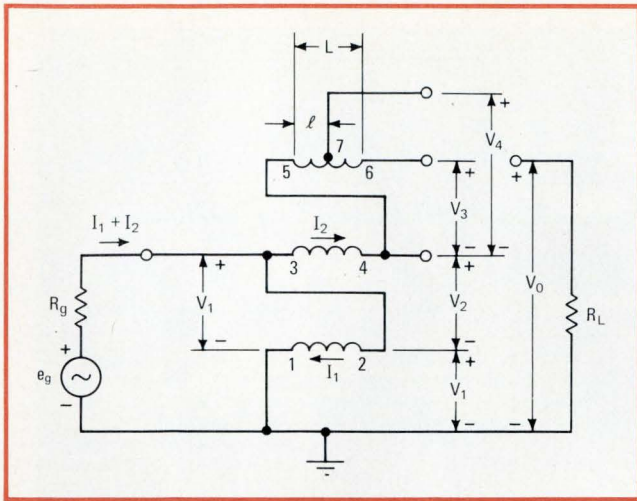

3. Other ratios. A 4:1 impedance ratio results when the transmission-line transformer's output is connected between ground and terminal 4, 9:1 when it is connected between ground and terminal 6. Tapping off the top winding (terminal 7) yields non-integer ratios.

is contained in this analysis. In the transmission-line mode, the magnetic fields cancel at high frequencies, so that almost no flux threads the core.

However, the core's effect needs stating at low frequencies. At this end of the range, the transformer's response is determined mainly by the reactance of the bottom winding to the flow of a shunting current. If the reactance is made large enough, only transmission-line current will flow, and the impedance transformation ratio will be maintained.

One way to increase reactance would be to increase the number of turns of the transmission line, but that would lengthen it and so degrade its high-frequency performance. The preferred way is to use high-permeability core material, particularly in the case of a toroidal configuration.

The model for the low-frequency region can then be represented by an inductance in parallel with an ideal transformer. In mathematical terms:

$$\frac{\text{available power}}{\text{output power}} = \frac{R_g^2 + 4X^2}{4X^2} \quad (2)$$

where X is the reactance of the bottom winding with the secondary open-circuited.

A different mechanism

Although this equation is identical to that for the low-frequency response of the conventional transformer, the modes of operation are different. The transmission-line transformer, for as long as it is transferring considerable quantities of power at low frequencies, is still acting like a transmission line and not like a conventional transformer, which transfers power entirely by the common flux linkage. But it may start acting as an autotransformer at still lower frequencies if it experiences appreciable core flux and the choking action is inadequate to prevent the generation of excessive currents in the bottom winding.

The analysis of the transmission-line transformer's operation need not stop here. If it is carried a step

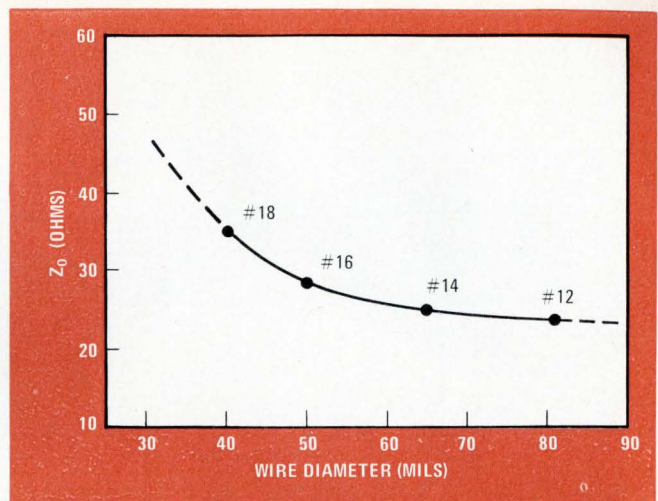

4. Experimental data. Characteristic impedance Z_0 is plotted for closely wound coils of the size of wire used in power applications. Twisting the wires together decreases Z_0 slightly; reducing the spacing between adjacent pairs lowers Z_0 as much as 40%.

further, it is possible to show that single-core transmission-line transformers can be constructed with integer impedance ratios of other than 4:1 and even with non-integer impedance ratios—in other words, with fractional impedance ratios.

Figure 3 presents the model for the extended analysis, which employs the same sort of loop equations as before. In this case, three windings are used, instead of two, and the associated voltages V_1 , V_2 , and V_3 are summed across the load. Conventional transmission-line equations determine V_2 with respect to V_1 , as well as V_3 with respect to V_2 . Output voltage V_0 is determined from two transmission lines of equal lengths, not from one transmission line of twice the length. The voltages simply add when transmission lines are short— V_0 is three times larger than the input voltage V_1 , and I_1 is twice as large as I_2 , complying with the principle of the conservation of energy. Also, the flux from the bottom winding tends to cancel the flux from the other two, minimizing core losses. The result is an impedance transformation ratio of 9:1.

Obtaining fractional ratios

Impedance ratios of other than 9 or 4 to 1 become possible if the top winding is tapped. Since all windings are tightly coupled electrically, a common voltage gradient of V_1 exists from left to right along the windings, and the voltage at the tap, terminal 7, becomes $V_0 = V_1 + V_2 + V_4$. Now $V_1 = V_2$, and $V_4 = (l/L)V_1$, where L is the length of the transmission line and l the length to the tap. Consequently:

$$V_0 = V_1(2 + l/L)$$

To generalize this equation, let n = the number of windings below the top winding which is tapped so that:

$$V_0 = V_1(n + l/L)$$

Rod-core transformers allow for fractional turns, so their l can have any value up to L . But for toroidal-core

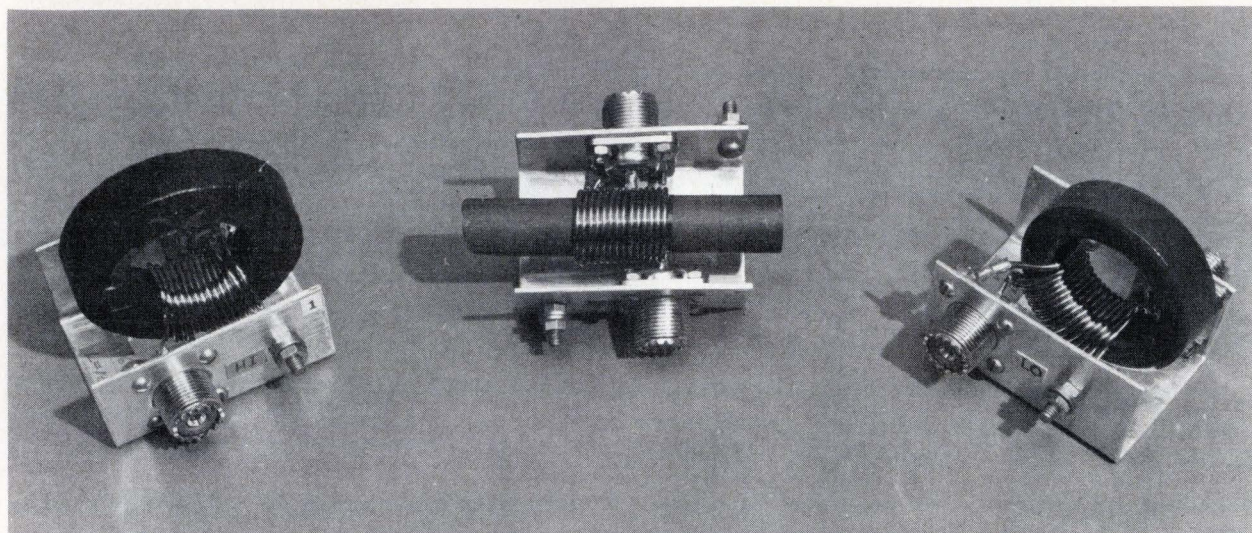

(a)

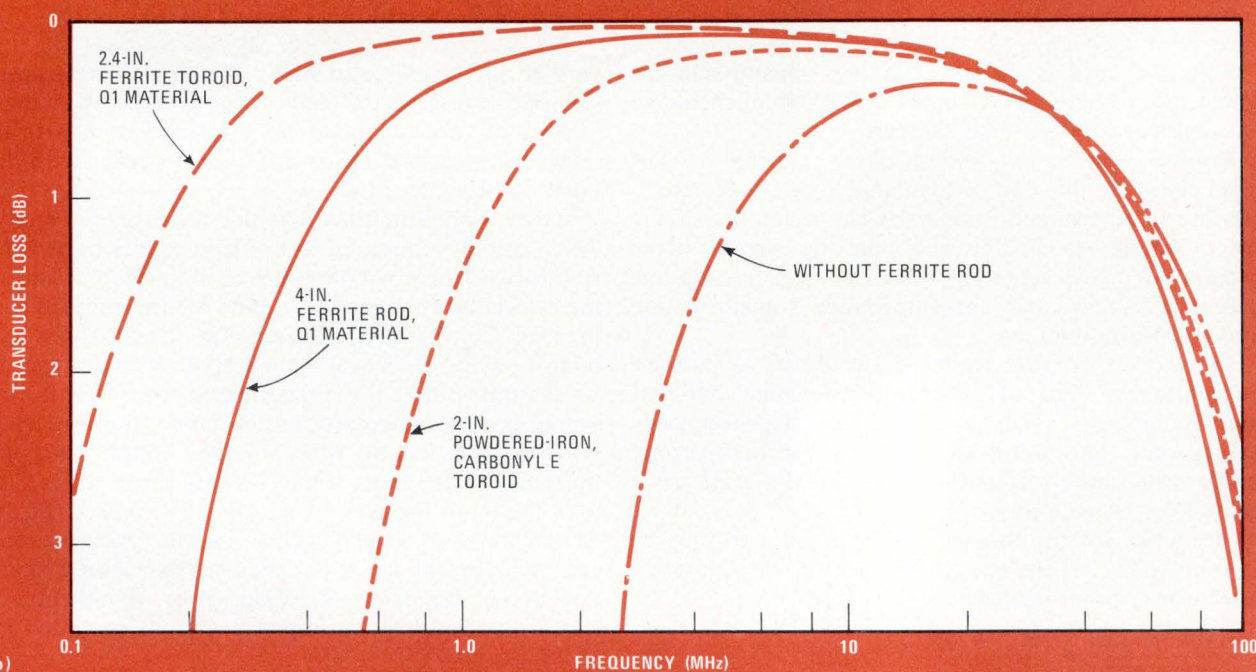

(b)

5. Comparing response curves. All transformers provide a 4:1 impedance ratio to match 50 ohms to 12.5 ohms. The tightly wound transmission-line windings use 14-gauge enameled wire on cores that employ different materials and geometries (solenoidal or toroidal).

transformers, which do not allow fractional turns, the equation becomes:

$$V_o = V_1(n + n_t/N)$$

where n_t equals the number of tapped integer turns and where N equals the total number of integer turns.

Simply tapping off the top winding of the two-winding 4:1 transformer shown in Fig. 2 makes n equal 1, so that ratios of less than 4:1 become possible.

Since the output voltage depends on the length ratio or turns ratio, it is easy to design a matching transformer for a particular impedance. For example, to match a 50-ohm coaxial cable to a 35-ohm self-resonant vertical antenna, the impedance ratio must be 50/35 or 1.43. Since the voltage ratio is proportional to the square root

of the impedance ratio, $V_o/V_1 = (1.43)^{1/2} = 1.2$. Then the value of l/L can be found from the general equation for a bifilar-wound rod-core transformer:

$$\begin{aligned} V_o/V_1 &= n + (l/L) \\ 1.2 &= 1 + (l/L) \\ l/L &= 0.2 \end{aligned}$$

Thus, the two-winding network with a rod core will require a tap at 0.2 of its length from terminal 3 of Fig. 2. For a toroidal-core transformer, tapping 2 out of 5 turns, or 4 out of 10, would give a similar result.

Besides the two basic equations (1) and (2), three parameters are needed to design broadband transformers. They are: characteristic impedance Z_o , which depends on the number of turns and the shape and

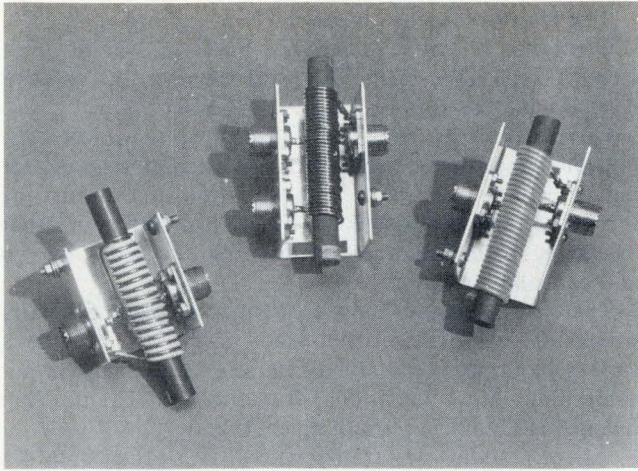

6. Varying the impedance ratio. Two-winding step-up transmission-line transformers provide a 1.55:1 ratio (left) and a 2:1 ratio (right), while a three-winding transformer (middle) can provide either a 9:1 or 4:1 ratio. All three devices were wound with 14-gauge enameled wire on 1/2-inch-diameter, 4-inch-long ferrite rods. The frequency response of each of the transformers is plotted in Fig. 7.

spacing of the windings; the shunting inductance that affects low-frequency rolloff and itself depends on the size and type of core material; and the effective phase constant of the coiled transmission line, which determines the transformer's high-frequency response and depends on the dielectric of the wire insulation and coupling between windings.

As already noted, the optimum value for the characteristic impedance of the transmission line of a 4:1 matching transformer is the geometric mean of the input and output resistance, $Z_o = (R_g R_L)^{1/2}$. Initial results for fractional-ratio designs indicate that for them, too, the optimum values of Z_o are the geometric means of their input and output resistances. It has been found that generally, with characteristic impedances of twice or half the optimum value, the transducer loss is less than 0.2 dB with short transmission lines of 0.09λ or less.² The author found experimentally that little degradation is observed at the high-frequency cutoff with departures as large as 10% from the optimum value of Z_o . The characteristic impedance, however, does vary with frequency because the permeability of the core material is frequency-sensitive. Usually the optimum value of Z_o should be determined at the highest frequency of operation.

To lower the characteristic impedance, should that be necessary, transmission lines can be twisted together. Twisting them lowers Z_o by increasing their distributed capacitance. A more significant change, however, can be made by just tightly coiling the transmission lines and so minimizing spacing between windings.

How to adjust Z_o

Figure 4 shows experimental data for various tightly wound, bifilar coils of typical wire sizes used in power step-down applications. For instance, Z_o can be lowered about 40% by reducing the spacing between adjacent pairs of wires from three wire-diameters to that of the insulation of the wires.

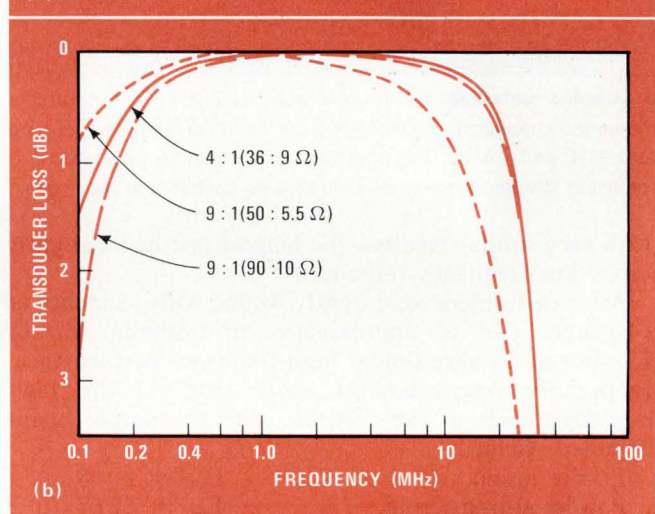
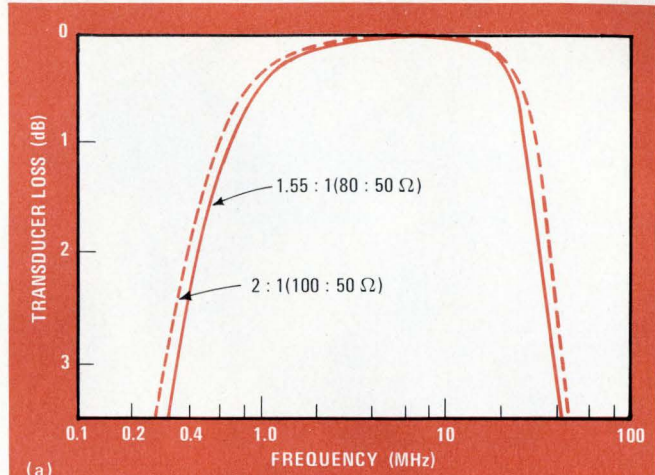

7. Plotting response. The characteristic impedance is optimum for the 4:1 transformer but for the 9:1 transformer only when matching 90 to 10 ohms, not 50 to 5.5 ohms. For the latter case this less-than-optimum impedance causes a more rapid falloff at high frequencies, but, since an inductive reactance of only 5.5 ohms, not 10 ohms, has to be exceeded, the low-frequency end is improved.

For step-up transformers to maintain high-frequency performance, however, larger winding separations are necessary. This can be done by separating the turns with extra insulation, such as Teflon tubing, to increase the characteristic impedance. For example, tightly wound turns, separated by Teflon sleeving, approach a Z_o of 70 ohms and are useful in step-up transformers that must match 50 ohms or more.

The core's role

Shunting inductance varies with the geometry and permeability of the transformer's core material. To define the core role more closely, three 4:1 matching transformers were tested (Fig. 5). Two used toroidal cores, and one used a solenoid. One toroid was of Q1 ferrite material with an outer diameter of 2.4 in. and a thickness of 1/2 in. The other toroid was powdered iron (Carbonyl E, $\mu = 10$ nominally) with an outer diameter of 2 in. and a thickness of a little less than 1/2 in. The solenoid was a rod of ferrite material, 3/8 in. in diameter and 4 in. long. (Various lengths of rod were tried, but

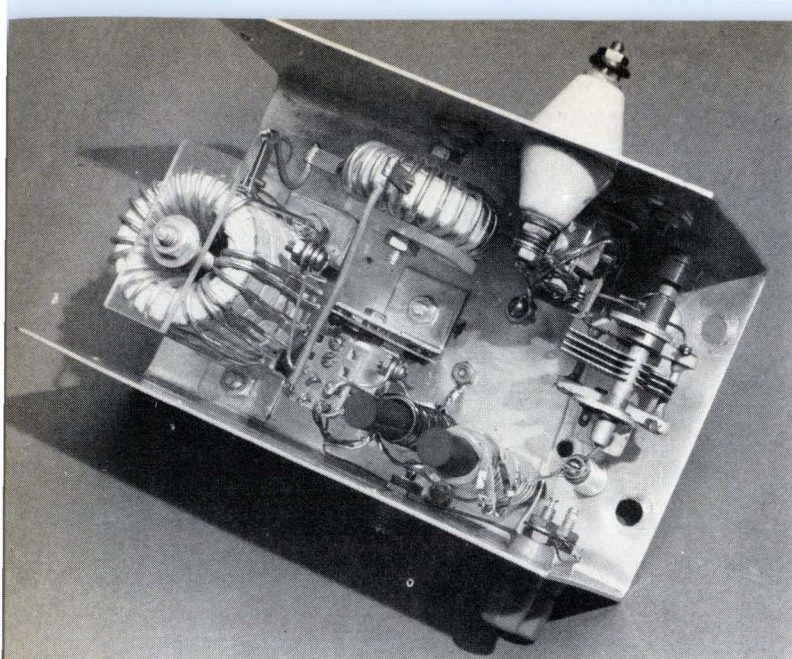

8. Antenna matching. Two transmission-line ferrite-rod transformers match the changing impedance of a 29-ft vertical antenna operating at 1.8, 4, and 7 MHz. The antenna is resonated by powdered-iron toroids at low frequencies, by a variable air capacitor at high ones.

with very similar results—the longest just had a slightly better low-frequency response.)

All transformers were tightly wound with 15 inches of 14-gauge wire to approximate an optimum Z_0 of 25 ohms and assure similar high-frequency performance. Inductance measurements at 1 MHz on the low-impedance side of the network, with the output open-circuited, yielded:

Ferrite toroid,	$L_{oc} = 11.08 \mu\text{H}$
Powdered-iron toroid,	$L_{oc} = 1.67 \mu\text{H}$
Ferrite rod, 7.5 in. long,	$L_{oc} = 6.07 \mu\text{H}$
Ferrite rod, 4 in. long,	$L_{oc} = 4.67 \mu\text{H}$
Ferrite rod, 2.5 in. long,	$L_{oc} = 3.69 \mu\text{H}$
Ferrite rod, rod removed,	$L_{oc} = 0.413 \mu\text{H}$

The low-frequency performance of a toroid is clearly superior to a rod's owing to the former's enclosed reluctance path and hence higher inductance. Because of the much higher value of reluctance in the airpath around the rod, little is gained at the low-frequency end by increasing its permeability. But with a toroid, inductance is proportional to the material's permeability, so that the higher the permeability, the better the low-frequency performance. Note the poor performance of the powdered-iron toroid with its lower permeability.

Finally, to ensure that these transformers were free of nonlinear or amplitude effects, they were subjected to various power levels. Invariably no additional power loss was discernible at levels up to 1 kw.

The design potential

The transformers with ferrite cores covered a rather wide frequency range with losses of only about 0.05 db. Since this loss is a combination of mismatch and transformer losses, efficiencies were greater than 98% over that range. Few networks can compete with such high efficiencies, which allow these transmission-line transformers to be cascaded to obtain higher impedance transformation ratios.

The major difficulty, however, is in getting the proper value of characteristic impedance for large step-down or step-up impedance ratios. For step-down a low value is needed, whereas step-up requires a higher value.

Generally, for very low values of characteristic impedance, stripline techniques are used. However, for higher values of Z_0 , the transmission lines must be separated. This is easily done. The use of Teflon or other insulating materials between windings provides known and controllable spacing.

These transmission-line transformers provide typically wideband performance even when tapped to provide a variety of impedance transformation ratios. This is not achievable with conventional transformers that use flux linkage as the energy-coupling method.

Figure 6 shows two transformers with other than 4:1 ratios, along with a transformer of three windings on a rod connected in a 4:1 and 9:1 fashion. The transformer on the left is tapped for a 1.55:1 impedance transformation, while the one on the right is a 2:1 step-up.

All were designed for operation with 50-ohm coaxial cable, and their loss versus frequency is plotted in Fig. 7. Even using rod-type cores, these transformers exhibited rather wide frequency response. Of course, the bandwidth could be further increased if a toroidal core were used. But unless the extra bandwidth is necessary, it does not pay to use the more expensive toroid.

One difference is worth noting. The 1.55:1 and 2:1 transformers performed similarly whether matching 50 to 5.5 ohms or 90 to 10 ohms. But in the 9:1 transformer, matching between 50 and 5.5 ohms produced better low-frequency performance. The reason is that the inductive reactance of the transformer, although the same in either case, needs only to be greater than 5.5 ohms of inductive reactance instead of 10 ohms. However, when matching to the higher impedance, the upper frequency cutoff was greater since the characteristic impedance of the transformer was equal to the optimum value.

Cool operation

All transformers were tested at 1-kilowatt operation. As was also the case with the 4:1 transformer, they suffered no discernible power loss or heating. Consequently, these fractional-ratio transformers can be cascaded to provide all sorts of impedance ratios. One instance is the network shown in Fig. 8, which can handle 1 kw of power and uses two transmission-line transformers wound on ferrite rods to match a 50-ohm cable to a 29-foot vertical antenna having a 13-ft top hat at 1.8, 4 and 7 MHz.

The ferrite toroid was not fully looked into and now bears further investigation. The only comparison made was with a single value of permeability, that of Q1 material, which was the first nickel-zinc ferrite used for amplitude-modulated radio antennas, i-f and rf transformers. Toroids with greater permeability look very promising for transmission-line transformers requiring even larger bandwidths at rather high power levels. □

References

1. C. L. Ruthroff, "Some Broadband Transformers," Proc. IRE, vol. 47, August 1959, pp. 1,337-1,342.
2. O. Pitzalis and T. P. Couse, "Practical Design Information for Broadband Transmission Line Transformers," Proc. IEEE, April 1968, pp. 738-739.

Who's the performance winner in 16k and 32k memory systems?

Check the specs.

Fabri-Tek has packed more speed and total performance into single-board 16K and 32K memory systems than anybody else in the business. Compare our 696 and 698 systems against the competition, and you'll see what we mean. We'll not only beat them in specifications — we're the only company that offers you total upward compatibility to 32K. At competitive prices, too. It's what you'd expect from a company with years of leadership in the memory business. Go with the winner — call us today for the best in both off-the-shelf and custom memory systems.

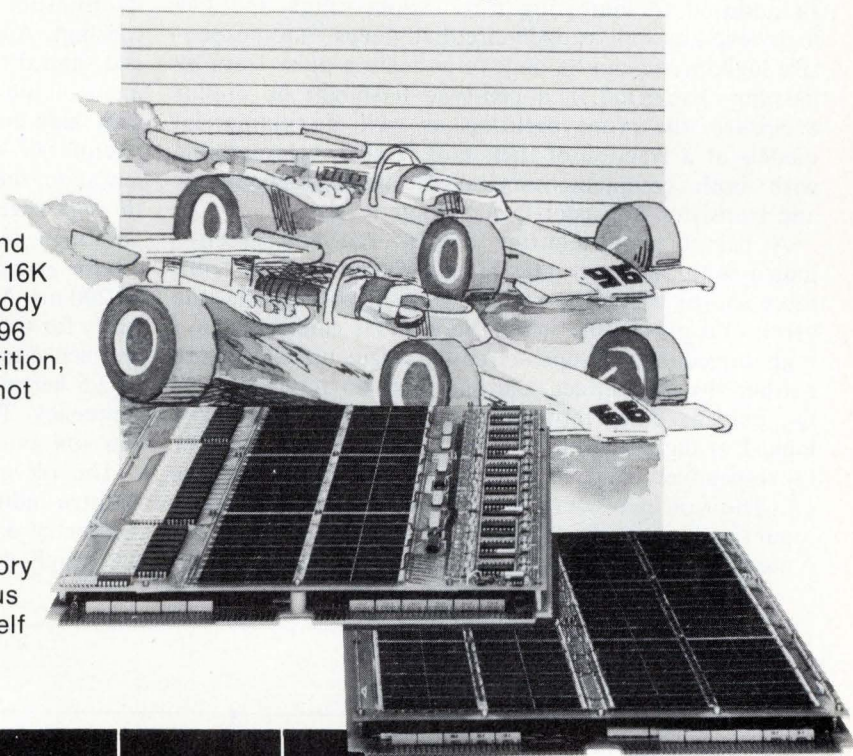

MODEL	FABRI-TEK		EMM		DATA PRODUCTS		DATARAM	
	696	698	Micro 3000 D.D.	Micro 3000 Q.D.	Store 1680		DR-103	DR-103
MEMORY SIZE	16K	32K	16K	32K	16K	32K	16K	32K
CYCLE TIME	650	650	650	850	650		650	750
ACCESS TIME	250	250	270	300	280		265	300
PHYSICAL SIZE	11.75x15.4 x1.0	11.75x15.4 x1.0	11.75x15.4 x1.0	11.75x15.4 x1.0	11.75x15.4 x1.0		11.5x13.7 x1.0	11.5x13.7 x1.0
COMPATIBILITY 16K TO 32K	YES		NO		NO		NO	



FABRI-TEK INC.
COMPUTER SYSTEMS

5901 South County Road 18 • Minneapolis, MN 55436 • (612) 935-8811

SALES OFFICES:

Boston
(617) 969-5077

Pennsauken, N.J.
(201) 222-6250

Chicago
(312) 437-4116

San Jose, Calif.
(408) 246-8391

Dallas
(214) 234-8438

Minneapolis
(612) 935-8811

Hawthorne, Calif.
(213) 973-0484

Versatile logic probe displays four modes

by Gordon W. Martin
Bendix Environmental and Process Instruments Division, Lewisburg, W. Va.

In addition to indicating static states—high and low logic levels as well as open-circuited nodes—an inexpensive logic probe can be built to indicate a pulse train by flashing. Packaged in a pen-type flashlight or similar enclosure, the probe performs as well as commercial models at a fraction of their cost, and it is compatible with both complementary-metal-oxide-semiconductor and transistor-transistor-logic voltage levels.

A pair of light-emitting diodes—red and green—indicates the various states in accordance with the truth table shown below. As evident from the schematic, the green LED glows only when the input is connected to a high impedance or open-circuited logic node; because neither situation affects the quiescent on state of Q_1 or Q_2 , current flows through the LED. Application of a logic-1 or logic-0 level to the probe input turns off Q_1 or Q_2 respectively, and, in either event, the green LED goes off. The NOR gates turn on the red LED when a logic-1 input is applied through current-limiting resistor R_6 . Note that the red LED will also glow when the 1Q output

of the dual monostable multivibrator goes high. The monostable is employed solely for the fourth condition in the truth table—the dynamic input of a pulse train to the probe.

The 74C221 C-MOS dual monostable has both positive- and negative-transition-triggering inputs, either of which can be used to inhibit the other—the output Q remains low whenever input A is high or input B is low. Firing the monostable generates a positive pulse at Q that has its duration determined by an external RC time constant. A pulse-train input to the probe is ac-coupled and shaped through C_1 and R_3 to the positive-transition input of the first monostable, 1B. The 1Q output then goes high for $T = R_4 \times C_2 = 200 \text{ k}\Omega \times 1.0 \text{ }\mu\text{F} = 200 \text{ milliseconds}$. Upon returning to the low state, the 1Q output triggers the second monostable through negative-transition input 2A, and its 2Q output goes high, inhibiting the first monostable through input 1A for an additional $T = R_5 \times C_3 = 200 \text{ k}\Omega \times 1.0 \text{ }\mu\text{F} = 200 \text{ ms}$. After this 400-ms period, the monostables are ready for triggering by the next positive transition at 1B, and hence the system exhibits a characteristic frequency of 2.5 hertz or $(400 \text{ ms})^{-1}$, regardless of the input-pulse frequency. The 2.5-Hz signal at 1Q is coupled through the NOR gates to flash the red LED at this rate.

The OR gate consisting of D_3 , D_4 , and R_7 ensures positive indication of pulse-train inputs, irrespective of symmetry or duty cycle. Waveforms with very low or very high duty cycles, which could not otherwise be

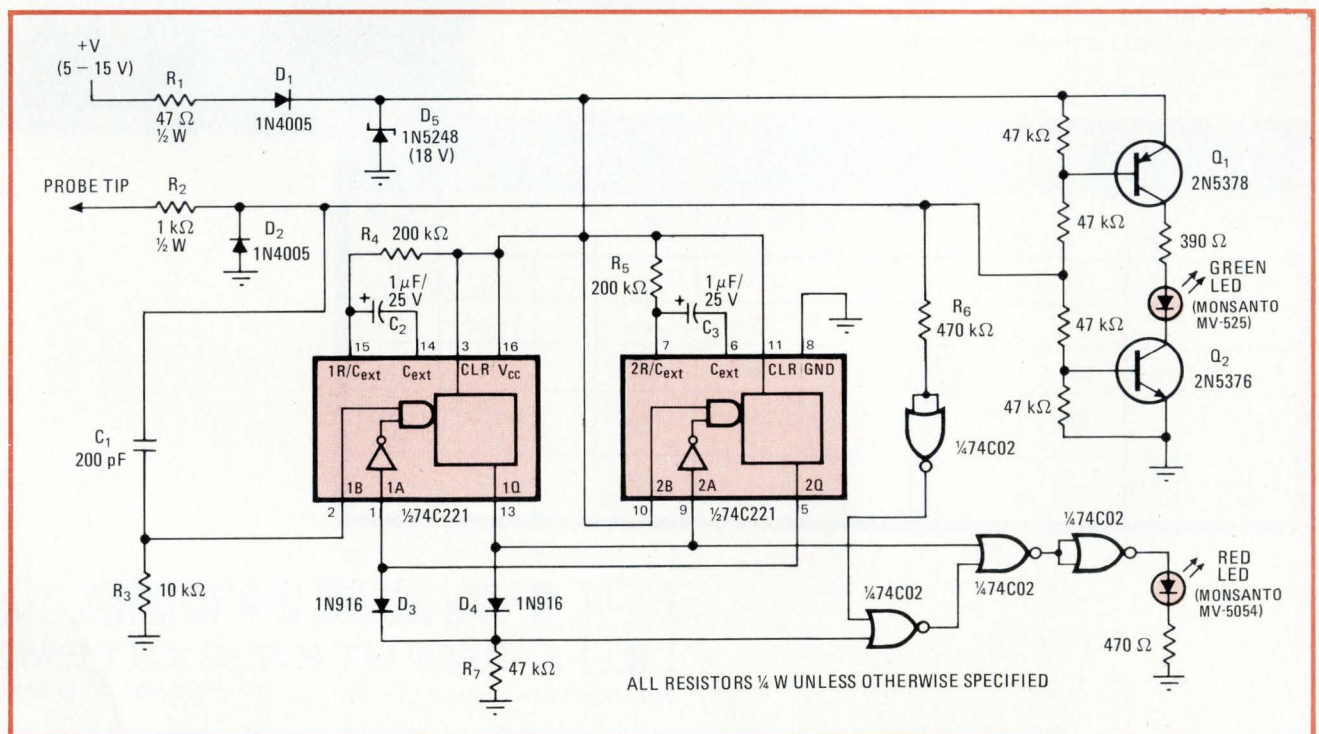

Discriminating probe. A 74C221 dual monostable and a 74C02 quad NOR gate enable this logic probe to indicate pulse trains as well as static inputs. Housed in a pen-type case with clip leads for ground and supply connections, the unit simplifies digital troubleshooting.

RESPONSES OF LOGIC PROBE

Input condition	Output indication	
	Red LED	Green LED
Open circuit (Hi-Z)	Off	On
Logic 0	Off	Off
Logic 1	On	Off
Pulse train	Flashes at 2.5 Hz	Off

IC timer drives electric fuel pump

by Sudarshan Sarpangal
ISRO Satellite Systems Project, Bangalore, India

A 555 integrated-circuit timer and a transistor provide an efficient driving system for a high-speed electric fuel pump. This arrangement allows the pumping rate to be adjusted and can be used with any pump of the solenoid-plunger type.

As the schematic diagram shows, the timer and components R_1 , R_2 , and C form a basic square-wave oscillator circuit. The output at pin 3 drives transistor Q on and off and so operates the solenoid-driven plunger of the pump. Commutating diode D protects the transistor from surges at turnoff.

The components shown are used to drive a Bendix fuel pump at 16 strokes per second, with the speed adjustable by change of R_2 . If a different pump is used that requires current of more than 1 ampere, a different transistor must be chosen. □

distinguished from constant-dc levels, will therefore flash the red LED at the 2.5-Hz rate.

The probe input is protected from negative-polarity signals by R_2 and D_2 . The unit, which will operate from any 5-v to 15-v source, is protected against overvoltage by D_5 and R_1 and against the wrong supply-voltage polarity by D_1 . Logic-level thresholds are about 20% and 80% of the supply voltage, and the probe draws only about 10 milliamperes from a 5-v source. □

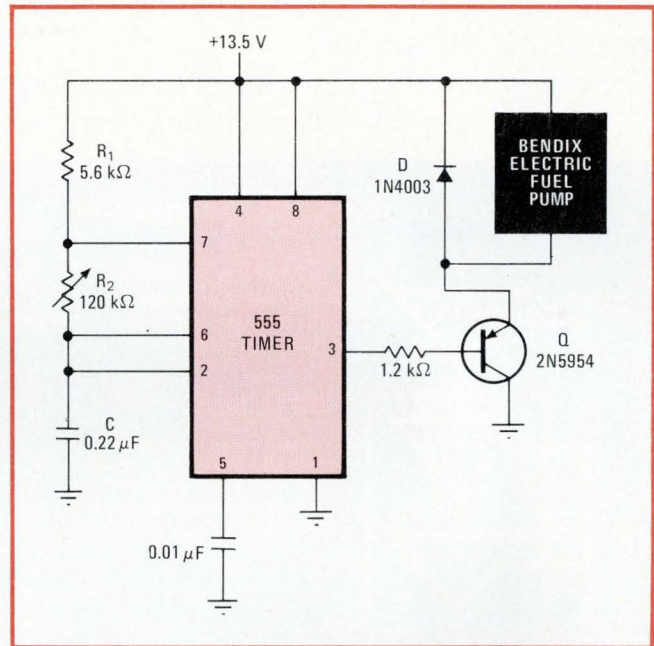

Adjustable-speed pump driver. This IC timer arrangement drives the Bendix plunger-type electric fuel pump at a rate of 16 strokes per second. Adjustment of R_2 permits other pumping rates.

Calculator notes

Programable calculator analyzes filter designs

by Tom Martin
Collins Radio, Dallas, Texas

An SR-56 calculator can provide a quick check on low-pass circuits laid out with the excellent filter-design programs in its applications library or on any other active or passive low-pass filter with up to four components. The calculator can be programmed to analyze the performance of these filter circuits, giving the gain or

Circuits analyzed. The frequency responses of the active low-pass filter in a and the passive low-pass filter in b are quickly plotted by use of the programs given for the SR-56 calculator. The decibel value of $A(f)$ is displayed at a chosen initial frequency f_1 and at successive incremented frequencies ($f_1 + \Delta f$), ($f_1 + 2\Delta f$) ... as the R/S key is pushed repeatedly.

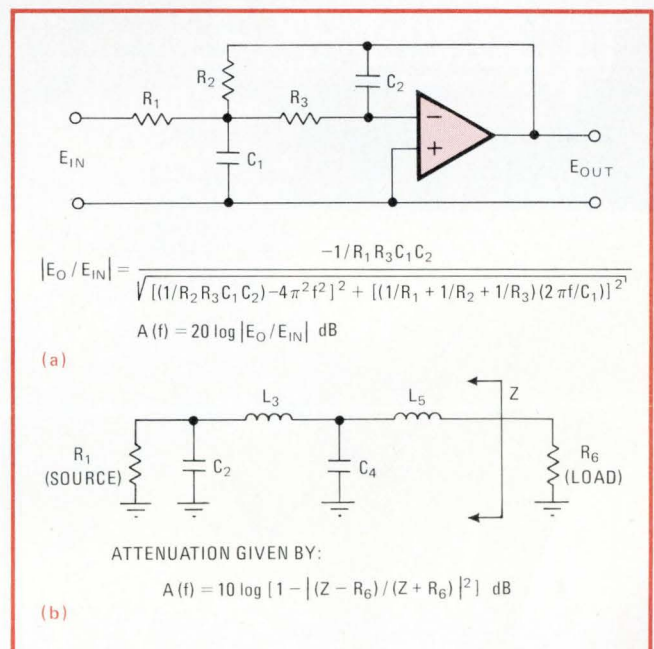

I.F. A-to-D, P.D.Q.

We may have just come up with the triple play of the century, an instant IC IF-to-video-to-digital system.

And we've done it with proven, plug-in Plessey products.

The Plessey SL550 is a low-noise, high-gain AGC-able front-end amplifier

that's not only unique, but superb.

The SL1521 is the simplest, easiest-to-use and least expensive wideband amp you can buy for your log IF strips.

And the SP750 is the world's fastest IC comparator, with a bonus batch of features that reduce your hardware count and increase your reliability.

They all plug together as if they were made for each other and they're available now, so send for all the details.



We'll get back to you, P.D.Q.

PLESSEY SEMICONDUCTORS

1674 McGaw Avenue, Irvine, CA 92714
Tel: (714) 540-9945. TWX: 910-595-1930
Represented world-wide.

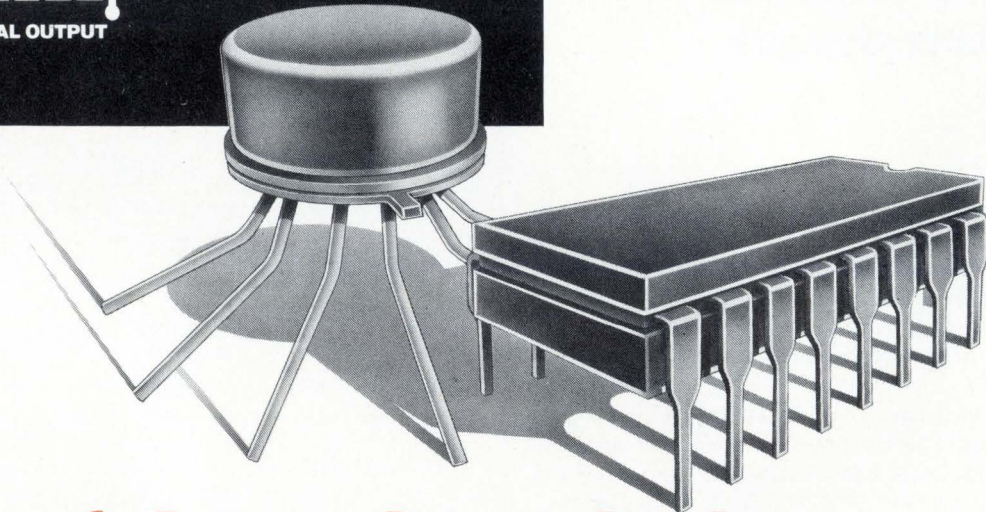
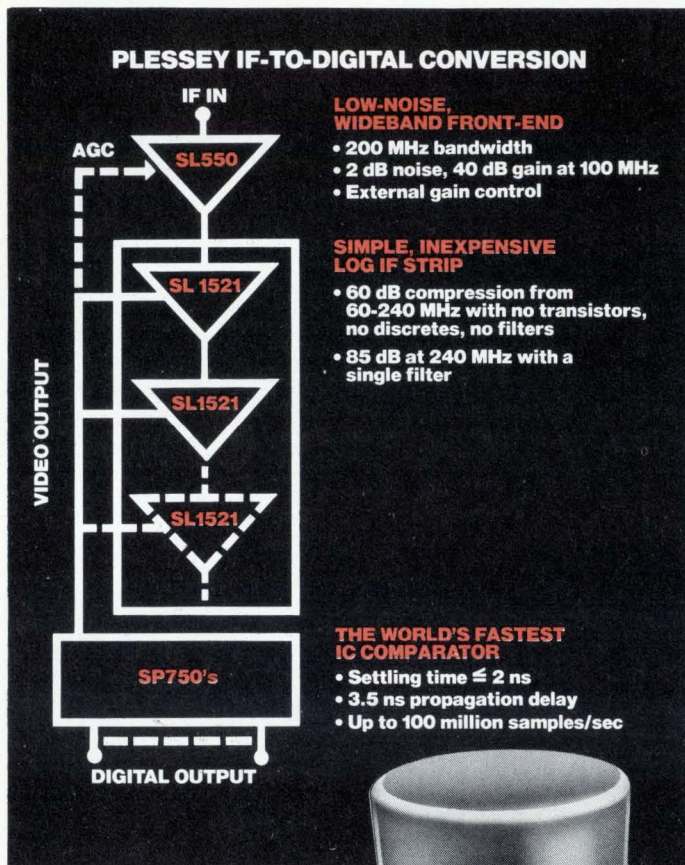

State-of-the-art brought down to earth

Limiting wideband amplifiers TV, radio & telephone communications circuits High-speed dividers

attenuation at an incremental frequency each time the R/S key is pushed.

The theory of operation for the active-filter analysis is straightforward. It simply solves the gain-versus-frequency equations that are shown along with the circuit diagram in part a of the figure. The program (Table 1) includes provision for entering a starting frequency, f_1 , and a frequency step size, Δf . Then simply pressing R/S repeatedly produces the data for plotting a linear frequency-response graph.

The passive-filter analysis works by calculating, at each frequency, the complex impedance that is seen looking back into the filter network from the load, as

illustrated in part b of the figure. This filter impedance and the load resistance are then used in the equation given below to calculate the attenuation through the circuit.

The passive-filter program (Table 2) also provides for rapid plotting of frequency response curves, using f_1 and Δf . For filters with fewer than four reactive elements, zeroes should be inserted in place of the unused element values. The run time for this program is about 8 seconds for each frequency. □

Engineer's notebook is a regular feature in *Electronics*. We invite readers to submit original design shortcuts, calculation aids, measurement and test techniques, and other ideas for saving engineering time or cost. We'll pay \$50 for each item published.

TABLE 1: SR-56 PROGRAM FOR ANALYSIS OF ACTIVE LOW-PASS FILTER

LOC	KEY	LOC	KEY	LOC	KEY
00	STO	30	RCL	60	X
01	7	31	0	61	RCL
02	RCL	32	1/x	62	6
03	2	33	+	63	+/-
04	X	34	RCL	64	÷
05	RCL	35	1	65	RCL
06	3	36	1/x	66	0
07	X	37	+	67	=
08	RCL	38	RCL	68	x
09	4	39	2	69	LOG
10	=	40	1/x	70	X
11	1/x	41	=	71	2
12	STO	42	÷	72	0
13	6	43	RCL	73	=
14	÷	44	3	74	STO
15	RCL	45	X	75	8
16	1	46	2	76	RCL
17	-	47	X	77	5
18	RCL	48	π	78	SUM
19	7	49	X	79	7
20	x^2	50	RCL	80	RCL
21	X	51	7	81	8
22	4	52	=	82	R/S
23	X	53	x^2	83	GTO
24	π	54	+	84	0
25	x^2	55	RCL	85	2
26	=	56	9		
27	x^2	57	=		
28	STO	58	\sqrt{x}		
29	9	59	1/x		

REGISTERS	
0	R_1
1	R_2
2	R_3
3	C_1
4	C_2
5	Δf
6	temporary
7	temporary
8	temporary
9	temporary

STEP	PROCEDURE	ENTER	PRESS	DISPLAY
1	enter program, initialize	CLR	CMS RST	
2	enter data	R_1 STO	0	
		R_2 STO	1	
		R_3 STO	2	
		C_1 STO	3	
		C_2 STO	4	
		Δf STO	5	
3	enter initial frequency	f_1 R/S		A (f_1)
4	continue	R/S		A ($f_1 + \Delta f$)
				A ($f_1 + 2\Delta f$)

Note: For single-frequency analysis, enter the frequency and press RST, then R/S.

TABLE 2: SR-56 PROGRAM FOR ANALYSIS OF PASSIVE LOW-PASS FILTER

LOC	KEY	LOC	KEY	LOC	KEY	LOC	KEY
00	X	30	7	60	=	90	PROD
01	π	31	5	61	LOG	91	9
02	X	32	SUBR	62	X	92	RTN
03	2	33	8	63	1	93	x^2
04	=	34	1	64	0	94	+
05	SUM	35	RCL	65	=	95	RCL
06	0	36	6	66	R/S	96	9
07	RCL	37	INV	67	CLR	97	x^2
08	1	38	SUM	68	STO	98	=
09	1/x	39	8	69	8	99	RTN
10	SUM	40	X	70	STO		
11	8	41	2	71	9		
12	RCL	42	+	72	RCL		
13	2	43	RCL	73	7		
14	SUBR	44	8	74	RST		
15	7	45	=	75	X		
16	5	46	SUBR	76	RCL		
17	RCL	47	9	77	0		
18	3	48	3	78	=		
19	SUBR	49	1/x	79	SUM		
20	7	50	X	80	9		
21	5	51	/	81	RCL		
22	RCL	52	RCL	82	8		
23	4	53	8	83	SUBR		
24	SUBR	54	SUBR	84	9		
25	7	55	9	85	3		
26	5	56	3	86	1/x		
27	RCL	57	+/-	87	PROD		
28	5	58	+	88	8		
29	SUBR	59	1	89	+/-		

REGISTERS	
0	$2\pi f$
1	R_1
2	C_2
3	L_3
4	C_4
5	L_5
6	R_6
7	Δf
8	temporary
9	temporary

STEP	PROCEDURE	ENTER	PRESS	DISPLAY
1	enter program, initialize	CLR	CMS RST	
2	enter data	R_1 STO	1	
		C_2 STO	2	
		L_3 STO	3	
		C_4 STO	4	
		L_5 STO	5	
		R_6 STO	6	
		Δf STO	7	
3	enter initial frequency	f_1 R/S		A (f_1)
4	continue	R/S		A ($f_1 + \Delta f$)
		R/S	+	A ($f_1 + 2\Delta f$)

Note: For single-frequency analysis, press CLR, STO 0, STO 8, STO 9; enter the frequency, press RST, R/S.

LEDs work well with an ac line in New Zealand

The controversy continues over light-emitting diodes and whether or not you can hook them up to an ac line. Remember? Alan Miller said you could [*Electronics*, June 10, p.132] and Elliott Simons and Nathan Weiner said you could not [*Electronics*, July 22, p. 124, and Aug. 19, p.114]. Now Robert J. Hall and Malcolm Dean of Medical Teletronics Ltd., Auckland, New Zealand, are saying they do it all the time—in display signs, warning lamps, and **various other equipment that has been operating continuously for over a year with a single LED failure.** “We have made up 7-by-5-dot-matrix pc boards and put between 1 and 35 LEDs in series across the line,” they say.

In New Zealand, where the power mains are 230 volts rms at 50 hertz, they use a 0.22-microfarad, 630-v $\pm 10\%$ polycarbonate capacitor and a 680-ohm $\frac{1}{4}$ -watt carbon-film resistor in series with the LEDs, plus a 100-v 1-ampere silicon junction diode connected in parallel across the LEDs, but with reverse polarity. For the 110-v, 60-HZ line used in the U.S., they recommend the same resistor and diode values and connections, but a 0.18- μ F, 325-v polycarbonate series capacitor.

The clean approach to counting complex waveforms

Getting inconsistent frequency readings on your counter when measuring complex waveforms? You can eliminate the guesswork if you have an oscilloscope with a sweep output terminal. Feed the signal into the vertical input of the scope and connect the counter to the sweep output. Use the scope's internal triggering mode, so that less than a complete period is displayed, because then **the time-base frequency or period between trigger pulses is equal to that of the input signal.** And the sweep output waveform is a neatly countable ramp.

Glass doubles the life of IC masks

If you'd like to knock down the costs of IC fabrication, you could do worse than check into the results of some joint experiments conducted recently by Corning Glass Works and Hewlett-Packard. They compared contact-printed photomasks made of three types of glasses: soda-lime, alumina soda-lime, and alumina borosilicate. The results, reported at the recent Optical Instrumentation Engineers Conference in San Diego, showed that the last one makes an excellent starting material. It doubles the life of the mask and **substantially increases mask yields, especially during multi-layer fabrication,** a critical part of the process.

Build your own expanded-scale voltmeter for free

If you're a collector of spare parts, then you probably already have on hand **the two components—a three-terminal IC voltage regulator and a conventional analog meter—needed to build an inexpensive expanded-scale voltmeter.** Just connect the meter across the input and output terminals of the regulator, and you have your voltmeter, says John Okolowicz, who is with the Process Control division of Honeywell Inc., Fort Washington, Pa. But you have to scale the reading, cautions Okolowicz, because the regulator produces an accurate well-regulated reference voltage only if its input voltage is at least 2 volts higher than the output voltage.

Laurence Altman

AO

If this is all you're seeing,

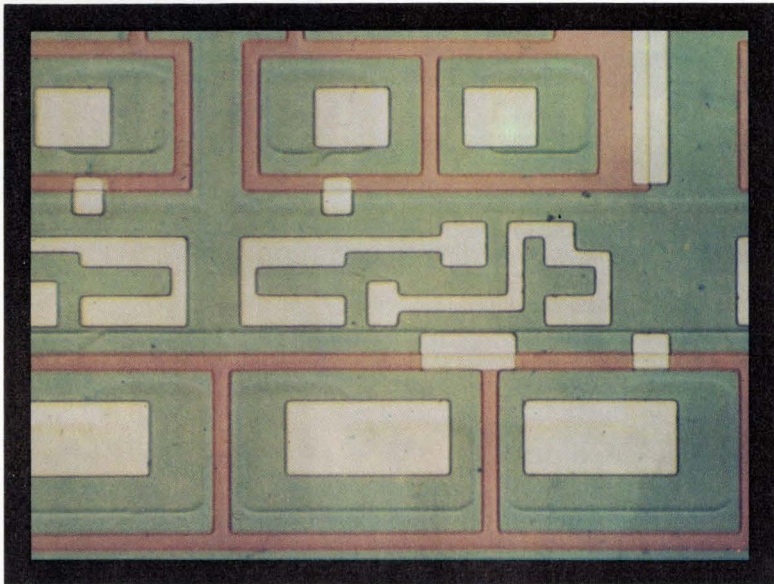

this is what you're missing

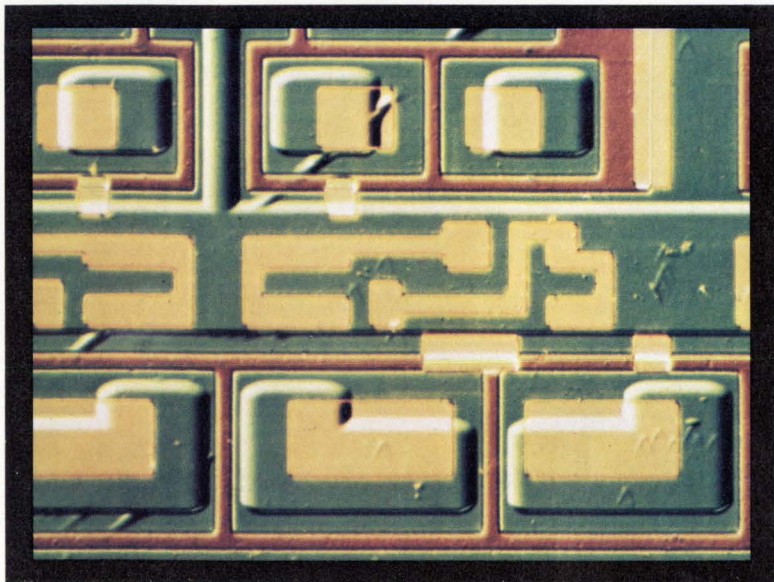

The AO® DICV Differential Interference Contrast Microscope makes the big difference.

With a standard brightfield microscope you see only what is shown in the top sample.

Now look at the bottom sample. The AO DICV Microscope can help you see surface irregularities, inclusions and faults long before final testing. Long before you have invested more production time and money in a circuit or component that is defective.

By using incident light, after Nomarski, the AO DICV Microscope reveals significant detail in outstanding relief through vivid contrast enhancement.

So, if missing detail is costing you money, you can't afford to overlook the AO DICV Microscope. For details or a demonstration see your AO Dealer or write American Optical, Scientific Instrument Division, Buffalo, NY 14215.

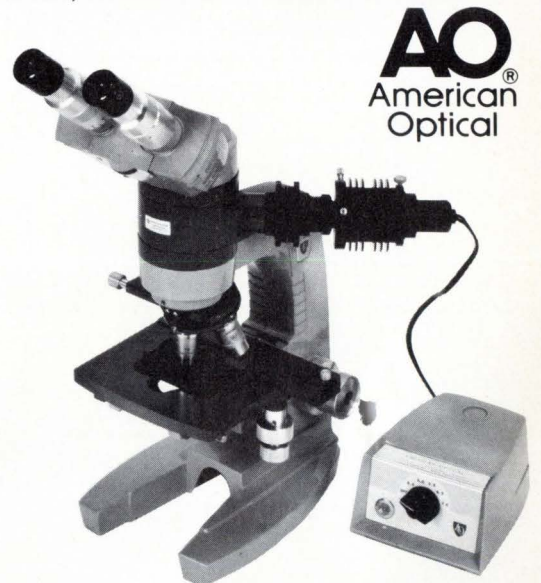

AO
American
Optical

Some of these components will probably

SNAP-ACTION V3, 5M AND 5X SWITCHES PROVIDE HIGH RELIABILITY AND ARE CAPABLE OF HANDLING HIGH OR LOW ENERGY CIRCUITS; PROVIDE OUTSTANDING PERFORMANCE FOR SELECTION, TIMING AND DISPENSING FUNCTIONS IN VENDING MACHINES.

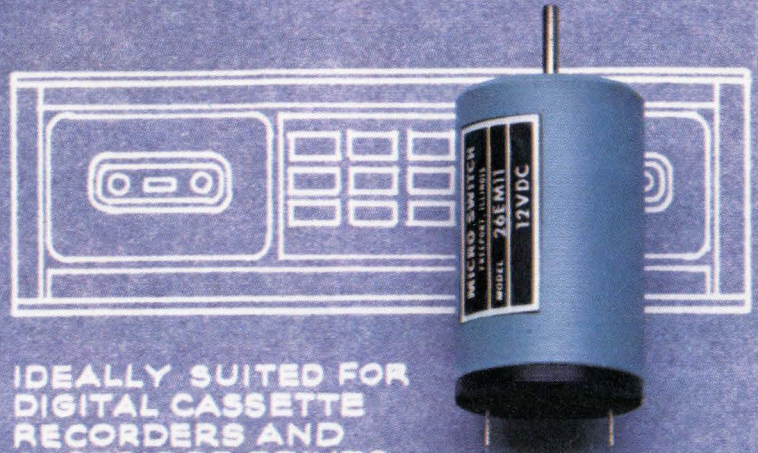

IDEALLY SUITED FOR DIGITAL CASSETTE RECORDERS AND CARTRIDGE DRIVES, THE 26 EM MOTOR USES A HOLLOW ROTOR TO PROVIDE THE LOWEST POSSIBLE ROTOR MASS, RESULTING IN VERY LOW INERTIA. DIRECTLY INTERCHANGEABLE WITH MOTORS MADE OUTSIDE USA.

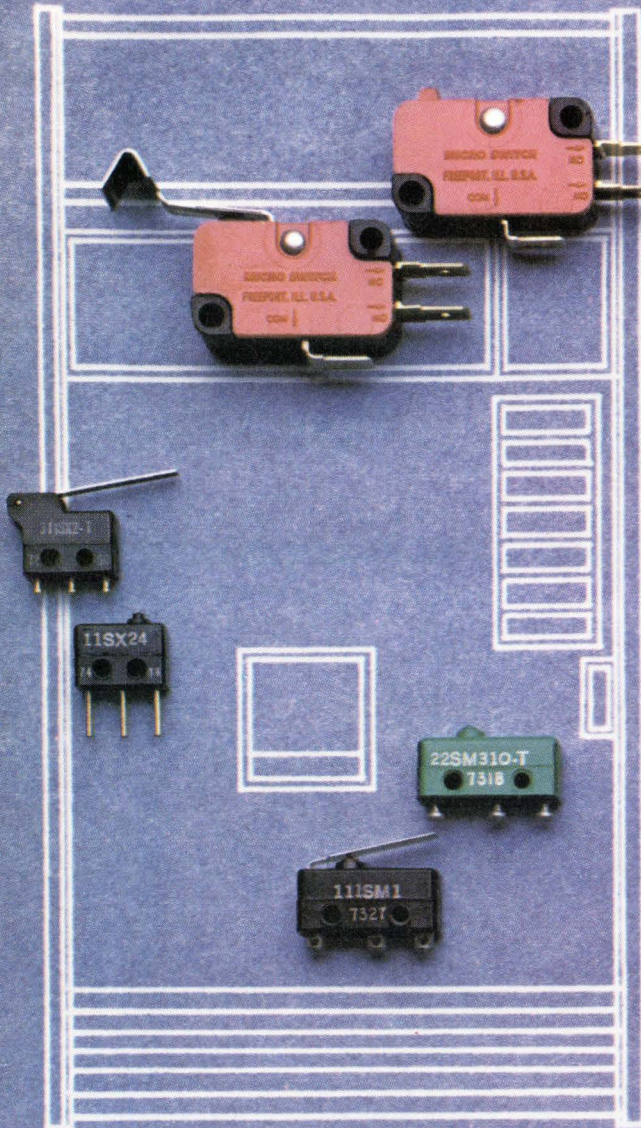

MINIATURE SERIES 8 SWITCHES PROVIDE THE ATTRACTIVE APPEARANCE, SMALL SIZE AND RELIABILITY NEEDED FOR HAND-HELD DIGITAL TIMERS. OFFER A WIDE VARIETY OF OPERATORS INCLUDING TOGGLES, PADDLES, PUSHBUTTONS, LIGHTED AND UN-LIGHTED ROCKERS.

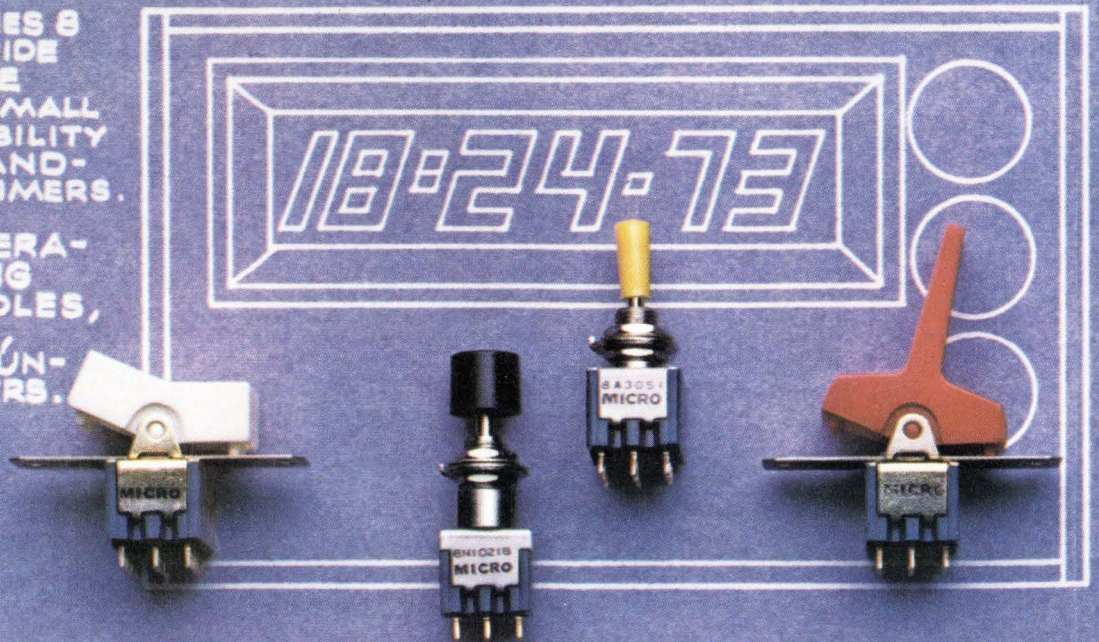

never wear out. The others will just come close.

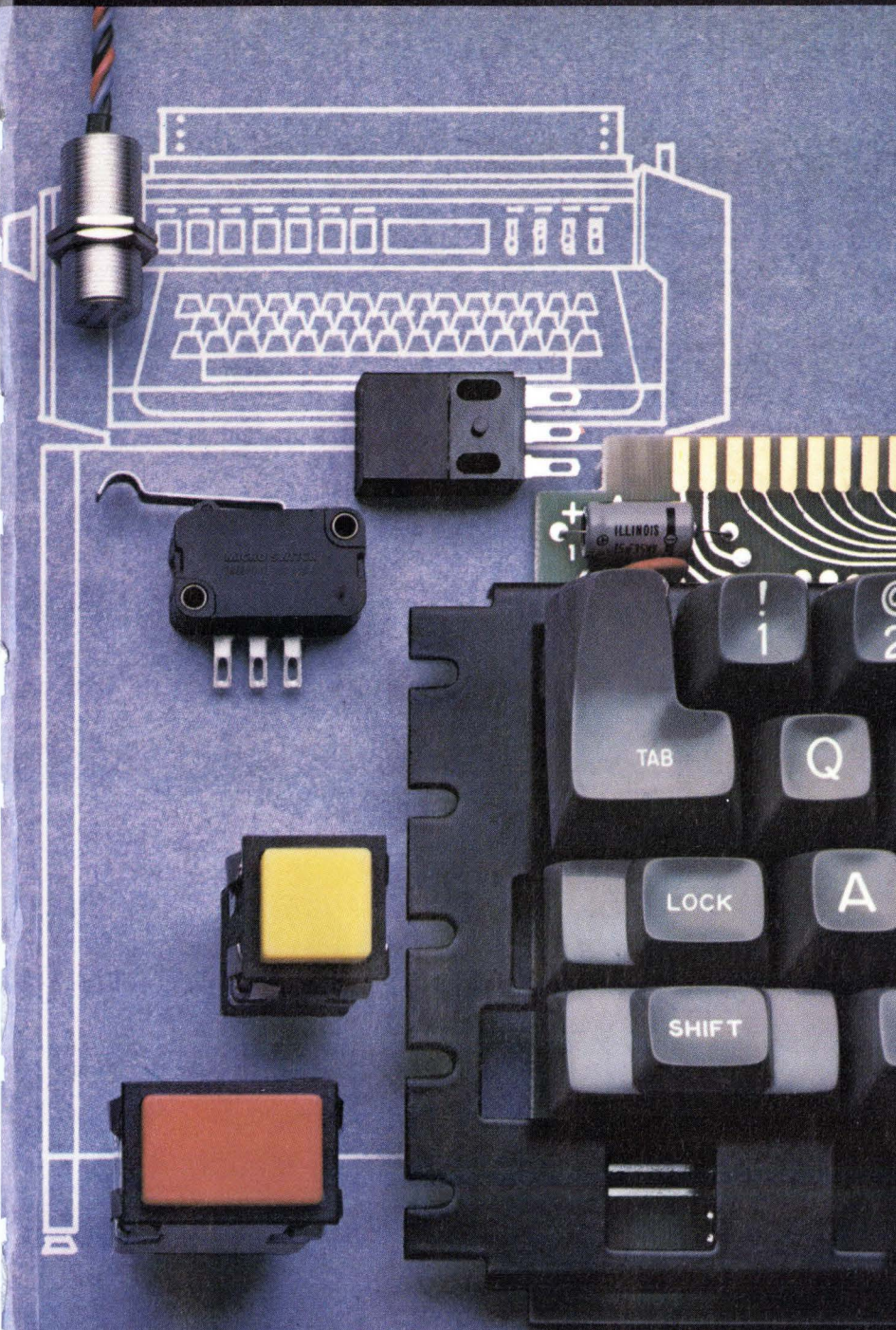

MICRO SWITCH COMPONENTS ARE IDEALLY SUITED FOR APPLICATIONS LIKE THIS PRINTER AND OTHER COMPUTER PERIPHERAL EQUIPMENT. FOR INSTANCE, THE SD KEYBOARD OFFERING HIGH RELIABILITY, LOW PROFILE AND LOW COST; THE AML LIGHTED PUSHBUTTONS, FEATURING QUALITY APPEARANCE AT A LOW COST, ELECTRICAL FLEXIBILITY, INCLUDING SOLID STATE VERSIONS; PLUS A COMPLETE LINE OF SOLID STATE POSITION SENSORS OFFERING ALMOST INFINITE LIFE AND COMPATIBILITY WITH COMPUTER LOGIC.

The solid state keyboard, AML lighted pushbuttons and solid state position sensors you see here will probably never wear out. Because they're all solid state.

Each is based on a Hall effect integrated circuit. A circuit that's been tested through billions of operations without failing. Even once. And proven by performance in a variety of applications. The other components you see here come close. Simply because of the way they're designed and put together.

Like the long-life versions of our snap-action V3, SM and SX precision switches. Available in a wide variety of sizes, electrical capabilities and ratings, terminals, actuators, contact forms and operating characteristics—they've been tested to a mechanical life of over 10,000,000 operations.

Or the Series 8 miniature manual switches. Designed with epoxy-sealed terminals on most versions for extra reliability. And offered with virtually any operator you might need. Plus terminals that include solder, quick-connect, printed circuit or wire-wrap.

The same standards of quality and product flexibility go into the 26EM DC motor. It's a miniature motor designed with low inertia operational characteristics. And just one of a line that ranges up to the 500VM, a motor capable of accelerating to 4000 RPM and stopping over 1000 times per second.

If you'd like more information on any of these components, contact your nearest MICRO SWITCH Branch Office or Authorized Distributor.

And find out how you can get a component that goes on forever. Or at least comes very, very close.

MICRO SWITCH

FREEPORT, ILLINOIS 61032

A DIVISION OF HONEYWELL

MICRO SWITCH products are available worldwide through Honeywell International.

Circle 137 for Data.

CHAMP mass-termination connectors
you can use anywhere with low power.
Affordable technology
from AMP.





A complete connector terminated at one stroke—
that's mass-termination. Fast. Reliable. Low cost.
That's AMP.

CHAMP connectors handle unstripped solid and stranded wire, multi-conductor cable, even woven and laminated cable without costly wire preparation. They're especially useful for cable-to-cable, cable-to-panel and cable-to-printed circuit board connector applications. And are available in 14, 24, 36, 50 and 64 positions, with a broad variety of mounting accessories.

With all this versatility, you'll find CHAMP connectors at work in a wide range of equipment such as instrumentation, test equipment and business machines.

So come to AMP, the Company which believes professional engineers deserve support. We will work with you from the laboratory to your production line. At AMP, our goal is to make sure you get the most from our products—and from yours.

For more information on CHAMP mass-termination connectors, just call Customer Service at (717) 564-0100. Or write AMP Incorporated, Harrisburg, PA 17105.

AMP
INCORPORATED

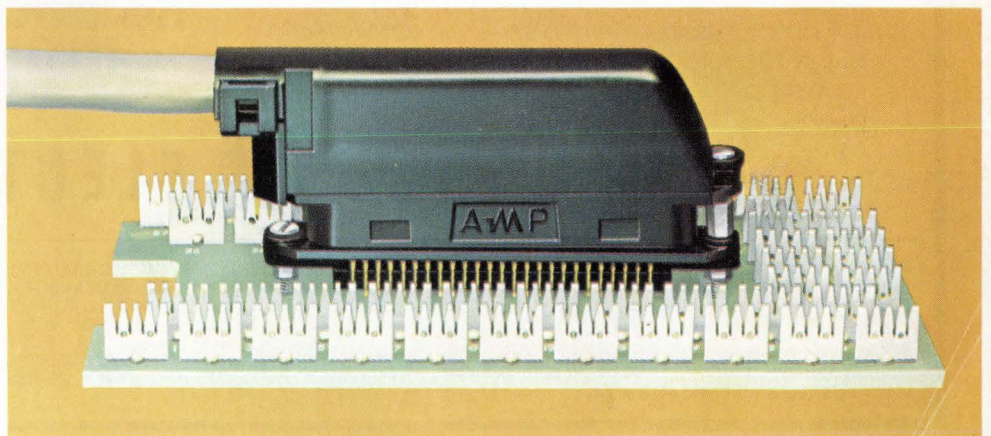
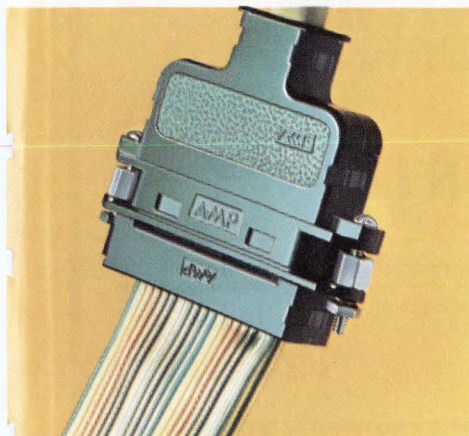
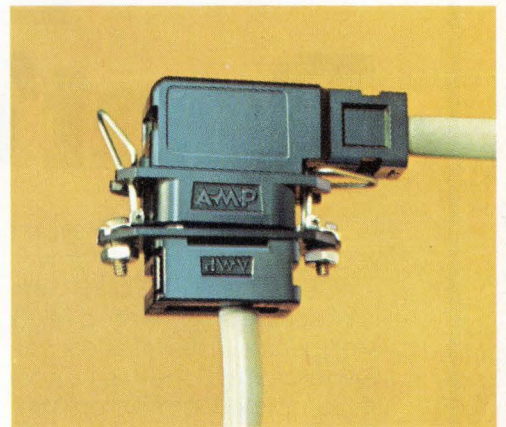
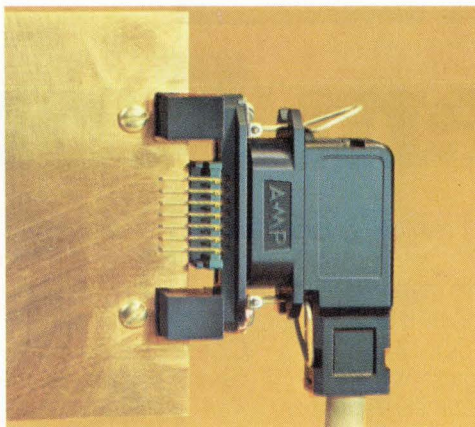
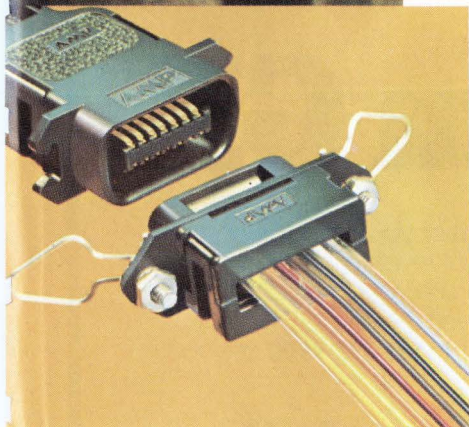

You Don't Have To Beg, Borrow Or Buy...

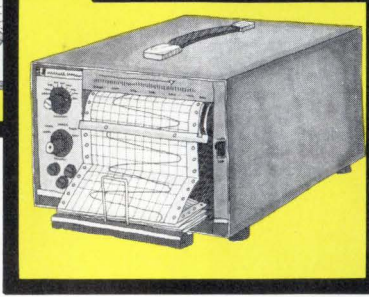
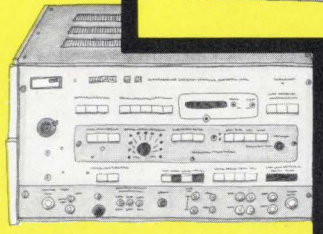
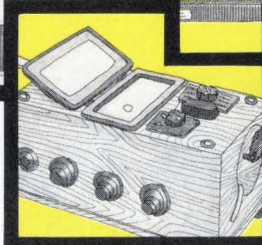
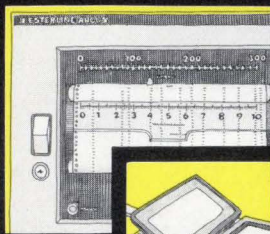
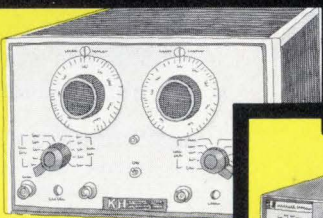
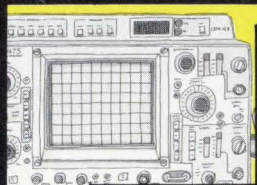
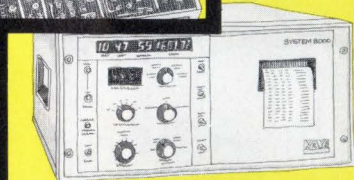
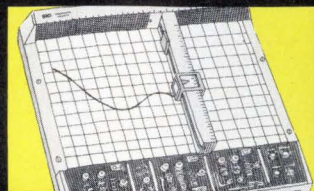

Rent'em From GE

Short or long-term instrument rentals give you flexibility and economy.

GE has over 9,000 instruments available for immediate shipment: □ Tek Scopes □ Biddle Megger Insulation Testers □ H-P Signal Generators □ Honeywell Oscillographs □ Complete Data Systems □ Esterline Angus Recorders □ GE Chart Recorders □ Modems □ Communication Terminals . . . all calibrated to the manufacturer's specs.

We have over 100 Sales/Service Centers,

and one of them is near you. In addition to maintaining our Rental Inventory, they can also repair and calibrate your own equipment.

Don't borrow someone else's GE Rental Catalog. **Call collect (518) 372-9900** or your nearest Sales/Service Center.

**Quick-rental[®]
instruments**

GENERAL  **ELECTRIC**

ALA. BIRMINGHAM (205) 925-3101 • **ARIZ.** PHOENIX (602) 278-8515 or 8516, TUSCON (602) 294-3139 • **CAL.** LOS ANGELES (213) 674-7900, SAN FRANCISCO (415) 436-9260 • **COL.** DENVER (303) 371-1260 • **CONN.** SOUTHWINGTON (203) 261-4059 • **FLA.** JACKSONVILLE (904) 751-0610 • **GA.** ATLANTA (404) 458-2231 • **ILL.** CHICAGO (219) 933-4500 • **IND.** INDIANAPOLIS (317) 639-1565 • **KY.** LOUISVILLE (502) 452-3311 • **LA.** NEW ORLEANS (504) 367-6528 • **MD.** BALTIMORE (301) 837-4500 • **MASS.** BOSTON (617) 396-9600 Ext. 160, SPRINGFIELD (413) 781-1111 • **MICH.** DETROIT (313) 285-6700 Ext. 212 or 209 • **MINN.** MINNEAPOLIS (612) 522-4396 • **MO.** KANSAS CITY (816) 231-4377, ST. LOUIS (314) 342-7835 • **N.J.** CLIFTON (201) 471-6556 • **N.Y.** BUFFALO (716) 876-1200, SCHENECTADY (518) 385-2195 • **N.Y.C.** CLIFTON, N.J. (201) 471-6556 • **N.C.** CHARLOTTE (704) 525-0311 • **OH.** CINCINNATI (513) 874-8512, CLEVELAND (216) 523-6382, TOLEDO (419) 691-3501 • **OR.** PORTLAND (503) 221-5101 • **PA.** PHILADELPHIA (609) 424-4450, PITTSBURGH (412) 462-7400 • **TEX.** DALLAS (214) 357-7341, HOUSTON (713) 672-3569 • **VA.** RICHMOND (804) 232-6733 • **WASH.** SEATTLE (206) 854-0211 • **W.V.** CHARLESTON (304) 346-9421 • **WISC.** MILWAUKEE (414) 744-0110 • **PUERTO RICO** PONCE (809) 843-4225.

Microcomputer gets analog I/O card

Input/output interface plugs into card cage of 80/10 one-board system for process control, laboratory experiments, other applications

by Lawrence Curran, Boston bureau manager

Users of microcomputer systems are often more at home in the digital than the analog world. However, planners at Analog Devices Inc. estimate that fully 40% of those who work with Intel Corp.'s widely used SBC-80/10 single-board microcomputer require analog interfacing for applications ranging from process control to laboratory experimentation. That's why Analog Devices engineers have designed the RTI-1200 real-time analog input/output subsystem for the SBC-80/10. The RTI-1200, which plugs directly into the microcomputer's card cage, is the first in a family of such analog interface units for microcomputers.

The data-acquisition section includes a complementary-MOS multiplexer, a programmable-gain amplifier, a sample-and-hold amplifier, and a 12-bit analog-to-digital converter. The basic version provides either 16 single-ended or 8 differential analog inputs, and an on-board expander option is available to double the number of input channels. Two optional general-purpose logic drivers in the output section can also be accessed through software to convert 12-bit digital data into analog command signals to actuate recorders or servos, for example.

The subsystem, by means of its memory-mapped I/O feature, appears to the microcomputer as a set of memory locations. James D. Fishbeck, marketing manager, says this is important because it allows use of all the microinstructions in the 80/10's memory with the RTI-1200. It also permits all data and command signals going into the 1200 to be done with write com-

mands, and all data output can be accomplished with read instructions. For example, a 12-bit a-d conversion command can't normally be implemented with one 8-bit-byte instruction, but the 8080 comes with an instruction that allows two bytes to be read with a single instruction, and the RTI-1200 takes full advantage of this to speed throughput, according to the company.

In addition to the two general-purpose logic drivers, other features that Fishbeck says are novel in the RTI-1200 are its real-time clock system, a 5-volt reference signal brought out from the board for testing or calibration, a dc-to-dc power converter, and a built-in socket for a programmable read-only memory that either expands the microcomputer's program storage or can accommodate subroutines unique to the RTI-1300 if the user wants more than one analog-interface subsystem to work with the microcomputer.

The real-time clock system pro-

vides for two clocks that can precisely trigger action at a predetermined time after some real-time event. For example, the system could signal a computer interrupt to increment the counter and ultimately trigger the opening or closing of a valve in a process-control system.

The dc-to-dc power conversion is an option that derives a ± 15 -v signal from the microcomputer's basic 5-v supply, allowing the RTI-1200 to be run off the microcomputer's supply. There's also an overvoltage-protection network of diodes and fusible resistors in the analog-input section that allows the unit to tolerate as much as 28 v continuously. If that level is exceeded, the replaceable resistors will blow to protect the board up to about line voltage.

The basic RTI-1200 board sells for \$629, depending on options.

Analog Devices Inc., P.O. Box 280, Route 1 Industrial Park, Norwood, Mass. 02062. Phone Lowell Wickersham at (617) 329-4700 [338]

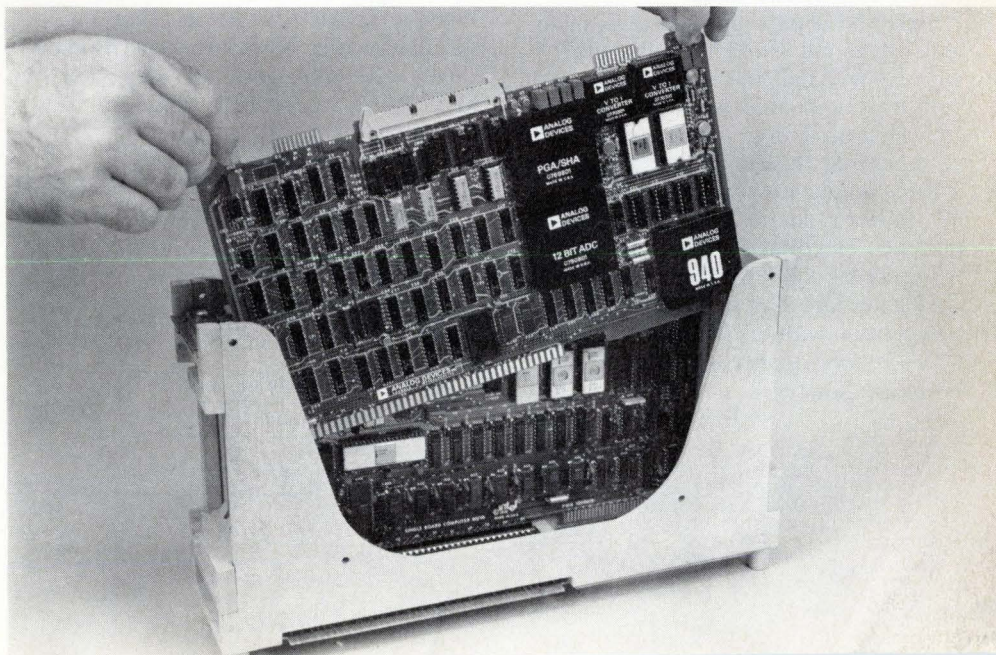

Super speed, low power, double density

Faster, RAMs.

22 pin dynamic 8K 150ns RAM.

Go from 4K to 8K, and faster, without a major redesign. Our brand new 7008 offers 8192 bits of Silicon Gate NMOS random access memory as a direct plug-in enhancement/replacement in popular 4K RAM sockets. No major redesign. Pin 16, unused in 4K, becomes the extra address line you need with 8K. Still directly TTL compatible on all inputs except Clock, with three-state data output, standard $\pm 5V$, +12V power supplies, and low 500mW power. Every advantage offered by our 7280, 4K RAMs, with twice the density at the same power. And faster. How about that?

A major enhancement at a fraction of the cost.

If you're building a high speed 4K memory system and would like twice the capacity with only minor modification of your existing boards, we've got it. The 7008 lets you double your memory, using your existing 4K designs and boards, without adding extra power. With its 50% power reduction, the 7008 features twice the bit count for the same power, twice the bit count for the same space. And super fast. Get a leg up on the competition with the high density, super fast, top performance 8K RAM. From us. Now!

22 pin static 2K 60ns RAM with $10\mu W/\text{bit}$ standby power.

Twice the density of our popular 7001 and even lower standby power dissipation. The lowest around. Our new 7003 is 2048 bits of static Silicon Gate NMOS RAM in 22 pin dual in line ceramic package. At $10\mu W/\text{bit}$ standby power dissipation, it's the coolest device in its class.

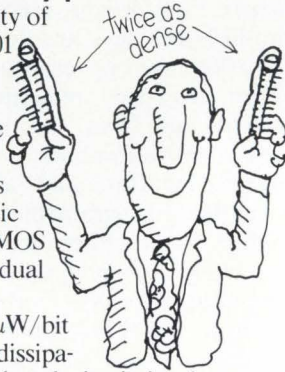

Bipolar Statics look sick by comparison.

When a bipolar even comes close in speed, its power dissipation heats up like Death Valley in August. And even other MOS RAMs swelter by comparison.

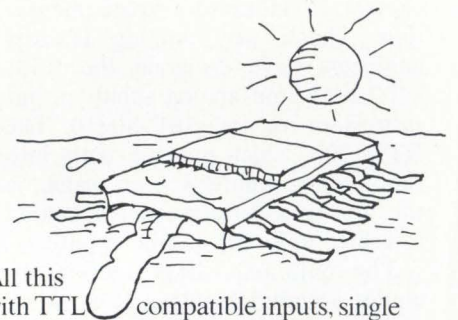
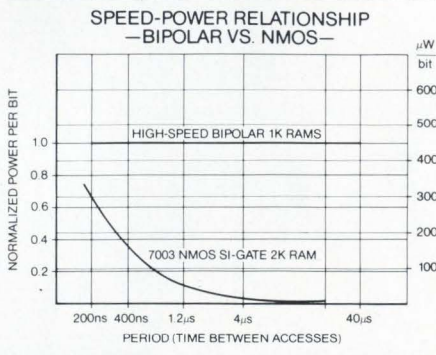

All this with TTL compatible inputs, single MOS clock (Capacitive), differential outputs. No refresh required; data retention by charge pumping, and that's included in the standby power (see chart). The savings in system power consumption are phenomenal. Not to forget that the double density of the 7003, 22 pin dual in line saves a bunch of real estate.

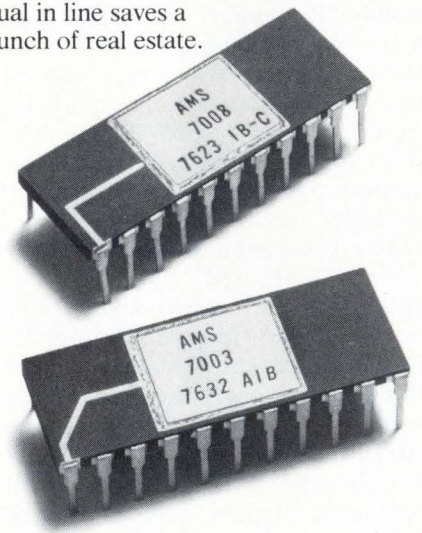

in 22 pins. Dynamic 8K 150 Nsec.

denser Now!

We're producing.

Both of our new high density RAMs are immediately available, backed by the full production facilities of Advanced Memory Systems, one of the largest RAM producers in the world. We've already shipped more than fifteen million RAMs and our pace is accelerating.

Every popular RAM in use today.

If you're building memory systems, we have the RAMs you need. 1K, 2K, 4K and 8K in production now. Among our RAMs, you'll find the fastest and coolest, or fastest and densest, or even some which are slower and smaller where economy outranks speed. In 16, 18 and 22 pin dual in line ceramic packages. Some in plastic.



Multiplexed. Static or dynamic. Silicon Gate NMOS RAMs. Industry firsts, standards and second sources. If you're into RAMs, look into Advanced Memory Systems.

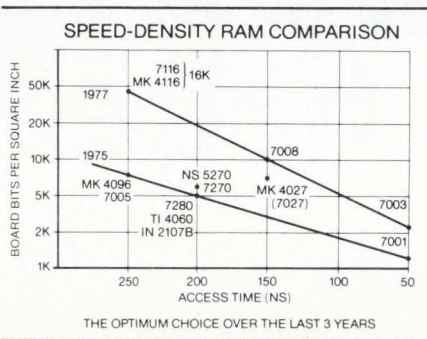

No bad memories.

We're closer to that goal than any other supplier. Our current rate is a whopping 0.01%/1000 hours. It comes from experience. With over fifteen million RAMs shipped to date, we've earned our reputation for RAM reliability.

Our systems helped.

Our expertise in RAMs derives naturally from the fact that we're the largest independent memory systems producer in the world. No other RAM supplier can touch our systems experience. Testing alone is a science in its own right, and we have perfected it. The benefits? Advanced technology. Advanced components. Device performance. Production. Testing. And above all, systematic thinking.

Information is free.

Write or call collect for immediate requirements. And ask for our complete RAM Roster, and our article, "RAM Cost Analysis," a complete, systematic review of all cost elements in building RAM memories. It's the definitive work on the subject. Advanced Memory Systems, 1275 Hammerwood Avenue, Sunnyvale, California 94086. (408) 734-4330. Ask for Semiconductor Marketing.

Advanced Memory Systems
1275 Hammerwood Avenue
Sunnyvale, California 94086

Send me your RAM Cost Analysis, the definitive analysis of all elements of cost in building RAM memories.

Name _____
Title _____
Company _____
Street _____
City _____
State/Zip _____

AMS Advanced Memory Systems.
Memories with a future.

Designing passive filters?

Here
comes
help



LOWER COST—Our new Filter-Rated™ ferrites are designed with a positive temperature coefficient that matches the negative TC of inexpensive polystyrene capacitors. You get improved temperature stability without paying “improved” prices for capacitors.

SMALLER SIZE—Your passive filter not only stays flat—it stays small because our Filter-Rated cores are manufactured specifically for this application and give you the inductance you need in a smaller package.

BETTER SPECS—Our new design guide shows you how our FR10000 series components will help you tighten up filter specs while you tighten up costs. The Bingo Card gets you a copy. If you're in a hurry or have a specific design problem, just call Application Engineering—(201) 826-5100 or write Indiana General, Keasbey, New Jersey 08832.

EMM indiana general
a division of Electronic Memories & Magnetics Corp.
Keasbey, N.J. 08832 • (201) 826-5100

New products

Semiconductors

Linear-IC voltages zoom

Nine families of regulators, interface circuits to have improved breakdown ratings

It takes larger and larger voltages to destroy linear integrated circuits these days. Over the next few months, Signetics Corp. will introduce as many as nine separate bipolar families of voltage regulators and interface circuits with improved breakdown-voltage ratings.

Being announced now is the 78HV00 family of 1-ampere, three-terminal positive voltage regulators with guaranteed minimum input breakdowns of 60 volts. According to Lew Johnson, general manager of linear/analog products, soon to follow will be 60-v breakdown versions of the industry-standard 7900 series of negative voltage regulators as well as the 78MG series of adjustable regulators.

Also in the works, he says, are the UDN 5711/12/13/14 series of dual peripheral drivers with guaranteed minimum breakdowns of 80 v as well as a 90-v-breakdown version of the NE541 power driver and 100-v models of the NE584/585 gas-discharge-display segment and digit drivers.

To achieve high-voltage performance, says Johnson, Signetics uses a special linear bipolar process that employs a thick sloped oxide on each transistor structure, eliminating the traditional "stair-step" profile usually associated with linear bipolar devices. By varying the slope of the transistor profile, he says, breakdown voltages can be varied, depending on the particular constraints of each device family, from a guaranteed minimum of 60 v up to about 110 to 125 v. Work is also under way, he says, to boost the minimum breakdowns to about 150 v by ion-implantation techniques without any

other substantial changes in processing.

In the 78HV00, 79HV00 and 79MG voltage-regulator families, says Jim Wyland, industrial products marketing manager, the combination of 60-to-100-v breakdowns with thermal shutdown and output transistor safe-area compensation provides "virtual destructibility in standard circuit applications." The higher ratings, he says, improve a system's reliability, permitting it to handle large transients and ac line fluctuations without damage. With adequate heat-sinking, output current is typically in excess of the specified 1-ampere rating. Unlike present devices, no external components are required, he says, in standard regulator applications. Units in the 78HV00 line are available with output voltage ratings of 5, 6, 12, 15, 18 and 24 v in either TO-220 or TO-3 packages.

The UDN5711 series of dual peripheral drivers is designed for applications where breakdown voltage must be higher than that provided by the industry-standard 75451 series. The pinout is similar to that of the 75451 through 75454 devices. The new series features 80-v breakdown

in the off state as well as high current, about 300 milliamperes per driver, in the on state.

The NE541 is a monolithic class AB power amplifier designed specifically to drive a pair of complementary output transistors. Supply voltage is ± 42 v, current gain 70 to 90 decibels. Gain variation over temperature with 40-dB gain is ± 0.1 dB. Frequency response at 40-dB gain, ± 1 dB, is 100 kilohertz.

Typical price on the high-voltage regulators is \$1.56 in quantities of 100 to 999 for the 78HVO5CU (rated for 5 v and housed in a TO-220 package) and \$2.26 for a 178HV24CDA (rated for 24 v in a TO-3 package).

Signetics, 811 E. Arques Ave., Sunnyvale, Calif. 94086 [411]

Schottky barrier diodes
sell for 45 cents

The low forward-voltage drop of a Schottky barrier diode makes the device an excellent replacement for a germanium pn junction diode in many general-purpose switching applications, provided that its cost is

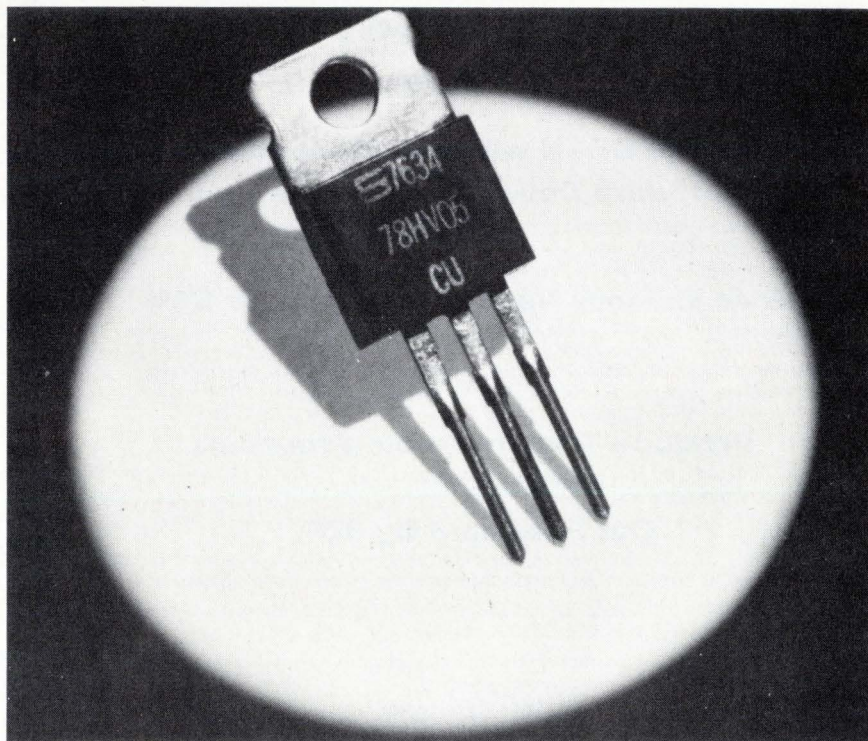

sealed high density miniature switching

for 12 PDT to 108 PDT with MIL-R-5757 protection against humidity ... sand ... dust ... moisture ... corrosion ... splash ... explosion ... built to withstand shock/vibration!

HERMETICALLY SEALED

Tbar[®]
SERIES
881/981
RELAYS

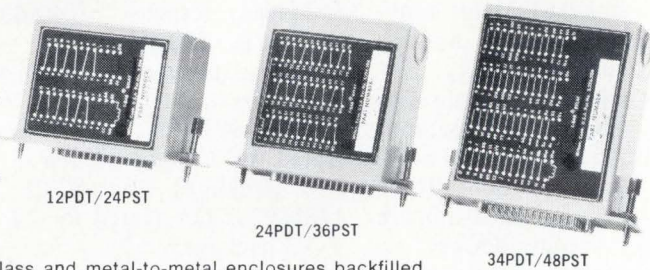

12PDT/24PST

24PDT/36PST

34PDT/48PST

Hermetically sealed glass and metal-to-metal enclosures backfilled for ground support and selected airborne applications. Mates with MS connectors. Pulse operated magnetic latching available. 48 circuits switched in a space as small as 1 3/4" x 4 3/8" x 4 7/8".

Interested? Write or phone T-Bar today for complete facts, prices, quantity discounts.

Tbar[®] INCORPORATED

SWITCHING COMPONENTS DIVISION

141 Danbury Road, Wilton, CT 06897 • Telephone: 203/762-8351 • TWX: 710/479-3216
Circle 146 on reader service card

microFORTH[®] The High-Level Language For Microprocessor Development Systems

**microFORTH will Simultaneously:
Slash Software Development Time Up to 90%**

Users find that software development time is cut from three to ten times. Save important development time and money beginning today! Write for results of a recently completed study.

Slash Memory Requirements Up to 90%

On development systems — microFORTH's operating system provides powerful interactive high-level capabilities and runs independently of any other system in less than 8K plus diskette. Compare with Intel's PLM, requiring 64K plus diskette!

In production systems — microFORTH produces programs 50% smaller than assembler code, 60-90% smaller than PLM or other high-level languages!

Produce Transportable Programs

High-level microFORTH is processor independent! This gives you a new flexibility in choosing microprocessors; you can change later without extensive re-programming.

Cut Run Time By 60%

microFORTH runs several times faster than other high-level languages. This speed difference can be critical in your present or future microcomputer applications.

The microFORTH software price including Primer, Technical Manual and telephone Hot Line consultation is \$1,000.00 plus options.

For further information on microFORTH and applications, call or write:

FORTH inc.

815 Manhattan Ave., Manhattan Beach, CA 90266 (213) 372-8493

New products

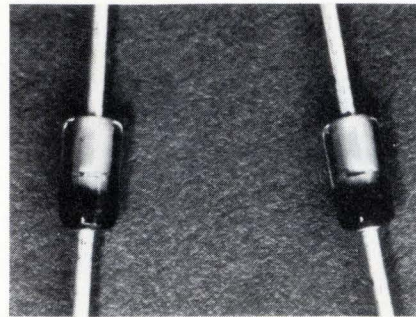

kept low enough. At 45 cents each in lots of 1,000, the HSCH-1001 is expected to meet this criterion.

The diode has a maximum effective carrier lifetime of 100 picoseconds and a maximum forward-voltage drop, at 1 milliampere, of 410 millivolts. Forward current is at least 15 mA at 1 v, and leakage current is less than 200 nanoamperes at a reverse voltage of 50 v.

The HSCH-1001 is housed in a rugged, hermetic package that meets JEDEC outline DO-35 and is well suited for use in automatic insertion equipment. Its leads can survive a 10-pound pull. In small quantities, the diode sells for 80 cents.

Inquiries Manager, Hewlett-Packard Co., 1501 Page Mill Rd., Palo Alto, Calif. 94304 [413]

Multiplexed up counter
operates to 5 megahertz

The LS7030 is an eight-decade up counter that operates from dc to 5 megahertz. All counter outputs are latched, and data is available in multiplexed BCD and seven-segment formats. The multiplex scan counter is driven by an external clock or by an on-chip oscillator with a frequency that is determined by an external capacitor. Maximum multiplex frequency is 500 kilohertz.

The ion-implanted p-MOS device requires only one power supply. Its voltage should be between +5 v and +15 v dc. Housed in a 40-pin dual in-line package, the LS7030 sells for \$8.15 in hundreds.

LSI Computer Systems Inc., 22 Cain Dr., Plainview, N.Y. 11803. Phone (516) 293-3850 [416]

Counting without Controls

Fully automated 80 & 520 MHz performance

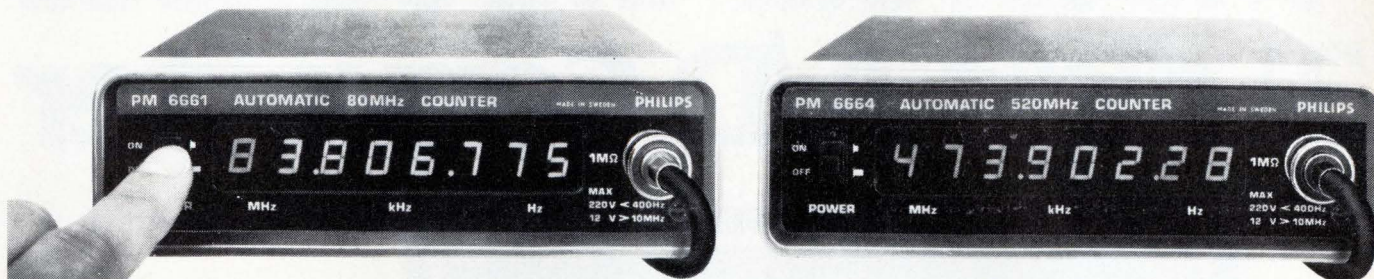

These frequency counters represent the ultimate in easy operation by having no controls, other than the on/off switch. Such simplicity is made possible by the use of advanced LSI circuitry, developed in house, which allows all control functions to be automated. The low power requirements of the Philips LSI LOC MOS circuitry also allows the instruments to be housed in a compact, rugged case without ventilation holes. Reliability in all operating environments

is therefore at the highest possible level.

- Automatic everything:
 - triggering, the input signal is conditioned to give optimum triggering
 - noise suppression, to avoid noise and other interference influencing the measurement
 - 80 or 520 MHz input selection (on model PM 6664)
 - leading zero suppression
- MHz, kHz and Hz grouped readout
- High 20 mV sensitivity

- High stability timebase
 - Lightweight, rugged case
 - Bright 8-digit LED display
- For more information in the United States:
400 Crossways Park Drive
Woodbury, New York 11797
(516) 921-8880
In Canada:
6 Leswyn Road
Toronto, Ontario Canada M6A1K2
(416) 789-7188

Utilize our toll free Hot Line number 800 645-3043. New York State residents, call (516) 921-8880 collect.



Test & Measuring Instruments

Philips Test & Measuring Instruments, Inc.
A NORTH AMERICAN PHILIPS COMPANY

Circle 147 for Information
Circle 203 for Demonstration

PHILIPS

MDB SYSTEMS presents... The LSI-11 Connection

GP Logic Modules · Peripheral Controllers · Communications · Interfaces · Special Purpose Modules · Accessory Hardware

Plus: DEC's own LSI-11 Microprocessor Module. MDB Systems products always equal and usually exceed the host manufacturer's specifications and performance for a similar interface. MDB interfaces are software and diagnostic transparent to the host computer. MDB products are competitively priced; delivery is usually within 14 days ARO or sooner.

Here are some MDB Systems connections to LSI-11 microprocessors:

- General Purpose Controllers:
 - Serial for TTY, displays, communications
 - Parallel for programmed I/O and DMA
 - Do-it-yourself dual and quad wirewrap for any

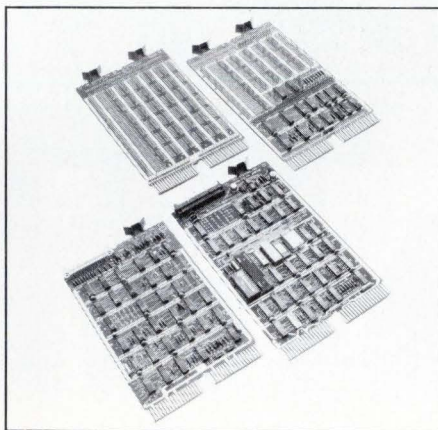

DIP design

- Device Controllers for most major manufacturer's
 - Printers
 - Card equipment
 - Paper tape equipment
 - Plotters
- Communications/Terminal Modules
 - Asynchronous Serial Line Interface
 - Synchronous Serial Line Interface

- MDB Backplane/Card Guide Assembly
 - MDB's is a *real* chassis, accepts eight quad modules
- Special Purpose Modules and Accessories
 - System monitoring unit provides front panel Switch addressing
 - Power on/off sequencing
 - Bus extenders/terminators
 - E-PROM and PROM modules
 - Bus connectors for backplane assemblies

Check first with MDB Systems for your LSI-11 interface requirements.

MDB also supplies interface modules for DEC PCP-11, Data General NOVA, and Interdata minicomputers.

MDB

MDB SYSTEMS, INC.

1995 N. Batavia St., Orange, California 92665
714/998-6900 TWX: 910-593-1339

Motorola introduces 3½ digit A/D Converter

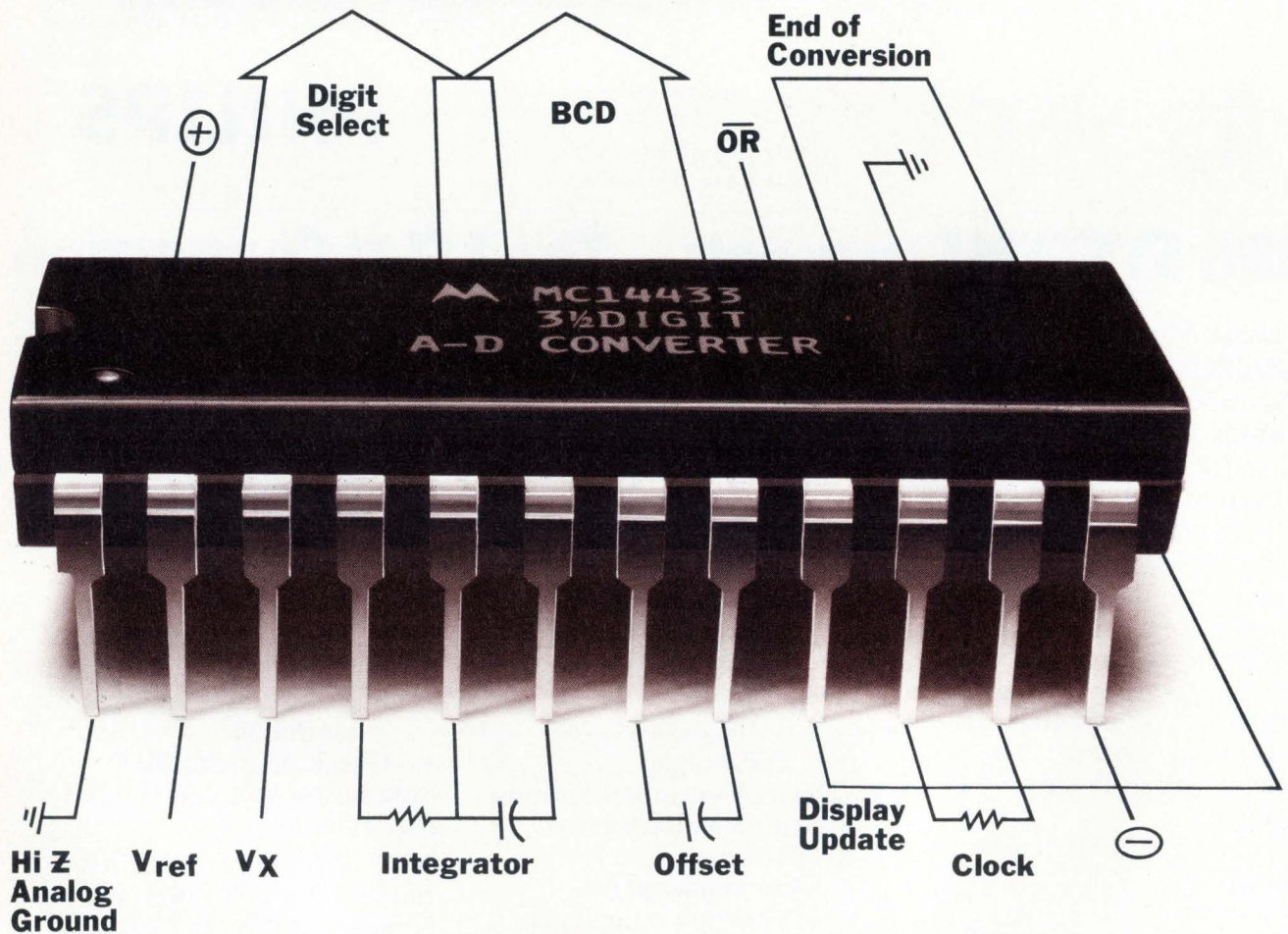
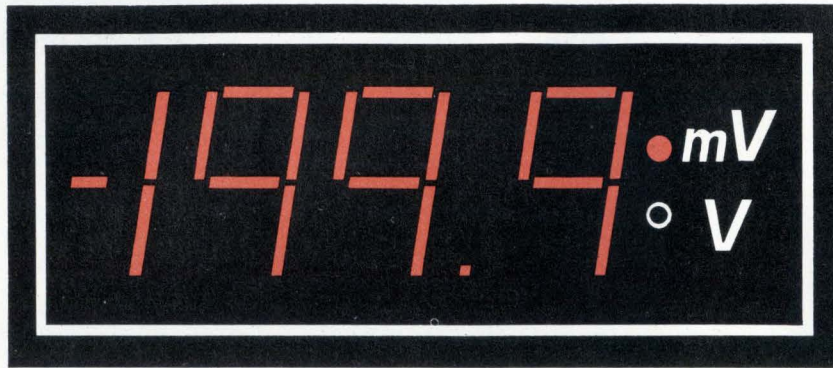

MOTOROLA

the single-chip that beats them all.

Two-chip A/D converter approaches were the beginning, but they were a bit primitive. Early single-chip A/D converters were a step in the right direction, as far as they went. Now it's time for something better. It's time for Motorola's full 3½ digit all-CMOS, single-chip A/D converter.

Who doesn't prefer 3½ digits to three in just about any low cost digital meter or A/D measuring system. For some, the additional low voltage range of the MC14433 is the big advantage. For others, it's the miserly power consumption of this LSI unit which combines Motorola's state-of-the-art CMOS linear and reliable CMOS digital on the same chip.

Get it all for under \$10.00

That combination of features in one device would have made the MC14433 a bargain at a much higher price. Happily, initial yield and output are so good we're introducing the MC14433P at \$9.97 in 100-999 quantities. And, look at the added savings you get from the requirement for just four inexpensive external passive components to make it work as a converter. You save on board layout and manufacturing, too.



	Motorola MC14433	Siliconix LD130	Siliconix LD110/111	Integrated Photomatrix MC904
No. Chips	1	1	2	1
No. Digits	3½	3	3½	3½
On Chip OSC	Yes	Yes	No	No
Low Voltage Range 200 mV (100 µV res.)	Yes	No	Yes	Yes
Power Supplies	2	2	3	2
External Passive Parts	4	3 + 1 JFET	7	10
No. References	1	1	1	2
Power mW	8	25	220	300
No. Pins	24	18	16/16	28
Control Signals	2	0	1	1

Of course the MC14433 has all the other features you'd expect and want: auto polarity, auto zero, single positive voltage reference, low cost power supply requirements, up to 25 conversions per second, overrange and under-range signals, versatile operation with LED, LCD, and gas discharge displays, and accuracy of $\pm 0.05\% \pm 1$ count.

Not the least of the MC14433's advantages is confidence. It rolls off the same lines as our high volume digital CMOS, so you know it's

going to be available when you need it. The special MC14433 data sheet has seven pages of applications information in addition to the usual data. Your copy is waiting. Just circle the reader service number or write to Motorola Semiconductor Products Inc., P.O. Box 20912, Phoenix, AZ 85036.

Order all the MC14433s you want right away. We've got plenty. Contact your favorite authorized Motorola distributor or your Motorola sales office.

Semiconductors

— CMOS reliability at its best

Bypass the middleman!

**Save more than 55%
with unsurpassed quality
and performance!**

Delivery from stock!



Deltron Slashes the Price of μ Processor Power Supplies

MPS-1: \$77

MPS-2: \$88

In any quantity!

Full one year
guarantee.
Designed for U.L.

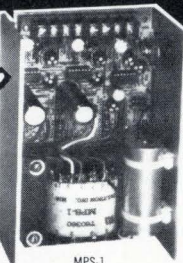

MPS-1

The MPS-1 or
MPS-2 powers
virtually any
Microprocessor
available. For that
rare exception,
talk to us about
a custom unit.

Automatic
overload and
adjustable
overvoltage
protection. Dual
input voltage,
0.1% regulation,
1.5 mV ripple
and noise.

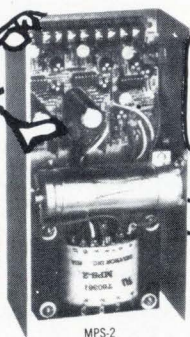

MPS-2



MODEL	VOLTS	AMPS			PRICE ANY QUANTITY
		40°C	50°C	60°C	
MPS-1 7 x 4% x 2%	5 ± 5% Adj.	3.0	2.5	2.0	\$77
	12 ± 5% Adj.	0.6	0.5	0.4	
	9 to 12V Adj.	0.6	0.5	0.4	
	or 5V	0.38	0.38	0.38	
MPS-2 9 x 4% x 2%	5 ± 5% Adj.	7.0	6.0	5.0	\$88
	12 ± 5% Adj.	1.0	0.9	0.8	
	9V	1.2	1.1	1.0	
	or 5V	0.75	0.65	0.55	

Why buy brand A?
Deltron's got them
spec for spec
at half the price.

**Next time get the best
for a lot less...
write or call collect to:**

Deltron inc.

Wissahickon Avenue, North Wales, Pa. 19454
215-699-9261, TWX 510-661-8061



New products

Components

CB switch cuts parts count

Circuit boards are stationary
in simplified design
that uses four basic parts

Smaller size and fewer parts are the design goals achieved by Digitran Co. in a select-switch developed for the 40-channel citizens' band radio.

Most of the switches built for CB use rotating printed-circuit boards—connected to a shaft—against stationary wipers attached to a housing, and the switches are in packages about 1½ inches square [*Electronics*, Aug. 19, p. 120]. The Digitran switch, on the other hand, keeps the pc boards stationary and uses a one-piece shaft and a rotating disk housing the switching contacts for both the code and light-emitting-diode display circuit boards. Contact alignment accuracy is thus gained with tight tolerances throughout. An example is concentricity of ±0.003-0.004 inch on all holes, according to Richard N. Erickson, head of the product development team.

Compared with more complex components, Digitran's design using only four basic parts (see photo)

gives it a big advantage, says Bob Alexander, marketing manager. Furthermore, its simplicity is responsible for the small size (1¼ by 1½ by ½ in.).

The development group at Digitran had three goals its switch had to meet, says Erickson. Topping the list was recognition of the role that phase-loop circuits would play in synthesizing frequencies from a single crystal. "Our switch had to handle currents in the sub-microampere range, in some cases as low as tens of microamperes," he says. Operating in the highly polluted highway environment came second. The old rotary wiper switches with contact pressure of 30-40 grams were self-cleaning, but pc-type units, with an average pressure of 12 grams, would be subject to contamination. Finally, the new switch had to be much smaller than existing ones, because a trend toward mounting the CB set out of sight to prevent theft would require remote switching in the microphone.

The key design feature in meeting the first two objectives is gold for contacts and for pc-plating. Erickson, in fact, says that low-current switching "can only be done with the gold contacts in a low-pressure environment." The nature of gold molecules in acting as a lubricant when plated over nickel on the pc boards, also works against particle contamination. In addition to the smaller

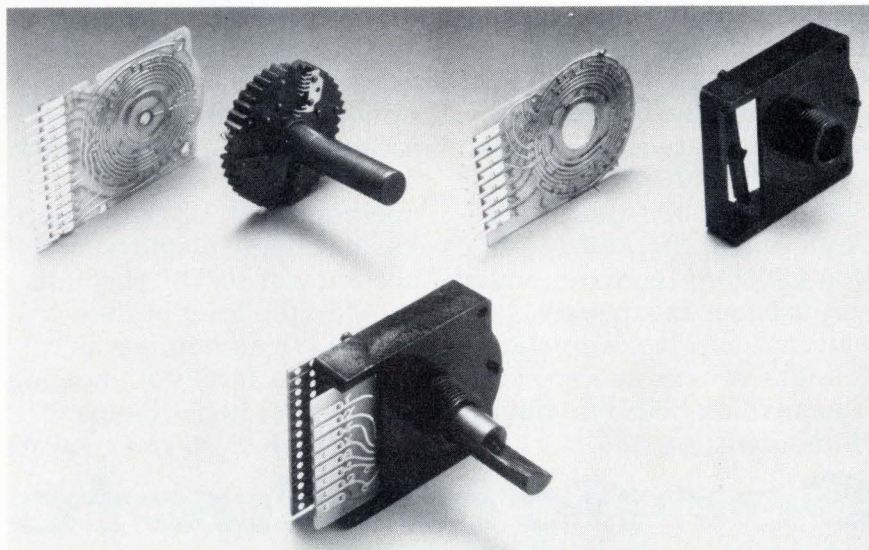

TEKTRONIX now has 5 ways to look at logic.

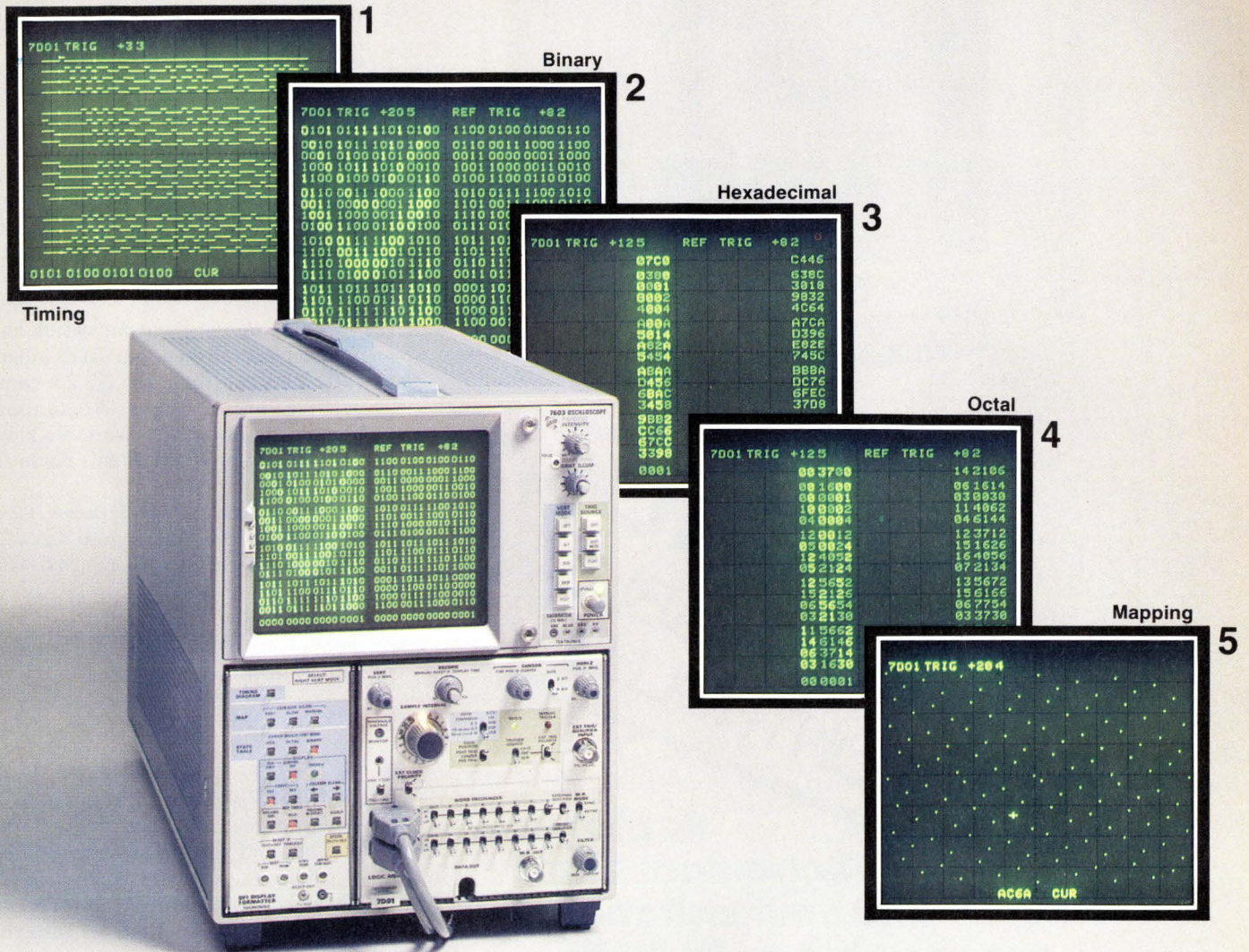

The New DF1 Formatter

First, we gave you the timing display and binary readout with our 7D01 Logic Analyzer. Now, with the DF1 Display Formatter, which is dedicated to the 7D01, you have five display formats to operate from, all in a 7000-Series mainframe. Now you can convert a timing display into tables of words in Binary, Hexadecimal, Octal ... or a mapping configuration ... whatever your application requires.

A STATE TABLE mode of operation produces standard tables of up to 16 lines of 16-bit words. Using the 7D01's cursor, you can step through these tables word-by-word in Binary, Hex, or Octal. A 17th word is added to each table emerging from the 7D01's memory, to serve as a "key" and indicate you are indeed scrolling correctly through the long memory. The 7D01's fine cursor

control steps the display line-by-line, while the coarse control advances it table-by-table.

One of the most powerful analytical capabilities provided by the STATE TABLE mode is that you can display two tables—a reference table of "proved" data plus a "new" data table drawn from a system under test—on the same crt for side-by-side comparison. New data that is different from the reference data is automatically intensified ... you immediately know faulty data exists, and you know its location.

With the DF1 you can map, not just one, but three ways. The ability to map FAST, SLOW, or MANUAL lets you quickly recognize a word of interest, track it, isolate it, then pinpoint it for detailed analysis. The importance of mapping is derived from the speed with which you can isolate problems.

The logic analyzer package shown (7603 Option 1, 7D01, DF1) starts as low as \$5790. If you already own a 7000-

Series mainframe, add the 7D01-1 (7D01/DF1 combination) for only \$4390. Also consider that your money buys you these important 7D01 features: 1) Word recognition, 2) 16 channel operation, 3) 15-ns asynchronous timing resolution, 4) 4k formattable memory (4, 8 or 16 channels), and 5) High Z probes.

For more information or a demonstration of the DF1, contact a Tektronix Field Engineer near you. Or write Tektronix, Inc., P.O. Box 500, Beaverton, OR 97077.

United States sales prices are F.O.B. Beaverton, OR. For price and availability outside the United States, please contact the nearest Tektronix Field Office, Distributor, or Representative.





CAMTROL

PROGRAMMABLE CAM CONTROLLER

**Replaces
mechanical cams
and limit switches...
expandable to 20 limits...
not effected by noise**

Theta CAMTROL is a replacement for mechanical cams and limit switches. Through the use of reliable programmable electronics, dwell settings can be remotely adjusted within an accuracy of .01 degrees.

A totally modular concept has been implemented in this heavy duty industrial design to permit range expansion or accuracy changes through the use of plug-in control modules.

LITERATURE:

Write for descriptive literature on the Theta CAMTROL Programmable Cam Controller.

Theta

3003

INSTRUMENT CORPORATION

Fairfield, New Jersey 07006 • Phone: 201-227-1700

152 Circle 152 on reader service card

New products

package resulting from the simplified design, Erickson observes, "fewer parts and integrated design mean greater reliability."

Electrical-output characteristics of the Digitran switch include 125 mA at 28 v maximum, with a minimum switching current of 500 μ A at 12 v dc. Initial contact resistance of 200 milliohms increases to no more than 1,000 m Ω at rated life of 12,500 cycles.

Pricing on the Digitran switch has not been established, but "it is inherently cheaper than the \$2.25 competitive units," says Alexander. Sample quantities are available now, and volume production will begin in February.

The Digitran Co., Division of Becton, Dickinson and Co., 855 South Arroyo Parkway, Pasadena, Calif. 91105. Phone (213) 449-3110 [341]

GE invades market for wound lead-acid cells

Structurally, a wound, sealed, lead-acid cell is very like a nickel-cadmium cell: in both cases, the positive and negative plates consist of single strips separated by a layer of absorbent insulation and rolled up to form a cylinder that fits into the cell casing.

So General Electric battery designers were able to apply their extensive experience in wound Ni-Cad cells to produce a line of rechargeable SLA cells.

The new cells cost less than comparable nickel-cadmium units but have a shorter charge/discharge cycle life—300 cycles for an SLA versus more than 1,000 for a Ni-Cad. They can be used in any position and are already powering burglar and fire alarms, supplying emer-

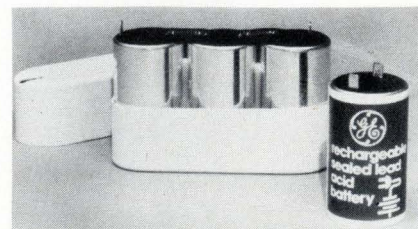

Electronics / November 25, 1976

Dialight Switches

A switch for all reasons.

Reason 1: Dialight offers three switch configurations to meet all your needs—*snap-action switches with silver contacts* for moderate-level applications, *snap-action switches with gold contacts* for intermediate-level applications, and *wiping-action switches with gold contacts* for low-level applications.

Each of these ranges is served by two switching actions—momentary (life: 750,000 operations) and alternate (life: 250,000 operations).

Reason 2: Dialight's snap-action and wiping-action switches come in a new modular design concept . . . a common switch body for either high or low current operation. All 554 series switches and matching indicators have the same rear-panel projection dimensions.

The snap-action switching mechanism guarantees a fast closing and opening rate. This insures that contact force and contact resistance

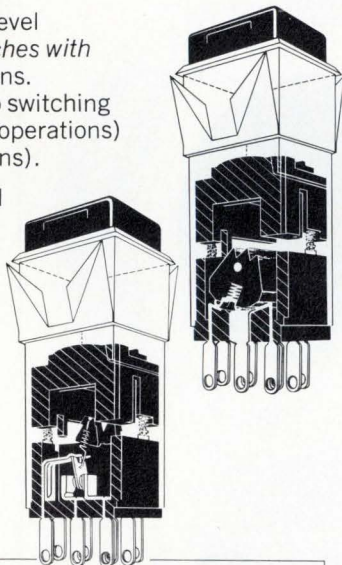
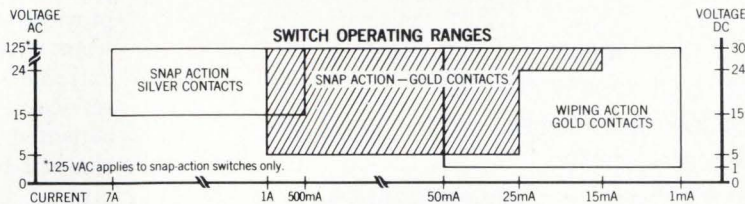

types. There are over 240 switch variations to choose from.

The 554 illuminated switch, designed for front of panel lamp replacement, gives you a choice of five different bezel sizes . . . $\frac{3}{4}$ " x 1", $\frac{5}{8}$ " x $\frac{3}{4}$ ", $\frac{3}{4}$ " square, $\frac{5}{8}$ " square, and $\frac{1}{2}$ " square. The first four sizes are also available with barriers. You also get a choice of six cap colors . . . white, blue, amber, red, green, and light yellow . . . four different underlying filter colors . . . red, green, amber, and blue and a variety of engraved or hot-stamped legends . . . over 300 cap styles . . . over 100,000 combinations.

There is also a variety of terminal connections . . . solder blade, quick connect, and for PC board insertions.

Reason 4: Dialight's 554 series is designed as a *low cost switch with computer-grade quality.*

Reason 3: Dialight offers a wide variety of panel and snap-in bezel mounting switches with momentary and alternate action configurations in SPDT and DPDT



PRODUCT SELECTOR GUIDE						
SWITCHING ACTIONS	Snap-Silver contacts		Snap-Gold contacts		Wiping-Gold contacts	
	SPDT	DPDT	SPDT	DPDT	SPDT	DPDT
MOMENTARY	<input type="checkbox"/>	<input type="checkbox"/>	<input type="checkbox"/>	<input type="checkbox"/>	<input type="checkbox"/>	<input type="checkbox"/>
ALTERNATE	<input type="checkbox"/>	<input type="checkbox"/>	<input type="checkbox"/>	<input type="checkbox"/>	<input type="checkbox"/>	<input type="checkbox"/>
OPTIONS						
	PUSH BUTTON CAP SIZES					
	$\frac{1}{2}$ " Sq.	$\frac{5}{8}$ " Sq.	$\frac{5}{8}$ " x $\frac{3}{4}$ "	$\frac{3}{4}$ " Sq.	$\frac{3}{4}$ " x 1"	
BEZEL MOUNTING TO ACCOMMODATE	<input type="checkbox"/>	<input type="checkbox"/>	<input type="checkbox"/>	<input type="checkbox"/>	<input type="checkbox"/>	
BEZEL MOUNTING WITH BARRIERS TO ACCOMMODATE		<input type="checkbox"/>	<input type="checkbox"/>	<input type="checkbox"/>	<input type="checkbox"/>	
PANEL MOUNTING TO ACCOMMODATE	<input type="checkbox"/>	<input type="checkbox"/>	<input type="checkbox"/>	<input type="checkbox"/>	<input type="checkbox"/>	
MATCHING INDICATORS	<input type="checkbox"/>	<input type="checkbox"/>	<input type="checkbox"/>	<input type="checkbox"/>	<input type="checkbox"/>	

are independent of the switch's actuation speed.

In the wiping-action switch, the contacts are under constant pressure (A unique Dialight design). This insures long life with a minimum build-up of contact resistance.

Both switch types are tease-proof.

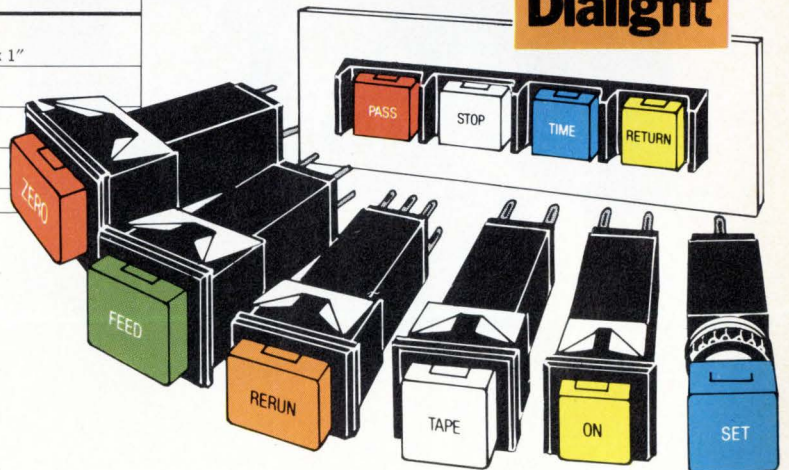

DIALIGHT

A North American Philips Company
203 Harrison Place, Brooklyn, N.Y. 11237
(212) 497-7600

Our carry-in recorder/reproducer will carry on for 32.8 hours!

The 70-lb. Sabre VI: It's a giant leap beyond any other small, high performance IRIG analog tape recorder/reproducer. Records at 8 electrically selectable speeds: 120 ips through 15/16 ips; reproduces at any 3 electrically selectable speeds; records from 15.3 minutes at the highest speed to 32.8 hours at the slowest on 14" reels. Remote speed selection and LED footage counter. LED bar data monitor. Let us give you full details.

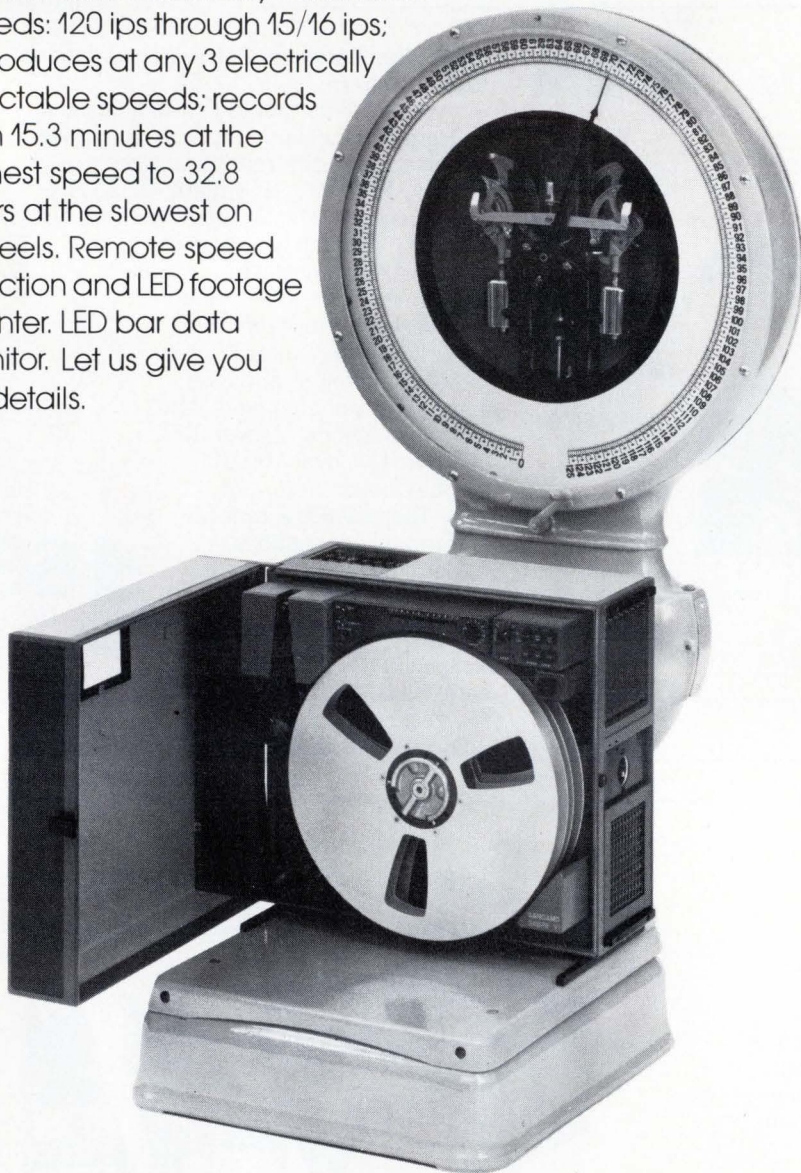

SANGAMO DATA RECORDER DIVISION
P.O. BOX 3347 • SPRINGFIELD, ILLINOIS 62714

SANGAMO WESTON

Schlumberger

670A

154 Circle 154 on reader service card

New products

gency lighting, and backing up ac-powered supplies in point-of-sale terminals.

First units marketed will be in the popular "D" size. High-capacity "X" cells will be available shortly. A patented, resealable safety vent is provided to prevent an explosion from excessive gas pressure under extreme loading. But in normal service, the vent should never be activated. The cells are normally charged by a constant-voltage supply.

The "D" cells have a capacity of 2.5 ampere-hours at a discharge rate of 250 milliamperes. They can deliver up to 40 amperes continuous or 75 A surge. Nominal cell voltage is 2 v dc, and internal resistance is 10 milliohms. Weighing 6.4 ounces and measuring 2.67 inches high by 1.34 in. in diameter, the new cells are electrically and mechanically equivalent to competitive units. Standard batteries of the "D" cells, in 6-v and 12-v packs, are also available. Prices for the "D" cells range from \$2.40 to \$4.80 each, depending upon quantity.

General Electric Co., Battery Dept., Gainesville, Fla. 32602 [342]

7.5-ampere, 4-pole relay is TTL-compatible

A four-pole, single-throw relay that can switch four separate 7.5-ampere circuits can be actuated directly by a single TTL gate. The model R10A-E2-X4-S140 requires just 36 milliamperes at 5 v dc to close its normally open contacts. Pick-up time is approximately 22 milliseconds, and drop-out time is about 15 ms—22 ms when the relay is driven with an IC, since it then needs a protective diode in parallel with it.

The 7.5-A rating of the relay contacts is for a resistive load at a maximum of 28 v dc or 115 v ac. Mechanical life expectancy is 100 million operations. Electrical life expectancy depends upon the nature of the load and duty cycle. In large quantities, the R10A-E2-X4-S140 sells for as little as \$3.03. Delivery

**LINEAR INNOVATIONS
FROM TI**

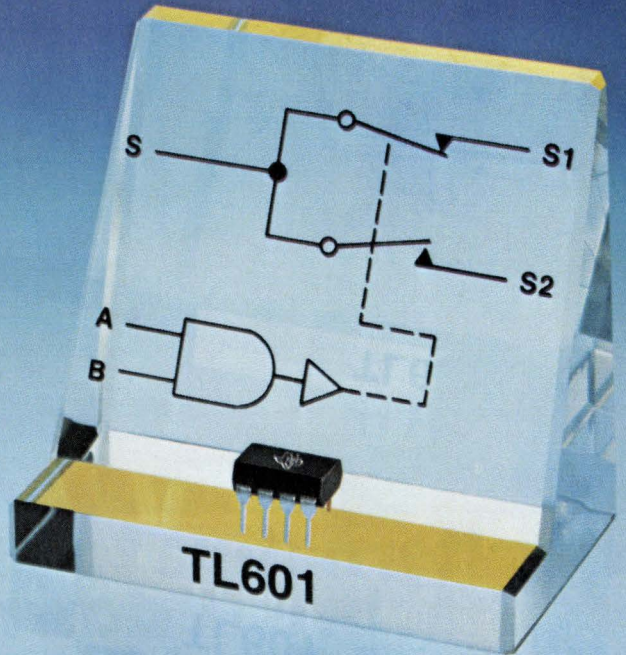
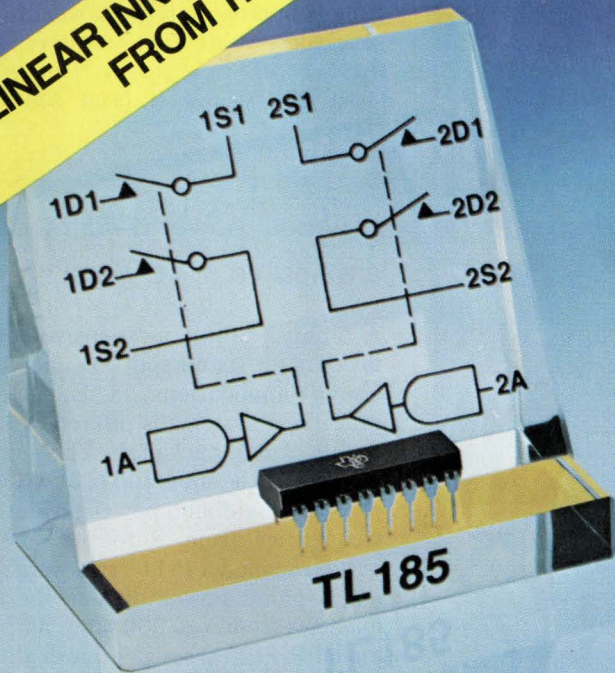

LINEAR ICs

Now, analog switches go monolithic. Priced for commercial applications.

Expensive hybrid analog switches are out. TI's pioneering use of BIMOS, BIFET, and ion implantation technologies introduces a major innovation: single-chip, monolithic analog switches. At less than \$1.00 per switch.

You also get fast speeds. High reliability. TTL compatible inputs. Easy triggering. Low leakage. No latch-up.

TI's new TL600 Series is a general-purpose family featuring high r_{off}/r_{on} ratio and no offset voltage. Ideal for signal switching, multiplexing, and controlling op amp gain. \$0.88 in 1K quantities.

TI's new TL181 Series provides symmetrical on-state resistance to allow switching of precision AC signals without distortion. JFET control input allows series to be

driven by TTL, ECL, CMOS, or PMOS circuits. The series is functionally interchangeable with the Siliconix DG181 Series having the same pinouts. Just \$1.88 each in 1K quantities.

For more details about these new TI analog switches priced for widespread use, return the coupon.



TI Analog Switches

AVAILABLE NOW

Series	Channel	Type	Typical On-State Resistance (Ohms)
TL601	1	SPDT	75
TL604	1	Dual SPST (Complement)	75
TL607	1	SPDT (with inhibit)	75
TL610	1	SPST	40
TL182	2	SPST	50
TL185	2	DPST	75
TL188	1	Dual SPST (Complement)	50
TL191	2	Dual SPST (Complement)	75

Texas Instruments
P. O. Box 5012, M/S 964
Dallas, Texas 75222

EL-11

Please send information on the following:

- TL600 Series
- TL181 Series
- Voltage Regulators
- Please have salesman call
- Switching Regulators
- BIFET Op Amps
- New Linear Control Catalog

NAME _____ TITLE _____
 COMPANY _____
 ADDRESS _____
 CITY _____ STATE _____ ZIP _____

TEXAS INSTRUMENTS
INCORPORATED

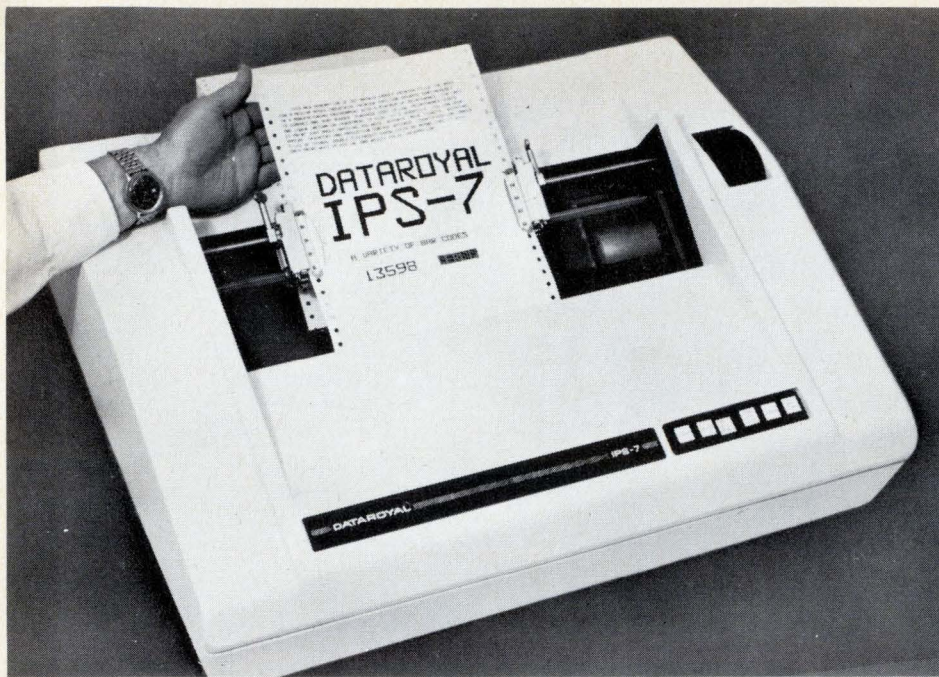

the alternative to printers that break down in the middle of the night!



OEM's now have a super-reliable 24-hour-a-day medium speed printer—designed by request. Clean, straightforward design makes IPS-7 flexible, mechanically reliable—electronically sound. Prices and capabilities are competitive.

OEM's want as few brands as possible. IPS-7 is all the printer you'll need for years to come. You don't have to put tinkertoys together to assemble your custom configuration. The functional structure is built in. Just plug in your options. Compatible? Yes. interchangeable with the printer you designed in.

How does the "7" pack in so much? Start with a big healthy micro-processor that gives the flexibility—programmable forms control, diagnostic package, character size and serial or parallel interface. This takes the burden off the computer. Use rapid, super-reliable servo and stepping motors to get rid of troublesome gears, clutches, brakes, bearings and shafts—at least 75% fewer parts (consider the MTBF of those!)—and ruggedize the rest. Provide

positive filtered air flow for operation in heat, cold and dirt without a clean room. Include sensible ideas like three head-speeds—to print, to move and to give double density without double printing time. IPS-7 has low parts cost, and low downtime which is quickly back to uptime.

Only DATAROYAL says, "our printer will run and run and run."

Ask for proof of the performance you're waiting for.

DATAROYAL INCORPORATED

235 MAIN DUNSTABLE ROAD
NASHUA, NEW HAMPSHIRE 03060 (603) 883-4157

Circle 156 on reader service card

CAREER OPPORTUNITIES

Usually the best opportunity to grow in your field lies within your present company. You have made an investment in them. They have an investment in you.

But occasionally the best opportunity lies somewhere else. No one can decide but you.

Companies looking for good people run their recruitment ads in our Classified Section in the back of this magazine. Perhaps you'll find an opportunity there that's worth following up.

New products

time is approximately six weeks. Potter & Brumfield Division of AMF Inc., 200 Richland Creek Dr., Princeton, Ind. 47671. Phone Don Morrow at (812) 386-1000 [343]

Low-cost power dividers are housed in TO-5 cans

A family of three inexpensive power dividers for signal-splitting and combining applications in i-f signal-processing systems is offered in low-profile TO-5 packages. The family consists of the model P-110 two-way reactive broadband power divider for frequencies from 5 to 500 megahertz, the model P-111 two-way 180° out-of-phase power divider for frequencies from 5 to 300 MHz, and the model P-112 three-way power divider for frequencies from 1 to 200 MHz. The P-110 sells for \$12 each in small quantities, while the other two units are priced at \$29. All three dividers are hermetically sealed 50-ohm units with a minimum isolation of 25 dB. The packages are said to reduce installation, soldering, and drilling costs. Deliveries are from stock to four weeks.

Merrimac Industries Inc., 41 Fairfield Pl., West Caldwell, N.J. 07006. Phone Alan Egger at (201) 228-3890 [344]

LED indicator is small and bright

Designed specifically for applications requiring the use of a light-emitting-diode lamp without the use of a lens, the 1L3 series of LED lamps provide the brightness of a T 1-3/4 unit in a device with a quarter-inch threaded metal body. Brightnesses of approximately 14 to 16 millicandelas are provided for red, green, and amber LEDs. Built-in dropping resistors allow operation from sources up to 14 v dc. In lots of 1,000 pieces, the lamps sell for \$1.79 each. Delivery time is two to three weeks after receipt of order.

The Sloan Co., 7704 San Fernando Rd., Sun Valley, Calif. Phone (213) 875-1123 [346]

Big 0.6" double and single digits.

Our new super bright orange double- and single-digit displays are available in both common cathode and common anode configurations. These 0.6" digits (with overflow) incorporate our latest rounded-corner solid segment font to give you a display that's easy to read and easy to like.

The package is new, too. It has a colored face for optimum ON/OFF contrast. It's just under an inch in length and packs densely to provide digits on .50" centers.

The light emitting material is our new GaAsP:N on GaP, so you get all the benefits of this new high brightness technology – including direct MOS drive – plus all the inherent shock resistance and long life of solid state. Not bad.

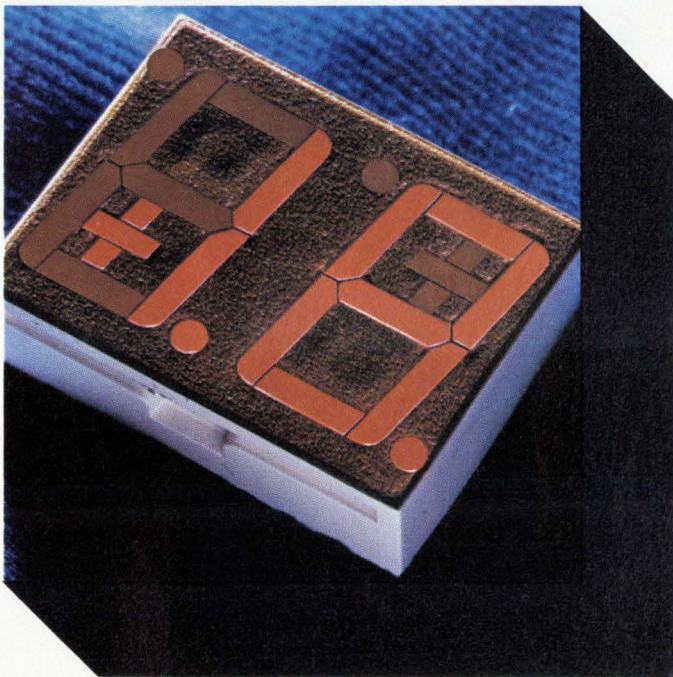

Model Number	Description	Color	Luminous Intensity*
MAN 6610	2 Digit; Common Anode, RHDP	Orange	510 μ cd
MAN 6630	1½ Digit; Common Anode, Overflow (± 1.8), RHDP	Orange	510 μ cd
MAN 6640	2 Digit; Common Cathode, RHDP	Orange	510 μ cd
MAN 6650	1½ Digit; Common Cathode, Overflow (± 1.8), RHDP	Orange	510 μ cd
MAN 6660	Single Digit; Common Anode, RHDP	Orange	510 μ cd
MAN 6680	Single Digit; Common Cathode, RHDP	Orange	510 μ cd
MAN 6710	2 Digit; Common Anode, RHDP	Red	125 μ cd
MAN 6730	1½ Digit; Common Anode, Overflow (± 1.8), RHDP	Red	125 μ cd
MAN 6740	2 Digit; Common Cathode, RHDP	Red	125 μ cd
MAN 6750	1½ Digit; Common Cathode, Overflow (± 1.8), RHDP	Red	125 μ cd

*Minimum digit average @ 10mA, DC per segment

So if it's bright you want, and your application calls for 0.6" displays, call your Monsanto man in and have a look at the MAN6600 and MAN6700 series. They're terrific.

Monsanto:
the science
company.

IN EUROPE CONTACT: Monsanto Europe S.A.,
Electronics Division, Avenue de Tervuren 270-272,
B-1150, Brussels, Belgium

Please send me a data sheet on your MAN6600 and MAN6700 series digits.

Name

Title

Company

Street

City

State Zip

Mail to Monsanto Electronics Division,
Dept. MCD, 3400 Hillview Ave., Palo Alto,
CA 94304. Phone (415) 493-3300.

© Monsanto Company Electronics Division, 1976



Introducing The Most Advanced Line Of Quad OP Amps Ever Made. Nothing Performs Quite Like Them.

The HA 4602/4622 high performance quad operational amplifiers are keys to a whole new concept in amplifier design. They're unique in that they have bipolar, CMOS, and dielectric isolation all in one chip. So they give you a full measure of confidence like you've never known before in general purpose amplifiers.

For example:

- Eight times the slew rate and bandwidth of the 741 at only three-fifths quiescent power.
- High accuracy and stability, even at high gains, over the specified temperature ranges.
- Monolithic construction to provide optimum parameter matching and temperature tracking.
- High performance and a quad structure which is ideal for active filter applications.

STANDARD FEATURES. Both Harris high performance quad amps have standard features you won't find in any other quad amps. The 4602 typically offers a slew rate of $4V/\mu\text{sec}$, unity gain bandwidth of 8MHz, input noise voltage of $8nV/\sqrt{\text{Hz}}$ and input offset voltage of 0.3mV. The 4622 is uncompensated and provides stability at $A_v=10V/V$, gain bandwidth of 70MHz and a slew rate of $25V/\mu\text{sec}$.

PERFORMANCE/PRICE.

Impressed with this high performance? You'll be just as impressed by the price. For military use the HA 4622-2 and HA 4602-2 cost \$9.90. For commercial, the HA 4625-5 and the HA 4605-5 cost \$4.95 (100 up prices).

ECONOMY TOO. For those of you more inclined to go the economy route, there's our very popular HA 4741 quad op amp. With its superior typical bandwidth of 3.5 MHz, slew rate of $1.6V/\mu\text{sec}$ and input voltage noise of

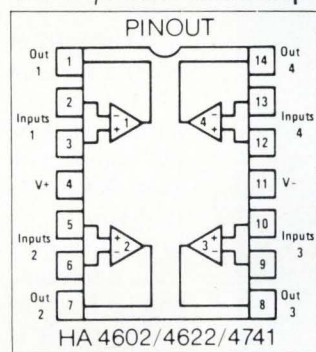

$9nV/\sqrt{\text{Hz}}$, it offers you a lot of amp for not a lot of money. For instance, the HA 4741 for military usage costs just \$4.60, while the HA 4741-5 for commercial is just \$2.48.

AND FAST DELIVERY... Right now we have a full inventory of our new quad op amps. So whether you prefer high performance, or economy, rest assured your order can be honored immediately.



HARRIS
SEMICONDUCTOR
A DIVISION OF HARRIS CORPORATION

P.O. Box 883, Melbourne, Florida 32901 (305) 724-7412

OEM SALES OFFICES: CALIFORNIA: Long Beach (213) 426-7687; Palo Alto (415) 964-6443 FLORIDA: Fort Lauderdale (305) 971-3200; Melbourne (305) 724-7430 ILLINOIS: Hinsdale (312) 325-4242 MASSACHUSETTS: Wellesley Hills (617) 237-5430 MINNESOTA: Minneapolis (612) 835-2505 NEW YORK: Endwell (607) 754-5464; Melville, L.I. (615) 249-4500 OHIO: Dayton (513) 226-0636 PENNSYLVANIA: Wayne (215) 687-6680 TEXAS: Richardson (214) 231-9031
SALES REPRESENTATIVES: ALABAMA: Huntsville (205) 533-6640 ARIZONA: Scottsdale (602) 948-5590 CALIFORNIA: Los Angeles (213) 870-9191; Mountain View (415) 961-8121; San Diego (714) 565-9444 COLORADO: Denver (303) 773-0666 CONNECTICUT: East Norwalk (203) 838-1493 FLORIDA: Boca Raton (305) 395-6108; Orydedo (305) 365-3283; Tampa (813) 933-1759 ILLINOIS: Elk Grove Village (312) 640-1850 INDIANA: Indianapolis (317) 849-6454 IOWA: Cedar Rapids (319) 377-8275 KANSAS: Wichita (316) 943-6221 MARYLAND: Lanham (301) 459-1556 MASSACHUSETTS: Burlington (617) 273-1313 MICHIGAN: Farmington (313) 476-2446 MISSOURI: Hazelwood (314) 731-5799; Independence (816) 737-1100 NEW JERSEY: Keasbey (516) 567-5900; West Caldwell (516) 567-5900 NEW MEXICO: Albuquerque (505) 265-5655 NEW YORK: Albany (518) 489-7408 or 4777; Huntington Station (516) 567-5900 NORTH CAROLINA: Winston Salem (919) 722-5151; OHIO: Cleveland (216) 831-8292; Dayton (513) 890-2150 OREGON: Beaverton (503) 643-1644 PENNSYLVANIA: Allison Park (412) 487-4300; King of Prussia (215) 265-0634 SOUTH CAROLINA: Greenville (803) 268-1125 TEXAS: Dallas (214) 691-4592; Houston (713) 661-3007 VIRGINIA: Charlottesville (804) 973-6672 WASHINGTON: Bellevue (206) 454-0300 CANADA: Mississauga, Toronto (416) 676-1042; Montreal (514) 626-6723; Ottawa (613) 749-0740
NATIONAL DISTRIBUTORS: Hamilton/Avnet; The Harvey Group, Inc; Schweber Electronics R.V. Weatherford Company CANADA: Prelco Electronics Ltd.

Q.

How do you resolve two signals spaced

1 Hz apart at 2 MHz?

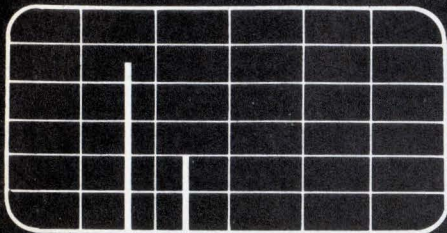

A.

With EMR's new

Model 1520 Digital Spectrum Translator and Model 1510-03 Digital Real-Time Spectrum Analyzer.

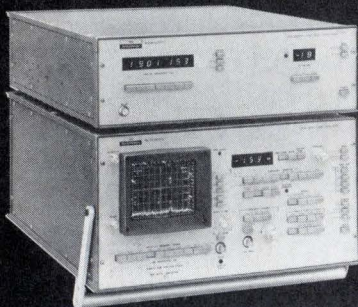

Why go partway in analyzing data? Get the resolution/performance edge of our Model 1510-03 Digital Real-Time Spectrum Analyzer, then go it one better. Enhance frequency resolution still more by adding the Model 1520 Digital Spectrum Translator to concentrate the full resolution of the Analyzer about a selectable point of interest in the spectrum. For that matter, why stop there? Step up from 25.6 kHz to a full 2 MHz upper frequency limit by adding the optional Model 1521 Range Extension Module, too!

Other features of the unequalled 1520 Translator: nine translatable frequency ranges from 25.6 Hz to 10.24 kHz; center frequency selectable in 1-Hz steps and automatic gain ranging — each with an easy-to-read LED display; plus, an automatic frequency sweep. Full-scale out-of-band signal to minimum-detectable in-band signal exceeds 100 dB.

EMR Schlumberger

EMR Telemetry
Weston Instruments, Inc.
Box 3041, Sarasota, Florida 33578
(813) 371-0811

Circle 160 on reader service card

New products

Instruments

Tester checks CB radio sets

Modified spectrum analyzer measures transceivers against new standards

When the Federal Communications Commission announced an increase in the number of citizens' band channels from 23 to 40, it also ordered a decrease in the levels of spurious radiation that may emanate from a CB radio. The tighter restrictions, which affect harmonics, too, have created a demand for test equipment that is sensitive enough to measure low levels, yet still is low in price.

"A spectrum analyzer is a perfect way to measure the performance of CB transceivers against FCC standards," says Satish Mehta, marketing manager of Kay Elemetrics. To keep the price down, Kay chose not to design a completely new unit but to modify one of its existing spectrum analyzers to cover the CB band and its harmonics.

The result is the model P9041A, which can plug into a series 5100 or series 5700 oscilloscope made by

Tektronix. The spectrum analyzer is also available with its own power supply for use with other scopes.

Priced at \$2,400, the P9041A has a bandwidth of 1 megahertz to 300 MHz, a resolution of 1 kilohertz, and a dynamic range of 72 decibels. At present, harmonic outputs up to 270 MHz, or 10 harmonics from the 27-MHz broadcast frequencies, must be only 60 dB down, but manufacturers will soon be required to test CB transceivers to 70 dB down.

As for adjacent channel interference, the spectrum analyzer can measure it at the 10-kHz spacing of CB channels to the necessary 60-dB level. Spurious signals can also be detected to 60 dB down.

Kay Elemetrics Corp., 12 Maple Ave., Pine Brook, N.J. 07058 Phone (201)227-2000 [351]

Analyzer operates in time and data domains

Designed for the hardware and software debugging of microprocessor systems, the model DM 230 logic-waveform analyzer has a built-in memory with a capacity of 128 32-bit words. The start or stop address is set on a four-digit hexadecimal thumbwheel switch, and digital data is displayed on a six-digit hexadecimal readout. For a real-time look at

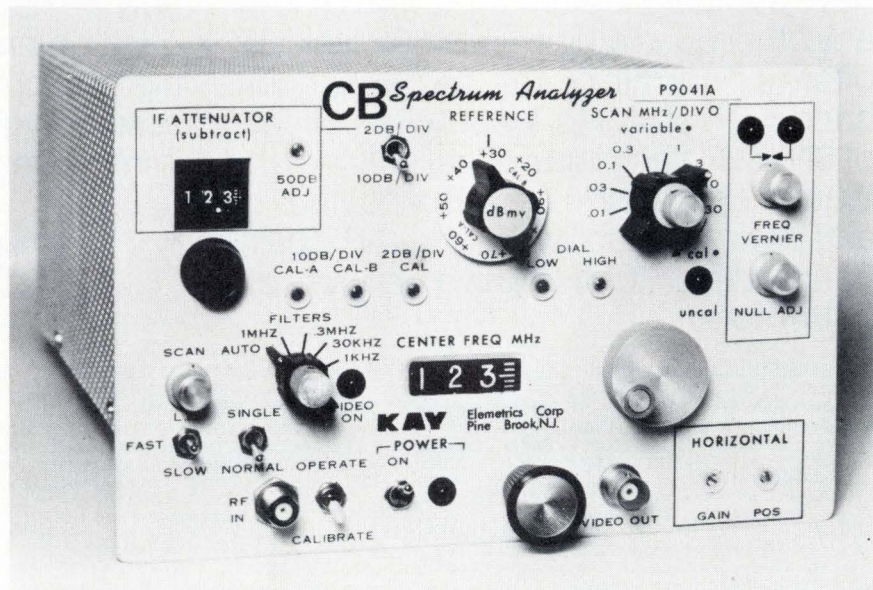

SLIMSWITCH LOW PROFILE...

**DIGITRAN QUALITY
AT LESS THAN 25¢ PER POSITION**

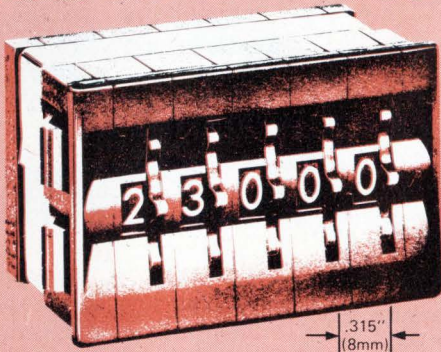

Series 23000 "SNAP-IN" SLIMSWITCH

They're low cost switches, but their life expectancy is still over 1,000,000 detent operations.

- Only .315" (8mm) wide.
- Assemble without the use of tools.
- Install without the use of tools or hardware.
- Available from local distributor stock.
- Specials available from the factory.

Send for a Series 23000 "SNAP-IN" SLIMSWITCH Data Sheet.

**... AND TRUE
TACTILE FEEL AS WELL !!**

**Series KL MINIKEY Keyboards
from the originators of the DIGISWITCH®**

- Less than .275" thick
- Excellent tactile feel
- Two-color molded keys
- Back or front mounting configuration
- 12 or 16 key models are standard
- Special "touch tone" versions available too
- Standard units available from local Distributor stock
- Special models available from the factory



Send for a SERIES KL MINIKEY Data Sheet

DIGITRAN®

Pasadena, California 91105 • Phone (213) 449-3110

Circle 220 on reader service card

DIGITRAN®

Pasadena, California 91105 • Phone (213) 449-3110

Circle 161 on reader service card

ECONOMY

Series 29000 "ECONOMY" MINISWITCH®...

...The lowest cost thumbwheel switch available that provides true environmental protection

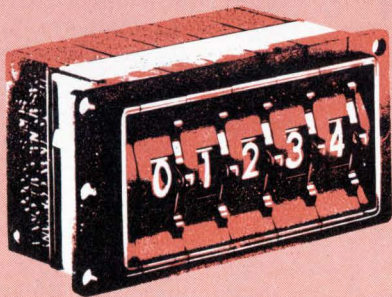

IT'S WHAT YOU GET FOR THE PRICE THAT COUNTS!

- Dust and moisture resistant construction
- Large easy to read dial characters
- Positive tactile characteristics
- Assemble without the use of tools
- Less cost (per digital position) than most rotary switches
- Available from local Distributor stock
- Specials available from the factory

Send for a Series 29000 "ECONOMY" MINISWITCH Data Sheet.

RAIN! RAIN! RAIN!

IT'S A DIRTY WORLD!

**BUT NOT WET OR DIRTY ENOUGH TO
CONTAMINATE OUR SEALED DIGITAL
SWITCHES.**

We make five different lines of environmentally sealed DIGITAL SWITCHES.

- Series 200 MINISWITCH®
- Series 700 MINISWITCH®
- Series 9000 DIGISWITCH®
- Series 12000 MINIBUTTON
- Series 24000 DIGILEVER

and they are all QPL Approved to MIL-S-22710.

Send for Data Sheets describing these switches.

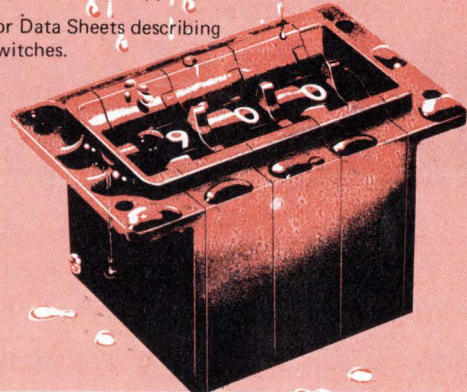

DIGITRAN®

Pasadena, California 91105 • Phone (213) 449-3110

Circle 219 on reader service card

DIGITRAN®

Pasadena, California 91105 • Phone (213) 449-3110

Circle 218 on reader service card

MEASURING DEGREES?

Temperature, Rotation, or ϕ Angle? Our $\pm 4,000$ count DPI will do it!

We have filled the gap between $3\frac{1}{2}$ and $4\frac{1}{2}$ digit units with two $\pm 4,000$ count Digital Panel Instruments. These units provide more than enough resolution to measure up to $+4,000^\circ$ temperature, or a full $\pm 360.0^\circ$ rotation or phase angle.

AN2539 - Exceptional accuracy and stability. Measures voltages over f.s. ranges of $\pm 3.999V$ DC or $\pm 399.9mV$. Resolution of $\pm 0.025\%$. True-differential, balanced symmetrical inputs. Optional BCD outputs can be field installed.

AN2560 - Combines the true balanced differential high impedance input of the AN2539 with latched and buffered parallel BCD output, compatible with CMOS and TTL/DTL interfaces. Significant input/output versatility and flexibility.

Outstanding Features:

- Resolution: $\pm 0.025\%$
- Accuracy: $\pm 0.05\%$ of reading, ± 1 count
- Temp-co: $35ppm/^\circ C$
- Input resistance: 10^9 ohms
- Instrumentation-type true differential input
- Optimized signal input filter
- Fully shielded power transformer
- MTBF $> 40,000$ hrs.
- CMOS/LSI design
- Operating temperature: $-10^\circ C$ to $+60^\circ C$
- Universal power: 100, 117, 220, and 240Vac, 47 to 63Hz
- DIN/NEMA standard size case
- Choice of 0.43" LED or 0.55" gas plasma display
- Options: Metal case, isolated BCD outputs, screw terminal connector, and more!

Want complete data? Ready to evaluate? Call Analogic's Marketing Dept. at (617) 246-0300, for your local Analogic sales office or stocking distributor, or write today: Analogic Corp., Audubon Road, Wakefield, Ma. 01880.



ANALOGIC ■

...The Digitizers

**Does Twice
As Much As
A $3\frac{1}{2}$ Digit
For Only
A Fraction
More!**

Circle 162 on reader service card

HELP WANTED

While it is not our policy to encourage job hopping—quite the opposite, in fact—the headline above must have got your attention for a reason.

Perhaps you should turn to the back of this issue to our Classified Section. One of the job descriptions might fit you.

New products

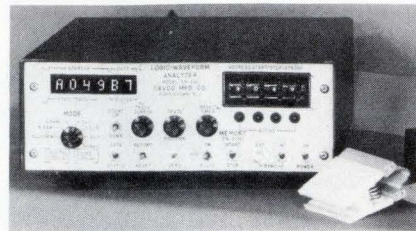

analog waveforms, including timing relationships and noise spikes, the instrument allows a standard single-channel oscilloscope to be used as a 32-channel measuring tool. Access to the microprocessor under test is by means of a clip-on probe. A probe buffer is positioned close to the probe to minimize loading of the circuitry under test. Since different microprocessors require different buffers, the buffer type must be specified when ordering the instrument.

The price of the DM 230 is \$2,900 including one buffer; additional buffers sell for \$750. Delivery time is 60 days.

Davco Manufacturing Co., 169 Ridgedale Ave., Morristown, N.J. 07960. Phone (201) 267-4990 [353]

True-rms millivoltmeter
works up to 1.5 gigahertz

The model 301 rf millivoltmeter is a true-rms instrument that covers the range of 10 kilohertz to 1.5 gigahertz, producing a dc output proportional to the rms value of its input. The analog meter uses a dual sampling technique to keep its residual noise below 20 microvolts. Because of the low noise, resolution is $100 \mu V$ on the meter's lowest (1-millivolt) range.

Maximum error is 2% of reading plus 3% of full scale for frequencies between 100 kHz and 500 megahertz. For 500 MHz through 1 GHz, it increases to 7% of reading plus 3% of full scale. From 1 GHz through 1.5 GHz, the measurement uncertainty is 17% of reading plus 3% of full scale.

The instrument's probe, which is used for all measurements, has an input impedance of 100 kilohms. It

Is Modular Sensorialization the Answer to Efficient Microprocessor Testing?

by Richard C. McCaskill, Manager, Applications Services



With the development of LSI technology have come testing problems every bit as complex as the new circuits themselves. Consequently, a serious question has arisen. Do we continue with traditional "gate" test methods such as "path sensitization" or look to newer perhaps more well suited methods?

New Methods

Modular sensorialization, one of these new methods, is designed to test a module or a subsystem — instead of concentrating on each of the hundreds of MPU gates. And since a single chip MPU consists of relatively few modules, the procedure is relatively simple. Here is a brief description of that method.

Circuit Architecture

The first step in modular sensorialization is the investigation of the architecture of the MPU and the consequent partitioning of the MPU into modules. Each module should be accessible on the I/O bus by executing a proper set of

microprocessor instructions in order to propagate its results directly or indirectly to the I/O bus for sensing externally by executing a defined set of instruction sequences in the microprocessors own language. When dealing with each particular module, every effort should be made to run a worst-case test pattern, subject to the instruction executability. Once the first module is fully tested, then the procedure applies to each module until all modules within the MPU are covered. As a result of this, the entire MPU will be fully tested from the hardware viewpoint.

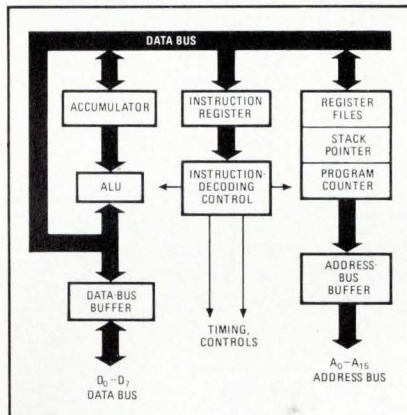

On the bus. Microprocessors may be viewed as assemblies of independent functional blocks that can be tested separately. Address and data buses tie the blocks together and provide access to each.

Software Architecture

Software is tested in a similar manner. A set of MPU instructions should be executed when testing the first module. Then, on the second module, another set of new MPU instructions (the same instruction could be executed previously) can be executed. This same procedure applies to all modules and hence all sets of instructions until

all specific MPU instructions are executed one or more times.

This approach provides two-fold diagnostic information. First, from a hardware viewpoint, any faulty module on the MPU will be isolated. Due to the fact that this approach is a modularity procedure, a break point is inherent in the test flow of each module to facilitate the modular diagnosis. Secondly, in conjunction with each module, a set of MPU instructions will be executed and thus any malfunction on a specific instruction or a specific set of instructions can be identified.

Systems to Solve Your Problems

Because of the ever increasing pace of technology, Macrodata recognizes there can be no one answer to every testing problem. That's why we are continuing to update and broaden the capability of our LSI test systems and our library of test programs and software to stay abreast of industry needs.

For more information on this or other LSI test subjects, consult Jack Salvador, vice president of engineering and marketing.



MACRODATA

Macrodata Corporation,
P.O. Box 1900, Woodland Hills,
Calif. 91365, Phone: (213) 887-5550,
Telex: 69-8489

ATE? GO DDS!



Model 5100: Manual/Automatic Programming

Direct Digital Synthesis for Glitchless Switching, Constant Resolution, Smooth Sweeping, Spectral Purity, and Phase Continuity.

For automatic test systems, and a host of other manual and computer-programmed frequency-generating applications in the 0-3MHz range, our Model 5100 Direct Digital Synthesizer (U.S. Patent No. 3,735,269) provides optimum performance at remarkably low cost. Optimum? Read on . . .

DDS, unlike all other methods of frequency synthesis, does *not* use either heterodyning or phase locking. Therefore, it provides *much lower* phase noise (-70dB spurious, -55dB harmonic), extremely high and constant resolution (0.001Hz, over the entire range), and stability entirely determined by its reference (internal or external) . . . sync it to an atomic standard, if you wish, for ultimate stability.

But the greatest advantages of DDS are revealed when you start *switching* frequencies. There's just *no* switching transient . . . amplitude and phase are *continually maintained* between frequencies. And the switching speed of the Model 5100 is *orders of magnitude faster* than is theoretically possible in an indirect synthesizer (1.5 microsecond programming delay, 625 nanosecond update rate). Frequency sweeping, under remote digital programming control, is smoother than ever before — and the frequency/time

curve can be either linear, or exponentially "shaped" for best response display.

Finally, DDS allows you to control the phase of the output signal, asynchronously, for any period. Only DDS, for example, will generate sinusoidal *bursts* with each burst starting at *exactly* zero phase.

The Model 5100 provides both manual (10-dial) and remote digital programming (binary or BCD) by computer, programmer, or contact closures. The blank-front-panel Model 5110 is digitally programmable only — for OEM systems, at OEM prices.

HOW & WHY DDS is your best bet for almost every application is explained in this *free* engineering data file. Request it today — use the inquiry number below, call, or write:

Rockland Systems Corporation
230 W. Nyack Road
W. Nyack, N.Y. 10994
TEL: (914) 623-6666
TWX: 710-575-2631



ADVANCED SIGNAL TECHNOLOGY
ROCKLAND
SYNTHESIS • PROCESSING • ANALYSIS

Our Second Decade of Leadership

Circle 164 on reader service card

New products

also has a press-to-hold button, which allows readings to be held for up to 3 minutes—a useful feature when it is impossible to position the probe and read the meter at the same time.

Designed for incorporation into automatic test systems, the meter is programmable.

Data Tech, a Division of Penril Corp., 2700 Fairview, Santa Ana, Calif. 92704 [354]

Making four-terminal measurements in tight places

Small enough to probe a pad only 20 mils on a side, a dual-tip probe allows true four-terminal measurements when used with ESI's model 1700 digital ohmmeter. By elimi-

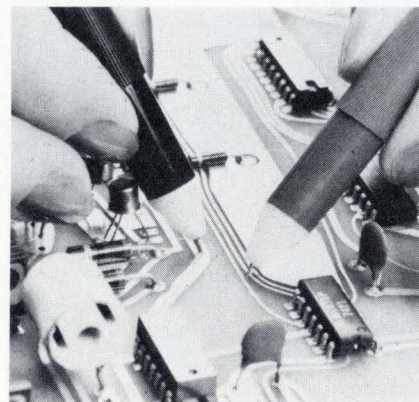

nating lead-resistance effects, the four-terminal technique permits high-accuracy measurements of extremely low resistances. Two of the dual-tip probes, which sell for \$95 each, are needed to make a four-terminal measurement.

Electro Scientific Industries, 13900 N.W. Science Park Dr., Portland, Ore. 97229. Phone (503) 641-4141 [356]

Dc source simulates thermocouples to within 0.1°

A versatile thermocouple simulator/calibrator, the model 1100, allows the user to simulate any of four common thermocouple types over the full range of NBS tables. The

If high start-up costs have delayed your expansion, contact Georgia.



The Bettmann Archive, Inc.

We're wired into the needs of the electronics industry. And we'll come to you with profit incentives you can appreciate.

Like available buildings and low-cost construction. A skilled and stable work force that

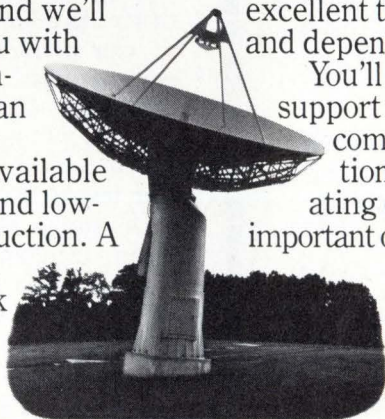

we'll train free. Fiscally-responsible government, excellent transportation and dependable utilities.

You'll also find good support from allied companies. In addition to lower operating costs, we offer important opportunities for higher education. Including the country's

second largest electrical engineering school at Georgia Tech. And the cultural amenities that help provide a pleasing lifestyle.

For more information contact Milt Folds, Commissioner, Georgia Bureau of Industry & Trade, P.O. Box 1776, Atlanta, Georgia 30301, Dept. EL-7543.



Georgia



There's still nothing like vacuum tubes for an exceptional TWT amplifier

Sure our amplifier uses solid state components—everywhere, in fact, except in the high voltage regulator and the TWT itself.

Why a vacuum tube regulator? Because of the greater reliability with this inherently high voltage component.

It qualifies our TWT amplifier especially for antenna pattern measurement, EMI susceptibility testing and r-f power instrument calibration.

But we utilize contemporary concepts when they add to reliable performance. Our modular construction and plug-in boards will accommodate a variety of TWTs for example.

And we can and do add VSWR protection, harmonic filtering and variable output, where required.

Octave band width 10, 20, 100 and 200 watts TWTAs from 1 GHz to 18 GHz. For detailed specifications write MCL, Inc., 10 North Beach Avenue, La Grange, Illinois 60525. Or call (312) 354-4350.



Circle 166 on reader service card

All LSI-11[®] And PDP-11/03[®]

Microcomputers Are Created Equal.

So Why Pay More?

Call "FIRST" (312) 920 1050!

First Computer Corporation can provide you with LSI-11 and PDP-11/03 modules or complete systems, virtually the complete Digital Equipment Corp. (DEC) vast product line, fast and at discounts to delight the toughest buyer.

For the latest available versions, with personalized service, call the FIRST. Ask for your customized discount and delivery schedule programmed specifically to fit your needs.

® Registered trade mark of Digital Equip. Corp.

FIRST COMPUTER CORPORATION

764 BURN OAK DRIVE, WESTMONT, ILLINOIS 60559

no magic — just performance

166 Circle 206 on reader service card

New products

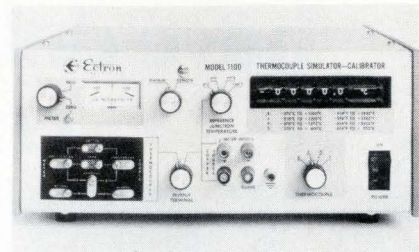

desired temperature is entered into the instrument by means of a five-digit thumbwheel-switch array, in either °F or °C, and the proper voltage appears at the output terminals constructed of the chosen thermocouple materials. Conformity to NBS tables is to within 0.1°.

The simulator sells for \$1,970 and has a delivery time of 30 days. Extra-cost options include remote programming and a rack-mounting kit.

Ectron Corp., 8159 Engineer Rd., San Diego, Calif. 92111. Phone (714) 278-0600 [357]

Benchtop tester

handles many IC types

Designed specifically for manufacturers who use small quantities of many different types of digital integrated circuits, the model 2400 digital-IC tester is principally a functional tester with limited parametric capability. It can test a wide variety of ICs with up to 24 pins, including C-MOS, ECL, TTL, and n-MOS devices, plus units with open-collector and three-state outputs.

As a functional tester, the 2400 can operate at rates up to 1.3 megahertz. As a limited parametric tester, it can perform partial dc output-voltage tests, and it can measure propagation delays from 20 nanoseconds to 99 microseconds. The 2400, when connected to an autohandler, can test 10,000 devices per hour.

A 16-pin version of the instrument, including a program library for more than 1,000 devices, sells for \$4,500. The 24-pin version is priced at \$5,900. Delivery time is 60 days. Biomation Corp., 10411 Bubb Rd., Cupertino, Calif. 95014. Phone (408) 255-9500 [360]

HERMES LOOP ANTENNA

THREE SAMPLE SITES
ON THE NORTH AMERICAN
CONTINENT —

DIFFERENT LATITUDES
DIFFERENT CLIMATE

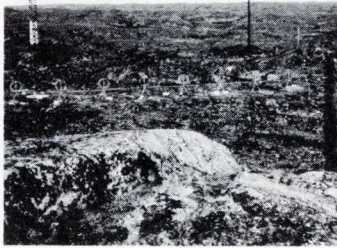

64°N

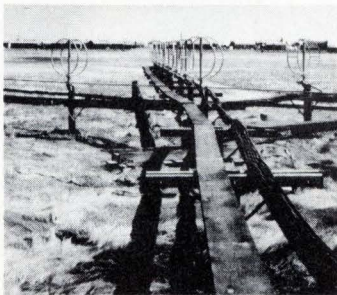

42.5°N

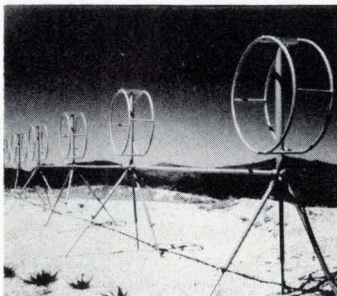

32.5°N



Good Listeners maintain a low profile

Even in the solitude of the forest depths, from rooftops, arctic tundra, swamps to sweltering tropics, 'neath snow, sand or ice,

the Hermes Loop antenna keeps an ear to the sky.

The amazing aperiodic antenna does away with vast log periodic and rhombic arrays - those towering antenna farms.

In rosette configuration, the Hermes loop antenna provides an omnidirectional broadband receiving array in space merely 1/100th that of the traditional antenna farm.

More than 53 government agencies around the world have pressed the loop antenna into service.

A new, even more compact version is available.

Only Hermes Electronics makes it.

**2-32MHz
BROADBAND**



ASK US Send for our Brochure

Hermes Electronics Limited

Suite 315

2020 F Street NW

Washington, DC 20006 USA

202-296 2978

TWX 710 822 1106

Our byte-size brain food for 'little' thinkers:

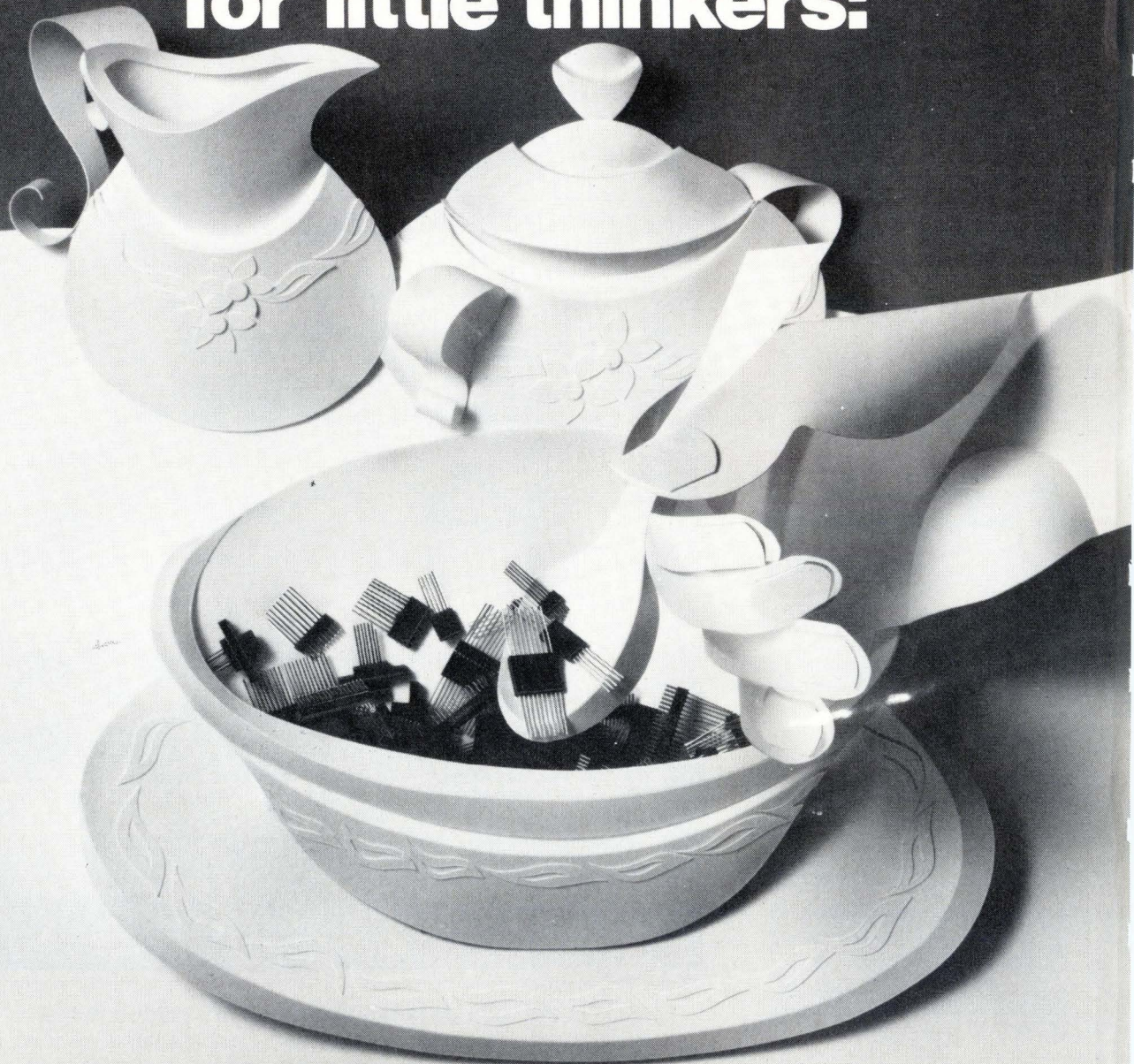

TRW/Cinch microminiature Dura-Con* connectors

No matter how large your byte, you still have to think "little" to reduce space and weight. That's why TRW/Cinch microminiature Dura-Con connectors offer so much food for thought.

The trim microminiature rectangular series of Dura-Con connectors is available in 9, 15, 21, 37, and 51 positions. Or consider the possibilities in stacking .075" thick Dura-Con strips. Only 33 grams of strips with .050" centers supplies 247 contact positions in a single square inch. Both types are available from TRW/Cinch distributors.

Besides high contact density, the unique Dura-Con design provides highly reliable connections. Each pin contact, formed from precision miniature spring cable of gold-plated 24 gauge copper alloy,

provides seven points of peripheral contact with the mating socket wall. Thus continuous mating is assured, no matter what radial forces are applied, from dry circuit to 3 amps.

Also available are TRW/Cinch Dura-Con connectors with #30 AWG contacts on .025" centers in custom configurations. That's up to 1521 contacts in a square inch for those who think much about "little."

For additional information, contact your TRW/Cinch distributor or your nearest TRW/Cinch sales office. Or write for technical bulletin CD-205 to TRW/Cinch Connectors, an Electronic Components Division of TRW Inc., 1501 Morse Avenue, Elk Grove Village, Illinois 60007; phone (312) 439-8800.

*Trade Name TRW Inc. CC-7502

TRW CINCH CONNECTORS

ANOTHER PRODUCT OF A COMPANY CALLED TRW

Circle 168 on reader service card

New products

Data handling

Computer kit sells for \$995

'Personal' machine, built around 8080 microprocessor, includes RAM and ROM

The cost of personal computers continues to come down. A complete computer kit, built around the Intel 8080 microprocessor, is being offered for \$995 by Processor Technology Inc., Emeryville, Calif., which claims this is the lowest-priced complete computer on the market. It comes with a walnut-sided cabinet and includes 1,024 words of static low-power random-access memory, 1,024 words of preprogrammed read-only memory, a 1,024-character video-display circuit, and an 85-key solid-state keyboard. It also has an audio-cassette interface that can control two tape recorders at 1,200 bauds, as well as parallel and serial standardized interface connectors, a power supply and a fan.

The unit runs the company's version of Basic—Basic-5, which is included in the package as a tape cassette, plus a new version called PT 8K Basic, for \$29, also in cassette form. This requires 8 kilobytes of memory. Other software includes two resident assemblers, a new compiler for Focal, the high-level language developed for the Digital Equipment Corp. PDP-8, a set of video games, and a video calculator called Mathpack.

The unit's memory is expandable to 65,536 kilobytes. The latest memory-expansion module from the company is one with 16 kilobytes of RAM, selling for \$529 in assembled form. The computer cabinet has five expansion slots, for such modules as memory, and an interface expansion board with two 8-bit parallel input/output ports with full handshaking logic and a serial data rate that can be set between 35 and 9,600 bauds.



The company also has a set of peripherals that include line and serial printers, perforated tape readers, floppy-disk memories, black-and-white and color displays, and analog-to-digital and digital-to-analog converters. With the displays, which are modified television monitors, the unit will show 16 lines of 64 characters each, including 86 ASCII upper- and lower-case characters, plus 32 selectable characters. The display position is continuously adjustable in both the horizontal and vertical directions.

The unit works with all S-100 bus types, including those of Altair and Imsai. The basic one-board computer is available alone in kit form for \$475.

Processor Technology Inc., 6200 Hollis St., Emeryville, Calif. 94608 [361]

Tape formatter is compatible with IEEE interface bus

What its manufacturer says is the first buffered magnetic-tape formatter that is compatible with the IEEE 488-1975 interface bus allows users to add any industry-standard tape drive to a bus-oriented system. The model 1015A provides asynchronous data transfer both to and from synchronous tape recorders such as those made by Cipher, Pertec, Wangco, and Kennedy.

Available in seven- and nine-track versions with a choice of several packing densities, the formatter pro-

vides read-after-write error checking with automatic correction. It uses a Z-80 microprocessor both to control the bus interface and to perform the memory-management function.

Dylon Corp., 7854 Ronson Rd., San Diego, Calif. 92111. Phone (714) 292-5584 [363]

One-card disk controller sells for \$1,900

A single-board disk controller that can interface an Interdata minicomputer with up to four CalComp Trident disk drives sells for only \$1,900 in unit quantities. Designated the TDC803, the controller occupies only one slot in the chassis of any current Interdata computer. It reduces the price of a 50-megabyte disk system to less than \$8,000.

The controller provides sector buf-

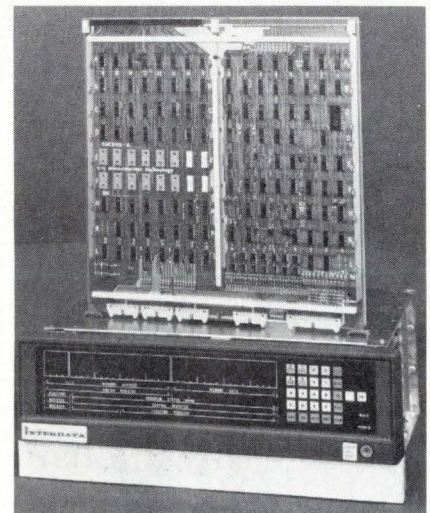

How to save up to 50% on flat cable/connectors just by changing colors.



It's easy to spot new Great Jumpers™ and great Daisy Jumpers™ from A P Products. Our ribbon is Electric Pink. And we're jumps ahead of any other flat cable/connector system. We come to you fully factory assembled and tested. Our connectors are molded on and feature integral strain relief plus complete line-by-line probability. Nothing could be easier to use. And we cost less. Just name your jump and watch us hop to it. We offer the five most popular flat cable widths, solid or stranded Electric Pink or rainbow cable, single ended, double ended or daisy chained. And Great Jumpers are directly-interchangeable replacements for the jumpers you're using now.

Connect with the A P rep nearest you.

(203) 868-7748	(219) 447-9623	(314) 434-6242	(512) 443-9687	(617) 272-8163
(206) 822-8223	(301) 484-5400	(315) 437-8343	(513) 433-0966	(713) 691-3961
(212) 682-5844	(303) 420-4646	(414) 421-2300	(602) 946-4437	(714) 560-6266
(214) 238-0408	(305) 894-3351	(415) 328-3232	(602) 949-8424	(714) 833-1802
(215) 923-5195	(312) 298-4830	(416) 638-1322	(609) 429-4013	(816) 765-2998
(216) 333-4120	(313) 356-2161	(503) 223-3374	(612) 922-7011	

Faster and easier is what we're all about.



A P PRODUCTS INCORPORATED

Box 110-E Painesville, OH 44077 (216) 354-2101 TWX: 810-425-2250

Circle 170 on reader service card

New products

fering so that it may be operated with or without a selector channel. It also generates error-checking codes, senses rotational position, and provides dual-access capability. The OEM discount schedule includes a price of \$1,520 at a volume of 100 units per year.

MiniComputer Technology, 1901 Old Middlefield Way, Mountain View, Calif. 94043. Phone Steve Gibson at (415) 965-4567 [364]

Chain printer competes with dot-matrix units

Designed for use with small computers or sophisticated communications terminals, the model 8201 chain-printer mechanism can print 300 lines of 132 characters each per minute. It has no duty-cycle limitation.

Offered at prices said to be competitive with those of dot-matrix printers that operate at 165 to 200 characters per second, the model 8201 is offered as a mechanism only. It is therefore expected to appeal to OEMs who want to add the required power supply, cabinetry, and interface circuitry.

C. Itoh Electronics Inc., 280 Park Ave., New York, N.Y. 10017. Phone Michael Fujiwara at (212) 573-9496 [365]

Computer system offers memory-mapping

The Eclipse S/230 computer is intended for large-system users in scientific, instrumentation, and computational applications. Its main memory capacity is 512 kilobytes,

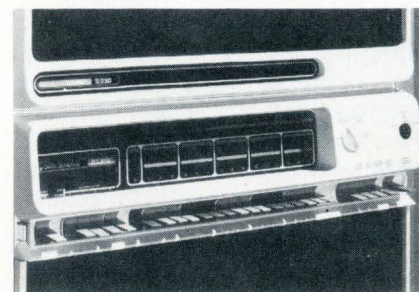

TEXAS ON SALE



Chafitz has the lowest prices on Texas Instruments calculators. While supplies last, we will meet or beat the advertised price of any model in our competitors' stocks.

	Model	List Price	Sale Price
Save \$ 5	30	\$ 24.95	\$ 19.95
Save \$ 7	40	\$ 39.95	\$ 32.95
Save \$10	51-II	\$ 79.95	\$ 69.95
Save \$70	SR52	\$299.95	\$229.95
Save \$ 2	1200	\$ 9.95	\$ 7.95
Save \$25	SR56	\$109.95	\$ 84.95
Save \$ 5	1600	\$ 24.95	\$ 19.95
Save \$ 5	1650	\$ 29.95	\$ 24.95
Save \$ 5	2550-III	\$ 34.95	\$ 29.95
Save \$20	5100	\$ 69.95	\$ 49.95
Save \$10	5040	\$149.95	\$139.95
Save \$66	PC100	\$295.95	\$229.95
Save \$ 2	1250	\$ 12.95	\$ 10.95
Save \$30	5050M	\$129.95	\$ 99.95
Save \$ 5	Bus. Anal.	\$ 49.95	\$ 44.95

When you think calculators, think

Chafitz

©1976 Chafitz

Order now by mail or phone.

Call Toll-Free 800-638-8280

Md. D.C. No Va Res call 301-340-0200
Major credit cards accepted—MC, BAC, AMEX, DC
Add \$3 shipping & handling for 1st unit.
\$1 each additional unit. Md. Res add 4% sales tax
856 Rockville Pike, Dept. 214
Rockville, Maryland 20852

What You Need Is What You Get.

Ramtek's new RM9000 modular graphics and imagery system gives you expandability, economy and flexibility.

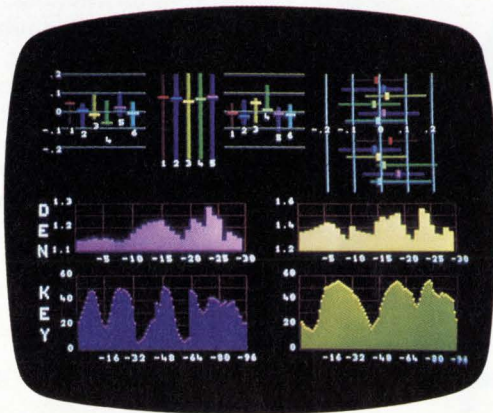

Process Control: Color printing press.

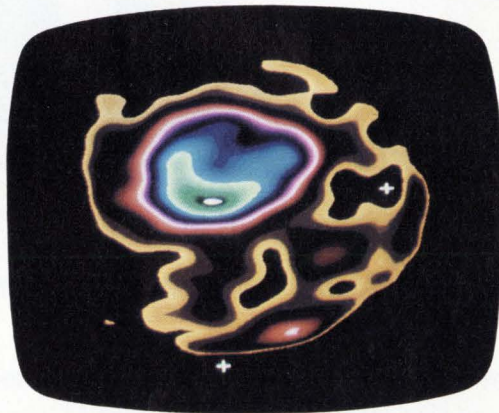

Medical Imaging: Nuclear heart study.

Select The Performance You Need.

The RM9000's total modularity lets you select the exact performance you need to fill your particular application. You pay only for the performance you need. Nothing more. And that's like money in the bank.

Add On As You Have To.

As your needs change and grow, the RM9000's capability will grow right along with them. A comprehensive list of options such as expansion from black and white to grey scale or color—even a complete range of interactive peripherals and additional independent channels.

Microprocessor-Controlled Raster Scan.

The RM9000 is the first raster scan graphics and imagery system to be totally microprocessor

controlled. That means you can implement a higher-order user language to minimize programming costs without a sacrifice in system throughput.

Functional. Reliable. Maintainable.

High reliability is the direct result of intensive testing of components and systems prior to shipment. Solid state components and printed circuit construction are used exclusively. Result? No special preventive maintenance measures are required. In fact, the RM9000 can be pre-programmed with self-diagnostic capability.

You Need To Know More.

To fully appreciate the RM9000's capability, you need more details. Call or write Ramtek Corporation, 585 N. Mary Ave., Sunnyvale, CA 94086. (408) 735-8400.

ramtek
Our Experience Shows

Parallel Entry Printer

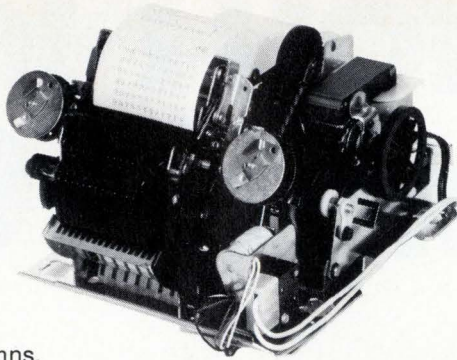

Prints 3 lines per second, 11 character locations per column with a capacity up to 16 columns. Print mechanism is small (5 1/4" x 10" x 8").

Options available: Serial or parallel BCD interface
Power supply Attractive case

With the addition of calculator logic, it becomes our "Intelligent Printer".

Write for catalog of Addmaster computer peripherals.

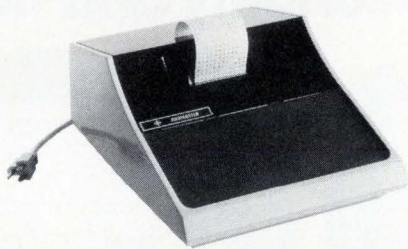

416 Junipero Serra Drive • San Gabriel, California 91776

Circle 172 on reader service card

HIGH ANALOG TECHNOLOGY #1

OUR ANALOG PRODUCTS DELIVER HIGH VOLTAGE.

Ideal for all markets—games, automotive, medical, appliances, audio. Our digit drivers, NE584 & 585. MOS and TTL compatible. Plus our power amplifier, NE541.

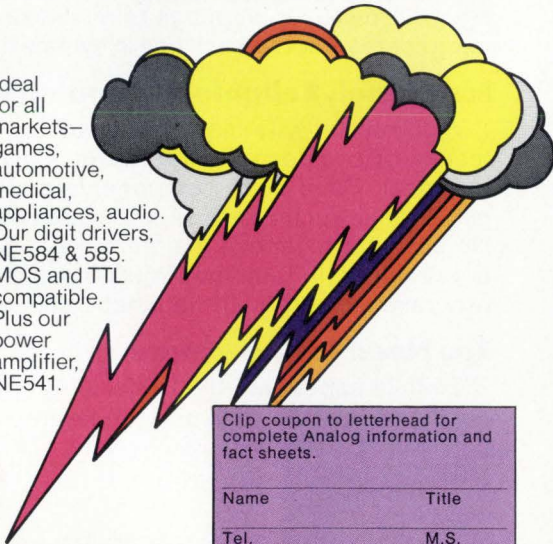

Clip coupon to letterhead for complete Analog information and fact sheets.

Name	Title
Tel.	M.S.
811 E. ARQUES, SUNNYVALE, CA. 94086	

THINK Signetics

a subsidiary of U.S. Philips Corporation

© 1976.

172 Circle 208 on reader service card

New products

which can consist of high-speed semiconductor devices, magnetic cores, or a mixture of the two. Full memory-mapping and protection allows virtual overlaying of user memory with the aid of a 64-kilobit buffer. Used in conjunction with external disk memories, this technique provides a hierarchical memory system that can be adapted to various specific applications.

An additional feature of the S/230 is an optional writable control store (WCS). The WCS consists of 256 56-bit words of user-programmable random-access memory for writing specialized instructions, an optional fast single- and double-precision floating-point processor, and a comprehensive instruction set with hardware stack and vectored-interrupt servicing instructions as well as bit, byte, word, and block manipulation. Data General Corp., Southboro, Mass. 01772. Phone (617) 485-9100 [366]

Programmable terminal

works with any computer

A programmable interactive terminal with a printing speed of 180 characters per second can be matched to any computer processor because it possesses microprocessor logic that



lets it talk in any existing protocol, code, or mode. Designated the LX1010, the terminal leases for approximately \$200 a month, or it can be purchased for about \$6,000 in single quantities.

The terminal has a universal communications capability that allows it to communicate in ASCII, BCD, or Telex code at speeds ranging from 75 bauds to 4,800 bauds both synchronously and asynchronously. Delivery time for the terminal is

Electronics / November 25, 1976

KEYBOARD SWITCHES for INSTRUMENT PANELS

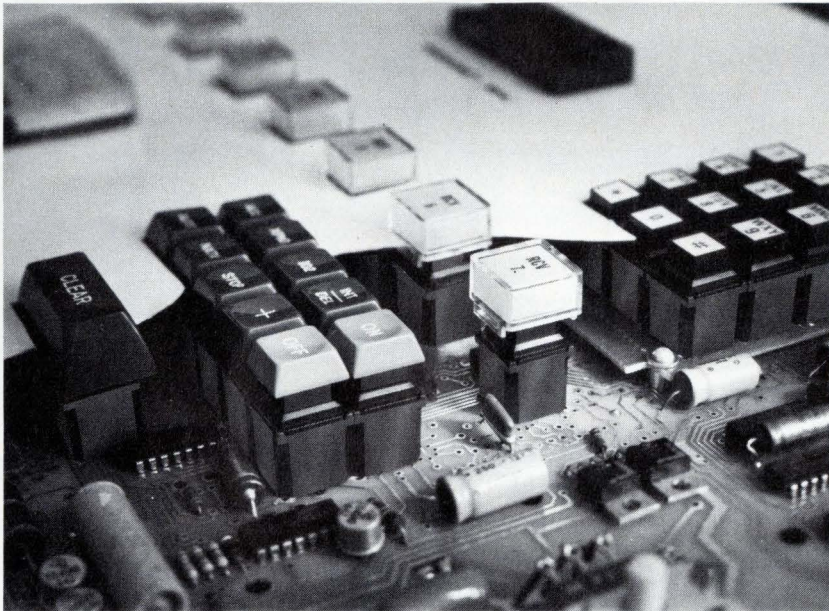

Now is the time to stop hand wiring to *expensive* panel-mounted switches.

Mechanical Enterprises' keyswitches are available at about *half-the-cost*. And, they are *self-supporting* on the PC board without the need for metal sub-plates.

Our switches feature —

- Sealed contacts or inexpensive gold bar mechanical contacts
- 3/4" or 5/8" spacing, or stand-alone
- Selection of legending systems including doubleshot keytops
- Lighted models in three lens styles, all relampable from front
- Single or double pole, NO or NC
- Momentary or alternate action
- Wave solderable
- 20 million cycle life at TTL loads with guaranteed low bounce

Please phone for a free sample with keytop.



Mechanical Enterprises, Inc.

8000 Forbes Place Springfield, Virginia 22151 (703) 321-8282 TWX 710-832-0942

Germany - NEUMULLER GMBH, MUNICH / U.K. - TEKDATA Ltd., STOKE-ON-TRENT / France - TEKELEC AIRTRONIC, SEVRES / Switzerland - DIMOS, AG ZURICH

Circle 173 on reader service card

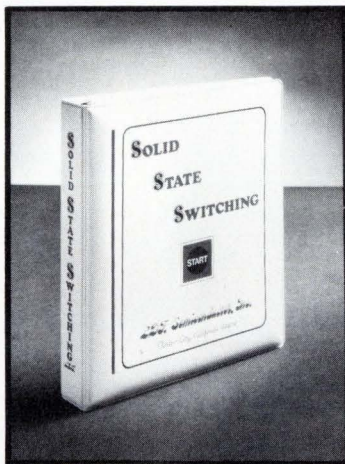

Revolutionary New Type of Solid State Switch

Could you use switches that never need service or adjustment? How about 100% environment-proof keyboards that cost so little you just throw them away in case of failure?

Before you make any decisions about keyboard or switch applications on current projects, you should get the facts about new technology available in our SOLID STATE SWITCHING Kit.

Our DEMO-BOARD incorporates 4 different applications. We show you how to design and produce low-cost keyboards. Test the switches. Make measurements through provided points. Available in English, German, French, Japanese and Spanish. For a FREE COLOR BROCHURE, write or call us today.

Please send me a copy of your FREE BROCHURE.

NAME _____ TITLE _____
 COMPANY _____
 CITY _____ STATE _____ ZIP _____
 TELEPHONE _____ COUNTRY _____

DDF. Semiconductor, Inc.

1191 Chess Drive • Foster City, CA 94404 • (415) 574-2541
 TELEX 349389 DYNALOC

Circle 209 on reader service card

HIGH ANALOG TECHNOLOGY #2

OUR ANALOG PRODUCTS ARE LEADERS IN HIGH SPEED.

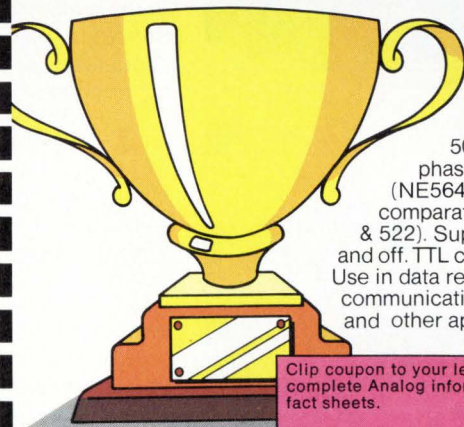

The first 50 MHz digital phase locked loop (NE564) and dual comparators (NE521 & 522). Super fast on and off. TTL compatible. Use in data recording communications and other applications.

Clip coupon to your letterhead for complete Analog information and fact sheets.

Name _____ Title _____
 Tel. _____ M.S. _____
 811 E. ARQUES, SUNNYVALE, CA. 94086

THINK Signetics

a subsidiary of U.S. Philips Corporation

©1976.

Circle 210 on reader service card 173

HUGHES

HUGHES AIRCRAFT COMPANY
CONNECTING DEVICES DIV.

Today we
supply the spark
for America's
defense.

Connections were much simpler 200 years ago. Torch the fuse and the cannon fired.

Supplying the vital spark that makes a modern weapon system do its job is a lot more complicated.

That's where we come in. For many years, primes and OEMs for military and aerospace products have depended on us to provide the vital links in their electronic systems—flat cable, etched circuitry, connectors, and total interconnection systems.

Our high-rel connections have to be the best. They're used in systems like Phoenix, Maverick, Lance, Minuteman, AWACS, F-14, F-15, Space Shuttle, Viking, Sonobuoy, F-4, A-7, Condor, Standard Missile, F-18, AAH, Cruise Missile, F-8, Trident, Hobo, Sprint and many more.

To learn how we can serve your interconnection needs, contact Jack Maranto or Dave Cianciulli: Hughes Connecting Devices, 17150 Von Karman Ave., Irvine, CA 92714.

Or call (714) 549-5701.

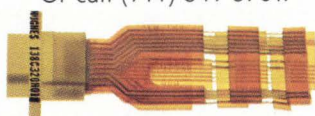

**Hughes
Connecting Devices**

Circle 174 on readerservice card

New products

30-60 days after receipt of order.

LogAbax (U.S. Division), 10889 Wilshire Blvd., Los Angeles, Calif. 90024. Phone (213) 477-0494 [367]

Bidirectional printer

hammers out 200 lines/min

The model T-1602 matrix printer uses optimized bidirectional printing to achieve throughput speeds in excess of 200 lines per minute. The 160-character-per-second unit contains a microprocessor, which computes the shortest distance to each successive print position.

Standard features include a 7-by-7 matrix font, double-width char-

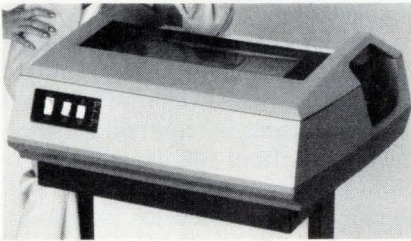

acter capability, upper- and lower-case printing, forms-length selection, and self-test. Capable of handling form widths from 4 inches to 15 in., the T-1602 prints an original plus four carbons. OEM prices start at \$3,115; delivery time is 60 to 90 days.

Tally Corp., 8301 S. 180th St., Kent, Wash. 98031. Phone John Roberts at (206) 251-5644 [368]

Circuit board couples digitizer with PDP-11

An interface in the form of a single quad-width circuit board connects the Summagraphics Corp. data-tablet/digitizer with DEC's PDP-11 minicomputers. The interface transfers X-Y coordinate information to the computer and operates in either programed input/output or interrupt mode. Price of the interface with a 10-foot connecting cable is \$1,350. Summagraphics Corp., 35 Brentwood Ave., Fairfield, Conn. 06430 [369]

1702A MANUAL EPROM PROGRAMMER

Features hex keypad, two digit hex address and two digit hex data display. Controls include load, clear, go! (step), key/copy, data in/data out, and counter up/down. Profile card includes high voltage pulse regulator, timing, 8 bit address and 8

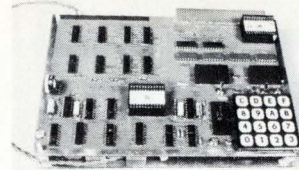

bit data drivers/receivers. Two 6½" x 9" stacked cards with spacers. Allows programming in 20 minutes - copying in 5 minutes. Requires +5, -9, and +80 volts.

ASSEMBLED \$299.95
KIT \$189.95

NOW

The best of two worlds... use our 1702 EPROM programmer as a manual data/address entry programmer... or connect it to your processor.

IMSAI/ALTAIR computer interface (requires 3 output ports, +1 input port) and software \$49.95

Briefcase unit with power supplies and interface connectors (assembled and tested only) \$599.95

ANNOUNCING

Our NEW 16K Byte Pseudo-Static, IMSAI/ALTAIR compatible RAM. Single card slot. Uses less power than equivalent low power RAM. All memory chips socketed. Uses all prime, factory fresh ICs. High quality, two-sided, through-hole-plated circuit board. Crystal controlled, totally invisible refresh system requires NO software management. Just plug it in and use like STATIC memory.

Complete kit \$349.95
Assembled, tested, and burned in \$549.95

ASSOCIATED ELECTRONICS

12444 Lambert Circle • Garden Grove, CA 92641
(714) 539-0735

Circle 175 on reader service card

HIGH ANALOG TECHNOLOGY #3

OUR ANALOG PRODUCTS ARE HIGH ON CURRENT.

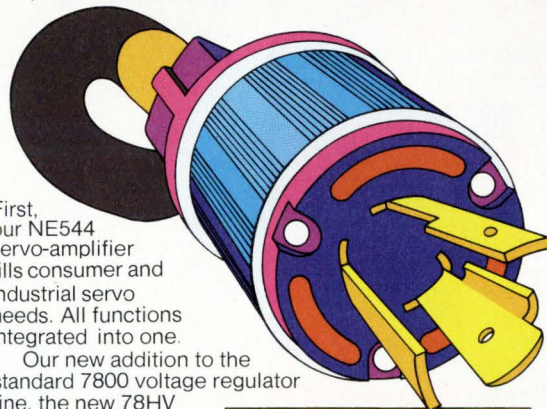

First, our NE544 servo-amplifier fills consumer and industrial servo needs. All functions integrated into one.

Our new addition to the standard 7800 voltage regulator line, the new 78HV high voltage regulator offers high breakdown voltage for better reliability.

Clip coupon to letterhead for complete Analog information and fact sheets.

Name _____ Title _____

Tel. _____ M.S. _____

811 E. ARQUES, SUNNYVALE, CA. 94086

THINK Signetics

a subsidiary of U.S. Philips Corporation

©1976.

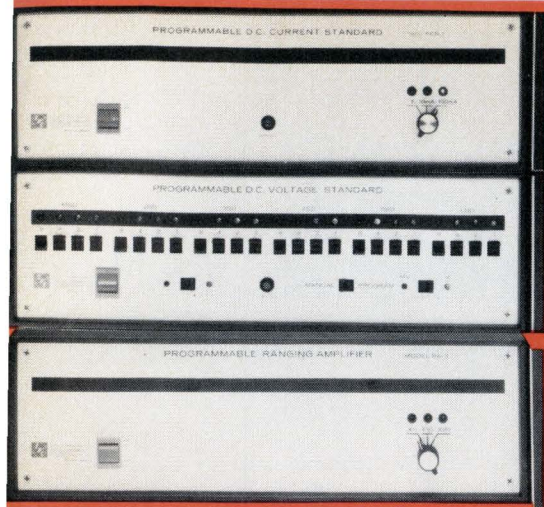

Programmable D/C Standards Voltages & Currents

Your Programmer?

Our 501J system lets most CPU's μ P's or programmable calculators call up voltages from 0.1 μ V to 200 Vdc or current from 10 nA to 100 mA dc at speeds to 50 μ s.

Ours?

Model RCM-4 has 40 address memory, manual programming, adjustable clock, 3 sequence modes. Field installable.

Or Both?

Use our RCM-4 to write the program and yours to control it. 501J's the ultimate in programmable ranging, resolution, low noise and NBS traceable dc voltage and current. Price from \$1595. Contact Bob Ross at (617) 268-9696.



ELECTRONIC
DEVELOPMENT
CORPORATION

11 Hamlin St., Boston, MA 02127 (617) 268-9696

Circle 176 on reader service card

New products

Subassemblies

Photodetectors include filters

One-package detector arrays
use interference filters
for 10-nm resolution

Expertise in both optical filtering and electronics—an unusual combination—has enabled Isotek Corp. to develop a series of detector/filter arrays. The family is being offered for a variety of applications in spectrum scanning, ranging from lot-to-lot dye-matching of paints and fabrics during production to determining the spectral diffusion of flash lamps used in laser-fusion experiments.

The arrays consist of 11 silicon photodiode detectors that are combined with the appropriate interference filter to cover wavelengths from 410 to 1,000 nanometers in increments of 10 nm. The detector array and filter are both housed in a glass-lidded 16-pin dual in-line package. Donald Drew, Isotek's general manager, points out that, in addition to combining the filtering and detection functions in a single DIP, the arrays can be scanned faster than some

\$3,000 instruments. And the 10-nm resolution of Isotek's arrays, though not as good as in those more expensive instruments, is better than the 100 nm or so typical of discrete TO-18-type filtered detectors.

All 11 channels or detectors can be scanned in approximately 500 microseconds, depending on the scanning circuitry used, Drew says. This compares very favorably with 30 seconds or so for the high-priced instruments.

Drew expects that speed and the price of \$325 in quantities of 1 to 24 will make the arrays attractive for production-line applications in color-matching. Eventually, Isotek plans to couple the detector/filter arrays with scanning electronics in a potted module for simpler use, company engineers report.

The detectors operate on a photovoltaic principle, using transmitted or reflected light, which means that no bias current is required. Further, the output from all detectors is in parallel, allowing data from all channels to be stored for later analysis before the event being monitored decays, which could happen with serial output.

The DIP is 1/2 inch wide, 7/8 in. long and just over 3/8 in. high. A total of 59 filters is available to accommodate the visible and near-infrared portion of the spectrum covered, and the price of each array in quantities

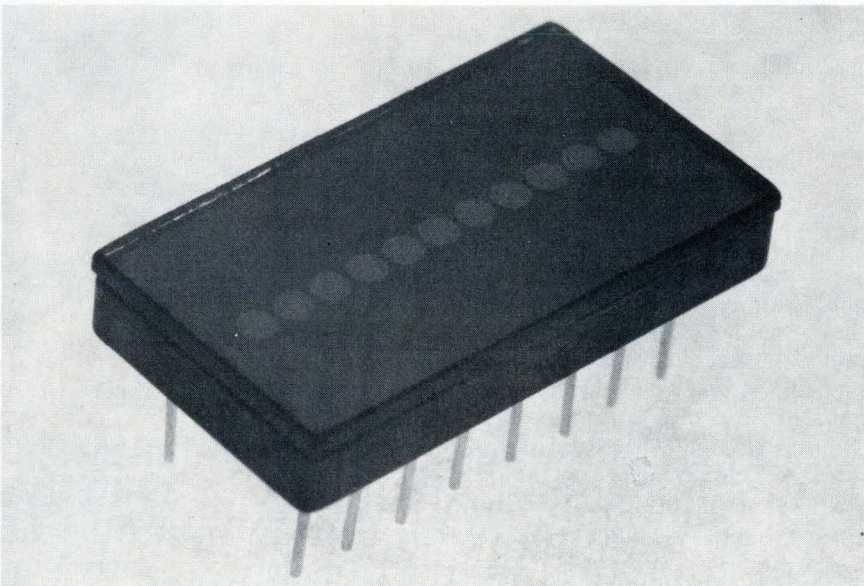

Problem:

No one makes a standard enclosure that'll house your system design.

Solution:

Contact Bud and tell us your problem. We'll solve it.

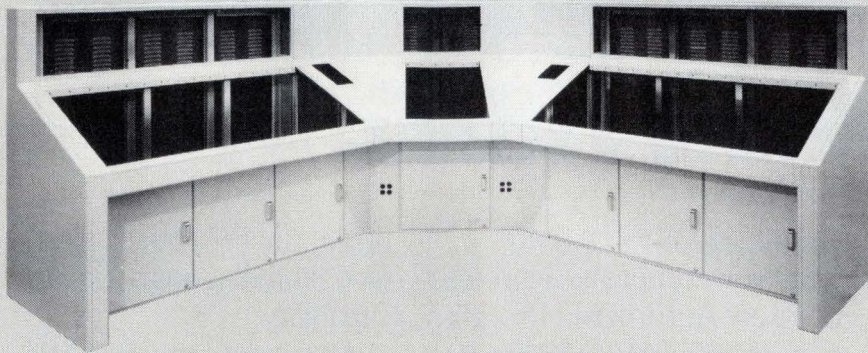

This is a special enclosure Bud helped design, then we built and delivered it on time. Special fabrication is a big part of our business; we know what we're doing — and we do it one of three ways: Adapting a standard product that'll fit a system; creating an entirely new enclosure; using the Imlok system, one that's ideal for short runs or prototypes. **YOUR PROBLEM IS SOLVED!**

Call toll free:

(800) 321-1764 for more facts. In Ohio, (800) 362-2265.

BUD

BUD RADIO, INC.
Willoughby, Ohio 44094

NEW!

The TROMPETER Connection!



FEATURES:

- 1 Enclosed hardened Beryllium Copper outer conductor spring.
- 2 Positive shield integrity — metal to metal.
- 3 Positive jacket retention. Meets Mil C 39012 Cat. A. Patent Pending.

**WRENCH
CRIMP™
CONNECTORS**
BNC - TNC - N

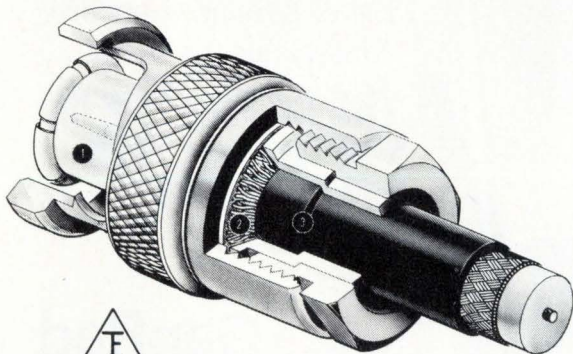

**TROMPETER
ELECTRONICS, INC.**

8936 Comanche Avenue, Chatsworth, CA. 91311 • (213) 882-1020/TWX: 910-494-1210

Circle 177 on reader service card

HIGH ANALOG TECHNOLOGY #4

OUR ANALOG PRODUCTS PAY OFF WITH HIGH PERFORMANCE.

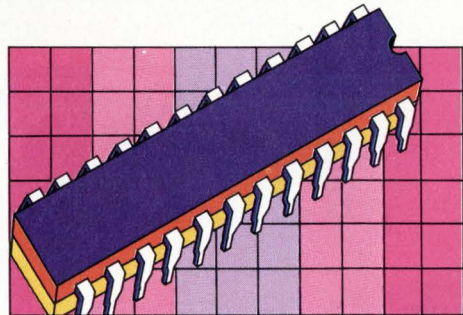

New heights in Analog performance. Our SE & NE535 op-amps with high slew rate, low offset voltage and bias current. SD5301 Analog multiplexer with all control logic on one chip. SE & NE558 & 559 quad-timers and NE570 & 571 Compressor/Expander Audio Amplifier.

Clip coupon to letterhead for complete Analog information and fact sheets.

Name	Title
Tel.	M.S.
811 E. ARQUES, SUNNYVALE, CA. 94086	

THINK Signetics

a subsidiary of U.S. Philips Corporation

Circle 212 on reader service card

©1976.

177

INTRODUCING THE ONLY BOARD TESTERS THAT SHOW WHO'S AT FAULT. SHORTS, BAD COMPONENTS, EVERYTHING.

Now, thanks to our new CAPS VIII software, our GR board testers can take you beyond identifying the faulty node to pinpointing random shorted tracks, opens, and faulty components. And they get there at least twice as fast as other testers that only get you to the node. So they save you both troubleshooting time and repair time and require fewer rework support people.

But that's not all. CAPS VIII software also gives you faster setup, to reduce

testing costs even more. This is accomplished through our new Automated Program Generation (APG) Software which includes an incremental simulator, event tracking capability, equation generation and test-generation language. It will give you a test program that detects a greater percentage of faults in less time than any other setup method on the market.

To make CAPS VIII even more attractive, we're also offering a new Smart Clip, a new pulse-catching logic

probe, an IEC buss interface, and diagnosis logging capability.

Of course, to get CAPS VIII's big improvements in fault resolution, setup and troubleshooting speed, and cost, you first



New Smart Clip reduces diagnostic time.

need a GR digital or hybrid circuit board tester. But that's no problem either. The number to call is 617-369-8770 ext. 273.

Gen Rad, Inc. Test Systems Division, 300 Baker Avenue, Concord, Massachusetts 01742.

THE DIFFERENCE IN SOFTWARE IS THE DIFFERENCE IN TESTERS.

 **GenRad**



New products

of 500 or more is \$63. Delivery time is 30 days after receipt of order.

Isotek Corp., 567 Chickering Rd., North Andover, Mass. 01845. Phone Donald Drew at (617) 685-1511 [381]

Standard clock module is developed for autos

By working with each auto maker on an almost custom basis—designing a particular system to a specific model line—semiconductor manufacturers have hoped to gain an inside track on possible future business, even though it leaves their options in the existing automobile market somewhat limited. National Semiconductor Corp. has decided to do things differently.

In an unorthodox move, it is going after both markets, introducing as a standard product a 12-volt automotive instrument clock module that is designed to meet or exceed most of the criteria demanded for automobile use.

According to Jerry Zis, module products marketing manager at National, the MA1003 is based on the MM5377 monolithic p-channel large-scale-integrated clock circuit. To this is added a 2,097-megahertz crystal, supporting buffer components, and a four-digit 0.3-inch-high green fluorescent display, to form a complete digital clock for 12-v dc applications.

The module, says Zis, is fully protected against battery reversal conditions and automotive transients (+40 v for 50 milliseconds, +80 v for 5 ms, and -200 v for 1 ms). Timekeeping is maintained down to 5 v dc.

Brightness is controlled automatically. The chip logic blanks the display when the ignition is off, halves brightness when park or head lamps are on, and follows the dimmer-control setting for the dashboard lamp. The bright green display is filterable to various shades of green, blue-green, blue, and yellow.

The hours-advance and minutes-advance switches are closed to set time. To prevent tampering, the

Let our fast clipper speed you out of troubled waters.

Troubleshooting DIP ICs can be a pain in the probe if you can't get at their pins. But you can make the job faster and easier with Super-Grip™ IC test clips from A P. Our "contact comb" design prevents shorting while our superior gold-plated phosphor bronze terminals make contact. Then your probe is welcome aboard its handy topside pins. And this gutsy little spring clip is perfect as an IC puller, too. So use it for its connections or use it for its pull. Either way, you're full speed ahead with A P.



A P has a Super-Grip™ Clip for any DIP.

MODEL	ROW-TO-ROW DIMENSION	PART NUMBER	PRICE
TC-8	.3 in.	923695	\$ 7.35
TC-14	.3 in.	923698	\$ 4.50
TC-16	.3 in.	923700	\$ 4.75
TC-16LSI	.5/.6 in.	923702	\$ 8.95
TC-18	.3 in.	923703	\$10.00
TC-20	.3 in.	923704	\$11.55
TC-22	.4 in.	923705	\$11.55
TC-24	.5/.6 in.	923714	\$13.85
TC-28	.5/.6 in.	923718	\$15.25
TC-36	.5/.6 in.	923720	\$19.95
TC-40	.5/.6 in.	923722	\$21.00

Order from your A P distributor today. Our distributor list is growing daily. For the name of the distributor nearest you call Toll-Free 800-321-9668.

Send for our complete A P catalog, The Faster and Easier Book.



A P PRODUCTS INCORPORATED

Box 110-E Painesville, OH 44077 (216) 354-2101 TWX: 810-425-2250

Circle 179 on reader service card

HIGH ANALOG TECHNOLOGY #5

OUR ANALOG PRODUCTS TUNE IN ON CONSUMER NEEDS.

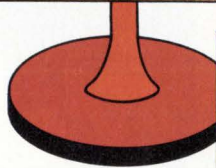
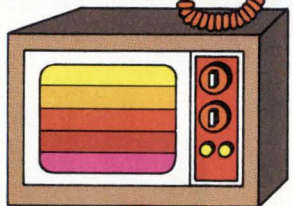
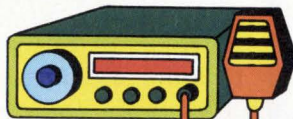

Offering all the benefits of designing with Analog for consumer products. Games, automotive control and entertainment systems, TV, CB, just to name a few.

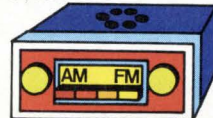

Simply clip coupon to letterhead for complete Analog information and fact sheets.

Name _____ Title _____
Tel. _____ M.S. _____
811 E. ARQUES, SUNNYVALE, CA. 94086

THINK Signetics

a subsidiary of U.S. Philips Corporation

© 1976.

What makes Plenco a leader in Heat-Resistant Phenolics?

A few good words good companies say about Plenco:

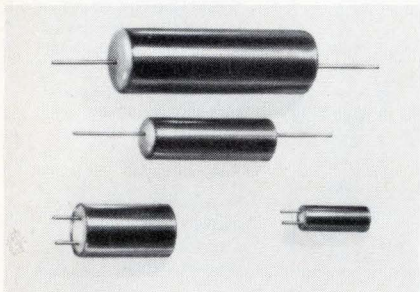

"High heat-resisting Plenco 349 gave us insulating properties and electrolyte resistance that provides us with the ability to easily change the electrical characteristics of our capacitors."



"When it came to selecting a molding compound, what our recessed downlight fixtures needed was a black material that was highly heat-resistant, not brittle, able to hold a sharp edge and keep up a good appearance. The answer your Plenco 349 phenolic gave us was Yes."

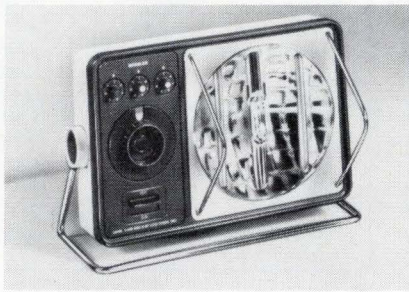

"Your Plenco 466 Black is not only highly heat-resistant, but also has good dimensional stability, good looks, and molds to a very nice matte finish produced by a textured mold."

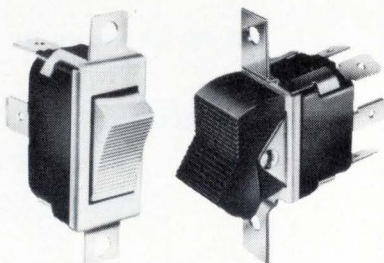

"Results are extraordinary. Plenco 485 Black gives our switches the required resistance to high temperatures—plus extremely fast cure, fine surface finish, rigid set and low shrinkage. It's the best we have had."

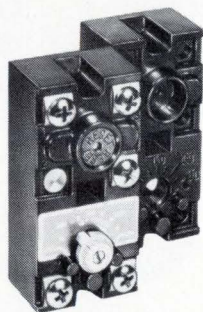

"Our experience with Plenco 414 Black heat-resistant/electrical phenolic compound showed it to be a dependable and versatile material. Its ability to withstand elevated temperatures did a job for our water heater controls."



"Lab design testing for the base of our fryer was done on a number of plastics . . . Your Plenco 466 Black phenolic was chosen as most desirable for its resistance to high temperatures, and facilitated obtaining UL approval."

Plenco produces diversified thermoset materials with a wide range of properties, formulated with or without asbestos, to meet a world of varied and demanding customer requirements. It's likely Plenco can provide a thermoset that's suitable for your particular application.

See us at the Show—Booth 1132

PLENCO
THERMOSET PLASTICS

PLASTICS ENGINEERING COMPANY
Sheboygan, WI 53081

Through Plenco research . . . a wide range of ready-made or custom-formulated phenolic, melamine-phenolic and alkyd thermoset molding compounds, and industrial resins.

New products

switches are disabled when the display is blanked. Interconnection to the automobile system is simplified through the use of a six-pin connector on the pc-board module, which measures 3 by 2 inches.

The clock modules cost \$40 each for 1 through 99; \$25 each in 100-up quantities.

National Semiconductor Corp., 2900 Semiconductor Dr., Santa Clara, Calif. 95051 [382]

F-v converter sells for \$39

Two modular frequency-to-voltage converters with low-quantity prices as low as \$39 offer an output current of 20 milliamperes and a maximum nonlinearity as low as 80 ppm. The 10-kilohertz model 451 and the 100-kHz model 453 provide the versatility of programable input threshold, gain, and output offset voltage. Three versions of each converter are offered; they differ only in nonlinearity and gain-drift performance characteristics.

The 451J and 453J have a 0.03% maximum nonlinearity, 100 ppm/°C gain drift, and respective prices of \$39 and \$41. For the K versions, the figures are 0.015% nonlinearity, 50 ppm/°C gain drift, and \$45 and \$47 for the 10-kHz and 100-kHz converters, respectively. The top-of-the-line L versions have the same drift specification as the K units, but the maximum nonlinearity is reduced to 80 ppm, and the prices are raised to \$51 and \$55. All the units are housed in modules that measure 1.5 by 1.5 by 0.4 inches.

Analog Devices Inc., P.O. Box 280, Norwood, Mass. 02062. Phone Lowell Wickersham at (617) 329-4700 [384]

25-watt dc-dc converter produces little noise

An isolated, regulated dc-to-dc converter that puts out up to 830 milliamperes at ± 15 v produces only 40 millivolts of peak-to-peak

TAKE YOUR PICK!!

NLS' DPMs fill every need and the prices are pleasing.

PM SERIES DC OR AC VOLTS

Features Include:

- Operates from a +5-volt separate power supply.
- MOS/LSI construction.
- Smallest package available anywhere - 1" H x 2.5" W x 3.25" D.
- Automatic zeroing.
- Programmable decimal.
- Overload indication.
- Protected input.
- Low power consumption.
- Large 0.3" LED display.



PM-4 PANEL METER

MODEL	RANGES	ACCURACY	AUTO POLARITY	MUX BCD OUTPUT	RATIO OPERATION	DIGITS	PRICE
PM-3	VDC	$\pm 0.1\%$ F.S.	No	No	No	3	\$ 85
PM-3A	1V, 10V, 100V, or 1000V	$\pm 0.1\%$ F.S.	Standard	Standard	Standard	3	\$ 89
PM-3.5	(PM-3.5 has 100% over-range - 1200V maximum)	$\pm 0.05\%$ F.S.	Standard	Standard	Standard	3-1/2	\$ 99
PM-4		$\pm 0.02\%$ F.S.	Standard	Optional	Optional	4	\$170
PM-3.5AC	VAC - 2V, 20V, 200V or 1000V	$\pm 0.5\%$ F.S.	N/A	Standard	Standard	3-1/2	\$136



Non-Linear Systems, Inc.

Originator of the digital voltmeter.

Box N, Del Mar, California 92014 Telephone (714) 755-1134

See your local distributor!
Distributor inquiries invited.

Circle 181 on reader service card

HIGH ANALOG TECHNOLOGY #6

**OUR ANALOG PRODUCTS
KEEP DATA PROCESSING
HUMMING.**

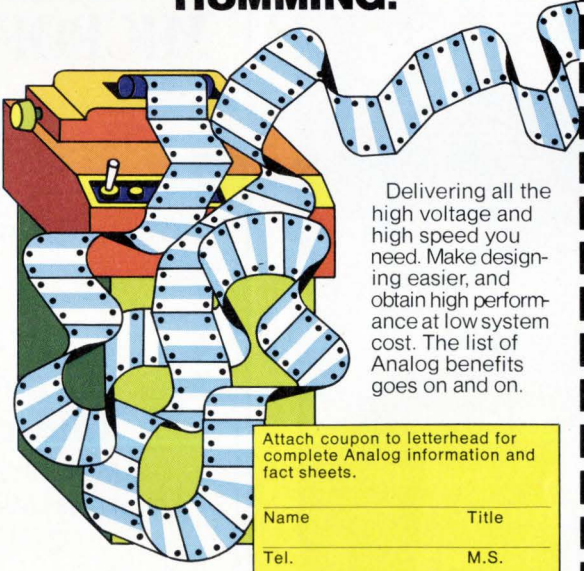

Delivering all the high voltage and high speed you need. Make designing easier, and obtain high performance at low system cost. The list of Analog benefits goes on and on.

Attach coupon to letterhead for complete Analog information and fact sheets.

Name _____ Title _____

Tel. _____ M.S. _____

811 E. ARQUES, SUNNYVALE, CA. 94086

THINK
Signetics

a subsidiary of U.S. Philips Corporation

©1976.

HIGH ANALOG TECHNOLOGY #7

OUR ANALOG PRODUCTS MAKE INSTRUMENTATION MEASURE UP.

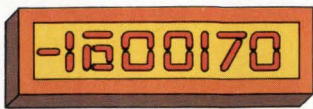
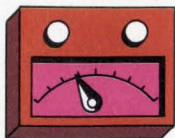

The high voltage, high speed and high current advantages of Analog fit right into your instrumentation requirements. Scientific, medical, processing instruments keep on beam with Analog.

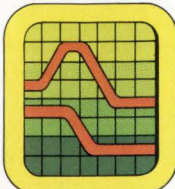
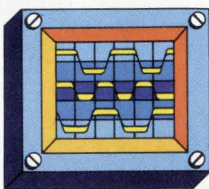

Clip coupon to letterhead for complete Analog information and fact sheets.

Name	Title
Tel.	M.S.
811 E. ARQUES, SUNNYVALE, CA. 94086	

THINK Signetics

a subsidiary of U.S. Philips Corporation

©1976.

Circle 215 on reader service card

New products

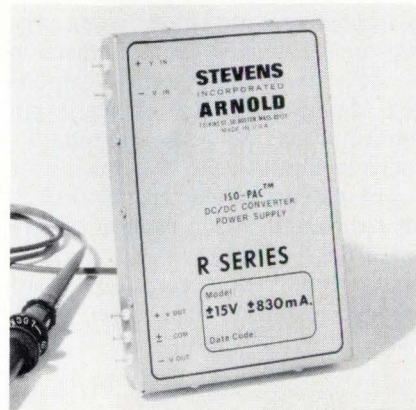

noise over the frequency band from 5 hertz to 20 megahertz. The true-rms noise level is only 1 mv.

The heavily shielded and filtered supply is offered with any one of the following input ratings: 48 ± 6 v, 28 ± 4 v, $24 +4/-3$ v, and $12 +2.5/-2$ v. It is regulated to within 0.1% and has an average temperature drift of 0.01%/°C. Housed in a 4-by-6-by-0.78-inch metal case, the converter sells for \$165 in lots of 1 to 9 pieces. Availability is from stock to six weeks.

Inquiry Manager, Stevens-Arnold Inc., 7 Elkins St., So. Boston, Mass. 02127. Phone (617) 268-1170 [385]

Altitude display shows analog and digital data

The Quanticircle is a microprocessor-based display device that uses light-emitting-diode lamps and numeric readouts to present data in both analog and digital form. Intended principally to show altitude or depth in aviation and marine applications,



RF & MICROWAVE SOURCES INFRA-RED, LF, UHF and VHF

RADAR SYSTEMS: 150 MHZ to 35 GHZ

AUTOTRACK ANTENNA MOUNTS: Nike Hercules, Nike Ajax, SCR 584. Capacity 50 lbs. to 10,000 lbs. Light Airborne to Sage Systems

RADAR INDICATORS: PPI-RHI-A/B/C/Scopes

PULSE MODULATORS: 25KW to 10 Megawatts

HIGH VOLTAGE POWER SUPPLIES: Up to 20KV 2A

MICROWAVE TUBES: TWT, Klystron, BWO, Carcinotron, Magnetron Every Frequency

MICROWAVE COMPONENTS

SONAR SYSTEMS

SEND FOR FREE 24 PAGE CATALOG ON YOUR LETTERHEAD



RADIO RESEARCH INSTRUMENT CO. INC.

2 LAKE AVENUE EXTENSION, DANBURY, CT. 08610 (203) 792-6666

This Publication is Available in MICROFORM

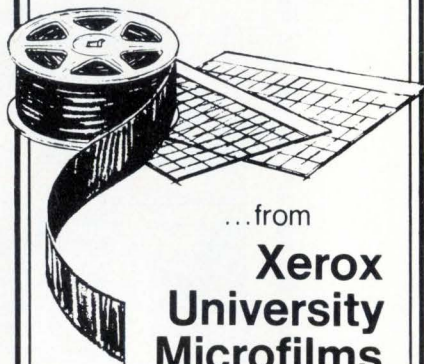

...from

Xerox University Microfilms

300 North Zeeb Rd.,
Ann Arbor, Mich. 48106
(313) 761-4700

PLEASE WRITE
FOR COMPLETE
INFORMATION

the Quanticircle works over four ranges, and has an autoranging mode of operation. The microprocessor, an RCA 1802D, permits squeezing all the electronics into a standard 4-inch ARINC case.

The display uses a circular array of 100 LED lamps to display analog information and to show secondary echo returns. Trend information is also inherently presented as it would be on any analog display. Principal applications are expected in helicopters, hovercraft, and automatic landing systems. The Quanticircle sells for \$5,000 in small quantities.

Osborne-Hoffman Inc., 304 Richmond Ave. (Hwy. 35), Point Pleasant Beach, N.J. 08742. Phone Edwin Hoffman at (201) 899-2770 [386]

480-character display panel is only 1.25 inches thick

Organized as 12 lines of 40 characters each, a 480-character display panel measures a compact 11 inches long by 6 in. wide by only 1.25 in. deep including driver electronics. The driver requires a minimum link to a host system. The gas plasma panel, which has a 100-piece price of \$315, is available now in sample quantities at \$480. Since the alpha-



numeric characters are made up of elements of a 5-by-7 dot matrix, the model SII 1240-PD2 display can handle thousands of special characters and symbols in addition to the 64-character ASCII set and foreign-language fonts such as Cyrillic, Hebrew, and Katakana.

Burroughs Corp., Electronics Components Division, P.O. Box 1226, Plainfield, N.J. 07061. Phone (201) 757-5000 [387]

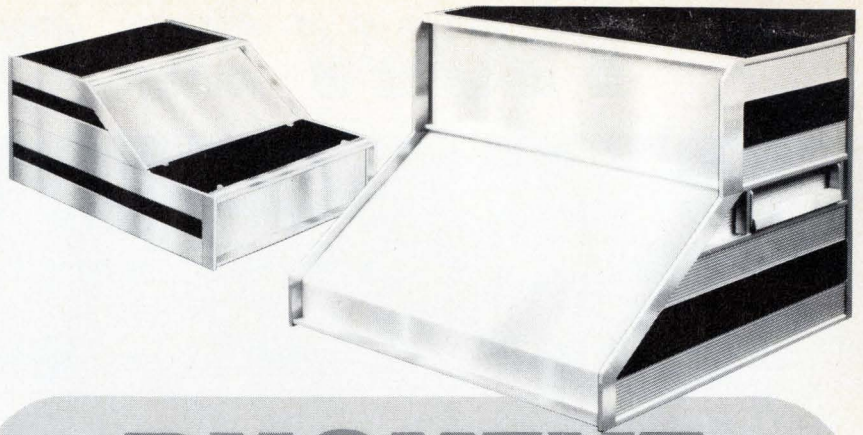

BUCKEYE slant-front CASES



New, sloped-front aluminum cases have the modern, crisp lines of custom design at off-the-shelf costs. Stocked in a range of widths, heights and depths. Write today for detailed literature.



the BUCKEYE stamping co.

555 Marion Rd., Columbus OH 43207 Phone: 614/445-8433

Circle 183 on reader service card

HIGH ANALOG TECHNOLOGY #8

OUR ANALOG PRODUCTS ANSWER COMMUNICATION NEEDS.

Encode, decode, display, switch, digitize with analog for highest voltage, speed and current. Products on hand to keep telecommunications and communications systems talking.

Clip coupon to letterhead for complete Analog information and fact sheets.

Name	Title
Tel.	M.S.
811 E. ARQUES, SUNNYVALE, CA. 94086	

**THINK
Signetics**

a subsidiary of U.S. Philips Corporation ©1976.

How to get high

HIGH VOLTAGE

HIGH SPEED

HIGH CURRENT

HIGH PERFORMANCE



Signetics' high technology products fit all markets.

We have a lot of things to talk about. From our broad line of analog products available to fill consumer, data processing, instrumentation and communication requirements—including new products, exclusive products, interface products, industrial products, military products, you name it. Right down to our special applications assistance which includes detailed literature and our experienced engineering staff that's always on-call to help you on a one-to-one basis.

Then there are the specific benefits offered by our analog products. In fact, when you see the high voltage, high current, high speed and high performance...you'll see why Signetics is "high on analog"

And, see how easy it is for you to take advantage of all the benefits for yourself.

So where do we begin?

High voltage. Just for example, there's the Signetics NE541 Class AB monolithic power driver that offers an operation up to 80 volts, low standby current, and a wide power bandwidth. Perfect for driving large audio output stages and similar applications. Signetics has many other analog products rated at high voltages to meet your latest requirements.

High speed. Signetics analog devices act faster to provide better performance when computer logic

on analog.

DIGIT DRIVERS (NE584 & 585)	POWER AMPLIFIER (NE541)	DIGITAL PHASE LOCKED LOOP (NE564)	DUAL COMPARATORS (NE521 & 522)	SERVO-AMPLIFIER (NE544)	HIGH VOLTAGE REGULATOR (78HV)	OP-AMPS (SE & NE535)	MULTIPLEXER (SD5301)	QUAD-TIMERS (SE & NE558 & 559)	COMPRESSOR/EXPANDERS (NE570 & 571)
yes	yes				yes				
		yes	yes			yes			
	yes			yes	yes			yes	
yes	yes	yes	yes	yes	yes	yes	yes	yes	yes

and memory function faster with low signal levels. Signetics sense amps, dual comparators and other products turn on and off faster. Perfect for data recording and communication applications.

High current. Examine the NE544 servo-amplifier that is a linear one-shot, all purpose servo driver with all functions integrated into one, and you will see it is truly unequalled. You'll also see why Signetics is "high on current."

High performance. There's a whole list of high performance analog products available from Signetics. Multiplexers, quad-timers, compressor/expanders, operational amps. They feature low input offset voltage, low input bias current, TTL compatibility, all logic on a single chip, economy, everything to make designing easier.

Electronics/November 25, 1976

The more you know about analog, the higher you get on it. Don't wait. Start now by mailing the coupon.

Attach this to your letterhead for fast response.

- Send me the complete analog information and fact sheets.
- Have a Field Applications Engineer call me for a one-to-one appointment.

My application is _____

Name _____ Title _____

Telephone _____ Mail Stop _____

THINK **Signetics**

811 E. Arques Ave., Sunnyvale, Ca. 94086

© 1976.

A subsidiary of U.S. Philips Corporation

Circle 185 on reader service card 185

Materials

Protective chokes made smaller

Core materials for thyristor protectors have wide induction ranges

One important characteristic for the core material in a protective choke is the usable range of induction, also called the flux-density swing. Two magnetic materials developed by a West German metals company and intended for use in thyristor chokes have an unusually wide induction range, making them suitable as core materials in chokes operated in the unipolar mode. The materials, from Vacuumschmelze GmbH, are designated Permax-F and Ultraperm-F.

Unipolar chokes are often used in thyristor circuits for protection, noise suppression, and commutation.

When used to protect thyristors, the chokes should be effective only during the switching period, and afterwards they should not significantly affect the circuit. The chokes are therefore driven into saturation where their inductance is reduced to a very small value.

In unipolar operation, when current flows in only one direction, the usable induction range is the difference between the core material's remanence—or residual—and its saturation states.

For most magnetic materials, this range is small, and for choke cores, it necessitates a large cross section and hence a large core volume. This is where Vacuumschmelze's new materials come in. With their wide induction range, the materials make it possible to design small cores that occupy little space. They also provide good electrical and magnetic characteristics, the company says. For Permax-F, the range is 5,500 gauss, and for Ultraperm-F, it is 8,000 gauss—ranges that are from two to three times wider than for

most magnetic materials, according to the company.

Besides a wide induction range, the materials have a high pulse permeability and low losses. These characteristics are achieved by certain additives and by special magnetic annealing processes. Besides iron, the prime component in the materials is nickel—about 65% in Permax-F and 76% in Ultraperm-F.

For Permax-F, the saturation inductance is 12,500 gauss, the static field strength 0.07 amperes-percentage, and the curie temperature 520°. The corresponding values for Ultraperm-F are 8,000 gauss, 0.012 A/cm, and 400°C.

The materials are supplied to users in the form of toroidal strip-wound cores with outer diameters as large as 100 millimeters. The normal strip-thickness is 0.05 mm, but cores with strips that are 0.1 and 0.03 mm thick are also available upon request. The cores come either protected or unprotected in two standard sizes. The protected ones are covered with a lacquer or plastic coating.

The smaller cores have an outer diameter of 45 mm, an inner diameter of 15 mm, and height of 20 mm. In large quantities, these cores sell for about \$9.50 each if made of Ultraperm-F and for about \$5.20 if Permax-F.

The larger core has an outer diameter of 60 mm, an inner diameter of 25 mm, and height of 25 mm. In large quantities, this core sells for about \$18 if made of Ultraperm-F and for about \$9.70 if Permax-F. Upon request, Vacuumschmelze will make cores with outer diameters as large as 100 mm.

Vacuumschmelze GmbH, 6450 Hanau, P.O. Box 109, West Germany [475]



Silicone elastomers have low resistivity

A silicone elastomer loaded with silver-coated inert particles, Consil-II is intended primarily for sealing against electromagnetic interference. Designed and tested to remain conductive indefinitely when mating

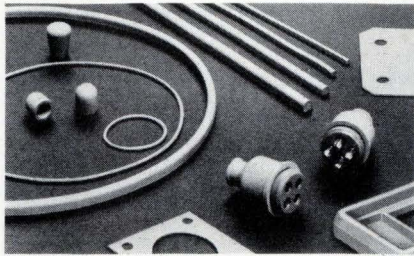

surfaces are properly aligned and required pressure is maintained, the material is manufactured in sheets, flat gaskets, and various strips. Available strip shapes include round, rectangular, D, and U cross sections.

Consil-II type 470 has a durometer hardness of 47 on the Shore A scale, while type 700 has a hardness of 70. Both have a volume resistivity of 0.01 ohm-centimeter and an operating temperature range of -51°C to 177°C . Sheets measuring 1 foot by 1 foot by 20 mils thick sell for \$18 each in lots of 15. Prices for strip material start at 65 cents per foot for 100 to 249 feet.

Technical Wire Products Inc., 129 Dermody St., Cranford, N.J. 07016. Phone (201) 272-5500 [476]

Molding powders yield lossy dielectrics

Ecomold MF117A and MF124B are molding powders that can be transfer- or compression-molded to produce the lossy elements used in transmission-line attenuators and terminations. The powders have electrical properties similar to rod and sheet stock designated Eccosorb MF117 and MF124. Thus, parts can be machined from the rod and/or sheet stock to establish a design and then put into production with the new powders.

At a temperature of about 300°F to 350°F and a pressure of 500 to 1,500 pounds per square inch, molding time is approximately two to three minutes. Mold shrinkage is less than 4 mils per inch.

Emerson & Cuming Inc., Canton, Mass. 02021. Phone (617) 828-3300 [478]

33% more power to the people. Power/Mate presents Econo/Mate II. The open frame power supply.

Now Power/Mate brings you 33% more power in the same package size with the second generation of our Econo/Mate series.

The size is the same, the basic components are the same for easy interchangeability. But that's where the similarity ends.

Econo/Mate II adds features like dual AC primary and a plug-in IC regulator for improved regulation.

And Econo/Mate II is tough. Computer design, quality control, and Power/Mate's experience helps insure 100,000 hr. MTBF even at this higher power output.

But for all its features, Econo/Mate II is still, most of all, economical.

We wouldn't call it Econo/Mate if it wasn't.

Econo/Mate II is in stock, ready for delivery. Send for our free brochure.

Prices start at \$19.95.

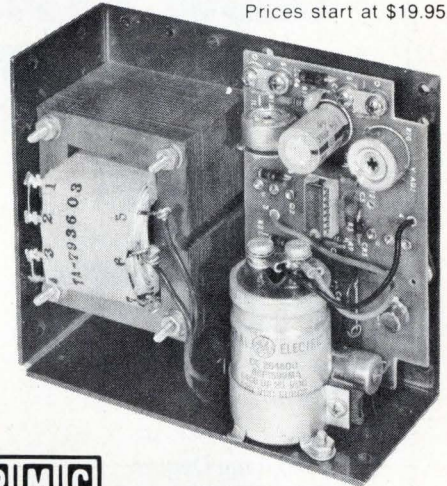

POWER/MATE CORP.

World's largest manufacturer of quality power supplies.

514 South River Street/Hackensack, N.J. 07601/Phone (201) 343-6294 TWX 710-990-5023

Circle 187 on reader service card

Think of what
just one company
can do to stop
pollution.
We have.



People start pollution.
People can stop it.

Please send me a free copy of your guide.

Name _____

Street _____

City _____

State _____ Zip _____



A Public Service of
The Magazine &
The Advertising Council

Keep America Beautiful
99 Park Avenue New York 10016

Gas Sensing Semiconductor

FIGARO GAS SENSOR

TGS quickly senses
even small
amount
of gas.

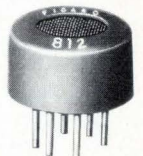
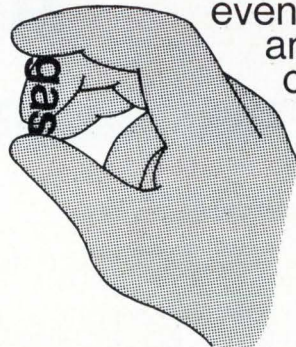

New Models,
some with highly sensitive
CO sensor, now on the market.

Please contact the address below directly for
catalogs and price/delivery information.

FIGARO ENGINEERING INC.

3-7-3, Higashitoyonaka, Toyonaka City, Osaka 560,
Japan/Tel: (06) 849-2156

Cable: FIGARO TOYONAKA/ Telex: 05286155 FIGARO J

Circle 189 on reader service card 187

Classified section FOR ENGINEERING/TECHNICAL EMPLOYMENT OPPORTUNITIES

CLASSIFIED SALES REPRESENTATIVES

Atlanta ... Joe Lane ... 404/892-2868
 Boston ... Holt Buchanan ... 617/262-1160
 Chicago ... Bill Higgins ... 312/751-3733

Cleveland ... Mac Huestis ... 216/781-7000
 Dallas ... Paul Reiss ... 214/742-1747
 Denver ... Shirley Kotz ... 303/837-1010
 Detroit ... Mac Huestis ... 313/873-7410

Houston ... Paul Reiss ... 713/659-8381
 Los Angeles ... Stan Kassir ... 213/487-1160
 New York ... Dave Hawksby ... 212/997-3594
 Philadelphia ... Dan Ferro ... 215/568-6161

Pittsburgh ... Dan Ferro ... 412/391-1314
 San Francisco ... M.E. Kenny ... 415/362-4600
 Stamford ... Holt Buchanan ... 203/359-2860
 XEROX 100 TELECOPIER ... 212/997-6800

Computer

GROW, EXPAND, ADVANCE YOUR CAREER WITH BURROUGHS

SYSTEM SOFTWARE DEVELOPMENT

Burroughs is actively staffing a small, motivated team of computer professionals to play a key role in the development of software for business minicomputers. Systems software experience or graduate degree in computer science required.

Prime areas of interest are:

- Language Design
- Data Management
- Test Systems
- Generative Software
- Operating Systems
- Microprocessor Design

About Location...

Our facility is convenient to attractive Ann Arbor and the University of Michigan. We offer an excellent salary and benefits package, plus the stability and growth of our highly successful company. For prompt and confidential evaluation of your credentials, please forward your resume and salary history to:

Manager of Professional
Employment,
Burroughs Corporation,
41100 Plymouth Road,
Plymouth, Michigan 48170.

PRODUCT ENGINEERING MANAGERS

These are immediate openings with the Small Systems Group, a high technology division responsible for the engineering and manufacture of business minicomputers, terminal systems, encoding equipment and small applications devices such as electronic calculators.

We are looking for senior engineers with experience in small data systems engineering. Candidates for these positions will have a background in and a desire to use formal analytical methods in design & problem solving. Must have ability to recruit, train, motivate and retain more junior professionals. Some management experience would be helpful.

Mechanical Design Manager

10 years' related experience in the industry plus a MSME or Physics Degree with emphasis on Mechanical Engineering are required. You should be expert in high speed mechanisms, mechanical packaging, and structural analysis. Familiarity with modern plastic packaging methods would be beneficial.

Electrical Design Manager

A MSEE or Physics background plus 10 years' related experience are required. Essentially a circuit designer, you will have experience in IC's, particularly MOS technologies, and electrical packaging and power design.

Intermediate and junior level engineers in the above disciplines are also required with 3 to 8 years' related experience.

Burroughs

an equal opportunity employer male/female



Non-Impact Printer Advanced Development

ENGINEERS—Embark with us on a new venture. The nation's leading Band Printer manufacturer is again boldly sharing a new and exciting course.

Due to our phenomenal growth, career opportunities now exist in our ink Jet and Electro-Photographic programs. Innovation, time-proven decisions, and success have demanded that we now seek out several levels of professionals—Program Managers, Project Engineers, and individual contributors. Those who are able to meet the challenge and marry Non-Impact Printer Technology to successful end-products will be guaranteed a unique and rewarding growth opportunity.

You should have experience in the Non-Impact Printing area. An advanced degree in Engineering/Physics or a B.S. with equivalent experience is required. Please submit your resume to:

Mr. Bob Brown
COMPUTER
PERIPHERALS, INC.

1480 N. Rochester Rd.
Rochester, Mi., 48063
(313) 651-8810—Ext. 229
An Affirmative Action Employer M/F

LE CENTRE TECHNIQUE DE L'INDUSTRIE HORLOGERE

Recherche
UN INGENIEUR EN
MICROELECTRONIQUE,

- Bonne connaissance des technologies de semiconducteurs,
- Pratique des procédés de montage et d'assemblage des circuits intégrés,
- Expérience industrielle,
- Langue anglaise indispensable et allemande souhaitée,
- Sens des responsabilités et qualité d'animateur d'une équipe.

Objectifs:

- Développements nouveaux en électronique horlogère et diversification industrielle.
- Assistance technique aux entreprises en mutation.

Candidature manuscrite avec C.V. à adresser au

Directeur General du CETEHOR
39, avenue de l'Observatoire
B.P. 1145
25003 BESANCON CEDEX

We have been placing graduate ENGINEERS



in FEE-PAID positions
THROUGHOUT THE U.S. since
'59. Over 1,000 client companies.
We are graduate engineers working
full-time for you. Send resume
& salary history today or request
confidential application.

ATOMIC PERSONNEL, INC.

Suite L. 1518 Walnut St., Phila., Pa. 19102
An Employment Agency
For All Technical Fields

BIOMEDICAL PRODUCT SPECIALISTS

Our clients have numerous openings for
qualified and experienced individuals in
Technical, Marketing and Managerial positions
nationwide. Send resume in confidence to:

HEALTH INDUSTRY CONSULTANTS
P.O. Box 2634, Evergreen, Colorado 80439
or call (303) 674-4696

POSITIONS VACANT

Georgia Tech—Engineering Experiment Station. Needs Electrical Engineers to perform radar and defense systems analysis/operations research in client-oriented environment. Computer Modeling and electronic system simulation experience desired MSEE/MSIE and U.S. citizenship required. Send resume to Mr. R. P. Zimmer, (Code E1) Engineering Experiment Station, Georgia Institute of Technology, Atlanta, Georgia 30332. Tel. 404-894-3519. An Equal Opportunity Employer.

EE Staff Positions—A number of openings are anticipated for both visiting and regular staff positions in various specialties for 1977-78. Applicants should have the Ph.D. Rank will depend upon detailed qualifications. The department has a large undergraduate enrollment, a small but expanding M.S. program, a growing research activity, and superb facilities. Applicants should clearly state their especial expertise and indicate what sort of position they wish. A limited number of graduate assistantships are also available. Contact Dr. R.F. Schwartz, Head, Department of Electrical Engineering, Michigan Technological University, Houghton, Michigan 49931. An equal opportunity educational institution/equal opportunity employer.

HERE IS A SAMPLING OF EXCEPTIONAL OPPORTUNITIES AWAITING A FEW EXCEPTIONAL PEOPLE TO JOIN AN EXCEPTIONAL COMPANY.

AT AMDAHL:

BUILDER OF THE WORLD'S MOST EXCITING COMPUTER.

Six years ago, a small group of leading designers of large computers—under the direction of a preeminent, pioneering computer scientist—set out to design and build a new generation of large computers.

Today, the Amdahl 470V/6 system is just that: a top-of-the-line, 3.8 to 5.2 million dollar computer that performs more work at lower cost than any other general-purpose computer. It's unprecedented, and so is the company.

Within the past 18 months, this exceptional company has delivered 21 of these systems. Over \$88,000,000 worth. But more to the point: 8 of the 21 were shipped within the past 90 days. Which is why we need help...from exceptional, enthusiastic individuals who need to perform well because the task is worth it, and because it's fun. We made a commitment to that philosophy when we began, and we're sticking to it. We have intentionally created a friendly environment where personal efforts are recognized. We are keeping it that way, despite our growth.

Below are some of our more immediate needs. Karen Daly would like to hear from you at Amdahl Corporation, 1250 East Arques Avenue, Sunnyvale, California 94086. Please indicate on your resume which position you are responding to in this ad. We are, of course, an equal opportunity employer.

ENGINEERING/TECHNICAL OPPORTUNITIES AT AMDAHL

CIRCUIT DESIGN GROUP MANAGER

You will be responsible for directing state-of-the-art high speed logic and memory circuit programs, interfacing with vendors and users. BSEE with 7-10 years' experience in bipolar and MOS digital or memory designs. Recent project or engineering management experience. Advanced degree preferred.

CIRCUIT DESIGNER

Your responsibilities will include device characterization, circuit simulation, chip layout, system performance trade-off, and interfacing with process engineers. Minimum BSEE, preferably MSEE, with 5 years' experience in high speed bipolar digital circuits or MOS/CMOS circuit design.

QUALITY ASSURANCE ENGINEERS

You will be responsible for achieving and sustaining uniform levels of quality for materials, assemblies, and product consistent with established specifications, workmanship standards, and reliability objectives. Positions require BSEE or equivalent plus 5 years of responsible Quality Engineering experience. You must possess thorough working knowledge of manufacturing processes and inspection methods as applicable to the design, fabrication, and production of complex electronic equipment.

SYSTEMS TEST ENGINEER

Your background should include ECL, TTL and computer hardware logic. Preferably experience with IBM 370 theory of operation. Position also requires BS/MSEE or Computer Sciences degree with 2 years' related experience.

MANUFACTURING ENGINEER

Senior manufacturing engineer with proven experience in PCB assembly and electro-mechanical assembly of electronic systems. You will be responsible for operator instructions, methods and processes. BSIE or BSME preferred.

TEST ENGINEERS

You will be responsible for ensuring the adequacy of manufacturing test, solving test correlation problems and implementing appropriate corrective action to improve testing deficiencies. Experience required in analyzing circuits, determining test requirements, and implementing appropriate test procedures and methods. Positions require BSEE with 5 years' experience in printed circuit board and sub-system test engineering utilizing computer controlled automatic test equipment.

amdahl

ENGINEERS

Come in and investigate these challenging opportunities with the nation's leading band printer manufacturer.

MICROPROCESS ENGINEER

Candidate will have responsibility for hardware/software design and implementation of Microprocessor techniques to peripheral computer controller devices. Applicants for this position must demonstrate experience in:

- Design and implementation of microprocessor controllers
- TTL Logic Designs on peripheral equipment
- Intel 8080 Microprocessor family or equivalent

The above position requires a BS with a MS preferred.

Because the demand for our new products has risen to an all time high and thus launched us off into a period of expansion and growth, we shall need people in the following areas.

MECHANICAL PROJECT ENGINEER

Outstanding growth opportunities exist in creative line printer development group for imaginative and creative project leader. Experience should include vibration, stress, structural, dynamic and thermal analysis of electro-mechanical equipment. Responsibility will also include product definition and generation of product specification. MSME required BSME preferred with 5 years experience on business equipment or related field. Supervisory experience with engineers and technicians essential.

ELECTRICAL PROJECT ENGINEER

Experience will include knowledge of microprocessor technology, power supplies, power drive circuitry. Experience directing efforts of other engineers plus technicians is essential. Minimum qualifications are BSEE and 5 years experience in business equipment or related field. Experience should also include budgeting, scheduling of tasks and writing of proposals and specifications. Send resume to:

Mr. Bob Brown

Computer Peripherals, Inc.

1480 N. Rochester Road, Rochester, Michigan 48063
(313) 651-8810 — Ext. 229

An Affirmative Action Employer M/F

COMMUNICATIONS TECHNICIAN COOK INDUSTRIES

Cook Industries, a Memphis based Fortune 500 company, is seeking an individual interested in a career in communications. The candidate chosen will have a knowledge of fundamental electronics and experience as a computer field engineer or as a maintenance engineer with a communications company. Duties will include maintenance of an in-house corporate tele-communications network. The network consists of computer based voice switching, message switching and digital voice processing systems. Responsibilities will be primarily maintenance related with limited administrative duties. Occasional travel will be necessary. We offer a competitive salary, a complete fringe benefit package and excellent advancement opportunity. Please send resume detailing experience and salary requirements to:

Employment Manager
COOK INDUSTRIES
P.O. Box 16902
Memphis, TN 38116

EQUAL OPPORTUNITY
EMPLOYER
M/F

POSITIONS VACANT

Assistant or Associate Professor of Electrical Engineering—A position is available for a regular faculty position in the area of electronic materials. Candidate must possess the Ph.D. degree, have an electrical engineering background, and must be interested in and capable of working on an existing interdisciplinary project involving investigation of point defects in intermetallic compounds and oxides. In addition, the position will involve teaching regular electrical engineering courses and the expectation of separately-developed research. Some non-academic or post-doctoral experience is desirable though not essential. Funds are available for some summer support and for student help, supplies, and travel. The department has a large undergraduate E.E. enrollment, a small but growing M.S. program, expanding research activities, and superb new facilities. Send resume to Dr. R.F. Schwartz, Head, Department of Electrical Engineering, Michigan Technological University, Houghton, Michigan 49931. An equal opportunity educational institution/ equal opportunity employer.

Electronics Engineers—All Disciplines, Microwave, Analog, Digital, Circuitry, Instrumentation and Controls, openings nationwide for design, applications and sales. \$14-40K, Fee Paid. Write, in confidence, to Mr. C. Robin, P.E., Dunhill Tech Search, 182 Forbes Road, Braintree, MA 02184, 617-848-6320

IMMEDIATE OPPORTUNITIES AVAILABLE WITH UNITED ASBESTOS

Employment opportunities are available in our new mining and milling plant in Matachewan, Northern Ontario. Immediate openings available for the following positions:

CHIEF ELECTRICIAN

Must be a licenced electrician with a varied working background and experience in the following areas:

- Industrial Electrical Work
- Automative Maintenance
- Construction and Modification

Preference will be given to those with a mining background, although others will be given complete consideration.

ELECTRICIAN

Should have 3 to 5 years of electrical experience in a heavy industry setting.

This new open-pit operation is located in Matachewan Ontario (55 miles from Kirkland Lake, Ontario) in an excellent fishing and hunting area. Our employees enjoy good competitive wages, a good benefits program and an outstanding HOME OWNERSHIP POLICY.

Please send resume in confidence to:

Wm. E. Fisher

United
Asbestos
Inc.

P.O. Box 99
Matachewan, Ontario
POK IMO



Job-seekers... be the first to know with McGraw-Hill's Advance Job Listings

By having our weekly ADVANCE JOB LISTINGS sent to your home every Monday you can be the first to know about openings both in and out of your field. AJL will enable you to contact anxious recruitment managers BEFORE their ads appear in upcoming issues of 21 McGraw-Hill publications. To receive a free sample copy, plus information about our low subscription rates, fill out and return the coupon below.

ADVANCE JOB LISTINGS / P.O. BOX 900 / NY 10020

PLEASE SEND A SAMPLE COPY
OF ADVANCE JOB LISTINGS TO

NAME _____

ADDRESS _____

CITY _____

STATE/ZIP _____



**Would
you hire
an engineer
who
couldn't
understand
this
magazine?**

Of course not. ELECTRONICS is the technical publication for technical people. If they can't understand it, they can't receive it. That's why, when you're looking for qualified engineers, you should consider our Classified Section.

For only \$46.00 per inch your recruitment advertising will reach 46,000 pre-screened engineers—that's just \$1 per thousand!—as they're reading to combat job obsolescence, while they're thinking about their future and bettering themselves.

There's no charge for typesetting and free layout service is provided.

For more information call or write:

ELECTRONICS

Post Office Box 900
New York, N.Y. 10020
Phone: 212/997-2556

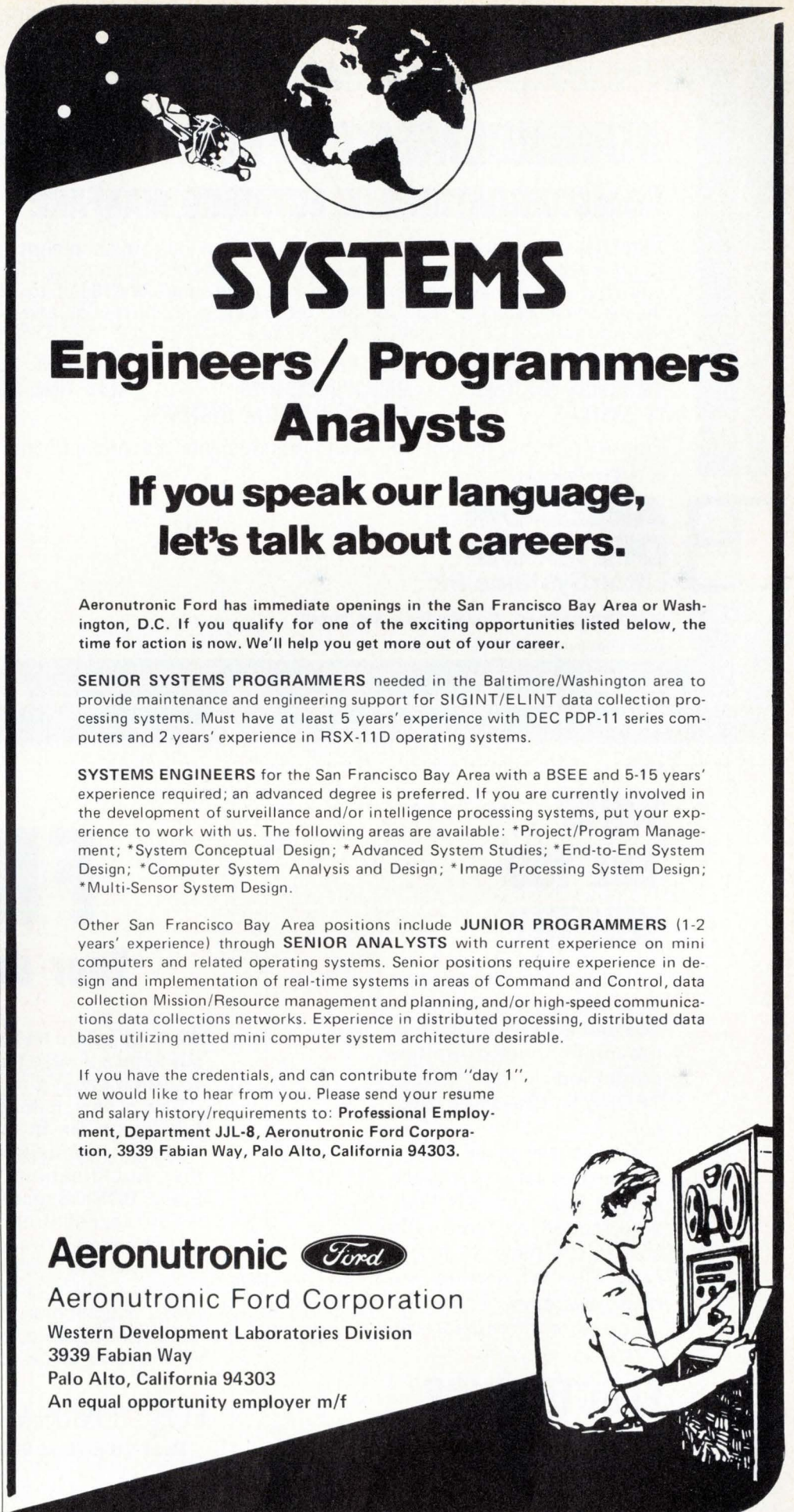

SYSTEMS

Engineers / Programmers Analysts

**If you speak our language,
let's talk about careers.**

Aeronutronic Ford has immediate openings in the San Francisco Bay Area or Washington, D.C. If you qualify for one of the exciting opportunities listed below, the time for action is now. We'll help you get more out of your career.

SENIOR SYSTEMS PROGRAMMERS needed in the Baltimore/Washington area to provide maintenance and engineering support for SIGINT/ELINT data collection processing systems. Must have at least 5 years' experience with DEC PDP-11 series computers and 2 years' experience in RSX-11D operating systems.

SYSTEMS ENGINEERS for the San Francisco Bay Area with a BSEE and 5-15 years' experience required; an advanced degree is preferred. If you are currently involved in the development of surveillance and/or intelligence processing systems, put your experience to work with us. The following areas are available: *Project/Program Management; *System Conceptual Design; *Advanced System Studies; *End-to-End System Design; *Computer System Analysis and Design; *Image Processing System Design; *Multi-Sensor System Design.

Other San Francisco Bay Area positions include **JUNIOR PROGRAMMERS** (1-2 years' experience) through **SENIOR ANALYSTS** with current experience on mini computers and related operating systems. Senior positions require experience in design and implementation of real-time systems in areas of Command and Control, data collection Mission/Resource management and planning, and/or high-speed communications data collections networks. Experience in distributed processing, distributed data bases utilizing netted mini computer system architecture desirable.

If you have the credentials, and can contribute from "day 1", we would like to hear from you. Please send your resume and salary history/requirements to: **Professional Employment, Department JLL-8, Aeronutronic Ford Corporation, 3939 Fabian Way, Palo Alto, California 94303.**

Aeronutronic 

Aeronutronic Ford Corporation
Western Development Laboratories Division
3939 Fabian Way
Palo Alto, California 94303
An equal opportunity employer m/f

ADVANCEMENT OPPORTUNITIES

COMMUNICATIONS/ELECTRONIC WARFARE

AMECOM, a leading Eastern R & D organization, has advancement opportunities at all levels: design & development, project engineering, and program management. These positions are in the salary range of \$18,000 to \$28,000 in the systems analyses, requirements definition, systems design and advanced development of COMMUNICATIONS, EW and INTELLIGENCE SYSTEMS.

TELECOMMUNICATIONS
SWITCHING SYSTEMS
RF SYSTEMS

MINICOMPUTERS
MICROPROCESSORS
ANALOG & DIGITAL SYSTEMS

HARDWARE/SOFTWARE
REAL TIME PROGRAMMING

Please send your resume and salary requirements in confidence to:

J. J. FitzGerald



**AMECOM
DIVISION**
Litton Systems, Inc.

Litton

5115 Calvert Road, College Park, Md. 20740

An Equal Opportunity Employer M/F

WHAT ARE YOU WORTH?

In today's job market, that is. One way to see if you're in demand is to check the employment opportunities contained in ELECTRONICS' Classified Section.

Another way to get a reading on your value is to place a blind (box number) Position Wanted ad there. The cost is low (only \$1.25 per line) and the results are often rewarding.

For more information call or write:

ELECTRONICS

Post Office Box 900
New York, N.Y. 10020
Phone: 212/997-2556

FREE

Your dream job.

We hope you're happy in your current position, but there's always that ideal job you'd prefer if you knew about it.

That's why it makes sense to have your resume on file in the Electronics Manpower Register, a computerized data bank containing the qualifications of career-conscious ELECTRONICS readers just like yourself.

You'll benefit from nation-wide exposure to industry firms privileged to search the system, and since the computer never forgets, if you match up with their job requirements you'll be brought together in confidence.

To take advantage of this free service, mail your resume to the address below.

ELECTRONICS MANPOWER REGISTER

Post Office Box 900/New York, N.Y. 10020

We're still adding to the world's most complete pool of microcomputer expertise.

It took a lot of talent to develop and introduce the microcomputer. Intel did it in 1971, and microcomputers soon became the fastest growing market in the business—with our industry-standard 8080 leading the way.

We're committed to staying #1 in microcomputers. And we need more professionals with the technical expertise, desire and aggressiveness to contribute to—and share in—our success. Specific opportunities at our San Francisco Peninsula headquarters include:

Microcomputer Product Manager

This is an exceptional opportunity for a marketing/engineering professional with a strong background marketing microprocessor circuits to very-high-volume customers. A technical understanding of microcomputers and their related markets is essential, accompanied by a BS in EE or computer science.

Project Leaders Compiler Development & Language Design

You'll join a dedicated team building sophisticated tools to support the construction of advanced microcomputer-based systems. This is a unique "ground-up" opportunity to design the software systems of the future. You will take leadership responsibility for the design of modern programming languages, and the development of compilers based on state-of-the-art

techniques. We require a demonstrated history of high-level technical accomplishment and leadership ability in language and translator development. MS or PhD in computer science and several years practical experience are essential.

Marketing Applications Engineers Domestic & International

The persons selected for these opportunities will demonstrate good technical understanding of computer systems and microcomputer applications. Proven ability to develop and implement marketing strategies which result in long-term business objectives required. Will be responsible for all customer marketing activities within a specific sales region. This will extend to field sales and applications support, forecasting and market analyses. You should have a BS plus at least 2 years experience marketing semiconductor memories, microprocessors or microcomputer/minicomputer systems.

Microcomputer Product Marketing Engineers

Involved with next-generation microcomputer products, your responsibilities will range from new product definition to market research. You will interface with design engineering, review data sheets and present seminars. You should have a BSEE (MBA preferred) plus 2-5 years

background in engineering and/or marketing. Familiarity with the design and/or application of CRT terminals is essential.

Software Reliability Engineers

If software engineering means more to you than eliminating GO TO's—if the joy of writing structured code no longer satisfies your concern for quality—then consider this opportunity. You will analyze and approve software specifications, review the design of software products, manage testing projects, consult with development engineers to propose quality assurance strategies, and develop tools for evaluating and assuring software reliability in all its aspects. Successful candidates will have the technical understanding to implement software of superior quality and the experience to evaluate the economic consequences of reliability. Familiarity with recent software reliability theory desired, together with an MS or PhD in computer science or equivalent.

For immediate consideration, send your resume, including salary history, in confidence to Intel Professional Employment, 3065 Bowers Avenue, Santa Clara, California 95051. An Equal Opportunity Employer M/F.

The Intel logo is displayed in a large, bold, lowercase sans-serif font. The letters are black and have a slightly irregular, hand-drawn appearance. The 'i' and 'l' are particularly tall and thin, while the 'n' and 't' are shorter and wider. The 'e' is also lowercase and has a distinctive shape.

Electronics advertisers

November 25, 1976

Abbott Transistor Labs Inc.	30	Deltron	150	‡ Kollmorgen Corp. Photocircuits Div.	70,71
Addmasters Corporation	172	■ Dialight Corporation	153	LDF Semiconductor	173
* Adret Electronique	23E	Digital Equipment Corporation (OEM)	114	Macrodata Company	163
Advanced Memory Systems	142,143	‡ Digital Equipment Corporation (Components)	74,75	* Magneti Marelli	4E
Advanced Micro Devices	10,11	The Digitran Company	161	MCL Inc.	166
* AGFA Gevaert NV	49	‡ Eastman Kodak Company Graphics Markets Division	15	MDB Systems	147
■ Airpax Electronics	45	‡ Electronic Development Corp.	176	Mechanical Enterprises, Inc.	173
Allen Bradley Company	34	Electro 77 New York	196	Micro Power Systems	76
American Optical Scientific Instrument Division	135	Electronic Memories & Magnetics	90,91	Micro Switch Division of Honeywell	136,137
■ AMP Incorporated	38,39	Electronic Navigation Industries	50	* Monsanto Company	157
Amphenol Connectors Division Bunker Ramo Corporation	87	EMR-Telemetry	160	Mostek Corp.	68,69
* Amphenol Tuchel	13E-16E	Fabri-Tek Inc.	129	■ Motorola Semiconductor Products Inc.	92,93,148,149
Analog Devices Inc.	98	Faultfinders Inc.	82	‡ National Semiconductor Corporation	55-58
Analogic Corporation	162	Figaro Engineering Inc.	187	* National Semiconductor GmbH	55-58
AP Products Incorporated	170,179	First Computer Corporation	166	* NEC Dusseldorf	140
Applied Digital Data Systems	38,39	Forth, Inc. Responsive Computing	146	‡ Nec Microcomputer Inc.	94,95
Associated Electronics	175	‡ General Electric, Optoelectronics Systems & Operations	64	■ Non-Linear Systems	181
‡ Baron-Blakeslee	31	‡ General Electric Instrument Rental Division	140	* Norma Messtechnik GmbH	22E
Biomation	28,29	* General Instrument Corporation, Semi. Comp. Division	15	* Philips Elcoma	2E,3E,64
■ Bourns Inc.	3rd C	General Magnetics	198	* Philips Industries	72,73
Brand Rex Corporation	2nd C	GenRad	49,178	‡ Philips Test & Measuring Instruments Inc.	147
Buckeye Stamping Company	183	Georgia Dept. of Community Development	165	Plastics Engineering Company	180
Bud Radio, Inc.	177	■ Gould Inc.	79,81,83,85	Plessey Semiconductors	132
* Burr Brown Research Inc.	97	‡ Harris Semiconductor	158,159	■ Powermate	187
* Carlo Erba	71	Hermes Electronics, Ltd.	167	Practical Automation Inc.	195
Chafitz	170	■ Hewlett-Packard	17-26	Precision Monolithic Inc.	7
■ Cherry Electrical Products Inc.	88	■ Hughes Aircraft Company	174	Pro-Log Corporation	40
Clairex Corporation	4th C	ILC Data Devices	51	Radio Research Instrument Corporation	182
Coil-Ler Mfg Inc.	52	Indiana General	44	Ramtek	171
Continental Rentals	8	Intel-Microcomputer Components	32,33	Raytheon Semiconductor	111
Control Data Corp	2	* Inter-Rep SVL	19E	RCL Electronics Inc.	14
Crown Industrial	54	Interstate Electronics Corp.	9	Reticon Corporation	53
‡ CTI-Cryogenics	62	* ITT Cannon	67	* Rhone Poulenc	61
* Dale Electronics Inc. A Subsidiary of Lionel Corporation	8E,9E	‡ ITT Semiconductors	96,97	T.L. Robinson Company Inc.	8
Data General Corporation	37	■ Johnson Company, E.F.	86	Rockland Systems	164
Dataroyal, Inc.	156	■ Kepco Inc.	5	* Rohde & Schwarz	1E
				Sangamo Data Recorder	154

• Seimart	7E
• Sescosem	47,11E
• Sfernice	10E
SGS Ates	13
• Siemens A.G. Munich	62
Signetics Corporation Division of U.S. Philips	172, 173, 175, 177, 179, 181, 182, 183, 184, 185
‡ Siliconix	72,73
Silicon Systems	6
• Sodeco	24E
• Solartron/Schlumberger	31
• SPI-ITT	21E
Standard Microsystems Corp	1
‡ T-Bar, Incorporated	146
■ Tektronix Inc.	151
Teledyne Philbrick	116
Teledyne Relays	27
Texas Instruments Incorporated Components Div.	155
Theta Instruments	152
Trompeter Electronics	177
■ TRW Cinch Connectors	168
• Ultra Electronics Components Ltd.	12E
‡ Wabash Electronics	61
• Wandel und Goltermann	67
■ Wavetek Indiana Inc.	95
Wiltron Company	8
Wima Westermann	16
‡ Carl Zeiss, Inc.-Micro	47

Classified and employment advertising

F. J. Eberle, Manager 212-997-2557

Aeronautronic Ford	191
Amdahl	189
Amecom Division Litton Systems	192
Atomic Personnel Inc.	188
Burroughs Plymouth Computer	188
Cook Industries	190
Centre Technique De L'Industrie	188
Computer Peripherals Inc.	190, 188
Health Industry Consultants	188
Intel	193
United Asbestos Inc.	190

- For more information of complete product line see advertisement in the latest Electronics Buyers Guide
- * Advertisers in Electronics International
- ‡ Advertisers in Electronics domestic edition

One good turn...



deserves another.



You flipped over our Matri-Dot alphanumeric mini for "first line down" data printing; now we've flipped our design to give you "first line up" text print format, too. So you're ahead, whatever your point of view. Because no one else makes printers as small as 3"H x 3½"W x 7"D. No one else sells them as low as \$140 (in quantities of 100). And no one else offers our features. Instead of a drum, our unique print head purrs along at 138 lines per minute for 18 data columns, even faster for fewer columns. Instead of messy ribbons, our exclusive drop-in ink platen lasts for 75,000 lines and replaces from the front panel. And instead of engraved drum limitations, our 7 x 5 dot matrix characters provide full alphanumeric with a complete ASCII 63 character set. Enhanced characters are also available...8, 10, 12, or 14 characters per inch. All this, plus multiple-copying capabilities and plug-in panel mounting. No matter how you look at Matri-Dot, it's a turn for the better.



**PRACTICAL
AUTOMATION,
INC.**

Trap Falls Road ■ Shelton, Connecticut 06484
Tel: (203) 929-5381
Circle 195 on reader service card

What you must know about Microprocessors

Using articles from the pages of Electronics, this book contains practical and up-to-date information on available microprocessor devices, technology and applications—ranging from the simplest 4-bit p-channel MOS system to the second-generation n-MOS 8-bit processor chips, and the new injection logic and Schottky TTL bipolar processor families needed for the toughest computer-based control applications.

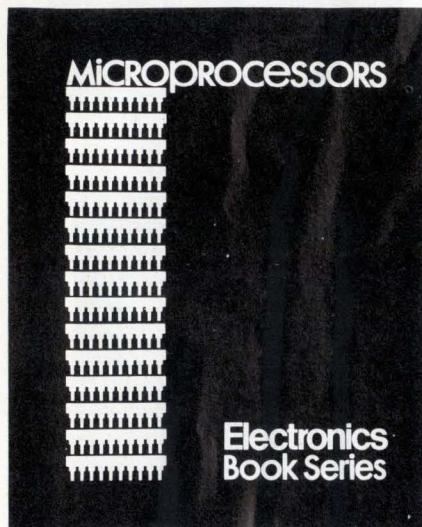

Electronics Book Series

P.O. Box 669
Hightstown, N.J. 08520



Send me _____ copies of "Microprocessors" at \$8.95 per copy.

I must be fully satisfied or you will refund full payment if the book is returned after 10 days free trial examination.

Payment enclosed Bill firm
 Bill me

Credit Cards Charge My Book To:
 American Express Master Charge
 Diners Club BankAmericard

Acct. No. _____

Date Card Expires _____

Interbank No. _____

(1st No's. above name on Master Charge only.)

Name _____

Title _____

Company _____

Street _____

City _____

State _____ Zip _____

Signature _____

Advertising Sales Staff

Atlanta, Ga. 30309: Glen N. Dougherty
100 Colony Square, 1175 Peachtree St., N.E.
[404] 892-2868

Boston, Mass. 02116: Frank Mitchell
607 Boylston St. [617] 262-1160

Chicago, Ill. 60611
645 North Michigan Avenue
Robert W. Bartlett (312) 751-3739
Robert M. Denmead (312) 751-3738

Cleveland, Ohio 44113: William J. Boyle
[716] 586-5040

Dallas, Texas 75201
2001 Bryant Tower, Suite 1070
[214] 742-1747

Denver, Colo. 80203: Harry B. Doyle, Jr.
123 Speer Blvd. #400
[303] 837-1010

Detroit, Michigan 48202: Robert W. Bartlett
1400 Fisher Bldg.
[313] 873-7410

Houston, Texas 77002: Paul Reiss
601 Jefferson Street, Dresser Tower [713] CA 4-8381

Los Angeles, Calif. 90010: Robert J. Rielly
Bradley K. Jones, 3200 Wilshire Blvd., South Tower
[213] 487-1160

New York, N.Y. 10020
1221 Avenue of the Americas
Warren H. Gardner [212] 997-3617
Michael J. Stoller [212] 997-3616

Philadelphia, Pa. 19102: Warren H. Gardner
Three Parkway,
[215] 997-3617

Pittsburgh, Pa. 15222: Warren H. Gardner
4 Gateway Center, [212] 997-3617

Rochester, N.Y. 14534: William J. Boyle
9 Greylock Ridge, Pittsford, N.Y.
[716] 586-5040

San Francisco, Calif. 94111: Don Farris
Robert J. Rielly, 425 Battery Street,
[415] 362-4600

Paris: Alain Offergeld
17 Rue-Georges Bizet, 75116 Paris, France
Tel: 720-73-01

Geneva: Alain Offergeld
1 rue du Temple, Geneva, Switzerland
Tel: 32-35-63

United Kingdom & Scandinavia: Robert Ghey
Tel: 01-493-1451, 34 Dover Street, London W1

Scandinavia: Andrew Karnig and Assoc.
Kungsholmsgatan 10
112 27 Stockholm, Sweden
Tel: 08 51 68 70 Telex: 179 51

Milan: Luigi Rancati
1 via Baracchini, Italy Phone 86-90-656

Brussels: Alain Offergeld
23 Chaussee de Wavre
Brussels 1040, Belgium
Tel: 13-73-95

Frankfurt/Main: Fritz Krusebecker
Liebigstrasse 27c, Germany
Phone 72 01 81

Tokyo: Tatsumi Katagiri, McGraw-Hill
Publications Overseas Corporation,
Kasumigaseki Building 2-5, 3-chome,
Kasumigaseki, Chiyoda-Ku, Tokyo, Japan
[581] 9811

Australia: Warren E. Ball
IPO Box 5106, Tokyo, Japan

Business Department

Thomas M. Egan,
Production Manager [212] 997-3140

Gayla Black
Production Manager [212] 997-2044

Carol Gallagher
Production Manager International
[212] 997-2045

Dorothy Carter
Production Manager Domestic
[212] 997-2908

Frances Vallone
Reader Service Manager
[212] 997-6057

Electronics Buyers' Guide

H.T. Howland, General Manager
[212] 997-6642

Regina Hera, Directory Manager
[212] 997-2544

Gayla Black, Production Manager
[212] 997-2044

Classified and Employment Advertising

Frank Eberle, Manager
[212] 997-2557

ELECTRONICS REPRINTS

No. of
copies
wanted

New reprints

- _____ R-612 Fiber-optic communications special report 24 pp \$3.00
- _____ R-610 Hybrid-circuit technology special report 19 pp \$3.00
- _____ R-606 Special issue—microprocessors \$4.00
- _____ R-600 World market report 1976 24 pp \$5.00
- _____ R-526 How reliable are today's components 16 pp \$3.00
- _____ R-524 Bipolar large-scale integration special report 12 pp \$3.00
- _____ R-522 Special report on power semi-conductors 12 pp \$3.00
- _____ R-512 Design of circuits for dangerous environments 4 pp \$3.00
- _____ R-510 Bipolar integration advances with ¹/_L microprocessor 8 pp \$2.00

Charts

- _____ R-516 Electronic symbols \$2.00
- _____ R-326 Optical spectrum (6-page report and chart) \$3.00
- _____ R-213 Electromagnetic spectrum (chart) \$2.00
- _____ R-211 Electromagnetic spectrum (16-page report and chart) \$4.00

Books

- _____ R-608 Basics of Data Communications—Electronics Book Series \$12.50
- _____ R-602 Large-Scale Integration—Electronics Book Series \$9.95
- _____ R-520 Microprocessors—Electronics Book Series \$8.95
- _____ R-011 Computer-aided Design 135 pp \$4.00
- _____ R-032 Active Filters 88 pp \$4.00
- _____ R-031 Circuit Designer's Casebook 182 pp (U.S. only) \$5.50 (rest of world) \$12.00

Payment must accompany your order

Make check or money order payable to Electronics Reprints. All orders are shipped prepaid by parcel post. Allow two to three weeks for delivery.

Mail your order to:
Janice Austin, ELECTRONICS REPRINTS
P.O. Box 669 Hightstown, N.J. 08520

Back issues now available:
1960 to 1969, \$5.00 each
1970 to 1973, \$3.00 each
1974 to 1975, \$4.00 each

The Right Time The Right Place The Right People



Electro77 **April 19-21, 1977** **New York Coliseum**

Now that the nation's economy and the electronics revolution are accelerating again, next April is an ideal time to display electronics products and services directly to the key domestic and international audiences who will attend **Electro77**.

The site is New York. Yes, New York, with its fresh outlook and renewed vitality. Within 500 miles of that metropolis more than 400,000 electronics specialists design, produce, and market a consistent 40 percent of the U.S. electronic volume.

Of course, people are **Electro77's** main ingredient. The right people. Technologists who design new equipment and new systems. Engineers in specifications, testing, manufacturing, quality control, and packaging. Specialists in purchasing and marketing, and end-users in industry, government and science.

Electro77 New York brings the right people to the right place at the right time. Make exhibit arrangements today.



Electro77
999 North Sepulveda Blvd., El Segundo, California 90245

Send Exhibit Information To:

E

(Attach Your Business Card Here)

SOLID STATE 3 WIRE SYNCHRO TO LINEAR D.C. CONVERTER



FEATURES:

- Develops a DC output voltage linearly proportional to a synchro angle over a $\pm 180^\circ$ range.
- Completely solid state with all of the inherent advantages over a mechanical system such as:
 - High reliability (since there are no moving parts)
 - Light weight—6 ozs.
 - Small size
 - All units hermetically sealed

RESPONSE CURVE

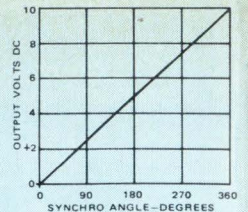
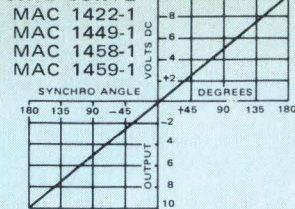

RESPONSE CURVE

MAC 1460-1
MAC 1461-1

- Wide temperature range operation
- Output short circuit protected
- Three wire inputs isolated from ground
- Package size may be altered at no extra cost
- Units can be altered to accept different line to line voltages or different operating frequencies at no extra cost
- Not affected by reference voltage or power supply variations.

UNIT	MAC 1422-1	MAC 1449-1	MAC 1458-1	MAC 1459-1	MAC 1460-1	MAC 1461-1
TRANSFER EQUATION	$\pm 1V/18^\circ$	$\pm 1V/18^\circ$	$\pm 1V/18^\circ$	$\pm 1V/18^\circ$	$+1V/36^\circ$	$+1V/36^\circ$
ACCURACY (+25°C)	½%	½%	½%	½%	½%	½%
ACCURACY (-25°C+85°C)	1%	1%	1%	1%	1%	1%
L - L SYNCHRO INPUT (VRMS)	11.8	90	11.8	90	11.8	90
FREQUENCY (Hz)	400	400	60	60	400	400
FULL SCALE OUTPUT	$\pm 10V$	$\pm 10V$	$\pm 10V$	$\pm 10V$	+10V	+10V
OUTPUT IMPEDANCE	$<1\Omega$	$<1\Omega$	$<1\Omega$	$<1\Omega$	$<1\Omega$	$<1\Omega$
L - L INPUT IMPEDANCE	$>10K$	$>30K$	$>2K$	$>10K$	$>10K$	$>30K$
REFERENCE VOLTAGE (VRMS)	26	115	26	115	26	115
OPERATING TEMP. °C	-25 - +85	-25 - +85	-25 - +85	-25 - +85	-25 - +85	-25 - +85
D.C. SUPPLY	$\pm 15V$	$\pm 15V$	$\pm 15V$	$\pm 15V$	$\pm 15V$	$\pm 15V$
D.C. SUPPLY CURRENT	$\pm 75MA$	$\pm 75MA$	$\pm 75MA$	$\pm 75MA$	$\pm 75MA$	$\pm 75MA$
BANDWIDTH	10Hz	10Hz	OPT.	OPT.	10Hz	10Hz
WEIGHT	6 oz.	6 oz.	6 oz.	8 oz.	6 oz.	6 oz.
SIZE	3.6x2.5x0.6	3.6x2.5x0.6	3.6x3.0x0.6	3.6x3.0x1.0	3.6x2.5x0.6	3.6x2.5x0.6

A.C. LINE REGULATION

A new method has been developed which allows us to provide a low distortion highly regulated AC waveform without using tuned circuits or solid state active filters of any kind.

The result is a frequency independent AC output regulated to 0.1% for line and load with greater than 20% line variations over a wide temperature range.

FEATURES:

- 0.1% total line and load regulation
- Independent of $\pm 20\%$ frequency fluctuation
- 1 watt output
- Extremely small size
- Isolation between input and output can be provided

Specifications: Model MLR 1476-1

AC Line Voltage: 26V $\pm 20\%$ @
400Hz $\pm 20\%$

Output: 26V $\pm 1\%$ for set point

Load: 0 to 40ma

Total Regulation: +0.1%

Distortion: 0.5% maximum rms

Temperature Range: $-55^\circ C$ to
 $+125^\circ C$

Size: 2.0" x 1.8" x 0.5"

Other units are available at different power and voltage levels as well as wider temperature ranges. Information will be furnished upon request.

SOLID-STATE SINE-COSINE SYNCHRO CONVERTER - NON VARIANT

This new encapsulated circuit converts a 3 wire synchro input to a pair of dc outputs proportional to the sine and cosine of the synchro angle independent of a-c line fluctuations.

- Complete solid state construction
- Operates over a wide temperature range
- Independent of reference line fluctuations
- Conversion accuracy—6 minutes
- Reference and synchro inputs isolated from ground

Specifications Model DMD 1508-2

Accuracy: Overall conversion accuracy 6 minutes. Absolute value of sine and cosine outputs accurate to $\pm 30MV$

Temperature Range: Operating $-40^\circ C$ to $+85^\circ C$, Storage $-55^\circ C$ to $+125^\circ C$

Synchro Input: 90V RMS $\pm 5\%$ LL 400Hz $\pm 5\%$

DC Power: $\pm 15V$ DC $\pm 10\%$ @ 50MA

Reference: 115VRMS $\pm 5\%$ 400Hz $\pm 5\%$

Output: 10V DC full scale output on either channel @ 5ma load

Temperature coefficient of accuracy: ± 15 seconds/ $^\circ C$ avg. on conversion accuracy ± 1 MV/ $^\circ C$ on absolute output voltages

Size: 2.0" x 1.5" x 2.5"

Units are available with wider temperature ranges and 11.8V LL, 26V reference synchro inputs. Information will be supplied upon request.

There is No Substitute for Reliability



GENERAL MAGNETICS • INC

135 Bloomfield Ave., Bloomfield, New Jersey 07003 - Tel. (201) 743-2700

Circle 198 on reader service card

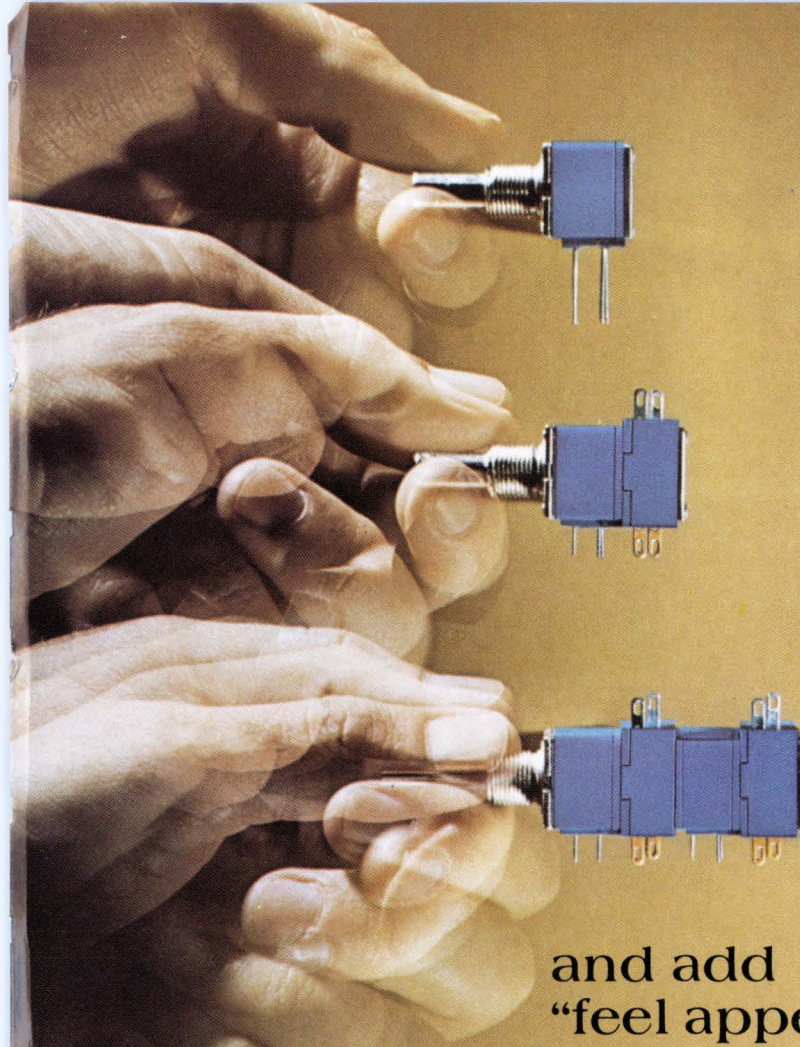

FEEL
the pot . . .

CLICK
the switch . . .

GANG
the modules . . .

and add
“feel appeal” to your product.

FEEL THE POT . . . a smooth, quality feel, only from Bourns® 81/82 Model Potentiometers. Rotational torque range, only .3 to 2.0 oz. inch, is consistent for one, two, three or four cup assemblies.

Independent linearity of $\pm 5\%$ and low 1% CRV provide exceptional setability in both cermet and conductive plastic element types.

CLICK THE SWITCH* . . . one that really clicks, with positive action detent at either CW or CCW end. The Bourns Model 85/86 potentiometer/switch combination is rated at 2 amps in DPST style and 1 amp in DPDT. Contacts are constructed of fine silver with gold overlay. This provides exceptionally low contact resistance, for reliable operation at low level analog or logic signal levels — or any application requiring an “on-off” function.

GANG THE MODULES . . . potentiometers and switches. Up to 4 modules can be ganged on the same single or dual concentric shaft, without sacrifice to the satin-smooth feel or the sure-fire click. Other options include a wide choice of bushing and shaft styles, P.C. pins or solder lugs. Think of the possibilities! Now you can specify custom pots and switches assembled from “off-the-shelf” modules — at standard cost and leadtime.

Add “feel appeal” to your equipment with BOURNS Model 80 Family of Modular Potentiometers and Switches. Write or call today for complete technical information, direct or through your Bourns distributor.

FEEL, CLICK, GANG . . . BEAUTIFUL!

TRIMPOT PRODUCTS DIVISION, BOURNS, INC., 1200 Columbia Avenue, Riverside, California 92507, Telephone (714) 781-5122 — TWX 910 332-1252.

*Patent pending

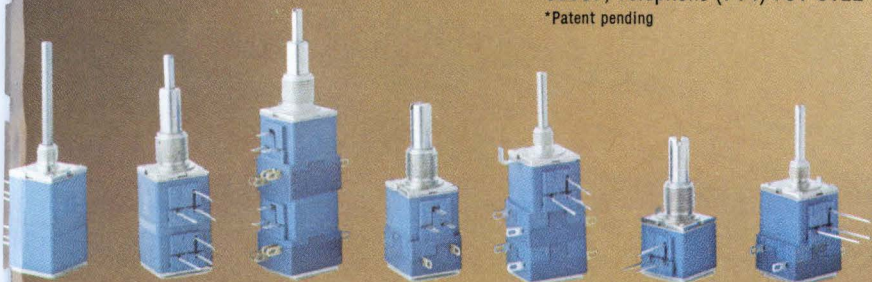

Int'l Sales Offices: European Hdqtrs. — Switzerland, 042/23 22 42 • Belgium 02/218 2005 • France 01/2039633 • Germany 0711/24 29 36
• Italy 02/32 56 88 • Netherlands 070/88 93 18 • United Kingdom 01/572 6531 • Japan 075 92 1121 • Australia 86 9410 • Brazil 257-3535

Circle 901 on reader service card

CLAIREX OPTO-ISOLATORS

5 darlington, 10 transistor, 4 with a-c input

Clairex now offers 19 standard DIP opto-isolators for logic functions. All units feature 2500 PVAC isolation.

Five isolators have Darlington outputs with characterized CTRs @ 1 ma

and/or 10 ma with a guaranteed minimum of 100% to 600%.

The 10 transistor output units feature controlled CTRs @ 1 ma and/or 10 ma ranging from 6% to

100% guaranteed minimum.

Four isolators utilize 2 IREds connected in inverse parallel to permit the input to operate directly from a-c. Two of these have a transistor

output while two have a Darlington output with controlled CTRs at 1 ma and 10 ma on all units.

Call (914) 664-6602 or write Clairex®, 560 South Third Avenue, Mount Vernon, New York 10550.

Circle 902 on reader service card

September 1976
September 1976
September 1976
September 1976

Product Data
Product Data
Product Data
Product Data

CLI-2
CLI-3
CLI-4
CLI-7
CLI-8
CLI-9
CLI-10
CLI-11
CLI-12
CLI-13
CLI-14

Clairex Darlington Opto-Isolators

The Clairex series of opto-isolators with a darlington output provide a wide range of controlled transfer ratios at I.E.D. input currents of 1mA and 10mA. Choices range from the CLI-10 with an ultra high transfer ratio of 600% at 1mA and 800% at 10mA to min. levels of 500%, 200% respectively at 1mA and 100% at 10mA. All units feature a 2500 volt P.A.C. isolation voltage.

ABSOLUTE MAXIMUM RATINGS
Maximum Temperature -55C to +150C
Storage Temperature -55C to +100C
Operating Junction Temperature +100C
Lead solder temperature +260C for 10 sec.

EMITTER (GaAs Diode)
Power Dissipation At 25C ambient P_T = 100mw, derate linearly 1.33mw/C
Maximum Voltage V_R Reverse Voltage -3.0 volts
Maximum Current I_F DC Forward Current -60mA (continuous)

DETECTOR (NPN Silicon Planar Photo darlington)
Power Dissipation At 25C ambient P_T = 200mw, derate linearly 2.0mw/C
Maximum Current I_C = 200mA (Pulsed)

Symbol	Characteristics	CLI-10		CLI-11		CLI-12		CLI-13		CLI-14		Units
		Min.	Max.	Min.	Max.	Min.	Max.	Min.	Max.			
V _F	Forward Voltage	1.5	1.5	1.5	1.5	1.5	1.5	1.5	1.5	1.5	1.5	volts
I _R	Reverse current	10	10	10	10	10	10	10	10	10	10	μA
BV _{CEO}	Collector to Emitter breakdown voltage	50	40	10	40	55	30	100	100	100	100	volts
BV _{ECO}	Emitter to Collector breakdown voltage	6	6	6	6	6	6	6	6	6	6	volts
I _{CEO}	Leakage Current	6	100	100	100	100	100	100	100	100	100	nA
I _C	Collector Current	2500	2500	2500	2500	2500	2500	2500	2500	2500	2500	volts PAC
V _{CE(SAT)}	Collector to Emitter Saturation voltage	600	500	300	300	100	100	1.0	1.0	1.0	1.0	volts
t _{ort}	Rise or Fall Time	800	150	150	150	150	150	150	150	150	150	μSEC Typ

Capacitance: LED (Emitter) - Detector

CLAIREX ELECTRONICS
A DIVISION OF CLAIREX CORPORATION
560 South Third Avenue, Mount Vernon, N.Y. 10550 (914) 664-6602

CLAIREX ELECTRONICS
A Division of Clairex Corporation