

LIBRARY
STATE TECHNICAL INSTITUTE
AT MEMPHIS

DECEMBER 9, 1976

SOLID STATE SCORES GAINS AT ELECTRON DEVICES MEETING/90

How electrically alterable ROMs aid designers/101

Microwave-oven control: microprocessors as mother's helper/105

38134

1470 TCH598 MCSA9 SEP78
STATE TECHNICAL INST
FREEMAN LIBRARY 017023
5969 MACON COVE
MEMPHIS TN

FOUR DOLLARS A MCGRAW-HILL PUBLICATION

Electronics®

CONVERTERS MEET MICROPROCESSORS



Sharpen your competitive edge.

Use an HP computing calculator for design, analysis, control, and test.

In the highly competitive, high-technology electronics business, everything counts: keeping costs in line, exploring promising design alternatives, shortening lead times, product and prototype testing, increasing productivity. That's where HP computing calculators, software, peripherals, and interfacing capabilities come in. They can help you get and maintain a competitive edge.

Three computing calculators and plenty of peripherals: it's your choice.

Three different models—the low-cost HP 9815, the powerful HP 9825 and the all-purpose HP 9830—offer a range of computing power.

HP peripherals include paper tape punch and readers, printers, storage devices, a digitizer, a CRT, and an X-Y plotter. You choose the model and I/O options to configure a system just right for you.

Software, specialized and generalized, helps you look at more alternatives.

HP engineers developed software to optimize designs and analyze engineering problems quickly. There's a State Variable package for control system analysis. There's CNAP for circuit design and analysis, BAMP for microwave design and analysis, and Digital Simulation for state and timing analysis.

You can add other programs, too—commonly needed math routines and statistical programs to name but two. Programs are also available for accounting applications, report generation, and financial analysis.

Automate your instruments. We make the connection friendly.

From simple data logging to complex integration, our programming commands and interface cards make instrument interfacing easy. Whether your instruments require BCD, bit-parallel, RS-232-C, or HP-IB (HP's implementation of IEEE Standard 488-1975), you plug the correct interface into the calculator and connect the cable to your instrument. It's the friendly connection.

HP computing calculators: from initial design to final test.

Whether you're in research, design, production, or test—or all four—we can provide the computing power and programs to help you increase productivity and sharpen your competitive edge. Our new brochure for electronic engineers will show you how. Get a copy from your HP representative, or circle our reader service number in this magazine.



HP desktop computing systems put the power where the problems are.

HEWLETT  PACKARD

Sales and service from 172 offices in 65 countries.

P.O. Box 301, Loveland, Colorado 80537
 For assistance call: Washington (301) 948-6370, Chicago (312) 677-0400,
 Atlanta (404) 434-4000, Los Angeles (213) 877-1282, Toronto (416) 678-9430

For literature circle 900
 For information on OEM applications circle 250

SURPRISE!



The World's First Rectangular LED Lamps

For the first time LEDs are offered in a rectangular epoxy package. Available in high-efficiency red, yellow and green, they feature a flat, high intensity, light emitting surface.

And, since they're end or side stackable, they're ideal for flush mounted panel indicators, backlighting legends, and linear arrays. Plus you get long life and solid state reliability. And they're in stock right now. Choose our 5082-4570 for yellow, the 5082-4670 for high efficiency red, or the 5082-4970 for green. Priced at \$1.00* in quantities of 1000. *U.S. Domestic prices only

In the U.S., contact Hall-Mark, Schweber, Wilshire or the Wyle Distribution Group (Liberty-Elmar) for immediate delivery.

In Canada, contact Schweber Electronics or Zentronics, Ltd.

HEWLETT  PACKARD

Sales and service from 172 offices in 65 countries.
1507 Page Mill Road, Palo Alto, California 94304

HP's new thermal printer just keeps purring along.

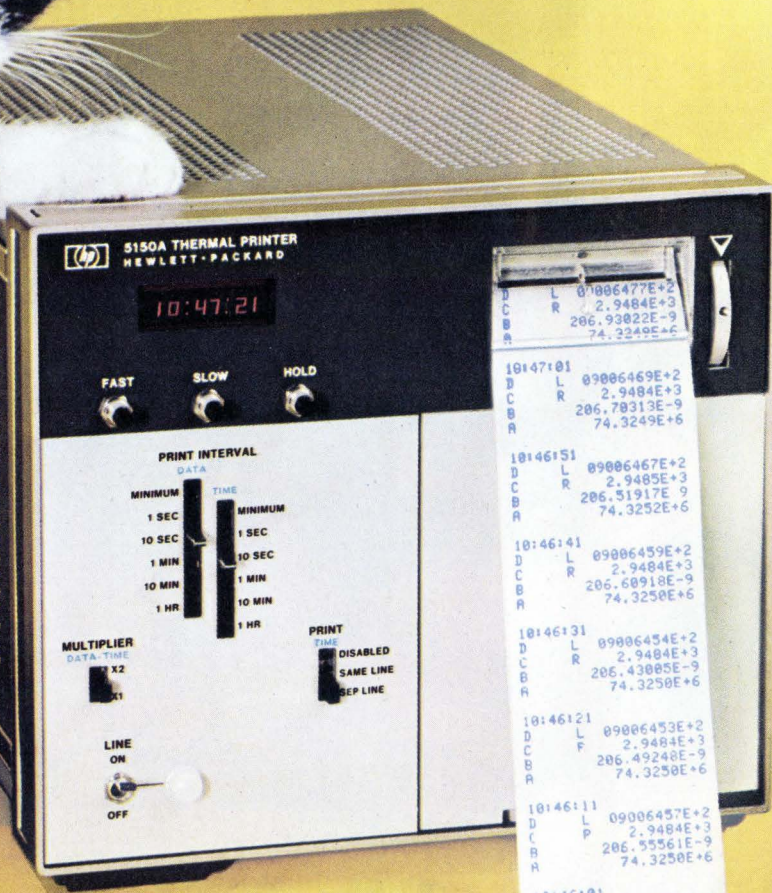

Say goodbye to the clank and rattle of mechanical printers and say hello to quiet, reliable operation. With its thermal printing technique, the new HP 5150A Thermal Printer needs only two moving parts — those that transport the tape.

That's just a beginning. Built-in flexibility and plug-in options mean that, at last, there is a printer that you can custom-tailor to your data printout needs without delay or compromise.

Alphanumeric printout. A full 64-character upper case ASCII printing set, with figures and symbols that read and reproduce clearly. Print speed is three lines per second.

ASCII Interface option. Interfaces to most ASCII coded sources or HP Interface Bus. Full 64-character, 20-column printout.

BCD Interface option. Interfaces with BCD \pm 8421 sources. Prints standard 16-character set, but can draw on the full 64-character complement of the 5150A. Ten or 20 columns.

Scanner option. The 5150A can function as a system controller for up to 13 instruments on the HP Interface Bus, providing automatic data-acquisition capability.

Clock option. With it, an entirely new order of convenience, flexibility and control becomes possible. Simple, front-panel controls let you record the time of day and select the time interval between samples.

Special BCD printouts. Special formats or re-interpretation of BCD inputs can be provided at minimum cost.

The price is right. Only \$875* for the 5150A mainframe. Plug-in options range from \$125* to 350*. At the price, no other printer matches its

flexibility, quietness and reliability. Write, or call your nearby HP field engineer, for complete technical specification or a demonstration.

*Domestic USA prices only.

HEWLETT  PACKARD

Sales and service from 172 offices in 65 countries
1501 Page Mill Road, Palo Alto, California 94304

Circle 2 on reader service card

- 31 **Electronics Review**
MICROPROCESSORS: Intel to produce 8080 successor next year, 31
SOLID STATE: Fairchild has one-chip emulation of Nova 1200, 32
PACKAGING & PRODUCTION: Film carriers set for low-volume users, 33
MICROPROCESSORS: Texas Instruments readies 4-bit-slice family, 33
Motorola prepares low-power Schottky TTL, 34
MILLIMETER WAVES: 90-GHz radiometer detects 30-ft objects, 34
CAREERS: IEEE lobbies to protect service-contract engineers, 36
MEMORY: 262 kilobits fit on a single wafer, 38
NEWS BRIEFS: 38
PACKAGING & PRODUCTION: Flush socket fits plated-through holes, 41
- 55 **Electronics International**
GREAT BRITAIN: 10-bit a-d converter chip needs only a clock, 55
WEST GERMANY: Grundig automates pc-board production, 56
DENMARK: Minicomputer-aided system designs pc boards, 56
AROUND THE WORLD: 55
- 65 **Probing the News**
INSTRUMENTATION: Is test-equipment shakeout coming? 65
ELECTRONICS ABROAD: West Germany's economy stays healthy, 69
MANUFACTURING: Semiconductor equipment makers bullish, 74
CONSUMER: Matsushita's TV turns on worldwide, 76
- 81 **Technical Articles**
COMPONENTS: Interfacing data converters and microprocessors, 81
SOLID STATE: Several technologies show surprising new paces, 90
DESIGNER'S CASEBOOK: Regulator extends battery life, 96
Multiple feedback filter has low Q and high gain, 97
Up/down latching sequencer keeps order, 99
COMPUTERS: An electrically alterable ROM—without nitride, 101
CONSUMER: Single-chip microprocessor rules the roast, 105
ENGINEER'S NOTEBOOK: Predicting gate current from specs, 112
Charged capacitor reduces relay actuating power, 113
Standard-deviation program combines recurring data, 115
- 121 **New Products**
IN THE SPOTLIGHT: Modules link LSI-11 to analog systems, 121
INSTRUMENTS: Logic probes' prices plummet, 123
SEMICONDUCTORS: Bi-FET switches use n-channel process, 131
DATA HANDLING: Three Varian minicomputers aim at OEMs, 142
PACKAGING & PRODUCTION: Two-part fixture cuts testing costs, 153
MATERIALS: 162
- Departments**
Publisher's letter, 4
Readers' comments, 6
News update, 8
Editorial, 12
People, 14
Meetings, 20
Electronics newsletter, 25
Washington newsletter, 49
Washington commentary, 50
International newsletter, 55
Engineer's newsletter, 116
New literature, 166
- Services**
Reprints available, 164
Employment opportunities, 174
Reader service card, 189

Highlights

Cover: Converters and microprocessors meet, 81
Successful intelligent data-acquisition systems depend upon proper design of the interface between the microprocessor and the analog-to-digital converter. The goal is to keep the microprocessor as busy as possible.

Art director Fred Sklenar designed the cover; Ed Lada photographed it.

Some ATE firms to die? 65

A shakeout may be imminent among automatic-test-equipment manufacturers, as problems of small size, personnel turnover, and tight money plague some companies. But no single firm feels it is in trouble.

IEDM features semiconductor surprises, 90

This week's International Electron Devices Meeting includes reports of metal-oxide-semiconductor variations, such as a new structure and faster, denser complementary-MOS logic, and of charge-coupled-device logic, growing microwave power, and brisk activity in optoelectronics.

No nitride in electrically alterable ROM, 101

Two programable read-only memories achieve the convenience and speed of electric erasure with standard metal-oxide-semiconductor processing techniques. The stored charges don't deteriorate upon reading, unlike in electrically alterable metal-nitride-oxide-semiconductor types.

And in the next issue . . .

Leading industry executives ponder 1977 . . . troubleshooting microprocessor-system prototypes . . . techniques for expanding microcomputer memories.

EDITOR-IN-CHIEF: Kemp Anderson

EXECUTIVE EDITOR: Samuel Weber

MANAGING EDITOR: Arthur Erikson,
International

SENIOR EDITORS: Laurence Altman,
Ray Connolly, Lawrence Curran,
John Johnsrud, H. Thomas Maguire,
Stephen E. Scrupski

ART DIRECTOR: Fred Sklenar

ASSOCIATE EDITORS: Howard Wolff,
Gerald M. Walker, Alfred Rosenblatt

DEPARTMENT EDITORS

Aerospace/Military: Ray Connolly
Circuit Design: Raymond P. Capece
Communications & Microwave:

Richard Gundlach

Components: Lucinda Mattered

Computers: Stephen E. Scrupski

Consumer: Gerald M. Walker

Industrial: Raymond P. Capece

Instrumentation: Andy Santoni

New Products: H. Thomas Maguire,

Michael J. Riezenman

Packaging & Production: Jerry Lyman

Solid State: Laurence Altman

CHIEF COPY EDITOR: Margaret Eastman

COPY EDITORS: Everett C. Terry, Ben Mason

ART: Charles D. Ciatto, *Associate Director*
Paula Piazza, *Assistant Director*

EDITORIAL SECRETARIES: Janet Noto,
Penny Rothman, Marilyn B. Rosoff

FIELD EDITORS

Boston: Lawrence Curran (Mgr.), Pamela Leven

Los Angeles: Larry Waller (Mgr.)

Midwest: Larry Armstrong (Mgr.)

New York: Bruce LeBoss (Mgr.)

San Francisco: Bernard Cole (Mgr.)

Judith Curtis

Washington: Ray Connolly (Mgr.)

Frankfurt: John Gosch

London: William F. Arnold

Paris: Arthur Erikson

Tokyo: Charles Cohen

McGRAW-HILL WORLD NEWS

Editor: Michael Johnson

Brussels: James Smith

Milan: Andrew Heath

Moscow: Peter Gall

Paris: Joel Stratte-McClure

Stockholm: Robert Skole

Tokyo: Colin Gibson

PUBLISHER: Dan McMillan

MARKETING ADMINISTRATION MANAGER:

Wallis Clarke

CIRCULATION MANAGER: Karl Peterson

MARKETING SERVICES MANAGER:

Tomlinson Howland

RESEARCH MANAGER: Margery D. Sholes

Microprocessors and microwave ovens now have a lot more in common than their prefixes. Some of the newest microwave oven models owe their ease of operation and their range of features to a built-in microprocessor.

For an intriguing look at how one company, Texas Instruments, went about perfecting the design of a microprocessor-controlled microwave oven, turn to page 105. There, authors Bill Bell and Deene Ogden describe the project, which was, in a way, a solution looking for a problem. Planners at TI wanted a good demonstration vehicle for their TMS 1000 and, eyeing the consumer market, decided to design and breadboard a multi-mode oven using a microprocessor controller plus a capacitive keyboard.

Author Bell, in TI's microprocessor testing group specializing in the TMS 1000, was moved to the application group because of his familiarity with the devices. Bell, incidentally, designed his own mini-computer at home. He is using it for customized TV games and plans to put recipes in memory.

Coauthor Ogden has already published several articles in *Electronics*, covering memory and microprocessor work. His interest in flying has led to an offbeat microprocessor application. He is not only building his own airplane—he is two thirds of the way toward completing a four-seat plane—but he has plans for a microprocessor-based controller to help fly it.

Designing an intelligent data-acquisition system "is a lot simpler than it used to be," says Intersil's David Fullagar. "Only a few years

ago, designers had to build many things from scratch. Now, there are LSI building blocks that make it easy, and parts count for a complete simple system is down to around 15 to 20 ICs.

Our cover article (see p. 81) this issue, about interfacing converters and microprocessors for building smart data-acquisition systems, was written by Fullagar, along with Peter Bradshaw, Lee Evans, and Bill O'Neal. The first three are senior staff scientists at Intersil, while the latter is the manager for digital-to-analog products. Each contributed his own brand of expertise to the article—Fullagar gave it perspective, Bradshaw wrote about the microprocessor interface, Evans is an a-d expert, and O'Neal is the d-a expert.

Before the microprocessor, it was still cost-effective for a designer to spend about \$500 on an analog interface card to hook up with a mini-computer, notes Fullagar. But nowadays, this approach is just not economical enough; a do-it-yourself data-acquisition system, including the hardware for the microprocessor interface, may be put together for only \$75 to \$100.

"Also, all the circuitry is going onto one card, not into large boxes—so it's much more difficult to leave the analog design to 'Joe' and let 'Fred' do the digital." More than ever, it's essential that a digital designer feels as comfortable with the analog circuitry as he does with the digital, and vice versa.



December 9, 1976 Volume 49, Number 25
94,092 copies of this issue printed

Published every other Thursday by McGraw-Hill, Inc. Founder: James H. McGraw 1860-1948. Publication office 1221 Avenue of the Americas, N.Y., N.Y. 10020; second class postage paid at New York, N.Y. and additional mailing offices.

Executive, editorial, circulation and advertising addresses: Electronics, McGraw-Hill Building, 1221 Avenue of the Americas, New York, N.Y. 10020. Telephone (212) 997-1221. Teletype 12-7960 TWX 710-581-4879. Cable address: MCGRAWHILLNEWYORK.

Subscriptions limited to professional persons with active responsibility in electronics technology. No subscriptions accepted without complete identification of subscriber name, title, or job function, company or organization, and product manufactured or services performed. Based on information supplied, the publisher reserves the right to reject non-qualified requests. Subscription rates: in the United States and possessions \$12.00 one year, \$30.00 three years, company addressed and company libraries \$18.50 one year, \$46.00 three years; APO/FPO addressed \$35.00 one year only; Canada and Mexico \$14.00 one year, \$32.00 three years; Europe \$35.00 one year, \$87.50 three years; Japan, Israel and Brazil \$60.00 per year; Australia and New Zealand \$60.00 per year, including air freight; All other countries \$40.00 per year. Limited quota of subscriptions available at higher-than-basic rate for persons allied to field served. Check with publisher for these rates. Single copies: \$4.00. Please allow four to eight weeks for shipment.

Officers of McGraw-Hill Publications Company: Gordon L. Jones, President; Paul F. McPherson, Executive Vice President; Gene W. Simpson, Group Vice President; Senior Vice Presidents: Ralph Blackburn, Circulation; John B. Hoglund, Controller; Ralph R. Schultz, Editorial; David G. Jensen, Manufacturing; Vice Presidents: James E. Boddorf, Planning & Development; Edward E. Schirmer, Marketing Administration.

Officers of the Corporation: Harold W. McGraw, Jr., President, Chief Executive Officer, and Chairman of the Board; Robert N. Landes, Senior Vice President and Secretary; Ralph J. Webb, Treasurer.

Title registered in U.S. Patent Office; Copyright © 1976 by McGraw-Hill, Inc. All rights reserved. The contents of this publication may not be reproduced in whole or in part without the consent of copyright owner.

Subscribers: The publisher, upon written request to our New York office from any subscriber, agrees to refund that part of the subscription price applying to copies not yet mailed. Please send change-of-address notices or complaints to Fulfillment Manager; subscription orders to Circulation Manager, Electronics; at address below. Change-of-address notices should provide old as well as new address, including postal zip code number. If possible, attach address label from recent issue. Allow one month for change to become effective.

Postmaster: Please send form 3579 to Fulfillment Manager, Electronics, P.O. Box 430, Hightstown, N.J. 08520.

From DC to 1 megahertz, the Model 7500 direct coupled amplifier puts up to 75 watts and 125 VRMS at your fingertips. This all solid state unit offers typical frequency response of $\pm .05$ db and harmonic distortion of .05%. Output circuit is both current and voltage protected. Voltage gain is 0 to X100, fixed or variable. Both AC and DC input coupling are provided. Ideal for precision meter calibration and transducer driving. Price \$1500.00. Stick with the WAVEMAKERS.TM Write for complete details, phone (617) 580-1660 or any listed office.

KH KROHN-HITE CORPORATION

Avon Industrial Park, Avon, Mass. 02322 • (617) 580-1660

SALES OFFICES: **ALA.**, Huntsville (205) 534-9771; **ARIZ.**, Scottsdale (602) 957-9110; **CAL.**, San Jose (408) 292-3220, Inglewood (213) 674-6850; **COL.**, Denver (303) 773-1218; **CONN.**, W. Hartford (203) 525-7647; **FLA.**, Orlando (305) 894-4401; **GA.**, Atlanta (404) 237-7272; **HAWAII**, Honolulu (808) 941-1574; **ILL.**, Arlington Hts (312) 394-3380; **LA.**, Lafayette (318) 232-8390; **MD.**, Baltimore (301) 321-1411; **MASS.**, Burlington (617) 273-0198; **MINN.**, St. Paul (612) 645-5816; **MO.**, St. Louis (314) 423-1234; **N.M.**, Albuquerque (505) 255-2330; **N.J.**, Cherry Hill (609) 482-0059; **N.Y.**, Elmont (516) 488-2100, Rochester (716) 328-2230, Syracuse (315) 437-6666, Vestal (607) 785-9947; **N.C.**, Burlington (919) 227-3639; **OHIO**, Chesterland (216) 729-2222, Dayton (513) 434-8993; **OKLA.**, Tulsa (918) 299-2636; **ORE.**, Portland (503) 297-2248; **TEX.**, Dallas (214) 661-0400, Houston (713) 688-1431; **VA.**, Falls Church (703) 573-8787; **WA.**, Bellevue (206) 454-3400; **CANADA**, Montreal, Quebec (514) 341-7630, Ottawa, Ontario (613) 235-5121, Toronto, Ontario (416) 445-9900, Vancouver, British Columbia (604) 253-5555, Halifax, Nova Scotia (902) 454-8321, St. John's, Newfoundland (709) 726-2422.

the 7500 amplifier ... WIDEBAND-AID for system designers



Circle 4 on reader service card



Tansitor

Specialists in
Tantalum Capacitors

PURITAN™

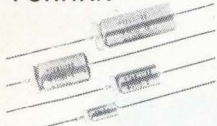

CLR 79
Tantalum case
Tantalum-to-glass
hermetic seal

FOIL TYPES



Tubular Style
CL, CLR or TE
Elastomer or
Hermetic Seals



Rectangular Packages
CL or TE 51, 52, 53, 54
Tantalum to Glass
Hermetic Seal



Special Designs
WF, TES, THS
Volumetrically efficient
Filter Capacitors



Custom Modules
Wide range of ratings
designed to meet
your requirements

WET TYPES

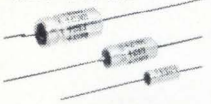

CL 65, CL 67, CLR65
Elastomer or
Hermetic Seals
Standard or High Cap



Rectangular Packages
CL or TE 55
Hermetic Seal
High Cap Values

MINIATURE SOLIDS



Type HA Cylindrical
Type TC Rectangular
Axial or Radial Leads
Subminiature size

For more information on TANSITOR
capacitors, call your local
Tansitor Representative, or contact:



Tansitor
ELECTRONICS
DIVISION OF AEROTRON, INC.

West Road, Bennington, Vermont 05201
Phone: (802) 442-5473 TWX: (710) 360-1782
Specialists in Tantalum Capacitors
TM Trademark of Tansitor Electronics

Readers' comments

Watch that signal

To the Editor: I would like to draw your attention to a small error in the solar-cell item of the Sept. 2 Engineer's newsletter ["Another odd job for solar cells," p. 112].

An artificial-light source connected to the 60-hertz line will cause a 120-Hz signal in a photodetector, not a 60-Hz signal. The reason for this 120-Hz interference is because the detector will respond equally to positive and negative excursions of the line voltage.

Mathematically, the power (or light output) of a light source is proportional to the square of the voltage or the square of the current (neglecting small nonlinearities in the load resistance). Incandescent lamps are better [interfere less with selenium solar cells than fluorescent types] because of the much larger thermal time constant of their filaments compared to filaments of fluorescent lamps.

With silicon solar cells, though, the light signal from a fluorescent lamp, for the same number of foot-candles, interferes less than that from an incandescent source. The spectral content of fluorescent light is different from the spectral response that is characteristic of silicon photodetectors.

Sidney V. Soanes
JVA Scientific Consultants Ltd.
Toronto, Ont., Canada

Job-seeking same everywhere

To the Editor: Thanks for printing the rebuttal editorial [on the role of the educator in influencing the supply of engineers, p. 12, Oct. 14]. I had had the feeling you may have been overstating your point a little, and Professor Comer makes sense.

I am as sensitive as the next fellow to the competition for jobs. But perhaps engineering is no worse than other fields.

At the present time, electronics, particularly computers, has a lot of glamour as a profession, when seen by the public. Perhaps this helps to obscure the actual professional market situation.

Nick Jordan
Brighton, Mass.

Gas Sensing Semiconductor

FIGARO GAS SENSOR

TGS quickly senses
even small
amount
of gas.

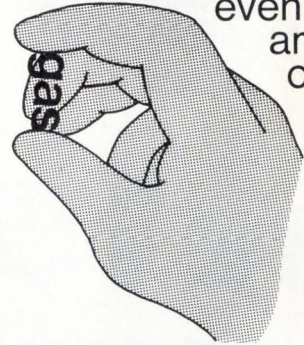

New Models,

some with highly sensitive
CO sensor, now on the market.

Please contact the address below directly for
catalogs and price/delivery information.

FIGARO ENGINEERING INC.

3-7-3, Higashitoyonaka, Toyonaka City, Osaka 560,
Japan/Tel: (06) 849-2156

Cable: FIGARO TOYONAKA/Telex: 05286155 FIGARO J
Circle 191 on reader service card

FREE
with your
business card
or send \$1.00



Giant Catalog

64 Pages of News about the
Amazing Technological Break-
throughs in the Mini-Micro
Computer Field!

CATALOG INCLUDES:

1. Reproductions of manufacturers complete catalogs including IMSAI's—normally \$1.00
2. Articles and news on Mini-Micro Computers
3. \$2.00 Gift Certificate
4. Includes all this and more!

CATALOG OFFERS ITEMS LIKE:

1. \$289 complete Computer System for home use. Not a kit!
2. Thorough Home Study Course on How To Computer Program. Includes text books and computer!
3. Low cost New and Used Peripherals
4. Many more items!

Send \$1.00 now (refundable on first order)
or Free with Business Card!

Newman Computer Exchange
1250 North Main, Dept. 35
Ann Arbor, Michigan 48104

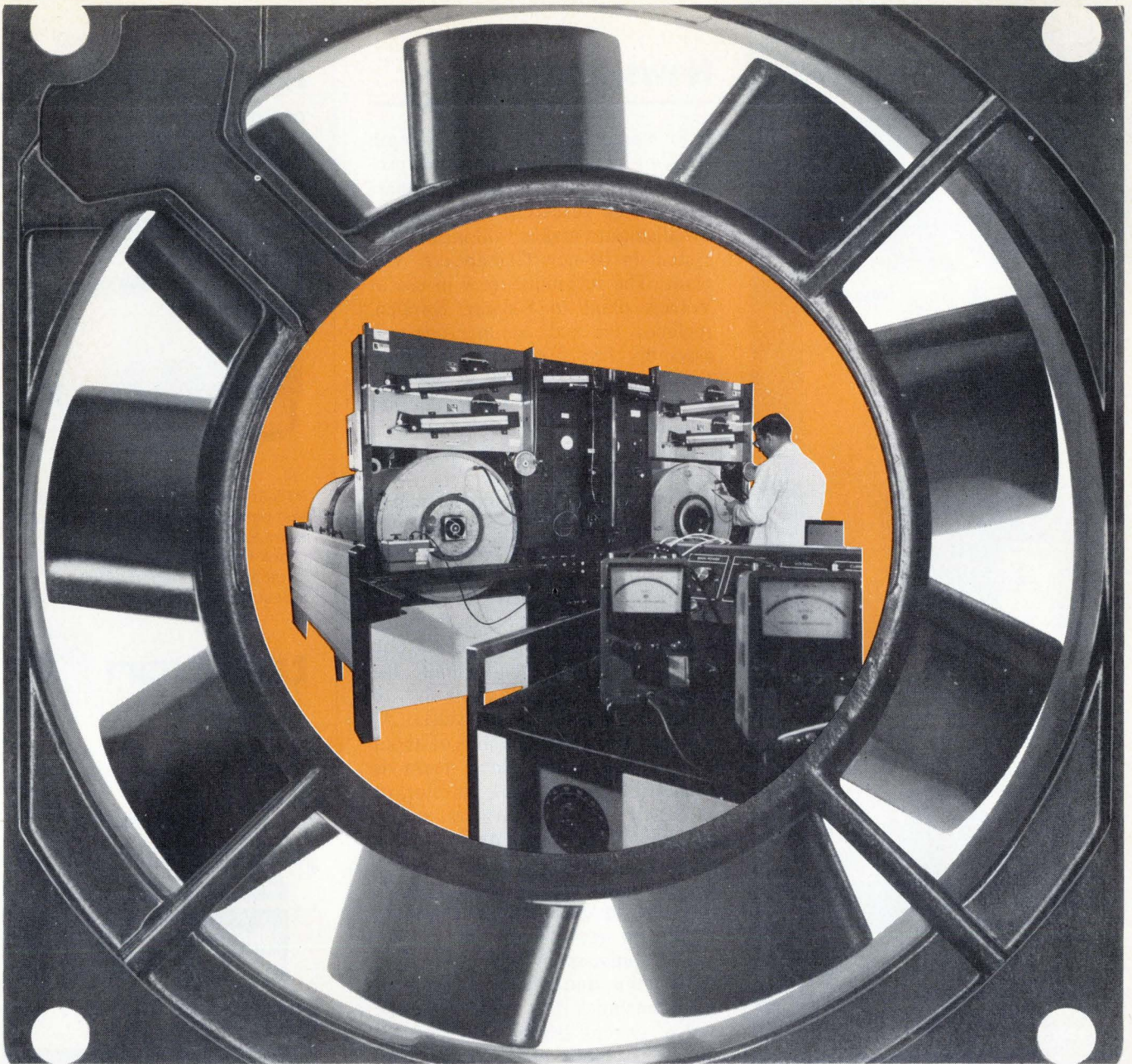

Behind every Rotron fan and blower... Product Quality

A "pretty face" isn't enough when you buy a fan or blower. You want it to be able to perform under the conditions that prevail. And you want assurance that the product won't quit when you least expect it.

That's why it's good to know that aesthetics is only a small part of what you buy when you buy Rotron. You buy the most experienced, most extensive product engineering in the precision air moving business. And

you buy manufacturing facilities and equipment that are unequalled. With test and inspection facilities and procedures more stringent than you might apply yourself.

In short, you buy reliability. Products that are designed better. That are made better. That perform better.

Why settle for less when the best costs no more?



ROTRON INC.
AN  **EG&G COMPANY**

Woodstock, N. Y. 12498 □ 914 • 679-2401 □ TWX 510-247-9033
Garden Grove, Cal. 92641 • 714-898-5649 • Rotron B.V., Breda, Netherlands, Tel: 79311, Telex: 844-54074

18513

Circle 7 on reader service card

Get the scope you need-Now!

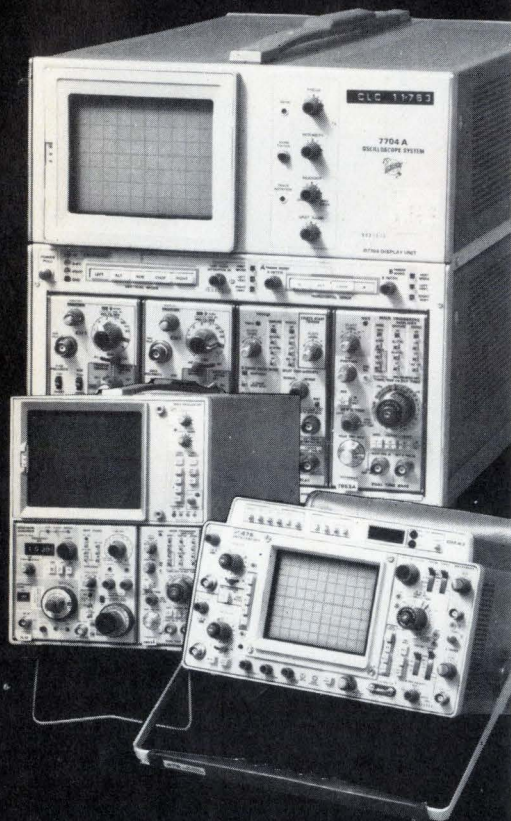

Our "Instrument Professionals" will tell you which scope will do the job best, at the lowest cost, make immediate delivery and guarantee performance.

Write or call for data on our other specialties: Instrument Leasing • Computer Peripherals • Equipment Sales • Instrument Service.

Circle 8 on reader service card

Call Continental Rentals



Get our FREE Catalog

Div. Continental Leasing Co., Inc.
175 Middlesex Turnpike, Bedford, MA, 01730 (617) 275-0850

Metuchen, NJ (201) 549-8500;
Gaithersburg, MD (301) 948-4310; TX (214) 357-1779; Elk Grove, IL (312) 439-4700; Costa Mesa, CA (714) 540-6566; Santa Clara, CA (408) 735-8300; Los Angeles, CA (213) 477-7521

News update

■ Bolstered by the first in-depth study of its computer-controlled production system yet made by impartial outside researchers, Volvo, the Swedish auto maker, will install that system in its new Chesapeake, Va., plant. The technique, now in use at Volvo's plant in Kalmar, Sweden, replaces the old one-man-one-task assembly line first used by Henry Ford for the Model T with a computer-controlled technique that allocates each system in a car to a team of workers [*Electronics*, May 16, 1974, p. 78].

Each car being assembled moves around the plant on its own transport wagon. The wagons may be controlled by a central computer, or they may be taken off the line and moved manually. In Sweden, the system is used to turn out 30,000 cars a year in one shift, while the goal in Chesapeake will be to produce 100,000 in two shifts. At Kalmar, there are 25 teams of about 15 workers each. Each team is responsible for the car's interior, or electrical controls, or wheels, and so on. Each team picks its own work mode: one person might install a complete system, several might work together, or each might be responsible for a small detail.

The study, sponsored jointly by a trade union and employer organization, concludes that workers like the Volvo system better than conventional assembly lines. Productivity and quality, too, are just as high as at Volvo's other plants. However, two original aims of the plant design have not worked out as hoped. One would allow each team to plan its own breaks by shoving cars they are working on off into a buffer area. But the plant's complex flow scheme hindered this. Also, workers are using CRTs at each assembly area to plan their breaks—though the CRTs were supposed to be used to carry quality-control data. Instead, the teams are getting 75% of their information about faults orally. Interestingly, the workers' major criticism—27% of them mentioned it—was the fact that the plant attracts so many visitors inspecting the novel assembly system.

FOR BIT ERROR RATE TESTING ...

of Coaxial, Optical, Satellite and Digital Radio Systems



PTS-107, one of our line of digital test sets. Other models cover data rates to 1 GHz. User features: Clock recovery, auto phasing, burst and continuous data measurement and error injection.

tau-tron inc.
11 Esquire Road, North Billerica, Mass. 01862
Tel: (617) 667-3874

Circle 193 on reader service card

Think of what just one company can do to stop pollution. We have.



People start pollution. People can stop it.

Please send me a free copy of your guide.

Name _____

Street _____

City _____

State _____ Zip _____



A Public Service of The Advertising Council

Keep America Beautiful
99 Park Avenue New York 10016

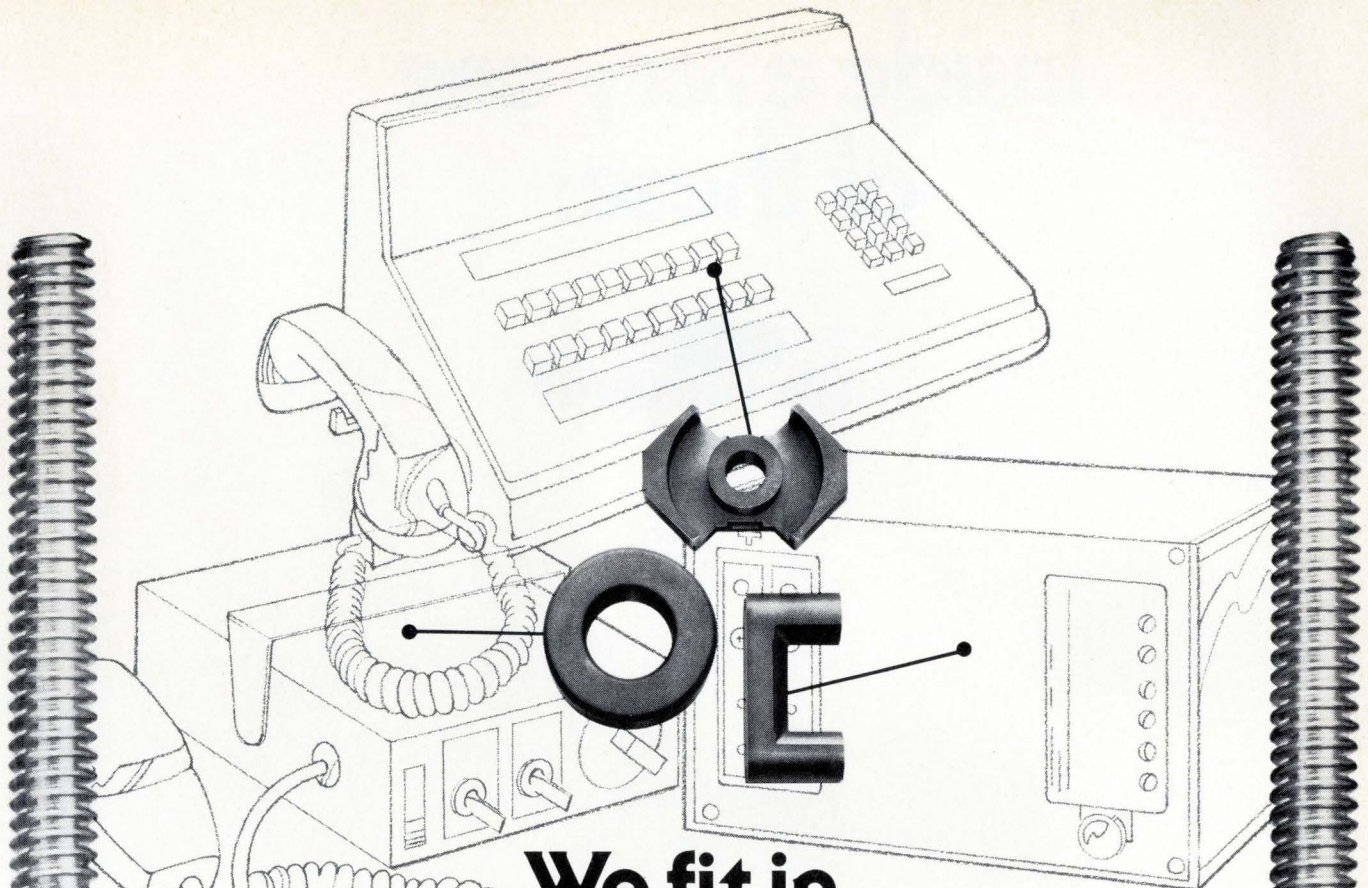

We fit in just about anywhere.

For any application demanding high Q, high stability of inductance or low power losses at high flux density and minimum volume, all at the tightest specs, turn to the Cube.

Expanding your line? We're constantly expanding ours. Ferroxcube offers the most complete selection of linear ferrite materials. You get the electrical properties you want. In a broad variety of sizes and shapes. You get consistent quality. And you get delivery. Whatever the application we can supply the material. We'll even help you develop the application.

New from the Cube

U64 Core, with the largest cross-sectional area available in 3C8 material. Designed for high-flux density applications. It offers low losses under high-flux levels, high B saturation, and a high Curie temperature. It is ideal for high-power transformer and choke applications.

RM Square Cores, both RM6 and RM8 cores are now available in 3E2A material. This is a high-permeability material with a Curie temperature higher than 170 °C. Specifically developed for broad band and pulse transformer applications, they are particularly suited for voice frequency transformers.

Toroids, from 0.5- to 1.5-inches are now available in 4C4 material. This is a low-permeability, high-frequency, material designed for use in the 1 to 30 MHz range, making it ideal for hybrid combiners in citizen band radios.

A wide selection of bobbins and mounting brackets are available from the Cube. We've added hardware and bobbins for the EC-series of Power E-cores that are inexpensive and simple to use. The bobbins are designed for either chassis or PC board mounting. Termination for the most complex multiwinding transformer is facilitated by separate pins that can be inserted to your specifications.

Call on the Cube

The products shown here are just a sample of the materials, components and design information contained in the new Ferroxcube Linear Ferrite catalog. Write for your free copy today.

FERROXCUBE

Division of Ampere x Electronics Corporation / 5083 Kings Highway / Saugerties, N.Y. 12477 / (914) 246-2811
A North American Philips Company



**Inside every one
of these:**

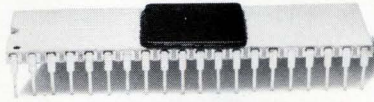

Japanese TV competition: a U.S. industry view

When it comes to the complex and perplexing question of whether Japanese makers are competing unfairly in the U.S. TV market, some consumer-products industry leaders feel that the years of Government stalling represent more than just a classic case of inefficiency. To Zenith Radio Corp.'s chief, John J. Nevin, for instance, the Government's continued refusal to come to grips with the problems faced by U.S. TV makers looks much more like a calculated effort to trade a key consumer market for concessions from the Japanese in who knows what other areas.

Take dumping, for example. Nevin argues that there are laws on the books that compel the Treasury Department to assess countervailing duties to balance out any economic advantages given to a foreign manufacturer when its government grants certain export subsidies. Therefore, Zenith petitioned the Treasury Department in April 1970 to impose such countervailing duties because of a commodity tax rebate given by the Japanese government.

It took nearly six years for the Treasury Department to issue its "final determination"—that such rebates were not subject to countervailing duties. The six-year delay tied Zenith's hands. It could not go to court for immediate relief, because court appeals could not begin until the Treasury Department's final determination was issued.

In a recent address, Nevin said: "The Treasury Department's six-year delay in reaching a final determination was, in my view, calculatedly and deliberately designed to prevent Zenith from access to the courts for a judicial review of the issue. It has long been a principle of American law that 'justice delayed is justice denied.'"

In that six years, of course, a number of irreversible things happened. Thousands of jobs were lost as one after another of the veteran names in consumer electronics closed

or sold off their TV manufacturing plants. Some companies, too, have been "sold off" and are now in the hands of non-U.S. companies.

Nevin cites and documents other instances of unfair trade activities that, he feels, the U.S. Government, at best, has merely winked at, or, at worst, promoted to the detriment of American industry. One is accounting practices that put one price—a price high enough to avoid dumping duties—on contracts and another, much lower price on the final product, via rebates to the buyer. Another is price-fixing and market-splitting agreements by the Japanese. A third is a concerted effort to acquire control of U.S. companies and thus stifle competition. These allegations are being investigated by the U.S. International Trade Commission, which, because other agencies were being too slow, was given significant power to deal with such complaints by the Trade Act of 1974.

A strong supporter of free trade, Nevin wants nothing from the Government but protection against unfair practices. "We believe strongly that given equal protection under the law, Zenith can compete with all comers," he says. However, "we have been disappointed and, in fact, outraged by the determined effort of the Departments of State, Treasury, and Justice in recent weeks to cause the International Trade Commission to terminate its investigation."

There is merit in Nevin's conclusion that the Treasury Department and, in its investigations of the monopoly implications of merger plans, the Justice Department "have been deliberately avoiding their responsibilities to enforce American law." Further: "I believe that the consumer electronics industry of the United States has been calculatedly deprived of the protection that it is entitled to expect under the laws of the United States."

INTRODUCING THE ONLY BOARD TESTERS THAT SHOW WHO'S AT FAULT. SHORTS, BAD COMPONENTS, EVERYTHING.

Now, thanks to our new CAPS VIII software, our GR board testers can take you beyond identifying the faulty node to pinpointing random shorted tracks, opens, and faulty components. And they get there at least twice as fast as other testers that only get you to the node. So they save you both troubleshooting time and repair time and require fewer rework support people.

But that's not all. CAPS VIII software also gives you faster setup, to reduce

testing costs even more. This is accomplished through our new Automated Program Generation (APG) Software which includes an incremental simulator, event tracking capability, equation generation and test-generation language. It will give you a test program that detects a greater percentage of faults in less time than any other setup method on the market.

To make CAPS VIII even more attractive, we're also offering a new Smart Clip, a new pulse-catching logic

probe, an IEC buss interface, and diagnosis logging capability.

Of course, to get CAPS VIII's big improvements in fault resolution, setup and troubleshooting speed, and cost, you first



New Smart Clip reduces diagnostic time.

need a GR digital or hybrid circuit board tester. But that's no problem either. The number to call is 617-369-8770 ext. 273.

Gen Rad, Inc. Test Systems Division, 300 Baker Avenue, Concord, Massachusetts 01742.

THE DIFFERENCE IN SOFTWARE IS THE DIFFERENCE IN TESTERS.

 **GenRad**





OPTRON REFLECTIVE TRANSDUCERS

NEW OPB 704 OFFERS
MAXIMUM RELIABILITY
IN A SINGLE
HERMETIC PACKAGE

OPTRON's new, low cost OPB 704 reflective transducer assures maximum reliability by combining a high efficiency solution grown LED with a silicon phototransistor in a single miniature hermetic package.

The hermetically sealed glass-metal-ceramic package offers extremely high reliability and stable performance at a cost competitive with that of plastic encapsulated devices. And, the OPB 704 has a usable continuous operating life of more than five years when operated at an average LED device current of 20 mA.

The OPB 704's phototransistor senses radiation from the LED only when a reflective object is within its field of view. With an LED input current of 50 mA, the output of the phototransistor is typically 0.5 mA when the unit is positioned 0.100 inch from a 90% reflective surface. With no reflective surface within the phototransistor's field of view, maximum output is 10 μ A with a LED input of 50 mA and V_{CE} of 5 volts.

Ideal applications for the OPB 704 reflective transducer include EOT/BOT sensing, mark sensing, detection of edge of paper or cards and proximity detection.

The OPB 704 and other low cost, high reliability OPTRON reflective transducers are immediately available. Custom designed versions for special applications are available on request.

Detailed information on the OPB 704 reflective transducer and other OPTRON optoelectronic products... chips, discrete components, limit switches, isolators and interrupter assemblies... is available from your nearest OPTRON sales representative or the factory direct.



OPTRON, INC.

1201 Tappan Circle
Carrollton, Texas 75006, U.S.A.
TWX-910-860-5958
214/242-6571

People

Rosen sets up national net to sell projection TV

Sales of projection-television sets, minuscule now, will finally start to take off in 1978 when several hundred thousand will be sold. So says the president of Sega Enterprises Inc., a manufacturer of coin-operated arcade games and a newcomer (since June) to projection-TV manufacturing and sales. But though new to the market, Sega's David Rosen plans for his company to make a major impact.

"We've just begun to set up a distribution network, and by next year we'll have a national net with sales and service centers in place," he says. He will rely for financial support on Sega's wealthy parent, Gulf + Western Industries Inc., which in its last fiscal year had sales of \$3.4 billion. "With Gulf and Western's support, we'll try to put projection TV on the map as a viable consumer product," he says.

Mad Man Muntz. Sega, a 20-year-old company organized by Rosen in Japan, got into projection television by acquiring the California-based business of Earl Muntz, known some 25 years ago as Mad Man Muntz in his promotions of black-and-white TV receivers. Rosen claims that sales of projection-TV receivers have been limited because the efforts have been limited mainly to the geographic areas around the dozen or so small companies that build the sets.

The largest is Advent Corp., first in the field with its three-tube system, and next comes Sega, followed by one or two other single-tube set makers, Rosen points out. By next year, total sales should reach some 50,000 to 75,000 sets. Prices at Sega, for example, run between \$995 and \$2,395 each.

But Rosen predicts that by 1978 the field will get a shot in the arm when a major TV-set maker or two like Magnavox or Admiral will enter the field, thereby increasing acceptance of big-screen sets by consumers. "The price of projection TV may seem high, compared to a table



Wide view. Sega's David Rosen promises video games on 50-inch television screens.

model," Rosen admits, "but it's not so high compared to a 25-in. console. And each unit, with its 50-in.-[diagonal] screen, takes up no more floor space than a console TV."

U.S. move. Sega was still in Japan a year ago, when Gulf + Western took over and moved the management to California. Though not an engineer, Rosen switched, when the technology was ready, into video and other electronic games. Now he's also going after home games built around microprocessors, as well as capitalizing on projection TV.

"We have a very promising combination—video games and projection TV. People will really appreciate playing video games on the big screens," he predicts.

Oshman's chairmanship may see Wema go East

"The time is ripe for plans and decisions," says Kenneth Oshman, the newly elected 1977 chairman of Wema, the Western electronics trade association based in Palo Alto, Calif. The biggest issue is whether Wema should become truly national in outlook.

The 998 members include a fair number outside the West, points out the boyish-looking, 37-year-old pres-

Don't let offset voltage eat up your error budget!

Precision instrumentation can be only as precise as its components and the sum of their error specs. That's why we want you to consider specifying our monolithic OP-07—the industry's standard of Op Amp excellence—in your next system. Especially if you're working with low level (μV range) signals.

NO POT NEEDED! We zener-zap trim every OP-07 chip to give it the exact performance specs you find on the data sheet. There's no nulling, no trimming, and *no pot* to worry about. **SPECS?** Compare these to any real part:

V_{os} $10\mu\text{V}$
 TCV_{os} $0.2\mu\text{V}/^\circ\text{C}$
Stability $0.2\mu\text{V}/\text{mo.}$
Noise $0.35\mu\text{V}/\text{p-p}$

Precision Monolithics, Inc.
1500 Space Park Dr.
Santa Clara, CA 95050
(408) 246-9222
TWX: 910-338-0528
Cable MONO.



SECOND SOURCE? You'll find an "equivalent" data sheet on page 12-184 of the 1976 Fairchild catalog. Our price is \$7 (100's) and since we've been in high volume production for over two years, we deliver from stock. Send a P.O. Literature and application notes are yours by simply circling the reader card number; for a sample order, call your PMI distributor.



THE FIRST \$5.00* MICROPROCESSOR INTERFACE

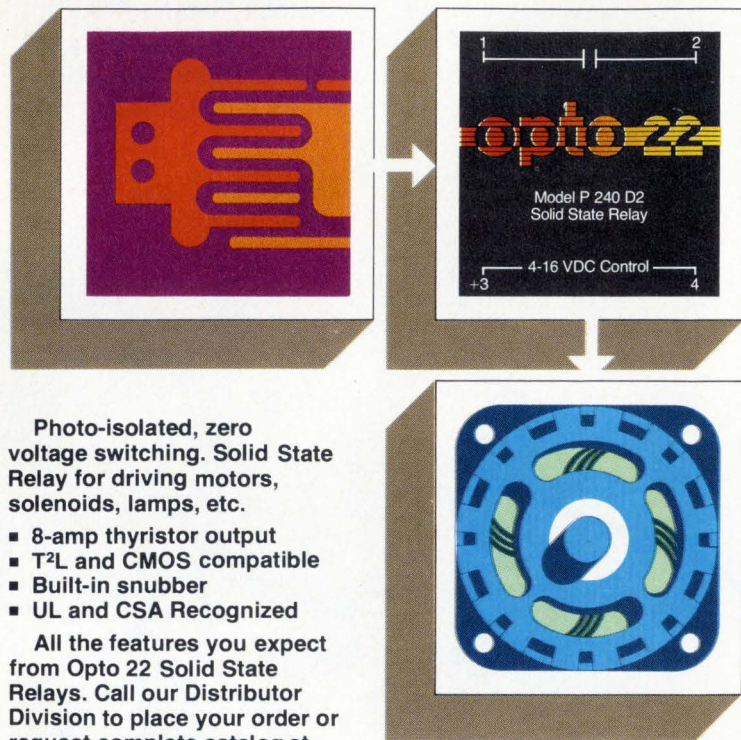

Photo-isolated, zero voltage switching. Solid State Relay for driving motors, solenoids, lamps, etc.

- 8-amp thyristor output
- T²L and CMOS compatible
- Built-in snubber
- UL and CSA Recognized

All the features you expect from Opto 22 Solid State Relays. Call our Distributor Division to place your order or request complete catalog at (714)892-7676 or (714)892-3313.

*O.E.M. Production Quantities

OPTO 22

5842 Research Drive
Huntington Beach, California 92649

Circle 16 on reader service card

CAREER OPPORTUNITIES

Usually the best opportunity to grow in your field lies within your present company. You have made an investment in them. They have an investment in you.

But occasionally the best opportunity lies somewhere else. No one can decide but you.

Companies looking for good people run their recruitment ads in our Classified Section in the back of this magazine. Perhaps you'll find an opportunity there that's worth following up.

People

ident of Rolm Corp., which manufactures general-purpose digital computers in Cupertino, Calif. But no area east of Texas has yet been authorized to set up a regional Wema council, through which members have the opportunity to participate in policy making.

Wema has served its Western members well, however, sponsoring testimony by top electronics-industry executives before governmental bodies on such matters as taxes and foreign trade, and on questions concerning air-shipping rates and renegotiation of contracts. So members who lack regional councils are now clamoring for them, according to Oshman, particularly the more than 20 Wema members located in New England.

Whether to oblige "will be resolved at the February meeting of the board of directors," promises Oshman, who holds a Ph.D. degree in electrical engineering from Stanford University. He refuses to predict the outcome, but the feeling of other Wema officials seems to be running toward an Eastern expansion. Opposition in the past has come from members who feared such a move would diminish Wema's effectiveness in the West.

Plans. Overall, Oshman expects another good year for Wema, whose present membership—821 electronics firms and 177 associated businesses and institutions—is at an all-time high. "The direction is clearly forward for services," he says. He looks forward to staff being added to expand several operations, including the public affairs, or lobbying, efforts, counseling services on salary levels for members' employees, and statistical summaries and reports on various business aspects of the electronics industries.

Also planned for 1977 is a Wema first—a "Microfair" to be held in Chicago sometime next October. It will be a combination seminar and product exhibit, pointed to the non-electronic manager who wants to learn about microprocessors. Its success could prompt similar meetings, perhaps, and some could even be held overseas, Oshman says.

Amphenol® 17-Series rear-release connectors, contacts, and crimpers.

A family that
works together
to save
together.

Cut your assembly costs with a total termination systems approach. Our 17 Series has everything you need for rear-release, input/output connections for data transmission. You get the lowest possible installed cost.

First, the connectors: 50% less costly to assemble. These rear-release connectors permit fingertip contact insertion. Without insertion tools. You can snap several of our crimp Poke-Home® contacts in place in the time normally required for a single contact inserted with a tool. So you can cut labor costs in half—at least. And no special skills or training are needed either.

Some important electrical improvements, too. Our 17 Series connectors have a shrouded rear-release insert to prevent shorting and arc-over. No potting or sleeving is required. These connectors meet EIA Standard RS-232C for data-communication input/output connectors and have an insulation resistance greater than 5000 megohms, per MIL-STD-202A, Method 302.

Second, the contacts: big savings for volume users. With our 15,000-contact capacity reels, you can save a bundle over loose contacts.

Finally, the crimpers: high-speed for lowered costs. Our new hand crimp tool makes accurate, identical crimps—time after time. And our semi-automatic crimping machine can turn out up to 2000 terminations per hour.

Get them all—connectors, reeled contacts, crimpers. And get them now. Five basic contact configurations in 17 Series connectors are now available. So is all termination equipment, backshells, and accessories. For more details, contact: Bob Ashley, Amphenol Connector Systems, Bunker Ramo Corporation, 900 Commerce Drive, Oak Brook, Illinois 60521.

The right idea
at the
right time.

AMPHENOL Connector Systems **BUNKER RAMO®**

Circle 17 on reader service card

Hand crimpers
and semi-automatic
crimping machine.



time
domain.

data
domain.

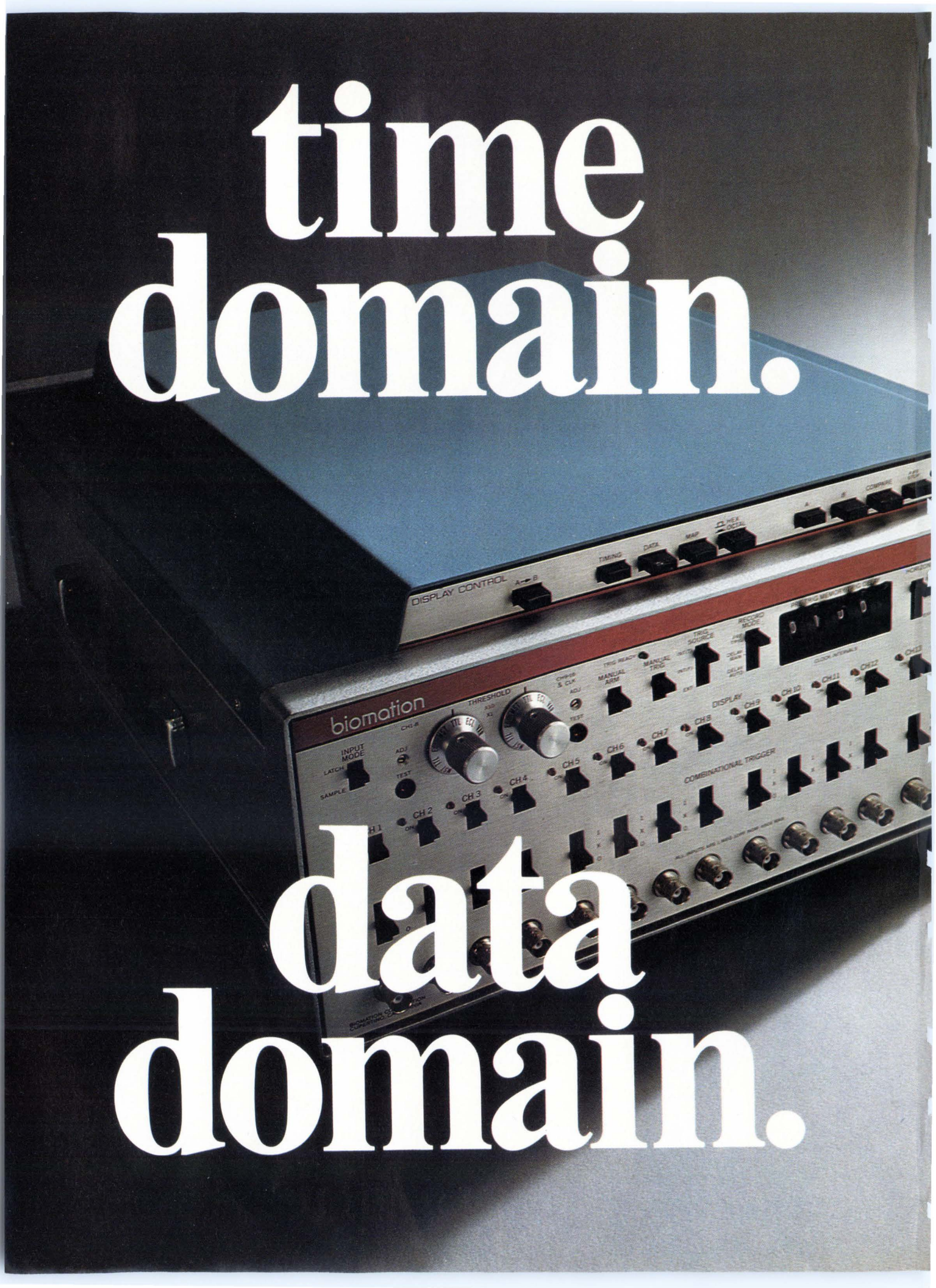

CURSOR
LOCATION

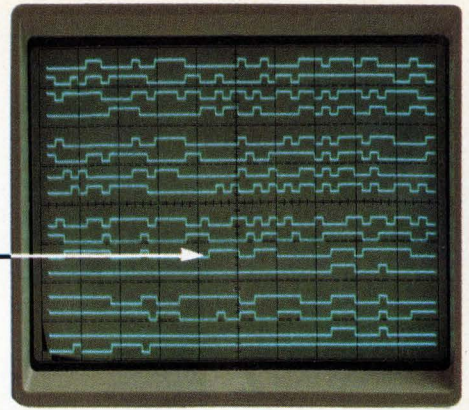

Biomation's new 1650-D produces a repetitive display output reconstructing precisely 500 bits per line for a 16-line timing diagram on a conventional oscilloscope or CRT display. Separate selection of individual channel outputs allows viewing of 1, 2...16 channels at one time with automatic vertical expansion.

Biomation's new logic analyzers give you both.

When your job is to interface, integrate and program a complex new digital logic system, you want as much information as you can get.

That's why we're providing a new set of tools which let you display timing information as well as logic word content—in the language of your choice.

Our new 1650-D logic analyzer gives you 16 channels at 50MHz. Our 851-D gives you 8 channels at the same speed. Accessories can now give you a logic state (1's and 0's) display of any 16 stored words; hex or octal translation; and a vector map of memory contents. The 8 and 16-channel logic analyzers feature:

- Pretrigger and delayed trigger recording
- Trigger point can be easily identified
- Latch record mode for fast pulse capture
- Combinational triggering (true or false)
- Movable display cursor that stays with the data when you switch display modes
- Display expansion, mixed or full, X5, X10 or X20

These are complex instruments and we can't give you all significant details here. But please write, call, or use the reader service card. We want to get this useful information into your hands. Biomation, 10411 Bubb Road, Cupertino, CA 95014, (408) 255-9500. TWX: 910-338-0226.

CURSOR
WORD

CURSOR

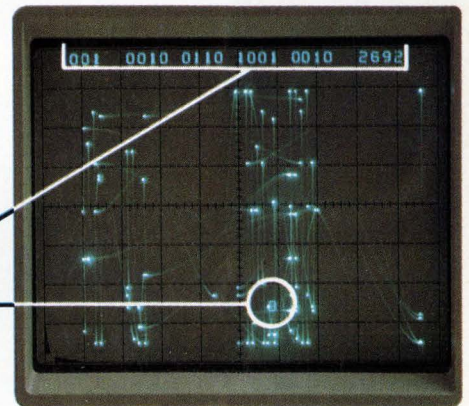

Map—each word in memory is transformed via two DAC's to form a unique dot which characterizes that word. All 512 words of the 1650's memory can be accessed for mapping. The cursor word is circled in the map as well as displayed at the top of the screen in alphanumeric form. The cursor may be moved to any of the points in the map for positive identification of that word. In addition, a map of only 16 words may be selected.

CURSOR
WORD

RELATIVE
ADDRESS

TRUTH
TABLE

HEX OR OCTAL
TRANSLATION

136	1	111	111	110	000	101	177608
137	0	001	101	011	111	111	01537
138	0	001	011	010	000	110	013206
139	1	000	010	010	000	111	102207
140	1	000	010	010	000	111	102207
141	0	000	111	110	100	000	007640
142	1	000	101	010	100	001	105211
143	0	011	000	010	100	010	030242
144	1	000	000	110	100	011	100843
145	0	011	101	010	100	100	036244
146	0	010	010	110	100	101	022645
147	0	000	010	010	100	110	002246
148	1	000	000	010	100	111	10024
149	0	101	010	000	001	011	052013
150	1	000	000	010	100	111	100247
151	1	101	100	100	001	000	154410

Logic state—provides memory address location, binary output of the 16 channels and selectable octal or hexadecimal translation. 16 words are displayed at one time with the cursor address location at the top of the screen. Movement of the cursor control allows accessing any 16 words of the entire 512 words stored in the 1650-D. The display control memory can store 16 words while a different set of 16 is selected from the 1650's main memory (or a new recording is made). These two sets of 16 words can then be overlaid on the CRT. Any differences will blink and be easily identified.

biomation
Creating tools for technology

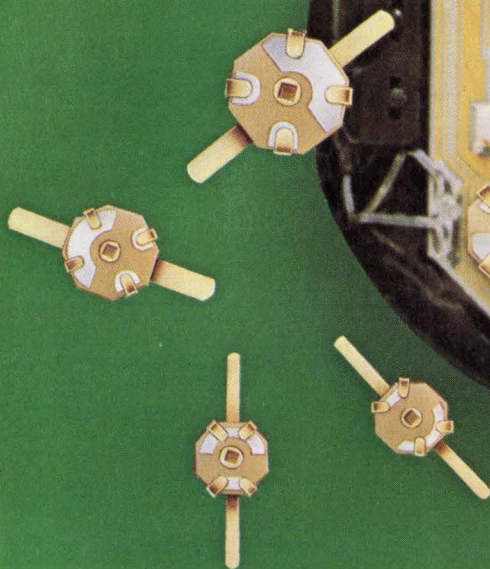

Thin-Trim[®] capacitors

Tucked in the corner of this Pulsar Watch is a miniature capacitor which is used to trim the crystal. This Thin-Trim capacitor is one of our 9410 series, has an adjustable range of 7 to 45 pf, and is .200" x .200" x .050" thick.

The Thin-Trim concept provides a variable device to replace fixed tuning techniques and cut-and-try methods of adjustment. Thin-Trim capacitors are available in a variety of lead configurations making them easy to mount.

A smaller version of the 9410 is the 9402 series with a maximum capacitance value of 25 pf. These are perfect for applications in sub-miniature circuits such as ladies' electronic wrist watches and phased array MIC's.

Johanson Manufacturing Corporation
Rockaway Valley Road
Boonton, New Jersey 07005
(201) 334-2676 TWX 710-987-8367

Meetings

Solar Cooling and Heating: A National Forum, Energy Research and Development Administration, Fontainebleau Hotel, Miami Beach, Fla., Dec. 13-15.

1977 Winter Consumer Electronics Show, EIA, Conrad Hilton Hotel, Chicago, Jan. 13-16, 1977.

1977 Annual Reliability and Maintainability Symposium, IEEE, ASME, et al., Marriott Hotel, Philadelphia, Jan. 18-20.

Power Engineering Society Winter Meeting, IEEE, Statler Hilton Hotel, New York, Jan. 30-Feb. 4.

Fifth Annual Computer Science Conference, ACM, Marriott Motor Hotel, Atlanta, Jan. 31-Feb. 2.

Electro-Optical Warfare Technical Symposium, Association of Old Crows Cabrillo Coven (San Diego, Calif.), Naval Electronics Laboratory Center, San Diego, Calif., Feb. 3-4.

Wincon—Aerospace and Electronic Systems Winter Convention, IEEE, Sheraton-Universal Hotel, North Hollywood, Calif., Feb. 7-9.

PC-77—Personal Communications Two-Way Radio Show, EIA, Las Vegas Convention Center, Las Vegas, Feb. 15-17.

ISSCC—International Solid State Circuits Conference, IEEE, Sheraton Hotel, Philadelphia, Feb. 16-18.

Optical Fiber Transmission Conference, IEEE, Williamsburg Lodge, Williamsburg, Va., Feb. 22-24.

Comcon Spring, IEEE, Jack Tar Hotel, San Francisco, Feb. 28-March 3.

Nepcon '77 West—National Electronic Packaging and Production Conference, Industrial and Scientific Conference Management Inc. (Chicago, Ill.), Anaheim Convention Center, Anaheim, Calif., March 1-3.

What You Need Is What You Get.

Ramtek's new RM9000 modular graphics and imagery system gives you expandability, economy and flexibility.

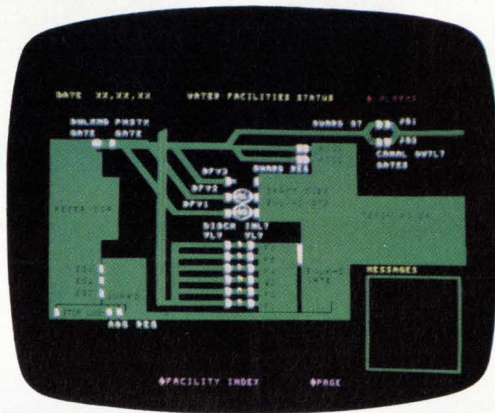

Process Control: Water facilities plant.

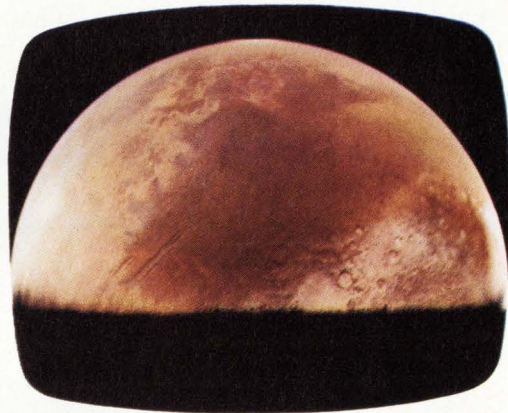

Imaging: Viking I Orbiter.

Select The Performance You Need.

The RM9000's total modularity lets you select the exact performance you need to fill your particular application. You pay only for the performance you need. Nothing more. And that's like money in the bank.

Add On As You Have To.

As your needs change and grow, the RM9000's capability will grow right along with them. A comprehensive list of options such as expansion from black and white to grey scale or color—even a complete range of interactive peripherals and additional independent channels.

Microprocessor-Controlled Raster Scan.

The RM9000 is the first raster scan graphics and imagery system to be totally microprocessor

controlled. That means you can implement a higher-order user language to minimize programming costs without a sacrifice in system throughput.

Functional. Reliable. Maintainable.

High reliability is the direct result of intensive testing of components and systems prior to shipment. Solid state components and printed circuit construction are used exclusively. Result? No special preventive maintenance measures are required. In fact, the RM9000 can be pre-programmed with self-diagnostic capability.

You Need To Know More.

To fully appreciate the RM9000's capability, you need more details. Call or write Ramtek Corporation, 585 N. Mary Ave., Sunnyvale, CA 94086. (408) 735-8400.

ramtek
Our Experience Shows

If you think Mostek's only industry standard memory is the 4K RAM, forget it!

Our 4116 was setting standards even before it hit volume production. It's the smallest, fastest, most flexible and reliable 16K RAM in the industry. These are strong claims, but we've got the facts to back them up.

Speed/Power. We have the industry's two fastest 16K RAMs: The MK4116P-2 at 150 ns access time and 375 ns cycle time. And the MK4116P-3 at 200 ns access time and 375 ns cycle time. Max power ratings are 462 mW active and 20 mW standby.

Easy to Use. Mostek's 4116 features $\pm 10\%$ tolerance on all power supplies (+12V, $\pm 5V$.) This is a Mostek exclusive but you should expect it from all of your memory suppliers. Also, the 4116 features Schottky-TTL compatibility for truly high performance systems.

Unlatched Outputs. You asked for it, you

got it. And the reasons are self-evident: A common I/O data bus. Full control of data out, thereby controlling the length of valid output time. Extension of page mode boundaries beyond the 128 column locations in a single chip. And two methods of chip select.

Operation Flexibility. The 4116 offers greater versatility in operating modes — read, write, read-write, read-modify-write, and page mode. The unique page mode allows for successive memory operations at multiple column locations of the same row address. Access time during page mode is just 100 ns for the MK4116P-2 and 135 ns for the MK4116P-3.

Reliability. Mostek memories are recognized as the quality standard throughout the industry. And for good reason. Every memory circuit we make — and that includes the 16K

Introducing Mostek's industry

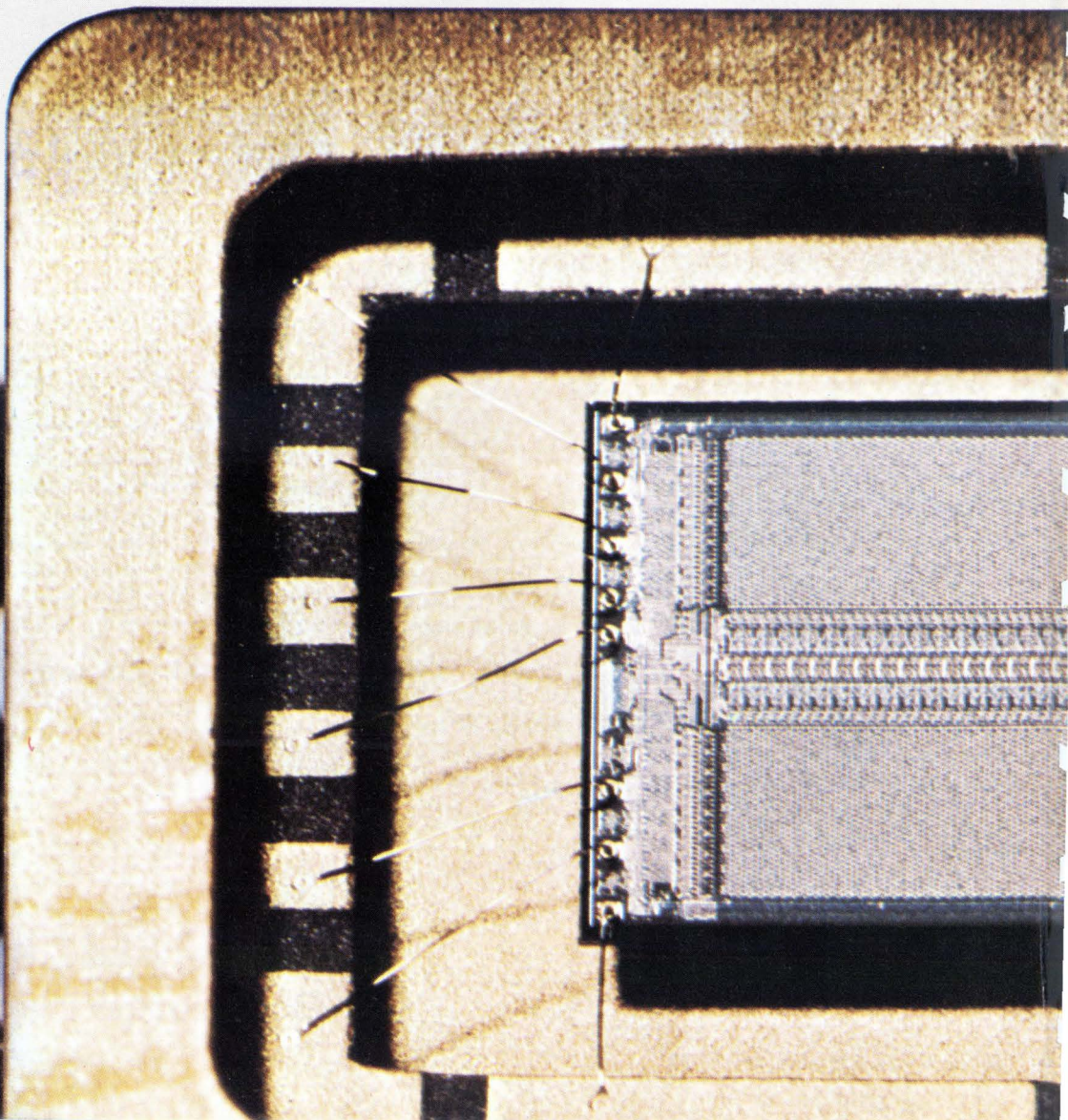

RAM — goes through an arduous series of screens and stresses: Full parametric pre-burn-in testing. Temperature cycling. Centrifuge. Dynamic burn-in at 125°C. And final test at high temperature with wide guardbands. Want proof? Ask our customers.

Processing. Mostek's state-of-the-art POLY-II™ process (double-level polysilicon) is an evolution of the N channel, silicon-gate process — the same process used with our high-performance 4027 4K RAM. And POLY-II™ is now a production-proven process.

Chip Size. At 122 mils x 227 mils, Mostek's 4116 is the smallest in the industry. 22% smaller than Intel's and 59% smaller than TI's. Remember, smaller chip sizes mean increased manufacturing productivity.

Mostek is the recognized leader in 16-pin

4K RAMs, shipping more 16-pin 4K's than all other manufacturers combined. This same production know-how will make Mostek the industry's largest producer of 16K RAMs in 1977.

How about alternate sources? Eleven other manufacturers planning to build 16K RAMs are designing for pin compatibility as well as functional compatibility with Mostek.

There are lots more facts on Mostek's industry standard 16K RAM. Just drop a note on your letterhead or call your Mostek sales representative.

MOSTEK
setting industry standards

1215 W. Crosby Rd., Carrollton, Texas 75006

214/242-0444

In Europe, contact:

MOSTEK GmbH, TALSTR. 172, 7024 Filderstadt-1,

West Germany

Telephone: (0711) 701096

standard 16K RAM. The 4116.

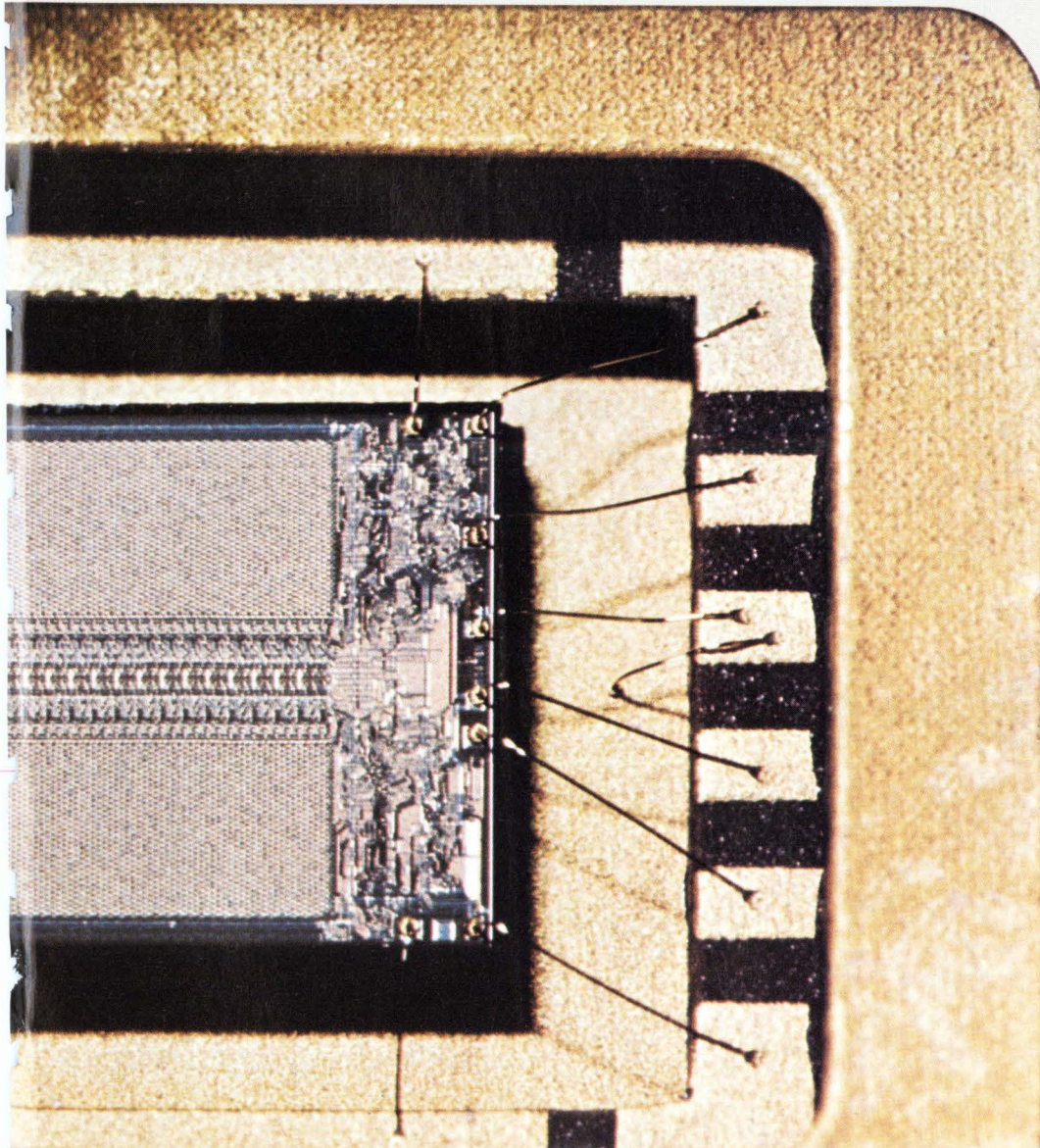

Circle 23 on reader service card

State of the art leadership in mass terminations ...that's what the BLUE MACS™ System is all about!

LEADERSHIP IN MASS TERMINATION DESIGN FLEXIBILITY begins with a complete package of BLUE MACS connector styles and sizes to meet your varied interconnect requirements. An expanded standard cable package that includes round conductor cable for intra-cabinet wiring, flat conductor cable for high flex life applications, and U.L. listed jacketed cable for external interconnect requirements. A tool package that includes hand and bench versions, cable cutters and separators, discrete wire fixtures and accessories.

LEADERSHIP IN MASS TERMINATION CONTACT RELIABILITY starts with our exclusive patented TULIP™ contact that provides 4 points of electrical contact per conductor for gas-tight, corrosion-free ter-

minations. Comprehensive test information is available upon request.

LEADERSHIP IN LOWER INSTALLED COSTS begins with a one piece connector design that eliminates unnecessary handling to reduce installation time by as much as 65%. This one piece design incorporates mating grooves which assures positive cable to connector alignment, and it eliminates the operator variable when assembling the cable to the connector. Insulation displacing TULIP contacts let you simultaneously mass terminate up to 60 conductors in seconds—without wire stripping or soldering.

A colorful reference guide tells the full reliability story about our complete systems package. Ask your local Ansley distributor for a free copy of the BLUE MACS Wall Chart. Or write us, direct.

T&B / Ansley

The mass termination company.

T&B/Ansley Corporation
Subsidiary of Thomas & Betts Corporation
3208 Humboldt St., Los Angeles, CA 90031
Tel. (213) 223-2331 • TWX 910-321-3938



Stocked and sold through authorized Ansley distributors.

International Offices: AUSTRALIA, Brookvale, (02) 938-1713 • CANADA, Iberville, Quebec, (514) 658-6611 • SOUTH AFRICA, Benrose, 24-8134 • ENGLAND, Luton, (0582) 597-271 • WEST GERMANY, Dreieichenhain bei Frankfurt, 06103-8 20 21 • FRANCE, Rungis, 687-23-85 • JAPAN, Tokyo, 03-354-9661 • SWEDEN, Upplands Vasby, 0760-86140 ITALY, Milano, 02-431216.

Circle 24 on reader service card

LCD display shortage is already here, says Beckman

A 1977 shortage of liquid-crystal displays for digital watches, predicted by some industry officials, is already here in the opinion of one of the biggest suppliers, Beckman Instruments Inc. "Most capacity is already booked for 1977. I know ours is, and so is that of the other majors," says Leslie W. Chapin, vice president and manager of Beckman's Electroproducts group.

He explains that the battery and operating problems plaguing the light-emitting-diode watches prompted retail demand to switch to LCDs so rapidly that **suppliers will be hard put to meet module-manufacturer's needs next year.** Chapin estimates that, if LCDs are available, they could account for half of the worldwide 25-28 million digital sales estimated for next year. LCDs are making up only about one quarter of the 16 million or so digitals produced in 1976.

Beckman has no plans to expand its LCD capacity, he says. Although the company does not disclose LCD production volume, an official at a watch firm puts it at nearly 2.5 million displays a year.

French researchers find way to scan NLC matrix

Researchers at Laboratoire d'Electronique et de Physique Appliquée, a French laboratory that's part of the Philips group, **have hit on a way to make dynamically scanned nematic liquid-crystal displays.** The LEP experimental 2-by-2-centimeter display panel is deceptively simple—a 7-micrometer layer of a biphenyl compound is sandwiched between two glass plates. These plates, which carry electrode lines 250 μm wide, spaced by 50- μm dielectric mirrors, are positioned at right angles to get a 64-by-64-element matrix.

LEP drives its display as fast as 10 images per second by scanning lines sequentially with pulses of about 12.5 volts and at the same time applying positive or negative pulses a little higher than 1 v to the columns. Intersections selected this way transmit 20 times more light (the display is back-lit by a midget 1-watt lamp) than nonselected intersections. The high contrast ratio, points out LEP researcher Michel Goscianski, stems mainly from the way a pair of polarizing plates are positioned front and back of the cell proper, and it holds for matrixes with up to 128 by 128 elements. What is more, the drive voltages can be adjusted to keep the contrast constant, despite temperature changes.

Militarized chips used by Norden in microcomputer

United Technologies Corp.'s Norden division in Norwalk, Conn., is developing a microcomputer **built around militarized Advanced Micro Devices Inc. Am2901 4-bit bipolar slices.** The Norden advanced micro-program processor (Noramp) uses a 4,096-bit random-access memory and has its control program stored in a bipolar read-only memory. Expandable in 4-bit increments, the microprocessor is being used by Norden in a 16-bit configuration for two military programs—one a digital moving-target indicator and automatic target-detector system designed to be integrated with an existing U.S. Navy shipboard surveillance radar and the other an update of the division's F-111D display equipment.

The company had hoped to use Noramp in building the multipurpose display group for the Navy/McDonnell Douglas Corp. F-18 air combat fighter, but the displays contract was awarded to Kaiser Aerospace and Electronics Corp. which is believed to be using its own microcomputer.

National goes n-channel, doubles speed of SC/MP

National Semiconductor Corp. is going to n-channel to speed up the p-channel MOS SC/MP microprocessor it introduced last March. The company will introduce its new 8-bit single-chip SC/MP II next March. The device will have all the features of the original but operate at **twice the speed and dissipate less than 200 milliwatts of power**—about 25% as much as the first SC/MP.

Working on a single 5-volt power supply, the SC/MP II combines 8-bit data-handling with 16-bit addressing and has serial input/output ports for each interfacing. It also provides an on-chip clock, built-in flags and jump conditions, and three bus-access signals, as well as an interrupt structure that responds quickly to asynchronous events. A delay instruction simplifies timer operations, and there are 46 control-oriented instructions. The SC/MP II will be completely pin- and software-compatible with the SC/MP with minor modifications to the crystal frequencies. The quantity price per unit in a plastic package will be less than that of the SC/MP.

National's William D. Baker, group director for microprocessors, claims that the system's multiprocessor flexibility and range of distributed processing stretch the spectrum of micro application and narrow the performance gap between micro- and miniprocessors.

Motorola's Stein predicts 'bloody' 4-k RAM price war

Look for a bloodbath of price cutting in 4-kilobit dynamic random-access memories that is likely to start early next year. That's the word from Alfred J. Stein, general manager of Motorola Semiconductor's Integrated Circuits division. **This threat particularly puts the pressure on Motorola**, which plans to introduce its much-delayed 4-k RAM and also a 16-k unit by the end of 1977 first quarter. However, Stein recently told security analysts in Phoenix that Motorola still can be price-competitive with the popular device, despite its late start.

The loss-plagued IC division turned profitable in 1976's third quarter after nearly three years in the red, notes group vice president John R. Welty. Furthermore, despite an industry-wide softness in orders that has prevailed since last summer, this pared-down division should remain in the black "at the present volume level," Welty told the analysts.

Addenda

As it predicted, General Instrument Corp. has shipped its 5 millionth video-game chip this year. However, 1976 sales of finished video games may fall below the 3 million mark projected by the industry **because of delays in delivery and in gaining FCC type approval**. Frank G. Hickey, board chairman and chief executive officer, says the firm reached the 5-million mark three months earlier than forecast. He also notes that, shipping at the current rate, the company's order backlog would carry it through March or April . . . Theodore H. Maiman, who holds the basic patent for the ruby laser, has been named to a newly created post at TRW Electronics. **He will be assistant for advanced technology** to J.S. Webb, corporate executive vice president in charge of the group. Maiman will advise technical managers in the electronics divisions, while serving as the interface for exchanges of ideas with TRW Systems group. He also will work closely with Simon Ramo, vice chairman of the corporation, and its principal spokesman on technology.

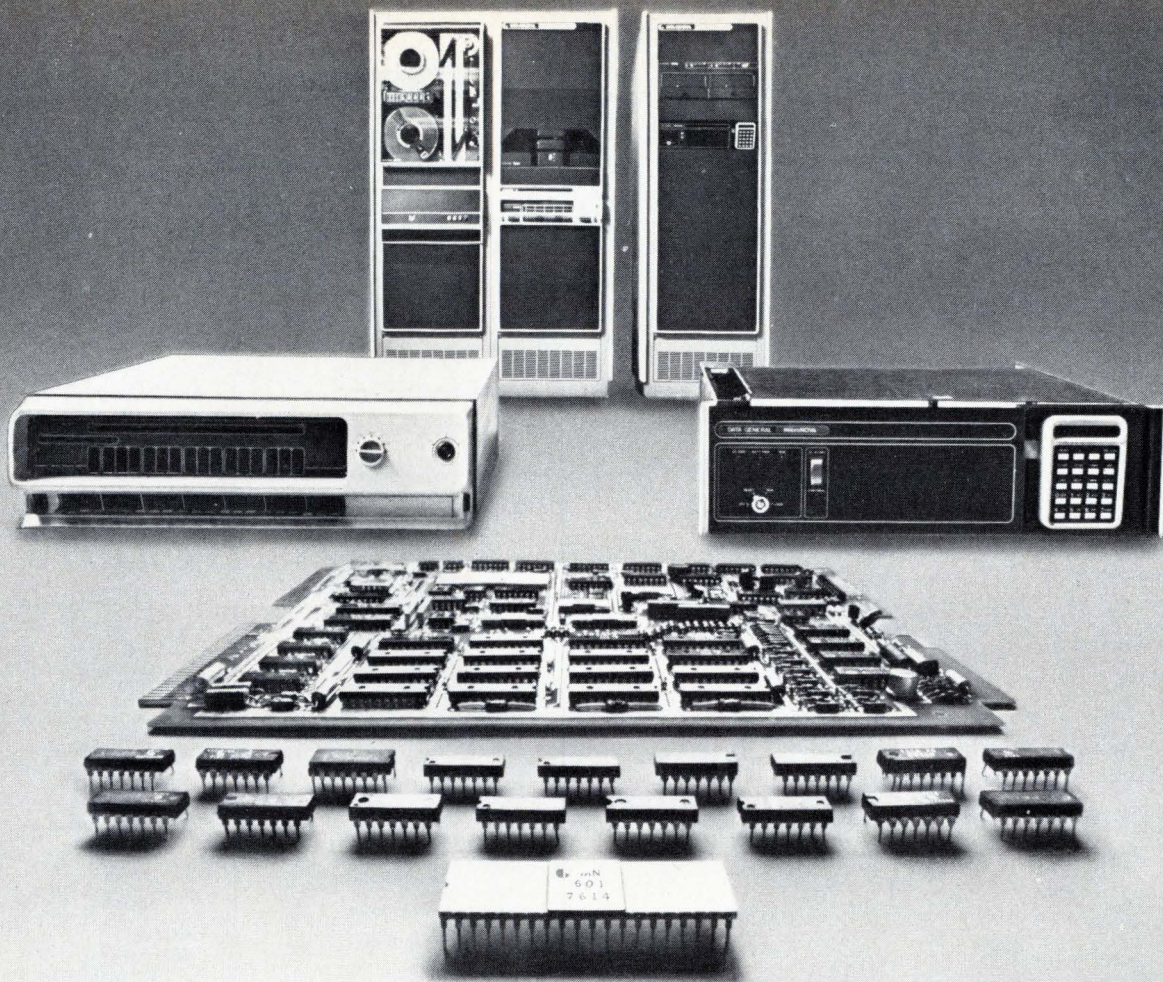

With a line of minis and micros like ours, we don't have to push any one of them.

With other companies, you might set out to buy a microprocessor chip and end up with the whole chassis. Or get a box when all you need is a board.

But Data General doesn't work that way. We don't have to push you into buying something you weren't really looking for. Because we can let you choose from microprocessor chip sets, microcomputer boards, completely packaged MOS minis and full-blown NOVA 3 systems. All four are compatible. And they give you a range of performance with a range of prices.

So, if you're a component user, there are both high-performance microNOVA chip sets and microcomputer boards that feature Data General's mN601 microprocessor. The mN601 is a full 16-bit NOVA-on-a-chip. And the microcomputer is a full 4K-word computer-on-a-board. You package them yourself, for greatest economy. (Speaking of economy, the board costs only \$589 in OEM quantities of 100.)

And if you're not ready for components yet, there's our fully-packaged microNOVA MOS minicomputer. It's available with up to 32K words of MOS memory and peripherals like

our diskette subsystem. And it's supported by our Real-Time Operating System and diskette-based Disc Operating System. You can get our mini with 4K words of MOS memory for only \$1995. Or as a complete development system with the diskette.

If you need bigger systems capabilities, take a look at our NOVA 3 computer. It's compatible with our microNOVA family. And it runs with high-performance peripherals, sophisticated software like Real-Time Disc Operating System, high-level languages like FORTRAN 5 and BASIC, and memory expansion to a full 128K words.

We've got it all. But we won't try to sell it all. Unless it's what you really need. If you don't believe that line, call us. Dial 800-225-9497 (in Massachusetts, 1-617-485-9100, extension 2509) and ask for information on microNOVA and on the free half-day microNOVA seminars that happen this fall all over the country.

Or write for our microNOVA and NOVA 3 brochures. And see for yourself.

DataGeneral

Data General, Route 9, Southboro, Mass. 01772 (617) 485-9100. Data General (Canada) Ltd., Ontario.
Data General Europe, 15 Rue Le Sueur, Paris 75116, France. Data General Australia, Melbourne (03) 82-1361
NOVA is a registered trademark of Data General Corp.

Authorized General Electric Distributors and Modification Centers

ALABAMA

Birmingham
Argo & Company
Forbes Distributing Co.
Mobile
**Brownell-Electro, Inc.
Turner Supply

ARIZONA

Phoenix
Hamilton Avnet
**Metermaster, Inc.

ARKANSAS

Little Rock
Carlton Bates Co.

CALIFORNIA

Culver City
Hamilton Electro
El Monte
General Electric Supply Co.
Emeryville
General Electric Supply Co.
Glendale
**Western Electronics
Division
Los Angeles
**Metermaster, Inc.
Modesto
Wille Electric Supply
Mountain View
Hamilton Avnet
Palo Alto
**Metermaster, Inc.
Sacramento
Sacramento Electronic Supply
San Diego
Hamilton Avnet
Metermaster, Inc.
Santa Clara
**Dynametron

COLORADO

Denver
Electronic Parts Co.
General Electric Supply Co.
Hamilton Avnet
**Metermaster
Wintronics

CONNECTICUT

Hartford
General Electric Supply Co.
Hartford
General Electric Supply Co.
Middletown
**The Mancib Co.
North Haven
Cramer Electronics
Stonington
Mystic Electric Supply Co.

FLORIDA

Jacksonville
General Electric Supply Co.
Orlando
**Brownell-Electro, Inc.

GEORGIA

Atlanta
General Electric Supply Co.
Lykes Electronics Corp.
Hapeville
**Brownell-Electro, Inc.

HAWAII

Honolulu
**Kems, Inc.

ILLINOIS

Bridgeview
**EIL Instruments, Inc.
Elk Grove Village
**Metermaster, Inc.
Oak Park
Pacific Indicator Co.
Schiller Park
Hamilton Avnet

INDIANA

Evansville
Hutch & Son, Inc.
Hammond
General Electric Supply Co.
Indianapolis
General Electric Supply Co.
Graham Electronics Supply
**EIL Instruments, Inc.

IOWA

Cedar Rapids
Hupp Electric Motors, Inc.

KANSAS

Lenexa
Hamilton Avnet

KENTUCKY

Louisville
General Electric Supply Co.

LOUISIANA

Harahan
**Industrial Instrument Works, Inc.
Lafayette
Ralphs of Lafayette, Inc.
Morgan City
Electric Machinery
& Supply Co.
New Orleans
Argo International
**Industrial Instrument Works
New Orleans Electronic Supply
Shreveport
Industrial Electronic Supply,
Inc.

MARYLAND

Elkridge
Sunshine Scientific Inst. Inc.
Gaithersburg
Cramer - E/W
Hanover
Cramer
Hamilton Avnet
Timonium
**EIL Instruments, Inc.

MASSACHUSETTS

Boston
General Electric Supply Co.
Burlington
**The Mancib Co.
Dedham
Gerber Electronics
Newton Center
Cramer Electronics
Springfield
T. F. Cushing, Inc.

MICHIGAN

Augusta
Great Lakes Electronics
Troy
General Electric Supply Co.
Ferndale
**Ram Meter
Muskegon
Fitzpatrick Electric Supply

MINNESOTA

Minneapolis
**Control Assemblies

MISSISSIPPI

Jackson
Ellington Electronic Supply

MISSOURI

Hazelwood
Hamilton Avnet
Kansas City
General Electric Supply Co.
University City
Olive Electronics

NEBRASKA

Lincoln
Scott Electronic Supply Co.
Omaha
Schneider Electric
West Dodge Elect. Supply Co.

NEW JERSEY

Camden
General Radio Supply
Carlstadt
Brown & Ross of N.J.
Cedar Grove
Hamilton Avnet
Clifton
Metro Electric Supply Co.
Moonachie
Cramer Electronics
Mount Laurel
Hamilton Avnet
S. Plainfield
**Brownell-Electro, Inc.

NEW MEXICO

Albuquerque
Cramer Electronics

NEW YORK

Clarence
**Trott Electronics, Inc.
Glens Falls
Glens Falls Electric
Hauppauge
Cramer Electronics
Liverpool
**WEI, Inc.
New York City
Hudson Electric Co., Inc.
Power Inst & Controls
Rockville Centre
**A & M Instruments, Inc.
Westbury
Hamilton Avnet
Woodside
General Electric Supply Co.

NORTH CAROLINA

Charlotte
**Brownell Electro Inc.
Dixie Radio Supply
Greensboro
General Electric Supply Co.
Raleigh
Southeastern Radio
Winston-Salem
Cramer Electronics

OHIO

Cincinnati
General Electric Supply Co.
Cleveland
**Christie Laboratories, Inc.
General Electric Supply Co.
**Pioneer Cleveland Inst. Lab.
Dayton
**Pioneer Dayton Inst. Lab.
Warren
Rem Electronics Supply Co.

OKLAHOMA

Oklahoma City
John H. Cole Co.
Tulsa
Electrical & Instr. Sales

PENNSYLVANIA

Allentown
A. A. Peters, Inc.
General Electric Supply Co.
Philadelphia
Almo Electronics
**Electric Tachometer Corp.
Joseph T. Fewkes & Co.
General Electric Supply Co.
**Sunshine Scientific
Pittsburgh
**EIL Instruments, Inc.
General Electric Supply Co.
York
Rosen Electronics

RHODE ISLAND

Warwick
W. H. Edwards Co., Inc.

SOUTH CAROLINA

Columbia
Dixie Radio Supply
Greenville
Graves Elect. Supply

TENNESSEE

Chattanooga
Electric Motor Sales
Harpe Electronics
Knoxville
General Electric Supply Co.
Industrial Electronics
Memphis
**Brownell Electro, Inc.
Elec. & Mech. Depot
Nashville
**Brownell-Electro, Inc.

TEXAS

Garland
**Metermaster, Inc.
Houston
**Electrical Instrument &
Meter Co.
General Electric Supply Co.
**Meters & Inst. Corp.

UTAH

Salt Lake City
General Electric Supply Co.
Newark Electronics
Argo International

VIRGINIA

Richmond
Meridian Electronics, Inc.

WASHINGTON

Bellevue
Hamilton Avnet
Seattle
Almac-Strom Electronics
**Eicher-Richards Co.
**I.L.I.
Tacoma
C & G Electronics, Inc.

WEST VIRGINIA

Bluefield
Bluefield Supply
Charleston
McJunkin
Huntington
Huntington Electric Supply

WISCONSIN

Appleton
General Electric Supply Co.
Green Bay
Beemster Electric Co.
Milwaukee
**Electro Mechano Co.
General Electric Supply Co.
West Allis
Marsh Radio

Outside U.S.A.

MEXICO

**GESAMEX
ADPO Postal 14-175
Mexico 14, DF Mexico

PUERTO RICO

Hato Rey
**International General Electric
Puerto Rico, Inc.

**Modification center

How to pick the right frequency meter for your product.

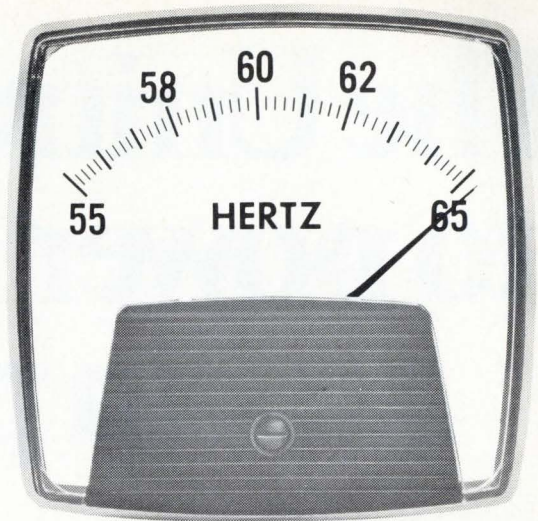

Two distinctly different kinds of panel meters exist for the purpose of measuring frequency — indicator type and vibrating-reed type. It's important to know these and other differences enumerated here if you want to pick the frequency meter that's right for *your* product every time.

1 Decide whether price, or accuracy plus appearance, is your prime consideration.

Manufacturers who buy strictly on price prefer vibrating-reed type meters. They cost from 20 to 30 percent less than analog readout types. But analog readout meters permit faster, more accurate readings of frequency without guesswork.

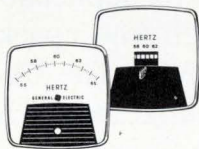

Pointer and large numerals in analog-type GE frequency meters are clear and easy-to-read... match BIG LOOK® and HORIZON LINE® styling of other GE panel meters.

with a solid-state circuit board and transducer. If the meter you pick needs a "black box" to go with it, that will of course add extra design and component cost considerations to your product.

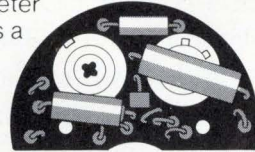

GE's Compact design includes both the circuit board and the transducer as integral parts.

2 Determine what frequency range you want to measure.

Nearly all frequency measurements can be made utilizing these standard five ranges: 45-55 Hertz, 45-65 Hertz, 55-65 Hertz, 50-70 Hertz, and 380-420 Hertz.

3 Determine the right voltage rating, and the right panel meter case size, too.

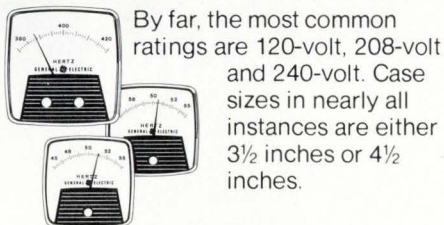

By far, the most common ratings are 120-volt, 208-volt and 240-volt. Case sizes in nearly all instances are either 3½ inches or 4½ inches.

GE frequency meters come in all standard ratings in 3½ and 4½-inch sizes.

5 Make sure your meter will work in dirty environments.

There's no way you can control where your customer will use your product. As with all panel meters, frequency-type meters should be protectively enclosed in a good, tight case.

Gasketed cover on BIG LOOK® design helps keep dust and moisture out. Most distorted wave forms no problem for newest GE models.

6 Will the meter you pick be easy to replace later?

Make sure both the frequency meter and the mounting requirement you have specified for your panel are flexible enough to permit easy replacement.

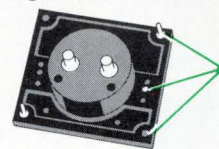

GE solves your mounting problems by ultrasonically placing studs to match your panel cutouts... for new or replacement meters.

4 Find out whether the frequency meter needs accessory equipment.

Analog-type frequency meters, for example, must operate in conjunction

7 And don't forget the manufacturer's reputation.

Make sure he stands behind his products... and that all his panel meters meet ANSI C39.1 specifications.

For a free guide entitled, "Pick the Right Panel Meter" (GEA-10340) and our complete Catalog (GEP-307), write to General Electric Co., Section 592-68, Schenectady, N. Y. 12345.

Specify General Electric Just for good measure.

592-68

GENERAL  ELECTRIC

The Unitrode approach to power Darlingtons in plastic.

TO-202's up to 10A.

Introducing classic Unitrode quality and reliability in a brand-new line of inexpensive power Darlingtons in TO-202 plastic packages. These new fast switching Darlingtons are available in ranges from 3 to 10 amps and 60 to 300 volts.

And the 5 amp, 300 volt package is the only high voltage, high current, fast switching plastic Darlington now on the market.

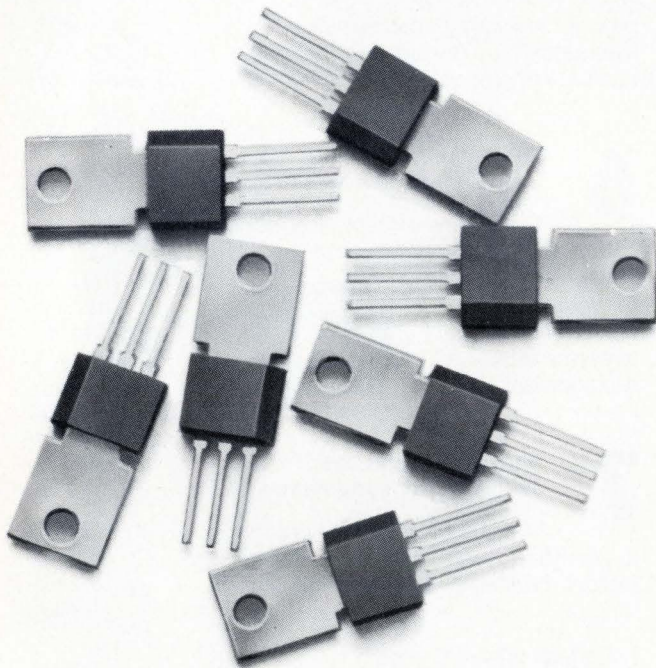

The first 3A in a TO-92.

We've also come out with the industry's first 3 amp, 100 volt power Darlington in a TO-92 plastic package. So for applications where you don't need a high power package, you no longer have to pay for it. The 3A TO-92 is less than 40¢ in volume and can be used with automatic insertion equipment.

Unitrode's new line of plastic power Darlingtons. Never before has so much performance been offered for so little money. The perfect answer for computer peripheral, POS, and industrial control applications.

For complete details, contact:
Unitrode Corporation,
580 Pleasant St.,
Watertown, MA 02172,
617-926-0404.

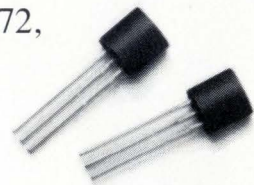

Intel to produce 8080 successor early next year

New family has one 5-V supply, a 3-MHz data rate, and works directly with a 16-k UV-erasable PROM

For the second time in less than a month, Intel Corp. has dropped a technological bombshell in the laps of its competitors in the byte-oriented microcomputer marketplace. The Santa Clara, Calif., company says it will be in production by April 1977 with the successor to the MCS-80, the microcomputer built around Intel's industry-standard 8080 microprocessor.

The new microcomputer is the MCS-85, a 1.3 microsecond, 5-volt, n-channel depletion-load metal-oxide-semiconductor system that increases throughput using standard-speed memory by more than 50%, according to the firm. A typical three-chip system replaces as many as 15 MCS-80 parts. The new family is both upwards and downwards compatible with all 8080 software.

Evolutionary step. The aim of the MCS-85 is "to provide an evolution from the 8080 system that raises system integration and performance without wasting previous investments in software and hardware design," said Kenneth McKenzie, product manager for midrange computer systems, at last month's *Electronica 76* in Munich. As such, it is at the other end of the spectrum from the MCS-48, the one-chip microcomputer (*Electronics*, Nov. 25, p. 99) the firm announced less than a month ago for the high-volume, low-end controller market.

What should concern competitors, including second-source suppliers of 8080s, is that both new entries use a technology that Intel alone has in production—a 5-v ultraviolet-erasable programmable read-only memory technique with on-chip biasing borrowed from Intel's fast 2115 static random-access memory. The company uses the technique in an 8,192-bit Eprom on the MCS-48 processor chip and on a 16,384-bit Eprom in the MCS-85 family. This means that no other manufacturer can be a complete supplier of these parts until it acquires the technique in production, which could take 6 months to two years.

The central processing unit of the MCS-85, the 8085, has six 8-bit registers, accumulator, arithmetic/logic unit, 16-bit program counter, and 16-bit stack pointer, McKenzie says. It can directly address up to 65 kilobytes of memory and 256 input/output ports, as can the 8080. But unlike the 8080, a built-in inter-

rupt control handles four levels of vectored priority interrupt, as well as the serial I/O ports, which may be used for serial transmission of straight binary or CPU-format data.

Bus design. Intel has also made a significant technological contribution in the 8085 bus structure. Instead of driving separate 16-line address and 8-line data buses as in the 8080 CPU, the 8085 has an 8-line control bus and an 8-line multiplexed address/data bus, points out product manager D. W. Sohn. The control bus informs the other components whether the latter bus contains address or data.

"This change does not degrade performance or restrict the use of MCS-80 peripheral and I/O devices in 8085 designs," McKenzie says. "It frees 8 CPU pins for the four interrupt inputs and fully controlled serial in/out ports." With an 8212 8-bit I/O port as a latch/buffer for the multiplexed portion of the address, the 8085 can directly address the

What's in the family

The three key elements in Intel's MCS-85 microcomputer family are:

- The 8085 central processor that replaces the 8080 central processing unit, the 8224 system clock generator, the 8228 system controller and in many cases, a serial input/output device.
- The 8155, a 2,048-bit random-access memory with on-chip I/O and timer that replaces two 1,024-bit static RAMs, a programmable I/O unit (or three I/O parts), and, often, an interval timer/event counter.
- The 16,384-bit 8355 read-only memory or 8755 ultraviolet-erasable programmable ROM with on-chip I/O, which replaces either a 16-k ROM, two to eight smaller ROMs, or two 2708 UV-erasable PROMs, and either two I/O ports or a programmable I/O unit.

In addition, the three power supplies required for the CPU and most ROMs and Eproms are replaced by a single +5-volt supply. And since each component sources up to 400 microamperes (versus only 100 μ A for the 8080A), the system can be expanded without using TTL buffers.

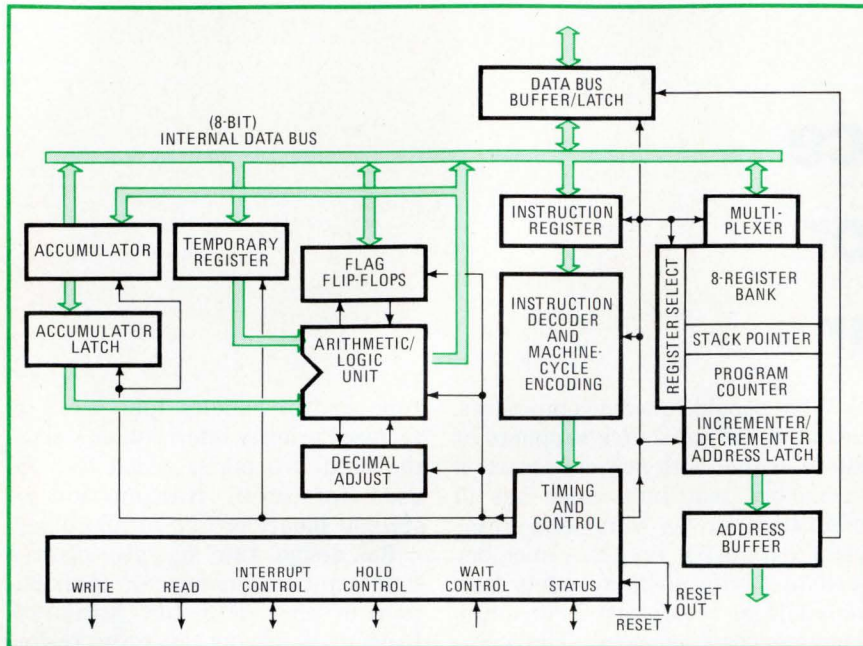

Meet the chip. The new 8085 microprocessor, which incorporates all the features of the older 8080 plus the clock generator and system controller, also has a multiplexed data bus. Addresses are split between the 8-bit address and the 8-bit data buses.

memory boards that are used with the 8080A.

This approach dramatically boosts throughput. Although a typical instruction execution time for the 8085 is only 1.3 μ s (about equal that of the fastest CPU in the 8080A series), the clock cycle is 320 nanoseconds, a

50% improvement over the 8080A. Thus, the 8085 can easily maintain an operating rate of 3 megahertz—instead of 2 mHz—with inexpensive 450-ns memory. In contrast, the fastest 8080A CPU requires high-speed memory (300 ns or less) to operate at 3 mHz, Sohn says. □

Solid state

Fairchild develops one-chip emulation for the Nova 1200 central processor

Looking to dominate the high performance 16-bit bipolar processor marketplace as it does bipolar memories, Fairchild Camera and Instrument Corp. has developed a one-chip emulation of the Nova 1200 minicomputer's central processing unit.

Designated the 9440, the 34,000-square-mil chip is built with a combination of the Mountain View, Calif., company's standard isoplanar TTL and its newer I^3L , or isoplanar integrated injection logic. It is faster and 32% smaller than the n-channel MOS single-chip CPU built by Data General Corp. for its microNova. But the microNova is more akin to a

microcomputer in power than a minicomputer, while the Fairchild device is probably the first minicomputer CPU on a chip.

However, says Thomas Longo, technical vice president at Fairchild, the 9440 operates with an instruction set similar to the Nova 1200. With a 10-MHz clock and a cycle time of 100 ns, typical instruction-execution times range from 800 ns to 2.4 μ s, which is comparable to the transistor-transistor-logic-implemented Nova 1200.

In fact, says Longo, with little or no trouble, the 9440 chip could replace the 15-by-15-in. Nova 1200

CPU board with its 200 to 250 medium-scale- and small-scale-integrated devices or even the 45 to 65 devices in the newer 2- and 4-bit bipolar slice emulations. By comparison, the one-chip n-channel MOS microNova executes its instructions over a 2.4-to-10- μ s range, depending on whether it is using a 120- or 90-ns clock.

Two logic blocks. According to Peter Verhofstadt, department manager for advanced-products operations, the one-chip 9440 is implemented in two major logic blocks: the microprogram control, organized around a programmable logic array (PLA), and the data path with four 16-bit accumulators, four 16-bit special registers, and an arithmetic/logic unit. Timing is generated by an on-chip oscillator.

"Basically, the 9440 is a stored-program machine using homogeneous memory," he says. "That is, instructions and data are stored in the same memory. Although the processor handles 16 bits of information, only 15 bits are used for addressing the memory. Thus, the intrinsic memory capacity of a 9440-based system is 32,768 16-bit words."

The data path and clock logic are implemented in I^3L , with a typical speed-power product per cell of about 0.6 picojoules at 100 microamperes, Longo says. Gate delay is under 100 ns. The PLA and input/output circuitry, however, are fabricated with standard isoplanar TTL, using vertical pnps as the basic building block. In normal operation (5 volts), power dissipation is low, about 750 mw.

Other parts. The single-voltage, dual in-line 40-pin device is expected to be available in sample quantities by January 1977 and in volume production, on a selected basis, by the end of the first half, Longo says. Also in development are several other I^3L parts to complement the new chip and further reduce component count—I/O controllers for disc and printer peripherals, a universal controller, and memory controllers. And Fairchild's spectacular 4,096-bit I^3L dynamic RAM, is being built

with an eye toward working closely with the 9440 chip, Longo says. "Put all those together and you've got a very powerful system."

Initially, the 9440 and the other compatible L³L devices, will be sold as components. Single-board systems and completely boxed units may come later, says Longo, depending on how the market develops. "But our projections indicate the 16-bit approach is going to be very popular in the 1980s," he says. "And the name of the game there is high performance. We believe the 9440 will set the standard and give us a dominant position." □

Packaging & production

Film carriers ready for low-volume users

Manufacturers that use large numbers of integrated-circuit chips have learned that the ICs are easier to handle if they are first bonded to reels of plastic-film carriers. Now, hybrid-circuit houses that produce products with relatively few such chips, can also benefit from the ruggedness and easy testability of film carriers.

Tailor-made. Pactel Corp., Westlake Village, Calif., has developed a technique for quickly tailoring the film carrier to individual chip dimensions and lead patterns. "Designs can be engineered and photo-tooled in two to three weeks at a lower cost than competitive film-carrier processes," asserts president Sanford Lebow. This is the turn-around time Lebow says he needs to produce film carriers with the right-size windows and copper-lead patterns to which the chips are bonded. Conventional turn-around times are six to seven weeks.

Moreover, Pactel can place special conductive metal bumps on the inner leads of the carriers so that standard "bump-less" chips may be used [*Electronics*, June 10, p. 25]. Other film-carrier systems use chips to which bumps are added as protection from heat and pressure during bond-

ing. The company can also place bumps on the outer leads to facilitate soldering or bonding the film and chip to the substrate. They can be solder-plated to help reflow-soldering to a substrate.

"Our process is aimed strictly at the short runs of diverse ICs required by hybrid firms," emphasizes Lebow. "We have no desire to compete in the mass-produced tape-carrier field for high-volume ICs."

In the fabrication of copper-patterned tapes, windows and sprockets usually are first punched out in the reels of film by special mechanical dies. Then, a copper foil is laminated to the tape and the lead pattern is etched out.

Pactel's process is photolithographic and batch, rather than serial. More than this Lebow won't say. The technique eliminates the need for the special dies, which take time to make and may cost from \$400 to \$900, a steep price for a hybrid house to pay. Strips of tapes are available in widths ranging from 11 to 35 millimeters for 20 to 64 leads.

Among the manufacturers that

are evaluating Pactel's tapes are General Dynamics Corp., Pomona, Calif., and Owens-Illinois Corp.'s corporate research center in Toledo, Ohio. Bill Johnson, chief of advanced electronics at Owens-Illinois says, "The Pactel tapes are working very well, and we have been able to get small quantities of tape strips in two to three weeks, as promised." Owens-Illinois is using the tapes to build a display.

Working well. General Dynamics engineers are evaluating the tapes for possible use in military hybrid work. In this application, chips are thermocompression bonded to the tape by a standard laboratory bonder. Then the chip plus its copper interconnects are removed from the tape frame and bonded by thermocompression to a hybrid substrate. Both alumina and polyimide substrates [*Electronics*, July 22, 1976, p. 101] are being tried. Frank Jones, a development specialist for advanced manufacturing techniques, says, "All work to date has firmed our decision that this tape technique will work for us in the future." □

Microprocessors

Texas Instruments readies Schottky TTL LSI 4-bit-slice family for minicomputers

While 8- and 16-bit n-channel microprocessors are taking over from transistor-transistor logic, bit-slice microprocessors are supplanting Schottky TTL and emitter-coupled logic. That is why Texas Instruments Inc., which dominates the TTL and Schottky TTL markets, also will introduce a 4-bit processor slice in February.

This device will be the most important element in TI's family of high-performance, low-power Schottky bipolar LSI parts, which make up a microprogrammable microcomputer that can be expanded in 4-bit slices [*Electronics*, Nov. 11, p. 26]. Around these parts can be built minicomputers and controllers that will be able to outperform the advanced metal-oxide-semiconduc-

tor microcomputers—and which till now have been served by Schottky TTL and ECL families.

The 4-bit processor slice, the SN54S/74S481, is both micro- and macroprogrammable. It will recognize, decode, and execute more than 24,000 different operations—a phenomenal number of microinstructions—each in a single 100-nanosecond clock cycle.

In addition, TI provides hard-wired algorithms for several signed and unsigned multiply and divide macroinstructions, as well as for cyclical-redundancy character calculations, which are useful for formatting data for serial transmission. Four slices wired into a 16-bit configuration will, for example, perform a double-precision multiply in

less than 3 microseconds.

On-chip control logic differentiates between macro- and micro-instructions and decodes three input levels. The trinary logic input—seen as high, low, or floating—designates the most significant 4-bit slice in a multi-slice system. This slice then orders the other slices in their execution of the macroinstructions.

The 481 uses memory-to-memory architecture, which TI estimates is two to six times as fast as conventional memory-to-register architecture. It incorporates both a memory counter and a program counter. Main memory operates as register space, eliminating the need for register files between the processor and the program memory.

Controller. To use the macroinstruction capability, TI's SN54S/74S482 bit-slice controller is needed. In production since mid-year, the 482 is used primarily to build fast, next-address generators for microinstruction sequencing. It can also operate on its own as a low-end high-speed sequential controller for industrial applications—a busi-

ness that TI's Controls division in Attleboro, Mass., entered this year.

Other parts in the LSI family, defined and designed at the same time as the new 4-bit slice, include a range of Schottky-clamped programmable read-only memories for the system's microcontrol memory (all in production) and Schottky random-access memories for program memory (including two 256-word-by-4-bit RAMs due in January).

Coming in February is a field-programmable logic array to be used in the microprogram memory instead of programmable ROMs for faster throughput or to replace the medium-scale-integrated instruction decode logic on the front end of the controller. Also promised is a 16-word-by-5-bit first-in, first-out memory array for a high-speed (up to 10 MHz) peripheral interface.

New mini. Since the 481 slice can easily be programmed to execute the instruction set for TI's model 990 minicomputer, the first equipment to use the parts will probably be a new 990 from TI's Digital Systems division in Houston. □

Motorola prepares low-power Schottky TTL

While Texas Instruments is readying its Schottky microprocessor slice, Motorola Semiconductor Products Group is filling a gap in an older product line. It is entering the market for standard low-power Schottky transistor-transistor logic, an area the company has neglected. However, Motorola is already a supplier of the Advanced Micro Devices 2900 bit-slice family of Schottky products involving similar technology.

Firm plans call for Motorola to have low-power Schottky devices encompassing about 30 functions in production as early as the first quarter of 1977. With the technology provided by an exchange agreement with Fairchild Camera and Instrument Co. (*Electronics*, Nov. 11, p. 30), the Phoenix-based group says it has an all-out effort underway to establish itself in a TTL product line.

Prime mover in this decision is Al Stein, named general manager of the Integrated Circuits division last May after having spent many years at Texas Instruments. Last month, Stein told a meeting of security analysts that Motorola "absolutely must compete in low-power Schottky in the digital marketplace," even though its major competitors are already far ahead. Motorola has processed trial devices using Fairchild masks, Stein says, obtaining high yields.

Present plans are to manufacture the low-power Schottky devices offered by the industry, plus some new ones, within a year, says digital bipolar marketing manager Robert C. Bacher. The first 30 functions are chosen to cover about 70% of the volume, including both small- and medium-scale integration. An additional 35–40 functions are slated for introduction during the second and third quarters of 1977, covering another 20% of the market. A final 30–40 functions are scheduled for the fourth quarter.

Millimeter waves

90-GHz radiometer detects 30-ft objects

To spotlight the potential of airborne radiometry, researchers at Aerospace Corp. have operated a prototype 90-gigahertz system they claim racks up some significant firsts. It is the first airborne radiometric equipment with enough resolution to identify ground objects as small as 30 feet in diameter. It is the first to display its images in real time. On one flight, it even distinguished clearly between objects on the ground through 2,000 ft of cloud cover.

"We wanted to demonstrate the sensitivity of such a system and what it could do in order to open up wider uses," says Arnold H. Silver, head of the electronic research laboratory of the nonprofit firm in El Segundo, Calif. The millimeter-wave spectrum was chosen for the system, he explains, because the desired resolution can be attained with a relatively small antenna 6 inches in diameter. On the other hand, present equipment, most of which operates in the 30-GHz range, uses antennas three times larger and cannot resolve objects smaller than about 150 feet in diameter. Also, at 90 GHz, attenuation by clouds is relatively less.

Wide appeal. The appeal of radiometry as a remote-sensing technique is that it could be developed into a single system doing virtually all of the observation jobs now performed by different pieces of equipment, such as infrared at night and visual gear during the day. "Ideally, radiometry has almost an all-weather capability," Silver says.

Why has nobody so far come up with good, compact radiometry equipment? "The critical components, and particularly the mixer, were not good enough," explains Howard E. King, head of the antenna and propagation department, who directed the Aerospace effort.

Since a radiometric signal is

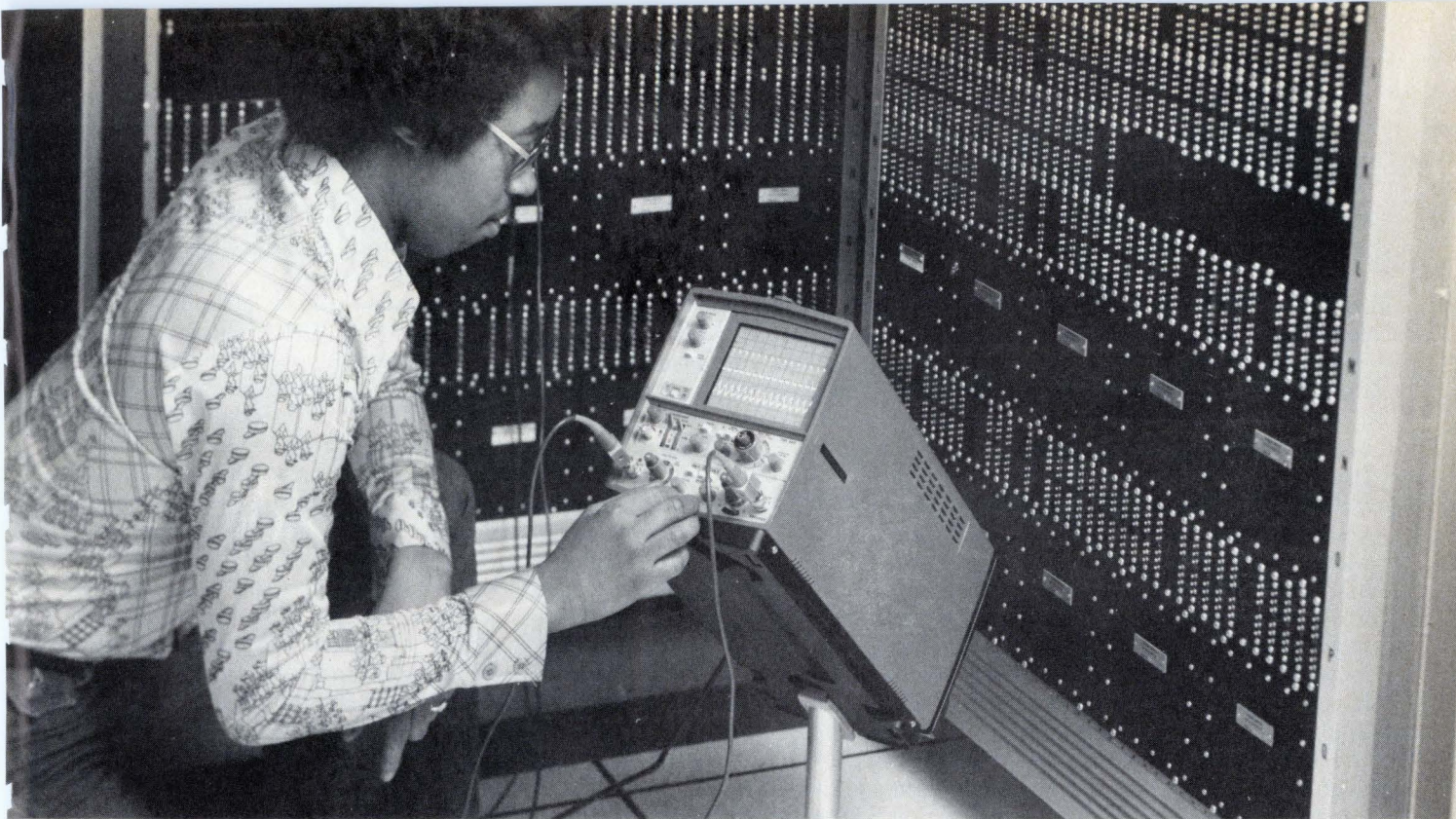

Now you can service with a Tektronix Oscilloscope for as little as \$695*

Cost of service instruments is an important factor in any purchase. But so is reliability. Now T900 Oscilloscopes give you both Tektronix quality *and* reliability at prices *designed* for cost sensitive applications.

- T921—Dc to 15 MHz; single trace,
single time base \$695*
- T922—Dc to 15 MHz; dual trace,
single time base \$850*
- T932—Dc to 35 MHz; dual trace,
single time base \$1195*
- T935—Dc to 35 MHz; dual trace,
delayed sweep time base \$1395*
- T912—Dc to 10 MHz; bistable storage;
writing speed to 250 cm/ms; dual trace,
single time base \$1300*

Performance to Spare

All T900 scopes feature large (8 x 10 cm), bright crts; sensitivity

of 2 mV/div to 10 V/div in twelve calibrated steps; regulated power supplies and 3% accuracy. For convenience, T900 Oscilloscopes are equipped with beam finder, single knob triggering, automatic selection of chopped or alternate mode, and automatic selection of tv line or frame display (except T912 Storage model). T900 scopes are compact (7x9x18 in.) and lightweight (only 16 lb.). They are available with a full selection of accessories.

T900 Series— the *quality* low-cost oscilloscopes

For a demonstration of any T900 Oscilloscope or a free copy of the new T900 brochure, write to Tektronix, Inc., P.O. Box 500, Beaverton, OR 97077. For immediate assistance, call (503) 644-0161, extension T900.

*All prices include 10X probes.
U.S. Sales Prices FOB Beaverton, Oregon



TEKTRONIX®

committed to
technical excellence

essentially thermal noise, which is not narrowband nor coherent, the system must get as broad a bandwidth as possible and maintain a low conversion loss across it, Silver points out. Aerospace accomplished this mainly by using a mixer that has a conversion loss of only 6 to 8 decibels, which King calls the key to the overall system performance. The mixer itself consists of a gallium-arsenide Schottky-barrier diode, with contacts 2.5 micrometers in diameter mounted in a WR-12 waveguide. Intermediate-frequency bandwidth is 1 to 2 GHz. In contrast, conventional commercial mixers have much larger conversion losses of about 10 dB, King says.

The radiometer has a noise-output fluctuation of 0.22 K over a 1-second integration time—proof of the sensitivity needed for high resolution.

The system relies on a scanning mirror that operates at a rate of 640° per second over a $\pm 32^\circ$ angle to produce a zigzagging ground track. The radiometer output is passed through a filter, sampled at 1° intervals, and digitized for storage in a core memory.

Tests with the radiometric system, a joint effort with the National Aeronautics and Space Administration and the Naval Research Laboratory, were flown over a variety of terrains, under many different conditions, and at altitudes between 1,500 and 3,000 ft. Their success illustrates a "number of interesting potential uses of 90-GHz passive imagery for both civil and military applications," King points out. Among them are forest-fire detection, law enforcement, tactical warfare, and post-attack assessment. □

amendment was introduced in the last session of Congress but did not come to a vote.

Now the institute is lining up a campaign to get the bill, sponsored by Representatives James C. Corman (D., Calif.) and Frank Thompson (D., N.J.), re-introduced early in the new session of Congress. Many Defense Department and NASA service contracts are going out for rebidding now, and fast action is vital, so far as IEEE is concerned. A key requirement on the Washington scene is to put together enough support to ensure passage before the bill is even introduced. Opposition to the bill for being too broad includes the National Society of Professional Engineers and the association that is lobbying for the service-contract companies.

Campaign. The IEEE's Washington office is working with staff members of Rep. Thompson's subcommittee on Labor-Management Relations as well as with other congressmen and senators to round up support. Meanwhile, institute sections hardest hit by service-contract abuses are coordinating efforts with other organizations such as the American Society of Mechanical Engineers and the Aerospace Industries Association of America to document cases of abuse, drum up support from local politicians, and provide information for other IEEE sections to mount letter-writing or telephone contact drives to influence congressmen. Seventy IEEE sections with established professional activities committees will be involved.

"This effort," says Jack Templeton, IEEE section chairman in Huntsville, Ala., "does affect every engineer, for if they let it happen to the other guy, one day it will happen to them. Remember that many large companies base salaries on national averages, and the pay for engineers in Florida, Huntsville, and other hard-hit areas is dragging down the average."

According to Frank H. Palmer, professional activities chairman for the Canaveral Section, engineers in the Kennedy Space Center and Patrick Air Force Base area have

Careers

IEEE lobbies for legislation to protect engineers working for service contractors

The Institute of Electrical and Electronics Engineers, to paraphrase the familiar slogan, feels that now is the time for all good EES to come to the aid of their fellows who work for aerospace service-contract companies. Electronics engineers at these companies often find themselves unable to protect their salary levels,

pensions, and other fringe benefits.

The IEEE wants the 1976 Service Contract Act, which now protects only blue- and white-collar workers from contract-bidding abuses, to be amended to cover engineers and other professionals as well (see "Service-contract abuses and remedies"). A bill containing such an

Service contract abuses and remedies

In the pressure to get the lowest bid for service contracts to maintain hardware at Government facilities, some aerospace companies have put engineers through a wringer. It happens in a couple of ways. The most devastating is for a prime contractor to form a new division to handle service contracts. Then engineers working for the prime are laid off and rehired by the offshoot—salaries are lower, fringe benefits are cut, and pensions are lost. Yet the unemployed engineers often have no alternative but to take the job offered.

Another technique is to run an employment ad making a vague reference to bidding for a Government contract and asking for resumés and salary histories. The contractor can bid using the lowest salaries received. To correct these practices, the Service Contract Act amendment would adjust low wages upward and require contractors to follow the prevailing salary levels as listed in the guidelines of the U.S. Department of Labor's National Survey of Professional, Administrative, Technical, and Clerical Pay.

The digital knob.

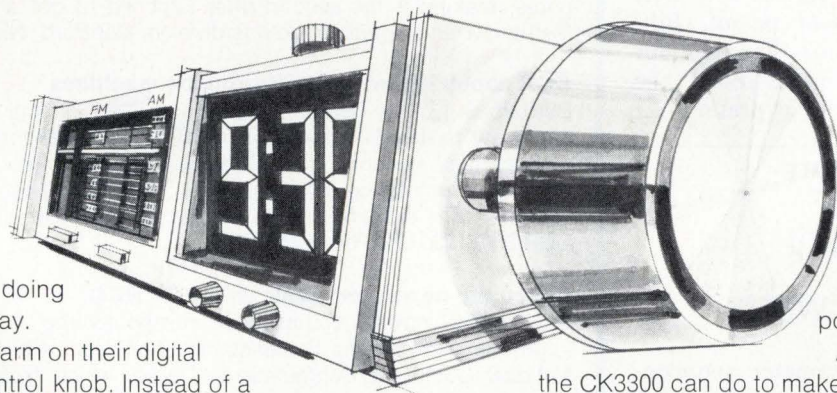

Some people still like doing it the old-fashioned way.

Like setting the alarm on their digital clock-radio with a control knob. Instead of a push-button.

You remember the control knob? You turn it to the setting you want. No guessing. No hassle. No wonder the digital knob is turning people on.

But what makes the digital knob work? General Instrument Microelectronics' CK3300 circuit. And this versatile circuit helps clock-radios perform other functions, too.

GI's CK3300 works with a doze bar. Touch it, and the radio volume goes soft. Touch it again, and the volume goes up. If you fall asleep with soft volume, the radio turns off in 30 minutes and comes on in the morning with the volume up.

How about a self-canceling alarm? If you leave home and forget to turn off your radio, don't worry. The CK3300 remembers. It shuts it off, automatically.

Power failure is no problem, either. The GI circuit switches to battery power, so your digital clock keeps on keeping time. If the power goes off at night, the alarm still goes off in the morning. And a tiny flashing light on the dig-

ital face signals that the power was off.

And there's a lot more the CK3300 can do to make your clock-radio more appealing. It lets you tape record your favorite radio programs, or turn on your coffee pot five minutes before the alarm goes off.

We've talked a lot about the CK3300. But GI Microelectronics also makes nine other clock circuits. You can select 4-digit 12 or 24 hour circuits for 7-segment fluorescent displays or with BCD outputs. A series of four alarm clock circuits offer snooze alarm and direct drive for either LED or plasma displays. We're also developing a circuit for a 4-digit automobile clock.

Whatever products you make, GI circuits can make them more electronically versatile. That's our business. Making chips that make progress. We produce them by the millions. In complete families. In depth. To help you make your products function better, more reliably, at less cost.

If you'd like to make your products more competitive, write or call, General Instrument Microelectronics, 600 West John Street, Hicksville, New York 11802, Tel: (516) 733-3107.

We help you compete.

**GENERAL INSTRUMENT CORPORATION
MICROELECTRONICS**



taken an average \$5,600 cut in pay since 1969. In 1974, EES with 10 to 20 years experience, some with Ph.D.s, were getting as little as \$7,800 a year.

"The heat is on us now," says John Guarrera, the former IEEE president who has been spearheading the Washington drive to line up Congressional support. "We have no political action fund like other associations have to support legislative activities. The soonest the amendment could go through is April. We're hoping to have it at least by June."

The IEEE will try to get the Government to hold off on signing the next round of service contracts until the amendment passes. But, according to Labor-Management Relations subcommittee aides, the bill has a low priority at present. □

Memory

262 kilobits fit on a single wafer

A single 3-inch-diameter semiconductor wafer with a capacity of 262,144 bits has been experimentally fabricated as part of a project to decrease the cost and size of semiconductor memories. Redundancy at the bit, word, and storage-unit level is the key, say engineers at the Musashino Electrical Communication Laboratory of Nippon Telegraph and Telephone Public Corp.

The n-channel metal-oxide-semiconductor memory is divided into four quadrants, each of which has 16 4,096-bit storage units. Also in each chip quadrant are five spare 4-k storage units. These small auxiliary random-access memories make it possible to program the system to substitute them for defective storage units and to reconfigure the memory at any time. It is also possible to substitute small blocks of data of several words or more. Additional redundancy of a spare bit added to each word also permits operation despite defective data-buffer circuits, the lab says.

News briefs

Dry plasma etching produces subnanosecond ICs

A dry plasma etching system for integrated circuits developed by Bell-Northern Research Ltd. in Ottawa, Canada, makes possible smaller, faster ICs with inherently better performance, lower cost, and higher reliability, says the company. The process removes material by the action of ionized gas molecules in a weak vacuum under the influence of a radio-frequency field. Wafer temperatures are below 100°C and the contamination problems inherent in wet etching processes are eliminated.

Nominal gate widths of two μm have been achieved in fully ion-implanted, plasma-etched complementary MOS using either bulk silicon or silicon-on-sapphire substrates. Gate delay times of typically 600 picoseconds per stage were obtained for ring oscillators with 2 μm gates. The work was done by Bell-Northern for U.S. Army Electronics Command, Fort Monmouth, N.J.

RCA plans to produce programable game

Too late to catch the Christmas rush, RCA Corp. has received type approval from the Federal Communications Commission for a programable video game, making it the second after Fairchild to get a go-ahead. The RCA Distributor and Special Products division, Deptford, N.J., will market it.

OCR capability added to Burroughs machines

Burroughs Corp., Detroit, Mich., is adding optical-character-recognition capability to its S1000 series of data capture, transmission, and document management systems. The OCR capability allows processing of such documents as remittance invoices, utility bills, credit card slips, and banking vouchers. The system will read any two of the following fonts: OCR A/1428, OCR B/1403, and Farrington 7B.

Bimonthly newsletter deals with 1977 NCC

A bimonthly newsletter has been started by the American Federation of Information Processing Societies Inc. that deals with the June 13-16 1977 National Computer Conference in Dallas, which the federation sponsors. Complimentary subscriptions to NCC Roundup are available by contacting AFIPS, 210 Summit Ave., Montvale, N.J. 07645.

Musashino engineers say the goal is to obtain a higher effective yield than usual for such n-channel chips. They expect to achieve this, however, because the capability to substitute small blocks of data should enable them to use the device even if it has defects. Testing and analysis of the first devices is scheduled to be completed by the end of March.

Concept test. The experimental memory was designed to probe the concept of putting this large memory capacity on a chip, rather than as a prototype for production. Production designs would probably consist of 16,384-bit storage units and have less than the present 1-microsecond access time. The memory was not developed for use in any specific system—just for large systems with a 32-bit word length. The data width

for reading and writing is 36 bits, consisting of two words of 16 data bits plus a parity bit and a spare bit in each word.

Each storage unit therefore actually contains 4,608 bits, and its organization is different from that of ordinary 4,096-bit memory chips. It stores 256 words, with parallel write-in or read-out of each 18-bit word; thus, only one unit need be selected for reading or writing a single word and parity. This uses less power than the usual arrangement, which requires selection of 16 bits for data and another for parity.

The mask used for fabrication of the full-wafer memory is made by a composite technique. Mask exposure in a step-and-repeat process provides separate reticles for memory units, interconnections between units, and RAMS for changing memory configu-

The HSDC-14 is a thick-film MSI hybrid that opens up a whole new range of operating environments where conventional discrete converters can't stand the punishment. High resolution (14 bits) coupled with ratio-metric conversion and Type II tracking servo dynamics ($K_a = 58,000$), plus a power requirement of only 750 MW add up to superlative performance. The HSDC-14 features, in addition, a DC velocity output signal and requires only a +15V power supply in addition to logic voltage.

Reliability is built into this SEM-compatible unit with MIL-STD-883 Level C or B processing included, assuring the utmost in consistent high-level performance at an accuracy of $\pm 4'$, ± 0.9 LSB worst case error.

Separating the solid-state control transformer (SSCT) and error processor into two hybrid packages permits

great flexibility for other S/D functions such as ECDX and two-speed conversion. Its tiny size (two 0.8" by 1.9" by 0.21" modules) makes the HSDC-14 the ideal converter for remotely located, hard to access equipment where MTBF really counts — where rugged military, avionic and industrial demands can be met only by the finest product there is.



ILC DATA DEVICE CORPORATION

A Wholly Owned Subsidiary of ILC Industries, Inc.

AIRPORT INTERNATIONAL PLAZA
BOHEMIA, LONG ISLAND, N.Y. 11716 • (516) 567-5600

West Coast: 7337 Greenbush Ave., N. Hollywood, CA 91605 • (213) 982-6454
Interested engineers, write or call Harry Lewis or send for our 164-page product line catalog

DDC does it again

with the world's smallest 14 bit S/D converter!

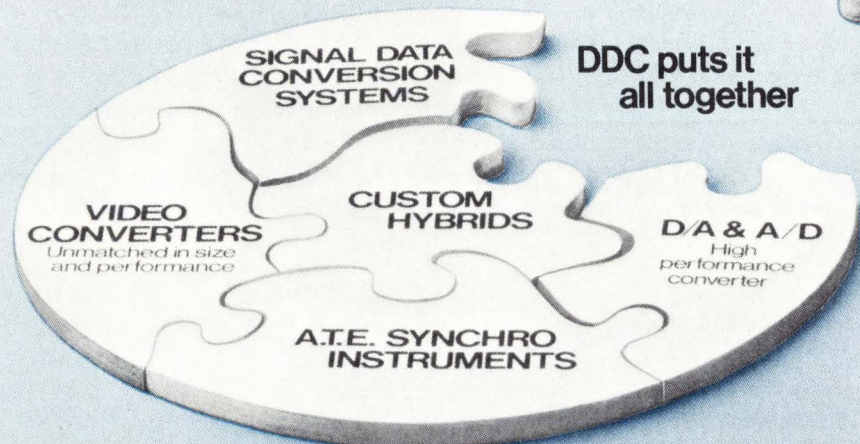
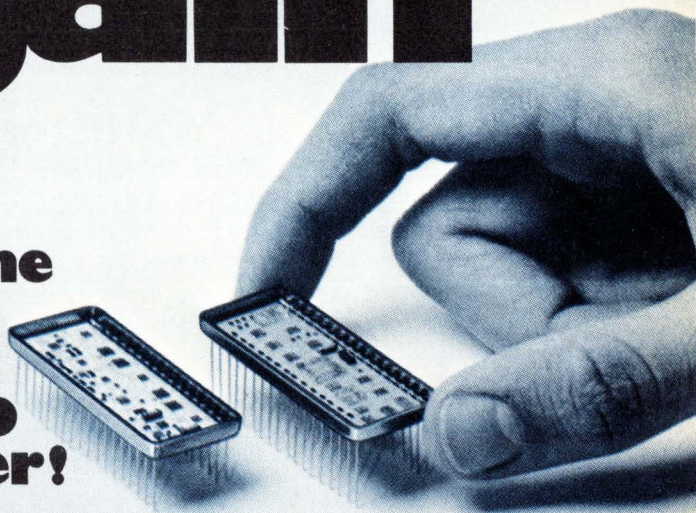

DDC puts it all together

Circle 39 on reader service card

DDC ILC DATA DEVICE CORPORATION
Airport International Plaza/Bohemia, Long Island, N. Y. 11716

Please send me technical data on the HSDC-14
 ... And on DDC's full product line

NAME: _____
TITLE: _____
FIRM: _____
ADDRESS: _____
CITY: _____ STATE: _____ ZIP: _____

SCIENCE / SCOPE

The world's first all-weather, day-and-night attack system for aircraft has been ordered for the Navy's A-6E Intruder. The TRAM (Target Recognition and Attack Multisensor) System, built by Hughes, is the only attack system that successfully integrates a forward-looking infrared (FLIR) sensor, a laser designator-ranger, a laser receiver, and a precision-stabilized turret. The FLIR is the first one designed with a continuous optical-zoom capability. Because the FLIR forms an image from heat radiated by objects in view, it can operate as well in total darkness as in daylight and can also "see" through bad weather. A ship can be seen on the blackest of nights or an oil depot can be spotted on land with the amount of fuel clearly visible because of temperature differences. TRAM can deliver a variety of laser-guided and conventional weapons.

Detection and identification of tactical-size targets in any weather, day or night, has been a major goal of the US Air Force. This goal has been achieved by the development of real-time Synthetic Aperture Radar (SAR), made possible through new digital signal-processing technology. The Hughes-built APG-63 radar, with its basic digital signal processing and coherent-frequency technology, will provide a SAR capability with the inclusion of programmable signal processing. Not only are smaller tactical targets visible, but also SAR detects mobile targets, cues forward-looking infrared and electro-optical sensors, and allows precise navigation.

Hughes has many immediate openings for engineers and scientists in several areas. Electro-optics, optomechanics, and infrared, experienced in advanced adaptive optical systems, optical design & analysis, electromagnetics & electro-optical properties, solid-state physics, advanced IR imaging, systems design, MOS/bipolar circuit design . . . Laser device development, experienced in sensor/digital pattern recognition, laser alignment-control systems . . . Programming, experienced in airborne avionics, satellite ground stations, automatic test, telemetry, graphics, commercial applications. US citizenship required. Please send resume to: Professional Employment, Hughes Aircraft Company, 11940 West Jefferson Blvd., Culver City, California 90230.

The famous sound of Morse code's dah-dit may be phasing out for the maritime industry. This is because two communications satellites are in synchronous orbit over the Atlantic and Pacific oceans. These maritime satellites, built by Hughes, are owned and operated by a consortium of carriers headed by COMSAT General Corporation. Called Marisat, the satellites are currently relaying high-quality voice, telex, facsimile, and data over both oceans for the international maritime industry. Marisat also serves the US Navy for fleet communications.

A third satellite, for Navy use and commercial backup, was placed in synchronous orbit over the Indian Ocean last October. Four-foot-diameter ship antennas allow ships to make instant contact with home port or to be reached instantly by ship telephone. Ships can also reach other ships via the system's ground stations for telex messages.

Creating a new world with electronics

HUGHES

HUGHES AIRCRAFT COMPANY

Electronics review

ration to switch in spare units and for data buffers.

The entire wafer, attached to a ceramic substrate with a thermal expansion like silicon's, is then sealed conventionally with a ceramic cover. Although not needed for present wafers, parallel-to-serial data-converter chips have been experimentally attached to the periphery of the substrate to prepare for the stage when wafers of still larger capacity would require an unwieldy number of leads.

Because of the large size of the wafer, the usual silicon-gold eutectic bond to substrate is not suitable. Instead, both the underside of the wafer and the top side of the substrate have gold deposited on them, a thin sheet of solder is sandwiched between them, and they are heated gently in a furnace. □

Packaging & production

Flush socket fits plated-through hole

The socket for an integrated circuit may be small and plain looking. But to Augat Inc., the Attleboro, Mass., maker of electronic socketry, it looks like Cinderella. It represents a market that company president Roger D. Wellington calculates could grow from this year's \$96 million to as much as \$370 million by 1980.

In the hope of sharing heavily in this market, Augat has introduced a

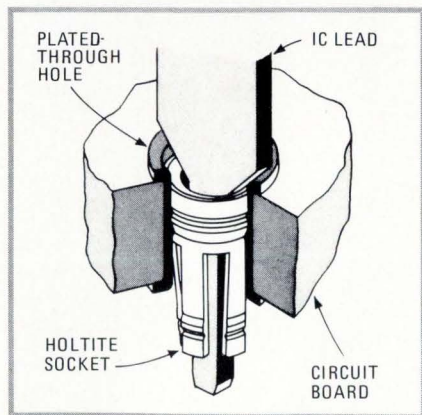

Converter. Augat's four-leaf contact is press-fitted into plated-through hole, converting it to low-profile, plug-in socket. □

method for converting the plated-through holes in a printed-circuit board to low-profile plug-in sockets that accept components without soldering. Called Holtite, the new system centers around a specially designed, precision-machined beryllium-copper contact socket that is press-fitted into a plated-through hole to make a gas-tight connection.

The profile of the new tapered sockets, which can be gold- or tin-plated, looks the same as the profile of the plated-through hole alone. But the sockets can be used to mount axial-lead components, as well as ICs in dual in-line packages. Card rack spacing can be as low as possible when components are soldered directly into the holes.

Same artwork. Existing pc-board artwork can be used with the Holtite system, Wellington points out. All that is required is that the holes be drilled with a slightly larger drill—0.0465-in.-diameter—and then the hole is plated down to 0.041 in.

The new Holtite sockets are loaded into the boards en masse using an Augat loading machine that vibrates the sockets into place. Pressing of a loaded board with hundreds of sockets will take less than one minute using a standard hydraulic press. Typical installation rate is 30,000 contacts per hour.

Because of the press fit, the installed Holtite socket actually enlarges the finished hole somewhat—to 0.044 in. And because components can be inserted and held in place without solder, considerable time is saved in manufacturing the pc boards, according to the company. And the potential for heat damage and warpage during soldering, as well as for corrosive residues, is eliminated. The socket is also compatible with component insertion equipment, the company says.

With no soldering, printed-circuit traces can be run between IC pads, raising the component density. Cost of the new contacts will be 1.5¢ each in large quantities. Augat says a large New England electronics manufacturer is evaluating Holtite but results of the evaluation are not yet available. □

For microelectronic circuits and systems

Call Hughes (714) 548-0671

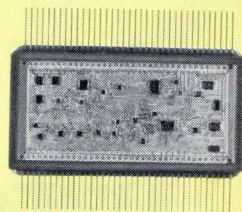

Hybrid Microcircuits—both thick film and thin film

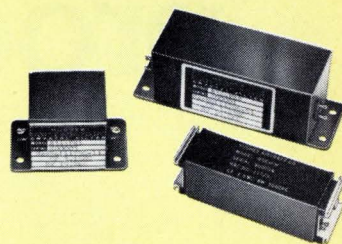

Communications Products: crystal filters and crystal oscillators



Bipolar LSI Cell Arrays—interconnection of MSI functions

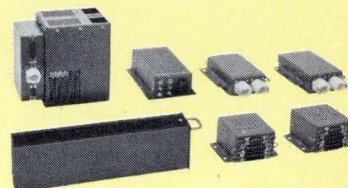

Microelectronic Systems for remote communications/control

We've been solving tough problems in microelectronic circuits and systems for years. Designing, manufacturing, testing...all within one organization specializing in microelectronics technology. That's why you can call on us for answers you need in a hurry—on specs, specials, prices and delivery. For product literature, write 500 Superior Ave., Newport Beach, CA 92663.

HUGHES

HUGHES AIRCRAFT COMPANY

**Why Rockwell
microcomputers
turn your good ideas
into better
products.**

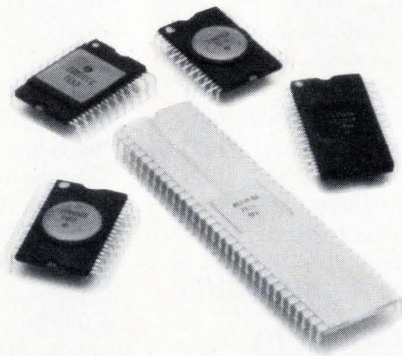

Rockwell's broad line of microprocessor systems are making all kinds of new products possible as well as practical because they fit the application so precisely. You get the right functional capability at the right price—and the Rockwell in-house capability to make sure your product idea becomes a reality.

The Rockwell advantage — a 5-family approach.

Rockwell offers five compatible microcomputer families, from low-cost one chippers through multi-chip 8-bit systems. You select the most cost-effective microprocessor system for your immediate design requirements, then expand models up or down with our compatible systems. You don't need to redo your total program.

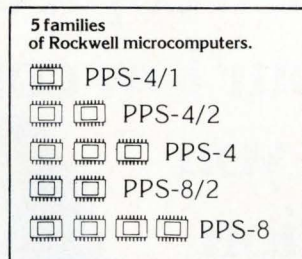

Our one-chip PPS-4/1 family with CPU, ROM, RAM, and 31 or more I/O ports cover a wide range of applications at lowest possible cost.

The two-chip PPS-4/2 and the multi-chip PPS-4 systems offer more power at low cost. Both have fast execution speeds, high throughput, and are expandable with dozens of LSI I/O peripheral controllers and memory options.

Rockwell's 8-bit systems include the PPS-8/2 (two chip microcomputer with I/O) and the fully compatible multi-chip PPS-8 system. Both use the same multi-function 109 instruction set and accept the same broad range of provided LSI memory and I/O controller options.

And Rockwell backs its microcomputers with all needed design aids and a worldwide network of applications centers, representatives and distributors.

Better products like these are made possible with Rockwell cost-effective systems.

Cash registers and P-O-S terminals—Inside some of the most popular machines on the market today are Rockwell microcomputers. At the low end, PPS-4/1 one-chippers. In P-O-S terminals, two-chip microcomputers combine with any of dozens of available LSI I/O and memory options.

Home and commercial products—Weighing scales, security systems, copiers, scanning

radios, hi-fi record changers and appliances are now being controlled or automated with Rockwell microcomputers.

High-speed printer—The functional ability and low cost of a six-chip PPS-8 Rockwell microcomputer is why it was selected to control a matrix printer which zip-prints at 200 characters/second and tabs at 550.

Hand held computer terminals—Two and a half hours of paperwork for meter readers and sales clerks are reduced to 30 seconds. The reason—a Rockwell PPS-4/2 microcomputer in a hand-held terminal that records transactions and interfaces directly with central computers.

Electronic games and pinball machines—Rockwell's compatible microcomputers are reducing manufacturing costs and shortening design time in all kinds of exciting new games. We have supplied custom design services for makers of these games.

Heart-monitoring bicycle exerciser—This unique but functionally complex idea was made economically possible with a Rockwell PPS-4/2 microcomputer. Rockwell is producing the microcomputer as a cost-saving subassembly.

Automobile computers—A 1977 production car has the first digital computer to control spark firing—based on a custom Rockwell two-chip system.

Stationary and mobile telephones—Our versatile one, two and multi-chip systems have expanded telephone usage with features like credit verification and automated mobile service. Other types of communications equipment, like auto-dialers and facsimile machines, now also use Rockwell microcomputers.

Get the full story. Write on your company letterhead to: Marketing Services, D/727-E Microelectronic Device Division, Rockwell International, P.O. Box 3669, Anaheim, CA 92803, U.S.A. or phone (714) 632-3729.



Rockwell International

“Our DG300 analog two new ways to make system

“Siliconix’ new DG300 CMOS analog switches give you an unprecedented combination of high speed, low power and economy. Along with our much copied DG180-190 JFET switches and our low cost DG170 PMOS switches, you have such a broad selection that design compromise is practically eliminated. And to help you get the most out of analog switches, we’ve got a new applications handbook.”



switches and this handbook- design easier than ever."

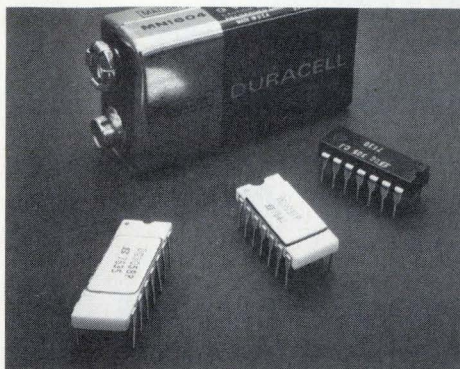

	Siliconix DG300 Series	Analog Devices 75 Series	Harris HI Series	Intersil IH Series	National LF Series	Texas Instruments TL Series
t _{off} (typ)	70 ns	400 ns	280 ns	500 ns	90 ns	350 ns
t _{on} (typ)	110 ns	700 ns	370 ns	1000 ns	500 ns	175 ns
Power Requirement	1 μ W	4 mW	1.5 mW	1.5 mW	135 mW	120 mW

Our new DG300 series of eight CMOS analog switches is one more reason why design engineers come to Siliconix.

The DG300 virtually quadruples the speed of previous CMOS switches, with quiescent power dissipation up to ten times lower. It operates over a 30 volt signal range with low, nearly constant "on" resistance, has negligible leakage currents and isolates 30 volts peak to peak.

Yet prices for the DG300 are lower than or comparable to other CMOS switches that can't match its performance. You can use the DG300 in many applications as a low cost alternative to JFET switches, or to multiply the performance of low power designs.

A choice of CMOS-compatible logic inputs makes the DG300 series ideal for micropower applications. DG300, 301, 302 and 303 interface with low voltage CMOS, open collector TTL or DTL and operate on a few milliwatts. Typical t-on/t-off times are 150/130 ns. DG304, 305, 306 and 307 interface with higher voltage CMOS and need only a few hundred microwatts, with typical t-on/t-off times of 110/70 ns.

Both groups of switches are available in four different configurations: dual SPST, SPDT, dual DPST and dual SPDT. Guard terminals on the SPDT and dual SPST packages further improve isolation.

And for extra reliability, these CMOS switches are immune to latchup and are protected against static on all terminals. And they are available in commercial, industrial and military versions at prices very competitive with previously available CMOS switches.

For more detailed information, write for the 24-page DG300 series design catalog.

Or, to take full advantage of the 52 different analog switches Siliconix delivers, and to smooth out the wrinkles in designing with analog switches, send \$4 for our authoritative 352 page handbook—"Analog Switches and Their Applications."

It includes six informative chapters on analog switch theory, covering basic FET switch information, switch and driver circuits, multiplexing, sample and hold circuits, N-path filters, and signal conversion using analog switches. Each chapter is concluded with useful application circuits, and a seventh chapter is devoted entirely to application notes.

You can order all Siliconix products and literature from our franchised distributors: Components Plus, Elmar, Hamilton/Avnet, Pioneer, Quality Components, Semiconductor Specialists, Wilshire or RAE.

Yes, I'd like more information:

- Send me the free DG300 series design catalog.
- I've enclosed a check or money order for \$4. Rush me a copy of "Analog Switches and Their Applications."

Name/title _____

Company _____

Address _____

City/State/Zip _____

Siliconix Incorporated, 2201 Laurelwood Road,
Santa Clara, CA 95054 (408) 246-8000.

Siliconix incorporated

INTERFACE

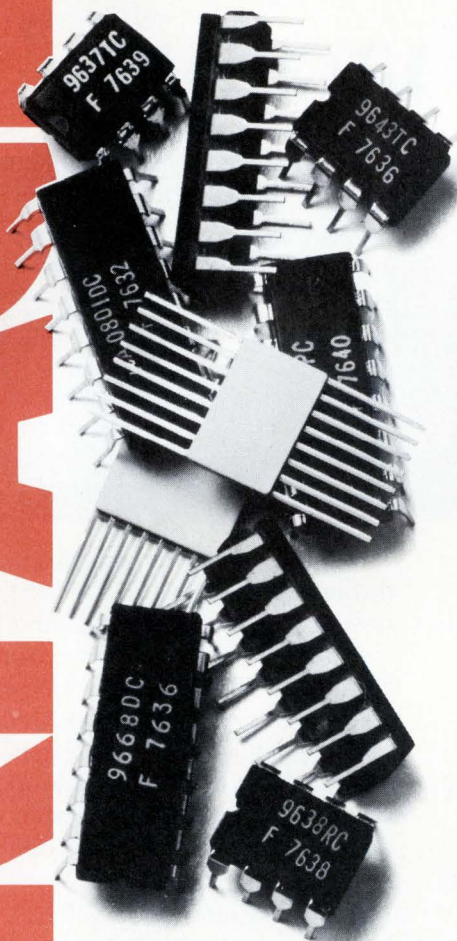

ANNOUNCING ENOUGH NEW INTERFACE DEVICES TO START A FOOTBALL TEAM.

Eight new drivers, two converters and a receiver. Eleven additions to one of the broadest interface lines in the industry.

Including:

LINE DRIVERS AND RECEIVERS

The very first RS 422 and 423 devices available in 8-pin mini dips: The 9636 Dual Single-ended Line Driver (RS 423). The 9637 Dual Differential Line Receiver (RS 422 and 423). And the 9638 Dual Differential Line Driver (RS 422). All three devices have inputs across from outputs for ease of connecting.

They can be mixed or matched in multiples of two for efficient use of board space. And they offer increased power dissipation. (Two 8-pin Fairchild interfaces provide a full Watt of power compared to 620 mW for competitive 16-pin devices.)

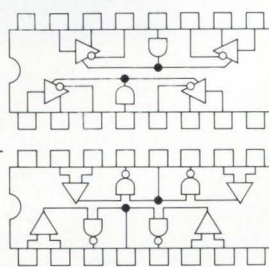

Their way.

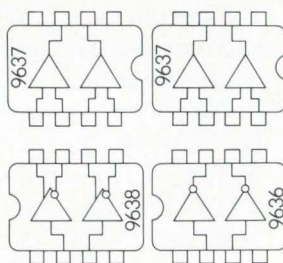

Our way.

MOS MEMORY DRIVERS

Our new 9643 Schottky Dual AND TTL-to-MOS Driver is an improved pin-for-pin SN75322 replacement. It requires no external pnp transistors and will drive CCD memories. The 9643 is also available in an 8-pin mini-dip for increased package density.

Our new 9644 Dual NAND TTL-to-MOS Driver is the very first Schottky high voltage MOS clock driver in an 8-pin mini-dip package.

PERIPHERAL DRIVERS

We're also introducing a new family of 7-segment High-voltage, High-current Darlington Drivers: The 9665 for general purpose use. The 9666 for PMOS inputs. The TTL and CMOS compatible 9667. And the

CMOS and PMOS compatible 9668. All four are available in a 16-pin plastic package with optional copper lead frame which increases power dissipation to 2 Watts.

8-BIT D-TO-A CONVERTERS

Our new industry standard 8-bit DACs include the μ A0801 pin-for-pin replacement for PMI DAC-08, and the μ A0802 pin-for-pin replacement for Motorola's MC1408 and 1508. Both devices will interface directly with most other logic families. They provide lower power dissipation and more speed than competitive products. They're available in a cost-effective plastic package for industrial applications.

ALL YOUR FAVORITES, TOO

Following is a summary of the Fairchild Interface product line. Most devices are available in commercial and military temperature ranges, molded and hermetic packages and processing to Class B or MIL STD 883A. They're also available right now at the right price.

FAIRCHILD INTERFACE PRODUCTS				
Memory Drivers/Sense Amps				
9643	9647/A*	55/7534/35	55/75224/225	55/75325
9644	9648/A*	55/7538/39	55/75232/233	55/75326
9645*	55/7524/25	55/75207	55/75234/235	55/75327
9646*	55/7528/29	55/75208	55/75238/239	
Peripheral Drivers				
9665	55/75430	55/75450A/B	55/75460	55/75471
9666	55/75431	55/75451A/B	55/75461	55/75472
9667	55/75432	55/75452A/B	55/75462	55/75473
9668	55/75433	55/75453A/B	55/75463	55/75474
	55/75434	55/75454A/B	55/75464	
Line Drivers/Receivers				
9612	9621	9634*	55/75107A	55/75121/8T13
9613	9622	9636	55/75107B	55/75122/8T14
9614	9626*	9637	55/75108A	55/75123/8T23
9615	9627	9638	55/75108B	55/75124/8T24
9616	9628*	9640*	55/75109	75150
9617	9629*	9641*	55/75110	55/75154
9620	9630*	9642*	55/75112*	1488*
				1489/A*
Display Drivers/Other				
9624	9664A	55/75491	55/75491B	55/75492A
9625	9664B	55/75491A	55/75492	55/75492B
9664				

*TO BE ANNOUNCED

If you don't see what you need, or you need more information on what you've seen, call or write your Fairchild sales office, distributor or representative today and ask for a line card. Fairchild Camera and Instrument Corp., Linear IC Division, 464 Ellis Street, Mountain View, CA 94042. TWX: 910-379-6435.

FAIRCHILD

**CALL US ON IT.
(415) 962-2444**

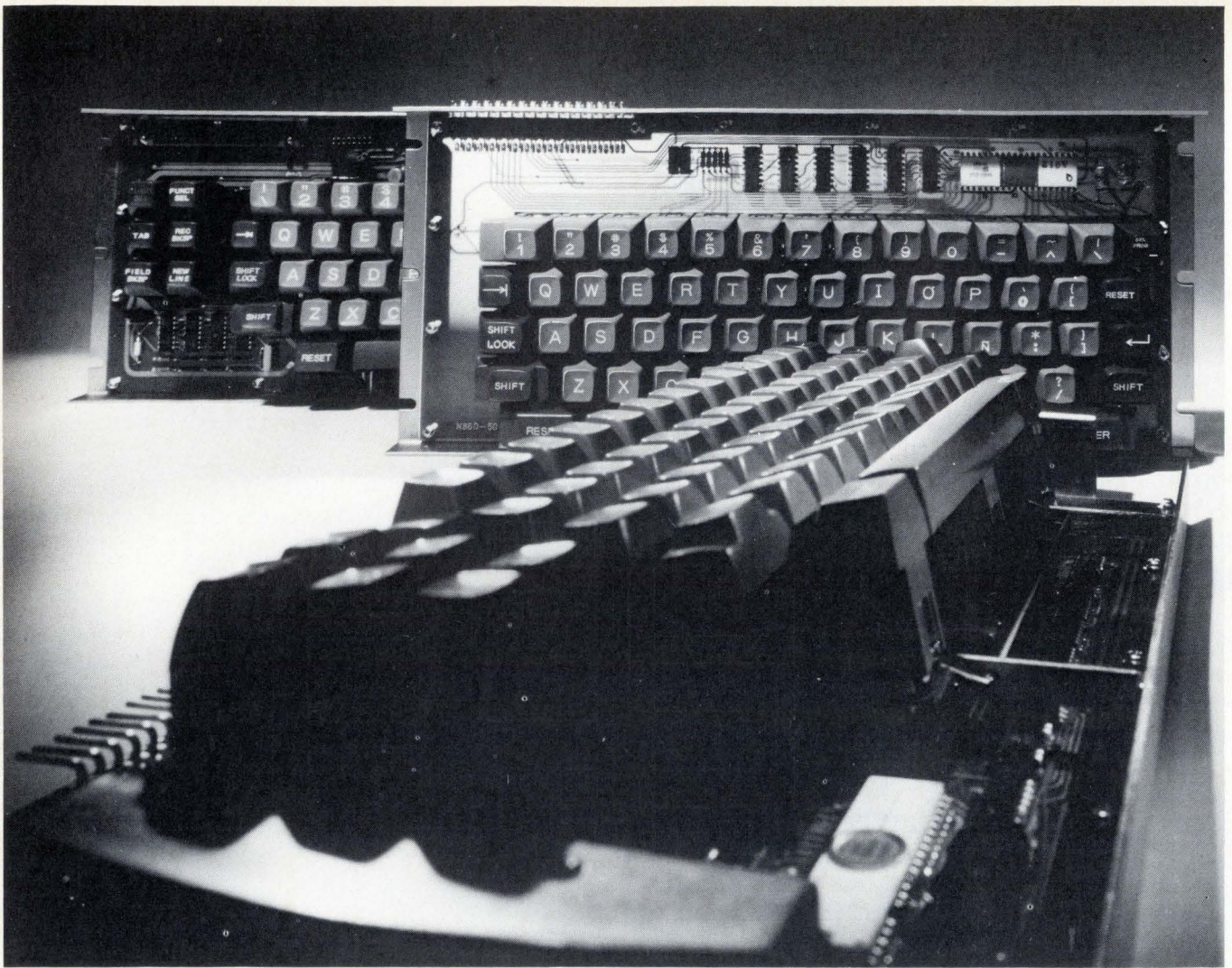

Fujitsu brings you the light touch in keyboards

Are you a design engineer, production engineer, or other involved in the section and purchase of components that go into the terminal equipment your company manufactures? Did you know that there is another type of keyboard on the market that offers a different type of key touch — a touch that can lead to productivity gains for your customers? Well, if you are, and if you didn't, then take a look at these new keyboards from Fujitsu and see what you (and your customers) have been missing. Fujitsu has a full line of keyboards available for terminal equipment, all

featuring the use of the Fujitsu FES-series snap-action key assembly. This highly reliable key assembly is a Fujitsu-engineered snap-action device that makes our keyboards easier to operate because it makes each key lighter to stroke, and with excellent tactile qualities. Thus, with smoother and lighter key touch, operators are less fatigued and, therefore, less prone to error. Fujitsu keyboards offer other advantages, too. Take the large capacity encoder fitted on each board — it's a MOS LSI ROM that helps to keep equipment size down and performance up. And there is a full selection of keyface styles (including

sloped, stepped and sculptured) in arrangements to meet your every need. N-key rollover, 2-key lockout, a wide range of codes (USASCII, EBCDIC, etc.), and even a range of options including illuminated keytops and capped keytops, all increase the choice for you. Remember, the touch can make the difference, so when you need the different touch come to Fujitsu. All at prices you're sure to appreciate.

FUJITSU LIMITED
Communications and Electronics
Tokyo, Japan

For further information please contact:

■ **Components Group (Head Office):** Syuwa Onarimon Bldg., 1-1, Shinbashi 6-chome, Minato-ku, Tokyo 105, Japan Phone: (03) 437-2111 Cable: FUJITSULIMITED TOKYO Telex: 2424511 FT SIN J ■ **New York Office:** 680 Fifth Avenue, New York, N. Y. 10019, U. S. A. Phone: 212-265-5360 Telex: 23 234969 ■ **Fujitsu America, Inc. (Components Sales Office):** 1251 West Redondo Beach Blvd., Gardena, Calif. 90247, U. S. A. ■ **London Office:** Norman House, 105/109 Strand, London, W.C. 2, England Phone: 240-0461/0462 Telex: 51 22305

FCC plans retests of some CBs for radiation

The Federal Communications Commission's laboratory division is putting in Saturday overtime retesting 40-channel citizens' band radios. The sets **failed the chassis radiation requirement of 5 microvolts per meter measured 3 meters from the chassis.** But FCC chief engineer Raymond Spence says that only the units that radiated 25 microvolts or less will be retested and only if the manufacturer asks it in writing.

Commission sources estimate that about 200 of the nearly 500 models submitted will be approved by Jan. 1 when 40-channel models may go on sale. By November's end only 70 transceivers from 31 companies had been approved, with Sears, Roebuck and Co., and General Electric Co. leading with seven models each. Runners-up include Midland International with six models, Kraco Enterprises with five and Matsushita with four. Three models each have been certified for Lafayette Radio, Radio Shack, Regency Electronics, and Teaberry Electronics. Two model certifications have been issued to Commando Communications, Fanon/Courier Corp., Hy-Gain de Puerto Rico, Pearce Simpson, RCA Corp., Sharp Electronics, and Well Inc.

Tuner standard for uhf TV to stay at 2 MHz

Television-receiver makers won't have to develop 20-position uhf tuners with an accuracy of ± 1 megahertz by next July 1. After proposing the more rigid standard last February, the Federal Communications Commission has backed off, extending indefinitely the existing requirement for uhf tuners with accuracies of ± 2 MHz without fine tuning.

The FCC said its action came after determination that **only one tuner could meet the ± 1 -MHz requirement in 1977.** The commission also says that uhf broadcasters failed to effectively counter the arguments of receiver and tuner manufacturers that a receiver designed to meet the existing requirement produces excellent results and that a ± 1 -MHz receiver "would not produce any significant consumer benefits."

NRL's Chubb gets patent on solar electric system

A system that may be a major competitor for solar-energy honors has received a patent. The Naval Research Laboratory's Talbot Chubb, the physicist who devised a system for **converting sunlight chemically into electricity**, has received a patent for the power system that is the heart of his Solchem concept to provide demand-responsive power around the clock.

Solchem's gas dissociation system consists of a solar furnace in which sulfur trioxide is heated by a sun-ray reflector. The SO_3 dissociates with absorption of heat into SO_2 plus O_2 , Chubb explains. The dissociated gas is directed through a salt-heat chamber where it recombines into SO_3 and emits heat. The gas is then directed back to the solar furnace, and the cycle is repeated.

Heat can be drawn from the salt-heat chamber to operate a power generator or can be stored in large tanks for use at night. Chubb says he expects Solchem to be a contender in the Energy Research and Development Administration's program to develop economically viable solar energy on a large scale.

Making RPVs pay

Available money for remotely piloted vehicles and their avionic controls and reconnaissance relay systems jumped by more than one third in the new Federal fiscal year that began in October. One of the key leaders in RPV development is USAF's Maj. Gen. George H. Sylvester of the Aeronautical Systems division. Gen. Sylvester believes that the RPV is beginning to come into its own as it is used in combination with manned aircraft for tactical defense suppression, rather than by itself in a tactical-strike role. Speaking not long ago to a group of industry leaders at the Aeronautical Systems division, Gen. Sylvester outlined his view of the development of the RPV marketplace and the role in it for avionics as follows. **Ray Connolly**

One measure of over-all Air Force acceptance of RPVs is the magnitude and the trend of the R&D budget. The Air Force R&D budget for fiscal 1976 devotes approximately \$80 million to strategic and tactical RPVs. Next year that amount will increase to approximately \$110 million. Contained within these figures is \$30 million each year devoted to tactical RPVs. The out years tend to be significantly higher, but if past experience is repeated, the budget for tactical RPVs will probably be back down to the \$30 million level when that budget year rolls around.

Forecasting roses

There have been numerous articles regarding the potential of RPV systems in tactical war. Numerous forecasts—generally written by proponents of RPVs—predict a rosy future. Yet, I submit, there are only very special applications for conventional-sized RPVs in the tactical-strike role—not for routine applications. As in the case of the manned aircraft, you still have the crucial problem of target acquisition, only with the RPV you must add the equally complex problem of command and control in a hostile electronic environment and with a command and control system already fully taxed. Where manned-aircraft attrition might be prohibitive, then RPVs could well be the preferred approach.

But I see another mission for RPVs, in a complementary role with manned systems, that could prove a tremendous boon for our conduct of tactical air operations. I'm speaking of defense suppression. Until and unless we succeed in greatly reducing or totally silencing the enemy's radar-controlled, ground-based defenses, many of which are mobile, it's going to be a very tough job to execute the basic air

missions of close air support, interdiction, and tactical reconnaissance. But once having done so, it's a whole different ball game.

Tough, not impossible

I submit that defense suppression is not an impossible task—just a very difficult one. First, I don't think we should look at the problem as if every system we build has to have the inherent capability to do the job alone. Rather, we should be thinking in terms of many different weapons systems operating synergistically to form a total defense suppression.

The Precision Emitter Location Strike System could be a member of that team. Active jamming with electronic jammers and chaff would be another, with RPVs, EF-111, and strike aircraft all involved. Wild Weasel with its standoff, anti-radiation missiles would be a third member. [Then there are] decoys to force enemy radars to come on the air to force him to expend firepower; low-cost harassment drones by the hundreds, and at the risk of heresy, even artillery. You will note that I haven't even mentioned sending strike aircraft down his throat with gravity weapons—because by and large I don't think that's the way to go.

Note, however, that every system I mentioned has day, night and all-weather capability. That, of course, is tremendously important in the European scenario where the weather is often bad, the winter nights very, very long. Furthermore, the inherent nature of the target, namely ground-based radar, is all-weather.

Changing focus

I hope you also noted the opportunities for RPVs among the various systems I listed. So if you have your sights set on RPVs in the tactical strike role, I suggest you focus in on defense suppression as a particularly promising, albeit technically demanding, mission area. RPVs have gained a permanent position in the Air Force in a number of mission zones, namely, nuclear strike, reconnaissance and electronic warfare. Their use will become more widespread as we gain experience with these systems, provided all the potential offered by RPVs turns to reality. In the tactical strike role, there will be some specialized but limited applications, particularly where severe manned-aircraft attrition is a factor of overriding importance. And finally, one of the most lucrative potential applications for RPVs in the future lies in the area of defense suppression. I hope the RPV community is prepared to take on that challenge.

NEED

low-pass passive devices that perform as well as active filters but don't cost nearly as much? Investigate Sprague Series JW33 Audio Filters . . . you'll be pleasantly surprised at all they can do for you . . . at a price you can afford.

AUDIO

filters in this new series utilize stock parts, permitting quick and precise construction to your requirements . . . your choice of attenuation characteristics (Chebyshev or Cauer), your choice of cut-off frequency (1 to 50 kHz), and your choice of operating impedance (250Ω to $10K\Omega$).

FILTERS

shown here are metal-encased to reduce pickup or cross-talk, hermetically-sealed to ensure dependable operation at environmental extremes, and solidly constructed to resist physical damage. Standardized pin terminal spacing and low profile (.500" height) make them ideal for PC boards.

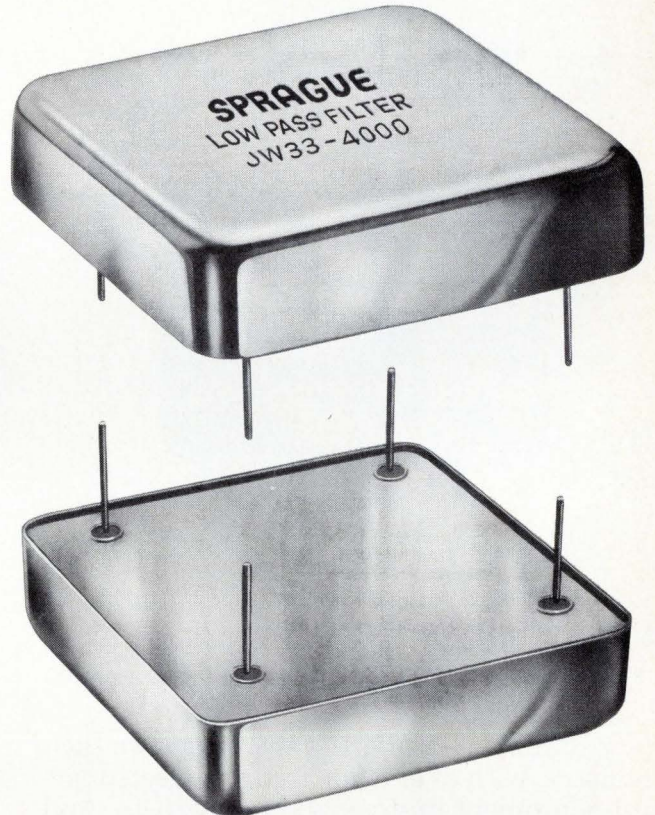

FAST?

Because Series JW33 Filters are pre-engineered and can be quickly customized to match the needs of your equipment, all orders are efficiently processed for fast shipment. Whether you want a few pieces for prototype use or a large run for production purposes, you can count on rapid delivery.

*For complete information, write or call
Harris Johnson, Sprague Electric Company,
P.O. Box 39, Annapolis Junction, Md. 20701.
Telephone 301/792-7657*

... and you thought we only make great capacitors.



Here's why REI can rent you what you want when you want it.

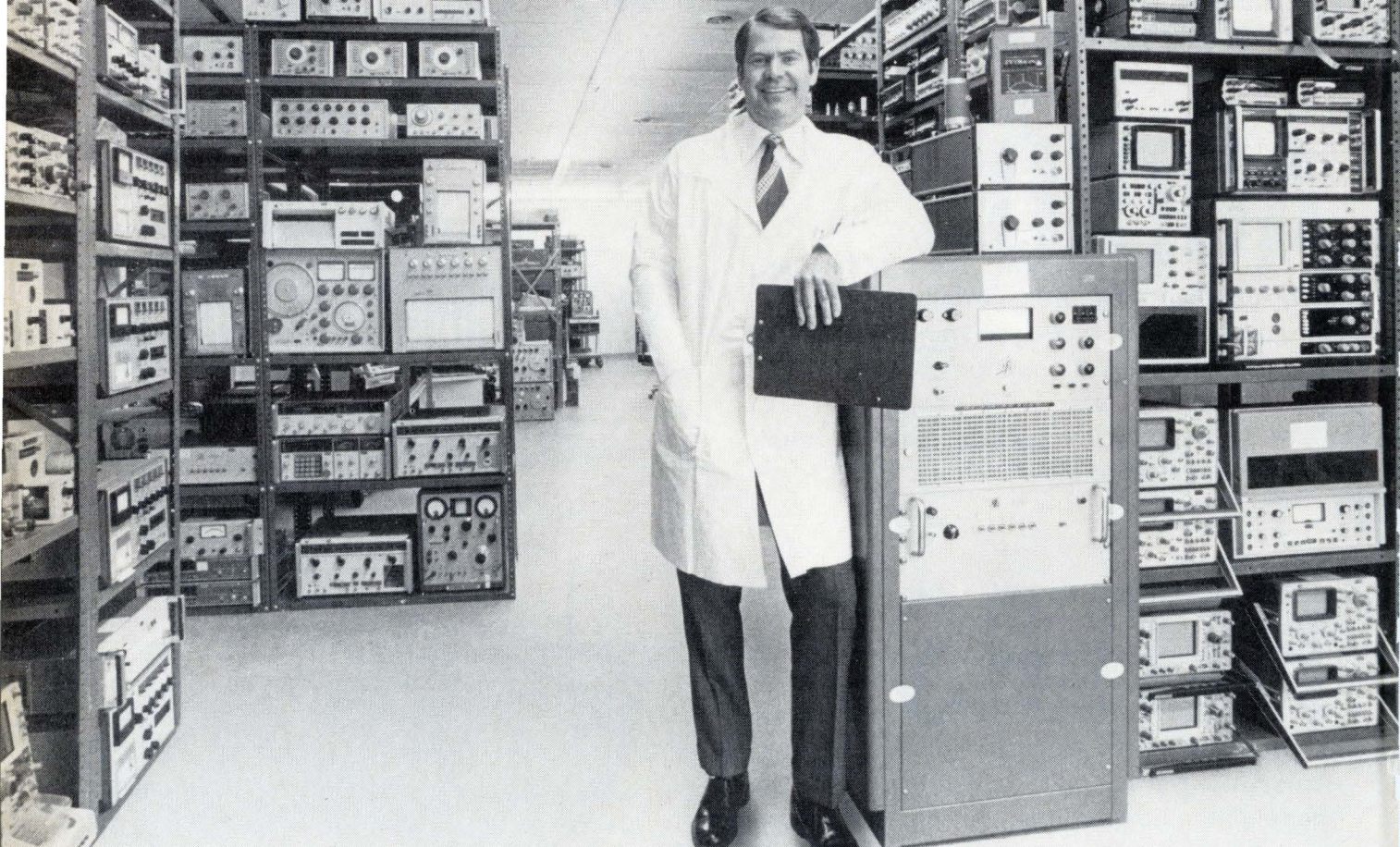

Our inventory. It's the biggest in the industry, with over 8,000 items of electronic test equipment in stock and ready to go. And it's getting better all the time, because we add more state-of-the-art equipment every month. This means we can deliver one special instrument... or a dozen... within hours of the time you place your order.

Now, more than ever, renting makes sense... to stretch your equipment budget, to fill temporary needs, and to avoid the long delivery lead times associated with purchasing. And renting from REI makes even more sense... because we're better equipped to fill your needs than any other rental company.

REI is backed by the tremendous resources of the PepsiCo organization, which gives us the financial strength to keep on hand whatever test equipment you may need. And renting from us helps *your* financial strength,

too. Since you pay only for the time you have your instruments, you'll never have to spend your money on idle equipment.

Send for our catalog today for a description of our rental, rental/purchase and leasing plans, and for our low rental prices. Or call the instant inventory center nearest you for immediate assistance.

Rental Electronics, Inc.,
99 Hartwell Avenue, Lexington, Mass. 02173.
Please send me your free instrument rental catalog:

Name _____ Title _____

Company _____

Address _____

City _____ State _____ Zip _____

Tel. Number _____

Rental Electronics, Inc.

A PEPSICO LEASING COMPANY

Burlington, MA (617) 273-2770 • Gaithersburg, MD (301) 948-0620 • Oakland, NJ (201) 337-3757 • Ft. Lauderdale, FL (305) 771-3500
Des Plaines, IL (312) 827-6670 • Dallas, TX (214) 661-8082 • Mountain View, CA (415) 968-8845 • Anaheim, CA (714) 879-0561
Rexdale, Ontario (PLC Leasing Ltd.) (416) 677-7513

Circle 52 on reader service card

Toshiba develops experimental 64-k charge-coupled RAM

Japan's Toshiba is about a year away from a commercial 64-kilobit charge-coupled random-access memory. **The company plans to use four of these devices in a 256-kilobit memory for storage of graphic information in cathode-ray-tube computer terminals and as a frame grabber to show still pictures on television screens.**

The Toshiba Research and Development Center already has an experimental 64-kilobit RAM from which a 2-kilobit block of data can be read out in 400 microseconds for a data-transfer rate of 5 megabits a second. The RAM is built by a tightly controllable process in a double-layer polysilicon structure used in some high-capacity programable read-only memories and 16-kilobit dynamic RAMs. Further development will be focused on design, including cutting chip size, now 5.3 by 6.1 mm.

Two British firms and Thomson-CSF team up in ICs

Sescosem, the Thomson-CSF semiconductor division, and two United Kingdom semiconductor houses expect added mutual strength in integrated circuits, particularly in telecommunications and television applications from separate second-source pacts. For telecommunications, the French company and General Instruments Microelectronics Ltd. have agreed to second-source one another's **MOS circuits that replace electromechanical dialing pulsers in telephone sets.** The first batch of devices covered by the agreement includes push-button decoders, a complementary-MOS clock generator, tone-frequency generators, and receivers.

For television, Sescosem has tied up with Plessey Semiconductors in a two-way second-source pact covering surface-acoustic-wave (SAW) filters. Although both Plessey and Sescosem have professional SAW devices under development, **the big market they are after is color-television sets where SAW filters seem destined to supplant conventional slug-tuned intermediate-frequency sections.** The deal covering SAW filters is the first concrete result from a general agreement between Thomson and Plessey to cooperate in integrated circuits

Siemens sales boom for microcomputer programing gear

Sales of Siemens AG SME800 microcomputer-programing stations have topped 60 units since introduction six months ago [*Electronics*, April 1, p. 62]. Priced between \$10,000 and \$25,000, depending on the configuration, the unit is used to develop programs for the company's n-channel SAB8080 and its p-channel 4004/4040 microprocessor systems. **The programs cover such diverse gear as electronic scales, copying machines, construction equipment, and measuring systems.**

Schottky variation increases I²L packing density

A yield of 800 gates per square millimeter—two to three times the packing density of conventional I²L—is the strong point of a variation of integrated injection logic in advanced development by the Allen Clark Research Centre of Britain's Plessey Co. Called substrate-fed logic or Schottky I²L, the design replaces the lateral pnp injector of conventional I²L with a vertical arrangement in which logic element is a multi-input, multi-output gate with diffused collectors and Schottky base contacts.

The resulting reduction in the interconnection area gives more gates on the chip and the low speed-power product of 0.03 picojoules. Typical gate delays are less than 10 nanoseconds for the process, which requires one epitaxial layer, four masks, and extensive ion implantation.

And now minis too! All from a catalog, at discount prices.

Digital's Direct Sales Catalog — the first catalog to offer computer products by mail with off-the-shelf delivery — was such a success, we've come out with an expanded second edition that includes the PDP-8A, the newest member of the world's most popular mini-computer family.

We've also added the LA180 line printer and expanded the sections on microcomputers,

logic modules, terminals, cabinets, connectors, accessories, and supplies from the first edition.

Of course, you still get our 5% catalog discount, plus another 4% for cash with your order. You also get a 10-day free trial period, plus our standard 90-warranty. (Since we're selling by mail, you do have to install the equipment yourself.)

If you were among the thou-

sands who ordered our original catalog, you'll get the new one automatically by mail.

If you weren't, why not sign up now?

For your free copy, call 800-225-9480 (Mass. 617-481-7400 ext. 6608). Or write: Components Group, Digital Equipment Corp., MR2-2/M59, One Iron Way, Marlborough, MA 01752. (Catalog sales to U.S. only.)



Ferranti develops a-d converter chip containing everything except clock

Most monolithic 10-bit analog-to-digital converters of the successive-approximation type require both an external comparator and clock, and none of the commercially available devices has included the reference voltage on the chip. However, Ferranti Ltd. of England has packed an entire 10-bit successive-approximation monolithic a-d converter on one chip—all except for the clock.

The chip is expected to become commercially available early next year. Its initial price is expected to be less than \$68 each in small quantities, the firm says.

Made by a standard bipolar process, the ZN432CE offers significant savings in space and weight, as well as work in assembly and testing, says Peter Krebs, product-marketing executive. Applications for the ZN432CE are in computer- or microprocessor-based data systems that need to handle multiplexed analog measurements or sensing inputs. These would include uses in process control, pollution monitoring, electric-power control, avionics, and shipboard monitoring.

The chip is so accurate that it is monotonic over the whole temperature range. Its linearity is specified at $\pm 1/4$ the least significant bit, and its differential linearity is $\pm 1/2$ the LSB.

Spike-free outputs. Other advantages are a fast conversion time of 10 microseconds, an accurate current source that eliminates the need for trimming, and low internally generated noise, which yields essentially spike-free outputs.

Onto the chip, which is 160 mils square, Ferranti designers have packed a buffered 2.5-volt precision voltage reference, a current switching array, a fast comparator with good overload recovery, and successive-approximation logic with transistor-transistor-logic interfacing. But they had to leave off either the

clock or the comparator because "we were rather short on pins," comments Roy Wells, head of linear-IC design, and "we preferred to leave off the clock." With an external clock, the chip gives the designer greater flexibility in applications than he would otherwise have.

The 28-lead dual in-line package comes in two temperature ranges, -40°C to 85°C or 0°C to 70°C . The chip was fabricated with Ferranti's collector-diffusion isolation (CDI) processing technology. With CDI,

explains design engineer Jeffrey Kane, "we can pack a lot into a small space because of its smaller geometry"—it needs no special isolation region around the transistors or resistors.

An example of the benefit is an on-chip current-switching matrix using 56 diffused resistors. With the configuration and the CDI process, the designers were able to allow for the shortcomings of the resistors, Kane says. Actually, this current-switching matrix is the heart of the

Around the world

Huge Valvo klystron to supply electron accelerator

At the Philips affiliate Valvo GmbH in Hamburg, West Germany, engineers are developing an electron tube that stands 3.5 meters tall and weighs just under 500 kilograms. The tube, a klystron with the development designation V75SK, will supply a new electron accelerator with a maximum power of 600 kilowatts. At this high a rating, the tube's collector must have an area large enough to withstand beam-power levels exceeding 1 megawatt and needs a cooling system that can circulate hundreds of gallons of water per minute.

The high-power klystron is intended for the \$40 million electron-accelerator system Petra (for positron-electron tandem-ring accelerator) under construction in Hamburg. For particle acceleration, Petra requires a maximum of 5 megawatts of radio-frequency power. Eight of these klystrons will be used to supply acceleration power at 500 megahertz. Together, the eight klystrons call for an input power of 8 MW. The tandem particle-accelerator tunnel forms a circle with a circumference of about 2.3 kilometers. With the 2×19 gigaelectronvolt Petra system, nuclear physicists plan to probe deeper than ever before into the basic makeup of matter.

Video instrument measures LSI lines

A precision micrometer is adding to the impact of the usual impressive display being presented by France's government-run atomic-energy commission at the Physics Exposition Dec. 6-10 in Paris this year. The instrument, which facilitates measurement of ultra-rapid movements and even the line widths of integrated circuits, supplements the developments in linear acceleration and solar-energy developments that the Commissariat à l'Énergie Atomique is revealing to public scrutiny.

Designed by the CEA's Laboratoire d'Électronique et de Technologie de l'Informatique in Grenoble, the instrument can measure line widths of 1 to 5 micrometers in both semiconductor devices and magnetic-bubble memories. The versatile instrument has two speeds, which makes possible the measurement of various distances during device fabrication by comparing photographed images to the micrometer images on a television screen. What's more, the use of two basic lenses has resolved the precision problems usually associated with transferring microscopic images to a TV screen. The different lenses and speeds make it possible to view lines no wider than 1 micrometer without observing distortion.

converter, he adds. As with most approximation-type a-d designs, Ferranti's is based on a feedback loop using a digital-to-analog conversion within the a-d conversion to measure the analog voltage.

Another feature of the Ferranti design is the buffered 2.5-volt precision logic reference using the silicon bandgap technique. This is similar to a classic Widlar diode circuit, consisting of three transistors with an amplifier. Such a circuit helps stability and temperature performance, among other advantages.

The converter requires a supply of ± 5 v at ± 40 milliamperes. Specifications include a gain/temperature coefficient of ± 50 parts per million, and an output voltage of 2.5 v. □

West Germany

Grundig automates pc-board factory

Squeezed between high wage levels at home and low-price competition from the Far East, Grundig AG, West Germany's largest entertainment-electronics manufacturer, is going all out for automated production. That response to competition from areas in the Far East with low labor costs has already proved highly successful in many sectors for the country's other electronics firms. Grundig, in its home town of Nürnberg, has readied what the company claims is the most extensively automated center in Europe to manufacture printed-circuit boards. The sophisticated installation, called Plant 20, covers 110,000 square feet and employs 350 workers, who can produce more than 13,000 square feet of pc boards daily.

Controls. From a central station, a computer system controls the flow of all basic materials needed in pc-board manufacture, as well as all production processes required to make more than 800 different board types. Besides automation, much attention was devoted to environmental factors. In Plant 20, the supply of chemicals, electric power,

air, and water needed in the various production processes comes through a subterranean system of ducts and cables. Furthermore, water consumption has been reduced by about 80% below the requirements of other pc-board manufacturers.

The water used for cleaning pc boards is desalinated in circulating ion-exchange systems and then reused. This recycling, which is also electronically controlled, not only reduces consumption but also enhances solderability because the water is much cleaner than tap water. The waste gases emanating from production equipment that may contain noxious or acid-laden vapors are purified in an exhaust-gas cleaning system.

Processes. Three basic manufacturing methods are used in the new Grundig plants—subtractive screen printing for 80% of production, subtractive photoprinting for 10%, and the additive technique for the remaining 10%. Screen printing is a continuous process, and the computer system controls the double-etching equipment.

Inductances and small conductor widths are formed by photo-printing. In the additive technique, monitoring and control equipment developed by Grundig continuously controls the chemical-copper baths.

The plant has been prepared to eventually handle another pc-board technology—photo-forming. □

Denmark

Minicomputer helps design pc boards

A manufacturer in Denmark has developed a computer-aided-design technique to cut the time and costs of producing printed-circuit boards. Dansk Data Elektronik has teamed a Tektronik 4014 graphic display terminal with a Texas Instruments 960B minicomputer to produce tapes for production of pc boards in only 8 or 10 hours of working time. The firm, which claims that competing processes can take weeks to produce

a tape, adds that its method provides dense component packing density.

DDE sells the system, complete with program, for the equivalent of \$60,000. When a program is part of the package, it is restricted to the buyer's use. However, the customer may rent time on a system in the DDE plant. If DDE personnel work out the design, the hourly fee is slightly less than \$70 an hour. If the buyer furnishes the operator, the price is \$50 an hour.

The system has a small library of standard components in common configurations and sizes. Guided by a cross hair on the screen, an operator uses a joystick or similar entry device to transfer the components from a diagram to the representation of the pc board on the screen, which is marked off in a grid system representing twentieth parts of an inch.

The operator can see both sides of the pc-board diagram at once. Horizontal lines represent one side of the board and vertical lines the other. Lines are dotted for one side, and solid for the other. The operator asks the computer to find the shortest route from point A to point B, and this line is shown on the screen. All the other points can be linked in the same fashion, but these routes always follow the grid system's vertical and horizontal lines.

Routing. The operator can also insert his own routing when it appears that the computer routings are about to block off a vital point. When the labyrinth has been completed, it is transferred to a paper tape for production. A second tape programs the drilling unit to make the holes connecting the two sides of the pc board.

Company director Claus Erik Christoffersen says the system can also detect layout errors and correct them before the pc board goes into production, because the operator can test out all the circuits on the screen before they are committed to tape.

The system can handle pc boards as large as 528 square centimeters. The longer side can be 30.6 cm. Cofounder Tom Hertz says at least 95% of all pc boards used in Europe fall within this size. □

three
The ~~one~~ and only...

Three Series of Amphenol® connectors are now qualified to MIL-C-26482, MIL-C-38999 and MIL-C-83723.

One company offers connectors qualified to all three specs—Amphenol Connector Systems, Bunker Ramo Corporation.

These three connector series are preferred under military standard MIL-STD-1353A. They're designed for general-purpose and high-density applications in ground-support and airborne equipment.

Polymer retention is a big plus. Each of these Amphenol connectors uses a one-piece, molded polymer retention disc. (It's an advanced design we pioneered. For a closer look at how it works, see the cross-sectional view at lower left.) Polymer retention eliminates as many as 128 troublesome metal clips. And you know the fewer parts there are, the less can go wrong.

To learn more, call or write. Ask about the wide range of shell sizes, insert arrangements and termination tooling available for the Amphenol Connector 118, 418 and 518 Series. And ask for a free catalog, too. Call Vince Pusateri, (312) 986-3761. Or write: Amphenol Connector Systems, Bunker Ramo Corporation, 900 Commerce Drive, Oak Brook, Illinois 60521.

MIL-C-83723/Series III
Amphenol Connector 518 Series

MIL-C-38999/Series I & II
Amphenol Connector 418 Series



MIL-C-26482/Series 2
Amphenol Connector 118 Series

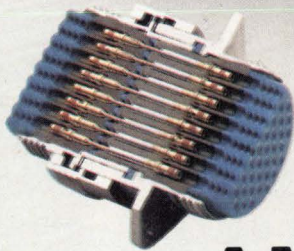

The right idea
at the
right time.

AMPHENOL Connector Systems **BUNKER RAMO**®

Circle 57 on reader service card

Now Norden gives
DEC's PDP-11/34
all the muscle it needs
to work in any
military environment.

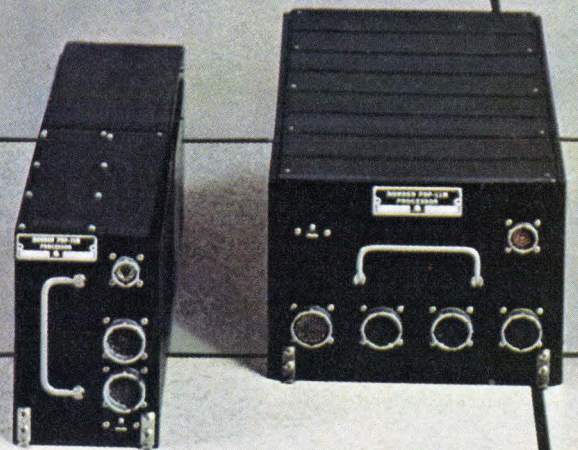



Announcing the new PDP-11/34M in half ATR and full ATR versions

First of a family of military computers to spring from the union of Norden's experience in high technology military electronics and DEC's leadership in minicomputers.

The PDP-11/34M has the muscle for severe environment operation, meeting airborne (MIL-E-5400), shipborne (MIL-E-16400), and land based (MIL-E-4158) specs. It's packaged in a compact half ATR chassis or a versatile full ATR chassis each with cooling and mounting options.

Fully compatible with PDP-11

The PDP-11/34M is completely compatible with DEC's commercial counterpart. Thus, the most extensive, proven software in the mini-computer industry is now available on a true military computer. Powerful, efficient operating systems cover single user, time-sharing, real-time, and multi-function choices included in RT-11, RSX-11, and RSTS/E. High level languages include MACRO-assembler FORTRAN, FORTRAN Plus, COBOL, BASIC and BASIC Plus.

Extensive features

The Norden PDP-11/34M comes with the extended PDP-11 instruction set (over 400 instructions); multiple register architecture; hardware stack processing; multiple priority level vectored interrupts; and integral direct memory addressing (DMA).

What's more, the PDP-11/34M can be configured with up to 124K words of byte parity core memory using 16K or 32K word modules, and with a memory management system for program protection — plus a floating point processor for high speed number crunching.

In addition, it boasts integral CPU and memory diagnostics. And large selection of peripherals and interfaces.

An unbeatable combination

Add it up and you get a military computer so muscular, so powerful, and so easy to use, it makes the others look like under-achievers. To learn more, write or call Marketing Manager, Computer Products Center, Norden Division, United Technologies Corporation, Norwalk, CT 06856. (203-838-4471)

PDP-11 data processing with military muscle

NORDEN



Circle 59 on reader service card

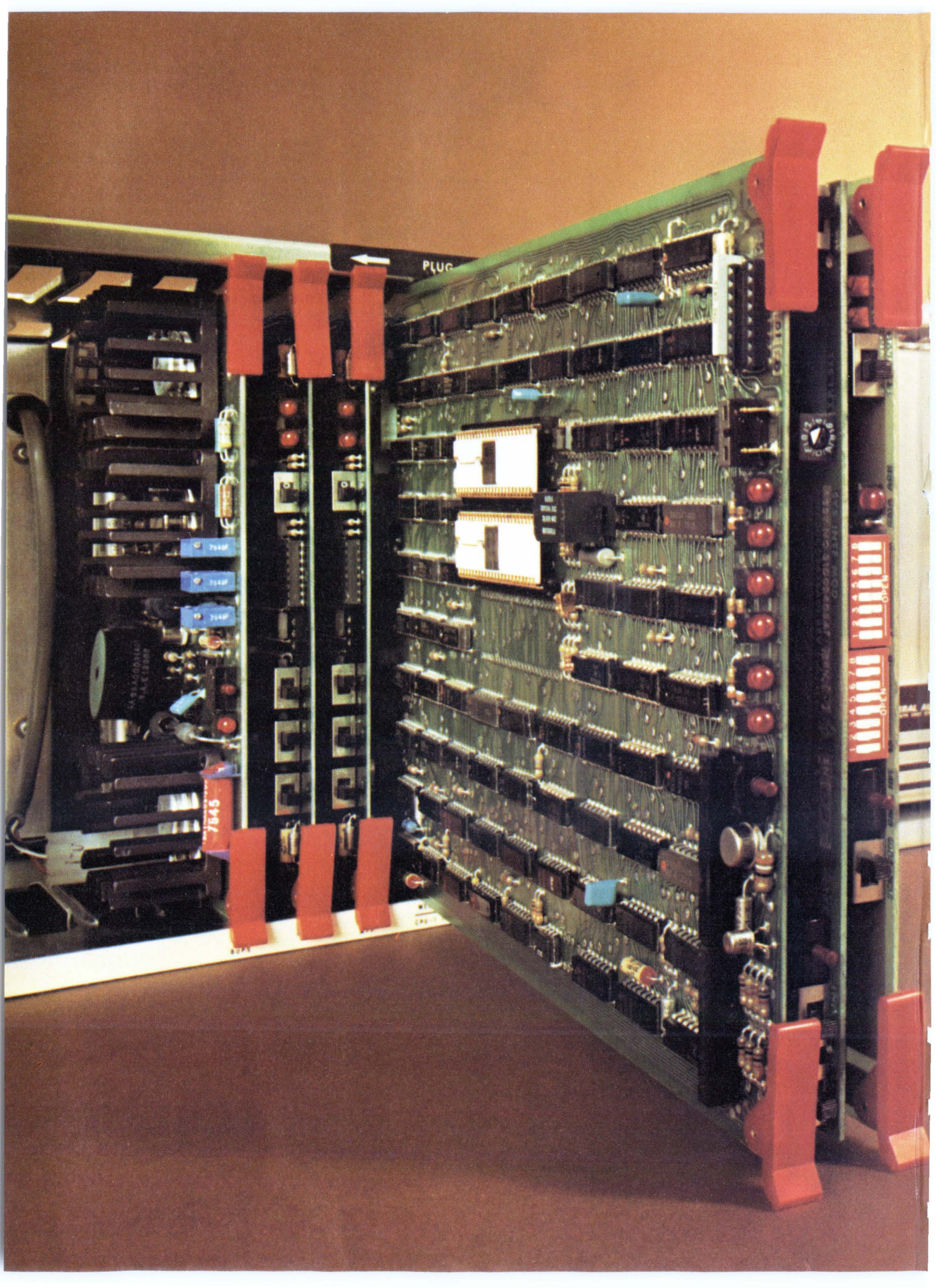

GA counts in microcomputing.

There's not a machine that can touch GA's 220. Not from DEC, Data General, or anywhere else.

- 1. The only μ C with COBOL, FORTRAN and in-depth software support.**
- 2. The only μ C with a full file management system.**
- 3. The only μ C to offer OEMs a wide choice of operating systems:** like FSOS, DBOS, RTX, RTOS.
- 4. The broadest μ C instruction repertoire:** speeds program development, conserves memory, accelerates execution.
- 5. The only μ C that can handle big disks:** I/O rate is 2.0 mB/second.
- 6. The fastest μ C:** LDR/STR (indexed) 2.6 μ s.
- 7. The only μ C with parity built-in:** hardware test, verification, fault isolation, plus write protect.
- 8. The only μ C with a back-up power supply built-in:** protects semiconductor memory from power failures.
- 9. The only μ C with board-level operator controls, switches and displays:** in a microconsole.
- 10. The only μ C with over 100 field-proven I/O controllers.**

GENERAL AUTOMATION

A big break for OEMs: family compatibility, throughout General Automation's extensive micro/mini line, gives GA-16/220 instant access to multiple batch and real-time operating systems, and to software off-the-shelf.

- Rush me full details on GA-16/220 μ C capabilities.
- Contact me for immediate requirements.

Name _____

Title _____

Phone _____ Ext _____

Clip coupon to company letterhead and send to General Automation, 1055 South East Street, Anaheim, CA 92803. Or call (714) 778-4800.

E

NEW FROM KEITHLEY: TWO "BEST BUY" DMMs. 4½ DIGITS. 30000 COUNTS. UNDER \$500.

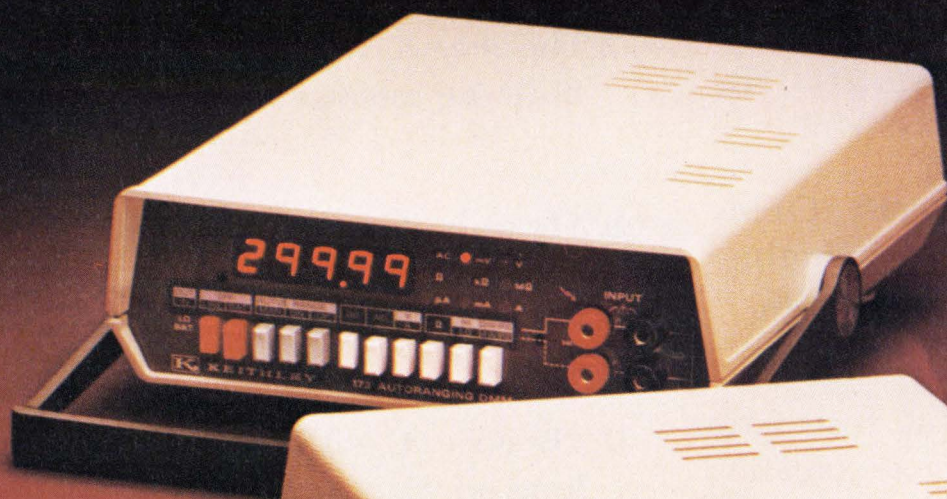

Model 173



Model 172

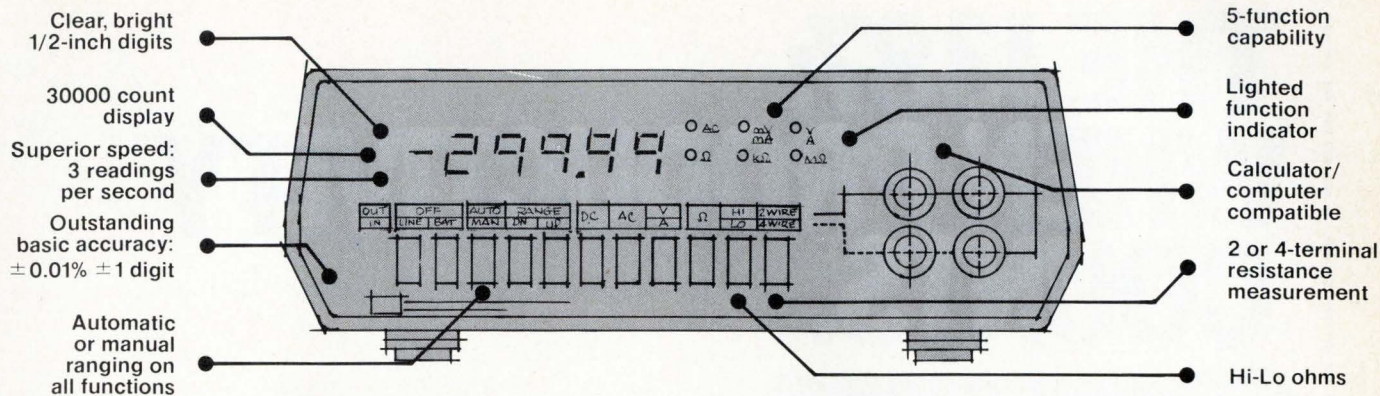

Take a look at the remarkable features of the new Keithley Digital Multimeters. They're unmatched in the industry.

Now consider price. At \$499 we think you'll agree the Keithley 172 is the best buy in a general purpose 4½-digit DMM.

There isn't another 4½ that matches the price-performance value of the 172. Except for its higher-rated companion, the Keithley 173.

For \$499: the exceptional 172.

To begin with, you get a dependable, durable, portable, easy-to-use, autoranging instrument with five functions. Designed for research, engineering or production applications.

Measure from 10 microvolts to 1200 volts dc, 10 microvolts to 1000 volts ac, 10 milliohms to 300 megohms, 10 microamps to 2 amps, ac or dc. DC accuracy is 0.01% ± 1 digit.

There's more: 3 month recal cycle. No-nonsense, full-year guarantee on parts, workmanship, and specs. 30000-count display yields maximum accuracy for 15, 18, 24 and 28-volt measurements.

For \$625: the even more exceptional 173.

The Keithley 173 is our top-rated 4½-digit DMM. It gives you all the performance and accuracy of the 172 plus superior autoranging current measurements from 10 nanoamps to 3 amps. This makes the 173 the most complete and versatile general purpose 4½-digit DMM in the world—at any price.

More versatility. Now or later.

Options and accessories expand the 172 or 173 to your specific needs: Rechargeable battery pack you can buy now or add later. Digital output/control. RF probe. 50-amp shunt. Clamp-

on ammeter. High-voltage probe. Rack mount kits. Test lead sets. Carrying case. IEEE 488 interface.

Make this easy decision.

For most 4½-digit DMM applications, the new Keithley 172 is your best buy. When you require more current measuring capability, the 173 is.

For convincing proof, send for detailed specs or request a demonstration. Or if you're already convinced, send your order to: Keithley Instruments, 28775 Aurora Road, Cleveland, Ohio 44139. (216) 248-0400. Europe: Heighhofstrasse 5, D-8000 München 70, West Germany. (089) 7144065.

DMMs for all your needs.

We know you have a variety of measurement requirements. So we offer a growing family of DMMs — 3½ to 6½ digits — to satisfy your application. And your budget.

3½ digits	4½ digits	5½ & 6½ digits
<p>Model 168 General purpose. Low cost.</p> <p>Model 160B 1 µV and 10 pA sensitivity.</p> <p>Model 616 Super-sensitive. 0.1 pA full-scale.</p>	<p>Models 172 and 173 Two "Best-Buys!"</p> <p>Model 171 1 µV sensitivity. 5-functions.</p> <p>Model 174 0.1 µV sensitivity. (coming soon)</p> <p>Model 180 30 nV sensitivity.</p>	<p>Model 190 Multi-function. Low cost.</p> <p>Model 590 0.001% accuracy. High stability.</p> <p>Model 6900 Accuracy, stability and sensitivity measured in ppm.</p>

New guide available: "How to get more from your DMM." Send for yours today.

KEITHLEY
The measurement engineers.

THE J387: WHEN PRODUCTIVITY COUNTS.

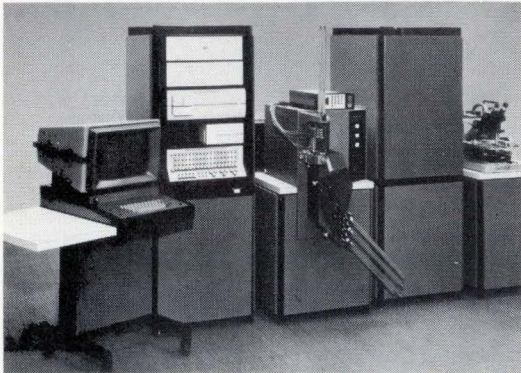

Here are seven ways in which the J387 Memory Test System helps increase productivity. Study them closely. When it's time to invest in memory testing equipment, you'll want to remember them all.

REPEATABLE RESULTS WITH HANDLERS or PROBERS.

Because the system was designed to drive devices at the end of cable, test results are consistently repeatable even when wafer probers or automatic handlers are connected to the system.

NO TEST STATION TWEAKING.

The system's software eliminates the need to modify the program every time you change test stations. Once set, the times stated in the test program are always valid.

PROGRAM YOUR OWN PATTERNS.

Teradyne's new programmable pattern generator allows you to produce whatever patterns will exercise your memories best in the least amount of time.

TWO STATIONS MEAN HIGH THROUGHPUT.

The basic J387 arrives with two test stations because experience has shown that two usually offer the lowest cost per device tested. Should you require more, they can be added.

TESTS RAMs, ROMs, EVEN 16Ks.

The J387 will test many different RAMs and ROMs, including 4k devices in 16-, 18-, and 22-pin packages. Even memories with up to 16 address inputs can be handled.

ALL THE DATA YOU NEED.

You're provided with cumulative Schmoop plots, lot summaries, distribution analyses, datalogged parametric values, and all the other data you need to increase yield and improve productivity.

TERADYNE PRODUCTIVITY TURNS UP EVERYWHERE.

You'll find it in hardware optimized for memory testing. And in Teradyne's unique 10-year circuit module warranty. It's why we maintain a seven-day, 24-hour troubleshooting service. And a global service program backed up by local parts stocking centers.

Whether you're a memory user or manufacturer, the J387 delivers what you need. Optimized memory testing that will boost your throughput and increase your productivity. For the full story on the J387 Memory Test System, write: Teradyne, 183 Essex Street, Boston, Massachusetts 02111. In Europe: Teradyne, Ltd., Clive House, Weybridge, Surrey, England.

WE SELL PRODUCTIVITY.

TERADYNE

CHICAGO (312) 298-8610/DALLAS (214) 231-5384/NEW ENGLAND (617) 458-1256/NEW YORK (201) 334-9770
SUNNYVALE (408) 732-8770/LONDON (0932) 51431/PARIS 073 16 98/ROME 59 47 62/MUNICH (089) 33 50 61/TOKYO (03) 406-4021

*For people with memory problems
cut this out and save.*

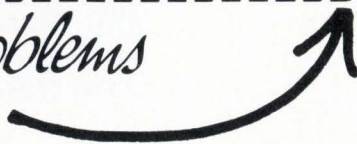

Is test equipment shakeout coming?

Some manufacturers say that smaller companies will fall by the wayside as customers look for gear that is compatible worldwide

by Andy Santoni, Instrumentation Editor

Many manufacturers of automatic test equipment forecast a shakeout of smaller companies or those with personnel or money problems next year. But, in the highly segmented and specialized industry, each manufacturer thinks that only the next guy will be affected, while seeing himself as prospering from next year's projected sales increases.

The industry is nothing if not fractionated—and fractious. It is not unusual for a company to stake out a narrowly defined slice of the market and proclaim itself the leader, an atmosphere making it difficult to gain a consensus. That's why one of the few items of agreement among manufacturers is that Fairchild Camera and Instrument Corp.'s Instrumentation Systems group is the industry sales leader.

More typical is the case of Teradyne Inc. of Boston, which had \$37 million in sales last year and \$37.9 million through the first three quarters of 1976. Jack Salvador, a former vice president and general manager of its Semiconductor Test division, says Teradyne has cut back substantially at its West Coast facility, with only some of the slack taken by shifting operations to Boston.

But Teradyne says it is "certainly not cutting back," and that "anybody who says we're cutting back is wrong." A Teradyne executive says several persons, including Salvador, left a while ago, but for personal reasons. The company, he says, is actually adding personnel.

At the same time, Salvador's present employer, Macrodata Corp. of Woodland Hills, Calif.—he's vice president of marketing and engineering—is having its share of problems.

A number of engineering and marketing managers left the firm a year ago. Earlier this year the firm's president and chairman, William Mow, became a staff scientist with Macrodata's parent firm, Cutler-Hammer Inc., Milwaukee, Wis., after disclosing accounting irregularities in Macrodata's reports. As a result, some industry observers say Macrodata is on shaky financial ground, but Salvador says the firm is through the worst of its problems.

Coming. He agrees, though, that a shakeout is under way with the "timing stretching over the next couple of years." Most likely to drop out, he says, are companies with sales less than several million dollars, because the largest customers want worldwide compatibility in their equipment. Therefore, service and support have to be provided in Europe and Asia.

One exception to Salvador's rule is Datatron Inc., a \$2 million producer in Irvine, Calif. Though small, Datatron is moving into European and Asian markets to push up its sales.

Generally, those looking toward a thinning-out process are with the larger companies, while those who don't expect to see a shakeout are heads of small firms. For example, Eric Mudama, marketing manager

at GenRad Inc.'s Test System division in Concord, Mass., says that only about five companies will maintain significant footholds in the board-testing sector in the next five years. In addition to GenRad, he says they are Membrain Ltd. in Britain; Hewlett-Packard Co., Palo Alto, Calif., which is just beginning to take a piece of the business; Teradyne, which has the resources for the long haul, and probably one other.

James Fischer, general manager of Tektronix Inc.'s Semiconductor Test Systems group, Beaverton, Ore., does not see a significant shakeout in the device-testing area until the next downturn in the semiconductor industry—"probably late 1978 or early 1979. The companies that you'll see going under are the ones that try to be all things to all people, trying to serve each device-type market with a specific tester."

Alyn Holt, manager of Siemens Corp.'s Measurement Systems division, Cherry Hill, N.J., agrees that designing a tester for a single device type is expensive and dangerous. For example, he says, to choose the right parameters and build a tester dedicated to microprocessors "will cost us about \$500,000, and if we're wrong, we're dead."

Earl Olsen, new product market-

WORLDWIDE SALES OF ATE SYSTEMS
(IN MILLIONS OF DOLLARS)

	1974	1975	1976	1977	1978	1979
Component	111	84	115	131	143	130
Subsystem*	71	79	103	134	159	175

*include pc board, module, and backplane testers

SOURCE: PRIME DATA

Probing the news

ing manager for programable instrumentation at E-H Research Laboratories Inc. in Oakland, Calif., says the company plans to stay in the ATE marketplace with its big general-purpose test systems. His competitors point to recent staff cutbacks and cash-flow problems and conclude that E-H may better apply its resources in other product lines.

Olsen does say that his firm is putting most of its sales and marketing effort into programable instrumentation and is selling modularized test system components to users who can customize a test system with or without company help. "Most users have their own group of test-system designers," he says. "In the long run it's easier and less expensive for both of us if we sell the modules and let the systems guys dedicate them to particular applications."

Wider gap. In the view of Robert Anderson, vice-president of ATE consultants Omnicomp Inc. of Phoenix, Ariz., the business will become concentrated more in some of the larger companies, and there will be a larger gap between the leaders and the smaller firms. He says recent personnel shifts "have been more the result of politics within the companies," such as disagreements over product plans, and not signs of severe problems. The suppliers that are likely to have problems surviving he says, are small companies that got started by filling a niche, but are now trying to compete across-the-

board with the better-capitalized industry leaders.

But there are dissents to the view that small is bad and that growth is almost as bad.

Robert Ward, president of Instrumentation Engineering Inc. of Franklin Lakes, N.J., foresees no shakeout in the industry. He feels the market can do nothing but grow, as long as printed-circuit boards keep getting more complex. "Users have got to have some test capability with diagnostics and trouble-shooting," he says "Manual probing with conventional instruments is too slow and costly, while the payback calculations for computer-controlled testing are very attractive." Ward is bullish about his firm's prospects, too, now that a major refinancing has been completed.

Alyn Holt of Siemens agrees with Ward. "I know there are some companies that have had difficulties, particularly in bench-top testers, and that some have been acquired by other companies. So if combinations are symptoms of a shakeout, yes we've had some of that. But other than that, they're all still out there in the marketplace competing."

In certain segments of his firm's business, such as semiconductor-memory test systems, Holt sees a change in the mix of firms he considers major competitors. But, he adds, "the others are still out there, as are some new ones." He notes that while some people are getting nervous about another recession, it isn't reflected in business levels. "We have increased backlog, we're ship-

ping well, and orders are coming in."

Computer Automation Inc.'s Industrial Products division in Irvine, Calif. has also made heavy investments in ATE, including a new plant, says Earl Jacobs, general manager. "Next year looks like a boomer, and we want to be ready for it." He sees no signs of a shakeout in his segment of the business, module and subsystems testing, which he estimates is growing at about 25% a year.

Also seeing itself in a good position is Fluke Trendar Corp. of Mountain View, Calif. President Barry Saper says of board testers costing \$5,000 to \$30,000, "We dominate this segment."

Looking good. And what of Fairchild, the acknowledged industry leader? "Our business is very profitable," says James D. Bowen, vice-president and general manager of Instrumentation Systems group. Two indications, he notes, are the opening this month of a 48,000-square-foot addition to the firm's 180,000-ft² plant in San Jose, and another 180,000-ft² plant in planning now.

Fairchild is estimated to hold about a quarter of the \$120 million worldwide market for semiconductor device testers, a position gained by "concentrating on the areas you're good at," says Bowen. The division once had a much broader, and less profitable product line, he says, and its present success may make a return to the printed-circuit and linear-integrated-circuit testing market possible. □

From the leader. This is the Integrator, a semiconductor test system from Fairchild, generally acknowledged as the industry leader.

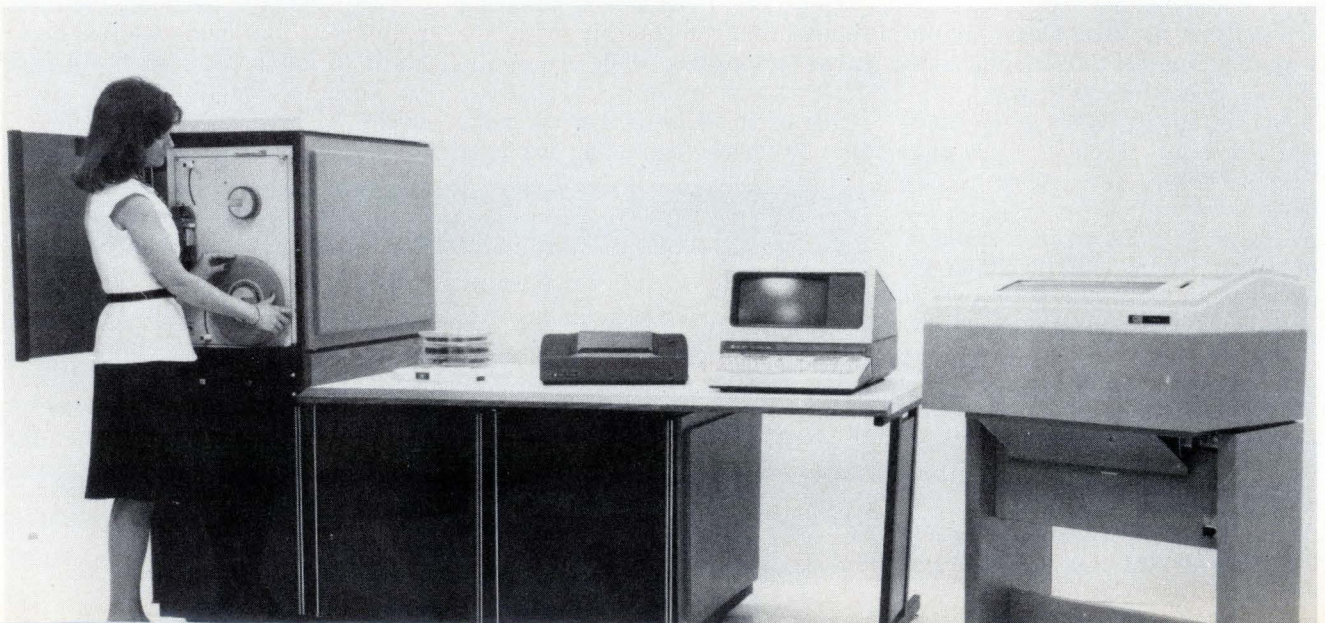

NEW

IN SEMICONDUCTOR PROTECTION!

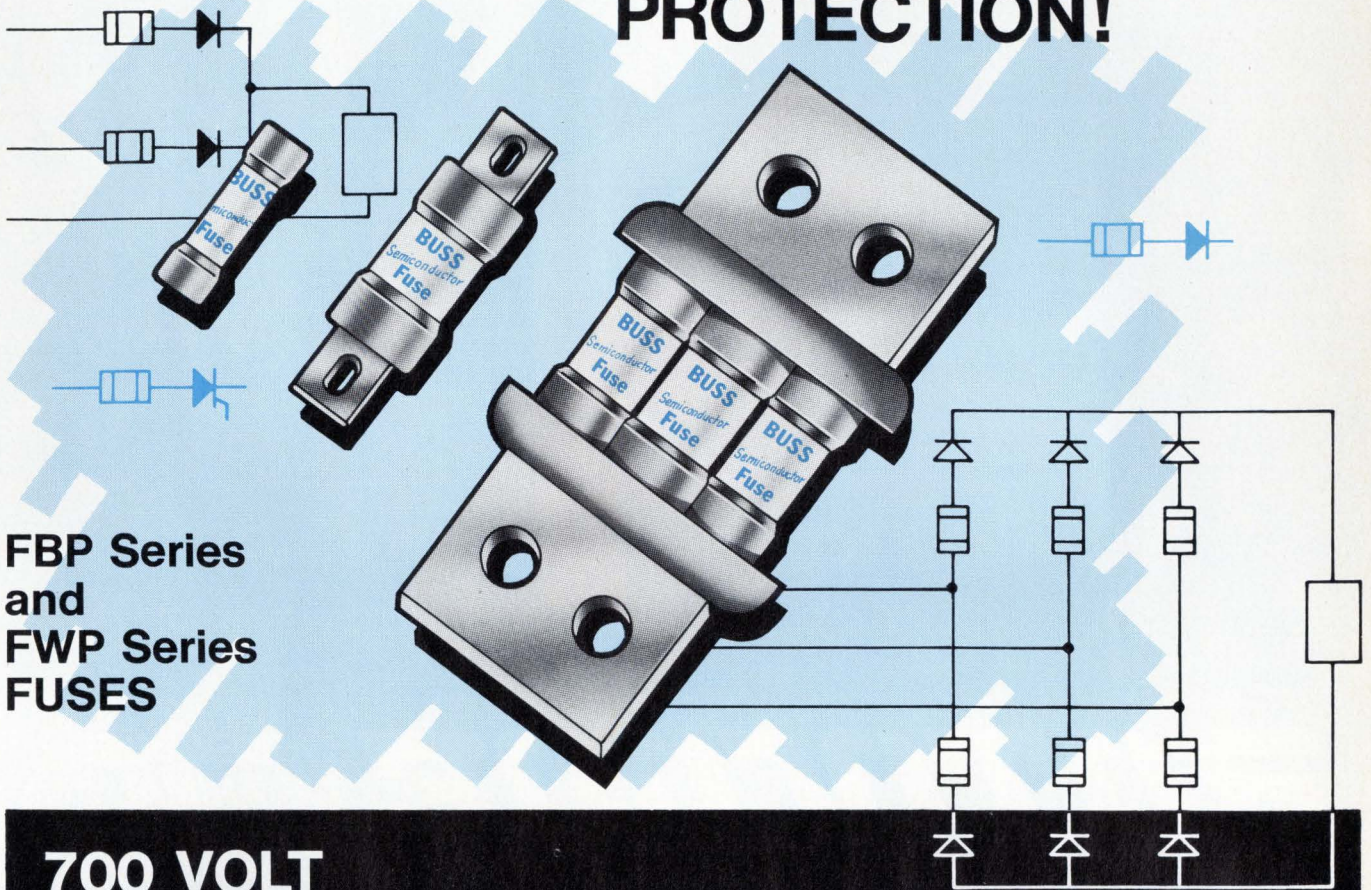

**FBP Series
and
FWP Series
FUSES**

700 VOLT BUSS[®] SEMICONDUCTOR FUSES EXTREMELY LOW I^2t and I_p LET-THRU VALUES

AMP RATINGS

15 to 1000

VOLTAGE RATINGS

700 V. a-c 700 V. d-c

BUSS Semiconductor Fuses provide a very high degree of current-limitation so necessary for the protection of Diodes, SCR's and other Semiconductors.

For detailed information and characteristic curves, write for **BUSS Bulletin SCFP.**

AVAILABLE IN TWO SIZES



FWP Series

dimensions made to fit mountings for 700 volt fuses that have been used in the past.



FBP Series

compact dimensions — shorter than FWP fuses — save equipment space.



BUSSMANN MANUFACTURING
a McGraw-Edison Company Division
St. Louis, Missouri 63107



What would you get if you crossed
a rotary switch with a coded thumbwheel switch?

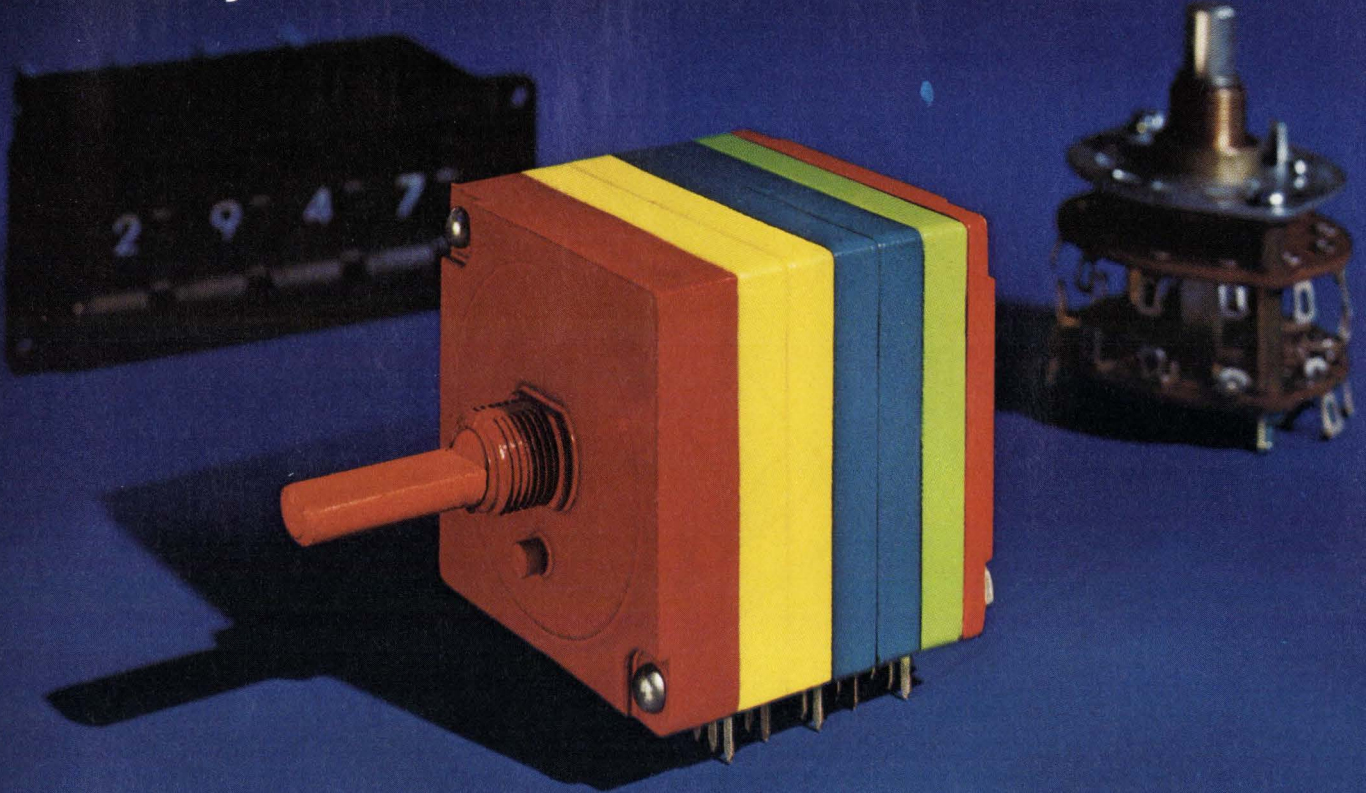

ROTOCODE® A NEW KIND OF ANIMAL ALTOGETHER!

The shaft actuation of a **rotary switch** . . . with the coded electrical output of a **thumbwheel switch**. We call it Rotocode. You'll call it revolutionary! Ideal as a channel selector in CB, aircraft or marine radios and TV's. **Perfect** for item and price changing in vending machines. **Great** for quantity control in photocopy machines. **Versatile** enough to be modified and expanded to precisely the number of positions required . . . whether 1 or 23 or 40 or **more**. **Modular** design permits assembly of as many decks as needed for specific function. **Superb** for programming virtually any electronic instrumentation or equipment in place of conventional thumbwheel switches or multi-deck rotary switches.

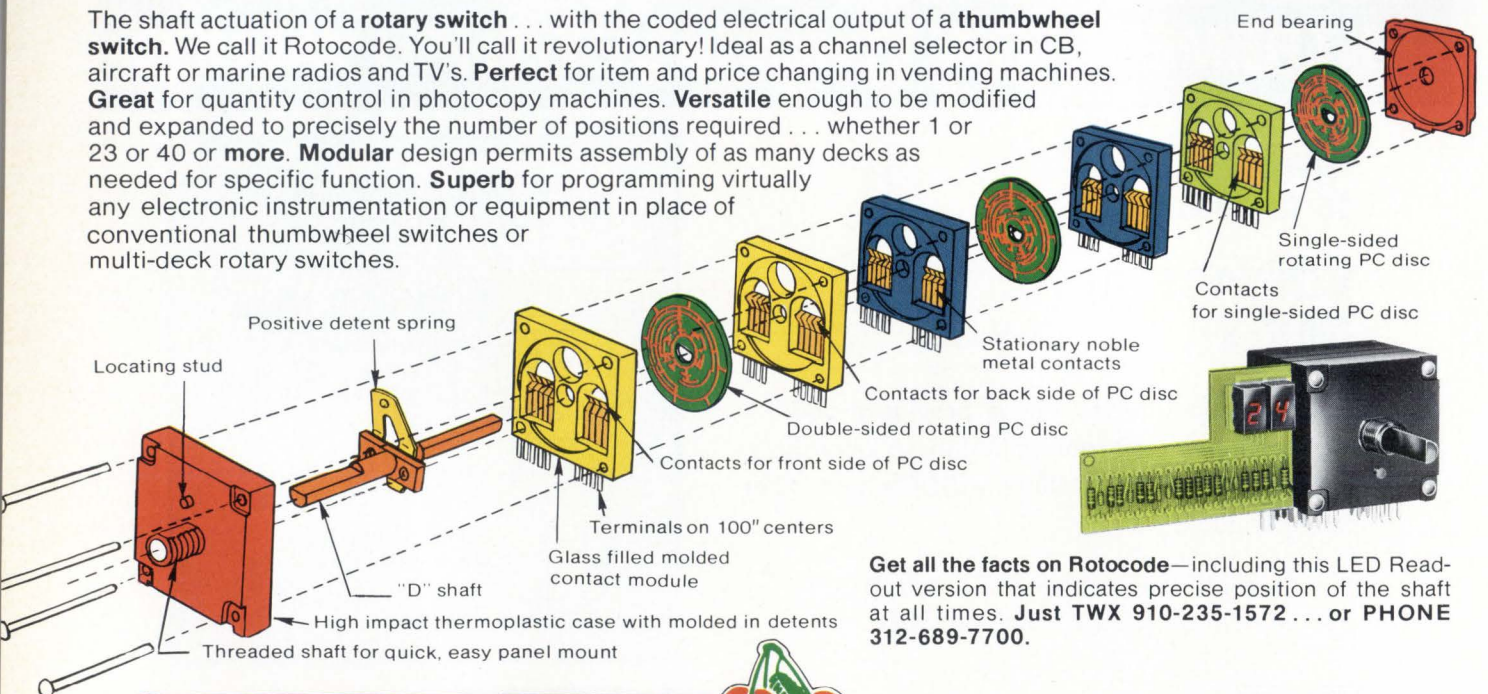

Get all the facts on Rotocode—including this LED Read-out version that indicates precise position of the shaft at all times. Just TWX 910-235-1572 . . . or PHONE 312-689-7700.



CHERRY ELECTRICAL PRODUCTS CORP.
3608 Sunset Avenue, Waukegan, Illinois 60085

SWITCHES and KEYBOARDS — Available locally from authorized distributors.

Circle 68 on reader service card

Electronics abroad

West German economy stays healthy

With inflation at only 5%, equipment markets chalk up 9.3% rise in 1976 for electronics industries with 1977 expected to be a bit slower

by John Gosch, Frankfurt bureau manager

The economy in Western Europe with the most going for it right now is West Germany's. The inflation rate is running below 5% at a time when most other European countries are trying to cope with double-digit rates. And the modest climb in the inflation has not come from throttling business. This year's gross national product will top \$450 billion, about 6% higher, in real terms, than the country logged in 1975, admittedly a very poor year. Next year's numbers should be much the same, although the GNP growth-rate figures do edge downward to around 5%. Overall, then, the outlook for 1977 is not bad; neither does it look exceptionally good.

Much the same holds for the electronics industries. Equipment markets this year moved up a solid 9.3% to \$7.82 billion—a rise not as good as it might seem at first glance because 1975 was so poor. Somewhat slower growth is in store for German electronics markets next year, most market watchers feel. Warns Werner Matschke, director of marketing policy for Siemens AG, "Consumer demand is slackening, communications isn't going, and, in the industrial sector, investments are off." So it's no surprise that *Electronics'* estimate points to equipment markets totaling \$8.60 billion in 1977—a gain that doesn't quite match this year's. [The exchange rate is calculated at \$1 equals 2.4 Deutsche marks.]

As always, the outlook differs for individual sectors. Manufacturers of entertainment electronics, for example, will be hard put in 1977 to repeat this year's outstanding advance, but they'll still outpace most

WEST GERMAN ELECTRONICS MARKETS FORECAST (IN MILLIONS OF DOLLARS)			
	1975	1976	1977
Total assembled equipment	7,148	7,814	8,604
Consumer electronics	2,306	2,482	2,655
Communications equipment	1,100	1,118	1,172
Computers and related hardware	2,635	3,016	3,451
Industrial electronics	471	500	548
Medical electronics	392	430	487
Test and measurement equipment	160	178	192
Power supplies	85	90	99
Total components	1,839	2,097	2,371
Passives	900	1,000	1,111
Semiconductors	487	577	687
Tubes	452	520	573

(Exchange rate: \$1 = 2.4 Deutsche marks)

Note: Estimates in this chart are consensus estimates of consumption of electronic equipment obtained from a survey made by *Electronics* magazine in September and October 1976. Domestic hardware is valued at factory sales prices and imports at landed costs.

other sectors. Computer makers, too, are entering 1977 with much confidence. The orders they had expected this summer have now started actually coming in, and the catch-up is expected to gain momentum during the months ahead. As for telecommunications-equipment makers, they will continue singing the blues next year as the Post Office keeps its purse strings tight. And industrial-equipment producers face at least a slow first half.

Components. All told, equipment makers should keep busy enough to ensure another not-bad year for components manufacturers. "We are now figuring on a 1976 market growth of nearly 15%," comments Gert Lorenz, head of the Hamburg-based Philips subsidiary Valvo GmbH. One factor in this expansion, Lorenz notes, was a 30% jump in

color-television production this year. Another was that customers built up their inventories instead of depleting them. But, even so, the 1976 recovery wasn't strong enough to push components production in West Germany back to the 1974 level, points out Alfred Prommer, vice president in charge of sales at the components division of Siemens.

Wide range. For the year ahead, there's a fairly wide spread in marketing men's assessments. Some, like Valvo's Lorenz, expect components production to expand 5% at the upper end of the scale, while Siemens' Prommer is projecting a bubbly 13%. *Electronics* spots the 1977 market at \$2.371 billion, 13% above the \$2.097 billion logged this year.

Scoring above-average gains, as usual, will be semiconductors, and,

a little A-300 goes a long way.

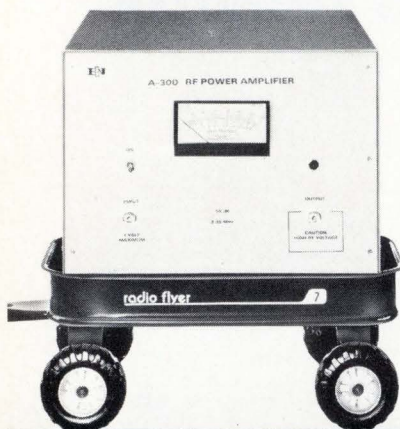

In high frequency transmission. RF power generation for industrial and research processes. RFI/EMI and general laboratory applications, too.

The Model A-300 is a totally solid state power amplifier, covering the frequency range of 0.3 to 35MHz with a gain of 55dB. Capable of delivering 300 watts of linear Class A power and up to 500 watts in the CW and pulse mode, the A-300 is the ultimate in reliability.

Although the unit is perfectly matched to a 50 ohm load, it will deliver its full output power to any load (from an open to a short circuit) without oscillation or damage.

Complete with power supply, RF output meter and rack mount, the A-300 weighs a mere 89 pounds and operates from ordinary single phase power.

For further information or a demonstration, contact ENI, 3000 Winton Road South, Rochester, New York 14623. Call 716-473-6900 or TELEX 97-8283 E N I R O C

ENI

The World's Leader
in Power Amplifiers

Probing the news

for them, market forecasts also vary widely—from a low of 10% to an overly optimistic 35%. The survey indicates a 1977 market of \$687 million, up from \$577 million.

As for components generally, semiconductors also find their biggest buyers among consumer-equipment makers. Gerhard Liebscher, director of marketing services at Intermetall GmbH, the German member of the ITT semiconductor group, predicts that about 54% of next year's consumption will go into consumer products such as radio and TV sets, automobiles, and kitchen appliances, compared with 50% last year. Benefiting particularly from TV-set sales are MOS devices, notes Helmuth Schutt, a market researcher at Siemens.

Semiconductors. Among semiconductors, the biggest gainers next year will be, as expected, integrated circuits. Intermetall's Liebscher forecasts that IC sales will jump 36%, while power devices will go up by 12% and discretes by 8%. From now through 1981, he adds, ICs will enjoy an average market growth of 20% yearly. By themselves, MOS devices will do much better—an annual growth of 33%, Liebscher says.

Good, too, are the prospects for optoelectronic devices. Fritz-Georg Hohne, manager of worldwide marketing at AEG-Telefunken's semiconductor division, says optoelectronic sales should accelerate by more than 30% next year. Even better gains are in the offing for microprocessors. Dirk G. Vogler, manager of marketing administration at Texas Instruments GmbH, reports that domestic sales of microprocessors, including central processors, memories, and input/output chips, were three times higher this year than last. In 1977, sales will be twice the level of this year, Vogler forecasts.

Apart from slim profit margins, entertainment-electronics producers have little to complain about. Demand for big-ticket items like color-TV and hi-fi sets is strong, so despite the prospect of a slight slowing next year, the industry doesn't seem to be overly worried. At \$2.48 billion this year, the market moved up a bit less

than 8% over the 1975 figure. For next year, most marketing experts expect the growth rate to decline somewhat. They project the 1977 market at \$2.66 billion, a 7% gain.

Color sets. A lift for color-set sales could come from video games. Several German firms have already incorporated games in their latest models. It's likely that most, if not all, of West Germany's dozen TV makers will offer sets with games by the summer of 1977. Wieland A. Liebler, who runs the market-research arm for SABA Werke GmbH, thinks that some 20,000 sets featuring games will be sold by the end of this year. In 1977, he predicts, between 100,000 and 150,000 sets with games will find their way into German homes.

For larger computer systems, Jochen Rossner, a marketing specialist at Sperry Univac, foresees a rise next year of about 10%, an improvement over this year's performance. Optimism about 1977 is also the word from Nixdorf Computer AG, a market leader in equipment ranging from terminals to magnetic-disk systems. Next year, the Westfalian firm expects its sales to grow by 10% to 15%, about the same as this year.

For communications-equipment makers, it's going to be another bleak year as the federal Post Office continues to keep the reins on spending. And when that agency is tight-fisted, the industry really feels the effects because the Bundespost, as it is called, accounts for nearly two thirds of communications business.

Last year, the agency's outlays for cable and equipment came to something like \$1.9 billion, which was already down from the 1974 level. This year, the figures are down again; so much, in fact, that the real-term value of post-office-related equipment production will be about 2.5% lower than last year's value, says one industry observer.

As in 1976, real-term production of Post Office equipment should decline in 1977, and perhaps business from private and foreign customers will increase. *Electronics* puts the communications equipment market at \$1.12 billion in 1976 and forecasts a very slight edging up to \$1.172 billion in 1977. □

Second in a series examining European markets.

Looking at price? Then look to the future... With glass TAX capacitors from ITT Components Group



Today is the time to replace the Sprague 150D or the Kemet T110 you're using now with a compatible solid tantalum axial leaded capacitor available at a competitive price. Look into glass encapsulated, hermetically sealed TAX capacitors from ITT Components Group.

Glass . . . it's the look of the future. Your better buy because glass tantalums can be produced by super automation processes and require no insulating sleeves. The simple manufacturing process will make glass — as time goes by — the increasingly economical alternative to metal-canned, axial leaded tantalum capacitors. And with future assurance of good delivery levels.

The TAX series is packaged to run

right off its reel and into your operation. Automatically. And if you are using Kemet's T310 you will want to compare the reliability of epoxy against our **better priced better option — glass**. Each unit is 100% tested for hermeticity and to all data sheet parameters because sample testing just isn't good enough for ITT Components.

Look to the future today by checking out glass tantalum capacitors. For technical specifications and free samples of the TAX, write to George Kase at ITT Components Group, 1551 Osgood St., No. Andover, MA 01845. Or call him at (617) 688-1881. Tell him you want to look into our better alternative!

Ratings

Capacitance:0.1 to 47 μ F
Tolerance Range:	$\pm 20\% \pm 10\%$
Voltage:6.0 to 35 volts DC (50 volts on request)
Temperature Range:	-80° C to +125° C.

We're listed in sections 1500 and 4500 in your 1976-7 EEM catalog.

Components **ITT**

When you need capacitors, our better alternative will be your first choice.

**the
Fastest
Biggest
Bipolar
Multipliers
you can buy**

Dual in-line packages Off-the-shelf delivery

130 ns

40-Pin Ceramic DIP

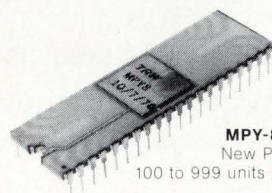

MPY-8AJ
New Price
100 to 999 units \$70

8 by 8 Bits – Ideal for on-line multiply in micro and mini computers – operates directly on most data bus lines – consumes only 1.8 watts (typical)
Price \$100 each in 1-9 quantities.

150 ns

64-Pin Ceramic DIP with Heat Sink

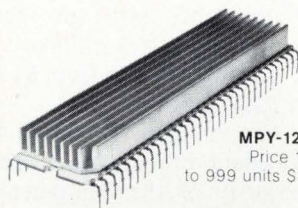

MPY-12AJ
Price 100
to 999 units \$117

12 by 12 Bits – New size multiplier for data communications and Signal Processing – needs only 3-1/2 watts for room temperature operation – single TTL Clock – fully TTL compatible – Price \$168 each in 1-9 quantities.

160 ns

64-Pin Ceramic DIP with Heat Sink

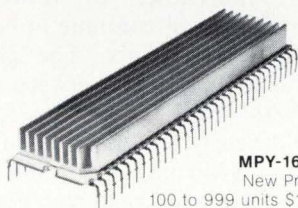

MPY-16AJ
New Price
100 to 999 units \$175

16 by 16 Bits – Smaller chip improves performance – New 64-Pin DIP easier to use – easily dissipates 5 watts with built-in heat sink – perfect for micro/mini applications – signal processing – new price \$300 each in 1-9 quantities.

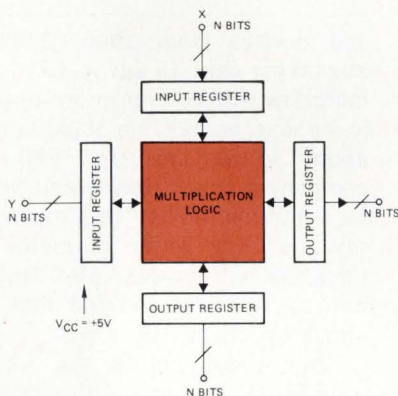

Operating Sequence Mini/Micro Computer Data Bus Operation

- Load Input Registers
- Wait Multiply Time
- Load Output Registers
- Read-Out

Features

- Two's Complement Multipliers
- Double Precision Products
- Single Chip Bipolar Design
- Asynchronous Multiply
- Single or Multi Bus Operation
- TTL Compatible Input/Output
- Single +5V Power Supplies
- Microprocessor Bus Compatible

Delivery is 30 days or less. For detailed data, applications information and prices, call (213) 535-1833 or order samples direct with coupon. **TRW Electronic Systems Division**, One Space Park, E2/9043, Redondo Beach, Calif. 90278.

Order Samples or Literature Today

- Send Data Sheets
 Enclosed is check or purchase order for _____ (qty) _____ (type)

Name _____

Title _____

Company _____

Div/Dept. _____

Mailing Code _____

Street _____

City _____

State _____ Zip _____

- Please call with price and delivery information.

Area Code _____ Phone _____

More LSI Products from a Company Called

TRW

Circle 73 on reader service card

Manufacturing

Rolling bigger dice

Survey for semiconductor equipment makers predicts annual sales rise of 32.9% for next five years, as devices grow in size and complexity

by Bernard Cole, San Francisco bureau manager

Despite near-term concerns about a sluggish economy and dependence on an irrepressibly cyclical semiconductor industry, makers of fabrication equipment are preparing for five years or more of spectacular growth. Their optimism stems from a report prepared for the Semiconductor Equipment and Materials Institute Inc. by Gnostic Concepts Inc.

Worldwide consumption of semiconductor fabrication equipment will increase from an estimated \$514 million in 1976 to \$922 million in 1980 and well over \$1 billion by 1982, the report concludes. "What this represents is an average annual growth of 32.9%," says Frederick Van Veen, chairman of the SEMI information-services committee and assistant to the president at Tera-dyne Inc. in Boston, one of the 400 member companies contributing to the report. "What it means, however, is that there is an opportunity for tremendous growth out there for the company with the right mix."

While the market share of the six major categories in the semiconductor equipment business will not change significantly—6% to 7% for wafer making, 8% to 9% for mask generation, 22% to 23% for wafer processing, 17% to 18% for wafer masking, 14% to 15% for assembly, and 28% to 29% for testing—total dollar volume will.

- Wafer-making sales will jump from an estimated \$37.5 million in 1976 to \$56.3 million in 1980.
- Mask generation will go from \$44.2 million to \$86.7 million.
- Wafer processing will rise from \$117.6 million to \$214.9 million.
- Wafer masking will jump from \$91.9 million to \$165.1 million.

- Assembly will go from \$72.4 million to \$138.3 million.
- Testing will rise from \$153 million to \$261 million.

According to Robert Simko, vice president of Gnostic Concepts, the majority of the equipment used in the fabrication of semiconductor products will continue to be used by digital-IC makers. The percentage will grow slightly between 1976 and 1980—from 73.9% to 75.3%—but will nearly double in actual value—from \$380 million to \$695 million. Discrete semiconductor devices will still consume only a relatively small portion of the total equipment value, \$91 million or 17.6% in 1976 and \$126 million or 13.7% in 1980.

Two growth sources. According to Paul Reagan, IC group vice president at GCA Corp., Bedford, Mass., the dramatic increases in dollar volume come from two sources. "One is the normal increase in demand due to the expansion of the electronics sector into new areas," he says. "And as the semiconductor industry grows, so does the fabrication-equipment business."

"But more important is the second source, the major efforts by semiconductor makers to fabricate circuits and devices more economically, with generally enhanced performance, mostly in digital ICs." To do this, he says, generally means reducing structural line widths and IC-component dimensions and to increase the functional density per chip, resulting in slowly increasing chip dimensions.

Reagan points out that chip size for typical production circuits will increase from an average of 125 mils on a side in 1976 to 185 mils in 1980,

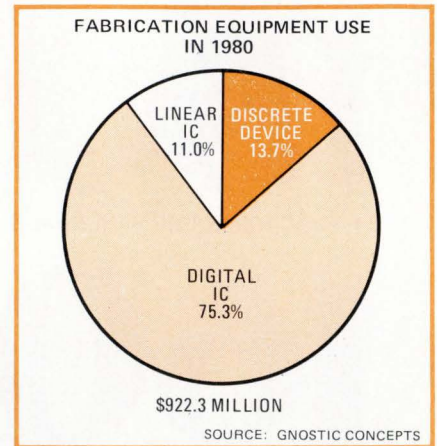

Growth. Sales of semiconductor-fabricating gear will grow to \$922 million in 1980 as market shares hold steady.

and devices from about 2,000 to 20,000 per chip. In advanced ICs, the increases will be even more dramatic, he says, going from 30,000 mil² to about 45,000 mil² in 1980, and component count from about 50,000 to 1 million. What this means, he says, is that wafer diameter and thickness will increase also, from 71 mm to 102 mm and 0.8 mm to 1 mm, respectively, by 1980.

"But these anticipated circuit-complexity advances will have to be accompanied by decreases in individual circuit-component dimensions in order to be feasible at all," says Larry Hansen, president of Varian Associates' Industrial Equipment group in Palo Alto, Calif. "And current photolithographic techniques now being used in MOS and bipolar devices are simply running out of gas. To remain competitive in the 1980s, semiconductor manufacturers are going to have to make some huge capital equipment expenditures." Key targets of opportunity for semi-

conductor-equipment makers, he says, will be in such areas as ion implantation, electron-beam mask generation, and direct writing on wafers.

Reagan of GCA agrees, but adds two other areas: X-ray exposure and "some sort of advanced step-and-repeat system directly on the wafers." The trend toward larger wafers, he says, will necessitate the development of low-temperature dielectric and plasma deposition systems. "The higher the temperature, the more problems you have—such as wafer buckling, or 'potato-chipping,' especially as wafer diameters increase," he says.

And as wafers get thicker, improved methods of wafer cutting and scribing will be required. Because of their substantial capital outlays over the next 5 to 10 years, semiconductor manufacturers will seek to reduce costs in one area they have control over: labor content, either reducing it or making it more efficient, Reagan says. "This means automation,"

According to P. Michael Uthe, president of Uthe Technology International, Sunnyvale, Calif., and a member of the SEMI board of directors, moving wafers from step to step in the fabrication process will also be automated. It will be done "not just to reduce labor content," he says, "but more because of the ultra-clean environments needed by LSI and VLSI devices to ensure reliability."

All these demands for new fabrication equipment, says Varian's Hansen, are going to change the complexion of the industry with fewer and larger companies taking larger shares of the market. Reagan of GCA agrees. "For the semiconductor industry to go from 50,000 to 1 million devices per chip—even from 16 kilobits to 64 kilobits in RAMS—is going to demand a new generation of fabrication equipment," he says. "And to meet that the industry equipment is making, and will continue to make, huge investments in research and development." To maintain visibility, equipment makers will have to sell more per year, "and that means that smaller companies will either get out of the market, merge, or seek acquisition by larger ones." □

Ben would have liked you.

Ben thought that there had to be more to lightning than just fire in the sky. So he ignored what people told him and did a little rainy-day research on his own.

Determined curiosity—like Ben's—has guided your imaginative progress in the microelectronics field. At Kodak, we have combined extensive research with a deep understanding of your industry, so that our skilled representatives can help improve your product or production techniques.

We try to make your job

a little easier, a little more efficient.

For more information about our products for microelectronics, write Eastman Kodak Company, Dept. 412L (48-F), Rochester, N. Y. 14650.

RESULTS COUNT

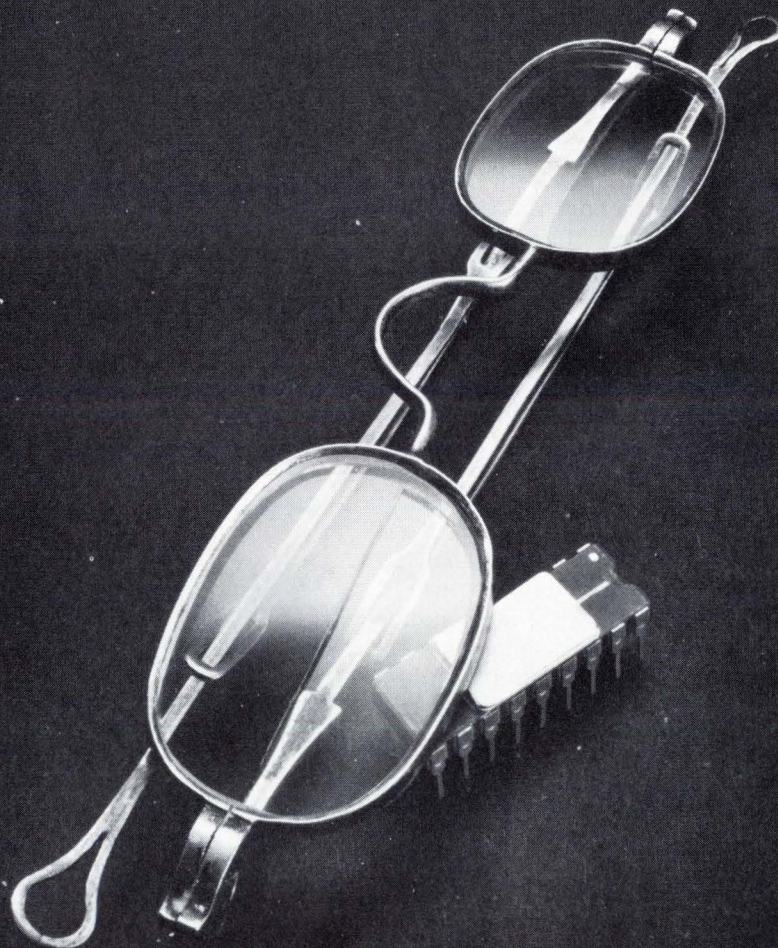

Consumer

Matsushita's TV turns on worldwide

1975 was a low point for Japan's television export giant, but the company has turned things around toward a record-setting year

by Gerald M. Walker, Consumer Electronics Editor

The U.S. knows it as Panasonic; most of the rest of the world calls it National. But back home in Japan it is Matsushita Electronic Television Export department, with headquarters in Osaka.

Its 23 television plants around the world and six others in Japan, all wholly or partly devoted to production of sets using six monochrome TV systems and three color systems, give Matsushita one of the farthest-flung and most varied empires in the business. The company sells black-and-white sets in 123 countries with six transmission standards and color sets in 33 countries using the NTSC (American), PAL (European), or Secam (French) standard.

The bulk of production takes place in Japan at the Moriguchi factory for color sets and the Fujisawa factory for black-and-white. The Moriguchi facility turns out approximately 50,000 units a month in all three color broadcast systems.

According to the company, world sales of television by all manufacturers in 1976 should be about 40.5 million units, 21.5 million color and 19 million black-and-white. Next year Matsushita predicts industry sales of 41.3 million units worldwide, 23.3 million color sets and 18 million monochrome. Matsushita puts its share in this non-Communist world market at about 21%—a figure that could make it the world's largest TV producer.

Achieving such a position requires not only a large sales organization, but design and production groups capable of mastering multiple requirements. Frank Ohgai, general manager of the television export department, points out: "With six

black-and-white systems and three color-TV systems around the world, there are 18 combinations possible. Power sources are different—120 volts to 240 v, 50 cycles and 60 cycles—country to country and area to area. Some areas have vhf only, others uhf only, others use both. The variety required is almost impossible to count."

Attempting mass production at a single plant of all the three different color-TV systems is the most demanding task. But the company has risen to the challenge with a "universal" design approach. First came a universal power system, which enables any set to plug into any of the world's power sources.

More recently, Matsushita has developed switchable PAL/Secam sets, which can be sold in any European country without changing the receiver circuits. A PAL/NTSC set is also planned. The ultimate, says Ohgai, will be an NTSC/PAL/Secam-switchable receiver.

At present, PAL/Secam color chas-

sis have five basic modules, two interchangeable to switch the set for either system. A subsystem switches the deflection to 90° or 110° for either a delta or in-line gun. In short, the chassis can meet any combination of requirements.

Combining the American NTSC system with PAL or Secam will be more of a problem, but Ohgai is convinced that a universal color set will be practical by next year.

While flying high this year, Matsushita's TV business was anything but high-flying in 1975. Sales to the U.S., for example, were virtually nil as a result of a massive recall program caused by excess radiation. The domestic market, meanwhile, was stagnant because of the recession triggered by the oil crisis.

But Matsushita took the production lull as an opportunity to push ahead with a four-year-long automation program. Today about 85% of color-TV production is automated, and that may be as far as the company wants to go. □

Juggling systems. Frank Ohgai, general manager of Matsushita's TV export department, oversees an operation that turns out six black-and-white and three color systems.

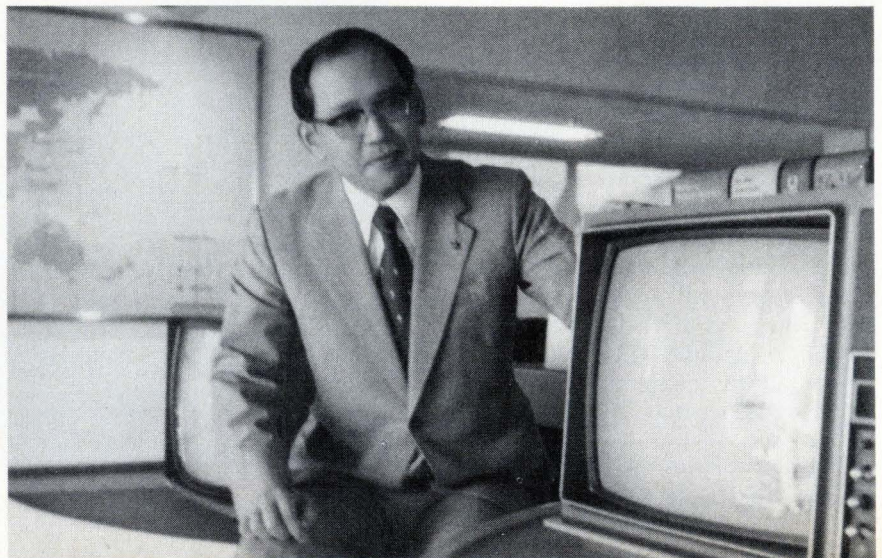

We'll flip you
over your ceramic capacitor specs...
heads you win
tails you win

Heads are our standard line of MONO-KAPS™. Radial-leaded, epoxy-coated monolithic ceramic capacitors with noble-metal electrodes whose proven formulation has not been modified or compromised. They meet MIL requirements, and are available off-the-shelf in a broad range of capacitances and voltage ratings to meet your specific needs.

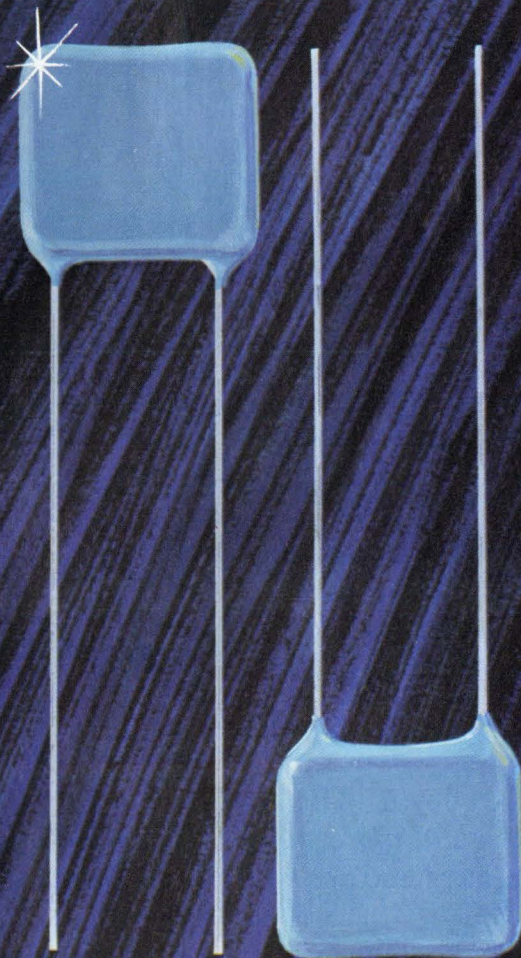

Tails are our BME-Radials™. They protect you from the noble metal cost spiral, and save you money right up front. They are the product of our unique BME capacitor technology which eliminates noble metal entirely from electrodes and terminations. But they'll meet most of the same circuit requirements with no sacrifice.

So you see, it's up to you — MONO-KAPS or BME-Radials. Both are immediately available in quantity from the only people who give you the choice. Either will do the job without compromise. Call or write for all the details today.



CENTRALAB/USCC 4561 Colorado Blvd. • Los Angeles, CA 90039 • (213) 240-4880

Electronics • GLOBE-UNION INC.

The Answer Book. It makes your job easier. \$25.

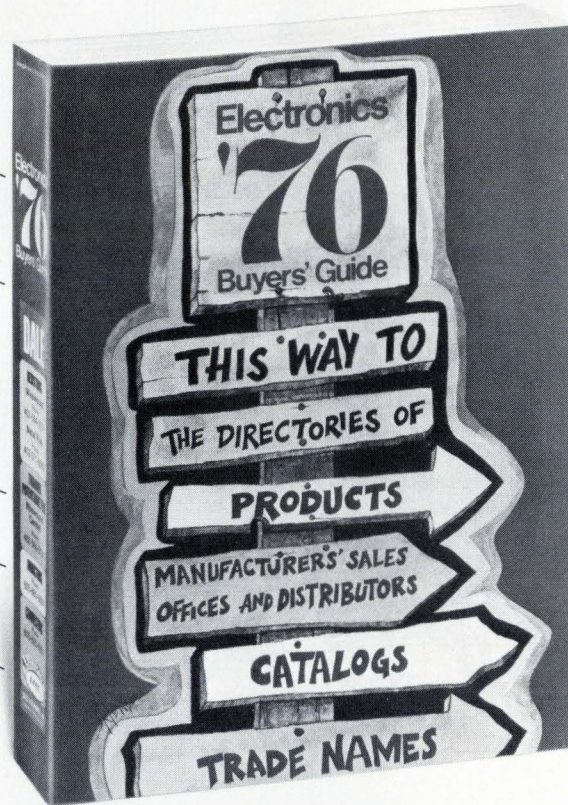

“WHO MAKES WHAT?”

“WHAT COMPANIES MAKE THE PRODUCTS I NEED?”

(See alphabetical directory of 4000 products)

“WHERE ARE THEIR NEAREST SALES OFFICES?”

“WHO ARE THEIR DISTRIBUTORS?”

“WHAT ARE THEIR LOCAL PHONE NUMBERS?”

(See alphabetical directory of 6000 manufacturers)

“HOW CAN I GET THEIR CURRENT CATALOGS FAST?”

(See directory of catalogs by product and by company, including catalog inquiry card for 5-second ordering, page 901)

“WHO MANUFACTURES THIS TRADE NAME?”

(See directory of trade names, page 1276)

Special no-risk offer. If The Answer Book is not everything we say it is and more, return the book to us within ten days and we will refund your \$25.

Electronics Buyers' Guide (EBG) is as easy to use as your telephone directory. The whole international world of electronics is at your fingertips. Great emphasis is put on *localizing* the information you need. You won't have to call half-way across the country to company headquarters because we list local sales offices and distributors.

To order from our Directory of Catalogs, simply circle the corresponding number on the Inquiry (“bingo”) Card and mail. This way you get *current* catalogs. Also, semi-annually we mail out an updated list of current catalogs plus a “bingo card.” The Answer Book's objective: Make your job easier.

Electronics Buyers' Guide

1221 Avenue of the Americas
New York, N.Y. 10020

Yes, send me a copy of The Answer Book.

I've enclosed \$25 (USA and Canada only, elsewhere send \$35). Full money back guarantee if returned within 10 days.

Name _____

Company _____

Street _____

City _____

State _____

Zip _____



The Electronics Book Series offers you:

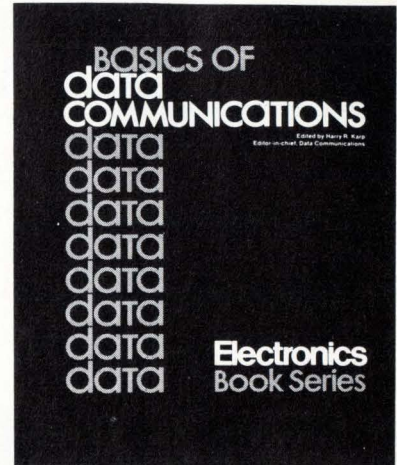
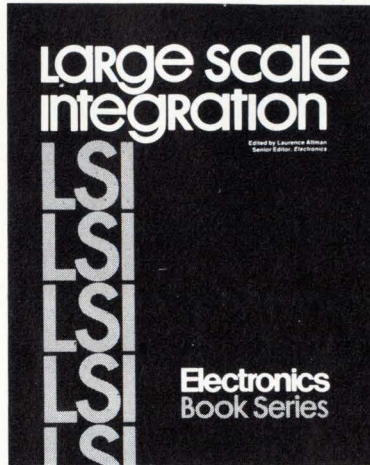
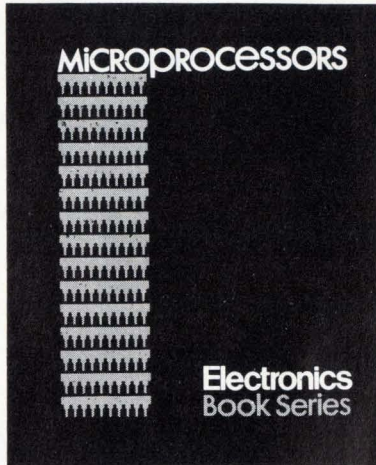

1 MICROPROCESSORS

The microprocessor has permanently changed the methods of designing and building electronic equipment—from process and industrial control to computer-based designs in instruments communication and consumer/commercial equipment.

This book cuts through the confusion, presenting the design and application potential of this exciting technology in a manner that will appeal to the design engineer who needs to know how to use microprocessors as well as the system analyst who must assess the tradeoffs between microprocessors and other techniques to accomplish his system goals.

Using articles from the pages of Electronics, this book contains practical and up-to-date information on available microprocessor devices, technology and applications.

2 LARGE SCALE INTEGRATION

The Electronics Book Series offers you a handbook on the current and revolutionary impact of LSI on digital design. This 220-page book presents a unique opportunity for circuit designers, systems designers, and engineering managers and supervisors to bring their expertise into line with today's LSI design requirements.

"Large Scale Integration" is a compendium of recent articles published in Electronics. Although in some ways it is a companion piece to "Microprocessors" because it explains the new circuits that play in mp systems, it is much more. "Large Scale Integration" deals with the entire range of design applications: main memory systems, peripheral memories, memory controllers, on-line industrial controllers, data acquisition boards, communication systems, calculators, watches, etc.

3 BASICS OF DATA COMMUNICATIONS

Data communications is one of the fastest-growing electronic equipment markets in the U.S.—during the decade of the '70's, better than 15-20% per year, compounded!

Chances are you are going to be a part of the data communications market. There's no better place to start than getting a copy of "Basics of Data Communications"—a 316-page compilation of essential articles which have appeared in Data Communications magazine. From the basic, tutorial, still state-of-the-art information published in the 1972 and 1973 Deskbook issues (now out of print), on through information on the practice of present-day data communications, this book includes forty-seven articles covering more than eleven key areas.

Electronics Book Series • PO Box 669, Hightstown, N.J. 08520



- 1 Send me _____ copies of "Microprocessors" at \$8.95 per copy.
- 2 Send me _____ copies of "LSI" at \$9.95 per copy.
- 3 Send me _____ copies of "Basics of Data Communications" at \$12.50 per copy.

Discounts of 40% on orders of ten or more copies of each book.

I must be fully satisfied or you will refund full payment if the books are returned after ten day trial examination.

Payment enclosed Bill firm Bill me

Credit Cards Charge My Book To

American Express Master Charge
 Diners Club BankAmericard

Name _____
 Title _____
 Company _____
 Street _____
 City _____
 State _____ Zip _____
 Signature _____

Acct. No. _____
 Date Card Expires _____
 Interbank No. _____

(1st No.'s. above name on Mastercharge only.)

WATCH THIS SPACE FOR DETAILS

WAVETEK MODEL 172
PROGRAMMABLE SIGNAL SOURCE

UNIT RCL AMPL SPEC LOAD



This is the face of our new Model 172 programmable signal source.

It gives you 7 function generator waveforms over a frequency range of 0.0001 Hz to 13 MHz. It's GPIB compatible, has a microprocessor-controlled interface, plus a 5½ -digit synthesizer option.

We'll give you more details in the next installment. Meanwhile, circle the inquiry card or contact us direct. Wavetek, P.O. Box 651, San Diego, CA 92112. Phone (714) 279-2200. Or TWX 910-335-2007.

WAVETEK®

Interfacing data converters and microprocessors

In intelligent data-acquisition systems, microprocessors must stay as busy as possible

by David Fullagar, Peter Bradshaw, Lee Evans, and Bill O'Neill, *Intersil Inc., Cupertino, Calif.*

□ By latching onto the power and versatility of microprocessors, data-acquisition systems are vaulting into more extensive and demanding new applications. But the success of these "intelligent" data systems depends on the ability of the designer to mate the microprocessor to the other key system component, the analog-to-digital converter.

For a long time, converters have evolved independently of microprocessors, and there is often a communications gap between the two when they must work together as a team. Although this interface problem is usually not difficult to solve, many subtle details can make the difference between an efficient system and a wasteful one.

Oddly enough, the interface itself is not affected by the type of converter chosen—this decision depends largely on the particular application (see "Selecting the right converter," p. 84). Instead, the interface is primarily influenced by whether the digital data is transmitted in serial or parallel format and by the assistance options provided by the converter and the microprocessor being used.

Choosing between serial and parallel data

Clearly, the question of data format must be resolved before any progress can be made on the interface hardware at either the converter or microprocessor end. This choice is usually straightforward, and it depends principally on the distance separating the converter and the microprocessor.

Basically, the two methods of interfacing may be characterized as close-in parallel and remote serial. If



high sampling rates are required, the converter should be located near the microprocessor, and the interface between the two should certainly be parallel. On the other hand, when data is gathered several hundred yards from the microprocessor, a twisted-pair serial connection makes better sense than a parallel one.

At the a-d end of the system, there is not much difference between successive-approximation and integrating converters in terms of the ease with which they produce either parallel or serial data. For the most part, both types are designed to put out parallel data with no additional components, and both can produce serial data with a little help.

In contrast, the task of interfacing at the microprocessor end appears formidable at first sight, because even the popular chips differ greatly. In some, such as the Intel 8080 and Intersil's IM6100, both addresses and data are timeshared on the same bus lines, and control signals differentiate between them. In others, like Motorola's MC6800 and the MOS Technology 650X series, addresses and data flow on different lines simultaneously, though sometimes they require strobing to indicate when each is valid.

These mixed situations come about because of crowding between bits and pins. The 6800 provides 40 pins for 8 bits, whereas the 8080 has only 18 pins for 8 bits. Although some efforts toward bus standardization are under way, significant progress is unlikely soon, if ever, in view of the already wide acceptance of substantially different products.

Even so, there are ways around the situation. For serial data, there is a ready-made standard just waiting

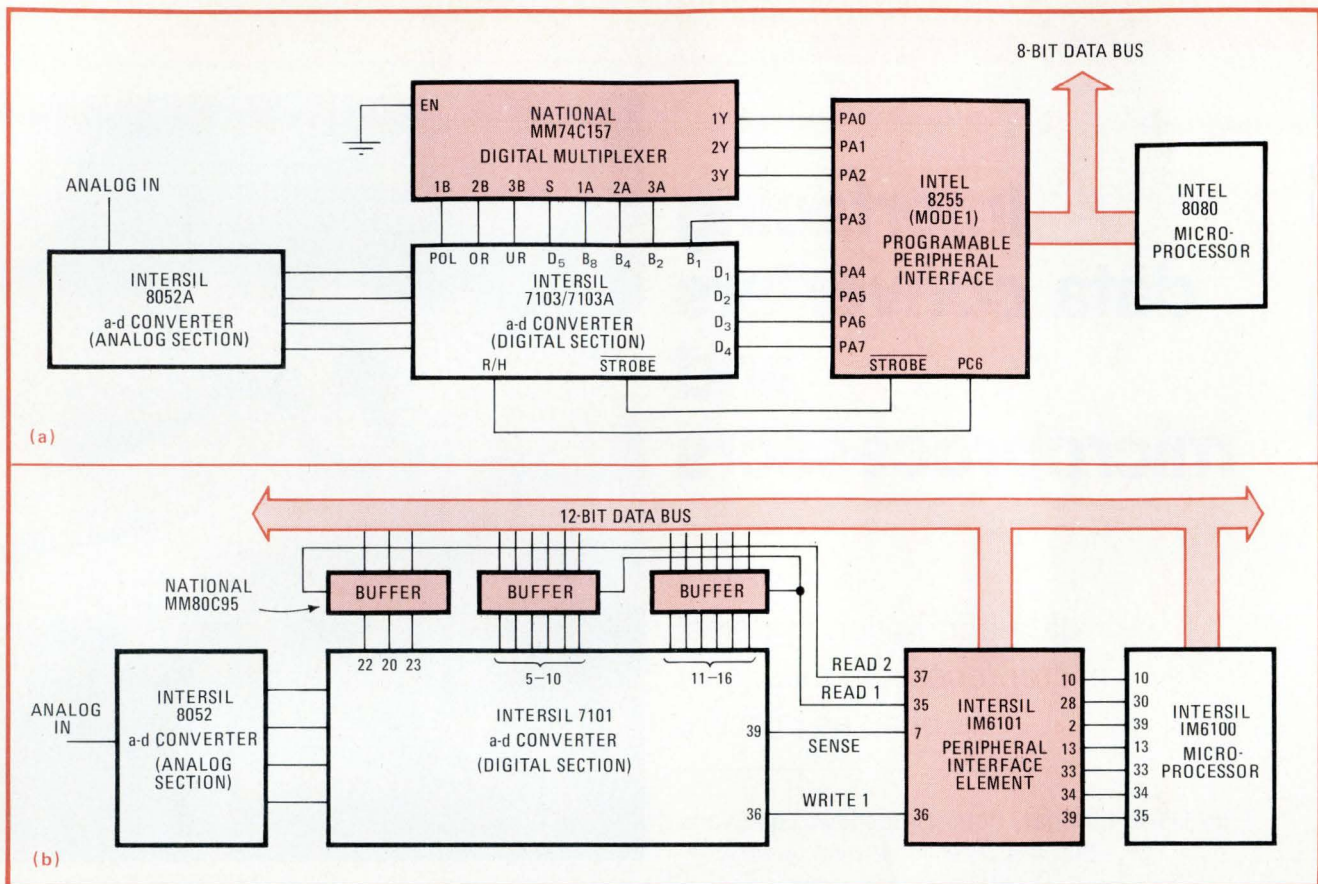

1. Parallel interface. All microprocessor families contain a programmable interface device that can mate the converter and the microprocessor when the data format is parallel. Some of these devices (a) handle data directly, while others (b) have read and write lines.

to be hooked up. And for parallel data, a *de facto* standard is available from the same people who created the problem in the first place—the microprocessor manufacturers.

All microprocessors are members of chip families, and somewhere in each family is a device called a programmable peripheral interface, programmable interface element, programmable interface adapter, or something similar—it may even be called “universal.” This programmable interface device handles address latching and decoding, relevant instruction recognition, interrupt processing, and bus access. It also has registers to control the polarity of incoming and outgoing signals, input/output status of outside lines, interrupt enabling and sensing, external flag lines, and the like.

De facto standard for parallel interfacing

When viewed from the outside, these devices look so similar that they constitute a *de facto* standard for parallel interfacing. Many, such as the Motorola MC6820 programmable interface adapter and the Intel 8255 programmable peripheral interface, give or take data directly on 4, 8, 12, 16, or even 24 pins. Figure 1a shows an a-d converter connected to one of these. Others, like the Intersil IM6101 programmable interface element, do not handle the data directly themselves but have write-enable and read-latch lines to put triple-state data onto and latch data off the bus. Figure 1b shows the same converter interfaced in such a system.

In both situations, the converter can be set to run continuously or commanded to start. When a conversion has been completed, the microprocessor is interrupted to read back the data, if enabled to do so. Therefore, any a-d converter that provides a signal transition identifying the presence of new data and having standard triple-state output-disable controls in 8-bit bytes can interface with one of these programmable devices without the need for additional components, as long as the logic levels are compatible. Similarly, any digital-to-analog converter with input latches in 8-bit groups can also interface directly with one of these chips.

In the past, a-d converters with serial outputs have been difficult to interface. The serial output was usually synchronous with some conversion clock and either had no synchronizing signals or had them on separate lines requiring gating for recognition. However, both these problems were solved by a device called a universal asynchronous receiver/transmitter (UART), which has become a standard pin-compatible part available from several suppliers.

UARTs handle serial interface

Any reasonable microprocessor family will interface with a UART or have a member of the family that looks like one from the outside—and two of these devices can talk to each other over pairs of wires. Although the UART grew out of teletypewriter-signal specifications, it can operate at much higher speeds and still provide synchro-

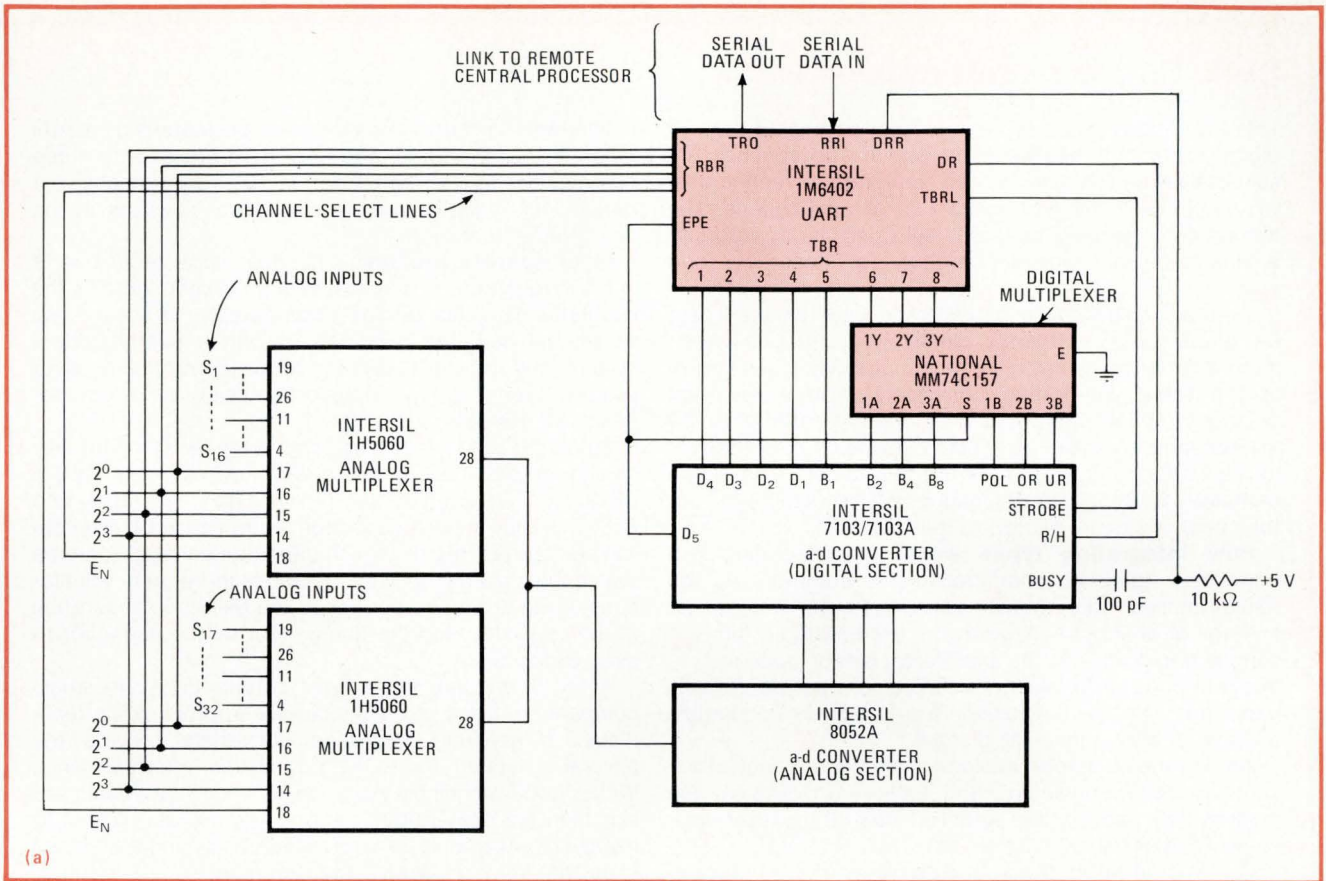

nization, a controlled data rate, parity generation, and clocking, as well as a full complement of handshaking signals for the microprocessor. With two-way communications and a phone-line tie-in through acoustic couplers, any UART-compatible a-d or d-a converter may talk to a friendly microprocessor, no matter how far away it is, over telephone lines.

Unfortunately, however, most converters cannot talk to a UART unless supplemented by lots of external components. One exception is the Intersil 8052/7103 integrating a-d, which happens to have the right signals available for interfacing with a UART via only one external digital multiplexer and a single RC differentiator, as indicated in Fig. 2a. Even these components may be omitted if the system can tolerate continuous conversion and lack of overrange information, and polarity can be sent on the parity system, as in Fig. 2b.

Considering multiword applications

The number of bits that can be handled with the serial or parallel interface may not coincide with the requirements of the converter, which usually has words of 8, 10, 12, 14, or 16 bits. Depending on the microprocessor, a parallel interface can handle words of 4, 8, 12, or 16 bits, but the UART can cope with only 5, 6, 7, or 8 bits at a time.

When the interface is wider than the converter, the extra bits may be ignored, but the more common situation of a wider converter requires that several microprocessor data words be transferred to complete one converter word. In such multiword applications, some

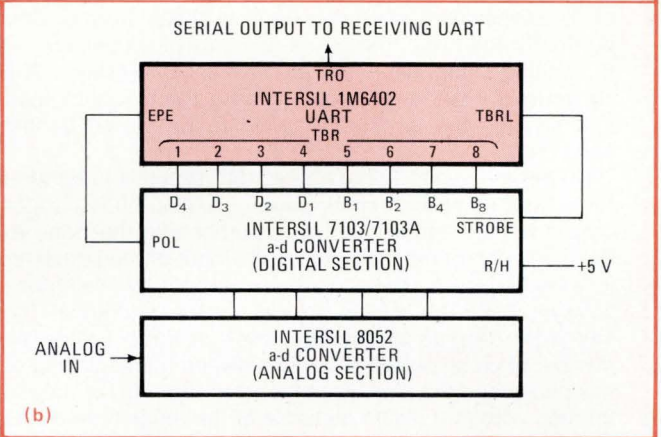

2. Serial interface. A universal asynchronous receiver/transmitter easily handles serial interfaces, although extra components are needed at the converter end (a). Even these can be eliminated (b) by running the a-d continuously and sending polarity on parity system.

sequencing and recognition requirements must be met by both the converter and the microprocessor, and a way must be provided to avoid use of only partially updated information. In many systems, a programmable interface device can simplify this operation somewhat.

Logic levels must be compatible

Most digital devices are directly compatible with each other with respect to logic level. Typically, converters have bipolar outputs (usually for mating with transistor-transistor logic) or either p-channel MOS or complementary-MOS outputs, which generally are TTL-compatible at

Selecting the right converter

There are many different ways to convert analog data to digital form, but the two most popular approaches are successive-approximation and integrating techniques, which dominate more than 95% of all applications. The three most important factors in selecting the appropriate analog-to-digital converter are speed, accuracy, and cost.

If speed were the only consideration, the choice would be simple because there's almost no overlap between integrating and successive-approximation types, as shown in the table. Integrating converters provide excellent accuracy at low cost, but they require from 1 to 30 milliseconds to make a 10-bit conversion. Successive-approximation converters are a lot faster. Some can complete a 12-bit conversion in only 2 microseconds, but their cost is directly related to their accuracy.

How integrating types work. All integrating a-d converters have two characteristics in common. As the name implies, their output represents the integral or average of an input voltage over a fixed period of time. A sample-and-hold circuit, therefore, is not required to freeze the input during the measurement period. Equally important, because they use time or frequency to quantize a signal, the linearity error is small.

Among the numerous versions of integrating converters, such as charge-balancing and triple-ramp devices, the most widely used is the so-called dual-slope technique, shown in a simplified diagram (a).

With a dual-slope device, the conversion takes place in three distinct phases. During the first phase, or auto-zero portion of the cycle, the errors (such as offset voltage) of the analog components are automatically nulled out. The converter's input is grounded, closing the feedback loop and causing the error information to be stored by the capacitor.

During the second phase, the input signal is integrated for a fixed number of clock pulses, yielding an integrator output voltage that is directly proportional to the input. At the beginning of the third phase, the input of the converter is switched from the signal voltage to the reference voltage. Because of the polarity of the reference, the integrator output discharges back toward zero. The number of clock pulses counted between the beginning of this phase and the time when the integrator output passes through zero is a digital measure of the magnitude of the input voltage.

In theory, the linearity of such a conversion is limited only by the equality of the individual clock-pulse periods within a given cycle. This short-term frequency jitter can easily be held to 1 part in 10^6 . Successive-approximation

converters, on the other hand, rely on matching resistor ratios for quantization and are hard-pressed to keep nonlinearities to less than 1 part in 10^3 —and to achieve 1 part in 10^4 requires trimming individual resistors in the binary ladder network.

Error sources are few. The dual-slope technique is immune to long-term changes in such components as the integrator capacitor and the comparator. In a very real sense, the designer is presented with a nearly perfect system, and his principal job is to avoid introducing error sources through ground loops or the use of noisy components, for example.

Although the integrating converter is conceptually straightforward, designing a good one is by no means a trivial task. Several sources of error must be taken into account. They include capacitor droop caused by switch-leakage current, the change in capacitor voltage when the switch turns off, the nonlinearity and high-frequency limitations of the analog components, the dielectric absorption of the capacitor, and the charge lost by the capacitor to stray capacitance.

All in all, though, these error contributions are small, compared to those of the successive-approximation technique. In general, integrating converters provide the accuracy needed for making precision measurements. With a good monolithic part, for instance, the offsets are less than the peak-to-peak noise, typically as little as 10 microvolts. Also, rollover error, which is encountered when changing from a positive measurement to an identical negative measurement, should be held within $50 \mu\text{V}$, or the equivalent of half a count.

Successive approximation offers speed. When conversion times of 1 ms to $1 \mu\text{s}$ are required, successive-approximation devices are without competition. They are

FASTEST SPEEDS FOR a-d CONVERTERS

Type of converter	Relative speed	Conversion time			
		8 bits	10 bits	12 bits	16 bits
integrating	slow	20 ms	30 ms	40 ms	250 ms
	medium	1 ms	5 ms	20 ms	—
	fast	0.3 ms	1 ms	5 ms	—
successive-approximation	general purpose	$30 \mu\text{s}$	$40 \mu\text{s}$	$50 \mu\text{s}$	—
	high performance	$10 \mu\text{s}$	$15 \mu\text{s}$	$20 \mu\text{s}$	$400 \mu\text{s}$
	fast	$5 \mu\text{s}$	$10 \mu\text{s}$	$12 \mu\text{s}$	—
	high speed	$2 \mu\text{s}$	$4 \mu\text{s}$	$6 \mu\text{s}$	—
	ultra-fast	$0.8 \mu\text{s}$	$1 \mu\text{s}$	$2 \mu\text{s}$	—

some supply voltages. Similarly, microprocessors come with bipolar or various MOS outputs, which are also usually TTL-compatible at some supply voltages.

Problems arise in only two situations—when different logic-supply voltages are desired in different parts of the system and when long bus lines must be driven. The former could apply, for instance, when interfacing a C-MOS microprocessor and random-access memory operating at 10 volts (for maximum speed) with a bipolar programmable successive-approximation register operating at 5 v.

However, integrated circuits are available for dealing with problems like these. Among them are Intersil's recently announced IM6404, which is a hex latch/driver capable of performing level translations from either C-MOS/MOS to TTL or from TTL to C-MOS/MOS, and Intel's 8216, a 4-bit bidirectional bus driver/receiver that can transmit data over long bus lines.

Another possible problem is the signal polarity, but this can be easily handled by the software via a COMPLEMENT DATA instruction. Also, the "high true" polarity convention for binary-coded-decimal data is

most frequently used in data-acquisition systems that have a large number of inputs multiplexed through a single converter. Admittedly, successive-approximation converters are more expensive than integrating types of similar accuracy, but, because of their much faster data-throughput rate, they are usually less expensive on a per-channel basis.

Typically, a successive-approximation converter (b) consists of a digital-to-analog converter in a feedback loop with a comparator and some clever logic, which is usually referred to as a successive-approximation register. The output from the d-a is compared with the analog input, progressing from the most-significant bit to the least-significant bit (LSB), one bit at a time.

The bit being processed is set to logic 1. If the d-a output is less than the input voltage, the bit in process is left at logic 1. But, if the d-a output is greater than the input voltage, the bit is set to logic 0, and the register moves onto the next bit. Since the decision to turn each

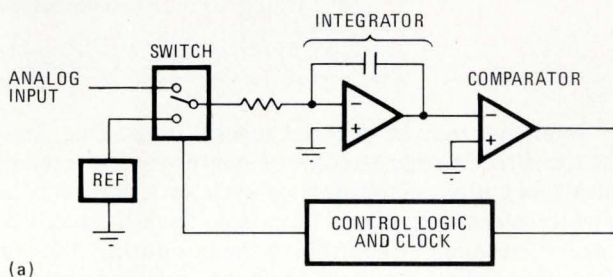

(a)

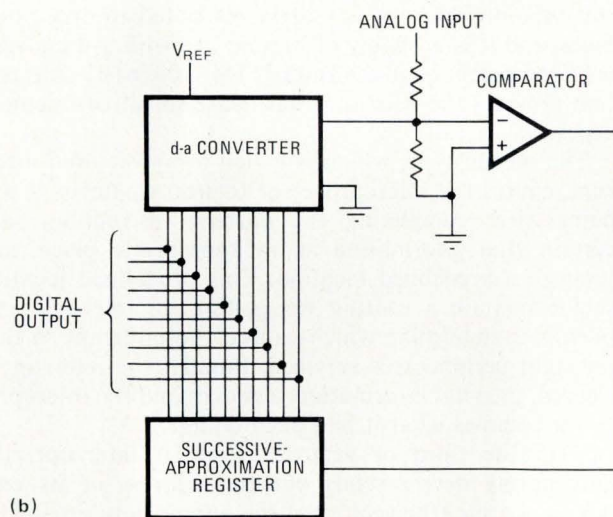

(b)

bit on or off is made before the next bit is tried, the digital output data can be presented in either serial or parallel format, after all decisions have been made.

Accuracy can be expensive. Probably the greatest disadvantage of a successive-approximation converter is its numerous sources of error—conceptually, it is simply not as elegant as an integrating converter. The primary error-contributing components are the d-a converter and, to a lesser extent, the comparator and the voltage reference.

All in all, nearly 10 different error contributions affect the fidelity of the conversion. They include quantization uncertainty, nonlinearities of the transfer function, output-leakage current, offset errors, and temperature drift.

Because many of the error sources are interrelated, a worst-case error analysis must be done to determine just how accurate the conversion will be. After all major error contributions are taken into account, any well-designed part should provide an accuracy of within $\pm 1/2$ LSB over its full operating temperature range.

Making converter tradeoffs. In selecting the most appropriate a-d converter for a given application, the decision is seldom clear-cut. Because cost is always the bottom line, the designer is forced to shop around within a budget—trading off speed against accuracy and size requirements.

Integrating converters provide the tightest accuracy for the money; however, they are comparatively slow. On the other hand, successive-approximation converters are inherently fast, but because of their numerous error sources, tight accuracy at high throughput rates can be expensive. If the data-acquisition system contains a microprocessor, the selection process takes on yet another dimension—the necessity to make the most efficient use of computer time.

For example, the conversion time of successive-approximation converters and the instruction-execution time of MOS microprocessor chips are on the order of a few microseconds. So putting the chip's central processor unit into a wait loop while the converter does its work doesn't waste much computing time. This combination is probably the best when many channels of analog data must be processed, but individual channels require minimal data manipulation.

In contrast, integrating converters are a wise choice when only a few channels of analog information are being gathered, but a large number of computations must be carried out for each channel. While the microprocessor is executing its instructions, the converter can take its time to digitize the next channel.

virtually a universally accepted industry standard.

Furthermore, the computing power of microprocessors permits ready conversion between two's complement and sign-magnitude notation. That leaves only control-signal polarity to worry about; however, all of the interface chips are programable enough to cope with almost any eventuality. Also, if the one selected has a triple-state enable that is low-active (strictly a disable line in positive logic), connections can be made directly from pin to pin without the need for intermediate inverters.

Another important consideration is the software to

handle the interface. Besides shaping hardware requirements, the operating mode of the converter affects software.

In general, d-a converters are easier to work with than a-d converters. A data word or a series of data words arrives, is assembled, and proceeds through the d-a. Some provision may be needed to avoid conversion of data that is partly new and partly old in multiword applications, and some users are expressing interest in read-back capability.

However, most d-a converters look much like the

POSSIBLE SOFTWARE ROUTINES

For successive approximation

```

START, O
  CLA
  DCA RESULT
  CLL CML RTR / set up MSB
  RAR / for first trial
LOOP, MQL / save trial pointer
  TAD RESULT
  MQA / new trial value
  WRITE 1 ATOD /
  NOP / time to settle
  NOP /
  ACL / load trial pointer
  SKIP 1 ATOD / sense comparator
  CLA / if too high, clear
  TAD RESULT / new intermediate answer
  DCA RESULT / save
  MQA / reload trial pointer
  RAR / shift to next bit
  SZA / test if done
  JMP LOOP / if not, continue
  TAD RESULT /
  JMP I START / return with result in AC
  
```

For tracking a-d

```

RESTART, O
  DCA SAVE
  CLL CML RTR
  RAR
LOOP, WRITE 1 ATOD
  DCA RESULT
  NOP /
  NOP / time to settle
  TAD RESULT /
  SKIP 1 ATOD / sense comparator
  JMP DECR
  IAC RTL / increment value
  SZL / test overflow
  JMP SLAM / out-of-limit routine
  RTR
  JMP LOOP
DECR, CMA IAC / decrement value
  SPA / test underflow
  JMP SLAM / out-of-limit routine
  CMA
  JMP LOOP
  
```

For doing both
(substitute boxed instructions)

```

[ RESA, JSR START / save AC
  establish starting point
  MQL / save value
  TAD TRKLM
  DCA TRKLM / reset downstep limit
  ACL / restore value
  ISZ TRKLMU / check upstep limit
  JMP LOOP
  JMP RESA / if over limit, do s-a
  MQL
  TAD TRKLM / reset upstep limit
  DCA TRKLMU
  ACL
  ISZ TRKLM / check downstep limit
  JMP LOOP
  JMP RESA / if over limit, do s-a
  
```

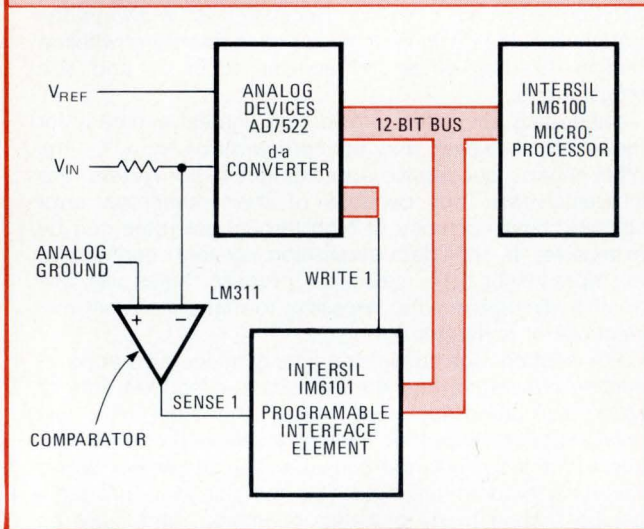

3. Lending a helping hand. The microprocessor can even become part of the converter loop. With the setup shown, the software permits changing from a successive-approximation a-d to a tracking a-d, or even using both methods to their best advantage.

infamous write-only memory. The latch and read-back capability may be provided directly by a number of different programable interface chips, while other interface devices can produce this function via external latches. If a converter has its own latches, they can achieve double buffering or de-skew multi-word data.

A trio of software interrupts

A-d converters offer many more choices of operating modes than d-a converters. If the a-d is operated continuously, the microprocessor can access the most recent data, treating the a-d much like read-only memory. For a nonmultiplexed one-word interface, such a system may be adequate. However, most other interfaces require an interrupt capability.

Interrupts may be of three general types. One, known as the direct-memory-access or non-processor interrupt, steals an entire microprocessor cycle or a portion of one and transfers the digitized data from the a-d directly to a memory location by controlling the bus during this cycle. Because of the amount of hardware required, however, this type of interrupt is largely restricted to disk interfaces, and it is probably of limited use with a-d converters. One exception is the Intersil IM6100/6102 chip pair that provides the necessary hardware for direct-memory access.

The second type, which is called a nonvectored interrupt, causes the microprocessor to stop whatever it was doing after completing the current instruction, save certain vital information in an appropriate place, and jump to a predefined location. This predefined location should contain a routing for polling all relevant peripherals to determine which caused the interrupt so that the right peripheral is serviced. Finally, the interrupt is cleared, the vital information restored, and the microprocessor resumes what it had been doing.

With the third or vectored type of interrupt, the interrupting device sends out the address of its own service routine (the vector) at the appropriate time. This type of interrupt does not require polling of all the peripherals. Both the vectored and nonvectored interrupts can be regarded as software techniques, since the actual data transfer is controlled by instructions.

In systems that might have several peripherals interrupt simultaneously, some priority system is essential. The polling sequence of the nonvectored interrupt performs this function almost automatically, but the other two interrupts usually have hardware provisions for establishing priority. Motorola's MC6800/6820 chip pair is an example of a nonvectored or polling interrupt, while Intersil's IM6100/6101 devices provide vectored priority interrupt, as well as direct-memory-access capa-

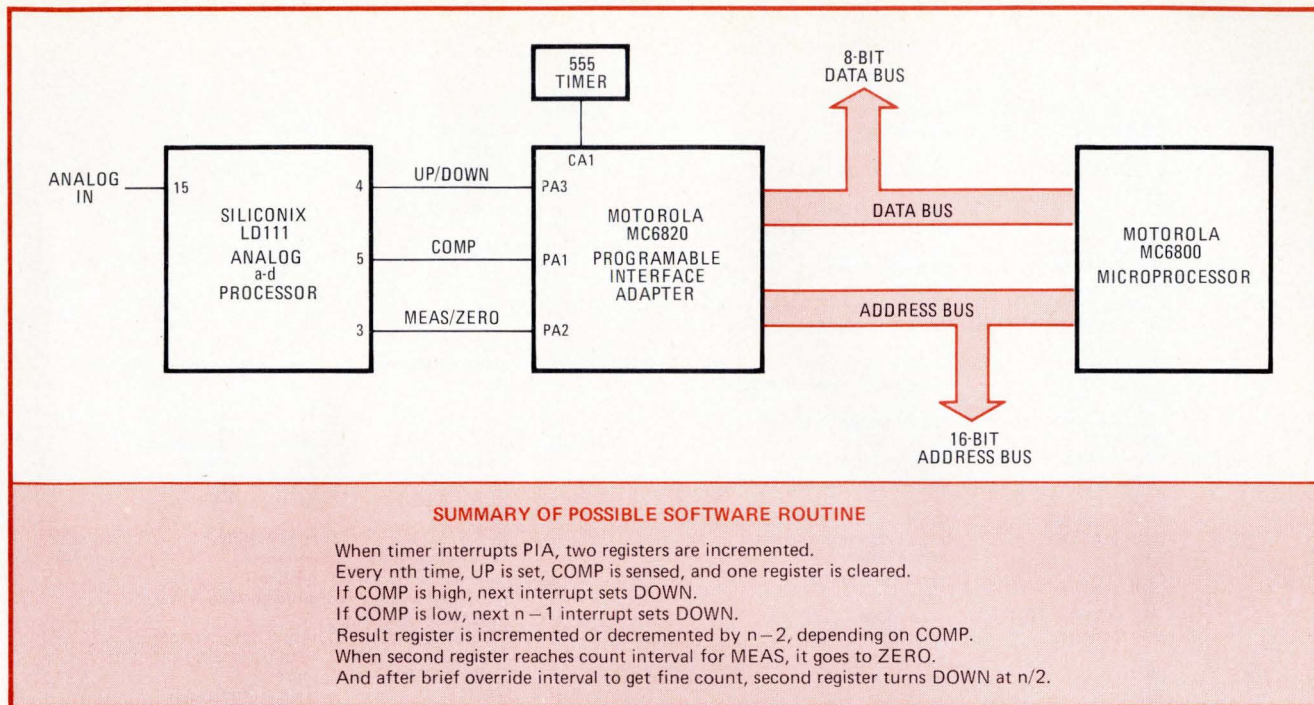

4. Another approach. The microprocessor can do the digital processing for charge-balancing a-d. However, because the up/down switching for this type of converter must be continued throughout its operating cycle, microprocessor overhead can be substantial.

bility with the addition of some extra hardware.

With any of these interrupt schemes, the a-d converter may run continuously. But every time new data is available, the converter will interrupt the microprocessor, and the data will be transferred to memory. For multiword applications, the word sequence may be controlled by the converter with several interruptions, as in Fig. 1a, or by the microprocessor on one interrupt, as in Fig. 1b. Multiplexer-command words may be sent out during these interrupts, if they are of the software type.

Alternatively, the a-d may be instructed to convert, and the microprocessor is interrupted only after a conversion has been completed. A variation of this technique is depicted in Fig. 2a, which shows how the bidirectional characteristics of the UART are used to send out a multiplex address that triggers a conversion after it has been received. At the end of the conversion caused by the multiplex address, the microprocessor is interrupted with the data. This whole operation could be performed at the ends of a long two- or three-wire system or even over telephone lines if one end of the system is as far away as the other side of the world.

One additional interface possibility is the interrogate-and-wait-till-ready approach. Although this method involves only polling of a status word, rather than interrupt processing, it is limited to use with underutilized microprocessors or fast a-d converters. However, such an approach does simplify the software, and for one-of-a-kind designs, it may prove cost-effective.

Finally, as might be expected, all the above interfaces can be run by a programable interface device under software control that permits the operating mode of a converter to be changed at any time.

The software depends on the microprocessor, of course. The instruction set uses one of two methods for

transferring data between peripheral devices and memory.

One involves specific I/O-transfer instructions, which usually transfer data between an accumulator or register and the converter register (or a register of the programable interface device). This method has some portion of the I/O-transfer instruction devoted to a peripheral address and another portion for controlling the operation to be performed. Thus, instructions other than those involving only data transfer can be performed—for instance, skip on flag for wait-till-ready routines. Microprocessors that permit this form of software include the Intersil IM6100, DEC's PDP-8 on which it is based, and Intel's 8008 and 8080.

Another way to handle data transfer

The other form of software data transfer involves treating the peripheral device registers the same as memory. In this situation, no special I/O instructions are needed, and both arithmetic and logical operations can be performed directly on the peripheral's data. The simplicity and power of this method has led to its wide acceptance in such minicomputers as the DEC PDP-11, and it has appeared in several microprocessors, too, including Motorola's 6800 and MOS Technology's 650X families.

However, that technique has its drawbacks. The peripheral-device registers occupy what would otherwise be memory space, and only full words (sometimes bytes) can be exchanged or handled between registers. A wait-till-ready routine, for example, requires reading the control words and stripping the relevant bits, as well as test and skip operations.

An additional software concern related to a-d and d-a converters is the ease of working with double-precision

POSSIBLE SOFTWARE ROUTINE FOR 12-BIT SYSTEM

START,	O	LOOPS,	O
CLA CLL IAC RAL	/ equalize initial	LOOP1,	NOP
DCA CNTR	/ 3-count delay	CLA RAL	/ delay
TAD IPB		RAR	/ in loops
WCRB ATOD	/ set-up control reg. B	ISZ CNTR	/ test if done
CLA		JMP LOOP1	
IOF	/ disable all interrupts	JMP I LOOPS	/ return if done
TAD IPINT	/ set flag 2, I/P integrate		
WCRA ATOD		0,	O
JMS LOOPS	/ go to loop time	1,	IOF
NOP	/ equalize time	.	
CLA CLL RAL		.	
SKIP 1 ATOD	/ check comparator, polarity	.	
JMP MINUS		.	
TAD RFPB	/ positive input, set	VECTOR1,	JMP ZEROC
WCRB ATOD	/ comparator sense direction	.	
CLA		.	
TAD RFPINT	/ flag 3, enable interrupt	ZEROC,	CLA
JMP REF		TAD CNTR	/ zero crossing occurred
MINUS,	TAD RFMB	DCA CNTR	/ get # loops done
SCRB ATOD	/ negative input, set	DCA RESULT	/ which is result
CLA	/ comparator sense direction	RCRA ATOD	/ get register A
TAD RFMINT	/ flag 4, enable interrupt	RAL	
REF,	WCRA ATOD	GLT	/ strip polarity
ION	/ begin reference integrate	DCA POLARITY	/ and save
CLA	/ enable interrupts	TAD AZ	/ set flag 1
ISZ CNTR	/ equalize loop time	WCRA ATOD	/ go to auto-zero
JMS LOOPS	/ counter	CLA CLL CML RTR	
JMP OVRNG	/ go to loops	DCA CNTR	/ set-up auto-zero time
	/ value is overranged	TAD AZB	/ reset comparator
AZ,	0400	SCRB ATOD	/ sense
IPINT,	1000	ION	/ enable interrupts
RFPINT,	2001	JMS LOOPS	/ go to loops
RFMIN,	4001		/ next operation
AZB,	0020		
IPB,	0020		
RFPB,	0000		
RFMB,	0020		

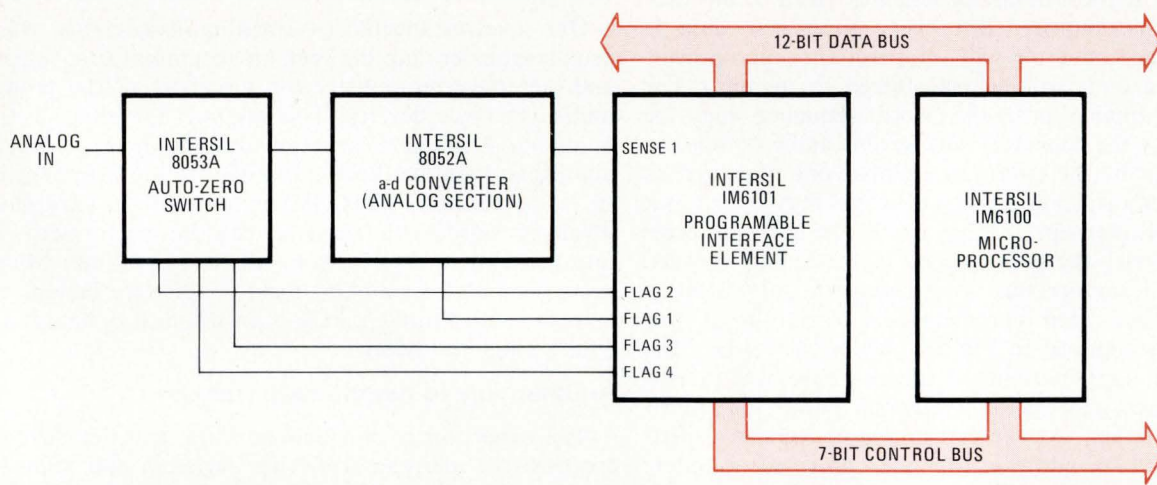

5. For dual slope. Designing the microprocessor into a dual-slope converter loop is comparatively easy on the software. In fact, during both the input and reference integration intervals, the microprocessor can service other routines, as well as interrupts.

(or multiprecision) arithmetic for handling, say 10 to 16 bits in an 8-bit machine. For applications involving BCD converters, the degree of difficulty in converting between binary and BCD codes can be a factor in the interface. Some microprocessors, however, offer the ultimate in software simplicity, even including code-conversion instructions—among them, the Intel 4004 and the MOS Technology 650X series.

One factor sometimes overlooked when considering converter speeds is the length of the service routine required to handle the data. This routine usually involves more than simply storing the data in some memory location until it is overwritten by the next value.

A typical service routine could require that a zero correction factor be accessed and subtracted, maybe a scale factor used, and then upper- and/or lower-limit values accessed and compared, or a comparison made with a previous value.

On the basis of an out-of-limit value, a certain rate of change, or a possible maverick reading, a decision might have to be made either to flag an alarm or to adjust some system parameter. Also, a new conversion should be initiated. All this activity can easily take several hundred instruction cycles, especially if double-precision arithmetic is required, and total execution time can run as long as 1 millisecond.

One aspect of the microprocessor-converter interface that does not fit easily into any of the preceding discussions certainly deserves mention is the use of the microprocessor as part of the a-d system.

For successive-approximation conversion, a d-a converter and a comparator can be interfaced to the microprocessor, as shown in Fig. 3. The successive-approximation routine is implemented in software, and the same d-a can be used for analog outputs. For a moderate increase in the software overhead, a tracking a-d converter can be substituted, or better yet, a routine can be used to convert readily from one conversion system to the other, thereby utilizing the advantages of both techniques. Software routines to do this are available in such microprocessor-system libraries as Intel's MCS4 and MCS8.

The integrating converter system

For the under-utilized microprocessor, the same technique can be applied to dual-slope and charge-balancing conversion systems. The digital signals to control the integration steps can be derived from the control signals or one of the data registers of a programable interface device, with the microprocessor counting the time periods. Timing may be accomplished by having a timer interrupt the microprocessor at regular intervals or by counting around instruction loops of known length, although this process may preclude interrupts from other peripherals.

For a charge-balancing device like Intersil's LD111 analog a-d processor, the timer interrupt is virtually mandatory. The up/down switching for this device must be continued through all cycles, including auto-zero, so the microprocessor overhead can be substantial. A suitable interface is shown in Fig. 4, along with a summary of a possible software routine.

Dual-slope conversion (Fig. 5) is easier on the software. During the auto-zero portion of the conversion cycle, no actions are necessary. Since only a minimum time is required, any extra unaccounted time taken by interrupts is not important. During the input-integration interval, other routines and interrupts can be serviced if the time-counter location is incremented and tested after the correct number of instruction cycles. (All routines take a multiple of this number.) If the comparator is set to interrupt on the integrator's zero crossing, other routines and interrupts can also be serviced during the reference-integrate interval of the a-d conversion cycle.

With care in programing, one microprocessor could handle several a-d conversions simultaneously. This type of interface is generating some interest in applications where scale factors are important and where a microprocessor may be waiting for the result, as in point-of-sale terminals.

Interfacing v-f converters

A few words should be said about interfacing with voltage-to-frequency converters, which offer another approach to a-d conversion. These devices do not have much value in microprocessor-based systems because of the asynchronous nature of their outputs. Their value lies in the transmission of single-parameter information over

twisted-pair wires to a remote location, where the receiver is a frequency-to-voltage converter or a low-cost digital frequency meter.

If a v-f converter is essential to the application, a programable interface device can communicate with a gated counter, too. But if the microprocessor must do the counting, two sets of interrupts are required—one on each incoming pulse with a routine to increment a memory location, and another at the gating period to transfer the result and reset the counter. The gating timer may be implemented with standard clock-generating chips like the Intersil ICM7038, or by one of the microprocessor peripheral timers, like MOS Technology's 6530 or Intersil's IM6102.

Interfacing an a-d converter with a microprocessor may be a fairly complex job, but new hardware developments are helping to simplify the task. Some converters now provide triple-state buffered outputs that deliver handshake-oriented signals for the microprocessor interface. Some complete data-acquisition subsystems on printed-circuit boards or implemented as compact hand-sized modules can even be plugged directly into microprocessor-based systems.

Easier times ahead

In the near future, converters are likely to offer direct compatibility with UART devices, and converters may be built to contain their own universal asynchronous transmitters or receivers. If bus standards are developed, converters probably will include at least some of the address and handshake signals, in addition to the data-line interface. Also, microprocessors with on-board user-accessible memory are already beginning to appear and will go a long way toward taking the hardships out of interfacing.

Since software is closely tied to the specific application, its development depends on how microprocessors and converters will be used in the future. Additional applications assistance probably will take the form of example interface routines for popular or proprietary microprocessors oriented to generalized tasks. Software optimization may also have some influence on the fine design details of microprocessor-oriented converters, although the increasingly lower cost of ROMs will not permit extensive improvements along these lines to be sufficiently viable. □

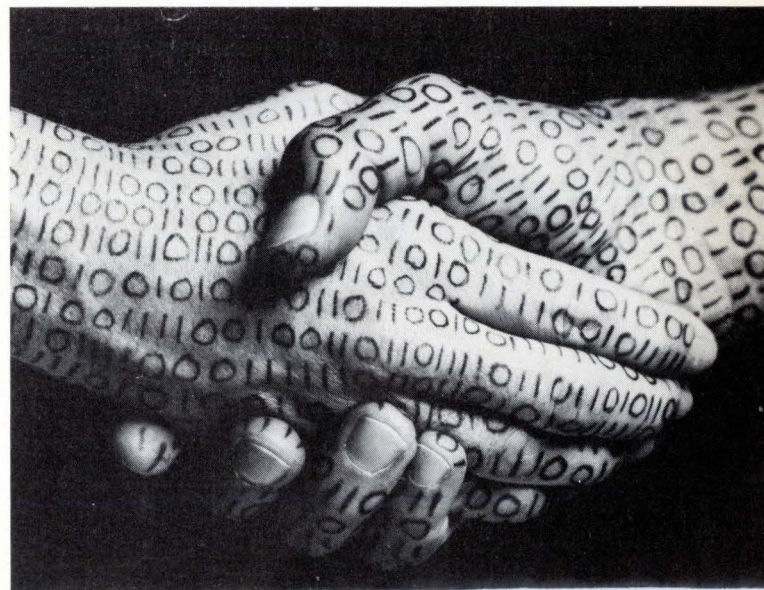

Several solid-state technologies show surprising new paces

Reports at the International Electron Devices Meeting tell of MOS variations, CCD logic, growing microwave power, and brisk activity in optoelectronics

by Laurence Altman, *Solid State Editor*,
and Lucinda Mattered, *Components Editor*

□ Semiconductor technology is an expanding universe. As anyone at the International Electron Devices Meeting this week in Washington, D.C., soon learned, its limits are pushing outward in a dozen different directions. Most notable among the discoveries are:

- A metal-oxide-semiconductor gate structure called B-MOS that dissipates a little less power than complementary-MOS devices yet condenses into a little less area than injection logic.
- New C-MOS logic that is as fast and dense as n-channel MOS logic.
- Charge-coupled-device logic—yes, logic.
- A nitride-MOS memory that looks easy to build.
- The real reason some random-access memories fail.
- A mixed-process device that is faster and quieter.
- A MOS voltage reference.
- A temperature-triggered silicon controlled rectifier (more or less).
- Many microwave improvements.
- Much activity in optoelectronics.

B-MOS for low power

If there is a limiting factor in packing more digital circuitry onto a chip, power dissipation is it. A watt is about today's commercial limit. Finer photolithography may be one way to achieve lower power (smaller devices run on smaller currents), but Hitachi's Central Laboratory in Tokyo has come up with a method of designing gates that could accomplish the same thing without straining present lithographic limits.

It is called B-MOS logic because a back- or grounded-gate metal-oxide-semiconductor field-effect transistor serves as the input device (Fig. 1). A back-gate transistor can operate with gain and current modulation at input voltage levels as low as 0.1 volt, or well below the 1- or 2-v thresholds of the ordinary insulated-gate MOSFETs that make up the bulk of today's circuits. When the back-gate input device drives a normally biased MOS output transistor, logic elements can be built that operate stably yet dissipate mere microwatts.

The B-MOS inverter in Fig. 1a is constructed out of an n-channel B-MOS driver and a conventional p-channel MOS current source. In configuration, it resembles a complementary-MOS inverter, in which an n-channel element acts in conjunction with a p-channel element. But it is much more compact than conventional low-power C-MOS, where n and p transistors lie side by side. The p-type well of the back-gate input terminal slips tidily into the n-type substrate needed for the output transistor (Fig. 1b). Just as in integrated injection logic, the B-MOS transistor pair merges into the space of a single transistor, keeping the level of power consumption low and of circuit integration high.

Hitachi workers in fact have demonstrated that a quad-gate B-MOS structure combines the low power and superior load characteristics of C-MOS equivalents with the high packing density of I²L equivalents, while requiring no additional process steps (Table 1). B-MOS' only drawbacks are its fairly low speed (50-nanosecond gate delays) and its need for an extra power supply to bias the current-source gate.

While the Hitachi work is very promising, it may be

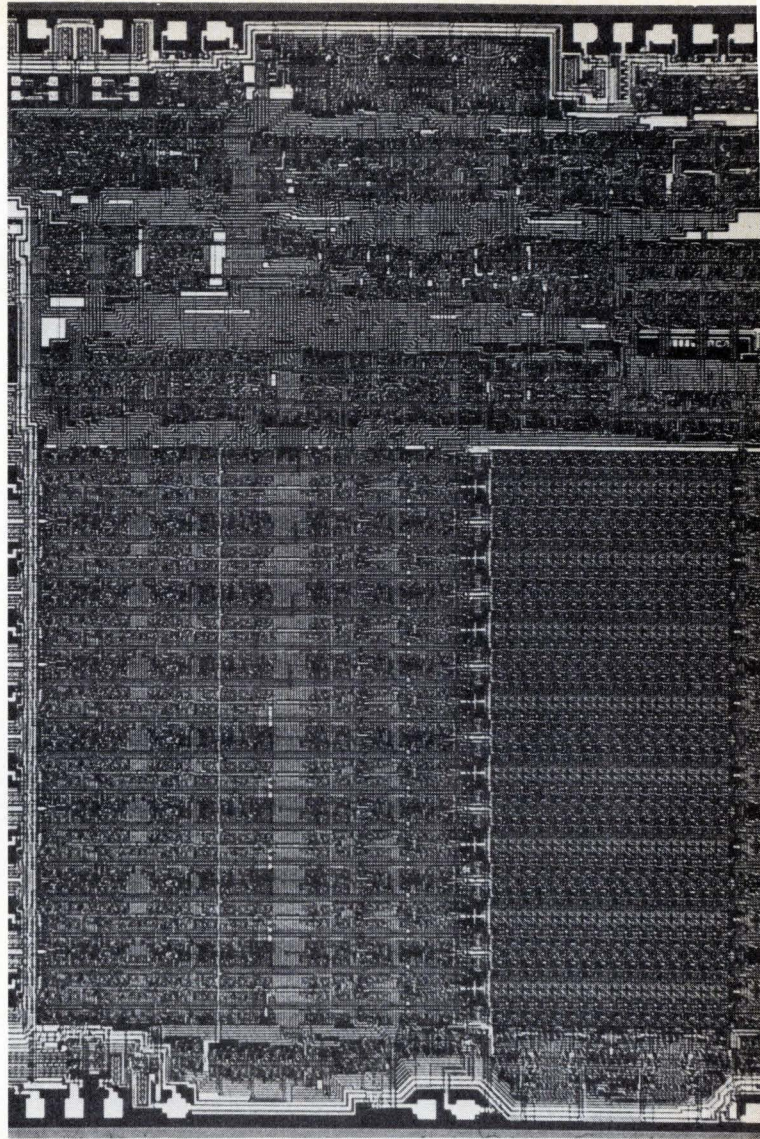
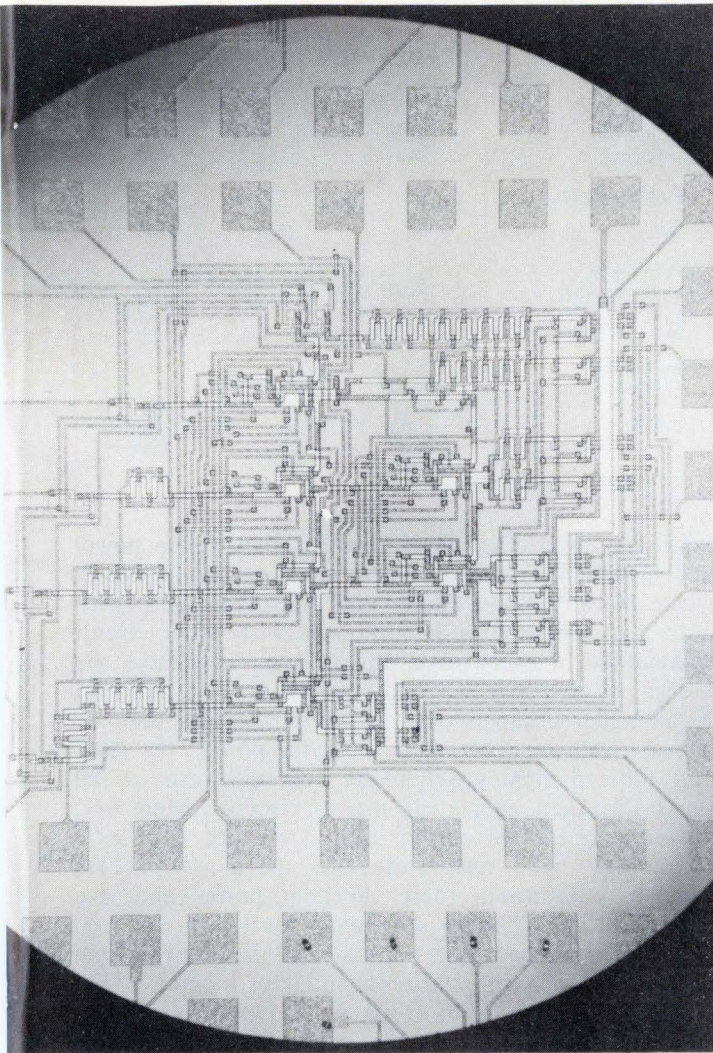

New triumphs. Armed with new processes and improved device designs, solid-state technology is extending the frontiers of performance. From TRW comes the first CCD logic chip (above), a 4-by-4-bit digital multiplier; RCA has built an 8-bit microprocessor (top right) from its new closed C-MOS logic, and Bell Labs' electron-beam technology is producing low-noise microwave bipolar transistors.

misleading to compare it with standard C-MOS technology, when that technology is also advancing swiftly. The replacement of aluminum-gate by silicon-gate structures is shrinking the area occupied by C-MOS logic while at the same time retaining its inherent advantages—very low static power dissipation, high noise immunity, and operating voltages from 2 to 15 v at temperatures ranging from -55° to $+125^{\circ}\text{C}$. Best known of the new C-MOS types is RCA's C^2L (for closed C-MOS logic), the subject of a paper by Al Dingwall of RCA's Solid-State Technology Center in Somerville, N.J. The C^2L process is already in production on the Cosmac 1802 8-bit microprocessor chip as well as some memories.

C^2L is a self-aligned silicon-gate technique and, according to Dingwall, saves space by eliminating the guard rings that are required to separate the n and p transistors in aluminum-gate C-MOS logic devices. Besides significantly increasing packing density, the C^2L process also boosts circuit speed by reducing parasitic

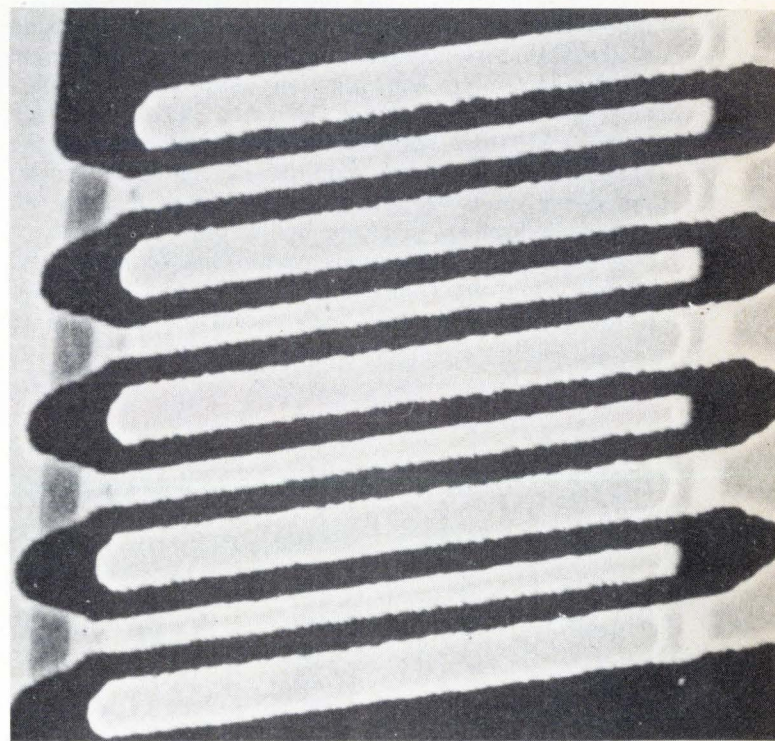

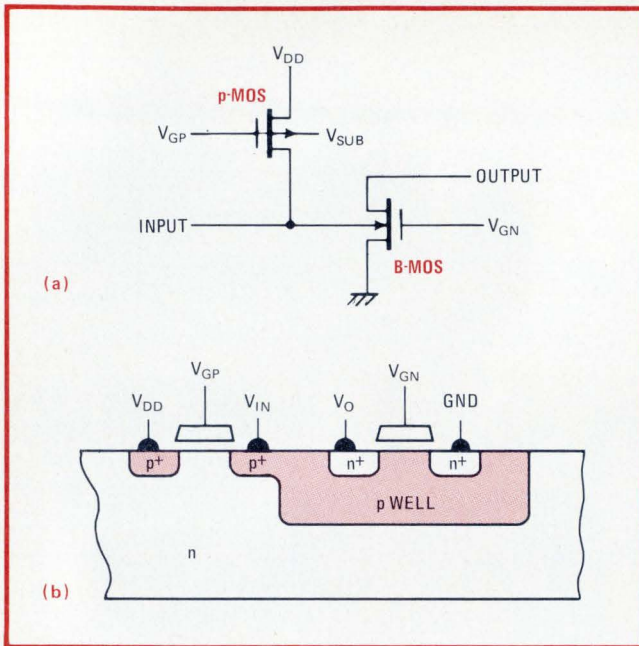

1. Now for B-MOS. A logic called back-gate-input MOS or B-MOS from Hitachi achieves low power and small size by using a back-gate driver to modulate a p-MOS current source (a). The B-MOS p well fits into the n substrate, taking up no extra space (b).

capacitance. The work in C²L is still going forward, but already it has tripled packing density and yielded operating frequencies that are approximately four to six times faster than for standard C-MOS. Moreover, the process actually takes one less step than C-MOS, or the same number as needed in silicon-gate n-channel MOS logic devices.

CCD logic

Revolutionary describes the work under way at TRW Inc.'s Defense and Space Systems Group, Redondo Beach, Calif., where a team headed by Tom Zimmerman is building complex logic functions out of charge-coupled devices. Under a contract from the Naval Research Laboratory, the group has already implemented all the logical building blocks required in computer central processing units—8-, 16-, and 32-bit half and full adders, multipliers, inverters, and so on.

Although CCD applications are well known in memory, analog signal processing, and imaging, this is the first time the technique has been successfully applied to digital configurations for making computer logic. The

TABLE 1: B-MOS COMPARES WELL WITH C-MOS AND I²L

Characteristic	B-MOS	C-MOS	I ² L
Cell area:			
inverter	0.58	1	0.31
logic gate	0.35	1	0.14
Power (W/gate)	10 ⁻⁶	10 ⁻⁶	10 ⁻³
Delay time (ns/gate)	50	10	10
Power-delay product (pJ)	0.01	—	0.3
Supply voltage (V)	0.15 - 0.5	1	0.5
Number of masking steps	5 - 6	5 - 6	5 - 6
Drawbacks	multiple power supply	low packing density	limited fanouts

SOURCE: HITACHI

advantages over other techniques in achieving low power and high density are dramatic, as shown in Table 2, where 16- and 32-bit adders and multipliers built with CCDs are compared with ones built with other circuit techniques. In every case, the CCD circuits have the lowest power dissipation and smallest size—a full CCD 32-bit adder occupies only 21 mil², 50% less than its closest rival, an n-MOS adder. As for power, the same CCD adder dissipates well under 100 milliwatts, or 20 times less than equivalent n-MOS circuits. Moreover, TRW developers are certain that a mature CCD logic technology need not trade off speed or process complexity to attain these excellent power and size properties, as I²L circuits apparently must.

Everyone agrees that nonvolatility is the principal deficiency of conventional semiconductor memories, but few agree on the way to overcome it. One longstanding approach, metal-nitride-oxide silicon, gets a needed boost from researchers at the University of Maryland's Department of Electrical Engineering, who propose an MNOS capacitor array that resembles a simple cross-point matrix (Fig. 2).

A simpler nonvolatile memory

Their scheme overcomes the problems of fabricating very thin nitride layers, only 100 to 200 angstroms thick, over equally thin oxide layers in complex MOSFET configurations. The nitride must be very thin to provide the proper storage mechanism, while the oxide must be very thin to allow the charge to tunnel back and forth without loss when the cell is written into and read out of. The

TABLE 2: HOW CCD LOGIC MEASURES UP

Logic	Power dissipation (mW at 1 MHz)				Active area (mm ²)			
	16-bit adder	32-bit adder	8-bit multiplier	16-bit multiplier	16-bit adder	32-bit adder	8-bit multiplier	16-bit multiplier
CCD	16.2	68.8	13.6	79.4	6.19	21.4	5.39	47.1
C-MOS	582	2,300	820	4,100	11.3	49.2	12.2	67.7
p-MOS	2,900	13,300	2,500	15,000	7.78	34.7	7.65	44.2
n-MOS	531	2,300	559	3,100	16.5	70.2	19.5	104
I ² L	29.8	134	27.2	160.9	14.9	64.9	26.2	137

SOURCE: TRW

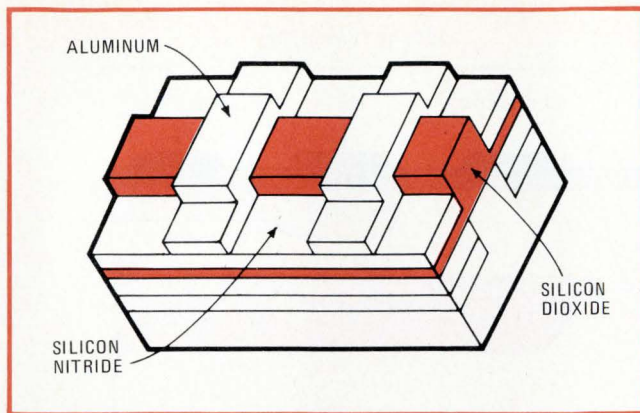

2. Double cross. Made by the University of Maryland, this nonvolatile memory structure, a cross-point MNOS capacitor array, is simpler to build than conventional MNOS memories and more reliable because it uses very little of the problematic thin-oxide region.

cross-point capacitor approach uses a storage mechanism of n-over-n⁺ polysilicon buses isolated by p regions on a p substrate, greatly reducing the area of the thin-oxide region. Thin oxide is now only needed on these n buses. Orthogonal to the n buses are the thick-oxide p buses that are aluminum-coated to serve as metal contacts to access the storage sites. Each cross point between the aluminum bus and the silicon bus creates an MNOS capacitor memory cell. The finished structure, with isolated n regions, also allows the required peripheral circuits, decoders, drivers, and sense amplifiers to be built with standard p-MOS transistors.

Why RAMs fail

One important paper to come out of this year's meeting is a study of the failure modes and (conversely) the reliability of dynamic MOS random-access memories. Intel Corp. did the study on 4,096-bit devices, using statistical analysis and accelerated testing procedures. The conclusion is that defects in the gate oxide cause most RAM failures—66% of them (Table 3).

Intel engineers C.R. Barrett and R.C. Smith next investigated ways of screening for oxide defects, bearing in mind that oxide breakdown is highly dependent on supply voltages. Using this knowledge, they were able to set up an effective screening process. The cells of devices on a wafer or in packages were stressed by supply voltages raised about 50% above maximum ratings while various data patterns were cycled through the memory array for about 1 second. Typical fallout was about 1%,

which jibed with their calculations for the dispersion of failures caused by bad oxides.

With this study Barrett and Smith were then able to put to rest a widely held belief that failure rates are dependent on temperature. That theory is current in many handbooks that give equations to predict semiconductor device failures. But the failure rates predicted by these formulas are generally much higher and more strongly temperature-dependent than the ones actually observed (Table 3). In short, the primary failure mode for MOS RAMs is oxide breakdown, and this failure mechanism can be minimized if parts are prescreened at high voltages.

Power gains ahead for mixed-process linears

In linear integrated circuits, higher operating frequency and more power capability are on the way for mixed-process devices. Hewlett-Packard Laboratories, Palo Alto, Calif., has come up with a new combination—vertical, rather than lateral, junction-type FETs integrated on the same chip as bipolar devices. The vertical structure of the JFETs extends both the operating frequency and the power-handling capability of the circuit, while at the same time keeping its noise figures relatively low.

The basically bipolar process does not require any additional steps to produce the vertical JFETs. As shown in Fig. 3, a bipolar n⁺ subcollector diffusion forms the drain of the JFET, a base insert diffusion the JFET's gate, and an n⁺ emitter diffusion the JFET's source. To accommodate the source contact, which is wider than the channel, the source overlaps the gate diffusion. A vertical JFET with such a structure has maximum operating frequency of 7 gigahertz for a source-gate breakdown voltage of 10 v, and its on resistance is approximately 30 ohms.

In a linear-related area, the hunt continues for high-stability reference-voltage sources that can be easily integrated into data-converter and interface chips. These references have usually been bipolar circuits, but the Corporate Research and Development group of General Electric Co., Schenectady, N.Y., is using standard MOS technology to build a reference that can easily be incorporated into MOS microprocessors or interface circuits like logic-level translators.

The new reference (Fig. 4) is a short-channel MOSFET that operates in a punchthrough mode—that is, when the drain voltage exceeds a certain level, the drain depletion region extends back and merges with the source deple-

TABLE 3: WHAT MAKES RAMs FAIL

Causes of failure			Inadequacy of temperature-based predictions			
Failure mode	Number	% of total	RAM size (bits)	Temperature (°C)	Failure rate (%/1,000 h)	
					Predicted	Actual
Surface defects	22	17.3	1,024	70	0.4	0.02
Oxide defects	83	66.0		125	12	0.07
Metalization defects	1	0.8	4,096	70	1.0	0.02
Masking defects	7	5.5		125	28	0.07
Assembly defects	10	8.0	16,384	70	25	0.07
Degraded inputs	3	2.4		125	649	0.27

SOURCE: INTEL

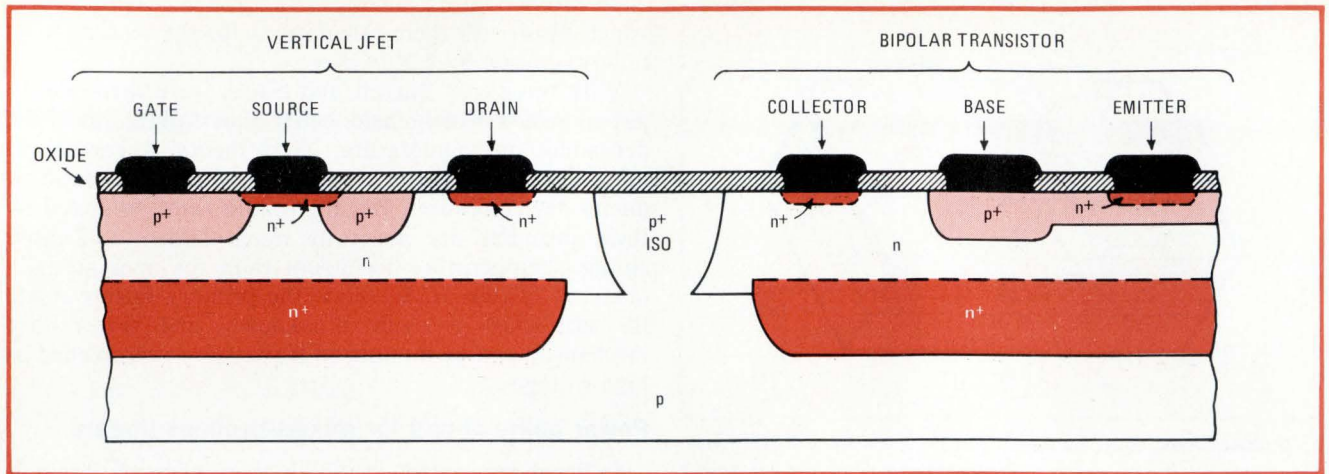

3. Mixed devices. With basically bipolar process, Hewlett-Packard has fabricated vertical JFETs on the same chip as bipolar transistors—with no additional processing steps. The vertical JFETs promise higher frequency and power capabilities for mixed-process linears.

tion region. It is a two-terminal device, with its gate, source, and substrate connected to ground and with a constant-current source connected to its drain. With an appropriate value for this current source, the reference voltage becomes essentially insensitive to temperature variations while operating in the punchthrough mode.

Experimental data for a device having a channel length of about 2 micrometers is promising. It indicates that a reference voltage of 3.8058 v can be maintained to within ± 0.0005 v over a temperature range of 25°C to 150°C, when the device operates at approximately 1 v above punchthrough and with a 400-milliampere current source. Performance as good as that corresponds to a temperature coefficient of around 1 part per million per degree celsius.

Temperature switch resembles thyristor

As usual, a number of new devices are staking their claims for attention—among them, a temperature-sensitive switching device called the Thermosenstor. Developed by Japan's Mitsubishi Electric Corp., the new switch is a four-layer pnpn semiconductor device

(Fig. 5). When forward-biased, it can turn on at a predetermined temperature anywhere in the range of 50°C to 150°C—just where depends on the value of the gate resistance connected in parallel with the device's emitter junction.

Like a conventional silicon controlled rectifier, it has three terminals; but a rather different structure encourages its forward breakover voltage to fall rapidly at low temperatures, rather than to remain high at elevated operating temperatures. To obtain this effect, the p-base and n-base layer are made thinner in the new device, and the resistivity of the n-base layer is made higher to generate more leakage current at the collector junction.

In operation, though, the Thermosenstor behaves very like an SCR—except that temperature triggers it, rather than a gate current. At temperatures below the turn-on threshold, it can even be triggered as a conventional SCR—by applying an appropriate gate current. Once triggered on, the Thermosenstor continues to conduct until its on-state current goes almost to zero—even though temperature may be below the turn-on threshold.

Since it combines temperature-sensing and switching functions in a single device, the Thermosenstor does not require nearly as much associated external circuitry as thermistors do. (Sometimes they need both Schmitt triggers and differential amplifiers.) Also, the device's turn-on can be remotely controlled through its gate terminal.

Microwave devices march onwards

Microwave semiconductors are operating faster, handling more power, and making less noise. One piece of proof comes from Bell Telephone Laboratories in Reading, Pa., and in Murray Hill, N.J. Using electron-beam technology to obtain submicrometer device geometries, workers have made low-noise microwave bipolar transistors on 2-inch wafers. With electron-beam processing, they can hold alignment errors between critical device areas to under 0.25 μm . As a result, device performance is impressive—at 1.7 gigahertz, the noise figure ranges from only 1.8 to 1.9 decibels, and available gain is as high as 11 to 12 db.

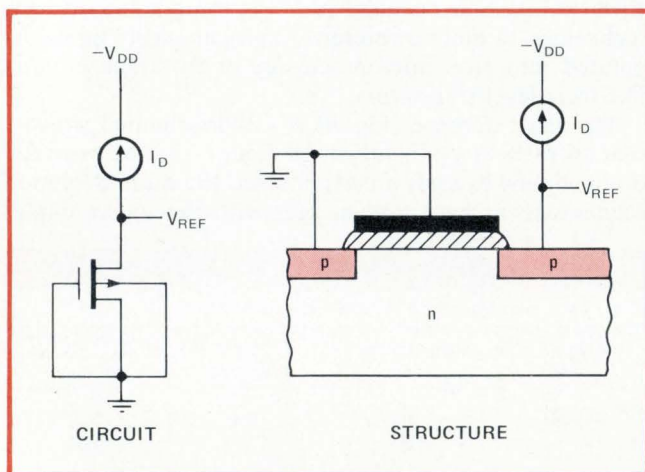

4. MOS reference. With standard MOS technology, General Electric is building a short-channel MOSFET voltage reference that can easily be integrated into MOS interface or digital LSI chips. Over the range of 25°C to 150°C, it maintains a temperature stability of 1 ppm/°C.

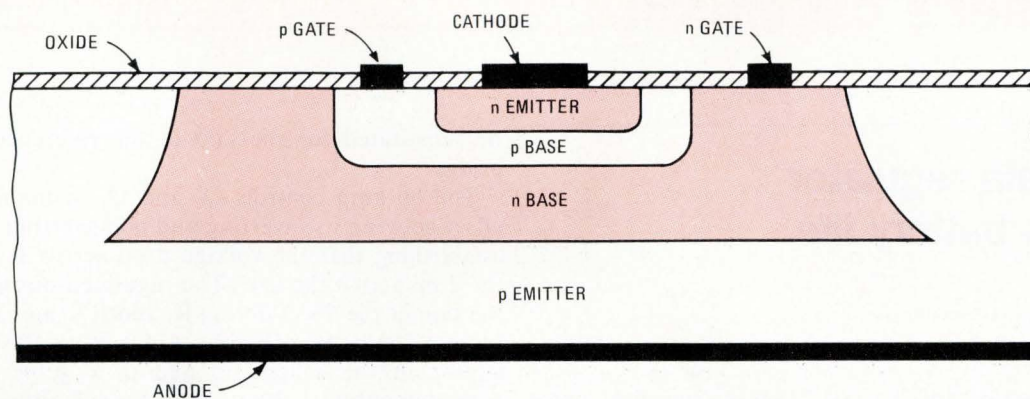

5. Temperature-sensitive. New four-layer thyristor-like switching device from Mitsubishi Electric Corp. turns on at predetermined temperature anywhere in the range of 50°C to 150°C. Triggering temperature depends on the value selected for the gate shunt resistance.

More proof is available from Japan. Fujitsu Laboratories Ltd. has developed low-noise high-power Gunn diodes for use as pumping sources in parametric amplifiers at frequencies of greater than 50 GHz. With a diamond heat sink, the devices deliver 220 mW of continuous-wave output power at 3.5% efficiency for frequencies from 50 to 60 GHz, and up to 160 mW with 3% efficiency at 65 GHz. They are gallium-arsenide devices made from wafers grown by a gallium-arsenide-chloride-nitrogen vapor-phase epitaxy.

Back in the U.S.—at Sandia Laboratories, Albuquerque, N.M., to be precise—researchers have found an intriguing way to improve the performance of trapatt diodes. They generate carriers in the active device area optically. The improvement in performance is so dramatic that illuminated trapatts not only promise better system performance in conventional rf applications, but also may open up many new applications for trapatts. Ultra-precision phase-tracking radars and high-data-bit-rate phase coding for transponders are two that come to mind.

The optically generated carriers arise in the depletion region of the diode in response to light hitting its p⁺ surface from either a Xenon flashlamp or a GaAs laser diode. (The trapatt itself is mounted at the end of a slung-tuned coaxial cavity.) With illumination, the oscillation frequency of the device can be shifted on the order of one rf period, permitting elimination of undesirable intrapulse frequency drift. Illumination also extends the trapatt's bias, tuning, and temperature ranges over which its output leading-edge pulse jitter stays short.

Applications extending up to millimeter-wave frequencies are being studied at Rockwell International's Science Center, Thousand Oaks, Calif. The Center is producing beam-lead Schottky-barrier GaAs mixer diodes with a technique that appears to be amenable to batch processing. To obtain definitions for isolation and junction device areas, proton bombardment and shadow masking are used, and the result is fully planar diodes having minimal parasitics. Also since the metalization system is self-aligning, the photoresist processing is noncritical.

Measured data looks hopeful. A zero-bias cutoff

frequency of 850 GHz characterizes devices having a series resistance of 3 ohms and a zero-bias junction capacitance of 0.06 picofarad. Preliminary rf measurements at 10.7 GHz indicate that the noise figure is typically 5.8 dB and conversion loss only 3.8 dB.

Optosemiconductors for communications

Optoelectronic semiconductors are lively this year, too, now that optical communications has almost arrived. A worldwide focus of interest is the working wavelength of optical systems. The goal is to increase it to 1 μm or longer, to improve compatibility with existing optical fibers.

In England, the Allen Clark Research Centre of the Plessey Co. has made light-emitting diodes and photodiodes with a gallium-indium-arsenide system. The 1.06-μm LEDs can still produce usable light after 100,000 hours, and the 1.15-μm photodiodes operate with a peak quantum efficiency of 80%. In the U.S., Rockwell International's Science Center, Thousand Oaks, Calif., has built 1.06-μm avalanche photodiodes as multiple-layer step-graded structures of a gallium-arsenide-antimony alloy system. Average gain for the devices is better than 14 at a dark (leakage) current of 150 nanoamperes.

In a related development, Japan's Musashino Electrical Communication Laboratory has found a way to make long-life GaAs laser diodes for fiber-optic applications. The devices are double-heterojunction semiconductors grown by a new liquid-phase-epitaxial technique. The entire surface of the wafers grown by this method is suitable for diode fabrication, and the new diodes are capable of producing a continuous-wave output for at least 1,000 hours.

Finally, for making high-accuracy measurements optically, Sweden's Chalmers University of Technology has developed a highly linear position-sensitive photodetector that can accurately monitor remote light sources, like LEDs. Making use of the lateral photoeffect, the device delivers a set of electrical signals that correspond to the position of an incident light spot on its detecting surface. Maximum nonlinearity is held to within 0.1%, and resolution for the new photodetector is better than one part in 50,000. □

Low-drain regulator extends battery life

by T. C. Penn
Texas Instruments Inc., Dallas, Texas

Stable regulation of battery power supplies once required dumping current into a zener diode or sacrificing several volts and milliamperes to a three-terminal regulator. Powering up voltage-controlled oscillators and other supply-sensitive circuits with batteries becomes practical when the circuit described here regulates the supply voltage. Providing ± 1 -millivolt regulation with loads ranging from 5 to 55 milliamperes, the circuit maintains accuracy even when the battery voltage is only 50 mv higher than the regulated output, and it draws rather less than 1 mA of quiescent current.

As evident in the schematic, the simplicity of the circuit belies its performance. The regulating operational amplifier A gets its reference voltage from the bridge made up of R_1 to R_3 and a light-emitting diode. The drop across the LED, which varies from device to device, is about 1.4 v and it remains relatively stable over a wide temperature range. Changing the temperature from 20°C to 40°C varies the regulated-output voltage only about 1 mv. If greater stability is required, a low-voltage reference diode or even a two-terminal regulator may

be substituted for the LED in the reference leg of the bridge.

The op amp controls Q_2 and Q_1 to maintain a zero offset between its inverting and noninverting inputs, thus establishing that the voltage drop across R_2 is equal to the drop across the LED. The regulated-output voltage is the sum of the drops across R_1 and R_2 ; this can be shown to be $V_{REG} = V_{LED}(R_1/R_2 + 1)$. With the values that appear in the schematic and if $V_{LED} = 1.4$ v, the regulated-output voltage V_{REG} by substitution becomes $1.4(22 \text{ kilohms}/10 \text{ kilohms} + 1) = 4.48$ v. If the voltage must be trimmed to a particular value, a 5-kilohm potentiometer can be inserted between R_1 and R_2 , with its wiper connected to the op amp.

Although the op amp is powered by the bus it regulates, the circuit exhibits no start-up problems. As soon as power is applied, Q_2 , biased on by the current through R_6 , turns on Q_1 , supplying power to the op amp and reference bridge. Q_1 and Q_2 , in conjunction with R_4 and R_5 , form a feedback pair with a voltage gain of about 3. For that reason, a high-gain op amp may be used with no danger of oscillation.

The op amp is half of a dual package, although it could equally well be one fourth of a quad package. In either case, the regulated bus can power all the op amps in the package, so long as the total current required does not exceed 55 mA. The current drawn by the TLO 22 dual op amp alone is about 800 microamperes. Also pictured in the schematic are optional filtering and decoupling components, C_1 , C_2 , and R_7 . □

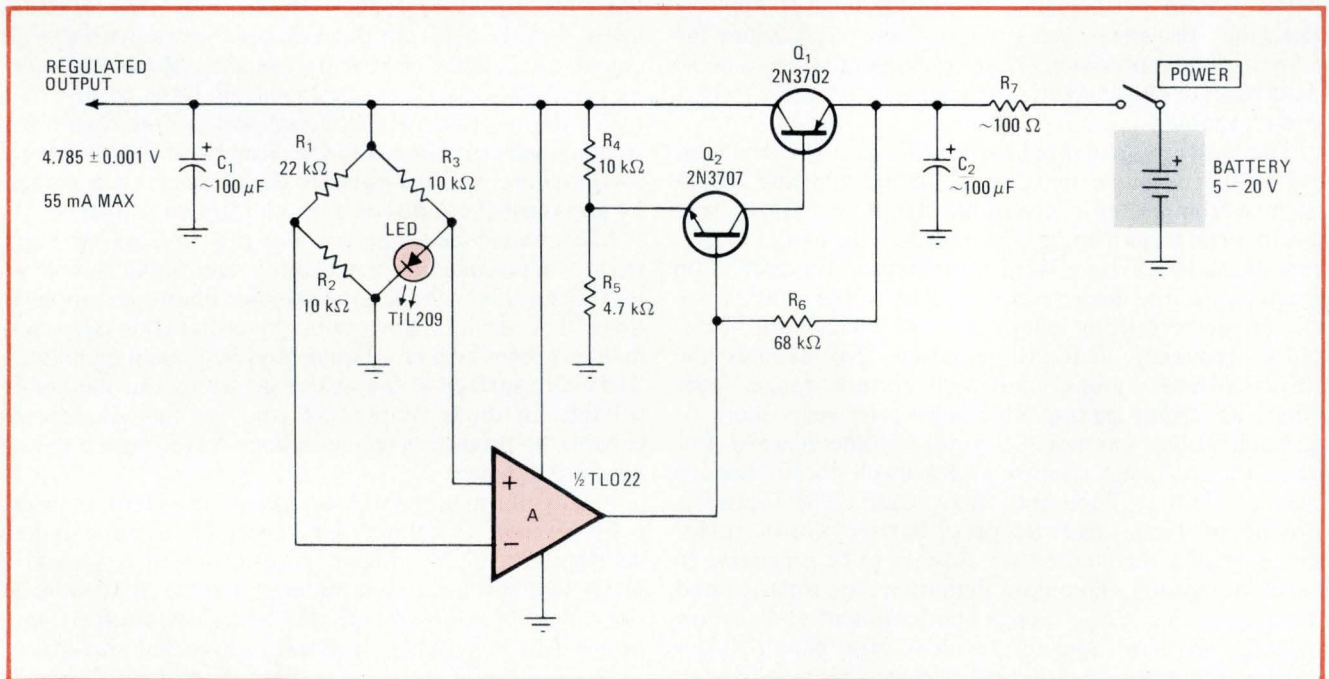

Battery supply regulator. Voltage drop across LED in bridge references op amp, controlling transistors in feedback loop. Under 5-milliampere load current, regulated output of $4.785 \pm .0005$ V is achieved with supply voltages ranging from 4.835 to 20.00 V. With a 9.000-V supply, the regulated output is $4.785 \pm .001$ V with loads ranging from 5 to 55 mA. Current through LED is barely enough to make it glow.

Multiple-feedback filter has low Q and high gain

by Gregory O. Moberg
Eastman Kodak Co., Rochester, N.Y.

The multiple-feedback operational-amplifier circuit found in many applications manuals for operational amplifiers readily generalizes into an active filter with both high gain and low Q. This versatile design saves one or more gain stages and is useful in any filtering application.

The multiple-feedback bandpass filter is shown in Fig. 1. To simplify its design equations, C_1 and C_2 are usually made equal. The price paid for this simplification, however, is that the Q of the filter can not be made less than $(A_o/2)^{1/2}$, where Q is the ratio of the filter's center frequency, f_o , to the 3-decibel bandwidth, Δf , and A_o is the gain at f_o (see Fig. 2). Therefore high gain must be accompanied by high Q.

This limitation is removed by allowing the two capacitors to have different values. The Q can then be made as low as desired just by making C_2 sufficiently less than C_1 . The design equations for the generalized filter are:

$$R_3 = Q(C_1 + C_2)/2\pi f_o C_1 C_2$$

$$R_1 = R_3 C_1 / A_o (C_1 + C_2)$$

$$R_2 = R_1 C_2 A_o / [Q^2 (C_1 + C_2) - A_o C_2]$$

PERFORMANCE OF DESIGN-EXAMPLE FILTER		
Characteristic	Calculated value	Measured value
A_o	104	101
f_o	101 Hz	102 Hz
Q	3.0	2.8

To design a filter that has a given A_o , f_o , and Q, the steps are as follows:

1. Assume $C_1 = 1$ microfarad.
2. Choose a standard value for C_2 equal to or less than $C_1 Q^2 / (A_o - Q^2)$.
3. Calculate R_1 , R_2 , and R_3 .
4. Multiply all the resistors and divide all the capacitors by a scaling factor that produces convenient impedance levels. For example, it may be convenient to have the scaled value of R_1 much greater than the source resistance of whatever is driving the filter.
5. Make sure that the closed-loop gain of the filter, A_{CL} , is 20 dB below the open-loop gain of the op amp, A_{OL} .

As an example, a filter was constructed with a National Semiconductor LM307 op amp and the following components:

- $R_1 = 9.1$ kilohms
- $R_2 = 11$ kilohms
- $R_3 = 1$ megohm
- $C_1 = 0.1 \mu F$
- $C_2 = 0.005 \mu F$

The results shown in the table were obtained from this network. The deviation between the measured and

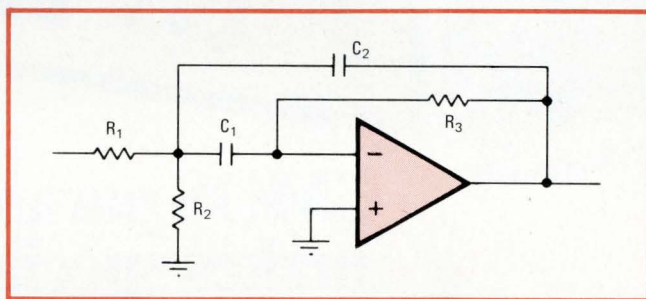

1. Active filter. If the two capacitors are equal in this multiple-feedback filter, the gain must be low when the Q is low. But if C_1 is greater than C_2 , the filter can combine high gain with low Q, thus saving a gain stage.

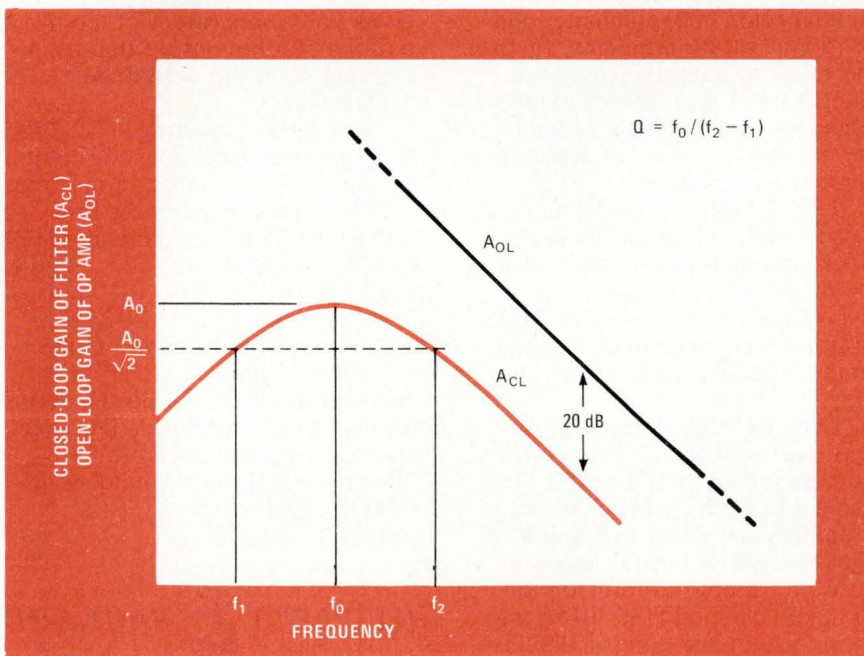

2. Frequency response. For given A_o and f_o , the Q of the filter in Fig. 1 can be set by the choice of capacitor values. The filter should have a closed-loop gain that is 20 dB below the open-loop gain of the op amp. This will ensure ideal behavior of the op amp.



Instrument as shown has pulse-burst option and optional handles.

CMOS parametric testing makes special demands... Meet them with HP's 8015A Pulse Generator.

This pulse generator has standard features and options that make it ideal for MOS and CMOS parametric testing. For example:

You get dual-channel outputs, each variable to 16V. Or, they combine into a single 30V channel adjustable within a $\pm 16V$ window. That versatility makes the 8015A compatible with CMOS, and most MOS devices. You can delay channel B with respect to A for generating 2-phase nonoverlapping clocks. And combine the adjustable B delay with A + B to generate three-level signals.

Selectable source impedance on both channels lets you choose the best output termination configuration for your application. Of course you can vary the width (10ns to 1s), transition time (6ns to 0.5s), and rate (1Hz to 50 MHz). High-speed capability lets you work with advanced TTL and HTL logic as well as MOS. And low rep. rates or manual operation let you slowly step through logic states.

The 8015A options makes CMOS testing even easier. Pulse Burst (option 002) eliminates conventional gating problems. Just set the exact number of pulses you want (from 1 to 9,999) on thumb-wheel switches. That's exactly the number you get... independent of pulse-rate settings.

Upper Output Level Tracking (option 006) automatically keeps clock and data-pulse amplitudes at the proper level relative to the supply voltage. This prevents CMOS circuit damage due to overvoltage on the inputs, even if the power supply is turned off.

Direct Output Amplifier Access (option 004) lets you convert word generator outputs, or TTL signals, to MOS/CMOS levels, or amplify low-level analog control signals to MOS/CMOS levels.

With Remote Control (option 003), you can build the 8015A into a test system and control all pulse parameter ranges with digital signals. Verniers are controlled by

current or voltage inputs.

And TTL Output (option 005) gives you a separate TTL compatible, 50-ohm output that tracks channel A output with fixed TTL levels.

The 8015A, starting at \$2,250*, gives you parametric testing flexibility and saves valuable setup time.

Or, if your need is for functional CMOS testing, consider HP's 8011A. Priced at just \$525*, it gives you high amplitude (to 16V) pulses at rates from 0.1 Hz to 20 MHz, and offers the Pulse-Burst Option.

Contact your local HP field engineer for all the details. Or, write for the 8015A and 8011A data sheets and our Application Note 195 — "Pulse Generator Techniques in CMOS Applications."

*Domestic U.S.A. prices only.

086/9

HEWLETT  PACKARD

Sales and service from 172 offices in 65 countries.
1507 Page Mill Road, Palo Alto, California 94304

calculated performance is well within the range expected from the 5% components used.

It is important that the difference between the closed-loop gain of the filter and the open-loop gain of the op amp be at least a factor of 10, in order to ensure ideal behavior of the op amp. A sufficient condition for this is

that $A_o f_o (1 + 1/2Q)$ be equal to or less than 0.1 BW, where Q is equal to or greater than unity, and BW is the op-amp unity-gain bandwidth. For low gain or low f_o designs, the LM307 op amp (BW = 800 kilohertz) will suffice. For higher gains or higher f_o , an op amp such as the LM 318 (BW = 15 megahertz) should be used. □

Up/down latching sequencer keeps order

by Marc D. Williams
Standard Telephone Co., Cornelia, Ga.

Circuits sometimes need energizing in a prescribed order and de-energizing in the reverse order, on a first-on, last-off basis. At a high-power radio station, for instance, the antennas are switched for transmitting and receiving, and the linear amplifier must be turned off before the switching and on afterwards if its output section is not to be destroyed. A sequencer that performs this task can be built with transistor-transistor-logic circuits, having a sequence rate controlled by an external TTL clock and a completely expandable number of outputs.

The circuit uses AND gating and inhibiting inputs on the control flip-flops to execute the proper sequence. As shown in the schematic, closing the ENABLE switch allows clock pulses to pass to the flip-flops, which are inhibited by the low level at their J inputs. Turning on

the RUN switch allows the first flip-flop, FF₁, to toggle upon receipt of the next clock pulse, and the Q output of FF₁ enables FF₂ to toggle with the following clock pulse. The Q output of FF₂ inhibits FF₁, while the Q output of FF₂ allows FF₃ to toggle, and so on down the line to the last flip-flop, FF_n, as long as the RUN switch remains on. The circuit now is stable with all the Q outputs high.

Turning the RUN switch off starts the unlatch sequence by enabling FF_n to return to its off state due to the high K and low J input levels. The Q output of FF_n enables the preceding flip flop FF_{n-1} to return to its low state, and so on back to FF₁. Opening the ENABLE switch simultaneously resets all the flip-flops and prevents further toggling.

A three-stage sequencer will require five TTL packages, excluding the clock circuit. Driving displays or relays requires buffering of the Q outputs on the flip-flops.

Although the sequencing may be extended to many stages, the inverters may have to be buffered to drive the AND gates for many stages. □

Designer's casebook is a regular feature in *Electronics*. We invite readers to submit original and unpublished circuit ideas and solutions to design problems. Explain briefly but thoroughly the circuit's operating principle and purpose. We'll pay \$50 for each item published

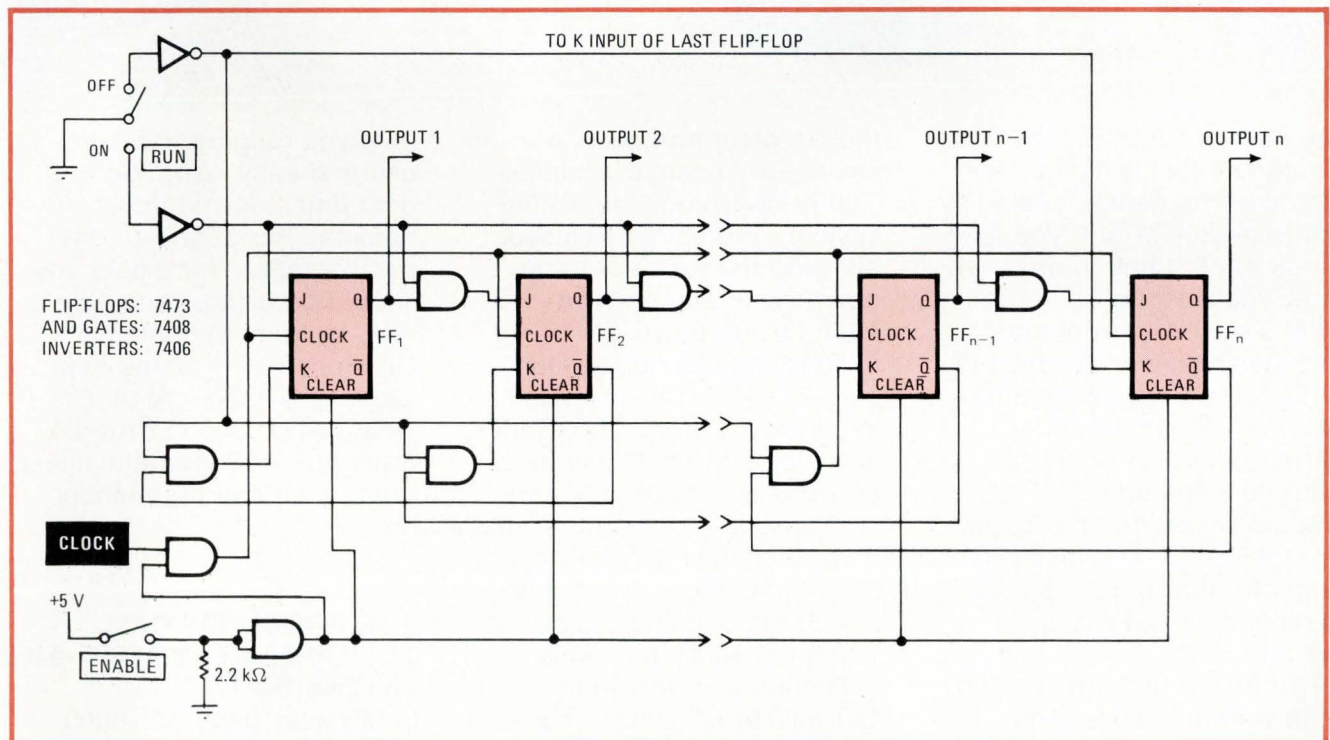

First on, last off. With ENABLE switch on, turning RUN switch on starts the latching sequence: with each clock pulse Q output of each flip-flop goes high in ascending order, until all are high. Turning RUN switch off unlatches outputs in descending order. The circuit was designed to permit switching of antenna couplers only after removing power from radio transmitter, and RUN function was performed by keying.

The GOULD/Brush 2000 Series.

The most significant advance in direct writing recorders in the past decade.

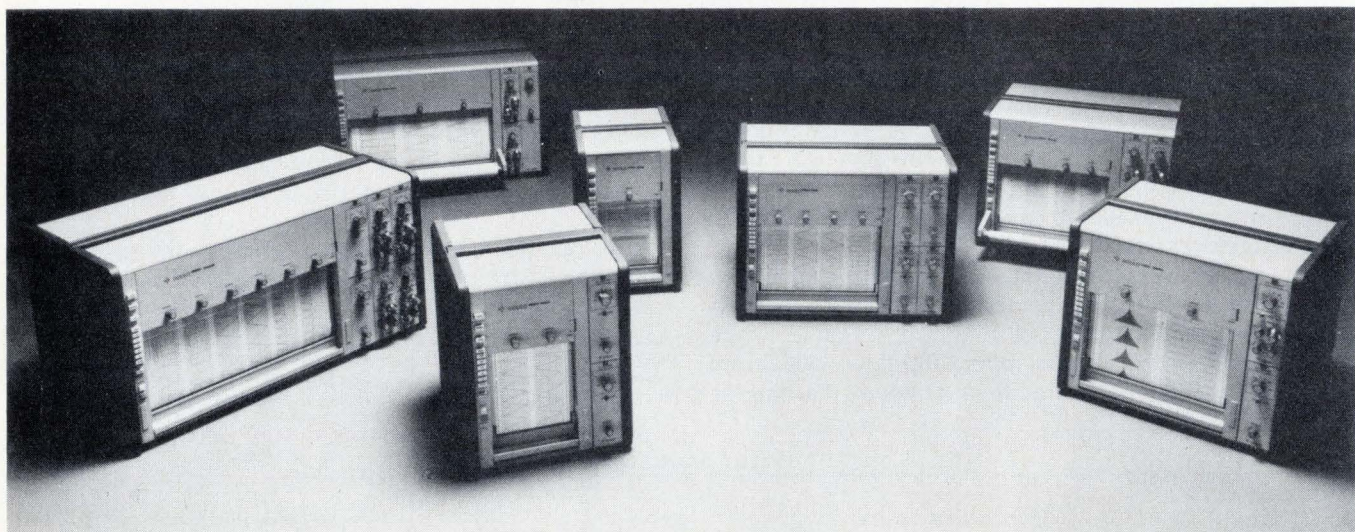

The new GOULD/Brush 2000. We can modestly say it's the best in performance, versatility and reliability. And if you take a look at all it has to offer, we know you'll agree.

Let's start with frequency response that's unexcelled in performance. An exceptional 30 Hz at 100mm, 50 Hz at 50mm, and up to 125 Hz at reduced amplitude.

Superior resolution is assured through a high-stiffness servo penmotor that enforces 99.65% linearity over the entire channel width.

Traces are uniform in width at all writing speeds. And

they're clear and crisp, with no smudges, smears or puddles. The pressurized fluid writing system is completely closed, allowing the recorder to be operated in any position—even upside down.

Then take flexibility. Our plug-in signal conditioners fit every model in the 2000 Series, and record virtually any function you could possibly want.

Thanks to its modular design, it's as versatile as your needs. Channel choices range from 1 to 8. In combinations of 100mm or 50mm channels.

There's a lot more the GOULD/Brush 2000 Series can

give you ranging from easy use and easy servicing to a cost that's downright economical. For details on the oscillographic recorders you should be using, write Gould Inc., Instrument Systems Division, 3631 Perkins Ave., Cleveland, Ohio 44114. Or Gould Allco S.A., 57 rue St. Sauveur, 91160 Ballainvilliers, France. Or call the number below.

**FOR BROCHURE CALL
TOLL FREE AT (800) 325-6400.
EXTENSION 77.**

In Missouri: (800) 342-6600.

 **GOULD**
The product development company

An electrically alterable ROM— and it doesn't use nitride

Information can be read, written and erased electrically
in new floating-gate MOS memories

by James W. Kelley and David F. Millet, *NEC Microcomputers Inc., Lexington, Mass.*

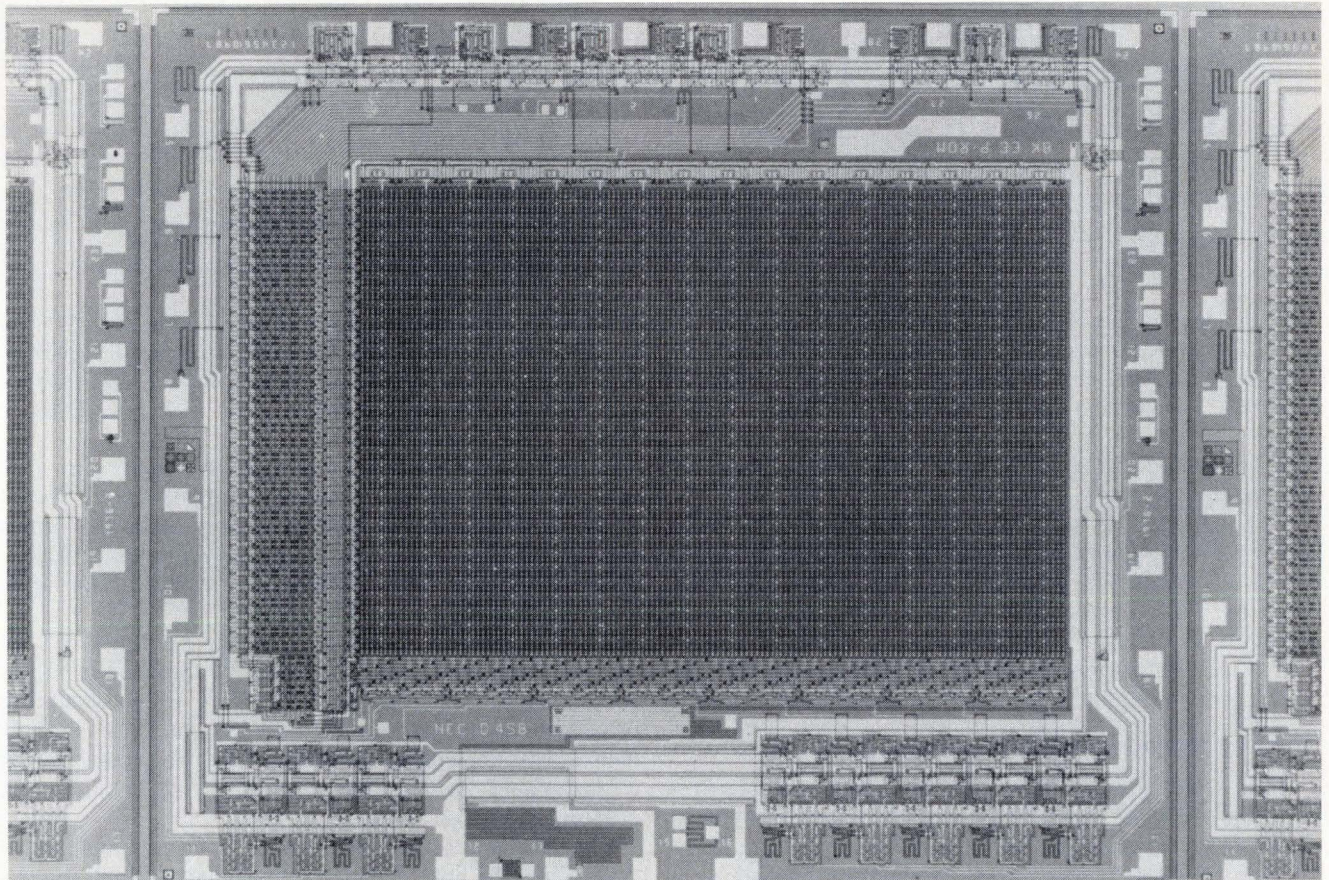

□ Applications of semiconductor read-only memories are booming, especially now that the ROMs can be made to forget as well as remember. Erasability permits reprogramming during design and development, as well as in low-volume production of systems in which the memories require occasional updating to accommodate design changes or to correct programming errors.

Erasure has been achieved with ultraviolet light in the floating-gate avalanche-injection metal-oxide-semiconductor (Famos) types and with electrical signals in metal-nitride-oxide-semiconductor (MNOS) types. Now a new type of PROM extends the Famos process to allow erasure with electrical signals.

Neither UV-erasable nor MNOS types have as many advantages as the electrically erasable 2,048-bit μ PD454

and 8,192-bit μ PD458. They have simpler and lower-current programming circuitry than the UV-erasable types and erase faster than they do. Since they have no ultraviolet sensitivity, stray UV or X rays cannot erase them accidentally.

Reliability a factor

They are more reliable than the MNOS types, in which the charge is stored at the surface layer between the nitride and the oxide. This stored charge deteriorates upon reading and must be refreshed after a number of read operations. Access time is under a microsecond compared to the 2μ s typical for MNOS devices. Also, the electrically erasable PROM is based on standard MOS processing techniques, which are far better understood

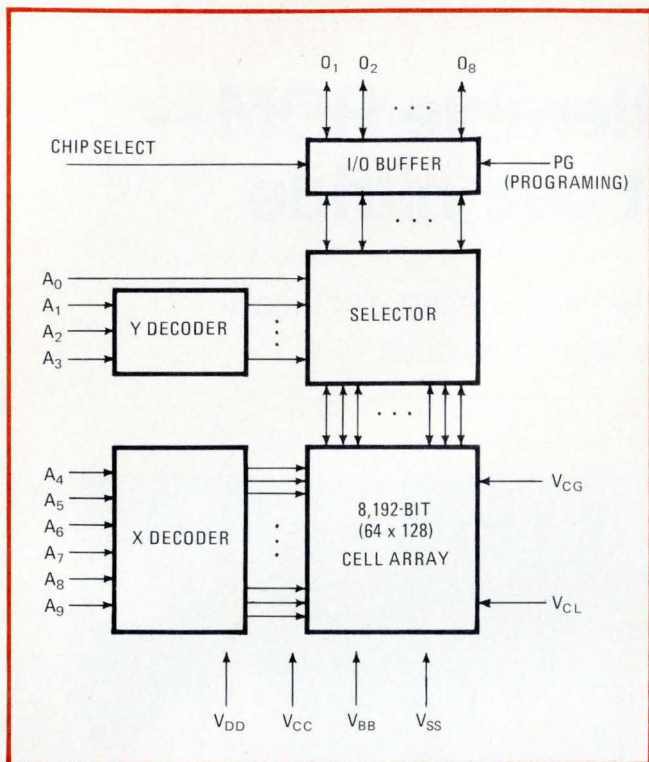

1. In the blocks. The electrically erasible PROM comprises an 8,192-bit array of memory cells, organized as 1,024 8-bit words plus decoders and buffers. In programming, all bits are initially turned off from the V_{CL} terminal and then selected bits are turned on from PG.

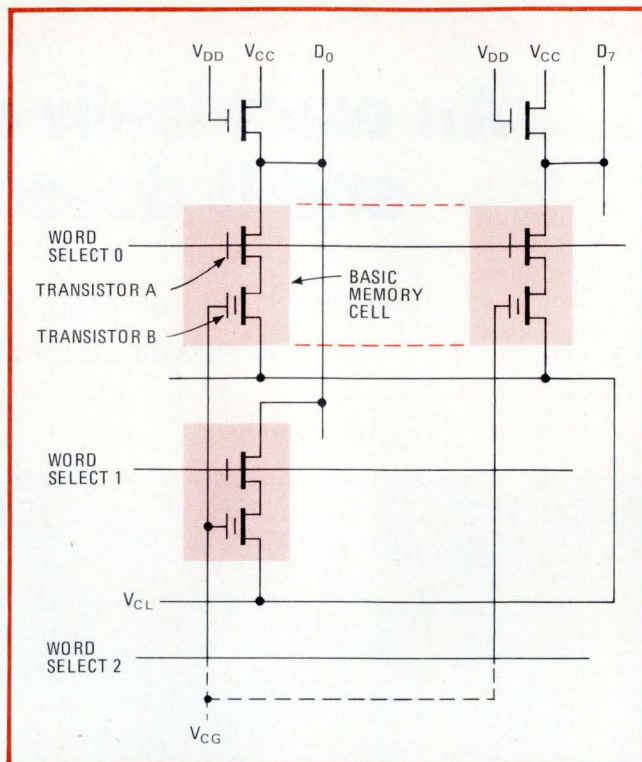

2. Basic cell. The memory cell contains two transistors—A, for selection, and B, for bit storage. Transistor B is shown schematically with a second, floating gate, which performs the basic storage operation. Eight memory cells are connected along one word line.

and controlled during production with today's semiconductor equipment.

The μ PD458 is a larger version of the 2,048-bit μ PD454, which was introduced in late 1975. It is an 8,192-bit memory organized as a fully decoded 1,024-word-by-8-bit device and is a static memory that requires no clock. The new device is compatible with transistor-transistor-logic levels for reading and writing, and has a three-state output and wired-OR capability.

Cost vs reprogrammability

In a typical system—say, a digital sequence controller—the designer can choose between factory-masked ROMs, conventional one-shot fusible-link PROMs, complementary-MOS random-access memories backed by a battery to preserve data when the power is off, UV-erasable PROMs, or electrically erasable/alterable ROMs.

Factory-masked ROMs are impractical for this type of system because of the high front-end mask charges and the turn around time for changes (up to 12 weeks). One-shot PROMs should be ruled out unless the designer is sure the program is error-free and not likely to need frequent revision. Errors and revisions mean lost programming time and cost of replacing the memory.

A C-MOS RAM would eliminate the cost of memory replacement if reprogramming proved necessary. But the designer runs the risk of wasting time and losing all the stored data if there is a failure in the battery backup. Also, C-MOS RAMs are less dense and more expensive than are PROMs.

On a cost-per-bit basis, such PROMs are more expen-

sive than other semiconductor read-only memories. One can expect to pay about 1 cent per bit for erasable PROMs in small-lot purchases, generally more than five times the cost of one-shot PROMs. The convenience of reprogrammability, however, overrides the price differential in many applications.

The UV-erasable types are proven products readily available in quantity, but they must be removed from the circuit board for erasure. This is a time-consuming procedure, as the full erasure may take as long as a half hour. Also, the pins of the device may be damaged or contaminated during the removal and replacement procedure.

Electrically erasable PROMs—both Famos and MNOS types—may be erased and reprogrammed without removing the devices from the circuit boards. Erasure and writing procedures are significantly faster than UV types. But the balance is tipped in favor of the Famos electrically erasable devices by their superior access time and memory-data retention over the MNOS chips (although each type is available with 8-kilobit capacity).

The 8-kilobit cell array of the μ PD458 is surrounded by X and Y decoders, a selector, and an input/output buffer (Fig. 1). In programming the device, the first step is to erase the previous contents of all memory cells by turning on the memory transistors of all the bits simultaneously from the V_{CL} terminal. Then writing in from the programming terminal (PG) turns off selected bits. The write-in is performed 1,024 times, once for each 8-bit word. The programmed information is read with V_{CG} , V_{CL} , V_{BB} , and PG grounded.

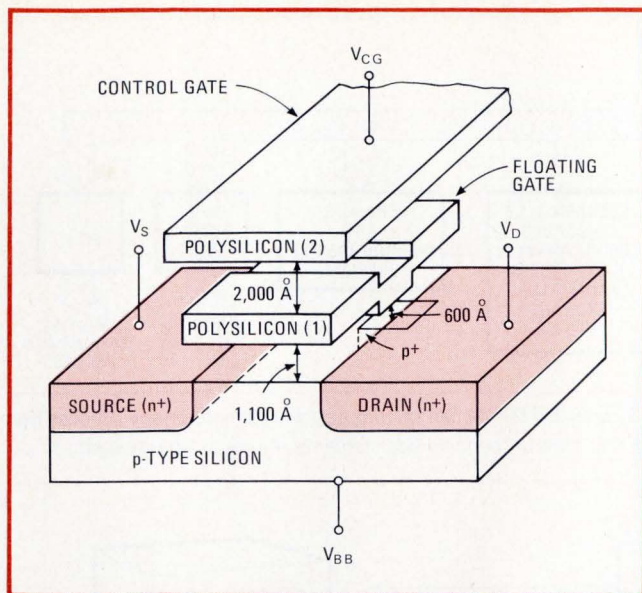

3. Construction. The memory transistor has two polysilicon gates: the control gate and a floating gate. The floating gate is stepped down to a thinner oxide region over the p+ diffusion. Charges are injected into the floating gate in this region to form the basic storage

Each μ PD454/8 cell (Fig. 2) has two transistors fabricated by n-channel MOS technology. Transistor A, an enhancement-mode device, responds to external addressing, while transistor B is the actual memory device.

In the μ PD458 memory transistor (Fig. 3), polysilicon processing is used for a control gate and a floating gate that is either charged (a logic 1) or discharged (a logic 0) to determine the cell readout.

The insulator between the floating gate and the semiconductor surface has two different thicknesses. Over the entire gate region, the oxide is typically 1,100 angstroms thick, but over the p+ auxiliary region, the oxide is typically 600 Å to enhance charge injection. The substrate is a p-type single crystal silicon. A p+ auxiliary diffused region is formed in contact with the drain.

After erasure, the memory device (transistor B) is in the conductive, or on, state, which corresponds to a positive charge on the floating gate. A write operation switches transistor B to the nonconductive, or off, state, which corresponds to a negative charge on the floating gate. The memories are usually shipped in the erased state. Upon reading, the data-out terminal is in the low, or 0, state for all 1,024 words—that is, transistor B of the cell is on.

3 voltages for erasure

In erasing, the typical applied voltages are 36 volts on the source, -40 v on the control gate, and -5 v on the substrate with the drain open. When the 36 v is applied to the source terminal, a surface breakdown of the source n+p junction generates hole-electron pairs. The direction of the electric field in the gate insulator insures that only holes are injected into the floating gate. After completion of erasure, B turns on and thereafter has a memory threshold voltage of about -30 v. (The

TABLE: COMPARISON OF PROGRAMMABLE ROMs ERASABLE BY ULTRAVIOLET LIGHT OR ELECTRICALLY

Type	Format	Write		Read		Erase	
		Voltage	Time (typical, s)	Voltage	Time (max, ns)	Method	Time (typical, min)
170A	256 x 8	+12, -35, -48	120	+5, -9	1,000	UV	20
2708	1,024 x 8	± 5 , +12, +26	120	± 5 , +12	450	UV	30
μ PD454	256 x 8	-2, +26	5.5	+5, +12	800	elect.	0.5
μ PD458	1,024 x 8	-2, +26	80	+5, +12	450	elect.	0.5

threshold voltage is defined as the control-gate voltage necessary to turn transistor B on once the floating gate has received its charge.)

To write a logic 1, electrons are injected onto the floating gate by using the low-voltage breakdown of the drain n+p+ junction. The injected electrons neutralize the accumulated holes on the floating gate and eventually cause it to become negatively charged. At this point, transistor B turns off.

Under writing conditions, which are 26 v on the control gates and -2 v on the substrate with the source terminal, a 40-millisecond, 15-v write pulse will cause the memory threshold voltage to become +10 v. The erased conductive state in transistor B represents a stored 0, while the written nonconductive state represents a stored 1.

To read data out, the word line is pulsed, turning on A, the selection transistor. A current then flows to the output buffer through B and the series-connected A, if B is on, which corresponds to a 0. If B is off, no current flows and the output buffer therefore generates a logic 1 level.

Fewer voltages needed

As the table shows, four voltages are required for writing in two typical UV-erasable chips—the 2704 and the 2708. However, only two voltages are required for writing in the μ PD454/8. Also, their lower current requirements help prevent chip damage during repeated erasure and writing. Read times for the two different types of devices are comparable, but the 2708 needs three different voltage sources for the same 450-nanosecond access as the two-voltage μ PD458 with the same density.

The μ PD454D is packaged in a standard 24-pin ceramic dual in-line package, but its pin locations are not compatible with those of the 1702A, a 2-kilobit UV-erasable chip. The 8-kilobit μ PD458 and 2708 are, however, plug-compatible although the μ PD458 is a 28-pin part and the 2708 is a 24-pin part. Compatibility may be achieved with the μ PD458 pinout pattern that has 24 of its pin locations matching those of the 2708. The user need only add four more pins to his board layout to accommodate the memory. These four pins are needed for electrical erasure and reprogramming.

Alternatively, since all UV-erasable PROMs are placed in sockets to allow them to be easily removed, erased, and reprogrammed, the μ PD458 may be made compatible with the UV-device sockets by using an adapter printed-

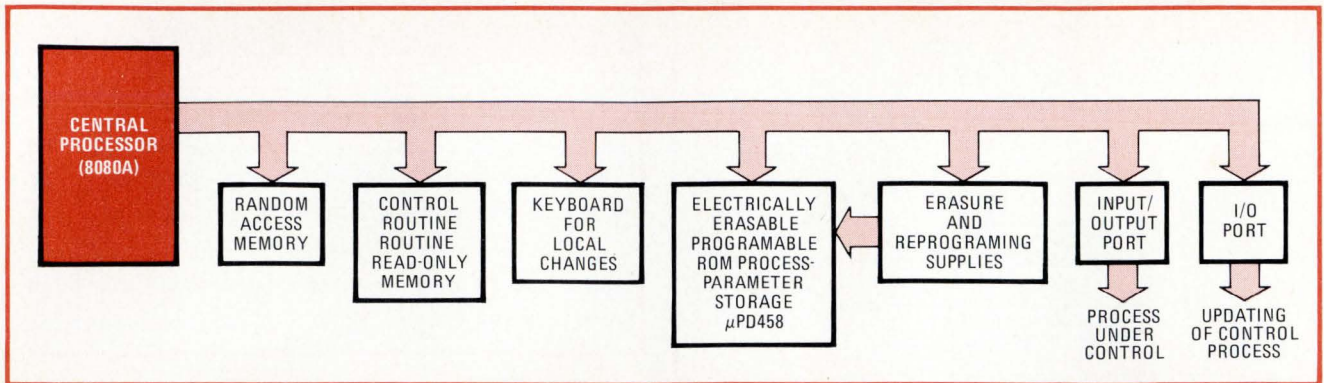

4. Process control. A typical process control system using the electrically erasable PROM can be remotely programmed for any process from a central controller. This would be useful in such cases as machine wear that calls for periodic adjustments of process parameters.

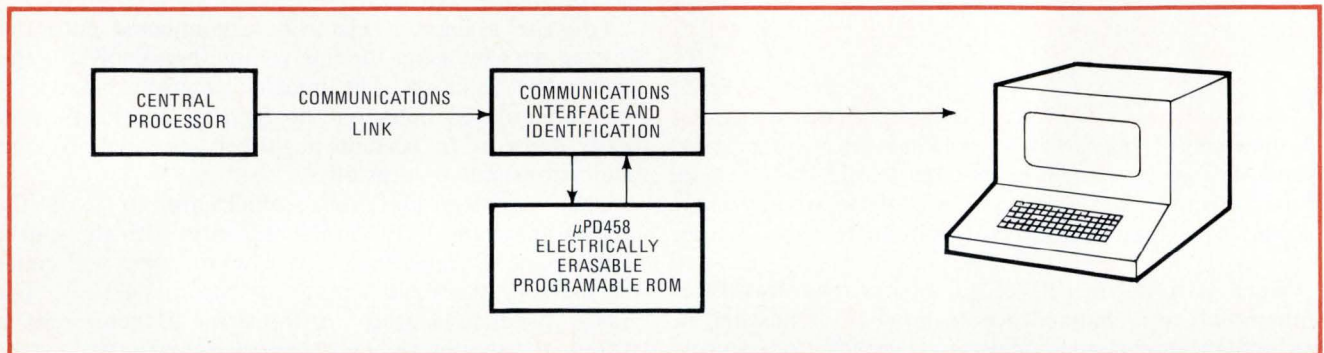

5. Security. Data-network security can be obtained by storing an access code or algorithm in the electrically erasable PROM, which can be updated from a central processor to allow a new terminal to be added to the system. The terminal operator need not know the codes.

circuit board, which would typically cost from 15 to 20 cents. This board connects pin 12 (ground) of the UV-type socket to pins 13, 14, 15, and 16 of the electrically erasable PROM.

The UV-erasable PROMs may be erased superficially with only a few minutes of exposure. But, unless erasure is sustained for the periods shown in the tables, the erased data may reappear and result in ambiguities. The electrically erasable PROMs are typically erased in less than 1 minute. If the input voltage levels are properly controlled, there is little danger of damaging the devices.

The electrical erasing procedure of the μ PD454/8 is not susceptible to the formation of radiation-induced leakage paths that shorten the life of the UV-erasable memories. As a result, once a data pattern is programmed, it will be retained without the need for refresh for more than 10 years.

Tests performed on randomly selected memories in a computer-controlled setup bear out the prediction of long life. A microcomputer was programmed for systematic erasure and writing of a varying pattern of 1s and 0s. More than 10,000 erasure/write/verify cycles were carried out on a number of standard production memories with no failures and no indications of any data ambiguities.

Serving systems

As well as proving useful for development, erasability can also be a functional part of a system. For example, a central controller can remotely program a process-

control system for a specific process (Fig. 4). Corrections and tailoring for local connections can be performed through a keyboard. The nonvolatility and easy erasure/reprogramming well suit the devices for cases where adjustments for machine wear, changes in system characteristics, and the like must be determined and made periodically.

For data-network security (Fig. 5), the access code or algorithm for attaching to the central processor is stored in the electrically erasable PROM. To supply an updated code to a terminal, the central processor instructs the identification circuitry to erase the PROM, then supplies it with the new code for future "log-ons". Since the terminal operator does not need to know the code to enter data, he or she cannot be a security leak for the system. The nonvolatility of the electrically erasable PROM also makes it suitable for such applications as portable terminals.

There will be many new circuit designs and applications for the μ PD454/8, especially those that can profit from the remote erasure and reprogramming feature. For example, these memories will permit the remote erasure and reprogramming of computers or instruments in inaccessible or hazardous locations. Digital equipment may be located in or near atomic reactors, in the depths of the sea, or in the far reaches of space.

The new memories also make possible rewriting programs as often as desired for the most effective service. Erasure and reprogramming signals may be transmitted by cable for hundreds of feet or by telemetry across millions of miles of space. □

Single-chip microprocessor rules the roast

Device controls microwave oven and allows the cook to program cooking cycles, temperatures, and speeds

by Bill Bell and Deene Ogden, *Texas Instruments Inc., Houston, Texas*

Millions of golden-brown Christmas turkeys will pop out of microwave ovens this year, and some of them will owe their flavor to microcomputers. These versatile components are displacing conventional electromechanical timers for controlling microwave ovens. They provide the same control functions—timing and heat settings—but they also make life easier for the cook by offering programmable sequences of cooking cycles and programable temperature-controlled cooking, as well as

programmable cooking speeds for these two modes.

The TMS 1100, a one-chip, 4-bit microcomputer (see "Six chips make up the TMS 1000 family," p. 107), is typical of the low-cost microprocessor units controlling microwave ovens. In combination with the TMS 1976 capacitive-touch interface chip, it provides the minimum-chip-count circuitry of Fig. 1. As well as controlling the cooking, the circuitry controls a clock, a digital display and mode lights, the magnetron micro-

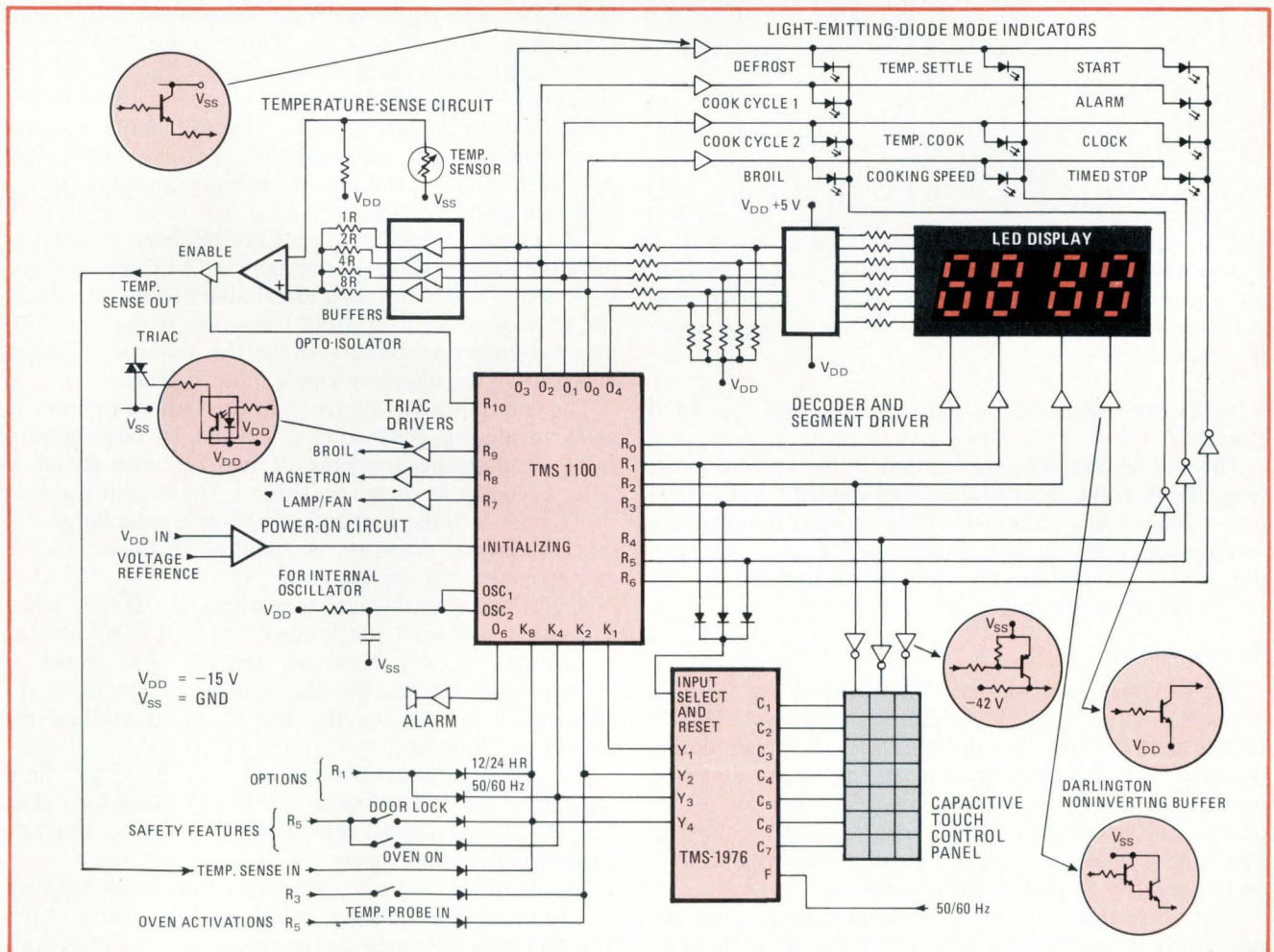

1. Oven electronics. The TMS 1100 controls the circuitry for time and temperature cooking methods, generates a precise time base, and controls triacs for supplying ac power to the oven's magnetron, fan, light, and broil element.

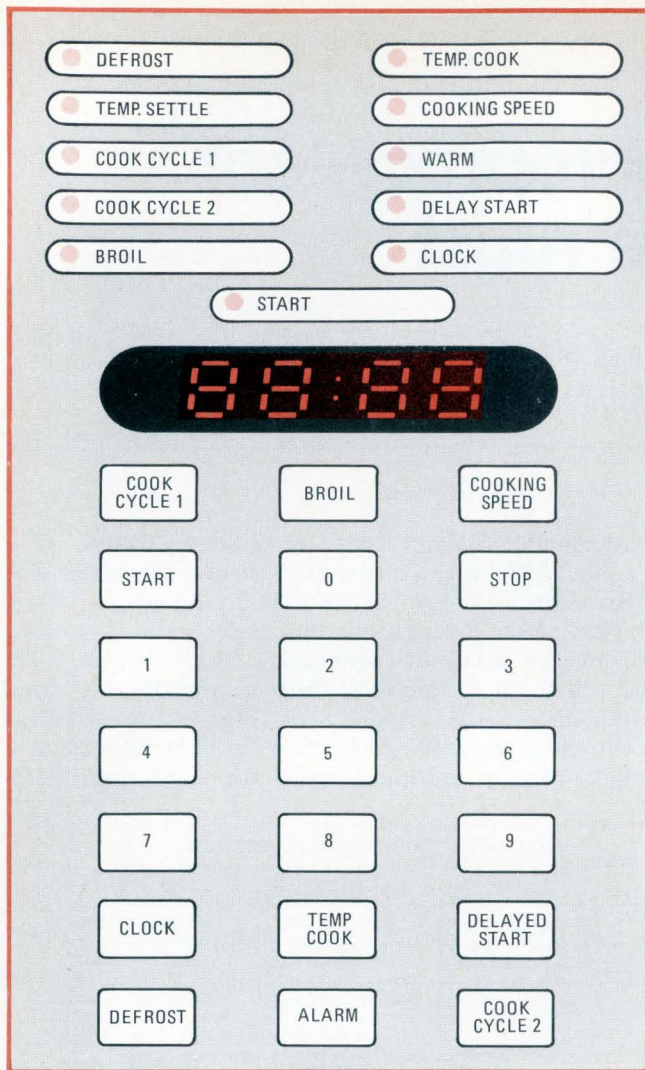

2. Touch control. A glass control panel with 21 capacitive switches, a 4-digit LED display, and 11 LED mode indicators is used to enter program commands to place the microwave oven in one of a number of cooking modes.

wave power oscillator, a fan, a light, and the broil element.

The key to the oven's operation is the control panel (Fig. 2). A large, four-digit, seven-segment light-emitting-diode display shows the time of day, temperature settings, or timer settings. Above this display, 11 LEDs indicate the operation the oven is performing or the activation of the clock.

How it works

The cook programs through the 21 capacitive switches below the LED display. For example, to set the clock to 10:20, he or she touches the CLOCK switch, then enters the time by touching 1, 0, 2, 0 (the clock can be set at the factory for 12- or 24-hour cycles). Then she or he pushes the START switch to start the clock's counting. The time is displayed on the four-digit display and may be temporarily displaced during cooking.

Capacitive-touch switches are formed by placing two capacitors in series for each switch on the plate-glass control panel, which also seals the circuitry from the outside environment. Application of the ac-grounded

TABLE 1: FUNCTIONAL OPERATION OF THE TMS 1976

Input set and reset	Detected input	Outputs			
		Y ₄	Y ₃	Y ₂	Y ₁
L	C ₁	L	L	L	H
L	C ₂	L	L	H	L
L	C ₃	L	L	H	H
L	C ₄	L	H	L	L
L	C ₅	L	H	L	H
L	C ₆	L	H	H	L
L	C ₇	L	H	H	H
L	C ₈	H	L	L	L
L	C ₉	H	L	L	H
L	no key	L	L	L	L
L	reset	L	L	L	L

body capacitance of the cook to the junction of a switch's two capacitors alters the net capacitance, thereby lowering the voltage to the capacitive input lines. The interface chip (Fig. 3) detects the voltage change and encodes it into a 4-bit binary word, which goes to the microcomputer.

What the interface chip actually detects is the absence of a scan pulse from the R-output lines of the microcomputer. The scan pulses generate transitions on the interface chip's input lines, C₁₋₉. These transitions are 0.5 volts more negative than the reference voltage applied to the chip's V_{ref} pin, which permits their detection and then the latching of the level detector's output. When a switch is touched, the input voltage becomes at least 0.3 v more positive than V_{ref}, sending a new logic condition to the interface chip's decoder.

The microcomputer's R lines are buffered in order to drive the keys with a large voltage (-42 v) to make level detection of a switch touch as reliable as possible. Since the R lines make a positive transition when scanning, external inverting buffers drive the control switches, which drive the interface chip's input buffers.

The chip takes the inputs from the buffers by priority so as to prevent generation of invalid encoder outputs from simultaneous touching of two or more switches. After encoding as shown in Table 1, the output goes out the Y lines into the K inputs of the microcomputer. No other interface circuitry is required between the Y outputs and the K inputs.

A high level on the interface chip's ISR (input select and reset) will reset the latches and will maintain the reset until a low level is sensed. The reset is accomplished by the R₁, R₃, and R₅ scans from the microcomputer; the R₂, R₄, and R₆ scans address the control-switch inputs.

The microcomputer's O-output and R-output lines control the four-digit display and the 11 indicator lights. The R outputs strobe the O-output data to the LED display and LED indicators.

The interface chip also provides a time-base input for the clock, the four cooking timers, and the alarm timer. The time-base reference is the frequency of the ac line. A line pulse is recorded every 16.6 milliseconds at 60 hertz or every 20 ms at 50 Hz. This signal is tied to the

Six chips make up the TMS 1000 family

The TMS 1000 series is a family of p-channel metal-oxide-semiconductor 4-bit microcomputers with read-only and random-access memories, arithmetic/logic unit, oscillator, and clock generator fabricated on a single chip. The TMS 1000 (28 pins) and the TMS 1200 (40 pins with two additional outputs) are the basic family members. They have 1,024 instruction words of ROM and 256 bits of RAM. The TMS 1070 (28 pins) and TMS 1270 (40 pins with four additional outputs) interface directly to high-voltage displays of up to 35 volts. Otherwise they are functionally identical to the TMS 1000/1200. The TMS 1100 (28 pins) and TMS 1300 (40 pins with five additional outputs) are extensions of the basic TMS 1000/1200 with 2,048 words of ROM and 512 bits of RAM.

Customers' application programs are reproduced on

the internal ROM during wafer processing by a single-level mask. The ROM program controls data input, storage, processing, and output, plus branching, looping, and subroutines. The RAM is used to store input data, flags, and results for later use.

When an input instruction is executed, the four external data inputs, K_1 , K_2 , K_4 , and K_8 , are gated to the adder. The inputs can be stored in the RAM for subsequent use.

The R outputs are individually latched and can be used to multiplex inputs, to strobe O outputs or other R outputs, and to address external devices such as memories. The O-output latches are set when a transfer-data-to-output instruction is executed. This transfers the 4-bit accumulator and 1-bit status-register contents to the O register, which is decoded by a user-programmable logic array.

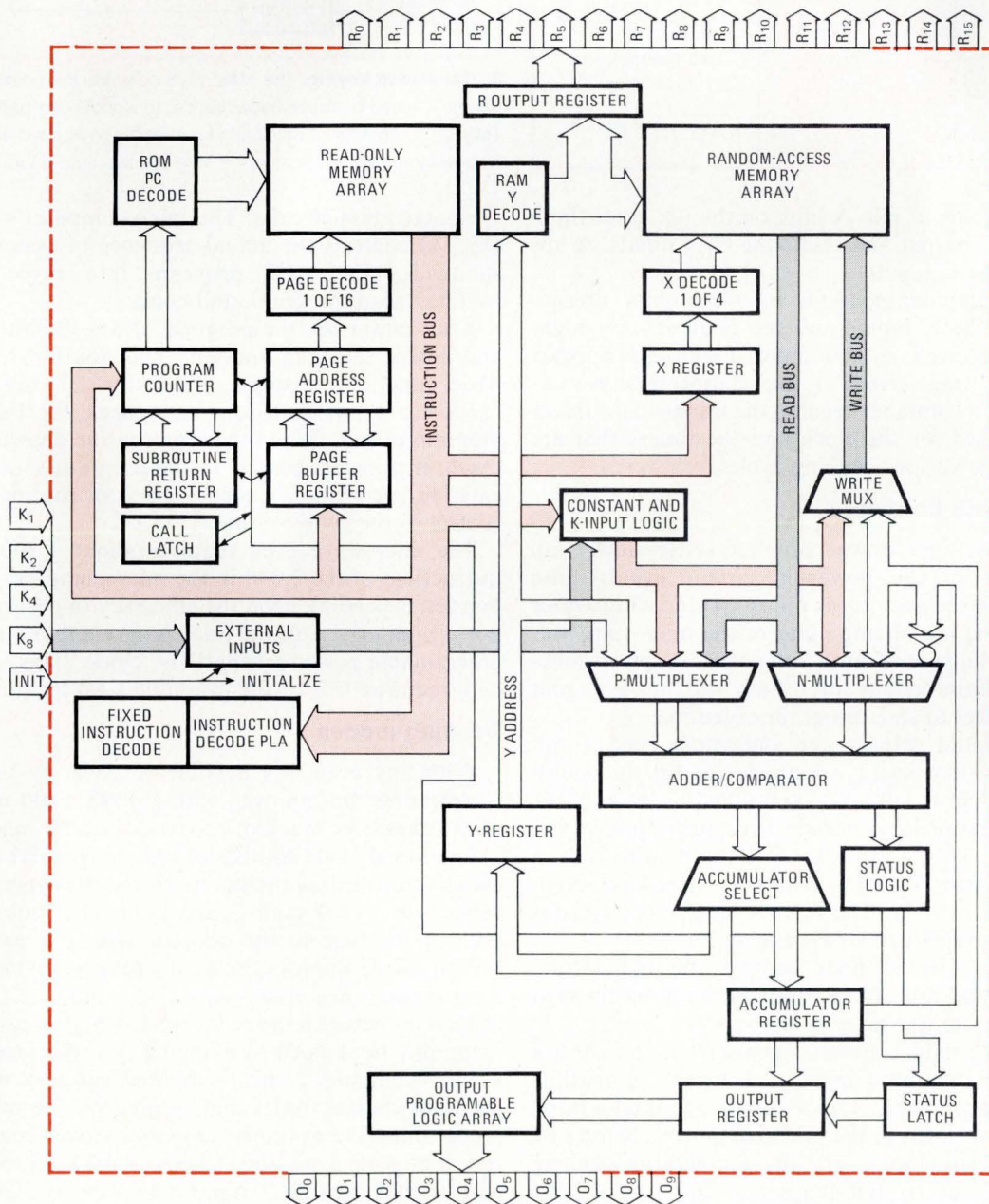
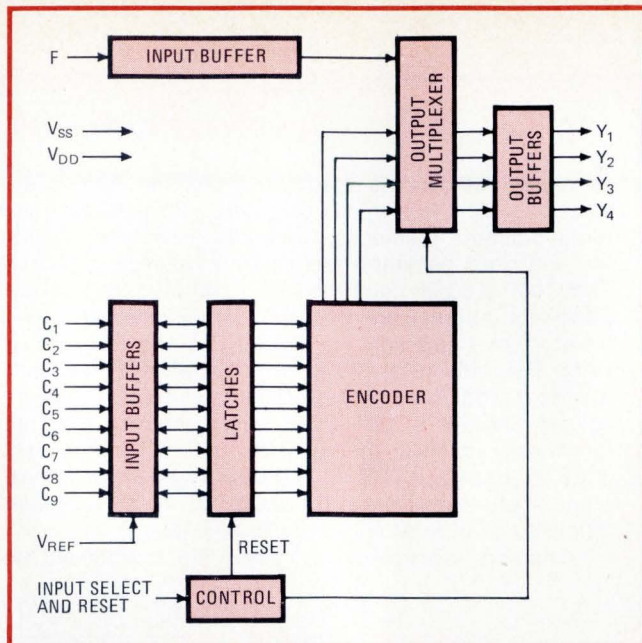

TABLE 2: CONVERSION TABLE FOR TEMPERATURE COOKING

Keyboard value	Cooking temperature (° F)	Type of cooking
1	120	extra rare
2	130	rare
3	140	medium rare
4	150	medium
5	160	medium well
6	170	well
7	180	high temperature 1
8	190	high temperature 2
9	200	high temperature 3



3. Capacitive keying. The TMS 1976 converts keyboard imbalance signals, caused by touch capacitance, to signals compatible with the TMS 1100. Another of the chip's functions is to convert a line-voltage frequency signal, fed in at pin F, to a precise time base.

chip's F (fixed) input pin. A high on the ISR gates the F input to the Y₁ output and resets the C₁₋₉ inputs. A low on ISR gates the C inputs.

The microcomputer polls the interface chip, alternately checking the C inputs and the F input. If a high-level input is received on the F input, a high level appears on Y₁ and is transferred to the microcomputer's K₁ input. The microcomputer records the inputs in a subsecond counter used for the clock and the timers that are required for the various cooking cycles.

Interfacing with hardware

Since the system's power supplies settle slowly, an external reset in the power-on circuit avoids false programs when the oven turns on. A voltage comparator circuit holds the initializing input of the microcomputer to a source-voltage level until the power supply reaches the required drain-voltage level, then switches the input to the drain level to start program execution.

The LED digital display and indicators need a full source-to-drain 15-v swing, so interfacing for the microcomputer's O and R outputs is simplified by making the transistor-transistor-logic decoder's ground equal to the -15 v drain. This means the O lines require only a simple two-resistor voltage divider to drive the seven-segment decoder driver. The R lines require one resistor and a Darlington pair to strobe the digits.

Triacs driven by R lines control the magnetron, broiler, lamp, and fan. The R lines are buffered through optical isolators to the gates of the triacs.

The interface chip converts signals from the control panel and the time-base input to a signal compatible with the microcomputer. Other inputs are diode-OR-ed together and are gated to the microcomputer's K lines by its R lines. These inputs are the temperature-sensing circuit, the 50-/60-Hz line-frequency and 12-/24-hour clock options (set at the factory), and the power-on and

oven-activation circuits. The microcomputer's algorithm (Fig. 4) controls the actual sequence of operations and subdivides the main program into three separate routines: scan, program, and cook.

After power-up, the program clears the internal RAM and enters the scan routine. This routine serves four basic functions: display, check for 50-/60-Hz input, check for a switch touch, and check for the cooking program chosen. When the scan routine detects a switch touch, it transfers control to the program routine. After entering a cooking sequence, the scan routine transfers control to the cook routine.

The microwave oven requires about 1,700 program instructions of the 2,048 in the microcomputer's instruction set, depending upon the efficiency in programing the ROM. Similarly, storing four programmable timers, two programmable power settings, the clock, flags, and other data requires 75% of the available RAM locations

Cooking modes

With any oven, it's possible to cook by time or by temperature. But an oven with a TMS 1100 microcomputer takes over much of the work in both modes.

The timed mode consists of four programmable cooking cycles controlled by the microcomputer's timers: defrost, cook cycle 1, cook cycle 2, and broil. The cook programs each of the four to the desired time. For example, to defrost for 25 minutes, he or she touches DEFROST, then 2 and 5, and then either START or another of the cycles. The cycles occur in the sequence listed above, but any of them may be skipped by skipping it in the programing.

Microcomputer control simplifies the task of figuring out total cooking times and turning on the oven at the proper time. For example, suppose a frozen roast is to be served at 6:40 p.m., and it needs 45 min defrosting, 50 min for cook cycle 1, 20 min for cook cycle 2, and 25 min for broil (since microwaves cook from the inside out,

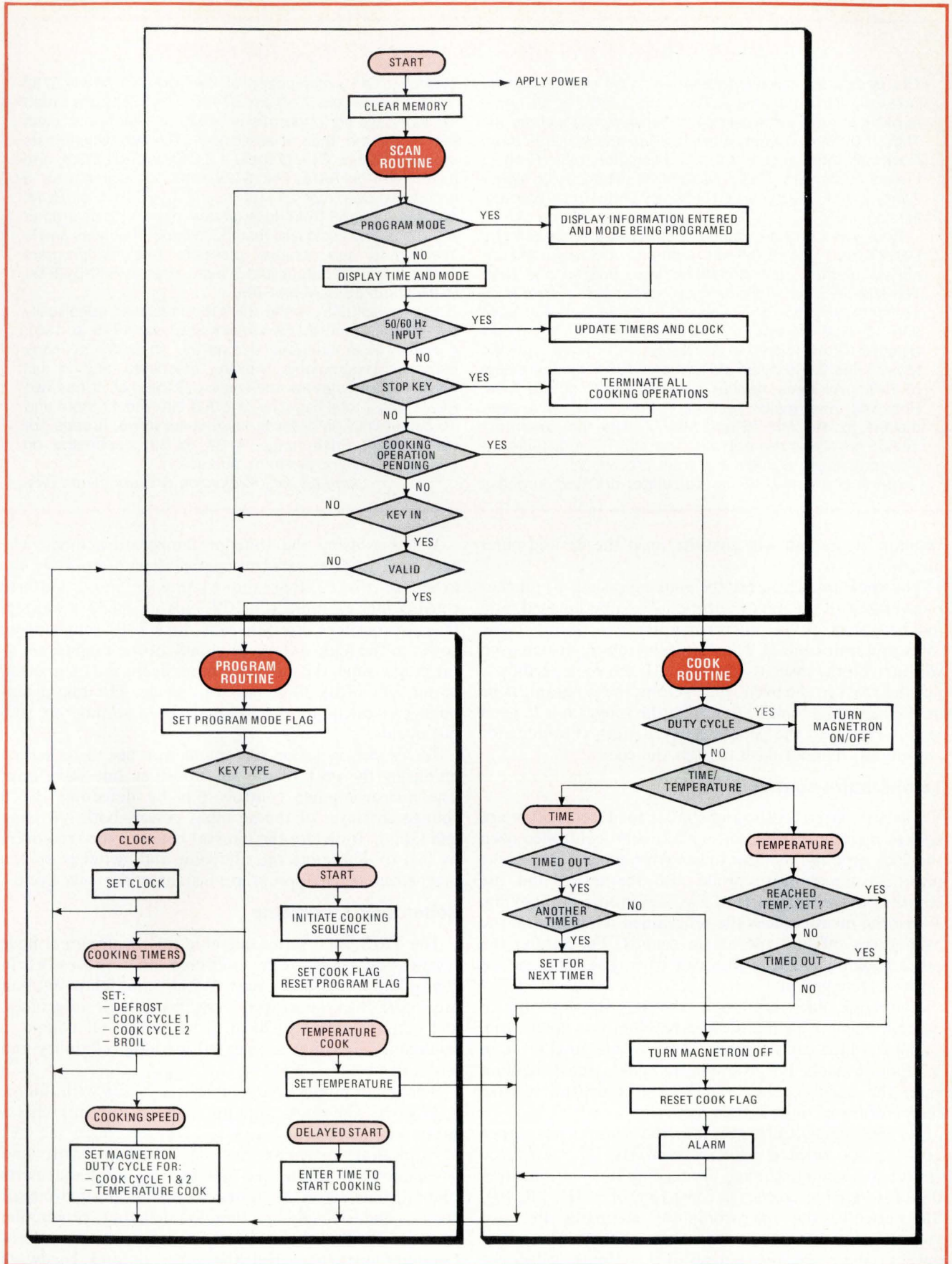

4. Oven algorithm. The oven program is subdivided into scan, program, and cook routines. The scan routine continually monitors the other two routines and transfers control from the program to the cook routine.

Three other firms offer low-cost microprocessors

The dedicated, calculator-oriented, 4-bit microprocessor is rapidly finding itself a niche as the controller for home appliances and electronic cash registers. As well as the TMS 1000 series, three other families are available, from Rockwell International Corp.'s Microelectronic Product division, Anaheim, Calif., National Semiconductor Corp., Santa Clara, Calif., and ITT Semiconductors, Woburn, Mass.

Rockwell's PPS-4/1 family is composed of the MM-76, MM-77, and MM-78, all with read-only memory, random-access memory, and arithmetic/logic unit on one chip. The MM-76 is the firm's simplest and cheapest microprocessor, at less than \$5 in volume. It has 640 bytes of ROM and 48 4-bit characters of RAM. The MM-77 has 1,344 bytes of ROM and 96 4-bit characters of RAM, and the MM-78 has 2,000 bytes of ROM and 128 4-bit characters of RAM. All three devices have 31 input/output lines. Rockwell has major contracts from microwave-oven makers for the MM-76 and MM-77, with the lower-cost device proving more popular. The MM-78 is suitable for electronic cash registers and word processors.

National's entry is its calculator-oriented process

system (COPS), composed of the two-chip 5781/5782 and the single-chip 5799 and 57140. The 5781/2 is aimed at sophisticated applications such as electronic cash registers, rather than at appliances. The set, which costs around \$12, has 23 I/O lines, a 2,048-by-8-bit ROM, and a 160-by-4-bit RAM. The 5799, which is suitable for a microwave oven, has 21 I/O lines, a 1,536-by-8-bit ROM, and a 96-by-4-bit RAM. In large quantities, it costs around \$5. The 57140 costs less than \$3 in large quantities and is intended for less complex products than multiprogram ovens. It has 18 output and 7 input lines, a 630-by-8-bit ROM, and a 55-by-4-bit RAM.

The newest entry is the ITT 7150, designed specifically for appliance control [*Electronics*, Sept. 16, 1976, p. 138]. It already is in extensive use as the controller of many European programmable washing machines, and is just beginning to penetrate the same U.S. market. It has two ROMs with a total capacity of 2,000 bits and 17 input and 10 output lines. In order to keep costs down, it does not use a RAM. Price range is \$4 to \$8, depending on package, quantity, program, and so on.

Jerry Lyman, *Packaging & Production Editor*

broiling at the end will give the roast the desired outer browning).

The cook simply enters the cooking program, touches DELAYED START, enters the time it is to be finished, and touches START. The microcomputer will subtract the total program time of 2 hr, 20 min from 6:40 p.m. and will turn on the oven at 4:20 p.m. All the cook need do is put the roast in the oven when setting the program. If he or she has waited until after 4:20, the program is flagged as an error, and the panel's delayed start LED indicator and digital readout flash to alert the cook.

Temperature control

Turkeys, large roasts, and similar food items often are cooked by temperature, but with an MPU-controlled oven the cook need not monitor the cooking process. He or she inserts a temperature probe into the meat, and the circuitry in the upper left of Fig. 1 monitors the cooking. When the meat reaches the programmed temperature, the oven turns off and the alarm sounds. For safety, the other cooking mode is disabled when the temperature sensor is plugged in.

The cook does not enter the temperature, but a number relative to the desired temperature taken from Table 2, which can be either on the touch panel or in an instruction book. For example, to cook a roast medium rare, the cook touches TEMP COOK, then the relative temperature setting, 3, then START.

As the temperature goes up, the sensor's resistance goes up. A resistor network converts this resistance change to a voltage change. By feeding its O outputs to a digital-to-analog converter consisting of a 1R, 2R, 4R, 8R network, the microcomputer compares the two voltage changes to control the magnetron's power output. There are nine temperature settings. When the temperature setting reaches the programmed value, the magnetron shuts down, and the alarm sounds.

Whether using the time or temperature mode, the cook can vary the speed to control more accurately the extent of the cooking and to provide more uniform cooking. For example, if a 70% cooking speed is wanted, the cook touches COOKING SPEED, then 7. By removing ac power to the high-voltage dc supply of the magnetron at the proper time, the microcomputer keeps the magnetron on for 70% of its 30-second duty cycle. The microcomputer can calculate ten different speed settings in 10% increments.

For proper operation, the magnetron has to be turned on during the peak of the 50-/60-Hz ac line waveform. The microcomputer controls this by detecting the 0 voltage crossover of the ac input power, both on rising and falling. It divides the interval between the crossovers by two to determine the midpoint and switches on the magnetron at the appropriate instant in the next cycle.

Better than a multichip

The TMS 1000 series one-chip microcomputers have several advantages over multichip microprocessors in controlling microwave ovens. With a multichip MPU, an oscillator, clock generator, ROM, RAM, logic interfaces, and output latches all have to be added. Of course, a minimum chip count is essential for high reliability and low cost.

Since high production volume is a factor with microwave ovens, the multichip approach not only presents a substantial increase in parts cost, but also hikes the cost of inspecting incoming devices, stocking parts, and assembling and testing the system. The additional parts count also increases the times for design, printed-circuit layout, and debugging, thereby delaying production start-up. Finally, the relatively simple one-chip microcomputer does not need the software and hardware interrupts and larger program storage and memory area of more sophisticated MPUs. □

Things that run long and hard deserve more than crummy bridges that don't

Most bridges that cost as little as two-bits* don't run quite as good as this one.

Matter of fact, some don't run at all. You get 'em in and instead of single-phase, full-wave, you've got no-phase, short-wave.

These are different. And EIA registered. 3N246/253.

So different they meet stringent MIL and Motorola quality standards others will just surrender to unconditionally.

Like 1,000-hour HTRB at 600 volts, 150° ambient with no failures.

Or 5,000 cycles of power cycling at 2.2 amps (10% over rated current) with a ΔT_J of 100°C and no failures.

Or 1,000 hours of high-temperature storage with no failures.

Or solder heat, solderability and moisture resistance testing to MIL standards /202B and /202D with no failures.

Like 1% AQL.

And so on. And on. And on. With no failures.

Even Underwriter's Laboratories recognizes them.

And you know how *they* are.

Electrically, the series consists of 1 and 2 A, 50 to 1,000 V, single-phase, full-wave bridges with 30 A and 60 A surge capability, respectively, with the 2 A units operating to +165°C T_J .

Physically, their slimline cases save considerable board space requiring only in-line sockets instead of symmetrical pin spacing.

And economically, their very aggressive prices will give even the cheapest bridge a real run for its crummy money.

Our volume production is running long and hard to give you what you want in a bridge — top quality at a low price.

You deserve it.

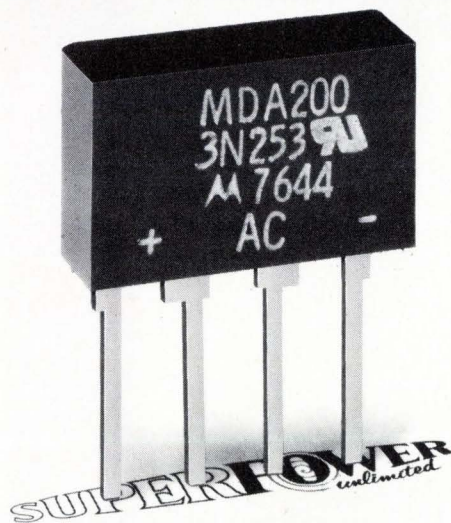

MOTOROLA Semiconductors

Motorola Semiconductor Products, Inc., Box 20912, Phoenix, AZ. 85036

*1 A, 50 V unit, 25,000 up.

Predicting actual gate current from data-sheet specifications

by Jerald Graeme
Burr-Brown Research Corp., Tucson, Ariz.

The superior input current characteristic of a junction field-effect transistor results from the extremely low gate current, which has the leakage of a reverse-biased junction as a constituent. While the I_{GSS} specification (gate current with source shorted to drain) is the most general indication of a J-FET's leakage current, that figure conveys no information as to the actual gate current drawn when the transistor is operating under other bias voltages.

But analyzing the J-FET input as a simple reverse-biased junction does not suffice; in doing so, the predictions of gate current as a function of bias voltage and temperature prove erroneous. The junction equation incorrectly implies that the gate current (I_G) of silicon J-FETs is equal to the reverse saturation current (I_S) under condition of reverse bias:

$$I_G = I_S (e^{qV/kT} - 1)$$

where V in the Boltzmann equation is the bias voltage. Although the equation includes the current caused by

Carrier-multiplication effects. Under operating conditions, the gate currents of some n-channel J-FETs can greatly exceed I_{GSS} because of carrier multiplication, which has a net effect of reducing the breakdown voltage of the devices.

thermal generation of carriers in the charge-neutral regions (away from the junction), it excludes the current caused by thermal generation of carriers in the space-charge layer, or depletion zone (close to the junction). For silicon junctions, increasing the reverse-bias voltage makes the space-charge-layer leakage component far greater than I_S , since the current is proportional to the volume of the layer, which increases with the square root of the reverse-bias voltage.

From drain to source, the reverse-bias voltage across the junction varies from the gate-drain voltage, V_{GD} , to the gate-source voltage, V_{GS} . If uniform channel-doping is assumed, the effective reverse bias can be approximated by the average of the two $(V_{GD} + V_{GS})/2$. The leakage current is specified as I_{GSS} at a test reverse bias of V_{GST} volts by the manufacturer, and, in accounting for space-charge-layer considerations, the current as related to I_{GSS} will be proportional to the square root of the ratio of $(V_{GD} + V_{GS})/2$ to V_{GST} . Therefore, the corrected gate current I_G is approximately:

$$I_G \approx I_{GSS} \sqrt{\frac{V_{GD} + V_{GS}}{2V_{GST}}}$$

This can be substituted for I_S in the junction equation to calculate thermal dependency.

It can be shown from the junction equation that the leakage current nearly doubles with every 6°C rise in temperature. However, since the rate of generation of carriers in the space-charge layer is much less tempera-

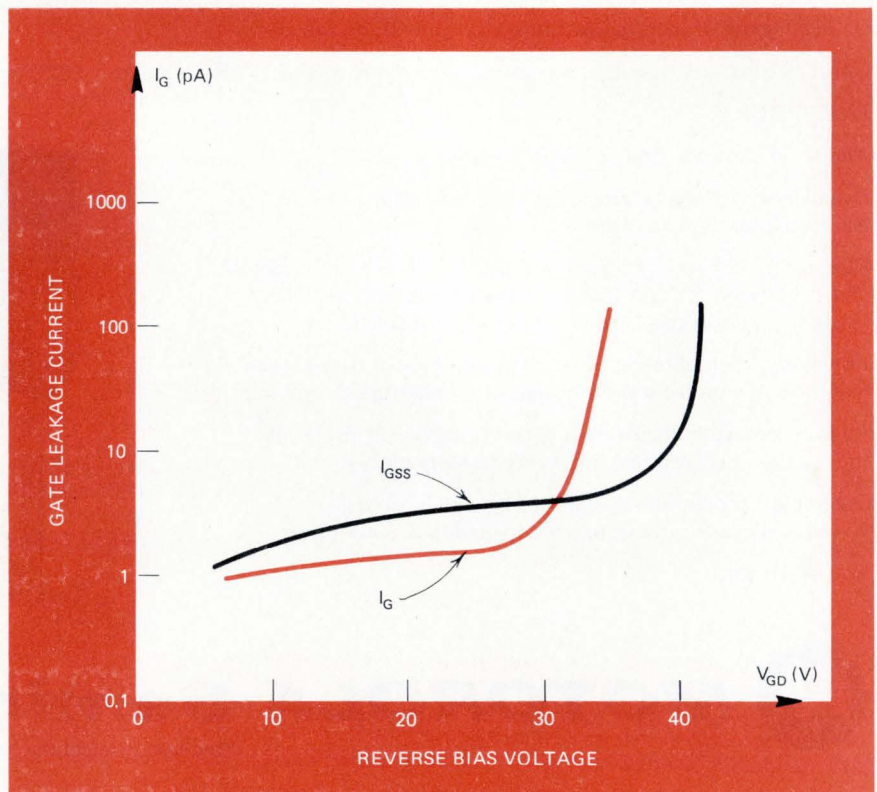

ture-sensitive than in the neutral regions, the gate currents of silicon J-FETS will not double until after about each 10°C rise in temperature.

Gate currents of a few types of n-channel J-FETS will increase beyond I_{GSS} even under reverse-bias conditions well below the specified breakdown voltage, and possibly even below the test voltage, V_{GST} . For example, this phenomenon may be observed when common-mode-testing certain FET input operational amplifiers—input current increases inordinately when a certain differential voltage level is reached. This effect is the result of carrier multiplication—the increased number of carriers present

under operating conditions raises the collision rate at lower reverse-bias voltages. The net effect simulates a decrease in breakdown voltage, as shown in the graph on p. 112.

Before relying on gate-current predictions from I_{GSS} , the reverse-bias voltage at which carrier multiplication occurs must be determined. One experiment that would determine this would be measuring gate leakage current as a function of bias voltage while the transistor is in operation. Note in the graph how the actual leakage current exceeds the manufacturer's specified I_{GSS} at a reverse bias of about 30 v. □

Charged capacitor reduces relay actuating power

by John R. Nelson
Motorola Inc., Government Electronics Division, Scottsdale, Ariz.

Operating a relay at its nominally rated voltage wastes power. Usually half that voltage or even less is enough to keep the device energized after actuation, and the same voltage can also actuate the relay if first given a boost by a simple circuit.

By using a transistor to add the voltage across a charged capacitor to the source voltage, the actuator circuit energizes a 26-volt relay with only 12 v. The comparison in the table indicates the substantial saving in power that results.

The capacitor is initially charged to 12 v through R_1 and R_2 in the figure. Closing the switch applies 12 v to the relay coil, and at the same time, turns on the transistor, which drops the positive side of the capacitor to ground. This effectively forces -12 v on the other side of the capacitor, and the relay pulls in with 24 volts across its coil. Once the capacitor has discharged through R_2 and the coil, the approximately 7 v across the relay coil is sufficient to keep it energized, as evident in

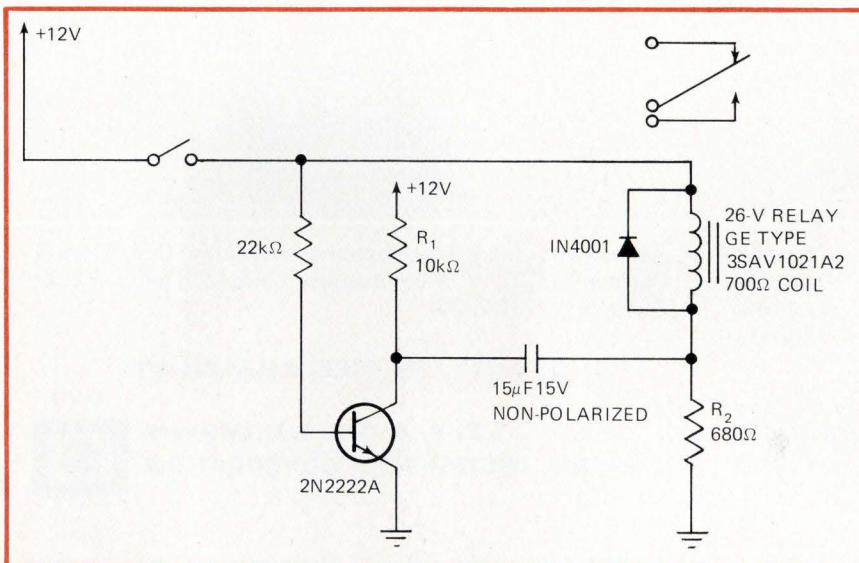

Energizer. In driving a 26-volt relay with only 12 V, this circuit makes use of the fact that the device's holding current is very much less than its pull-in current.

RELAY POWER REQUIREMENTS

Parameter	Alone			With Actuator Circuit*		
	Voltage	Current	Power	Voltage	Current	Power
Nominal	26V	35mA	910mW	12V	10.3mA	124mW
Threshold of pull-in	12.9V	18mA	232mW	9.1V	7.8mA	71mW
Threshold of drop-out	3.5V	4.9mA	17mW	6.9V	5.9mA	41mW

*Current and power measurements include transistor circuit requirements

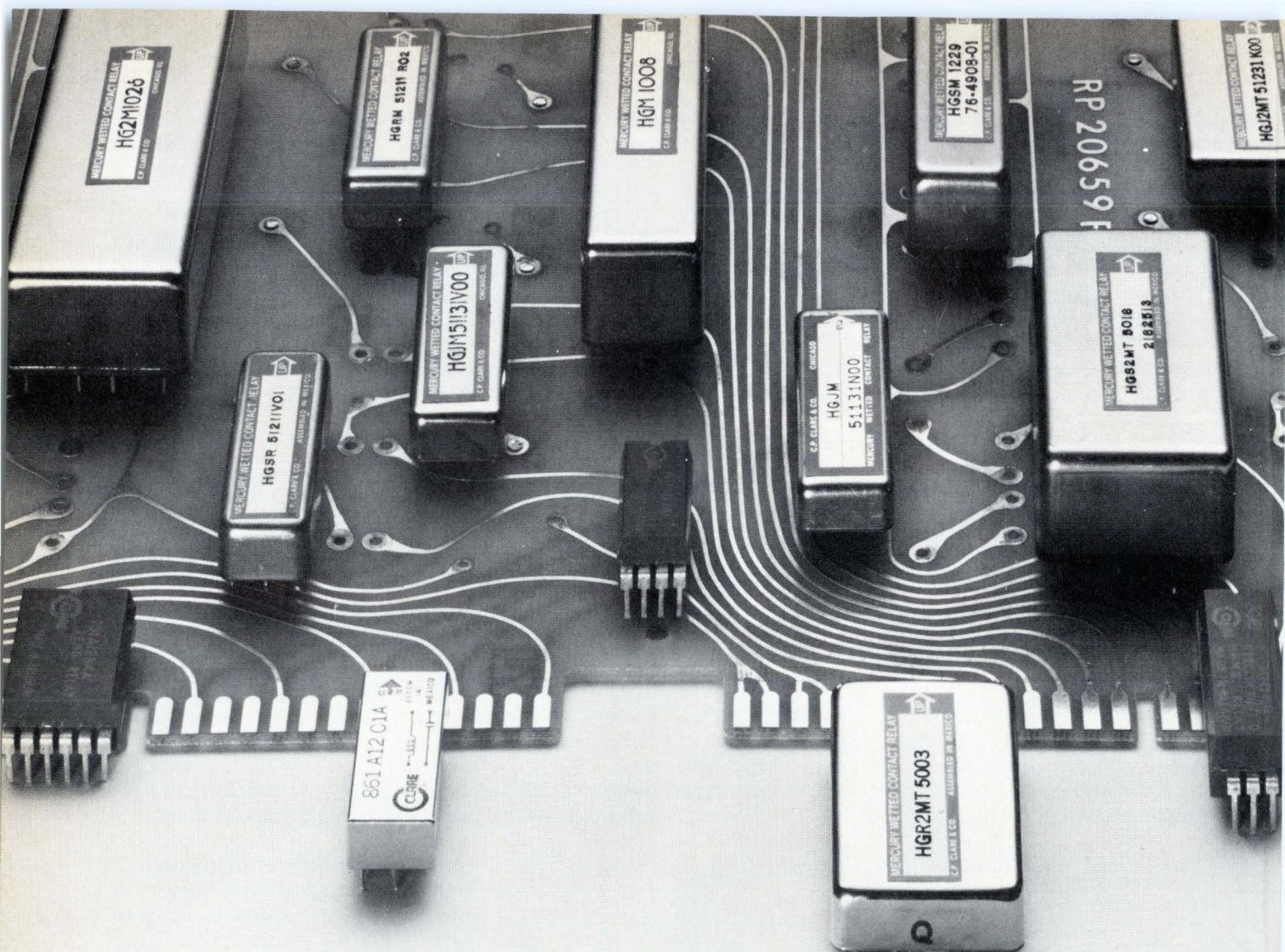

There's a CLARE MERCURY-WETTED RELAY for every PCB application.

From microvolt to 500 volt levels. Nanoamperes to 2 amps. DC to megahertz frequencies. Clare can supply a reliable mercury-wetted relay to enhance operations for process control, data logging/acquisition, automatic component/system testing, telecommunications, whatever.

Every Clare mercury-wetted relay is designed to lead a long and productive life. Billions of operations. Constant ON, OFF impedances—every operation. No contact wear, no contact bounce.

Just call your Clare Representative, or contact C. P. Clare & Company, 3101 W. Pratt Avenue, Chicago, Illinois 60645. Phone (312) 262-7700.

QUALITY, SERVICE, RELIABILITY

**C. P. CLARE & COMPANY
GENERAL INSTRUMENT CORPORATION**



Use CLARE mercury wetted relays across the board.

Circle 114 on reader service card

the table that is shown on page 113.

The circuit works well with 26-v relays having coil resistances in the region of 1,000 ohms. However, the value of R_2 may have to be changed to suit the requirements of different relays.

The capacitor should be a nonpolarized unit, because there will be a reverse voltage across it whenever the

relay is energized. If power to the circuit is interrupted, the switch must be opened and closed to reactuate the relay. The diode across the relay coil protects the transistor from transients. □

Engineer's notebook is a regular feature in *Electronics*. We invite readers to submit original design shortcuts, calculation aids, measurement and test techniques, and other ideas for saving engineering time or cost. We'll pay \$50 for each item published.

Calculator notes

Standard-deviation program combines recurring data

by Richard Nelson
Santa Ana, Calif.

Standard deviation as a firmware feature on many scientific calculators saves considerable time in statistical work. The mean, \bar{x} , and standard deviation, s , are usually calculated from lists of data in which every value must be keyed, regardless of whether there are many duplicate values. Although at least one statistical calculator has a key labeled **FREQ** for frequency of occurrence of a particular value, in most cases recurring data must be reentered each time it appears. A program for summing the data when calculating the mean and standard deviation can be written for the HP-25 in which **R/S** performs the **FREQ** function, simplifying statistical calculations for large tables of data.

In operation, the **FREQ** function retrieves the last entered value, performs the operations, and tests to see if it has done this $n - 1$ times, where n is the number of duplicate data values. Finally, **FREQ** retrieves the value from the data-entry counter (register) and displays the number of effective entries at the last summation, keyed by $\Sigma+$. For example, if the user noticed after keying the 10th data value that the next four values were the same, and he pressed 4, then **FREQ**, the display would show 14.

In this program, the $\Sigma-$ key, used to correct errors in data entry, also works with the **FREQ** function. If the number of duplicate data values, n , is negative, the $\Sigma-$ function is executed n times when **FREQ** is pressed.

This sample data indicates the use of the program:

1	777	
2	123	
3	456	
4	456	
5	456	$\bar{x} = 602.667$
6	789	
7	789	$s = 240.802$
8	789	
9	789	

After data value 3 is entered and operated on, keying 2 (the number of duplicate data values) and then **R/S** is enough to perform the same operations on data 4 and 5. Then, after data 6 is entered and operated on, keying 3 and **R/S** completes the entire calculation of the mean and standard deviation. □

HP-25 PROGRAM FOR ADDING FREQUENCY FUNCTION TO STANDARD DEVIATION

Step	Key	Code	Comments
01	$g x=0$	15 71	If $x=0$ clear registers
02	GTO 23	13 23	
03	STO 0	23 00	Store n in $R0$
04	$g x<0$	15 41	If negative n , do $\Sigma-$ loop
05	GTO 15	13 15	
06	$f \text{ LAST } x$	14 73	Start $\Sigma+$ loop
07	$\Sigma+$	25	
08	1	01	
09	STO -0	23 41 00	
10	RCL 0	24 00	
11	$g x\neq 0$	15 61	
12	GTO 06	13 06	End $\Sigma+$ loop
13	RCL 3	24 03	Recall data counter
14	GTO 00	13 00	Stop for additional data
15	$f \text{ LAST } x$	14 73	Start $\Sigma-$ loop
16	$f \Sigma-$	14 25	
17	1	01	
18	STO +0	35 51 00	
19	RCL 0	24 00	
20	$g x\neq 0$	15 61	
21	GTO 15	13 15	End $\Sigma-$ loop
22	GTO 13	13 13	
23	$f \text{ REG}$	14 33	Clear all for new data
24	$f \text{ STK}$	14 34	
25	GTO 00	13 00	Stop for new data

INSTRUCTIONS

- Use $\Sigma+$ normally
- If additional data is duplicate of last entry, key number of duplicates, **R/S**.
- If wrong data is entered, use $\Sigma-$ normally. If more than one duplicate is to be removed, key number of duplicates, **CHS**, **R/S**.
- For new set of data, clear display and registers by **CHS**, **R/S**.

NOTE: If a value is entered incorrectly, key 1, **CHS**, **R/S** to remove it.

Monostables delay for more than a microsecond . . .

Suppose you need to delay a pulse in a digital circuit for more than 1 microsecond—perhaps to sequence asynchronous processes or to start different operations at different times—well, you'll be lucky if you find a packaged delay circuit to suit you, says Mansoor Ahmed of the University of Pittsburgh, Pa. Instead, he suggests, why not use a pair of retriggerable monostable multivibrators, like the 9602-type dual device?

Wire the monostables in series, connecting the Q output of the first one to the input of the second. (The input pulse is applied to the input of the first device, and the delayed pulse is taken from the output of the second.) Each monostable has its own external timing network, with the first one producing an output pulse of width T_1 , and the second an output pulse of width T_2 . So, when T_2 is the same as the input pulse width, the circuit provides a delay time of T_1 . However, cautions Ahmed, **the shortest monostable delay cannot be smaller than the width of the input pulse.** Also the circuit cannot be used for pulse trains.

. . . and work well with carbon pots

To vary the timing of monolithic monostable multivibrators without degrading their stability, most of us reach for a precision-like cermet or wirewound potentiometer. One who doesn't is John T. Heizer, Narco Avionics, Fort Washington, Pa. He has thought of a way **to use an inexpensive carbon pot to obtain variations as large as $\pm 10\%$, while retaining the basic stability of popular one-shots, like the 74121.**

Make the usual connections for the timing resistor and capacitor, he says. Now, run a second resistor from the mutual junction of the two to the wiper of the pot, which is connected between the supply voltage and ground. The value of the extra resistor is $5R$, while the pot's value is $0.1R$, where R is the resistance of the "normal" timing resistor.

When the arm of the pot is at the supply end, the equivalent timing resistance is $0.83R$, and the time delay is at its minimum. Adjusting the arm to ground reduces the effective charging voltage for the capacitor, and increases the timing interval by about 20%. **With precision resistors and a silver mica capacitor, temperature stability can be better than 100 parts per million,** notes Heizer. Replacing the pot with a voltage source yields a stable voltage-controlled one-shot, he adds.

Microprocessors speak with many tongues

Microprocessor manufacturers may be putting a lot of energy into strengthening their software support functions, but the independent software houses are far from idle. In fact, you might say they are capitalizing on the situation. The high-level-language compilers they are producing for popular microprocessor chips actually run on the chip manufacturers' microcomputer development systems. Forth Inc., Manhattan Beach, Calif., for example, recently came out with **a new high-level language called micro-Forth, which will run on the Intel microcomputer development system for the 8080, as well as on the RCA CDP 1800 development system.** Just announced is a version for the 6800 to run on Motorola Semiconductor's Exorciser. The new language, the company says, cuts execution times by as much as 90% while also reducing memory needs.

Another recent development is **a resident monitor-diagnostic program called Phantom-II** from Wintek Corp., Lafayette, Ind. Designed to run on a 6800 and shipped in a 1-kilobit read-only memory, the program allows users to single-step through a routine and insert breakpoints.

Lucinda Mattera

TAKE IT AS A COMPLEMENT

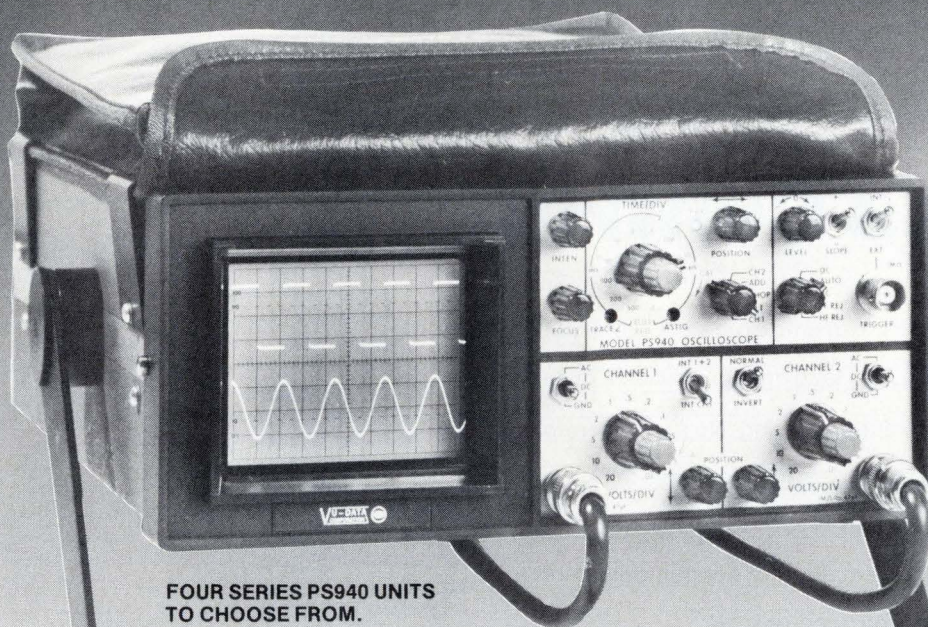

FOUR SERIES PS940 UNITS
TO CHOOSE FROM.



SUBSTITUTE THIS FIELD-
PROVEN "MINI-SCOPE"
FOR A BIG
PORTABLE
NEXT TIME YOU BUY!

STOP AND COMPARE

Size and weight are two of the most important specifications when selecting a portable scope for field service, in-plant maintenance or mobile test applications. Series PS940 Mini-scopes from Vu-data offer the best performance to size/weight ratio of any others on the market—and at a price that can cut your new scope purchase dollars in half!

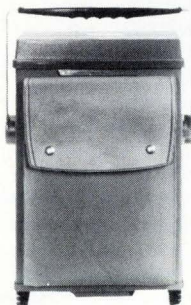

Typical Portable
Wt. 25 lbs.
Size 1300 in.³
Price \$2,145



Vu-data PS940
Wt. 10 lbs.
Size 400 in.³
Price \$1,145

"Complement" means to add to or enhance. So, complement your "big scope" inventory with a Series PS940 Mini-scope the next time your field service requirements call for small size and light weight. These rugged units offer the best performance for the price you pay. All the basic features required for servicing today's sophisticated electronics are included—things like dual trace, delay line, selectable DC coupled triggering, algebraic addition and subtraction, composite trigger, battery operation and many others. With a 20 MHz bandwidth, these scopes are plenty to troubleshoot to the sub-assembly level. And they'll trigger as well as, or better, than any 100 MHz scopes around.

If you're interested in a service scope that will do the job without the burden of "overkill" features, then examine a PS940. These are scopes that can be carried to every job, every time without hesitation. They'll probably give you a better return on investment than any scope you now have. Join the numerous other major service groups who have already selected a Vu-data mini-scope—buy one!

INTERESTED? Call AI Agent at (714) 279-6572, or write to us at 7170 Convo Court, San Diego, California 92111.

From a Leader in Portable Oscilloscopes

**VU-DATA
CORPORATION**



MEMORY AT WORK

Process Control

Loss of power on

a computer-controlled processing system is real trouble. Get back on line fast—or risk losing an entire batch or run. EMM's reliable MICROMEMORY core memories take care of that. Just push your restart button and you're up and operating. No program reloading. No back-up batteries to worry about. We have designs for 4-bit, 8-bit and 16-bit microprocessors — even larger systems with capacities to 32K x 18. We make semiconductor memories, too. But for process control you need reliable MICROMEMORY core memory.

EMM

COMMERCIAL MEMORY PRODUCTS

A Division of
Electronic Memories & Magnetics Corp.
12621 Chadron Ave., Hawthorne, Calif. 90250
(213) 644-9881

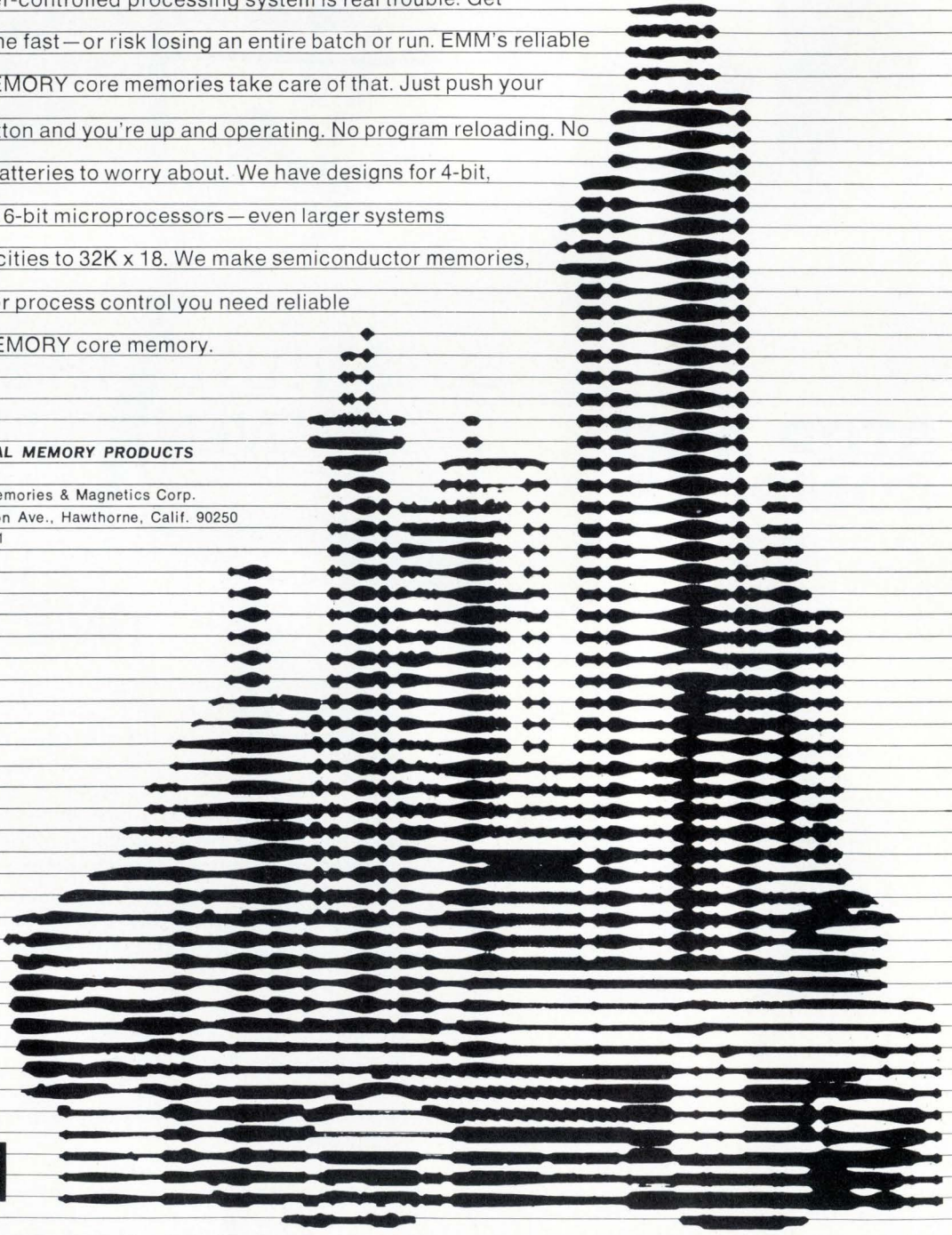

MEMORY AT WORK

Diagnostics Memory for medical

diagnostic equipment must be reliable. Human lives are involved. It must be fast; dynamic imaging calls for high speed CRT refresh. Those are two reasons our MICRORAM static RAM memory systems are chosen so often. Cycle speeds are sufficient for CRT refresh. Our metal-gate technology is inherently reliable. And the support circuitry needed by static RAMS is very simple. That adds up to an overall system reliability you just can't beat.

You can't beat our 15-year experience in the memory business, either. Give us a call today and tell us what you need.

Emm

COMMERCIAL MEMORY PRODUCTS

A Division of Electronic Memories & Magnetics Corp.
12621 Chadron Ave., Hawthorne, Calif. 90250
(213) 644-9881

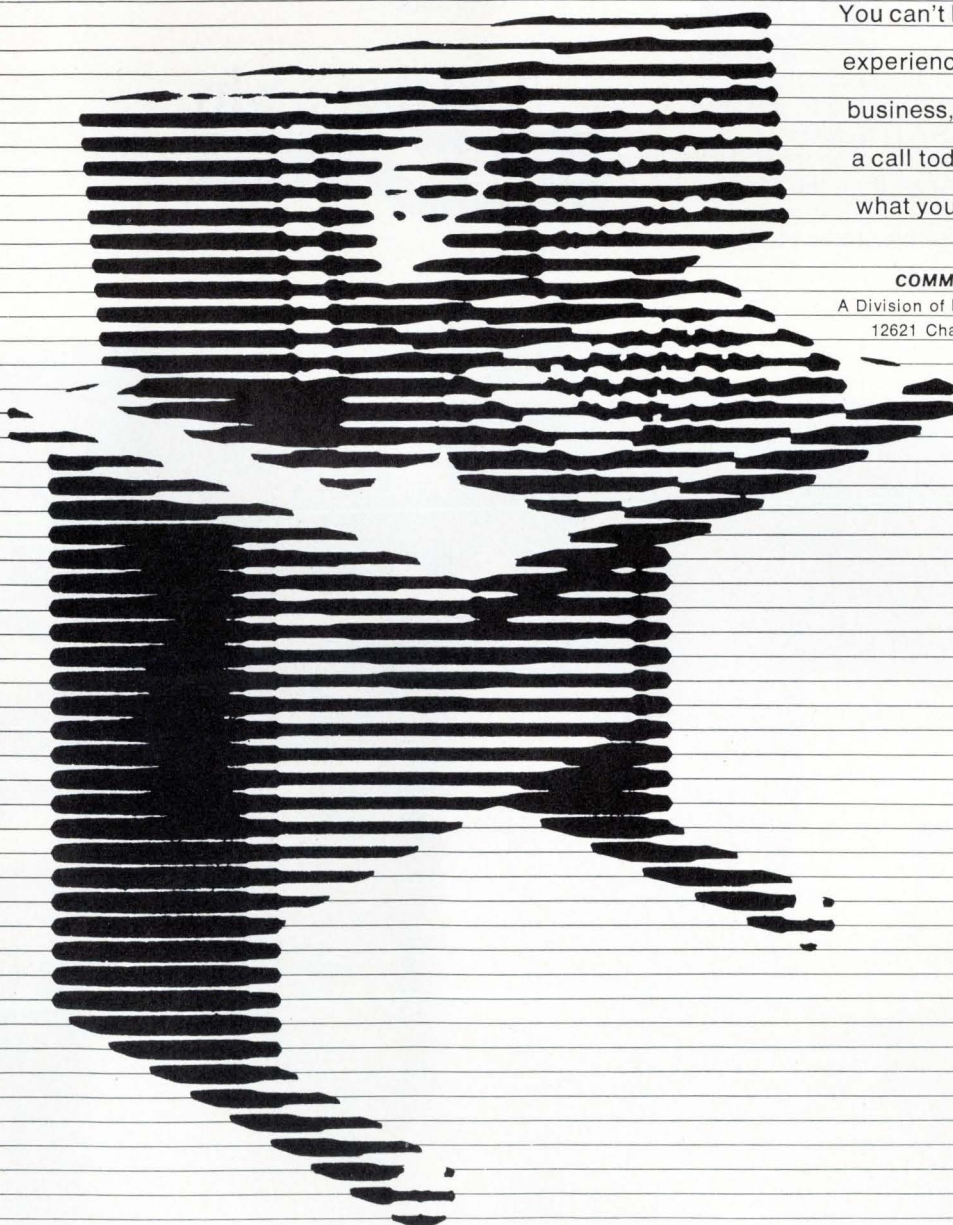

MOS for the new generation of organs (easy!)

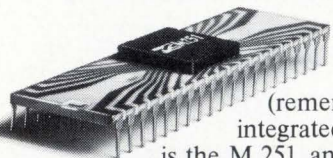

A new first from SGS-ATES (remember their integrated rhythm generator?) is the M 251, an automatic accompaniment generator integrated on a single MOS-LSI chip.

You've already selected your rhythm, and now you can correctly key-in the automatic accompaniment (chords, walking bass and arpeggio) for your melody, by pressing, that's it, just one key. A memory ensures that you can then proceed with your favorite "hands-off" operation.

All this thanks to SGS-ATES' MOS experience and many years of collaboration with major organ producers. Apart from the M 251, SGS-ATES manufactures a complete range of MOS integrated circuits for electronic musical instruments:

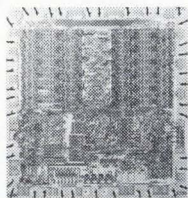

- M 087 top octave synthesizer
 - M 147 pedal sustain (13 bit latch, left priority)
 - M 251 chords, bass and arpeggio generator
 - M 252 rhythm generator (15 rhythms, 8 instruments)
 - M 253 rhythm generator (12 rhythms, 8 instruments)
 - M 254 rhythm generator (8 rhythms, 12 instruments)
 - M 255 rhythm generator (6 rhythms, 5 instruments)
 - HBF 4727 7-stage frequency divider (2+2+1+1+1)
 - HBF 4737 7-stage frequency divider (3+2+1+1)
- and in bipolar technology
- H 629 1x12 multiplexer
 - H 632 2x6 multiplexer

And that's why



SGS-ATES SEMICONDUCTOR CORPORATION
Newtonville, Mass., tel: 617-9691610



Modules link LSI-11, analog systems

Four input/output boards are said to cover 95% of microcomputer's applications; top-of-line provides 16 channels, 12-bit conversion

by Lawrence Curran, Boston bureau manager

A variety of modules on the market can interface single-board microcomputers with analog equipment, but probably no company offers a broader family for a single microcomputer than does Data Translation Inc. for users of the Digital Equipment Corp. LSI-11. Data Translation has developed four analog input/output systems designed to cover 95% of all measurement and control applications of the LSI-11, says Fred Molinari, president.

Data Translation isn't abandoning its model DT1751 analog I/O interface for the Intel Corp. SBC-80/10, but Molinari says that calls his company has been getting from LSI-11 users indicate to him that there is substantial interest in a fast 16-bit machine that can do arithmetic calculations and draw on the large body of software available for the LSI-11, and they can't get what they need elsewhere.

Offers 16 input channels. Each of the systems is contained on an 8-1/2-by-10-inch printed-circuit board. The DT1761 is probably the most versatile in the family. It offers 16 input channels with 12-bit analog-to-digital conversion, plus two analog output channels, along with 12-bit digital-to-analog conversion. Molinari says this system will be particularly attractive to users acquiring high-level (5- to-10-volt) signals for a laboratory computer.

The output channels have a point-plotting capability so that data can be displayed on a cathode-ray tube for analysis and reduction. The DT1761 also accommodates an optional 100-kilohertz data-acquisition subsystem for users needing fast throughput, such as in fast-Fourier-

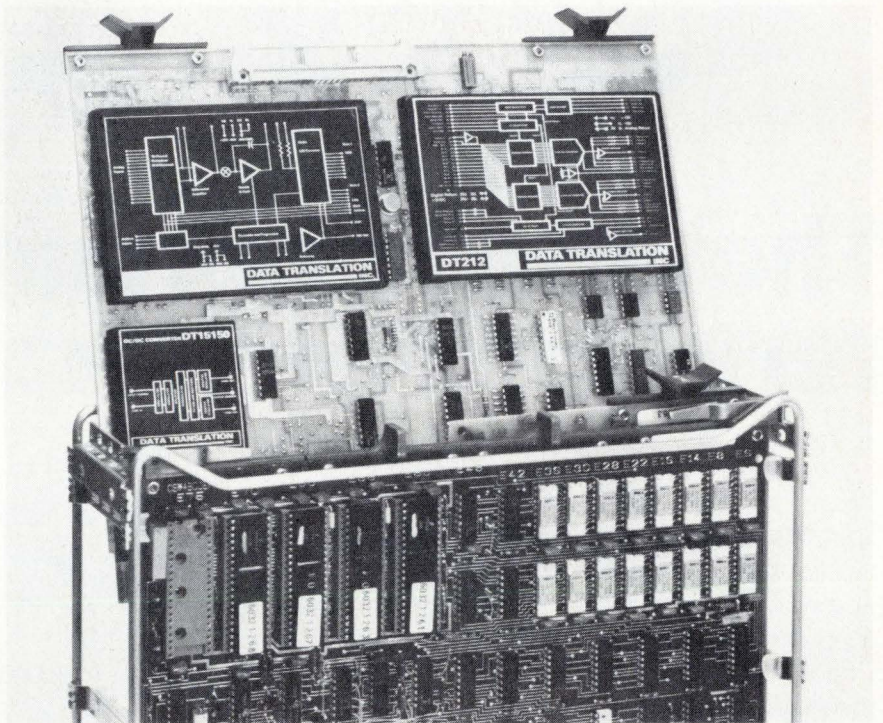

transform analysis. The DT1761's unit price is \$995.

Users with industrial applications are covered by the DT1764, which allows direct connection between the computer and transducers picking up low-level signals in the range from 10 millivolts to 10 v. The DT1764 is priced at \$795.

Between those two classes of users are those who want the least expensive analog interface possible and customers who need more than 16 input channels but high resolution. For those looking for an inexpensive unit, there's the DT1763, a \$495 system with 32 input channels, four output channels and 8-bit conversion. A stripped-down version of this one offers OEM users 16 input and

two output channels for \$295 in quantities of 100.

There are two models of the DT1762 for the user needing higher resolution. A 16-channel version sells for \$695 singly, and a 64-channel model carries a \$1,095 price. Both offer a programmable-gain amplifier and direct memory access as options, as does the DT1761. The programmable-gain amplifier extends the 12-bit resolution of analog measurements to the 14-bit dynamic range. And Molinari says the optional direct-memory access can cut down on throughput time and software overhead.

Data Translation Inc., 23 Strathmore Rd., Natick, Mass., 07160. Phone (617) 879-3595. [338]

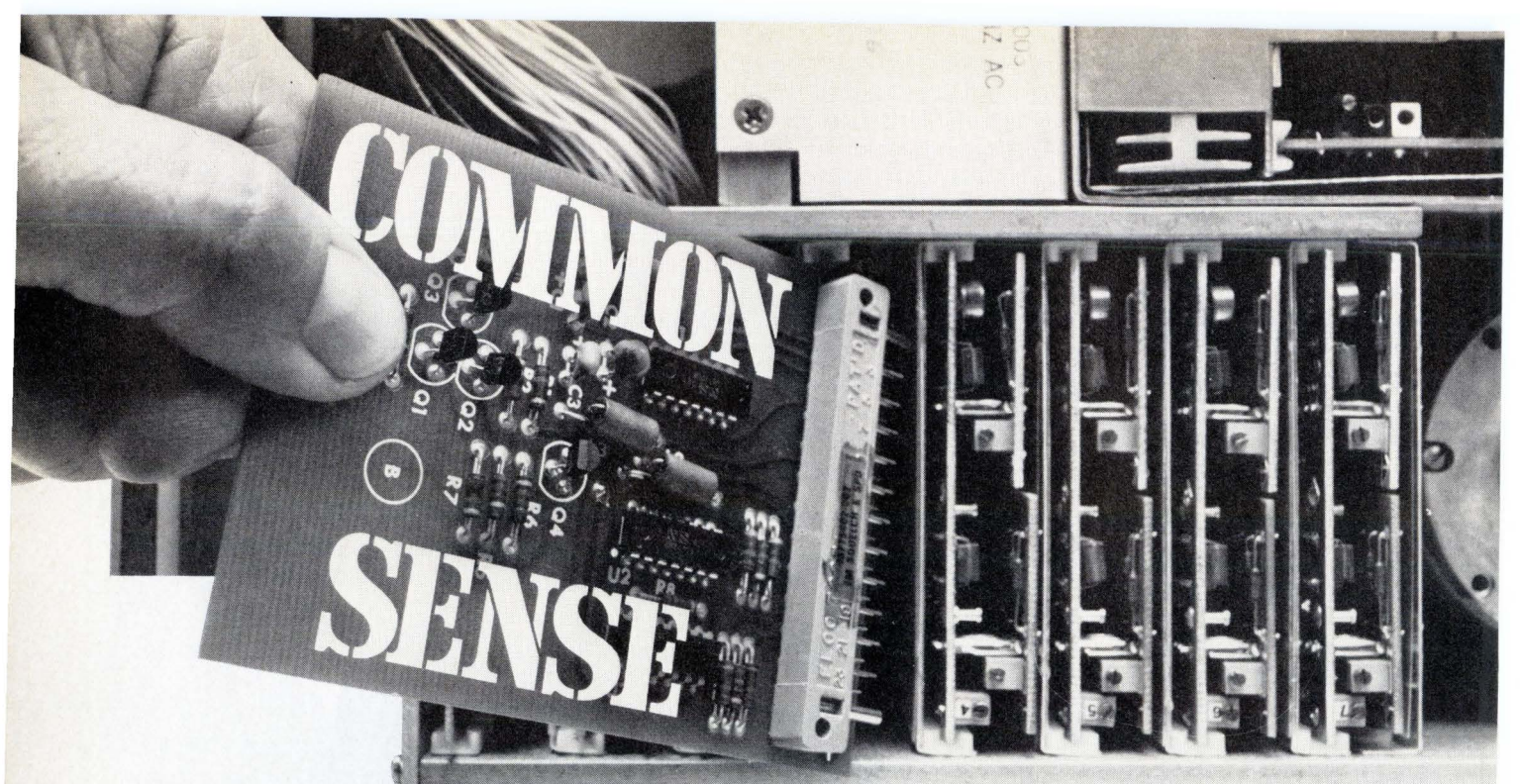

COMMON
SENSE

The most important part of every Honeywell tape system.

Common sense is basic to Honeywell's tape engineering philosophy. When we innovate for one tape product, we believe it's only common sense to apply that technology to other tape products in our broad line . . . lab, portables, high environmental and airborne recorders. The result is a solution exactly right for your tape need.

And if it's not, common sense dictates that we provide you with a custom tape system. Our consistent success with custom tape applications is common knowledge in the industry.

For more information and a catalog of our high-performance, common-sense tape solutions, write or call Chuck Miller at Honeywell Test Instruments Division, P.O. Box 5227, Denver, Colorado 80217, (303) 771-4700.

For literature request circle 107



Circle 122 on reader service card

Honeywell

New products

Instruments

Logic probes' prices plummet

Multifamily units with automatic pulse memory sell for less than \$25

The no-frills logic probe is rapidly going the way of the no-frills pocket calculator—way down in price. Successful units either sell for around \$25 or can justify their higher cost on the basis of extremely high speed, current-tracing capability, or some other special features.

Typical of the low-cost instruments is the Catch-a-pulse probe from AVR Electronics. Compatible with RTL, DTL, TTL, C-MOS, and MOS levels, the unit responds to pulses as narrow as 50 nanoseconds and operates from voltages of between 3.5 and 15 volts dc. It is protected against reversal of its power leads and against intermittent overvoltages of up to ± 200 v dc. Catch-a-pulse has an input impedance of 60 kilohms and pulls a maximum of 9.5 milliamperes from a 5-v supply.

Like many similar probes, the

instrument uses a small number of display devices to convey information about a large number of situations. Specifically, it uses two light-emitting diodes to differentiate among six situations: positive-going pulses, negative-going pulses, square waves, a logic 1, a logic 0, and no signal. An automatic resetting memory allows the probe to detect pulses.

Power is supplied to the lightweight, portable probe by means of a removable coiled cord that stretches out to 6 feet. Normally priced at \$29.95 plus \$1.75 for handling, the Catch-a-pulse is being offered for \$24.95 until Jan. 1. A similar probe from Logic Systems Inc., Provo, Utah, also is currently being offered for \$24.95.

AVR Electronics, P.O. Box 45167, San Diego, Calif. 92145 [351]

Word-generating system plugs into TM-500 mainframe

Three plug-in instruments that fit into the Tektronix TM-500 series mainframes are intended primarily for high-speed digital and analog testing. Priced at \$695, the PI-100 four-channel delay/width clock generator is a 50-megahertz unit with one master channel and three

delayed outputs. The PI-200 four-channel, 32-bit word generator, which is designed to be driven by the PI-100, sells for \$850. Finally, the PI-400 four-channel, 5-volt interface driver with ± 5 -v offset can function as a stand-alone unit or as a power stage for the other two instruments. It sells for \$595. Installed interface cables are priced at \$75.

Pulse Instruments Co., P.O. Box 1655, San Pedro, Calif. 90733 [359]

Pulser covers 5 Hz to 5 MHz, sells for \$119

Instead of the usual controls for pulse-repetition rate, and pulse duration, the model WR549A pulse generator has a pair of controls labeled T1 and T2. These set the time the pulse spends at each of its



two voltage levels, and thus determine the pulse waveform as completely as the more conventional controls, but with no possibility of incompatible settings. T1 and T2 can be varied from 100 nanoseconds to 100 milliseconds, thus covering the frequency range from 5 hertz to 5 megahertz. Rise and fall time is less than 20 ns on all ranges. The WR549A sells for \$119.

VIZ Test Instruments Group, VIZ Mfg. Co., 335 E. Price St., Philadelphia, Pa. 19144. Phone Bob Liska at (215) 844-2626 [354]

Programable oscillator puts out many waveshapes

The model 172 programable signal source is an extremely versatile function generator that uses a microprocessor for easy interfacing with a

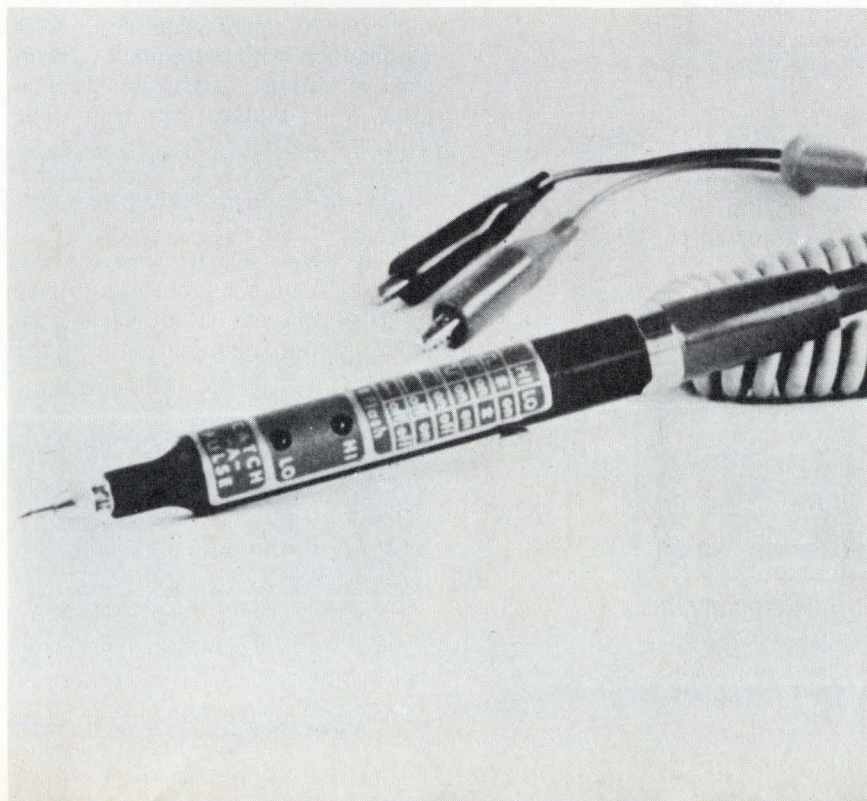

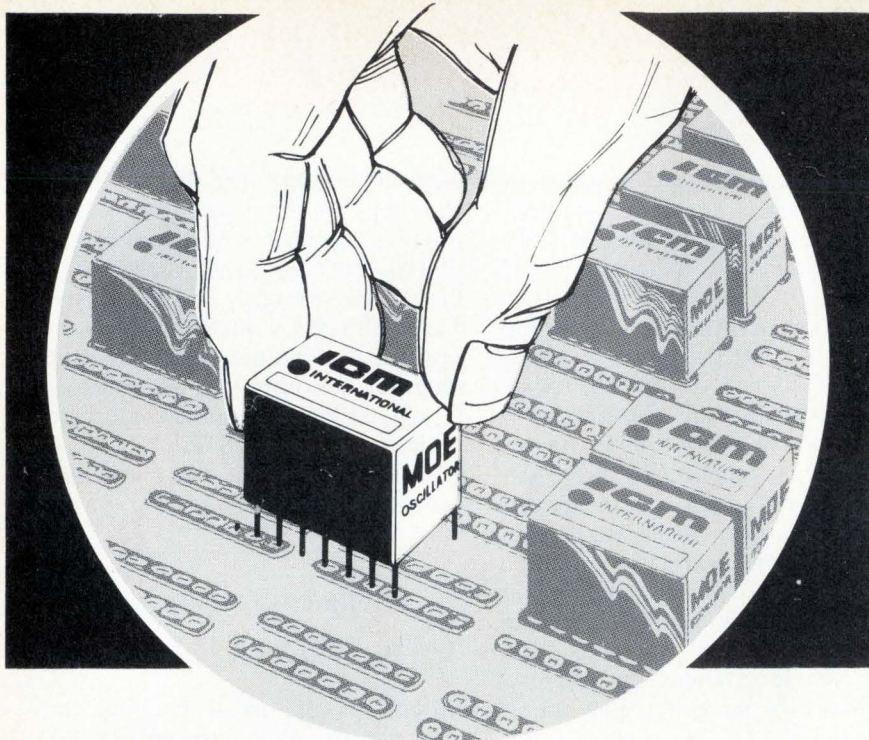

INTERNATIONAL'S
moe
**CRYSTAL OSCILLATOR
 ELEMENTS**

A Complete Controlled Signal Source from 6000 KHz to 60 MHz

The MOE series is designed for direct plug-in to a standard dip socket. The miniature oscillator element is a complete source, crystal controlled, in an integrated circuit 14 pin dual-in-line package with a height of 1/2 inch.

Oscillators are grouped by frequency and temperature stability thus giving the user a selection of the overall accuracy desired. Operating voltage 6 vdc. Output wave shape — non sine.

TYPE	CRYSTAL RANGE	OVERALL ACCURACY	25°C TOLERANCE	PRICE
MOE-5	6000KHz to 60MHz	+ .002% -10° to +60°C	Zero Trimmer	\$35.00
MOE-10	6000KHz to 60MHz	+ .0005% -10° to +60°C	Zero Trimmer	\$50.00

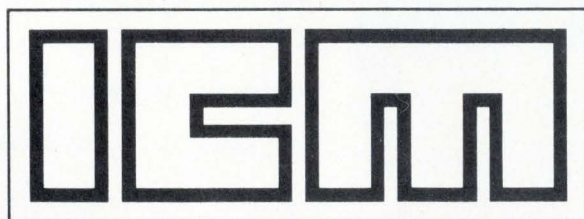

International Crystal Manufacturing Company, Inc.
 10 North Lee, Oklahoma City, Oklahoma 73102

New products

wide variety of options. The basic generator puts out sine, square, triangle, pulse, ramp, haversine, haversine, and dc waveforms. And it puts them out continuously, in gated bursts, or in single triggered cycles. Frequency coverage extends from 0.1 millihertz to 13 megahertz. The basic model 172 sells for \$3,175.



Options include a 5 1/2-digit synthesizer for \$700, a keyboard front panel and a 32-character alphanumeric display for \$425, and programming via a general-purpose interface bus, which is compatible with IEEE standard 488-1975, for \$150.

Wavetek, P.O. Box 651, San Diego, Calif. 92112. Phone John Roth at (714) 279-2200 [353]

Signal generator is tailored to needs of CB industry

Tailored to the specific needs of the citizens' band radio industry, the model 2040 signal generator covers 50 channels with a frequency precision of within 5 parts per million after a 15-minute warm-up. The generator obtains its precision by means of a crystal-controlled oscillator and a phase-locked-loop circuit.

A microvolt-output meter and calibrated attenuators combine to give the 2040 accurate output levels down to 0.1 μv. Maximum output from the

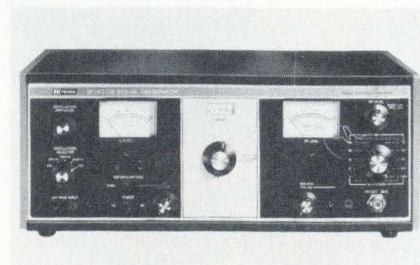



The Model 175
the world's most accurate 3½ digit miniature portable \$189.



The Model 3400
the world's most accurate 4½ digit lab and systems multimeter \$795.



The Model 7500
the world's most accurate high speed 5½ digit systems multimeter \$2995. base



The Model 245
the world's most accurate 4½ digit portable \$295.

**When
you want
the world's
most accurate
multimeters...**

**you want
Data Precision
multimeters.**

For a demonstration or a copy of our comprehensive Digital Instrumentation catalog contact Data Precision Corporation, Audubon Road, Wakefield, Mass. 01880, USA Phone (617) 246-1600, Telex (0650) 949341

Price U.S.A.

DATA PRECISION[®]
...years ahead

For demonstration circle 125
For additional information circle 194

ME434A/B/C

Meets INTELSAT and other international standards

Extensive IF coverage, 35-105MHz

0.1 dB/cm sensitivity for amplitude measurements

0.3ns/cm sensitivity for group delay measurements

0.1°/cm sensitivity
for differential phase measurements

Comprehensive BB frequency range,
83.333kHz-12.39MHz

Wideband sweep for simultaneous measurement
of inside and outside bands

Loopback and end-to-end measurements

Wide 20dB dynamic range

Easy readout of comb marker (1, 5 and 10MHz)

Simple measurement
of AM-PM conversion coefficient

Lightweight and compact for space-saving installation

Also available:

140MHz-band ME515A/B/C and 70/140MHz dual-band ME525A/B/C

**Everything you expect
from
a microwave system analyzer.**



ME434A

Anritsu

ANRITSU ELECTRIC CO., LTD.

MEASURING INSTRUMENTS DIVISION

SALES DEPARTMENT:

12-20, Minamiazabu 4-chome, Minato-ku, Tokyo 106, JAPAN

Phone: (03) 446-1111/Telex: 0-242-2353

Cable: ANRITDENKI TOKYO

U.S.A. Tau-Tron Inc. Tel: (617) 667-3874 • West Germany Knott Elektronik GmbH Tel: (0 8178) 4085 • England Dymar Electronics Limited Tel: Watford 37321 • France Tekelec Airtronic Tel: (1) 946-96-48 • Italy Vianello S.p.A. Tel: 544041 • Holland Uni-Office B.V. Tel: (010) 22 94 44 • Sweden Teleinstrument AB Tel: 08-38 03 70 • Singapore O'Connor's (Pte.) Ltd. Tel: 637944 • Australia NEC Australia Pty. Ltd. Tel: Melbourne 560-5233

New products

generator is 0.1 v. To aid in receiver troubleshooting and alignment, the generator has an additional output fixed at the standard intermediate frequency of 455 kilohertz.

Amplitude modulation and metering are provided for the testing of amplitude-modulated transceivers, and a delta-frequency adjustment is provided for testing single-sideband sets. Also provided is internal protection in case a transceiver under test is accidentally keyed. Because of this protection, the generator can withstand radio-frequency input of 5 watts at 27 MHz for one minute without component damage.

The model 2040 sells for \$475.

B&K Precision, Dynascan Corp., 6460 W. Cortland Ave., Chicago, Ill. 60635. Phone Paul D. Mangione at (312) 889-9087 [358]

Wattmeter spans

25 to 512 MHz

Intended principally for use in the servicing of two-way communications equipment, the model 6156 absorption wattmeter covers the frequency range from 25 megahertz to 512 MHz. The analog instrument has four power ranges: 5, 15, 50, and 150 watts full scale. Maximum measurement error is 5% of full scale, while maximum VSWR is 1.1 at the 50-ohm type-N input connector. Priced at \$249, the model 6156 is available from stock to six weeks.

Bird Electronic Corp., 30303 Aurora Rd., Cleveland, Ohio 44139 [356]

Test set measures delay
and amplitude distortion

Since excessive group-delay distortion and amplitude distortion can wreak havoc with high-speed data-communications lines, equalizers are often used in these lines to keep such distortion down to acceptable levels. The L 2020 delay and amplitude test set is intended to be used in the adjusting of those equalizers. It operates over the frequency range from 200 hertz to 20 kilohertz and

Compare: Monsanto Alpha-numeric LED displays cost less per character.

For systems which require 32 characters or less.

It's clear and simple. If your display requirements call for both letters and numbers and you use 32 characters or less, our MAN2A LED (Monsanto Alpha-Numeric) outperforms both CRT and gas plasma from a cost effectiveness standpoint.

Our MAN2A LED is a 35-dot (5 columns, 7 rows) matrix, 0.350" red character, with full upper case alphabet and numeric capabilities (ASCII Code) that costs less per character and has a lower life cycle cost than other display systems if you use fewer than 32 characters.

In addition, it is IC compatible and highly reliable, as you would expect an LED display to be.

In short, it's the smartest, least expensive, best buy you can make.

Offering proven advantages.

The MAN2A also delivers a long list of other advantages. Starting with instant on/off, cool, long-life operation; they go on to include extremely high resistance to shock and vibration, wide operating and storage temperature range, and IC compatible voltage and current characteristics.

Filling a variety of applications.

It's an existing display within Monsanto's total line of LED displays and available now.

The list of applications is growing every day—including data displays, computer peripherals, automated controls, analyzers, point of sale terminals, scientific calculators, and avionics applications. And that's only mentioning a few.

Read our FREE Reliability Evaluation Report.

Our new QA Reliability Report is now available, covering all the quality assurance features of the MAN2A. It details how Monsanto ensures quality and reliability, which ensures maximum cost saving advantages for you—now and in the future.

It is absolutely FREE—simply mail the coupon for fast response.

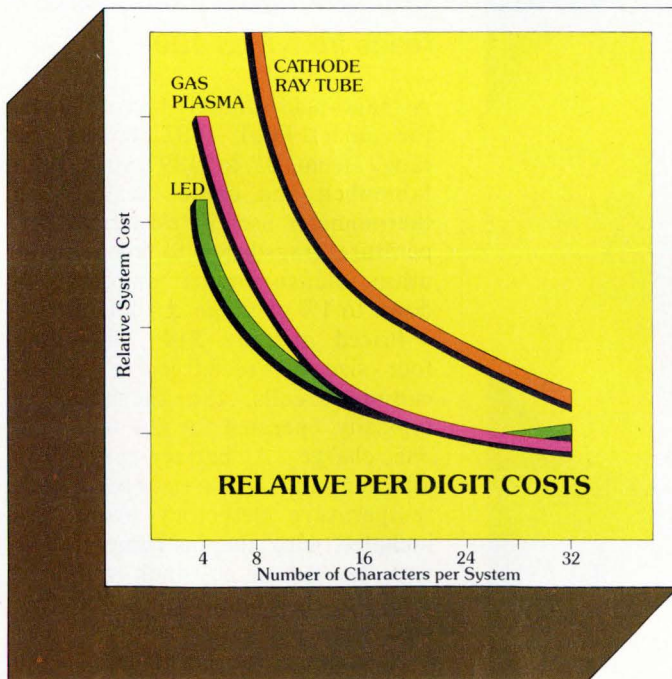

Monsanto:
the science
company.

IN EUROPE CONTACT: Monsanto Europe S.A.,
Electronics Division, Avenue de Tervuren 270-272,
B-1150, Brussels, Belgium

Send me your FREE Reliability Report and
specifications on the MAN2A LED display.

Name Title

Company Street

City State Zip

Mail to: Monsanto Electronics Division
Dept. MCD, 3400 Hillview Ave., Palo Alto, Ca. 94304
Phone (415) 493-3300 © Monsanto Company Electronics Division, 1976

The new chip inductor. A miniature specifically designed for reflow soldering and hybrid circuits.

Delevan proudly announces another first in hybrid circuit component design. Only .1" square by .075" high, the newest member of the Delevan Micro-i, inductor series was engineered to withstand the hi-temperature exposure of reflow soldering used for thick film processing.

High temperature insulated magnet wire is thermal compression bonded to gold plated metallic solder rails. The solder rails wrap around the sides of an alumina substrate to provide a visual indication of the solder bond.

Thermal exposure during assembly or rework is a severe test of component capability . . . and can be a controlling factor in reliability and performance.

When dependability is first priority, check out the new series 103 miniature leadless chip inductor . . . built to stand the heat. Ask for bulletin 103.

Delevan
Division



AMERICAN
PRECISION
INDUSTRIES INC.

270 QUAKER RD./EAST AURORA, N. Y. 14052
TELEPHONE 716/652-3600 TELEEX 091-293

OTHER DIVISIONS OF AMERICAN PRECISION INDUSTRIES INC.:
BASCO • DUSTEX

New products



measures delay distortion from ± 20 microseconds to ± 10 milliseconds, attenuation distortion from ± 0.2 decibels to ± 50 dB, and absolute level from -50 dBm to $+10$ dBm. A reference signal synchronizes the test sets at both ends of the line. A four-digit frequency counter indicates the frequency of the reference or test signal, and, in the case of swept operation, the upper and lower cutoff frequency of the test signal.

Siemens, 186 Wood Ave. South, Iselin, N.J. 08830. Phone (201) 494-1000 [355]

Compact digital thermometer
reads from 0 to 199°F or C

A hand-held digital thermometer, the model DRT 1102, covers the range from 0° to 199° with both fahrenheit and celsius scales. The thermometer uses a resistance temperature transducer to keep maximum measurement uncertainty down to 1% of range ± 1 count.

Priced at only \$149, including four size AA rechargeable nickel-cadmium cells, the thermometer typically operates for 24 hours on one charge. A battery-charger/ac adapter and an RTD (resistance temperature detector) probe are included with the instrument. The RTD, housed in a 2-inch stainless-steel sheath, comes with a four-foot lead wire.

A companion thermometer, the model DRT 1104, is similar to the 1102, except that it covers the temperature ranges from 0° to 399°. It sells for \$169.50. Both thermometers use 0.25-inch red light-emitting-diode displays, and will operate in ambients from 32°F to 132°F (0°C to 55.5°C).

West Coast Research Corp., P.O. Box 25061, Los Angeles, Calif. 90025. Phone (213) 478-8833 [357]

Coming through...

with people, ideas, products—
whatever it takes to get the job done



Wire, cable and cord sets usually cost less to buy than install. And poor performance can cut into your product's profitability deeper than potential savings on an initial buy. Belden is ready with whatever it takes to get the job done right.

BROAD LINE: Belden comes through with thousands of standards that fit your toughest environmental and application needs. And if a standard won't work, we will custom design an answer to your need.

ENGINEERING HELP: When you have problems in stripping, terminating, installing, fabricating, safety engineering, ordering, quality control, or want information on the codes or design parameters, ask a Belden specialist. "Hot-line" assistance is as near as 317-966-6681. Call and see.

UNIQUE PUT-UP CAPABILITY: Ask about Belden's UNREEL® dispensing system. Pays out wire continuously without snarls, backlash, or tensioning devices. One company cut processing time by 30%*

And Belden is coming through with a lot more. A design kit that covers performance characteristics, costs, material capabilities. And we've increased production capability for shorter lead times, great delivery.

Quality wire, cable and cord—whatever it takes to protect your bottom line performance every day. Belden Corporation, Electronic Division, P.O. Box 1327, Richmond, IN 47374, 317-966-6661.

8-6-6 B

*Information available upon request.



Circle 129 on reader service card

Coming through...

with new ideas for moving electrical energy

Copyright © 1976 by Belden Corporation

AMP's new laminar system takes the bulk out of board-to-board connectors. And puts tin-to-tin economy in.

Now, from AMP engineering research, comes a different concept in board-to-board connectors—the economical laminar interconnect system. It utilizes flame retardant insulating film which substantially reduces housing size, weight and cost, yet maintains contact insulation and protection.

The new system increases packaging versatility. Contacts are available which enable boards to be interconnected at any angle and in various combinations. The tin plated, clip-shaped contacts engage both sides of a board and can be used on all four edges.

AMP laminar connectors can also improve reliability. The deflection designed into the contact assures good electrical connection for virtually any pc board thickness as well as for warped or bowed boards. And when you need extra ruggedness and protection, simple auxiliary plastic housings are available.

There are more features you'll like about AMP's unique laminar board-to-board interconnect system including AMP engineering backup all along the line, whenever you need it. So why not put them all to

work for your product. Just call Customer Service at (717) 564-0100. Or write AMP Incorporated, Harrisburg, PA 17105.

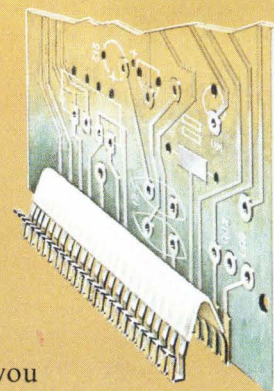

AMP INCORPORATED

Circle 130 on reader service card

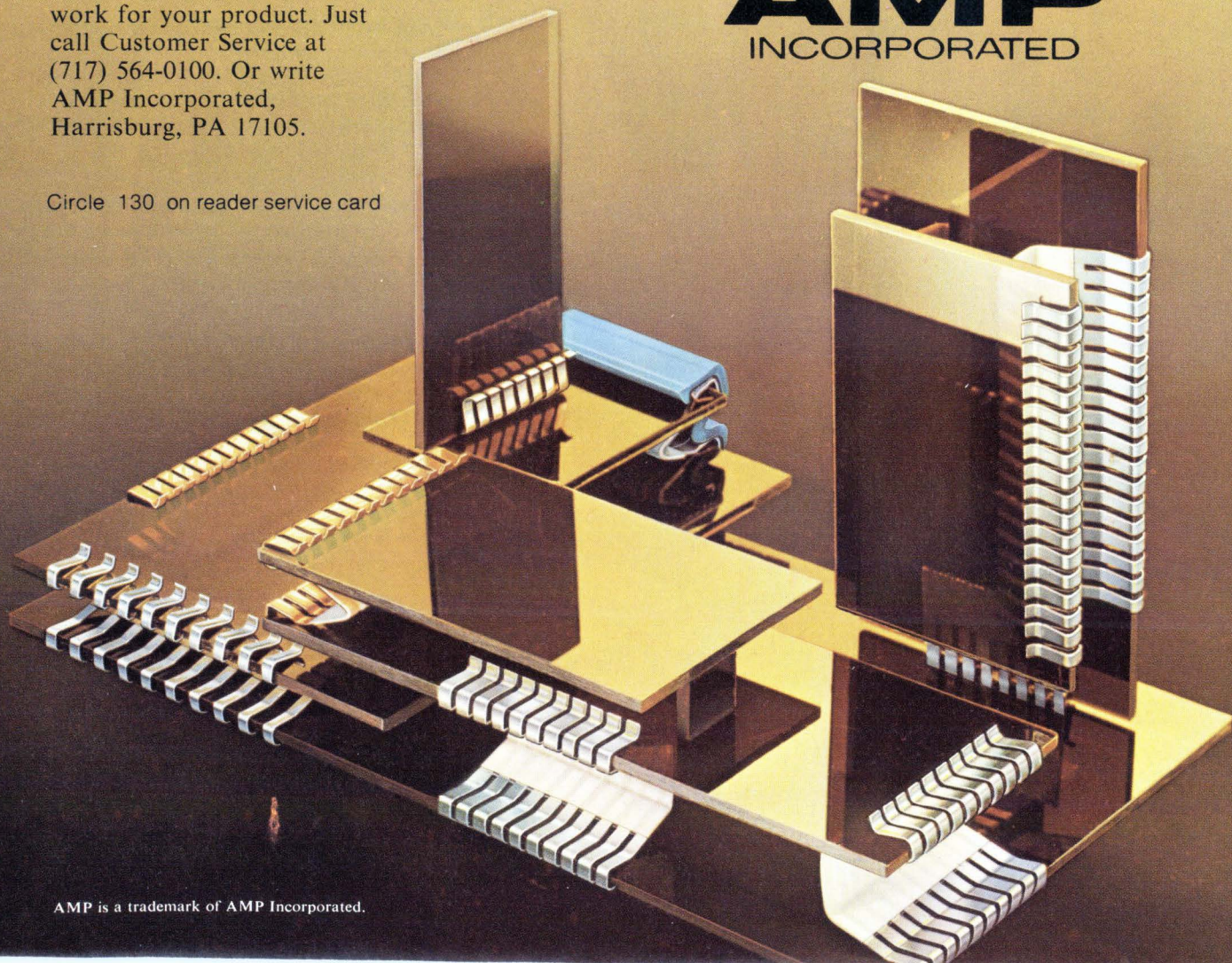

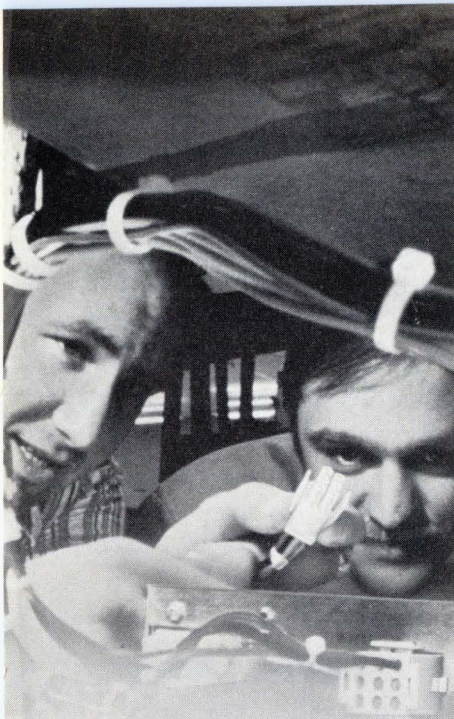

AMP EUROPE

Austria — AMP Austria. Branch of AMP Deutschland GmbH. Markgraf-Ruediger Str. 6-8, 1150 Vienna. Phone: 924191/92

Belgium — AMP Belgium. Branch of AMP-Holland B.V., Rue de Brabant 62-66, Brussels. Phone: 322.17.55.17

France — AMP de France. 29 Chaussée Jules-César. Boite Postale No. 39. 95301 Pontoise France. Phone: 030 82 20, 030 92 30

Germany — AMP Deutschland GmbH. Ampérstrasse 7-11, 607 Langen, B. FFM., West Germany. Phone: (06103) 7091

Great Britain — AMP of Great Britain Limited, Terminal House, Stanmore, Middlesex, England. Phone: 01-954-2356

Holland — AMP Holland B.V., Papierstraat 2-4 's-Hertogenbosch, Holland. Phone: (04100) 25221

Italy — AMP Italia S.p.A., Via Fratelli Cervi 15, 10093 Collegno (Torino), Italy. Phone: 785-656

Spain — AMP Española, S.A., Apartado 5294. Pedro IV, 491, 495, Barcelona 5, Spain. Phone: 307-75-50

Sweden — AMP Scandinavia AB, Datavägen 5, 17500 Jakobsberg, Sweden, Mailing Address: Fack S-175 20 JARFALLA 1, Sweden. Phone: 0758/10400

Switzerland — AMP AG, Haldenstrasse 11, 6006 Luzern, Switzerland. Phone: (414) 235421, 235422, 235423

AMP NORTH AMERICA

Canada — AMP OF CANADA LTD., 20 Esna Park Drive, Markham, Ontario, Ph: 416-495-6222

Mexico — AMP de Mexico, S.A., Apartado Postal 179, Naucalpan de Juarez, Edo. de Mexico, Phone: Mexico City 576-41-55

Puerto Rico — AMP OF CANADA LTD., 677 Calé de Diego, Rio Piedras, Puerto Rico 00924, Phone: (809) 766-2346

United States — AMP Incorporated, Harrisburg, Pa. 17105, Phone: 717-564-0100

AMP SOUTH AMERICA

Argentina — AMP S.A. Argentina 4 de Febrero, 76 Villa Zagla — SAN MARTIN, Buenos Aires, Argentina, Phone: 752-4612

Brazil — AMP do Brasil Ltda., AV Comendador Martinelli 185, Lapa, Sao Paulo, Phone: 262-4353

AMP PACIFIC

Australia — Australian AMP Pty. Limited, 155 Briens Road, Northmead, N.S.W. 2152 Australia, Mailing Address: P.O. Box 194, Baulkham Hills, N.S.W. 2153 Aus. Ph: 630-7377

Japan — AMP (Japan), Ltd., No. 15-14, 7-Chome, Roppongi Minato-Ku, Tokyo, Japan, Ph: 404-7171

Products and services for many specialized industries are provided by the AMPLIVERSAL Division. In the United States, this division is known as AMP Special Industries.

For AMP products and services in other countries, write: AMP International Division, Harrisburg, PA 17105, USA.

New products

Semiconductors

Bi-FET switches use n-channel

Mixed-process analog units provide on-resistance of 30 to 100 ohms at 25°C

Mixed-process linear circuits, which perform like hybrids for only monolithic prices, are gaining momentum. Now, National Semiconductor Corp. is introducing the first commercial devices—a family of analog switches—to be made with an n-channel bi-FET mixing process for lower on-resistance and higher operating speeds.

Other bi-FET linears have p-channel junction-type field-effect transistors as their front ends. Also, p-FET mixed processing is basically a bipolar technology in which input JFETs are ion-implanted. In contrast, n-FET mixed processing is a JFET technology that makes use of ion-implanted bipolar transistors.

Designated the AM181/184/187/190, the new n-channel bi-FET analog switches provide a low on-resistance of about 30 to 100 ohms at 25°C, compared with the 150 to 200 Ω of their p-channel bi-FET counterparts. Moreover, the new switches stack up well against comparable hybrid devices, which typically have on-resistances in the range of 45 to 150 Ω.

Indeed, says Michael Turner, FET marketing manager, the AM181 family is designed to compete directly with the industry standard for low on-resistance, high-speed applications, Siliconix Inc.'s DG181, a hybrid family of devices, typically containing 3 to 5 JFETs in a package about 20 to 50 mils on a side.

National's family, Turner says, combines the same number of devices onto a single monolithic die, only 64 by 74 mils in area, without sacrificing speed nor increasing crosstalk or off-isolation. Crosstalk and isolation are lower than -60

decibels at 10 megahertz. Switching time equals that of most hybrid switches with an on-time of about 105 nanoseconds and an off-time of 95 ns. In p-channel bi-FET devices, while off-time is typically about the same as that of the AM181, on-time is about five times longer, around 500 ns.

The performance advantage of the AM181 over standard bi-FET technology, says John Maxwell, applications engineer, results from the innate advantage of n-channel devices over p-channel devices. "Essentially, n-type structures have twice the mobility of p-types," he says. "For the same number of carriers, n-type devices have one half the resistivity." This means five to six times the gain with one fourth the noise of p-channel types and substantially lower on-resistance.

But n-type FETs are much harder to fabricate than p-channel types. As in its p-channel bi-FET process, ion implantation was used by National to make the problem much simpler. Turner explains, "By using high-energy ion beams of the desired dopant, instead of the standard high-temperature diffusion technique, low-concentration profiles can be easily generated."

But the difference between the two techniques is that the standard bi-FETs are made with an essentially bipolar process that starts with a p-type substrate, in which p-type JFET front ends are added. The AM181 family is fabricated by means of a process that is almost exactly the reverse. "The starting material is an n-type substrate onto which JFET devices are fabricated," Turner says. "Ion implantation is then used to fabricate npn and pnp transistor-driver structures."

The monolithic AM181 family aims at the same market as hybrid devices like the DG181: high-performance military and industrial applications, as part of analog-to-digital and d-a converters, data acquisition, signal multiplexing, sample-and-hold circuits, and video switching systems.

The family includes the series AM181/182/281/282 dual drivers

asking about SUBMINIATURE LAMPS?

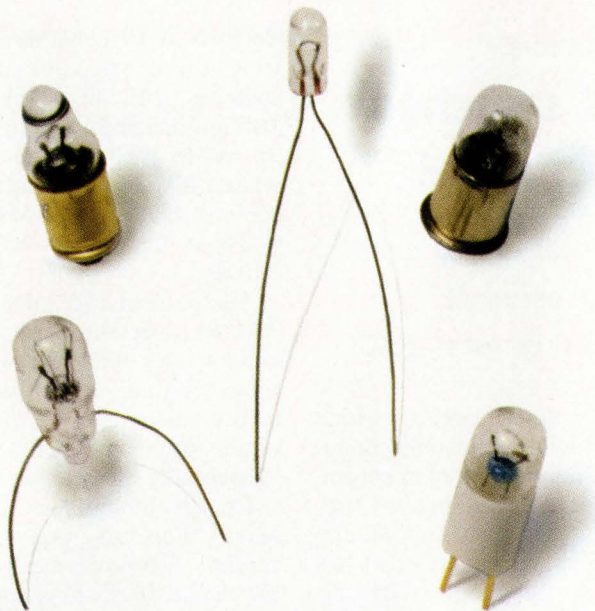

CHICAGO MINIATURE HAS THE ANSWER!



Chicago Miniature has the answer for every subminiature application. All base configurations or wire terminal . . . all colors . . . standard products and specials . . . whatever you need with high quality at competitive prices. There's off-the-shelf delivery on most items from your distributor. For more information, or expert design help, contact Chicago Miniature Lamp Works, 4433 N. Ravenswood Avenue, Chicago, Illinois 60640. Phone (312) 784-1020.

CHICAGO MINIATURE LAMP WORKS

GENERAL INSTRUMENT CORPORATION 

New products

with single-pole, single-throw switches; the AM184/185/284/285 dual drivers with double-pole, single-throw switches; the series AM187/188/287/288 spdt switches; and the AM190/191/290/291 dual drivers with spdt switching. In large volumes, says Turner, the devices will be priced about the same as hybrid competitors: \$9 to \$15 each. National Semiconductor Corp., 2900 Semiconductor Dr., Santa Clara, Calif. 95051 [411]

MOS phone-signal detector replaces analog filtering

Push-button dialing, or Touch-Tone signaling as the Bell System calls it, has not only made the telephone more convenient but is finding use in control applications and computer signaling, as well. Collins Commercial Telecommunications division of Rockwell International Corp. has introduced a dual-tone multifrequency detector on a chip, which can be used in all Touch-Tone signaling systems—central offices, keyphones, and mobile radio telephones.

In the past, such DTMF receivers used all-analog filter techniques such as phase-locked loops, LC filters and active filters. But the Collins CRC-8030 detector uses a newly developed digital-filter algorithm and, when linked with a front-end band-split filter/limiter, provides a complete DTMF receiver. The company claims the detector outperforms a phase-locked-loop receiver and costs less to manufacture than either LC or active-filter receivers.

The p-channel metal-oxide-semi-

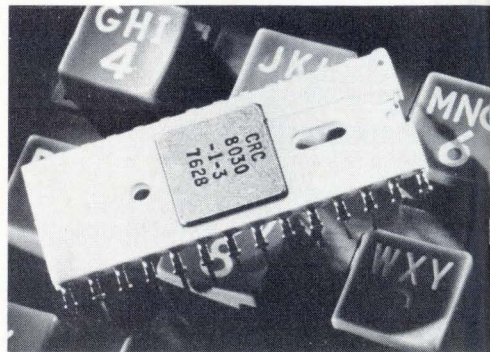

machinable glass? you've got to be kidding!

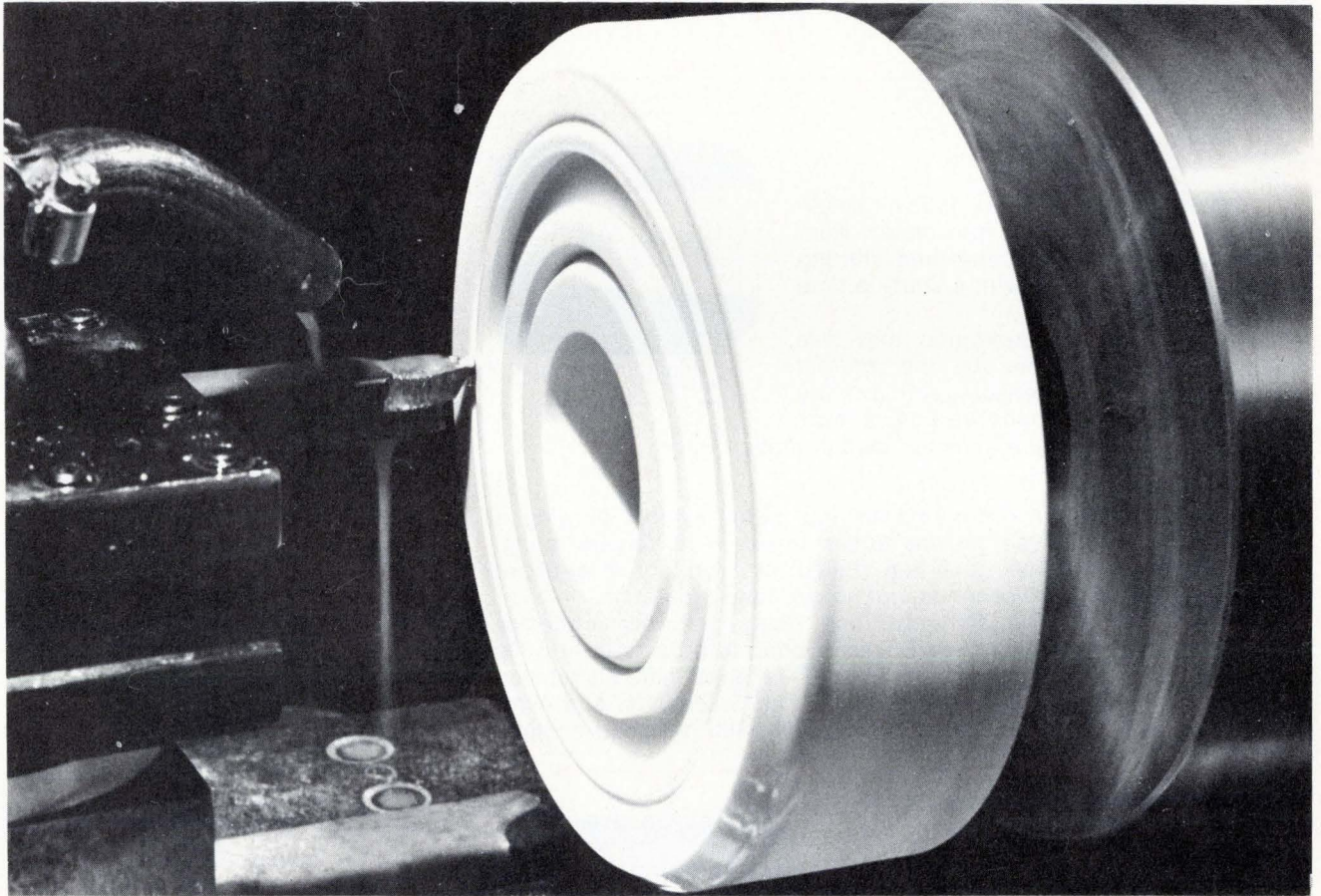

Corning Introduces MACOR™ Machinable Glass-Ceramic

Normally, glasses, ceramics, and glass-ceramics are not machinable without using diamond tooling. But MACOR™ glass-ceramic has a unique, partially crystalline structure which enables it to be machined to precision tolerances with ordinary metalworking tools and equipment.

MACOR™ glass-ceramic does not sacrifice strength, hardness or porosity to achieve this machinability, nor does it have to be fired after machining. Now, for the first time, there is a truly machinable, insulating material with physical properties that equal or exceed those of the best technical ceramics and glasses.

MACOR™ glass-ceramic can be hermetically sealed to metal, glass or ceramic utilizing a simple, glass-frit process that does not require brazing. It can also be metallized with thick-film inks and can be polished to excellent surface finishes.

MACOR™ glass-ceramic has outstanding dielectric properties and is completely nonporous; in fact its electrical and vacuum properties are as good as the best alumina or glass materials. However, MACOR™ glass-ceramic is available in standard sizes from stock and can be conveniently fabricated in your own shop saving you time and money while increasing your control over results.

Features at a Glance

- machinable with ordinary metalworking tools
- no firing after machining
- excellent dimensional stability
- good thermal shock resistance
- ultra high dielectric strength
- compatible thermal expansion coefficient
- low thermal conductivity
- low loss tangent
- zero porosity and zero water absorption
- non-magnetic

For technical specifications and a stock/price list, write:

MACOR™ Glass-Ceramic Dept., E-1276
Corning Glass Works, Corning, N.Y. 14830

CORNING

AIRPAX™

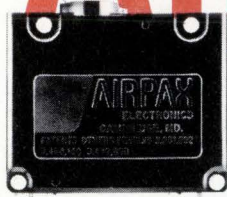

UPG Delay 66 Circuit Protector



Problem Solver!

Problem:

Customer had a 1/3 hp, 115 volt single phase capacitor-run 3450 rpm motor. Running current was 4.6 amperes and starting current was 28 amperes with a start-up time of 1.6 seconds.

He needed overload protection that was faster than that supplied by the internal sensors and a fairly quick dropout in case of a jammed load or stalled rotor.

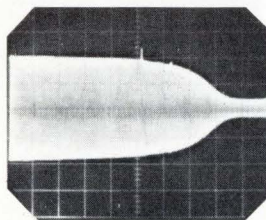

Start-up Current Envelope
Vertical 7.5 amps rms/div.
Horizontal .2 sec./div.

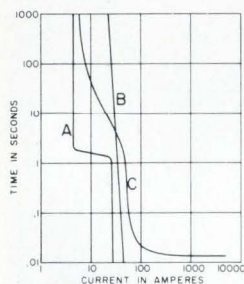

Time vs Current
A — Motor Characteristics
B — 15A Fuse
C — UPG Delay 66, 5A

In order to start the motor without blowing a fuse, he was forced to use a 15 ampere rating. This gave him stalled rotor protection at about 10 seconds, but no overload protection. The standard long delay magnetic protector required a 7 1/2 amp rating to be able to turn his motor on reliably. This gave him his stalled rotor protection at about 5 seconds, and overload protection at 200%. Still not good enough.

Solution:

The Airpax UPG Delay 66, at 5 amp rating eliminated this problem with turn on . . . locked rotor protection at about 4 1/2 seconds . . . and overload protection at about 150% on nameplate in approximately 400 seconds. This allowed short periods of overload without nuisance tripping. His problem was solved. (Delay 66 is also available in larger Airpax Type 219 and 229 Molded Case units up through 100 amperes.)

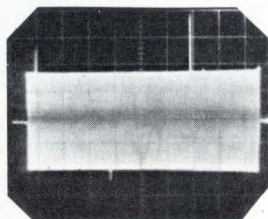

Stalled Rotor Trip Out
Vertical 7.5 amps rms/div.
Horizontal .5 sec./div.

If you have an application with a special protection problem, call Airpax Electronics at Cambridge, Maryland (301-228-4600) or write for literature on Airpax Circuit Protectors and Circuit Breakers.

AIRPAX™

**AIRPAX ELECTRONICS
CAMBRIDGE DIVISION**
Cambridge, Maryland 21613 • Telex 8-7715 • TWX: 710-865-9655
Other Airpax Divisions:
CONTROLS DIVISION, Ft. Lauderdale, Florida
Instruments for Industry
AMERICAN DATA, Huntsville, Alabama
TV Products

New products

conductor detector is made by ion-implantation techniques and is packaged in a 28-pin dual in-line package. It operates from a 5-volt supply, dissipates less than 200 milliwatts, and needs only a single 3.579545-MHz crystal for clock generation.

The digital-range filter of the CRC-8030 detects the valid tones of dialed numbers and converts them into binary data or 2-of-8-coded data in 22 to 39 milliseconds, depending on the front-end filter used. Out-of-tolerance frequencies are rejected, and the detector is designed to ignore the first few pulses of the input signal to avoid any errors due to transients of the Touch-Tone pad.

The CRC-8030 sells for \$29 in quantities of 100 and is now in production with one-week delivery for small orders. A military version will be available in February.

Rockwell International Corp., Collins Commercial Telecommunications Division, Newport Beach, Calif. 92663 [412]

16-kilobit dynamic RAM has 150-ns access time

Claimed to be the fastest 16-kilobit random-access memory yet announced, the MK 4116P-2 is a dynamic device with an access time of 150 nanoseconds and a cycle time of 375 ns. Built using Mostek's n-channel, silicon-gate Poly-II process, the memory is extremely com-

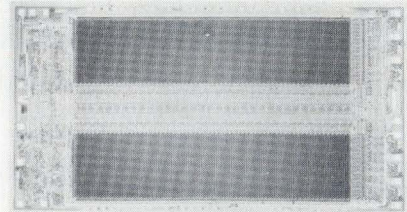

part—it occupies just 122 by 227 mils—and is housed in a standard 16-pin dual in-line package.

The RAM pulls only 462 milliwatts when active and has a maximum standby power drain of 20 mw. It contains on-chip address and data registers. In addition to the usual

Let's talk about the easy way for you to spot microprocessor HARDWARE PROBLEMS

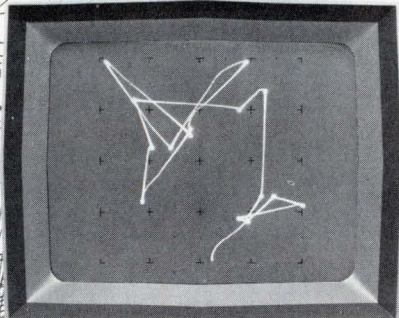
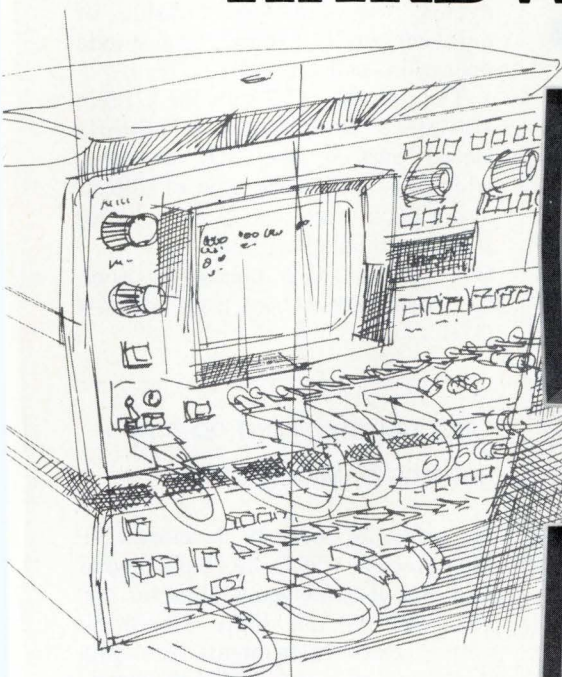

HP's 1600S Logic State Analyzer, in the MAP mode, lets you examine the unique "fingerprint" of every logic system.

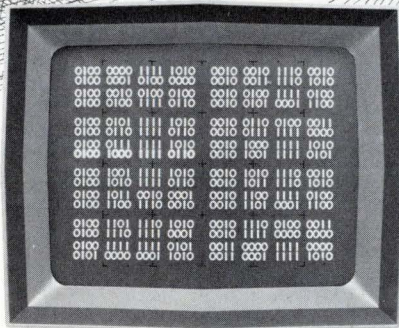

In the TABLE mode, the 1600S displays up to 16 32-bit words. These words could be combinations of addresses, instructions or states of the control lines.



We've probably both spent hours at the simulator to prove we had good software and then discovered

the hardware won't play — what do we do? You know the traditional answer. Dig out the scope, get out the program printout, and brace yourself for hours of grinding, point-by-point checks. But I can tell you that doesn't have to be the case. Especially now that HP has introduced some new tools that can really cut down your troubleshooting time.

HP's Logic State Analyzers can really take a lot of pain out of your troubleshooting procedures. You'll find wiring errors, defective components, and even solder splashes; and you'll find them a lot more quickly than ever before.

Let me give you an example. We had an eight-bit microprocessor system with start-up problems. The clocks were running and phased right, and the address lines toggled, but the machine didn't function. So, we

set up an HP 1600S Logic State Analyzer to look at both the Address and Data buses. It was then we noticed that only "zeros" were being fetched from memory. Knowing the ROM was good, we then added several control lines to the display and the problem showed up immediately. The "Enable" line never went high. A quick look at the "Enable" driver showed the input was ok, but no output. Obviously, the gate was defective.

I don't know how long it would have taken to find that one without HP's Logic State Analyzers, but I know it would have taken us a lot longer.

Call your local HP field engineer. He'll give you all the details on the 1600S (priced at \$7100*) including spec sheets and application notes detailing the use of mapping for troubleshooting minicomputer and microprocessor systems. He'll tell

you about the seminars that HP has arranged around the country and tell you when one will be held in your area and how you can attend. You ought to go to one, because you'll discover an exciting new concept in digital troubleshooting.

*Domestic U.S.A. price only.



HEWLETT  PACKARD

Sales and service from 172 offices in 65 countries.
1507 Page Mill Road, Palo Alto, California 94304

KEYBOARDS BY THE MILE

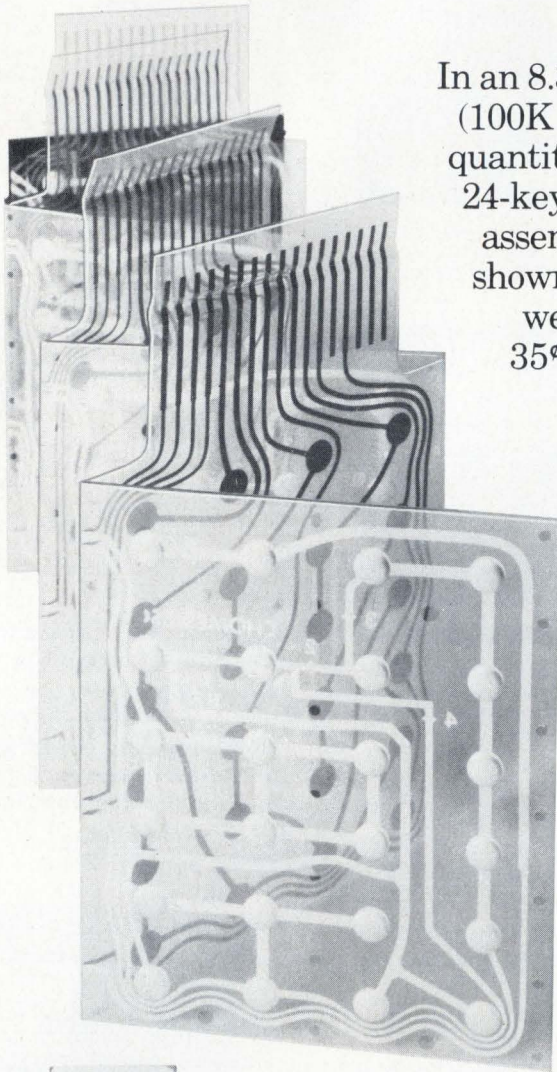

In an 8.3 mile (100K piece) quantity, the 24-key KCS assemblies shown here went for 35¢ each.



These one piece units provide circuit coding, board edge connections, springs for your keytops and contact closures for 10M cycles. You provide the top and bottom, we'll supply the action for as little as a penny a key! Write or phone today.

CHOMERICS

77 Dragon Court
Woburn, Ma. 01801
(617) 935-4850

New products

read, write, and read-modify-write cycles, the 4116 is capable of delayed write cycles, page-mode operation, and RAS-only refresh.

The MK 4116P-2 sells for \$100 in 100-piece quantities. A slightly slower version, the MK 4116P-3, which has an access time of 200 ns and a cycle time of 675 ns, sells for \$50 in similar quantities.

Mostek Corp., 1215 W. Crosby Rd., Carrollton, Texas 75006. Phone (214) 242-0444 [414]

Chopper-stabilized op amp exploits bi-MOS process

By using its recently developed bi-MOS process, which puts both bipolar and metal-oxide-semiconductor devices all on the same monolithic chip, Texas Instruments has produced a chopper-stabilized operational amplifier that sells for only \$14.50 in hundreds. Previous chopper-stabilized op amps were available only as expensive hybrids, modules or dielectrically isolated circuits.

The TL089CL has a maximum input offset voltage of 80 microvolts for temperatures between -25°C and 85°C . Typical input offset drift is $0.2 \mu\text{V}/^{\circ}\text{C}$.

Texas Instruments Inc., Inquiry Answering Service, P.O. Box 5012, M/S 308 (Attn: Circuit Types TL089), Dallas, Texas 75222. Phone John Spencer at (214) 238-3527 [416]

Fast character generator has on-board shift register

A scanned-character generator with a repertoire of 64 dot-matrix characters is intended for use with CRT terminals and matrix printers. The model DM8678 generates nine seven-dot rows at a rate of 350 nanoseconds per row. The bipolar LSI device has on-board circuitry to perform such systems functions as parallel-to-serial shifting, character address latching, character spacing, and line spacing. In existing systems,

TELONIC

Specialists in the world of RF and Microwave

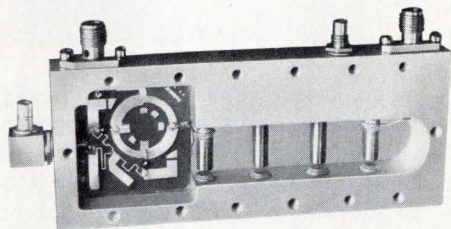

MICROWAVE SUBASSEMBLIES

Circle 260 on reader service card

Telonic can custom design, manufacture, and integrate microwave components for specific packages and subassemblies. Our in-house capabilities for stripline and microstrip production permit quick turn around and attractive pricing structures.

The following list is representative of the type of components we can design and integrate into subassemblies to meet your requirements.

Preamplifiers • Power Amplifiers • Frequency Multipliers • Comb Generators • Oscillators • PIN Switches • Digital Phase Shifters • Phase & Amplitude Modulators • Detectors • Mixers • Discriminators • Limiters • Voltage Controlled Attenuators • Receiver Front Ends • Filters • Couplers • Multiplexers • Multicouplers • Hybrids • Power Dividers & Combiners • Attenuators • Baluns

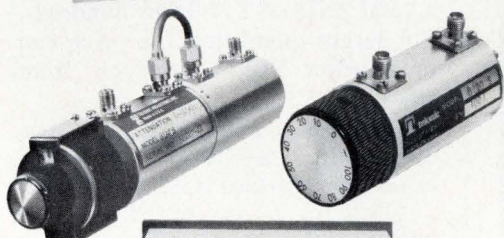

ATTENUATORS

Circle 261 on reader service card

Incorporating thick film, solid state construction, Telonic attenuators can guarantee precise operating parameters, high power handling capabilities and dependable service. Rotary type models may be specified with attenuation steps as low as .1 dB up to 10 dB in ranges from 1 dB to 110 dB, 50 or 75 ohms. Power rating for all units is 3 watts average, 1000 watts peak. Various combinations of rotary types permit tandem and parallel configurations for panel mounting and bench top units. A variety of connectors are also available.

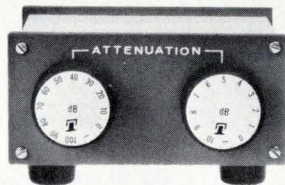

FILTERS

Circle 262 on reader service card

Telonic produces a range of RF and microwave filters so extensive that most requirements can be filled from standard catalog series. The product line covers 20 MHz to 12 GHz in low pass tubular types and bandpass in tubular, cavity, interdigital, and combine. Several series of tunable bandpass and band reject are also available. Our latest Filter Catalog provides complete specifications, performance curves, and simplified ordering procedures for all models. Special requirements should be directed to our marketing department.

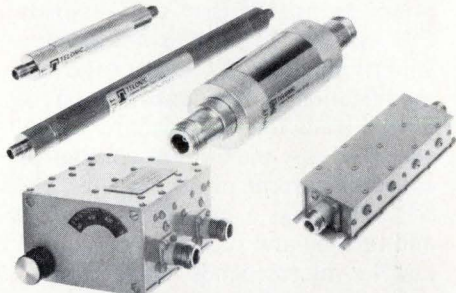

TEST INSTRUMENTS AND DISPLAYS

Circle 263 on reader service card

Telonic has long been recognized as a leader and innovator in the development of sweep/signal generation equipment. The 1200 series sweep generators encompass 8 instruments with frequency coverage from DC to 1.5 GHz.

Our display oscilloscopes are large screen types (11-inch) in single and dual trace. Both models, 121 and 122, have built-in marker adders for Y and Z pulse markers, are highly stable, and will operate with a wide variety of input instruments and devices.

Telonic's Rho-Tector line of VSWR instrumentation permits low cost, reliable test systems for VSWR determination over a 1.02:1 to 3:1 range. Various detectors, terminations, mismatches, meters, and kits are available.

Inquiries on Telonic equipment in the continental U.S. should be directed to the main office in Laguna Beach, California. Our TOLL FREE no. is 800-854-2436 (except in California). Overseas, Telonic is represented by distributors in 33 countries.

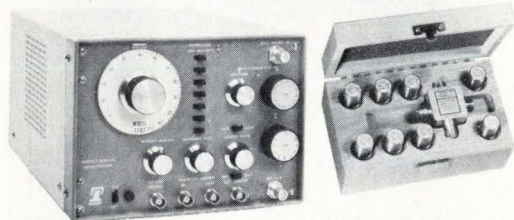
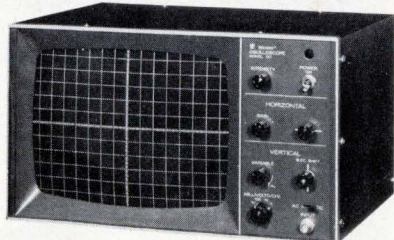

TelonicAltair

2825 Laguna Canyon Rd. • Box 277 • Laguna Beach, CA 92652
714-494-9401 or Toll Free 800-854-2436

MAGNETIC SHIELDS

Magnetic shields manufactured in any size from small components to large vacuum chambers. **CO-NETIC** AA alloy has high permeability that provides maximum attenuation. Shields are fully hydrogen annealed after fabrication. We offer material and custom shields. Applications range from shielding earth's field to high intensity AC and DC fields.

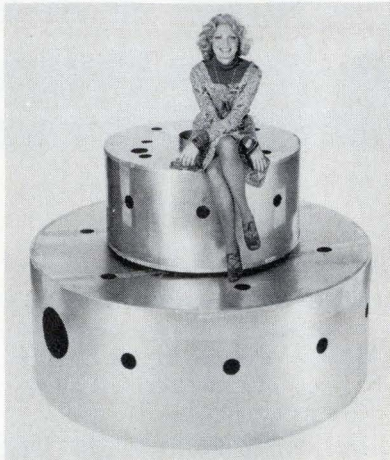

*Please Call or Write
For Design Assistance*

Send For Application Notes

MAGNETIC SHIELD DIV.



PERFECTION MICA CO.
740 North Thomas Drive
Bensenville, Ill. 60106, USA
Phone 312 / 766-7800
TWX 910-256-4815

Circle 138 on reader service card

HAVE A HANDLING PROBLEM?



...LOOK TO PERMAG

Permanent magnets, assemblies,
Alnico, Ceramics, Ferrites, and Beryllia.
24 hour off-the-shelf delivery.
Design and engineering assistance.
Complete magnetizing, grinding and
cutting facilities. Call or write
for our new catalogs.

YOUR NO. 1 SOURCE
FOR ALL MAGNETIC MATERIALS



ALL ACROSS THE COUNTRY



Consult your Yellow Pages for address and telephone number of Permag near you.

138 Circle 195 on reader service card

New products

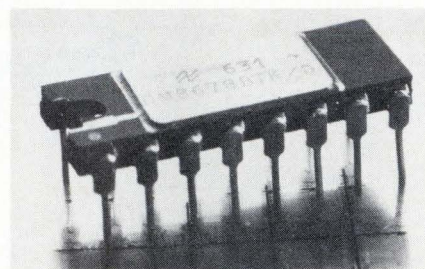

a character-generating read-only memory typically requires from two to four additional chips to perform these functions at a cost of from \$15 to \$30. The DM8678 does the job at a total price of \$14.95 in hundreds. For larger quantities, the price can drop below \$10. Delivery is from stock.

National Semiconductor Corp., 2900 Semiconductor Dr., Santa Clara, Calif. 95051. Phone (408) 737-5000 [415]

Transistor dissipates 500 W in TO-3 package

The model STC 9160 is a 50-ampere power transistor that can dissipate 500 watts at 25°C. It is housed in a slightly modified TO-3 package; the modification is the substitution of 60-mil leads for the standard 40-mil wire. At its maximum continuous collector current of 50 amperes, the STC 9160 has a minimum h_{FE} of 10 and turn-on and turn-off times of 3.5 and 7.2 microseconds, respectively.

Recommended as a replacement for parallel arrays of lower-power transistors in a variety of applications, the transistor sells for \$36 each in quantities from 1 to 99 and for \$26 each in lots of 100 to 999. Delivery is from stock.

Silicon Transistor Corp., Katrina Rd., Chelmsford, Mass. 01824. Phone William A. Schromm at (617) 256-3321 [418]

64-bit correlator operates at 20 MHz

A digital-input/analog-output correlator with a clock rate of 20 megahertz is suitable for such communications applications as bit synchroni-

Ask
CONTROL DATA for the **OEM** industry standard:
40, 80, 150 and 300 MByte Storage Module Drives
you can interchange without changing your design.

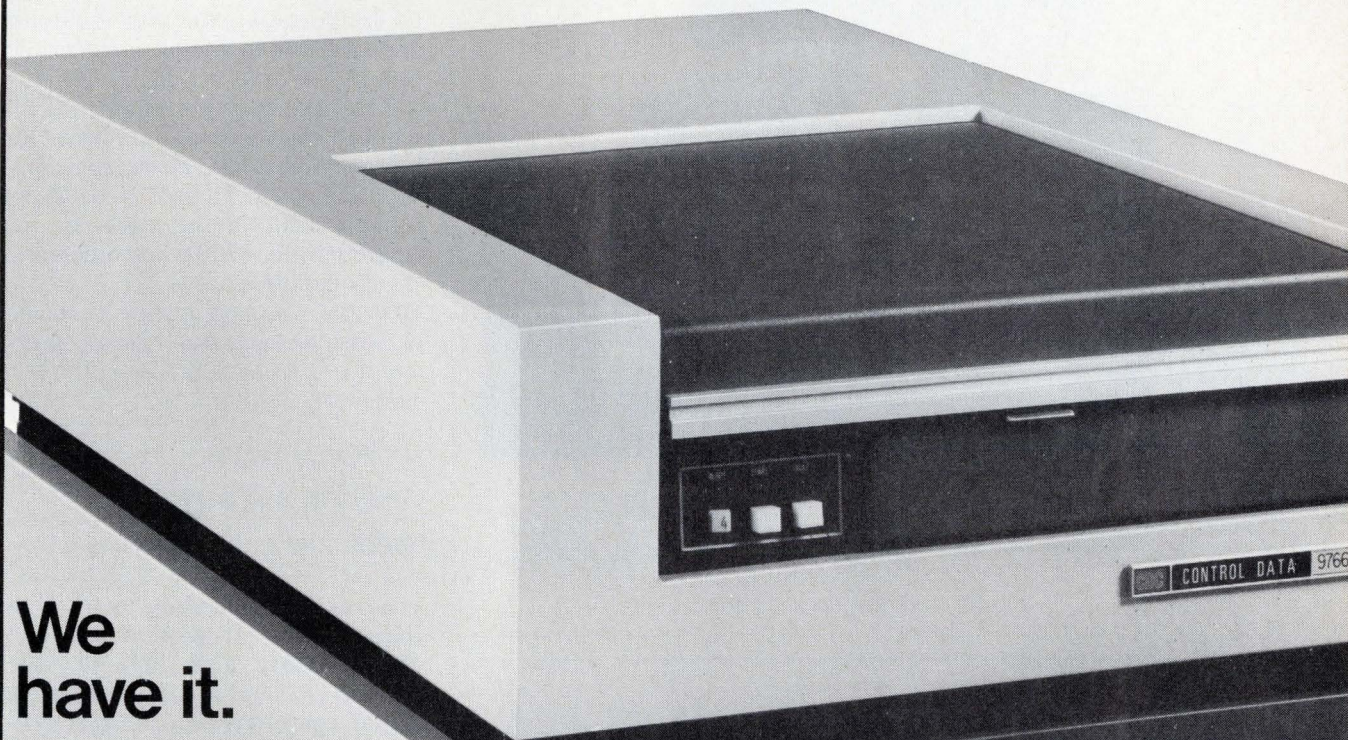

**We
 have it.**

Ask who makes and ships the storage module drives that have become the industry standard and you'll get just one answer. Control Data. We've already delivered close to 3000 SMD's—all with removable media—to more than 100 customers. And all models are in production.

What's more, we offer easy system integration through common interface software and firmware. That means you can select the best drive for any given proposal without spending big dollars to modify your basic system design. And that's a big benefit for you in any price-competitive situation!

Now—with the introduction of the "Mini-module" drive—get an even more complete family of compatible drives.

Capacity	Type	TPI	Model	Media	Interface
12 MB	MMD	300	9730-12	Fixed, Sealed	Industry std. SMD I/O format and interface common to all models.
24 MB	MMD	300	9730-24		
48 MB	MMD	600	9730-48		
40 MB	SMD	200	9760	Removable	
80 MB	SMD	400	9762		
150 MB	SMD	200	9764		
300 MB	SMD	400	9766		

For more information call (612) 830-5741 or return coupon to: Ray Crowder,
 OEM Product Sales Manager, Control Data Corporation, 7801 Computer Avenue South,
 Minneapolis, MN 55435, Dept. E-1296.

Please send information on your Storage Module Drives.

NAME _____ TITLE _____
 COMPANY _____ ADDRESS _____
 CITY _____ STATE _____ ZIP _____ AREA CODE _____ PHONE _____

Ask the CDC OEM people



WE SUPPORT YOUR FLOPPY!!

...With a complete line of Floppy-Disk power supplies for single and dual drive applications.

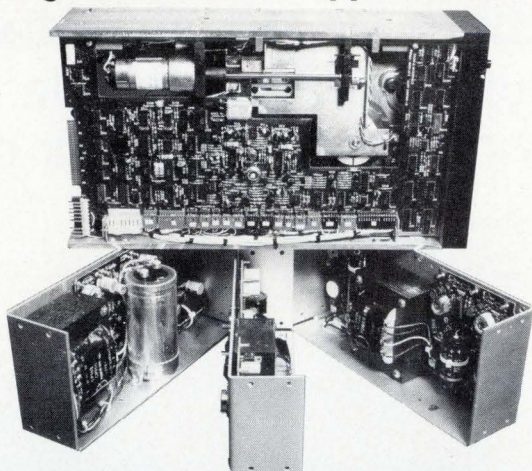

Another New Series of Microcomputer dedicated models from Power-One.

Our Disk-Drive Series offers three new triple-output models designed to power virtually any Floppy system on the market today.

Disk-Drive Model	Output Ratings			Price (Single Qty.)
	+24V	+5V w/OVP	-5V w/OVP	
CP-205	1.7A	1A	0.5A	\$69.95
CP-206	3.4A	2.5A	0.5A	91.95
CP-162	6A	3A	0.6A	120.00

Check our complete line of standard "off-the-shelf" models. All available for immediate delivery. For your custom requirements, just give us a call. Discover for yourself why more major Microcomputer System manufacturers rely on Power-One than any other source.

It's a Fact!
531 Dawson Dr. Camarillo, CA 93010
Phone 805/484-2806 TWX: 910-336-1297

POWER-ONE, INC.

Circle 140 on reader service card

Choose from the great family of HP strip chart recorders.

Hewlett-Packard, the great name in strip chart recorders, lets you choose from a complete family of high quality models. With proven performance in both laboratory and field, the HP recorder family includes general purpose lab recorders, battery operated portables, models with interchangeable plug-in signal conditioners, and recorders specifically designed for OEM users. Select from a wide choice of writing systems; capillary ink, disposable pen, thermal or electric. Operate them anywhere with confidence because HP recorders are backed by a worldwide sales and service organization. Send for complete technical details on the premium quality line from Hewlett-Packard, the great family of strip chart recorders. OEM discounts available.

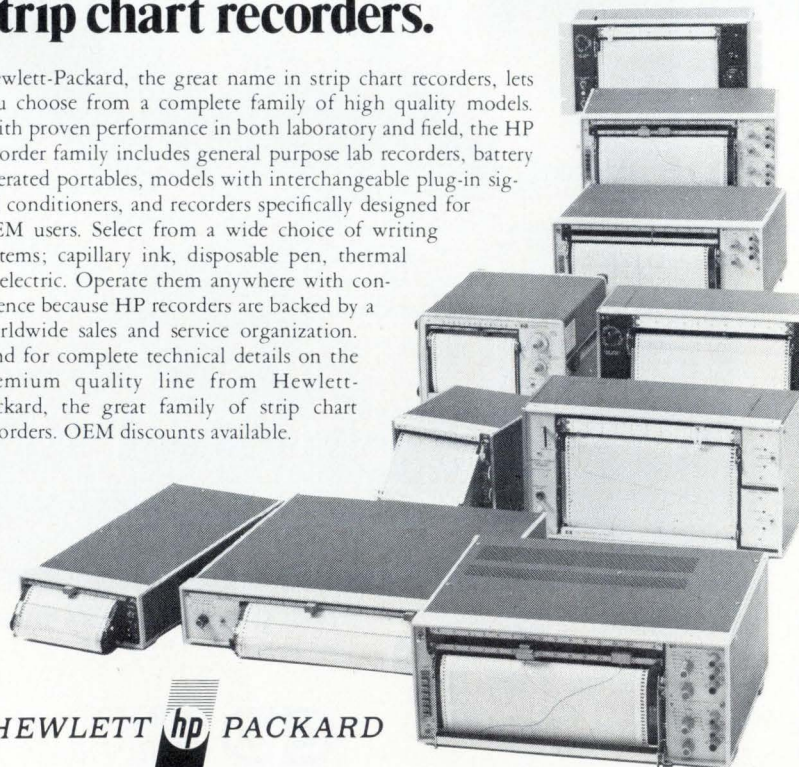

HEWLETT  PACKARD

Sales and service from 172 offices in 65 countries.
1507 Page Mill Road, Palo Alto, California 94304

11702

140 Circle 196 on reader service card

New products

zation, bit detection, error correction coding, and pulse compression. The model 64BCIV contains two independently clocked 64-bit shift registers. Corresponding bits in each register are constantly compared by 64 exclusive-OR gates whose outputs are converted to analog currents and summed to form the device output.

The 64BCIV is TTL-compatible; it requires two standard TTL clocks for bit synchronization. Power consumption is 2 watts. Housed in a 40-pin ceramic dual in-line package, the device sells for \$250 when ordered in small quantities.

TRW Defense and Space Systems, E2/9085, One Space Park, Redondo Beach, Calif. 90278. Phone Bill Groves at (213) 536-1977 [417]

One-chip a-d converter needs few external parts

The rapidly expanding market in chips for digital multimeters and panel meters now includes the MC14433 single-chip analog-to-digital converter. The IC is a 3½-digit dual-slope device that needs only a voltage reference such as the MC1403 plus four passive components to become a complete a-d converter. It consumes just 8 milliwatts from a 5-volt supply and can handle supplies from ±4.5 v to ±8.0 v. The converter is accurate to approximately 10 bits at a speed of 25 conversions per second.

Autozeroing and autoranging are standard features on the MC14433. Autozeroing essentially eliminates zero drift over the temperature range from -50°C to 75°C. Autoranging provides full-scale ac and dc voltage ranges from 200 millivolts to 200 v, current ranges from 2 milliamperes to 2 A, and resistance ranges from 2 kilohms to 2 megohms.

In a plastic package, the MC14433 sells for \$9.97 each in quantities of 100 to 999; in a ceramic package, \$14.95.

Motorola Inc., Integrated Circuit Division, Technical Communications Group, 3501 Ed Bluestein Blvd., Austin, Texas 78721 [413]

Electronics/December 9, 1976

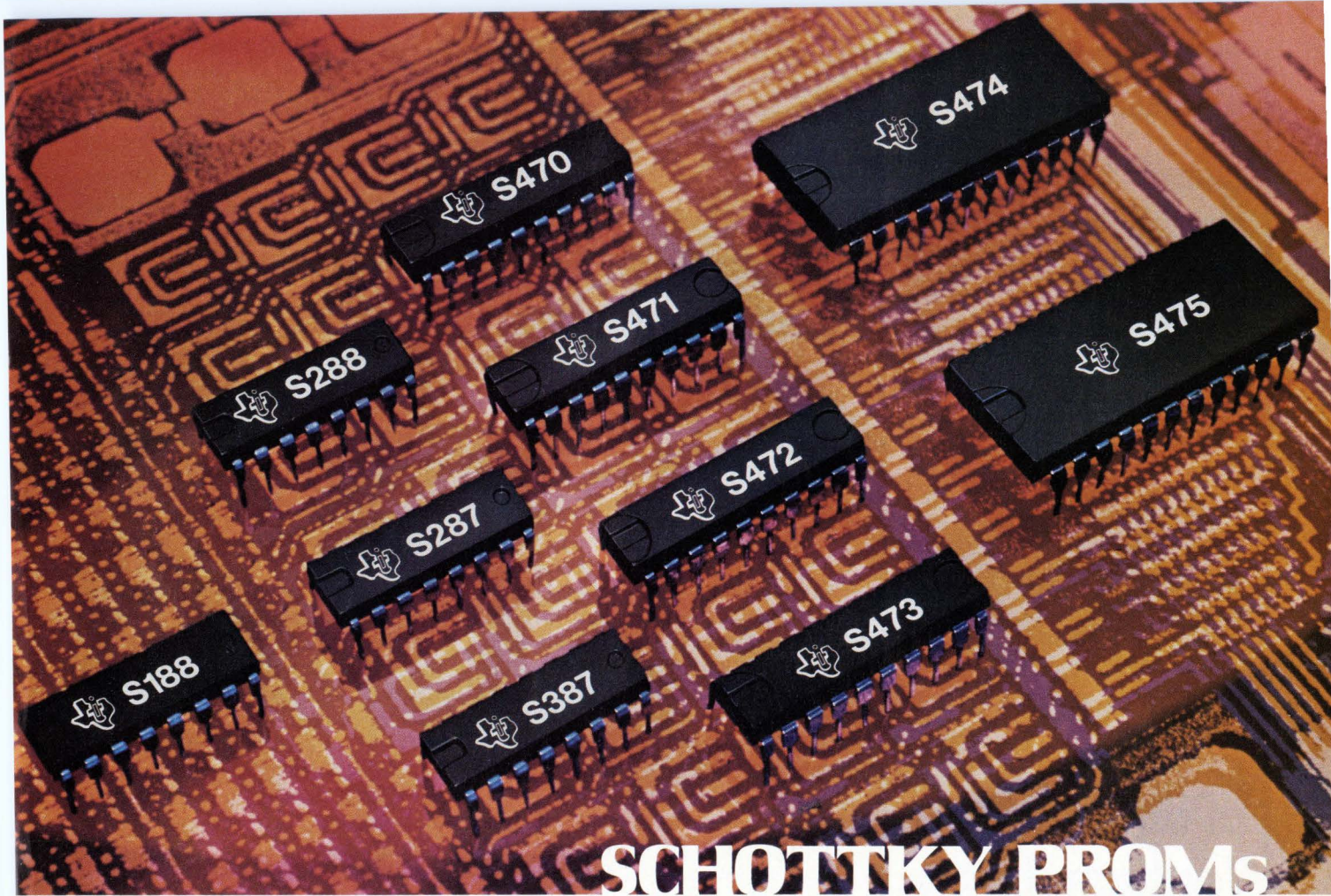

SCHOTTKY PROMs

The PROM family. It means more flexibility. Higher efficiency. And lower costs.

TI's broad 10-member family of matched PROMs means plenty of options. And options mean you can design within the PROM family.

So all your PROMs are manufactured using the same process technology. The same design rules. The same packaging. And, what's especially important when using PROMs: All share common programming techniques. This way you not only get more efficient designs but a cost savings too.

Consider these options: You need a small amount of read-only memory. So, use the smaller family members, the 256 or 1K 16-pin PROMs. No need to pay for more memory than you need.

Suppose you're into new designs and want the highest possible board density offered. OK, take advantage of TI's 2K and 4K, space saving 20-pin PROMs. Some designers have

cut PC board area by as much as 54%. And they have a wide 8-bit output for use in today's, and tomorrow's, microprocessor based designs.

On the other hand, if you have an older design already committed to the large 24-pin package, TI has you covered there,

too. No need to move away from TI's broad family of Schottky PROMs.

All are Schottky clamped for superior speed/power characteristics and are relatively insensitive to variations of temperature and supply voltage. All have low-current, pnp inputs for interface with MOS as well as Bipolar microprocessors.

And finally, all TI PROMs are made with titanium-tungsten fuse links—the result of a unique metallurgical technique in use for over five years. It makes low voltage programming fast and reliable.

Available Now

Order TI PROMs from your authorized TI Distributor. For a copy of TI's Schottky Memory brochure, contact your local TI sales Office, or write Texas Instruments Incorporated, P. O. Box 5012, M/S 308, Dallas, Texas 75222.



TI Schottky PROM Line Summary			
Part Number	Description	Address Access Time	Power Dissipation
SN54S/74S188	32W x 8B, 0-C, 16 pins	25ns	400mW
SN54S/74S288	32W x 8B, 3-S, 16 pins	25ns	400mW
SN54S/74S287	256W x 4B, 3-S, 16 pins	42ns	500mW
SN54S/74S387	256W x 4B, 0-C, 16 pins	42ns	500mW
SN54S/74S470	256W x 8B, 0-C, 20 pins	50ns	550mW
SN54S/74S471	256W x 8B, 3-S, 20 pins	50ns	550mW
SN54S/74S472	512W x 8B, 3-S, 20 pins	55ns	600mW
SN54S/74S473	512W x 8B, 0-C, 20 pins	55ns	600mW
SN54S/74S474	512W x 8B, 3-S, 24 pins	55ns	600mW
SN54S/74S475	512W x 8B, 0-C, 24 pins	55ns	600mW

TEXAS INSTRUMENTS
INCORPORATED

A New Standard of Keyboard Quality

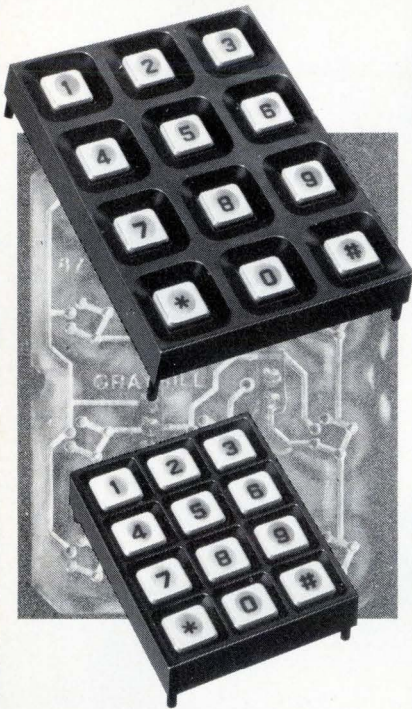

Grayhill 3x4 Keyboard Pads for data input and telecommunications

2 out of 7 coded output—
tested for millions of operations!

- 1/2" or 3/4" button centers
- Excellent tactile and audio feedback
- Patented snap-action dome contact provides rugged, durable performance

These new Grayhill low-profile, 12-button keyboard pads feature a 2 out of 7 coded output, standard mounting dimensions, and are ready for top-side or sub-panel mounting. The contact system is life-rated for 3,000,000 operations per button, and is readily interfaced with logic circuitry. The new Grayhill Series 87 modules offer excellent audio and tactile feedback characteristics with total button travel of only .015". These durable keyboards are molded of tough ABS plastic; feature buttons with black on white molded-in legends as standard, and a variety of other legend options including clear snap-on caps for user legending. Complete specifications and truth table are provided in Bulletin #262, available free on request from Grayhill, Inc. 561 Hillgrove, La Grange, Illinois 60525 (312) 354-1040.

Grayhill
INC.

New products

Data handling

Varian adds 3 minicomputers

OEM machines

take aim at

multiprocessing uses

With introduction of a three-member family of minicomputers, Varian Data Machines says it now has products for all but the one-board segment of the original-equipment minicomputer market. The V77 family covers a price range from a model 200 processor board at \$1,200 to a fully packaged model 600, with 64,000 words of MOS memory selling for \$22,450.

All three machines share the same dual-bus, fully microprogrammed processor architecture, 32-bit arithmetic capability, and 187-instruction set, notes James Orris, marketing vice president. The family is designed especially for multiprocessing applications, with hardware redundancy

for network availability, load-sharing to speed throughput, and modularity for expansion. "As a family, more than one unit can be coupled into communications or data-network configurations, shared-memory systems, or into distributed networks," he says.

All are compatible with Varian's library of operating systems, high-level languages, and applications programs developed for use with its higher-priced minicomputers. Typical applications for the V77s will be in governmental, technical, and financial environments where systems expansion is anticipated.

In the middle of the family, the model 400 has additional features that include power-fail/restart, memory-protect and dual-port capability for stored-memory uses. A memory controller supports up to 256 kilowords of main memory. The dual-port memory permits sharing modules with other V77 processors and linking high-speed peripherals directly to the bus. Data may be transferred in this channel at a rate of more than 1 million words per second.

The top-of-the-line model 600 has

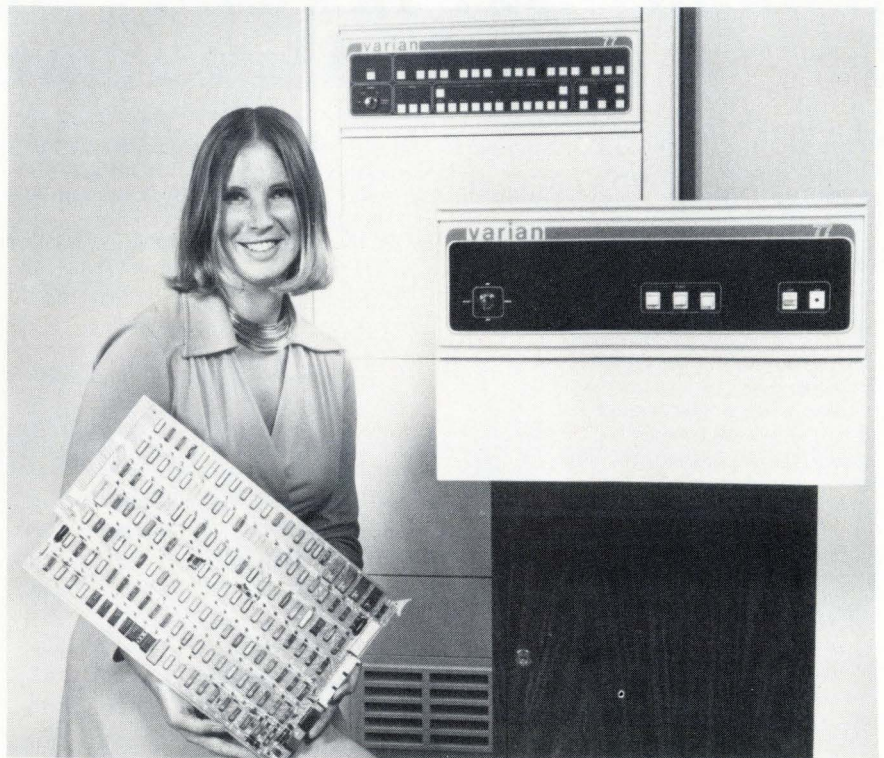

New: tone receiver hybrids from Beckman.

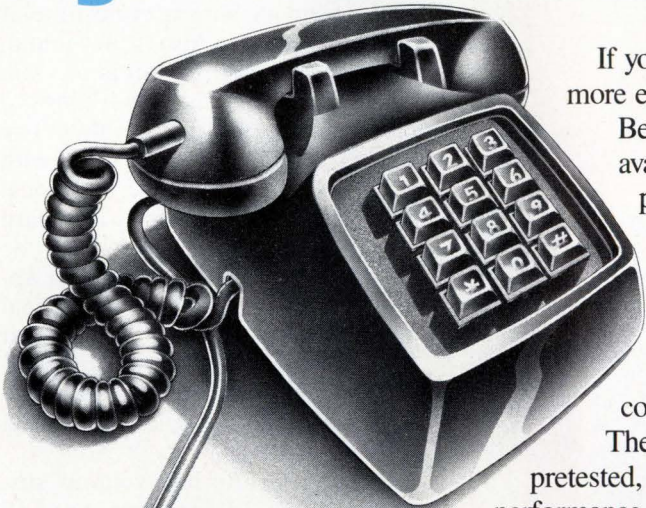

If you're into tone receiver applications, here's a smaller, more economical solution for your designs.

Beckman Series 883 Telephone Tone Receiver Hybrids, available off-the-shelf as individual modules or as preassembled systems.

First, they give you up to 75% space savings over conventional tone-receiver systems. They're so much smaller because we use hybrid technology. And each whole subsystem fits on one standard 4½" x 6" PC board. Picture it: your entire system cut to ¼ of the conventional size.

Then, you save money. That's because Series 883 is pretested, calibrated, and pretuned to meet tough Bell System performance requirements. And you also save on design, engineering, production and inventory costs.

Series 883 hybrids are perfect for telephone central office or PBX tone receiver applications. And, with proper interfacing, they can turn standard push-button phones into computer terminals for banking, accounting, security, and other signal communications systems.

Find out more about these excellent, space-saving hybrids now by calling Beckman Helipot Division, (714) 871-4848, Ext. 1776.

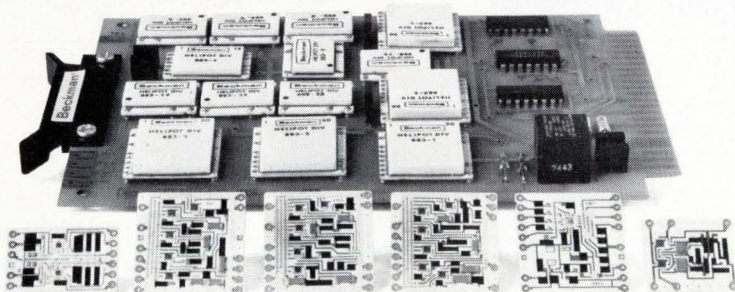
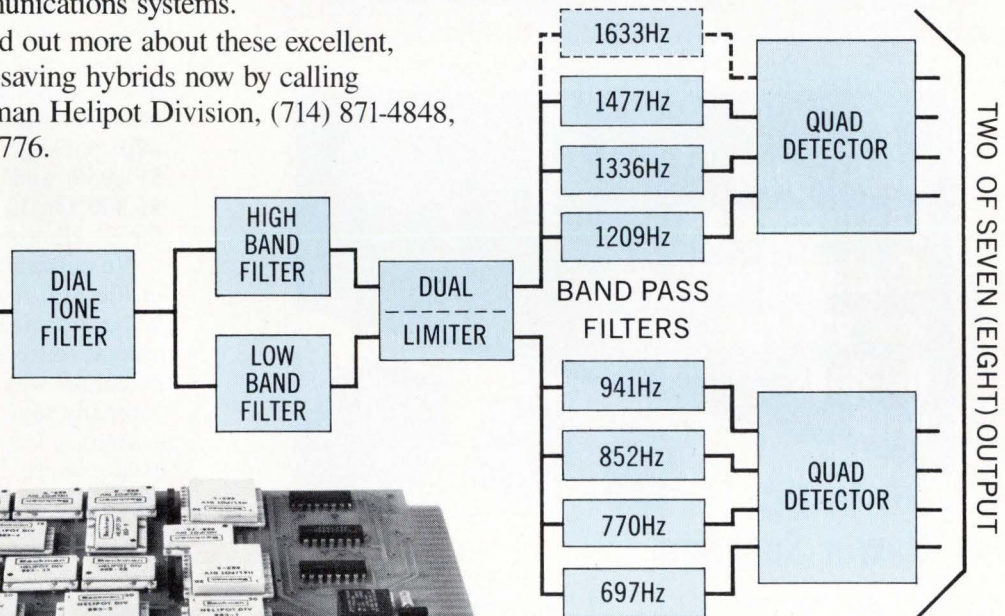

BECKMAN®

HELIPOT DIVISION

If you need hybrids, you should know about Beckman.

when you need it NOW call NATIONAL

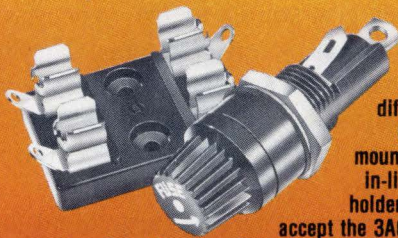

Take fuse holders. We offer twelve different types including molded and fabricated mounting bases, as well as in-line and panel mounted holders. All are designed to accept the 3AG cartridge style fuse.

As with most other N.T.T. products, custom designs are easily formed and delivery is off-the-shelf. So whenever you need terminals or connectors of any kind, call National.

Write today for more information.

State Road Hill
Meadville, PA 16335
814/724-6440

ntt
NATIONAL
TEL • TRONICS

Circle 144 on reader service card

**"Light" your
gas discharge
displays from
low voltage
DC lines
with**



DC-to-DC Power Supplies



When you must convert low DC line voltages to nominal 200 or 250 V DC levels in order to activate gas discharge displays, ask us to recommend the DC-to-DC power supply that's right for your application.

Various models available:

- Standard inputs—5, 9, 12, 15 V DC; others under 5 V DC and up to 48 V DC.
- For seven-segment and matrix-type displays.

- Regulated and unregulated.
- Single and dual output, capable of up to 12 W total.
- Outputs from 5 V to 1500 V DC.

Compact size and light weight help give easy portability to equipment in which they are used!

Need custom designed power supplies for your gas discharge displays? Ask about our custom engineering and production capabilities.

Write for
free
literature:



ENDICOTT COIL

32 Charlotte St., Binghamton, N.Y.
13905 (607) 797-1263

Circle 197 on reader service card

New products

all the features of the smaller machines in addition to a high-speed cache memory with a cycle time of 370 nanoseconds. Also, it accommodates up to 1 million words of main memory in 16-, 32- or 64-kiloword modules. The 600 is available in two chassis sizes, a 7-inch version with processor board and five additional slots and a 14-in. model with board and 14 slots.

The three minicomputers are approximately 25% faster in internal processing time than the next lowest Varian model. The 600, for example, has a cycle time of 165 ns for a microinstruction, while the model 400 offers 220 ns.

Varian is offering volume discounts up to 42% for purchase of 10 to 15 units over the period of a year. Single quantity prices are \$7,600 for a complete model 200, including memory and standard features, while the 400 board set sells for \$2,650. A 400 package of CPU, power supply, operating console and chassis, but without memory, is priced at \$6,500, and memory modules are \$3,600 for 32 kilowords. The 600 package without memory is \$11,050, and memory modules add \$5,300 for 32 kilowords and \$8,900 for 64 kilowords.

No custom MOS LSI chips are used in the new machines. The chips are being procured off the shelf from several sources. Delivery of the new machines will start next month, the company says.

Varian Data Machines, 2722 Michelson Dr., Irvine, Calif. 92713. Phone (714) 833-2400 [361]

Microprocessor controls floppy-disk tester

The addition of an Intel 8080 microprocessor to the FD-33 floppy-disk tester gives it the ability to perform such new tests as amplitude and resolution determination, as well as such standard measurements as drop out, extra pulse, and modulation. The microprocessor also allows users to select exactly what tests they wish to have performed. For example,

How to get through a bandwidth in ten easy steps.

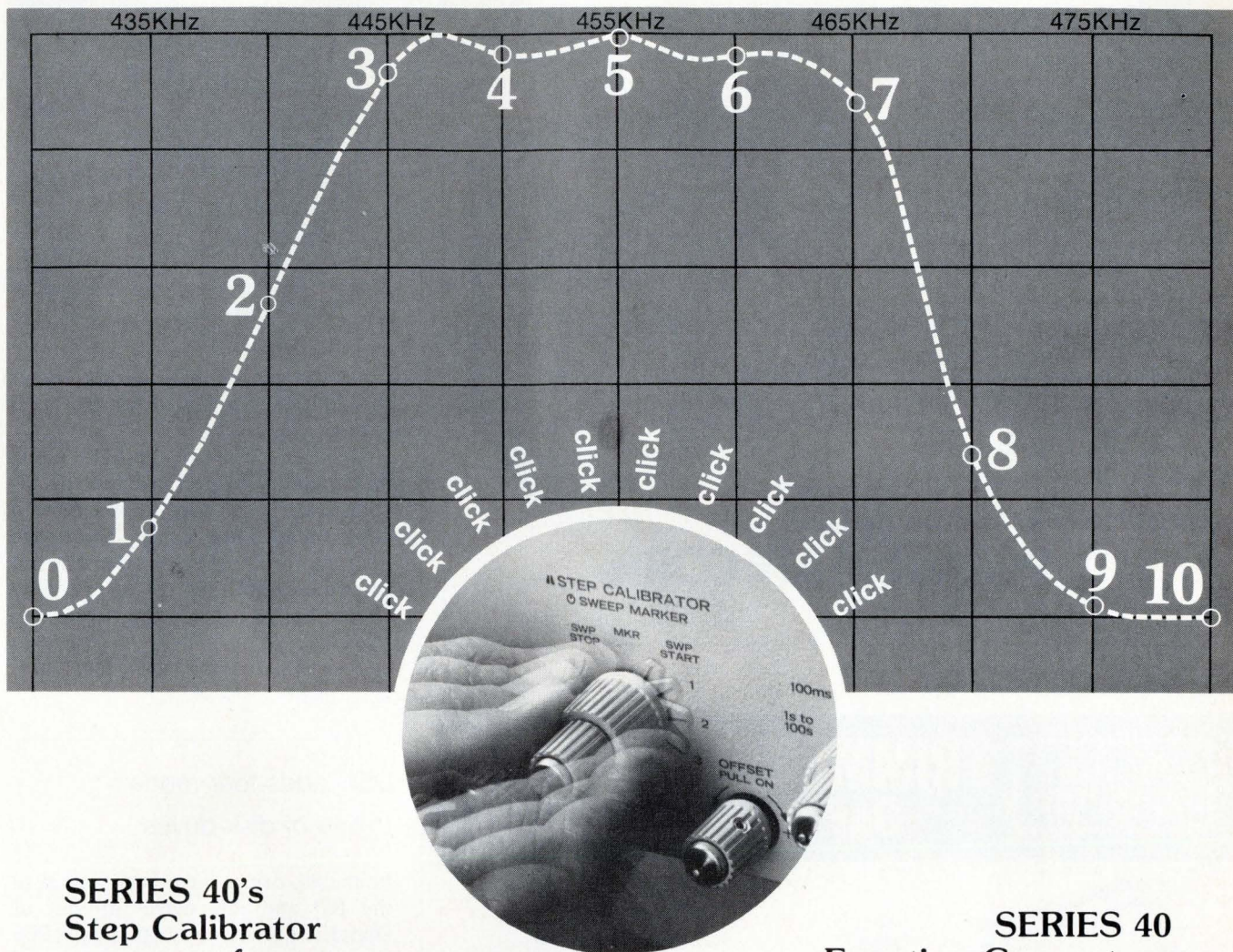

SERIES 40's Step Calibrator measures frequency response with the click of a switch.

Set SERIES 40's main dial *once*, and you'll get eleven precise frequencies in ten equal steps by simply clicking the Step Calibrator switch from zero to ten. With 1000:1 frequency change in the log mode, each step is equivalent to approximately one octave, which is particularly useful in audio testing. And unlike other function generators, SERIES 40 allows you to step up or down without having to cycle through the entire ten steps.

So — when you're testing frequency response, just set up the band edges and click through the ten steps, measuring amplitude at each step... it's that easy.

SERIES 40 Function Generators — New from INTERSTATE

SERIES 40 gives you plenty of amplitude — 40 V peak-to-peak (open circuit) — and takes the guesswork out of pinpointing response with its continuously variable Frequency Marker. SERIES 40 also offers you INTERSTATE's exclusive direct-reading sweep limit control and full spectrum of function generator capabilities in five models from \$475 to \$695. For additional SERIES 40 specifications, call Product Marketing at (714) 549-8282, or write Interstate Electronics, Dept. 7000, Box 3117, Anaheim, CA 92803.

INTERSTATE
ELECTRONICS CORPORATION
Subsidiary of A-T-O Inc.



33% more power to the people.

Power/Mate presents Econo/Mate II.

The open frame power supply.

Now Power/Mate brings you 33% more power in the same package size with the second generation of our Econo/Mate series.

The size is the same, the basic components are the same for easy interchangeability. But that's where the similarity ends.

Econo/Mate II adds features like dual AC primary and a plug-in IC regulator for improved regulation.

And Econo/Mate II is tough. Computer design, quality control, and Power/Mate's experience helps insure 100,000 hr. MTBF even at this higher power output.

But for all its features, Econo/Mate II is still, most of all, economical.

We wouldn't call it Econo/Mate if it wasn't.

Econo/Mate II is in stock, ready for delivery. Send for our free brochure.

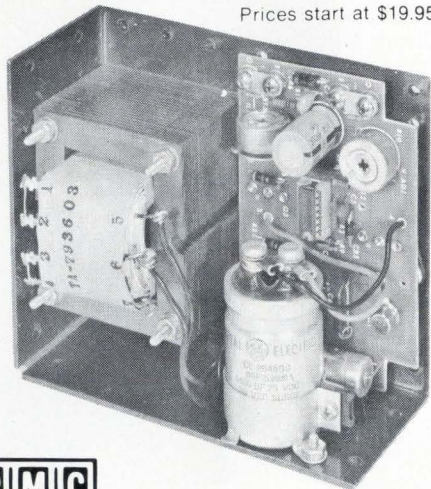

Prices start at \$19.95.



POWER/MATE CORP.

World's largest manufacturer of quality power supplies.

514 South River Street/Hackensack, N.J. 07601 / Phone (201) 343-6294 TWX 710-990-5023

Circle 146 on reader service card

**SPRAGUE
GOODMAN**

TRIMMER CAPACITORS

Our only business!

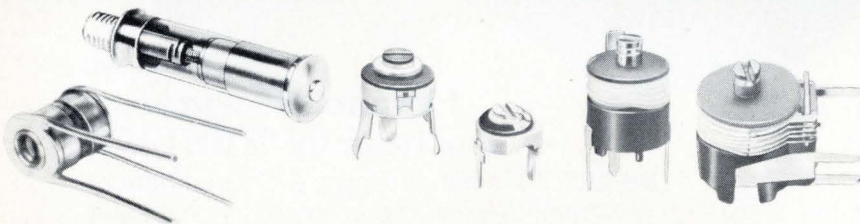

PISTONCAP® Multi-Turn Tubular

- Low-Loss, Glass or Quartz
- High Stability/High Reliability
- Simple, Long-Life Adjust Mechanism
- Professional / Military Applications, MIL Approved

CERAMIC Single-Turn

- Compact, Conserves Board Space
- Variety of Mounting Configurations
- Low Cost for Commercial/Industrial Applications

FILMTRIM* Single-Turn Film

- PTFE, Polypropylene, Polycarbonate
- Most Stable Trimmer for Size
- Very Wide Capacitance Ranges
- Low Cost for Commercial/Industrial Applications

*Trade Mark

Tired of broken delivery promises and poor quality? Deal with the trimmer capacitor specialist, for quality products delivered on schedule! Call on us for custom designs too, we deliver!

TRIMMER CAPACITORS — OUR ONLY BUSINESS!

Sprague-Goodman Electronics, Inc.

(An Affiliate of the Sprague Electric Company)

134 FULTON AVE., GARDEN CITY PARK, N.Y. 11040 · 516-746-1385 · TLX: 14-4533

New products

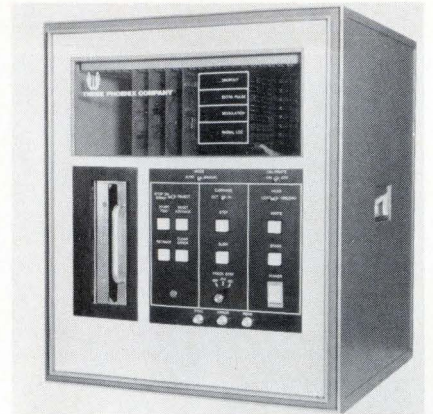

AQL tests can be dropped for higher throughput or included for thorough quality analysis.

Another feature of the FD-33M is its capability to perform user-developed tests if the user knows how to program an 8080. In the future, the manufacturer plans to offer custom software packages to users who choose not to develop their own.

Three Phoenix Co., 10632 N. 21st Ave., Phoenix, Ariz. 85029. Phone (602) 944-2222 [363]

DEC adds four models to line of disk drives

Four disk drives have been added to the RP and RK drive families of Digital Equipment Corp. The RP06 has a formatted storage capacity of 176 million bytes for PDP-11s and 197 million seven-bit ASCII characters for DECsystem-10 and DECsystem-20. The other new member of the RP family is the RP05, which uses the same disk pack as the earlier RP04.

A mid-range disk drive, the RK06, accepts a new dual-disk cartridge with a storage capacity of 14 million bytes. As many as eight of the drives can be handled by a single controller. The RK05F is a double-density version of the RK05. Intended for use with the PDP-8 and PDP-11 families, the RD05F has a capacity of 5 million 8-bit bytes.

The RP05 sells for \$29,900, the RP06 for \$34,900, the RK06 for \$9,500, and the RK05F for \$6,500. All units except the RK06 are ready

AO

If this is all you're seeing,

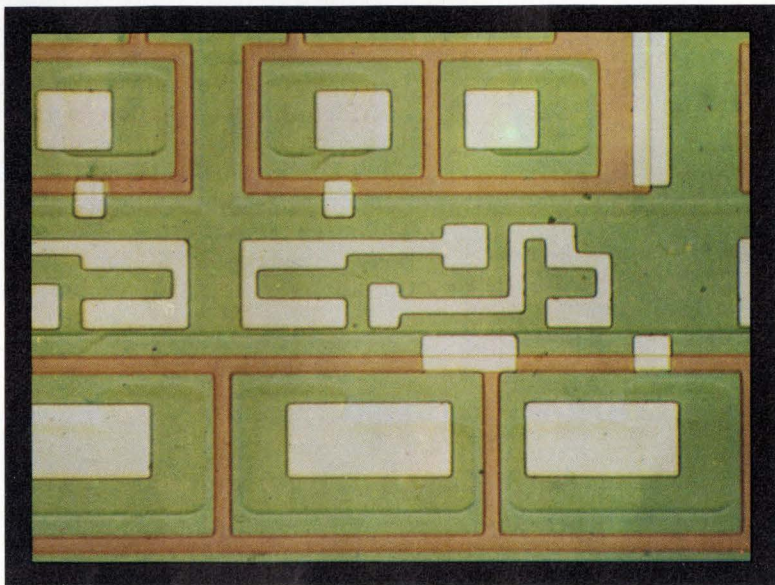

The AO® DICV Differential Interference Contrast Microscope makes the big difference.

With a standard brightfield microscope you see only what is shown in the top sample.

Now look at the bottom sample. The AO DICV Microscope can help you see surface irregularities, inclusions and faults long before final testing. Long before you have invested more production time and money in a circuit or component that is defective.

By using incident light, after Nomarski, the AO DICV Microscope reveals significant detail in outstanding relief through vivid contrast enhancement.

this is what you're missing

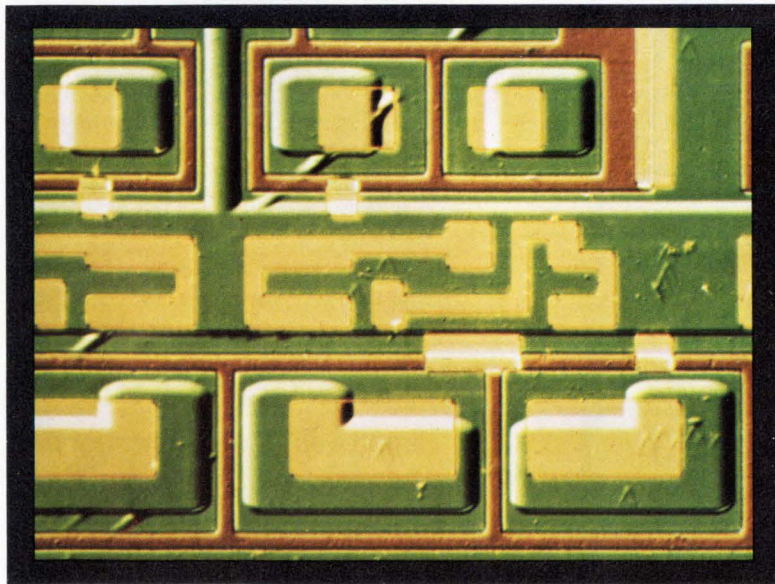

So, if missing detail is costing you money, you can't afford to overlook the AO DICV Microscope. For details or a demonstration see your AO Dealer or write American Optical, Scientific Instrument Division, Buffalo, NY 14215.

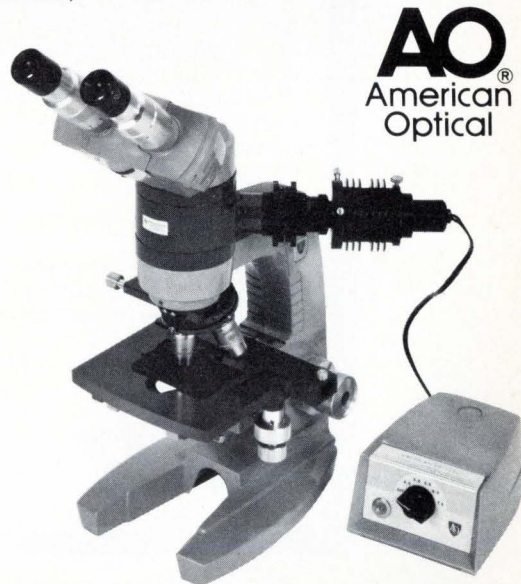

AO
American
Optical

Circle 147 on reader service card

THE SUNSHINE STATE OFFERS HIGHER PROFIT POTENTIALS TO ELECTRONIC PRODUCTS MANUFACTURERS THAN ELSEWHERE IN THE COUNTRY!

Florida's substantial labor and operating cost advantages, plus ready access to the markets of the United States, Latin America and the world, combine to offer a unique profit opportunity for a Florida-based manufacturer.

Before you make any decisions regarding your business, this new industry study documenting Florida's position should be reviewed carefully.

To get your copy of *Florida Profit Potentials in Electronic Products Manufacturing*, write or call:



FLORIDA
WE'RE MORE THAN SUNSHINE

Joe Hennessy, Director
Division of Economic Development
Florida Department of Commerce
107 W. Gaines Street, Room 103E
Tallahassee, Florida 32304
(904) 488-5507

Circle 148 on reader service card

NI 2001 WAVEFORM AND DATA RESEARCH SYSTEMS



Imagine an analog to digital signal acquisition system, with a waveform and alphanumeric CRT display combined with keyboard computing power, that doesn't require you to know any program language or to hire a programmer to set up your tests and experiments.

Take it out to a field site, to the production line, on a ship, airplane or down a submarine hatch. With a NI 2001 you are ready for any change in your experiment without having to return for a program rewrite. With 25 keystroke OPERATORS, 11 PROGRAMMING keys, more than 30 REGISTER-ARRAYS, 2 CURSORS and 14 NUMERIC keys, changes in your test or experiment can be handled by you on the spot.

NI 2001 prices start at \$15,400. You can start using it as soon as it arrives.



NORLAND INSTRUMENTS
A Subsidiary of Cordis Corporation

Fort Atkinson, Wisconsin 53538 (414) 563-8456

148 Circle 199 on reader service card

New products

now. The company expects the RK06 to be available for delivery early next year.

Digital Equipment Corp., Maynard, Mass. 01754. Phone (617) 897-5111 [365]

Cartridge disk drives offer high storage density

The Super T (top load) and Super F (front load) series of cartridge disk drives can store 5, 10, or 20 megabytes of data in the space usually required for 2.5-megabyte drives. The Super T uses an IBM-5540-type cartridge in combination with a fixed disk. It offers data densities to 4,400 bits per inch with up to 200 tracks per inch for a total capacity of 200 megabytes per drive. A rotational speed of 2,400 rpm allows transfer rates to 5,000 kilobits per



second. The Super F, using IBM-2315-type cartridges, provides up to 2,200 bits per inch, a capacity of 10 megabytes, and a transfer rate of 2,500 kilobits per second.

In OEM quantities, prices for the drives are \$3,100 for the 5-megabyte units, \$3,575 for the 10-megabyte versions, and \$4,470 for the 20-megabyte machine. Delivery time is 60 days.

Wangco Inc., 5404 Jandy Pl., Los Angeles, Calif. 90066. Phone (213) 390-8081 [366]

Intelligent disk controller improves PDP-11 throughput

A low-cost disk controller interfaces up to eight drives with a total capacity of 20 megabytes to any PDP-11 computer. The controller

Electronics / December 9, 1976

57* La 138.90	59 Pr 140.90	64 Gd 157.25	70 Yb 173.04
58 Ce 140.12	60 Nd 144.24	65 Tb 158.92	68 Er 167.26
	62 Sm 150.4	66 Dy 162.50	69 Tm 168.93
39 Y 88.90	63 Eu 151.96	67 Ho 164.93	90 Th 232.03

rare earths Rhône-Poulenc

all grades ranging
from 95% to 99,9999% purity

rhodia inc. Chemicals Division, P.O. Box 125 - Monmouth Junction - NEW JERSEY 08852 (USA) - Telex 844.527 - Tel. 846.77.00

rhône-poulenc (CF/PSP), 21 rue J.-Goujon - F. 75360 PARIS - Cedex 08 - Tel. (1) 256.40.00



Name

Address

Tél.

Please send me information on rare earths.

CF.G1.6/12 - Electronics



CSC'S NEW DESIGN-MATE 4. AN 8-FUNCTION DIGITAL PULSE GENERATOR FOR LESS THAN MOST DVM'S.

Wherever you need crisp, clean, fast output pulses compatible with virtually all logic families and discrete circuits, Design-Mate™ 4 is the logical choice. It produces symmetrical and unsymmetrical pulses ranging from 0.5Hz to 5MHz. And has a 100mV–10V variable output, with rise/fall times of less than 30 nanoseconds plus TTL sink output for up to 40 loads. Pulse width and spacing are independently-controllable from 100 nanoseconds to 1 second (10⁷:1 duty cycle) in seven overlapping ranges. And with the DM-4 you can select continuous operation, manual one-shot or external triggering to 10MHz with synchronous output gating. And a lot more. Which adds up to a high quality clock source, delayed pulse generator, synchronous clock source, manual system stepper, pulse stretcher, etcetera, etcetera, etcetera . . . minus the 'high quality' price tag.



For more information, see your CSC dealer. Or write for our catalog and distributor list.
CONTINENTAL SPECIALTIES CORPORATION



EASY DOES IT

44 Kendall Street, Box 1942
New Haven, CT 06509 • 203-624-3103 TWX: 710-465-1227
West Coast office: Box 7809, San Francisco, CA
94119 • 415-421-8872 TWX: 910-372-7992

Circle 150 on reader service card

New products

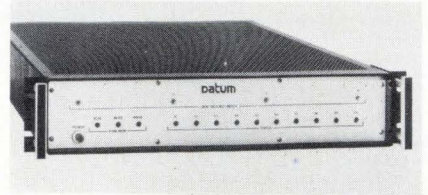

uses an 8-bit bipolar microprocessor to provide fast input/output operations while eliminating bus-hogging. Software-equivalent to the Digital Equipment Corp. RK11D, the Datum controller sells for \$2,900.

The microprocessor uses PROM resident firmware routines to perform status control, interface formatting, and error checking—functions usually handled by hardware. Through firmware control, the processor also handles seek, read, and write functions, read and write checks, control and drive reset, write lock, and hardware pool. Bus hogging is prevented through the use of first-in/first-out buffer data registers for temporary storage. Delivery is from stock.

Datum Inc., Peripheral Products Division,
1363 S. State College Blvd., Anaheim, Calif.
92806. Phone (714) 533-6333 [367]

© Continental Specialties Corp. 1976

Hot Semis? Get relief fast!



IERC



Heat Sinks

INTERNATIONAL ELECTRONIC RESEARCH CORPORATION/A SUBSIDIARY OF DYNAMICS CORPORATION OF AMERICA/135 WEST MAGNOLIA AVENUE, BURBANK, CA 91502

Add-in memories developed
for PDP-11 computers

The ADD-IN 11 is a semiconductor add-in memory system for the Digital Equipment Corp. PDP-11 series of computers. Based on dynamic MOS random-access memories, it is completely plug-compatible with the following PDP-11 computers: 04, 05, 10, 34, 35, 40, 45, 50, and 55. It expands in 16-kiloword increments up to a total of 128 kilowords, and a word may contain either 16 or 18 bits per word. Both versions are contained on single printed-circuit boards that plug directly into the host computer. They are directed primarily to OEM customers. In quantities of 100 boards, the 18-bit version currently sells for \$1,250 including an on-board regulator. Delivery time is 10 days.

Fabri-Tek Inc., 5901 County Rd. 18, Minneapolis, Minn. 55436 [364]

Don't blow it.

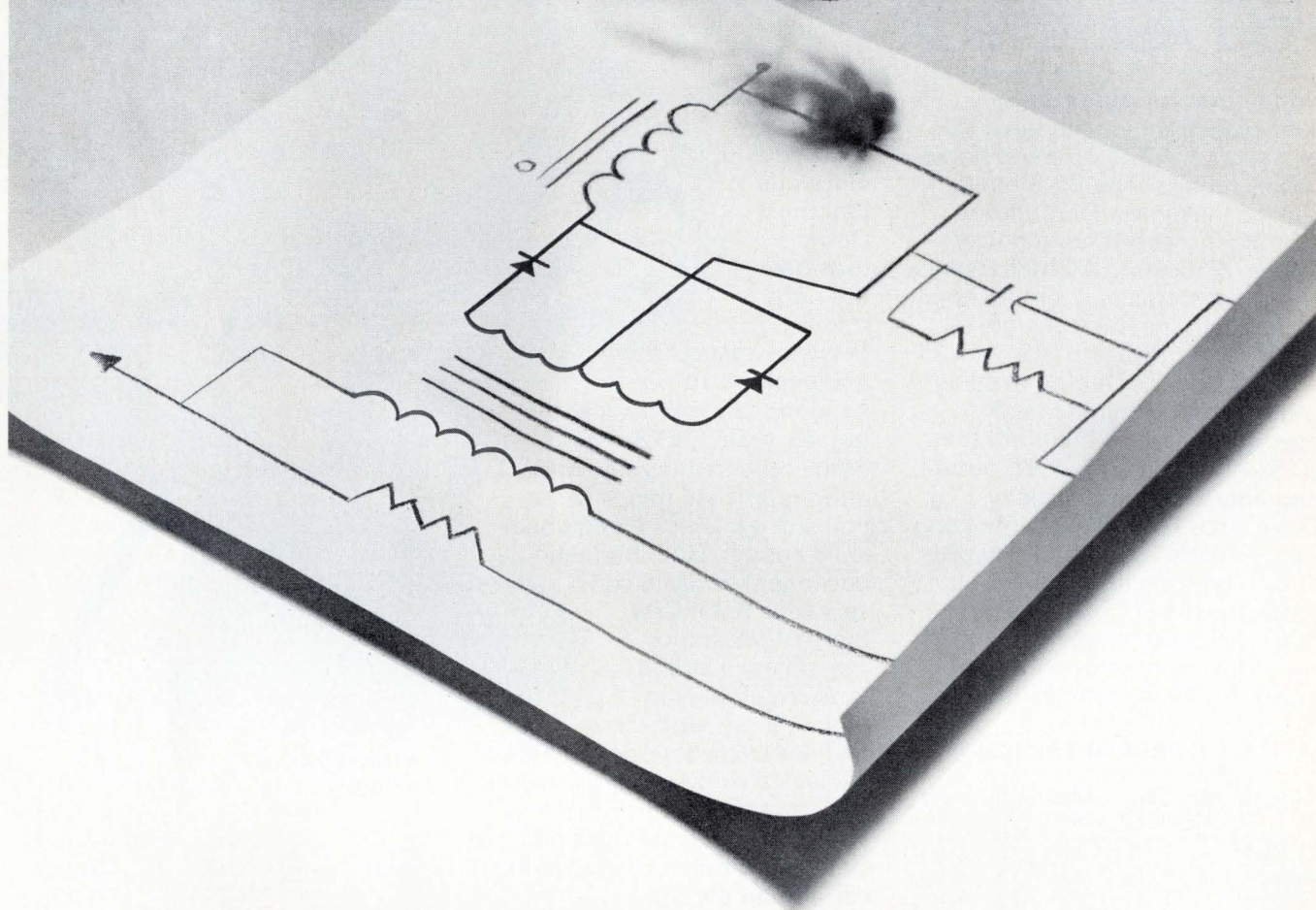

TRW's new Transient Voltage Suppressors are low-cost insurance in 8.2 to 200V circuits

Our new solid state Transient Voltage Suppressors rapidly lower their shunt impedance to limit voltage until the fuse or circuit breaker shuts down the system. An extension of TRW Zener technology, they are capable of almost instantaneously changing impedance from a very high standby value to a very low conducting value when they are subjected to high energy surges. In operation, they effectively shunt damaging effects by clamping voltage at predetermined levels, and have proved effective against secondary lightning effects, load switching and human errors.

TRW's Transient Voltage Suppressors (TVP's) are 100% surge-tested before shipment, have a very fast response time, lower leakage currents, tighter tolerances and can be customized to your design by computer analysis. They are currently available in .5 Joule, 1.0 Joule and 1.5 Joules power-energy packages.

The potential for these relatively inexpensive TVP's is enormous. Fill in the coupon below for detailed specifications and samples as required.

TRW Capacitors Solid State Operation

An Electronic Components Division of TRW, Inc.
301 W. "O" Street
Ogallala, Nebraska 69153 • (308) 284-3611

Please send me specifications on your new Transient Voltage Suppressors.

I would also like samples. My application is _____
_____ for _____ voltage _____ Joules.

NAME _____

FIRM NAME _____

ADDRESS _____

CITY _____

STATE _____

ZIP _____

TRW CAPACITORS

SOLID STATE OPERATION

ANOTHER PRODUCT OF A COMPANY CALLED TRW



DELCO'S NEW 25-AMPERE HIGH VOLTAGE DARLINGTONS WITH THE SPEED AND ENERGY CAPABILITY YOU ASKED FOR.

Good news for motor speed control designers who have expressed a need to upgrade horsepower ratings. The 25-ampere gain of these new Darlings permits increased horsepower ratings of existing AC motor speed control systems and a reduction in paralleling in new designs. However, grouping of t_{off} is available for current sharing in designs with parallel Darlings. A speed-up diode is built into the DTS-4074 and DTS-4075 permitting data sheet t_f typicals of $1.0 \mu s$. Drive circuit techniques involving $1_{B2} \geq 2A$ and a Baker clamp produce t_f typicals in the $0.4-0.6 \mu s$ range for the DTS-4066, DTS-4067, DTS-4074, and DTS-4075.

Our experience with tolerances, faults, transients, and start-

stall conditions in most systems convinces us that these Darlings have the right trade-off between speed and peak power handling capability. Note the greater than 10kVA region of the reverse bias safe operating graph. All this, and you still get Delco's traditional solid copper TO-3 hermetic package that has a conservative $0.75^\circ C/W$ thermal resistance.

These Darlings are already in high volume production and are available on distributor shelves. For prices, applications literature and data sheets, visit your nearest Delco sales office or Delco distributor, or mail in the coupon on the right.



MAJOR PARAMETER LIMITS

Type	h_{FE} @ 25A	h_{FE} @ 10A	V_{CEO} (sus)	V_{CE} (sat) @ 20A	I_{CEO} @ 600V
DTS-4066	5	75	350V	3.5V	0.25mA
DTS-4067	10	150	350V	2.0V	0.25mA
DTS-4074	5	75	350V	3.5V	0.25mA
DTS-4075	10	150	350V	2.0V	0.25mA

TYPICAL SWITCHING

	DTS-4066 DTS-4067	DTS-4074 DTS-4075
t_r	$0.5 \mu s$	$0.5 \mu s$
t_s	$5.0 \mu s$	$3.2 \mu s$
t_f	$4.5 \mu s$	$1.0 \mu s$

NPN triple diffused silicon Darlings are packaged in solid copper cases conforming to JEDEC TO-3 outline dimensions.

SAFE OPERATING CURVES

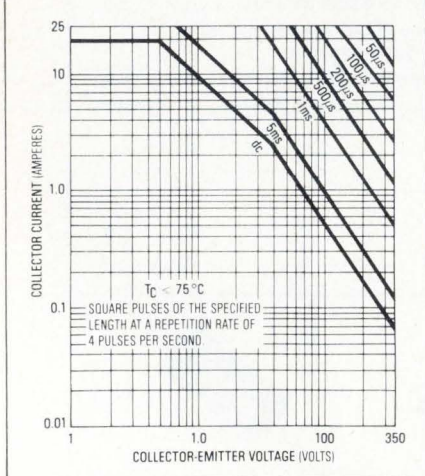

CLAMPED INDUCTIVE SWITCHING PERFORMANCE

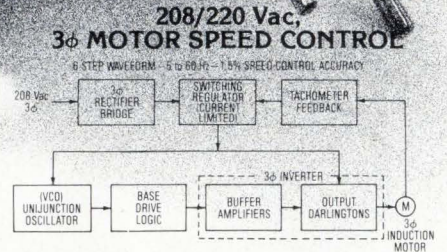
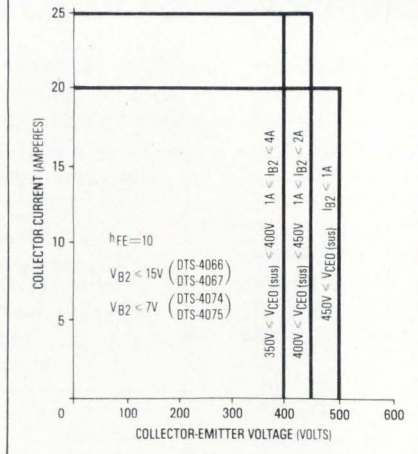

FOR MORE INFORMATION ABOUT DELCO'S NEW 25-AMPERE HIGH VOLTAGE DARLINGTONS, MAIL THIS COUPON TO:

Delco Electronics Division
General Motors Corporation
Marketing Services MS A-213
700 E. Firmin Street
Kokomo, Indiana 46901

NAME _____ TITLE _____

COMPANY _____

ADDRESS _____

CITY _____ STATE _____ ZIP _____

PHONE _____

Delco Electronics



DELCO ELECTRONICS SALES OFFICES
Kokomo, Indiana (317) 459-2175
Charlotte, North Carolina (704) 527-4444
Van Nuys, California (213) 988-7550

New products

Packaging & production

Two-part fixture cuts test costs

Bed-of-nails uses single fixture base plus interchangeable test heads

One of the key elements in the automatic testing of printed-circuit boards or wrapped panels is a complex interface of spring-loaded pins that are brought into contact by mechanical or vacuum-actuation with either pc-board lands or wire-wrapped pins. This type of test fixture has become known as a bed of nails. Normally a new fixture, at a cost as high as \$1,700, is required with each variation in circuit-board design.

By using a single fixture base, along with interchangeable vacuum-actuated test heads, Everett/Charles

Inc. has developed a standard test-fixturing system that significantly reduces fixturing costs. Now a company testing a board can simply buy a Series 30 base fixture for a typical one-time cost of \$575 plus an interchangeable test head for a cost of \$250. This new approach drastically cuts fixturing costs.

With the two-piece unit, a user sends his board artwork or specifications to Everett/Charles. After receiving the new test head, the user plugs it into the fixturing base (see photo). The base has four groups of 200 replaceable spring probes that electrically interface with molded connector blocks in the bottom of the interchangeable test head. The two mating pieces are aligned by locating pins and locked down by pawls at the four corners of the base.

On the interchangeable head, the interface blocks are wired to spring-probe receptacles that are located for a particular board or panel configuration under test. Rather than soldering, two-level wire-wrapping is used. Since the probe pins

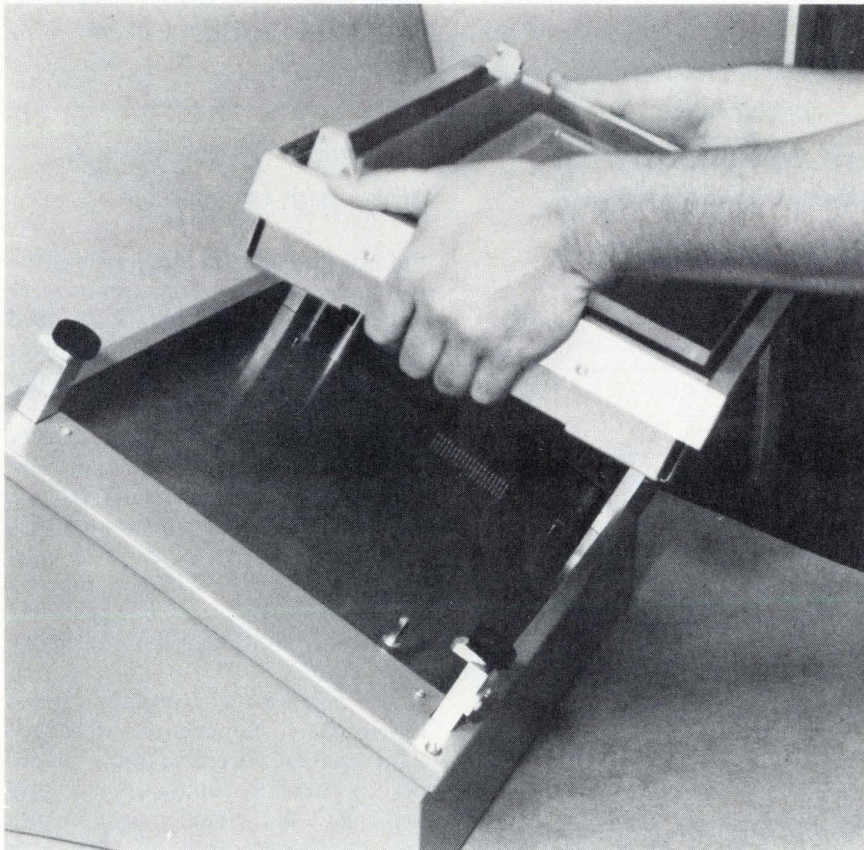

Without our software, we're just another flasher.



Let's face it. No microcomputer is worth a dime if you can't make it work. Even E&L's Mini-Micro-designer would be just a "light flasher" if it weren't for our software system.

But the fact is that our tutorial software is the best in the business. Not just a pathetic rehash of chip manufacturers' specifications. But a clearly written, step-by-step instruction that teaches you all about the microcomputer. How to program it. How to interface it. How to expand it.

The teaching material is written by Rony/Larsen/Titus (authors of the famous Bugbooks). It's called Bugbook V. And it teaches through experiments designed specifically to get you up to speed on our Mini-Microcomputer (MMD-1). *And you don't need any prior knowledge of digital electronics!*

The best news? E&L's MMD-1 costs only \$380 in kit form, including all software and teaching material.



E&L INSTRUMENTS, INC.

61 First Street, Derby, Conn. 06418
(203) 735-8774 Telex No. 96 3536

Order directly from one of our stocking representatives.

Los Angeles, CA (213) 377-0975
San Francisco, CA (415) 961-2828
Woodbridge, CT (203) 397-1461
Denver, CO (303) 744-2501
Orlando, FL (305) 351-1841
Chicago, IL (312) 956-8090
Kansas City, KS (913) 649-8952
New York, NY (201) 467-8585
Syracuse, NY (315) 699-2651
Dayton, OH (513) 222-0011
Philadelphia, PA (215) 723-8733
Dallas, TX (214) 690-4004
Fairfax, VA (703) 273-1803
Seattle, WA (206) 938-4166

5½ DIGIT ACCURACY. 4½ DIGIT PRICE.

The 4600 is our brand new 4½ digit multimeter. It gives you the accuracy and resolution of typical 5½ digit multimeters. At half the cost.

And the 4600 stays accurate longer than other DVM's. DC accuracy stays within 0.01% ± one digit for six months at a time. We guarantee it.

80dB normal mode noise rejection produces a 10,000:1 reduction of excess noise. A full decade better than the 1,000:1 reduction of comparable instruments.

Loading errors are virtually eliminated by the 4600's 10,000MΩ input impedance on the two lowest DC voltage ranges.

There's a lot more. Send for a free catalog on our new 4½ digit 4600 multimeter. And find out how to get 5½ digit accuracy without paying for it.

Dana Laboratories, Inc.,
2401 Campus Drive, Irvine,
California 92715. 714/833-1234.



DANA

Others measure by us.

"Now available through Electro Rents"

For Product Demonstration circle 154

For Literature Only circle 201

HELP WANTED

While it is not our policy to encourage job hopping—quite the opposite, in fact—the headline above must have got your attention for a reason.

Perhaps you should turn to the back of this issue to our Classified Section. One of the job descriptions might fit you.

New products

may get dirty or bent after many actuations, all spring probes are replaceable.

The interface base is available from stock in a range of sizes from units that can accommodate 5-by-7-inch boards to units that can take 21-by-23-in. boards. The base can be tailored to mate with any test set or analyzer by use of patch panels or standard connectors, the company points out.

The test heads are available from stock in a range to accommodate sizes up to 21 by 23 in. Test-point densities of 14 points per square inch for loaded boards and 75 points per square inch for bare boards are readily achieved. A complete line of accessories is available, including valves, pumping systems, and test-head storage cabinets.

The fixture is being used for continuity and in-circuit testing of bare and loaded pc boards and backplanes. In one application, the device accesses the wired pins on the wrapped side of integrated-circuit socket panels.

Everett/Charles, Inc., 2806 Metropolitan Pl., Pomona, Calif. 91767. Phone 714-593-2541 [391]

Chemically etched needles probe high-density ICs

Before large-scale integration, the pad areas on integrated circuits were large enough to be reliably probed by machined needles with a diameter in the range of 20 to 40 mils and a sharply pointed tip with a radius of approximately 2 mils. High-density LSI circuits, on the other hand, need probes that taper gradually from a very fine tip (1 mil maximum) to a maximum diameter of 10 to 20 mils. To fabricate these fine, tapered probes, the J.M. Ney Co. has turned to chemical milling of its proprietary alloy Paliney 7.

The result is two probes that make low-resistance connections with very light contact forces, exhibit longer tip life than beryllium-copper, and don't have the tendency to plow into the contacted area as tungsten

YOU WERE HIRED FOR YOUR BRAINS, NOT YOUR BODY.

It's not as silly as it sounds. Because many bright engineers and technicians are still spending their time soldering, desoldering and resoldering. Instead of designing.

Which *is* pretty silly, considering the waste of talent. Especially when there's a better alternative.

With CSC Proto-Board* solderless breadboards, assembling a circuit is practically as fast as designing one. No special jumpers or patch cords required—all types of components—from complex microprocessors to resistors, capacitors and LED's—connect and interconnect as simply as pushing in a lead... or short lengths of #22-30 solid hookup wire. And circuit changes are done with the same

*Manufacturer's suggested list
Prices and specifications subject
to change without notice

MODEL	NO. OF TIE-POINTS	14-PIN DIP CAPACITY	MFR'S SUGGEST LIST *	OTHER FEATURES
PB-6	630	6	\$15.95	Kit—10-minute assembly
PB-100	760	10	19.95	Kit—with larger capacity
PB-101	940	10	29.95	8 distribution buses, higher capacity
PB-102	1240	12	39.95	Large capacity, moderate price
PB-103	2250	24	59.95	Even larger capacity, only 2.7¢ per tie-point
PB-104	3060	32	79.95	Largest capacity, lowest price per tie-point
PB-203	2250	24	75.00	Built-in 1% regulated 5V, 1A low-ripple power supply
PB-203A	2250	24	120.00	As above plus separate 1/2-amp +15V and -15V internally adjustable regulated outputs

plug-out, plug-in ease. All thanks to rugged, nickel-silver contacts and CSC's superior use-tested design.

Proto-Board breadboards are available in a variety of sizes, from 630 to 3060 solderless tie-points (six to thirty-two 14-pin DIP capacity), at prices from \$15.95* (kit) to \$79.95. And if you'd like built-in regulated supplies, they're available too, in models priced at \$75 and \$120.

Before you start your next project, put down your soldering iron and call 203-624-3103 (East Coast) or 415-421-8872 (West Coast) for full specifications and ordering information. Once you do, you'll find yourself soldering less... and more than likely, earning more.

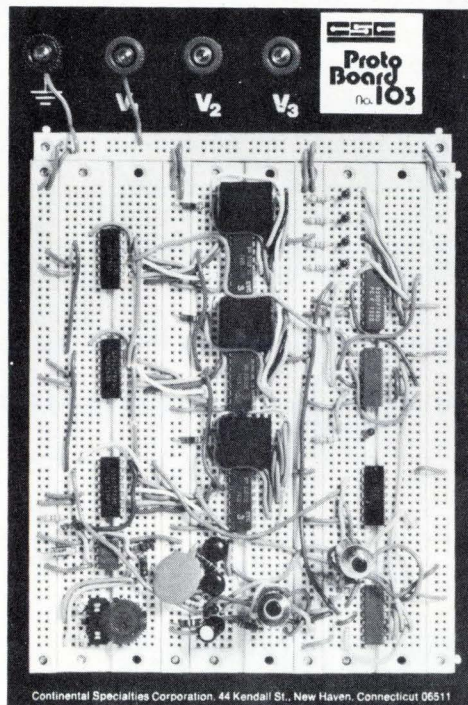

Continental Specialties Corporation, 44 Kendall St., New Haven, Connecticut 06511

CONTINENTAL SPECIALTIES CORPORATION



44 Kendall Street
Box 1942 New Haven CT 06509
203-624-3103 TWX 710-465-1227
West Coast office Box 7809, San Francisco CA
94119 • 415-421-8872 TWX 910-372-7992

© 1976, Continental Specialties Corporation

Circle 155 on reader service card

New S-D Communication Counters

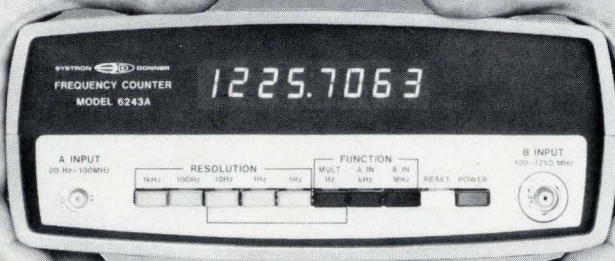

Automatically measure up to 4,500 MHz!

Four new S-D Communications Counters offer the latest technical advances in high speed, precision frequency measurement. They are small and light, but they pack enormous capability.

- **Ranges:** 100 MHz, 512 MHz, 1250 MHz, and 4500 MHz.
- **Sensitivity:** 10mV RMS (Models 6241A, 6242A, 6243A). Model 6244A: 10mV RMS to 500 MHz, -13 dBm above 500 MHz.
- **Overload protection:** Withstands high input signal levels without damage.
- **Display:** 8 LED digits, 0.1 Hz resolution.
- **Tone measurement (opt.):** Example: measure 1020.01 Hz automatically in 1 sec.
- **Meet the whole family:**
 - 100 MHz Model 6241A—\$ 595
 - 512 MHz Model 6242A—\$ 795
 - 1250 MHz Model 6243A—\$ 995
 - 4500 MHz Model 6244A—\$2150

For sales assistance, contact Scientific Devices or Systron-Donner at 10 Systron Drive, Concord, California 94518. Phone (415) 676-5000.

SYSTRON  **DONNER**

Circle 156 on reader service card

CAREER OPPORTUNITIES

Usually the best opportunity to grow in your field lies within your present company. You have made an investment in them. They have an investment in you.

But occasionally the best opportunity lies somewhere else. No one can decide but you.

Companies looking for good people run their recruitment ads in our Classified Section in the back of this magazine. Perhaps you'll find an opportunity there that's worth following up.

New products

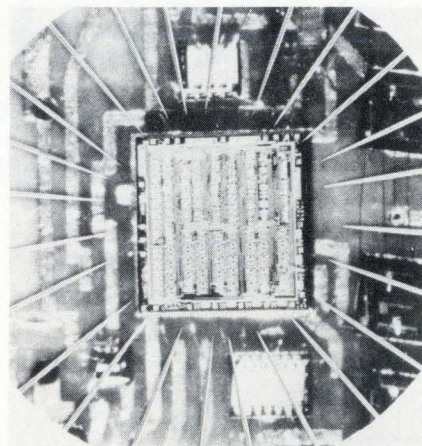

probes sometimes do. Because Pallinex 7 is a solid wrought metal, it is not subject to the flaking, peeling, or porosity of plated materials. The high-palladium alloy contains silver, gold, platinum, and copper, allowing it to remain free of tarnish and corrosion even at elevated temperatures. The probes currently offered are the 10-mil-diameter model 1650 and the 12-mil 1651.

The J.M. Ney Co., Maplewood Ave., Bloomfield, Conn. 06002. Phone Robert Trombley at (203) 242-2281 [393]

Test system analyzes semiconductor resistivity

A calculator-controlled automatic test system called the System 53 is designed to measure, compute, and statistically analyze the resistivity of semiconductor materials. The instrument system uses a four-point probe to make measurements of slice resistivity, bulk resistivity, and sheet resistance.

Measurement data can be analyzed, stored, retrieved, and the results printed out in meaningful terms. The heart of the system is a microprocessor-based calculator with sufficient memory for 256 data registers and 2,048 steps of program memory. Additional memory can be provided by a floppy disk or low-cost magnetic tape.

In addition to the calculator, System 53 includes a 4½-digit multimeter, a constant-current source, and a 10-channel low-voltage scan-

**newest member
of the team...**

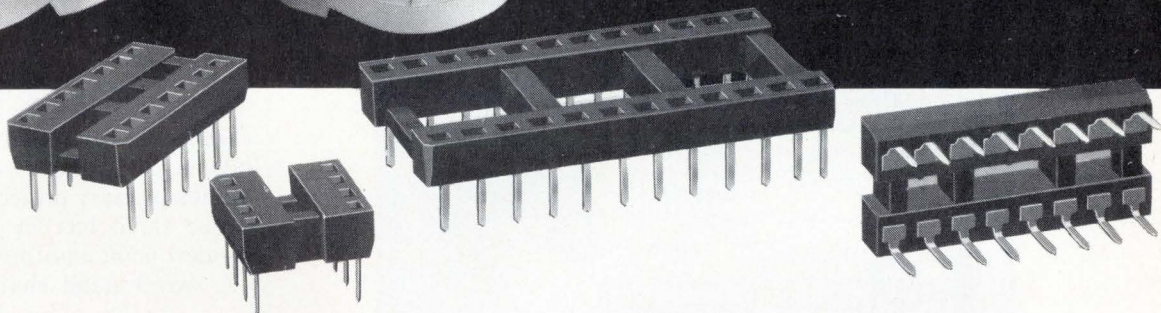
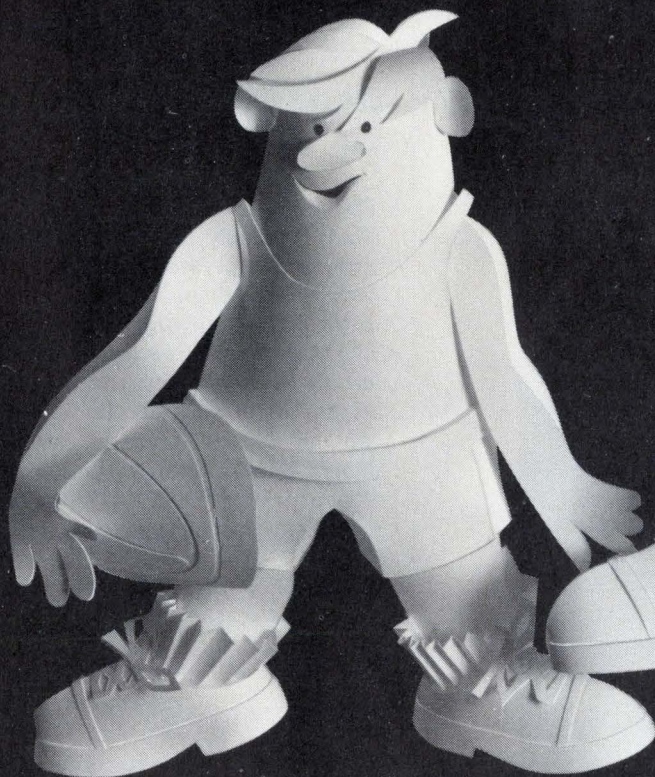

TRW/Cinch low profile DIP sockets

Don't let the small size and low cost fool you. These low profile DIP sockets are first string all the way. The unique TRW/Cinch design incorporates many features previously available only in larger more expensive sockets, resulting in improved performance and reduced assembly costs. With a height of only 0.150", these low-profile sockets are high scorers with a high tensile strength contact material that provides 16 ounce min. contact retention force, pointed terminal tips for easy PC insertion, generous lead-in dimensions and tapered socket entry to align bent DIP leads during automatic insertion.

Center slots with cross bars permit air flow under the DIP for more efficient cooling, and the glass-

fiber filled 94V-0, U.L. rated insulator allows operating temperatures from -40°C to $+75^{\circ}\text{C}$. The sockets also feature recessed ends for ample removal tool clearance and stand-off bosses for rapid flushing of flux residue.

TRW/Cinch low profile DIP sockets are available in 8, 14, 16, 18, 22, 24 and 40 contact sizes. And a full bench of other sizes will be developed when the need arises. For fast team action, contact your local TRW/Cinch distributor, or TRW/Cinch Connectors, an Electronic Components Division of TRW Inc., 1501 Morse Avenue, Elk Grove Village, Illinois 60007; Phone: (312) 439-8800.

CC-7617

TRW CINCH CONNECTORS

ANOTHER PRODUCT OF A COMPANY CALLED TRW

Circle 157 on reader service card



HP 9830A/B* users... forget memory overflow problems

With our EM-30 Extended Memory System, you'll eliminate the need to redesign programs because of memory overflow.

Make it easy for yourself . . . an EM-30 gives you these important features:

- **economic expansion** of your HP 9830A/B* read/write memory to 32K bytes
- the ability to **easily work** with large arrays of data without peripheral storage
- **full compatibility** with all software, peripherals and HP ROM options
- **easy installation** in minutes — the EM-30 is a direct plug-in replacement for HP memory.

NEW! Powerful ROMs on the way. A RUN FAST command will greatly accelerate program execution. And a LIST ALL command permits listing of all programs. These capabilities will be conditionally available to buyers of EM-30 memory systems.

As low as \$4230 for 32K. Expand a fully loaded 15K-byte 9830 to 32K for only \$4230. By adding the EM-30, your HP 9830A/B* will give you minicomputer memory capacity with desk-top convenience. And you'll get the same high quality and reliability you'd expect from an HP product.

Other INFOTEK-9830A/B Compatible Products:
 FD-30 Mass Memory System
 FAST BASIC I ROM
 FAST BASIC II ROM
 TC-30 Real Time Clock
 PS-30 Paper Tape Punch/Reader

*a product of Hewlett-Packard



Infotek Systems

733 EAST EDNA PLACE • COVINA, CALIFORNIA 91723
 (213) 966-7431 • TWX 910-584-1812

New products

ner. Its basic price is \$10,500.

Keithley Instruments Inc., 28775 Aurora Rd., Cleveland, Ohio 44139. Phone (216) 248-0400 [396]

Die-adhesion tester is
safe and easy to use

The model 520D die-adhesion tester is an extremely fast instrument that eliminates operator judgment as a variable by displaying the applied force on a four-digit LED display. The unit applies force smoothly from left to right for easy and precise alignment of the die. Its operation can be closely observed with no danger that loose dice will constitute a hazard. Priced at \$1,410, the tester meets MIL specification 883, method 2019.

Anza Technology, Box 4659, Mountain View, Calif. 94040. [398]

Blower eliminates
static electricity

A 100 cubic-foot-per-minute fan that blows ionized air more than six feet protects integrated circuits from damage by static electricity. The unit's primary protective volume is a cone three feet in diameter at its widest point and three feet in length. A swivel stand enables the user to

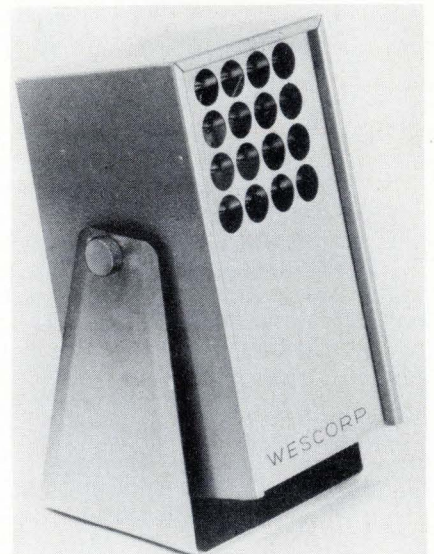

17 days from now this trace will look the same as it does today. Now that's storage!

The Gould OS-4000 Digital Storage Oscilloscope . . .

will store any signal up to 450 kHz for as long as you need, while providing the performance of a conventional 10 MHz scope as well. The OS-4000 opens the door for entirely new viewing possibilities involving low frequency measurements. It is ideal for displaying and recording transient waveforms for medical, electrical, vibration, dynamic testing and pulse testing applications.

The digital storage capability provides a non-flickering, full trace at low frequencies and a unique "Dot Joining" technique.

The OS-4000 will allow you to simultaneously view stored and real time signals. These may even be superimposed to reveal small changes.

The OS-4000 also allows you to examine a single event trace prior to, as well as after, a trigger point; and it's stored indefinitely as long as power is supplied to the unit.

If you'd like a hard copy of a stored trace, you can record it in either analog or digital form on your recorder by using the Gould 4001 Output Unit.

Find out how the unique Gould OS-4000 Digital Storage Oscilloscope and the companion 4001 Output Unit can make your work more efficient and easier. Call your nearest Gould Sales Engineer for details. Or write Gould Inc., Instrument Systems Division, 3631 Perkins Avenue, Cleveland, Ohio 44114.

PHONE TOLL FREE FOR BROCHURE (800) 325-6400.

(In Missouri (800) 342-6600)

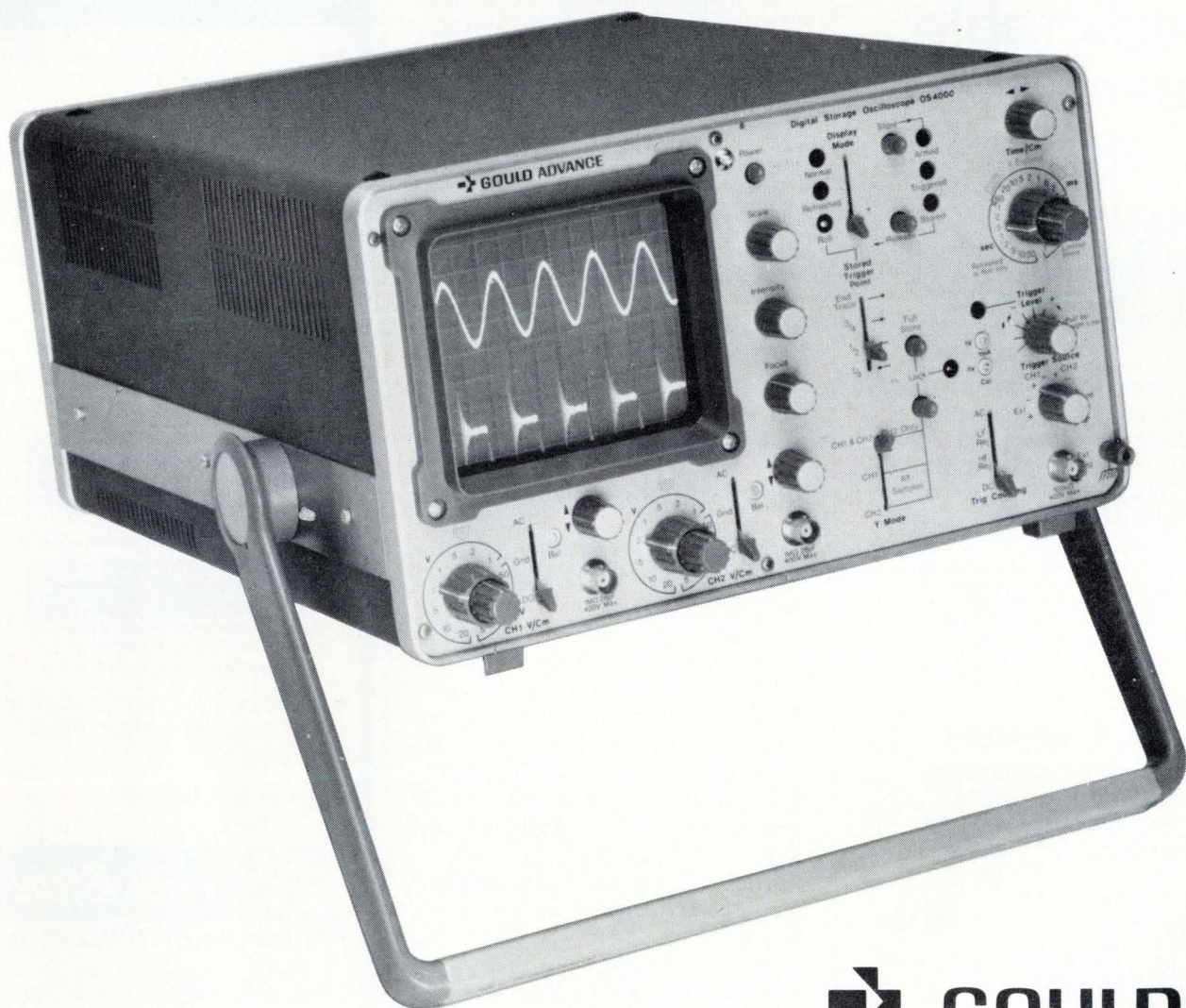

 **GOULD**

Finally.



A low-cost, predictable, dual-channel filter.

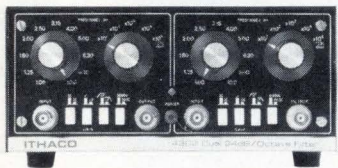

Each of the two 24dB/octave filters can be used as high pass or low pass with selectable gain of 1 or 10. Connect them in series for bandpass, 48dB/octave high pass, 48dB/octave low pass, with selective gain of 1, 10 or 100. Butterworth and Bessel modes. Switch selectable frequency settings from 10Hz to 1MHz, .005% distortion at 20 volts output. 100dB outband rejection. 25 μ volts noise.

Send for our data sheet.

It'll tell you all you need to know about our newest filter. And when you need a filter that does just what you expect, you'll know where to find it. The predictable filter.™ \$655. Ithaco, Box 818, Ithaca, New York 14850. Call (607) 272-7640.

ITHACO

© Ithaco, Inc.

160 Circle 160 on reader service card

New products

direct the ionized air exactly where it is needed. The destaticizing blower weighs 11 pounds and pulls 1.5 amperes at 115 v ac. It sells for \$244 and has a one-week delivery time.

Wescorp, 1601 Stierlin Rd., Mountain View, Calif. 94040. Phone (415) 969-7717 [395]

Infrared microscope permits viewing of buried IC layers

Although it does not transmit visible light, silicon is transparent to infrared radiation. Thus an infrared microscope, such as the model D, permits direct viewing of diffusions, buried layers, crystal defects, and nonuniformities in silicon integrated circuits. The microscope, which provides magnifications up to 600 times, can resolve objects down to 1 micrometer. By means of an infrared polarizing attachment, it can display strain patterns and bonding defects. Provision is made for viewing by both transmitted and reflected light. The system includes built-in infrared filters, a mechanical stage, a power supply for the illuminator, and a high-voltage supply.

Research Devices Inc., 616 Springfield Ave., Berkeley Heights, N.J. 07922. Phone (201) 464-0668 [394]

Solder-tab sockets extend only 0.156 in. above board

Two solder-tab DIP sockets, the 14-pin P/N 703-4014-01-XX-12 and the 16-pin P/N 703-4016-01-XX-12, are low-profile devices that extend only 0.156 inch above the board. Contact spring compliance is achieved with no compromise in the normal force on the component leads. One aspect of the design that helps achieve this is the use of inverted contacts that apply pressure to the broad side of the DIP lead.

The socket bodies have antimois-ture bosses included in the profile height.

Cambridge Thermionic Corp., 445 Concord Ave., Cambridge, Mass. 02138. [397]

Autoranging Frequency Counting to 60 MHz with 1Hz Resolution



B&K-PRECISION MODEL 1801 \$240

- For laboratory, production line or maintenance applications
- Automatic ranging, 20 Hz to 40 MHz is guaranteed...readout to 60 MHz is typical
- TTL circuitry updates the six-digit display five times per second
- Resolution to 1 Hz obtained by suppressing digits above 1 MHz when switching to 1 SEC mode



MHz display of 3.579548 MHz input (AUTO mode)



KHz display of overflow of 3.579548 MHz input (1SEC mode)

- Available for immediate delivery, from local B&K-PRECISION distributors
- 10-day free trial offer

B&K PRECISION
PRODUCTS OF DYNASCAN

6460 West Cortland Avenue
Chicago, Illinois 60635 • 312/889-9087
In Canada: Atlas Electronics, Toronto

Circle 203 for Product Information
Circle 222 for Product Demonstration

UTFORDRING I NORSK INTERNASJONAL ELEKTRONIKK

Direktør Gustav A. Ring søker etterfølger som vil kunne sikre den videre fremgang for Ring-gruppen.

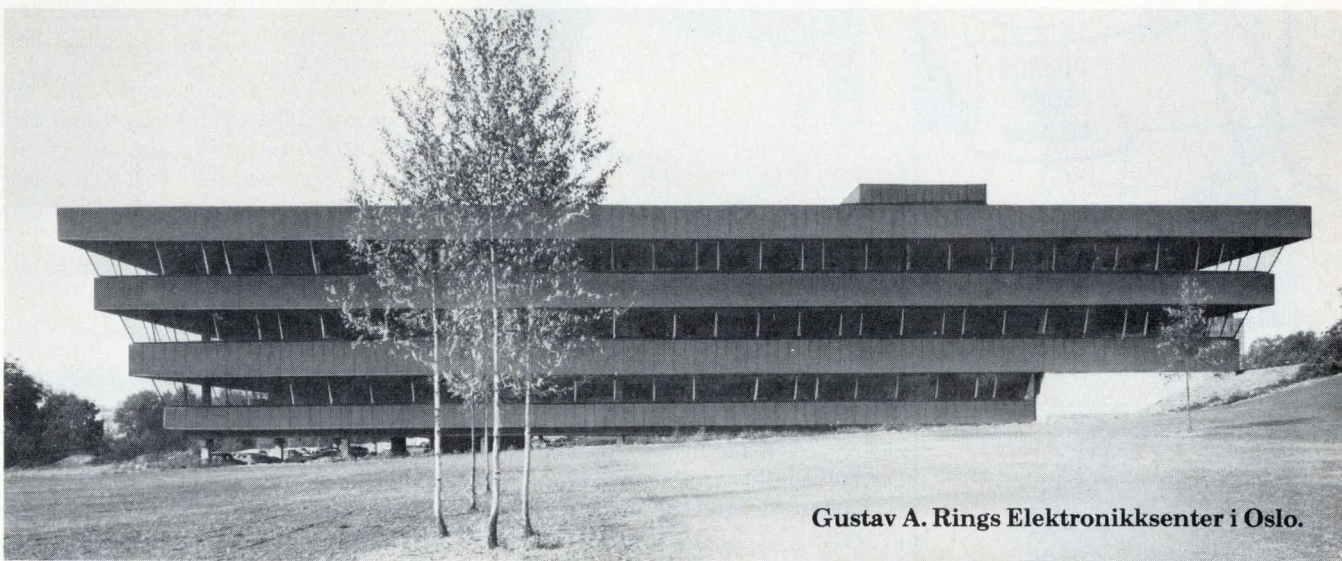

Gustav A. Rings Elektronikkenter i Oslo.

Utviklingen hittil

Gustav A. Ring System Maskiner A/S har gjennom de siste årtier befestet sin stilling som det ledende norske forhandlerfirma for kontortekniske spesialmaskiner. Eksempelvis diktafoner, postbehandlingsmaskiner, tekstautomater, skrive- og regnemaskiner, EDB-teknikk osv. Med støtte i denne virksomheten har bedriften ekspandert raskt ved å utvikle egne, nye systemer innenfor teleteknikk og sambandskontroll. Våre egne produkter omfatter Ring-Master interne telefonsystemer, GAREX sambandskontroll og ACD elektronisk kø- og fordelingsentral for innkommende telefoner. Vi har drevet en intens forskning og utvikling og bygget opp en lovende eksport i konkurranse med verdenskjente stor-konsern.

Stillingen idag

Med en omsetningsvekst på gjennomsnittlig 20 % pr. år gjennom de siste 12 år, nær-

mer firmagruppen seg nå 150 millioner i omsetning. Vi er over 700 medarbeidere med mange avdelinger og aktivitetsområder innenlands og utenlands. Egne datterselskaper og salgskontorer i flere land. Ved løpende inntektsoverføringer fra handelsiden har vi skapt et profesjonelt miljø som grunnlag for videre utfordringer og satsing på nye systemer for norske og internasjonale behov.

Målsetting og politikk

Vi vil være til nytte for samfunnet og samtidig utvide og trygge et fremtidsinteressert arbeidsmiljø for alle våre medarbeidere. Vi vil være nyskapende, men derfor trenger vi sunn økonomi og løpende lønnsomhet til egenfinansiering av veksten. Vi vil bevare vår uavhengighet som norsk firma-gruppe, men med internasjonal orientering og aktivitet. Derfor vil vi åpent søke samarbeid, gjerne over landegrensene, men først og fremst mellom norske virksomheter med samme mål.

Vilkår

Den leder vi søker må selv kunne gå foran i utviklingen av vår fremtidspolitikk. Det er i første omgang en dynamisk styring av vår virksomhet innen elektronikk og industri det tas sikte på. Evner, utdannelse og erfaring må gi bakgrunn for en forretningsmessig vurdering ved valg av teknologi og systemer. Den viktigste oppgaven blir imidlertid å finne, utvikle og stimulere gode medarbeidere. Evne til kontakt med offentlige og private institusjoner og samarbeidspartnere innen- og utenlands blir stadig viktigere. Samfunnsmessig holdning og menneskelig interesse for medarbeidere må kunne styrke den solidaritetsånd vi vil bygge på. Vi vil etter en viss innarbeidelsestid gi forsterket styringsrett og venter binding til gruppens fremtid. Avtale om aksjonærdeltagelse på gunstige vilkår er forutsatt. Modenhet og oppnådde resultater er mer avgjørende enn alder.

Avgjørelse søkes tatt før årsskiftet.



For nærmere opplysninger kan De ringe direktør Ring tlf. (02) 46 68 90, styremedlem disponent Jan Thesen tlf. (02) 44 50 06 eller sjefsredaktør K. Endresen tlf. (02) 55 48 80. Skriftlig søknad sendes Gustav A. Ring A/S, Ringhuset, Volvat, Oslo 3.

POWER SUPPLY MAGIC



There's no trick! Get a full house everytime with Deltron's dual and triple power supplies.

U.L. recognized.
One year warranty.

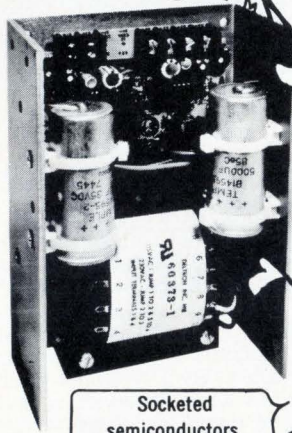

Socketed
semiconductors.
Barrier block interface.

MODEL	RATINGS volts/amps	PRICE		
		1	100	250
QD12/15-0.6	±12 to ±15/0.6	\$42	\$36	\$35
QD12/15-1.7	±12 to ±15/1.7	\$62	\$54	\$49
QD12/15-3.0	±12 to ±15/3.0	\$79	\$67	\$64
QT-1	5/3.0 ±12 to ±15/0.5	\$69	\$66	\$65
QT-2	5/6.0 ±12 to ±15/1.0	\$89	\$82	\$79

Deltron inc.

Wissahickon Avenue
North Wales, PA 19454
Tel: 215/699-9261 Twx: 510/661-8061
AC-12

New products/materials

A ceramic paper that melts at 3,200°F can be cut with ordinary hand scissors and formed into complex shapes. An electrical insulator, type 300 ceramic paper is an asbestos-free material with a continuous-service temperature rating of 2,300°F, a dielectric strength of 100 volts per mil, and a dielectric constant of 1.61 at 100 megahertz. Applications of the paper include use

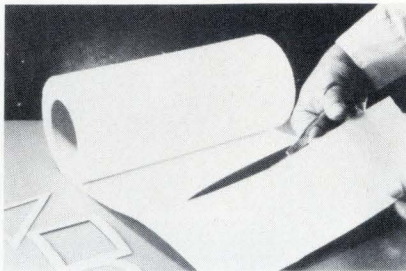

in crystal-growing furnaces, as a thermocouple insulator, as an insulator for high-temperature lamps, and as a gasket material in the handling of molten metals. Type 300 ceramic paper is made in 20-, 40-, and 80-mil thicknesses. Standard width is 24 inches. A trial kit is available for \$15.

Cotronics Corp., 5008 Ave. M, Brooklyn, N.Y. 11234. Phone Alan Marks at (212) 531-9376 [476]

A solder cream especially formulated for soldering aluminum and most of its alloys, including 6051 and 5052, is a homogeneous mixture of oxide-free prealloyed powder suspended in a thixotropic flux. It is tacky and can be used as a temporary adhesive to hold parts in place before the application of heat. Joints made with Alu-Sol cream are highly resistant to electrochemical corrosion. Precleaning or abrasion of oxidized surfaces is not required before application. To prevent corrosion of electronic components, flux residue should be removed after soldering. This is easily accomplished with warm water.

In addition to aluminum and its alloys, Alu-Sol cream can be used on brass, copper, tin plate, and nickel. It will join any combination of these metals and most other solderable metals. Priced from 10 cents to 25

NEW!

REVOLUTIONARY INSTRUMENT

IN AC & DC CURRENT MEASUREMENT

No longer is it necessary to break the circuit to make an ac and dc current measurement! This time-saving feature is extremely useful in troubleshooting, maintenance, design and other fields. Now it is possible to obtain current measurements more easily and safely than voltage measurements by use of clamp-on probes.

Model 1776 features include digital readout, peak read and hold capability, resolution 10 mA on lowest range, wide dynamic range, portability with built-in recharging circuitry, three clamp-on probes, extremely low insertion impedance.

The 1776 is the only current meter of its type in the world!



MODEL 1776 DIGITAL CURRENT METER

Current Ranges	10, 100, 1,000 amperes, FS.
Accuracy	
D.C.	±0.5%, FS.
A.C. (Sinusoidal)	±2.0%, FS.
Peak Detection (D.C. Accuracy)	± 0.2%, FS.
Frequency Response	D.C. to 10kHz
Readout	Digital (3½ digit)

The Gaussmeter People

F. W. Bell, Inc.

4949 Freeway Drive East
Columbus, Ohio 43229
614/888-7501
TWX: 810-337-2851

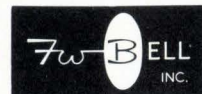

A subsidiary of The Arnold Engineering Company

Circle 204 on reader service card

Price & Performance that can't be matched!

DigiTec's full-function Universal Counter/Timers and Frequency Counters supply extended frequency ranges at a ratio of price to performance that can't be matched.

Outstanding features include dual input channels with independent controls, high input sensitivity, oven controlled crystal, and full 9 digit LED display with autoranging.



50 MHz Universal Counter	8510A	\$725
150 MHz Frequency Counter	8720A	625
150 MHz Universal Counter	8520A	850
500 MHz Universal Counter	8530A	995
600 MHz Frequency Counter	8730A	795
1 GHz Frequency Counter	8740A	995
1 GHz Universal Counter	8540A	1295

DigiTec UNITED SYSTEMS CORPORATION

918 Woodley Road, Dayton, Ohio 45403
(513) 254-6251, TWX (810) 459-1728

DigiTec: precision measurements to count on.

*These instruments available under
GSA contract GS-00S-27741.*

"Information only" Circle 163 on Reader Service Card

"Demonstration only" Circle 205 on Reader Service Card

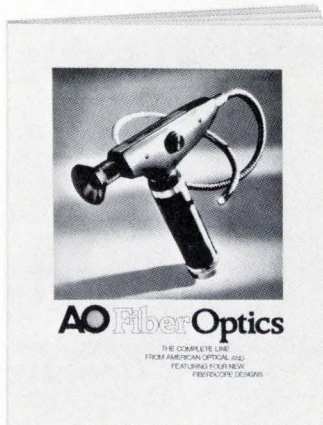

**FREE
Fiber
Optics
Catalog**

Features the complete AO line of fiber optics products—from Inspection Fiberscopes and Light Guides to Illuminators, Image Conduits, Faceplates and Custom Components. Includes the four newest remote inspection fiberscopes now available.

Describes the principle, technology and techniques used to make flexible light and image transmissions a proven, practical fact. Write today for your FREE copy of the AO Fiber Optics catalog to American Optical Corporation, Fiber Optics Division, Southbridge, Mass. 01550.

AO
American
Optical

Circle 217 on reader service card

PRINTED CIRCUIT SLIDE



MSS-4
SERIES

We've used the inner mechanism of our best quality toggle switch to create the world's greatest SLIDE SWITCH SERIES. You

have available a high current capability built into a compact, low profile case. Available either for upright or right angle mounting, all on 0.1" centers.

Call our applications people for details, applications, samples and quantity quotations.

Circle 218 on reader service card

BI-DIRECTIONAL PUSHBUTTON

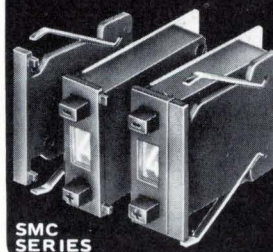

SMC
SERIES

Smallest size ever with large easy-to-read numerals. Occupies only 0.3 sq. in. of panel space, impractical with thumbwheels.

Heavy gold plated contacts. Available in a variety of coded outputs (includes decimal) and mating accessories. Matte black finish. Detailed information on this and larger mating types available upon request.

Circle 219 on reader service card

ALCO ELECTRONIC PRODUCTS, INC.
1551 OSGOOD STREET, NORTH ANDOVER, MA. 01845 U.S.A.
Tel: (617) 685-4371 TWX: 710 342-0552

A SUBSIDIARY OF **AUGAT** INC.

FEATURE ARTICLES FROM *ELECTRONICS* AVAILABLE IN REPRINT FORM

No. of
copies
wanted

New reprints

- ___ R-612 Fiber-optic communications special report 24 pp \$3.00
- ___ R-610 Special report on hybrid-circuit technology 19 pp \$3.00
- ___ R-606 Special issue—microprocessors \$4.00
- ___ R-600 World market report 1976 24 pp \$5.00
- ___ R-526 How reliable are today's components 16 pp \$3.00
- ___ R-524 Special report on bipolar large-scale integration 12 pp \$3.00
- ___ R-522 Special report on power semiconductors 12 pp \$3.00
- ___ R-512 Design of circuits for dangerous environments 4 pp \$3.00
- ___ R-510 Bipolar integration advances with PL microprocessor 8 pp \$2.00

Charts

- ___ R-516 Electronic symbols \$2.00
- ___ R-211 Electromagnetic spectrum (16-page report and chart) \$4.00
- ___ R-326 Optical spectrum (6-page report and chart) \$3.00

Books

- ___ R-608 Basics of Data Communications—Electronics Book Series \$12.50
- ___ R-602 Large Scale Integration—Electronics Book Series \$9.95
- ___ R-520 Microprocessors—Electronics Book Series \$8.95
- ___ R-011 Computer-aided Design 135 pp \$4.00
- ___ R-032 Active Filters 88 pp \$4.00
- ___ R-031 Circuit Designer's Casebook 182 pp (U.S. only) \$5.50 (foreign) \$12.00

Other Reprints

- ___ R-518 Special issue—productivity \$4.00
- ___ R-514 Eight ways to better radio receiver design 6pp \$3.00
- ___ R-508 Designing microprocessors with standard logic devices 12pp \$3.00
- ___ R-506 The case for component burn-in 7 pp \$2.00
- ___ R-434 Designing automated systems with the new standard interface 12 pp \$3.00
- ___ R-432 An update on communications satellites 8 pp \$2.00
- ___ R-430 Choosing the right bipolar transistor model for computer-aided design 20 pp \$3.00
- ___ R-428 Designing with low-cost lasers 6 pp \$2.00
- ___ R-504 U.S. forecast 1975 20 pp \$3.00
- ___ R-502 European forecast 1975 20 pp \$3.00
- ___ R-500 Japanese forecast 1975 16 pp \$3.00
- ___ R-426 Special issue—technology update 1974 \$4.00
- ___ R-424 Microprocessor applications 28 pp \$3.00
- ___ R-422 A microprogramable mini-computer 8 pp \$2.00
- ___ R-420 Computerized text-editing and typesetting 8 pp \$2.00
- ___ R-418 Computer analyses of rf circuits 8 pp \$2.00
- ___ R-416 Optical waveguides look brighter 8 pp \$2.00
- ___ R-414 The ion-implanted n-channel process 6 pp \$2.00
- ___ R-412 Liquid cooling of power semiconductors 6 pp \$2.00
- ___ R-410 Special report on passive components 16 pp \$3.00
- ___ R-408 Bringing sight to the blind 8 pp \$2.00
- ___ R-406 Designing with the new logic, C-MOS and bipolar 16 pp \$3.00
- ___ R-328 Special issue—pervasiveness of electronics \$2.00
- ___ R-324 Semiconductor memories are taking over data-storage applications 16 pp \$3.00
- ___ R-322 Special report: new displays complement old 10 pp \$2.00
- ___ R-320 Special report on designing with flat cable 14 pp \$3.00
- ___ R-318 Special report on auto electronics 16 pp \$3.00
- ___ R-316 Hybrid circuits solve tough design problems 16 pp \$3.00
- ___ R-312 Leadless, pluggable IC packages reduce costs 7 pp \$2.00
- ___ R-310 Penetration color tubes are enhancing information displays 6 pp \$2.00
- ___ R-308 Program for transition from nonlinear to linear transistor model 6 pp \$2.00
- ___ R-306 Charge-coupling improves its image, challenging video camera tubes 8 pp \$2.00
- ___ R-209 Semiconductor RAMs land computer mainframe jobs 15 pp \$2.00
- ___ R-207 Technology gap starts to close for computer peripherals 16 pp \$3.00
- ___ R-205 Bridging the analog and digital worlds with linear ICs 16 pp \$3.00
- ___ R-113 Optoelectronics makes it at last 34 pp \$4.00
- ___ R-104 The new concept for memory and imaging: charge-coupling 12 pp \$2.00
- ___ R-023 Special report on tomorrow's communications 32 pp \$3.50

Payment must accompany your order

Make check or money order payable to Electronics Reprints. All orders are shipped prepaid by parcel post. Allow two to three weeks for delivery.

Back issues now available:
1960 to 1969, \$5.00 each
1970 to 1973, \$3.00 each
1974 to 1975, \$4.00 each

USE THIS PAGE AS YOUR ORDER FORM

Cost of orders \$ _____
Plus 10% handling charge \$ _____
TOTAL AMOUNT ENCLOSED \$ _____

SEND REPRINTS TO

Name _____
Company _____ Dept. _____
Street _____
City _____ State _____ Zip _____

Mail your order to:
Janice Austin
ELECTRONICS REPRINTS
P.O. Box 669
Hightstown, N.J. 08520

New products/materials

cents per gram, the versatile solder cream is available from stock.

Multicore Solders, Westbury, N.Y. [478]

A family of solder pastes for general thick-film and printed-circuit applications consists of 15 pseudoplastic formulations of various alloys. Included are alloys of tin and lead; tin, lead, and silver; gold and tin, and several that contain indium. Many types exhibit very low leaching when

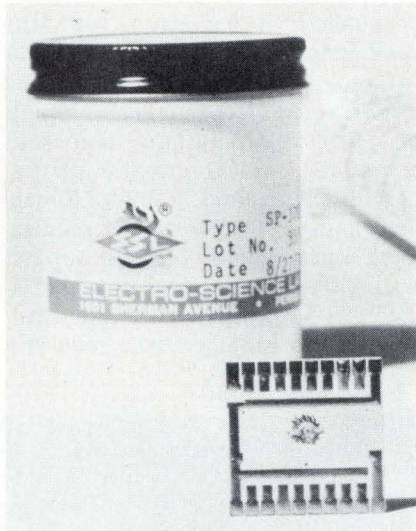

used with gold conductors. Available with the family of solder pastes are special cleaners for safe flux removal and a copper cleaner for removing oxides from thick-film copper conductors.

Electro-Science Laboratories Inc., 1601 Sherman Ave., Pennsauken, N.J. 08110. [477]

Thick-film conductors with special high-performance characteristics mark the entrance of AVX into the thick-film materials market. The special materials include a dotting gold that eliminates die-off, a palladium-silver that inhibits silver migration, a platinum-palladium-silver that resists oxidation during sequential firings, and a palladium-silver that is designed to retain its bond strength through extreme temperature cycling. The latter material is especially aimed at the under-the-hood automotive market.

AVX Materials Division of AVX Corp., 10441 Roselle St., San Diego, Calif. 92121 [480]

Please, note on your agenda

31



march

1



april

2



april

4



april

5

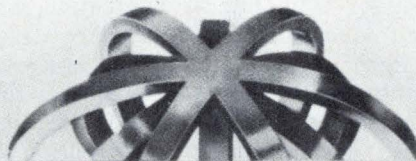

april

6

*PARIS
closed on
sunday 3*

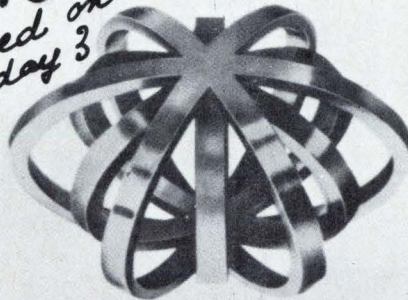

april

salon international des
**composants
électroniques 77**

4 sections: Components - Measuring,
Material and Products - Equipment and Methods

an ever increasing number of visitor

1974 - 57000

1975 - 61000

1976 - 72000

permanent cards

you must be in Paris this year again

New literature

Pulse capacitors. The effect of dc voltage on the discharge life of pulse capacitors, is the subject of a seven-page technical paper offered by Capacitor Specialists Inc., Del Dios Highways, Escondido, Calif. 92025. Technical Paper No. 112 points out that the failure mechanism and lifetimes of capacitors depend on whether the voltage applied is ac, dc, or pulsed. In many applications, the capacitor is subject to both dc and pulsed conditions. The paper also discusses the effect of different types of power supplies. Circle 422 on reader service card.

Frequency stability. Three techniques for measuring and interpreting short-term frequency stability in microwave signal sources are discussed in an eight-page applications bulletin. After a brief introduction on the nature of short-term instability, the bulletin points out

that any of three parameters may provide the most convenient and accurate means of measurement: residual fm noise, single-sideband phase noise, and phase jitter. Three practical methods of measuring short-term instability, using these parameters, are then described and are illustrated by curves and diagrams. The bulletin is available from Eduardo Cabrera, Marketing Manager, Communication Techniques Inc., 1279 Route 46, Parsippany, N.J. 07054. [421]

Relay reliability. A 16-page brochure on relay reliability describes in detail the aspects of relay design, fabrication, processing, and testing that are essential for consistent performance. To make the specification of relay reliability easier, several levels are described. A separate section deals with the screening tests that are available to qualify relays

for specific applications. A major subject of the brochure is configuration and traceability controls, the most misunderstood and most costly relay specifications. The brochure is available from Hi-Rel Product Manager, Leach Corp., 5915 Avalon Blvd., Los Angeles, Calif. 90003. [423]

Shielding. Entitled Metex Emi/rfi Shielding Handbook & Catalog, a 124-page publication contains comprehensive information that the packaging or design engineer needs to know about shielding against unwarranted electromagnetic signals or pulses. It contains numerous equations, tables, graphs, photos, practical hints, and examples to help the engineer determine his requirement and select the shielding material. Although the price of the publication is \$10, the handbook is available free to engineers who request a

Impossible? Easy!

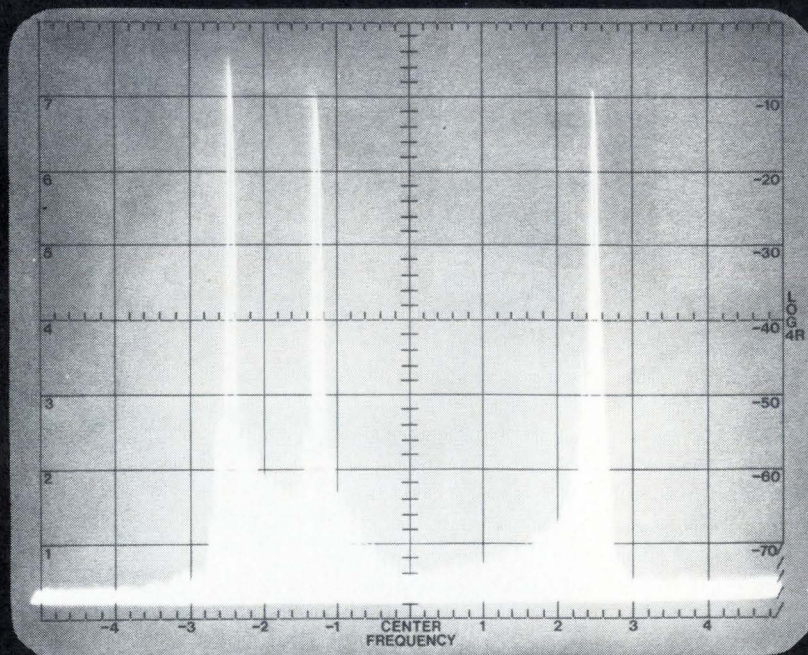

Obtainable by three controlled frequency changes within a single magnetron pulse.

copy on company letterheads. Write to Metex Corp., 970 New Durham Rd., Edison, N.J. 08817.

Power supplies. Underwriters Laboratories Inc. has published the first edition of its standard for safety of power supplies. Designated the UL 1012, the standard covers portable, stationary, and fixed supplies that are rated at 600 volts and lower, both dc and ac, and are intended to be used in ordinary locations in accordance with the National Electrical Code. The first edition is \$3, but a subscription to the standard plus all subsequent revisions is \$8. Underwriters Laboratories Inc., Publications Department, 207 East Ohio St., Chicago, Ill. 60611

Ferrite components. A 10-page color brochure explains the operation of ferrite devices, including circulators, isolators, and filters. It also discusses

the use of the devices in microwave communications, electronic countermeasures, and radar systems. The brochure provides a guide to the engineer in selection of the proper microwave component for the specific application. UTE Microwave Inc., 3500 Sunset Ave., Asbury Park, N. J. 07712. [426]

Display devices. A line of display devices for a variety of industrial and military applications is covered in a 22-page catalog. The illustrated publication is divided into sections according to product category—cathode-ray tubes, display-storage tubes, and a developmental electro-luminescent flat-panel display. Also included are application and manufacturing photographs. Westinghouse Electric Corp., Industrial and Government Tube Division, Westinghouse Circle, Horseheads, N.Y. 14845 [427]

Test sockets. Carriers and test sockets for integrated and hybrid circuits, rectifiers, and other semiconductors are described in an eight-page condensed catalog from Textool. The sockets are designed for

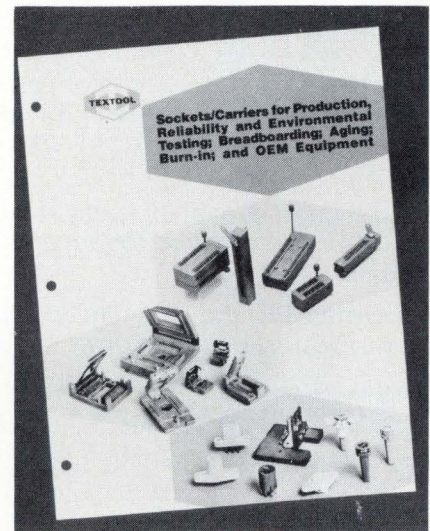

This is how.

With EEV's new MTM— the world's first electronically tuned magnetron.

EEV is proud to announce the Multipactor Tuned Magnetron.

For the first time, an effective method of electronic tuning for magnetrons is available.

EEV engineers have turned the multipactor phenomenon—until now a parasitic problem—to the advantage of magnetron users.

EEV's new patented MTM is basically an auxiliary resonant cavity which is coupled to the main magnetron anode. Several of these auxiliary cavities can be fitted to the same anode to increase the total frequency shift or to give a selection of frequencies.

The MTM has no moving parts, does not interfere with normal magnetron characteristics and adds very little to overall size and weight.

The MTM therefore solves the problems which are intrinsic in existing mechanical tuning systems. It offers frequency agility—a wide tuning range, and a tuning rate so fast that the frequency can be changed many times within a single pulse. Because it has no mechanism to wear out, it is dependable, durable and rugged in any environment. It is simple, and considerably less expensive than other tuning techniques.

Multipactor tuning can be applied to most magnetrons in the EEV range, offering random pulse to pulse frequency agility, pulse shaping, clutter decorrelation... the possibilities are enormous.

Think about it. Talk about it. Read about it. Contact our magnetron engineers at Chelmsford. Today.

EEV and M-OV know how
Members of GEC—turnover £1902 million

ENGLISH ELECTRIC VALVE CO LTD, Chelmsford, Essex, England CM1 2QU. Tel: 0245 61777. Telex: 99103. Grams: Enelectico Chelmsford.



A/D and D/A Converters... Call the Can-Do Company



CPS specializes in medium-to-high resolution and fast settling time devices for data acquisition, instrumentation, process control and many other signal converter applications where product reliability is a must.

CPS function modules are backed by more than eight years of know-how in producing standard or custom high-technology products which are tailored for specific OEM industrial or

Mil-Spec needs. And we've solved a lot of engineering design problems that others tend to stay away from.

Our production capability is backed by a stringent QC program which ensures a quality product along with on-time delivery schedules.

Call or write CPS, the "Can-Do" company, for the economical answer to your signal converter requirements.

CPS INC.
CYCON

722 E. Evelyn Avenue
Sunnyvale, California 94086
Phone (408) 738-0530 Telex 357-450

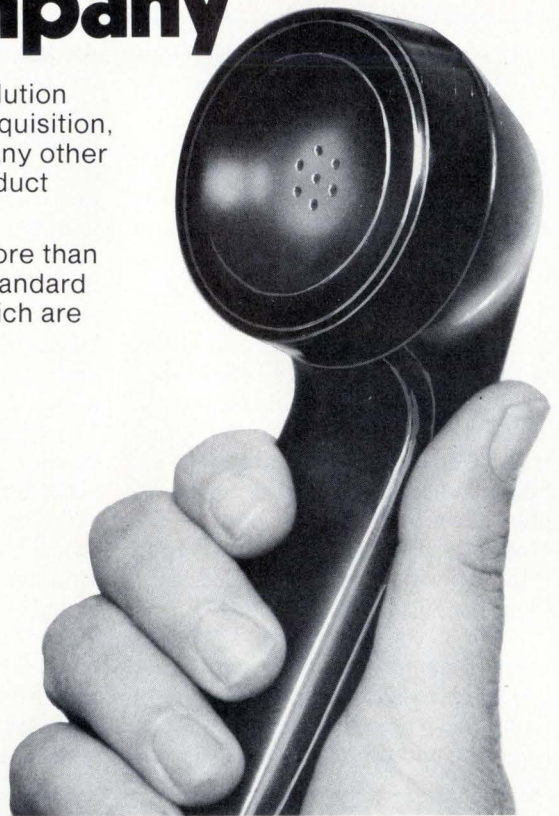

Circle 168 on reader service card

Solar photovoltaic – greater output now at lower cost!

**Fuel and Maintenance Free
Long Term Reliability for All
mW to KW Applications!**

Unlimited, clean, dependable electric power wherever you need it. Life cycle cost lower than primary batteries and fuel operated generators. Thousands of Solarex panels and systems in use throughout the world.

1335 Piccard Drive/Rockville, Md. 20850
301-948-0202/TWX: 710-828-9709/Cable: SOLAREX



SOLAREX CORPORATION
 CELLS PANELS
 SYSTEMS

All sizes
to 4" diameter
Chevron™
cells (shown)

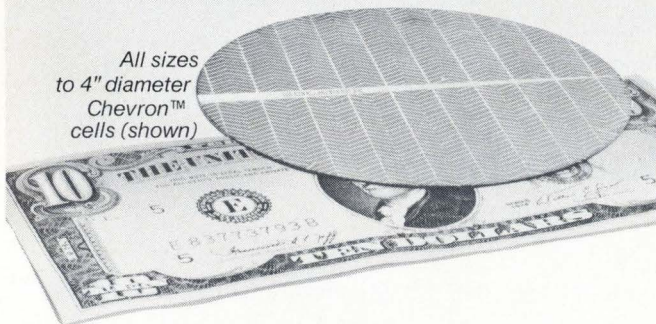

168 Circle 206 on reader service card

low cost data system

**Easiest to use: Monitoring Processes, Logging Data,
Tracking Tests & Studies**

Gather analog or digital data from up to 248 channels—thermocouples, transducers, etc.—print out results, tape them, feed your computer. It's all under your keyboard control with a microprocessor in the proven PD 2064 System. You easily set or change all functions: crystal clock timing, scan intervals, channel signal conditioning, alarms, auto-programming with new multi-program bank and program printout, plus timesaver subroutines like true integration and averaging if you want. We believe it's the most powerful, versatile, and lowest cost standardized way to reduce more data per dollar in industry, lab, or field applications. Some units stocked for quick shipment. Request Bulletin B110 from Esterline Angus Instrument Corporation, P.O. Box 24000, Indianapolis, IN 46224. Tel. 317-244-7611.

ESTERLINE ANGUS
AN ESTERLINE COMPANY



Circle 207 on reader service card

NEW US INSTRUMENT RENTALS

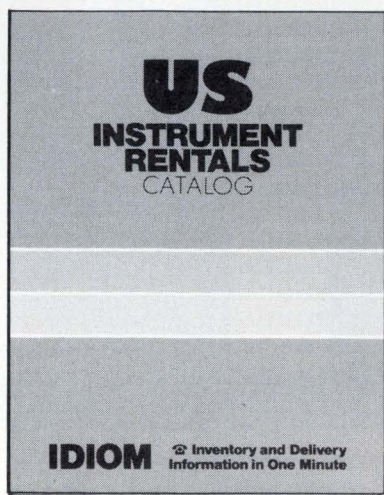

A RENTAL GUIDE
FOR INSTRUMENTATION
USERS

- Why **US**?
- Rental Concept & Applications
- Complete New Equipment Index

Your Complimentary
Copy is Waiting.
Circle the Bingo or
Call Any of the 14
USIR Regional Offices.

Headquarters
951 Industrial Road
San Carlos, CA 94070
(415) 592-9225

Circle 169 on reader service card

New literature

reliability and efficiency in bread-boarding, burn-in, and aging. Textool Products Inc., 1410 W. Pioneer Dr., Irving, Texas 75061 [428]

Data conversion. A 288-page Engineering Product Handbook from Datel Systems includes a tabular selection guide on a broad line of data-conversion devices. Information is given on the following products: analog-to-digital and d-a converters,

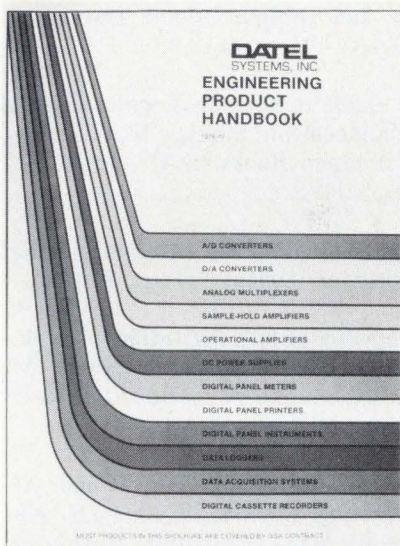

sample-holds, analog multiplexers, operational amplifiers, power supplies, dc-dc converters, digital panel meters and other instruments, data-acquisition systems, and analog input/output systems for use with computers. Monolithic, hybrid, and modular technologies are included. Datel Systems Inc., 1020 Turnpike St., Canton, Mass. 02021 [429]

Wirewound resistors. Full electrical and mechanical specifications of wirewound resistors made by General Resistance Inc. are provided in the company's new catalog. Standard values and nonstandard resistance ranges are shown, together with quantity pricing (1 to 999 pieces). Custom-designed active and passive networks—such as reference temperature simulators, precision voltage modules and constant-current modules—are also discussed. General Resistance Inc., 75 Haven Ave., Mt. Vernon, N.Y. 10553 [430]

Q. How do you resolve two signals spaced 1 Hz apart at 2 MHz?

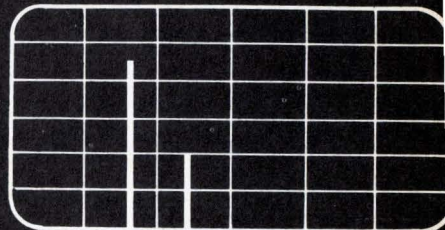

A. With EMR's new Model 1520 Digital Spectrum Translator and Model 1510-03 Digital Real-Time Spectrum Analyzer.

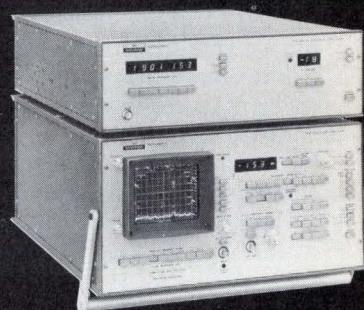

Why go partway in analyzing data? Get the resolution/performance edge of our Model 1510-03 Digital Real-Time Spectrum Analyzer, then go it one better. Enhance frequency resolution still more by adding the Model 1520 Digital Spectrum Translator to concentrate the full resolution of the Analyzer about a selectable point of interest in the spectrum. For that matter, why stop there? Step up from 25.6 kHz to a full 2 MHz upper frequency limit by adding the optional Model 1521 Range Extension Module, too!

Other features of the unequalled 1520 Translator: nine translatable frequency ranges from 25.6 Hz to 10.24 kHz; center frequency selectable in 1-Hz steps and automatic gain ranging — each with an easy-to-read LED display; plus, an automatic frequency sweep. Full-scale out-of-band signal to minimum-detectable in-band signal exceeds 100 dB.

EMR Schlumberger

EMR Telemetry
Weston Instruments, Inc.
Box 3041, Sarasota, Florida 33578
(813) 371-0811

Circle 208 on reader service card

A great place
to start
expanding
your
company
is right here.

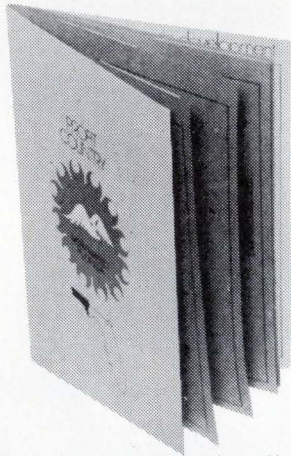

Our 16 page book talks about the labor force, about deep water ports, about utilities, temperatures, taxes. There's everything here from financing to flying times, from industries to schools—all the things that make Northwest Florida one of the most profitable, most livable business climates in the country. And it's free.

Gulf Power Company
Manager, Area Development
Department D-8
P. O. Box 1151
Pensacola, Florida 32520
Please send me your book.

Name _____

Title _____

Company _____

Address _____

City _____

State _____

Zip _____

New books

Solid-State Electronics, Frank P. Tedeschi and Margaret R. Taber, Van Nostrand Reinhold, 202 pp., \$8.95.

Introduction to Exchange Systems, T. H. Flowers, Wiley, 326 pp., \$28.

Handbook of Electronic Safety Procedures, Edward A. Lacey, Prentice-Hall, 269 pp., \$14.95.

Principles of Active Network Synthesis and Design, Gobind Daryanani, Wiley, 495 pp., \$18.95.

A Guide to Systems Engineering and Management, Stanley M. Shinnars, Lexington Books, D. C. Heath, 221 pp. \$18.95.

Thyristor Physics, Adolph Blicher, Springer-Verlag, 304 pp., \$29.80.

Van Nostrand's Scientific Encyclopedia, fifth edition, Douglas M. Considine, ed., Van Nostrand Reinhold, 2,382 pp., \$67.50.

Circuit Concepts: Direct and Alternating Current, Thomas S. Kubala, Van Nostrand Reinhold, 207 pp., \$8.95.

Applied Operations Research, Gary E. Whitehouse and Ben L. Wechsler, Wiley, 434 pp., \$14.95.

Communication System Principles, Peyton Z. Peebles Jr., Addison-Wesley, 488 pp., \$22.50.

Handbook of Basic Electronic Troubleshooting, John D. Lenk, Prentice-Hall, 239 pp., \$15.95.

Handbook of Chemical Lasers, R. W. F. Gross and J. F. Bott, eds., Wiley, 744 pp., \$39.95.

Electronic Transition Lasers, Jeffrey I. Steinfeld, ed., MIT Press, 311 pp., \$14.95.

Professional Engineer's Examination Questions and Answers, third edition, William S. LaLonde Jr., and William J. Stack-Staikidis, McGraw-Hill, 601 pp., \$16.50.

What you must know about Microprocessors

Using articles from the pages of Electronics, this book contains practical and up-to-date information on available microprocessor devices, technology and applications—ranging from the simplest 4-bit p-channel MOS system to the second-generation n-MOS 8-bit processor chips, and the new injection logic and Schottky TTL bipolar processor families needed for the toughest computer-based control applications.

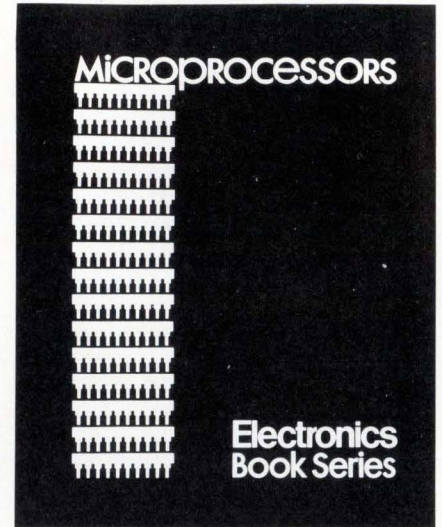

Electronics Book Series

P.O. Box 669
Hightstown, N.J. 08520



Send me _____ copies of "Microprocessors" at \$8.95 per copy.

I must be fully satisfied or you will refund full payment if the book is returned after 10 days free trial examination.

Payment enclosed Bill firm
 Bill me

Credit Cards Charge My Book To:
 American Express Master Charge
 Diners Club BankAmericard

Acct. No. _____

Date Card Expires _____

Interbank No. _____

(1st No.'s. above name on Master Charge only.)

Name _____

Title _____

Company _____

Street _____

City _____

State _____ Zip _____

Signature _____

HR-40

3 and 4 Channel

Strip Chart Recorder

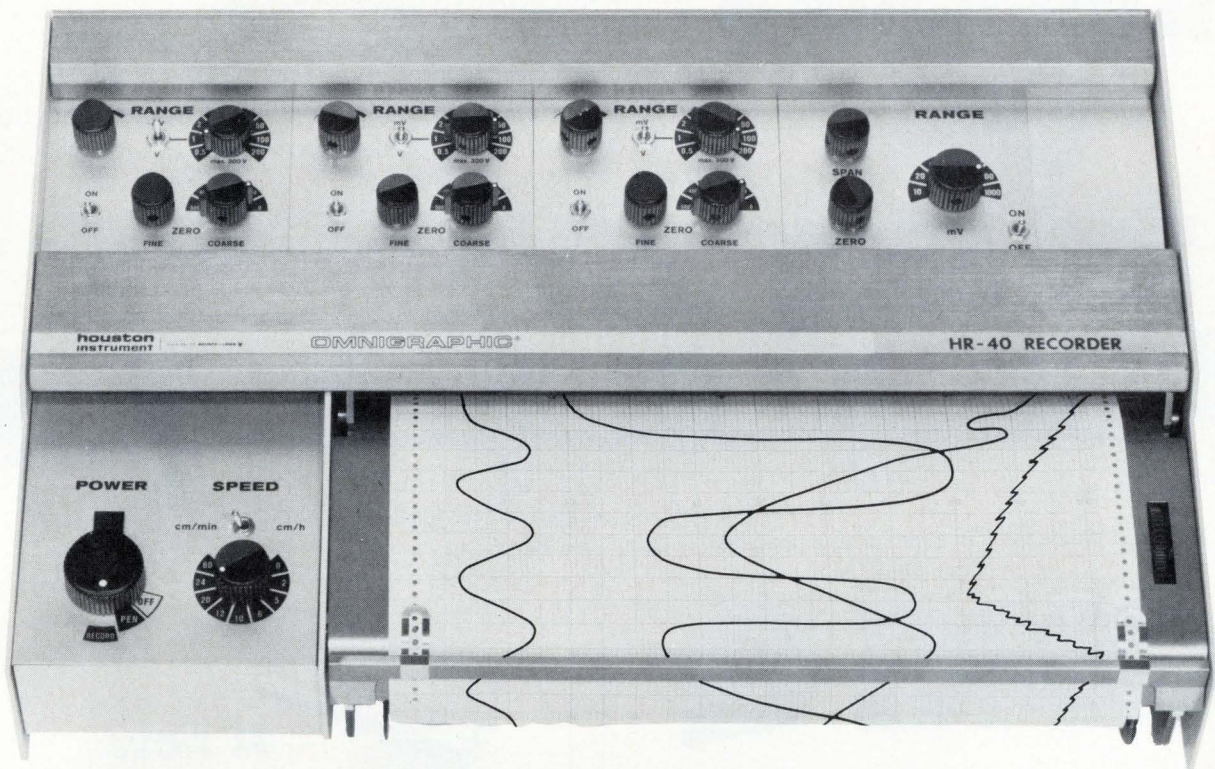

OMNIGRAPHIC®

New from Houston Instrument

- Standard options available
- 10" or 250 mm recording width
- Disposable fiber tip cartridges in four colors
- All pens cover full chart width (Writing distance between channels only 2 mm)
- Price from \$3200.
- Full scale response ¼ sec.
- Choice of 2 interchangeable, plug in, input modules. 0.5mv to 200v full scale
- Either English or Metric chart speeds
- 16 Switch selectable chart speeds 1 inch/min. to 24 inches/hr.

**houston
instrument**

® A registered trademark of Houston Instrument

DIVISION OF **BAUSCH & LOMB** ▼

ONE HOUSTON SQUARE (at 8500 Cameron Road) AUSTIN, TEXAS 78753
 (512) 837-2820 TWX 910-874-2022 cable HOINCO
 EUROPEAN HEADQUARTERS Rochesterlaan 6 8240 Gistel Belgium
 Phone 059/277445 Telex Bausch 81399

"the recorder company"

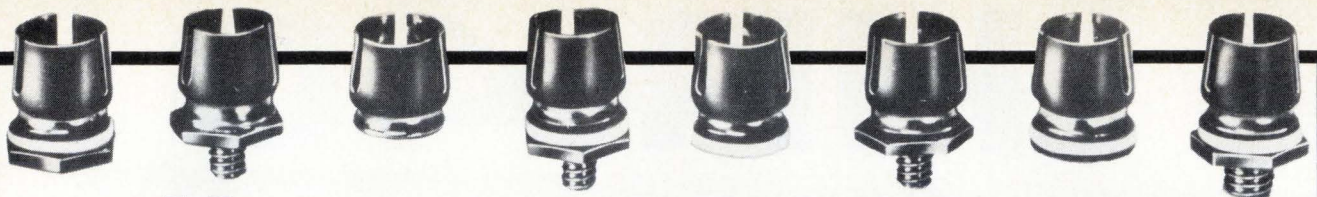

Keep Transistors Cool and Snug

Now your TO-5 and TO-18 case style transistors can be held more securely while improving thermal resistance at the same time.

Wakefield's Series 260 Cup Clips have a unique one piece construction that gives greater surface contact between the case and the clip. Results are greater holding strength and cooler operation.

These popular semi-conductor retainers are more economical than competitive makes, too. Only 10¢ apiece in quantity. Non-insulated, epoxy insulated or beryllium insulated, all types feature a flared lip for easy component insertion.

Call or write for full details and free samples.



WAKEFIELD ENGINEERING INC.

77 AUDUBON ROAD, WAKEFIELD, MA 01880 (617) 245-5900
TWX 710-348-6713

AN **EG&G** COMPANY

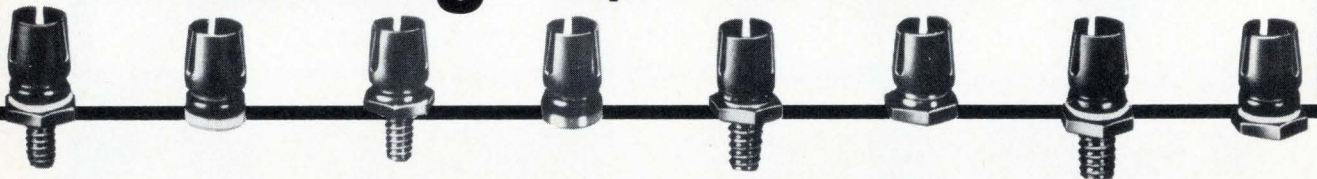

Circle 172 on reader service card

KING Q

At Vanguard, when it comes to high Q hybrid chip inductors, we definitely don't monkey around. From field-proven fixed chip inductors like the Magna Q Mini or Micro to the world's smallest variable chip inductor to complete tuned circuits, we've got all your inductive needs covered.

With every VE chip inductor, you get high Q, low DCR and high

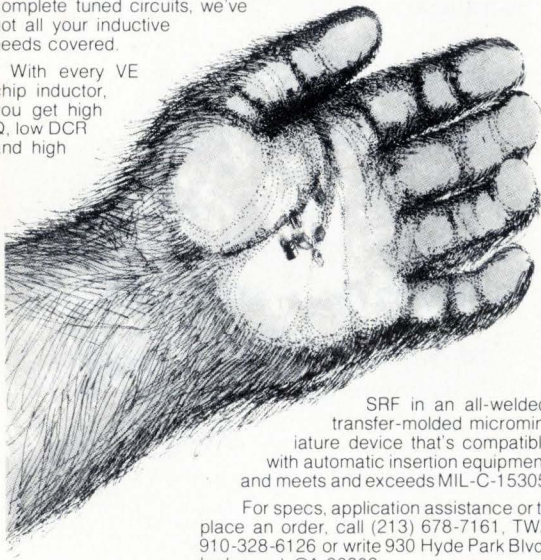

SRF in an all-welded, transfer-molded microminiature device that's compatible with automatic insertion equipment, and meets and exceeds MIL-C-15305.

For specs, application assistance or to place an order, call (213) 678-7161, TWX 910-328-6126 or write 930 Hyde Park Blvd., Inglewood, CA 90302.

VANGUARD ELECTRONICS COMPANY, INC.
King of high Q hybrid chip inductors



A new source for your custom hybrid needs.

Hydelco is ready to turn your designs into quick reality. We can do big orders. We can do small ones. We can do complex multilayers. We can do trimmers. We can do assemblies. And we can do them all fast, at a price you'll like. Next time you have a hybrid question, call Hydelco - we'll give you a high-quality answer!

HYDELCO INC.
Manufacturer of Hybrid Microcircuits

3481 Old Conejo Rd., Suite A-3, Newbury Park, Ca 91320 • (805) 498-3688

172 Circle 209 on reader service card

Circle 210 on reader service card

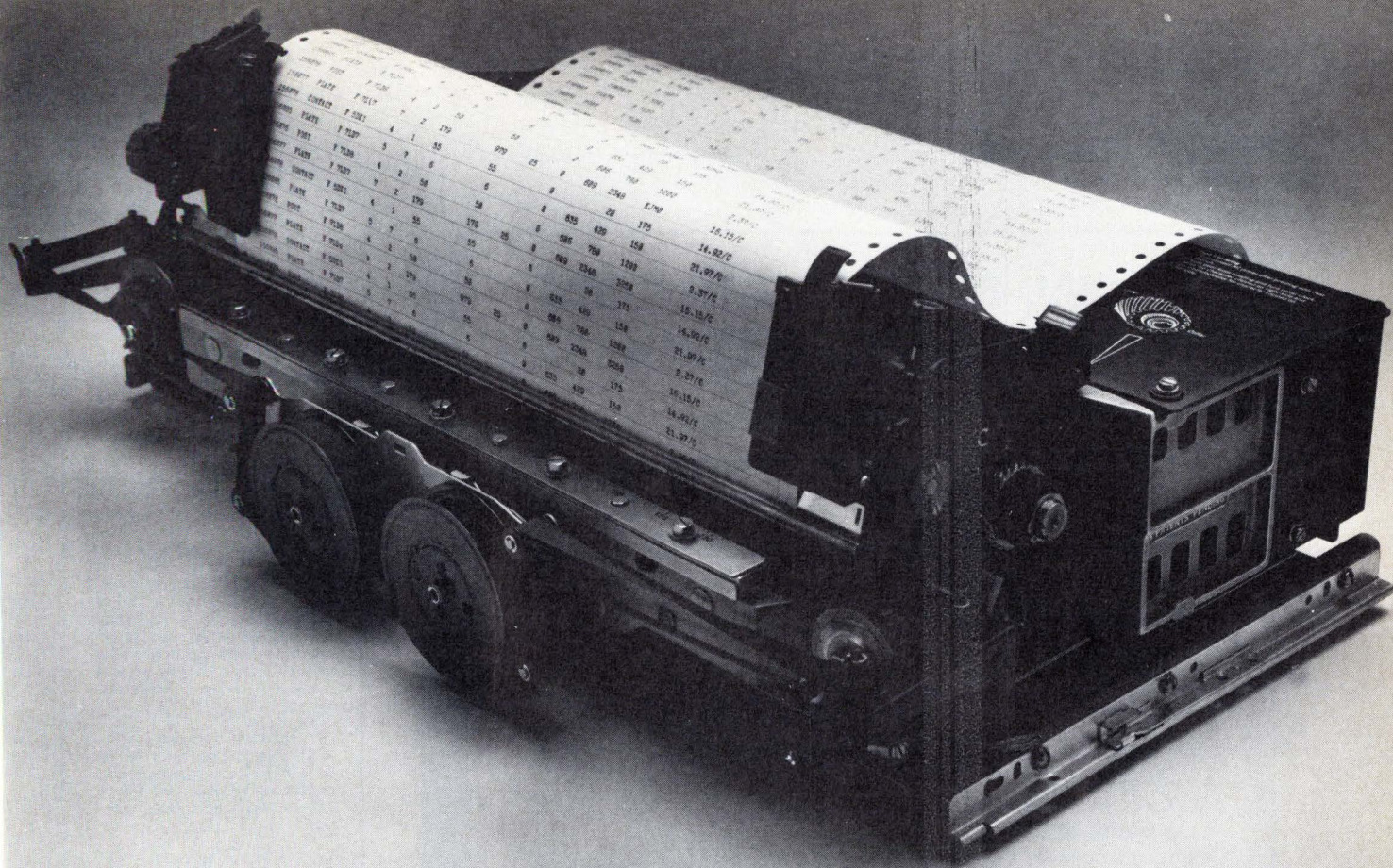

**132 columns. Over 300 lines per minute.
Under \$2000*.**

In printers, it's not just a question of how much they cost, but one of how much you get for your money. And on a price/performance basis, nothing even comes close to the Teletype® model 40 OEM printer.

Besides getting a 132-column, heavy-duty impact printer that delivers over 300 lpm for less than \$2000, you also get a printer with outstanding flexibility and reliability.

The big reason behind the model 40's price/performance advantage over the competition is our unique design. Even though it operates at speeds over 300 lpm, wear and tear is less than you'd find in a conventional printer operating at a much slower speed. Fewer moving parts and solid-state components add up to increased reliability and reduced maintenance.

We'd be ahead if we just stopped there, but the model 40 also offers you a number of other features. Like a choice of character sets, operator-adjustable form width and form length, parity error indication, and a built-in self-test feature, just to name a few.

For complete information, please contact our Sales Headquarters at: 5555 Touhy Ave., Skokie, Ill. 60076. Or call Terminal Central at: (312) 982-2000.



**The Teletype model 40 OEM printer.
Nothing even comes close.**

Teletype is a trademark and service mark registered in the United States Patent and Trademark Office.
*80-column-version available for under \$1400.

Classified section FOR ENGINEERING/TECHNICAL EMPLOYMENT OPPORTUNITIES

CLASSIFIED SALES REPRESENTATIVES
 Atlanta... Joe Lane ... 404/892-2868
 Boston... Holt Buchanan ... 617/262-1160
 Chicago... Bill Higgins ... 312/751-3733

Cleveland... Mac Huestis ... 216/781-7000
 Dallas... Paul Reiss ... 214/742-1747
 Denver... Shirley Klotz ... 303/837-1010
 Detroit... Mac Huestis ... 313/873-7410

Houston... Paul Reiss ... 713/659-8381
 Los Angeles... Stan Kassir ... 213/487-1160
 New York... Dave Hawksby ... 212/997-3594
 Philadelphia... Dan Ferro ... 215/568-6161

Pittsburgh... Dan Ferro ... 412/391-1314
 San Francisco... M.E. Kenny ... 415/362-4600
 Stamford... Holt Buchanan ... 203/359-2860
 XEROX 100 TELECOPIER ... 212/997-6800

Computer

GROW, EXPAND, ADVANCE YOUR CAREER WITH BURROUGHS

SYSTEM SOFTWARE DEVELOPMENT

Burroughs is actively staffing a small, motivated team of computer professionals to play a key role in the development of software for business minicomputers. Systems software experience or graduate degree in computer science required.

Prime areas of interest are:

- Language Design
- Data Management
- Test Systems
- Generative Software
- Operating Systems
- Microprocessor Design

About Location...

Our facility is convenient to attractive Ann Arbor and the University of Michigan. We offer an excellent salary and benefits package, plus the stability and growth of our highly successful company. For prompt and confidential evaluation of your credentials, please forward your resume and salary history to:

Manager of Professional
Employment,
Burroughs Corporation,
41100 Plymouth Road,
Plymouth, Michigan 48170.

PRODUCT ENGINEERING MANAGERS

These are immediate openings with the Small Systems Group, a high technology division responsible for the engineering and manufacture of business minicomputers, terminal systems, encoding equipment and small applications devices such as electronic calculators.

We are looking for senior engineers with experience in small data systems engineering. Candidates for these positions will have a background in and a desire to use formal analytical methods in design & problem solving. Must have ability to recruit, train, motivate and retain more junior professionals. Some management experience would be helpful.

Mechanical Design Manager

10 years' related experience in the industry plus a MSME or Physics Degree with emphasis on Mechanical Engineering are required. You should be expert in high speed mechanisms, mechanical packaging, and structural analysis. Familiarity with modern plastic packaging methods would be beneficial.

Electrical Design Manager

A MSEE or Physics background plus 10 years' related experience are required. Essentially a circuit designer, you will have experience in IC's, particularly MOS technologies, and electrical packaging and power design.

Intermediate and junior level engineers in the above disciplines are also required with 3 to 8 years' related experience.

Burroughs



an equal opportunity employer male/female

Non-Impact Printer Advanced Development

ENGINEERS—Embark with us on a new venture. The nation's leading Band Printer manufacturer is again boldly sharing a new and exciting course.

Due to our phenomenal growth, career opportunities now exist in our ink Jet and Electro-Photographic programs. Innovation, time-proven decisions, and success have demanded that we now seek out several levels of professionals—Program Managers, Project Engineers, and individual contributors. Those who are able to meet the challenge and marry Non-Impact Printer Technology to successful end-products will be guaranteed a unique and rewarding growth opportunity.

You should have experience in the Non-Impact Printing area. An advanced degree in Engineering/Physics or a B.S. with equivalent experience is required. Please submit your resume to:

Mr. Bob Brown
**COMPUTER
PERIPHERALS, INC.**

1480 N. Rochester Rd.
Rochester, Mi., 48063
(313) 651-8810—Ext. 229
An Affirmative Action Employer M/F

LE CENTRE TECHNIQUE DE L'INDUSTRIE HORLOGERE

Recherche
UN INGENIEUR EN
MICROELECTRONIQUE,

- Bonne connaissance des technologies de semiconducteurs,
- Pratique des procédés de montage et d'assemblage des circuits intégrés.
- Expérience industrielle,
- Langue anglaise indispensable et allemande souhaitée,
- Sens des responsabilités et qualités d'amateur d'une équipe.

Objectifs:

- Développements nouveaux en électronique horlogère et diversification industrielle.
- Assistance technique aux entreprises en mutation.

Candidature manuscrite avec C.V. à adresser au

Directeur General du CETEHOR
39, avenue de l'Observatoire
B.P. 1145
25003 BESANCON CEDEX
FRANCE

We have been placing graduate
ENGINEERS

in **FEE-PAID** positions
THROUGHOUT THE U.S. since
'59. Over 1,000 client companies.
We are graduate engineers working
full-time for you. Send resume
& salary history today or request
confidential application.

ATOMIC PERSONNEL, INC.

Suite L. 1518 Walnut St., Phila., Pa. 19102
An Employment Agency
For All Technical Fields

BIOMEDICAL PRODUCT SPECIALISTS

Our clients have numerous openings for qualified and experienced individuals in Technical, Marketing and Managerial positions nationwide. Send resume in confidence to:

HEALTH INDUSTRY CONSULTANTS
P.O. Box 2634, Evergreen, Colorado 80439
or call (303) 674-4696

POSITIONS VACANT

Georgia Tech—Engineering Experiment Station. Needs Electrical Engineers to perform radar and defense systems analysis/operations research in client-oriented environment. Computer Modeling and electronic system simulation experience desired MSEE/MSIE and U.S. citizenship required. Send resume to Mr. R. P. Zimmer, (Code E1) Engineering Experiment Station, Georgia Institute of Technology, Atlanta, Georgia 30332. Tel. 404-894-3519. An Equal Opportunity Employer.

EE Staff Positions—A number of openings are anticipated for both visiting and regular staff positions in various specialties for 1977-78. Applicants should have the Ph.D. Rank will depend upon detailed qualifications. The department has a large undergraduate enrollment, a small but expanding M.S. program, a growing research activity, and superb facilities. Applicants should clearly state their especial expertise and indicate what sort of position they wish. A limited number of graduate assistantships are also available. Contact Dr. R.F. Schwartz, Head, Department of Electrical Engineering, Michigan Technological University, Houghton, Michigan 49931. An equal opportunity educational institution/equal opportunity employer.

We're still adding to the world's most complete pool of microcomputer expertise.

It took a lot of talent to develop and introduce the microcomputer. Intel did it in 1971, and microcomputers soon became the fastest growing market in the business—with our industry-standard 8080 leading the way.

We're committed to staying #1 in microcomputers. And we need more professionals with the technical expertise, desire and aggressiveness to contribute to—and share in—our success. Specific opportunities at our San Francisco Peninsula headquarters include:

Microcomputer Product Manager

This is an exceptional opportunity for a marketing/engineering professional with a strong background marketing microprocessor circuits to very-high-volume customers. A technical understanding of microcomputers and their related markets is essential, accompanied by a BS in EE or computer science.

Project Leaders Compiler Development & Language Design

You'll join a dedicated team building sophisticated tools to support the construction of advanced microcomputer-based systems. This is a unique "ground-up" opportunity to design the software systems of the future. You will take leadership responsibility for the design of modern programming languages, and the development of compilers based on state-of-the-art

techniques. We require a demonstrated history of high-level technical accomplishment and leadership ability in language and translator development. MS or PhD in computer science and several years practical experience are essential.

Marketing Applications Engineers Domestic & International

The persons selected for these opportunities will demonstrate good technical understanding of computer systems and microcomputer applications. Proven ability to develop and implement marketing strategies which result in long-term business objectives required. Will be responsible for all customer marketing activities within a specific sales region. This will extend to field sales and applications support, forecasting and market analyses. You should have a BS plus at least 2 years experience marketing semiconductor memories, microprocessors or microcomputer/minicomputer systems.

Microcomputer Product Marketing Engineers

Involved with next-generation microcomputer products, your responsibilities will range from new product definition to market research. You will interface with design engineering, review data sheets and present seminars. You should have a BSEE (MBA preferred) plus 2-5 years

background in engineering and/or marketing. Familiarity with the design and/or application of CRT terminals is essential.

Software Reliability Engineers

If software engineering means more to you than eliminating GO TO's—if the joy of writing structured code no longer satisfies your concern for quality—then consider this opportunity. You will analyze and approve software specifications, review the design of software products, manage testing projects, consult with development engineers to propose quality assurance strategies, and develop tools for evaluating and assuring software reliability in all its aspects. Successful candidates will have the technical understanding to implement software of superior quality and the experience to evaluate the economic consequences of reliability. Familiarity with recent software reliability theory desired, together with an MS or PhD in computer science or equivalent.

For immediate consideration, send your resume, including salary history, in confidence to Intel Professional Employment, 3065 Bowers Avenue, Santa Clara, California 95051. An Equal Opportunity Employer M/F.

The Intel logo, consisting of the word "intel" in a lowercase, bold, sans-serif font. The letters are closely spaced, with the 'i' and 'n' being particularly prominent.

ADVANCEMENT OPPORTUNITIES

COMMUNICATIONS/ELECTRONIC WARFARE

AMECOM, a leading Eastern R & D organization, has advancement opportunities at all levels: design & development, project engineering, and program management. These positions are in the salary range of \$18,000 to \$28,000 in the systems analyses, requirements definition, systems design and advanced development of COMMUNICATIONS, EW and INTELLIGENCE SYSTEMS.

**TELECOMMUNICATIONS
SWITCHING SYSTEMS
RF SYSTEMS**

**MINICOMPUTERS
MICROPROCESSORS
ANALOG & DIGITAL SYSTEMS**

**HARDWARE/SOFTWARE
REAL TIME PROGRAMMING**

Please send your resume and salary requirements in confidence to:

J. J. FitzGerald



**AMECOM
DIVISION**
Litton Systems, Inc.

Litton 5115 Calvert Road, College Park, Md. 20740

An Equal Opportunity Employer M/F

ENGINEERS

Come in and investigate these challenging opportunities with the nation's leading band printer manufacturer.

MICROPROCESS ENGINEER

Candidate will have responsibility for hardware/software design and implementation of Microprocessor techniques to peripheral computer controller devices. Applicants for this position must demonstrate experience in:

- Design and implementation of microprocessor controllers
- TTL Logic Designs on peripheral equipment
- Intel 8080 Microprocessor family or equivalent

The above position requires a BS with a MS preferred.

Because the demand for our new products has risen to an all time high and thus launched us off into a period of expansion and growth, we shall need people in the following areas.

MECHANICAL PROJECT ENGINEER

Outstanding growth opportunities exist in creative line printer development group for imaginative and creative project leader. Experience should include vibration, stress, structural, dynamic and thermal analysis of electro-mechanical equipment. Responsibility will also include product definition and generation of product specification. MSME required BSME preferred with 5 years experience on business equipment or related field. Supervisory experience with engineers and technicians essential.

ELECTRICAL PROJECT ENGINEER

Experience will include knowledge of microprocessor technology, power supplies, power drive circuitry. Experience directing efforts of other engineers plus technicians is essential. Minimum qualifications are BSEE and 5 years experience in business equipment or related field. Experience should also include budgeting, scheduling of tasks and writing of proposals and specifications. Send resume to:

Mr. Bob Brown

Computer Peripherals, Inc.

1480 N. Rochester Road, Rochester, Michigan 48063
(313) 651-8810 — Ext. 229

An Affirmative Action Employer M/F

IMMEDIATE OPPORTUNITIES AVAILABLE WITH UNITED ASBESTOS

Employment opportunities are available in our new mining and milling plant in Matachewan, Northern Ontario. Immediate openings available for the following positions:

CHIEF ELECTRICIAN

Must be a licenced electrician with a varied working background and experience in the following areas:

- Industrial Electrical Work
- Automotive Maintenance
- Construction and Modification

Preference will be given to those with a mining background, although others will be given complete consideration.

ELECTRICIAN

Should have 3 to 5 years of electrical experience in a heavy industry setting. This new open-pit operation is located in Matachewan Ontario (55 miles from Kirkland Lake, Ontario) in an excellent fishing and hunting area. Our employees enjoy good competitive wages, a good benefits program and an outstanding HOME OWNERSHIP POLICY.

Please send resume in confidence to:

Wm. E. Fisher

United
Asbestos
Inc.

P.O. Box 99
Matachewan, Ontario
POK IMO



HERE IS A SAMPLING OF EXCEPTIONAL OPPORTUNITIES AWAITING A FEW EXCEPTIONAL PEOPLE TO JOIN AN EXCEPTIONAL COMPANY.

AT AMDAHL:

BUILDER OF THE WORLD'S MOST EXCITING COMPUTER.

Six years ago, a small group of leading designers of large computers—under the direction of a preeminent, pioneering computer scientist—set out to design and build a new generation of large computers.

Today, the Amdahl 470V/6 system is just that: a top-of-the-line, 3.8 to 5.2 million dollar computer that performs more work at lower cost than any other general-purpose computer. It's unprecedented, and so is the company.

Within the past 18 months, this exceptional company has delivered 21 of these systems. Over \$88,000,000 worth. But more to the point: 8 of the 21 were shipped within the past 90 days. Which is why we need help...from exceptional, enthusiastic individuals who need to perform well because the task is worth it, and because it's fun. We made a commitment to that philosophy when we began, and we're sticking to it. We have intentionally created a friendly environment where personal efforts are recognized. We are keeping it that way, despite our growth.

Below are some of our more immediate needs. Karen Daly would like to hear from you at Amdahl Corporation, 1250 East Arques Avenue, Sunnyvale, California 94086. Please indicate on your resume which position you are responding to in this ad. We are, of course, an equal opportunity employer.

ENGINEERING/TECHNICAL OPPORTUNITIES AT AMDAHL

CIRCUIT DESIGN GROUP MANAGER

You will be responsible for directing state-of-the-art high speed logic and memory circuit programs, interfacing with vendors and users. BSEE with 7-10 years' experience in bipolar and MOS digital or memory designs. Recent project or engineering management experience. Advanced degree preferred.

CIRCUIT DESIGNER

Your responsibilities will include device characterization, circuit simulation, chip layout, system performance trade-off, and interfacing with process engineers. Minimum BSEE, preferably MSEE, with 5 years' experience in high speed bipolar digital circuits or MOS/CMOS circuit design.

QUALITY ASSURANCE ENGINEERS

You will be responsible for achieving and sustaining uniform levels of quality for materials, assemblies, and product consistent with established specifications, workmanship standards, and reliability objectives. Positions require BSEE or equivalent plus 5 years of responsible Quality Engineering experience. You must possess thorough working knowledge of manufacturing processes and inspection methods as applicable to the design, fabrication, and production of complex electronic equipment.

SYSTEMS TEST ENGINEER

Your background should include ECL, TTL and computer hardware logic. Preferably experience with IBM 370 theory of operation. Position also requires BS/MSEE or Computer Sciences degree with 2 years' related experience.

MANUFACTURING ENGINEER

Senior manufacturing engineer with proven experience in PCB assembly and electro-mechanical assembly of electronic systems. You will be responsible for operator instructions, methods and processes. BSIE or BSME preferred.

TEST ENGINEERS

You will be responsible for ensuring the adequacy of manufacturing test, solving test correlation problems and implementing appropriate corrective action to improve testing deficiencies. Experience required in analyzing circuits, determining test requirements, and implementing appropriate test procedures and methods. Positions require BSEE with 5 years' experience in printed circuit board and sub-system test engineering utilizing computer controlled automatic test equipment.

amdahl

Hybrid Circuit Engineers

Packaging Engineer

Plans and develops hybrid processes and products. Evaluates and introduces new materials and techniques into hybrid and IC packaging. Requires minimum of 2 years hybrid assembly experience plus BS engineering with emphasis in mechanics and materials or equivalent professional experience. Connector experience desirable.

Thick Film Prototype Engineer

Works with hybrid design engineers in development of thick film circuits. Develops and documents processes. Interface with manufacturing to transfer processes. Evaluates and introduces new materials. Requires minimum of 2 years thick film processing experience plus a BS engineering or equivalent professional experience.

Tektronix, Inc., develops, manufactures and markets internationally recognized precision electronic measurement instruments, computer peripherals and related electronic instrumentation. Located near Portland, Oregon, we are within a two hour drive of the Cascade Mountains or Ocean Beaches. The close-by nature playgrounds and the City of Portland provide a variety of recreational and cultural interests.

Both positions offer competitive salary, profit sharing and an outstanding benefits package.

Please send resumes and salary history to: Bob Chambers, TEKTRONIX, INC., P.O. Box 500, E12, Beaverton, OR 97077.

An Equal Opportunity Employer M/F.



TEKTRONIX
committed to
technical excellence

RATES \$46 per advertising inch (7/8"). Commissionable.
SIZES 7/8" to 10" deep in widths of one column (1 5/8"), two (3 3/8"), three (5 1/8"), and four (7").
CLOSING Two weeks prior to mailing.
MAILING One week prior to issue date.
ISSUE DATE Every other Thursday.
AD ORDERS/BOX NUMBER ANSWERS Send to Electronics, Post Office Box 900, New York, N.Y. 10020.

ADC

SENIOR DESIGN ENGINEER TEST INSTRUMENTS

ADC is an aggressive electronics company involved in the design and manufacture of test equipment for the telephone industry.

We are currently seeking a BSEE with 5 years experience in test instrument design. Background should include analog and audio frequency experience.

Will be involved in development of specifications for state-of-the-art test instruments; perform complete instrument design, including control and display layout, as well as the measuring circuit design; serve as the test instrument consultant to other design engineers and to marketing.

For consideration, please forward resume in confidence to:

MIKE WETHERBEE

ADC PRODUCTS

4900 W. 78th St. Minneapolis, Minn. 55435
An Equal Opportunity Employer

ADC

FREE

Your dream job.

We hope you're happy in your current position, but there's always that ideal job you'd prefer if you knew about it.

That's why it makes sense to have your resume on file in the Electronics Manpower Register, a computerized data bank containing the qualifications of career-conscious ELECTRONICS readers just like yourself.

You'll benefit from nation-wide exposure to industry firms privileged to search the system, and since the computer never forgets, if you match up with their job requirements you'll be brought together in confidence.

To take advantage of this free service, mail your resume to the address below.

ELECTRONICS MANPOWER REGISTER
Post Office Box 900/New York, N.Y. 10020

CAREER OPPORTUNITIES

TOTAL SYSTEMS ENGINEERING

Think of NCR as over 70,000 people, all involved—one way or another—with the processing of information. We're active. We research, invent, develop, manufacture, market and service many kinds of information products and systems and we do it in all the major cities in the United States plus over 100 foreign countries.

We are seeking career-oriented persons for the positions listed below:

CORPORATE STAFF - R&D

DATA COMMUNICATIONS SYSTEMS

Join the NCR professionals and become a vital part of our growing communication systems planning staff.

We are seeking several highly qualified people to be contributors on our dynamic team that will influence and guide our future in Data Communication Systems. These individuals will be highly qualified in current technologies and also have skills in business planning and program management.

Applicants must have strong systems orientation and substantial experience with communication systems. Creativity with systems concepts and architectures is essential. In addition, several years of pertinent experience and in-depth knowledge in one or more of the following areas are desired.

- Operating system provisions towards communications, including Communication Access Methods.
- Communication Processor Architecture
- Packet Switching Network Architecture
- Communication Link Disciplines, especially SDLC
- Communication Systems Diagnostics
- Interfacing different vendors' terminals and mainframes or minicomputers.

A degree in Engineering, Computer Science or equivalent is required with preference being an advanced degree. An MBA would be a substantial asset. Salary is commensurate with experience.

PRODUCT DEVELOPMENT PROGRAM MANAGEMENT

Growth has created several openings for senior professionals and managers in our Product Development/Program Management areas.

If you have expertise in the above areas dealing with total business systems plus engineering, software and business planning experience, you will want to investigate these outstanding opportunities.

R&D ENGINEERS

Become a part of our Corporate Advanced Development Engineering staff and apply your ideas and skills in the following areas:

- Data Communications, Terminals and Terminal Networks.
- Data Processing, Terminal Systems, Architecture and Software/Hardware interfaces
- Computer Peripherals and Input/Output Subsystems.

If you don't see your career opportunity, write anyhow. We'll evaluate your desires and qualifications. We might have the opportunity you are looking for. Act now! Don't delay!

For a quick response, send your resume to:

Mr. Vernon L. Mirre

Corporate Executive & Professional Recruitment

NCR Corporation

Dayton, Ohio 45479

TERMINAL SYSTEMS DIVISION-DAYTON DAYTON, OHIO

Our division is actively involved in the design and implementation of financial terminal systems. If you are seeking a "Hands-On Environment" consider the following positions:

SYSTEMS ENGINEERS

Requires the development of concepts and specifications for new systems for financial terminal systems.

Requires the ability to analyze and participate in hardware and software development programs. Basic educational qualifications for these positions are a BS or MS in EE, CS or Math and 2 to 7 years experience.

We offer an excellent fringe benefit package and a salary commensurate with your experience. If you are interested in a challenging opportunity, submit your resume and salary requirements to:

Mr. Robert L. Opalek
Employment Department
Terminal Systems Division-
Dayton
NCR Corporation
Dayton, Ohio 45479



An Equal Opportunity Employer

ELECTRONIC ENGINEERS Analog Circuit Design

Kearfott Division, the leader in aerospace navigation and guidance, has exciting ground-floor opportunities for experienced analog circuit designers. These assignments on the latest aerospace, aircraft and missile programs offer long-term stability, career growth and technical challenge.

BSEE required (MS preferred) together with in-depth experience in analog circuit design as well as a comprehensive knowledge of feedback theory. Additional experience in digital design and familiarity with design techniques and components applicable to micro-miniaturized system is necessary. A background in hybrid and/or nuclear hardened circuits an added plus.

Send resume including salary requirements in complete confidence to: **Mr. E. DeGennaro, Singer Company, KEARFOTT Division, 1150 McBride Avenue, Little Falls, N.J. 07424.**

SINGER
AEROSPACE & MARINE SYSTEMS

*An equal
opportunity
employer,
m/f
Who creates
opportunities*

POSITION WANTED

Electronic Technical/Engineering Aide—8 years experience radars and CPU's. 4 years weapons system design. 12-15K. Interested in relocation. PW-3760, Electronics.

Sr. Digital Engineer

San Francisco Peninsula

At GTE Sylvania, we're deeply involved in a variety of technical projects and programs in Reconnaissance, EW and lasers. We seek an individual with a working knowledge of FORTRAN, and assembly language programming, data communications, computer architecture and interfacing to specify and develop hardware and system configurations for Real Time Signal Processing Systems. These systems will involve distributed processing and special FFT Processors. Candidates should have a BSEE or equivalent plus 6 years of applicable experience. Additional background in Analog design is desirable.

Expand your career today and expect an informal yet professional environment where meaningful challenges, excellent starting salary and a wide range of benefits await you.

For immediate consideration, please forward your resume with salary history/requirements to P.O. Box 188, Dept. E-363, Mountain View, Ca. 94040. An equal opportunity employer.

GTE SYLVANIA

POSITION VACANT

Cost Account.—Semi Conductor background. \$20-25,000. Materials Mgr-Supervise, purch., invent. contr., traffic \$20-27,500. Financial mgr. heavy cost and financial mgt., \$20-25,000. Low cost of living, great climate, outstanding growth potential. All positions fees, relocation etc. company paid. Send resumes in confidence or call Chaya McKenney, CEC, Snelling & Snelling, 428 Plaza Bldg., Pensacola, FL 32505 (904) 434-1311.

Assistant or Associate Professor of Electrical Engineering—A position is available for a regular faculty position in the area of electronic materials. Candidate must possess the Ph.D. degree, have an electrical engineering background, and must be interested in and capable of working on an existing interdisciplinary project involving investigation of point defects in intermetallic compounds and oxides. In addition, the position will involve teaching regular electrical engineering courses and the expectation of separately-developed research. Some non-academic or post-doctoral experience is desirable though not essential. Funds are available for some summer support and for student help, supplies, and travel. The department has a large undergraduate E.E. enrollment, a small but growing M.S. program, expanding research activities, and superb new facilities. Send resume to Dr. R.F. Schwartz, Head, Department of Electrical Engineering, Michigan Technological University, Houghton, Michigan 49931. An equal opportunity educational institution/equal opportunity employer.

Electronics Engineers—All Disciplines, Microwave, Analog, Digital, Circuitry, Instrumentation and Controls, openings nationwide for design, applications and sales. \$14-40K, Fee Paid. Write, in confidence, to Mr. C. Robin, P.E., Dunhill Tech Search, 182 Forbes Road, Braintree, MA 02184, 617-848-6320.

STILL LOOKING FOR YOUR DREAM JOB?

Then be sure to check out the employment opportunities contained in ELECTRONICS' Classified Section.

Or, why not consider placing a Position Wanted ad? The cost is low (only \$1.25 per line) and the results are often rewarding. For more information call or write:

ELECTRONICS Post Office Box 900
New York, N.Y. 10020 • Phone: 212/997-2556



Hutson Has Thyristor Chips

We Can Also Design One For Your Specific Applications... And Save You Money, Too

TRIAC and SCR chips are available from Hutson in standard geometrics. Or, if you have a special application, Hutson will design the chip you need to meet exact specifications. Hutson standard chips feature all-diffused construction. All chips are glass-passivated and hermetically sealed with reflow-solder construction for ease, reliability and economy of chip mounting. Many Hutson chips are available with center gating for improved di/dt and dv/dt characteristics. Call Hutson... or contact one of the Hutson representatives nearest you.

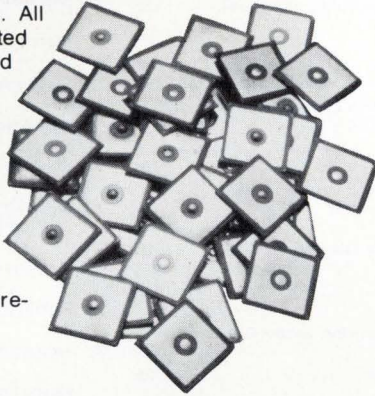

REPRESENTATIVES

ALABAMA Huntsville: K&E Associates (205) 883-9720. **ARIZONA** Tempe: Gassner & Clark (602) 968-9037. **CALIFORNIA** Glendale: Orion Sales (213) 240-3151; Redwood City: Parks & Pruitt (415) 364-1640; Tustin: Orion Sales (714) 832-9687. **COLORADO** Denver: Electrodyne, Inc. (303) 757-7679. **CONNECTICUT** Newton: Gerber Sales (203) 426-3440. **FLORIDA** Lighthouse Point: R. C. Simon (305) 941-2757. **GEORGIA** Hartwell: K&E Associates (404) 376-5438. **ILLINOIS** Chicago: L-Tec, Inc. (312) 286-1500. **INDIANA** Greenwood: Valentine/Schillinger (317) 888-2260; South Bend: Valentine/Schillinger (219) 291-6258. **KANSAS** Wichita: Dytronix, Inc. (316) 943-6221. **MARYLAND** Baltimore: Stemler Associates (301) 944-8262; Pasadena: Stemler Associates (703) 548-7818. **MASSACHUSETTS** E. Longmeadow: Gerber Sales (413) 525-3059; Waltham: Gerber Sales (617) 890-8040. **MICHIGAN** Grosse Pointe Park: Greiner Assoc. (313) 499-0188. **MINNESOTA** Minneapolis: Bitronics Sales Co. (612) 835-7744. **MISSISSIPPI** Corinth: K&E Associates (601) 287-5369. **MISSOURI** Hazelwood: Dytronix, Inc. (314) 731-5799; Independence: Dytronix, Inc. (816) 737-1100. **NEW JERSEY** Haddonfield: Sunday-O'Brien (609) 429-4013; Irvington: Murray Gallagher, Inc. (201) 399-4350. **NEW YORK** N. Syracuse: Precision Sales (315) 458-2223 (NYC. Gallagher — see New Jersey). **OHIO** Chagrin Falls: Midwest Marketing Association (216) 249-2816; Dayton: Midwest Marketing Assoc. (513) 433-2511. **OREGON** Beaverton: N. R. Schultz (503) 643-1644. **TEXAS** Plano: Precision Devices (214) 423-7618. **WASHINGTON** Bellevue: N. R. Schultz (206) 454-0300. **WISCONSIN** Greenfield: L-Tec, Inc. (414) 545-8900. **UTAH** Salt Lake City: Electrodyne, Inc. (801) 277-8392.

HUTSON INDUSTRIES

P. O. Box 34235
2019 West Valley View Lane
Dallas, Texas 75234
(214) 241-3511
TWX 910-860-5537

EUROPEAN OFFICE
30 Rue Pierre Semard
Yverres, 91, France
Telephone: Paris 925-8258
TELEX 210-311

Circle 183 on reader service card

COMBINATION LOCK

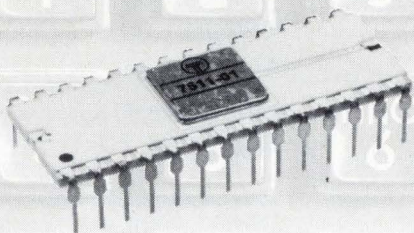

Combine Telenetics 7511 Address Selector with a set of keyswitches to produce an electronic combination lock.

Combine the 7511 Address Selector with Telenetics 7516 Touch-Tone Decoder to provide station selection with high coding security for busy communications systems.

Code programming is simply a matter of pin selection...program capacity can be 10¹² discrete codes or higher with more switches. The 7511 comes in a 28 pin DIP. Telenetics also offers:

- 7507 Analog Switches
- 7508 Multiplexers
- 7509 Solid State Switches
- 7516 Touch Tone Decoder
- 7603 Touch Tone Encoder
- 7635 Keyswitch Assemblies

Call or write today for catalogs, prices and applications assistance.

Telenetics Telenetics, Inc., 4120 Birch Street,
Newport Beach, California 92660
Phone: (714) 752-6363

Circle 211 on reader service card

OAK MINIATURE TOGGLE SWITCHES

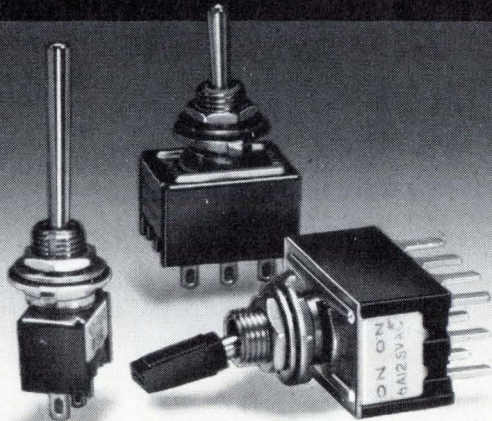

The same Oak quality and dependability you expect and get in rotary and pushbutton switches is now available to you in these Oak toggle switches.

- Single to 4 pole double throw switching
- Seven basic actuator styles
- Solder tab, Wirewrap™ or PC terminals
- 6 amp rating at 125 VAC
- Silver or Gold plated contacts
- Competitively priced

Stocked for immediate delivery by Oak distributors. For a catalog and the name of your nearest distributor, contact

OAK Industries Inc.
SWITCH DIVISION / CRYSTAL LAKE, ILLINOIS 60014
TELEPHONE: 815-459-5000 ■ TWX: 910-634-3353 ■ TELEX: 72-2447
TM: Gardner-Denver

Circle 212 on reader service card 183

RF & MICROWAVE SOURCES INFRA-RED, LF, UHF and VHF

RADAR SYSTEMS: 150 MHZ to 35 GHZ

AUTOTRACK ANTENNA MOUNTS: Nike Hercules, Nike Ajax, SCR 584. Capacity 50 lbs. to 10,000 lbs. Light Airborne to Sage Systems

RADAR INDICATORS: PPI-RHI-A/B/C/Scopes

PULSE MODULATORS: 25KW to 10 Megawatts

HIGH VOLTAGE POWER SUPPLIES: Up to 20KV 2A

MICROWAVE TUBES: TWT, Klystron, BWO, Carcinotron, Magnetron Every Frequency

MICROWAVE COMPONENTS

SONAR SYSTEMS

SEND FOR FREE 24 PAGE
CATALOG ON YOUR LETTERHEAD



**RADIO RESEARCH
INSTRUMENT CO. INC.**

2 LAKE AVENUE EXTENSION, DANBURY,
CT. 08610 (203) 792-6666

Circle 221 on reader service card

L BAND HI-POWER CW RF PACKAGE (755 to 985 MHz)

150KW **CW**

OR

75KW **CW**
SYSTEMS

INPUT POWER: 460V 3 ϕ 60CPS, 208/120 3 ϕ 60CPS—Solid State Power Supplies (Westinghouse Interteen Class OA 480KVA LV614)

COMPLETE SYSTEMS: Demineralizers, RF Loads, Filters, 3 Each Varian VAB53 Klystrons, Coolers, Large Quantity WR-975 Hardware, Technical Manuals, Etc.

TECHNICAL/MAINTENANCE: Personnel Available with Ten Years Practical L Band High Power RF Application Experience

AVAILABILITY: Immediate Availability—Sales Terms/Conditions, Other Details Upon Request

FS-3732-ELECTRONICS
CLASS. ADV. DEPT., P.O. BOX 900
N.Y., N.Y. 10020

184 Circle 184 on reader service card

Electronics advertisers

December 9, 1976

ADAC	185	Delevan Division American Precision Industries, Inc.	128
* Adret Electronique	54	Deltron	162
Advanced Micro Devices	10, 11	■ Dialight Corporation	188
* AEG Telefunken	17E	‡ Digital Equipment Corporation (Components)	54
■ Airpax Electronics Inc.	134	‡ Eastman Kodak Company Graphics Markets Division	75
Alco Electronics Products Inc.	163	■ E&L Instruments Inc.	153
American Optical Scientific Instrument Division	147	Electronic Memories & Magnetics	118, 119
■ AMP Incorporated	130, 131	Electronic Navigation Industries	70
Amphenol Connectors Division Bunker Ramo Corporation	17, 57	EMR-Telemetry	169
* Amphenol Tuchel	32E	Endicott Coil Co. Inc.	144
Ansley Electronics Corp.	24	* English Electric Valve Company Ltd.	12E, 13E, 166, 167
Anritsu Electric Co., Ltd.	126	Esterline Angus Instrument Corporation	168
* Bayer AG	31E	Fairchild Camera & Instrument Corp.	46-47
‡ Beckman Instruments Inc. Helipot Division	143	‡ Ferroxcube Corp.	9
Belden Corporation	129	Figaro Engineering Inc.	6
Bell, F.W.	162	Florida Department of Commerce	148
Biomation	18, 19	Fujitsu Limited	48
B & K Precision Division Dynascan Corporation	160	* Ganz Measuring Instruments	8E
■ Bourns Inc.	4th C	General Automation	60-61
* Burr Brown Research Inc.	29E	General Electric Panel Meter	28-29
‡ Bussman Mfg. Division of McGraw Edison Co.	67	General Instrument Corporation, Microelectronics Division	37
Centralab USCC	77	* General Instrument Corporation, Semi. Comp. Division	71
* Centronics	117	GenRad	13
■ Cherry Electrical Products Inc.	68	■ Gould Inc.	100, 159
Chicago Miniature Lamp Works	132	Grayhill Inc.	142
Chomerics Inc.	136	Gulf Power Company	170
* Communication Associates Inc.	67	Gustav A. Ring A/S	161
Continental Rentals	8	■ Hewlett-Packard	1,2,98,135, 140, Second Cover
Continental Specialties Corporation	150, 155	Honeywell Test Instrument Division	122
Control Data Corp	139	Houston Instruments	171
Corning Glass Works Fluidic Products Department	133	■ Hughes Aircraft Company	40, 41
C. P. Clare & Company	114	Hutson Industries	183
CPS-Converter Products	168	Hydelco	172
■ Custom Electronics Inc.	186	ILC Data Devices	39
* Dale Electronics Inc. A Subsidiary of Lionel Corporation	14E, 15E	Infotek Systems	158
Dana Laboratories	154	International Crystal Manufacturing Company	124
Data General Corporation	27	International Electronics Research Corporation	150
■ Data Precision	125	Interstate Electronics Corp.	145
* Datron Electronics, Ltd.	52	* Italtel/SIT	21E, 25E
Delco Electronics Division General Motors Corporation	152	■ Ithaco, Inc.	160

Electronics/December 9, 1976

‡ ITT Components Group	71	Solarex Corp	168
■ Johanson Manufacturing Corporation	20	* Solartron/Schlumberger	6E, 30E
Keithley Instruments	62, 63	SPI-ITT	27E
Krohn Hite Corporation	5	Sprague Electric Company	51
* LTT	16E	■ Sprague Goodman Electronics Inc.	146
* Magneti Marelli	9E	Systron Donner Concord Instrument	156
Magnetic Shield	138	Tansitor Electronics	6
Markarian Bros. & Associates	184	Tau-tron, Inc.	8
3M Electronics Division	Third Cover	* TEAC Corp.	45
* Monsanto Company	127	■ Tektronix Inc.	35
Mostek Corp.	22, 23	Teletype	173
■ Motorola Semiconductor Products Inc.	111	Telenetics, Inc.	183
National Tel-tronics	144	Telonic Altair	137
Newman Computer Exchange	6	Teradyne Inc.	64
Norland Instruments	148	Texas Instruments Incorporated Components Div.	141
OAK Industries Inc. Switch Division	183	TRW Capacitors	151
Opto 22	16	■ TRW Cinch Connectors	157
Optron, Inc.	14	TRW Systems Group	72, 73
Permag Corporation	138	United Systems Corp. a Sub of Monsanto Co.	163
* Philips Elcoma	10E, 22E, 23E	United Technologies, Norden Division	58-59
■ Powermate	146	Unitrode Corporation	30
Power-One, Inc.	140	U.S. Instrument Rentals Inc.	169
Precision Monolithic Inc.	15	Vanguard Electronics	172
Radio Research Instrument Corporation	184	Varo Semiconductor Inc.	188
Ramtek	21	‡ Vu-Data	117
Raytheon Co. Industrial Components	9	Wakefield Engineering Inc.	172
‡ Rental Electronics Inc.	52	Wavetek San Diego Inc.	80
Rhone Poulenc	149	* Wilmot Breedon Electronics Ltd	19E
* Rifa	18E	Wiltron Company	186
Rockwell International Electronics Group	42, 43		
* Rohde & Schwarz	1E		
Rotron Incorporated	7		
* SDSA	165		
* S.E. Labs. (EMI) Ltd.	4E		
* Seimart	5E		
‡ Semicoa	187		
* Sepa S.p.A	44		
* Sescosem	2E, 3E		
* Sfernice	28E		
SGS Ates	120		
* Shell Intern'l Chemical Co. Ltd.	114		
Siliconix	44, 45		
* Sodeco	11E		

Classified and employment advertising

F. J. Eberle, Manager 212-997-2557

ADC Products	178
Aemcom Div., Litton Systems	176
Aeronutronics Ford	181
Amdahl Corp.	177
Anchor Hocking Corp.	181
Atomic Personnel Inc.	174
Burroughs Plymouth Computer	174
Centre Technique Del'Industrie Horlogere	174
Computer Peripherals Inc.	174, 176, 182
GTE Sylvania	180
Health Industry Consultants	174
ITT Aerospace/Optical	182
Intel-SC	175
NCR Corp., Dayton OH	179
Singer Kearfott	180
Tektronix	178
United Asbestos Inc.	176
Vought Corp.	182

■ For more information of complete product line see advertisement in the latest Electronics Buyers Guide
 * Advertisers in Electronics International
 ‡ Advertisers in Electronics domestic edition

LSI-11 Micro- computer Data Acquisition System

The ADAC Model 600-LSI-11 is the first data acquisition system available for use with the DEC LSI-11/PDP-11/03 microcomputers.

Both software and hardware compatible, the Model 600-LSI-11 A/D system plugs directly into the bus of the LSI-11/PDP-11/03 systems.

Features include a 12 bit A/D converter, high speed sample and hold circuit, from 16 to 64 channels of MUX., DC/DC power converter and bus interfacing. A/D system throughput rate is 35 KHz.

Optionally available are: one or two 12 bit D/As and programmable gain amplifier with auto zeroing circuit.

Basic system price in single quantity is \$895.

Send for full technical data on the Model 600-LSI-11 and other ADAC minicomputer data acquisition and control systems and modules.

ADAC Corporation,
15 Cummings Park, Woburn,
MA 01801. (617) 935-6668.

GSA Contract Group 66.

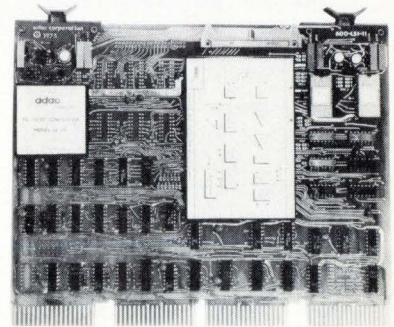

adac
corporation

Balco

DIVISION

- Capacitors for
Time Circuits
Delay Lines
R. C. Oscillators
Integrators
- Smallest Size
 - Exceptional Performance
 - Low Cost
 - Fast Delivery
 - Long Term Stability

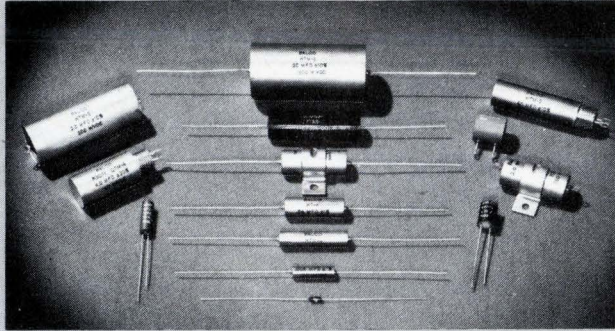

featuring Clear and Metalized DuPont TEFLON® types

Style Parameters	Extended Foil (RTWGX)	Metalized Film (RTWGMX)
Capacitance Range (μF)	0.0005 to 2.0	0.05 to 4.0
Working Voltage (Vdc)	50 to 600	50 to 600
Temperature Coefficient	± 1.5%	- 90 PPM/°C ± 40
DF at 25°C and 1 kHz (%)	0.05	0.1
Operating Temperature Range (°C)	- 55 to + 175	- 55 to + 175
Dielectric Absorption (%)	< 0.05	< 0.05
IR (Ohms)	> 1 × 10 ¹²	> 1 × 10 ¹⁰

Contact Custom for capacitors to suit your applications. Write for Brochure



CUSTOM ELECTRONICS, Inc.
Balco Division
12 Browne Street, Oneonta, N.Y. 13820
Ph: 607-432-3880 TWX: 510-241-8292

Circle 186 on reader service card

RF detectors for every application

100 kHz to 18.5 GHz
Field replaceable diodes

You can get the detector suited to your needs from WILTRON's broad line.

And in all of these high-performance detectors the diodes are field replaceable.

Note, too, the variety of available connectors: BNC, N, APC and SMA (see table).

Discounts to 15% in quantity. Stock delivery.

Call Walt Baxter at WILTRON now for details.



Model	Range	Connectors		Flatness	Price \$
		In	Out		
71B50	100 kHz-3 GHz	BNC Male	BNC Fem.	± 0.5 dB	70
73N50	100 kHz-4 GHz	N Male	BNC Fem.	± 0.2 dB	75
74N50	10 MHz-12.4 GHz	N Male	BNC Fem.	± 0.5 dB	145
74S50	10 MHz-12.4 GHz	SMA Male	BNC Fem.	± 0.5 dB	165
75A50	10 MHz-18.5 GHz	APC-7	BNC Fem.	± 1 dB	190
75N50	10 MHz-18.5 GHz	N Male	BNC Fem.	± 1 dB	170
75S50	10 MHz-18.5 GHz	SMA Male	BNC Fem.	± 1 dB	170



930 E. Meadow Drive • Palo Alto, Ca. 94303 • (415) 494-6666 • TWX 910-373-1156

186 Circle 214 on reader service card

Advertising Sales Staff

Atlanta, Ga. 30309: Glen N. Dougherty
100 Colony Square, 1175 Peachtree St., N.E.
[404] 892-2868

Boston, Mass. 02116: Frank Mitchell
607 Boylston St. [617] 262-1160

Chicago, Ill. 60611
645 North Michigan Avenue
Robert W. Bartlett (312) 751-3739
Robert M. Denmead (312) 751-3738

Cleveland, Ohio 44113: William J. Boyle
[716] 586-5040

Dallas, Texas 75201
2001 Bryant Tower, Suite 1070
[214] 742-1747

Denver, Colo. 80203: Harry B. Doyle, Jr.
123 Speer Blvd. #400
[303] 837-1010

Detroit, Michigan 48202: Robert W. Bartlett
1400 Fisher Bldg.
[313] 873-7410

Houston, Texas 77002: Paul Reiss
601 Jefferson Street, Dresser Tower [713] CA 4-8381

Los Angeles, Calif. 90010: Robert J. Rielly
Bradley K. Jones, 3200 Wilshire Blvd., South Tower
[213] 487-1160

New York, N.Y. 10020
1221 Avenue of the Americas
Warren H. Gardner [212] 997-3617
Michael J. Stoller [212] 997-3616

Philadelphia, Pa. 19102: Warren H. Gardner
Three Parkway,
[212] 997-3617

Pittsburgh, Pa. 15222: Warren H. Gardner
4 Gateway Center, [212] 997-3617

Rochester, N.Y. 14534: William J. Boyle
9 Greylock Ridge, Pittsford, N.Y.
[716] 586-5040

San Francisco, Calif. 94111: Don Farris
Robert J. Rielly, 425 Battery Street,
[415] 362-4600

Paris: Alain Offergeld
17 Rue-Georges Bizet, 75116 Paris, France
Tel: 720-73-01

Geneva: Alain Offergeld
1 rue du Temple, Geneva, Switzerland
Tel: 32-35-63

United Kingdom & Scandinavia: Robert Ghey
Tel: 01-493-1451, 34 Dover Street, London W1

Scandinavia: Andrew Karnig and Assoc.
Kungsholmsgatan 10
112 27 Stockholm, Sweden
Tel: 08 51 68 70 Telex: 179 51

Milan: Luigi Rancati
1 via Baracchini, Italy Phone 86-90-656

Brussels: Alain Offergeld
23 Chaussee de Wavre
Brussels 1040, Belgium
Tel: 13-73-95

Frankfurt/Main: Fritz Krusebecker
Liebigstrasse 27c, Germany
Phone 72 01 81

Tokyo: Tatsumi Katagiri, McGraw-Hill
Publications Overseas Corporation,
Kasumigaseki Building 2-5, 3-chome,
Kasumigaseki, Chiyoda-Ku, Tokyo, Japan
[581] 9811

Australasia: Warren E. Ball
IPO Box 5106, Tokyo, Japan

Business Department

Thomas M. Egan,
Production Manager [212] 997-3140

Gayla Black
Production Manager [212] 997-2044

Carol Gallagher
Production Manager International
[212] 997-2045

Dorothy Carter
Production Manager Domestic
[212] 997-2908

Frances Vallone
Reader Service Manager
[212] 997-6057

Electronics Buyers' Guide

H.T. Howland, General Manager
[212] 997-6642

Regina Hera, Directory Manager
[212] 997-2544

Gayla Black, Production Manager
[212] 997-2044

Classified and Employment Advertising

Frank Eberle, Manager
[212] 997-2557

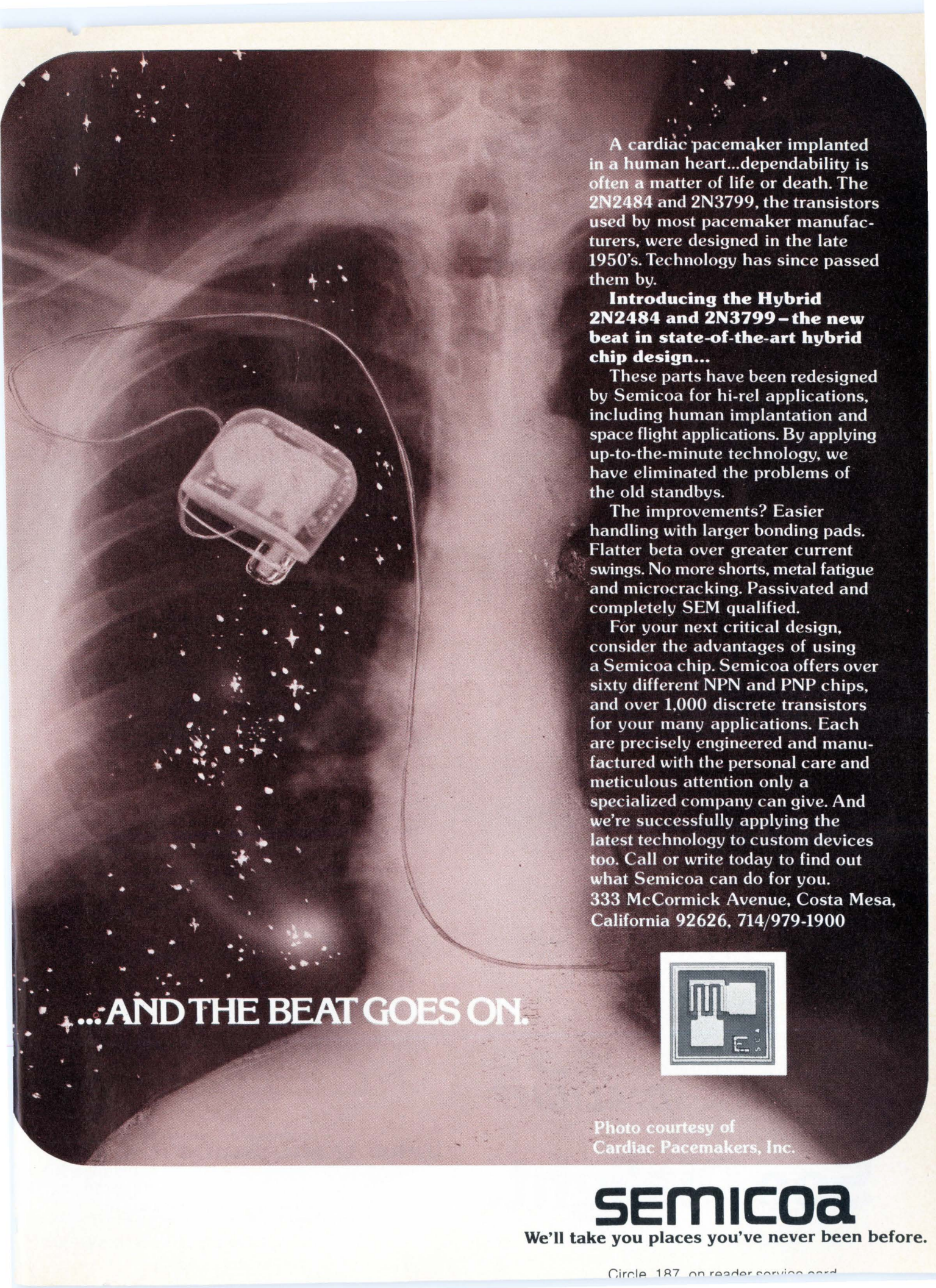

A cardiac pacemaker implanted in a human heart...dependability is often a matter of life or death. The 2N2484 and 2N3799, the transistors used by most pacemaker manufacturers, were designed in the late 1950's. Technology has since passed them by.

Introducing the Hybrid 2N2484 and 2N3799 - the new beat in state-of-the-art hybrid chip design...

These parts have been redesigned by Semicoa for hi-rel applications, including human implantation and space flight applications. By applying up-to-the-minute technology, we have eliminated the problems of the old standbys.

The improvements? Easier handling with larger bonding pads. Flatter beta over greater current swings. No more shorts, metal fatigue and microcracking. Passivated and completely SEM qualified.

For your next critical design, consider the advantages of using a Semicoa chip. Semicoa offers over sixty different NPN and PNP chips, and over 1,000 discrete transistors for your many applications. Each are precisely engineered and manufactured with the personal care and meticulous attention only a specialized company can give. And we're successfully applying the latest technology to custom devices too. Call or write today to find out what Semicoa can do for you.
333 McCormick Avenue, Costa Mesa, California 92626, 714/979-1900

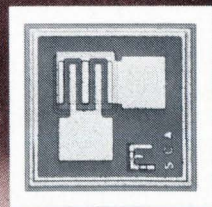

Photo courtesy of
Cardiac Pacemakers, Inc.

...AND THE BEAT GOES ON.

SEMICOA

We'll take you places you've never been before.

Circle 187 on reader service card

Dialight LED Displays

The widest choice for your every application.

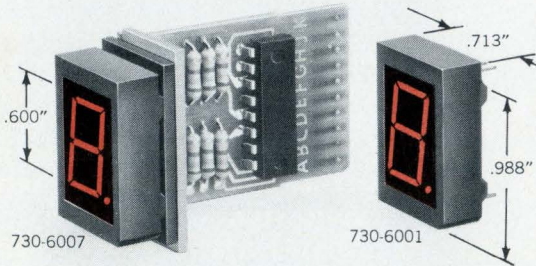

730 SERIES A new 0.600" LED character in super bright red, seven-segmented readout . . . low power . . . draws 10mA/segment or less . . . operates with standard IC power supply levels. Very high contrast ratio . . . visible from 40'. Available with or without on-board decoder/driver, plus or minus bar, and with bezel mounting. In 1000-lot quantities each LED
730-6007 . . . \$6.95. 730-6001 . . . \$2.55.

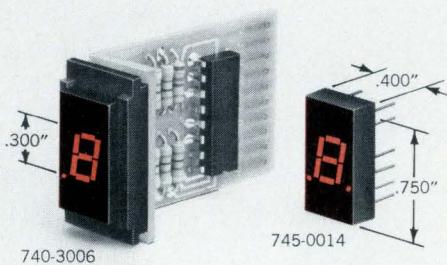

745 SERIES A new 0.300" LED character in a very bright red, seven-segmented readout . . . low power requirements. Standard 14-pin DIP . . . available with left and right decimal with ± 1 , and with and without on-board decoder/driver. Compatible with most TTL and DTL circuits. In 1000-lot quantities each
740-3006 . . . \$6.43. 745-0014 . . . \$2.10.



Dialight, the company with the widest choice in switches, LEDs, indicator lights and readouts, looks for needs . . . your needs . . . and then they develop solutions for your every application. No other company offers you one-stop shopping in all these product areas. And no other company has more experience in the visual display field. Dialight helps you do more

with these products than any other company in the business, because we are specialists that have done more with them. Talk to the specialists at Dialight first. You won't have to talk to anyone else. Send for your free new copy of Dialight's current catalog.

DIALIGHT

Dialight, A North American Philips Company
 203 Harrison Place, Brooklyn, N. Y. 11237
 (212) 497-7600

See Dialight.

188 Circle 188 on reader service card

SCHOTTKY BARRIER RECTIFIERS

40V PIV

AVAILABLE FROM STOCK

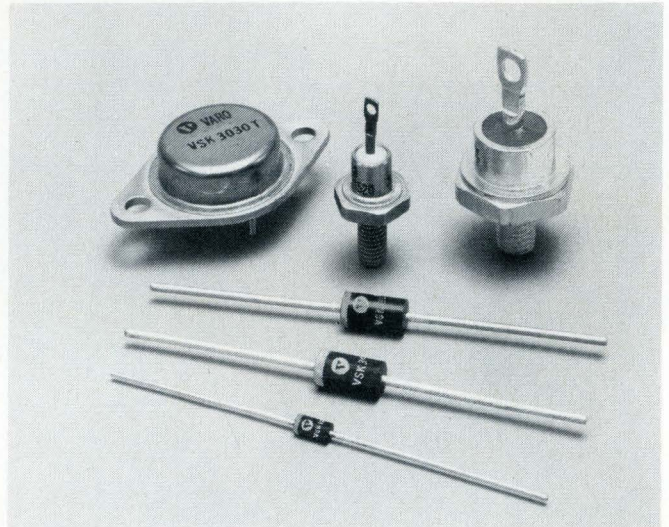

Varo Schottky Barrier Rectifiers offer you many significant advantages:

VERY LOW FORWARD VOLTAGE DROP (V_F)

Because of the large metal-barrier-to-silicon junction, V_F ranges are from 550 mV, $I_F = 1$ A, to 620 mV, $I_F = 40$ A. This results in less heat dissipation, low power loss, and greatly improved efficiency.

EXTREMELY FAST RECOVERY TIMES (t_{rr})

Typically ≤ 10 nsec. Schottkys are ideally suited for low-voltage power supplies, free-wheeling diode and flyback diode applications, and polarity protection in high-speed switching circuits.

MAJORITY CARRIER CONDUCTION

In addition to fast recovery, Schottky barrier construction results in high surge capacity and low stored charge. Schottkys are not subject to conventional P-N diode forward and reverse recovery transients caused by minority carriers.

OTHER VARO SCHOTTKY FEATURES ARE:

- -65 to $+150^\circ\text{C}$ junction operating temperatures
- 1 A, 3A, 5A, 15A, 30A and 40A (I_O) ratings
- 20V, 30V, and 40V (V_{RRM}) ratings
- Low reverse leakage
- Epoxy axial lead, DO-4, DO-5, and TO-3 package configurations
- Competitive pricing

Try one in your circuit; you will see for yourself these advantages and more.

For more information and data sheets on all Varo Schottky Barrier Rectifiers call Mike Hawkins, 214/272-4551



VARO SEMICONDUCTOR, INC.

P.O. BOX 6/6, 1000 N. SHILOH, GARLAND, TEX 75040

(214) 272-4551 TWX 910-860-5178

EUROPEAN OFFICE: UK: VARO SEMICONDUCTOR INTERNATIONAL, INC.
 Deepdene House, Bellegrave Road, Welling, Kent, England DA163PY, 01-304-6519/0

Circle 215 on reader service card

Want mass terminations for I/O interconnecting? We have the widest choice.

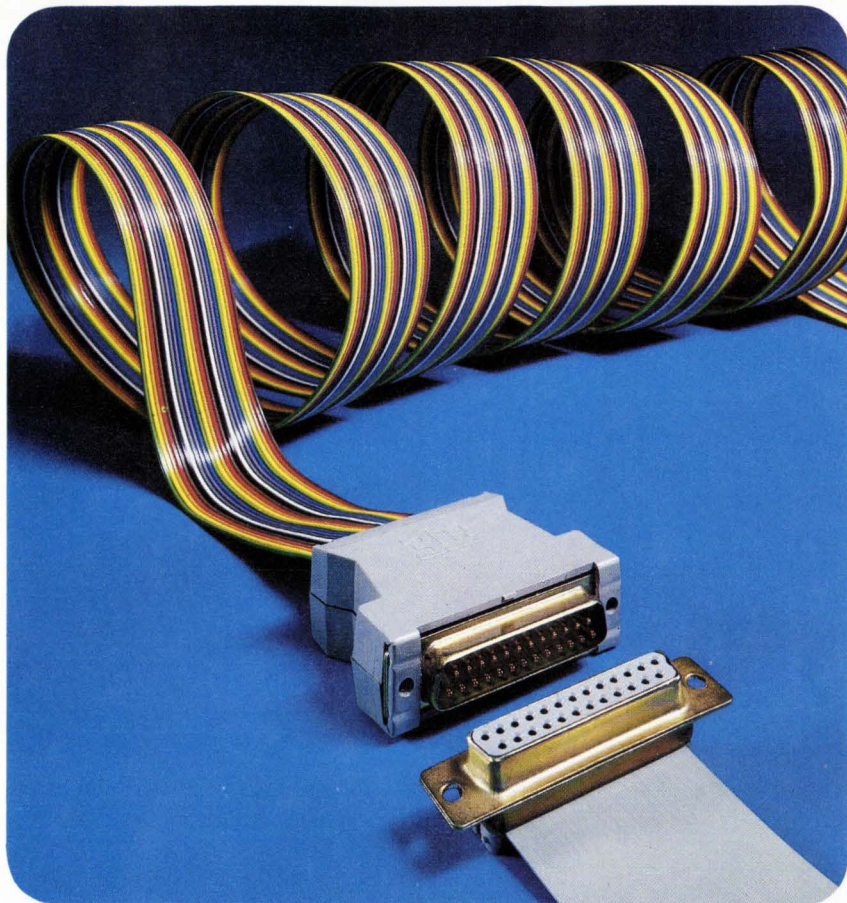

Now Scotchflex brand DELTA Connectors bring the proved labor-savings of 3M's mass termination system to subminiature connections. DELTA series components include pin and socket connectors, junction shells, 25-conductor flat cable and strain relief clips. These system assemblies interface directly with all other industry standard "D" series subminiature connectors. They're also compatible with all connectors in our complete Scotchflex line.

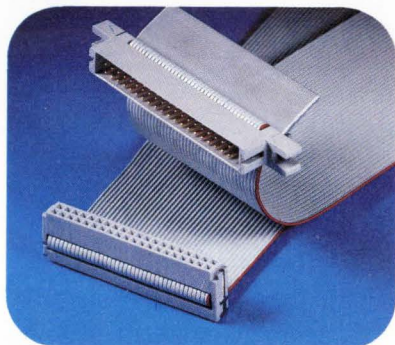

A family of Scotchflex male plug connectors is now available in sizes from 10 to 50 contacts to mate with Scotchflex socket connectors for T-tap or mid-span connections or rack and panel applications.

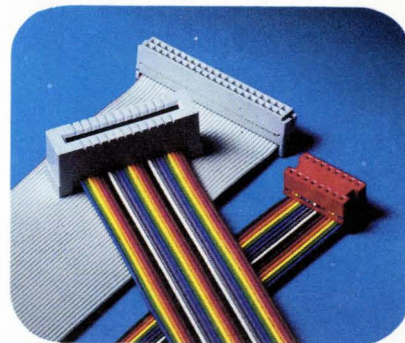

Our broad line of Scotchflex socket connectors includes a variety of 12 different sizes and center spacings to fit standard wrap panels and custom configurations. Also offered are Scotchflex card-edge connectors in sizes for 20 to 50 conductors.

Only 3M offers you so wide a choice of mass terminating flat cable and system components for fast, economical assembly of I/O interconnections between modules or sub-assemblies in your equipment designs. Plus off-the-shelf availability from experienced distributors, and the unmatched experience of the people who pioneered electronic mass terminations.

"Scotchflex" is a registered trademark of 3M Co.

Scotchflex[®] systems from 3M. The source.



See our
catalog in EEM,
page 1056



FEEL
the pot . . .



CLICK
the switch . . .



GANG
the modules . . .

and add
"feel appeal" to your product.

FEEL THE POT . . . a smooth, quality feel, only from Bourns® 81/82 Model Potentiometers. Rotational torque range, only .3 to 2.0 oz. inch, is consistent for one, two, three or four cup assemblies.

Independent linearity of $\pm 5\%$ and low 1% CRV provide exceptional setability in both cermet and conductive plastic element types.

CLICK THE SWITCH* . . . one that really clicks, with positive action detent at either CW or CCW end. The Bourns Model 85/86 potentiometer/switch combination is rated at 2 amps in DPST style and 1 amp in DPDT. Contacts are constructed of fine silver with gold overlay. This provides exceptionally low contact resistance, for reliable operation at low level analog or logic signal levels — or any application requiring an "on-off" function.

GANG THE MODULES . . . potentiometers and switches. Up to 4 modules can be ganged on the same single or dual concentric shaft, without sacrifice to the satin-smooth feel or the sure-fire click. Other options include a wide choice of bushing and shaft styles, P.C. pins or solder lugs. Think of the possibilities! Now you can specify custom pots and switches assembled from "off-the-shelf" modules — at standard cost and leadtime.

Add "feel appeal" to your equipment with BOURNS Model 80 Family of Modular Potentiometers and Switches. Write or call today for complete technical information, direct or through your Bourns distributor.

FEEL, CLICK, GANG . . . BEAUTIFUL!

TRIMPOT PRODUCTS DIVISION, BOURNS, INC., 1200 Columbia Avenue, Riverside, California 92507, Telephone (714) 781-5122 — TWX 910 332-1252.

*Patent pending



Int'l Sales Offices: European Hdqtrs. — Switzerland, 042/23 22 42 • Belgium 02/218 2005 • France 01/2039633 • Germany 0711/24 29 36
• Italy 02/32 56 88 • Netherlands 070/88 93 18 • United Kingdom 01/572 6531 • Japan 075 92 1121 • Australia 86 9410 • Brazil 257-3535

Circle 902 on reader service card