

Mini-Micro Systems

A CAHNERS PUBLICATION

JANUARY 1983

PRINTERS:

- Matrix nears daisy quality
- Laying the dots perpendicularly

435 645 0009 04/ 01
0782 11 2 F 3 JHI 05210
R HELLENTHAL ASST PROF
BIOLOGY DEPT
UNIV OF NOTRE DAME IN 46556
NOTRE DAME

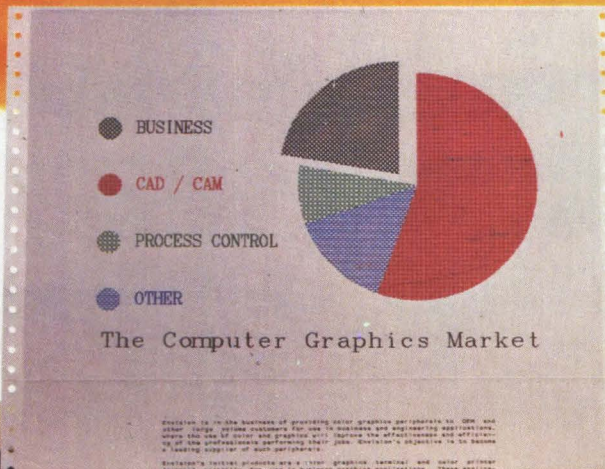

Envision's vector-to-raster color printing

Kennedy is making good even better.

The 6170 Series 8" Winchester disk drives have always provided unmatched performance for the lowest unit price in the industry.

Now, Kennedy engineering has made the product line even better. And, it still remains the lowest price unit available.

Models 6172 and 6173 have capacities of 24.5 and 40.9 megabytes respectively. They feature a linear voice coil positioner and a brushless DC spindle motor located outside of the sealed head/disk assembly to avoid inducing heat into the HDA, which yields high reliability and extends component life. Interface options allow the OEM to select between SMD, ANSI, and our inexpensive Disk Bus.

The 6170 Series has all the essentials: reliability, high performance, low cost, and immediate availability.

If you have never evaluated one of the 6170 drives, we suggest that you do so today, and if you have, we think the product warrants another look. We believe you'll like what you see. We know you'll like the price.

KENNEDY

An Allegheny International Company

1600 Shamrock Ave., Monrovia, CA. 91016

(213) 357-8831 TELEX 472-0116 KENNEDY

TWX 910-585-3249

KENNEDY INTERNATIONAL INC.

U.K. and Scandinavia

McGraw-Hill House

Shoppenhangers Road

Maidenhead

Berkshire SL6 2QL England

Tel: (0628) 73939

Telex: (851) 847871 KEN UKS G

KENNEDY INTERNATIONAL

Koningin Elisabethplein, 8

B-2700 Sint-Niklaas

Belgium

Tel: (03) 777 1962

Telex: 71870 KEN CO



KENNEDY • QUALITY • COUNT ON IT

CIRCLE NO. 2 ON INQUIRY CARD

THE GIANT KILLER

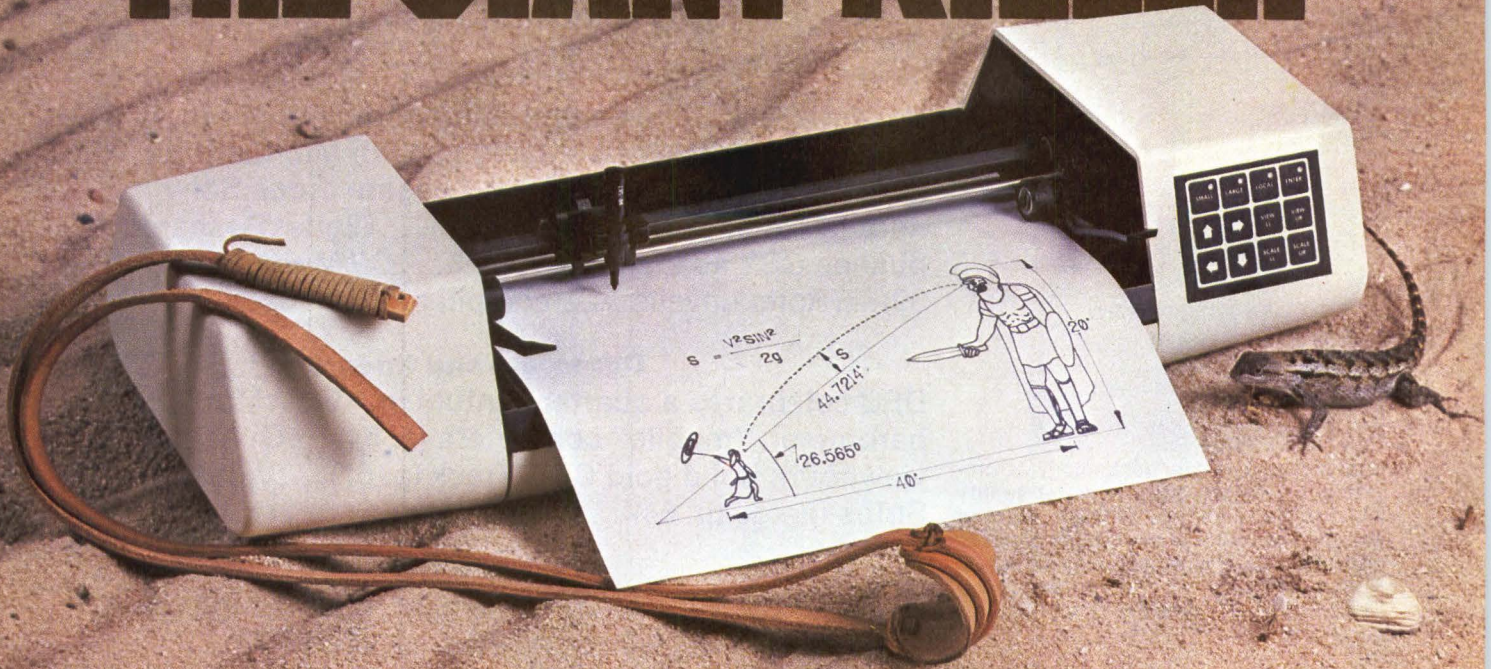

Vanquishes The High Cost Of Plotters

Small, smart and cost effective, the DMP-40 single-pen plotter puts big-plotter power at the command of the small-system user. With this amiable and competent aid at your side, you can create colorful 8½ x 11" and 11 x 17" graphics—images of professional quality for stand alone use, binding into reports or as overhead transparencies for group presentations.

Circles, arcs, ellipses and general curves are automatically generated by robust internal firmware, freeing you and your computer from wasteful low-level busywork.

By plotting in increments of only 0.005", you are assured of virtually step-free traces. The result is precisely defined graphics of high accuracy and solid repeatability.

Standard RS-232-C interfacing matches the DMP-40 to all current computers.

Multicolor plots on the DMP-40 are a simple matter since built in firmware and most commercial software provide 'pause' commands for pen changing.

These and more big-plotter capabilities are yours at small-plotter cost.*

For the name and location of your nearest distributor, call 512-835-0900 or 1-800-531-5205 outside Texas, or write Houston Instrument, 8500 Cameron Rd., Austin, Texas 78753. In Europe contact Bausch & Lomb NV, Rochesterlaan 6, 8240 Gistel, Belgium, Tel 059-27-74-45, Tlx 846-81399.

*US retail \$995.

BAUSCH & LOMB 
houston instrument division

CIRCLE NO. 1 ON INQUIRY CARD

48006

Mini-Micro Systems

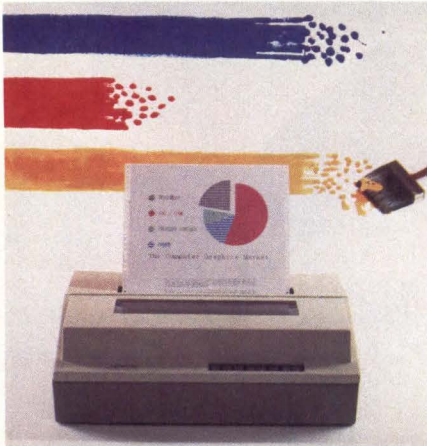

Impact-matrix printer technology is providing characters close to letter-quality while at the same time offering improved graphics—in color. One example of this is detailed in the article beginning on P. 145. Photography by Light Language, San Francisco; Courtesy of Envision Technology Inc.

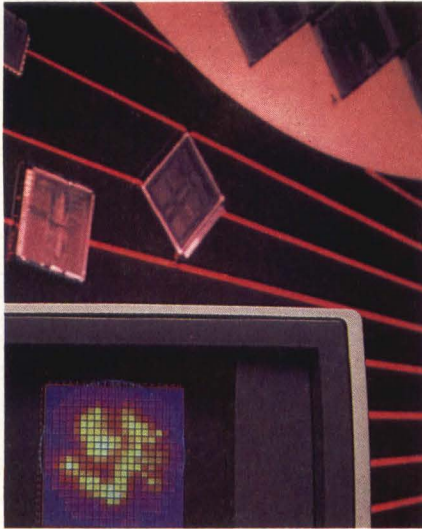

P. 21 HP uses its own 32-bit chip

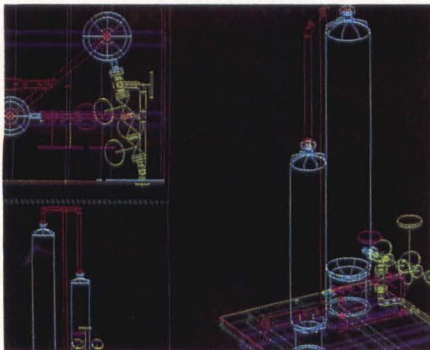

P. 113 . Calma expands CAD market thrust

MINI-MICRO WORLD

News

Hewlett-Packard uses proprietary chips in 32-bit systems (p. 21) . . . Intel teams up with Microsoft (p. 23) . . . Confusion abounds as Seagate drops Sony, adopts Tabor microfloppy (p. 26) . . . Digital Research pushes GSX as standard (p. 28) . . . CP/M updated (p. 39) . . . Rolm unveils Ada compiler (p. 40)

Corporate and financial

DEC celebrates a quarter-century (p. 49) . . . Market barometer: "mobile" computers (p. 54) . . . Guest viewpoint: Solid-gold CADD lack (p. 57) . . . Victor and Sirius merge (p. 64)

International

Comdex Europe's attendance light, quality high (p. 73) . . . Software gives MUMPS graphics (p. 73)

INTERPRETER

- 81 **Pioneering vendors attempt to develop infant broadband local-area network market . . .** The standards issue is still unsettled, but pioneering vendors press ahead in the hope of establishing their broadband local-area network as the norm.
- 97 **U.S. mini manufacturers base software development in Britain . . .** U.S. firms are shifting more of their software-development operations overseas, primarily to the United Kingdom.

SYSTEMS IN MANUFACTURING

- 113 **Calma expands CAD market thrust, product line with support from parent GE . . .** Calma Co., long a force in computer-aided design for the electronics industry, is expanding into three-dimensional mechanical design applications.
- 125 **Two products link HP computers to factory-floor applications . . .** Hewlett-Packard Co. is offering a processing monitoring and control system and an interface to link HP hardware to Allen-Bradley Co. programmable controllers.

FEATURES

- 131 Market overview: minicomputer line printers . . .** The technology of non-impact line-printers has advanced to the point where this year may mark the end of the long wait for units designed specifically for mini and microcomputers.
- 145 Impact matrix printers reach for daisy quality . . .** The old limitations on impact dot-matrix printing are disappearing as major manufacturers introduce models with print quality that approaches that of formed-character machines.
- 161 Printer combines plotter interface with matrix technology . . .** A built-in vector-to-raster conversion system allows a dot-matrix printer to offer high-quality text with plotter graphics.
- 169 High-speed magnetic printer uses perpendicular recording . . .** High-speed magnetic printers now can produce letter-quality text at 6000 lpm with the help of perpendicular recording techniques.
- 179 Controller/transceiver board drives Ethernet into PC field . . .** VLSI controller chips have helped to make it practical to connect microcomputers to Ethernet local-area networks.

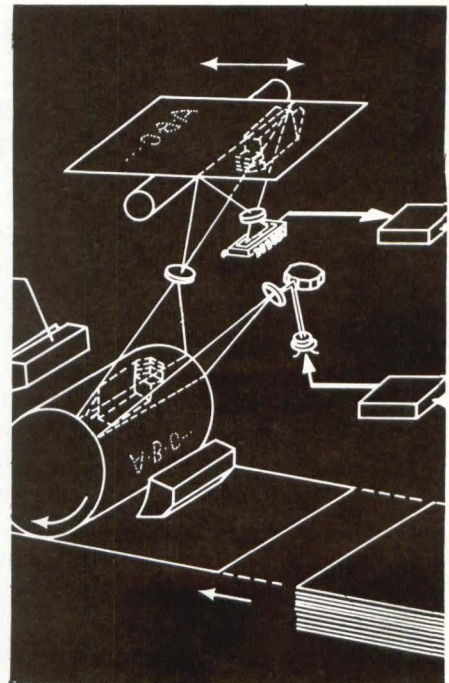

P. 131 Minicomputer line printers

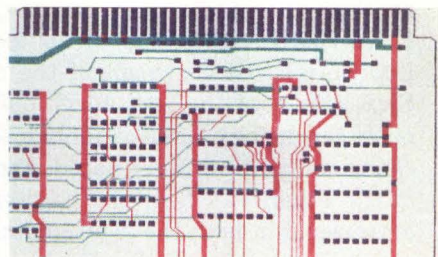

P. 161 Plotter interface for matrix printer

DEPARTMENTS

- | | |
|----------------------|----------------------------|
| 4 Editorial | 317 Data communications |
| 4 Editorial staff | 223 Software |
| 7 Publisher's letter | 228 Mini-Micro Marketplace |
| 11 Breakpoints | 231 Literature |
| 63 Box score | 232 Classified advertising |
| 194 Calendar | 234 Career opportunities |
| 199 Systems | 240 Index to advertisers |
| 207 Peripherals | |

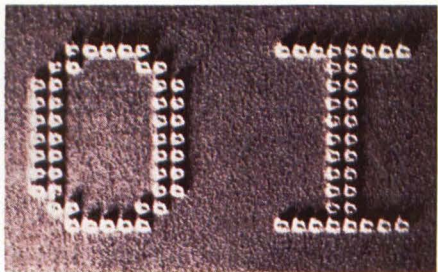

P. 169 High-speed magnetic printing

MINI-MICRO SYSTEMS (ISSN 0364-9342) is published monthly by Cahners Publishing Company, Division of Reed Holdings, Inc., 221 Columbus Avenue, Boston, MA 02116. Norman L. Cahners, Chairman; Saul Goldwetz, President; Ronald G. Segel, Financial Vice President and Treasurer. MINI-MICRO SYSTEMS is published by the Cahners Magazine Division: J. A. Sheehan, President; William Platt, Executive Vice President; H. Victor Drumm, Group Vice President. Circulation records are maintained at Cahners Publishing Co., 270 St. Paul St., Denver, CO 80206. Second class postage paid at Denver, CO 80202 and additional mailing offices. Postmaster: Send address changes to MINI-MICRO SYSTEMS, 270 St. Paul St., Denver, CO 80206. MINI-MICRO SYSTEMS is circulated without charge by name and title to U.S. and Western Europe based corporate and technical management, systems engineers, and other personnel who meet qualification procedures. Available to others at the rate of \$45.00 per year in the U.S.; \$50.00 in Canada and Mexico; \$65.00 surface mail in all other countries; \$100 foreign air mail (14 issues). Single issues \$4.00 in the U.S.; \$5.00 in Canada and Mexico; \$6.00 in all other countries.

©1983 by Cahners Publishing Company, Division of Reed Holdings, Inc. All rights reserved.



Technology pool revisited

Three months ago, I editorialized about a need for a U.S. technology pool (MMS, October, 1982, p. 133). I didn't know then that one such vehicle has been established, at least for semiconductor research: the Semiconductor Research Cooperative, a subsidiary of the Semiconductor Industry Association.

The SRC is a consortium of 12 companies* that hope eventually to provide about \$50 million a year to three to six U.S. universities to be used for concentrated long-term research projects. SRC is planned as a nonprofit corporation, governed by a board of directors, and is looking for more members. A third of that board will be elected by and be members of the parent SIA. The remaining board members will come from participating companies and academia. Importantly, there is to be no government support or participation.

I think the computer industry would be wise to monitor and encourage the efforts of SRC in any way it can because semiconductor and computer technology are so closely intertwined. I agree with Erich Bloch, vice president for technical personnel development at IBM Corp., and chairman of the SRC. Writing in the book *Global Stakes*** about the SRC, Bloch opines that semiconductor and computer technology "are so highly interdependent that cause and effect can no longer be differentiated. Progress in one depends on progress in the other." In fact, the charter SRC members have feet firmly entrenched in both the semiconductor and computer camps.

SRC member fees will be based on revenues. Bloch says the goal for this year is to raise \$10 million to \$15 million, and that current estimates foresee a doubling of yearly support by the semiconductor and computer industry to university research.

SRC membership is open to all companies that manufacture semiconductors in the U.S. SRC and member companies will own patent rights "and other intellectual property," which can be licensed to nonmember companies for an appropriate fee.

Further details about the consortium can be obtained by writing to Larry Sumney, executive director, SRC, P.O. Box 12053, Research Triangle Park, N.C. 27709.

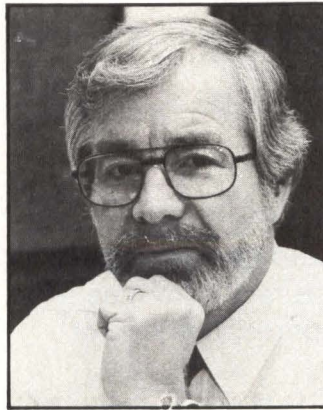

A handwritten signature in black ink that reads "Lawrence J. Curran".

Lawrence J. Curran
Editor-in-chief

*Members as of late November were: Advanced Micro Devices, Inc.; Control Data Corp.; Digital Equipment Corp.; General Instrument Corp.; Hewlett-Packard Co.; Honeywell, Inc.; IBM Corp.; Intel Corp.; Monolithic Memories, Inc.; Motorola, Inc.; National Semiconductor Corp.; Silicon Systems, Inc.

**by James Botkin, Dan Dimancescu and Ray Stata, with John McClellan. Ballinger Publishing Co., Cambridge, Mass.

STAFF

Vice President/Publisher

S. Henry Sacks

Editor-in-chief

Lawrence J. Curran

Managing Editor

George N. Bond III

Executive Editor

Alan R. Kaplan

Boston editorial staff

Lori Vallgra: senior editor, news

Dwight B. Davis: senior editor

Frank Catalano: associate editor

David H. Freedman: associate editor

Sarah Glazer: associate editor

Frances T. Granville: associate editor

Mary Anne Weeks: production editor

Steven F. Frann: new products editor

David Bright: reporter

Editorial field offices

New York

Geoff Lewis: correspondent

San Jose

Kevin Strehlo: correspondent

Bob Sehr: correspondent

Los Angeles

Nancy Love: reporter

London

Keith Jones: correspondent

Art Staff

Vicki Blake: art director

Mark Fallon: assistant art director

James Willey: artist

Editorial Services

Phyllis Anzalone, Debra Codiga, Adrienne DeLeonardo, Elizabeth Kress

Contributing Editors

Malcolm L. Stiefel: product profiles

Walter A. Levy: data communications

Production Staff

William Tomaselli: supervisor

Noel Boulanger: production services

Diane Malone: composition

Executive VP/Group Publisher

H. Victor Drumm

VP/Group Editorial Director

Roy Forsberg

Director of Graphics

Lee Addington

Vice President, Production

Wayne Hullitzky

Vice President, Research

Ira Siegel

Assistant to the Publisher

Linda L. Lovett

Group Circulation Manager

Sherri Gronil

(303) 388-4511

Marketing/Promotion Staff

Richard B. Dalrymple, Mktg. Director

Susan Rapaport, Promotion Director

Editorial Offices

Boston: (617) 536-7780, 221 Columbus Ave., Boston, MA 02116. **Los Angeles:** (213) 826-5818, 12233 W. Olympic Blvd., Los Angeles, CA 90064. **San Jose:** (408) 296-0868, 3031 Tisch Way, San Jose, CA 95128. **New York:** (212) 949-4400, 205 E. 42nd St., New York, N.Y. 10017. **London:** 011-44-1-661-3040, The Quadrant, Sutton Surrey, SM2 5AS, England.

Reprints of Mini-Micro Systems articles are available on a custom printing basis at reasonable prices in quantities of 500 or more. For an exact quote, contact Art Lehmann, Cahners Reprint Service, 5 S. Wabash, Chicago, IL 60603. Phone (312) 372-6880.

THE MOST POWERFUL
MINICOMPUTER FAMILY
IN THE WORLD

GOULD CONCEPT/32™

NOW SUPPORTS

UNIX™

Since we're the price/performance super-minicomputer leader, you'd expect us to offer UNIX on our product line. And we do. The Gould CONCEPT/32 series of 32-bit minicomputers now provides an authorized version of Bell Labs' 32V UNIX operating system. You get optimum software productivity with processor power up to six times that of our closest competitor.

The compute power and speed that's put us in front of the competition, a full line of peripherals, and all the advantages of single vendor hardware and software support. You get them all now...with Gould S.E.L. Computer Systems.

Just call our UNIX hotline: 1-(305) S.E.L.-UNIX.

Gould Inc., S.E.L. Computer Systems Division,
6901 West Sunrise Boulevard,
Fort Lauderdale, Florida 33313. 1-800-327-9716.

 **GOULD**
Electronics & Electrical Products

™ CONCEPT/32 is a trademark of Gould Inc. ™ UNIX is a trademark of Bell Labs

CIRCLE NO. 5 ON INQUIRY CARD

ROBOTIC DISK HANDLER

Looking to your future, Applied Data Communications proudly presents the **ROBOTIC DISK HANDLER** — the ultimate in automatic handling of floppy diskettes. This innovative system has the capacity to load and unload up to 100 floppy diskettes, unattended. Diskettes are handled in a very gentle manner as the system simulates the action of a human hand. It is a third generation modular design which enhances the state-of-the-art by effecting total reliability, not apparent in earlier designs. Enhance your company's future in the automated handling of floppy diskettes with a **ROBOTIC DISK HANDLER**.

Realistically you will save time and money with this futuristic system, priced as low as \$5995.00. Inquire into the multitude of outstanding features that are incorporated in the **ROBOTIC DISK HANDLER**. Your future is here — now!

DALLAS, TX
(214) 352-4012

BOSTON, MA
(617) 273-4844

SANTA CLARA, CA
(408) 748-8686

TUSTIN, CA
(714) 731-9000

WASHINGTON, D.C. — (703) 356-7450

ALSO: TOYKO, FRANKFURT, PARIS, LONDON
STOCKHOLM, OSLO, MILANO, COPENHAGEN
SYDNEY, BOMBAY, TAIPEI

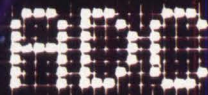

**APPLIED DATA
COMMUNICATIONS**

14272 CHAMBERS ROAD, TUSTIN, CALIFORNIA 92680

CIRCLE NO. 6 ON INQUIRY CARD

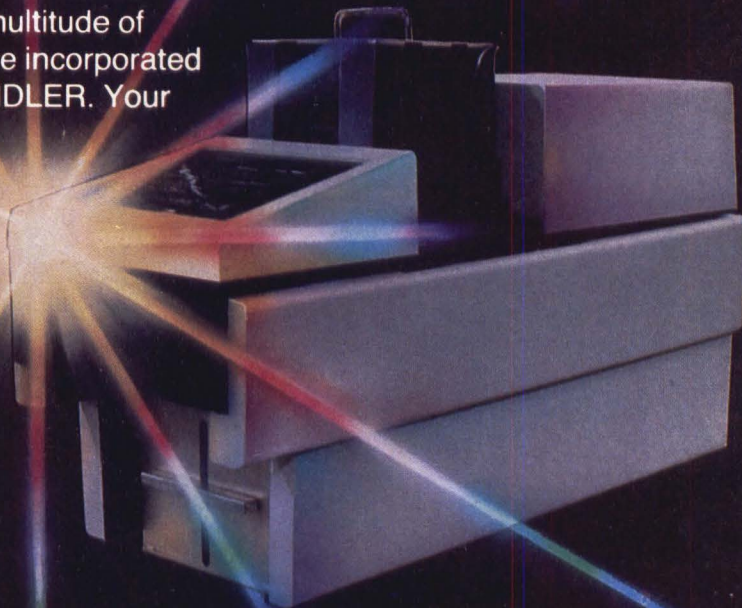

Strengthening the staff

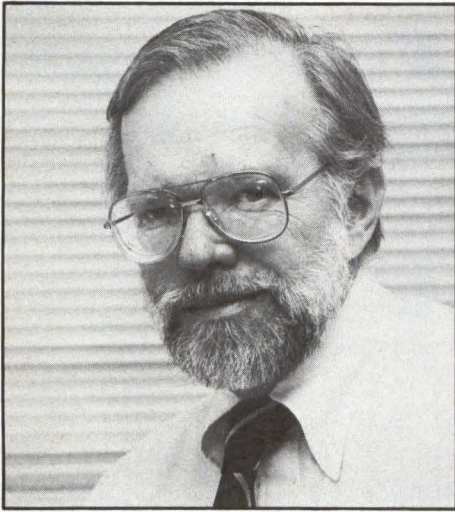

Bond

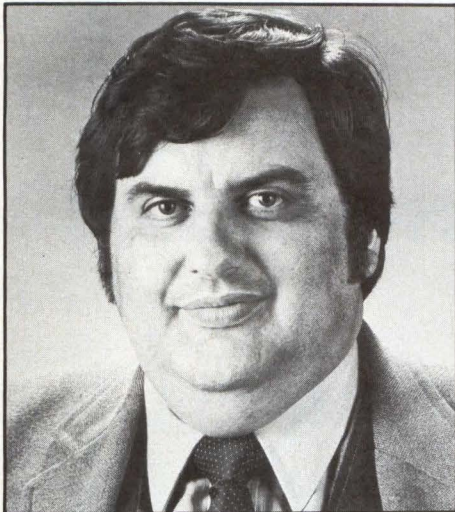

Sehr



Bachmann

Three recent additions to the *Mini-Micro Systems* editorial staff will strengthen us in important staff positions. They are George Bond, Bob Sehr and Linda Bachmann. George is managing editor, Bob is San Jose correspondent, and Linda is an associate editor. George and Linda are in the Boston headquarters.

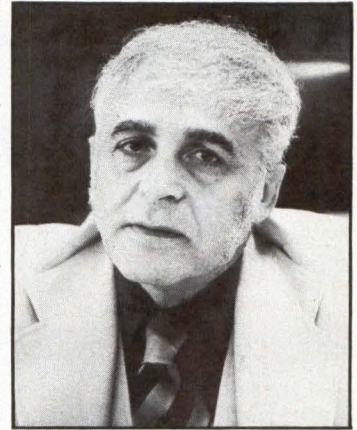

Sacks

George is a journalist with more than 20 years of newspaper and magazine experience. He comes to us from *Electronic Business*, another Cahners magazine, where he was managing editor for 14 months. It is George's responsibility to make sure that the myriad tasks required to produce this publication each month take place in an orderly fashion. The managing editor establishes and enforces copy deadlines and, on the *MMS* staff, supervises the copy desk and production editor. In addition, all section editors report to the managing editor.

We also expect George to contribute articles because of his experience as a small system user and writer on high-technology topics. Before joining *Electronic Business*, George spent some 12 years at *The Washington Star* as a high-tech writer and was a news editor for the newspaper for several years. He held a variety of newspaper staff positions during the '50s and '60s, including a term as managing editor of the *Northern Virginia Sun* in 1968-1969. George also taught English and electronics in the Somali Republic as a Peace Corps volunteer from 1962 to 1964. He has a B.S. in journalism from Temple University.

Bob Sehr succeeds John Trifari in covering the disk drive beat from the San Jose office. He joined *MMS* in November, and is quite familiar with the industry, having spent the last two years as West Coast editor of *Computer Systems News*, the OEM computer newspaper. At *CSN*, Bob concentrated on software issues, including the emergence of the retail market, software piracy and the continuing struggle toward operating-system stan-

When it's time to stop playing games and get down to business...

Unfortunately, many of today's desk top computers are designed with too much emphasis on home use. That's fine, if you want to balance your checkbook, play "space war" or draw pictures. But when you have serious business requirements for a computer, you want one designed specifically for business.

The RAIR Business Computer is just that. A computer system designed specifically for business applications, incorporating a host of features—optimized for the business environment. 8- and 16-bit microprocessors allow users to run available 8-bit—plus newer 16-bit—applications software simultaneously. And an integral high-capacity Winchester disk drive—plus provision for additional hard disk support—provides sufficient on-line storage for virtually any business application.

Advanced communications software allows the RAIR Business Computer to connect to mainframe systems and networks. And expanded RAM memory supports simultaneous access from up to four user workstations, each including an ergonomically designed, detached keyboard, high-resolution color display, and optional workstation printer.

So if you're serious about a computer for business, call RAIR for details about our Business Computer. We're not playing games.

RAIR Limited
6-9 Upper St. Martins Lane
London WC2H 9EQ
Phone (01)836 6921, Telex 298452

CIRCLE NO. 9 ON INQUIRY CARD

SYSTEM SPECIFICATION

Microprocessors: Concurrent 16-bit 8088 plus 8-bit 8085
RAM Memory: 256 kbytes expandable to 1 Mbyte
Integral Disk Storage: 19-Mbyte Winchester drive plus 1-Mbyte floppy drive
Storage Options: Up to 4 add-on Winchester drives plus streaming tape backup
Communications: 4 workstation ports (RS-422-compatible), plus 2 synchronous/asynchronous programmable RS-232 ports

WORKSTATIONS

Keyboard: Ergonomic, low-profile, 83 keys, 10 programmable function keys, 10-key numeric keypad (with cursor/editing functions)
Color Display: High-resolution, 80 characters x 25 lines, upper and lower case, 8 programmable foreground/background colors
Printer: Bidirectional, 80 characters-per-second, friction and tractor feed

SOFTWARE

Operating System: User-friendly, multi-tasking, CP/M, MP/M, PC-DOS compatible
Languages: BASIC, COBOL, Pascal
Applications: Spreadsheet, Database, Text Processing Communications

CP/M and MP/M are trademarks of Digital Research
PC-DOS is a trademark of IBM

the RAIR Business Computer.



dards for 16-bit microcomputers. His *CSN* experience also includes coverage of the increasing number of major lawsuits in the computer industry.

Bob's career in journalism began 13 years ago when he was hired as a copy messenger for the *Houston Chronicle*. He quickly progressed to various editing and reporting assignments there, and then to the *Los Angeles Herald-Examiner*, the *Oxnard Press Courier* and the *Vallejo Times-Herald*. The latter is a newspaper in Northern California, where he covered state and local politics.

Linda Bachmann comes to us from Manhattan, where she covered new product development and edited and wrote feature articles on a range of communications topics for *Data Communications*, a McGraw-Hill magazine. Linda assists Alan Kaplan, *MMS* executive editor, in soliciting and editing contributed feature articles from industry authorities.

Before joining *Data Communications*, Linda held positions as an editor of technical and medical books for McGraw-Hill Book Co. and as editor of a regional magazine in Springfield, Mass. She has a B.A. in English and German from St. Lawrence University in Canton, N.Y., and has taken courses in computer science.

S. Henry Sacks
Vice President/Publisher



SWITCHING TERMINALS A PROBLEM?

WTI has a lineup of low cost solutions... RS232 Switching Devices!

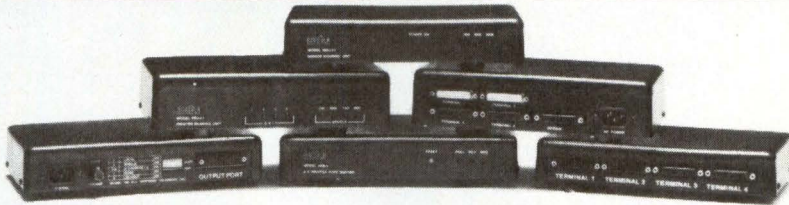

AB MiniSwitch

\$89

End the hassle of plugging and unplugging data cables. MiniSwitch lets you manually switch between two RS232 devices and a common device such as a Modem and a Printer sharing a Minicomputer.

TM-41 4 Port Push Button Switch

\$295

Switch ports electronically from the Terminal by pressing a button instead of flipping switches on a common AB Switch box. Selectable operating modes include—equal priority lockout, multiple and single port select.

CAS-41 4 Port ASCII Code Activated Switch

\$395

Your Computer may select one or any combination of up to 4 RS232 ports by a user selectable code sequence.

CAS-161 16 to 64 Port Code Activated Switch

\$795

Your Computer may select between any one of 16 ports by a two character ASCII code sequence. The unit is field expandable to 32, 48, or 64 ports.

SMRT-1 8 Port "Smart Switch"

\$795

This flexible microprocessor controlled 8 port switch allows a user on any port to communicate with an RS232 device on any other port. Up to 4 pairs of users can communicate simultaneously. "User Friendly" commands aid in port selection, port status and sign off. The unit's so smart, it even signals you when the port you wanted is no longer busy! Each port can be configured for DTE or DCE by pressing a button.

PSU-41 Printer Port Sharing Unit

\$395

Allows up to 4 CRTs to share one Printer automatically without software changes! The PSU-41 scans each CRT and locks on until the screen has been sent to the Printer, then resumes scanning.



western telematic inc.

2435 S. Anne St., Santa Ana, CA 92704 • (714) 979-0363
Outside California call toll free (800) 854-7226

CIRCLE NO. 7 ON INQUIRY CARD

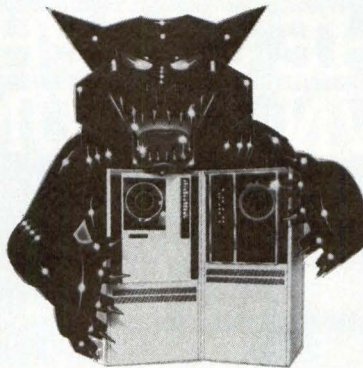

THE BIG BYTE

Tri-Density Tape System
for 11/70 and VAX

A real beast of a subsystem — the IPS BIG BYTE tape system outperforms all competitors. The tape subsystem comes complete with drive, controller, formatter and cables for all DEC Unibus and Cache Bus systems. Features include 32K FIFO Buffer and intelligent dynamic NPR throttle.

The BIG BYTE from IPS — increased system performance without taking a bite out of your budget.

IPS-Information Products Systems, Inc.
6567 Rookin St. • Houston, Texas 77074
Phone (713) 776-0071 • Wire IPS HOU • Telex 792413

Call our toll free number: 1-(800)-231-7972



CIRCLE NO. 8 ON INQUIRY CARD

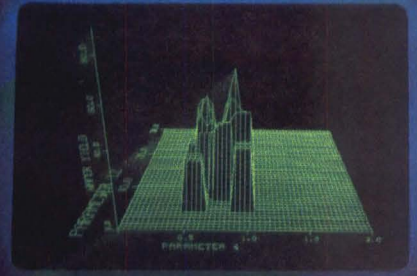
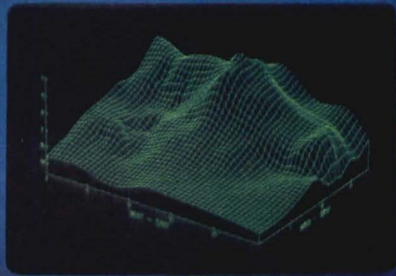

TURNING THE GRAPHICS WORLD UPSIDE DOWN FOR UNDER \$2,000.

C. Itoh's CIT-414.

Our CIT-414 terminal is really shaking up the graphics world with Tektronix® 4010/4014 compatible performance and a price tag under \$2,000!

So what's the trade-off? Not a thing. The CIT-414 offers a complete range of features that make it a true price/performance leader.

It provides crisp 640 x 480 resolution, a 4096 x 4096 plot area in the Tektronix mode, and standard ANSI-compatible alphanumeric.

Plus, the CIT-414 offers a host of standard features that are only available as cost options with other graphics

terminals. Like five different vectors — including dotted, dot-dashed, short-dashed and long-dashed as well as solid. Both incremental plot and point plot modes. Four selectable character sizes and an APL character set for enhanced alpha versatility.

With the CIT-414, the graphics world is wide open to your imagination. It gives you tremendous flexibility in business, scientific and design applications because it's compatible with most major graphics software packages such as PLOT 10,TM DISSPLA,[®] TELLA-GRAF,[®] SAS/GRAPH,[®] DI3000/[®] GRAFMAKER,[®] and others.

Like all C. Itoh terminals, the CIT-414 is built right and tested tough to give you day-in-day-out performance you can count on. We think you'd be hard pressed to find a better terminal buy in today's market.

Find out more about how we're turning the graphics world upside down. Contact C. Itoh's exclusive representative, ACRO Corporation: Irvine, CA (714) 557-5118; Houston, TX (713) 777-1640; Cherry Hill, NJ (609) 983-5075; Chicago, IL (312) 992-2346; San Jose, CA (408) 977-1146.

 **C. ITOH**
ELECTRONICS, INC.
One World of Quality

® Tektronix is a registered Trademark of Tektronix, Inc., DISSPLA and TELLA-GRAF are registered Trademarks of ISSCO, SAS/GRAPH and DI3000/GRAFMAKER are registered Trademarks of PRECISION VISUALS. PLOT 10 is a trademark of Tektronix, Inc.

CIRCLE NO. 10 ON INQUIRY CARD

Breakpoints

APOLLO ADDS VIRTUAL MEMORY SYSTEM AT HALF OF ITS CURRENT LINE PRICE

A virtual memory version of Apollo Computer Inc.'s Domain distributed system is scheduled for release at the end of this month. The system incorporates Motorola's virtual memory 68010 chip in place of the two MC68000s used on earlier Domain versions, and will be about half the price of the earlier versions. Apollo officials declined to specify a price at press time. The new system is a desktop unit instead of a separate free-standing cabinet. Targeted at technical professionals, the system includes 16M bytes of virtual address space per process performed, up to 15 of which can be run concurrently by each user. Also standard is ½M to 1½M bytes of memory, a 12M bit/sec. token passing baseband local area network, an object oriented virtual memory operating system called Aegis (a UNIX System III shell is available) and 1024 × 800 pixel bit-mapped graphics on a 17-in. display. The new system shares peripherals so that each system does not require its own disk nearby.

DIGITAL RESEARCH PLANS PRODUCT ROLLOUTS AT CP/M '83

Digital Research, Inc., plans to enliven its CP/M '83 show—which is expected to draw more than 20,000 buyers, developers and retailers of CP/M compatible products to Moscone Center in San Francisco from Jan. 19 to 23—with several announcements. Foremost is the expected formal unveiling of CP/M-68K for Motorola's MC68000, which will include DRI's new C compiler, for the basic licensing fee of \$75,000. CP/M-68K may help end the dearth of UNIX application software, since it will run as a task under UNIX. DRI will expand its push in graphics with two new products developed jointly with Graphics Software Systems, Inc., Wilsonville, Ore.—GSS Graph and GSS Draw, menu-driven systems for presentation graphics and "freehand" graphics, respectively. Both packages will retail for \$500 and will include extensive tutorial material. DRI also is expected to announce a LOGO compiler that has been the pet project of DRI founder Gary Kildall. Although a new subsidiary being established to handle LOGO is aimed at the retail and educational markets, DRI thinks LOGO may become important in mainstream commercial applications as artificial intelligence gains acceptance. To that end a symbolic debugger and other programming aids for the compiler are under development. Finally, DRI is expected to enhance product support, including the establishment of an electronic bulletin board for end users.

START-UP EXCELAN OFFERS FRONT-END PROCESSOR FOR ETHERNET

Excelan, a San Jose networking start-up, this month will introduce its first products, front-end processors optimized to run higher-level communications protocols. The company's EXOS/101 products contain an 8088-based board and an operating system core optimized to run communications protocols. Excelan customers can port protocols out of a host's operating system onto EXOS, which increases performance and allows better scheduling of memory management resources, claims company vice president of marketing Dale W. Way. The front-end processor controllers are Multibus compatible and can run as either non-intelligent Ethernet controllers that have 60K of memory available for buffering or as front-end processors that act as processors on a bus after protocols are downloaded from the host into the EXOS memory. Excelan expects to support the International Standards Organization layers over the next several years, beginning later this year with layer 4, the transport layer. Higher-level protocol software is expected to be offered through Excelan or third party remarketers later this year. No protocols will be offered by Excelan initially. The front-end processor and operating system core available this month come in two configurations: EXOS/101 model 1 with 64K memory is priced at about \$800 in quantities of 500 or more, while model 2 with 128K memory is priced at about \$900 in similar quantities.

Breakpoints

DESK-TOP VERSION PLANNED FOR PIXEL LINE

The Pixel division of Instrumentation Laboratory, Inc. is getting ready to add a desk-top model to its line of Motorola MC68000-based systems in the second quarter of this year. The 50/AP will start at less than \$5000 with a Winchester disk, 512K bytes of RAM and a separate MC68000 processor for I/O management. The system is designed to use SyQuest Winchester cartridge disks and 256K-bit RAM chips, Pixel officials say, and will include UNIX and an Ethernet interface. Like the earlier 100/AP, the system will be marketed to OEMs, but because of its low price may also be made available through distributors. In the first quarter of this year, the company plans to introduce the 80/AP, which will include 5¼-in. peripherals rather than the 8-in. ones used in the 100/AP, and will sell for about \$14,000 list. The company plans to use Motorola's 68010 virtual memory processor across the AP line, as well as to move toward supporting Bell's forthcoming System V UNIX.

HIGH-END SYSTEM BASED ON MC68000 EXPECTED FROM ONYX

Onyx Systems, Inc., the San Jose supplier of Zilog Z8000-based systems running the UNIX operating system, is getting ready to extend its line upward with a 12-MHz Motorola MC68000-based system. Said to offer performance in the Digital Equipment Corp. PDP 11/70 or VAX range, the "Ultra Micro" line is expected to emerge next month with a starting price of \$30,000. Using SMD-type disk interfaces and dual Z8000 I/O controllers, the system is aimed at outperforming systems from Plexus Computers, a UNIX rival which recently landed an OEM contract with Interactive Systems of Santa Monica, a long-time Onyx customer. The Onyx system, which can be configured to support as many as 48 users and is being designed to accommodate both virtual memory and full 32-bit addressing as they are made available with Motorola parts, may also be the first system on the market to offer UNIX System V. The company is doing its own System III port, but may switch to the updated package if shipments from Western Electric begin soon enough. Onyx officials claim the new UNIX release is already running on Onyx hardware within AT&T.

HARRIS TO CHALLENGE DEC'S VAX WITH TWO NEW 800 MINIS

Harris Corp. intends to take a more aggressive stance against Digital Equipment Corp.'s VAX-11/780 superminicomputer this month by adding two top-of-the-line models to its 800 Series minicomputers. The H800-2B and H800-2BP incorporate a new single-board memory called the integrated-memory subsystem, which includes the timing and control functions previously allocated to a separate board. The IMS can hold as much as 1.5M bytes of memory and has a typical access time of 250 nanosec. and a cycle time of 335 nanosec. for 48 bits of data. The H800-2BP is priced to compete directly against the VAX, but offers 30% more performance, Harris officials claim. The H800-2B is positioned to equal the performance of the VAX, but at a lower price. The H800-2B is priced from \$139,000 and the H800-2BP from \$164,000.

HONEYWELL MICROCOMPUTER TO BE AIMED AT DEALER CHANNELS

Nordata, Inc., a Mountain Lakes, N.J., Honeywell, Inc., reseller that last year signed a three-year contract for \$20 million in DPS/6 and Level 6 minicomputers, plans to be in the vanguard of resellers handling Honeywell's long-anticipated microcomputer. The system, developed under the code name Hercules, is expected to emerge early this year in desktop and floor-standing models that will start at under \$5000. While Honeywell plans to sell the system directly to high-volume end users and remains undecided about retail outlets, its Dealer Sales Operations Group is expected to be the primary channel for Hercules. Nordata and other DSO firms were given a sneak preview of the system at the fall Comdex show, but final pricing and distributor terms were not complete. In addition to running Honeywell's GCOS/6 Mod 200 and 400 operating systems, the micros are

HOLD MEMORY COSTS IN CHECK.



Ever feel rooked by memory prices? Well, you can play the game for less if you make the move to Plessey.

We've just converted our entire memory production to CAD/CAM. That means greater capability, even more consistent quality, and something else—low price.

The savings are the same on all our boards. Core and MOS. 16 Kbytes to 1.0 Mbytes. With Omnibus, Unibus, Q-bus, MJ11, SJ-780, or NOVA bus chassis compatibility.

In fully populated and depopulated versions. Plus, every Plessey memory comes with a free 1-year warranty. And if we install your memory for you, you also get free on-site repair for 30 days.

But chances are you'll never have any problems. Because we inspect and test every memory we make.

So if you want to hold your memory costs in check, mate your system with Plessey. It's the only move you need to remember.



Plessey Peripheral Systems

1674 McGaw Avenue, P.O. Box 19616, Irvine, CA 92714
(714) 540-9945 TOLL FREE: 800-992-8744 (Outside CA.)

Omnibus, Q-bus, Unibus, and VAX are trademarks of Digital Equipment Corporation
NOVA is a trademark of Data General Corporation
CIRCLE NO. 11 ON INQUIRY CARD

THE LEADING EDGE IN PRINTERS

ONE GREAT LINE. ONE GREAT WARRANTY.

Finally, there's one full family of printers that covers every business or word processing application—all from C. Itoh, a company known for packing more product into less price; and all distributed exclusively by Leading Edge, a company known for searching out and providing that very thing. Which means that one call to one source can get you any printer, any time you need it, for any purpose. All backed by a full years' warranty from Leading Edge. (Try *that* on any other line of printers.)

THE PRO'S.

The Prowriters: business printers—and more. The "more" is a dot-matrix process with more dots. It gives you denser, correspondence quality copy (as opposed to business quality copy, which looks like a bad job of spray-painting).

Prowriter: 120 cps, 80 columns dot matrix compressable to 136, 10" carriage. Parallel or serial interface.

Prowriter 2: Same as Prowriter, except 15" carriage allows full 136 columns in normal print mode. Parallel or serial interface.



THE STAR.

The Starwriter F-10. In short (or more precisely, in a sleek 6" high, 30-pound unit), it gives you more of just about everything—except bulk and noise—than any other printer in its price range. It's a 40 cps letter-quality daisy-wheel with a bunch of built-in functions to simplify and speed up word processing. It plugs into almost any micro on the market, serial or parallel.



THE MASTER.

The Printmaster F-10. Does all the same good stuff as the Starwriter except, at 55 cps, the Master does it faster.

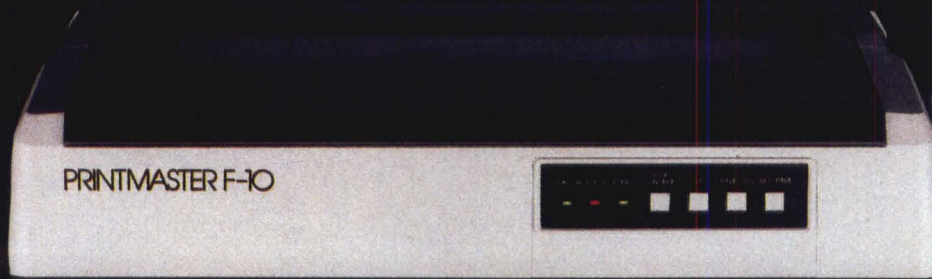

*Distributed Exclusively by Leading Edge Products, Inc., 225 Turnpike Street, Canton, Massachusetts 02021.
Call: toll-free 1-800-343-6833; or in Massachusetts call collect (617) 828-8150. Telex 951-624.*

CIRCLE NO. 12 ON INQUIRY CARD

Breakpoints

expected to have an empty card slot to accept an industry standard co-processor and operating system such as a Z80-CP/M combination or an 8088-MS/DOS package. Nordata, a former Data General OEM, perceiving an opportunity in DG's ailing enterprise program, is hoping to expand beyond its base of Honeywell dealers, with a conversion program that will put DG BASIC packages on the Honeywell machine.

DURANGO PLANS MICROCOMPUTER SYSTEMS UPGRADES

Durango Systems, Inc., the San Jose desktop computing pioneer, is planning to breathe new life into its four-year-old Intel 8085-based product line. The company, whose founder and chairman George Comstock recently handed over the presidency to Memorex veteran James Simpson, is planning an upgrade to an undetermined 16-bit processor that will require the exchange of two boards in existing systems. In addition, the company is reportedly looking at UNIX or Microsoft Xenix to replace the proprietary DX85M operating system.

MC 68000-BASED PUBLISHING SYSTEM TO COME FROM MASS. START-UP

An MC 68000-based documentation publishing system is targeted for introduction in April by Woburn, Mass., start-up Xyvision. The product is a production tool for documentation and is aimed at commercial printers and typesetters or in-house technical publications departments. Components of the distributed system include the 68000, the UNIX operating system, C, Xyview screens that are black and white and can show five document pages in five windows simultaneously, input editing terminals similar to word-processing terminals, 8-in. Winchester disk storage and a laser printer. Storage of 35M, 70M, or 105M bytes is available. The laser printer incorporates Canon's LBP-10 engine, but Xyvision has added a raster image processor. The company estimates it is addressing \$9 billion market for technical documentation tools in 1990, and will offer the systems for \$50,000 to \$100,000 to end users.

TECHFILES: A QUICK LOOK AT INDUSTRY DEVELOPMENTS

Random Disk Files: While **Seagate Technology** stunned the industry with the decision to drop its evaluation of the **Sony** 3.5-inch floppy drive in favor of a licensing agreement with Westford, Mass., startup **Tabor Corp.**, it is going ahead with a 3.5 in. Winchester that is likely to be announced by NCC. The new Winchester will measure 4 inches wide, 1.6 inches high, and will fit nicely in the form factor used by the Sony floppy spurned by Seagate. The 5M-byte drive was shown privately at a Seagate reception during last fall's Comdex show. The first customer for the Winchester is likely to be current Seagate customer **Hewlett-Packard**, which is already shipping desktop units containing 3.5-inch Sony floppies...**Tabor Corp.** meanwhile is ramping up its new 30,000-square-foot production facility to begin shipping its 3.25-inch floppies by late April. Sources say the company was prepared for any eventuality in the controversy surrounding sub-4-inch floppies. The company filed its business plan a year ago to support 3¹/₄-inch media. It also has a design for a 4-inch drive should **IBM** go ahead with plans for its rumored microfloppy that now appears far larger than everyone else's. Tabor defends its soft jacket envelope, saying that it is the only real standard that now exists and is accepted by all media manufacturers. "Other companies are talking about establishing a standard, but the soft jacket has been a standard for about 10 years," says Tabor's president Mike Hanley. Tabor, which was for a time part of a standards committee led by **Shugart Associates** and **Verbatim Corp.**, said it dropped out because the committee asked the company to wait for a standard while Tabor already had customers for its drive. The first evaluation customer for the Tabor drive is believed to be **Olivetti Research** in Cupertino, Calif. The R&D arm of the giant international firm may be using the microfloppies in a new generation of electronic typewriters...Sony, jilted by Seagate, has been embraced by Shugart Associates after the Japanese firm decided to modify its media in conformance

Breakpoints

with the industry standards committee. Shugart executives are busy playing shuttle diplomacy to convince Sony and its chief rival **Matsushita Electric Corp. of America (Panasonic)** to make up and agree on the committee standard. Should MECA, which is now advancing a 3-inch floppy along with **Maxell** and **Hitachi** agree on the committee standard, it would leave Tabor and Seagate by themselves. However, prospects for a compromise between the two Japanese giants are slim since the two have been bitter rivals since they went their separate ways—Beta and VHS—in the manufacture of video tape recorders...Sirjang Lal "Jugi" Tandon has become director of what is essentially a research-and-development operation set up as a stock incentive for **Tandon** engineers, in Campbell, Calif. Called **MicroTek**, the subsidiary is chartered with producing an unspecified new product that will be manufactured by Tandon. The president of the new company is J. Brent Nilson. The company is 80 percent owned by Tandon Corp., while the rest is owned by MicroTek engineers.

Terminal Files: That sleek new terminal in **Altos Corp.**'s ads is its own, an ANSI X3.64 compatible unit scheduled to be available in June for \$995 list... Rumors are flying that **Digital Equipment Corp.**'s next generation video display terminal, the VT-200, will be introduced during the first quarter. The terminal is expected to offer bit-mapped graphics at 768 × 480 resolution in a box patterned after the Professional Series display and keyboard. Protocols for text are said to be identical to the VT-100's, while the graphics mode uses the REGIS (REmote Graphics Instruction Set) protocol developed originally for DEC's VT125 graphics terminal. Sources disagree on whether the unit will have a true graphics overlay capability but agree that pricing will be in the \$2000 range. A DEC spokesman had no comment.

Micro Files: Business was booming at the fall Comdex show in Las Vegas. **Callan Data Systems** claims to have rung up \$4 million in orders for its Motorola MC68000-based Unistar systems, while fellow UNIX/MC68000 supplier **CIE Systems** claims to have racked up \$3 million in orders...At the same time, **Corona Data Systems**, which unveiled its IBM Personal Computer look-alikes at the show (MMS, Dec. p. 8) signed up 12 distributors in the U.S. and Canada and has commitments for almost 60,000 units, which president Daniel R. Carter says would amount to a \$95 million sales year. However, he says sales will fall short of that because the company is not beginning production of its desk-top model until this month and does not expect to have the portable version ready before April...Comdex also was the setting for the low-key debut of what is bound to be the lowest-priced IBM PC-compatible portable on the market—at least temporarily. The system is called Chameleon and includes a Z80A CPU running CP/M as well as an 8088 running MS/DOS. With a nine-inch screen, dual floppies, operating systems, PerfectWriter and PerfectCalc it lists for \$1995. It is the first end-user system to be marketed by **Seequa Computer Corp.** of Annapolis, Md., which previously built S-100 bus microcomputers under contract with Martin Marietta Corp., among other OEMs. The single-board system has no internal card slot, but is said to have 80 percent of the features which IBM customers order including 640 × 200 or 320 × 200 graphics.

Printer Files: Japan's **Seiko Group**, which has been ushering in a series of products from its different subgroups into the U.S., including a microcomputer from **Sci-Com**, and a color printer from **Seiko Instruments U.S.A.**, is reorganizing its operations. While most products fell under Seiko's two watch group subsidiaries, a new division within Seiko will be set up to handle the industrial products, such as computers and peripherals. The new group will have the same profit and loss responsibility as the watch group, thus emphasizing Seiko's commitment to high technology products...**General Electric** previewed multi-color printing for its GE 3000 matrix printers at Comdex. The color versions, which will add about \$600 to the price of GE's line, will be available in production quantities in March.

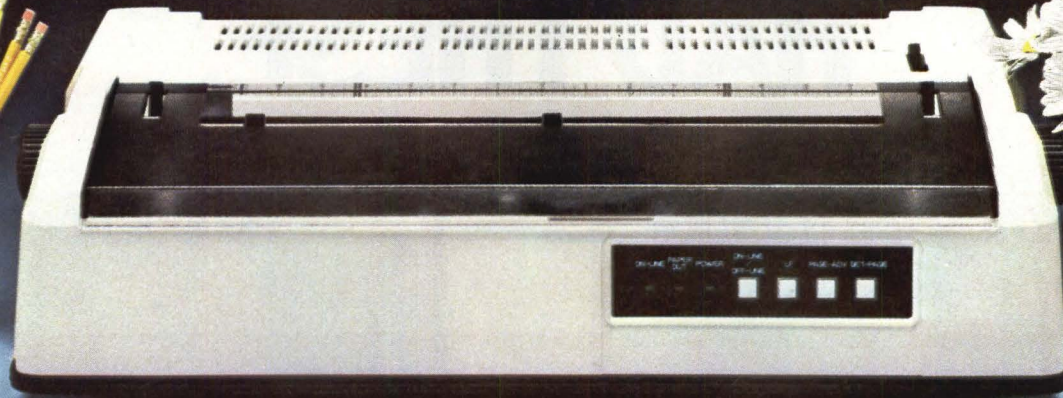

C. Itoh's F-10 Daisy-wheel printer is the compact beauty you can easily get attached to. Just look at all the useful features you get.

1. Small footprint, low-profile design (only 6" high) fits easily into your system.
2. Downloading wheel and impact sequences allow use of a variety of unique wheels and permit OEM's to tune the printer to specific needs.
3. Comes in two Shannon-text-rated speeds. 40 CPS and 55 CPS.
4. Industry-standard parallel or RS 232-C interfaces and ETX/ACK, XON/XOFF protocols provide maximum OEM flexibility and installation ease.
5. Extensive, built-in word processing functions allow easy adaptability and reduced software complexity.
6. Uses mono and dual-plastic wheels. (Unlike metal wheels, dual-plastic provides superior print quality over the entire life of the wheel.)
7. Field proven, firmware intensive technology for increased reliability.
8. Cast aluminum base plate with high quality metal parts provide lasting dependability.
9. Low-noise operation is ideal for office environment.
10. Choice of friction feed or bidirectional tractor feed for precise print positioning of tabular and graphics data.
11. Uses industry-standard wheels and ribbon cartridges available from multiple sources at low prices.
12. Universal power supply is standard and allows worldwide power source compatibility.
13. FCC approved and under 50 lbs. in weight for fast shipments and sales.
14. Easy-to-load wheels with tested and proven method of wheel support (spring loaded with positive detent).

We could go on. But quite frankly, once you see the F-10 perform, you'll never look at another Daisy.

The F-10 is fully backed by C. Itoh's warranty and complete support organization. Contact C. Itoh Electronics, Inc. 5301 Beethoven St., Los Angeles, CA 90066 (213) 306-6700.

 **C. ITOH
ELECTRONICS, INC.**
One World of Quality



HOW DO I LOVE YOU? LET ME COUNT THE WAYS.

CIRCLE NO. 14 ON INQUIRY CARD

IF OTHER WINCHESTERS HAD THESE,

VERTICAL INTEGRATION

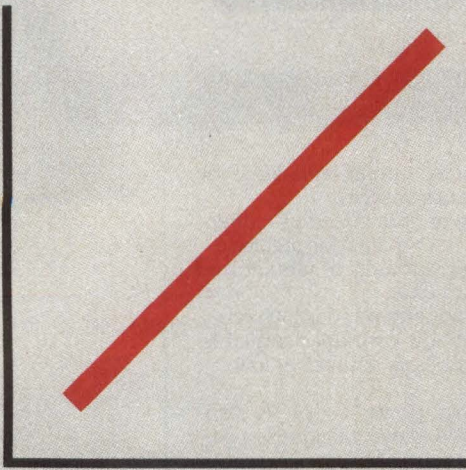

PRODUCTION

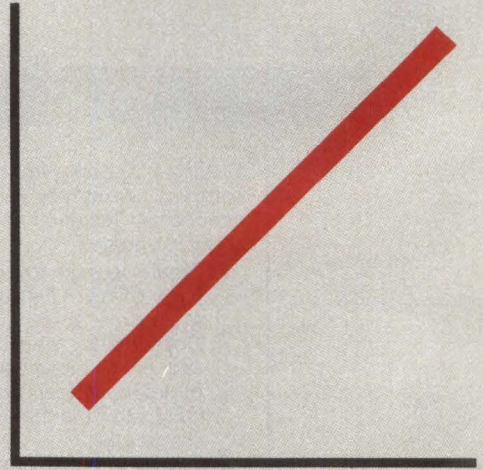

R&D

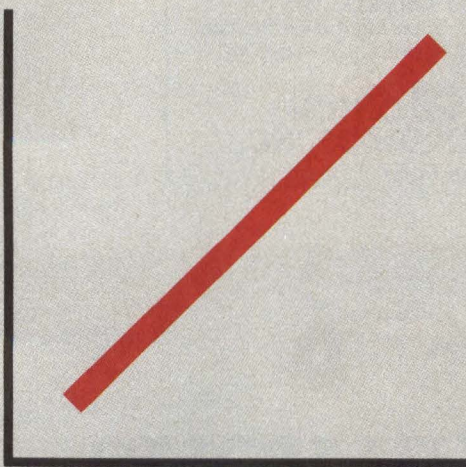

STORAGE CAPACITY

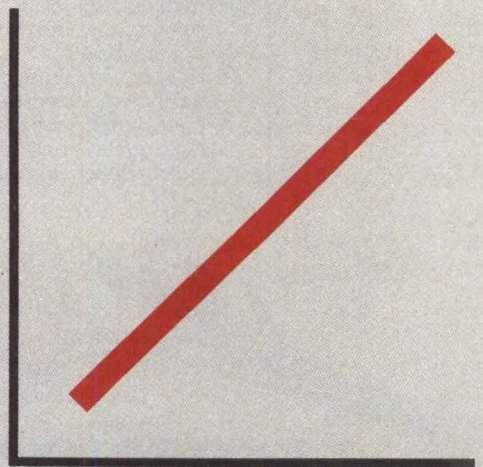

Tandon Corporation, 20320 Prairie, Chatsworth, CA 91311, (213) 993-6644, TWX: 910-494-1721, Telex: 194794, Regional (312) 530-7401 • Plano, TX (214) 423-6260 • Irvine, CA (714) 675-2928 • Sunnyvale, CA (408) 745-6303 • Kelsterbach

THEY COULD GIVE YOU THIS.

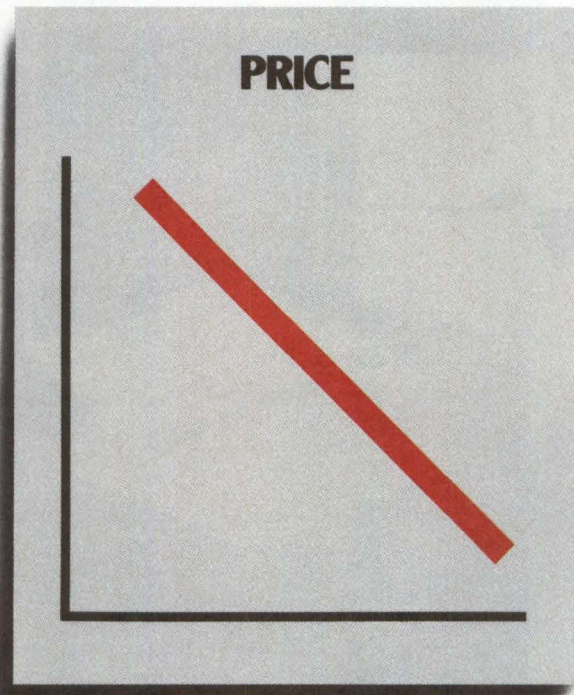

Nobody can match our prices because nobody builds Winchester's the way we do.

We make more of our own critical drive components than any other manufacturer. That helps us keep quality up and costs down.

We also keep our production capabilities at least 50% above our order level. So we can always deliver. Right now, we have the facilities in place to produce 40,000 Winchester's a month. And we're planning to expand.

To ensure that we stay ahead of the market in technology as well as low prices, we have committed ourselves to the most aggressive R&D program in the industry. We spend millions every year on pure product research.

As you can see, we're into Winchester's in a big way. With a wide range of drives, including both open and closed loop models.

They start with the world's lowest priced 5¼" family—the TM500 Series: 1, 2, & 3 platter drives, 5MB (formatted) per platter. TM500 Series drives have 306 cylinders and 345 tracks/inch and are virtually temperature-insensitive. The top of our line is the TM703, a closed-loop, high capacity 31MB drive with 600 tracks/inch. And we're working on a variety of new products, so you can continue to grow with us.

Since we're the world leader in 5¼" floppies, you can fill all your small drive needs from one source. In whatever volume you want. Backed by an impressive 105% guarantee.

No wonder we're the hot shop for Winchester's. Nobody's drives give you more. For less.

Tandon

THE MOST SUCCESSFUL DISK DRIVE COMPANY YOU EVER HEARD OF.

Sales Offices: Woburn, MA (617) 938-1916 • Sea Girt, NJ (201) 449-7720 • Tucker, GA (404) 934-0620 • Elmhurst, IL West Germany (6107) 2091, Telex: 411547 • Reading, Berkshire RG6 1AZ, England (0734) 664-676, Telex: 848411.

The ultimate under \$1000 printing machine.



The one machine solution to every application.

For word processing, plotting and just plain printing.

Save the expense of a costly daisy wheel. Eliminate the limited capability of cheap matrix printers. And get plotting in the process!! Get the all new, advanced MT 160 multifunctional micro printer. You'll be amazed that such a small printer can house so much horsepower.

Capability? You name it, this printer's got it. A resident Report Package puts you in the Word Processing world... letter quality characters, proportional spacing, margin justification, auto centering. A resident Graphics Package

lets you plot whatever your micro wants to portray. The standard print mode lets you generate reports fast—speeds up to 200 lines per minute. Also, print eight different resident character widths.

There's more. Clip-on paper handling attachments let you use fan-fold forms, letterhead, cut sheets or continuous roll paper. The control panel has a "menu select" for machine configuration. When you look under the hood, you'll see what is meant by "solid construction." And the MT 160 is

plug compatible to your micro.

In short, the MT 160 is the epitome of engineering excellence. And it should be. After all, Mannesmann Tally is the technology leader in matrix printing.

MANNESMANN TALLY

8301 South 180th St.
Kent, Washington 98032
Phone (206) 251-5524

IN DISTRIBUTION NOW!

WEST
Anacomp
(206) 881-1113
Byte Industries
(415) 783-8272

Kierulff Electronics
(213) 725-0325
PGI Distribution
(602) 967-1421
Waybern
(714) 554-4520
Western Micro Technology
(408) 725-1660
Acorn Data Products
(303) 779-6644

CENTRAL
Hall-Mark Electronics
(214) 341-1147
Information Systems
(312) 228-5480
D.L. MacNeil, Inc.
(312) 952-8300

Sysprint
(214) 669-3666
Tek-Aids
(312) 870-7400

EAST
Computermass
(904) 878-4121
Digital Solutions
(404) 955-4488
Hansen & Hughes
(201) 652-7055

US Plus
(203) 234-0444
Mannesmann Tally Canada
(416) 661-9783

CIRCLE NO. 46 ON INQUIRY CARD

Mini-Micro World

NEWS

HP uses proprietary chips in single-, multi-user systems

Hewlett-Packard Co. has introduced its long-anticipated 32-bit computer family, which marks the company's first use of Ethernet networking. It comes as no surprise that the Palo Alto, Calif., company has built the hardware around the five-chip set that attracted so much attention at the past two International Solid-State Circuits Conferences. At the same time, the company has formed a new organization within its Technical Computer Group called the Engineering Systems Division, in Fort Collins, Colo., to manufacture and market the new machines and all follow-on products for the scientific and engineering markets.

Called the HP9000 family, the systems are aimed primarily at the computer-aided engineering market, which HP has cultivated with its Desktop Computer Division's 9800 series machines for more than five years. There are three members of the HP9000 family: the series 500 with one CPU, the series 600 with two CPUs and the series 700 with three CPUs. Each series is available in a desk-top workstation, rack-mount or cabinet version for a variety of single- and multi-user configurations. HP9000 competition includes Digital Equipment Corp.'s VAX family, Apollo Computer, Inc.'s Domain and Fortune Systems Corp.'s 32:16.

Key to the HP9000 is the memory/processor module, so-called because it houses the boards containing the five-chip set: CPU, I/O processor with eight direct-memory-access channels, 128K bytes of RAM, memory controller and 18-MHz clock. The CPU, memory and I/O processor communicate over



a 36M-byte-per-sec. backplane bus. The CPU has a 55-nsec. cycle time that company officials say results in performance of 1 million instructions per sec. and a 6M-byte-per-sec. I/O rate. Memory cycle time is 110 nsec.

Preliminary benchmarks from HP pitting the HP9000 against its chief competition show the machine running double-precision Whetstones, in some cases, six times faster than comparably configured hardware. HP officials say the B1 Whetstone was used because it

represents the most computer-bound applications in scientific and engineering markets.

An HP9000 series 500 model 20 desk-top workstation with one CPU, for instance, performed 340,000 instructions per sec. In benchmarks against HP's own hardware, the HP9000 was found to be more than a match for the HP1000 A600, 700 and 900 minicomputers introduced last year. These systems, however, are targeted for real-time industrial markets. The stand-alone series 500 outperforms the HP9845 top-of-the-

Mini-Micro World

NEWS

line desk-top computer. Company officials expect the workstation version of the series 500 to replace the HP9845 in the future.

Two operating systems are available for the HP9000 family: HP-UX, the company's version of Bell Laboratories' UNIX, and HP's enhanced BASIC. HP-UX is a single- or multi-user, time-shared system with virtual-memory capabilities. It supports FORTRAN, Pascal and C compilers, and includes a 3270 emulator, Ethernet compatibility and HP's Shared Resource Manager

to connect HP9000s with each other or with HP9800 series machines. HP-UX also supports the Image/9000 database-management software and the Graphics/9000 2D and 3D graphics package.

HP's BASIC is a single-user operating system that includes a run-time compiled BASIC, embedded 2D and 3D graphics, plus Image DBMS, Query, a 3270 emulator and Shared Resource Manager software.

Application software will come from HP, OEMs and independent software houses, company officials say. Plans call for introducing several proprietary packages this year, with emphasis on electrical and mechanical engineering applications. HP currently is offering HPSPICE, a circuit emulation package; FE II, a general-purpose,

single-element finite-analysis system; and HP Design, an engineering-drawing package. Company executives expect a large quantity of software to be available through HP's third-party software program, HP Plus. Several major software houses delivering packages for 32-bit systems have signed agreements or are in discussions with HP to make their packages available for the HP9000.

Among those third-party software vendors that have already signed licensing agreements with HP are Softool Corp. and MARC Software International Corp. Softool will supply a FORTRAN programming environment, Change and Configuration Control and transportation tools for FORTRAN programs now on IBM Corp. or DEC systems. MARC will supply MUSE, a



From chip set to workstation and in between: the heart of the HP9000 is the module (center), which houses the boards containing HP's proprietary NMOS-III five-chip set. The workstation version of the HP9000 family can include a built-in thermal printer and 270K bytes of floppy disk storage. Monochromatic or color displays can be interchanged. The basic model 500 can be upgraded with additional CPUs.

FIVE-CHIP SET IS THE HEART OF HP HARDWARE

From the start, Hewlett-Packard Co. executives knew the five-chip set being developed at HP's Fort Collins, Colo., facility would be used in the company's 32-bit system. Code-named Focus, the devices were introduced in papers presented by HP engineers at the past two International Solid-State Circuits Conferences. No mention was made of Dawn, however, the project that would become the HP9000, and speculation grew as to when the company would unveil a 32-bit system to face those from Digital Equipment Corp., Data General Corp., Perkin-Elmer Corp. and Prime Computer, Inc.

Unlike its competitors, though, when HP did roll out its 32-bit, it took the shape of a desk-top workstation rather than that of a mainframe, to carry out HP's "one engineer, one computer" philosophy. What makes that desk-top workstation package possible is the VLSI at the heart of the hardware.

The five devices that make up the HP9000 are built with HP's NMOS-III, a very high-density semiconductor process that uses 1.5-micron line and

1-micron spacing design rules. One result of this process is very dense devices, such as HP's 128K-byte RAM that has about 600,000 transistors on chip. Another is that the company can build a machine with 1M byte of memory using 98 chips; with more conventional LSI components, the same system would require more than 800 devices. Mainframes need nearly 5000 chips.

HP's chip set includes:

- A CPU with 32-bit data and address buses with pipelined data transfers at 36M bytes per sec., a 55-nsec. cycle time, 230 instructions such as IEEE math formats and 9K 38-bit words of resident control store.
- An I/O processor with eight DMA channels and 4.5K 38-bit words of control store.
- A 128K-byte RAM with 165-nsec. access time and 110-nsec. cycle time.
- A memory controller with 256 bytes of RAM; single-bit error correction and double-bit error detection; and byte, half-word, word and semaphore operations.
- A clock chip that generates two overlapping 18-MHz signals.

technical word-processing package.

Statistical software from McMaster University, including SPSS, SCSS, BMDP and Minitab, will be available through HP Plus, as will Comsat General Integrated System's logic-simulation software, TEGAS-5, and microwave design program Super Compact.

Networking is available through Ethernet, making the HP9000 the first HP product to incorporate the LAN scheme. HP will also support the IEEE's 802 LAN standard when it

is specified.

Prices for an HP9000 series 500 single-CPU workstation start at \$28,250 for the model 20 and include the workstation with CPU, 912K bytes of RAM, 270K bytes of floppy disk storage and a black-and-white display. The same configuration with a color display sells for \$39,855. Increasing RAM to 1M byte and adding 10M bytes of hard disk storage, a thermal printer, BASIC and HP-UX operating systems and languages boost the price to

\$49,945. With a color display, the price goes to \$64,565.

A rack-mount model 30 sells for \$23,105 and includes a single CPU and 512K bytes of RAM. In a cabinet as the model 40, the same setup sells for \$24,115. A model 40 with 1M byte of RAM, IEEE 488 interface, an eight-channel multiplexer, HP-UX, BASIC, FORTRAN and graphics sells for \$44,900.

Prices for the two-CPU series 600 and three-CPU series 700 have not been set.

—Larry Lettieri

Intel teams up with Microsoft, pushes hardware/software for UNIX OEMs

Several months after Motorola, Inc., teamed with Alcyon to support the UNIX-like Regulus operating system (see "Assessing Intel's eye for UNIX," p. 24), Intel Corp. is bolstering its arrangement with Microsoft, Inc., to offer and support the Xenix operating system for several Intel products. The stakes could be a UNIX market as large as 100,000 licenses—more than \$3 billion worth by Xenix pricing standards—or as small as 25,000 licenses by year-end because of the continuing poor economy.

Intel's chances to assume a strong market position look positive. Bill Gates, Microsoft's chairman, claims that 80 percent of the UNIX licenses are units from Microsoft's Xenix license. Gates expects the first three years of his company's contract with Intel to generate \$5 million in software license sales.

UNIX consultant Jean Yates of Yates Ventures, who projects the 100,000 units by year-end, shares Gates's enthusiasm. She estimates that Intel's 80286 16-bit processor with Xenix will create a market for more than 200,000 such Intel systems by the end of 1986. Omri



Microsoft chairman Bill Gates expects to realize \$5 million in Xenix license sales through the first three years of his company's contract with Intel.

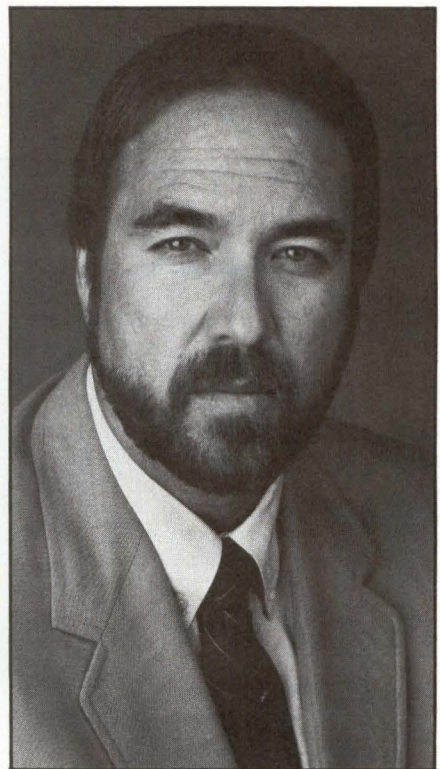

Alan M. Davis, general manager of Intel's Software Distribution and Support Operation, says, "The UNIX market is so explosive we put our first effort there."

Serlin, president of Icom International Co., a Los Altos, Calif., consulting firm, is less optimistic

than Yates about the UNIX market, partly because of the poor economy. "I'll be amazed and delighted if the

Mini-Micro World

NEWS

numbers of (end-user) UNIX installations are 50,000 by the fourth quarter. By the end of the year, 25,000 to 50,000 is more realistic," he says.

Intel was drawn to the multi-user operating system strongly enough to push its availability before that of other Intel projects. "The UNIX market is so explosive we put our first effort there," says Alan M. Davis, general manager of Intel's Software Distribution and Support Operation (SDSO) in Santa Clara. "There is no de-emphasis of MP/M. The most important products to Intel by strategic focus are the database system and the 86/330 system, both of which lend themselves better to Xenix." Davis notes Intel's efforts with Digital Research, Inc., are ongoing. He does not view the two operating systems as competitors because MP/M is for small, fast, real-time systems, and



UNIX consultant Jean Yates, of Yates Ventures, estimates Intel's 80286 16-bit processor running Xenix will create a market for more than 200,000 such Intel systems by the end of 1986.

UNIX is for larger multi-user systems that require an easy human interface.

This recent turning point in Intel's efforts to seduce third-party software vendors comes from a market requirement to get products out quickly, and from Intel's wanting not to duplicate efforts made by independent software suppliers. "It takes two years from design to use in the production of a typical LSI component," notes Davis, "and it takes two more years for software to catch up to the new Intel hardware." The company hopes to streamline application software-development efforts and costs by offering an operating system that is compatible in its 16-bit line, and future generations thereof, and thus cut into the two-year development lag. Intel has licenses to many operating systems, including CP/M-86 and MS/DOS.

ASSESSING INTEL'S EYE FOR UNIX

"The one standard in UNIX is how everyone spells UNIX," quips Lovell Chase, vice president of marketing for Alcyon, the company that produces the UNIX-like Regulus operating system recently adopted by Motorola, Inc., for its MC68000 processors.

Intel Corp. faced a host of choices for its UNIX path. The company opted for a Bell Laboratories-licensed version, which narrowed its choices to two: developing UNIX under license from Bell Labs, or adopting Microsoft's Xenix, a licensed version of Bell's that is the only such one with ports to the 8086, says Alan M. Davis general manager of Intel's Software Distribution and Support Operation. Intel chose the latter approach.

Alcyon's Chase believes there are good alternatives to the Bell license, noting that lower cost alternatives are important. Alcyon charges \$37,000 for an OEM license to distribute 4000 Regulus copies, which includes one copy of source code. This means \$9.25 per copy to OEMs. CIE Systems, Inc., McDonnell Douglas's Vitek medi-

UNIX goes commercial

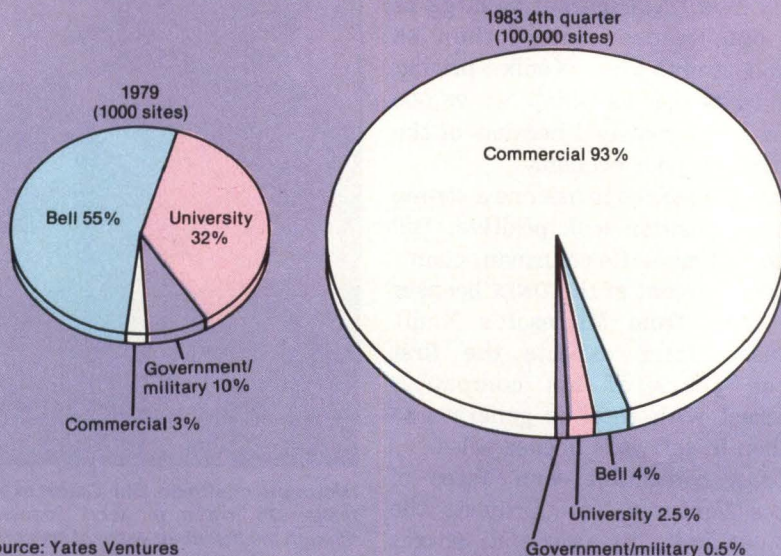

Source: Yates Ventures

The UNIX market is rapidly shifting to commercial versions of the operating system optimized for end-user sites. In 1979, most Bell license use was by data-processing professionals on minicomputers.

Intel already supports Xenix system integrations for iAPX-86 family members, and for the 86/300 family systems. Support for 8086 components and board-level products will be available this quarter. Intel's Xenix-86, with a C compiler and debugger, also runs on the 8087 math co-processor. Future Xenix-86 versions will run on the 80286 and the 80287 advanced floating-point co-processor, which gives a growth path for applications developed on the 8086. Intel and Microsoft plan to produce Xenix upgrades jointly. Xenix-86 is one of the first SDSO products.

Xenix-86 for the 86/330 is available under license. Intel's prices range from \$3000 to less than \$900 for multiple copies. Support for Xenix-86 ranges from \$240 to \$1950 per year for standard service, which includes newsletters, technical reports, software application ex-

change, updates, system performance reporting, modifications, fixes and a telephone hot line. The 86/330 is priced between \$12,000 and \$20,000 to OEMs buying five or six systems. Xenix for the same number of systems is priced at \$1000. Davis will not comment on royalties Intel will pay to Microsoft

for distributing the operating system.

By this year's National Computer Conference, the 80286 with Xenix will be available in sample quantities. No prices are set for Xenix on the 80286, but Davis expects them to be similar to those of the 86/330's.

—Lori Valigra

INTEL ADDS SINGLE-CHIP 8088

Intel Corp., Santa Clara, Calif., has introduced a single-chip version of its popular 8088 8-16-bit microprocessor. Called the iAPX 188, the device is the latest member of Intel's family of chips that includes the 16-bit iAPX 186 (MMS, August, 1982, p. 19) and virtual memory 286 (MMS, April, 1982, p. 52). Like the 186, the 188 is said to reduce the functions of 15 to 20 chips onto a single component. The 188 includes the 8088 CPU with an 8-bit data bus and a 16-bit address bus, a two-channel DMA, an 8-MHZ clock, timers, an interrupt controller, chip-select logic and a ready generator. The 188 operates with Intel's 8087 math co-processor, 8089 I/O processor and 80150 CP/M-in-silicon and 80130 iRMX 86 operating system-in-silicon chips. In quantities of 100, the 188 sells for \$50. It will be available during the first quarter of this year.

cal subsidiary, has signed up for Regulus, and Doric, which manufactures an MC68000-based industrial instrument data logger was ready to sign at press time.

Intel's strongest competitor on the semiconductor level, Motorola, has announced a team-up with Regulus supplier Alcyon. Rather than going outside for an operating system, Motorola chose to internalize the project, says Bill Lowery, software marketing manager for Motorola's Microsystems operation in Phoenix. He notes Motorola has made minor modifications to Regulus for performance and for fixing bugs. After next month, the company will be able to offer support for at least eight users on its EXORMacs development system, which Lowery says is UNIX Version 7 compatible. Price for the Regulus version, called Unidos, on EXORMacs, will be about \$3000 in single-unit quantities, including utilities. OEM pricing will be aggressive, says Lowery, which is one reason Motorola chose Regulus.

UNIX has gained more popularity since license prices were dropped on

System III more than a year ago. Western Electric Co. dropped licensing fees by about half, to a flat rate of \$25,000 for a System III license, plus \$100 per processor for single-user systems and \$250 per processor for systems that supported more users. For very large-volume customers, the UNIX price can drop as low as \$40 per user.

Microsoft chairman Bill Gates was hurt by the license price drop because he did not receive credit under the Version 7 license. Gates estimated that cost him \$750,000, and he is still working on getting credit.

The team effort still may require fine tuning by Intel. "The Intel and Microsoft deal makes sense in that Intel is getting into the systems game with UNIX systems," says Heinz Lycklama, chairman of the /usr/ Group Standards Committee, which was scheduled to meet at the recent Comdex show to adopt a standard that will conform closely with System III. Members of the group include Fortune Systems Corp., Microsoft, Digital Equipment Corp., Ryan-McFarland Corp. and the Mark Williams Co.

One drawback to the Intel/Microsoft arrangement, Lycklama notes, is that Intel depends on Microsoft somewhat for the operating system.

It will be important for the two companies to work together on updates, especially to consume small shifts in the UNIX market. A new version of UNIX is forthcoming from Bell, but Gates does not believe it will conflict with Xenix enhancements. Microsoft also is doing some shifting. While some Xenix versions now are in Version 7 and are used on Intel 8086 and 86/330 products, Microsoft plans to make all Xenix versions System III compatible. The differences between the two versions are minor, says Gates, who chose System III because it falls under the lower licensing fees from Bell. Gates says the 80286 will have System III-based UNIX. The 8086 and 86/330 will have updates to include System III. Microsoft's Xenix based on System III includes a few more utilities than Version 7, and boosts I/O performance 30 percent, Gates notes.

Confusion abounds as Seagate drops Sony, adopts Tabor microflop

Just when it appeared safe for floppy disk drive manufacturers to return to the assembly line with a quasi-standard for sub-4-in. drives in hand, Seagate Technology reversed itself in mid-course, triggering renewed confusion about media standards for those drives. Industry participants fear a replay of the chaos surrounding the 8-in. Winchester's introduction just three years ago. Those drives came to market lacking a standard interface.

In a move that has stunned many competitors, Seagate has abandoned its evaluation of Sony Corp.'s 3½-in. floppy drive and entered a licensing agreement for a 3¼-in. drive designed by Westford, Mass., start-up Tabor Corp. The Tabor drive features a flexible jacket diskette from Dysan Corp., a track density of 140 tpi and a recording density of 9250 bpi. In comparison, the Sony drive uses a hard jacket media, has a 140-tpi track density and a recording density of 7610 bpi.

"We have made a fair assessment of the availability of the low-priced media," says Seagate's executive vice president Finis Conner, "and we firmly believe that the Dysan product has the best opportunity to be available from a number of alternate sources." Conner does not elaborate on just what alternate sources are available, or if any other licensing agreements had been arranged by Tabor or Dysan.

Conner and Tabor president Mike Hanley firmly deny any pressure from Dysan president Norm Dion to accelerate the deal. Dysan is a minority stockholder in both Seagate and Tabor.

The key to the success of the Tabor/Seagate drive will be the ability of the two companies to

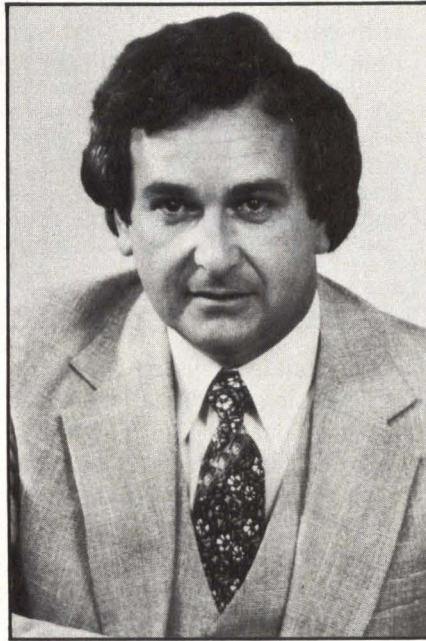

Seagate executive vice president Finis Conner says Dysan's flexible media microflop drive has the best chance of being available from a number of alternate sources, but will not elaborate on what sources are available.

convince others to join them in making the 3¼-in. flexible jacket drive a standard. From initial responses in the industry, it appears that job will be difficult. "They have snatched defeat from the jaws of victory," says one executive of a rival disk drive manufacturer, referring to the industry's apparent preference for hard jacket media.

Most observers agree the confusion created by the lack of a standard interface caused controller manufacturers to hesitate in building controllers for 8-in. Winchesters. Consequently, sales of 8-in. Winchester disks were slowed for the first year until manufacturers agreed on an interface.

Not until Shugart Associates introduced its SA1400 controller

could OEMs evaluate the 8-in. hardware. As a result, Shugart's SA1000 interface became a de facto standard for that class of drives. Many now fear a similar hesitance among media manufacturers to introduce products for the sub-4-in. market until a single standard emerges.

While most of the microflops make life easier for controller manufacturers by using the 5¼-in. ST506 interface (Sony's is ST506 compatible), the differences in the media form factor may create some problems among system integrators and end users. One independent observer puts the blame for the confusion about the form of the sub-4-in. floppies squarely on the shoulders of the product's pioneer. Raymond C. Freeman of Freeman Associates, a Santa Barbara, Calif., consulting firm, says Sony should have entrenched itself deeper and earlier when it had the market to itself. "The Sony drive would have been the clearly defined standard, had Sony been ramming this marketplace fast and hard," he says.

Freeman recalls Shugart's introduction of the 5¼-in. floppy in 1978. Shugart cornered the market by working with 12 manufacturers of word-processing systems that saw the advantage the smaller drives would give their desk-top units. All 12 participated in evaluating the drive, and there was little space for another manufacturer to take the same idea and reshape it.

Seagate's decision to join Tabor creates a fifth interest group seeking the favor of an ANSI committee (MMS, October, 1982, p. 17). In addition to Sony, another Japanese consortium including Hi-

**You'll
Think
It's Magic!**



Supermux 600 Series Statistical Multiplexers

The Supermux 600 Series, Infotron's new line of statistical multiplexers that make it easy for you to do so much more—you'll think it's magic!

They make installation programming easy, remember alternate network configurations, grow with you, diagnose network problems, make transmission errors vanish and, best of all, they make your big telephone bills disappear.

Supermux 600 Series multiplexers prompt you with simple, English language instructions displaying choices of speeds, codes, priorities and other configuration parameters on any ASCII-compatible terminal. Simply keying "HELP" provides more details when you need them.

These remarkable units pay for themselves by concentrating data from up to 32 synchronous and asynchronous inputs at speeds to 9600 bps over a single high speed telephone line or over two lines to two different remote locations. They include important network capabilities like dual trunks, switching and contention and end-to-end compatibility with Infotron's powerful 790 Network Concentrator.

The new 600 Series multiplexers are transparent to existing hardware and software so they are easily installed without requiring network changes. They are available in 16 and 32 channel models, both with unbelievably attractive prices. The new 600 Series from Infotron—they make it easy for you to do so much more—you'll think it's magic!



Infotron Systems

First in Performance and Reliability

Infotron Systems Corporation, Cherry Hill Industrial Center, Cherry Hill, New Jersey 08003

Telephone: 800-257-8352 609-424-9400 TWX: 710-940-1247

CIRCLE NO. 16 ON INQUIRY CARD

Mini-Micro World

NEWS

tachi, Hitachi-Maxel and Matsushita is developing a separate sub-4-in. floppy. In the U.S., Tandon Corp. also is competing against the industry drive committee standard with a microflop drive that will be compatible with the Sony media (MMS, October, 1982, p. 18).

Seagate officials will not comment on reports that the company has contacted rival Tandon Corp. in Chatsworth, Calif., to interest that company in a product based on the Tabor design. Tandon president Jugi Tandon was not available for comment at press time. An endorsement by Tandon, one of the three largest makers of low-end disk drives, would greatly increase the credibility of the Tabor design. It also would give Seagate a boost in the floppy drive market—a new venture for Seagate.

Charles Payne, manager of business planning for Verbatim Corp. and chairman of the industry committee to formulate a standard, says it was the fear of too many standard contenders that caused the committee to be formed in the first place. Both Dysan and Tabor were originally on the committee, Payne notes, but became disenchanted when the committee failed to adopt a flexible jacket as a standard. "Every survey we ever made

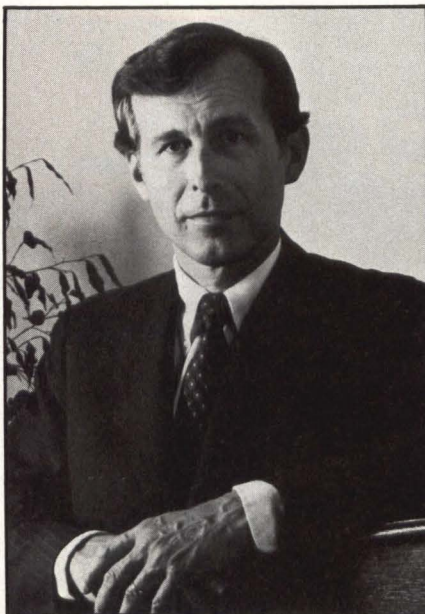

"The Sony drive would have been the clearly defined standard, had Sony been ramming this marketplace fast and hard," says Raymond C. Freeman of consulting firm Freeman Associates.

showed that both OEMs and end users preferred the hard-cased jacket," Payne says.

But Tabor's Hanley says one Tabor engineer responsible for the microflop drive had worked at Memorex Corp. when it attempted a floppy disk with a hard casing. "It didn't work then for Memorex, and it won't work for us now," Hanley says.

The hard casing also costs more to

manufacture, says Seagate's Conner, but members of the industry committee, including Payne, sharply disagree with that assessment. Among those disagreeing is Shugart Associates' George Sollman, executive vice president and general manager of the marketing and sales division, who notes that the flexible jacket cannot provide the media protection required in smaller microflops. Because it requires fewer parts, the Tabor drive is likely to reduce Seagate's costs and give the 5¼-in. Winchester pioneer a quick and inexpensive foothold in the emerging microflop market. More importantly, the trail will be cleared for Seagate to create a niche for sub-4-in. Winchesters just as 5¼-in. floppies on the market cleared the way for Seagate's hard drives.

Seagate is expected to have evaluation units of its microflop available in the second quarter of 1983, with production units available by the third quarter. Tabor is expected to have its production units available in the first quarter of 1983. The Tabor drive, dubbed the TC500, is priced at \$315 in single-unit quantities. Neither designation nor price has been set for the Seagate microflop.

—Bob Sehr

Digital Research pushes GSX as the micro graphics standard

Digital Research, Inc., hopes to cash in on what chief operating officer John Rowley calls the highest potential growth market in micro-computer software by incorporating Graphics Systems Extension (GSX) on all versions of CP/M and making it available for other operating systems. Rowley hopes GSX will become a de facto industry stan-

dard.

"Graphics is becoming the fourth requirement on microcomputers after word processing, a spreadsheet capability and database management," says Future Computing analyst Egil Juliussen. "But a lack of standards is holding back an even more vigorous microcomputer graphics boom." Other observers,

such as Okidata Corp.'s vice president of marketing, Chet Baffa, say a dearth of software to drive graphics output devices is the bottleneck. Digital Research, Pacific Grove, Calif., hopes to remedy both complaints with GSX, an operating-system enhancement incorporating the emerging ANSI-standard Virtual Device Interface (VDI), plus drivers for a large number of graphics devices. Moreover, Digital Research will offer GSX in versions compatible with operating systems competing with

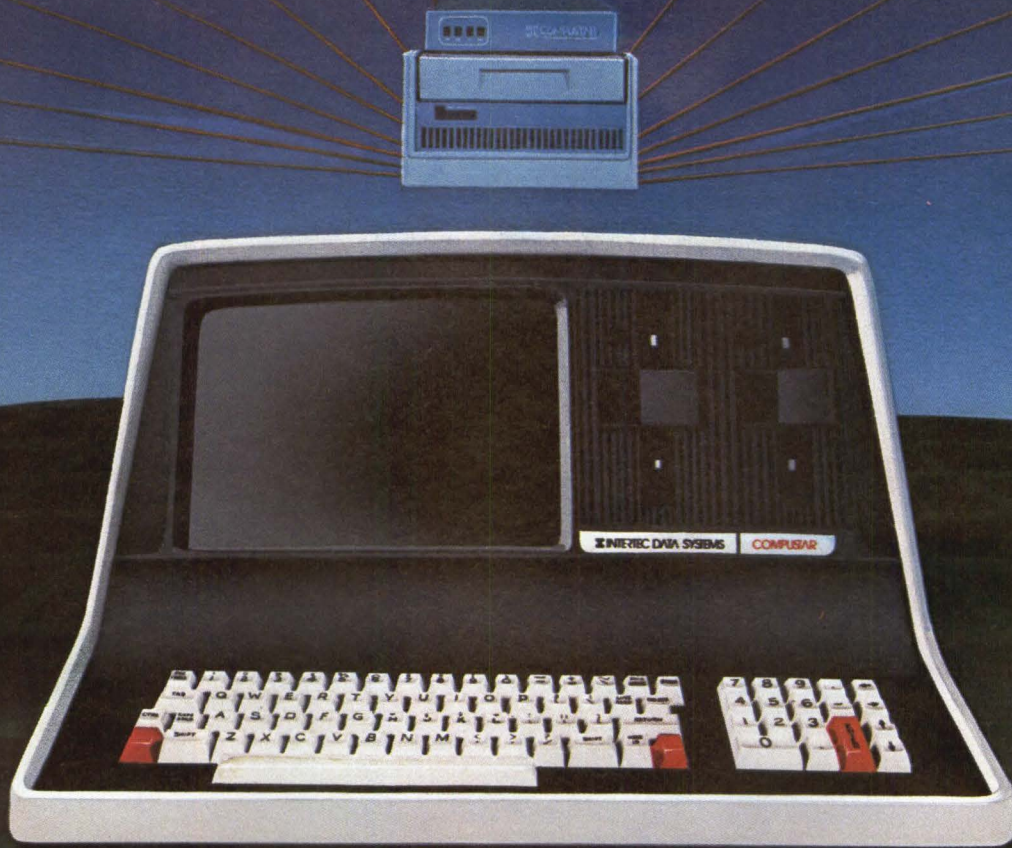

TOUGH TO OUTGROW

It's no surprise so many businesses today are using our CompuStar® multi-user microcomputer. All sorts of businesses, those at the top and those on the way, know that only CompuStar can give them the big system performance they'll need as they grow. And they know that *only* CompuStar can deliver that performance at a fraction of the cost of most other systems.

CompuStar® solves the small business computer dilemma. It's ideal for those first time business users who need only single-user capability. But it's also perfect when those small businesses grow into large corporations. That's because CompuStar is *truly* expandable... all the way up to 255 workstations, each with its own processor and internal computer memory. And that means fast, fast response, even when many users are on-line at the same time.

Whether you're a small business with big plans or a big business with an eye for economy, CompuStar® has the performance and versatility that's tough to outgrow... the price/performance ratio that's impossible to beat!

STANDARD FEATURES

- 350K/750K/1.5 MB workstation disk capacities
- 64K RAM and twin processors in each workstation
- An easy-to-read 12-inch non-glare screen
- Operator convenience features—numeric keypad and visual text highlighting
- Microsoft® Basic
- CP/M+ operating software
- Truly multi-user and multi-processor

STORAGE OPTIONS

- 10 MB—compact, low-cost and tabletop
- 96 MB—80 fixed and 16 removable megabytes
- 144 MB—reliable, rugged Winchester storage

CompuStar® is built and backed by the company that's been in the microcomputer business as long as microcomputers have been in business. Would you trust *your* business to anything less? CompuStar®. Tough to beat. Tough to outgrow!

*Microsoft is a trademark of Microsoft Corp.
†Registered trademark of Digital Research.

CIRCLE NO. 17 ON INQUIRY CARD

CORPORATE HEADQUARTERS: 2300 BROAD RIVER ROAD • COLUMBIA, SOUTH CAROLINA 29210 • (803) 798-9100 • TWX 810-666-2115

**INTERTEC
DATA
SYSTEMS®**

Let your imagina

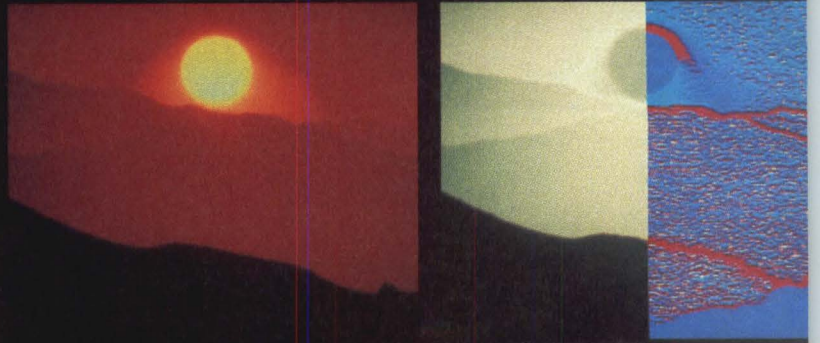

tion run wild, not your budget.

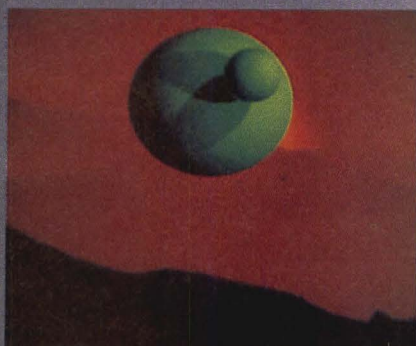
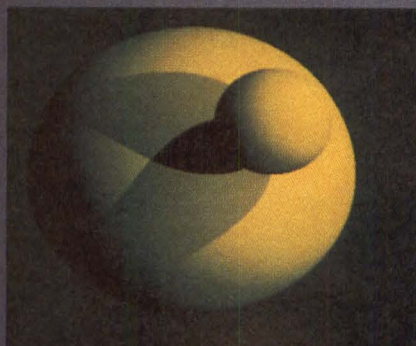
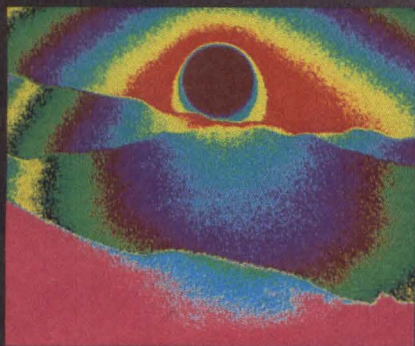

Introducing the Grinnell 2800 Image Processing / Graphic Display System.

Whatever your mind can imagine, the new Grinnell 2800 System can visualize. And it does it at an astonishingly cost effective price.

Power and flexibility in a compact system.

For 512x512, 512x640, 480x640, 1024x1024 and 1024x1280 graphics, image enhancement and image processing, the 2800's exceptionally fast, easily programmed distributed computing architecture (built around a high-speed bit slice processor) puts an incredible repertoire of graphics instructions and image processing capability at your disposal for a wide range of monochrome, 3-color and multi-spectral applications.

Exactly what you need, when you need it.

Because of its unique, modular design, the 2800 System can be sized to your specific needs without sacrificing performance, allowing for

multiple, modular processors and controllers for parallel, multi-spectral processing. And each processor is individually programmable, letting you manipulate input, graphics and imaging for simplified operation and maximized throughput.

For added cost-effectiveness, each video controller is associated with an ultra-fast pipeline processor. And should you need it: an optional microprocessor (Motorola MC68000, 512K RAM, 32K PROM) for Command Control Processing.

Programmable for your applications.

With the 2800 System, its microprogrammable System Controller gives you the choice of using standard or special instruction sets, with the option of downloading from the host computer or through the Command Control Processor. The CCP can also be programmed to interface

with your choice of interactive control devices and off-load frequently used routines from the host computer. In addition, the system's Intelligent Host Interface offers you several data transfer modes to further enhance throughput.

Now imagine how it can work for you.

Compare its performance to anything on the market. Then, when you compare prices, you'll buy Grinnell. For details, write or call (408) 629-9191. Whether you're an OEM, end user, or involved in educational or industrial research, you'll agree: the Grinnell 2800 lets your imagination run wild, but not your budget.

GRINNELL SYSTEMS

6410 Via Del Oro Drive
San Jose, CA 95119 (408) 629-9191

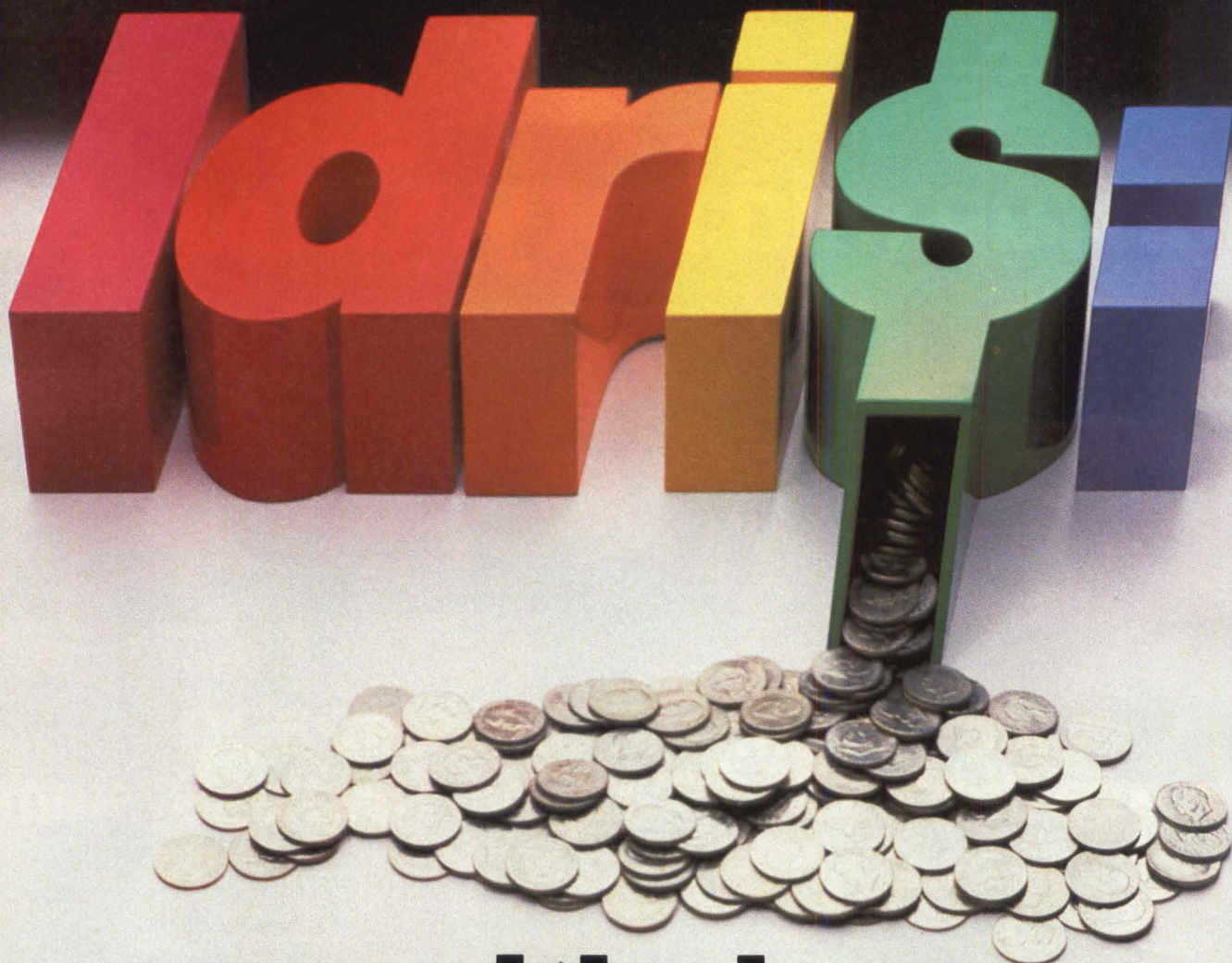

UNIX, with change.

Idris is a trademark of Whitesmiths, Ltd. / UNIX is a trademark of Bell Laboratories.

Put off by the UNIX price tag and licensing restrictions? If you are, take a closer look at Idris.

Idris gives you all the power of UNIX at a fraction of the cost—and they're highly compatible—even pin-for-pin in some cases. Upfront expenses are much lower, you only pay for the parts you ship, and the end-user licenses can be transferable.

What's more, we wrote Idris ourselves—from the ground up—so you'll have fewer licensing hassles. We wrote it almost entirely in C, for maximum portability across a wide

range of processors. And we kept it small.

Idris can run comfortably where UNIX can't even fit: On an MC68000 with no memory management hardware, for example. On a bank-switched 8080 or Z80. Or on any LSI-11 or PDP-11 with memory management. A very big Idris plus.

Find out how you can put Idris to work in your favorite configuration today. Write Whitesmiths, Ltd., 97 Lowell Road, Concord, Massachusetts, 01742. Or call (617) 369-8499, TLX 951708 SOFTWARE CNCM.

With Idris, you pocket the change.

Whitesmiths, Ltd.

Crafting Software Tools for your Trade.

Distributors: **Australia**, Fawncray Pty. Ltd. P.O.B. 224 Hurstville NSW 2220 (612) 570-6100
Japan, Advanced Data Controls, Corp., Chiyoda-ku, Tokyo (03) 263-0383
United Kingdom, Real Time Systems, Newcastle upon Tyne 0632 733131

CIRCLE NO. 19 ON INQUIRY CARD

Mini-Micro World

NEWS

CP/M, including MS/DOS and UNIX.

The key advantage offered by GSX is its device independence. In effect, programmers write their programs to draw in a normalized coordinate system using a standard protocol defined by ANSI's VDI. They need not worry about hardware peculiarities because GSX maps the standard's coordinates and protocol to the hardware coordinates (such as 320×240 for the IBM Corp. PC's color raster display) and protocols (such as vector pairs for a plotter). Therefore, an application program accommodates a variety of graphics hardware devices without changing the object code. The same object code runs unchanged on any computer equipped with the same operating system.

For programmers who do not wish to write at the low level defined by GSX's VDI, Digital Research offers two sets of subroutine libraries that are based on the Graphics Kernel System (GKS), the draft international standard. The lower level product, GSS-Kernel, supports Pascal, FORTRAN, PL/1, BASIC and C with standard graphics procedure calls. GSS-Plot, a higher level programming tool, defines plots and graphs with just a few calls from a high-level language. (GSS stands for Graphics Software Systems, Inc., a Wilsonville, Ore., Tektronix, Inc., spin-off, with which Digital Research developed GSX and adapted the subroutine libraries for CP/M.) Both tie to CP/M's underlying GSX and offer a programmer the same device-independence and program portability. Finally, an emulation of the Tektronix 4010/4014 terminal protocols, called GSS-4010, is available to provide compatibility with Plot 10 software.

The most common graphics devices in microcomputers are an internal raster-scan monitor, a printer or a plotter and perhaps an analog input device such as a mouse.

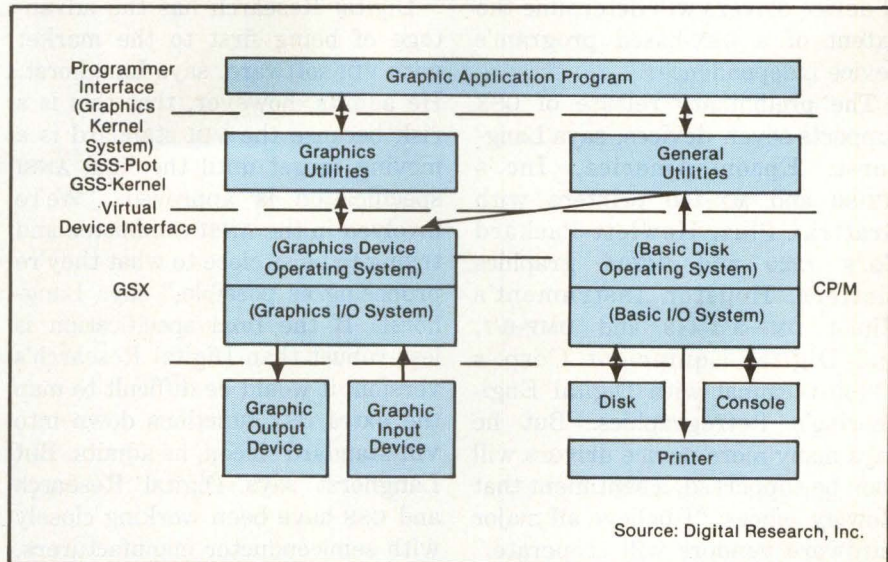

Source: Digital Research, Inc.

GSX is an extension of CP/M and its components GDOS and GIOS, which correspond roughly to BDOS and BIOS. GDOS interfaces to the normal BDOS calling sequence by trapping all calls to BDOS and examining the function code. If the code is 115 (73 Hex), the call is a graphics request and is serviced by GDOS. All other codes are passed to BDOS and serviced as normal CP/M I/O. (Source: Digital Research, Inc.)

A number of such devices can be supported under GSX within an application. A memory-resident file called Graphics Device Operating System (GDOS) loads the appropriate device driver off the disk when a device is requested by the application program, overlaying the previous driver. Memory is conserved because only one driver is resident at a time.

The library of device drivers is called Graphics I/O System (GIOS). Each driver communicates with the graphics device to perform basic drawing commands. In some cases, the device driver emulates standard GDOS capability not provided by the graphics hardware. For example, the device driver may simulate dashed lines with a series of short vectors.

To interest graphics hardware vendors in cooperating in writing such device drivers, a large installed base is necessary. Therefore, says Digital Research's Rowley, GSX's pricing is intended to make it nearly ubiquitous. Digital

Research initially considered charging OEMs \$25,000 up front and \$25,000 more after 10,000 copies were distributed, but opted instead to charge \$2.50 a copy for the first 10,000 and \$1.25 a copy thereafter. "An OEM would be foolhardy not to design it in at those prices," says Rowley. Independent software vendors, meanwhile, pay \$500 to base applications on GSX's capabilities. GSS-Plot and GSS-Kernel are also available for \$500 per copy.

The success of GSX will depend in large part on the number of device drivers offered. Ironically, the need for such device drivers eventually will disappear. Intel Corp. will produce VLSI devices that will allow graphics vendors to provide the standard VDI in hardware. But such chips are probably 18 months from production and much further from design into a new generation of graphics devices, says the director of Digital Research's Graphics Product Group, Fred Langhorst. For at least several years, therefore, the extent of the GIOS library

Mini-Micro World

NEWS

of device drivers will determine the extent of a GSX-based program's device independence.

The preliminary release of GSX supports seven devices, says Langhorst: Epson America, Inc.'s MX-80 and MX-100 printers with Grafrax Plus, Hewlett-Packard Co.'s 7220 and 7470A graphics plotters, Houston Instrument's Hiplot DMP-3/4-443 and DMP-6/7, and Digital Equipment Corp.'s VT100 terminal with Digital Engineering's Retrographics. But he says many more device drivers will soon be supported, a sentiment that Rowley echoes: "I believe all major hardware vendors will cooperate," he says. "Because we have close to 1000 OEMs and 1 million CP/M users, the hardware people want us to support their graphics devices."

Another factor favoring acceptance of GSX, says Langhorst, is its inherent ability to tailor output to the characteristics of a device. "You need that for good quality using the device-independent approach," he says, and adds it was the chief reason for Digital Research's choice of VDI as GSX's indigenous base over the roughly equivalent, North American Presentation Level Protocol Syntax (NAPLPS) draft standard. "VDI was designed to be an interactive workstation interface," he says, "while NAPLPS is a one-way dump." Under VDI, an application program can inquire about the capabilities of a device; if color is available on a CRT, for example, the device driver would automatically use it instead of gray shading. Area fill might be in color if available; otherwise, the application program could provide cross-hatching. NAPLPS provides no such adjustments and offers limited resolution. "Yet there will be a demand for NAPLPS," says Langhorst, "so it's available under GSX via a mapping routine." NAPLPS is intended primarily for videotex terminals.

Digital Research has the advantage of being first to the market with VDI software, says Langhorst. He admits, however, that this is a risk because the VDI standard is a moving target until the final ANSI specification is approved. "We're involved in the ANSI committee and trying to be as close to what they're proposing as possible," says Langhorst. If the final specification is less robust than Digital Research's version, it would be difficult to map the extra GSX functions down into VDI-standard silicon, he admits. But Langhorst says Digital Research and GSS have been working closely with semiconductor manufacturers, including Intel Corp., the prime mover behind the VDI push. "If discrepancies crop up, I think the Digital Research version would be as influential as the standard," he says, because of an early lead in the market.

Even before the question of whether GSX will be an official or a de facto standard has been answered, Digital Research's independent software vendors that have graphics applications under development or on the market are leaning toward the GSX approach.

Al Dynarski, president of DataGraph, Arnold, Calif., says, "Using GSX would greatly simplify our job." DataGraph's Accuchart, which is offered under OEM agreement by Vector Graphic, Inc., supports only Diablo Systems, Inc., protocol daisy-wheel printers for output, although DataGraph has several other device drivers under development. "But it would be nice if we could interface to anything without having to buy one of each hardware device," he says. And Micro Focus, a vendor of productivity tools designed to aid the creation of business applications, says it has already committed to GSX.

Meanwhile, support from Digital Research's computer OEMs is swell-

ing. Digital Research confirms it has commitments to license GSX from TeleVideo, Inc., NEC Information Systems, Inc., NCR Corp., DEC, Xerox Corp., Ontel Corp., Otrona Corp. and others.

Other major operating-system software vendors have taken different approaches and have no plans to jump on the GSX bandwagon. "We've put graphics capabilities into the 16-bit BASIC that comes as part of the OASIS-16 operating system package," says Howard Sedorski, president of Phase One, Inc., Oakland, Calif. "Because it's a true complied BASIC, you can use the commands in programs written in other languages," he says. Phase One has written device drivers for a number of color raster-scan CRT displays, including that of the IBM PC, with support for such output devices as Epson printers, HP plotters and "whatever else there's a demand for" soon to follow, Sedorski says. "Putting graphics into a language rather than the operating system makes it easy for the programmer," Sedorski claims, "and that's what it's all about."

Microsoft has taken a similar approach. Its new release of GW BASIC (Version 2) incorporates additional graphics commands into the language, but only screen raster graphics are supported. Microsoft's operating system MS/DOS may add graphics capabilities eventually as well, but a company spokesman declines to comment about that addition.

Although it is not clear that GSX will become a standard for other operating systems as Digital Research hopes, a recent study from Frost & Sullivan, Inc., says the drive for graphics software will increase the use of the GSX-enhanced CP/M operating system.

—Kevin Strehlo

**When you're looking for
a heavyweight performer
at a low price,
IBC outweighs the competition.**

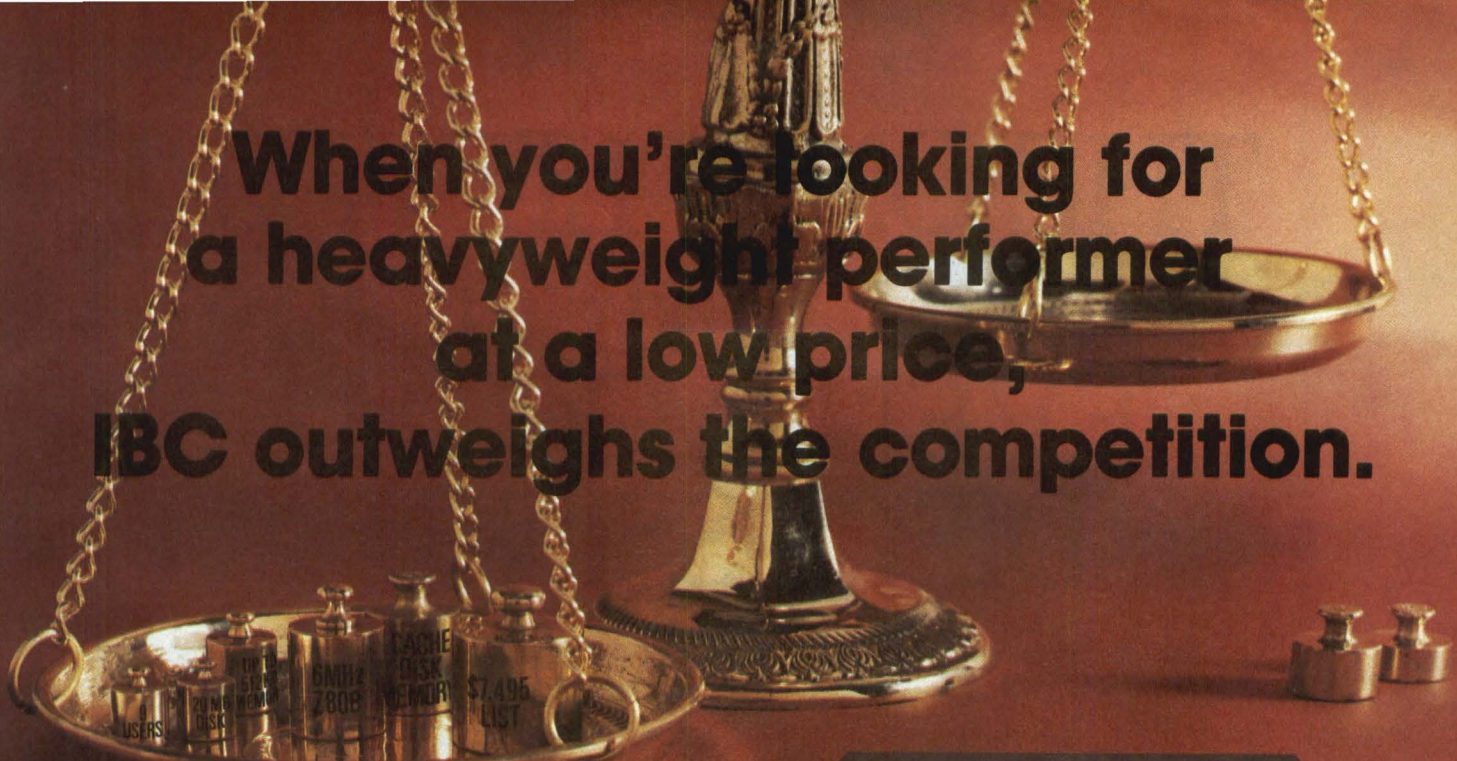

IBC MIDDI CADET™

Maximum Users	9
Disk Storage	20 MB
Memory	256 KB * *
CPU Speed	6 MHz
Benchmark (Elapsed time)	1:44 Minutes *
List Price	\$7495.00

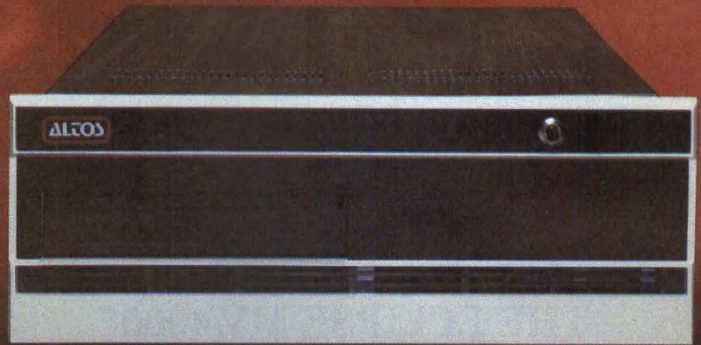

ALTOS™ ACS 8000-10

Maximum Users	4
Disk Storage	10 MB
Memory	208 KB
CPU Speed	4 MHz
Benchmark (Elapsed time)	5:03 Minutes *
List Price	\$7995.00

The IBC MIDDI Cadet is better, faster and less expensive than the ALTOS ACS-8000-10 and others. That's why we call it the heavyweight performer.

Because the MIDDI is completely software compatible with ALTOS, ONYX™, Dynabyte™ and others using CP/M™ 2.2, MP/M™ II or OASIS™, you can transport your applications software to the MIDDI without modification. So why not take the benchmark test yourself.

If you are an OEM, system integrator, multiple end user, or dealer for any of our competitors, send a copy of your application program to IBC. We will run your software on the MIDDI without modification and give you the elapsed time in minutes. You be the judge. If it really is faster than your current hardware and it is, then you owe it to yourself and your customers to switch to IBC.

So remember! When you want a heavyweight performer at a low price, contact:

OUTSIDE THE USA

IBC / Integrated Business Computers

21592 Marilla Street
Chatsworth, CA 91311
(213) 882-9007 TELEX NO. 215349

WITHIN THE USA

IBC / DISTRIBUTION

4185 Harrison Blvd., Suite 301
Ogden, UTAH 84403
(801) 621-2294

*Four users under OASIS

** Upgradeable to 512 K Bytes

ALTOS is a trademark of ALTOS Computer Systems; ONYX is a trademark of Onyx Systems, Inc.; DYNABYTE is a trademark of Dynabyte Business Computers; CP/M & MP/M are trademarks of Digital Research, and OASIS is a trademark of Phase One Systems.



CIRCLE NO. 20 ON INQUIRY CARD

THE ONLY LITTLE 32-BIT COMPUTER EVEN WORTH DISCUSSING.

The problem with most low end 32-bit computers is that their usefulness is right down there with their price.

So we've come out with a low end 32-bit computer that has up to twice the performance and twice the memory of comparable machines.

Which means it can actually do the kinds of things you want a 32-bit computer to do.

THE ECLIPSE MV/4000™ COMPUTER.

The ECLIPSE MV/4000 has 600K-Whetstone compute power. And an

I/O bandwidth of 5 megabytes per second.

And to make that performance easy to perform with, the ECLIPSE MV/4000 has virtual addressability, 16 KB of user microcode space, nine I/O slots, and a rack-mountable OEM chassis version. As well as the ability to handle up to 8MB of memory, 4.7 Gigabytes of on-line storage and 64 terminals. All of which you don't usually find on a low end 32-bit computer.

THE SOFTWARE YOU NEED.

Unlike most low end 32-bit computers, the ECLIPSE MV/4000 gives you a choice of compatible operating sys-



tems: AOS/VS (our interactive advanced operating system with virtual storage). Or AOS/RT 32 (our lean, deterministic, real-time operating system). Plus a wide variety of industry and international standard communication protocols. As well as our XODIAC™ network management system, SNA, CEO™ (office automation) and data base management software. And an array of commercial and technical languages, productivity tools, and third party software packages.

THE COMPATIBILITY YOU EXPECT.

Should you one day need even more of a computer, you can take all your code (and all your peripherals) onto the bigger members of the ECLIPSE family. Because the ECLIPSE MV/4000 is fully compatible with the entire Data General ECLIPSE MV product line.

Should you find yourself staying with the ECLIPSE MV/4000 system,

you'll find it stays with you. Partly because of our worldwide network of field service engineers. And partly because of some inherently reliable design considerations. Like extensive self diagnostics on power up. The simple, two board implementation. And

the 55°C burn-in test it goes through. In fact, we're offering an uptime guarantee of 96 to 99%. And a remote diagnostic program.

The way we see it, making a little 32-bit computer is no excuse for making any less of a computer.

Want to discuss the only little 32-bit computer worth discussing? Call your local Data General office. Or write us TPD, F134, 4400 Computer Drive, Westboro, MA 01580.

600K-Whetstone	✓
8MB Maximum memory	✓
5MB/sec I/O	✓
Virtual addressability	✓
Real-time operating system	✓
4.7 Gigabytes of On-Line Storage	✓
Multiple I/O slots	✓
User microcode space	✓
Low Price	✓

Data General



Hard Disk is Easy to Control

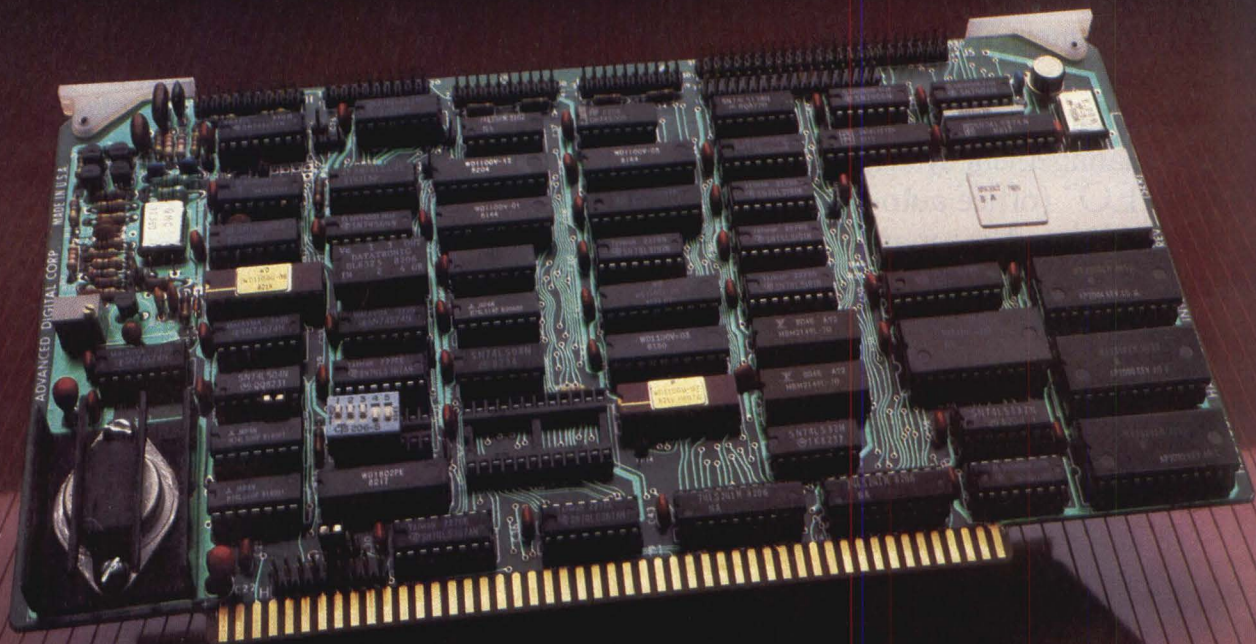

With Advanced Digital's Error Correcting Controller!

Advanced Digital has solved the problem of hard disk control with the HDC-1001, a unique, error-correcting, microprocessor-based hard disk controller board for S-100 based computers. Now, control of up to four 5 $\frac{1}{4}$ " or four 8" Winchester drives is a snap.

Occupying only one slot in the S-100 chassis, the HDC-1001's unique error-correcting capabilities will detect and correct errors before you're even aware of them. In addition, you get up to 8-Bit single burst correction, multiple burst detection, programmable correction/detection span, and much, much more.

Look at these outstanding features:

- Built-in data separator
- Up to 5 MBits/sec data rates
- 256 sector addressing range
- CRC generation/verification on ID fields
- ECC generation/correction on data fields
- Automatic retries on all errors
- Automatic restore and reseek on seek error
- 32 Bit computer generated polynomial
- Complete documentation
- One year warranty
- Retail price: \$500

And now Advanced Digital has really made it easy to add hard disk capabilities by offering you a perfectly matched, thoroughly-tested disk subsystem. The subsystem combines the HDC-1001 controller with an industry-standard 5 MByte hard disk and comes complete with cable and CP/M BIOS disk. With a suggested retail price of \$1800 (an optional 20 MByte drive is available for only \$200 more), Advanced Digital is by far your most cost effective way to gain control of a hard disk.

 **ADVANCED
DIGITAL
CORPORATION**

Ask about our full line of S-100 products, including our SUPER QUAD® single board computer, SUPER SLAVE® processor boards and SUPER SYSTEM® multi-user, multi-processor computer. Write or call: Sales Department

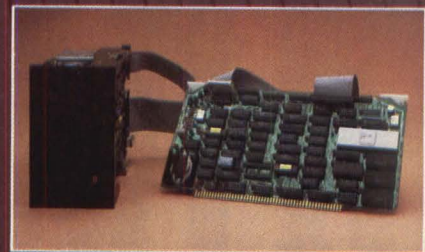

12700-B Knott Street • Garden Grove, California 92641 • (714) 891-4004 TELEX 678401 tab irin

® Registered Trademark of Digital Research Corp.

CIRCLE NO. 22 ON INQUIRY CARD

© Copyright 1981 Advanced Digital Corp.

CP/M update has help feature, addresses bank-switched memory

Digital Research, Inc., has released CP/M 3.0, the latest update of the popular 8-bit microcomputer operating system, which the company has dubbed CP/M Plus and which it claims brings CP/M users a high-performance option.

Among the major enhancements to the package are the ability to address multiple 64K-byte banks of memory on Z80- and 8085-based systems and a help facility that presents users with an explanation of system commands and their use. In addition, the new version has an optional file time- and date-stamping feature, error trapping and recovery, automatic disk log-in, hashed directory access, record buffering and multiple-sector I/O.

Harold R. Elgie, product marketing manager for 8-bit operating-systems marketing, says the updated CP/M package performs two to four times better than release 2.2 in standard applications, but adds that no formal benchmarks have been conducted. He denies that Version 3 is an effort to solve alleged problems with Version 2.2, but says, "It is based on input from 2.2 users."

The new system is now in use at 55 test sites and has been ordered by three large minicomputer/mainframe vendors as well as several high-volume software suppliers, Elgie points out, but declines to name the customers.

Commercial shipments were scheduled to commence last month with an evaluation copy price of \$350. The price includes the symbolic instruction debugger, relocatable macroassembler, link and other utilities.

Elgie says the operating system consumes about 10K bytes of

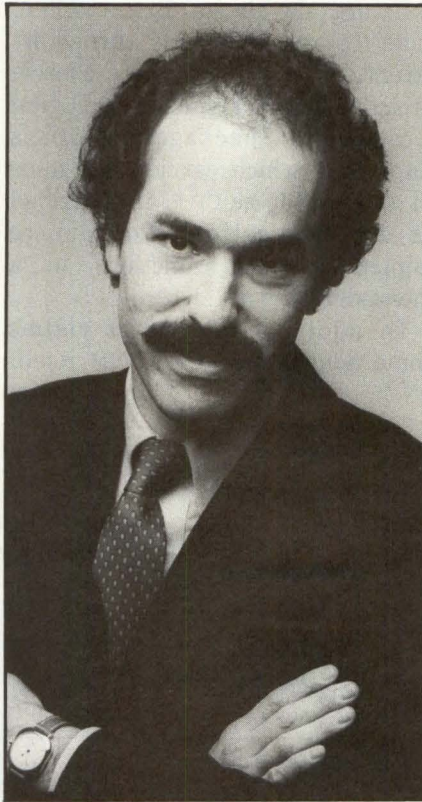

Harold R. Elgie, product marketing manager for 8-bit operating systems at Digital Research, says the new CP/M Plus performs two to four times faster than its predecessor, Version 2.2.

memory without data buffering or about 4K bytes more than Version 2.2. He says the system can now address as much as 512M bytes per drive on as many as 16 disk drives. Version 2.2 supports as many drives with a maximum of 8M bytes per drive.

The features of CP/M Plus said to provide more sophisticated operating-system functions are hashed directory access, LRU (least recently used) record buffering and multisector I/O. Hash sectoring is designed to provide quick access to files by creating a numerical index to disk files in RAM so that the file can be located without searching

through an entire disk. LRU buffering provides a buffer for directory and data entries that automatically drops the least recently used entry when the buffer is filled. Multisector I/O can speed loading and writing a file.

User interface improvements to the operating system include the error-trapping routine that allows application programs to detect systems errors and issues English messages instructing users how to correct them. Automatic disk log-in eliminates the need to reset the disk every time a disk is changed. A user facility lets end users store frequently used programs under the User 0 directory division, while allowing access to the program from any of 16 directory divisions, a capability unavailable on Version 2.2.

The help function, which gives English language explanations of system functions, is not seen as a user-friendly shell—at least not by Taurus Software Corp., San Francisco, purveyor of CP+. Taurus president John Simpson notes the CP/M Plus help function is similar to the CP+ user-friendly shell and acknowledges use of the name CP/M Plus may be more than a coincidence, but adds, "I wouldn't go as far as to say we have influenced them."

Simpson explains that the \$150 CP+ program is not intended to replace the CP/M operating system, but replaces the command console program commands used by Digital Research with a set of English prompts. He describes CP+ as a series of transient programs designed to do "98 percent of what most people want to do with the operating system." For example, he

Mini-Micro World

NEWS

says, CP+ takes the programmer or operator through a series of prompted procedures to erase files, compiling a list of files to be erased and verifying each selection before the erasure is completed.

Simpson says CP+ is being ordered by OEMs including Epson America, Inc., Seiko, Vector Graphic, Inc., Toshiba, Four-Phase Systems, Inc., and Xerox Corp. He says Taurus plans to update CP+ for CP/M Plus and says he is not concerned about CP/M Plus's help routines. "It makes it a little easier for programmers to use, but it's not really a user-friendly shell as far as

I've seen."

However, Taurus competitor Epic Computer Systems, San Diego, takes a different view. "I think it's our impetus," says Epic software developer Bruce Allen. Like Taurus, Epic has turned its attention to the command-console program portion of the Digital Research package. Epic's Supervyz, which carries the same \$150 price tag as CP+, is described as an application program to implement CP/M functions in a menu-driven way.

In addition, Supervyz claims some advantages over CP/M itself.

For example, Allen says, Supervyz enables users to implement a submit from the default disk, while CP/M Version 2.2 supports submits only from the A disk. Elgie says CP/M Plus offers the same submit capability as Supervyz. Supervyz also supports nested submits and the ability to tailor output formats to the specifications of various printers and display terminals.

While Epic is working on a new version of Supervyz and improved user manuals, Allen says there are no plans to do CP/M Plus extensions for the program.

—Geoff Lewis

Rolm unveils Ada compiler, hopes to get jump on competitors

Hoping for at least a six-month jump on competitors eyeing government markets, Rolm Corp. has unveiled an Ada compiler that the company says fully implements Department of Defense specifications for the Ada development language.

However, DOD specifications for Ada were not submitted to the American National Standards Institute for final approval until the end of last year. Rolm is gambling that its new compiler will pass final DOD validation testing.

The Ada compiler is the software portion of the new Rolm Ada work center, an integrated package of hardware, software and technical support for development of Ada language applications. The hardware segment of the system is built

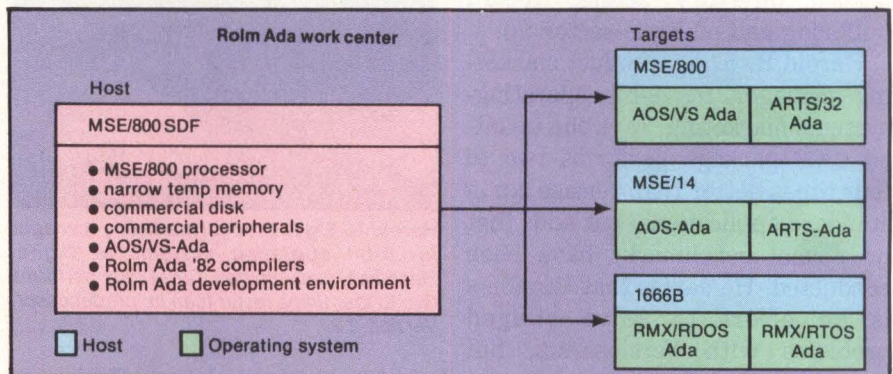

The three target computers for native-code generation from the Ada compiler are the MSE/800, MSE/14 and the 1666B, which run under the operating systems designated.

Rolm's Ada work center includes the ANSI 1982 standard ADA compiler that is said to comply with forthcoming Department of Defense specifications, eight to 128 Ada development terminals, a 32-bit processor and support for three target processors.

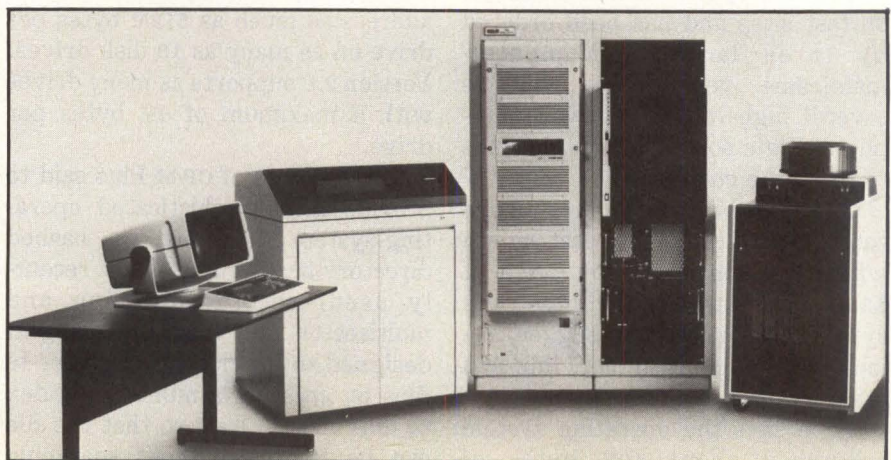

The KMW Family of IBM Protocol Converters

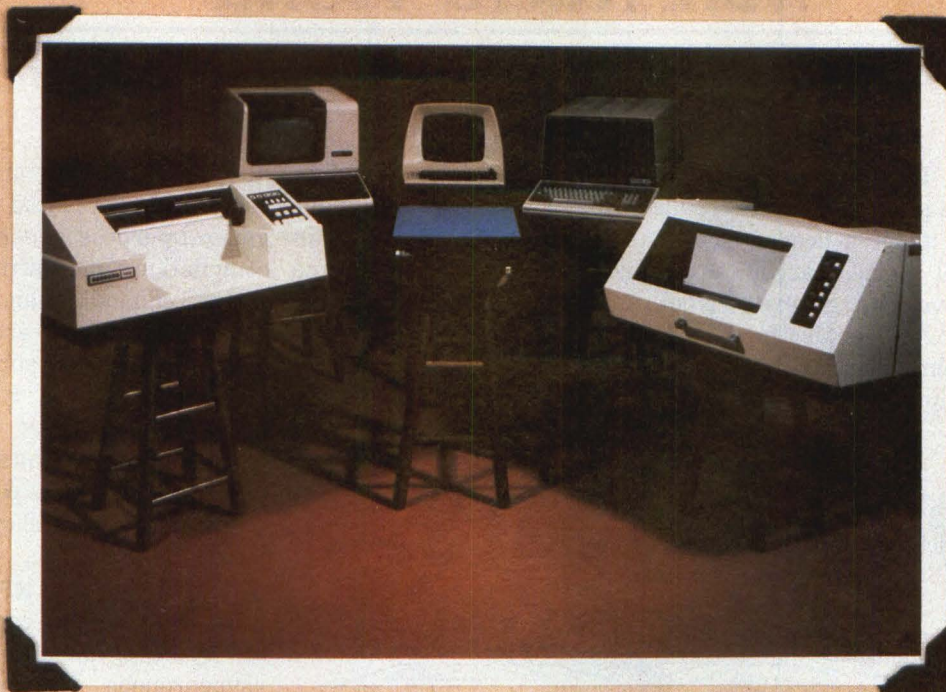

KMW Systems Corporation has developed a comprehensive range of communications devices which allow non-IBM peripherals or systems to communicate directly with IBM mainframes. The KMW Series II family of protocol converters represents the second generation of devices designed expressly for this purpose. The most notable of these are:

3270FS—A converter which makes the use of low cost async CRT's feasible and practical.

The 3270FS also:

- Emulates the IBM 3271 Controller
- Accommodates 1-8 async CRT's and printers
- Features switch selectable baud rates of up to 19.2k
- Features switch selectable Control Unit addresses
- Supports PA1, 2, 3; PF1-24; Enter; Clear; and other 3270 keyboard functions

HASP Workstation—a versatile IBM Model 20 Workstation which:

- Supports 1-8 input or output devices in addition to a console
- Provides parallel ports for Dataproducts and Printronix printers, as well as Documation and Truedata card readers
- Features switch selectable support for Calcomp, Houston Instrument, and Zeta pen plotters

The newest additions to the family . . . KMW now offers board level versions of the complete line of protocol converters to assist the OEM. Using KMW boards, system and peripheral suppliers can integrate IBM protocol converters into their products and, by simply changing PROMs, support most of the popular synchronous protocols.

Other branches of the KMW family include protocol converters to support IBM 2780/3780, Univac 1004, and Honeywell GRTS protocols.

For more information on the complete KMW family of protocol converters, contact



**KMW
SYSTEMS
CORPORATION**

8307 Highway 71 West Austin, Texas 78735 512/288-1453

TWX: 910-874-2005/CABLE: KMWSYS

CIRCLE NO. 23 ON INQUIRY CARD

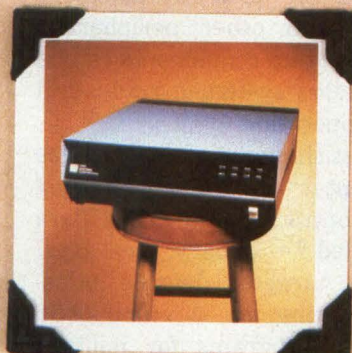

Mini-Micro World

NEWS

around the 32-bit Rolm MSE/800 host processor, the architecture of which was created under a license from Data General Corp. Target computers for native-code generation from the compiler include the MSE/800 and the Rolm 16-bit MSE/14 and 1666/B minicomputers.

The work center is designed to reduce Ada software-development costs and make people productive in Ada programming, says Bruce Noel, Rolm's Ada product manager.

The work center can support as many as 128 simultaneous users for Ada program design, application

development and training. The compiler features real-time tasking, general-purpose generics, separate compilation, unconstrained arrays, exception handling and propagation and parameter overloading. The MSE/800 processor supports demand paging, a 4G-byte virtual-address space and a 36.4M byte-per-sec. main-memory bandwidth. Rolm pegs the processor's performance at more than 1.2 million Whetstone instructions per sec.

Supporting the MSE/800 in the basic work-center configuration is 2M bytes of main memory, eight asynchronous terminal lines for connection of Ada development terminals and other peripherals. Optional system components can be added to allow system upgrades and mil-spec operation.

The first shipment of the \$463,000 work center to an unidentified defense contractor near Santa Clara is scheduled for January, Noel says. Rolm has targeted defense industries wishing to develop Ada application programs for military agencies as prime customers. The U.S. Army has committed to converting to Ada for all development programs in 1983, followed by the Air Force in 1984 and complete DOD conversion in 1985. By 1986, according to estimates made by Softech, the total market for Ada support software in the military and defense contractors will total approximately \$800 million.

Rolm envisions a larger market developing for the MSE/800, the MSE/14 and the 1666/B units, the target computers on which the Ada programs are run. "There can be hundreds of follow-on orders for our target machines," Noel estimates. "We have a two-pronged approach to the Ada marketplace: the work center and the three target computers."

Industry reaction to Rolm's claim that it has a fully implemented DOD

Soup to Nuts.

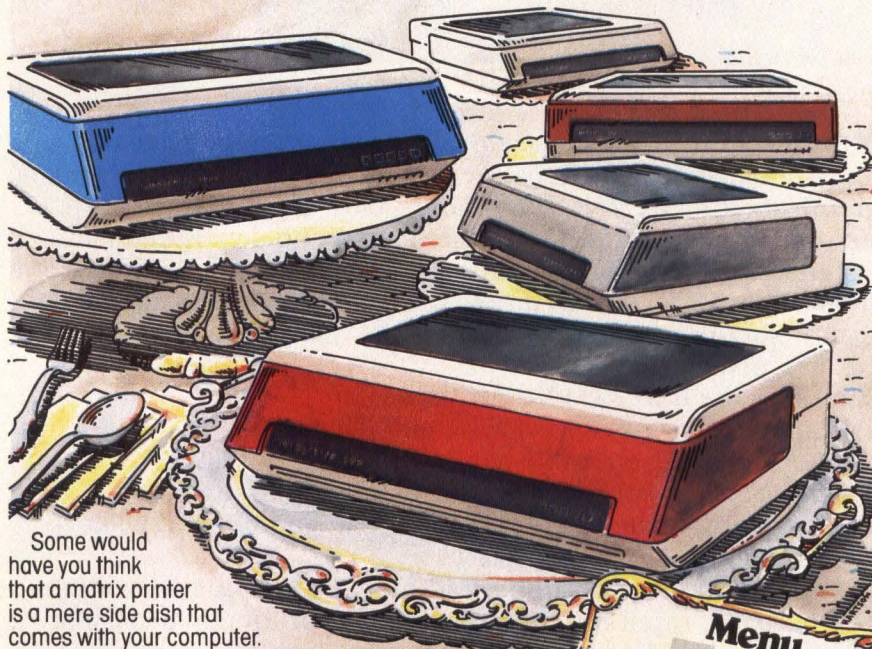

Some would have you think that a matrix printer is a mere side dish that comes with your computer.

Don't believe it.

What you get out of your printer is what you get out of your computer. If your printer is small, slow, noisy or unreliable, your computer will be limited, sluggish, irritating, or inoperable. Just telling it like it is.

That's why Infoscrite has come up with a gourmet line of multifunction matrix printers specifically for business and professional users.

You can switch from high-speed data processing to business letters, at will; handle up to 16-inch-wide paper; make up to five crisp carbons; generate gorgeous graphics in up to eight colors; and enjoy truly elegant and incredibly quiet operation, day-in and day-out.

Check the menu for the printer that meets your exact needs. Why go with the computer manufacturer's combo plate when the same money will let you buy Infoscrite, a la carte?

Your favorite computer dealer or systems specialist will be delighted to arrange a demonstration for you. Or contact the *matrix d'*: Infoscrite, 2720 South Croddy Way, Santa Ana, California 92704, USA, Phone (714) 641-8595, Telex 692422.

Menu						
MODEL	DRAFT (CPS)	CORRESPONDENCE (CPS)	LETTERS (CPS)	GRAPHICS (72 x 72)	GRAPHICS (144 x 144)	PROGRAMMABLE FONTS
500	150	75				
1000	200	100	X	X		
1100	200	100	40	X	X	X
1200	200	100	40	X	X	X
1500	400	200		X	X	

PRINT WITH INFOSCRIBE

Remember good old-fashioned value?

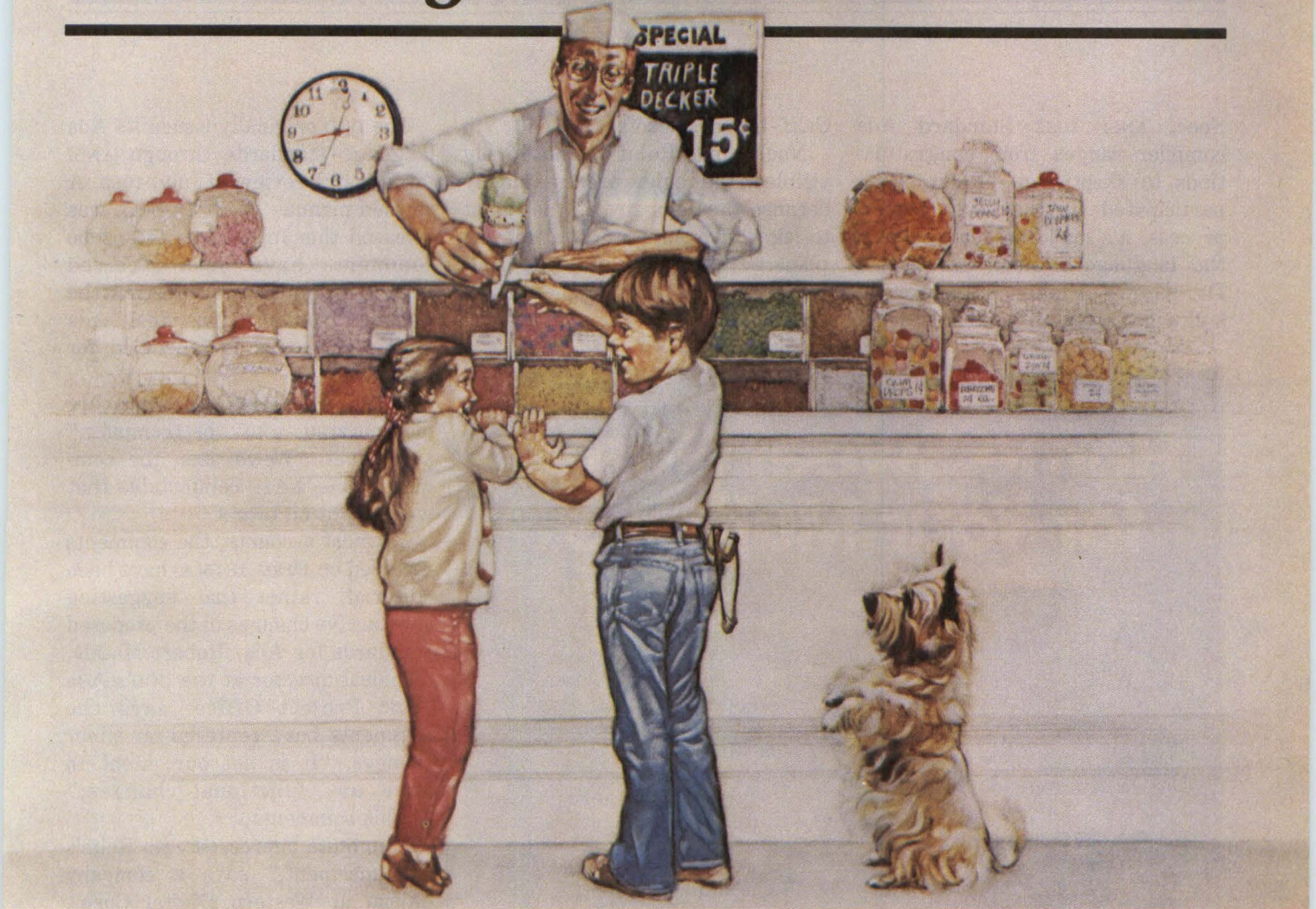

You'll find it today...at California Computer Systems.

Whether you need an economical single-user system, or a multi-tasking system supporting up to five users, you'll find a generous serving of good old-fashioned value in the 2300, 300, and 400 microcomputer systems from California Computer Systems.

These modular Z-80® based systems will meet your exact needs today, and let you grow tomorrow. Choose from floppy, Winchester, and Winchester/tape subsystems, plus a wide variety of CCS board-level enhancements. Our standard CP/M® operating system supports thousands of existing programs. MP/M® and our multi-user Oasis® are available as well.

We offer you still more value in the way we make our systems. For instance, we put bare boards, components, loaded boards — the whole candy store — through one of the toughest Q.A. programs in the industry. And we test and burn-in our boards *in system*, too, so you can be sure our systems are reliable.

We also give you great technical goodies, such as interrupts, DMA, and full ECC. A Centronics parallel interface. Plus operational status protection in case of a power failure. You'll like our highly responsive service as well. Sweet prices, too.

It all adds up to great value . . . something you might expect from a company with extensive experience making reliable systems. And with thousands proven in applications worldwide.

Why wait? Treat yourself to the good old-fashioned value you deserve, with the family of microcomputer systems from CCS. For the whole scoop, call or write our marketing department today!



California Computer Systems

250 Caribbean Dr., Sunnyvale, CA 94086
(408) 734-5811 Telex: 171959 CCS SUVL

Z80 is a trademark of Zilog, Inc. CP/M and MP/M are trademarks of Digital Research Corporation
Oasis is a trademark of Phase One Systems, Inc. ©1982, California Computer Systems, Inc.

Mini-Micro World

NEWS

Spec, ANSI 1982 Standard Ada compiler ranges from congratulations to skepticism. "Rolm hasn't participated in the ANSI review process; it's made no comments on the language manual," comments Dr. Gerry Fisher, director of language research at San Diego,

Calif.-based Telesoft.

Noel admits Rolm was not highly visible in the review process, mainly because the company did not want to tip off competitors about its plans. He says Rolm has been involved with key people in the review cycle.

The DOD originally issued its Ada language standards through ANSI for industry review in July, 1980. A revised manual, Draft 1815(A), was released this July. More than 3000 comments have been received suggesting additional changes in the revised manual. The final Ada language manual is scheduled for release now.

"The July, 1982, standards are incorporated into the compiler," says Noel. "We've seen the comments, and we're comfortable that we're right on target."

By most accounts, the comments received on Draft 1815(A) have been editorial, rather than suggesting substantive changes in the proposed standards for Ada. Robert Mathis, technical director at the DOD's Ada Joint Project Office, says the comments have centered on minor changes. "It is not our intent to have any functional changes," Mathis comments.

"I'm quite impressed with Rolm's announcement," says a company official at Western Digital Corp., who declines to be identified. Western Digital is the only company that the Ada Joint Project Office says has formally requested to schedule the required validation testing on its Ada language compiler, which is still under development. The Western Digital source estimates there are 45 efforts under way in the U.S. for Ada compilers, and 15 to 20 non-U.S. efforts. He adds, "But the bottom line for all of us is who gets through the DOD validation tests." DOD's Mathis concurs. "No compiler is fully DOD-compatible until DOD says it is."

The DOD official expects the first Ada language compiler to be validated in the first quarter of this year.

—Stephen Shaw

Stephen J. Shaw is a free-lance writer working in Washington, D.C.

Home Sweet Home for Your Multibus*

Finally there's a system chassis that is designed and manufactured with the thoroughness and care you expect in your Multibus system. It's Electronic Solutions' new Multichassis™.

- 9 slots, 0.6" spacing—or 7 slots, 0.75" spacing
- Hefty 4-output 300W power supply— 40A at +5V
- Cool operation even with high-density boards

There's a field-proven card

cage and backplane, plus full RFI filtering, locking front panel function switch, power fail detection, and quiet dual cooling fans with quick-change filters.

And best of all, the removable front panel lets you easily customize the Multichassis to match your company color and logo.

So treat your Multibus system to an elegant but affordable new home—the Multichassis by Electronic Solutions. Call us today for full specifications and prices.

Electronic Solutions
5780 Chesapeake Ct.
P.O. Box 85244
San Diego, CA 92138
Call Toll Free
(800)854-7086
in California
(619)292-0242

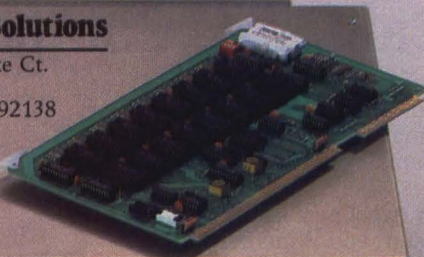

*Multibus is a Trademark of Intel Corp.

CIRCLE NO. 27 ON INQUIRY CARD

THE BEST HAS JUST
BECOME THE BEST DEAL.

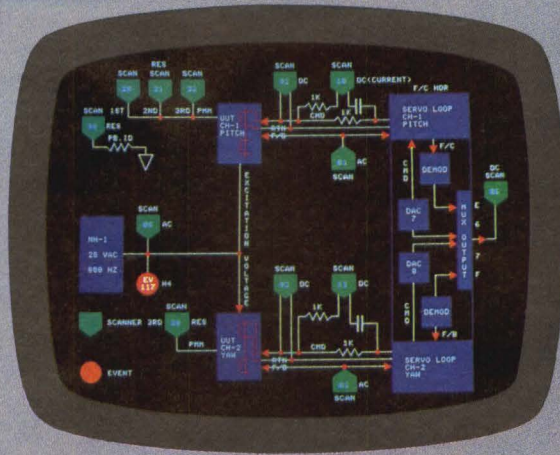

Ramtek's popular 6211 Colorgraphic Terminal is now just \$4995*. This versatile desk-top unit is ideally suited for the majority of color graphic applications in CAD, science, business, and control systems. Rack mounted (without monitor), it's even more of a value at just \$3995.

Need data terminal functions, too? The companion 6221 with full VT 100™ compatibility is priced at just \$5995. Plus there's a 12% discount available through March 31, 1983 on systems with both color printer and 35mm slide camera.

The price of quality has never been lower. Volume discounts are also available. For details, call our office nearest you. Or, contact us at 2211 Lawson Lane, Santa Clara, CA 95050. (408) 988-1044.



OUR EXPERIENCE SHOWS.

- World Headquarters**—Santa Clara, CA (408) 988-2211
- European Offices**—Amsterdam (31) 2968-5056; London (8956) 76211; Cologne (2234) 78021
- U.S. Offices**—Dallas, TX (214) 422-2200; Los Angeles, CA (714) 979-5351; Seattle, WA (206) 575-1600; Chicago, IL (312) 397-2279; Houston, TX (713) 774-2233; McLean, VA (703) 893-2020; Denver, CO (303) 694-0758; Cleveland, OH (216) 524-1882; Upper New York/Canada (716) 425-1742; New Jersey (201) 238-2090; Florida (305) 645-0780; Boston, MA (617) 273-4590; Atlanta, GA (404) 252-5066.

*Light pen sold separately.

VT 100 is a registered trademark of Digital Equipment Corporation.

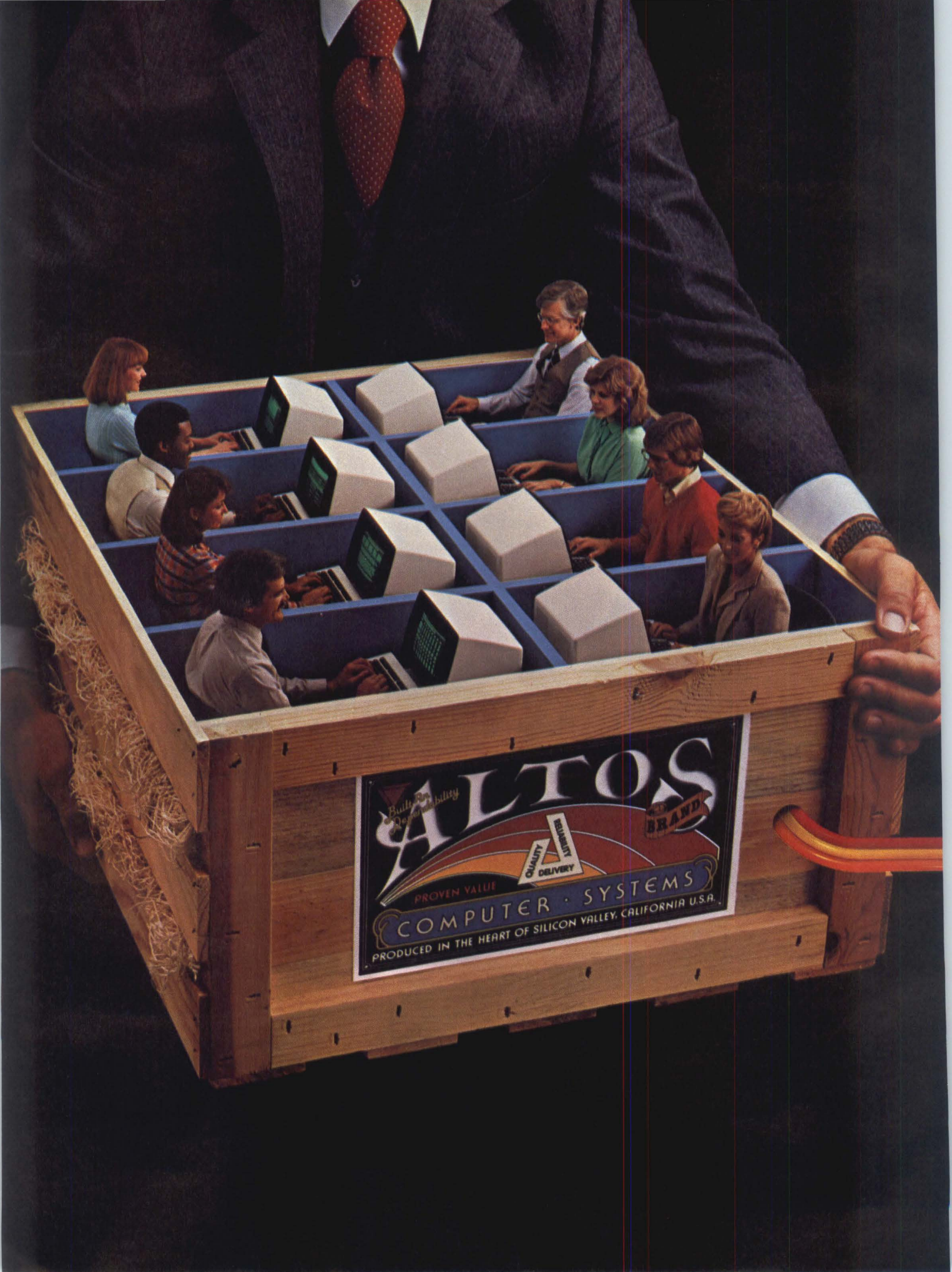

ALTOS
BRAND
COMPUTER SYSTEMS
PROVEN VALUE
PRODUCED IN THE HEART OF SILICON VALLEY, CALIFORNIA U.S.A.
QUALITY DELIVERY

1 TO 16 USERS TO GO

Altos multi-user 8086 or 68000-based networking computers are chosen by more OEMs and Fortune 1000 companies. Here's why...

ALTOS® 16-bit computer systems do more for more users. They give you more power. More features. And more reliability. For less money.

You get a choice of 8086 or 68000-based family processors, memory management to one MB of RAM, an intelligent Z80™ I/O and disk controller, plus up to 160 megabytes of fast Winchester storage.

A single Altos computer can serve up to 16 users. And every Altos 16-bit computer gives you



Altos also has high-level languages (BASIC, FORTRAN, COBOL and PASCAL), and applications software (ABS/86 and ABS/68 for general accounting, word processing and financial planning).

Since 1977, Altos has delivered more than 30,000 highly reliable, fully socketed, proven single board microcomputers and peripherals built for business.

If you've been looking to go with a more powerful computer that can serve from 1 to 16 users for less money, call or write us today.

INTER-ALTOS LOCAL NETWORK



Series 586, ACS8600 and ACS68000
20-160 MByte Winchester
**1-16 USERS with
ALTOS-NET**

ETHERNET



Series 586, ACS8600 and ACS68000
20-160 MByte Winchester
**1-16 USERS with
ALTOS-NET/UNET™**

REMOTE COMMUNICATIONS



Series 586, ACS8600 and ACS68000
20-160 MByte Winchester
**1-16 USERS with
ALTOS-NET/UNET**
2780/3780
3270
X.25
SNA/SDLC

added features like Multibus™ interfacing, real time clock, power fail detection and comprehensive diagnostics.

But that's just the beginning. Link multiple Altos' together and communicate in the office of the future today. Serve hundreds of users with full Ethernet™ and ALTOS-NET™ hardware and software support. And save money with fewer interconnects.

In addition, Altos supports remote communications protocols such as 2780/3780, 3270, X.25, and SNA/SDLC.

Altos has all the 16-bit software you need, too. With popular operating systems like XENIX™ / UNIX™ (with a user-friendly "business command menu interface"), CP/M-86,™ MP/M-86,™ OASIS-16, MS™ -DOS and PICK for 8086-based systems; plus UNIX System III™ and RM/COS™ for 68000-based systems.

Altos Computer Systems
2360 Bering Drive
San Jose, CA 95131
(408) 946-6700
Telex 171562 ALTOS SNJ
or 470642 ALTO UI

**Packed with
fresh ideas
for business**

ALTOS
COMPUTER SYSTEMS

800-538-7872
(In Calif. 800-662-6265)

ALTOS is a registered trademark and ALTOS-NET is a trademark of Altos Computer Systems. Ethernet is a trademark of Xerox Corporation. CP/M-86 and MP/M-86 are trademarks of Digital Research, Inc. MS and XENIX are trademarks of Microsoft Corporation. XENIX is a microcomputer implementation of the UNIX operating system. UNIX is a trademark of Bell Laboratories. UNIX System III is a trademark of Western Electric. RM/COS is a trademark of Ryan-McFarland, Inc. OASIS-16 is a product of Phase One Systems, Inc. PICK is a product of Pick & Associates and Pick Computer Works. Multibus is a trademark and 8086 is a product of Intel Corporation. 68000 is a product of Motorola, Inc. UNET is a trademark of 3Com Corp. Z80 is a trademark and product of Zilog, Inc. © 1982 Altos Computer Systems.

Check The Chart Before You Choose Your New 16-Bit Computer System.

**Columbia Data Products'
New Multi-Personal® Computer,
Featuring IBM-PC® Compatibility,
Excels In Professional, Business
And Industrial Applications.
Check it out.**



Columbia Data Products' MULTI-PERSONAL® COMPUTER can use software and hardware originally intended for the IBM® Personal Computer . . . while enjoying the flexibility and expandability of all Columbia Data's computer systems.

Available operating system software includes single-user MS-DOS® or CP/M 86® or multi-user, multi-tasking MP/M 86® or OASIS-16®, with XENIX® available soon, providing users with a host of compatible software packages for personal and professional business and industrial applications. A large selection of higher level languages are also available, including BASIC, FORTRAN, COBOL, PASCAL and MACRO Assembler.

Our standard 16-Bit 8088 hardware configuration provides 128K RAM with parity, two RS-232 serial ports, Centronics parallel printer port, interrupt and DMA controllers, dual floppy disks with 640K storage, Winchester disk and keyboard interfaces, and eight IBM-PC compatible expansion slots . . . and lists for only \$2995. Winchester hard disk configurations, featuring cache buffer controllers for enhanced disk access performance are also available, starting at \$4995.

So, when you need to grow, why gamble and hassle with independent third party hardware and operating system vendors which may or may not be compatible . . . not to mention the hidden expense and frustration of implementing peripheral drivers in the different operating systems and upgrades? Who needs the finger-pointing when things don't work out?

After you review our chart, you will agree . . . for overall 16-Bit microprocessor superiority, expandability, flexibility, compatibility and real economy, Columbia Data is your *total source*.

Our Multi-Personal Computer . . . the 16-Bit system born to grow!

Get yours now. **CIRCLE NO. 31 ON INQUIRY CARD**

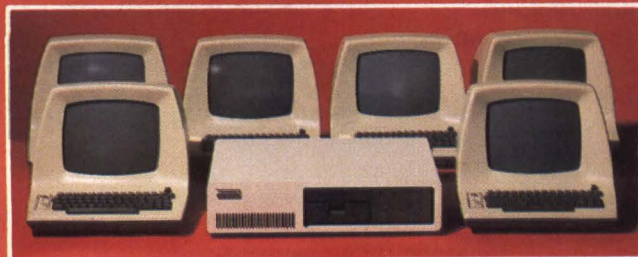

MAIN FEATURES	CDP-MPC	IBM-PC*	OTHERS
Microprocessor	16-Bit 8088 8-Bit Z-80 (Opt)	16-Bit 8088	?
USER Memory	128K-1 Mbytes	16K-256 Kbytes	?
IBM-PC Compatible Expansions Slots Beyond Professional Configuration ¹	8 Slots	0	?
Resident Floppy Disk Storage	Dual 320K (std)	Dual 160K (Opt) Dual 320K (Opt)	?
Resident Cache Buffer Hard Disk Storage	5M/10M	—	?
OPTIONAL OPERATING SYSTEMS (Supported by Company)²			
MS-DOS (PC-DOS)	Yes	Yes	?
CP/M 86	Yes	Yes	?
MP/M 86	Yes	—	?
OASIS-16	Yes	—	?
XENIX	Soon	—	?
OPTIONAL HARDWARE EXPANSION BOARD (Supported by Company)			
RS-232 Communications	Yes	Yes	?
B/W and Color Display Controller	Yes	Yes	?
Expansion Memory	Yes	Yes	?
Z-80 CP/M-80 Board	Yes	—	?
Cache Buffer Hard Disk	Yes	—	?
Time/Calendar Board	Yes	—	?
IEEE Bus Controller	Yes	—	?
8" Floppy Disk System	Yes	—	?
8" Hard Disk System	Up to 40 Mbytes	—	?
Tape Cartridge System	Yes	—	?

¹For comparison purposes, typical professional configurations consist of 16-Bit 8088 Processor, 128K RAM with Parity, Dual 320K 5-inch Floppies, DMA and Interrupt Controller, Dual RS-232 Serial Ports, Centronics Parallel Port and Dumb Computer Terminal or Equivalent.

²Columbia Data Products also supports CP/M 80® with an optionally available Z-80 CP/M Expansion Board.

*As advertised in BYTE Magazine, August 1982.

COLUMBIA
DATA PRODUCTS, INC.

Home Office:
8990 Route 108
Columbia, MD 21045
Telephone 301-992-3400
TWX 710-862-1891

West Coast:
3901 MacArthur Blvd.
Suite 211
Newport Beach, CA 92663
Telephone 714-752-5245
Telex 277778

Europe:
P.O. Box 1118
450 Moenchengladbach 1
West Germany
Telephone 02161-33159
Telex 852452

IBM is the trademark of International Business Machines. CP/M and MP/M are trademarks of Digital Research. OASIS is the trademark of Phase One. MS-DOS and XENIX are trademarks of MICROSOFT.

Mini-Micro World

CORPORATE AND FINANCIAL

DEC celebrates quarter-century in business amidst lower earnings, hiring freeze

The tone exuded by Digital Equipment Corp. president Kenneth H. Olsen at the company's recent 25th annual meeting prompted a feeling of long-term stability for the nearly \$4-billion company. Nonetheless, it is clear the giant Maynard, Mass., computer firm, like other minicomputer companies, is feeling the harsh effects of the worldwide recession.

The gathering followed disconcerting announcements by both DEC and Massachusetts neighbor Honeywell, Inc., just days earlier. Honeywell laid off 800 workers, primarily white-collar workers, as part of a corporate reduction that began last year. DEC had announced results for the first quarter of this year that reflected a 10-percent increase in revenues but a 36-percent decline in earnings over last year's quarter. Olsen expects second-quarter earnings to be down.

"We were isolated for the first one to two years during the recession," says Olsen. He adds that while DEC's OEM business was not affected for a while, it is being hit worse by the recession than other DEC businesses. The reason, he says, is that OEMs usually sell directly to the capital equipment market. Orders in that market have been slow during the spring and summer, and Olsen sees no short-term improvement.

Olsen says DEC's goal last year was to sell to the world's largest corporations, and notes, "Very large companies have canceled projects (for computers) they hadn't expected to cancel." Olsen emphasized DEC has long-term projects with major firms that stretch over changes in the economy, which has helped the company remain somewhat recession-proof until now. "We have a long-term concentration for stability in the future," he says.



Digital Equipment Corp. president Kenneth H. Olsen spoke optimistically of the company's growth with new products during the recent 25th annual meeting, despite a continuation of a hiring freeze and salary-increase delays.

Despite the comforting words, Olsen could not designate an end to the hiring freeze. The company also is delaying salary increases. For its fiscal year ending July 3, 1982, revenues were \$3.9 billion, compared with \$3.2 billion last year. Although DEC's costs were down, product prices were lowered to meet competition and get revenues. Service and other revenues in-

creased from \$814 million to \$1.1 billion. Net income increased from \$343 million to \$417 million. Business in Europe hasn't changed much, and was 38 percent of revenues. DEC's revenues were \$188 million 10 years ago, while net income was \$15 million, and service and other revenues were \$21 million. Net income per share was 50¢ in 1972, \$6.70 in 1981 and \$7.53 in 1982. DEC's 10-year growth in operating revenues is 31 percent. Over the past few years, the firm has moved from position 280 to 137 among the Fortune 500 companies.

For the first quarter, which ended on Oct. 2, 1982, results were not as strong as for the year. Revenues increased 10 percent from \$839 million during last year's first quarter to \$927 million this quarter. Net income declined 36 percent from last year's first quarter from \$89 million to \$57 million, partly because of higher research expenditures. Earnings per share declined over the quarters from \$1.60 to \$1.02. Service and other revenues

Continues on page 63

Digital Equipment Corp. 11 year financial summary					
	Equipment sales revenues (\$ millions)	Service and other revenues (\$ millions)	Total operating revenues (\$ millions)	Net income (\$ millions)	Net income per share
1982	\$2,793.7	\$1,087.1	\$3,880.8	\$417.2	\$7.53
1981	\$2,384.2	\$ 813.9	\$3,198.1	\$343.3	\$6.70
1980	\$1,779.4	\$ 588.6	\$2,368.0	\$249.9	\$5.45
1979	\$1,381.8	\$ 422.3	\$1,804.1	\$178.4	\$4.10
1978	\$1,128.1	\$ 308.5	\$1,436.6	\$142.2	\$3.40
1977	\$ 847.5	\$ 211.1	\$1,058.6	\$108.5	\$2.78
1976	\$ 586.6	\$ 149.6	\$ 736.3	\$ 73.4	\$1.98
1975	\$ 433.2	\$ 100.6	\$ 533.8	\$ 46.0	\$1.28
1974	\$ 360.8	\$ 61.1	\$ 421.9	\$ 44.4	\$1.27
1973	\$ 229.1	\$ 36.4	\$ 265.5	\$ 23.5	\$.72
1972	\$ 166.3	\$ 21.3	\$ 187.6	\$ 15.3	\$.50

Source: Digital Equipment Corp.

Buy a BitGraph™ Terminal for \$4995 and save the tough decision for later.

With BitGraph, you get a lot to choose from. For starters, it's a high resolution graphics terminal. And thanks to state-of-the-art raster-scan technology and a 1024 x 768 pixel display, its pictures are spectacular. So good, in fact, you won't be able to come up with many graphics jobs BitGraph can't do. It can handle business, scientific and even engineering applications.

But graphics is just the beginning. BitGraph is also an exceptional text

processing terminal. Its full-page format makes it perfect for document previewing and editing. What's more, its high resolution screen can reproduce almost any type font.

And, to make your decision even harder, BitGraph is a text *and* graphics terminal as well. It can mix words and pictures anywhere on the screen, and in any combination.

BitGraph has a lot of other things going for it, too. Like its high performance 68000 microprocessor (with up to 512K RAM). Its ability to emulate the Tektronix® 4010 and DEC's VT100™ and VT52™ terminals. And its compatibility—it can plug in to just about any host sys-

BUY BEFORE

BitGraph is a high resolution—1024 x 768 pixels—graphics terminal.

BitGraph is a multiple font text terminal.

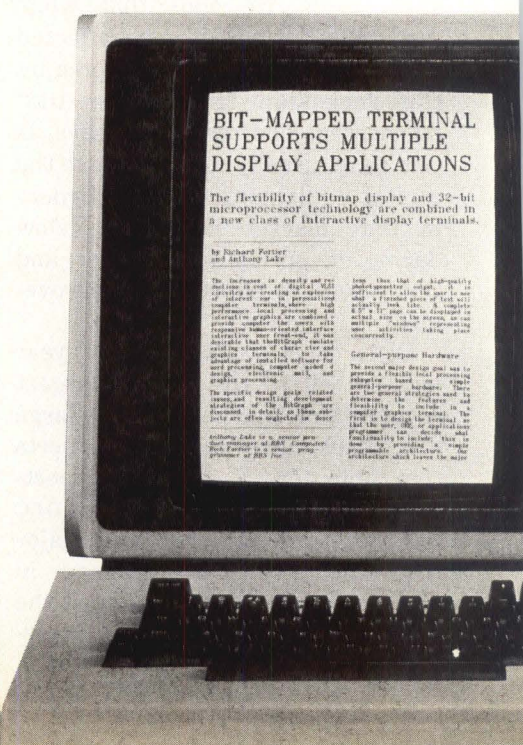
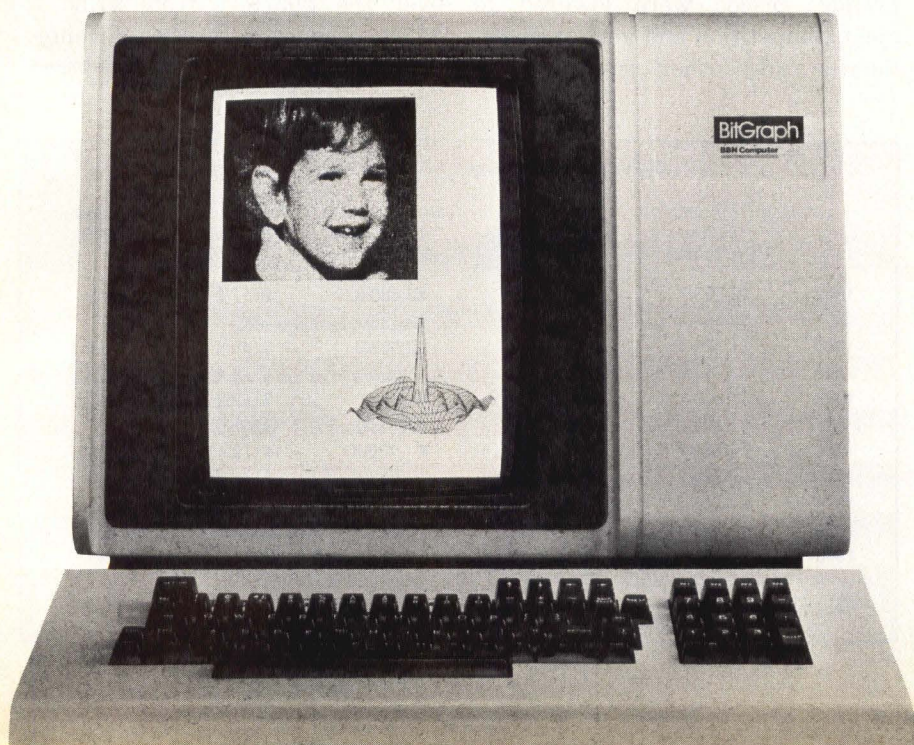

tem through an RS232 port. Plus BitGraph has a high-speed parallel printer interface.

And then there's the price. At \$4995, no other terminal can come close to delivering so much for your money.

Of course, you may have already decided exactly why you want a BitGraph, and we think that's great. But isn't it a nice feeling to know that you can always change your mind.

For more information about all the things BitGraph can do, send in the coupon or call (617) 497-3268.

BitGraph is a trademark of BBN Computer Corporation.
DEC VT100 and VT52 are trademarks of Digital Equipment Corporation.
Tektronix is a registered trademark of Tektronix, Inc.

I want to know more about BitGraph.™

- Please send me a brochure.
- Please have your sales representative call.

Name _____

Company _____

Phone _____

Address _____

City _____

State _____

Zip _____

Send to: BBN Computer Corp.
33 Moulton Street, Cambridge, MA 02238.

BBN Computer

A subsidiary of Bolt Beranek and Newman Inc.

CIRCLE NO. 32 ON INQUIRY CARD

YOU CHOOSE.

BitGraph is a combination text
and graphics terminal.

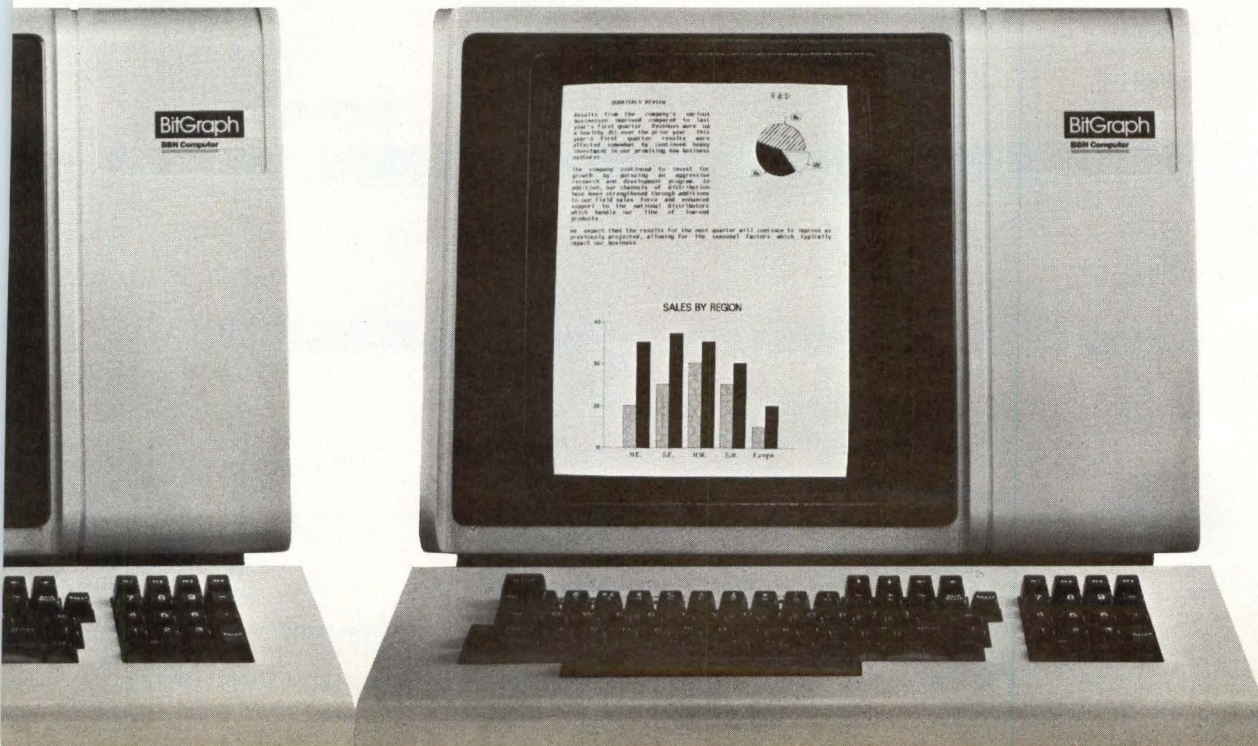



FLOPPYDISK

WP ACTIVE POWER

DATA SYSTEMS DESIGN

TAPE DRIVE

BCH FLT ACTIVE EJECT

DATA SYSTEMS DESIGN

WINCHESTER

WP FLT ACTIVE EJECT

DATA SYSTEMS DESIGN

PROCESSOR

LTC RUN POWER

DATA SYSTEMS DESIGN

**StacPac, HyperDiagnostics, Rapid Module Exchange and HyperService are trademarks of Data Systems Design, Inc.
*DEC is a registered trademark of Digital Equipment Corporation. *Multibus is a registered trademark of Intel Corporation.

DSD STACKS THE DEC. AND THE MULTIBUS, TOO.

Presenting StacPac™ systems and modules.

This is a brand new deal for systems integrators.

StacPac systems and modules. Modular storage and backplane units that stand alone or stack together to form the basis of a small but powerful tabletop computer.

They're available in either DEC®- or Multibus®-compatible versions. And there are lots of advantages to both.

On the DEC side, you can put a StacPac system in places a rack-mount just doesn't fit.

On the Multibus side, you can use our StacPac system to deliver serious minicomputer performance with microcomputer economy.

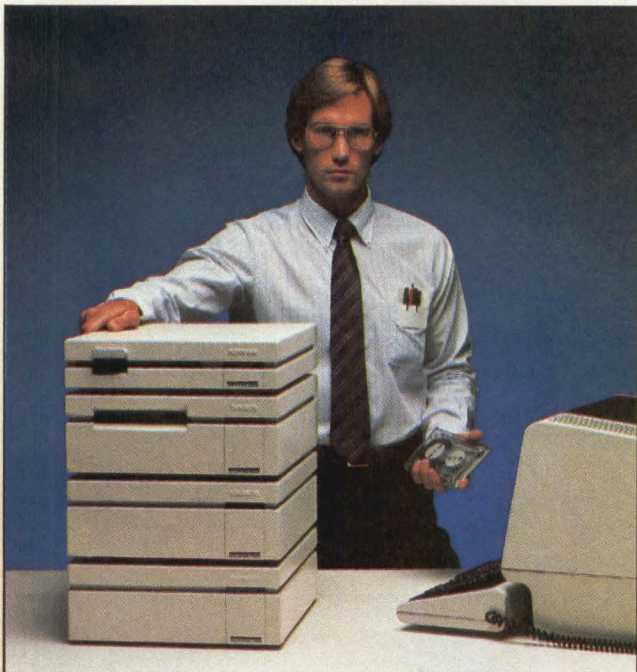

Either way you get greater flexibility to configure just the right system. And the easy upgradability to expand it whenever you like.

But perhaps one of the most important advantages is that you can protect your software investment—and your customers'—because inside, you're still selling the same system. You'd just never know it to look at it.

Which brings up another point.

Underneath that slick, compact exterior is the very latest in storage technology. 8" slimline floppy drives. High capacity, highly reliable 8" Winchester. Compact 1/4" cartridge tape drives. And the best high performance controllers in the business. (Packaged systems are also available without controllers at your option.)

And if you're thinking about 5 1/4" storage, there's our 5 1/4" Winchester/floppy module. (Available in the Spring of 1983.)

Configuring an elegant system solution is a simple matter of picking out the storage option you want and adding your own CPU boards, I/O and memory to our uncommonly accommodating backplane units.

Naturally, we back it all up with HyperDiagnostics™, Rapid Module Exchange™ and HyperService™. Some of the most economical and intelligent service features ever devised.

And you can have more information about StacPac modules just by writing for our brochure.

But you just watch. You start marketing your systems in our StacPac modules and your competition will say you have an unfair advantage.

And you know something? They'll be right.

Corporate Headquarters: 2241 Lundy Avenue, San Jose, CA 95131. Eastern Region Sales and Service: Norwood, MA, (617) 769-7620. Central Region Sales and Service: Dallas, TX, (214) 980-4884. Western Region Sales: Santa Clara, CA, (408) 727-3163.

DATA SYSTEMS DESIGN

INTERNATIONAL SALES (DEC-compatible products only): Australia 03/544 3444; Belgium and Luxembourg 02/7209038; Canada 416/625 1907; Denmark 02/63 22 33; Finland 90/88 50 11; France 03/411 5454; Hong Kong and Peoples Republic of China 03/668252; Israel 03/298783; Italy 02/4047648; Japan, Osaka 06/323 1707; Tokyo 03/345 1411; Netherlands 020/02977-22456; New Zealand 04/693 008; Norway 02/78 94 60; Singapore, Malaysia and Indonesia 2241077; Spain 01/433 2412; Sweden 08/38 03 70; Switzerland 01/741 41 11; Taiwan, ROC 02/7719803-5; United Kingdom 7073/34774; West Germany and Austria 089/1204-0; Yugoslavia 61/263 261.

INTERNATIONAL SALES (Multibus-compatible products only): Canada 416/625 1907; Denmark 1/83 50 90; Finland 0/692 60 22; Hong Kong 3/338893; Israel 03/298783; Netherlands 020/02977-22456; Norway 2/786 210; Portugal 19/545 313; Sweden 8/635 040; Switzerland 01/741 41 11; United Kingdom 7073/34774.

CIRCLE NO. 33 ON INQUIRY CARD

Mini-Micro World

CORPORATE AND FINANCIAL

MARKET BAROMETER

A monthly column devoted to an expert's look at an industry

Mobile computers' special system-integrator challenge

By Richard J. Matlack
Infocorp

The introduction of the Osborne 1 with its carrying case and under-the-airline-seat size began to stimulate the growth of full-capability computers that could be carried conveniently by a user. In the last year, the field has grown dramatically to at least 13 suppliers, which may be joined next year by IBM Corp., Apple Computer, Inc., and Japanese suppliers.

The new class of "mobile" comput-

ers—general-purpose computing devices with a keyboard and built-in display and programmable in a high-level language—will attract add-on suppliers, system integrators and other third parties. Because of a requirement for the computers to be conveniently moved, third parties will face some special design considerations. Add-on peripherals must be compact and lightweight, but still fully functional.

Though mobile computers hardly existed a year ago, their sales should grow to 5.1 million units by 1985 (valued at \$3.1 billion), from 527,000 units in 1982 (valued at \$372 million).

The most rapidly accelerating segment, portable computers, will grow from \$11 million last year to \$2.3 billion in 1987. The growth in units for the period is 2000 to 750,000. Portable computers such as the Epson HX-20, GRID Compass and Teleram T-3000 typically are based on 8- or 16-bit, low-power CMOS proces-

sors. They have 64K of RAM, and as much as 256K bytes of bubble-memory storage, a four-line × 80-character LCD, a typewriter-style keyboard and remote or plug-in peripherals. Weight ranges from 2 to 25 lbs. Prices range from \$500 to \$5000.

The second fastest growing segment is hand-held computers, such as the Panasonic LINC and Sharp PC1500. That market will grow from \$136 million last year to \$630 million in 1987, representing an increase from 400,000 to 4.2 million units. Hand-held computers typically are based on 8-bit CMOS processors, have ROM storage and about 16K bytes of RAM and contain a 1-line × 80-character LCD. The keyboard is button-like, and peripherals are plug-in. Hand-holds weigh from 8 oz. to 5 lbs., and are priced from \$100 to \$500. These computers can be programmed in a high-level language.

Continues on page 57

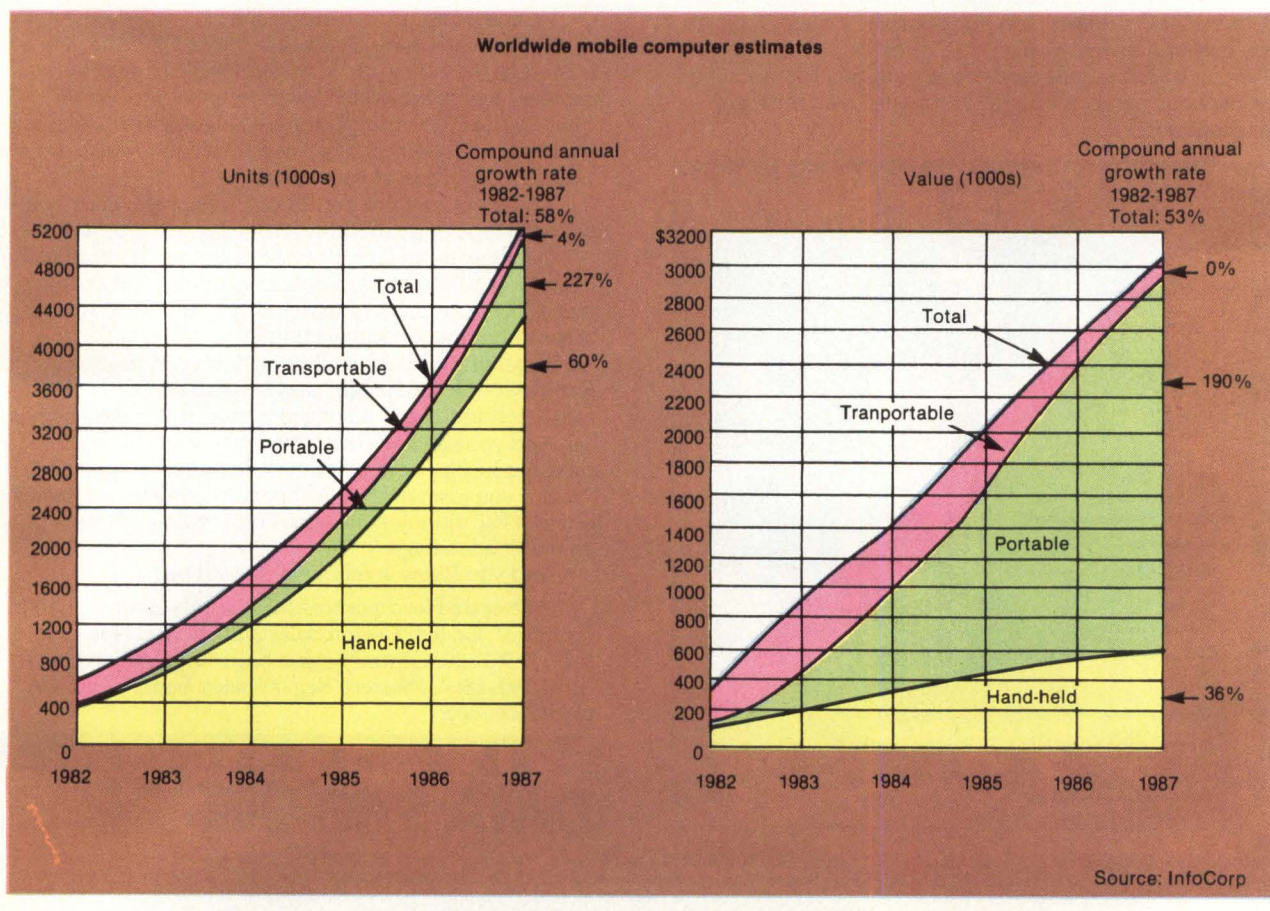

FORTY. FOUR MB FOR MATTED CAPACITY: \$4395.

THE MD-44

- A complete 5¼" Winchester subsystem, fully compatible with IBM-PC*, APPLE*, OSBORNE*, KAYPRO*, ALSPA*, XEROX 820*, HEATH/ZENITH*, TRS-80 II*, COMPUPRO 816*, NORTHSTAR*, any Z-80, CP/M* system.
- Software includes SOURCE CODE and enhanced utilities. Drivers available for OASIS*, TURBODOS* and others.
- Easy installation. Fast data access. No special buss required.
- Full six-month warranty.

ALSO AVAILABLE:

- MD-10 (11 MB formatted): \$2695.
MD-20 (22 MB formatted): \$3595.
- A networking option handling up to 16 micros—either 8 or 16 bit. With special software and DMA channels.
- A 20 MB streaming tape back-up.



DEALER
INQUIRIES
INVITED



4444 Scotts Valley Drive
Scotts Valley, CA 95066
Call (408) 438-5454

* Registered trademarks of IBM Corp., Apple Computer, Inc., Osborne Computer Corp., Kaypro, Inc., Alspa Computer, Inc., Xerox Corp., Heath Company, Tandy Corp., Godbout Electronics, Inc., North Star Computers, Inc., Digital Research, Inc., Phase One Systems, Inc. and Software 2000, Inc.

CIRCLE NO. 34 ON INQUIRY CARD



We think these are the best ideas you've ever had.

AT GE, YOUR IDEAS WERE THE KEY TO THE IDEAL OEM PRINTER.

Is there such a thing as an ideal OEM printer?

We'd like you to take a close look at the GE 3000 family. A compact, lightweight, functionally styled family of printers. A single line of eight basic tabletop matrix printers that offer cost effective solutions to virtually all your printing requirements.

SINGLE-DESIGN SIMPLICITY. FLEXIBILITY. PRICE/PERFORMANCE LEADERSHIP.

The GE 3000 family of printers is a multi-model concept which eliminates the application limitations of single-model product lines. So you can solve your customers' needs efficiently and effectively. All from a single-source supplier. All with high parts commonality. All with reliable, worldwide GE service.

DISCOVER THE ALL IN ONE PRINTER FAMILY.

Select standard print quality from 180 to more than 500

cps. Near letter quality printing from 45 to 200 cps. We have 80 and 136 column models.

Our full range of standard features includes 72 x 72 dot/in. graphics with precision paper movement, self-threading paper load mechanism, close tear-off, six part forms capability, optional popular parallel and serial interfaces, local and downline configuration selection with non-volatile storage. Plus a range of options and paper handling accessories for office and factory applications.

We're proud to say we think you've thought of everything.

OF COURSE, INNOVATIVE IDEAS ARE NOTHING NEW TO GE.

Our roots go back to Thomas Edison. It was in his tradition that in 1969 we introduced the first electronic data printer with modern LSI circuitry. Since then, we've continued in that inventive spirit, supplying OEM's with the finest in advanced printer solutions. What other printer supplier offers that much experience?

General Electric. We're the industry leader in electronic printing. After all, we pioneered the industry in the first place.

First In Electronic Printing.

For the solution to your printing needs, call

TOLL FREE 1-800-368-3182.

General Electric Company, Data Communication Products Department F03P1, Waynesboro, VA 22980. In Virginia, call 1-703-949-1170.

GENERAL  ELECTRIC

CIRCLE NO. 35 ON INQUIRY CARD

Mini-Micro World

CORPORATE AND FINANCIAL

Continues from page 54

The high predicted growth in the hand-held and portable-computer categories will detract from that of transportable computers. These suitcase-sized computers, such as the Osborne 1, Otrona Attache and Dynalogue Hyperion, are growing rapidly in sales now, but we believe this market will peak in 1983 as technological advances allow more portability. While that market was \$225 million last year, it will grow to \$442 million in 1984, then decrease to \$225 million by 1987. Unit growth will rise slightly from 125,000 to 265,000 in 1984 before declining to 150,000 in 1987. Transportable computers generally are based on an 8-bit NMOS processor, have 500K bytes of RAM and 500K bytes of rotating memory and include a 24-line x 80-character CRT display. Peripherals are plug-in, and the keyboard is typewriter style. Weighing 25 lbs. each, they typically

are priced at about \$1800 to \$5000. The rapid pace of both the market and technology growth challenges system integrators to plan ahead. The target system in 1987, as we see it, might include: a 16-bit, high-speed, low-power CMOS processor with multiple 8-bit auxiliary processors; 1M-byte CMOS main memory, 1M-byte bubble memory and 10M to 20M bytes of rotating storage; a full-page, flat, low-power display with full graphics; a typewriter-style keyboard; an 8-hour battery; an integral full-page, plain-paper printer; UNIX, a relational database module, Query language and graphics package; and full communications including links to a local network or standard terminal emulation. All will fit into a standard briefcase weighing less than 20 lbs. The system will offer functions equivalent to a large minicomputer today for less than \$3000 to end users.

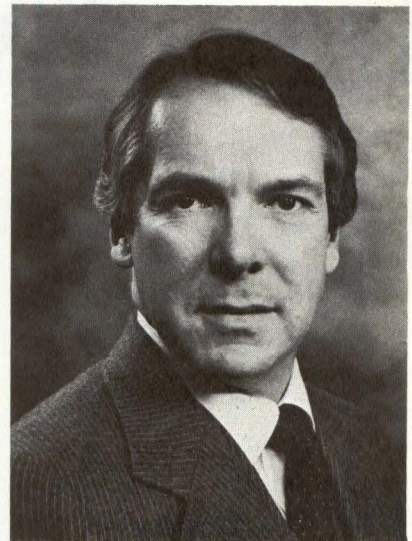

Richard J. Matlack is president of Infocorp, Cupertino, Calif., a new market research firm.

GUEST FORUM

A monthly column for guest experts to speak out

Solid-gold CADD lack

Dr. Joel N. Orr
Orr Associates, Inc.

There is a rapidly growing need for small computer-aided-design and -drafting systems, representing a significant opportunity for system integrators. The CADD system market, dominated by systems averaging \$400,000 for a minicomputer, software and four workstations, grossed some \$1.2 billion in 1982. About \$70 million of that amount was for "small" systems—those typically selling for less than \$100,000, with one or two workstations, and generally limited to 2D drafting, rather than design. It is expected that the market will grow to more than \$3.3 billion by the end of 1985, with more than \$650 million in less-than-\$100,000 systems. And while half the 1982 small systems was sold to the electronics (PC and IC) design and drafting market, that

percentage is expected to drop to 25 percent by the end of 1985, yielding first place to architectural systems (35 percent) and second place to mechanical (30 percent). More than 10 percent of the small systems will go to educational institutions in 1985.

There are currently more than 20 small CADD systems on the market; the list is growing at the rate of one to three per month, by my observation. What characterizes a "winner" in this market?

- First, make your system solve a specific set of user problems, in terms meaningful to users. "General-purpose" small CADD systems are not sales leaders.

- Use existing powerful microcomputers, with reliable, flexible operating systems. It does not pay to write special-purpose operating systems for this market.

- Make the system expandable and define a clear growth path.

- Devote most of your energies to creating a system that speaks the user's language. It should also be friendly, reliable and responsive.

- There is little excuse for not using a color display, at least as an option.

- Aim at the architectural and mechanical market, rather than

electronics. Go for a narrow market segment, such as space planning or piping in architecture, or mold design in mechanical design.

- Consider "OEMing" a general-purpose CADD package and turning it into a "solution system."

A major pitfall in this market is the temptation to write your own graphics software. Don't do it! There are many subroutine packages and general systems available, whose authors have shed the requisite volume of tears to make them functional.



Dr. Joel N. Orr is chairman and principal consultant of Orr Associates, Inc., Danbury, Conn. Orr Associates is a large computer graphics consulting firm.

Complete Protection Needed

Dedicated Power Lines Leave Computers Vulnerable.

Power-line noise is a major source of computer problems; it can cause program errors, component malfunction and hardware damage. The many sources of noise include lightning, the switching of power grids and power-factor correction capacitors by utility companies, and the operation of countless electrical devices from elevators to electric pencil sharpeners. Power-line noise is so troublesome that most computer manufacturers recommend that users provide some form of noise protection in order to keep sensitive equipment operating properly.

Dedicated Lines are Ineffective Against Most Noise Transients.

Many computer users believe that the best way to provide noise protection is with a dedicated power line. But a dedicated line protects *only* against noise that originates *within* the computer facility. It provides virtually no protection against the majority of noise transients — those which originate outside the facility. This external noise enters the building through the main power feeder and *actually travels down the dedicated line to the computer.*

Ultra-Isolators Provide COMPLETE Noise Protection.

A Topaz Ultra-Isolator installed between the computer and the electrical power source blocks the only path through which noise

can pass. This ensures complete protection against all power-line noise regardless of its source. (See table.)

More Ultra-Isolator Advantages.

Distribution — A dedicated line offers only limited noise protection — and for only one piece of equipment. A Topaz Ultra-Isolator offers complete protection and also offers output receptacles for as many as 21 pieces of sensitive electronic

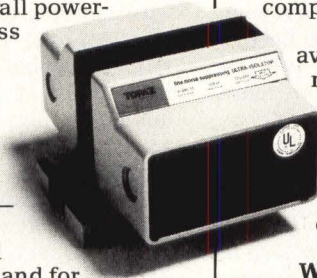

Isolator can be moved if the computer is ever relocated.

Topaz Ultra-Isolators are available in 50 Hz and 60 Hz models and in styles and power ratings to suit virtually any application. Other features include UL listing, attractive computer-room styling, quiet and efficient operation and guaranteed performance.

Why install a dedicated power line when you can provide more protection for more equipment in less time for less money with a Topaz Ultra-Isolator? Contact us today for the complete solution to

noise-related computer problems.

Topaz Electronics Division,
3855 Ruffin Road
San Diego, CA 92123
(619) 279-0831
TWX: 910-335-1526

SOURCES OF NOISE	PROTECTION	
	DEDICATED LINE	ULTRA-ISOLATOR
Electrical devices within your facility	YES	YES
Electrical devices in neighboring facilities	NO	YES
Lightning	NO	YES
Power-network switching	NO	YES
Switching of power-factor correction capacitors	NO	YES

equipment. This feature allows users to distribute noise-free AC power to an entire computer system simply by plugging each piece of equipment into the Ultra-Isolator.

Convenience — Installing a dedicated power line often requires building modifications that can disrupt normal facility operations for days. A Topaz Ultra-Isolator typically can be installed in less than one hour — and with practically no inconvenience.

Economy — In most cases, the cost of an Ultra-Isolator will be considerably less than the cost of a dedicated power line. And unlike a dedicated line, a Topaz Ultra-

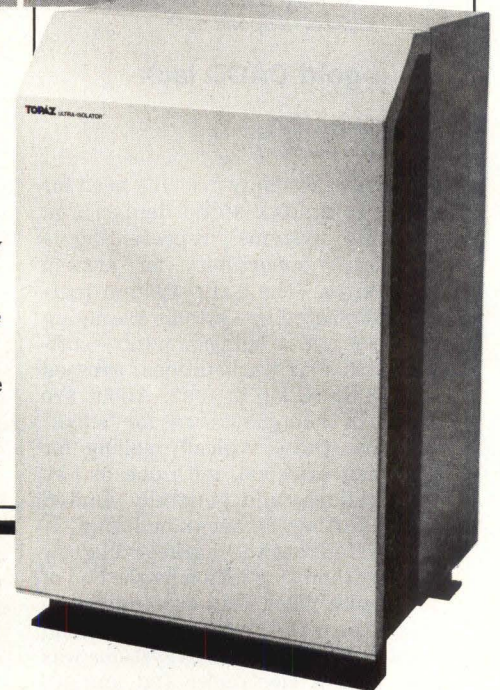
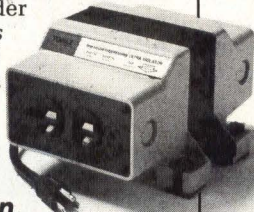

TOPAZ
SOLUTIONS TO POWER PROBLEMS™

CIRCLE NO. 36 ON INQUIRY CARD

Minicomputer users:

Timeplex offers a one-stop system solution for communicating with multiple remote terminals. Economically.



Asynchronous statistical multiplexer

Synchronous statistical multiplexer

High speed modem

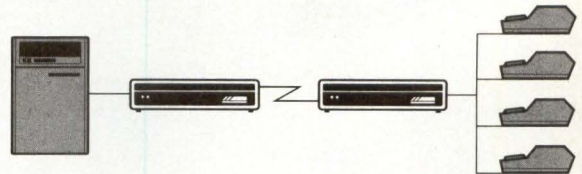

The Timeplex E/SERIES is a complete data concentrator system designed to economically link clusters of remote terminals to your minicomputer.

E/SERIES: Cuts communications costs. Suddenly, saving communications costs by linking several terminals to one shared telephone line becomes easy.

Unlike the competition, the Timeplex E/SERIES simplifies the challenge of point-to-point communications by incorporating three functions in a single compact unit. One system offers you a statistical multiplexer supporting 4 to 16 asynchronous channels, *plus* an optional statistical multiplexer for an additional synchronous channel, *plus* an optional integral high speed modem.

E/SERIES: Puts it all together. Putting three functionally distinct modules in one enclosure eliminates external communications units and bulky, expensive cables. And, a minicomputer interface option further reduces costs. The result: System planning and installation is extremely simple. Reliability is enhanced. Costs are dramatically reduced.

Free step-by-step Guide. This easy-to-understand booklet contains all the facts on how to remote your terminals, simply *and* economically. Just write or call Timeplex for your free copy.

For the name of the E/SERIES stocking distributor nearest you, call 201-368-0736.

Timeplex, Inc./One Communications Plaza/
Rochelle Park, N.J. 07662.



The technology leader
in data communications

CIRCLE NO. 37 ON INQUIRY CARD

NOW ANYBODY CAN MAKE THEIR BUSINESS LOOK GREAT.



The explosion in business graphics is just getting started.

To help OEM's cash in on the boom, Convergent Technologies now offers spectacular, low-cost graphics hardware, plus revolutionary software that lets even untrained users create sophisticated business graphics.

Picture-perfect hardware.

There are two ways to add great graphics to a Convergent system.

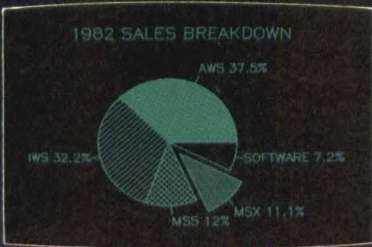

The monochrome option comes on a single Multi-bus[®] board that plugs into any IWS[™] workstation. Using a dedicated 8MHz 16-bit processor with on-board ROM and RAM, it displays either of two 656 x 510 bit maps on the existing high resolution monitor.

Color comes as an option in our new AWS[™] Turbo workstation. Using the same dedicated processor approach, you get dazzling 64-color images with 432 x 319 resolution.

A complete set of graphics primitives gives high-level languages access to all the features of both systems.

Sensational Software.

Now generating business graphs and charts is as simple as using the highly-acclaimed Multiplan[™] spreadsheet program.

With Convergent's enhanced Multiplan and our proprietary Business Graphics Package, you just select a range of rows and columns for graphing in any of several standard formats (pie and bar charts, line graphs, etc.)

If you want to get creative, use our unique graphics editor to resize, rescale, move, and combine charts—interactively, right on the screen. Then produce presentation quality hard copy on an inexpensive plotter.

Convergent graphics software is 100% interchangeable between color and monochrome systems; shading and cross-hatching are automatically substituted for color when necessary!

The Convergent OEM revolution continues.

Combine *accessible* graphics power like this with all our other advantages, and it's easy to see why so many OEM's are making major, long-term commitments to Convergent systems.

Shouldn't you get the full story now?

Convergent Technologies

Where great ideas come together.

Call toll-free (800) 538-7560; in Calif. (408) 727-8830 or return this coupon.
Send to: Convergent Technologies Inc., 2500 Augustine Drive, Santa Clara, CA 95051
I'm an OEM. Give me the whole picture on Graphics.

Name	Title	Company	Address	City	State	Zip	Tel. ()	Ext.

MM0183

© 1982 Convergent Technologies Inc.
Multibus is a trademark of Intel Corp.
Multiplan is a trademark of the Microsoft Corporation.

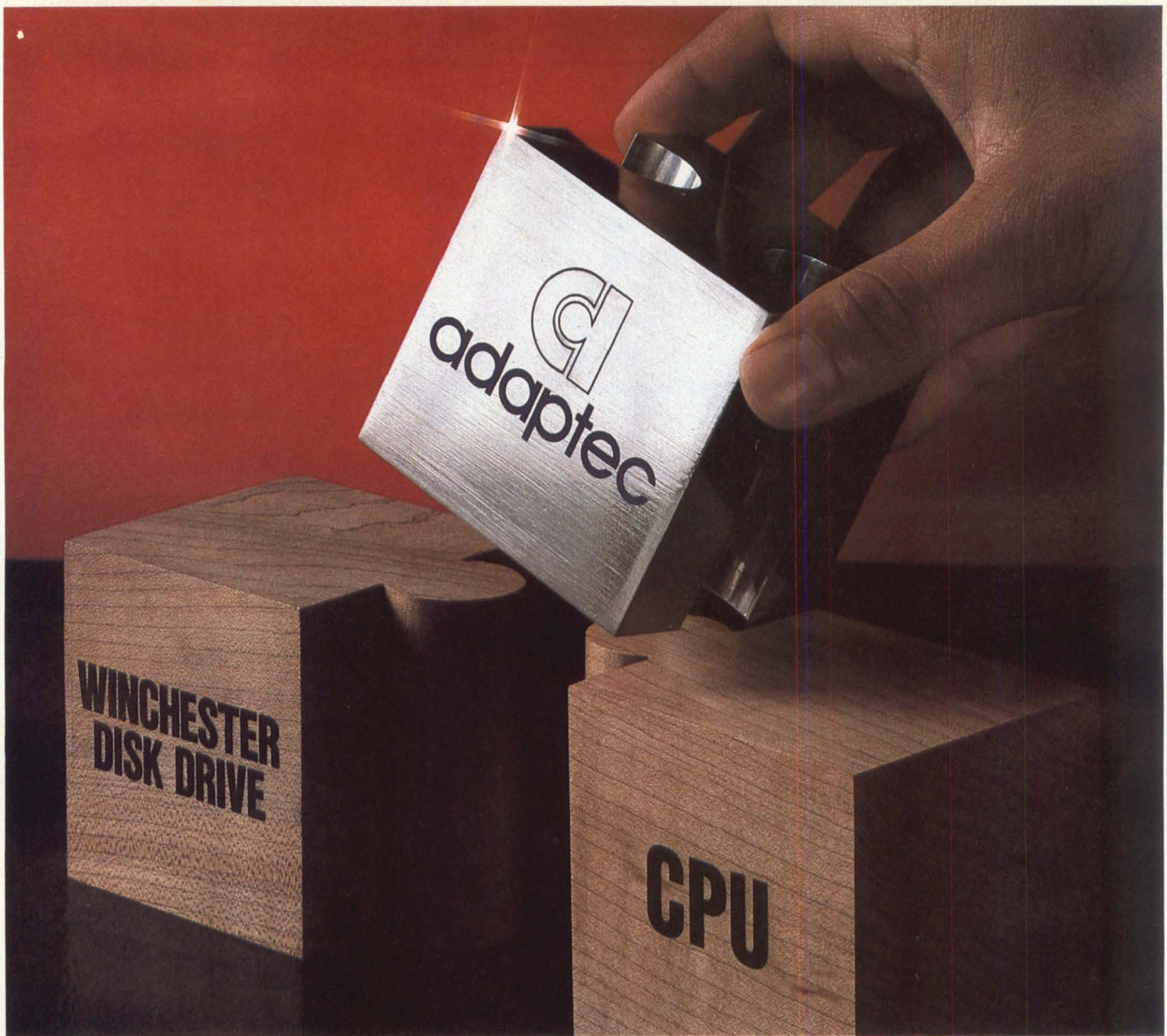

MAKE THE ADAPTEC CONNECTION

The Adaptec Connection: Controllers that actually enhance your system's I/O capability. Superior quality and reliability. Detailed attention to customer support. Leader-of-the-pack performance at low cost. Sound like the connection you need for your Winchester? Read on.

The High Performance Connection: Adaptec intelligent ANSI SCSI (SASI) bus controller devices. Fully-featured Adaptec LSI 5000 Series Chip Sets and Controller Boards complete your high performance, multi-tasking system perfectly. Popular ST-506, SA-1000 and Q-2000 drive interface compatibilities assure a tight fit no matter what drives you select. And a range of features allowing complete device independence, logical block addressing, disconnect/reconnect, and a 10Mbit/second transfer rate mean that these low cost controllers won't be a performance bottleneck.

The Very Low Cost Connection: The Winchester Controller Chip™. This device lets you design your own controller board with as few as eleven "glue" chips. You still get power-

ful features like automatic error correction and software selectable sector sizes. You still get Adaptec reliability and support. But you also get costs (and margins) that let you compete in the personal computer marketplace. Finally, a Winchester controller that costs a fraction of the drive.

Adaptec people are experts in systems, drive and LSI technology. We even provide complete PCB design and manufacturing information for volume chip customers. And since you can build or buy, and choose the right performance level for your needs, you don't waste money. So don't waste time. Call Don Rector, vice president of marketing, at (408) 946-8600. Or write Adaptec, 1625 McCarthy Boulevard, Milpitas, CA 95035.



adaptec, inc.

The best controller connection you can make . . . or buy.

CIRCLE NO. 38 ON INQUIRY CARD

Mini-Micro World

CORPORATE AND FINANCIAL

Continues from page 49

rose from \$233 million during last year's first quarter to \$303 million. Many analysts expect DEC's second-quarter earnings to be down, but this does not concern George R. Balaschak, a DEC follower and vice president at First National Bank of Boston. Balaschak expects earnings per share for the year to be between \$6 and \$6.50, but to climb to about \$8 per share in 1984 because of new products. He notes that DEC experienced flat growth in 1975 during the last recession. He questions whether DEC can make up for lost growth in the second half of this year, but expects the personal-computer line to help.

Besides noting the strength of service during the annual meeting, Olsen stressed long-term emphasis in several product areas, notably its disk business. DEC has manufactured disk drives for several years, and Olsen has considered the company two to three years behind IBM Corp. until now. "We want to become a leader in disks, and now we are equal with IBM, or maybe better," he claims, referring to the cost per bit stored in two rack-mountable storage devices introduced by DEC at last year's National Computer Conference—the RA60 and RA81—a DEC spokesman says. Olsen says DEC has the technology in place to be a leader, but will not elaborate.

In pointing to DEC's heavy investment in technology, and noting that the company's heavy investments in engineering have hurt the financial statement, Olsen focused on other product areas—semiconductors and personal computers. He notes that DEC will make VAX superminicomputers on one or four chips, but says those products are still two to four years away. Research and engineering expenditures for the first quarter were up 39 percent over last year's period to

BOX SCORE OF EARNINGS

This monthly table lists the revenues, net earnings and earnings per share in the periods indicated for companies in the computer and computer-related industries. Parentheses denote losses. Comments are from corporate summaries unless otherwise noted.

Company	Period	Revenues	Earnings	Eps
Ayden Corp.	9 mos 9/25/82	88,012,000	6,892,000	1.47
	9 mos 9/26/81	75,458,000	4,861,000	1.04
Burroughs Corp.	9 mos 9/30/82	3,066,668,000	99,716,000	2.37
Computer Consoles, INC.	9 mos 9/30/82	43,909,312	4,110,192	.73
	9 mos 9/30/81	33,438,378	3,691,300	.64
Computer Sciences Corp.	26 wks 10/1/82	330,960,000	9,369,000	.70
	26 wks 10/2/81	297,632,000	6,912,000	.61
Convergent Technologies, Inc.	9 mos 9/30/82	54,086,000	6,946,000	.40
	9 mos 9/30/81	4,773,000	(741,000)	(.07)
CPT Corp.	3 mos 9/30/82	37,041,000	3,394,000	.21
	3 mos 9/30/81	30,012,000	3,349,000	.21
Gray Research, INC.	9 mos 9/30/82	78,492,000	6,833,000	.60
	9 mos 9/30/81	61,661,000	10,163,000	.74
Genrad, Inc.	9 mos 10/2/82	130,675,000	4,572,000	.64
	9 mos 10/3/82	117,748,000	(1,925,000)	(.25)
Hazeltine Corp.	9 mos 9/30/82	114,562,000	4,108,000	2.00
	9 mos 9/30/81	108,308,000	3,004,000	1.46
Informatics General Corp.	year 9/30/82	166,646,000	6,133,000	1.44
	year 9/30/81	139,409,000	4,426,000	1.27
Lexidata Corp.	year 9/30/82	28,561,600	3,134,300	.68
	year 9/30/81	14,529,100	2,063,300	.60
Logicon, Inc.	6 mos 9/30/82	32,884,000	1,529,000	.76
	6 mos 9/30/81	28,690,000	977,000	.48
NBI Inc.	3 mos 9/30/82	27,168,000	3,123,000	.31
	3 mos 9/30/81	19,273,000	2,235,000	.24
NCR Corp.	9 mos 9/30/82	2,463,825,000	140,440,000	5.26
	9 mos 9/30/81	2,387,892,000	118,077,000	4.37
Rolm Corp.	3 mos 10/1/82	115,000,000	8,300,000	.47
	3 mos 10/1/81	83,000,000	6,700,000	.38
Tandem Computer, Inc.	year 9/30/82	335,899,000	37,283,000	.96
	year 9/30/81	208,397,000	26,549,000	.72
Triad Systems Corp.	year 9/30/82	82,000,000	3,300,000	.47
	year 9/30/81	78,000,000	8,700,000	1.35
Tymshare, Inc.	9 mos 9/30/82	231,719,000	11,117,000	.93
	9 mos 9/30/81	218,875,000	16,116,000	1.37
Visual Technology, Inc.	9 mos 9/30/82	18,305,693	2,031,892	.66
	9 mos 9/30/81	12,336,834	1,286,141	.42

Comments: **Convergent Technologies, Inc.** revenues for the nine-month period represent an 11-fold increase over the same period in 1981. Third-quarter earnings were \$3,939,000, up from a loss of \$470,000. The company attributed the increases to greater acceptance of its products. **Tandem Computers, Inc.** noted that its seventh straight year of record revenues was the result of a continued commitment to new-product development. The company said it spent \$33 million on R & D and \$63 million on plants and equipment for the fiscal year. **Triad Systems Corp.** blamed weak economic conditions and high interest rates for its drop in earnings. The company said the fourth-quarter results, while lower than 1981,

showed improvement over the previous three quarters. Fourth-quarter earnings were \$1.5 million, compared to \$3.3 million last year, a loss of 30¢ per share. **Tymshare, Inc.** said the sale of its bank-credit-card-processing business helped third-quarter earnings show only a small decline from \$2,813,000 in 1981 to \$2,260,000, or 6¢ per share. **Visual Technology, Inc.** said sales for its third quarter were about \$1 million below expectations. Revenues for that quarter were 5,800,304 up 18 percent from \$4,917,367 in the previous year. The company said the cause was a one-time production problem created by a supplier had been corrected; therefore the company expects a return to sales growth.

Mini-Micro World

CORPORATE AND FINANCIAL

\$101 million, or 11 percent of revenues.

The personal computers are being

shipped; 1000 are now in test sites, and Olsen expects production to be in full tilt by the end of winter. A

DEC spokesman says shipments are on schedule.

—Lori Valigra

Victor and Sirius merge under Sirius president Chuck Peddle

In a move to strengthen the Sirius/Victor marketing effort, Sirius Systems Technology, Inc., has merged with Victor Business Products, its exclusive U.S. distributor. The new company, which will be headquartered at Sirius' Scotts Valley, Calif., facility, is headed by Chuck Peddle, founder of Sirius. The merger comes a year after Victor disclosed its distribution plan with Sirius and introduced the Victor 9000 microcomputer.

As of press time, the name of the

new entity had not been decided. The original name, Victor, Inc., was not accepted by the State of Delaware, where the company is being incorporated, says Sirius finance vice president David Monroe. He expects the company to emerge as Victor Technology, Inc.

The new company is being established as an independent, privately held corporation, although Kidde, Inc., Victor's parent company, owns a majority share in the enterprise. The transaction creating

the company involved the acquisition of Victor Business Products by Sirius, which paid for the Chicago-based calculator and cash-register company by issuing Kidde preferred shares. Kidde had invested \$2.5 million in Sirius in return for preferred shares equivalent to 5.4 million common shares, Monroe says. Monroe adds that all outstanding common stock would total 14.5 million shares. Of that, Kidde could hold as much as 67 percent if it exercises all its preferred stock

FAST.

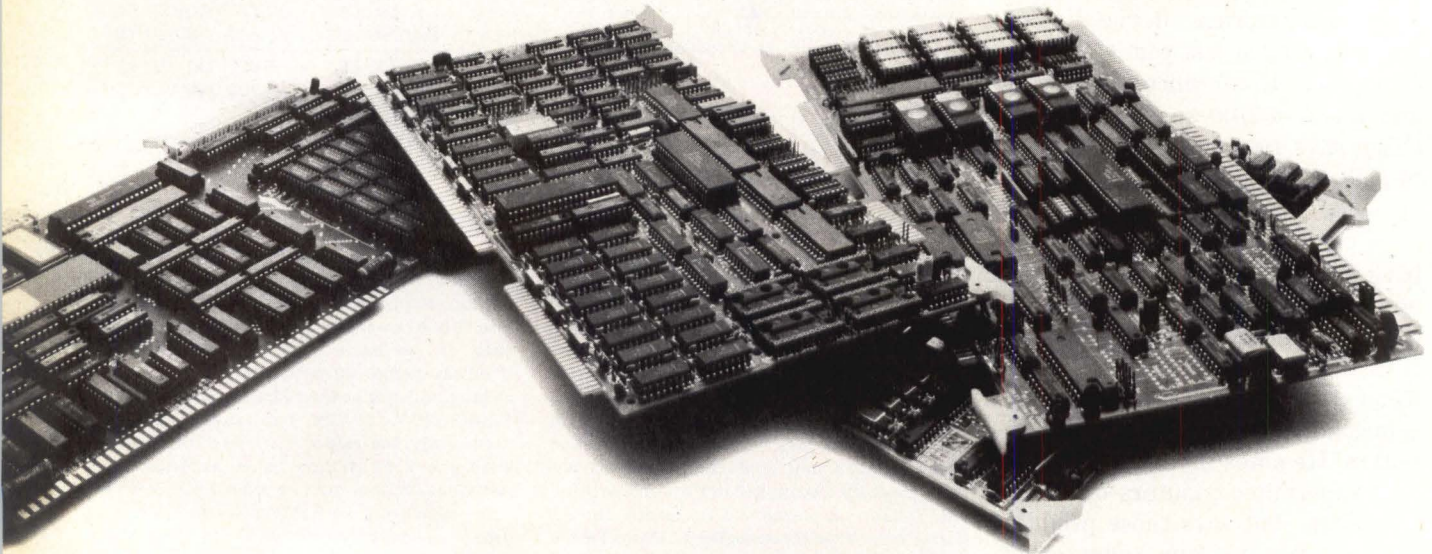

Dual Bus is a trademark of Microbar Systems Inc. *Multibus is a trademark of Intel Corporation. UNIX is a trademark of Bell Telephone Laboratories, Inc. XENIX is a trademark of Microsoft Corporation.

options, a Kidde spokesman says.

Monroe declines to specify the capitalization of the new firm, citing the company's plans to make a public stock offering this year. A Victor spokesman says the combined company would have 1982 sales of approximately \$180 million, including the \$80 million Peddle estimates Sirius made in its first year of operation.

The new organization will market the Sirius Intel 8088-based desk-top computer and Victor Business Machines' desk-top calculators and electronic cash registers. The sales, marketing and product-development efforts for all three lines will be centralized at the Scotts Valley facility. With the new entity, the Sirius product is expected to move beyond the 50 Victor branches in the U.S. that



Chuck Peddle has been named president of a new unnamed company resulting from the merger of Peddle's Sirius Systems Technology, Inc., and Victor Business Products, Sirius' U.S. distributor.

have handled the product to date. Victor also has 700 dealers. Peddle says he plans to establish a 1000-outlet dealer network, about half of which will be current Victor dealers.

Peddle says a particular strength

of the new company is Victor's combination of direct and dealer locations. The Victor-owned outlets will continue to concentrate on major end-user sales but will also have responsibility for dealers in their areas, Peddle says.

The Sirius system will still be sold under the Sirius name in Europe, where the company has had the bulk of its worldwide sales to date. The company will be prohibited from using the Sirius name in the U.S. as it had planned to do after 3-year Victor contract ran out. Sirius' rights to the name were lost in a suit settled in October with Sirius Software, Sacramento, Calif.

Ed Carlson, who was president of Victor Business Products, has been named senior marketing vice president of Kidde's Victor United Group.

—Geoff Lewis

FAST AND A HALF

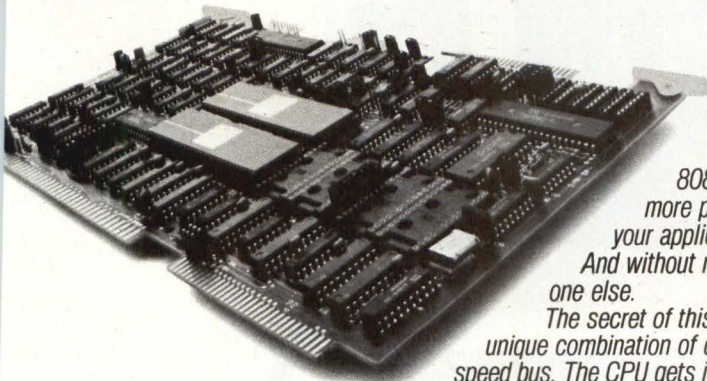

That's the kind of performance you can expect from Microbar's 8086- or MC68000-based Dual Bus™ Computers. Up to 50% more performance in your Multibus* system, depending upon your application. Without sacrificing Multibus compatibility. And without requiring on-board memory that's off-limits to everyone else.

The secret of this "fast and a half" performance is Microbar's unique combination of dual ported memory and a dedicated, high speed bus. The CPU gets its own zero wait state access path into memory. While other devices use the Multibus bus as usual.

So your software can get the most out of this high performance hardware, Dual Bus Computers fully support memory management. Handy for organizing 16 Mbyte address spaces. Absolutely necessary for running advanced operating systems like UNIX* and XENIX*.

To help you get the most out of your design efforts, Microbar has developed a Dual Bus Computer design kit. With all the information you need to add a Dual Bus Computer to your system. In a hurry. Because today designing a system fast is not enough. You have to be fast and a half.



Microbar Systems Inc./1120 San Antonio Road/Palo Alto, California 94303/(415) 964-2862

I want to design in fast and a half performance. Fast. Here's \$9.95. Rush me the Dual Bus™ Computer design kit, including manuals and technical specs, for the CPU indicated below. Also include the latest copy of the IEEE P796 specifications for the Multibus bus.

8086 _____ MC68000 _____

Check enclosed _____ MC _____

VISA Card _____ Exp. Date _____

I can't wait for the mail. Have a sales representative contact me.

Name _____

Title _____

Company _____

Address _____

Telephone _____

City _____ State _____ ZIP _____

ESPRIT III™

goes TVI-950 one better.

The new Hazeltine Esprit III™ is a plug-to-plug replacement for the TeleVideo TVI-950. Same command set. Same keyboard layout. The same features. Even the same user-PROM capability.

But Esprit III goes TVI-950 one better. And that one important difference is price. Esprit III costs \$300 less. In fact, it costs \$100 less than TeleVideo's far less capable TVI-925.

Look at the numbers. TVI-950 performance for less than TVI-925 cost. You'll agree. Esprit III is the best one.

	Esprit III	TVI 925*	TVI 950*
Buffered mode	Yes	Yes	Yes
Programmable function keys	Yes	No	Yes
Line graphics	Yes	No	Yes
Page/line transmit	Yes	Yes	Yes
Smooth scrolling	Yes	No	Yes
Price	\$895	\$995	\$1,195

*Trademarks of TeleVideo Systems, Inc.

Hazeltine Corporation, Computer Terminal Equipment, Commack, NY 11725 (516) 462-5598 or call toll free: 800-645-4508

Hazeltine

The new terminal technology.



CIRCLE NO. 40 ON INQUIRY CARD

IMI reinvents the 5¼" Winchester. And backs it with a 2-year warranty.

If our new 5000H Series drives weren't the most reliable 5¼" Winchesters ever built, we wouldn't give them an unprecedented 2-year warranty.

Don't expect to use it, though. 5000H Series drives are made to withstand the everyday abuse known as "normal system usage." And to give continuously superior performance in even the most demanding applications.

So the overwhelming odds are that the 2-year warranty will expire long before the drive ever does.

THIN-FILM PLATED MEDIA PRESERVES DATA INTEGRITY, INCREASES STORAGE CAPACITY.

To ensure that 5000H drives withstand harsh treatment without sacrificing data integrity, the media is thin-film plated. Thin-film plating is orders of magnitude more shock resistant than ferric oxide coatings and many times harder. Because it's not easily damaged, data is not easily lost, and the drive remains in service.

Thin-film plated media also allows greater bit densities, as much as 10,700 bpi. This has enabled IMI to up the unfor-

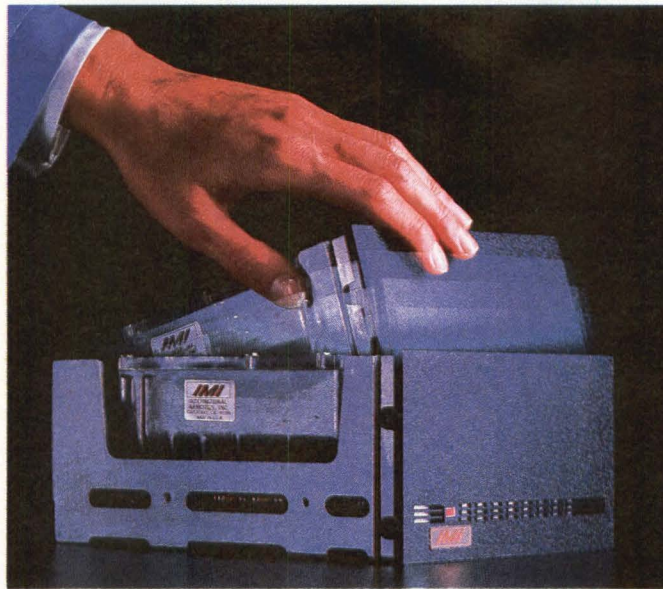

matted storage capacity of the 5021H drive, for example, to 21 Mbytes.

And to improve data integrity even further, we've maintained industry standard formats and transfer rates with lower track densities.

NEW 2-PIECE SHOCK-MOUNTED CHASSIS EXTENDS SERVICE LIFE.

To protect the heads and disks, we've recessed the head/disk assembly inside a rigid, die-cast frame enclosure. Integral shock mounts at the center of gravity insulate the head media interface from the environment.

Besides reducing acoustical noise, this 2-piece design minimizes vibration and shock loads transferred to the heads and disks during installation and use. Even the printed circuit boards utilize the shock-mounted design to lessen stress on the components.

NEW THERMALLY STABLE DESIGN ENSURES OPTIMAL HEAD POSITIONING.

5000H Series drives have a deeply finned die-cast base and cover that increase both the stiffness of the structure and the surface area for heat transfer.

When thermal distortion of the head/disk assembly is minimized, head positioning is optimized. And the combination of temperature stability and lower track densities substantially reduces the potential for off-track errors.



**NOW FASTER.
68
MSEC
(INCLUDES SETTLING
TIME)
ACCESS TIME**

HEAD-MOUNTED PREAMPLIFIER PROVIDES MAXIMUM NOISE IMMUNITY.

Only IMI puts the read/write preamplifier on the head stack, where it greatly reduces EMI/RFI noise susceptibility. This, coupled with the inherently higher signals of plated media (>50%) and the shielding of the all metal frame, yields the best signal to noise ratio in the industry.

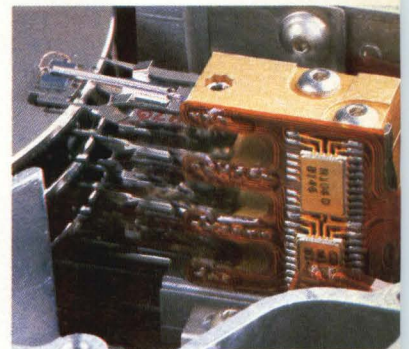

A FULL LINE OF HIGH PERFORMANCE 5¼" WINCHESTERS.

Although the unformatted storage capacity ranges from 6.38 Mbytes to 21 Mbytes, depending upon the drive model and interface, all 5000H Series drives feature:

- 68 msec access time.
- 303 tpi.
- 3600 rpm.

For specification sheets, call or write: International Memories Incorporated, 10381 Bandy Drive, Cupertino, CA 95014. (408) 446-9779. TWX: 910-338-7347

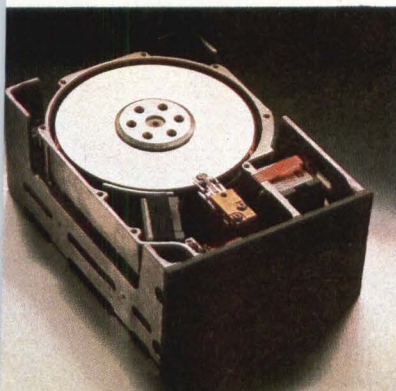

IMI
We're at it again.

CIRCLE NO. 41 ON INQUIRY CARD

NCR

- Disk
- Communications
- Fault
- Battery

On
Off

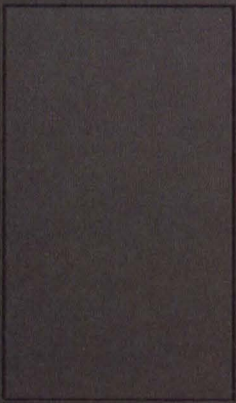
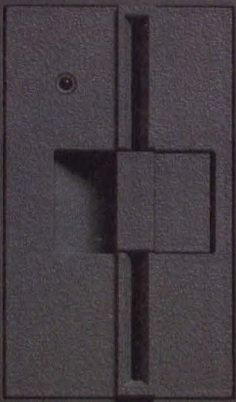

TOWER 1632. IT TOWERS OVER THE MINICOMPUTER. AND FITS UNDER A DESK.

Tower™ 1632.

The power and performance of a minicomputer. At the size and price of a micro.

Only 29 inches tall. Yet it casts its shadow over everything before it. And, upon the system builder with the foresight to sell it, it will confer a truly towering advantage.

This single sleek package conceals as much as two megabytes of memory. Plus 60 megabytes of mass storage. And up to 5 additional add-on modules (each seven inches wide) can boost mass storage to one billion bytes.

Tower 1632's capacity to interface is equally vast. From networking to peripherals, it's as ready for the future as it is right for today.

We enhanced its full-scale UNIX* operating system for maximum software capability and flexibility.

And the NCR name guarantees maximum support, with more than 16,000 field engineers around the world.

But we've barely begun to explore the ground floor. Call us to learn more about this towering achievement.

The OEM price starts under \$10,000. The performance never stops.



BUILT FOR SYSTEMS BUILDERS.
TOWER 1632.

NCR
OEM Marketing Division

NCR Corporation World Headquarters, OEM Marketing Division, Dayton, OH 45479. Nationwide (800) 222-1235. In Ohio (513) 445-2380.

*UNIX is a trademark of Bell Laboratories.

CIRCLE NO. 42 ON INQUIRY CARD

IMAGE PROCESSING: THE FASTEST, LEAST EXPENSIVE WAY TO FIND OIL.

Where to drill? Traditionally, exploring a 25,000 square mile frontier for an answer to that question could take months. And cost over a million dollars for consultant fees and aerial photography.

Today, a DeAnza Image Processing System can narrow the same frontier to a few miles using roughly \$100.00 worth of satellite data. And help project the final drill site in less than thirty days. Remarkably, the system itself is paid for several times over, exploring just a single frontier.

Get The Complete Picture

Image processing is the *only* way all geological data can be considered *simultaneously*: LANDSAT, SEASAT, radar, magnetic, gravity, topographical, etc. Step-by-step, a DeAnza Image Processing System graphically displays faults, folds and stratigraphic units to pinpoint areas small enough for seismic exploration. Finally, the system enhances seismic data gathered in the field to project final drill sites. And these projections stay completely confidential, because they're done in-house.

The Gould/DeAnza Advantage

Gould/DeAnza is one of the world's leading suppliers of image processing systems. For one very good reason. No other supplier offers systems with power, flexibility, and range of operations equal to ours. Nobody. Call or write us today. Let us help you explore the possibilities of image processing. It may be the richest find you make this year.



Enhanced seismic data of an oil find.



Gould Inc.
DeAnza Imaging & Graphics Division

1870 Lundy Avenue, San Jose, CA 95131
(408) 263-7155 • TWX (910) 338-7656
Eastern (516) 736-3440 • Central (312) 965-8110
Southwestern (214) 458-0052 • Western (408) 263-7155
Distributors Worldwide

CIRCLE NO. 43 ON INQUIRY CARD

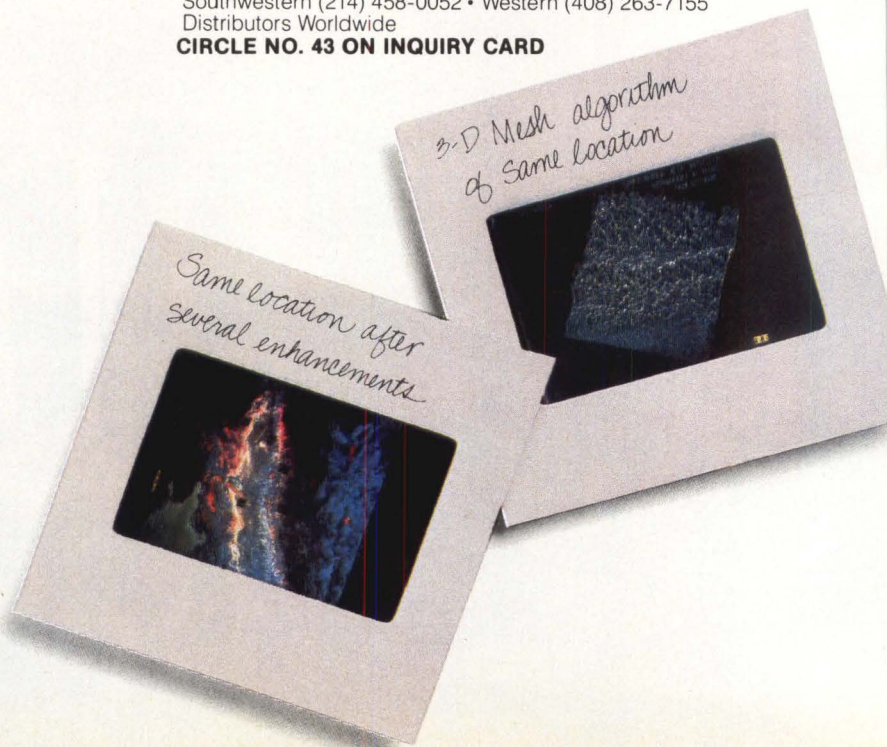

NEW FROM
MICRO-TERM

A 66 LINE WORD PROCESSING
TERMINAL FOR ONLY

\$1695



**ERGO
4000**

At last, the ERGO 4000 -- the full-page word processing terminal you've been waiting for. At the price you've been waiting for -- \$1695 (with quantity discounts available).

ERGO 4000 is a 66-line by 80-character terminal, compatible with VT-100⁺ codes as well as other popular code structures.

The newest member of the ERGO Series, the ERGO 4000 gives you complete performance for the price. The tiltable cabinet with crisp green display for increased comfort and productivity, and the many additional ergonomic features, are all standard with the ERGO 4000.

The ERGO 4000 offers the following additional features:

- Four video attributes
- Pass through printer port
- Savable set up mode
- Screen saver
- Fifteen function keys
- Diagonal cursor movement
- Alternate character generator
- Transparency mode
- Settable tabs

ON SITE SERVICE IS AVAILABLE IN OVER 450 CITIES THROUGH WESTERN UNION

MICRO-TERM, INC.

1314 HANLEY INDUSTRIAL COURT,
ST. LOUIS, MISSOURI 63144,
(314) 968-8151 TWX: 9107601662,
MICROTERM, STL

*VT-100 is a registered trade mark of Digital Equipment Corporation.

MICRO-TERM. Terminals are our only product, and we put more into them.

CIRCLE NO. 44 ON INQUIRY CARD

Versatility you can count on.



Trilog's new family of line printers put you in control.

You select the interface: serial or parallel.

You select the fonts to be utilized: customize your printer for multi-lingual, special symbols, or script capability to fit your particular application.

You select the print density: standard (10 CPI), or one of two compressed densities ($13\frac{1}{3}$ CPI or $16\frac{2}{3}$ CPI) for paper savings or for special format requirements.

You select the print quality: Data Processing Quality at rated speed or Letter Quality at reduced print speed.

You select paper direction: the bi-directional paper drive allows you greater formatting capability.

You select the mode: printing or industry standard plot mode for high resolution graphics.

With Trilog's new family of printers, you stay in control.

Built-in field upgradeability to 300 LPM ensures that your TIP-150 can keep pace with your printing needs.

Non-Stop-Printing™ made possible with the TIP-300 through Trilog's exclusive two print head design, drastically reduces down time by allowing you to continue printing at a reduced rate if either print head should be temporarily out of order.

Modular design and commonality of parts provide ease of maintenance and reduced spare parts stocking levels. And no periodic adjustments mean low maintenance cost.

Another Trilog exclusive, the use of upper and lower sets of paper drive tractors, reduces paper jams.

Built-in diagnostics minimize down time and assist in fault isolation. A numerical read-out differentiates between operator correctable and service required situations.

Write or call today for ordering or product information.

TRILOG

Trilog, Inc.
17391 Murphy Avenue
Irvine, CA 92714
(714) 549-4079
TWX (910) 595-2798

FOR SALESMAN CONTACT, CIRCLE 25
FOR INFORMATION CONTACT, CIRCLE 137

Mini-Micro World

INTERNATIONAL

Comdex Europe's attendance low, but attendees were high-quality

In general, exhibitors at the first Comdex Europe '82—mostly U.S. companies—regarded the quality of attendees at the Amsterdam show as very high and were impressed that they came from all over Europe. But most exhibitors chose the word "quiet" to describe the show's visitor numbers. Peter Young, a spokesman for the Framingham, Mass., Interface Group, the show's sponsor, estimates that more than 4000 who attended fit Interface's profile of an Independent Sales Organization. ISOs are the distributors and retailers that form the main target audience for Comdex events and account for the show's popularity among U.S. exhibitors. The exhibitors at Amsterdam met some first-rate distributors, but found the retailer population fairly thin.

Young estimates that the total ISO universe in Europe numbers 25,000 and points to efforts to attract a much higher proportion of them to Comdex Europe '83, including mailings to attendees after the '82 event to check what periodicals they read. Interface president Sheldon Adelson says that more than 60 percent of exhibitors had signed to appear at Comdex Europe '83 by the end of the '82 show.

Comdex Europe coincides with

several major and established European computer shows—notably Sicob in Paris, Compec in London and the biennial Systems Show in Munich, Young acknowledges. The last will probably lure some West German ISOs away from Comdex Europe '83. But Young notes that all those shows—like the National Computer Conference in the U.S.—are aimed at a more diverse audience than Comdex, including end users.

Young also notes that the '82 Amsterdam show was no more "quiet" than the first Comdex events staged in the U.S. Young's view is supported by Robert Kresek, worldwide third-party marketing manager with Hewlett-Packard Co., one of the largest exhibitors at the Amsterdam event. "Comdex Europe compares well with the early Comdex exhibitions in Las Vegas, and HP will probably go ahead with a booth at the 1983 Amsterdam show," Kresek declared at the show.

Kresek regards Comdex Europe '82 as an appropriate arena in which to announce major enhancements to HP's value-added system supplier program for OEMs. The main new feature is a plan under which an OEM with a software package designed to run on HP machines

receives a compensatory payment of as much as 6 percent of the value of HP hardware shipped to an end user if HP supplies the hardware directly. This would deprive an OEM of a markup. "This plan will be costly for HP," Kresek admits, "but it will ensure that existing OEMs stay with HP, and we hope it will convert OEMs to HP that are having problems with their existing hardware suppliers. With this plan, we believe HP is the first vendor to come up with a creative solution to conflicts with OEMs."

Some U.S. companies at the Amsterdam show were not satisfied enough to want to appear at Comdex Europe '83. Tom Reynolds, European marketing vice president for Onyx Systems, notes that his company's European distributor network is in place and that Onyx had hoped to make contact with dealers at Amsterdam. They are needed to work with Onyx's European distributors, who went to the show to meet dealers as well as to discuss business with each other. "But there are not too many dealers here," Reynolds wistfully observed at the show, "so we will not be appearing at Comdex Europe '83."

—Keith Jones

Software gives MUMPS users graphics, multiterminal DEC professional support

MUMPS, the interactive high-level language and operating system with powerful file-handling capabilities, is adopted most widely among the Digital Equipment Corp. user community. Now, two European

software houses, both dedicated to MUMPS work, have developed products that should enhance the software's attractiveness for DEC users.

HRD Ltd., Birmingham, England,

offers a product that can generate a variety of graphics from MUMPS files, while Structured Data Systems, Newton Stewart, Scotland, has developed a version of MUMPS that supports as many as eight

Mini-Micro World

INTERNATIONAL

concurrent terminals on a DEC Professional computer. This is the personal machine intended by DEC for single-user work only.

Bill Davies, sales manager of HRD, says his company is seeking U.S. distributors for its product, Business Graphics Package. Davies stresses potential distributors must have DEC software expertise and, preferably, involvement with DEC Standard MUMPS, DSM. He notes that in Europe, DEC has expressed an interest in adding the product to its DEC Classified Software catalogue. Davies says DEC is attracted by the VAX version of Business Graphics Package.

He stresses that DEC users in the U.S. can buy the product now if they order directly from HRD. User configurations must include one essential hardware ingredient, the

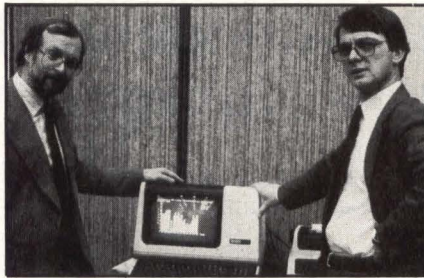

Using HRD Ltd.'s Business Graphics Package, a DEC VT125 graphics terminal shows bar charts generated from DEC Standard MUMPS files. Shown at the recent U.K. MUMPS User Group meeting in London are Richard Davies (right) managing director, and Bill Davies, sales manager, of the company.

VT125 graphics terminal, and run under DSM Version 2.1. Davies quotes about \$1200 as the price of a license allowing use on two VT125s hosted by a PDP-11, and about \$200 for each extra VT125. The VAX version will sell for about \$1520, and

Davies says the extra charge is justified by an interface allowing RSX and RSTS files to be transferred to the Business Graphics Package via DSM.

HRD technical director Steve Rawlinson explains that the Business Graphics Package is designed to reformat MUMPS files so they can be handled by Regis, a microprocessor-hosted executive that resides in the VT125. He stresses that no modifications have been made to Regis.

The graphics package can be driven by an MUMPS application program. Supplied with the necessary file and key information, it can extract the required records and format the data so Regis can generate any of a variety of graphics, notably bar charts and histograms.

BACKED-UP BACK-UP

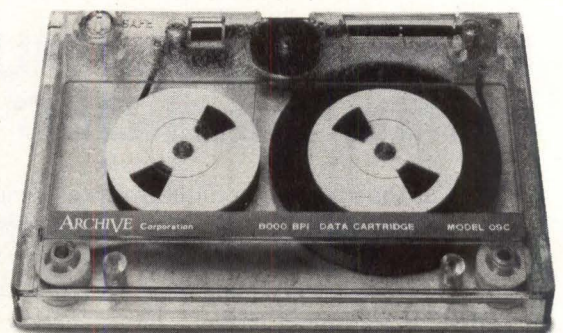

Rawlinson says the Business Graphics Package is written in MUMPS so users can easily extend it for their requirements. A user might break the license by copying the package, but Rawlinson says that a user's license would be removed if this happened.

HRD managing director Richard Davies explains that his company's main business is producing general commercial applications using MUMPS. Structured Data Systems has developed its own version of MUMPS called Standard MUMPS Micromachine, which supports language and data structures resembling those of DSM. A version called SMM-11 is available for PDP-11 machines. Now, the DEC Professional models, 325 and 350, can host new implementations called SMMFL and SMMWI.

According to the Structured Data Systems specification for the Professional versions, a theoretical maximum of 40 concurrent tasks can share the I/O devices on a Professional machine, and support for three to eight terminals is achievable. SMMWI needs an RD50C Winchester disk unit, while SMMFL is designed for a 325 with an RX50 floppy drive.

The specification for SMM in general notes that SMM does not provide the features of DSM-11 that are used by larger installations, such as journaling and spooling.

SDS director Mike Davey points to his background with DEC as a European support specialist for DSM.

Davey notes that SMM for the Professional machines will be made available in the U.S. by Computer Technology Inc., Germantown,

Tenn., a Memphis suburb. CT's president, Joe Lerner, says the product will be sold under the name CSM 350, and will retail at prices between \$500 and \$1000, depending on whether users want it bundled with another SDS product, a word-processing system called SMMWPS. Davey expects DEC in Europe to add the Professional versions of SMM to the DEC Classified Software catalogue.

DCS is similar to the external application software library maintained by DEC in the U.S. Davey explains that DEC in Europe is interested because SMM will enhance the sales prospects of Professional machines in the enormous market for personal computers among doctors. Medicine has always been a major application for MUMPS. —Keith Jones

Archive backs up Winchesters 10 times faster than floppies.

Today's business computer system simply can't afford floppy Winchester back-up anymore. Not when our Archive Super Sidewinder ¼" Streaming Cartridge Tape Drive can copy 45MB in just nine minutes.

A floppy, on the other hand, takes more than an hour to do the same job. Not counting the time you spend inserting a new disk every few minutes.

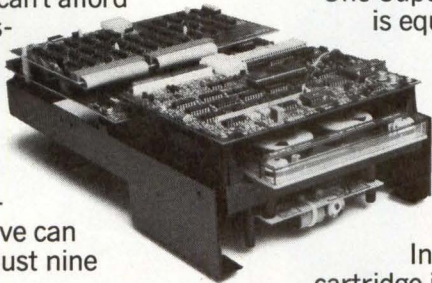

Saves "handling" charges.

One Super Sidewinder cartridge is equal in capacity to 38 eight-inch disks.

That will save you over \$200, plus the cost of handling all those disks—inserting, removing, jacketing, labeling, and filing.

In addition, a Sidewinder cartridge is completely enclosed when out of the drive, virtually eliminating damage due to handling.

More than just a back-up.

Our ¼" streaming tape drives provide the complete removable media needs of any system: Software distribution, data collection and program loading. All performed at the touch of a button.

System integration made simpler.

Both our 20MB and 45MB drives are specifically designed to fit an 8" floppy disk footprint. To use the same power supply. And to use the same simple 8-bit parallel interface.

We could go on. But let's get specific, contact us today. And ask for our new handbook on streaming tape drives and how to use them. Archive Corporation, 3540 Cadillac Ave., Costa Mesa, CA 92626. (714) 641-0279, Telex 4722063, TWX 183561. Distributed nationally by Hamilton/Avnet.

ARCHIVE
CORPORATION
¼" Streaming Tape Drives

A man in a black leather motorcycle suit and white helmet stands on a road at sunset. The background is a gradient of orange, yellow, and blue. The man is looking to the right. The text "FLY SORCIM" is written across the middle of the image in a stylized, white, italicized font.

FLY SORCIM

SUPERWARE™

**SuperCalc²™, SuperWriter™,
Super SpellGuard™, SuperChart™,
SuperData™-File Manager**

**Fly the first family of super powered software.
Super-Fast. Super-Easy.**

**Super-Reliable. Service-Free.
SORCIM SUPERWARE!**

Now running on more computers than anything else you can buy. Many more operating systems, CP/M*, CP/M 86*, IBM DOS, and MS/DOS** based. With common interface commands that let you change programs without a super-headache.

**FLY SORCIM SUPERWARE.
LEAVE THE REST BEHIND.**

*CP/M and CP/M 86 are registered trademarks of Digital Research, Inc.
**MS/DOS is a registered trademark of Microsoft Corporation.

For the Sorcim dealer
nearest you call toll-free:

800-762-4754

In California, Alaska, Hawaii,
call 408-942-1727

 **SORCIM**

SORCIM CORPORATION, 2310 LUNDY AVENUE, SAN JOSE, CALIFORNIA 95131

WE LEAVE THE REST BEHIND.

SuperWare, SuperCalc², SuperWriter, Super SpellGuard, SuperChart and SuperData are all trademarks of Sorcim Corporation.

YOU'RE LOOKING
AT ALL 96
OF OUR UNIX-BASEDTM
MICROCOMPUTER
SYSTEMS.

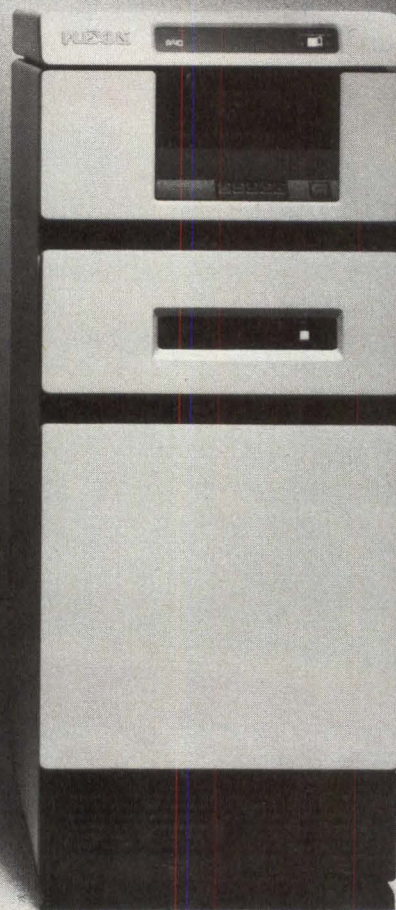

Your eyes are fine. You're just seeing everything in two.

The Plexus P/25.

And the Plexus P/40.

Two complete, UNIX-based microcomputer systems. Being delivered in volume, today.

We're totally committed to the UNIX operating system. Because of its simplicity, flexibility and popularity.

We're also totally committed to performance. Both our microcomputer systems deliver all the power of the largest minicomputer systems.

At two to five times less cost.

But where do we get 96 UNIX-based systems?

From disk sizes, RAM sizes and user configurations.

The options available to you, with the P/25 and the P/40.

The P/25 offers 24 possible system combinations. With three disk sizes. (22, 36 and 72 megabytes.) Four memory sizes. ($\frac{1}{2}$, 1, $1\frac{1}{2}$ and 2 megabytes.) And two user configurations. (8 or 16 terminals.)

The P/40 offers an impressive 72 system combinations. With its three disk sizes. (72, 145 and 290 mega-

bytes.) Eight memory sizes. ($\frac{1}{2}$, 1, $1\frac{1}{2}$, 2, $2\frac{1}{2}$, 3, $3\frac{1}{2}$ and 4 megabytes.) And three user configurations. (8, 16 and 24 terminals.)

All these options are offered with a single vision in mind.

Choice.

With 96 possible system combinations, Plexus gives you the opportunity to custom-build systems to your ideal specifications.

Allowing you to more accurately meet the demands of your customers. With the capability to expand, as their needs grow.

Helping you to more effectively control your costs.

So you can maximize your profits.

We think that shows our far-sightedness.

Contact us. Plexus, 2230 Martin Ave., Santa Clara, CA 95050. (408) 988-1755. TWX/Telex 910-338-2223.

Compare our two systems to the others. Price, performance, delivery, support and configurations. Once you do, you'll see. There's more to Plexus, than what meets the eye.

IPLEXUS

The world's best printer is a plotter.

The Versatec V-80 is three times better than a conventional printer. It prints more than three times faster—1000 vs. 300 LPM for comparably priced matrix impact printers.

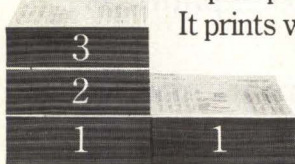

It prints with three times

the character resolution—256 vs. 81 points to

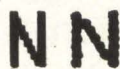

define a standard character. Three machines in one—a printer, a plotter, a hard copy device for display terminals—V-80 does all three jobs without compromising speed or quality. And it does them all quietly, without the nerve-racking clatter of hammers.

V-80 plots graphics, maps, even halftone

XEROX® is a trademark of XEROX CORPORATION
™ Versatec is a trademark of Versatec

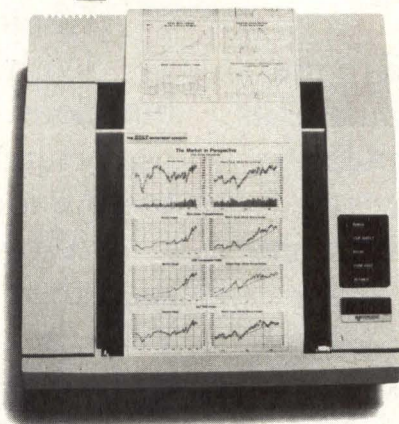

pictures, with resolution of 40,000 points per square inch. A simultaneous print/plot feature allows you to generate reports that combine words and pictures without cutting and pasting. And no matter how complex the plot, each page is produced in just seven seconds.

Interfaces and intelligent controllers for all popular computers and display terminals. Supported by the world's largest electrostatic printer/plotter sales and service network. Circle our readers' service number for a free full-color brochure. **CIRCLE NO. 48 ON INQUIRY CARD**

VERSATEC
A XEROX COMPANY

2805 Bowers Avenue, Santa Clara, California 95051, (408) 988-2800
27/35 London Road, Newbury, Berkshire, England, (0635) 31221

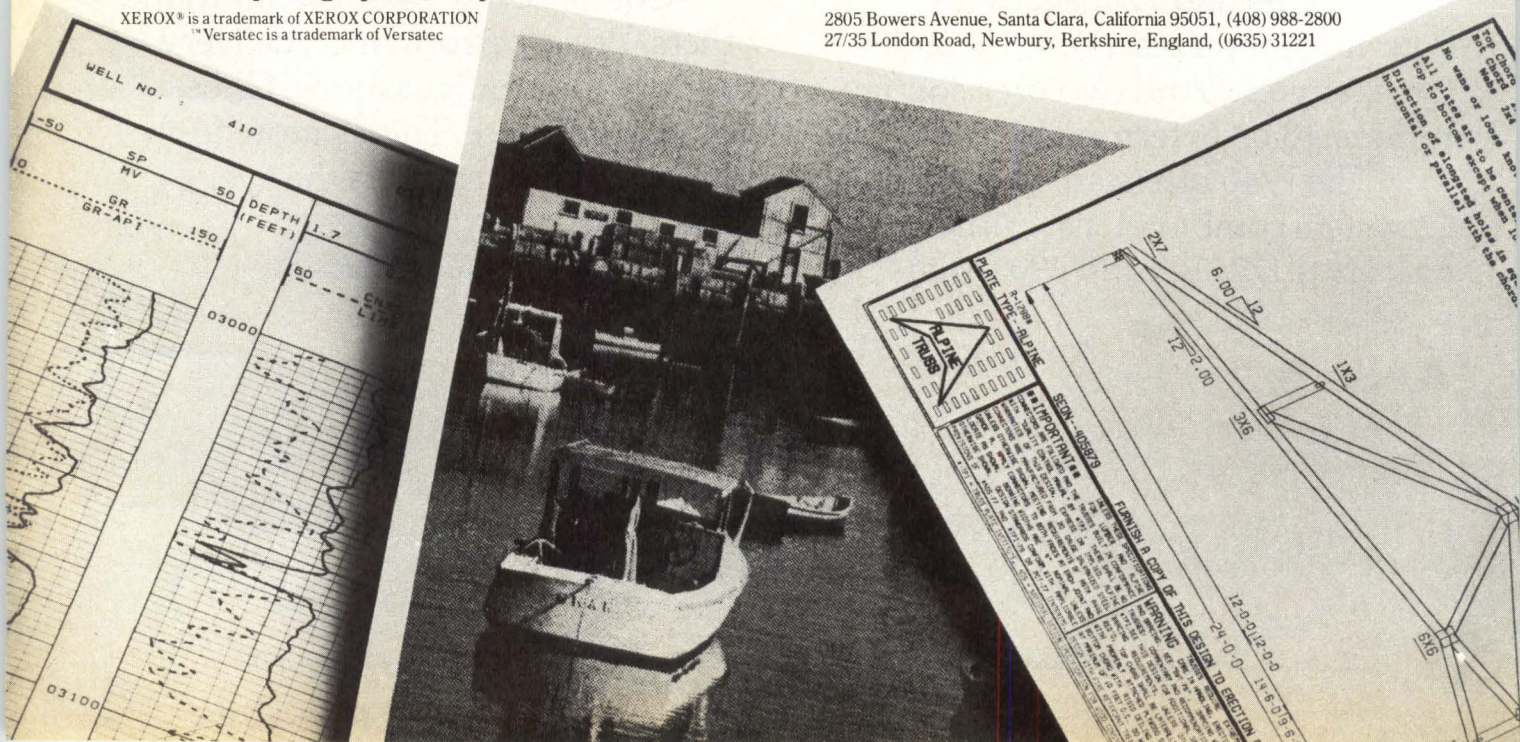

Mini-Micro Interpreter

An analysis of news, issues and trends affecting the computer industry

Pioneering vendors attempt to develop infant broadband local net market

By Dwight B. Davis

Just one year ago, the controversy about the relative merits of single-channel baseband networks and multi-channel broadband networks was at its peak. While far from settled, the debate has moderated considerably, with most vendors in each camp admitting that each type of local-area network meets the requirements of certain types of users. The standards issue on the baseband side has also cleared considerably over the past several months (MMS, August, 1982, p. 29), with a slightly modified Ethernet scheme emerging as the single-channel flagship for bus-architecture networks using the carrier sense multiple access with collision detection (CSMA/CD) technique. IBM Corp. will probably

soon challenge Ethernet's supremacy by introducing its long-rumored token-passing-ring LAN, but, for now, the Ethernet forces are taking a breather.

Not so for the several vendors selling broadband LANs. Although a truce exists between the baseband and broadband camps, with some vendors selling products of both types, the broadband vendors are increasingly fighting among themselves to gain market acceptance for their LAN solutions (see "CATV foundation breeds diverse broadband networks," p. 88). With many crucial broadband issues still unresolved—or unaddressed—by standards bodies, each LAN vendor hopes to gain enough market share to ensure that its design will succeed.

The broadband LAN market is still limited, with only

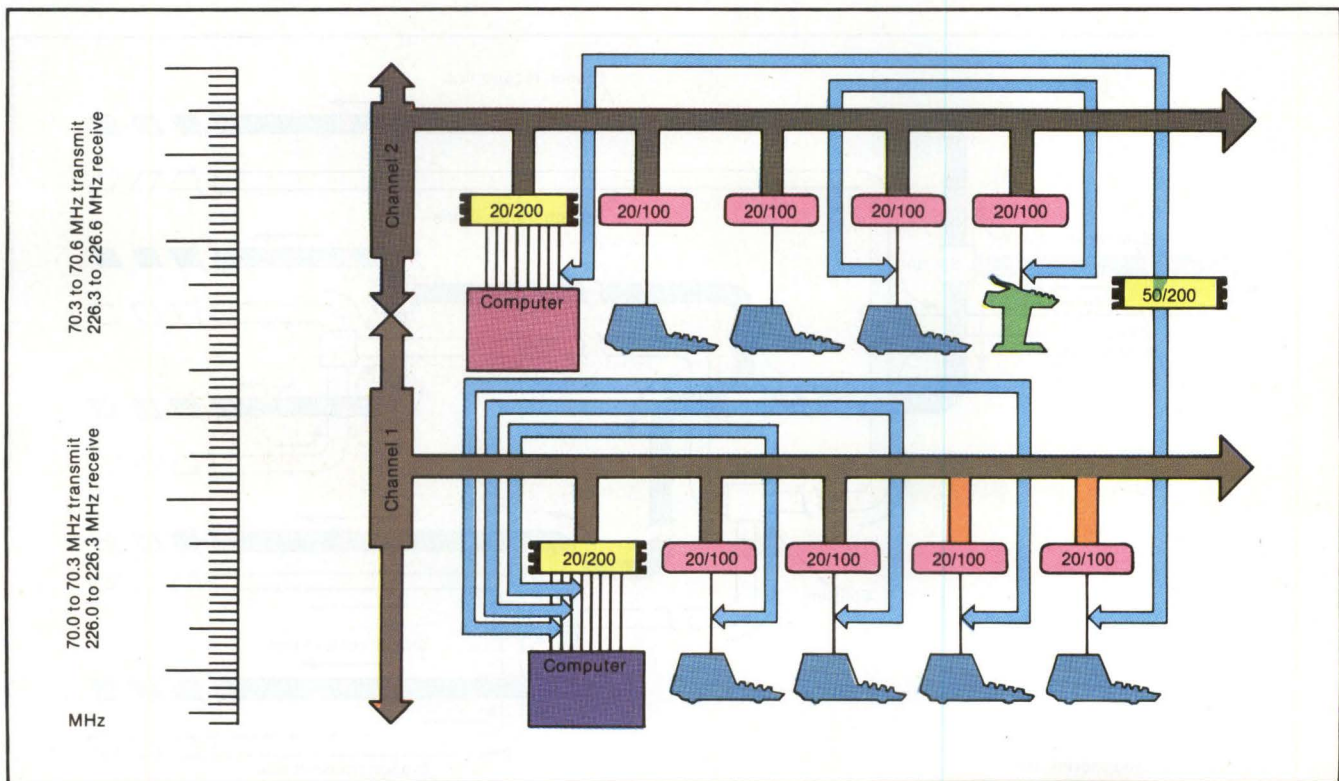

Sytek, Inc.'s LocalNet 20's logical layout illustrates the basic configuration typical of most single-cable broadband LANs. Channels are defined through the use of frequency-division multiplexing, and each channel is split into mirrored transmit and receive sections of the frequency spectrum. Computers with parallel ports or clustered terminal nodes access the network through Sytek's multi-port 20/200 devices, while serial-interface devices access the network through 20/100 packet communications units, which can each support two serial devices. Sytek also sells an inter-channel bridge, the 50/200, which routes packets originating from devices on one frequency channel to devices residing on a different frequency channel.

The Interpreter

about 720 intra-company networks installed as of 1982, according to figures from Strategic, Inc., San Jose, Calif. By 1986, the market research firm predicts, approximately 7000 broadband nets will be installed. While office-automation applications are expected to account for a large percentage of the future applications, the office market is just a small part of the current broadband market, says Ralph Ungermann, president of Ungermann-Bass, Inc., Santa Clara, Calif. "The market is now mostly CAD/CAM users, R&D laboratories and universities," he says. "People in these settings are working with leading-edge technologies, so they're not afraid to install broadband networks. Also, these people have big communications problems to solve."

As distributed computers and terminals become more commonplace in commercial environments, broadband vendors expect their LANs to add office applications to the existing factory-floor and research-center bases. This migration is especially likely into companies with mixed data- and video-communications needs—traffic that broadband is ideally suited to carry.

Broadband coax can also carry voice traffic, but the relatively high expense of broadband voice equipment compared to standard PBX equipment has limited customer demand for this feature so far.

Broadband's capacity to link thousands of communicating devices over longer distances than typically possible with baseband technology is resulting in the formation of two general configuration scenarios into which broadband neatly fits. One consists of fairly large customer installations in which broadband is the sole LAN, with branches of its tree-like trunk traveling to every network node. In the second scenario, a broadband trunk links various baseband (or PBX) networks and serves as the main data highway over which the baseband network devices communicate from network to network. The small baseband networks might serve different floors or departments within a building or might serve entire buildings within a multi-building complex.

Battling for the broadband LAN crown

With fewer than 10 broadband LAN vendors selling to

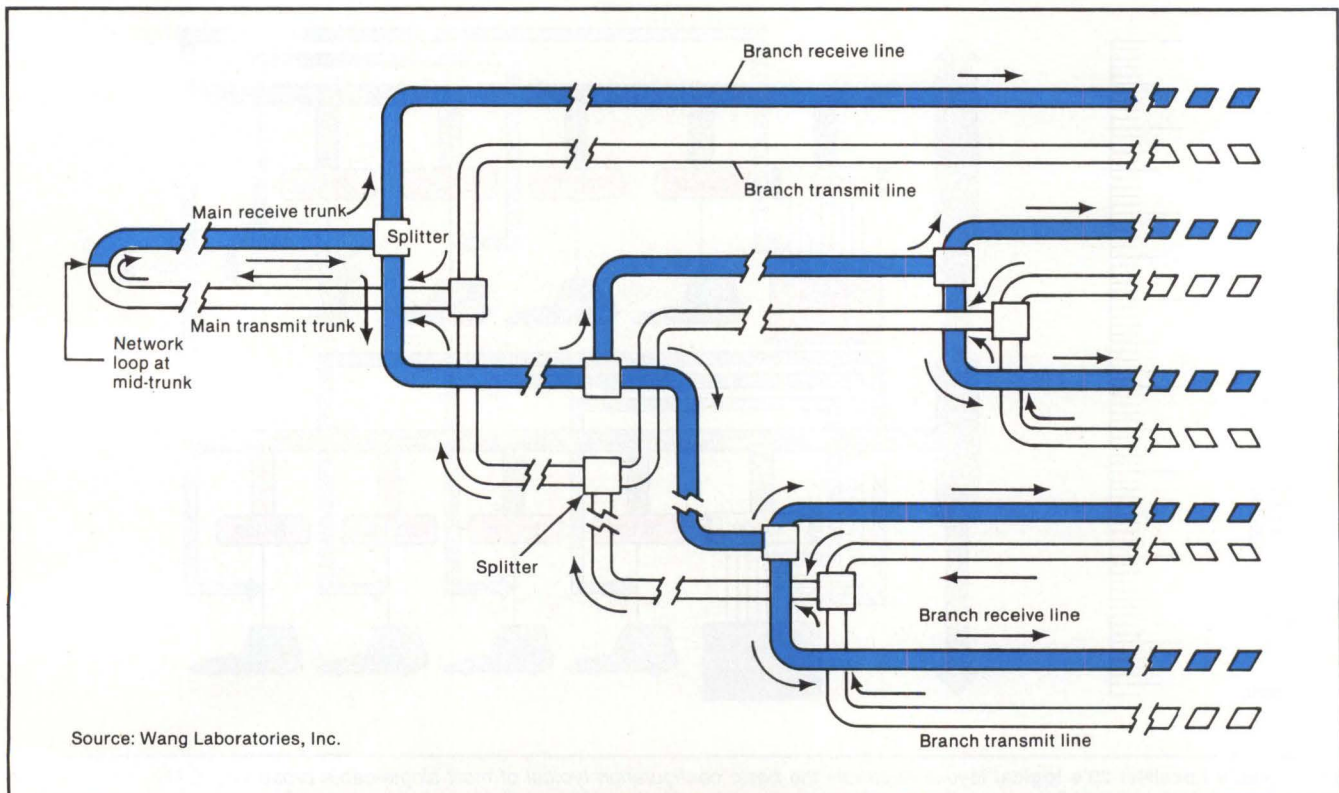

Wang Laboratories, Inc.'s dual-cable branching-tree WangNet has a transmit/receive crossover loop at the mid-point of the main coaxial trunk. The cable is divided into a transmit and a receive half, and both halves are folded together. Because network traffic is unidirectional over the entire 10- to 400-MHz bandwidth of the transmit and receive cables, WangNet eliminates the need for head-end frequency translators required by single-cable broadband LANs, which divide the cable into transmit and receive spectrums.



HERE'S THE ONLY EDGE YOU NEED TO GET A DEC SYSTEM FROM CDS UP AND RUNNING

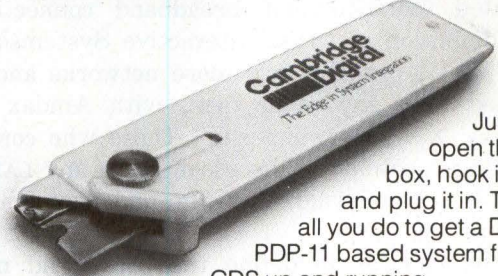

Just open the box, hook it up and plug it in. That's all you do to get a DEC PDP-11 based system from CDS up and running.

The secret is complete system integration, and it's just one part of the edge you get when you buy from Cambridge Digital. The Edge isn't just a slogan, it's a comprehensive set of performance guarantees that come with every Cambridge Digital system. Seven guarantees in all.

Like competitive or better-than-competitive prices. Delivery in as little as 10 days on our pre-packaged systems. State-of-the-art hardware and software. An enormous choice of DEC and DEC-compatible equipment, and more.

You can only get The Edge from Cambridge Digital. To receive our DEC PDP-11 based system catalog, including a description of the seven guarantees you get when you get The Edge, call 1-800-343-5504 (in Massachusetts 1-617-491-2700), or send the coupon to Cambridge Digital Systems, Dept. 7401, P.O. Box 568, 65 Bent Street, Cambridge, Massachusetts 02139. Telex 92-1401/COMPUMART CAM

Cambridge Digital Systems is a division of Compumart Corp.

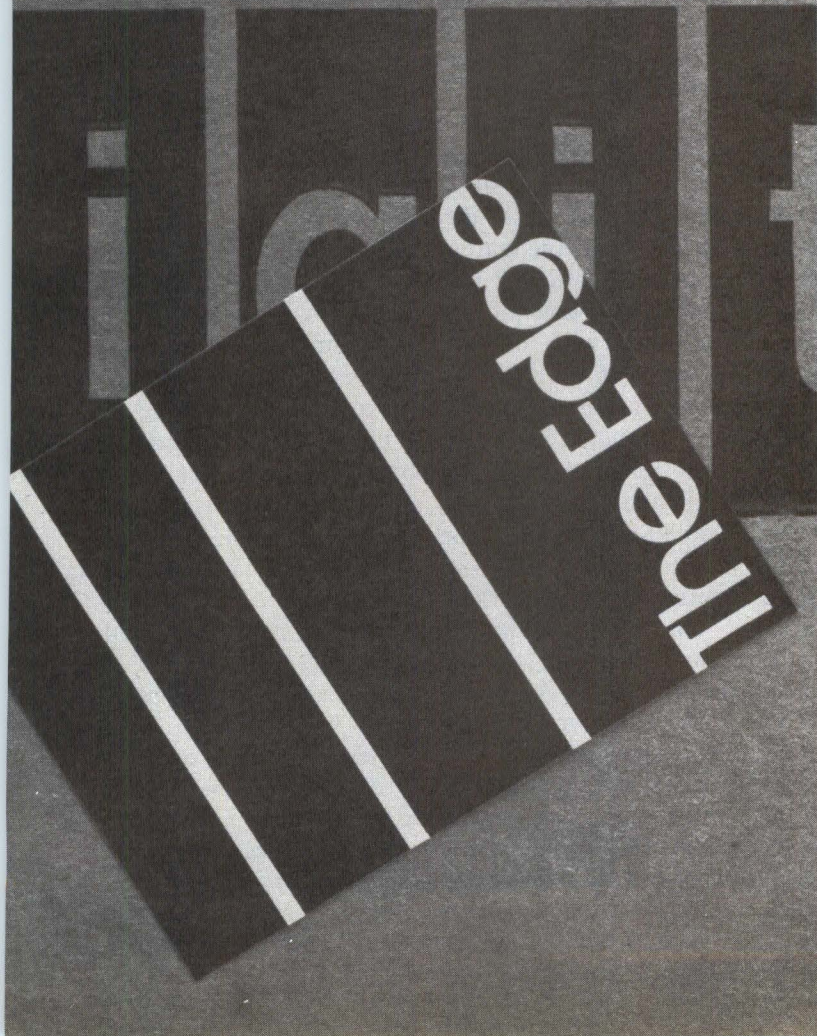

I want The Edge: FOR FAST FACTS, CALL: 1-800-343-5504

Name _____

Title _____

Organization _____

Address _____

City _____ State _____ Zip _____

Phone (____) _____
(7401)

Cambridge Digital
DIVISION OF COMPUMART
The Edge in System Integration
 CIRCLE NO. 49 ON INQUIRY CARD

The Interpreter

a still-small market, it might appear simple to determine the relative success of each firm. But each vendor defines the broadband LAN market somewhat differently, which allows each to claim superiority over all other competitors in some way. For those that include dedicated, point-to-point broadband connections in their definition of LANs, Interactive Systems/3M, St. Paul, Minn., probably has more networks and nodes installed than any other firm, with Amdax Corp., Bohemia, N.Y., the runner-up. Those who consider a switching capability to be essential to any LAN place Sytek, Inc., Sunnyvale, Calif., far and away in the lead (see chart, p. 91).

"Sytek chooses to define the broadband network market by ignoring dedicated circuits," says Ivan Socher, president and chief executive officer of Amdax. "I agree that Sytek is the biggest with switched services, but if you take the total number of nodes, dedicated or switched, we're a lot bigger." Socher says that even though "the market is enamored with switching services," he has yet to see a big demand for such capability. "Most terminals, 99 percent of the time, are talking to the same computer and doing the same application," he says.

Mort Fortgang, vice president, operations of ConTel's Information Products Division, Great Neck, N.Y., disagrees with Socher's assessment. The company's ConTelNet broadband LAN—with first installations scheduled to begin last month—provides both switched and virtual-circuit links. "I don't think the need for switching capabilities is overblown," Fortgang says. "Cheap, distributed intelligence is showing up more and more every day, making the switching capability an absolute necessity." Ungermann agrees, noting, "Switching is an absolute requirement in every system we have sold." He adds, "The term LAN has come to mean what we and Sytek are selling, not point-to-point communications."

Sytek jumps to packet-switched lead

Leading the switched-network pack with more than 220 installations, Sytek offers products in three categories. Its first broadband LAN, the single-cable, mid-split LocalNet 20, connects serial interfaced synchronous and asynchronous devices with a network data rate of 128K bps. Designed for higher speed processors and peripherals with parallel interfaces, the 2M-bps LocalNet 40, like LocalNet 20, provides packet switching of data and uses a CSMA/CD scheme to let numerous devices share each frequency channel. Sytek's LocalNet 50 products consist of special function devices such as the 50/50 head-end frequency converter, the 50/100

network-control center and the 50/200 bridge, which routes data to and from frequency channels in the network.

Although it has sold most of its systems to large end users such as universities and government installations, Sytek will also try to pick up some OEM customers such as computer manufacturers, says Michael Pliner, Sytek's president. "The networks will get better support and more software if computer vendors market them with their products," he says. Broadband networks are best suited for medium to large installations, Pliner believes. "Our networks are not very cost-effective for small users," he says.

A key direction for Sytek is to move beyond the LAN installations into wider range broadband networks called metropolitan-area networks. Working with its affiliate, General Instruments, Sytek is moving to implement its MetroNet MAN, which will combine Sytek's local networking expertise with GI's CATV products and skills to build city-wide networks that serve both business and residential users. Standards for such MANs are embryonic, and some in the industry question Sytek's MetroNet approach.

Despite Sytek's claims that MetroNet will serve both business and residential applications, Socher at Amdax believes the product is focused more at home users. If so, Socher questions the viability of an expanded LAN approach, which is designed to carry an equal amount of traffic in both directions. "In the commercial environment, the traffic tends to be somewhat balanced in both directions," he says. "In the home, there's a tremendous amount of information being sent to the residence with only a small amount coming out." Because of the unevenness of residential information flow, Socher suggests that a network serving this market should have a much higher outbound data rate than inbound, and he notes the reliability of the outbound information is not as critical a factor as it would be in business communications. "The techniques are completely different for home versus commercial metropolitan networks," he concludes.

For its existing local network, Sytek provides communications protocols through level six of the International Standards Organizations's seven-layer networking model, according to Pliner. However, because no protocols are well-defined above level two, the functions provided by Sytek's higher level protocols differ from those performed by the higher protocols of some other broadband vendors. Such protocols provide more of a total networking solution than available from some broadband networks, which essentially provide standard physical and data-link interfaces and proto-

Talk to the Intermec Representative nearest you.

NORTHEAST

- Boston, MA 617/653-8655
- New York City, NY 201/368-0123
- Philadelphia, PA 215/248-5050
- Pittsburgh, PA 412/892-2953
- Rochester, NY 716/467-0076
- Rockville, MD 301/744-7700
- Washington, DC 301/881-5300

SOUTHEAST

- Atlanta, GA 404/455-1035
- Columbia, SC 803/798-8070
- Durham, NC 919/683-1580
- Ft. Lauderdale, FL 305/776-4800
- Huntsville, AL 205/883-8660
- So. Mississippi 504/626-9701
- Melbourne, FL 305/723-0766
- Oak Ridge, TN 615/482-5761
- Orlando, FL 305/425-5505
- Richmond, VA 804/320-8801
- Tampa, FL 813/985-0394

MIDWEST

- Chicago, IL 312/394-3380
- Cleveland, OH 216/524-5930
- Dayton, OH 513/434-7500
- Detroit, MI 313/247-1316
- Indianapolis, IN 317/247-1316
- Kansas City, KS 913/649-6996
- Milwaukee, WI 414/476-3555
- St. Louis, MO 314/878-5042
- St. Paul, MN 612/645-5816

SOUTHWEST

- Albuquerque, NM 505/292-1212
- Colorado Springs, CO 303/594-0880
- Denver, CO 303/777-8070
- Dallas, TX 214/234-4137
- El Paso, TX 915/542-1762
- Houston, TX 713/461-4487
- Lafayette, LA 318/232-6275
- Las Cruces, NM 505/524-9693
- Odessa, TX 915/332-9540
- Phoenix, AZ 602/994-5400
- Salt Lk. City, UT 801/466-6522
- San Antonio, TX 512/340-6507
- Tulsa, OK 918/743-6892

WEST

- Anaheim, CA 714/635-7600
- Portland, OR 503/646-6800
- Sacramento, CA 209/334-1961
- San Diego, CA 714/565-1557
- San Jose, CA 408/298-7290
- Seattle, WA 206/745-5311

INTERNATIONAL

- Reading, England 0734 67331/2
- Brussels, Belgium (2) 5125107
- Frankfurt, Germany 06081-7091
- Paris, France (3) 969.04.52
- Stockholm, Sweden 8-63 0880
- Toronto, Canada (416) 793-4388
- Zurich, Switzerland 01/49-19956
- Singapore 2952-660
- Osaka, Japan 06-282-5111
- Melbourne, Australia (3) 758-7983

• **FACTORY-AUTHORIZED SERVICE FACILITIES.**
For areas not listed contact factory office.

How can you get accurate reports with input like this?

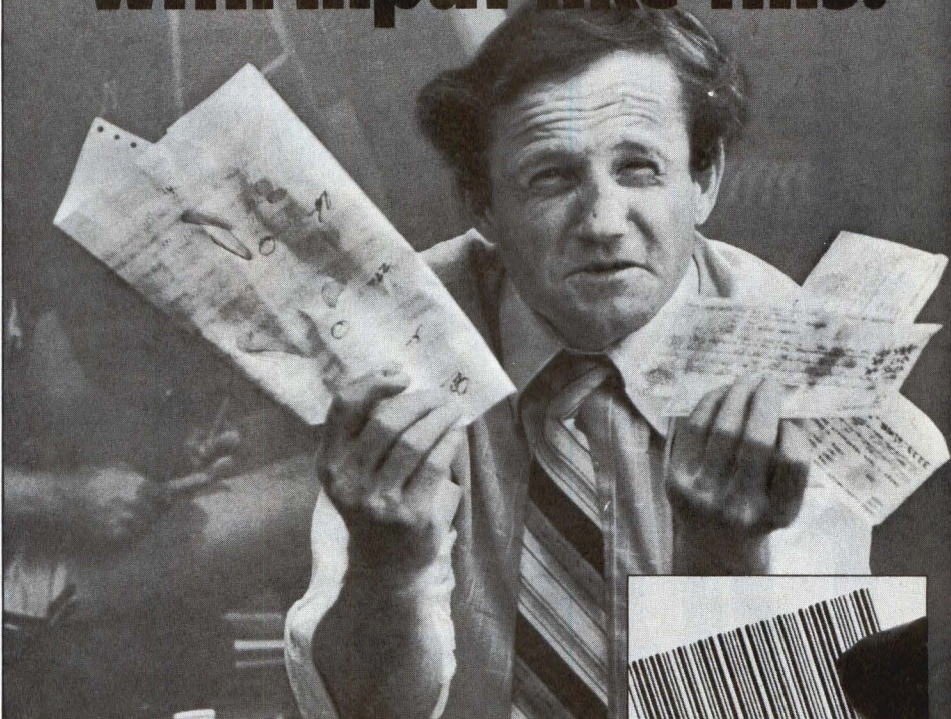

With Intermec, production line workers can input work-in-process data by simply scanning a bar code traveler or label.

Production line personnel hate paperwork. But at the same time, you need timely, accurate data for good computer based production control and inventory management systems. The answer to both the paperwork problem and the data problem can be summed up in two words: Bar Code.

Intermec printers can print individual bar code labels or complete bar coded traveler documents. Production personnel simply scan the bar code at key points in the production process to input data directly to your computer. You reduce paperwork and get complete, accurate data.

Intermec printers and readers may be installed right on the production floor. Readers can replace, or operate in tandem with your existing terminals.

- Improve production efficiency.
- Control individual parts and sub-assemblies moving through production.
- Reduce work-in-process inventory.

Get the facts about Intermec. Circle reader service numbers or contact the Intermec representative nearest you.



INTERMEC[®]
The Bar Code Experts

Intermec Corp.
4405 Russell Road
P.O. Box N.
Lynnwood, WA 98036
Phone 206/743-7036
TELEX: U.S. 152447
INTL 4740080

**In an
industry
where ideas
come and go,
there is one
notable
exception.**

The computer industry is littered with products whose time came. And went.

That's why, when we designed the PDP-11 architecture in the early 1970s, we wanted to create a computer family that would last. And not only last, but constantly improve and offer more to the people who invest in it.

Well, 13 years later, we're happy to say that our plan looks better than ever. This year Digital has introduced several important new PDP-11 products.

Among them:

A series of personal computers that are being hailed as the new industry standard.

A small, powerful Winchester-based system for under \$10,000* that opens up a whole new range of possibilities for both technical and commercial applications.

And a new micro-processor that's the equivalent of the PDP-11/70, Digital's most powerful 16-bit minicomputer. Naturally, this product has immediate value to OEMs.

But it also has importance for every other computer user.

Because now that we've gotten all that power down to one micro-processor, we're busy thinking of all the new PDP-11 computers we'll be able to design.

Which should give you something to look forward to for the next 13 years.

To learn more call 800-225-9222 and ask for information package MM-117. In MA, HI, AK and Canada, call (617) 568-5707. Or attach your business card to this ad and mail it to us.

Digital Equipment Corporation, Attn. Dept. 117/MM-12-82,

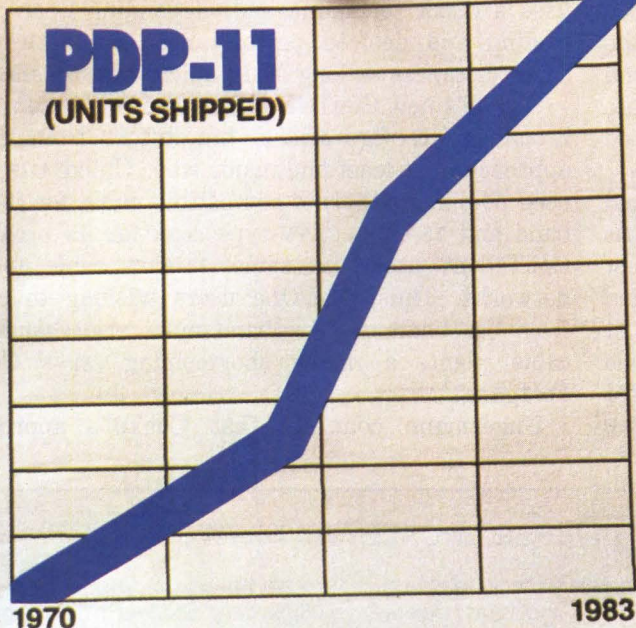

*U.S. price only
© Digital Equipment Corporation 1982

The Interpreter

cols, leaving higher level communications tasks to the devices attached to the network.

Playing both sides of the fence

Sytek, in conjunction with Bridge Communications, Inc., plans to offer a gateway product to link its broadband LocalNets to baseband Ethernet networks. While Sytek will offer bridges to baseband LANs, Pliner says, "I don't really see my company getting into the baseband side of the business." Two other broadband vendors, however, are trying to cover the complete market by offering both baseband and broadband versions of their products.

Ungermann-Bass established itself as a baseband vendor with its Ethernet-compatible Net/One LANs before announcing a broadband version of Net/One last year, (MMS, March, 1982, p. 75). The broadband Net/One provides five 6-MHz channels that operate at 5M bps in a mid-split, single-cable or a dual-cable configuration. Net/One software remains the same for both baseband and broadband versions of the U-B

networks and includes protocols that provide some level seven ISO functions, according to Ungermann. To shift from a baseband to a broadband configuration, users add a modem interface board to each network interface unit and replace the baseband transceivers at each node with radio-frequency modems. A head-end frequency remodulator is also required. The broadband Net/One uses a CSMA technique and, depending upon system loading and desired performance, the network can cover distances as long as 10 miles, Ungermann says.

ConTel's new ConTelNet also comes in baseband and broadband configurations, but differs from the U-B approach in at least one major way. Unlike U-B, which uses 50-ohm, Ethernet-compatible cable for its baseband and 75-ohm, CATV-type coax for its broadband, ConTelNet uses the same 75-ohm cable for both networks. Thus, Net/One users wishing to convert from baseband to broadband must also change their cable plant, a major shortcoming, says ConTel's Fortgang.

Ungermann counters that ConTel's approach is

CATV FOUNDATION BREEDS DIVERSE BROADBAND NETWORKS

Broadband local-area networks trace their roots to the Community Antenna TV systems that first appeared in 1949 and now serve more than 20 million subscribers. But designers of broadband LANs have had to improve on the technology associated with CATV, which typically carries one-way video traffic (although this is changing) over relatively long distances. The enhancements developed by broadband designers have resulted in several LAN configurations that have little in common other than the very basic CATV equipment upon which the networks are built.

The standard CATV transmission medium used in every broadband LAN is coaxial cable with a 75-ohm impedance. The cable and the various devices attached to it cause signal attenuation and loss, which, if uncorrected, would result in an unacceptable signal degradation at nodes distant from the transmission's point of origin. Amplifiers spaced as required along the cable solve this problem and ensure that every network node receives a signal of virtually the same strength. Other standard CATV components common

to broadband networks include filters, directional couplers, multitaps, power supplies and connectors.

A single broadband cable can carry numerous transmission channels

through the use of frequency-division multiplexing. Standard CATV components operate within a frequency spectrum of 0 to 300 MHz (some LANs stretch this to 400 MHz), and each TV

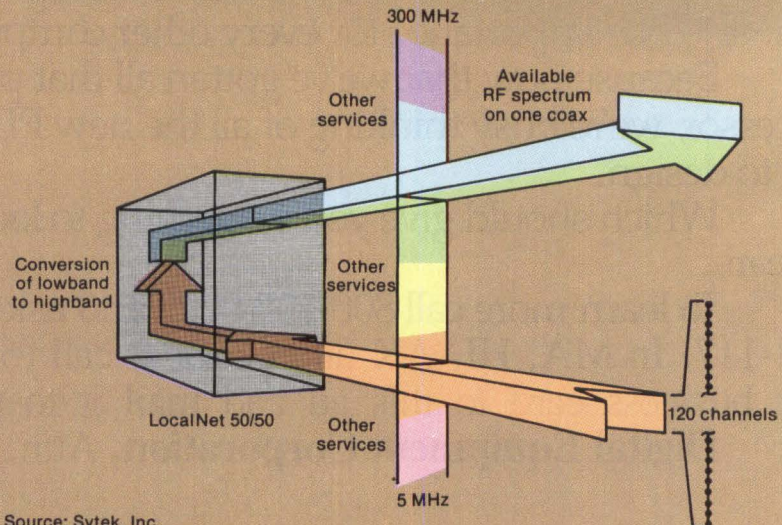

Source: Sytek, Inc.

Shifting low-frequency inbound signals into high-frequency outbound signals, a head-end frequency converter—in this case a Sytek LocalNet 50/50—sets up receive and transmit channel paths over single-cable broadband networks. The Sytek network channels take up a just fraction of the available 300-MHz bandwidth, permitting the cable to carry additional services on other sections of the frequency spectrum.

flawed because it ignores the Ethernet baseband standard. "I don't see a market for a baseband network using 75-ohm cable," he says. "People are picking up on Ethernet because they want to have a baseband industry standard." Ungermann says a company might buy a baseband Net/One simply to get a network up and running while it waits the several months required to install a broadband cable plant. "But it's very unlikely a customer will go in and install a total Ethernet system and then decide he wants to go broadband," he says. "Broadband will usually be a trunk between buildings or floors, and the baseband nets are spurs off of that." U-B sells a bridge product that connects Net/One networks of any type and combination.

ConTelNet, which will eventually have an Ethernet gateway, uses a single, mid-split cable to support five 6-MHZ paths at speeds of 2M, 5M or 10M bps. A single channel can support 255 nodes with as many as 64 virtual circuits per node, for a total of 8160 point-to-point connections. The network uses CSMA/CD and runs under the firms TICOS operating system, which pro-

vides functions through level three of the ISO model, Fortgang says. The network's bus interface units incorporate Multibus backplanes, permitting direct network access for Multibus-compatible devices. Each BIU also has four RS232C ports and one parallel port.

Because ConTel is a division of a major telephone company, Fortgang says, "We will obviously provide interfaces to wider networks. But," he notes, "our primary focus is the local network." And, despite ConTelNet's phone-company association, "Voice is a very low priority on our development schedule," Fortgang says. "With the investment in voice equipment that already exists, it doesn't make sense to force an interrelationship between voice and data at this point." This sentiment apparently is shared by most broadband vendors and their customers.

Broadband data net pioneers

Long before debates over LAN definitions came to the forefront, Interactive Systems was using broadband technology to solve factory communications problems.

video signal requires a bandwidth of just 6 MHz. Data transmissions require considerably less bandwidth per channel than video signals and, through the use of RF modems LAN designers can configure hundreds of data channels, each at a different frequency within the available spectrum. The RF modems are set to operate over a single frequency or, if they are frequency-agile modems, can alter the frequency of their transmissions under software control to access different channels and their devices.

Beyond the use of similar CATV components and FDM splitting of the bandwidth, broadband LANs go their separate ways. Different channels can be allocated for data, video and voice traffic; data rates, modulation techniques and access schemes can vary from channel to channel; channels can carry self-contained datagram messages, can operate as point-to-point virtual circuits or can carry combinations of both services; and channels can be designated as dedicated, switched or shared. Dedicated channels link pairs of communicating devices, switched channels alternate the communicating devices on a request basis, and shared

channels connect numerous devices that must use either a contention or a time-division technique to access the channel. The combinations of configurations are myriad, and with few standards to direct them, vendors in the young broadband LAN market are offering products that vary widely in their design and operation.

Even the fundamental cable architecture is not immune to variation. Most vendors use a single cable to carry traffic in both directions, but a few companies offer dual-cable designs, with one cable carrying transmit data and the other carrying receive data. Single-cable broadband LANs must split (typically mid-split) the cable's bandwidth into dedicated transmit and receive spectrums, with each transmit channel having a corresponding receive channel offset from it by a specific bandwidth jump (see illustration, p. 88).

Single-cable vendors, which often offer dual-cable options, point to the media compatibility of their networks with the single-cable CATV approach and claim dual-cable systems require twice as much cable and twice as many amplifiers and taps, which results in higher costs, less reliability and greater complexity. Dual-cable

proponents emphasize their networks' ability to offer almost twice the bandwidth possible with split-frequency single-cable networks. They also claim the simplicity of one-way components coupled with the absence of a head-end translator—needed by single-cable networks to split the bandwidth—improves network reliability and cuts costs.

As the broadband LAN market becomes more crowded, the variations on the CATV theme are bound to grow, and the task of choosing a LAN will become even more confusing. Robert Shatzer presented a list of LAN selection criteria at a recent broadband LAN conference sponsored by Sytek, Inc. The list illustrates points buyers should evaluate and also indicates some ways in which broadband LANs differ. The criteria include: topology, connectivity, control mechanisms, protocols, data rate, error rate, interface/device support, internetworking concerns, services, network management, user transparency, standards issues, performance, reliability, life-cycle cost, ease of installation, maintainability, failure-recovery mechanisms, expandability, safety issues and vendor issues.

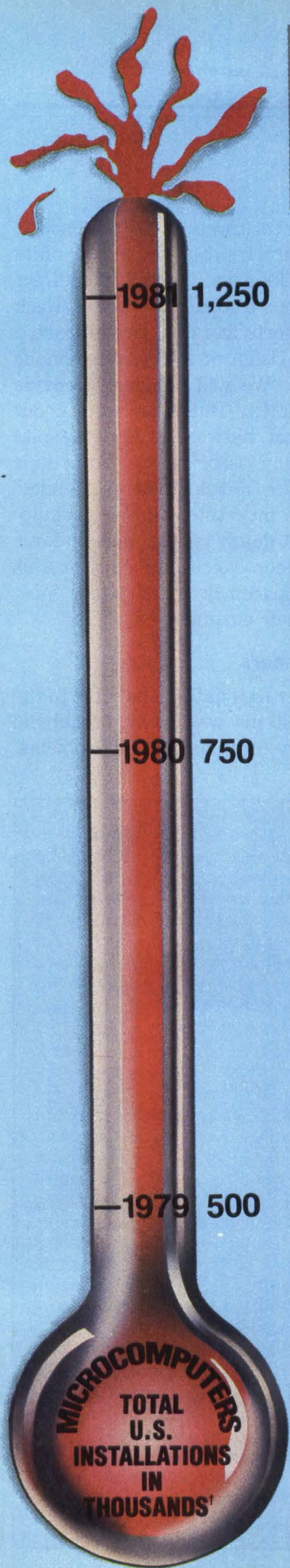

MICRO FEVER

More and More Systems Houses are Catching it with the HOTTEST NAME in Microcomputers

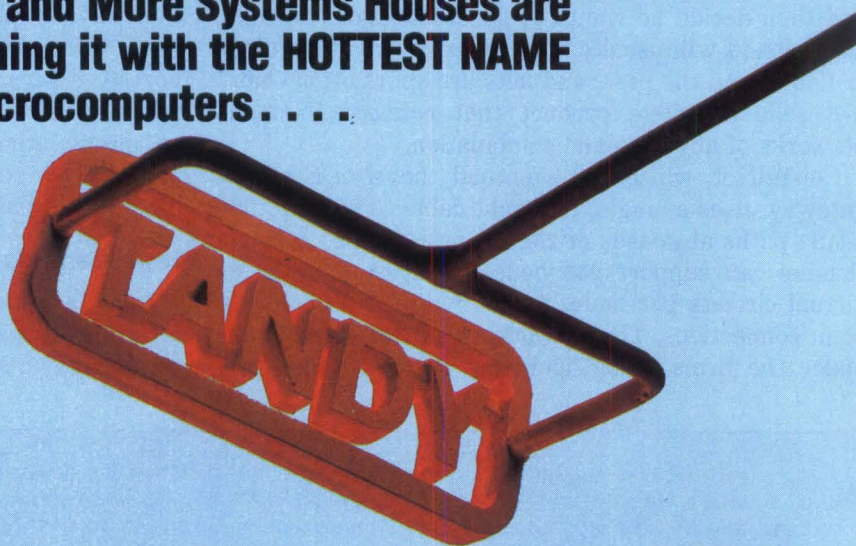

In a recent study* conducted by Time Magazine, an estimated 90% of the small businesses in the U.S. have yet to computerize. The same study shows Tandy second only to Big Blue in first time unit sales!

Team your Vertical-Market software with our hardware. Then watch your sales *really* take off. Tap a market that has a \$9 billion potential with Tandy—the people who set the market on fire with the phenomenally successful TRS-80® microcomputers. Go ahead—make our success story *your* success story.

Hot products—the heart of your vertical market turnkey system. Choose from cost-effective 8-bit desktop computers as well as a state-of-art 16-bit multi-user system. Each model includes a monitor, keyboard—even disk storage—*built-in*.

System Houses: Tandy is your single source microcomputer supplier. Forget about having to do business with a variety of suppliers. *Need a terminal or hard disk system?* We're your source. *Printers?* We're your source. *Program development software?* Tandy has it all, and virtually everything is available for *immediate delivery*. We also offer our own nationwide network of service centers. You and your customer can turn to Tandy for expert installation as well as on-site service. It's another "plus" you'll enjoy as a Tandy marketeer.

Don't let your sales cool off. Call or write today. We'll have one of our sales representatives tell you how you can sell Tandy microcomputers. Go ahead, offer the Tandy line and watch your sales catch micro fever!



Tandy Contract Marketing Sales

1700 One Tandy Center • Fort Worth, Texas 76102 • 817/390-3099

*Focus Research, West Hartford, Connecticut as commissioned by Time Magazine.

†Source: Mini/Micro Systems Magazine Estimates

CIRCLE NO. 51 ON INQUIRY CARD

The Interpreter

In 1972, the company introduced its Videodata network, which placed hundreds of point-to-point channels on a single coaxial cable. 3M acquired the company in 1979 and broadened its focus beyond the factory into commercial applications. "Videodata was the first commercial broadband network," says Allan Edwin, business unit manager for IS/3M. Early this year, Edwin says, 3M will begin beta tests on a new 2.5M-bps, token-passing LAN, which will provide more flexibility than the aging point-to-point-oriented Videodata systems.

The Videodata nets function almost like a utility service, providing dedicated communications between pairs of devices, but little in the way of higher level communications protocols. Several Videodata product families exist: 9600-bps point-to-point and multidrop modems, which can be configured 75 to a single 6-MHZ channel; 100K-bps point-to-point or time-division-multiplexing modems (as many as 248 terminals per channel in TDM mode); a 2.1M-bps OEM modem; and a 5M-bps OEM modem, still in beta test. Protocols supported include RS232 synchronous and asynchronous, SDLC and bisynchronous.

Other companies are following IS/3M's long-standing lead into factory applications, including the major broadband vendors, which view factory networking as an important segment of their target markets. At least

two companies that sell factory equipment have also entered the broadband LAN fray—Gould's Modicon division with its Modway network and General Electric Co., with its GENET (MMS, June, 1982, p. 177).

The LAN company that's not a LAN company

Like IS/3M, Amdax was an early entry in the broadband market, selling point-to-point dedicated modems. In June, 1981, the company unveiled what it described as its CableNet local-area communications network, a 7M- or 14M-bps network said to be targeted largely at IBM Systems Network Architecture environments. CableNet uses a time-division multiple-access technique and supports asynchronous, bisynchronous or SDLC/HDLC communications protocols. While some competitors point to the unusual TDMA as a system flaw, Socher argues that TDMA has three major advantages over CSMA/CD.

"First and most important," he says, "is distance. Contention systems are limited to about 15 miles, and we're at 50 miles. Secondly, we believe the local networks in the market we're after will interlink via satellites, which transmit using TDMA. Finally, we believe that in the long term, TDMA will be a much better way than contention of implementing switched voice over broadband."

If it seems that Socher's concern for the ability to

	Amdax CableNet	ConTel ConTelNet	IS/3M Videodata	Sytek LocalNet 20; 40	Ungermann-Bass Net/One	Wang WangNet
Number of Installations (nodes)	15 (1000)	Beta Sites	300 + (10,000 +)	220 (12,000)	Below 10 (100)	Beta Sites
Standard Network Architecture	Single-cable mid-split	Single-cable mid-split	Single-cable mid-split	Single-cable mid-split	Single-cable mid-split	Dual-cable unidirectional
Channel Access Technique	FDM; TDMA reservation	FDM; CSMA/CD	FDM; TDM (AutoPoll)	FDM; CSMA/CD	FDM; CSMA	FDM; CSMA/CD
Channel Data Rates	7M, 14M bps	2M, 5M, 10M bps	100K, 2.1M 5M bps	128K bps (L20); 2M bps (L40)	5M bps	64K, 12M bps
Data Device Interfaces	RS232; RS449	RS232; 32-bit parallel Multibus	RS232; 16-bit parallel; IBM 3274/3278	RS232	RS232; 32-bit parallel; 8-bit TTL; IEEE 488	RS232; RS449 RS336
Protocols Supported	Sync; Async Bisync; SDLC/HDLC	Sync; Async; TTY; X.25	Sync; Async; TTL	Sync; Async; HDLC derivative	Async; 3270/2780 Bisync; IEEE 488; 8/16-bit parallel DEC DR-11B/W	Sync; Async HDLC
Modulation Technique	Vestigial Sideband Amplitude; Bi-Phase Shift Keyed	Frequency Shift Keyed; Amplitude Modulation	Frequency Shift Keyed	Frequency Shift Keyed; Phase Coherent Frequency Mod.	Vestigial Sideband Amplitude	
Network	Software that runs on IBM PC, other processors	Network Control Center	Network monitor	Network Control Center	NIU-resident software	DataSwitch based; More comprehensive system planned

The Interpreter

transmit as far as 50 miles removes CableNet from the realm of LANS, there's a good reason. Socher claims that CableNet's initial description as a LAN was largely for marketing clout, and says the true direction for the network is the metropolitan broad-area market. "We're not really a LAN," he now says, "and we're not trying to sell to single buildings. It isn't clear to us that broadband was the way to go in the local environment. Twisted pair or baseband might be a better approach."

Socher expects to see two new players enter the broadband networking market in a big way—CATV franchises and the divested Bell Operating Companies. "We've tried to position ourselves to become vendors to both the cable franchise industry and to the BOCs," he says. "The BOCs are not allowed to manufacture (by regulation), so they will become our customers and provide all the support and service. It will be the greatest thing that ever happened to Amdax."

Socher thinks the service provided by the cable and telephone companies will prove to be a crucial factor that most broadband vendors have not properly addressed. "All the broadband people claim to have these big service organizations calling on their customers and doing cable maintenance," he says, pointing out that the cable runs up elevator shafts, through air ducts and in underground tunnels. "You ask your first IBM-type service guy with his three-piece suit to go shimmying up an elevator shaft, and he'll turn around and say, 'I quit.' The only guys that can handle that cable maintenance are Bell and cable guys and electrical contractors."

Welcome to Wangland

Unlike the other broadband LAN vendors, Wang Laboratories, Inc., Lowell, Mass., is first and foremost an office-automation vendor that also sells the processing equipment it wants to network. Also unlike the others, Wang uses proprietary cable components and bases its network on a dual-cable networking architecture. Just one other network—Mitre Corp.'s MitreNet, sold under different names by several companies that license the technology—pushes the dual-cable approach. And even Mitre's approach uses more standard equipment and techniques than Wang's (MMS, October, 1981, p. 34). "I think Wang made an incredible error," says Ungermann. "They're the only company that's really trying to go totally proprietary."

Tony Bolton, senior product manager for networking at Wang, points out that the company will probably open some of its proprietary technology to other vendors once broadband standards become better resolved. "It's a new technology, and we want to see

how things pan out before we decide what portions of WangNet we will license and how we will license it," Bolton says. And, while the IEEE 802 committee broadband standard focuses on a mid-split, single-cable approach, "We think that two-cable will become part of a draft and may become part of a standard at some point," he notes.

WangNet is divided into four major service bands—the Interconnect Band, the Utility Band, the Peripheral Band and the Wang Band (MMS, August, 1981, p. 26). The Interconnect Band has three channel groups: 16 dedicated-frequency channels that connect RS449 devices at data rates of 64K bps, 32 dedicated-frequency channels that connect RS232C devices at data rates of 9600 bps and 256 switched-frequency channels that connect as many as 512 RS232 devices at data rates of 9600 bps. The Utility Band carries seven standard CATV video channels in the 174- to 216-MHz portion of the bandwidth. The Peripheral Band contains six channels that can each support 32 logical connections between Wang serial devices and Wang VS, OIS or Alliance systems. The Wang Band connects various Wang processors over virtual circuits at data rates of 12M bps. Devices connect to the Wang Band through a cable interface unit, which performs functions such as packet assembly/disassembly, flow control and CSMA/CD operations.

While Socher questions the viability of broadband for intra-building communications applications, Bolton questions the technology's place in wide-area communications. "We see the advantage of broadband within a building," Bolton says, "and we see other means of transmission as possibly more viable than broadband outside the building. There are many products and devices that can serve for wide-area networking, including microwave and satellite technologies. We're looking at everything because we don't think broadband will be the only solution to networking problems." □

NEXT MONTH IN MMS

The February issue of Mini-Micro Systems will feature disk drives. Topics covered will include small and large Winchester systems and floppy-disk drives and how technology and market forces are affecting them. Some Highlights:

- * Multiple-megabyte Winchester disk drives.
- * A profile of the floppy-disk drive market.
- * A profile of the small Winchester system market.
- * Thin-film technology and its implications.
- * Large disk drives.

Using the latest in Winchester's?

If you've bought Winchester disks then you know all about the time-consuming, dollar-draining problems of mounting, power and cooling. And the whole set of different problems associated with installing back-up floppy, streamer or removable Winchester's.

Use a Datatypes box to put it in.

Now your Winchester disks and back-up devices can be fully operational in minutes with Datatypes' unique subsystems enclosures.

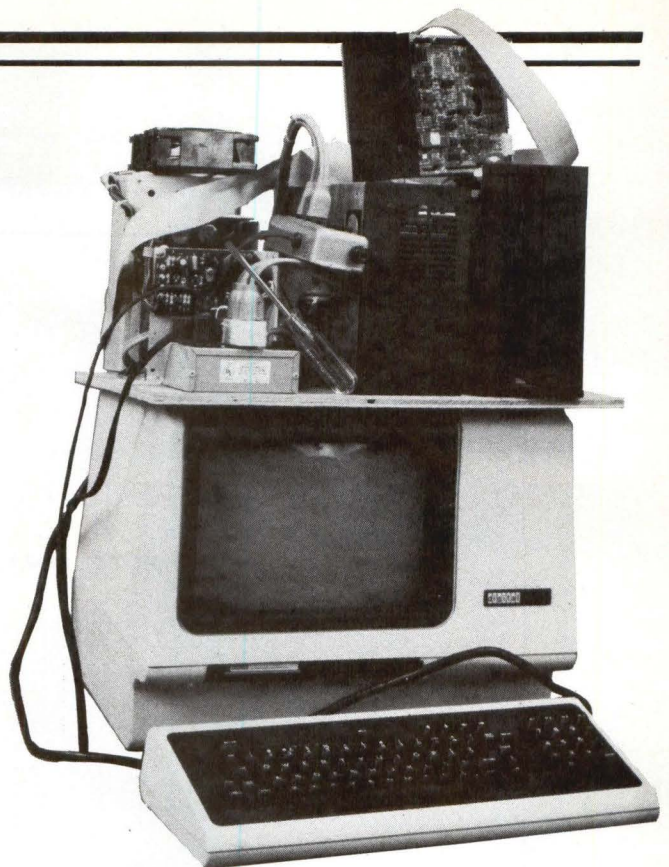

These enclosures were designed for the systems integrator who needs to deliver operational, problem-free disk subsystems quickly and profitably.

Just about any combination of 5¼" or 8" Winchester disks, standard or slim-line floppy, removable Winchester, or ¼" streamer can be accommodated. We provide all necessary power and cooling in an all steel chassis with a contemporary front panel which includes Power and Drive Select indicators.

A Datatypes Subsystem Enclosure can be used with any micro or mini computer and is available in both a 19" rack mount or table-top versions.

We also offer preconfigured Subsystem Enclosures with 5¼" or 8" disks already included. And to interface an LSI-11, use our Series 5000 controller for total DEC software (RL01/02) compatible emulation.

So...if you want to make your Winchester Disk Subsystems operational quickly, easily and profitably, call (619) 566-5500 or write today.

 **DATATYPES™**
a **WESPERCORP** subsidiary

We make the difference.

10072 Willow Creek Road, San Diego, CA 92131 • (619) 566-5500

CIRCLE NO. 52 ON INQUIRY CARD

Dogged attempt to learn a second language.



CP/M is a registered trademark of Digital Research Corp.

For more information on MicroPro dealerships, phone (415) 499-1200 or write MicroPro, 33 San Pablo Avenue, San Rafael, CA 94903.

And now, InfoStar.™

The first DBMS you can use without speaking programmerese.

So put away your GO TOs and DO WHILEs.

InfoStar is one microcomputer data base system that doesn't ask you to write in code or learn a programming language. Instead you make selections from an on-screen menu written in one easy language. English.

Which means you don't have to be a programmer to use it. (Or a computer jock to sell it.) But, in case you are, there's something in it for you, too.

With InfoStar, you can generate a custom application four times faster than with other DBMS software.

Reason being InfoStar has a lot of the features that made WordStar® the standard of the industry. For instance, select-as-you-go menus prompt you through all procedures. And to format a data entry form or report, you simply draw it on the screen. We've said it before: what you see is what you get.

But, of course, that's not all you get.

Fact is, InfoStar has more informative (and self-documenting)

capabilities than you've come to expect from any microcomputer DBMS.

Starting with report writing. A custom report feature — complete with transactional updating and exception processing abilities — lets you format, manipulate and merge countless different ways. And a quick report feature lets you finish faster than you can count them — usually in 60 seconds or less.

Not that you have to slow down to sort things out either. Because InfoStar can sort five to six times faster than any other DBMS in its class.

And for data entry, there are high-end minicomputer features. Like batch editing. And 200 editing mask combinations, to name a few.

All of which should make this a fairly easy sell. But for an added incentive, there's the fact InfoStar can help you sell a lot of different computers.

Any of a growing number running the CP/M operating system.

You see, no matter how you look at it, InfoStar is one DBMS that speaks your language.



MicroPro®
The Microcomputer Software Company

IT TAKES GUTS TO OFFER A 365 DAY WARRANTY.

Dataproducts' new daisywheel printer is built not just for high performance, but also for long-term reliability. Designed from the ground up, the DP-55 prints at 55cps with an MTBF of over 3,000 hours. And we've added printing with either metal or plastic print-wheels, user diagnostics, a print-head mechanism which tilts 90 degrees for easy print-wheel changing, and more. Find out about the finest of the new generation daisywheel printers.

Heavy duty 5½-amp power supply. Conservative specking builds in a safety factor of over 50%. It also leaves a full 2½-amp reserve for function expandability and custom interfaces.

Heat-reducing electronic design. By separating analog and digital circuitry, we eliminated a major source of heat build-up. The DP-55 runs so cool, it doesn't even need a fan.

A name you can trust. Dataproducts is the world's largest independent manufacturer of computer printers. Our reputation for dependability is built on 20 years of supplying printers to the most demanding OEM's in the industry.

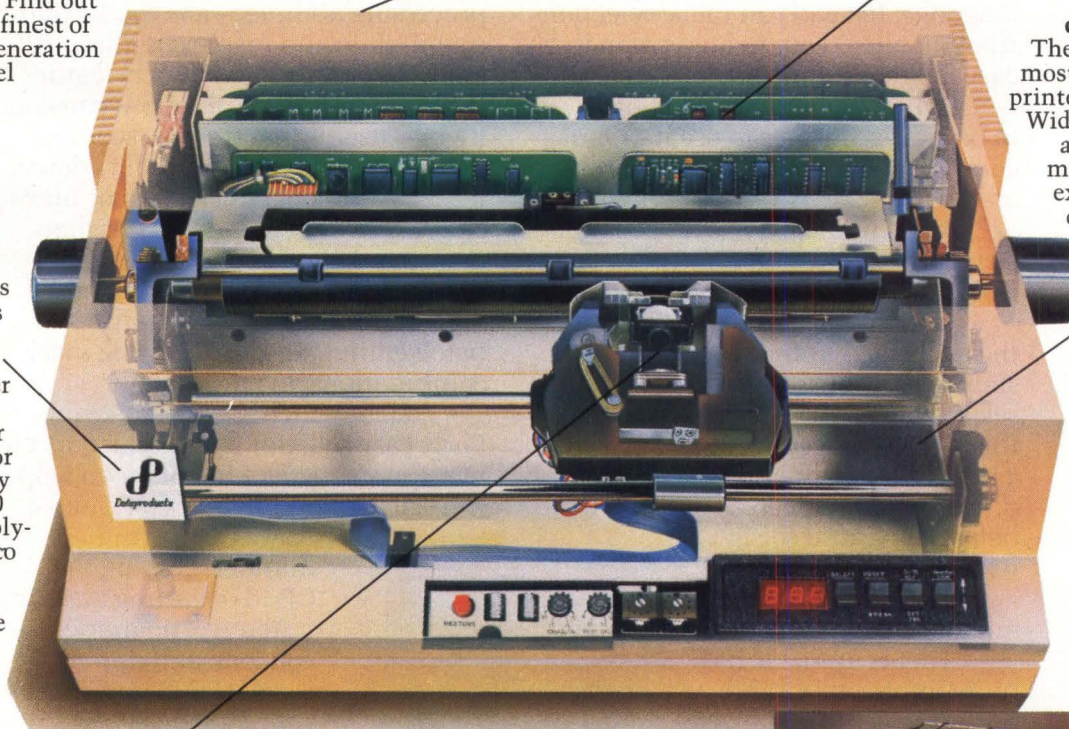

Extra-sturdy construction. The DP-55 is the most solidly built printer in its class. Wide mechanical and electronic margins ensure excellent print quality over a long life for high-use customers.

Single-action sealed hammer. With only one moving part, the DP-55 hammer is significantly more dependable than conventional 3-piece designs. The sealed housing locks out contaminants, extending life and ensuring consistent performance.

365 Day Warranty. When you build a daisywheel with guts like this, you can back it with a full 365 day OEM warranty.

Write our Marketing Department at: 6200 Canoga Avenue, Woodland Hills, CA 91365. Or phone us at: (213) 887-8057 (Western); (617) 237-4711 (North Eastern); (215) 293-1810 (Eastern/Southeastern); (612) 835-2066 (Central).

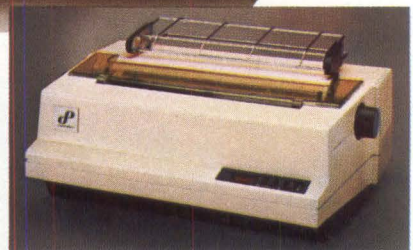

DP-55 DAISYWHEEL PRINTER

DATAPRODUCTS



CIRCLE NO. 54 ON INQUIRY CARD

The Interpreter

U.S. mini manufacturers base software development in Britain

By Keith Jones
European Editor

Hardware technology development continues to be led by U.S.-based computer companies and spearheaded by their U.S.-based personnel. But U.S. firms are increasingly placing key software-development operations on foreign shores—primarily in the U.K. and Europe and with a heavy concentration in the London area. U.S. minicomputer manufacturers that maintain software-development teams near London include Digital Equipment Corp., Hewlett-Packard Co., Modular Computer Systems, Inc. (Modcomp), Honeywell Information Systems, Inc., Perkin-Elmer Corp. and Prime Computer, Inc.

The development of fundamental systems software, notably operating systems, remains in the hands of U.S. staff. But software to handle functions between system-control programs and end-user application packages is appearing in substantial quantities from Old World locations. Products include sophisticated software for jobs such as transaction processing, database management, electronic mail, videotex and packet-switched communications.

European-based software-development branches of U.S. computer companies apparently have grown and flourished because they can tackle certain software technologies more effectively than U.S.-based operations. Some European software teams actually originated independent of their U.S. parents to develop software for requirements specific to the European markets.

First projects: bits and pieces

DEC set up its European engineering operation 10 years ago, initially sending U.S. staff to the offices of its British subsidiary in Reading, England. European engineering manager Dick Davies, a Briton who heads the operation, says the aim at the time was mainly to hand over "bits and pieces" of software development that engineering in the U.S. was not keen to tackle. This included projects involving the European real-time languages Coral and Pearl.

"The engineering team at Reading was built up to 60 or 70 people without a clear charter or purpose," Davies notes. But the Reading operation, based in DEC



Several U.S. minicomputer manufacturers have established London-area software-development centers. These include Digital Equipment Corp., Reading; Hewlett-Packard Co. and Modular Computer Systems, Inc., both in Wokingham; Perkin-Elmer Corp., Slough; Honeywell Information Systems, Hemel Hempstead; and Prime Computer, Inc., Bedford.

Park, the new headquarters of DEC Ltd., has established itself as a major center for office automation and distributed-system software development. Davies points to his team's development of X.25 software that enables DEC equipment to communicate via packet-switched networks such as Telenet. The European team handled this project because "the development of packet switching in Europe has been forced by the high cost of communications, a result of the monopoly position of the common carriers here," Davies explains. His team also has worldwide responsibility for the continuing development of DEC Mail, the electronic-mail facility sold as part of DEC's Office Plus product group.

Davies supports the European development of office automation and other products for end users, claiming, "We are more conscious of the diversity of users in Europe." He points to the need to cater to different languages, currencies and conventions—the formatting of dates, for example. Davies doubts whether a U.S.-based development team could implement foreign-

Who hells Pixel

It's the Pixel 100/AP?

**The company that delivers
the best 68000-based
UNIX™ system you can buy,
and fully supports it.**

That's who!



If you're in the market for a high-performance, low-cost supermicro, take a hard look at the Pixel 100/AP™ system.

For starters, it's the fastest 68000-based supermicro available.

Expandable, too, with up to 16 terminals, 160mB of on-line winchester disk storage, and 6mB RAM.

And, whether you're developing a new product, or adapting an existing application, Pixel makes it easy with a wide choice of industry standard languages like C, FORTRAN 77, PASCAL, SMC-BASIC/IDOL, DEC-compatible SVS BASIC, RM/COBOL™ MICRO FOCUS LEVEL II COBOL™ and APL.

You get a full range of integrated decision support software, too. Software that compares feature for feature with the best packages in the business. Our relational data

base, spread sheet package, and word processing packages work as independent components, or as a totally integrated decision support capability.

There's something else you should know about the Pixel 100/AP supermicro. Our UNIX operating system comes with tutorial documentation that makes it easy to learn. We offer customer training, too.

And, every Pixel system is supported by 125 company Technical Service Representatives, nationwide. That means you can rely on a substantial support organization from day one.

If you're an OEM/Systems House, you owe it to yourself – and your customers – to see how much more the Pixel 100/AP system has to offer both of you for so much less. Call or write today for your Pixel Information Package and price list.

Pixel

DIVISION

One Burt Road, Andover, MA 01810



Instrumentation Laboratory

CALL 617-470-1790

The Interpreter

language versions of office products. At the same time, he feels confident that his team at Reading, staffed almost entirely with British personnel, can cater adequately to the needs of U.S. users. "I spend about a quarter of my time with DEC in the U.S. and make six to eight visits a year," Davies says. "There are six or seven other people here at Reading who go there as much as I do, and 20 or 30 others who also travel a lot. We're good news for the airlines."

Touching home base

Davies notes that most of his time in the U.S. is spent at DEC locations in the Boston area. "We need to visit DEC in Boston to get clear, well-understood decisions and to find out what engineering is doing there," Davies explains. He points to his team's need to understand what is happening to fundamental software products such as VAX/VMS, so the team can create workable interfaces in its products. He adds, "There is a lot of misunderstanding at the moment, especially in office-automation technology, which is changing quickly and is ill-defined." Davies says he also has to play company politics. "There is a danger that a European project may wither on the branch unless a key U.S. person can be persuaded to take it under his umbrella and commit himself to its success." It's Davies's job to do the persuading.

He identifies the problems at Reading as the need to find enough fresh and challenging work to make the talented members of his team feel that they are making progress in their careers. The European engineering group at Reading numbers about 170, but Davies

believes it is still not big enough to provide a varied long-term career.

Although Davies and his team work mainly with the U.S. engineering group, they are funded by the British company, DEC Ltd., which receives no payments or royalties from any other parts of DEC. Explaining this arrangement, Davies notes that DEC Ltd. is the biggest DEC subsidiary in Europe and benefits from the presence of a significant software engineering operation. He also points to the benefits DEC Ltd. realizes from products developed by DEC's U.S. engineering teams.

HP's team self financing

Like DEC, HP's British subsidiary also initially funded its rapidly growing software-development team. But Dave Townsend, marketing manager for commercial systems within HP Ltd., says the British software operation is now self financing because it bills worldwide HP sales offices that sell its main product offering, HPmail (MMS, April, 1982, p. 60). The overall charter of HP's British software group also embraces word-processing and telex/teletex products for worldwide use.

Like DEC's European engineering group, HP's British software team shares the company's British headquarters, located in Wokingham, just a few miles from DEC Park. Called Pinewood, the new 100,000-sq.-ft. building will eventually be taken over completely by the software-development team, Townsend says. "We have 50 people in software-product development at the moment, but we are growing at 100 percent a year," he says.

As for staffing requirements, Townsend says, "It is easier to get good computer-science graduates in Britain than in the U.S. We have to compete for them against other computer companies and software houses, but Britain has some of the world's best computer science departments." He lists the Universities of Strathclyde, Manchester, Aston, Loughborough and Cambridge as among the best. Townsend also acknowledges that the salaries of British graduates tend to be lower than their U.S. equivalents—starting as low as £6000 (about \$10,000). However, he stresses that overall employment costs equal those in the U.S. because overhead costs such as office accommodations are higher in Britain.

The Pinewood team was established two years ago and is now one of five worldwide development groups. One other group is located outside the U.S., in Beoblingen near Stuttgart, West Germany. Its activities complement Pinewood, concentrating on financial

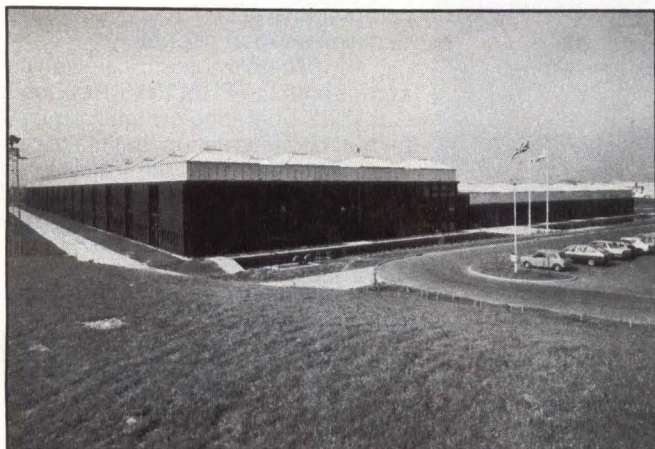

DEC Ltd.'s headquarters at DEC Park in Reading houses a software-development operation that handles some of the office-automation software, including DEC Mail, that is sold worldwide to the company's user base.

CIPHER INTRODUCES THE 5 1/4" FORM FACTOR...



...a 1/4-inch
streaming cartridge
tape drive with
45 megabytes for
\$800.*

New, powerful, economical—and uniquely CIPHER.
Choose CIPHER for your 1/4-inch tape drives.
We've got a product that fits your needs.

- 45 MB capacity
- easy front loading
- Q I C-02 interface standard
- 90 ips tape speed
- 5-1/4-inch form factor,
Model 540-CT
- 8-inch form factor,
Model 440-CT

cipher[®]
data products (uk) ltd.

Compton Place, Surrey Avenue, Camberly, Surrey GU15 3DX,
England, Telephone: 0276-682912, Telex: 858329

CIPHER Data Products SARL, Fresnes Cedex, France
Telephone: (1) 668 87 87, Telex: 203935

CIPHER Data Products GmbH, Munich, West Germany
Telephone: (089) 807001/02, Telex: 521-4094

*O.E.M. Quantities

CIRCLE NO. 56 ON INQUIRY CARD

The Interpreter



H-P Ltd.'s Dave Townsend says software such as HPMail that is developed in England must complement the products developed at HP's four other software facilities. Three of these are in the U.S., and one is in Beoblingen, West Germany.

applications such as multi-currency accounting, an ideal project for a European-based team.

Complementary U.S. software

Townsend explains that the Pinewood team works most closely with HP's Cupertino, Calif., Office Systems Group, whose products also complement those emanating from Pinewood. The U.S. products cover personal-decision-support functions such as business graphics and spread-sheet generation. Townsend says both the Pinewood and Cupertino teams report to HP's information networks division manager, André Schwager. All products must work together; for example, business graphics generated by Cupertino software can be disseminated by Pinewood's HPMail.

Underlining the importance of coordinated activity with HP, Townsend notes that the development of software systems by all the company's groups must now be executed in Pascal. "This is an HP edict," Townsend explains. "We used HP's Systems Programming Language to develop HPMail, but if we had started six months later, we would have used Pascal."

Outlining the history of HPMail development, Townsend explains, "Our own people went over to the U.S. during the early design stages and talked to a lot of HP customers—members of HP's Partner Program. Later, we sent them a prototype users' manual." He says some "subtle" changes in the users' interface were made at the alpha test phase, although these will not be implemented until the second release of HPMail next year.

Continuing work includes the transfer of some HPMail functions from the HP 3000 host to the HP 125 personal computer that acts as a terminal. The

Pinewood team is also implementing an interface enabling HPMail to support document communication conforming with the teletex standard—the "super telex" technology now at a more advanced stage of development in Europe than in the U.S.

Videotex's European roots

Videotex is another European-dominated technology, and ModComp has its European Special Systems Department to thank for the videotex software it now sells in the U.S. The U.S. market for private videotex systems was recently boosted by IBM Corp.'s decision to make its videotex software (developed by its British subsidiary) available in the U.S. on Series/1 minicomputers (MMS, September, 1982, p. 145). IBM's choice of a system functionally compatible with the Prestel standard pioneered by common carrier British Telecom will also help Modcomp because its ViewMax product is a powerful superset of Prestel.

ViewMax sprang from the success of a videotex-like system, Topic, developed by the London Stock Exchange on ModComp Classic computers. John Linford, a technical field consultant at Modcomp's European headquarters, explains, "Modcomp was chosen by the Stock Exchange because of the communications capability of the Classic family. We had to present Modcomp in the U.S. with a proposal before going ahead with ViewMax, but the impetus definitely came from Britain. Videotex has been peculiarly British until now."

Modcomp's international marketing manager for communications products, Dick Howe, notes that Modcomp staffers from the U.S. visit Britain "in a continuous stream" to familiarize themselves with ViewMax and related products. He says Modcomp employees also exchange ViewMax product information across the Atlantic using ViewMax's electronic-mail facilities. Underlining the importance of these exchange activities, Howe anticipates that the U.S. personnel may have to modify ViewMax in a few years if non-Prestel videotex standards, such as AT&T's PLP, are widely adopted, despite IBM's backing of Prestel. But Howe stresses that Modcomp's U.S. staff will not have to rewrite ViewMax from the ground up. "ViewMax is highly modular so they will be able to plagiarize it extensively," he says.

Honeywell transaction processing

Users of Honeywell DPS-6 minicomputers who run transaction processing under TPS-6 are entrusting their transaction work load to a software product conceived,

Continues on page 108



We Asked UNIX* Users What They Wanted in an Integrated Workstation. Here's What They Said...

1. "We want a full Bell Labs UNIX operating system — not a look alike."

UNISTAR™ 100 is just that. It runs on an eight MHz, 68000, 16/32 bit CPU with 256K bytes of local memory, expandable to 1M bytes. UNISTAR provides the ultimate in cost-effective, versatile computing power for professionals.

2. "Give us a wide selection of languages."

UNISTAR 100 comes with C and 68000 ASM, with Pascal, COBOL, Fortran 77 and BASIC as options.

3. "We need plenty of disk storage."

An integral 5¼-inch, 10M byte Winchester and 5¼-inch, 0.6M byte floppy is standard, with additional 21M byte Winchester capacity to be available.

4. "We'd like room for additional options."

UNISTAR 100 has a built-in, six slot Multibus* card cage. It also has two, two RS-423 multiprotocol serial ports and a parallel 16-bit input/output port, too.



Another product of Callan Engineering and Manufacturing Excellence

5. "Give us a CPU that will take full advantage of fast memory chips."

UNISTAR 100 has advanced CPU board design with 256K bytes of on-board memory, together with a unique two-level, segment paged, multiprocess memory management scheme that eliminates CPU/MMU wait cycles, provides a timed-integer computational rate of 40% to 50% of a 11/780.

6. "We feel it's important to be Ethernet* -compatible."

UNISTAR 100 enhancements include an Ethernet interface controller, with UNIX-based UNET* software.

7. "If possible, we'd like all of this in a single, attractive package."

You've got it! UNISTAR 100 has packaged all of your needs — and more — in a desktop workstation with a detachable keyboard.

DISTRIBUTOR, OEM/SYSTEM INTEGRATOR INQUIRIES WELCOME.

Contact Callan™ Data Systems today.

Callan

DATA SYSTEMS

2645 Townsgate Road Westlake Village, CA 91361
(805) 497-6837 in CA or 800-235-7055
TWX 910 336 1685

CIRCLE NO. 57 ON INQUIRY CARD





TELEVIDEO SYSTEMS INC PRESENTS THE 970

ANSI 3.64

256 DOWNLOADABLE FONT

14" SCREEN

VT-100 COMPATIBLE

32 NON-VOL. FUNCT. KEYS

ACCOUNTING KEYPAD

24 X 132 COLUMN

NO SPACE ATTRIBUTES-16

LOGICAL ATTRIBS.

TELEVIDEO 970

TeleVideo
MODEL 970

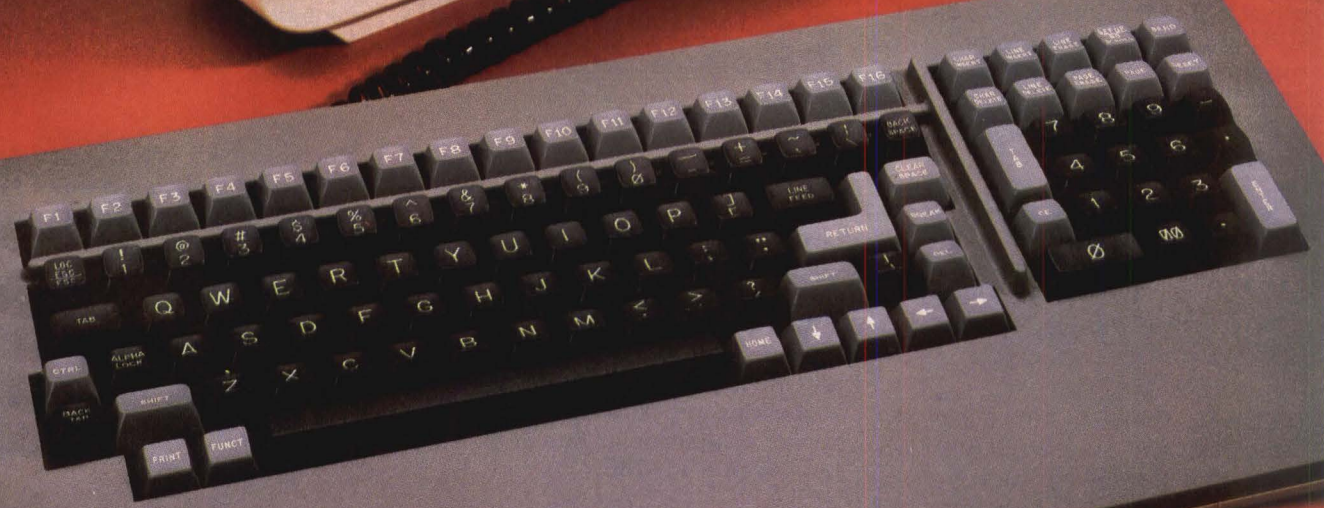

The new 970 from TeleVideo. Nothing else looks like it. Nothing else performs like it.

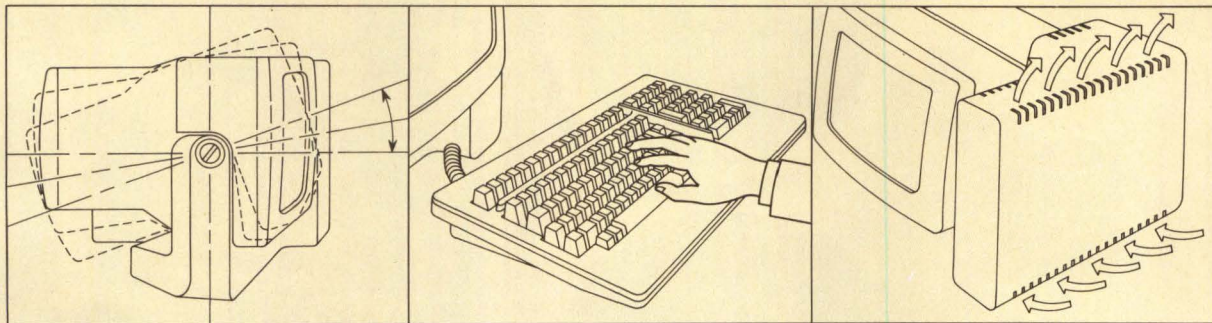

Productive office work depends on people and their equipment working efficiently together.

That's why we have engineered the exciting, new TeleVideo 970 to perform better than any other terminal.

For instance, only our "natural balance" tilting mechanism lets you easily adjust the screen at a touch, so you avoid neck-craning, straining and glare.

Our unique keyboard is designed to avoid user fatigue. We've created a natural palmrest, sculpted keys and the best ten-key accounting pad in the industry. Our non-volatile function keys save time and energy.

Like every feature of the new 970, the screen is designed for ease of use. Our non-glare 14-inch green screen is restful on the eyes, and its 132 column display can format more information. All in highly legible double-high, double-wide characters.

Our communications protocol is the industry standard ANSI 3.64.

As you probably know, most terminal downtime is caused by overheating that results from extended use. There's no such problem with our unique vertical convection cooling tower.

And because we wanted to extend the life of your CRT, we've installed a screen saving

feature that automatically turns it off after fifteen minutes of idle time.

Naturally, like all TeleVideo terminals, service is available nationwide from General Electric's Instrumentation and Communication Equipment Centers.

The new 970 from TeleVideo. Nothing else looks like it and nothing else can perform like it.

For more information about TeleVideo's new 970, call 800-538-8725; in California 408-745-7760.

TeleVideo Systems, Inc.
Dept. #216F
1170 Morse Avenue
Sunnyvale, CA 94086

Yes, I'd like to know more about the unique 970 from TeleVideo:

NAME _____

ADDRESS _____

CITY _____

STATE _____ ZIP _____

TELEPHONE (____) _____

California/Santa Ana 714-557-6095, Sunnyvale 408-745-7760, Georgia/Atlanta 404-255-9338, Texas/Dallas 214-980-9978, Illinois/Chicago Area 312-351-9350, Boston/Massachusetts 617-668-6891, New York/New Jersey 201-267-8805, United Kingdom/Woking, Surrey 44-9905-6464.

 **TeleVideo Systems, Inc.**

CIRCLE NO. 58 ON INQUIRY CARD

NOW—DUAL-MODE STREAMERS THAT REALLY DRIVE DOWN THE COST OF OWNERSHIP.

DUAL-SPEED MODE. The 92180 runs at 12.5 ips start/stop mode for traditional applications; 100 ips streaming mode. The 92181 runs at 25 ips start/stop and 100 ips streaming. ANSI Standard 1600 bpi, phase-encoded format.

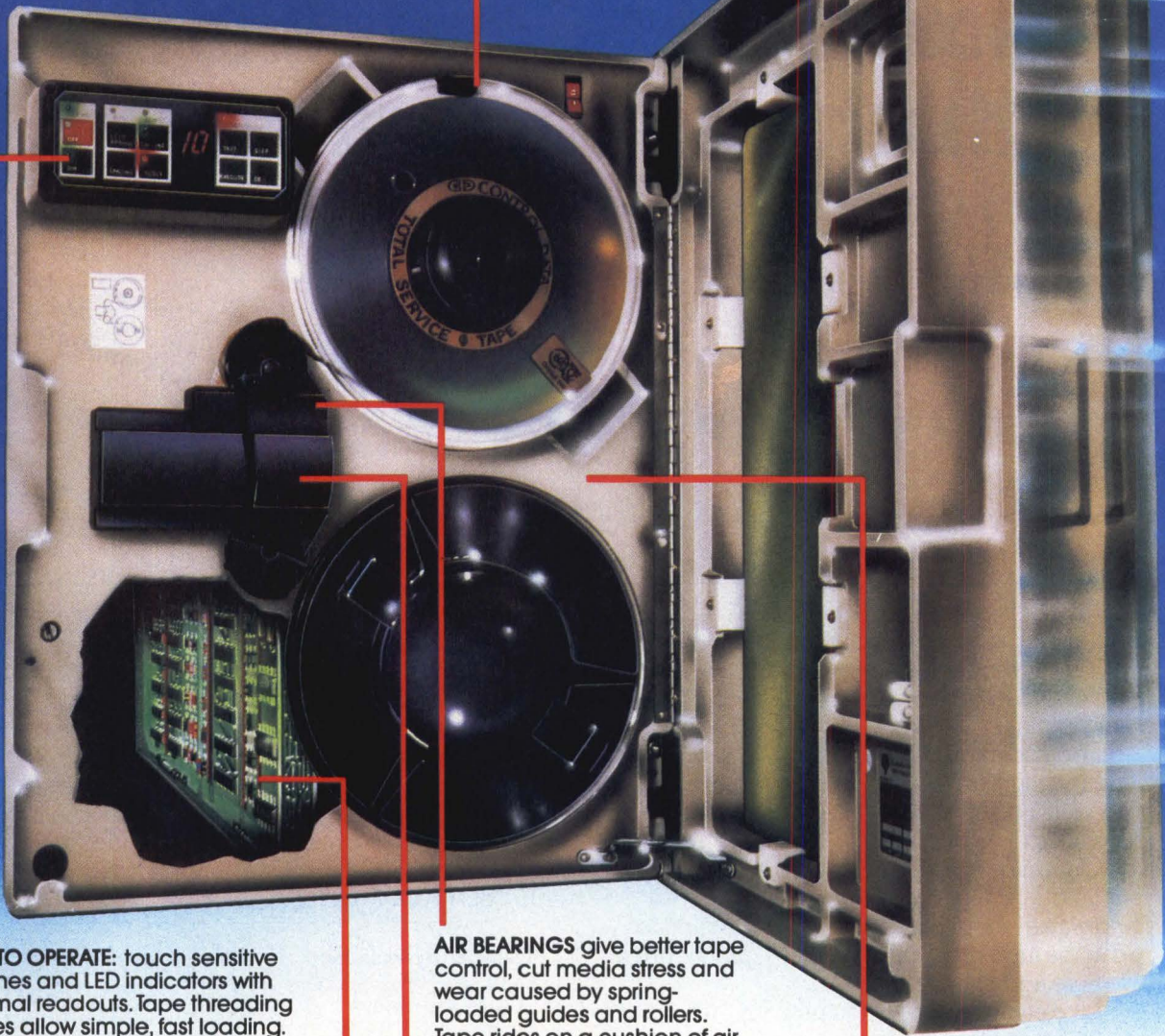

EASY TO OPERATE: touch sensitive switches and LED indicators with decimal readouts. Tape threading guides allow simple, fast loading.

MAINTAINABILITY MEANS RELIABILITY. Keystone tape units need no field adjustments of any kind. No scheduled preventive maintenance either.

AIR BEARINGS give better tape control, cut media stress and wear caused by spring-loaded guides and rollers. Tape rides on a cushion of air.

OPTIMUM TAPE PATH. Unique, patented tape path (only 13"), solid-state tension sensing, and μ P-controlled servos for gentle, precise tape motion control.

SIMPLE MECHANICAL DESIGN. No tension arms, vacuum columns, capstan motors or guide rollers.

THE KEYSTONE™ SERIES

We designed the Keystone Series with built-in diagnostics and maintenance features that make it simple to operate, easy to service, low in life-cycle costs. For more information, call your local Control Data OEM Sales Representative or write: OEM Product Sales, HQN08H, Control Data Corporation, P.O. Box 0, Minneapolis, MN 55440.

GD CONTROL DATA

*Addressing society's major unmet needs
as profitable business opportunities*

CIRCLE NO. 59 ON INQUIRY CARD



RADICAL RADIAL...

True, the radial hookup scheme of DEC's UDA-50 allows you to drop a drive without saying "good-bye" to your entire system. But, is this really an advantage with new drives boasting long MTBF specs. Emulex controllers let you daisy-chain your drive connections using fewer, shorter (and cheaper) cables.

SEEK AND YE SHALL FIND...

The UDA-50's ability to stack 16 seek commands does boost throughput—mainly for single drive systems. For all you multi-drivers, however, speedup isn't as pronounced. An Emulex-controlled multi-drive system stacks its seek commands (in effect) via its built-in system of overlapped seeks. Plus, overlapped seek and search commands (new to DEC in the UDA-50) already operate in Emulex controllers under all DEC operating systems.

TO ERR IS HUMAN...

The 80-bit ECC of the UDA-50 can catch a lot of errors—it has to: High bit densities (try 11.4K bits per inch) on state-of-the-art media make 80-bit error correction a necessity, not a feature. And, the trade-off for correcting all those densely packed bits is loss of performance in skipping rotations every time an error occurs—All this in contrast to Emulex's proven 32-bit ECC.

PUTTING ON THE BRAKES...

To slow the 2 MByte transfer rate of the disk to 800 KBytes at the Unibus, the UDA-50 uses a hefty 12 sector buffer. This means the UDA-50 can transfer 16-19 contiguous sectors at most before it skips a rotation and makes your software cry, "Uncle!"

In almost all applications, Emulex controllers can handle full (repeat full) track transfers of contiguous sectors and spiral read/write across cylinder head boundaries—and never skip a rotation. Why? Emulex passes data to your memory at rates much closer to those coming off your drives.

THINGS YOUR MOTHER NEVER TOLD YOU...

For a complete discussion of these and other UDA-50 matters, write to Emulex for a free report.

FROM THE EMULEX FILE...

Results for the First Quarter, Fiscal Year 1983 are in: Revenues up 100 percent, net earnings up 109 percent, earnings per share up 100 percent (all compared to the same quarter last year). Check your latest Emulex mailing for price reductions on some Q-bus and Unibus products. Not on our mailing list? Just drop us a note, or better yet, telephone us toll free at (800) 854-7112. In California, that's (714) 557-7580, and let's talk DEC.



DISK • TAPE • COMMUNICATIONS

(DEC, Unibus, and Q-bus are trademarks of the Digital Equipment Corporation.)

The Interpreter

Continues from page 102

designed, written and tested at the General Systems Division center of Honeywell Information Systems Ltd., Hemel Hempstead, just north of London. TPS-6 was the result of an initiative by the Hemel center, encouraged by the experience it acquired in the late 1960s and early 1970s implementing transaction-processing applications for European users of the earlier Honeywell Series 16 minicomputer.

Tony Hutchinson, development director at Hemel, explains, "We proposed the TP project to HIS corporate when DPS-6 was announced as Level 6 in 1976 because we saw TPS-6 as a necessary weapon in our armory in Britain. The project was funded by HIS Ltd., not by HIS corporate. But, by 1980, TPS-6 was adopted by the engineering center in Billerica, Mass., as a worldwide product. By then it was already adopted by U.S. marketing."

Malcolm Murdoch, manager of the minicomputer software group at Hemel, adds, "TPS-6 is so important now that any new release of the DPS-6 operating system, MOD 400, must support it." Looking at further developments for TPS-6, Murdoch points to application generators and local-area networking as two important enhancements. On the question of keeping in touch with U.S. needs, Murdoch declares, "We go to Boston frequently, and we talk to the marketing people in Waltham as well as the engineering people in Billerica. But Boston does not tell us what to do. We work jointly and have quite a say these days in software development in general, including operating-system evolution. We also attend TPS-6 user meetings in the U.S. and gather remarks, mainly detailed, about the product."

HIS in Boston now formally coordinates the worldwide marketing plan for TPS-6, but product development continues to be based in Hemel. Hutchinson estimates that 200 man years of effort have gone into TPS-6, and notes that about 30 of the 300 professional staffers at the Hemel center are directly involved with the continuing product development.

Funding from home

Two major U.S. minicomputer suppliers, Prime and P-E, maintain software-development centers in England that are funded entirely by the U.S. parent rather than by the company's British subsidiary or European sales office.

Prime's center in Bedford, 50 miles north of London, was set up with 12 staff members in 1979 to develop emulators for various remote-job-entry terminals. "But having won our spurs, we are now working on transaction-processing monitors and other commercial



Honeywell Information Systems Ltd.'s 112,000-sq.-ft. headquarters in Hemel Hempstead houses a software group that conceived, designed and produced the company's TPS-6 transaction-processing system.

systems software," says Jim Foy, senior manager in Bedford. He notes that the operation's staff now numbers 95.

Like his British-based competitors, Foy is well aware of the vital importance of effective communication between the European staff and the U.S. engineering and marketing people. He explains that Prime's proprietary networking system, Primenet, carries heavy electronic-mail traffic between the British and U.S. facilities. The company uses the Telenet public packet-switching network to achieve the transatlantic link between Bedford and Boston. "From Bedford, we can log onto development systems in Boston, and we employ a sophisticated file-transfer system," Foy says. "Everyone at Bedford has a terminal." Foy also says, "I make around six trips to Boston a year, and so do the other senior managers at Bedford. We also have people from Boston here every month."

P-E's software center at Slough, just west of London, has been in operation since the mid-'70s and develops most of P-E's commercial system software. One major project produced by the Slough team was the Reliance transaction-processing system (MMS, October, 1982, p. 116). Established seven years ago by Interdata before its acquisition by P-E, the Slough center now employs a team of 75. □

NEXT MONTH IN MMS

The February issue of Mini-Micro Systems will feature disk drives. Topics covered will include small and large Winchester systems and floppy-disk drives and how technology and market forces are affecting them.

Digi-Data Cartridge Systems Don't Care Which Bus You're On.

Select just about any popular microcomputer. Digi-Data has a Series 70 Cartridge tape drive that's ready to go, adding up to 30 Mbytes of unformatted storage capacity to your system. Delivering data reliability through proven conservative electro-mechanical design. Performing now . . . without additional hardware or software design.

Cartridge tape drive systems are available in standard or serpentine configurations to record on ANSI standard 1/4" data cartridges and are supplied as a small, attractive desk top unit.

Model 70R systems house their controller within the desk top unit, and interface with any RS-232C port having asynchronous protocol emulation.

Models 70S, 70M and 70Q include single board imbedded controllers for S-100, Multibus* and Q-bus** processors respectively. Compatible interface software is included for S-100 and Multibus

configurations operating under CP/M*** or MP/M.***

Model 70Q emulates DEC** TM11/TU10 magnetic tape subsystems, and is supported by RT-11V4, RSX-11MV4.0 and RSTS/EV7.0 operating systems without modification. The Q-bus controller occupies one quad-slot.

So take the easy road to microcomputer bus-compatible storage. Select a Series 70 system from Digi-Data.

If you need conventional 1/2" tape systems, investigate our Series 40 start/stop line and our Series 2000 streamer, the best value in large volume Winchester drive back-up.

Registered Trademark of *Intel Corp.,
Digital Equipment Corp., *Digital Research, Inc.



**DIGI-DATA
CORPORATION**

8580 Dorsey Run Road
Jessup, MD 20794
(301) 498-0200
TWX 710-867-9254

In Europe contact:
Digi-Data Ltd.
Kings House, 18 King Street
Maidenhead, Berkshire
England SL6 1EF
Tel. No. 0628 29555-6
Telex: 847720



MULTIBUS

Q-BUS

RS-232

S-100

CIRCLE NO. 66 ON INQUIRY CARD

We've got connections.

INTERFACE '83 is the place to connect with information/communications systems managers from the nation's largest organizations. Managers with purchasing interest, and authority, for a wide range of products and services. Data processing. Office automation and communication systems. DBMS. Networks. LAN and DDP products and systems. Electronic mail. Fax. CBX. Teleconferencing equipment. Microwave. Fiberoptics. Videocom. Products and services that promote a continuous and cost-efficient flow of corporate information.

Our large and loyal following of data communications, DP and MIS professionals will include more high level corporate managers this year than ever before. Because information processing is playing an increasingly vital role in organizations and purchasing decisions are becoming more complex.

These professionals will learn all about

INTERFACE '83 via an extensive advertising and promotional campaign. An effort that includes extensive editorial coverage by our co-sponsors, *BusinessWeek* and *DataCommunications* magazines.

At INTERFACE '83, these professionals will have the opportunity to attend our Conference with sessions presented by the industry's leading experts. Discussions focusing

on corporate issues, technical trends and applications solutions. The Conference plays an important role in delivering a highly-qualified audience to the Exhibition.

If you're looking for the systems user who's looking to buy, you should exhibit at INTERFACE '83. To reserve your space, call 800-225-4620. (In Massachusetts, call 617-879-4502.) Or, write: INTERFACE '83, The Interface Group, 160 Speen Street, P.O. Box 927, Framingham, MA 01701.

This year, make the right connections.

INTERFACE '82 audience by job function

Corporate/Operations Management	30.7%
Data/Telecomm. Operations	27.9%
Finance/Purchasing	2.8%
Marketing/Sales	16.3%
Consultants	.9%
Miscellaneous	14.7%

INTERFACE '82 audience by purchasing interest.*

Line & Modem Test Equipment	56.7%
Muxes & Controllers	45.4%
WP Systems	37.7%
Genl Purpose CRTs	35.8%
Telephone Switching/PABX Systems	28.4%
Intelligent Terminals	28.4%
Microcomputers	27.0%
Peripherals	23.7%
Acoustic Couplers	21.6%
Microprocessors & Systems	35.2%

*NOTE: Figures (from survey commissioned by *DataCommunications Magazine*) reflect equipment INTERFACE '82 audience plans to purchase/lease before December 1983.

11th Annual Conference & Exhibition
March 21-24, 1983 • Miami Beach Convention Center

INTERFACE '83

Co-Sponsored by **BusinessWeek** and **Data Communications** Magazines

Brought to you by The Interface Group, world's largest producer of computer conferences and expositions, including: INTERFACE, COMDEX/SPRING, COMDEX/FALL, COMDEX/EUROPE, FEDERAL DP EXPO, COMPUTER SHOWCASE EXPOs (Nationwide).

RIXON'S NEW R212A AUTO DIALER MODEM



...OFFERS MORE USER FRIENDLY FEATURES...FOR LESS!

- User Friendly HELP List of All Interactive Commands Are Stored In Modem Memory For Instant CRT Display.
- Terminal Displays All Numbers Stored In Modem Memory...PLUS Alpha Notations
- Auto/Manual Dialing From Keyboard
- Auto Dial Next Number If First Number Is Busy
- Instant Redial Once Or Until Answer
- Stores Last Number Dialed
- Can Also Auto Dial Through PBX
- Pulse Or Tone Dialing
- Rack Mountable In RM50 Rack

**ANOTHER
MODEM
GOOD ENOUGH
TO BE CALLED
RIXON**

The R212A transmits and receives data up to 300 BPS asynchronously or 1200 BPS synchronously or character asynchronously. Fully Bell compatible, the R212A operates full duplex over the DDD switched network. In addition to the standard features that you'd expect, the fully equipped R212A offers auto dial, auto answer with or without a 500 phone, abort timer disconnect, modular phone and line jacks, front panel talk/data switch, and more.

Buy a modem from a real modem manufacturer and you get:

- 14 Regional Free Dial-In Test/Maintenance Centers
- 44 Installation and Maintenance Centers.

Call Don Pyle today, at RIXON INC., at (301) 622-2121 Ext. 292. Don can explain to you the cost effectiveness of a R212A modem in your data communications system.

RIXON INC.

2120 Industrial Pky., Silver Spring, Md. 20904
301-622-2121 • TWX 710-825-0071 • TLX 89-8347

Choose between Winchester systems or controllers

Complete systems to minimize system costs . . .

SMS FWT series disk peripherals provide up to 40M bytes of 8" Winchester disk storage and 1M bytes of floppy disk storage for DEC's* PDP-11, LSI-11, and VT-103, INTEL Multibus** and other microcomputers! In only 5 1/4" of table top or rack space you also get the following benefits:

- Choose 8.9Mb, 17.8Mb, or 35.6Mb of formatted Winchester disk storage.
- Up to 427K bytes/sec data transfer for Winchester and 63K bytes/sec for floppy.
- Supports IBM single and double density diskette formats plus DEC's RX01/RX02 formats or INTEL 202 format depending on host computer.
- Single board interfaces are compatible with PDP-11 Unibus, LSI-11 Q-Bus, INTEL Multibus or use your own adapter card for special microcomputer busses.
- Convenient Winchester backup requires only 40 seconds per 1.2M byte floppy diskette.
- Off-line and on-line system and drive tests verify correct disk and controller operation.
- Automatic error retry, ECC (Error Correction Code) and Winchester disk flaw management insure exceptional data integrity.

Or just controllers to optimize system packaging.

All controllers used in SMS disk peripheral systems are available separately. Each controller supports (2) Shugart/Quantum Winchester and (2) Shugart floppy disk drives, utilizes patented PLL circuitry to provide maximum margins for worst case bit shifted data recovery, incorporates ECC (Error Correction Code) and includes on-board self test! Additional features are:

DEC PDP-11/LSI-11

- Single LSI-11 dual height or PDP-11 quad height interface plus formatter board.
- On board bootstrap and 22 bit Q-bus support.
- Standard RT-11, RSX-11M, UNIX,*** and SMS utility software support selective file backup and load operation.
- High performance data transfer of up to 427 bytes/sec.
- Emulates DEC RX02 floppy disk controller.
- Automatic recognition of RX01, RX02 and IBM diskette formats.

INTEL MULTIBUS

- Single Multibus compatible PC board requires only 5A (max.) @ 5 volts.

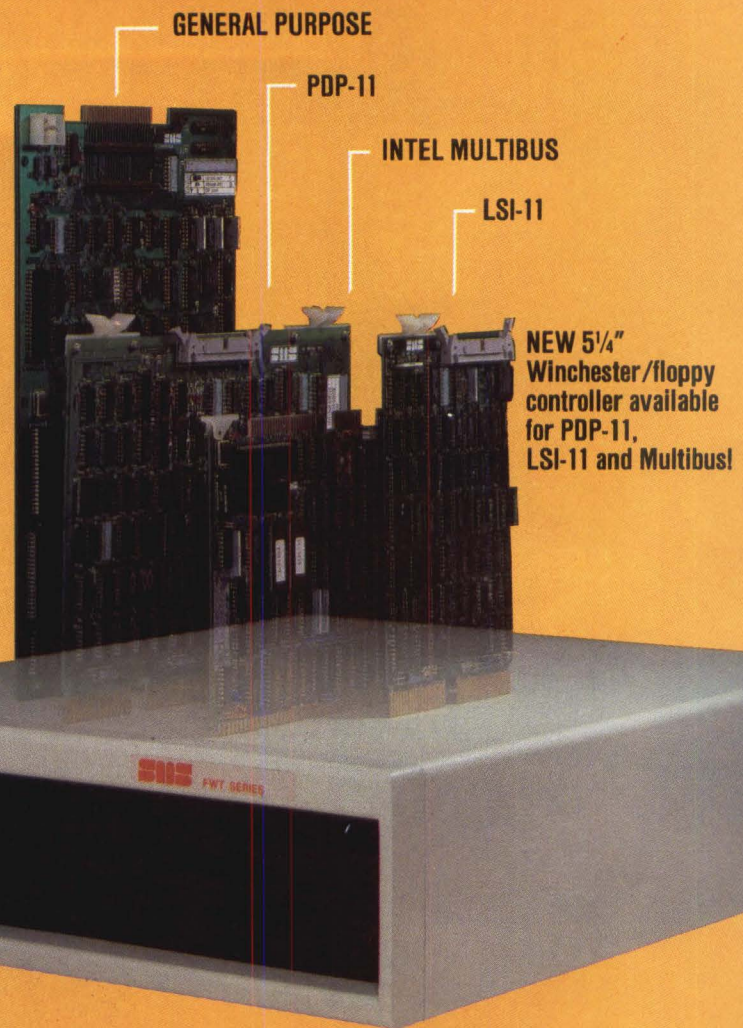

- Direct connection to (2) Shugart/Quantum and (2) Shugart floppy disk drives. Eliminates external data separator board.
- Interface and command compatible with INTEL iSBC 215A and iSBX 218 controller boards.
- Supports IBM and INTEL iSBC 202 diskette formats.

GENERAL PURPOSE

- Single board controller requires only 5A (max.) @ 5 volts.
- Interface, dimension and connector compatible with Shugart 1403D.
- Direct multi-sector disk transfer of up to 427K bytes/sec.
- Easy to use byte parallel general purpose interface.



Scientific Micro Systems, Inc.

777 E. Middlefield Road Mountain View, California 94043
(415) 964-5700

AUTHORIZED SMS DISTRIBUTOR
FOR DEC Q-BUS PRODUCTS:
FIRST COMPUTER CORPORATION—(312) 920-1050

SALES OFFICES: **Phoenix, Arizona** —
(602) 978-6621 **Boston, MA** — (617) 246-2540
Atlanta, Georgia — (404) 296-2029 **Morton Grove, Illinois** —
(312) 966-2711 **Yorba Linda, California** — (714) 993-3768

*Trademark of Digital Equipment Corporation **Trademark of INTEL Corporation ***Trademark of Bell Telephone Laboratories

Systems in Manufacturing

Exploring the use of computers in manufacturing

Calma expands CAD market thrust, product line with support from parent GE

By Sarah Glazer

In the two years since General Electric Co. acquired Calma Co., Santa Clara, Calif., GE's influence on the supplier of turnkey CAD systems has become apparent. Most striking is the expansion of Calma's market beyond its traditional electronic circuit design base and into 3D mechanical design applications. Calma has also introduced new systems in the past six months at both the low and high ends of its product line. The high-end system is its first to be based on Digital Equipment Corp.'s VAX machines rather than on Data General Corp.'s processors.

Two years ago, 90 percent of Calma's revenues were from systems sold to the electronics industry and only 10 percent from those sold to mechanical design customers, says Calma president Robert Benders. He puts the mix this year at 50 percent electronics and 50 percent mechanical. He estimates that in 1983, when projected revenues are \$190 million (up from more than \$130 million in 1982), 60 percent will be mechanical.

"There are a lot more businesses that are candidates for mechanical CAD systems than for ICS or electronics," Benders explains. He defines the mechanical market as manufacturers of "piece parts" and those running other 3D applications such as architectural-engineering and construction. In contrast, he describes electronics design applications as basically schematic preparations that require less complex software than 3D applications.

Merrill Lynch Pierce Fenner & Smith estimates that 38 percent of the \$1.1-billion worldwide market for turnkey CAD/CAM business in 1982 is mechanical, and another 17 percent is architectural-engineering and construction. In contrast, the electronics market accounts for only 26 percent, and other 2D applications account for another 13 percent.

GE's corporate emphasis on the "factory of the future" was also a factor on Calma's shift to mechanical. James A. Baker, GE's executive vice president in charge of factory automation, says, "Besides providing capital backing and engineering resources, GE's sales force has aggressively pushed Calma systems on our machine-tool customers."

Benders says Calma had decided to move into the mechanical area before GE bought the company, but he admits GE has helped Calma in this area, especially with marketing. "The main reason," he says, "is that GE



Robert Benders, president of Calma Co., says, "Our value added is software."

is offering a more comprehensive product than just CAD/CAM." Baker explains the relationship from GE's standpoint, saying, "Calma, a CAD vendor, gave GE a new product line that is indispensable for a company moving into the factory marketplace. If you don't have CAD at the front end of a manufacturing process, the process can't be automated further on."

CAD is also an important factory-automation component in GE's push to automate its own plant operations. Benders says Calma has developed software for GE applications in a number of joint efforts with its sister subsidiaries. For example, Calma's new solids-modeling package grew out of a project with Computer Aided Engineering International, a joint venture of GE and Milford, Ohio-based Structural Dynamics Research Corp.

"We are the world's largest user of CAD systems," Baker says of GE, "so it made sense for us to acquire a CAD company." However, Calma's management makes it clear that the company will not become a captive supplier for GE. "Last year, about 11 or 12 percent of our revenues were from internal GE sources," Benders says. "This year it's going to be less—about 8 percent."

In addition to supplying Calma with marketing help, GE has financed extensive R&D efforts. These expenditures offset the dramatic rise in Calma's revenues from \$62 million in 1980 to Benders' estimate of more than \$130 million in 1982, says Tom Kurlak of Merrill Lynch. "GE has given a lot of money for R&D," he explains. "Because it has developed a lot of new products, the company has shown a small loss since it was acquired."

Systems in Manufacturing

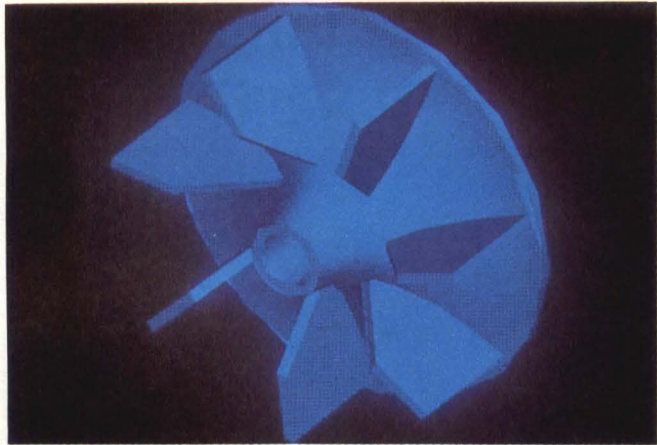

An impeller design that was made with a solids-modeling package. Rather than using traditional graphics techniques of making 3D figures out of lines and surfaces, this package uses more lifelike shaded graphics.

Benders refuses to comment on his company's profits over the last few years. However, GE's Baker lends credence to Kurlak's analysis, saying, "We're putting a lot of money into Calma, such as equipping the systems with VAX computers, with the idea of sacrificing short-term profits for long-term market share."

The expanding product line

The results of GE's investment are new products at both the high and low ends of Calma's product line. The most recent addition, announced at Autofact '82 in late November, is a new high-end offering, the Calma 7000 series (see "Calma's new VAX-based system," p. 120).

Unlike almost all of Calma's previous products, which run on Data General Corp. 16-bit Eclipse computers, the 7000 series runs on Digital Equipment Corp.'s 32-bit VAX machines. The decision to switch to the VAX, rather than use DG's MV/8000 32-bit CPU, says Benders, was closely tied to the company's desire to penetrate the mechanical CAD market. "We've discovered over the past couple of years that the mechanical engineering community is enamored with the VAX, and I think justifiably so," Benders says. "It's a better machine for the engineering applications."

Sherm Rutherford, Calma's director of industrial marketing, adds, "DEC has very effectively managed to become the de facto standard of the engineering industry with the VAX product line." However, he admits that supporting two computer lines will cause initial problems for Calma. For example, Calma had to reformat its existing mechanical design and architectural-engineering and construction software for the 7000 series. "Obviously, it would have been easier from

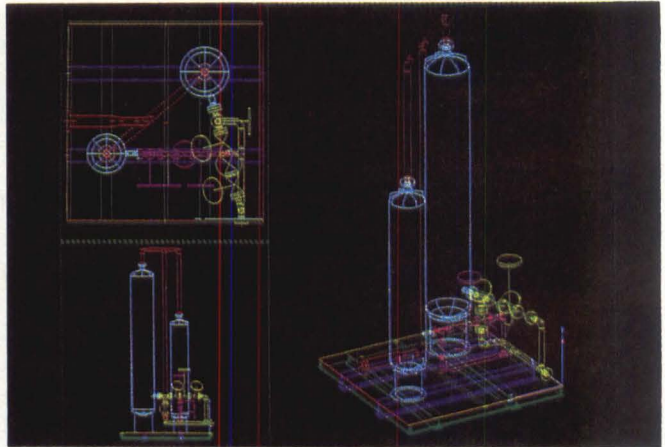

The piping layout and design pictured on this screen is made by using 3D design software. This is a typical application in architectural engineering and construction.

a technical standpoint to go with DG," Rutherford concedes. "But how many university engineering departments are raving about the MV/8000?"

Kurlak of Merrill Lynch agrees that the new VAX-based system will open doors to users of mechanical CAD systems. "It will be very costly to support two systems initially, but Calma has made the right decision ultimately," he concludes. Benders also admits that supporting both DEC and DG computers will be expensive. "Even though there is a short-term pain financially," he says, "in the long term, keeping reasonable options open pays off."

One way it may pay off is to improve Calma's competitive stance against the CAD system market leader, Computervision Corp., Bedford, Mass. Ken Anderson, a Simi Valley, Calif., consultant and publisher of a newsletter about computer graphics, says, "For mechanical and other applications outside electronics, people want the VAX. I think it's going to give Calma a competitive edge, not only on Computervision, but on other CAD companies that do not offer VAX."

Anderson ranks Computervision number one in the CAD/CAM market and IBM Corp. (which, unlike other turnkey vendors, sells its hardware with software developed by third parties) number two. He ranks Calma running neck and neck for third place with Huntsville, Ala., Intergraph Corp., another company that has introduced equipment using the VAX.

Despite its choice of VAX technology for its high-end system, Calma has no plans to abandon its DG-based systems, Benders stresses. "The electronics industry is perfectly happy with the DG Eclipse," says consultant Anderson. "The DEC VAX is just a factor in the

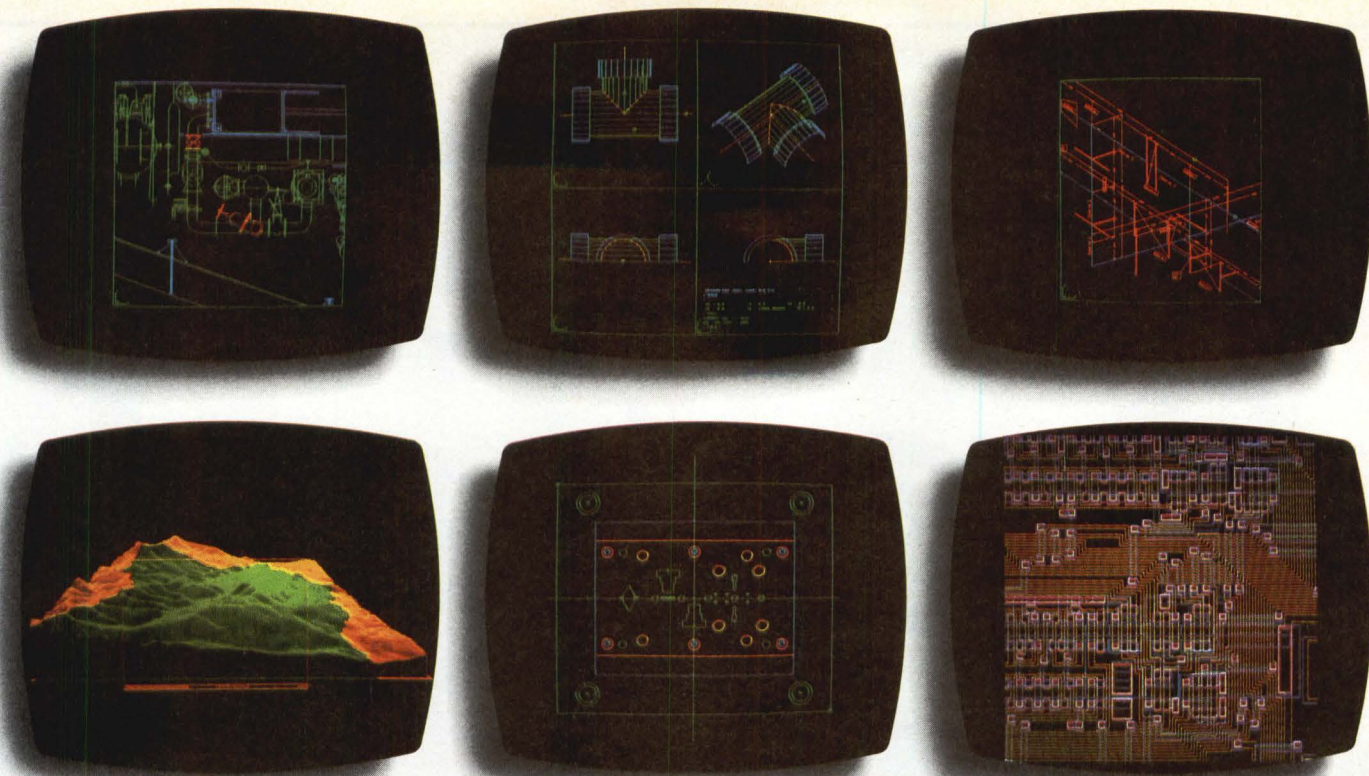

IT'S TIME TO TAKE YOUR PLOT 10 IDEAS OUT OF STORAGE.

Give your imagination the benefit of the latest graphics technology, with a D-SCAN dual-microprocessor GR-2412 raster terminal.

For example, the GR-2412's remarkably fast, remarkably accurate 4014 emulation makes it a snap to add color and selective erase to existing PLOT 10 routines.

And its high resolution 1024 x 780 raster display, with exclusive anti-aliasing hardware, means image quality that rivals a storage tube.

If your ideas grow too big for PLOT 10 to handle, you can always take advantage of the GR-2412's unsurpassed collection of standard graphics features. Like local transformations. Closed figure drawing. Up to 768K bytes of local segment memory. And a software utility package that

can replace lines of PLOT 10 code with a single FORTRAN statement.

Something else to consider while you're thinking about the future.

Our past.

D-SCAN products have been field proven for over a decade. And every one is crafted by Daini Seikosha Co., Ltd. (Seiko), known worldwide for its precision watches, robots, and computer peripherals.

For immediate information on the GR-2412, contact Seiko Instruments U.S.A., Inc., 2620 Augustine Drive, Santa Clara, California 95051.

Telephone (408) 727-0768.

Because ideas in storage don't get any better. Just older.

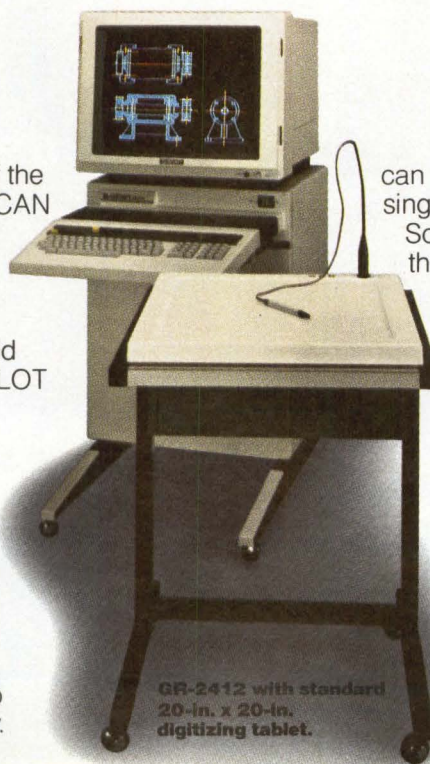

GR-2412 with standard 20-in. x 20-in. digitizing tablet.

D-SCAN
Seiko Instruments U.S.A., Inc.

CIRCLE NO. 63 ON INQUIRY CARD

The 5 $\frac{1}{4}$ " Quantum L

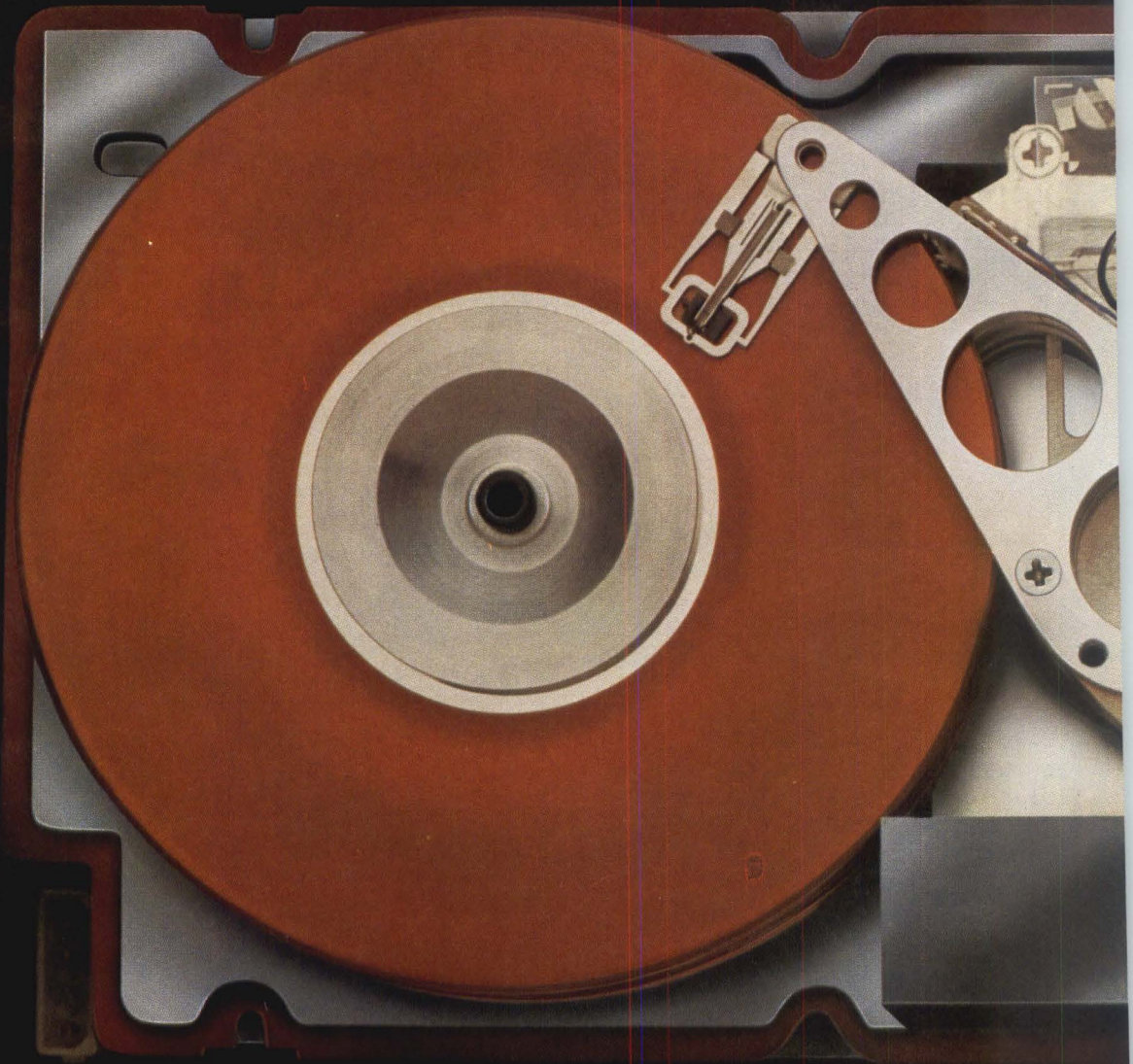

eap.

Not a totally unexpected jump.

After we designed, built, and delivered the most cost-effective and manufacturable 8" Winchester on the market, most people figured it would only be a matter of time until we came out with a 5¼" version. And they were right.

But while our Q500™ Winchesters are no giant step for us, they do put quite a bit of distance between us and the rest of the 5¼" market.

You see, we didn't have to reinvent the wheel. Just make it a little smaller. And that makes a big difference.

For example, by using the proven technology we developed for our Q2000™ 8" drives, we're able to offer our Q500 drives in 20-, 30- and 40-megabyte versions. Capacities that are extremely difficult to achieve with a stepper motor drive. But which are no trouble at all for our rotary torque actuator, optical encoder and temperature compensation servo combination.

We've also been able to build in the technical margin of our Q2000 series. And the speed of our new 85 megabyte 8" drive. At 45 ms access time, our Q500 is ideal for the multi-user applications you're thinking about.

Finally, and perhaps most important, the Q500 series can be manufactured quickly, easily and in large volume, just like the other members of our Quantum family.

Our ability to produce as promised is one of the things that helped make us the leader in the 8" market.

And it can help you, too. Especially when it comes time to fill orders.

Speaking of which, you really should find out more about our Q500 drives as soon as possible.

In fact, the sooner the better. There's a lot to be said for getting the jump on your competition.

Quantum Corporation, 1804 McCarthy Blvd., Milpitas, California 95035. Eastern Regional Sales Office: Salem, New Hampshire (603) 893-2672. Western Regional Sales Office: Santa Clara, California (408) 980-8555. International Sales Office: Milpitas, California (408) 262-1100. TWX: 910 338-2203.

QUANTUM

©1982 Q. C. Q500 and Q2000 are trademarks of Quantum Corporation.

CIRCLE NO. 64 ON INQUIRY CARD

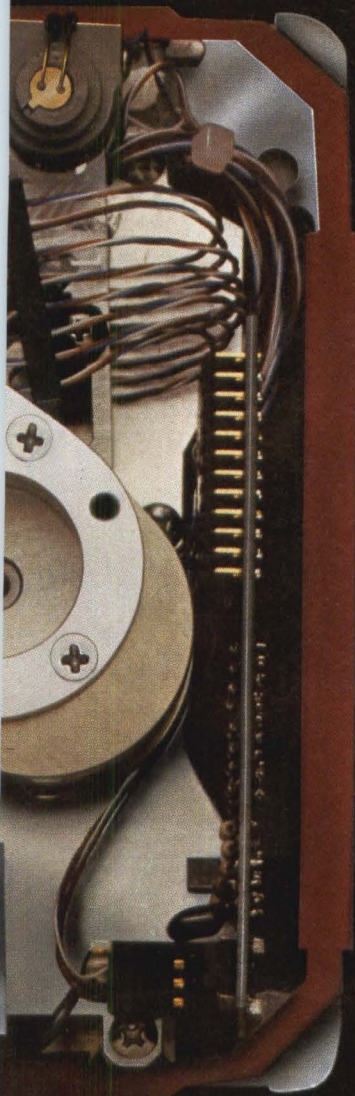

The World's Best Data Base Management System runs on more micros and minis than any other DBMS.



Computers courtesy of Computer Mart, Ann Arbor, MI.

Why not have the World's Best DBMS for your computer? Choose MDBS III.

MDBS III runs on hundreds of computers including:

- IBM Personal Computer
- DYNABYTE
- TRS-80 Model II
- APPLE II
- IMS
- ALTOS
- PDP-11
- WICAT

MDBS III is the most powerful and flexible DBMS for micros and minis.

Based on the latest innovations, MDBS III is the only DBMS—in the mainframe, mini, or micro world—that surpasses relational, hierarchical and CODASYL data structures.

MDBS III—The cost/performance leader

MDBS III can usually cut application development time by 80%. Its many developer-friendly features provide the key to rapid development of flexible, high performance applications.

High Power—Defines data structures naturally and conveniently without relational redundancies, thereby assuring data base integrity. Allows direct, named representation of many-to-many and recursive relationships.

Increased Productivity—Powerful conversational query system. Generates reports

automatically in response to simple non-procedural statements. Supports virtual tabular end-user views, without costly data redundancies.

Improved Protection—Encryption, password assignment, and read/write restrictions down to the field level. Crashed data bases may be recovered automatically without data re-entry through special transaction logging and recovery.

Extensive Portability—Applications are easily transported across hardware environments—allowing a single, uniform approach to application development.

Operating Systems and Machine Environments

CP/M, MP/M:	Z80	UNIX, XENIX, etc.:	Z8000
	8080		68000
	8085		8086
	8086		PDP-11
	8088	RSX-11M:	PDP-11
MSDOS:	8086	TURBODOS:	Z80
	8088	TRSDOS (II):	Z80
IBM PCDOS:	8088		

Developed by:

Micro Data Base Systems, one of the world's leading software R&D firms, creators of SCREEN MASTER, C' and other fine software products.

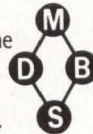

Offered by:

International Software Enterprises, an international consortium of the world's leading software and consulting firms, providing developer-friendly tools for building user-friendly applications.



To find out whether your computer runs MDBS III, contact:

In the U.S. and Canada

ISE-USA
85 West Algonquin Road, Suite 400
Arlington Heights, IL 60005
(312) 577-6800

In the United Kingdom and Ireland

ISE-PACTEL 01-828-7744

In West Germany

ISE-ADV/ORG 089-192-071 (72, 73)

In France

ISE-CEGOS 620 61 61

In Sweden

ISE-DATEMA 08 83 4020

In Norway

ISE-DATEMA 02 670880

In Finland

ISE-TIETOTEHDAS 0-5261

In Switzerland and Austria

ISE-ADV/ORG 041-2323 60/61

ELSEWHERE

ISE-INTERNATIONAL (317) 463-4561



ISE-USA, Inc.
85 West Algonquin Road, Suite 400
Arlington Heights, IL 60005

- Please have an authorized ISE-USA Sales Representative contact me.
- Send _____ set(s) of complete documentation (\$100 plus \$10 shipping and handling per set).*
- Send _____ set(s) of "How to Evaluate and Select a DBMS" (\$5 plus \$1 shipping and handling).*
- Send free brochure.

Prices subject to change without notice.

Processor _____ Operating System _____

Name _____

Title _____ Phone(_____) _____

Company _____

Address _____

City _____ State _____ Zip _____

Check enclosed VISA MasterCard

Card No. _____ Expiration Date _____

Signature _____

*Indiana Residents add 4% Sales Tax.

MDBS III, SCREEN MASTER and C' are Trademarks of Micro Data Base Systems, Inc. DYNABYTE is a Registered Trademark of DYNABYTE; APPLE II of APPLE; ALTOS of ALTOS; CP/M, MP/M of Digital Research; TRS-80, TRSDOS of Tandy; MSDOS, XENIX of Microsoft; UNIX of Western Electric; RSX-11M, PDP-11 of Digital Equipment; IBM PC, PCDOS of IBM; Z80 of Zilog; TURBODOS of Software 2000; IMS of Industrial Micro Systems.

CIRCLE NO. 65 ON INQUIRY CARD

Systems in Manufacturing



Screen shows a symbolic drawing of circuit elements used in VLSI design. The display is created by using STICKS, Calma's symbolic IC-design system.

CALMA SYSTEMS SPEED GATE-ARRAY DESIGN

A big selling point touted by gate-array semiconductor chip suppliers is that their semi-custom-designed chips reduce the time it takes customers to get IC-based products to market. Intersil, a newly acquired subsidiary of General Electric Co. and a manufacturer of CMOS gate-array ICs, claims that by designing its chips using Calma Co. CAD systems, the company can cut design and implementation time even further. "Calma provides us with quick turnaround time for customers," says Jerry Zis, a product marketing manager at Intersil. "We can complete most designs and have prototypes to customers in six to eight weeks."

John Dosio, a senior software engineer at Intersil, says circuit diagrams that once took three weeks to a month to accomplish manually now take only three days using Calma systems. Although Intersil employees

may be biased in their assessments because Intersil and Calma are sister GE subsidiaries, Dosio says that in his 20 years of experience with CAD systems supplied by Calma competitors, Calma is the leader in his opinion. "I like the GPL operating system used by Calma as well as the STICKS software package," he says. "The software can be easily tailored by a customer for his application." STICKS provides designers with the basic logic symbols such as rectangles, squares and triangles that are used in IC design.

Intersil uses eight GDS 2 Calma workstations equipped with Data General Corp. Eclipse processors. The GDS 2 is Calma's top-of-the-line system intended for IC-design applications. A VAX 11/780 computer contains the system software and the design database, and performs the routing function—the final step in

gate-array design. Logic, circuit and master designs are performed locally at the Calma workstations, and design data are then transferred to the VAX via paper tape. Dosio notes that the Calma systems will eventually be linked directly to the VAX using Calma's new networking scheme. All application software involved in the system was designed at Intersil using the STICKS package as a building block.

James Baker, executive vice president of GE's Technical System Division, the group responsible for GE's factory-automation effort, says Intersil's gate-array application software will be marketed commercially through Calma. Two of the eight Calma workstations at Intersil are dedicated to such software development.

—Frank Catalano

Systems in Manufacturing

CALMA'S VAX-BASED SYSTEM

Announced at Autofact '82, Calma's new top-of-the-line system, the 7000 series, contains software packages for mechanical and architectural engineering and construction applications. It comes in two configurations, one based on Digital Equipment Corp.'s VAX-11/750 and the other on the VAX 11/780.

Both configurations also contain DEC tape drives and DEC 300M-byte removable-pack disk drives. Both can be used with four types of workstations, all of which have resolution of 1280 × 1024 pixels. Calma manufactures two: the RC-1000 (color) and the RB-1000 (black and white). The other two, the CDS-70 (black and white) and

the CDS-80 (color) contain firmware made by Calma and hardware made by Lexidata Corp., Billerica, Mass. The VAX-11/750-based system supports as many as six workstations, and the 11/780-based system supports as many as 12, says a Calma spokesman.

mechanical engineering environment." A Calma spokesman reports that he knows of no plans to reformat electronics application software for the new 7000 series.

Another product announced by Calma at the International Machine Tool Show in September falls at the low end of its product line. The Calma 170, based on the DG Eclipse, can support two terminals and sells for about \$100,000 with one workstation and \$140,000 with two. "The 170 is an effort to get into the broader market," says Benders. "We think it's time to start coming to the smaller companies with, perhaps, only 10 engineers or architects." He sees most applications in the mechanical and architectural-engineering and construction market, but estimates the 170 will also be used in electronics, especially in PC-board applications.

Another product, introduced in late November, is Calmanet, the company's broadband communications network. A Calma official explains that Calmanet allows Calma systems to communicate with each other and to share a database. Benders says that Calmanet was developed closely with GENet, GE's communication network for the factory environment, and it is compatible with other networking products as well. "Calmanet is essentially a software protocol that allows you to use various communication systems products," says Benders.

A healthy outlook

With an expanded product line and its new focus on mechanical applications, Calma is in a strong position in the CAD/CAM market, says consultant Anderson. "Calma is going to be one of the survivors," he asserts. "I don't think there's any doubt of that." He also forecasts a bigger market share for Calma, predicting that the company will be the first- or second-ranked supplier of turnkey CAD/CAM systems by 1990.

Kurlak of Merrill Lynch also sees a brightening picture for Calma. "Calma was losing market share for

a couple of years because it had no clear focus on where it was going," he comments. He credits GE with changing the situation and points to specifics such as its hastening Calma's entry into the mechanical market, its professional style of management and its money. "Calma is gaining market share now," Kurlak adds.

In making his own forecasts, Benders says, "Our biggest problem is the IC market. It's been experiencing terrible problems." He explains, "We have a 70-percent market share in the IC market, and when they stop buying, it has a significant effect on our revenues." He predicts no recovery for the IC industry until late 1983 at the earliest.

Of the entire CAD/CAM market, Benders says, "The competition has been very tough. There's a lot of price cutting, and Computervision has put up a good fight to keep us out of the mechanical market." He claims Computervision has cut prices by as much as 50 percent, and believes its total vertical integration (Computervision makes all the components for its systems) allows it the profit margins to make such large price cuts.

Computervision's vice president and general manager of the North America division, Robert Gothie, denies his company has made such deep price cuts. "Historically, Computervision has enjoyed the highest gross margins in the CAD/CAM industry," he says. "Those margins are public facts. And you can't have them at 50-percent discounts."

However, Glen Palmer, vice president of engineering at Productivity International, a Connecticut-based consulting firm, thinks Computervision may have reason to worry about Calma's move into the mechanical market. "Calma's got an advantage over Computervision by use of vendor-supplied hardware," he says. He believes Calma is well-positioned for the future, adding, "Now that they've got the bugs out, I think Calma's going to be one of the big contenders in the marketplace." □

**In 1981,
Hewlett-Packard
announced the world's
densest single chip
32-bit CPU.**

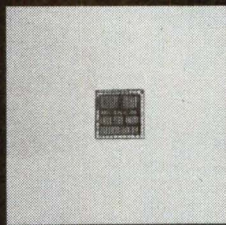

**Today, this 450,000-transistor
of the HP 9000 family that gives**

...in a \$20K box

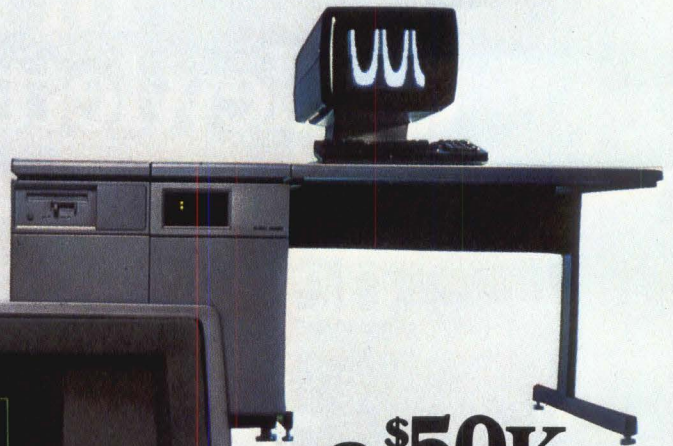

**...a \$50K
multi-user
system**



...a \$30K workstation.

computer chip is the heart you full 32-bit power...

Our tiny ¼" square CPU contains 450,000 transistors. So there's nothing small about the 32-bit power it gives our new HP 9000 family of technical computers. Even our \$20K model gives you the performance of a mainframe computer costing up to four times as much.

And now you can have all this power in a configuration that really fits your application. The densities of the CPU and surrounding 'super chips' allow you the choice of a rack-mountable box; an integrated workstation; and a mini-cabinet suitable for a variety of single and multi-user applications.

Of course, the benefits of one-micron geometry don't stop there. This new technology has also let us develop a multi-CPU architecture that offers you three levels of processing power. Each configuration described above can take one, two or three CPUs. So you can almost double or triple the computer's capacity without adding to its size. Whether you order it that way or add the extra power later, it's transparent to the user.

32-bits, every bit of it.

The HP 9000 family has 32-bit internal and external data paths, 32- and 64-bit math (IEEE floating point format), and virtual memory addressing of up to 500 Mbytes.

And it is fast! The system will handle a million instructions per second. The 18 MHz clock permits the execution of a micro-instruction every 55 nanoseconds. The I/O rate can reach 6 Mbytes per second for every I/O slot. And the memory cycle time is a lightning-quick 110 nanoseconds.

There's also lots of program space, with up to 2.5 Mbytes of main memory. A flexible disc drive and optional 10

Mbyte Winchester are built right into the integrated workstation.

Each memory board has a Memory Controller Chip that provides automatic error detection/correction, memory mapping and 'healing'. Every time you power up, this chip actually maps out single-bit memory error locations, and assigns a back-up memory location in place of the old one—without slowing the access time or reducing memory capacity.

We've also made the CPU more efficient by assigning many of its time-consuming tasks to our Input/Output Processors. And to give you even more speed, the HP 9000 has a backplane bandwidth of 36 Mbytes/second. That's enough to support all three CPUs, each backed up by its own IOP. You can imagine the effect that has on throughput!

All the benefits of a UNIX® operating system. And then some.

Our HP-UX is an enhanced version of this increasingly popular operating system. It supports FORTRAN 77, Pascal and C language. And lets you take advantage of the many programs and utilities already available for UNIX. In addition, HP-UX offers significant extensions like 3-D graphics, virtual memory, IMAGE Data Base Management, a variety of data communication products and enhanced file capability.

The integrated HP 9000 workstation also supports our highly evolved, high-performance Enhanced BASIC, augmented by 3-D graphics. Its run-time compile feature provides the friendliness and interactive capabilities of an interpreter with the speed of a compiler.

Powerful networking made easy.

Even our stand-alone models won't have to work alone. Each can be part of a network of powerful, dedicated, interactive workstations. They'll support several different networking options, including Ethernet™. And in late 1983, LANs based on the industry-standard IEEE-802. So you can share peripherals and data files locally.

With HP's broad range of peripherals and instruments to choose from, it isn't hard to build precisely the system you need. Once your HP 9000s are up and running, we can make sure they stay that way. Our service is good enough to be rated Number One in Datapro surveys for the past two years.

We've also developed two special marketing programs that could mean extra sales for you. If you're a software supplier, there's our HP PLUS program, which we designed to open new doors for you. And if you're a hardware OEM, our volume discount schedules and third-party support program make the HP 9000 even more intriguing.

To get a close look at the way our new computer has changed the 32-bit world, phone your nearest HP office listed in the White Pages. Ask a Technical Computer Specialist to give you a hands-on demonstration. Or write for complete information to Pete Hamilton, Dept. 08149, Hewlett-Packard, 3404 East Harmony Road, Fort Collins, CO 80525.

UNIX is a registered trademark of Bell Laboratories.
Ethernet is a trademark of Xerox Corporation.



**HEWLETT
PACKARD**

CIRCLE NO. 67 ON INQUIRY CARD

Perk up your Perkin-Elmer 3200 with DATARAM MEMORY

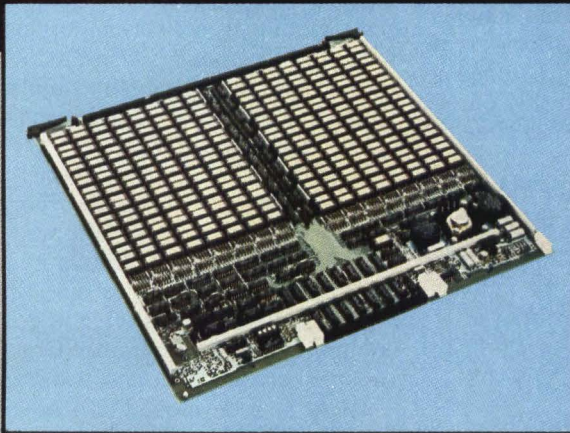

2.0MB ADD-IN

Dataram Corporation, the leader in Perkin-Elmer compatible memory, introduces two new memory products for the Perkin-Elmer 3200 — with storage capacities from 256KB to 128MB. A dramatic demonstration of our ongoing commitment to Perkin-Elmer users, these new memory products are the latest in an impressive family of products that has been meeting the memory needs of the minicomputer market since 1967.

Both feature speed, capacity, reliability, performance...and low price. Features you won't find in memory from any other Perkin-Elmer memory supplier. Products such as high-performance BULK SEMI that are available only from Dataram. All good reasons why Perkin-Elmer users should look to Dataram when they're looking to perk up their 3200 Series computers.

Dataram 2.0MB DR-330 semiconductor ADD-IN memory operates across the complete range of Perkin-Elmer 3200 Series — 3210, 3220, 3230, 3240 and 3250. Smaller capacities of 1.0MB, 512KB, and 256KB are also available and all are compatible with Perkin-Elmer memory management and ECC. Sockets are standard and a spare on-board RAM is provided. These simple-to-install, highly reliable memory boards are backed up by Dataram's standard one-year warranty.

Write or call now for more information:
Dataram Corporation,
Princeton Road, Cranbury, NJ 08512
609-799-0071

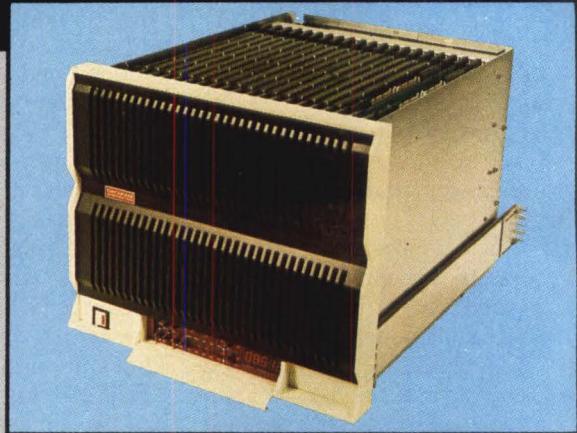

32MB BULK SEMI

Dataram's new BS-702, the industry's only high-performance BULK SEMI to interface to Perkin-Elmer's 3200 Series. With everything you need to get optimum performance from your 3200 system. Compact size — 32 MB in 15 3/4". The I/O driver required to support the BS-702. And the impressive capability to drive up to four 32MB chassis...for a whopping capacity of 128MB!

Solid-state speed enables the BULK SEMI to run at the full SELCH rate of 4.0MB/sec. More than that, solid-state technology means high reliability, further enhanced by standard Dataram features like error correcting and off-line test capability.

And when you talk about capability, you'll talk about the BS-702's unique dual-port operation that allows you to bring your image processing, array processing, or data acquisition input in on one port and off-load to your 3200 on the other.

CIRCLE NO. 68 ON INQUIRY CARD

**DATARAM
CORPORATION**

Systems in Manufacturing

Two products link HP computers to factory-floor operations

By Frank Catalano and Dwight B. Davis

As part of its drive into the factory-automation market, Hewlett-Packard Co. is starting to take orders this month for a process monitoring and control (PMC) system, as well as an interface that links HP hardware to networks of Allen-Bradley Co. programmable controllers. The PMC/1000 software package and the Programmable Controller Link/1000-AB interface each run on HP 1000 series computers.

Both products are equipped with what Jim Olsen, applications manager at HP, terms "generic software" that gives end users and system integrators building blocks upon which to structure higher level application packages.

The systems are among the first products offered by HP as part of the company's Manufacturing Planning Network strategy of providing linked computer solutions in the industrial areas of administrative and office services, operational planning and control, computer-aided engineering and factory and plant automation.

By providing its HP 1000 computers with generic software, HP hopes to tap what Olsen calls a "wide-open" market for factory-oriented application software. "There's a lot of money to be made in software and services," he says, "so we're setting up separate software groups within our organization specifically dedicated to factory applications."

John Myers, president of Tech Tran Corp., a Naperville, Ill., market research and consulting firm that specializes in factory automation, says the move by computer vendors such as HP to provide systems with software runs parallel to such vendors' strategies in the office-automation market. "Some of the most successful business-application software on the market has come from hardware-oriented vendors like HP or Digital Equipment Corp.," says Myers. "That only makes sense because such vendors know their computer systems, their operating systems and their computing capabilities. Now, with all the interest in factory systems, we're starting to see DEC and HP come out with factory-oriented application packages."

Olsen notes, however, that by providing software with its systems, the company will not be competing with system integrators specializing in narrow factory applications. Instead, says Olsen, HP will be helping those vendors. "Our application software is not tailored to any specific application, but covers a broad range of

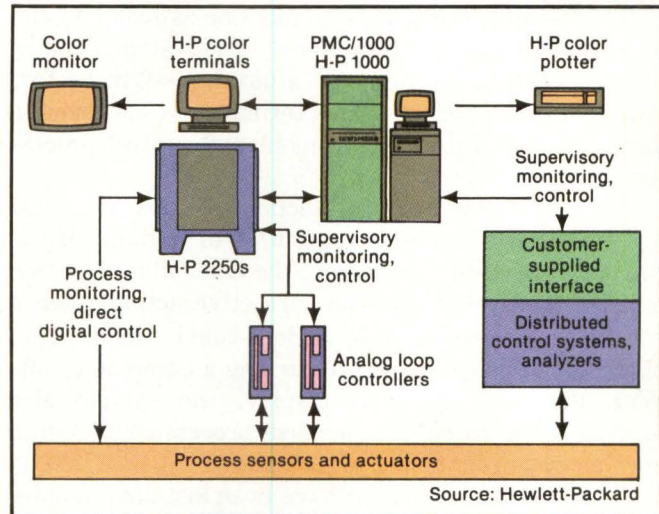

HP's PMC/1000 system can directly control and monitor process sensors and actuators on a factory floor through the 2250 measurement and control processor or can perform supervisory monitoring and control of a distributed-control system through a customer-supplied interface. That interface could range from a standard RS232 port to a more sophisticated parallel interface.

industries," says Olsen. "We recognize that every manufacturer has a different application from the next one and that our software will have to be tailored for those different applications. That's where system integrators come in. We want to help them, as well as end-users, start with something rather than build the software from scratch." Olsen adds that, later, HP will tap its own factory experience and start offering more application-specific packages aimed at discrete manufacturers.

Process monitoring and control

The new PMC package, which runs on the HP 1000 F-series minicomputer, is intended primarily for small-to medium-scale continuous-process and discrete-manufacturing environments. Olsen describes the target processes as those that involve 200 to 300 control points such as temperature and pressure.

With a base price of \$130,000, the PMC/1000 system includes the HP 1000 16-bit computer with the RTE 6/VM real-time operating system and 1M byte of memory, an HP color graphics terminal, a dot-matrix printer, a Winchester disk drive with 28M bytes of storage and an HP 2250 measurement and control processor. The HP 2250 provides a direct link between the PMC/1000

Systems in Manufacturing

system and process sensors and actuators on the factory floor. Besides the process control and monitoring software, the package also includes color graphics software (see diagram, p. 125).

A high-end system, able to monitor as many as 500 process points, sells for \$280,000. That system includes another 1M byte of memory, a 65M-byte Winchester, two additional color graphics terminals, a line printer and additional 2250 measurement and control processors.

While the monitoring function of the PMC/1000 system consists of alerting operators to malfunctions or breakdowns within processes, the controlling function enables the system to take corrective action when a breakdown occurs. Such action could range from opening or closing a valve to turning a pump on or off. With the color graphics display, the system also enables users to log and analyze process-control data such as cycle counts and error rates.

Three PMC/1000 systems have been installed to date. One monitors and controls an ore-crushing and -separation operation at an Australian mining firm, a second manages a film-coating process for a Belgian photographic filmmaker, and a third manages a wastewater treatment operation at HP's Sunnyvale, Calif., PC-board facility. Olsen says HP's in-house installation cut a year from the time it took to get the Sunnyvale facility up and running and is saving the company an average of \$100,000 a year through proper wastewater treatment.

"Our primary market thrust with the PMC/1000 will be to discrete manufacturers, like ourselves, who have embedded processes, such as wastewater treatment or furnace control, which are part of their overall manufacturing operation," he says. "Most discrete manufacturers don't have the budget to purchase a complete turnkey process-control system from a process-control vendor, nor do they have the engineering resources to develop a complete system themselves. Our customers are telling us that they want something in between. We feel the PMC/1000 fills that gap."

Programmable controller link

HP's second new product, the PCL/1000-AB, serves as a hardware and protocol interface between HP 1000 computers and Allen-Bradley's Data Highway networks of programmable controllers. A single HP 1000 computer can support three interfaces, which can each control eight Data Highways. Because as many as 32 programmable controllers can reside on each Data Highway, a single computer can theoretically supervise 1512 controllers, but CPU response time would suffer at the upper limits of this range.

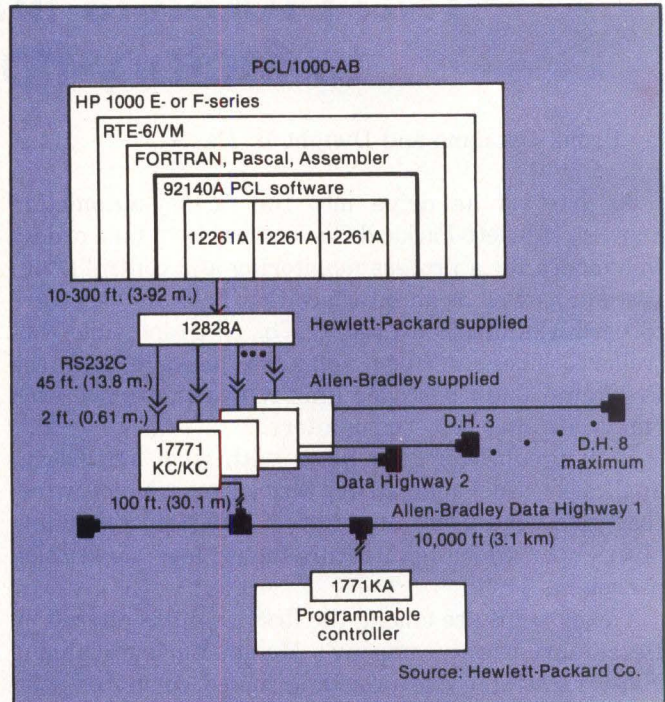

Hewlett-Packard's PCL/1000-AB interfaces HP 1000 computers to Allen-Bradley's Data Highway networks of programmable controllers. Elements in the diagram specific to the interface are the 92140A PCL software, the 12261A eight-channel multiplexer interface cards (as many as three per computer) and the 12828A multiplexer panel. The permissible cable lengths between the components are indicated.

Although HP was the sole developer of PCL/1000-AB, Allen-Bradley, Highland Heights, Ohio, did cooperate with the HP program. "We were very supportive of the HP effort," says Al Fink, Allen Bradley product manager, "and we provided technical capability, test equipment and some of our software for evaluation purposes."

HP is the first computer vendor to develop an interface between its own computers and the Data Highways independently. Until now, the only option Data Highway users had for adding supervisory computers to the network were DEC PDP-11 minicomputers, connected to the networks through an Allen-Bradley-supplied interface.

The PCL/1000-AB link consists of three main elements—an HP 92140A software package, an HP 12261A multiplexer interface card and an HP 12828A multiplexer panel. These connect to an Allen-Bradley 1771-KC/KD communications controller interface (see diagram, above). The Z80-based HP 12261 interface card performs buffering, retries, checksums and protocol specifics.

"With the PCL/1000-AB and the database-management and networking capabilities of an HP 1000



**WORLD'S SMALLEST
1/2" TAPE BACK-UP OFFERS
REEL ALTERNATIVE
TO THE
1/4" CARTRIDGE**

9800



Providing low cost back-up for Winchester drives the miniature 2-speed EMISTREAMER 9800 is as easy to use as a cartridge, offers proven reliability and universal interchange.

The 9800 fits within a twin 8" floppy enclosure and automatically loads the standard, multisourced 7" reel of 1/2" wide computer tape. The unformatted capacity is 15 Mbytes at 1600 bpi, PE, optional 30 Mbytes at 3200 bpi. With full IBM/ANSI format compatibility the world's smallest standard 1/2" tape drive with Industry standard interface is the REEL alternative you have been looking for.

Also in the EMISTREAMER range are the autoloading 9900 with total capacity of over 60 Mbytes (120 Mbytes optional) and the high performance 8900. These low cost streamers provide reliable data interchange between the smallest micro and the largest mainframe. Contact us now for full details.

9800 is designed for high reliability — practical features include:

- Short tape path ■ Autoload ■ PCB access from the top
- Three levels of diagnostics ■ Alphanumeric display



**THORN EMI
Datatech**

THORN EMI Technology Inc 8601 Dunwoody Place Suite 301
Atlanta GA 30338 tel: (404) 587 0017 telex 810766 2267

In Europe contact:

THORN EMI Datatech Ltd Data Products Division Spur Road
Feltham Middlesex TW14 0TD England tel 01-890 1477 telex 23995

THORN EMI companies

EMISTREAMERS FOR BACK-UP PLUS UNIVERSAL DATA INTERCHANGE

CIRCLE NO. 69 ON INQUIRY CARD

Systems in Manufacturing

computer, a manufacturer can get both immediate status reports and historical trend information showing exactly what's happening on the factory floor at any time," Olsen says. He admits, however, that the interface is just a foundation upon which to build higher level supervisory and monitoring software. Such application-specific packages must be provided by a user or by a third-party system integrator. On the programmable controller side, Fink points out, certain Allen-Bradley PCs already provide some support for higher level software, for example, by offering sophisticated report-generation capabilities.

Permitting full-duplex, 9600-bit-per-sec. operation, the PCL/1000-AB lets FORTRAN-77, Pascal/1000 or Macro Assembler programs monitor PC status, download commands and programs and send information to and from any Data Highway device. A user interface isolates the PCL/1000-AB from the computer's RTE 6/VM operating system and automatically handles error conditions.

HP plans to offer interfaces between its computers and other manufacturers' programmable controller

networks, Olsen says, and the company will probably announce three such links within a year. While Olsen won't comment on which vendor's PCs HP has targeted for interfaces, likely candidates include Gould Inc., General Electric Co. and Texas Instruments Inc.

A single PCL/1000-AB—including software for as many as three interfaces, an interface card, a multiplexer panel and cabling for connection to an Allen-Bradley 1771-KC/KD communications controller—carries a U.S. list price of \$7200. Quantity discounts are available. □

NEXT MONTH IN MMS

The February issue of Mini-Micro Systems will feature disk drives. Topics covered will include small and large Winchester systems and floppy-disk drives and how technology and market forces are affecting them. Some Highlights:

- * Multiple-megabyte Winchester disk drives.
- * A profile of the floppy-disk drive market.
- * A profile of the small Winchester system market.
- * Thin-film technology and its implications.
- * Large disk drives.



Single Board Computer

6 MHz Z80

DSB-4/6 is Fast, Powerful and Compact

- 4 MHz Z80-A* or 6 MHz Z80-B* Processor and I/O
- Full DMA for Both 5¼-inch and 8-inch Disk Drives
- High Speed Bi-directional Parallel Port
- 4 RS-232 Serial Ports (110-38,400 baud)
- Centronics Type Parallel Printer Port
- 64K of RAM and 2K of ROM

Davidge Corporation
1951 Colony Street, Suite X
Mountain View, CA 94043
(415) 964-9497

* Z80 is a registered trademark of Zilog

MAGNETIC STORAGE PERIPHERAL EQUIPMENT (MSPE) MARKET IN EUROPE

Frost & Sullivan has completed a two-volume 387-page report on the MAGNETIC STORAGE PERIPHERAL EQUIPMENT MARKET. Analyses and sales forecasts in dollars, numbers of units and average unit prices are provided for each category of magnetic storage peripheral device: conventional half-inch wide Magnetic Tape, Cartridge and Cassette Tape; Diskette drives; a variety of Rigid Disc storage equipment comprising Fixed Drives, Exchangeable Disc Pack Units, Cartridge Discs, also Head-per-Track Drums/Discs and their Electronic Memory successors; Mass Storage Systems.

Price: \$1,550. Send your check or we will bill you. For free descriptive literature, plus a detailed Table of Contents, contact:



FROST & SULLIVAN
106 Fulton Street
New York, New York 10038
(212) 233-1080

The CONCEPT AVT

Because VT100 users deserve more than just VT100 compatibility.

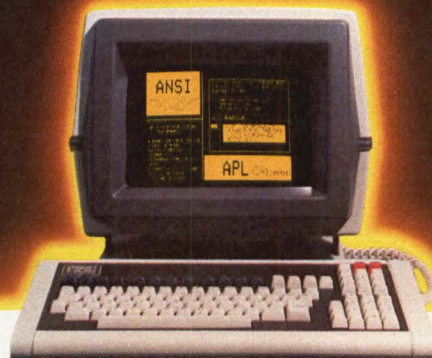

THE CONCEPT DISPLAY TERMINAL

VT100 compatibility is one thing, but eight pages of memory, programmable function keys, windowing, multiple computer capabilities, ANSI standard conformance...and VT100 compatibility is something else. Only from Human Designed Systems.

A good news/great news story from Human Designed Systems.

First the good news. The *concept* AVT display terminal gives you everything you need in an 80/132-column ANSI/VT100-compatible display terminal. And at a very competitive price.

Now the great news. The *concept* AVT display terminal provides an exciting, new set of capabilities that lets you do much more. Without changing the price.

It starts with ANSI standard conformance, DEC software compatibility, and 80/132-column capability, and extends that even further by offering eight pages of display memory to relieve the interactive user of the need to generate unnecessary hardcopy printouts and to provide the application developer with a powerful tool for applications requiring multiple formats and storage of large volumes of text; by enabling users to permanently configure a terminal for their needs or applications; by providing

functionality designed to improve the effectiveness of slow-speed applications; by enabling users to create true windows within display memory; by providing programmable function keys which transmit data and/or execute terminal commands; by providing up to three additional communications ports for connection to other peripherals and computers; by providing flexible user networking functionality for use in a wide range of different applications, including multiple computer connections; and by doing much more.

VT100 compatibility and ANSI standard conformance. Add it to the *concept* display terminal's 132-column performance, in ASCII or APL/ASCII models, with multiple computer capabilities, windowing, programmable function keys, multiple pages of memory, and much more, and you can see why Human Designed Systems has given terminals a new meaning...and that means true economy.

human designed systems, inc.

3440 Market Street, Philadelphia, PA 19104
215-382-5000

DEC and VT are registered trademarks of Digital Equipment Corporation.

Human Designed Systems. We're redefining terminal performance.

Boston — (617) 329-3510; Chicago — (312) 825-2960; Dallas — (214) 696-8031; Delaware — Infocon: (302) 239-2942; Hawaii — Gray Associates: (808) 261-3751; Los Angeles — (213) 410-9454; Northern New Jersey — Infocon: (201) 624-1372; New York City Area — Infocon: (212) 689-8833; New York State — Naco Electronics: Rochester: (716) 223-4490, Syracuse: (315) 699-2651; San Francisco — (415) 692-4184; Washington, DC — International Systems Marketing: (301) 279-5775; Australia — I. O. Peripherals Pty. Limited: (02) 427 3555; Belgium — BELCOMP: 091/25 22 88; Canada — CAIL Systems: Toronto: (416) 362-1063; Denmark — ADCOM Data Aps: 1-19 44 66; Finland — Modulsystem OY: 0-6926511; France — Walton: (1) 226 06 90; Singapore — DTS Singapore: (65) 33-88-566; Sweden — Allnovo Data AB: 08-37 25 15; Switzerland — Mitek ag: 02/461 22 52; United Kingdom — Shandell Systems Ltd.: 02407-2027; West Germany — COMKO Computersystemges, mbH: 0221-48 30 51.

DISTRIBUTORSHIP INQUIRIES INVITED.
CIRCLE NO. 71 ON INQUIRY CARD

THE PRINTSTATION 350. ITS BEAUTY IS MORE THAN SKIN DEEP.

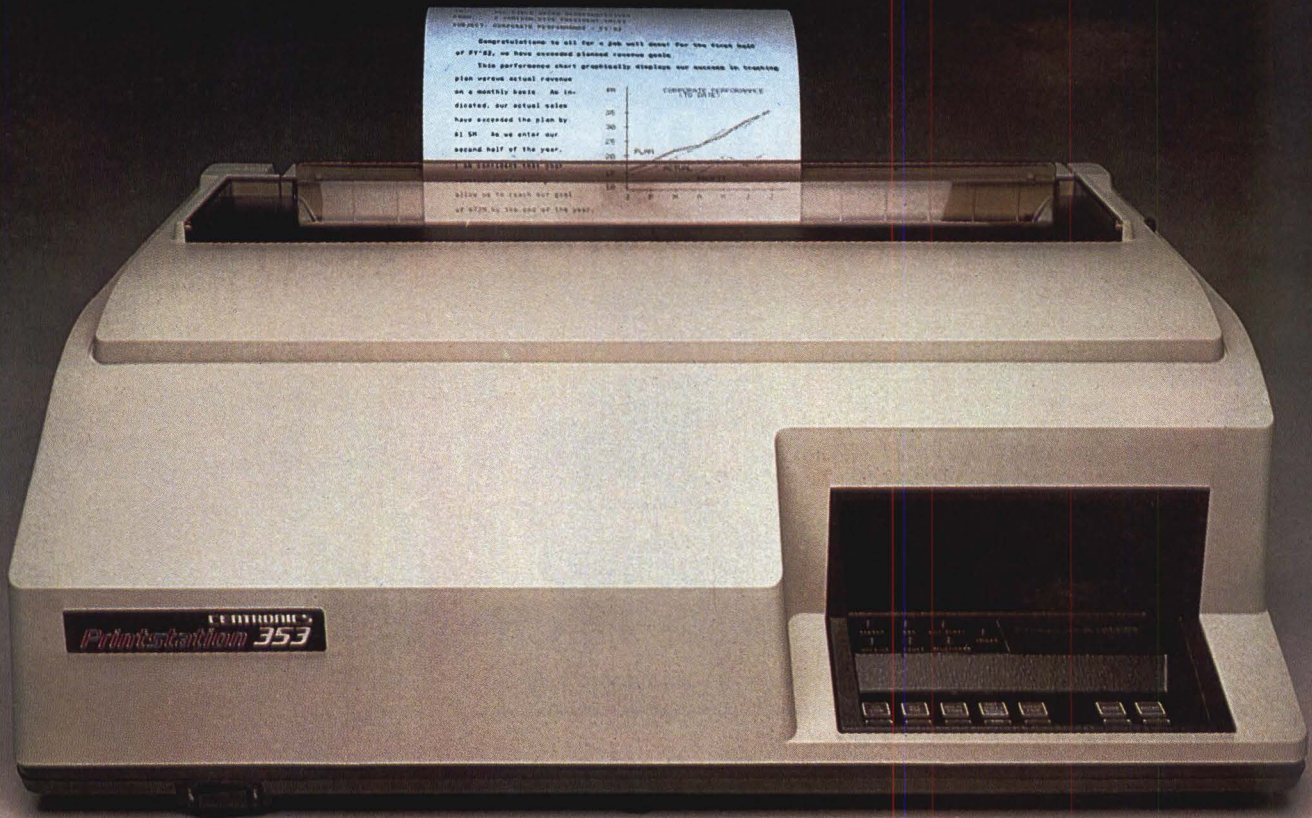

THE MULTIFUNCTION PRINTER WITH UNMATCHED PAPER HANDLING CAPABILITY.

If all you look at is the handsome, office-styled cover you'll miss the real beauty of its functionality, its revolutionary paper handling design and its list of standard features that even competitors' "options" lists can't match.



Centronics' new Printstation 350 is truly the "one-printer solution to the complete range of data processing, business processing, and word processing printing needs".

SEMI-AUTOMATIC PAPER HANDLING... FAN-FOLD, MULTI-PART FORMS, AND CUT SHEET loaded instantly and switched rapidly. In fact the Printstation 350 can be loaded with cut sheets faster and easier than a typewriter.

LETTER QUALITY PRINTING, a word processor's dream... using multipass

technique for high resolution, high density characters.

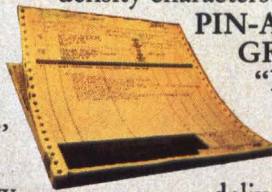

PIN-ADDRESSABLE GRAPHICS PLUS "NO-WASTE" DEMAND DOCUMENT REMOVAL

deliver true business processing capabilities.

HIGH SPEED "DRAFT" MODE with standard 200 CPS bi-directional logic-seeking feature for data processing operation.

ECONOMY-MINDED, OPERATOR-ORIENTED SERVICE FEATURES.

Self-diagnostics are standard. So is the operator-replaceable printhead and the truly "clean hands" snap-in ribbon cartridge.



FAMOUS CENTRONICS BACK-UP. 12 years and 400,000 printers-worth of experience

CIRCLE NO. 72 ON INQUIRY CARD

backed up with a world-wide network of factory service locations.

So don't judge a printer by its cover especially when it's one of the Printstation 350

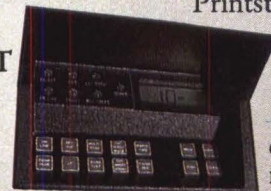

family. Because underneath there's a unique collection of capabilities, mechanical architecture, and

electronics that provide a level of versatility we call PRINTSTATION PROCESSING. But if beauty is in the eye of the beholder, you should behold the Printstation 350 in operation. For more information or a demonstration, contact your local distributor.

**CENTRONICS®
PRINTSTATIONS**

Centronics Data Computer Corp.,
Hudson, New Hampshire 03051
603-883-0111

Market overview: minicomputer line printers

PATRICK KENEALY, Associate Editor

*Non-impact printers come off the drawing boards
to threaten today's dominant technologies*

Users of general-purpose minicomputers and small-business systems have always relied on line-printer technology they "inherited" from their supercomputer and mainframe brethren. While this has brought them ever faster, cheaper and more reliable impact printers, they've been waiting for non-impact units designed and priced with them in mind. The structure of the line-printer industry and the high cost of both impact and non-impact printer design and manufacturing have made their wait long, but a number of 1982 developments indicate that the wait should be over this year.

A stable industry

Four kinds of vendors still control the line-printer industry: data-processing-system manufacturers, plug-compatible manufacturers, printer integrators and leasing companies. The computer and minicomputer systems manufacturers such as IBM Corp. and Digital Equipment Corp. make and sell printers to their captive customers. The system manufacturers sell more dollars worth of printers than any other kind of vendor. Independent printer manufacturers such as Data Printer Corp. and Dataproducts Corp. operate as OEMs and sell their printers to other vendors that, in turn, resell to end users under their own labels. Independents sometimes function as plug-compatible manufacturers and sell directly to end users. Printer integrators such as Digital Associates Corp. and Southern Systems, Inc., buy OEM printers and add software, interfacing, packaging and marketing expertise before selling them to end users, often with maintenance support (Fig. 1). The last group of line-printer vendors is the third-party leasing companies that buy printers for lease or resale with little, if any, value added.

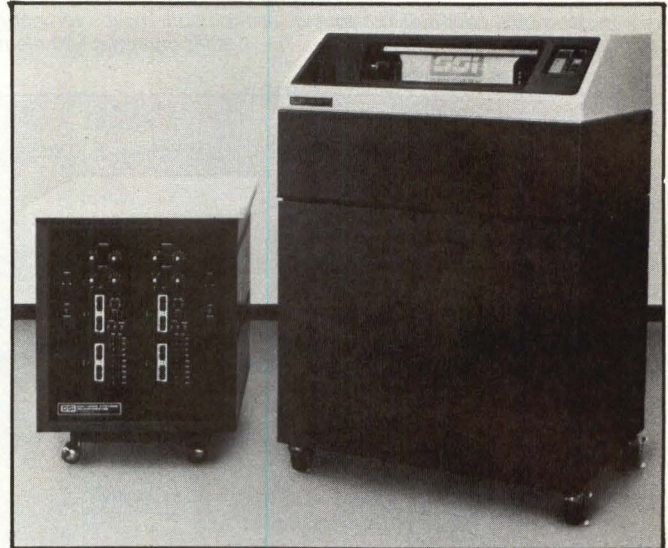

Fig. 1. An IBM 3203-5 printer replacement system from Southern Systems, Inc. By combining its 32/5 controller with a 1130-lpm OEM band printer from Control Data Corp., Southern Systems can offer a less-than-\$20,000 printer system—less than half the price of its plug-compatible IBM counterpart. Southern Systems and its competitors also offer replacement printers for DEC, DG, HP, Burroughs Corp. and Texas Instruments, Inc.

Line printers can still be divided into three basic speed ranges, but the advent of super-fast non-impact units has broadened the ranges. Low-speed line printers are the first step above fast serial printers and print from 125 to 500 or so lines per min. They can sell for well under \$10,000 and use matrix and other impact printing methods. Medium-speed line printers print between 600 and 1500 lpm and use traditional electro-mechanical belt, band, chain and train mechanisms. They sell to end users from \$10,000 to \$70,000 and are the most popular minicomputer line printers. High-

speed line (or page) printers use non-impact laser, magnetic, thermal, electrostatic and ion-deposition technologies to print 4000 to 45,000 lpm (70 to more than 700 pages per min.). High-speed line printer prices have recently fallen below \$100,000, but most

units still are priced between \$150,000 and \$350,000.

Line-printer applications have changed very little. Superminicomputer systems have the power to generate as much output as older mainframes and are usually equipped with medium- to high-speed line printers. Multi-user traditional minicomputers used for general-purpose, business and educational applications are still the biggest users of medium-speed line printers. The new 16- and 16-/32-bit, multi-user microcomputer systems are voracious consumers of low-speed line

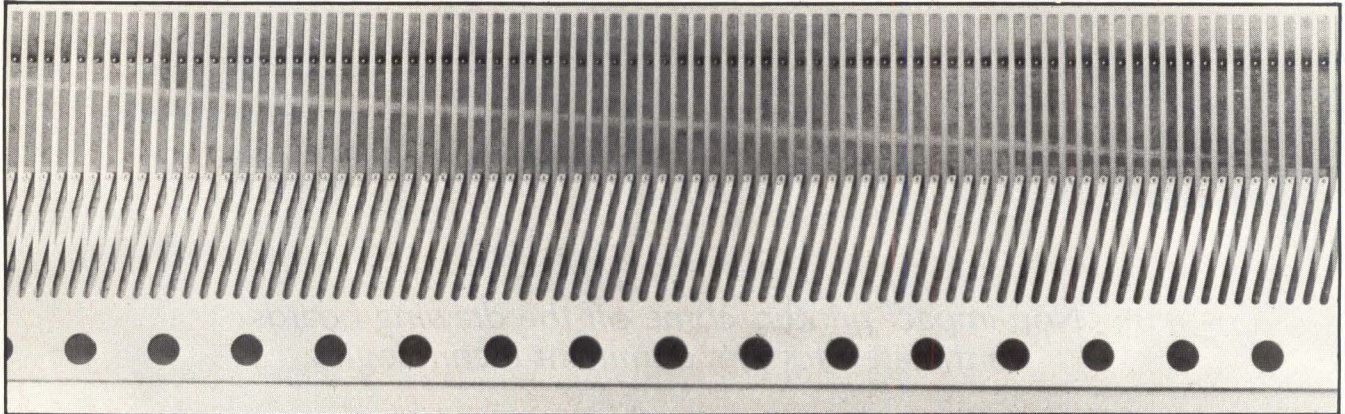
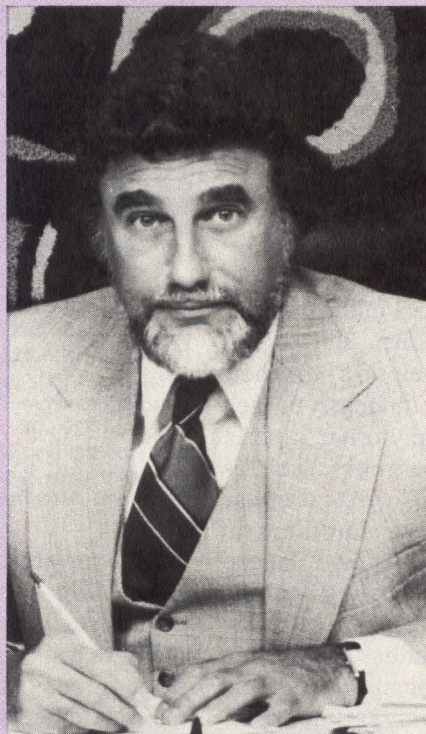

Fig. 2. A print comb from a Mannesmann Tally Corp. T-3000 impact matrix line printer (above) features 132 hammers, one for each column of output. The comb oscillates horizontally as the paper moves vertically, yielding 7 × 7, 7 × 9, 7 × 11, 7 × 13 or 7 × 16 dot characters in any of 10 standard and optional languages. The T-3000 can print 600 element character sets at a true 300 lpm.

WHAT ARE END USERS BUYING?

Digital Associates Corp. is a value-added supplier of line-printer systems, primarily to the minicomputer-based end-user community. The Stamford, Conn., company was the first to develop a plug-compatible line-printer system for minicomputer applications in 1971, and has grown to be the largest organization of its type in the industry. Its product line encompasses 27 models in band, chain train, belt, drum and matrix technologies as well as a complete line of printer controllers/interfaces and communications interfaces for a broad range of CPUs. All of the company's products are supported by a nationwide, centrally dispatched service network.

"As a major printer supplier in the end-user marketplace, we have noticed some interesting trends in configuration requirements," says company founder and president Thomas Loucas. "Speed requirements are on the increase; the driving force behind this phenomenon seems to be the growth in the superminicomputer marketplace. Bands have replaced the venerable drum as the predominant printing technology pur-



Thomas Loucas, Digital Associates Corp. president, comments on trends in configuration requirements.

chased by today's users. The reasons for this are lower price, better print quality, ease of print-font changes and built-in user friendliness.

"The increasing popularity of the band printer has also reduced the average printer system sale. Two years ago, it was a bit over \$12,000; this year, it's pegged at approximately \$11,000. Nearly all band printers manufactured today incorporate diagnostic, LED status displays to aid operator convenience and ease of maintenance. Requirements for vertical format control have also changed in the past few years. Forms length selector switches and/or direct access vertical format units are requested on nearly all of our printers. The paper-tape VFU is no longer a popular item. One thing that seems to remain constant is character-set requirements. The large majority of our printers are still shipped with 64-character, upper-case sets. However, some of our band printer customers are ordering an extra 96-character upper-/lower-case band after purchasing their printers with a 64-character band."

printers and have the software and processing power to drive medium-speed units.

The stability of line printer distribution channels, performance ranges and applications has not affected the slow but steady pace of technical innovation in line-printer design and manufacturing. Low-speed units are becoming faster, medium-speed units are becoming more reliable, and high-speed units are becoming more affordable. Fine tuning of impact technologies has been matched by basic research in non-impact technologies. Non-impact page printers have proven their reliability in mainframe applications, and minicomputer users covet their multiple speeds and forms and font flexibility. The technologies available this year will not radically differ from last year's, but the market shares they hold should change noticeably during 1983.

Impact technologies

The biggest impact line-printer news of 1982 was a discontinuation rather than an announcement. In September, having sold more than 75,000 units, Dataproducts announced it would no longer accept orders for its 2200 series drum line printers. Drum printers had topped 1200 lpm, but their drums were expensive and difficult to change, and their hammer

assemblies needed frequent adjusting. Dataproducts had been selling both drum and band line printers for the past few years, and its decision to drop drum units is testimony to the technical and marketing superiority of band technologies.

Chain and train line printers such as those made by IBM and Data Printer are the fastest impact line printers, reaching speeds of 1500 to 3000 lpm. They are expensive, and their character sets are hard to change, but they are reliable and print multiple copies with high-quality print.

Impact matrix line printers offer multiple fonts, bar codes, graphics and multi-copy capability at various resolutions. Printronix, Inc., Hewlett-Packard Co., Tally, Okidata Corp. and IBM offer units priced between \$3000 and \$10,000 that print from 125 to 600 lpm (Fig. 2). A number of 200- to 500-character-per-sec. bidirectional impact *serial* printer technologies compete in low-speed line-printer markets. Matrix printer resolution (typically 9×7 dots per character) is inversely proportional to speed, and both are inversely proportional to price. Many matrix line printers feature fast printing of draft-quality characters and slower printing of near-letter-quality characters, but fast printing of high-resolution characters is still beyond matrix technology. In the long and short runs, matrix

What line printer buyers purchase
(Characteristics of machines)

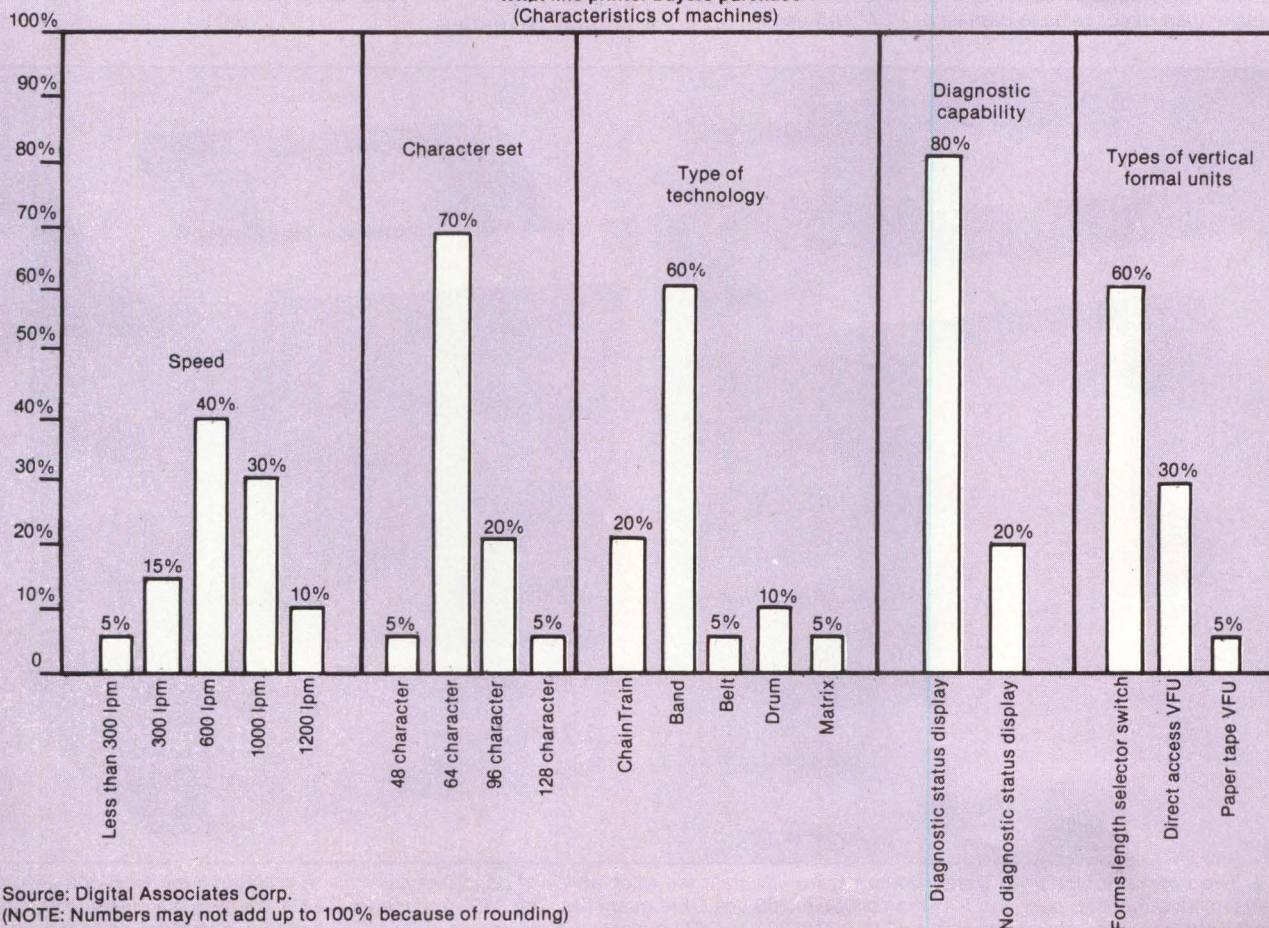

Source: Digital Associates Corp.
(NOTE: Numbers may not add up to 100% because of rounding)

line printers will be very popular in single-printer systems in which cost and flexibility are the most important printer attributes.

Band printers are the darlings of the impact line-

1981 IMPACT LINE PRINTER MARKET BY TECHNOLOGY AND DISTRIBUTION		
Fully formed characters		
Captive:	OEM/distributor:	End user:
\$1050 million (EU)	\$690 million (EU)	\$60 million (EU)
35,000 units	60,000 units	1000 units
8% unit growth	20% unit growth	15% unit growth
Dot matrix		
Captive:	OEM/distributor:	
\$24 million (EU)	\$184 million (EU)	
2,000 units	23,000 units	
20% unit growth	20% unit growth	
Source: Datek Information Services, Inc.		

Impact line-printer shipments topped \$2 billion and 121,000 units in 1981, according to Datek Information Services, Inc., a Newtonville, Mass., printer research and publishing company. The tables above are Datek's breakdowns of worldwide line-printer shipments by U.S.-based companies and foreign companies with a significant U.S. presence in printers. Dollar values are all expressed as end-user values for ease of comparison between distribution channels. Line-printer sales through OEMs and distributors are expected to grow faster than direct sales to captive or PCM end users.

printer market (Fig. 3). They are mechanically simpler and hence less expensive and more reliable than chain and train printers. They use inexpensive, easily changed print bands along with proven inking and paper-handling mechanisms. It's not surprising they've forced drum printers off the market and are outselling chain and train printers that run in their speed ranges.

Eight companies now manufacture band printers, and every major minicomputer-system vendor offers one or more band printers. Most band printers have end-user prices between \$5000 and \$20,000 and print between 300 and 1500 lpm. Control Data Corp., Dataproducts, General Electric Co., Data Printer, Centronics Data Computer Corp. and Teletype Corp. all offer band or similar belt-type units. Because of their speed and flexibility, one band printer can often replace several other types of printer.

Non-impact technologies

Demand for increased speed, low noise levels and character-set versatility has inspired a dozen vendors to develop electro-optical, thermal, electrostatic, ink-jet, magnetic and ion-deposition technologies (MMS, January, 1982, p. 157). Frost & Sullivan estimates that non-impact line printers will increase their share of the total number of computer printers sold from today's 1 percent to roughly 4 percent in 1985, when, they predict, non-impact line printers will be printing 454 billion pages per year and generating \$7.2 billion in annual revenues.



Fig. 3. Two band printers from Dataproducts Corp. illustrate the adaptability of band mechanisms. The 300-lpm model B-300 (left) is a pedestal-mounted printer priced at less than \$4000 in 100-unit OEM quantities. The 1500-lpm model B-1500 (right) is a floor-standing model with a 60-dBa acoustic cabinet that sells for \$11,300 in 50-unit OEM quantities. Both printers print 132-column, six-part forms and are available with 12-channel tape-controlled or direct-access vertical forms units. More than 250 bands in 50 font styles are available for B series printers.



*For different needs,
different speeds.*

*Word processing at 80 lpm.
Data processing at 150 lpm.
Compressed print at 200 lpm.
All pushbutton selectable
on the versatile MVP Matrix
Line Printer.*

*Different speeds for different
needs, too. High resolution graphics
at 4 ipm. Or high-speed graphics
at 14 ipm. With the MVP, you can
create high quality, multi-part
forms, logos, business graphics,
labels and bar codes right on the spot.
All of this versatility with breakthrough*

*price/performance.
And unlike low
cost serial and
character printers,
the rugged MVP
is designed for
continuous duty.
Printronix line
printers. Quality
that creates lasting
impressions. For your
nearest distributor,
call today.*

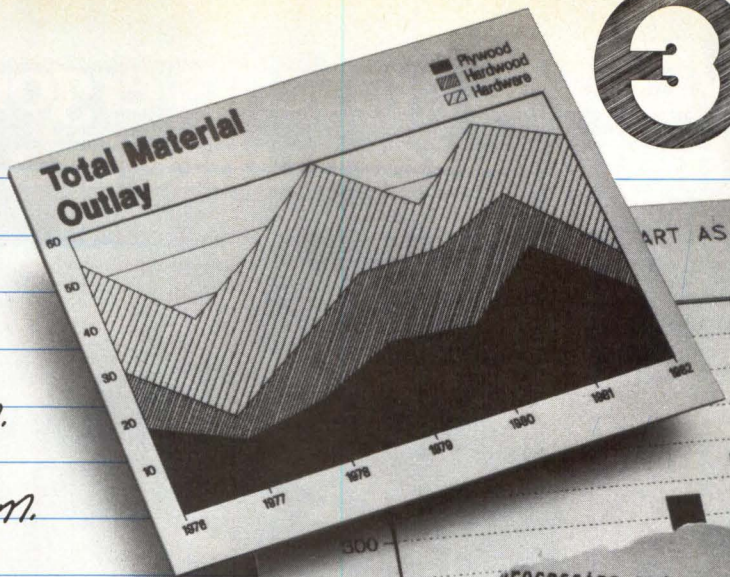

...processing and compressed
n-speed plotting, the MVP is
-application environments.
nts an exciting range of

100
200
300

choose dot density and reso-
appropriate for each applica-
to produce just the output you
-part forms print quality you
s.) I'm also more than a match
lications, such as business
labels, plotting, and block
font selection.

...ed to serial. Why is that
e printer is designed and
neration. That means
ous serial printer.

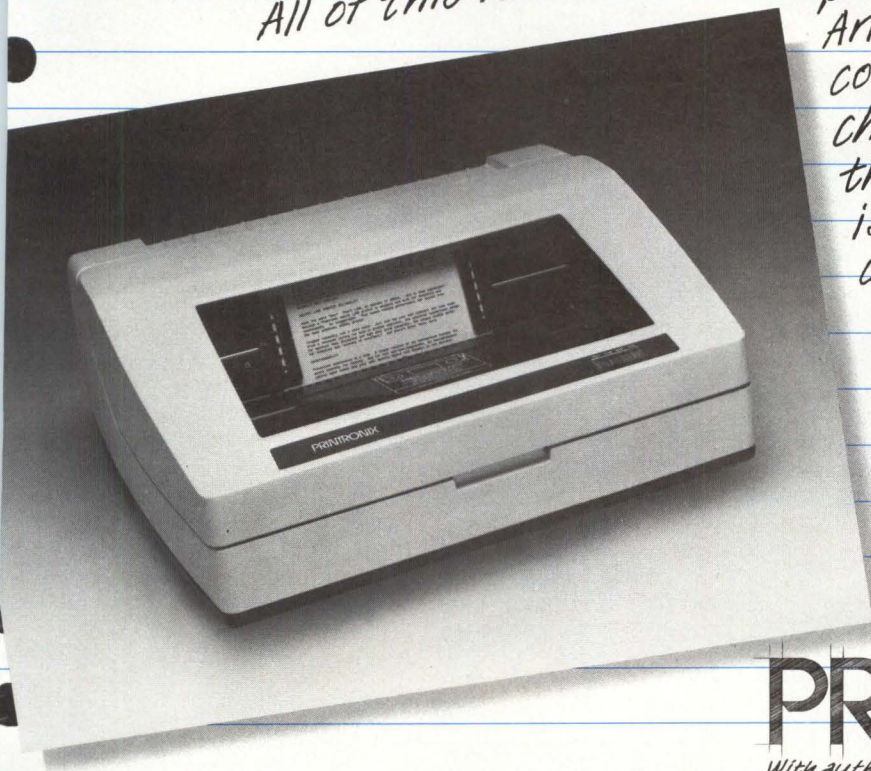

Graphics shown courtesy of ISSCO.

PRINTRONIX

*With authorized distributors worldwide.
17500 Cartwright Rd., P.O. Box 19559, Irvine, CA 92713
Phone: (714) 549-1700 TWX: 910-595-2535*

VISUAL presents ergonomic elegance and high performance in a low-cost terminal.

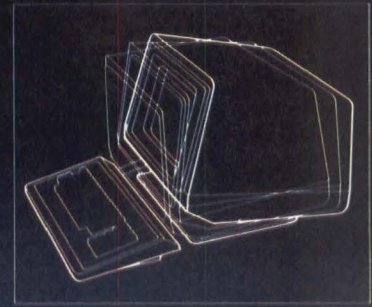

Tilt: 10° forward, 15° backward

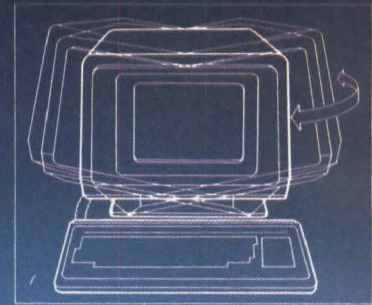

Swivel: 270°

\$695 list

The VISUAL 50 represents a new approach in low cost terminals. Although it costs drastically less, it offers the features you expect from the high priced units.

For example, the VISUAL 50 enclosure is ergonomically designed in light weight plastic and can easily be swiveled and tilted for maximum operator comfort. A detached keyboard, smooth scroll, large 7 x 9 dot matrix characters and non-glare screen are a few of the many human engineering features normally offered only on much higher priced terminals.

Another distinctive feature of the VISUAL 50 is its emulation capability. VISUAL 50 is code-for-code compatible with the Hazeltine Esprit,[™] ADDS Viewpoint,[™] Lear Siegler ADM-3A[™] and DEC VT-52.* Menu driven set-up modes in non-volatile memory allow easy selection of terminal parameters.

And you're not limited to mere emulation. As the chart shows, the VISUAL 50 has features and versatility the older, less powerful low cost terminals simply cannot match.

The price of the VISUAL 50? Only \$695 list. Call or write for full details on the latest in the industry's finest line of video terminals.

Service available in principal cities through Sorbus Service, Division of Management Assistance, Inc.

FEATURE COMPARISON CHART

FEATURE	VISUAL 50	Hazeltine Esprit	ADDS Viewpoint	Lear Siegler ADM-5	Televideo 910
Tilt and Swivel	YES	NO	NO	NO	NO
Detached Keyboard	YES	NO	YES	NO	NO
N-Key Rollover	YES	NO	YES	NO	NO
Audible Key Click	YES	YES	NO	NO	NO
Menu Set-Up Mode	YES	NO	NO	NO	NO
Status Line	YES	NO	NO	NO	NO
Full 5 Attribute Selection	YES	NO	NO	NO	YES
Smooth Scroll	YES	NO	NO	NO	NO
Line Drawing Character Set	YES	NO	NO	NO	NO
Block Mode	YES	YES	NO	NO	YES
Insert/Delete Line	YES	YES	NO	NO	YES
Bi-Directional Aux Port	YES	YES	NO	YES	NO
Columnar Tabbing	YES	YES	NO	NO	YES
Independent RCV/TX Rates	YES	NO	NO	NO	NO
Answerback User Programmable	YES	NO	NO	OPT.	NO

VISUAL See for yourself

Visual Technology Incorporated
540 Main Street, Tewksbury, MA 01876
Telephone (617) 851-5000. Telex 951-539

CIRCLE NO. 74 ON INQUIRY CARD

PRINTERS

Xerox Corp., Honeywell Information Systems, Inc., IBM, Wang Laboratories, Inc., Canon USA, Inc., HP and Siemens Corp. pioneered non-impact page printing in the 1970s, and they are still the market-share leaders. Roughly a dozen companies market about two dozen non-impact page printers in the U.S. today. Xerography is used in IBM, Honeywell and Xerox printers and is likely to remain the dominant high-speed non-impact page-printing technology for some time. This method is used in all the fastest page printers and, as new office-copier-based print engines become available, it should dominate the low-end non-impact market as well.

Xerographic printers (Fig. 4) print from 5000 TO 50,000 lpm and sell for less than \$100,000 to more than \$350,000. They store multiple fonts and forms overlays, print graphics with or without text and print enlarged

and reduced pages. Although xerographic printers cannot print multipart forms, they often print more than six times as fast as printers that can print six-part forms. The xerographic units save money by using less expensive single-thickness paper and by eliminating the use of expensive forms-bursting hardware.

A number of non-xerographic, non-impact technologies made it to market during 1982. The 5280-lpm Delphax Systems ion-deposition print engine was offered to end users in the Southern Systems Mercurion 1 at the Info '82 conference in New York in October. The unit sells for about \$60,000, stores eight type fonts and features a resolution of 240×240 dots per in.

Magnetic or magnetographic printers use magnetic-tape recording technology to write magnetic images that attract toner that is transferred to paper roughly the same way as in other non-impact page printers. AM International and the Cynthia Peripheral Corp. division of Cii Honeywell Bull offer magnetic printers, and GE and others are said to be pursuing this technology.

Electrostatic and thermal line printers have their

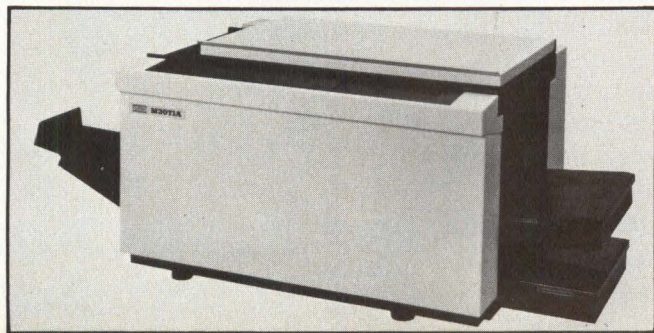
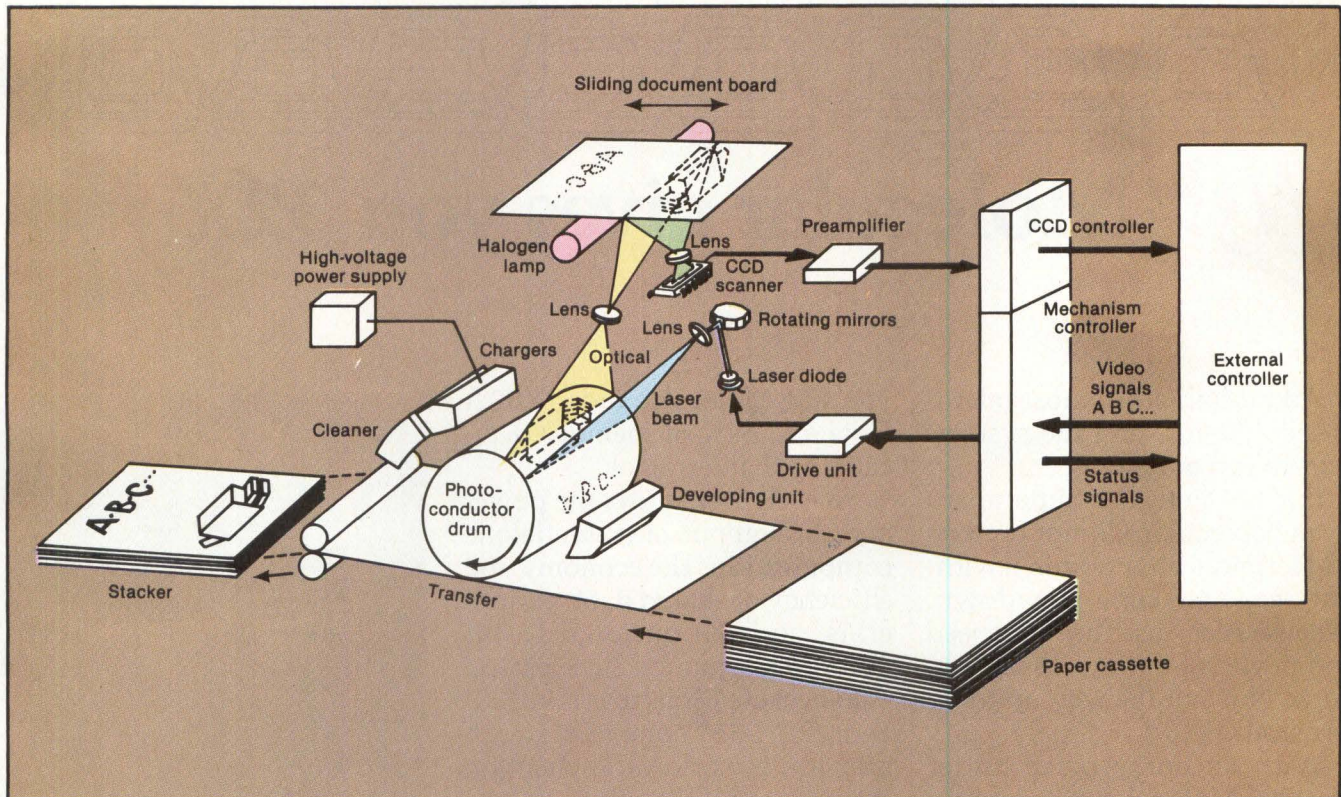

Fig. 4. The Fujitsu M3071A OEM integrated printer module (left) is a 12-page-per-min. line printer, photocopier and document scanner in one. The desk-top unit is offered as a non-impact computer printer but can be configured to make photocopies, to combine photocopy and computer input and to scan documents for facsimile and OCR applications. The innards of the 3071A (above), like those of most non-impact line printers, are based around a modified office-copier engine. Light beams from the laser optics system (in printing) or the halogen lamp optics system (in copying) generate sharp images on the photoconductor drum. These images are developed and transferred onto a printing or copying paper and fixed by pressure. In image scanning, a charge-coupled device in the image scanner reads information from a document to send video signals to the host computer via the external controller.



Any microsystem gives you one fast terminal.



Now Molecular gives you ~~32.64~~.

Add terminals to most micro-based systems, and the systems start to run out of gas.

But not with the Supermicro from Molecular Computer. You add terminal after terminal without response time slowdown. Because every user has the speed and power of a standalone computer. Now all the way up to 64 terminals.

With an entry price under \$8,000, Molecular gives you a smooth growth path to mainframe power. So your system can grow as fast as your business. And if you're an OEM, basing your product on a Molecular Supermicro will help your business grow faster.

A unique bus architecture connects each user with shared peripherals—and with every other user. With each terminal

you add, Molecular adds a Z80A CPU and 64K of memory dedicated to that terminal.

So each user enjoys the power and throughput of a standalone computer. Plus the economy and efficiency of shared data, peripherals, and the optional 16-bit 8086 Performance Accelerator. And because Molecular is CP/M® and CP/M-86™ compatible, each user has a world of application software to work with.

To schedule a demonstration at a distributor in your area, or to get full information, call or write Molecular Computer, 251 River Oaks Parkway, San Jose, CA 95134 (408) 262-2122.

It's the computer system that doesn't slow down as it grows up.

CP/M and CP/M-86 are trademarks of Digital Research Corp.

CIRCLE NO. 75 ON INQUIRY CARD

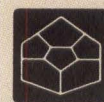
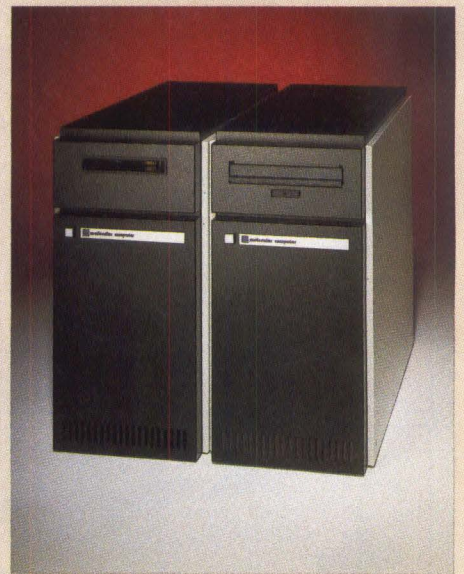

**molecular
computer™**

The Supermicro Company®

See Us at CP/M 83 Booth #927

PRINTERS

origins in the printer/plotter industry. They use selectively charged comb-like electrostatic and thermal matrix print elements to write matrix images on specially coated paper. Printing speeds vary from 250 to 3000 lpm and are related to resolution and price as in any matrix printer. Versatic, Inc., Houston Instrument, Olivetti Corp. and HP manufacture these kinds of printers.

Ink-jet printers are for the most part serial rather than line printers. Like fast impact matrix serial printers, they compete against low-speed line printers. Most ink-jet printers run at between 200 and 500 cps, but Mead Digital Systems' Dijit uses multiple jets to spray ink onto a moving web of paper at speeds as high as 60,000 lpm.

A faster future

The structure of the line-printer industry and the technologies that serve it should remain relatively

unchanged over the next five years. The market shares held by non-impact line printers should grow enormously as xerographic line printers based around mass-produced office-copier engines are offered in speed and price ranges attractive to supermini, mini and even supermicro users. Combination printer/copier/facsimile machines will become key parts of automated offices offering flexibility, speed and silence not possible with band or matrix printers. Page printers have overcome many actual and perceived reliability problems and are now arguably as reliable as their impact competitors.

Band printers should dominate medium-speed line-printing applications until non-impact units become price competitive, and they should become more reliable and easier to use as electromechanical refinements are made. Vertical forms units are gaining sophistication, and most printer parameters can be set both remotely and from comprehensive operator/diagnostic panels. Band-printer manufacturers have very capable service staffs and national and even international maintenance programs that vendors of high- and low-end non-impact line printers would do well to imitate.

Vendor	LINE PRINTER TECHNOLOGY									
	band	belt	chain	chaintrain	drum	electrostatic matrix	Impact matrix	laser	thermal	train
Burroughs Corp.	•		•					•		•
Canon, U.S.A.								•		
Centronics Data Computer Corp.	•									•
Control Data Corp.	•		•							
Data General Corp.	•									
Data Printer Corp.	•		•							
Dataproducts Corp.	•									
Digital Associates Corp.	•	•		•			•			
Digital Equipment Corp.	•									
Fujitsu Limited		•						•		
General Electric Co.		•								
Harris Corp.	•		•							
Hewlett Packard Co.	•		•			•	•			
Honeywell Information Systems, Inc.	•								•	
IBM Corp.	•		•					•	•	
Mannesmann Tally							•			
NCR Corp.			•						•	
NEC Information Systems Inc.	•									
Okidata							•			
Printer Systems Corp.	•						•			
Printronix, Inc.							•			
Ricoh of America									•	
Siemens Corp.								•		
Sperry Corp.	•	•								
Storage Technology	•									
Teletype Corp.		•								
Trilog, Inc.							•			
Versatec, Inc.						•				
Wang Laboratories, Inc.								•		
Xerox Corp.								•		

Impact matrix technology should dominate low-speed line-printer markets in which flexibility and low cost are most attractive. Price-related and absolute

resolution limitations will restrict impact matrix technology's market in the short term, and ink-jet technology could win away its customers in the long term.

While not as dynamic as the disk or serial printer markets, the line-printer industry is keeping up with end-user needs. Much of the recent action has been in line-printer design labs, and much of the action this year will be out in the market. □

LINE PRINTER VENDORS

AM International

811 S. San Fernando Blvd.
Burbank, Calif. 91502
(213) 841-4232

Burroughs Corp.

Burroughs Place
Detroit, Mich. 48232
(313) 972-7000

Canon, U.S.A

1 Canon Plaza
Lake Success, N.Y. 11042
(516) 488-6700

Centronics Data Computer Corp.

1 Wall St.
Hudson, N.H. 03051
(603) 883-0111

Control Data Corp.

P.O. Box 0
Minneapolis, Minn. 55440
(612) 853-8100

Data General Corp.

4400 Computer Dr.
Westboro, Mass. 01580
(617) 366-8911

Data Printer Corp.

99 Middlesex St.
Malden, Mass. 02148
(617) 321-2400

Dataproducts Corp.

6200 Canoga Ave.
Woodland Hills, Calif. 91365
(213) 887-8860

Digital Associates Corp.

1039 E. Main St.
Stamford, Conn. 06902
(203) 327-9210

Digital Equipment Corp.

146 Main St.
Maynard, Mass. 01754
(617) 897-5111

Fujitsu Ltd.

61 Marunouchi 2-chome
Chiyoda-ku, Tokyo 100, Japan
(03) 216-3211

General Electric Co.

G.E. Dr.
Waynesboro, Va. 22980
(703) 949-1188

Harris Corp.

2101 Cypress Creek Rd.
Fort Lauderdale, Fla. 33309
(305) 974-1700

Hewlett-Packard Co.

1501 Page Mill Rd.
Palo Alto, Calif. 94304
(415) 857-1501

Honeywell Information Systems

200 Smith St.
Waltham, Mass. 02154
(617) 890-8400

IBM Corp.

Old Orchard Rd.
Armonk, N.Y. 10504
(914) 765-1900

Mannesmann Tally

8301 S. 180th St.
Kent, Wash. 98031
(206) 251-5524

Micro Peripherals, Inc.

4426 S. Century Dr.
Salt Lake City, Utah 84107
1 (800) 821-8848

NCR Corp.

1700 S. Patterson Blvd.
Dayton, Ohio 45479
(513) 445-5000

NEC Information Systems, Inc.

5 Militia Dr.
Lexington, Mass. 02173
(617) 862-3120

Okidata Corp.

111 Gaither Dr.
Mount Laurel, N.J. 08054
(609) 235-2600

Printer Systems Corp.

9055 Comprint Court, Suite 200
Gaithersburg, Md. 20877
(301) 840-1070

Printronix, Inc.

17500 Cartwright Rd.
Irvine, Calif. 92713
(714) 549-7700

Ricoh of America, Inc.

20 Gloria Lane
Fairfield, N.J. 07006

Siemens Corp.

186 Wood Ave. S.
Iselin, N.J. 08330
(201) 494-1000

Sperry Corp.

1290 Avenue of the Americas
New York, N.Y. 10104
(212) 484-4444

Storage Technology Corp.

2270 S. 88th St., MD-3N
Louisville, Colo. 80028
(303) 673-3989

Teletype Corp.

5555 Touly Ave.
Skokie, Ill. 60077
(312) 982-2000

Toshiba America, Inc.

Information Systems Division
2441 Michelle Dr.
Tustin, Calif. 92680
(714) 730-5000

Trilog, Inc.

17391 Murphy Ave.
Irvine, Calif. 92714
(714) 549-4079

Versatec, Inc.

2710 Walsh Ave.
Santa Clara, Calif. 95051
(408) 988-2800

Wang Laboratories, Inc.

1 Industrial Ave.
Lowell, Mass. 01851
(617) 459-5000

Xerox Corp.

701 S. Aviation Blvd.
El Segundo, Calif. 90245
(213) 536-9127

OVERBUILT.



In Touch with Tomorrow
TOSHIBA

Now you can afford to be choosy. With the Toshiba P1350 dot matrix printer. Choose quality when you want it. Speed when you need it. At a price you'd expect to pay for just one or the other.

For speed, choose the draft mode. 160 CPS. About a page a minute. For quality, choose the LetterPerfect mode. 100 CPS. About twice as fast as a daisy wheel. Or choose the graphics mode at 192 CPS.

The technological breakthrough that makes it possible: Toshiba's fine-wire, overlapping, 24-pin, impact print head. For incredibly high 180 dots per inch density with a single pass.

More choices: variable pitches of 12 CPI or 10 CPI.

Three character fonts. Variable line spacing. Single sheet paper or continuous forms, from 5" to 15" wide, with up to four copies. Friction feed, pin feed tractor or Toshiba's ultra-reliable sheet feeder. And a choice of interfacing: parallel or serial.

Toshiba P1350. It gives you the choices you want. The quality you expect. The reliability you need.

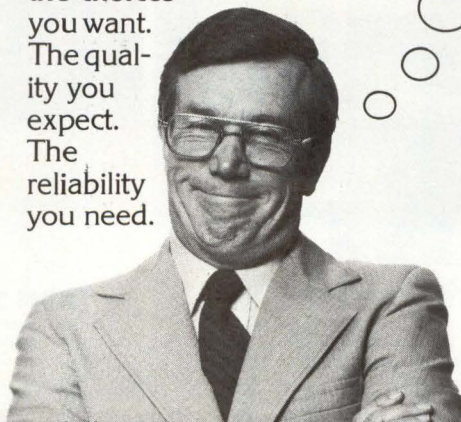

The precision you require. The low-maintenance long life you like. The price you love. With versatility and

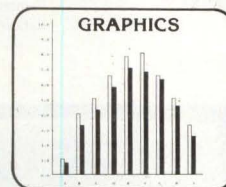

performance that's been proven in more than 7,000 installations.

When it comes to printers, you really have no choice. There's only the Toshiba P1350. Write for the details on everything it can do for you. Toshiba America, Inc., Information Systems Division, 2441 Michelle Drive, Tustin, CA 92680.

Better yet, call toll-free... now!

1-800-648-5000

Ask for operator #198

In Nevada, call (702) 329-9411

UNDERESTIMATED.



ADM 3A DUMB TERMINAL®

The Original Dumb Terminal.*
 1920 Character Display in 24 Rows of
 80 Columns.
 Full/Half Duplex up to 19.2K Baud.
 RS232C and 20mA Current Loop Modem
 Interface.

RS232C Gated Extension Port.
 Direct Cursor Addressing.
 Over 200,000 Dumb Terminals In Use.
 Optional Vector Drawing Graphics.



ADM 5 DUMB TERMINAL®

All ADM 3A Features Plus:
 Reverse Video, Reduced Intensity or
 Combination of Both.
 Limited Editing with Erase To End of
 Line/Page.

Integral Numeric Keypad.
 Individual Cursor Control Keys.
 Lower Case Display.
 Optional Vector Drawing Graphics.



ADM 22 ERGONOMIC SMART TERMINAL

Detached Selectric® Keyboard/Small
 Footprint.
 7 Function Keys.
 Non-Volatile Set-Up Mode.
 Visual Attributes.

Full Single Key Editing/Protect Mode.
 Conversation/Block Mode.
 Business Graphics.
 Printer Port.
 X-ON/X-OFF Transmission Control.

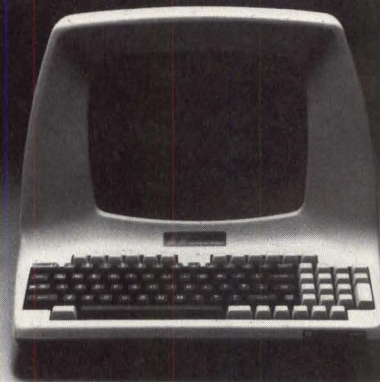

ADM 31 INTERMEDIATE TERMINAL™

Two Pages of Display Memory.
 Conversation/Block Mode.
 Printer Port.
 Polling and Addressing.
 Business Graphics.

Complete Visual Attributes.
 Full Single Key Editing/Protect Mode.
 Modifiable Personality.
 Function Key Mode.
 Optional Vector Drawing Graphics.



ADM 36 DEC™ COMPATIBLE TERMINAL

Detached Keyboard.
 ANSI X3.64 Compatible Code Structure.
 80 or 132 Columns by 24 Line Display.
 Jump or Split Screen and Smooth Scroll.
 Non-Volatile Set-Up Mode Using English
 Prompts.

Non-Embedded Visual Attributes—
 Double High/Wide.
 Business Graphics.
 Selectable International Character Sets.
 Optional Vector Drawing Graphics,
 300/1200 Baud 212A Compatible
 Modem, and Block Mode Operation.



ADM 24 OEM EXPANDABLE SMART TERMINAL

Detached Selectric® Keyboard with 8
 Programmable Function Keys.
 25th Line for Status and Function Key
 Display.
 Complete Non-Embedded Visual
 Attributes, Jump or Smooth Scroll, and
 Display Area Lock.
 Full Editing Capability with Page Insert Mode.
 Selectable International Character Sets

plus Greek/Math Symbols.
 Business Graphics.
 Non-Volatile Set-Up Mode.
 Accommodates Extra Logic Board, Extra
 Memory and Program Expansion.
 Options for Text Editing: 48 or 96 Line
 Display Memory with Window to
 Memory and 212A Compatible Modem.

Sales & Service: Boston (617) 456-8228, Chicago (312) 279-7710, Houston (713) 780-9440, Los Angeles (714) 774-1010, Ext. 219, Philadelphia (215) 245-4080, San Francisco (415) 828-6941, England
 780-2585, Los Angeles (213) 454-9941, Philadelphia (215)

Dumb Terminal,® Intermediate Terminal,™ VersaPrint,™ and Express Depot™ are trademarks of Lear Siegler, Inc. Selectric® is a trademark of IBM Corporation. DEC™ is a trademark of Digital Equipment Corporation.



ADM 23 SMART TERMINAL

- 2-Page Display Memory.
- Conversation/Block Mode Operation.
- 8 Shiftable Function Keys.
- Full Editing/Protect Mode.
- Complete Visual Attributes.
- Full Screen Reverse Video, Selectable.
- 2K Buffer.
- X-ON/X-OFF Transmission Control.
- Printer Port.
- International Character Sets/Graphics Available.
- Popular Terminal Emulations Offered.



ADM 32 ERGONOMIC SMART TERMINAL

- Detached Keyboard with Programmable Function Keys.
- Two Pages of Display Memory with 25th Status Line.
- Printer Port.
- Jump or Smooth Scroll.
- Conversation/Block Mode.
- Business Graphics and Complete Visual Attributes.
- Full Single Key Editing/Protect Mode.
- Modifiable Personality.
- Optional Vector Drawing Graphics, 300/1200 Baud 212A Compatible Modem, and Polling.

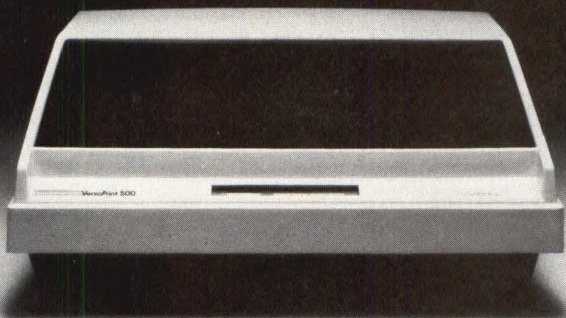

VERSAPRINT™ 500 MULTIFUNCTION PRINTER

- Selectable Print Speed/Quality: 180 cps Draft Quality, 90 cps Memo Quality, 45 cps Near Letter Quality.
- Dot Addressable Graphics.
- Selectable International Character Sets.
- Elongated Print.
- Proportional Spacing.
- 10, 12 or 16.5 Pitch Character Spacing.
- Optional Color Printing, Friction Feed, and Automatic Cut Sheet Feeding.

THE ANSWER IS LEAR SIEGLER. THE QUESTION IS WHICH ONE.

Over the years, the whims and fancies of terminal buyers have changed more often than Central American presidents.

But three things have always remained constant. Some of our competition can match our prices. Some of our competition can match our performance. Nobody can match both.

Lear Siegler features a complete family of low-priced, high-performance printers and terminals. Display terminals come with your choice of attached or detachable keyboards. White or green screens. Dumb or smart. Plus optional larger screens.

And as if that weren't enough, we back them all with the industry's most comprehensive service program. With service in 3000 cities nationwide. Plus walk-in Express Depot™ service, on-site service, and extended warranties.

For more information or the name of your nearest distributor, just call us at 800-LEAR-DPD or 714-774-1010. Because when it comes to terminals, Lear Siegler has all the answers.



Please send me further information. MM1

NAME _____

TITLE _____

COMPANY _____

ADDRESS _____

CITY _____ STATE _____ ZIP _____

PHONE _____

Mail to: Lear Siegler, Data Products Division,
714 North Brookhurst St., Anaheim, CA 92803.
Or Call: 800-LEAR-DPD (800-532-7373).

**EVERYBODY MAKES TERMINALS.
ONLY WE MAKE LEAR SIEGLERS.**

(04867) 80666, OEM Sales: Boston (215) 245-1520, Chicago (312) 279-5250, Houston (713) 245-1520, San Francisco (415) 828-6941, England (04867) 80666.

Equipment Corporation.



PrintMate™ 150

THE MOST ADVANCED PRINTER IN ITS CLASS.

Good news for microsystem and personal computer users! MPI offers four wide carriage printers with excellence in price and performance. The two "A" versions of PrintMate™ 150 feature a factory installed "SoftSwitch™" front panel keypad, with a 4K buffer on PrintMate™ 150 model A1 and a 16K buffer on model A2. PrintMate™ 150 models B1 and B2 are factory equipped with a 2K and 16K buffer, respectively. PrintMate™ 150 models have an exceptional set of outstanding graphics and font capabilities, optional expansion, and other advanced features that differentiate the PrintMate™ 150 from its competitive rivals as the superior performer. A bold claim? The strong and widespread acceptance of the excellent PrintMate™ 150 is based on outstanding user features:

HIGH SYSTEM THRUPTUT—150 characters per second advanced logic seeking impact printing with an accelerated print head slew rate and turnaround makes PrintMate™ 150 a high speed performer.

WIDE CARRIAGE VERSATILITY—The PrintMate™ 150's wide carriage can accommodate print lines from 136 to 231 characters in length and can easily handle forms from 3 to 15 inches wide and as long as 31 inches.

LARGE SELECTION OF PRINT CAPABILITIES
—The 7x9 dot matrix allows user selection

of 10, 12, 15 or 17 characters per inch or the 11x9 serif font provides document quality printing at 10 characters per inch.

"SoftSwitch™" FRONT PANEL CONTROL—The PrintMate™ 150 A models have SoftSwitch™ front panel keypads for externally changing forms length, print density, horizontal and vertical tabs, baud rate and character set. A simple "SoftSwitch™" entry will display the operating mode you have selected and PrintMate™ 150 responds to every entry with a pleasant tone of confirmation. With the "SoftSwitch™", you can turn off the printer—even unplug it—and PrintMate™ 150 will retain every detail in its non-volatile memory. The "SoftSwitch™" may be added to the PrintMate™ B models.

EXPANDABLE PRINT BUFFER—PrintMate™ 150 models A2 and B2 have a factory installed 16K buffer. Both the 4K buffer model A1 and the standard 2K buffer model B1 are optionally expanded in increments to 16K. The PrintMate™ 150's expanded buffer allows application extensions for high speed interleaved printing and spooling, greatly improving the host computer's performance in applications that are print bound.

DOWNLINE LOADABLE FONTS—The powerful microprocessor based command set of the PrintMate™ 150 allows a custom character set to be developed in the host computer and downloaded to any Print-

Mate™ 150 model with a 4K or larger buffer. **GRAPHICS**—The standard graphics capabilities of all PrintMate™ 150 models allow printing of up to 6,120 individually addressable dots per square inch giving exceptional resolution for graphics and special characters.

PrintMate™ APPLICATIONS PACKAGES—Turn-key graphics and display fonts can be implemented with an extensive line of MPI supported and maintained AP-PAK™ applications packages providing specialized fonts, custom graphs, tables, and picture graphics. Specialized characters such as logos may be easily defined and edited for printing directly from your computer.

CONSIDER THE FEATURES—Only PrintMate™ 150 offers so many ways to get your message across: graphics; display fonts; downline loadable character sets; high print speed; advanced logic seeking; 15 inch wide carriage; a variety of forms and paper capabilities and; friendly "SoftSwitch™" interaction. The PrintMate™ 150 is the responsive performer that perfectly mates with your microsystem or personal computer. With prices beginning at \$995, it is evident that the PrintMate™ 150 is the superior performer in function and price.

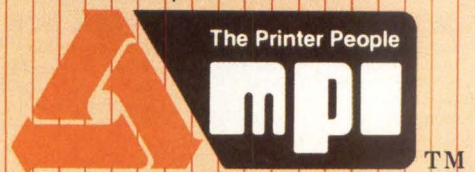

The Printer People
Micro Peripherals, Inc.
4426 South Century Drive
Salt Lake City, UT 84107
Phone 1-800-821-8848

CIRCLE NO. 78 ON INQUIRY CARD

Impact matrix printers reach for daisy quality

NEIL ROSENBERG, Integral Data Systems

Steady technology advances will adapt these printers to word processing and other applications now claimed by letter-quality printers

Impact dot-matrix printing is usually considered to be limited to rough-draft, medium-speed applications and to have no real future in word processing. Generally, a buyer of such a printer also needs a daisy-wheel printer for jobs that require letter-quality printing and cut-sheet feeding. But these limitations are disappearing. Nearly all major matrix manufacturers are introducing products with near-letter-quality printing and automatic or semiautomatic cut-sheet feeding. With the continuing technical advances in print-head design, carriage motion and control, paper handling, ink-delivery systems, software and electronics and acoustic suppression, a new class of printer is inevitable. The emergence of the ribbonless ink system and high-speed, high-pin-count print heads is making dot-matrix printers suitable for high-speed applications and color graphics as well as for word processing.

The print head

Modern matrix impact printers employ the same basic methods they did 10 years ago. By moving the head and paper in a controlled fashion, they can very rapidly place dots just about anywhere on a sheet. However, head design and pin arrangement have evolved to achieve greater speed and better letter quality.

To print dots requires a method of converting electrical energy to mechanical motion, along with a geometry that provides ink in the right place at the right time. The term "solenoid" encompasses a broad range of energy-conversion devices used for matrix printing. Its functional elements usually include a coil and a ferromagnetic mass. When a controlled electrical current is sent through the coil, the two parts move

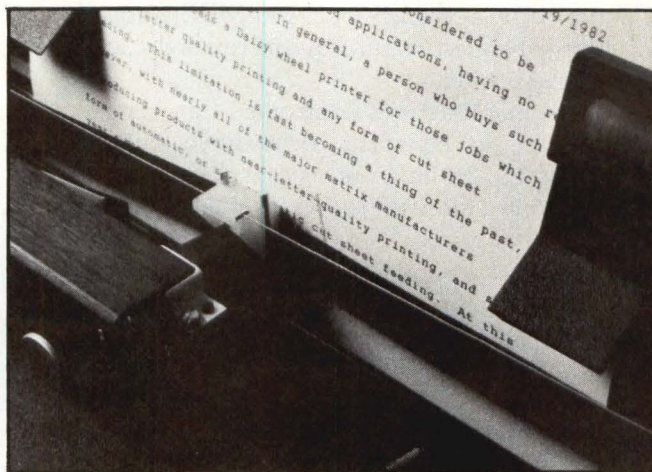

The letter-quality print being output from this dot-matrix printer is visibly close to that of a daisy-wheel printer.

with respect to each other, providing the energy for printing. The earliest matrix print heads used a tubular solenoid to create dots (Fig. 1). This original solenoid approach has some serious technical drawbacks. First, tubular solenoids are inefficient. To deliver adequate energy to the pin, 20 to 50 times as much energy must be delivered to the coil. This causes the head to run very hot and requires a large power supply and high current drivers. Second, this design is critical of head-to-paper distance and needs readjustment for each new form thickness. This head will operate only in a high-precision printer, making the head expensive to use. Something better than tubular solenoids was needed.

Hydra was one of the first companies to produce a clapper-type solenoid print head. This head still uses a

Line Printer Controllers that test themselves— **MDB makes the difference!**

Only MDB has Line Printer Controllers that are completely self testing with PrinTest™, Loop Back and LED's for visual indication of the data being transmitted. You save maintenance costs and down time. MDB's exclusive PrinTest feature, when activated by an edge mounted toggle switch allows you to exercise the controller's printer interface, interconnection cable and all parameters of the printer (except VFU). Then flip a second switch for Loop Back which causes the controller to function as if in full operation with a printer while, in fact, the printer is disconnected. You verify controller operation or troubleshoot the module without noise, paper waste or confusion. And MDB controllers with the PrinTest feature can be remotely activated from the printer.

MDB manufactures controllers for every major line printer in the world (for example, we make the only LSI-11 line printer controller with a Data Printer interface) so you can have the

exact printer system at the exact speed you need—whether you use a PDP* 11, VAX* LSI-11/2 or 11/23, PDP-8, DG, H-P, PE or IBM Series/1 computer.

And that's not the only difference MDB interface products can make to you. MDB makes the only DZ11 compatible multiplexors for DEC's LSI-11 series. They offer RS-422, RS-232 and current loop capability. We offer PROM modules with window mapping, communications interfaces that support X.25 and a unique LSI-11/23 system with 22 bit addressing and up to 4 Mbytes of memory. Our boards are warranted for a full year, many are available off the shelf and they can be purchased under GSA contract #GS-OOC-03330.

Want to see the difference we can make in your system? Call or write for all our specifications.

*Trademark Digital Equipment Corp.

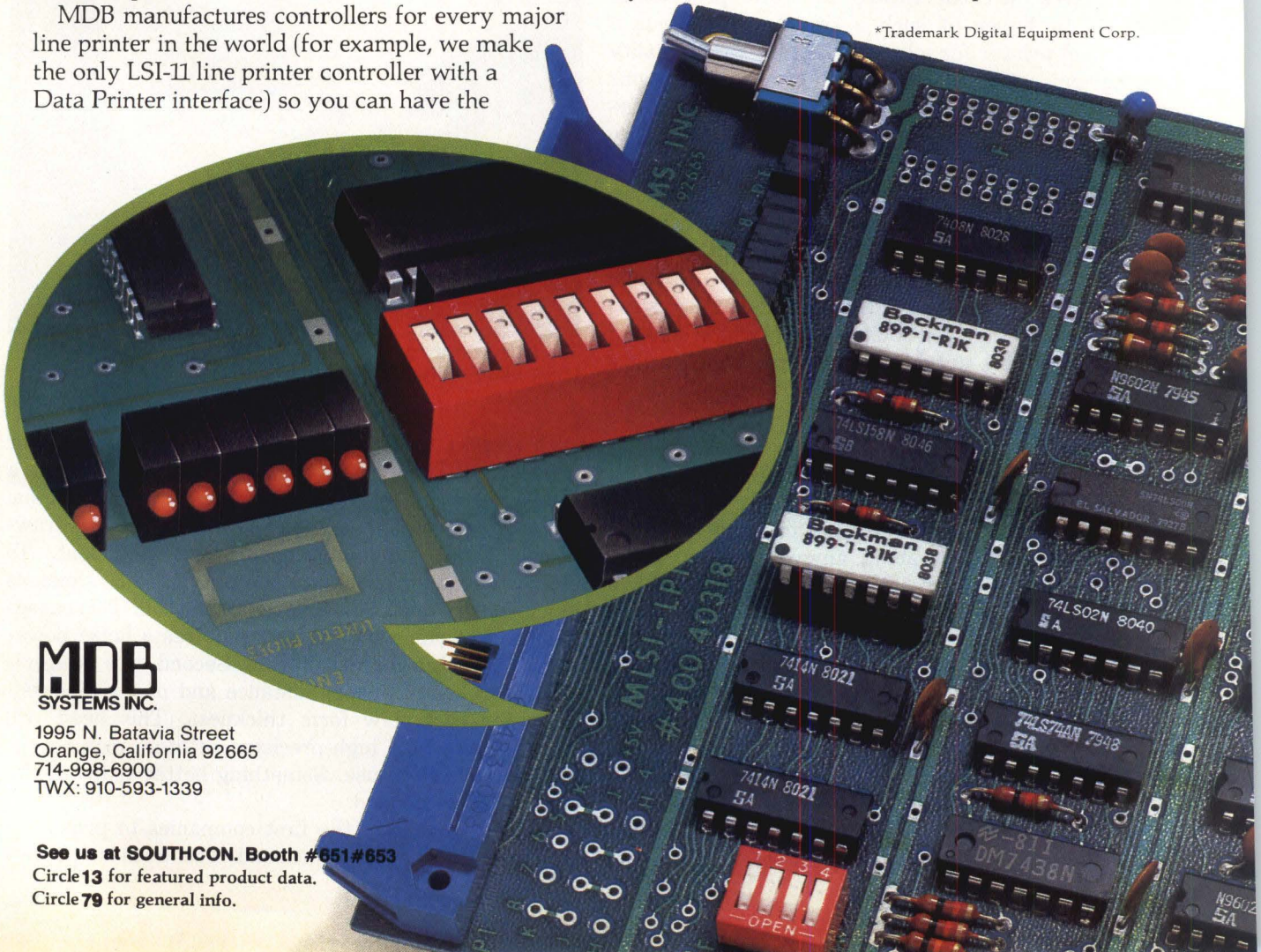

MDB
SYSTEMS INC.

1995 N. Batavia Street
Orange, California 92665
714-998-6900
TWX: 910-593-1339

See us at **SOUTHCON**. Booth #**651#653**
Circle **13** for featured product data.
Circle **79** for general info.

coil to form the magnetic field, but the field now attracts an armature or clapper, rather than a ferrite slug as in the tubular design. This configuration allows the print wires to be much straighter and closer together and reduces the side forces within the head. It is also substantially more energy efficient because of the geometry of the magnetic path. The tubular solenoid is about 4 percent efficient, and the clapper style is as high as 10 percent efficient. Consequently, the clapper head has quickly become the industry standard.

In many clapper heads, known as free-flight, or ballistic heads, the pin is not attached to the armature (Fig. 2). Advantages of this head is that it may not need re-gapping when going from multipart to single-part forms. It is also more tolerant of dimensional variations within the printer. In addition, the free-flight head can provide much improved high-speed performance through proper balancing of spring forces within the head and careful control of the mass and magnetic path around the armature. One recent clapper-head design sustains 350-character-per-sec. speed, with medium-density characters. More typical, however, is 180 to 200 characters per sec.

The most recent technology is the "stored-energy" head, so-called because of its special actuator that

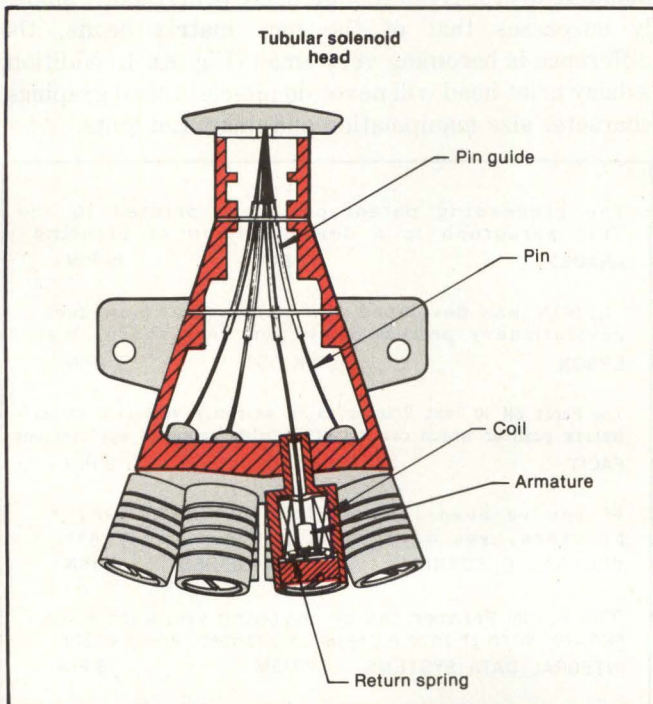

Fig. 1. The tubular solenoid head, the earliest matrix print head, typically had seven or nine solenoids, each comprising a coil and a ferromagnetic mass, arranged conically on a die-cast housing with a stiff tungsten pin or needle attached to each solenoid core. When activated, the solenoid caused the pin to protrude rapidly from the front of the head, where it impacted the back of the ribbon, which in turn hit the paper.

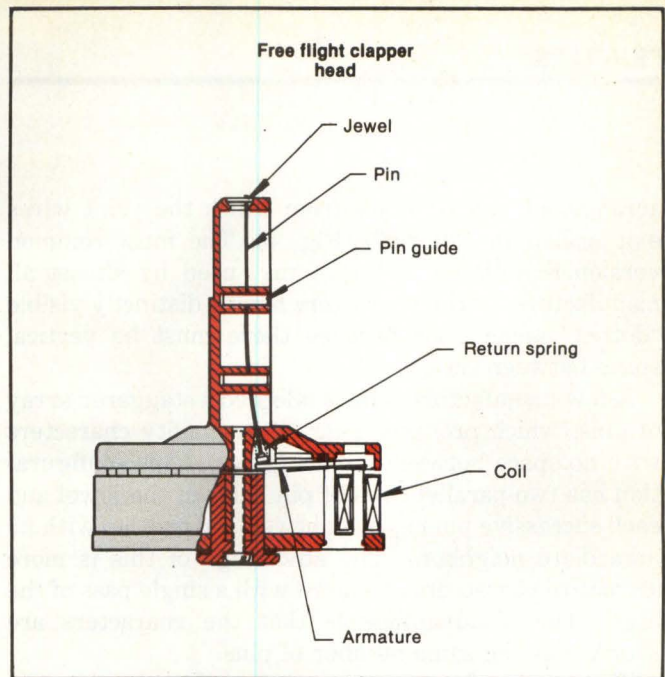

Fig. 2. In the free-flight clapper head, the pin is not attached to the armature. Thus, when the armature reaches its fully closed position, the pin continues in "free-flight" until it hits the ribbon and paper. If the head is properly spaced from the print surface, printing occurs during this free-flight period, and the pin's impact on the ribbon, paper and print surface provides most of the energy for rebound into the head. The pin has its greatest available force just as the armature bottoms out, and less as the pin travels further.

includes a permanent magnet and a spring (Fig. 3). By virtue of its design, the stored-energy head is extremely efficient, long-lived and potentially very fast, capable of as many as 600 characters per sec.

Speed is only one ingredient to successful head design. Two heads that print at the same speed do not necessarily produce the same appearance of finished output. For instance, there are different designs for the

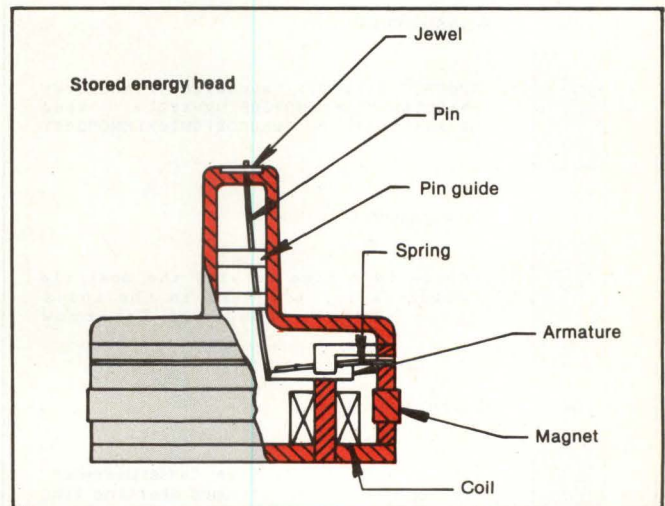

Fig. 3. The stored energy head contains a magnet that keeps the spring and print wire poised and pre-loaded, ready to fire forward. The coil acts as a trigger, providing enough opposing magnetic field to release the spring, which then pushes the wire forward to print. While the wire is traveling forward, the current to the coil is shut off, and the rebound from the impact carries the print wire back to the position where the magnet can once again capture and hold it.

PRINTERS

arrangement of the holes from which the print wires exit (called the "jewel") (Fig. 4). The most common version is a simple in-line array, used by almost all manufacturers. The characters have a distinctly visible "dotted" appearance because there must be vertical space between the pins.

A few manufacturers have adopted a staggered array of pins, which produces near-letter-quality characters with no space between dots (Fig. 4B). This configuration has two parallel rows of pin holes in the jewel and each successive pin has a slight vertical overlap with its immediate neighbors. The advantage of this is more attractive characters produced with a single pass of the head. The disadvantage is that the characters are shorter for the same number of pins.

This quest for ever increasing dot density has spawned a new family of heads. These newest heads hold as many as 24 print wires in a package no larger than their nine-wire ancestors (Fig. 4C and 4D). Almost without exception, the older nine-wire designs use print wires that are 0.014 in. in diameter. These higher density heads use either 0.012- or 0.010-in. diameter wire. The resultant dots are smaller, and more dots can be compressed into an area, giving potentially better

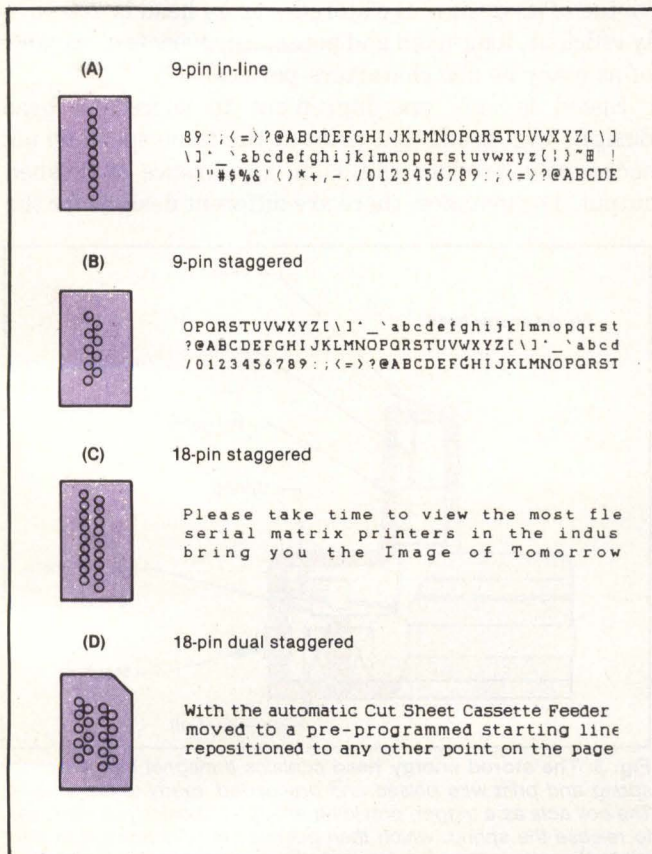

Fig. 4. A comparison of jewel layouts and their associated printouts shows that the higher the vertical density, the smoother the character formation.

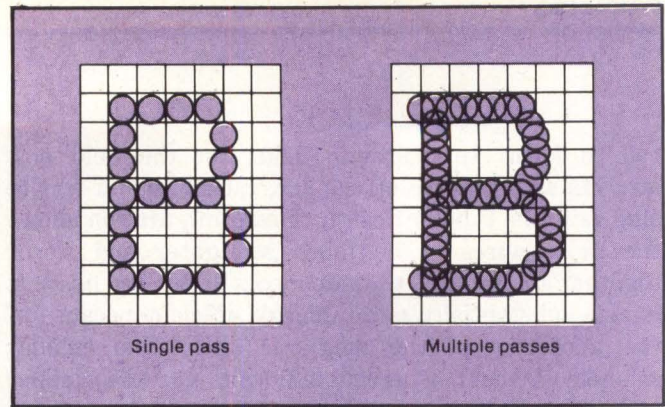

Fig. 5. Building a solid-looking character requires several passes of the printer head. These dots show the letter "B" being formed by a nine-pin head matrix printer after one pass and after multiple passes.

character formation and denser graphics.

Before the advent of these high-pin-count heads, the only ways to achieve higher vertical dot density were overlapped pins or multiple passes of the head, with small incremental vertical head or paper motion between passes (Fig. 5). But multiple passes have a negative effect on throughput. A 180-cps, nine-wire printer doing three-pass printing achieves a maximum print speed of 60 cps. By comparison, the new heads can accomplish similar density in a single pass, with no appreciable reduction in throughput.

This latest development, the high-pin-count head, has created the greatest concern for the daisy-wheel manufacturers. Even though daisy print quality slightly surpasses that of the new matrix heads, the difference is becoming very small (Fig. 6). In addition, a daisy print head will never do pin-controlled graphics, character size manipulation and unlimited fonts.

```
The preceding paragraphs were printed in the
This paragraph is a demonstration of printing
ANADEx                               WP6000                               18 PIN
```

```
EPSON has developed this spectacular new tech
revolutionary process allow you very sharp, legi
EPSON                               INK DOT                               24PIN
```

```
The Facit SM 10 Text Printer is an extremely versatile serial
matrix printer which can satisfy a wide range of applications
FACIT                               SM 10                               9 PIN
```

```
If you've been looking for the FIRST FAMILY
printers, you have come to the right place.
GENERAL ELECTRIC                       3000 SERIES                               18 PIN
```

```
The Prism Printer can be anything you want it to
modules turn it into a graphics printer, and a color
INTEGRAL DATA SYSTEMS                PRISM                               18 PIN
```

```
This letter was printed using corresponden
on an OKIDATA Microline 84 run by the Xerox 8
OKIDATA                               MICROLINE 84                               9 PIN
```

Fig. 6. Representative printing samples show letter-quality printing from several matrix printers, many of which were introduced at the National Computer Conference in 1982.

Like DEC's.*

Under \$10,000 system price**

Memory expansion to 1Mb
(4Mb addressability)

Media and software
compatibility with
DEC's RX02 8" floppy
(vs. MICRO/PDP-11's non-
compatible 5 1/4" floppy)

Auto self-diagnostics

8-quad slot
Q-bus card cage

Supports RT-11, RSX-11M,
and RSX-11-M Plus

LSI-11 processor, memory,
and interface boards
available direct from
Charles River Data Systems

1.0Mb floppy disk
back-up (vs. 2 x 400Kb
for MICRO/PDP-11)

10.3Mb 5 1/4"
Winchester disk

30-day delivery
(vs. shipments
beginning
"This fiscal year"
from DEC)

Only better.

Our new RLX1001B Winchester micro system lets you pack an amazing amount of computer in a very small box, at a very exciting price. A lot like DEC's new MICRO/PDP*-11. Only you can get *our* micro system now, not months from now. And it's RX02 software and media compatible, while DEC's isn't. For more on the RLX1001B or our other DEC-compatible disk systems starting at \$2,395, just send in this coupon or call (617) 655-1800.

Send information. Contact me immediately.

Name _____

Company _____

Address _____

City _____ State _____ Zip _____ Phone _____

Return to: Charles River Data Systems, 4 Tech Circle,
Natick, MA 01760

MM01

CHARLES RIVER DATA SYSTEMS

*DEC and PDP are trademarks of Digital Equipment Corporation

**Quantity one, U.S. only, including LSI-11/23 processor, 256Kb memory, and DLV11J quad serial interface.

MINI-MICRO SYSTEMS/January 1983

CIRCLE NO. 80 ON INQUIRY CARD

149

Head motion

A basic requirement of any printer is that the head and carriage move in a controlled and predictable manner. For a matrix printer, this means that the carriage should accelerate quickly and smoothly. Once at running speed, it should keep moving at a constant rate. It should slow down and stop quickly and smoothly. Additionally, the head must be kept on a level and straight path, with vibration and backlash held to a minimum.

Most printers use a stepping motor to move the carriage, connected by a timing belt. A stepping motor moves in small increments of rotation and usually requires a microprocessor for control. Acceleration occurs by step commands, with gradually decreasing time between the steps, until the motor reaches running speed. This is called "ramping." Creating the right ramp is key to proper acceleration of the motor and carriage (Fig. 7). Possible effects of improper ramp design include excessive time and distance before running speed is achieved, inability of the motor to tolerate variations in system friction and vibration of the entire carriage system during printing. These effects are reflected in the print quality as unevenly compressed or expanded characters or graphics.

Mechanical carriage support has recently changed dramatically. The earliest matrix printer, the Centronics 100 series, had a massive cast-iron frame and a carriage with precision ball bearings riding on hard-

ened machined surfaces. This approach was copied until about five years ago, when a few printer manufacturers began offering smaller, more cost-effective printers. These new designs were not nearly as rugged or precise as the Centronics 100 series, and even to the untrained eye, print quality was visibly poorer. To cut costs, these new products had inexpensive, usually oversized carriage bearings that rode on inexpensive shafts, which were typically bent and bowed (Fig. 7). The result was that the dot locations ended up being exact images of the uncontrolled location of the head.

The emerging high-pin-count heads and their application in word processing cannot tolerate these weaknesses. A few low-cost printers have recently begun to solve this problem through careful application of self-aligning bearings and low-cost, spring-loaded sleds or rollers on the carriage. Even printers with nine-wire heads are showing better carriage designs, perhaps in anticipation of incorporating the high-pin-count heads.

Head control

To control the sending of dot-firing information, the printer must know where the carriage is. Two basic methods of determining this are open loop and closed loop.

Open loop implies that the printer control electronics gets no feedback about position from the carriage drive system except for an occasional initializing with a home-position sensor. The control electronics assumes that if it sends pulses to the stepping motor, the carriage will move predictably. By synchronizing the motor-motion commands with pin-firing commands, the printer forms characters on the page blindly. In a properly designed mechanical system, with the right ramps and predictable friction and masses, this is an

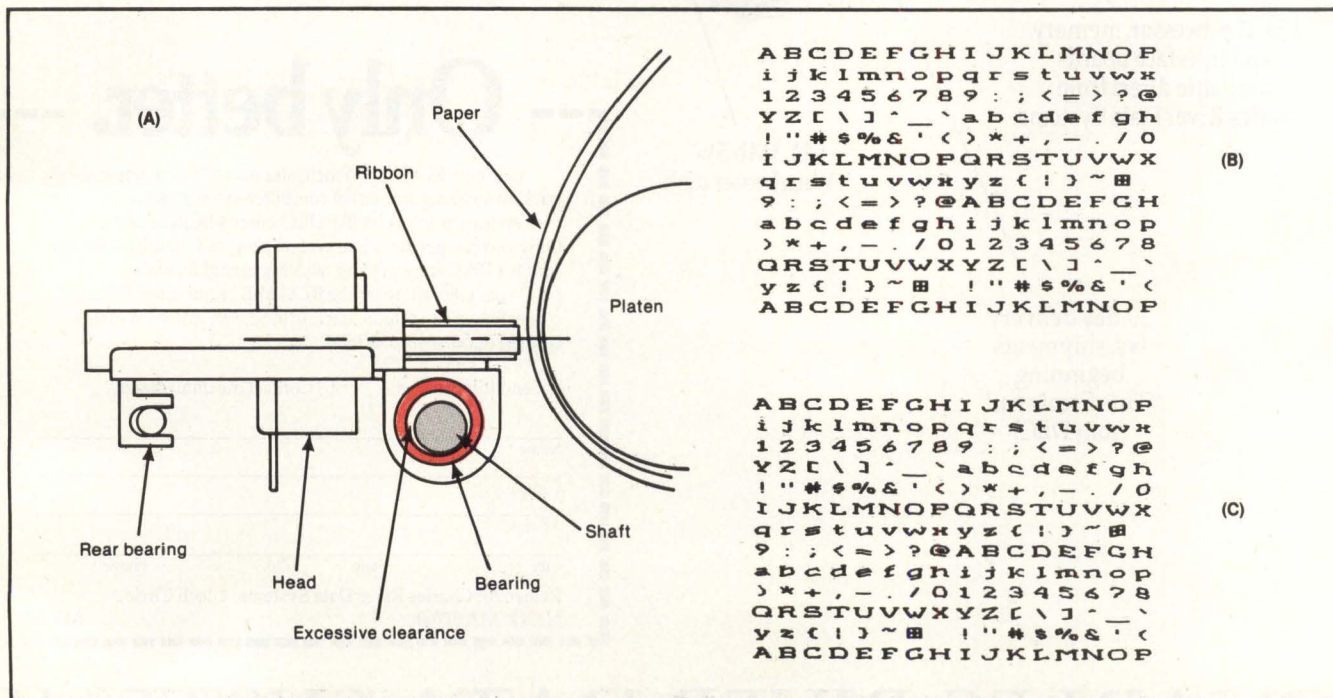

Fig. 7. A carriage with excessive clearance between the shaft and the bearing results from using inexpensive bearings and shafts (A). This causes vertical vibration and motion, which is reflected in wavy printing (C). B shows the printout of a carriage with minimal (proper) clearance.



THE PRINT HEAD THAT'S BUILT LIKE A SHERMAN TANK. PERFORMS LIKE A BALLERINA.

Choose a printer that won't crack under pressure. Our secret weapon? Okidata's stored-energy, non-ballistic print head. It has one moving part instead of three which means a smaller heat sink, less maintenance, and ultimately, an extremely low cost of ownership. For added durability, its armature is laser welded, not soldered. And its tough tungsten pins crank out 200,000,000 characters with ruthless precision.

But, a virtually invincible print head isn't the only reason our nationwide network of service people get so few calls. Okidata printers have exceptional MTBF and MTTR ratings; up to 4000 hours and as little as fifteen minutes, respectively. And no duty

cycle limitations.

Yet, all this rugged reliability is delivered with the speed and grace of a prima ballerina. Inside their stamped steel bodies, our fastest models perform at up to 350 cps bi-directionally, with short line seeking logic and fast horizontal and vertical slew. As for style, our correspondence quality truly rivals a daisy-wheel's at speeds up to 85 cps. All models boast superior talents for their modest prices. Most, for instance, accept downline loadable character sets.

Plus, Okidata's compatibility is unlimited, and our technical staff can make alterations to fit your special OEM needs. Our innovations get

standing ovations. For our latest product specification sheets, call 1-800-OKIDATA. In New Jersey, (609) 235-2600. Okidata, Mt. Laurel, NJ 08054.



OKIDATA

A subsidiary of Oki Electric Industry Company Ltd.

acceptable method; otherwise, it can result in improper character registration on the page. In most cases, however, careful manufacturing and process control yields an inexpensive and basically reliable product.

Closed-loop systems typically have optical, capacitive or magnetic detectors that send out pulses as the motor rotates or as the carriage moves. This feedback information can be used to ensure proper motor ramping and speed regulation and also serves as finite "tic" or location marks for the firing of the head pins. Closed-loop systems can achieve the ultimate in location control, and they can even conceal the presence of certain kinds of vibration, but at a higher cost. First, these location-detection schemes require additional detection and electronic hardware to perform this task, often adding as much as \$25 to the unit's manufacturing cost. Second, if the printer relies on the encoder alone to tell it when to fire the pins, and if excess vibration exists, the carriage may get to the next tic mark before the head has recovered from the last dot. This can result in one or more weak or missing dots. The open-loop system is less likely to have this problem because dot firing is based on time intervals, not position. This advantage and its low manufacturing cost would appear to make the open-loop approach a better choice for low- to medium-performance printers.

However, the high-pin-count heads and their increased resolution of dot placement require optimal control of carriage location. In this context, the difference between the open- and closed-loop systems becomes less clear. Although closed-loop printers have additional costs inherent with the required hardware, open-loop printers also experience increased costs of manufacture because of tighter controls on mechanical consistency in such areas as carriage friction and motor parameters. The market is fairly evenly divided, with significant examples of each approach delivering roughly equal state-of-the-art performance.

Paper motion

The days when a printer need handle only pin-feed or roll paper are about gone. For word-processing applications, the ability to cope with sheet paper has become relatively commonplace, particularly in printers that use the high-pin-count heads. Some new machines make sheet feeding effortless, requiring minimal operator involvement and permitting unattended multiple-sheet printing.

The abilities of sheet-feeding printers range from manual insertion and manual alignment to fully automatic units with "twin-sheet" (letterhead and blank) capabilities. Some products require the installation of bulky accessory top-loading feeders; others partially or fully integrate these functions in the basic framework

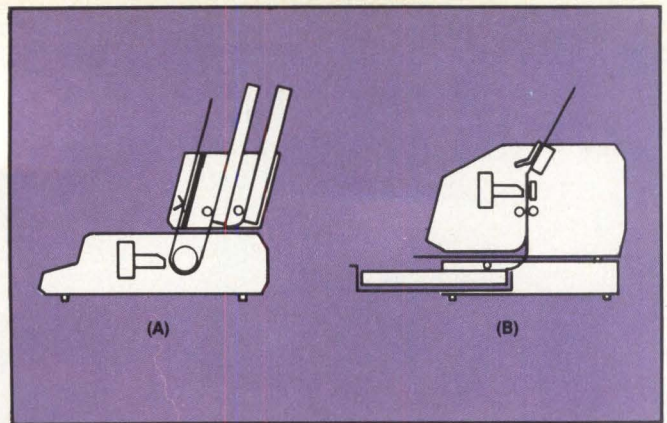

Fig. 8. Two paper-entry methods are (A) top feed with an add-on unit and (B) bottom and front feed with a bottom-mounted feeder that is partially integrated in the printer framework.

of the printer (Fig. 8).

Sheet feeding places special demands on a printer and can add a significant amount of mechanical hardware. When printing continuous forms, it is not difficult to achieve consistent and accurate placement of data from form to form. By setting the first form, the rest fall into place. This is not as easily accomplished with single forms, and many sheet-feeding products incorporate optical edge sensors and precise diameter rollers to provide similarly acceptable tracking accuracy.

Almost all Japanese printers have manual cut-sheet capability, and most employ a rotating cylindrical platen and handle sheets much like a typewriter. Although most people are accustomed to using typewriters, this is not necessarily the most efficient means of sheet manipulation. To facilitate sheet handling, some manufacturers have adapted standard commercially available top-loading feeders (Rutishauser, BDT Products Inc. and others) for use with their printers. These feeders, although costly (usually retailing at \$1000 or more), do provide unattended multipage document output and easy manual sheet insertion. Yet, from a user's viewpoint, the feeders are bulky and must be physically removed to permit tractor operation.

A more economical approach, both in terms of size and cost, is the integration of all or part of these abilities into the basic printer framework. The Integral Data Systems Prism printer (Fig. 9) has an optional front-loading chute, an optical edge sensor for semiautomatic loading and a fully automatic feeder that resides below the printer (Fig. 8) and tucks away like a drawer when not in use. Florida Data Corp. also has built an advanced sheet feeder inside its printer. A much lower priced product from Micro Peripherals Inc. provides for manual-only front loading but lacks a semiautomatic feature.

Envelope feeding presents a much more difficult technical challenge, because of the awkward proportions and uneven stiffness and bulk of the medium. Envelope feeders were notable by their absence at last year's National Computer Conference, present only in

Dataproducts Design Engineers created a matrix printhead so reliable, we guarantee it for life.

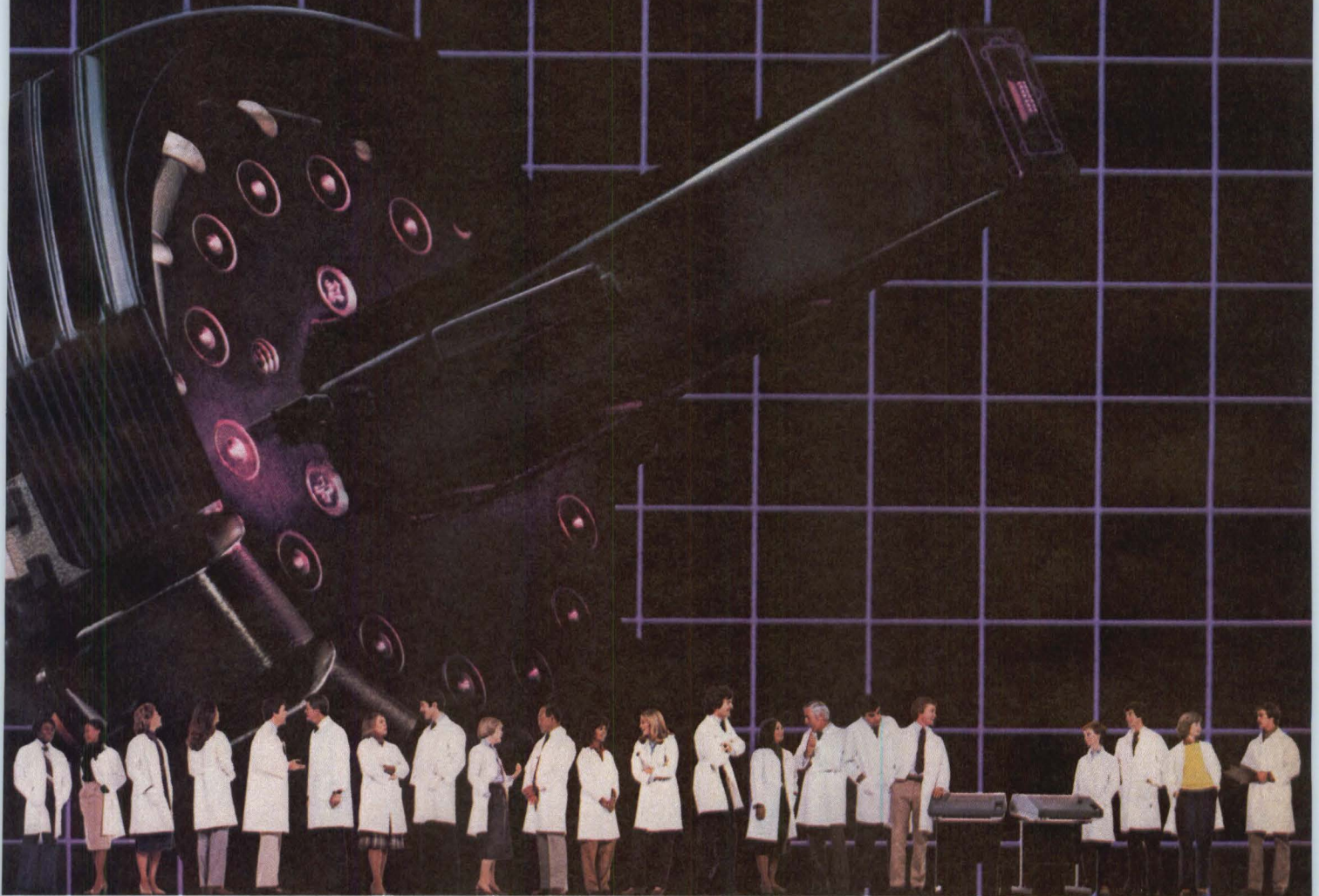

If the printhead on any new M-200 or M-120 matrix printer fails or wears out, Dataproducts will replace it free.

Three years from now or 30 years from now.

We make this remarkable promise because we make a remarkable printhead — a major achievement of Dataproducts Design Engineers.

These men and women are an elite group charged with a singular objective:

To make Dataproducts printers the most affordable you can own.

They designed this unique matrix printhead to last. And to stay within specifications for life.

Reliability is engineered into the entire printer. Quality is built in.

That's why the biggest OEMs put their names on Dataproducts printers. (Forty thousand are already proven in the field.) It's why we back every one

with a full year warranty.

The M-200 prints up to 340 characters per second. The M-120 prints 180 cps.

Learn how quality Dataproducts printers can reduce your company's Cost of Ownership. Write Dataproducts Marketing Department, 6200 Canoga Ave., Woodland Hills, CA 91365. Or call (714) 752-7411 (Western); (617) 237-4711 (Northeastern); (305) 788-2124 (Eastern/Southeastern); (214) 231-2240 (Central).



Dataproducts printers. Engineered for long-time uptime.

Dataproducts M-200 and M-120 are registered trade marks of Dataproducts Corporation.

CIRCLE NO. 82 ON INQUIRY CARD

Ithaca 525/800™

A computer system so advanced, the technology you'll need later
is already here. And waiting.



The Ithaca 525/800 gives you the ability to address an almost unlimited number of applications in business, scientific, and educational environments.

Its state-of-the-art hardware gives you a single or multi-user 8-bit system in one machine that handles 5¼" or 8" floppy and hard disks.

It has a processor that's 50% faster than conventional systems. A unique Cache CP/M® - MP/M® system that's typically 500% faster. That's right, 500%. And up to 1 Mbyte of memory.

It has add-on capacity built-in now, ready to expand when you're ready. There are no hidden costs to pay for later. Everything you need comes with the

Ithaca 525/800. In fact, it could be the only system you'll ever need.

It's simply the finest price/performance Z-80® based system available. And it's here now, waiting for your call.

800-847-2088

In New York State
(607) 257-0190

Ithaca
Dinter Systems™

We think as fast as you do.

1650 Hanshaw Road, P.O. Box 91
Ithaca, NY 14850
TWX: 510-255-4346

© CP/M and MP/M Digital Research, Inc. © Z-80 Zilog, Inc. ™ Ithaca 525/800 Ithaca InterSystems, Inc.

CIRCLE NO. 83 ON INQUIRY CARD

the booths of Wang Laboratories, Inc., and manufacturers of accessory sheet-feeding equipment. Envelope feeding is necessary to satisfy word-processing stations, and many auto-sheet-feeding printers will likely include envelope feeding in the near future.

The ink supply

Designing a reliable and convenient ink-delivery system has been a major focus of matrix printer manufacturers. Spool-to-spool fabric ribbons are giving way to stuffing-box ribbon cassettes and mylar multi-strike ribbons. The more recent advances provide such capabilities as clean-hand ribbon changes, extended ribbon life and multicolor printing.

Fabric ribbons are still the most widely used ink-delivery system for matrix printers. However, when used with the new high-density heads, the high impact forces and small print wires place an extreme burden on the ribbon, and any flaw in the weave can create serious problems. For instance, if the weave has an opening, the print wires can pierce the ribbon, get snagged and destroy the head as the head continues to move.

The ink's chemical composition is a significant factor in head performance because many head designs rely on a lubricative property of the ink to keep the wires moving smoothly. A printer manufacturer generally supplies ribbons with an ink chemistry optimized for its head. Yet, some inks inadvertently used by re-inking services were designed for typewriters. If misapplied, they can impair printer performance and shorten the useful lifetime of a matrix print head. For instance, certain pigments contain abrasives designed to polish continually the print hammers on a typewriter, but these will wear out the jewel of a matrix head prematurely. Other inks contain lubricants that dry and solidify in time, leaving a residue that attracts paper dust and can cement the wires to the jewel.

Mylar ribbons, formerly restricted to daisy-wheel printers and typewriters, are suitable for use with higher density heads. They give clearer and more well-defined dots than their fabric counterparts. However, there is not yet a good method of recirculating mylar in a stuffing box or other simple arrangement. The ribbon drives are still spool-to-spool and must either reverse when reaching the end, be turned over or be discarded. Even if a printer could reverse ribbon direction, mylar cannot withstand the punishment of multiple overstrikes as a fabric ribbon can and must therefore be replaced more frequently.

The latest development in ink delivery is in the Epson of America ink-dot printer, a ribbonless product, in which the ink is delivered to the tips of the print wires from a reservoir traveling with the carriage. The

clarity of a dot is excellent and, coupled with Epson's 24-wire print head, produces some of the finest impact matrix printing available (Fig. 6). When the ink supply is exhausted, a user simply refills the reservoir. A similar approach is expected to appear in an imminent Centronics Data Computer Corp. product.

Color printing has attracted much attention, and many sources of high-quality multicolor ribbons have recently appeared. The colors generally occupy parallel bands on the ribbon, each a little taller than the line of print wires in the head. Ribbons with 10 vivid colors are now available, although available printers are limited to four-color bands. Through special processing, the colors are prevented from bleeding into each other, a problem that has plagued ribbon manufacturers. Color printing, joined with dot-control graphics and multiple overstrike, is a new capability, and there is a shortage of systems and software that can now fully support it.

Electronics and software

Applying microprocessors to printer-control logic has allowed some innovations, such as pin-control graphics, justification, plotting and color printing. There are almost as many features as printers, and as electronic-component costs continue to plunge, even the least expensive models will have some fancy capabilities.

As more efficient heads become practical, the bulk and cost of an electronics package will drop. It is not unrealistic that a single chip will perform almost the entire logic, I/O, head driving and housekeeping functions. This leaves motor drivers, which will probably remain discrete devices for the next few years.

Microprocessors, such as Intel Corp.'s 8049 and 8051, are in several small printers, providing both program memory and I/O functions. Memory prices are tumbling, making it feasible to store complete graphic page images in printer memory, perhaps even via a direct connection to the composite video output of a host computer or terminal.

Other enhancements include absolute positioning for plotting, incremental printing for terminal applications and bidirectional multipass printing for improved letter-quality output. Techniques borrowed from daisy-printer technology improve throughput, such as high-speed tabbing over spaces and ramping of the paper drive for multiple line or form feeding.

As with any new technology, it is possible to make a product that is too smart and therefore suffers poor market acceptance. The capabilities must be useful to prospective buyers, or they may not be interested enough to use all that power. Specifically, if a printer has a special protocol for graphics or justification that requires substantial effort to make it work, then that feature is useless. For example, the Centronics 737 has a proportional mode with an attractive font; yet, to make that font run, a user needs a post-processing program. Only now, after that printer has been on the

market for three years are people beginning to write this software, and it is limited in application to a few computers.

With most printers, getting hard copy of text information is easy when compared with graphic data printout. Because of the lack of standards for graphic information interchange, each manufacturer has developed its own standard, with no two alike. Unfortunately, it seems unlikely that a standard will emerge.

Several OEM system suppliers have resorted to specifying a printer for graphic software packages, and they will provide occasional updates to include other models or capabilities. Color capabilities only further complicate the matter. The only real hope of standardization is that newcomers will copy existing products in the hopes of providing alternative sources for system builders.

Framework, cabinet, acoustic suppression

Whenever good design is joined with a high level of tooling, both the manufacturer and the customer benefit. With intensive tooling comes the ability to design parts that work better. It is conceivable to make a printer with two molded (or die-cast) parts that do everything from supporting PC cards, power supplies and fans to acting as carriage supports, print surfaces and paper guides. If cleverly conceived, a molded part can do all this work on the inside, while achieving an attractive outer appearance. An example of this is the DataProducts Corp. M200, which is popular in the OEM line-printer market. This printer integrates functions excellently and is particularly well-designed. Similar efforts will follow in the next generation of tabletop printer, from both domestic and foreign sources.

One potentially important feature of well-designed, highly tooled cabinetry and framework is the reduction of sound and noise output to a level acceptable for office environments. To date, matrix printers have earned a shabby reputation for acoustic noise. The sound level of most printers is so high that any nearby conversations must stop while one is running. An average typewriter puts out about 50 to 60 decibels on the A-weighted scale. By comparison, a modern matrix printer puts out nearly 75 dBA. This huge difference is a major reason this type of product has not attained acceptance in the office environment.

Providing quietized cabinets or attachments does help; however, it is tricky because noise can travel around corners, through walls and on paper extending from the print area through an exit hole. One approach is to enclose the paper path fully, thus containing the noise. While effective, this greatly increases a printer's size and is inappropriate for a product that is supposed to supplant the typewriter. Another approach is to

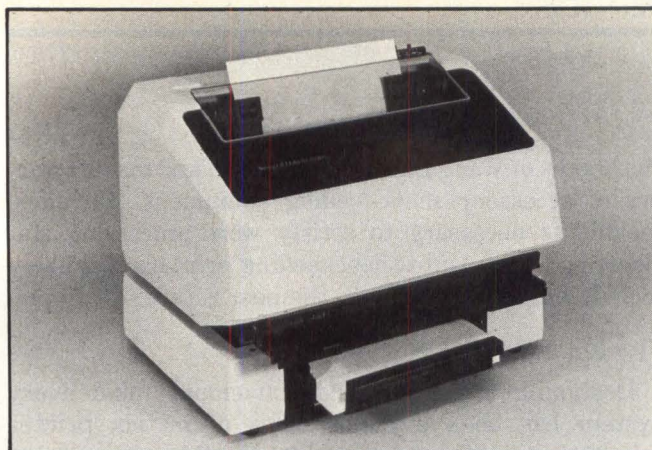

Fig. 9. The IDS Prism matrix printer is shown installed on the new auto sheet feeder that handles as many as 200 sheets. This option allows versatility of printer use because it need not be removed when the user wants to load sheet- or tractor-feed paper manually or semiautomatically.

attack noise at its source, the head. Many new heads run much quieter through the application of baffles, boots, and other sound-deadening devices within the head. These efforts will probably eventually provide enough acoustic dampening to obviate the need for fully enclosed cabinets and still be at an appropriate level for office usage.

What's next?

Experts close to the industry expect a rapid rise in the popularity of matrix printers as new features become a practical reality. But the manufacturers of daisy printers are not likely to lie down and play dead. In addition to reducing their products' cost and providing enhanced features, some daisy makers are also introducing their own matrix printers.

Of particular concern to domestic printers, daisy and matrix alike, is the influx of foreign printer products, notably from Japan. In general, domestic manufacturers spend most of their engineering budgets on the application of existing and recent technology. On the other hand, much R&D is occurring in Japan. This will probably mean that U.S. firms will begin to do to Japan what Japan has done to them in the past several years: copy, adapt, improve and market.

With the emergence of the ribbonless ink systems and ultra-high-efficiency and -speed print heads, dot-matrix printers will be able to accompany the workstation computers now gaining popularity. These printers will be capable of the common print modes (word processing, high-speed draft and color), and will likely employ modular upgrades for most of the major options. □

Neil Rosenberg is an engineering manager at Integral Data Systems, Milford, N.H., where he participated in the design and development of the new Prism printer family and related accessories.

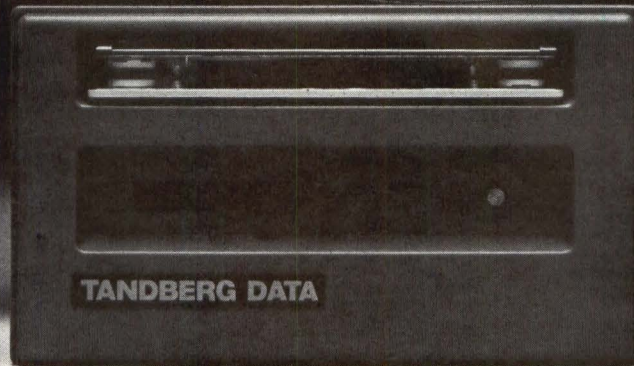

A STRONG STATEMENT ABOUT OUR STREAMER'S ACCURACY AND RELIABILITY.

We're standing on our streamer to show you just how well Tandberg's 3200 family of 20 MB and 45 MB $\frac{1}{4}$ " cartridge drives are engineered. Of course, we didn't design them to be stepstools.

DESIGNED FOR DATA INTEGRITY.

Unlike most other drives, the 3200's body is fully cast to keep drive mechanisms stable and accurate. What's more, Tandberg's exclusive 3-point positioning and cartridge locking system ensures that cartridges are always correctly loaded and can't be jarred off track.

And while others still use less accurate mechanical referencing to locate the edge of the tape, Tandberg's exclusive Floating Head System finds this reference point dynamically using a signal seeking method. A precision, microprocessor-controlled stepping motor then locates the desired track—with better than 16 track accuracy. (Since our

20 MB and 45 MB units have 4 and 9 tracks respectively, the system is at least twice as accurate as it needs to be.)

Tandberg's system completely eliminates interchangeability problems caused by cartridge wear, drive wear, and mechanical tolerance build-up. It's the main reason why our streamer gets more reliable performance from $\frac{1}{4}$ " cartridge tapes than anyone else in the industry.

A HEAD ABOVE THE COMPETITION.

Our 20 MB drive has the same cast body, the same cartridge lock, the same head positioning system as our 45 MB unit. Even the standard features are the same: QIC compatible interface, expandable circular FIFO buffer (up to

16 KB) for increased throughput, and full saturation recording. So what's the difference between our 20 and 45?

The head.

One screwdriver and one 9 track head are all you need to upgrade our 20 to 45 MB—with no mechanical adjustments whatsoever.

So if you're looking for a streamer that's accurate, reliable, and extremely flexible, step up to the only one you can stand on.

Tandberg.

For more information contact, Tandberg Data Inc., DATA STORAGE DIVISION, 571 North Poplar, Suite H, Orange, CA 92668/(714) 978-6771.

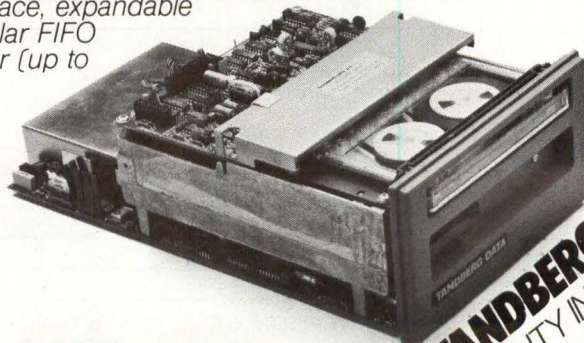

TANDBERG DATA
QUALITY IN EVERY BIT.

STAY ON TOP!

Plan NOW to attend...

National Electronic Packaging and Production Conference



MARCH 1-3, 1983 • Anaheim Convention Center, Anaheim, California

NEPCON exclusive:

**AUTOMATED
"P.C. BOARDWALK"**

A short continuous journey through ten years of technological development in the manufacture of printed circuitry!

See...Hear...Learn the Latest Technology at the World's Largest Electronics Manufacturing Exposition

* 1,800 DISPLAYS

Cost-effective equipment, tools, hardware, supplies and test equipment to improve productivity.

* JOB-ORIENTED CONFERENCE PROGRAM

Experts share new techniques, systems, methods to help you do a better job.

* OVER 800 EXHIBITORS

The nation's leading suppliers demonstrate their latest products.

* EFFICIENT NEW FLOOR PLAN

Saves you time by dividing exhibits into 5 major product areas.

For prototype designers, PCB designers, manufacturers and buyers, testing/support personnel, and electronic engineers

Save time. Pre-register now!

Mail This Coupon For FREE Admission To The Exhibition

ORGANIZED BY



**Cahners
Exposition
Group**

Cahners Plaza
1350 E. Touhy Ave.
P.O. Box 5060
Des Plaines, IL 60018
(312) 299-9311
Telex: 82882
CEG/CHGO

Please send application for free admission to the exhibition; also include details of the technical program.

Name _____

Job Title _____

Company _____

Address _____

City _____ State _____ Zip _____

Phone (_____) _____

**TO: NEPCON WEST '83 c/o Cahners Exposition Group, Cahners Plaza
1350 E. Touhy Ave., P.O. Box 5060, Des Plaines, IL 60018**

MAKE COPIES FOR YOUR ASSOCIATES

L

For those
who think a
quality 8-inch
disk drive
has to be
expensive...



It doesn't.

For example, our 47-Mbyte, 8-inch Winchester disk drive is competitively priced. Without any compromise in the performance you'd expect from an advanced disk drive—or in the quality you'd expect from Fujitsu. ☺

MODEL	M2301B	M2302B	M2302BE	M2303BE
CAPACITY (MB)	11.7	23.4	23.7	47.5
AVG. POSITIONING TIME (ms)	70	70	70	70
TRANSFER RATE (KB/s)	593	593	1,200	1,200
INTERFACE	SA4000			
AVERAGE LATENCY (ms)	10.1	10.1	10.1	10.1
RECORDING DENSITY (BPI)	6,100	6,100	12,360	12,360
TRACK DENSITY (TPI)	195	195	195	195
NUMBER OF CYLINDERS	244	244	244	244
NUMBER OF DATA HEADS	4	8	4	8
POSITIONING METHOD	Buffered Stepper			
DIMENSIONS (HxWxD in.)	4.4x8.5x14.0			

Fujitsu America Sales Offices:
Northwest 408/988-8100 Southwest 714/558-8757
East Coast 617/229-6310 Europe 44-1/493-1138

© 1982, Fujitsu America, Inc.



QUALITY LIVES

CIRCLE NO. 85 ON INQUIRY CARD

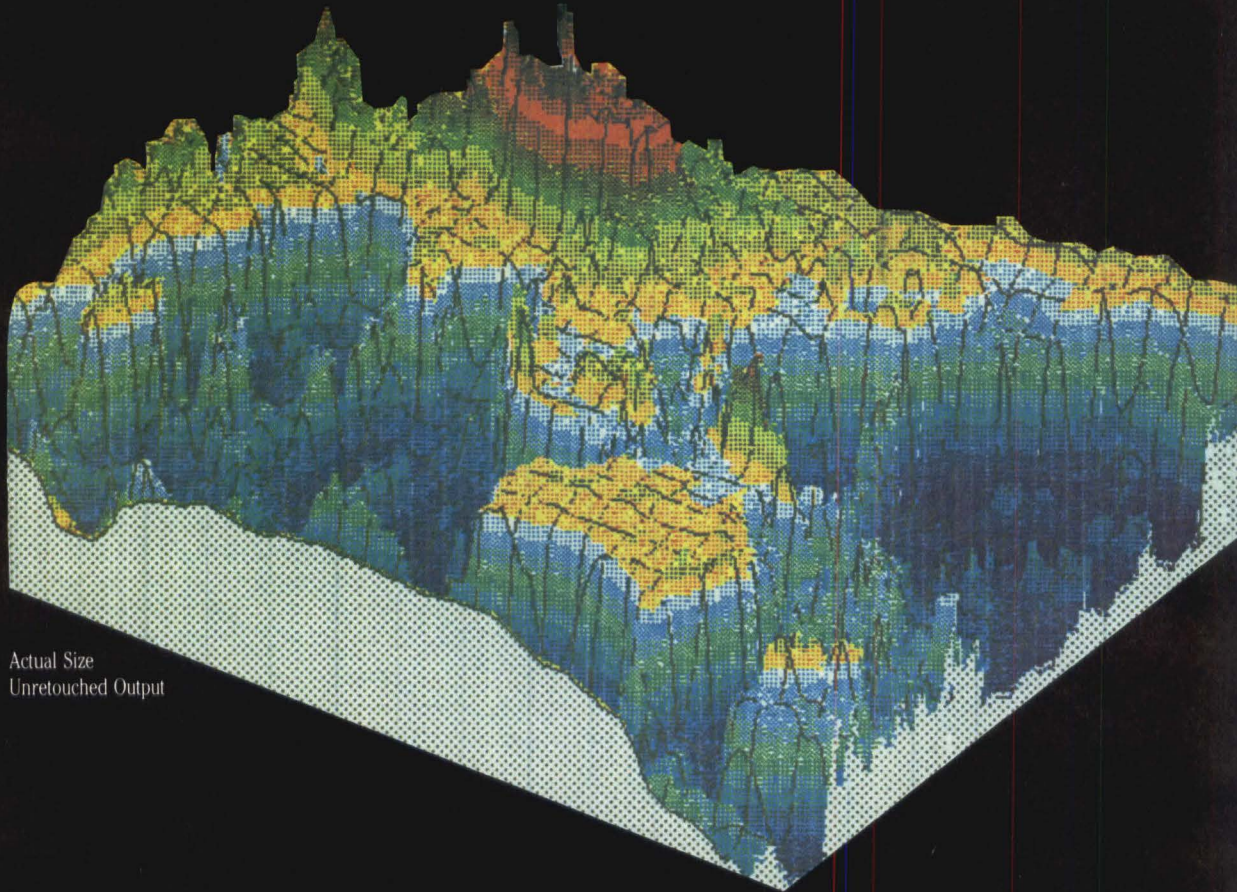

Actual Size
Unretouched Output

PEAK PERFORMANCE

GRAPHIC SYSTEMS OEM'S CAN NOW CAPITALIZE ON MODULAR FLEXIBILITY. In the world of color graphics, output quality used to be a function of price, purely and simply. That is, until Integral Data Systems introduced the revolutionary new Prism Printer™ featuring modularly upgradable color graphics. By specifying or adding Prism Color™ and Dot Plot™ graphics options to our rugged Prism Printer, OEM's can now offer their customers the capability to produce bright, brilliant color like the one you see here from Woods Hole Oceano-graphic Institution. And at a cost far below anything comparable that's available today in color graphics printer/plotters.

The optional Prism Color module can chart the ups and downs of financial trends quickly, output changes in CAD/CAM modeling, or analyze changes of complex medical or scientific data. The result is that your system will perform better. And that will make you look good.

Modular graphics is only one competitive edge that the Prism Printer offers the OEM. Standard



features include Maisey Mode™, our exclusive overlapping-dot correspondence-quality print, and dual speed capability with Sprint Mode™, for printing at 200 cps, as well as parallel and serial interfaces. Other performance modules can be added as well, such as an Auto Sheet Feeder and companion cassette for word-processing applications.

In addition, we'll help you with special character sets, unique interface requirements or custom paint colors and logo identification to meet your system needs. With more than 70,000 printers in the field and a nationwide service network featuring both depot and on site-service, Integral Data can give you the product and support you need to meet your OEM printer requirements.

So, before you invest in any printer to go with your system, check out the Prism Printer. It's a tough no-nonsense competitor flexible enough to meet virtually any color graphics application. Call our OEM Marketing Group today. We'll show you a colorful way to enhance your capabilities without going in the hole.



Integral Data Systems, Inc.

A Whole New Spectrum of Imaging Ideas

Milford, NH 03055

Telex: 953032

Toll-free, 1 (800) 258-1386

NH, Alaska and Hawaii, (603) 673-9100



PRISM PRINTER™
CIRCLE NO. 86 ON INQUIRY CARD

Printer combines plotter interface with matrix technology

EDWARD M. GOLDBERG and PETER MOULDS, Envision Technology, Inc.

Built-in vector-to-raster conversion allows plotter graphics with letter-quality text

Many computer-graphics software applications generate images in the form of a list of vectors. Plotters can accept and draw these vectors without translation, using a simple interface that minimizes communications overhead. But because alphanumeric characters are composed of several vectors, plotters are extremely slow at text printing (about 3 characters per sec.),

making them impractical for word- and data-processing applications. Plotter-drawn characters, furthermore, appear almost handwritten. Raster hard-copy devices create images by selectively turning dots on and off in a fixed matrix. They are much faster than plotters at text printing, but cannot plot vectors directly; vector information must be translated into a raster or bit-map

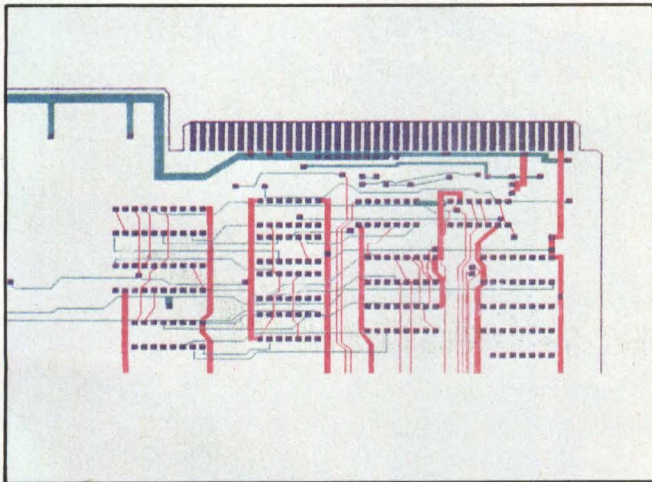

```

.1.2.3.4.5.6.7.8.9.0.\.
.!.\".#.$.%.&.'.(.)_.=~/|.(.)[

.a.b.c.d.e.f.g.h.i.j.k.l.m.n.o.p
.A.B.C.D.E.F.G.H.I.J.K.L.M.N.O.P
.1.2.3.4.5.6.7.8.9.0.\.
.!.\".#.$.%.&.'.(.)_.=~/|.(.)[

.a.b.c.d.e.f.g.h.i.j.k.l.m.n.o.p
.A.B.C.D.E.F.G.H.I.J.K.L.M.N.O.P
.1.2.3.4.5.6.7.8.9.0.\.
.!.\".#.$.%.&.'.(.)_.=~/|.(.)[

.a.b.c.d.e.f.g.h.i.j.k.l.m.n.o.p.q.r.s.
.A.B.C.D.E.F.G.H.I.J.K.L.M.N.O.P.Q.R.S.
.1.2.3.4.5.6.7.8.9.0.\.
.!.\".#.$.%.&.'.(.)_.=~/|.(.)[.] + *

.a.b.c.d.e.f.g.h.i.j.k.l.m.n.o.p.q.r.s.t.u.v.w.x.y.z.
.A.B.C.D.E.F.G.H.I.J.K.L.M.N.O.P.Q.R.S.T.U.V.W.X.Y.Z.
.1.2.3.4.5.6.7.8.9.0.\.
.!.\".#.$.%.&.'.(.)_.=~/|.(.)[.] + * ' , ; : @ < > ? , / ...

.A.B.C.D.E.F.G.H.I.J.K.L
.A.B.C.D.E.F.G.H.I.J.K.L
.1.2.3.4.5.6.7.8.9.0.\.
    
```

Print samples from the Envision 430 include a PC-board design, a stereoscopic image pair and six character fonts.

image, typically requiring add-on vector-to-vector conversion hardware and/or software.

The Envision Technology, Inc., 430 Color Vector-Printer is an impact matrix printer that can be controlled with high-level vector commands like a

plotter through a built-in vector-to-raster conversion system. But because it is a matrix printer, it can provide 300-cps alphanumeric character printing (or 125-cps letter-quality printing) and faster graphics area fills. The printer incorporates two microprocessors and an 18-wire print head, achieving a resolution of 0.007×0.003 in.

The Envision 430 incorporates two Intel Corp. 8088 16-bit microprocessors (Fig. 1). One controls the print mechanism; the other handles the host interface and

MAXIMIZING RIBBON LIFE

The Envision 430 maximizes ribbon life through a four-cartridge ribbon system. While conventional multicolor ribbons are advanced even if only one color is used, the 430's separate color cartridges are advanced individually as each color is used, ensuring complete use of every cartridge. In addition, the 430 adjusts ribbon advance based on the number of times each of 18 print-head wires are fired, rather than at predetermined intervals.

The 430 can print four colors without ribbon blending. Ribbon blending produces eight colors, with one of the ribbons black. Ribbon cartridges are available in mylar for high-quality print, and nylon for longer ribbon life.

Print head	Carriage position (vertical)	Electromagnet	Pivot position	Ribbon cartridge
Fixed position	Down	Off	Forward	#1
		On	Back	#2
	Up	Off	Forward	#3
		On	Back	#4

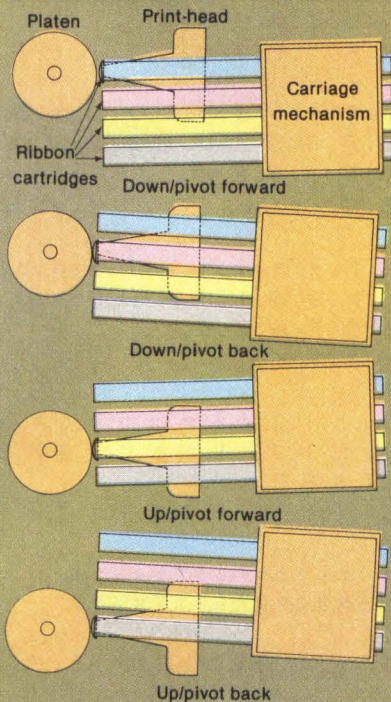

Four ribbon cartridge positions are achieved by moving the carriage and cartridges up and down and pivoting them back and forth.

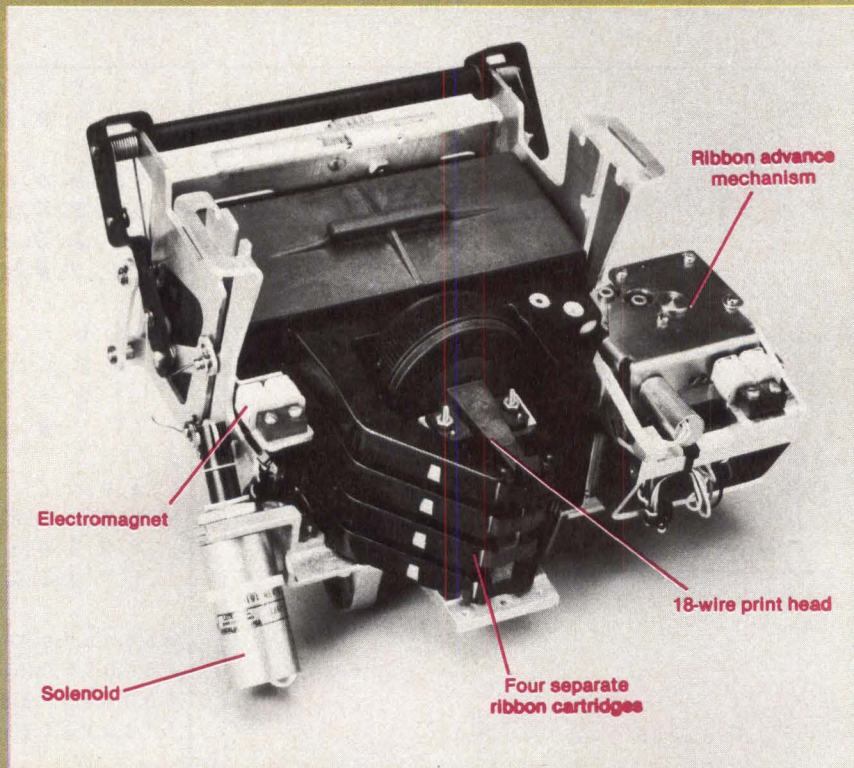

Printing and ribbon selection mechanism incorporates four separate ribbon cartridges for multicolor printing without ribbon waste. Colors are selected by both moving the carriage and cartridges up and down via a solenoid, and pivoting the bank back and forth with an electromagnet. The combination of these two motions positions any one of the four ribbons in front of the print-head. Ribbons are advanced individually as they are used.

THE NEED...

QUIET, FLEXIBLE WORD PROCESSING AND GRAPHICS APPLICATIONS

THE SOLUTION...

QMS LASERGRAFIX 1200™

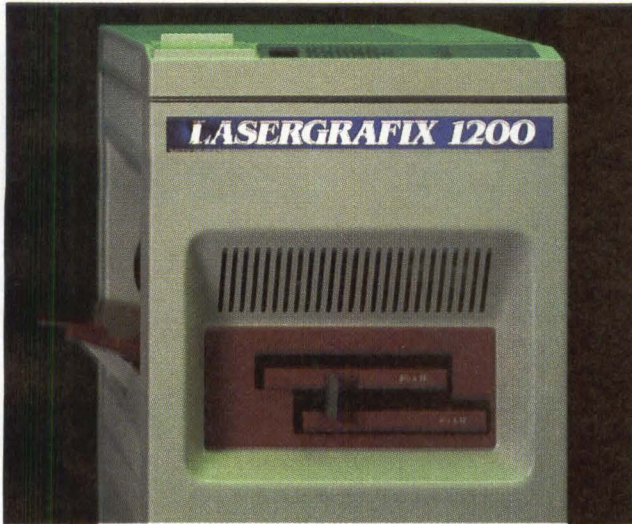

QMS LASERGRAFIX 1200...a totally new concept in electronic page printing! We've merged laser printing with the most sophisticated intelligent controller on the market. The result—a compact laser printer that offers easy to program graphics and letter quality output with a resolution of 300 dots per inch...and all at a whisper quiet level.

OUR APPLICATIONS FIRMWARE PACKAGE WILL SAVE YOU TIME AND MONEY!

INDUSTRIAL GRAPHICS BUSINESS GRAPHICS LETTER QUALITY WORD PROCESSING
 MULTIPLE FONTS OCR CRT HARDCOPY FORMS CREATION EDP LINE PRINTING
 GRAPHIC PRINTING/PLOTTING for scientific, analytical and CAD/CAM... and our list goes on and on. **AND OUR CONTROLLERS DO THE PLOTTING FOR YOU!** All you do is supply simple print instructions to the printer in your normal data stream. **AND OUR INTERFACES COVER ALMOST ANY COMPUTER SYSTEM YOU CAN THINK OF...** Burroughs, DEC, IBM, NCR, Sperry Univac, Wang, and others.

QMS LASERGRAFIX 1200... "A PICTURE IS WORTH A THOUSAND WORDS."

QMS QUALITY MICRO SYSTEMS
P.O. Box 81250 • Mobile, Alabama 36689 • (205) 343-2767

Telex 505-405 QMS MBL

Quality is more than our name. It's our business.

YES! I'm interested in your LASERGRAFIX 1200 solutions to my printing and graphics needs. Please send me your LASERGRAFIX 1200 literature.

NAME: _____ TITLE: _____

COMPANY: _____ TYPE OF BUSINESS: _____

ADDRESS: _____

CITY: _____ STATE: _____ ZIP: _____

PHONE: () _____ I WOULD _____ WOULD NOT _____ LIKE A SALESMAN TO CALL.

I WOULD _____ WOULD NOT _____ BE INTERESTED IN BECOMING A LASERGRAFIX 1200 OEM. MMS02

CIRCLE NO. 87 ON INQUIRY CARD

command interpretation. The two microprocessors share a 128K-byte bit-map memory. An entire picture in the form of a list of vectors is loaded from the host computer into the printer memory. The interpreting microprocessor sorts this vector list according to location and color. It then scans the list and segments it into 18-line windows, or one line for each print-head wire (Fig. 2). Each window from the top down is

converted into lines of dots and queued in the memory, in which it is accessed by the print-control microprocessor. The two microprocessors operate in parallel, so the processing of subsequent windows can continue while earlier windows are printed.

The 430's memory spools several graphs, or as many as 70 pages of 66 lines, and can generate multiple copies without host intervention.

Printing mechanism

Envision uses an 18-wire, high-frequency print head for 360-dot-per-in. horizontal resolution. Most matrix printers use seven- or nine-wire heads, requiring more

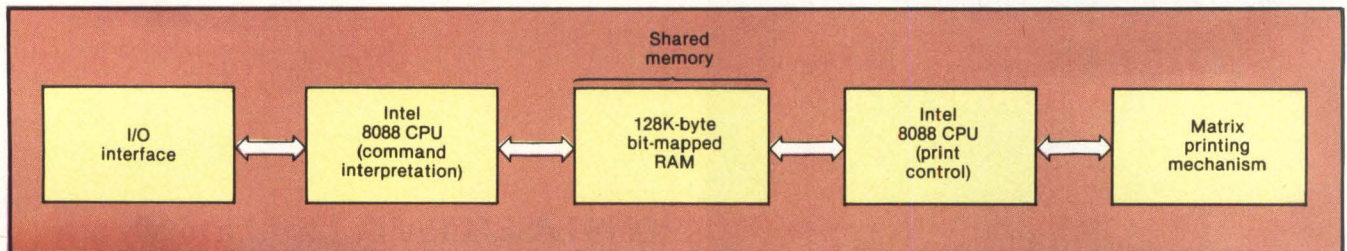

Fig. 1. Dual 16-bit microprocessor architecture incorporates bit-mapped RAM to print letter-quality text and color graphics. The command interpretation microprocessor receives characters and creates a bit-mapped image in the shared memory. The print-control processor interprets the bit-map data, making no distinction between text and graphics.



The Envision 430 ColorVector Printer offers eight-color graphics printing via a plotter interface. Priced at less than \$5000, it also offers letter-quality printing and high-speed mode for drafts.

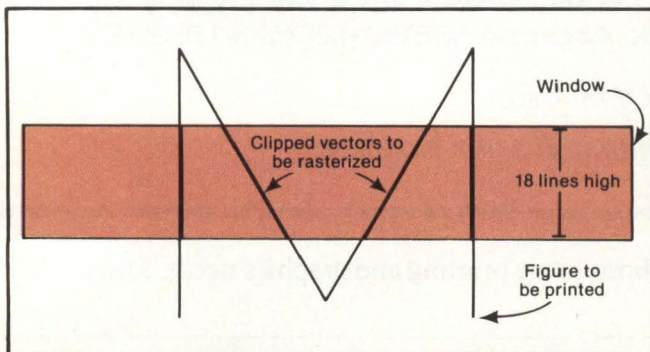

Fig. 2. Vector-to-raster conversion involves dividing the figure to be printed into several windows, each of which is 18 lines high (one line for each wire on the print head). Windows are converted one at a time, starting from the top of the figure, with vectors clipped at the edge of the window. Portions of vectors within the window are converted to raster format and stored in the bit-map memory for printing.

than one pass over a line and slight offsetting of the print-head position for high-quality, but slow, text printing. The 430's 18-wire print head prints letter-quality characters in a single pass without offsetting its position. An operator or a host can select character densities of 8, 10, 12 and 16.5 pitch. A variety of fonts are available, including elite, pica, Orator, italics, bold and user-defined fonts. Because fonts are contained in firmware, they can also be changed under host control.

Most printers cannot print until the print mechanism has reached a fixed velocity. A heavy-duty carriage drive can minimize the delay by providing high acceleration, but such drives add to weight, size and cost. The 430 eliminates the delay by printing while the carriage accelerates. The print-control microprocessor tracks the carriage through a closed-loop servo system, and adjusts for carriage velocity and direction during dot placement.

The Envision 430 supports Centronics and Diablo text protocols. The graphics protocols supported are similar to those of many popular plotters, including those from Hewlett-Packard Co. and Tektronix, Inc. OEMs can customize the hardware interface and protocols for emulation of other printer manufacturers through a translation table in firmware. An optional bidirectional tractor feed allows unattended paper handling. Communications rates can reach 38.4K baud with an RS232C interface and 60K bytes per sec. using a Centronics parallel interface. □

Edward M. Goldberg is software development manager, and Peter Moulds is product manager at Envision Technology, Inc., San Jose, Calif.

TIME-PROVEN PERFORMANCE



While new printers with impressive specifications are introduced on an almost daily basis, only time will tell the true quality of the product. Over the past 2 years our customers have continued to buy the DS180 printer, not only because of its impressive performance and competitive price, but also because of our outstanding track record for product reliability and customer support.

We have continually improved on the performance of the DS180 by incorporating such enhancements as dot addressable graphics, 6 user-selectable print sizes and a 2000 character buffer. These features coupled with 180 cps printing, parallel and serial interfaces, adjustable tractor feed and over 40 other programmable features, make the DS180 one of the most versatile matrix printers available today.

Before you select your next printer, why not take a look at a time-proven performer—the Datasouth DS180.

The DS180 printer is available nationwide through our network of sales/service distributors.

datasouth computer corporation

P.O. Box 240947 • Charlotte, NC 28224 • 704/523-8500

Telex: 6843018 DASOU UW CIRCLE NO. 88 ON INQUIRY CARD

Zilog's System

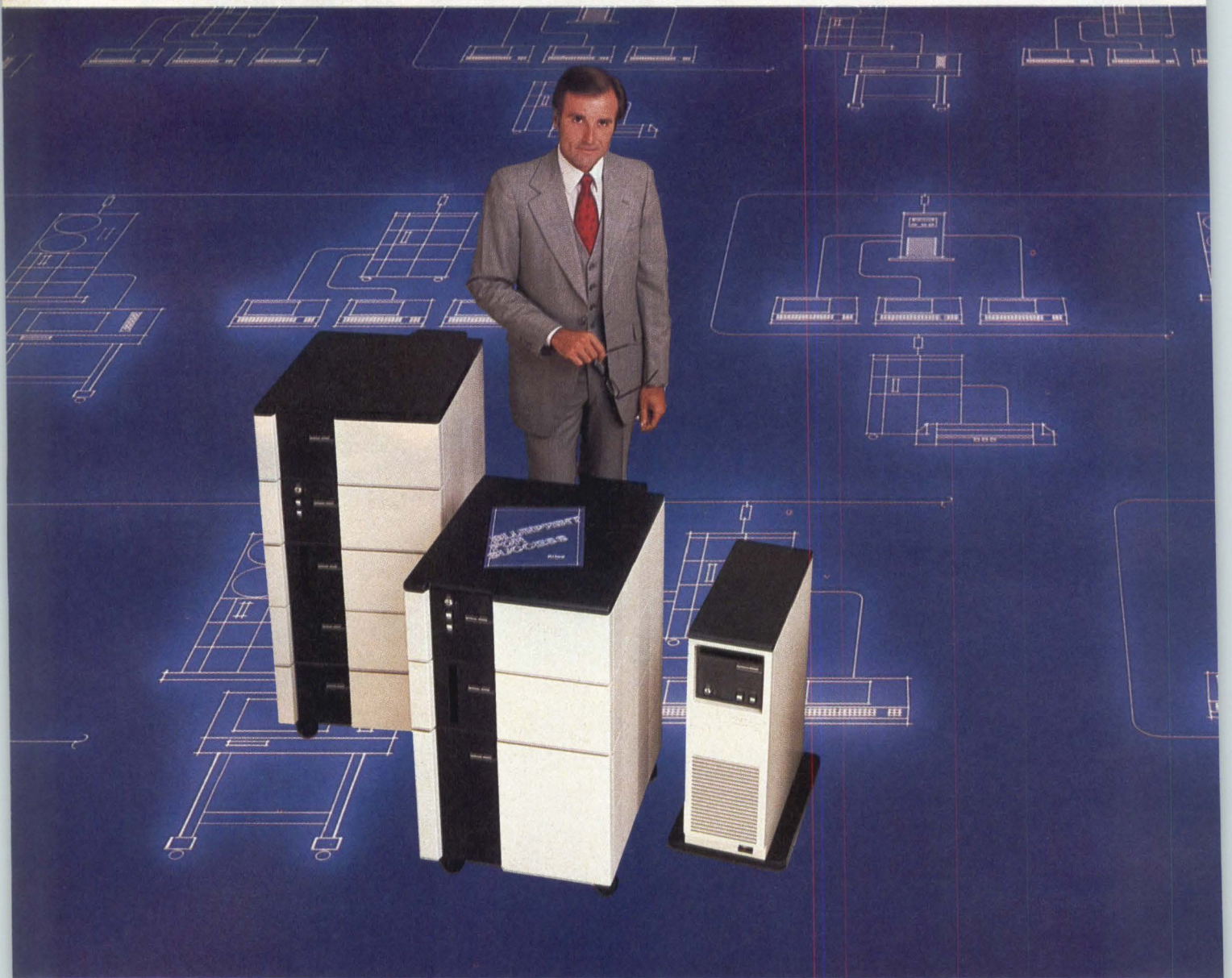

8000 family spells OEM success.

Zilog's System 8000 is a growing family of totally compatible general purpose 16-bit micro-computers designed for high performance and reliability. Priced from \$14,950 to \$37,950, they are rapidly becoming the choice of successful OEM's for a growing variety of applications.

The entry level Model 11 gives you 256 KB of parity memory, and an 18 MB Winchester disk for on-line storage. It supports up to eight users, making it the perfect low-cost micro for commercial users.

For higher performance, choose the Model 21. It features 1 MB of ECC memory, a 32 MB Winchester disk and a 17 MB cartridge tape for backup.

For the highest performance of all, select the Model 31, the remarkable micro comparable in performance to minis, yet priced far less. It delivers up to 4 MB of ECC memory, plus up to 320 MB of SMD compatible disk and offers an optional 9 track tape. Model 31 also supports up to 24 users simultaneously.

Best of all, the System 8000 family has been designed to take full advantage of the powerful UNIX* operating system. System III has been added to further enhance application software development, making System 8000 computers your best choice to run high level languages such as BASIC, COBOL, FORTRAN 77, C, Pascal, PL/Z/SYS and Z8000 assembler. All software is code and data compatible, allowing for total portability among all family systems. Inside all System 8000s are the high performance VLSI components you've come to expect from Zilog. The Z8000™ is a 16-bit CPU with 16 general purpose registers, an 8 MB address space and expanded capability to perform 8-bit, 16-bit and 32-bit operations.

Zilog's System 8000 family. Flexible, cost-effective solutions for today's OEM applications.

Let us spell success for you. Call our toll-free number today: 800-841-2255. Ask for your free copy of the Zilog "Blueprint for Success" kit and poster. The kit contains detailed information on Zilog's System 8000 family and Zilog's unique OEM opportunities.

INTERNATIONAL

Paris 33-1-0163

Munich 89-612-6046

London 44-0628-39200

Tokyo 03-587-0528

Zilog

*Pioneering
the Microworld.*

An affiliate of EXON Corporation

CIRCLE NO. 89 ON INQUIRY CARD

*UNIX is a trademark of Bell Laboratories. Zilog is licensed for Version 7 and System III by Western Electric, Inc.

"The merger of Victor and Sirius creates a unique combination of advanced technology, marketing and worldwide distribution."

Chuck Peddle, designer of the Victor 9000 microcomputer and President of the new Victor Technologies, Inc.



The combination of Victor Business Products and Sirius Systems Technology, Inc., creates a new company designed to meet the most demanding needs of the modern business office. It unites the advanced technology capabilities of Sirius with the distribution, support and marketing strengths of a company with over 65 years of experience in solving business application problems.

The result is Victor Technologies, Inc., a company ideally suited to dramatically impact today's international computer marketplace.

The new Victor: Streamlined for success.

The Chairman of the Board of the new Victor Technologies is Fred Sullivan, Chairman and Chief Executive Officer of Kidde, Inc., a diversified \$3 billion company. The financial support of this giant conglomerate will help focus Victor's goal of becoming one of the three leading computer companies in the world.

President and Chief Executive Officer of the new company is Chuck Peddle. It was Chuck Peddle's focus and insight which led to the design and manufacture of the Victor 9000, the first and most powerful of the "third generation" of microcomputers. Acknowledged as the "father" of the personal computer concept,

Peddle introduced this useful and very affordable third generation microcomputer in the European market with startling results.

The Victor 9000: Number One in Europe, in a class by itself in America.

In Europe the Victor 9000, sold under the name of Sirius 1, is the best selling microcomputer in the market. As a matter of fact, it was recently named "Computer of the Year" in West Germany.

There are demonstrably good reasons for this success. As in the United States, the Victor 9000 is the most powerful microcomputer available, offering substantially more internal memory, storage capacity and engineering advances than any other comparable product. And the Victor 9000 library of business application software and innovative line of peripherals and accessories make it a business tool of great versatility.

A vital part of the new Victor is a total commitment to the development of new

software, both internally and by third parties. The reputation of Chuck Peddle and the proven success of the product family will continue to attract the efforts of the brightest minds in the high technology industry.

Over 10,000 outlets throughout the world.

Victor, long established as a world leader in desktop calculators and innovator of electronic cash registers, will be accelerating and expanding the distribution channels for these products. And with the outstanding acceptance of the Victor 9000 desktop computer, the new company is committed to make substantial new product offerings and support for all product lines through its large branches and dealer networks.

A commitment to growth and excellence.

The new Victor is committed to nothing less than a major leadership role in the computerized office of tomorrow. The company's synthesis of high technology expertise and innovation with the experience, stability and financial strength of one of the most respected business product companies in the world assures that success.

VICTOR

Victor Technologies, Inc. P.O. Box 1135 Glenview, Ill. 60025 1-800-VIC-9000

CIRCLE NO. 90 ON INQUIRY CARD

High-speed magnetic printer uses perpendicular recording

JOHN M. FREEMAN, Cynthia Peripherals Corp.

*Magnetic drum recording head modules
produce letter-quality text at 6000 lpm*

Within the past few years, many attempts have been made to make magnetic printing a viable alternative to laser printing. Most of these attempts have used conventional magnetic printing components such as longitudinal recording heads and magnetic tape.

The MP-60 printer from Cii Honeywell Bull, the parent company of Cynthia Peripheral Corp., uses a magnetic printing technology that eliminates many of the disadvantages of Xerographic and magnetic-tape processes, including the need to change or regenerate the printing medium continuously. This new technology is based on a hardened magnetic drum on which dots are recorded perpendicularly by an array of recording heads.

Non-impact printing techniques

Most low-speed non-impact printers use thermal or ink-jet techniques. In the high-speed range (several thousands of lines per min.), electrostatic or electro-optical (Xerographic or laser) technologies dominate. These high-speed, non-impact printers are sophisticated, with correspondingly high purchase and maintenance costs.

Both electrostatic and electro-optical techniques are based on a photosensitive drum that records a latent electrostatic image (Fig. 1). The drum rotates in front of an inking station, attracting toner to the latent image, and then transfers the toner to paper, on which the toner is then fixed. Poor reliability of the drum,

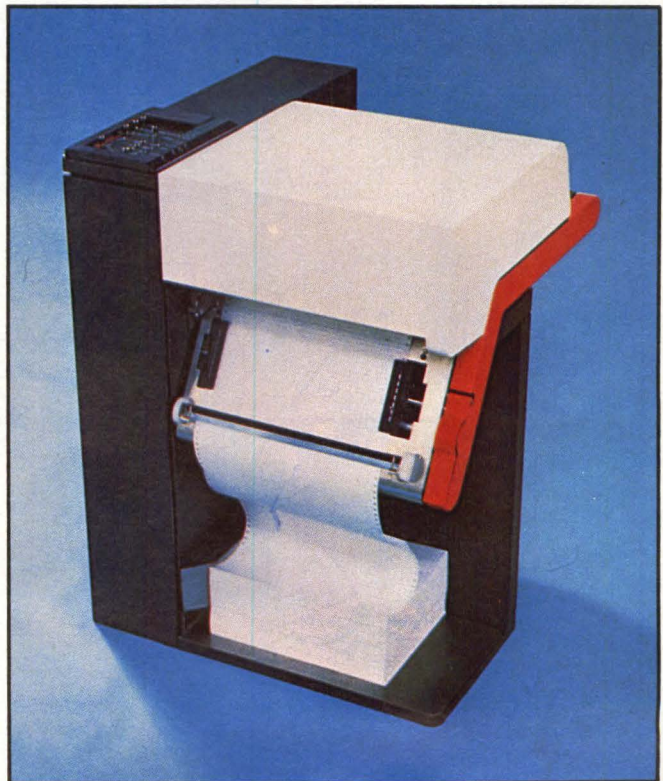

The Cii Honeywell Bull MP-60 magnetic line printer uses perpendicular recording on a magnetic drum to print at 6000 lpm. It accepts cut-sheet or fanfold paper, and is available with a minicomputer-oriented interface. Price is approximately \$20,000 in 500-unit quantities.

recording head and transfer station has resulted in many suppliers' basing prices on the volume of pages printed each month, to help defray the large maintenance costs associated with higher printing volumes. In addition, electrostatic printers require special paper, while laser printers require sophisticated control and adjustment devices.

Perpendicular recording on a drum

The MP-60's technology is based on a metallic, 100-mm.-diameter, magnetic drum (Fig. 2) with an external layer of magnetic alloy. The drum runs at a

In the high-speed range, electrostatic or electro-optical technologies dominate.

constant speed of 12.5 in. per sec. (linear speed at the edge of the drum). This speed leads to a printing rate of 6000 lpm, or 88 pages per min.

In operation, each region of the drum first passes under a demagnetizing head. The printing station, consisting of 3360 recording heads, can then selectively record on the region. This process is repeated over

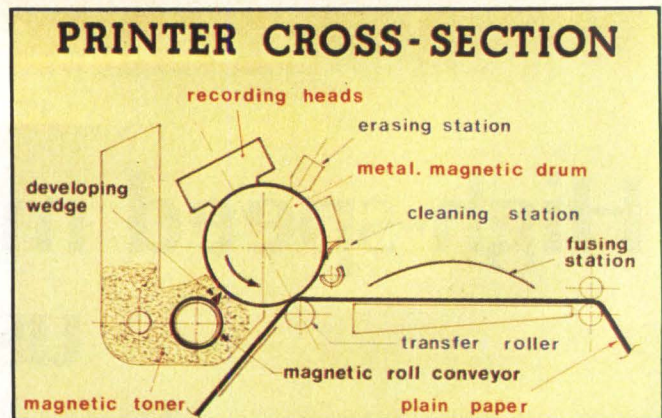

Fig. 2. Magnetic printer mechanism uses an array of magnetic heads to record dots on a hardened drum. Toner is then applied to the drum through a wedge, and transferred to paper by a roller. Excess toner is removed by a scraper, and the region of the drum just printed is demagnetized.

different regions as the drum rotates. The dot configurations in the rows produce a latent magnetic matrix forming an image of the page to be printed. The image can comprise any combination of alphanumeric or graphics.

The magnetized regions then pass through the toning or inking station in which dry magnetic-ink particles are attracted to the drum, resulting in image "development." The ink toner is a single-component toner; that is, the development process uses only one type of particle. Many technologies use cascade or magnetic-brush development, requiring a mixture of toner and carrier. The need to control the mix of toner and carrier, despite the unpredictable consumption that

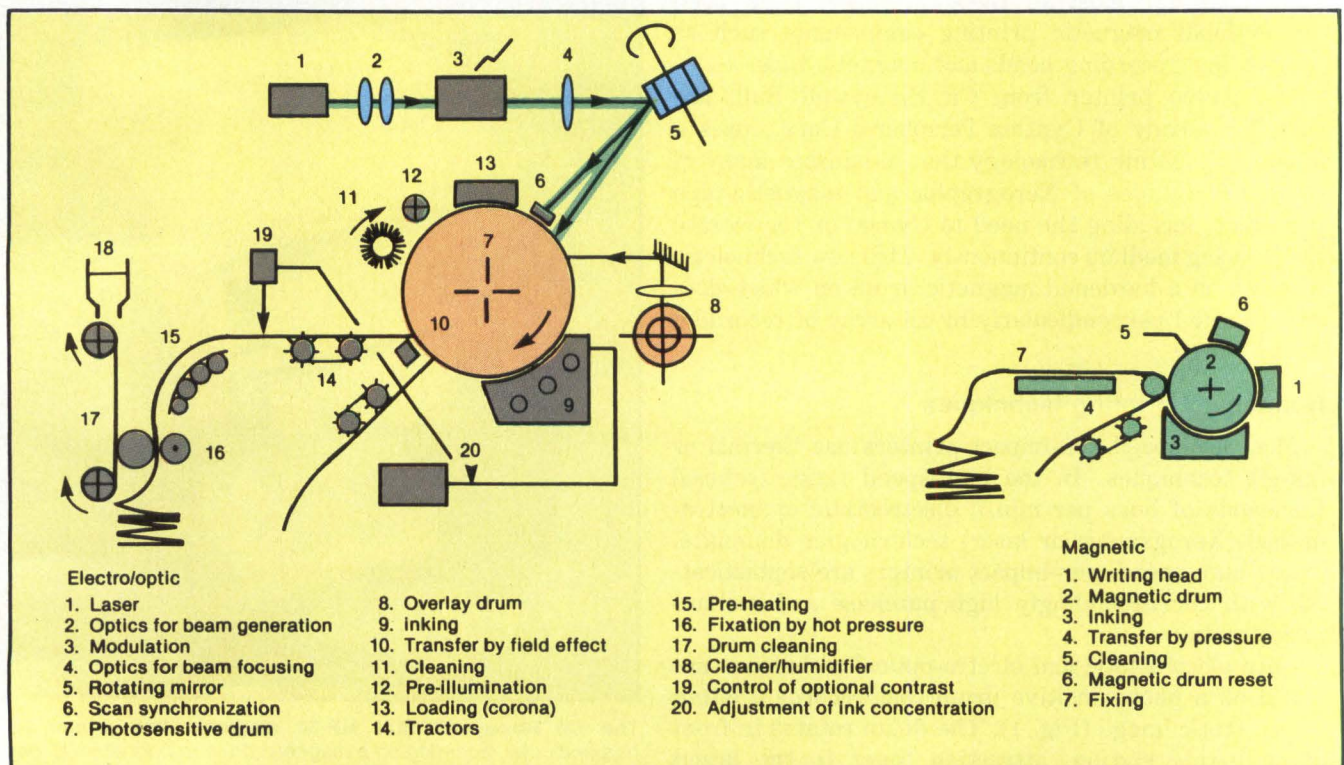
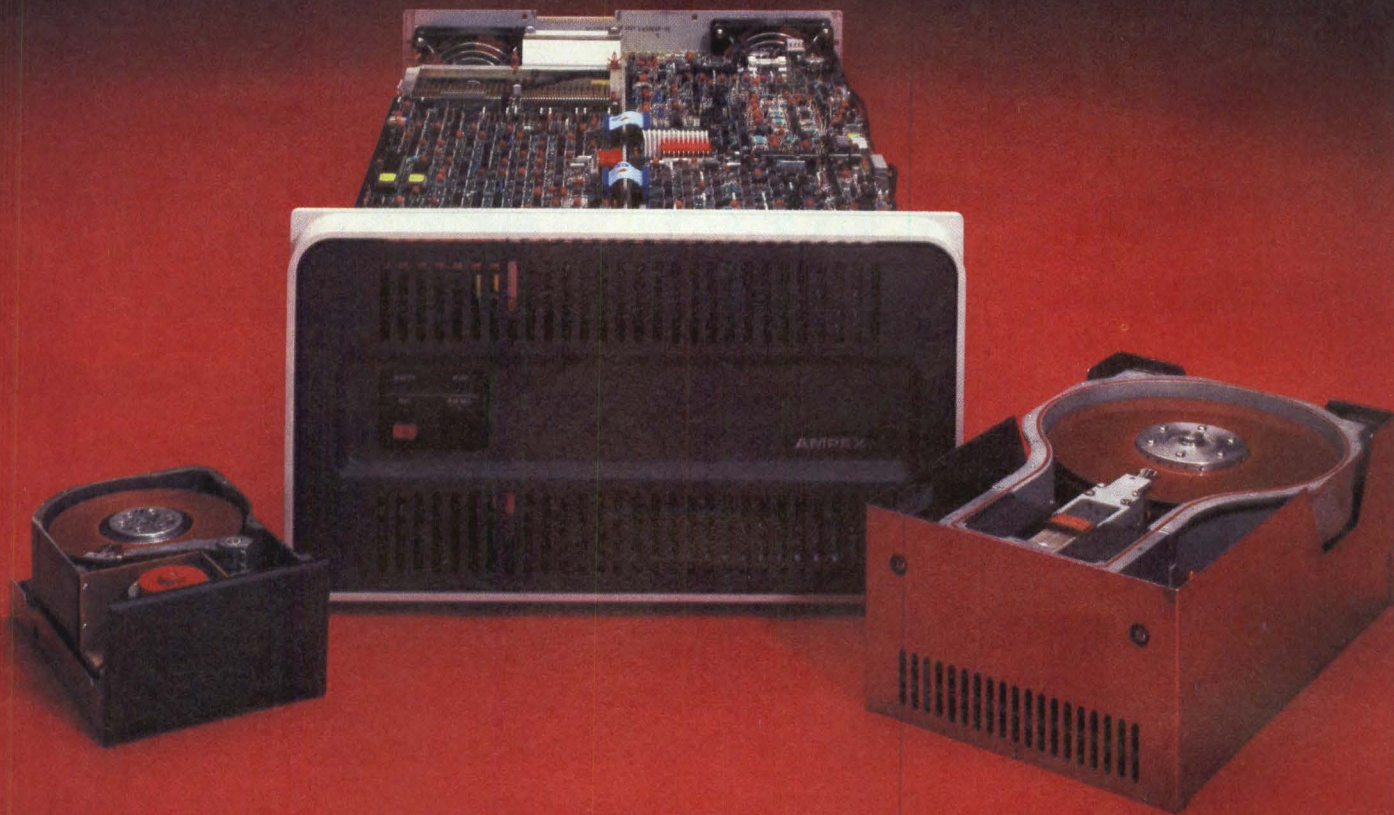

Fig. 1. Comparison of electro-optic and magnetic printing technologies shows relative simplicity of magnetic technique. Figures are drawn to same scale.

WE'VE GOT IT ALL



FROM 7MB TO 330MB IN 5¼", 8" AND 14" WINCHESTER FAMILIES.

Ampex's Winchester families deliver the performance you need in today's competitive marketplace. There's 5¼" Pyxis with up to 27MB; 8" Scorpio with up to 83MB; and 14" Capricorn with up to 330MB. All offer the features you want, like automatic disk and head locking; industry-standard interfaces and packaging; power-up self-test and diagnostics; and capacity expansion. None requires any preventive maintenance.

Our Winchester disk drives are backed by a continuing Ampex commitment to leading-edge technology research, automated processes, and vertical

integration beginning with heads and media; by a highly professional worldwide service and support organization; and by manufacturing capacity in excess of a half-million square feet located in four countries.

That's why you can count on Ampex to deliver whatever you need in Winchester disk drives, today and tomorrow.

Ampex Corporation, Memory Products Division, 200 North Nash Street, El Segundo, CA 90245. 213-640-0150. TWX: 910-343-6243.

AMPEX

Ampex Corporation • One of The Signal Companies 
CIRCLE NO. 91 ON INQUIRY CARD

SIEMENS

Siemens OEM Ink Jet Printer Model 2712

The Unbeatable Combination. Economical...Silent...Dependable.

Siemens Model 2712 puts it all together: exceptional print quality...high reliability...economical performance. It's everything you want in an ink-jet printer—and more—all in one compact super-silent unit.

The 2712 is the lowest cost plain paper non-impact printer available today, with reliability figures far

exceeding those of the best serial impact printers. Our printing head has a lifetime in excess of 10 billion characters.

Our non-clogging ink-jet system is perfect for those discriminating individuals who require consistent printing quality at the lowest available cost of ownership.

For further information contact

Siemens Communication Systems, Inc.
Office Terminals Division
240 E. Palais Road
Anaheim, California 92805
(714) 991-9700 or call
Atlanta, GA (404) 441-0882
Dallas, TX (817) 461-1673
Iselin, NJ (201) 494-5311
Milwaukee, WI (414) 529-5730
Sunnyvale, CA (408) 735-7770.

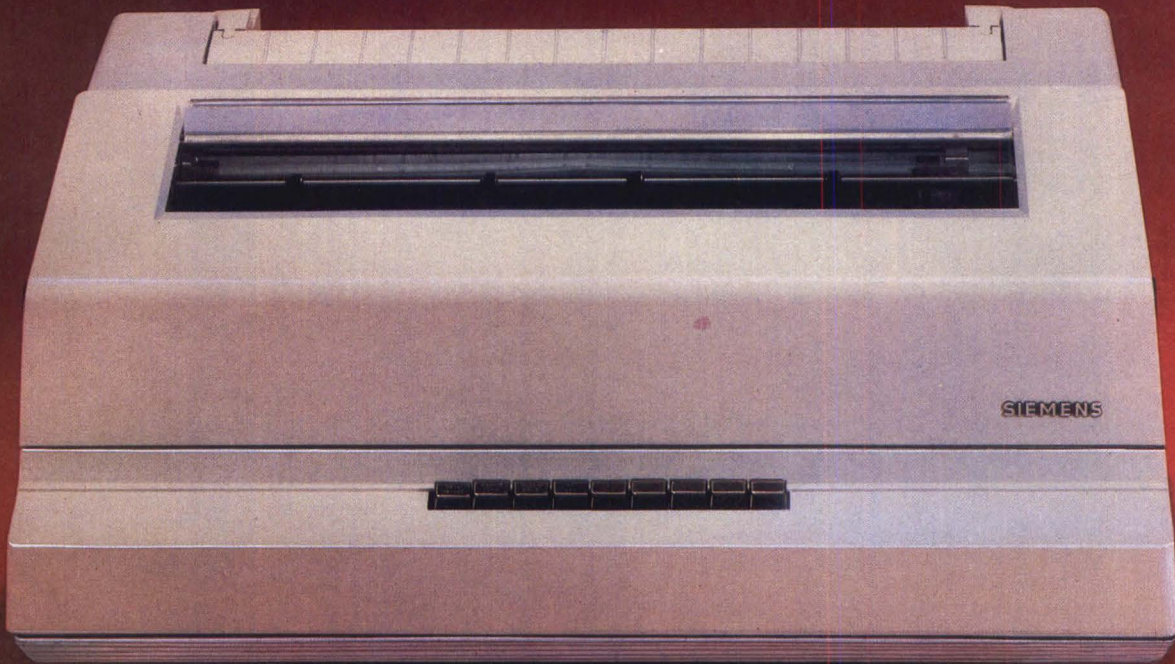

Siemens. Committed to quality.

CIRCLE NO. 92 ON INQUIRY CARD

CC3020 013A SIO 279Z

results from random image density, leads to problems with such systems.

The single-component toner basically consists of thermoplastic resin particles ranging in size from 10 to 50 microns, enclosing several tiny submicron magnetic fillers. Image development results from the magnetic force exerted by the magnetized dots to these magnetic fillers. The particles are applied by a permanent magnetic roller, as in most single-component toning systems. However, unlike most other systems, the developing effect is obtained through a wedge that presses the toner against the drum instead of simply brushing the surface.

MP-60 SPECIFICATIONS

- Speed:** 68 pages per min. (8½ × 11 in.) or 6000 lpm at 8 lpi
- Resolution:** 240 dots per in. vertical and horizontal
- Character pitch:** 6, 8, 10, 12, 15, or 20 characters per in., host-selectable, mixable within a page
- Character Rotation:** 90, 180 or 270 degrees
- Buffer:** 12,000 characters, 24,000 optional
- Character set capacity:** 512 characters, host-selectable
- Based control lines:** 48
- Enable lines:** seven per module, 10 modules
- Control Current:** 70 mA
- Control time:** 4 μsec.

After the image is developed, it is transferred onto plain paper by means of a pressure roller. This roller allows the paper to be friction-driven synchronously with the magnetic drum. This mechanical transfer technique is less sensitive to humidity than the electrostatic transfer used in Xerography and other fragile-medium printers, and avoids the use of high-voltage corona wires. The hardness of the magnetic medium permits the use of such a pressure-based technique.

After the image is transferred to the paper, and before a new print cycle can be initiated, excess toner remaining on the drum is removed by a static scraper blade, as opposed to the conventional rotating-brush mechanism. The scraped toner is then transported mechanically by helicoidal screw.

Recording head design

The large number of recording heads along the drum require a small head that can be controlled with a low drive current, provides a short response time to permit multiplexed control and can be manufactured inexpen-

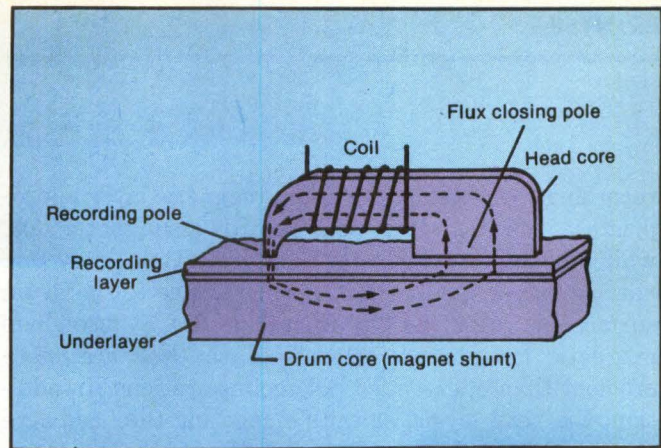

Fig. 3. Recording head sets up a closed-loop magnetic circuit running from the recording pole, through the surface of the drum, to the flux-closing pole and through the core of the head back to the recording pole. The drum retains only the higher intensity field from the recording pole, perpendicular at the surface.

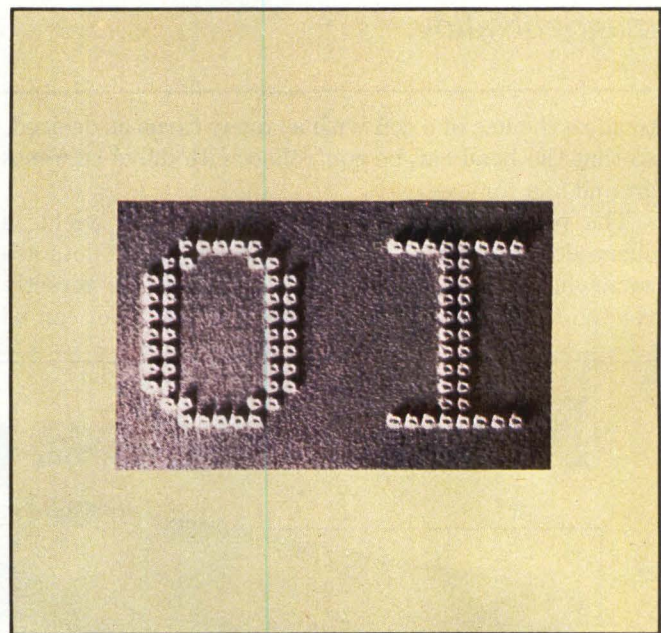

Fig. 4. Section of drum surface shows toner held by magnetic force to magnetic image of characters.

sively.

The head consists of a thin, highly permeable, metallic core bearing a wound coil (Fig. 3). The core contains a recording pole and a flux-closing pole, both facing the drum surface. When the head coil is energized, a magnetic flux is created in the closed magnetic circuitry, composed of the head core and the drum ferromagnetic core, which acts as a magnetic shunt.

Two gaps exist in the closed magnetic circuit, one at the recording pole, the other at the flux-closing pole. In both gaps, the magnetic field is perpendicular to the drum's external magnetic layer, which passes through these two gaps. Because the flux-closing pole is much wider than the recording pole, the field intensity under the recording pole is much greater than the field intensity under the flux-closing pole. By positioning the

recording threshold of the drum magnetic layer appropriately, the recording pole records a magnetic dot, while the flux-closing pole does not. Thus, only one narrow magnetized region, perpendicular to the drum surface, is required to record a dot. Closed-loop magnetic circuits are used because they are more efficient than open-ended pole configurations. In addition, the head layout permits elongating the head core

The MP-60's technology is based on a metallic, 100-mm.-diameter magnetic drum with an external layer of magnetic alloy.

to allow the use of a coil with as many turns as desired, so that the head can be controlled with drive currents around 100 mA.

The perpendicular recording of the layer yields a sharp dot definition. The remanent magnetic dots are somewhat square (Fig 4). The dot size is directly related to the recording pole size, and each dot can be

recorded with only one pulse of current.

Very close to the surface of the drum, toner particles tend to accumulate along the edges of the square dot, producing a "doughnut" effect. This gradually disappears further from the surface; at 30 to 50 microns from the drum surface, toner attraction is maximum at the middle of the dot. This height is reached by using relatively large particles, or a sufficient quantity of small particles.

The shape and layout of the head core is well-suited to high-density packing. The longest dimension of the core lies in the longitudinal direction—the direction of drum motion, or vertically with respect to the paper. In the transverse direction—parallel to the drum axis or horizontally with respect to the paper—the head core is flat, allowing the packing of head cores at the required pitch.

Heads are packaged in sealed modules, each containing 336 heads. The heads are arranged in two rows, one for even-numbered heads and the other for odd-numbered heads, with all the recording poles aligned. A print station of 3360 heads comprises 10 modules, side by side, capable of letter-quality text or graphics printing. □

John M. Freeman is printer product marketing director at Cynthia Peripherals Corp., Palo Alto, Calif.

Now, here's a printer for you.



**The Silver-Reed EXP550
Electronic Bi-directional,
Daisy Wheel Printer.**

The new Silver-Reed EXP550 is one of the finest machines for the money on the market today. For starters, the EXP550 offers carrier feed in units of 1/120 inch and forward/reverse paper feed in units of 1/48 inch.

Other features include: 16 CPS Shannon text • Subscript • Superscript • Bold • 17 inch paper capacity • 10, 12, 15, PS pitch • and much more. The EXP550 will provide you with letter quality printing at a cost that will amaze you. For more information, call (800) 421-4191 and ask for printer sales division.

SILVER-REED
SILVER-REED AMERICA, INC.
8665 Hayden Place, Culver City, CA 90230
(213) 837-6104, Outside of California (800) 421-4191.

OEM & DISTRIBUTOR INQUIRIES WELCOME.

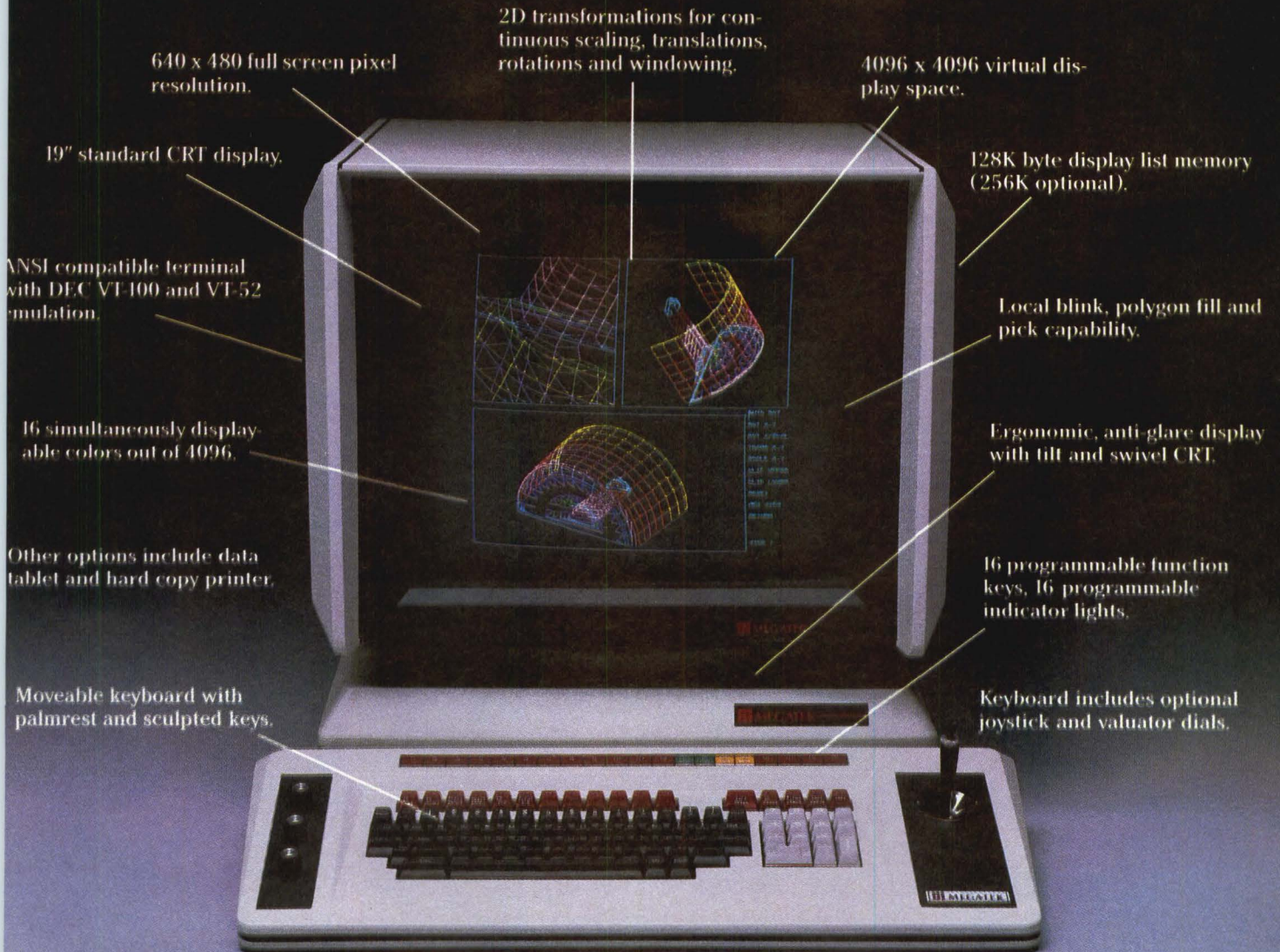

640 x 480 full screen pixel resolution.

2D transformations for continuous scaling, translations, rotations and windowing.

4096 x 4096 virtual display space.

19" standard CRT display.

128K byte display list memory (256K optional).

ANSI compatible terminal with DEC VT-100 and VT-52 emulation.

Local blink, polygon fill and pick capability.

16 simultaneously displayable colors out of 4096.

Ergonomic, anti-glare display with tilt and swivel CRT.

Other options include data tablet and hard copy printer.

16 programmable function keys, 16 programmable indicator lights.

Moveable keyboard with palmrest and sculpted keys.

Keyboard includes optional joystick and valuator dials.

Thaumaturgy.*

Graphics miracles right on your desk. Our latest Whizzard.™ The 1650 desk top design terminal. Now, anyone can afford the power and performance of our more expensive Megatek Whizzards. Your own design station right at your fingertips. Another product of Megateknology.™

Finally. Everything an engineer or designer could want in desk top computer graphics. Convenience. High quality and powerful performance. VT-100 compatibility.

Functionality. Greatly increased productivity. Shouldn't every desk top design terminal offer this?

Tomorrow's graphics technology on your desk top today... thanks to Megateknology.

Making History out of State-of-the-Art.

*Thaumaturgy (thō'ma tūr jē), n., the performance of miracles.

MEGATEK CORPORATION
UNITED TELECOM COMPUTER GROUP

World Headquarters • 3985 Sorrento Valley Blvd., San Diego, CA 92121 • 619/455-5590 Telex: 910-337-1270

CIRCLE NO. 94 ON INQUIRY CARD

Perfect printer. Perfect fit.



Let the world's largest match your specs

The perfect printer is the one that fits your specs exactly. And you can get it from Epson OEM.

Epson is the largest manufacturer of printers and print mechanisms in the world. We have the highest engineer-to-staff ratio, so we can custom-build printers and mechanisms to your specs, using one of the renowned Epson printer and mechanism product lines as the foundation. We'll customize firmware, packaging and manuals all for a lower total cost than most standard units.

You choose the options

The best full-size printers you can buy start with Epson's 80-column or 136-column dot matrix printers. Then you choose the character fonts you need, the speed to meet your throughput requirements, the density of graphics resolution, friction and/or tractor feed and more.

YOU'VE GOT A FRIEND
IN THE PRINTER BUSINESS.



CIRCLE NO. 129 ON INQUIRY CARD

Any printer you need

Epson OEM builds custom printers in sizes from 16 to 136 columns, including the world's smallest thermal, and impact dot matrix printers. And since we're the world's largest, with an enormous engineering staff, we can quickly custom-design printers for almost any application for about the same price as many off-the-shelf units. And we can build a thousand, or a hundred-thousand, and deliver them ... on time.

Get a quote from the leader

Call Epson OEM. Let us show you how we can take your specifications and give you the perfect printers for your applications. And a perfect fit.

EPSON
EPSON AMERICA, INC.
OEM PRODUCTS

3415 Kashiwa Street Torrance, CA 90505
(213) 534-0360

How do you create a microcomputer to match the power of the UNIX™ operating system?

Imagine. You are perfecting a revolutionary operating system. In about two years, it will be the system of choice for 16-bit microcomputers.

It will be called the UNIX operating system.

But the breakthrough features of this operating system are going to make stringent demands on the computer.

The microcomputer developed specifically for the UNIX operating system more than two years before its commercial distribution is called ONYX.*

ONYX will live up to every demand and expectation.

To achieve the ultimate flexibility, simplicity, efficiency and productivity, the UNIX operating system will incorporate a file system of highly uniform sets and sub-sets of directories, arranged in a tree-like hierarchical structure.

And flexible directory and file protection modes, allowing all combinations of "read," "write," and "execute" access, independently for each file or directory, for a group of users.

But these advantages will require intensive disk access, and superior memory management. In simple language, disk access must be as fast as possible, and the disk must have an unusual capacity to maintain complex file systems on-line at all times.

Floppy disks with their low capacities and high access times won't do.

Winchester disk drives that utilize slow-moving stepper motor head positioning devices won't do.

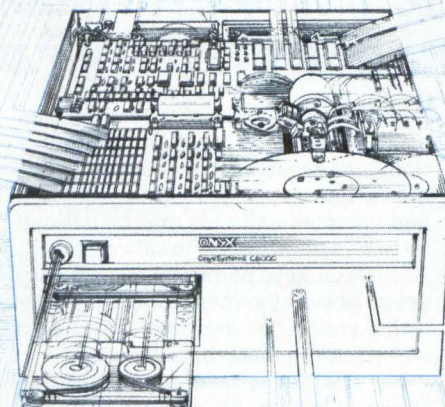

ONYX's IMI Winchester disk storage system, with its servo-driven voice coil head positioning, is more than twice as fast!

So, obviously the ONYX C8002 will do.

And, as developed, the ONYX C8002 features expandable memory up to 1 Mbyte, and disk storage up to 160 Mbytes on-line. Its cartridge tape back-up offers cyclical redundancy checking on every backup. Both the Winchester disk storage system and the cartridge tape backup are *internal*.

In the UNIX operating system environment, the disk becomes an extension of main memory. "Swapping" programs between the disk and main memory



increases the number of operations that can run concurrently. ONYX's memory management system utilizes "scatter" instead of "contiguous" allocation, and the more efficient swapping minimizes demand on the disk channel. That's why ONYX assures a highly efficient environment for the UNIX operating system.

Now it's 1982. The UNIX system's pre-eminence among 16-bit operating systems is established. And ONYX is the only company that has significant production experience with UNIX systems.

ONYX has installed over 1500 UNIX systems.

Today there are a lot of systems being developed to operate UNIX (and "look-alike") operating systems. But there are many reasons why you should consider ONYX and the UNIX operating system as inseparable.

System III available now for immediate delivery.

Phone this special number: (408) 946-6330 Ext. 251. Ask about these System III enhancements, including:

- Multi-key index sequential files under RM COBOL;
- "Term Cap" capability that supports a wide variety of terminal interfaces;
- Enhanced printer handling capability;
- SCCS to maintain edit histories in text management applications.

*UNIX is a trademark of Bell Laboratories.

CIRCLE NO. 95 ON INQUIRY CARD

Make the Connection

ONYX UNIX

OPERATING SYSTEM

Onyx Systems Inc., 25 East Trimble Road, San Jose, CA 95131

WHICH TWIN HAS THE TANDBERG?

The ergonomic terminal with simplified local editing and software controlled operating features.

If your operators need a stack of manuals and a degree in Computer Science to operate your terminals then, chances are, you haven't yet heard of the new Tandberg Data conversational terminal. The Tandberg terminal's efficient, "friendly" operating features increase productivity and ease the operator's workload while they enhance your distributed data processing capability.

As a full ANSI standard editing terminal, the Tandberg TDV 2220 allows virtually all functions to be performed locally as well as from the host. For maximum flexibility all functional characteristics are prompted from easily understood "English" menus and may be stored in non-volatile memory.

The TDV 2220 will operate in character, line or block mode. Up to eight pages of local memory can be recalled and

amended by page or "window." Sixteen editing functions allow insertions, deletions and erasure of characters, fields, areas, lines or pages while protected and unprotected fields may be defined in ten variations for local checking. Navigation keys permit quick and easy set-up of even the most complex tabular forms and PUSH-keys implement data strings at the touch of one button.

Not only is the Tandberg the easiest terminal to use, it's also the only terminal in the world that meets the stringent 1985 German ergonomic standard—with tilt, swivel and height adjustments, an ultra-low profile, detachable keyboard, all non-reflective surfaces, an anti-reflex tube, et al. Your operators will cheer.

TANDBERG DATA
Tandberg Data, Inc.

In addition to the advanced performance Model TDV 2220 terminal, the Tandberg TDV 2200 family includes models which emulate the DEC VT 100/VT 52, Datapoint 3600 and 8200, Data General 6053 and D 200, IBM 3101 and others. Firmware development tools and hardware building blocks are also available to the OEM who wants to develop a terminal with its own personality.

So why put up with a terminal headache? The "face" of your computer system that the user sees could be a Tandberg terminal. Call or write today for our new brochure.

TANDBERG DATA, INC., P.O. Box 99, Labriola Court, Armonk, New York 10504, Telephone: (914) 273-6400—Telex #137357 Tanberg Arnk.

CIRCLE NO. 96 ON INQUIRY CARD



Controller/transceiver board drives Ethernet into PC domain

BOB METCALFE, 3Com Corp.

Outfitted with a compact circuit board, IBM PCs can be part of a high-speed LAN at reasonable cost

Until very recently, the cost of connecting microcomputers to the Ethernet local network was prohibitive to both personal-computer makers and users. But the introduction of VLSI controller chips, refinements in Ethernet transceivers and space-efficient board design have brought Ethernet connection within the realm of the second-generation, 16-bit-based microcomputer. By putting the transceiver on the controller board and using VLSI data-link controllers, it is possible to provide a complete local-network connection, including software, for less than \$1000 per station.

Initially aimed at IBM Corp.'s Personal Computer, 3Com Corp.'s EtherSeries provides the Ethernet physical and data-link control layers at board level and supplies networking software for such applications as file and printer sharing and electronic mail. The product's levels of networking service allow flexibility of configuration and implementation by both OEMs and nonprogramming end users.

Shaving component size and cost

To meet the goals of providing low-cost Ethernet connection required eliminating some high-level controller functions not necessary in a microcomputer local network, shrinking the controller circuitry and redesigning the transceiver to fit on a controller board. The combined power consumption of the controller and transceiver was reduced by a factor of four, and 104 sq. in. of components were squeezed onto a 52-sq.-in. PC board.

3Com worked closely with Seeq Technology Inc. in designing and testing a suitable Ethernet controller chip. Like most other chips being developed by semiconductor manufacturers, Seeq's meets the required OSI level two requirements, but it has fewer added functions, which lowers production costs (see "Transmission control chip," p. 180). Because this

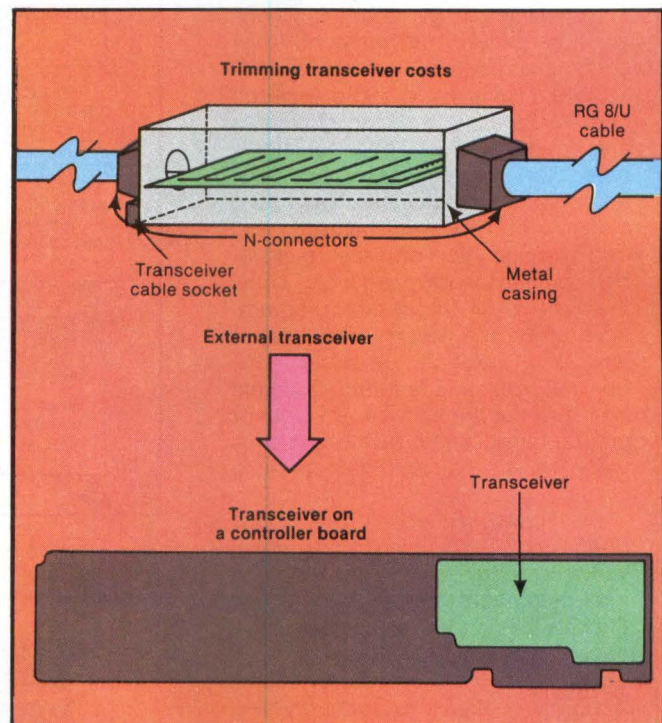

Fig. 1. Until EtherSeries, Ethernet transceivers were separately housed circuits connected directly to the network cable and interfaced to the station using a transceiver cable containing four twisted pairs. Now, the transceiver can be located on the board next to the controller chips. A redesigned circuit also yields fewer parts, lowering the cost of the transceiver and its cable. Future VLSI of the transceiver function will facilitate implementation and eventually, with volume production, reduce board costs.

controller incorporated much of the circuitry found on board-level controllers, the board size could be reduced, and other Ethernet functions could be built on the same smaller board. This favorably affected the economics of board manufacturing: the layout was less complex, boards were less costly, parts count fell

drastically, and statistical reliability increased.

The transceiver also needed cost trimming. Until EtherSeries, Ethernet transceivers were housed in separate enclosures containing the transceiver circuitry, a tap or a pair of N-connectors and a transceiver

cable socket. With redesign, it was possible to put the transceiver circuit on the same PC board as the controller chip and its support circuits. This immediately eliminated the cost of the separate enclosures, the transceiver cable connector, the transceiver cable and the power regulator (Fig. 1). The EtherSeries controller is connected directly to the transceiver through copper connections on their common board.

In putting the transceiver on the board, parts location becomes even more critical than for a separate-

TRANSMISSION CONTROL CHIP

At the heart of 3com's EtherSeries is Seeq Technology Inc.'s 8001 Ethernet data-link controller chip. The 8001 provides the minimum CSMA/CD functions according to Ethernet specifications, allowing system integrators to supply the higher level functions such as buffer management, DMA control and address hashing.

Developed with the help of a silicon compiler, the 8001 silicon structures are arranged in a logical functional order. The chip contains (from lower left, counterclockwise) two FIFO buffers, an address-checking and CRC-stripping section, the receive-byte processor program-logic array, the receive-bit processor program-logic array, the CPU interface registers, the back-off generator, the transmit-byte and attempt counters and the transmit-byte processor program-logic array. In the center is the parallel/serial and CRC-checking circuitry.

On 3com's EtherLink board, the Seeq chip is coupled to a serial interface subsystem on one side and a 2k-byte packet buffer on the other. Packets intended for transmission are transferred via DMA over the PC system bus to the on-board transmit FIFO. The controller performs framing of the packet to include the prescribed preamble and CRC information. (The address fields, type field and data field are prepared in external memory before initiating transmission and pass transparently through the EDLC chip.)

If the network has been quiet for at least 9.6 μ sec. and the back-off time requirements are satisfied, the packet data are serialized and shifted to the transceiver for transmission. If collision occurs, the controller halts the transmission by sending a jam pattern and signaling the CPU to begin the

back-off algorithm. Transmission is reinitiated when the initial bytes of the

frame information field are reloaded into the EDLC transmit FIFO.

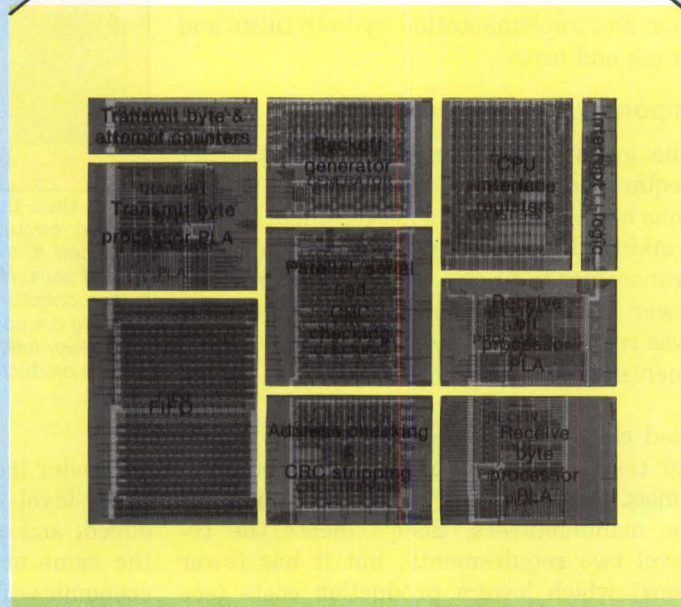
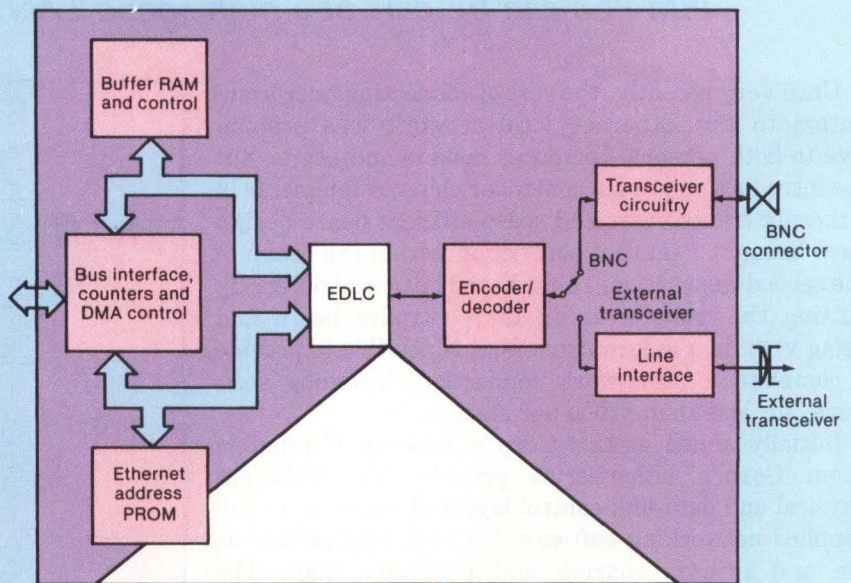

From computer to slide for 50¢



**Now you can put your raster graphics
on slides quickly and easily.**

The VideoSlide 35™ Computer Graphics Camera from Lang Systems lets you record raster graphics on standard 35mm slide film, then produce your slides for no more than the cost of the film and processing. . . about 50¢ a slide. The result? You enhance your slide presentation capabilities with beautiful, computer-generated graphics, while eliminating conventional artwork and design costs.

A snap to use, VideoSlide 35 works with most computers having raster graphics capability, including the IBM Personal Computer and Apple II, plus a wide range of color graphics terminals. It uses standard 35mm slide films like Kodak Ektachrome or Kodachrome, and will accommodate Polaroid's '5-minute' processing system for slide production on the spot.

VideoSlide 35 preserves computer graphics in the universal slide format, which offers greater convenience, flexibility, and economy than overhead projector transparencies. And at only \$2799, including TTL RGB interface and all cabling, VideoSlide 35 is a great investment that pays for itself quickly through reduced slide-production costs.

Why wait? Take your raster graphics from computer to slide for 50¢ each. It's pushbutton simple with VideoSlide 35. For more information, call or write us today. Lang Systems, Inc., 1010 O'Brien Drive, Menlo Park, CA 94025, (415) 328-5555.

TMVideoSlide 35 is a trademark of Lang Systems, Inc.

VideoSlide³⁵

will make you slide happy

CIRCLE NO. 28 ON INQUIRY CARD

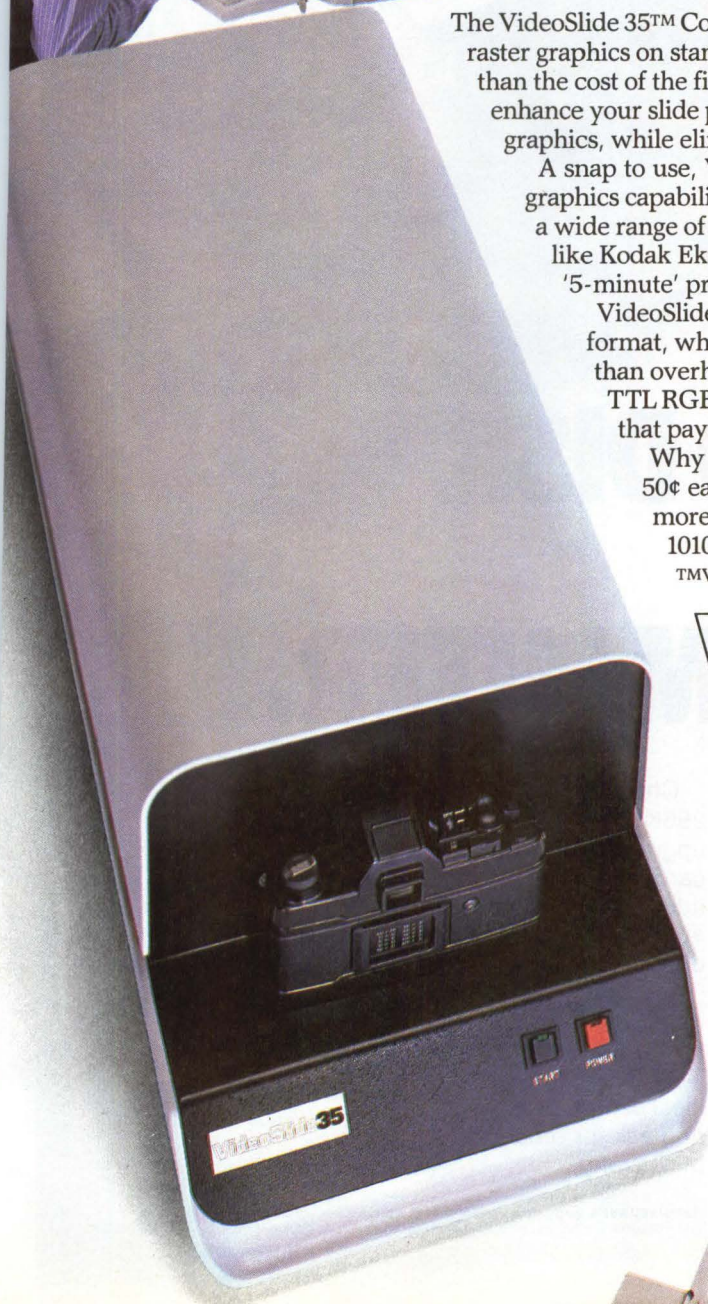

LANG
SYSTEMS, INC.



The DSI-501 Disk Drive fits into the 2nd slot on your IBM Personal Computer, to give you 5 MB formatted (6MB unformatted) storage for \$1995. The DSI-512 provides 10 MB formatted (12 MB unformatted) storage for just \$2495. And the DSI-519 provides 15 MB formatted (19 unformatted) for \$2995. Compatible with IBM software.

\$1995.* PLUG IN HARD DISK FOR THE IBM® PERSONAL COMPUTER.

One low price buys you the expanded storage, speed and reliability of a Winchester technology hard disk system. The DSI-501, DSI-512 and DSI-519 support IBM DOS.® Full software support includes an installation program and complete diagnostics.

The DSI-ASYNC+ RAM provides 64K RAM, expandable to 256K with parity, and 2 serial I/O ports on one card. Select the option and save space as well as dollars. The price of \$495* includes extensive software for flexibility.

More low-priced expansion options. Our wide selection lets you mix and match products to fit your needs and your pocketbook.

Choose the DSI-64K, DSI-192K, or the DSI-256K fixed RAM cards with parity. For powerful upgrades, select the DSI-EX64K—a 64K RAM card that easily expands to up to 256K with the addition of individual memory chips. Prices start at \$299*. Also available is the DSI-ASYNC, a dual port serial I/O card priced at \$199*.

Expand your IBM Personal Computer for a lot less money. Take this ad to your local computer retailer and ask for products by Davong.

 **DAVONG**
Systems, Inc.

610 Palomar Avenue
Sunnyvale, CA 94086
(408) 773-8370

* Manufacturer's suggested retail price. Includes all required components. IBM Personal Computer and IBM DOS are registered trademarks of IBM Corporation.

ly housed transceiver. Now, standard logic circuits and buses with 5V square-wave pulses coexist in close proximity with precision analog circuits designed to respond to millivolt levels. This called for the combined talents of analog and digital engineers to ensure conformity to both FCC regulations and Ethernet specifications.

Because EtherSeries' on-board transceiver allows direct or indirect Ethernet connection, users have a choice of cabling. Ethernet uses a 50-ohm coaxial cable, which is available in more than one diameter and price. Therefore, users can take advantage of lower cost, thinner cable for shorter distances.

The main differences between a thick, 50-ohm cable and a thin one are flexibility and attenuation. Thinner cable is easier to bend around corners and, consequently, easier to bring to a workstation cabinet rather than to install in walls and ceilings and bring a transceiver to it. Thinner cable has a higher attenuation factor, though, which means that signal levels reach limiting values over shorter distances than with thicker cables.

EtherSeries permits two connection methods (Fig. 2). The on-board transceiver has a BNC connector located at the rear of the IBM PC to which a BNC "tee" connector and the thinner RG 58 A/U coaxial cable can be

connected. This coaxial cable, in turn, can be directly connected to the thicker RG 8/U type, using a standard adapter. Users can alternately connect the PC to an external transceiver that is connected to RG 8/U-type cable. The use of thinner cable in no way interferes with the 10M-bps Ethernet-specified data-transfer rate. EtherSeries supports as much as 350m. of thin coaxial cable.

Implementation

EtherSeries has several levels of networking services. The fundamental connection of the IBM PC to Ethernet is implemented by EtherLink. Higher level local-network services (those providing network-through application-level protocols) are handled through EtherShare, EtherDisk, EtherPrint and EtherMail. The hardware and software can be combined to build configurations ranging from a backbone local network to a complete networking system (Fig. 3). Consequently, OEMs can purchase the hardware and possibly system software, but add value to their products by supplying application software. On the other side, professional nonprogramming users can buy the whole package to take advantage of application programs that require little or no training, an option that will become even more attractive as 16-bit-based personal computers infiltrate high-level management in business.

IBM PCs equipped with EtherLink become network stations retaining all their personal-computer charac-

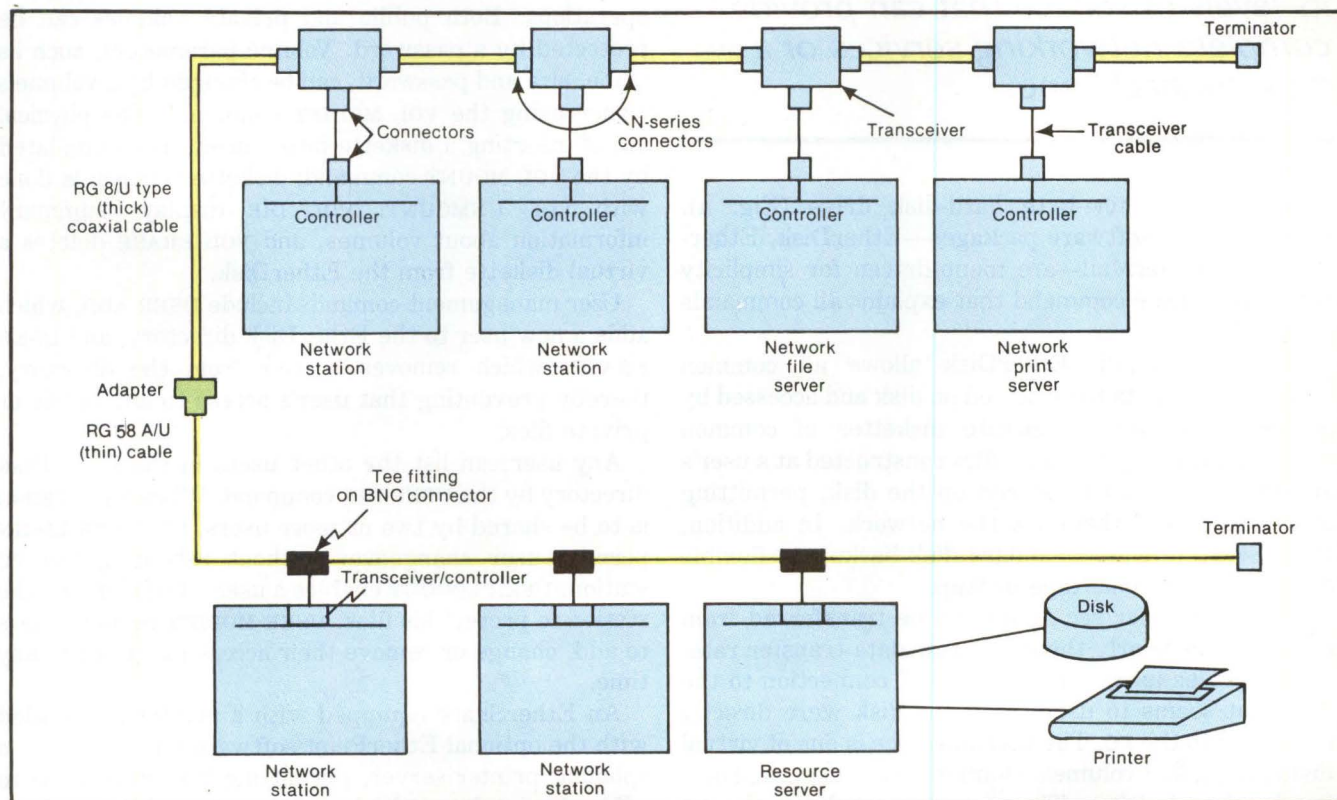

Fig. 2. Cable and connector costs can be lowered by using thin RG 58 A/U instead of thick RG 8/U coaxial cable. Thick cable requires an external transceiver and cabling from the controller board to the transceiver; thin cable connects directly to Ethernet's "tee" connector. There is no performance penalty in thinner cable, although its attenuation factor does limit distance. Thin and thick cables can be connected through an adapter.

teristics and gaining access to networked resources such as expensive peripherals. EtherLink consists of an Ethernet controller/transceiver board that plugs into the PC's backplane, a software diskette and a user's manual. The EtherLink software package includes two applications: remote disk access from one PC to any other connected to the network and printer sharing. All disk requests, including those of IBM DOS, are automatically and transparently routed across the network so that file transfer is achieved through the IBM DOS copy command. A PC with a printer can be shared by other PCs that are attached to the network but do not have their own printer. In both cases, the PC with the printer or disk to be shared effectively becomes a resource server.

Higher level services

Extended disk- and printer-sharing capabilities, as well as other higher level services such as electronic mail, are available through EtherShare, a network resource server. The basic EtherShare is a 16-bit

An important feature of EtherSeries is its levels of service that can provide complete networking services or a network backbone.

computer with 10M-byte hard-disk drive (Fig. 4). Accompanying software packages—EtherDisk, EtherPrint and EtherMail—are menu-driven for simplicity and offer a HELP command that explains all commands and procedures.

EtherShare with EtherDisk allows all common programs and data to be stored on disk and accessed by any PC, eliminating separate diskettes of common programs at every PC. Data files constructed at a user's PC station also can be stored on the disk, permitting others to access them via the network. In addition, EtherShare provides standard disk backup on flexible diskettes or optional tape backup.

At 10M bits per sec., data can be transferred from disk to PC at nearly the disk's raw data-transfer rate. This provides users with a "virtual" connection to the disk that seems to users as if the disk were directly connected to the PC. The user interface is one of virtual diskettes, called volumes, mounted and unmounted on a user's virtual drive. The software emulates the PC diskette drive such that, once a virtual diskette has been mounted, all standard IBM DOS functions work as usual.

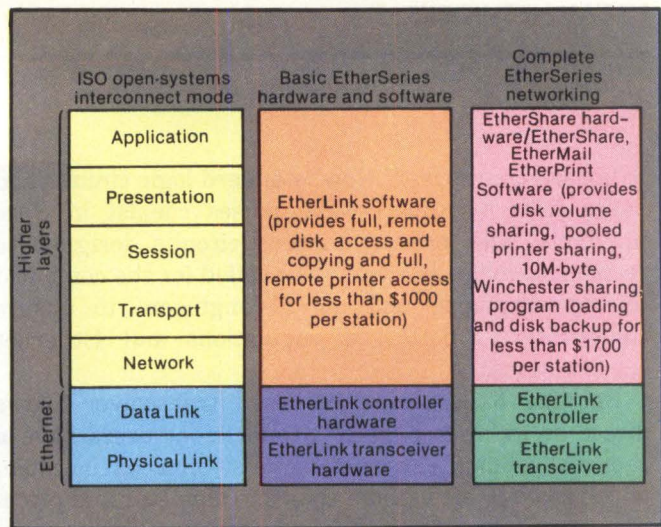

Fig. 3. EtherSeries provides all levels of the ISO's open-systems-interconnection model. Because of EtherSeries' modularity, users can add or subtract services at the higher levels to suit their networking needs.

Two programs support the EtherDisk software. One is for creating and manipulating volumes in the EtherShare, and one is for managing users assigned to the EtherShare. When volumes are created through the VOL CREATE command, they are defined as "public" or "private." Public volumes are available to all users listed in the EtherShare directory and are limited to read-only operations. Private volumes can be accessed only by their creator and are available for read/write operations. Both public and private volumes can be protected by a password. Volume parameters, such as name, size and password, can be changed by a volume's owner using the VOL MODIFY command. The physical act of inserting a diskette into a user's PC is emulated by the VOL MOUNT command; diskette removal is done with VOL UNMOUNT. VOL DIR displays summary information about volumes, and VOL ERASE deletes a virtual diskette from the EtherDisk.

User management comands include USER ADD, which adds a new user to the EtherDisk directory, and USER ERASE, which removes a user from the directory, thereby preventing that user's access to any public or private files.

Any user can list the other users in the EtherDisk directory by the USER DIR command. When a PC station is to be shared by two or more users, the USER LOGIN permits user changeover without rebooting the PC station. USER LOGOUT enables a user who is leaving the station to protect his files. USER MODIFY permits users to add, change or remove their access password at any time.

An EtherShare equipped with a printer and loaded with the optional EtherPrint software will behave as a spooling printer server, permitting the PC stations to off-load print data at high speeds and continue handling other tasks. This is an advantage in a text-intensive environment, such as an office, in which a high-performance PC can be severely restrained by the



Why install cables for data when there's a network...

right under your nose? If you're tired of the endless hassle of expanding your local area network—not to mention the expense of installing cable and limited distance modems—Teltone has some very good news for you.

It's called the DCS-2 Data Carrier System, and it lets you use existing PABX wires to carry both voice and data traffic *simultaneously*.

That's right. Up to 9600 BPS of dedicated-channel, full duplex asynchronous data can be transmitted or received by any ASCII terminal in your system—and the data won't interrupt phone service.

With the DCS-2 your PABX becomes a common communications network, where making a computer hookup is as easy as plugging in a phone. It's fast, FCC Part 68 registered, and it won't cost you the roof over your head.

So before you make another equipment move, find out how Teltone can help you keep it simple. Just call our toll-free hotline at 1-800-227-3800 Ext. 1122 (in California 1-800-792-0990 Ext. 1122) or write Teltone Corporation, PO Box 657, Kirkland, WA 98033. In Canada call (416) 475-0837 or write 91 Telson Road, Markham, Ontario L3R 1E4.

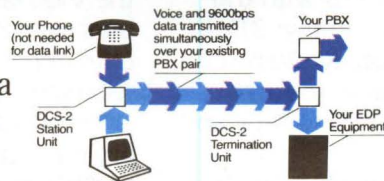

TEL TONE®

For users of DEC, Prime, Data General, Tandem, IBM Series/1, H-P and other asynchronous computers.

CIRCLE NO. 98 ON INQUIRY CARD

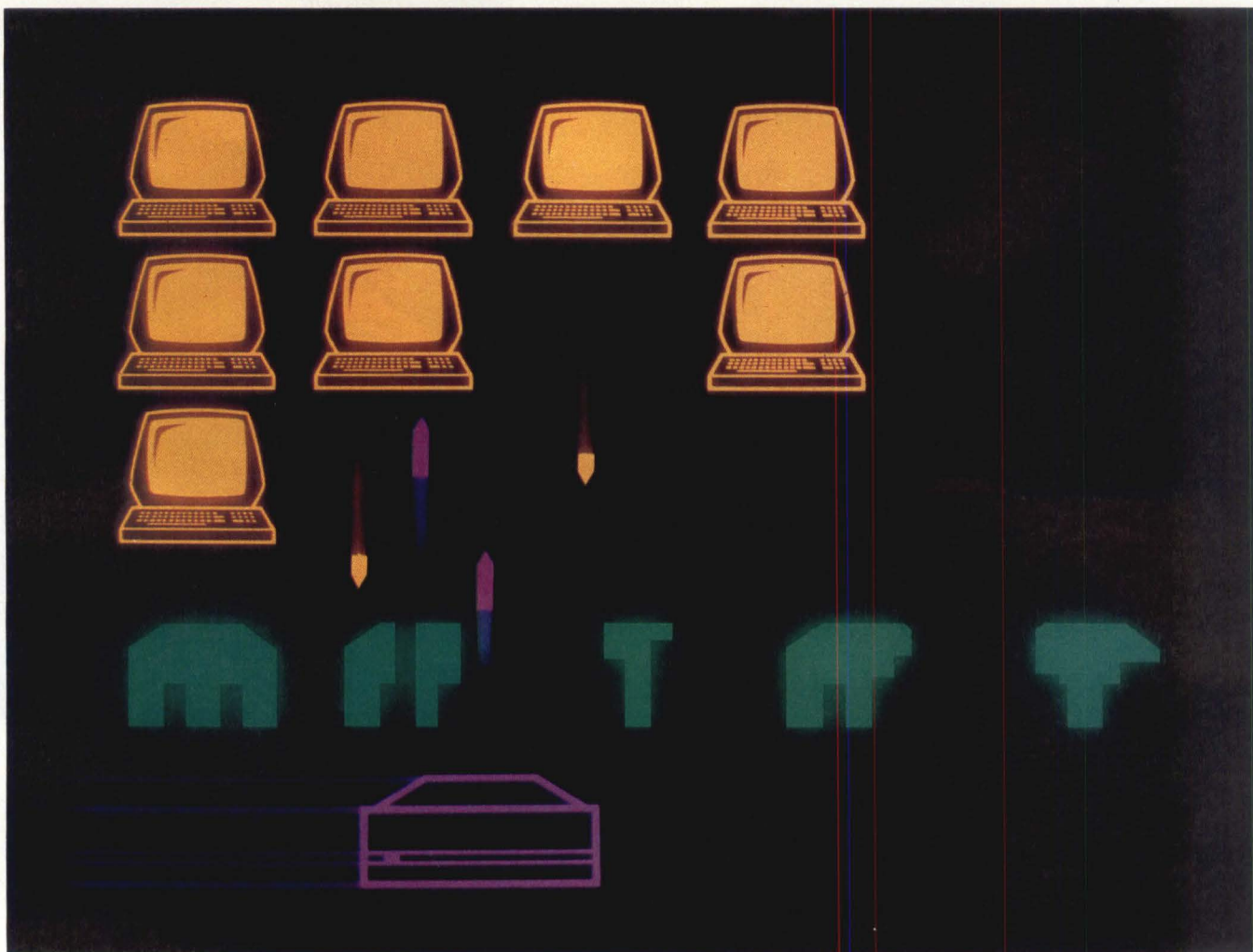

DON'T LET 5 1/4" WINCHESTERS SHOOT DOWN YOUR MULTI-USER SYSTEM PLANS

Now you can design truly high performance systems with the VERTEX V100 5 1/4" family; 31MB, 52MB, 72MB capacity; 30 msec average access time; industry standard mounting, interface and transfer rate.

There was a time when "high performance system" meant "big disk system." Not anymore. The low cost VERTEX V100 family brings you big disk performance, all right. But in a compact 5 1/4" format. What's more, your system is prob-

ably already designed for the V100 family since it uses the industry standard interface and 5 Mbits/sec transfer rate.

The V100 family is actually the first of a series of VERTEX drives designed for even higher performance and capacities. That means you get peak performance today with superior design integrity. And each VERTEX drive is backed by a team that has been responsible for the design and

CIRCLE NO. 99 ON INQUIRY CARD

manufacture of over 3,000,000 disk drives. So while VERTEX is a new company, our production and quality assurance programs have been fine-tuned to deliver highly reliable products, on time. You can plan on it!

Don't delay your high performance system plans any longer. Call Norm Hayes, Director of Marketing, today at (408) 942-0606. Or write VERTEX, 2150 Bering Drive, San Jose, CA 95131.

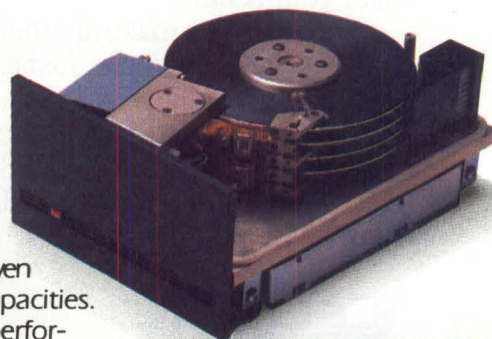

VERTEX
PERIPHERALS

You Can Plan On Us . . .

difference between its bus transfer rate and lower printer speed. The EtherShare/EtherPrint duo performs queuing and buffering so that the printer operates at its highest rate without causing the PCs to

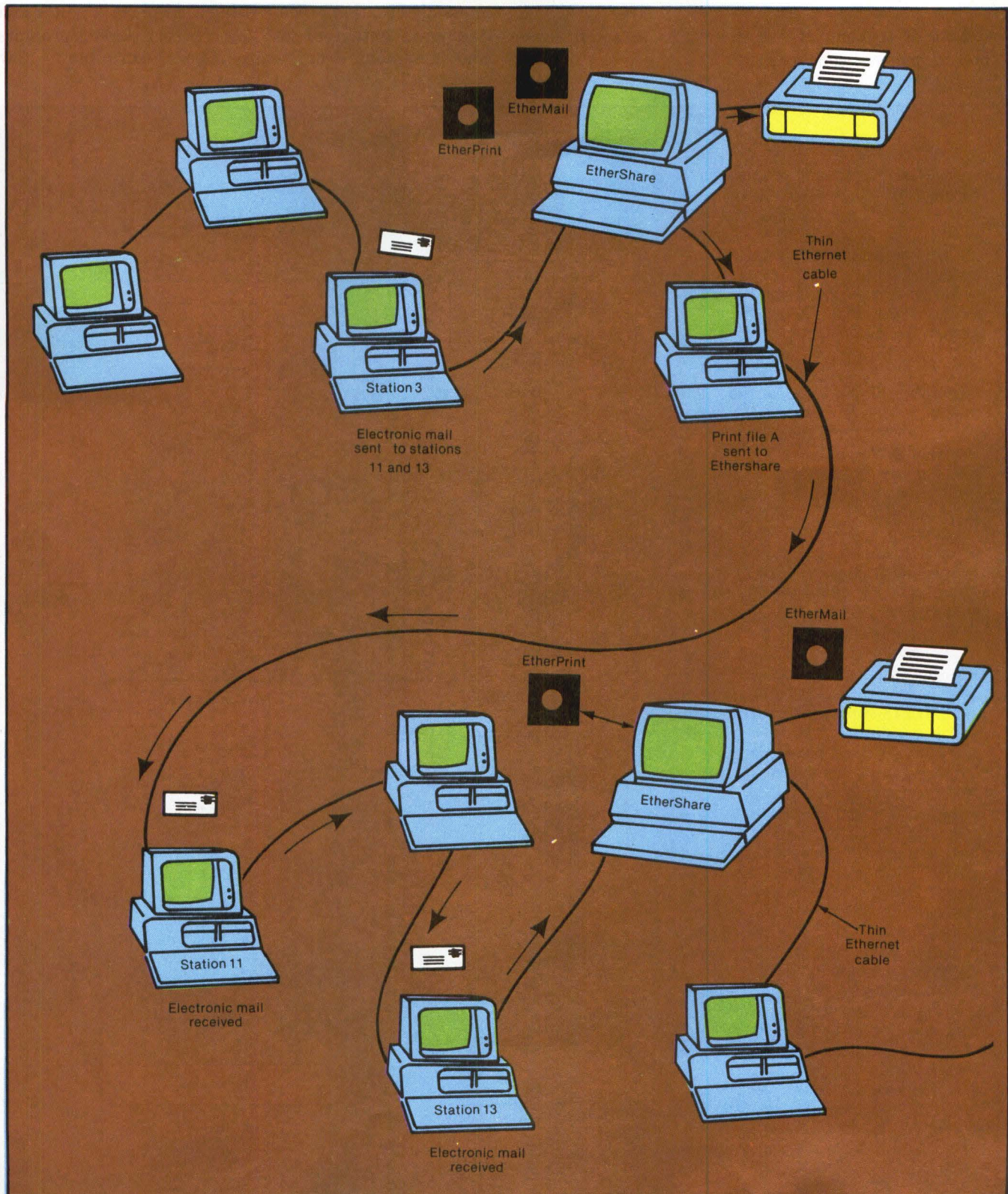

Fig. 4. EtherShare is a network resource server that can also be used as a spooled printer (print server) when equipped with a letter-quality or high-speed printer. The standard EtherShare provides disk sharing, disk backup and networked program loading and optionally supports tape backup. When loaded with EtherMail software, EtherShare provides a simple yet comprehensive electronic-mail capability. EtherPrint software plus an add-on printer permits EtherShare to provide shared spooling printer service. EtherShare is also used for running EtherSeries application software.

wait for it to complete its service. Users can access spooled printers concurrently.

An EtherShare loaded with optional EtherMail software becomes a post office for receiving and distributing electronic mail among PC network users. The EtherMail software supports a very simple message-creation process using a simple text editor and taking advantage of soft-key controls, screen prompts and mnemonic commands. Users can obtain new

EVOLUTION TO LOWER COST CONTROLLERS

Technology advancements have reduced the Ethernet-computer interface from multiple boards to one microcomputer-sized card, decreasing connection costs by more than 30 percent.

Following the 1980 joint announcement of Ethernet specifications by Digital Equipment Corp., Intel Corp. and Xerox Corp., the first controllers brought to market were subsystems designed using microprocessor and/or SSI and MSI bipolar (TTL) logic chips. To implement these controllers usually required two or more boards, and the costs ranged from \$3000 to \$3500, not including transceivers or software.

Within a year, more controllers were announced using off-the-shelf programmable-array-logic chips. Aimed at the moderate ranges of Ethernet network applications, these newer controllers lowered the costs of connection by more than half to about \$1500, including compatible transceivers. Nevertheless, that level of integration still imposed size, cost and power constraints, barring Ethernet's entry into the personal-computer fold.

Through the new LSI and VLSI controller chips, 3com Corp. finally scaled down the board size, power requirements and cost to fit the personal-computer market. These chips, being produced by semiconductor manufacturers such as Intel, American Micro Devices, Inc., Mostek Corp., Fujitsu, Seeq Technology Inc., National Semiconductor Corp. and Zilog, Inc., provide the basic Ethernet data-link protocol, although they vary considerably in price and added functions.

To squeeze more on a board, 3com incorporated Seeq's EDLC 8001, which packs the controller circuitry onto one chip that occupies only one portion of a microcomputer board. This allowed room on the board for other Ethernet functions, including the transceiver.

Ethernet connection boards will shrink even more in size and price when the encoder/decoder and transceiver chips arrive.

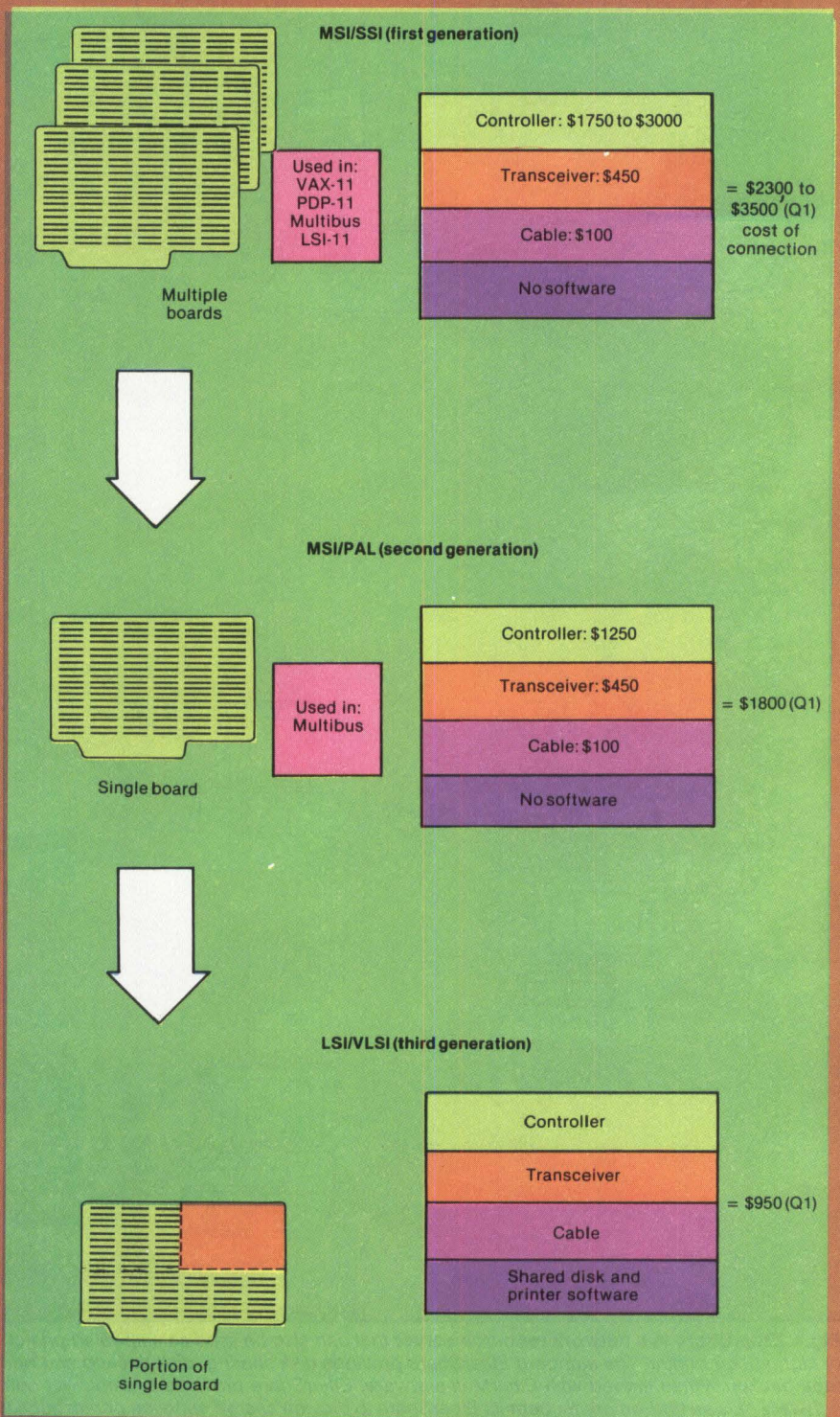

BEACON™ PUTS MORE GRAPHICS AT YOUR FINGERTIPS.

It's a rare graphics system that can produce business graphics and also operate as an engineering work station for under \$20,000. The Beacon™ System from Florida Computer Graphics puts it all right at your fingertips.

Using Multi-Processor Architecture (MPA) and 48-bit microcoded firmware, the Beacon System produces virtually instantaneous generation of vectors, arcs, circles, rectangles,

and polygon fills. And BeaconBRIGHT™ makes those images far more visible even in brightly lit areas.

With the addition of 640KB of optional graphics memory, Beacon's 640 X 480 resolution can create a 1280 X 960 addressable image, typical of many CAD/CAM applications. This higher resolution, combined with the standard BeaconROAM™ and Zoom features, makes Beacon ideal for many engineering and scientific applications.

Check these unique Beacon features, standard on all models.

- A wide range of true graphics and character graphics including dot

addressability, IX zoom increments (up to 16X), horizontal and vertical scrolling in variable speed, and more.

- A palette of 256 colors; 32 usable at one time (16 in the graphics planes, 16 in the alphanumeric plane).

- Superior ergonomic design. From a display that's *twice as steady* as those advertised as "flicker free" to the monitor that tilts, swivels, and adjusts in height. Beacon leads the way in human-factors engineering.

Beacon works with joysticks, light pens, digitizer tablets, printers or plotters. It also interfaces with slide cameras, color copiers and even large screen video projectors.

For generating either business or engineering graphics, the Beacon System (stand alone or host dependent), offers a spectrum of capabilities unmatched in its price category. To find out more write for our full color literature:

Marketing Communications Manager
Florida Computer Graphics, Inc.

1000 Sand Pond Road, Lake Mary, FL 32746.
Or call (305) 321-3000. In the Continental U.S. outside Florida, dial 1-800-327-3170.

FCG

FLORIDA COMPUTER GRAPHICS
VISION IN COMPUTERS
CIRCLE NO. 100 ON INQUIRY CARD

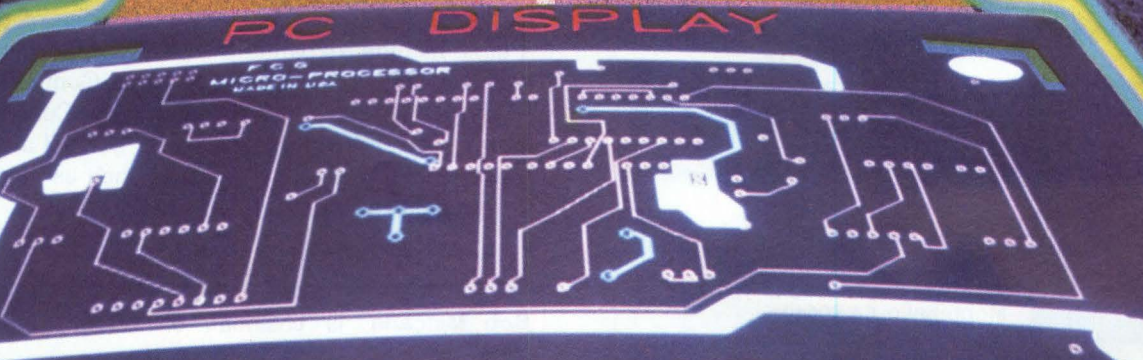
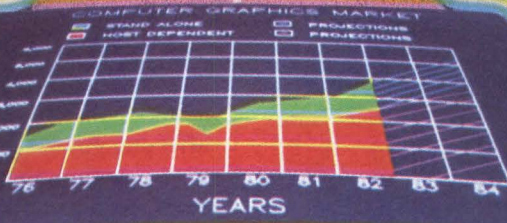

HALF HIGH

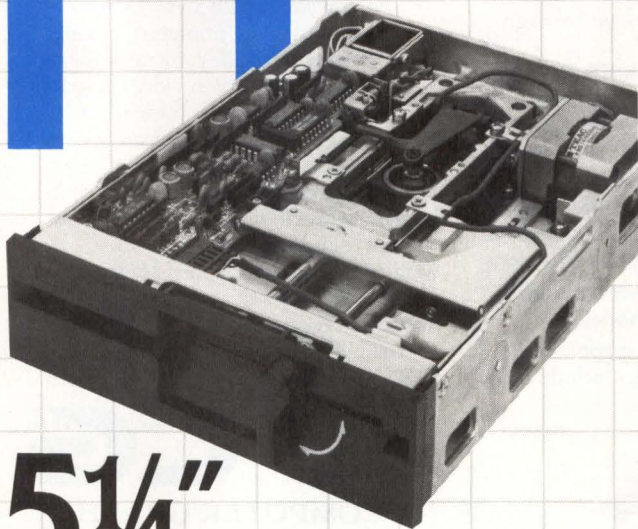

5 1/4"

Floppy Disk Drives

TEAC FD-55 Series

AT 1 5/8" HIGH, TEAC FD-55 SERIES 5 1/4" FLOPPY DISK drives use half the space and run cool at half the power of conventional drives. High-reliability, low-noise brushless DC motors provide an MTBF of over 10,000 hours, backed by a one-year parts and labor warranty.

FD-55A <ul style="list-style-type: none">• 48tpi• 40 track• 250KB• single side	FD-55B <ul style="list-style-type: none">• 48tpi• 40 track• 500KB• double side	FD-55E <ul style="list-style-type: none">• 96tpi• 80 track• 500KB• single side	FD-55F <ul style="list-style-type: none">• 96tpi• 80 track• 1MB• double side
--	--	--	--

Power Requirements:

DC +12V \pm 5% 0.3A typical, 0.7A max.
DC + 5V \pm 5% 0.5A typical, 0.7A max.

Phone, write or wire TEAC Corporation of America for complete technical data, price and delivery.

TEAC Corporation of America
Industrial Products Division
7733 Telegraph Road
Montebello, CA 90640
213/726-0303

© 1982 TEAC Corp.
MP82501M

LOCAL NETWORKS

messages addressed to them, display the messages, delete them, forward them to others and add attachments and create their own new messages. The recipients of messages can include EtherShare user names as well as distribution lists.

The electronic-mail user interface is human-engineered and simple. For example, the MAIL command returns a list of all messages in the current message volume. In addition, the bottom of the screen offers a list of soft-key numbers and the commands associated with them. These allow a user to GET new

The combined power consumption of the controller and transceiver was reduced by a factor of four, and 104 sq. in. of components were squeezed onto a 52-sq.-in. board.

messages transferred to his PC station, SHOW (display) any message on the screen and return to IBM DOS with DONE if that is all the user requires.

When a message has been created and the recipient list has been completed, the user makes a request to send. The EtherShare locates all destination addresses. Next follows an "OK-to-send?" query. If the user types "Y," the server begins distributing the mail, and the PC station can then go on to other processing tasks.

First of a series

As second-generation personal computers continue to penetrate the professional nonprogramming user domain, demand will increase for the interconnection of different vendors' machines. Connecting these computers to enable them to share information, peripherals and messages will be made easier as VLSI-chip technology becomes more sophisticated.

3Com is working with semiconductor manufacturers in developing the encoder/decoder and transceiver chips that will further reduce the size of the boards. Plans include expanding the EtherSeries line with products for connecting the Apple Computer, Inc. (in early 1983), and Digital Equipment Corp. microcomputer (within a year and a half), as well as application software for providing services such as voice mail and forms generation.

Bob Metcalfe is chairman of 3Com Corp., Mountain View, Calif.

Emulex solves the age-old problem of communicating with a DEC computer.

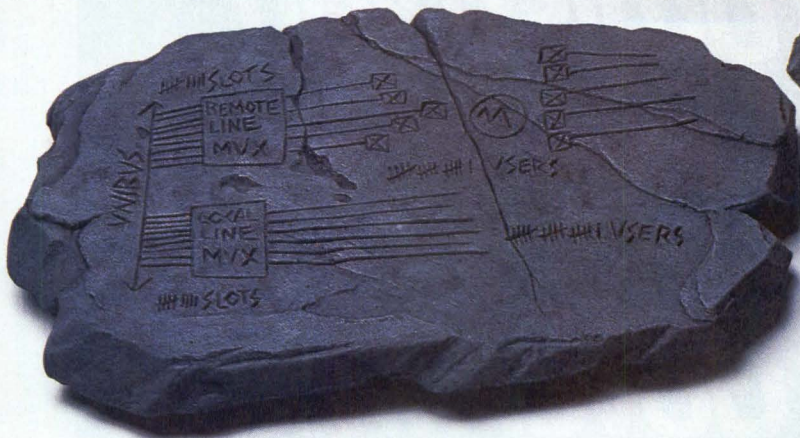

The Stone-Age Way.

One line per remote terminal. Slow, noisy voice-grade lines, open-ended costs. Port-consuming, slot-consuming controllers for both local and remote terminals. Expensive custom software.

The Middle-Ages Way.

Enter remote concentration. Lines and modems reduced. Cleaner, higher baud-rate lines. Re-transmission solves error-rate problem. Local and remote terminals still handled separately. Multiple controllers still required.

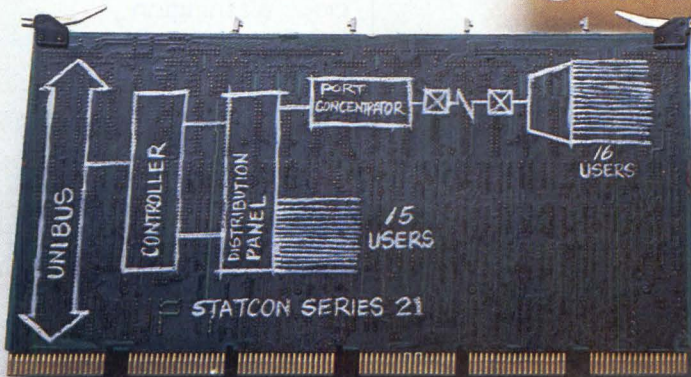
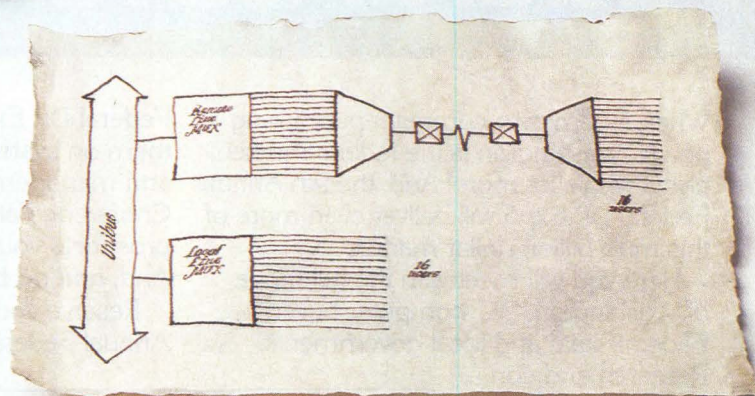

The Emulex Way.

Introducing *statistical concentration*. Remote concentrated lines are handled by a simple, low-cost port concentrator. All data is funneled on one cable into a single MUX port. All those unused ports now freed to work local terminals.

Emulex announces two complete, software-transparent packaged solutions: STATCON Series 11 and 21.

Now you can connect up to 64 remote *and* local terminals through just one single-slot communications controller. No expansion chassis. No extra power supplies. No upgrade to a new computer needed. DH11 and DZ11 emulations available.

Proprietary controller firmware handles all the details. You're backed by proven Emulex quality, reliability and support.

Communicate with Emulex today. Phone toll-free: (800) 854-7112. In Calif.: (714) 557-7580. Or write: Emulex Corporation, 2001 E. Deere Ave., Santa Ana, CA 92705.



The genuine alternative.

DEC and UNIBUS are registered Trademarks of Digital Equipment Corp.

CIRCLE NO. 102 ON INQUIRY CARD

We Promise You More Than The Federal Government

When it comes to computer-purchasing power, Washington is the federal market and a whole lot more! And, the 9th Annual Federal DP Expo will deliver even more of this multi-billion dollar market.

Here you will meet with the full range of Washington, DC computer buyers. Federal, state and local governments.

Research and consulting firms. Associations. Lobbyists. Financial organizations. Hospitals. Universities. Businesses. Professionals who are shopping for a wide array of computers as well as office automation products and services.

For eight years, DP and MIS professionals have relied on

Federal DP Expo Conferences to update them on systems technology, policy and management issues. Each year our Conference attracts the kind of high quality prospects you want to do business with. And, *will* do business with.

Reserve your space now for the 9th Annual Federal DP Expo conveniently

located in the spacious Washington DC Convention Center. Call our sales staff, toll-free, at: 800-225-4620. (In Massachusetts, call 617-879-4502.) Or write: Federal DP Expo, The Interface Group, 160 Speen St., P.O. Box 927, Framingham, MA 01701.

We promise you won't regret it.

FEDERAL DP EXPO '82 audience.

Non-Government	42.3%
Government	57.7%

FEDERAL DP EXPO '82 audience by job function.

DP Admin./Management	28.8%
Data Comm. Management	6.7%
Technical Management	13.6%
Programming Supervision	4.1%
DP Operations	5.9%
Programming	15.1%
Sales/Marketing	7.7%
Consulting	8.8%
Other	9.3%

9th Annual Conference & Exhibition
April 12-14, 1983 • Washington DC Convention Center

★^{9th} FEDERAL DP EXPO®

Brought to you by The Interface Group, world's largest producer of computer conferences and expositions, including: FEDERAL DP EXPO, INTERFACE, COMDEX/SPRING, COMDEX/FALL, COMDEX/EUROPE, and COMPUTER SHOWCASE EXPOS (Nationwide).

★ ★ ★ E X T R A ★ ★ ★

32-Bit Computer Breaks \$10K!



Universe 68/05 First to Smash Price Barrier

The new Universe 68/05 is the first true 32-bit computer priced under \$10,000 (OEM quantity one). "True" because, unlike other 68000-based systems, the Universe 68/05 handles 32 bits in parallel on its VERSAbus.

Outperforms VAX*

Its price is even more impressive when you look at Universe 68/05

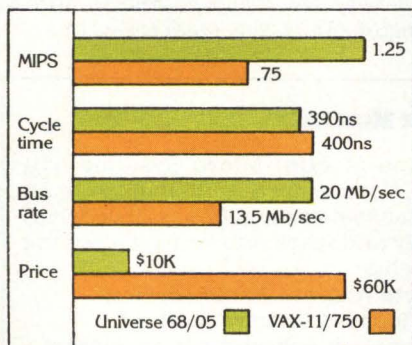

performance versus that of 32-bit "superminis" several times more expensive, like the VAX-11/750.

High-Speed 68000, 4Kb Cache, 32-Bit Bus

The key to that performance is a 4Kb cache that eliminates processor wait-states and takes full advantage of a 12.5MHz 68000 processor. Also included are a separate 68000 I/O processor, four serial I/O ports (expandable to 64), 256Kb RAM (expandable to 3Mb), 20Mb/sec, 32-bit VERSAbus, 10Mb Winchester, 1.25Mb floppy disk, and 5-slot card cage. All in a 7-inch enclosure.

UNIX-Compatible Real-Time OS, Too

UNOS*, our UNIX* Rev7-compatible operating system with real-time features, runs Pascal, Fortran, C, BASIC, DBMS, and third party application programs.

For more information, just attach your business card to this ad and mail to Charles River Data Systems, 4 Tech Circle, Natick, MA 01760. Or call us at (617) 655-1800. We'll send you a copy of "The Insider's Guide to the Universe," a detailed discussion of the technical concepts behind this remarkable new computer.



CHARLES RIVER DATA SYSTEMS

*VAX is a trademark of Digital Equipment Corporation. UNIX is a trademark of Bell Laboratories. UNOS is a trademark of Charles River Data Systems.
CIRCLE NO. 103 ON INQUIRY CARD

Mini-Micro World

CALENDAR

JANUARY

- 12 Meeting of the Association for Women in Computing**, Los Angeles, sponsored by the AWC. Contact: Vicky Gray, publicity vice president, P.O. Box 43677, Los Angeles, Calif. 90043.
- 18-21 Distributed Processing short course**, Los Angeles, sponsored by Integrated Computer Systems. Contact: Ruth Dordick, Integrated Computer Systems, 3304 Pico Blvd., Santa Monica, Calif. 90405, (213) 450-2060.
- 18-21 Local Area Networks short course**, Los Angeles, sponsored by Integrated Computer Systems. Contact: Ruth Dordick, Integrated Computer Systems, 3304 Pico Blvd., Santa Monica, Calif. 90405, (213) 450-2060.
- 18-20 Strategic Systems Planning seminar**, New York, sponsored by IM Computer Services, Inc. Contact: Seminar Coordinator, IMCSI, 230 Park Ave., New York, N.Y. 10169, (212) 490-3366.
- 18-20 Southcon/83**, Atlanta, sponsored by Atlanta Section, Florida Council and Region 3 IEEE, and Dixie, Sunshine and Piedmont Chapters ERA. Contact: Southcon/83, 999 N. Sepulveda Blvd., El Segundo, Calif. 90245, (213) 772-2965.

FEBRUARY

- 1-4 Embedded Computer Systems short course**, San Francisco, sponsored by Integrated Computer Systems. Contact: Ruth Dordick, Integrated Computer Systems, 3304 Pico Blvd., Santa Monica, Calif. 90405, (213) 450-2060.
- 1-4 Computer Network Designs and Protocols short course**, San Francisco, sponsored by Integrated Computer Systems, 3304 Pico Blvd., Santa Monica, Calif. 90405 (213) 450-2060.
- 6-9 Telecommunications and Financial Networks Workshop**, Kissimmee, Fla., sponsored by the American Bankers Association. Contact: ABA, 1120 Connecticut Ave. N.W., Washington, D.C. 20036, (202) 467-6738.
- 21-23 1983 Office Automation Conference**, Philadelphia, sponsored by the American Federation of Information Processing Societies, Inc. Contact: AFIPS, 1815 N. Lynn St., Arlington, Va. 22209, (703) 558-3617.

**The PIPS Revolution:
Strategic Planning Software Plus
Popularly Priced Desktops**

While Visicalc* was growing up and becoming the in language of business computing in America, a parallel revolution has been taking place in Japan. SORD Computer Systems, Japan's fastest growing company, made it happen with PIPS, a sophisticated non-programming business system. PIPS is actually far superior to Visicalc for business purposes. It can do anything that Visicalc, Visifile*, or Visiplot* can do plus a lot more—and a lot more easily. PIPS is perfect for strategic computing applications like marketing and product pricing, and you don't need computer experience to put it to work for you.

The PIPS revolution is about to happen here, too. PIPS is now available with a wide range of desktops from SOCIUS. There's the M23P: a portable desktop with 2 built-in micro-floppy drives, a Z-80A microprocessor and 128K of RAM—so light and compact, it travels in a briefcase, yet is more powerful than many larger computers. There's also the M343: a compact giant with a 16-bit microprocessor, a high-speed arithmetic processor, 256K of RAM, color graphics with a 1024 x 1024 dot memory, multi-terminal timesharing capability, communications interface and more.

Lots more software is also available with SOCIUS com-

puters, including the SB-80* operating system for compatibility with all CP/M*-based programs.

The SOCIUS wonder computers.

Sorry to keep you waiting.

**SOCIUS
M23P**
Suggested
retail price:
\$2395

(CRT not included)

*Visicalc, Visifile, and Visiplot are trademarks of Visicorp. SB-80 and CP/M are trademarks of Lifeboat Associates and Digital Research Inc. respectively.

SOCIUS

SORD Computer of America, Inc.

c/o Mitsui (U.S.A.) Inc., 200 Park Ave., New York, N. Y. 10166-0130
Attn: M. Taketani or M. Kitamura, Tel: 212-878-4403

CIRCLE NO. 104 ON INQUIRY CARD

NEXT MONTH IN MMS

The February issue of Mini-Micro Systems will feature disk drives. Topics covered will include small and large Winchester systems and floppy-disk drives and how technology and market forces are affecting them. Some Highlights:

- * Multiple-megabyte Winchester disk drives.
- * A profile of the floppy-disk drive market.
- * A profile of the small Winchester system market.
- * Thin-film technology and its implications.
- * Large disk drives.

**FOR HIGH
CAPACITY, FAST
ACCESS 8-INCH
WINCHESTERS,
COME TO NEC.**

*You
get more
from
NEC.*

**NEC gives you up to
85 megabyte capacity and
25 millisecond access time.**

Put NEC's D2246 8-inch Winchester to work in your medium and heavy volume interactive applications. Its speed and capacity make it perfect for virtual memory, database access, communications, or anything else requiring frequent disk access.

The D2200 family includes 8-inch Winchester with capacities of 22.5, 42.5 and 85 megabytes, with even higher capacities on the way.

The entire line offers significant savings in installation, packaging, maintenance, cost of ownership and cost per megabyte. Just the kind of savings you'd expect from the **Spinwriter™** people.

NEC technology gives you more. For easy systems integration, the D2200s use a conven-

tional Storage Module Device (SMD) interface.

With the D2200 Series you get sealed-module Winchester technology, accurate rotary arm-voice coil actuators, direct coupled dc motors, and state-of-the-art LSI circuitry. All these combine to provide an MTBF in excess of 10,000 hours. With a 30-minute MTTR.

Get the same reliability that's made our Spinwriter printers a legend. In the final analysis, that's what makes our D2200 Series the last word in 8-inch Winchester.

For more information, send the coupon to NEC Information Systems, Inc., 5 Militia Drive, Lexington, MA 02173.

NEC

NEC Information Systems, Inc.

NEC Information Systems, Inc. MM0183
5 Militia Drive, Lexington, MA 02173

- Have a representative call me.
 Send more information on the
D2200 Series 8-inch Winchester.

Name _____

Title _____ Telephone _____

Company _____

Address _____

City _____ State _____ Zip _____

Spinwriter is a trademark of Nippon Electric Co., Ltd.

CIRCLE NO. 105 ON INQUIRY CARD

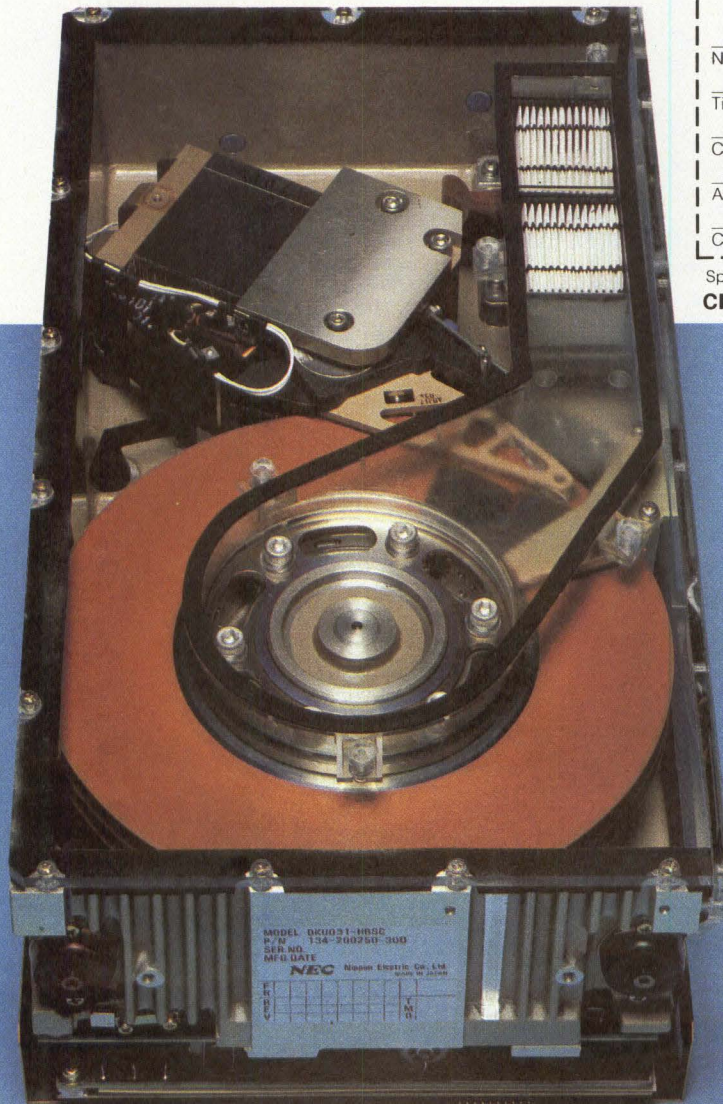

MOST DISK DRIVE C SPOTTED HORSE, WYO

Same goes for Irene, South Dakota. Lame Deer, Montana. And Unalaska, Alaska.

Most low end drive manufacturers can't provide OEM's in towns like these the service and support they deserve.

But Shugart can.

With a whole spectrum of services and expertise to help you make the most of our products. Whether you're in Buffalo, Brussels, or Weeping Water, Nebraska.

Our applications team helps you get the right drive, right performance, right cost for your system. Because we've trained them to know the market as thoroughly as the product.

Should you need a field call, we're prepared to respond with more than a phone call. By sending out a qualified service technician, part of our world-wide field engineering force. They too are carefully trained — to help you perform receiving inspections, interface assistance, and fast repairs.



COMPANIES BELIEVE MING IS BEYOND HELP.

To make them even faster, we've established service centers throughout North America and Europe (including under-the-bubble Winchester clean-rooms). A spare parts group, to speed replacements. And a special headquarters support team, for technical trouble-shooting that can't be achieved in the field.

And naturally, all our efforts are well documented. With OEM manuals, application manuals, service manuals. The kind of literature you come to expect from a company with nine years'

experience as the industry leader.

For more details, contact Shugart Associates, 475 Oakmead Parkway, Sunnyvale, CA 94086, (408) 733-0100. Or Hamilton/Avnet, our authorized distributor.

We'll be glad to help.

Even if you think you're beyond it.

Shugart

Right from the start.

Milpitas, CA 408/263-2600, Minneapolis, MN 612/574-9750,
Framingham, MA 617/879-1700.

CIRCLE NO. 124 ON INQUIRY CARD



OUR NEW 68000[®]-BASED COMPUTER COMES WITH UNIX[™], PRO-IV,[™] AND A GIANT COMMITMENT.

In today's competitive computer market, what's behind a system has become as important as what's in it. And what's behind CIE Systems is the backing of a world-wide corporation with over \$50 billion in sales and 124 years of business experience. That's a commitment to the future.

Of course, one look at how we designed our M68000-based family of business computers and you'll realize just how committed we are to OEMs.

Advanced 32/16-bit architecture. Industry standard Multibus[™] UNIX System III operating system. Everything you've been reading about. And wanted.

The hardware is completely modular. So you can add a wide variety of internal and external memory, peripheral controllers, and a broad range of printers. And, since we supply everything from board level on up, you can easily configure your system for virtually any market.

You can also get our unique PRO-IV Applications Processor. Unlike language processors or program generators, PRO-IV lets you develop applications directly from specified user needs. Without programming, compiling, or interpreting. What's more, documentation is automatically updated and permanently stored whenever an application is developed or modified.

Quality? We're committed to it 100%. That's why we've combined resources with one of the world's largest and most respected electronics firms to manufacture our systems. So you not only get the reliability you need, but high volume OEM quantities.

CIE Systems' M68000-based business computer. Performance. Quality. And a Giant Commitment.

Call or write today for more information. 2515



cie systems

McCabe Way, Irvine,
CA 92713-6579
(714) 957-1112

CIRCLE NO. 106 ON INQUIRY CARD



® M68000 is a Registered Trademark of Motorola, Inc.
™ Multibus is a Trademark of Intel Corporation.
PRO-IV is a Trademark of Data Technical Analysts, Inc.
UNIX is a Trademark of Bell Laboratories.

Systems

NEW PRODUCTS

Software-development system has 8-MHz MC6800

The OB68K/SYS is an MC68000-based software-development system. At the heart of the system is the OB68K1 single-board computer featuring an 8-MHz, 16-bit Motorola MC68000 CPU, 128K bytes of dynamic RAM, eight sockets that can be user-configured for as much as 64K bytes of EPROM, two RS232C ports, two 16-bit software-definable parallel ports, a crystal-controlled baud-rate generator (50 to 19.2K baud), three 16-bit timer/counters and Multibus/IEEE 796 bus compatibility.

A companion board for the OB68K1, the OB68K/INT, acts as an interface between the IEEE 796 bus and the mass-storage system. It features a high-speed interface for the controller board, a Centronics printer port and two user-definable 16-bit parallel ports.

A stand-alone floppy/hard disk controller is mounted above the mass-storage area. It controls as many as two SA850 type floppy disk drives and two Q20XX type Winchester drives. The system includes a 20M-byte Winchester disk memo-

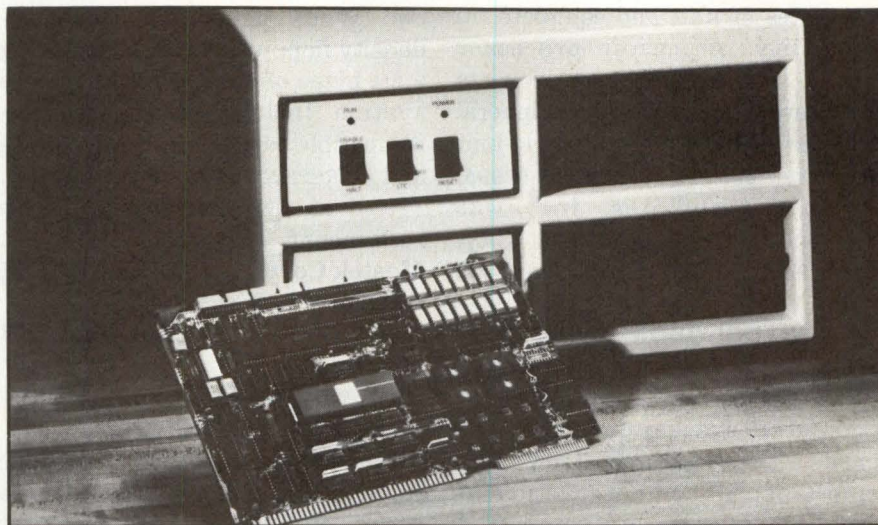

Omnibyte Corp.'s OB68K/SYS MC68000-based software-development system combines a 128K RAM single-board computer with an interface board, a floppy/hard disk controller, a 20M-byte hard disk, a 1M-byte floppy disk and development software for less than \$12,000.

ry storage subsystem and a 1M-byte, double-sided, double-density floppy disk memory storage subsystem.

MSP, a real-time, multitasking operating system with editor, assembler, linking loader and utilities, is available. The OB68K/SYS package comes with an eight-slot

card cage, dual 200W switching power supplies and dual cooling fans with removable filters. The unit can be rack-mounted into standard 19-in. RETMA racks or used in its desk-top enclosure. Typical system price is less than \$12,000. **Omnibyte Corp.**, 245 Roosevelt Rd., West Chicago, Ill. 60185. **Circle No 300**

OEM workstations use Intel 8086

The AWS Turbo workstation uses an 8-MHz, 16-bit Intel 8086 microprocessor and has as much as 512K bytes of RAM and as much as 5M bytes of mass storage in a combination of minifloppy and mini-Winchester disk drives. It incorporates the vendor's CTOS operating system for real-time, multitask operation and supports COBOL, FORTRAN, BASIC, Pascal and Assembly language. It also supports 3270 terminal emulator,

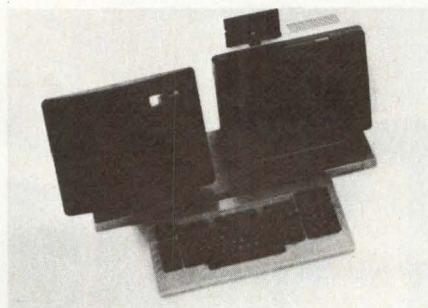

2780/3780 remote-job-entry terminal emulator, asynchronous terminal emulator and X.25 emulator communications protocols. The workstations can be used as

stand-alone units or clustered in various configurations that share peripherals and databases. Prices start from \$4790. **Convergent Technologies**, 2500 Augustine Dr., Santa Clara, Calif. 95051.

Circle No 301

Business system provides word processing

Z-Disk, a multi-user, multitasking small-business system based on MP/M, CP/NOS and COMSTAR software provides word processing, file processing, electronic mail, special-

Systems

NEW PRODUCTS

ized office-forms output, financial planning and interoffice communications. For each user, Z-Disk dedicates a user processor module consisting of a Z80A microprocessor, 64K bytes of RAM and complete I/O capability. A master processor module supervises all user requests for shared storage and peripheral devices on the system. Single-unit quantity prices start at \$2995. **Product Associates, Inc.**, 465 Convention Way, Redwood City, Calif. 94063. **Circle No 302**

User-expandable system uses STD bus

The Z80-based Matrix 200 micro-computer system includes two cards, the vendor's MDX-CPU3 single-board computer and the vendor's MDX-FLP2 floppy disk

controller card, leaving eight slots of the 10-slot card cage available for user expansion options. Designed around the STD bus, the system features 64K bytes of memory, with two 8-in., double-sided, double-density floppy disk drives providing 3.2M bytes of storage capacity. The system includes a Centronics-compatible parallel printer interface and an RS232C-compatible interface. Priced at \$5995, it is available in rack-mount or tabletop versions. **Mostek Corp.**, 1215 W. Crosby Rd., Carrollton, Texas 75006. **Circle No 303**

Multibus SBC uses FPLS technology

The MC 86 Multibus-compatible single-board computer, based on a 5- or 10-MHz 8086 CPU, contains 128K

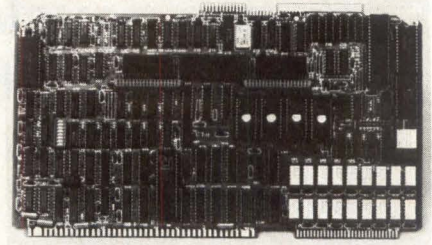

bytes of dual-ported parity RAM, 64K bytes of PROM, one RS232 port, 24 parallel I/O lines, three 16-bit interval timers, two SBX I/O expansion ports, multi-mode interrupt controller and 8087 co-processor or 951 math processor. By using field-programmable logic sequencers, the 10-MHz MC 86 can complete a RAM cycle in 400 nsec. (maximum). Price is \$2795 in single-unit quantities. **Comark Corp.**, 257 Crescent St., Waltham, Mass. 02154. **Circle No 304**

Single-board processor is S-100 bus compatible

The model CPZ-48000 Z80A-based, board-level computer system interfaces with any S-100 bus product. It operates at 4 MHz and has 64K bytes of on-board dynamic RAM with memory bank selection of 4K to 64K bytes under software control. Its floppy disk controller can drive as many as four 5¼- or 8-in. drives in DMA, interrupt or programmed I/O mode. The CPZ-48000 has two synchronous or asynchronous serial I/O channels and two parallel I/O channels with software-selectable baud rates. It supports CP/M, MP/M and Turbodos operating systems and includes an implementation of Turbo-Disk. Other features include a real-time clock, a memory management unit that can address 16M bytes of system memory and a 2K- or 4K-byte on-board EPROM. Price is \$995. **Intercontinental Micro Systems**, 1733 S. Douglass Rd., Suite E, Anaheim, Calif. 92806. **Circle No 305**

Sound Control Systems

QUIETER MACHINES MEAN HAPPIER PEOPLE

Solve Office Noise Problems with Sound Control Enclosures from Jensen Engineering.

Machines aren't paid to think. Your employees are. And when the incessant chatter of office machines reaches a certain noise level, productivity goes down, tempers go up and business suffers.

Jensen Acoustical Enclosures quietly solve the problem with such standard features as:

- Vents, ducts and fans for temperature control
- Specially-designed paper guide assemblies
- Low profile angle sides for easy access
- On/off switch on the outside
- Over 500 attractive stock designs
- One-year guarantee

(or custom-designed to your specifications)

JE Jensen Engineering
Santa Rosa, CA 95401
Toll Free: (800) 358-8272
In Calif.: (707) 544-9450
TWX: 510-744-8230

Here's Why Precision Visuals Is Now The Leader In Graphics Software Tools!

One Program Drives Many Devices

This single advantage can save you hundreds of hours of programming time. It enables you to use your hardware (both host computer and graphics devices) to its fullest. It protects your software investment against obsolescence and frees you from exclusive ties to hardware vendors.

Precision Visuals currently offers tailored interfaces for over 30 graphics devices from these companies: AED Applicon Calcomp Calcomp lookalikes Chromatics DEC Digital Engineering HP Houston Instruments IBM Imlac III KMW Megatek Printronix Ramtek Raster Technologies Sanders Selanar Servogor Tektronix Tektronix lookalikes TI Trilog Versatec Visual Technology Zeta.

They Run On Most Popular Computers

Including IBM, VAX, PRIME, Hewlett-Packard, CDC, Honeywell, Data General, DEC 10/20, Harris, Univac, Cray, and DEC PDP-11.

Precision Visuals software tools require a surprisingly small amount of computer resources. Even on smaller machines they provide access to the full capabilities of the CORE graphics standard.

"At Martin Marietta, DI-3000 serves as a common interface between our numerous graphics devices and software applications. We use DI-3000 for applications including structural analysis, business charts, graphs, animation, 3D modeling, and general-purpose graphics."

Karin Bruce
Senior Graphics Software Engineer
Martin Marietta Denver Aerospace

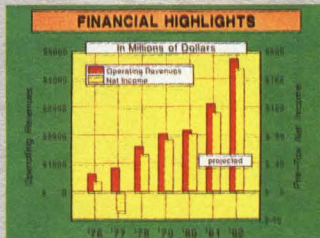

Make better decisions, faster, using GRAFMAKER's specially-placed annotation and color.

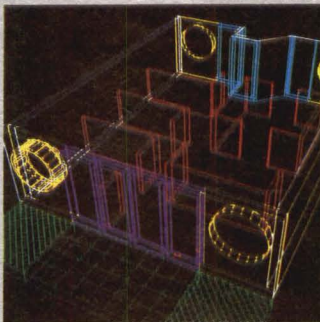

Build highly interactive computer-aided design applications with the DI-3000 core system.

Rich Capabilities Mean Limitless Applications

Precision Visuals software tools are proven in applications such as computer-aided design, business graphics, process control, mapping, geological data analysis, document layout, plus many specialized applications. System integrators (OEMs) use them as the graphics nucleus in turnkey systems and as the graphics component of database management and financial modeling systems.

\$12,000 For Our Most Popular System

DI-3000™, the core system, starts at \$8,000 and goes to \$12,000 for our most powerful and best-selling level. Add \$6,000 for GRAFMAKER™, the business presentation specialty system, and you'll have one of the most versatile graphics systems available at any price. Other popular options include the METAFILE SYSTEM for a device-independent

picture library, and our new CONTOURING SYSTEM for advanced surface graphics.

These are single-CPU, end-user, U.S. list prices. Multiple CPU and OEM discounts are also available.

Find out how Precision Visuals graphics software tools can open a new world of flexibility, economy, and standardization for your graphics applications. Call us at 303/530-9000.



Precision Visuals

6260 Lookout Road
Boulder, Colorado 80301 USA
303/530-9000
TELEX 45-0364/TWX 910-940-2500

Amsterdam: Ponder Associates
Phone 030445352 / TELEX 70634
Sydney: Techway
Phone 02920858 / TELEX 27987
Tokyo: Nichimen Company Ltd.
Phone 032775017 / TELEX 22329
Zurich: Computer Graphix AG
Phone 019323482 / TELEX 875447

CIRCLE NO. 107 ON INQUIRY CARD

Systems

NEW PRODUCTS

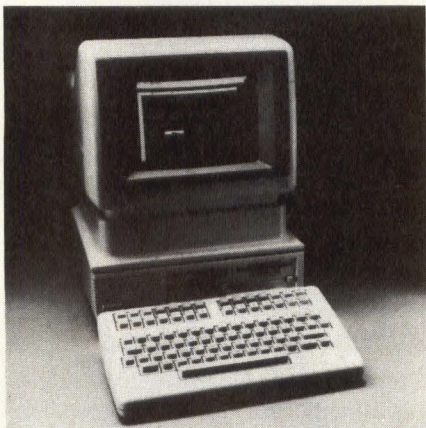

Personal computer features optional 3½-in. floppy

The HP 120 personal office computer features dual Z80A microprocessors, 64K bytes of main memory, 16K bytes of screen display memory and 32K bytes of ROM for internal functions. It has an IEEE-488 connector and two RS232C ports. Its 9-in. screen is available with a tilt and swivel option. Mass storage is available in the form of single or dual 3½-in. microfloppy disk drives that store 248K bytes (formatted) each or in a combination of a 3½-in. microfloppy and a 4.6M-byte Winchester disk drive. Base price of the HP 120 is \$2775 including a processor, a display, 64K bytes of internal memory and a keyboard. **Hewlett-Packard Co.**, 3000 Hanover St., Palo Alto, Calif. 94304. **Circle No 306**

Desk-top micro has 15M bytes of disk storage

The enhanced version of the DMS-15 CP/M-based microcomputer has a DSC-3 (Z80A) processor, 64K bytes of RAM, a 9-in. CRT, one 5¼-in. double-sided, double-density floppy disk drive that stores 614K bytes, 15M bytes of formatted Winchester disk storage and four RS232 ports. This stand-alone system can also serve as the master station in the vendor's HiNet local-area network and includes the

network interface. The DMS-15, including CP/M, sells for \$7495 in single-unit quantities. The software needed to run the system as the HiNet master station sells for \$500. **Digital Microsystems**, 1755 Embarcadero, Oakland, Calif. 94606.

Circle No 307



Microcomputer features networking capabilities

The five-user Altos 586 microcomputer uses a 10-MHZ, 16-bit Intel 8086 processor with 256K or 512K of RAM, expandable to 1M byte. It features six RS232 ports, and can be upgraded to 10 through an integral communications board that provides communication with mainframes. Protocols include IBM 2780/3780 (synchronous), 3270, SNA/SDLC and X.25. The board also offers an auto-dial/auto-answer modem. As many as 32 other 16-bit Altos microcomputers can be networked using RS422 cabling connected to an integral interface and Altos-Net networking software. Users can upgrade to Ethernet by adding a board slotted into the system's Multibus-type interface. In addition to XENIX/UNIX, the system supports MS/DOS, Pick, CP/M-86, MP/M-86 and OASIS-16 operating systems. Languages include BASIC, COBOL, FORTRAN, Pascal and C. Model 586-2

CALL YOUR LOCAL DYSAN OFFICE

- CA: Los Angeles (213) 907-1803
Orange County (714) 851-9462
Sacramento (916) 966-8037
San Francisco/Sunnyvale (408) 727-9552
- DC: Washington (703) 356-6441
- GA: Atlanta *(404) 952-0919
- IL: Chicago (312) 882-8176
(800) 323-5609
- MA: Boston (617) 273-5955
*(617) 229-2800
- MI: Detroit (313) 525-8240
- MN: Minneapolis *(612) 814-7199
- MO: St. Louis (314) 434-4011
- NY: New York (212) 687-7122
- OH: Cleveland (216) 333-3725
- PA: Pittsburgh (412) 261-0406
Philadelphia (609) 939-4762
- TX: Dallas/Ft. Worth *(817) 261-5312
- WA: Seattle (206) 455-4725

*Includes OEM Sales

Dysan Diskettes are also available from all ComputerLand Stores, Sears Business Systems Centers, and many independent computer outlets nationwide.

For the location of the Dysan sales outlet nearest you, contact Dysan at: (408) 988-3472

Toll Free: (800) 538-8133
Telex: 171551 DYSAN SNTA
TWX: 910-338-2144

 **Dysan**
CORPORATION

WHAT IS THE TRUE COST OF A DISKETTE?

If you said at least \$186.50*, you're probably close.

Confused? It's simple. The minimum cost of a one-sided, single density 8" diskette equals the purchase price plus the cost of the time to fully load the data onto the disc*. The adjacent diagram tells the story. As you can see, the purchase price of a diskette is a small fraction of the total cost of ownership. So why not pay a few cents more for the best diskette available?

That's where Dysan's quality comes in. Dysan diskettes and mini-diskettes are manufactured to the toughest quality standards in the industry. Every diskette is tested between the tracks as well as on the tracks to insure you 100% error-free recording over the entire disc surface. Dysan quality protects your investment of \$186.50.

You know how costly time and data losses can be should your "bargain" diskette be faulty. Every penny you think you save on the purchase of magnetic media could cost you dearly. Why take the risk when you can have Dysan?



dy/Jan **Dysan**
CORPORATION

Our Media Is Our Message

5201 Patrick Henry Drive
Santa Clara, CA 95050

*\$4.00 represents Dysan's suggested retail price for a one-sided, single density 8" diskette, packaged ten to a box. Minimum total cost of ownership = \$186.50

*\$182.50 represents the cost of data loading (approximately 22 hours at 11,106 keystrokes/hour at a labor cost of \$8.23/hour), based on 1981 Data Entry Management Association (DEMA) National Averages.

CIRCLE NO. 108 ON INQUIRY CARD

More Room . . . More Multibus® Cages.



More Room

You get more room for extra cards without increasing overall size, because our design gives you greater inside dimensions.

More Reliability

All cages are constructed of sturdy, durable anodized aluminum with a single mother board backplane . . . a concept that increases reliability and minimizes interconnections.

More Models

We have more models than all our competitors combined. Choose a cage with 3, 4, 5, 6, 7, 8, 9, 12, 14, 15,

16, 20, 24 or 26 slots for the right solution to your problem. We have models with either 0.6" or 0.75" card centers and can even accommodate wirewrap cards.

More Rack Mount Models

Standard 19-inch rack mounting available for all cages.

More Warranty

A three year warranty is your assurance of quality.

For Fast Delivery.

Call our toll free number
(800) 854-7086
In Calif. call
(619) 292-0242



Electronic Solutions

5780 Chesapeake Court
San Diego, CA 92123

MULTI-CAGE®

Note: Multi-Cage is a registered trademark of Electronic Solutions
Multibus, trademark of Intel.

**Fully Multibus Compatible,
Terminated Mother Board.**

CIRCLE NO. 109 ON INQUIRY CARD

See your subject with 17x more resolution than standard video.



Digitize any subject with 1720 by 2592 by 8 bit resolution.* Capture that image with reliable CCD array. No film. No tubes. Gain higher resolution and sensitivity than vidicon cameras at a comparable price. Linear response in every axis. Compact design (4" by 5 3/8" by 7"). Versatile control options. Easy interfacing. Circle our readers' service number for complete specs and application data.

* Other resolutions and aspect ratios available

DEC Interfaces Available

DATACOPY

1070 East Meadow Circle
Palo Alto, California 94303
(415) 493-3420

CIRCLE NO. 110 ON INQUIRY CARD

Systems

NEW PRODUCTS

offers dual 5¼-in., 1M-byte floppy disks and is priced at \$4990. Model 586-10 features 10M-byte hard disk storage with floppy disk backup priced at \$7990. **Altos Computer Systems**, 2360 Bering Dr., San Jose, Calif. 91531. **Circle No 308**

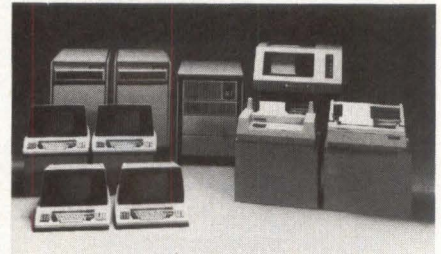

Computer systems feature mass-storage capabilities

The Business System 800 series of multitasking, multi-user mini-computers consists of six packaged computer systems. Data storage capabilities range from 80M bytes of formatted data storage in the System 861 to 238M bytes in the System 886. The computers use the high-speed 16-bit model 990/12 processor and 512K to 2M bytes of error-correcting memory. Each 800 series system, in its minimum configuration, includes two model 911 video display terminals that feature high-resolution display screens, upper- and lower-case ASCII character sets and separate cable-connected keyboards with 10-key numeric pads and special function keys. The Business System 800 series supports the DX10 and DNOS operating systems. Both operating systems support COBOL, FORTRAN, BASIC, RPG II and Pascal programming languages. Available utilities include a data dictionary, a database-management system, a query language and word-processing capabilities. Prices range from \$51,000 to \$86,000 in single-unit quantities. **Texas Instruments Inc.**, P.O. Box 202146, Att: H-636, Dallas, Texas 75220

Circle No 309

SUPPORT THIS UNION AND AVOID A WORK SLOWDOWN.



Organize your DP operation around a VAX computer and Direct 831 terminals and enjoy an important benefit of a DEC-Direct union. More power. The kind that gets work done faster.

To the 831's VT100-compatible features you can add an optional integral modem to put the power of your VAX in the hands of anyone with a telephone.

Or add PLOT 10 graphics and deliver the big picture when there's no time to wade through words.

But that's just for starters.

The 831's block mode frees your VAX from the chore of creating and editing data. (That's why many users, including DEC itself, view block mode as an answer for overburdened CPUs.)

And if that's not enough, you can unite host and personal processing by field-upgrading the 831 to our Direct 1031, a self-contained terminal/personal computer. The 1031 makes the entire array of CP/M-compatible software available to off-load your host, leaving you more VAX processing power for the jobs only a VAX can handle.

To further our cause, we're prepared to stage a demonstration at your place of business. Contact us at Direct, Inc., 4201 Burton Drive, Santa Clara, CA 95054. Telephone 800-538-8404 (408-980-1414 in California). Direct and DEC. It's one union that gives you more than you bargained for.

DIRECT

DEC, VAX, and VT100 are registered trademarks of Digital Equipment Corporation. CP/M is a registered trademark of Digital Research, Inc. ©1982 Direct, Inc.

CIRCLE NO. 111 ON INQUIRY CARD

The WDC11 series...

The FIRST family of Winchester/Floppy controllers for the LSI-11/Q-Bus

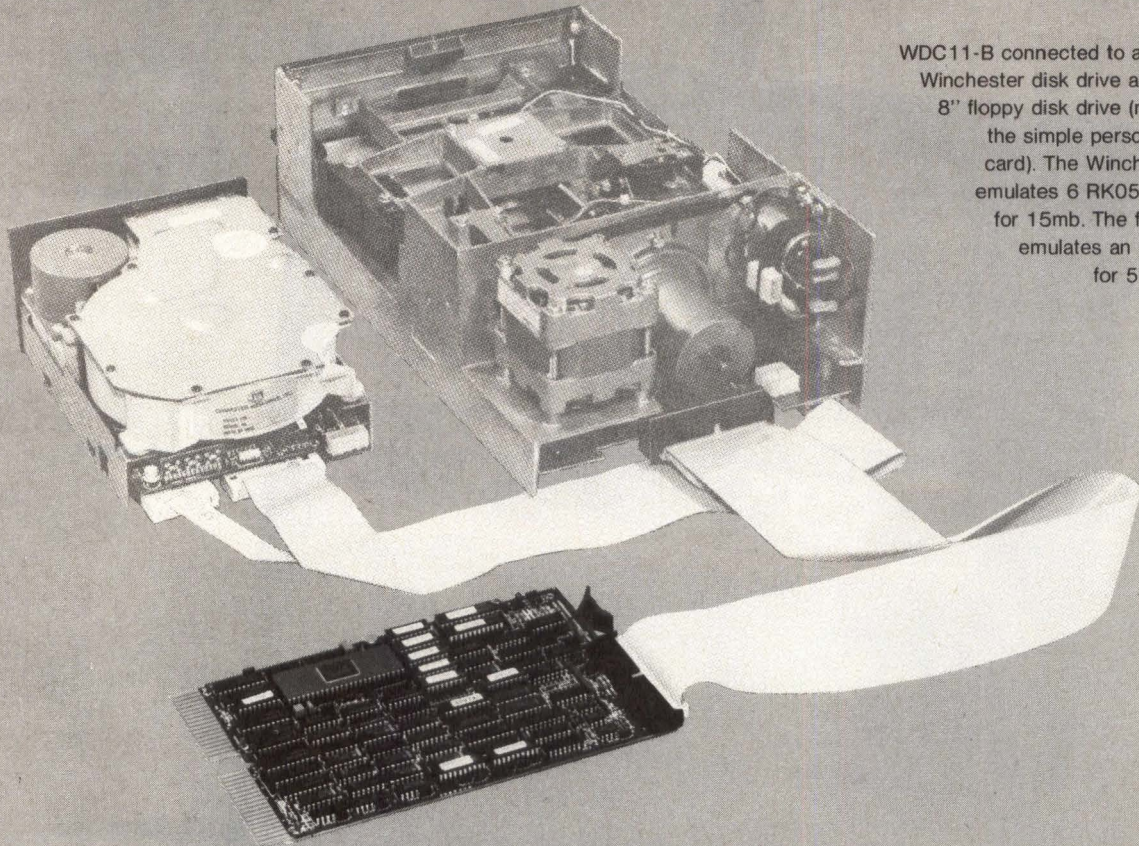

WDC11-B connected to a 5 1/4" Winchester disk drive and an 8" floppy disk drive (notice the simple personality card). The Winchester emulates 6 RK05 units for 15mb. The floppy emulates an RX02 for 512kb.

Unsurpassed Freedom Of Choice

Choose the **disk drive sizes** that are right for YOUR application: The WDC11 controls 8" and 5.25" drives, Winchester and floppy.

The **DEC emulations** that YOU need: RK05, RL01/02, RP02 for the Winchester and RX02/03 for the floppy. All Winchester emulations provide 22-bit addressing; RLV12-compatible.

The **disk drive vendors** that YOU want to use: The following manufacturers build drives that are currently supported: Shugart, Quantum, Tandon, Qume, Computer Memories, Discron (RMS), Rodime, Ampex, Micro Peripherals, Seagate. Any drive with a standard interface (SA1000, SA800/850, ST506, or TM100-4) can be controlled by the WDC11. A single PROM chip adapts the WDC11 to a specific drive configuration.

The **controller form-factor** YOU want: A single, dual-width card includes the Winchester controller, the floppy controller and an intelligent bootstrap. There is no external formatter board that you need to mount and supply power to. The WDC11 requires only 2.7A of +5V. Simple personality cards adapt the WDC11 to multiple drives, various pinouts and signal levels.

The **experience** YOU are looking for: Andromeda has been shipping WDC11's since the Summer of 1981.

The **growth potential** that YOU require: As new, higher capacity, higher performance disk drives become available, the WDC11 can be adapted to them by simply changing the configuration PROM. New emulations and data formats can be handled in a similar fashion.

DEC, LSI-11, RK05, RL01/02, RX02, and RP02 are trademarks of the Digital Equipment Corp.

ANDROMEDA[®]
SYSTEMS
INC.

9000 ETON AVENUE
CANOGA PARK, CA 91304
Ph: [213] 709-7600
TWX: [910] 494-1248



Peripherals

NEW PRODUCTS

Data Printer makes first foray into end-user market

Data Printer Corp., a Malden, Mass., supplier of OEM chain-train printers, this month makes its first foray into the end-user market with the introduction of the BT 1500 band-train printer.

The 1500-lpm unit offers a choice of bands containing 48-, 64- or 96-character sets. The company's Gothic type style is available, and special type in special arrangements for codes is optional. The band prints as many as 132 characters at 10 cpi, and 136-character printing is optional. The MTBF for the BT 1500 is rated at 1000 hours for 60-percent duty cycles. The company defines a 60-percent duty-cycle printer as one that operates approximately 14 out of 24 hours.

Bit-parallel, character-serial, externally strobed and TTL-compatible interfaces are standard. The BT 1500 is also pin/plug-compatible with the company's S-1003 universal interface. Control Data Corp., Dataproducts 2200 series, Centronics parallel and RS232 interfaces are optional.

The printer is the first member of a band-train family, and incorporates an Intel 8080A 8-bit microprocessor controller to provide electronic character alignment. The microprocessor memorizes where each character should be, and if a character goes out of alignment, an operator can adjust it using two buttons on the printer. Pressing the left or right button, the operator increments the character slightly in either direction. This feature, says Paul Goldberg, product marketing specialist at Data Printer, allows a user to align characters in minutes instead of requiring three hours of a technician's time twice a year.



The BT 1500 is the first member of Data Printer's Band Train family of printers, and the company's first foray into the end-user market. Print speed is 1500 lpm.

Two comparable offerings in IBM's chain-train printer line are the 1110-lpm 1403-N1 and 1404-2. Both offer 48-character sets and 132 print positions, the same specs as the BT 1500. The BT 1500's single-unit price is \$19,100. The 1403-N1 is \$40,040, and the 1404-2 sells for \$99,390.

Dataproducts' band offering, the BP 1500, is almost identical in price and specifications to the BT 1500. At a retail price of \$19,950, the printer offers a 1500-lpm speed; 48-, 64- and 96-character sets; and 132 or 136 print positions.

Data Printer is also interested in claiming its share of the replacement market. According to research firm Advanced Resources Development, one-half the line printers in use were installed in 1977 or before. "IBM 1403s have been out there 10 or 15 years," says Goldberg, "and Data Printer can replace those."

Goldberg says that the design of

the BT 1500 allows quick font changing. It takes a few minutes to replace the band, he says, compared with the hours it takes to replace a chain. The width of the cloth ribbon, (15 yd. × 14½ in.) adds to ease of use, compared to changing paper and carbon ribbons. The printer accepts single sheets and fanfold paper, and prints on multipart paper.

A novel feature of the BT 1500 is its vacuum-cleaner system, designed to keep the band area free of paper dust. Goldberg says it was incorporated into the printer without additional cost.

The BT 1500's \$19,100 single-unit price is discounted to \$17,000 in low OEM quantities. Production quantities will be available this month.

—Nancy Love

Data Printer Corp., 99 Middlesex St., Malden, Mass. 02148

Circle No 310

DEC-compatible printer includes plotting package

The model 1000A printer/plotter gives DEC users the ability to print and plot with one device. It is based on a 200-cps serial dot-matrix line printer with a 72-dpi graphics print capability. The package includes CCSI-PLOT, a FORTRAN-callable, Cal-Comp-compatible plot library that allows a user to generate a variety of plotted information including labeled and annotated axes, textual or character-string data, graphs from data arrays of x and y coordinates and FORTRAN IV variables in F or I format. Available interfaces include RS232C or Centronics parallel. Price is \$3500 including a printer/plotter, an expanded buffer option (3.5K bytes), a printer stand, software, documentation and license. **Basic Information Systems, Inc.**, 230 W. Florence Ave., Inglewood, Calif. 90301.

Circle No 311

Low-cost terminal features MC68008

Beehive International's ATL-008 interactive video terminal uses the 8-MHz, 16-bit MC68008 microprocessor and sells for \$1395 in single-unit quantity. A standard model comes with 32K bytes of RAM (expandable to 128K bytes) and 512 bytes of nonvolatile RAM (expandable to 2048 bytes). Eight soft function keys allow multiple functions from a single key depending on the operating mode selected. In addition, there are 16 pre-programmed function keys and eight user-defined keys.

The 14-in. P31 phosphor tilt and swivel display screen features a 7 × 9 character matrix displayed in a 9 × 13 cell. The screen displays 24 rows of data, a status line and a soft-key label line in 80- or 132-column format. In addition to the 256-character set that includes control characters, 64 plotting and business graphics characters and 10 resident foreign character sets, an additional 256-character set can be addressed on a character-by-character basis. A 15-in., bit-mapped monochrome display monitor and a 13-in., bit-mapped color display monitor will be available by 1984.

The ATL-008's editing capabilities include fixed and variable tab stops, programmable editing extents, insert/delete character and line, many erase commands and logical attributes.

The ATL-008 is compatible with ANSI X3.64. Its programmable, bidirectional buffered communications port allows asynchronous and isochronous (similar to asynchronous but externally clocked) operation with data rates as fast as 19.2K baud.

The ATL-008 is the first in a series



Beehive International's ATL-008 terminal's ergonomic design features a detached keyboard with 14-station numeric keypad with Enter key.

of seven products the vendor will introduce into new markets. By 1986, the company expects that two-thirds of its revenues will come

Smart terminal can be customized by users

The Esprit III video display terminal, which emulates the Tele-Video 950, incorporates a 6502 microprocessor and provides a PROM set with a remote access command for user-designed functions. The terminal features a tilting, non-glare, green phosphor screen that displays 24 lines of 80 characters and a 25th programmable status line. Other display features include reverse video, half intensity, blink,

from new workstation business. Beehive International, P.O. Box 25668, Salt Lake City, Utah 84125.

Circle No 312

blank and underline video attributes and line-drawing graphics. The detached keyboard features a 14-key numeric pad and 22 user-definable function keys. Available interfaces include RS232C, current loop and a bidirectional auxiliary port with independent baud-rate selection. Price is \$895 in single-unit quantities. Hazeltine Corp., Computer Terminal Equipment, Commack, N.Y. 11725.

Circle No 313

THIS YEAR THE PDP-11/23 HAS MORE IN STORE FOR YOU.

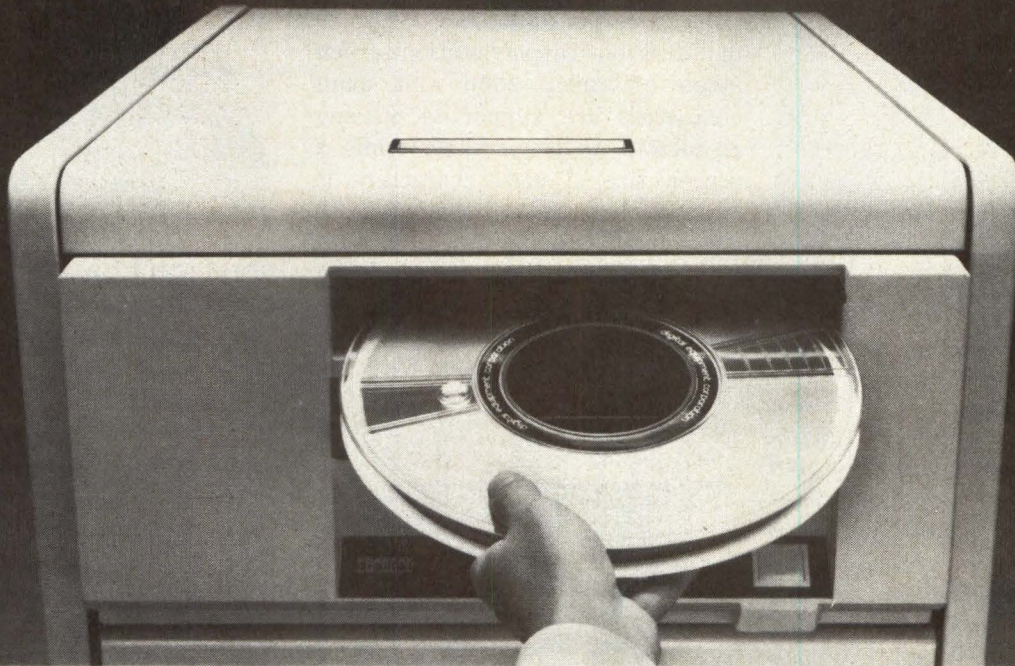

Digital's TSV05. A high-speed streaming magtape unit designed for the PDP-11/23 and PDP-11/23 PLUS small systems.

Built to operate with the PDP-11/23 and PDP-11/23 PLUS, the TSV05 is also compatible with Digital's MINC and MICRO/PDP-11 small systems. And the TSV05 can store up to 46mb of data. That's *four to ten times* the storage capacity you're currently getting with hard or floppy disks.

The TSV05 uses any of three 1/2" tape reel sizes (7", 8", or 10.5") formatted in ANSI standard 1600 bpi. It will handle a variety of applications including interchange, journaling, archiving, software distribution, and disk backup. In fact, it now delivers an unparalleled 100 ips for high-speed streaming disk backup.

As for making room for it in your office, the TSV05 is only big on the inside. The 9" tape transport and its power controller are attractively packaged in Digital's standard 40" high cabinet series. And it uses less power than traditional magtape units.

Thanks to its unique front-loading design with automatic tape threading, inserting a TSV05 magtape is as easy as loading a floppy disk. Even routine servicing has been reduced to its simplest form with easy service access to all system components.

As you might expect from any Digital product, the TSV05 meets Digital's rigid standards for reliability and quality. In fact, every unit features special built-in micro-processor-based diagnostics to insure the integrity of your tape subsystem.

Then there's one final back-up system, and it comes standard with every TSV05 Digital sells: our worldwide network of 16,000 service professionals, and our fully stocked spare parts service centers.

To find out more about magtape capability for your PDP-11/23 series computer, call 800-832-6277. Or write **Digital Equipment Corporation**, 5 Flagstone Drive, Hudson, NH 03051.

digital

Peripherals

NEW PRODUCTS

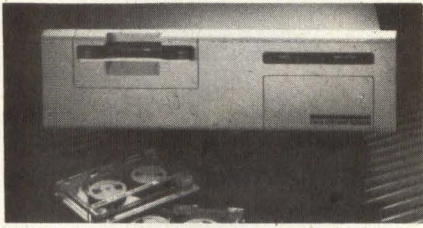

Winchester is compatible with DEC Q-bus minis

The model DSD 890 combines a 31.2M-byte (formatted) capacity, 8-in. fixed Winchester disk with a 16.25M-byte capacity, 1/4-in., removable cassette-tape backup. The DSD 890's Winchester emulates three DEC RLO2 cartridge disks, while the 890's 1/4-in. tape emulates the 1/2-in. TSV05 tape subsystem. The DSD 890 is compatible with DEC LSI-11 (Q-bus) minicomputers and operates with RT, RSX, TSX, RSTS and UNIX operating software. It also supports 22-bit addressing. Operating in a noninterleaved mode, the DSD 890 features a transfer rate of 364K bytes per sec. The hard disk portion of the system also features a 65-msec. average access time. The tape portion of the system features 6400-bpi recording on four tracks and operates at 30 ips. Price is \$9895 in single-unit quantities. **Data Systems Design**, 2241 Lundy Ave., San Jose, Calif. 95131

Circle No 314

SNA controller works with ASCII CRTs

The 6274 communications control unit allows ASCII CRTs to access IBM host systems operating under Systems Network Architecture. The 6274 communicates with the IBM host computer via Synchronous Data Link Control protocol and is a Physical Unit Type 2 device. Using ASCII CRTs with cursor addressing, the 6274 is compatible with IBM 3274-21C control units and attached 3278 display stations and 3287 printers, and can run with existing IBM 3270 applications without

modification. Display station screen sizes of 1920, 2560 and 3440 characters are supported on any 80-column ASCII terminal, while a screen size of 3564 characters is supported on ASCII terminals with 132-column capabilities. Price is \$10,950. **Carterfone Communications Corp.**, 1111 W. Mockingbird Lane, Suite 1400, Dallas, Texas 75247.

Circle No 315

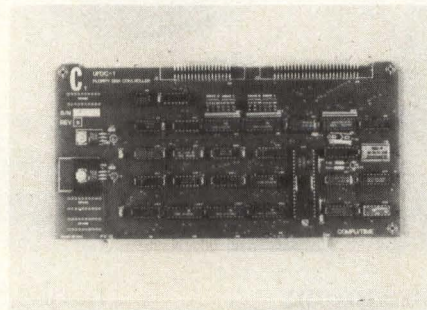

Floppy disk controller reads different-sized disks

The Compu/time Universal Floppy Disk Controller I (UFDC-1) is an S-100 IEEE 696-compatible board capable of connecting as many as four floppy disk drives. The controller can connect any combination of 5 1/4- or 8-in. drives with ANSI-standard interfaces and supports single- or double-density formats and single- or double-sided drives. By placing the CP/M boot program in ROM and the CP/M disk-translation tables on the disk sector normally containing the boot program the controller allows the automatic mixing of disk densities and the ability to read various types of formatted disks. Supplied with the UFDC-I is a technical information and user's manual and an 8-in., single-sided, single-density CP/M disk containing the Monitor/BIOS and disk formatter source listings. The UFDC-I is priced at \$325 for the assembled and tested version or \$295 in kit form. **GSR Computers**, 60-10 69th St., Maspeth, N.Y. 11378.

Circle No 316

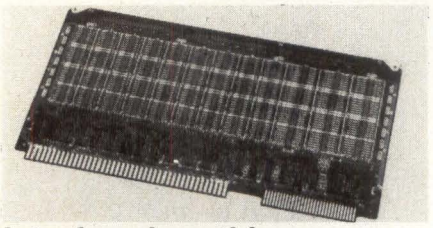

Interface board is for Multibus computers

The MNTL-GPIO-16 general-purpose bus foundation module for Intel Multibus computers consists of basic Multibus logic elements plus wire-wrap positions for as many as 48 ICs using low-profile sockets or direct mounting of 14- to 40-pin ICs. Wire-wrap posts are on the component side of the board and permit designer-wired options for multiple controller applications, address selection and interrupt control. The module has provisions for as many as three 50-pin ribbon cable connectors to external devices or modules. Price is \$295. **MDB Systems, Inc.**, 1995 N. Batavia St., Orange, Calif. 92665

Circle No 317

LSI devices control DRAMs

The DP8408-2 DRAM controller/driver and the DP8409-2 multi-mode dynamic RAM controller/driver 48-pin devices can drive all 4K-, 16K- and 64K-byte dynamic RAMs in all configurations. Both devices feature many modes of operation including externally controlled refresh and access, all-RAS write and automatic access. The automatic access modes make dynamic RAMs appear static to a system designer. The DP8409 device also includes automatic refresh, burst refresh and all-RAS automatic write. The DP8408N-2 is priced at \$37.45 each, and the DP8409N-2 is priced at \$42.75 in quantities of 100 or more. **National Semiconductor Corp.**, 2900 Semiconductor Dr., Santa Clara, Calif. 95051. Circle No 318

Available now!
And SMS is
not afraid
to show it

A Micro Winchester System
in a Micro Package

Compact 9.5"W x 11.2"H x 17"D table top package

256Kb main memory (4Mb addressability)

Expansion space for 4 dual LSI-11 boards

PDP-11* architecture compatible with DEC*
RT-11, RSX-11M and Unix** software

LSI-11/23 processor

4 serial ports

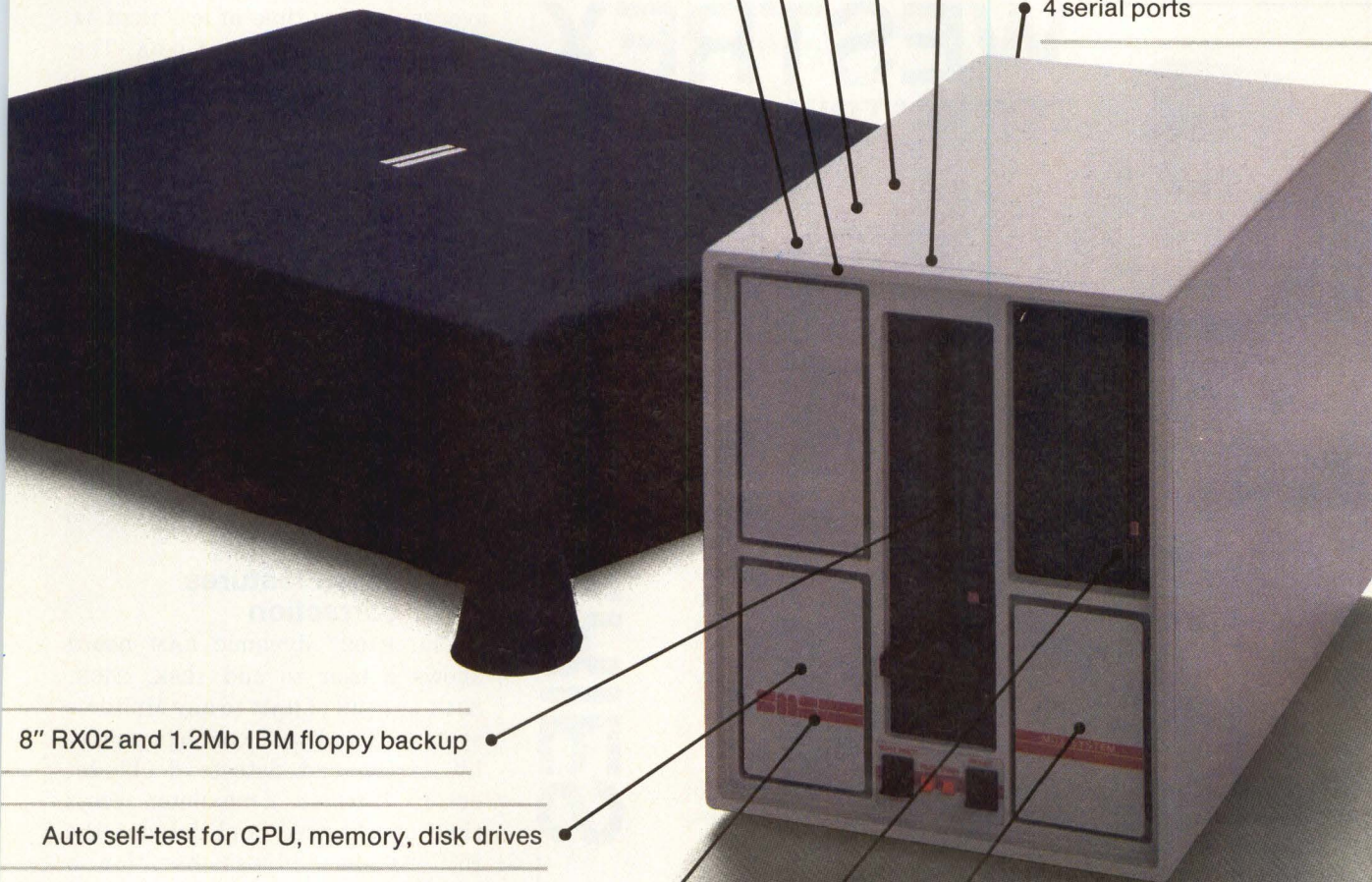

8" RX02 and 1.2Mb IBM floppy backup

Auto self-test for CPU, memory, disk drives

Easy access to LED display of system faults

10.6Mb or 15.9Mb 5¼" Winchester package

Advanced disk controller with ECC, flaw management, bootstrap,
error retry, and direct non-interleave data transfer

AVAILABLE WITHOUT CPU and memory for volume requirements

SMS
Scientific Micro
Systems, Inc.

777 E. Middlefield Road
Mountain View, California 94043
(415) 964-5700

AUTHORIZED SMS DISTRIBUTOR FOR DEC
Q-BUS PRODUCTS: FIRST COMPUTER
CORPORATION (312) 920-1050

SMS SALES OFFICES:

Phoenix, Arizona (602) 978-6621;
Boston, MA (617) 246-2540; **Atlanta, Georgia**
(404) 296-2029; **Morton Grove, Illinois** (312)
966-2711; **Yorba Linda, California** (714) 993-3768.

* Trademark of Digital Equipment Corporation. ** Trademark of Western Electric.

Peripherals

NEW PRODUCTS

Bubble-memory system is for Multibus micros

The MBI-1 magnetic-bubble mass-storage system for Multibus micro-computer systems includes a Z80-based intelligent controller and as much as 512K bytes of solid-state

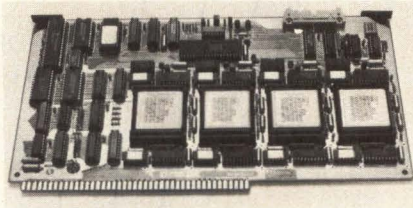

mass storage on a PC module. The system is available in 128K-, 256K- and 512K-byte capacities and can be expanded to as much as 8M bytes using expansion boards available from the vendor. The 512K-byte capacity module features a 270K-bit-per-sec. transfer rate and an average access time of less than 41 msec. It consumes 5V at 0.9A. The MBI-1 is priced at \$997 for a 128K-byte version and \$2247 for a 512K-byte system in 100-unit quantities. **Bubbl-Tec**, 6800 Sierra Court, Dublin, Calif. 94568

Circle No 319

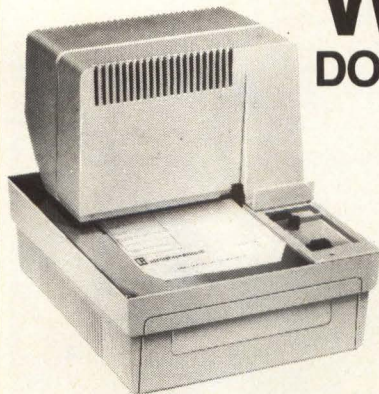

WESTREX DOT MATRIX PRINTERS

NEW!
**STAND-ALONE,
150 CPS
SLIP/DOCUMENT
PRINTERS**

**8000
SERIES**

MODELS 8400/8410

Model 8400 and Model 8410 are new, packaged, stand-alone, alphanumeric, bi-directional, flat bed, Slip/Document dot matrix printers. They print up to 40 columns at 12 characters per inch at 3 lines per second. Both models provide side or front form insertion; top and bottom-of-form sensors and adjustable Slip/Document Stop. The print head employs a 7-needle vertical array that permits selection of fonts and characters (5x7, double width, etc). The character set is fully alphanumeric under software control. The 100% duty cycle print head life is rated at 100 million characters.

Model 8400 and Model 8410 are complete with control and drive electronics. Serial RS-232C or TTY and parallel interfaces are available. Both units can provide multiple print lines and carbon or pressure sensitive copy.

Model 8410 additionally features a stepping motor paper drive system which permits variable and programmable forward/reverse line spacing for applications requiring line selection and/or unique form indexing.



For full details, write or call us

WESTREX OEM PRODUCTS
Litton

1140 Bloomfield Avenue, West Caldwell, N.J. 07006 (201) 227-7290 TELEX: 651490, WNJW
IN FRANCE — WESTREX OEM PRODUCTS, 103-105 Rue de Tocqueville, 750 Paris,
France 01-766-32-70 TELEX: 610148
IN SWEDEN — WESTREX OEM PRODUCTS, Box 3503, S-17203 Sundbyberg,
Sweden 46/8 +981100 TELEX: 12139

CIRCLE NO. 115 ON INQUIRY CARD

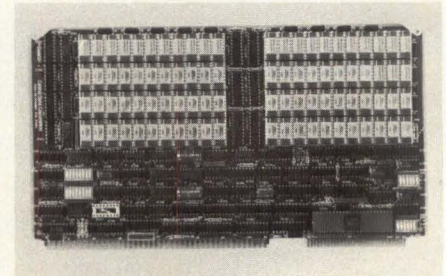

RAM board features error correction

The B1027 dynamic RAM board allows a user to add 128K, 256K, 384K or 512K of RAM to any Multibus system. The board corrects single-bit errors and detects double-bit errors. It runs at a maximum access time of 275 nsec. and decodes the full 24-bit address bus for a system-wide memory of 16M bytes. The board is divided into two 256K sections, each of which can be addressed on a 256K memory boundary. Sockets with built-in bypass capacitors increase the noise immunity of the board. The PC board is constructed in four layers, with the two internal layers being power and ground, to further minimize noise. In 100-unit quantities, the 128K-byte board is priced at \$895, and the 512K-byte board is priced at \$1725. **Central Data Corp.**, 1602 Newton Dr., Champaign, Ill. 61820

Circle No 320



MAKING THE LEADING EDGE WORK FOR YOU

Introducing a brainy new solution from the Wizards of Winchester Disk Controllers.

A new Winchester controller. Plus floppy controller. On one low cost board. Small enough to mount atop a 5 1/4" drive. And ST500/SAI000 compatible. "Smart," you say? What did you expect from the Wizards of Winchester Disk Controllers?

We promised you more for less. Our new WD1002 delivers. At \$195 (U.S. OEM quantities) it's \$50 less than its predecessor, the WD1001.

The big news, though, is that we've made the WD1002 the brainiest disk controller yet, with an abundance of new LSI innovations. Such as our WD1010 single-chip Winchester controller device. It replaces the microprocessor on our earlier boards. And about 25 other devices. Plus we've added the new WD1014 Error Correction device and the WD1015 Buffer Manager device.

Because just about every system with a Winchester has a floppy nearby, we included our new WD279X single chip floppy disk controller, too. So you get a complete, powerful solution on one reliable 5 3/4" x 8" board. And you're on the upgrade path to our upcoming WD1003 and WD1004 boards.

To make our disk controllers even more irresistible, we'll customize them to your bus and form factor. Or sell you our LSI, along with everything you need to build a controller yourself.

It doesn't take too much brains to see that it's safe, smart and simple to commit your disk-based systems to WD. Call our controller hotline, 714/966-7827 and we'll arrange to sit down with you and get into the details you need.

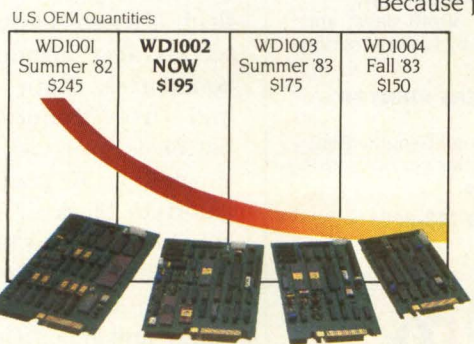

Components Group, 2445 McCabe Way, Irvine, CA 92714, (714) 557-3550

WESTERN DIGITAL
C O R P O R A T I O N

Peripherals

NEW PRODUCTS

Add-in for P-E 3200 series stores 2M bytes

The single-board DR-330 semiconductor add-in memories for Perkin-Elmer's 3200 series of minicomputers are available in 256K-, 512K-, 1M- and 2M-byte configurations.

The 256K- and 512K-byte versions use 16K RAMs; the 1M- and 2M-byte versions employ 64K dynamic RAMs. The 2M-byte DR-330 is internally organized as 512K × 39. All DR-330 devices have 400- and 240-nsec. cycle and access times, respectively.

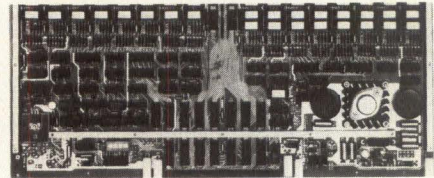

Address selection is implemented with on-board switches. The 256K-, 512K-, 1M- and 2M-byte DR-330 are priced at \$2640, \$3900, \$6400 and \$10,600, respectively. **Dataram Corp.**, Princeton Rd., Cranbury, N.J. 08512. **Circle No 321**

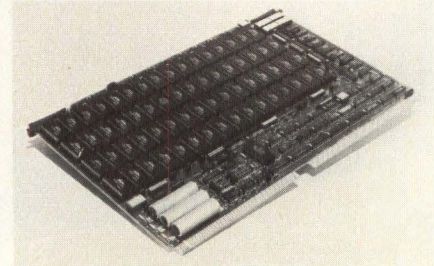

Add-in memory offers nonvolatile 128K

Intended for Versabus microprocessor systems, the MM-68000C add-in memory provides 128K bytes of storage and a real-time calendar. The board is available with rechargeable batteries with a two-week data-retention rating, or with nonrechargeable batteries having one-year data retention. The board features cycle and access times of 220 nsec. with no refresh delays. Module selection is on 1000 (hex) boundaries that are switch-selectable in the 16M-byte address field. Switch-selectable write protect is also included with 8K-byte boundaries. Static, CMOS memories and three redundant, on-board batteries provide the nonvolatile capability. A user can unplug a 32K-byte block of CMOS RAMs and substitute 2716 EPROMs, providing fixed program memory as well as CMOS RAM. Price is \$2350 in single-unit quantities. **Micro Memory, Inc.**, 9436 Irondale Ave., Chatsworth, Calif. 91311.

Circle No 322

WHAT IS A PRINTER STORE?

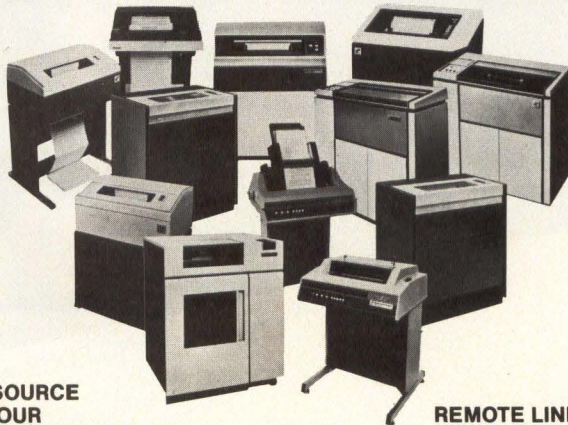

THE ONE SOURCE FOR ALL YOUR LINE PRINTER NEEDS.

Only The Printer Store offers a complete line of Band, Belt, Matrix, ChainTrain and Drum printers in speeds of 150 to 1500 LPM, nationwide service, and a full line of ribbons, spares and accessories.

GUARANTEED PLUG COMPATIBLE WITH YOUR SYSTEM.

Every printer we sell is guaranteed plug-compatible with your CPU via our custom controllers/interfaces.

SAVE UP TO 50% OFF YOUR MINI VENDOR'S PRICE.

You pay less because printers are our *only* business. We buy in quantity and pass the savings along to you.

SHOP BY PHONE FOR RIBBONS, SPARES AND SUPPLIES.

We stock a full line of ribbons, spares and supplies for your convenience. Call **800-243-9054** and we'll ship your order within 24 hours.

REMOTE LINE PRINTING ANY WAY YOU NEED IT.

Only The Printer Store has five cost-effective answers to your remote printing needs: RS-232; Long Lines; Remote Line Printer System; Remote Batch Printer and Remote Communication Printer. Choose the one that best fits your application.

COMPLETE SERVICE AND SUPPORT.

Our nationwide, centrally dispatched service network is the largest and most responsive in the industry.

FAST DELIVERY AND PROFESSIONAL INSTALLATION.

We typically deliver in 30-40 days, and your printer is installed by factory-trained technicians.

WE GUARANTEE EVERY PRINTER FOR 2 YEARS.

With our exclusive "Printer Security Blanket" we pay for all printer service, parts and labor for 24 months.

CALL TOLL-FREE 800-243-9054*

The Printer Store

Digital Associates Corporation

1039 E. Main Street, Stamford, CT 06902 TWX 710-474-4583
(800) 243-9054 *In Connecticut call (203) 327-9210

CIRCLE NO. 116 ON INQUIRY CARD

DEC-COMPATIBLE PERIPHERAL CONTROLLERS

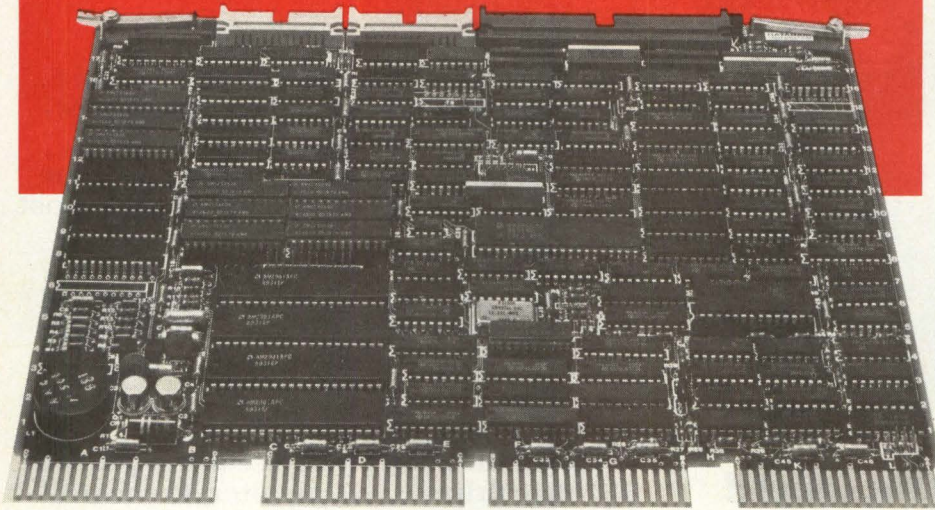

LSI-11® compatible controller
for 80-300MB SMD and
Winchester drives from
CDC, Ampex, and Fujitsu

Dataram Corporation offers the industry's widest range of DEC-compatible peripheral controllers — from comparatively simple NRZI tape controllers to complex 300 MB storage module drive (SMD) controllers.

An impressive array of state-of-the-art controllers, all built around high-speed bipolar microprocessors. All software compatible with the host LSI-11, PDP®-11, or VAX® minicomputer...and all available now.

And Dataram's controllers are designed to save you money, and, more importantly, space — our controllers typically occupy half the space required for the comparable controller from DEC. Doing it with a level of performance that makes any member of this family worth looking at.

The chart shows our current family of peripheral controllers, growing every day. If you don't see the controller you need, we're probably working on it right now. Call us and discuss your requirements.

**DATARAM
CORPORATION**

Princeton Road
Cranbury, New Jersey 08512
Tel: 609-799-0071 TWX: 510-685-2542

CONTROLLER	DESCRIPTION	COMPATIBILITY
C03	Cartridge disk controller	RK05
C33	Cartridge disk controller	RK05
T03	NRZI mag tape controller	TM11/TU10
T04/C	Mag tape streamer coupler	TM11/TU10
T04/N	NRZI mag tape controller	TM11/TU10
T04/D	Dual density mag tape controller	TM11/TU10
T34/C	Mag tape streamer coupler	TM11/TU10
T34/N	NRZI mag tape controller	TM11/TU10
T34/D	Dual density mag tape controller	TM11/TU10
T36	Dual density mag tape controller	TM11/TU10
T34/T	GCR mag tape controller	TM11/TU10
S03/A, S04/A	80 MB/300 MB SMD controller	RM02/RM05
S03/A1, S04/A1	80 MB/160 MB SMD controller	RM02
S03/B	80 MB/300 MB SMD controller	RK07
S03/C	200 MB/300 MB SMD controller	RP06
S03/D, S04/D	96 MB CMD controller	RK06
S33/A	80 MB/300 MB SMD controller	RM02/RM05
S33/A1	80 MB/160 MB SMD controller	RM02
S33/B	80 MB/300 MB SMD controller	RK07
S33/C	200 MB/300 MB SMD controller	RP06
S33/D	96 MB CMD controller	RK06

Products printed in red are LSI-11 Bus compatible.
Products printed in black are UNIBUS® compatible for PDP-11 and/or VAX minicomputers.

DEC, LSI-11, PDP, UNIBUS and VAX are registered trademarks of Digital Equipment Corporation.



**Verry
Interesting . . .**

FREE SOFTWARE
\$3500 worth of office productivity programs with each \$4995 system.

"You can search the world over and probably never find a value like Voyager."

— Arte Johnson

Besides having a really great design to it — it has its own bundled software (everything from word processing to spread sheet) that's among the hottest programs around. It's easy to use because it's menu driven.

More useful because it can do two jobs simultaneously with background printing.

You'll find its business capabilities, outstanding performance and price interesting too. And while you're discovering what you can get for your money, you'll find there's lots more to look into.

You can clearly see a difference.

Voyager isn't boxy, stationary and boring looking.

The disk drives and computer itself fit under or near a desk. The keyboard's lightweight and conveniently detachable. It has a classy look that goes along with its design of exacting European standards. And the monitor is what's really interesting.

It's mounted on a base that not only allows you to adjust your viewing angle, you can rotate it almost 360 degrees. That means you can change the position for com-

fort, show someone else the screen, even use it for conferences, where visual information can be almost instantly created, displayed and changed. And the easy viewing screen has higher resolution than most.

More that's interesting.

If you want big business power plus upgradability, you'll find it with Voyager. You can add hard disks and easily upgrade the original machine to get the most from a small priced system.

With the complete system you get two 5¼" disk drives, CPU, monitor, keyboard, everything but the printer (it's optional), including CP/M* and Voyager software library packages. Plus, it costs a lot less than any comparable system.

And with our unique service program, if anything goes wrong anytime, we'll loan you a replacement fast. Within 8 business hours.

So if you're looking for the best value in business systems your search is over. See Voyager at your local dealer. You should find its low introductory price verriy interesting.

Call for your nearest dealer.

*Trademark of Digital Research

DEALERS
NOTE: This is the first ad in a series to help bring customers to you.

Voyager™



Voyager Systems, Inc.
2192 Anchor Court,
Newbury Park, CA 91320,
(805) 496-8933, (213) 707-0330
(800) 235-3561 Outside California

Datacomm

NEW PRODUCTS

Modem operates at 4800 bps

The AJ 4048 full-duplex, originate/auto answer modem for communications at 4800 bps over dial-up or two-wire unconditioned leased lines features selectable synchronous or asynchronous operation, data terminal interface via RS232C connector, front-panel display indicators and membrane front switches. The unit is available for stand-alone or rack-mounted applications. Diagnostics include CCITT recommended local analog and remote digital loopback as well as local and remote self-testing. In addition, remote modem diagnostics report-back can be initiated under local control. Price is expected to be less than \$5000 in single-unit quantities. **Anderson Jacobson, Inc.**, 521 Charcot Ave., San Jose, Calif. 95131

Circle No 323



Modem module has 300-baud capability

The model CS-30A modem module provides a direct access to phone lines through a single component for microprocessor control. The module has a 300-baud capability with logic-selectable answer or originate modes and is capable of dial out in DTMF or rotary format. It features a ring detector for auto-answer and auxiliary audio-input/received-line audio-output functions. The unit measures 4 x 3 1/4 x 1 in. Price is \$149.95 each in quantities of one to nine or \$109 in quantities of 100. **Avcom, Inc.**, P.O. Box 29153, Columbus, Ohio 43229

Circle No 324



International dial modem operates at 2400 bps

Designed for the international market (and meeting CCITT recommendation v.22bis), the model CDS v.22bis dial modem operates at 2400 bps full duplex in synchronous and asynchronous modes. It features automatic adaptive equalization and local and remote diagnostics including analog and digital self-tests and an internal test-pattern generator/checker. The modem supports HDLC, SDLC, X.25 and Teletex protocols. Price is \$1795 in single-unit quantities. **Concord Data Systems**, 303 Bear Hill Rd., Waltham, Mass. 02154

Circle No 325

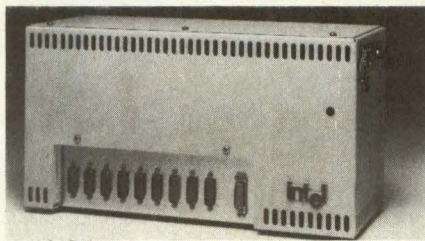

Cluster module replaces Ethernet transceivers, cables

The Intellink cluster module provides an Ethernet-compatible interface for as many as nine Ethernet workstations. Instead of using one transceiver per workstation and a length of coaxial cable, nine workstations can be attached to the Intellink using Ethernet-specified cables and connectors. The module can also serve as a transceiver multiplexer that permits eight workstations to share a single transceiver, which in turn, is connected to a standard Ethernet

network coaxial cable. The module can also be used with the vendor's iSBC 550 Ethernet controller board and iNA 950 LAN S/W to form a complete Multibus-based local-area network. The single-unit price of the Intellink cluster module, model iDCM 911-1, is \$2450. **Intel Corp.**, 3065 Bowers Ave., Santa Clara, Calif. 95051. **Circle No 326**

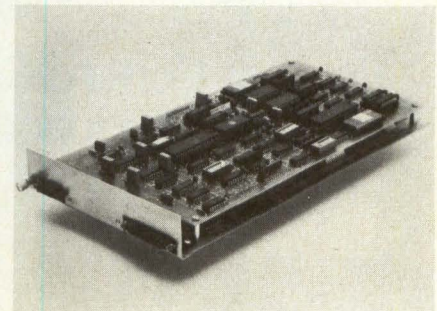

4800-bps modem is Bell-compatible

The Bell 208A/B-compatible VA4840 4800-bps modem operates without conditioning-level requirements over two-wire switched networks or two-/four-wire leased lines. It can operate in a point-to-point network or in a multi-point environment. Automatic adaptive equalization allows the modem's receiver to change its filtering and adapt to telephone-line conditions involving amplitude roll-off, phase delay, frequency offset and carrier phase jitter. Its built-in general-purpose, 8-bit microprocessor controls a 16-bit multiplier and memory to perform all signal-processing functions. The VA4840 is FCC approved for direct connection to the switched network using programmable data jacks or RJ11C telephone jacks. Automatic idle test, analog loopback/busy/out, local and remote digital loopback and self-test user diagnostics are included. Price is \$1600 in single-unit quantities. **Racal-Vadic**, 222 Caspian Dr., Sunnyvale, Calif. 94086.

Circle No 327

Datacomm

NEW PRODUCTS

Multiplexer provides remote programming

The enhanced Babymux statistical multiplexer provides remote programming, which lets a system manager reconfigure or inspect his remote Babymux multiplexers

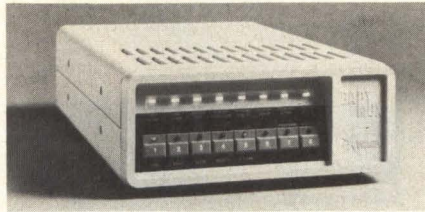

through local multiplexers at a central computer site. Remote programming also allows an unbalanced configuration between the local and remote multiplexers. Babymux is programmed through its front panel, which also provides status information on communications line usage, terminal activity and data transmitted. It supports any standard RS232 asynchronous device. The basic Babymux two-channel multiplexer unit sells for \$1350. It is expandable to five or eight channels with the addition of three-channel expander kits priced at \$475. **Network Products, Inc.**, Progress Center, Research Triangle Park, N.C. 27709.

Circle No 328

The CompuDAS® Family from ITHACO Process Control & Data Acquisition in a language that won't be Greek to you



When you can't afford the limitations of ladder diagrams or the months it takes to learn complicated computer software—you need DABIL™, ITHACO's unique BASIC language derivative, resident in every CompuDAS system.

DABIL is a language developed by process engineers like you. In a matter of hours, you can learn to

use CompuDAS with confidence, even if you've had no previous programming experience.

Whatever your industry or application, CompuDAS will get you on-line on time. Call or write us. We'll send you our DABIL language summary—FREE. It'll show you how CompuDAS speaks your language.

ITHACO

... A MEASURABLE DIFFERENCE.

ITHACO, INC. 735 West Clinton Street, P.O. Box 6437
Ithaca, New York 14850-6437
Telephone (607) 272-7640

810C-MMS-0183

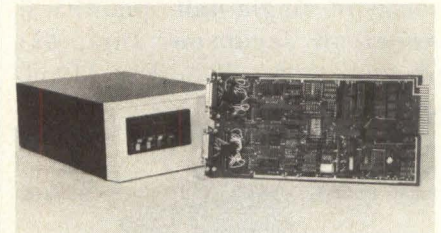

Multiplexer features error checking

The Prism 3/A statistical multiplexer allows a user to employ as many as three computer terminals over one telephone line. The device dynamically assigns high priority to keyboard input and has a special error-checking and -detection protocol for high-priority lines. Each channel can be programmed for speeds as high as 19.2K bps with receive and transmit rates independently selectable. Local echo, print-head flyback buffering delay and parity can be specified on a line-by-line basis. Space compression and hardware or software flow control can make the apparent data rate much higher than that obtained from the modem. The hardware flow control line is byte-aligned to interface with Hewlett-Packard or Data General machines. The Prism

CIRCLE NO. 119 ON INQUIRY CARD

UDS serves up 9600 bps

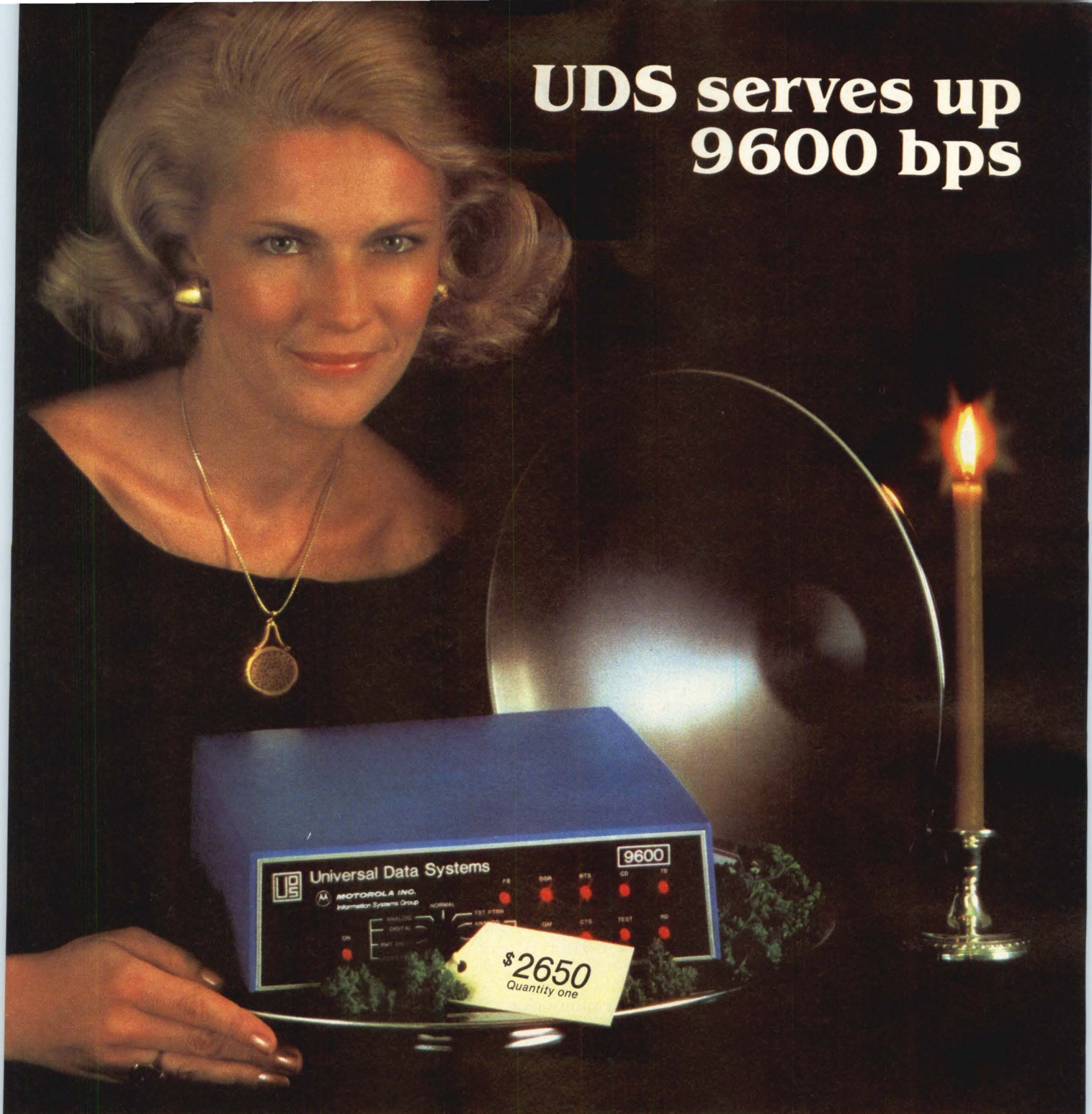

Universal Data Systems' new 9600 bps modem brings economy and operating ease to high speed data communications systems.

- Front panel switch selects operating/test modes. Rear panel switch initiates fall-back frequency operation.
- Analog and remotely activated digital loopback capability conforms to CCITT V.54. A 511 pseudo-random test pattern, compatible with CCITT V.52, is provided.
- Digital adaptive equalizer is strappable to T or T/2 configuration.
- V.29 compatible and 100 ms mode are strap selectable.

- Pre-equalizer available for operation over unconditioned lines.

Contact Universal Data Systems, 5000 Bradford Drive, Huntsville, AL 35805-1953. Telephone 205/837-8100; TWX 810-726-2100.

 **Universal Data Systems**

 **MOTOROLA INC.**
Information Systems Group

DISTRICT OFFICES:
Old Bridge, NJ, 201/251-9090 • Blue Bell, PA, 215/643-2336 • Atlanta, 404/998-2715 • Chicago, 312/441-7450 • Columbus, OH, 614/895-3025 • Boston, 617/875-8868
Richardson, TX, 214/680-0002 • Englewood, CO, 303/694-6043 • Houston, 713/988-5506 • Tustin, CA 714/669-8001 • Sunnyvale, 408/738-0433

Datacomm

NEW PRODUCTS

3/A can be used with any asynchronous modem or line driver, and is designed for installation within a Racal-Vadic modem chassis. Price is \$875. **Western DataCom**, 5083 Market St., Youngstown, Ohio 44512. **Circle No 329**

Modems feature 4800- or 9600-bps operation

Measuring 8 x 11 x 2 in., the Micro4000 models 4048/V.27+ and 4096/V.29+ synchronous modems operate at 4800 and 9600 bps, respectively, and feature multipoint



and point-to-point operation, remote loopbacks for multipoint and point-to-point troubleshooting, speed-shift synchronization and an anti-streaming feature that prevents a malfunctioning terminal from monopolizing a multidrop line. The modems operate over unconditioned leased telephone lines and are capable of two-wire, half-duplex or four-wire, full- or half-duplex operation. Prices are \$2595 for the model 4048/V.27+ and \$3095 for the model 4096/V.29+. **Micom Systems, Inc.**, 20151 Nordhoff St., Chatsworth, Calif. 91311

Circle No 330



Terminal-controlled modem is Bell 212-compatible

The model 212 terminal-controlled modem is Bell 103- and 212-compatible and operates over two-wire dial-up networks in the full-duplex mode at asynchronous data rates of 0 to 300 and 1200 bps. It features auto-dialing, menu-controlled options and operation, complete keyboard control of modem functions and diagnostics and a nonvolatile memory. Price is \$795 in single-unit quantities. **Prentice Corp.**, 266 Caspian Dr., Sunnyvale, Calif. 94086

Circle No 331

UNIX™ VIDEO-BASED TRAINING

A Complete Curriculum for:

End Users Management Applications Staff Technical Support

- Professionally produced instructional video-based courses including workbooks with hands-on exercises.
- For UNIX and UNIX look-alike systems on a wide variety of hardware, including DEC, ONYX, PLEXUS, ZILOG, FORTUNE, VICTOR, NCR and many more.
- Flexible course design for either self-paced or group instruction.
- Available in your choice of video formats: 3/4" U-Matic, Beta or VHS.

NOW AVAILABLE

Call Toll-Free to Order or for Further Information

(800) 621-3155

or, in Illinois, (312) 987-4092

8:30-5:30 central time

Ask also about our public and in-house seminars featuring hands-on workshops.

Computer Technology Group UNIX courses are developed by experts in V7, PWB, SYSTEM III... and beyond. Each developer is experienced in teaching UNIX as well as in designing and implementing UNIX-based systems.

™ UNIX is a trademark of Bell Laboratories

**COMPUTER
TECHNOLOGY
GROUP**

Telemedia, Inc.

310 S. Michigan Ave., Chicago IL 60604

COMPUTER TECHNOLOGY GROUP—our business is UNIX training.

CIRCLE NO. 121 ON INQUIRY CARD

A WORD TO THE WISE.

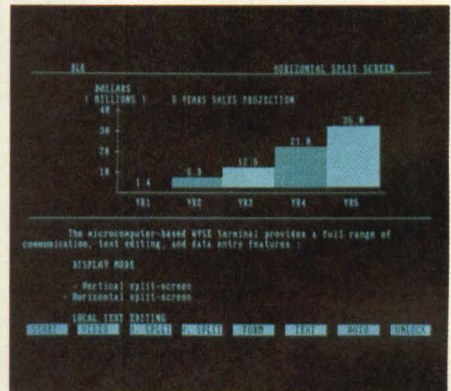
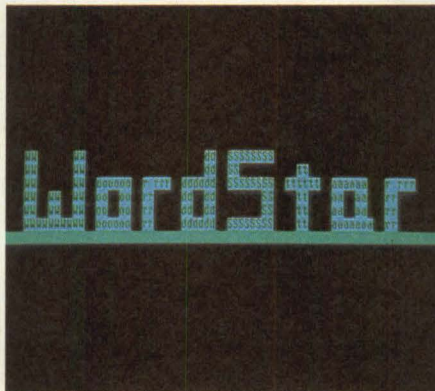
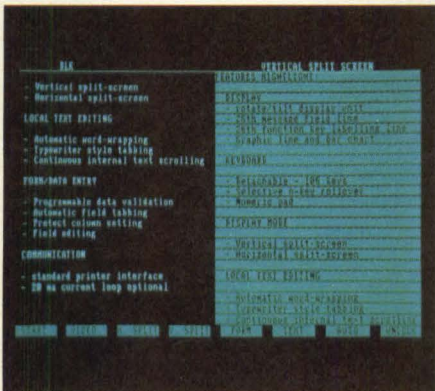
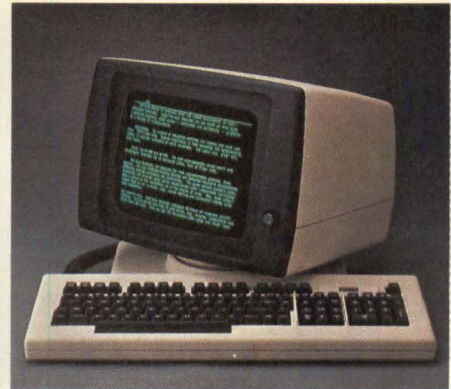

No one gives you more in an ergonomically engineered smart terminal than Wyse.

These days there's little room for waste of the corporate dollar. And these days the WY-100 smart terminal looks even better when you compare it to the other guys.

You definitely get more from Wyse — the leader in low-cost, high-performance, ergonomically engineered smart terminals.

To begin with, you get a great looking terminal that features die cast aluminum packaging and takes up a minimum of desktop space.

You also get a terminal with an uncanny way of pleasing people. It comes with an easy-on-the-eyes green phosphor screen. And a fully tilting/rotating display and detached keyboard. (After all, one person's just-right-tilt is another's not-quite-right-tilt).

When the workload seems impossible, horizontal and vertical split screen capabilities with independent scrolling allow you to be in two places at once.

There's more. You get programmable function keys and transparent print. Plus 128 characters with upper and lower case, line drawing and graphics, and a keyboard with 105 keys — including cursor pad, special mode and function keys.

Of course, all of this wouldn't mean much if you couldn't count on Wyse quality. That's why each WY-100 is put through an extensive on/off testing program.

On top of that, WordStar® and other emulations are now available from your distributor. Which means you can automatically get 32 of WordStar's most commonly used multi-key commands fully-implemented on our function keys for faster, easier use.

We think you'll be quite impressed when you compare the WY-100 to other terminals in its class. But don't take our word for it. Call or write us today. We'll send you detailed information on why the WY-100 smart terminal gives you more. A lot more.



**WYSE
TECHNOLOGY**

3040 North First St., San Jose, CA 95131
(408) 946-3075 TLX 910-338-2251
In the East, call (516) 293-5563
Outside California, 800-538-8157 ext. 932
Inside California, 800-672-3470 ext. 932

WordStar is a registered trademark of MicroPro, Inc.
UL and FCC approved. ©1982 Wyse Technology, Inc.

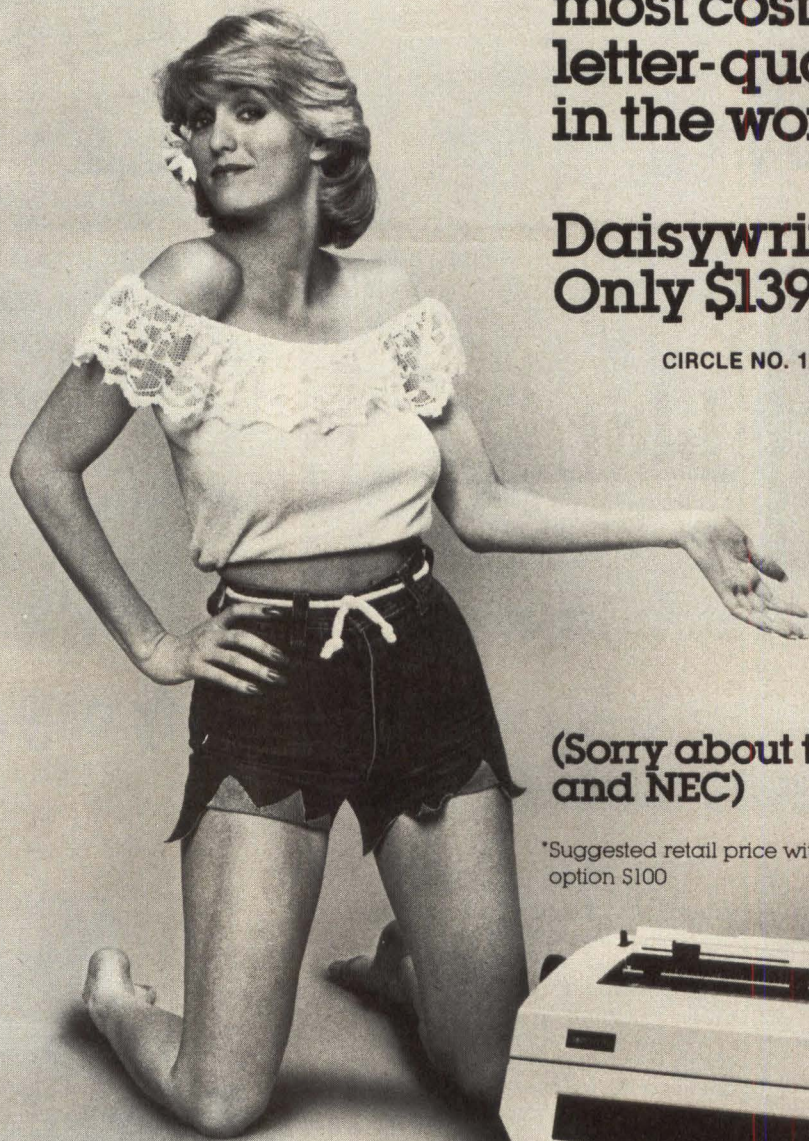

**The most powerful...
most reliable...
most cost-effective...
letter-quality printer
in the world.**

**Daisywriter®
Only \$1395***

CIRCLE NO. 128 ON INQUIRY CARD

**(Sorry about that Diablo, Qume
and NEC)**

*Suggested retail price with 16 Kbyte buffer. 48 Kbyte buffer
option \$100

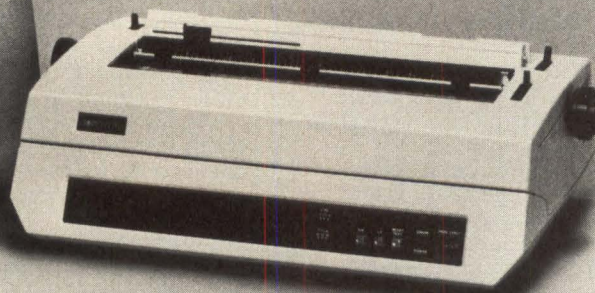

daisywriter®

Division of Computers International
3540 Wilshire Boulevard, Los Angeles, CA 90010
(213) 386-3111 TWX/TELEX 910-321-4209

Software

NEW PRODUCTS

Software workstations have many applications

The Boeing Intelligent Terminal System family of software products turns personal computers such as the Terak 8510, Xerox 820 models 1 and 2, IBM PC, DEC PDP 11/50 and PDP 11/23 and others into workstations that perform functions such as business or technical chart and graph preparation, document preparation and maintenance, local data entry and verification, remote job entry to a mainframe, electronic spread-sheet calculation and preparation of presentation-quality graphics.

The BITS family includes eight software workstations. An intelligent terminal software workstation, the basic system around which the others are built, contains a hardware-independent control program, a screen editor and a standard teletype TTY telecommunications ability for BITS-to-host or BITS-to-BITS communications. The remaining software workstations include two data-entry workstations, three business - management workstations, an EIS/ODC workstation and a text-processing workstation.

The two data-entry software workstations include a forms compose/editor program for generating full-screen templates (forms) and a data-entry program for collecting data against the screen forms.

The three business-management software workstations offered are BITSCALC, a 3D electronic spread-sheet processor; BITSGRAF, a menu-oriented graphics system; and Business Graphics Utilities for generating bar, pie, schedule, manpower and other charts.

The EIS/ODC software workstation is an off-line data-collection facility for EIS, a fully integrated

decision-support system available from the vendor on a time-sharing basis.

In addition to the software workstations, other BITS offerings include Pascal, FORTRAN and BASIC compilers for application development, an R3780 communications option that allows a BITS terminal to function as an IBM 3780 for use as a remote-job-entry station and a graphics primitive library of routines that can be used in user-developed FORTRAN programs.

Price of the intelligent terminal software workstation is \$300, or \$200 when ordered with another BITS software workstation. Prices of the remaining software workstations are \$300 to \$600 each, depending on workstation. **Boeing Computer Services Co.**, 7980 Gallows Court, Vienna, Va. 22180.

Circle No 332

UNIX benchmarks are portable

Designed for use by end users, OEMs and system integrators, a set of portable UNIX benchmarks includes nine tests that run unattended on any UNIX-based system. The benchmarks first examine the system for Version 7 command-list completeness and local command additions. Then two CPU measurements time looping and floating-point calculations. Benchmarks examine disk-transfer speeds for various record lengths. C-compiler optimization is examined for short, integer and long types. Memory/paging throughput, context switching and communications speeds are also measured. Multi-user performance is examined for simulated

COMPUTER STOCK FORMS & LABELS

BUY DIRECT AND SAVE!

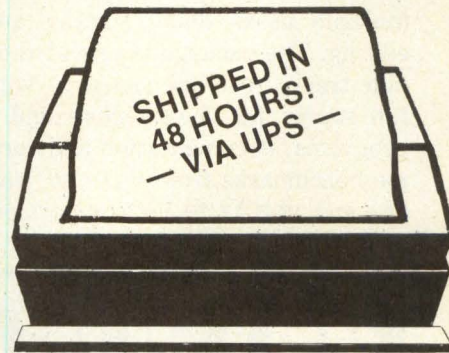

Stock No. 1-951115-BW

Specs: 9 1/2 x 11, 15lb 1-Pt Blank White, 3500 Sheets P/Carlon
Price Per Carton: 25.75 (1), 24.80 (2-4), 23.84 (5-9)

Stock No. 1-951120-BW

Specs: 9.5 x 11, 15lb 1-Pt Blank White, 2500 Sheets P/Carlon
Price Per Carton: 24.25 (1), 23.36 (2-4), 22.46 (5-9)

Stock No. 1-141115-BW

Specs: 14 7/8 x 11, 15lb 1-Pt Blank White, 3500 Sheets P/Carlon
Price Per Carton: 37.15 (1), 35.77 (2-4), 34.39 (5-9)

Stock No. 1-141120-BW

Specs: 14 7/8 x 11, 20lb 1-Pt Blank White, 2500 Sheets P/Carlon
Price Per Carton: 32.36 (1), 31.16 (2-4), 29.97 (5-9)

Stock No. 1-951115-GB5

Specs: 9 1/2 x 11, 1-Pt 1/2" Greenbar, 3500 Sheets P/Carlon
Price Per Carton: 26.32 (1), 25.37 (2-4), 24.41 (5-9)

Stock No. 1-951120-GB5

Specs: 9 1/2 x 11, 20lb 1-Pt 1/2" Greenbar, 2500 Sheets P/Carlon
Price Per Carton: 25.69 (1), 24.79 (2-4), 23.89 (5-9)

Stock No. 1-141115-GB5

Specs: 14 7/8 x 11, 15lb 1-Pt 1/2" Greenbar, 3500 Sheets P/Ctn
Price Per Carton: 37.98 (1), 36.60 (2-4), 35.22 (5-9)

Stock No. 1-141120-GB5

Specs: 14 7/8 x 11, 20lb 1-Pt 1/2" Greenbar, 2500 Sheets P/Ctn
Price Per Carton: 33.08 (1), 31.88 (2-4), 30.68 (5-9)

Stock No. 351516-1A

Specs: 3 1/2 x 15/16, 1-Across Self-Adhesive Labels, 5000 P/Ctn
Price Per Carton: 17.22 (1), 16.40 (2-4), 15.17 (5-9)

Stock No. 351516-2A

Specs: 3 1/2 x 15/16, 2-Across Self-Adhesive Labels, 10M P/Ctn
Price Per Carton: 33.39 (1), 29.42 (2-4), 27.83 (5-9)



OR



... For our complete Catalogue of Stock Forms and Labels, send \$2.95 plus \$1.50 for shipping and Handling. Make your Check or Money Order payable to: EAGLE COMPUTER FORMS

Eagle Computer Forms
820 Lane Allen Road
P.O. Box 11490
Lexington, Ky 40576

(606) 277-2811 ... 8:00 AM - 5:30 PM (EST)
(606) 277-8369 ... 6:30 PM - 11:00 PM (EST)

CIRCLE NO. 131 ON INQUIRY CARD

Software

NEW PRODUCTS

multiple users doing sorting and editing. The package is provided on nine-track, 1600-bpi TAR/tape with full source for shell scripts and C programs, documentation and sample benchmarks from VAX 750, VAX 780 and PDP 11/70 for comparison.

Price is \$1250. **Aim Technology**, 3333 Bowers Ave., #199, Santa Clara, Calif. 95051. **Circle No 333**

IMSL Library is available on the HP-1000

The IMSL Library, more than 540

FORTRAN subroutines, is now available for the Hewlett-Packard 1000 Series. The IMSL Library subroutines serve as building blocks in scientific and engineering application programs. The subroutines cover a broad range of applied mathematics and statistics including linear and nonlinear equations, Eigensystem analysis, interpolation, differential equations, optimization, analysis of variance, regression, forecasting, multivariate statistics, random number generation and special functions. The library offers HP-1000 users 32-bit, single-precision and 64-bit, double-precision accuracy. Annual subscription rates are \$2000 for an initial subscription, \$1500 per year for renewals. **IMSL, Inc.**, 7500 Bellaire Blvd., Houston, Texas 77036. **Circle No 334**

RETRO-GRAPHICS™

AND

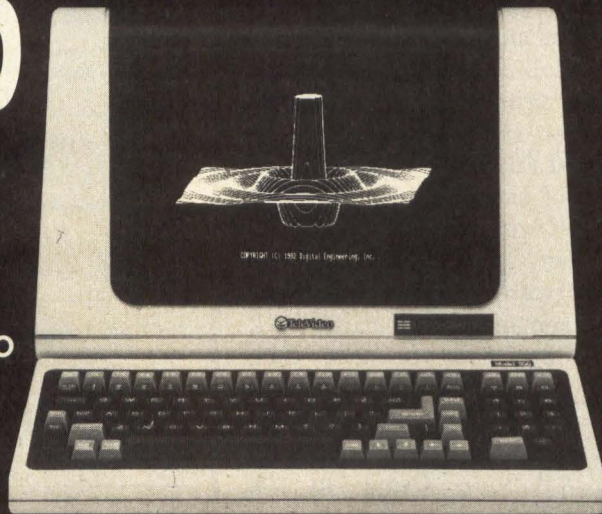

TeleVideo

Digital Engineering is offering new GEN.II™ Retro-Graphics terminal enhancements for TeleVideo's® 910, 912, 920, 925 and 950, Lear Siegler's ADM 3A and 5, and the ADDS Viewpoint.

GEN.II Retro-Graphics, our second generation enhancement, turns these popular text terminals into powerful, bit-map graphics terminals. With no loss of existing features. Tektronix® 4027 and 4010 simulation and protocol familiar to most programmers. "Resident" graphics intelligence and English-like commands for speed and ease of operation. Compatibility with industry-standard graphics software. Extensive documentation and timely customer backup. And at a price half that of comparably equipped graphics terminals.

GEN.II Retro-Graphics for TeleVideo. Lear Siegler and ADDS. Available only from Digital Engineering. Call Vicki at (916) 447-7600 or telex 910-367-2009 for ordering details.



630 Bercut Drive, Sacramento, CA 95814
(916) 447-7600 Telex: 910-367-2009

GEN.II and Retro-Graphics are trademarks of Digital Engineering, Inc. TeleVideo is a registered trademark of TeleVideo Systems, Inc. Tektronix is a registered trademark of Tektronix, Inc.
© 1982 Digital Engineering, Inc.

CIRCLE NO. 123 ON INQUIRY CARD

Software makes Cluster/One compatible with CP/M

Software that makes the Cluster/One local-area network compatible with CP/M on the Apple II is now available. Version 1.3 of the Network File Server, an upgrade of the vendor's network file-management program, provides the base for the Apple II CP/M support feature. The support feature allows users to define and use CP/M format virtual diskettes with storage capacities from 32K to 8M bytes. The system requires no local disks to initialize CP/M at a user station. The support station requires that each user station have the Microsoft Softcard or equivalent cards. The Apple II CP/M support feature, including one Softcard, is available for \$995; Network File Server Version 1.3 is priced at \$1995. **Nestar Systems, Inc.**, 2585 E. Bayshore Rd., Palo Alto, Calif. 94303. **Circle No 335**

Why IBM Value Added Remarketers like IBM.



Our Value Added Remarketers tell us that IBM service, support and products sold them on our VAR program in the first place. And keeps them sold.

That stands to reason. Our nationwide network of maintenance service locations puts help just a call away. But IBM service is more than convenient. As one IBM VAR says, "It's the best." Another VAR cites, "the worldwide availability of parts," as being important. That reservoir of parts—and experience—goes hand in hand with our reputation for fast, reliable service.

Our VARs also give IBM support as a very good reason. We not only help them decide on the right IBM products, we also help them sell with support that ranges from a broad spectrum of marketing aids to technical assistance and business management seminars. In one VAR's words,

"It's the team of people we can turn to. IBM always comes up with the answers we need."

Several VARs mention IBM hardware as a big plus. One says: "Its standing in the field helps reduce the selling hurdles." Another praises IBM's ability to, "keep customers up to date as new hardware develops." Both are referring to the success they had with the Series/1. We expect we'll soon be hearing the same praise about the Datamaster small business computer, which is now available to our VAR customers.

And one customer simply says: "IBM's Value Added Remarketer program offers enhanced revenue opportunities." That's a polite way of saying you make more money. Which is probably the very best reason of all.

If you'd like to learn more about our VAR program, we'd like to give you the details. Call Richard E. Patten collect, 914-696-4471.

Or send us the coupon.

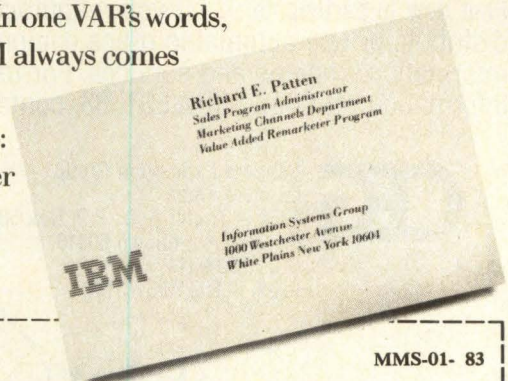

MMS-01- 83

Mr. Richard E. Patten
IBM Corporation
1000 Westchester Avenue
White Plains, New York 10604

Please have your IBM Value Added Remarketer representative contact me.

Name _____

Title _____

Company _____

Address _____

City _____ State _____ Zip _____

Phone _____

I market application solutions to the following industries:

You can't help but consider **COEE MIDWEST '83...**

COEE MIDWEST '83 is a proven winner . . . the Midwest's largest exhibition/conference of computerized and automated office equipment, information systems and related services...

...when you consider the facts:

- U.S. businesses will spend over \$400 billion on information processing in the next five years!
- By 1986, there will be over 8 million computers installed in the U.S., over 17 million terminals and over 5 million word processing/electronic typing workstations — over 3 times the number of keyboards in place today!
- Growth is at an average yearly rate of 16%, with many sizeable sectors running at 25% or higher!

Plan now to participate . . . if you manufacture, distribute or use automated office equipment, information systems and services. For more information on COEE MIDWEST '83, contact:



Cahners Exposition Group
Cahners Plaza
1350 E. Touhy Ave., P.O. Box 5060
Des Plaines, Illinois 60018
(312) 299-9311
telex: 82882 CEG/CHGO

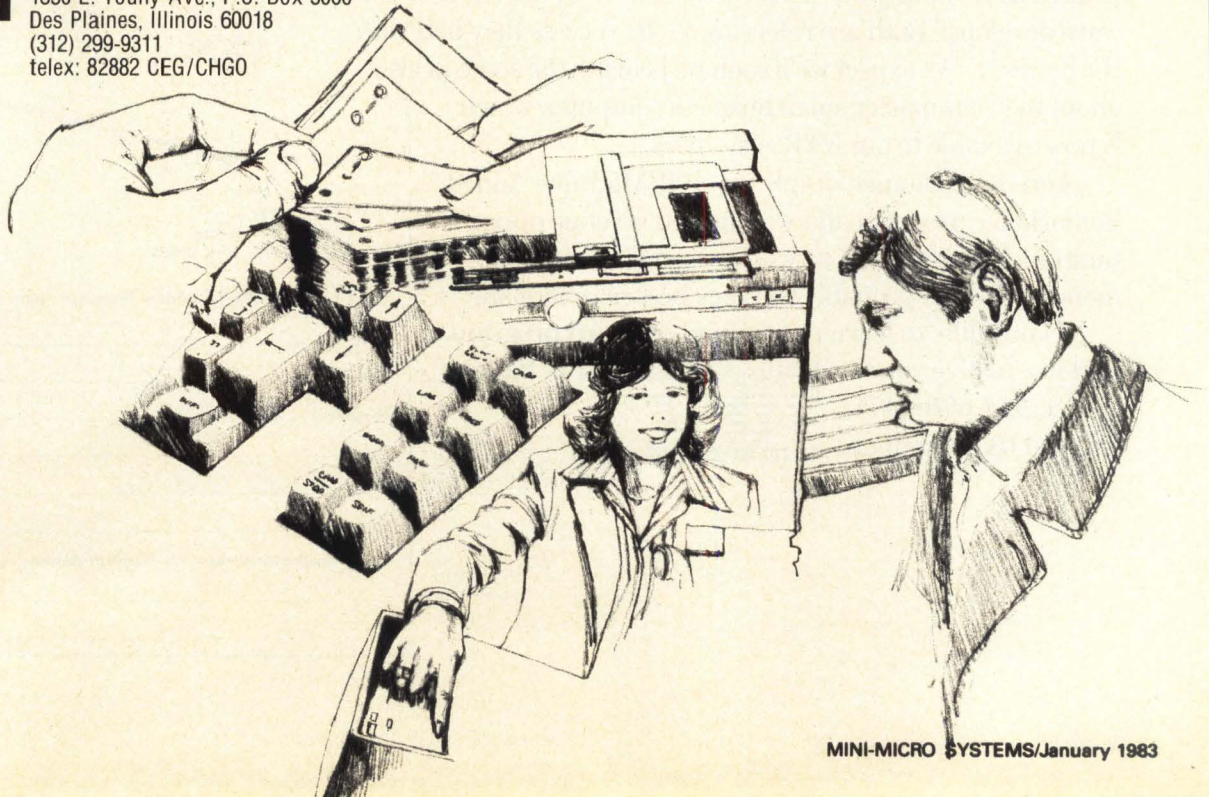

7th Annual

Computerized Office Equipment Expo



INCLUDING COMPUTERS • WORD PROCESSING
COPYING/DUPLICATING • TELECOMMUNICATIONS

April 5-7, 1983

O'Hare Exposition Center
Rosemont, Illinois

Anadex SILENT SCRIBE™ printers. Quietly going about your business.

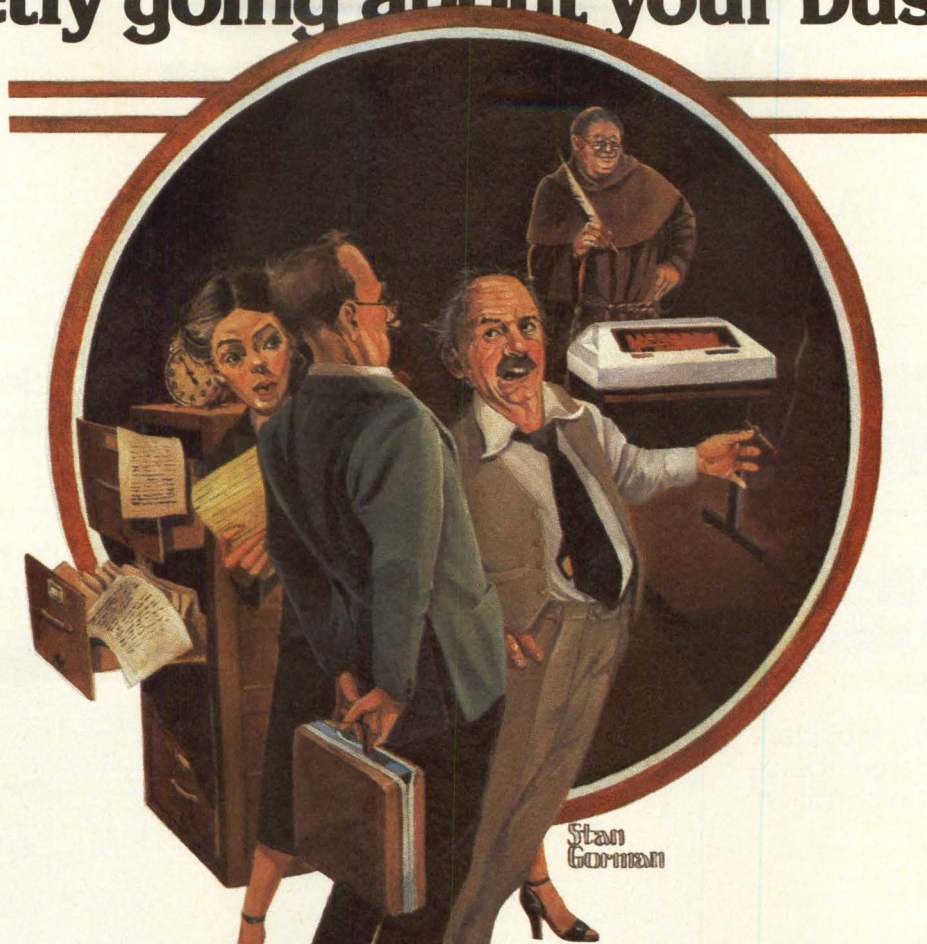

Now and then office noise levels can go sky-high. But with Silent/Scribe – our new family of matrix impact printers – you can raise your printer expectations while significantly lowering your office noise level.

How quiet is "silent"? Silent/Scribe operates at less than 55 dBA, which means that in the average office you may have to look at it to determine whether it's printing.

Also standard are sophisticated communications controls and protocols, flexible and easy-to-use operator controls, quick-change continuous loop ribbon cartridge, and universal interfaces that work with virtually any computer system.

For full details on how Silent/Scribe can fit your application – quietly – contact Anadex today. You'll find the units attractively packaged, quality engineered, modestly priced, and available now.

SILENT/SCRIBE MODELS

Standard Features	Chars per inch					
	DP-9000A	DP-9000B	DP-9001A	DP-9001A	DP-9001A	DP-9002A
Printing Speed (Char. per Sec.)	10	150	150	120	120	200
	12	180	180	—	—	120
	12.5	—	—	150	150	—
	13.3	200	200	—	—	—
	15	—	—	180	180	150
	16.4	—	—	200	200	164
Enhanced	10	—	—	—	—	100
Expanded Print (Double Width)	Yes	Yes	Yes	Yes	Yes	Yes
Dot Addressable Graphics (Dot/in., HV)	60/72	60/72	75/72	75/72	72/72	72/72
Max. Line Width (in.)	8.0	13.2	8.0	13.2	13.2	13.2
Audible Alarm	Opt.	Opt.	Opt.	Opt.	Yes	Yes
Out-of-Paper Sense	Yes	Yes	Yes	Yes	Yes	Yes
Ribbon, Continuous Loop Cartridge (Yds)	30	30	30	30	30	30
Interfacing:						
Parallel Cent. Comp.	Yes	Yes	Yes	Yes	Yes	Yes
RS-232-C Serial	Yes	Yes	Yes	Yes	Yes	Yes

And Silent/Scribe is as easy to buy as it is to live with. You can select a variety of printing speeds, fonts and line widths. Some models provide both draft and enhanced quality copy. All models have superb dot-addressable graphics at no extra cost.



© Copyright 1982
Anadex, Inc.



DP-9000A



Silent/Scribe. The Quiet Ones from Anadex.

ANADEX, INC. • 9825 De Soto Avenue • Chatsworth, California 91311, U.S.A. • Telephone: (213) 998-8010 • TWX 910-494-2761
U.S. Sales Offices: San Jose, CA (408) 247-3933 • Irvine, CA (714) 557-0457 • Schiller Park, IL (312) 671-1717 • Wakefield, MA (617) 245-9160
 Hauppauge, New York, Phone: (516) 435-0222 • Atlanta, Georgia, Phone: (404) 255-8006 • Austin, Texas, Phone: (512) 327-5250
ANADEX, LTD. • Weaver House, Station Road • Hook, Basingstoke, Hants RG27 9JY, England • Tel: Hook (025672) 3401 • Telex: 858762 ANADEX G

CIRCLE NO. 130 ON INQUIRY CARD

Mini-Micro Marketplace

A special section for advertisers of
hardware, software and services.

Software & services

READERS: Please circle reader
service numbers for additional
information.

Mini-Micro Marketplace

READERS: Please circle
reader service numbers
for additional information.

Software & services

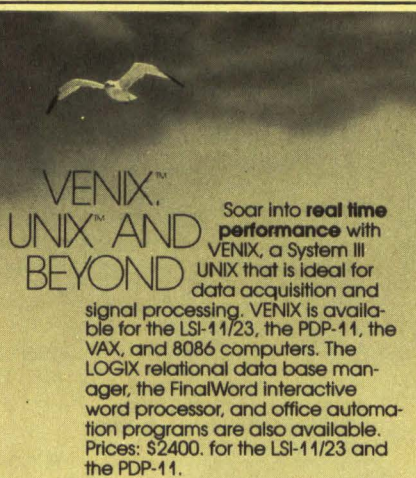

**VENIX,[™]
UNIX[™] AND
BEYOND**

Soar into **real time performance** with VENIX, a System III UNIX that is ideal for data acquisition and signal processing. VENIX is available for the LSI-11/23, the PDP-11, the VAX, and 8086 computers. The LOGIX relational data base manager, the FinalWord interactive word processor, and office automation programs are also available. Prices: \$2400. for the LSI-11/23 and the PDP-11.

VENTURCOM

139 Main Street, Cambridge, MA 02142 617/661-1230

*UNIX is a trademark of Bell Laboratories
**VENIX is a trademark of VenturCom, Inc.

CIRCLE NO. 201 ON INQUIRY CARD

Like-new products



For free catalog,
phone toll-free (800) 225-1008
In Massachusetts (617) 938-0900

Genstar REI Sales Company

6307 Desoto Ave. Suit J
Woodland Hills, CA 91367

CIRCLE NO. 202 ON INQUIRY CARD

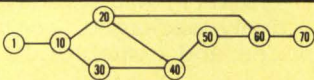

**WE DARE YOU TO COMPARE ANY
PROJECT MANAGEMENT SYSTEM TO**

PSM-II/RMS-II

- I-J Critical Path
- Draws Activity Diagram
- Complete Bar Charting
- Super- and Sub-Networking
- Resource Conflict Control
- Budget and Actual Cost Control
- Funding Schedule and Graph
- Earned Value Analysis
- True and Free Float
- Exceeds Government Requirements
- Runs on any Microll

pmr-II — \$1295.00 rms-II — \$995.00

REQUIRES CP/M (TM) AND CBASIC-2 (TM)
DEMO SYSTEM — \$100**
SEND FOR FREE LITERATURE

NORTH AMERICA MICA, INC.
11772 Sorrento Valley Rd., San Diego, CA 92121
619-481-6998

CIRCLE NO. 203 ON INQUIRY CARD

Mini-Micro Marketplace

LOW COST HIGH EXPOSURE

Call Lorraine Marden
617-536-7780

COMPLETE 68000 DEVELOPMENT TOOLS FOR VAX/VMS*

MOTOROLA PASCAL → 68000
optimizing cross-compiler.....\$2995
MOTOROLA 68000 relocatable
cross-assembler.....\$ 995
MOTOROLA cross-linker.....\$ 995
VMS ↔ VERSADOS†
file transfer.....\$ 395

All products run in VAX native mode.
Developed in cooperation with Motorola
for guaranteed EXORMACS/VERSADOS†
compatibility.

*tm Digital Equipment Corp. †tm Motorola

octal
INCORPORATED

1951 Colony Street, Mountain View, CA 94043
(415) 962-8080 Telex: 172933

CIRCLE NO. 204 ON INQUIRY CARD

Mini-Micro Marketplace

READERS: Please circle reader service numbers for additional information.

Hardware

Sprint 68 Microcomputer

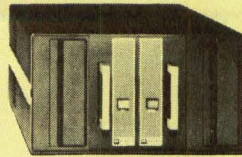

CONTROL COMPUTER DEVELOPMENT SYSTEM
6800 MPU, serial I/O, 48K RAM, dual 8" drives, WIZRD multitasking DOS, editor, assembler, 16K BASIC, all for \$3949.

OPTIONS
C, PL/W, PASCAL, FORTRAN, EROM programmer, analog I/O, parallel I/O, 488 GPIB interface, CMOS RAM/battery, power fail detect/power on reset



Wintek Corp.
1801 South Street
Lafayette, IN 47904
317-742-8428

CIRCLE NO. 205 ON INQUIRY CARD

THE INDOOR MULTIPLEXER \$495

- Eight channel capacity
- Completely transparent up to 9600 bps for each channel
- No modem needed: 2000 ft. distance between muxes
- Free 30 day trial

SOLANA ELECTRONICS

249 SOUTH HIGHWAY 101
SOLANA BEACH, CA 92075 (714)/481-6384

CIRCLE NO. 206 ON INQUIRY CARD

ERGONOMIC TILT-TURNTABLE



ONLY
\$59.00

For:

- VIDEO TERMINALS
- PERSONAL COMPUTERS

Attractive Walnut finish with Exclusive TOUCH-TILT

ORDER TODAY

Satisfaction Guaranteed
DONNAY TECHNOLOGY
16669 Evergreen Circle
Fountain Valley, CA 92708
(714) 839-4255

CIRCLE NO. 207 ON INQUIRY CARD

MICRODRIVE

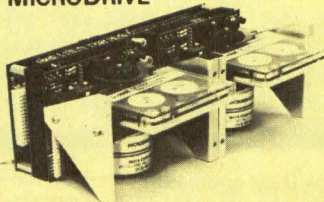

DC100 CARTRIDGE DRIVE HAS SMART I/O

MicroDrive/OEM now features a micro processor based I/O. This unit performs all control and formatting for quick systems integration. A high level command set (22 commands) allows full peripheral status for the model 125I/O. Serial and parallel options are available priced as low as \$400 in OEM qty.

MOYA CORPORATION
9001 Oso, Unit B
Chatsworth, Ca. 91311
Tel: (213) 700-1200

CIRCLE NO. 208 ON INQUIRY CARD

NEW PRODUCT!

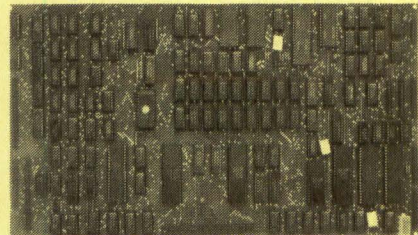

CP/M Z80-A SINGLE BOARD COMPUTER

- On board video • Wide line and thin line graphics
- 128K of RAM • Sasi interface • Floppy disk controller for up to four 5-1/4 and four 8 inch drives, single/double density simultaneously • 4 serial ports • Full Centronics printer port • Expansion bus • Extended track buffer • 16K printer buffer
- DMA • Compact size (8-1/4 x 12-1/4)

\$600.00 on orders placed and paid for prior to March 1, 1983 FOB Los Angeles, CA \$7.00 shipping

INSIGHT ENTERPRISES, CORPORATION
373 N. Western Ave., Suite 12,
Los Angeles, CA 90004 (213) 461-3262



Dealer, OEM, International Inquiries Welcome
CIRCLE NO. 209 ON INQUIRY CARD

PROMOTE NEW LITERATURE AT LOW COST

To Advertise in
The Mini-Micro Marketplace
Call Lorraine Marden
617-536-7780

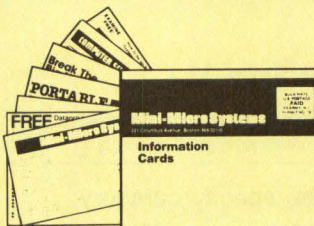

HIGH INQUIRIES LOW COST

- Sell products and services directly
- Introduce new products
- Investigate new applications
- Develop new sales leads

MINI-MICRO SYSTEMS DIRECT RESPONSE POSTCARDS

NOVEMBER MAILING CLOSES OCTOBER 24

Call Lorraine Marden 617-536-7780
CIRCLE NO. 210 ON INQUIRY CARD

Computer Discounts

Printers, Terminals, Modems, Systems

All Major Brands • Best Prices
We back-up everything we sell!!!

- Signalman MK1 or MK2 \$87.69
- Okidata Microline 80 \$335.95
- Hazeltine Esprit \$\$\$ call \$\$\$

We have Kaypro II in stock now!!!

KOPAK Creations, Inc.
d/b/a Computer Discount Services
Radio City Station /P.O. Box 1076
New York, NY 10019
(212) 757-8698, 757-9774

DEPT MMS-1

CIRCLE NO. 211 ON INQUIRY CARD

EDGE-86
AN INDUSTRIAL QUALITY
8086 OEM SYSTEM

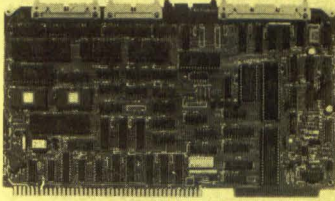

• HARDWARE

- A Multibus[®] COMPATIBLE 8086 CPU BOARD WITH DMA FLOPPY CONTROLLER, INTERRUPT CONTROLLER, PROGRAMMABLE TIMERS, 3 SERIAL PORTS, TWO PARALLEL I/O PORTS, AND 8K BYTES OF PROM WITH BOOT STRAP LOADER FOR CPM/86™.
- 128K BYTES DYNAMIC RAM BOARD.
- 4-SLOT MULTIBUS CARD CAGE, WITH COMPLETE DOCUMENTATION AND SCHEMATICS; ALL FOR

• SOFTWARE

- CPM/86 O.S. WITH COMPLETE UTILITIES... \$250.
- OFF THE SHELF DELIVERY -

EDGE MICRO SYSTEMS
195 W. EL CAMINO REAL, SUNNYVALE, CA 94086
TELEPHONE: 408-738-4729

* Multibus TM of Intel, *CPM/86 TM of Digital Research.

CIRCLE NO. 212 ON INQUIRY CARD

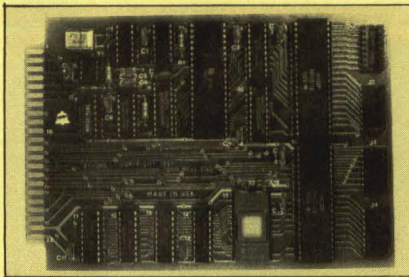

"SLIM" 81-260, Single board Large scale Integration Microcomputer. This 4.5 x 6.5 board uses the 6502 Microprocessor, two 6522 VIA's, 2K of RAM, 2K or 4K EPROM. The fully buffered 44 pin bus is similar to the AIM bus.

An EPROM (2532) with Monitor and Tiny Basic is available.

Single unit price \$199.95
OEM Pricing available.

JOHN BELL ENGINEERING, INC.
1014 Center St., San Carlos, CA 94070
(415) 592-8411

CIRCLE NO. 213 ON INQUIRY CARD

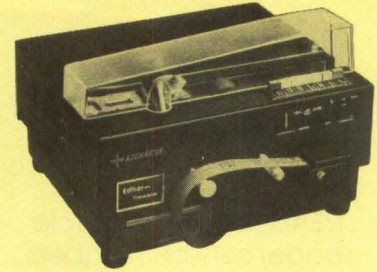

A word for this Punch/Reader Combo is

Speed! Model 510 punches paper tape at 110cps, reads at 150cps. This rugged machine is computer compatible offering RS232C, current loop, parallel inputs. The ASCII-to-Baudot code conversion permits direct keyboard entry for Telex/TWX transmission. Plus: 256 character storage, 75-9600 baud rate, 5-8 level tape, stock. ADDMASTER CORP. 416 Junipero Serra Dr., San Gabriel, CA 91776 * 213/285-1121.

CIRCLE NO. 214 ON INQUIRY CARD

FOR ONLY \$450.00
REACH NEW
BUSINESS COMPUTER
USERS
BY ADVERTISING IN THE
BUSINESS COMPUTER
MARKET

One ninth ad pages in a similar layout, appearing each month in

BUSINESS COMPUTER SYSTEMS

magazine

For information call Lorraine Marden
617-536-7780

CIRCLE NO. 215 ON INQUIRY CARD

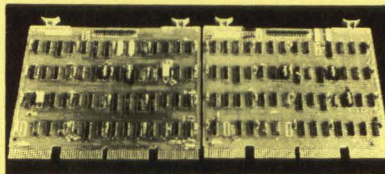

New DEC-compatible shared memory link obsoletes traditional CPU links.

The PPL-1 Peripheral Processor Link is a unique shared memory interface between any two Q-bus (LSI-11) and/or Unibus (PDP-11)-based DEC CPU's. Two quad boards and a connecting cable link the peripheral unit with the host. Up to 32KB of memory can be accessed by the peripheral processor in 4KB boundaries anywhere in the address space of the host. Address spaces are 18 bits for Unibus and 22 bits for the Q-bus. This memory sharing does not require software to support the link. 16 vectored interrupts (8 from each direction) provide necessary hardware for protocol implementation.

DEC, LSI-11, PDP-11 Q-bus and Unibus are registered trademarks of Digital Equipment Corp.

RANYAN 15239 Springdale St.
Huntington Beach, CA 92649
714-895-5504

CIRCLE NO. 216 ON INQUIRY CARD



PORTABLE VDT EMULATOR

The **TransTerm 2** has a single line 80 character LCD display, 24 line buffer, 58 key membrane keyboard and communicates in RS-232 serial asynchronous ASCII with 20 ma C/L or RS-422 optional. Half/full duplex, 8 baud rates and parity are switch selectable. Display supports 96 char. upper/lower case ASCII with cursor and audible bell code. Powered by 115VAC or 8-16 VDC.

COMPUTERWISE, INC.

4006 E. 137th Terrace
Grandview, Missouri 64030
(816) 765-3330

CIRCLE NO. 217 ON INQUIRY CARD

ADVERTISE
IN
THE MINI-MICRO
MARKETPLACE

The Marketplace appears in every issue of **MINI-MICRO Systems**

Order Form

Please run my advertisement in the following issues:

Please specify category:

Software Hardware Services
Literature Other

1983 Rates	1X	3X	6X	12X	18X
	\$560.	\$540.	\$520.	\$500	\$480.

Company _____

Address _____

City _____ State _____ Zip _____

Telephone _____

Signature _____

Material Materials to follow

Literature

NEW PRODUCTS



Catalog lists data-comm products

The vendor's line of data-communications equipment, including synchronous and asynchronous limited-distance modems; terminal, port and modem-sharing devices; and modem eliminators is described in a 41-page publication. The catalog lists the vendor's latest additions to its product line including the model 67/60 modem and multiplexer tester, the model 4020+4030 datacomm testers and the model 4031 ROM-PAC programmer. Included are descriptions of miniTech, EIA Patch, monitor and switching modules and data-interface cables. Photos and general specifications of the vendor's line of high-speed tests, data traps and monitors and error-correction systems are included. **International Data Sciences, Inc.**, 7 Wellington Rd., Lincoln, R.I. 02865. **Circle No 336**

Brochure describes integrated office system

The Omny integrated office system, a Motorola 68000-based minicomputer that supports numerous full-page proprietary terminals for heavy-volume word processing, is described in a technical brochure. The six-page brochure explains the system's task switching, I/O and design expansion, and lists speci-

fications. In addition, Omny's CPU board, I/O controller board and configuration are illustrated. **Sharedata, Inc.**, 1995 Oakcrest, St. Paul, Minn. 55113. **Circle No 337**

Brochure describes display system

A 20-page brochure describes the vendor's PDS 270, a microprocessor-based communications display system that uses high-speed synchronous data-loop technology for interconnecting display terminals and printers. Highlighted in the brochure is the display system's ability to eliminate CPU polling and overhead, allow for minimum operator training resulting from system software transparency and increase productivity resulting from faster response time. **Paradyne**, P.O. Box 1347, 8850 Ulmertown Rd., Largo, Fla. 33540. **Circle No 338**

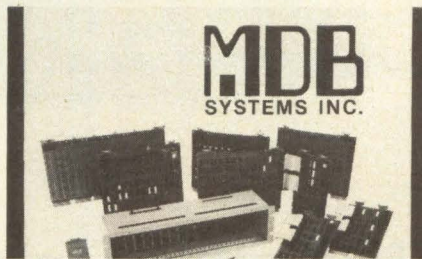

Brochure describes PDP-11, VAX interfaces

Interface products for Digital Equipment Corp. PDP-11 and VAX computers are described in a 16-page brochure. Product categories include synchronous and asynchronous communications/terminal interface modules, multiplexers, inter-processor link subsystems, peripheral-device controllers, system modules, PROM modules, foundation modules and special performance products and accessories. The illustrated brochure incorporates interface data and I/O pin connections. **MDB Systems, Inc.**, 1995 N. Batavia St., Orange, Calif. 92665. **Circle No 339**

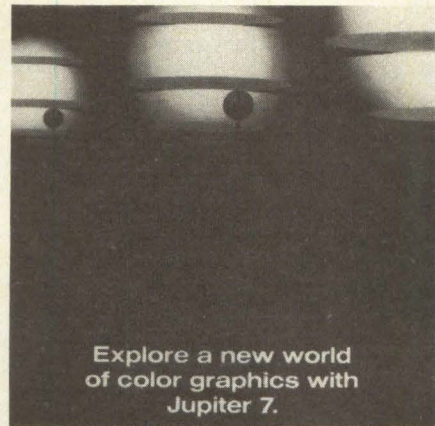

Color graphics terminal described in brochure

The Jupiter 7 color graphics terminal, a raster device with 768 x 575 viewable pixel resolution and 256 simultaneously displayable colors, is described in a full-color, eight-page brochure. The brochure describes the Jupiter 7's detached keyboard with 30 user-definable keys, a hexadecimal keypad and twin joysticks. It also describes the terminal's firmware anti-aliasing capability and hardware grid system. Application packages that can be run with this AED 512 and 767 plug-compatible terminal are also listed. **Jupiter Systems, Inc.**, 2126 Sixth St., Berkeley, Calif. 94710. **Circle No 340**

Bulletin describes 64K-byte microcomputer

The Z80A-based QDP-100 microcomputer with 64K bytes of standard RAM is described in a two-page bulletin. The bulletin notes that several versions of the QDP-100 are available. One has dual 8-in. floppy disk drives, and another has a 10M- or 15M-byte hard disk and one floppy disk drive. The bulletin also details the system's one-key start-up, an on-line help system and a menu-style listing of operating options. **Quasar Data Products**, 10330 Bracksville Rd., Cleveland, Ohio 44141. **Circle No 341**

This publication is available in microform.

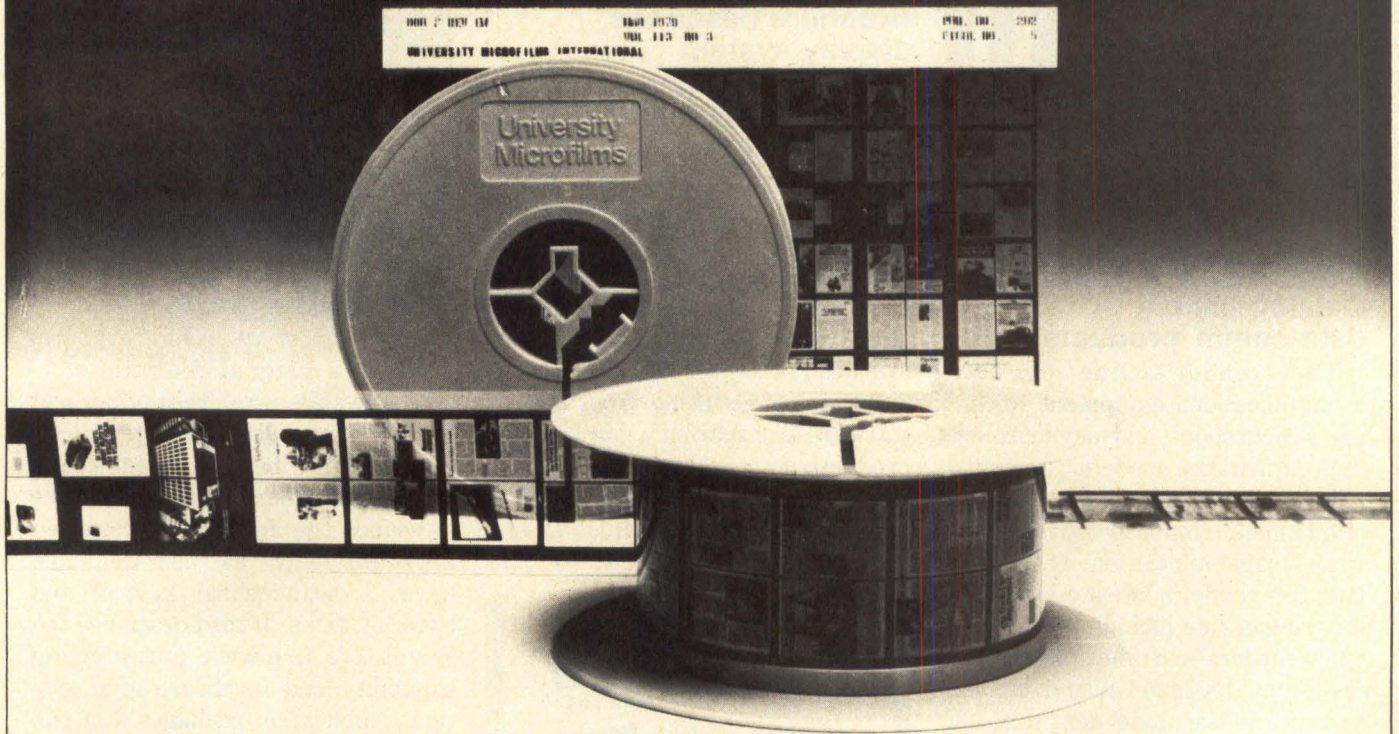

University Microfilms International

Please send additional information for **Mini-Micro Systems**
(name of publication)

Name _____

Institution _____

Street _____

City _____

State _____ Zip _____

300 North Zeeb Road
Dept. P.R.
Ann Arbor, Mi. 48106
U.S.A.

30-32 Mortimer Street
Dept. P.R.
London WIN 7RA
England

Classified Ads

SEMINARS

RMX-86 SEMINAR

- 5 days on-site intensive seminar
- Equivalent to Intel's 2 weeks workshop
- Guarantee to boost productivity
- Low budget cost

contact: **SAMUEL KIANG 213 308-9911**
P.O. Box 6156 Alhambra, CA 91802
MSEE MBA + 10 yrs exp.

CIRCLE NO. 231 ON INQUIRY CARD

HARDWARE

MICRO PIE

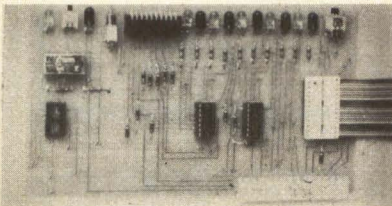

Each MICRO PIE (Parallel Interface Experimenter) directly connects to 6821-6522-8255 type chips to provide input signals and/or output display of 10 lines. Simplifies debugging of system software. Connects in minutes and uses very small space. Under \$100.00.

Teksym Corporation
14504 County Rd. 15,
Minneapolis, MN 55441
(612) 473-1225.

CIRCLE NO. 232 ON INQUIRY CARD

HARDWARE

OVERSTOCKED
with

CENTRONICS M150 PRINTERS PARALLEL INTERFACE PRICED BELOW WHOLESALE

MINIMUM ORDER OF 6

Contact: Gregg Makepeace
Phone: (714) 540-8340, ext. 4651
PERTEC COMPUTER CORPORATION



HEWLETT PACKARD

Desktop & Mini
Computer
Products

SAVINGS ALL MODELS

9845B/C HP 85 Non-HP memory
9836A 9826A and peripherals

CALL OR WRITE FOR FREE CATALOG

digital resources inc.

Box 23051 Portland, OR 97223 USA
503-246-0202
International Sales Telex 360-143

CIRCLE NO. 233 ON INQUIRY CARD

SOFTWARE

CBASIC-86 SOFTWARE

The following application systems are now available to run via CBASIC-86:

- General Ledger
- Accounts Receivable
- Accounts Payable
- Inventory
- Payroll
- Mailing List
- Time Accounting
- Medical Accounting
- Other Utilities Available

For information contact:

P&O Falco, Inc.
ATTN: Data Processing-C86
P.O. Box 108
Shreveport, LA 71161
1-318-746-7441 Ext. 266
1-800-551-8680 Ext. 266

CIRCLE NO. 234 ON INQUIRY CARD

ISIS ↔ CP/M®

CP/M users may transfer data bi-directionally to ISIS diskettes. The "ISIS-CP/M UTILITIES" provide complete high speed data transfer to/from ISIS diskettes to/from CP/M diskettes and also include a utility to display the ISIS directory. Will work in any version CP/M environment with any density drive.

\$250 on single density 8" diskette. Free brochure on other software development tools.

Southern Computer Systems

2304 12th Avenue North
Birmingham, AL 35234
Phone: 205-933-1659

CP/M® is a registered trade mark of Digital Research. ISIS is a trade name of Intel Corp.

CIRCLE NO. 235 ON INQUIRY CARD

CLASSIFIED ADVERTISING ORDER FORM

Mini-Micro Systems classifieds reach more mini-micro people

Rates: \$80.00 per column inch

Our rates apply to both display classified and regular classified listings. There is no charge for typesetting regular classified listings. Plan approximately 50 average words to a column inch, 8 lines of approximately 38 characters per line. Please send clean typewritten (double-spaced) copy.

Category: The following categories are available; be sure to specify the category you wish to be listed under: Business Opportunities, New Literature, Selling, Buying, Trading, Seminars, Services, Software, Supplies & Accessories. (Other categories may be employed at our discretion.)

Run this ad in _____ (number issues)
Ad size _____ col. wide by _____ inches deep Under _____ (category)
Check enclosed for \$ _____ (Pre-paid orders only)

Signature _____

Name _____ Title _____

Company _____ Telephone No. _____

Address _____

City _____ State _____ Zip _____

MAIL TO: Linda L. Lovett, Classified Advertising, Mini-Micro Systems,
221 Columbus Ave., Boston, MA 02116

CP/M® COMMUNICATIONS

COMMXTM supports links with mainframes and other CP/M systems. Easy to use menu supports terminal, terminal log, and file transfer. Protocol supports XON/XOFF, line/continue, character echo wait, and CRC 16 bi-sync for error free transfers of any file. Local mode supports sorted disk DIR, rename, delete, login, + more. Supports auto-dial, remote control and acoustic or direct connect modems.

Manual \$10 Source Code \$500

Free brochure on other 8080/Z80 products (Utilities, Subroutines, Language Systems)

Hawkeye Grafix Phone: 213/348-7909
23914 Mobile • Canoga Park •
CA 91307

MicroPERT™
Project Management
for Tektronix, IBM PC
For information, call or write
SHEPPARD SOFTWARE COMPANY
4750 Clough Creek Rd.
Redding, CA 96002
(916) 222-1553

CIRCLE NO. 236 ON INQUIRY CARD

Career Opportunities/Recruitment Advertising

Regional Systems Engineering Manager

CORVUS OFFERS BIG OPPORTUNITIES IN SMALL PACKAGES: MICROCOMPUTERS

Our growth has been phenomenal in the past few years, making CORVUS SYSTEMS a major force in the microcomputer and computer peripherals industry. This success is attributed not only to the superiority of the products we market and manufacture, but to the high quality of our technical and support staff.

In this newly created Westchester County, New York-based position, your field marketing responsibilities will encompass working with dealers and end-users, providing technical training at sales seminars and acting as general support person for the dealers' sales personnel. You must have a minimum of 3-5 years' experience, to include a thorough familiarity with FORTRAN, COBOL, and PASCAL and a working knowledge of microcomputers in the areas of business and education, specifically CP/M working under a 6800 based microcomputer system. Good oral communication skills, training background, and a degree in Computer Science, Mathematics or Engineering highly desirable.

We offer an excellent salary and benefits package, including stock option plan; company-paid major medical, life and dental insurance for you and your dependents. Please send your confidential resume, indicating salary requirements, to: Michael Davis, Regional Sales Manager, Corvus Systems, 122 East 42nd Street, Suite 1700, New York, NY 10168. No Agencies Please. We are an equal opportunity employer.

CORVUS SYSTEMS

CIRCLE NO. 237 ON INQUIRY CARD

EMPLOYMENT SERVICE FOR PROGRAMMERS AND ANALYSTS

National Openings With Client Companies
and Through Affiliated Agencies

Scientific and commercial applications • Software development and systems programming • Telecommunications • Control systems • Computer engineering • Computer marketing and support.

Call or send resume or rough notes of objectives, salary, location restrictions, education and experience (including computers, models, operating systems and languages) to either one of our locations. Our client companies pay all of our fees. We guide, you decide.

RSVP SERVICES, Dept. MM
Suite 700, One Cherry Hill Mall
P.O. Box 5013
Cherry Hill, New Jersey 08034
(609) 667-4488

RSVP SERVICES, Dept. MM
Suite 211, Dublin Hall
1777 Walton Road
Blue Bell, Penna 19422
(215) 629-0595

RSVP SERVICES

Employment Agents for Computer Professionals

CIRCLE NO. 238 ON INQUIRY CARD



**THE
ACCESS
GROUP, INC.**

Career opportunities available nationwide for engineering professionals skilled in design, development and manufacturing. Confidential search conducted by degreed engineers. Positions fee paid. Free resume service.

Call or write for a free career/salary guide.

Northeast 179 Allyn Street,
Hartford, CT 06103
(203) 527-9107

NY/Mid-Atl/SE Box 3267,
Stamford, CT 06905
(203) 356-1166

**SW/West/
Mid-West** P.O. Box 18302,
Las Vegas, NV 89114
(702) 644-3328

Affiliate offices in 120 cities
nationwide.

ENGINEERS/SOUTHEAST

Our 12 Offices in NC, SC, GA and FL specialize in Control Systems, Instrumentation, Electronic Design and Engineering positions from 18 to 40K. Aggressive, confidential. Fee Paid service. Send resume to Ted F McCulloch, BEALL PERSONNEL P.O. Box 5042, Spartanburg, SC 29304.

PROFESSIONAL RESUME SERVICE

1125 S. Cedar Crest
Allentown, PA 18103

Complete resume preparation for design engineers and design managers in electronics. Call collect or write:

PROFESSIONAL RESUME SERVICE
(215) 433-4112

**OPENINGS FOR ENGINEERS
& other degreed professionals.**
Send resume to:



Scientific Placement, Inc.

P.O. Box 19949 • Dept. 538
Houston, TX 77224
713/496-6100

A small ad here
could attract
a lot of attention!

More and more advertisers of minicomputers, microcomputers, CRT terminals, printers, disk drives, memories, modems, distributed data processing systems, etc., are consistently turning to **MINI-MICRO SYSTEMS**. Call **Stuart Tilt** at **203-964-0664**.

BE PART OF OUR EXCITING PAGE IN DATA PROCESSING ...AT FEDERAL EXPRESS!

Bring your special expertise to our dynamic operation. As we lead the industry in reliable overnight movement of high priority business goods and documents - and continue to grow rapidly - we need additional talented professionals to guide and maintain our sophisticated telecommunications and data processing systems. Consider continuing your career in one of these key positions:

Voice/Data/Radio/Software SENIOR ENGINEER

Our current openings for senior-level Engineers cover many areas of specialization. All involve demanding design and implementation responsibilities and require a BSEE (MSEE preferred) plus 2-4 years of closely related experience and excellent communications skills.

PROGRAMMER ANALYST/ SENIOR PROGRAMMER ANALYST

Develop and transform user requirements in applications with documentation for real time and/or batch systems, including testing. You'll need a BS in Computer Science, Math, Engineering, Business or equivalent professional experience plus 3-5 years of programming experience in systems development (using IBM systems if possible) and demonstrated skills in more than one language. Project coordination skills required for senior level.

SYSTEMS PROGRAMMER/ SENIOR SYSTEMS PROGRAMMER

Install, maintain, and evaluate current and new computer systems, addressing problem determination, systems control and operational procedures. You'll need a BS or equivalent professional experience plus 0-4 years in systems programming in a large IBM shop, plus knowledge of several of the following: MVS, JES2, VS1, IMS, VM, COBOL, PL/1, FORTRAN and IBM utilities.

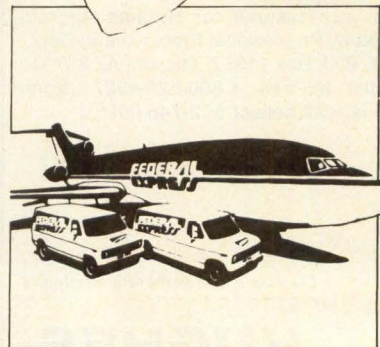

PROGRAMMER/ SENIOR PROGRAMMER

Prepare for all phases of applications programming for real time or batch systems, working from functional specs. You'll need a BSCS or 1 year of programming experience and programming skills in one or more systems development languages.

TELECOMMUNICATIONS ENGINEER/SENIOR TELECOM- MUNICATIONS ENGINEER

Forecast requirements, optimize current voice systems capacity, and implement voice systems expansions. You'll need a BSEE or equivalent professional experience plus 2-4 years of professional experience in communications or computer systems engineering - electronic systems theory, design, implementation, voice switches/transmission, and excellent communications skills.

TECHNICAL ADVISOR/ Systems Development/ Microelectronic Software

Provide technical expertise to project groups, defining, reviewing applications and ensuring timely projects completion. Coordinate activities between users and data personnel, and lead on selected projects. You'll need a BSCS or equivalent professional experience (for System Development: BS also in Math, Engineering, or Business) and 7 years of professional experience, along with top human relations and communications skills.

Build your career in the rewarding and satisfying professional atmosphere of Federal Express. Send your resume and salary history today to:

**FEDERAL EXPRESS
CORPORATION**
Employment Services
P.O. Box 727 - Dept. 2411-2
Memphis, Tennessee 38194

Equal Opportunity Employer M/F

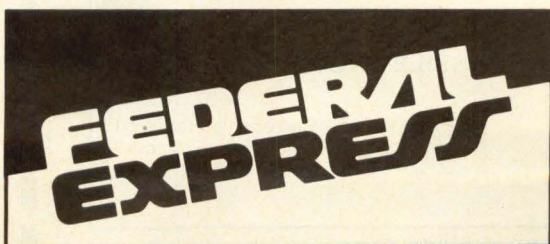



Find your place in the sun.

Come discover career opportunities as wide-open as our Arizona landscape.

At Hughes Aircraft Company in Tucson, you'll work in an engineering-oriented environment where state-of-the-art is a state of mind.

So, if you're an engineer with a BSEE/MSEE, we invite you to explore the following opportunities:

RF/MW Test Equipment Design Engineer
Microwave Engineering
 (components, devices, subsystems)
Circuit Design
 (analog, digital, hybrid)
Mechanical Design Engineer
Missile System
 (analysis, design, test)
Missile System
 (test equipment, test software design)
Production Test Engineers
Software Engineers/Scientific Programmers
Quality Assurance Engineers

You'll get an average of 13 paid holidays a year — including a week between Christmas and New Year's — besides vacation. Vision-care, dental, and medical insurance. Continuing education plans including studies at U. of Arizona. And relocation assistance, too.

To find your place in the sun, look into the Hughes Story. With more than 1,500 different projects company-wide, Hughes offers both stability and technological growth, as well as an excellent salary. Write yourself in!

Send your resume to: Hughes Aircraft Company, Professional Employment, Dept. MM-1, P.O. Box 11337, Tucson, AZ 85734. Or dial toll-free 1-800-528-4927 (from Arizona, call collect 602-746-8925).

Creating a new world with electronics

HUGHES

HUGHES AIRCRAFT COMPANY

MISSILE SYSTEMS—TUCSON

Proof of U.S. Citizenship Required
 Equal Opportunity Employer

Call today.

United States:

Arizona	
Phoenix	602/279-1010
California	
(Northern)	Mountain View 415/969-4910
	San Francisco 415/434-2410
	Walnut Creek 415/945-1910
(Southern)	Century City 213/203-8111
	Fullerton 714/871-6500
	Los Angeles 213/688-0041
	Newport Beach 714/833-1730
	San Diego 619/231-1900
	Torrance 213/540-7500
	Van Nuys 213/781-4800
Colorado	
Denver	303/571-4450
Englewood	303/773-3700
Connecticut	
Hartford	203/522-6590
Stratford	203/375-7240
District of Columbia	
Washington D.C.	202/466-5890
Florida	
Miami	305/624-3536
Georgia	
Atlanta (Downtown)	404/588-9350
Atlanta (North)	404/953-0200
Atlanta (Northeast)	404/325-8370
Illinois	
Chicago (East Loop)	312/938-4400
Chicago (West Loop)	312/782-0857
Oak Brook	312/986-0422
Rolling Meadows	312/392-0244
Indiana	
Indianapolis	317/631-2900
Kansas	
Overland Park	913/888-8885
Kentucky	
Louisville	502/581-9900
Louisiana	
New Orleans	504/561-6000
Maryland	
Baltimore	301/727-4050
Towson	301/321-7044
Massachusetts	
Boston	617/482-7613
Burlington	617/273-5160
Wellesley	617/237-3120
Michigan	
Detroit	313/259-7607
Southfield	313/352-6520
Troy	313/362-0070
Minnesota	
Minneapolis (Downtown)	612/332-6460
Minneapolis (West)	612/544-3600
Missouri	
Clayton	314/862-3800
Kansas City	816/474-3393
New Hampshire	
Nashua	603/880-4047
New Jersey	
Cherry Hill	609/482-2600
Edison	201/494-2800
Morristown	201/267-3222
Paramus	201/845-3900
Princeton	609/452-7277
New York	
New York City	
(Grand Central)	212/557-8611
(Penn Station)	212/736-7445
(Wall Street)	212/962-8000
Rochester	716/263-2670
Syosset, L.I.	516/364-0900
White Plains	914/683-9300
Ohio	
Akron	216/535-1150
Cincinnati	513/769-5080
Cleveland	216/771-2070
Columbus	614/224-0660
Dayton	513/461-4660
Oklahoma	
Tulsa	918/599-7700
Oregon	
Portland	503/223-6160
Pennsylvania	
King of Prussia	215/265-7250
Philadelphia	215/665-1717
Pittsburgh	412/261-6540
Wilkins Township	412/247-4400
Texas	
Dallas (Central)	214/954-1100
Dallas (North)	214/387-1600
Fort Worth	817/338-9300
Houston (Downtown)	713/751-0100
Houston (N. Loop West)	713/957-8555
Houston (S.W. Freeway)	713/626-8705
San Antonio	512/342-9898
Virginia	
McLean	703/790-5610
Washington	
Bellevue	206/454-6400
Wisconsin	
Milwaukee	414/277-0345
Canada:	
Ontario	
Don Mills	416/425-5730
Mississauga	416/272-3333
Toronto	416/865-1125
Québec	
Montréal	514/849-7043

CIRCLE NO. 240 ON INQUIRY CARD

Somehow, Did Your Last Raise Seem Insignificant?

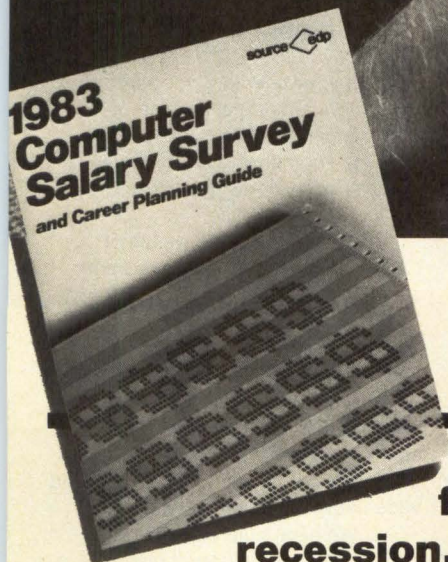
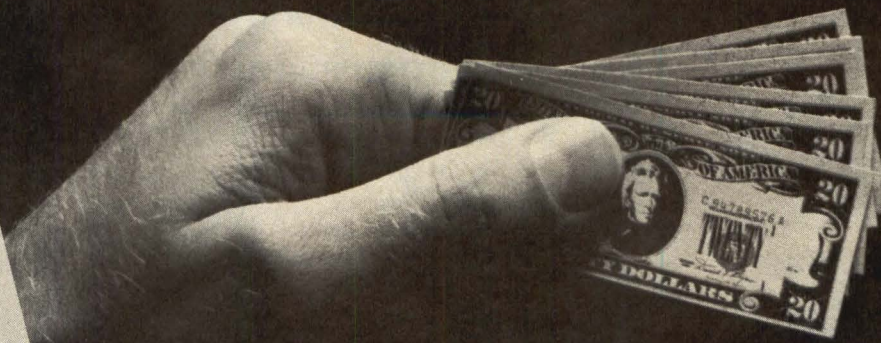

New, Free Computer Salary Survey!

Learn about compensation in the computer field, including the effects of inflation and recession, and which career paths offer the greatest compensation from a 28-page report prepared by Source Edp.

Despite past inflation and recession, demand for computer systems and the people needed to support them continues to grow.

But which professionals, with what specialized experience and skills, are really in the best positions for long term career and salary growth? And is your salary really keeping pace?

In our new Survey, you'll get answers to these questions and much more.

Compare your salary with many others.

The new Survey not only provides salary medians for 48 position categories, but it also shows "highs" and "lows" for each one as well. Figures are organized by types of professionals, including those ranging from commercial pro-

grammers to management and marketing positions; by experience level and by size of computer installation site. So you'll be able to compare your salary with those computer professionals who have similar responsibilities and skills and to learn who in computing, in what kinds of specialized disciplines, are earning the most.

No other Survey we know of is more comprehensive. It's based on contacts with more than 50,000 professionals and 25,000 organizations.

Learn about new growth areas.

Most significantly, you'll also read about which specific areas of specialization are forecasted for unusual growth in this decade and beyond. The past year saw many

changes in the economy and has altered career prospects for some professionals who were not properly prepared, so the need to stay abreast of current trends and career planning has never been so critical.

Whatever computer specialty you're in, or plan to explore—programming, software, systems design, data communications, mini/micro systems, data base, computer marketing, sales, management or others—our Survey can help you make the most of your career. You'll be able to keep up with changes in the profession, establish career goals, develop action plans, evaluate your progress, spot potential dangers, take corrective action when needed, and in general, keep your career on the best possible course for growth.

Call for your free copy.

The new 1983 *Computer Salary Survey and Career Planning Guide* is available without charge. You owe it to yourself to get a copy of the report—especially if most of your career lies ahead of you.

Call today and our free 28-page Survey will be mailed to you in strict confidence, without obligation.

source edp
Personnel Services

The world's largest recruitment firm that specializes exclusively in the computer profession.

Client companies assume our charges.

Call today.

Call the office nearest you that is listed to the left. If you're unable to call, write:

Source Edp
Department MM1
P.O. Box 7100
Mountain View, CA 94039

(When writing, be sure to include your title.)

You may know us.

We're involved in all aspects of software, hardware, and systems engineering for communications systems.

We're Computer Sciences Corporation.

If your talents, skills, and education encompass program management, communications systems engineering or computer processing systems, get to know us better.

At the Systems Division of CSC, our communications systems activities involve jobs on a world wide basis — from the subway in Washington, D.C. to the oilfields of Saudi Arabia. Our involvement in data telecommunications and telecommunications range from small, local-area-networks in support of office automation to massive, world wide packet-switching systems.

We have built and designed communications systems that involve the most advanced technologies including PROTOCOLS, TRANSMISSION SUBSYSTEMS, HARDWARE, SOFTWARE, SECURITY AND ANALYSIS. And the application of our communications expertise spans a wide variety of applications including: LARGE SCALE NETWORKS, INDUSTRIAL AUTOMATION, MASS-TRANSIT AUTOMATION and VOICE COMMUNICATIONS.

Opportunities for career advancement exist for experienced professionals and entry-level personnel in all areas of our communications systems activities.

We're the Systems Division of Computer Sciences Corporation.

The problem solvers. Talk to us.

Computer Sciences Corporation
Systems Division
6565 Arlington Boulevard (MM-1)
Falls Church, VA 22046

An Equal Opportunity Employer

CSC

COMPUTER SCIENCES CORPORATION

Get to know us better.

CIRCLE NO. 241 ON INQUIRY CARD

Computer Consultants Corner



Microcomputer Applications

- Hardware/Software solutions
- Custom Software development
- Communications and networking specialists
- Corvus hard disk multiplexing

SBSG, 6 Carlisle Road
Westford, MA 01886
(617) 692-3800

CIRCLE NO. 242 ON INQUIRY CARD

ELECTRICAL NOISE PROBLEMS SOLVED

in Electronic Data Processing and Microprocessor Based Control Systems

CALL (814) 466-6559
Dr. E. Thomas Chesworth, P.E.
Seven Mountains Scientific Inc.
Boalsburg, PA 16827

CIRCLE NO. 246 ON INQUIRY CARD

VAX/VMS, RSX-11M, RT-11 USERS

- Short-Long Term Software Projects
- Real-Time, Lab. Automation & Security Systems
- Staffed by Former DEC[®] Specialists
- Recommendations from Major Corporations
- Call or Write for More Information

DIGITAL CONSULTANTS
Box 3781 Englewood, CO 80155
(303) 773-0717

CIRCLE NO. 250 ON INQUIRY CARD

DAVID SAUNDERS, INC.

Consultants in Electrical Engineering
Microprocessor Applications
Electronics • Power Electronics

228 Sycamore St.
Watertown, MA 02172 (617) 489-2509

CIRCLE NO. 243 ON INQUIRY CARD

T/C/G REAL-TIME

- DATA CAPTURE
- ANALYSIS
- DISPLAY
- CONTROL
- WORLDWIDE
- CALL US!

THE CREATIVE GROUP, INC.
McLean, VA (703) 821-2270

CIRCLE NO. 247 ON INQUIRY CARD

DEC COMPATIBLES

Specialist in all DEC compatible hardware and services

Rick Eriksen
ERIKSEN & ASSOCIATES
23461 Ridge Route S#H
Laguna Hills, CA 92653
714-859-8982

CIRCLE NO. 251 ON INQUIRY CARD

μP CONTROL & TEST

- Real-Time Systems-Development & Fabrication
- Experience with LSI-11, 8085, 68XX, 3870, others
- PDP-11 based Real-Time Emulation/Trace Facility
- RT-11, Macro-Assembler, Fortran, Pascal, Basic
- Integrated hardware & software for industrial control, servo systems, ATE & special interfaces.

INNOVATEK MICROSYSTEMS INC.
Millerton, NY 12546 914-373-9003

CIRCLE NO. 244 ON INQUIRY CARD

- Real Time Software Engineering
- Instruction for high technology systems
- Specification and development of microcomputerized product

SOFTWARE ENGINEERING & INSTRUCTION, INC.

P.O. Box 70998, Sunnyvale, CA
408-738-8568

CIRCLE NO. 248 ON INQUIRY CARD

PROCESS CONTROL SYSTEMS

- DESIGN, PROGRAM, INSTALL, SERVICE
 - BATCHWISE and CONTINUOUS PROCESSES
 - PROCESS & QUALITY CONTROL ANALYSIS
 - DDC, SETPOINT & SUPERVISORY CONTROL
 - MICRO, MINI, ASSEMBLER, FORTRAN, BASIC
 - IBM, DEC, INTEL, STARPLEX, FISHER
 - ESTIMATES, JUSTIFICATIONS, SOLUTIONS
- BS/Chem Engr, MS/Sys Engr (Honors), 18 yrs. exp.
\$40/Hr. plus travel & lodging, 100 Hr. min.
Discuss with Bill Wedel @ 904-932-4315

CIRCLE NO. 252 ON INQUIRY CARD

HARDWARE—SOFTWARE—COMMUNICATIONS
High technology marketing services at realistic prices to create a cost effective return on investment.

Pro-Spectrum

P.O. Box 74 - SPRING VALLEY,
OHIO 45370-0074
(513) 885-4589



CIRCLE NO. 245 ON INQUIRY CARD

MICRO—PROCESSOR SERVICES INC.

- Specializing in microcomputer software and hardware design for all INTEL MICROPROCESSOR FAMILIES (from 8021 to 8086).
- We use our own development equipment and staff.
- Fixed price contract and warranty.
- Free initial consultation and quotation.

MICRO—PROCESSOR SERVICES INC.
92 STONEHURST LANE
DIX HILLS, L.I., NEW YORK 11746
(516) 499-4461

CIRCLE NO. 249 ON INQUIRY CARD



CHESAPEAKE SOFTWARE, INC.

9 Maplewood Lane
Wilmington, DE 19810
(302) 475-5229

PDP-11 / VAX

Real-time Process Control
Interactive Graphics Systems
Scientific / Engineering Programming

CIRCLE NO. 253 ON INQUIRY CARD

COMPUTER CONSULTANTS ORDER FORM INTRODUCTORY OFFER

1" 1x \$150, 1" 3x's \$225 1" 12x's \$1,440

(There is no charge for typesetting)

Enclose check for \$_____ Bill me monthly

Run this ad in _____ (number issues)

(Please print, type or attach business card)

Name _____ Title _____

Company _____ Telephone _____

Address _____

City _____ State _____ Zip _____

MAIL TO: Stuart Tilt

MINI-MICRO SYSTEMS,
999 Summer Street, P.O. Box 3809,
Stamford, CT 06905
or Call: **203-964-0664**



BASS-SNEED ASSOCIATES, INC.

Specialists in Microprogramming, Signal processor implementations, Image processing, Floating Point systems, Bit-slice machines, Real-time digital control systems design, Microprocessor applications

Integrated Hardware/Firmware/Software solutions
Lawrence P. Bass
Box 646, Ridgewood, NJ 07451
(201) 444-3411

CIRCLE NO. 254 ON INQUIRY CARD

MICROPROCESSOR APPLICATIONS

New product development - industrial and consumer. Designers of cost-effective hardware/software solutions since 1973.

LOGICAL SERVICES INCORPORATED

2340A Walsh Avenue Santa Clara, CA 95051
Bob Ulrickson (408) 727-1470

CIRCLE NO. 255 ON INQUIRY CARD

MicroPERT™

Project Management
for Tektronix, IBM PC

For information, call or write
SHEPPARD SOFTWARE COMPANY
4750 Clough Creek Rd.
Redding, CA 96002
(916) 222-1553

CIRCLE NO. 256 ON INQUIRY CARD

Advertisers Index

Adaptec, Inc.	62	Federal DP Expo	192	Pixel (Instrumentation Laboratory)	98-99
Advanced Digital Corp.	38	Florida Computer Graphics	189	Plessey Peripheral Systems	13
Altos Computer Systems	46-47	Frost & Sullivan	128	Plexus Computers	78-79
Ampex Corp., Memory Products Div.	171	Fujitsu America, Inc.	159	Precision Visuals	201
Anadex, Inc.	227	General Electric Co.	56	Printronic, Inc.	135
Andromeda Systems, Inc.	206	Gould Inc., DeAnza Imaging Div.	70	Quality Micro Systems	163
Applied Data Communications	6	Gould Inc., S.E.L.		Quantum Corp.	116-117
Archive Corp.	74-75	Computer Systems Div.	5	Radio Shack	90
BBN Computer	50-51	Grinnell Systems	30-31	Rair Microcomputer Corp.	8
C. Itoh Electronics	10,17	Hazeltine Corp.	66	Ramtek Corp.	45
Cahners Exposition Group	158, 226	Hewlett-Packard	121-123	Rixon Inc.	111
California Computer Systems	43	Houston Instrument Div.		Scientific Micro Systems	112, 211
Callan Data Systems	103	of Bausch & Lomb	1	Seiko Instruments	115
Cambridge Digital Systems		IBM Corp.	225	Shugart Associates	196-197
(Div. of Compumart)	83	IBC/Integrated Business Computers	35	Siemens Corp.	172
Centronics Computer Corp.	130	IMI (International Memories, Inc.)	67	Silver Reed	174
Charles River Data Systems	149, 193	Information Product Systems (IPS)	9	Sorcim	76-77
CIE Systems	198	Infoscribe	42	Sord Computer of America	194
Cipher Data Products, Inc.	101	Infotron Systems Corp.	27	Tandberg Data Inc.	178
COEE MW '83	226	Integral Data Systems	160	Tandberg Data Inc.,	
Columbia Data Products	48	Interface '83	110	Data Storage Div.	157
Computer Technology Group	220	Interface Group	110, 192	Tandon Corp.	18-19
Computers International		Intermec, Inc.	85	TEAC Corp. of America	190
Daisywriter Div.	222	Intertec Data Systems Corp.	29	Teltone Corp.	185
Control Data Corp.—OEM	106	ISE International	118	Topaz Electronics Div.	58
Convergent Technologies	60-61	Ithaca InterSystems, Inc.	154	Toshiba	141
Daisywriter Div.		Ithaco, Inc.	218	Trilog, Inc.	72
/Computers International	222	Jensen Engineering	200	Universal Data Systems, Inc.	219
Datacopy	204	Kennedy Co.	Cover 2	Versatec, Inc., A Xerox Co.	80
Data General Corp.	36-37	KMW Systems Corp.	41	Vertex Peripherals	186
Dataproducts	96, 153	Lang Systems	181	Victor Business Products	168
Dataram	124, 215	Leading Edge Products	14	Visual Technology, Inc.	136
Datasouth Computer Corp.	159	Lear Siegler, Inc.	142-143	Voyager Systems, Inc.	216
Datasystems,		Mannesmann Tally	20	Western Digital	213
a Wespercorp subsidiary	93	MDB Systems, Inc.	146	Western Peripherals	
Data Systems Design, Inc.	52-53	Media Distributing	55	Div. of Wespercorp	Cover 3
Davidge Corp.	128	Megatek Corp.	175	Western Telematic, Inc.	9
Davong Systems	182	Micom Systems, Inc.	Cover 4	Westrex OEM Products	212
Digi-Data Corp.	109	Microbar Systems	64-65	Whitesmiths, Ltd.	32
Digital Associates	214	MicroPro	94-95	Wyse Technology	221
Digital Engineering	224	Micro-Term	71	Zilog, Inc.	166-167
Digital Equipment Corp.	86-87, 209	Molecular Computer	138		
Direct, Inc.	205	MPI (Utah)	144		
Dysan Corp.	202-203	NCR Corp.	68-69		
Eagle Computer Forms	223	NEC Information Systems, Inc.	195		
Electronic Solutions	44, 204	NEPCON West '83	158		
Emulex Corp.	107, 191	Okidata Corp.	151		
Epson America, Inc.	176	Onyx Systems	177		

This index is provided as an additional service. The publisher does not assume any liability for errors or omissions.

REGIONAL SALES OFFICES

BOSTON

John J. Fahey
Eastern Regional Manager
221 Columbus Avenue
Boston, MA 02116
(617) 536-7780

PHILADELPHIA

Richard W. Molden
Regional Manager
999 Old Eagle School Rd.
Wayne, PA 19087
(215) 293-1212

CHICAGO

Robert D. Wentz
Regional Manager
Cahners Plaza
1350 E. Touhy Ave.
P.O. Box 5080
Des Plaines, IL 60018
(312) 635-8800

DALLAS

Don Ward
Regional Manager
13740 Midway
Suite 515
Dallas, TX 75234
(214) 980-0318

DENVER

John Huff
Regional Manager
270 St. Paul Street
Denver, CO 80206
(303) 388-4511

LOS ANGELES

Robert Billhimer
Regional Manager
12233 West Olympic Blvd.
Los Angeles, CA 90064
(213) 826-5818

ORANGE COUNTY

Debra Huisken
Regional Manager
2041 Business Center Drive
Suite 109
Irvine, CA 92715
(714) 851-9422

SAN FRANCISCO

Frank Barbagallo
Regional Manager
Rick Jamison
Regional Manager
Sherman Building, Suite 1000
3031 Tisch Way
San Jose, CA 95128
(408) 243-8838

ENGLAND

Ian Hardman
Systems International
Quadrant House,

The Quadrant
Sutton Surrey,
SM2 5AS England
Tel: (01) 661-3022

JAPAN

Tomoyuki Inatsuki
General Manager
Trade Media Japan Inc.
R. 212 Azabu Heights
1-5-10 Roppongi
Minato-ku,
Tokyo 106 Japan
Tel: (03) 585-0581

Career Opportunities

Stuart Tilt
Recruitment Advertising Manager
999 Summer Street
P.O. Box 3809
Stamford, CT 06905
(203) 964-0664

DEC, Data General, HP communications costs are down, again

Phone line rates are up, and if you're supporting multiple remote terminals on your minicomputer—DEC, Data General, HP or any other—chances are you're paying a fortune in communications costs and still not running the terminals as fast as you'd like. And to add insult to injury, you have to put up with the occasional phone line "glitch" which drives your CRT's crazy.

What you really need is a smart little box that will provide error control for your terminals and allow several of them to share one telephone line. The line savings alone will pay for the concentrator in only a short time, and the *error control comes free!*

MICOM's Micro800/2 Data Concentrator represents a major new breakthrough in low-cost data concentration (sometimes called "statistical multiplexing"). Allowing up to

16 terminals to share a single phone line, *it will pay for itself even supporting only a single CRT and a printer.* It requires absolutely no changes to existing hardware and software, and typical prices are only \$1050 for a 2-channel unit, \$1400 for a 4-channel version. (Even single-channel versions are available to provide error-free data communications for lone terminal installations.)

More than 40,000 Micro800s and Micro800/2s are already in service, having been installed by their users as painlessly as plugging in terminals. And with some of those customers supporting four 2400 bps CRTs on a single 2400 bps line, it's no wonder that so many have been installed.

Send for our free 10-page booklet describing the Micro800/2 and its applications.



MICOM® *MicroComputers for DataCommunications*™

MICOM SYSTEMS, INC. • 2015 Nordhoff Street • Chatsworth, CA 91311 • Telephone (213) 998-8844 • TWX 910/494-4910
 Regional Sales and Service • Boston, MA • (617) 527-4010 • St. Louis, MO • (314) 576-7626 • Woodbridge, NJ • (201) 750-1120
 Other Regional Sales Offices • Atlanta, GA • (404) 435-2999 • Dallas, TX • (214) 258-0774
 MICOM-BORER LTD. • Bel Court • 15 Cradock Road • Reading, Berkshire RG20JT, England • (0734) 866801 • Telex 847135

Available now from these stocking reps...

AK: Anchorage (907) 276-5616/Juneau (907) 789-3310 • AL: (800) 327-6600 • AR: (214) 620-1551 • AZ: (602) 994-5400 • CA: Anaheim (714) 635-7600/Lodi (209) 334-1961/San Diego (714) 565-1557/San Jose (408) 298-7290 • CO: Colorado Springs (303) 594-0880/Denver (303) 777-8070 • CT: (203) 226-4281 • DE: (609) 779-0200
 FL: (800) 432-4480 • GA: (800) 327-6600 • HI: (808) 523-8881 • IA: (402) 895-5850 • ID: (801) 466-6522 • IL: (312) 255-4820 • IN: (317) 846-2591 • KS: (816) 252-3700
 KY: (317) 846-2591 • LA: (800) 327-6600 • MA: (617) 235-5520 • MD: (301) 261-4344 • ME: (617) 235-5520 • MI: (313) 588-2300 • MN: (612) 425-4455 • MO: Independence (816) 252-3700/St. Louis (314) 721-0401 • MS: (800) 327-6600 • MT: (801) 466-6522 • NC: (800) 327-6600 • ND: (612) 425-4455 • NE: (402) 895-5850 • NH: (617) 235-5520
 NJ: North (212) 687-2455/South (609) 779-0200 • NM: Albuquerque (505) 292-1212/Las Cruces (505) 524-9693 • NV: (714) 635-7600 • NY: East Aurora (716) 655-4322/Loudenville (518) 459-5891/New York City (212) 687-2455/Rochester (716) 442-5631 • OH: Cleveland (216) 267-0445/Dayton (513) 434-7500 • OK: (214) 620-1551
 OR: (503) 224-3145 • PA: East (609) 779-0200/West (412) 892-2953 • RI: (203) 226-4281 • SC: (800) 327-6600 • SD: (612) 425-4455 • TN: (800) 327-6600 • TX: Dallas (214) 620-1551/El Paso (915) 542-1762/Houston (713) 353-7728 • UT: (801) 466-6522 • VA: (301) 261-4344 • VT: (617) 235-5520 • WA: (206) 364-8830 • WI: (414) 784-9379
 WV: East (301) 261-4344/West (412) 892-2953 • WY: (303) 371-2422 • Washington, DC: (301) 261-4344 • Guam: (671) 646-7280 • Puerto Rico: (809) 723-9689

CIRCLE NO. 4 ON INQUIRY CARD

IT'S SUPERCONTROLLER!

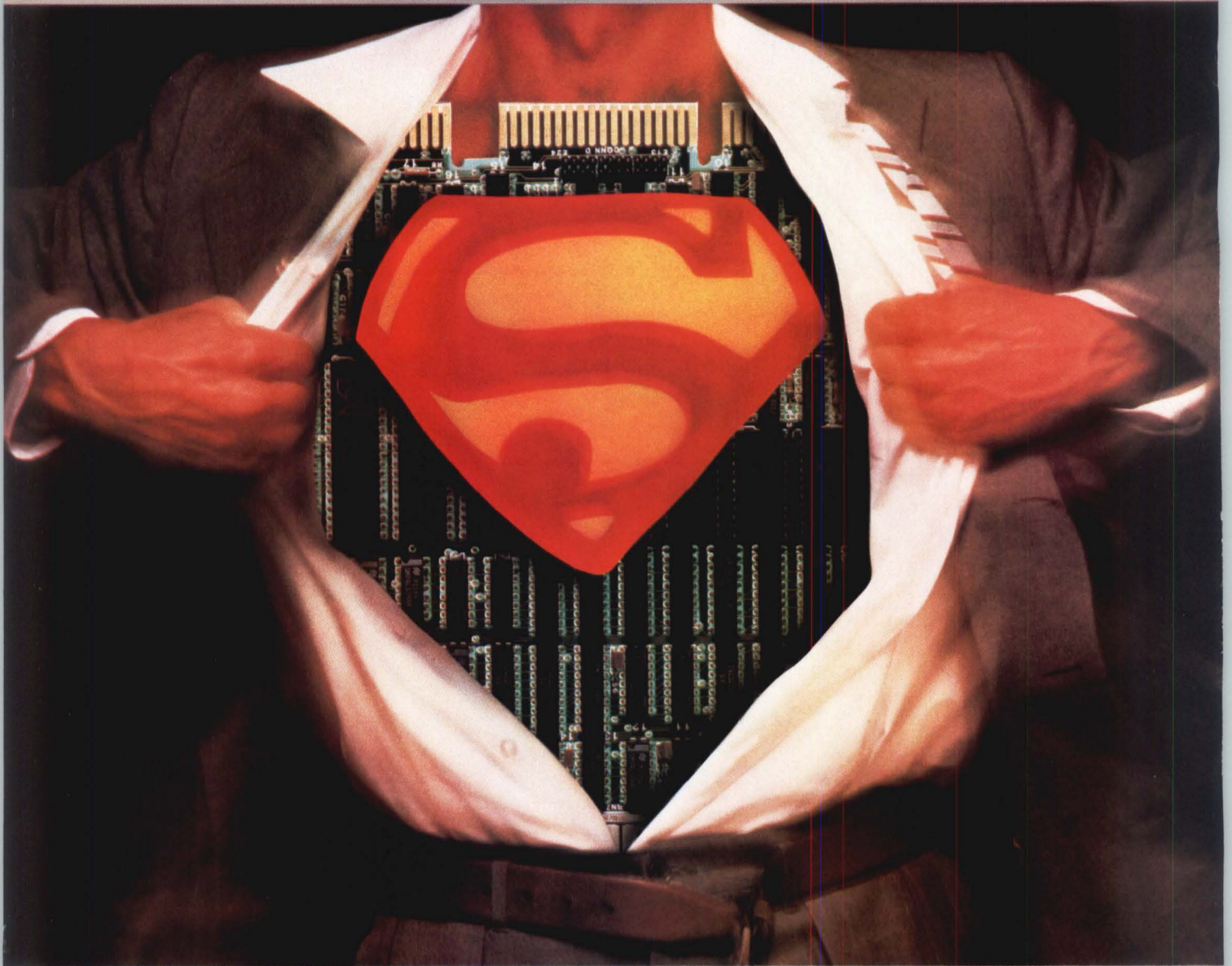

It's a 6250 BPI (GCR) controller that can handle dual and tri-density drives from STC and Telex.

It's a software compatible streamer controller for today's streaming 1/2" drives.

It's a TS11* emulator.

It's a 6250 BPI streamer controller for tomorrow's new technology GCR streaming drives.

It's a single board imbedded controller with a 64K byte on-board memory that acts like a large buffer in start-stop mode and as a multiblock staging

buffer while streaming.

It's the TS-6251 Supercontroller from Western Peripherals, the company that has put more magnetic tape on DEC Unibus computers than any other independent supplier. Call or write us for technical details.

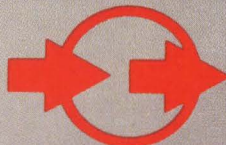

western peripherals

Division of WESPERCORP

14321 Myford Road, Tustin, CA 92680

(714) 730-6250 TWX: 910 595-1775 CABLE: WESPER

*Trademark Digital Equipment Corporation

CIRCLE NO. 3 ON INQUIRY CARD