

# Mini-MicroSystems

A CAHNERS PUBLICATION

FEBRUARY 1983

VCRs for disk backup  
Floppy market overview

435 645 0009 04/ 01  
0782 11 2 F 3 JHI 05210  
R HELLENTHAL ASST PROF  
BIOLOGY DEPT  
UNIV OF NOTRE DAME  
NOTRE DAME IN 46556

5¼-inch Winchester stores 140 Mb



# DEC-COMPATIBLE SEMI ADD-INS

**NEW!**  
1.0 MB  
VAX 730  
1.0 MB  
VAX 750  
2.0 MB  
VAX 780

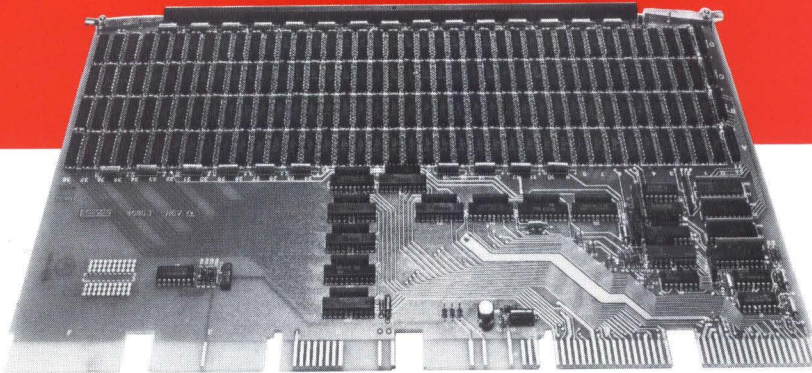

## FROM THE LEADER

Look to the leader — Dataram — for your DEC-compatible semiconductor ADD-IN memory. Offering not only the broadest, most complete line of semi ADD-INS, but the most capable...no matter what your yardstick. Compatibility, throughput, cost, power efficiency, size...no matter how you measure capability, Dataram DEC-compatible semi ADD-INS are the clear leader.

A leadership position earned by improving on DEC's price and delivery...and then adding features available from no one else in the industry.

The chart provides a glimpse at the industry-pace-setting family of DEC-compatible semi ADD-INS. Call us today at (609) 799-0071, and we'll give you a close-up look at the products that have made us the leader.

**DATARAM  
CORPORATION**

Princeton Road  
Cranbury, New Jersey 08512  
Tel: 609-799-0071 TWX: 510-685-2542

DEC Mini	Dataram ADD-IN	Board Size	Maximum Capacity
LSI-11®	DR-115S	dual	64 KB
LSI-11	DR-215	dual	256 KB
LSI-11	DR-213	quad	1.0 MB
PDP®-11	DR-114S	hex	256 KB
PDP-11	DR-114SP	hex	256 KB
PDP-11	DR-214	hex	1.0 MB
PDP-11	DR-144	hex	256 KB
PDP-11	DR-244	hex	1.0 MB
VAX®-11/750	DR-175	hex	256 KB
PDP-11/70			
VAX-11/750	DR-275	hex	1.0 MB
VAX-11/730			
VAX-11/780	DR-178	extended hex	512 KB
VAX-11/780	DR-278	extended hex	2.0 MB
DECSYSTEM 2020®	DR-120	extended hex	256 KB

DEC, DECSYSTEM 2020, PDP and VAX are registered trademarks of Digital Equipment Corporation.

Dataram also provides core ADD-INS, core and semiconductor ADD-ONS, memory system units, memory management, and a wide range of memory-related accessories for DEC users.



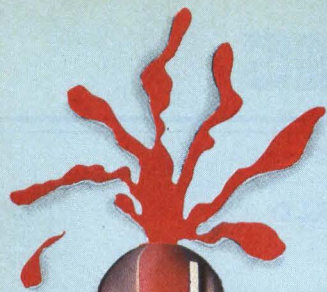

# MICRO FEVER

**More and More Systems Houses are Catching it with the HOTTEST NAME in Microcomputers . . . .**

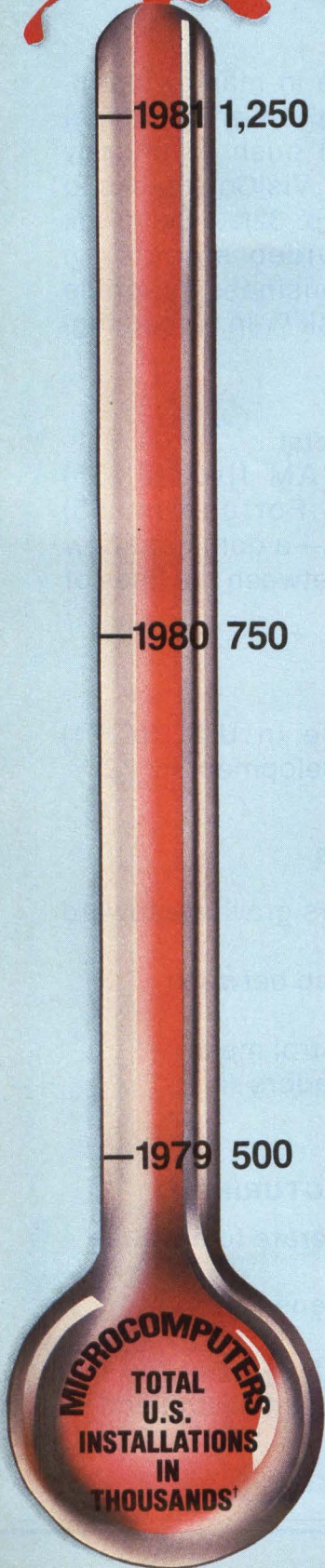
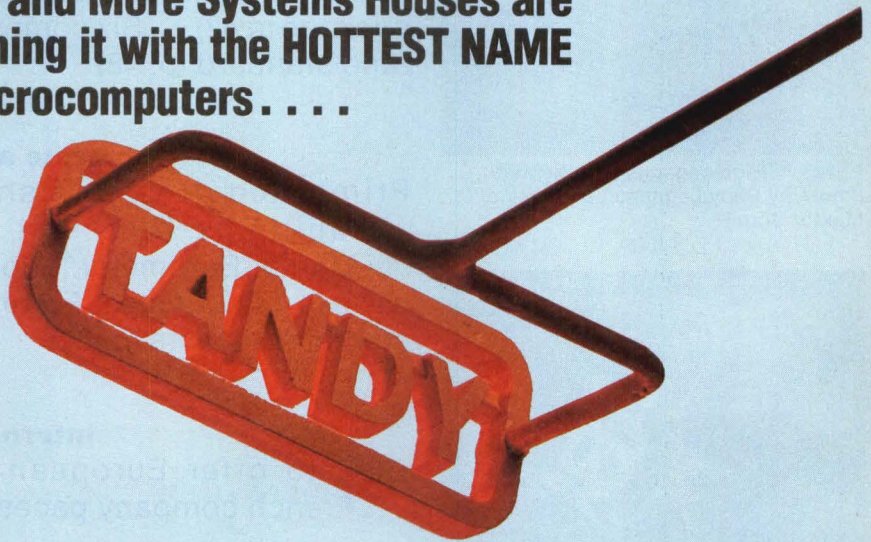

In a recent study\* conducted by Time Magazine, an estimated 90% of the small businesses in the U.S. have yet to computerize. The same study shows Tandy second only to Big Blue in first time unit sales!

**Team your Vertical-Market software with our hardware.** Then watch your sales *really* take off. Tap a market that has a \$9 billion potential with Tandy—the people who set the market on fire with the phenomenally successful TRS-80® microcomputers. Go ahead—make our success story *your* success story.

**Hot products—the heart of your vertical market turnkey system.** Choose from cost-effective 8-bit desktop computers as well as a state-of-art 16-bit multi-user system. Each model includes a monitor, keyboard—even disk storage—*built-in*.

**System Houses: Tandy is your single source microcomputer supplier.** Forget about having to do business with a variety of suppliers. *Need a terminal or hard disk system? We're your source. Printers? We're your source. Program development software? Tandy has it all, and virtually everything is available for immediate delivery.* We also offer our own nationwide network of service centers. You and your customer can turn to Tandy for expert installation as well as on-site service. It's another "plus" you'll enjoy as a Tandy marketeer.

**Don't let your sales cool off.** Call or write today. We'll have one of our sales representatives tell you how you can sell Tandy microcomputers. Go ahead, offer the Tandy line and watch your sales catch micro fever!



**Tandy Contract Marketing Sales**

1700 One Tandy Center • Fort Worth, Texas 76102 • 817/390-3099

\*Focus Research, West Hartford, Connecticut as commissioned by Time Magazine.

†Source: Mini/Micro Systems Magazine Estimates

**CIRCLE NO. 1 ON INQUIRY CARD**



# Mini-Micro Systems

## MINI-MICRO WORLD

### News

Apple bets on proprietary software in market bid (p. 17)...Qume takes on TeleVideo in low-end terminal market (p. 21)...Amlyn, Drivotech push minifloppy capacities above 3M bytes (p. 26)...VisiCorp seeks to set standard with Visi<sup>ON</sup> package (p. 32)...Seiko ink sheet color printer processes video signals (p. 41)...High hopes for IBM PC business graphics package (p.42)...Six companies back 1/4-in. streaming-tape standard (p. 48)

### Corporate and financial

Prime acquires British CAD/CAM firm (p. 55)...Multiplex files suit against Fortune (p. 55)...Market Barometer: Supermicros—a dominant new wave (p. 58)...Guest Forum: read between the lines of market forecasts (p. 62)

### International

DEC to offer European software in U.S. (p. 71)...French company paces Ada development (p. 72)

### INTERPRETER

- 81 High-end 16-bit microcomputers gravitate toward MC68000 chips
- 89 Software distributors fill the gap between developers and dealers
- 101 Network management and control mean different things to different vendors

### SYSTEMS IN MANUFACTURING

- 113 Industry and universities cooperate to advance robotics, vision
- 119 Manufacturing package brightens lighting company's path
- 127 Prime adds electronic CAE/CAD system
- 131 Cadlink provides a bridge between design and manufacturing



P. 143...High-capacity Winchesters  
(Photo by Rudy Legname, courtesy of Maxtor Corp.)

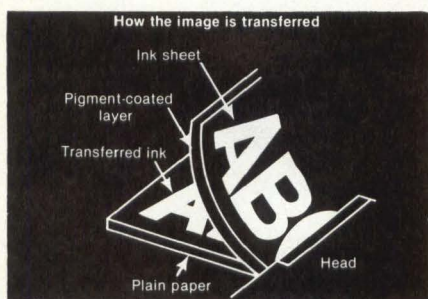

P. 41...Color printer processes video signals

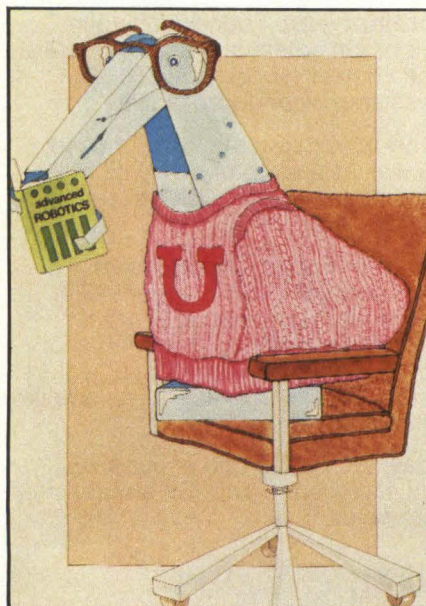

P. 81...Industry, university cooperation



**FEATURES**

- 135 **Highlights**
- 143 **Mass storage** . . . putting 140M bytes into 5 1/4-in. Winchester
- 155 **Markets** . . . floppy disk opportunities are alive and well
- 167 **Driving the market** . . . applications push small Winchester developments
- 189 **Technology** . . . perpendicular recording adds capacity to media
- 199 **Faster operations** . . . closed-loop servo systems speed access time
- 211 **Miniaturization** . . . half-height floppies squeeze more into less
- 219 **Cartridge drives** . . . Winchester cartridge uses embedded servo
- 231 **Disk control** . . . floppy disk controller uses cache for speed
- 239 **Doing business** . . . sharing test results helps keep relations cordial
- 245 **Office automation** . . . bit-map graphics enhance workstation
- 253 **Operating systems** . . . MP/M-86 handles real-time and multi-user applications

**DEPARTMENTS**

- |                   |                            |
|-------------------|----------------------------|
| 4 Editorial staff | 298 Mini-Micro Marketplace |
| 7 Breakpoints     | 302 Classified advertising |
| 64 Box score      | 304 Career opportunities   |
| 260 Calendar      | 310 Index to advertisers   |
| 263 New products  |                            |

MINI-MICRO SYSTEMS (ISSN 0364-9342) is published monthly by Cahners Publishing Company, Division of Reed Holdings, Inc., 221 Columbus Avenue, Boston, MA 02116. Norman L. Cahners, Chairman; Saul Goldwetz, President; Ronald G. Segel, Financial Vice President and Treasurer. MINI-MICRO SYSTEMS is published by the Cahners Magazine Division: J. A. Sheehan, President; William Platt; Executive Vice President; H. Victor Drumm, Group Vice President. Circulation records are maintained at Cahners Publishing Co., 270 St. Paul St., Denver, CO 80206. Second class postage paid at Denver, CO 80202 and additional mailing offices. Postmaster: Send address changes to MINI-MICRO SYSTEMS, 270 St. Paul St., Denver, CO 80206. MINI-MICRO SYSTEMS is circulated without charge by name and title to U.S. and Western Europe based corporate and technical management, systems engineers, and other personnel who meet qualification procedures. Available to others at the rate of \$45.00 per year in the U.S.; \$50.00 in Canada and Mexico; \$65.00 surface mail in all other countries; \$100 foreign air mail (14 issues). Single issues \$4.00 in the U.S.; \$5.00 in Canada and Mexico; \$6.00 in all other countries.

© 1983 by Cahners Publishing Company, Division of Reed Holdings, Inc. All rights reserved.

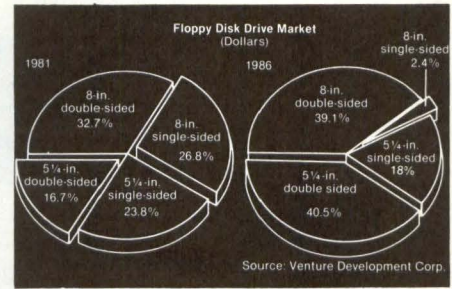

P. 155 . . . Floppy-disk drive markets



P. 167 . . . Trends in small Winchesters

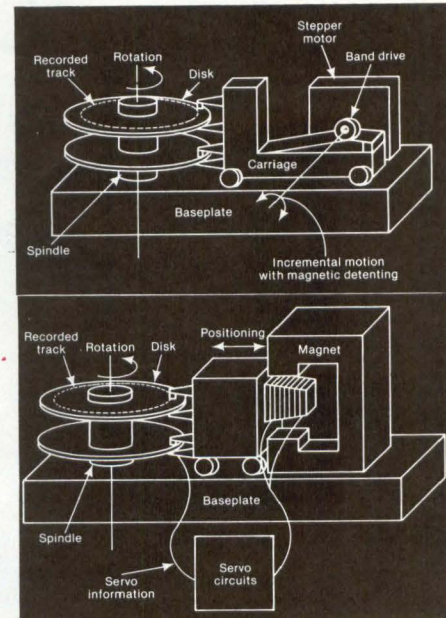

P. 199 . . . Increasing drive performance





# Mainframe Enclosure

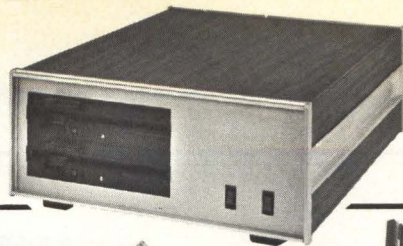

The Buckeye MFE-100 is a rugged, fully enclosed, aluminum Mainframe enclosure designed for quick, inexpensive packaging. A 6 slot rigid aluminum cage set-up for the S-100 is included which can be purchased separately. Overall size is 17" wide x 7.75" high x 23" deep.

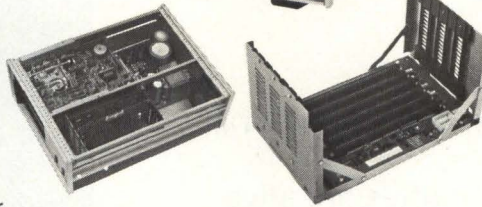

- Front panel punched to accept 2 slimline disk drive units and switches.
- Rear panel punched for fan, six RS 232 connectors, one 25 pin connector, one 50 pin connector, and 1/2" dia. power cord hole.
- Bottom panel slotted for ventilation.
- CHASSIS—punched for mounting power supply and card cage.
- BRACKETS—formed and drilled for slimline disk drives.



Call or Write Today!

## Buckeye

the BUCKEYE stamping company

555 Marion Road, Columbus OH 43207 Phone: 614/445-8433

CIRCLE NO. 5 ON INQUIRY CARD

# alpha data DISCS ARE RESPONSIVE!

- 128 Megabyte capacity
- Less than 18 Msec. Av. Access
- 1 Megabyte cylinder

Alpha Data's new ATLAS moving head Winchester drive responds to your system requirements with unparalleled thruput and performance.

There's more. The ATLAS offers ANSI/SMD interface, proven-in-the-field reliability, retracting heads, and cobalt-plated thin-film discs in a sealed, shock mounted chamber. It's the price/performance leader in mass memory disc drives!

There's even more... write or call for literature.

## alpha data

20750 Marilla St., Chatsworth, CA 91311  
Tel. (213) 882-6500  
TWX: (910) 494-4914

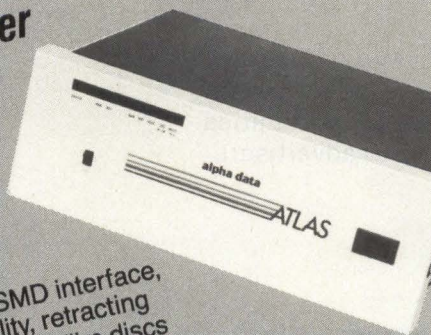

## STAFF

Vice President/Publisher  
**S. Henry Sacks**

Editor-in-chief  
**Lawrence J. Curran**

Managing Editor  
**George N. Bond III**

Executive Editor  
**Alan R. Kaplan**

Boston editorial staff

**Dwight B. Davis:** senior editor

**Patrick Kenealy:** senior editor

**Lori Valigra:** senior editor, news

**Frank Catalano:** associate editor

**David H. Freedman:** associate editor

**Sarah Glazer:** associate editor

**Frances T. Granville:** associate editor

**Mary Anne Weeks:** production editor

**Steven F. Frann:** new products editor

**David Bright:** reporter

Editorial field offices

**New York**

**Geoff Lewis:** correspondent

**San Jose**

**Kevin Strehlo:** correspondent

**Bob Sehr:** correspondent

**Los Angeles**

**Edward S. Foster:** correspondent

**London**

**Keith Jones:** correspondent

**Art Staff**

**Vicki Blake:** art director

**Mark Fallon:** assistant art director

**James Wiley:** artist

Editorial Services

**Phyllis Anzalone, Adrienne DeLeonardo,**

**Jeanne Howat, Elizabeth Kress**

Contributing Editors

**Malcolm L. Stiefel:** product profiles

**Walter A. Levy:** data communications

**Efrem Mallach:** computer architecture

Production Staff

**William Tomaselli:** supervisor

**Noel Boulanger:** production services

**Diane Malone:** composition

Executive VP/Group Publisher

**H. Victor Drumm**

VP/Group Editorial Director

**Roy Forsberg**

Director of Graphics

**Lee Addington**

Vice President, Production

**Wayne Hulitzky**

Vice President, Research

**Ira Siegel**

Assistant to the Publisher

**Linda L. Lovett**

Group Circulation Manager

**Sherri Gronli**

(303) 388-4511

Marketing/Promotion Staff

**Richard B. Dalrymple,** Mktg. Director

**Susan Rapaport,** Promotion Director

**Elizabeth Gotoff,** Promotion

Coordinator

**Wendy Whittemore,** Production

Coordinator

Editorial Offices

**Boston:** (617) 536-7780, 221 Columbus

Ave., Boston, MA 02116. **Los Angeles:**

(213) 826-5818, 12233 W. Olympic Blvd.,

Los Angeles, CA 90064. **San Jose:** (408)

296-0868, 3031 Tisch Way, San Jose, CA

95128. **New York:** (212) 949-4400, 205 E.

42nd St., New York, N.Y. 10017. **London:**

011-44-1-661-3040, The Quadrant, Sutton

Surrey, SM2 5AS, England.



# Open the door to a new UNIX™ performance environment.



Exciting new doors are opening up for UNIX™ users. The Gould CONCEPT 32/87 is the key. Now there's a powerful alternative for the VAX-bound user. Running the authorized version of Bell Laboratories' UNIX operating system, the Gould CONCEPT 32/87 benchmarks at triple the performance of the VAX 11/780\*. This new processing power can make you more productive. Whether you are dealing with VLSI design, molecular modeling, or simulation processing, the 32/87 has the versatility and performance you need for increased productivity.

Now Gould S.E.L. minicomputers offer a comprehensive ICSC-Ada\*\* language translator to open new doors into the state-of-the-art DOD

language environment. The ICSC-Ada translator operates in conjunction with the C compiler under UNIX to enable users of Gould computers to learn Ada and to develop programs to satisfy emerging Ada requirements of military and scientific computer applications.

Let us open new doors to performance and productivity in your compute-bound UNIX environment. Just call or write.

**Gould Inc., S.E.L. Computer Systems Division,**  
6901 West Sunrise Boulevard,  
Fort Lauderdale, Florida 33313 1-800-327-9716.

\*UNIX is a trademark of Bell Labs

\*\*VAX 11/780 is a trademark of Digital Equipment Corporation

\*\*\*ICSC-Ada is a proprietary software product of Irvine Computer Sciences Corporation. Ada is a trademark of the U.S. Department of Defense.



## GOULD

*Electronics & Electrical Products*

CIRCLE NO. 7 ON INQUIRY CARD



# MICROFAZER THE "ANY COMPUTER ANY PRINTER" BUFFER™

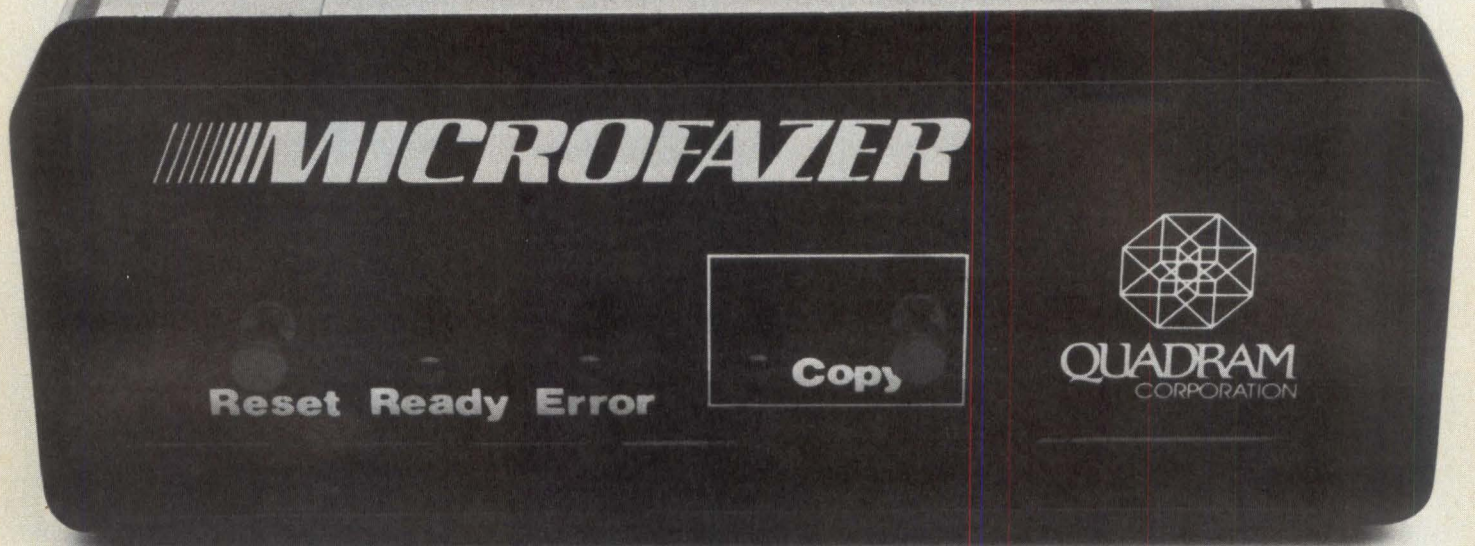

**Time is money.** You have a computer system because you know that it saves you money by simplifying procedures and reducing time normally involved in your work. Time is an important resource which should not be wasted. You are wasting valuable time if you ever wait for your printer.

**No waiting.** Now with Microfazer by Quadram there is no more waiting.

Microfazers are inexpensive universal printer buffers which any computer user cannot afford to be without. Any computer—any printer (or plotter!), whether parallel or serial. Microfazer receives information from the computer at ultra high speeds causing the computer to think the printer is printing just as fast as the computer can send. Microfazer holds the information until your printer can handle it, and then sends it on.



**More copies.** Microfazer is equipped with a copy feature allowing additional copies of the buffered information—from one to as many as you want—with the mere press of a button. When you

need your information repeated, for whatever reason, it's always right there—inside Microfazer.

**Microfazer™ stack.** Microfazer can be stacked with popular modems or other peripherals. Some models can plug directly onto the back of your printer. Install it in less than 60 seconds, and choose the amount of buffer

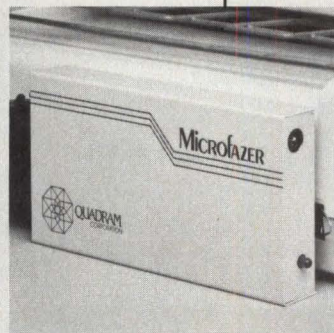

memory you need— 8K, 16K, 32K, or 64K. One model even comes with up to 512K! You may use several Microfazers in series to create just what's right for you.

Take data in from a serial computer and out to a parallel printer. Or in from a parallel computer and out to a serial printer. Microfazer is just as flexible as you need it to be.

**Low price.** Only \$169 for 8K of buffering, \$189 (16K), \$225 (32K) and \$299 for a full 64K. Serial-to-Parallel, Parallel-to-Serial and Serial-to-Serial models have slightly higher prices.

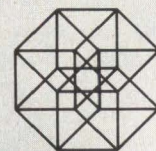

**QUADRAM**  
CORPORATION

4357 Park Drive / Norcross, Ga. 30093  
(404) 923-6666

CIRCLE NO. 8 ON INQUIRY CARD



## Fine tuning an organization



Frann



Glazer

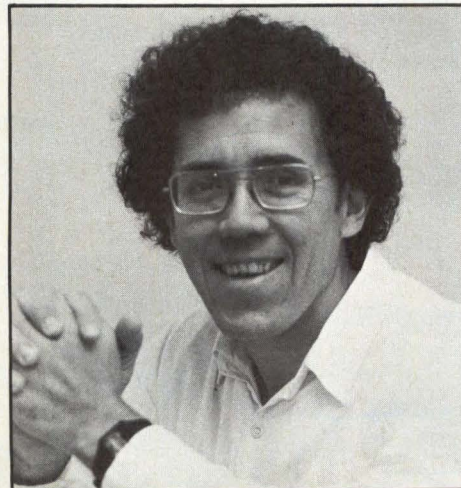

Bright

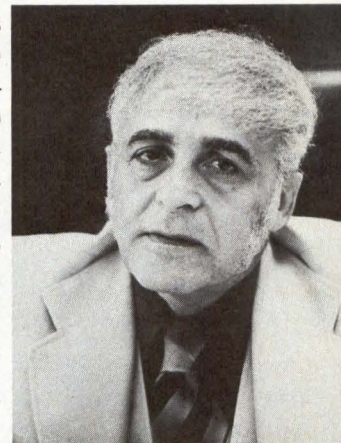

Any organization that has grown as fast as the editorial staff of *Mini-Micro Systems* has in the last few years—from five full-time editors in early 1979 to 18 today—needs fine tuning to adjust to a changing industry and audience. We're doing that fine tuning. Last month, we introduced you to George Bond, managing editor; Bob Sehr, a San Jose correspondent; and Linda Bachmann, an associate editor in Boston. Three other editors take a bow this month: Steve Frann, Sarah Glazer and David Bright.

All three work in the Boston headquarters, but each has a different assignment. Steve Frann, our new products editor for the past several issues, brings a varied background to that section, which always scores very high in readership studies. He has a B.S. in humanities and science from the Massachusetts Institute of Technology, where he majored in a self-developed program that combined elements of cultural anthropology, linguistics, political science and science writing.

Steve was new products editor for *80 Micro* magazine before coming to us, a role that involved writing, copy editing and magazine layout. He's also served internships at *Technology Review* magazine (science writing) and WGBH-TV in Boston.

Sarah Glazer's task is to concentrate on trends, technologies and corporate strategies so that she can contribute in-depth, staff-written articles to The Interpreter and Systems in Manufacturing sections. The latter is a section we've devoted to exploration of the increasingly important role of computers in factory applications.

Before joining *Mini-Micro Systems*, Sarah was managing editor of *Telematics*, a magazine covering the telecommunications and data-communications fields. She also contributed to *International Fiber Optics and Communications*, a sister publication to *Telematics*. Sarah has served as editor of the *Record*, a technical magazine for the industrial property sector of the insurance industry, and has been a technical editor in General Electric Co.'s aircraft engine division in Lynn, Mass.

Sarah earned a B.A. from Harvard College, where she majored in English.

David Bright is serving in a newly created staff position—reporter/news assistant. In that capacity, he will report, write and edit stories for the Mini-Micro World section directed by Lori Valigra, senior editor for news. David is a 1982 graduate from the University of Massachusetts/Boston, with a major in English. He comes to us from a Boston area supply company, where he was a computer operator and director of VisiCalc and DigiCalc training.

S. Henry Sacks  
Vice President/Publisher



# Four reasons why you should look at our Winchester

1. **100% SMD format and interface compatible.**  
Just plug it in and it is ready to accept data.
2. **The best price/performance ratio available.**  
Kennedy can save you an average of \$2000.00 per unit over comparable disk equipment.
3. **Immediate availability.**  
Most models are ready to ship 30 days ARO.
4. **Produced by an industry leader.**  
Kennedy has been manufacturing Winchester since 1978 and its reputation for reliability is known world-wide.

## **KENNEDY**

*An Allegheny International Company*

1600 Shamrock Ave., Monrovia, CA 91016

(213) 357-8831 TELEX 472-0116 KENNEDY

TWX 910-585-3249

### **KENNEDY INTERNATIONAL INC.**

U.K. and Scandinavia

McGraw-Hill House

Shoppenhangers Road

Maidenhead

Berkshire SL6 2QL England

Tel: (0628) 73939

Telex: (851) 847871 KEN UKS G

### **KENNEDY INTERNATIONAL**

Koningin Elisabethplein, 8

B-2700 Sint-Niklaas

Belgium

Tel: (03) 777 1962

Telex: 71870 KEN CO

165 Megabytes



82 Megabytes



# **KENNEDY • QUALITY • COUNT ON IT**

CIRCLE NO. 9 ON INQUIRY CARD



# Breakpoints

---

## **NEW SYSTEMS, REPRICING, MARK HP LOW-PRICE STRATEGY**

Hewlett-Packard Co., as part of what it terms an assault on the market for lower priced business computer systems, will introduce the 3000 Series 39 this month. The 39 offers the same performance as the 40SX, which it supersedes, at prices as much as 20 percent lower. Prices of packaged systems range from \$33,900 to \$45,200. Prices of mid-range 3000 Series 40 and 44 models have been reduced 15 to 17 percent, and add-on memory prices have been reduced 15 to 26 percent. HP also offers 17 percent lower prices on a typical HP 250 model 20 small-business computer. A new model 25 with 256K bytes of memory, 9.7M bytes of disk memory, a 1.2M-byte floppy disk drive, a console and a printer is list-priced at \$17,000. Software developments added recently by HP include an HPMENU for 3000 systems programs, graphics software for the 250 models and larger volume discounts on some application software.

## **XEROX PC STRATEGY TARGETS MAJOR ACCOUNTS**

After its admittedly weak first stab at the personal computer market, Xerox Corp. has refined its strategy for the revamped 820-II. Now the system is being pushed through Xerox's major accounts marketing force as an entry-level managerial workstation. Xerox officials say sales into major accounts in this market have doubled from month to month since the introduction of the 820-II last summer. To advance the 820 as a workstation for managers and other office personnel, Xerox is expected to announce a direct Ethernet connection early this month. Previously, the 820 could connect only to the local-area network via a communications server. In addition, Xerox officials say they will have an integrated package similar to Visicorp's Visi<sup>on</sup> by the time that product is shipped with IBM systems this summer. The addition of such software could make the 820 a kind of poor-man's Star workstation and possibly an alternative to Apple Computer Inc.'s Lisa.

## **TANDY ADDS ALTERNATE MODEL II, MODEL 16 OPERATING SYSTEMS**

After relying exclusively on its proprietary TRS-DOS operating system, Tandy Corp. is augmenting its personal computer line with industry-standard operating systems. The company last month conceded to peer pressure in the low-end market and added Digital Research's CP/M + operating system as a \$250 option for its model II line. On the high-end dual-processor Z80/MC68000 model 16, the company has added its long-awaited, multi-user UNIX operating system, which is Microsoft's XENIX instead of the anticipated UNOS version from Charles River Data Systems. The XENIX package is free to model 16 customers in a run-time version and is priced at \$750 as a development system with the C language. Other languages such as COBOL and BASIC are offered on the run-time version, as are Microsoft's Multiplan and accounting packages. Tandy also plans to offer FORTRAN and Pascal this spring. For small-business system OEMs, the company has added RM-COS.

## **FAULT-TOLERANT DPS 6 EXPECTED FROM HONEYWELL**

By mid-year, Honeywell Information Systems is expected to launch a highly resilient hardware/software package for DPS 6 minicomputer transaction-processing networks. Marilyn Maleckas, manager of marketing support for the DPS 6, notes that several divisions within Honeywell are installing the resilient system. They include the company's Automatic Response Centers that handle urgent customer problems. She identifies industrial control and on-line order entry as promising applications. Software for the resilient system comprises an enhancement to the TPS 6 transaction-processing system, which, in turn runs under the GCOS 6 operating system. Essential hardware includes two DPS 6 minicomputers, a high-speed line linking their buses and a unit for switching terminal communications lines between the processors.

## **TABOR MICROFLOPPY DEBUTS IN FORTHCOMING SOROC SYSTEM**

Soroc Corp., Anaheim, Calif., will become one of the first manufacturers to market a desk-top system using the Tabor 3¼-in., 500K-byte floppy disk drive. Soroc will use the



# Breakpoints

---

microfloppy in its Excecline series due out late this month. Soroc expects to retail its small-footprint system at less than \$2000, including bundled software. Under a \$12-million contract with Tabor, Soroc will initially use single-sided floppies and then double-sided floppies as they become available. The system may also be enhanced in the near future with a SyQuest 3.9-in. fixed/removable cartridge or a Seagate 3½-in. Winchester drive (MMS, January, p. 15), depending on availability.

## **NCC MOVES TO LAS VEGAS IN 1984**

In the face of a threat by more than 200 exhibitors, representing more than 100,000 sq. ft. of exhibit space, to pull out of the National Computer Conference, show sponsor the American Federation of Information Processing Societies has shifted the location of the 1984 show from Houston to Las Vegas. Exhibitors had complained about poor and scattered facilities as well as intolerable heat and humidity at last year's show. After this year's show in Anaheim, NCC will be rotated for the next four years between Las Vegas and Chicago. The two cities represent the only sites large enough to accommodate the show, says Larry Jennings, manager of exhibit operations at AFIPS.

## **INTEL MAY ADOPT CAP-CPP X.25 BOARD**

Packet-switching applications involving the X.25 protocol are the target for a board-based package being prepared for Intel Corp. systems by software house CAP-CPP Ltd., Reading, England. Intel's Software Distribution and Support Operation, Santa Clara, is evaluating the product with a view toward selling and supporting it or just recommending it. SDSO's strategic marketing manager, Peter Chess, offers no additional comments. Peter Weston, CAP-CPP industrial systems manager, hopes that Intel will adopt the product but notes that it will be made available in the U.S. through the offices of CAP-CPP Inc., New York. The X.25 software will run on a PC board configured around the Intel 8088 processor and will be sold like a disk controller, says Weston. He explains that it will interface with the Intel Multibus and will enable the host Intel CPU to communicate over an X.25 network. The CPU could be an 8086, an iAPX 186 or 286 or an 8-bit processor.

## **START-UP TO OFFER LOW-END FAULT-TOLERANT SYSTEM**

Tolerant Transaction Systems, Inc., San Jose, has been formed to market a low-end fault-tolerant computer. The system, expected to be introduced in the last quarter of this year, will be based on National Semiconductor Corp.'s recently introduced NS16000 chip, and will be aimed at the OEM market. The company has obtained an undisclosed amount of venture capital from Adler & Co., New York, and is looking for a "benefactor"—a large company such as Burroughs Corp. or NCR Corp. that would like to enter the fault-tolerant market without the expense of in-house development.

## **SOFTWARE HELPS RPG II PROGRAM MIGRATION FROM IBM SYSTEM /34 TO PRIME MINIS**

The Escape/34 software package, due for shipment mid-month, is said to allow IBM Series/34 users to move RPG II programs easily and inexpensively to Prime Computer Inc.'s 32-bit minicomputers. Available from Database Systems Corp., Phoenix, Ariz., which develops software exclusively for Prime products, Escape/34 employs a menu-driven screen utility to help users operate an application after it is moved. Escape/34's RPG II compiler accepts System/34 RPG II code for recompilation. RPG II application programs can then be run on Prime machines. The product is priced at \$10,000.

## **UTILITY ALLOWS FILE TRANSFERS AMONG MINICOMPUTERS AND MICROCOMPUTERS**

A file-transfer utility using an SDLC-like protocol is said to allow a wide range of minicomputers and microcomputers to send and accept each other's files across standard dial-up telephones, satellite links, local-area networks, packet-switched networks and direct cable connections. Called Blast, for blocked asynchronous transmission, the utility is priced at \$250 to \$900, depending on CPU size. The product from Communications



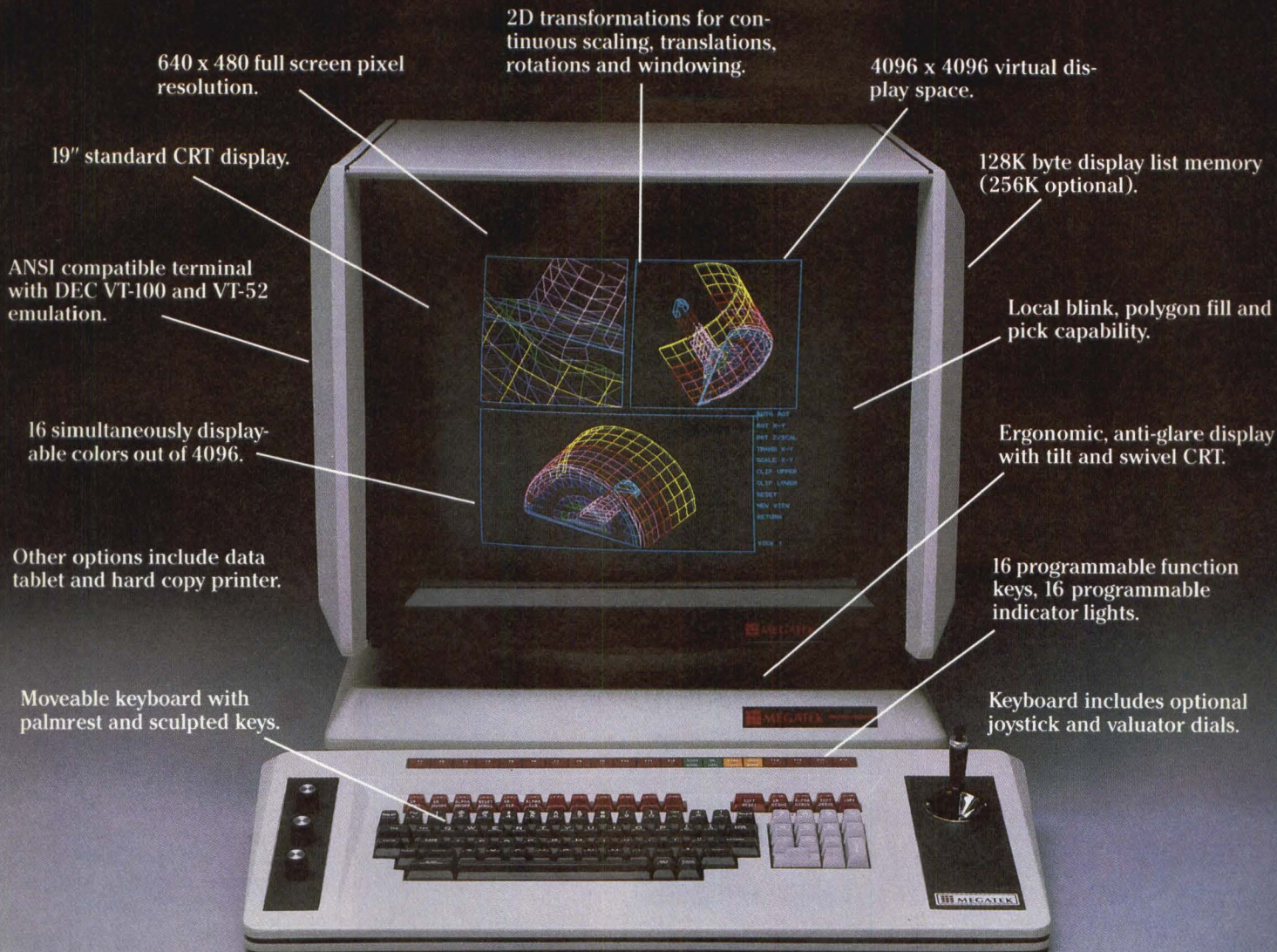

640 x 480 full screen pixel resolution.

2D transformations for continuous scaling, translations, rotations and windowing.

4096 x 4096 virtual display space.

19" standard CRT display.

128K byte display list memory (256K optional).

ANSI compatible terminal with DEC VT-100 and VT-52 emulation.

Local blink, polygon fill and pick capability.

16 simultaneously displayable colors out of 4096.

Ergonomic, anti-glare display with tilt and swivel CRT.

Other options include data tablet and hard copy printer.

16 programmable function keys, 16 programmable indicator lights.

Moveable keyboard with palmrest and sculpted keys.

Keyboard includes optional joystick and valuator dials.

# Thaumaturgy.\*

Graphics miracles right on your desk. Our latest Whizzard.™ The 1650 desk top design terminal. Now, anyone can afford the power and performance of our more expensive Megatek Whizzards. Your own design station right at your fingertips. Another product of Megateknology.™

Finally. Everything an engineer or designer could want in desk top computer graphics. Convenience. High quality and powerful performance. VT-100 compatibility.

Functionality. Greatly increased productivity. Shouldn't every desk top design terminal offer this?

Tomorrow's graphics technology on your desk top today... thanks to Megateknology.

**Making History out of State-of-the-Art.**

\*Thaumaturgy (thō ma tūr jē), n., the performance of miracles.

**MEGATEK CORPORATION**  
UNITED TELECOM COMPUTER GROUP

World Headquarters • 3985 Sorrento Valley Blvd., San Diego, CA 92121 • 619/455-5590 Telex: 910-337-1270

CIRCLE NO. 10 ON INQUIRY CARD



# THE PROWRITER COMETH.

*(And It Cometh On Like Gangbusters.)*

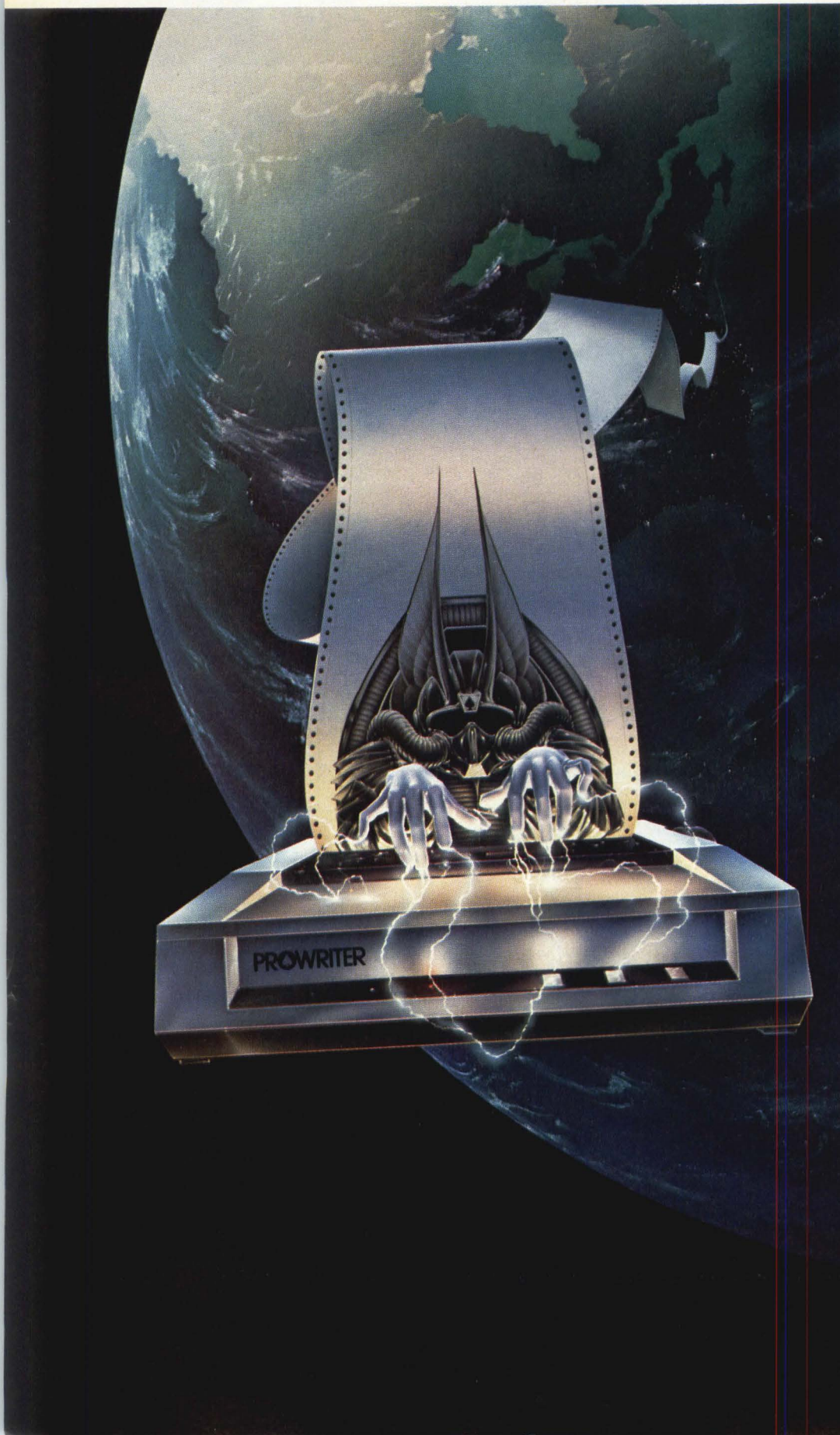

Evolution.

It's inevitable. An eternal verity.

Just when you think you've got it knocked, and you're resting on your laurels, somebody comes along and makes a dinosaur out of you.

Witness what happened to the Centronics printer when the Epson MX-80 came along in 1981.

And now, witness what's happening to the MX-80 as the ProWriter cometh to be the foremost printer of the decade.

## **SPEED**

MX-80: 80 cps, for 46 full lines per minute throughput.

PROWRITER: 120 cps, for 63 full lines per minute throughput.

## **GRAPHICS**

MX-80: Block graphics standard, fine for things like bar graphs.

PROWRITER: High-resolution graphics features, fine for bar graphs, smooth curves, thin lines, intricate details, etc.

## **PRINTING**

MX-80: Dot matrix business quality.

PROWRITER: Dot matrix correspondence quality, with incremental printing capability standard.

## **FEED**

MX-80: Tractor feed standard; optional friction-feed kit for about \$75 extra.

PROWRITER: Both tractor and friction feed standard.

## **INTERFACE**

MX-80: Parallel interface standard; optional serial interface for about \$75 extra.

PROWRITER: Available standard—either parallel interface or parallel/serial interface.

## **WARRANTY**

MX-80: 90 days, from Epson.

PROWRITER: One full year, from Leading Edge.

## **PRICE**

Heh, heh.

*Marketed Exclusively by Leading Edge Products, Inc., 225 Turnpike Street, Canton, Massachusetts 02021. Call: toll-free 1-800-343-6833; or in Massachusetts call collect (617) 828-8150. Telex 951-624.*

## **LEADING EDGE™**

*For a free poster of "Ace" (Prowriter's pilot) doing his thing, please write us.*

**CIRCLE NO. 11 ON INQUIRY CARD**



# Breakpoints

Research Group Inc., Baton Rouge, La., was expected to be announced late last month for Data General Corp., Digital Equipment Corp. VAX, Apple Computer Inc., IBM Corp. PC and CP/M- and MP/M-based computers. The Blast products use a high-level full-duplex sliding window protocol that is said to allow error-free data transfer.

## **TRIDATA PROTOCOL CONVERTER TO LINK VARIOUS SMALL SYSTEMS**

Tridata Corp., Mountain View, Calif., this month is expected to release Netway, a protocol converter designed to link a variety of dissimilar minicomputers, microcomputers and mainframes using more than six protocols. The protocols include those for IBM SNA/SDLC and 2780/3780, Burroughs poll/select, X.25 and one from Control Data Corp. Tridata, which has marketed intelligent modems, says Netway will go far beyond protocol conversion to function as a multiplexer, a data concentrator and a packetizer as well. The Z80-based Netway 100 board will handle the data conversion at the system node level, using instructions down-loaded from the dual Z80 Netway 200 host. A base price of \$250 per connection is projected. Tridata will cater to OEMs with a protocol development language for custom needs and is leaving a slot in the 200 for add-ins.

## **MEMOREX JOINS 5¼-IN. RIGID DISK DRIVE MARKET**

Memorex Corp. has made a first move into the explosive 5¼-in. rigid disk drive market by announcing a joint R&D and manufacturing license agreement with DMA Corp. Under the agreement, Memorex will immediately manufacture DMA's Micro Magnum fixed/removable 10M- to 15M-byte, 5¼-in. cartridges. For its part, DMA will share in R&D of a 5¼-in. Winchester with Memorex and will get a manufacturing license for a 5¼-in. fixed Winchester. As part of the deal, Memorex also obtained a minority interest in DMA.

## **TOKEN-PASSING LAN PRODUCTS SAID TO MEET IEEE-802 STANDARDS**

Token/Net, a local-area network interface system operating on CATV-compatible broadband cable, is expected to be unveiled next month at Interface '83 by Concord Data Systems, Waltham, Mass. The system uses a 5M-bps RF modem with token passing and a bus topology. Token/Net is said to comply fully with IEEE 802 LAN standards. The products are slated for June or July availability at a price of less than \$1000 per port.

## **TECHFILES: A quick look at industry developments**

**Micro files: Callan Data Systems has signaled its intention to pursue the federal government market.** Last month, the company added an Ada package supplied by Computer Science Corp., Irvine, Calif., and signed up Falls Church, Va., General Services Administration contractor Terminals Unlimited for a \$1.8-million order. In addition to the Ada package for its MC68000-based UNIX system, Callan has purchased a \$595 word-processing package and a program-oriented text editor that will be bundled with its Unistar system.... **Commodore Business Machines is the latest vendor to add its entry to a flurry of portable computer announcements.** The company has announced a monochromatic display portable unit with prices starting at \$995 and a color version with prices starting at \$1495. But Commodore's big news is a deal with Zilog Inc. that will give Commodore access to Zilog's Z8000 16-bit microprocessor design, which is expected to emerge in Commodore high-end products as early as this year's Hanover Fair.... Meanwhile, **Colby Computer**, Oakland, Calif., has developed a solution to the IBM "compatibility problem" among portables. Colby is marketing an \$895 kit that enables a nontechnical person to remove an IBM PC from its case and convert it into a portable, including the 9-in. standard display. The procedure is expected to take only 20 to 40 min. using a screwdriver and has reportedly raised the possibility of gaining some large OEM and other major orders among customers who want to avoid the compatibility issue. For another \$135, Colby will offer a kit that will make the desk-top IBM chassis a five-slot expansion box.... In another part of the IBM PC forest, **Sritek Inc.**, Columbus, Ohio, is offering Z80, 8086, 80286, MC68000 and National 16032 boards for the IBM box. Each



# Breakpoints

processor can be attached to a 0.5M-byte card, and is expected to be available with XENIX or another UNIX implementation....**IXO Inc.**, Culver City, Calif., is delaying announcement of a networking product using an IBM PC as a host computer because of a change in the company's presidency. Jeffrey Bachman, formerly vice president and chief financial officer, replaces Jeffrey Rochlis, who left to form an entertainment software start-up....Under its Digital Classified Software program, **Digital Equipment Corp.** is selling and supporting COBOL compilers and programming tools developed for its microcomputer products by Micro Focus, Santa Clara. The compilers and tools will be available for Robin and DECMate II machines under CP/M and for the Rainbow 100 under CP/M-86.

**Communications lines: Ungermann-Bass** has agreed in principle to acquire **Amdax Corp.**, Bohemia, N.Y. The acquisition of Amdax strengthens Ungermann-Bass's position in the broadband CATV market—the installed base of Amdax broadband modems is greater than 10,000. Research at the Amdax facility in Boca Raton, Fla., on high-speed mainframe-to-mainframe communications makes the entry of Ungermann-Bass into the SNA market likely late this year....Meanwhile, in Ungermann-Bass's own R&D labs in Santa Clara., work is nearing completion on a lower priced, smaller version of the company's general-purpose Net/One communications system, based on the LAN chip set it developed jointly with Fujitsu.

**Random disk files:** Media appears to be the message being received in the Silicon Valley venture-capital community as at least three media start-ups have sprung up in the last two months. **Grenex Corp.** received a third of its funding from Seagate Technology and the rest from venture capitalists. The Sunnyvale, Calif., firm will specialize in vertical recording media and expects to have a product in early 1984. It is headed by former Seagate chemical engineer Earl Blevis....**Akashic Memories** was formed in December by John Scott, formerly general manager of Apple Computer Inc.'s Disk Drive division. Akashic will concentrate on thin-film media, in the hope of filling anticipated heavy demand in a market now dominated by Ampex Corp....**Trion Corp.**, Santa Clara, Calif., is still in the formative stages, with principals expected to emerge this month from Verbatim Corp. and Dysan Corp. The start-up will concentrate on 5¼- and 8-in. floppy disks and is expected to offer new packaging and wider distribution. A company spokesman says Trion will attempt to repeal the pseudo-scientific image of floppy disks by distributing them through drugstores and discount outlets....**In just three and one-half months, Hewlett-Packard Co.'s personal computer division has sold nearly 10,000 of its Series 70 systems, incorporating the Sony 3½-in. floppy.** A source high in the personal computer division says 3½-in. floppies already comprise most of the floppy disk systems that HP sells....Perhaps in deference to HP's demands, **Sony Corp.** will continue to manufacture its first-generation 3½-in. floppy. Meanwhile, Sony has agreed to manufacture a second generation of 3½-in. floppies with automatic shutters and other features prepared to the standard sought by a U.S. industry committee including Shugart Associates and Verbatim.

**Terminal files:** Introductions of low-cost color ASCII terminals from **Applied Digital Data Systems** and **Wyse Technology** have fueled speculation about whether other independent terminal vendors will introduce color units. **Hazeltine Corp.**, for example, is believed to have a 640 × 480 dot resolution graphics terminal running in-house based on Intel Corp.'s 82720 color video controller chip, but rumors about Hazeltine wanting to sell its terminal division make the product's introduction uncertain....**Zentec Corp.** is readying a medium-resolution graphics terminal for the OEM that should premiere at NCC, with a list price of less than \$7000....But that price may not be low enough if the rumor of a **Tektronix Inc.** graphics terminal, code-named Unicorn and priced at less than \$5000, proves true....Meanwhile, Berkeley, Calif. start-up **Cubic Systems**, which offers the \$9870 CS-3 graphics system with 512 × 512 dot resolution that performs 3D object manipulations locally, is close to introducing a less expensive product with similar capabilities based on the IBM PC.



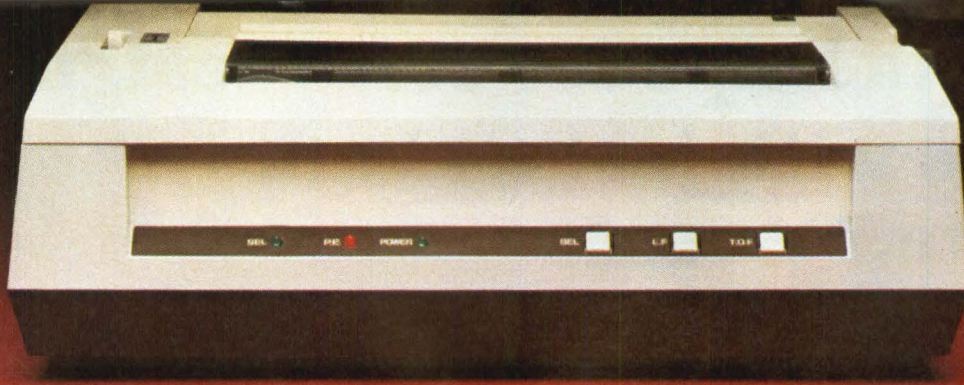

8510A Pro/Writer

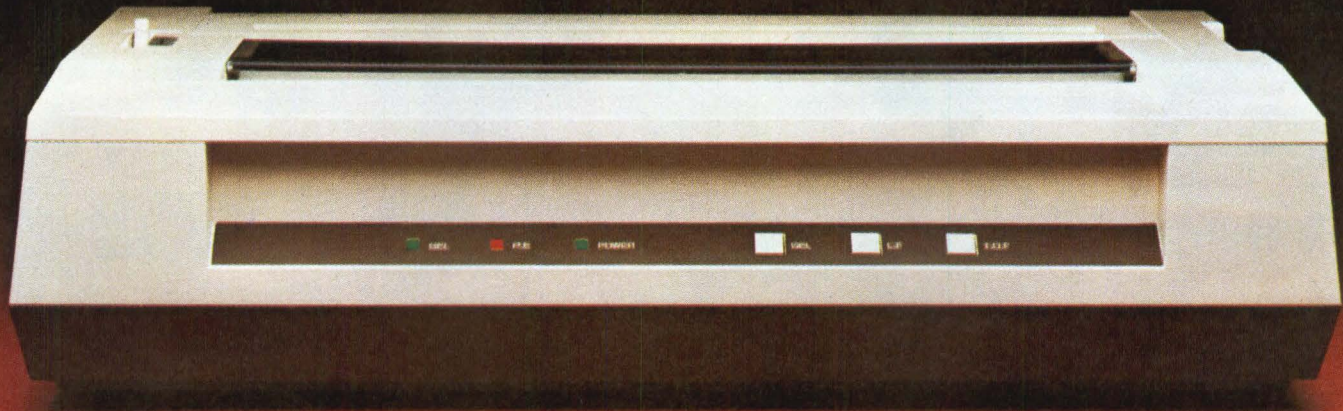

1550 Pro/Writer II

## OUR LINE KEEPS GROWING WIDER.

C. Itoh's high-performance family of low-profile printers has grown bigger and better than ever. There's the Series 8500 Pro/Writer, our feature-loaded 8" compact with 120 cps print speed and 80-column capacity. And now there's Pro/Writer II, the new 15½" wide-track that prints up to 230 columns at a fast 120 cps print speed.

Both feature heavy duty castings and stepper motor, high reliability print mechanism, and a synthetic ruby print head that maintains a high print quality throughout its entire 100-million plus character life. No wonder Pro/Writers can deliver an estimated 15 months service (average use) — without a single failure.

You get consistent, correspondence quality printing too. Plus a long list of most-wanted features, including:

1. True incremental printing
2. Five unique alphabets,

eight character sizes (two proportionately spaced)

3. Mixed fonts during a single line pass

4. Bidirectional, quick-cancel printing for higher throughputs than comparable printers spec'd at greater print speeds

5. Graphics mode with better resolution (144 x 160 dots per square inch) than many graphics plotters

6. Variable form length, six-channel electronic vertical formatting

7. Automatic vertical and horizontal tabbing

8. Bidirectional tractor and roll feed

9. 1K Byte buffer (expandable to 3K) for Series 8500 Pro/Writer. Pro/Writer II comes with 3K Byte buffer standard

10. Easy-load cartridge ribbon
11. Industry-standard parallel

or serial interfacing with popular X/ON, X/OFF protocols

Pro/Writers are designed for easy maintenance throughout and feature "Microcomputer-on-a-board" technology and convenient, operator-replaceable print head. Result: Mean Time to Repair for a trained technician is just half an hour — worst case.

It all adds up to the dependability and high performance OEM's have been waiting for. C. Itoh's reliable Pro/Writer family of printers. It's growing wider all the time.

For full details, contact C. Itoh Electronics, Inc., 5301 Beethoven Street, Los Angeles, CA 90066. (213) 306-6700

 **C. ITOH  
ELECTRONICS, INC.**  
One World of Quality

DESIGNED FOR THE OEM

For information circle 12



**“My modem helps me solve design problems with just a single keystroke.”**

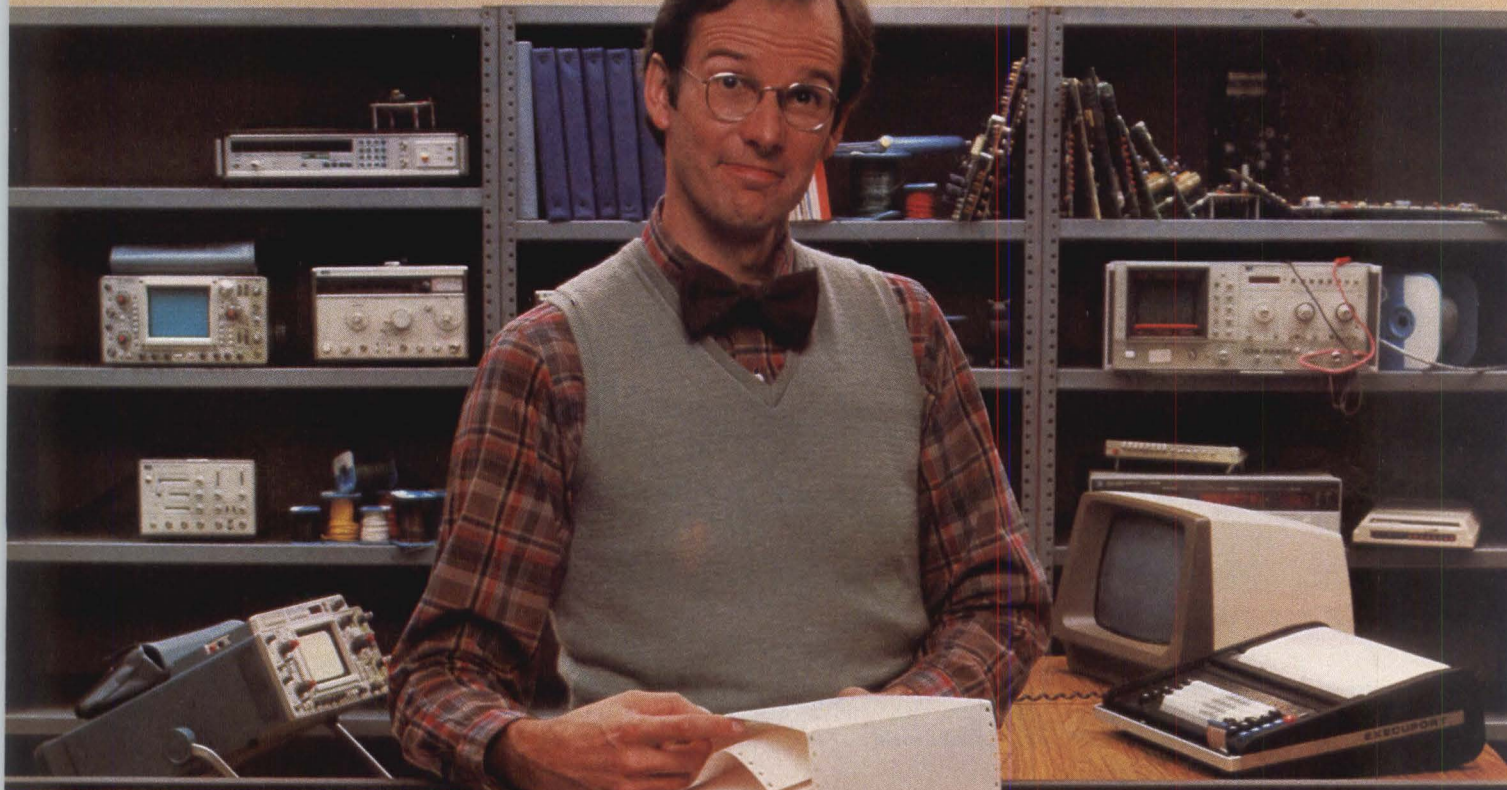

## **The One-Button Modem Solution**

**The MD212 Plus II™ does the *MENIAL* tasks so the busy design engineer is free to *create*.**

I used to be a pretty harried guy. I've always been in a hurry to solve my design problems. But I didn't have a lifetime to spend dialing numbers, re-dialing, typing in passwords, account numbers, etc. Then there was all the aggravation of retyping the data every time.

But that's all behind me now. Now, I spend my time solving problems, not typing. Using an MD212 Plus II is like having a "personal computer" right inside my modem. My productivity shot up by 200%. I can work any problem in 1/5 the time. I can even submit multiple design parameters with just the push of a button. My modem does all the mechanical



1200/300 bps compatible, 212A originate, auto-answer standalone modem with integral autodialer.

data entry whenever and as often as I want; even when I'm out of the room. With my Ven-Tel modem, I can enter any design parameter; I can even add and delete steps before I use expensive computer time. I store each design routine in the modem's memory. And I can even take the modem home with me. The data stays right in the modem's memory, ready to work when I am.

If you've got designs in your future, get yourself a good head start with a Ven-Tel modem. It's the "one button" solution that's tough to beat. And you can take that from a frustrated two finger typist.



Trademark of Ven-Tel, Inc.

CIRCLE NO. 14 ON INQUIRY CARD

**CALL** OUTSIDE CALIFORNIA **800-538-5121** IN CALIFORNIA **(408) 727-5721**  
2342 WALSH AVENUE • SANTA CLARA, CALIFORNIA 95051



# Mini-Micro World

NEWS



**Barry Smith, Apple's product marketing manager for Lisa software, says the bundled \$9995 Lisa MC68000-based microcomputer required added memory and disk space to run a complement of six proprietary application packages. The price also includes 1M byte of main memory, two built-in minifloppy drives, a Seagate 5M-byte, 5¼-in. Winchester disk drive, a keyboard with calculator keypad, a 12-in., black-and-white bit-mapped display, a mouse data-entry device, two serial ports and one parallel port, the Lisa operating system and five application packages. (Photo by Mort Thomas)**

## Apple bets on proprietary software in its bid for office systems market

Apple Computer, Inc., last month became the latest vendor attempting to bring office automation to the desks of office professionals and middle managers with the introduction of its long-anticipated Lisa system. Based on a Motorola MC68000, the system is offered in a tightly bundled \$9995 package that includes a proprietary UNIX-like operating system and six proprietary application packages.

With an optional Apple local-area-networking scheme, Lisa appears to be aimed squarely at the major account office-automation territory that Xerox Corp. staked out almost two years ago with its Star 8010

workstation/Ethernet combination.

The basic Lisa system is built around a 5-MHZ, 16-bit MC68000 microprocessor with 1M byte of main memory implemented in 64K-bit RAMs. It includes two built-in Apple minifloppy disk drives (see "Apple to manufacture disk drives," p. 18), a Seagate 5M-byte, 5¼-in. Winchester disk, a typewriter keyboard with calculator keypad, a 12-in. black-and-white, bit-mapped display, a mouse, two serial ports and one parallel port. The \$9995 package also includes the Lisa operating system, LisaCalc, LisaWrite, LisaGraph, LisaDraw, LisaList and LisaProj-

ect application packages that are, respectively, spread-sheet analysis, word-processing, business-graphics, diagram-drawing, database-management and project-management packages.

The company originally had planned to market the system in a \$6995 version with 512K bytes of main memory, a keyboard, a display, dual floppy disks and the operating system, but shortly before introduction, marketing management decided to offer the bundled \$9995 version instead. The added memory and disk space are necessary to run the full complement of Lisa software efficiently,



says Barry Smith, Apple product marketing manager for Lisa software. The \$9995 version, with the added memory, rigid disk and application programs (each of which was to have been separately priced at \$300 to \$500), represents \$13,000 to \$14,000 worth of hardware and software, he claims.

The Lisa system is the first product of Apple's two-year-old, 70-employee Personal Office Systems division, headed by former software vice president John Couch. The Lisa project, initiated four years ago, represents a major corporate commitment to enter the high-stakes office-automation market against not only Xerox Corp., but also Wang Laboratories, Inc., and IBM Corp., among others.

However, Apple has also taken steps to retain its position in the traditional personal-computer market, in which its new office-automation rivals have already invaded Apple turf with their personal computers. With the Lisa introduction, the company announced a re-engineered version of its mainstay, the Apple II (see "E stands for extended life," p. 20).

Lisa, which stands for locally integrated software architecture, embodies many of the user interface principles that Xerox's Office Products division pioneered with its \$16,500 8010 Star workstation. Both systems use a proprietary operating environment that is tied to the system hardware. Both use multiple windows on a high-resolution display to replicate papers on an executive's desk, and both rely on an electromechanical mouse device to point and select data or functions represented by symbols on the screen.

One of the key differences, and one that Apple president Mike Markkula cites as among "the most significant" aspects of the Lisa program, is a third-party software

program. Unlike Star, which is restricted to Xerox applications, Lisa is expected to have an array of third-party applications that will be developed using a Lisa tool kit. Price for the Pascal-based tool kit has not been set, but Smith says he expects it will be available to software developers in the fourth quarter of this year. For other applications that Smith calls "classic high-end personal-computing packages," Apple offers developers and end users a choice of BASIC, Pascal or COBOL packages that have been tentatively priced at around \$1000. Smith says FORTRAN will also be

added.

While Smith says the Lisa software system will remain "married" to the Lisa hardware package, he indicates that the company is looking at other operating systems to coexist with Lisa's. "In addition to our own operating environment, we want to bring up CP/M, and we're moving on UNIX," he says. The company's own Apple DOS and SOS operating systems proved too expensive to adapt as emulation packages on Lisa, he says.

The Lisa operating system is written mainly in Pascal, as are the applications. About 2 percent of the

## APPLE TO MANUFACTURE DISK DRIVES

Apple Computer, Inc., a pioneer in personal computers, is one of the first personal computer companies to design and manufacture its own disk drives. Even Apple's newest and most serious rival, IBM Corp., buys drives for its Personal Computer from Tandon Corp., a high-volume, low-cost supplier.

The new drives will be offered with the Apple III, as well as the new generation of Apple microcomputers.

Apple previously bought its drives from Alps Electronics of Japan and added electronics and heads from its head manufacturing plant in Newbury Park, Calif. The new generation of higher capacity drives—UniFile and DuoFile—will be completely manufactured at the Southern California facility. Alps will continue to supply its drives for the Apple II and will become a second source for the new generation of Apple drives.

Software and controller modifications would be required to make UniFile and DuoFile compatible with the Apple II, says Barry Yarkoni, marketing manager for Apple's Peripheral Systems Division. "Those modifications are not in the works, but that's not to say it isn't planned in the future," he says.

UniFile is a single drive unit with an unformatted capacity of 871.4 bytes, or four times the capacity of the current generation of Apple drives.



DuoFile contains two drives, for a total unformatted capacity of 1.6M bytes. To achieve that capacity, Apple will buy media from Verbatim Corp., 3M Co. and others. Apple's new drives will operate at 62.5 tpi, up from 48 tpi on the current generation of Apple drives. Apple did not go to 96 tpi for reliability reasons, Yarkoni says. "We don't believe—and our media suppliers certainly don't believe—that 96-tpi densities will provide enough data integrity for our users," he says.

The foremost consideration in the media is to the sensitivities of personal computer users, Apple officials say. Even though the Apple III and the new generation of Apples are aimed at the business market, many of the new users have not been trained in the proper care and feeding



operating system is written in assembly language, and most of that is dedicated to the graphics kernel so that Lisa can have quick graphics processing without the expense of a graphics co-processor, Smith says. He adds that Apple looked at UNIX as Lisa's operating system, but decided too many alterations would be required to attain Lisa's rapid inter-process communications and file protection.

In the near term, Apple is concentrating its efforts on selling the system through select members of its dealer network and a national accounts sales force that is expected

### ETHERNET TO BE OFFERED ON APPLE II AND III

3com Corp. has signed a multimillion-dollar contract with Apple Computer, Inc., to provide Ethernet local networking products for the Apple II and III. Ethernet has been adopted as a standard by more than 40 U.S. and foreign companies, the European Computer Manufacturers Association and the Institute of Electrical and Electronics Engineers. Bill Krause, 3com president, predicts a shift to networked personal computers in the next five years as a cost-effective replacement for time-shared minicomputers. Shipment of Ethernet prototypes to Apple were scheduled to begin last month. The contract covers 3com shipments to Apple through June, 1986.

to reach 100 representatives—double the current level—when Lisa is shipped in late spring. About 150 dealers had previewed the system by the end of last year,

Smith says, and Apple anticipates that 15 to 20 percent of the company's 1400 domestic retail outlets will qualify to handle the new system. Dealers that qualify must demonstrate the ability to provide training and on-site support as well as the financial strength to carry a more expensive product. Other computer dealers that have found previous Apple products not sophisticated enough for their markets may sign with Apple for Lisa, Smith says.

Beyond 1983, however, the company sees "OEMs as a really big potential outlet for this product," Smith points out. Both hardware and software OEMs will be signed to address vertical market niches by 1984, he predicts. In the meantime, Apple will concentrate on selling the tightly bundled Lisa package to end users.

As in Star and the recently introduced Visi<sup>On</sup> package from VisiCorp (MMS, February, p. 00), the application programs and documents created are presented as multiple, overlapping windows on the screen. Using the mouse to point and select, a user can bring a "page" to the top of the screen and shrink or expand the size of the window. The bit-mapped screen addresses 720 pixels vertically and 364 pixels horizontally.

The Apple networking scheme uses coaxial cable, which will be sold in pre-cut lengths for easy installation. Smith says the company

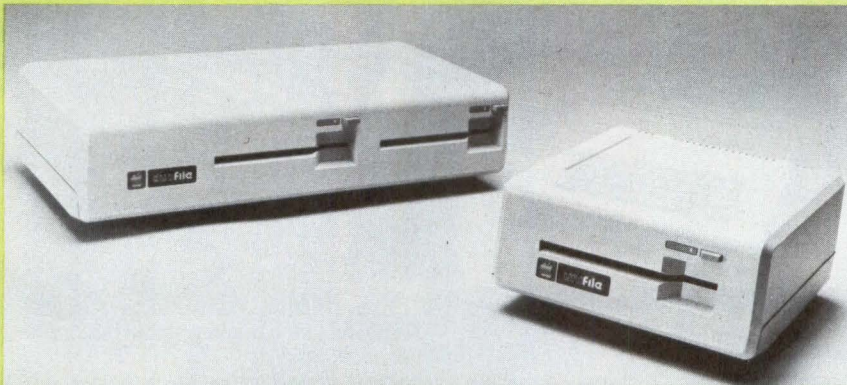

Apple Computer has redesigned its disk drives for the Apple III and its new generation of business computers both inside and out (right). The new design stresses ergonomics on the outside and data integrity on the inside. The first generation of minifloppies will continue to be manufactured for Apple by Alps Electronics of Japan for use on the Apple II.

of media. "Most media is made to withstand the extremes of room temperature. We have gone beyond that to allow the media to withstand temperature ranges as high as 140°," Yarkoni says.

He adds that users often move flexible media from place to place. For example, they store it in a cool place such as a briefcase in a car trunk and then take it indoors. The result is often damaged media, Yarkoni says. Use of the head-disk assembly also reduces media wear because heads are located at opposite ends and sides of the diskette, unlike a standard double-sided assembly, which posi-

tions the heads on the same end and thereby increases pressure on the media.

The drive has eight electronically controlled motor speeds, which vary from track to track to use each track to its fullest bit density. Outside tracks previously could not achieve the same density as inside tracks because of the ways the heads were moved over the diskette.

Both drives will be available in the second quarter of this year. UniFile lists at less than \$1000 each, and DuoFile lists at less than \$1700.

—Robert A. Sehr



# Mini-Micro World

NEWS

decided on a proprietary network instead of Ethernet or other commercially available networks to assure easy installation. Apple Net is a 1M-bit-per-sec. baseband system that uses carrier-sense, multiple-access with collision detection techniques similar to and, Smith says, "very compatible" with the Xerox Ethernet scheme. He says an Ethernet interface is under development. Apple Net has a practical limitation of 128 nodes, but is

optimized for work groups in the four- to 20-node range, he adds.

He says Apple Net connections—using one of three available card slots in the Lisa cabinet—are expected to retail for \$500 per terminal. The principal applications for the network are peripheral sharing and data exchange. Apple Net is expected to support Apple II and III connections as well, but plans for those products are not complete.

For communicating with corporate data-processing installations, Apple offers LisaTerm at introduction. Priced in the \$300 to \$500 range, the package emulates standard Teletype and Digital Equipment Corp. VT52 and VT100 protocols. Packages for IBM 2780/3780, 3270 bisynchronous and 3270 SNA protocols are expected to follow within a year.

—Geoff Lewis

## AT APPLE, E STANDS FOR EXTENDED LIFE

Apple Computer, Inc., is hoping to keep its mainstay Apple II line in high-volume production through the mid-1980s, and possibly beyond, with a re-engineered version of the original machine. The Apple II, which came to the market five years ago and helped take personal computing from a hobbyist base to a worldwide business market, has reached the end of its manufacturing cycle in terms of cost reductions, Apple officials say.

Its replacement, the Apple IIe, is introduced in a \$1395 configuration that includes 64K bytes of memory, upper- and lower-case characters, a full ASCII keyboard and a system disk. The price is only slightly higher than street prices for the 48K-byte Apple II+ version it replaces, which is limited to an upper-case display.

However, although both products use the 8-bit 6502 microprocessor, the IIe is more than a straightforward replacement for the aging II, product manager George Johnson notes. Not only does it offer an advance in packaging—the IIe is based on a single printed-circuit board with 31 integrated circuits that replaces the II's three-board, 109-IC design—but it also positions Apple to battle more aggressively in the growing market for unsophisticated users and international customers, Johnson says. He points out that the unsophisticated user segment now accounts for 75 percent of all personal computer purchases. That user, which Apple research defines as the well-educated consumer with an annual income of \$35,000 and a desire to become a



The Apple IIe is Apple's attempt to extend the life of its popular Apple II.

computer literate, will be the main focus for Apple IIe and competitive products. Apple feels that a fully configured system package selling for around \$2000 will appeal to this market and has configured a \$1995 IIe with a CPU, one disk drive, a monitor, a monitor stand and an 80-column card. To address the international market better, Apple has included the full ASCII keyboard and has designed a switch for the back of the system box that will activate a choice of 15 ROM-based foreign-language character sets.

More significant for Apple is the IIe's design, which allows easy manufacture and further cost reductions. The IIe is also designed to be twice as reliable as its predecessor, says Apple engineer Walt Broedner. The CPU board can eventually be manufactured in Singapore using auto-insertion machines, robot stampings.

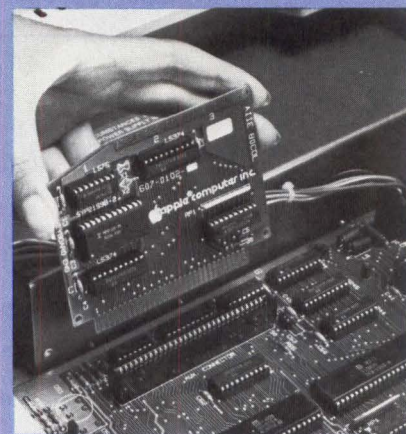

A special video display slot in the Apple IIe accepts a new low-cost 80-column card. Apple will market an additional card providing 80 columns and 64K of RAM. Apple redesigned the main logic board for the Apple IIe, using one printed-circuit board with 31 ICs instead of 109 ICs on the three-board Apple II. Both products are based on the 8-bit 6502 microprocessor.

Other improvements in the IIe address both the needs of the naive user and frequently cited shortcomings of the II. While the basic system is still restricted to 40 columns, a new 80-column card includes the 64K-byte memory expansion, taking the system to a new maximum memory of 128K bytes. That card is list-priced at \$295, while the 80-column card without the memory expansion is \$125. The 80-column card also includes controls for high-resolution (560 × 192) graphics. For the first time, users can combine a text window with graphics on the same screen. —Geoff Lewis



# Qume takes on TeleVideo in low-end terminal market

Most independent CRT terminal manufacturers sweated blood when TeleVideo, Inc., slashed out a leading market share, and it may be time to sweat again. This year, it's Qume Corp.'s turn. The San Jose manufacturer this month is springing volume shipments of its first ASCII video display units into distribution channels that are already fiercely competitive. Qume plans to fight its way into the ranks of the top five independent VDT vendors within a year. This will require carving up some well-established competition in a low-growth market, and convincing dealers its products offer a significant price/performance advantage.

The new VDTs are being built to Qume's design and quality-control criteria in Taiwan under exclusive contract, with quality assurance supervised by Qume's recently established Taiwan subsidiary. The first entry is the QVT102, a unit that is list-priced at \$695, with such ergonomic features as a detachable, low-profile keyboard, a non-glare tilt and swivel display in standard green or optional amber phosphor and 9 x 12 character cell resolution with true lower-case descenders. Qume compares the features of the QVT102 to the \$695 list-price offerings of the four highest volume VDT manufacturers—TeleVideo, Lear Siegler Inc., Applied Digital Data Systems and Hazeltine Corp.—all of which the QVT102 emulates via a menu-driven setup mode, to illustrate what director of marketing Keith Rapp claims is unparalleled price/performance.

But what chance does Qume have in such a competitive market, which is marked by eroding margins? Sources close to both Qume and the Taiwan electronics industry confirm



**Qume's new terminal line, all members of which are housed in the above casing of the QVT102, is said to offer better price/performance than competing low-end CRT's. Qume hopes to become one of the leaders in that fiercely competitive market.**

that Qume will have sufficient margin to support the QVT102, given an estimated price to Qume of \$250 for the QVT102. And although

TeleVideo vice president of marketing Steve Tatum thinks the window for gaining large market share with superior price/performance has closed, he says a company that has sufficient margins, makes the right marketing moves and brings to the contest a reputation for timely delivery of quality products could do exactly what Qume intends to in the ASCII terminal market.

It will take more than one model, however. Qume plans first shipments in February of the smooth-scrolling QVT108, which emulates the TeleVideo 925/950 code structure and features 11 function keys, six direct editing keys and two pages of memory for \$895. A third terminal sharing the common family housing is a Digital Equipment Corp. VT100/132 emulator dubbed the QVT103. Although the specification on the ANSI X3.64-compatible 103 is not firm, Qume hopes to include memory expansion to four pages and several open slots. But achieving that may be tough, says Rapp, because at a list price of \$895, the unit is already several hundred

QVT-102 Comparison chart of standard features	Qume QVT 102	Televideo 910	LSI ADM 5	ADDS Viewpoint	Hazeltine 1500
Display character size	7 x 9	7 x 8	5 x 9	5 x 8	7 x 8
25th status line	Yes	No	No	No	No
Menu set-up	Yes	No	No	No	No
Line drawing set	Yes	No	No	No	No
Detachable keyboard	Yes	No	No	Yes	No
Low-profile keyboard	Yes	No	No	No	No
Separate programmable function keys	4	0	0	0	0
Switching power supply	Yes	No	No	No	No
Screen tilt	Yes	No	No	Yes	No
Screen rotate	Yes	No	No	No	No
Line block transfer mode	Yes	No	No	No	No
Page block transfer mode	Yes	No	No	No	No
Unprotected block transfer	Yes	No	No	No	No
Screen-saver time out	Yes	No	No	No	No
Insert/delete line	Yes	No	No	No	Yes
Insert/delete character	Yes	No	No	No	No
Clear unprotected	Yes	No	No	No	Yes
Forward/Backward tab	Yes	Yes	No	No	Yes
Column tab positions	80	80	0	0	0
Print key	Yes	Yes	No	No	No
Programmable answerback	Yes	No	No	No	No

Source: Qume Corp.



# YOU CAN'T CO YOU'VE GOT NO

That's quite a claim. How can we make it? Quite simply, because no one else is trying to do what we've set out to do.

In the words of our President, Sirjang Lal Tandon: "Tandon Corporation has been built on a strategy of producing high performance micro-computer peripherals at prices so low that they increase the markets for the computers themselves. If we can help the computer industry create a reliable

To start with, we make more of what goes into our drives than any other manufacturer: 80% of the cost of every drive consists of parts we actually make ourselves.

This assures that we can control the quality of each critical component to our own high-level specifications.

It also allows us to engineer advanced designs from the start that lend themselves to more efficient mass production and higher overall performance.

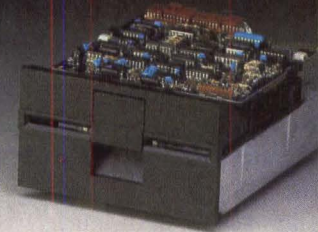

\$200 or \$300 'home' system with meaningful capacity—not just a game or toy—most households will be able to afford one. Then we will see a real mass market.

"At the upper end, if we can give small business and personal computers 10 to 50 times their current memory/storage capabilities at a practical cost, we will enlarge the market for more sophisticated desktop systems, and of course, our own market as well!"

To accomplish this, we have designed and organized our business unlike all other disk drive manufacturers' businesses.

How?

We make sure that our production capabilities exceed our orders by at least 50% so we are always in a position to deliver.

And we use separate production facilities for each of our product lines,

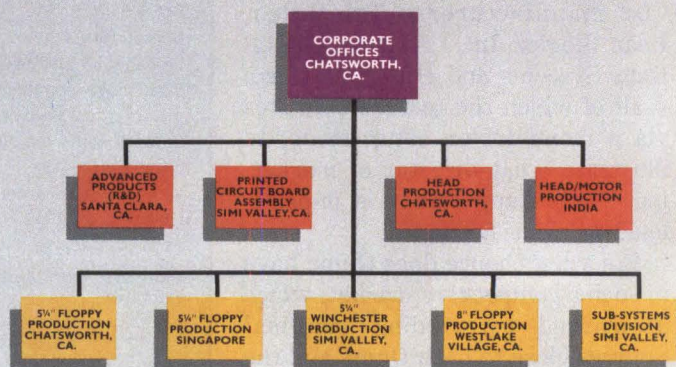



# MPETE WHEN COMPETITION.

keeping their individual priorities distinct to further increase productivity and, ultimately, throughput.

We also offer our customers the most generous guarantee in the industry, to back up the reliability we've achieved.

And finally, we offer our customers a very broad line of drives—16 models in all. So we're the single source that can meet almost any need.

Has it worked?

You decide. In three short years we've become the world leader in small disk drives, shipping more 5¼" floppies, high capacity Winchesters and 8" ThinLine™ floppies than anyone else.

And now we're introducing five new floppy and Winchester drives that push prices lower and capacities higher than the industry has ever seen.

That's why we say we're not competing in the disk drive business.

Times have changed. Three years ago, Tandon wasn't considered competition.

Now we don't consider the competition.

ThinLine is a trademark of Tandon Corporation.

**Tandon**  
**THE MOST SUCCESSFUL DISK DRIVE  
COMPANY YOU EVER HEARD OF.**

938-1916 · Sea Girt, NJ (201) 449-7720 · Tucker, GA (404) 934-0620 · Elmhurst, IL 411547 · Reading, Berkshire RG6 1AZ, England (0734) 664-676, Telex: 848411.

**CIRCLE NO. 15 ON INQUIRY CARD**

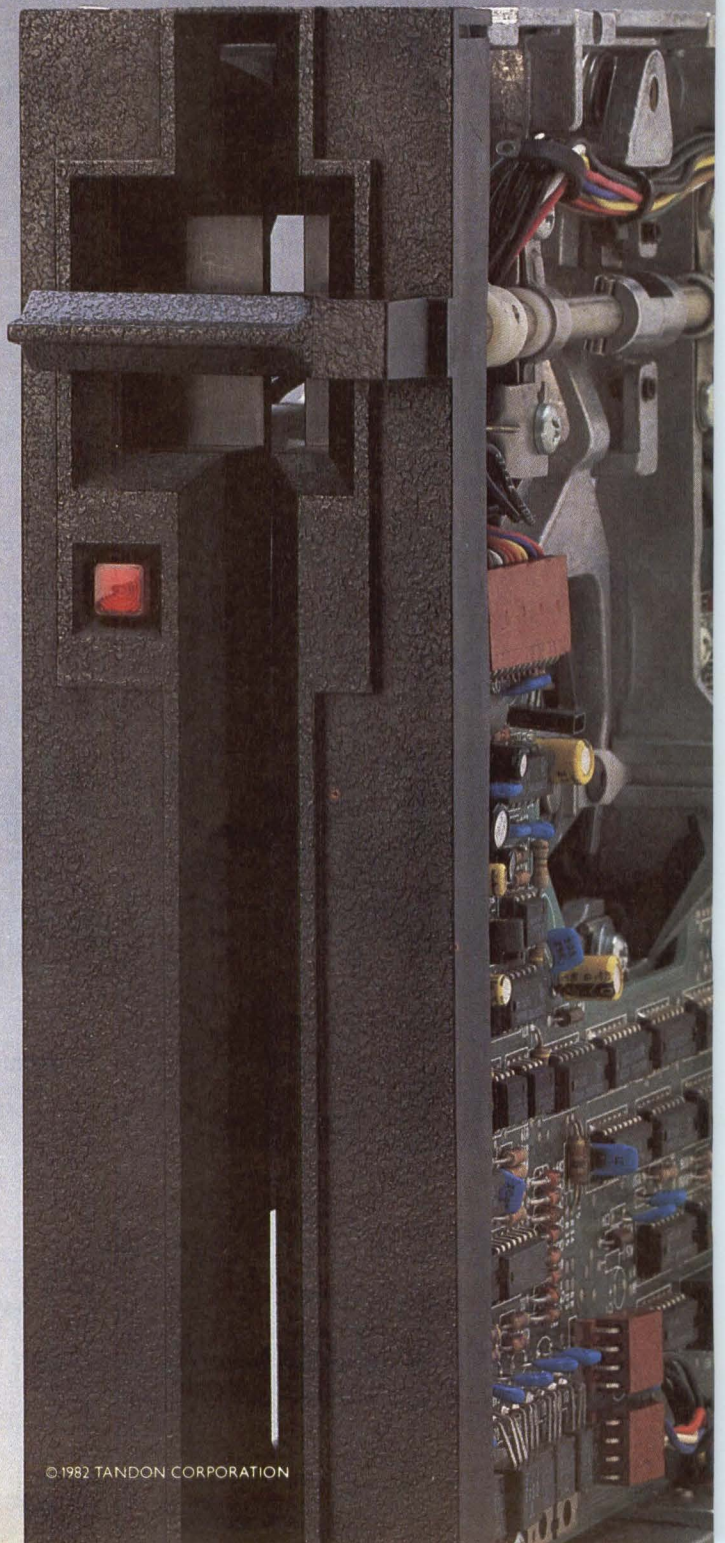

© 1982 TANDON CORPORATION



# Mini-Micro World

NEWS

dollars less than any other ANSI-compatible terminal on the market.

Rapp says Qume has strong backing from parent ITT Corp. for its ambitious and expensive plans, which include matching the advertising budgets of the competition from the outset. The corporation is willing to take the risk, Rapp says, because top management carefully examined TeleVideo's aggressive distribution strategy that helped catapult TeleVideo from ground zero to the top of the independent VDT heap in less than two years and convinced top management they could succeed. Rapp looks to TeleVideo as the model rather than to the OEM emphasis that led to Qume's success in printers. He expects an 80:20 mix of distribution and OEM sales, but the company

needs a number of high-volume distributors to achieve it.

"We are as serious as a heart attack about satisfying the demands of the distribution channels," he says. David M. Aronowitz, program manager of electronic office services for market research firm Gnostic Concepts, Menlo Park, Calif., says that kind of emphasis will be necessary if Qume is to succeed.

"Most of the major distribution channels for terminals are saturated," says Aronowitz, "and the dealers have tremendous brand loyalty. Qume is going to have a tough time gaining the necessary shelf space unless dealers perceive a significant price/performance advantage."

Although confident on that score, Rapp concedes it will take time.

"We don't expect distributors to trip over themselves tossing current brands out the door to bring us in," he says. "But flexible terms on initial shipments will make it painless to try the product." Rapp declines to spell out those terms.

Qume will ask distributors to handle the entire line of VDTs, but allow them to swap slow-moving for fast-moving products twice a year. Distributors will get price protection in the form of product credits, equal to the difference between the old and new price at quantity of stock on hand, if competitive pressure or lower costs dictate list-price reductions by Qume. Rapp also pledges to avoid pitting Qume distributors against each other by guaranteeing territories.

Another major selling point for

## PLUG-IN MODULES KEY IN QUME'S LATEST PRINTER OFFERING

In line with Qume Corp.'s intention to become a one-stop shopping center for computer peripherals, the San Jose, Calif., manufacturer also plans to become the plug-in printer house for the word-processing and desk-top computer industry. The first two members of the company's new letter-quality daisy-wheel printer family, the Sprint 11/40 and 11/55 Plus, showed up at Comdex '82 in Las Vegas.

The Sprint 11s get their "plus" from an interchangeable communications module, designated the Qume connection, that plugs into the back of a CRT. This provides compatibility to perform word-processing application software used on microcomputers from such companies as IBM Corp., Hewlett-Packard Co., Xerox Corp., Commodore Business Machines, Inc., Tandy and North Star Computers, Inc. "We specifically targeted the rapid desk-top computer market when we designed the communications module," says Lee Cannon, Qume's director of printer marketing. Three interfaces—an RS232C, a Centronics parallel and and IEEE-488 (HP-IB)—will interface with 95 to 99 percent of



Qume's Sprint Plus daisy-wheel printers include the "Qume connection," an interchangeable communications module that plugs into the back of a CRT to make the printers compatible with a number of microcomputers running word-processing software.

Qume's target systems, he explains. Future uses for the printers are word-processing, scientific, engineering, financial and multilanguage applications.

Based on an Intel 8085 8-bit

microprocessor, the Sprint 11/40 Plus and 11/55 Plus feature print speeds of 40 and 55 cps, respectively, MTBF rates of 5500 hours at 25-PERCENT DUTY CYCLES AND 63- to 65-dba acoustic noise levels. The fully formed character printers use Qume's standard 96-character print wheels. The company's future plans, however, call for higher speed Sprint 11 family members with 130-character print wheels. The 11/40 and 11/55 print 132-, 158- and 197-character lines at 10, 12 and 15 cpi, respectively.

The Sprints use a Qume continuous-loop, fabric ribbon enhancement designated the Multistrike IV cartridge. A bidirectional forms tractor and a single-bin sheet feeder are also available for paper handling. The printers handle paper as wide as 15 in.

The list price of each communications module is approximately \$100, and the retail price of the printer is \$1776. OEM discounts are available. Qume will market the devices through its traditional distributors, dealers and OEMs, says Cannon. Deliveries have begun.

—Nancy Love





# THE PERSONABLE BUSINESS COMPUTER™

Intertec announces what may well be the industry's first *personable* microcomputer—SuperBrain II.™

What's a *personable* computer? It's a computer with business application versatility at personal computer prices. It's a computer powerful enough to tackle even your toughest business jobs, yet at a price that won't put you out of business. But most importantly, it's a computer you can put to use right out of the box. That's because SuperBrain II™ boasts the industry standard CP/M\* operating software. So whatever your business application, SuperBrain II can handle it. There are literally hundreds of ready-to-run business applications available "off-the-shelf."

Unlike many microcomputers, the SuperBrain II™ is time-tested and field-proven. It's built and backed by a company that's been around as long as the industry itself. A company you can count on for product support and customer satisfaction.

\*Registered trademark of Digital Research.  
†Microsoft is a trademark of Microsoft Corporation.

## STANDARD FEATURES

- Dual 5¼" disk drives
- 350K/750K/1.5 MB disk capacities
- 64K RAM
- Twin Z80A microprocessors
- An easy-to-read 12-inch non-glare screen
- An 18-key numeric keypad
- 10 MB disk expansion capability (Optional)
- Microsoft† Basic

When you think about it—price, performance, and the reputation of the manufacturer—it's no wonder so many discriminating microcomputer users have become "personal" friends with our new SuperBrain II™—the industry's one and only *personable* desktop microcomputer.



CORPORATE HEADQUARTERS: 2300 BROAD RIVER ROAD • COLUMBIA, SOUTH CAROLINA 29210 • (803) 798-9100 • TWX 810-666-2115

CIRCLE NO. 16 ON INQUIRY CARD



the new terminals, says Rapp, is Qume's new policy of one-year guarantees for its entire product line. Six months of the guarantee goes to the distributor, and six months to the end user, although distributors can pass along the remaining portion of their guarantee if the product moves in less than six months. "The competition offers 90 days," Rapp says.

Lear Siegler, Inc., director of marketing Catherine Raftery confirms the 90-day norm, but dis-

counts the impact of extending the warranty because, she says, "Today's terminals are pretty reliable." George Chao, president of San Francisco terminal importer Liberty Electronics, agrees. The mortality curve for VDTs is greatest up front, he says, and a guarantee beyond 90 days is just fluff.

But Gnostic's Aronowitz says the one-year guarantee will help Qume gain market share, especially if the company isn't touchy about customers breaking the seal. "If they

certify that the addition of particular endorsed graphics and modem boards won't blow the warranty, dealers will be attracted by the chance for add-on sales," he says. Rapp says Qume policy is not set in this area, but hints that dealers' desire for add-on sales will be satisfied by forthcoming options.

Qume plans extension of its new terminal line by the end of the year, adding such features as a full-page, display, bit-mapped graphics and possibly color. —Kevin Strehlo

## Amlyn, DriveTec push minifloppy capacities to more than 3M bytes

The 5¼-in. minifloppy, which helped launch a revolution in desk-top computer systems, has been relegated to limited backup roles because of limited capacities.

Until Amlyn Corp. last year developed an 8M-byte minifloppy drive, using five 1.6M-byte platters, minifloppies were limited to at best 1M byte.

Now, however, Amlyn and DriveTec Inc.—both San Jose start-ups—have begun a new era in minifloppies with drives yielding 3.2M and 3.3M bytes, respectively. In addition to the start-ups, established floppy manufacturers such as Shugart Associates, which developed the minifloppy in 1979, are believed to be developing a 5M-byte floppy on a single platter that may be available by this year's National Computer Conference.

Sophisticated operating systems such as UNIX and OASIS take up almost all the disk capacity of this generation of minifloppies, leading system integrators to specify a minimum 5¼-in. Winchester in desk-top systems. Users of desk-top systems, however, are believed to prefer removable floppies.

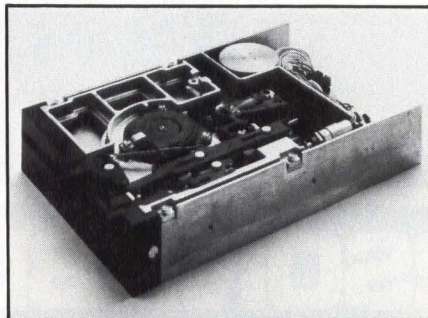

DriveTec Inc. has packaged its 3.3M-byte minifloppy in a half-height design, allowing a double-drive 6.6M-byte capacity in the same space as that typically used by a regular minifloppy.

Until recently, track densities on the minifloppies were limited by technology to 96 tpi, consequently limiting capacity. "It's the age-old game of the disk-drive industry," says Jim Snow, vice president of marketing for Amlyn, referring to the natural tendency of disk-drive manufacturers of any-sized products to put more capacity in a smaller space. "If these (minifloppies) didn't do that, it would be an industry first."

Amlyn has been shipping its original drives since last April, and has now retooled the 8M-byte drive to a single-platter arrangement

that, like the original drive, uses coated media. The drive has a track density of 170 tpi and a recording density of 9500 bpi. The drive is available in both single- and double-sided versions, achieving 1.6M- and 3.2M-byte capacities, respectively. The 1.6M-byte version is dubbed the 1850, and the 3.2M-byte version is the 1860.

The Amlyn drive's 170 tpi is achieved through a servo track configuration. In contrast, the DriveTec version uses a proprietary servo to achieve its 192-tpi density, which translates into 3.3M-byte capacity on the double-sided, half-height drive.

The DriveTec 320 drive features a two-stepper-head actuator, allowing one stepper to be used to make large movements of the gum-ball-shaped head and a second stepper for more precise movements. The result is that heads can move at the precision of 200 µin., with less pressure on the 50-µin. media.

Media for the DriveTec drive is manufactured by Dysan Corp., Maxell Corp. of America, BASF

Continues on page 32



# THE 8MBYTE FLOPPY SURPRISE

At last, a disk drive which accommodates both stand alone removable media data storage and Winchester backup applications — all with one device. The Amlyn drive is a superstar as the sole storage device on your system. It combines the benefits of high performance, high capacity data storage with removable, low cost user friendly media. All this for less than half the price of a Winchester drive and its backup device.

If you use Winchester drives, you need backup. Amlyn's drive is THE backup device which is interface, format and software compatible with the Winchester itself. So compatible, it can take over for your Winchester when it fails so that a Winchester failure doesn't shut your system down. Amlyn backs up your Winchester drive itself — not just the data on it. Now backup is more than something you hold in your hand when your Winchester fails.

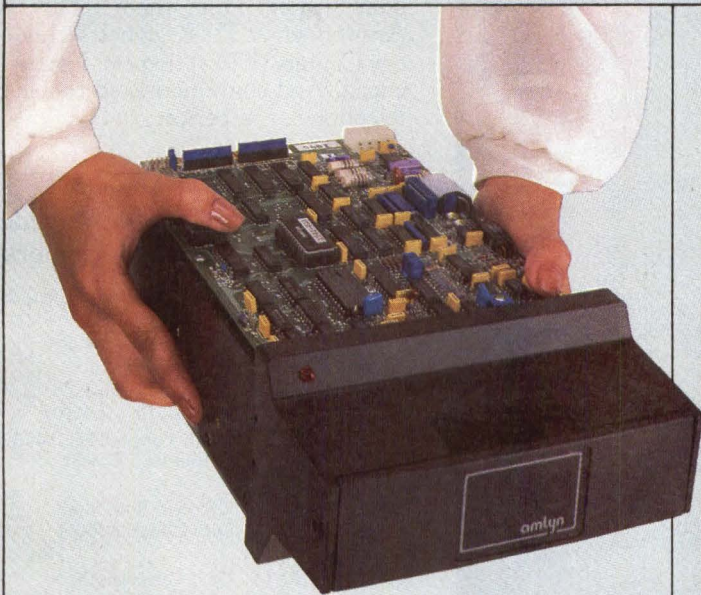

## Dynamic On-Line Operation

Amlyn drives provide 8 MBytes in the same space as a standard mini-floppy. Amlyn has combined the capacity of Winchester drives with the advantage of removable media.

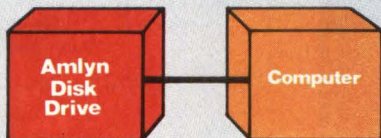

Available Now,  
Contact Us At 408-946-8616

**amlyn**

2450 Autumnvale Drive  
San Jose, CA 95131  
(408) 946-8616  
TWX 910-379-0029  
TLX 171627 Amlyn

## Random Access Winchester Back-Up

Now, you can have Winchester system backup, not just data backup with interface and software compatibility to your Winchester as well.

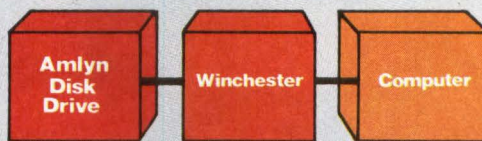

## Removable Media

Amlyn's 8 MByte removable MiniPac cartridge holds and protects diskettes from damage and mishandling, and is easily removed and replaced. Each cartridge holds five mini-floppy diskettes.



## Standard and Flush Mount Design

Amlyn drives allow OEM and systems house design flexibility with a variety of styles which assure form factor compatibility with standard mini-floppy dimensions.





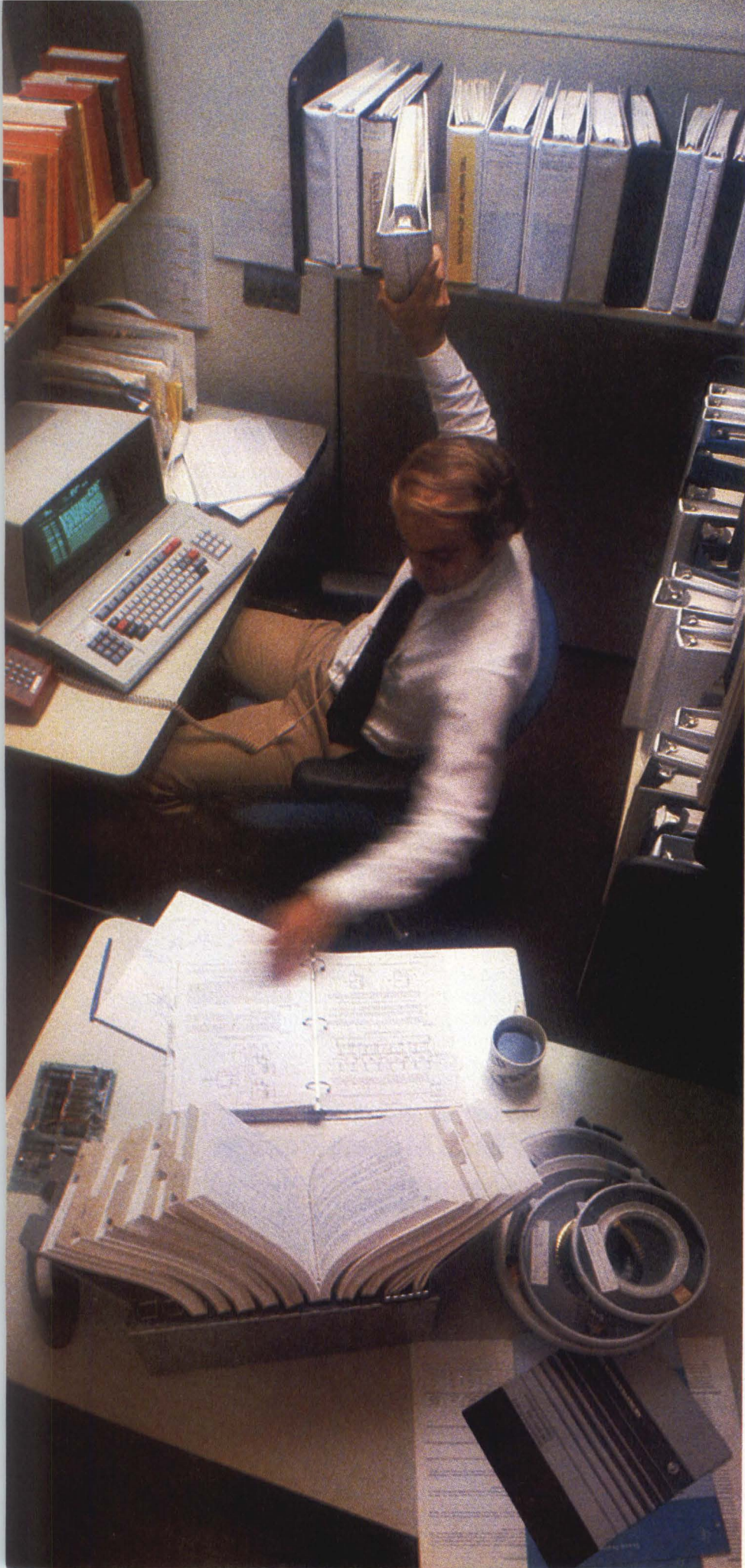

*No. 1 in a series:*

# When are

Whenever you need highly specialized logic structures at near-standard prices. At Texas Instruments, off-the-shelf master logic arrays — a collection of uncommitted gates — can be rapidly and economically transformed into your specific interconnect pattern by an advanced design automation system.

In determining when and if logic arrays are feasible for your needs, many questions, like the following, will require answers. From whom? The Answermen at TI's Regional Technology Centers (RTCs). Expert. Experienced. And conveniently accessible by telephone or in person.

## **Texas Instruments Worldwide Regional Technology Centers**

**ATLANTA** 3300 N.E. Expressway, Bldg. 8  
(404) 452-4686 Atlanta, GA 30341

**BOSTON** 400-2 Totten Pond Rd.  
(617) 890-4271 Waltham, MA 02154

**CHICAGO** 515 W. Algonquin Rd.  
(312) 228-6008 Arlington Hts., IL 60005

**DALLAS** 1001 E. Campbell Rd., M/S 347  
(214) 680-5096 Richardson, TX 75081

**NORTHERN  
CALIFORNIA** 5353 Betsy Ross Drive  
(408) 980-0305 Santa Clara, CA 95054

**SOUTHERN  
CALIFORNIA** 17891 Cartwright Dr.  
(714) 660-8164 Irvine, CA 92714

**BEDFORD,  
ENGLAND** Manton Lane  
0234 223000 Bedford MK41 7PA

**FREISING,  
WEST GERMANY** Haggertystr. 1  
08161 800 8050 Freising

**HANNOVER,  
WEST GERMANY** Kirchhorsterstr Str 2  
0511/643021 3000 Hannover 51

**TOKYO, JAPAN** Aoyama Fuji Bldg.  
03 - 498 - 2111 6-12, Kita Aoyama 3 Chome  
Minato-Ku, Tokyo

◀ **RTC Answermen** at TI Regional Technology Centers have the knowledge as well as resources at hand to handle many logic array questions by telephone. The strategically located technology centers are also your readily available access to the courses and seminars, demonstrations, laboratories, development systems, and consultation that will help you find the right TI semiconductor solution for you.



# Ask the RTC Answermen at Texas Instruments

## logic arrays logical for me?

### What major factors determine whether fully custom logic or logic arrays is the best way for me to go?

Early in your deliberations, two factors will indicate whether or not you should proceed. One is how quickly you need to get to market. If you want to move fast, TI logic arrays can cut your design cycle by as much as 25 percent. TI currently delivers prototypes 12 to 14 weeks after the design is initiated.

Another factor is the size of your run. If your volume requirements will not bring the cost of a totally custom design within reason, logic arrays from TI can cut your design costs by as much as 30 percent.

The key to these savings is TI's comprehensive design and layout automation system that allows you quickly and accurately to specify your logic and completely simulate the design in advance of production.

### Before I get in too deep, can I get an advance idea of how many gates I'll need to do the job I want?

Yes. TI's software library of macro functions is available to help you estimate the number of gates you'll need.

If you want a more precise estimate, you can send us a schematic for evaluation at no charge.

We'll get back to you with a recommendation of which TI logic array best

fits your needs (see table below) and a suggestion for the type of package.

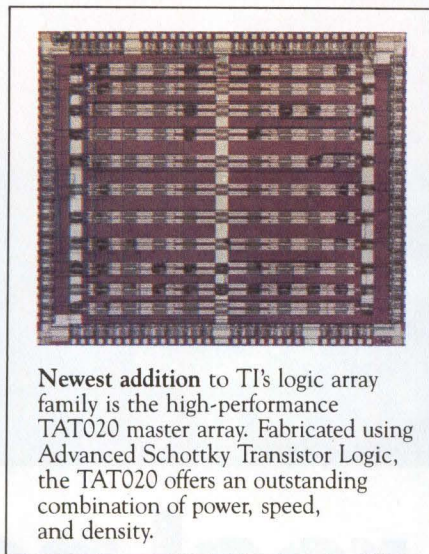

Newest addition to TI's logic array family is the high-performance TAT020 master array. Fabricated using Advanced Schottky Transistor Logic, the TAT020 offers an outstanding combination of power, speed, and density.

### Can I determine if my design will perform correctly before prototyping?

At Texas Instruments, our goal is first-pass success. Our integrated design automation system minimizes the need for redesigns by eliminating many manual, error-prone design techniques. Using our Hardware Description Language (HDL) and Test Description Language (TDL), you can describe your logic and build a computer model. You can run a simulation routine as a test, and check the design for timing and functionality,

even apply a set of inputs and watch them propagate through the entire model. Once you give an okay, we'll partition the logic and make all the routing interconnects automatically. Then we run verification software comparing a schematic analysis against your model — actually a transistor-by-transistor, resistor-by-resistor verification.

### What help are you prepared to supply in getting me to the point of a computer model?

We're on your team, and we make our design automation capability convenient and simple to use.

We hold a five-day technical design course where you'll learn the performance characteristics of our master arrays. You'll also learn how to use the various design software tools. These tools, which screen out most problems, include HDL and TDL as well as a design for testability. Other tools available to you include advanced simulation, design rule checking, design verification, and test pattern grading.

### Where can I get this help?

At TI's Regional Technology Centers. That's where each RTC Answerman is located and where you'll find the applications engineers who will assist you with your logic arrays. The technical design course is taught at these centers. And each has terminals where you can input your design description directly into our software system.

If more convenient for you, you can come to our plant for logic array design and applications help, or we'll come to yours.

For fast answers to more of your technical questions about logic arrays, call the Answermen at the Hot Line numbers on the opposite page. Or visit the Regional Technology Center nearest you, or call your local TI sales engineer. For our Logic Array brochure, write Texas Instruments, P.O. Box 202129, Dallas, Texas 75220.



# TEXAS INSTRUMENTS

### Fast, Efficient TI Logic Array Family

Array	Gates**	Technology†	Gate Delay	Gate Power	I/O Signals
TAL002*	280	LPS	5.0 ns	1.25 mW	29
TAL004*	400	LPS	5.0 ns	1.25 mW	42
TAT004	400	STL	2.5 ns	600 $\mu$ W	76
TAT008	800	STL	2.5 ns	600 $\mu$ W	104
TAT010	1000	ASTL	1.0 ns	300 $\mu$ W	88
TAT020	2000	ASTL	1.0 ns	300 $\mu$ W	120

\*TAL Series Arrays are manually routed by you and schematically verified by TI with your software HDL model prior to prototyping.

\*\*Usable gates

†LPS — Low-power Schottky

†STL — Schottky Transistor Logic

†ASTL — Advanced Schottky Transistor Logic

MIL versions of all these logic arrays are available from Texas Instruments.

CIRCLE NO. 18 ON INQUIRY CARD



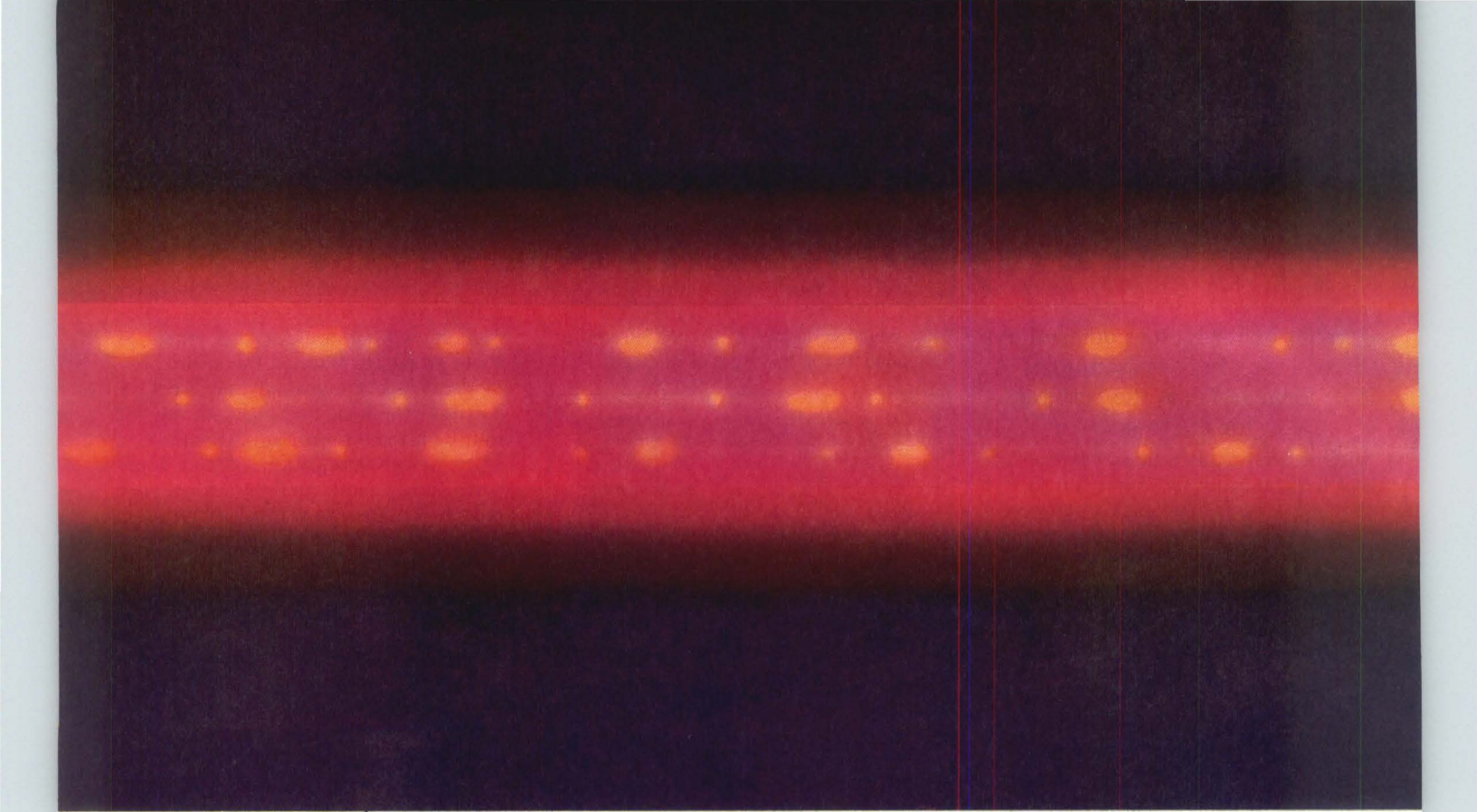

**It takes real nerve  
to compare our  
1/4" back-up system  
with 1/2" drives.**

**It also takes  
67 megabytes.**

---



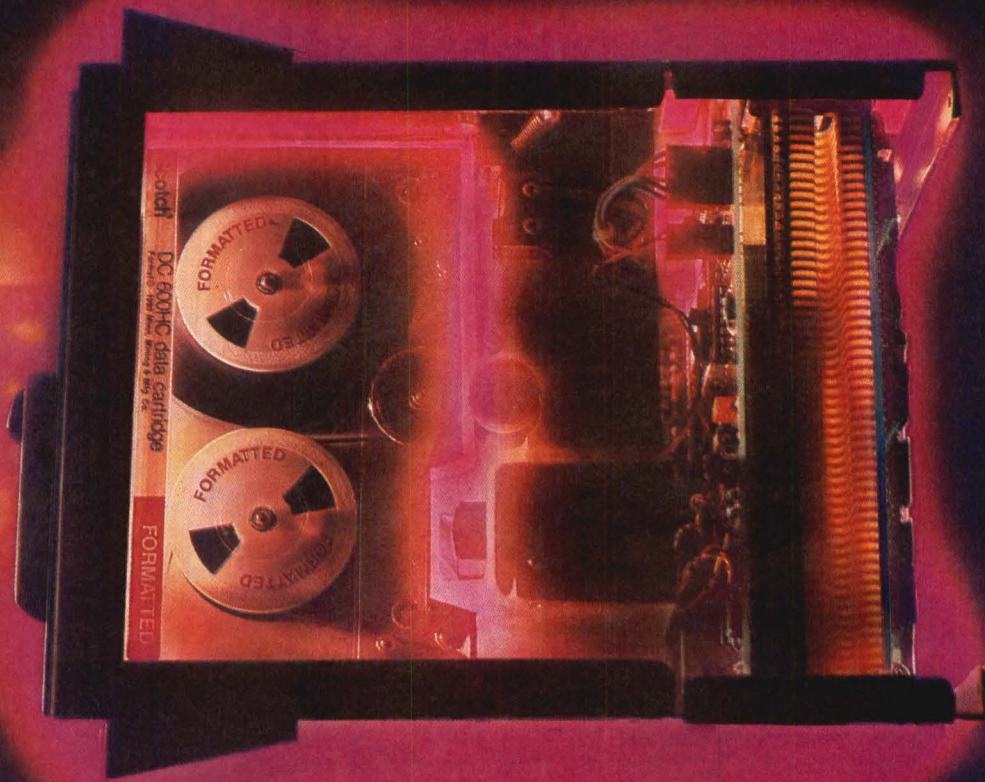

## HCD-75: so much for so little.

Presenting the only 1/4" cartridge back-up system that'll go head to head with 1/2-inchers in the critical 30-70 Mbyte range.

The reason is simple. The 3M Brand HCD-75 Data Cartridge Drive System gives you 67 Mbyte per cartridge formatted. No other cartridge drive gives you so much capacity.

There's nothing medium about the medium, either. Each Scotch® DC 600HC cartridge is pre-recorded with permanent forward/reverse-reading block keys. They give you block-addressable storage. You get compact recording on all 16 tracks, with a density of 10,000 frpi, without rewinds.

The HCD-75 system, including drive and controller, is about one-fifth the size of a 1/2" tape drive. You don't have to put back-up and I/O plans on the back burner because of size constraints.

## Interchange for the better.

Cartridges interchange quickly and

easily. Tape-to-head alignment is ensured by a special sub-routine. It automatically aligns the read-write head and stepper motor controller to the tape edge each and every time the operator puts a cartridge in the system.

There's brain to this back-up, too. First, all its functions are handled through its controller. And second, there's minimal host involvement, so host time can be freed up for more critical functions.

## All the reliability without high cost.

You can run one HCD-75 drive off the controller, or two, or three, or four. You still get all the reliability of the high-priced drives. The HCD-75 runs self-test routines to ensure proper operation. It gives you sophisticated error messages when faults are detected.

Advanced error-detection/correction routines keep working to deliver extremely low error rates. The micro-processor controls the drive functions; so potentiometer adjustments are a thing of the past.

## Back-ups without back orders.

The whole shooting match—drive, controller, preformatted Scotch DC 600HC cartridges—is ready for immediate delivery. One at a time or in production quantities—you name it. (Also ask about 3M's proven family of 8" Winchester compact disk drives.) Haven't you waited long enough for a reasonable, reliable, truly high-capacity alternative to 1/2" drives?

## As close as your phone.

In fact, if you have been holding off on a back-up decision—or even if you haven't—make us put our back-up where our mouth is.

Call toll-free 800-328-1300. (In Minnesota, call collect: 612-736-9625.) Ask for the Data Recording Products Division. We'll give you the name of the 3M HCD-75 representative in your area. He's just waiting for the chance to show off his latest, greatest back-up. Or write us at Building 223-5N, 3M Center, St. Paul, MN 55144.

**3M hears you ...**

CIRCLE NO. 19 ON INQUIRY CARD

# 3M



*Continues from page 26*

Systems Corp., Brown Disk Manufacturing Co. and others. The Amlyn media is manufactured by Dysan, Brown Disk and Verbatim Corp. DriveTec officials contend that their drive can also read data from the Amlyn drive. The Amlyn drive can read media from any standard 5¼-in. drive.

Compatibility will be key to the acceptance of the drives. Both Amlyn and DriveTec are searching for manufacturers willing to second-source their drives. Amlyn has signed French media manufacturer Rohne Poulac to second-source its drive in Europe and is signing a second source in the U.S. Amlyn was expected to name a domestic second source in the first quarter of this year.

DriveTec too is in discussions for a second-source agreement, which it puts as top priority in its post-introduction marketing strategy.

Independent disk-drive authority Jim Porter cites the need for both companies to establish second-source agreements quickly. He recalls the major role played by Texas Instruments Inc. in its decision to second-source Seagate Technology Corp.'s 5¼-in. Winchester. That decision affected the early acceptance of the pioneer technology. "The acceptance for these

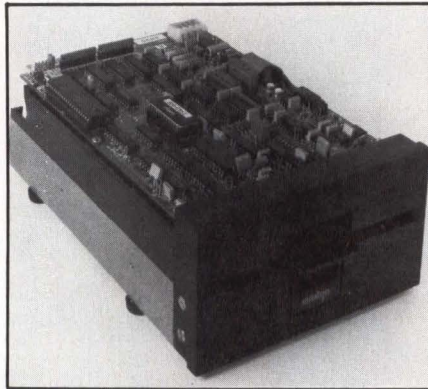

**Amlyn will ship a half-height version of its high-capacity 3.2M-byte floppy drive this year.**

drives will be there," Porter says, "but it will be slow at first until the technology is endorsed by others in the industry."

Although the most obvious role for the new drives is as backup for the new generation of higher capacity 5¼-in. Winchesters, both DriveTec and Amlyn contend that this will not be the primary role. "We don't expect to position ourselves in the Winchester backup marketplace—although we naturally aren't going to turn down that business," says DriveTec marketing director Vlad Langer. "We expect our drives to go into the newest generation of desk-top systems."

Many of these new systems will require operating systems such as UNIX or OASIS, which demand large

disk space, Langer contends. Even 8-in. floppy drives have a maximum capacity of 1M byte, he notes.

Amlyn's Snow agrees, noting floppy drives are still far from their peak capacity. Media availability, especially the thin-film media being used, has been the stumbling block to increasing floppy capacity, Snow says. With the new media available in volume, new technology is likely to increase floppy capacity by as much as 3 or 4 times over current drives.

Snow says there are likely to be several more manufacturers of high-capacity floppies joining DriveTec and his company by the end of 1983.

Evaluation units of the Amlyn drive were to be shipped this quarter, with volume shipments due to begin in the second quarter of 1983. The 1.6M-byte Amlyn 1850 is priced at \$300 in OEM quantities of 1000, and the 3.2M-byte Amlyn 1860 is priced at \$370 in OEM quantities of 1000.

The DriveTec product, the first for the year-old start-up founded by Shugart Associates co-founder Herbert E. Thompson, will be shipped to evaluation sites in the first quarter, with production volumes slated to begin in the second quarter. The DriveTec 320 is priced at \$325 in OEM quantities of 500.

—Robert A. Sehr

## VisiCorp seeks to set standard with Visi<sup>On</sup> applications-environment package

VisiCorp, the San Jose, Calif., software publisher that skyrocketed to a top position in the retail microcomputer software business with the VisiCalc spread-sheet package, is trying its hand at marketing a homegrown product for OEM customers that it hopes will set standards for the next generation of

personal productivity tools. The product, Visi<sup>On</sup>, is labeled an "applications environment" and is basically a user interface to present applications in a consistent, easily learned format.

Aimed at the largely untapped executive workstation portion of the market, Visi<sup>On</sup> resembles the Xerox

Star and other products developed at Xerox's Palo Alto Research Center, where Visi<sup>On</sup> had its inspiration, say VisiCorp officials.

Like Star, Visi<sup>On</sup> replicates the way an executive deals with sheets of paper on his desk: each application program or document is represented on the screen by a





## MULTI-VENDOR LOCAL AREA NETWORK COMMUNICATIONS MARCHES TOWARD REALITY.

INTRODUCING ETHERNODE 1000™ SERIES. COMPLETE ETHERNET DATA COMMUNICATIONS SYSTEMS LINKING DEC VAX's, PDP-11's AND UNIX BASED COMPUTERS.

High speed, reliable communications between computers with dissimilar system architectures is no longer just fantasy.

It's reality. And it's called ETHER-NODE 1000. From Interlan.

The ETHERNODE 1000 Series consists of all hardware and software required for high-performance, embedded Ethernet communications among DEC VAX, PDP-11 and UNIX based systems. Each offers a complete Ethernet transport service to user-written application programs.

An integral part of each ETHER-NODE is the NS4200 software, consisting of the Internet Transport Protocols (ITP). Because these protocols were modeled after the Xerox Network Systems ITP Specifications, communications can be

achieved between VAX, PDP-11 or UNIX based machines and ITP compatible systems manufactured by Xerox and other vendors.

### ETHERNODE 1000 Series features:

- Supports high bandwidth communications.
- Minimizes CPU loading.
- Supports internet communications.
- Provides virtual circuit communication services.
- Provides network management (NETMAN™).

NETMAN, an integral part of ETHERNODE, is a screen-oriented, menu-driven utility that displays a wide variety of performance, configuration and utilization parameters.

Other elements of the ETHER-NODE 1000 Series include Interlan's intelligent UNIBUS, QBUS, or MULTIBUS

Ethernet communications controller, a non-intrusive tapping transceiver unit, and transceiver cabling.

If you are presently using or evaluating Ethernet, and require reliable, program-to-program communications, call or write for details on how Interlan can provide the total data communications solution:

The ETHERNODE 1000 Series.

# INTERLAN

WE MAKE NETWORKS WORK.

3 Lyberty Way, Westford, MA 01886  
(617) 692-3900 TELEX 95-1909

EASTERN REGIONAL SALES OFFICE: 10 Kearney Rd., Suite 24, Needham, MA 02194, WESTERN REGIONAL SALES OFFICE: 2091 Business Center Drive, Suite 100, Irvine, CA 92715

INTERNATIONAL DISTRIBUTORS: ADCOMP Equipment Ltd., Switzerland 741-4111, ASR Arizona, Disc, Japan 781-2422-723, Data Translation Ltd., England 044-86-3412, Prosoftware, S.A., Spain 3-321-32-55, Stemmer Elektronik, West Germany 089-8060-61, Transduction Ltd., Canada 416-625-1907, Yrel, France 956-81-42

CIRCLE NO. 21 ON INQUIRY CARD



# Mini-Micro World

NEWS

window that appears to overlap the "page" beneath it. Like Star, Visi<sup>On</sup> uses a mouse pointing device to invoke commands and select data. Unlike Xerox's icons, Visi<sup>On</sup> uses written English commands displayed on the bottom of the screen.

The most striking contrast to its Xerox model, however, is Visi<sup>On</sup>'s marketing program. Instead of being tied to one machine or operating system, Visi<sup>On</sup> is expected to be converted for use on a wide variety of operating systems and machines. "We truly believe that Visi<sup>On</sup> will become the next standard in personal-computer software. Certainly it will be the standard product under which applications will run," says VisiCorp vice president C. Gerald Diamond.

To promote Visi<sup>On</sup> as a standard, Diamond says, the company will be putting new emphasis on OEM arrangements with leading personal-computer manufacturers and will encourage independent software suppliers to adapt their applications for use in the Visi<sup>On</sup> environment.

The first target systems for Visi<sup>On</sup> are IBM Corp.'s Personal Computer and Digital Equipment Corp.'s Professional 350 personal computers. The IBM implementation is scheduled for release this summer and requires a 256K-byte main memory and 620K bytes of disk. Diamond says Visi<sup>On</sup>, combined with the operating system, occupies 100K bytes of main memory. The DEC version's introduction is not scheduled yet.

Diamond claims that transporting the product to a particular computer or an operating system will not be a major task for OEMs. VisiCorp will sell its OEMs licenses for the lowest layer of the Visi<sup>On</sup> package, Visi-Host, which Diamond describes as the interface between Visi<sup>On</sup> and the operating system. Visi<sup>On</sup> can be customized at this level for using target system attributes without



Multiple windows with separate applications can be viewed simultaneously on the same screen with VisiCorp's Visi<sup>On</sup> package. The product is shown on IBM's Personal Computer, which will be the first system to support the product. The "mouse" at right connects to a standard RS232 port and is used to point to functions and data on the screen.

diminishing the system's portability, he adds.

Diamond declines to specify an OEM license price for the package, but expects the end-user price to be consistent with prices for personal computer operating systems. Industry analysts and VisiCorp competitors expect it to have an end-user price of about \$500. Diamond also declines to specify licensing fees for third-party software vendors. He says part of the marketing plan is for VisiCorp to supply some key application packages and for independent vendors to supply Visi<sup>On</sup> versions of their applications.

Files created from VisiCorp programs are said to be upwardly compatible with Visi<sup>On</sup>. The programs, however, are not expected to be integrated with the new product. VisiCorp customers will be given purchase credit toward the price of Visi<sup>On</sup>.

Brian Fischer, vice president of

operations at VisiCorp competitor Context Management Systems, says he is unsure how desirable it will be for independent software suppliers to adapt their products for Visi<sup>On</sup>. "Without any question, VisiCorp is to be congratulated for bringing this type of product into the personal-computer market. It's very, very sexy, but the question is how long will it take to rewrite applications for it, and how much will it cost?" Diamond declines to give prices for the licenses independent software houses would require, but says costs will not be a barrier to making Visi<sup>On</sup> a standard.

Diamond maintains Visi<sup>On</sup> is not comparable to other products, and denies the product was previewed some seven to 10 months before availability as a preemptive marketing move. However, as industry analysts and competitors observed the product at introduction, many

*Continues on page 41*



# PRO-IV™

## INTRODUCING A GIANT STEP TOWARD NO PROGRAMMING.

To fully appreciate what PRO-IV is, let's begin with what it isn't.  It isn't a program generator. It isn't a language processor.  With PRO-IV there is no programming, no code generation, no compiling, no interpreting, no language barriers.

**BREAKS THE APPLICATIONS BOTTLENECK** PRO-IV is the most advanced business applications processor on the market today.  In one processing environment you can develop menus, screens, reports, system security, documentation and logic operations.  With minimal training, anyone with a fundamental understanding of computers will experience significant productivity improvement in applications development.  PRO-IV reduces the time needed to develop or modify an application by up to 80% when compared to conventional methods. **STATE-OF-THE-ART CIES 680**

PRO-IV is available on our CIES 680 state-of-the-art

68000-based business computer, utilizing UNIX™ and industry standard

Multibus™ architecture. **A GIANT**

**COMMITMENT** The backing of a world-wide corporation assures quality in high volume OEM quantities and ensures our commitment to the future.

For more information, just call or write CIE Systems, Inc., 2515 McCabe Way, Irvine, CA 92713-6579 (714) 957-1112.



TM PRO-IV is a Trademark of Data Technical Analysts, Inc.  
Multibus is a Trademark of Intel Corporation.  
UNIX is a Trademark of Bell Laboratories.

 **cie systems**

© 1982 CIES

CIRCLE NO. 22 ON INQUIRY CARD



NCR

• Disk

• Communications

• Fault

• Battery

•

On



Off

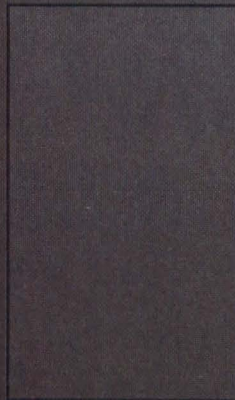
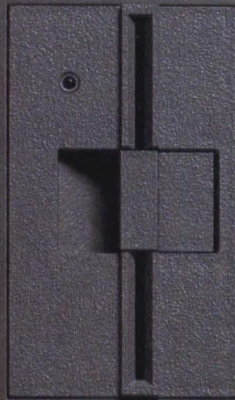



# TOWER™ 1632. IF YOU THINK IT'S BEAUTIFUL IN COLOR, LOOK AT IT IN BLACK & WHITE.

---

**PROCESSOR:**

16-bit 10MHz Motorola 68000 processor off-loads I/O functions to as many as six micro-processor-based controllers with Direct Memory Access (DMA) for powerful minicomputer performance. Memory management unit uses full 24-bit addressing. Clear migration path to 32-bit technology.

---

**USERS:**

1 to 16, local or remote.

---

**MEMORY:**

Up to 2 megabytes ECC memory, in 256K increments.

---

**MASS STORAGE:**

10 megabytes to one billion bytes.

---

**OPERATING SYSTEM & SOFTWARE:**

NCR enhanced operating system derived from UNIX.\* Five user personality levels. Dictionary driven applications generator.

---

**LANGUAGES:**

Cobol, Business BASIC, Fortran, C.

---

**INDUSTRY STANDARD INTERFACES:****I/O Bus:**

Multibus\*\* IEEE-796.

**Magnetic Media:**

SA400—5.25" floppy disks, ST506—5.25" Winchester, SMD—high performance 8" Winchester, QIC II—streaming tape.

**Communications:**

RS232C [ASCII TTY, Bisync (2780/3780)], NCR DLC, SDLC/SNA, X.21/X.25, Networking.

---

**PRICE:**

Under \$10,000 in OEM quantities.

In the foregoing sketch you see the outline of the new shape in computing. Tower™ 1632.

Now that you know what it looks like in black & white, we invite you to see it in action. Call us at (800) 222-1235.



**BUILT FOR SYSTEMS BUILDERS.  
TOWER 1632.**

**NCR**  
OEM Marketing Division

NCR Corporation, World Headquarters, OEM Marketing Division, Dayton, OH 45479. Nationwide (800) 222-1235. In Ohio (513) 445-2380. In Canada (800) 268-3966.

\*UNIX is a trademark of Bell Laboratories. \*\*Multibus is a trademark of Intel Corporation. Products for delivery in U.S.A. will comply with appropriate FCC rules.

CIRCLE NO. 23 ON INQUIRY CARD



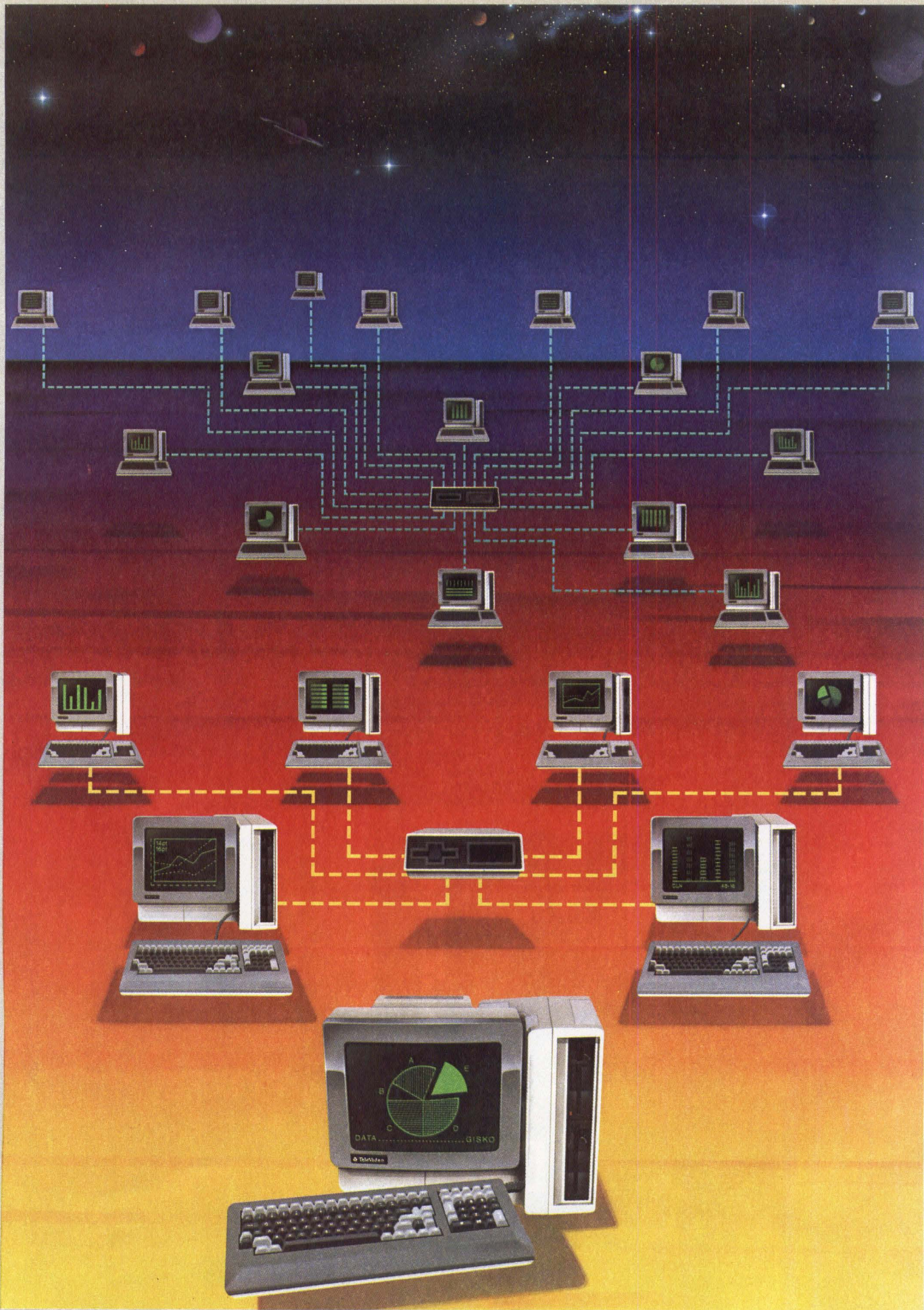



# Of all the small business computers you can choose today, TeleVideo gives you more choices for tomorrow.

Any TeleVideo desktop computer can be used as a single-user, stand alone computer. Then, when you want to expand its professional performance capabilities, you have a choice of ways to grow into a multi-user system of up to sixteen TeleVideo computers. You can use our 8 or 16-bit computers, or any combination, starting with your original unit.

TeleVideo also gives you more choices of professional CP/M® software, including advanced graphics. And, thanks to TeleVideo's unique MmmOST™ executive program, the software used on your single-user computers will run on any TeleVideo multi-user system without modification. So if you want a small business computer that gives you professional performance,

it's obvious that you have a lot of choices for today.

But there's only one with choices for tomorrow. TeleVideo.

For more information, write TeleVideo Systems, Inc., 1170 Morse Ave., Sunnyvale, CA 94086, call toll-free 800-538-1780 (in California call 408-745-7760), call one of our authorized distributors or dealers, or contact one of our regional sales offices, listed below.

Northeast Region, 617-369-9370.  
Eastern Region, 212-308-0705.  
Southeast Region, 404-447-1231.  
Midwest Region, 312-969-0112.  
South Central Region, 214-258-6776.  
Northwest Region, 408-745-7760.  
Southwest Region, 714-752-9488.  
European Sales (Holland), (31) 075-28-7461.

TeleVideo Systems are fully serviced nationwide by TRW.

 **TeleVideo Systems, Inc.**



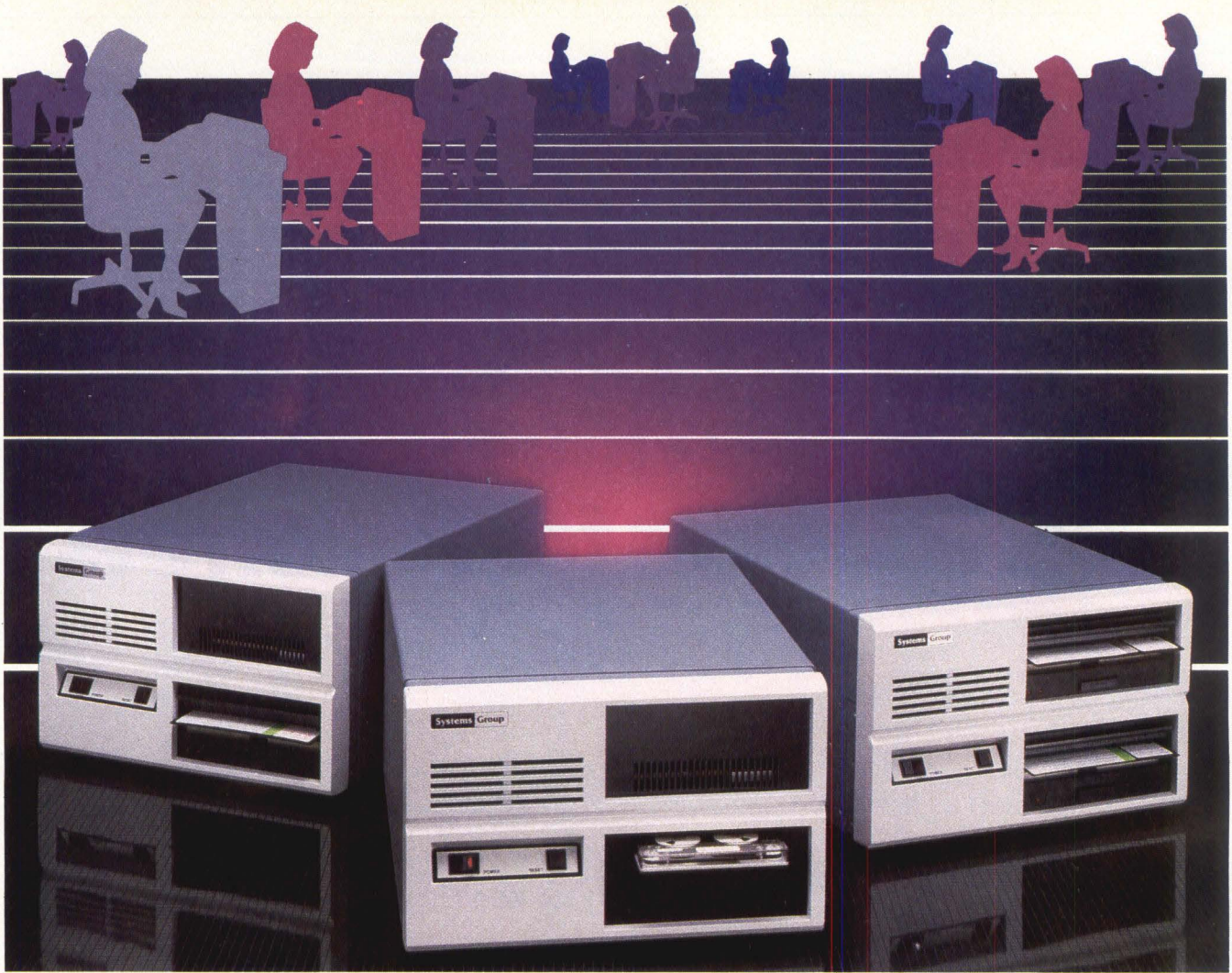

## THE MULTI-USER MICRO THAT REPLACES A MINI

The system integrator's edge on the multi-use business market can be calculated in terms of **COST PER USER**...precisely the reason OEM/System Houses are switching to the System 2900 Computer series.

The versatile multi-user System 2900 supports up to eight users with existing popular operating systems such as CP/M\*, MP/M\* and OASIS,\*\* and **up to 20** users under Systems Group's new Business Express.™

### EXPANDABLE HARDWARE FEATURES

The System 2900 offers minicomputer performance at microcomputer prices. Important features include:

- Modular design allowing configuration with any combination of floppy disks, hard disks and tape drives.

- Easy upgrade through addition of memory modules, I/O interfaces and mass storage subsystems.
- Products designed to incorporate industry-standard peripheral and software compatibility.

### POPULAR OPERATING SYSTEMS

The System 2900 offers these popular software options:

- Use Systems Group's enhanced high-performance versions of CP/M, MP/M and OASIS to develop application software.
- Take advantage of the variety of application packages available for these operating systems.

### BUSINESS EXPRESS—EXPANDED MULTI-USER CAPABILITIES

Systems configured with up to 20

users allows system integrators to offer minicomputer multi-user operation at microcomputer costs. In addition, Business Express offers these unique application development features:

- Develop custom application software **50 to 100** times faster than conventional methods.
- Use or customize Business Express' standard word processing and business application packages.

Systems Group products are designed to offer the OEM/System House software flexibility, and overall system reliability, as well as unbeatable price performance advantages. Call (714) 633-4460 or write for further information.

\* CP/M and MP/M are registered trademarks of Digital Research.

\*\* OASIS is a trademark of Phase One Systems, Inc.

™ Business Express is a trademark of Measurement Systems & Controls, Inc.

**Systems Group**

A Division of MEASUREMENT systems & controls  
incorporated

1601 W. Orangewood Ave., Orange, CA 92668  
Telephone (714) 633-4460  
TWX/TLX 910-593-1350 SYSTEMGRP ORGE



# Mini-Micro World

NEWS

*Continues from page 34*

compared it to some recently introduced "integrated" personal computer packages on one hand, and to Apple Computer, Inc.'s new Lisa computer on the other. Diamond points out that existing integrated packages are "closed-ended" and will not support a growing number of applications, as Visi<sup>On</sup> is expected to do.

Context Management's MBA product combines spread sheet, word processing, database management, graphics and telecommunications. Fischer says that, while VisiCorp has provided a consistent, simple interface, it has overlooked a more pressing need in the market: integrating information from one application to another and automatically updating information through several applications. That capability is supported on MBA, which has been installed on some 1500 IBM PCs in its first five months on the market. It is also available on Lotus Development Corp.'s 1-2-3 (MMS, December, 1982, p. 21). Unlike Lotus, however, MBA simultaneously supports as many as four screen windows, so that a user can change data in the spread sheet and watch how it will affect a graph on the same screen, Fischer says. He claims it appears from early information that Visi<sup>On</sup> would require updating of each application on the screen separately.

VisiCorp customer support manager Laura Burnham agrees that users would have to invoke a transfer command to use the same data in multiple windows.

As for VisiCorp's ability to set standards, industry analyst Esther Dyson of Rosen Research says, "They've got a great opportunity to be the standard. Look at what they've done with VisiCalc, and you'll see they've got a pretty good chance." However, she points out,

VisiCorp will not be alone in offering a standard applications

environment for professional personal computer users. —Geoff Lewis

## Seiko printer processes video signals, offers 8-color output

Japan's renowned Seiko group has brought a bevy of products to the U.S., including Epson printers and computers. A recent entrant flaunts the conglomerate's graphics expertise. Seiko Instruments USA, Inc., Santa Clara, Calif., has introduced the D-Scan 5201 copier/printer that processes video display signals into medium-level plotter resolution, eight-color output on plain paper at less than 25¢ per page. D-Scan uses a scheme called ink sheet, a combination of thermal transfer technology and treated color sheets of paper.

The product produces true screen copy, and is focused on raster graphics applications, says Andrew Wei, manager of graphics devices and systems. D-Scan supports RS170 and RS343 links to one terminal. Wei says Seiko will customize its product for other users. Late this year, Seiko will be able to multiplex as many as four terminals for use with the product, but must develop a multiplexer to handle the differing clock rates of those terminals. A Centronics interface is also offered. Price is \$13,000 in single-unit quantities, and OEM discounts are available.

D-Scan uses a 150-nib thermal print head to achieve an output of 150 × 150 dpi resolution. To produce color copy, the RGB video signal from the terminal goes to a Z80A microprocessor in the copier/printer. The Z80A controls an analog-to-digital converter, which decodes the signal in ½ sec., and moves the signal to the 1280 × 1024 pixel buffer video memory, which

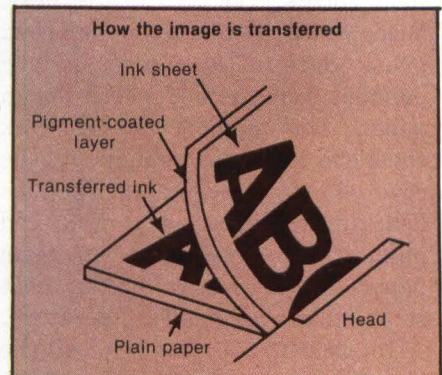

The plain paper and ink sheet are run between the thermal print head and the platen in three passes to pick up yellow, magenta and cyan pigments from the underside of the ink sheet. At the same time, the nibs on the print head heat up and transfer the image to plain paper.

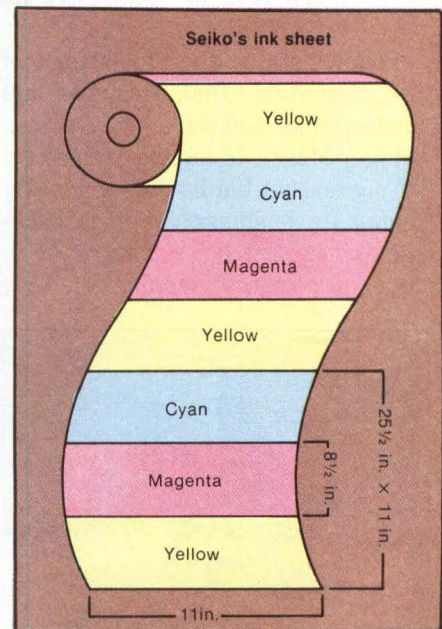

Consecutive page-sized bands of yellow, magenta and cyan contain a rugged pigment that Seiko says is fade-resistant.

holds one screen of information. Copying the signal for printing is



# Mini-Micro World

NEWS

done from the buffer under control of the Z80A.

To produce physical copy, an ink sheet passes over the stationary print head. An ink sheet consists of recurring sheets of pigments of yellow, cyan and magenta measuring  $8\frac{1}{2} \times 11$  in. The sheets come in a segmented roll of 300 sets of three color sheets. The nibs in the print head, which are aligned in one row, press dots of the appropriate pigment from the ink sheet to plain paper. The pigments on the ink sheet are contained in pigment cells covered by a wax medium. The nibs heat up to liquefy the wax and pigments for placement on plain paper. D-Scan has a built-in heat sensor to control head temperature.

To pick up all three colors, the plain paper is aligned around the platen with the first ink band, which

allows the head to transfer the cyan dots. The plain paper retracts to align itself with the second sheet of color, magenta. The process then repeats for the yellow band, requiring less than 1 min. in all.

D-Scan can print eight saturated colors: cyan, magenta, yellow, red, blue, green, black and white. The pigments used, claims Seiko, are fade resistant, unlike the dyes used in ink-jet printers, the technology that competes most closely with thermal. As a result, the output achieved is more permanent and durable, and is easy to mark for editing. The company compares pigment versus dye to oil-type versus water color paints used by artists.

Wei says the ink sheets used in the D-Scan are not a technological breakthrough, but the method of

controlling them is. Because the plain paper must make three passes to achieve the primary colors, high-precision motors and temperature control of the head is mandatory. Because the paper goes back and forth to pick up the dots, the dots must register exactly, so the company integrated a special stepper motor.

D-Scan's integrated video memory stores graphic data while printing copies. An optional multi-copy function key is also available, which allows 99 multiple copies to be produced. Per-copy cost of less than 25¢ includes the cost of both ink sheet and plain paper. The copier accepts plain paper rolls cut into standard-sized sheets. Prototypes are scheduled for this month, with shipments to begin in March and April.

## High hopes for IBM PC graphics package

Following in the footsteps of Software Arts, Inc., Business and Professional Software, Inc., Cambridge, Mass., is hoping to make a strong market bid by independently selling its business graphics package for the IBM PC. Software Arts, developer of the popular VisiCalc

program marketed by VisiCorp, took a similar tack in marketing its new product, TK!Solver (MMS, August, 1982, p. 44). BPS's first product, Apple II Business Graphics (and subsequently Apple III Business Graphics), was marketed by Apple Computer, Inc.

Called BPS Business Graphics, the software, which runs under PC DOS and p-System, can be used with more than 40 output devices. It retails for \$350. In comparison, competitive packages VisiTrend and VisiPlot sell for \$300, and Lotus's integrated 1-2-3 is priced at \$495.

BPS officials are encouraged by optimistic market studies on the future of business graphics and personal computers, and by the success of its packages for the Apple II and III. The programs were introduced in January and April,

1982, respectively, and 7941 units had been sold by September.

The Yankee Group, a Boston market research firm, predicts IBM Corp. will own a 19.2-percent share of the desk-top computer market by 1986. That represents nearly 4 million PCs. The firm expects the business graphics hardware market to jump from \$359 million in 1981 to \$3.3 billion by 1985. More than \$1.8 billion of that will be in desk-top computers. Major manufacturers such as IBM and Digital Equipment Corp. will account for \$1.2 billion, according to the Yankee Group.

With BPS Business Graphics, PC users can create standard graphic formats—lines, horizontal and vertical bars, multiple bars (as many as four sets), pie charts, areas, points, any combinations of those on the same axes and horizontal and vertical grid lines. The system can display as many as six colors.

Data are extracted from VisiCalc and SuperCalc spread sheets and PC DOS and p-System files, or are

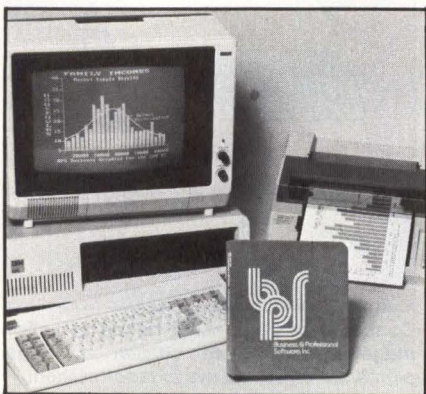

Business and Professional Software, Inc.'s BPS Business Graphics for the IBM PC can be used with more than 40 output devices.



**In 1981,  
Hewlett-Packard  
announced the world's  
densest single chip  
32-bit CPU.**

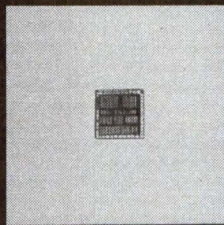



**Today, this 450,000-transistor  
of the HP 9000 family that gives**

---

**...in a \$20K box**



**...a \$50K  
multi-user  
system**



**...a \$30K workstation.**



# computer chip is the heart you full 32-bit power...

Our tiny 1/4" square CPU contains 450,000 transistors. So there's nothing small about the 32-bit power it gives our new HP 9000 family of technical computers. Even our \$20K model gives you the performance of a mainframe computer costing up to four times as much.

And now you can have all this power in a configuration that really fits your application. The densities of the CPU and surrounding 'super chips' allow you the choice of a rack-mountable box; an integrated workstation; and a mini-cabinet suitable for a variety of single and multi-user applications.

Of course, the benefits of one-micron geometry don't stop there. This new technology has also let us develop a multi-CPU architecture that offers you three levels of processing power. Each configuration described above can take one, two or three CPUs. So you can almost double or triple the computer's capacity without adding to its size. Whether you order it that way or add the extra power later, it's transparent to the user.

## 32-bits, every bit of it.

The HP 9000 family has 32-bit internal and external data paths, 32- and 64-bit math (IEEE floating point format), and virtual memory addressing of up to 500 Mbytes.

And it is fast! The system will handle a million instructions per second. The 18 MHz clock permits the execution of a micro-instruction every 55 nanoseconds. The I/O rate can reach 6 Mbytes per second for every I/O slot. And the memory cycle time is a light-quick 110 nanoseconds.

There's also lots of program space, with up to 2.5 Mbytes of main memory. A flexible disc drive and optional 10

Mbyte Winchester are built right into the integrated workstation.

Each memory board has a Memory Controller Chip that provides automatic error detection/correction, memory mapping and 'healing'. Every time you power up, this chip actually maps out single-bit memory error locations, and assigns a back-up memory location in place of the old one—without slowing the access time or reducing memory capacity.

We've also made the CPU more efficient by assigning many of its time-consuming tasks to our Input/Output Processors. And to give you even more speed, the HP 9000 has a backplane bandwidth of 36 Mbytes/second. That's enough to support all three CPUs, each backed up by its own IOP. You can imagine the effect that has on throughput!

## All the benefits of a UNIX® operating system. And then some.

Our HP-UX is an enhanced version of this increasingly popular operating system. It supports FORTRAN 77, Pascal and C language. And lets you take advantage of the many programs and utilities already available for UNIX. In addition, HP-UX offers significant extensions like 3-D graphics, virtual memory, IMAGE Data Base Management, a variety of data communication products and enhanced file capability.

The integrated HP 9000 workstation also supports our highly evolved, high-performance Enhanced BASIC, augmented by 3-D graphics. Its run-time compile feature provides the friendliness and interactive capabilities of an interpreter with the speed of a compiler.

## Powerful networking made easy.

Even our stand-alone models won't have to work alone. Each can be part of a network of powerful, dedicated, interactive workstations. They'll support several different networking options, including Ethernet™ And in late 1983, LANs based on the industry-standard IEEE-802. So you can share peripherals and data files locally.

With HP's broad range of peripherals and instruments to choose from, it isn't hard to build precisely the system you need. Once your HP 9000s are up and running, we can make sure they stay that way. Our service is good enough to be rated Number One in Datapro surveys for the past two years.

We've also developed two special marketing programs that could mean extra sales for you. If you're a software supplier, there's our HP PLUS program, which we designed to open new doors for you. And if you're a hardware OEM, our volume discount schedules and third-party support program make the HP 9000 even more intriguing.

To get a close look at the way our new computer has changed the 32-bit world, phone your nearest HP office listed in the White Pages. Ask a Technical Computer Specialist to give you a hands-on demonstration. Or write for complete information to Pete Hamilton, Dept. 08149, Hewlett-Packard, 3404 East Harmony Road, Fort Collins, CO 80525.

UNIX is a registered trademark of Bell Laboratories.  
Ethernet is a trademark of Xerox Corporation.



CIRCLE NO. 26 ON INQUIRY CARD



# Mini-Micro World

NEWS

entered directly from the keyboard. Moving averages, curve fitting and exponential smoothing can be performed.

Business Graphics differs from integrated packages such as Lotus's 1-2-3 in that it concentrates on graphics. David Solomont, president of BPS, insists that by

concentrating on graphics, BPS will become the best in its niche. Lotus's 1-2-3 has spread-sheet capabilities, database management and word processing as well as graphics. It does not automatically offer the statistical functions, such as moving average and standard deviation, that the BPS package does—a 1-2-3

user can only conceptualize such functions by inserting the appropriate formulas.

A major feature of the BPS package is its device independence. Some of the more than 40 output devices supported by the system include Houston Instrument's DMP-3 and Hewlett-Packard Co.'s HP7220 plotters, several Diablo Systems, Inc., printers and Integral Data Systems' Prism dot-matrix printer.

The BPS software is designed to run eventually under several operating systems. Solomont says the package will run under Digital Research, Inc.'s CP/M and OASIS operating systems in the future.

Written in Pascal, Business Graphics requires at least 128K bytes of memory, an IBM graphics card and any standard monitor. The system resides in 100K bytes of dynamically allocated memory.

The \$350 price tag includes a backup disk, a tutorial manual with 70 sample charts and telephone support. Update disks will become available as the system interfaces with more plotters and printers. Marketing, scheduled to begin last month, is through ComputerLand and independent dealers carrying the IBM PC.

BPS had 1982 sales of \$400,000 and has received \$300,000 in venture capital from Eastech Associates, Boston, for new-product development. It has also established a \$400,000 credit line with Arlington Trust Co., Lawrence, Mass., for general operations. Solomont says the company hopes to go public or get acquired this year.

He believes 80 percent of the graphics supply is for sophisticated presentation applications, which he says account for only 20 percent of the demand. The other 80 percent of the demand, he claims, is for low-cost, analytical business graphics for desk-top computers.

—David A. Bright

**WHEN YOUR MODULE DRIVE  
RUNS OFF TRACK,  
WE'LL GET IT BACK  
ON THE ROAD. FAST.**

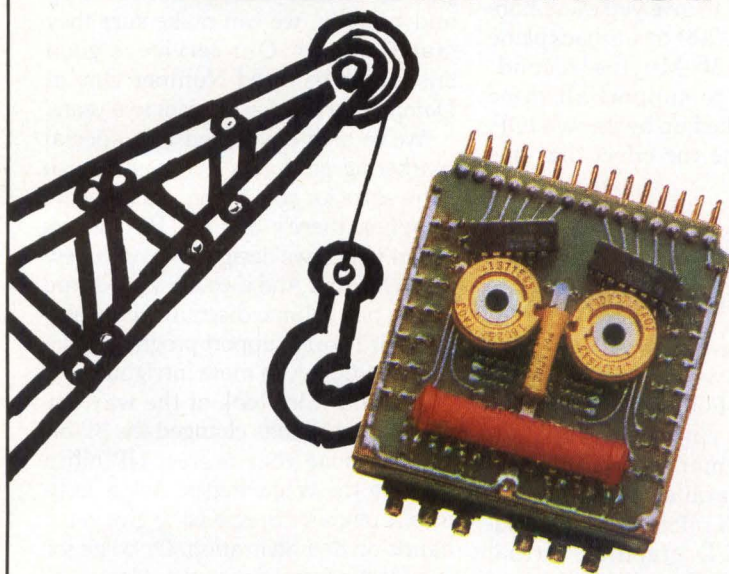

**CALL CONTROL DATA.  
800/328-3980**

When your CMD (or any other drive in the storage module family) isn't running smoothly, call us. We repair and maintain dozens of makes and models. We're located nearby, in 50 cities throughout the United States.

**CD CONTROL DATA**

*Addressing society's major unmet needs  
as profitable business opportunities*

CIRCLE NO. 27 ON INQUIRY CARD



# We planned our family of color terminals and printers to work the way you use them.

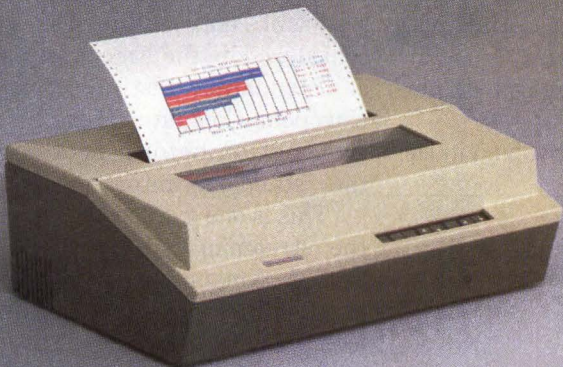

## Together.

You're looking at the new Envision family of color terminals and printers. Built with all the features you've been waiting for—family compatibility, upgradeability, text with graphics.

How did we do it?

We made our terminals support everything from business applications to demanding CAD/CAM. We also made them upgradeable so you could change the amount of color graphics you need.

For instance. Our model 230 terminal includes distributed graphics processing features like local storage and manipulation of graphics objects. Local 2-D transformations. True zoom and pan. 16K x 16K virtual resolution. 16 colors from a palette of 4,096. And more.

We designed our letter quality color VectorPrinter™ like a printer/plotter, using 8 colors and a fast 300 cps print speed.

Finally, we put each and every product through intensive 100% reliability testing. And if that wasn't enough, we also made them affordable\*.

Best of all, you won't have to wait for Envision's color family. It's available now.

Amazing what a little planning can do.

# Envision

631 River Oaks Parkway  
San Jose, CA 95134  
(408) 946-9755

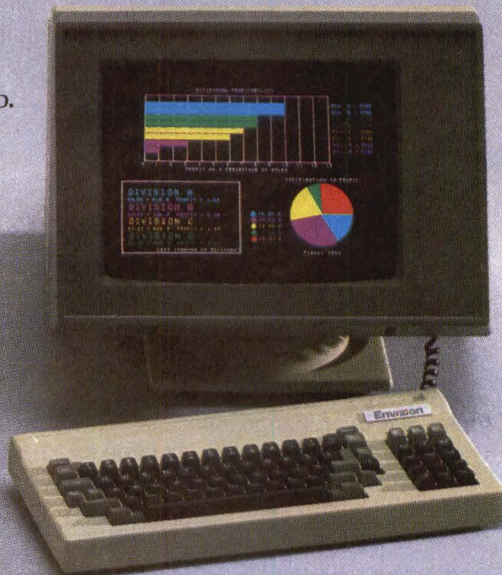

\*Envision 210 Color Terminal: \$2,750  
Envision 220 Color Graphics Terminal: \$4,950  
Envision 230 Advanced Color Graphics Terminal: \$6,950  
Envision 420 Color Printer: \$3,950  
Envision 430 Color VectorPrinter: \$4,950

*OEM pricing available*

VectorPrinter is a trademark of Envision Technology Inc.

CIRCLE NO. 28 ON INQUIRY CARD



## Six companies back standard for 1/4-in. streaming tape

Manufacturers of 1/4-in. streaming-tape cartridges, hastened by market pressure for 5 1/4-in. rigid disk drive backup, have settled on a standard. The standard covers

format and interface and was developed by the Working Group for Quarter-Inch Cartridge Drive Compatibility (QIC).

The six companies involved in the

group—Archive Corp., Cipher Data Products Inc., Data Electronics Inc., Irwin/Olivetti, Inc., Qantex Division of North Atlantic Industries Inc. and Tandberg Data A/S—will not even wait to be considered by the American National Standards Institute and the European Computer Manufacturers Association before incorporating the standard into products.

"This is one giant step forward for the streaming-tape market," says Tom Makmann, vice president of marketing for Archive, whose format—with some modifications—was adopted as the new QIC-24 standard. "The need for a standard has been established by the marketplace, and this was a swift response to that need."

The committee unanimously adopted the Archive format with four- and nine-track formats, but with the modification of an address identifier for each written block and a track reference burst on track zero between the beginning of tape and the load point.

The committee rejected the only other format in the running, proposed by Control Data Corp., which did not meet the requirements of the committee members, says Bob Oakley, marketing manager for DEI. CDC is not a formal member of the group.

The committee was formed at last spring's National Computer Conference in Houston, and two months later, it decided on a QIC-02 standard interface for streaming tapes. The format decision was announced at the November Comdex show. "This decision by the member companies should stimulate much greater market demand for 1/4-in. streamers as companion devices for 5 1/4-in. rigid disk drives above the 10M-byte capacity level," says independent consultant Ray Freeman Jr., president of Freeman Associates, Santa Barbara, Calif. Freeman mediated at the committee discussions. —Robert A. Sehr

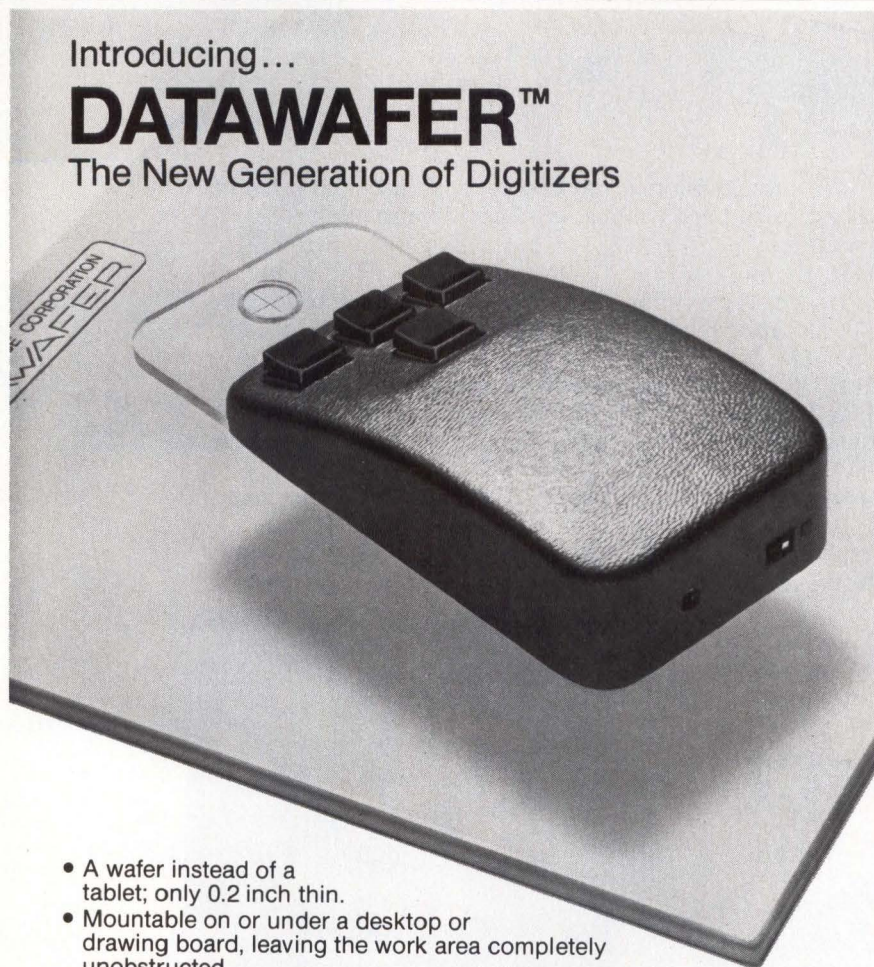

Introducing...

### DATAWAFER™

The New Generation of Digitizers

- A wafer instead of a tablet; only 0.2 inch thin.
- Mountable on or under a desktop or drawing board, leaving the work area completely unobstructed.
- A mouse without tail, a cursor without wire, a stylus without cable — completely interchangeable.
- Working areas as small as you'd like, as large as 20-by-20 inches.
- Designed for the man-display interface, for designing and menu selection directly on CRT.
- Replaces light pens, joysticks, trackballs, and clumsy cabled cursors and styluses.
- Priced for tomorrow's market. (We understand the need for low prices.)

If your system requires interaction between hand and display, contact DIC for more complete information on Datawafer, the successor to old-fashioned digitizers.



**DISPLAY INTERFACE CORPORATION**

525 Boston Post Road, P.O. Box 250  
Milford, Connecticut 06460 (203) 877-7661

CIRCLE NO. 29 ON INQUIRY CARD



# LASER PRINTING.

IT'S YOURS FOR AS LITTLE AS \$17,500.

On the right you're looking at sample output from our IMPRINT-10™.

If you're considering a local laser printer, we can deliver, at an unmatched price and performance level.

## Practical Applications

The IMPRINT-10 provides line printer speed, daisy wheel quality, plotter graphics capability and typesetter font flexibility.

In the office, it's producing reports and internal documents at higher speeds and with substantially less noise than other printing devices. In data processing, it's delivering higher quality output than line printers in convenient 8½" x 11" page size. IMPRINT-10's allow graphic plotter users to merge high quality graphics with high quality text. Graphic arts applications include proofing for typesetting and demand publishing.

## Proven Hardware, Exceptional Software

The IMPRINT-10 uses a proven electrophotographic marking engine that has provided reliable service to thousands. Exceptional software is the key to IMPRINT-10 versatility. After years of development at a leading university, Imagen's proprietary image process-

ing software produces superior results with both efficiency and ease of use.

## Satisfied Users

In the 15 months prior to its commercial announcement over a hundred IMPRINT-10 systems have been in field use. Many customers have multiple systems installed and most customers are now planning future installations.

## Let Us Prove Our Claims

Call or write for more information about the IMPRINT-10. We want the opportunity to prove that its performance can't be beat.

If you are thinking about laser printing, then you should be thinking about Imagen.

# IMAGEN™

IMAGEN Corporation  
2660 Marine Way  
Mountain View, CA 94043  
(415) 960-0714

The difference between one typeface and another is often very subtle; it may be no more than a slight difference in the shape of the serif, the length of the ascenders and descenders, or the size of the x-height. But regardless of how small the difference, the typeface, AND THEREFORE THE APPEARANCE OF THE PRINTED PAGE, WILL BE AFFECTED.

$$\psi(P) = \frac{1}{4\pi} \oint_S \left( \psi \nabla \frac{e^{ikr}}{r} - \frac{e^{ikr}}{r} \nabla \psi \right) \cdot \mathbf{n} da$$

IMAGEN and IMPRINT-10 are trademarks of Imagen Corporation.

CIRCLE NO. 30 ON INQUIRY CARD

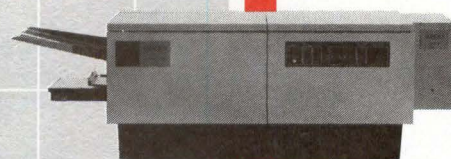

*No. 2 in a series:*

# Should I from my

Yes. In fact, insist upon it. At Texas Instruments, our goal is first-pass success on your logic array. And to achieve that goal, we provide in-depth support and assistance throughout the entire design cycle. From initial training and documentation; through actual design, analysis, and consultation; to the verification of your design before we begin production to your specifications.

## **What immediate help is there to get me started?**

The Answermen at TI's strategically located Regional Technology Centers (RTCs). Expert and knowledgeable, they are ready now to answer your preliminary questions over the telephone, and to help you determine the feasibility of TI logic arrays.

### **RTC Answermen Hot Line Numbers**

ATLANTA	(404) 452-4686
BOSTON	(617) 890-4271
CHICAGO	(312) 228-6008
DALLAS	(214) 680-5096
NORTHERN CALIFORNIA	(408) 980-0305
SOUTHERN CALIFORNIA	(714) 660-8164
BEDFORD, ENGLAND	0234 223000
FREISING, WEST GERMANY	08161 800
HANNOVER, WEST GERMANY	0511/648021
TOKYO, JAPAN	03-498-2111

The RTC Answermen can also describe how TI's design automation system, with its series of checks and balances, minimizes errors and redesign. And they will explain the software tools available to ease and speed the design procedure.

◀ **At the ready:** The RTC Answermen in TI's Regional Technology Centers are equipped to provide virtually instantaneous information about TI logic arrays and a host of other TI semiconductor products. The RTCs are your most accessible entry point to TI's unmatched combination of product depth, design knowledge, and development tools that can result in the most cost-effective TI semiconductor solution for you.



# Ask the RTC Answermen at Texas Instruments

## expect extensive design help logic array supplier?

### What design training is available?

A five-day, design-level seminar is conducted regularly at the RTCs. This course will familiarize you with the techniques and capabilities of TI's design languages and automated software system.

During the course, you will learn TI's Hardware Description Language (HDL) and Test Description Language (TDL). They are used to define complex logic functions in a generalized format for compilation into a data base transferable into TI's design automation system.

The course also covers other tools available to you, including advanced simulation, design testability, design verification, and test-pattern grading.

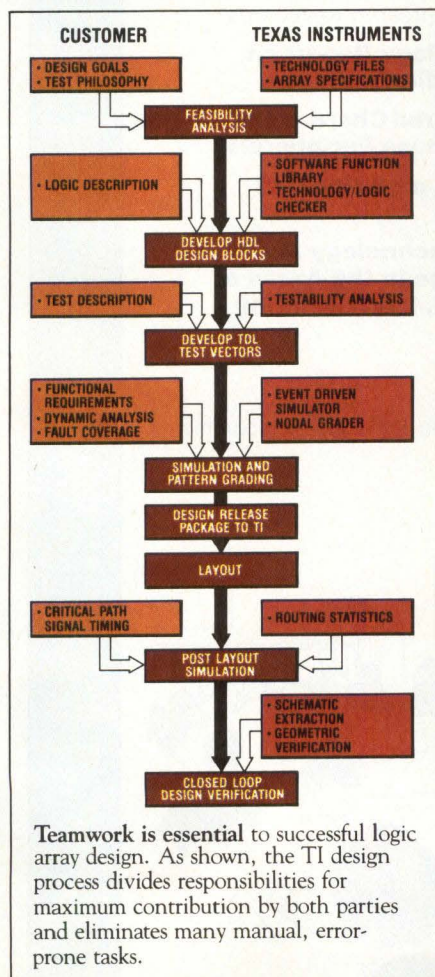

### Fast, Efficient TI Logic Array Family

Array	Gates**	Technology†	Gate Delay	Gate Power	I/O Signals	Commercial/Military
TAL002*	280	LPS	5.0 ns	1.25 mW	29	C
TAL004*	400	LPS	5.0 ns	1.25 mW	42	C
TAT004	400	STL	2.5 ns	600 μW	76	C/M
TAT008	800	STL	2.5 ns	600 μW	104	C/M
TAT010	1000	ASTL	1.0 ns	300 μW	88	C
TAT020	2000	ASTL	1.0 ns	300 μW	120	C/M
STL700	560	STL	3.0 ns	300 μW	61	M
SBP96700	1120	‡L	11/15 ns	100 μW	96	M
SBP96600	2120	‡L	11/15 ns	100 μW	140	M

\*TAL Series Arrays are manually routed by you and schematically verified by TI with your software HDL model prior to prototyping.

\*\*Usable gates

†LPS — Low-power Schottky

‡L — Integrated Injection Logic

†STL — Schottky Transistor Logic

†ASTL — Advanced Schottky Transistor Logic

When circumstances warrant, we'll conduct the seminar at your plant.

If you want to study on your own, appropriate documentation may be obtained from TI. This consists of a detailed Logic Array Designers Manual, data sheets of logic array characteristics, information packets on library-accessible, predesigned software functions, and related technology application notes.

### Where can I get actual design assistance?

At TI's RTCs, home of the Answermen. TI engineers at the RTCs will evaluate your schematic at no charge. This evaluation includes assessment of your general performance requirements. Gate count. And associated I/O, as described by you.

The RTC will recommend the type of TI logic array best suited for your job (see table) as well as the appropriate package.

Each RTC has the facilities which you can use to describe your logic and prepare the HDL and TDL data base. If you prefer, the RTC will contract to do this work for you.

### How readily can I access the design tools?

Everything at TI is done to make the design process as simple and as fast as

possible. Access to TI's efficient design-automated system can be by terminals at the RTCs; by dial-up communication links from your plant, tied directly to TI's worldwide computing network. And by the Transportable Design Utility (TDU). The TDU allows you to perform your design work — utilizing the TI design software — at your own pace and on your in-house hardware.

The TDU, written in Pascal, includes the HDL compiler/syntax checker, TDL compiler, an interconnect rule checker, a design testability analyzer, and an event-driven logic simulator.

### When should I start my design?

There's no better time than now. The RTC Answermen are standing by their Hot Line telephones (see listing opposite page) to answer your technical questions and assist you in taking advantage of the time and money savings inherent in TI's logic array design automation system. Or visit the RTC nearest you, or call your local TI sales engineer.



# TEXAS INSTRUMENTS

27-5030A



# Call for Papers

to be presented at...



**September 13, 14, 15, 1983**  
**Moscone Center**  
**San Francisco, California**

You can be an integral part of a totally new exposition — the only conference and exhibition devoted exclusively to the evaluation, selection and application of peripheral equipment.

The following is a list of subjects that the organizers feel would be of major interest to conference attendees. If you are working in any of these areas and would like to contribute to the program, we welcome your response. The material should be new and unpublished and non-commercial in nature. Please send a 200-300 word abstract to the address below.

**Reliability Tests on Drives and Thin Film Heads**

How Do We Test for the Most Reliable Product?

**What Is the Status of Magnetic Media?**

A Price/Performance Survey

**Reducing the Peripheral Cost by Component Price Reduction**

What Is Happening to the Cost of Connectors, Drives, Devices?

**How Do You Compare Price and Quality of Fully Formed Characters Versus Dot Matrix?**

Survey of Technology and Market

**Where Is the IBM Compatible Equipment?**

**The Market for DEC Compatible Equipment**

A Survey of Products

**The Status of I/O's, Barcode Reader's, OCR's, Voice**

Are They a Veiled Threat to Keyboards?

**The Latest Technology Report on Vertical Recording**

**What Are the Required Characteristics for Small Business Peripherals?**

**What's Happening with Non CRT Displays?**

**Will We See the Technology of Printers Emerge in the Areas of ION Deposition, Laser Printing and Ink Jet?**

If your abstract is selected, instructions on paper presentation will be sent to you at the time of program's announcement.

**Abstract deadline is:**

April 30, 1983

**Mail your abstract to:**

William D. Ashman  
Program Coordinator  
Cahners Exposition Group  
Cahners Plaza  
1350 E. Touhy Avenue  
P.O. Box 5060  
Des Plaines, Illinois 60018  
Phone: (312) 299-9311  
Telex: 82882 CEG/CHGO

**Organized by:**



A leader in high technology expositions throughout the world. Offices in Boston, Chicago, Stamford, Los Angeles, Hong Kong, London, Singapore and Tokyo.

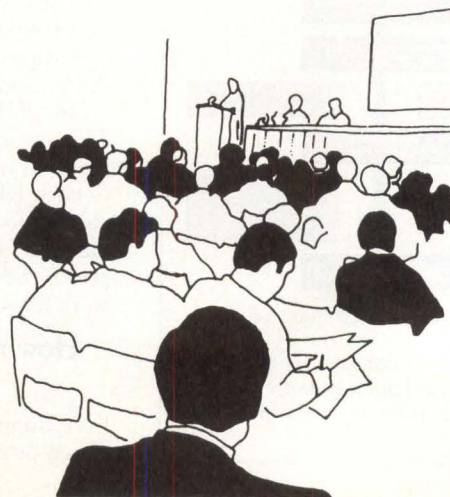



# EXPAND YOUR MULTIBUS SYSTEM'S OUTER LIMITS.



## XYLOGICS HAS SOLD MORE HIGH PERFORMANCE MULTIBUS PERIPHERAL CONTROLLERS TO MORE MAJOR OEMs THAN ANYONE.

That's a fact. But it's sometimes obscured by the breadth and popularity of Xylogics' full range of peripheral controllers for mini and micro computers.

Yet for Multibus™ systems employing 68000, 8086 or Z8000 class microprocessors with large capacity disk and tape drives, no other Multibus controllers offer better performance or more advanced features.

### NEW 450 AND 472 CONTROLLERS JOIN POPULAR XYLOGICS 440.

For the past three years, the Xylogics 440 peripheral controller—the industry's first Multibus SMD controller—has offered the highest peripheral control performance in Multibus benchmark tests and customer installations.

Now Xylogics has developed two new advances in Multibus periph-

eral control: the 450 and 472. Together, they set the standard for price, performance and size for IEEE-796 Multibus applications.

The new Xylogics 450 peripheral controller provides even more performance for Multibus disk control applications. The 450 can address up to 16MB of memory and control up to four SMD disk drives at data rates of up to 1.8 MB/sec. non-interleaved.

The new Xylogics 472 is a high performance, single-board tape controller for streaming and start-stop tape drives. It can address up to 16MB of memory and control up to four tape drives—running at speeds from 12.5 ips to 125 ips and at densities of 800 bpi NRZI, 1600 bpi PE, 3200 bpi, or 6250 bpi GCR.

The 440, 450 and 472 feature advanced channel control tech-

niques and are designed to work together for system optimization. For Multibus users, this means low bus usage, non-interleaved disk operation and true high-speed streaming with no repositioning. All three work with any 16, 20 or 24 bit address Multibus system.

Xylogics. The leader in high performance Multibus peripheral control.

TM Multibus is a registered trademark of Intel Corp.



144 Middlesex Turnpike, Burlington, MA 01803  
Tel: (617) 272-8140 TWX: 710-332-0262  
Xylogics European Headquarters: (Slough, U.K.)  
Tel: (0753) 78921 Telex: (851) 847978  
Xylogics Germany (Eschborn)  
Tel: (49) 6196-47004

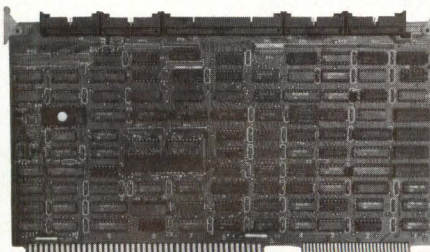

Xylogics 450 Multibus Disk Peripheral Controller.

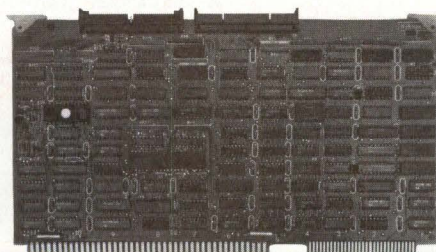

Xylogics 472 Multibus Tape Peripheral Controller.

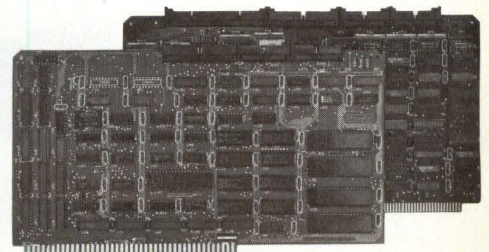

Xylogics 440 Multibus Disk Peripheral Controller.

CIRCLE NO. 32 ON INQUIRY CARD



# Consider Us Family.

When you are looking for the best long term means of capitalizing on today's new generation of 68000 based computers, don't confuse WICAT with other micro-vendors. The WICAT family supports 1 to 32 users with mainframe software and minicomputer performance at microcomputer prices. Our complete system software offering makes it almost trivial to port your application packages. Operating systems include MCS and UNIX\* (UniPlus<sup>™</sup>) with language support including RM COBOL, FORTRAN 77, DIBOL\* (DYBALL\*) APL, PASCAL, C, CIS COBOL, and BASIC.

WICAT began installing, maintaining and enhancing our 68000 based product line over two years ago and maintains the technological lead in this market. We offer OEMs a unique relationship, indeed a partnership of two-way assistance and flexibility. WICAT is serious about your future. Consider us family!

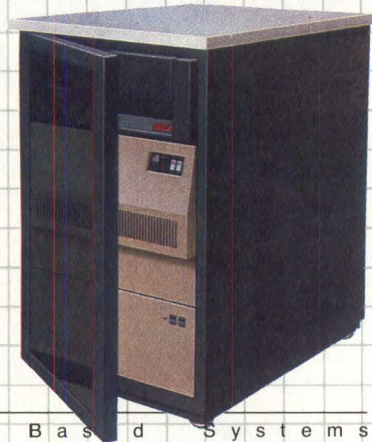

The WICAT Family of 68000 Based Systems

## System 150

1 to 6 users  
256 KB - 1.5MB RAM  
10-60MB Winchester Disk Storage

## System 160

1 to 12 users  
512KB - 4.5MB RAM  
10 - 474MB Disk

## System 200

8 to 32 users  
512KB - 5 MB RAM  
40MB - 474MB Disk (x4)

Get to know the WICAT Family. Call your local OEM Sales Manager:



- A Jim Camilleri (San Francisco) (415) 834-6723
- B Dennis Hunter (Utah) (801) 224-6400
- C Bruce Baillio (Dallas) (214) 387-3303
- D Gene Gentges (Chicago) (312) 630-0010
- E Jim Ryan (Cleveland) (216) 831-5737
- F Watson Coverdale (New York) (212) 697-4740

**WICAT**systems

P.O. Box 539 1875 South State Orem, UT 84057 (801) 224-6400

CIRCLE NO. 33 ON INQUIRY CARD

\*UNIX is a trademark of Bell Labs  
UniPlus is a trademark of Unisoft  
\*DIBOL is a trademark of Digital Equipment Corporation  
\*DYBALL is a trademark of Paradata of New York and New Jersey



# Mini-Micro World

CORPORATE AND FINANCIAL

## Prime acquires British CAD/CAM firm, other British companies ready to change hands

Prime Computer, Inc., has substantially strengthened its position in the CAD/CAM market with the acquisition of Compeda, a British-government-backed company that markets commercial and industrial software products.

The most noteworthy product is Plant Design Management System, a powerful design package that can be hosted by Prime machines. The package permits 3D modeling of pipelines and such complex plants as nuclear power stations. U.S. users include engineering construction company C.E. Lummus, a subsidiary of Combustion Engineering Inc., Windsor, Conn.

The terms of the acquisition leave the property rights of PDMS with the British government's Department of Industry, which funds PDMS developer the Computer Aided Design Center, Cambridge, England.

Compeda will operate as an autonomous unit within Prime, maintaining its headquarters in Stevenage, England. A Prime spokeswoman says Compeda's four U.S. offices in Paramus, N.J., Menlo Park, Calif., Schaumburg, Ill., and Houston will be merged with Prime's sales offices.

Computervision Corp. also bid for Compeda, but its offer was rejected because of disagreement over the rights to PDMS. Computervision is acquiring another British CAD/CAM company, Cambridge Interactive Systems. CIS developed the Medusa modeling system, which is sold through Prime (MMS, November, 1982, p. 148) and Applied Graphics Systems, Rotterdam, the Netherlands, which sells Medusa in continental Europe.

Computervision cannot immediately sell Medusa in the U.S.—under an existing agreement, Prime has exclusive U.S. rights to the product through 1985. (Prime acknowledges that Computervision will be able to sell Medusa after 1985.) However, there is some uncertainty about whether Medusa will be mounted on Computervision hardware sold in Europe or whether CIS will continue to sell Medusa indefinitely on other vendors' hardware. Prime machines are now the most common Medusa hosts. CIS marketing director Grispin Gray hopes that CIS will continue to operate independently of Computervision after the acquisition.

As part of its policy of selling publicly owned companies, the British government also plans to sell the Computer Aided Design Center this year. Apart from PDMS, the CAD Center product line also includes Graphical Numerical Control, which is sold in the U.S. by Cadlink, Inc., Troy, Mich. CAD Center financial controller Brian Pickton says the government hopes to sell to several joint owners, making it unlikely that a controlling interest will be sold to any one purchaser. The center is staffed by personnel from Britain's biggest computer company, ICL Plc.

—Keith Jones

## Multiplex files suit against Fortune

A trademark-infringement suit before a Los Angeles federal court may cost one of its participants a fortune—in more ways than one. In a case brought by systems house Multiplex Information Systems, Los Angeles, against Fortune Systems Corp., San Carlos, Calif., Multiplex claims Fortune, the widely publicized year-old start-up that manufactures systems under the name of Fortune 32:16, has violated a trademark Multiplex has held for seven years.

Multiplex contends it began selling its "Fortune 2000" products in 1978, after Cincinnati Milacron ceased production of its "George" microcomputer. Multiplex had been an OEM for Cincinnati Milacron, added its own hardware and software enhancements to George

and marketed the product under the name Fortune 2000.

"Defendant's advertising, offering selling of computer system, component parts therefor and computer software under the marks Fortune 32:16 and Fortune Systems are likely to cause confusion," contends Multiplex's legal brief.

Multiplex is asking the court to order Fortune Systems to stop using the name for its products and to award all of Fortune's profits from its use of the name, which Multiplex estimates at "well over \$10 million," to Multiplex. The suit contends the confusion has caused an estimated \$1 million in damages to Multiplex.

Fortune Systems president Gary Friedman says the suit is "totally without merit," noting that Fortune



# Here's Why Precision Visuals Is Now The Leader In Graphics Software Tools!

## One Program Drives Many Devices

This single advantage can save you hundreds of hours of programming time. It enables you to use your hardware (both host computer and graphics devices) to its fullest. It protects your software investment against obsolescence and frees you from exclusive ties to hardware vendors.

Precision Visuals currently offers tailored interfaces for over 30 graphics devices from these companies: AED  Applicon  Calcomp  Calcomp lookalikes  Chromatics  DEC  Digital Engineering  HP  Houston Instruments  IBM  Imlac  III  KMW  Megatek  Printronix  Ramtek  Raster Technologies  Sanders  Selanar  Servogor  Tektronix  Tektronix lookalikes  TI  Trilog  Versatec  Visual Technology  Zeta.

## They Run On Most Popular Computers

Including IBM, VAX, PR1ME, Hewlett-Packard, CDC, Honeywell, Data General, DEC 10/20, Harris, Univac, Cray, and DEC PDP-11.

Precision Visuals software tools require a surprisingly small amount of computer resources. Even on smaller machines they provide access to the full capabilities of the CORE graphics standard.

*"At Martin Marietta, DI-3000 serves as a common interface between our numerous graphics devices and software applications. We use DI-3000 for applications including structural analysis, business charts, graphs, animation, 3D modeling, and general-purpose graphics."*

Karin Bruce  
Senior Graphics Software Engineer  
Martin Marietta Denver Aerospace

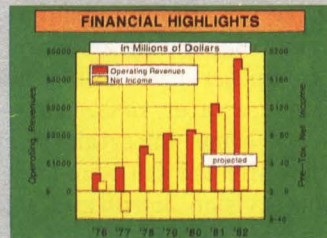

*Make better decisions, faster, using GRAFMAKER's specially-placed annotation and color.*

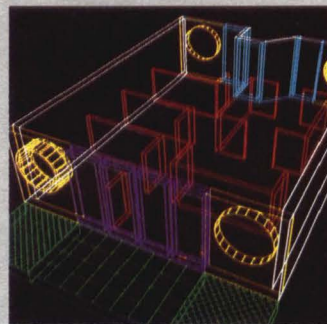

*Build highly interactive computer-aided design applications with the DI-3000 core system.*

## Rich Capabilities Mean Limitless Applications

Precision Visuals software tools are proven in applications such as computer-aided design, business graphics, process control, mapping, geological data analysis, document layout, plus many specialized applications. System integrators (OEMs) use them as the graphics nucleus in turnkey systems and as the graphics component of database management and financial modeling systems.

## \$12,000 For Our Most Popular System

DI-3000™, the core system, starts at \$8,000 and goes to \$12,000 for our most powerful and best-selling level. Add \$6,000 for GRAFMAKER™, the business presentation specialty system, and you'll have one of the most versatile graphics systems available at any price. Other popular options include the METAFILE SYSTEM for a device-independent

picture library, and our new CONTOURING SYSTEM for advanced surface graphics.

These are single-CPU, end-user, U.S. list prices. Multiple CPU and OEM discounts are also available.

Find out how Precision Visuals graphics software tools can open a new world of flexibility, economy, and standardization for your graphics applications. Call us at 303/530-9000.

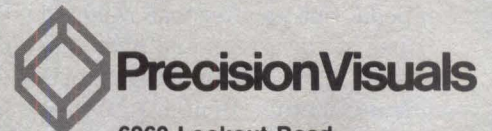

**Precision Visuals**  
6260 Lookout Road  
Boulder, Colorado 80301 USA  
303/530-9000  
TELEX 45-0364/TWX 910-940-2500

Amsterdam: Ponder Associates  
Phone 030445352 / TELEX 70634  
Sydney: Techway  
Phone 02920858 / TELEX 27987  
Tokyo: Nichimen Company Ltd.  
Phone 032775017 / TELEX 22329  
Zurich: Computer Graphix AG  
Phone 019323482 / TELEX 875447

CIRCLE NO. 34 ON INQUIRY CARD



# More Room... More Multibus® Cages.



ONLY FROM ELECTRONIC SOLUTIONS!

## More Room

You get more room for extra cards without increasing overall size, because our design gives you greater inside dimensions.

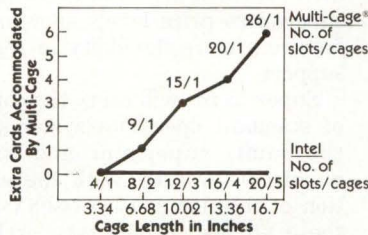

## More Reliability

All cages are constructed of sturdy, durable anodized aluminum with a single mother board backplane... a concept that increases reliability and minimizes interconnections.

## Rack Mounting Too!

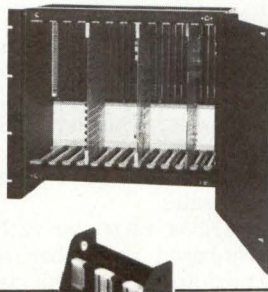

## More Models

We have more models than all our competitors combined. Choose a cage with 3, 4, 5, 6, 7, 8, 9, 12, 14, 15, 16, 20, 24 or 26 slots for the right solution to your problem. We have models with either 0.6" or 0.75" card centers and can even accommodate wirewrap cards.

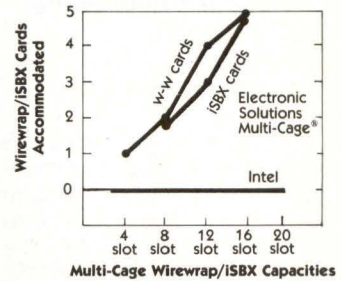

All models are electrically and dimensionally interchangeable with Intel's iSBC-80® Cages.

## More Warranty

A three year warranty is your assurance of quality.

## More Information?

Call our toll free number  
(800) 854-7086



## Electronic Solutions

5780 Chesapeake Ct., San Diego, CA 92123  
(619) 292-0242  
Telex II (TWX): 910-335-1169

Note: Multi-Cage is a registered trademark of Electronic Solutions. Multibus, Intel and iSBC-80 are trademarks of Intel.

# MULTI-CAGE®



# Mini-Micro World

CORPORATE AND FINANCIAL

conducted a thorough patent and trademark search before adopting the name. "A lot of lawsuits are filed

by people who expect the defendant to pay them some money just to shut up," Friedman says. "If that's

the case here, they've chosen the wrong company to sue."

—Robert A. Sehr

## MARKET BAROMETER

A monthly column devoted to an expert's look at an industry

### Supermicros: a dominant new wave

By Omri Serlin  
ITOM International Co.

Supermicros are taking over the world. These general-purpose computers combine a fast, 16/32-bit MPU (such as the Motorola 68000) with 64K-bit RAM chips and the new generation of dense, 5¼-in. Winchester. Supermicros offer up to supermini performance in desk-top packaging at less than \$15,000.

Such start-ups as Convergent Technologies, Inc., Fortune Systems Corp. and Wicat Systems, Inc., have hitched their wagons to the rising supermicro. But the significance of the trend has not been lost on IBM Corp., NCR Corp., Hewlett-Packard Co. and Tandy, now offering such systems, as do Intel Corp., Zilog, Inc., and Texas Instruments Inc. Burroughs Corp., NCR and others sell supermicros under private-label arrangements. By 1986, supermicros will generate nearly half of the worldwide revenues from microsys-

tems sales (see chart 1).

Supermicros are of special interest to small and medium resellers, which may be locked out of the 8-bit field by overcrowding and lack of product differentiation. The higher supermicro price levels allow manufacturers more flexibility in reseller support.

Supermicros will carry the concept of standard operating systems into the mini, supermini and small-mainframe worlds. With the exception of the IBM 370/43XX/30XX lines, these ad hoc, proprietary architecture machines are supported almost exclusively by vendor-supplied software. Their installed bases are too small to attract third-party software suppliers. This is no longer a tenable approach.

We have an excellent model of the future in CP/M, an operating system usable on the huge installed base of 8080/8085/Z80-based machines (estimated at more than 700,000 by year-end 1982). A vigorous third-party software market has emerged around CP/M and the popular 6502-based Apple Computer, Inc., and Commodore Business Machines lines. The wide availability of third-party software in turn encourages hardware sales.

Various CP/M derivatives run on 8086-based and other supermicros. Another contender is UNIX, a multi-user operating system devel-

oped at Bell Laboratories. UNIX is much richer than CP/M, but requires much more memory and is notoriously unfriendly. Its main attraction is the relative ease with which it can be transported ("ported"), because it is coded mainly in C.

UNIX usage is currently very limited. Despite the mass hysteria around this operating system, I do not expect it to become a dominant factor in the overall microsystems market (see chart 2). But by 1986, it will probably be running on about 20 percent of the installed base of about 615,000 supermicros.



Omri Serlin heads ITOM International Co., a Los Altos, Calif., research and consulting firm. ITOM recently issued a supermicro market study and is publishing a monthly newsletter on the subject.

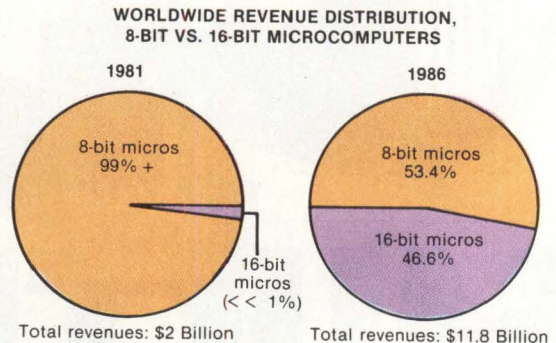
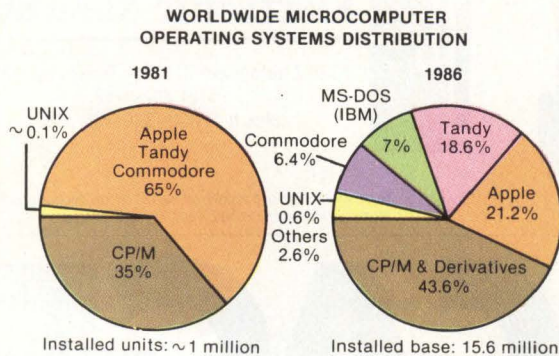

Source: 1982 ITOM International Co.





MAKING THE LEADING EDGE WORK FOR YOU

# Introducing a brainy new solution from the Wizards of Winchester Disk Controllers.

A new Winchester controller. Plus floppy controller. On one low cost board. Small enough to mount atop a 5¼" drive. And ST500/SA1000 compatible. "Smart," you say? What did you expect from the Wizards of Winchester Disk Controllers?

We promised you more for less. Our new WD1002 delivers. At \$195 (U.S. OEM quantities) it's \$50 less than its predecessor, the WD1001.

The big news, though, is that we've made the WD1002 the brainiest disk controller yet, with an abundance of new LSI innovations. Such as our WD1010 single-chip Winchester controller device. It replaces the microprocessor on our earlier boards. And about 25 other devices. Plus we've added the new WD1014 Error Correction device and the WD1015 Buffer Manager device.

Because just about every system with a Winchester has a floppy nearby, we included our new WD279X single chip floppy disk controller, too. So you get a complete, powerful solution on one reliable 5¼" x 8" board. And you're on the upgrade path to our upcoming WD1003 and WD1004 boards.

To make our disk controllers even more irresistible, we'll customize them to your bus and form factor. Or sell you our LSI, along with everything you need to build a controller yourself.

It doesn't take too much brains to see that it's safe, smart and simple to commit your disk-based systems to WD. Call our controller hotline, 714/966-7827 and we'll arrange to sit down with you and get into the details you need.

U.S. OEM Quantities

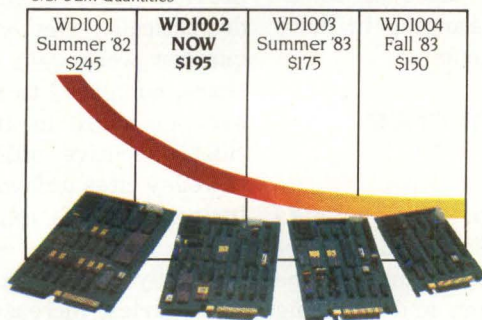

Components Group, 2445 McCabe Way, Irvine, CA 92714, (714) 557-3550

**WESTERN DIGITAL**  
C O R P O R A T I O N

CIRCLE NO. 36 ON INQUIRY CARD





## Do-it-yourself with our WD1010 LSI Winchester Disk Controller.

Your component-level disk controller project will go much smoother and quicker with our WD1010 LSI Winchester controller. It's a 40-pin device with all the control circuitry needed to control ST500/SA1000 type drives and is compatible with most 8- and 16-bit microprocessor busses, handling data rates up to 5MHz.

Buy our board-level disk controllers. Have us build a custom board for you. Or do-it-yourself with our LSI. If you choose the latter, we'll provide schematics, microcode and generous engineering assistance.

We've got all the support components your design needs, too. To wit:

WD1011: Digital Data Separator

WD1012: Write

Precompensation

WD1014: ECC

WD1015: Buffer Manager

WD1510: LIFO/FIFO

external sector buffer

WD279X: Single Chip

Floppy Disk Controller.

Interested? Write on your letterhead for a free sample.

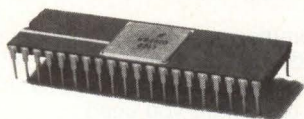

**WESTERN DIGITAL**  
CORPORATION

Components Group,  
2445 McCabe Way,  
Irvine, CA 92714, 714/966-7827  
CIRCLE NO. 37 ON INQUIRY CARD

# Mini-Micro World

CORPORATE AND FINANCIAL

## In transition

Kendata, Inc., has purchased M/A-Com's small-business computer manufacturing facility, M/A-Com Office Systems, Inc., for an undisclosed amount of cash, notes and other considerations. Kendata was known as Ohio Scientific, Inc., before its acquisition by M/A-Com in 1980. Kendata says it changed the name back to Ohio Scientific, Inc., to take advantage of Ohio Scientific's reputation.

## Formations

The first of several **Businessland** retail centers has opened in San Jose, Calif. The centers will focus on automating small businesses. Businessland, whose management includes such notables as David Norman, president and founder, who previously founded and headed market research firm Dataquest, Inc.; Enzo Torresi, a Businessland co-founder and vice president of systems who was previously president and founder of Olivetti's Advanced Technology Center, Inc.; and Phil Reed, vice president of marketing, who was previously general manager of On-Line Microcenters, a chain of about 20 franchised computer stores. Businessland prides itself on having system-integration expertise, and has assembled a series of small-business systems ranging in price from \$2500 to \$15,000.

## Distribution/service deals

**Datapoint Corp.** has completed agreements with independent companies in three countries for the distribution, support and servicing of its products: Ecosistemas S.A., Ecuador; Abdulla Fouad Corp., Saudi Arabia; and Emirates Elec-

tronics Establishment, United Arab Emirates....**Centronics Data Computer Corp.** will supply Leasametric, Inc., with the model 6081 600-lpm line printers and model 353 Printstation dot-matrix printer....**Plexus Computers, Inc.**'s first order for its MC68000-based systems running under UNIX System III came from Southwest Modular Systems, Inc. The one-year, \$2-million agreement concerns the Plexus 16-bit P/40 and P/25 and the 16/32-bit P/35 and P/60 supermicros.

## Quarterly report

Although **Datapoint Corp.**'s revenues for its first fiscal quarter ending Oct. 31, 1982, rose slightly to \$132 million from \$126.5 million the



**Datapoint chief executive officer Harold E. O'Kelley** predicts a difficult time for the company during the remainder of fiscal 1983, but notes that Datapoint is well-positioned to participate in an economic recovery.

previous year, net earnings dropped dramatically. Net earnings for the quarter were \$461,000 or 2¢ per share, compared to \$10.9 million or 54¢ per share in 1981. Datapoint chief executive officer Harold E. O'Kelley cites unfavorable manufacturing variances, expanded international marketing costs incurred primarily by the addition of new subsidiaries, increased product advertising, legal costs and financing expenses as primary reasons for the decline.





MAKING THE LEADING EDGE WORK FOR YOU

# Who says SMD Controller design is so r-r-rough? Introducing our new WD1050.

When you make the Wizards of Disk Controllers your design partners, there's no cause to approach any disk interface task with trepidation. Because now, in addition to our industry standard floppy disk controllers and ST500/SA1000 Winchester disk controllers, Western Digital delivers a single chip solution to SMD, CMD, MMD, LMD and FHT interfaces. Oh my!

It's the WD1050, a 64-pin VLSI controller/formatter. That's *one* chip, instead of up to 40MSI devices and a microprocessor. And instead of innumerable nights and weekends of software drudgery.

How powerful is the WD1050? Powerful enough to handle eight high level macro commands, auto format/verify with programmable interleaving, single/multiple record operation, hard sector formatting, CRC checking with external ECC compatibility and a 16-bit direct buffer access interface for disk drive-to-buffer data transfers.

Systems builders already following our Yellow Brick Road of disk controller solutions know that our ongoing LSI innovations soon turn into cost effective board level products for those who prefer "buy" to "build."

Starting today, though, adding the extra capacity and higher performance of SMD compatible drives to your system doesn't take courage. Just the brains to start with our new WD1050.

The next step is yours. Call our Controller Hot Line, (714) 966-7827 for more details. Or write on your letterhead.



Components Group 2445 McCabe Way, Irvine, CA 92714, (714) 557-3550

**WESTERN DIGITAL**  
C O R P O R A T I O N



# Mini-Micro World

CORPORATE AND FINANCIAL

## GUEST FORUM

A monthly column for guest experts to speak out

### Read between the lines of market forecasts

By Daniel M. Sullivan  
Frost & Sullivan, Inc.

In 21 years of market research publishing, I've never seen such a hunger for information as that from small computer system manufacturers and integrators today. But with new and usually conflicting forecasts issued almost daily from a growing roster of forecasters, whom can you believe? The answer, unfortunately, is no one.

Unlike a profit-and-loss statement, a market forecast can in no sense be summed up for its user by the bottom line. Investors now have vehicles that allow them to buy (or, more accurately, to bet on) the stock market as a whole, as reflected in popular indexes. But no high-technology company (excepting perhaps IBM Corp. in mainframes) identifies its market with *the* market for a given product category.

All surveys are crude approximations of reality. Even a 100-percent sample of a population induced by sodium pentathol to tell nothing but truth could not tell you the precise size of a future market, because, as any salesman knows, a buying intention is not a sale, particularly when talking about five or ten years down the road.

User and supplier surveys are just one tool used by our report authors, each of whom is an independent management consultant who has devoted his professional life to understanding an industry.

The true value of a market research forecast is not the numbers, but the detailed picture of future changes in technology, users, applications, suppliers, distribution channels and the general economic, cultural

and regulatory contexts in which they develop.

That is why our reports are rarely less than 200 pages in length and often more than 300. Our smartest customers read the whole thing and use it just as they use their trade magazine reading, conversations with customers and colleagues and rumors about competitors. They take what is fundamentally consistent with, but expands upon, their own view of the future market; they put aside—with not unfurrowed brows—conflicting views, perhaps to be reviewed later if their long-term marketing plan proves flawed.

Does this mean we forecasters have carte blanche for inaccuracy? Absolutely not! The market is our master, too. If we published useless reports, we would lose repeat business, which is most of the business we get. Our consultant-authors would in turn lose their publishers. And my editors and I would lose peace of mind.

But if, two years or five years from now, we turn out to have hit a forecast to the third decimal place, does that prove our reports worthwhile? Not if the numbers were generated by incorrect though mutually canceling assumptions about the future market because it is these "details," by which businessmen live, succeed or fail.

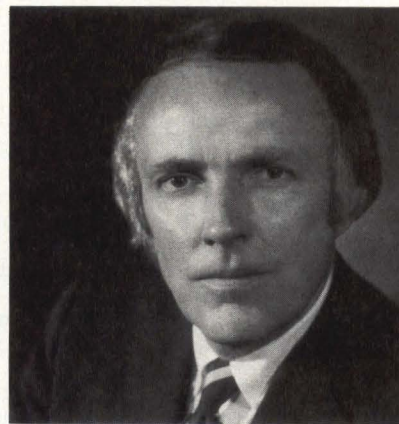

Daniel M. Sullivan is president and founder of Frost & Sullivan, Inc., a large publisher of market research reports, with principal offices in New York and London.

## CALL YOUR LOCAL DYSAN OFFICE

- CA: Los Angeles (213) 907-1803  
Orange County (714) 851-9462  
Sacramento (916) 966-8037  
San Francisco/Sunnyvale (408) 727-9552
- DC: Washington (703) 356-6441
- GA: Atlanta \*(404) 952-0919
- IL: Chicago (312) 882-8176  
(800) 323-5609
- MA: Boston (617) 273-5955  
\*(617) 229-2800
- MI: Detroit (313) 525-8240
- MN: Minneapolis \*(612) 814-7199
- MO: St. Louis (314) 434-4011
- NY: New York (212) 687-7122
- OH: Cleveland (216) 333-3725
- PA: Pittsburgh (412) 261-0406  
Philadelphia (609) 939-4762
- TX: Dallas/Ft. Worth \*(817) 261-5312
- WA: Seattle (206) 455-4725

\*Includes OEM Sales

Dysan Diskettes are also available from all ComputerLand Stores, Sears Business Systems Centers, and many independent computer outlets nationwide.

For the location of the Dysan sales outlet nearest you, contact Dysan at: (408) 988-3472

Toll Free: (800) 538-8133  
Telex: 171551 DYSAN SNTA  
TWX: 910-338-2144

 **Dysan**  
CORPORATION



# WHAT IS THE TRUE COST OF A DISKETTE?

If you said at least \$186.50\*, you're probably close.

Confused? It's simple. The minimum cost of a one-sided, single density 8" diskette equals the purchase price plus the cost of the time to fully load the data onto the disc\*. The adjacent diagram tells the story. As you can see, the purchase price of a diskette is a small fraction of the total cost of ownership. So why not pay a few cents more for the best diskette available?

That's where Dysan's quality comes in. Dysan diskettes and mini-diskettes are manufactured to the toughest quality standards in the industry. Every diskette is tested between the tracks as well as on the tracks to insure you 100% error-free recording over the entire disc surface. Dysan quality protects your investment of \$186.50.

You know how costly time and data losses can be should your "bargain" diskette be faulty. Every penny you think you save on the purchase of magnetic media could cost you dearly. Why take the risk when you can have Dysan?



**dy Jan** **Dysan**  
CORPORATION

Our Media Is Our Message.

5201 Patrick Henry Drive  
Santa Clara, CA 95050

\*\$4.00 represents Dysan's suggested retail price for a one-sided, single density 8" diskette, packaged ten to a box. Minimum total cost of ownership = \$186.50

\*\$182.50 represents the cost of data loading (approximately 22 hours at 11,106 keystrokes/hour at a labor cost of \$8.23/hour), based on 1981 Data Entry Management Association (DEMA) National Averages.

CIRCLE NO. 39 ON INQUIRY CARD



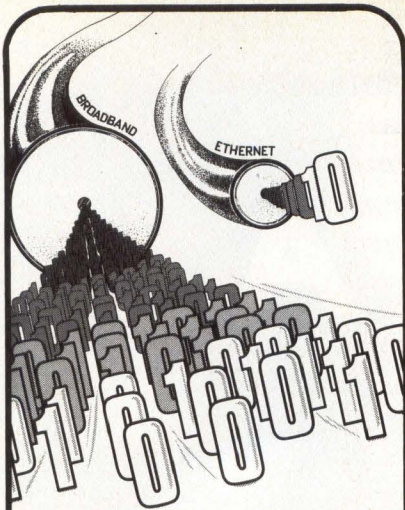

## BROADBAND VS. ETHERNET

**Broadband gives  
you 50 times  
the capacity.**

So, if you're installing coax, why not go with the technology that gives you room to grow? With broadband you'll have an actual aggregate data capacity of over 350 MBS compared to Ethernet's much less than 10 MBS. You'll have a multi-drop capacity of up to 24,000 compared to Ethernet's 1,024. And, broadband gives you voice and video capability you just can't have with baseband.

Unlike other technologies, broadband equipment is readily available now. Over the past four years Comtech has delivered hundreds of broadband modems into networks around the world. Comtech is committed to broadband technology. We are continually enhancing our broadband product line.

Comtech's engineering excellence is helping networkers find solutions to their data communications problems. For help with yours, call Comtech. Applications notes, specifications, prices and delivery sent on request. Call or write Comtech Data Corporation, 350 North Hayden Road, Scottsdale, AZ 85257, (602) 949-1155 or TWX 910-950-0085.

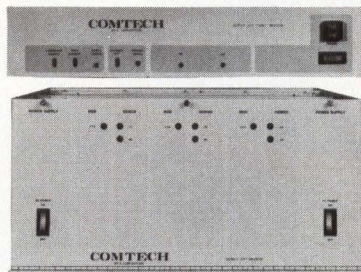

**COMTECH**  
Data Corporation

Creative Solutions in Data Communications

CIRCLE NO. 40 ON INQUIRY CARD

# Mini-Micro World

CORPORATE AND FINANCIAL

## BOX SCORE OF EARNINGS

This monthly table lists the revenues, net earnings and earnings per share in the periods indicated for companies in the computer and computer-related industries. Parentheses denote losses. Comments are from corporate summaries unless otherwise noted.

Company	Period	Revenues	Earnings	Eps
AGS Computers, Inc.	9 mos 9/30/82	\$46,073,000	\$1,803,000	.54
	9 mos 9/30/81	26,332,000	1,141,000	.38
Applied Materials, Inc.	year 10/31/82	88,269,000	(9,237,000)	(1.86)
	year 10/25/81	77,490,000	4,264,000	.90
Centronics Data Computer Corp.	3 mos 10/3/82	40,847,000	(13,497,000)	(1.20)
	3 mos 10/3/81	28,383,000	(2,675,000)	(.44)
Communications Group, Inc.	6 mos 9/30/82	3,746,000	(90,000)	(.09)
	6 mos 9/30/81	3,639,000	184,000	.46
Cullinane Database Systems, Inc.	6 mos 10/31/82	34,177,000	4,991,000	.73
	6 mos 10/31/81	21,735,000	3,444,000	.50
Dataterminal Systems, Inc.	9 mos 10/31/82	73,522,000	(9,450,000)	(1.61)
	9 mos 11/1/81	89,006,000	(7,190,000)	(1.28)
Genesco Technology Corp.	year 9/30/82	28,288,782	1,511,021	.77
	year 9/30/81	23,280,373	1,236,266	.63
Harris Corp.	3 mos 10/1/82	425,561,000	14,701,000	.47
	3 mos 9/25/81	392,287,000	23,949,000	.77
Intercom, Inc.	3 mos 9/30/82	10,987,000	1,933,000	.16
	3 mos 9/30/81	3,253,000	(1,447,000)	(.16)
ITT Corp.	9 mos 9/30/82	11,813,467,000	430,813,000	2.91
	9 mos 9/30/81	12,353,640,000	429,640,000	2.91
M/A-COM, Inc.	year 10/2/82	587,646,000	33,933,000	.88
	year 10/2/81	498,484,000	40,275,000	1.05
Molex, Inc.	3 mos 9/30/82	41,672,000	4,902,000	.74
	3 mos 9/30/81	39,585,000	5,178,000	.79
Perkin-Elmer	3 mos 10/31/82	235,253,000	10,982,000	.25
	3 mos 10/31/81	251,040,000	18,655,000	.43
Scan-Data Corp.	9 mos 9/30/82	9,827,111	(2,572,438)	(1.01)
	9 mos 9/30/81	9,314,143	(2,583,723)	(1.02)
Tandem Computers, Inc.*	year 9/30/82	312,143,000	29,856,000	.76
	year 9/30/81	208,397,000	26,549,000	.72
Timeplex, Inc.	3 mos 9/30/82	9,327,000	522,000	.13
	3 mos 9/30/81	7,038,000	467,000	.11
The Ultimate Corp.	6 mos 10/31/82	16,781,347	1,854,882	.31
	6 mos 10/31/81	14,914,097	1,198,607	.21
Unitrode, Inc.	9 mos 10/30/82	89,339,323	9,584,019	1.63
	9 mos 10/31/81	84,817,855	8,339,583	1.45

Comments: **M/A-COM's** earnings were down 3 percent from fiscal 1981. The company cited the recession, approximately 60 percent higher research and development investments, pricing pressures in the cable and components industry and the write-off of old inventory at one of its operating companies as major factors in the decline. M/A-COM's fourth-quarter earnings, however, were \$12 million, up from \$11.5 million, an increase of 1 per share. M/A-COM projected growth in the second half of fiscal 1983, based on an improved economy. **Centronics Data Computer Corp.** is attempting to cut costs—it has discontinued its Quietwriter printer development and has shut down its line printer plant in Stevenage, England, transferring the operation to Rochester, Mich. Subsequent to the financial release, Centronics announced it is transferring its Puerto Rican operation to its Hudson, N.H., facility.

**Centronics** said its recently acquired Line Printer Division accounted for approximately \$16 million of the quarter's sales. The company has changed its fiscal year to correspond with the 1983 calendar year. Although **Data Terminal Systems, Inc.'s** nine-month sales and earnings were down from 1981, the company reported its first profitable quarter in two years. Third-quarter earnings were \$209,000, or 4 per share, compared with a loss of \$312,000, or 5 per share, in 1981. **Perkin-Elmer's** Data Systems Group reported revenues of \$52.6 million for its first quarter, compared to \$51.5 million in 1981. (The 1981 figure includes \$7.6-million net sales from the sale of the Memory Products Division.) **Tandem Computers, Inc.'s** revenues and earnings are restated. The company said the restatement reflects a deferral of revenue, not a loss of sales.



# UNIX\*/C



As a company of computer professionals, we have earned a leadership position in the design and production of complex software systems for the electronics industry. Our software production system, developed through many man-years of experience, has a proven track record of on-time, on-budget results. Structured for performance, and honed from large jobs with tight delivery schedules, we pursue custom software contracts with both computer end-users and computer-based product OEMs. We have realistic solutions to your software requirements.

If you're searching for UNIX\* expertise in the areas listed in the coupon, please check the appropriate boxes, and mail directly to us for a quick response. For details call Suzanne B. Hartig at (201) 327-8014.

\* UNIX is a registered trademark of Bell Laboratories.

**HHB SOFTRON**

CIRCLE NO. 41 ON INQUIRY CARD

**I am interested in:**

- UNIX\* PORTATIONS**
- CUSTOM UNIX\* SOFTWARE**
- UNIX\* APPLICATIONS**

Name \_\_\_\_\_

Title \_\_\_\_\_

Company \_\_\_\_\_

Phone \_\_\_\_\_

Address \_\_\_\_\_

City \_\_\_\_\_

State \_\_\_\_\_

Zip \_\_\_\_\_

Mail to: **HHB•SOFTRON**  
116 Route 17 North  
Upper Saddle River, NJ 07458



**THE iAPX 286.  
IT'S SO HOT,  
NOTHING  
CAN TOUCH IT.**

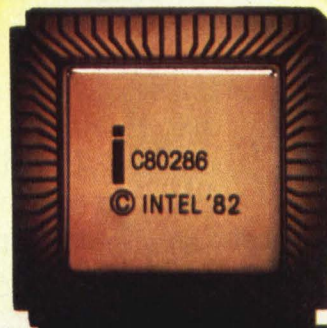



Introducing the 16-bit processor that can outperform, outclass any microprocessor.

Anywhere.

The Intel, iAPX 286.

It gives you three times the performance of what you thought was the fastest chip in the market.

More hot news. This CPU was designed from the very beginning to include memory management and protection on chip.

Which means, now you can design these sophisticated capabilities into your system. Without the cost, complexity or performance degradation of external hardware.

If 16 Megabytes of physical memory isn't enough, there's a virtual memory capacity of 1 gigabyte per user.

The 286 has been optimized to handle advanced operating systems. Such as the UNIX\* and iRMX™ O.S. It also provides new instructions for languages such as Pascal, BASIC, FORTRAN, C and ADA.

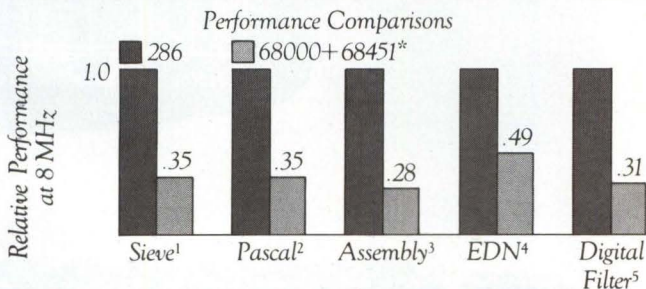

\*Performance adjusted to reflect indicated system configuration. Details available from Intel. <sup>1</sup>"A High Level Language Benchmark," Byte, Sept., 1981. <sup>2</sup>"A Performance Evaluation of the Intel iAPX 432," Computer Architecture News, June 1982. <sup>3</sup>"16 Bit Microprocessor Benchmark Report," Intel Corporation, 1981. <sup>4</sup>"16 Bit Microprocessor Benchmarks," EDN, Sept., 1981. <sup>5</sup>"Digital Filter Implementation on 16 Bit Microprocessors," IEEE MICRO, Feb., 1981.

And to simplify sophisticated system development even further, there's an integration of performance-critical functions. Such as task switching, interrupt handling and O.S. call.

A couple more hot facts about software. The 286 is compatible with the iAPX 86, 88. So not only will you have the hottest chip on the market, but also immediate access to a huge software base.

### System Comparisons

	iAPX 286 System	68000 + 68451* System	Advantages of Integrated Memory Management & Protection
Typical System (16 Users)	1 CPU	1 CPU 1-4 MMU's 2 Transceivers 1 MMU Selector	Less Board Space
Wait States Required 8 MHz	0. W.S.	2. W.S.	Higher Performance
Task Switch Overhead	22 μS	>120 μS	Faster Response
Max. BUS Bandwidth at 8 MHz	8 MB/Sec	2.67 MB/Sec	Higher Throughput

\*Based on published data sheets.

On the hardware side, the 286 is a well integrated 16-bit family. It delivers full performance at the systems level, through support circuits like the 8207 DRAM controller and the 80287 floating point numerics processor.

All this allows us to give you the kind of performance no other manufacturer can touch.

Write us. Or call us, toll-free. (800) 538-1876. In California, (800) 672-1833. Within 24-hours, we'll send you complete information on the 286.

Including a wall-size poster of the part.

Everything you need to know, to burn your competition.

**intel** delivers solutions

3065 Bowers Ave., Santa Clara, CA 95051

United States and Canadian Distributors: Alliance, Almac/Stroum, Arrow Electronics, Avnet Electronics, Component Specialties Inc., Hamilton/Avnet, Hamilton Electro Sales, Harvey, L.A. Varah, Measurement Technology Inc., Mesa, Pioneer, Wyle Distribution Group, Zentronics. In Europe and Japan, contact your local Intel sales office.

\*UNIX is a trademark of Bell Labs.



# IN THE HISTORY OF TER HAD A BETTER PIC

Lear Siegler has installed more terminals than anyone else. More than three times as many as our closest competitor. Three times!

Who would have suspected eleven years ago that one Dumb idea could have taken us so far?

In those days, Lear Siegler looked like many of our competitors do today. Small. Struggling. Searching for an identity. Hanging our hat on one product.

Today, we've got a complete line of terminals — from our famous Dumb Terminal® video display to smart terminals to printers. These products have made us the world's favorite independent terminal company. And that's not just us tooting our own bells and whistles. It's been substantiated in survey after survey, includ-

ing those conducted by Datamation, Infosystems, and Data Communications\*.

Our innovative, state-of-the-art product line offers a growth path for OEMs and end users alike. What's more, our products probably offer all the features you'll ever need. For example, our terminals can be upgraded with modems, voice recognition, touch screens, and graphics (in fact, the graph shown here was produced

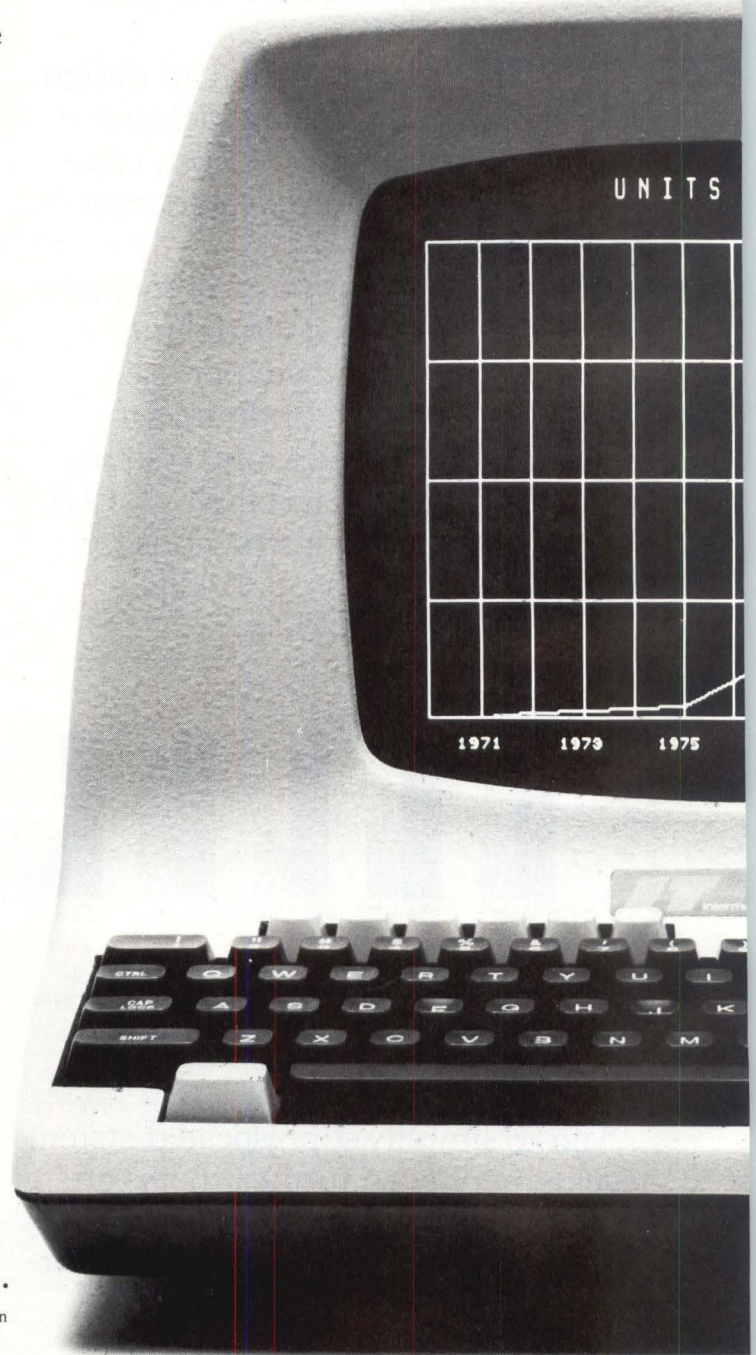

Lear Siegler, Data Products Division, 714 North Brookhurst St., Anaheim, CA 92803, 800-532-7373. SALES & SERVICE: Boston (617) 456-8228 • Chicago (312) 279-7710 • Houston (713) 780-9440 • Los Angeles (714) 774-1010, Ext. 219 • Philadelphia (215) 245-4080 • San Francisco (415) 828-6941 • England (04867) 80666. OEM SALES: Boston (215) 245-1520 • Chicago (312) 279-5250 • Houston (713) 780-2585 • Los Angeles (213) 454-9941 • Philadelphia (215) 245-1520 • San Francisco (415) 828-6941 • England (04867) 80666



# TERMINALS NOBODY HAS MORE SECURITY THAN THIS.

by our own LSI Vector Drawing Graphics Board). Our printers can be upgraded with color and sheet feeding. And both will accommodate custom logic boards and add-on memory.

Of course, it stands to reason that because we have a lot more users than anyone else, we also have a lot more service centers than anyone else. Lear Siegler users can have our products cared for in 3000

cities nationwide. That includes walk-in Express Depot™ service, on-site service, and extended warranty service.

For the name of your nearest distributor or more information, call 800-LEAR-DPD or 714-774-1010.

We're Lear Siegler. The standard that everyone else in this industry copies. And quite frankly, we don't know whether to be insulted or flattered.

 LEAR SIEGLER, INC.  
DATA PRODUCTS DIVISION

## EVERYBODY MAKES TERMINALS. ONLY WE MAKE LEAR SIEGLERS.

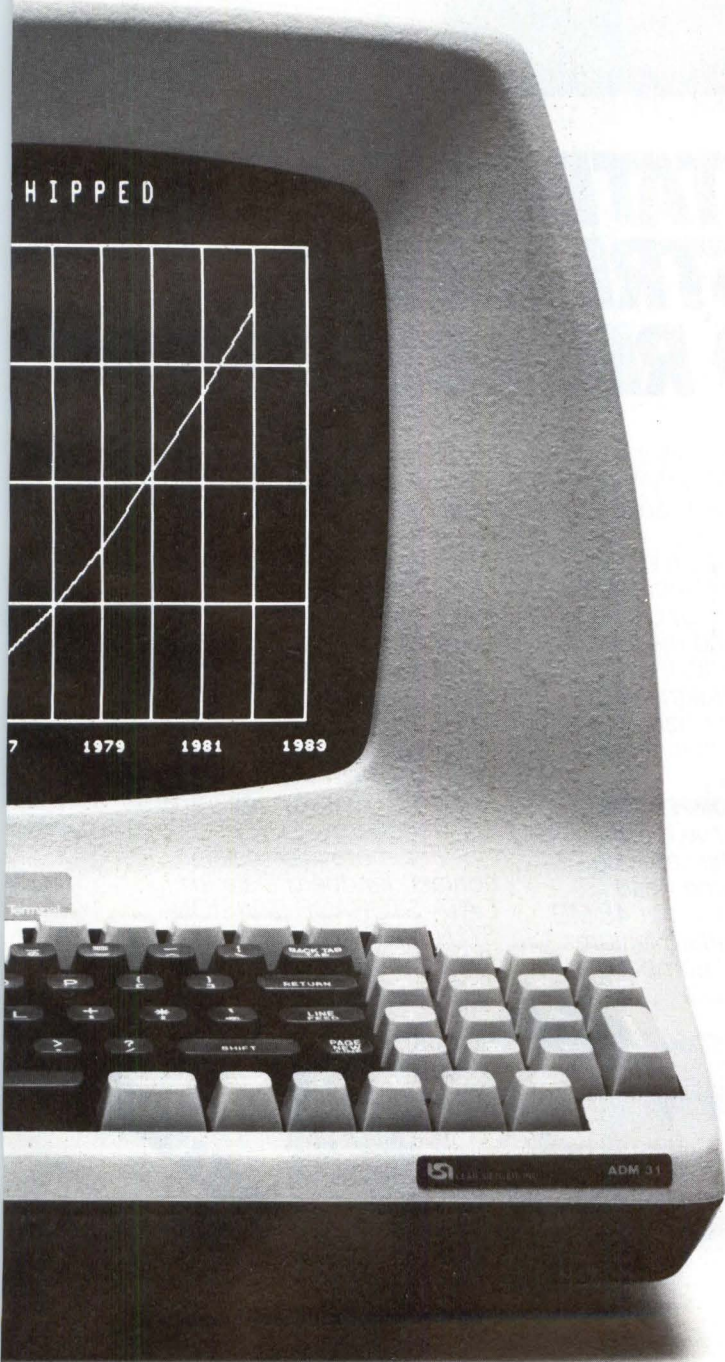

Dumb Terminal® and Express Depot™ are trademarks of Lear Siegler, Inc.

\*1981 Datamation Brand Preference Study of the Data Processing Industry, OEM and End-User Markets. Infosystems Magazine, 1981 Survey of Terminal Usage. 1982 Brand Preference Survey conducted by Data Communications Magazine.

CIRCLE NO. 43 ON INQUIRY CARD



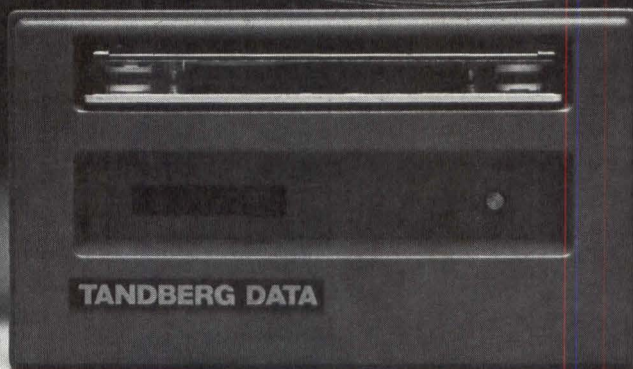

## A STRONG STATEMENT ABOUT OUR STREAMER'S ACCURACY AND RELIABILITY.

We're standing on our streamer to show you just how well Tandberg's 3200 family of 20 MB and 45 MB  $\frac{1}{4}$ " cartridge drives are engineered. Of course, we didn't design them to be stepstools.

### **DESIGNED FOR DATA INTEGRITY.**

Unlike most other drives, the 3200's body is fully cast to keep drive mechanisms stable and accurate. What's more, Tandberg's exclusive 3-point positioning and cartridge locking system ensures that cartridges are always correctly loaded and can't be jarred off track.

And while others still use less accurate mechanical referencing to locate the edge of the tape, Tandberg's exclusive Floating Head System finds this reference point dynamically using a signal seeking method. A precision, microprocessor-controlled stepping motor then locates the desired track—with better than 16 track accuracy. (Since our

20 MB and 45 MB units have 4 and 9 tracks respectively, the system is at least twice as accurate as it needs to be.)

Tandberg's system completely eliminates interchangeability problems caused by cartridge wear, drive wear, and mechanical tolerance build-up. It's the main reason why our streamer gets more reliable performance from  $\frac{1}{4}$ " cartridge tapes than anyone else in the industry.

### **A HEAD ABOVE THE COMPETITION.**

Our 20 MB drive has the same cast body, the same cartridge lock, the same head positioning system as our 45 MB unit. Even the standard features are the same: QIC compatible interface, expandable circular FIFO buffer (up to

16 KB) for increased throughput, and full saturation recording. So what's the difference between our 20 and 45?

The head.

One screwdriver and one 9 track head are all you need to upgrade our 20 to 45 MB—with no mechanical adjustments whatsoever.

So if you're looking for a streamer that's accurate, reliable, and extremely flexible, step up to the only one you can stand on.

Tandberg.

For more information contact, Tandberg Data Inc., DATA STORAGE DIVISION, 571 North Poplar, Suite H, Orange, CA 92668/(714) 978-6771.

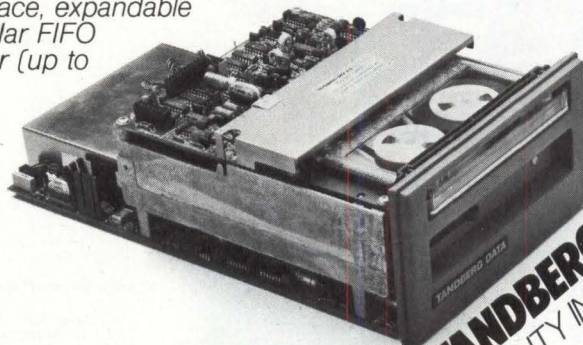

**TANDBERG DATA**  
QUALITY IN EVERY BIT.

CIRCLE NO. 44 ON INQUIRY CARD



# Mini-Micro World

INTERNATIONAL

## DEC to offer European software in U.S.

Though much attractive application software has been developed by software houses in Western Europe for Digital Equipment Corp. computers, many talented, but small, European software companies lack the resources to make their products widely available in the U.S. But now, DEC appears ready to sell and support European-developed products in the U.S. through its DEC Classified Software plan.

Dave Luccini with DEC's DCS program in the U.S. is unable to name any European product accepted by DCS managers in the U.S. yet. But he stresses that one goal of DCS is to have an unlimited flow of software from the U.S. to Europe and from Europe to the U.S.

DEC's European subsidiaries initiated their own DCS programs in 1982 and have just published their first catalogs. The catalogs include products developed by independent companies. DEC will sell and



**Geoff Beacroft**, head of DEC's Classified Software program in England, is bullish about prospects for some British products listed in the catalog.

support those products. Although some of the products in the catalog are from U.S. software houses, most are European. DEC has nonexclusive rights to the products, but those rights allow the products to be sold by DEC offices worldwide.

Robert DePicciotto, application

software manager at DEC's European headquarters in Geneva, Switzerland, is confident that DEC in the U.S. will adopt products from the European catalogs, and says, "Europe has tremendous software know-how." He believes that language problems will not seriously limit the spread of products developed in Europe. "The engineering community throughout Europe speaks English," he says. "DEC is encouraging software producers in Europe to make software transportable between countries." Britain is DEC's largest European market.

Geoff Beacroft, head of the DCS program at DEC's British headquarters in Reading, England, is optimistic about the prospects for some British products in the DCS catalog. He acknowledges that accounting application software is unlikely to create much interest, but says many products have universal applications, such as graphics, data management, financial modeling and communications.

DePicciotto, who is responsible

### LONDON SOFTWARE HOUSE SEEKS DISTRIBUTOR FOR DEC-COMPATIBLE PRODUCTS

A graphics package aimed at schematics generation, a document-preparation system, an operator-interface construction package and a videotex system are four software products for Digital Equipment Corp. machines available from Systems Technology Ltd., London. DEC is evaluating the oldest package, the document system IGOR, for possible inclusion in its DEC Classified Software catalog. Systems Technology managing director Les Hayden says he is independently seeking U.S. distributors for the products.

IGOR, for PDP-11s, was developed by Systems Technology in 1980 for internal use and is said to be far more powerful than a word-processing

package. A user can type in text in free format, and IGOR provides document features such as margin widths, page lengths, indentations and section headings. Hayden quotes end-user prices of \$1500 for the RT-11 version and \$3000 for the version that runs under RSX.

The graphics package, called Insight, is already used in Europe by a leading oil company at refinery installations, says Hayden. It can run on a PDP-11 under RT-11 or a VAX under VMS. Versions are also available for Hewlett-Packard Co. 1000 and 3000 systems. An Insight user can build a library of commonly used graphics—such as valves and process columns—for any display.

Episode, the operator-interface generation package, sells for \$1000 and is designed to run on PDP-11 machine under RT-11 or RSX with VT125 or VT131 display terminals. An application program can drive Episode via subroutine calls, and the package is said to relieve the application programmer of terminal-handling functions such as input and output for individual fields, input validation and the display of help information and fixed text.

The videotex package is aimed at PDP-11 hosts running under RSX, and is compatible with the Prestel standard adopted by IBM Corp. in the U.S. It currently lacks data-collection capabilities. Price is \$10,000.



# Mini-Micro World

INTERNATIONAL

for DEC's DCS strategy in Europe, including Britain, notes that most European products being adopted by DEC are aimed at users of the Professional and Rainbow personal computers launched last year. But Beacroft points to several products in the catalog aimed at PDP-11 and VAX users. They include at least two products already with small user populations in the U.S. acquired through channels independent of DEC: Xoren IPL-11 from Xoren Computing Ltd., London, and Simpleplot from Bradford University Software Services Ltd., Bradford.

Xoren IPL-11 enables files to be transferred between remotely located PDP-11 and VAX machines running under RSX, RT-11, TSX, RSTS or VMS. Xoren managing director John Jarvis says the product is already distributed in the U.S. by Softpak Associates, Inc., Marina del Rey, Calif., and Midcom Inc., Orange County, Calif. Jarvis names the City of San Jose, Mattel Electronics, Hawthorne, Calif., and Computer Timesharing Inc., San Diego, as users. U.S. end-user prices are less than \$1100.

Simpleplot is a library of FORTRAN subroutines for scientific and engineering graphics. Bradford's Dr. David Butland names the Life Sciences division of San Antonio Laboratory and the Hawaii University Physics Department as users. He says a version of Simpleplot for the Professionals will be available soon.

The British DCS catalog also includes Business Modeller for PDP-11s from Software Unlimited Ltd., Sunningdale, England, and two productivity aids from Filetab Support Services Ltd., London: Rapid Programming Language and Rapid Query Language, both of which can also be used on VAX machines. Filetab managing direc-

tor Richie McGladdery says the products are used at 300 European DEC sites, mostly in Britain, where together they sell for \$10,000 to \$15,000. British users include the Plessey Co. Ltd. and the *Financial Times*.

RPL is called an automatic language with logic capabilities based on decision tables, while RQL is a very powerful reporting system that uses a concise English instruction set.

"None of these products was developed to DEC specifications," notes Beacroft, "but we are talking to British software houses about future products that will meet our specifications." He lists graphics, communications and financial modeling as major applications.

Beacroft says DEC has four staff members in Britain engaged in the technical evaluation of products for possible inclusion in the DCS catalog. He notes that their investigations include talking to end users and

asking the opinion of appropriate user departments within DEC.

DePicciotto reveals that DEC's policy in Europe is to offer a deal under which a software house gets 17 to 18 percent of the end-user price charged by DEC for its product. This rate applies to worldwide sales. Each software house will deal only with the DEC company in its own country, which will collect information on sales of the product from DEC offices worldwide and pay the appropriate amount. Beacroft says, "They have to trust us," adding that the software houses he deals with also trust that DEC will not alter their software so much that DEC will be able to claim it as a DEC product. But he stresses that some of the products adopted for DEC catalogs will be altered somewhat by DEC, and that DEC will seek to influence the further development of products by their originating software houses.

—Keith Jones

## French company paces international Ada development

Development of the Ada real-time process, a fact underlined by the key role played by French company

### 5000 ORGANIZATIONS CONTRIBUTE TO ADA SPECIFICATIONS

More than 5000 worldwide organizations contributed to the Ada specification submitted to ANSI in January by the Ada Joint Program Office of the Department of Defense. Dr. Robert Mathis, technical director of the AJPO, notes that the companies' comments were all given "careful consideration" and affected the final definition produced by AJPO in cooperation with Alsys.

Mathis notes that nearly 100 of the more than 5000 organizations were asked to vote on whether the final definition was technically acceptable. The 100 included most major manufacturers of computers, universi-

ties, professional organizations and end users. Mathis says 81 companies responded positively, five reacted negatively, and the rest abstained.

Mathis explains that the final definition does not differ substantially from the 1980 Ada definition as far as programmers are concerned, but it is implemented somewhat differently. He says adoption by the International Standards Organization will follow acceptance of the definition by ANSI. Because of the "slow and deliberate" workings of ISO, Mathis says, it will probably take three to four years to adopt the Ada standard.



Designing for network efficiency ...

# DATASWITCH Puts The Magic In Your Datacomm System

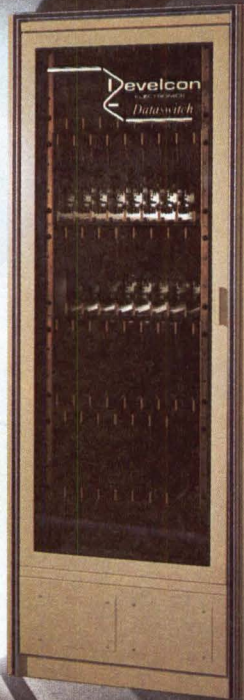

Wouldn't it be nice to handle data as smoothly as a prism handles light? Think of the efficiencies you'd bring to your datacomm system.

There is a way. Our DATASWITCH Intelligent Switching System allows any of 2046 connections to carry on 1023 simultaneous full duplex conversations. With automatic port contention and prioritized queuing. And true universal access between all connections. The system provides the *total control* you need for maximum network utilization and flexibility. You'll increase uptime

and lower overall costs while assuring data security. All with simple English language commands.

If you need port contention, port selection, or have more terminals than ports, you need the control that only DATASWITCH offers. Talk to us. We're an engineering organization first. We can work magic for your network to help you get the most from it. And in these times of tight budgets and even tighter demands, our straight talk will help you see the light - without the hocus pocus. Let us hear from you today.



DEVELCON ELECTRONICS INC.  
4037 Swamp Road  
Doylestown, PA 18901  
Telephone: (215) 348-1900  
Telex: 84-6389

DEVELCON ELECTRONICS, LTD.  
856-51st Street East  
Saskatoon, Saskatchewan  
Canada S7K5C7  
Telephone: (306) 664-3777

*Develcon has authorized representatives in most metropolitan areas.  
Call us for the name and number of the nearest one.*



★ ★ ★ EXTRA ★ ★ ★

# 32-Bit Computer Breaks \$10K!

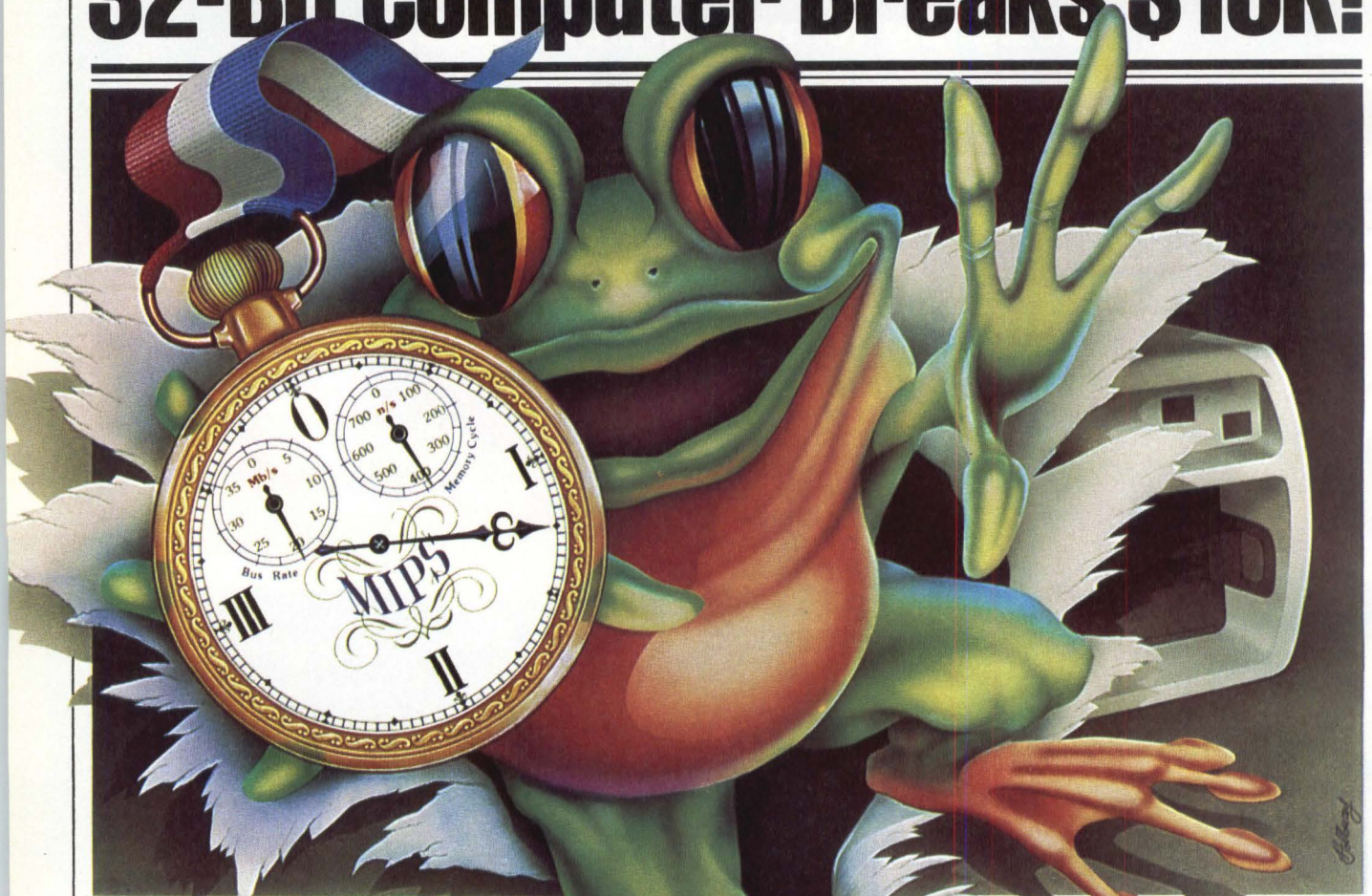

## Universe 68/05 First to Smash Price Barrier

The new Universe 68/05 is the first true 32-bit computer priced under \$10,000 (OEM quantity one). "True" because, unlike other 68000-based systems, the Universe 68/05 handles 32 bits in parallel on its VERSAbus.

## Outperforms VAX\*

Its price is even more impressive when you look at Universe 68/05

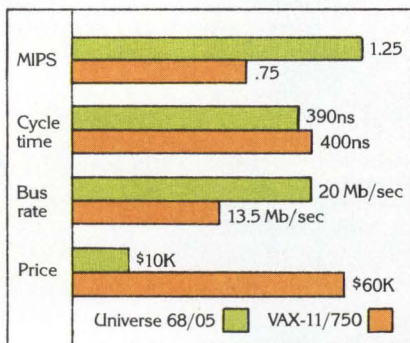

performance versus that of 32-bit "superminis" several times more expensive, like the VAX-11/750.

## High-Speed 68000, 4Kb Cache, 32-Bit Bus

The key to that performance is a 4Kb cache that eliminates processor wait-states and takes full advantage of a 12.5MHz 68000 processor. Also included are a separate 68000 I/O processor, four serial I/O ports (expandable to 64), 256Kb RAM (expandable to 3Mb), 20Mb/sec, 32-bit VERSAbus, 10Mb Winchester, 1.25Mb floppy disk, and 5-slot card cage. All in a 7-inch enclosure.

## UNIX-Compatible Real-Time OS, Too

UNOS\*, our UNIX\* Rev7-compatible operating system with real-time features, runs Pascal, Fortran, C, BASIC, DBMS, and third party application programs.

For more information, just attach your business card to this ad and mail to Charles River Data Systems, 4 Tech Circle, Natick, MA 01760. Or call us at (617) 655-1800. We'll send you a copy of "The Insider's Guide to the Universe," a detailed discussion of the technical concepts behind this remarkable new computer.



# CHARLES RIVER DATA SYSTEMS

\*VAX is a trademark of Digital Equipment Corporation. UNIX is a trademark of Bell Laboratories. UNOS is a trademark of Charles River Data Systems.  
CIRCLE NO. 46 ON INQUIRY CARD



# Mini-Micro World

INTERNATIONAL



**Jean Ichbiah, director general of Alsys S.A., France, was a principal designer of Ada in the late 1970s. Alsys has played a major role in the proposed final ANSI Ada specification. The company is also developing an Ada compiler for the MC68000 and a training course for programmers converting to Ada from other languages.**

Alsys S.A. With the U.S. Department of Defense, Alsys has led the work resulting in the final definition of Ada, which is now in the hands of the American National Standards Institute.

Alsys is developing compilers for high-performance microprocessors. A fully optimized compiler for the Motorola 68000 should be available by the second quarter of 1984, says Alsys director general Jean Ichbiah. The company is also developing microcomputer-based training courses for professional programmers converting to Ada from FORTRAN, Pascal and other languages.

Working at Cii Honeywell Bull in the late 1970s, Ichbiah was a principal designer of Ada, which was selected by the DOD in 1979. In 1980, he left Cii HB to establish Alsys, and has since then worked with the DOD's Ada Joint Program Office in preparing the final definition of the language submitted to ANSI this January.

Ichbiah notes that the Ada compilers will possess some portability, but that substantial efforts

will still be required to tailor them for specific machines. "The machine-dependent part is about 80 percent," Ichbiah explains. "We have already started development of the 68000 compiler and are

considering a compiler for the 8086, but that is less definite."

Ichbiah acknowledges that Ada products for the 68000, including an interpreter from Telesoft Corp. and a cross-compiler from Softech, Inc.,

## ONLY RODIME GIVES YOU NO-NONSENSE RELIABILITY IN A 5 $\frac{1}{4}$ " WINCHESTER DISK DRIVE

With an unprecedented 12,000 hour MTBF, RODIME's no-nonsense approach to reliability is the envy of the industry. It's a direct result of our total no-nonsense approach to designing 5 $\frac{1}{4}$ " Winchester disk drives. For example, the microprocessor incorporated into the drive to give you precise control of all head movements also has built-in fault diagnosis including fault conditions between the drive and controller. These fault conditions are indicated on our unique front panel LED display. Another no-nonsense feature is our two-chamber design which allows us to exclude potential contamination generators from the highly critical head/disk chamber and, together with the advanced design and material selection of components, to provide precise compensation for off-track error due to thermal expansion in the arms, disk and other components. Plus, with our electronics, there are no adjustments or select-on-test components.

There's more to our no-nonsense approach to Winchester disk drives than our reliability. Our storage capacities range from 6 megabytes up to 54 megabytes with a broad array in between to choose from. We give you an industry standard interface that makes upgrades simple. Our access times—with 50 ms average in high capacity drives—are among the best.

For the sensible approach to Winchester disk drive reliability, see the no-nonsense people at RODIME.

# RODIME

RODIME PLC

25801 Obrero, Mission Viejo, CA 92691, (714) 770-3085  
Nasmyth Road, Southfield Industrial Estates, Glenrothes, Fife, KY6, 2SD, Scotland  
Telephone: 0592 774704

CIRCLE NO. 47 ON INQUIRY CARD



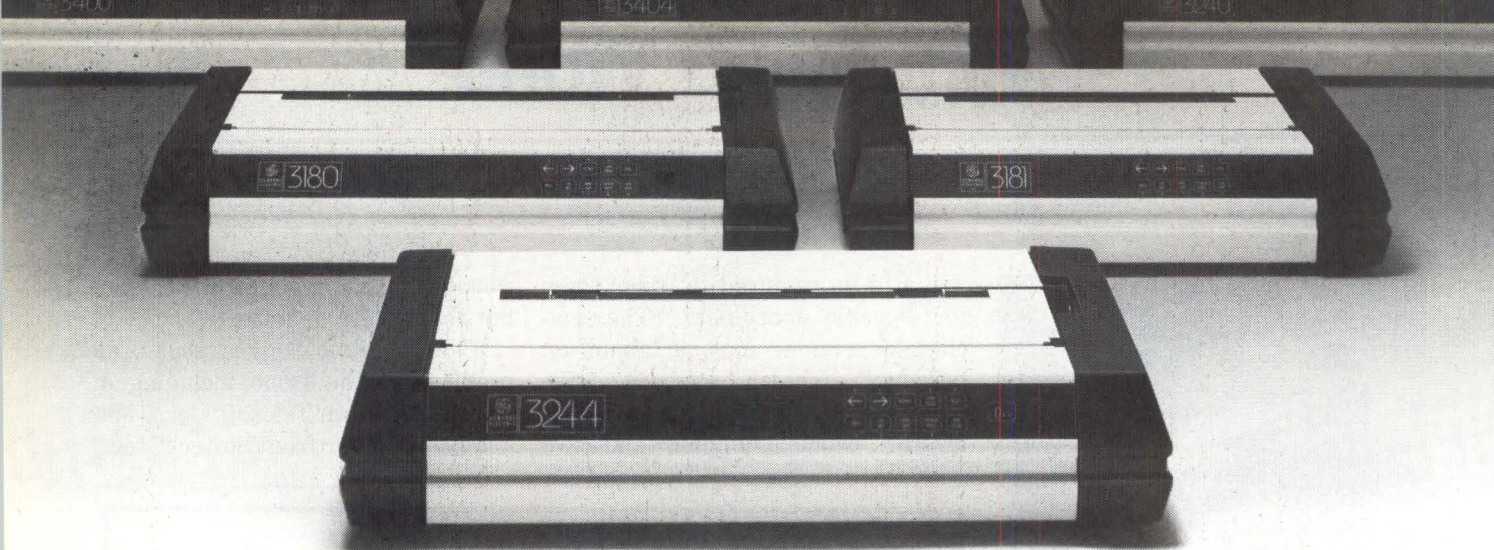

# We think these are the best ideas you've ever had.

## AT GE, YOUR IDEAS WERE THE KEY TO THE IDEAL OEM PRINTER.

Is there such a thing as an ideal OEM printer?

We'd like you to take a close look at the GE 3000 family. A compact, lightweight, functionally styled family of printers. A single line of eight basic tabletop matrix printers that offer cost effective solutions to virtually all your printing requirements.

### SINGLE-DESIGN SIMPLICITY. FLEXIBILITY. PRICE/PERFORMANCE LEADERSHIP.

The GE 3000 family of printers is a multi-model concept which eliminates the application limitations of single-model product lines. So you can solve your customers' needs efficiently and effectively. All from a single-source supplier. All with high parts commonality. All with reliable, worldwide GE service.

### DISCOVER THE ALL IN ONE PRINTER FAMILY.

Select standard print quality from 180 to more than 500

cps. Near letter quality printing from 45 to 200 cps. We have 80 and 136 column models.

Our full range of standard features includes 72 x 72 dot/in. graphics with precision paper movement, self-threading paper load mechanism, close tear-off, six part forms capability, optional popular parallel and serial interfaces, local and downline configuration selection with non-volatile storage. Plus a range of options and paper handling accessories for office and factory applications.

We're proud to say we think you've thought of everything.

### OF COURSE, INNOVATIVE IDEAS ARE NOTHING NEW TO GE.

Our roots go back to Thomas Edison. It was in his tradition that in 1969 we introduced the first electronic data printer with modern LSI circuitry. Since then, we've continued in that inventive spirit, supplying OEM's with the finest in advanced printer solutions. What other printer supplier offers that much experience?

General Electric. We're the industry leader in electronic printing. After all, we pioneered the industry in the first place.

## First In Electronic Printing.

For the solution to your printing needs, call  
TOLL FREE 1-800-368-3182.

General Electric Company, Data Communication Products Department F03P1, Waynesboro, VA 22980. In Virginia, call 1-703-949-1170.

**GENERAL**  **ELECTRIC**



# Mini-Micro World

INTERNATIONAL

already exist, but claims that the Alsys offering will be the first fully optimized compiler for the 68000. He notes it will comply fully with the Ada definition that ANSI has. Development is taking place under UNIX.

The compiler work at Alsys is funded in part by the European Economic Community, which has allocated about \$6 million to cover 40 percent of the cost of Ada-oriented products at several European companies. Besides Alsys, Cii Honeywell Bull and Siemens are also receiving funds for compilers from the EEC. Olivetti SpA, Ivrea, Italy, and Danish companies Christian Rovsing and the Dansk Datamatic Center are being helped with work on Ada Program Support Environment tools. The funding was allocated about 18 months ago for a period ceasing at the end of this year. The EEC's Council of Ministers is considering new funding.

A consortium of four British companies, the Ada Group Ltd., is seeking about \$10 million in funding from the government to develop APSE tools for a variety of target machines. The four members are leading British computer manufacturer ICL Plc, computer services group Software Sciences, SPL International and Systems Designers Ltd. SPLI and SDL have considerable experience in projects based on Digital Equipment Corp. hardware.

One of the earliest Ada products from Britain is a compiler for DEC VAX machines complying with the 1980 Ada definition and developed by the University of York (MMS, November, 1982, p. 138).

Softech Inc. and Intermetrics Inc. are leading APSE development in the U.S. (MMS, September, 1982, p. 223). The Ada training course from Alsys is expected to be

available in the U.S. in 1983, says Kit Lester, an Alsys software engineer. He notes that it will be tailored to suit English-speaking users and is designed to be "more flexible than a textbook." Development is on a Pascal-based Intel

8086. Paradoxically, Pascal is one of the languages that Ada is intended to supersede, at least in some applications. Lester explains that Pascal was chosen because of its portability across numerous microcomputers. —Keith Jones

## ONLY RODIME GIVES YOU THE NO-NONSENSE APPROACH TO 5¼" WINCHESTER DRIVES

Our no-nonsense approach is simple. Design and build a Winchester drive with the highest capacity, reliability, performance and quality. Only RODIME gives you a full range of storage capacities — 6, 13, 20, 27, 40 and 54 megabytes. All with industry-standard interface so that as your storage requirements grow, you can simply upgrade capacity and performance without redesign. And, we are shipping more high capacity drives worldwide than anyone else. RODIME drives are reliable with an unprecedented 12,000 hour MTBF. An on-board microprocessor reduces components, enhances performance and precisely controls the drive's mechanics. Our performance is among the best—an average access time of 50 ms in the higher capacity drives. As for quality, ask our customers, they'll tell you RODIME's 5¼" Winchester drives are the best.

For the sensible approach to Winchester disk drives, see the no-nonsense people at RODIME.

# RODIME

RODIME PLC  
25801 Obrero, Mission Viejo, CA 92691, (714) 770-3085  
Nasmyth Road, Southfield Industrial Estates, Glenrothes, Fife, KY6, 2SD, Scotland  
Telephone: 0592 774704

CIRCLE NO. 49 ON INQUIRY CARD



**In an  
industry  
where ideas  
come and go,  
there is one  
notable  
exception.**



The computer industry is littered with products whose time came. And went.

That's why, when we designed the PDP-11 architecture, we wanted to create a computer family that would last. And not only last, but constantly improve and offer more to the people who invest in it.

Well, we're happy to say that our plan looks better than ever. Because Digital has recently introduced several important new PDP-11 products.

Among them:

A series of personal computers that are being hailed as the new industry standard.

The Winchester-based MICRO/PDP-11 system for under \$10,000\* that opens up a whole new range of possibilities for both technical and commercial applications.

And a new micro-processor that's the equivalent of the PDP-11/70, Digital's most powerful 16-bit minicomputer. Naturally, this product has immediate value to OEMs.

But it also has importance for every other computer user.

Because now that we've gotten all that power down to one micro-processor, we're busy thinking of all the new PDP-11 computers we'll be able to design.

To learn more call 800-225-9222 and ask for information package MM-117. In MA, HI, AK and Canada, call (617) 568-5707. Or attach your business card to this ad and mail it to us.

**Digital Equipment Corporation**, Attn. Dept. 117/MM-2-83, HL02-1/E10, 77 Reed Road, Hudson, MA 01749.

\*U.S. price only  
© Digital Equipment Corporation 1983  
MINI-MICRO SYSTEMS/February 1983

**digital**



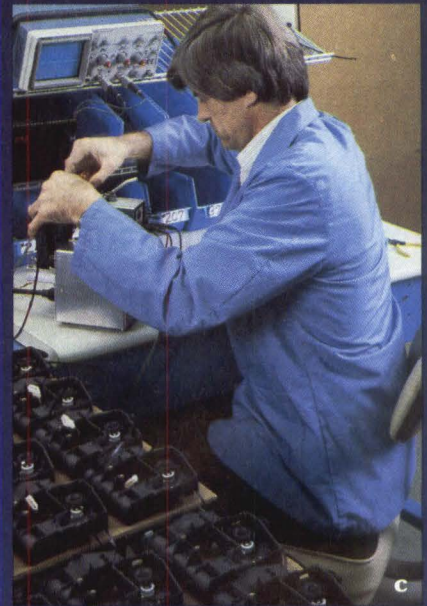

## How PRINTEK printers get their extra quality.

Extra attention to Quality Control is the key. It is evident everywhere in PRINTEK's clean, efficient factory (a) with its 24 QC check-points.

Take print heads, for example (b). Each is inspected for 11 parameters including impact force, flight time, pin alignment, and print quality. With 100% inspection, you get a full year head warranty and 250 million character life expectancy under normal use.

Just as important is the head carriage. Again 100% inspection (c) and precise adjustment yields extreme positioning accuracy for best print quality.

An elaborate computer-controlled circuit board tester (d) makes sure all components are functioning properly. Another 100% effort.

And all circuit boards are subjected to a 48 hour test run at elevated temperatures (far above those normally encountered) to assure long life.

After assembly, each printer endures a 72 hour continuous test run (e), during which an 8-page print out of every operation is produced on each printer — your tangible evidence of its quality and that its minimum 2500 hour MTBF is realistic.

This meticulous PRINTEK Quality Control is available on the 200 cps model 910 and the 340 cps model 920, both with dot addressable full-raster graphics, near-letter quality correspondence, 8 character pitches (to 227 cols.), and easy interfaces.

For full information on the exceptional quality PRINTEK printers, contact PRINTEK, Inc., 1517 Townline Road, Benton Harbor, Mich. 49022. TWX 810-270-3112. For the name of your nearest sales office, call Cheryl at 616/925-3200.

**printek**   
making printers that do more  
CIRCLE NO. 50 ON INQUIRY CARD





# Mini-Micro Interpreter

An analysis of news, issues and trends affecting the computer industry

## High-end, 16-bit microcomputers gravitate toward MC68000 chips

By Sarah Glazer

Introduced in late 1979, the Motorola MC68000 has cut a wide swath through the field of 16-bit microprocessors, emerging as designers' favorite chip for high-end microcomputer systems. Although it still costs considerably more than its two main competitors—the Intel 8086 and the Zilog Z8000—the MC68000's 32-bit internal architecture, speed and well-designed instruction set are making it the chip of choice for systems that must perform sophisticated, multi-user applications.

Produced by Motorola, Inc., Austin, the MC68000 accounted for 25 percent of the 16-bit microprocessors shipped in 1982, says Kenneth McKenzie of Dataquest, Inc., a Cupertino, Calif., research firm that follows the microprocessor industry. He estimates that the iAPX 8086 from Intel Corp., Santa Clara, Calif., had 70 percent of the 1982 16-bit market and the Z8000 from Zilog, Inc., Campbell, Calif., had about 5 percent. Egil Juliussen, chairman of Future Computing, a market research firm in Richardson, Texas, says the MC68000 appears in systems at the high end of the market and predicts it will remain strong there for some time. "For the future, the 68000 will be very prominent in what we call the \$10,000 computer," he says.

"Although the 68000 is called a 16-bit machine, the architecture is more of a 32-bit machine. That is the key," Juliussen explains. The 68000 has a 16-bit-wide external data path, and thus is tagged a 16-bit chip. However, internally it has 32-bit registers throughout—eight general-purpose data registers and eight general-purpose address registers. "When programs become larger and the applications more sophisticated, this becomes very important," Juliussen stresses.

Roger Melen, vice president of R&D at Cromemco, Inc., a Mountain View, Calif., manufacturer of desk-top computer systems based on the MC68000, agrees with this analysis of the 68000's popularity. He explains that the MC68000's linear, 32-bit architecture allows it to address far more memory than can a chip with 16-bit internal architecture. The MC68000's address space goes from 0 to 16M bytes, with any location equally accessible. "The 68000 is much more like a mainframe than like a 16-bit machine, at least in its ability to address large amounts of memory," Melen says. This is important, he emphasizes, when running software

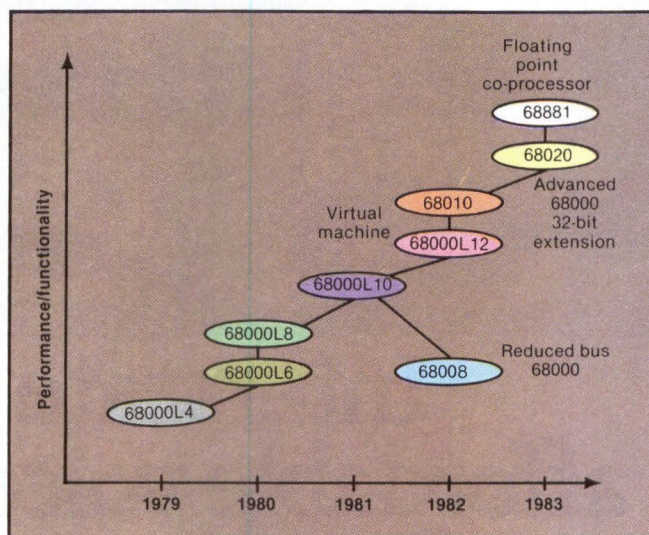

**Genealogy of the MC68000 processor family.** The first chip on the market was a 4-MHz version, denoted by the L4 at the end of the model number. Its siblings are either faster or have different functional features.

packages that previously ran on mainframes. "Mainframes are designed to address megabytes as easily as they address a byte," he says. "If you try to patch their software to run on a truly 16-bit microprocessor, you can do it, but you run into software bugs."

### Segmented addressing limits

Juliussen explains that an architecture using segmented, 16-bit registers theoretically can directly address only 64K bytes of memory at a time, although memory-management schemes allow the chips to address more memory. He describes such memory management as "a 64K window you can move around within the larger memory space." But he notes, "It's cumbersome for programmers. You'd prefer not to do it."

Both the 8086 chip family and the Z8000 family have segmented registers. Jeffrey Miller, marketing manager for Intel's microprocessor operation, dismisses the segmentation issue, saying, "This is primarily a religious issue—segmented address space versus flat address space." He believes that Intel's most powerful chip, the iAPX 80286, scheduled to begin volume production this month, will find a home in high-end, multi-user systems with its memory-management, memory-protection and virtual-memory features, even





# Interstate announces affordable voice recognition for both DEC and C.I.T.O.H terminals.

**Now DEC and C.I.T.O.H users  
can plug-in voice recognition  
for only \$1295.\***

Interstate Electronics' high-accuracy, single-board VRT300 instantly adds new capabilities to DEC VT100™ and C. I.T.O.H CIT-101 terminals. The need for special programming has been eliminated by resident voice recognition firmware which enables spoken words to be transmitted to the host computer as if they had been keyed in. The VRT300 has a 100-word vocabulary and over 99% accuracy. The price includes mike and cable. And the system's proven itself in a variety of real-world applications.

In factory automation, we've increased final inspection productivity up to 60% with hands-free operation. And in the process of delivering real-time quality control data, we've demonstrated that direct voice data entry is a workable concept in noisy plant environments.

Interstate also talks medical applications—in depth. For example, our menu-driven system uses less than 80 words input vocabulary to let hospital patients order more than 10,000 services.



In computer-aided design, we've doubled productivity and shown that voice and graphics can work perfectly together. In security, we've proven that voice recognition offers a highly accurate, low-cost means of speaker identification. We're also involved with office automation, banking, and other applications.

We'd like to hear about your application—and help turn your concept into fact. Interstate can give voice to virtually any ASCII terminal—easily, economically and without special software. In fact, we even have a testing/training vocabulary already in place.

Let's talk. For application studies and product literature, contact:

Interstate Electronics Corporation,  
P.O. Box 3117, Anaheim, CA 92803,  
(714) 635-7210. Call Toll Free:  
(800) 854-6979, in California:  
(800) 422-4580. TWX: 910-591-1197,  
Telex: 655443. In the U.K. Telex: 82431.

\*\$995 in quantities of 50 or more.

**INTERSTATE  
ELECTRONICS  
CORPORATION**



A FIGGIE INTERNATIONAL COMPANY

CIRCLE NO. 51 ON INQUIRY CARD

VT100™ is a trademark of Digital Equipment Corporation.



# The Interpreter

though it has a segmented address space and 16-bit registers.

However, Melen of Cromemco says that memory addressing strongly influenced Cromemco's choice of microprocessor when designers began planning its computer three years ago. They considered three chips, he says: the iAPX 8086, the Z8000 and the MC68000. "Since memory was coming down in price very rapidly, we wanted a processor that could accommodate vast amounts of memory efficiently and effectively," he says. The designers had planned initially for a 256K RAM chip, which Melen explains would provide memory economically in the several-megabyte range. "When you look at the 8086 in that context, it has only a 1M-byte address space," Melen says. "And that's a severe limitation." The Z8000 relies on an external chip to address large amounts of memory, but that support

chip wasn't available when Cromemco's decisions were being made, he adds.

James Groff, product marketing manager at Plexus Computers, Inc., Santa Clara, Calif., which manufactures a supermicro based on the MC68000, says the Motorola chip is leading its competition notably in some applications. He names intensive program development, relational database management, computer-aided design, large inventory control and material requirements planning systems as MC68000 strongholds.

In addition to address space, Groff credits the chip's popularity to its speed. His company uses a 12.5-MHz MC68000. (The chip is also produced in 4-, 6-, 8- and 10-MHz versions.) Groff explains that in multi-user applications such as program development, there might be four or five simultaneous C compiles. "There, the

16-bit Microprocessors				
	MC68000	iAPX 8086*	Z8002	NS16032
Speed	10 MHz (also available in 4, 6, 8 and 12.5 MHz)	8 MHz (8 and 12 MHz for the 286)	4 MHz (also available in 6 and 10 MHz)	6 MHz (also available in 10 MHz)
No. memory fetches per sec.	2.5M	2M (4M for 286)	1.3M	1.5M
No. fetches per instruction	1-5	1/2-4	1	1-5
Time from valid address until data needed from memory	225 nsec.	295 nsec. (242 nsec. for the 286)	295 nsec.	125 nsec.
Floating-point chip	Not yet available	8089	Not yet available	16081
Memory-management unit	68451	Not available (integral to 286)	8010, 8015	16082
Virtual-memory CPU	68010	80286	8003, 8004	16032
Physical address space	16M bytes	1M byte (16M bytes for 286)	8M bytes	16M bytes
No. of instructions	52	87 (103 for the 286)	114	86
Second sources	Signetics, Hitachi, Mostek, Philips, Rockwell, Thomson CSF	AMD, NEC, Western Digital	AMD, SGF, Sharp, Toshiba	Fairchild Synertec, Eurotechnique
Chip with 32-bit-wide external data path	68020 (prototype Dec., 1983)	80386 (prototype late 1984)	Z80,000 (prototype late 1983)	32032 (prototypes now; sampling mid-1983)
Price (each)	in 100 quantity: 68000 \$61 (8 MHz) 68008 \$38.25 68010 \$185 68451 \$58.80	in 100 quantity: 8086 \$25 8088 \$14.10 186 \$50 188 \$50 286 \$237	in 100 quantity: 8001ps \$28.50 8002ps \$20.75 8003ps \$57 8004ps \$41.50 8010ps \$28.50 8015ps \$71.50	quantity of one: 16032 \$162
Source: Motorola, Intel, Zilog and National Semiconductor *Where information for the iAPX 80286 is significantly different, it is given in parentheses.				



# The Interpreter

brute processing power of the 68000 is very appropriate." Relational database management also requires CPU power to manipulate large tables of data, he notes. In addition, he says, the more of a table that can fit into memory at once, the better it is for such an application. "All these things play strongly to the 68000's advantage," he says.

Plexus manufactures a sister computer system to its MC68000-based system that uses a Zilog Z8000 as the CPU. For I/O-intensive applications, such as inquiry response for verifying bank account balances, Groff believes, the Z8000 is an excellent CPU. In such a case, he stresses, "There's no need to spend the additional money for the performance-assistance 68000." A standard MC68000 sells for \$61 each in 100-unit quantities, whereas in similar quantities, a Z8000 CPU sells for \$20.75, and an 8086 sells for \$25.

## Ties to an 8-bit base

Some of the reasons for the differing technical features among 16-bit chips can be traced to their ancestry in the 8-bit market. "Intel had such a large installed base for its 8-bit chip [the 8080] that it had to come out with a 16-bit version of the 8-bit chip to save that base," says Miles Rickard, general manager of Ryan McFarland Corp., an Austin software company. Because compatibility with its installed base was very important, Intel designed the 8086 so that application software need not be rewritten. (Zilog also designed the Z8000 to be software-compatible with its popular Z80 8-bit chip.)

Although compatibility is a big selling point for users, Cromemco's Melen believes it is a double-edged sword. "Because Intel was attempting to get backward compatibility with the 8080, its upgraded chips have essentially the same instruction set. The 8086 is just patch upon patch," Melen says. He describes the instruction set as unsymmetrical, saying the attributes of instructions change radically from one to another. "It's a compiler designer's nightmare," he concludes.

"The 8086 doesn't program like a real computer," says Robert Osborn, a computer systems consultant in Arlington, Mass. He terms its instruction set "terrible," but adds, "Some people argue it doesn't matter because you write all your code in high-level language." He gives the Z8000 higher marks, although, he says, "It still has a microprocessor-oriented instruction set." In contrast, he says of the MC68000, "It's the only one that has a minicomputer-type instruction set."

Rickard of Ryan McFarland believes this break with a more primitive type of instruction occurred when Motorola decided to abandon its 8-bit base. "Motorola

leapfrogged to a 32-bit chip and then came out with a 16-bit version they could implement," he says. In so radically changing its architecture and instruction set, Motorola abandoned existing software as well. "In the short term, they may suffer," Rickard says, "but in the long term, they're probably going to have better success."

In addition to the MC68000, Motorola has added other CPUs to its family, all based on the 32-bit internal architecture. The MC68008 has an 8-bit-wide external data path. The MC68010, scheduled to be in volume production by now, has a 16-bit external data path like the standard MC68000, but it supports virtual memory. And scheduled to be introduced next December is the MC68020, which is planned as a fully 32-bit chip, with a 32-bit-wide external data path.

Another microprocessor family with 32-bit internal architecture that is entering the 16-bit market is Santa Clara, Calif., National Semiconductor Corp.'s NS16000 series. And, because the NS16032 CPU was introduced only last May, National had several years more than its competitors to hone technical features. "It's one of the best-thought-out devices from an architectural standpoint," says McKenzie of Dataquest. "National is last into the market, so it had the last look at the mistakes everyone else made." McKenzie questions the NS16000's ability to gain market share but says the recession has bought National some time by causing customers to postpone purchases. "The longer the recession lasts, the healthier the prospects for the 16032 become," he says.

## The software issue

Because the MC68000 represents a departure from the previous generation of Motorola chips, it entered the market with virtually no software support. "There's a very large new market for the 68000 that requires new software," says Ron Conway, vice president of marketing at Altos Computers, Inc., San Jose, Calif. Altos is handling this problem by producing two lines of computers—one based on the MC68000 and the other on the 8086. Conway explains that Altos is directing its 8086 line at its existing 8-bit customer base that uses CP/M, MP/M and OASIS operating systems. "We had to offer those users an upgrade path to a 16-bit computer that would run their software," he says. The 68000-based line is aimed at what he describes as "the emerging market—engineering workstations and new OEMs who haven't written any software yet."

Some MC68000 users insist software is not an issue because so many application programs are written in high-level languages that can be transported to 68000-



# DILOG TAPE COUPLER EMULATES TS-11 FOR VAX\*

You can't beat the Model DU132 for easy coupling between your VAX-11 and 1/2" magnetic tape transports.

DILOG's single quad size Tape Coupler interfaces VAX-11/730, 11/750, 11/780 and 11/782 and up to four formatted, start-stop, 9-track, tape drives or streaming tape drives with embedded formatters (start-stop/streaming selectable under software program control). The coupler offers data transfer rates to 600 KB and tape speeds to 125 ips. It also interfaces the new "Cache Streamer" \*\* and GCR transports.

The Model DU132 is software compatible with TS-11 under RT-11, RSX-11, RSTS and VMS operating systems. In addition, it offers 800/1600

BPI dual density not available on DEC TS-11.

The coupler has parity for increased data reliability plus a 1 KB buffer and selectable DMA burst sizes of 2 or 4 words to eliminate errors due to DMA latency.

Contact your local DILOG sales office for complete details and O.E.M. quantity discount pricing on the Tape Coupler that emulates TS-11 for VAX.

#### Corporate Headquarters

12800 Garden Grove Blvd. • Garden Grove, Calif. 92643  
• Phone: (714) 534-8950 • Telex: 681 399 DILOG GGVE

#### Eastern Regional Sales Office

64-A White Street • Red Bank, New Jersey 07701  
• Phone: (201) 530-0044

#### European Sales/Service Office

12 Temple Square • Aylesbury, Buckinghamshire • England  
• Phone: 44-296-34319 or 34310 • Telex: 837 038 DILOGI G

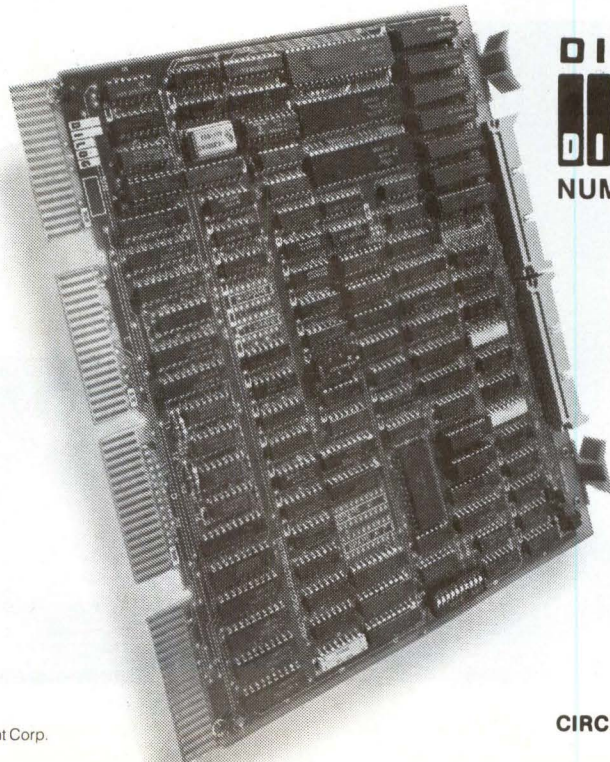

**DISTRIBUTED  
LOGIC CORP.**  
**DILOG**   
NUMBER 1 FOR DEC-11

\*DEC, VAX, RSTS, RSX Trademarks Digital Equipment Corp.  
\*\*Trademark Cipher Data Products

CIRCLE NO. 52 ON INQUIRY CARD



# The Interpreter

based systems. "The issue of software went away with the introduction of UNIX-compatible systems on the 68000," says Jim Isaak, product manager at Charles River Data Systems, Inc., Natick, Mass., which produces a multi-user microcomputer system based on the MC68000. "All the major languages are available on the 68000 now," he adds.

The significance of the UNIX operating system is that it runs on computers ranging from micros to mainframes, says Jean Yates, president of Yates Ventures, a Los Altos, Calif., publishing company that specializes in operating systems. UNIX allows programmers to use all the features of a mainframe—compilers, debuggers, database managers and editors. Yates declares that UNIX has become a "portable software standard" that allows easy networking between 68000-based microcomputer systems, minis and mainframes.

"In terms of design-ins in UNIX-land, the 68000 is the chip of choice," says Yates. She credits this to its direct addressing capability and to the snowball effect of 68000-based systems coming on the market. "Everybody knows that Apple Computer and Tandy have

computers with it. Then Fortune Systems made a big splash. It's the name-brand value of the companies that are selling them," she says.

Consultant Osborn also believes that UNIX and the MC68000 are a good fit because of the chip's large address space. "UNIX is a hog," he says of the operating system's memory requirements. However, he explains that UNIX was written for a machine with a small address space, the Digital Equipment Corp. PDP-11, so it can be put on any 16-bit processor. "You can do UNIX on the 8086," he says, "but the 68000 is easier to use." Microsoft has written XENIX, a version of UNIX System III, for the 8086.

Yates believes that the 68000 will continue to dominate in UNIX-based computer systems. Of the more than 1 billion microprocessors she estimates will be UNIX related by the end of 1986, 70 percent will be in the 68000 family, 28 percent in the 8086 family and 2 percent in the Z8000 family, she predicts.

Even though UNIX has smoothed the path for the 68000, much application software remains to be written. Application software is still one of the main

## BACKED-UP BACK-UP





strengths of the 68000's chief competitor, the 8086—especially for single-user computer systems, says Yates. "I think it's a drawback for the 68000 that they don't have that kind of software support," she says.

McFarland's Rickard believes software support will continue to be a strength for the 8086 family in the personal computer market. Even before IBM Corp. chose the iAPX 8088 (part of the 8086 family) as the CPU for its personal computer, Rickard says, software written for the 8086 had become the "single-user de facto standard." An additional strength he cites for the 8086 family is a strong base of low-cost support chips, giving computers based on it a competitive price edge. Support chips lower design costs by cutting the need for custom circuitry. "The 8088," he says, "is the obvious choice for a personal computer from a marketing standpoint, if not from a technical standpoint."

To hasten the development of its own support chips, Motorola is building an impressive second-source team, says Charles River's Isaak. "Second sourcing is an important factor in the way the marketplace works," says Isaaks, naming, in addition to plentiful support

chips, cost reduction, availability and promotion of the entire chip family as benefits. However, most of the MC68000's second sources are not yet in production, says Motorola's director of marketing and applications for advanced microprocessors, Jack Browne. "Second sources are coming on line as soon as they get their engineering problems ironed out," he says.

Still, the MC68000 has created excitement that is itself an important marketing tool. Groff of Plexus describes it as "a bandwagon effect." He explains, "There are a lot of vendors announcing, and it's a favorite with programmers and technical people." In addition, there is a persistent industry rumor that IBM's Instruments Division may market a 68000-based desktop computer as a high-end personal computer.

Even without the added boost of riding on IBM's marketing coattails, the MC68000 has a strong image. Groff says customers are demanding Plexus's 68000-based system whose needs could be met by the less expensive Z8000-based system. "Nonetheless, they perceive the 68000 as leading-edge technology," he says, "And you can't argue with that." □

## Archive backs up Winchesters 10 times faster than floppies.

Today's business computer system simply can't afford floppy Winchester back-up anymore. Not when our Archive Super Sidewinder ¼" Streaming Cartridge Tape Drive can copy 45MB in just nine minutes.

A floppy, on the other hand, takes more than an hour to do the same job. Not counting the time you spend inserting a new disk every few minutes.

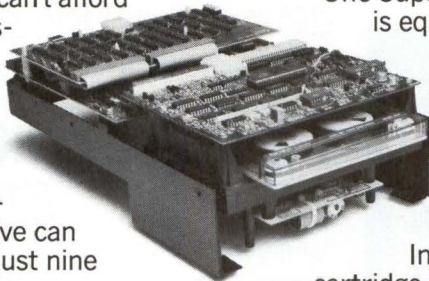

### Saves "handling" charges.

One Super Sidewinder cartridge is equal in capacity to 38 eight-inch disks.

That will save you over \$200, plus the cost of handling all those disks—inserting, removing, jacketing, labeling, and filing.

In addition, a Sidewinder cartridge is completely enclosed when out of the drive, virtually eliminating damage due to handling.

### More than just a back-up.

Our ¼" streaming tape drives provide the complete removable media needs of any system: Software distribution, data collection and program loading. All performed at the touch of a button.

### System integration made simpler.

Both our 20MB and 45MB drives are specifically designed to fit an 8" floppy disk footprint. To use the same power supply. And to use the same simple 8-bit parallel interface.

We could go on. But let's get specific, contact us today. And ask for our new handbook on streaming tape drives and how to use them. Archive Corporation, 3540 Cadillac Ave., Costa Mesa, CA 92626. (714) 641-0279, Telex 4722063, TWX 183561. Distributed nationally by Hamilton/Avnet.

**ARCHIVE**  
CORPORATION  
**¼" Streaming Tape Drives**



# The Incredible Shrinking 212A!

## For High- and Medium-Volume Users — Intelligent Custom 212A Modems on a Card with Incredible Features at Incredible Prices

### FOR HIGH-VOLUME USERS — AN INTELLIGENT CUSTOM 212A

The "Make or Buy" decision becomes incredibly easy for high-volume 212A modem users. The answer is "Buy" Racal-Vadic intelligent modems, custom designed to your specifications.

These intelligent custom modems, designed around a new breed of 212A and 103 LSI chips are incredibly small and flexible, incredibly low in cost, and Racal-Vadic takes an incredibly short time from prototype to high-volume production.

Tiny 18- and 24-pin dual in-line chips contain a modulator and demodulator, transmit and receive filters, a carrier detector, automatic gain control, and answer tone generator/detector. Racal-Vadic has added telephone line, user, and control interfaces to these dual in-line chips. And our custom 212A modems are delivered to you FCC Registered and TAP Certified.

And that's just the beginning! A built-in micro-processor gives you all the options you've dreamed of: automatic dialing with stored numbers, interactive conversation with the data terminal operator, sophisticated diagnostics... and more.

If you need a lot of 212As, each packaged in less than 50 square inches, come to Racal-Vadic. We'll build them to your size, shape and specifications — and deliver them in a minimum of time.

### FOR MEDIUM-VOLUME USERS — A STANDARD INTELLIGENT 212A

For medium-volume 212A users, the perfect solution is our V5212P — a standard intelligent modem packaged on an 8.85- by 5.50-inch PC Board. The V5212P fits comfortably inside most terminals and computers, because each modem occupies less than 50 square inches.

The V5212P, which uses the same chips, micro-processor and functional modules that make up a custom 212A, provides 1200 and 0 to 300 bps full-duplex operation with manual and automatic originate/answer. It's FCC Registered and TAP Certified for direct connection to the switched network and has built-in RS232C and TTL interfaces to simplify integration into new or existing systems.

A sophisticated automatic dialer, which allows up to 32 digits to be stored in memory and instantly retrieved by the terminal operator, is included in the V5212P. The modem provides a unique digital or analog input/output capability and can be used in systems where voice and data transmissions are required.

The price is right. Just \$420 in lots of 100.

Whether you need an incredibly small custom 212A or an incredibly small standard 212A, we've got 'em. And at prices much lower than you ever thought possible.

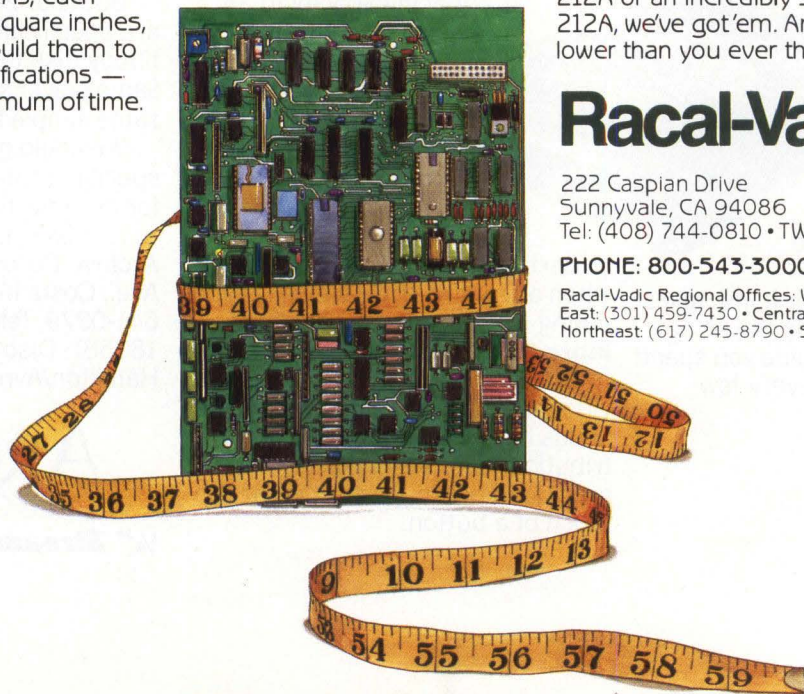

**Racal-Vadic** Member IDCMA

222 Caspian Drive  
Sunnyvale, CA 94086  
Tel: (408) 744-0810 • TWX: 910-339-9297

**RACAL**

PHONE: 800-543-3000, OPERATOR 507

Racal-Vadic Regional Offices: West: (408) 744-0810  
East: (301) 459-7430 • Central: (312) 932-9268  
Northeast: (617) 245-8790 • Southwest: (817) 277-2246



## Software distributors fill gap between developers and dealers

By Geoff Lewis

The explosive growth of the personal-computer/desktop microcomputer market has seeded many ancillary businesses. Among the most dynamic of these beneficiaries is the software-distribution industry. Almost nonexistent three years ago, distribution companies are beginning to play a dominant role in the sales and marketing of microcomputer business software.

Companies such as Softsel Computer Products, Inc., Software Distributors and Micro D, Inc., have become the latest variety of overnight sensations in the microcomputer market. They have done so, says industry analyst Egil Juliussen of Future Computing, because they "filled a crying need in the market." The need was for some order in an uncontrolled, chaotic market in which retailers had to choose from among thousands of packages from hundreds of suppliers. And once the retailers made their choices, they had little assurance that the products would operate as advertised or would meet commercial standards. Hardware distributors did the little they could to supply a software repertoire with their machines, but neither they nor the dealers had the resources to sort out the rapidly rising flood of software products for small-business applications.

"Hardware distributors just didn't carry software," explains Juliussen, whose Richardson, Texas, firm tracks the personal-computer market and the retail channels through which its products flow. "When Softsel started two years ago, they were the first in the market, and they and the others have performed a tremendous service. Store owners previously had to order from hundreds of vendors, and now they can get a wide variety of products from a single source," he says.

Starting from that simple premise—one-stop shopping—software wholesalers have taken on additional responsibilities. Perhaps the most significant is their intermediary role between software developers or publishers and computer dealers and software stores. As products flow from the suppliers, software distributors claim to perform a screening function, rejecting inadequate products before they reach the store shelves. The distributors also act as a conduit to the suppliers, carrying market-response information from the dealers.

Softsel, based in Inglewood, Calif., claims to be the



Illustration by Jim Wiley

largest software distributor, expanding from distribution of computer games (recreational software) to business applications in the 2½ years since its inception. Executive vice president David Blumstein says the company enjoys a 700-percent annual growth rate and had more than \$35 million in gross sales last year. Its chief rival, Software Distributors, was established almost two years ago and claims to be the largest distributor of business application packages with revenues comparable to Softsel's.

Software Distributors president Linda Johnson notes that as Softsel has added business applications to its line of game software, the company has begun adding recreational software. Using this strategy, Johnson says, Software Distributors is growing 20 percent per month. Softsel now derives as much as 80 percent of its revenues and 50 percent of its unit volume from business packages. Johnson says recreational packages account for about 35 percent of Software Distributors' unit volume.

Overall, software distributors—which include in their ranks other national organizations such as Micro D as well as dozens of regional operations—handle 50



If you really want protection against downtime, you can always tuck away an extra printer and use it strictly for emergencies.

But why buy two of their printers, when one Non-Stop Trilog TIP-300 will do? It's the only printer made that comes with a built-in back-up print head.

**Two heads are better than one.**

Most dot-matrix line printers use

only a single print head. That's fine – unless something goes wrong with the head. Then you're out of business until a service representative shows up.

On the other hand, the Trilog TIP-300 uses an exclusive two-headed system. Both 150 lpm print heads run simultaneously. Giving you a total output of 300 lpm.

Should one print head temporarily

fail, the user simply flips a switch and the remaining head continues printing at 150 lpm.

Now that's Non-Stop-Printing™!

Dual heads offer another advantage, too. Instead of being pushed to capacity like most single heads, each Trilog head runs at a 50% duty cycle. This makes them much more reliable than conventional print heads.

# This is a printer with a spare for unexpected breakdowns.



For more information circle 55

MINI-MICRO SYSTEMS/February 1983



**Advanced innovation isn't just in our heads.**

That's why we also gave Trilog printers dual tractors. They not only stabilize the paper and minimize friction, but allow the paper to move forward and backward. This gives you plotting capability and lets you generate forms. You can also print bar codes. Plus business and engineering graphics.

**Five printers for the price of one.**

Besides graphics, the TIP-300 gives you four other types of printing: standard data processing characters. Letter quality characters that approach the sharpness of fully formed characters. And two versions of compressed characters for paper savings and special formats.

For more information contact:

Trilog, Inc., 17391 Murphy Ave., Irvine, CA 92714. Or call (714) 549-4079. TWX (910) 595-2798.

You'll see that one of the most reliable printer combinations you can buy is a single Trilog Non-Stop Printer.

**Non-Stop-Printing starts with**



**So's this.**





# The Interpreter



**Linda Johnson, president of Software Distributors, says, "Software-only retailers have hundreds of products in their stores [compared with hardware dealers that frequently carry fewer program products]. It is, therefore, critical for them to use distributors."**

percent or more of all the business application software sold, Juliussen estimates. According to Future Computing's projections, sales of business application software such as personal productivity tools, accounting and word processing for machines in the \$3000 to \$10,000 range will grow from \$330 million annually in 1981 to \$2.6 billion in 1986. For the over-\$10,000 personal-computer segment, Future Computing expects software packages to rise from \$100 million annually to almost \$1 billion in the same period. Overall—with entertainment and consumer applications factored in—sales are expected to rise from \$500 million annually to \$6 billion in 1986.

The software distributors' share of this market is the difference between the discount they receive from manufacturers and the price they charge dealers. Distributors typically get discounts as high as 60 percent, while dealer discounts are around 40 percent, leaving distributors with about 20 percent of the retail purchase price on each package they sell.

In the case of Software Distributors, however, the margin can be higher. Johnson explains that her company has established a floppy disk-duplication facility able to produce floppies for 37 computers. The company has duplication licensing agreements with 45 manufacturers, she says. She declines to disclose what financial arrangements Software Distributors has with

these companies, but acknowledges that her company's profits are higher on company-duplicated products. She also points out that this method enables her company to supply dealers with packages that manufacturers have not formatted for some computer brands.

## Distributors add value

As distributors gain clout in the business software market, they are taking on added functions to help move packages smoothly through the dealer channel. However, providing any value added is a challenge for Softsel and Software Distributors, each of which carries about 1000 titles for sale to more than 2000 dealers. Nevertheless, Johnson and Blumstein both stress the service aspects of their companies. In addition to providing a one-stop shopping service, both companies offer dealers liberal return policies, 24-hour shipment on orders (most of which come over the telephone) and discounts based on dollar volumes.

In addition to the standard reseller discount, which varies according to the price of a package, Softsel deducts as much as 10 percent more for stores ordering \$20,000 a month. Software Distributors takes volume discounts on a case-by-case basis, Johnson says, declining to specify representative examples.

Both Johnson and Blumstein stress their companies' roles in evaluating packages. Blumstein says more than a dozen Softsel employees work full time evaluating about half of the 300 or so packages submitted monthly by authors and manufacturers. Of those evaluated, 3 to 4 percent are chosen for resale to dealers. Johnson says, "Before we'll include any new title, it goes through a technical evaluation, then we look at the documentation, then we look at the market demand for such a product, and finally, we evaluate how support-intensive it will be."

"When we started, there was only a limited number of products available," Blumstein recalls. "Now it's an easier process because we can compare a new product against what has already succeeded in the market." He points out that some rejected products are resubmitted after the publisher has attempted to rectify a product's shortcomings.

"Now that there are a number of major distributors," Johnson says, "we can make some demands on the manufacturers, and if they don't live up to them, we won't handle their products." As the market gets more competitive, with more first-time users going to stores to purchase business packages, the distributors are pressuring the manufacturers for better documentation and merchandising materials, she notes. "I don't think any of the distributors would indiscriminately add new





## Take A Closer Look At The Affordable Desktop Family

Now! DIGILOG offers the total solution for information processing needs... the most attractively priced and complete line of commercial quality desktop business computers available today!

With features you need. Look closer:

- From 1 MB to 50 MB storage, to
  - Stand-alone and networking systems, with
  - Floppy and Winchester storage devices, and
  - Advanced dual Z80A and 80186 processors.
- DIGILOG has them all... NOW!

At prices your business can afford. Look closer:

### STAND-ALONE SYSTEMS

(WITH CPM\*) (NETWORK OR 16-BIT UPGRADEABLE)

SYSTEM 1000-I (720KB)	\$2995
SYSTEM 1000-II (1.6MB)	\$3995
SYSTEM 1500-I (5MB)	\$4995
SYSTEM 1500-II (10MB)	\$5995

### NEW DUAL 8/16-BIT PROCESSOR PRODUCT

(CP/M-86 AVAILABLE)

SYSTEM 1016-I (720KB)	\$3995
SYSTEM 1016-II (1.6MB)	\$4995
SYSTEM 1516-I (5MB)	\$5995
SYSTEM 1516-II (10MB)	\$6995

### NETWORKING SYSTEMS

(TurboDOS™ AVAILABLE)

SYSTEM 1800-I (5MB)	\$6995
SYSTEM 1800-II (10MB)	\$7995
SYSTEM 1800-III (20MB)	\$8995
WORK STATION 900	\$1995

NOTE: PRICES QUOTED ARE RECOMMENDED RETAIL PRICES AND INCLUDE CP/M-80.

TurboDOS™ is a trademark of Software 2000 Inc. and is CP/M compatible. CP/M\* is a registered trademark of Digital Research Corp.

Take a closer look at DIGILOG—the affordable full-line vendor of desktop business computers. Let's talk business.



For information contact:

**DBS** DIGILOG BUSINESS SYSTEMS INC.

Welsh Rd. & Park Dr., P.O. Box 355, Montgomeryville, PA 18936 • (215) 628-4810 • TLX 846419 DBS MMLL

CIRCLE NO. 56 ON INQUIRY CARD



# The Interpreter

products at this point," she says.

## Distributors' role questioned

However, some software suppliers, including Microsoft, Inc., national sales manager for consumer products Nick Roche, question Johnson's statement. "I don't think distributors can prevent bad products from coming into the marketplace," he says. "They are in the same boat with everybody else. There are so many products out there that it's impossible to keep up. If VisiCalc were garbage, but if it were still the best selling product on the market, they'd carry it."

Roche, whose operation handles some 60 versions of about six basic products, adds, "The distributors are really a conduit at this point. I would like to think otherwise, but I see no evidence." Roche, whose background is in consumer products, adds, "It used to be that a distributor would go out and push a good product, build a market for the manufacturer and help the dealer." He complains that many software distributors don't pay enough attention to merchandising issues such as shelf facings and promotional materials, but acknowledges that distributors' margins do not leave much room in their budgets for these items.

While manufacturers are happy to have distributors give their products rapid and widespread markets, they sometimes have difficulty delineating who has responsibility for supporting the dealer and end user.

Software Distributors' Johnson says, "Theoretically, the guy who sells the dealer the package should support the dealer, and the manufacturer should support the distributor. We don't support end users, but we do support the dealer," she continues, "If they have a technical problem with a package, they call in and can talk to an expert on database-management systems, accounting or spread sheets, all in one call." Dealer training itself, however, "is a responsibility of the software manufacturer," says Johnson. The manufacturer is expected to provide materials and personnel to make the dealer conversant in the product.

Software Distributors does plan to augment vendor training, Johnson says. This year, the company is launching a 12-month road show that will travel throughout the U.S. to give dealers intensive training on generic packages such as spread sheet, word processing and accounting. Johnson says her company is also working on additional merchandising aids such as in-store display racks.

Microsoft's Roche agrees with Johnson's view that training is largely the responsibility of software vendors. "There is absolutely no question that we as a manufacturer have an obligation—and probably it's in



David Blumstein of Softsel Computer Products, Inc., recalls, "We got a head start when only hardware distributors existed. We slipped in there, and people have said to us we were the first."

our best interest—to train dealers how to sell and service our products. Therefore, we are hiring reps all over the country to train dealers who then will be able to do the end-user handholding."

A similar effort has been launched at VisiCorp, whose VisiCalc remains one of the top-selling business applications. Vice president C. Gerald Diamond says, "We have a support center with an 800 number to handle dealer questions. In addition, we send dealers a monthly newsletter giving answers to frequently asked questions about VisiCorp products." The company also has a cadre of sales trainers who travel throughout the country, training 800 dealers per calendar quarter.

## Categorizing dealers

Another solution, adopted by Management Science America's Peachtree Software, Inc., subsidiary, is dividing the dealer network between those dealers serviced by distributors and those that deal directly with the company. Peachtree marketing and sales manager Julian Puckett says the move was made last summer when the company created a new class of dealers known as Authorized Software Centers. Some 350 of 1500 dealers, which traditionally acquired Peachtree's business and accounting packages through distributors, have signed for the program. Under ASC, a dealer receives a better price than available from a distributor, but must provide merchandising, promo-



# FOR HIGH CAPACITY, FAST ACCESS 8-INCH WINCHESTERS, COME TO NEC.

You get more from NEC.

**NEC gives you up to 85 megabyte capacity and 25 millisecond access time.**

Put NEC's D2246 8-inch Winchester to work in your medium and heavy volume interactive applications. Its speed and capacity make it perfect for virtual memory, database access, communications, or anything else requiring frequent disk access.

The D2200 family includes 8-inch Winchester with capacities of 22.5, 42.5 and 85 megabytes, with even higher capacities on the way.

The entire line offers significant savings in installation, packaging, maintenance, cost of ownership and cost per megabyte. Just the kind of savings you'd expect from the **Spinwriter™** people.

**NEC technology gives you more.** For easy systems integration, the D2200s use a conven-

tional Storage Module Device (SMD) interface.

With the D2200 Series you get sealed-module Winchester technology, accurate rotary arm-voice coil actuators, direct coupled dc motors, and state-of-the-art LSI circuitry. All these combine to provide an MTBF in excess of 10,000 hours. With a 30-minute MTTR.

**Get the same reliability that's made our Spinwriter printers a legend.** In the final analysis, that's what makes our D2200 Series the last word in 8-inch Winchester.

For more information, send the coupon to NEC Information Systems, Inc., 5 Militia Drive, Lexington, MA 02173.

## NEC

**NEC Information Systems, Inc.**

NEC Information Systems, Inc. MMS0283  
5 Militia Drive, Lexington, MA 02173

- Have a representative call me.  
 Send more information on the D2200 Series 8-inch Winchester.

Name \_\_\_\_\_

Title \_\_\_\_\_ Telephone \_\_\_\_\_

Company \_\_\_\_\_

Address \_\_\_\_\_

City \_\_\_\_\_ State \_\_\_\_\_ Zip \_\_\_\_\_

Spinwriter is a trademark of Nippon Electric Co., Ltd.

**CIRCLE NO. 57 ON INQUIRY CARD**

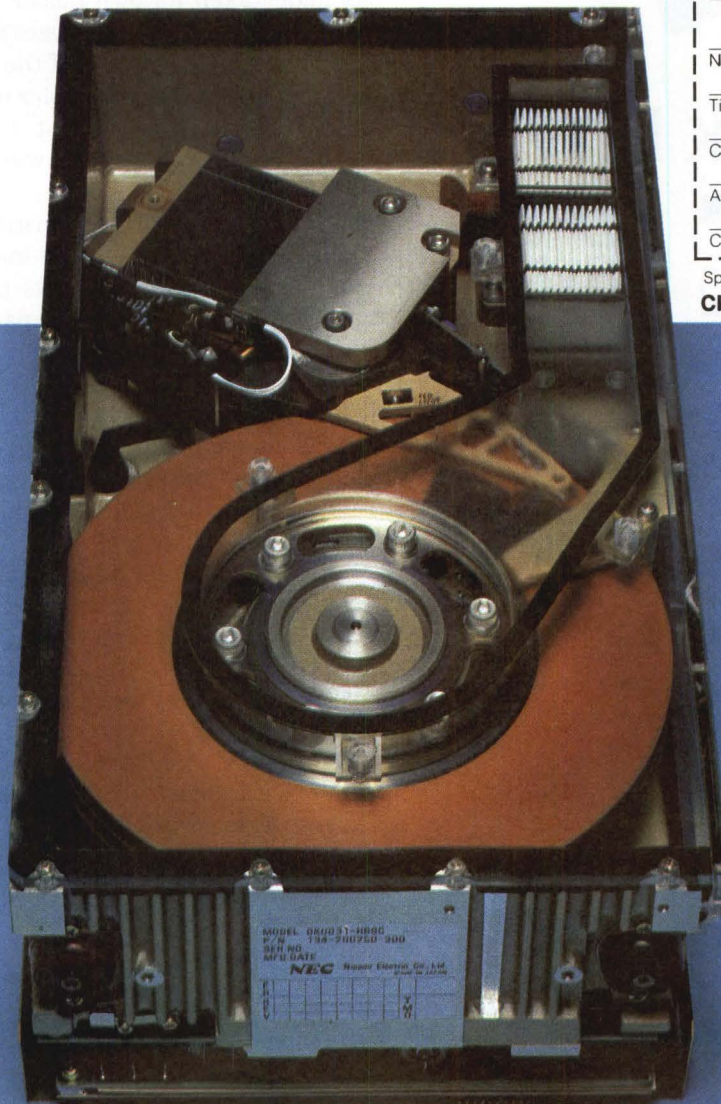



# HALF HIGH

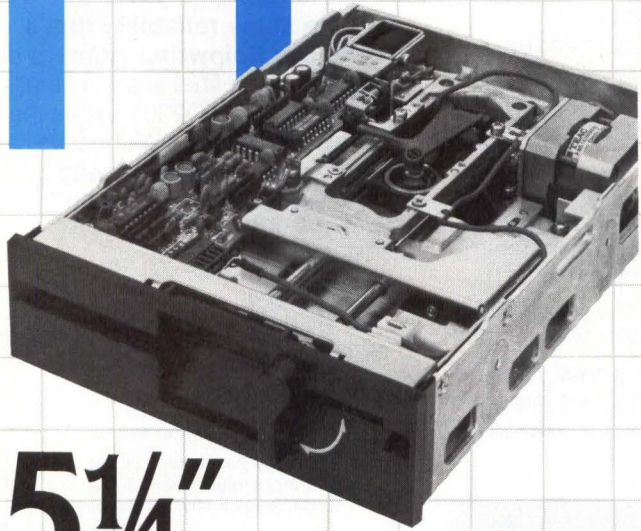

## 5 1/4" Floppy Disk Drives

# TEAC FD-55 Series

AT 1 5/8" HIGH, TEAC FD-55 SERIES 5 1/4" FLOPPY DISK drives use half the space and run cool at half the power of conventional drives. High-reliability, low-noise brushless DC motors provide an MTBF of over 10,000 hours, backed by a one-year parts and labor warranty.

<b>FD-55A</b>	<b>FD-55B</b>	<b>FD-55E</b>	<b>FD-55F</b>
• 48tpi	• 48tpi	• 96tpi	• 96tpi
• 40 track	• 40 track	• 80 track	• 80 track
• 250KB	• 500KB	• 500KB	• 1MB
• single side	• double side	• single side	• double side

#### Power Requirements:

DC +12V ±5% 0.3A typical, 0.7A max.  
DC + 5V ±5% 0.5A typical, 0.7A max.

Phone, write or wire TEAC Corporation of America for complete technical data, price and delivery.

TEAC Corporation of America  
Industrial Products Division  
7733 Telegraph Road  
Montebello, CA 90640  
213/726-0303

© 1982 TEAC Corp.

CIRCLE NO. 58 ON INQUIRY CARD MP82501M

## The Interpreter

tion and support. For dealers that acquire products through distributors, prices are higher but include end-user support from Peachtree. "A support card is included in every package and entitles a user to 30 days of free support via a toll-free hot line to our support center," Puckett says, adding that the service is available for a fee after the 30 days.

Dealer training in the distribution channel falls to the distributors, Puckett says. "We do not supply dealer support in distribution products, but the distributors are moving very quickly to train dealers. To date, we have had very good experience with distributors supplying support to dealers," he adds.

However, other suppliers are less sanguine about leaving sales training to their distributors. Software Publishing, Inc., Mountain View, Calif., for example, moves most of its products through distributors, but has undertaken its own dealer training performed by Software Publishing employees and independent representatives. "The key role of the distributor is one-stop shopping and letting the dealer mix and match products for volume discounts. What is missing, however, is in-store training," says Software Publishing president Fred Gibbons.

Software Publishing has installed more than 120,000 copies of its PFS database-management system on Apple systems. Gibbons says products such as those marketed by his company are part of the initial systems sale in many cases and therefore require a more knowledgeable salesperson. "We really don't see the distributors offering support beyond a macro level—such as knowing which packages will work with which printer. What the distributor can do is keep the dealer from buying blind and keep him informed about what products are selling well."

Softsel "would like to educate dealers," says Blumstein, but has been prevented from doing thorough dealer training by the company's rapid expansion. Dealer training sessions are now taped, and Blumstein says the tapes may be made available to dealers who could not attend.

The company, however, has developed a monthly binder with information on all Softsel lines for its dealers. That project was the result of a year-long effort aimed at keeping dealers up-to-date on Softsel's offerings and features of various packages. In addition, the company supplies a newsletter listing products the company plans to offer and provides dealers with advance copies of new products under a special program. Another merchandising aid is a weekly poster listing the 100 top-selling packages. □





\*SA-600 disk drive photo and media platters courtesy of Shugart Associates, and head arm assembly courtesy of INFOMAG.

# Literate IC's for your Winchester disk drive.

## SSi's first read/write Winchester IC developed in 1976.

In 1976, Silicon Systems developed its first read/write monolithic bipolar integrated circuit for the IBM-type 3350 Winchester disk drive. Dubbed the SSI 104, it integrated all of the required read/write, control, and data protection functions on one chip in a flat pack that could be mounted directly on the head arm assembly. The SSI 104 soon became the industry standard.

## Now meet the SSi family of IBM-type Winchester IC's.

Today, SSi offers a whole family of IC's for the IBM plug-compatible Winchester market. The SSI 104 and 105 read/write circuits and associated servo amplifier are available now for use with the IBM-type 3340/3350 ferrite-head series; and two circuits, the SSI 114 and 116,

have been introduced for the IBM-type 3370/3380 thin-film-head series. SSi's "literate" chips not only read and write data on the disks, but they also detect fault conditions and provide for head selection.

## IC's for micro's, mini's, streamers, and tape drives too.

For the rapidly expanding 5¼-inch micro and 8-inch mini-Winchester market, Silicon Systems offers its SSI 115 and 117, 5 and 6 channel read/write IC's; and for 8 and 14-inch IBM non-compatible drives there's the SSI 108. In fact, SSi has also developed more than a dozen custom IC's for rotating memories of various designs, including floppies, streamers, and tapes. So if we don't have the exact chip you need - we'll make a custom IC for you.



- Please call me.
  - Please send me product information on your SSi family of disk-drive read/write IC's.
  - Please send me a copy of your "Custom Integrated Circuits" brochure.
- If you're in a hurry, call (714) 731-7110, Ext. 168.

Name \_\_\_\_\_

Company \_\_\_\_\_

Address \_\_\_\_\_

City \_\_\_\_\_ State \_\_\_\_\_ Zip \_\_\_\_\_

Phone \_\_\_\_\_

**Silicon Systems incorporated**  
14351 Myford Road, Tustin, CA 92680



**Silicon Systems  
incorporated**

CIRCLE NO. 59 ON INQUIRY CARD



**YOU CAN FIND A LOT OF  
COMPANIES WHEN YOU WANT  
TO BUY A MONITOR...**





# ...BUT HOW MANY CAN YOU FIND WHEN YOU WANT TO SERVICE IT?

There's one you won't have to search for. Conrac.

We're committed to giving OEMs the service and support you need—when you need it and where you need it. We're implementing an extensive network of regional and local technical centers throughout the country, and that means service and replacement parts along with sales support nearby, where you need it. And with our ongoing training program, the skills that our people can offer your people are constantly being polished and upgraded.

When you look at the total picture—our 36 years of expe-

rience, the broadest range of products in the industry, high quality, performance, reliability, serviceability, availability and responsive engineering and customer service—it's easy to see why Conrac is the first choice in OEM markets. You know that once you buy from us—you won't have to search for us.

For more details on Conrac's complete line of monitors, and our schedule of training programs, call or write:

Conrac Division, Conrac Corporation, 600 N. Rimsdale Ave., Covina, CA 91722.

Regional Offices:

Western (213) 966-3511,

Mid West (312) 833-3310,

Eastern (203) 348-2100,

New England (617) 272-6720.

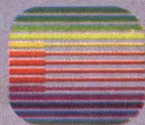

CONRAC



# SUPPORT THIS UNION AND AVOID A WORK SLOWDOWN.



Organize your DP operation around a VAX computer and Direct 831 terminals and enjoy an important benefit of a DEC-Direct union. More power. The kind that gets work done faster.

To the 831's VT100-compatible features you can add an optional integral modem to put the power of your VAX in the hands of anyone with a telephone.

Or add PLOT 10 graphics and deliver the big picture when there's no time to wade through words.

But that's just for starters.

The 831's block mode frees your VAX from the chore of creating and editing data. (That's why many users, including DEC itself, view block mode as an answer for overburdened CPUs.)

And if that's not enough, you can unite host and personal processing by field-upgrading the 831 to our Direct 1031, a self-contained terminal/personal computer. The 1031 makes the entire array of CP/M-compatible software available to off-load your host, leaving you more VAX processing power for the jobs only a VAX can handle.

To further our cause, we're prepared to stage a demonstration at your place of business. Contact us at Direct, Inc., 4201 Burton Drive, Santa Clara, CA 95054. Telephone 800-538-8404 (408-980-1414 in California). Direct and DEC. It's one union that gives you more than you bargained for.

**DIRECT**

DEC, VAX, and VT100 are registered trademarks of Digital Equipment Corporation. CP/M is a registered trademark of Digital Research, Inc. ©1982 Direct, Inc.

**CIRCLE NO. 61 ON INQUIRY CARD**



# The Interpreter

## Network management and control: different meanings to different vendors

By Dwight B. Davis

Over the past 10 to 15 years, networks have become integral parts of many companies' operations. Firms with widely dispersed offices and personnel, such as banks, insurers and airlines, were the first to embrace networking concepts and products, but hundreds of other businesses have followed the lead of the pioneering firms. In doing so, these companies have realized benefits equivalent to those generated by the advent of stand-alone data-processing equipment. But as networks have grown to include hundreds of lines supporting thousands of users, the implications of network failures have become staggering.

In response to networking users who faced severe consequences to their businesses when network failures occurred, communications vendors began introducing automated test and monitoring equipment about 10 years ago. Before the 1973 introduction of the MPT 500 network control system by Intertel, Inc., users had to rely on manually operated equipment such as oscilloscopes and patch panels to isolate and repair network problems. Such "tech control" equipment still performs an important role in network diagnosis and reconfiguration, but the trend has been to automate as many control functions as possible and to generate detailed reports from the data gathered by the monitoring equipment.

It was natural for Intertel, Andover, Mass., to enter the network monitoring and control business because the company was already selling modems to network users. Other modem and network component suppliers, including Codex Corp., Paradyne Corp., Racal-Milgo, Inc., and General DataComm Industries, Inc., have also added central-site monitoring and control equipment to their lines. While the functions performed by each of these companies' products vary, they all have one common denominator. The monitoring and control equipment links to the networks' remote modems and polls them to obtain information about their status and about the analog communication lines' parameters. "The term 'network control' is synonymous with 'modem control,'" says Van Chu, director of network control products at Intertel.

Therein lies a semantic problem that blurs the distinction among products sold in this market. Other vendors—non-modem suppliers—also sell products

Alarm Parameter	LSI FP Series	MX Series	CS Series
Carrier on	X	X	X
Carrier off	X	X	X
RTS on	X	X	X
RTS off	X	X	X
Good data off	X	X	X
Marginal circuit on	X	X	X
DTR off	X	X	X
Streaming device disconnect	X	X	X
DSR off	X	X	X
User special No. 1 on	X	X	X
User special No. 2 on	X	X	X
Receive level low		X	X
Receive level high		X	X
Marginal poll		X	X
Signal-to-noise ratio		X	X
Phase jitter		X	X
Gain hits		X	X
Phase hits		X	X
Impulse hits		X	X
Dropouts		X	X
Frequency offset			X
Nonlinear distortion			X
Retrans			X

**Alarm parameters monitored by three series of Codex modems** are said by the company to be the most extensive in the business. Codex contends that the detail provided by such analog and EIA status monitoring helps reduce finger pointing between vendors when problems occur, but some competitors claim users rarely need or understand such detailed information.

billed as network control, monitoring and/or management devices. Rather than poll the network modems to obtain information, products from these independent vendors, such as Avant Garde Computing, Inc., Dataproducts New England, Inc., and Datacomm Management Sciences, monitor and collect actual network transmissions to and from the central site. The functions performed by these independent products, which essentially overlay any existing network, can differ substantially from those performed by the modem vendors' network management and control products. Not surprisingly, each camp believes its approach is the best.

### Secondary-channel monitoring

Modems that operate in a network control environment with central-site equipment provided by the modem vendor require the addition of network control



# The Interpreter

and secondary-channel test cards. Some modem models may not be able to incorporate such cards, but most recent versions have been designed with network control in mind. Intertel, known primarily as a network control and management vendor, designs all its modems for operation in controlled networks, for example.

To communicate with the network's modems, the central-site control equipment from these vendors uses a secondary channel that resides at a different frequency on the same analog lines that carry the main data channels. Control information passes to and from the intelligent modems at a relatively low rate over the secondary channel, usually at about 75 to 110 bps. The modems supply the central-site equipment with information about their own operation and about the condition of the analog communications line.

This reliance on modem-supplied data prompts David Tolwinski, director of marketing for control systems at Codex, to note, "Any kind of network control that you've got is only as good as the modem." He claims the analog parameter measurement and EIA status monitoring capabilities of Codex's modems are more extensive than any competitive products (see table, p. 101).

Parameters monitored by the network control equipment can be set to trigger alarms if the condition of any falls below a specified threshold. Such alarming is a key aspect to these control systems because a major objective of the systems is to diminish network downtime and the losses associated with it. If deteriorating conditions can be spotted early, the network manager can take corrective action to avoid an all-out crash. And the extent of the parameters monitored also helps users determine exactly what equipment or line in a multi-vendor network is malfunctioning. Such detailed diagnostic data prevent responsible vendors from claiming the network problem resides in another vendor's component, Tolwinski says.

Because of their tight link with the network modems, network control products from modem vendors typically can effect some corrective actions when network components or lines malfunction. For example, most network control products in this category can automatically disconnect a streaming modem from the network. Also, if remote sites are configured with "hot" spare modems, these control systems usually permit a system operator to switch in the backup modem if another modem at that site fails. And, if a leased communications line goes down, these systems typically have a dial backup feature, with which a temporary toll connection between the remote and central sites can be manually or automatically set up.

In addition to monitoring and reconfiguring net-

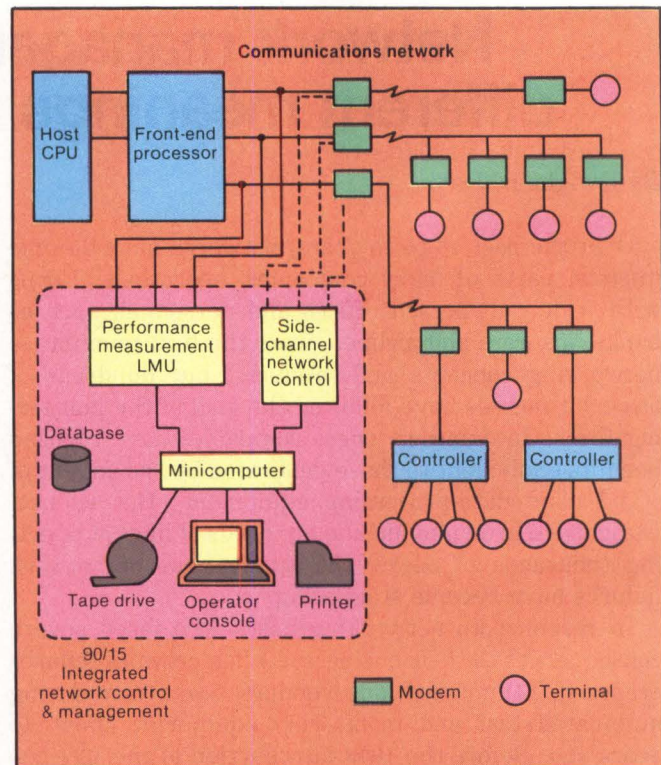

**Intertel's 90/15 system** includes a performance-measurement line-monitoring unit, a PDP-11/24 minicomputer for analysis and report-generation functions, Z80-based satellite processors that monitor as many as eight lines each and a central-site modem control facility (the EMS-One system). The modem control portion of the system communicates over secondary channels to the network's remote modems, and the performance-measurement module monitors and analyzes traffic on the main data channel.

works, some control systems from the the modem vendors have storage and report-generation capabilities. With such capabilities, a system can collect statistics about modem and line operation and present the data in reports designed to help network users evaluate their network reliability and configurations. But collecting data from the modems over a secondary channel has a major drawback that severely limits the type of information collected and the scope of the management reports. Intertel's Chu explains, "The fundamental drawback to secondary-channel monitoring is that you have no visibility into what's occurring on the main data channel."

To solve this problem, several of the modem control vendors have introduced modules that monitor the main data channel and report such parameters as terminal response time, number of transactions within certain time periods, CPU processing time when answering inquiries and line use. Commonly called performance measurement or monitoring systems,



# How do Unibus\* users spell peak I/O rate relief?

High speed data acquisition can be a real headache. Especially during peak I/O rates when transfer can exceed the CPU's capacity and key bits of information go off in thin air.

So we developed a DR11-W module. First for the Unibus. Now for the Q-Bus. Both feature our exclusive DMA Throttle that efficiently regulates data flow down to average rates to maximize overall CPU performance. But that's not all.

Additional design features make it a cure for many other troublesome Unibus or Q-Bus system ills. For example, it offers:

- Edge mounted LED's to illuminate performance status
- Micro-sequencer driven, self-test diagnostics
- Long lines capability
- Switch selectable 22-bit addressing (Q-Bus)

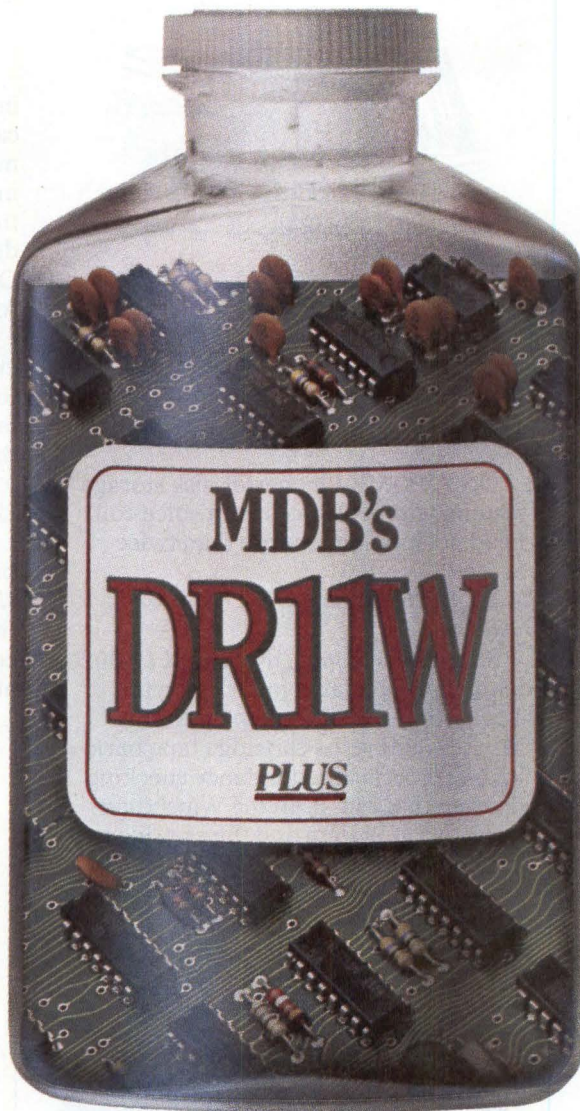

- Bus Address Extension for memory transfer throughout the 4 megabyte range (Q-Bus)
- Switch selectable, 4-level or single level interrupt arbitration (Q-Bus)
- Compatibility with 16, 18 and 22-bit backplanes (Q-Bus)

This high speed, digital input/output device is prescribed for such typical applications as:

- High speed graphics
- Digital data acquisition
- Parallel information processing
- Interprocessor linking between a Unibus and Q-Bus

There's more. And we're anxious to spell out all that the DR11-W and our complete line of computer interfaces can do for you. Call or write today and ask about full year warranty. Available under GSA contract #GS-00C-03330.

## Now for Q-Bus\* users too.

\*TM Digital Equipment Corp.

**MDB**  
SYSTEMS INC.

1995 N. Batavia Street, Orange, CA 92665  
714-998-6900 TWX: 910-593-1339

Circle 20 For LSI-11 99 for PDP-11



# How do you create a microcomputer to match the power of the UNIX™ operating system?

Imagine. You are perfecting a revolutionary operating system. In about two years, it will be the system of choice for 16-bit microcomputers.

It will be called the UNIX operating system.

But the breakthrough features of this operating system are going to make stringent demands on the computer.

The microcomputer developed specifically for the UNIX operating system more than two years before its commercial distribution is called ONYX.™

ONYX will live up to every demand and expectation.

To achieve the ultimate flexibility, simplicity, efficiency and productivity, the UNIX operating system will incorporate a file system of highly uniform sets and sub-sets of directories, arranged in a tree-like hierarchical structure.

And flexible directory and file protection modes, allowing all combinations of "read," "write," and "execute" access, independently for each file or directory, for a group of users.

But these advantages will require intensive disk access, and superior memory management. In simple language, disk access must be as fast as possible, and the disk must have an unusual capacity to maintain complex file systems on-line at all times.

Floppy disks with their low capacities and high access times won't do.

Winchester disk drives that utilize slow-moving stepper motor head positioning devices won't do.

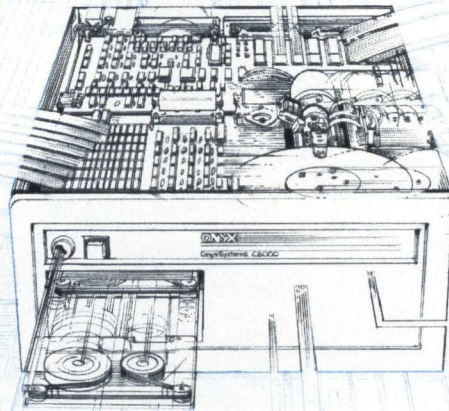

ONYX's IMI Winchester disk storage system, with its servo-driven voice coil head positioning, is more than twice as fast!

So, obviously the ONYX C8002 will do.

And, as developed, the ONYX C8002 features expandable memory up to 1 Mbyte, and disk storage up to 160 Mbytes on-line. Its cartridge tape backup offers cyclical redundancy checking on every backup. Both the Winchester disk storage system and the cartridge tape backup are *internal*.

In the UNIX operating system environment, the disk becomes an extension of main memory. "Swapping" programs between the disk and main memory



increases the number of operations that can run concurrently. ONYX's memory management system utilizes "scatter" instead of "contiguous" allocation, and the more efficient swapping minimizes demand on the disk channel. That's why ONYX assures a highly efficient environment for the UNIX operating system.

Now it's 1982. The UNIX system's pre-eminence among 16-bit operating systems is established. And ONYX is the only company that has significant production experience with UNIX systems.

ONYX has installed over 1500 UNIX systems.

Today there are a lot of systems being developed to operate UNIX (and "look-alike") operating systems. But there are many reasons why you should consider ONYX and the UNIX operating system as inseparable.

## System III available now for immediate delivery.

Phone this special number: (408) 946-6330 Ext. 251. Ask about these System III enhancements, including:

- Multi-key index sequential files under RM COBOL;
- "Term Cap" capability that supports a wide variety of terminal interfaces;
- Enhanced printer handling capability;
- SCCS to maintain edit histories in text management applications.

\*UNIX is a trademark of Bell Laboratories.

CIRCLE NO. 62 ON INQUIRY CARD

Make the Connection

# ONYX UNIX

OPERATING SYSTEM

Onyx Systems Inc., 25 East Trimble Road, San Jose, CA 95131



# The Interpreter

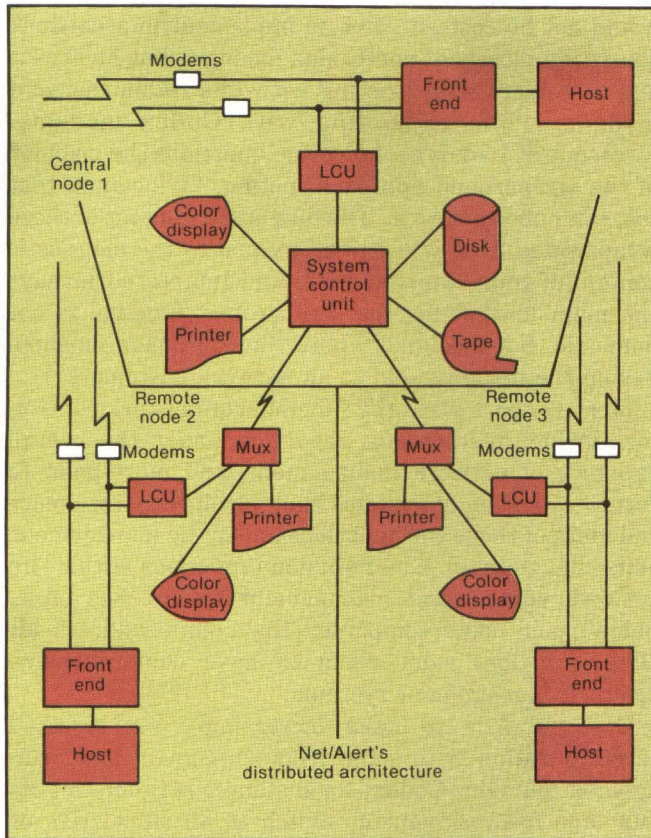

Avant Garde Computing, Inc.'s Net/Alert system includes a central-site system control unit (based on a 3200 series Perkin-Elmer minicomputer); as many as 128 line-monitoring units, which monitor digital data on the main data channels; a color graphic CRT; disk and tape storage; and various printers and color plotters. The SCU can support remote LMUs to monitor distributed networks, but the system has no direct link to the analog portion of the networks.

these modules are integrated with the vendors' modem control systems. Intertel, which claims to be the only modem vendor that builds its own performance module, the 90/15, claims to have a more integrated total system than its competitors, which buy the module from outside vendors.

Performance measurement products such as the 90/15, the Datalyzer from Paradyne and the Network Performance Facility from Racal-Milgo expand these firms' network control systems into the realm of main-channel monitoring, which was once the exclusive domain of the non-modem network control and management vendors. But even as the modem suppliers adapt some of the capabilities inherent in the independent suppliers' products, the independents still claim the modem vendors' approach has a serious flaw. The modem vendors' systems, say the independents, lock the customers into the vendors' entire communications product lines.

## Marketing sizzle to sell modems

"Companies such as Codex, Paradyne and Racal-Milgo are in the business of selling modems, and the strategy of using network control systems to sell modems is a very good strategy," says Tim Ahlstrom, president of Avant Garde Computing, Cherry Hill, N.J. Ahlstrom claims the Net/Alert network management system sold by his firm is a more generalized approach that permits various vendors' modems to operate in users' networks. Like the performance-measurement modules, Net/Alert monitors the digital traffic on the main data channels entering the central site. The system, incorporating a Perkin-Elmer Corp. 3200 series minicomputer, generates extensive management reports and color graphic displays about the information collected.

Peter Frigon, marketing manager at Dapaproducts New England, Wallingford, Conn., echoes Ahlstrom's criticism of the network control products from modem vendors. "Our Cenpat 700 system overlays existing data-communications hardware so we can operate with anybody's modems or in an all-digital network," Frigon says. "With our approach, customers also have flexibility for future growth of the networks. They can acquire the best modems available, regardless of which vendor is selling them."

Even though the Cenpat 700 and Avant Garde's Net/Alert both monitor the main channel data, the systems provide very different functions, illustrating another split in the network management and control market. While the Net/Alert is essentially a powerful performance-measurement system with management report-generation capability, the Cenpat 700 is a computerized network-testing system. It offers no storage or report-generation capability, but it automatically performs extensive diagnosis operations and can perform some central-site port switching. By using remote voice-frequency and EIA control modules, the Cenpat 700 can also obtain information about remote line and component failures, but, because it has no secondary channel, main data traffic must be disrupted to perform remote tests.

In response to the independents' charges that the modem vendors' control systems are just ploys to sell more modems, the accused admit they are guilty as charged—with one important caveat. "Once a network reaches a certain size and complexity, it really needs network control to test continuously and report degradations or outages," says Mike Levesque, general manager of Paradyne's Special Products division, Largo, Fla. Tolwinski at Codex concurs. "Customers absolutely benefit from having network control."



# The Interpreter

On the other hand, Levesque admits, "Network control does the selling, but modems are the high-volume item with which we make money. Network control is important, but at Paradyne, we never lose sight of the fact that we only use network control devices to sell modems."

Even at Intertel, known for its network control systems, not for its modems, "Over 75 percent of our profits come from modem margins," says Thomas J. Mercer, director of market development. He says this percentage is probably typical for companies such as Racal-Milgo and Paradyne.

## Wraparound capability

While the modem vendors admit their primary source of revenues comes from the high-volume sales of modems, not from central-site equipment, some dispute the charge that their network control systems lock customers into just a single vendor's modems. Codex, for example, points to its NA 1296 network adapter, which permits its DNCS network control systems to encompass virtually any modem.

In operation, an NA 1296 box is attached to the digital and analog sides of each non-Codex modem, and central-site signals pass through the adapter before reaching the modem. "With the NA 1296, you get all the EIA signals and signal quality measurements," Tolwinski says. "You don't get all the detailed analog parameters you would get from, say, our CS modem, but you do get most of the analog functions you would get from most competitive modems."

Tolwinski admits that the wraparound approach

would not be cost-effective to implement in a network consisting mostly of non-Codex modems, but he says it lets customers with existing networks retain their old modems while expanding with Codex modems. Levesque at Paradyne, however, questions the viability of the wraparound approach, noting, "We can do that too, but nobody buys it. The diagnostic content of those wraparound lines is not nearly equal to the diagnostic content of your own modems." And Intertel's Chu says the main market for the wraparound function is not domestic, but foreign, "where the PTTs have monopolies on the modems sold to all network customers."

Most vendors place the functions of network control, monitoring, testing and reporting under the overall category of network management, and most point to future evolution of systems that will incorporate more and more of these sub-functions under the management umbrella. Intertel places six main functions within the network control and management sphere (see table, below), and says companies that don't address all these functions can't claim to have comprehensive network management systems.

One trend is to have increasingly sophisticated reconfiguration within the network control and management domain. Codex, for instance, is promoting its IMS 7760 network control switch as an alternative or complement to the company's primary network control system, the DNCS. "The DNCS functions are heavily weighted toward the analysis side," says Mike Zak, Codex director of switching products. "The IMS is very physical, on the other hand. It takes lines and devices and rearranges connections from one device to another, in addition to doing some monitoring and testing as well."

Will the evolution of networks away from analog transmissions toward digital transmissions leave customers with modem-control equipment out in the cold? Intertel's Chu answers that modem companies already provide some digital capability with systems such as the performance-measurement modules. But he admits the complexion of the networking world is changing. "Right now, about 10 to 20 percent of all installed lines are digital," he says, "and that will probably go to 90 percent 10 years from now. But there will always be a small percentage of analog lines, and for the next two to five years, the modem will remain a very important part of the communications network." And, he suggests, network management devices that ignore the modems still residing in most networks are missing an important part of the network control and management equation. □

### NETWORK CONTROL & MANAGEMENT SYSTEM FUNCTIONS

- |  |   |
|--|---|
| • Network Configuration <ul style="list-style-type: none"><li>- System build</li><li>- Port-line-drop</li><li>- Logic-site-name</li><li>- Site info</li></ul>    | • Backup/restoral <ul style="list-style-type: none"><li>- Dial backup</li><li>- Hot spares (internal)</li></ul>   |
| • Alarm monitoring <ul style="list-style-type: none"><li>- Auto monitoring</li><li>- Auto preventive maint.</li><li>- Audible alarm</li></ul>                    | • Management reports <ul style="list-style-type: none"><li>- Report generator</li><li>- AM/AMP reports</li><li>- Trouble tickets</li><li>- Site info reports</li><li>- Graphical analysis</li></ul> |
| • Line/modem tests <ul style="list-style-type: none"><li>- Modem self test</li><li>- Loopback test</li><li>- Block error rate test</li><li>- Snapshots</li></ul> | • Performance measurement <ul style="list-style-type: none"><li>- Main channel analysis</li><li>- Response time</li><li>- Line utilization</li><li>- Color graphics</li></ul>                       |

**Intertel's view of network management and control functions.** Modem suppliers have only recently begun to add performance-measurement modules to gain a window on main channel traffic. Independent system suppliers have always accessed the main channel, but they don't typically get direct information about the analog lines or the analog side of the network modems.



*For different needs,  
different speeds.*

*Word processing at 80 lpm.  
Data processing at 150 lpm.  
Compressed print at 200 lpm.  
All pushbutton selectable  
on the versatile MVP Matrix  
Line Printer.*

*Different speeds for different  
needs, too. High resolution graphics  
at 4 ipm. Or high-speed graphics  
at 14 ipm. With the MVP, you can  
create high quality, multi-part  
forms, logos, business graphics,  
labels and bar codes right on the spot.  
All of this versatility with breakthrough*

*price/performance.*

*And unlike low  
cost serial and  
character printers,  
the rugged MVP  
is designed for  
continuous duty.*

*Printronix line  
printers. Quality  
that creates lasting  
impressions. For your  
nearest distributor,  
call today.*

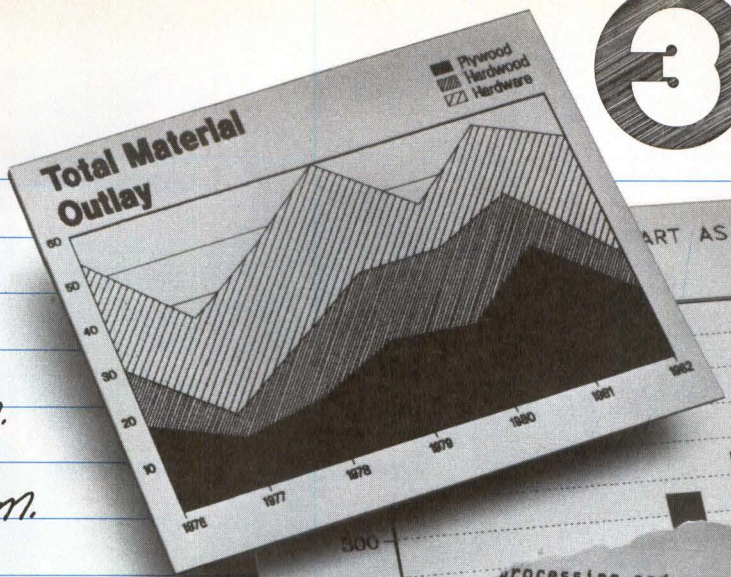

processing and compressed  
n-speed plotting, the MVP  
-application environments.  
nts an exciting range of

choose dot density and reso-  
appropriate for each applica-  
to produce just the output you  
-part forms print quality you  
s.) I'm also more than a match  
lications, such as business  
labels, plotting, and block  
font selection.

ed to serial. Why is that  
e printer is designed and  
eneration. That means  
ous serial printer

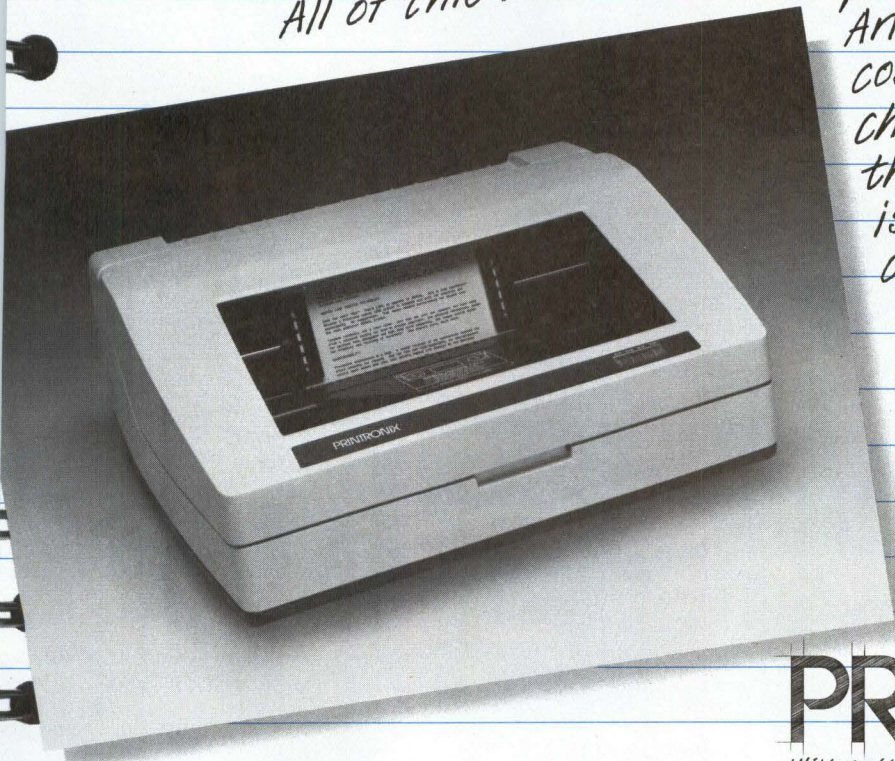

Graphics shown courtesy of ISSCO.

# PRINTRONIX

With authorized distributors worldwide.

17500 Cartwright Rd., P.O. Box 19559, Irvine, CA 92713

Phone: (714) 549-7100 TWX: 910-595-2535

CIRCLE NO. 63 ON INQUIRY CARD



# turbo

## SALES ANALYSIS FOR CONSOLIDATED BUSINESS INDUSTRIES, INC.

**Region 1** - Increased sales in Region 1, as expected, was the result of adding additional field manpower during the early part of the year. The higher resource level, coupled with greater operating efficiencies and tighter policies, paid dividends.

**Region 2** - The limited results in Region 2 were directly derived from the reduced demand for automobiles. Lower automobile demand and high interest rates resulted in both budget cutbacks and spending deferrals in this industry-dependent area.

**Region 3** - A nominal increase in sales in Region 3 was achieved against a backdrop of higher-than-planned personnel turnover. Market demand in this area remains strong but additional staffing and more senior management are prerequisites for next year.

R E G I O N				
	1	2	3	4
A	+11	+06	-02	+08
B	+07	+04	+16	+03
C	-01	+10	+17	+13

Percentage 1982 vs. 1981

### SALES BY REGION





# 400% MORE PERFORMANCE. 0% MORE DOLLARS.

## INTRODUCING THE CONVERGENT TURBO WORKSTATION.

The original Convergent IWS workstation literally defined the hardware and software standards of the Electronic Office. Its powerful 16-bit distributed intelligence architecture, built-in clustering capability, and state-of-the-art software made it an instant success with OEM's.

Then our AWS workstation line made most of the same advantages available in a significantly smaller package, at a dramatically reduced price.

Now meet the AWS Turbo Workstation. The same compact packaging. The same low price. *With over four times the processing speed.*

### The world's first high-performance mini on a desktop.

The Turbo takes advantage of new IC and memory technology to provide true minicomputer capabilities —including mass storage—in a package hardly bigger than a terminal. The slim lectern contains a

16-bit, 8 MHz processor plus optional 630 kB minifloppies and/or Winchester disks up to 16 MB.

Add a printer and Convergent software, and you've got a superb word processor. Other software options let you do spreadsheet modeling, handle standard communications protocols (3270, 2780, 3780, X.25), and use an advanced electronic mail system. The powerful multitasking operating system supports applications in COBOL, FORTRAN, BASIC, Pascal, and assembler, with complete portability between stand-alone and clustered systems.

### The OEM opportunity of the decade.

The new Turbo Workstation offers a sensational price/performance package. But it also offers some things that nothing remotely like it can match:

- A fast-growing community of Convergent users approaching thousands of installed systems.
- A software development environment tailor-made for OEM's.
- Quick delivery. Like now.

Better get the details soon. An opportunity like this doesn't come along every day.

## Convergent Technologies

Where great ideas come together.

Call toll-free (800) 538-7560; in Calif. (408) 727-8830 or return this coupon.  
Send to: Convergent Technologies Inc., 2500 Augustine Drive, Santa Clara, CA 95051  
I'm an OEM. Tell me more about the Turbo.

Name \_\_\_\_\_ Title \_\_\_\_\_ Company \_\_\_\_\_ Address \_\_\_\_\_ City \_\_\_\_\_ State \_\_\_\_\_ Zip \_\_\_\_\_  
Tel. ( ) \_\_\_\_\_ Ext. \_\_\_\_\_

MM 283



**Let your imagina**

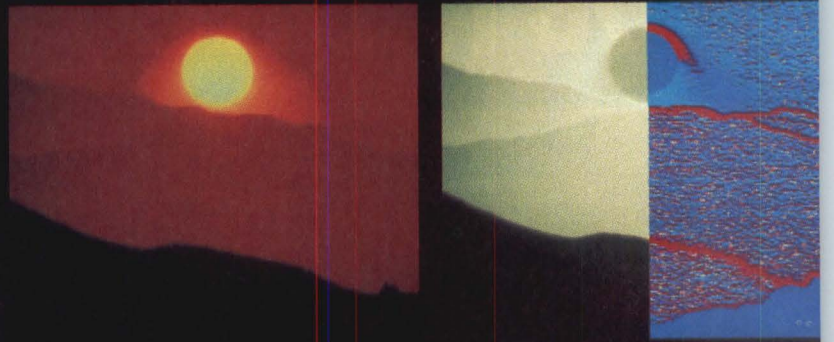



# tion run wild, not your budget.

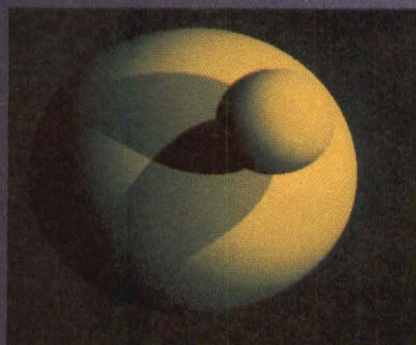
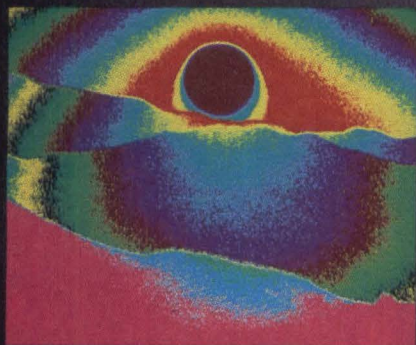

## Introducing the Grinnell 2800 Image Processing / Graphic Display System.

Whatever your mind can imagine, the new Grinnell 2800 System can visualize. And it does it at an astonishingly cost effective price.

### **Power and flexibility in a compact system.**

For 512x512, 512x640, 480x640, 1024x1024 and 1024x1280 graphics, image enhancement and image processing, the 2800's exceptionally fast, easily programmed distributed computing architecture (built around a high-speed bit slice processor) puts an incredible repertoire of graphics instructions and image processing capability at your disposal for a wide range of monochrome, 3-color and multi-spectral applications.

### **Exactly what you need, when you need it.**

Because of its unique, modular design, the 2800 System can be sized to your specific needs without sacrificing performance, allowing for

multiple, modular processors and controllers for parallel, multi-spectral processing. And each processor is individually programmable, letting you manipulate input, graphics and imaging for simplified operation and maximized throughput.

For added cost-effectiveness, each video controller is associated with an ultra-fast pipeline processor. And should you need it: an optional microprocessor (Motorola MC68000, 512K RAM, 32K PROM) for Command Control Processing.

### **Programmable for your applications.**

With the 2800 System, its microprogrammable System Controller gives you the choice of using standard or special instruction sets, with the option of downloading from the host computer or through the Command Control Processor. The CCP can also be programmed to interface

with your choice of interactive control devices and off-load frequently used routines from the host computer. In addition, the system's Intelligent Host Interface offers you several data transfer modes to further enhance throughput.

### **Now imagine how it can work for you.**

Compare its performance to anything on the market. Then, when you compare prices, you'll buy Grinnell. For details, write or call (408) 629-9191. Whether you're an OEM, end user, or involved in educational or industrial research, you'll agree: the Grinnell 2800 lets your imagination run wild, but not your budget.

## **GRINNELL SYSTEMS**

6410 Via Del Oro Drive  
San Jose, CA 95119 (408) 629-9191



# Zilog's new System 8000 speaks seven languages. Fluently!



Now, there's a microcomputer that speaks seven high-level languages at a price that won't leave you speechless.

The Zilog System 8000 Model 11 is a general purpose, time-sharing computer that features the powerful UNIX\* operating system, with enhanced System III capabilities. It is especially attractive to OEM's since all the software needed to make programming more productive is of the highest quality, and is accompanied by superb documentation.

For example, commercial users can select from high-level COBOL and BASIC business languages; systems programmers can select C, Z8000 assem-

bler and PLZ/SYS; technical users can opt for FORTRAN 77 or Pascal. Inside the Model 11 are the high performance VLSI components you've come to expect from Zilog. Each 8-user system is equipped with 256 KB of parity memory and an 18 MB Winchester disk for on-line storage. Optional ECC memory and additional disk storage capacity are offered. We also provide clear, easy to follow manuals, comprehensive training and dependable field technical support.

Zilog's new System 8000. Priced at just \$14,950, it is the powerful entry level system that speaks like a mini for micro prices.

To find out more about the System 8000 product family, call our toll-free number 800-841-2255. Ask for your free copy of the Zilog "Blueprint for Success" kit and poster. The kit contains detailed information about Zilog's unique OEM opportunities.

INTERNATIONAL  
Paris 33-334-60-09 Munich 89-612-6046  
London 44-0628-39200 Tokyo 03-587-0528

\*UNIX is a trademark of Bell Laboratories. Zilog is licensed for System III by Western Electric, Inc.

## Zilog

*Pioneering the Microworld.*

An affiliate of EXXON Corporation

CIRCLE NO. 65 ON INQUIRY CARD



# Systems in Manufacturing

Exploring the use of computers in the factory

## Robotics, vision advances emerge from industry, university cooperation

By Frank Catalano

Recognizing the limitations of robot and vision systems, manufacturing system suppliers and end users are looking for new technologies that will serve as the next generation of factory-floor products. But rather than relying solely on their own in-house research labs or on the labs of system houses or engineering consultants, companies are starting to pour money into universities interested in tackling problems associated with the factory of the future.

As a result, a new, mutually beneficial relationship is developing between industry and academia. The relationship provides cash-conscious universities not only with money and equipment, but also with the ability to train students to solve real-world, industrial problems. Industry gains relatively inexpensive research expertise as well as a pool of well-trained future employees.

Such industry/university relationships are commonplace in Japan but less so in the U.S., where only 1 percent of every research dollar spent by universities in both the hard and soft sciences is supplied by the commercial sector, says Thomas Hogan, director of the Industry Study Group of the National Science Foundation. Although companies as large as IBM Corp. and as small as Object Recognition Systems Inc.—a vision-specialized start-up—are participating in factory-technology research projects with U.S. universities, Ronald Sanderson, a market analyst with Tech Tran Corp., Naperville, Ill., says such participation is still a new phenomenon and is not at the level that it is in Japan.

One Japanese project that was sponsored at Yamanashi University by a number of competitive robot suppliers, including Pentel Corp., Nippon Electric Corp., Yamaha Co. and Sankyo Seiki Manufacturing Co., resulted in the development of a new robot arm and controller design, called selective compliance assembly robot arm (SCARA). Each participating company incorporated the technology into its own products. Products differed in terms of mechanics, gripper design, human interfaces and payloads, but the basic technology was the same.

Sanderson says that a stagnant climate in the U.S. robot market may make such industry/university cooperative projects more common in the U.S. "The robot industry has suddenly come to a grinding halt," he says. "Two years ago, we were seeing growth



Illustration by Jennifer Menn

projections as high as 50 percent, and now the industry is lucky if it's growing at all. Not only can users not afford to buy systems, they don't want to buy them. People have tried robots, they've seen their capabilities, and they've also seen their limitations. Now they're standing back and waiting for the next generation of products to come along."

Laura C. Conigliaro, a market analyst with Bache Halsey Stuart and Shields, notes that robot suppliers looking for new technologies are realizing that "they can't do it all," and are turning to universities for assistance. "Here we have a tiny little industry with umpteen competitors in the market," says Conigliaro. "Vendors can't sit around and worry about technologies or applications that are future-oriented. They have to worry about marketing and developing today's techno-



# YOU WON'T BELIEVE YOUR EYES!



Introducing the Kratos KM1400 high-resolution color video display:

**1024 lines, non-interlaced.**  
**60 Hz refresh (64 kHz horizontal scan rate).**  
**100 MHz video bandwidth.**

For more information on the color video display with the highest resolution available today, call or write: KRATOS Display Systems • 101 Cooper Court • Los Gatos, CA 95030 • (408) 395-3700  
TELEX 171946

CIRCLE NO. 66 ON INQUIRY CARD

**KRATOS** Display Systems

© 1982 KRATOS Display Systems

MINI-MICRO SYSTEMS/February 1983



# Systems in Manufacturing

logies. I think they're looking to universities as a means of positioning themselves for the future."

But in helping companies prepare for future market needs, universities involved in robotics and vision research are trying to avoid some traditional academic pitfalls that they've met in the past. These include providing research results that industry can't readily use in products, spending too much time on projects and planning projects without considering markets or costs. "Universities are unfettered by commercial realities and don't worry about things like standard interfaces and components, manufacturing costs and final product costs," notes Michael Cronin, vice president of marketing at robot supplier Automatrix Inc., Burlington, Mass. "They might be very good at research into new technologies, but they're not so good at practical market development."

However, Dr. Eugene Bartel, director of research at Carnegie-Mellon University, says that by working closely with universities in the design and implementation of research projects, industry can reap more benefits from university research than it has in the past. Universities, in turn, can begin to understand the problems that industry needs to have addressed—whether those problems be technology or market related.

"We have a commitment at Carnegie-Mellon to develop technologies that are very quickly and readily transferable to industry," he says. "We encourage our sponsors to send their people here to work with us, so when we have a valuable new piece of technology, those sponsors can immediately transfer that technology into product development. Why waste time repeating one another's research when we can meet one another's objectives from the start?"

The goal of having industry and academia meeting

one another's objectives early is the basis of two National Science Foundation projects that began two years ago. With the charter of advancing the science base in the U.S., NSF is promoting the funding of university research. "Industry is a major user of university R&D and should be the major funder," notes Robert Colton, program manager for the Industry/University Centers project at NSF.

Colton's project is an attempt to bring together companies with similar research needs into a university research program tailored to meet those needs. NSF has thus far started 15 such programs that address research areas as diverse as polymer chemistry and VLSI technology, including a program for robotics research at the University of Rhode Island. Now in its second year, the program boasts 30 industrial participants including end users of robot technology, such as Digital Equipment Corp. and Chesebrough Ponds, Inc., as well as vendors in the robot market, such as Object Recognition Systems, Princeton, N.J.

"Our goal is to get the program started and then pull out our funding as soon as possible," says Colton. "Companies participating in each center then take over the program support through yearly fees."

The Robotics Institute at URI charges each of its participants \$25,000 annually. Nancy Harrison, a research assistant at the institute, says no company could duplicate the services it could receive at URI for the fee the university charges. "For \$25,000, a company couldn't hire researchers, buy equipment and allocate space," says Harrison. "Plus, they're getting the input from other companies involved. Each company provides its own technological expertise and marketing perspective."

From the program, Object Recognition Systems extracted the basic software design of its first product

## UNIVERSITIES CAN'T KEEP SECRETS

Any company that wants to do research leading to exclusive patents should confine its research efforts to in-house labs. Because one of the primary goals of academia is to add to knowledge, research performed within ivory towers usually ends up in the public domain via academic publications and conferences.

Many universities, however, provide that the results of any company-sponsored research project will not be released for two years after the project's completion. During the two-year interval, sponsor companies

can acquire, usually free, nonexclusive right to any patents resulting from the research. That allows a sponsor to get a jump on other companies and begin implementing the technology in in-house applications or commercial products.

Dr. Eugene Bartel, director of the Robotics Institute at Carnegie-Mellon University, says ownership of research results has not been a problem so far with companies that sponsor projects. The real problem, he says, is that companies sometimes supply the Institute with products that the

companies have on the market, but that they want the university to improve. "There is a real reluctance on the part of the engineering groups of various companies to release technical information about the products that they want us to work on," says Bartel. Such information, he says, usually details robot controllers or software. "Sponsors that finally agree to release such information usually require us to sign, in blood, confidentiality agreements."



# Systems in Manufacturing

—the i-Bot vision system (MMS, November, 1982, p. 201). ORS president William Artley notes that the company's affiliation with URI provided a springboard from which to develop the product in-house. "From a technological point of view, the program suggested some directions that we might not have considered in-house," says Artley. "We weren't looking for a blueprint of future products but for an input of ideas, suggestions and a focus."

He says the marketing input from other companies involved in the program was of primary interest to him and was itself worth the yearly fee. "The program gave us the opportunity to chat with other affiliates—some of them large corporations—and get a feeling as to what their vision requirements would be in the coming years," he says. "You get a much different interaction from this type of arrangement than you would from trade shows or individual company visits. Since people are there to learn and share knowledge, they are much more open and honest."

Tom Williams, manager of the manufacturing automation program within the corporate R&D center at Digital Equipment Corp., says DEC participates in the

URI program to learn what robots and vision systems can do for DEC's manufacturing processes and to gain insight into how computers will be used in such systems in the future. "Computers are involved across the entire spectrum of factory systems," says Williams. "We need to know about standard interfaces to robots, the integration of robots with factory computers and the use of computers in intelligent robots. All of these issues are involved in posturing DEC in the competitive marketplace."

Besides the Industry/University Centers program, NSF sponsors a University/Industry Projects program. That program promotes one-on-one research efforts between universities and companies. Like the Center program, NSF funds the university during the initial stages of the program so that the university can establish labs and solicit contracts. Once enough contracts are signed, NSF pulls its funding and lets industry take over. The goal of the program, says Fred Betts, program manager at NSF, is to coordinate the research efforts of universities with those of corporate labs. "We're trying to advance science in a way that is technologically relevant to industry," says Betts.

# FAST.

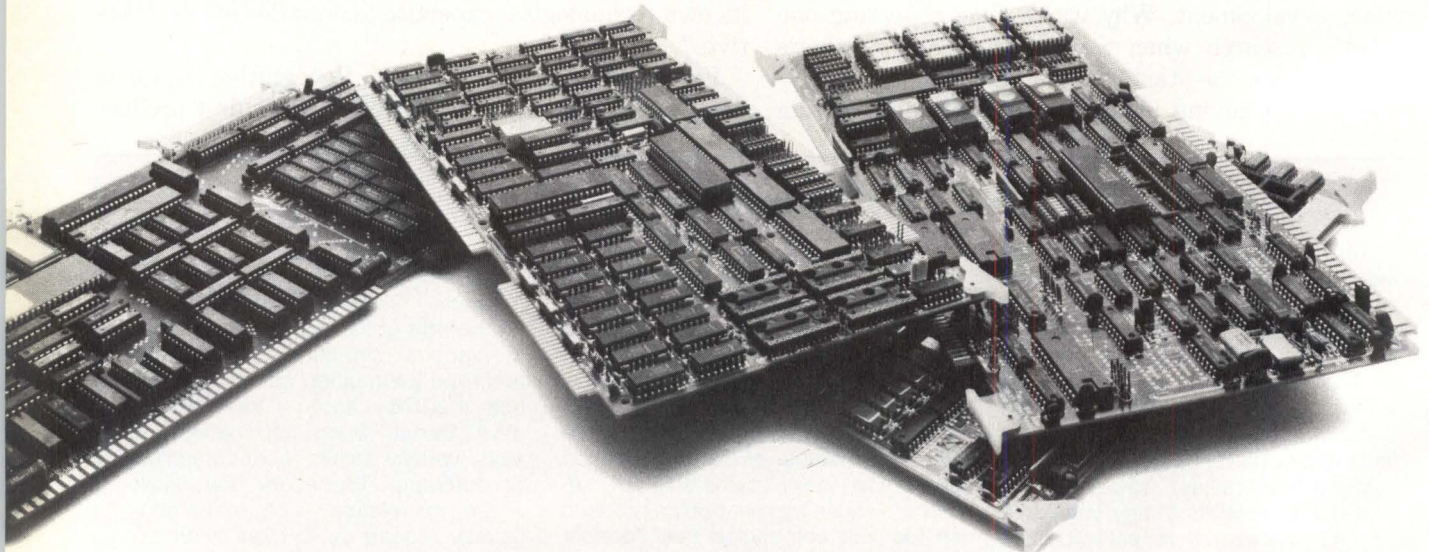

Dual Bus is a trademark of Microbar Systems Inc. \*Multibus is a trademark of Intel Corporation. UNIX is a trademark of Bell Telephone Laboratories, Inc. XENIX is a trademark of Microsoft Corporation.



"Through the University/Industry Projects program, we're trying to get universities and companies to coordinate their research expertise in a way that industry and academia both benefit. Industrial people are very good at knowing the relevance of a technology to a future product, and university people are good at coming out with the new technology. By working together, they can advance science while developing products (see "Universities can't keep secrets," p. 115).

General Electric Co. channels \$5 million annually into such one-on-one projects at Rensselaer Polytechnic Institute, Carnegie-Mellon, Stanford University and the Massachusetts Institute of Technology. Dr. Roland Schmitt, senior vice president for corporate R&D at GE, says GE uses university research as a source of new technologies and to augment the company's own in-house work. "Much of the work being done at universities is frequently at a level of sophistication that isn't ready for application or product development," he says. "But when we see some work at a school that we feel will eventually result in technologies that GE can use in-house or develop into products, it's to our benefit to support that work." He adds that GE will

also contract with a university for an in-house project that has already been started if the university is experienced to handle one aspect of that project.

Nick Yaroshuk, manager of university projects at Westinghouse Electric Corp., says Westinghouse issues contracts with universities when the company identifies schools with research expertise greater than the company's in-house resources. "We go to Carnegie-Mellon because of the school's computer science expertise and to Ohio State University and the University of Wisconsin because of their welding expertise," he says. "We've found that the cost of funding university projects is relatively low compared to developing the expertise in-house."

But besides research expertise, university involvement also provides Westinghouse with a source of qualified employees, says Chris Hudson, manager of technology for the company's Industrial Automation division. "When we have graduate or advanced degree people come through one of our projects—or even another company's projects—those people are clearly of more value to us than students who have never worked with industry," he says.

# FAST AND A HALF

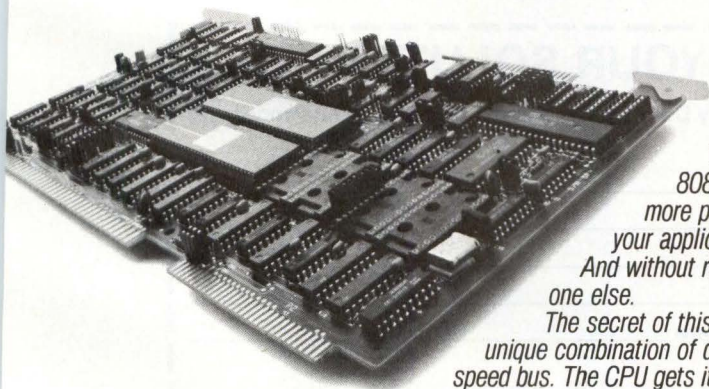

*That's the kind of performance you can expect from Microbar's 8086- or MC68000-based Dual Bus™ Computers. Up to 50% more performance in your Multibus\* system, depending upon your application. Without sacrificing Multibus compatibility. And without requiring on-board memory that's off-limits to everyone else.*

*The secret of this "fast and a half" performance is Microbar's unique combination of dual ported memory and a dedicated, high speed bus. The CPU gets its own zero wait state access path into memory. While other devices use the Multibus bus as usual.*

*So your software can get the most out of this high performance hardware, Dual Bus Computers fully support memory management. Handy for organizing 16 Mbyte address spaces. Absolutely necessary for running advanced operating systems like UNIX\* and XENIX\*.*

*To help you get the most out of your design efforts, Microbar has developed a Dual Bus Computer design kit. With all the information you need to add a Dual Bus Computer to your system. In a hurry. Because today designing a system fast is not enough. You have to be fast and a half.*

Microbar Systems Inc./1120 San Antonio Road/Palo Alto, California 94303/(415) 964-2862



*I want to design in fast and a half performance. Fast. Here's \$9.95. Rush me the Dual Bus™ Computer design kit, including manuals and technical specs, for the CPU indicated below. Also include the latest copy of the IEEE P796 specifications for the Multibus bus.*

8086 \_\_\_\_\_ MC68000 \_\_\_\_\_

Check enclosed \_\_\_\_\_ MC \_\_\_\_\_  
VISA Card \_\_\_\_\_ Exp. Date \_\_\_\_\_

\_\_\_\_\_ I can't wait for the mail. Have a sales representative contact me.

Name \_\_\_\_\_

Title \_\_\_\_\_

Company \_\_\_\_\_

Address \_\_\_\_\_

Telephone \_\_\_\_\_

City \_\_\_\_\_ State \_\_\_\_\_ ZIP \_\_\_\_\_



# Solve your puzzle at INTERFACE '83

INTERFACE '83 offers practical solutions, because it is that very special annual gathering of major users and vendors located precisely at the convergence of computer and communications technologies. If you're a decision-maker involved with today's increasingly complex information systems, already planning or working with various pieces of the puzzle like...

- Local area nets
- Front ends, modems and MUXs
- Policy and regulatory issues
- Network services
- Desktop computers
- Office systems integration
- DDP
- And more...

Then join your peers at the 11th annual INTERFACE '83, March 21-24 at Miami Beach Convention Center, where you will discover how to put all the pieces together for solutions to your particular puzzle.

Once again, the INTERFACE Conference will point the way,

with more than 200 experts offering presentations on all aspects of the DataComm/Info Processing puzzle. These experts tell it like it is, so that you can convert their insights into productive operational decisions.

With these new insights provided by our experts, you'll really be in position to profit from the state-of-the-art displays on the INTERFACE '83 exhibit floor. More than 250 leading supplier companies will be on the floor of the Miami Beach Convention Center with their newest hardware, software, services ... ready to discuss with you the solutions they offer.

To round it off, you'll want to attend the second annual Industry Awards Banquet (black tie optional), and you'll also want to spend many informal hours exchanging views with the industry's leading consultants and most distinguished executives.

For complete details, *call us today* - 617-879-4502. Or complete and return the coupon below.

## INTERFACE® '83 HAS YOUR SOLUTION

YES, I'd like to know how INTERFACE '83 can solve my Data Communications/Information Processing puzzle. I'd like more information.

Name \_\_\_\_\_

Title \_\_\_\_\_

Company \_\_\_\_\_

Address \_\_\_\_\_

City \_\_\_\_\_ State \_\_\_\_\_ Zip \_\_\_\_\_

Phone (        ) \_\_\_\_\_

Send to: The Interface Group, Inc. Registration Department 160 Speen Street P.O. Box 927 Framingham, MA 01701



## INTERFACE® '83

March 21-24, 1983 • Miami Beach Convention Center, Miami Beach, FL

Co-Sponsored by **BusinessWeek** and **Data Communications** Magazines

THE INTERFACE GROUP  
160 Speen Street, P.O. Box 927, Framingham, MA 01701 • (617) 879-4502

Producers of:  
INTERFACE, FEDERAL DP EXPO, COMDEX/SPRING, COMDEX/FALL, COMDEX/EUROPE, THE COMPUTER SHOWCASE EXPOS (Nationwide)

CIRCLE NO. 68 ON INQUIRY CARD



# Systems in Manufacturing

## Manufacturing package brightens lighting company's path

By Allan Ullman  
MiroFlector, Co., Inc.

In the past, overtime efforts by MiroFlector, Inc.'s employees were often able to solve manufacturing problems associated with the company's rapid growth and high customer demand for its products. But increasing competition and manufacturing costs have made it necessary for MiroFlector to acquire an Altos Computer Systems microcomputer to help manage time and materials. The microcomputer is enhanced by a comprehensive manufacturing software package from Trac Line Computer Corp.

Along with the manufacturing package, called M-Trac, the system includes a 12M-byte Winchester disk drive and four user terminals. M-Trac works well because MiroFlector had a hand in specifying what functions the package should include. Trac Line personnel asked MiroFlector and other small manufacturers (\$1 million to \$10 million) about their needs, and designed M-Trac to conform to those requirements. MiroFlector also served as a beta test site for the software, giving the company two years' experience with the package.

Implementation of the system occurred in stages, and the company expects to make continuing improvements in its use of the system. For instance, MiroFlector found the 12M-byte disk too small for its requirements and plans to replace it with a 50M-byte disk. The larger disk will enable the company to increase its user stations to eight and to add M-Trac's Project Evaluation Review Technique module. The company has used the PERT module for scheduling customer shipments and evaluating the impact of such scheduling on production, but disk limitations forced temporary dropping of the module.

Implementation of any computer system is not done overnight. While software can run immediately given the proper data, it can take a company years to refine its data and its operations to the point at which it will receive the full benefits of a manufacturing system. One strategy that MiroFlector followed was to ease the conversion process by implementing each product line one at a time and by involving each key employee.

### Software requirements

MiroFlector is a small manufacturing company that produces three types of interior lighting for commercial

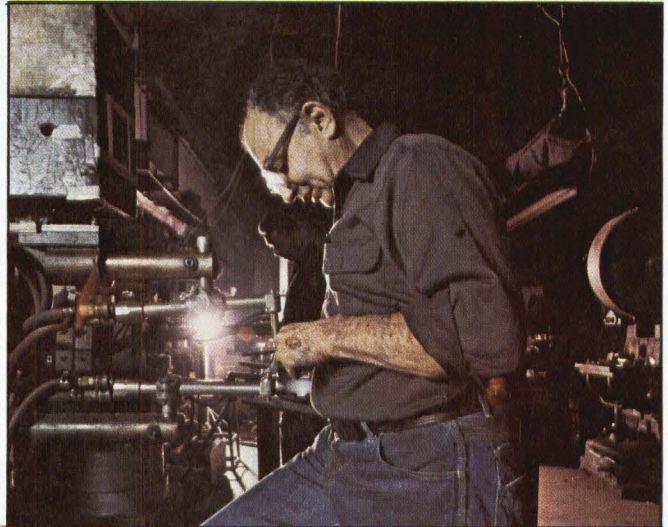

**A MiroFlector welder spot-welds subassemblies for the firm's lighting product line. M-Trac's bill of materials helps the company accurately monitor assemblies, subassemblies, purchased parts, manufactured parts and customized parts. (Photo: Jody J. Dole)**

and industrial markets. Its first product line, commercial incandescent, or high-intensity discharge, is used in large retail stores, shopping centers, airports, schools and other large public places.

The second line is TV Trac, a multiple raceway (a channel for holding electrical wires in buildings) consisting of both AC current and a television jack. Used primarily by television sections in major department and appliance stores, TV Trac guarantees near-perfect reception while concealing cabling.

The third product line consists of two power poles. The Com Power Post is used in offices to contain power and telephone lines at each desk. The Com Power Post Checkout Light operates in supermarkets and other places in which checkout aisles are indicated by a light that works with a point-of-sale device.

Because its clientele is varied, MiroFlector's products must be made to customer specifications. This creates several inventory problems. For example, the company had difficulty in converting amounts of materials. Wire is purchased in feet, but used in inches. The company needed a software package that would allow it to retain standard measurements, but make the conversions to ensure that sufficient wire and other parts had been purchased to complete a job.

MiroFlector also had other requirements; because the company uses many identical parts, it must know



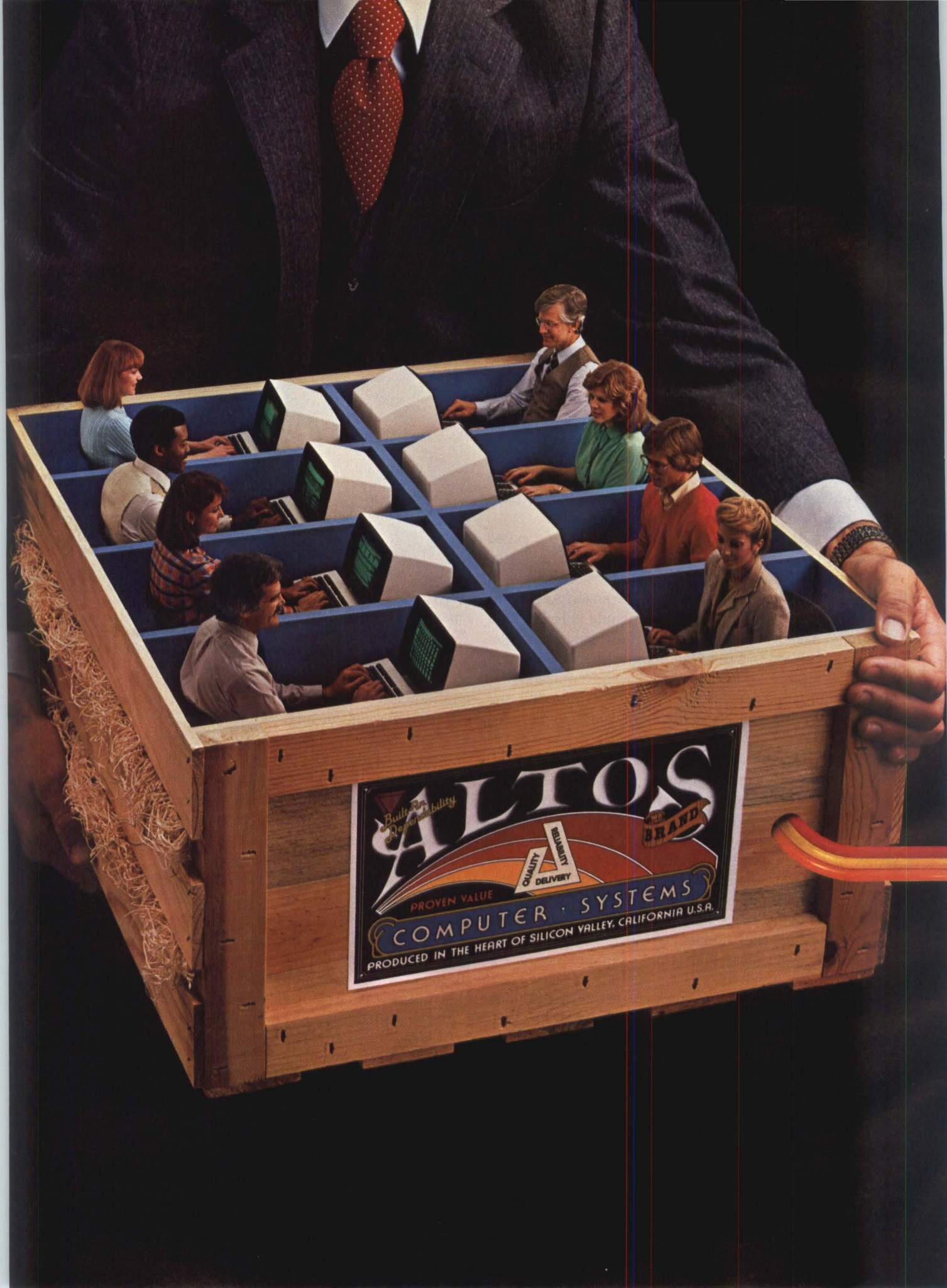

*Built on  
Reputation*

# ALTOS

PROVEN VALUE

QUALITY  
DELIVERY

COMPUTER  
SYSTEMS

PRODUCED IN THE HEART OF SILICON VALLEY, CALIFORNIA U.S.A.

BRAND



# 1 TO 16 USERS TO GO

**Altos multi-user 8086 or 68000-based networking computers are chosen by more OEMs and Fortune 1000 companies. Here's why...**

ALTOS® 16-bit computer systems do more for more users. They give you more power. More features. And more reliability. For less money.

You get a choice of 8086 or 68000-based family processors, memory management to one MB of RAM, an intelligent Z80™ I/O and disk controller, plus up to 160 megabytes of fast Winchester storage.

A single Altos computer can serve up to 16 users. And every Altos 16-bit computer gives you

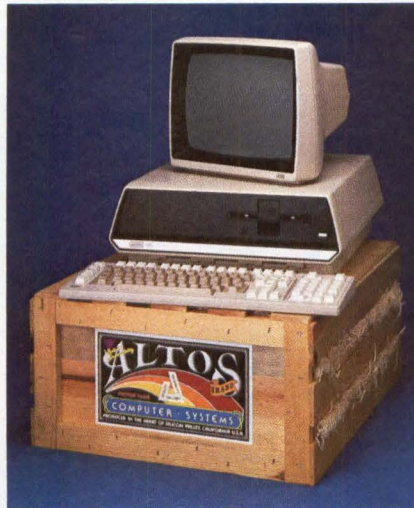

Altos also has high-level languages (BASIC, FORTRAN, COBOL and PASCAL), and applications software (ABS/86 and ABS/68 for general accounting, word processing and financial planning).

Since 1977, Altos has delivered more than 30,000 highly reliable, fully socketed, proven single board microcomputers and peripherals built for business.

If you've been looking to go with a more powerful computer that can serve from 1 to 16 users for less money, call or write us today.

Altos Computer Systems  
2360 Bering Drive  
San Jose, CA 95131  
(408) 946-6700  
Telex 171562 ALTOS SNJ  
or 470642 ALTO UI

## INTER-ALTOS LOCAL NETWORK



Series 586, ACS8600 and ACS68000  
20-160 MByte Winchester  
**1-16 USERS with**  
ALTOS-NET

## ETHERNET



Series 586, ACS8600 and ACS68000  
20-160 MByte Winchester  
**1-16 USERS with**  
ALTOS-NET/UNET™

## REMOTE COMMUNICATIONS



Series 586, ACS8600 and ACS68000  
20-160 MByte Winchester  
**1-16 USERS with**  
ALTOS-NET/UNET  
2780/3780  
3270  
X.25  
SNA/SDLC

added features like Multibus™ interfacing, real time clock, power fail detection and comprehensive diagnostics.

But that's just the beginning. Link multiple Altos' together and communicate in the office of the future today. Serve hundreds of users with full Ethernet™ and ALTOS-NET™ hardware and software support. And save money with fewer interconnects.

In addition, Altos supports remote communications protocols such as 2780/3780, 3270, X.25, and SNA/SDLC.

Altos has all the 16-bit software you need, too. With popular operating systems like XENIX™ / UNIX™ (with a user-friendly "business command menu interface"), CP/M-86,™ MP/M-86,™ OASIS-16, MS™ -DOS and PICK for 8086-based systems; plus UNIX System III™ and RM/COS™ for 68000-based systems.

**Packed with fresh ideas for business**

**ALTOS**  
COMPUTER SYSTEMS

**800-538-7872**  
(In Calif. 800-662-6265)

ALTOS is a registered trademark and ALTOS-NET is a trademark of Altos Computer Systems. Ethernet is a trademark of Xerox Corporation. CP/M-86 and MP/M-86 are trademarks of Digital Research, Inc. MS and XENIX are trademarks of Microsoft Corporation. XENIX is a microcomputer implementation of the UNIX operating system. UNIX is a trademark of Bell Laboratories. UNIX System III is a trademark of Western Electric. RM/COS is a trademark of Ryan-McFarland, Inc. OASIS-16 is a product of Phase One Systems, Inc. PICK is a product of Pick & Associates and Pick Computer Works. Multibus is a trademark and 8086 is a product of Intel Corporation. 68000 is a product of Motorola, Inc. UNET is a trademark of 3Com Corp. Z80 is a trademark and product of Zilog, Inc.  
© 1982 Altos Computer Systems.

**CIRCLE NO. 69 ON INQUIRY CARD**



# Systems in Manufacturing

how a part change in one product will affect production on other jobs. It also wanted an effective method of handling bills of material and production-line operations.

## M-Trac operation

When MiroFlector receives an order, delivery data are ascertained via the computer by determining whether the finished product or the necessary parts are in inventory. A pick slip is then generated through a special menu. Using this menu, data such as a customer's alphanumeric code, shipping address and

order revisions can be entered.

Next, the customer's credit history appears on the screen, giving the date of last payment, date of last sale, credit rating, credit limit and credit available. A salesperson then proceeds with the remainder of the order by generating a slip that itemizes the item and quantity to be shipped. M-Trac automatically prices and extends the order.

If an order depletes a part or a product to less-than-minimal reorder levels, the screen flashes, indicating the amount of the shortage. This helps establish the delivery date. There is also space for any

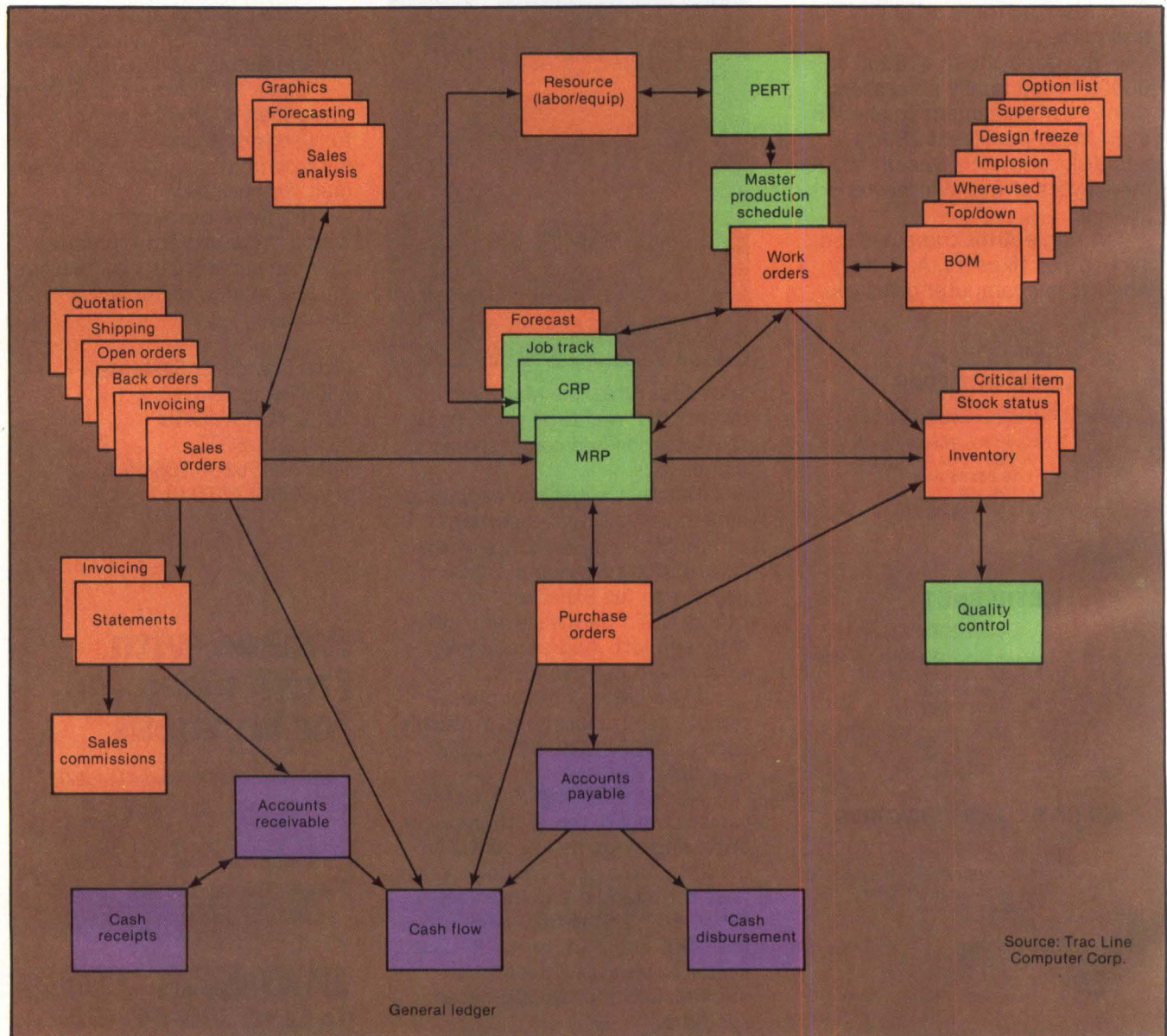

**M-Trac, a comprehensive, closed-loop manufacturing package, addresses both accounting and manufacturing. As information from various sources enters the system, it is integrated and synthesized into the general ledger. Of the functions illustrated, six are optional: material requirements planning, capacity requirements planning, job tracking, master production schedule, project evaluation review technique and quality control. End-user price for the basic M-Trac system is \$4600.**



## RADICAL RADIAL...

*True, the radial hookup scheme of DEC's UDA-50 allows you to drop a drive without saying "good-bye" to your entire system. But, is this really an advantage with new drives boasting long MTBF specs. Emulex controllers let you daisy-chain your drive connections using fewer, shorter (and cheaper) cables.*

## SEEK AND YE SHALL FIND...

*The UDA-50's ability to stack 16 seek commands does boost throughput—mainly for single drive systems. For all you multi-drivers, however, speedup isn't as pronounced. An Emulex-controlled multi-drive system stacks its seek commands (in effect) via its built-in system of overlapped seeks. Plus, overlapped seek and search commands (new to DEC in the UDA-50) already operate in Emulex controllers under all DEC operating systems.*

## TO ERR IS HUMAN...

*The 80-bit ECC of the UDA-50 can catch a lot of errors—it has to: High bit densities (try 11.4K bits per inch) on state-of-the-art media make 80-bit error correction a necessity, not a feature. And, the trade-off for correcting all those densely packed bits is loss of performance in skipping rotations every time an error occurs—All this in contrast to Emulex's proven 32-bit ECC.*

## PUTTING ON THE BRAKES...

*To slow the 2 MByte transfer rate of the disk to 800 KBytes at the Unibus, the UDA-50 uses a hefty 12 sector buffer. This means the UDA-50 can transfer 16-19 contiguous sectors at most before it skips a rotation and makes your software cry, "Uncle!"*

*In almost all applications, Emulex controllers can handle full (repeat full) track transfers of contiguous sectors and spiral read/write across cylinder head boundaries—and never skip a rotation. Why? Emulex passes data to your memory at rates much closer to those coming off your drives.*

## THINGS YOUR MOTHER NEVER TOLD YOU...

*For a complete report on these and other UDA-50 matters, write to Emulex.*

## FROM THE EMULEX FILE...

*Results for the First Quarter, Fiscal Year 1983 are in: Revenues up 100 percent, net earnings up 109 percent, earnings per share up 100 percent (all compared to the same quarter last year). Check your latest Emulex mailing for price reductions on some Q-bus and Unibus products. Not on our mailing list? Write: Emulex Corporation, 3545 Harbor Blvd., P.O. Box 6725, Costa Mesa, CA 92626. Or better yet, telephone us toll free at (800) 854-7112. In California, that's (714) 662-5600, and let's talk DEC.*



DISK • TAPE • COMMUNICATIONS

(DEC, Unibus, and Q-bus are trademarks of the Digital Equipment Corporation.)



# Systems in Manufacturing

notes regarding the order, such as a request for special delivery requirements.

Because each customer is assigned a salesperson, M-Trac automatically credits the correct commission file. It also provides a special feature that helps with agents' sales commissions.

M-Trac handles such conversions as feet to inches with wire so it also can make substitutions. For example, if a product calls for an 832 x 1/2 screw, but there are none in stock, the computer searches for a substitute such as an 832 x 5/8 screw.

In the bill of materials, the system deducts the screw used from inventory while showing usage of the screw originally required. This helps with reorders in determining whether to increase stock on an item. MiroFlector plans to implement M-Trac's word-processing package, which will permit the production of letters, reports and other written material required by the company.

## Rethinking operations

Because MiroFlector worked closely with Trac Line in developing M-Trac, implementation is a continuing

process that includes reorganizing each facet of the company and its operations. For example, in developing a bill of material, a key processing problem is a manufacturer's tendency to rationalize product components into assemblies, subassemblies, purchased parts, manufactured parts and customized parts. Each component needs a part number, and the number changes when a part goes into an assembly or is modified.

When similar subassemblies are needed in filling large or multiple orders, one bill of materials is insufficient. The company solved that problem with a bill of materials that could be used to add and delete items; this enables MiroFlector to offer high-end items in the same way that different models of automobiles are offered.

The company also established material interchangeability that prompts a user in the work-order sequence.

Allan Ullman is vice president of MiroFlector, Co. Inc., Inwood, N.Y.

## ON THE PROWL FOR KNOWLEDGE.

Ithaco presents AUTO GAIN® TAC-CAT; a family of flexible, intelligent, subsystems specifically designed for system integrators, original equipment manufacturers and engineers building distributed process systems to acquire, compute/control and transfer data.

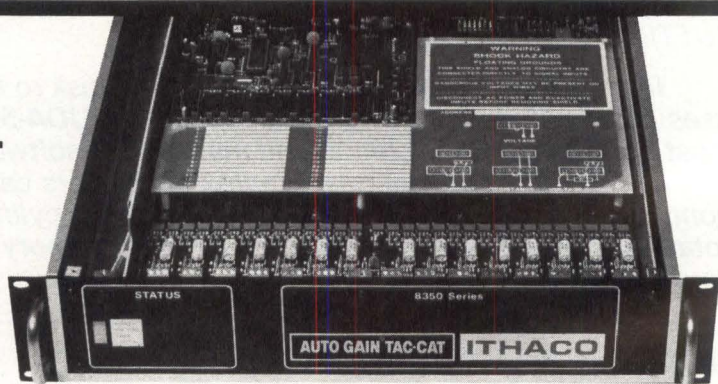

### ACQUIRE

- Intermix 30 inputs: TC, MA,  $\mu$ VDC, HVAC, Resistance
- Expand to 210 analog & 64 digital I/O (optional)
- Auto-zero & slope, line synchronous integrating ADC
- Built-in filters and cold junction compensation
- AUTO-GAIN® and user programmable gain per channel
- >180dB CMRR, >80dB NMRR, and 250V isolation
- Definable scan sequence and group assignments

### COMPUTE/CONTROL

- Continuous scanning allows real-time limit checking
- 3 to 6 full digit programmable resolution and integration
- Full Z80 single board computer with bus extension
- Multi-point piecewise-linear scaling functions
- Non-volatile RAM for set-up, acquired and calibration data
- Digital outputs for external DACs and on/off control (optional)
- Linearization tables, mx+b and post scaling transformations

### TRANSFER

- Host and local operator RS232 communications ports
- Remote-computer, full-duplex, message oriented protocol
- Highly stylized serial link management, easy interfacing
- Asynchronous event reporting, error checking and hand-shaking
- Names identify transducers/sensors, scale functions and groups
- High speed differential current-loop, 6000 ft. daisy chaining

- Additional GPIB interface per IEEE 488 (optional)
- Catch a CAT of your own. Call, write or telex Ithaco today for complete information. ITHACO, Inc., 735 West Clinton Street, P.O. Box 6437, Ithaca, New York 14850-6437, (607) 272-7640 Telex 510-255-9307

139C-MMS-283

**ITHACO**

... A MEASURABLE DIFFERENCE.

CIRCLE NO. 71 ON INQUIRY CARD



"I JUST LOVE  
EMULEX FEATURES  
AND QUALITY..."



"BUT CAN YOU  
BELIEVE THEIR  
NEW LOW PRICES?"



# FOR ALL THOSE LSI-11 PEOPLE WHO NEVER CONSIDERED EMULEX ON PRICE.

Consider the products and prices below:

You'll soon see that Emulex is as unbeatable on price as we are in quality and performance. Included are two new Winchester disk controllers with remarkably high performance and reliability (MTBF over 70,000 hours).

All Emulex Q-bus tape and disk controllers have the same microprocessor architecture and all the key features of our PDP-11 and VAX-11 products, including error correction, micro-diagnostics, and software transparency. Price our performance. Write or call: Emulex Corporation, 3545 Harbor Blvd., P.O. Box 6725, Costa Mesa, CA 92626; (714) 662-5600; Outside Calif.: (800) 854-7112.

In Europe: Emulex Corp., 10th floor, Cory House, The Ring, Bracknell, Berkshire, England. Telephone: 0344-84234; Telex 851-849781.

SC01 (RM02/05, RP06) \$2530\*

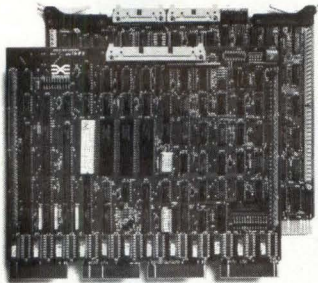

Put big SMD drives on your LSI-11.

Links Q-bus with 1-2 SMD-type drives. Software transparent & media compatible with DEC RM02, RM05, RP06. Features 3-sector data buffer, 32-bit ECC, up to half a billion bytes capacity. Over 1500 units in service!

\*Price each in 100 quantities. All Emulex disk, tape, and communications products can be combined to reach quantity price breaks.

Coming soon: Emulex's SC03, full-performance 11/23 disk controller. \$1790

SC02 (RL01/02, RP02/03, RK06/07)  
Now \$1410\*



Low cost for smaller-sized disks.

Single quad-board interfaces LSI-11s to 8" & 14" SMD hard disk drives. Same great SC01-level performance in most applications. Software transparent. Full 32-bit ECC, self-test, 512-word bootstrap, real-time clock control, and bus terminators. Mix and match drives on one controller. 72,000 hours MTBF!

SC04 (RL01/02, RP01/02, RK06/07)  
Now \$1410\*

New! ANSI interfacing for 8" Winchesters.

Supports up to 8 drives per single quad-board controller. Fits into any single LSI-11 back plane quad slot. Same design, performance, and high reliability as the SC02.

TC01 (NRZ) Now \$1150\*  
TC01 (PE) Now \$1470\*

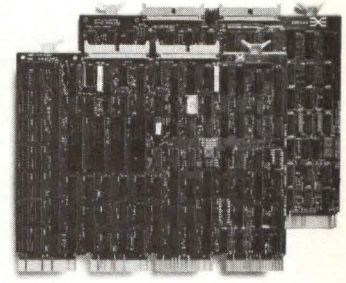

Q-bus embedded dual-density tape controller.

Handles all open-reel half-inch tapes — 800/1600 bpi, operating at 12.5-75 ips. Compatible with DEC's TU10/TM11. Daisy-chain up to 4 drives. Firmware includes a self-test and extended diagnostics. Fully embedded.



**The genuine alternative**



---

---

# Knowing about power line pollution only asks the question.

# Knowing about Shape answers it.

---

---

The symptoms of power line pollution, such as unexplained memory loss or excessive downtime, are self-evident, but the answer isn't—unless you already specify Shape Magnetronics Line Tamer™ ferroresonant transformers.

The experience of the industry's leading computer suppliers demonstrates that ferroresonant technology provides the best line isolation and regulation properties for the money. Shape uses state-of-the-art manufacturing techniques and materials that result in smaller, lighter packages that save you even more in shipping costs and space without sacrificing quality. You save again with our network of independent distributors shipping from local stocks.

We used our expertise as a manufacturer of custom OEM magnetics to create a broad standard line. With standard sizes ranging from 70 VA for electronic cash registers up to 150 KVA single-phase and 250 KVA three-phase for large installations, it's likely that the Line Tamer™ ferroresonant transformer you need is in stock. If not, that same OEM expertise provides fast turnaround on modifications to meet your unique needs.

Let Shape answer your power questions. Call or write for complete information on controlling power pollution and the name of your local Shape source.

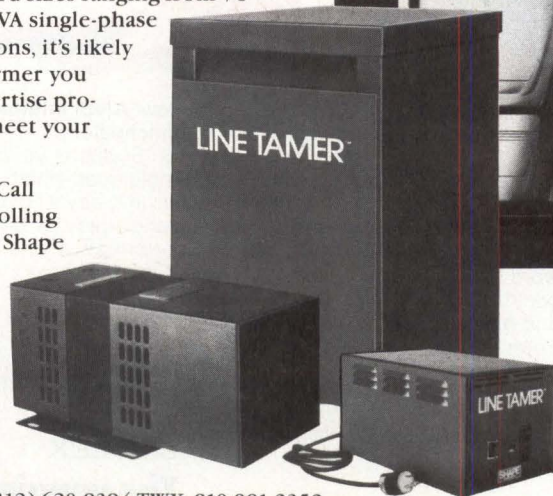
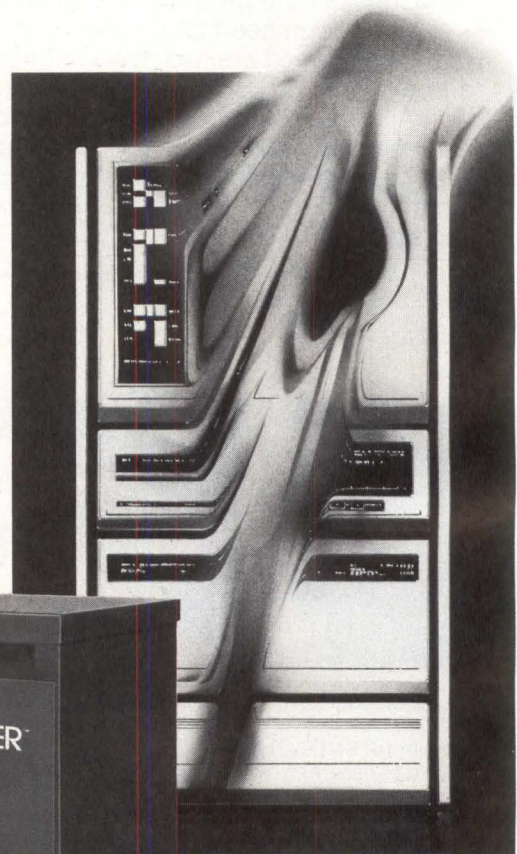

**SHAPE**  
MAGNETRONICS, INC.

901 DuPage Avenue • Lombard, Illinois 60148 • (312) 620-8394 TWX: 910-991-2352

CIRCLE NO. 73 ON INQUIRY CARD



# Systems in Manufacturing

## Prime adds electronic CAE/CAD system

After a year and a half of marketing its Medusa mechanical design and drafting system, Prime Computer, Inc., Natick, Mass., has added an electronic CAE/CAD system to its product line. Prime's Electronic Design Management System exploits the company's Database Management System to integrate the logical schematic design function performed by engineering personnel with the physical design function performed by drafting personnel.

Roy Brubaker, Prime's vice president of sales and service, says the EDMS will almost double the company's potential CAD market. He estimates that 40 percent of the CAD market consists of mechanical design, 35 percent consists of electronic design, and the remainder includes such functions as mapping and building design.

EDMS uses two integrated databases—an electronic parts library and a repository for all project-design information—both under the control of Prime's DBMS. The library, which contains approved parts and their specifications, is generated and maintained using the EDMS Library Management System. Audit trails track all design changes in ongoing projects, and the databases are automatically updated when changes are made at any level.

The system provides interfaces to application programs required by personnel throughout the design process. One interface accesses the TEGAS-5 logic-simulation package, developed by Comsat General Integrated Systems. With TEGAS-5, engineers can run simulations of the logic schematic's operation before proceeding to the physical design stage.

Prime offers several physical design application packages, including the SCICARDS printed-circuit design program from Scientific Calculations, Inc. Also supported by EDMS are V-R Information Systems, Inc.'s MERLYN-G package for gate-array routing and an MP2D for standard cell layout. With these application packages, Prime says, users can convert the schematic designs into PC-board, wire-wrap-board or IC layouts without reentering the logical design data.

EDMS, which runs under the PRIMOS operating system on any of Prime's 50 series 32-bit minicomputers, uses simple English commands. The electronic engineering and design system can use Prime's 19-in. PW95 color graphics workstation. It also operates with the AED512 and AED767 workstations from Advanced Electronics Design, Inc., and the Jupiter 7 from Jupiter

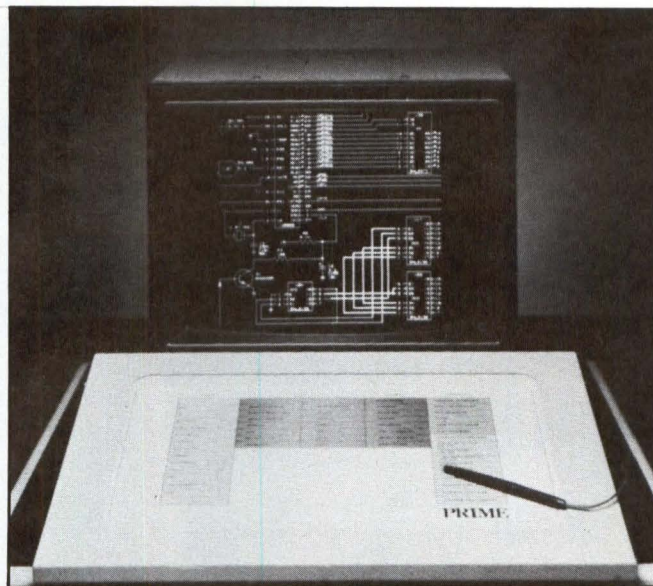

Prime Computer, Inc.'s Electronic Design Management System can help engineers design IC and PC-board schematics, as shown on this PW95 graphics workstation. EDMS also simplifies the transfer of these schematics into IC layout and PC-board design.

Systems, Inc. Because of its compatibility with Prime's other hardware and software, EDMS has access to the company's networking capabilities such as PrimeNet and X.25 links.

A system consisting of the EDMS software, eight graphics workstations, 24 alphanumeric terminals, a Prime 750 minicomputer with 4M bytes of main memory and two 300M-byte disk drives sells for \$615,000. The EDMS software license is priced at \$75,000 with a monthly user fee of \$2800, which includes maintenance.

—Dwight B. Davis

### NEXT MONTH IN MMS

The March issue of Mini-Micro Systems will feature data communications. Heading the articles will be two profiles of "smart products," complete with extensive tables of what is available. Articles planned for the issue include:

- \* Statistical multiplexers product profile,
- \* Intelligent modems product profile,
- \* Cellular radio and its implications for local-area networks,
- \* Innovative networking approaches to local-area networks and distributed processing



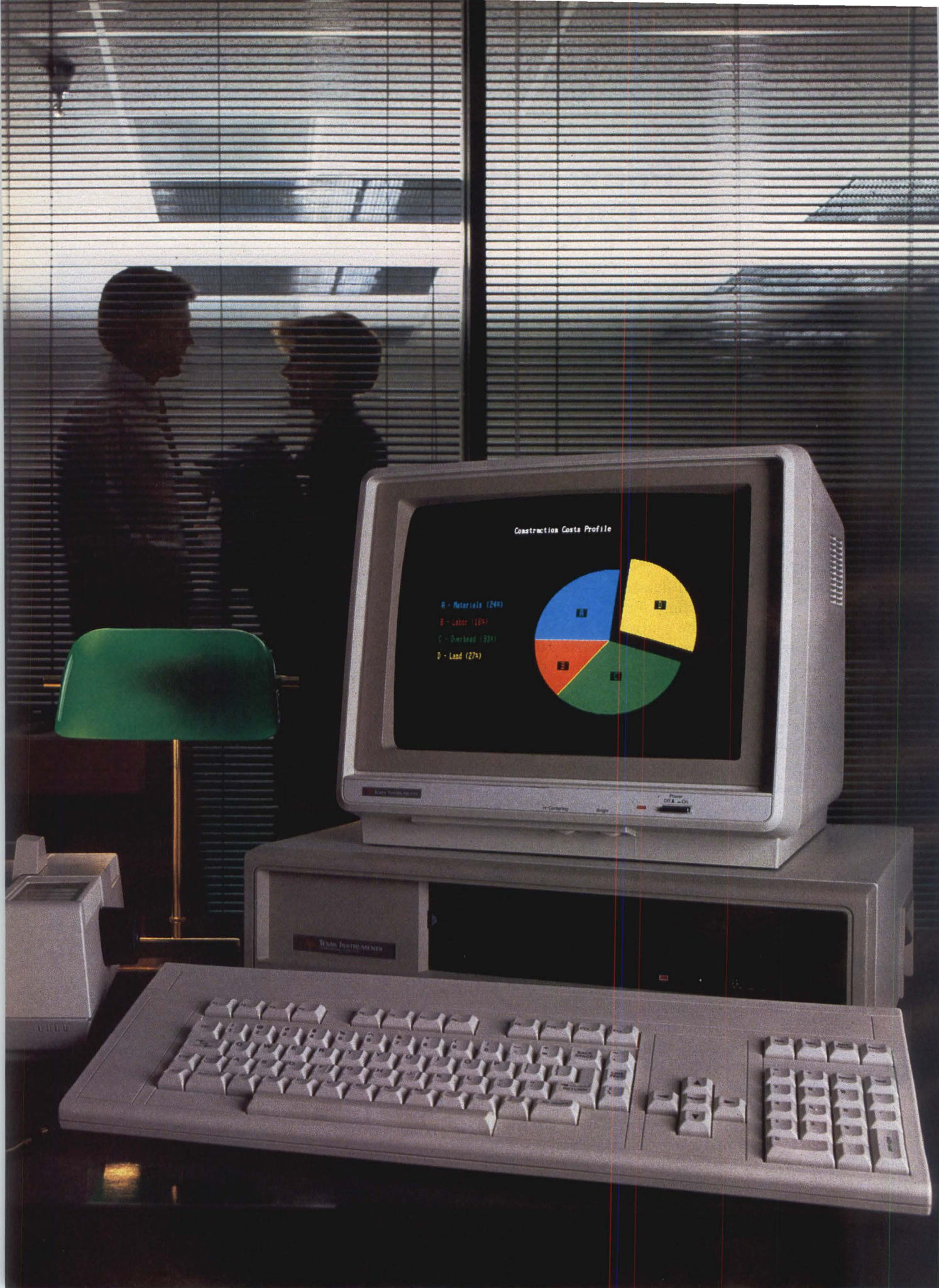

Construction Costs Profile

- A - Materials (24%)
- B - Labor (12%)
- C - Overhead (33%)
- D - Lead (27%)

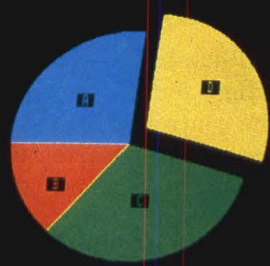



# The new TI Professional Computer. It's the answer for information systems managers.



When it's your responsibility to choose a professional computer, you look for the one that's not only powerful and easy to use, but is also expandable enough to meet your company's present and future needs. A computer that helps increase productivity. One with the advanced design to permit it to effectively co-exist with information systems, today and tomorrow. The new Texas Instruments Professional Computer is the answer.

**It works with you and your system.** The new TI Professional Computer has the memory, the software and the user-friendly design that will quickly help the unsophisticated user become more productive. Its versatile communications capabilities enable it to work well with mainframes and office automation systems.

**High resolution displays with dedicated memory.** You get brilliant full-color or monochromatic graphics and text displayed with extremely high resolution. And

since our graphics board has its own memory, using graphics doesn't tie up the main memory. As a result, graphic displays appear on the screen much faster than other desktop computers.

**An Easier-To-Use Low-Profile Keyboard.** The slim profile of our keyboard features the popular typewriter layout and infinite height adjustment from 5 to 15 degrees slope. It also provides separate numeric keypad and cursor control clusters, plus improved key tactile response for quick positive entries.

**It's the answer to your microcomputer needs. Now and in the future.** All the leading operating systems and programming languages are available. You can use many popular application programs from the best software suppliers to help your managers generate spreadsheets, do word processing, construct graphics, commu-

nicate with other data bases and create their own.

Future enhancements will include speech recognition, speech synthesis, telephone management, natural language query capability with a true relational data base package. All this means greater productivity in your company today and tomorrow.

**There's more information in store for you.** It's simple to get more answers about how the TI Professional Computer can meet your needs. Just complete the coupon below and mail to: Texas Instruments, Dept. 1B, P.O. Box 402430, Dallas, Texas 75240. Or call toll free: 1-800-527-3500.

Creating useful products and services for you.



## TEXAS INSTRUMENTS

### SPECIFICATIONS

#### System Unit

16-bit, 8088 microprocessor  
64K byte RAM, expandable to 256K bytes  
4K byte graphics display memory  
5-slot expansion bus

#### Keyboard

Specially designed low profile  
Popular typewriter layout  
97 keys, including 12 function keys  
Separate numeric keypad and cursor control clusters  
Tactile response, for quick positive entry  
Upper- and lower-case letters

#### Display Units

12-inch monochrome (green phosphor) or  
13-inch full-color, 25 lines x 80 columns  
High resolution, 720 x 300 pixels

#### Mass Storage

Built-in 320K byte diskette standard  
Additional internal storage of 320K byte diskette, or 5 or 10 Mbyte Winchester disks optional

#### Communications Options

300 BPS or 300/1200 BPS internal modem  
TTY, 3780  
3270 SNA stand-alone (Summer 1983)  
3270 BSC and SNA cluster (Fall 1983)

#### Operating Systems

MS™ -DOS, Digital Research™ CP/M-86®, and  
Concurrent CP/M-86™, UCSD p-System™

#### Languages

BASIC, COBOL, FORTRAN, Pascal

#### Applications Software

Over 100 programs available from the most popular software vendors such as Microsoft, Ashton-Tate, Micro-Pro, IUS, Sorcim, Peachtree, BPI, Lifeboat and others.

#### Printers (Available Spring 1983)

150-cps TI 850 Series for most applications

FOOTNOTES: MS-DOS is a trademark of Microsoft Corporation. CP/M-86 and Concurrent CP/M-86 are trademarks of Digital Research, Inc. UCSD p-System is a trademark of the Regents of the University of California.

**Get the Answer.** Please send more information about the new Texas Instruments Professional Computer.

Name: \_\_\_\_\_

Title: \_\_\_\_\_

Company: \_\_\_\_\_

Address: \_\_\_\_\_

City: \_\_\_\_\_

State: \_\_\_\_\_ Zip: \_\_\_\_\_

Phone: (\_\_\_\_) \_\_\_\_\_  Have Salesman Call.

**Return Coupon To:** Texas Instruments, Dept 1B,  
P.O. Box 402430, Dallas, Texas 75240

291427 T



## Minicomputer users:

# Timeplex offers a one-stop system solution for communicating with multiple remote terminals. Economically.



Asynchronous statistical multiplexer

Synchronous statistical multiplexer

High speed modem

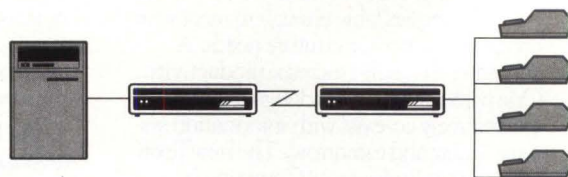

The Timeplex E/SERIES is a complete data concentrator system designed to economically link clusters of remote terminals to your minicomputer.

**E/SERIES: Cuts communications costs.** Suddenly, saving communications costs by linking several terminals to one shared telephone line becomes easy.

Unlike the competition, the Timeplex E/SERIES simplifies the challenge of point-to-point communications by incorporating three functions in a single compact unit. One system offers you a statistical multiplexer supporting 4 to 16 asynchronous channels, *plus* an optional statistical multiplexer for an additional synchronous channel, *plus* an optional integral high speed modem.

**E/SERIES: Puts it all together.** Putting three functionally distinct modules in one enclosure eliminates external communications units and bulky, expensive cables. And, a minicomputer interface option further reduces costs. The result: System planning and installation is extremely simple. Reliability is enhanced. Costs are dramatically reduced.

**Free step-by-step Guide.** This easy-to-understand booklet contains all the facts on how to remote your terminals, simply *and* economically. Just write or call Timeplex for your free copy.

For the name of the E/SERIES stocking distributor nearest you, call 201-368-0736.

Timeplex, Inc./One Communications Plaza/  
Rochelle Park, N.J. 07662.



The technology leader  
in data communications



# Systems in Manufacturing

## Cadlink provides a bridge between design and manufacturing

By Frank Catalano

Evolving from a company that provided custom software for major machine tool users such as General Motors Corp. and General Dynamics Inc., Cadlink, Inc., Elk Grove, Mich., has combined its software expertise with other vendors' hardware to create its Series 80 CAD/CAM network. The system automates many of the steps required between the design stage and the actual manufacture of parts in the metalworking industry.

The Ethernet-based network system comprises Motorola 68000 microprocessor-based workstations with the Intel Multibus, the UNIX operating system and a monochrome 1024 × 792 pixel graphics display screen. Each workstation includes 1M byte of RAM and 10M bytes of disk storage via a 5¼-in. Control Data Corp. floppy disk drive or a 5¼-in. Winchester from Seagate Technology Corp. or other vendors. Software available for the Series 80 was designed by Systems Associates Inc., which Cadlink acquired in 1981.

Priced at \$25,000 per workstation, the system is intended for large metalworking manufacturers and targeted for applications that are one step removed from the actual manufacturing process.

Clem Meas, marketing manager for Cadlink, says the Series 80 will most likely be used with CAD systems supplied by other vendors within a manufacturing organization. The system was designed to interface to products from such companies as Computervision Corp., Calma, Co., CADAM Corp., Gerber Systems Technology, Inc., and Prime Computer, Inc. Once an engineer designs a part on one of those systems, the design would be further refined and readied for the actual manufacturing process on the Series 80. "Traditional CAD systems have done a very good job in styling a part, but that's where they stop," says Meas. "What usually happens is that a blueprint of the completed part design is generated on a plotter and then sent to manufacturing for conversion into machine tool language."

Cadlink software offerings help designers perform additional drafting operations on the part design, plan the manufacturing process, design tooling and program the design for use on a numerical-control machine.

John West, president of Cadlink, says, because most CAD systems were designed for applications in the electronics industry, suppliers of those systems ignored



*The Cadlink Series 80 allows up to 16 programs to run simultaneously on a single screen—each program having its own screen area.*

the needs of machine tool users. "The steps between design and manufacturing in the electronics industry are completely different from those in heavy industry," says West. "Traditional CAD systems do little to answer the numerical-control-programming or process-design needs of metalworking manufacturers."

The networked Series 80 allows several users to share a database while performing computing functions at their workstations. Data are stored and managed within a file manager that includes four 160M-byte Winchester disk drives. The file manager also provides security for a set of released drawings and files, maintains administrative control over user access and supports peripheral sharing. Besides the file manager, the Series 80 is available with a peripherals manager, an inter-network gateway that connects a number of remote networks and a data gateway that connects the Series 80 with other CAD systems within a company. The network allows for communications as fast as 10M bytes per sec. and supports as many as 1024 users.

Although Cadlink configures the CAD/CAM system itself, the company buys system components from the board level up from outside vendors, says Meas. "We don't perceive ourselves as trying to be a computer company coming out with new hardware technologies," he says. "Our strength is in the value that we add by way of software. We equipped the system with standard hardware such as Ethernet and the MC68000 so that we could enter the market quickly without having to incur a lot of design costs." □



## Buy a BitGraph™ Terminal for \$4995 and save the tough decision for later.

With BitGraph, you get a lot to choose from. For starters, it's a high resolution graphics terminal. And thanks to state-of-the-art raster-scan technology and a 1024 x 768 pixel display, its pictures are spectacular. So good, in fact, you won't be able to come up with many graphics jobs BitGraph can't do. It can handle business, scientific and engineering applications.

But graphics is just the beginning. BitGraph is also an exceptional text processing terminal. Its full-page format

makes it perfect for document previewing and editing. What's more, its high resolution screen can reproduce almost any type font.

And, to make your decision even harder, BitGraph is a text *and* graphics terminal as well. It can mix words and pictures anywhere on the screen, and in any combination.

BitGraph has a lot of other things going for it, too. Like its high performance 68000 microprocessor (user programmable with up to 512K RAM). Its ability to emulate the Tektronix® 4010 and DEC's VT100™ and VT52™ terminals. And its compatibility—it can plug into just about any host system through

# BUY BEFORE

BitGraph is a high resolution—  
1024 x 768 pixels—graphics terminal.\*

BitGraph is a multiple font  
text terminal.\*

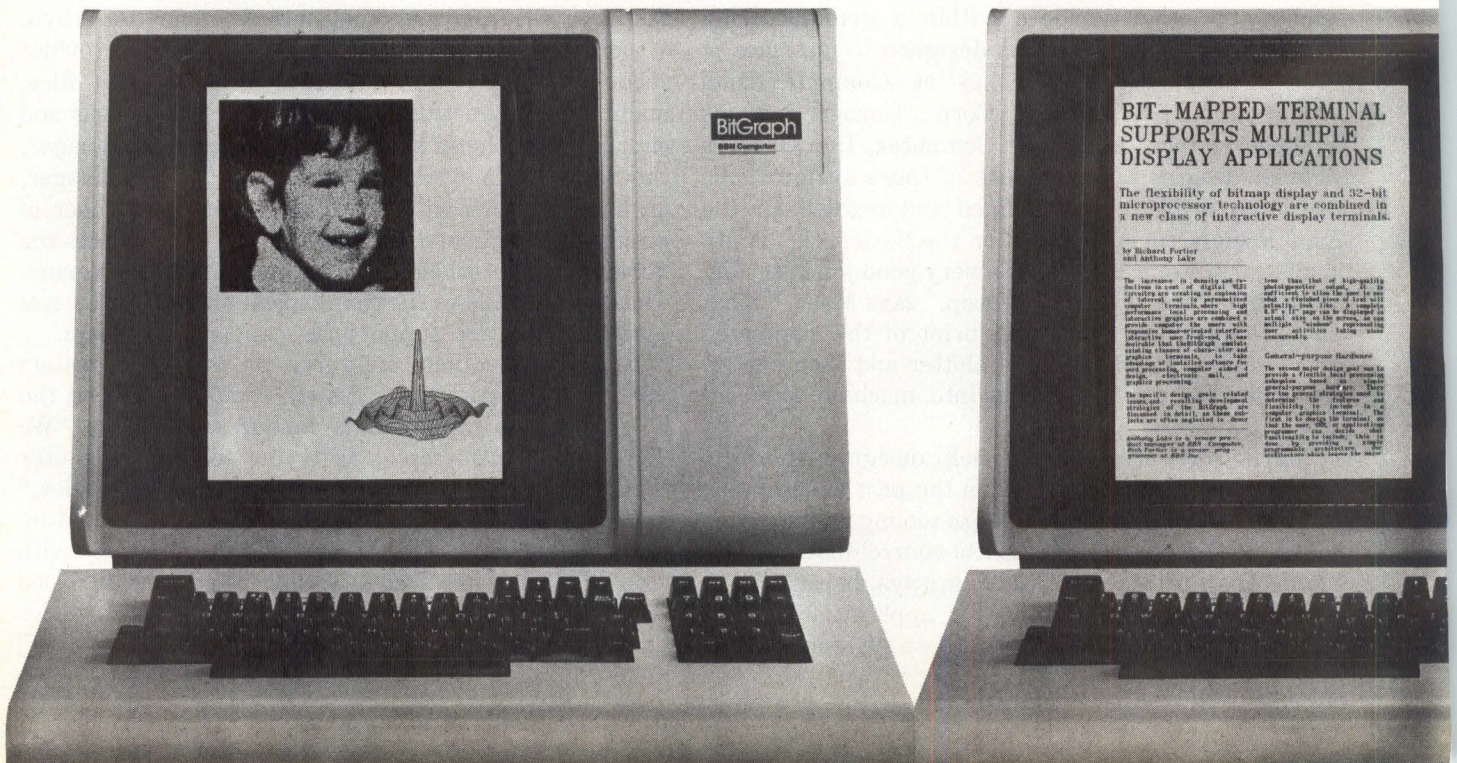



an RS232 port. Plus BitGraph has a high-speed parallel printer interface.

And then there's the price. At \$4995, no other terminal can come close to delivering so much for your money.

Of course, you may have already decided exactly why you want a BitGraph, and we think that's great. But isn't it a nice feeling to know that you can always change your mind.

For more information about all the things BitGraph can do, send in the coupon or call (617) 497-3268.

BitGraph is a trademark of BBN Computer Corporation.  
DEC VT100 and VT52 are trademarks of Digital Equipment Corporation.  
Tektronix is a registered trademark of Tektronix, Inc.

\*Actual screen reproduction.

**I want to know more about BitGraph.™**

- Please send me a brochure.
- Please have your sales representative call.

Name \_\_\_\_\_

Company \_\_\_\_\_

Phone \_\_\_\_\_

Address \_\_\_\_\_

City \_\_\_\_\_

State \_\_\_\_\_

Zip \_\_\_\_\_

Send to: BBN Computer Corp., Marketing  
33 Moulton Street, Cambridge, MA 02238.

## BBN Computer

A subsidiary of Bolt Beranek and Newman Inc.

# YOU CHOOSE.

BitGraph is a combination text and graphics terminal.\*

CIRCLE NO. 76 ON INQUIRY CARD

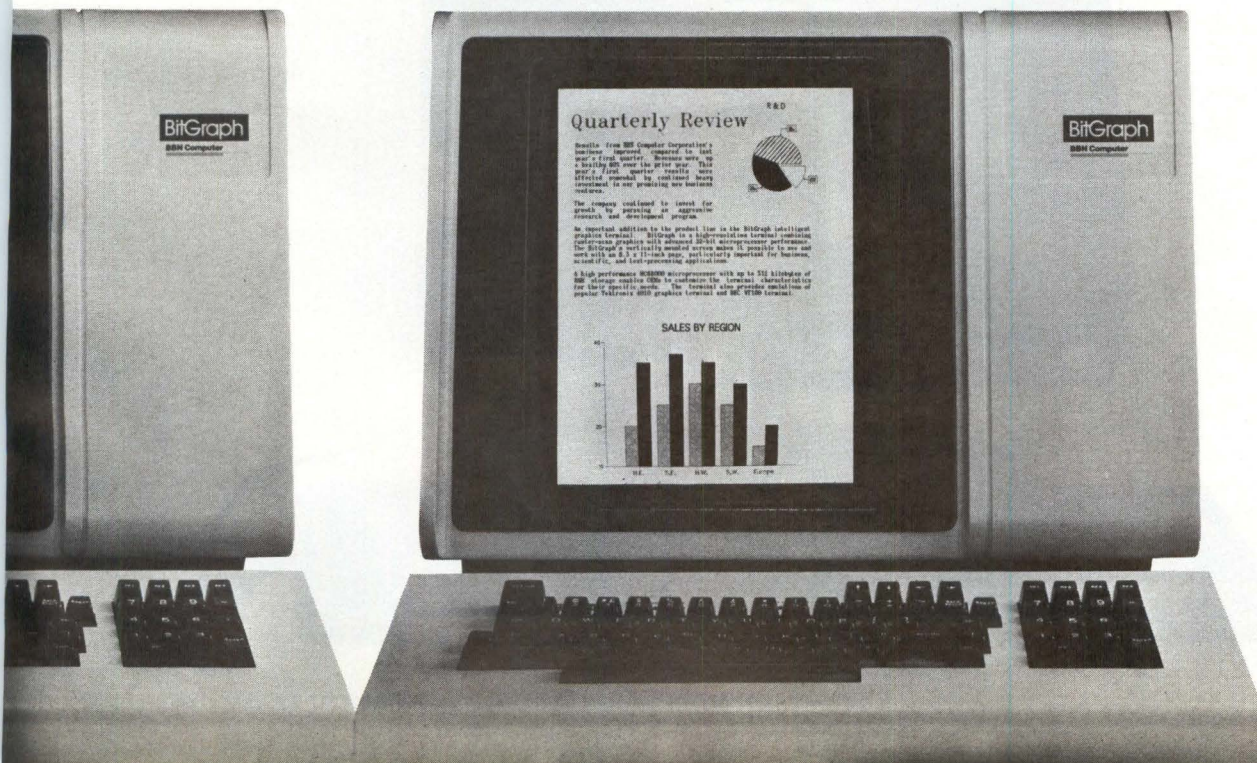



# OK OEMS

we're playing your game.

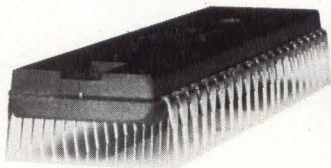

Hazeltine's new Executive 10™ is factory programmed to meet your system application. So, you get a highly customized terminal instead of just an "off the shelf" product. And you get a long list of features:

- precision balanced ball-joint tilt and swivel
- detached keyboard
- split screen
- video attributes
- programmable function keys,

a unique combination of features for terminals in its price class.

Your system deserves a special display. We call it the Executive 10. But we designed it so that you can call it your own.

Hazeltine Corporation  
Computer Terminal Equipment  
Commack, NY 11725  
(516) 462-5598  
or call toll free: 800-645-4508

## Hazeltine

The new terminal technology.

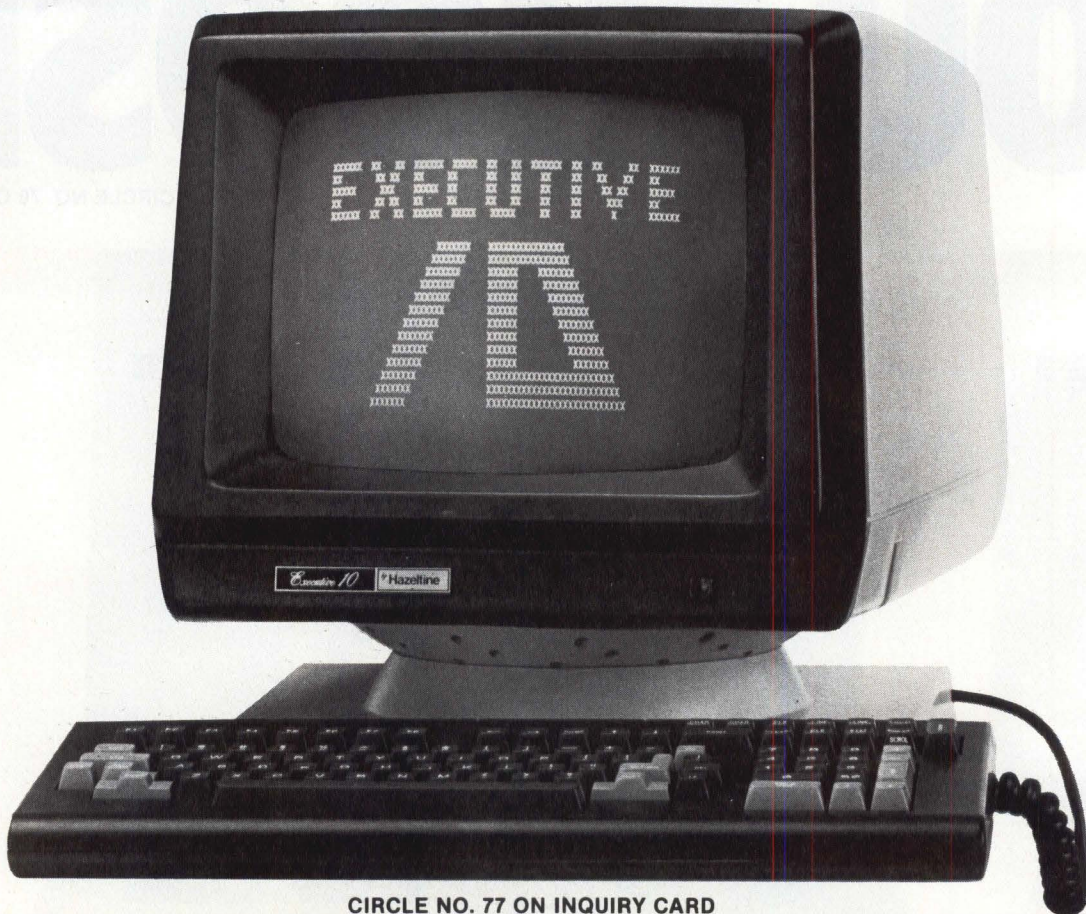

CIRCLE NO. 77 ON INQUIRY CARD



# FEATURE HIGHLIGHTS

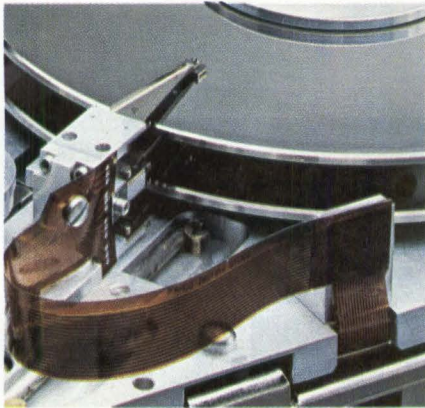

**DISK DRIVES:** By placing the motor in the spindle, it now is possible to get 140M bytes in a 5¼-in. Winchester drive (Page 143) . . . The 8-, 5¼- and sub-4-in. floppy disk drive markets are all healthy in their own ways (Page 155) . . . Application needs are driving the requirements for small Winchester disk drives ever upward, and companies are appearing to meet these needs (Page 167) . . . By aligning magnetic particles like soldiers standing in a row rather than like cars along a busy street, engineers are crowding more and more data onto magnetic disks (Page 189) . . . A closed-loop servo positioning system can improve drive capacity and access time (Page 199) . . . Half-height floppies and hard disks pack more into less space (Page 211) . . . An embedded servo in a 5¼-in. Winchester cartridge keeps the media interchangeable (Page 219) . . .

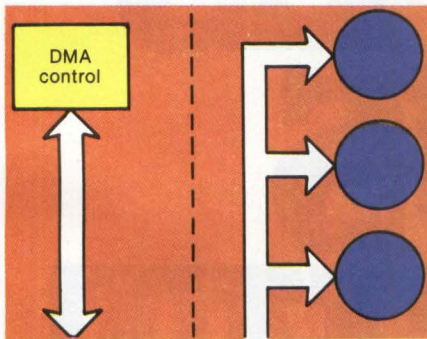

**DISK CONTROLLERS:** A cache helps a new floppy disk controller speed access time (Page 231)

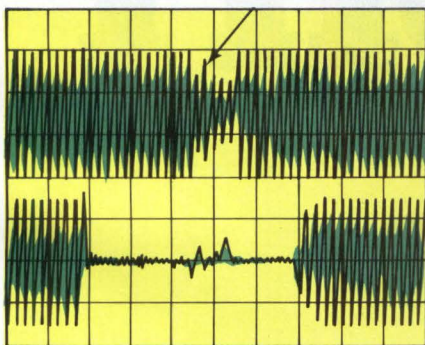

**MEMORY SYSTEMS:** Manufacturers and OEMs can correlate test results of Winchester disk drives to keep their relations on keel (Page 239)

**OFFICE AUTOMATION:** Bit-map graphics move into the office workstation market (Page 245)

**OPERATING SYSTEMS:** MP/M-86 handles real-time and multi-user business applications (Page 253)

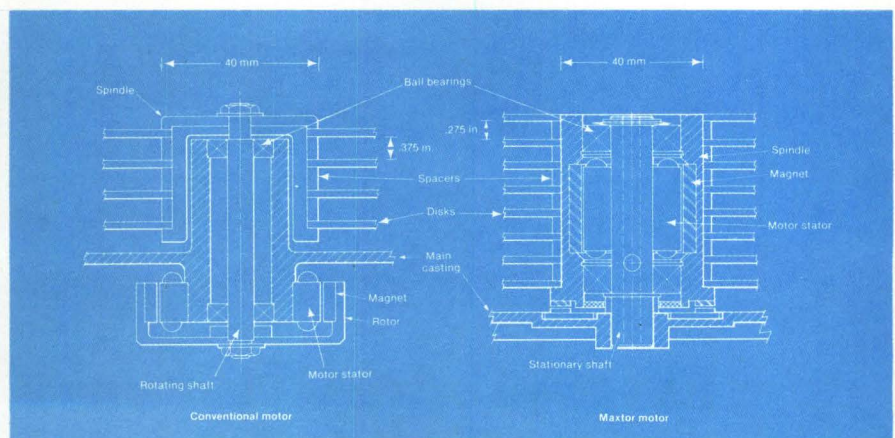
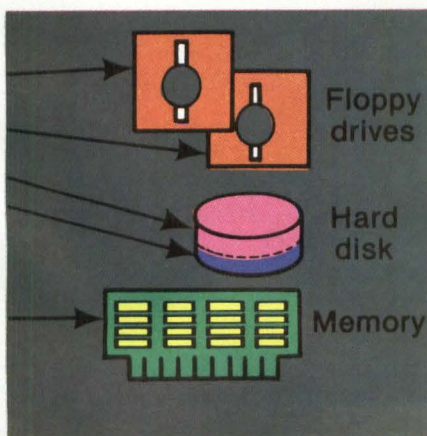



**OUR NEW  
8" DRIVES  
PUT US  
IN A TIGHT  
SPOT.**



They're half the height of a conventional 8-inch floppy.

The exact depth of a standard 12-inch CRT terminal.

And actually capable of squeezing 8-inch drive performance into desktop systems that haven't room for full size 8-inch drives.

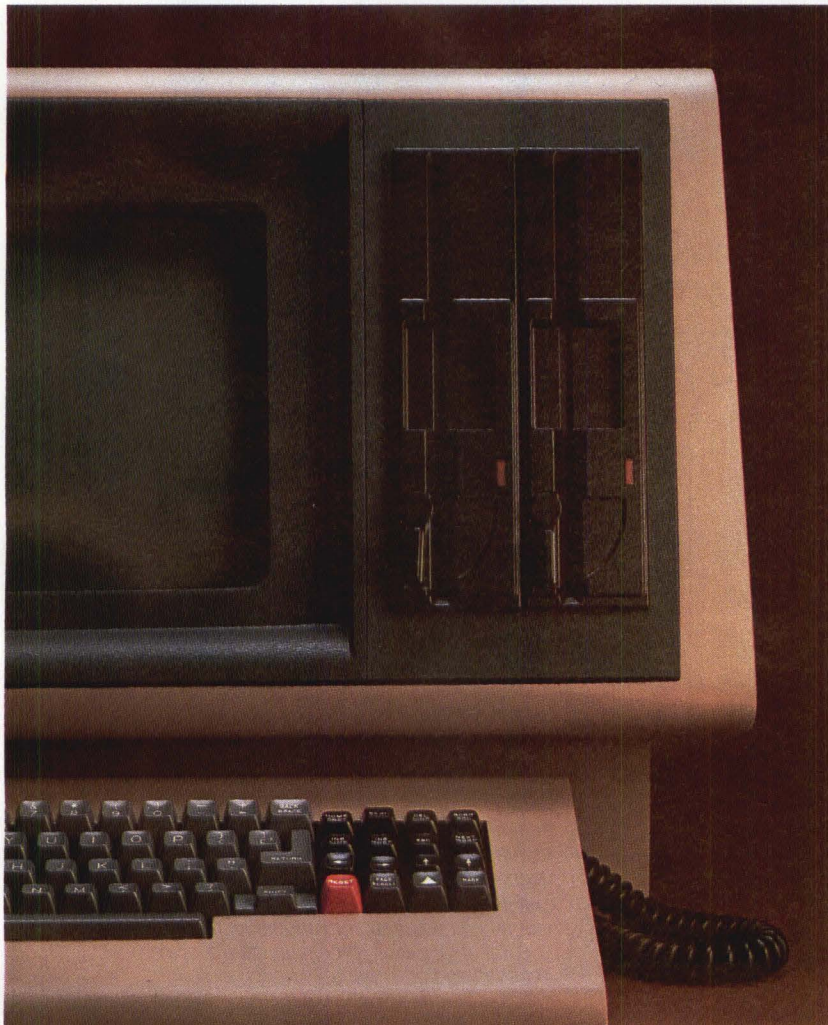

What's more, they're Shugart's newest family members — our SA810 single-sided and SA860 double-sided floppy disk drives.

These half-height 8-inch drives offer the OEM more design flexibility, while providing an attractive new alternative to today's minifloppies.

Unlike other reduced height drives, only Shugart's SA810/860 series eliminates the need for major redesigning of hardware. And software. And controllers.

Because they're compatible with our industry standard SA801/851 8-inch drives. Same mounting holes. Same internationally recognized DC power supply. Same controller interface. And all the jumper options you need to build in the features you need.

They're also compatible with the existing user base of over 200 million 8-inch diskettes.

And the SA810 and SA860 offer distinct advantages over 5¼-inch drives, including more capacity. In the case of the SA860 (1600 kilobytes), 60 percent more than a double-sided 96-TPI minifloppy. With faster access times (89 msec versus 158 msec average). And faster transfer rates (500 versus 250 kilobits per sec).

They also offer a bundle of features not found in conventional 8-inch drives.

The rapid start DC motor, for example, eliminates the need for belts, pulleys, and head-load solenoids. So reliability is substantially increased. Media wear is reduced. And overall operation is much quieter.

All of which makes our new SA810/860 drives the smart solution for a wide range of high performance desktop

applications — from word processing to distributed network systems.

All backed by the industry's largest and most experienced engineering, sales and service organizations.

For more details, contact Shugart Associates, 475 Oakmead Parkway, Sunnyvale, CA 94086, (408) 733-0100 (Hamilton/Avnet, authorized distributor).

And see if you can squeeze us in.

**Shugart**  
Right from the start.



Electronic Engineers in the South:

# You Supply The Problems, And We'll Provide The Answers

For PC designers, production engineers, fabricators, buyers and specifiers

## IN THE SOUTHWEST

**southwest**

Printed Circuits & Microelectronics Exposition

Packaging

Production

Testing

**APRIL 6 and 7, 1983**

MARKET HALL  
DALLAS, TEXAS

Presenting new equipment and technology for the surging Southwest

- **A Learning Experience** . . . Conference Program by recognized industry authorities: timely technical sessions and workshops give new insights to improved productivity and lower costs
- **See over 175 displays of** the latest equipment, tools, hardware, supplies and instruments required in modern PCB manufacturing
- **MAKE YOUR PLANS NOW TO ATTEND!**

## IN THE SOUTHEAST

**southeast**

Printed Circuits & Microelectronics Exposition

Packaging

Production

Testing

**APRIL 19-21, 1983**

ORANGE COUNTY CONVENTION  
CENTER, ORLANDO, FLORIDA

**E-X-P-A-N-D-E-D to 3 full days in a beautiful, newly-professional exposition facility**

Featuring . . .

- **Full range** of modern PCB production equipment and accessories that can solve your work-a-day problems
- **Conference program** geared to the special needs of electronic engineers in the Southeast: 12 technical sessions, professional advancement course, and a "how-to" workshop
- **Held concurrently with PCI/MOTORCON '83** — Motion Control and Power Equipment Exposition

## FREE ADMISSION TO EXHIBITS!

TO: Cahners Exposition Group, Cahners Plaza, 1350 E. Touhy Ave.,  
P.O. Box 5060, Des Plaines, Illinois 60018

H

I am interested in ATTENDING the event(s) checked below. Please send application for free admission to exhibits . . . plus program details.

**SOUTHWEST PRINTED CIRCUITS AND MICROELECTRONICS EXPO '83**  
April 6-7, 1983  
Market Hall, Dallas, Texas

**SOUTHEAST PRINTED CIRCUITS AND MICROELECTRONICS EXPO '83**  
April 19-21, 1983  
Orange County Conv. Ctr, Orlando, FL

Name \_\_\_\_\_ Title \_\_\_\_\_

Company \_\_\_\_\_

Address \_\_\_\_\_

City \_\_\_\_\_ State \_\_\_\_\_ Zip \_\_\_\_\_

Phone (\_\_\_\_\_) \_\_\_\_\_

**MAIL COUPON TODAY. MAKE COPIES OF COUPON FOR YOUR ASSOCIATES**

### ORGANIZED BY



**CAHNERS  
EXPOSITION  
GROUP**

Cahners Plaza, 1350 E. Touhy Avenue  
P.O. Box 5060, Des Plaines, IL 60018  
(312) 299-9311 Telex 82882 CEG CHGO



# SOMETIMES, THE BEST PLACE TO GET A DEC PDP-11 SYSTEM ISN'T DEC



When you buy DEC PDP-11 based System 58 from Cambridge Digital, it's ready to get to work as soon as you hook it up. Because at Cambridge Digital, we sell enhanced-performance DEC systems that are fully integrated with DEC-compatible products. Products you can't buy from DEC. So you spend your time working on your system, instead of just trying to make it work. It's part of the edge you get when you buy from Cambridge Digital.

Take our ready-to-run System 58. It features a DEC LSI-11/02, 21, or 23 with internal RAM memory of 32Kb, expandable to 1Mb. The 11/23 based system directly addresses up to 4Mb of memory. Plus you get an RLV12 compatible Winchester disk with your choice of 5, 10, 15 or 20Mb, and a floppy with usable capacity of 1.02Mb.

And, you get a full range of development tools from CDS, too. Like a fully-supported and enhanced operating system based upon UNIX\* System III. Also TSX-Plus, RT-11,  $\mu$ -power PASCAL, and RSX-11M.

It's all ready to run. Available for as little as \$7,350. Available in as little as 10 days. But it's *not* available from DEC, so call Cambridge Digital, instead, and get The Edge.

For more information on our System 58 and a copy of our DEC PDP-11 based system catalog, including a description of the seven guarantees you get when you get The Edge, call 1-800-343-5504 (in Massachusetts 1-617-491-2700), or send the coupon to Cambridge Digital Systems, Dept. 7401, P.O. Box 568, 65 Bent Street, Cambridge, Massachusetts 02139.  
Telex 92-1401/COMPUMART CAM

Cambridge Digital Systems is a division of Compumart Corp. \*UNIX is a trademark of Bell Laboratories.

**I want The Edge: FOR FAST FACTS, CALL:  
1-800-343-5504**

Name \_\_\_\_\_

Title \_\_\_\_\_

Organization \_\_\_\_\_

Address \_\_\_\_\_

City \_\_\_\_\_ State \_\_\_\_\_ Zip \_\_\_\_\_

Phone ( \_\_\_\_\_ ) \_\_\_\_\_  
(7401) \_\_\_\_\_

58

**Cambridge**  
**Digital**  
DIVISION OF COMPUMART

**The Edge in System Integration**  
CIRCLE NO. 79 ON INQUIRY CARD



YOU'RE LOOKING  
AT ALL 96  
OF OUR UNIX™-BASED  
MICROCOMPUTER  
SYSTEMS.

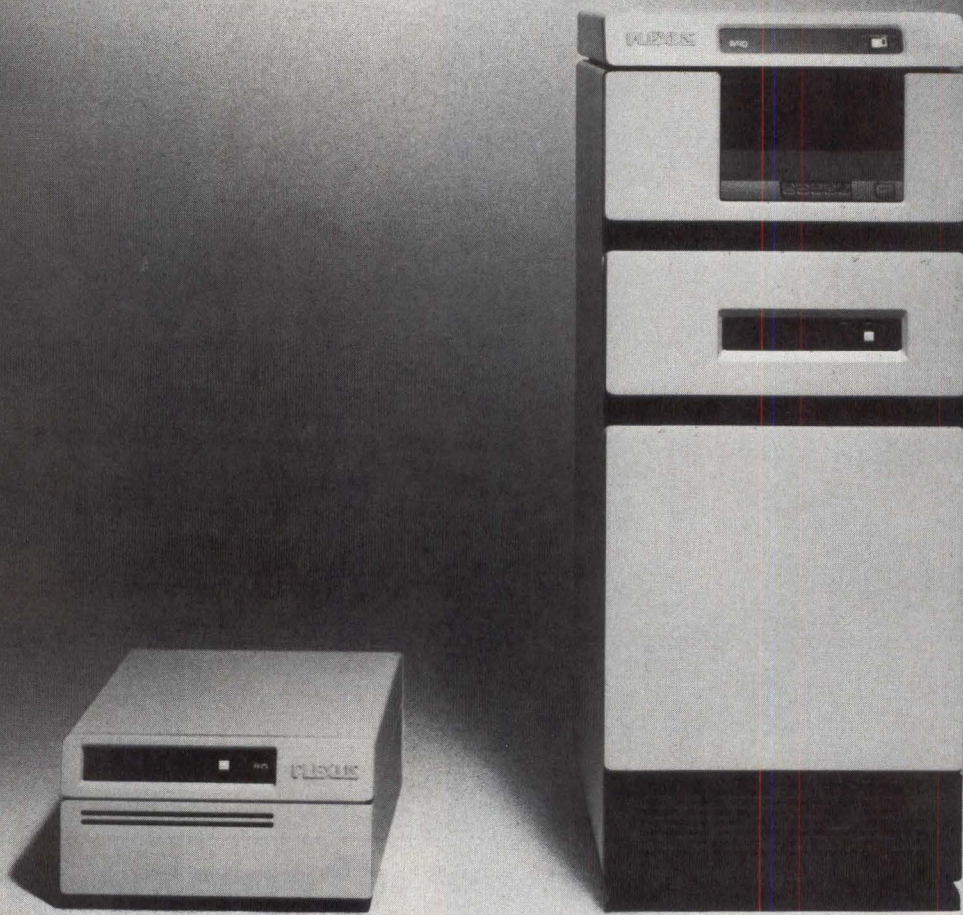



Your eyes are fine. You're just seeing everything in two.

The Plexus P/25.

And the Plexus P/40.

Two complete, UNIX-based microcomputer systems. Being delivered in volume, today.

We're totally committed to the UNIX operating system. Because of its simplicity, flexibility and popularity.

We're also totally committed to performance. Both our microcomputer systems deliver all the power of the largest minicomputer systems.

At two to five times less cost.

But where do we get 96 UNIX-based systems?

From disk sizes, RAM sizes and user configurations.

The options available to you, with the P/25 and the P/40.

The P/25 offers 24 possible system combinations. With three disk sizes. (22, 36 and 72 megabytes.) Four memory sizes. ( $\frac{1}{2}$ , 1,  $1\frac{1}{2}$  and 2 megabytes.) And two user configurations. (8 or 16 terminals.)

The P/40 offers an impressive 72 system combinations. With its three disk sizes. (72, 145 and 290 mega-

bytes.) Eight memory sizes. ( $\frac{1}{2}$ , 1,  $1\frac{1}{2}$ , 2,  $2\frac{1}{2}$ , 3,  $3\frac{1}{2}$  and 4 megabytes.) And three user configurations. (8, 16 and 24 terminals.)

All these options are offered with a single vision in mind.

Choice.

With 96 possible system combinations, Plexus gives you the opportunity to custom-build systems to your ideal specifications.

Allowing you to more accurately meet the demands of your customers. With the capability to expand, as their needs grow.

Helping you to more effectively control your costs.

So you can maximize your profits.

We think that shows our far-sightedness.

Contact us. Plexus, 2230 Martin Ave., Santa Clara, CA 95050. (408) 988-1755. TWX/ Telex 910-338-2223.

Compare our two systems to the others. Price, performance, delivery, support and configurations. Once you do, you'll see. There's more to Plexus, than what meets the eye.

# IPLEXIUS





The DSI-501 Disk Drive fits into the 2nd slot on your IBM Personal Computer, to give you 5 MB formatted (6MB unformatted) storage for \$1995. The DSI-512 provides 10 MB formatted (12 MB unformatted) storage for just \$2495. And the DSI-519 provides 15 MB formatted (19 unformatted) for \$2995. Compatible with IBM software.

# \$1995.\* PLUG IN HARD DISK FOR THE IBM® PERSONAL COMPUTER.

**One low price** buys you the expanded storage, speed and reliability of a Winchester technology hard disk system. The DSI-501, DSI-512 and DSI-519 support IBM DOS.® Full software support includes an installation program and complete diagnostics.

**The DSI-ASYNC+ RAM** provides 64K RAM, expandable to 256K with parity, and 2 serial I/O ports on one card. Select the option and save space as well as dollars. The price of \$495\* includes extensive software for flexibility.

**More low-priced expansion options.** Our wide selection lets you mix and match products to fit your needs and your pocketbook.

Choose the DSI-64K, DSI-192K, or the DSI-256K fixed RAM cards with parity. For powerful upgrades, select the DSI-EX64K—a 64K RAM card that easily expands to up to 256K with the addition of individual memory chips. Prices start at \$299\*. Also available is the DSI-ASYNC, a dual port serial I/O card priced at \$199\*.

**Expand your IBM Personal Computer for a lot less money.** Take this ad to your local computer retailer and ask for products by Davong.

**DAVONG**  
Systems, Inc.

610 Palomar Avenue  
Sunnyvale, CA 94086  
(408) 773-8370

\* Manufacturer's suggested retail price. Includes all required components. IBM Personal Computer and IBM DOS are registered trademarks of IBM Corporation.

CIRCLE NO. 81 ON INQUIRY CARD



## DISK DRIVES

# Motor in spindle gives micro-Winchester room for 140M bytes

JACK SWARTZ, Maxtor Corp.

*Space-saving motor, head and actuator get the most out of a 5¼-in. package*

A new family of 5¼-in. Winchester disk drives provides as much as 140M bytes of storage on eight platters with an average access time of 30 msec. Developed by Maxtor Corp., the XT-1000 disk drive family (MMS, October, 1982, p. 55) incorporates an in-spindle drive motor, a rotary voice-coil actuator, Whitney-type heads and a closed-loop, track-following servo system.

### Integral motor/spindle

To fit as many as eight disks in a standard 5¼-in. package, Maxtor departed from the conventional design of a separate drive motor and disk spindle. In most small disk drive designs, the motor is attached to the base casting below the stacked disks, taking up ¾ to 1½ in. of vertical height. The XT-1000 design places the drive motor inside the disk hub (Fig. 1), allowing almost the entire height of the package to be used for stacking disks. Although mounting a disk drive motor in the spindle had been accomplished in some early IBM Corp. products, it has not been previously achieved in a 5¼-in. disk drive.

The XT-1000 direct-drive DC motor has a two-bearing configuration in which the motor shaft is stationary and the outer race of the the ball bearings rotates. This design reduces vibration by providing a shorter load path between the spindle hub and support base than do conventional designs. Although the XT-1000 motor is smaller than the inside hub diameter, it accelerates an eight-disk stack to head-flying speed quickly enough to avoid unnecessary head and disk wear. At the same time, its efficiency is high enough and its power consumption low enough to reduce heating, a crucial



**Maxtor XT-1000, 5¼-in. Winchester disk drives** provide as much as 140M bytes of unformatted storage on eight plated disks with an average access time of 30 msec.

consideration with the disks mounted close to the motor. The hub material is thin enough to provide the necessary space for the motor, but thick enough to keep flux leakage below 1.5 Gauss. a 0.5-in. diameter drive shaft helps make the assembly rigid and keeps resonant frequencies higher than the critical frequencies of the drive itself.



**Rotary voice actuator**

The XT-1000 uses a rotary voice-coil actuator, in which permanent magnets surround a cylindrical electromagnet (the voice coil) mounted on a pivot. When a current is applied to the coil, the field from the permanent magnets causes the coil to rotate, swinging

the head assembly across the disk. The two-bearing rotary design takes up less space and creates less friction than six-bearing linear voice-coil actuators, which move back and forth on two fixed carriage rails.

One problem with rotary actuators is head skew caused by the curved path of the arm. The skew can be minimized by lengthening the arm, thus increasing the radius of the arc described by the head's path and decreasing its curvature. Increasing arm length is difficult in conventional actuator designs, in which the coil is horizontal. The XT-1000 coil is mounted vertical-

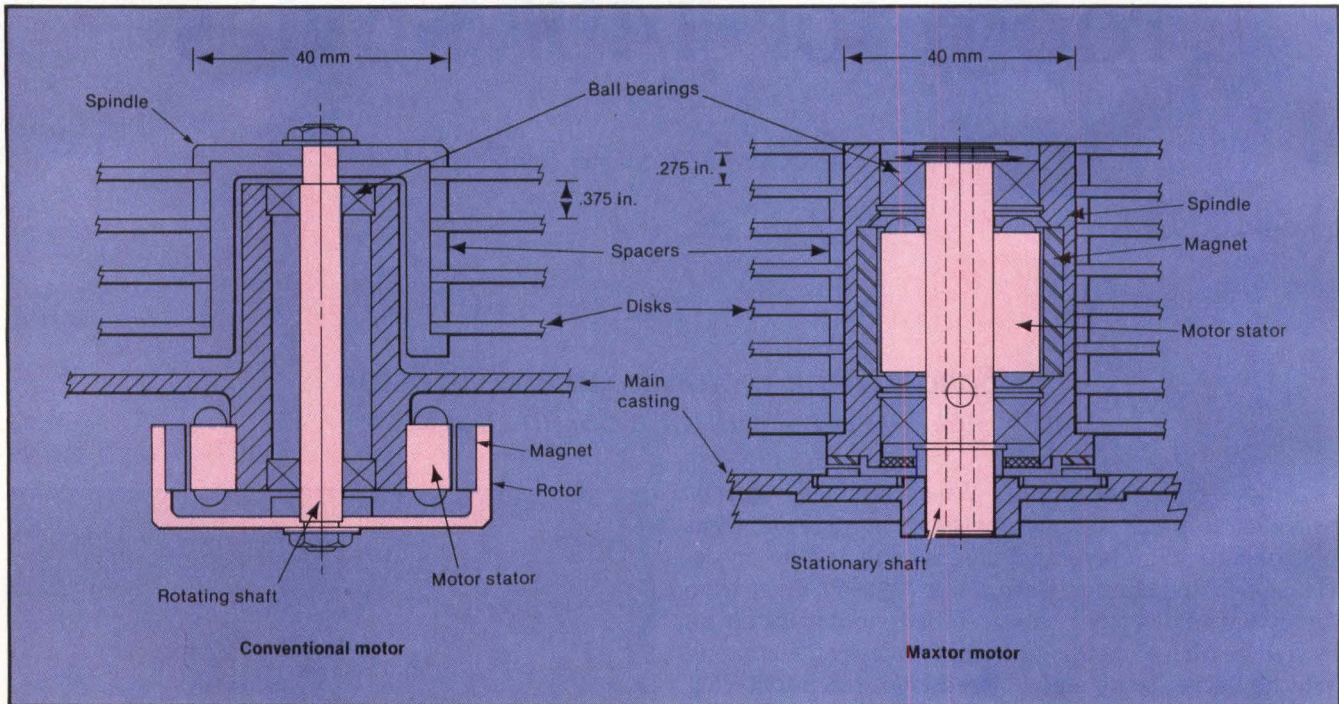

**Fig. 1. Comparison of conventional and Maxtor motors** illustrates integration of motor and spindle in Maxtor design. Conventional motors are placed underneath the spindle, where a rotor turns a shaft connected to the spindle. The Maxtor motor is placed within the disk, with the spindle serving as the rotor, turning around a stationary shaft. The chief advantage to the Maxtor motor is the space savings afforded by bringing the motor into the spindle.

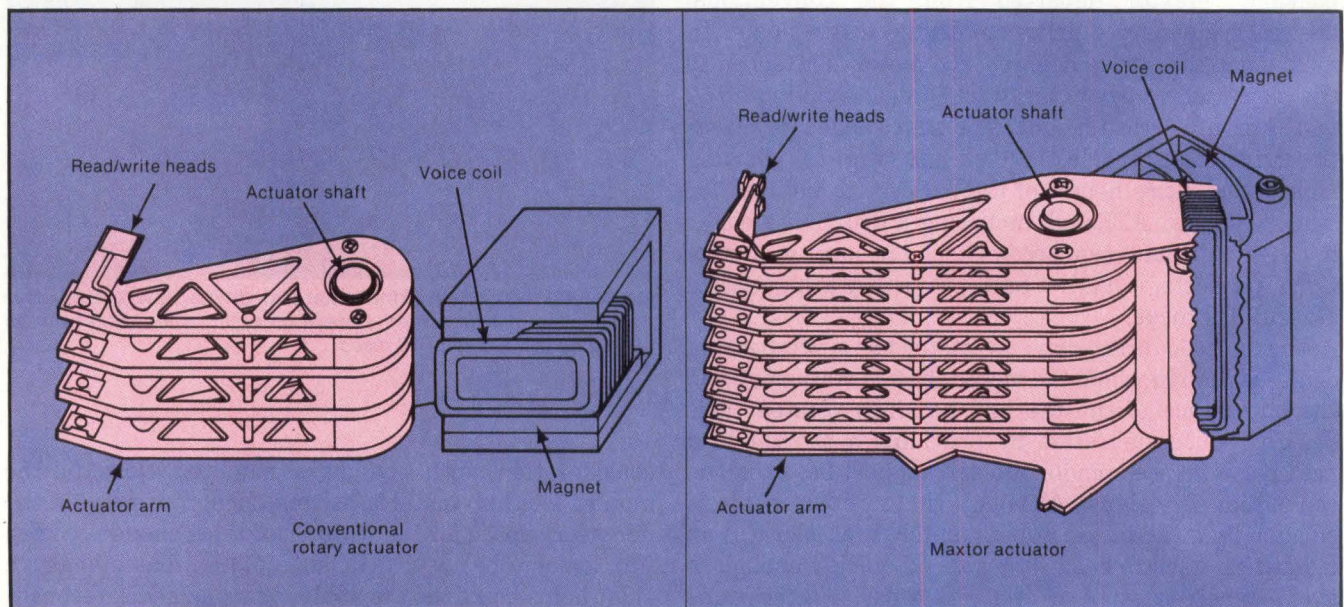

**Fig. 2. Comparison of conventional and Maxtor rotary actuator designs** shows that Maxtor's curved magnets and vertically wound coil leaves room for a longer actuator arm. The longer arm swings in a less curved path, reducing head skew.



# Introducing the first removable Whitney technology disk drive for OEMs.

**Cartridge convenience with fixed media performance and reliability in an 8-inch, fixed/removable drive.**



- **50 Mbytes Total Storage**
- **25 Mbyte ANSI Standard Cartridge**
- **35 msec average access**
- **CDC Lark™ compatible SMD interface**
- **8-inch floppy envelope**

Now there's a disk drive with the combination of speed, capacity, reliability and packaging efficiency to complement your high-performance mini- or microcomputer based system.

It's the Arapahoe 7110 from Amcodyne.

Arapahoe features advanced Whitney head suspension and read/write technologies derived from the latest generation of mainframe disk drives. Improved aerodynamic stability, superior head/disk compliance and higher signal-to-noise ratio result in data reliability that is substantially better than that attainable with Winchester technology.

Arapahoe incorporates a microprocessor-controlled/embedded-servo system to eliminate the head/disk alignment problems which handicapped early cartridge disk drives. The microprocessor directs all head-movement operations and computes the runout profile for each cartridge. The result is fast, accurate seeks and absolute tracking accuracy for cartridge interchangeability.

Reliability is further assured by Arapahoe's proprietary head-loading mechanism and positive-pressure clean-air system. When a cartridge is loaded, Arapahoe's heads are held off the disk until the cartridge is purged to a fixed-media cleanliness level. Only then are the heads lowered into flying position. Together, these features mean you can employ Arapahoe with confidence in a wide variety of office, laboratory or industrial environments.

For Arapahoe product specifications and a free monograph on Whitney, the technology that's replacing Winchester in high performance disk, contact Amcodyne.

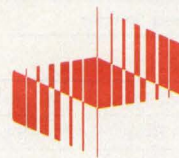

## Amcodyne

**Amcodyne Inc.**  
1301 South Sunset Street  
Longmont, Colorado 80501  
(303) 772-2601



# Five definitions of the word quality.



 Quality: over 15 years' experience producing disk drives, total vertical integration of manufacturing, and a caliber of product support you can measure by the loyalty of our customers. Quality that is a Fujitsu exclusive. Find it in our complete line of Winchester disk drives.

	a. 5 1/4-INCH			b. 8-INCH			
MODEL	M2231	M2233	M2234	M2301B	M2302B	M2302BE	M2303BE
CAPACITY (M Bytes)	6.7	13.3	20.0	11.7	23.4	23.7	47.5
AVG. POSITIONING TIME (ms)	95	95	95	70	70	70	70
TRANSFER RATE (K Bytes/s)	625	625	625	593	593	1,200	1,200
INTERFACE	ST506/SA4000			SA4000			
POSITIONING METHOD	Buffered Stepper			Buffered Stepper			
	c. 8-INCH		d. 14-INCH			e. 10 1/2-INCH	
MODEL	M2311K	M2312K	M2280K/N	M2284K/N	M2294K/N	M2351	
CAPACITY (M Bytes)	48.3	84.4	84.3	169	335	474	
AVG. POSITIONING TIME (ms)	20	20	27	27	27	18	
TRANSFER RATE (K Bytes/s)	1,229	1,229	1,012	1,012	1,012	1,859	
INTERFACE	SMD		SMD			Modified SMD	
POSITIONING METHOD	Rotary Voice-Coil		Rotary Voice-Coil			Rotary Voice-Coil	

Fujitsu America Sales Offices:  
 Northwest 408/988-8100 Southwest 714/558-8757  
 East Coast 617/229-6310 Europe 44-1/493-1138

©1982, Fujitsu America, Inc.

CIRCLE NO. 83 ON INQUIRY CARD



QUALITY LIVES



## DISK DRIVES

ly, allowing sufficient arm length to reduce skewing to acceptable levels (Fig. 2). Lengthening the arm, however, increases the torque needed to rotate the arm with a given acceleration. This increased torque is supplied by adding windings to the voice coil, as the torque exerted on the coil is proportional to the number of turns of wire. In addition, the XT-1000's permanent magnets are curved to keep 80 percent of the coil in the flux field, achieving a relatively high torque for a given current. Also, by closing both ends of the magnet structure, the efficiency of the actuator is further increased through a shorter flux return path.

*The XT-1000 design places the drive motor inside the disk hub, allowing almost the entire height of the package to be used for stacking disks.*

### Servo system and Whitney heads

The XT-1000 incorporates a closed-loop, track-following servo system. The servo system monitors head position relative to a reference track, correcting off-track conditions. Open-loop stepper motors, in contrast, move the head across the disk in predeter-

XT-1000 SPECIFICATIONS			
	XT-1065	XT-1105	XT-1140
Capacity, unformatted			
Per drive (M bytes)	66.93	105.18	143.43
Per surface (M bytes)	9.56	9.56	9.56
Per track (bytes)	10,416	10,416	10,416
Capacity, formatted*			
Per drive (M bytes)	52.64	82.72	112.80
Per surface (M bytes)	7.5	7.5	7.5
Per track (bytes)	8192	8192	8192
Per sector (bytes)	256	256	256
Sectors/track	32	32	32
Transfer rate (M bits/sec.)		5	
Access time (msec.)			
Average**		30	
Track-to-track**		8	
Maximum**		60	
Functional specifications			
Rotational speed (rpm)		3600	
Average latency (msec.)		8.33	
Recording density (bpi)		9430	
Flux density (fci)		9430	
Track density (tpi)		980	
Cylinders		918	
Tracks	6426	10,098	13,770
Sectors (000)*	206.1	323.0	441.6
Data heads	7	11	15
Servo heads	1	1	1
Platters	4	6	8

\*ST506/412-compatible format.  
\*\*Includes setting.

mined discrete steps, without feedback from the disk surface. Closed-loop systems can compensate for dimensional instabilities in the disk and drive mechanics, such as those caused by thermal expansion, and are required in drives with high track densities and thus decreased margin for error.

*Although the XT-1000 motor is smaller than the inside hub diameter, it accelerates an eight-disk stack to head-flying speed quickly enough to avoid unnecessary head wear.*

The XT-1000 uses Whitney head technology. Whitney heads, first used in the IBM 3380, use flexures and sliders that are smaller than those used in Winchester assemblies, yet have a higher load force for increased head-flying aerodynamic stability and superior head/disk compliance (Fig. 3). Because Whitney heads fly

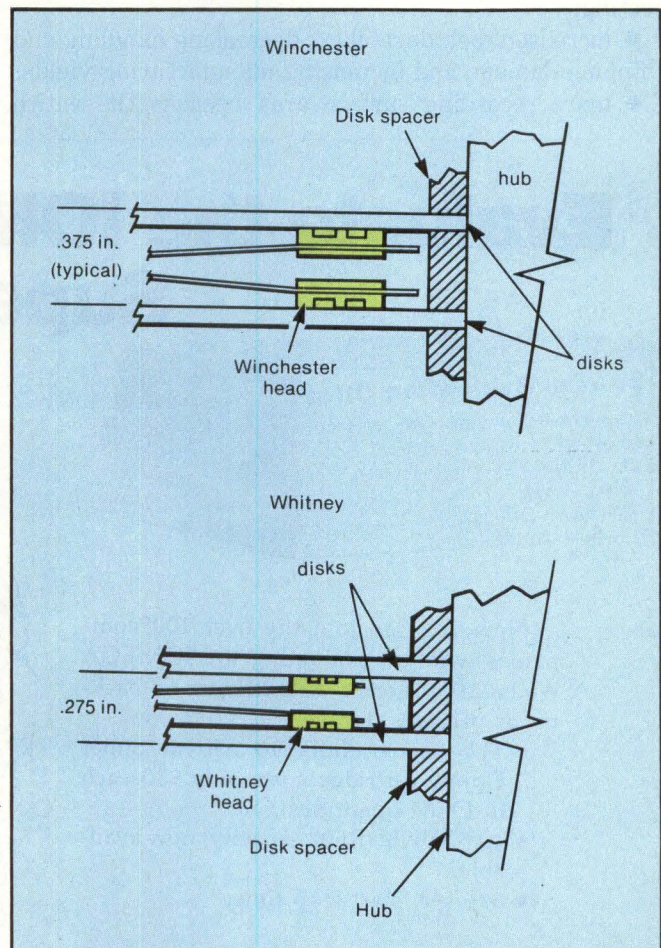

**Fig. 3. Whitney heads are smaller than Winchester heads, requiring less space between platters. Whitney heads can also get closer to inner and outer edges of disk surface, allowing additional tracks.**



closer to the surface of the disk, bit densities can be higher than those obtainable with Winchester. The smaller Whitney flexures and sliders, furthermore, allow disks to be spaced 0.1 in. closer than with Winchester heads, gaining additional space inside the 5¼-in. package. The smaller head suspension can also get closer to the hub and the outer wall, thus supporting extra inner and outer tracks on the disk surface.

**Thin-film media**

The XT-1000 incorporates thin-film-plated media. Although plated media is more expensive to produce than conventional oxide-coated media, it offers several important advantages, including:

- increased signal-to-noise ratio because of higher coercivity of the magnetic plating;
- higher linear bit density because the plated magnetic coating is thinner than conventional oxide coating;
- increased disk durability, decreasing handling and shipping damage and increasing manufacturing yields;
- more recording surface area because the entire

*Future disk drives from Maxtor will take full advantage of the abilities of plated media, offering higher densities than the XT-1000.*

surface of the disk is plated.

Future disk drives from Maxtor will take full advantage of the abilities of plated media, offering higher densities than the XT-1000.

The XT-1000 drive electronics are mounted on a single PC board. The advantages of using a single board include a reduced part count, lower manufacturing and maintenance costs and better use of space within the limited height of the enclosure. Maxtor uses surface-mounted devices, electronic components one-third the size of conventional ICs that are soldered directly to the board without plated-through holes. The area saved with these components can be used for interfaces and controller functions that might be added. □

**Jack Swartz** is co-founder and vice president of engineering of Maxtor Corp., Santa Clara, Calif. He was co-founder of Rotating Memory Systems, Inc., managed engineering teams that developed Shugart Associates' Winchester disk drives and worked on several disk drives for IBM Corp. during his 18-year tenure there.

# Evaluate the IOMEGA 10MB Super Floppy™ \$1,200.

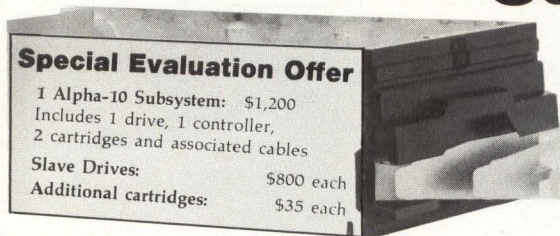

**Special Evaluation Offer**

1 Alpha-10 Subsystem: \$1,200  
Includes 1 drive, 1 controller,  
2 cartridges and associated cables

Slave Drives: \$800 each  
Additional cartridges: \$35 each

Now you can join the over 100 companies who are evaluating the IOMEGA Alpha-10... Ten reliable Mbytes of back-up or primary storage.

- The user-friendly 10 Mbyte Super Floppy cartridge costs only \$30 each in OEM quantities.
- 10.5 Mbyte (RL02 capacity) now available.
- 3/6 sec. start-stop time.



- 1.13 Mbyte per sec. data rate.
- 35 msec. average seek time.
- SCSI Compatible.
- Much more shock resistant than any Winchester. The secret: Technology inspired by Daniel Bernoulli that flies the media *over* the head.

Time is running out. To get immediate delivery of your specially priced Alpha-10 Evaluation Unit, Call Jim Linton at IOMEGA (801) 392-7581.

IOMEGA Corporation  
4646 South 1500 West  
Ogden, Utah 84403 (801) 392-7581



San Jose, CA (408) 263-4476  
Coral Springs, FL (305) 755-1060  
Woburn, MA (617) 933-2000

CIRCLE NO. 84 ON INQUIRY CARD



**Available now!**  
**And SMS is**  
**not afraid**  
**to show it**

**A Micro Winchester System**  
**in a Micro Package**

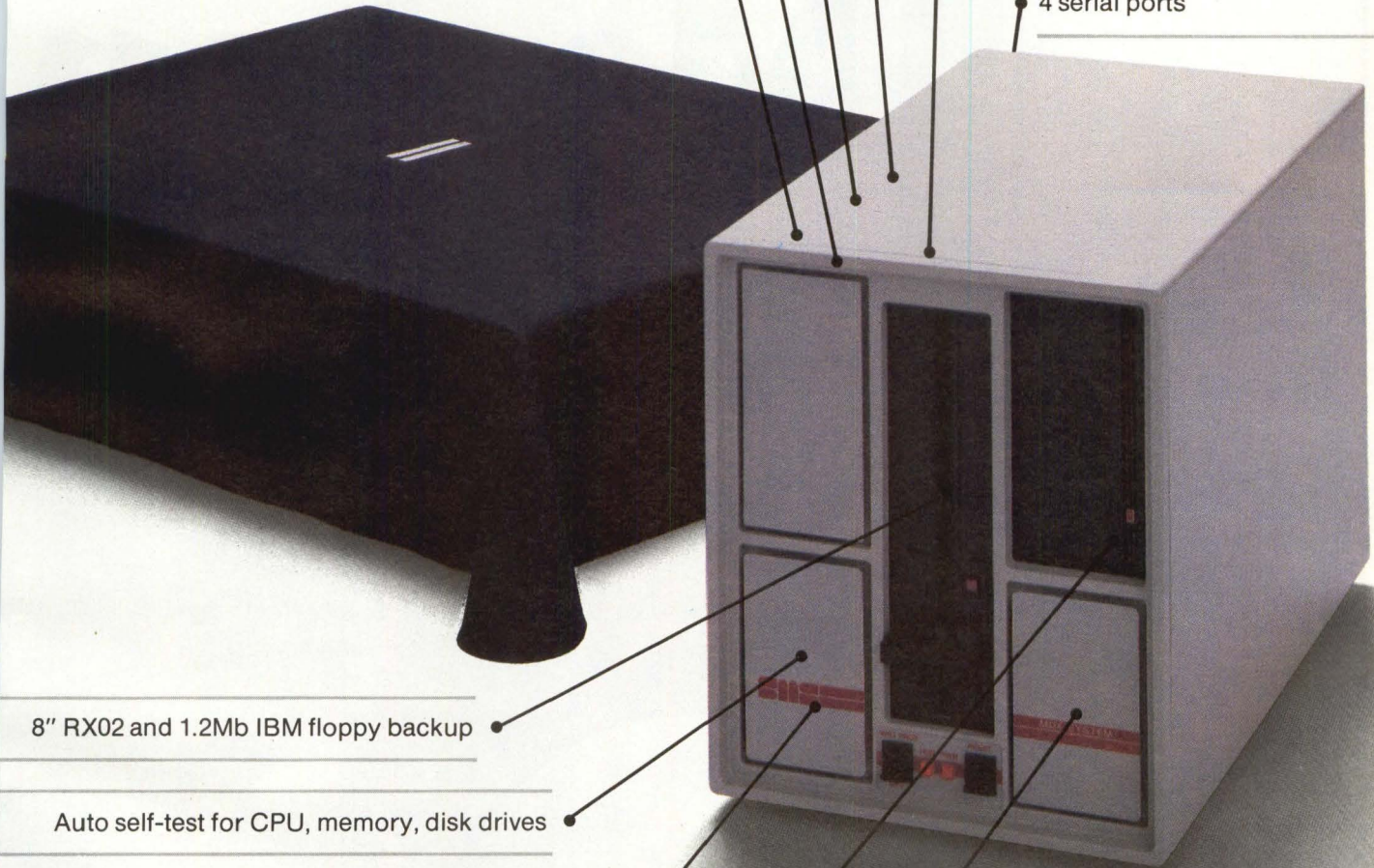

Compact 9.5"W x 11.2"H x 17"D table top package

256Kb main memory (4Mb addressability)

Expansion space for 4 dual LSI-11 boards

PDP-11\* architecture compatible with DEC\*  
RT-11, RSX-11M and Unix\*\* software

LSI-11/23 processor

4 serial ports

8" RX02 and 1.2Mb IBM floppy backup

Auto self-test for CPU, memory, disk drives

Easy access to LED display of system faults

10.6Mb or 15.9Mb 5 1/4" Winchester package

Advanced disk controller with ECC, flaw management, bootstrap,  
error retry, and direct non-interleave data transfer

AVAILABLE WITHOUT CPU and memory for volume requirements



**Scientific Micro  
Systems, Inc.**

777 E. Middlefield Road  
Mountain View, California 94043  
(415) 964-5700

AUTHORIZED SMS DISTRIBUTOR FOR DEC  
Q-BUS PRODUCTS: FIRST COMPUTER  
CORPORATION (312) 920-1050

SMS SALES OFFICES:

Phoenix, Arizona (602) 978-6621;

Boston, MA (617) 246-2540; Atlanta, Georgia

(404) 296-2029; Morton Grove, Illinois (312)

966-2711; Yorba Linda, California (714) 993-3768.

\* Trademark of Digital Equipment Corporation. \*\* Trademark of Western Electric.



# New Quantu Mechan

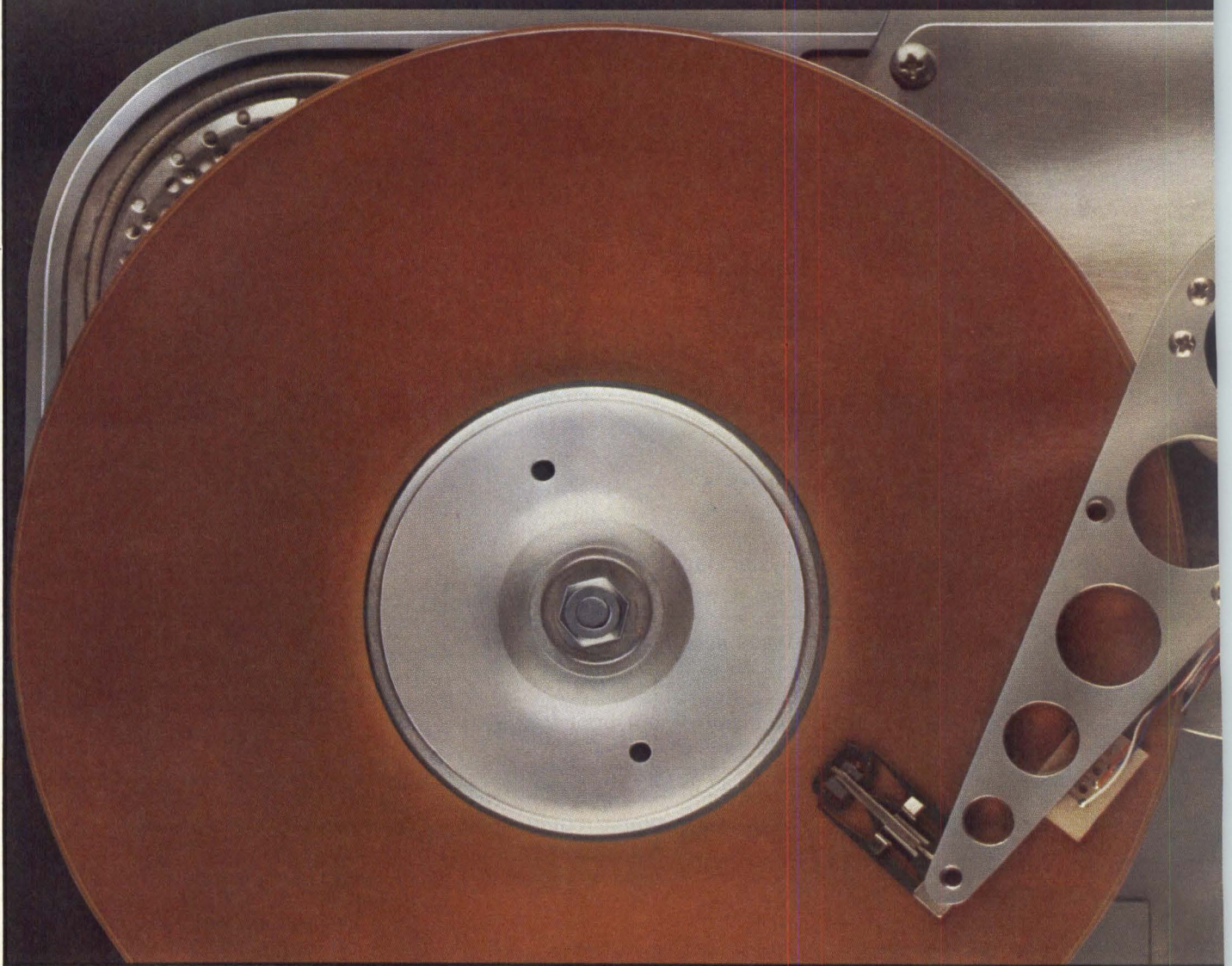





**m  
ics.**

## 85 Megabytes.

This is the Quantum Q2080™ disk drive. Our new 85 megabyte, 40 millisecond, 8" Winchester.

And a Quantum leap in Winchester technology. Because packed into this desktop-sized package is everything we've ever learned about taking a good idea and making it better.

For instance, it takes a considerable amount of finesse to get 85 megabytes into the same drive that previously contained only half that.

But it takes even more to improve access time, reliability, and availability—all at the same time.

That's where our Quantum Mechanics came in handy.

For the Q2080 drive, we developed the industry's simplest closed loop servo system. Exact head positioning derived from a dedicated servo disk surface.

In addition, we also decreased access time to 40 milliseconds, which is comparable to that found in drives having expensive voice coil actuators.

Yet we did both in such a way as to make the Q2080 easy to produce in high volume. Which is something we're both very much interested in.

The best part of all this magic, though, is that it enabled us to build a drive that's more economical than classical closed loop servo products.

In fact, the Q2080 drive has been designed to be the lowest priced 85 Mb 8" Winchester on the market.

Which means it'll pay off handsomely in your new office automation and local area network applications.

The new 85 Mb Q2080 Winchester.  
Amazing what a little tinkering can do.

Quantum Corporation, 1804 McCarthy Boulevard, Milpitas, California 95035. Eastern Regional Sales Office: Salem, NH (603) 893-2672. Western Regional Sales Office: Santa Clara, CA (408) 980-8555. International Sales Office: Milpitas, CA (408) 262-1100. TWX: 910 338-2203.

# QUANTUM

Q2080 is a trademark of Quantum Corporation. ©1982 Q.C.

CIRCLE NO. 86 ON INQUIRY CARD



# To 40 megabytes. Disctron 5 1/4-inch Winchester.

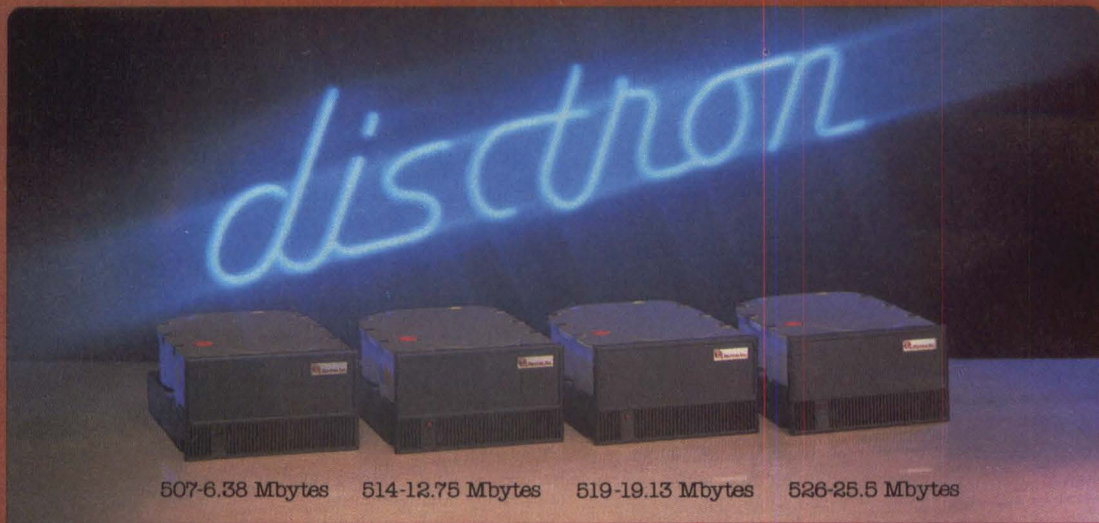

## Disctron Announces The 40 Megabyte Half-High 5 1/4" Winchester.



Disctron offers you more capacity, higher performance, and easier integration in 5 1/4-inch Winchester. With capacities to 40 megabytes. With average access times as low as 35 ms. And with special features—electronically dampened actuator, buffered step mode, electrical spindle brake, integral microprocessor control and built-in AGC.

Easy integration. Slip these 5 1/4-inch drives into an existing minifloppy cavity. Use standard minifloppy voltages. Use standard ST506/ST412 interfacing. These drives are ready to go.

**Plug in the Disctron difference in 5 1/4-inch Winchester.**



# To 160 megabytes. Disctron 8-inch Winchester.



(Lynx) 8"-Removable Disc Drive

8" Fixed Disc Drive



160 Mbytes Fixed Disc Drive

Disctron has it all. Fixed and removable Winchester with capacities to 160 megabytes. Thin film media. Internal diagnostics. Self-contained shock mounting. Internal carriage lock. SMD and ANSI-standard interfacing. DC power. □ Plug in 10.6 megabytes on an ANSI-standard, transportable cartridge. Linear voice coil, embedded servo and microprocessor control provide precise head positioning and reliable data access.

#### Plug in the Disctron difference in 8-inch Winchester.

Only Disctron offers a complete family of 5¼-inch and 8-inch Winchester in fixed and removable, proprietary head technology and manufacturing, high volume manufacturing, and the solid financial foundations of CCT's more than \$75 million in assets.

**More than megabytes. Discover the Disctron difference. For more information, circle our readers' service number. Or call us direct at (408) 946-6692.**

*the disctron  
difference*



**Disctron, Inc.**  
A Subsidiary of CCT

1701 McCarthy Boulevard Millipitas, California 95035  
Telephone: (408) 946-6692 TWX: 9103382068 DISCTRON MPTS  
European Representative: Micro Memory Systems Ltd., England 635-40405-Tel. 848277 Telex



**DISK DRIVES FROM VRC**

# RELIABILITY IN UNFRIENDLY ENVIRONMENTS

From 0° to 50° C, from the heat of the desert to the chill of the arctic circle, VRC disk drives operate with a high MTBF. Tolerance to thermal extremes, shock and vibration are part of the design criteria that has made Vermont Research the leading supplier of memory products for unfriendly environments.

## VRC 8520 8-INCH CARTRIDGE DISK DRIVE

The VRC 8520 puts 22 megabytes of storage capacity into virtually any existing system. An ANSI standard 11 megabyte removable cartridge and an 11 megabyte fixed disk, in a one-over-one configuration, give you the flexibility to create back-up files and off-line storage in one compact unit. Integral ANSI, SASI or DEC interfaces are available making the 8520 and 8010 plug-compatible with most host systems. Power supply package adding only 3.9 in. (99.06MM) to length is available.

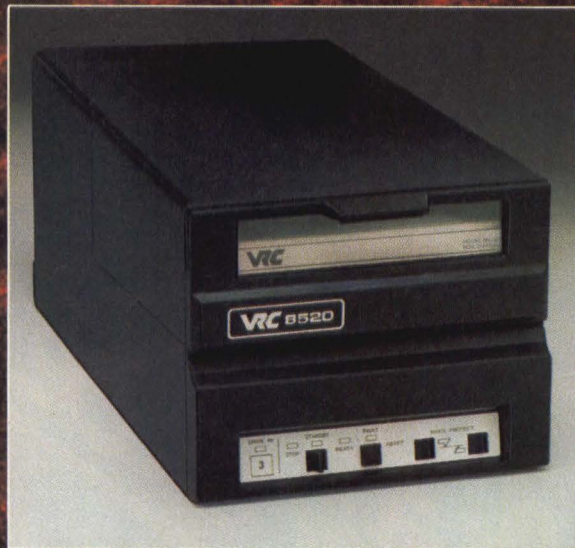

## NON-CONTACT, HIGH-FLYING HEADS ASSURE RELIABILITY

The VRC 8520 incorporates non-contact, high-flying heads that never touch the media in stop, start or transit modes. The stop mode automatically locks heads in a retracted position with manual intervention unnecessary for moving or shipping. A proprietary embedded-servo head positioning system minimizes re-seeks and eliminates head alignment problems. To protect heads and media from particulate damage, a closed-loop air filtration system has been combined with a self-sealing ANSI cartridge. Microprocessor controlled self-diagnostics, modular construction and accessible sub-assemblies make the 8520 easy to service; MTTR is 30 minutes. No preventive maintenance is required.

## WE FIT IN PRACTICALLY ANYWHERE

The VRC 8520 is designed for high-capacity storage in fixed or mobile installations. Where less capacity is required, the VRC 8010 offers 11 megabytes of storage on an 8-inch removable cartridge. Both units are available with ANSI, SASI or DEC interfaces and optional power supplies.

For more information contact:

Vermont Research Corporation,  
Precision Park,  
North Springfield, VT 05150.  
Tel: 802/886-2256. TWX: 710/363-6533.

In Europe call or write:  
Vermont Research Ltd.  
Cleeve Road, Leatherhead,  
Surrey, England  
Tel: Leatherhead 376221. TLX: 23280.

SASI is a trademark of Shugart Associates.  
DEC is a registered trademark of Digital Equipment Corp.

# VRC

VERMONT RESEARCH CORP.  
VERMONT RESEARCH LTD.

**Memory Products for Systems  
That Can't Stand Failure**

CIRCLE NO. 88 ON INQUIRY CARD



# Market snapshot: floppy disk drives

PATRICK KENEALY, Associate Editor

*Price, performance and compatibility determine sales  
in the three diskette drive market segments*

The floppy disk drive market has evolved into three markets based on 8-, 5¼- and sub-4-in. media. All three markets are healthy but in different phases of development. Growth in 8-in. floppy drive markets is fading, growth for 5¼-in. drives is still accelerating, and growth of sub-4-in. drives has just lifted off on an exponential curve. OEM customers have dozens of capacity, price and performance options, but smart shoppers start their selection process by deciding which media-based group of diskette drives to consider.

## 8-in. drives are commodities—almost

About \$400 million worth of 8-in. OEM diskette drives were sold in 1982 (Fig. 1). More than half the diskette drives sold last year were 8-in. units. Shipments of 8-in. drives are still growing at about 20 percent a year but should stabilize by 1985 and decline thereafter as full-sized diskette drives yield to competition from higher capacity 5¼-in. diskette drives and less expensive fixed and removable 5¼-in. Winchester. Although Pertec Computer Corp., Decitek Corp., Memorex Corp. and MFE Corp. are among companies that appear to be leaving the 8-in. drive market, at least two dozen U.S. firms plus a number of European and Japanese manufacturers are maintaining and expanding their 8-in. product lines.

Shugart Associates is still the industry leader, with Control Data Corp., NEC Information Systems, Inc., Qume Corp., the Remex division of Ex-Cell-O Corp. and Siemens Corp. still its major competitors. Tandon Corp. entered the 8-in. diskette drive market in 1981 with a half-height unit and has since landed major OEM contracts with Tandy Corp. and CPT Corp. New competition from Mitsubishi, Fujitsu and other Japanese producers will keep the pressure on.

Competition among 8-in. drive OEMs appears—at least for the moment—to be less directly based on

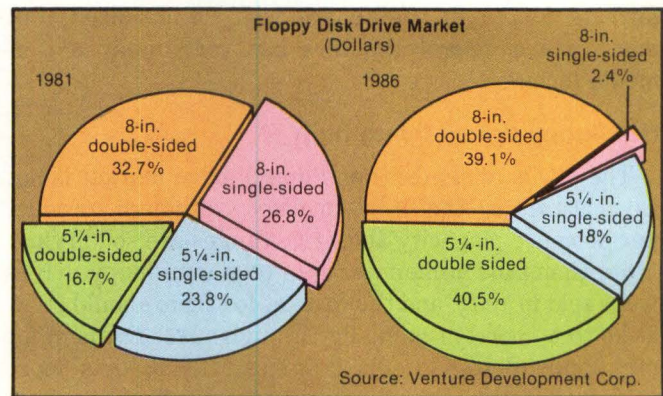

**Fig. 1. The OEM diskette drive market should grow from \$1.3 billion in 1981 to \$4.6 billion in 1986, according to Venture Development Corp., a Wellesley, Mass., research firm. This represents an annual growth rate of 28.7 percent per year. Venture Development found that 41 percent of diskette drives shipped in 1981 were integrated into personal computers, with smaller percentages being used in minicomputers, industrial microprocessor systems, word processors and intelligent terminals. By 1986, double-sided, half-height drives should dominate, but the effect of microflopies is still uncertain.**

technical virtuosity. Single- and double-sided, 8-in. diskette capacities have been limited to 1.6M bytes to date as a result of media properties, and the standardization that has resulted is one of the 8-in. drive's marketing strengths. The biggest recent technical innovation in 8-in. drives (and some say the last) is the half-height drive. Two half-height drives occupy the same space as one standard drive, doubling capacity while retaining media and interface compatibility. Tandon and Shugart are the half-height leaders, but NEC, Matsushita, CDC, Siemens and Qume have half-height units in production. Anyone wanting to remain in the 8-in. market must have one ready soon.

OEM pricing and delivery schedules are the main competitive variables in the 8-in. drive market. Quantity discounts vary among manufacturers, and published



## DISK DRIVES

prices do not usually represent true selling prices. End-user prices for 8-in. drives are in the \$800 to \$1200 range, 100-unit quantity prices are roughly \$400 to \$600, 500-unit quantity prices are roughly \$200 to \$400, and quantities of 1000 or more are a bit lower still. Many manufacturers win accounts because they are the only suppliers with production capacity, and some manufacturers cut prices lower than normal when they have excess production capacity.

The major 8-in. drive manufacturers all offer other hard or floppy disk products and can shift production toward those products as the 8-in. market loses steam. Half-height drives have kept the 8-in. industry healthy because they allow drive customers (system integrators) to increase storage without retooling their systems. As a stronger economy allows retooling, many 8-in. buyers will switch to 5¼-in. drives. Capacities and formats for 5¼-in. units are less standardized, but many newer microcomputers can read many 5¼-in. media formats.

### Minifloppy drives flying high

The 5¼-in. diskette (minifloppy) drive market is not as mature as the 8-in. market, although product performance, capacity and price ranges are solidifying. More than \$400 million worth of OEM minifloppy drives were sold in 1982, and the market for them should grow at 30 to 50 percent annually through 1985. Demand for minifloppy drives seems limitless. It supports more than two dozen manufacturers, led by Tandon, Shugart, Micropolis Corp., Micro Peripherals, Inc., and Alps Electric (Apple Computer, Inc.'s OEM supplier).

Minifloppy drives are available in single- or double-sided; single, double or quad recording density; and half- and full-height versions from all the major manufacturers. Single-sided, single-density (48-tpi), full-height drives are the least expensive, and double-

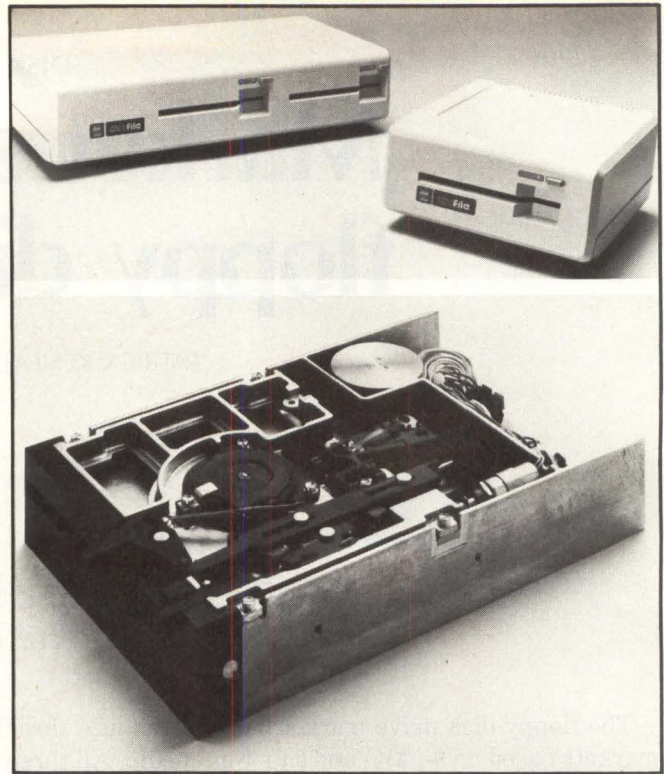

**Two nonstandard minifloppy drives.** Apple Computer, Inc.'s new drives (above) use nonstandard, double-sided, 5¼-in. media to store 871K bytes of data on a single diskette. Designed for Apple III personal computers, the Duofile (left) and Unifile carry end-user prices of less than \$1700 and less than \$1000, respectively. They replace the 140K-byte Apple Disk III and its many emulators. Apple claims the drives were designed for economy, capacity and media reliability, but the switch to nonstandard media has definite marketing implications. Drivetec's new half-height floppies were designed for capacity at the expense of compatibility. The model 320 (below) stores 3.33M bytes on specially manufactured, pre-formatted 5¼-in. diskettes.

sided, quad-density drives are the most expensive. Half-height minifloppy drives are available from all the major vendors and cost about as much as full-sized drives (Fig. 2). After manufacturers amortize half-height development costs and ramp up production, and after users become less willing to pay premiums for the small drives, half-heights should become less expensive

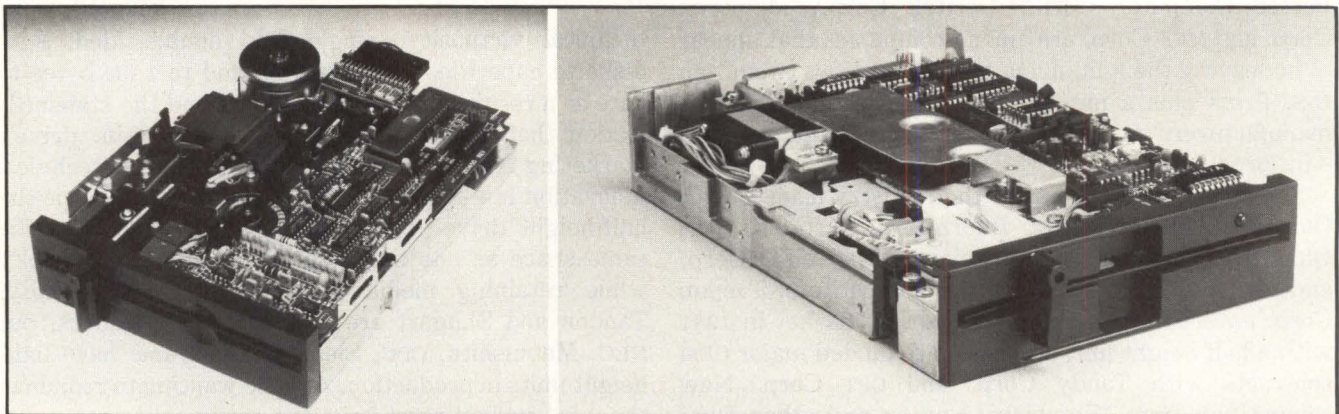

**Fig. 2. Half-height, 5¼-in. diskette drives** such as these from Tandon (left) and Shugart store 250K bytes, 500K bytes and 1M byte on a single diskette and represent the state of the art in mass-production mini-diskette drives. The Tandon unit measures 1.62 × 5.75 × 8 in., and the Shugart unit measures 1.62 × 5.75 × 8.46 in. Both units use brushless, direct-drive, DC motors and band actuators for 3-msec. track-to-track access time. Both units also sell for less than \$200 in large OEM quantities.



# Now you have a choice!

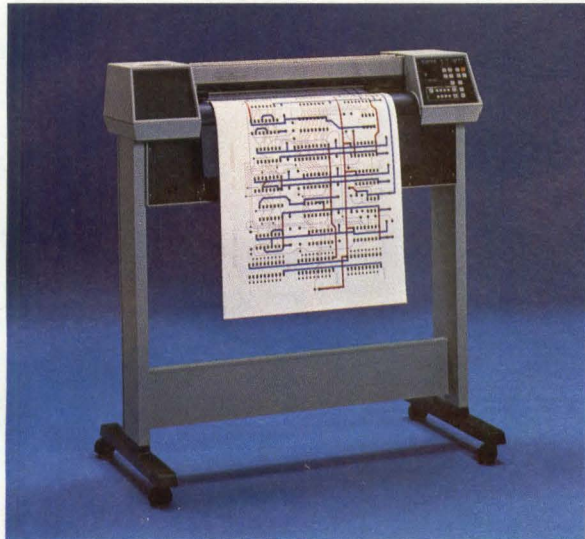

## The best way to make the HP 7580 better was to make it bigger.

### You asked for it!

Ever since its introduction two years ago, the HP 7580 Drafting Plotter has enjoyed an unparalleled reputation for price/performance excellence. User reaction has been overwhelmingly positive.

But some of you wanted *more*, and expressed the desire for even *larger* plotting capabilities. And now Hewlett-Packard has met your challenge.

The new HP 7585 Drafting Plotter maintains *all* of the many benefits of the HP 7580. The significant difference is the ability to output plots up to 36.5" x 48."

Now, *both* plotters can:

### Interface with HP, DEC®...

and other ASCII computers with RS-232-C or IEEE 488 (HP-IB, GP-IB) interfaces. (Both interfaces are standard on each plotter.) Also, a new capability for both plotters is modem operation for remote or timeshare applications.

### Interface with existing FORTRAN application programs...

using the HP Industry Standard Plotting Package, our version of the standard CalComp plotting software.

### Give you high throughput and quality output.

4 G's acceleration; 60 cm/s (24ips) speed; addressable resolution 0.0250 mm (0.000984"), with a mechanical resolution of 0.0032mm (0.00012").

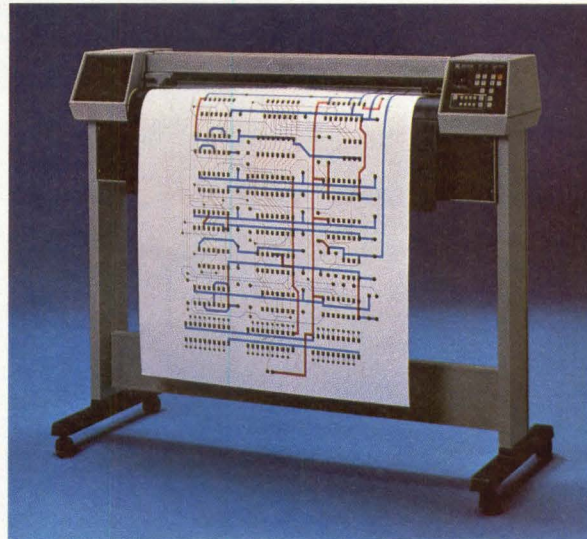

## Introducing the new, larger-format HP 7585 Drafting Plotter.

### Cut the cost of high-performance plotting in half.

It took a technological breakthrough to bring the price of an E-size, high-performance plotter in at only \$22,900, and a D-size unit at \$16,100. (*Domestic USA prices only.*)

### Provide long-term satisfaction with their ease of use and reliability.

Hewlett-Packard has a worldwide support organization that can provide quick on-site maintenance.

### Take the hassle out of handling pens.

8 pens are capped automatically in each of three carousels, keeping your pens always ready to write. Carousels are matched for fiber tip, roller ball, and liquid-ink drafting pens. This al-

lows automatic, manual, or program control of pen forces and speeds for optimum plot quality.

### Plot on a wide range of media and sizes.

Produce plots on paper, vellum, double matte polyester film — even preprinted forms. All standard sheet sizes from notebook size sheets to 24.5" x 48.0" for the HP 7580, and 36.5" x 48.0" for the HP 7585 are easily accommodated.

### For more information.

To receive a *free sample plot* and more detailed information, *mail the coupon today*. Or call Bill Fuhrer at:

**(619) 487-4100**

 **HEWLETT  
PACKARD**

Mail the coupon to: Hewlett-Packard  
16399 W. Bernardo Drive, San Diego, CA 92127  
Attn: Nancy Carter

11302-MM2

- Please send me more information about the HP 7585 and HP 7580.
- Send a sample plot from one of your drafting plotters.
- Have a Hewlett-Packard representative call me.
- I am interested in re-selling your plotter as part of my system. Have your OEM sales manager call me.

My computer and operating system are \_\_\_\_\_

My application and software are \_\_\_\_\_

Name \_\_\_\_\_ Title \_\_\_\_\_

Division/Dept. \_\_\_\_\_ Company \_\_\_\_\_

Address \_\_\_\_\_ City, State & Zip \_\_\_\_\_

Phone Number (\_\_\_\_) \_\_\_\_\_

DEC is a registered trademark of Digital Equipment Corporation.



# Why is it called the Electronics Industry, when there's more Plastics than Electronics?



Plastics have become the dominant material in the industry. Why? Because plastics provide the most cost-effective packaging material for electronics and computer systems.

For over 35 years, Data Packaging has worked with OEM's to develop innovative solutions for new applications, redesigns, and product enhancements. Today, Data Packaging is a worldwide company with vast material experience, financial strength, and manufacturing capacity.

Data Packaging can integrate your electronics with these proven plastic-forming techniques:

- Injection Molding
- Structural Foam
- Blow Molding
- Extrusions
- Vacuum Forming

Data Packaging has product experience in:

**Structures/Components**—CRT housings, keyboards, peripheral enclosures, and internal and structural supports.

**Ribbon Cartridges**—Our own high-yield matrix, direct replacements for RICOH, EPSON MX 80, and C-ITOH, and four-color ribbon.

**Media Packaging**—Removable disk packs and cartridges, tape reels and self-threading cartridges, and tape cassettes.

**Computer Accessories**—Dictation cassettes, tape reel and removable media storage units, and floppy disk boxes.

For more information on how Data Packaging can help you package your electronics or computer systems, call, write, or circle the number below.



Data Packaging Corporation  
205 Broadway  
Cambridge, MA 02139  
(617) 868-6200 TWX 710-320-0885

CIRCLE NO. 89 ON INQUIRY CARD



## DISK DRIVES

than standard minifloppy drives.

Minifloppy transfer rates are standardized at 125K, 250K and 500K bytes per sec., and unformatted capacities are roughly standardized at 250K, 500K, 960K, 1000K, 1600K and 2000K bytes. Capacities vary with track densities (48, 96 and 100 tpi), formatting and the number of recording surfaces. Use of brushless, direct-drive DC motors has increased drive reliability, and stepper-motor-driven, split-band-positioning mechanisms have cut average access times on many minifloppy units from 250 msec. or more to 95 msec. or less. Today's state-of-the-art production minifloppy drive is half as big, three times as fast and eight times more capacious than the minifloppy drives of four years ago.

Price and delivery time competition is not as cutthroat among minifloppy drive vendors as it is among 8-in. drive makers. Large-volume OEM prices for double-sided, double-density drives are in the \$200 to \$300 range but should be much less than \$200 by 1985. Products are more diverse (so competition is less direct), suppliers are just as numerous, and demand from system integrators is greater.

Huge economies of scale and careful manufacturing discipline are necessary for success as a minifloppy drive manufacturer. Tandon, Shugart and MPI manufacture overseas to cut costs, and other manufacturers cut costs heavily on a few big OEMs to achieve economies of scale over their total production runs. Minifloppy drive buyers have more choices than 8-in.

COMPANY NAME	5 1/4" DISKS		8" DISKS	
	UNITS (Millions)	VALUE (Millions)	UNITS (Millions)	VALUE (Millions)
Arber Industries	1.5	\$2.80	2.0	\$4.20
Control Data Corp.	2.0	4.20	4.0	10.20
CRI Inc.	1.0	2.50	.0	3.00
Dennison-Kybe	2.4	6.20	2.6	7.20
Dysan Corp.	9.75	19.50	7.8	19.50
IBM Corp.	3.0	9.00	18.0	57.60
Teijin-Memorex (Japan/USA)	7.4	14.80	7.6	17.50
3M Co.	9.6	19.20	13.0	35.75
Nashua Corp.	1.5	3.00	1.75	4.20
Verbatim Corp.	15.5	27.13	14.1	32.27
Wabash Datatech	3.0	5.40	7.0	16.10
BASF AG	4.5	9.45	4.5	11.70
Pyral/Dypyl (France)	1.0	2.10	3.0	8.25
Papier Industrien (W. Germany)	1.2	3.70	0.3	1.00
Fuji Photo Film (Japan)	0.1	0.30	0.6	1.80
Hitachi Maxell (Japan/USA)	3.75	9.38	3.5	12.25
Others	0.5	1.20	1.3	3.40
<b>TOTALS:</b>	<b>67.70</b>	<b>\$139.86</b>	<b>92.05</b>	<b>\$245.92</b>
Likely Redundancy	5 1/4": 10%;		8": 5.5%	
Range of Actual Production:	5 1/4": Min: 61; Max: 67.7 8": Min 88; Max: 93			

Source: Magnetic Media Information Services

Floppy disk media production topped 150 million units and \$375 million in 1981, according to Magnetic Media Information Services, a Chicago market research firm. Production of 8-in. diskettes rose 38 percent over 1980 levels, while 5 1/4-in. production was up 167 percent. MMIS estimates the 1982 market at 13.5 million units and \$672.4 million and reports that only 349,000 3 1/2-in. diskettes worth \$2.4 million were shipped that year. Sales of 3 1/2-in. media should grow at an annual rate of 97 percent over the next five years, MMIS predicts.

buyers but must shop carefully; it is still a sellers' market.

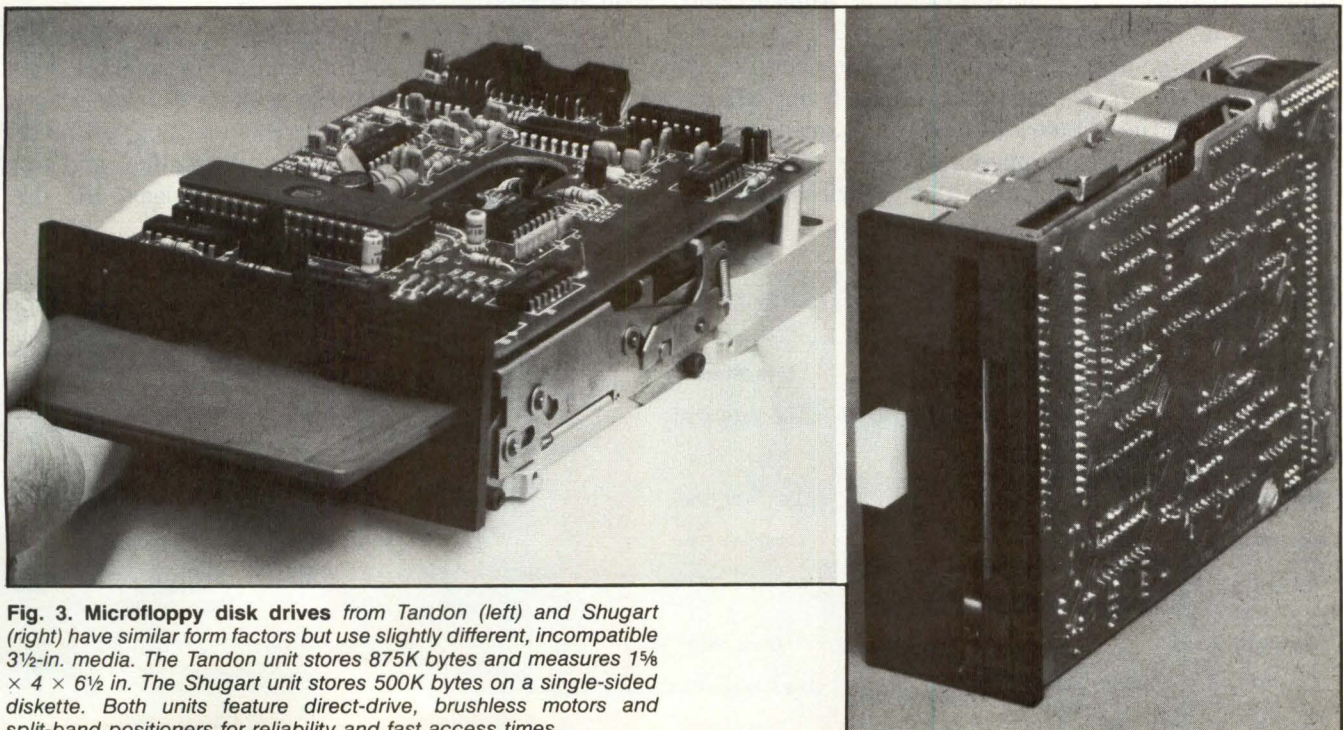

**Fig. 3. Microfloppy disk drives from Tandon (left) and Shugart (right) have similar form factors but use slightly different, incompatible 3 1/2-in. media. The Tandon unit stores 875K bytes and measures 1 5/8 x 4 x 6 1/2 in. The Shugart unit stores 500K bytes on a single-sided diskette. Both units feature direct-drive, brushless motors and split-band positioners for reliability and fast access times.**



**Microfloppy drives—promises and problems**

Minifloppies may be the hottest selling diskette drives today, but microfloppies are the hottest topic of conversation. The term "microfloppy" refers to four groups of diskette drives distinguished by the type of smaller than 5¼-in. diameter media they use (Fig. 3).

The first group, headed by Verbatim Corp., numbers 20 drive and media manufacturers including Apple, Atari, BASF Systems Corp., Cii Honeywell Bull, Memorex, Irwin/Olivetti, Remex and Shugart. The group, called the Microfloppy Standards Committee, supports a 3½-in. diskette in a rigid case that shares the transfer rate, track density and rotational speed of current minifloppies.

Sony Corp., originator of the microfloppy, is the main member of the second group, which has ambiguous support from Tandon, Hewlett-Packard Co. and others. The Sony diskette is similar to the "committee diskette" in size and hard shell, but is formatted differently (Fig. 4). Sony has its drive in production and has a number of large OEM orders in hand.

The third group centers around Tabor Corp., Westford, Mass., and its 3¼-in. soft-envelope micro disk. Seagate Technology, after reportedly failing to reach a licensing agreement with Sony, has announced plans to build the Tabor drive. Media vendor Dysan Corp., a financial backer of both Seagate and Tabor, is also solidly behind the 3¼-in. diskette.

The last of the four microfloppy drive manufacturer groups is based around Matsushita's 3-in. diskette. Hitachi America, Ltd., Maxell Corp. of America and others favor this standard.

Despite their media differences, the microfloppy drives have much in common. Drives using 3½-in. media, such as the Shugart SA300 (Fig. 3), measure 1.6 × 4 × 6 in. and occupy one-quarter the volume of a full-height minifloppy and store 1M byte without taxing technologies. Their small size has some inherent

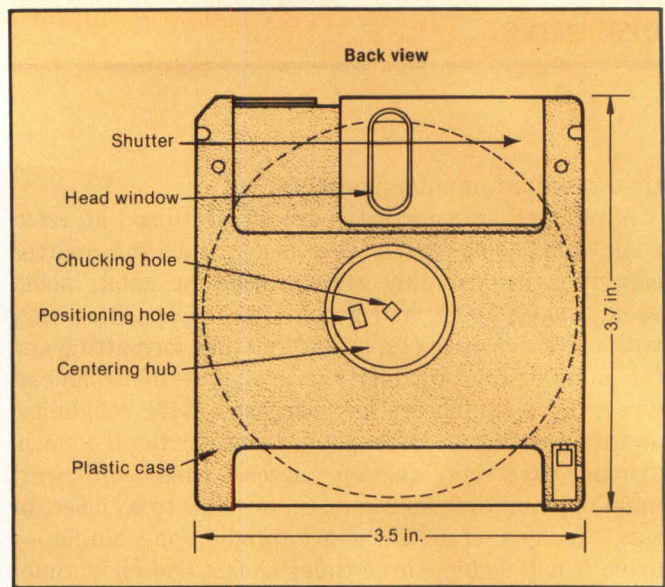

**Fig. 4. Back view of a Sony 3½-in. diskette shows a metal centering hub and sliding metal shutter that covers the head window when the diskette is not in use.**

benefits. Raw materials costs are lower, and power consumption is lower, typically less than 10W operating and less than 5W in standby mode. In designing for smallness, vendors cut parts counts and used the latest electromechanical and electronic technologies. Shugart, for example, claims an MTBF of 10,000 power-on hours for its microfloppy drive, 25 percent better than for its standard minifloppy drives.

Sony, Shugart and Tandon all claim OEM prices of less than \$200 for large OEM quantities of production units in the second quarter of 1983, but major OEM customers remain uncommitted, or at least unannounced. Initial units may be priced like current minifloppies between \$250 and \$500.

Five-year revenue predictions in the billions of dollars and success in the minifloppy market have inspired too many vendors to seek early leadership in the microfloppy market. The risks are as great as the rewards for media and drive vendors alike, and OEM customers may have to wait until at least the first round of this high stakes game is played. □

**Diskette Drive Manufacturers**

Manufacturer	City, State	Micro-floppy	Mini-floppy (5¼)	8-inch floppy	Capacities (KB)	Circle #
Advanced Electronic Design, Inc.	Sunnyvale, Calif.			x	1000	300
Alps Electric Co., Ltd.	Tokyo, Japan		x		256, 250, 500, 1000	301
Anderson Jacobson, Inc.	San Jose, Calif.		x		204	302
Apple Computer, Inc.	Cupertino, Calif.		x		140	303
BASF, AG	Mannheim, Germany		x	x	1600 250, 500, 1000	304
Burroughs Corp.	Detroit, Mich.			x	3131	305
C. Itoh Electronics, Inc.	Los Angeles, Calif.		x		1600	306
Caldisk, Inc. (Billings)	Provo, Utah			x	800, 1600, 3200	307



## Diskette Drive Manufacturers

Manufacturer	City, State	Micro-floppy	Mini-floppy (5¼)	8-inch floppy	Capacities (KB)	Circle #
<b>Columbia Data Products, Inc.</b>	Columbia, Md.		x		180	308
<b>Comark Corp.</b>	Waltham, Mass.			x	3200, 512	309
<b>Commodore Business Machines, Inc.</b>	Wayne, Pa.		x		170, 330, 1050, 2100	310
<b>Control Data Corp.</b>	Minneapolis, Minn.		x		125/250 250/500 500/1000 400/800 800/1600	311
<b>Elcomatic, Ltd.</b>	Glasgow, Scotland			x	1600, 3200	312
<b>Innotronics Corp.</b>	Lincoln, Mass.			x	802	313
<b>Iomega Corp.</b>	Ogden, Utah			x	14,000	314
<b>Irwin/Olivetti</b>	Ann Arbor, Mich.		x	x	250, 500, 1000 500	315
<b>Matchless Systems</b>	Gardena, Calif.			x	1300, 2600	316
<b>Matsushita Corp.</b>	Japan	x				317
<b>Memorex Corp.</b>	Santa Clara, Calif.			x	312, 802	318
<b>Micro Peripherals, Inc.</b>	Chatsworth, Calif.		x	x	250, 500, 525, 1050 1600	319
<b>Micro-Sci</b>	Santa Ana, Calif.		x		143, 164, 286, 572	320
<b>Micropolis Corp.</b>	Chatsworth, Calif.		x		500, 585, 960, 1000, 1113, 1170, 1200, 2025, 2175	321
<b>Miltope Corp.</b>	Melville, N.Y.			x	1000	322
<b>Mitsubishi Electronics America, Inc.</b>	Compton, Calif.		x	x	1000, 1600 1600	323
<b>Motorola Semiconductor Products, Inc.</b>	Phoenix, Ariz.			x	500, 1000	324
<b>NEC Information Systems, Inc.</b>	Lexington, Mass.			x	400, 1600	325
<b>Persci, Inc.</b>	Los Angeles, Calif.			x	800, 1600, 3200, 3776	326
<b>Pertec Computer Corp.</b>	Irvine, Calif.		x	x	250, 438 802, 1600	327
<b>Philips Data Systems</b>	Apeldoorn, Netherlands		x		438	328
<b>Qume Corp.</b>	San Jose, Calif.		x	x	250, 1000 1600	329
<b>Remex</b>	Irvine, Calif.		x	x	500, 1000 800, 1600	330
<b>Shugart Associates</b>	Sunnyvale, Calif.		x	x	256, 512, 1000 800, 1600 500	331
<b>Siemens Corp.</b>	Anaheim, Calif.		x	x	250, 500, 1000 800, 1600	332
<b>Sony Corp.</b>	Tokyo, Japan	x				333
<b>Tabor Corp.</b>	Westford, Mass.	x			500	334
<b>Tandon Corp.</b>	Chatsworth, Calif.		x	x	250, 500, 1000, 2000 800, 1600 875	335
<b>Teac Corp.</b>	Tokyo, Japan		x		250, 481, 500, 1000	336
<b>Techtran Industries</b>	Rochester, N.Y.		x		200, 400	337
<b>Toshiba Corp.</b>	Tokyo, Japan		x	x	438, 1094 400, 1600 3000 (prototype)	338
<b>Y-E Data, Inc.</b>	Tokyo, Japan		x	x	500, 1000, 1600 1600	339



A new company  
entered the  
5¼" Winchester  
market.

And closed  
the door  
behind them.



140 megabytes.  
And it's only the beginning.

Who makes Winchester with proven technology, eight platters, and the most capacity available? Maxtor. Our founders are people you already know. Industry veterans totally familiar with Winchester technology. So not only were we prepared to build a better drive, we knew what was important to OEMs. Price. Quality. Reliability. Availability. Support as you need it. We built Maxtor to satisfy those needs. And deliver the drives you've been waiting for . . . low-cost 5¼" Winchester with the highest capacity on the market.

Our doors are always open to OEMs. Let's talk. Call Leon Malmed at (408) 748-7740. Maxtor Corporation, 5201 Lafayette Street, Santa Clara, California 95050.



**Maxtor**

CIRCLE NO. 90 ON INQUIRY CARD





**HEY...UNIX\*, XENIX\*,**  
While others talk about 5 1/4" hard disks,





# OASIS\*, PICK\*, OEMs, ATASI could be shipping yours today!

**Why wait? ATASI is shipping 3 sizes of 5¼" hard disks right now.**

All high capacity: 19.84 Mbytes/33.07  
Mbytes/46.3 Mbytes

All low access time: 30 milliseconds average

All conventional technology

All ST506 compatible

All cost-effective

All with closed loop servo system and linear  
voice coil positioner

And all made right here in the U.S.A.

All you have to do is call

# ATASI

ATASI Corporation, 2075 Zanker Road, San Jose, CA 95131 (408) 995-0335

## RAMPED UP AND SHIPPING

\*UNIX is a trademark of Bell Laboratories \*XENIX is a trademark of Microsoft Corporation \*OASIS is a trademark of Phase One Systems \*PICK is a trademark of Pick Systems

**CIRCLE NO. 91 ON INQUIRY CARD**





# We specialize in the kind of disk drive R&D you can bank on: Response and Delivery.

MPI is one company that hasn't forgotten how it achieved its position as a solid third in a highly competitive market.

First, we got there by offering you floppy drives that are every bit as reliable as we are. Because producing top-quality, top-performing drives has always been our number one commitment.

Our 5¼" line comes in three different densities (48 TPI, 96 TPI, 100 TPI) to match your application. They're single and double-sided drives with capacities from 250 Kbytes to 1 Mbyte. And our Slimline™ series, at 2" thick and 11.5" deep, are quite simply the smallest 8" disk drives ever made.

Second, we understand that even the

world's best-performing drives aren't much good if you can't get them when you need them. So we've created our own second source: Singapore's first computer peripheral manufacturing company, a plant that mirrors our plant in California and duplicates its high-precision output.

Third, when you need help, we're always ready to respond. And we think that's important. It's why we've made our product support group part of top management. Consequently, they've seen to it that our field support has grown as fast as our sales.

What all this adds up to is Response and Delivery, the only kind of R&D you can bank on. And that's what we specialize in at MPI.

**MPI**   
Micro Peripherals, Inc.

**CIRCLE NO. 92 ON INQUIRY CARD**

9754 Deering Avenue, Chatsworth, CA 91311. Phone (213) 709-4202. TWX (910) 494-1213.



## DISK DRIVES

# Trends in small Winchester disk drives

ANDREW ROMAN, Roman Associates International

*Growing market demands and competition are pushing 5¼- and 8-in. drives into smaller boxes with higher capacities*

As applications for desk-top computers become more sophisticated, requirements for small Winchester disk drives become more demanding. New disk drive products—many from new companies—are being introduced to address these new market opportunities. Developments in thin-film heads, media and smaller motor components are providing higher storage densities on smaller disks, packaged in more compact boxes. Current products boast improvements in capacity for half-height, removable cartridges and standard fixed 5¼- and 8-in. designs.

### Half-height Winchester

The half-height disk drive trend began last year with half-height floppies, and quickly carried over to the

micro-Winchester industry. These "slim-line" packages provide storage capacities comparable to their full-sized counterparts, but two half-heights can be placed in the space occupied by a single 5¼-in. minifloppy.

Half-height 5¼ Winchester with capacities in the 6M- to 12M-byte range are offered by Seagate Technology Corp., Shugart Associates, Tandon Corp., Miniscribe Corp. and newly formed Microscience International, Sunnyvale, Calif. Another start-up, Cogito Systems Corp., founded by a group of ex-IBM Corp. engineers in San Jose, Calif., will introduce a family of half-height 5¼-in. Winchester this year. Disctron, formed by a merger of Rotating Memory Systems, Inc., and Data Peripherals, introduced a half-height 5¼-in. Winchester offering 42.5M bytes on three platters at

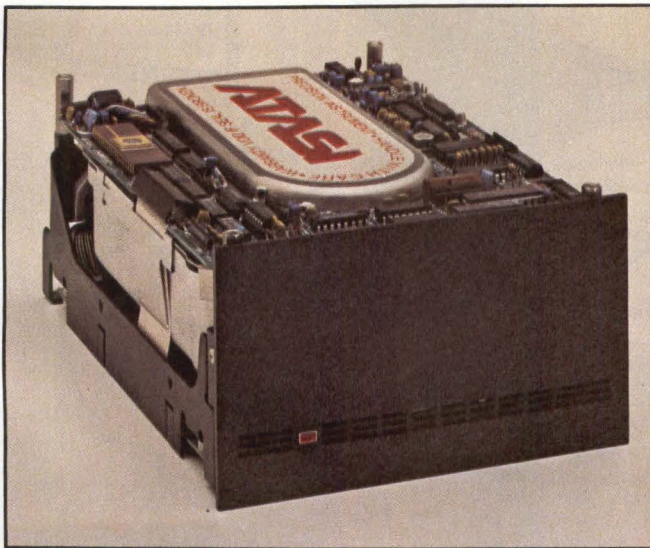

Atasi Corp.'s 5¼-in. 3000 series drive uses a linear voice-coil actuator controlled by a closed-loop servo system, providing 46M bytes of storage and a 30-msec. average access time.

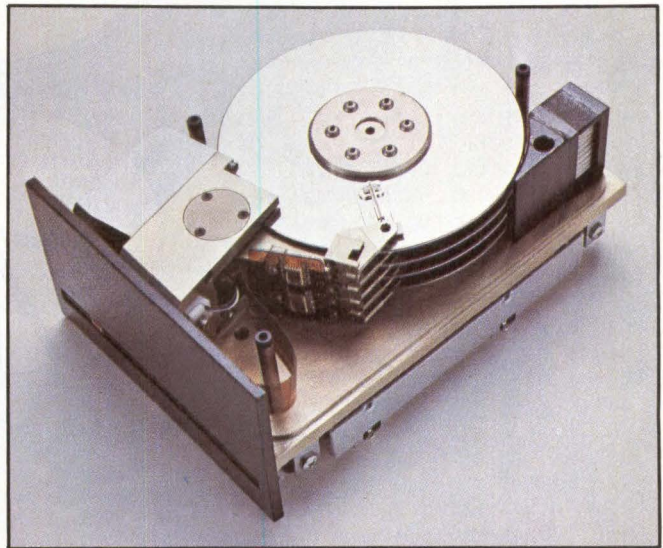

The Vertex V100 series of 5¼-in. Winchester offers as much as 72M bytes and a 30-msec. average access time using a dual-frequency servo system.



the 1982 Comdex in Las Vegas.

New media and head technologies promise to provide lower cost drives with greater capacity in smaller packages. Plated media and low-profile thin-film recording heads are two such technologies. Ampex Corp. and PolyDisc Systems, Inc., are the main suppliers of plated media to Winchester drive manufacturers. But many Winchester disk drive manufacturers are becoming vertically integrated and producing their own plated media. Such companies include Evotek, SyQuest Technology, Tandon, Disctron and long-established manufacturers Memorex Corp. and Control Data Corp.

Cybernex Corp., a year-old start-up in San Jose, Calif., will be among the first to manufacture non-IBM thin-film read/write heads. Cybernex will be joined by

independent thin-film head makers Magnex and Dastek Corp., as well as established head manufacturers Infomag and National Micronetics, Inc., both of which licensed their thin-film head designs from Cybernex.

Thin-film heads developed for 5¼- and 8-in. Winchesters resolve data signals at higher flux densities, which,

*Cartridge Winchesters provide data backup, convenient program/data loading and transportability.*

when combined with higher track densities, increase drive capacities without stacking more platters. Three-platter, slim-line, 5¼-in. Winchesters with capacities exceeding 100M bytes may not be far off. Diameter could shrink as well as height, leading to more drives such as SyQuest's 3.9-in., half-height Winchester. As long as the media is nonremovable, diameter standard-

**THE YEAR OF THE 5¼-IN. WINCHESTER**

By the end of the 1982 Comdex Conference in Las Vegas last December, the 5¼-in. Winchester industry numbered 40 manufacturers, accounting for 125 5¼-in. Winchester products. At the show, 25 new 5¼-in. Winchester products were announced and shown for the first time.

A total of 200,000 5¼-in. Winchester units valued at \$165 million were shipped in 1982. Shipments are projected to increase to 3 million units valued at \$3 billion by 1988. (Cost per megabyte continues to shrink, but higher capacities are pushing drive costs up.) These numbers include shipments for the two main market segments—the OEM and captive markets—and represent a combined annual growth rate exceeding 50 percent.

In 1982, 80 percent of 5¼-in. Winchester disk drive sales revenues were accounted for by drives with storage capacities of less than 10M bytes. Of projected 1988 revenues, 50 percent will be generated by 5¼-in. Winchester products with capacities as high as 25M bytes. The increasing market momentum caused by shipments in the Seagate Technology Corp. ST406/ST412/ST419 product category and those products' multiple second sources will maintain this high volume. In addition, the 3.9-in. Winchesters originated by SyQuest Technology and now second-sourced will account for 13 percent of 1988 sales revenues.

The growth of the 5¼-in. Winches-

ter industry has outstripped that of even the floppy disk industry. Total worldwide floppy disk drive shipments in 1976 accounted for only 175,000 units, valued at \$65 million, four years after Memorex Corp. and Shugart Associates announced the first independent OEM floppy disk drive design,

5¼-in. Winchester product mix 1982 Total sales: \$165 million

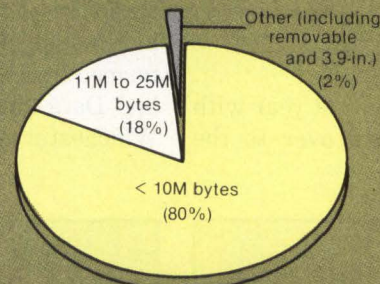

1988 Total sales: \$3.75 billion

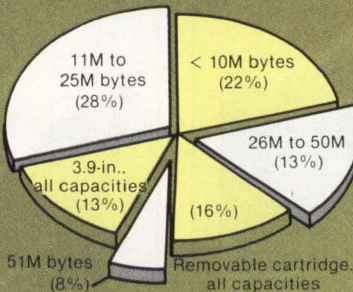

*The product mix for 5¼-in. drives will change over the next six years from one favoring drives with capacities of less than 10M bytes to one favoring higher capacity drives. Removable and 3.9-in. drives will also take a larger share of the market. Figures shown above are for 5¼-in. fixed disk drives except where noted.*

following IBM Corp.'s introduction of the floppy in 1971. In contrast, Seagate shipped 65,000 ST506 drives in the first full year of the drive's availability.

The 8-in. Winchester disk drive market also took four years to develop. In 1979, one year after IBM introduced the first 8-in. Winchester, OEM shipments totaled less than 10,000, valued at \$18 million. In 1982, OEM 8-in. Winchester shipments accounted for 175,000 units, valued at \$300 million. This market should increase to \$1.2 billion by 1988, including 9- and 10½-in. Winchesters.

8-in. Winchester market 1982

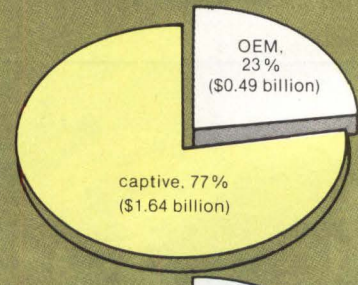

1988

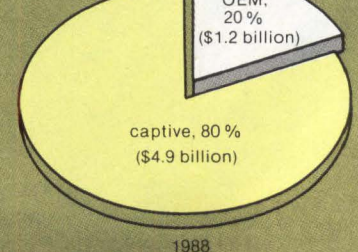

Source: Roman Associates International  
**The 8-in. Winchester market will almost triple over the next six years to more than \$6 billion.**



# IT'S HERE... IT'S NEW!

## A 5¼ INCH CARTRIDGE DISK DRIVE

### FOR

# \$495\*

That's right. You can now have a 5 megabyte Winchester 5¼" Cartridge Disk Drive for ONLY \$495.

The new Western Dynex Model WD505 Cartridge Disk Drive is an extraordinary memory system... offering all the advantages of removable and interchangeable media, and the precision of microprocessor controlled supervisory functions, including:

- Total thermal compensation
- High speed, micro-step data accessing
- Automatic data track calibration for each cartridge inserted
- Read/write and data recovery optimization
- Cartridge insertion and removal

The Model WD505 is a convenient low-cost memory solution for business, school and personal computer systems, and it offers expandability to 20 megabytes (4 drives) as your system grows. And perhaps more important, it provides virtually unlimited off-line storage with full cartridge interchangeability between drives.

And that's not all! The Model WD505 solves all the problems of both floppy disks and fixed disk Winchester drives. Reliability, data integrity and media durability is a great enhancement over the best of floppy systems. And as a backup to fixed disk Winchester drives, the WD505 is the ultimate answer. Other features include:

- Standard ANSI packaging... compatible with 5¼" fixed disk Winchester and mini-floppy drives
- Standard ST506 interface
- Soft sectoring, with variable format capability
- Automatic self-calibrating tracking
- Open loop positioning



### Call Today!

Western Dynex Corporation  
3536 West Osborn Road  
Phoenix, Arizona 85019  
(602) 269-6401  
TWX 910-951-4287

Order today! And remember, you can depend on Western Dynex, a company with more than 10 years of Cartridge Disk Drive manufacturing experience.

WESTERN  
**DYNEX**  
CORPORATION

CIRCLE NO. 93 ON INQUIRY CARD



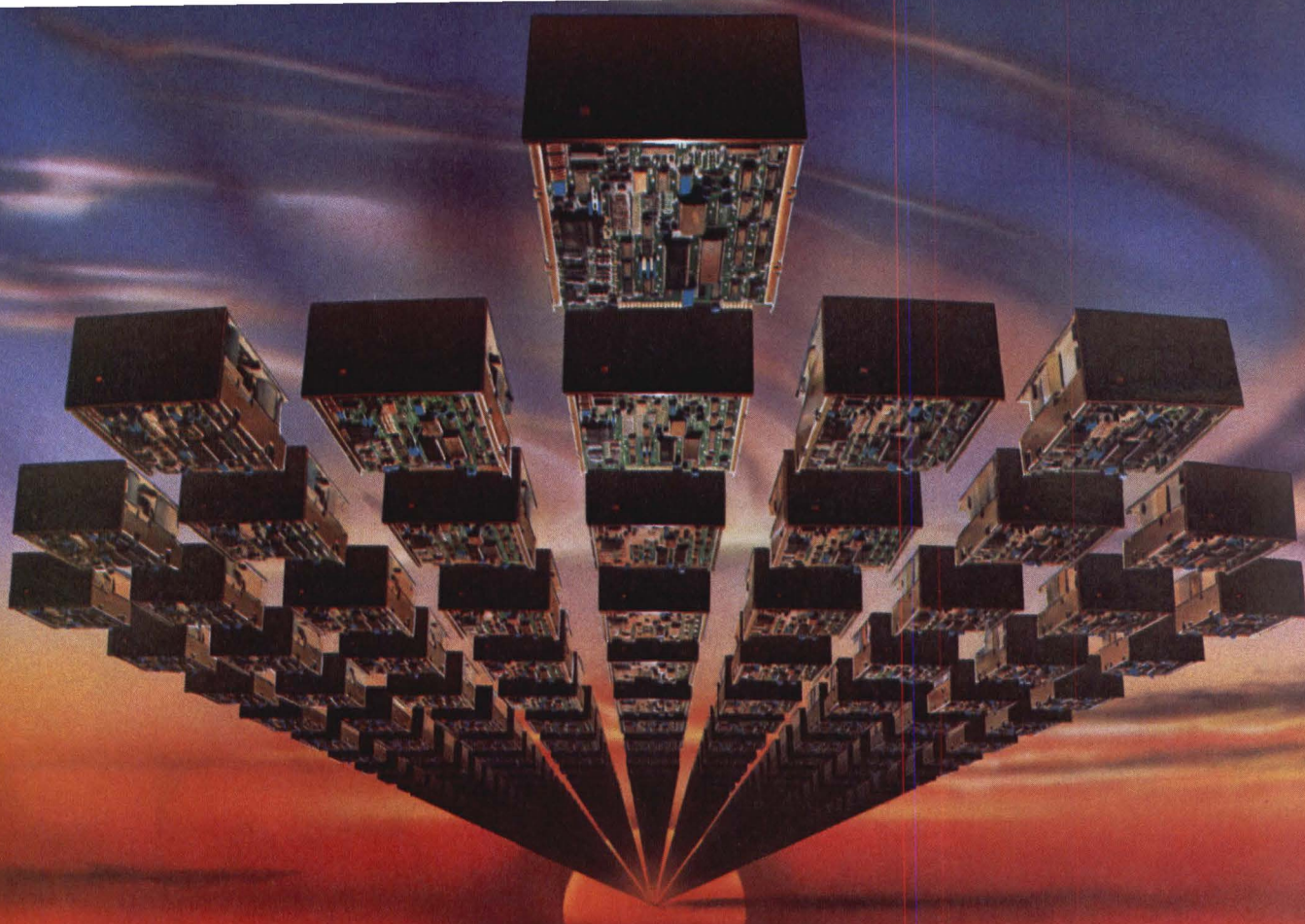

# 250 billion bytes delivered...

Reliable bytes, too. You've told us that. By the way you've ordered our high capacity 5 $\frac{1}{4}$ " Winchester drives. Again and again. By now we've delivered more high capacity drives than any other supplier. And we've increased our production capacity to 2,000 drives a day. Just to accommodate the demand.

But don't worry. It hasn't gone to our head. We're still just as careful of quality as ever. That care has given us the industry's lowest rejection rate. And the highest performance rating.

Whichever capacity you choose — 6MB, 12MB, 19MB or 40MB — you can always be confident that the last byte will be as good as the first. Call or write today for complete product and pricing information. 9216 Eton Avenue, Chatsworth, CA 91311 (213) 709-6445 TWX 910-494-4834

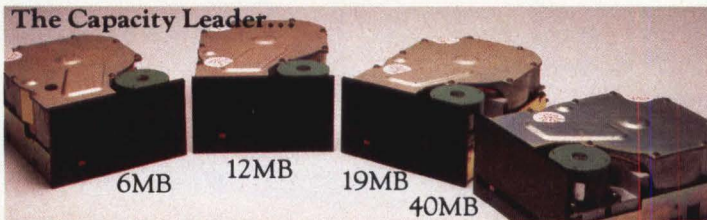

**Computer Memories, Inc.**

Ft. Worth, TX (817) 332-7859 / Irvine, CA, (714) 553-8880 / Springfield, MA, (413) 783-2386 / In Europe: Pangbourne Berks, UK, 07357-4120, Telex 849910. For small quantities, call Schweber Electronics, (800) 645-3040.

**CIRCLE NO. 94 ON INQUIRY CARD**



ization is not as important an issue.

Cartridge Winchesters provide data backup, convenient program/data loading and transportability. A major step in removability has been initiated with introductions of 5¼-in. removable cartridge drives from DMA Systems, Inc., Seagate, Western Dynex Corp., Memorex and Athenaem Technology, Inc., the first Boston-area small Winchester start-up.

The new DMA model 5/15, introduced at Comdex,

features 19.5M bytes of fixed and 6.5M bytes of removable storage, while the Athenaem drive provides 12.75M bytes of fixed and 12.75M bytes of removable storage. These drives all incorporate the ANSI standards for cartridge dimensions established by independent media manufacturer Dysan and second-sourced by Memorex. There are not, however, corresponding standards for data interchangeability, so one manufacturer's drives can't read data written on a cartridge by another manufacturer's drive.

Several new 8-in. Winchesters featuring removable cartridge drives were unveiled at the November Comdex. Newly formed Amcodyne, Longmont, Colo., demonstrated its 8-in. Winchester featuring 25.8M

**SMALL WINCHESTER TRENDS IN JAPAN**

Japanese companies shipping large-volume production units of 5¼-in. Winchesters include Mitsubishi, NPL, Fujitsu, TEAC (Seagate licensee), NEC and Nippon Electric Industries' Densai Division. A total of 90 percent of these drives are shipped to domestic customers or used internally.

The state of 5¼-in. disk technology in Japan is one year behind that of U.S. vendors. Some Japanese vendors' products store 6M bytes on two platters, compared to one platter for most U.S. vendors, with some storing as much as 20M bytes on three platters. All of these drives feature low-cost stepper-motor actuators and standard oxide-coated media. NEC, Fujitsu and Hitachi have developed plated-media technology and may incorporate it into their 5¼-in. drives when the market opportunity arises.

Missing in the 5¼-in. Winchester fray are established disk drive manufacturers Y.E. Data, Toshiba, Panasonic, Sony, Tokyo Electric Co. and Hokushin. These small Winchesters moved so fast in the U.S. during the past 30 months that many Japanese manufacturers feel that the market is too fluid for them.

Fujitsu, NEC, Hitachi and Mitsubishi will offer 8-in. Winchesters in the 160M-byte range to the U.S. market. All will offer the SMD interface, and aim at Control Data Corp.'s large, diversified customer base. The most unique drive in this category, effectively competing against both high-performance 8- and 14-in. Winchesters, is the 10½-in. Fujitsu Eagle, with a storage capacity of 474M bytes. More than 6000 units have been shipped since the product's introduction in 1981 (MMS, February, 1981, p. 111).

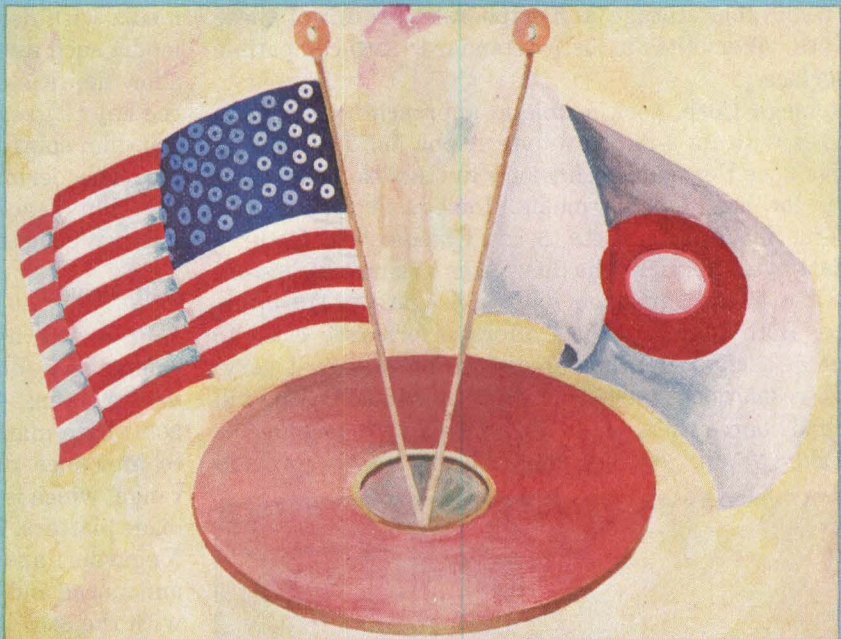

*Illustration by Mark Fallon*

Large computer companies such as Fujitsu, NEC and Hitachi are producing their own IBM-type Winchester heads and media (developed for their IBM-compatible 14-in. drives) and incorporating them in their own drives. Others, such as TEAC, Nippon Electric/Densai and Mitsubishi, purchase these critical drive components from these suppliers as well as the same industry suppliers used by U.S. manufacturers. NPL, 50 percent owned by Fujitsu and 50 percent by Hitachi, obtains its small Winchester drive components from its two parent companies.

The Fujitsu disk drive manufacturing plant in Kumagaya produces low-cost 8- and 14-in. Winchesters through highly advanced factory automation. Within four months after production start-up in June, the build

rate for 8-in. Winchester products had been ramped up to within 66 percent of maximum capacity. Automatic radio-controlled carts feed sub-assembly components to the disk drive assembly lines, while automatic handlers position the drives into and out of automated burn-in and test racks. After final test, the handlers and carts transport the finished Winchester for crating and shipping.

It seems likely that Japanese vendors will attempt to establish a leadership role for themselves in some segment of the disk drive market. For now, however, Japanese disk drive manufacturers still look to U.S. companies for technology and market leadership and will continue to develop and supply Winchester disk drives on a second-source basis.



bytes of fixed and 25.8M bytes of removable capacity, using cartridges compatible with the ANSI 8-in. standard. CDC's new Lark II also features 25.8M bytes of fixed and 25.8M bytes of removable storage, while Digital Equipment Corp. is expected to announce its Aztec 8-in. Winchester drive soon. The Aztec uses a proprietary cartridge that is not mechanically compatible with the ANSI standard. This ANSI cartridge was adopted earlier by Century Data Systems, Inc., in its model C2048 announced at the 1982 National Computer Conference, with 16M bytes of fixed and 32M bytes of removable capacity. Vermont Research unveiled its 8-in. model 8520 with 11M bytes of fixed and 11M bytes of removable storage at Peripherals '82. All of these drives offer the industry-standard SMD-compatible interface.

Iomega Corp. took a unique approach to cartridge drives with its 8-in., 10M-byte Alpha 10. The Iomega drive uses Bernoulli technology to stabilize head flight over low-cost flexible media. Iomega showed a new 5¼-in. model, the Beta 5, at Comdex. It features 6.38M-byte capacity. The drive uses a removable 5¼-in. flexible media cartridge with a Seagate ST412 interface. Both Iomega drives offer performance close to that of a rigid Winchester disk using standard very-high-resolution 8- or 5¼-in. flexible media. Dysan will second-source the 8-in. Iomega media and cartridge.

Like 5¼-in. drives, many 8-in. drives provide



**Cogito Systems' Cogitator 912** 6M- or 12M-byte half-height 5¼-in. Winchesters use a linear actuator with IBM 3380-type-head-suspension ramp-loaded manganese-zinc read/write heads.

physical cartridge compatibility, but not read/write compatibility. Development of an industry standard along these lines is mandatory if the cartridge drive industry is to continue its encouraging growth.

### High-capacity 5¼-in. drives

Increased competition between the 40 5¼-in. Winchester disk drive manufacturers accounts for 125 disk drive models introduced in the three years since Seagate originated the industry.

Second-wave competitors entered the fray with higher performance 5¼-in. drives featuring capacities ranging from 35M to 140M bytes. Such products open applications for 16- and 32-bit microcomputers used for high-resolution graphics, local-area networks and other multitasking/multi-user markets.

Closed-loop rotary, voice-coil actuators with servo-control information pre-recorded on a dedicated surface precisely position read/write heads over standard oxide media with densities of 960 tpi and 10,000 bpi. Plated media such as that used by Evotek and SyQuest could allow densities exceeding 2000 tpi and 25,000 bpi. But the key to greater densities on less real estate may be thin-film sputtered media designed for vertical recording. The performance of these media, enhanced with thin-film heads, should set new standards for the micro-Winchester industry in the next few years.

### 8-in. drives

Propelled up past the 100M-byte range by the competitive onslaught of the high-capacity, 5¼-in. drives, 8-in. Winchesters are now aiming at the 200M-byte mark. Several manufacturers are preparing to announce drives targeted close to the 200M-byte range, which is accomplished by stacking standard 8-in. oxide platters. Fujitsu America, Inc., Micropolis Corp., Megavault and NEC Information Systems, Inc., have announced and will soon ship such 8-in. Winchesters, all with the SMD interface.

The most significant recent product introduction was CDC's model 9715 last June at NCC. This 165M-byte fixed storage drive broke the 8-in. floppy form factor barrier, both with its 230-mm. (9-in.) diameter media and drive box dimensions of 10½ × 8¾ × 24 in. A companion drive featuring removable media with a three-platter cartridge for backup stores 92.9M bytes and mounts beside the fixed version in a standard 19-in. rack-mount slot 10½ in. high.

New entrants to the small Winchester battle will continue to emerge, but the competition will be much heavier. □

**Andrew Roman** is an independent technical and marketing consultant to the disk drive industry. He has held engineering and marketing management positions with NCR Corp., Control Data Corp., Pertec Computer Corp. and Diablo Systems, Inc.

The following tables, compiled by Andrew Roman Associates International, list specifications for 5¼- and 8-in. Winchester disk drives.



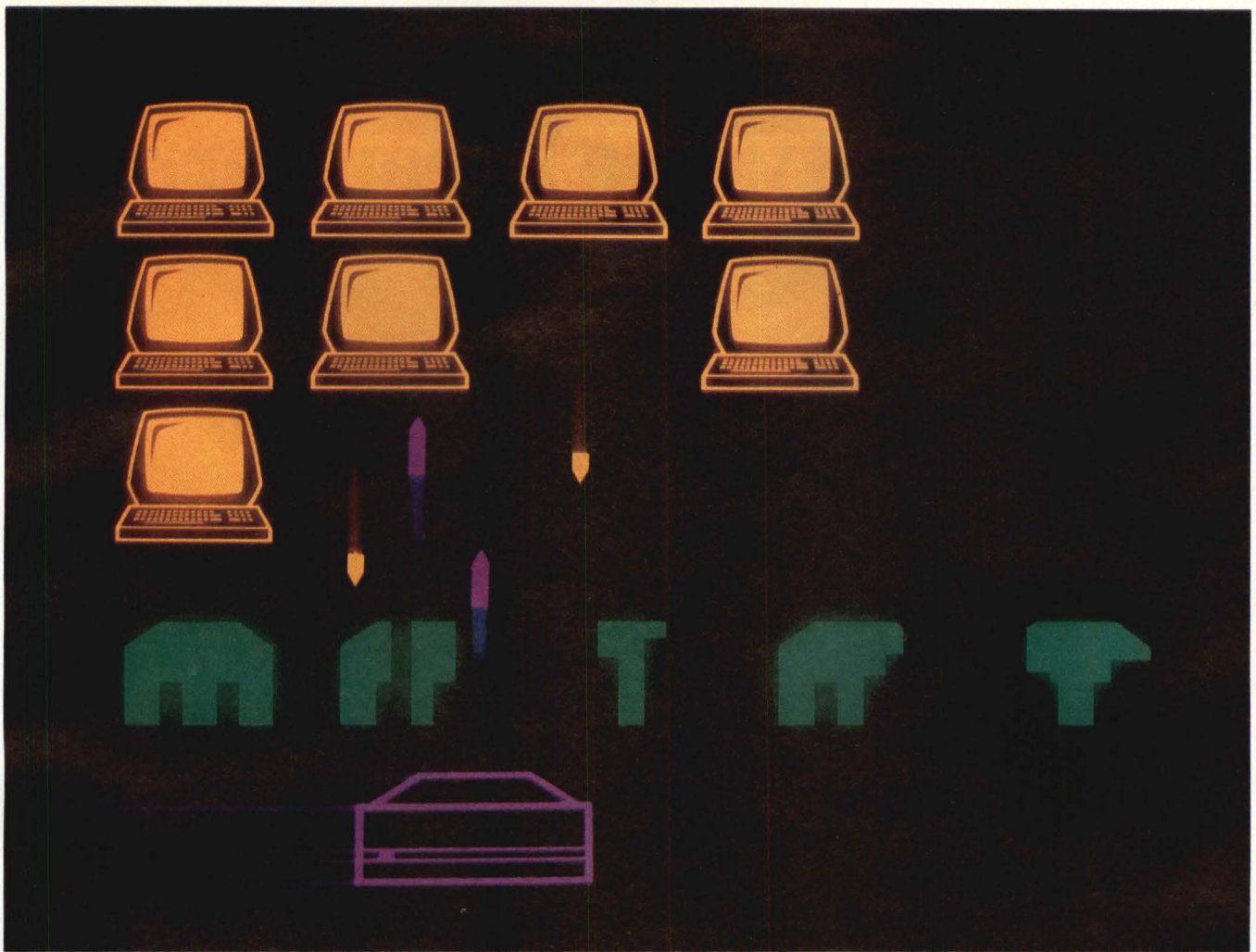

# DON'T LET 5 1/4" WINCHESTERS SHOOT DOWN YOUR MULTI-USER SYSTEM PLANS

Now you can design truly high performance systems with the VERTEX V100 5 1/4" family; 31MB, 52MB, 72MB capacity; 30 msec average access time; industry standard mounting, interface and transfer rate.

There was a time when "high performance system" meant "big disk system." Not anymore. The low cost VERTEX V100 family brings you big disk performance, all right. But in a compact 5 1/4" format. What's more, your system is prob-

ably already designed for the V100 family since it uses the industry standard interface and 5 Mb/secs transfer rate.

The V100 family is actually the first of a series of VERTEX drives designed for even higher performance and capacities. That means you get peak performance today with superior design integrity. And each VERTEX drive is backed by a team that has been responsible for the design and

**CIRCLE NO. 95 ON INQUIRY CARD**

manufacture of over 3,000,000 disk drives. So while VERTEX is a new company, our production and quality assurance programs have been fine-tuned to deliver highly reliable products, on time. You can plan on it!

Don't delay your high performance system plans any longer. Call Norm Hayes, Director of Marketing, today at (408) 942-0606. Or write VERTEX, 2150 Bering Drive, San Jose, CA 95131.

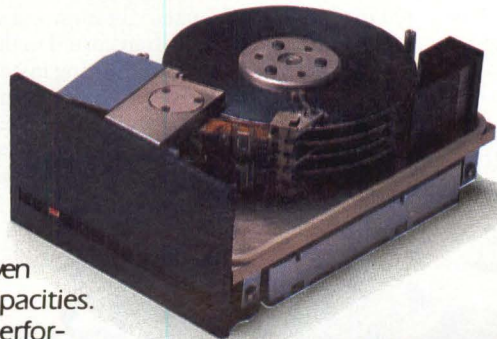

**VERTEX**  
PERIPHERALS

You Can Plan On Us . . .



# IMI reinvents the 5¼" Winchester. And backs it with a 2-year warranty.

If our new 5000H Series drives weren't the most reliable 5¼" Winchesters ever built, we wouldn't give them an unprecedented 2-year warranty.

Don't expect to use it, though. 5000H Series drives are made to withstand the everyday abuse known as "normal system usage." And to give continuously superior performance in even the most demanding applications.

So the overwhelming odds are that the 2-year warranty will expire long before the drive ever does.

## THIN-FILM PLATED MEDIA PRESERVES DATA INTEGRITY, INCREASES STORAGE CAPACITY.

To ensure that 5000H drives withstand harsh treatment without sacrificing data integrity, the media is thin-film plated. Thin-film plating is orders of magnitude more shock resistant than ferric oxide coatings and many times harder. Because it's not easily damaged, data is not easily lost, and the drive remains in service.

Thin-film plated media also allows greater bit densities, as much as 10,700 bpi. This has enabled IMI to up the unfor-

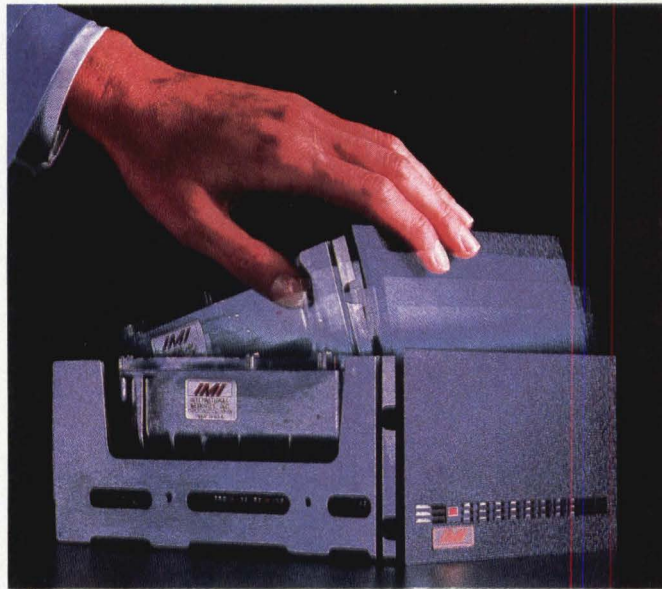

matted storage capacity of the 5021H drive, for example, to 21 Mbytes.

And to improve data integrity even further, we've maintained industry standard formats and transfer rates with lower track densities.

## NEW 2-PIECE SHOCK-MOUNTED CHASSIS EXTENDS SERVICE LIFE.

To protect the heads and disks, we've recessed the head/disk assembly inside a rigid, die-cast frame enclosure. Integral shock mounts at the center of gravity insulate the head media interface from the environment.

Besides reducing acoustical noise, this 2-piece design minimizes vibration and shock loads transferred to the heads and disks during installation and use. Even the printed circuit boards utilize the shock-mounted design to lessen stress on the components.

## NEW THERMALLY STABLE DESIGN ENSURES OPTIMAL HEAD POSITIONING.

5000H Series drives have a deeply finned die-cast base and cover that increase both the stiffness of the structure and the surface area for heat transfer.

When thermal distortion of the head/disk assembly is minimized, head positioning is optimized. And the combination of temperature stability and lower track densities substantially reduces the potential for off-track errors.



**NOW FASTER. TIME**  
**68 MSEC**  
(INCLUDES SETTLING TIME)  
**ACCESS TIME**

## HEAD-MOUNTED PREAMPLIFIER PROVIDES MAXIMUM NOISE IMMUNITY.

Only IMI puts the read/write preamplifier on the head stack, where it greatly reduces EMI/RFI noise susceptibility. This, coupled with the inherently higher signals of plated media (>50%) and the shielding of the all metal frame, yields the best signal to noise ratio in the industry.

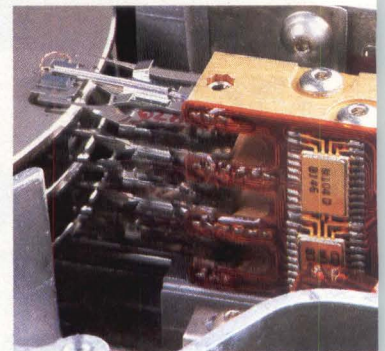

## A FULL LINE OF HIGH PERFORMANCE 5¼" WINCHESTERS.

Although the unformatted storage capacity ranges from 6.38 Mbytes to 21 Mbytes, depending upon the drive model and interface, all 5000H Series drives feature:

- 68 msec access time.
- 303 tpi.
- 3600 rpm.

For specification sheets, call or write: International Memories Incorporated, 10381 Bandy Drive, Cupertino, CA 95014. (408) 446-9779. TWX: 910-338-7347

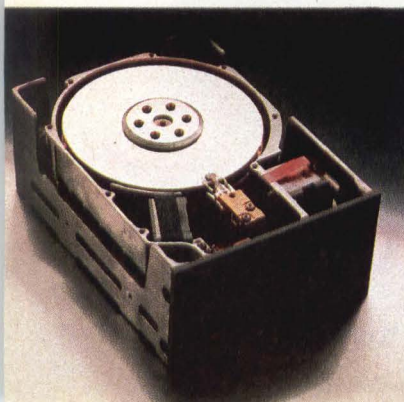

**IMI**  
**We're at it again.**

CIRCLE NO. 96 ON INQUIRY CARD



### 5¼-in. Winchester specifications

Company and model	Unformatted capacity (M bytes)	No. of disks/ no. of r/w heads	Bytes per track	Tracks per in./ bits per in.	Avg. positioning time (msec.)	Actuator type	Data-transfer rate (K bytes/sec.)	Interface type	OEM price (Qty. 100)	Comments
Ampex										
Pyxis 7, 13	6.67, 13.3	1/2, 2/4	10,417	360/8720	90	Stepper	625	ST506/ST412	\$660, \$735	Rodime licensee
Pyxis 20, 27	20, 26.6	3/6, 4/8	10,417	360/8720	90	Stepper	625	ST506/ST412	\$885, \$1025	
Atasi										
3020, 3033	19, 33	2/3, 3/5	10,416	800/8780	30	Linear voice coil	625	ST412	\$1920, \$2300	Linear closed-loop servo composite M <sub>n</sub> Z <sub>n</sub> r/w heads
3046	46.3	417	10,416	800/8780	30	Linear voice coil	625	ST412	\$2660	
Athenaeum										
Aegis 10/10	25.5	2/4	10,420	690/9074	35	Linear voice coil	625	ST506/ST706		12.7M bytes removable, 12.7M bytes fixed. Both drives feature closed-loop servo-controlled linear voice coil
Aegis 30	38.25	3/6	10,420	690/9074	35	Linear voice coil	625	ST506/ST412		
BASF										
6182	6.38	2/4	10,416	254/7690	61	Stepper	625	ST506/ST412		Not marketed in U.S.
6184	9.57	3/6	10,416	254/7690	92	Stepper	625	ST506/ST412		
Cogito Systems										
CG906	6.38	1/2	10,416	345/8841	85	Stepper	625	ST506/ST412		New slim-line series measures 1.625-in. high
CG912	12.76	2/4	10,416	345/8841	85	Stepper	625	ST506/ST412		
Computer Memories										
CM5412, 5619	12.7/19.1	2/4, 3/6	10,416	355/8650	130	Stepper	625	ST506/ST412	\$940, \$1190	Closed-loop servo positioner
CM5640	40	3/6	10,416	690/9650	40	Stepper	625	ST506/ST412	\$1680	
Control Data										
9415-19	19	2/3	10,080	800/8730	50	Rotary voice coil	605	CDC, ST506	\$1620	Closed-loop servo positioner
9415-32	32	3/5	10,080	800/8730	50	Rotary voice coil	625	CDC, ST506	\$1965	
Cynthia Peripheral										
D505, D510	6.38, 12.7	2/4, 2/4	10,416	255/7690	170	Stepper	625	ST506/ST412	\$1350*	Manufactured under Seagate license; 1 fixed, 1 removable
D520	25	2/4	10,416	860/9200	40	Stepper	625	ST706/DMA		
DMA Systems										
5R, 5/5	6.5, 13	1/2, 2/4	10,890	454/8617	40	Linear voice coil	625	ST706	\$1565, \$1800	Removable media
5/10, 5/15	19.5, 26	2/4	10,890	908, 1156 TPI	40	Linear voice coil	625	ST706	\$1395, \$1450*	Removable media
26F, 39F	26, 39			908, 1156 TPI	40	Linear voice coil	625	ST506/ST412	\$990, \$1250*	Fixed media
Disctron										
D507, D514	638, 12.75	1/2, 2/4	10,417	383/8944	77	Stepper	625	ST506/ST412	\$905, \$1140	Data separator
D519, D526	19.13, 25.5	3/6, 4/8	10,417	383/8944	77	Stepper	625		\$1305, \$1460	PCB available
Evotek										
ET5510, 5520, 5530, 5540	7, 15, 23, 31	1/2, 1/2, 2/4, 2/4	10,416	367/9825	49	Stepper	625	ST506/ST412	\$1275, \$1475, \$1975, \$2375	Plated media made by Evotek
ET5810, 5820, 5830, 5840	12, 25, 38, 51	3/6, 3/6, 4/8, 4/8	17,220	367/16,250	49	Stepper	1025	ST506/ST412	\$1375, \$2075, \$2375, \$2675	
Fujitsu										
M2233	13.3	2/4	10,416	254/8020	95	Stepper	625	ST506/ST412	\$875	Also available with SA400 interface
M2234	20	3/6	10,416	300/10,200	95	Stepper	625	SA4000	\$1050	
Hitachi										
DK501-2, -3	10, 13.3	3/6, 4/8	10,416	254/7800	78	Stepper	625	ST506		

\* Quantity 1000    \*\* Quantity 500    \*\*\* Quantity 2500



### 5¼-in. Winchester specifications

Company and model	Unformatted capacity (M bytes)	No. of disks/ no. of r/w heads	Bytes per track	Tracks per in./ bits per in.	Avg. positioning time (msec.)	Actuator type	Data-transfer rate (K bytes/sec.)	Interface type	OEM price (Qty. 100)	Comments
International Memories										
5012H, 5018H	12.7, 19.1	2/4, 3/6	10,416	303/9706	68	Stepper	625	ST506/ST412	\$800, \$900	On-board data separator, plated media, closed-loop servo
5014H, 5021H	15.9, 23.9	2/4, 3/6	11,459	303/10,700	120	Stepper	687.5	IMI bus ST506,	\$890, \$990	
5040H	41.25	3/6	10,417	606/10,300	68	Stepper	625	IMI		
Irwin Olivetti										
1510, 1516	12.2, 16	1/2	9950	900/924	33	Rotary voice coil	675	Irwin	\$2035, \$1406	Includes 6.38M-byte tape cartridge; plated disk, embedded servo
1416	16	1/2	9950	900/9950	34	Rotary voice coil	675	Irwin	\$2212	
562/12, 562/13	7.5, 11.2	2/1, 3/1	10,417	254/7820	84	Stepper	725	ST506/ST412	\$880, \$1075	
Matsushita Communications										
SA604, SA606	6.6, 10	2/1, 3/1	10,416	256/7900	75	Stepper	625	ST506		Shugart licensee, not sold in U.S.
Maxtor										
XT 1065, XT 1105	66, 105	4/7, 6/11	10,416	980/11,155	30	Rotary voice coil	625	ST506/ST412	\$1520, \$2100	Closed loop
XT 1140	143	8/15	10,416	980/11,155	30	Rotary voice coil	625	ST506/ST412	\$2690**	
Memorex										
306, 310	6.6, 10	2/1, 3/1	10,416	254/8020	95	Stepper	625	ST506/ST412	\$750, \$920	Manufactured by NPL
Micropolis										
1303, 1304	34.6, 51.9	2/1, 3/1	10,416	960/9400	38	Rotary voice coil	625	ST506/ST412	\$1313, \$1024*	Closed-loop servo
Microscience International										
HH612	12.76	1/4	10,416	648/9680	85	Stepper	625	ST506/ST412		Two heads per surface, dual micro-processors
Miniscribe										
2006, 2012	6.4, 12.8	1/2, 2/4	10,416	402/8280	85	Rack and pinion	625	ST412	\$600, \$675	Buffered seek, half-height, temperature compensated
3006, 3012	6.4, 12.8	1/2	10,416	588/10,000	85/155	Rack and pinion	625	ST412		
4010, 4020	10, 20	1/2, 2/4	10,416	588/8575	120	Rack and pinion	625	ST412	\$690, \$825	
Mitsubishi										
4863-2, -3	6.6, 10	2/4, 3/6	10,416	256/7900	75	Stepper	625	ST506		
NEC										
DT 210	6.38	2/4	10,416	200/8935	102	Stepper	625	ST506/ST412		
New World Computer										
Micro-Disk V 4/0, 2/2	4, 2	1/8, 2/16	13,000	250/9000	28	Stepper	782	ST506, SA1000	\$906, \$1006	2M bytes in removable HDA
Micro-Disk V 4/2, 44	6, 8	2/16, 2/6	13,000	250/9000	28	Stepper	782	ST506, SA1000	\$1196, \$1436	4M bytes in removable HDA
Nippon Electric-Densei										
RD-5067, RD-5100, RD-5133	6, 10, 13	2/4, 4/8	10,416	254/8200	95	Stepper	625	ST506		Not marketed in U.S.
Nippon Peripherals										
NP05-6, -10	6.6, 10	2/4, 3/6	10,416	254/8020	175	Stepper	625	ST506		Distributed by Memorex
Priam										
Diskos 502	55	4/7	10,416	960/9000	35	Linear voice coil	625	ST412		

\* Quantity 1000    \*\* Quantity 500    \*\*\* Quantity 2500



# The 100<sub>MM</sub> Winchester. Removable. Half Size. Half Price. Full Performance.

It's here. Winchester capacity and performance at half the size, half the price. And yes, available in removable or fixed disc drives.

The SyQuest 100mm (3.9") SQ306 packs five megabytes (formatted) in half the height of a 5¼" Winchester. And when the Q-Pak™ cartridge is full, just slip in another one. It's the best of both worlds—the reliability of Winchester with the portability of removable cartridges.

## A better drive.

**SyQuest drives give you a better fit.** Mount SyQuest drives almost anywhere. Under a keyboard. In your terminal. Fit two in one minifloppy space. SyQuest drives are only 1.625 inches high, 4.8 inches wide, and 8 inches deep.

**Easy integration.** The SQ306 has the same pin-outs, timing, data transfer rates, and track/sector formatting as industry-standard 5¼" Winchester drives. Use standard Winchester controllers and interfacing procedures, standard minifloppy DC power supplies.

**Better price/performance.** SyQuest delivers five megabytes with proven Winchester heads, positioning, brushless motors and air filtration. Buffered seek reduces average seek time to 75 msec. But the cost is half of comparable 5¼" Winchesters.



## Q-Pak™ —a better cartridge.

**Better reliability.** Closed-loop servo with imbedded digital servo (**DigiLok™**) ensures cartridge interchangeability while allowing variable sectoring. **Chromaflex™** graphite coated thin film metallic alloy discs protect against contamination. No long purge cycle required.

## Available now.

**SyQuest is shipping.** Second sources are available. So order your evaluation units today. For more product information, circle our readers' service number. For delivery and pricing information, write or call Larry Sarisky, SyQuest Technology.

## It Fits.



**SyQuest**  
TECHNOLOGY

47923 Warm Springs Blvd. Fremont, California 94538  
415/490-7511 TWX 910-381-7027

Distributed by Hamilton/Avnet  
213/615-3915

CIRCLE NO. 97 ON INQUIRY CARD



# WE'VE GOT IT ALL

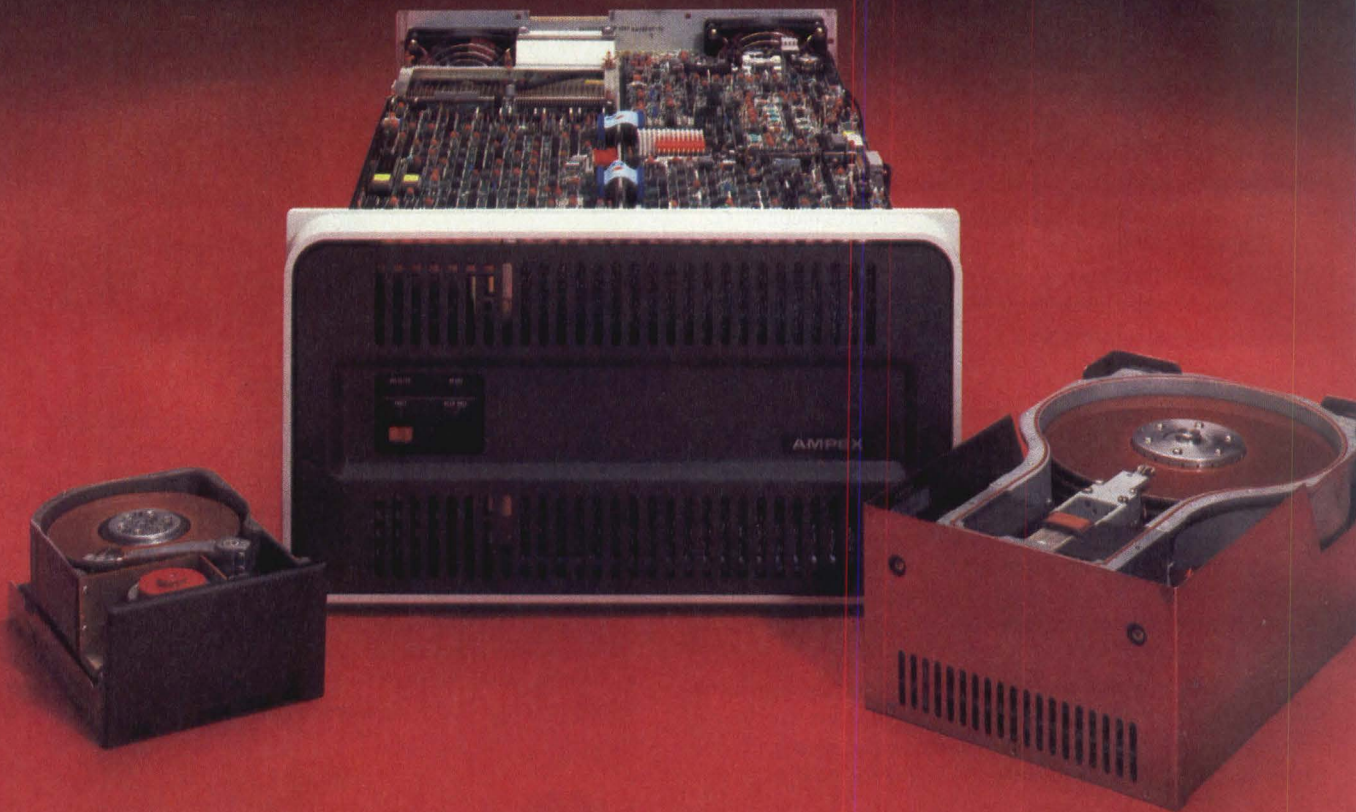

## FROM 7MB TO 330MB IN 5¼", 8" AND 14" WINCHESTER FAMILIES.

Ampex's Winchester families deliver the performance you need in today's competitive marketplace. There's 5¼" Pyxis with up to 27MB; 8" Scorpio with up to 83MB; and 14" Capricorn with up to 330MB. All offer the features you want, like automatic disk and head locking; industry-standard interfaces and packaging; power-up self-test and diagnostics; and capacity expansion. None requires any preventive maintenance.

Our Winchester disk drives are backed by a continuing Ampex commitment to leading-edge technology research, automated processes, and vertical

integration beginning with heads and media; by a highly professional worldwide service and support organization; and by manufacturing capacity in excess of a half-million square feet located in four countries.

That's why you can count on Ampex to deliver whatever you need in Winchester disk drives, today and tomorrow.

Ampex Corporation, Memory Products Division, 200 North Nash Street, El Segundo, CA 90245. 213-640-0150. TWX: 910-343-6243.

### AMPEX

Ampex Corporation • One of The Signal Companies   
CIRCLE NO. 98 ON INQUIRY CARD



### 5¼-in. Winchester specifications

Company and model	Unformatted capacity (M bytes)	No. of disks/ no. of r/w heads	Bytes per track	Tracks per in./ bits per in.	Avg. positioning time (msec.)	Actuator type	Data-transfer rate (K bytes/sec.)	Interface type	OEM price (Qty. 100)	Comments
Quantum										
Q520, Q530, Q540	21, 32, 42	2/4, 3/6, 4/8	10,416	591/9200	45	rotary coil	625	ST412		Temperature compensated servo
Rodime										
R0201, 202, 203	6, 13, 20	2/4, 3/6	10,416	360/8720	90	Stepper	625	ST506/ST412	\$720, \$890, \$1060	Made in Scotland
R0204, 206, 208	26, 40, 53	3/6, 4/8	10,416	600/10,200	90	Stepper	625	ST506/ST412	\$1285	
Seagate										
ST406, 412, 419	6, 12, 19	1/2, 2/4, 3/6	10,416	345/9074	85	Stepper	625	ST412	\$850, \$1030, \$1250	Manganese zinc composite heads, half-height, removable cartridge
ST206	6.38	1/2	10,416	345/9074	85	Stepper	625	ST412		
ST706	6.38	1/2	10,416	270/10,202	100	Stepper	625	ST706		
Shugart										
SA604, 606	6, 10	2/4, 3/6	10,400	256/7900	99		625	ST506	\$1090, \$1275	Half-height
SA706, 712	6.67, 13.3	1/2, 2/4	10,416	360/9036	99		625	ST412		
Syquest										
SQ 306F	6.38	1/2	10,416	435/12,000	75	Stepper	625	ST412	\$600	3.9-in. diam. plated disk
SQ 306R	6.38	1/2	10,416	435/12,000	75	Stepper	625	ST412	\$600	3.9-in. diam. disk, removable, half-height
Tandon										
TM501, 502, 503	6, 12, 19	1/2, 2/4, 3/6	10,416	345/9074	206	Stepper	625	ST412	\$705, \$890, \$1055	Buffered seek closed-loop servo
TM703	31	3/5		600/10,000	85	Rotary voice coil	625	ST412		
TEAC										
SD506, SD412	6, 12	2/4, 2/4	10,417	345/9074	170	Stepper	625	ST506/ST412		Seagate licensee; marketed only in Far East
Texas Instruments										
525/61	6.38	1/2	10,416	400/9200	115	Stepper	625	ST412	\$820	Plated media
525/122	12.76	2/4	10,416	400/9200	115	Stepper	625	ST412	\$1055	Plated media
Vertex										
V130, V150	30.8, 51.4	2/3, 3/5	10,416	960/9920	30	Rotary voice coil	625	ST412		Thin-film media, composite manganese zinc r/w heads
V170	72	4/7	10,416	960/9920	30	Rotary voice coil	625	ST412		
Western Dynex										
WD 505	6.38	1/2	10,416	345/9022	45	Stepper	625	ST412	\$875	Removable media

### 8-in. Winchester specifications

Company and model	Unformatted capacity (M bytes)	No. of disks/ no. of r/w heads	Bytes per track	Tracks per in./ bits per in.	Avg. positioning time (msec.)	Actuator type	Data-transfer rate (K bytes/sec.)	Interface type	OEM price (Qty. 100)	Comments
Amcodyne										
Arapahoe 7110	51.6	2/4	20,160	550/10,000	35	Linear voice coil	1229	SMD		Removable 8-in. ANSI cartridge
Ampex										
Scorpio 48, 84	49.7, 82.9	2/3, 3/5	20,160	826/10,104	32	Linear voice coil	1209	SMD	\$2,460, \$3445	
Century Data Systems										
C2048	50.19	3/6	20,160	480/9873	30	Linear voice coil	1209	SMD	\$2920	Removable 8-in. ANSI cartridge
* Quantity 1000	** Quantity 500	*** Quantity 2500								



### 8-in. Winchester specifications

Company and model	Unformatted capacity (M bytes)	No. of disks/ no. of r/w heads	Bytes per track	Tracks per in./ bits per in.	Avg. positioning time (msec.)	Actuator type	Data-transfer rate (K bytes/sec.)	Interface type	OEM price (Qty. 100)	Comments
Cii Honeywell Bull Cynthia D140, D145	24	2/4	12,800	500/4750	50	Linear voice coil	920	SASI	\$2970, \$3390	Removable 10½-in. diam. Fixed 10½-in. diam.
Cynthia Peripheral D160-8	145	4/8	12,800	500/4750	50	Linear voice coil	920	SASIL		
Control Data 9410-24, 32, 40 9457 Lark II	24, 32, 40 50	2/1, 3/4, 3/5 2/4	13,440 20,672	554/6800 715/10,161	50 35	Rotary voice coil Linear voice coil	806 1209	SMD, ISI, Lark, Finch SMD, ISI, Lark	\$1820, \$2045 \$2280 \$3440	Variable sectoring Removable 25M-byte cartridge Removable pack; 3 disks 9-in. diam. Fixed, 9-in. diam.
9710 (RSD)	82.9	3/5	20,160	550/10,000	30	Linear voice coil	1209	SMD	\$4960	
9715 (FSD)	165.9	6/10	20,160	550/10,000	30	Linear voice coil	1209	SMD	\$4910	
Disctron DP100 Lynx	10.6	1/2	13,440	478/6968	60	Linear voice coil	875	SA1000, LMD	\$1960	Removable 8-in. ANSI cartridge Fixed media
DP400 Puma	46.4	2/4	13,440	640/8335	60	Linear voice coil	875	SASI, SA1000, LMD	\$2250	
D1600	157.5	4/7	13,440	960/10,780	30	Linear voice coil	1209	SMD		
Fujitsu M2302, M2303	23.7, 47.5	2/4, 4/8	24,320	196/12,360	70	Rotary stepper	1200	SA4000	\$1850	
M2311K, M2312K	48.2, 84.4	3/4, 4/7	20,480	720/9550	20	Rotary voice coil	1229	SMD	\$2925, \$3400	Closed-loop servo control
M2351A Eagle	474.2	6/10	28,160	880/12,790	18	Rotary voice coil	1859	SMD	\$8800	Compact 10½-in. diam. disks
Hitachi DK811-4, -8	48, 89	4/6, 6/11	12,800	480/7495	25	Rotary voice coil	904	SMD		
Hokushin Electric CD8010P	11.5	2/4	15,151	180/7475	73	Stepper	900			Distributed by Priam in the U.S.
IBM (OEM) 676	38.6	2/4	21,700	523/10,312	40	Linear voice coil	1250	SASI	\$2750	S/23 drive, closed-loop servo Piccolo drive
680	64.5	6/11	16,384	450/8530	27	Rotary voice coil	1031		\$5500	
International Memories 7720, 7740	20, 41.9	2/3, 3/5	10,800	300/6200	35	Linear voice coil	648	IMI or ANSI	\$1475, \$1825	
8740, 8757	41.9, 58.7	3/5, 4/7	10,800	600/6200	50	Linear voice coil	648	IMI or ANSI		
8100	94.13	4/7	10,416	800/6588	39	Linear voice coil	625			
Kennedy 6172, 6173	24, 40	2/3, 3/5	13,444	500/6542	40	Linear voice coil	800	ANSI, SMD	\$2395, \$2555	Acquired from BASF
7300-1	41.9	3/5	20,160	560/9420	30	Rotary voice coil	1209	ANSI, SMD	\$2560	
7300-2	82.9	3/5	20,160	960/942	30	Rotary voice coil	1209	ANSI, SMD	\$3195	
Megavault MV 20L, 34, 48L	20, 34, 48	2/3, 3/5, 4/7	10,416	478/6000	45	Rotary voice coil	625 or 542	ST412 SA1000	\$2020, \$2200, \$2410	Sealed aluminum HDA; AC or DC
* Quantity 1000	** Quantity 500	*** Quantity 2500								



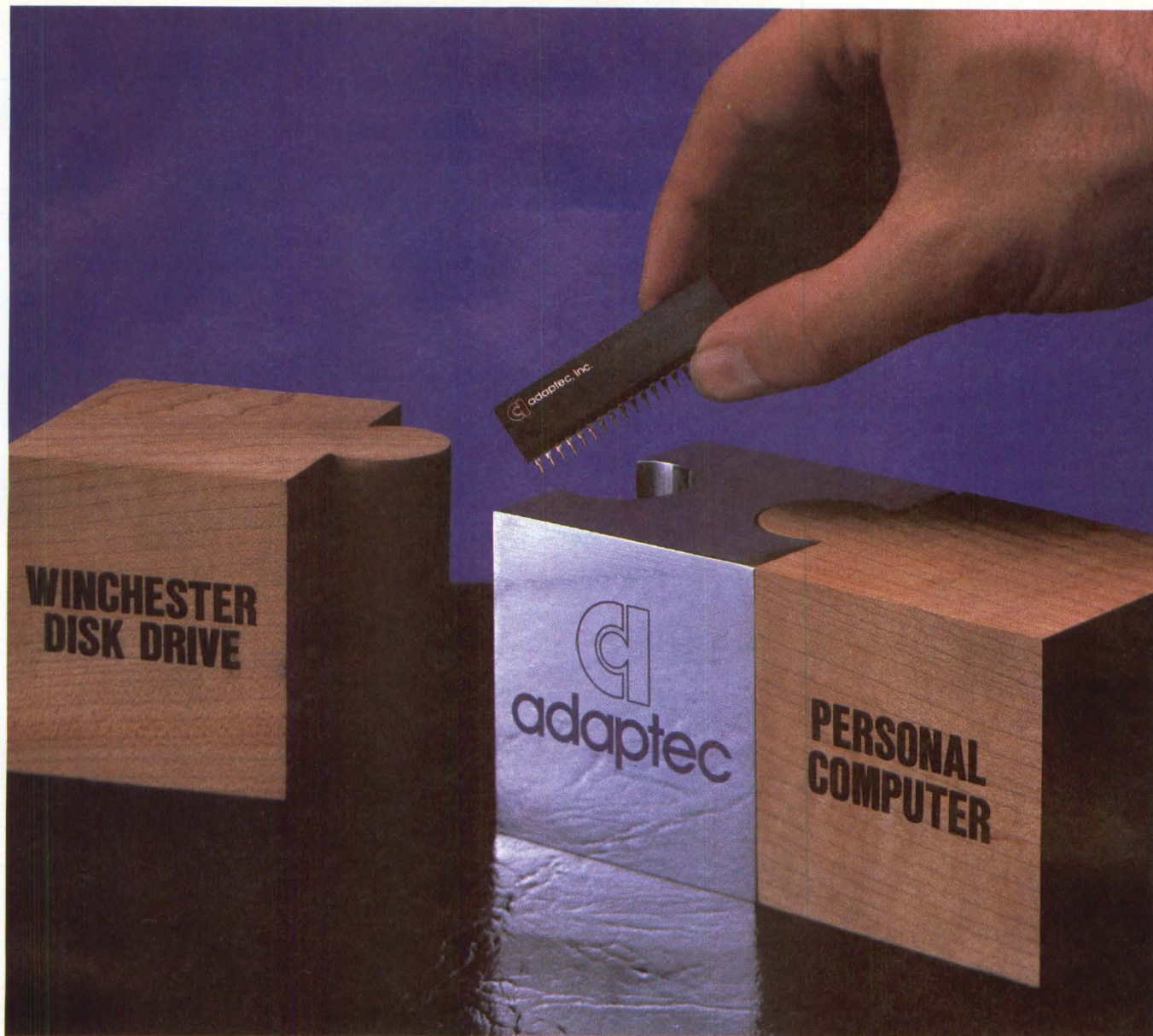

# ADAPTEC'S AIC-100: YOUR PC CONNECTION

**The Opportunity Window:** The Personal Computer marketplace is the fastest growing, most competitive market in the computer system and drive industry. Product opportunity windows close almost as fast as they open. And more than one company, finding their window closed, has wound up closing their doors. Adaptec's AIC-100, The Winchester Controller Chip,<sup>™</sup> is designed to make sure you hit your opportunity window quickly, powerfully and with minimum cost. The results just might be a competitive edge that shatters your competition.

**The Winchester Controller Chip:** The AIC-100 is a silicon gate NMOS device which provides the major portion of the hardware necessary to build a powerful Winchester disk controller. A few "glue" chips can complete the design of your choice. Or, you can get to market even faster by incorporating Adaptec's own Data Separator and FIFO Buffer controller chips.

On-chip 32 bit ECC, software selectable sector sizes and up to 10 Mbit/sec data rate capability are just a few of the AIC-100's features. Just as important, you get the full support and design assistance of the Adaptec team, experts in system, controller and LSI technology.

For more information about the AIC-100, and other Adaptec products please call Don Rector, vice president of marketing at (408) 946-8600. Or write Adaptec, 1625 McCarthy Boulevard, Milpitas, CA 95035.

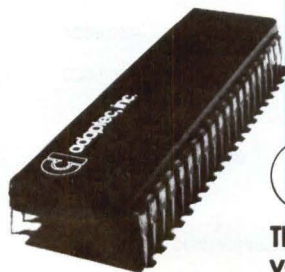

**adaptec, inc.**

The best controller connection  
you can make ... or buy



### 8-in. Winchester specifications

Company and model	Unformatted capacity (M bytes)	No. of disks/ no. of r/w heads	Bytes per track	Tracks per in./ bits per in.	Avg. positioning time (msec.)	Actuator type	Data-transfer rate (K bytes/sec.)	Interface type	OEM price (Qty. 100)	Comments
MV 26, 44, 62	26, 44, 62	2/3, 3/5, 4/7	13,545	478/7750	45	Rotary voice coil	812.5	SMD, ANSI	\$2390, \$2600, \$2820	SMD or ANSI I/O with PCB swap
MV 48, 83, 116	48, 83, 116	2/3, 3/5, 4/7	20,160	600/11,500	45	Rotary voice coil	1209	SMD, ANSI	\$2930, \$3190, \$3450	SMD or ANSI I/O
MV 212	212	4/7	20,160	960/11,500	45	Rotary voice coil	1209	SMD, ANSI		
Memorex										
101, 102	11.7, 23.4	1/2, 2/4	12,000	195/6100	70	Rotary stepper	1200	SA400	\$1450, \$1700	Manufactured by Fujitsu
213, 214	48.2, 84.4	3/4, 4/7	20,480	720/9550	20	Rotary voice coil	1229	SMD	\$3310, \$3430	
Micropolis										
1221, 1222, 1223	9, 26, 45	1/1, 2/3, 3/5	15,360	478/8623	42	Rotary voice coil	921		\$2048, \$2481, \$2896	Optional intelligent interface PCB
1202, 1203	26.8, 44.6	2/3, 3/5	15,364	478/8623	42	Rotary voice coil	921	ANSI	\$2192, \$2607	
1404, 1406	80, 160	3/5, 6/10	20,160	960/9287	26	Rotary voice coil	1209	SMD		
1403, 1405	100, 200	3/5, 6/10	20,800	960/11,380	28	Rotary voice coil	1248	ANSI		
Microscience International										
HH-612	12.8	1/2	8192	648/9680	85	Stepper	625	ST506	\$700***	Closed-loop servo
Mitsubishi										
M2860-2	50.72	4/7	13,440	480/7300	35	Linear voice coil	806	SMD		
M2860-3	85.37	4/7	20,160	546/10,900	30	Linear voice coil	1209	SMD		
NEC										
D-2220, 2230	25.5, 42.5	3/3, 3/5	20,480	480/8824	30	Rotary voice coil	1200	SMD	\$2375, \$2850	
D-2246	85	4/6	20,480	720/9040	25	Rotary voice coil	1200	SMD	\$3300	
Nippon Electric-Densei										
RD-8087, 8223	7.4, 22.3	1/1, 2/3	11,340	478/6424	45	Rotary voice coil	680	Proprietary		Not marketed in U.S.
RD-8731, 8520	37.1, 52	3/5, 4/7	11,340	478/6424	45	Rotary voice coil	680			Not marketed in U.S.
Priam										
3450	35.2	3/5	13,440	480/6670	42	Linear voice coil	800		\$2325	
7050, 804	70.49, 105.7	3/5	20,160	960/10,000	40	Linear voice coil	1209	SMD	\$3240	
Quantum										
Q2020, 2030, 2040	21, 32, 40	2/4, 3/6, 4/8	10,400	345/6600	60	Rotary torque	543	SA1000	\$2100, \$2450, \$2800	
Q2080	85.45	4/8			60	Rotary torque	543		\$2800	
Shugart Associates										
SA1002, SA1004	5.3, 10.6	1/2, 2/4	10,400	172/6270	70	Band stepper	543	SA1000	\$1140, \$1400	
SA1104, SA1106	20.3, 33.9	2/3, 3/5	10,400	500/600	35	Rotary voice coil	543	SA1000	\$1920, \$2300	Closed-loop servo
Texas Instruments										
WD 800-18, -43	18, 43	2/3, 4/7	9288	478/6500	40	Rotary voice coil	602	DS990		Sold only with TI 990 CPU
3M										
8431, 8432	10, 20	1/2, 2/4	17,920	219/8649	65	Rotary stepper	933.3	ANSI	\$1525, \$2735	
8533	60	2/4	17,920	693/8555	29	Rotary voice coil	933.3	ANSI	\$3380	
Toshiba										
MK80F-10, -20, -30	15, 23, 38	2/3, 2/3, 3/5	20,160	450/8824	40	Rotary voice coil	1210	SMD		Not marketed in the U.S.
MK182F, MK184F	83, 116	3/5, 4/7	20,160	900/9000	40	Rotary voice coil	1210	SMD		Not marketed in U.S.
Vermont Research										
8010	11	1/2	8192	500/6000	33	Linear voice coil	500	ANSI, SASI	\$2850	Removable 8-in. ANSI cartridge
8520	22	2/4	8192	500/6000	42	Linear voice coil	500	ANSI, SASI	\$3850	One fixed, one removable

\* Quantity 1000    \*\* Quantity 500    \*\*\* Quantity 2500



# Discover The OEM Array Processor.

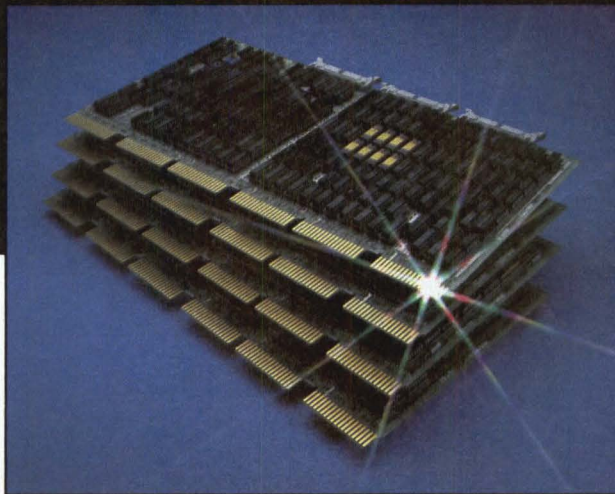

**Designed for the OEM.** Finally — Mini-MAP! A powerful array processor board set designed for the system integrator. Mini-MAP — brought to you by CSPI, the array processor specialists with fourteen years of experience and over 500 worldwide MAP installations. A perfect fit for PDP-11 based systems. Four hex boards that plug into your PDP-11 backplane, consume only 125 watts of power and provide full 32-bit floating point precision.

**Shared Memory.** Mini-MAP interfaces directly to UNIBUS for simplified programming and unprecedented throughput. The PDP-11 and array processing unit share memory to eliminate host/array processor DMA transfers and to minimize overhead.

**Arithmetic Power.** The wide dynamic range and precision of 32-bit floating point arithmetic, along with 7 MFLOPS of number crunching power, offers cost/performance advantages for OEMs. For example, a 1024 point Real FFT is done in 4.2 milliseconds — that's Mini-MAP math.

**Software Support.** Mini-MAP supplies: a scientific subroutine library of 150 FORTRAN callable routines . . . an exclusive MCL/FORTRAN compiler and linker for combining subroutines into convenient host-callable modules . . . a relocatable assembler for creating applications subroutines . . . and a full set of user-friendly debugging tools and diagnostics.

**Modularity.** Mini-MAP is expandable. You can select additional memory boards beyond the basic 64 KByte data memory, for up to 16 MBytes. And we can supply a wired backplane for your PDP-11 or provide a self-contained development system in a DEC\*-compatible enclosure complete with power supply and UNIBUS cables.

**Get The Facts.** Find out why Mini-MAP is the most cost-effective number crunching solution for your next product development. Call or write for complete specifications or for applications assistance.

\*DEC, PDP-11 and UNIBUS are trademarks of Digital Equipment Corp.

## Mini-MAP™

- 32-bit floating point precision
- 4 PDP-11\* Hex boards
- Shared-memory UNIBUS\* interface
- 150 FORTRAN-callable arithmetic routines
- Compiler/Assembler/Linker/Debugger
- Up to 16 MBytes of memory
- 4.2 msec for a 1024 point Real FFT
- \$14,700. for basic configuration in OEM quantities of 50

### CSPI

THE ARRAY PROCESSORS

40 Linnell Circle, Billerica, Massachusetts 01821 • 617/272-6020 • TWX: 710-347-0176

CIRCLE NO. 101 ON INQUIRY CARD



# A "true" Winchester memory

## Dual floppies are ok...

*but* microcomputers have already outgrown low-capacity, poor reliability, slow-access-time floppies. And what about tomorrow—as system software and data bases continue to expand? Will any floppy-based system be able to cope?

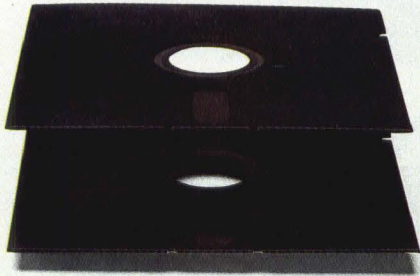

## Winchester with floppy is better...

*but* you haven't removed the limitations of floppies. In fact, they become even more of a time consuming burden, as stacks of floppies accumulate. System reliability and maintenance are compromised. It's really just a glorified floppy memory system.

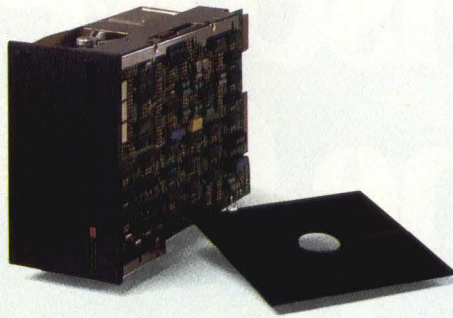

## Winchester with tape... is as good as floppies...

*but* tape cartridges aren't really right—except for routine archiving. Non-random-access, poor reliability tape cartridge drives are notorious for high cost of ownership. Access time is extremely slow. The whole system is now reduced to the tape-drive level.

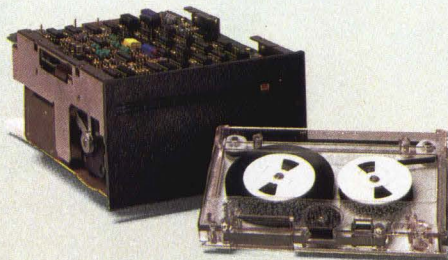

## The system solution is DMA Systems' all-in-one 5¼" Winchester with two "half-high" disks—one fixed, the other removable.

Here's a memory system that makes sense instead of problems. The Micro-Magnum™ fixed/removable disk drive has mass storage, data portability, and backup in one device.

The Micro-Magnum 5/5 is a highly reliable 5¼" fixed Winchester—backed by an equally reliable 5¼" industry-standard removable Winchester cartridge.

With 6.5 MBytes fixed and 6.5 MBytes removable, the Micro-Magnum drive holds 13.0 MBytes (5-and-5 MBytes, formatted). That's enough capacity to handle almost any application.

Equally important, the Micro-Magnum's access time is just 40 milliseconds.



# system with no buts about it.

## The right kind of removability and security.

If you're going to use a Winchester for primary memory, why back it up with anything else?

Unlike floppies, the Micro-Magnum's cartridge matches the fixed disk's capacity one for one. Unlike streaming tapes, the Micro-Magnum cartridge provides random access.

Unlike *both* floppies and tapes, the Micro-Magnum provides the same access time, the same data rates, the same zero maintenance schedule for both fixed and removable files.

And a full disk-to-disk backup takes less than 90 seconds.

## The right way to protect data.

The Micro-Magnum features a unique retractable head that never touches the disk. There's also a self-sealing clean air system that pre-

vents contaminants from reaching the data—even after thousands of cartridge insertions.

And the Micro-Magnum features an embedded servo for reliable cartridge interchange and positioning accuracy. Why wait until the old open loop systems are obsolete?

## Just the right size.

The Micro-Magnum is precisely matched to standard mini-floppy front panel dimensions. The space-saving fixed/removable concept uses only one of your front panels—unlike other combinations which use two. And its interface is designed so that existing 5¼" Winchester drive controllers can easily be adapted for use.

## The bottom line.

The bottom line is... "we are shipping!" Other 5¼" removable drive manufacturers promise delivery. Our class 100 manufacturing facility is producing. We're delivering.

The Micro-Magnum fixed/removable disk drive is a "true" Winchester memory system... without any ifs, ands, or buts.

For more information write DMA Systems, 601 Pine Avenue, Goleta, CA 93117. Or call us at (805) 683-3811, Telex 658341.

**DMA**  
**SYSTEMS**

**Just what the industry needs.**



CIRCLE NO. 102 ON INQUIRY CARD



# The Seagat

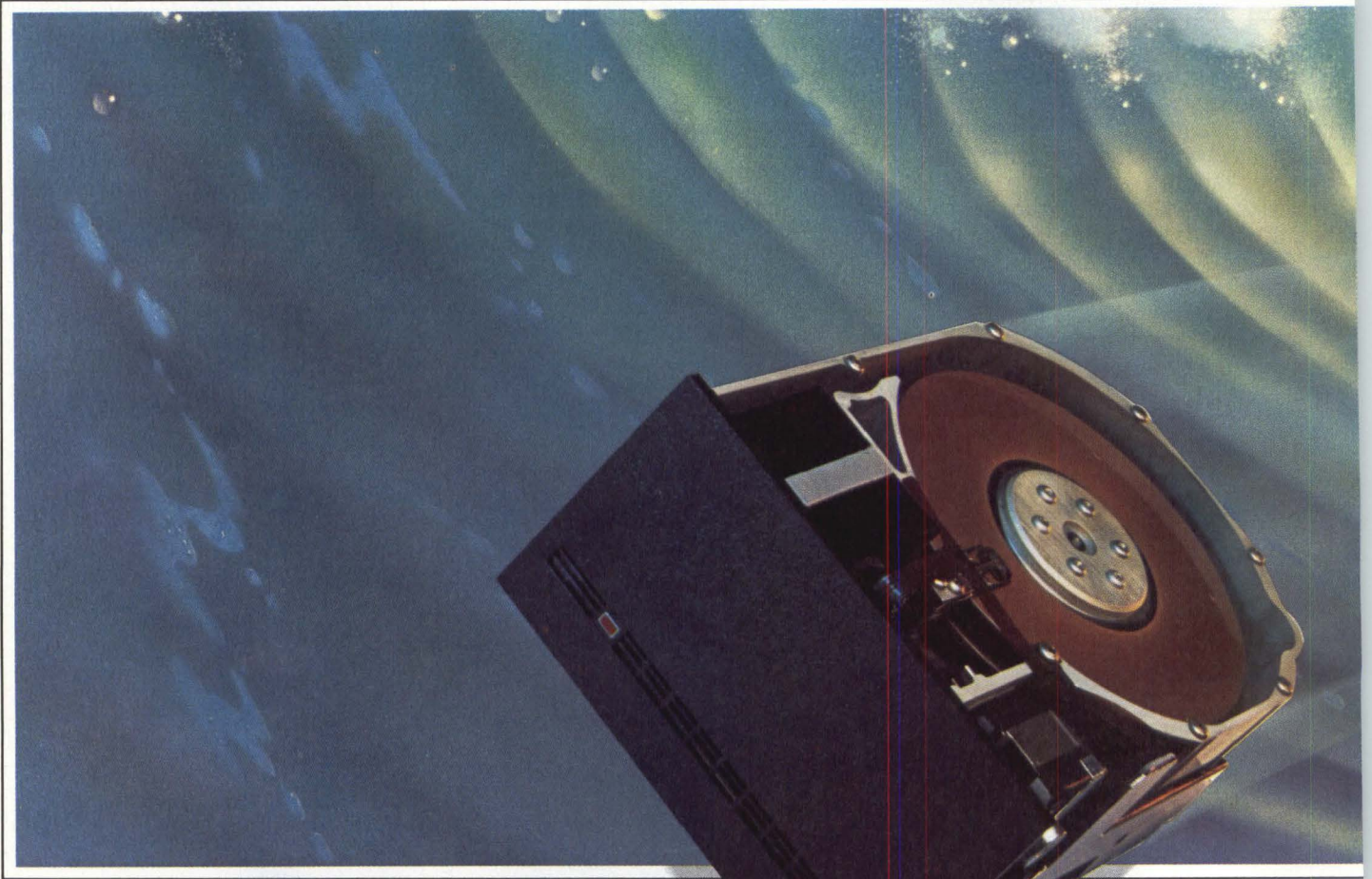

**Seagate's ST400 Series is the most popular family of Winchester disc drives ever offered. And no wonder. These 5 1/4" Winchesters deliver more value for your money. More quality. More reliability. More performance. And all at a better price.**

The ST400 Series offers the right capacities. 6.38, 12.76 or 19.14 megabytes (unformatted). All use the same

industry-standard ST506 controller and matching mini-floppy form factor for easy upgrade.

**The right features.**

All use manganese-zinc heads, advanced stepper motor, metal band actuator, open loop head positioner, and patented air flow spindle pump. An onboard microcomputer provides buffered seek and fast step algorithm for an average seek of 85 milli-

seconds, including settling time.

**The right quality.**

Seagate backs the ST400 family with a full one year warranty, our industry-leading "105% Seagate Guarantee," and the world's biggest support team devoted entirely to 5 1/4" Winchesters.

**Meeting special needs.**

Looking for faster, more reliable removable storage? Go with our new ST706



# e tide is in.

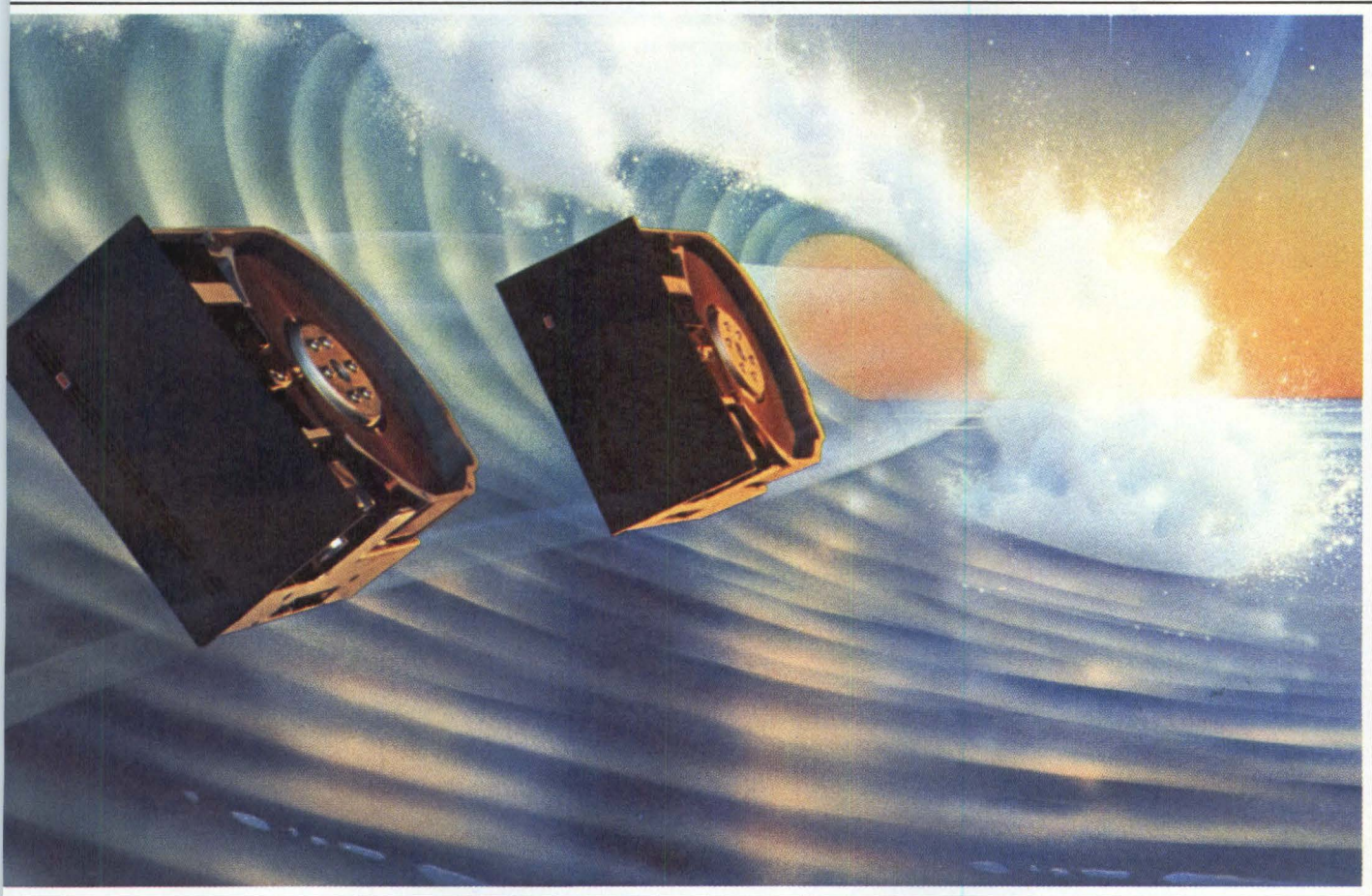

removable cartridge drive. Need a more compact drive? Pack more data in less room with our new ST206 half-high Winchester. Both new drives store 6.38 megabytes (unformatted) with reliable bit and track densities.

**We have what you want in Winchester.**

Selection. High volume delivery. Quality. Competitive pricing. So go with the tide. Call Seagate.

**The ST400 Series**

**Unformatted capacity (MB)**  
**Formatted capacity (MB)**  
**Average access time (ms)**  
**Price\***

ST406	ST412	ST419
6.38	12.76	19.14
5	10	15
85	85	85
\$610	\$735	\$890

**Seagate Technology**



360 El Pueblo Road, Scotts Valley, California 95066 (408) 438-6550, TELEX 172114 SCVL  
 Regional Sales Offices: Hopkinton, Massachusetts (617) 435-6961; Newport Beach, California (714) 851-9964; Dallas, Texas (214) 783-6711  
 European Sales Office: Krellerstrasse 21, 8000 Munich 80, West Germany, 89-43-13-900, TELEX 5 213 379  
 Authorized U.S. Distributor: Arrow Electronics.

**"Turning the tide in disc technology"**

Shipping volume now



# Now!!

## High Performance 8-Inch Winchester... Your Choice Of 3 Interfaces

MORE THAN  
20,000  
DELIVERED!

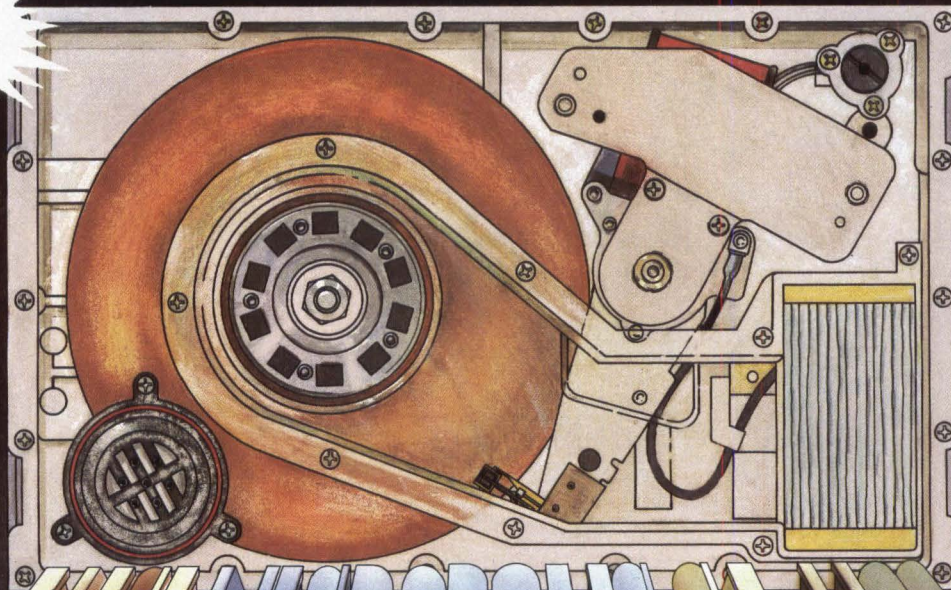

# ANSI MICROPOLIS SA-1100

With more than 20,000 delivered, Micropolis is the world leader. Nowhere else can you get time-proven, high-performance, high-capacity, 8-inch Winchesters, available with three different interfaces.

#### MII — Micropolis Intelligent Interface

You get 45 Mbytes of unformatted storage, a 922 Kbyte data transfer rate, 1 Kbyte of buffering, built-in data separation, and five bits of error correction — all within the 8-inch envelope you require.

#### ANSI Interface

ANSI is the emerging industry standard because it permits drives of varying performance, even different vendors, to be integrated into a single system. Like the other options, the ANSI Interface uses our 1200 series mechanics, respected for superior quality and high performance.

#### SA-1100 Interface

Using your existing controllers and software, replace your 8-inch floppies - or -expand your SA-1000 based Winchesters. Our SA-1100 compatible interface will do it, with its industry standard data density, data rate, and disk rpm.

For the highest performance 8-inch Winchesters with your interface option, contact Micropolis today! We're delivering!!

	1220	1200ANSI	1200SA
Unformatted Capacity (Mbytes)	44.6	44.6	34.3
Average Access (ms, 1/3 stroke)	42	42	45
Data Transfer Rate*	7.375	7.375	4.333

\*Mbits per second.

# MICROPOLIS™

21123 Nordhoff Street • Chatsworth, California • (213) 709-3300 • Telex 651486

European Operations • 210 Elgar Road, Reading, Berks • U.K. RG2 0PJ • (734) 751-315 • Telex 848591

CIRCLE NO. 104 ON INQUIRY CARD



## DISK TECHNOLOGY

# Increasing disk densities with perpendicular recording

BENNETT DY, Century Data Systems, Inc.

*By aligning regions side-by-side, rather than end-to-end, storage densities can be increased more than 40 times*

The growing demand for smaller disk drives with greater storage capacities has manufacturers looking for ways to increase disk recording density. Devices using longitudinal recording technology, in which magnetized regions line up end-to-end, are fast approaching practical density limits. A quantum jump in recording density may come from perpendicular recording techniques, in which regions line up in parallel, vertical to the disk. Perpendicular recording technology can potentially overcome some of the inherent limiting characteristics of magnetic recording, yielding dramatic increases in data storage at a competitive price.

### Longitudinal recording limits

Disks record data bits through flux changes, the change in a magnetic field associated with a reversal in the orientation of magnetized regions comprising a disk medium. The more flux change a disk can align along a given length of track, the higher the recording density.

During the past 30 years, linear recording density in available drives using longitudinal recording (Fig. 1) has increased from 100 flux changes per in. to more than 10,000 fepi. This progress has resulted from decreasing the distance over which a single flux change occurs. But two magnetic phenomena limit any further increase in longitudinal recording density: demagnetization and peak shift.

Demagnetization (Fig. 2) is the misalignment of

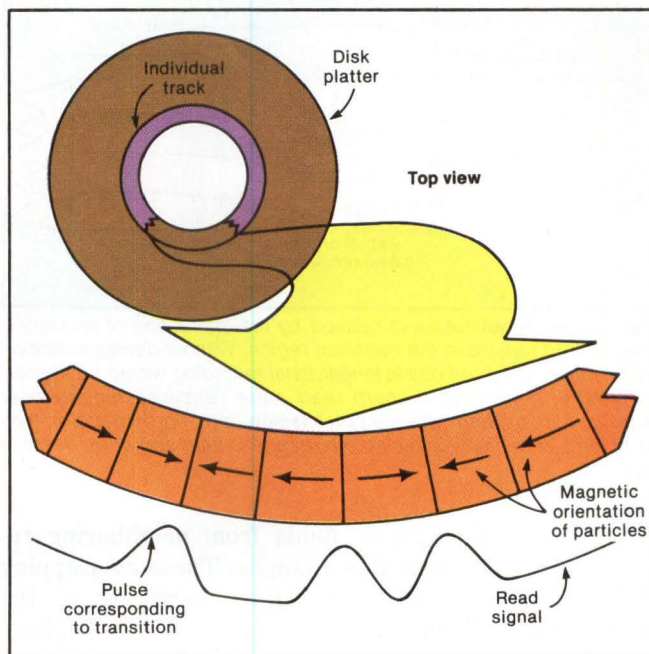

**Fig. 1. Longitudinal recording** stores information on the disk through flux changes, or reversals in the magnetic orientation of "bit cells" along the track. During read operation, the read head detects voltage pulses generated by passing over these flux changes. Magnetized regions are aligned parallel to the surface of the disk in longitudinal recording.

magnetized regions caused by the repulsion of like poles, as when two magnets lined up north pole-to-



north pole twist until they are aligned north-to-south. In magnetic recording, flux changes are recorded by reversing the orientation of magnetized regions. For longitudinal devices, this requires aligning regions near the point of transition with like poles facing. Demagnetization causes these regions to twist; no matter how sharp the transition made by the recording head, demagnetization causes the transition region to spread when the magnetizing field is removed. Using available processes and materials, demagnetization limits reading density to approximately 30,000 fcpi.

The second factor limiting linear recording density is peak shift (Fig. 3). Peak shift is caused by the

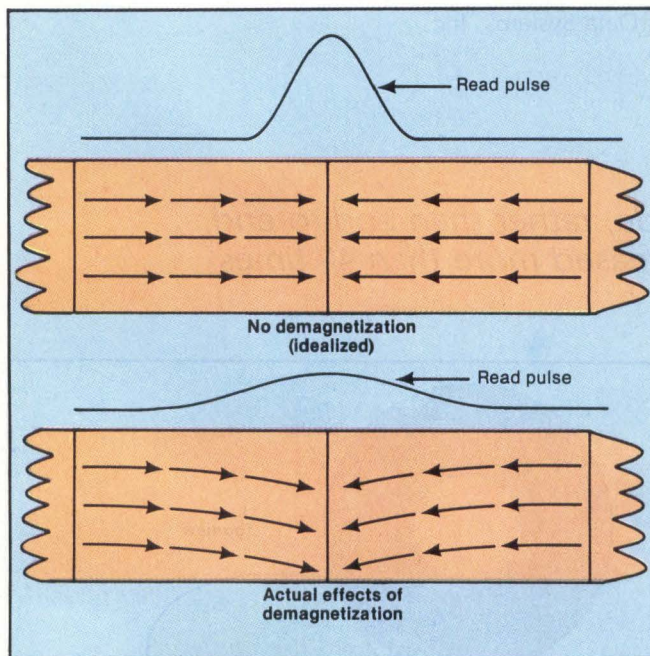

**Fig. 2. Demagnetization** is caused by the interaction of oppositely magnetized regions in the transition region. Without demagnetization (top), magnetized regions in longitudinal recording would be aligned in parallel, generating a sharp read pulse. Because regions near transition are aligned with like poles facing (e.g., north to north), they tend to twist away, weakening the magnetic field and spreading the pulse.

overlapping of magnetic fields from neighboring regions of regions near flux changes. These overlapping fields interfere with each other, resulting in the displacement of the transition points. If this displacement is greater than the size of a bit cell—the length of track in which 1 data bit is stored—the data become unreadable. Because demagnetization spreads transitions in longitudinal recording, peak-shift problems are significant. If peak shift were the only limiting factor, the best known magnetic medium would have a density limit of approximately 28,000 fcpi.

The 30,000-fcpi demagnetization and 28,000-fcpi peak-shift limits represent theoretical possibilities.

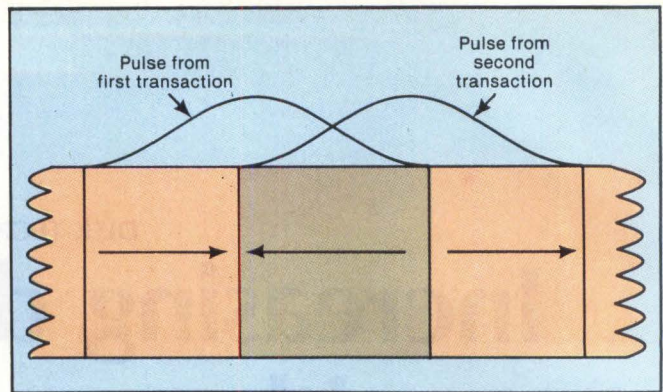

**Fig. 3. Peak shift** results from overlapping of pulses from neighboring flux changes. The overlapping pulses combine, displacing the apparent location of the transition. Peak shift is a problem in longitudinal recording as demagnetization creates wide pulses.

When other design constraints such as noise and temperature are considered, longitudinal recording will likely reach its practical limit at about 25,000 fcpi. This limit can be stretched by using better magnetic materials for the media in conjunction with thin-film heads, but such improvement will be minimal rather than a doubling or tripling of current densities.

### Perpendicular recording

In perpendicular recording (Fig. 4), the magnetized regions of the media are oriented perpendicularly to the disk, compared to the orientation of regions parallel to the disk in longitudinal recording. This perpendicular arrangement minimizes the effects of demagnetization and peak shift, allowing greater recording densities than those attainable with longitudinal techniques.

As with longitudinal recording, flux changes in perpendicular recording are recorded by reversing the orientation of magnetized regions. But while this reversal aligns particles end-to-end, with like poles facing each other in longitudinal recording, the regions near a transition in perpendicular recording media are aligned in parallel, without bringing like poles into proximity (Fig. 5). Thus, the regions near a transition do not tend to twist away from the appropriate orientations in perpendicular recording; this lack of demagnetization keeps transition distance nearly as short as that generated by the recording pulse from the head.

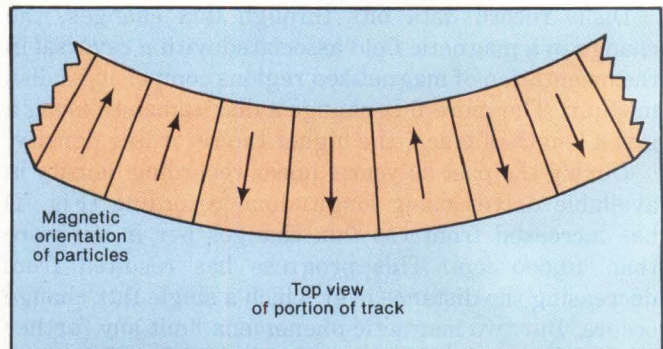

**Fig. 4. Perpendicular recording** stores information in the same way as longitudinal recording, except regions are aligned perpendicularly to the surface of the disk rather than parallel to the surface.



# Hard Disk is Easy to Control

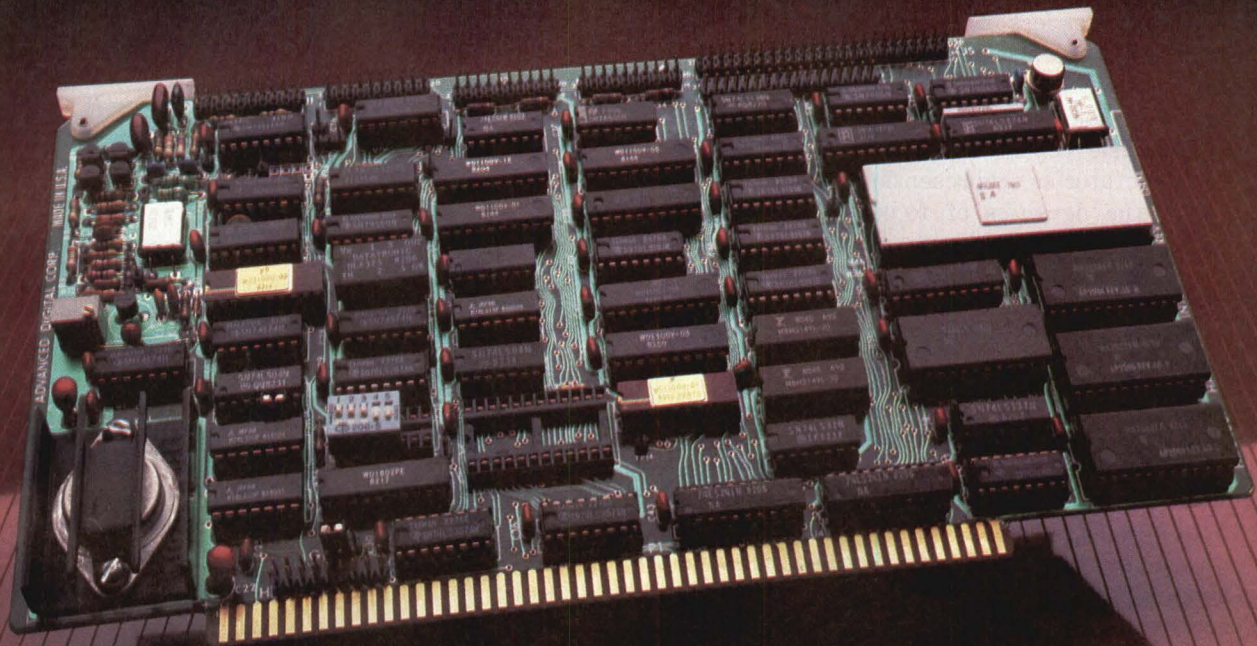

## With Advanced Digital's Error Correcting Controller!

Advanced Digital has solved the problem of hard disk control with the HDC-1001, a unique, error-correcting, microprocessor-based hard disk controller board for S-100 based computers. Now, control of up to four 5¼" or four 8" Winchester drives is a snap.

Occupying only one slot in the S-100 chassis, the HDC-1001's unique error-correcting capabilities will detect and correct errors before you're even aware of them. In addition, you get up to 8-Bit single burst correction, multiple burst detection, programmable correction/detection span, and much, much more.

Look at these outstanding features:

- Built-in data separator
- Up to 5 MBits/sec data rates
- 256 sector addressing range
- CRC generation/verification on ID fields
- ECC generation/correction on data fields
- Automatic retries on all errors
- Automatic restore and reseek on seek error
- 32 Bit computer generated polynomial
- Complete documentation
- One year warranty
- Retail price: \$500

And now Advanced Digital has really made it easy to add hard disk capabilities by offering you a perfectly matched, thoroughly-tested disk subsystem. The subsystem combines the HDC-1001 controller with an industry-standard 5 MByte hard disk and comes complete with cable and CP/M BIOS disk. With a suggested retail price of \$1800 (an optional 20 MByte drive is available for only \$200 more), Advanced Digital is by far your most cost effective way to gain control of a hard disk.



**ADVANCED  
DIGITAL  
CORPORATION**

Ask about our full line of S-100 products, including our SUPER QUAD® single board computer, SUPER SLAVE® processor boards and SUPER SYSTEM® multi-user, multi-processor computer. Write or call: Sales Department

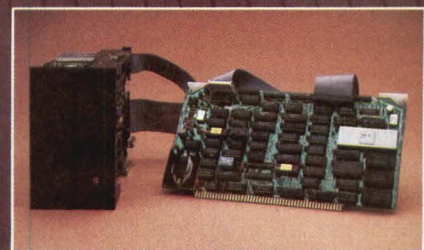

12700-B Knott Street • Garden Grove, California 92641 • (714) 891-4004 TELEX 678401 tab irin

® Registered Trademark of Digital Research Corp.

CIRCLE NO. 105 ON INQUIRY CARD

© Copyright 1981 Advanced Digital Corp.



Because these transitions are sharp, there is less overlap between neighboring pulses, and thus less interference (Fig. 6). Without interference, there is little significant shifting of the transition point; that is, peak shift becomes less of a problem.

Dramatic increases in density have been obtained through perpendicular recording. Densities of 100,000 fpci are now reported commercially feasible, while 440,000 fpci has reportedly been achieved by some Japanese laboratories, representing an increase of 44 times over the densities of 10,000 fpci on available longitudinal recording devices.

### Cost and competition

While cost per byte for perpendicular recording may eventually prove to be much less than with the longitudinal recording process, media costs may be greater. Some researchers believe that a specially designed head with a medium of perpendicularly oriented regions is required to take full advantage of the attributes of perpendicular recording; others believe that a regular thin-gapped ring head is sufficient to achieve higher density.

There are also two paths being followed with regard to disk media. Some believe that a single, 5- to 10- $\mu$ m layer of magnetic material is sufficient to obtain excellent results, while others believe that two-layer media are required: a top layer of perpendicularly oriented material for recording and a bottom layer for a magnetic sink, resulting in an approximately 30-percent increase in media cost. Eventual cost over performance factors for different combinations of heads and media in the market will settle these points. If the number of published papers is a measure of accomplishment in perpendicular-recording research, then Japanese corporations can be credited with most R&D in this field, with about eight Japanese companies involved. U.S. companies may not be that far behind though. One in San Jose, Calif., is reportedly prepared to market a 5 $\frac{1}{4}$ -in., rigid perpendicular disk this year, a Minneapolis company is reported to be exploring this technology for small floppy media, and a San Diego head manufacturer has achieved an experimental result of more than 100,000 fpci using perpendicular recording. The next five years will probably see a number of high-performance disk drives incorporating perpendicular recording in different forms.

One technology likely to compete with perpendicular recording is optical recording, with which densities of 25,000 markings per in. (comparable to fpci) have been recently achieved in a laboratory. This linear density is low compared to perpendicular recording, but the tracks per in. in optical recording is much higher—as much as 12,500 tpi has been reached, 10 times that of magnetic recording. When translated into areal densi-

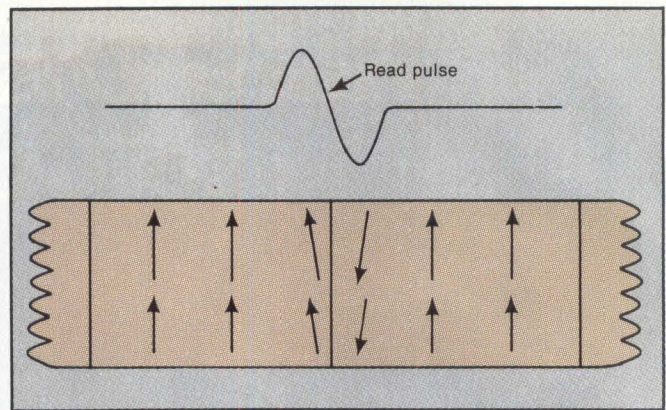

**Fig. 5. Reduced demagnetization in perpendicular recording** is the result of regions aligning side-by-side rather than end-to-end. Regions near transition are not aligned with like poles facing as they are in longitudinal recording, and do not tend to move out of alignment. Read pulses in perpendicular recording are, therefore, sharper. Perpendicular recording pulse is shaped different from longitudinal pulse because of different orientations in magnetic fields.

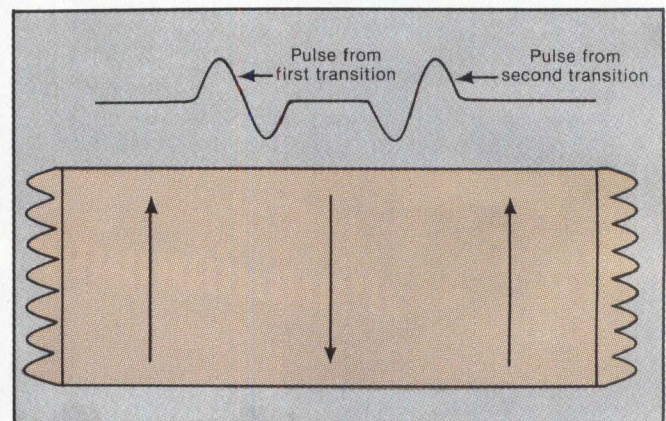

**Fig. 6. Peak shift is less significant in perpendicular recording** because pulses are sharper, and do not overlap as they do in longitudinal recording.

ty, optical recording has reached 300 million bits per sq. in., comparable to perpendicular recording. Optical recording devices, however, can write only once on a given surface. This write-once-only characteristic may be a drawback for many applications, but for some it is an advantage. For archival and tight security files, for example, write-once media is preferred.

Recent research has discovered that with Terbium Dysprosium Ferrite noncrystalline film media, both write and erase functions are feasible. The media, however, is still far from record-stable in field environments. In contrast, perpendicular recording uses magnetic media that is well understood, erasable and field stable. Optical recording will give perpendicular recording stiff competition when researchers develop a stable erasable optical medium. Until then, perpendicular recording has significant advantages over optical, as well as longitudinal, technology. □

**Bennett Dy** is read-write technology manager at Century Data Systems, Inc., Anaheim, Calif. He was previously advanced technology manager at Burroughs Corp.



**An Aggressive  
Start-Up Company  
Maximizes Your Upside.**

**A Conservative  
Fortune 500 Company  
Minimizes Your Risk.**

**A Company That  
Does Both  
Deserves Your Business.**



# e Reward.

companies to exploit new markets and technologies enjoy higher profit margins and healthier market shares. (Engineers who become experts in new technologies don't do too badly either.)

Evotek can help you get there.

Start from scratch and our applications engineers will assist you with everything from an optimal disk organization for UNIX to the best

way to mount a drive to a chassis.

Or enjoy a head start by taking advantage of where you are.

Our industry standard footprint and ST506, SMD, and SASI interfaces mean your system's probably ready to incorporate Evotek's performance today.

And we can deliver production volumes today in capacities ranging from 7.8 to 51.7 mbytes. Then grow to 300 mbytes later without a change in technology.

We're ready to demonstrate that we deserve your business. With technical information, applications guides, plant tours—and quality products. Call us now at (415) 490-3100, or the regional office nearest you. Or write Evotek, 1220 Page Avenue, Fremont, California 94538.

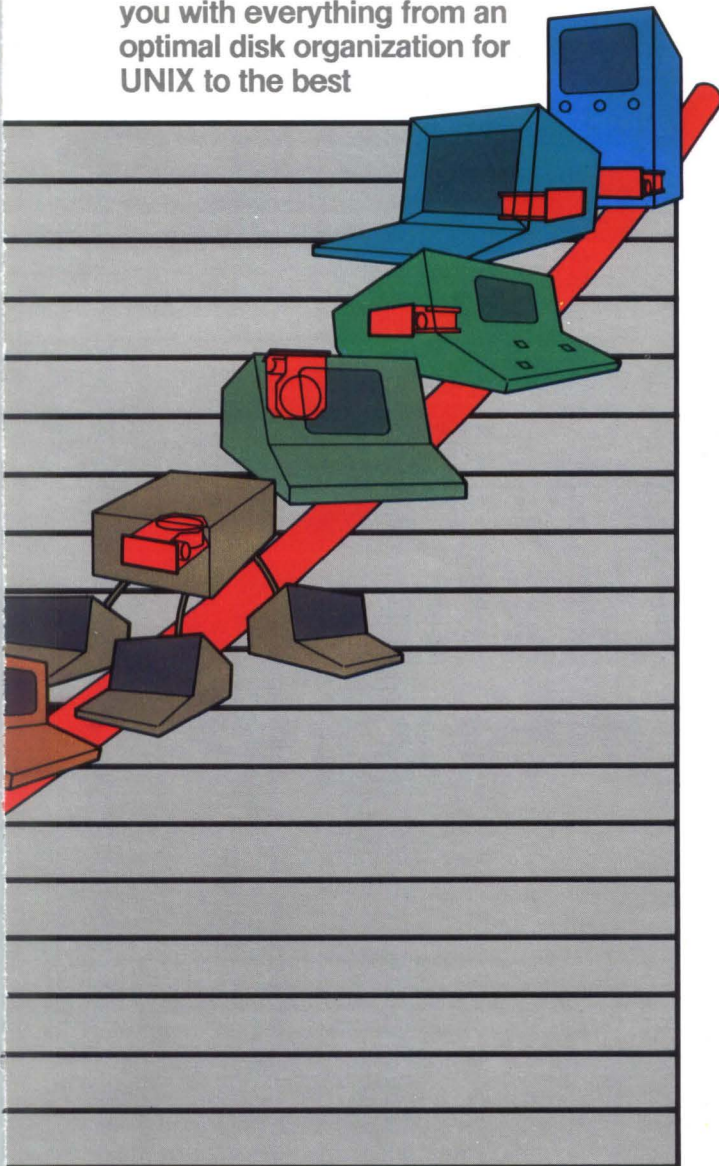

**EVOTEK**

1220 Page Avenue, Fremont, CA. 94538

East: (617) 545-3510 South: (301) 964-5533  
West: (415) 490-3100 Authorized Representatives:  
Basic Systems Crane & Egert Datcom, Inc.  
Glen White Associates Mel Foster Technical Sales  
Mycro Systems PDQ Associates QED Electronics  
Swenson Associates Thorson Rocky Mountain

UNIX is a trademark of Bell Telephone Laboratories, Inc.

© 1983 Evotek



# The U

**Head Landing Zones:** Our high storage density gives us extra space for head landing zones on every disk platter. Use the zones during power down or shipping to protect the integrity of your recorded data.

**Plated Media for Survivability:** Our thin-film media is three times harder than conventional ferric oxide. Perfect for withstanding the thousands of start/stops inherent in desktop applications.

**Comfortable in Harsh Environments:** A specially sealed shaft, pressure equalization port, and proprietary air filtration system eliminate the chance of contamination under the bubble. Evotek drives are remarkably adaptable to harsh environments like factories. Or offices.

**Smooth Drive Performance:** Military grade shock mounts protect your drive during shipping. They also mean you won't be embarrassed the first time someone pounds your keyboard a little too enthusiastically. Or sets your product on a tabletop a little too carelessly.

**Plug and Play:** Evotek drives conform to industry standards like ST506. They're compatible with a wide range of popular 5¼-inch controllers, including the one you're using now.

**Quick Access Time:** A linear actuator and microprocessor control give us an access time of 49 ms, including settling. That's twice as fast as many other Winchesters, and critical for swapping, data collection, and telecommunications applications.

**Extra Capacity:** Our wide bandwidth read/write channel lets you expand your storage capacity with a simple controller change. Switch from MFM encoding to the popular Run Length Limited (RLL) codes and increase capacity from 51.7 to 73.3 mbytes.

**Intelligence:** An on-board microprocessor controls head positioning and compensates for thermal expansion and contraction of the platters. In an office, a factory, or the field, no matter what the application, your system will take the heat. And the cold.

**Faster Data Transfer:** Two families of drives give you a choice of two transfer rates. Choose the standard 5.0 mbit/second rate, or our faster, IBM-compatible 8.2 mbit/second rate (ideal for graphics and local area network applications).

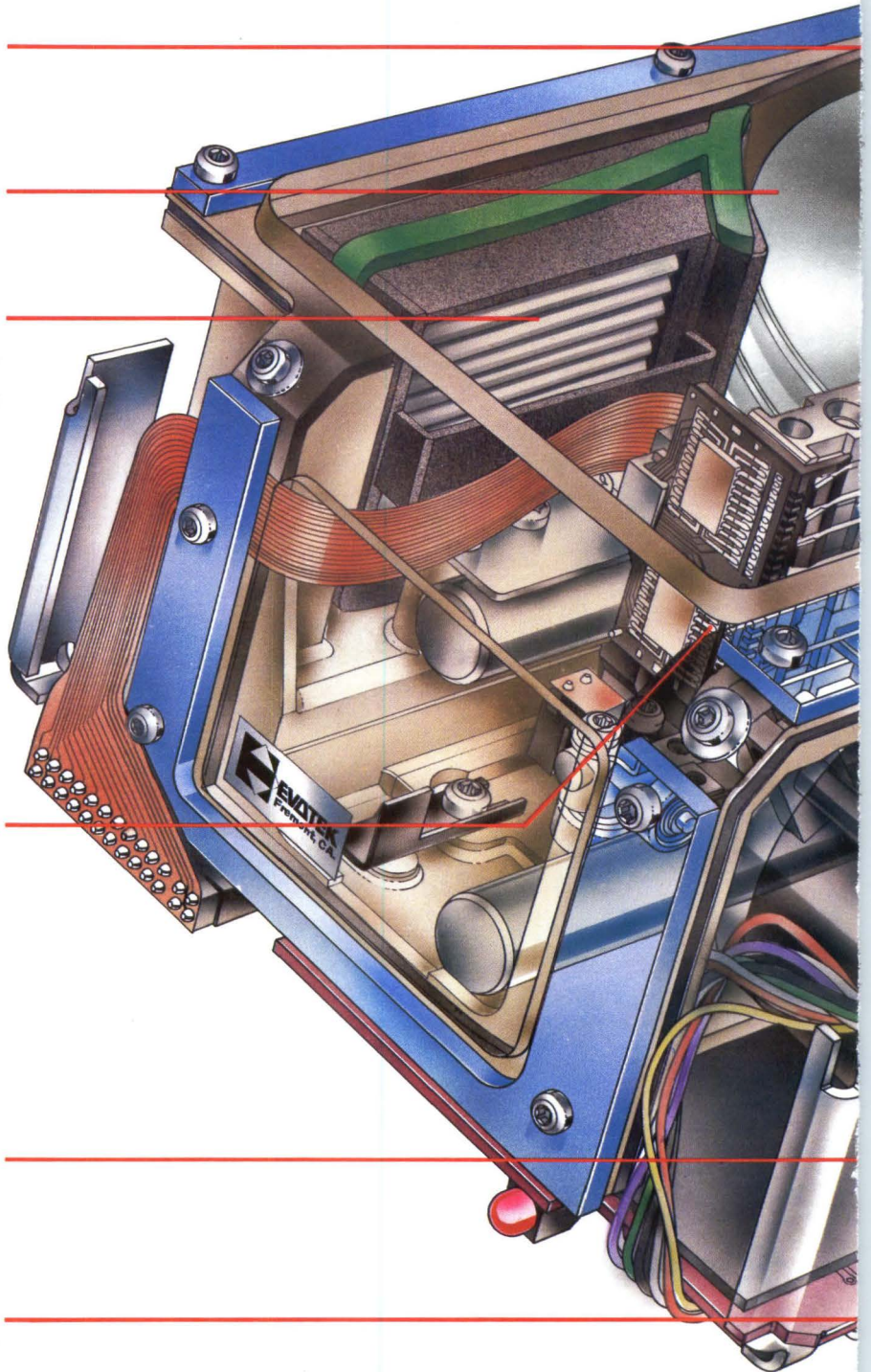



# The

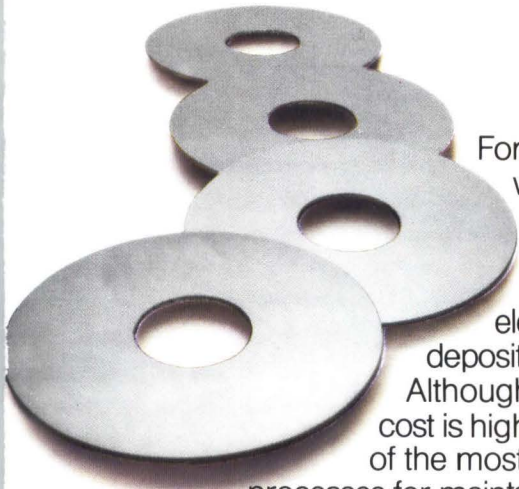

For example, we're one of the few lines to use electrolytic deposition.

Although its initial cost is high, it's one of the most accurate processes for maintaining film thicknesses in the 750 Angstrom range.

Automated disk handling equipment will be standard throughout the industry in six to 12 months. We're using it today to cut contamination losses and improve yields by 60%.

And we're the only 5¼-inch plated media maker using track by track testing instead of the faster, but less accurate, "fly by" method.

Our quality and consistency earned us an invitation to second source a leading 14-inch thin-film media supplier. And, after careful evaluation, we accepted them as our second source. Which assures you of a continued supply of media and drives.

There are easier ways to build our product. But none which are as consistently reliable. And reliability over time is our goal. Because our business relationship may begin with a promise, but it endures through performance.

**The reward for choosing Evotek? Time and money.**

Evotek drives, along with high performance 16-bit and 32-bit micro-processors, are opening up opportunities for supermini performance in desktop packages. And they're finding their way into powerful, personal graphics workstations, and compact, yet sophisticated, medical equipment.

History has proven that the first

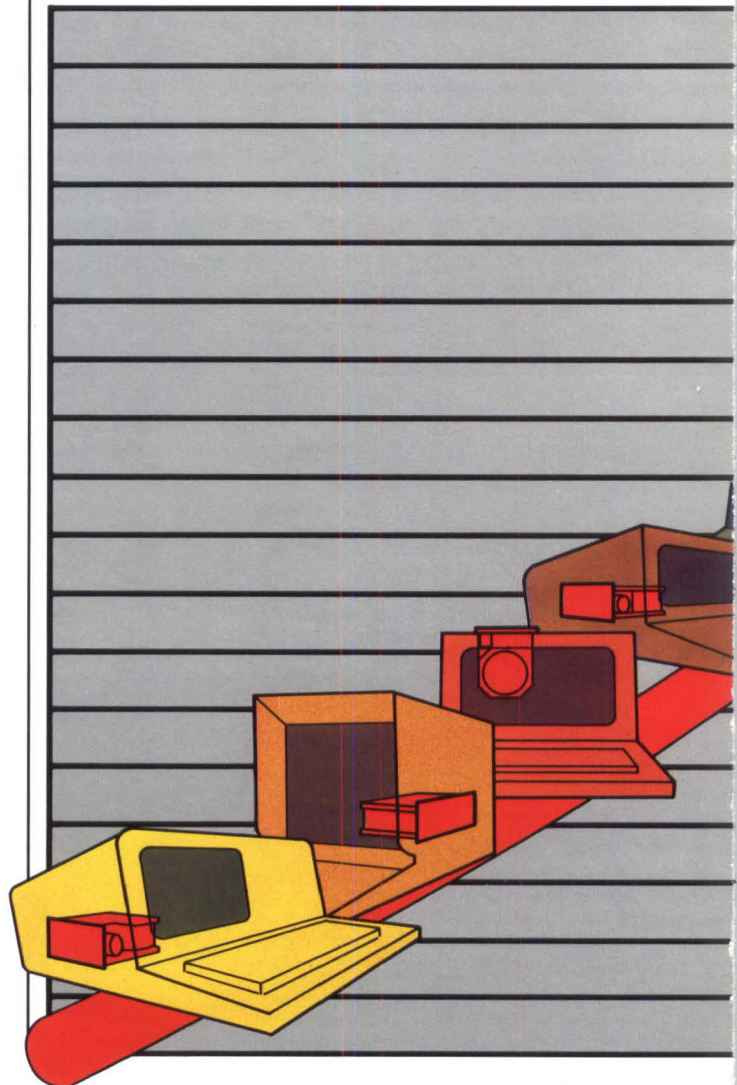



# Upside.

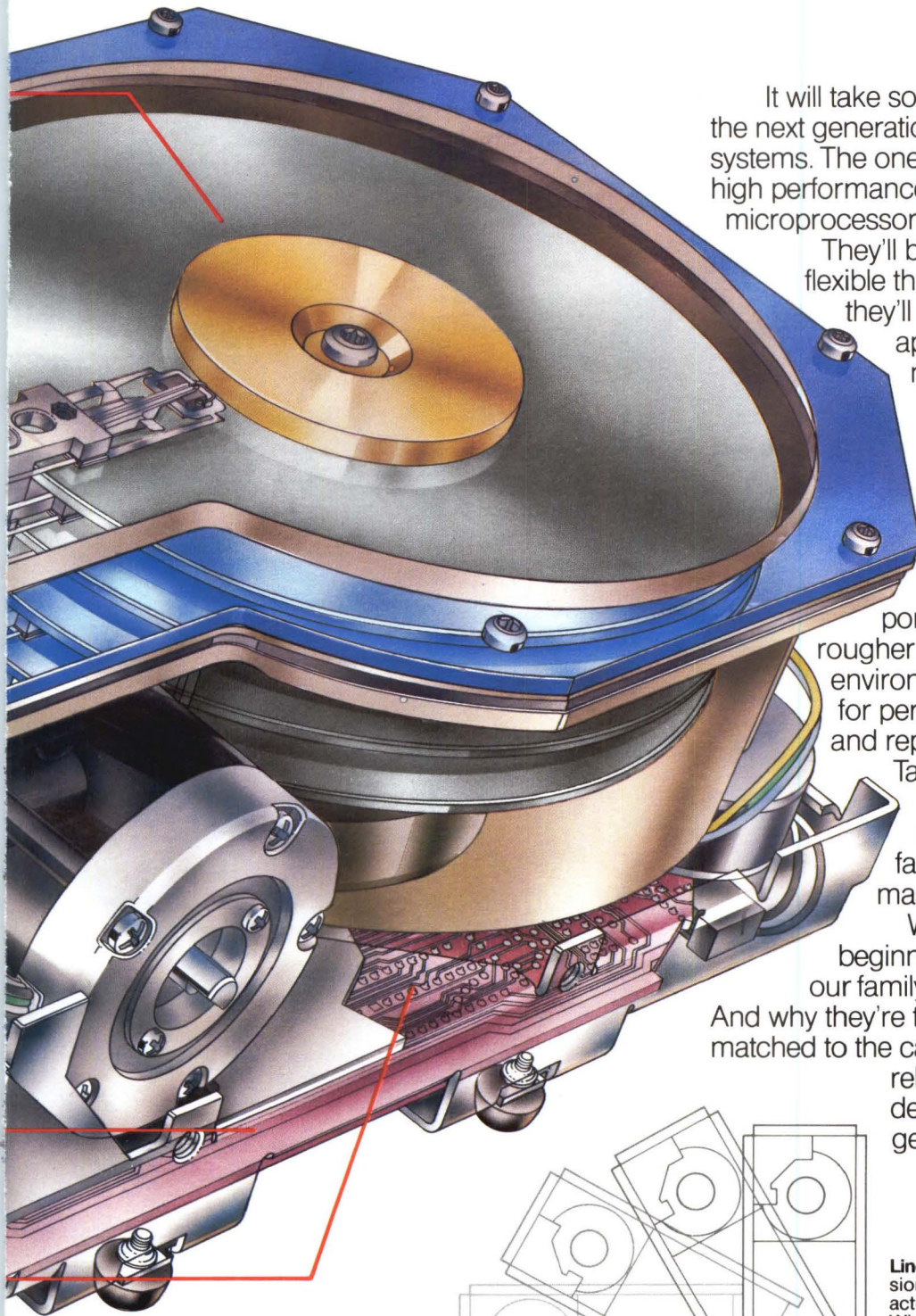

It will take something special to build the next generation of microcomputer systems. The ones that will revolve around high performance 16-bit and 32-bit microprocessors.

They'll be more powerful and flexible than today's systems. So they'll be pressed into new applications, not used to make today's applications go faster.

They'll improve throughput by a factor of four. So they'll be hungrier for data, and less prone to wait for it.

They'll be more portable. So they'll face rougher handling and harsher environments, without the time for periodic maintenance and repair.

Taking advantage of this market requires a new set of tools. Including smaller, faster, more rugged mass storage.

Which, from the very beginning, is how we designed our family of 5¼-inch Winchesters. And why they're the only drives uniquely matched to the capacity, performance, reliability, and availability demands of the next generation of applications.

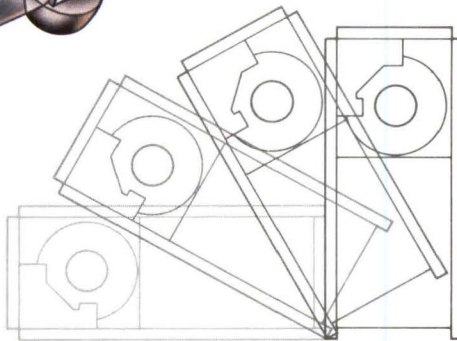

**Linear Actuator for Flexibility:** Our precision designed, six-bearing linear actuator is borrowed from 14-inch Winchester technology. It's driven by a five-phase microcontrolled stepper motor, and the combination lets you mount Evotek drives at any angle. Our design fits your design.



# The Risk.

A pre-production drive is a promise. That every production unit you receive will work in exactly the same way as the drive you first evaluated.

Now anyone can

make a prototype. Or a promise. But to deserve your business, a company ought to be willing to commit hard resources to take the risk out of your relationship.

Which is why we've invested \$12 million in a production facility where 70% of our drive assembly (including Class 100 clean room operations) is performed through robotics. It's money well spent.

Robotics, for example, allows us to use a single torque screw to anchor disk platters to the spindle. That eliminates a minor alignment problem in 10 mbyte disks which becomes catastrophic in high performance 50 mbyte applications.

But robotics is only a start.

To maintain quality over time, we borrowed a well-known principle of electronics—feedback.

At full capacity, our facility builds hundreds of thousands of drives a year. Yet each drive is completely assembled by a single person. And then tested on the spot.

Assemblers get a measure of their performance with every drive. And management can fine tune the operation faster, closing the loop of problems today, not long after they've been forgotten.

But more importantly, our approach assures you of a consistency of production across the board. Consistency that's the hallmark of manufacturing leaders around the world.

Nowhere is that consistency more critical than in the manufacture of thin-film (plated) media. Because the thinner and purer the media, the higher the recording density. And the less complicated the read/write electronics.

So we operate the largest 5¼-inch plated media line anywhere. Besides giving us absolute control over quality, our in-house facility lets us take advantage of the latest manufacturing techniques sooner.

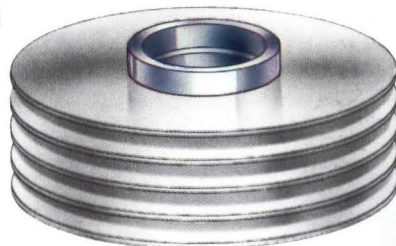
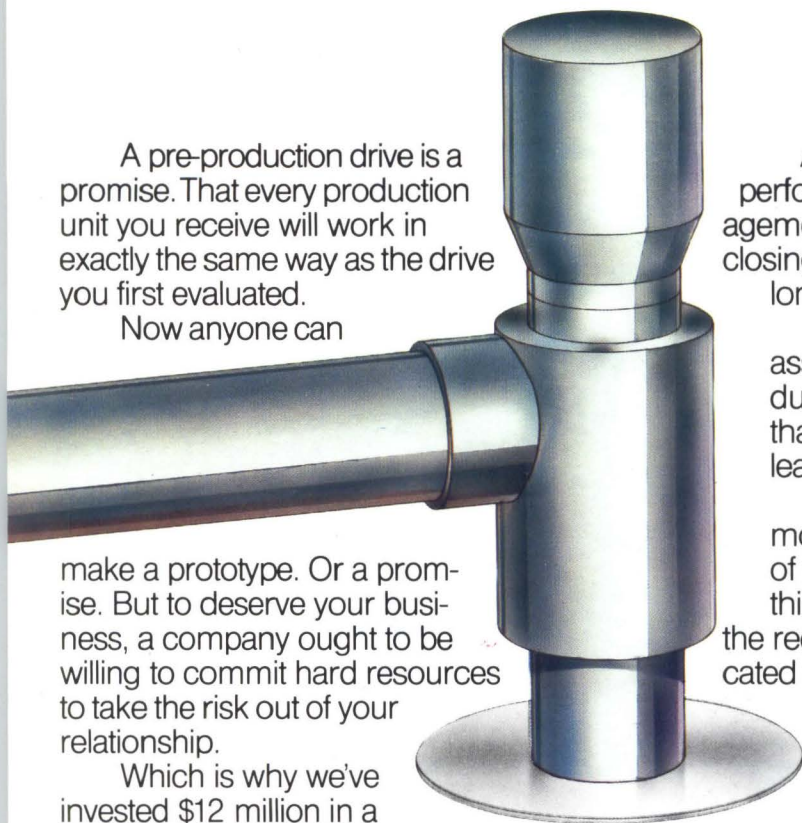



## DISK DRIVES

# Wringing higher performance from 5¼-in. Winchester

FRANK C. GIBEAU and STANLEY F. BROWN, Atasi Corp.

*Closed-loop servo-positioning system improves drive capacity and access time*

Existing mechanical positioning-system designs and the desire among suppliers to maintain compatibility with the ST506 interface place inherent limitations on the capacity and access times of 5¼-in. Winchester fixed-disk drives. These limitations place an apparent ceiling on technological improvement and the effectiveness of such products in supporting evolving computer systems. By replacing the traditional open-loop stepper-motor positioning system with a closed-loop servo-positioning system, normally found only in larger disk drives, manufacturers are producing 5¼-in. drives with greater capacity and lower access times. Suppliers can also achieve additional capacity by abandoning the ST506 interface and incorporating bit-density related technologies to increase capacity. These improvements

will enable 5¼-in. drive manufacturers to supply products allowing multi-user, multitasking applications and to expand into territory presently staked out by 8-in. disk drives.

### Old technologies reach their limits

Current 5¼-in. disk drive products combine rigid disks like those in 8- and 14-in. drives with the stepper-motor technology used in today's floppy disk positioning systems. The use of open-loop stepper technology allowed the development of a low-cost random-access device that provided a sixfold increase in capacity over current floppy disk drives. It also was one of the few positioning systems that could be designed into the small 5¼-in. package.

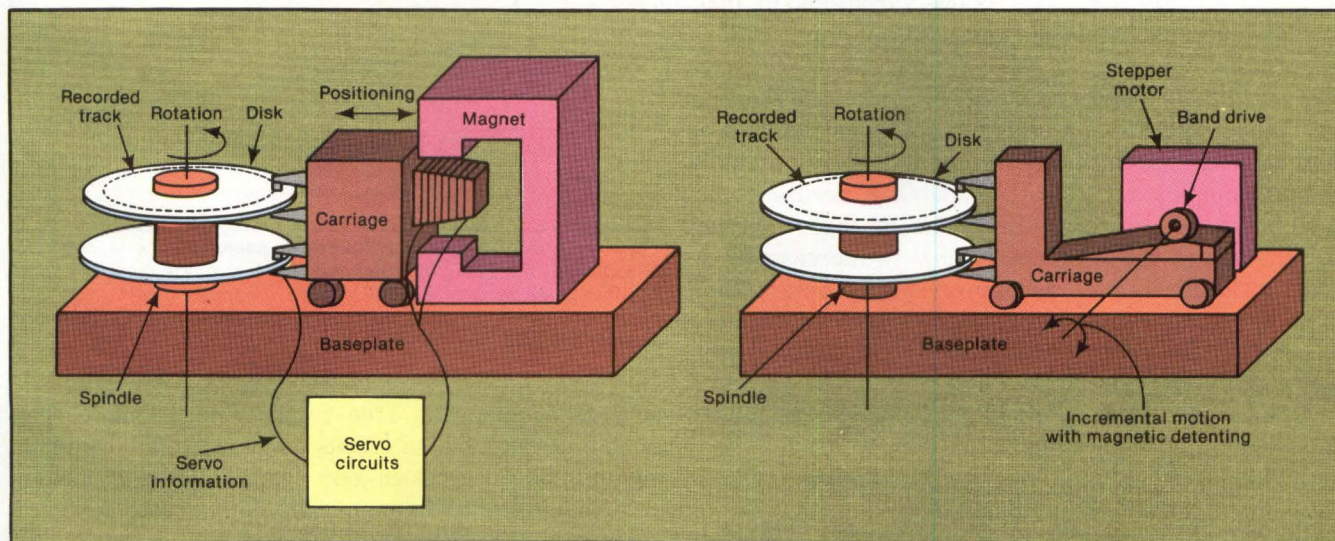

**Fig. 1. Closed-loop servo and open-loop stepper techniques center read/write heads over a track in different ways.** A closed-loop servo system uses servo information from the disk to modify current in a voice-coil-driven carriage. An open-loop stepper system uses a motor-driven band drive to move the carriage in discrete steps. Because a closed-loop servo can continuously vary head position, it can compensate for tracking variations from thermal distortion and vibration.

◀ **CIRCLE NO. 106 ON INQUIRY CARD**

MINI-MICRO SYSTEMS/February 1983



These first-generation rigid disk drives meet many users' needs, but the open-loop positioning system and the ST506 interface, which permits only 10.4K bytes per track, create serious limitations. There are only three ways to increase the capacity of these units while maintaining the ST506 interface: to add disk surfaces, which makes it difficult to maintain the standard 5¼-in. disk drive size and provide reliability; to use more disk surface by increasing the actuator stroke, which is limited by the usable magnetic surface of the disk; or to record more data tracks per inch.

Unfortunately, the stepper-motor positioning mechanism, as a classical open-loop servo system, has inherent positioning inaccuracies that restrict the number of tracks per inch that can be reliably recorded. These systems do not provide feedback information on position errors and consequently cannot correct for static or dynamic dimension variations that occur within the disk drive.

*The stepper-motor positioning mechanism has inherent positioning inaccuracies that restrict the number of tracks per inch that can be reliably recorded.*

Major causes of positioning problems include thermal distortions in the units that occur between initial power on and maximum operating temperature, thermal distortions caused by variations in ambient temperature, thermal deflection resulting from internally generated heat or externally applied heat, the inability of the open-loop servo to follow variations in disk rotation, carriage bearing tolerances and long settling time.

Despite these limitations, various open-loop stepper designs with both rotary and linear actuators have been implemented. Each design is an attempt to solve a unique, complex set of cost, availability, accuracy and manufacturing problems. But none of these stepper designs solves the problem of how to increase track density significantly to get more capacity on a 5¼-in. disk drive. Open-loop stepper-motor positioning systems using the popular four-phase incremental motor can achieve only about 3000 tracks in a four-disk unit, and are thus limited to about 30M bytes in an ST506 interface-compatible drive.

**Closed-loop servo positioning**

Reliably achieving more than 4000 tracks in a 5¼-in. drive with four disks requires the use of a closed-loop servo-positioning system. High-performance drives employing a linear or rotary voice-coil actuator can

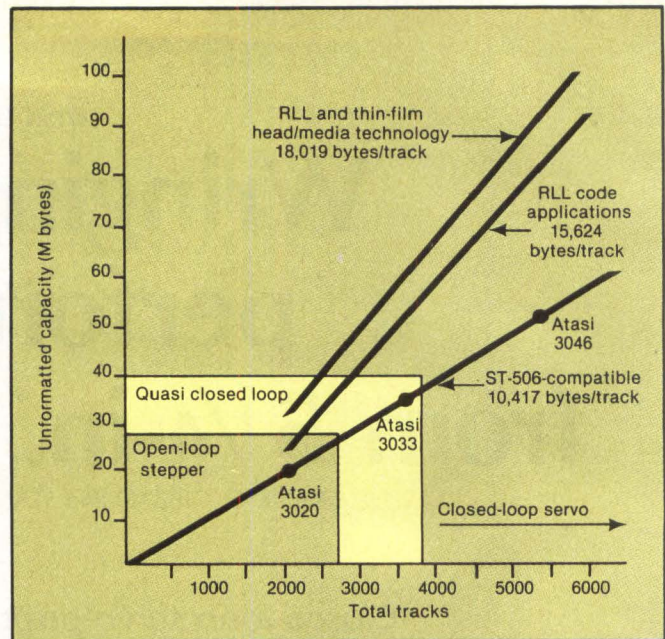

Fig. 2. Capacity versus number of tracks for different head-positioning and recording schemes shows the limited capacities of open-loop stepper and quasi-closed-loop techniques. Run-length-limited coding, especially when combined with thin-film technology, provides a higher capacity to number of tracks ratio than ST506-compatible coding.

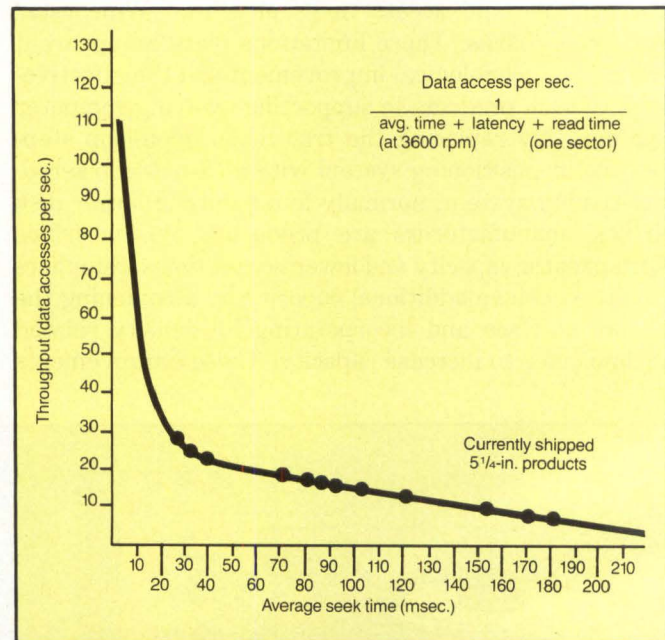

Fig. 3. Throughput versus average seek time is a nonlinear relationship with throughput defined as the average number of data accesses per second. The relationship changes most rapidly with seek times of less than 70 msec., the lower limit of most open-loop stepper systems.

achieve as many as 1100 tracks per in., more than double the number of tracks available in an open-loop system. Because closed-loop systems provide position feedback, they can dynamically compensate for environmental variations (Fig. 1).

The implementation of closed-loop servo systems makes it possible to build 5¼-in. disk drives with capacities equivalent to current stepper-motor models,





# DTC CONTROLLERS FOR "LITTLE" WINCHESTERS

**NOW AVAILABLE IN VOLUME**

We've ramped up production of our popular "little Winchester" controllers. Most models are now available off-the-shelf from Arrow, Hamilton/Avnet, Kierulff, and more than 25 international distributors. Or order in OEM quantities direct from DTC. Support two Winchesters, fixed or removable, 5 1/4" or new 3 1/2". At your option, control two floppy drives in 8" or 5 1/4". DTC host adapters link full-featured Winchester/floppy control and popular microcomputers. Our new 36,000 square foot plant is producing more than four thousand controllers a month. So when you need fast delivery, talk to DTC. For product information, circle our readers' service number. For faster response, call (408) 496-0434. East Coast call (617) 275-4044.

## THE CONTROLLER FOR TODAY'S WINCHESTERS.

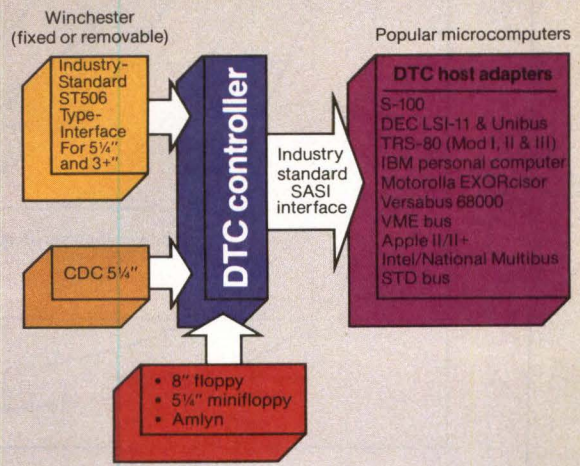

CIRCLE NO. 107 ON INQUIRY CARD

**DTC** Data Technology Corporation  
 2775 Northwestern Parkway  
 Santa Clara, California 95051  
 Telephone (408) 496-0434. TWX 919-338-2044  
 East Coast (617) 275-4044



## DISK DRIVES

but with fewer disks. For example, a 5¼-in. disk drive employing an open-loop stepper-motor positioning system might achieve a capacity of about 20M bytes by incorporating three disks. A closed-loop servo system could achieve the same capacity with only two disks. A third disk would boost the closed-loop drive capacity to more than 30M bytes.

*High-performance drives employing a linear or rotary voice-coil actuator can achieve as many as 1100 tracks per in., more than double the number of tracks available in an open-loop system.*

Capacity can be increased further by abandoning the ST506 interface and employing such technologies as run-length-limited coding and thin-film head/disks (Fig. 2).

Increasing the capacity of 5¼-in. drives satisfies only

half the challenge. Users who demand high capacity in smaller drives typically demand short access times as well. A major benefit of the closed-loop servo voice-coil positioning system is its inherently faster seek time. In a 5¼-in. drive with a 30M-byte capacity, it is possible to reduce the industry-standard 75- to 80-msec. average access time to about 30 msec.

### Closed loop speeds access

Equally important to data capacity is data availability, which is a direct function of throughput measured at the disk drive interface (Fig. 3). Closed-loop positioning technology provides micro-Winchesters with the access speeds necessary for high-performance systems.

Drive throughput can be measured in terms of the average number of random head arm accesses per second, derived by taking the reciprocal of the sum of average positioning time, average latency time and read time. Average seek times greater than 70 msec. provide the 4½- to 12-data-access-per-sec. throughput achieved by open-loop stepper positioning systems. Closed-loop servo systems permit average seek times of 30 msec. or less, providing throughput of 26 data accesses per sec. or more.

Because capacity and throughput are generally considered to be equally important in most applications, a reasonable definition of performance could be based

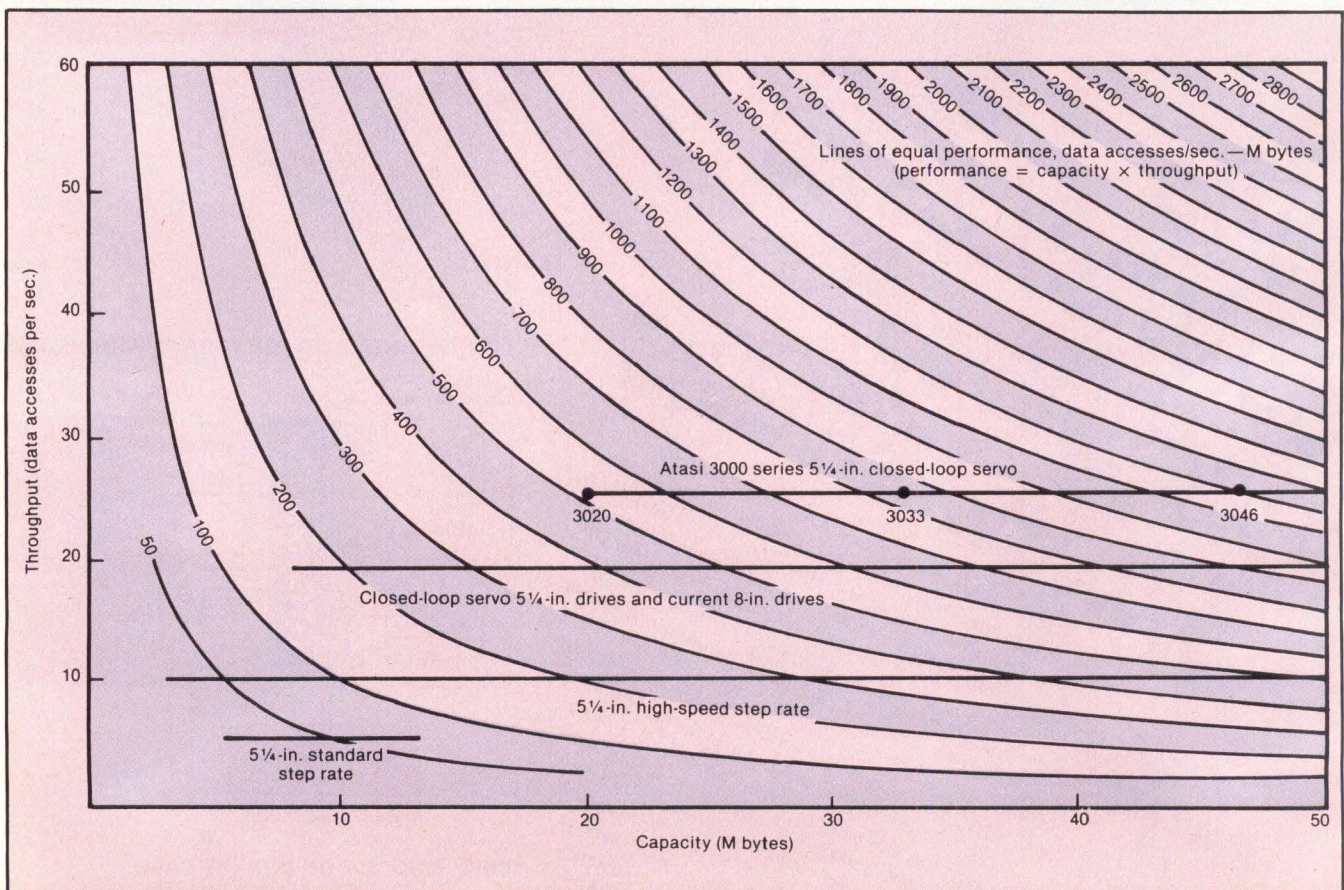

Fig. 4. Throughput versus capacity for small Winchesters shows higher throughput of closed-loop servo devices. Curves represent lines of equal performance, with performance defined as the product of throughput and capacity.



# Check The Chart Before You Choose Your New 16-Bit Computer System.

**Columbia Data Products'  
New Multi-Personal® Computer,  
Featuring IBM-PC® Compatibility,  
Excels In Professional, Business  
And Industrial Applications.  
Check it out.**



Columbia Data Products' MULTI-PERSONAL® COMPUTER can use software and hardware originally intended for the IBM® Personal Computer . . . while enjoying the flexibility and expandability of all Columbia Data's computer systems.

Available operating system software includes single-user MS-DOS® or CP/M 86® or multi-user, multi-tasking MP/M 86® or OASIS-16®, with XENIX® available soon, providing users with a host of compatible software packages for personal and professional business and industrial applications. A large selection of higher level languages are also available, including BASIC, FORTRAN, COBOL, PASCAL and MACRO Assembler.

Our standard 16-Bit 8088 hardware configuration provides 128K RAM with parity, two RS-232 serial ports, Centronics parallel printer port, interrupt and DMA controllers, dual floppy disks with 640K storage, Winchester disk and keyboard interfaces, and eight IBM-PC compatible expansion slots . . . and lists for only \$2995. Winchester hard disk configurations, featuring cache buffer controllers for enhanced disk access performance are also available, starting at \$4995.

So, when you need to grow, why gamble and hassle with independent third party hardware and operating system vendors which may or may not be compatible . . . not to mention the hidden expense and frustration of implementing peripheral drivers in the different operating systems and upgrades? Who needs the finger-pointing when things don't work out?

After you review our chart, you will agree . . . for overall 16-Bit microprocessor superiority, expandability, flexibility, compatibility and real economy, Columbia Data is your *total source*.

Our Multi-Personal Computer . . . the 16-Bit system born to grow!

Get yours now. **CIRCLE NO. 108 ON INQUIRY CARD**

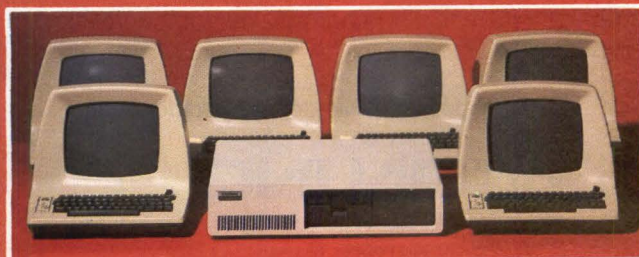

MAIN FEATURES	CDP-MPC	IBM-PC*	OTHERS
Microprocessor	16-Bit 8088 8-Bit Z-80 (Opt)	16-Bit 8088	?
USER Memory	128K-1 Mbytes	16K-256 Kbytes	?
IBM-PC Compatible Expansions Slots Beyond Professional Configuration <sup>1</sup>	8 Slots	0	?
Resident Floppy Disk Storage	Dual 320K (std)	Dual 160K (Opt) Dual 320K (Opt)	?
Resident Cache Buffer Hard Disk Storage	5M/10M	—	?
<b>OPTIONAL OPERATING SYSTEMS (Supported by Company)<sup>2</sup></b>			
MS-DOS (PC-DOS)	Yes	Yes	?
CP/M 86	Yes	Yes	?
MP/M 86	Yes	—	?
OASIS-16	Yes	—	?
XENIX	Soon	—	?
<b>OPTIONAL HARDWARE EXPANSION BOARD (Supported by Company)</b>			
RS-232 Communications	Yes	Yes	?
B/W and Color Display Controller	Yes	Yes	?
Expansion Memory	Yes	Yes	?
Z-80 CP/M-80 Board	Yes	—	?
Cache Buffer Hard Disk	Yes	—	?
Time/Calendar Board	Yes	—	?
IEEE Bus Controller	Yes	—	?
8" Floppy Disk System	Yes	—	?
8" Hard Disk System	Up to 40 Mbytes	—	?
Tape Cartridge System	Yes	—	?

<sup>1</sup>For comparison purposes, typical professional configurations consist of 16-Bit 8088 Processor, 128K RAM with Parity, Dual 320K 5-inch Floppies, DMA and Interrupt Controller, Dual RS-232 Serial Ports, Centronics Parallel Port and Dumb Computer Terminal or Equivalent.

<sup>2</sup>Columbia Data Products also supports CP/M 80\* with an optionally available Z-80 CP/M Expansion Board.

\*As advertised in BYTE Magazine, August 1982.

## COLUMBIA

### DATA PRODUCTS, INC.

**Home Office:**  
8990 Route 108  
Columbia, MD 21045  
Telephone 301-992-3400  
TWX 710-862-1891

**West Coast:**  
3901 MacArthur Blvd.  
Suite 211  
Newport Beach, CA 92663  
Telephone 714-752-5245  
Telex 277778

**Europe:**  
P.O. Box 1118  
450 Moenchengladbach 1  
West Germany  
Telephone 02161-33159  
Telex 852452

IBM is the trademark of International Business Machines. CP/M and MP/M are trademarks of Digital Research. OASIS is the trademark of Phase One. MS-DOS and XENIX are trademarks of MICROSOFT.



## DISK DRIVES

---

on the combination of the two. Performance is no longer a function of storage capacity alone. It is the product of capacity times throughput (Fig. 4).

### Higher performance wins new markets

The performance required from a disk drive in a small system depends on the application and the category into which it falls. Disk drives in single-user, single-task applications are generally used for data

---

*In a 5¼-in. drive with a 30M-byte capacity, it is possible to reduce the industry-standard 75- to 80-msec. average access time to about 30 msec.*

---

storage. Capacities can be relatively small, and access times can be relatively slow because the drive need perform for only one user. Disk drives based on open-loop stepper-motor positioning systems are more than adequate in such applications, which typically require capacities of less than 20M bytes and access times of 75 to 80 msec.

Multi-user, multitasking systems, on the other hand, are used in applications in which many users require access to a common database. Capacities, therefore, must be high, and, because many users must have access to that data, access times must be short. Disk drives with capacities of less than 30M bytes and access times greater than 40 msec. are unsuitable for such file-server applications. For example, a typical single-user workstation such as a stand-alone word processor requires about 3½ to 5 random data accesses per sec. A stepper-motor Winchester drive with positioning times from 70 to 150 msec. can readily satisfy this requirement for one or two workstations, which would require a maximum of 7 to 10 random data accesses per sec. For three workstations, however, the practicality of such disk drives becomes marginal, and for four stations, system performance is seriously degraded.

Consequently, as manufacturers of 5¼-in. disk drives produce high-performance drives in such small packages, they will begin to encroach on 8-in. drive territory. This incursion will become even more pronounced as 5¼-in. suppliers abandon the use of standard interfaces and explore other technologies designed to increase disk drive performance. □

---

**Frank C. Gibeau** and **Stanley F. Brown** are president and vice president, respectively, of Atasi Corp., San Jose, Calif.

---

# Flexible Disk Drive Testing Should Be Flexible, But...



Uncompromising! At Brikon we won't budge a nanosecond when it comes to accuracy, resolution, and quality. Brikon testers are completely self-contained units with many extra built-in features.

Brikon flexible disk drive testers are accurate, easy-to-use, and less costly than most others. Major OEMs around the world recognize Brikon as the standard for flexible disk testing. Compare these features:

- Easy to use: names in English and numbers in decimal
- Self-contained DC power supply for drives
- Automatic testing option: tests and qualifies all major subsystems within the drive under test.
- Multiple drive testing and radial alignment testing options

Contact Brikon today for in-depth specifications.

## **BRIKON INC.**

Brikon, Inc., 22981 Alcalde Dr., Laguna Hills, CA 92653  
Phone: (714) 768-3838, Telex: 181645

CIRCLE NO. 109 ON INQUIRY CARD



New from Cosmos Systems

# A Galaxy of Processing Solutions For The OEM & System Integrator

MC68000\* Microcomputer Systems with UNIX,\*  
Multibus\* & a Full Range of Capabilities.



## ANTARES

Our new "Starfield Series" offers you a universe of configuration alternatives for creating advanced processing systems.

Cornerstar of the series is ANTARES—a state-of-the-art system for major development projects. With 1M ECC memory, 40M 8" Winchester, 1/4" streamer tape backup and 16-channel intelligent I/O, ANTARES is the optimum solution for getting new applications developed quickly.

\* MC6800 is a trademark of Motorola, Inc.  
\* Ethernet is a trademark of Xerox.  
\* UNIX is a trademark of Bell Laboratories, Inc.  
\* MULTIBUS is a trademark of Intel Corp.

MINI-MICRO SYSTEMS/February 1983

## ORION

Centerstar is ORION—designed with 474M mass storage, 1/2" streamer tape backup, 1M ECC memory plus floating-point hardware and optional Ethernet. \* ORION is your solution for rapidly developing and running scientific applications.



Winning combinations.

**COSMOS SYSTEMS, INC.**

A Subsidiary of C.M. Technologies, Inc.  
430 Toyama Drive, Sunnyvale, CA 94086  
(415) 326-9150/TELEX: 334417  
CABLE: CHIMINGCO

CIRCLE NO. 110 ON INQUIRY CARD

## LYRA

Targetstar is LYRA, comprised of 8" 20M Winchester, 8" 1M floppy and 1/2M ECC memory. This sophisticated target-system solution shares aggressive volume pricing with all Cosmos products.

The Starfield Series supports "C," COBOL, FORTRAN, PASCAL and BASIC languages.

Combine Starfield capabilities with your imagination and our market-oriented policies. We don't promise the moon, but we do promise right-now options for right-now solutions. Call us today for full details.

205



**PRIAM**

**THE  
DRIVING  
FORCE IN  
WINCHESTERS.**



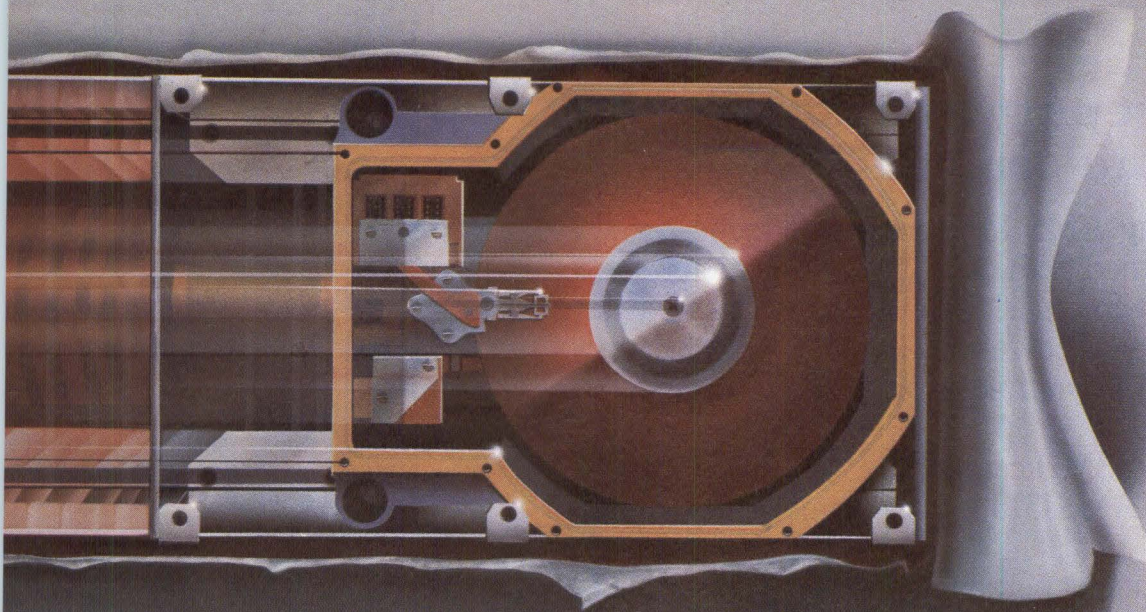

**In the world of Winchester's, only one company delivers the proven technology and breadth of line you need—PRIAM.**

**PRIAM Time.** We've paid our dues by delivering thousands of Winchester disc drives. We've proven our technical superiority and high reliability in the field. We're the force to be reckoned with on the high-performance Winchester scene.

**A growing family of winners.** From the beginning in 1978, PRIAM has been the driving force in high-end Winchester technology. We've proven our technology in the 14-inch Winchester market with our 34, 68 and 158 Mbyte units. Our 8-inch drives have capacities of 35, 70 and 105 Mbytes in a floppy-sized package. And, we're adding a 50 Mbyte 5¼-inch drive to our growing family.

**PRIAM Winchester Family.**

Size	Model	Capacity (MB)	Access Time
14"	3350	34	45 ms
	6650	68	45 ms
	15450	158	45 ms
8"	3450	35	42 ms
	7050	70	42 ms
	804	105	42 ms
5¼"	502	50	35 ms

**SMART Interfaces.** PRIAM gives you the finest in interfacing flexibility. Our intelligent interfaces can control up to four drives in any mix, plus tape or floppy backup. They're your fastest and easiest route to putting a Winchester database

in your system. Or, if you have an SMD or ANSI controller, our drives can be supplied with a matching interface.

**We keep listening.** We're driving upward to higher capacities, more compact packaging and enhanced performance with increased emphasis on quality and reliability. We believe our customers deserve high quality products. And we've committed the resources to meet that objective.

If you're thinking about Winchester's, think PRIAM. For more details, call (408) 946-4600 or the sales office nearest you. Los Angeles (714) 994-3593, Minneapolis (612) 854-3900, Boston (617) 444-5030, New York (201) 542-8778, London 44-7357-3575.



**PRIAM**

20 West Montague Expwy.  
San Jose, CA 95134  
(408) 946-4600  
TWX 910-338-0293  
FAX 408-946-5679



## It isn't just plug-compatible, it's software-compatible.

Introducing AMS 315, the first Winchester precisely designed to the storage specifications of 300-MB removable pack drives. So for the first time you get all the advantages of a 300-MB Winchester without rewriting your software. Or redesigning your interface.

We're truly SMD compatible.

Century's AMS 315 has the same 20,160 bytes per track.

Same 19 tracks per cylinder.

Same 823 cylinders per spindle.

Same 3,600 RPM rotation.

All in one-third the space.

Using less than half the power.

At about two-thirds the initial delivered cost.

Plus you get more than twice the reliability and eliminate preventive maintenance so the on-going cost of ownership is less, too.

Expand your mass storage alternatives with Winchester technology. You'll see the difference right away. Your system never will.

Call to arrange a test drive.

Century Data Systems, Marketing Communications  
C1-10, 1270 N. Kraemer Blvd., Anaheim, CA 92806,  
(714) 999-2660.

AMD House, Goldsworth Road, Woking, Surrey,  
England, GU 21 1JT, 44-4862-27272.

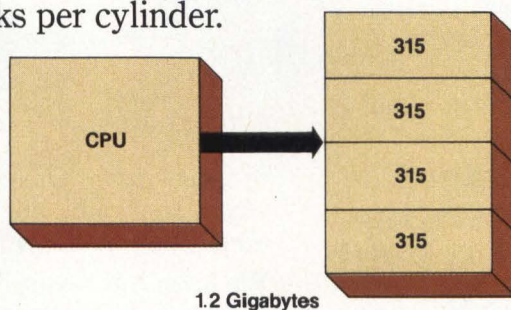

*Stack four AMS 315s for 1.2 gigabytes of Winchester storage in about the same space as your 300-MB removable pack drive.*

 **Century Data Systems**  
A Xerox Company

CIRCLE NO. 112 ON INQUIRY CARD



Finally, a Winchester that goes head-to-head, track-to-track, cylinder-to-cylinder, byte-to-byte with 300-MB removable pack drives.

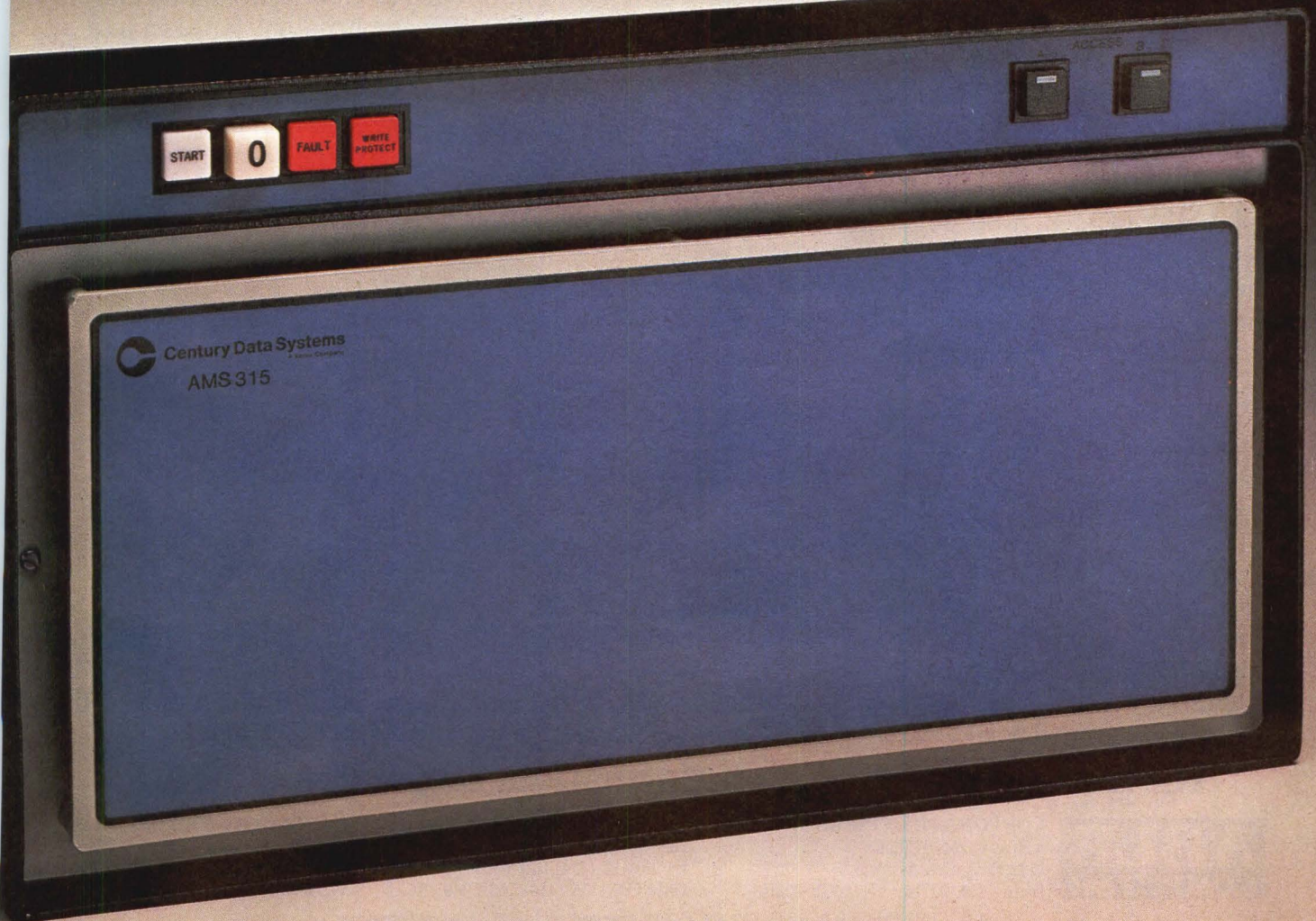



# If you're in the market for communications modules, make the ABLE connection now. And join the thousands who already have.

We are known as the innovators. Most of our products are industry "firsts" which become popular quickly, then settle into a stage of steady long-term acceptance. These four DEC-compatible, communications devices fit the pattern perfectly. They are ABLE originals. They achieved instant success worldwide. They provide top performance. And they are very reliable. Read on to find the one for you.

## INCREASED VAX THROUGHPUT.

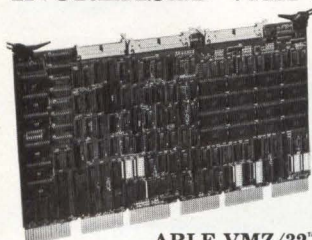

ABLE VMZ/32™  
16-line DMF/32 subset

Here's an asynchronous microcontroller with programmable DMA, fully transparent to VAX/VMS as two 8-line DMF 32's and contained on a single board. Priced

below the DZ11-E, it outperforms DZ or DH devices under VMS v.3, has interrupt-driven modem control on every line, and includes an output throttle which lets peripheral devices optimize their own data rate.

## #1 UNIBUS DMA.

Then there's our DH/DM, the original multiplexer which puts 16 lines with modem control on a single board. This popular device meets UNIX VAX system

needs for DMA communications requirements, serves UNIBUS systems equally well, and beats them all for MTBF, throughput and

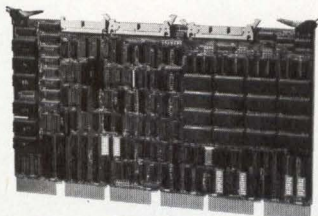

ABLE DH/DM™  
16-line combination DH11  
& DM11 replacement

price. Other features include on-board diagnostics, modem control on all lines, superior on-board silo depth and variable prom-set. **SYNC/ASYNCH FLEXIBILITY.**

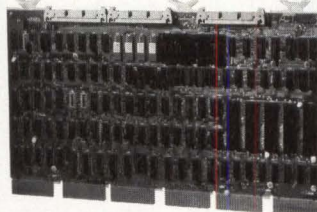

ABLE DV/16™  
16-line DV11 replacement

A controller for the PDP-11 user, the DV/16 contributes microprocessor-derived flexibility, which permits mixing of sync and async lines in combinations of 4 or 8 lines with modem control and full system software compatibility. It takes less than half the space of a DV11 and uses word transfer instead of byte DMA to gain a 2 to 1 speed advantage or permit operation in half the bandwidth required for data transfers.

## Q-BUS DMA.

The Q/DH is an asynchronous controller which makes DH-class performance possible on PDP-11/23 and LSI-11/23 Q-BUS systems. It connects the standard Q-BUS to as

many as 16 async lines with DMA output capabilities and allows optimum Q-BUS utilization. Features include software compatibility with RSTS/E and RSX operating systems, large input silo, modem control on all lines.

Write for details on our complete line of DEC-compatible products. Be on the lookout for exciting new ABLE communications products soon to come.

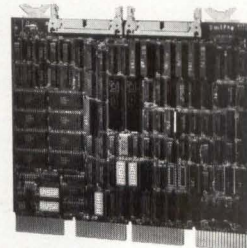

ABLE Q/DH™  
8 or 16-line DH/DM  
for Q-BUS

**For Immediate, Toll-Free Information, Dial 800 332 ABLE.**



**CORPORATE OFFICES**  
ABLE COMPUTER  
1732 Reynolds Avenue  
Irvine, CA 92714 • (714) 979-7030

**NATIONAL OFFICES**  
Burlington, MA (617) 272-1330  
Irvine, CA (714) 979-7030  
Daly City, CA (415) 755-6040

**INTERNATIONAL OFFICES**  
Canada (Toronto) (416) 270-8086  
England (Newbury) (0635) 32125  
W. Germany (Munich) 089/463080

DEC, PDP, UNIBUS, Q-BUS, LSI, VAX and VMS are trademarks of Digital Equipment Corporation.

**CIRCLE NO. 113 ON INQUIRY CARD**



## DISK DRIVES

# Less can be more with half-height disk drives

GERALD H. KILTZ, Shugart Corp.

*New floppies and Winchesters boast better specs in addition to slimmer profiles*

Half-height 5¼-in. floppy and rigid disk drives allow designers to place two standard-capacity drives in the space of one drive. While reduced size is a major feature of these drives, the height-saving design changes required to reduce a standard-height drive by half can result in other benefits. Shugart Corp.'s SA455/465 half-height minifloppy drives and SA706/712 half-height 5¼-in. Winchester drives incorporate designs that provide greater head positioning accuracy and cooler operation with fewer components.

### Greater positioning accuracy

The SA706/712 and SA455/465 achieve higher head positioning accuracy than earlier models. In the SA706/712 series, higher accuracy is a result of improved stepper and spindle motors and a streamlined head actuator carriage; in the SA455/465 series, it results from use of a better clamping mechanism, as well as refined motor designs.

The stepper motor used in the SA706/712 is a 16-pole, rather than an eight-pole, design. The increased number of poles allows the rotor to step at a 0.9-degree-per-track angle, half the 1.8-degree step angle in earlier motors, providing more torque to the read/write head. This greater torque results in less hysteresis, or magnetic lag, in the motor, and thus less of a difference between the intended and actual positioning of the read/write heads. The greater positioning accuracy allows an increase in track density from 256 to 360 tpi, doubling capacities over Shugart's first generation of 5¼-in. rigid disk drives.

A new "mini-slider" head also helps the SA706/712 handle increased bit density. These heads have a ferrite core more than 50 percent smaller than earlier Winchester heads (Fig. 1). In combination with a highly



Shugart's new half-height drives include the SA455/465 minifloppies (left) and the SA706/712 series of rigids (right). The SA455 and 465 offer 0.5M and 1M byte, respectively, while the SA706 and 712 offer 6M and 13M bytes. Both series feature improved positioning accuracy and greater reliability over earlier models. The two drives can be combined with Shugart's SA1620 intelligent controller for as much as 7M bytes of on-line storage and backup, in a standard minifloppy-sized package.

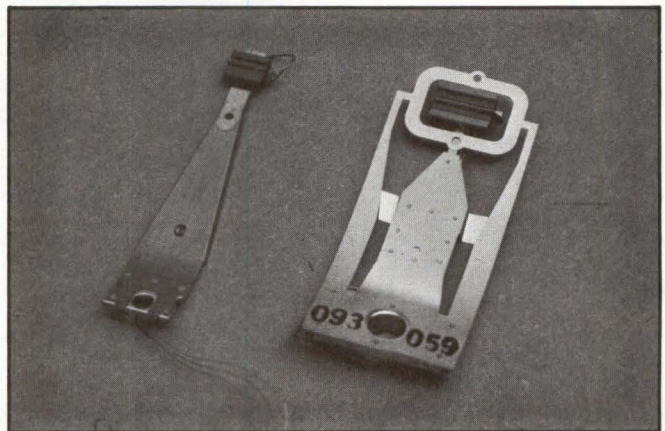

Fig. 1. Mini-slider heads (left) have a core that is about 50 percent smaller than those in previous Winchester heads (right). The flexure provides greater stability than earlier models, allowing heads to fly closer to the disk for better tracking and higher densities.



## DISK DRIVES

stable, stainless-steel flexure design, the mini-slider head flies closer to the disk than previous read/write

heads and is therefore less likely to read the signal from a neighboring track. Mini-slider heads have enabled Shugart to increase the bit density from 7900 flux changes per in. in the full-height SA600 series to 9036 fepi in the SA706/712 series. In addition, a smaller landing/shipping zone is required with the mini-slider

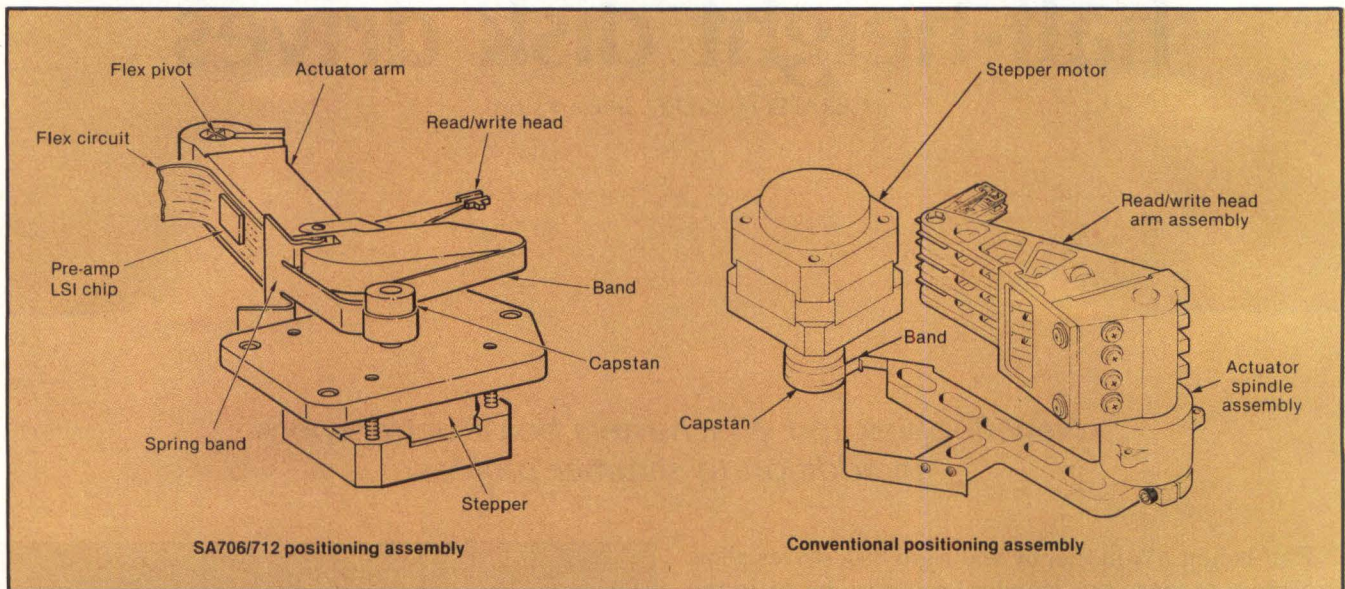

**Fig. 2. Comparison of SA706/712 and conventional positioning assemblies** shows how step pulses are more directly transmitted in the SA706/712 design. In conventional designs, pulses are sent from the motor through a secondary arm and actuator spindle. In the SA706/712, pulses are transmitted from the band directly to the head actuator carriage by mounting the capstan over the motor.

## DESIGNING FOR THE ASSEMBLY LINE

The SA455/465 minifloppies and SA706/712 5¼-in. Winchester drives are designed to be built on progres-

sive assembly lines, in which work moves in one direction, without returning to the same station. In

nonprogressive, or "unbalanced" lines, parts and sub-assemblies are returned to a materials handler after each assembly step is completed. The materials handler then must send the parts along the line to the next workstation. Nonprogressive systems are generally slower and require more handling of the work. In addition, progressive lines can more easily be adapted to automation.

The SA455/465 series has a block-built design: the plane of the casting is turned only once during assembly, rather than the six or seven times required with earlier minifloppies. After the DC spindle motor is installed, other components can be added without shifting the casting, further speeding the manufacturing process. The SA706/712 series are built in Class 100 clean tunnels in conjunction with progressive assembly lines. When combined with a highly automated system for moving parts, each tunnel can build 100,000 drives per year.



**Class 100 clean tunnel assembly line** produces Shugart 5¼-in. rigid disk drives. Automated conveyor system provides single-direction movement of the drive from unassembled components to final testing. Each tunnel can produce 100,000 drives per year.



# Microscience International Introduces 5¼" HALF-HEIGHT WINCHESTER

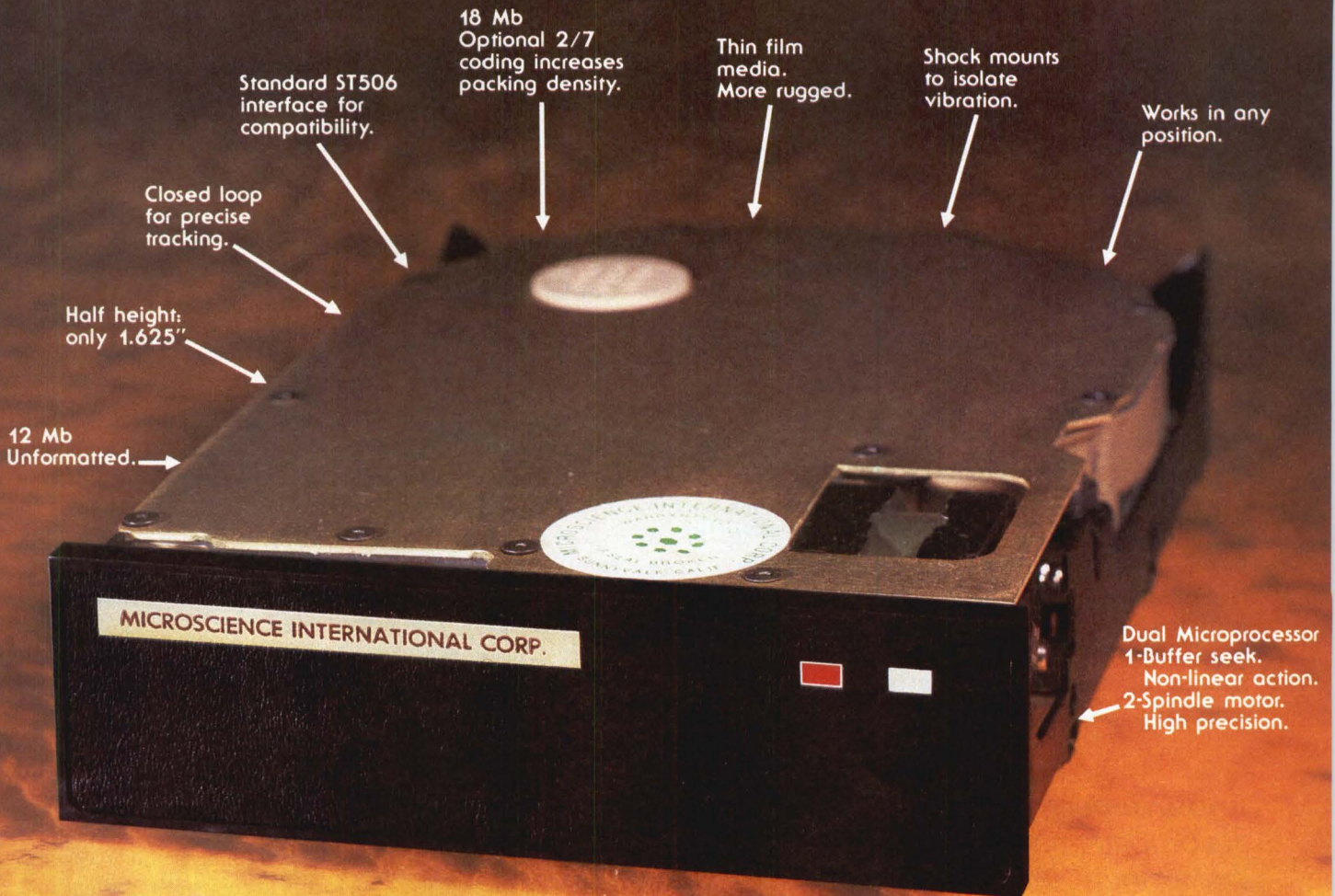

## The most cost-effective disk drive on the market

Your computer's memory capacity has just about doubled with Microscience's innovative half-height disk drive—the Model HH-612. Using half the space of conventional 5¼" Winchester drives, the HH-612 allows you to mount two drives with up to 25 Mb into the same area that held a 6.4 Mb unit.

Equally important are the HH-612's advanced features shown above. While only 1.625" high, this compact drive, using a rugged, thin-film media, can provide 10 Mb of formatted ST506-compatible storage, or alternate unformatted packing densities of 12 Mb and, with 2/7

MINI-MICRO SYSTEMS/February 1983

coding, 18Mb.

On the mechanical side, the HH-612 is shock mounted to reduce vibration; on the electronics side, dual microprocessors make it unique in the disk drive field. Superb tracking comes from a close loop positioning system, and rapid access time is achieved with a highly-innovative non-linear buffer seek program.

The second microprocessor maintains precise spindle motor velocity to exacting tolerances. The result is a compact, cost effective drive that will give high reliability at a lower cost per drive.

CIRCLE NO. 114 ON INQUIRY CARD

If you need more detailed information about how the HH-612 can fit into your computer, write or call us. Evaluation units are available to qualified OEM's.

 **Microscience  
International  
Corporation**

575 E. Middlefield Road  
Mountain View, CA 94043  
(408) 737-9158 Telex 176224

© Microscience International Corporation 1982  
Patent Pending

Most of the HH-612 special features, not found in other drives, are included in the base price.

213



## DISK DRIVES

---

heads, allowing 40 additional data tracks on each surface.

New HAC assembly and spindle motor designs also contribute to higher positioning accuracy. Step pulses are transmitted directly from the capstan, positioned above the motor, to the HAC. In previous models, the capstan was under the motor; step pulses were

---

*The SA706/712 rigid disk drive series retains the data safety and reliability features of earlier units.*

---

transmitted to an arm beneath the HAC, then to the actuator spindle and finally to the HAC (Fig. 2). A four-pole, three-phase spindle motor supplies a more consistent level of torque to the spindle, reducing the potential for speed variation and eliminating the possibility of a zero-null position, in which no torque is applied, when the drive is started.

---

*Improvements in component design accompany significant reductions in component sizes.*

---

In the SA455/465 series, the dynamic clamping mechanism brings the collet that holds the media against the drive straight down on the spindle. Previous designs brought the collet down at an angle, sometimes causing the diskette to wobble slightly while spinning, providing the potential for positioning errors. Single-piece spindle and spindle motor construction increases positioning accuracy through reduced tolerances, while elimination of the belt, pulley and bearings reduces "run-out," an elliptical rather than a circular spindle rotation. The reduced internal friction of the new stepper motor in the SA455/465 also reduces average access time from the 150 to 275 msec. in current minifloppies to 94 msec.

These improvements in component design accompany significant reductions in component sizes. In the SA455/465, the brushless, direct-drive DC motor is more than 60 percent smaller than previous motors, while the spindle motor in the SA706/712 series is more than 50 percent smaller than those used in earlier 5¼-in.

drives. The stepper motor in the SA706/712 series is 60 percent smaller than those used in the first generation of 5¼-in. rigid disk drives, and the HAC is streamlined as well.

---

*In the SA706/712 series, higher accuracy is the result of improved stepper and spindle motors and a streamlined head actuator carriage.*

---

### Cooler operation

The SA455/465 and SA706/712 drives dissipate less heat than their larger predecessors, although they have the same power requirements. The SA465 dissipates 12.5W when operating and 3.6W in standby, about half the amount of other drives. The SA706/712 spindle motor dissipates one-third less heat because it has less air to turn than in larger drives.

The SA706/712 rigid disk drive series retains the data safety and reliability features of earlier units, including built-in four-point shock mounts, automatic spindle and actuator locks and a dedicated head-landing/shipping zone. These features are especially important in half-height drives because they are likely to be used in desk-top and portable systems that are moved frequently.

Use of custom LSI circuitry reduces the number of board components as well as the size of the board used in both series. Read/write operations are controlled by an LSI chip, and in the SA706/712, a second LSI chip mounted on the HAC performs signal preamplification, buffering data as it is read and reducing the signal-to-noise ratio.

Surface-mounted device electrical components and IC chips in the SA706/712 series also reduce board size. The SMDs are about 50 percent smaller than earlier components and chips and are soldered without leads to the top of the board, rather than the underside, creating additional space. In the SA455/465, Himec packages reduce board size by performing functions previously requiring several chips.

Finally, the band actuator used in the SA455/465 series is held under spring tension to compensate for contraction of the band during manufacturing and shipping operations. The tension also has a damping effect on the band, resulting in quieter operation, an important consideration for drives used in office systems. □

---

**Gerald H. Kiltz** is product marketing director at Shugart Corp., Sunnyvale, Calif.

---



# NOW—SUPER-PERFORMING 5¼" WINCHESTERS WITH BUILT-IN RELIABILITY.

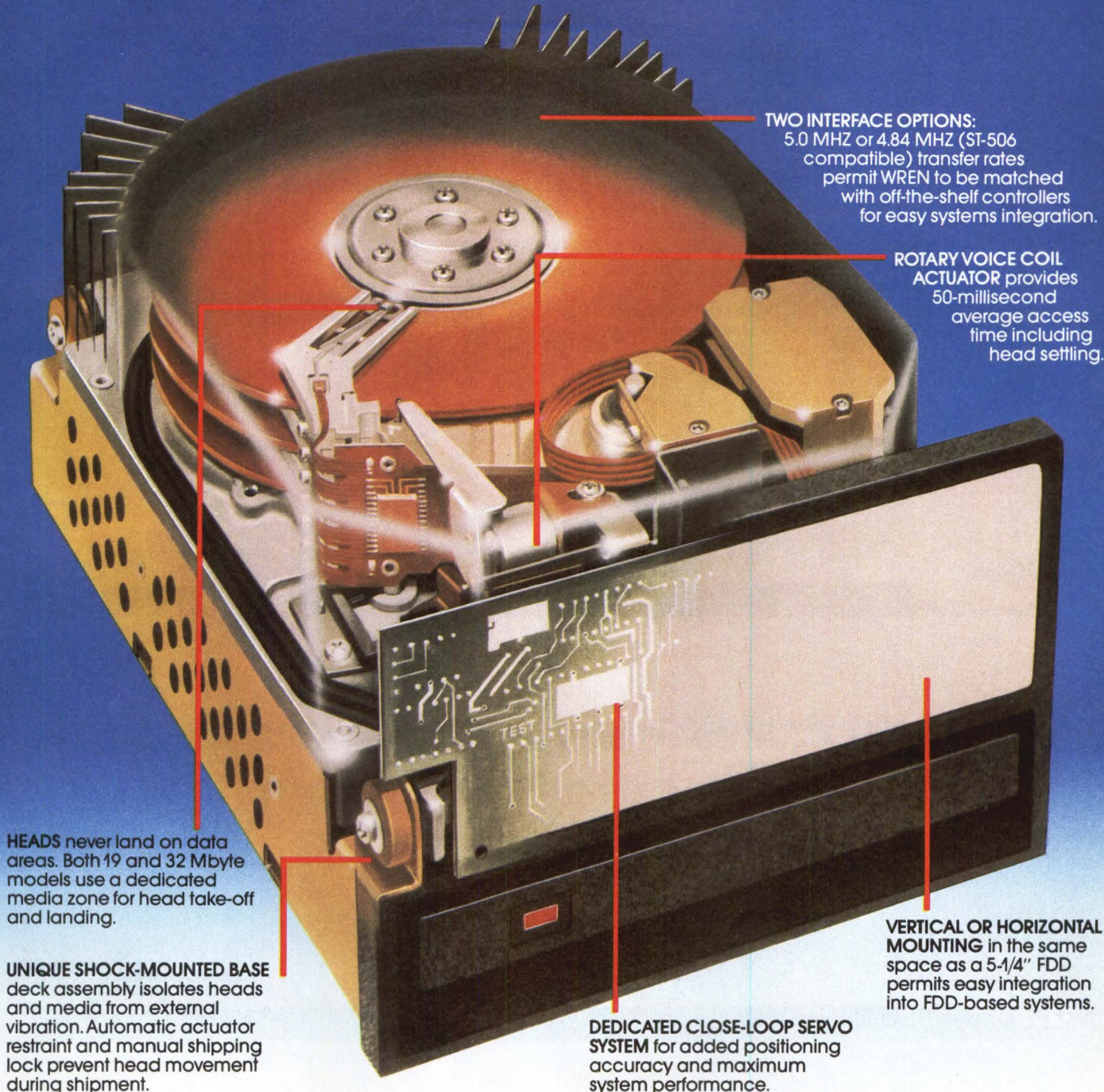

**TWO INTERFACE OPTIONS:**  
5.0 MHz or 4.84 MHz (ST-506 compatible) transfer rates permit WREN to be matched with off-the-shelf controllers for easy systems integration.

**ROTARY VOICE COIL ACTUATOR** provides 50-millisecond average access time including head settling.

**HEADS** never land on data areas. Both 19 and 32 Mbyte models use a dedicated media zone for head take-off and landing.

**UNIQUE SHOCK-MOUNTED BASE** deck assembly isolates heads and media from external vibration. Automatic actuator restraint and manual shipping lock prevent head movement during shipment.

**DEDICATED CLOSE-LOOP SERVO SYSTEM** for added positioning accuracy and maximum system performance.

**VERTICAL OR HORIZONTAL MOUNTING** in the same space as a 5-1/4" FDD permits easy integration into FDD-based systems.

## T H E W R E N™

The Model 9415 WREN disk drive gives you a host of value-added features. From microcomputer and LSI control logic to special-formula media, high technology has finally delivered a 5-1/4" winchester with more reliability. Compare for yourself. To qualify for a FREE evaluation unit, contact your local Control Data OEM Sales Representative or write: OEM Product Sales, HQN08H, Control Data Corporation, P.O. Box 0, Minneapolis, MN 55440.



**CD CONTROL DATA**

*Addressing society's major unmet needs  
as profitable business opportunities*  
CIRCLE NO. 115 ON INQUIRY CARD





\*StacPac, HyperDiagnostics, Rapid Module Exchange and HyperService are trademarks of Data Systems Design, Inc.  
\*DEC is a registered trademark of Digital Equipment Corporation. \*Multibus is a registered trademark of Intel Corporation.



# DSD STACKS THE DEC. AND THE MULTIBUS, TOO.

## Presenting StacPac™ systems and modules.

This is a brand new deal for systems integrators.

StacPac systems and modules. Modular storage and backplane units that stand alone or stack together to form the basis of a small but powerful tabletop computer.

They're available in either DEC®- or Multibus®-compatible versions. And there are lots of advantages to both.

On the DEC side, you can put a StacPac system in places a rack-mount just doesn't fit.

On the Multibus side, you can use our StacPac system to deliver serious minicomputer performance with microcomputer economy.

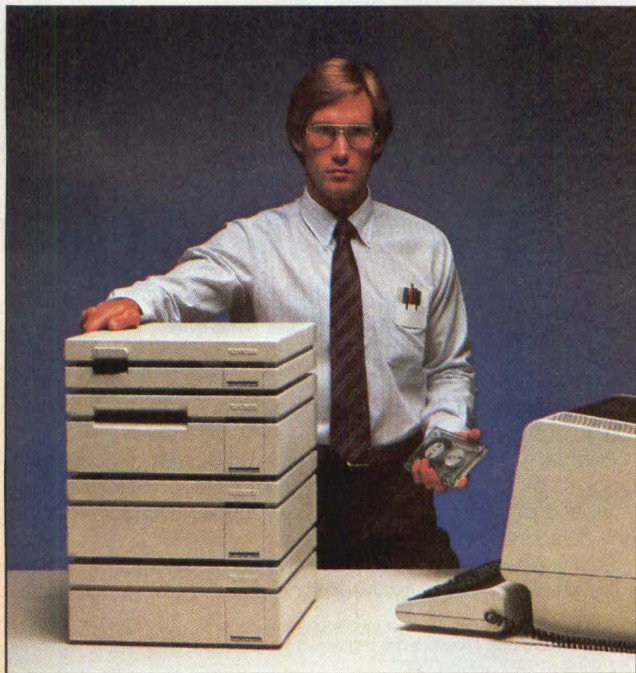

Either way you get greater flexibility to configure just the right system. And the easy upgradability to expand it whenever you like.

But perhaps one of the most important advantages is that you can protect your software investment—and your customers—because inside, you're still selling the same system. You'd just never know it to look at it.

Which brings up another point.

Underneath that slick, compact exterior is the very latest in storage technology. 8" slimline floppy drives. High capacity, highly reliable 8" Winchester. Compact 1/4" cartridge tape drives. And the best high performance controllers in the business. (Packaged systems are also available without controllers at your option.)

And if you're thinking about 5 1/4" storage, there's our 5 1/4" Winchester/floppy module. (Available in the Spring of 1983.)

Configuring an elegant system solution is a simple matter of picking out the storage option you want and adding your own CPU boards, I/O and memory to our uncommonly accommodating backplane units.

Naturally, we back it all up with HyperDiagnostics™, Rapid Module Exchange™ and HyperService™. Some of the most economical and intelligent service features ever devised.

And you can have more information about StacPac modules just by writing for our brochure.

But you just watch. You start marketing your systems in our StacPac modules and your competition will say you have an unfair advantage.

And you know something? They'll be right.

Corporate Headquarters: 2241 Lundy Avenue, San Jose, CA 95131. Eastern Region Sales and Service: Norwood, MA, (617) 769-7620. Central Region Sales and Service: Dallas, TX, (214) 980-4884. Western Region Sales: Santa Clara, CA, (408) 727-3163.

## DATA SYSTEMS DESIGN

INTERNATIONAL SALES (DEC-compatible products only): Australia 03/544 3444; Belgium and Luxembourg 02/7209038; Canada 416/625 1907; Denmark 02/63 22 33; Finland 90/88 50 11; France 03/411 5454; Hong Kong and Peoples Republic of China 03/668252; Israel 03/298783; Italy 02/4047648; Japan, Osaka 06/323 1707; Tokyo 03/345 1411; Netherlands 020/02977-22456; New Zealand 04/693 008; Norway 02/78 94 60; Singapore, Malaysia and Indonesia 2241077; Spain 01/433 2412; Sweden 08/38 03 70; Switzerland 01/741 41 11; Taiwan, ROC 02/7719803-5; United Kingdom 7073/34774; West Germany and Austria 089/1204-0; Yugoslavia 61/263 261.

INTERNATIONAL SALES (Multibus-compatible products only): Canada 416/625 1907; Denmark 1/83 50 90; Finland 0/692 60 22; Hong Kong 3/338893; Israel 03/298783; Netherlands 020/02977-22456; Norway 2/786 210; Portugal 19/545 313; Sweden 8/635 040; Switzerland 01/741 41 11; United Kingdom 7073/34774.



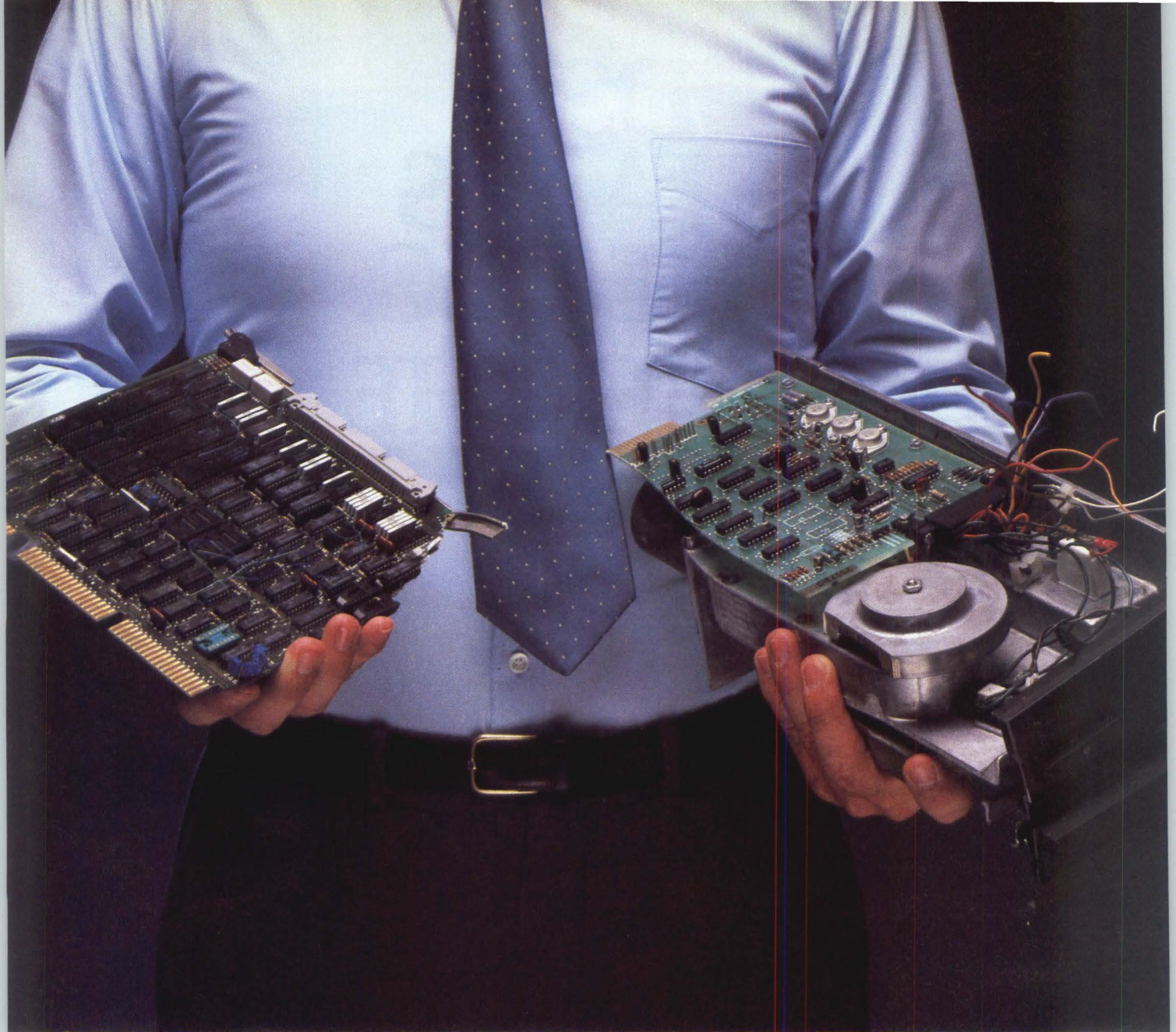

## Controllers and Subsystems with No Service Is Only Half a Deal.

Handle it. Every controller and subsystem supplier pushes product and price. But when it comes to factory-direct service, the talk gets half-hearted.

That's because most controller and subsystem manufacturers use third-party agencies to service their customers.

Not Plessey.

We offer direct, worldwide service from experienced, factory-trained Plessey specialists. You get fast, responsive professional service from people who know their products—from the inside out.

And we have a special toll-free user hot-line, too. To answer your questions about configuration, operation, or software. To give you all the support you need to make sure your Plessey controllers and subsystems perform to your satisfaction.

Plessey manufactures one of the broadest lines of DEC-compatible disc controllers in the world—for floppies, cartridges,

disc packs, Winchesters, even mag tape. And we sell the same range of subsystems, too.

Plus, we're compatible with Q-bus, Unibus, and Massbus. All backed by the Plessey tradition of field-proven reliability.

All at a price that makes Plessey your best bargain—for single unit buys and large quantity orders.

So if you're tired of getting only half a deal on controllers and subsystems, call Plessey. We'll hand you the whole package.

© 1982 by Plessey Peripheral Systems. All rights reserved.  
Q-bus, Unibus, and Massbus are registered trademarks of  
Digital Equipment Corporation.



**Plessey Peripheral Systems**

1674 Mc Gaw Avenue, Irvine, CA. 92714  
(714) 540-9945 • TOLLFREE 800-992-8744



## DISK DRIVES

# Embedded servo comes to 5¼-in. cartridge disk

WILLIAM POLLOCK, DMA Systems, Inc.

### *Servo data in Winchester cartridge keeps 5M-byte media interchangeable*

The primary requirement for removable-cartridge disk drives is interchangeability. System designers and users must be confident that data recorded on one drive can be accurately read by another compatible cartridge drive. To reduce per-megabyte media costs and the number of media changes, disks should also be able to store a maximum amount of data on available recording surfaces. But as data density grows, interchangeability becomes increasingly difficult.

Requirements for both interchangeability and high capacities are now being met by the first application of embedded-servo head positioning to 5¼-in. Winchester cartridge drives. The DMA Systems, Inc., Micro-Magnum drive stores as much as 5M bytes of formatted data on one cartridge disk. Pre-recorded servo data define the tracks, correcting any tolerance differences between cartridge and drive. The Micro-Magnum embedded-servo format has also been proposed as an American National Standard Institute standard to ensure interchangeability not only between drives from one manufacturer, but between any fixed/removable or removable-only devices that meet the embedded-servo standard.

#### **Servo solutions for cartridge problems**

Accurate head positioning is difficult even for fixed-disk drives as data densities increase to 400 to 500 tracks per in. Removable cartridges compound the positioning problem by adding another set of track-positioning variables, as the media itself must be properly positioned.

Distance between track center lines at 500 tpi is 0.002 in. If the maximum allowable head-to-track offset is 10 percent, write and read heads must be held within 200 µin. of a track center line in the face of a variety of

head-positioning hazards. Spindle-bearing wear, for example, can change the center of rotation. Thermal

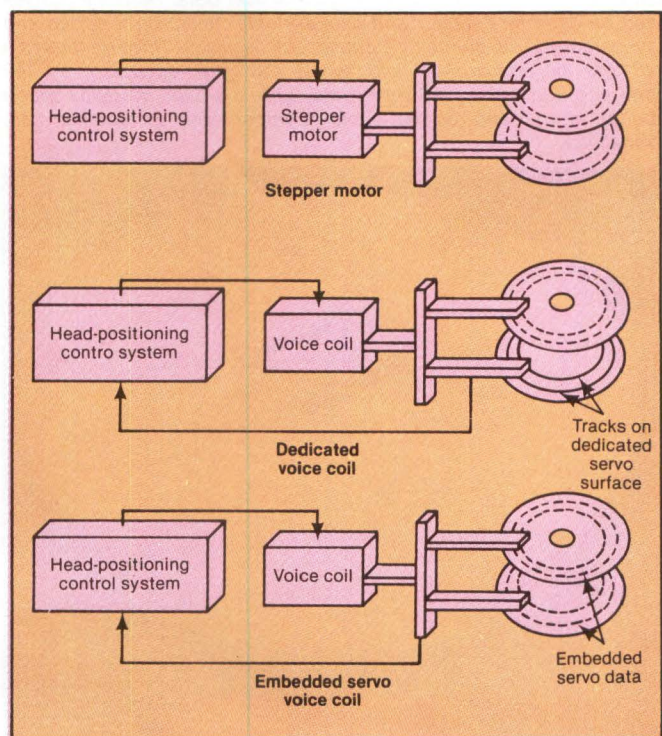

**Fig. 1. Servo head-positioning schemes include stepper motor, dedicated servo voice coil and embedded servo voice coil. Stepper motor digitally microsteps heads to correct positions, using read signal strength as feedback for corrections. Because there is no direct feedback line, stepper motor technique is usually an "open-loop" system. Voice-coil systems position head as a function of a continuously variable voltage modified by servo data on disk. Servo data can be located on a dedicated disk surface or embedded at the beginning of each sector on each surface. Because voice-coil techniques use direct feedback to position heads, they are "closed-loop" systems.**



expansion or contraction can alter the track radius. Disk or head vibrations can produce spurious, unpredictable off-center and off-round errors.

Cartridges present additional problems. A spring-loaded recess in a cartridge hub centers the disk on a precision spindle shaft, but wear and contamination can shift the center of rotation to one side. A magnetic chuck engages the hub, holding it firmly in place; again, however, contamination, wear or physical damage can tilt the disk or make it unstable. And factory alignment of fixed-disk heads and surfaces cannot be duplicated in the field with each cartridge insertion. The head-positioning system in a cartridge drive must compen-

Servo field	PLO sync	Sector ID field	PLO sync	Data field	Speed buffer
AAA... 26 bytes	000... 12 bytes	11 bytes	000... 12 bytes	256 user-data bytes, plus 8 CRC, ECC, format bytes	000... 5 bytes

**Fig. 2. DMA Systems sector format provides 330 bytes, including 26 bytes of servo data and 256 bytes of user data. Remaining bytes can be used for cylinder and sector identification, error codes and synchronizing the controller's phase-lock oscillator. Drive generates a 26-byte hexadecimal-A field to fill the gap occupied by the pre-recorded embedded-servo data, while a 5-byte, all-ZERO speed buffer at the end of the sector compensates for rotation rate variations.**

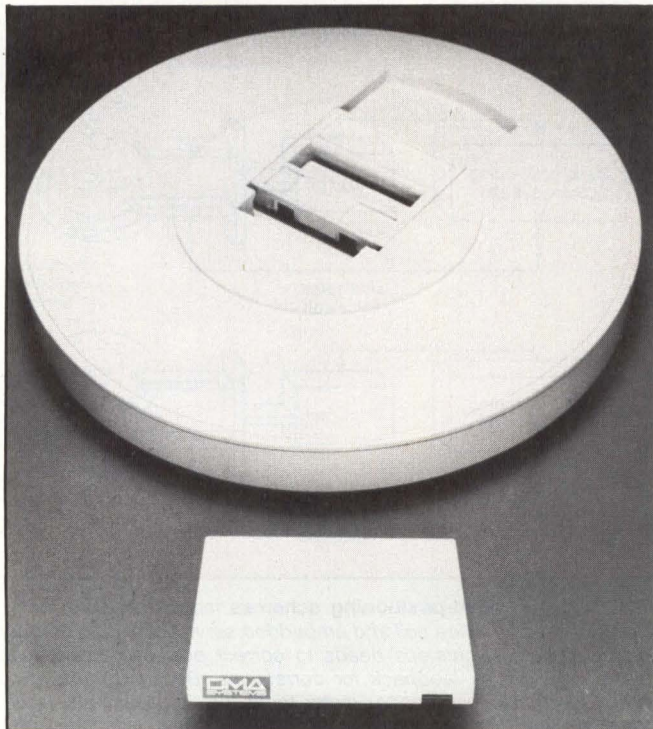

**14- and 5 1/4-in. cartridges use similar technologies, but smaller DMA 5 1/4-in. Winchester cartridge is practical for microcomputer applications. The DMA cartridge runs in DMA Systems' Micro-Magnum 5M-byte fixed/5M-byte removable and removable-only drives, which sell for \$1295 and \$995, respectively, in OEM quantities.**

sate for the worst-case combination of these potential positioning problems.

The most accurate head-positioning systems use servo, or feedback, techniques. Two basic servo schemes are now being applied to 5 1/4-in. drives: stepper motor and voice-coil (Fig. 1).

Stepper-motor systems move the write/read heads in fixed increments, defining the tracks by digitally counting the number of increments from a known "home" position. Read signal strength provides the feedback used for fine adjustment, but this technique cannot always guide head placement when temperature gradients, spindle runout or improperly seated cartridges create off-track errors. Stepper-motor systems are also relatively slow, increasing average access times and, therefore, effective transfer rates when a number of tracks are accessed.

In voice coil systems, by comparison, head positioning is a continuously variable function of current flowing through the coil; the current is modified by servo data on the disk surface. Because the current can vary continuously, the head assembly can be accelerated to match the distance to be traveled and decelerated to a stop with little overshoot. The position of the heads can also be altered as the disk rotates, tracking both off-center and off-round variations.

Servo data for voice-coil positioning can be provided on a dedicated servo surface on a dedicated disk, or as embedded data throughout each disk surface. A dedicated servo surface requires a read-only head for that surface. The mechanical link with the read-only head and the read/write heads can introduce positioning errors that limit track densities. The dedicated surface also costs the drive a large amount of capacity. Embedded-servo systems also have limitations. Servo data, prerecorded at the factory, permanently divide the disk or cartridge into sectors, reducing the flexibility of a system designer or programmer. It may even be necessary to rewrite system software if the fixed-sector size is different from that recognized by the current operating system or disk driver. Servo codes at the start of each sector also displace user data on each track, interrupting the data stream and reducing the average transfer rate for a given data density and disk-rotation rate. Furthermore, complex electronic interlocks must be incorporated into the drive to prevent accidental overwrites of the servo codes interspersed with user data.

Despite the limitations of embedded servo systems, the technique is best for cartridge drives, given their special accuracy and capacity requirements.

### Sector format includes servo data

Embedded servo format standardization will become increasingly important as cartridges become a widespread medium for fixed-disk backup, and for off-site applications such as software distribution and data exchange among users. DMA Systems' proposed ANSI 5 1/4-in. servo format retains the encoding and read/



# Improve Customer Relations In 60 Seconds Or Less.

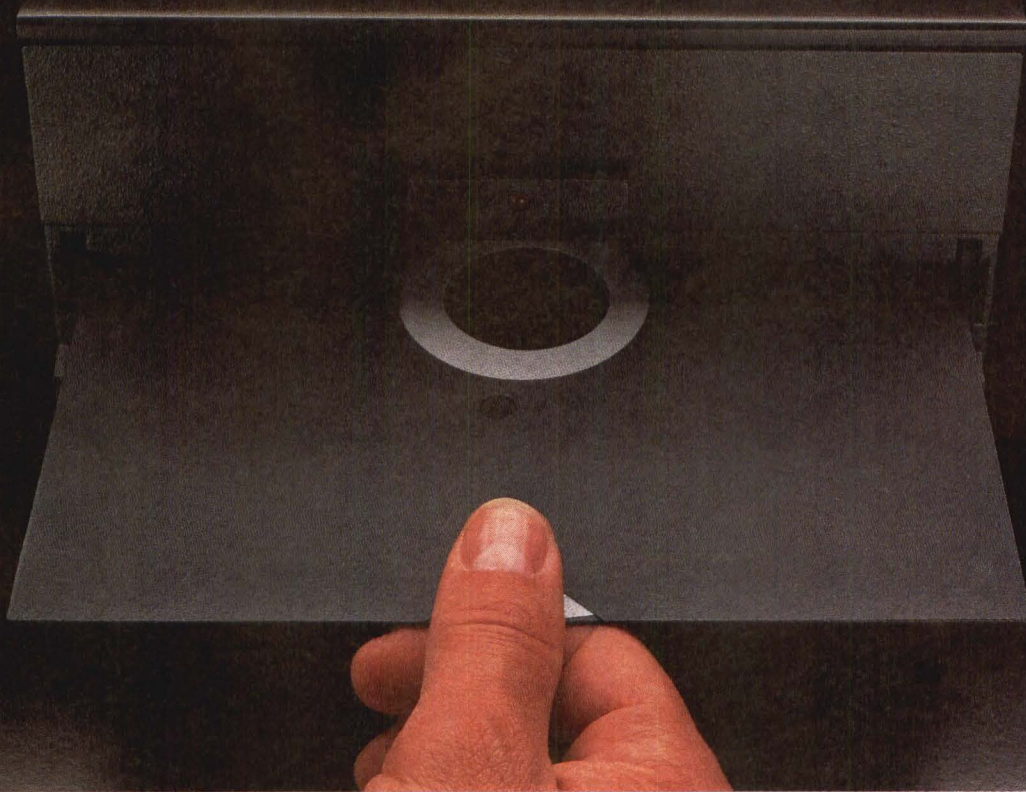

If you're selling or servicing flexible disk systems, here's a way to help keep customers sold on you:

### **Verbatim's OEM Head Cleaning Kit**

Now you can keep computers and word processors running clean and error-free. Easily. Economically. Because our OEM Head Cleaning Kit removes the dust, dirt and debris that can contaminate drive heads. Quickly. Safely.

### **Benefits for your customers and for you, too**

Improve customer relations with improved system performance. Minimize costly service calls. Save time and trouble on the calls you do make. Even make added profits, by selling both Kits and 10-pack replacement disks in your packaging, to your customers.

### **Quick and easy to use**

Just remove a cleaning disk from its sealed, protective pouch. Insert the disk in the special Lexan® jacket,

put it into the drive and turn on the system. In less than 60 seconds, the drive heads are clean—free of the debris that causes data loss and error, that hinders performance.

### **Cleaning, with no cleaning mess**

No hit-and-miss applying solvents that can splash and spill. Each disposable disk is presaturated with cleaning solution and sealed in a foil pouch. Economical, so you can use a fresh, clean disk for every cleaning. Never a chance of adding accumulated debris from a previous cleaning. And the Lexan jacket insures there's no possibility of depositing plastic residue onto newly cleaned heads.

### **Safely cleans both single and dual head drives**

Using Verbatim's non-abrasive OEM Head Cleaning Kit, there's no worry about damaging the heads, the drive or the system. It can safely clean virtually every single or dual head drive made.

**Clean up with your customers**  
Verbatim's OEM Head Cleaning Kit is your opportunity to make extra sales, lower service call costs and improve customer relations—all in one package, packaged under your brand name.

Call 800-538-1793 for the name of your nearest Verbatim sales representative. (In California and outside the U.S. call (408) 737-7771 collect.)

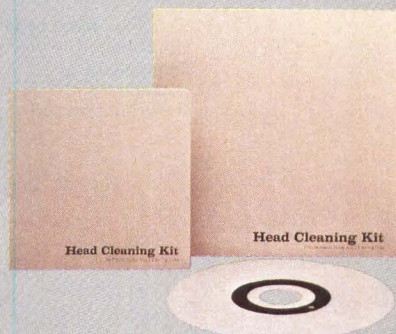

# Verbatim®

**OEM Products**



write rates that have become industry standards.

With the disk rotating at 3600 rpm—a de facto industry standard—as many as 83.3K bits can be recorded at the standard 5M-bit rate during each revolution of the disk. These bits represent more than 10.4K bytes per track, which can be conveniently divided, for example, into 32 sectors with 256 bytes per sector. There is also room for gaps between sectors, track and sector addressing, error-detection and correction codes and even to replace a defective sector. There is no space, however, for head-positioning codes

along the track.

To allow for these codes and still maintain a standard size and number of sectors, the 5¼-in. embedded-servo format calls for a reduction in the disk rotation rate to 3443 rpm. This rotation rate slowing increases flux density, to as much as 8617 flux changes per in. on the innermost data track. The higher flux density in turn increases the capacity of each track to nearly 10.9K bytes, permitting each track of each of 33 sectors (32 data sectors and a spare) to record 330 bytes (Fig. 2). Of these 330 bytes, 26 are dedicated to embedded-servo data (the drive generates a hexadecimal-A data output during this interval), 256 bytes are user data, and the remaining 48 bytes can be used for any formatting purpose. The 26 bytes of hexadecimal-A code represent a system overhead, reducing the average transfer rate

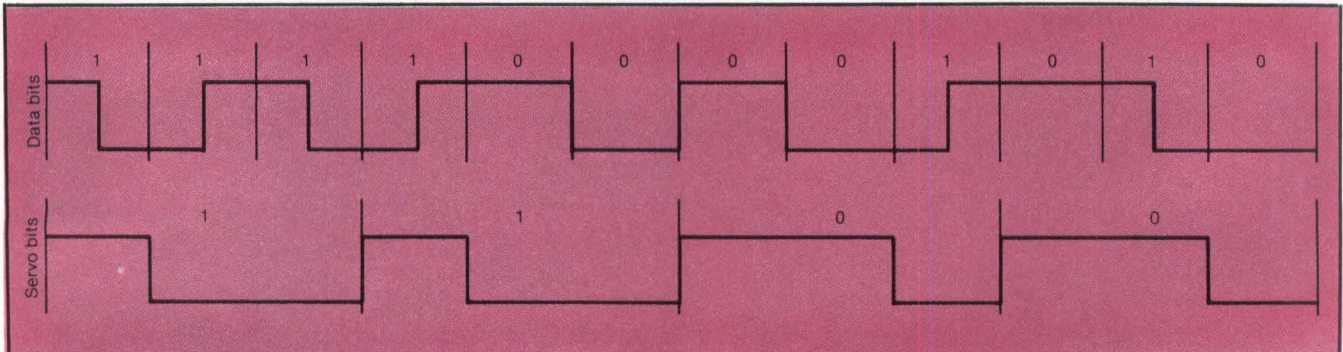

**Fig. 3. Data and servo codes** use different techniques to record information. Data are recorded in MFM code, with a flux change at the center of ONE bit cells and clock-type flux changes at the start of a ZERO bit cell following another ZERO. Embedded-servo information pre-recorded at the factory in a PDM code, uses three bit-cell intervals. PDM ONE pulses equal the bit-cell interval, and a ZERO pulse is equal to two bit-cells.

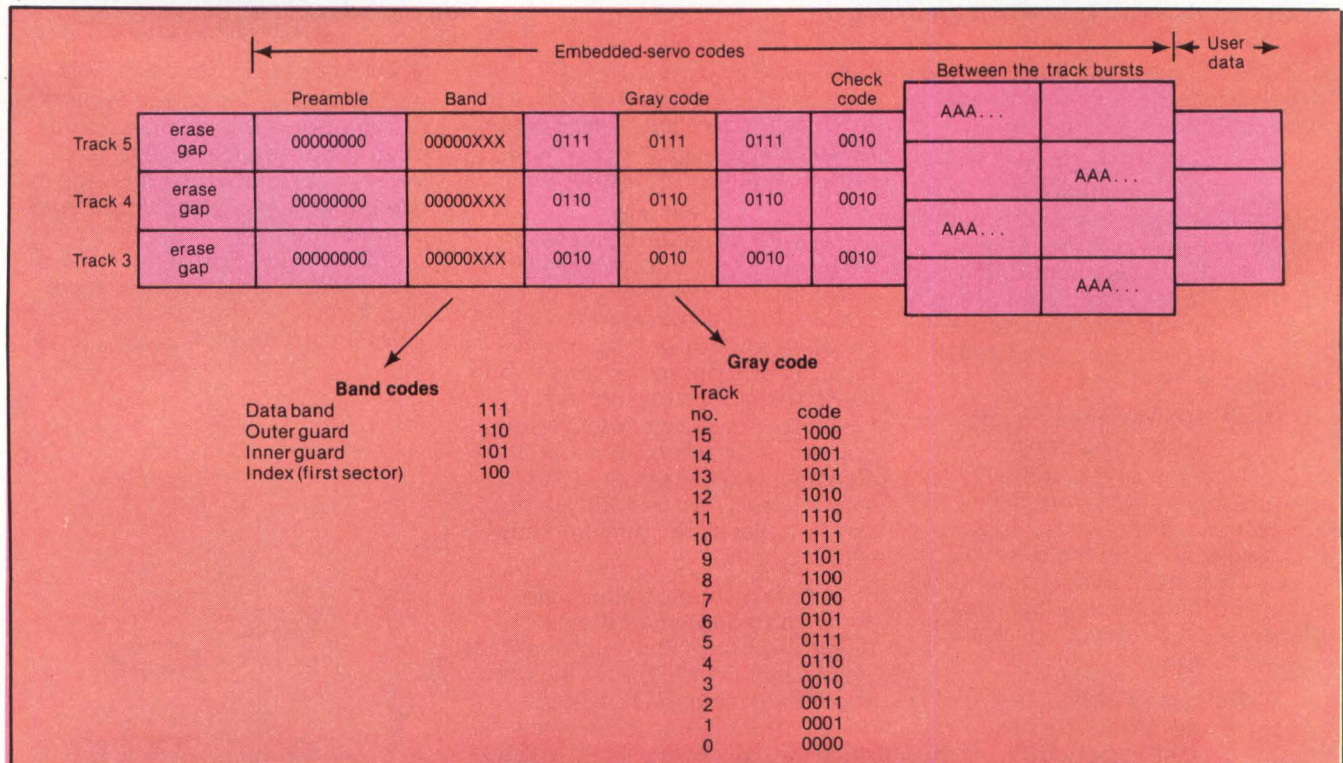

**Fig. 4. Servo data format** provides pre-recorded head-positioning information at the beginning of every sector. The first 2 servo bytes initialize the servo decoder, and specify whether the heads are in the data band or in the guard bands used for protection during cartridge loading. The Gray Code identifies the track number within a group of 16, and the check code identifies servo read errors. Off-track data bursts are used in fine positioning.



# The Electronic Workbench

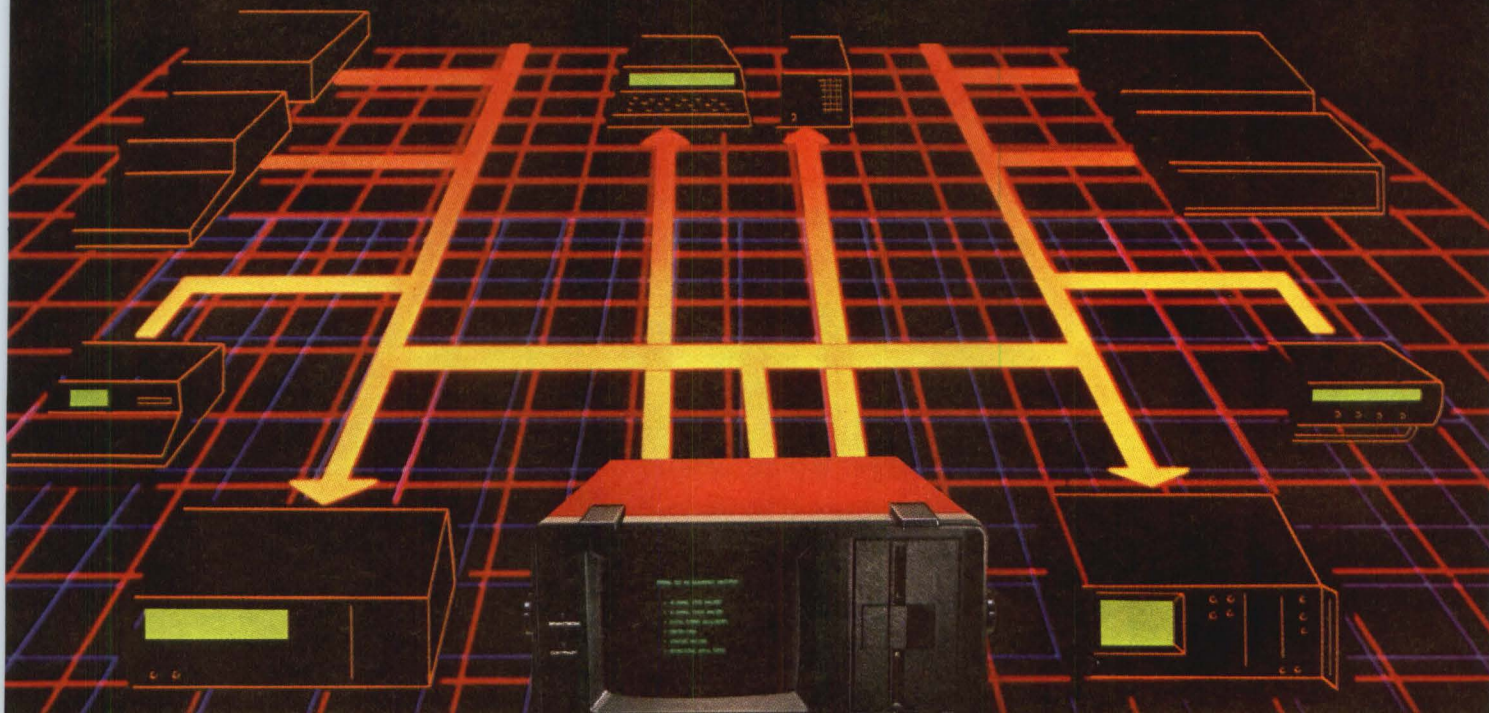

## Now, a Logic Analysis System that puts a bench-full of instruments at your fingertips.

The NPC-764. It just makes good sense. When performing logic analysis and other measurement functions, you shouldn't have to face different sets of knobs, switches and dials. That's why we've developed the NPC-764, the Electronic Workbench. Now your analysis tasks are all done the same way—with a familiar ASCII keyboard and easy-to-use, self-prompting menus. Simple keystrokes are all it takes to run tests and record data on disk. And all logic analysis and other internal functions are ROM-based and ready to go on power up. No messy setups. No relearning of multiple instruments.

The NPC-764 includes a 48-channel State Analyzer and a 16-channel, high-speed Timing Analyzer. And, as optional plug-ins, a single-channel Digital Storage Oscilloscope, a 5-function Counter-Timer/Signature Analyzer, and bidirectional Serial Tester.

But the NPC-764 is more than just a multiple-function instrument. It also incorporates a GPIB controller and RS-232 MASTER/SLAVE capability. Standard. A common set of commands lets you control the internal analyzers and any GPIB- or RS-232-compatible devices you include in your setup—pattern generators, emulators, spectrum analyzers, PROM programmers...

And that's not all. The NPC-764 is a full desk-top computer, with floppy disk storage and a CP/M® operating system. Use it for

general-purpose computational tasks or the execution of commercially available CP/M programs.

The NPC-764, with all its internal measurement functions, requires less than *half* the investment of the equivalent instruments purchased separately. And the ASCII keyboard and menus are so user friendly it sets a new standard for the industry.

Not quite ready for all this capability? Start with our basic NPC-748. It provides exactly the same measurement functions, but 16 fewer state channels and no floppy disk drive. Upgrade easily to the NPC-764 at any time.

There's a whole lot more we'd like to tell you about the Electronic Workbench. For additional information, applications assistance or a personal demonstration, just give us a call: **(800)-NICOLET, (415) 490-8300** (Calif.); TWX: **910-381-7030**. Nicolet Paratronics Corporation, 201 Fourier Avenue, Fremont, CA 94539.

\*CP/M is a registered trademark of Digital Research.

*Leading The Way In Analysis Technology.*

**NTE** Nicolet  
Paratronics Corporation



# Choose between Winchester systems or controllers

## Complete systems to minimize system costs . . .

SMS FWT series disk peripherals provide up to 40M bytes of 8" Winchester disk storage and 1M bytes of floppy disk storage for DEC's\* PDP-11, LSI-11, and VT-103, INTEL Multibus\*\* and other microcomputers! In only 5¼" of table top or rack space you also get the following benefits:

- Choose 8.9Mb, 17.8Mb, or 35.6Mb of formatted Winchester disk storage.
- Up to 427K bytes/sec data transfer for Winchester and 63K bytes/sec for floppy.
- Supports IBM single and double density diskette formats plus DEC's RX01/RX02 formats or INTEL 202 format depending on host computer.
- Single board interfaces are compatible with PDP-11 Unibus, LSI-11 Q-Bus, INTEL Multibus or use your own adapter card for special microcomputer busses.
- Convenient Winchester backup requires only 40 seconds per 1.2M byte floppy diskette.
- Off-line and on-line system and drive tests verify correct disk and controller operation.
- Automatic error retry, ECC (Error Correction Code) and Winchester disk flaw management insure exceptional data integrity.

## Or just controllers to optimize system packaging.

All controllers used in SMS disk peripheral systems are available separately. Each controller supports (2) Shugart/Quantum Winchester and (2) Shugart floppy disk drives, utilizes patented PLL circuitry to provide maximum margins for worst case bit shifted data recovery, incorporates ECC (Error Correction Code) and includes on-board self test! Additional features are:

### DEC PDP-11/LSI-11

- Single LSI-11 dual height or PDP-11 quad height interface plus formatter board.
- On board bootstrap and 22 bit Q-bus support.
- Standard RT-11, RSX-11M, UNIX,\*\*\* and SMS utility software support selective file backup and load operation.
- High performance data transfer of up to 427 bytes/sec.
- Emulates DEC RX02 floppy disk controller.
- Automatic recognition of RX01, RX02 and IBM diskette formats.

### INTEL MULTIBUS

- Single Multibus compatible PC board requires only 5A (max.) @ 5 volts.

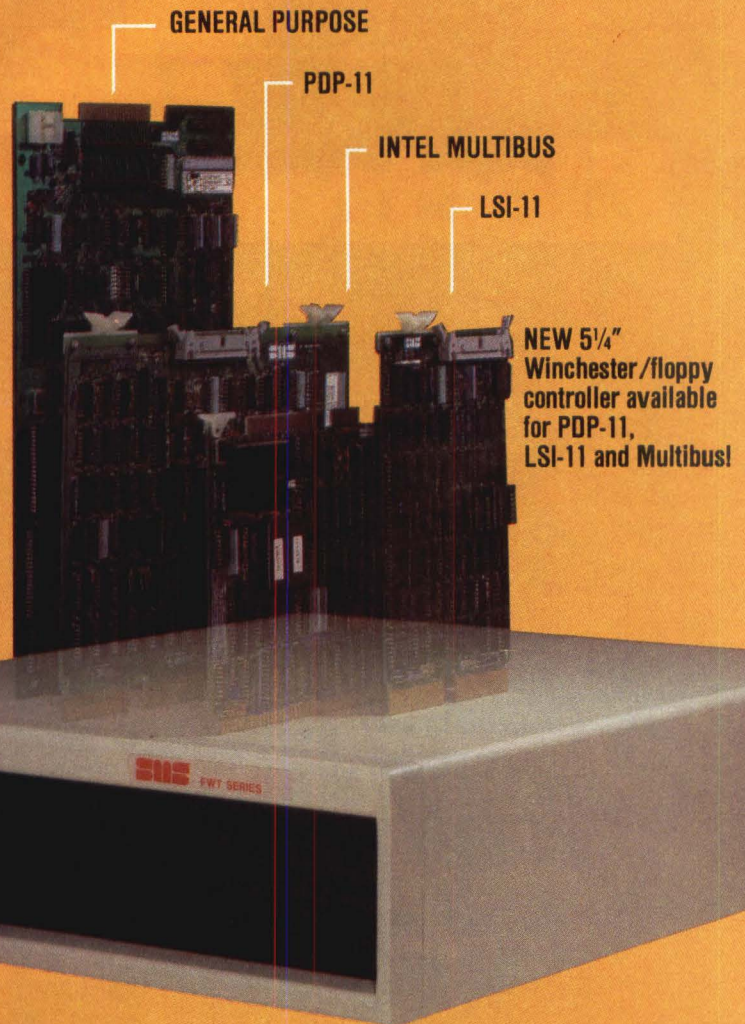

- Direct connection to (2) Shugart/Quantum and (2) Shugart floppy disk drives. Eliminates external data separator board.
- Interface and command compatible with INTEL iSBC 215A and iSBX 218 controller boards.
- Supports IBM and INTEL iSBC 202 diskette formats.

### GENERAL PURPOSE

- Single board controller requires only 5A (max.) @ 5 volts.
- Interface, dimension and connector compatible with Shugart 1403D.
- Direct multi-sector disk transfer of up to 427K bytes/sec.
- Easy to use byte parallel general purpose interface.



## Scientific Micro Systems, Inc.

777 E. Middlefield Road Mountain View, California 94043  
(415) 964-5700

AUTHORIZED SMS DISTRIBUTOR

FOR DEC Q-BUS PRODUCTS:

FIRST COMPUTER CORPORATION—(312) 920-1050

SALES OFFICES: **Phoenix, Arizona** —

(602) 978-6621 **Boston, MA** — (617) 246-2540

**Atlanta, Georgia** — (404) 296-2029 **Morton Grove, Illinois** —

(312) 966-2711 **Yorba Linda, California** — (714) 993-3768

\*Trademark of Digital Equipment Corporation \*\*Trademark of INTEL Corporation \*\*\*Trademark of Bell Telephone Laboratories

CIRCLE NO. 119 ON INQUIRY CARD



## DISK DRIVES

between controller and host by a small percentage. But as track densities and cartridge capacities increase, the price for this overhead will nearly vanish.

### Servo code and positioning

An embedded-servo drive must read, interpret and respond to prerecorded servo codes. The entire operation is internal to the drive, and uses a recording technique that is simple to detect and decode.

Most  $5\frac{1}{4}$ -in. disks use modified frequency modulation encoding for non-servo data (Fig. 3). This scheme calls for a flux change at the center of every bit-cell interval

### *Fine-positioning operations follow variations in the track radius.*

that represents a binary ONE and at the start of every ZERO bit cell that follows another ZERO. Servo information, on the other hand, is written in pulse duration modulation code, in which a ONE "pulse" has a duration of one data-bit cell, while a ZERO occupies the space of two data-bit cells.

The time interval between servo bits is 600 nsec., equal to three data-bit cells. The embedded-servo format (Fig. 4) starts with a DC-erased gap equal to 1 servo byte, or 3 data bytes. This is followed by an all-ZERO servo-byte preamble to verify the gap and initialize the servo decoder. The first 5 bits of the next servo byte are also ZEROS. The remaining 3 servo bits identify whether the write/read heads are within a

312-track data band (311 data tracks, including five spares, and one customer-engineering track) between two guard-band buffers that protect the data when, for example, a cartridge is inserted in the drive and heads are loaded on the revolving surfaces. The first sector of each track—including those in the guard band—starts with an index signal code.

Head positioning can be divided into two phases—coarse and fine. Coarse positioning locates a specific track, while fine positioning centers the read/write heads on the desired track and follows any variations in the track's radius.

The drive begins a read or write operation after receiving track-seek instructions consisting of a direction signal and the number of tracks to be moved. Coarse positioning is then accomplished by reading the "Gray Code" values that follow the band-identification code. Each 4-bit value identifies a track within a 16-track group. The Gray Code values are repeated three times at the front of each sector, or 99 times around each track. Head-positioning logic, therefore, has the opportunity to identify the tracks the heads cross as they accelerate toward their destination and decelerate to a stop on the selected track.

Gray Codes, rather than conventional binary notation, are used for coarse positioning to avoid read errors caused by combining the codes of adjacent tracks. If conventional binary notations were used for track 3 (0011) and track 4 (0100), for example, the combined codes could be misread as track 7 (0111). With the Gray Code, track 3 is 0010, and track 4 is 0110. Thus, no matter how the patterns are combined, the result will always be the code for track 3 or 4. By repeating the values three times at the start of each sector, the format allows the system to take a two-out-of-three vote on the correct track number.

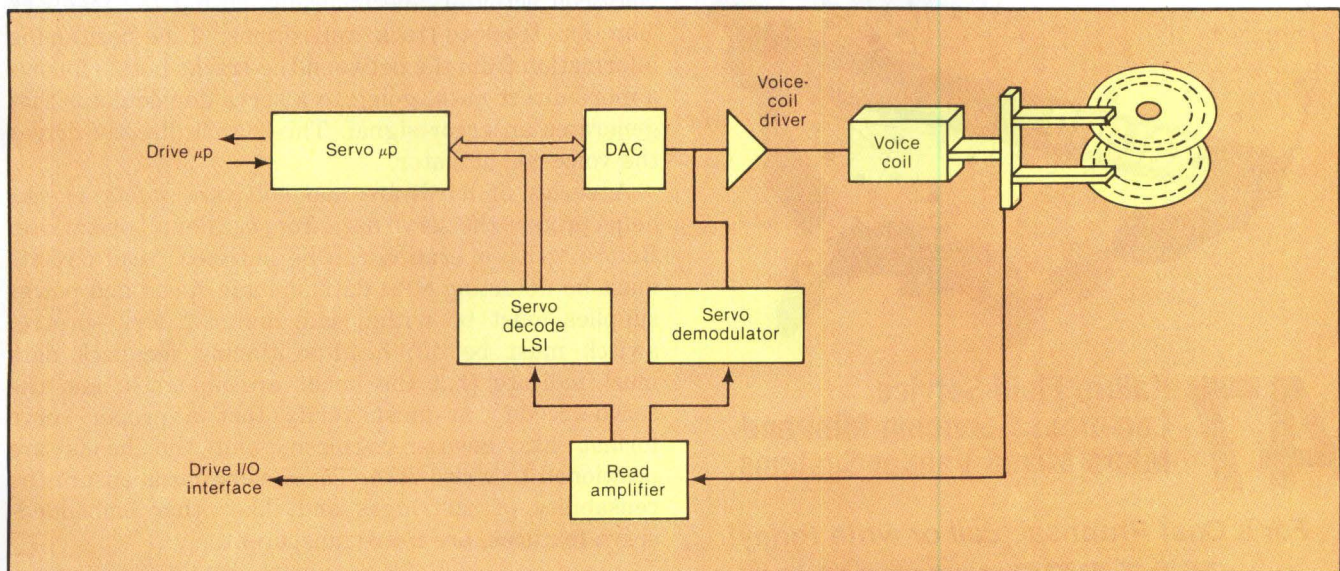

**Fig. 5. Servo feedback loop** uses servo data on disk to position head. Read head sends servo data to amplifier, which passes coarse-positioning data to a 500-gate LSI array for decoding, and fine-positioning data to a servo demodulator. The LSI array sends decoded information over a byte-wide bus to a servo microprocessor, which returns position commands over the same bus to a digital-to-analog converter. The D/A converter then sends an analog signal to the voice coil. The servo demodulator passes fine-positioning data directly to the voice coil.



## DISK DRIVES

These precautions are futile if the entire pattern has been shifted by, for example, a miscount of the ZEROS in the preamble. A check code detects such errors. If the check-code pattern is not 0010, the system assumes that a shift has occurred and that the Gray Code reading is incorrect.

After the Gray Code readings direct the embedded-servo system to the selected track and verify that the heads are on the correct track, a fine-positioning scheme centers the heads on the track. This scheme enables the heads to follow variations in the track

---

*Firmware calculates the acceleration and deceleration that will move the head a given distance in minimal time.*

---

radius that could lower the signal-to-noise ratio when data are read, increase the error rate or even destroy the integrity of the stored information. Fine-positioning functions are performed by comparing the strengths of two prerecorded data bursts between tracks. The two bursts, each consisting of approximately 15 bits of hexadecimal-A code (1010), occur in succession—one on the inside of the track center line, the other on the outside. If the two burst-signal

amplitudes are not equal, the read/write head assembly is immediately repositioned. A weak outer burst moves the heads away from the center of the disk, while a weak inner burst moves the heads toward the center.

The fine-positioning process is repeated 33 times with each revolution of the disk, or approximately once every 0.5 msec. The result is an almost-continuous sampling and feedback correction of the head-assembly position as it follows the pre-recorded embedded-servo tracks.

### The feedback loop

Both course- and fine-positioning are controlled by the servo loop (Fig. 5) in the drive. The loop starts with the same heads (one per surface) that read data stored on the disk. Servo-bit flux changes are detected and amplified in a conventional manner, and then are separated from the data stream by a read amplifier. A 500-gate LSI array decodes the embedded track-position data and transmits the information across a byte-wide bus to a servo microprocessor dedicated to head-positioning tasks. Firmware calculates, for example, the optimum acceleration and deceleration that will move the head assembly a given track-to-track distance in minimal time. The servo microprocessor also monitors the Gray Code values that indicate the current position of the heads. A second microprocessor performs more general control and interface functions.

Results of these calculations are transmitted across the same byte-wide bus to a high-speed digital-to-

---

## Discover the Nationwide Solution to Your Computer Maintenance Problem!



**47** Kalbro Field Service  
Locations Servicing Mini and  
Micro Mixed Vendor Systems.

*For a Cost Proposal, call or write today!*

**KALBRO** corporation  
An IAL Company

East—101 Foster Road, Moorestown, New Jersey 08057 (609) 778-1800  
Central—772 N. Church Road, Elmhurst, Illinois 60126 (312) 279-1960  
West—1160 Sandhill Ave., Carson, California 90746 (213) 637-1533

CIRCLE NO. 120 ON INQUIRY CARD

---

*Write and read head must be held within 200  $\mu$ in. of a track center line.*

---

analog converter that in turn drives a precision linear voice-coil actuator, mechanically closing the feedback loop for track-to-track repositions. Fine-positioning information from the between-the-tracks bursts follows a more direct path, going to a servo demodulator that generates an error signal. This signal directly drives the voice-coil actuator.

A series of hardware and software safety checks helps protect the servo data from accidental overwrite. Before write operation can be initiated, read circuits must be detecting MFM data; spindle speed and power supplies must be within safe limits; a write-protect switch must be off; head-positioning feedback data must indicate that the heads are on track; and the servo-decode LSI must verify that a proper servo format has been recognized, and the heads are positioned to write data. These safeguards ensure the reusability of cartridges and, like other embedded-servo features, are user-transparent.

---

**William Pollock** is manager of technology development at DMA Systems, Inc., Goleta, Calif.

---



# The terminals that face up to everyone's problems.

Now Qume offers a line of three CRT terminals that help you face every one of your company's needs: The Qume QVT™ series.

The low-cost Qume QVT 102™ has all the best features of the four most popular terminals and can emulate all four with a keystroke! QVT 103™ is code-compatible with the DEC VT100/VT 131 and offers 80 or 132 character/line, split screen and up to 4 pages of memory. And QVT 108™ faces up to the most demanding jobs with 22 function keys, 13 editing functions and 2 pages of memory.

Qume QVT terminals all share striking ergonomic design. Tilt/swivel screens in green or amber. Detached, low-profile keyboards. Big 9 x 12 character cells. And a long list of other features to make people more comfortable and productive.

Best of all, Qume QVT terminals are very competitively priced. You can have performance, features and reliability without facing a budget problem.

Talk to your Qume sales office about filling all your terminal needs with a single purchase of QVT terminals. Or write Qume, 2350 Qume Drive, San Jose, California 95131.



One size fits all.

**Qume**  
A Subsidiary of ITT®

## QUME CORPORATION

HEADQUARTERS  
2350 Qume Drive  
San Jose, CA 95131

CALIFORNIA  
San Jose (408) 995-6144  
Culver City (213) 410-1458  
Santa Ana (714) 957-4040

COLORADO  
Aurora (303) 752-3000

ILLINOIS  
Palatine (312) 991-7250

OHIO  
Dayton (513) 439-0469

TEXAS  
Irving (214) 659-0745

NEW JERSEY  
Edison (201) 225-5005

MASSACHUSETTS  
Bedford (617) 275-3200

GEORGIA  
Decatur (404) 284-8500

GERMANY  
Düsseldorf PH: 211743016

ENGLAND  
Reading, Berkshire  
PH: 734-584-646

FRANCE  
Boulogne PH: (1) 6082334

CANADA  
Quebec PH: (514) 695-3837





TELEVIDEO SYSTEMS INC PRESENTS THE 970

ANSI 3.64

256 DOWNLOADABLE FONT

14" SCREEN

VT-100 COMPATIBLE

32 NON-VOL. FUNCT. KEYS

ACCOUNTING KEYPAD

24 X 132 COLUMN

NO SPACE ATTACHMENT-14

LOGICAL ATTRIBS

TELEVIDEO 970

TeleVideo  
MODEL 970



# The new 970 from TeleVideo. Nothing else looks like it. Nothing else performs like it.

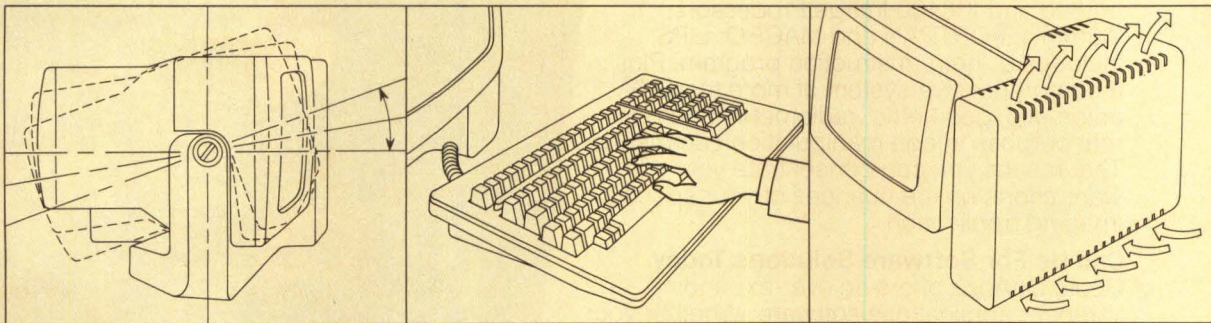

Productive office work depends on people and their equipment working efficiently together.

That's why we have engineered the exciting, new TeleVideo 970 to perform better than any other terminal.

For instance, only our "natural balance" tilting mechanism lets you easily adjust the screen at a touch, so you avoid neck-craning, straining and glare.

Our unique keyboard is designed to avoid user fatigue. We've created a natural palmrest, sculpted keys and the best ten-key accounting pad in the industry. Our non-volatile function keys save time and energy.

Like every feature of the new 970, the screen is designed for ease of use. Our non-glare 14-inch green screen is restful on the eyes, and its 132 column display can format more information. All in highly legible double-high, double-wide characters.

Our communications protocol is the industry standard ANSI 3.64.

As you probably know, most terminal downtime is caused by overheating that results from extended use. There's no such problem with our unique vertical convection cooling tower.

And because we wanted to extend the life of your CRT, we've installed a screen saving

feature that automatically turns it off after fifteen minutes of idle time.

Naturally, like all TeleVideo terminals, service is available nationwide from General Electric's Instrumentation and Communication Equipment Centers.

The new 970 from TeleVideo. Nothing else looks like it and nothing else can perform like it.

For more information about TeleVideo's new 970, call 800-538-8725; in California 408-745-7760.

TeleVideo Systems, Inc.  
Dept. #216G  
1170 Morse Avenue  
Sunnyvale, CA 94086

Yes, I'd like to know more about the unique 970 from TeleVideo:

NAME \_\_\_\_\_

ADDRESS \_\_\_\_\_

CITY \_\_\_\_\_

STATE \_\_\_\_\_ ZIP \_\_\_\_\_

TELEPHONE (\_\_\_\_\_) \_\_\_\_\_

California/Santa Ana 714-557-6095; Sunnyvale 408-745-7760; Georgia/Atlanta 404-255-9338; Texas/Dallas 214-980-9978; Illinois/Chicago Area 312-351-9350; Boston/Massachusetts 617-668-6891; New York/New Jersey 201-267-8805; United Kingdom/Woking, Surrey 44-9905-6464.

 **TeleVideo Systems, Inc.**

CIRCLE NO. 122 ON INQUIRY CARD



# THE LIBRARY OF IMAGE PROCESSING SOFTWARE.

## So You Don't Have to Draw a Blank.

Without good software, even the best image processor draws a blank. And as you know, software development can take months. Even years.

No more. The Gould DeAnza Library of Image Processing Software (LIPS\*) cuts the job down to size.

### A Comprehensive Command Processor.

Designed to run on Digital Equipment Corporation's PDP-11 and VAX minicomputers, LIPS provides the software tools you need to facilitate almost any image processing operation on our IP8500 and IP6400 Image Processors. Written in FORTRAN and MACRO, LIPS includes a "help" instruction program. Plus a comprehensive system of more than 30 arithmetic, geometric, radiometric and general purpose image manipulation commands. That means you can concentrate your software efforts on the nuances of your specific imaging application.

### Call Us For Software Solutions Today.

Gould DeAnza offers an ever-expanding library of applications software. Whether your application is medical imaging, remote sensing, publishing, non-destructive testing, CAD/CAM or media, LIPS can help you turn blanks into images. Call or write today for complete information and a copy of our brochure.

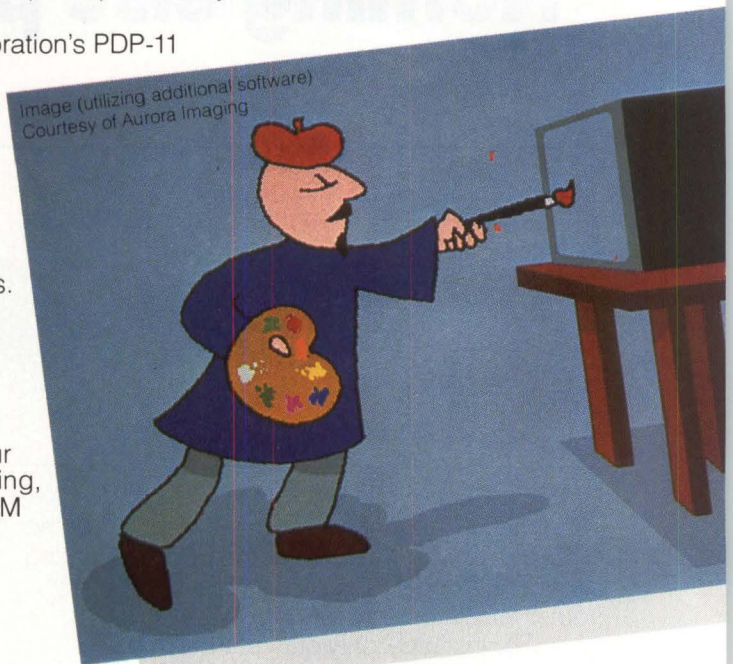

Sombrero Galaxy Image Courtesy of European Southern Observatory, Image Processing Group



**Gould Inc.**

**DeAnza Imaging & Graphics Division**

1870 Lundy Avenue, San Jose, California 95131

(408) 263-7155 • TWX (910) 338-7656

Eastern (516) 736-3440 • Central (312) 965-8110

Southwestern (214) 458-0052 • Western (408) 263-7155  
Distributors Worldwide

CIRCLE NO. 123 ON INQUIRY CARD



# Floppy controller speeds access with cache

STEPHEN GOLDMAN, Distributed Processing Technology

## *On-board file-management and paging systems keep floppy data in controller RAM*

Floppy-disk drives have remained a popular means of data storage despite challenges in the OEM market by Winchester drives and bubble memories. Floppy disks are inexpensive, removable and easily handled, and their storage capacity has been increased through double-density, double-sided and, more recently, 96-tpi drives. Little has been done, however, to improve access times for data stored on this media. Cache-memory and I/O paging have been used to decrease access times for rigid disks, but the added cost of the extra hardware required to implement such schemes has priced most of them out of the range of floppy-disk systems.

A floppy-disk controller introduced by Distributed Processing Technology, Maitland, Fla., uses on-board file-management and paging systems to greatly reduce floppy-disk access times.

### **Inside the PM-3001**

The PM-3001 is a single-board floppy-disk controller with an integrated ROM-based file-management system and capacity for as much as 32K bytes of on-board paging (cache) RAM. With bus adapter card, the PM-3001 controls as many as four 8-in. drives and three 5¼-in. drives. Disk access time is significantly decreased by using the on-board paging RAM, allowing floppy drives to handle many applications in place of higher cost rigid-disk drives. Two DMA channels operate simultaneously to transfer data between disk and the paging RAM and between paging RAM and the host computer memory (Fig. 1). All DMA, host-communications, disk-control, paging and file-management functions are controlled by multitasked firmware running on an on-board 8085 CPU.

The heart of the PM-3001 is the ROM-based paging file-management system. PFMS runs entirely on board the PM-3001, transparent to the host computer system. Because file management normally consumes both processor time and memory space, off-loading this function to the PM-3001 processor can increase total system performance.

All PFMS files appear to the user as 2M bytes of byte-addressable virtual memory space. PFMS allocates and deallocates actual disk space during and between disk accesses. Because files are treated as virtual memory, a user program need not consider record sizes and file-space allocation.

The PM-3001 uses a disk paging scheme to speed data access. Paging schemes use RAM as a fast buffer for a relatively slow I/O device. The paging buffer is often a reserved part of the computer's main memory. The paging area is segmented into blocks or pages that usually correspond to the size of the minimum data record on the I/O device. In traditional disk-paging schemes, each page holds one sector of disk data. When a sector is read from the disk, the data are placed in a page, which then acts as a fast buffer between the disk and the CPU. The next time the CPU requests data, it can be quickly read from the paging area, averting a relatively slow disk access.

Most paging methods are based on the least recently used algorithm (Fig. 2). Each page is assigned an age. When the CPU accesses the data in a page, the page's age is set to zero. All ages are incremented at intervals. When new data must be read into the paging area and all pages are being used, the oldest (least recently used) page is emptied and reused for the new data. Another way to implement an LRU scheme is to link all pages



into a list. When a page is accessed, it is removed from the list and relinked as the first page in the list. The last page in the list is then always the least recently used page.

The PM-3001 PFMS links its pages into a tree structure. Each level of each branch of the tree consists of a linked list of pages. By organizing pages into a tree structure, the number of pages to be searched for a data item is reduced, allowing search-and-replacement algorithms to be implemented in firmware. Thus, the PM-3001 can be priced in the same range as conventional controllers.

**PFMS file structure**

The PM-3001 hierarchical paging scheme reflects the hierarchical structure of PFMS disk files. PFMS files are byte-addressable. Data are accessed by transferring 1 byte to 64K-byte segments between a PFMS file and the host computer's memory. Data can be read from or written to any location within a file, regardless of the history of that file. File addresses range from byte

location 0 to byte location 2,097,151, providing each file with 2M bytes of memory space. Although every disk file appears to the user to be in 2M bytes of RAM, only the areas of a file that contain non-zero data require allocated disk space. This is accomplished by structuring each file as a three-level tree (Fig. 3).

The root level of the file, consisting of a single disk sector, is the file-header block. Each file header contains statistical information about the file plus 64 sector pointers. Each pointer points to an intermediate level sector or can contain a null value indicating that an intermediate level sectors does not exist for that pointer position. The intermediate level sectors, called bin blocks, each contain 128 sector pointers. Each pointer on this level can point to one of 128 top-level sectors or contain a null value indicating that a top-level sector does not exist for that position in the file. The 8192 top-level sectors contain the actual file data. All other sectors are file overhead and are thus transparent to users.

When a file is created, only the file header block is allocated to the file. All pointers to the next level are set to null. As non-zero data are written into the file, bin blocks and data blocks are allocated so that a three-level tree structure emerges. Branches are added to the tree in positions determined by the file

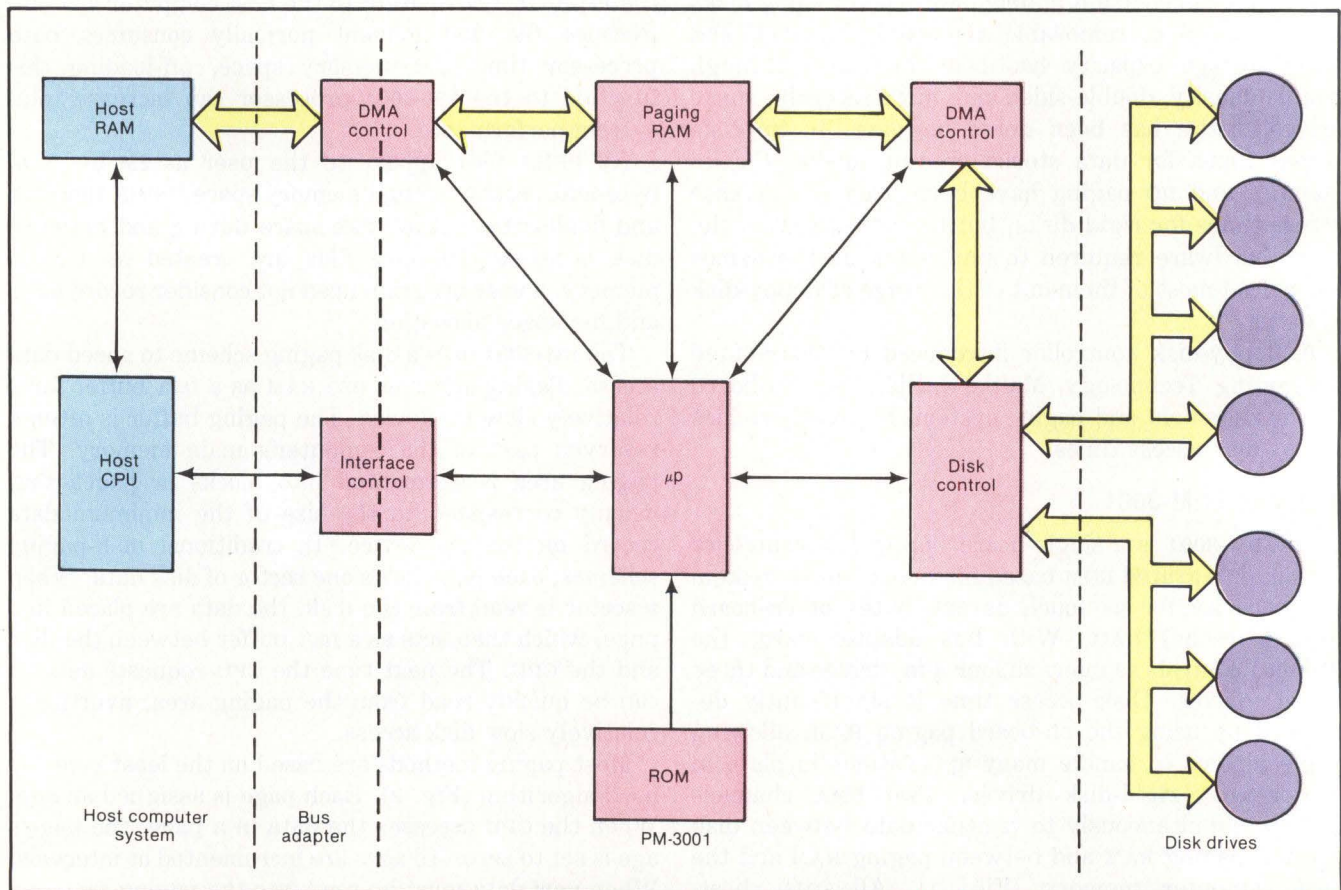

**Fig. 1. PM-3001 internal architecture** includes an on-board microprocessor that controls all DMA, host-interface, disk-control and paging functions. Two DMA channels operate simultaneously to transfer disk data between floppy drives and paging RAM, and between paging RAM and host memory. The microprocessor runs multitasked, ROM-based firmware, allowing paging algorithms, disk accesses and host-DMA activity to be overlapped.



---

# Now OEMs can buy IBM 8-inch Winchester disk assemblies. They're backed by IBM quality and a commitment to OEMs.

---



IBM's first products for OEMs are the Models 680 and 676 Disk Storage Assemblies.

These reliable disk assemblies are backed by an OEM product support team you can call on for free consultation on interface design and software.

The IBM 680 has 64.5 MB formatted capacity and 27 ms average access time with a 1.03 MB/sec data rate. The new IBM 676 has a formatted capacity of 30.8 MB, average access time of 40 ms and a 1.25 MB/sec data rate. And it comes with a 30-month Head Disk Assembly replacement guarantee. These high-performance characteristics, combined with outstanding reliability, a wide range of environmental tolerances and worldwide parts availability make the 680 and 676 excellent choices for OEMs.

IBM wants to discuss and understand your OEM requirements. We'd like to relate your needs to our technology and experience in making quality products. To learn more about the IBM program for OEMs, as well as the Models 680 and 676 Disk Assemblies, return the coupon. Or call Bruce Prestwich, collect, at (408) 224-4622.

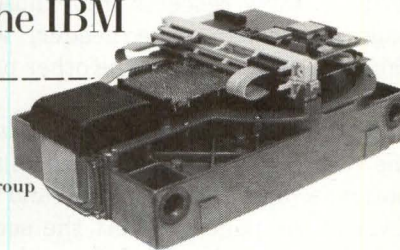

Bruce W. Prestwich  
IBM  
OEM Product Marketing Group  
44 West Brokaw Road  
San Jose, CA 95110

Please send me more information about IBM for OEMs and the 676 and 680 Disk Assemblies.

Name \_\_\_\_\_  
Title \_\_\_\_\_  
Company \_\_\_\_\_  
Address \_\_\_\_\_  
City \_\_\_\_\_ State \_\_\_\_\_ Zip \_\_\_\_\_  
Phone \_\_\_\_\_

MMS-2-83



addresses of the data written to the file.

If, in the course of writing to a file, a data sector is found to contain all zeros, that sector is automatically deallocated from the file and returned to the pool of free blocks. The pointer to that sector is set to null. Likewise, if a bin block is found to contain all null pointers, it too is deallocated. Branches grow to accommodate new data and are "pruned" from the tree as the data become zero-filled. Sectors that are deallocated from a file can then be reused by the PFMS operating system to create or expand files.

**PFMS page structure**

The PFMS paging area is also structured as a tree. In this case, pages are the nodes of the tree, each page

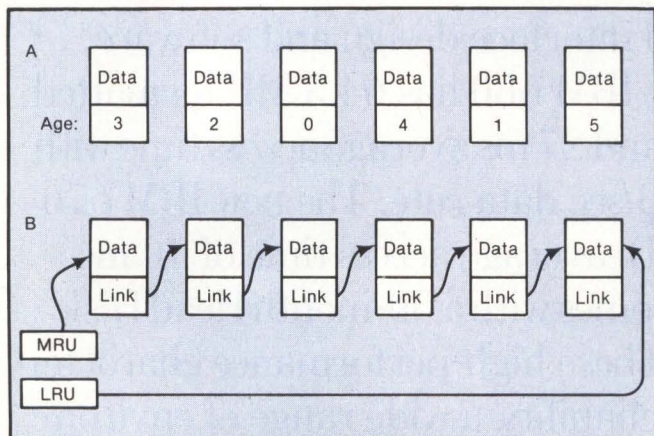
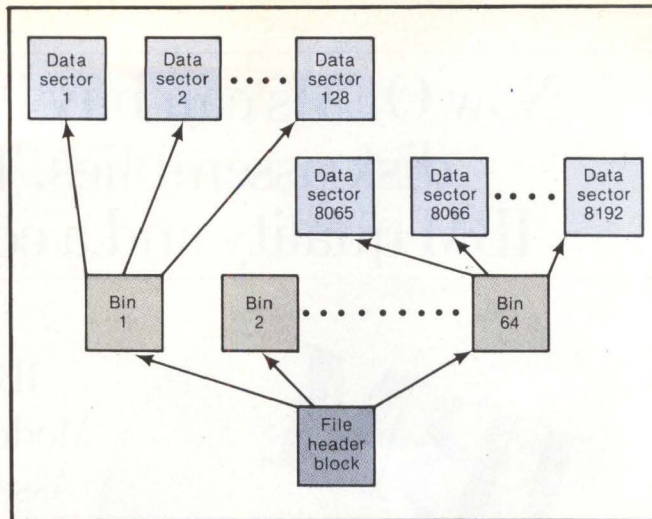

**Fig. 2. Two LRU paging schemes include:** (a) assigning an age to each page and setting the age of the most recently used page to zero and (b) a linked list of pages that tracks recency of use by placing the most recently used page at the head of the chain. The LRU page is then always at the end of the chain.

buffering one disk sector. The branches of this tree differ in some respects from those of disk files. Each page contains a page header, which, among other things, acts as a link to the other pages in the structure (Fig. 4).

At the lowest level of the tree is a single page called the root page. The root page acts as a general-purpose buffer for operating overhead and links into the second level of the page tree. At the second level are pages containing disk-header information. Each node at this level represents control data for a disk drive. All pages at this level are chained to form a linked list of nodes. The ends of the chain are linked back to the root page. Whenever data on a disk drive are accessed, the second level of the page tree is scanned to find the page containing disk-header information for that drive.

If the disk-header page is not in the paging area, it is read into a free page. That page is then linked into the second level as the beginning position in the chain. If



**Fig. 3. PFMS hierarchical file structure includes a file-header sector containing statistical information about the file, and linkage pointers for as many as 64 bin sectors. Each bin sector contains pointers for as many as 128 data sectors. All or none of the data and bin sectors can be allocated for any file.**

*The root page acts as a general-purpose buffer for operating overhead, and links to the second level of the page tree.*

the disk-header page is in the paging area, the page is simply relinked into the beginning position in the chain. The ordering of pages in the chain is thus determined by how recently each was used—the first page being the most recently used and the last page being least recently used. Pages can thus be searched, starting with the most recently used page, and the most frequently accessed pages take the least amount of time to find.

In the next level of the page tree are pages containing file-header blocks for paging-resident disk files. Each disk-header page in the previous level acts as the root node for one chain consisting of file-header pages for that disk. As before, each chain is connected at its ends to the previous level, and the ordering of pages in the chain is determined by recency of use.

The next two levels of the page tree are composed of bin pages and data pages, respectively. These pages are also chained into linked lists that are connected at the end points back to a node page on a previous level, to which the pages logically belong. Bin pages belonging to a file are grouped and linked into that file's header page. Data pages are chained and linked back to bin pages. The resultant structure is a five-level tree, each page acting as the root node for a sub-tree composed of pages on higher levels. When a page is relinked into the most recently used position in its chain, all pages belonging to its sub-tree get moved along with it.

In a more traditional scheme, paging and file



# CIPHER INTRODUCES THE 5 1/4" FORM FACTOR...

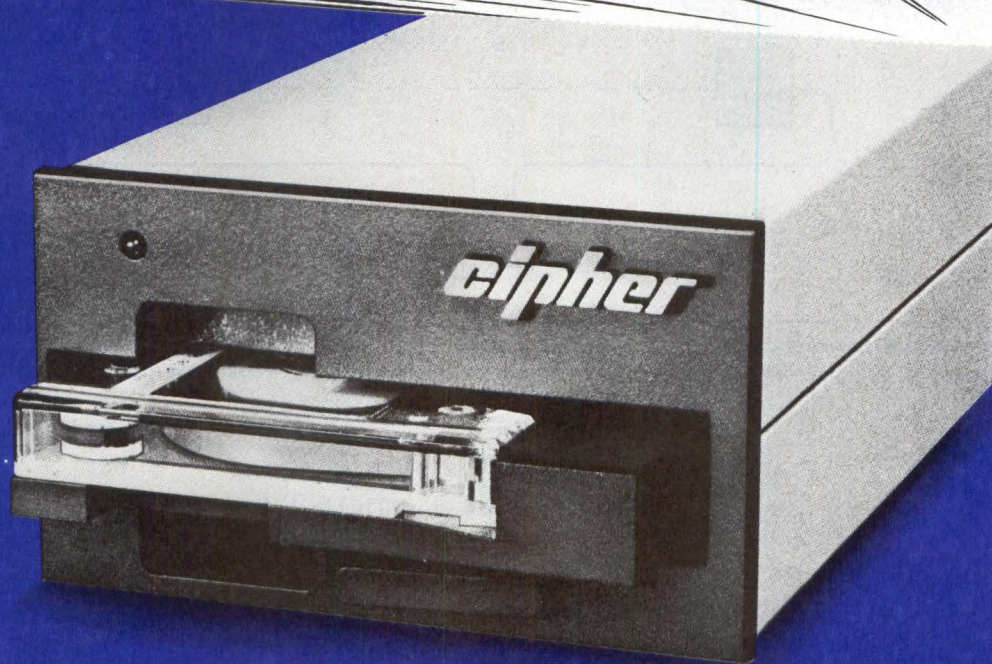

...a 1/4-inch  
streaming cartridge  
tape drive with  
45 megabytes for  
**\$800.\***

New, powerful, economical—and uniquely Cipher.  
Choose Cipher for your 1/4-inch tape drives.  
We've got a product that fits your needs.

- 45 MB capacity
- easy front loading
- QIC-02 interface standard
- 90 ips tape speed
- 5-1/4-inch form factor,  
Model 540-CT
- 8-inch form factor,  
Model 440-CT

***CIPHER***<sup>®</sup>  
*data products, inc.*

10225 Willow Creek Road, San Diego, California 92131  
P.O. Box 85170, San Diego, California 92138  
Telephone: 619/578-9100, TWX: 910-335-1251

\*O.E.M. Quantities

CIRCLE NO. 124 ON INQUIRY CARD



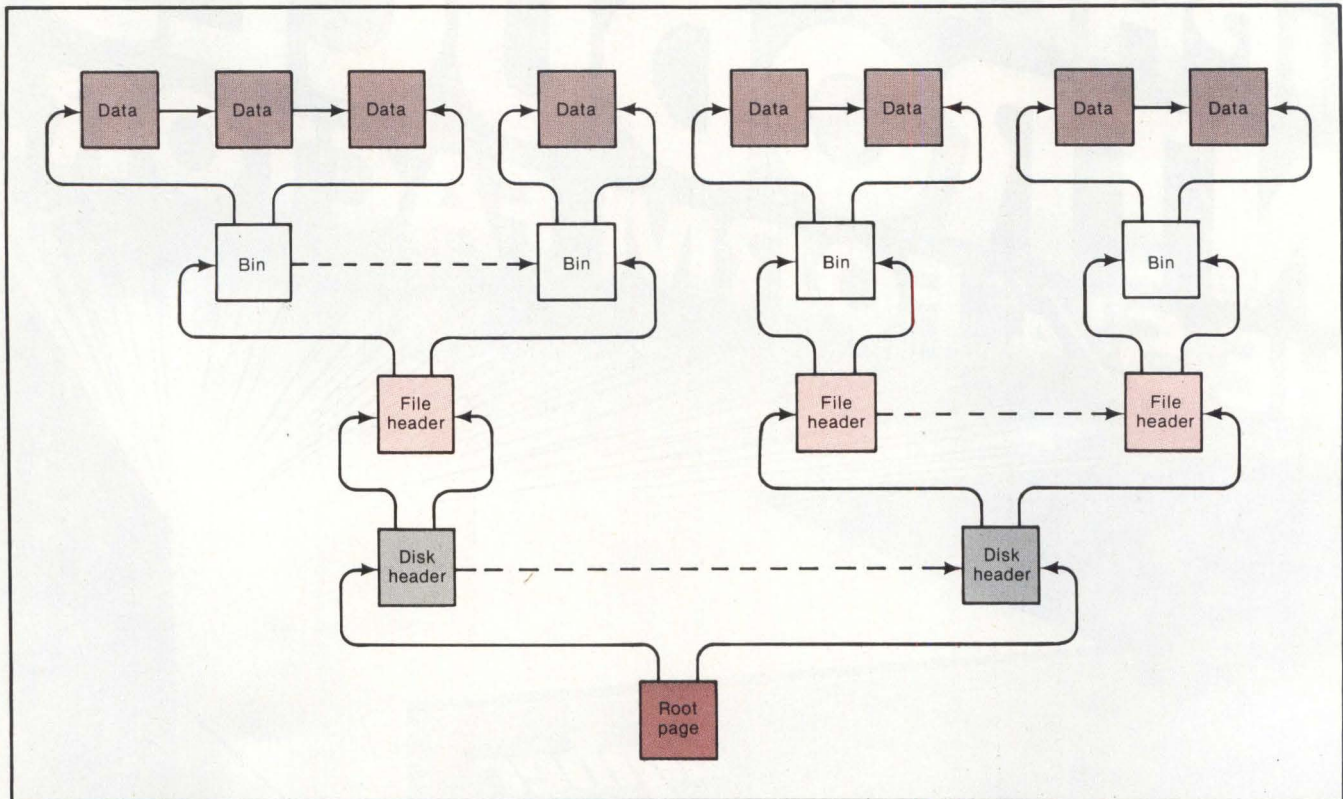

**Fig. 4. PFMS page structure** is hierarchical. A page's position within any level of a branch is determined by recency of use. The most recently used page is always at the beginning of each chain. Whenever a page gets relinked, all pages belonging to its sub-tree are moved with it.

management functions are separate. All file and disk-management overhead sectors must be buffered in main memory, or sector requests must be issued by the file-management software when an overhead sector must be accessed. If the overhead sector has not been accessed for a while or if a long block of data has been read from the disk, the overhead sector may have been paged out, necessitating an additional disk access.

The PM-3001 always pages out the highest level page of the least recently used branch in the page tree; for a complete five-level tree, this is the LRU data page of the LRU bin of the LRU file of the LRU disk. Consequently, pages used to buffer overhead information for other resident pages always remain in the paging area until after the other pages have been paged out.

Disk controllers normally perform best when sectors are read sequentially from a disk. Because of hardware speed limitations, however, disk sectors are usually interleaved so that two full rotations of the disk are required to read all the data on one disk track. This yields a best-case time of approximately 12.8 msec. per 256-byte sector when reading sequential disk sectors from an 8-in. floppy. The PM-3001 can access page resident data at a typical rate of 2.2 msec. per 256-byte

sector. This includes all file overhead manipulation, and the file data do not have to be in contiguous disk sectors.

Worst-case disk accesses using a conventional controller take one disk revolution plus the time it takes to read one disk sector. For an 8-in. floppy, this yields a worst-case access time of 172 msec. The worst-case time for accessing page-resident data using the PM-3001—when the data are located in the least recently used page—is 19 msec., including all file overhead accesses. Data that are not page resident are accessed in times comparable to those of other controllers.

Using the PM-3001 typically reduces access times by a factor of at least six when the file data is page resident. The improvement is greater for 5¼-in. floppy-disk drives. Host memory requirements for file-management software and file overhead buffering are reduced, and more host processor time can be allocated to other resources. □

**Stephen Goldman** is general manager at Distributed Processing Technology, Maitland, Fla.



# From out of the West... Leadership in disk controllers



*Long recognized as the dominant independent tape controller company serving the mini-computer industry, Western Peripherals has extended this leadership to disk controllers.*

**The industry measures leadership by the numbers.** Western Peripherals has the largest installed base of independent peripheral controllers operating in the field today. Products include disk and tape controllers for DEC, Data General, Perkin-Elmer and IBM System 1 com-

puters. They include controllers for Winchester and removable disk drives, streaming, start-stop and cartridge tape drives. No other supplier has as broad a line.

**Western Peripherals makes the numbers count.** Leadership in performance and reliability. All Western Peripherals controllers have multiple drive support capability and are software transparent to the host computer. All feature extensive self-testing, as well as the industry's

highest reliability — *over 45,000 hours actual (measured) MTBF.*

And leadership in product availability, delivery, service and support. Western Peripherals controllers are available either separately or as a complete, fully tested subsystem. They are supported by a full year factory warranty and a national field service organization. In most cases availability is 30 days ARO.

Find out how much our leadership can mean to you.



## western peripherals

Division of WESPERCORP

14321 Myford Road, Tustin, CA 92680  
(714) 730-6250 TWX: 910 595-1775 CABLE: WESPER



# PERIPHERAL TESTING: MORE THAN A QUESTION OF PASS/FAIL

Testing any rotating memory device involves more than the simple question of pass/fail. It is a complex set of questions encompassing the how's, when's and why's of testing. Applied Circuit Technology designs and manufactures final production and incoming inspection test equipment that answers the complex requirements of testing. Designed for volume throughput, ACT's equipment has solved the testing dilemma for many manufacturers. We've helped insure the reliable performance of rotating memory devices and assisted the manufacturers in achieving a low 2% return rate of shipped product.

ACT's equipment has tested more 5¼" Winchester disk drives than any other system in the world. Our expertise, however, does not stop at Winchester drives. Today,

Applied Circuit Technology is involved in floppy systems test, tape systems test, fixed/removable Winchester disk systems test as well as Servo Writers and Spiral Testers.

Whether you are shipping or receiving 10 or 10,000 units a month, Applied Circuit Technology provides the answer to high volume, in-depth, final production testing.

If you realize that testing is more than a question of pass/fail, contact Applied Circuit Technology.



Applied  
Circuit  
Technology

2931 La Jolla Street  
Anaheim, CA 92806  
(714) 632-9230



Available in first quarter 1983: ACT's new MTS (Modular Test System)

CIRCLE NO. 126 ON INQUIRY CARD



# Testing Winchester disk drives

MICHAEL F. JULIFF, Qubex Associates, Inc.

## *Correlation of manufacturer and customer tests can keep relations cordial*

The small Winchester disk drive is perhaps the biggest peripherals success story of this decade. More than 40 companies are manufacturing and shipping Winchesters to some 2000 worldwide customers. Experts predict that, by 1985, shipments of these drives will exceed 800,000 units a year, up from the 20,000 shipped in 1980.

In the rush to satisfy this market demand, many drive manufacturers did not develop the specialized equipment necessary for drive testing at customer sites. All drives are tested before being shipped to customers, but there are no standardized test criteria to ensure that the manufacturers' outgoing tests and the customers' incoming tests are the same. This test-correlation problem has created some major differences between manufacturers and customers. But which tests need to be better correlated? Is one more important than the others? Which ones lacking correlation are causing the most serious problems?

### Testing read performances

Determining a drive's read performances—specifically identifying hard and soft error rates—is the basic problem. Hard errors are usually caused by media defects and are relatively easy to identify. Soft errors are caused by a multitude of possibly unrelated events and are, therefore, difficult to identify (Fig. 1).

Manufacturers test drives in relatively controlled, clean and electrically noise-free environments. Drive testing includes one or more read/write passes over each disk surface to locate each media defect (hard error). Large media defects are easy to locate; the smaller ones—single-bit defects common with Winchester technology—are much harder to find. Any defect

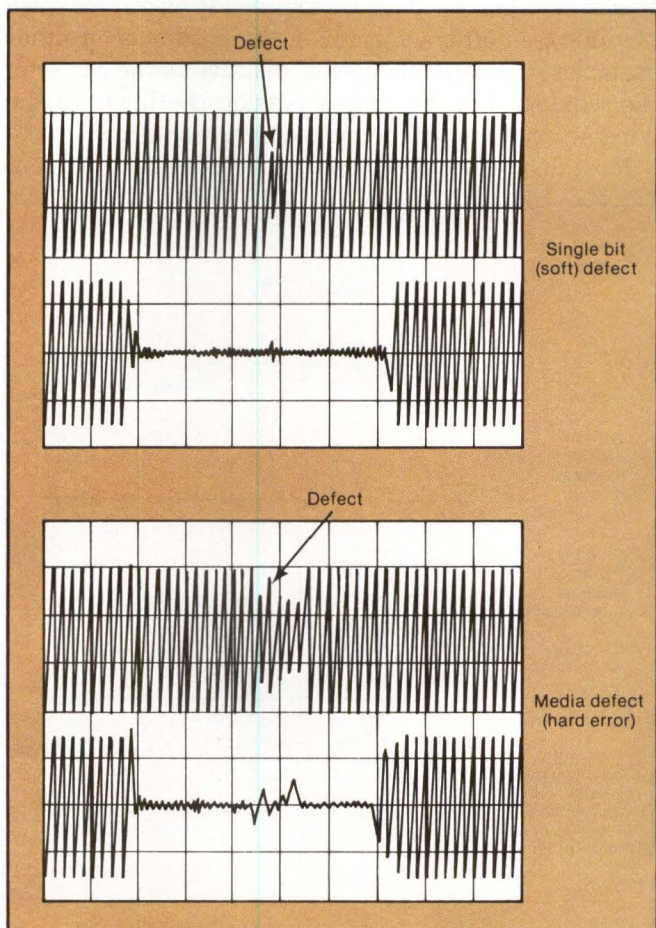

**Fig. 1. Disk errors** are available in two flavors, as these two test screens illustrate. Soft errors (top) are caused by a multitude of often unrelated events (e.g., shock, vibration or electrical or radio frequency interference) and are difficult to detect. Hard errors (bottom) are usually caused by media defects and are easy to identify.



detected is analyzed, logged by location and ignored in subsequent read/write testing. Once all tests are completed, a label identifying the number of defects and their locations is printed. The manufacturer attaches the label to the drive and ships it to a user.

In an ideal situation, a customer receives a drive and enters the manufacturer's test results into his system before he starts testing the drive. Unfortunately, many customers ignore the defect list provided by the manufacturer and opt to test for defects using their own system. They sometimes fail to find all of the defects the manufacturer found and, in subsequent testing, observe an excessively high read-error rate. The drive fails to meet specification and is returned to the manufacturer.

Determining a drive's read-error rate is at best difficult, time-consuming and often frustrating. In simplest terms, a data bit from the drive is detected as such if it occurs within a fixed window—commonly called the "data separator window" (Fig. 2). The window is locked to the incoming data and, under ideal conditions, remains centered about the data bits. However, when the data are exposed to electronic noise (EMI/RFI), an off-track error in the positioner or other variables, the data bit "moves" relative to the center of the window. If a bit moves outside the limits of the window, that bit will be logged as a read error.

Most drives are designed to have a 25- to 30-percent

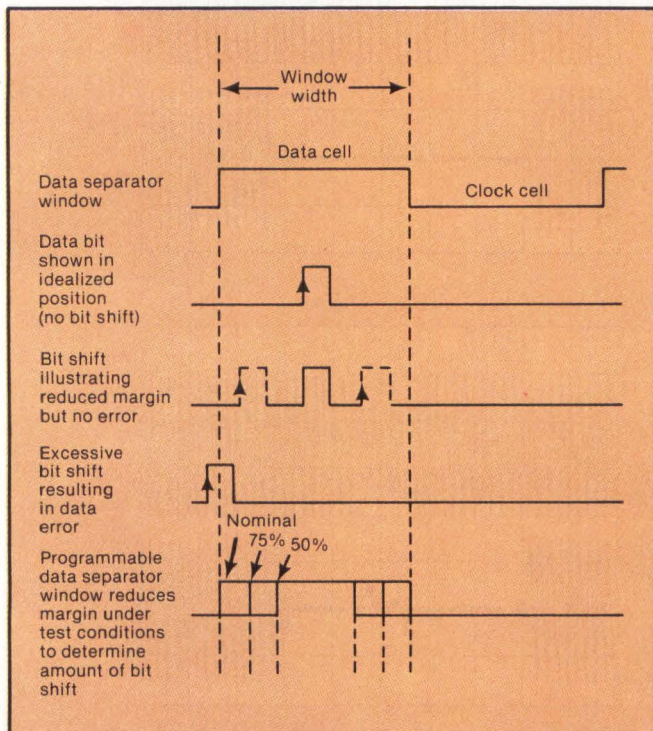

**Fig. 2.** The "data separator window" is the time during which data bits are detected by a disk drive. When electrical interference or other conditions cause "bit shifts," bits can fall outside the window, and errors can result. By allowing both a user and a manufacturer to vary the width of the window, the Qubex QA 2000 ensures that both parties can test at the same mutually specified tolerance.

margin between the window limits and the worst-case bit shift because of drive variables (Fig. 3). This margin can be substantially eroded by factors over which disk-drive manufacturers have little control once a drive leaves a plant. The presence of extraneous electrical noise from CRTs, switching power supplies and the like, coupled with a poor data separator, can reduce this margin and adversely affect drive-acceptance tests. When manufacturers and customers are testing under different conditions, using different test equipment, arriving at identical results is virtually impossible.

**Getting correlated**

Improved correlation between tests is needed to keep manufacturers and customers on good terms. The best way to achieve better correlation is to install the same test system in both manufacturer and customer locations.

Qubex Associates, Inc.'s founders formed the company and developed the QA 2000 disk tester because they saw a need for standardized testing. The QA 2000 (models A1 and A2) tests more than 50 functions and parameters (Fig. 4). It is designed to test for industry-standard specifications and to provide identical drive tests for both the manufacturer and the customer.

The QA 2000 has made large strides in overcoming the problems of measuring both hard and soft read-error rates because it tests for phase margin, a factor that can determine all the variables that affect read-error

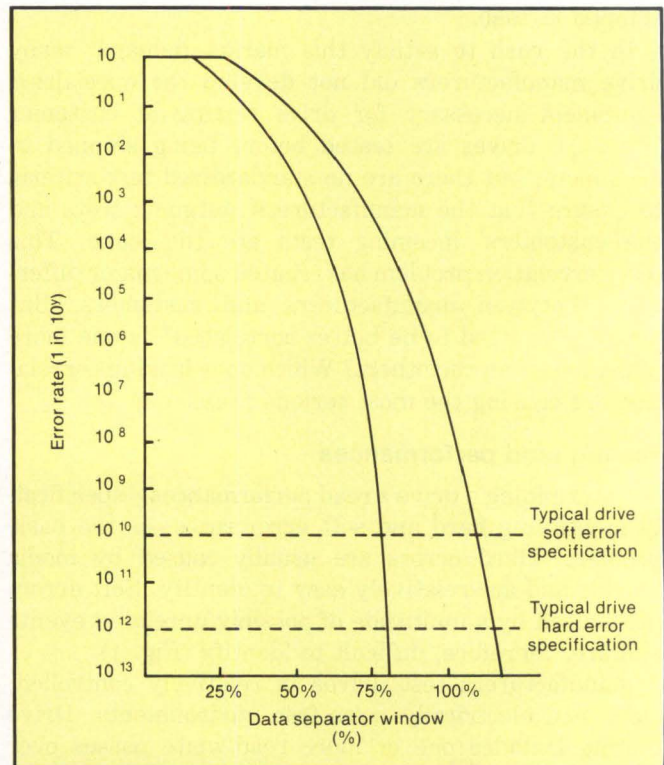

**Fig. 3.** The width of the data separator window and a disk's error rate are related. This exaggerated representation shows what might be observed as the programmable data separator window of the Qubex QA 2000 was gradually "opened."



# T-650

## WINCHESTER DRIVE TEST SYSTEM

PRICED UNDER \$10,000.00

### WINCHESTER DRIVE TEST "COURSE"

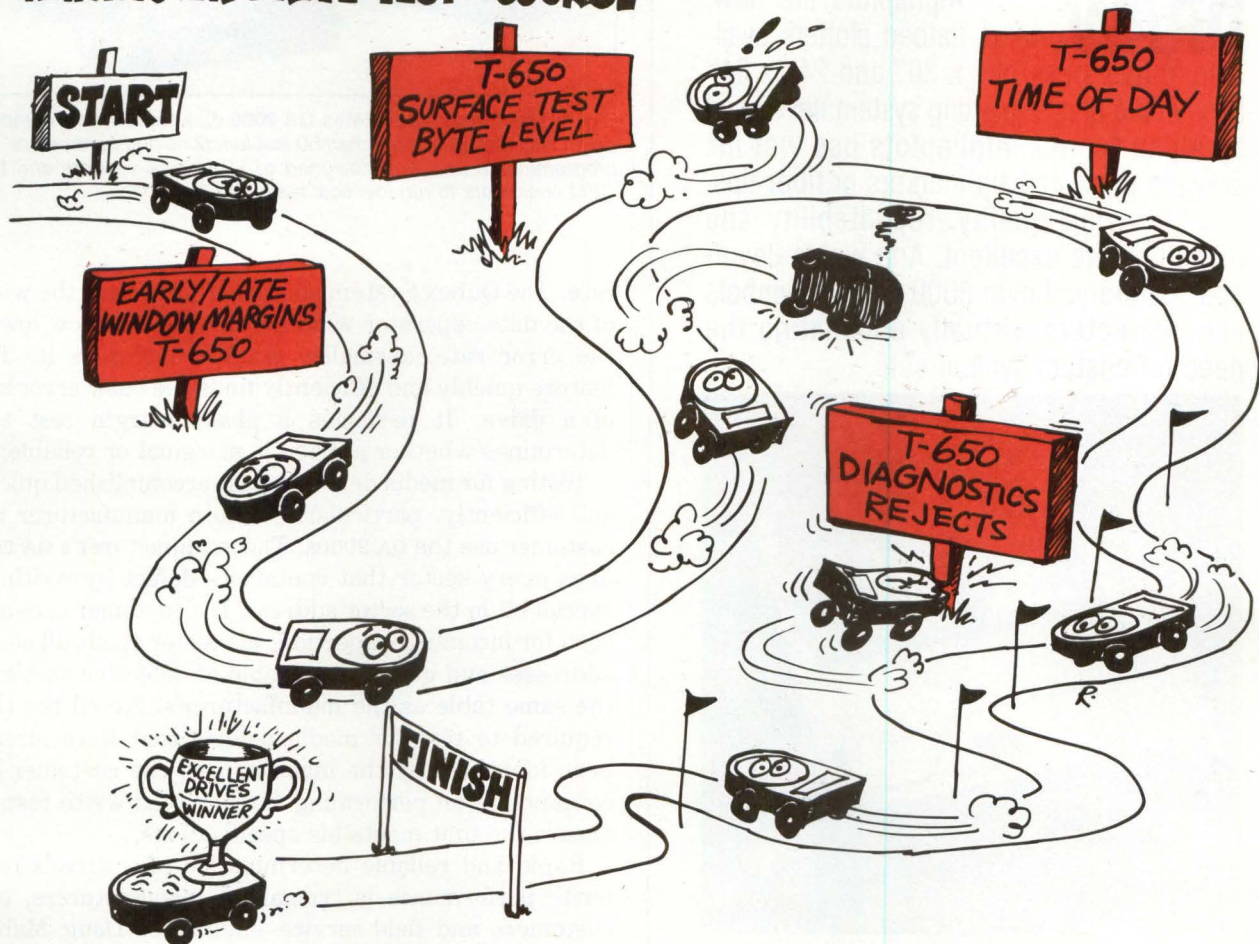

**WHEN YOUR WINCHESTER DRIVES PASS OUR TEST "COURSE" THEY ARE EXCELLENT DRIVES!**

#### Sales/Service Centers - Around the World



14272 Chambers Rd.  
Tustin, CA. 92680  
(714) 731-9000

50 Mall Rd.  
Suite 209  
Burlington, MA. 01803  
(617) 273-4844

2540 Walnut Hill Ln.  
Suite 158  
Dallas, TX. 75229  
(214) 352-4012

2000 Wyatt Dr.  
Suite 17  
Santa Clara, CA. 95050  
(408) 748-8686

7927 Jones Branch Dr.  
McLean, VA. 22101-1300  
(703) 356-7450

ALSO: TOYKO • FRANKFURT • PARIS • LONDON • STOCKHOLM • OSLO • MILANO • COPENHAGEN • SYDNEY



# GIVE YOUR SYSTEMS A LITTLE MORE DRAW.

The Alpha-plot I and II. If you're planning systems for engineering or drafting departments or large corporations with graphics needs, welcome to the future.

Alphaplots are new, large flatbed plotters available in two sizes: 18" x 30" and 24" x 34." Based on a unique plotting system developed by Alpha Merics, Alphaplots use wet ink drawing pens, felt tip markers or fiber tips.

Drawing quality, repeatability and resolution are excellent. And we've developed a library of over 3000 special symbols and characters, virtually eliminating the need for custom symbol sets.

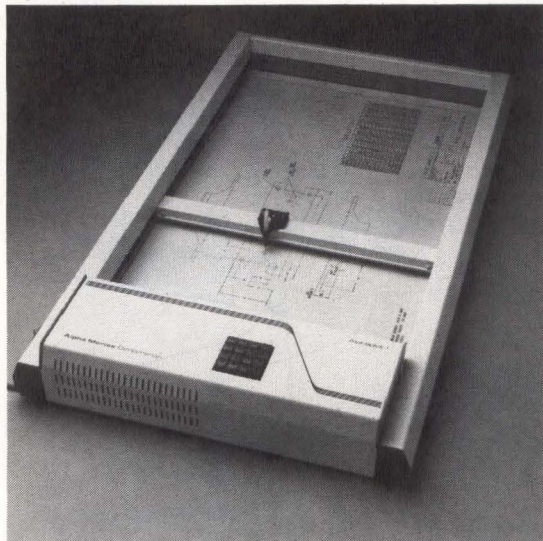

Both plotters feature a choice of RS-232C or IEEE-488 industry-standard computer interfaces. Plus software protocols compatible with most plotters currently available. Alphaplots incorporate dual Motorola 6809 microprocessors and feature an expandable 8K memory buffer.

Beat the competition to the draw. Ask us about the great new low-cost Alpha Merics plotters.

Before your customers ask you.

**AlphaMerics** Corporation  
 20931 Nordhoff Street  
 Chatsworth, CA 91311  
 (213) 709-1155  
 CIRCLE NO. 128 ON INQUIRY CARD

## MEMORY SYSTEMS



**Fig. 4. The Qubex Associates QA 2000 disk tester offers complete diagnostic testing of more than 50 test functions and parameters. The programmable unit was designed to allow disk vendors and their OEM customers to run identical tests.**

rate. The Qubex System allows a user to vary the width of the data separator window. A wider window lowers the error rate; a smaller window increases it. This feature quickly and efficiently finds the basic error rate of a drive. It performs a phase margin test that determines whether a drive is marginal or reliable.

Testing for media defects is also accomplished quickly and efficiently, particularly if both manufacturer and customer use the QA 2000s. The manufacturer's QA 2000 flags every sector that contains a defect by writing a special bit in the sector address. If a customer uses a QA 2000 for incoming inspection, his tester reads all sector addresses and generates a table of defective sectors—the same table as the manufacturer's. Saved the time required to test for media defects that have already been identified by the manufacturer, the customer can concentrate on performing further read/write tests to ensure the unit meets his specifications.

Rapid and reliable determination of a drive's read/write performance is crucial for manufacturers, OEM customers and field-service engineers. Doug Mahon, manager of engineering at Seagate Technology Corp., points out, "The manufacturers that don't pay attention to the correlation detail are going to pay for it sooner or later." Norman Zimmerman, manager of technical support at Quantum Corp., concurs: "The drive manufacturers see the importance of this kind of testing correlation. So do the people at the customer's incoming inspection. However, these aren't generally the people who want to get into test-equipment hardware." The QA 2000 gives large-volume disk customers powerful, flexible test capabilities, but more importantly, it provides a means of establishing standardized test criteria between manufacturers and customers. □

**Michael F. Juliff** is vice president, engineering, at Qubex Associates, Inc., Santa Clara, Calif.



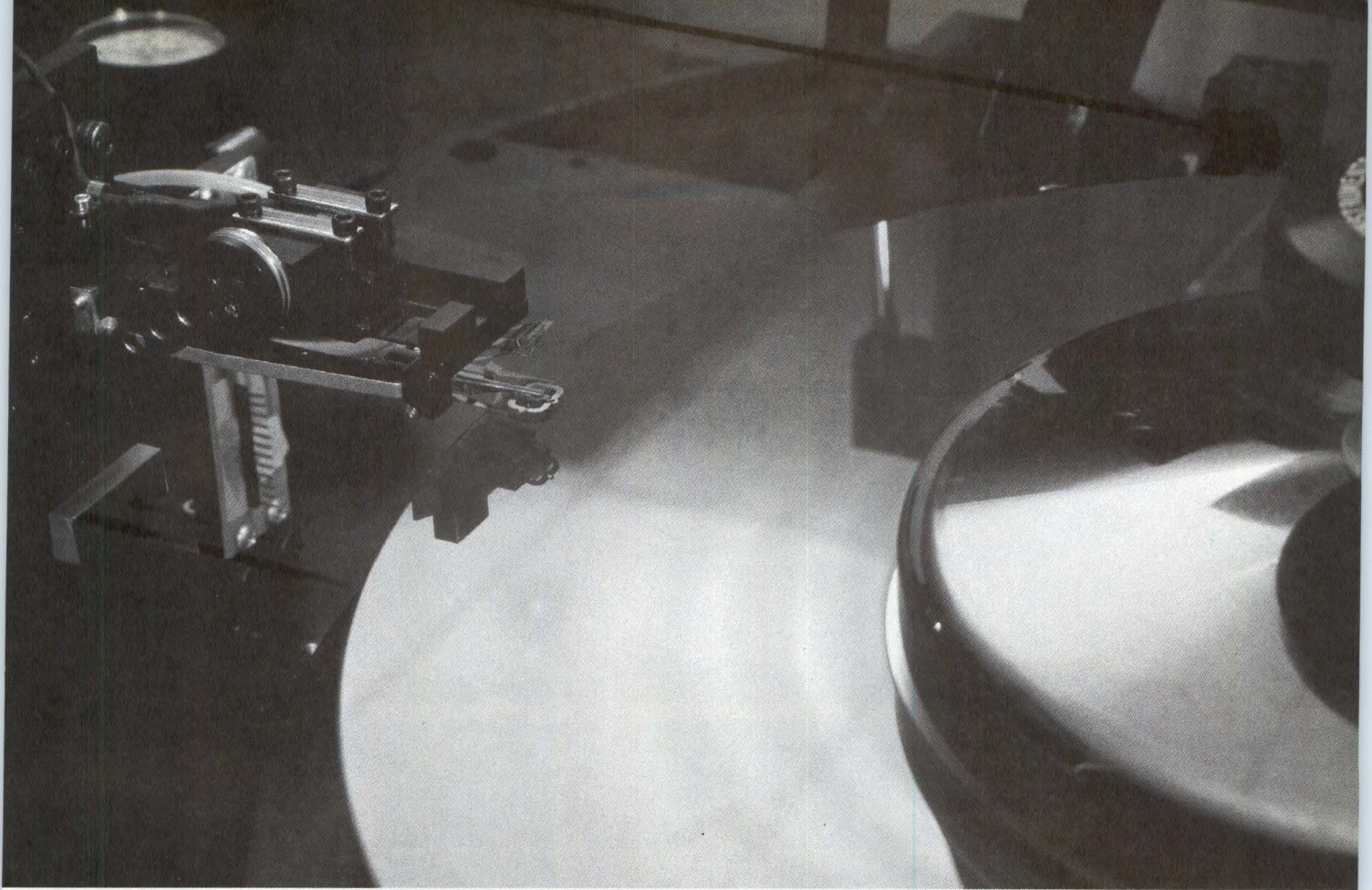

# Best assured for disk drive testing.

Whether you're a manufacturer of disk drives or a mainframe OEM, accuracy and performance are the keys to your success.

Precision test equipment that can measure heads, media, data channels and servo mechanisms in the design stage, or on the production line is essential.

In the past your test cycle may have consisted of a patch-work of equipment. Some dedicated, others adapted, usually about the only thing in common was inefficiency.

We've put together a team dedicated to disk drive test equipment. Over half are graduate engineers, and of those, fifty percent are disk drive specialists. That means expertise in the area where it's needed.

It also means you can have your choice of a unit capable of responding to your requirements from our existing line. Or an integrated custom system specially designed and built to your exact tolerances and accuracies.

That's probably why the world's leading disk drive related manufacturers are our best customers.

And, because we use a programmable design featuring a 50 MHz bandwidth, the system we build today will expand as you do.

Whatever your disk drive testing requirements, from media certification, to head testing, to window margin, speak first to the leader in disk drive testing technology.

And, rest assured.



## **Cambrian Systems, Inc.**

**The Leader in Disk Drive Testing Technology**

31364 Via Colinas, Westlake Village, CA 91362, (213) 991-7026



# WE'VE REDUCED DISK DRIVE TESTING TO THIS.

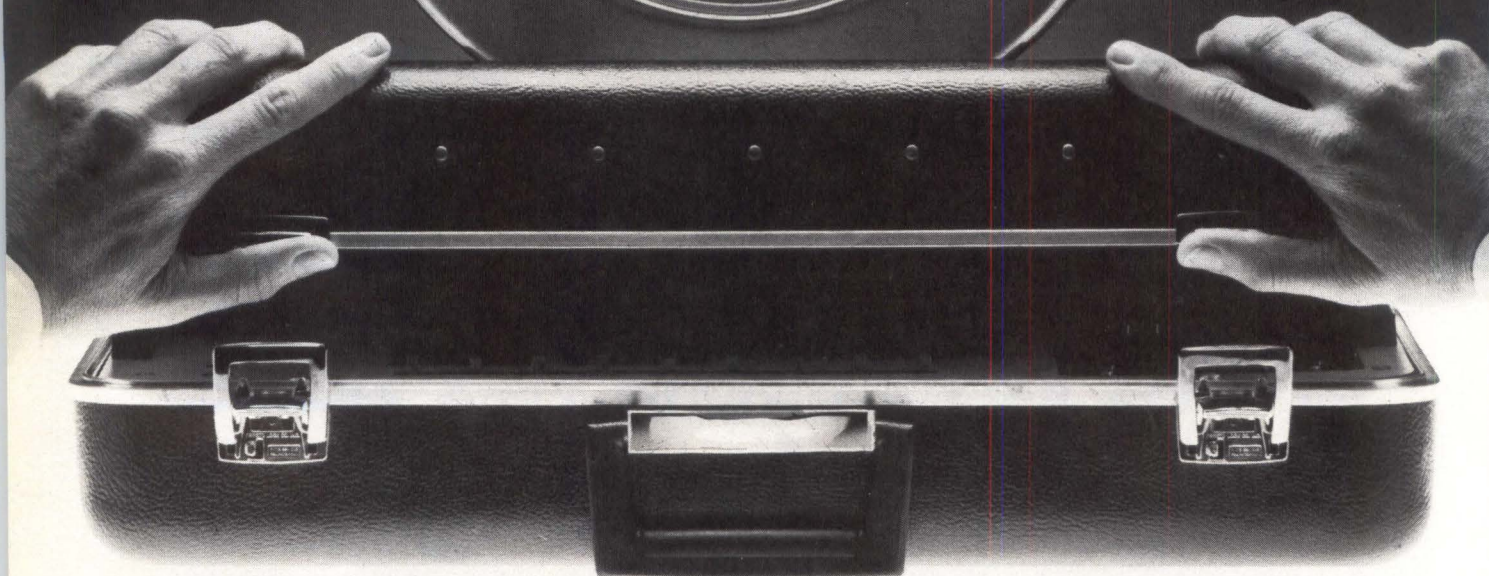

Thorough testing of disk drives and packs has always required an arsenal of expensive equipment. Now, all you need is the PM 4000 Disk Drive Qualifier.

With this programmable microcomputer in a briefcase, you no longer tie up mainframes and controllers. You run tests in real time. Eliminate cumbersome exercisers and null meters.

The Qualifier performs any number of sophisticated tests without a skilled operator. It's as simple as a calculator to use. Call up its powerful diagnostic programs at the touch of a key. Or, easily program your own. With the microcomputer controlled Qualifier, you format packs and align heads with unprecedented speed and accuracy.

It's compatible with any rigid disk moving head storage module drive and many others. The Qualifier offers revolutionary benefits to anyone involved with rotating media drives: original equipment manufacturer, system marketer, service company, user or media manufacturer.

For a brochure on this technological breakthrough, write or call Pioneer Research, 1745 Berkeley Street, Santa Monica, CA 90404 (213) 829-6751. Manufactured by Pioneer Magnetics.

## **THE DISK DRIVE QUALIFIER**

By Pioneer Research

CIRCLE NO. 130 ON INQUIRY CARD

Territories Open for  
Sales Representation





## GRAPHICS

# Office workstation gets bit-map graphics

DREW HOFFMAN, Convergent Technologies

### *Graphics board adds vector and raster displays to distributed system*

OEMs looking for graphics capabilities in a workstation have often had to choose between dedicated, high-performance bit-map graphics designs and more versatile, multifunction systems with low-resolution graphics. Convergent Technologies has combined these features by adding a bit-map graphics board to its intelligent workstations. The IWS graphics workstations provide both bit-map and character-oriented video, and include vector and raster drawing modes with multilevel software interfaces.

#### **Bit-map and character features**

The IWS workstations provide both full bit-mapped graphics and alphanumeric (character-oriented) video. The hardware and software required to generate these types of displays are different, and to perform both types well, a graphics processor board has been added to the existing alphanumeric video-control board.

Alphanumeric video is generated by a video-control board accessible by a main 8086 CPU via the proprietary CT-BUS (Fig. 1). A character and attribute map is maintained in system memory. The video control board transfers this map into its row buffers on a character line basis using direct-memory access, resulting in an alphanumeric screen format of 34 lines  $\times$  80 or 132 characters, with each character 10  $\times$  15 pixels. Characters of any shape or size can be displayed by programming the font RAM on the video-control board. A font consists of as many as 256 characters. The standard Convergent character set includes the entire printing ASCII character set, common symbols, selected

foreign alphabetic characters and graphics symbols, which can be used to create fairly simple rectilinear graphics such as forms.

Bit-mapped graphics are generated on the IWS graphics board, which resides on the application-hardware Multibus (Fig. 2). This board has its own 8086 processor. The main CPU performs the higher level graphics subsystem tasks such as scaling and clipping and hands a list of lower level commands such as Draw Line Absolute to the graphics processor, which executes them in parallel with the main processor's tasks. The main CPU also handles processes such as communi-



**IWS-110 and IWS-120 graphics workstations** from Convergent Technologies feature bit-map graphics in vector or raster mode. The workstations are hardware- and software-compatible with previous workstations in the series.



cations protocol handling.

Commands are sent from the main CPU to an 8K-byte inter-processor communications queue on the graphics board. The graphics processor draws into a 1024 × 1024 display RAM comprising 128K bytes of 64K-bit dynamic RAM chips. This memory is organized as two 1024 × 512 display planes, with each plane containing a 656 × 510 screen bit-map. All of the display memory is continuously refreshed by video refresh cycles. Either plane can be displayed; the nonvisible plane can be used to store graphics-character fonts, or real-time animation can be implemented by updating both planes and rapidly switching the viewport between them.

**Drawing modes**

While most graphics display systems are limited to drawing in vector or raster modes, the IWS displays can operate in both modes.

In vector mode, an image consists of a group of vectors, or line segments. This mode is commonly used for engineering and scientific applications, primarily because vectors can be efficiently scaled in size: to change the size of an object in vector format, one need only increase the length of all the vectors by a common factor. Raster operation consists of the high-speed logical combination of a rectangular display memory with another memory of the same dimension. This

mode is useful for implementing interactive text and graphics characters, as a font can be stored in nondisplayable memory and quickly raster-copied into displayable memory. The higher speed of this mode is also better-suited to manipulating and modifying images than is a vector mode (with the exception of scaling).

The IWS draws vectors at a rate of approximately 2500 50-pixel vectors per sec., and raster images at

*The IWS workstations provide both full bit-mapped graphics and alphanumeric video.*

about 940,000 pixels per sec.

All local memory and I/O on the graphics board are accessible via a 16-bit Multibus slave interface. The graphics processor executes its algorithms out of 8K bytes of firmware, and the main CPU can down-load microcode enhancements into the static RAM.

**Display memory**

The IWS display memory contains a one-to-one bit map of all of the pixels on the screen. This memory must be accessed by both the graphics processor, to change the contents of the display memory, and the video-control board, to refresh the screen with the information in the display memory, requiring a dual-ported display-memory scheme. To enable the graphics

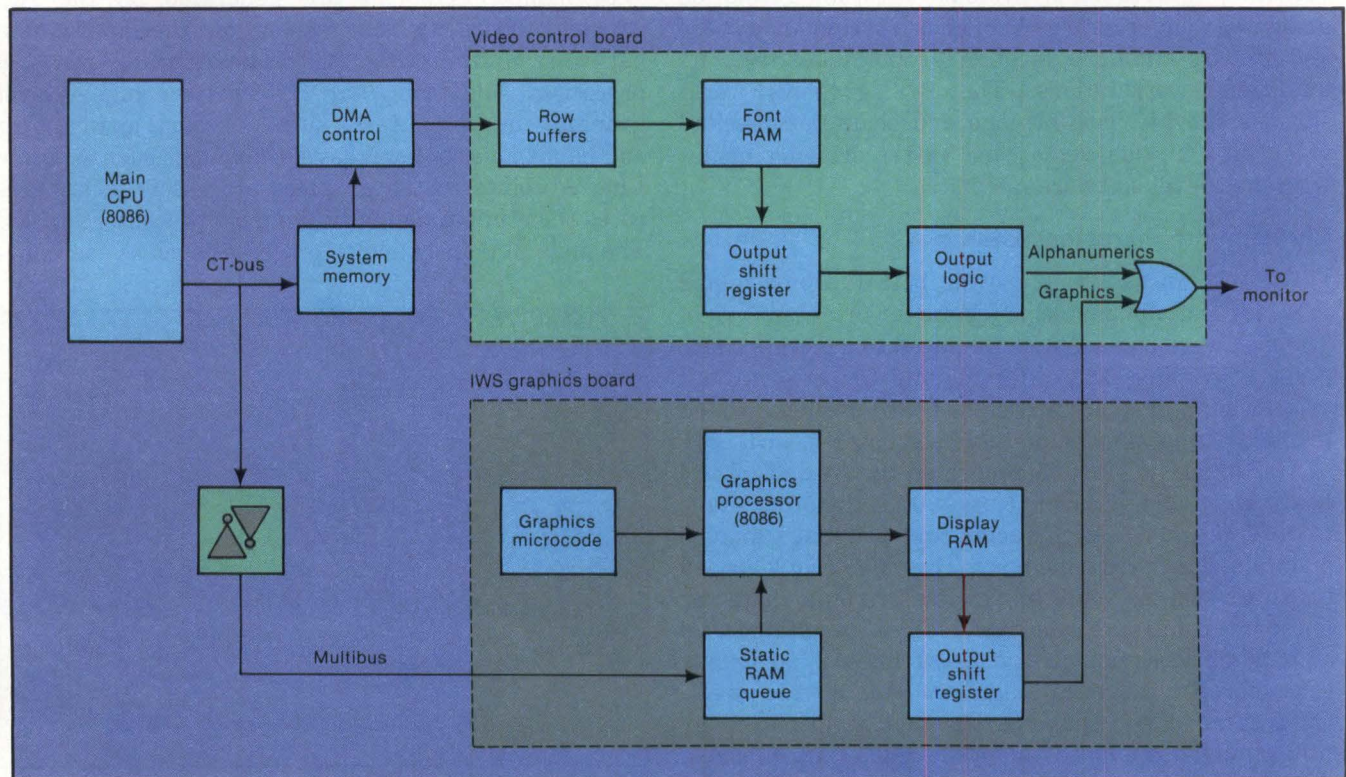

**Fig. 1. IWS video subsystem** provides concurrent alphanumeric and graphics displays. The workstation's main CPU down-loads graphics commands to the graphics processor, remaining free to perform scaling, translation and communications functions. Alphanumerics and graphics can be enabled independently by application software.





# Any microsystem gives you one fast terminal.



*Now* Molecular gives you ~~32~~.64.

Add terminals to most micro-based systems, and the systems start to run out of gas.

But not with the Supermicro from Molecular Computer. You add terminal after terminal without response time slowdown. Because every user has the speed and power of a standalone computer. Now all the way up to 64 terminals.

With an entry price under \$6,000, Molecular gives you a smooth growth path to mainframe power. So your system can grow as fast as your business. And if you're an OEM, basing your product on a Molecular Supermicro will help your business grow faster.

A unique bus architecture connects each user with shared peripherals—and with every other user. With each terminal

you add, Molecular adds a Z80A CPU and 64K of memory dedicated to that terminal.

So each user enjoys the power and throughput of a standalone computer. Plus the economy and efficiency of shared data, peripherals, and the optional 16-bit 8086 Performance Accelerator. And because Molecular is CP/M® and CP/M-86™ compatible, each user has a world of application software to work with.

To schedule a demonstration at a distributor in your area, or to get full information, call or write Molecular Computer, 251 River Oaks Parkway, San Jose, CA 95134 (408) 262-2122.

It's the computer system that doesn't slow down as it grows up.

CP/M and CP/M-86 are trademarks of Digital Research Corp.

**CIRCLE NO. 131 ON INQUIRY CARD**

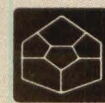

**molecular  
computer™**

The Supermicro Company®



processor to draw quickly, the memory must be readily accessible. In most graphics designs, the processor can access the memory only during display blanking or retrace, typically comprising 25 percent of the time. Such designs often compensate by using a costly bipolar bit-sliced processor able to update the display memory during blanked intervals.

The IWS graphics board can use a lower cost 16-bit MOS microprocessor by incorporating an interleaved synchronous memory controller. This controller time-division multiplexes or interleaves video refresh and local bus cycles in 616-nsec. cycles. Thus, the graphics

*The IWS display memory contains a one-to-one bit map of all of the pixels on the screen.*

processor or main CPU (via the Multibus wait only 616 nsec. to access a 16-bit word of display memory, not the 32  $\mu$ sec. of an entire scan line.

The memory controller is synchronized to the graphics pixel clock, which has a period of 39 nsec. There are 32 pixel clock states, comprising 16 states for two page-mode read cycle for video refresh and 16 states for a processor or Multibus read or write cycle (Fig. 3). During a memory controller cycle, 32 pixels are accessed. By accessing pixels in two 16-bit page-mode video-refresh cycles rather than one 32-bit cycle, the number of required RAM chips is reduced from 32 to 16, and the width of the display bus is reduced from 32 bits to 16 bits.

**Multilevel graphics software**

The IWS graphics workstations provide software

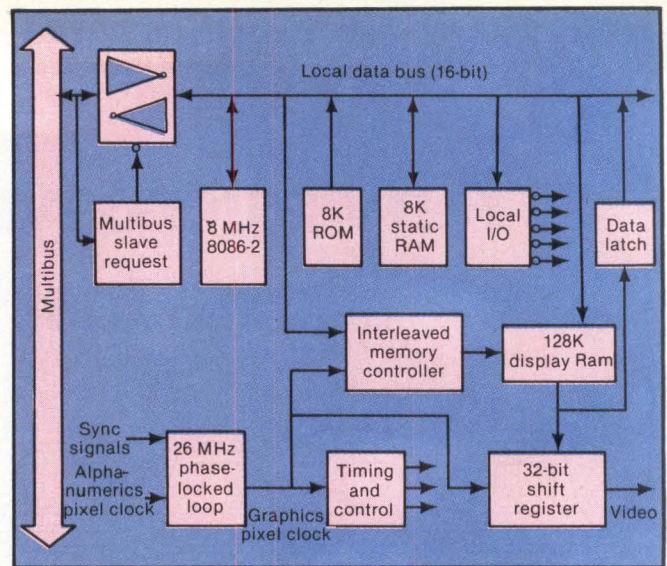

Fig. 2. Graphics board incorporates 8086 CPU and 128K bytes of display RAM, and is Multibus-compatible.

interfaces at both the system level, for OEM flexibility, and the application level, for end-user ease of use.

The system-level interface consists of a set of standard graphics primitives or procedures that provide a programmer with control over the full range of features of the graphics processor. The graphics primitives fall into two classes: device-dependent and device-independent routines.

Device-dependent primitives are those that are specific to the IWS graphics board in terms of resolution and capabilities such as Draw Line Absolute and Set Vector Mode Absolute. This level of software support is aimed at those applications that require a close interface to the hardware for maximum performance.

Device-independent routines are those that allow system designers to create images that can run on Convergent graphics workstations and output devices of any resolution. These routines fall into five categories:

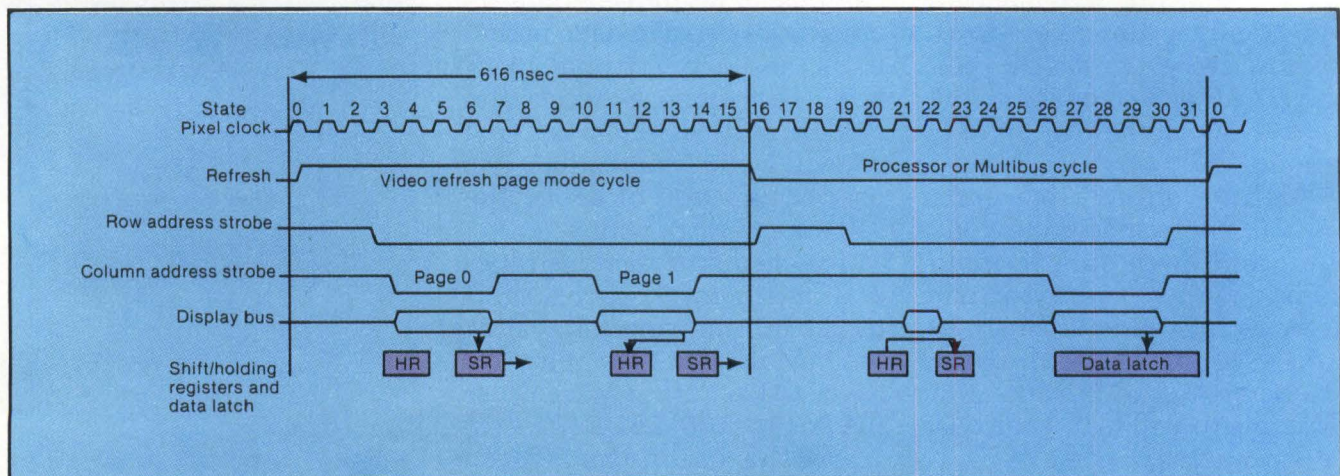
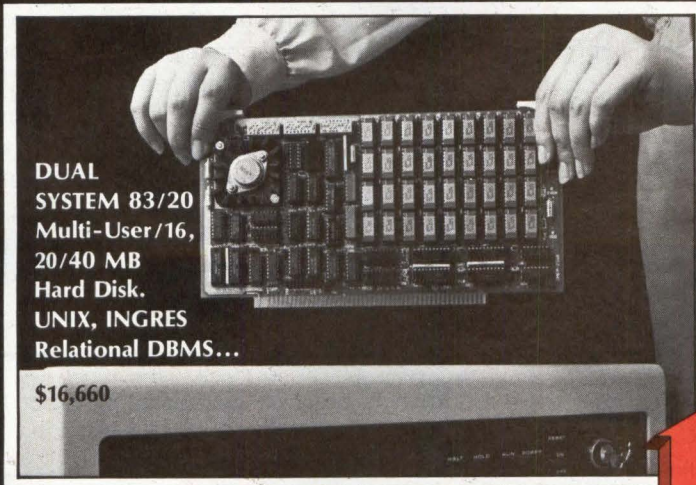

Fig. 3. Interleaved synchronous display memory controller scheme provides close coupling between the local graphics processor and the memory. Refresh cycles use page mode, reducing the number of dynamic RAM chips from 32 to 16.



# board the bus

INDUSTRIAL QUALITY BOARDS FOR THE  
IEEE-696/S-100 BUS



DUAL  
SYSTEM 83/20  
Multi-User/16,  
20/40 MB  
Hard Disk.  
UNIX, INGRES  
Relational DBMS...

\$16,660

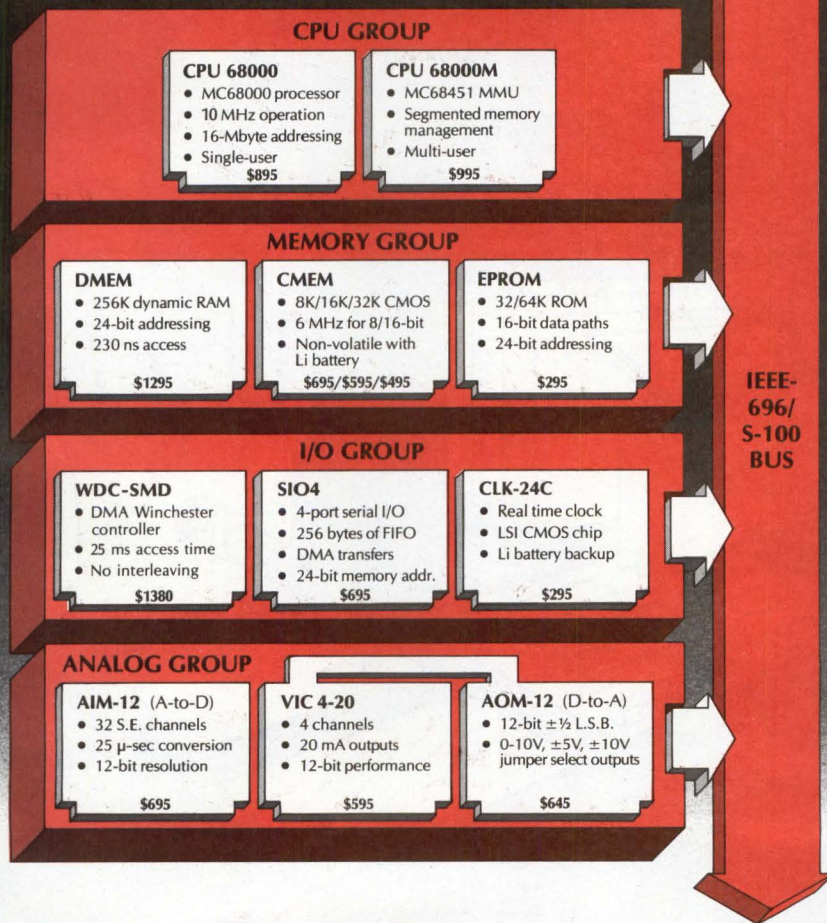

Sales representatives in most metropolitan areas.

# DUAL

OEM and Dealer pricing is available.

2530 San Pablo Avenue • Berkeley • CA 94702 • (415) 549-3854 • 172029 SPX

CIRCLE NO. 132 ON INQUIRY CARD

## THE ULTIMATE IEEE/S-100 MEMORY WOULD...

- **BE NONVOLATILE**, holding data for up to eight years with the power off.
- **RUN AT 6MHZ** without wait states.
- **HAVE EXTENDED 24-BIT ADDRESSING** and bank select.
- **HAVE DYNAMICALLY MOVABLE WRITE PROTECT AREAS** to prevent accidental erasure of programs and critical data.
- **GENERATE POWER-FAIL** interrupts for orderly system shutdown & power failure recovery.

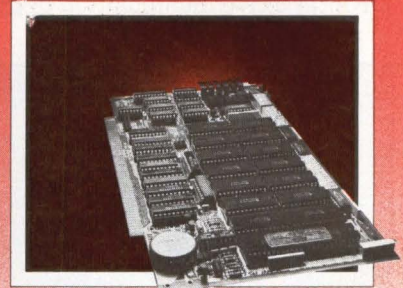

### CMEM

AVAILABLE NOW FROM DUAL SYSTEMS, the CMEM memory boards combine high-speed CMOS memories with a new 5-8 year lithium battery. The CMEM offers the nonvolatility of an EPROM board while retaining the instant writability of a high-speed read/write RAM. These industrial grade boards are subjected to a 168-hour burn-in and a 1000-cycle power interruption test to insure data retention and the highest degree of reliability possible.

CMEM-32K, 32K Bytes \$695  
CMEM-16K, 16K Bytes \$595  
CMEM- 8K, 8K Bytes \$495

# DUAL

DUAL SYSTEMS CORPORATION

2530 San Pablo Avenue • Berkeley  
CA 94702 • (415) 549-3854 • 172029 SPX



## GRAPHICS

- Output primitives such as Draw Line and Fill Polygon
- Input primitives such as Cursor On and Query Cursor Position
- Text primitives such as Set Font and Draw Characters
- Display control primitives such as Set Viewport and Set Scale
- Picture primitives such as Add Object and Close Picture.

Application-level software support consists of enhancements to the standard Convergent high-level programming languages for simple creation, manipulation and storage of graphics objects. For example, with a single parameterized statement, a pie chart can be drawn from BASIC, FORTRAN, COBOL or Pascal.

The IWS workstations also provide a business graphics plotting package designed to be used as part of an OEM's office-automation product. This package allows for interactive manipulation of graphics images such as

bar, line and pie charts. Multiple graphs or labels can be merged into a single picture and moved and scaled interactively via single-keystroke commands. Shading of charts and font styles of labels can also be changed. A single keystroke saves a picture on disk or outputs it directly to a color pen plotter. The picture can be plotted on standard 8½- × 11-in. paper for reports or on transparencies for viewgraphs.

This graphics cut-and-paste capability is accessible to Multiplan, Convergent's financial-planning and modeling package, through a transparent interface. Tabular data generated in Multiplan can be graphed immediately with a few Multiplan commands, and the resulting graphs can then be manipulated. A user can quickly return to Multiplan to change data and then regraph the new data. The business graphics package interface is designed so that OEMs can easily provide their own data-entry front ends other than Multiplan. □

**Drew Hoffman** is graphics development project leader at Convergent Technologies, Santa Clara, Calif.

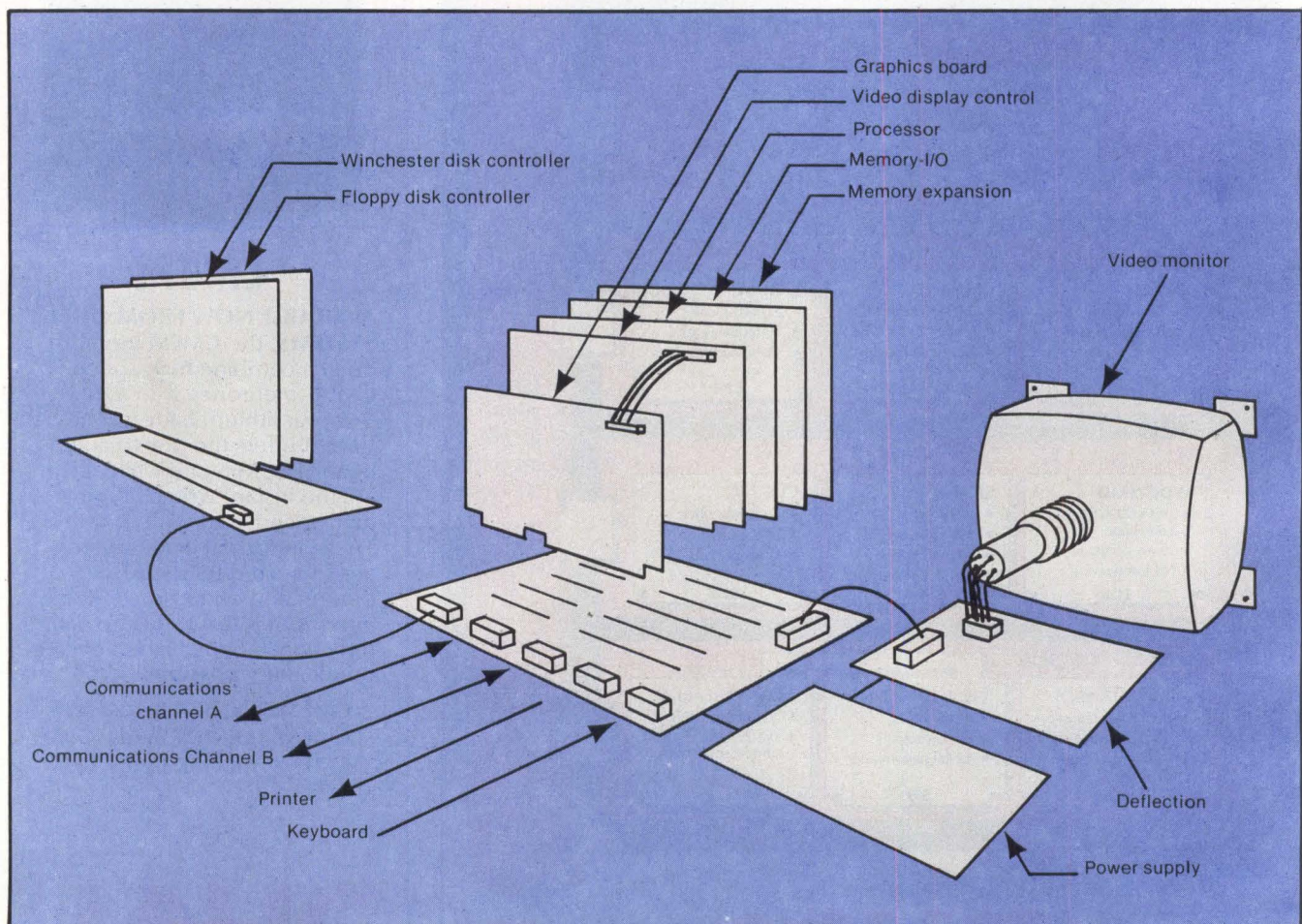

**IWS electronics** consists of five PC assemblies mounted vertically in a card cage that supports four Convergent CT-BUS boards, and two or five Multibus-compatible boards. The five assemblies comprise the IWS graphics board, a video-control board, a processor board, a memory-I/O board and an optional memory-expansion board. The last four assemblies are linked through the CT-BUS bus, separate from the Multibus logic, which supports the graphics board. Additional Multibus masters or slaves can be added to the system for customized I/O or additional processors.



# OVERBUILT.



In Touch with Tomorrow  
**TOSHIBA**

Now you can afford to be choosy. With the Toshiba P1350 dot matrix printer. Choose quality when you want it. Speed when you need it. At a price you'd expect to pay for just one or the other.

For speed, choose the draft mode. 160 CPS. About a page a minute. For quality, choose the LetterPerfect mode. 100 CPS. About twice as fast as a daisy wheel. Or choose the graphics mode at 192 CPS.

The technological breakthrough that makes it possible: Toshiba's fine-wire, overlapping, 24-pin, impact print head. For incredibly high 180 dots per inch density with a single pass.

More choices: variable pitches of 12 CPI or 10 CPI.

Three character fonts. Variable line spacing. Single sheet paper or continuous forms, from 5" to 15" wide, with up to four copies. Friction feed, pin feed tractor or Toshiba's ultra-reliable sheet feeder. And a choice of interfacing: parallel or serial.

Toshiba P1350. It gives you the choices you want. The quality you expect. The reliability you need.

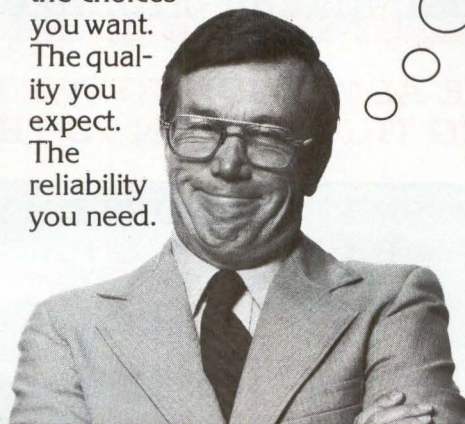

The precision you require. The low-maintenance long life you like. The price you love. With versatility and

performance that's been proven in more than 7,000 installations.

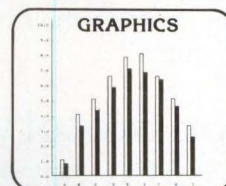

When it comes to printers, you really have no choice. There's only the Toshiba P1350. Write for the details on everything it can do for you. Toshiba America, Inc., Information Systems Division, 2441 Michelle Drive, Tustin, CA 92680.

Better yet, call toll-free... now!

**1-800-648-5000**

Ask for operator #198

In Nevada, call (702) 329-9411

# UNDERESTIMATED.



# STAY ON TOP!

Plan NOW to attend...

National Electronic Packaging and Production Conference



MARCH 1-3, 1983 • Anaheim Convention Center, Anaheim, California

NEPCON exclusive:

**AUTOMATED  
"P.C. BOARDWALK"**

A short continuous journey through ten years of technological development in the manufacture of printed circuitry!

## See...Hear...Learn the Latest Technology at the World's Largest Electronics Manufacturing Exposition

### \* 1,800 DISPLAYS

Cost-effective equipment, tools, hardware, supplies and test equipment to improve productivity.

### \* JOB-ORIENTED CONFERENCE PROGRAM

Experts share new techniques, systems, methods to help you do a better job.

### \* OVER 800 EXHIBITORS

The nation's leading suppliers demonstrate their latest products.

### \* EFFICIENT NEW FLOOR PLAN

Saves you time by dividing exhibits into 5 major product areas.

**For prototype designers, PCB designers, manufacturers and buyers, testing/support personnel, and electronic engineers**

**FOR FREE ADMISSION TO THE EXHIBITION,  
BRING THIS COUPON TO THE SHOW**

ORGANIZED BY



**Cahners  
Exposition  
Group**

Cahners Plaza  
1350 E. Touhy Ave.  
P.O. Box 5060  
Des Plaines, IL 60018  
(312) 299-9311  
Telex: 82882  
CEG/CHGO

**FOR FREE ADMISSION TO THE EXHIBITION,  
BRING THIS COUPON TO THE SHOW**

National Electronic Packaging and Production Conference



**Save  
\$10.00**

**FREE ADMISSION TO THE 1983 EXHIBITS  
WITH THIS COUPON**

COPY THIS COUPON FOR YOUR ASSOCIATES



# MP/M-86 handles real-time and multi-user business applications

FRANK HOLSWORTH, Digital Research, Inc.

*OEMs can tailor this 16-bit multi-user operating system to different applications without losing software compatibility*

As competition heats up in the 16-bit microcomputer market, OEMs are looking for ways to differentiate their products while maintaining compatibility with existing software. Digital Research, Inc.'s MP/M-86 operating system provides one possible solution, offering a modular design that facilitates customizing and is compatible with CP/M-86 software. The multi-user, multitasking operating system provides 8086-based systems with real-time capabilities based on system queues, and file-security features for business applications.

## Modules make customizing easier

MP/M-86 comprises several modules, each responsible for a set of physical or logical functions (Fig. 1). This modularity allows OEMs to adapt MP/M-86 to several hardware environments and applications with minimal effort. The modules are the extended input/output system (XIOS), the real-time monitor (RTM), the basic disk operating system (BDOS), the supervisor (SUP), the memory manager (MEM) and the character input/output manager (CIO).

The XIOS is of a set of simple routines that serves as the hardware interface. The XIOS handles physical disk and console I/O, the real-time clock, interrupt routines and memory selection for systems with memory-management hardware. OEMs adapt the XIOS to fit different hardware environments.

The other MP/M-86 modules are hardware-independent. The BDOS handles file management,

calling on the XIOS for physical file operations. The RTM controls process scheduling and communication. The TMP is a shared-code program that runs as an application program, serving the MP/M-86 user interface; it can be modified or replaced by OEMs to suit specific applications. Intermodule communication is handled by the SUP. The MEM supports shared-code programs and, as it becomes available, hardware memory management. As many as 254 character devices, such as consoles and printers, can be configured through the CIO.

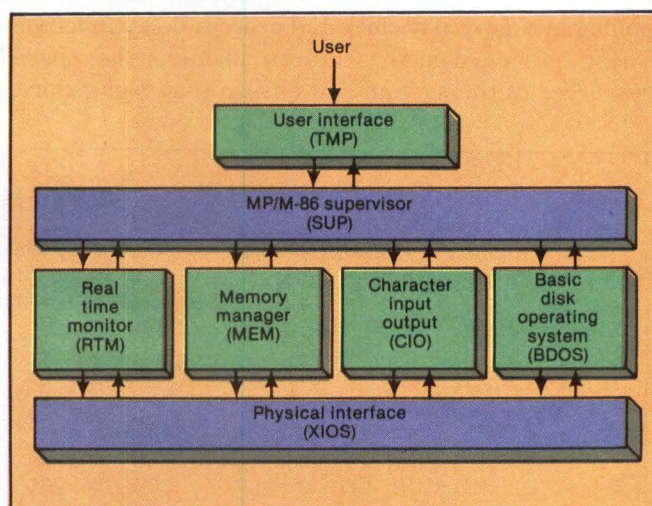

Fig. 1. MP/M-86 modular design separates all physical I/O in the XIOS. Other modules access I/O via system calls to the XIOS.



Minimum hardware requirements for MP/M-86 are an 8086, 8088 or a compatible microprocessor, a real-time clock and 64K bytes of RAM. The MP/M-86 kernel takes up less than 40K bytes, but 128K bytes is a suggested minimum for OEMs that intend to reconfigure the system. Special file-system and memory-management modules will be available for more sophisticated systems and memory-management hardware.

Because it contains a BDOS module compatible with other 16-bit Digital Research operating systems, OEMs can offer MP/M-86-based systems to customers using single-user CP/M-86 or single-user, multitasking Concurrent CP/M-86. All CP/M-86-compatible software runs unchanged under Concurrent CP/M-86 or MP/M-86.

*Physical processes are mapped within the operating-system kernel, communicating in real time.*

Because all Digital Research operating systems have compatible file structures, files created under 8-bit CP/M can be transported to MP/M-86-based systems without modification. Companies that developed languages for 8-bit CP/M are already developing versions for CP/M-86, facilitating the conversion of application programs from 8- to 16-bit environments.

### Real-time monitor

The real-time monitor (RTM) is the module responsible for MP/M-86's real-time and multitasking capabilities, controlling process creation, deletion, dispatching and communication (Fig. 2). The RTM also manages the logical interrupt structure using system flags, device polling, a time of day clock and process-delay functions. These process-control features manage the shared resources of the system and ensure that high-priority

tasks are accomplished.

Under MP/M-86, processes are represented by process descriptors. Combined with its extension, the user data area, a process descriptor contains all the information needed to manage a process, including state information, register locations and interrupt vector save areas for a process that is out of context.

*The BDOS handles file management, calling on the XIOS for physical file operations.*

All process descriptors are maintained on system lists. For example, all processes that are ready to run are maintained on a ready list, which consists of linked process descriptors maintained in priority order. When a process descriptor is inserted into a system list, it is placed in front of the first process descriptor that has a lower priority. The currently running process is always

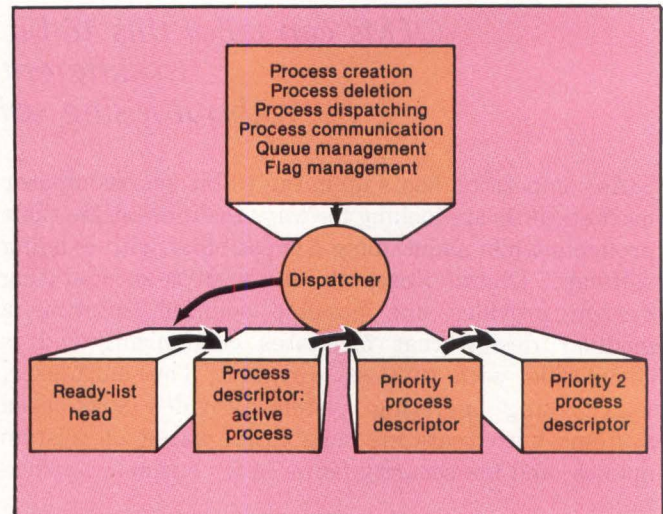

Fig. 2. Real-time monitor in MP/M-86 performs process-control and communication tasks. Processes are run on a priority-driven schedule, with processes of equal priority run on a round-robin basis. Priorities are established through a ready list, with the active process at the head of the list followed by processes in descending priorities.

### MP/M-86 UTILITIES

ABORT Terminate an active process  
 ASM-86 8086 assembler produces HEXfiles  
 ATTACH Attaches a program in the background to the console  
 CONSOLE Shows the current console number  
 DDT-86 Assembly-level debugger  
 DIR Shows files in current directory  
 DSKRESET Resets a disk drive for removal  
 ED Text line editor

ERA Erases disk files  
 ERAQ Erases disk files with query  
 GENCMD Produces command files from HEX files  
 GENSYS System generation  
 PIP Copies files between devices  
 PRINTER Shows and changes the default printer  
 REN Renames a file  
 SDIR Extended DIRSET Sets file and system attributes  
 SHOW Shows drive and system

attributes  
 SPOOL Spools disk files for printing  
 STAT Shows disk drive and file status  
 STOPSPLR Stops a file from printing  
 SUBMIT Executes a series of commands that have been placed into a disk file, allows SUBMIT commands anywhere within other SUBMIT scripts  
 TYPE Shows the contents of a disk file  
 USER Shows and changes the default user number



# Now you can build in seconds what used to take forever.

If you have been waiting to view your solid models, your waiting days (or even minutes) are over. Now there's SOLIDVIEW.™ A revolutionary, new display technology for viewing solid models that significantly increases system speed. And significantly decreases host overhead, software development time, and total system cost.

By processing tasks like hidden surface removal, visible surface shading, sectional views, contouring, and even piercing objects, SOLIDVIEW slashes image construction time from minutes to seconds. The host is then free to handle viewing transformations and clipping concurrently; system throughput is greatly improved.

What's more, SOLIDVIEW constructs images using polygons instead of pixels. These images are built piece by piece, instead of line by line. So you not only get more speed, but more information.

You can also do more with

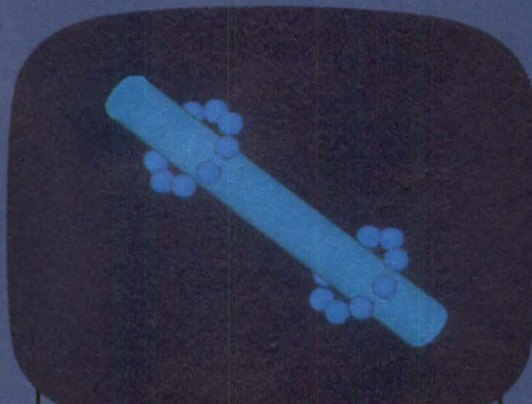

Construct images in less than four seconds.

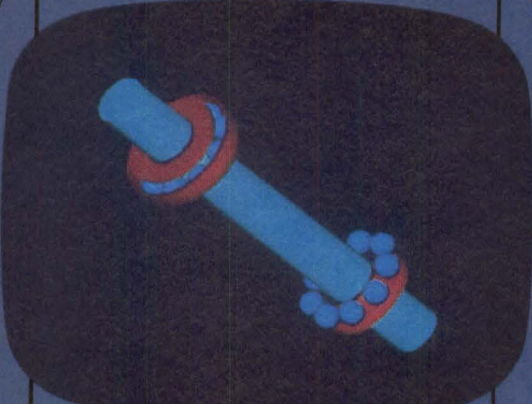

Then build incrementally. In seconds.

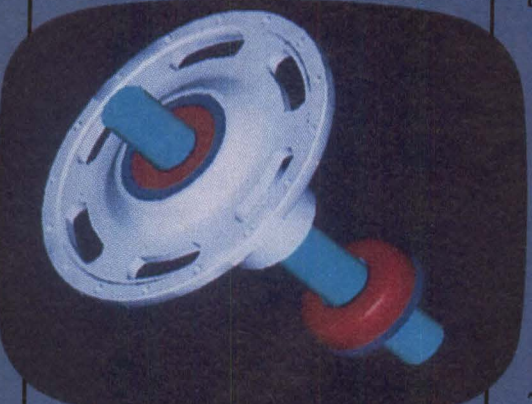

Create complex solids just as fast.



SOLIDVIEW by Lexidata.

SOLIDVIEW. You can add new parts without redrawing the entire screen. You can manipulate objects with a minimum of recalculating. You can make exploded or sectional views in seconds. You can even use translucent shading to see behind surfaces.

SOLIDVIEW is available in two models, with a wide array of features. Both offer you 12 x 24 color lookup table, 19" monitor, and the power required to view your images interactively for the first time. Options include pan/zoom, four overlays, hardware cursor, serial interface, and a selection of peripherals.

SOLIDVIEW from Lexidata. It's so fast, it will completely change the way you view your solid images. For fast and interactive response to all your questions, just call us at (617) 663-8550. Or write to us at 755 Middlesex Turnpike, Billerica, MA 01865. TWX 710-347-1574.

**LEXIDATA**  
The clear choice in  
raster graphics.

™SOLIDVIEW is a trademark of Lexidata Corporation





# A great pick from Hall-Mark

Faced with a difficult small computer system decision? Let Cromemco make your job easier.

Whether you need the power of multi-user Cromix® or just CPM accessibility, Cromemco's standard software is the answer.

For hardware, take your pick from a wide selection of configured systems, personal

computer or board level components, all designed by Cromemco and stocked by Hall-Mark, Your Systems Source for the '80s.

## **Cromemco™**

NORTHEAST Cherry Hill 609/424-7300 Fairfield 201/575-4415 New York 516/737-0600 Philadelphia 215/355-7300 SOUTHEAST Atlanta 404/447-8000 Baltimore 301/796-9300 Ft. Lauderdale 305/971-9280 Huntsville 205/837-8700 Orlando 305/855-4020 Raleigh 919/872-0712 Tampa/St. Petersburg 813/576-8691 MIDWEST Chicago 312/860-3800 Cincinnati 513/563-5980 Cleveland 216/473-2907 Columbus 614/891-4555 Milwaukee 414/761-3000 Minneapolis 612/854-3223 SOUTH CENTRAL Austin 512/258-8848 Dallas 214/341-1147 Houston 713/781-6100 Kansas City 913/888-4747 St. Louis 314/291-5350 Tulsa 918/665-3200 WEST Denver 303/694-1662 Phoenix 602/243-6601 San Diego 619/268-1201 Sunnyvale 408/773-9990 © 1982 Hall-Mark Electronics Corp/5169

# **HALL-MARK**

Hall-Mark Electronics Corp. — Dallas, Texas

Buy or lease from Hall-Mark.



at the head of the ready list.

The portion of the RTM that changes currently executing tasks is called the dispatcher. The dispatcher is called by a process every time a resource is needed or released within the operating system. It is also called at every system tick, which occurs 60 times per sec. in a typical MP/M-86 system. During a dispatch, the process descriptor at the head of the ready list is placed in a

*Each device that has a process waiting for it is polled at every dispatch.*

different system list, or in a different position on the ready list, depending on why the dispatcher was called. If the process is still ready to run, it is re-inserted into the ready list. If it has the highest priority, it stays on the top. If its priority is the same as a number of other processes, it is inserted below those processes, allowing round-robin scheduling for equivalent priority processes.

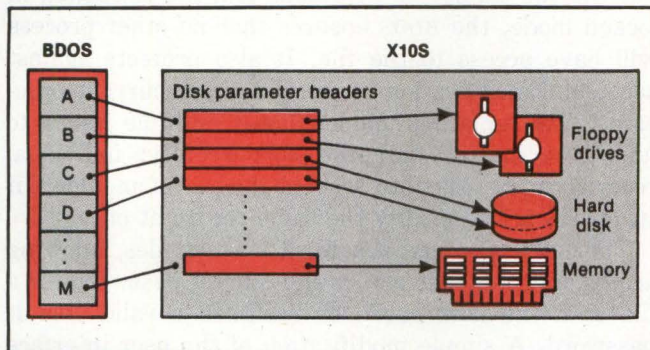

**Logical-to-physical drive mapping** is handled by a table of disk parameter headers in the XIOS. Files can be assigned to disks or to memory.

The RTM maintains a logical interrupt structure using system flags. A process that must wait for an interrupt calls the flag-wait function, which places that process in a waiting state. Through the dispatcher, the process is removed from context. Other processes can then run until the appropriate interrupt occurs, at which point the interrupt routine calls the flag-set function, which initiates the process. This scheme allows real-time response to the interrupt.

The number of system flags in MP/M-86 is determined in system generation, and their uses are defined through the XIOS. An arbitrary interrupt structure can thus be mapped into a logical interrupt structure.

When a process must wait for I/O, and the physical I/O

device is not interrupt driven, the RTM uses the poll-device function. The poll-device function places the current process on the poll list, removing it from context and allowing other processes to run. Each device that has a process waiting for it is then polled at every subsequent dispatch. If the device is ready, the process is placed into the ready list.

### Process communication via system queues

The RTM uses system queues to provide process communication, synchronization and mutual exclusion. Queues are resource-management mechanisms that serve a function similar to that of the "pipes" for UNIX. Unlike pipes, however, queues allow variable-sized messages to be written and read from any number of processes at once.

Processes communicate through a queue typically created by one of the processes. Each queue has an eight-character name. Once a queue is created, any process can open it, read it and write messages in it. While the length of message is defined when the queue

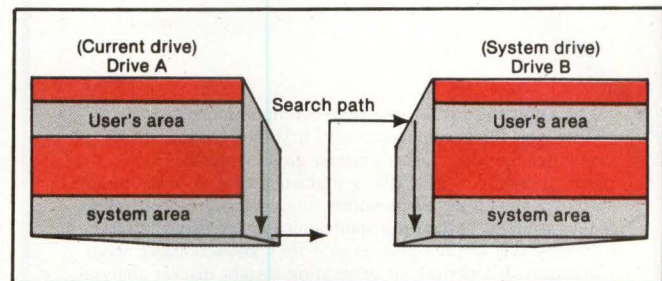

**A command file search** is initiated when a user types a command. The BDOS first searches for the command in the user's assigned area on the current logical drive (each user is assigned an area on each logical drive, with one area reserved for the system). If the command is not found, the BDOS looks at the system area on the current drive, then the user's area on the system drive and finally the system area on the system drive.

is created, the content of the messages can be arbitrary and are defined by the cooperative processes that use the queue.

There are many cases in which one process must wait for a certain point in the execution of another process to begin. This is called process synchronization, and is accomplished by having the process read such a message from an empty queue.

Mutual synchronization can be achieved through system queues, as well. If two processes must be synchronized, but it is not known which will arrive first, the processes can be synchronized using two queues, each containing one message. The first process reads from the first queue and immediately writes into the second queue. The second process reads from the second queue and writes to the first queue.

Because processes can communicate with each other through queues, MP/M-86 can manage sets of mutually dependent tasks typical in industrial process control. Physical processes are mapped within the operating-



**The PIPS Revolution:  
Strategic Planning Software Plus  
Popularly Priced Desktops**

Enter the PIPS revolution—computers made so easy you'll get results the very first day. SORD Computer Systems, Japan's fastest growing company, makes it possible with PIPS, a sophisticated non-programming system designed for businessmen, not computer people. PIPS makes strategic computing applications an everyday reality for everybody in the office, even if they know nothing about computers. It's perfect for generating instant market analyses, plotting the yearly sales figures in seconds, and doing routine calculations without the routine.

PIPS is now available with a wide range of desktops from SOCIUS. There's the M23P: a portable desktop with 2 built-in microfloppies and 128K of RAM—light enough to travel in a briefcase. There's also the M343: a compact 16-bit giant with 256K of RAM, color graphics, multi-terminal timesharing capability, communications interface and more. Both of these systems can be used as interactive terminals (they emulate 3270s) or as units in our ultra-sophisticated local area network.

Lots more software is also available with SOCIUS computers, including the SB-80\* operating system for compatibility with CP/M\*-based programs, and an

excellent word processor. The SOCIUS wonder computers. Sorry to keep you waiting.

\*SB-80 and CP/M are trademarks of Lifeboat Associates and Digital Research Inc. respectively.

**SOCIUS  
M23P**  
Suggested  
retail price:  
**\$2395**

(CRT not included.)



**SOCIUS**

**SORD Computer of America, Inc.**

c/o Mitsui (U.S.A.) Inc., 200 Park Ave. New York, N. Y. 10166-0130  
Attn: M. Taketani or M. Kitamura, Tel: 212-878-4403  
Distributor for New York, New Jersey, Connecticut:  
Business Computing International Inc. 342 Madison Ave.  
New York, N. Y. 10173 Attn: Michael Gansl, Marketing Div.  
Tel: 212-697-9400, Telex: 238901 BCI UR

**CIRCLE NO. 136 ON INQUIRY CARD**

**OPERATING SYSTEMS**

system kernel, communicating in real time. The application program can simultaneously monitor the processes and respond quickly with the appropriate control data.

**File security**

A multi-user, multitasking operating system is often used with a shared centralized database. Consequently, security features, such as file and record lockout and password protection, that enable users to protect their data are essential. These security features are provided in MP/M-86 through the BDOS module.

*A simple modification forces a user to specify a password to gain access to the system.*

MP/M-86 files can be opened in one of three modes: read-only, locked or unlocked. If a file is opened in the read-only mode, it can be opened by other processes in read-only mode. Multiple processes can access the file, but the file cannot be modified. If a file is opened in locked mode, the BDOS ensures that no other process will have access to the file. It also protects against accidental modification by unrelated, concurrent processes. The unlocked mode allows multiple users to update a master database concurrently; individual records can be locked to prevent the loss of an update if two users try to modify the same record at once.

The BDOS also can password protect files, allowing access only if a user enters the correct password for a file or if the user has been assigned a valid default password. A simple modification of the user interface sets a password into a LOGIN file, which forces the user to specify the password to gain access to the system. The BDOS also can stamp each file with the date and time of the last modification and a date of creation or last access. Such features reduce the chances of errors or tampering in a shared-database environment.

**Frank Holsworth** is product engineering manager of the Operating System Division of Digital Research, Inc., Pacific Grove, Calif.

**NEXT MONTH IN MMS**

- \* A distributed microprocessor front-end system,
- \* A fresh approach to database software.



# Your First Opportunity This Year!

## COMDEX/Spring '83 Now In April!

COMDEX means **Business** and spells **Opportunity** for you in 1983! This year you can get an early start at COMDEX/Spring '83 in the Georgia World Congress Center and The Atlanta Apparel Mart, Atlanta, Georgia, April 26-29. Don't let the competition get the jump on you. Take advantage of the earliest possible information on new products and services ... It's smart business! And COMDEX/Spring is your first real opportunity to see the latest industry offerings.

Do it in a business environment where exhibitors want to talk to you ... the Independent Sales Organization (ISO). COMDEX is where the computer industry meets to do business ... your business.

COMDEX doesn't try to be all things to all people ... This show was created solely as a meeting place for the business elements of the computer industry. And success speaks for itself!

COMDEX is where manufacturers and suppliers come to meet with distributors, retailers, dealers, systems houses, OEMs and other ISOs.

COMDEX/Spring will offer almost 650 exhibiting companies with a wide range of computer and word processing systems, related package software, media, forms, supplies, computer furniture and much, much more! All anxious to speak to you!

To help you sharpen that "competitive edge" everyone talks about, COMDEX/Spring offers its famous 50-session Conference, presented by outstanding industry experts on a broad cross-section of subjects of great interest to ISOs. The subject matter covers all facets of operating as an ISO ... whether you're an "old pro," a new-to-market ISO or thinking about getting into the business, there are COMDEX seminars to meet your needs.

Send for your free ISO Registration Kit today. Find out how to save time and money with COMDEX pre-registration and special COMDEX rates for airline tickets and hotel accommodations.

For complete details, write:  
COMDEX/Spring '83, ISO Registration,  
300 First Avenue, Needham, MA 02194.  
Or, call (617) 449-6600



## COMDEX™/SPRING '83

*Time to do business.*

April 26-29, 1983 • Georgia World Congress Center and  
The Atlanta Apparel Mart • Atlanta, Georgia



THE  
INTERFACE  
GROUP

Another computer conference and exposition from the Interface Group, Inc., the producer of COMDEX/Spring, COMDEX/Fall, COMDEX/Europe, INTERFACE, FEDERAL DP EXPO and the regional Computer Showcase Expos.



## Tape subsystems? IDT has the right solution...

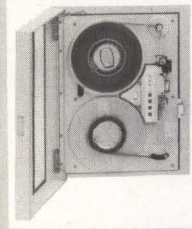

### Series 1012 TMS "Virgo" Streaming Tape Transports TD 1012-1

Basic vertical transport with reels up to 10½", 9-track, IBM compatible, Read-after-Write; 100 ips streaming, 12.5 ips start-stop. Integrated industry-standard formatter, 1600 cpi

(P.E.). Rack mountable. Available without front door.

### TD 1012-2

Drawer mounted version of the TD 1012-1, incorporating identical specifications and performance, with drawer slides.



### TD 1012-3

Table-top mounted version, including same specifications and performance of TD 1012-1.



### Series 1050 Magnetic Tape Drives and Subsystems

#### TD 1050

Basic tension arm magnetic tape subsystem with up to 10½" reels, speeds from 18.75 to 45 ips, 9-track, P.E. (1600 cpi) and/or NRZI (800 cpi). Available in 21 separate models which are compatible with a variety of host systems, for example: GPIB, RS232C, parallel I/O, Multibus and others.

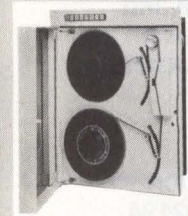
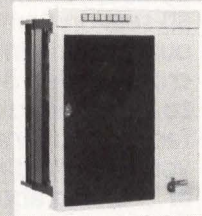

### TD 1750

75 ips tension arm magnetic tape subsystem, Read-after-Write, 9 track, P.E. (1600 cpi). Same interfaces available as TD 1050.

### Series TDC 3000 Digital Cartridge Drives and Subsystems

Digital cartridge drives featuring DC-300 ¼" tape or 450 ft. tape cartridges, integral power supply, 4-track raw head and track protect. 10 to 30 ips read/write; 90 ips search. 1600 bpi packing density. Available with formatters and interfaces compatible with a variety of host systems.



INNOVATIVE  
DATA  
TECHNOLOGY

4060 Morena Blvd. • San Diego, CA 92117  
(619) 270-3990 • TWX: (910) 335-1610

Eastern Regional Office:  
P.O. Box 1093 • McLean, VA 22101-1093  
(703) 821-1101 • TWX: (710) 833-9888

**IDT: Where  
innovation puts  
you ahead.**

## FEBRUARY

- 15-16 Four Fiber Optics Courses**, Dallas, sponsored by Communications and Information Institute. Contact: Course Registration, Information Gatekeepers, Inc., 167 Corey Rd., Brookline, Mass. 02146, (617) 730-2022. Also to be held March 2-3 in New Orleans.
- 16-18 Third Annual TALMIS Conference**, Chicago, sponsored by TALMIS. Contact: Mary O'Keefe, TALMIS Conference, 115 N. Oak Park Ave., Oak Park, Ill. 60301, (312) 848-4000.
- 21-23 1983 Office Automation Conference**, Philadelphia, sponsored by the American Federation of Information Processing Societies, Inc. Contact: Ann-Marie Bartels, AFIPS, Inc., 1815 N. Lynn St., Arlington, Va. 22209, (703) 558-3612.
- 22-25 INFO '83, Sixth European Information Technology and Office Automation Exhibition**, London, organized by BED Exhibitions Ltd., 44 Wallington Sq., Wallington, Surrey, SM6 8RG, England, (01) 647-1001.
- 23 "Data Communications for Minicomputer Users" Seminar**, Denver, sponsored by Micom Systems, Inc. Contact: Seminar Administrator, Micom Systems, Inc., 20151 Nordhoff St., Chatsworth, Calif. 91311, (213) 998-8844. Other dates and locations are available.

## FEBRUARY 28-MARCH 3

**COMPCON SPRING '83, 26th IEEE Computer Society International Conference**, San Francisco, sponsored by the IEEE. Contact: John Wakerly, Program Committee Chairman, (415) 968-9057.

## MARCH

- 1-4 National Data Base Management Symposium**, Los Angeles, sponsored by Digital Consulting Associates. Contact: Digital Consulting Associates, 5 Kimberly Terrace, Lynnfield, Mass. 01940, (617) 334-5755. Also to be held April 18-21 in Washington and May 16-19 in Chicago.
- 1-8 "CAD/CAM" Course**, Boston, sponsored by Integrated Computer Systems. Contact: Ruth Dordick, Integrated Computer Systems, 3304 Pico Blvd., P.O. Box 5339, Santa Monica, Calif. 90405, (213) 450-2060. Other dates and locations are available.
- 3 Invitational Computer Conference**, Frankfurt, Germany, managed by B.J. Johnson & Associates. Contact: Susan Fitzgerald, B.J. Johnson & Associates, Inc., 3151 Airway Ave., #C-2, Costa Mesa, Calif. 92626, (714) 957-0171. Also to be held March 9 in Paris and March 15 in London.
- 8-10 Localnet '83 (Europe)**, London, sponsored by Online Conferences Ltd. Contact: Online Conferences Ltd., Argyle House, Northwood Hills, HA6 1TS, Middlesex, England, (44) 9274 29211.



# From the Spinwriter® People: The new NEC FD 1165 diskette drive.



**NEC**

**NEC Information Systems, Inc.**

## **Half the space/twice the capacity.**

Boost your profit margins and add new capabilities to your system with NEC's new Model FD 1165 diskette drive.

Using half the space of conventional double-sided, double-density 8-inch drives, you can put two drives—3.2 megabytes—in the same area where 1.6MB used to fit. And get extra user benefits like disk sorting, storage backup, and archiving, all at less cost per drive.

The Model FD 1165 drive uses the same interface as your current floppies, so you can add this product advantage with no additional cost.

## **Get the usual NEC product extras.**

**Technical features.** NEC's patented microprocessor-controlled head loading mechanism. Microprocessor control of spindle speed, head positioning and internal diagnostics. A unique cam that loads heads softer on the diskette surface to extend media life. A special direct drive motor that eliminates belts and pulleys,

uses only DC voltage, and cuts power and power supply costs. These are just a few of the technical extras you get.

**Reliability.** An MTBF of 24,000 hours—over 5 years usage at normal duty cycles—an MTTR of 30 minutes and a 60% parts reduction, make the Model FD 1165 the most reliable product in its class.

**Ease of installation.** Vertical or horizontal mounting. Without modification.

By now you get the idea.

Find out more about NEC's new Model FD 1165 diskette drive. Call your nearest NECIS sales office to order an evaluation unit today.

NEC Information Systems, Inc.  
Home Office: 5 Militia Drive, Lexington, MA 02173, (617) 862-3120  
Eastern Office: 36 Washington Street, Wellesley, MA 02181, (617) 431-1140

Central Office: 551C Tollgate Road, Elgin, IL 60120, (312) 931-1850  
West Coast Office: 8939 S. Sepulveda Blvd., Suite 330, Los Angeles, CA 90045, (213) 670-7346

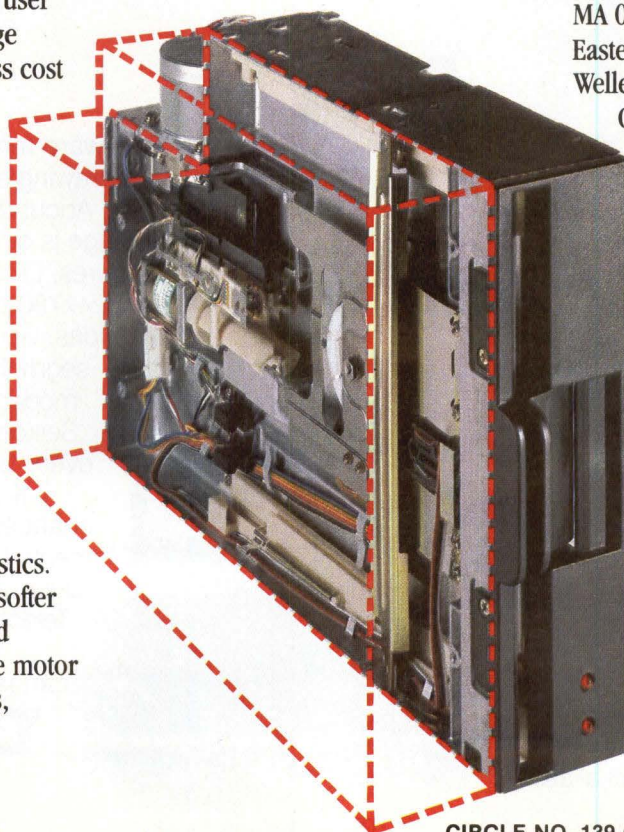

*NEC's new Model FD 1165 diskette drive doubles your storage capacity—from 1.6MB to 3.2MB—without doubling your space.*



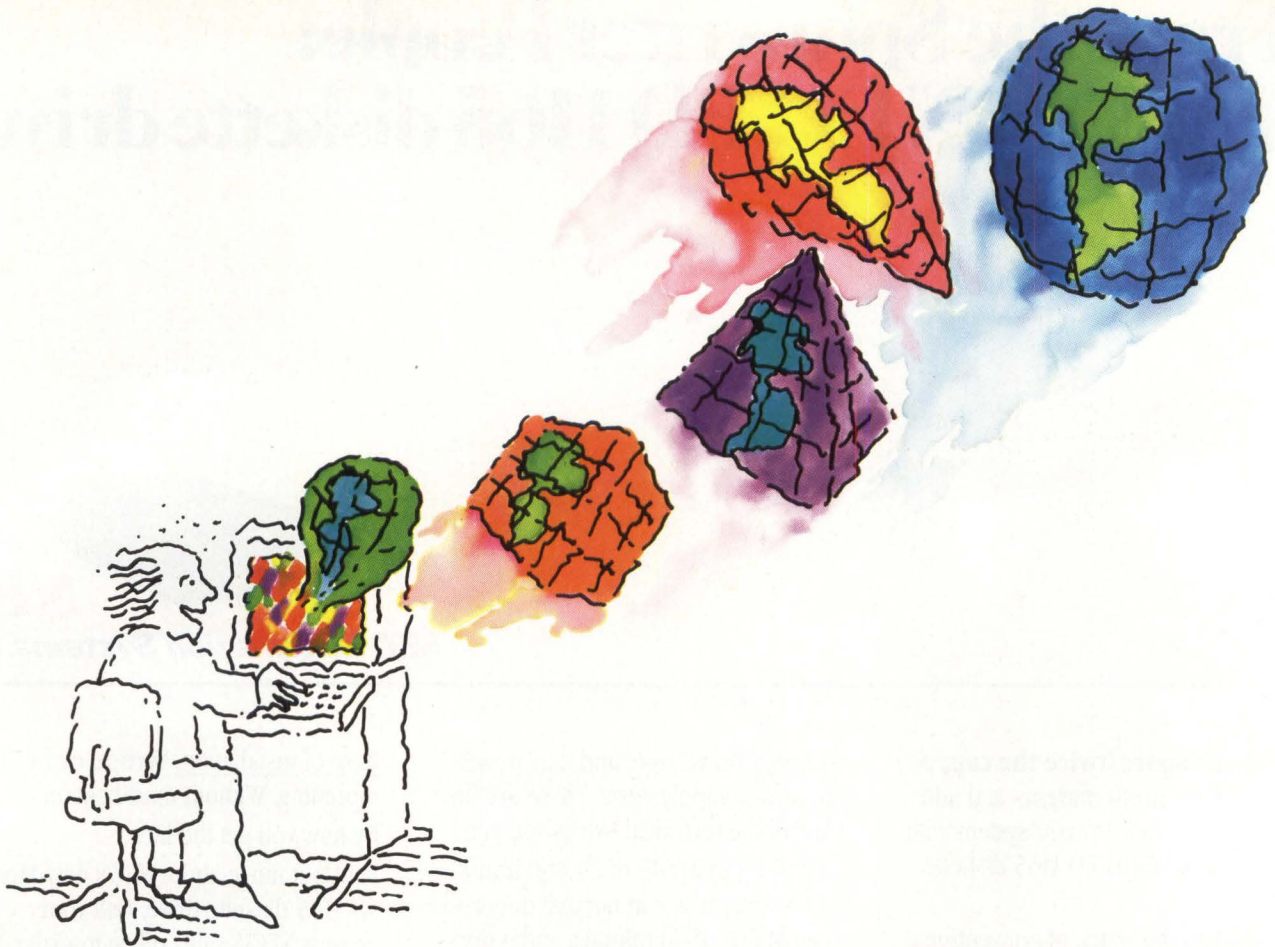

# CHANGE THE WORLD.

Or anything else you can display. Easier and faster than you imagine. Because D-SCAN's new GR-2412 terminal is changing the cost/performance standards for raster scan graphics.

Its world address space, for example, is a full 32K by 32K. Large enough to handle the most ambitious project. Yet easily manageable with dynamic zoom, pan, window, and viewport commands.

Its zoom operation faithfully preserves resolution and detail, instead of simulating it with pixel replication.

And those aren't all the improvements we've made.

Our dual microprocessor architecture draws 25,000 short vectors per second while transferring data at 19.2 kilobaud. And our exclusive anti-aliasing

© 1982 Seiko Instruments U.S.A., Inc.

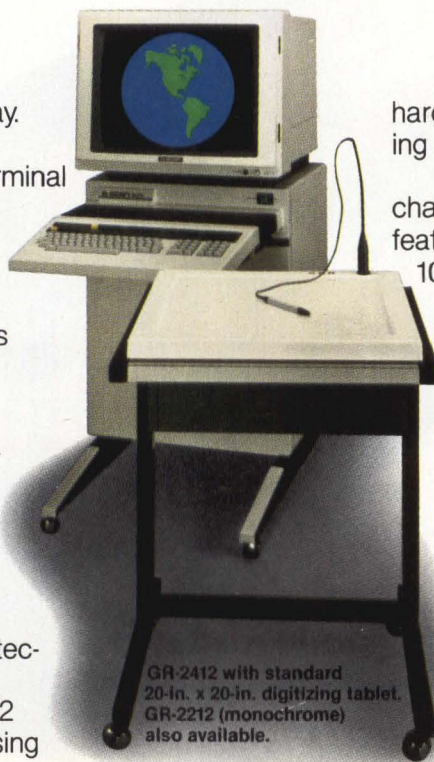

GR-2412 with standard 20-in. x 20-in. digitizing tablet. GR-2212 (monochrome) also available.

hardware removes jaggies without affecting drawing speed.

About the only thing we didn't change is our long list of standard features. Like our high resolution 1024x780 display. Local transformations. Up to 768K bytes of local segment memory. 4014 emulation mode. And the 10 years of Daini Seikosha (Seiko) craftsmanship in every D-SCAN product.

If you're ready to make some changes, contact us at Seiko Instruments U.S.A., Inc., 2620 Augustine Drive, Santa Clara, California 95051. Telephone (408) 727-0768.

We'll give you a terminal that can take on the world.

## D-SCAN

Seiko Instruments U.S.A., Inc.



## Microcomputers feature multiprocessor design

Plexus Computers has introduced two 16/32-bit MC68000-based systems that offer VAX 11/780 performance at prices beginning at \$13,500 in OEM quantities. The new systems are targeted for use by OEMs, large end users and systems houses.

The two new supermicrocomputers, called the P/35 and P/60, are designed to use the UNIX System III operating system and incorporate a multiprocessor architecture consisting of a central job processor that handles only the primary computational tasks and intelligent I/O processors that handle the I/O workload.

The central processor of the P/35 and P/60 is a proprietary Plexus module based on the MC68000 microprocessor operating at 12.5 MHz. It is augmented by five on-board performance assists including a cache memory implemented as 4K bytes of 45-nsec. static RAM, a RAM bank implemented as 16K bytes of static RAM, a hardware memory map, a 32-bit dedicated memory path and DMA.

Each I/O processor includes its own 16-bit Z8000 microprocessor and local memory. Down-loaded with instructions from the job processor, an intelligent communications processor is dedicated to data communications and terminal handling. An ICP supports eight serial ports and one parallel port. An intelligent mass-storage processor, down-loaded with UNIX code, supports disk and tape I/O.

The P/35 is a tabletop system that supports as many as 16 users. A basic, single-user P/35 system, with 512K bytes of main memory, 22M bytes of on-line, 8-in., Winchester disk storage, an MC68000 job

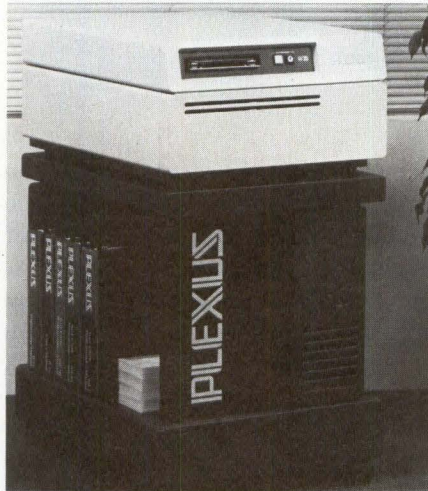

**The Plexus P/35 supermicrocomputer system** can be used in applications that call for heavy computational and data analysis loads in addition to terminal I/O. These applications include decision support, inventory analysis and economic and financial modeling.

processor and a built-in cartridge tape drive, is priced at \$13,500 in OEM quantities. An eight-user version sells for \$15,000 in OEM quantities.

The larger P/60 supports as many as 40 users. An eight-user P/60 system, with 512K bytes of main memory, 72M bytes of on-line, 14-in., Winchester disk storage and streaming nine-track tape drive, is priced at \$32,250. **Plexus Computers, Inc.**, 2230 Martin Ave., Santa Clara, Calif. 95050. **Circle No 350**

### Portable computer uses 6502 microprocessor

The Olympia portable computer features a 1-MHz 6502 microprocessor, a memory capacity of 116K bytes—64K bytes of ROM and 52K bytes of RAM—a 26-character LCD and a 65-character keyboard with

three user-definable keys. An internal battery pack enables the unit to remain operational for as long as 40 hours. Application software is contained on ROM capsules that plug into the primary unit. The OPC's standard capabilities include a 10-digit calculator, a clock/controller and a file system. Options include an RS232 port, an acoustic modem, a TV adapter, a thermal printer, an AC adapter and an I/O adapter. Price is \$380 in single-unit quantities. **Olympia USA**, Box 22, Somerville, N.J. 08876 **Circle No 351**

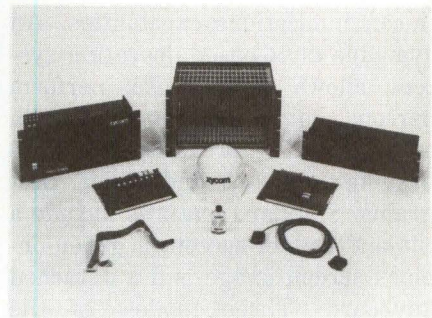

### Microcomputer starter kit features industrial BASIC

The 180+ industrial microcomputer starter kit includes a microcomputer module and a memory module with 32K bytes of EPROM containing the industrial BASIC system plus 14K bytes of battery-backed RAM for user BASIC programs and sockets for an additional 14K bytes of EPROM for user programs. The set also includes a 20-slot chassis, a rack-mounted power supply, RS232 communications adapters for connection to a terminal and to a serial printer, cassette unit or other device, a communications adapter rack with power supply for as many as three more communications adapters, cables and a 250-page industrial BASIC user's manual. Price is \$4790 in single-unit quantities. **Xycom**, P.O. Box 984, Ann Arbor, Mich. 48106. **Circle No 352**



# Systems

NEW PRODUCTS

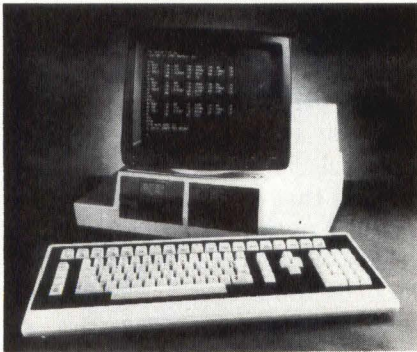

## Information processors fill personal-computing needs

The RDS-200 series of information processors combines word-processing features with data-processing, records-processing and data-communications capabilities. An available CP/M-based operating system allows a user to perform personal computing functions such as electronic spread-sheet, database-management and BASIC programs. Standard features include a tilt and swivel screen, a green-on-black screen image and a detached keyboard. Three models of the RDS-200 series are offered. The entry-level, non-menu-based RDS-200 with word-processing software and a 20-cps printer is priced at \$6495. The models RDS-201E and RDS-202E, priced at \$7995 and \$9745, respectively, are single- and dual-floppy disk drive versions of the basic model and feature many menu-based productivity aids. **Raytheon Data Systems**, 1415 Boston-Providence Turnpike, Norwood, Mass. 02062. **Circle No 353**

## Multi-user microcomputer features five processors

The Middi-Cadet and the Ensign are high-performance, multi-user microcomputer systems. The five-processor Ensign computer system supports as much as 8M bytes of main memory, more than 1G byte of SMD-type disk capacity, a cartridge-tape drive, a nine-track reel-to-reel tape drive and networking and

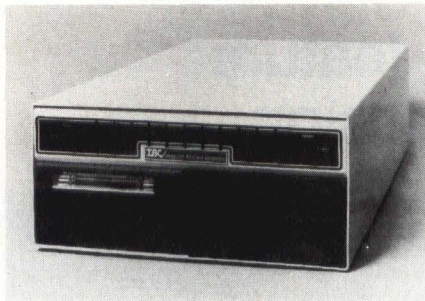

communications capabilities. The main CPU is the Motorola 68000 running at 8 MHz with no wait states. Two Motorola 6801 processors handle all serial I/O for as many as 32 users. A 6-MHz Z80B microprocessor supervises all disk and tape I/O, and another Z80B processor is used for memory management. The Ensign supports the OASIS-16 and UNIX operating systems. An eight-port Ensign system is priced at \$15,595. The Middi-Cadet, priced at \$7500, features a 6-MHz Z80B microprocessor, 256K bytes of RAM, 10 serial I/O ports, one Centronics port, a 20M-byte, 5¼-in. Winchester disk drive and a 1M-byte floppy disk drive. Options include a cartridge-tape controller, cache memory and bisynchronous communications hardware. The Middi-Cadet supports single- and multi-user OASIS, CP/M 2.2, MP/M II and MVT-FAMOS. **IBC/Integrated Business Computers**, 21592 Marilla St., Chatsworth, Calif. 91311. **Circle No 354**

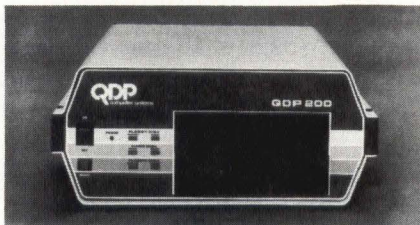

## User-friendly micro features slim-line floppies

The three-slot, S-100 bus model QDP-200 microcomputer features 64K bytes of RAM, an enhanced version of the CP/M operating

system and an on-line help facility for CP/M, MP/M and system utilities. Two slim-line, 8-in., double-sided, double-density floppy disk drives that store 1.2M bytes each are standard, and the model is also available with one drive. One 10M- or 15M-byte, 5¼-in. hard disk is optional. The model also features a programmable floppy disk drive shut-off that extends drive and media life. Using a 4-MHz Z80A microprocessor, the QDP-200 has two serial and two parallel ports and a real-time clock. The single-user system is available with the vendor's cache-memory disk buffering. The single- and dual-drive versions are priced at \$2995 and \$3495, respectively. **QDP Computer Systems**, 10330 Brecksville Rd., Cleveland, Ohio 44141.

**Circle No 355**

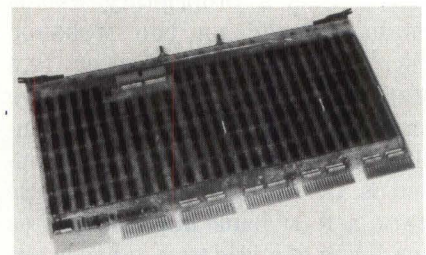

## Processor module is PDP-8 compatible

The CPU 8 PDP-8 processor replacement is hardware compatible with DEC HEX-wide Omnibus backplanes and software compatible with all PDP-8 software. It features a cycle time of 1.2  $\mu$ sec. and requires 5V DC at 2.2A. Its instruction set includes six memory-reference instructions, 20 microprogrammable operate microinstructions and eight I/O transfer instructions for each of as many as 64 I/O devices. The board measures 8½ × 15¾ in. Single-unit price is \$995. **Computer Extension Systems, Inc.**, 17511 El Camino Real, Houston, Texas 77058.

**Circle No 356**



# FOR SERIES/1: GET REMOVABLE AND FIXED STORAGE IN ONE DRIVE.



Easy to operate, with reliable front-loading disk cartridges.

13.3 Mbytes *removable* storage per cartridge, 64.5 Mbytes *fixed* storage per drive.

Fast, simple back-up: data can be easily copied from fixed to removable storage.

Save space: Dual CMDs mount in a single cabinet for 155.6 Mbytes of storage.

Full software compatibility with IBM 4963 disk subsystems.

## Attach your Series/1 to Control Data Cartridge Module Drives.

Fixed and removable storage in one drive—that's the unique feature you get with the Certainty® 280 Series CMDs. Fully compatible with IBM 4963 subsystems, these Control Data units make your Series/1 more effective than ever before, just like the other Certainty Series drives.

So fast, simple on/off-site back-up is the major benefit. You can use the removable, reliable cartridge for storing application programs, or for backing up your most critical data—while both fixed and removable storage remain available on line.

Because the controller card is already included,

these CMDs are ready for direct connection to the I/O bus of your Series/1—a feature you'll find on all Certainty drives. And all Certainty products are available now. You can put them to work immediately.

Add in complete support. More than 5000 Customer Engineers help make sure that Certainty miniperipherals live up to their name.

**Make increased effectiveness a Certainty.** No matter how you're using your Series/1, a Control

Data miniperipheral will pay off for you in price *and* performance. Call today for more information, toll-free 800/328-3390.



**GD CONTROL DATA**

*Addressing society's major unmet needs  
as profitable business opportunities*

CIRCLE NO. 141 ON INQUIRY CARD



# Systems

NEW PRODUCTS



## STD bus microcomputer includes Z80 or 8085 CPU

The ISB 80/85 stand-alone microcomputer with STD-bus-expansion capability includes a Z80 or an 8085 CPU card, a 64K-byte RAM card, a 12-in. CRT, a detachable keyboard and either two 5¼-in., dual-sided, dual-density floppy disk drives or one 5¼-in. floppy disk drive and one 10M-byte, 5¼-in. Winchester disk drive. Users can add as many as six STD bus cards to the built-in slim-line card cage. A fully integrated ISB-ICP/M operating system based on CP/M 2.2 is supplied along with a standard software package. Prices range from \$5990 to \$8990 in single-unit quantities. **Intersil Systems, Inc.**, 1275 Hammerwood Ave., Sunnyvale, Calif. 94086.

Circle No 357

## Computer system is expandable

Based on the MC68000 microprocessor, the Pertec 3000 16/32-bit microcomputer system supports as many as 19 terminals or printers in any combination as well as more than 1M byte of RAM and 100M bytes of mass storage. The basic system is equipped with 256K bytes of memory, one 8-in. Winchester disk drive with a storage capacity of 26M bytes, one 8-in. floppy disk drive with a 1.6M-byte storage capacity, one ¼-in. streaming cartridge-tape drive and three RS232 ports. Expansion capabilities include as much as 1.18M bytes of RAM, as many as three add-on Winchester disk drives and as many as 16 additional RS232 ports. The Pertec 3000's operating system supports Assembler, C compiler and Business BASIC languages and runs a variety of applications including order processing, billing inventory management, sales analysis, general accounting, financial planning, job costing, manufacturing and word processing. Price is less than \$19,000. **Pertec Data Systems**



**Division**, 17112 Armstrong Ave., Irvine, Calif. 92714.

Circle No 358

## Compact microcomputer is DEC compatible

The MDX-11 LSI-11-based 16-bit microcomputer contains a DEC-compatible Q-bus backplane that can be configured with the LSI-11/2 or LSI-11/23 CPU. The quad-sized backplane can accommodate as many as eight dual-height Q-bus cards. The system can be configured with as much as 10M bytes of 22-bit memory. The MDX-11 includes a 10.6M- or 15.9M-byte 5¼-in. Winchester disk and a double-sided, double-density, slim-line floppy disk drive that is RX02 compatible. Its SMS FWD0106 disk controller allows automatic recognition of DEC floppy

ATC BRINGS YOU —

# BARCODES LABELS FORMS

With ATC's new Model 195 plug-in conversion the proven reliable Texas Instruments 810 RO printer performs encoding and printing of twenty barcode types including Code 39 with OCR A annotation. Simple user command statements energize ATC programs which simplify generation and printing of forms and labels.



\* C O D E 3 9 \*

## MADE EASY

- Vary character size to 10 inches
- Rotate characters in 90° increments
- Reverse image
- Generate forms and boxes
- OCR A & B
- No modifications
- Numerous printing fonts - send for samples
- Texas Instruments warranty preserved



**ANALOG TECHNOLOGY CORP.**  
15859 EAST EDNA PLACE  
IRVINDALE, CA 91706  
(213) 960-4004



# Eight pens for the price of one

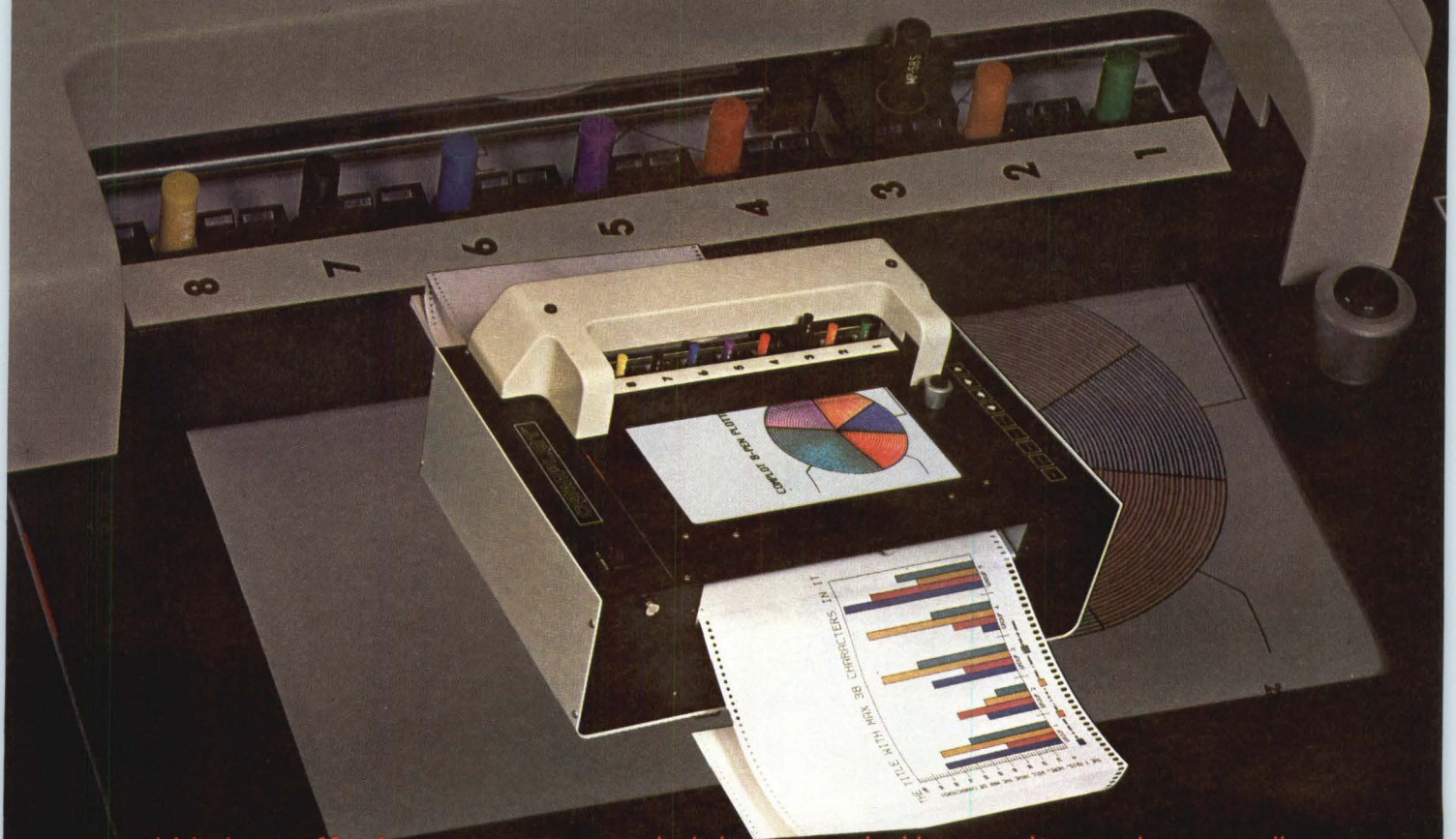

We're offering our new eight pen plotters at a price well below that of competitive one pen plotters.

That's right, the new eight-pen version of the CPS-20 from Houston Instrument can be yours at a price well below that of many competitive single-pen plotters.\* At that low price you get not only plot-size capability of 11" x 144", but CPS-20 performance, reliability and flexibility, in addition to eight microprocessor controlled pens.

The CPS-20 is a solid performer from the broad lineup of Houston Instrument plotters. For example, a choice of built-in sophisticated firmware attributes enables novice and experienced operators alike to take advantage of a host of automated features. DM/PL™ spares you and your computer from low-level housekeeping chores, enabling you to get the most from your investment. DM/PL is compatible with previous firmware, and offers extensive options in plot formatting.

With interface capabilities to match RS-232-C, IEEE-488 and Centronics™ parallel requirements, the CPS-20 will work effec-

tively and efficiently with all current computers.

Step size on the CPS-20 is only 0.005". When combined with a guaranteed accuracy within 1 increment on either axis, you are assured of precise virtually step-free traces.

Take advantage of this exceptional offer to own a proven and reliable Houston Instrument plotter, and enjoy the advantages of eight-pen color graphics essentially free of cost.

For the name, address and phone number of your nearest representative, write Houston Instrument, 8500 Cameron Road, Austin, Texas 78753. Phone 512-835-0900, or 1-800-531-5205 if outside Texas. In Europe contact Bausch & Lomb Belgium NV., Rochesterlaan 6, 8240 Gistel, Belgium. Tel 059-27-74-45. Tlx 846-81399.

**BAUSCH & LOMB**   
houston instrument division

\*US retail \$4495

DM/PL is a trademark of Houston Instrument  
Centronics is a trademark of Centronics Corp.



# What if you want more assurance your valuable data won't fade away?

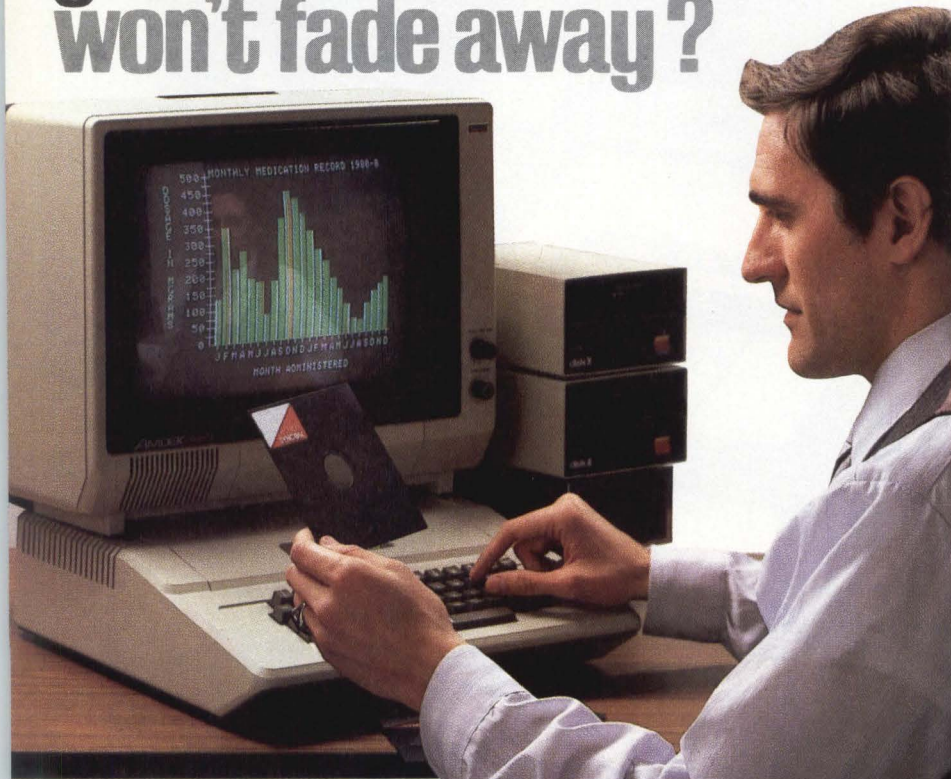

Rely on SYNCOM diskettes with Ectype® coating. Balanced coercivity means long-lasting signal life.

Syncom diskettes assure excellent archival performance in the following ways.

First, with calibrated coercivity — a precisely balanced blend of milled ferrous oxides that allows Ectype® coating to respond fully to "write" signals, for strong, permanent data retention.

Then, a burnished coating surface to boost both signal strength and packing density.

Carbon additives drain away static charge before it can alter data.

And, finally, every Syncom diskette is write/read-back certified to be 100% error free.

To see which Syncom diskette will replace the one you're using now, send for our free "Flexi-Finder" selection guide — and the name of the supplier nearest you.

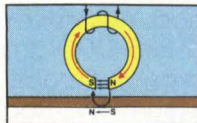

Balanced coercivity of Ectype® coating allows write current to saturate fully.

Syncom, Box 130, Mitchell, SD 57301.  
800-843-9862; 605-996-8200.

## SYNCOM

Manufacturer of a full line of flexible media

CIRCLE NO. 144 ON INQUIRY CARD

## Systems

NEW PRODUCTS

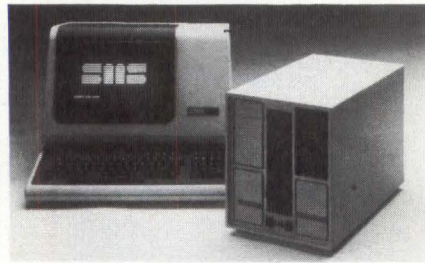

formats (RX01, RX02 and RX03) and IBM floppy formats (3740 and 2/2D). This 35-lb. tabletop microcomputer measures 11.2 × 9.5 × 17 in. Price for the 10.6M-byte version of the MDX-11 system without DEC CPU and memory is \$5700 in 15-unit quantities. Price for the 10.6M-byte version with LSI-11/23, 256K bytes of memory and DLV11-J is less than \$9000. **Scientific Micro Systems, Inc.**, 777 E. Middlefield Rd., Mountain View, Calif. 94043.

Circle No 359

### Computer runs CP/M-based application programs

The Micro 16S personal business computer system features two microprocessors (an 8-bit Zilog Z80 and a 16-bit Intel 8088), two 320K-byte, 5¼-in. floppy disk drives and 128K bytes of parity-checking RAM, expandable to 1M byte. The Micro 16S also has parallel and serial output ports and 640- × 200-dot resolution color graphics capability. The system has a detachable keyboard with separate numeric keypad and 10 programmable function keys. The CP/M-86 operating system, word-processing software and the SuperCalc electronic spread-sheet application program are standard. A 10M-byte, 5¼-in. Winchester disk and Omninet communications capability are optional. Price of the system, including software, 52K bytes of graphics RAM and a black-and-white monitor, is less than \$4000. **Fujitsu Professional Microsystems Division**, 2985 Kifer Rd., Santa Clara, Calif. 95051.

Circle No 360



# CIPHER GOES BEYOND



beyond streaming,  
beyond start/stop.

**CacheStreamer™**, the newest  
evolution in tape drive design.

### CacheStreamer goes beyond streaming:

- with greater than 125 ips start/stop equivalent performance.
- with total compatibility with today's operating software.
- with high burst rate performance.

### CacheStreamer goes beyond start/stop:

- with a cost that's at least 30% less than other performance-equivalent start/stop drives.
- with the reliability and simplicity of streaming mechanics.
- with all popular Microstreamer features.

Our CacheStreamer Series uses a solid-state Cache memory to isolate its interface from its simple streaming mechanics. By emulating a true start/stop at the interface, CacheStreamer becomes a streamer that "thinks" it's a start/stop drive.

For a product that goes beyond previous limits of streaming...beyond previous limits of start/stop...and into an innovative world of tape drive simplicity, high performance, and economy—choose the only solution for all backup and data storage needs.

***cipher***®  
***data products, inc.***

10225 Willow Creek Road, San Diego, California 92131

P. O. Box 85170, San Diego, California 92138

Telephone: 619/578-9100, TWX: 910-335-1251

CIRCLE NO. 145 ON INQUIRY CARD



Your problem is to make the information processing equipment you have work together, today. And to build an internal data communications foundation that will hold up under your growth, and stand up well no matter which way the technological winds blow.

Our answer is an internal data communications system you can do whatever you want with. Net/One™. A truly general purpose system that gives you everything you need, but doesn't lock you into one medium, one standard, one protocol. A system that makes as much sense for systems integrators as it does for sophisticated end users.

#### BROADBAND OR BASEBAND?

What you need is a system that keeps all your doors open. You don't have to be closed into one way or another. And right now, there is only one local communications system that gives you the option of either broadband or baseband or both, with architecture that will allow you to add other media such as fiber optics in the future. Net/One, from Ungermann-Bass.

#### WHAT ABOUT COMPATIBILITY WITH SPECIAL EQUIPMENT?

Net/One supports the widest range of physical interfaces and software protocols on the market: RS-232 serial, IEEE-488, 8-16- and 32-bit parallel, RS-449, V.35, Async, Bisync, HDLC and DEC DR-11B/W™. And the list is expanding every month. But if your equipment interface isn't in that list, Net/One is the only local area network that is fully programmable at every level, so you can add whatever special interface protocols you need.

That programmability means your future equipment options are always open. You're free to choose information processing equipment based solely on capability, because with Net/One, you have the programming tools you need to assure compatibility.

#### WHICH STANDARDS WILL END UP BEING PREDOMINANT?

We're not sure, either. Nobody is. That's why we

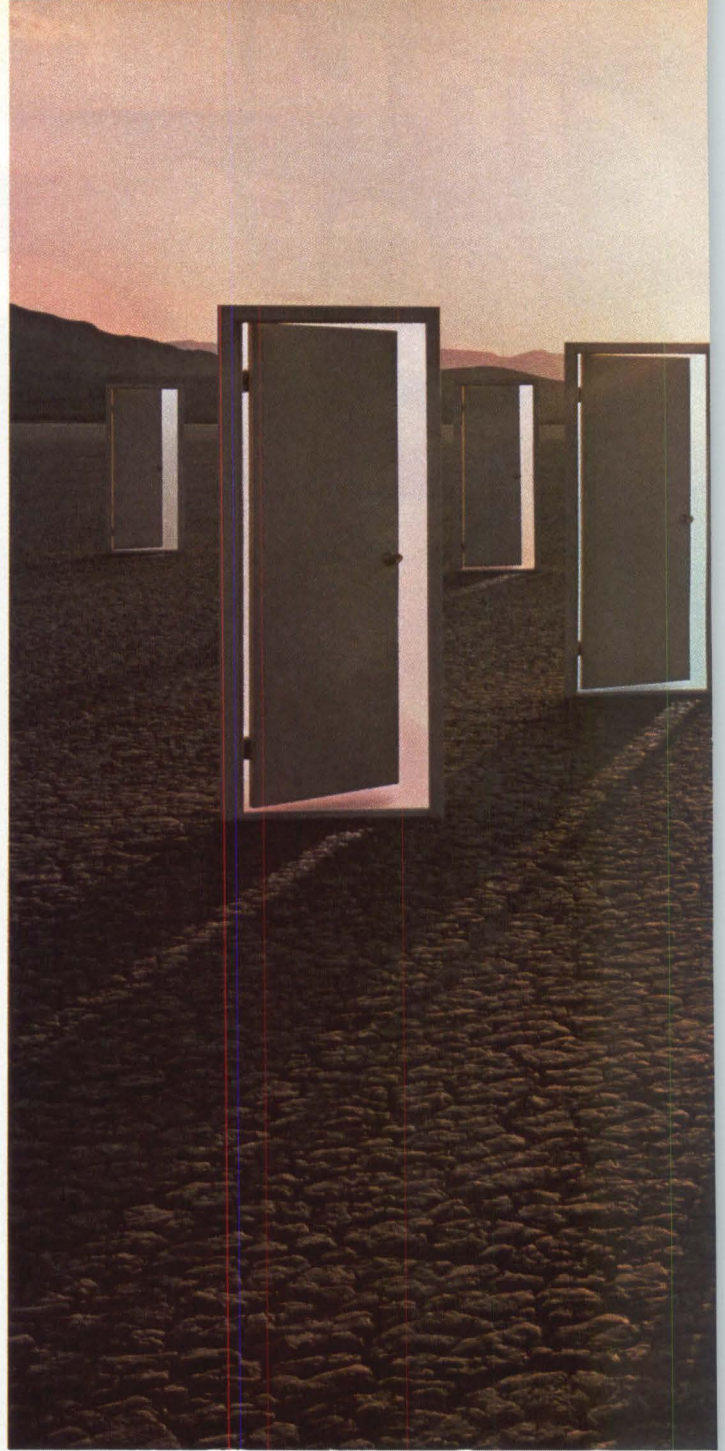

# Opt for a local area network that leaves you



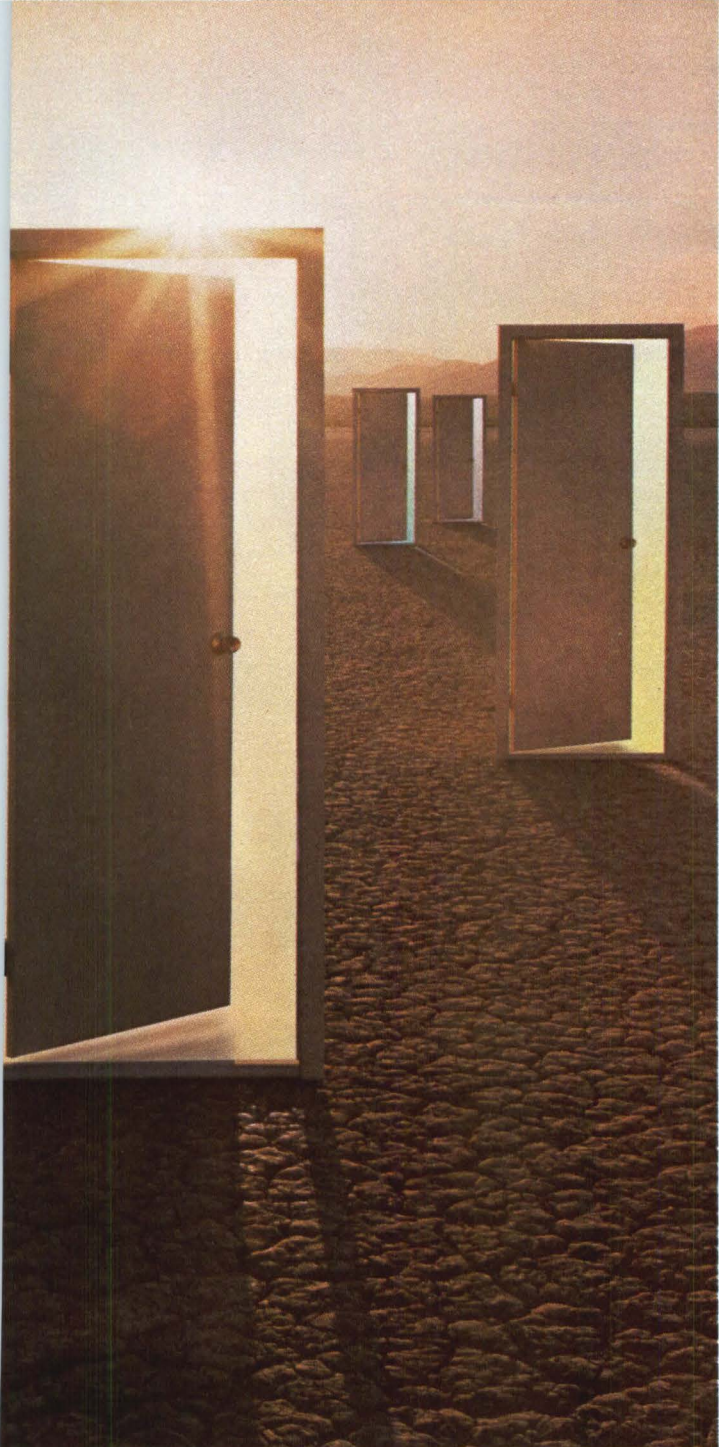

leave that option open, too. Net/One can be adapted to any standard, at any time. Simply. We're not in business to sell one communications technology or another. What we do is provide efficient solutions to make your internal data network work, with the equipment you have now, with the equipment you may want to add, with public networks, with whatever you want.

With Net/One, you also have the option to install it as a complete, "turnkey" system without writing a single line of software. It's delivered with all the communications software needed for general purpose use, including complete diagnostic and administrative services. But what you do with it beyond that is up to you. All the tools are there, all the pieces and all the flexibility you need to communicate however you want with whatever you want. Special applications. Custom interfaces. Broadband. Baseband. Whatever.

#### THESE OPTIONS OPEN DOORS FOR SYSTEMS INTEGRATORS

If you're enhancing or building local area communications systems for your clients, your Net/One enhancements can run on either broadband or baseband transmission. Or one now and the other later, when your client is ready to expand.

And because we've already written the interface protocols you're likely to need, your software people don't have to start from scratch.

With our new VLSI chip set, you can plan future system augmentations for your clients at decreasing costs. The chips are designed for general purpose use with any computer system, just as our systems are designed for general purpose applications. From chips to systems, you have the building blocks you need to give your clients the kinds of services they need.

Please call or write for detailed system descriptions, and for our "How to Choose a Local Area Network" brochure. Ungermann-Bass, Inc., 2560 Mission College Boulevard, Santa Clara, California 95050. Telephone (408) 496-0111.

Net/One from Ungermann-Bass 

# Local area network options open.



# Over 100 Companies on the Fortune 1000 List Now Rely on the Brilliance of the G-1000.

The Genisco G-1000 offers an unbeatable price/performance combination in a desktop, high-resolution (1024 x 792), 60 Hz monochrome interactive graphics terminal. Priced at a low \$9950\*, the G-1000 combines raster brightness, contrast and selective erasability to provide unsurpassed performance. The G-1000 was the first direct raster replacement for the Tektronix 4014-1 terminal—plug-to-plug and software compatible. Its track record and reliability are proven.

## A Powerful Answer for CAD/CAM

Based on advanced microprocessor design, the G-1000 meets your CAD/CAM requirements for high speed

interactivity. Add such features as a wide range of text and line styles, alphanumeric overlay, digitizer support and a variety of hardcopy options, and you'll understand why the Genisco G-1000 helped set the graphics standard. In addition, the G-1000 is software compatible with a growing number of application programs that include ANVIL™, DISSPLA™, DI-3000™, EIDS™, GARDS™, NISA™, PATRAN-G™ and TEMPLATE™. Or, a Software Development System is available to program special applications.

## Backed by Our Commitment to You

For nearly a decade, Genisco has maintained a commitment to design and production excellence. Now we

can promise you the most responsive support we know how to give through our nationwide service centers. Join the growing list of satisfied G-1000 users today. Call or write for more information to Genisco Computers Corporation, 3545 Cadillac Avenue, Costa Mesa, California 92626. (714) 556-4916.

\*Single unit price. Quantity discount available.

4014-1 is a registered trademark of Tektronix, Inc.  
ANVIL is a registered trademark of MCS, Inc.  
TEMPLATE is a registered trademark of Megatek Corporation.  
DI-3000 is a registered trademark of Precision Visuals.  
DISSPLA is a registered trademark of ISSCO.  
GARDS is a registered trademark of Silver-Lisco.  
PATRAN-G is a registered trademark of PDA Engineering, Inc.  
NISA is a registered trademark of EMRC.  
EIDS is a registered trademark of Rothe Development, Inc.

## THE COMPETITION IS STILL GREEN WITH ENVY

# Genisco

Computer Graphics Display Products

CIRCLE NO. 150 ON INQUIRY CARD





# Peripherals

NEW PRODUCTS

## Half-height floppy drives give OEMs a choice

The 500 and 900 series of half-height, 5¼-in. floppy disk drives from Micro Peripherals, Inc., Chatsworth, Calif., cover the spectrum from entry-level consumer products to high-performance industrial products. With a number of packaging and performance options, the drives are intended to meet the needs of minicomputer and microcomputer system integrators.

The single-sided model 501C and the double-sided model 502C are targeted for low-cost, personal-computer applications. They feature 20-msec. track-to-track access times and store 250K and 500K bytes, respectively, using double-density recording techniques.

Small-business and word-processing systems are the key applications for the single-sided model 501 and the double-sided model 502. They feature 6-msec. track-to-track access times and have the same storage capacities as the models 501C and 502C.

The single-sided model 901 and double-sided model 902, both 96 tpi, store 500K bytes and 1M byte, respectively, and are suited for industrial applications. They have 3-msec. track-to-track access times.

All six drives include split-band positioners, manganese-zinc heads, SASI compatibility, disk ejectors and a 250K-bit-per-sec. transfer rate. Options include a full-sized bezel on all six models and a half-height bezel with an IBM-type mechanical latch on the 501/502 and 901/902 versions. For applications in hostile environments, a head-loading solenoid can be provided.

Volume prices for the new family range from \$125 to \$265 each. **Micro Peripherals, Inc.**, 9754 Deering

Ave., Chatsworth, Calif. 91311.

Circle No 361

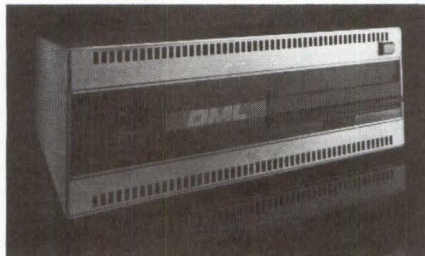

### Winchester for Intel systems stores 26.2M bytes

The model 1040 8-in. Winchester disk mass-storage subsystem gives Intel microcomputer development system users 26.2M bytes of formatted storage. The drive is ISIS-II compatible, has built-in error checking and correction and includes a selective backup and restore utility. It features a 4.36M-bit-per-sec. transfer rate and a 65-msec. average access time. The subsystem requires only one Multi-bus card slot. The model 1040, priced at \$9200, includes an 8-in. floppy disk drive that is software selectable to single- or double-density modes. The model 1041 without floppy disk drive is priced at \$8200. **Data Management Labs**, 2148 Bering Dr., San Jose, Calif. 95131.

Circle No 362

### Winchesters aimed at multi-user computer systems

The models V130, V150 and V170 5¼-in. Winchester disk drives offer 30M-, 50M- and 70M-byte capacities (unformatted), respectively, and a 30-msec. average access time. The drives use the ST412 interface and feature a 5M-bit-per-sec. data-transfer rate. The product line is targeted to high-performance computing systems and applications

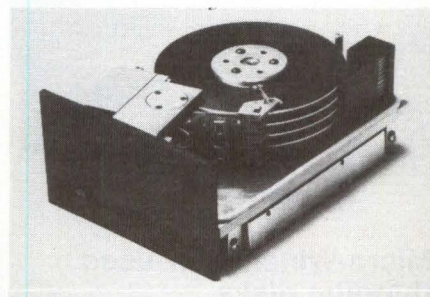

including multi-user, multitasking systems and graphics/image-processing applications. The drives use a dual-frequency, closed-loop servo system to reduce temperature-induced read/write and off-track errors. This servo technology allows the drives to operate at 960 tpi. The V100 series is designed to operate with thin-film or oxide media. Prices range from \$1100 to \$1500 in moderate OEM quantities. **Vertex Peripherals**, 2150 Bering Dr., San Jose, Calif. 95131.

Circle No 363

### Half-height minifloppy has high capacity

The half-height Drivetec 320 SuperMinifloppy offers an unformatted capacity of 3.33M bytes, a 160-msec. average access time and a 500K-bit-per-sec. transfer rate. The double-sided drive has a recording density of 192 tpi and uses a two-stepper head positioning system for accurate positioning over the desired track. Other features include an absolute-vertical clamping mechanism for diskette registration, an on-board microprocessor and brushless DC drive motor, an activity light and door lock, buffered track seek and downward compatibility with existing 48-tpi minidiskettes. Price is less than \$325 in OEM quantities of 1000. Manufacturing start-up of the drive is planned for the second quarter of 1983. **Drivetec**, 2140 Bering Dr., San Jose, Calif. 95131.

Circle No 364



# Peripherals

NEW PRODUCTS

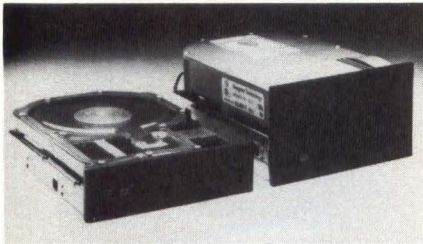

## Micro-Winchester uses thin-film disks

The model ST206 half-height 5¼-in. Winchester disk drive stores 6.38M bytes of unformatted data on two surfaces of a thin-film-plated rigid disk. The drive is compatible with the industry-standard Seagate ST506 interface and operates at a transfer rate of 5M bits per sec. Average access time is 85 msec. using a split-band positioner and stepper-motor-driven actuator. The Winchester is designed as a companion drive to a half-height floppy disk drive in single-slot intelligent terminals and portable computers. Price is \$745 in quantities of 500. Production units will be shipped during the second quarter of 1983. **Seagate Technology**, 360 E. Pueblo Rd., Scotts Valley, Calif. 95066. **Circle No 365**

## GCR tape system is Multibus compatible

Designed for use with Multibus computers, the MTC model 4000 GCR tri-density magnetic-tape system provides read/write capability at 6250 bpi (GCR), 1600 bpi (PE) and 800 bpi (NRZI) at tape speeds from 50 to 125 ips. The system can store 145M bytes of data on a nine-track reel of tape and features an average data-transfer rate as high as 630K bytes per sec. at 125 ips. Rewind speed is 500 ips. Software is provided for operation in the iRMX 86 environment or as a stand-alone procedure. The basic tape system including an MTC single-board Multibus-compatible controller, Telex tri-density model 6250 for-

matted tape transport, equipment rack, manuals and cabling sells for less than \$34,000. **Mesa Technology Corp.**, 16021 Industrial Dr., Gaithersburg, Md. 20877.

**Circle No 366**

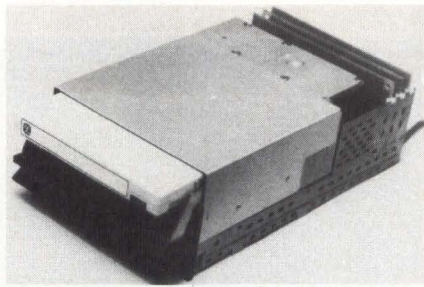

## Fixed/removable drive uses embedded-servo system

The model D520 5¼-in. Winchester disk drive stores 13M bytes on a fixed disk and 13M bytes on a removable disk cartridge. The new drive includes a 40-msec. average access time, a 5M-bit-per-sec. transfer rate, an embedded-servo tracking system and an ST706/DMA interface. The D520's removable cartridge is front loading and compatible with the proposed ANSI standard. The fixed disk and the removable cartridge each use a single oxide platter recorded on both sides at 860 tpi. MTBF of the drive is specified at 8000 power-on hours. The drive has the same mounting requirements and physical dimensions as a standard minifloppy or 5¼-in. Winchester drive. Evaluation units of the D520 will be available in April, with production units slated for mid-year. Price is \$1350 in 1000-unit quantities. **Cynthia Peripheral Corp.**, 3606 W. Bayshore Rd., Palo Alto, Calif. 94303. **Circle No 367**

## Tape drives fit into minifloppy cutout

The Scorpion series of ¼-in. streaming cartridge-tape drives stores 20M bytes on four tracks or 45M bytes on nine tracks. The

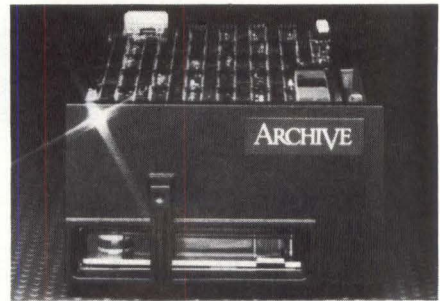

drives use a minifloppy form factor and can back up 5¼-in. Winchester drives from 5M to more than 50M bytes with data-transfer rates of 20M bytes in 4 min. and 45M bytes in 9 min. Intelligent versions of the Scorpion family stream at 30 or 90 ips and are designed for streaming environments at recording densities of 8000 bpi. The Scorpion series uses a front-loading cartridge that is media-compatible with existing Archive products. The Scorpion is also interface-compatible with all Archive products, using the industry-standard QIC-II interface. Prices start at \$800 in OEM quantities. **Archive Corp.**, 3540 Cadillac Ave., Costa Mesa, Calif. 92626.

**Circle No 368**

## Winchester drive stores 160M bytes

The Disctron model D-1600 8-in. Winchester disk drive stores 160M bytes (unformatted) using thin-film plating technology. Data are carried on four thin-film-fixed disks. Seven surfaces, each served by a dedicated read/write head, carry data. The eighth surface is reserved for track-following servo information. Average access time is 30 msec. The D-1600 has the same form factor as a standard 8-in. floppy disk drive. It uses standard +5V, +12V and +24V voltages. ANSI-standard and SMD interfaces are available. Price is \$1980 in OEM quantities. **Disctron**, 1701 McCarthy Blvd., Milpitas, Calif. 95035.

**Circle No 369**



# Easy on the eyes. Easy on the wallet.



There's only one thing more attractive than a monitor that's easy on the eyes — a monitor that's easy on the wallet.

Well, now you can have both. Because the new Comrex CR-5400 and CR-5600 are not only easy to read, but very, very competitively priced.

First, the differences. The CR-5400 features a 9" screen; the CR-5600 a 12" screen.

Now, the similarities. Both models have amazingly high resolution. And both give you a choice of three "easy-on-the-eyes" phosphors. Including green, yellow-green, and new amber.

That means, no matter what kind of lighting you have at your workstation, the data on your screen will come through bright and clear.

Sure, you could pay more for a monitor. But the Comrex CR-5400 and CR-5600 are two shining examples proving that a monitor that's easy to read can also be easy to buy.

Find out just how easy. The full line of Comrex monitors is at your nearby computer store.

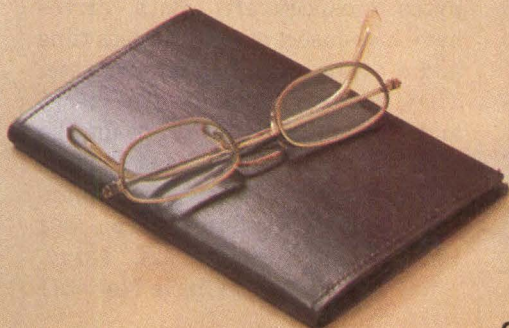

**COMREX**

INTERNATIONAL INCORPORATED

3701 Skypark Drive, Suite 120 • Torrance, CA 90505 • (213) 373-0280

CIRCLE NO. 147 ON INQUIRY CARD



# Peripherals

NEW PRODUCTS

## Tape drive features new front-load design

The models 540-CT and 440-CT  $\frac{1}{4}$ -in. streaming cartridge-tape drives store 45M bytes and are compatible with the industry-standard QIC-02 interface. The

540-CT allows front loading of a standard-sized tape cartridge by turning the cartridge sideways for insertion. The unit can be installed in any system using the same mounting holes and having the same physical dimensions as any  $\frac{5}{4}$ -in.

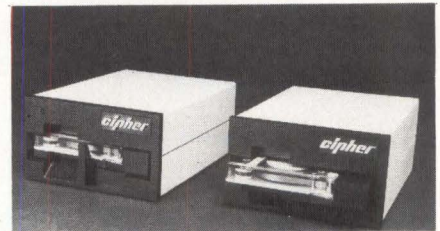

## Home Sweet Home for Your Multibus\*

Finally there's a system chassis that is designed and manufactured with the thoroughness and care you expect in your Multibus system. It's Electronic Solutions' new Multichassis™.

- 9 slots, 0.6" spacing—or 7 slots, 0.75" spacing
- Hefty 4-output 300W power supply— 40A at +5V
- Cool operation even with high-density boards

There's a field-proven card

cage and backplane, plus full RFI filtering, locking front panel function switch, power fail detection, and quiet dual cooling fans with quick-change filters.

And best of all, the removable front panel lets you easily customize the Multichassis to match your company color and logo.

So treat your Multibus system to an elegant but affordable new home—the Multichassis by Electronic Solutions. Call us today for full specifications and prices.

**Electronic Solutions**  
5780 Chesapeake Ct.  
P.O. Box 85244  
San Diego, CA 92138  
Call Toll Free  
(800)854-7086  
in California  
(619)292-0242

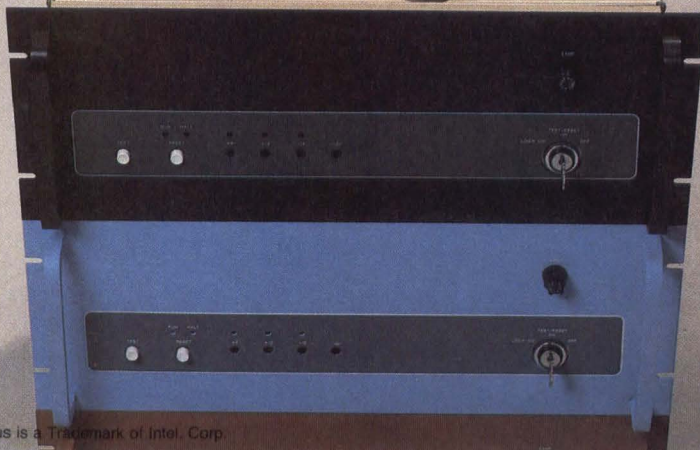
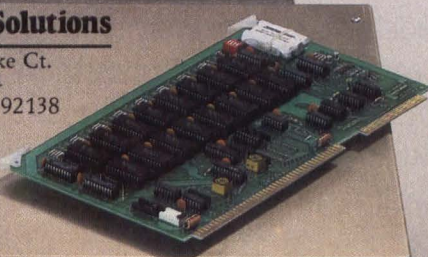

\*Multibus is a Trademark of Intel, Corp.

CIRCLE NO. 149 ON INQUIRY CARD

floppy or rigid disk drive. The model 440-CT fits an 8-in. footprint. Both models have an 87K-byte-per-sec. average read/write transfer rate and operate at 90 ips. They feature 8000 bpi recording on nine tracks and will be available for volume delivery in July. They will sell for approximately \$850 in OEM quantities. **Cipher Data Products, Inc.**, 10225 Willow Creek Rd., P.O. Box 85170, San Diego, Calif. 92138.

Circle No 370



## DEC replacement drives are improved

The  $\frac{5}{4}$ -in. Micro-Magnum 5/5 fixed/removable cartridge and the Micro-Magnum 5 removable-only cartridge Winchester disk drives emulate Digital Equipment Corp.'s RL-01 and RL-02 disk drives. The drives now feature higher formatted capacities of 10.48M and 5.24M bytes, respectively. Both drives have a 40-msec. average access time and a 5M-bit-per-sec. transfer rate. They feature an embedded servo and an SASI. price is \$1275 for the Micro-Magnum 5/5 and \$995 for the Micro-Magnum 5 in 1000-unit quantities. **DMA Systems Corp.**, 601 Pine Ave., Goleta, Calif. 93117.

Circle No 371



The VISUAL 100 video display terminal is 100% compatible with the DEC VT 100 terminal from identical software right down to the layout of the keys and the sculpturing of the keyboard.

But when it comes to ergonomics, the VISUAL 100 is something else! For example, the VISUAL 100 is designed in lightweight plastic that can easily be swiveled and tilted for maximum operator comfort. A detached, low profile keyboard, and 12" or 14" non-glare screen are just a few of the other human engineering advantages of the VISUAL 100.

The Advanced Video package and current loop interface that are optional with the DEC terminal are standard with the VISUAL 100. Plus we've added an optional Buffered Printer Interface with independent baud rate, independent parity and printer busy via "XON-XOFF" protocol. And although the VISUAL 100 is a step up from the DEC VT 100, it is priced a step below. Only \$1,345. Call or write for full details.

Service available in principal cities through Sorbus Service, Division of Management Assistance, Inc.

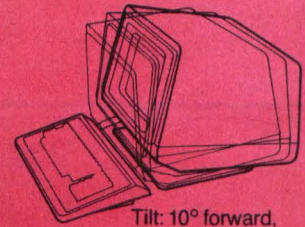

Tilt: 10° forward,  
15° backward

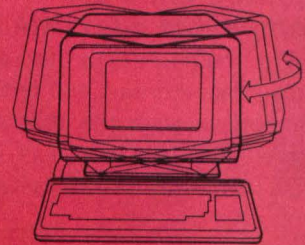

Swivel: 270°

# VISUAL 100.

Combines VISUAL'S ergonomic excellence  
with DEC VT 100<sup>®</sup> performance.



**\$1,345**

**VISUAL** See for yourself

Visual Technology Incorporated  
540 Main Street, Tewksbury, MA 01876  
Telephone (617) 851-5000. Telex 951-539

CIRCLE NO. 148 ON INQUIRY CARD



# Peripherals

NEW PRODUCTS

## Storage units are compatible with IBM 3375

The model CDC 33750 14-in. disk subsystem stores 1.63G bytes and is compatible with the IBM 3375 disk drive. The CDC 33750 is designed with thin-film read/write heads,

magnetic recording disks and actuators contained in fixed, sealed head/disk assemblies. Each CDC 33750 device includes four separate and independent head/disk assemblies. The devices feature a 3G-byte-per-sec. transfer rate and a 16-

msec. average access time. A dual access feature that allows any of 16 actuators in a string to be addressed through two internal data paths is optional. Prices range from approximately \$61,000 to \$84,000, depending on configuration. **Control Data Corp.**, P.O. Box 0, Minneapolis, Minn. 55440. **Circle No 372**

# Soup to Nuts.

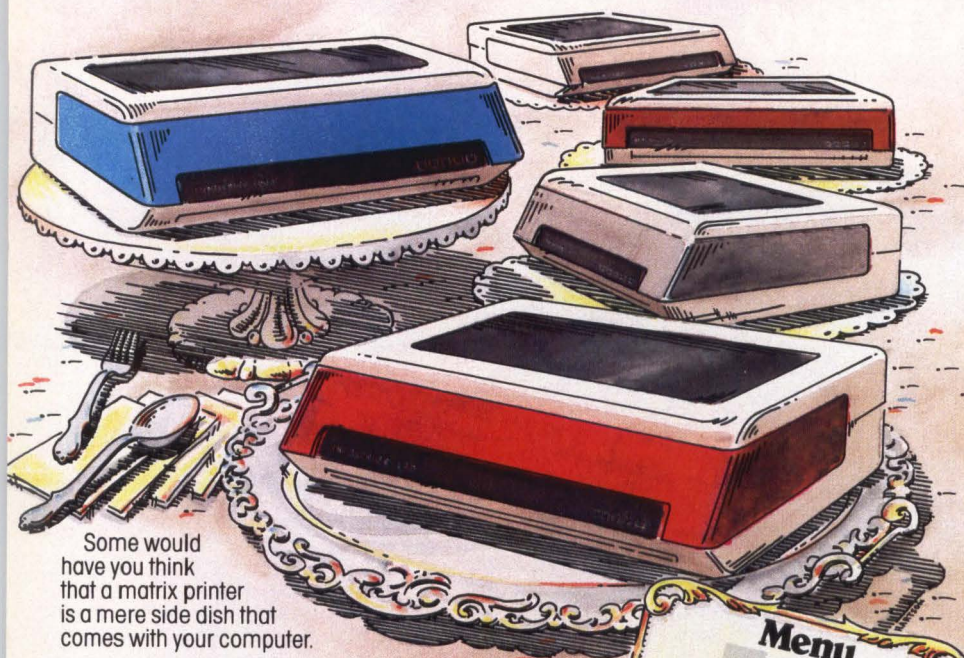

Some would have you think that a matrix printer is a mere side dish that comes with your computer.

Don't believe it.

What you get out of your printer is what you get out of your computer. If your printer is small, slow, noisy or unreliable, your computer will be limited, sluggish, irritating, or inoperable. Just telling it like it is.

That's why Infoscrite has come up with a gourmet line of multifunction matrix printers specifically for business and professional users.

You can switch from high-speed data processing to business letters, at will; handle up to 16-inch-wide paper; make up to five crisp carbons; generate gorgeous graphics in up to eight colors; and enjoy truly elegant and incredibly quiet operation, day-in and day-out.

Check the menu for the printer that meets your exact needs.

Why go with the computer manufacturer's combo plate when the same money will let you buy Infoscrite, a la carte?

Your favorite computer dealer or systems specialist will be delighted to arrange a demonstration for you. Or contact the *matrix d'*: Infoscrite, 2720 South Croddy Way, Santa Ana, California 92704, USA, Phone (714) 641-8595, Telex 692422.

Menu					
MODEL	DRAFT (CPS)	CORRESPONDENCE (CPS)	LETTERS (CPS)	GRAPHICS (72 x 72)	GRAPHICS (144 x 144)
500	150	75			
1000	200	100		X	X
1100	200	100	40	X	X
1200	200	100	40	X	X
1500	400	200		X	X

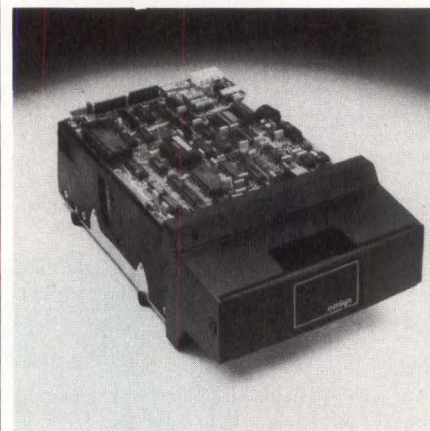

## Floppy disk drive stores 5M bytes

The model 5460 minifloppy disk drive uses Amlyn's proprietary MiniPac diskette cartridge that contains five flexible diskettes. The interface of the model 5460 is functionally compatible with that of Shugart Associates' SA460 minifloppy or its equivalent. The 5460 appears to the computer system as if it were five SA460 drives, with each of the five diskettes in the cartridge addressable as if it were a single drive. Typical unformatted capacities are 5M bytes per cartridge using 1M byte per diskette surface in double-density recording. The data-transfer rate for this capacity is 250K bytes per sec. The average access time is 95 msec. The drive is physically compatible with other minifloppy drives and can be mounted in a 3 1/4- x 5 3/4- x 8-in. space. Price is \$610 in 500-unit quantities. **Amlyn Corp.**, 2450 Autumnvale, San Jose, Calif. 95131.

**Circle No 373**

# PRINT WITH INFOSCRIBE



# Help stamp out OBSOLETE data.



Get Data Sources—the only quarterly DP buyer's directory. It tells you who's selling the hardware, software, systems, and services you need, today.

The first thing people do when they get Data Sources is use it.

A lot.

2.0 times a week, on the average.

With an average of 4.8 other people sharing in the use.

Because Data Sources gives them the first-cut information they need to list all their options. And the details they need to cull the misfits.

The next thing people do with Data Sources is throw it out.

Four times a year.

Because they know the price to be paid for trusting obsolete listings. Consider these typical increases from one quarterly issue of Data Sources to the next:

327 new computer system listings.

473 new software package listings.

120 new memory device listings.

That's an average of 25 new systems and 36 new software packages a week. Imagine the developments in peripherals. In communications networks. In word processing.

That's why we publish so often. And why our intelligent subscribers throw us away so often. They know that no annual publication alone will suffice. And that even a quarterly quickly becomes obsolete.

## What we are, what we're not.

What we are, is the first source to turn to when you're considering the purchase of any data processing hardware, software, systems, or services.

You come to us first because we have the most complete and up-to-date listings of what you need: 6,000 companies supplying more than 22,000 products, including mainframes, minis, micros, supplies and software (14,000 software listings alone). Fully indexed and cross-indexed by product type,

supplier, and system compatibility. With names and phone numbers to make your job easier.

You get to see all your options, not just some. And you get the information you need to identify the most practical choices. Quickly.

Which brings us to what we're not: an evaluative service. We don't, in our 1,200+ pages, rate or recommend things. Other people do that and do it very well. But they do it in such depth that they can only review a limited number of the products and services you'll find in Data Sources, and only annually at best. So even if you use an evaluative service—as well you should—you still need Data Sources for a complete and current picture of the industry.

## Our free offer. And bonus.

The best way to see how much Data Sources has to offer is to use a copy yourself. Let us send you our latest issue, FREE. We'll also send you an "OBSOLETE" stamp to use as you wish.

Then, after 30 days, we'll send you an invoice for a year's subscription to Data Sources at only \$60—half off the cover price of the four issues.

If you find Data Sources to be everything we've said it is, simply pay the invoice and receive a full year subscription at half price. If you're not convinced, write "cancel" on the invoice and return it.

Either way, keep the first issue and the stamp as our gift. But remember, if you miss the other three issues, get ready to use the stamp.

To accept our free offer, use the coupon below. Or call, toll-free, 800-227-1617 Ext. 251. (In California, 800-772-3545 Ext. 251)

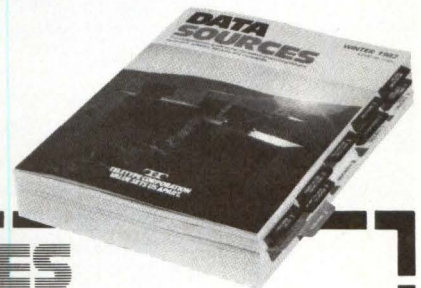

## DATA SOURCES

P.O. Box 5845, Cherry Hill, NJ 08034

Send my first issue of the Data Sources buyer's directory. And my free "OBSOLETE" stamp. I understand that, in thirty days, you will invoice me \$60.00 (half price) for a four-issue subscription and that I may decline your offer at that time by writing "cancel" on the invoice and returning it to you.

Name \_\_\_\_\_ Title \_\_\_\_\_

Company \_\_\_\_\_

Address \_\_\_\_\_

City \_\_\_\_\_ State \_\_\_\_\_ Zip \_\_\_\_\_

Telephone \_\_\_\_\_

Type of business:  End user  OEM  Distributor/Vendor

Other \_\_\_\_\_

T014

An information product of Ziff-Davis Publishing Co. Satisfaction guaranteed.

CIRCLE NO. 152 ON INQUIRY CARD



# Peripherals

NEW PRODUCTS

## High-speed printer is aimed at OEMs

The model EX401 non-impact electrosensitive printer prints 3 lines per sec. (as fast as 192 cps). It prints the 96-character ASCII set and uses 5-in.-wide electrosensitive

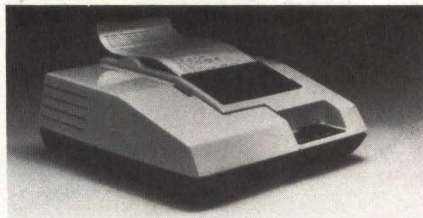

paper. It is available in a 40/20- or a 64/32/22-column configuration that includes 128 extra symbols and characters in the character set. A standard parallel, RS232C/20-mA or IEEE-488 interface is available. Standard software controls permit easy integration into an OEM system and allow transmission of user-generated 8-bit dot patterns for graphics printing. Single-unit quantity price is \$549. **Axiom Corp.**, 1014 Griswold Ave., San Fernando, Calif. 91340. **Circle No 374**

# RETRO-GRAPHS™

# AND

# ADDS

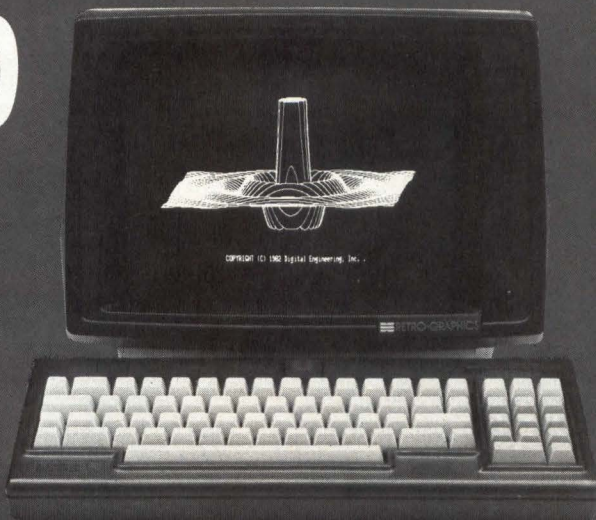

Digital Engineering is offering new GEN.II™ Retro-Graphs terminal enhancements for the ADDS VIEWPOINT and VIEWPOINT/3A PLUS, TeleVideo's® 910, 912, 920, 925, and 950, and Lear Siegler's ADM 3A, 3A+, and 5.

GEN.II Retro-Graphs, our second generation enhancement, turns these popular text terminals into powerful, bit-map graphics terminals. With no loss of existing features. Tektronix® 4027 and 4010 simulation and protocol familiar to most programmers. "Resident" graphics intelligence and English-like commands for speed and ease of operation. Compatibility with industry-standard graphics software. Extensive documentation and timely customer backup. And at a price half that of comparably equipped graphics terminals.

GEN.II Retro-Graphs for ADDS. TeleVideo. And Lear Siegler. Available only from Digital Engineering. Call Vicki at (916) 447-7600 or telex 910-367-2009 for ordering details.



**DIGITAL  
ENGINEERING**

630 Bercut Drive, Sacramento, CA 95814  
(916) 447-7600 Telex: 910-367-2009

GEN.II and Retro-Graphs are trademarks of Digital Engineering, Inc. TeleVideo is a registered trademark of TeleVideo Systems, Inc. Tektronix is a registered trademark of Tektronix, Inc.  
© 1982 Digital Engineering, Inc.

CIRCLE NO. 153 ON INQUIRY CARD



## Line printers feature nonstop printing

The TIP-150 and TIP-300 single- and dual-print-head-assembly impact dot-matrix line printers offer character printing at 150 and 300 lpm, respectively, and enhanced word-processor-quality printing at 45 and 90 lpm, respectively. Standard default print density is 10 cpi with condensed formats of 13.3 and 16.6 cpi. The printers can accommodate one- to six-part forms using 3- to 16-in.-wide fanfold paper. They feature a standard Centronics parallel interface and an optional Dataproducts parallel or RS232C interface. The model 150 can be field-upgraded to the model 300 by adding a second print-head-assembly and related electronics.



# CENTRONICS E-SERIES LINE PRINTERS.

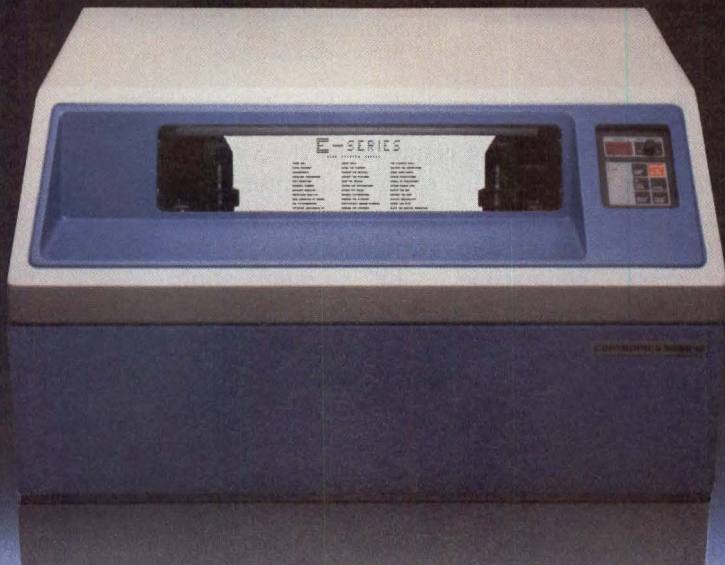

## WE COULD WRITE A BOOK ON HOW WE OUTPERFORMED THE COMPETITION.

Because every one of Centronics' E-Series family of line printers has been put through its paces in tough competitive evaluations at a range of customer sites.

And we won over 90% of those tests in head-to-head comparisons with our biggest line printer competitors.

Now that's something to write about. So we did. About how the E-Series checked out on spec-adherence. Throughput. MTBF. MTRR. Emissions. E.S.D. Maintainability. And many other points that include state-of-the-art E-Series features.

### NEW HIGH SPEED MODEL.

Our newest E-Series Model III printer is a high performance extension of our successful family of E-Series line printers. It will extend the speed range of the series up to 2400 LPM in burst mode operations.

### DESIGN FEATURES TO PLEASE OEMs.

In a long list of practical E-Series printer features for the OEM, two are of major significance—Design Integrity and Cost Effectiveness. Our printers feature 80%

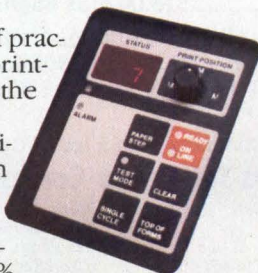

parts commonality to reduce the cost of spare parts inventory, service training and field service. The long life towel ribbon system delivers over 2,000,000 lines of print between changes—a major saving to the end user and advantage to the OEM.

### OPERATING FEATURES TO PLEASE USERS.

Some manufacturers forget who works with their printers. We don't. The E-Series is truly operator-friendly: Simple front panel controls and display, plus built-in diagnostics to help isolate problems quickly. Swing-out gate for easy, efficient paper handling and loading. Superior print quality. Office-quiet operation—as low as 60 dba.

### SUPPORT THAT WILL MAKE EVERYONE HAPPY.

With the experience of 25,000 line printers backing the E-Series, it's no wonder we win so many head-to-head

comparisons. But, when the time comes for service, you'll be happy to know that one of Centronics' worldwide network of service locations is nearby and available for third party service support.

To get more details on why Centronics line printers outperform the competition by such a wide margin, you should read our book. You will also find out all the reasons Centronics' E-Series line printers should be included in your product line evaluation.

Now, for all your high performance line printer and matrix printer needs, your source is Centronics. Remember, we wrote the book.

### For a copy of "HOW WE WIN COMPETITIVE PRINTER EVALUATIONS AND INFLUENCE OEMs"

and E-Series data, call our Line Printer Division, (313)651-8810, Ext. 397, or write Centronics Data Computer Corp., Dept. MM, One Wall Street, Hudson, NH 03051.



## CENTRONICS® PRINTERS

CIRCLE NO. 154 ON INQUIRY CARD



# Peripherals

NEW PRODUCTS

The dual-print-head-assembly design has a nonstop printing feature that allows uninterrupted printing by a single print-head assembly should one unit fail. Prices are \$3900 and \$4900 for the TIP-150 and TIP-300, respectively, in single-unit quantities. **Trilog, Inc.**, 17391 Murphy Ave., Irvine, Calif. 92714.

Circle No 375

## 120-cps mini-printer has five alphabets

The Scanset model 725 dot-matrix mini-printer offers five alphabets and eight character sizes and prints bidirectionally at 120 cps. It prints 40, 80 or 136 characters per line with automatic vertical and horizontal tabbing. The printer's built-in graphics mode has a 144 x 160-dot-per-sq.-in. resolution. The

model 725 connects to the vendor's Scanset line of personal information terminals and other RS232C-compatible terminals or to TTL-compatible, 7-bit parallel equipment. Price is \$795 in single-unit quantities. **Tymshare**, 20705 Valley Green Dr., Cupertino, Calif. 95014.

Circle No 376

## Dot-matrix printer features six character sizes

The D-82 F/T dot-matrix printer features a 7 x 7 or 14 x 7 expanded matrix, 100-cps bidirectional printing, short-line-seeking logic, an 800-character buffer and dot-addressable graphics. Under program control, a user can specify six character sizes and one- or two-pass printing. The printer prints the 96-character ASCII set at 40, 48, 66,

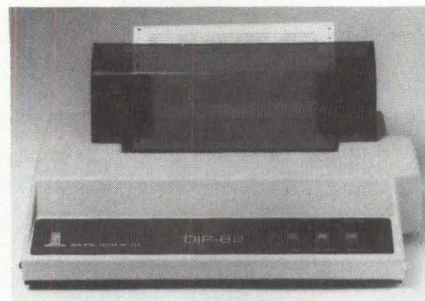

80, 96 or 132 characters per line on 8½-in.-wide paper. Operator controls include power switch, select/deselect, line feed, top of form, self test and variable-form-length setting. A Centronics-compatible parallel interface is standard, and an RS232C interface is optional. Price is \$595 for single-unit orders. **Data Impact Products, Inc.**, 745 Atlantic Ave., Boston, Mass. 02111.

Circle No 377

## Winchester/Floppy Drive Exercisers That Fit the Palm of Your Hand.



Only \$520

Now test both 5¼" and 8" Floppies, and many 5¼" and 8" Winchester with one lightweight, portable exerciser. Used by Tandon, Seagate, Shugart and other leading manufacturers, the Model 103D is ideal for incoming inspection, repair depot, and field service use.



Quality Disk Drive Exercisers Since 1974  
8010 Highway 9 Ben Lomond, CA 95005  
(408) 336-5048

## For All your EIA and Other INTERFACE CABLE



Only a few of nearly 200 cables and connectors we supply - in stock or to your specs.

**FAST  
RELIABLE  
ECONOMICAL**

We make cables that interface with DEC, IBM, Wang, DGC, TI, H/P and others... to name just a few. Extended Data Cables (EIA-EDC) up to 250 feet or more!

**NOW ONLY.....\$18.00 plus 65¢/foot (18 pins)**

EIA RS-232-C—all 25 pins connected M/M or M/F

**Regular—\$16.00 plus 60¢/foot**

**FIRE RETARDANT PLENUM...\$16.50 plus \$2.75/ft.**

**ds  
cc**

The Company with a lot of Connections  
**Data Set Cable Company, Inc.**

**East**  
722 Danbury Road  
Ridgefield, Connecticut 06877  
(203) 438-9684 TWX-710-467-0668

**West**  
3001 Contract Avenue  
Las Vegas, Nevada 89101  
(702) 382-6777

CIRCLE NO. 156 ON INQUIRY CARD



# INTRODUCING 1.6 Mb REPACKAGED

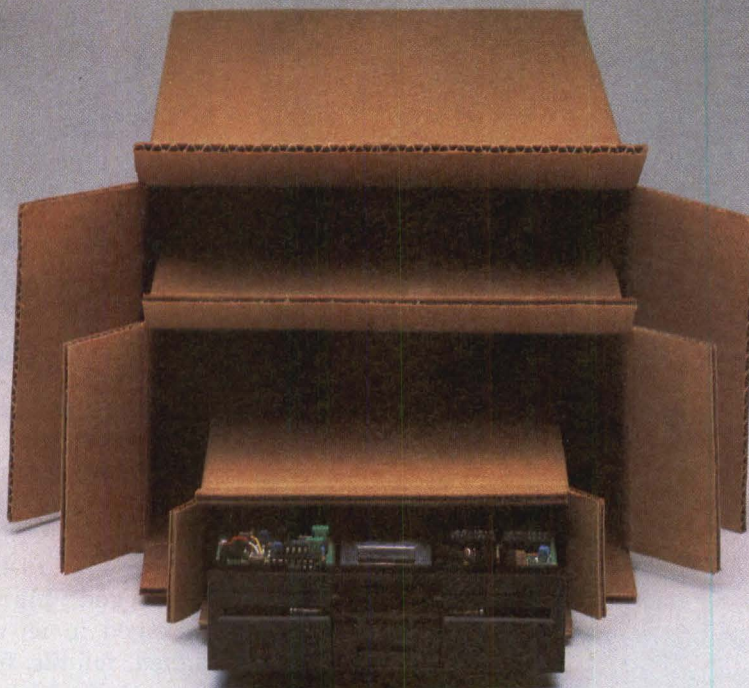

8" disk drive

8" half-height

5 1/4" half-height

## More Storage. Less Space.

It's new and it's from Mitsubishi: the M4854 half-height 5 1/4" flexible drive. The M4854 delivers up to 1.6 Mb of storage—the same as most 8" drives—yet it takes up only half as much space as a conventional 5 1/4" drive. Not bad, considering the M4854 is about the same price as most conventional 5 1/4" disk drives. And just in case you prefer a half-height unit with 1.0 Mb of storage, Mitsubishi also makes the M4853.

## More Features. Less Money.

As with all other Mitsubishi flexible disk drives, the M4854, 1.6 Mb, 5 1/4" half-height offers more than a lot of memory. It gives you many features:

Like a head load mechanism with all ferrite heads. A patented circular Gimbal support that ensures stable read/write operation and long media life. An advanced Direct Drive brushless DC Motor that eliminates all concern for changing drive belts. It also provides the torque necessary to reduce the disk rotation starting time to only 250 milliseconds. And for speed, the M4854 has a steel band head positioning mechanism which results in a track-to-track time of only three milliseconds and average access time of 91 milliseconds.

You'll also find Mitsubishi OEM prices are extremely competitive.

## More Products. Less Hassle.

Of course, features like these aren't just limited to Mitsubishi 5 1/4" half-height drives. You'll find them throughout the entire Mitsubishi line, which includes standard-height 5 1/4" fixed and flexible drives, 8" fixed drives and 8" full and half-height flexible drives.

## More Reliability. Less Maintenance.

Now that you know what goes into our drives, you'll know why they have a MTBF rate of 10,000 POH or more. Unit life is even more impressive—5 years or 20,000 power-on hours, whichever occurs first. No matter which type of drive you need, Mitsubishi has a package that's just right for you. For details on the entire line, contact your Mitsubishi representative today.





# Rent a universal development system today!



You can rent Hewlett Packard's 64000 Logic Development System . . . including logic state analysis plus timing analysis . . . off-the-shelf throughout North America! You can develop products based on virtually any 8-bit or 16-bit microprocessor in existence. Quickly. Inexpensively. Rental periods as short as 30 days. Or as long as you want. Call now.

GSA Contract #GS-04S-23560.

**GENSTAR**

**Rental Electronics, Inc.**  
**(800) 227-8409**

In California (213) 887-4000 • (415) 968-8845 • (714) 879-0561

**The HP 64000 is out of this world! Tell me more immediately!**

- It sounds great. Tell me more! Call me at \_\_\_\_\_
- I'm particularly interested in the following equipment: \_\_\_\_\_
- Send me your new Rental Catalog. \_\_\_\_\_
- I'd like a copy of your "like new" equipment for sale catalog, too. \_\_\_\_\_

NAME \_\_\_\_\_ TITLE \_\_\_\_\_

ORGANIZATION \_\_\_\_\_

ADDRESS \_\_\_\_\_ MAIL STOP \_\_\_\_\_

CITY/STATE/ZIP \_\_\_\_\_

TELEPHONE \_\_\_\_\_

Please complete coupon and mail to: Genstar Rental Electronics, Inc., 6307 De Soto Avenue, Suite J, Woodland Hills, CA 91367

MMS-283

© Genstar Rental Electronics, Inc. 1982

CIRCLE NO. 158 ON INQUIRY CARD

## Peripherals

NEW PRODUCTS



### Terminal displays eight colors

The MVI-100 model 813 eight-color terminal emulates the DEC VT100 and VT52 terminals. It features a 13-in., in-line pre-converged, high-resolution CRT packaged in an ergonomically designed, full-tilt, full-swivel cabinet. The terminal has an 80-column × 24-line display with an additional 25th line for status messages. Other features include vertical and horizontal scrolling, four split screens and the ability to insert and delete characters and lines, erase lines and pages and address the cursor independently. The detachable 87-key keyboard features 128 ASCII standard characters and 24 programmable function keys. The MVI-100 communicates with the host computer through an RS232C connector in half- or full-duplex mode at baud rates of 110 to 19.2K baud. Price is \$3000 in single-unit quantities. **Colorgraphic Communications Corp.**, 2379 John Glenn Dr., Atlanta, Ga. 30341. **Circle No 378**

### Data terminal converses at eight speeds

The model 4503 conversational data terminal, which is code-compatible with the Lear-Siegler ADM-3A, features a detached typewriter-style keyboard with auto-repeating keys and a 4-ft. coiled



Advanced electronics in a highly human mode . . .

Dealer  
Inquiries Welcome

# MICRO-TERM<sup>TM</sup>

## ergo<sup>TM</sup> SERIES

**\$1095**  
QUANTITY  
DISCOUNT  
AVAILABLE



The ERGO<sup>TM</sup> series, a unique combination of thoughtful ergonomics and smart electronics. Begin with a detached, low profile keyboard with integrated palm rest and LED status indicators. Add a tiltable (25° range), non-glare, green screen and you begin to see the point. Ergonomics means increased operator comfort and productivity.

The ERGO 2000 is fully code-compatible with the DEC VT52, Hazeltine 1500, ADM 3A and the Micro-Term ACT-5A, and includes features such as smooth scroll, full video attributes, host definable function keys, block mode transmission, sophisticated printer port and more.....

The new ERGO 3001 is totally VT100 compatible and offers as standard equipment 132 columns by 24 lines, a full range of video attributes, bidirectional printer port, plain english set-ups, user programmable function keys, diagnostic mode, screen saver, enlarged buffer and two pages of memory....

The ERGO 2000 (shown) is priced at only \$1095 and the new ERGO 3001 at only \$1375.....

ON SITE SERVICE IS AVAILABLE IN OVER 450 CITIES THROUGH WESTERN UNION

\*DEC and VT52 are registered trademarks of Digital Equipment Corporation, Hazeltine 1500 is a trademark of Hazeltine Corporation, ADM 3A is a trademark of Lear Siegler, Inc.



**MICRO-TERM, INC.**

*Terminals are our only product, and we put more into them.*

CALL OR WRITE:  
1314 HANLEY INDUSTRIAL COURT, ST. LOUIS, MISSOURI 63144,  
(314) 968-8151, TWX: 9107601662, MICROTERM, STL



# Who the hell is Pixel?

**The company that delivers  
the best 68000-based  
UNIX™ system you can buy,  
and fully supports it.**

**That's who!**



If you're in the market for a high-performance, low-cost supermicro, take a hard look at the Pixel 100/AP™ system.

For starters, it's the fastest 68000-based supermicro available. Expandable, too, with up to 16 terminals, 160mB of on-line Winchester disk storage, and 6mB RAM.

And, whether you're developing a new product, or adapting an existing application, Pixel makes it easy with a wide choice of industry standard languages like C, FORTRAN 77, PASCAL, SMC, BASIC/IDOL, DEC-compatible SVS BASIC, RM/COBOL™, and APL.

You get a full range of integrated decision support software, too. Software that compares feature for feature with the best packages in the business. Our relational data base, spread sheet package, and word processing packages work as independent components, or as a totally integrated decision support capability.

There's something else you should know about the Pixel 100/AP supermicro. Our UNIX operating system comes with tutorial documentation that makes it easy to learn. We offer customer training, too.

And, every Pixel system is supported by 125 company Technical Service Representatives, nationwide. That means you can rely on a substantial support organization from day one.

**NOW AVAILABLE  
WITH:**

- MicroINGRES™ DBMS
  - UNIFY™ DBMS
  - SEQUITUR™ DBMS
  - INFORMIX™ DBMS
  - MDBS III™ DBMS
  - XED™ wp
  - Versatel™ wp
  - SuperComp Twenty™ spreadsheet
  - Sibol™ compiler
  - Telesoft ADA™ language
- ...and others.

If you're an OEM/Systems House, you owe it to yourself—and your customers—to see how much more Pixel has to offer.

Send me a Pixel Information Package and price list immediately.

Have a salesman contact me ASAP

Name \_\_\_\_\_

Title \_\_\_\_\_

Company \_\_\_\_\_

Address \_\_\_\_\_

City \_\_\_\_\_ State \_\_\_\_\_ Zip \_\_\_\_\_

Telephone \_\_\_\_\_

**Pixel**

DIVISION

International Marketing Dept.  
One Burr't Road, Andover, MA 01810

 **Instrumentation Laboratory**

CALL 617-470-1790

Pixel 100/AP is a trademark of Instrumentation Laboratory Inc. • RM/COBOL is a trademark of Ryan-McFarland Corporation. • LEVEL II COBOL is a trademark of MICRO FOCUS • UNIX is a trademark and a service mark of Bell Laboratories. • The Pixel operating system is derived from UNIX system III and includes enhancements from Berkeley 4.1 BSD • MicroINGRES is a trademark of Relational Technology, Inc. • UNIFY is a trademark of North American Technology, Inc. • SEQUITUR is a trademark of Pacific Software Manufacturing Co. • INFORMIX is a trademark of Relational Database Systems, Inc. • MDBS III is a trademark of Micro Data Base Systems, Inc. • XED is a trademark of Computer Methods, Inc. • Versatel is a trademark of Applied Technology Ventures, Inc. • Super Comp Twenty is a trademark of Access Technology, Inc. • Sibol is a trademark of Software Ireland, Ltd. • Telesoft ADA is a trademark of Telesoft, Inc.



# Peripherals

NEW PRODUCTS



cord. The 12-in., non-glare, green screen displays 24 lines of 80 sharp 7 × 9 dot-matrix characters. The terminal is conversational at eight data rates from 110 to 19.2K baud. A transparent monitor mode displays received control codes. Other features include a serial asynchronous RS232C interface, absolute and relative cursor addressing and clear to end-of-line and end-of-screen functions. Price is \$495 in single-unit quantities. **NABU Commercial Terminals, 333 Metro Park, Rochester, N.Y. 14623. Circle No 379**

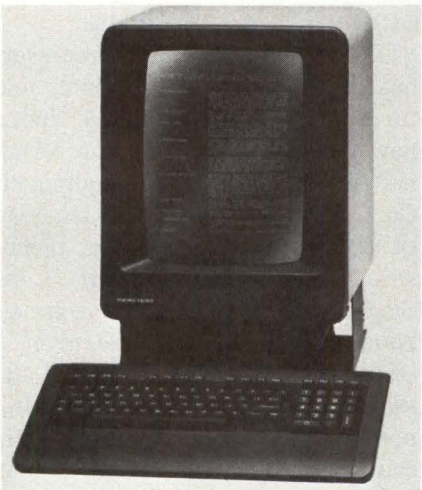

## Terminal features full-page word processing

The Ergo 4000 full-page word-processing terminal displays 66 lines of 80 characters on a 15-in., green, non-glare-screen. The terminal is compatible with Digital Equipment Corp.'s VT100 codes. It features four video attributes, a pass-through printer port, 15 user-

MINI-MICRO SYSTEMS/February 1983

# TOUGH BUBBLE, NO TROUBLE

**New! Emulate your floppy disk drive with Hicomp's high reliability one megabyte bubble memory peripheral.**

Now you can forget about the problems that plague disk drives. The MBM-1 is compatible with industry standard 5¼" and 8" floppy disk controllers and requires no software driver development.

**Reliable - your data is there when you need it.** The MBM-1 has no mechanical parts and fans to wear out or break down. It has a minimum MTBF of 30,000 hours - 2 to 5 times greater than commercial disk drives.

**Survivable - even in the toughest environments.** Bubble memory has high tolerance to extreme temperature, humidity, shock and vibration. This allows you to put your system in environments that would destroy floppy or Winchester disk-based systems.

**Non-volatile bubble memory - the technology that doesn't forget.** When the power goes down, the MBM-1 retains all data, without expensive battery back-up systems.

Add greater reliability and performance to your new or existing computer system. Call Hicomp and ask about our MBM-1 one megabyte bubble memory peripheral.



## HICOMP

Tough technology for hostile environments.

Hicomp Computer Corporation  
3860 148th Ave. N.E.  
Redmond, WA 98052 (206) 881-6030  
Telex: 32-0357

CIRCLE NO. 161 ON INQUIRY CARD





## SWITCHING TERMINALS A PROBLEM?

WTI has a lineup of low cost solutions... RS232 Switching Devices!



### AB MiniSwitch \$89

End the hassle of plugging and unplugging data cables. MiniSwitch lets you manually switch between two RS232 devices and a common device such as a Modem and a Printer sharing a Minicomputer.

### TM-41 4 Port Push Button Switch \$295

Switch ports electronically from the Terminal by pressing a button instead of flipping switches on a common AB Switch box. Selectable operating modes include—equal priority lockout, multiple and single port select.

### CAS-41 4 Port ASCII Code Activated Switch \$395

Your Computer may select one or any combination of up to 4 RS232 ports by a user selectable code sequence.

### CAS-161 16 to 64 Port Code Activated Switch \$795

Your Computer may select between any one of 16 ports by a two character ASCII code sequence. The unit is field expandable to 32, 48, or 64 ports.

### SMRT-1 8 Port "Smart Switch" \$795

This flexible microprocessor controlled 8 port switch allows a user on any port to communicate with an RS232 device on any other port. Up to 4 pairs of users can communicate simultaneously. "User Friendly" commands aid in port selection, port status and sign off. The unit's so smart, it even signals you when the port you wanted is no longer busy! Each port can be configured for DTE or DCE by pressing a button.

### PSU-41 Printer Port Sharing Unit \$395

Allows up to 4 CRTs to share one Printer automatically without software changes! The PSU-41 scans each CRT and locks on until the screen has been sent to the Printer, then resumes scanning.



**western telematic inc.**

2435 S. Anne St., Santa Ana, CA 92704 • (714) 979-0363  
Outside California call toll free (800) 854-7226

CIRCLE NO. 162 ON INQUIRY CARD

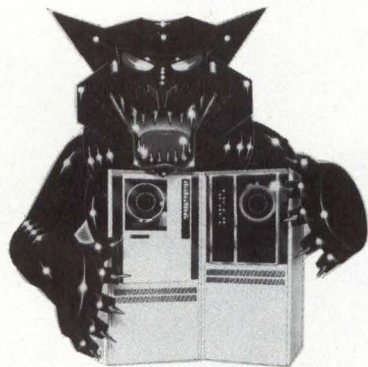

## THE BIG BYTE

Tri-Density Tape System  
for 11/70 and VAX

A real beast of a subsystem — the IPS BIG BYTE tape system outperforms all competitors. The tape subsystem comes complete with drive, controller, formatter and cables for all DEC Unibus and Cache Bus systems. Features include 32K FIFO Buffer and intelligent dynamic NPR throttle.

The BIG BYTE from IPS — increased system performance without taking a bite out of your budget.

IPS-Information Products Systems, Inc.  
6567 Rookin St. • Houston, Texas 77074  
Phone (713) 776-0071 • Wire IPS HOU • Telex 792413

Call our toll free number: 1-(800)-231-7972



CIRCLE NO. 163 ON INQUIRY CARD

# Peripherals

NEW PRODUCTS

programmable function keys, diagonal cursor movement, a savable setup mode, an alternate character generator, a transparency mode and settable tabs. Ergonomic features include a screen that tilts 25 degrees, an on/off switch on the front of the cabinet and a detached keyboard with an integrated palm rest. Price is \$1695 in single-unit quantities. **Micro-Term, Inc.**, 1314 Hanley Industrial Court, Saint Louis, Mo. 63144. **Circle No 380**



## Terminal offers emulation capabilities

The Visual 330, a microprocessor-based video display terminal, features emulation capabilities and a new ergonomic design. The terminal emulates Digital Equipment Corp.'s VT52 and Data General's D200 terminals and includes menu-selectable emulation of Lear Siegler's ADM-3A and Hazeltine's 1500 terminals. It features a streamlined plastic housing, tilt and swivel capabilities, a 12- or 14-in., non-glare screen, 7 x 9 dot-matrix characters and a detached low-profile keyboard with matte finish keycaps. Other features include block and character transmission modes; 12 user-programmable function keys; blink, underline, reverse, bold and blank video attributes; a line-drawing character set; and split-screen viewing. Single-quantity price is \$1150. **Visual Technology**, 540 Main St., Tewksbury, Mass. 01876. **Circle No 381**



# Anadex SILENT SCRIBE™ printers.

## Quietly going about your business.



Stan Gorman

Now and then office noise levels can go sky-high. But with Silent/Scribe – our new family of matrix impact printers – you can raise your printer expectations while significantly lowering your office noise level.

How quiet is "silent"? Silent/Scribe operates at less than 55 dBA, which means that in the average office you may have to look at it to determine whether it's printing.

And Silent/Scribe is as easy to buy as it is to live with. You can select a variety of printing speeds, fonts and line widths. Some models provide both draft and enhanced quality copy. All models have superb dot-addressable graphics at no extra cost.

Also standard are sophisticated communications controls and protocols, flexible and easy-to-use operator controls, quick-change continuous loop ribbon cartridge, and universal interfaces that work with virtually any computer system.

For full details on how Silent/Scribe can fit your application – quietly – contact Anadex today. You'll find the units attractively packaged, quality engineered, modestly priced, and available now.

### SILENT/SCRIBE MODELS

Standard Features	Chr. per Inch	DP-9000A	DP-9500A	DP-9001A	DP-9501A	DP-9000A
	10	150	150	120	120	200
Printing Speed (Char. per Sec.)	12	180	180	—	—	120
	12.5	—	—	150	150	—
	13.3	200	200	—	—	—
	15	—	—	180	180	150
	16.4	—	—	200	200	164
Enhanced	10	—	—	—	—	100
Expanded Print (Double Width)		Yes	Yes	Yes	Yes	Yes
Dot Addressable Graphics (Dot/In. H/V)	60/72	60/72	75/72	75/72	72/72	72/72
Max. Line Width (In.)	8.0	13.2	8.0	13.2	13.2	13.2
Audible Alarm	Opt.	Opt.	Opt.	Opt.	Yes	Yes
Out-of-Paper Sense	Yes	Yes	Yes	Yes	Yes	Yes
Ribbon, Continuous Loop Cartridge (Yds)	30	30	30	30	30	30
Interfacing:						
Parallel Cent. Comp.	Yes	Yes	Yes	Yes	Yes	Yes
RS-232-C Serial	Yes	Yes	Yes	Yes	Yes	Yes



©Copyright 1982  
Anadex, Inc.

DP-9000A



## Silent/Scribe. The Quiet Ones from Anadex.

**ANADEX, INC.** • 9825 De Soto Avenue • Chatsworth, California 91311, U.S.A. • Telephone: (213) 998-8010 • TWX 910-494-2761  
**U.S. Sales Offices:** San Jose, CA (408) 247-3933 • Irvine, CA (714) 557-0457 • Schiller Park, IL (312) 671-1717 • Wakefield, MA (617) 245-9160  
 Hauppauge, New York, Phone: (516) 435-0222 • Atlanta, Georgia, Phone: (404) 255-8006 • Austin, Texas, Phone: (512) 327-5250  
**ANADEX, LTD.** • Weaver House, Station Road • Hook, Basingstoke, Hants RG27 9JY, England • Tel: Hook (025672) 3401 • Telex: 858762 ANADEX G



# Datacomm

NEW PRODUCTS

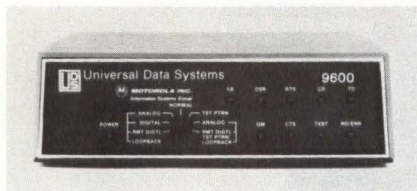

## Modem operates at 9600 bps

The UDS 9600 data modem for four-wire operation in point-to-point configurations processes 9600 bps of synchronous, digital data. The built-in test functions of the CCITT V.29-compatible product allow a rapid four-step check of data terminals, modems and telephone lines. An automatic digital adaptive equalizer overcomes the effects of large variations in delay and amplitude distortion. At 9600 bps, the modem operates at a 2400-baud signaling rate, encoding 4 bits per

signal element. If operating conditions deteriorate, fallback rates of 7200 or 4800 bps can be used. Test features include digital loopback, analog loopback, 511 test-pattern generation/checking, analog loopback with 511 test pattern and remotely activated digital loopback with 511 test pattern. The test features are selected and monitored via a front-panel rotary switch and 10 LED indicators. Single-quantity price is \$2650. **Universal Data Systems**, 5000 Bradford Dr., Huntsville, Ala. 35805.

Circle No 382

## Modem for Apple II is user-friendly

Designed for use with an Apple II, Apple II Plus or Bell and Howell

computers, the Modem II features menu-driven software with user prompts at all levels of command entry and keyboard dialing for ease of operation. It plugs directly into one of the I/O slots inside the computer for full- or half-duplex communications at 110 or 300 bps. It is equipped with firmware for direct communications from a bare-bones computer and comes with a software disk containing various utility programs including the terminal program. The unit is also equipped with a built-in speaker to allow audible monitoring of call progress as well as auto-dial and auto-answer. Price is \$369 in single-unit quantities. **Multi-Tech Systems, Inc.**, 82 Second Ave. S.E. New Brighton, Minn. 55112.

Circle No 383

*"Is there a reasonably-priced, reliable disc drive available now?"*



*"YES! Contact Linda Smith at Disc Tech One."*

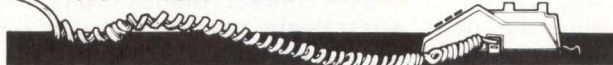

80 MB	160 MB	300 MB
\$3,000*	\$4,000*	\$5,000*

Features Include:

- SMD interface
- Compact rackmount size (7" high)
- Integrated power supply
- Clean air package
- Quick performance
- DEC, DG, Perkin Elmer, TI compatible

\*OEM Pricing



**DISC TECH ONE, INC.**

849 Ward Dr., Santa Barbara, CA 93111  
(805) 964-3535

CIRCLE NO. 165 ON INQUIRY CARD

## ADD IBM FORMAT-COMPATIBLE MAGNETIC TAPE TO ANY RS-232 PORT

With the **IBEX STC-100**, you can PLUG-IN IBM format-compatible 1/2" magnetic tape drives to any mini-micro computer or model via an RS-232 port... asynchronous or bisynchronous. Accommodates 10 1/2" or 7" reels, 9-track, 800/1600 cpi.

The **STC-100** features:

- Full read/write capability.
- Compatible with any operating system.
- Data buffer expandable to 8 K-Bytes. (4K std.)
- All std. baud/bit rates to 57 Kb/Sec.
- ASCII/EBCDIC conversion.
- Full IBM bi-sync compatibility.
- Write-only mode for data logging applications, with no software required.

Write or phone for detailed information.



**IBEX COMPUTER CORP.**

20741 Marilla St./Chatsworth, CA 91311  
(213) 709-8100 TWX: 910-493-2071

CIRCLE NO. 166 ON INQUIRY CARD



# IN THE RACE TO SAVE YOU MONEY... RIXON WINS



**ILC-2...** An Intelligent Line Contender that allows 2 terminals to simultaneously receive and alternately transmit data over one 4-wire private line via an integral 4800/9600 BPS modem.

**ILC-2 AT 9600 BPS  
ONLY \$2950\***

**COMMUX...** The lowest priced full featured 4 or 8 channel Statistical Multiplexer in the industry with an integral 4800/9600 BPS modem.

**COMMUX 4 CHANNELS  
AT 9600 BPS ONLY \$3990\*** | **COMMUX 8 CHANNELS  
9600 BPS ONLY \$4690\***

(\* Single Unit Price - Substantial Qty. Discounts Available.)

Two more low cost solutions for cutting your data communications expenses. SAVE ON: Initial Equipment Costs, Number of Telephone Lines, Cable Costs, Installation Costs, Maintenance Costs, Terminal Costs, and Space.

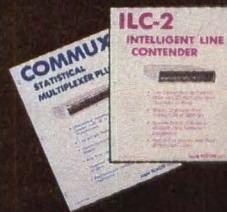

Call Paul Rothschild today at 301-622-2121, Extension 292 for detailed pricing and information.

**RIXON INC.**

2120 Industrial Pky Silver Spring, Md. 20904  
301-622-2121 TWX 710-825-0071 TLX 89-8347

RIXON Inc. 1982

3039

CIRCLE NO. 167 ON INQUIRY CARD



# Software

NEW PRODUCTS

## Business software is tailored for inexperienced users

Designed for first-time users of IBM personal computers, this business/accounting modular software library includes general ledger, accounts receivable, accounts payable, budget and financial report-



State of the Art, Inc.'s business/accounting application software products are offered with a patent-pending binder that forms a workstation easel when the binder's flap is open. The document is color-coded and features a flip-chart format. Space is provided in the binder for diskette storage.

ing, inventory control and sales invoicing application programs. All modules can be used separately in a stand-alone mode or in combination to form an integrated accounting system.

The vendor claims that users with no computer experience and an elementary knowledge of double-entry bookkeeping can install and begin using the software in about 2½ hours. The manual includes flow cards, sample reports, troubleshooting instructions and a glossary to assist the novice in implementing his system. All programs provide the user with screen prompts and instructions. The programs automatically check all keyboard entries to ensure data integrity and reject

invalid entries. The software library also features program customization. Each program offers a variety of options. The programs are initially released to operate on 5¼-in. floppy disk microcomputers, but they can be transported to hard disk mass-storage systems.

The modules are priced at \$495 to \$595 each. Written in UCSD Pascal, the programs are also available for the Apple II and III computers, and the vendor plans to make the packages available for other computers that support the p-Code interpreter. **State of the Art, Inc.**, 3183-A Airway Ave., Costa Mesa, Calif. 92626. **Circle No 384**

### New version of CP/M simplifies user interface

CP/M Plus, a new version of the industry-standard CP/M operating system, includes many features that simplify the user interface to the operating system. A HELP facility explains operating-system commands and how to use them. CP/M Plus gives users the option to add date and time stamps to files. It allows application programs to trap system errors and uses English messages to instruct users how to correct the errors. An automatic disk log-in feature eliminates the need to reset the disk every time media is changed. A new USER facility lets operators store commonly used programs under USER 0 while allowing access to those programs from any user number. CP/M Plus supports as many as 16 disk drives totaling 512M bytes of storage each, with files sizes as large as 32M bytes. hashed directory access, record-buffering and multi-sector I/O are also featured.

Evaluation copies for OEMs are priced at \$350. **Digital Research**, P.O. Box 579, 160 Central Ave., Pacific Grove, Calif. 93950. **Circle No 385**

### Utility links minicomputers with CP/M microcomputers

The BLAST data-communications utility now links many CP/M microcomputers with Data General computers to provide networking and file-transfer capability. It allows any two computers for which it has been implemented to exchange data files, text files, programs and console commands simultaneously through serial asynchronous modems. CP/M BLAST operates on 8080, 8085 and Z80 systems running under CP/M 2.2, MP/M or MP/M II. With a 4-MHZ Z80, CP/M BLAST can operate at 9600 baud full-duplex. A single-CPU license for CP/M BLAST sells for \$150. BLAST for Data General computers sells from \$250 to \$1000 per copy, depending on CPU size. **Communications Research Group**, 8939 Jefferson Highway, Baton Rouge, La. 70809. **Circle No 386**

### Software-development package for CP/M-80 micros

The ZAS Z-8000 software-development package Version 2 runs on all CP/M-80-based microcomputers and is aimed at Z8000 software developers, hobbyists and OEMs developing Z8000 software. Version 2 includes a relocatable macro assembler that supports both segmented and nonsegmented code using the standard Zilog Z8000 instruction set. The ZLK task builder, included in the package, can combine and rename programs that have been structured into named program or data sections. The ZLD family of object-code-manipulation utilities facilitates down-loading, translation to Intel HEX format and host-system memo-



# Here's Where MIS and DP Managers Find Out What Manufacturing Executives Really Want

Maybe you've been involved in manufacturing systems for quite a while — production scheduling, capacity planning, MRP systems, shop floor control, maintenance management...

Or maybe it's mostly new to you — something manufacturing management is just thinking about.

Whatever your experience, you know there's a big move on to bring computerized systems into the plant, and to integrate them with office systems. The factory of the future will be an automated factory, and the shop floor systems and office systems will be completely integrated.

This will require a lot of planning on the part of MIS and DP managers. It's not an easy job — you'll need help. And you'll get all the help you need at INFO MANUFACTURING and HI-TECH.

You'll see over 150 exhibits — virtually every leading supplier of manufacturing information systems will be on hand. We think we can promise that

you'll see systems you've never heard of, never dreamed of, but may well be using in a year or two — it's that kind of market. Thousands of manufacturing executives will be there, and you'll get a good idea of what they're thinking. So make your plans now to attend; just mail the coupon for complete information and reduced rate tickets.

## The Three-Day Conference Has Practical Approach to Productivity

There are more than 60 sessions on how to use advanced systems in both plant and office operations — and how to do it *right* the first time. There are sessions for corporate executives, sessions for MIS and DP managers — and sessions on how they can work together. The speakers are the leading experts on information and automation systems in the country. Mail coupon for Conference program, complete with speakers' names.

# Info Manufacturing 83/HI-TECH 83

**A Show and Conference on Information Systems,  
A Show and Conference on Automation Systems**

**McCORMICK PLACE, CHICAGO • APRIL 26-28, 1983**

Management: Clapp & Poliak (A Cahners Exposition Group Company)

### Special Registration for Material Handling Show

The 1983 Material Handling Show, April 25-28, at McCormick Place, will feature the Automated Factory.

INFO MANUFACTURING/HI-TECH registrants may have a Material Handling Show badge on payment of \$10 — a savings of \$15 from the regular \$25 registration fee.

If coupon is missing, write:

INFO MANUFACTURING/HI-TECH  
Clapp & Poliak, Management  
708 Third Avenue, New York, NY 10017  
Telephone: 212-370-1100.

### MAIL COUPON TODAY

INFO MANUFACTURING/HI-TECH  
Clapp & Poliak  
708 Third Avenue, New York, NY 10017

Please send \_\_\_\_\_ reduced-rate ticket(s) which requires only a \$5.00 registration fee instead of the regular \$10.00 fee.

Please send \_\_\_\_\_ Conference programs.

Name \_\_\_\_\_ Title \_\_\_\_\_

Company \_\_\_\_\_

Division \_\_\_\_\_

Street \_\_\_\_\_

City \_\_\_\_\_ State \_\_\_\_\_ Zip \_\_\_\_\_

I am interested in exhibiting. My product is \_\_\_\_\_



# ANNOUNCING...

An Indispensable Resource for Marketing, Research and Purchasing Decisions.

NOT AVAILABLE ELSEWHERE

# Microcomputer Review

**Product Reports on Over 800 Microcomputers Spanning All Applications and Price Ranges. Published from the World's Largest On-Line Computer Product Database. Updated Daily.**

Here is what you get with your subscription:

CONTENTS	MICRO-COMPUTERS	CONTENTS	MICRO-COMPUTERS
<b>PRICES</b>		<b>HARDWARE</b>	
Microcomputer Price Index from \$50,000 to \$99 in price descending order . . . . .	820	Board-level Micros . . . . .	90
<b>APPLICATIONS</b>		Box-level Micros . . . . .	150
Business Micros . . . . .	550	System-level Micros . . . . .	400
Process Control Micros . . . . .	190	Desktop system Micros . . . . .	340
Engineering/Scientific Micros . . . . .	270	Portable Micros . . . . .	40
Personal Computing Micros . . . . .	140	Multiuser Micros . . . . .	210
Word Processing Micros . . . . .	290	Micros supporting Hard Disks . . . . .	440
Ruggedized/Military Micros . . . . .	45	Micros and CPU Type . . . . .	820
Special Application Micros . . . . .	85	Micros and Memory Capacity . . . . .	820
<b>SOFTWARE</b>		Micros and Word Size . . . . .	820
Micros supporting BASIC . . . . .	610	Micros with Floating Point . . . . .	155
Micros supporting FORTRAN . . . . .	460	<b>COMMUNICATIONS</b>	
Micros supporting COBOL . . . . .	375	Micros with RS232 Interface . . . . .	510
Micros supporting Pascal . . . . .	405	Micros with IEEE Interface . . . . .	315
Micros and their Operating Systems . . . . .	675	Micros with Special Interfaces . . . . .	280

## PLUS...

This professional reference can save you thousands of dollars in research costs. Over 500 pages of detailed product reports on over 800 microcomputers ranging from board-level micros to supermicro systems. Reports include information on hardware characteristics, interfacing, packaging, communications, peripherals, software, and prices.

Your subscription also includes free, customized on-line searches. This will give you access to *all* the information on our exclusive database. Customized searches can be requested by phone, and provided within 48 hours. **FREE OF CHARGE!**

### ORDER NOW! SAVE \$25 off the \$175 subscription price.

Yes, I would like to subscribe to Microcomputer Review at the special introductory offer. Over 500 pages, in handy loose-leaf binder, updated three times a year and reprinted yearly in its entirety.

Bill my company       Payment enclosed

Name \_\_\_\_\_

Title \_\_\_\_\_

Company \_\_\_\_\_

Address \_\_\_\_\_

City \_\_\_\_\_ State \_\_\_\_\_ Zip \_\_\_\_\_

Signature \_\_\_\_\_

Mail to: **GML Corporation**

594 Marrett Road • Lexington, MA 02173 • (617) 861-0515

Information Services for Professionals

CIRCLE NO. 168 ON INQUIRY CARD



# Software

## NEW PRODUCTS

ry loading to support dual-processor configurations. The ZEX run-time monitor supports any dual-processor system with CP/M-80, and is supplied in source and object form. The package requires 48K bytes of memory. It is available on an 8-in., CP/M-80-formatted, single-density floppy disk for \$395. **Western Wares**, P.O. Box C, Norwood, Colo. 81423. **Circle No 387**

### System generates automatic microcode for VAX-11

Using the Automatic Microcode Generation System, a user can write programs for number-crunching or time-critical algorithms on DEC VAX-11 computers in a FORTRAN-like high-level language and compile the programs into microcode that executes at the

microengine level of the machine. The computer must be equipped with DEC's User Writable Control Store option. AMGS, written in Pascal, is licensed for a one-time charge of \$15,000. **JRS Research Laboratories, Inc.**, 202 W. Lincoln Ave., Orange, Calif. 92665.

**Circle No 388**

### Word processor runs under CP/M

Metatype runs on microcomputers under the CP/M operating system and provides proportional spacing with programmable character widths and boldface printing. Margin justification is achieved by adding spaces between words or between characters. Correct line and page breaks, along with headings and footings, are displayed

for monospacing and proportional spacing print fonts. Freeze and thaw operations isolate the text segment being edited and protect the rest from being changed, and a user can "undelete" text. The original version of the line where the cursor is located can be swapped with the current edited version. Price is \$360. **Amanuensis, Inc.**, R.D. #1, Box 236, Grindstone, Pa. 15442. **Circle No 389**

### FORTH language runs on 68000

Hemenway/FORTH, claimed to be a superset of the FORTH-79 language standard of the FORTH Interest Group, runs on MC68000-based microcomputers with at least 30K bytes of memory under the vendor's MSP/68000 operating sys-

## Solid-State Disc Replacement

Dramatic increases in throughput. Outstanding reliability.

- Capacities to 80 megabytes
- 10 megabytes in 7-inch chassis
- Interfaces to most minicomputers
- Battery back-up



When used as a disc replacement, the high speed, non-rotating MegaRam provides the software compatibility of a disc with the performance of main memory. Ideal for swapping, scratch files, overlay storage, process control, telecommunications, graphics, data acquisition, array processing, etc.

Let us show you how the MegaRam can enhance the performance of your computer while providing outstanding reliability.



**Imperial Technology, Inc.**

831 S. Douglas Street • El Segundo, California 90245 • Telephone: (213) 679-9501

**CIRCLE NO. 169 ON INQUIRY CARD**

## Business supplies from The Professionals

**Off-the-shelf delivery, competitive prices, guaranteed results**

TRW Customer Service Division is one of the largest suppliers of ribbons, cartridges, ink rolls, paper tapes and other materials for business machines and office automation equipment. Our supplies meet or exceed all applicable specifications, and are available from your local TRW Customer Service Division field office.

When you purchase supplies from TRW, you are assured of the best possible materials, along with prompt delivery, competitive prices and guaranteed results. Ask your TRW Customer Service representative for more details, or get in touch with us for a free copy of our comprehensive Ribbon Selection Guide.



15 Law Drive  
Fairfield, New Jersey 07006  
Telephone (201) 575-7110  
Toll-free (except NJ) 800-257-7464

**TRW**

**Customer Service Division**  
TRW Communications Group

**CIRCLE NO. 170 ON INQUIRY CARD**



# Software

## NEW PRODUCTS

tem. Features include 32-bit arithmetic, fast address interpretation, virtual memory with four 1K-byte block buffers and word names as long as 128 characters. Instructions added to the FORTH-79 complement provide manipulation of 32-bit numbers, an exit to the operating system and calls to set and retrieve the Julian date and time. Prices begin at \$115, with quantity discounts available. **Hemenway Corp.**, 101 Tremont St., Boston, Mass. 02108. **Circle No 390**

### Tool kit aids program development on HP 9845

The ROM-based Programmer's Tool Kit for HP 9845B/C desk-top computers aids in program development, debugging and creation of documentation. Editor commands

change identifier names, find specific information, copy and move text and renumber lines of code. Utilities generate memory maps, remove unwanted symbols and comments from programs and provide cross-reference listings. Program statements and functions can be invoked to show the amount of remaining memory; perform decimal-to-binary and decimal-to-hexadecimal conversion; and store, print and display lines of BASIC programs. Price is \$1500. **Structured Software Systems, Inc.**, Box 1072, Irick Rd., Mount Holly, N.J. 08060.

**Circle No 391**

### 68000 cross-assembler runs on VAX, PDP-11

This cross-assembler, said to be compatible with Motorola's 68000-

resident assembler, runs on DEC VAX-11 computers under the VMS or UNIX operating systems and on PDP-11s under RSX-11M. The package contains a relocatable assembler, linker, object module librarian and cross-reference utility. Features include conditional assembly, macro processing, INCLUDE facilities, command files that accept multiple input files and pseudo operations. A virtual-memory management capability permits creation of very large symbol tables; symbols can be as long as 30 characters. A permanent license sells for \$3000, and maintenance is \$300 per year. OEM distributor discounts are available. **Oasys, Inc.**, 60 Aberdeen Ave., Cambridge, Mass. 02138.

**Circle No 392**

## Single Board Computer



**6 MHz  
Z80**

### DSB-4/6 is Fast, Powerful and Compact

- 4 MHz Z80-A\* or 6 MHz Z80-B\* Processor and I/O
- Full DMA for Both 5 1/4-inch and 8-inch Disk Drives
- High Speed Bi-directional Parallel Port
- 4 RS-232 Serial Ports (110-38,400 baud)
- Centronics Type Parallel Printer Port
- 64K of RAM and 2K of ROM

**Davidge Corporation**  
1951 Colony Street, Suite X  
Mountain View, CA 94043  
(415) 964-9497

\* Z80 is a registered trademark of Zilog

## TERMINALS FROM TRANSNET

PURCHASE PLAN • 12-24 MONTH FULL OWNERSHIP PLAN • 36 MONTH LEASE PLAN

DESCRIPTION	PURCHASE PRICE	PER MONTH		
		12 MOS.	24 MOS.	36 MOS.
<b>* DEC</b>				
LA34 DECwriter IV Forms Ctrl. ....	\$1,095	\$105	\$ 58	\$ 40
LA100 Letter Printer RO .....	1,995	190	106	72
LA120 DECwriter III KSR .....	2,295	220	122	83
LA120 DECwriter III RO .....	2,095	200	112	75
LA12A Portable DECwriter .....	2,950	280	155	106
VT100 CRT DECscope .....	1,695	162	90	61
VT101 CRT DECscope .....	1,195	115	67	43
VT125 CRT Graphics .....	3,295	315	185	119
VT131 CRT DECscope .....	1,745	167	93	63
VT132 CRT DECscope .....	1,995	190	106	72
VT18XAC Personal Computer Option	2,395	230	128	86
<b>TEXAS INSTRUMENTS</b>				
T1745 Portable Terminal .....	1,595	153	85	58
T1765 Bubble Memory Terminal ..	2,595	249	138	93
T1940 CRT .....	1,795	173	96	65
T1785 Portable KSR, 120 CPS .....	1,795	173	96	65
T1787 Portable KSR, 120 CPS .....	2,195	211	117	80
T1810 RO Printer .....	1,695	162	90	61
T1820 KSR Printer .....	2,195	211	117	80
<b>LEAR SIEGLER</b>				
ADM3A CRT Terminal .....	595	57	34	22
ADM5 CRT Terminal .....	645	62	36	24
ADM32 CRT Terminal .....	1,165	112	65	42
<b>C-ITOH</b>				
CIT-101 CRT .....	1,525	147	82	55
CIT-161 Color CRT .....	2,675	257	143	97
CIT-427 Color Graphic CRT .....	3,095	297	165	112
<b>TELEVIDEO</b>				
910 CRT Terminal .....	650	62	36	24
925 CRT Terminal .....	850	82	46	31
950 CRT Terminal .....	1,075	103	57	39
<b>NEC SPINWRITER</b>				
Letter Quality, 7715 RO .....	2,695	259	144	98
Letter Quality, 7725 KSR .....	3,195	307	171	115
<b>GENERAL ELECTRIC</b>				
2030 KSR Printer 30 CPS .....	1,195	115	67	43
2120 KSR Printer 120 CPS .....	2,195	211	117	80
<b>EPSON</b>				
MX-80 F/T Printer .....	745	71	42	27
MX-100 Printer .....	895	86	48	32
<b>TIMEPLEX</b>				
E0400 4 Channel Stat Mux .....	1,525	147	82	55
E0800 8 Channel Stat Mux .....	2,050	197	110	74

\*DEC is the trademark of Digital Equipment Corporation

FULL OWNERSHIP AFTER 12 OR 24 MONTHS • 10% PURCHASE OPTION AFTER 36 MONTHS

### MICROCOMPUTERS

APPLE • COMMODORE • HP87 • DEC

### ACCESSORIES AND PERIPHERAL EQUIPMENT

ACOUSTIC COUPLERS • MODEMS • THERMAL PAPER • RIBBONS • INTERFACE MODULES • FLOPPY DISK UNITS



**TRANSNET CORPORATION**  
1945 ROUTE 22 • UNION, N. J. 07083 • (201) 688-7800  
TWX 710-985-5485 800-526-4965 OUTSIDE N. J.



# A WORD TO THE WISE.

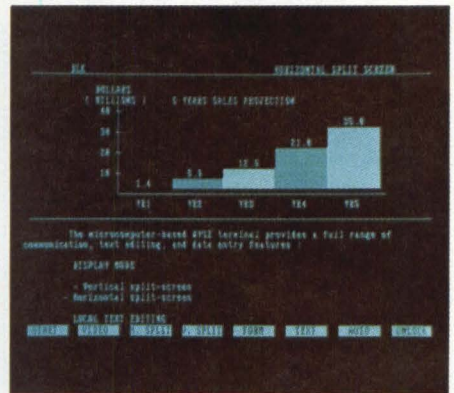
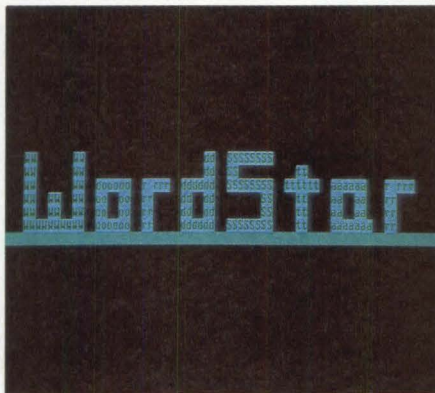
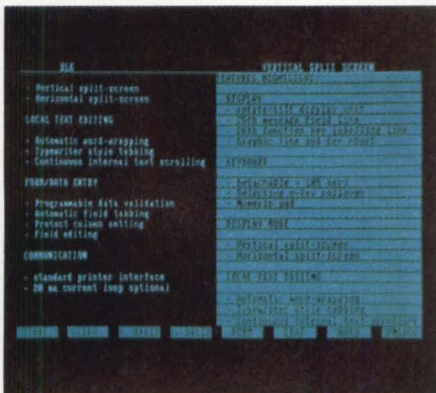
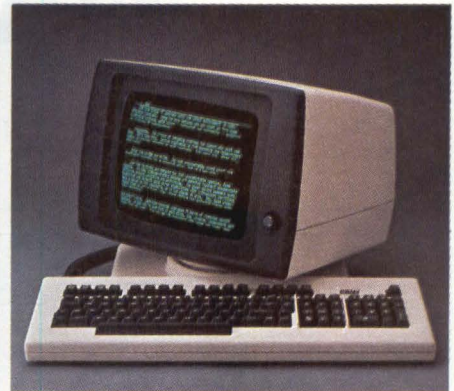
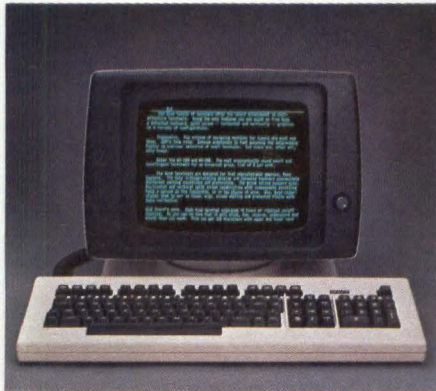

## No one gives you more in an ergonomically engineered smart terminal than Wyse.

These days there's little room for waste of the corporate dollar. And these days the WY-100 smart terminal looks even better when you compare it to the other guys.

You definitely get more from Wyse — the leader in low-cost, high-performance, ergonomically engineered smart terminals.

To begin with, you get a great looking terminal that features die cast aluminum packaging and takes up a minimum of desktop space.

You also get a terminal with an uncanny way of pleasing people. It comes with an easy-on-the-eyes green phosphor screen. And a fully tilting/rotating display and detached keyboard. (After all, one person's just-right-tilt is another's not-quite-right-tilt).

When the workload seems impossible, horizontal and vertical split screen capabilities with independent scrolling allow you to be in two places at once.

There's more. You get programmable function keys and transparent print. Plus 128 characters with upper and lower case, line drawing and graphics, and a keyboard with 105 keys — including cursor pad, special mode and function keys.

Of course, all of this wouldn't mean much if you couldn't count on Wyse quality. That's why each WY-100 is put through an extensive on/off testing program.

On top of that, WordStar® and other emulations are now available from your distributor. Which means you can automatically get 32 of WordStar's most commonly used multi-key commands fully-implemented on our function keys for faster, easier use.

We think you'll be quite impressed when you compare the WY-100 to other terminals in its class. But don't take our word for it. Call or write us today. We'll send you detailed information on why the WY-100 smart terminal gives you more. A lot more.



**WYSE**  
TECHNOLOGY

3040 North First St., San Jose, CA 95131  
(408) 946-3075 TLX 910-338-2251  
In the East, call (516) 293-5563  
**Outside California, 800-538-8157 ext. 932**  
**Inside California, 800-672-3470 ext. 932**

WordStar is a registered trademark of MicroPro, Inc.  
UL and FCC approved. ©1982 Wyse Technology, Inc.



# Mini-Micro MARKETPLACE

A special section for advertisers of hardware, software and services.

**READERS:** Please circle reader service numbers for additional information.

## Hardware

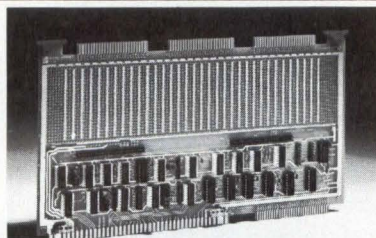

### MULTIBUS™ INTERFACE & PROTOTYPE

Prototype QUICKLY and EASILY. 100% of Multibus interfacing circuitry included. 20-bit Address, 8/16-bit Data. Delivery from stock.

Multibus™ Intel Corp. Model # PR 80A  
Price: \$355 each

#### ELECTRONIC SOLUTIONS

5780 Chesapeake Ct.  
San Diego, CA 92123

Toll Free (800) 854-7086

In California (619) 292-0242

TLX 910-335-1169

MULTIBUS PROTOTYPE WITH INTERFACE  
CIRCLE NO. 201 ON INQUIRY CARD

## \$73.80\*

### Single Board Computer

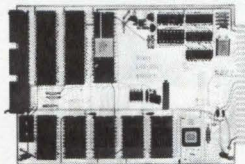

\* 100 piece price, model MCL41

6800 MPU, serial I/O, parallel I/O, RAM, EROM, 44-pin 4 1/2" x 6 1/2" PCB

#### EXPANSION MODULES

RAM, ROM, CMOS RAM/battery, analog I/O, serial I/O, parallel I/O, counter/timer, 488 GPIB, EROM programmer, power fail detect/power on reset



Wintek Corp.  
1801 South Street  
Lafayette, IN 47904  
317-742-8428

CIRCLE NO. 202 ON INQUIRY CARD

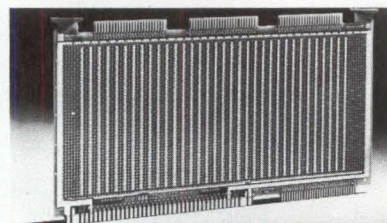

### MULTIBUS™ PROTOTYPING BOARD

Prototyping Board for Multibus™ systems has locations for up to 85 PIN-DIP IC's plus discrete components. The layout is on a grid of 0.1" holes, with bus strips individually strappable to any desired voltage.

Multibus™ Intel Corp. Model # PR 80H  
Price: \$85 each  
(Qty 1-9)

#### ELECTRONIC SOLUTIONS

5780 Chesapeake Ct.  
San Diego, CA 92123

Toll Free (800) 854-7086

In California (619) 292-0242

TLX 910-335-1169

#### PROTO BOARD

CIRCLE NO. 203 ON INQUIRY CARD

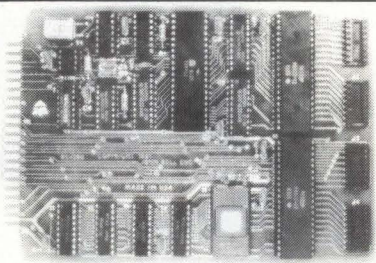

"SLIM" 81-260, Single board Large scale Integration Microcomputer. This 4.5 x 6.5 board uses the 6502 Microprocessor, two 6522 VIA's, 2K of RAM, 2K or 4K EPROM. The fully buffered 44 pin bus is similar to the AIM bus.

An EPROM (2532) with Monitor and Tiny Basic is available.

Single unit price \$199.95

OEM Pricing available.

**JOHN BELL ENGINEERING, INC.**  
1014 Center St., San Carlos, CA 94070  
(415) 592-8411

CIRCLE NO. 204 ON INQUIRY CARD

## THE INDOOR MULTIPLEXER

## \$495

- Eight channel capacity
- Completely transparent up to 9600 bps for each channel
- No modem needed: 2000 ft. distance between muxes
- Free 30 day trial

**SOLANA  
ELECTRONICS**

249 SOUTH HIGHWAY 101  
SOLANA BEACH, CA 92075 (714)/481-6384

CIRCLE NO. 205 ON INQUIRY CARD

## EDGE-86 AN INDUSTRIAL QUALITY 8086 OEM SYSTEM

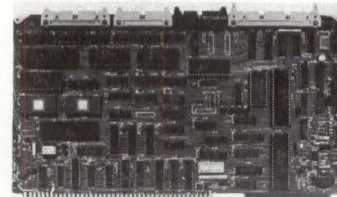

#### • HARDWARE

- A Multibus® COMPATIBLE 8086 CPU BOARD WITH DMA FLOPPY CONTROLLER, INTERRUPT CONTROLLER, PROGRAMMABLE TIMERS, 3 SERIAL PORTS, TWO PARALLEL I/O PORTS, AND 8K BYTES OF PROM WITH BOOT STRAP LOADER FOR CPM/IB8™.
- 128K BYTES DYNAMIC RAM BOARD.
- 4-SLOT MULTIBUS CARD CAGE, WITH COMPLETE DOCUMENTATION AND SCHEMATICS; ALL FOR.....\$1250.

#### • SOFTWARE

- CPM/86 O.S. WITH COMPLETE UTILITIES... \$250.
- OFF THE SHELF DELIVERY—

#### EDGE MICRO SYSTEMS

195 W. EL CAMINO REAL, SUNNYVALE, CA 94086  
TELEPHONE: 408-738-4729

\* Multibus™ of Intel,™CPM/IB8™ of Digital Research.

CIRCLE NO. 206 ON INQUIRY CARD



# Computer Discounts

## Printers, Terminals, Modems, Systems

All Major Brands • Best Prices  
We back-up everything we sell!!!

- Signalman MK1 or MK2 \$87.69
  - Okidata Microline 80 \$335.95
  - Hazeltine Esprit \$\$ call \$\$
- We have Kaypro II in stock now!!!

**KOPAK Creations, Inc.**  
d/b/a Computer Discount Services  
Radio City Station /P.O. Box 1076  
New York, NY 10019  
(212) 757-8698, 757-9774

DEPT MMS-2

CIRCLE NO. 207 ON INQUIRY CARD

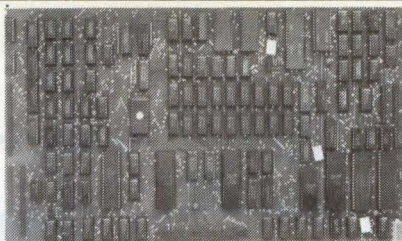

### CP/M Z80-A SINGLE BOARD COMPUTER

- On board video • Wide line and thin line graphics
- 128K of RAM • Sasi interface • Floppy disk controller for up to four 5-1/4 and four 8 inch drives, single/double density simultaneously • 4 serial ports • Full Centronics printer port • Expansion bus • Extended track buffer • 16K printer buffer
- DMA • Compact size (8-1/4 x 12-1/4)

**\$600.00** on orders placed and paid for prior to March 1, 1983 FOB Los Angeles, CA \$7.00 shipping

INSIGHT ENTERPRISES, CORPORATION  
373 N. Western Ave., Suite 12,  
Los Angeles, CA 90004 (213) 461-3262 **IEI**  
Dealer, OEM, International Inquiries Welcome

CIRCLE NO. 208 ON INQUIRY CARD



### PORTABLE VDT EMULATOR

The **TransTerm 2** has a single line 80 character LCD display, 24 line buffer, 58 key membrane keyboard and communicates in RS-232 serial asynchronous ASCII with 20 ma C/L or RS-422 optional. Half/full duplex, 8 baud rates and parity are switch selectable. Display supports 96 char. upper/lower case ASCII with cursor and audible bell code. Powered by 115VAC or 8-16 VDC.

## COMPUTERWISE, INC.

4006 E. 137th Terrace  
Grandview, Missouri 64030  
(816) 765-3330

CIRCLE NO. 209 ON INQUIRY CARD

## Our Winchester Disk Repair Commitment:

Meet or exceed the manufacturer's specs *without exception* – or you don't pay!

Examples:

- Shugart SA 1000
- Memorex 601, 3650, 3652
- IBM 3344, 3350
- Others



**DataMemory**  
CORPORATION  
6750 Elon Avenue, Canoga Park, Ca. 91303  
(213) 704-9500 Telex: 194561 LSA

CIRCLE NO. 210 ON INQUIRY CARD

## Instant Software Solutions

**MAGIC/L . . .** the interactive programming environment that blends Pascal-like syntax with Forth-like extensibility, will optimize your productivity.

- Ideal for hardware development, graphics, and robotics
- Includes software toolbox with interactive assembler
- Available for DEC, DG, and 68000-based systems

For more information call (617) 653-1120.



**LOKI**  
**ENGINEERING,**  
**INC.**  
P.O. Box 123 Wayland, MA 01778  
(617) 653-1120

CIRCLE NO. 211 ON INQUIRY CARD

## CROSS SOFTWARE FOR MICROPROCESSORS

COMPILERS – PASCAL & C  
ASSEMBLERS & META-ASSEMBLERS  
LINKING LOADERS – LIBRARIANS  
INTERACTIVE SIMULATORS

- |      |       |      |       |        |                   |
|------|-------|------|-------|--------|-------------------|
| 8048 | 6800  | 1802 | 6500  | F8     | • Portable        |
| 8051 | 6801  | 1804 | Z8    | 3870   | • Affordable      |
| 8080 | 6805  | 1806 | Z80   | Others | • Compatible      |
| 8085 | 6809  | 2900 | Z8002 |        | • Professional    |
| 8086 | 68000 | 2901 | 2650  |        | • Source Licenses |
- These programs written in Pascal and Fortran. will run on most mini and mainframe computers.

for more information, contact:

### microleo

505 W. Olive Ave., Suite 325  
P.O. Box 60337  
Sunnyvale, California 94086  
Phone:(408) 733-2919 TLX: 4990808  
CIRCLE NO. 212 ON INQUIRY CARD

## ORDER FORM

Advertise in the **MINI-MICRO MARKETPLACE**  
Please run my advertisement in the following issues

Please specify category:

- Software  Hardware  
 Literature  Services  
 Other \_\_\_\_\_

### 1983 RATES

1x	3x	6x	12x	18x
\$560	\$540	\$520	\$500	\$480

### MATERIALS

- Glossy photo with 50-75 words.  
We will typeset your ad at no charge.
- Camera ready artwork.
- Film negatives: right reading emulsion side down.

AD SIZE: 2 1/4" x 3 1/16"

COMPANY \_\_\_\_\_

ADDRESS \_\_\_\_\_

CITY \_\_\_\_\_

STATE \_\_\_\_\_

ZIP \_\_\_\_\_

TELEPHONE \_\_\_\_\_

SIGNATURE \_\_\_\_\_

Space reservation by the first week of the month proceeding issue date.

- Materials enclosed  Materials to come  Please send information

Send to: Lorraine Marden, **MINI-MICRO SYSTEMS**  
221 Columbus Ave.  
Boston, MA 02116

15% Agency commission to accredited agencies. Please specify agency.



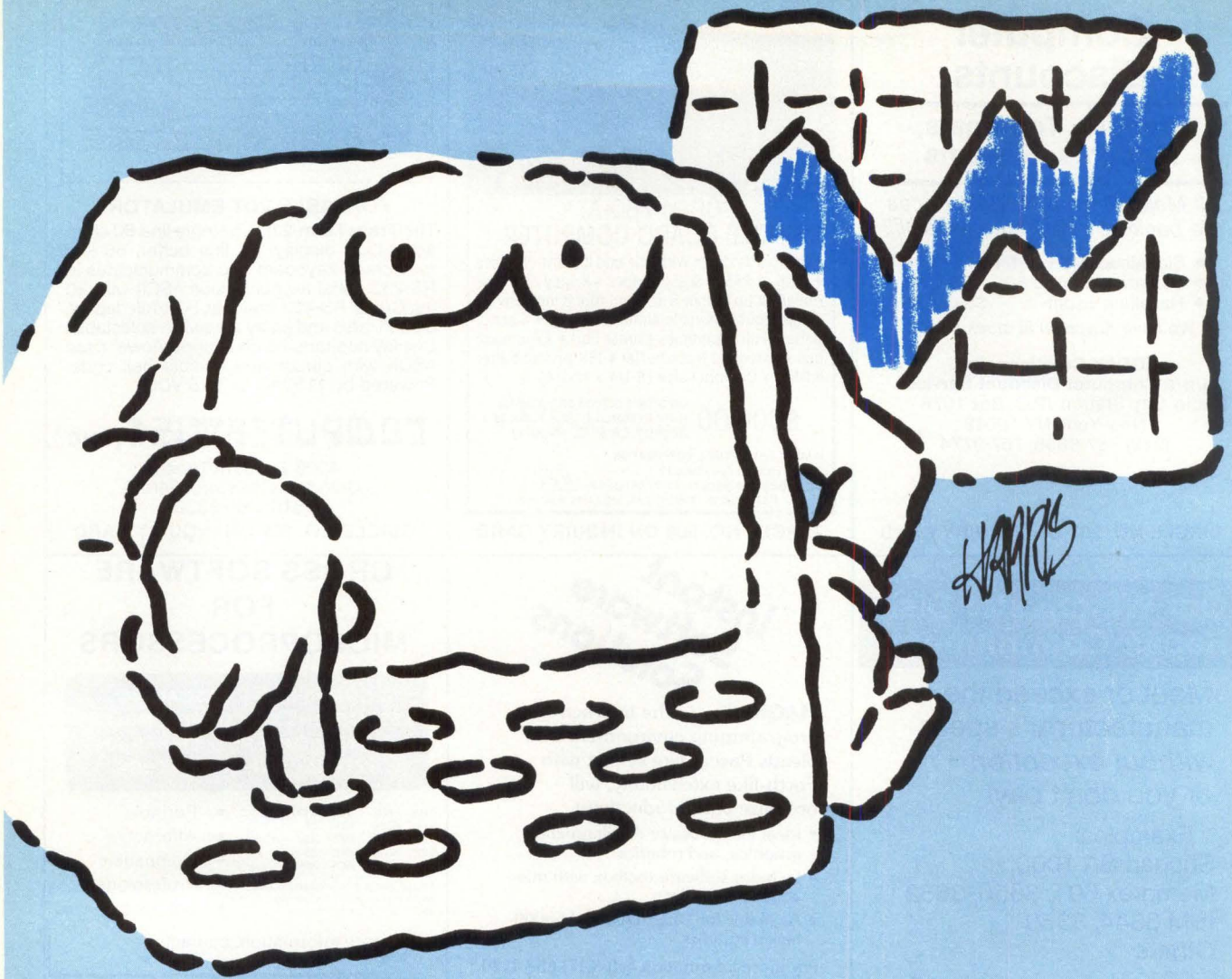

# The Business Computer

*Business Computer Systems* is the first publication to view the business computer market as a whole—not just a microcomputer market, not just a personal computer market, not just a small computer market—but all of these when used in business applications.

The business computer is more likely to be upgraded with addi-

tional capacity, peripherals and software and to require more services and supplies than any other computer.

Whether you market hardware, software, services or supplies, it's clear that your biggest market is the business computer market, and your ideal medium for reaching this market is *Business Computer Systems*.

**Business Computer Systems—Our circulation is the market**

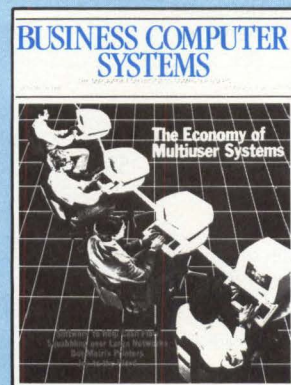

Boston-(617) 536-7780; Chicago-(312) 635-8800; Dallas-(214) 980-0318;  
Denver-(303) 388-4511; New York/Mid-Atlantic-(215) 293-1212;  
Southeast-(215) 293-1212; Southern California-(714) 851-9422;  
San Francisco-(408) 243-8838



# Literature

## NEW PRODUCTS

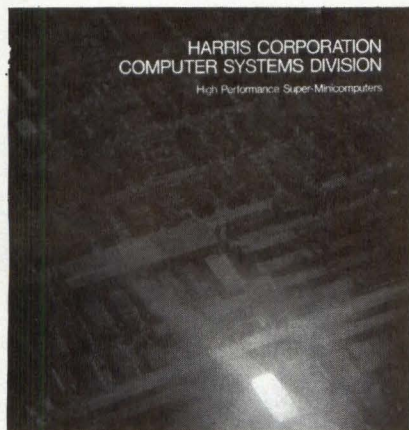

### Brochure describes line of CPUs

A line of superminicomputers is described in an illustrated, four-color brochure. The eight-page brochure has three sections. The architecture section explains the system's bus structure, pipeline processing and floating-point processors. The section on memory describes cache, virtual and shared memory. The third section is on I/O and explains the vendor's communications network processor. **Harris Corp., Computer Systems Division**, 2101 W. Cypress Creek Rd., Fort Lauderdale, Fla. 33309.

Circle No 393

### Data sheet details power supplies

A two-page, two-color data sheet describes the KRL series of single-output, 20W and 40W switching power supplies. The data sheet includes I/O specifications, dimensional drawings, product photos and one- to nine-unit quantity pricing. **KEC Electronics, Inc.**, 20817 Western Ave., Torrance, Calif. 90501.

Circle No 394

### Data sheet explains modem's features

A data sheet on the v.29 Plus Multiport modem describes the product, its applications and its specifications. The data sheet notes

that the v.29 Plus contains a time division multiplexer that accepts input from as many as four synchronous or asynchronous channels, with aggregate speeds as high as 9600 bps. Features such as front-panel programming and down-line loading of all parameters are also described. **Timeplex, Inc.**, One Communications Plaza, Rochelle Park, N.J. 07662.

Circle No 395

### Brochure describes telecommunications terminals

The Micronet 20 and 25 telecommunications terminals are described

in a color brochure. Based on the 6809 CPU, the Micronet 20 has two ports that can be configured from the keyboard for TWX, Telex, DDD (110 to 1200 baud) or IRC Telex. The Micronet 25 is identical, but has built-in single or dual 5¼-in. floppy diskettes that add 160K or 320K bytes of mass storage. The brochure also details the terminals' other features including archival RAM, EEPROM, keyboard programmability and integrated electronic diagnostics. **Sidereal Corp.**, 9600 S.W. Barnes Rd., Portland, Ore. 97225.

Circle No 396

## LITERATURE THAT COSTS

### Security guide lists product information

The 130-page *Who, What and Where in Communications Security* users' guide on voice- and data-communications security and its 58-page 1982 update contain information on the issues involved in designing a communications security system with information about products and their vendors. A product matrix section lists 39 national and international vendors offering 185 products and contains information on product capabilities, encryption algorithm, key management schemes, sales outlets, manufacturing facilities and telephone numbers. The publication also lists more than 500 terms with definitions and 200 acronyms used in security. Price of the directory and its update is \$75. **Marketing Consultants International, Inc.**, 100 W. Washington St., Hagerstown, Md. 21740.

Circle No 397

### CP/M Software Index lists 1688 programs

The third edition of the *CP/M Software Index* lists 1688 professionally supported programs offered by 507 vendors. A brief description, the vendor's name, address and phone number, the price and operating system versions are shown for each package. All indexed programs are available for the CP/M-80 opera-

ting system, and many are also available under CP/M-86, MP/M-80, MP/M-86 and Concurrent CP/M-86. The index is organized into system programs, general applications, accounting applications, utility applications and industry-specific software areas. These areas are broken into 89 categories. Single copies of the index are priced at \$10. **Small Systems Group**, Box 5429, Santa Monica, Calif. 90405.

Circle No 398

### Standard defines terms for microcomputers

JEDEC Standard No. 100, an updated version of JEDEC Publication No. 100, defines "cache memory," "virtual memory," "address," "branch," "buffer," "bus," "compiler," "diagnostic program," "firmware," "machine cycle," "multiprocessing," "polling," "utility program" and other terms. A section addresses the needs of the microcomputer industry in the area of timing intervals. It shows how the dynamic parameters for microcomputers and memories can be represented in symbolic forms with little ambiguity. Examples of the meaning and use of these terms and symbols are provided. Copies of JEDEC Standard No. 100, a 42-page document, are priced at \$12 each. **Standards Sales Office, Electronic Industries Association**, 2001 Eye St., N.W., Washington, D.C. 20006.

Circle No 399



# NCGA '83 CONFERENCE & EXPOSITION

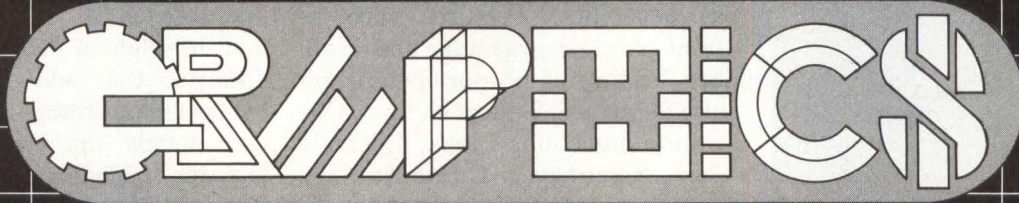

## AT WORK

In five days you can find out how to move years ahead in your field at the National Computer Graphics Association's 1983 Conference and Exposition, Graphics at Work.

From June 26-30, NCGA will bring the foremost experts in nearly every application of computer graphics together with over 200 exhibitors in the 300,000 square foot exhibit hall of McCormick Place in Chicago. The result will be five days packed with the knowledge and the technology to move you ahead—years ahead—in productivity, accuracy, creativity and profitability.

### WE PUT GRAPHICS TO WORK FOR YOU

NCGA '83 is designed to show you how to do more work, faster and better, with computer graphics. And that means you save time and money.

Whether you're a beginner or an expert in this dynamic field there's always something new. And we'll have it at NCGA '83.

Our technical sessions and tutorials will take you to the leading edge of technology. More than 65 sessions are offered covering current topics in  
Architectural CADD  
Biomedical Graphics  
Business and Scientific Graphics  
Defense Automation

Educational CAD/CAM  
Legal Issues in Computer Graphics  
Mechanical CAD/CAM  
Pattern Recognition and Image Processing  
Printing and Publishing  
Scientific Cartography  
Shipbuilding CAD/CAM  
Statistical Graphics  
Videotechnology  
Visual Arts and Design

### SEE GRAPHICS AT WORK AT THE SHOW

See the state-of-the-art, and beyond, in computer graphics technology for nearly every application. Talk with representatives of more than 200 premier worldwide marketers of computer graphics technology. Learn how their prod-

ucts can help you work smarter and easier with better results.

### IT'S A WHOLE NEW WORLD

This is the pacesetter. NCGA '83 is the largest U.S. conference devoted exclusively to computer graphics applications. It's the only such event selected to participate in the Foreign Buyers Program sponsored by the U.S. Department of Commerce. People from all over the world are coming. Don't you miss it.

### NCGA '83

... Five stimulating days designed to make your job more productive, more rewarding—with computer graphics at work!

### I WANT TO SEE GRAPHICS AT WORK AT NCGA '83

Call or write today to:  
NCGA/MM  
8401 Arlington Blvd.  
Fairfax, VA 22031  
(703) 698-9600

Please rush me registration information on the NCGA '83 Conference and Exposition

I cannot attend, but I would like to receive information about the National Computer Graphics Association



National Computer  
Graphics Association

Name \_\_\_\_\_

Address \_\_\_\_\_

City \_\_\_\_\_

State \_\_\_\_\_

Zip \_\_\_\_\_



# Classified Ads

## PUBLICATIONS

### Exclusively **UNIX\* & C** Information

That's **UNIQUE™**, the oldest and largest independent journal covering the **UNIX\*** and **C** marketplace.

- product reviews/listings/applications
- industry inside information/tutorials

Full year, \$54 (\$66 foreign) - write or call for full brochure and **FREE** sample copy.

#### InfoPro Systems

Dept. MM11 • Box 33 • E. Hanover, NJ 07936  
(201) 625-2925

\*UNIX is a trademark of Bell Laboratories

Formerly *The UNIX Software List*

CIRCLE NO. 231 ON INQUIRY CARD

## HARDWARE

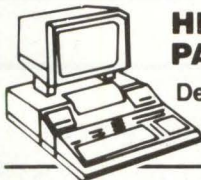

### HEWLETT PACKARD

Desktop & Mini  
Computer  
Products

#### SAVINGS ALL MODELS

9845B/C HP 85 Non-HP memory  
9836A 9826A and peripherals

CALL OR WRITE FOR FREE CATALOG

### digital resources inc.

Box 23051 Portland, OR 97223 USA  
503-246-0202  
International Sales Telex 360-143

CIRCLE NO. 232 ON INQUIRY CARD

## Copy Deadline:

Space reservations and advertising copy must be received by the 10th of the month preceding the issue date. Camera-ready mechanicals must be received by the 15th of the month preceding the issue date. For example, to appear in the February issue, copy must be received by January 10; mechanicals by January 15.

## BUYING

### WANTED TO BUY

Data relating to floppy disk directories and disk layout to be able to "re-create" a blown disk. Interest in Personal Computers, Word Processors, ETC. Contact Bill Ott:

#### ADC

14272 Chambers Road, Tustin, Cal. 92680  
(714) 731-9000

if you have any articles, books or your own documentation.

## SOFTWARE

### ISIS — CP/M®

CP/M users may transfer data bi-directionally to ISIS diskettes. The "ISIS-CP/M UTILITIES" provide complete high speed data transfer to/from ISIS diskettes to/from CP/M diskettes and also include a utility to display the ISIS directory. Will work in any version CP/M environment with any density drive.

\$250 on single density 8" diskette. Free brochure on other software development tools.

#### Southern Computer Systems

2304 12th Avenue North  
Birmingham, AL 35234  
Phone: 205-933-1659

*CP/M® is a registered trade mark of Digital Research. ISIS is a trade name of Intel Corp.*

CIRCLE NO. 233 ON INQUIRY CARD



This space should be  
working for you.

For details call: Linda Lovett  
(617) 536-7780

## SOFTWARE

### IBM SERIES 1 SOFTWARE

Vehicle maintenance with:  
Parts Inventory  
Purchase Order Requisition

Automated Office System with:  
Electronic Mail  
Text Processing

For information contact:

**P&O Falco, Inc.**  
ATTN: Data Processing-C86  
P.O. Box 108  
Shreveport, LA 71161  
1-318-746-7441 Ext. 266  
1-800-551-8680 Ext. 266

CIRCLE NO. 234 ON INQUIRY CARD

**MicroPERT™**  
Project Management  
for Tektronix, IBM PC  
For information, call or write  
**SHEPPARD SOFTWARE COMPANY**  
4750 Clough Creek Rd.  
Redding, CA 96002  
(916) 222-1553

CIRCLE NO. 235 ON INQUIRY CARD

## CLASSIFIED ADVERTISING ORDER FORM

Mini-Micro Systems classifieds reach more mini-micro people

### Rates: \$80.00 per column inch

There is no charge for typesetting classified listings. Plan approximately 50 average words to a column inch, 8 lines of approximately 38 characters per line (3 inch maximum). Please send clean typewritten (double-spaced) copy.

**Category:** The following categories are available; be sure to specify the category you wish to be listed under: Business Opportunities, New Literature, Selling, Buying, Trading, Seminars, Services, Software, Supplies & Accessories. (Other categories may be employed at our discretion.)

Run this ad in \_\_\_\_\_ (number issues) Reader Inquiry No. YES  NO   
Ad size 1 col. wide by \_\_\_\_\_ inches deep Under \_\_\_\_\_ (category)  
Check enclosed for \$ \_\_\_\_\_ (Pre-paid orders only)

Signature \_\_\_\_\_

Name \_\_\_\_\_ Title \_\_\_\_\_

Company \_\_\_\_\_ Telephone No. \_\_\_\_\_

Address \_\_\_\_\_

City \_\_\_\_\_ State \_\_\_\_\_ Zip \_\_\_\_\_

MAIL TO: Linda L. Lovett, Classified Advertising, Mini-Micro Systems,  
221 Columbus Ave., Boston, MA 02116



# Mini-Micro Systems

## Career Opportunities/Recruitment Advertising

### 7-Day Closing

(Prior to Issue Mailing Date)

### Rates

\$90 per column inch.  
Column width 1 3/4" x 10" (4-column/page).  
Full page: \$3,390 (1 x B&W).

### Circulation

Over 95,000 technically sophisticated professionals in computer operations/systems management, data communications, engineering management, systems engineering/integrators, educators and systems programming specialists.

Recruitment  
Hot Line

**(203) 964-0664**

Call your ad in—  
we'll set the type  
at no charge.

Mail Film to:

**Stuart Tilt**  
Recruitment Manager  
**CAHNERS PUBLISHING CO.**  
999 Summer St.  
P.O. Box 3809  
Stamford, CT 06905

OPENINGS FOR ENGINEERS  
& other degreed professionals.  
Send resume to:



**Scientific Placement, Inc.**

P.O. Box 19949 • Dept. 538  
Houston, TX 77224  
713/496-6100



**THE  
ACCESS  
GROUP, INC.**

Career opportunities available nationwide for engineering professionals skilled in design, development and manufacturing. Confidential search conducted by degreed engineers. Positions fee paid. Free resume service.

Call or write for a free career/salary guide.

**Northeast** 179 Allyn Street,  
Hartford, CT 06103  
(203) 527-9107  
**NY/Mid-Atl/SE** Box 3267,  
Stamford, CT 06905  
(203) 356-1166

**SW/West/  
Mid-West** P.O. Box 18302,  
Las Vegas, NV 89114  
(702) 644-3328

Affiliate offices in 120 cities  
nationwide.

### EMPLOYMENT SERVICE FOR PROGRAMMERS AND ANALYSTS

National Openings With Client Companies  
and Through Affiliated Agencies

Scientific and commercial applications • Software development and systems programming • Telecommunications • Control systems • Computer engineering • Computer marketing and support.

Call or send resume or rough notes of objectives, salary, location restrictions, education and experience (including computers, models, operating systems and languages) to either one of our locations. Our client companies pay all of our fees. We guide, you decide.

**RSVP SERVICES, Dept. MM**  
Suite 700, One Cherry Hill Mall  
P.O. Box 5013  
Cherry Hill, New Jersey 08034  
(609) 667-4488

**RSVP SERVICES, Dept. MM**  
Suite 211, Dublin Hall  
1777 Walton Road  
Blue Bell, Penna 19422  
(215) 629-0595

#### RSVP SERVICES

*Employment Agents for Computer Professionals*

#### ELECTRONIC

DESIGN (EE/ME) PROGRAMMERS  
PRODUCTION QUALITY/TEST  
TECHNICIANS TECH WRITERS

#### ENGINEERS

Our clients...leading national electronic firms...cover the entire spectrum of advanced technologies. Current career opportunities exist at all levels of responsibility and compensation.

FORWARD RESUME TO...**IMR**  
18582 Marion Way, Suite 502  
Villa Park, CA, 92667

ALL FEES ASSUMED BY CLIENT  
COMPANIES WE RESPOND TO EVERY  
RESUME

CIRCLE NO. 236 ON INQUIRY CARD

More and more advertisers of minicomputers, microcomputers, CRT terminals, printers, disk drives, memories, modems, distributed data processing systems, etc., are consistently turning to **MINI-MICRO SYSTEMS**. Call **Stuart Tilt** at **203-964-0664**.



# You may know us.

We're involved in all aspects of software, hardware, and systems engineering for communications systems.

We're Computer Sciences Corporation.

If your talents, skills, and education encompass program management, communications systems engineering or computer processing systems, get to know us better.

At the Systems Division of CSC, our communications systems activities involve jobs on a world wide basis — from the subway in Washington, D.C. to the oilfields of Saudi Arabia. Our involvement in data communications and telecommunications range from small, local-area-networks in support of office automation to massive, world wide packet-switching systems.

We have built and designed communications systems that involve the most advanced technologies including PROTOCOLS, TRANSMISSION SUBSYSTEMS, HARDWARE, SOFTWARE, SECURITY AND ANALYSIS. And the application of our communications expertise spans a wide variety of applications including: LARGE SCALE NETWORKS, INDUSTRIAL AUTOMATION, MASS-TRANSIT AUTOMATION and VOICE COMMUNICATIONS.

Opportunities for career advancement exist for experienced professionals and entry-level personnel in all areas of our communications systems activities.

We're the Systems Division of Computer Sciences Corporation.

**The problem solvers. Talk to us.**

Computer Sciences Corporation  
Systems Division  
6565 Arlington Boulevard (MM-2)  
Falls Church, VA 22046

An Equal Opportunity Employer

**CSC**

COMPUTER SCIENCES CORPORATION

# Get to know us better.

CIRCLE NO. 237 ON INQUIRY CARD

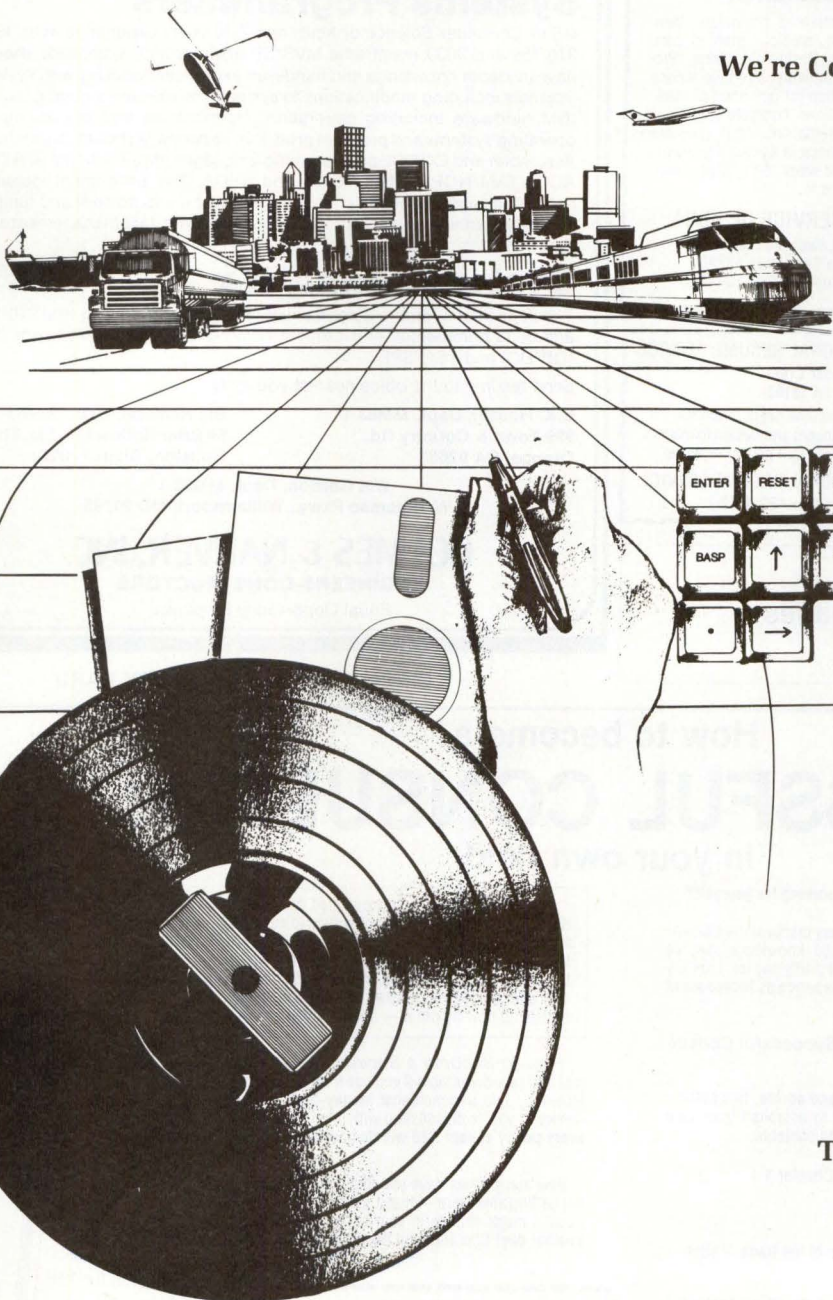



**Present  
Your Products  
To Your  
Marketplace  
Using Our  
Creativity**

Hardware - Software  
-Communications

High technology marketing  
services at realistic prices to  
create a cost effective return  
on investment.

Pro-Spectrum 

P.O. BOX 74  
SPRING VALLEY  
OHIO 45370-0074  
(513) 885-4589

**ENGINEERS/SOUTHEAST**  
Our 12 Offices in NC, SC, GA and FL  
specialize in Control Systems, In-  
strumentation, Electronic Design  
and Engineering positions from 18  
to 40K. Aggressive, confidential.  
Fee Paid service. Send resume to  
Ted F McCulloch, BEALL PERSON-  
NEL P.O. Box 5042, Spartanburg,  
SC 29304.

**MEDICAL SYSTEMS  
DESIGNER**

Computer oriented physician. Iden-  
tify, analyze, medical oriented com-  
puter needs. Design algorithms. Pro-  
duce, test software. Produce techni-  
cal information for operation of medi-  
cal applications computers. Design  
related presentations. M.D. plus one  
year experience in systems analysis.  
40 hours per week, \$11.50 per hour.  
Send resume to:

**JOB SERVICE OF IOWA**  
1810 Lower Muscatine Rd.  
Iowa City, Iowa 52240  
Job Order number 1344218

**PROFESSIONAL RESUME SERVICE**  
1125 S. Cedar Crest  
Allentown, PA 18103

Complete resume preparation for  
design engineers and design managers  
in electronics. Call collect or write:

**PROFESSIONAL RESUME SERVICE**  
(215) 433-4112

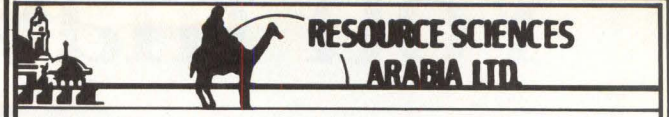

**RESOURCE SCIENCES  
ARABIA LTD.**

**WE'VE GOT THE PROFESSIONAL AND TAX ADVANTAGES YOU'RE  
LOOKING FOR.** RSAL, the Saudi Arabian affiliate of Holmes & Narver,  
Inc., is seeking personnel for ARAMCO projects. These are 12-month,  
single status contracts which offer superior compensation, liberal  
vacation and free food and lodging. Each position requires that you be  
eligible for a U.S. or Canadian passport.

**Systems Programmers**

BS in Computer Science or Math and 7-10 years experience in an IBM  
370/158 and 3033 mainframe MVS/SP environment. Candidate should  
have in-depth knowledge and hands-on experience working with system  
internals including modifications to system modules and a good grasp of  
IBM hardware including generation, maintenance and debugging of  
operating systems and program products. Experience should also include  
Assembler and COBOL programming languages, IMS TSO/SPF JES 2-3,  
ACF/VTAM/NCP, NSNF, NCCF, and NPDA. The assignment includes  
network design and installation, performance measurement and tuning,  
capacity planning and equipment forecasting with data management and  
data base design tasks.

**Systems Analysts**

These positions require a degree with 5 years experience in IBM 370/150  
and 3033 commercial environment utilizing COBOL and PL1 with IMS  
(DB/DC) and TSO/SPF.

Send resume to the office nearest you, only.

**E. K. Houser, Dept. MM83-1**  
999 Town & Country Rd.  
Orange, CA 92668

**Bill Hedlund, Dept. MM83-1**  
50 Briar Hollow Ln., Ste. 310W  
Houston, Texas 77027

**Will Gordon, Dept. MM83-1**  
2 W. Potomac Pkwy., Williamsport, MD 21795

**HOLMES & NARVER, INC.**  
ENGINEERS-CONSTRUCTORS  
Equal Opportunity Employer

**Call Today...**  
to advertise on these pages  
**964-0664**

CIRCLE NO. 238 ON INQUIRY CARD

**How to become a  
SUCCESSFUL CONSULTANT  
in your own field.**

Have you ever wished you could quit your job and start working for yourself?

Well, maybe you can! Many people are amazed when they discover the tremen-  
dous amount of professional experience and specialized knowledge they've  
accumulated — experience and knowledge that others will gladly pay for. Literally  
thousands of people who made that discovery are now prospering as independent  
consultants.

The way to begin is by reading *How to Become a Successful Consul-  
tant in Your Own Field*, by Hubert Bermont.

Clear, straightforward, packed with solid information and advice, this author-  
itative manual tells you everything you need to know to establish your own  
independent consulting practice. Here's a sampling of the contents:

- What does it take to be a successful consultant? (See Chapter 1.)
- How to get started. (See Chapter 3.)
- How to operate your business — a collection of "tricks of the trade." (See Chapter 5.)
- What to charge your clients — plus five helpful rules on fees. (See Chapter 6.)
- Why you should never work on a contingency (speculative) basis. (See Chapter 7.)
- Ingenious ways to promote yourself — and make people want your services. (See Chapter 9.)
- Contracts: why you should avoid them at all costs. (See Chapter 10.)
- Just what do consultants do all day? (See Chapter 11.)
- How to market your ideas. (See Chapter 11.)
- Why you'll never have to worry about competition. (See Chapter 13.)
- And much more!

Perhaps no one is better qualified to have written this book than Hubert  
Bermont. He has served as consultant to more than 70 major corporations and  
trade associations, including the U.S. Chamber of Commerce, McGraw-Hill,  
the Electronic Industries Association, Evelyn Wood Reading Dynamics and  
the Smithsonian Institution. Yet he made the decision to become a consultant  
only after being fired from an executive position at the age of 43. You'll learn  
first-hand how he did it — and how you can do it, too!

*How to Become a Successful Consultant in Your Own Field* is  
just \$20 (tax-deductible if you use it for business purposes), and you're fully pro-  
tected by this unconditional money-back guarantee: Keep the book for three  
weeks. If you're dissatisfied with it for any reason whatever, simply return it and  
every penny of your \$20 will be promptly refunded — no questions asked!

How many times have you told yourself that you're  
not getting anywhere — that it's time to think seriously  
about a major change in your career? **Don't put it off  
another day!** Clip and mail the coupon now!



Enclosed is my check or money order for \$20. Rush  
me, postpaid, *How to Become a Successful Consul-  
tant in Your Own Field*, by Hubert Bermont. I  
understand that I have the right to return the book  
within three weeks for a complete refund if I'm in any way unhappy with it.

Name \_\_\_\_\_  
Address \_\_\_\_\_  
City \_\_\_\_\_ State \_\_\_\_\_ Zip \_\_\_\_\_

**The Consultant's Library**  
Suite 1108  
815 15th St., N.W.  
Washington, D.C. 20005





## Find your place in the sun.

Come discover career opportunities as wide-open as our Arizona landscape.

At Hughes Aircraft Company in Tucson, you'll work in an engineering-oriented environment where state-of-the-art is a state of mind. If you have the appropriate degree and experience, join us as:

**SYSTEMS ENGINEER** — You must be experienced in mini-computer applications and have the ability to handle a wide range of computer-oriented tasks and software designs. Responsibilities include specifications, design, coding, debug, and documentation for special-purpose software systems, distributed systems and system-level software for automatic test positions. Proficiency in mini-micro-computer assembly language, and a basic knowledge of digital hardware instrumentation and/or real-time operating systems is required. A BSCS, BSEE or equivalent plus a minimum of 3 years' experience is also necessary.

You'll get an average of 13 paid holidays a year — including a week between Christmas and New Year's — besides vacation. Vision-care, dental, and medical insurance. Continuing education plans including studies at U. of Arizona. And relocation assistance, too.

To find your place in the sun, look into the Hughes Story. With more than 1,500 different projects company-wide, Hughes offers both stability and technological growth, as well as an excellent salary. Write yourself in!

Send your resume to: Hughes Aircraft Company, Professional Employment, Dept. MM-2, P.O. Box 11337, Tucson, AZ 85734. Or dial toll-free 1-800-528-4927 (from Arizona, call collect 602-746-8925).

*Creating a new world with electronics*

**HUGHES**

HUGHES AIRCRAFT COMPANY

**MISSILE SYSTEMS—TUCSON**

Proof of U.S. Citizenship Required  
Equal Opportunity Employer

## CLASSIFIED ADVERTISING

### Rates:

\$90 per column inch up to 8 inches.

Thereafter standard display rates apply. Frequency discounts available.

### Blind Box Service:

Add \$20 per insertion to cover postage and handling. Replies are mailed daily.

### Closing Dates:

March-Feb. 17, 1983

April-March 18, 1983

May-April 19, 1983

### Sales Office:

Stuart Tilt

Classified Advertising

Department

Mini-Micro Systems

Magazine

Cahners Publishing

Company

999 Summer Street

P.O. Box 3809

Stamford, CT 06905

203/964-0664

CIRCLE NO. 239 ON INQUIRY CARD



# Computer Consultants Corner



## CHESAPEAKE SOFTWARE, INC.

9 Maplewood Lane  
Wilmington, DE 19810  
(302) 475-5229

### PDP-11 / VAX

Real-time Process Control  
Interactive Graphics Systems  
Scientific / Engineering Programming

CIRCLE NO. 240 ON INQUIRY CARD

- Real Time Software Engineering
- Instruction for high technology systems
- Specification and development of microcomputerized product

### SOFTWARE ENGINEERING & INSTRUCTION, INC.

P.O. Box 70998, Sunnyvale, CA  
408-738-8568

CIRCLE NO. 241 ON INQUIRY CARD

### RMX86 SEMINAR

- 5 days on-site intensive seminar
- Equivalent to Intel's 2 weeks workshop
- Guarantee to boost productivity
- Low budget cost

contact: SAMUEL KIANG 213 308-9911  
MSEE MBA + 10 yrs exp.

CIRCLE NO. 242 ON INQUIRY CARD

**ELECTRICAL NOISE PROBLEMS SOLVED** in Electronic Data Processing and Microprocessor Based Control Systems **CALL (814) 466-6559**

Dr. E. Thomas Chesworth, P.E.  
Seven Mountains Scientific Inc.  
Boalsburg, PA 16827

CIRCLE NO. 243 ON INQUIRY CARD

### DEC COMPATIBLES

Specialist in all DEC compatible hardware and services

Rick Eriksen

### ERIKSEN & ASSOCIATES

23461 Ridge Route S#H  
Laguna Hills, CA 92653  
714-859-8982

CIRCLE NO. 244 ON INQUIRY CARD

### INDUSTRIAL APPLICATIONS

Automated QC Inspection  
Machine Control  
Measurement

Contact E.M. Gore, P.E.

### MG ASSOCIATES

207-774-5290

CIRCLE NO. 245 ON INQUIRY CARD

### 6800/68000 Experts

- Microprocessor hardware and software design
- Industrial control specialists
- Hierarchical software design methodology
- Environmental testing
- Complete prototype facilities

**CSA Computer System Associates**  
7562 Trade St. San Diego, CA 92121 (619) 566-3911

CIRCLE NO. 246 ON INQUIRY CARD

### MICROPROCESSOR APPLICATIONS

New product development - industrial and consumer. Designers of cost-effective hardware/software solutions since 1973.

LOGICAL SERVICES INCORPORATED

2340A Walsh Avenue Santa Clara, CA 95051  
Bob Ulrickson (408) 727-1470

CIRCLE NO. 247 ON INQUIRY CARD



### Microcomputer Applications

- Hardware/Software solutions
- Custom Software development
- Communications and networking specialists
- Corvus hard disk multiplexing

SBSG, 6 Carlisle Road  
Westford, MA 01886  
(617) 692-3800

CIRCLE NO. 248 ON INQUIRY CARD

### FIRMWARE SPECIALISTS

- Microprogramming
- Interface Design
- Multi-Tasking
- Real-Time
- Perf Eval
- Software Hardware
- Acquisitions
- Proposals
- Govt Procurement Research and Development

Michael Andrews, PhD  
303 484-9903



CIRCLE NO. 249 ON INQUIRY CARD

### VAX/VMS, RSX-11M, RT-11 USERS

- Short-Long Term Software Projects
- Real-Time, Lab. Automation & Security Systems
- Staffed by Former DEC Specialists
- Recommendations from Major Corporations
- Call or Write for More Information

**DIGITAL CONSULTANTS**  
Box 3781 Englewood, CO 80155  
(303) 773-0717

CIRCLE NO. 250 ON INQUIRY CARD

### HARDWARE—SOFTWARE—COMMUNICATIONS

High technology marketing services at realistic prices to create a cost effective return on investment.

### Pro-Spectrum

P.O. Box 74 - SPRING VALLEY,  
OHIO 45370-0074  
(513) 885-4589



CIRCLE NO. 251 ON INQUIRY CARD

## COMPUTER CONSULTANTS ORDER FORM INTRODUCTORY OFFER

1" 1x \$150

1" 3x's \$225

1" 12x's \$1,440

(There is no charge for typesetting)

Enclose check for \$ \_\_\_\_\_

Bill me monthly

Run this ad in \_\_\_\_\_ (number issues)

(Please print, type or attach business card)

Name \_\_\_\_\_ Title \_\_\_\_\_

Company \_\_\_\_\_ Telephone \_\_\_\_\_

Address \_\_\_\_\_

City \_\_\_\_\_ State \_\_\_\_\_ Zip \_\_\_\_\_

MAIL TO: Stuart Tilt

### MINI-MICRO SYSTEMS,

999 Summer Street, P.O. Box 3809,  
Stamford, CT 06905  
or Call: **203-964-0664**



# INVEST IN FUTURES.

To compete with the rest of the world, American business must have a steady supply of good engineers, managers, accountants, chemists, computer programmers—professionals of all kinds.

But colleges that educate these professionals are threatened by rising costs and less government funding. Without your help, the quality of higher education will decline. And so will the number of well-qualified graduates.

So, please, make sure your company gives all it can to higher education. It's an investment in futures. Yours. And America's.

Send for our free booklet: "Guidelines—How to Develop an Effective Program of Corporate Support for Higher Education." Write CFAE, 680 Fifth Avenue, New York, NY 10019.

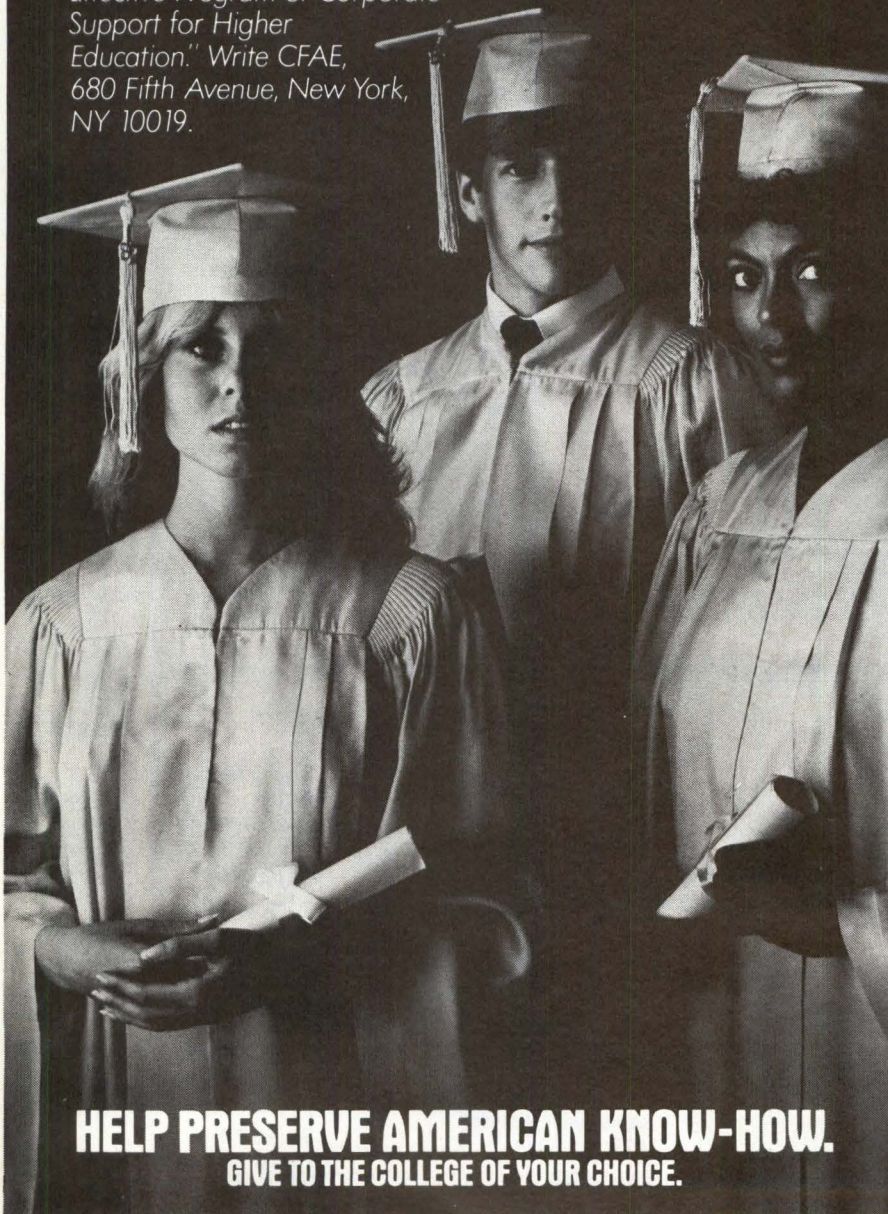

**HELP PRESERVE AMERICAN KNOW-HOW.  
GIVE TO THE COLLEGE OF YOUR CHOICE.**

COUNCIL FOR FINANCIAL AID TO EDUCATION INC.  
680 FIFTH AVENUE, NEW YORK, NY 10019



A PUBLIC SERVICE OF THIS MAGAZINE  
AND THE ADVERTISING COUNCIL

## CAHNERS PUBLISHING COMPANY

### **Cahners Magazine Division**

*J. A. Sheehan, President*  
*William Platt, Executive Vice President*  
*Harold Sugarman, Group Vice President*  
*David Sisk Wexler, Group Vice President*  
*H. Victor Drumm, Group Vice President*  
*Ellsworth M. Brown, Group Vice President*  
*Gordon Taylor, Vice President*  
*Publishing Services*  
*J. J. Walsh, Financial Vice President*  
*Thomas J. Dellamaria, Vice President*  
*Production and Manufacturing*  
*Jerry Neth, Vice President Planning*  
*Walter Cahners, Vice President*  
*Corporate Development*

### **Cahners Magazine Division**

*publishes the following business  
magazines and directories:*

### **Building/Construction Group**

*Brick & Clay Record*  
*Building Design & Construction*  
*Building Supply News*  
*Ceramic Industry*  
*Construction Equipment*  
*Modern Railroads*  
*Professional Builder*  
*Security Distribution Marketing*  
*Security World*  
*Specifying Engineer*

### **Foodservice Group**

*Foodservice Equipment Specialist*  
*Hotels & Restaurants International*  
*Restaurants & Institutions*

### **Electronics/Computer Group**

*Business Computer Systems*  
*EDN*  
*Electro-Optical Systems Design*  
*Electronic Business*  
*Electronic Packaging & Production*  
*Mini-Micro Systems*  
*Semiconductor International*

### **Manufacturing Industries Group**

*Appliance Manufacturer*  
*Design News*  
*Design News Directories*  
*Modern Materials Handling*  
*Package Engineering*  
*Plastics World*  
*Purchasing*  
*Traffic Management*  
*U. S. Industrial Directory*

### **Cahners Exposition Group**

*is the largest producer, operator and  
manager of trade and consumer  
shows in the world. . .  
with 58 shows, 3,300,000 square feet  
of exhibition space and total annual  
attendance of over three million.*



**CAHNERS  
PUBLISHING COMPANY**

221 Columbus Avenue  
Boston, MA 02116  
617/536-7780



# Advertisers Index

Able Computer	210	DMA Systems	184-185	NEPCON West '83	252
Adaptec, Inc.	181	Dual Systems	249	Nicolet Patatronics Corp.	223
Advanced Digital Corp.	191	Dysan Corp.	62-63	Onyx Systems	104
Alpha Data, Inc.	4	Electronic Solutions	57, 276	Peripherals '83	52
Alpha Merics Corp.	242	Emulex Corp.	123, 125	Pioneer Research	244
Altos Computer Systems	120-121	Envision	47	Pixel (Instrumentation Laboratory)	286
Amcodeyne	145	Evotek	193-198	Plessey Peripheral Systems	218
Amlyn Corp.	27	Fujitsu America, Inc.	146	Plexus Computers	140-141
Ampex Corp., Memory Products Div.	178	General Electric Co.	76	Precision Visuals	56
Anadex, Inc.	289	Genisco Computers	272	Priam	206-207
Analog Technology Corp. (ATC)	266	Genstar Rental Electronics	284	Printek Corp.	80
Applied Circuit Technology	238	GML Information Services	294	Printronic, Inc.	107
Applied Data Communications (ADC)	241	Gould Inc., DeAnza Imaging Div.	230	Quadram Corp.	6
Archive Corp.	86-87	Gould Inc., S.E.L. Computer Systems Div.	5	Quantum Corp.	150-151
Atasi Corp.	164-165	Grinnell Systems	110-111	Qume	227
Ava Instrumentation	282	Hall-Mark Electronics	256	Radio Shack (Tandy Corp.)	1
BBN Computer	132-133	Hazeltine Corp.	134	Rixon Inc.	291
Brikon, Inc.	204	Hewlett-Packard	43-45, 157	Rodime	75, 77
Buckeye Stamping Co.	4	HHB-Softtron	65	Scientific Micro Systems	149, 224
C. Itoh Electronics	15, Cover 3	Hicomp Computer Corp.	287	Seagate Technology	186-187
Cahners Exposition Group	52, 138, 252	Houston Instrument Div. of Bausch & Lomb	267	Seiko Instruments USA	262
Cambrian Systems	243	Ibex Computers Corp.	290	SE/SW Printed Circuits	138
Cambridge Digital Systems (Div. of Compumart)	139	IBM Corp.	233	Shape Magnetronics, Inc.	126
Centronics Computer Corp.	281	Imagen Corp.	49	Shugart Associates	136-137
Century Data Systems (A Xerox Co.)	208-209	IMI (International Memories, Inc.)	174	Silicon Systems	97
Charles River Data Systems	74	Imperial Technology, Inc.	295	Sord Computer of America	258
CIE Systems	35	Info Manufacturing	293	Syncom	268
Cipher Data Products, Inc.	235, 269	Information Products Systems (IPS)	288	SyQuest Technology	177
Clapp & Poliak	293	Infoscrite	278	Systems Group	40
Columbia Data Products	203	Innovative Data Technology (IDT)	260	Tandberg Data Inc., Data Storage Div.	70
COMDEX/Spring	259	Intel Corp.	66-67	Tandon Corp.	22-23
Computer Memories	170	Interface '83	118	TEAC Corp. of America	96
Comrex International	275	Interface Group	118, 259	Televideo Systems, Inc.	38-39, 228-229
Comtech Data	64	Interlan	33	Texas Instruments Inc.	28-29, 50-51, 128-129
Conrac Corp.	98-99	Interstate Electronics Corp.	82	Timeplex, Inc.	130
Control Data Corp.—Engineering Services	46	Intertec Data Systems Corp.	25	Toshiba	251
Control Data Corp.—MSD	265	Iomega	148	TransNet Corp.	296
Control Data Corp.—OEM	215	Ithaco, Inc.	124	Trilog, Inc.	90-91
Convergent Technologies	108-109	Kalbro Corp.	226	TRW, Inc./Customer Service Div.	295
Cosmos Systems	205	Kennedy Co.	8	Ungermann-Bass	270-271
CSPI	183	Kratos Display Systems	114	Ven-Tel	16
Data Packaging	158	Leading Edge Products	12	Verbatim Corp.	221
Dataram	Cover 2	Lear Siegler, Inc.	68-69	Vermort Research Corp.	154
Data Set Cable	282	Lexidata Corp.	255	Vertex Peripherals	173
Data Sources	279	Maxtor Corp.	162-163	Visual Technology, Inc.	277
Data Systems Design, Inc.	216-217	MDB Systems, Inc.	103	Western Digital	59, 60, 61
Data Technology Corp. (DTC)	201	Megatek Corp.	11	Western Dynex Corp.	169
Davidge Corp.	296	Micom Systems, Inc.	Cover 4	Western Peripherals Div. of Wespercorp.	237
Davong Systems	142	Microbar Systems	116-117	Western Telematic, Inc.	288
Develcon Electronics	73	Micropolis Corp.	188	Wicat Systems Inc.	54
Digilog Business Systems	93	Microscience International	213	Wyse Technology	297
Digital Engineering	280	Micro-Term	285	Xylogics, Inc.	53
Digital Equipment Corp.	78-79	Mitsubishi Electronics America	283	Zilog, Inc.	112
Dilog (Distributed Logic Corp.)	85	3M Co.	30-31		
Direct, Inc.	100	Molecular Computer	247		
Disc Tech One, Inc.	290	MPI (Micro Peripherals Inc., Calif)	166		
Disctron	152-153	National Computer Graphics Association	302		
Display Interface Corp.	48	NCR Corp.	36-37		
		NEC Information Systems, Inc.	95, 261		

See pages 298-300 for Mini-Micro Marketplace  
 See pages 304-308 for Career Opportunity Advertisers  
 See page 308 for Computer Consultants Corner

This index is provided as an additional service. The publisher does not assume any liability for errors or omissions.

## REGIONAL SALES OFFICES

### BOSTON

John J. Fahey  
 Eastern Regional Manager  
 221 Columbus Avenue  
 Boston, MA 02116  
 (617) 536-7780

### PHILADELPHIA

Richard W. Molden  
 Regional Manager  
 999 Old Eagle School Rd.  
 Wayne, PA 19087  
 (215) 293-1212

### CHICAGO

Robert D. Wentz  
 Regional Manager  
 Cahners Plaza  
 1350 E. Touhy Ave.  
 P.O. Box 5080  
 Des Plaines, IL 60018  
 (312) 635-8800

### DALLAS

Don Ward  
 Regional Manager  
 13740 Midway  
 Suite 515  
 Dallas, TX 75234  
 (214) 980-0318

### DENVER

John Huff  
 Regional Manager  
 270 St. Paul Street  
 Denver, CO 80206  
 (303) 388-4511

### LOS ANGELES

Robert Billhimer  
 Regional Manager  
 12233 West Olympic Blvd.  
 Los Angeles, CA 90064  
 (213) 826-5818

### ORANGE COUNTY

Debra Huisken  
 Regional Manager  
 2041 Business Center Drive  
 Suite 109  
 Irvine, CA 92715  
 (714) 851-9422

### SAN FRANCISCO

Frank Barbagallo  
 Regional Manager  
 Rick Jamison  
 Regional Manager  
 Sherman Building, Suite 1000  
 3031 Tisch Way  
 San Jose, CA 95128  
 (408) 243-8838

### ENGLAND

Ian Hardman  
 Systems International  
 Quadrant House,

The Quadrant  
 Sutton Surrey,  
 SM2 5AS England  
 Tel: (01) 661-3022

### JAPAN

Tomoyuki Inatsuki  
 General Manager  
 Trade Media Japan Inc.  
 R. 212 Azabu Heights  
 1-5-10 Roppongi  
 Minato-ku,  
 Tokyo 106 Japan  
 Tel: (03) 585-0581

### Career Opportunities

Stuart Tilt  
 Recruitment Advertising Manager  
 999 Summer Street  
 P.O. Box 3809  
 Stamford, CT 06905  
 (203) 964-0664





## Some interesting things happen when you sit down at our CII-161 Terminal.

Like any office worker, video terminal operators are bombarded by a tremendous spectrum of visual and audio stimulæ. Add to that their own thought distractions and you begin to see why a single-color display is at a severe disadvantage competing for user attention.

Our CII-161 Color Alphanumeric Terminal, on the other hand, makes use of some very interesting color phenomena. Which makes a much more efficient terminal... and makes users a lot more productive.

Studies have shown, for instance, that color can improve user response time by 50% — which translates into faster throughput and decreased time to job completion. Data is made more interesting and easy to follow with the use of color, resulting in less error in interpretation.

Color also has broad attention-getting power, affording the added ability to prioritize data by different hues and



create more significant and long-lasting impressions. Not to mention the subliminal conditioned responses we all have to color. (Red, for example, can be used to flag a problem instantly.)

And color dramatically accelerates the learning process. Meaning that training time can be substantially reduced so operators reach full productivity far more quickly.

How will our CII-161 fit into your system? Perfectly! It's an ANSI-compatible direct replacement for the DEC® VT-100 Series with a full range of advanced video features: 132/80-character column display, single-width or double-width/double-height characters, the unique Window Erase feature, split screen, and more.

Sound interesting? Contact C. Itoh Electronics, Inc. today for more information: 5301 Beethoven Street, Los Angeles, CA 90066, (213) 306-6700. Or call ACRO Corp., exclusive representatives: Irvine, CA (714) 557-5118; Houston, TX (713) 777-1640; Cherry Hill, NJ (609) 667-4114; Chicago, IL (312) 992-2346.

 **C. ITOH  
ELECTRONICS, INC.**  
One World of Quality



# Modems are all the same. True or False?

If you think modems are all alike, you're right, mostly. But if you have dumb terminals on a minicomputer from DEC, Hewlett-Packard, Prime or anyone else, you'll have to agree that MICOM's modems are very different.

For example, would you like to run your minicomputer terminals at 2400 bps? Try the Micro4000. It's small, reliable, doesn't cost much—and it has an *asynchronous* terminal interface designed for use with dumb terminals. That's different.

Or consider the Micro5000 Intelligent Modem and its unique retransmission-on-error feature. It automatically recovers from those phone line "glitches" that drive your CRTs crazy, transmitting perfectly over lines with error

rates worse than 1 in 1000 bits, even through total line outages of several seconds. That's different, too.

Want to cut phone line costs? Check out the Micro8000 Concentrator Modem. It will allow you to support clusters of asynchronous and synchronous terminals with a single phone line. Some models can even *multidrop* your dumb terminals, transparently. And that's very, very different.

There are 4800 and 9600 bps models of all of these, too, with industry-leading price/performance. But don't believe what you read in an ad. Make us prove it. Start by calling or writing today for literature on how MICOM's modems will work in your applications.



Shelling out too much for high-speed modems?

Try MICOM... intelligent modems... for peanuts.

**MICOM** Micro4000  
DataModem

**MICOM**® MicroComputers for DataCommunications™

MICOM SYSTEMS, INC. • 20151 Nordhoff Street • Chatsworth, CA 91311 • Telephone (213) 998-8844 • TWX 910/494-4910  
Regional Sales and Service • Boston, MA • (617) 527-4010 • St. Louis, MO • (314) 576-7626 • Woodbridge, NJ • (201) 750-1120  
Other Regional Sales Offices • Atlanta, GA • (404) 435-2999 • Dallas, TX • (214) 258-0774  
MICOM-BORER LTD. • Bel Court • 15 Cradock Road • Reading, Berkshire RG20JT, England • (0734) 866801 • Telex 847135

Available now from these stocking reps...

AK: Anchorage (907) 276-5616/Juneau (907) 789-3310 • AL: (800) 327-6600 • AR: (214) 620-1551 • AZ: (602) 994-5400 • CA: Anaheim (714) 635-7600/Lodi (209) 334-1961/San Diego (714) 565-1557/San Jose (408) 298-7290 • CO: Colorado Springs (303) 594-0880/Denver (303) 777-8070 • CT: (203) 226-4281 • DE: (609) 779-0200  
FL: (800) 432-4480 • GA: (800) 327-6600 • HI: (808) 523-8881 • IA: (402) 895-5850 • ID: (801) 466-6522 • IL: (312) 255-4820 • IN: (317) 846-2591 • KS: (816) 252-3700  
KY: (317) 846-2591 • LA: (800) 327-6600 • MA: (617) 235-5520 • MD: (301) 261-4344 • ME: (617) 235-5520 • MI: (313) 588-2300 • MN: (612) 425-4455 • MO: Independence (816) 252-3700/St. Louis (314) 721-0401 • MS: (800) 327-6600 • MT: (801) 466-6522 • NC: (800) 327-6600 • ND: (612) 425-4455 • NE: (402) 895-5850 • NH: (617) 235-5520  
NJ: North (212) 687-2455/South (609) 779-0200 • NM: Albuquerque (505) 292-1212/Las Cruces (505) 524-9693 • NV: (714) 635-7600 • NY: East Aurora (716) 655-4322/Loudenville (518) 459-5891/New York City (212) 687-2455/Rochester (716) 442-5631 • OH: Cleveland (216) 267-0445/Dayton (513) 434-7500 • OK: (214) 620-1551  
OR: (503) 224-3145 • PA: East (609) 779-0200/West (412) 892-2953 • RI: (203) 226-4281 • SC: (800) 327-6600 • SD: (612) 425-4455 • TN: (800) 327-6600 • TX: Dallas (214) 620-1551/El Paso (915) 542-1762/Houston (713) 353-7728 • UT: (801) 466-6522 • VA: (301) 261-4344 • VT: (617) 235-5520 • WA: (206) 364-8830 • WI: (414) 784-9379  
WV: East (301) 261-4344/West (412) 892-2953 • WY: (303) 371-2422 • Washington, DC: (301) 261-4344 • Guam: (671) 646-7280 • Puerto Rico: (809) 723-9689

CIRCLE NO. 4 ON INQUIRY CARD